

Final draft **EN 301 091** V1.1.1 (1998-04)

European Standard (Telecommunications series)

**Electromagnetic compatibility
and Radio spectrum Matters (ERM);
Road Transport and Traffic Telematics (RTTT);
Technical characteristics and test methods
for radar equipment operating in the 76 GHz to 77 GHz band**



European Telecommunications Standards Institute

Reference

DEN/ERM-RP08-0401 (a3o00ico.PDF)

Keywords

Radar, radio

ETSI Secretariat

Postal address

F-06921 Sophia Antipolis Cedex - FRANCE

Office address

650 Route des Lucioles - Sophia Antipolis
Valbonne - FRANCE
Tel.: +33 4 92 94 42 00 Fax: +33 4 93 65 47 16
Siret N° 348 623 562 00017 - NAF 742 C
Association à but non lucratif enregistrée à la
Sous-Préfecture de Grasse (06) N° 7803/88

Internet

secretariat@etsi.fr
<http://www.etsi.fr>
<http://www.etsi.org>

Copyright Notification

No part may be reproduced except as authorized by written permission.
The copyright and the foregoing restriction extend to reproduction in all media.

Contents

Intellectual Property Rights.....	6
Foreword	6
Introduction	7
1 Scope.....	8
2 Normative references	8
3 Definitions, symbols and abbreviations	9
3.1 Definitions	9
3.2 Symbols	10
3.3 Abbreviations.....	10
4 General	10
4.1 Presentation of equipment for testing purposes	10
4.1.1 Choice of model for type testing	11
4.2 Mechanical and electrical design	11
4.2.1 General.....	11
4.2.2 Controls.....	11
4.2.3 Marking (equipment identification).....	11
4.2.3.1 Equipment identification.....	11
4.2.3.2 Regulatory markings.....	12
4.3 Declarations by the applicant.....	12
4.4 Auxiliary test equipment.....	12
4.5 Interpretation of the measurement results	12
5 Test conditions, power sources and ambient temperatures.....	12
5.1 Normal and extreme test conditions.....	12
5.2 External test power source	12
5.3 Normal test conditions	13
5.3.1 Normal temperature and humidity.....	13
5.3.2 Normal test power source.....	13
5.3.2.1 Mains voltage	13
5.3.2.2 Regulated lead-acid battery power sources.....	13
5.3.2.3 Other power sources	13
5.4 Extreme test conditions.....	13
5.4.1 Extreme temperatures.....	13
5.4.1.1 Procedure for tests at extreme temperature.....	13
5.4.1.2 Extreme temperature ranges	14
5.4.2 Extreme test power source	14
5.4.2.1 Mains voltage	14
5.4.2.2 Lead-acid battery, regulated power sources.....	14
5.4.2.3 Power sources using other types of batteries	14
5.4.2.4 Other power sources	15
6 General conditions	15
6.1 Test fixture.....	15
6.1.1 Calibration.....	16
7 Methods of measurement and limits for the transmitter RF parameters.....	16
7.1 Permitted range of operating frequencies.....	16
7.1.1 Definition	16
7.1.2 Method of measurement.....	16
7.1.3 Limits	17
7.2 Radiated power density.....	17
7.2.1 Definition	17
7.2.2 Method of measurement.....	17

7.2.2.1	Equipment with a fixed beam antenna (i.e. non-steerable by either mechanical or electronic means).....	17
7.2.2.2	Equipment with (electronically or mechanically) steerable antenna(s).....	18
7.2.3	Limits	18
7.2.3.1	Equipment with fixed beam antenna.....	18
7.2.3.2	Equipment with (electronically or mechanically) steerable antennas	19
7.3	Maximum safe level for radiated power density	19
7.4	Modulation schemes	19
7.4.1	Pulse modulation.....	19
7.4.1.1	Definition.....	19
7.4.1.2	Methods of measurement.....	20
7.4.1.3	Limits.....	20
7.4.2	Frequency modulated continuous wave.....	21
7.4.2.1	Definition	21
7.4.2.2	Methods of measurement.....	21
7.4.2.3	Limits.....	22
7.4.3	Frequency shift keying (FSK)	22
7.4.3.1	Definition.....	22
7.4.3.2	Method of measurement	24
7.4.3.3	Limits.....	24
7.5	Radiated spurious emissions	25
7.5.1	Definition	25
7.5.2	Measuring receiver.....	25
7.5.3	Method of measurement for radiated spurious emission	25
7.5.4	Limits	26
7.6	Unwanted emissions caused by the application of the modulation	26
7.6.1	Definition	26
7.6.2	Measuring receiver.....	27
7.6.3	Method of measurement.....	27
7.6.4	Limits	28
8	Measurement uncertainty	28
Annex A (normative): Radiated measurements.....		29
A.1	Test sites and general arrangements for measurements involving the use of radiated fields	29
A.1.1	Open Area Test Site (OATS).....	29
A.1.2	Test antenna	30
A.1.3	Standard position	30
A.1.4	Optional additional indoor site.....	30
A.2	Guidance on the use of radiation test sites.....	31
A.2.1	Measuring distance	31
A.2.2	Test antenna	31
A.2.3	Substitution antenna.....	31
A.2.4	Auxiliary cables	32
A.3	Further optional alternative indoor test site using a fully anechoic RF chamber	32
A.3.1	Example of the construction of a shielded anechoic chamber.....	32
A.3.2	Influence of parasitic reflections in anechoic chambers.....	32
A.3.3	Calibration of the shielded RF anechoic chamber.....	33

Annex B (normative):	General description of measurement methods	35
B.1	Radiated measurements.....	35
Annex C (normative):	Subclauses of this EN relevant for compliance with the essential requirements of relevant EC Council Directives.....	37
Annex D (informative):	Maximum safe level of radiated power density	38
D.1	Definition	38
D.2	Method of measurement.....	38
D.2.1	Equipment with a fixed beam antenna(s) (i.e. non-steerable by either mechanical or electronic means).....	38
D.2.2	Equipment with (electronically or mechanically) steerable antenna	38
D.3	Limit.....	38
Annex E (informative):	Conversion of power density to EIRP	39
E.1	Assumptions:.....	39
E.2	Example.....	39
History	40

Intellectual Property Rights

IPRs essential or potentially essential to the present document may have been declared to ETSI. The information pertaining to these essential IPRs, if any, is publicly available for **ETSI members and non-members**, and can be found in ETR 314: "*Intellectual Property Rights (IPRs); Essential, or potentially Essential, IPRs notified to ETSI in respect of ETSI standards*", which is available **free of charge** from the ETSI Secretariat. Latest updates are available on the ETSI Web server (<http://www.etsi.fr/ipr>).

Pursuant to the ETSI Interim IPR Policy, no investigation, including IPR searches, has been carried out by ETSI. No guarantee can be given as to the existence of other IPRs not referenced in ETR 314 (or the updates on <http://www.etsi.fr/ipr>) which are, or may be, or may become, essential to the present document.

Foreword

This European Standard (Telecommunications series) has been produced by ETSI Technical Committee Electromagnetic compatibility and Radio spectrum Matters (ERM), and is now submitted for the Voting phase of the ETSI standards Two-step Approval Procedure.

This present document, together with ETS 300 683, is intended to become a Harmonized Standard, the reference of which will be published in the Official Journal of the European Communities referencing the Council Directive on the approximation of the laws of the Member States relating to ElectroMagnetic Compatibility ("the EMC Directive") (89/336/EEC as amended).

The technical parameters which are relevant to the ElectroMagnetic Compatibility (EMC) directive are listed in annex C.

Where equipment compliant with the present document is fitted to a motor vehicle as original equipment, then that vehicle will be subject to automotive EMC type approval and has to comply with Directive 95/54/EEC. For non-automotive use, compliance with an EMC Directive or standard appropriate for the application will be required.

Proposed national transposition dates	
Date of latest announcement of this EN (doa):	3 months after ETSI publication
Date of latest publication of new National Standard or endorsement of this EN (dop/e):	6 months after doa
Date of withdrawal of any conflicting National Standard (dow):	36 months after doa

Introduction

The present document contains the technical characteristics for radio equipment referencing CEPT/ERC Decision and Recommendations, including TR 01-06 [6].

The present document was drafted on the assumption that type test measurements performed by an accredited test laboratory, will be accepted by the various national regulatory authorities in order to grant type approval, provided the national regulatory requirements are met. This is in compliance with CEPT/ERC Recommendation T/R 01-06 [6].

The present document refers to short range radar systems using specified modulation schemes, and within the band 76 GHz to 77 GHz as specified by ERC/DEC/(92)02 [1].

Full use of the 76 GHz to 77 GHz band is permitted subject to the constraints as defined in clause 7.

There are two "classes" defined within the present document, class 1 and class 2. The single difference between these two classes is the level of permitted transmitted power in the 76 GHz to 77 GHz band.

The present document reflects the potential for the coexistence of the maximum number of systems in the same geographical location, with minimal interference.

For class 1, the mean power density at the carrier frequency does not exceed $0,9 \text{ W} / \text{m}^2$ at 3 m (50 dBm EIRP).

The peak equivalent power density at the carrier frequency does not exceed $3 \text{ W} / \text{m}^2$ at 3 m (55 dBm EIRP).

For class 2, the mean power density at the carrier frequency does not exceed $0,002 \text{ W} / \text{m}^2$ at 3 m (23,5 dBm EIRP).

The peak equivalent power density at the carrier frequency does not exceed $3 \text{ W} / \text{m}^2$ at 3 m (55 dBm EIRP).

In order to permit the greatest freedom of design of equipment, whilst protecting other radio services from disturbance, a balance is required between the permitted range of frequencies on which the equipment may be used, and its frequency stability and modulation characteristics. The present document specifies the operational frequency and bandwidth as covered by ERC/DEC/(92)02 [1].

Clauses 1 to 3 give a general description of the types of equipment covered by the present document and the definitions and abbreviations used. Clause 4 gives general information in order that type tests may be carried out and any markings on the equipment to be provided by the manufacturer.

Clauses 5 and 6 specify the test conditions.

Clause 7 specifies the limits of the parameters which are required to be tested. These limits have been chosen to minimize harmful disturbance to and from other equipment and services. These clauses also specify how the equipment is to be tested and the conditions which are applied.

Clause 8 specifies the maximum measurement uncertainty values.

Annex A provides normative standards concerning test sites for radiated measurements.

Annex B provides general information relating to measurement methods.

Annex C provides information on the technical parameters which need to comply with the EMC Directive.

Annex D is an informative annex relating to the permitted safe levels of radiated power.

Annex E is an informative annex on the equation for the conversion of power density to Equivalent Isotropically Radiated Power (EIRP).

1 Scope

The present document specifies the requirements for a short range 76 GHz to 77 GHz radar intended for Road Transport and Traffic Telematics (RTTT) applications (amongst others), such as Automotive Cruise Control (ACC), Collision Warning (CW) and Anti-Collision (AC) systems for vehicles, and to assure electromagnetic compatibility.

The present document applies to:

- low power motion and distance monitoring radars for mobile and fixed applications; operating on radio frequencies in the 76 GHz to 77 GHz band, with mean power densities of up to $0,9 \text{ W} / \text{m}^2$ at 3 m (50 dBm EIRP), and up to $3 \text{ W} / \text{m}^2$ peak at 3 m (55 dBm EIRP) for class 1, and mean power densities of up to $0,002 \text{ W} / \text{m}^2$ at 3 m (23,5 dBm EIRP), and up to $3 \text{ W} / \text{m}^2$ peak at 3m (55 dBm EIRP) for class 2.

It covers the minimum characteristics considered necessary in order to make the best use of the allocated frequency band. It does not necessarily include all the characteristics which may be required by a user, nor does it necessarily represent the optimum performance achievable.

The present document is based upon ERC/DEC/(92)02 [1]. It is a product standard covering various RTTT applications.

The present document covers radars for fixed and mobile applications. It covers integrated transceivers and separate transmit/receive modules.

The present document includes standards for methods of measurement for equipment fitted with associated antenna.

Additional standards or standards may be required for equipment such as that intended for connection to the public or private networks or other systems.

2 Normative references

References may be made to:

- a) specific versions of publications (identified by date of publication, edition number, version number, etc.), in which case, subsequent revisions to the referenced document do not apply; or
- b) all versions up to and including the identified version (identified by "up to and including" before the version identity); or
- c) all versions subsequent to and including the identified version (identified by "onwards" following the version identity); or
- d) publications without mention of a specific version, in which case the latest version applies.

A non-specific reference to an ETS shall also be taken to refer to later versions published as an EN with the same number.

- [1] ERC Decision of 22 October 1992 on the frequency bands to be designated for the co-ordinated introduction of Road Transport Telematic Systems (RTT) (ERC/DEC/(92)02).
- [2] CISPR 16-1: "Specifications for radio disturbance and immunity measuring apparatus and methods; Class 1: Radio disturbance and immunity measuring apparatus".
- [3] CISPR 16-2 Part 2: "Methods of measurement of disturbances and immunity measuring apparatus and methods. Part 2: Methods of measurement of disturbance and immunity".
- [4] EN 55022 (1995): "Limits and methods of measurement of radio disturbance characteristics of information technology equipment".
- [5] Regulation 95/54/EEC the Automotive EMC Directive.
- [6] ERC/REC Recommendation TR 01-06: "Procedure for mutual recognition of type testing approval for radio equipment".

- [7] ETR 028: "Electromagnetic compatibility and Radio spectrum Matters (ERM); Uncertainties in the measurement of mobile radio equipment characteristics".
- [8] ENV 50166-2 (1995): "Human Exposure to electromagnetic fields High Frequency (10 kHz to 300 GHz)".
- [9] Radio Regulations - International Telecommunication Union Edition of 1990 revised 1994.

3 Definitions, symbols and abbreviations

3.1 Definitions

For the purposes of the present document, the following definitions apply:

assigned frequency band: The frequency band within which the device is authorized to operate.

associated antenna: An antenna and all its associated components which are designed as an indispensable part of the equipment.

mean power: The mean power supplied from the antenna during an interval of time sufficiently long compared with the lowest frequency encountered in the modulation taken under normal operating conditions, see Radio Regulations [9].

duty factor: The ratio of the area of the beam (measured at its 3 dB point) to the total area scanned by the antenna (as measured at its 3 dB point).

Equipment Under Test (EUT): The radar sensor including the integrated antenna together with any external antenna components which affect or influence its performance.

maximum safe level for radiated power density: That level which can be transmitted in accordance with the current recommended safety levels in ENV 50166-2 [8].

operating frequency range: The range of operating frequencies over which the equipment can be adjusted through switching or reprogramming.

operating frequency (operating centre frequency): The nominal frequency at which equipment is operated. Equipment may be able to operate at more than one operating frequency.

peak envelope power: The mean power supplied from the antenna during one radio frequency cycle at the crest of the modulation envelope taken under normal operating conditions, see Radio Regulations [9].

permitted range of operating frequencies: The frequency range over which the approved equipment may operate.

Pulse Repetition Frequency (PRF): The inverse of the Pulse Repetition Interval, averaged over a time sufficiently long as to cover all PRI variations.

Pulse Repetition Interval (PRI): The time between the rising edges of the transmitted (pulsed) output power.

radiated power density: The power per unit area normal to the direction of the electromagnetic wave propagation. It is expressed in units of W/m^2 .

radiated spurious emissions: Emissions at frequencies other than those of the carrier and sidebands associated with normal modulation.

radome: An external protective cover which is independent of the associated antenna, and which may contribute to the overall performance of the antenna (and hence, the EUT).

3.2 Symbols

For the purposes of the present document, the following symbols apply:

λ	Wavelength
1/P	repetition rate of the modulation wave form
ac	alternating current
B	Bandwidth
BW	resolution bandwidth used in the measurement
d	largest dimension of the antenna aperture
D	Duty factor
df	spectral distance between 2 lines with similar power levels
Δf_{\max}	maximum amplitude of frequency shift between any two frequency steps
E	Field strength
E _o	Reference field strength
G	Blanking period
P	period of time during in which one cycle of the modulation wave form is completed.
P _a	mean power within the BW
PL	power of an individual spectral line
R	Distance
R _o	Reference distance
t	dwelt time
τ	frequency step duration
T	frequency step repetition frequency
T _x	Transmitter

3.3 Abbreviations

For the purposes of the present document, the following abbreviations apply:

EIRP	Equivalent Isotropically Radiated Power
EUT	Equipment Under Test
FMCW	Frequency Modulated Carrier Wave
FMICW	Frequency Modulated Interrupted Continuous Wave
FSK	Frequency Shift Keying
IF	Intermediate Frequency
OATS	Open Area Test Site
PRI	Pulse Repetition Interval
PRF	Pulse Repetition Frequency
RF	Radio Frequency
VSWR	Voltage Standing Wave Ratio

4 General

4.1 Presentation of equipment for testing purposes

Each equipment submitted for type testing shall fulfil the requirements of the present document (specifying the relevant equipment part number) over the frequency and in the application for which it is intended to operate. In the case of an automotive application, EMC type approval testing to 95/54/EEC [5] should be done on the vehicle.

The applicant shall complete the appropriate application form when submitting equipment for type testing. Additionally, technical documentation and operating manuals shall also be supplied.

The performance of the equipment submitted for type testing shall be representative of the performance of the corresponding production model. In order to avoid any ambiguity in that assessment, the present document contains instructions for the presentation of equipment for type testing purposes (subclause 4.1), conditions of testing (clause 5) and the measurement methods (clauses 7 and 8).

Stand alone equipment shall be offered by the applicant complete with any ancillary equipment needed for testing. The applicant shall declare the frequency range(s), the range of operation conditions and power requirements, as applicable, in order to establish the appropriate test conditions.

The equipment shall be complete, and include the associated antenna structure as will be used in its final application. The inclusion of a radome (if appropriate) is optional. If the equipment is qualified with the radome, then the equipment shall only be used with that radome.

Test fixtures may be supplied by the applicant (see subclause 6.1).

Complete sensor modules should be supplied by the manufacturer to facilitate the tests.

If the submitted unit is capable of meeting both class 1 and class 2 of the present document (i.e. has two modes of operation), it should be clearly documented with the necessary information. Such a unit shall be proven against the full Standard in each operating mode.

4.1.1 Choice of model for type testing

The applicant shall provide one or more complete production (or production intent) models of the equipment, as appropriate, for type testing.

Any essential change shall be notified to the approval authority.

If an equipment has optional features which are considered not to affect the Radio Frequency (RF) parameters, then the tests may only be performed on the equipment configured with the combination of features considered to be the most complex (as proposed by the applicant and agreed by the accredited test laboratory).

4.2 Mechanical and electrical design

4.2.1 General

The equipment submitted by the applicant, or his representative, shall be designed, constructed and manufactured in accordance with good engineering practice, and with the aim of minimizing harmful disturbance to other equipment and services.

Transmitters (Tx) and receivers may be individual or combination units.

4.2.2 Controls

Those controls which if maladjusted might increase the interference possibilities to and from the equipment shall only be accessible by partial or complete disassembly of the device and requiring the use of tools. This also applies (if applicable) to the mechanism which selects between class 1 and class 2 as defined in the present document.

4.2.3 Marking (equipment identification)

The equipment shall be marked in a visible place. This marking shall be legible and durable.

4.2.3.1 Equipment identification

The marking shall include as a minimum:

- the name of the manufacturer and/or his trade mark;
- the type designation.

Where this is not possible due to dimension constraints, the documentation which accompanies the equipment shall contain as a minimum, the information required above.

4.2.3.2 Regulatory markings

The equipment shall be marked where applicable in accordance with CEPT/ERC Recommendation TR 01-06 [6]. Where this is not applicable the equipment shall be marked in accordance with the national regulatory standards.

4.3 Declarations by the applicant

When submitting equipment for type testing, the applicant shall supply the necessary information according to the appropriate application form for the present document.

4.4 Auxiliary test equipment

All necessary test signal sources and setting up information shall accompany the equipment when it is submitted for type testing.

4.5 Interpretation of the measurement results

The interpretation of the results recorded on the appropriate test report form for the measurements described in the present document shall be as follows:

- the measured value related to the corresponding limit shall be used to decide whether an equipment meets the requirements of the present document;
- the measurement uncertainty value for the measurement of each parameter shall be recorded in the test report;
- the recorded value of the measurement uncertainty shall be, for each measurement, equal to or lower than the figures of measurement uncertainty given in clause 8.

5 Test conditions, power sources and ambient temperatures

5.1 Normal and extreme test conditions

Type testing shall be made under normal test conditions, and also where stated, under extreme test conditions.

The test conditions and procedures shall be as specified in subclauses 5.3 and 5.4.

5.2 External test power source

During type tests the power source of the equipment shall be replaced by an external test power source, capable of producing normal and extreme test voltages as specified in subclauses 5.3.2 and 5.4.2. The internal impedance of the external test power source shall be low enough for its effect on the test results to be negligible.

For battery operated equipment the battery shall be removed and the external test power source shall be suitably decoupled and applied as close to the equipment battery terminals as practicable. For radiated measurements any external power leads should be so arranged so as not to affect the measurements. If necessary, the external test power source may be replaced with the supplied or recommended internal batteries at the required voltage, or a battery simulator. This shall be stated on the test report. For radiated measurements on portable equipment with an integral antenna, fully charged internal batteries should be used. The batteries used should be as supplied or recommended by the applicant.

If the equipment is powered from an external source, the test voltage shall be measured at the point of connection of the power cable to the equipment.

During tests the external test power source voltages shall be within a tolerance of $\pm 1\%$ relative to the voltage at the beginning of each test. The value of this tolerance can be critical for certain measurements. Using a smaller tolerance provides a better uncertainty value for these measurements.

If internal batteries are used, at the end of each test the voltage shall be within a tolerance of $\pm 5\%$ relative to the voltage at the beginning of each test.

5.3 Normal test conditions

5.3.1 Normal temperature and humidity

The normal temperature and humidity conditions for tests shall be any convenient combination of ambient temperature and humidity within the following ranges:

Temperature: +15 °C to +35 °C;

Relative Humidity: 20 % to 75 %.

When it is impracticable to carry out tests under these conditions, a note to this effect, stating the ambient temperature and relative humidity during the tests, shall be added to the test report.

5.3.2 Normal test power source

5.3.2.1 Mains voltage

For the purpose of the present document, the nominal ac mains voltage shall be the declared voltage, or any of the declared voltages, for which the equipment was designed.

For test power sources derived from the ac mains, then the frequency of the ac mains shall be declared, and shall be maintained to within $\pm 2\%$. This applies for each declared voltage.

5.3.2.2 Regulated lead-acid battery power sources

When the radio equipment is intended for operation from the usual types of lead-acid battery regulated power source, the normal test voltage shall be the nominal voltage of the battery multiplied by 1,1 (e.g. 6 V \times 1,1; 12 V \times 1,1; etc.). The nominal battery voltage for a passenger vehicle is 13,5 V. For a goods vehicle it is 27 V.

5.3.2.3 Other power sources

For operation from other power sources or types of battery (primary or secondary), the normal test voltage and frequency for which the equipment was designed shall be that declared by the applicant and shall be stated in the test report.

5.4 Extreme test conditions

5.4.1 Extreme temperatures

5.4.1.1 Procedure for tests at extreme temperature

Before measurements are made, the equipment shall have reached thermal balance with the selected ambient test temperature, in the test chamber.

The equipment shall be switched off during the temperature stabilizing period.

If the thermal balance is not checked by measurement, a temperature stabilizing period of at least one hour, or such period as may be proposed by either the manufacturer or the accredited test laboratory, and agreed by the accredited test

laboratory, shall be allowed. The sequence of measurements shall be chosen and the humidity content in the test chamber shall be controlled so that condensation does not occur.

For tests at the upper extreme temperature, the equipment shall be placed in the test chamber and left until thermal balance is attained. The equipment shall then be switched on in the normal operating condition for a period of half an hour after which the equipment shall meet the specified requirements.

For tests at the lower extreme temperature the equipment shall be left in the test chamber until thermal balance is attained, then switched on in the normal operating condition for a period of one minute after which the equipment shall meet the specified requirements.

In the case of equipment containing temperature stabilization circuits designed to operate continuously, the temperature stabilization circuits shall be switched on for 15 minutes after thermal balance has been obtained, and the equipment shall then meet the specified requirements.

5.4.1.2 Extreme temperature ranges

For tests at extreme temperature, measurements shall be made in accordance with the procedures specified in subclause 5.4.1.1, at the lower and upper temperature limits of:

Temperature - 20 °C to +55 °C

5.4.2 Extreme test power source

5.4.2.1 Mains voltage

The extreme test voltages for equipment to be connected to an ac mains source shall be the nominal mains voltage $\pm 10\%$.

The mains source frequency shall be the nominal frequency $\pm 2\%$.

5.4.2.2 Lead-acid battery, regulated power sources

When the radio equipment is intended for operation from the usual type of regulated lead-acid battery power sources the extreme test voltages shall be the nominal voltage of the battery multiplied by 1,3 and 0,9 (e.g. 6 V \times 1,3; 6 V \times 0,9; 12 V \times 1,3; 12 V \times 0,9 etc.).

For float charge applications using "gel-cell" type batteries the extreme test voltages shall be the nominal voltage of the declared battery voltage multiplied by 1,15 and 0,85.

5.4.2.3 Power sources using other types of batteries

The lower extreme test voltages for equipment with power sources using batteries shall be as follows:

- for equipment with a battery indicator, the end point voltage as indicated;
- for equipment without a battery indicator the following end point voltage shall be used:
 - for the Leclanché or the lithium type of battery:
 - the nominal voltage of the battery multiplied by 0,85;
 - for the nickel-cadmium type of battery:
 - the nominal voltage of the battery multiplied by 0,9;
 - for other types of battery the lower extreme test voltage for the discharged condition shall be declared by the equipment applicant.

No upper extreme test voltages apply.

5.4.2.4 Other power sources

For equipment using other power sources or capable of being operated from a variety of power sources, the extreme test voltages shall be those agreed between the equipment applicant and the accredited test laboratory, and shall be recorded in the test report.

6 General conditions

Detailed descriptions of the radiated measurement arrangements are included in annexes A and B. In general, measurements should be carried out under far field conditions, however measurements in the 76 GHz to 77 GHz band may be carried out in the near field e.g. by using the test fixture as described in subclause 6.1 and shown in figure 1.

Absolute power measurements shall be made using an appropriate method to ensure that the wavefront is properly formed (i.e. operating in far field conditions). This prohibits the use of the test fixture, shown in figure 1.

For different frequency bands, different test sites, test antennas and standard positions are suitable and/or may be used.

Each test site shall fulfil specified conditions and requirements which are published (e.g. for OATS these are given in CISPR 16-1 [2]).

6.1 Test fixture

The test fixture enables the EUT to be physically supported, together with a waveguide horn antenna (which is used to couple/sample the transmitted energy), in a fixed physical relationship. The test fixture should be designed for use in an anechoic environment and allows certain measurements to be performed in the near field. Only relative or comparative measurements may be performed, and only those at the frequencies in the 76 GHz to 77 GHz band over which the test fixture has been calibrated.

At set-up, the EUT shall be aligned in the test fixture so that the maximum power is detected at the coupled output (see also subclauses 7.2.2 and 7.3.2). Orientation of the horn will take into account the polarization of the EUT.

In addition, the test fixture shall provide a connection to an external power supply.

The test fixture shall be provided by the manufacturer together with a full description, which should meet with the approval of the selected accredited test laboratory.

The performance characteristics of the test fixture shall be measured and shall be approved by the accredited test laboratory. It shall conform to the following basic parameters:

- the gain of the waveguide horn shall not exceed 10 dB;
- the physical distance between the front face of the EUT and the waveguide horn shall be between 50 and 60 cm;
- the physical height between the centre of the EUT and the supporting structure of the test fixture shall be between 50 and 60 cm;
- circuitry associated with the RF coupling shall contain no active or non-linear devices;
- the Voltage Standing Wave Ratio (VSWR) at the waveguide flange at which measurements are made shall not be greater than 1,5: 1 over the frequency range of the measurements;
- the performance of the test fixture when mounted in the anechoic environment, on an open test site, or in a temperature chamber, shall be unaffected by the proximity of surrounding objects or people outside the environment. The performance shall be reproducible if the EUT is removed and then replaced;
- the performance of the test fixture shall remain within the defined limits of the calibration report, when the test conditions are varied over the limits described in subclauses 5.3 and 5.4.

The characteristics and calibration of the test fixture shall be included in a calibration report.

6.1.1 Calibration

The calibration of the test fixture establishes the relationship between the detected output from the test fixture, and the transmitted power (as sampled at the position of the antenna) from the EUT in the test fixture. This can be achieved by using a calibrated horn with a gain of equal to or less than 10 dB, fed from an external signal source, in place of the EUT to determine the variations in detected power with temperature and over frequency.

The calibration of the test fixture shall be carried out by either the manufacturer or the accredited test laboratory. The results shall be approved by the accredited test laboratory.

The calibration should be carried out over the operating frequency band, at least three frequencies, for the declared polarization of the EUT, and over the temperature ranges specified in subclause 5.4.1.2.

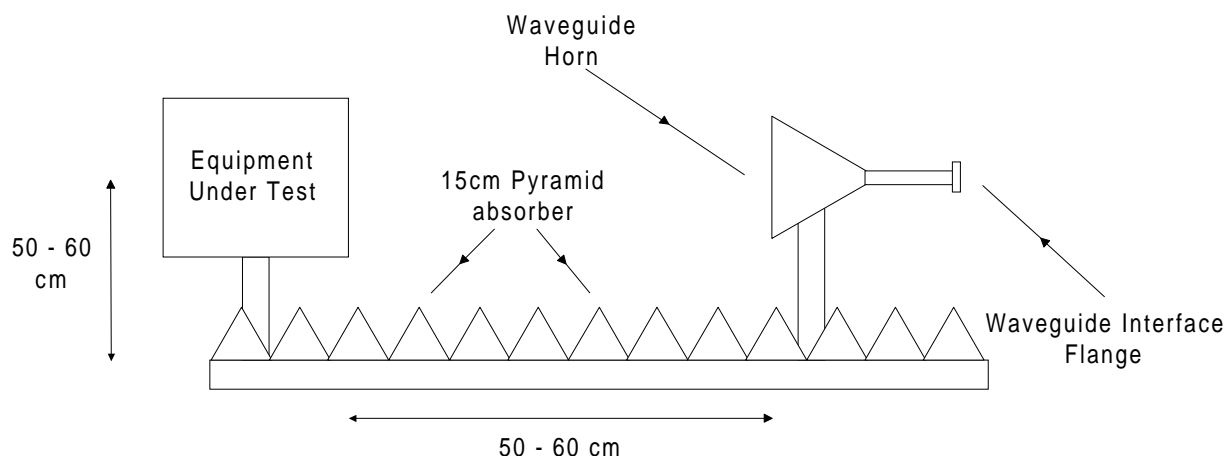

Figure 1: Test fixture

7 Methods of measurement and limits for the transmitter RF parameters

To meet the requirements for all applications the EUT shall be measured at its maximum mean output power level and maximum antenna gain. Antenna polar diagrams, together with any antenna sweep profiles (for systems with antenna beam steering capability) and details of polarization, shall be presented and agreed with the accredited test laboratory if they are necessary to enable the measurements described in clause 7 to be performed.

Alternative test methods to those described within the present document may be used with the agreement of the manufacturer, and at the discretion of the accredited test laboratory. Procedures shall comply with CEPT/ERC Recommendation TR 01-06 [6] and CISPR 16-1 [2].

There are two classes defined within the present document: class 1 and class 2. The only difference between the two class numbers is the permitted level of transmitted power. The class for which approval is sought, shall be stated in the application form for type approval.

7.1 Permitted range of operating frequencies

7.1.1 Definition

The permitted range of operating frequencies is the frequency range over which the equipment is authorized to operate.

7.1.2 Method of measurement

The minimum and maximum output frequencies at which the permitted spurious levels as specified in subclause 7.6, are exceeded and which are produced from the selected modulation scheme(s) shall be measured using the method shown in

figure 2. If more than one modulation scheme can be generated by the EUT, then the maximum and minimum frequencies generated by each modulation scheme shall be measured and recorded.

The measuring receiver may be a spectrum analyser, oscilloscope, selective power meter or any measuring receiver which is appropriate to perform the intended measurement of the device under test.

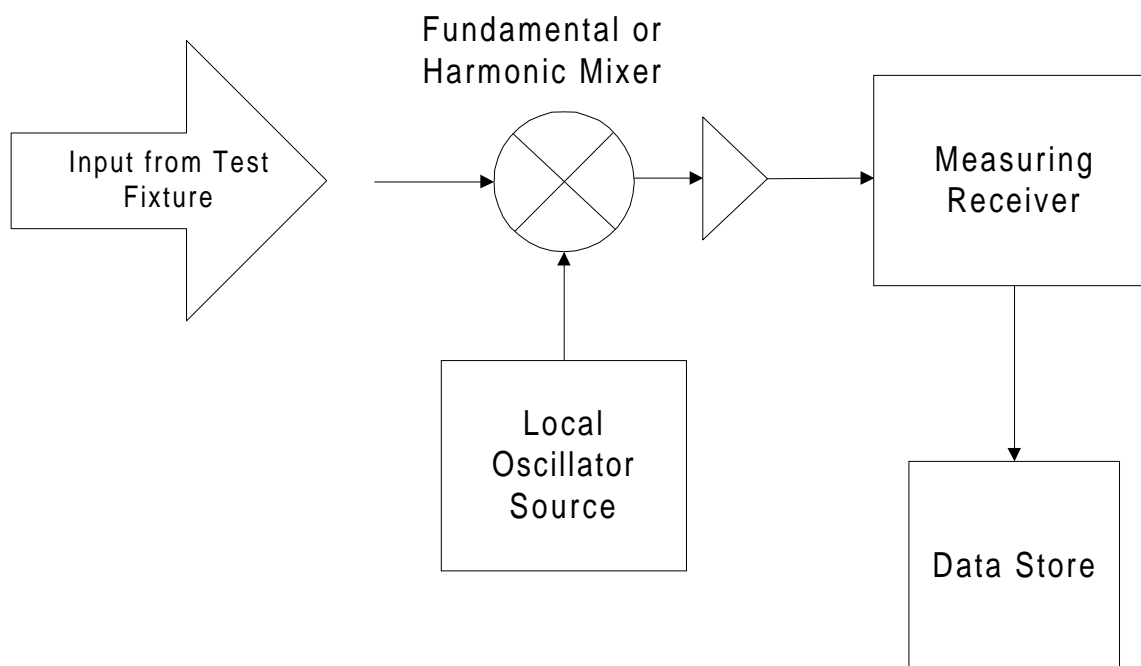

Figure 2: Test equipment for measuring the operating frequency range

This measurement shall be performed at normal and at extreme test conditions (see subclauses 5.3 and 5.4).

The method of measurement shall be documented in the test report.

7.1.3 Limits

The permitted range of operating frequency shall be 76 GHz to 77 GHz.

7.2 Radiated power density

7.2.1 Definition

The radiated power density is defined as the power per unit area normal to the direction of the electromagnetic wave propagation measured in the permitted range of operating frequencies (see subclause 7.1) and is expressed as an EIRP (dBm).

7.2.2 Method of measurement

7.2.2.1 Equipment with a fixed beam antenna (i.e. non-steerable by either mechanical or electronic means)

Using an applicable measurement procedure e.g. as described in annexes A and B, the power output shall be measured and recorded in the test report. Absolute power measurements should be carried out under far field conditions, however measurements over temperature may be carried out using comparative measurements in the near field e.g. by using the test fixture as described in subclause 6.1.

The method of measuring the power may be either by the use of a calibrated power meter, or by using a calibrated receiver. For both methods the substitution technique described in annex B shall be used to calibrate the measuring equipment.

The polar diagram together with details of the polarization for the transmit beam (if required to enable the measurement to be carried out) shall be submitted by the manufacturer and approved by the accredited test laboratory.

The maximum EIRP shall then be recorded.

The EIRP shall be measured under far field conditions under normal test conditions (subclause 5.3.1).

EIRP under extreme test conditions (subclause 5.4.1) may be measured in the near field e.g. with the defined test fixture (see subclause 6.1).

This measurement should be carried out in an anechoic environment or there should be no physical obstruction within a sector defined as "three times the 3 dB beamwidth of the antenna" during this test.

This measurement shall be performed at normal and at extreme test conditions (see subclauses 5.3 and 5.4).

The method of measurement shall be documented in the test report.

7.2.2.2 Equipment with (electronically or mechanically) steerable antenna(s)

Using an applicable measurement procedure e.g. as described in annexes A and B, the power output shall be measured and recorded in the test report. Absolute power measurements should be carried out under far field conditions, however measurements over temperature may be carried out using comparative measurements in the near field e.g. by using the test fixture as described in subclause 6.1.

The method of measuring the power may be either by the use of a calibrated power meter, or by using a calibrated receiver. For both methods, the substitution technique described in annex B shall be used to calibrate the measuring equipment.

Peak EIRP to be measured using a standard gain horn and spectrum analyser set to slow sweep and peak hold mode. This enables the EUT to be fully tested according to subclause 7.2.2.1.

The manufacturer shall provide information relating to the scanning. The limits for the EIRP are shown in table 2.

The EIRP shall be measured in the far field under normal test conditions (subclause 5.3.1).

EIRP under extreme test conditions (subclause 5.4.1) may be measured in the near field e.g. with the defined test fixture (see subclause 6.1).

This measurement should be carried out in an anechoic environment or there should be no physical obstruction within a sector defined as "three times the 3 dB beamwidth of the antenna" during this test.

This measurement shall be performed at normal and at extreme test conditions (see subclauses 5.3 and 5.4).

The method of measurement shall be documented in the test report.

7.2.3 Limits

7.2.3.1 Equipment with fixed beam antenna

The transmitted power for equipment with fixed beam antennas shall be less than the limits shown in table 1.

Table 1: Limits for transmitted power (fixed antenna)

	Class 1	Class 2
Mean Power(EIRP)	50 dBm	23,5 dBm
Peak Power(EIRP)	55 dBm	55 dBm

7.2.3.2 Equipment with (electronically or mechanically) steerable antennas

The transmitted power for equipment with steerable antennas shall be less than the limits shown in table 2.

Table 2: Limits for transmitted power (steerable antenna)

maximum dwell time	Class 1		Class 2	
	t < 100ms	t > 100ms	t < 100ms	t > 100ms
Mean Power(EIRP) (note 1)	(50 dBm × D) or 55 dBm (whichever is the greater)	50 dBm	(23,5 dBm × D) or 55 dBm (whichever is the greater)	23,5 dBm
Peak Power (EIRP)	55 dBm	55 dBm	55 dBm	55 dBm
NOTE 1: The duty factor (D) is the ratio of the area of the beam (measured at its 3dB point) to the total area scanned by the antenna.				
NOTE 2: The dwell time (t) is the largest dwell time at any angle.				

7.3 Maximum safe level for radiated power density

It is necessary for every EUT to comply with the current regulations regarding safe levels for radiated power. This is detailed in annex D of the present document.

7.4 Modulation schemes

Only the modulation schemes described in subclauses 7.4.1, 7.4.2 and 7.4.3 may be used.

7.4.1 Pulse modulation

7.4.1.1 Definition

For pulse modulation, the Tx "amplitude" is periodically switched on for a short time (called pulse duration) and switched off during the subsequent reception period. A typical example is shown in figure 3.

The time between the rising edges of the pulsed output power is called the Pulse Repetition Interval (PRI). The PRI may vary between subsequent pulses, in which case the modulation is called staggered PRI.

The Pulse Repetition Frequency (PRF) is the inverse of the PRI averaged over a time sufficiently long to cover all PRI variations.

The duty cycle is the product of the PRF and the pulse duration.

The radiated power averaged over the pulse duration is called the peak output power.

The peak output power multiplied by the average duty cycle is called the average output power.

Subsequent pulses may be on different frequencies (i.e. stepped frequency), but they shall be linearly sequential. This does not include unintentional frequency drift with temperature.

During the pulse duration, the frequency shall not be intentionally modulated (i.e. chirped). This does not include unintentional frequency drift with temperature.

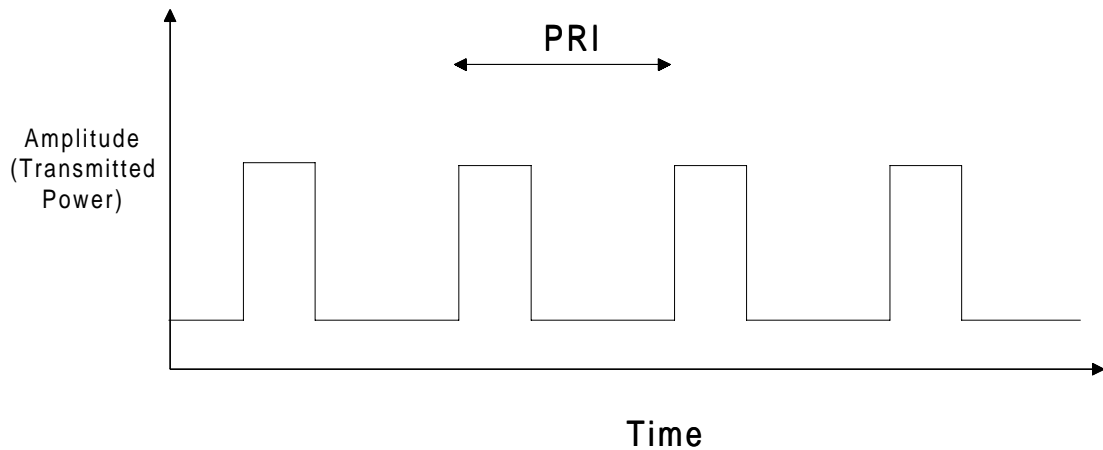

Figure 3: Typical pulse modulation scheme

7.4.1.2 Methods of measurement

Using the standard test fixture shown in figure 1 (see subclause 6.1.2), the test equipment shown in figure 4 is connected to the test fixture.

The measuring receiver may be a modulation domain analyser, spectrum analyser, oscilloscope, selective power meter or any measuring receiver which is appropriate to perform the intended measurement of the EUT.

The EUT shall be operated under normal and extreme conditions (subclauses 5.3 and 5.4), and the resultant modulation waveforms monitored and recorded.

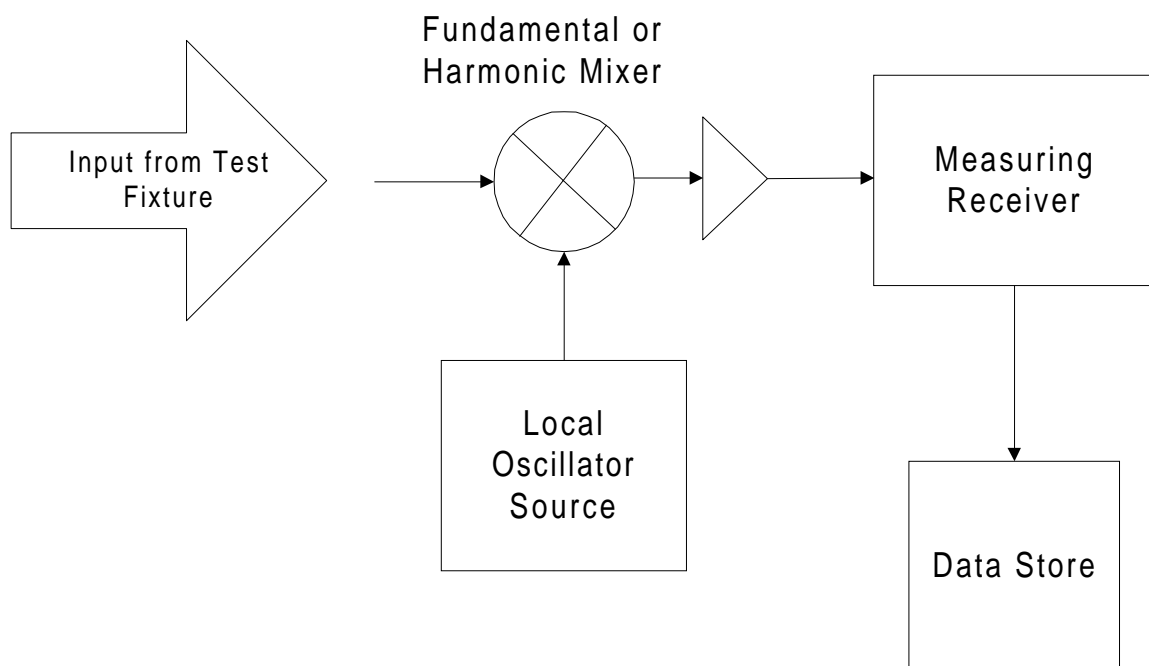

Figure 4: Test equipment for measuring the modulation waveform

7.4.1.3 Limits

The limits are shown in table 3.

Table 3: Limits for pulse modulation

Parameter	Minimum	Maximum
PRF	no limit	3 MHz
PRI	300 ns	no limit
Pulse length	20 ns	no limit
Maximum frequency step	no limit	100 MHz / ns
Duty cycle	no limit	10 %

No further limits apply to the parameters defined as long as the resulting signal spectrum satisfies the requirements defined in the other clauses of the present document.

7.4.2 Frequency modulated continuous wave

7.4.2.1 Definition

For Frequency Modulated Carrier Wave (FMCW) modulation, the transmitted waveform is frequency modulated over a period of time (P). This period of time may be constant, or may be varied within the limits shown in subclause 7.4.2.3. An example of a typical modulation scheme is shown in figure 5. During the time (P), the frequency may either increase or decrease, monotonically. The modulation may assume (but is not limited to) the form of a "sawtooth", "triangular" or a "sinusoidal" waveform. Also a constant frequency may be maintained and transmitted during one or more periods of time. Also the transmitted power may be switched off during one or more periods of time (e.g. Frequency Modulated Interrupted Continuous Wave (FMICW)). The modulation waveform may be repeated or varied over several periods of time, and a limited variation of the duration of time period (P) is permitted. The amplitude of the transmitted waveform shall not be intentionally modulated. At the beginning or end of each period of time (P), there may be a time "G" (the "blanking period") where the transmitted waveform is adjusting to the requirements of the beginning of the next period. No use is made of the transmitted waveform during the "blanking period" period. The blanking period may either be constant, or it may vary within the limits defined in table 4.

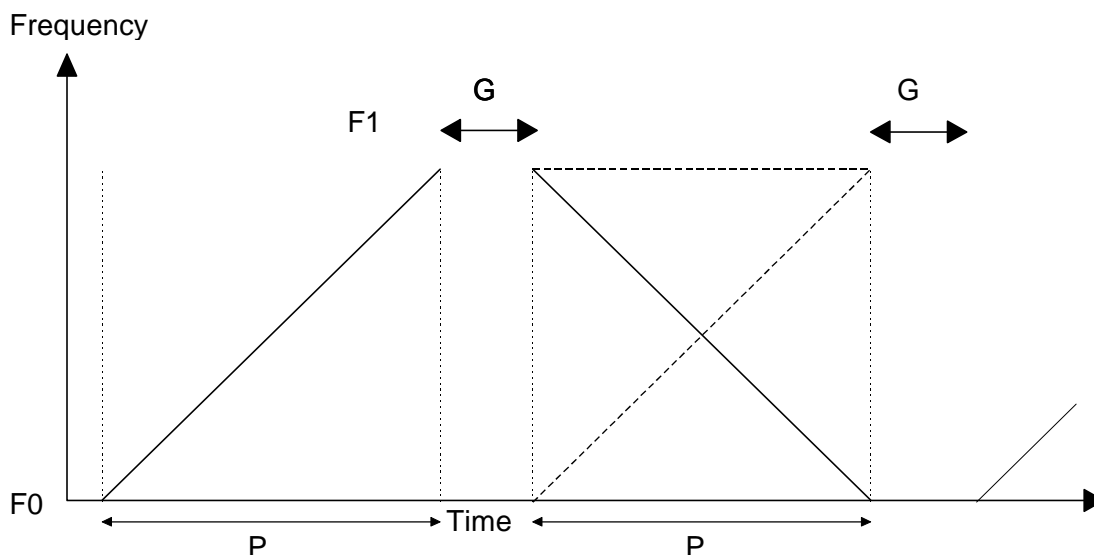
**Figure 5: Typical FMCW modulation scheme**

7.4.2.2 Methods of measurement

Using the standard test fixture shown in figure 1 (see subclause 6.1.2), the test equipment shown in figure 6 is connected to the test fixture.

The measuring receiver may be a modulation domain analyser, spectrum analyser, oscilloscope, selective power meter or any measuring receiver which is appropriate to perform the intended measurement of the EUT.

The EUT shall be operated under normal and extreme conditions (subclauses 5.3 and 5.4), and the resultant modulation waveforms monitored and recorded.

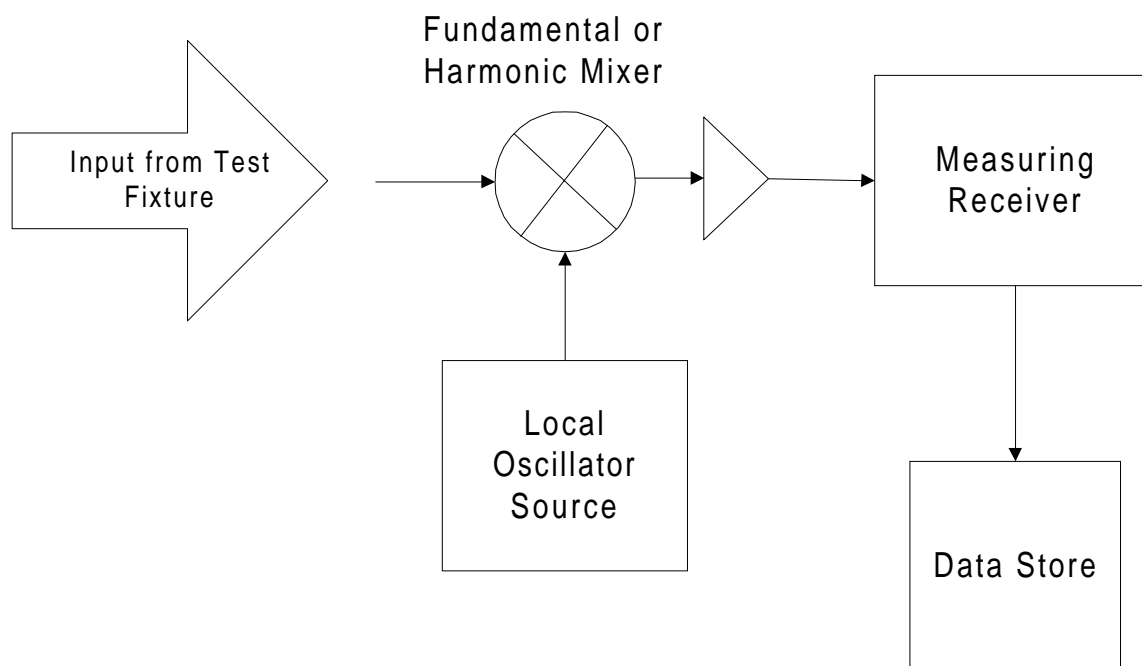

Figure 6: Test equipment for measuring the modulation waveform

7.4.2.3 Limits

The limits for FMCW modulation schemes are shown in table 4.

Table 4: Limits for FMCW Modulation Schemes

Parameter	Minimum Limit	Maximum Limit
Frequency deviation in one period	0 Hz	1 000 MHz
Rate of frequency modulation during a period (P)	0 Hz/ms	10 000 MHz/ms
Period of time for modulation (P)	100 μ s	40 ms
Variation of centre frequency between periods	no limit	no limit
Blanking Period (G)	0	2 ms

Blanking period "G": during this period of time, no intentional use shall be made of the transmitted waveform. The frequency during this period may change, but shall not deviate from a monotonic increase or decrease by more than 100 MHz.

7.4.3 Frequency Shift Keying (FSK)

7.4.3.1 Definition

With FSK modulation, an interleaved continuous FSK waveform is transmitted. The modulation frames are composed of interleaved continuously linearly stepped and sequential digital frequency steps.

During each frequency step the transmitted signal has a constant frequency.

The generic modulation scheme is characterized by the parameters shown in figures 7 and 8.

In a frame, the sequence of transmitted frequencies are:

$$f_{01}, f_{02}, \dots, f_{0j}, \dots, f_{0p}, f_{11}, f_{12}, \dots, f_{1j}, \dots, f_{1p}, \dots, f_{n1}, f_{n2}, \dots, f_{nj}, \dots, f_{np}$$

Where:

P is the number of interleaved linearly stepped waveforms;

$n + 1$ is the number of steps per linearly stepped waveform.

With:

$$f_{(a+1)j} = f_{aj} + \epsilon_j \times \Delta f_j \quad \text{for } 1 \leq j \leq n;$$

and where f_{aj} and $f_{(a+1)j}$ are sequential steps in the waveform identified by the "j" index.

Where:

Δf_j is the frequency deviation step of the waveform identified by the "j" index;

$\epsilon_j = 1$ (positive slope) or $\epsilon_j = -1$ (negative slope);

$\Delta F_j = n \times \Delta f_j \leq \Delta F_{\max} = 200 \text{ MHz}$ (negative or positive slope).

With:

τ = frequency step duration (constant within 1 frame);

ΔF_{\max} = maximum frequency deviation of one stepped frequency waveform;

T = frame repetition period (constant).

The bandwidth (B) is defined as the bandwidth at which the level of the power spectral density (W/Hz) is 27 dB below the peak level of the power spectral density.

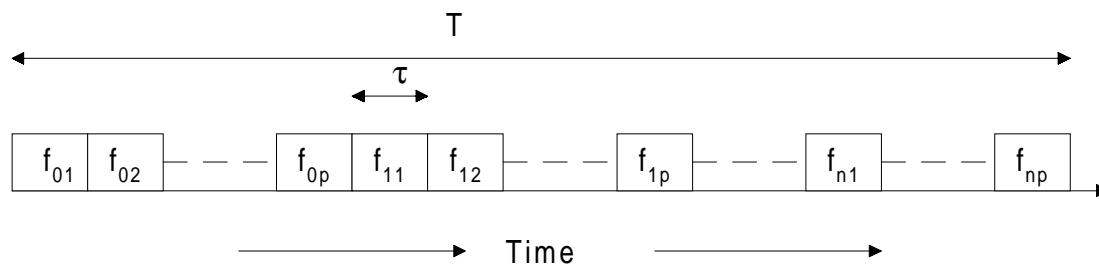

Figure 7: Typical FSK modulation scheme

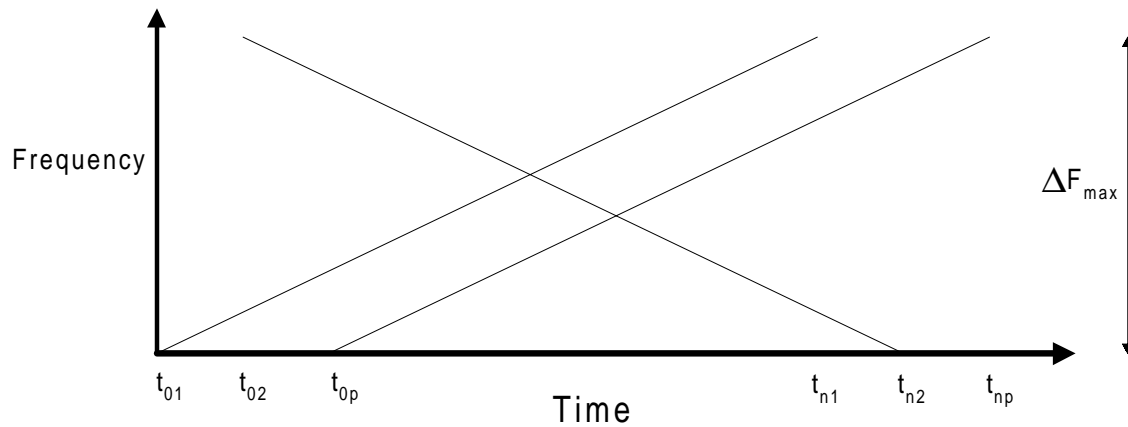

Figure 8: Typical FSK modulation sequence

7.4.3.2 Method of measurement

Using the standard test fixture shown in figure 1 (see subclause 6.1.2), the test equipment shown in figure 9 is attached to the test fixture.

The measuring receiver may be a modulation domain analyser, spectrum analyser, oscilloscope, selective power meter or any measuring receiver which is appropriate to perform the intended measurement of the EUT.

The EUT shall be operated under normal and extreme conditions (subclauses 5.3 and 5.4), and the resultant modulation waveforms monitored and recorded.

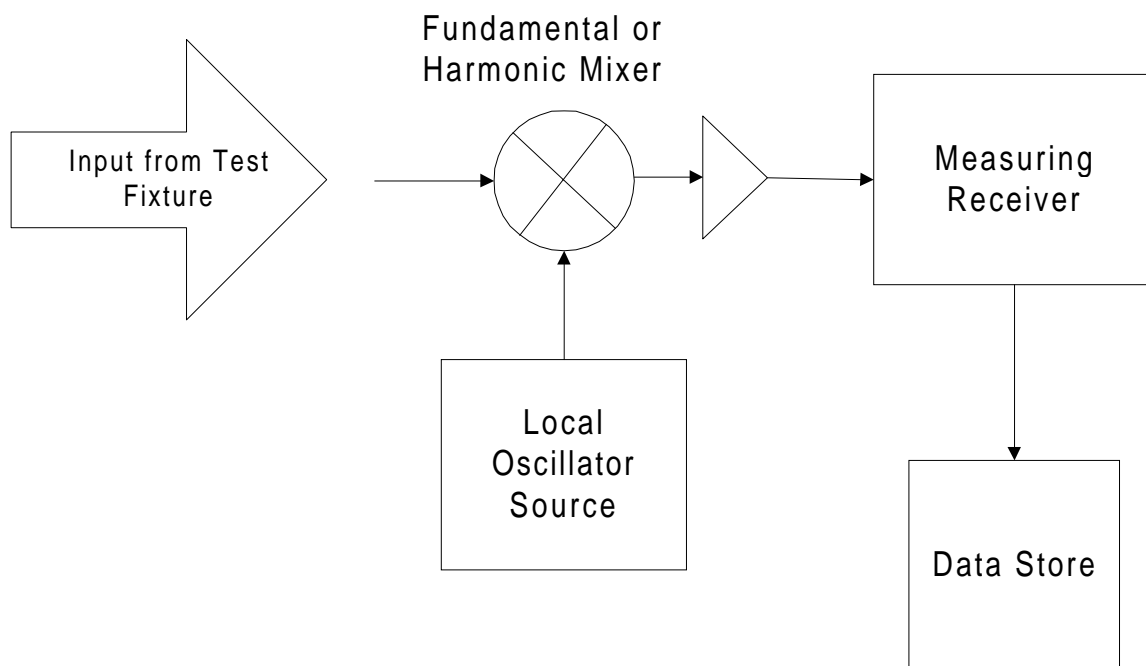

Figure 9: Test equipment for measuring the modulation waveform

7.4.3.3 Limits

The limits for FSK Modulation are shown in table 5.

Table 5: Limits for FSK Modulation

Parameter	Minimum	Maximum
τ	0,5 μ s	10 μ s
ΔF_{max}	100 KHz	200 MHz
T	2 μ s	
B	no limit	280 MHz
n + 1	1	8 192
p	1	10
$(\Delta f / T)_{max}$	no limit	100 MHz / 1 μ s

7.5 Radiated spurious emissions

7.5.1 Definition

Spurious emissions are emissions at frequencies other than those of the carrier and sidebands associated with normal modulation and include all emissions outside the 76 GHz to 77 GHz band. The level of spurious emissions shall be measured as their effective radiated power when radiated by the EUT, with the modulation on.

7.5.2 Measuring receiver

The term "measuring receiver" refers to either a selective voltmeter or spectrum analyser. The bandwidth of the measuring receiver shall, where possible, be according to CISPR 16-1 [2]. In order to obtain the required sensitivity a narrower bandwidth may be necessary, this shall be stated in the test report form.

The bandwidth of the measuring receiver shall be less than the maximum given in table 6.

Table 6: Maximum receiver bandwidths

Frequency being measured	Maximum measuring receiver bandwidth
$f < 1\ 000$ MHz	100 - 120 kHz
$f \geq 1\ 000$ MHz	1 MHz

7.5.3 Method of measurement for radiated spurious emission

A test site such as one selected from annex A, which fulfils the requirements of the specified frequency range of this measurement shall be used. The test method employed should be as described in annex B. The bandwidth of the measuring receiver shall be set to a suitable value to correctly measure the spurious emission. This bandwidth shall be recorded in the test report. For frequencies above 40 GHz a downconverter shall be used as shown in figure 10. The local oscillator used to downconvert the received signals shall be stable and with a phase noise of better than -80 dBc/Hz at 100 kHz offset. The local oscillator frequency shall be selected such that the downconverted signal is within the accepted band of the spectrum analyser, and maintaining an adequate Intermediate Frequency (IF) bandwidth to capture the full spectrum of the signal. The EIRP of the EUT shall be measured and recorded.

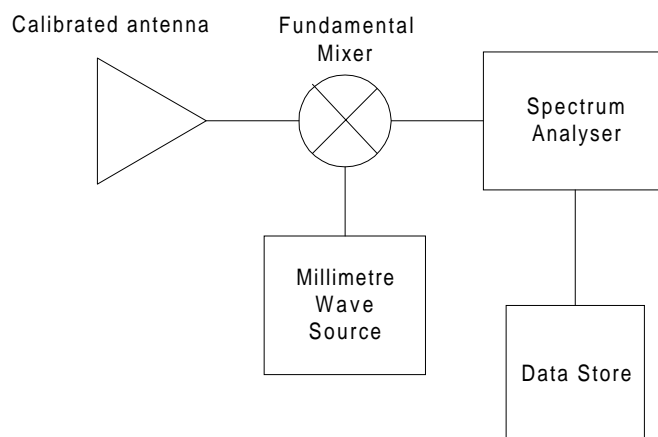

Figure 10: Test equipment for measuring spurious radiation above 40 GHz

7.5.4 Limits

The effective radiated power of any spurious emission shall not exceed the values given in table 7.

Table 7: Limits of radiated spurious emissions

Frequency range (MHz)	Limit values for spurious radiation
47 - 74	-54 dBm
87,5 - 118	-54 dBm
174 - 230	-54 dBm
470 - 862	-54 dBm
otherwise in band 30 to 1 000	-36 dBm
1 000 to 25 000	-30 dBm
25 000 to 40 000	-25 dBm
40 000 to 100 000	-20 dBm

7.6 Unwanted emissions caused by the application of the modulation

7.6.1 Definition

The unwanted emissions caused by the application of the modulation are measured as the spectral power density contained in the sidebands associated with normal modulation, falling into frequency bands outside the 76 GHz to 77 GHz band.

The level of the unwanted emissions shall be calculated as the effective radiated power density.

For line spectra the level of the unwanted emissions is regarded as the level of a single line.

The power density is defined for a line spectrum by:

- PL/df where PL = power of an individual spectral line;
- df = spectral distance between two lines with similar power levels.

The power density is defined for a continuous spectrum by:

- Pa/BW where Pa = mean power within the BW ;
- BW = resolution bandwidth.

7.6.2 Measuring receiver

The term "measuring receiver" refers to either a selective voltmeter or spectrum analyser. The bandwidth of the measuring receiver shall, where possible, be according to CISPR 16-1 [2]. In order to obtain the required sensitivity a narrower bandwidth may be necessary, this shall be stated in the test report form.

The bandwidth of the measuring receiver shall be less than the maximum given in table 8.

Table 8: Maximum receiver bandwidths

Frequency being measured	Maximum measuring receiver bandwidth
$f < 1\,000$ MHz	100 - 120 kHz
$f \geq 1\,000$ MHz	1 MHz

7.6.3 Method of measurement

A test site such as one selected from annex A, which fulfils the requirements of the specified frequency range of this measurement shall be used. The test method employed should be as described in annex B. The bandwidth of the measuring receiver shall be set to a suitable value to correctly measure the unwanted emission. This bandwidth shall be recorded in the test report. For frequencies above 40 GHz a downconverter shall be used as shown in figure 11. The local oscillator used to downconvert the received signals shall be stable and with a phase noise of better than -80 dBc/Hz at 100 kHz offset. The local oscillator frequency shall be selected such that the downconverted signal is within the accepted band of the spectrum analyser, and maintaining an adequate IF bandwidth to capture the full spectrum of the signal. The EIRP of the EUT shall be measured and recorded.

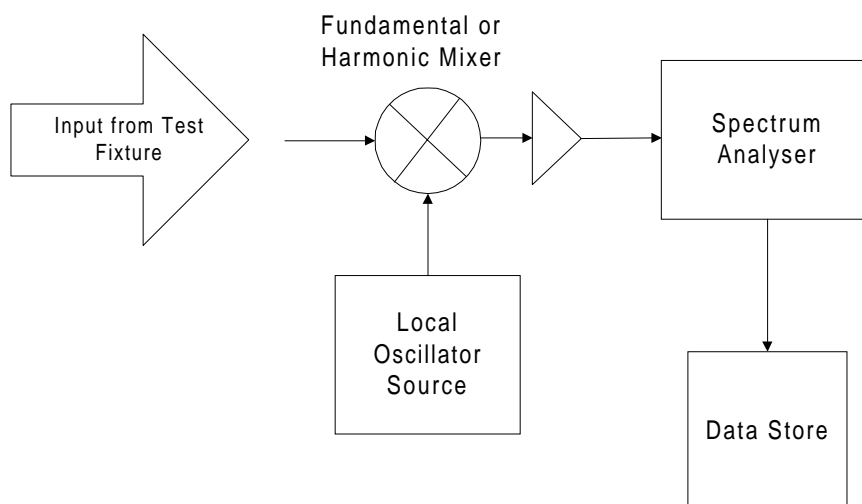

Figure 11: Test equipment for measuring out of band radiation

The spectral power density of the signal with normal modulation shall be measured and recorded in frequency bands adjacent to the 76 GHz to 77 GHz band, up to the frequencies where the spectral density is 40 dB below its maximum value.

7.6.4 Limits

The mean power density radiated outside the 76 GHz to 77 GHz band shall not exceed the values shown in table 9.

Table 9: Limits for out of band radiation

Frequency	Maximum mean power density (dBm/Hz)
47 - 74 MHz	-84
87,5 - 118 MHz	-84
174 - 230 MHz	-84
470 - 862 MHz	-84
otherwise in the band 30 MHz to 1 000 MHz	-66
1 - 25 GHz	-60
25 - 76 GHz	-60
77 - 100 GHz	-60

8 Measurement uncertainty

The accumulated measurement uncertainties of the test system in use, for the parameters to be measured, should not exceed those given in table 10 to ensure that the measurements remain within an acceptable standard.

Table 10: Absolute measurement uncertainty

Parameter	Uncertainty
Radio Frequency (out of band)	$\pm 1 \times 10^{-7}$
Radio Frequency (in band)	$\pm 1 \times 10^{-6}$
Out of band Radiated Emission (valid to 100 GHz)	± 6 dB
In-band Radiated Emission	± 3 dB
Temperature	± 1 K
Humidity	± 10 %

The uncertainty figures will be valid to a confidence level of 95 % calculated according to the methods described in ETR 028 [7].

Annex A (normative): Radiated measurements

A.1 Test sites and general arrangements for measurements involving the use of radiated fields

A.1.1 Open Area Test Site (OATS)

The OATS shall be on a reasonably level surface or ground. At one point on the site, an elliptical ground plane conforming to CISPR 16-1 [2] shall be provided. At one of the foci of this ground plane, a non-conducting support shall be located, capable of rotation in the horizontal and vertical planes, which is used to support the EUT in its standard position, between 0,75 m and 1,5 m above the ground plane. The test antenna shall be sited at the other focus. For measurements below 40 GHz, the test site shall be large enough to allow the erection of a measuring or transmitting antenna at a distance of $\lambda/2$ or 3 m whichever is greater. For measurements above 40 GHz an anechoic environment should be used, which should be large enough to allow the erection of a test antenna in the far field (i.e. at a distance of not less than $2d^2/\lambda$). The distance actually used shall be recorded with the results of the tests carried out on the site. The suitability of a test site shall be verified by the procedure recommended in CISPR 16-1 [2] and its amendments where applicable.

Sufficient precautions shall be taken to ensure that reflections from extraneous objects adjacent to the site do not degrade the measurements results.

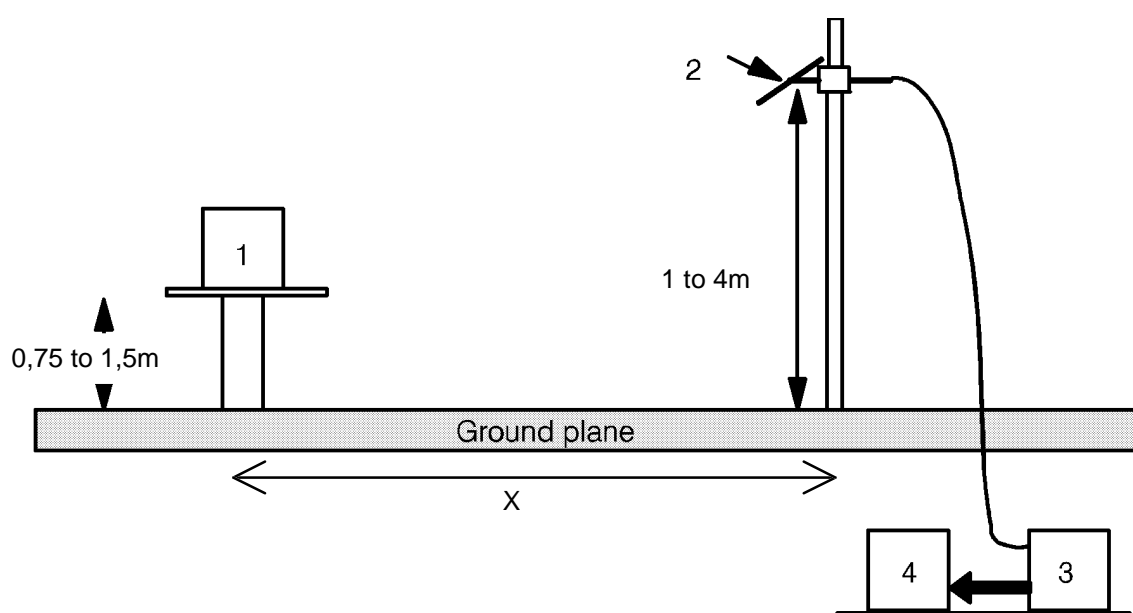

NOTE:

- 1 equipment under test;
- 2 test antenna;
- 3 high pass filter (may not be necessary);
- 4 spectrum analyser or measuring receiver.

Figure A.1: Measuring arrangement

A.1.2 Test antenna

The test antenna is used to detect the radiation from the EUT, when the site is used for radiation measurements.

This antenna shall be mounted on a support such as to allow the antenna to be used in either horizontal or vertical polarization and for the height of its centre above ground to be varied over the range 1 to 4 m. A test antenna with pronounced directivity should be used. The size of the test antenna along the measurement axis shall not exceed 20 % of the measuring distance.

For radiation measurements, the test antenna shall be connected to a measuring receiver, capable of being tuned to any frequency under investigation and of measuring accurately the relative levels of signals at its input.

When measuring in the frequency range up to 1 GHz the test antenna shall be a $\lambda/2$ dipole, resonant at the operating frequency, or a shortened dipole, calibrated to the $\lambda/2$ dipole. When measuring in the frequency range above 4 GHz a horn radiator shall be used. For measurements between 1 and 4 GHz either a $\lambda/2$ dipole or a horn radiator may be used.

NOTE: The gain of a horn antenna is generally expressed relative to an isotropic radiator.

For far field measurements, distance "X" should be a minimum of $2d^2/\lambda$, where d = largest dimension of the antenna aperture of the EUT.

Calibrated test antennae shall be used in all measurements.

The distance between the lower extremity of the test antenna and the ground shall not be less than 0,3 m.

A.1.3 Standard position

The standard position in all test sites, shall be as follows:

- for equipment with integral antenna, it shall be placed in the position closest to normal use as declared by the manufacturer;
- the polarization of the test antenna and the equipment antenna shall be identical within the bandwidth of the equipment antenna; at other frequencies the test antenna shall be vertical.

A.1.4 Optional additional indoor site

When the frequency of the signals being measured is greater than 80 MHz, use may be made of an indoor site. If this alternative site is used, this shall be recorded in the test report.

Care should be taken as it may not be appropriate to conduct far field measurements above 40 GHz on such a test site.

The measurement site shall be a laboratory room with a minimum area of 6 m by 7 m and at least 2,7 m in height.

Apart from the measuring apparatus and the operator, the room shall be as free as possible from reflecting objects other than the walls, floor and ceiling.

The potential reflections from the wall behind the EUT shall be reduced by placing a barrier of absorbent material in front of it. The corner reflector around the test antenna shall be used to reduce the effect of reflections from the opposite wall and from the floor and ceiling in the case of horizontally polarized measurements.

Similarly, the corner reflector reduces the effects of reflections from the side walls for vertically polarized measurements. For the lower part of the frequency range (below approximately 175 MHz) no corner reflector or absorbent barrier is needed. For practical reasons, the $\lambda/2$ antenna in figure A.2 may be replaced by an antenna of constant length, provided that this length is between $\lambda/4$ and λ at the frequency of measurement and the sensitivity of the measuring system is sufficient. In the same way the distance of $\lambda/2$ to the apex may be varied.

The test antenna and measuring receiver, are used in a way similar to that of the general method.

A.2 Guidance on the use of radiation test sites

For general guidance on the use of radiation test sites refer to CISPR 16-1 [2].

For measurements involving the use of radiated fields, use may be made of a test site in conformity with the requirements of clause A.1. For measurements above 40 GHz care shall be taken to ensure that the selected test site is appropriate. When using such a test site, the following conditions should be observed to ensure consistency of measuring results.

A.2.1 Measuring distance

Evidence indicates that the measuring distance is not critical and does not significantly affect the measuring results, provided that the distance is not less than $\lambda/2$ at the frequency of measurement and the precautions described in this annex are observed. Measuring distances of 3, 5, 10 and 30 m are in common use in european test laboratories.

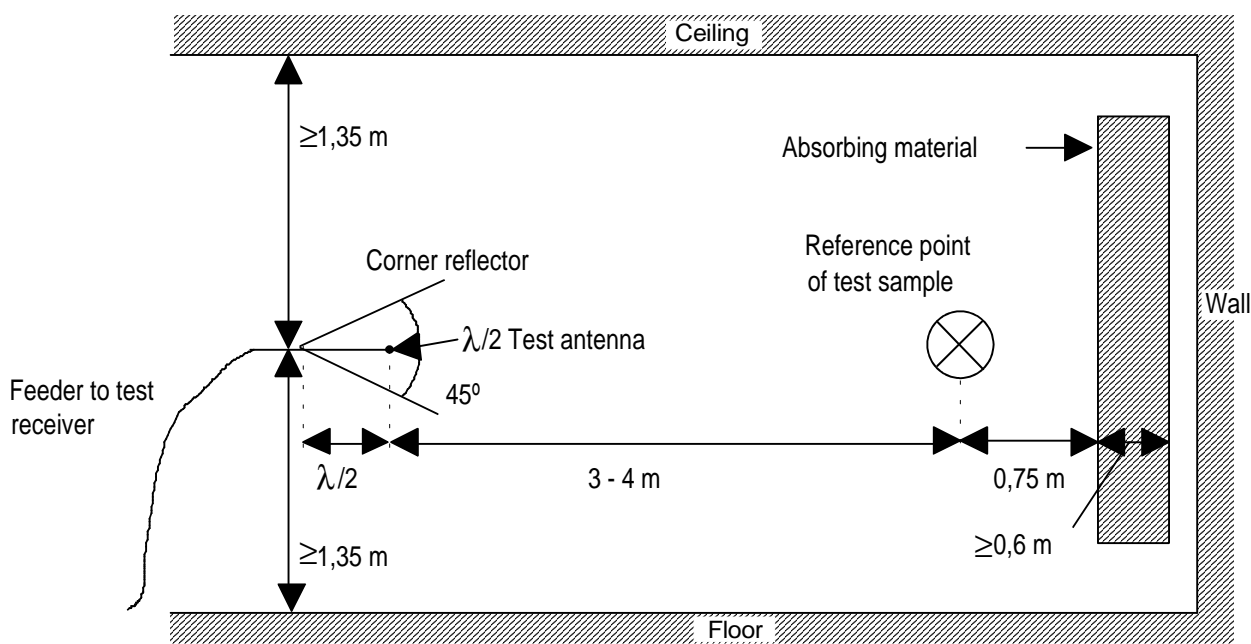

Figure A.2: Indoor site arrangement (shown for horizontal polarization)

A.2.2 Test antenna

Different types of test antenna may be used, since performing substitution measurements reduces the effect of the errors on the measuring results.

Height variation of the test antenna over a range of 1 m to 4 m is essential in order to find the point at which the radiation is a maximum.

Height variation of the test antenna may not be necessary at the lower frequencies below about 100 MHz.

A.2.3 Substitution antenna

The substitution antenna and signal generator is used to replace the EUT in substitution measurements. For measurements below 1 GHz the substitution antenna shall be half wavelength dipole resonant at the frequency under consideration, or a shortened dipole, calibrated to the half wavelength dipole. For measurements between 1 GHz and 4 GHz either a half wavelength dipole or a horn radiator may be used. For measurements above 4 GHz a horn radiator shall be used. The centre of this antenna shall coincide with the reference point of the EUT it has replaced. This reference point shall be the volume centre of the sample when its antenna is mounted inside the cabinet, or the point

where an outside antenna is connected to the cabinet. The distance between the lower extremity of the dipole and the ground shall be at least 300 mm.

A.2.4 Auxiliary cables

The position of auxiliary cables (power supply, etc.) which are not adequately decoupled may cause variations in the measuring results. In order to get reproducible results, cables and wires of auxiliaries should be arranged vertically downwards (through a hole in the non conducting support).

A.3 Further optional alternative indoor test site using a fully anechoic RF chamber

For radiation measurements when the frequency of the signals being measured is greater than 30 MHz, use may be made of an indoor site being a well-shielded anechoic chamber simulating free space environment. If such a chamber is used, this shall be recorded in the test report.

The test antenna and measuring receiver, are used in a way similar to that of the general method, clause A.1. In the range between 30 MHz and 100 MHz some additional calibration may be necessary.

An example of a typical measurement site may be an electrically shielded anechoic chamber being 10 m long, 5 m broad and 5 m high. Walls and ceiling should be coated with RF absorbers of 1 m height. The base should be covered with absorbing material 1 m thick, and a wooden floor, able to carry test equipment and operators. A measuring distance of 3 m to 5 m in the long middle axis of the chamber can be used for measurements up to 12,75 GHz. For frequencies above 12,75 GHz the chamber may be used provided it has been calibrated for use at the frequency being measured. The construction of the anechoic chamber is described in the following clauses.

A.3.1 Example of the construction of a shielded anechoic chamber

Free-field measurements can be simulated in a shielded measuring chamber where the walls are coated with RF absorbers. Figure A.3 shows the requirements for shielding loss and wall return loss of such a room. As dimensions and characteristics of usual absorber materials are critical below 100 MHz (height of absorbers < 1 m, reflection attenuation < 20 dB) such a room is preferably suitable for measurements above 100 MHz. Figure A.4 shows the construction of a shielded measuring chamber having a base area of 5 m by 10 m and a height of 5 m.

Ceilings and walls are coated with pyramidal formed RF absorbers approximately 1 m high or equivalent material with the same performance. The base is covered with absorbers which form a non-conducting sub-floor, or with special ground floor absorbers. The available internal dimensions of the room are 3 m × 8 m × 3 m, so that a measuring distance of maximum 5 m length in the middle axis of this room is available.

At 100 MHz the measuring distance can be extended up to a maximum of 2λ .

The floor absorbers reduce floor reflections so that the antenna height need not be changed and floor reflection influences need not be considered.

All measuring results can therefore be checked with simple calculations and the measurement uncertainties have the smallest possible values due to the simple measuring configuration.

A.3.2 Influence of parasitic reflections in anechoic chambers

For free-space propagation in the far field condition the correlation $E = E_0 \cdot (R_0/R)$ is valid for the dependence of the field strength E on the distance R , whereby E_0 is the reference field strength in the reference distance R_0 .

It is useful to use just this correlation for comparison measurements, as all constants are eliminated with the ratio and neither cable attenuation nor antenna mismatch or antenna dimensions are of importance.

Deviations from the ideal curve can be seen easily if the logarithm of the above equation is used, because the ideal correlation of field strength and distance can then be shown as a straight line and the deviations occurring in practice are clearly visible. This indirect method shows the disturbances due to reflections more readily and is far less problematical than the direct measurement of reflection attenuation.

With an anechoic chamber of the dimensions suggested in clause A.3 at low frequencies up to 100 MHz there are no far field conditions, and therefore reflections are stronger so that careful calibration is necessary. In the medium frequency range from 100 MHz to 1 GHz the dependence of the field strength on the distance meets the expectations very well. In the frequency range of 1 GHz to 100 GHz, because more reflections will occur, the dependence of the field strength on the distance will not correlate so closely.

A.3.3 Calibration of the shielded RF anechoic chamber

Calibration of the chamber shall be performed over the range 30 MHz to 100 GHz.

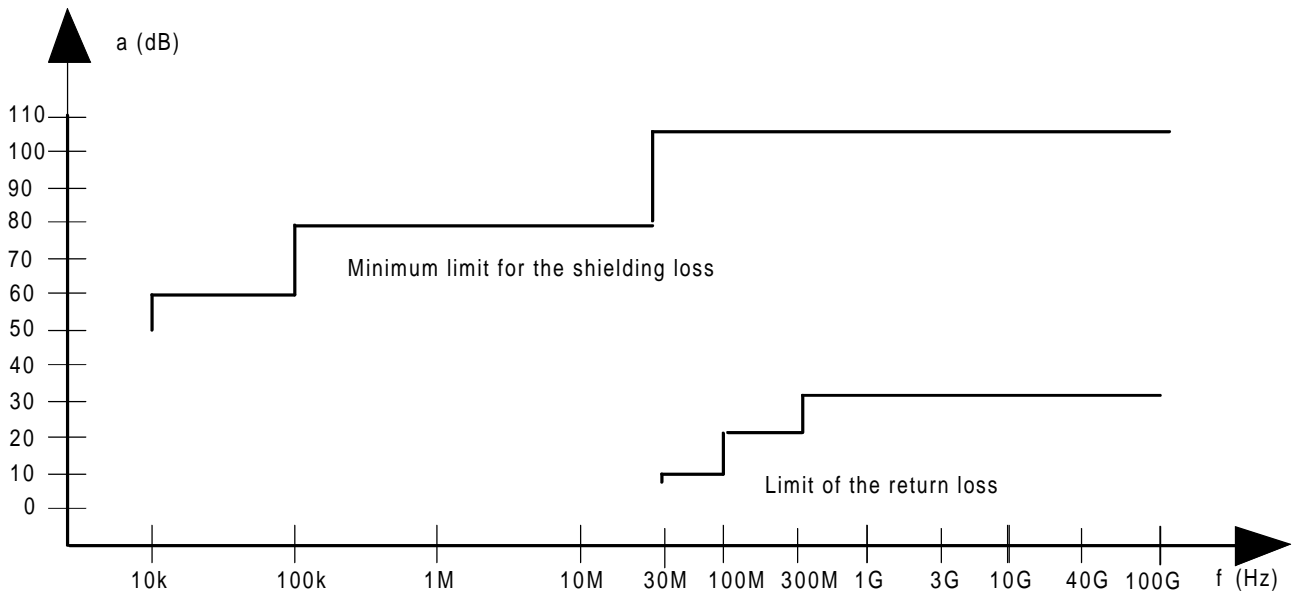

Figure A.3: Specification for shielding and reflections

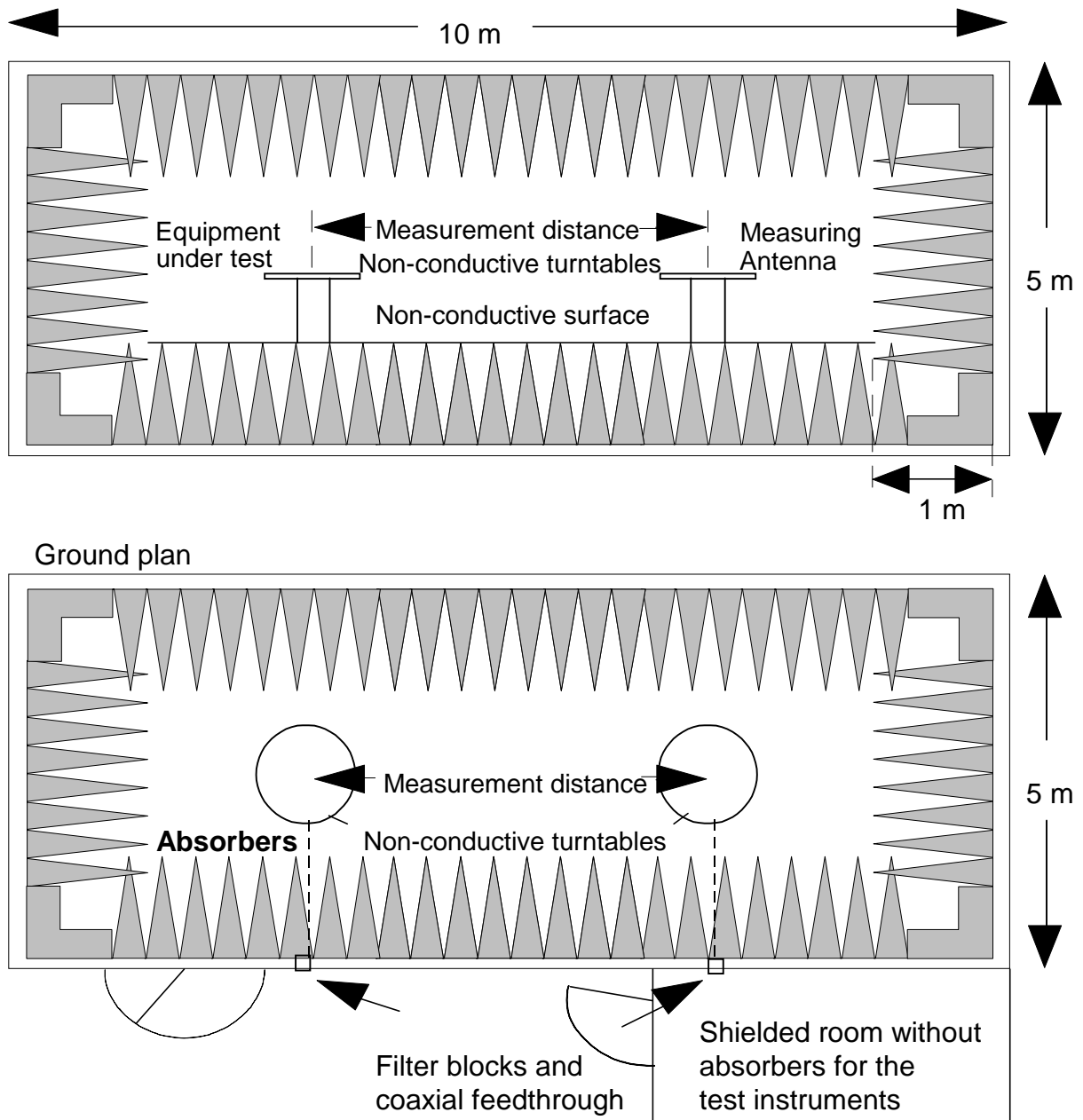

Figure A.4: Example of construction of an anechoic shielded chamber

Annex B (normative): General description of measurement methods

B.1 Radiated measurements

Radiated measurements shall be performed with the aid of a test antenna and measuring receiver as described in annex A. The test antenna and measurement receiver, spectrum analyser or selective voltmeter (including all cables) shall be calibrated according to the procedure defined in this annex. The EUT and the test antenna shall be oriented to obtain the maximum emitted power level. This position shall be recorded in the measurement report. The frequency range shall be measured in this position.

For equipment with multiple fixed beam antennas, the tests shall be carried out with the test antenna oriented to obtain the maximum emitted power level, and repeated for each beam position. If the equipment transmits more than one beam at a time, then the maximum EIRP shall be recorded.

If the equipment has an antenna which is either mechanically or electronically scanned, then the scanning shall be inhibited for these tests. With the scanning stopped, the EIRP for the EUT shall be measured with the antenna in its position of highest gain (i.e. highest output power) as stated by the manufacturer.

Measurements of absolute power levels below 40 GHz shall be carried out at a distance of $\lambda/2$ or 3m whichever is greater. For measurements of absolute power above 40 GHz an anechoic environment or test site is necessary which should be large enough to allow the erection of a test antenna in the far field (i.e. at a distance of not less than $2d^2/\lambda$).

Radiated measurements should be performed either with the EUT in the approved test fixture in an anechoic environment, or using the OATS as described in annex A.

The following conditions shall be fulfilled if an OATS is used for measurements;

- a) an OATS which fulfils the requirements of the specified frequency range of this measurement (CISPR 16-1 [2]) shall be used;
- b) the EUT shall be placed on the support in its standard position (subclause A.1.3) and switched on;
- c) the test antenna shall be oriented initially for vertical polarization unless otherwise stated. The test antenna shall be raised or lowered, through the specified height range until the maximum signal level is detected on the measuring receiver;
- d) the EUT shall be capable of rotation through 360° about a vertical axis to maximize the received signal;
- e) the test antenna shall be raised or lowered again, if necessary, through the specified height range until a maximum is obtained. This level shall be recorded:

(this maximum may be a lower value than the value obtainable at heights outside the specified limits);
- f) this measurement shall be repeated for horizontal polarization;
- g) the substitution (calibrated) antenna shall replace the EUT, in the same position and in vertical polarization. The frequency of the signal generator shall be adjusted to the Tx (carrier) frequency;
- h) steps c) to f) shall be repeated as necessary;
- i) the input signal to the substitution (calibrated) antenna shall be adjusted in level via a calibrated attenuator/signal generator until an equal or a known related level to that detected from the Tx is obtained in the test receiver;
- j) this measurement shall be repeated with horizontal polarization;
- k) the radiated power is equal to the power supplied by the signal generator, increased by the gain of the substitution antenna and the cable losses between the signal generator and the substitution antenna.

If an anechoic chamber is used as opposed to an OATS, the following change to this procedure applies:

- the test antenna shall be oriented initially for vertical polarization unless otherwise stated.

Annex C (normative):
Subclauses of this EN relevant for compliance with the essential requirements of relevant EC Council Directives

Table C.1: Subclauses of this EN relevant for compliance with the essential requirements of relevant EC Council Directives

Clause/subclause number and title		Corresponding article of Council Directive 89/336/EEC	Qualifying remarks
7.5	Radiated spurious emissions	4 (a)	

Annex D (informative): Maximum safe level of radiated power density

It is necessary for every EUT to comply with the current regulations regarding safe levels for radiated power. This is detailed in this annex.

D.1 Definition

The maximum safe level for the radiated power density is defined as that level which can be transmitted in accordance with the *current* recommended safety levels (see ENV 50166-2 [8]).

D.2 Method of measurement

The EUT should be tested as per subclause 7.2.2 (in accordance with the procedures outlined in section 5 of ENV 50166-2 [8]).

D.2.1 Equipment with a fixed beam antenna(s) (i.e. non-steerable by either mechanical or electronic means)

The polar diagram together with details of the polarization for the transmit beam (if required to enable the measurement to be carried out) should be submitted by the manufacturer and approved by the accredited test laboratory.

The maximum EIRP is then recorded.

D.2.2 Equipment with (electronically or mechanically) steerable antenna

It is necessary to engage a mode in the EUT whereby the antenna steering is disabled i.e. the unit operates with a fixed beam. This will enable the EUT to be fully tested as per subclause 7.2.2.1.

With the scanning stopped, the EIRP for the EUT should be measured with the antenna in its position of highest gain (i.e. highest output power) as stated by the manufacturer.

The manufacturer should provide all necessary information relating to the scanning.

D.3 Limit

The maximum safe level for the mean radiated power density is defined in subclause 4.2.2.1 of ENV 50166-2 [8].

The maximum safe level for the peak radiated power density is defined in subclause 4.2.2.2 of ENV 50166-2 [8].

The power density should not exceed the value given in this subclause at any point accessible without partial or complete disassembly of the device requiring the use of tools.

Annex E (informative): Conversion of power density to EIRP

This annex offers an example of the conversion from "power/unit area" (power density) to EIRP.

E.1 Assumptions:

EIRP is conventionally the product of "power into the antenna" and "antenna gain".

EIRP is the total power transmitted, assuming an isotropic radiator.

Area of a sphere = πd^2 .

E.2 Example

For a power density of 200nW/cm² (measured at 3m).

200 nW/cm² (at 3 m) = power measured in a 1 cm² area at 3 m distance.

EIRP = total radiated power over the whole area of a sphere

EIRP = [power measured in a 1cm² area at 3 m distance (W)] × [area of sphere at 3 m (in cm²)]
area of 1 cm²

EIRP = [(200 × 10⁻⁹) × (π × 36 × 10⁴)] W

EIRP = 226,19 mW

Hence: 200 nW/cm² (at 3m) ≡ 23,54 dBm

History

Document history				
V1.1.1	September 1997	Public Enquiry	PE 9803:	1997-09-19 to 1998-01-16
V1.1.1	April 1998	Vote	V 9824:	1998-04-14 to 1998-06-12