

Final draft **EN 301 006-1** V1.2.1 (1998-05)

European Standard (Telecommunications series)

**Q3 interface at the Local Exchange (LE)
for line and circuit testing of analogue
and Integrated Services Digital network (ISDN)
subscriber lines;
Part 1: Q3 interface specification**



Reference

DEN/SPS-03030-1 (9bc90ioo.PDF)

Keywords

TMN, information model, Q3 interface, LE, fault, testing, management, PSTN, ISDN

ETSI

Postal address

F-06921 Sophia Antipolis Cedex - FRANCE

Office address

650 Route des Lucioles - Sophia Antipolis
Valbonne - FRANCE
Tel.: +33 4 92 94 42 00 Fax: +33 4 93 65 47 16
Siret N° 348 623 562 00017 - NAF 742 C
Association à but non lucratif enregistrée à la
Sous-Préfecture de Grasse (06) N° 7803/88

Internet

secretariat@etsi.fr
<http://www.etsi.fr>
<http://www.etsi.org>

Copyright Notification

No part may be reproduced except as authorized by written permission.
The copyright and the foregoing restriction extend to reproduction in all media.

© European Telecommunications Standards Institute 1998.
All rights reserved.

Contents

Intellectual Property Rights.....	7
Foreword	7
Introduction	7
1 Scope.....	9
2 References.....	9
3 Definitions and abbreviations	10
3.1 Definitions	10
3.2 Abbreviations.....	11
4 Information model diagrams	12
4.1 Entity relationship diagram	12
4.1.1 Line testing and line circuit testing.....	13
4.1.2 The testResultNotifications of the tests	13
4.2 Inheritance hierarchy	14
4.3 Naming hierarchy.....	14
5 Information model description.....	15
5.1 Description of object classes.....	15
5.1.1 Access port fragment.....	15
5.1.2 Support fragment.....	15
5.1.2.1 Event report management	15
5.1.2.2 Log control function	15
5.1.3 Test fragment	16
5.1.3.1 Access test (accessTest).....	16
5.1.3.2 Dialed digit test (dialedDigitTest)	16
5.1.3.3 Dial tone test (dialToneTest)	16
5.1.3.4 Electrical measurement test (electricalMeasurementTest).....	17
5.1.3.5 Subscriber Private Meter (SPM) pulses (spmPulses)	17
5.1.3.6 Cable pair identification tone (cablePairIdTone).....	17
5.1.3.7 Ringing (ringing)	17
5.1.3.8 Test to line circuit (testToLineCircuit)	17
5.1.3.9 Dry Loop (dryLoop)	17
5.1.3.10 Loop test (loopTest)	18
5.1.3.11 Pattern test (patternTest).....	18
5.1.3.12 Voice access test (voiceAccessTest).....	18
5.1.3.13 Metallic test access (metallicTestAccess).....	19
5.1.3.14 Test threshold class administration (testThresholdClass)	19
5.1.3.15 ISDN quick test (isdnQuickTest).....	20
5.2 Definition of attributes.....	20
5.2.1 Relative distinguished name.....	20
5.2.2 State attributes	20
5.2.2.1 Operational state (operationalState)	20
5.2.2.2 Administrative state (administrativeState).....	21
5.2.2.3 Availability status (availabilityStatus)	21
5.2.3 Relationship attributes.....	21
5.3 Actions description	21
5.4 Notifications description.....	21
6 Formal object class definitions	22
6.1 Definitions of object classes	22
6.1.1 Access port fragment.....	22
6.1.2 Support fragment.....	22
6.1.3 Test fragment	22
6.1.3.1 ISDN quick test	23
6.1.3.2 Metallic test access	23

6.1.3.3	Test threshold class.....	24
6.2	Name bindings	24
6.2.1	Test fragment	24
6.2.1.1	ISDN quick test	24
6.2.1.2	Metallic test access	24
6.2.1.3	Test threshold class.....	24
6.3	Definition of packages	25
6.3.1	Metallic test access line package	25
6.4	Definition of attributes	25
6.4.1	AC voltage threshold.....	25
6.4.2	Capacitance threshold	25
6.4.3	DC voltage threshold.....	25
6.4.4	Dial speed threshold.....	25
6.4.5	ISDN quick test	26
6.4.6	Metallic test access message	26
6.4.7	Metallic test access timeout period.....	26
6.4.8	Proposed metallic test access	27
6.4.9	Pulse no pulse ratio	27
6.4.10	Resistance threshold.....	27
6.4.11	Test threshold class ID	27
6.4.12	Type of line	27
6.5	Definition of actions	27
6.6	Definition of notifications	27
6.7	Definition of parameters	27
6.8	ASN.1 defined types module	29
7	Protocol requirements	31

Annex A (normative): Requirements and specification of parameters for access port tests.....32

A.1	General test requirements	32
A.1.1	Scheduled testing	32
A.1.2	Test capability.....	32
A.2	Access port test requirements	32
A.2.1	Access port test management functions	32
A.2.2	Test scheduling	33
A.2.3	Test result management	33
A.2.4	Test threshold management.....	34
A.2.5	Test requirements description	34
A.2.5.1	PSTN line testing	34
A.2.5.1.1	Foreign voltage or current	34
A.2.5.1.2	Capacitance measurement.....	34
A.2.5.1.3	Insulation resistance measurement.....	34
A.2.5.1.4	Loop resistance measurement.....	35
A.2.5.1.5	Dial pulse test	35
A.2.5.1.6	DTMF dialling test	35
A.2.5.1.7	Subscriber private meter testing	35
A.2.5.1.8	Ring subscriber	35
A.2.5.1.9	Monitoring of the line.....	35
A.2.5.1.10	Cable pair identification tone.....	35
A.2.5.1.11	Dry loop.....	35
A.2.5.1.12	Register recall button test	36
A.2.5.1.13	Ring back procedure.....	36
A.2.5.2	PSTN inward tests.....	36
A.2.5.2.1	Line circuit testing	36
A.2.5.2.1.1	Feeding voltage.....	36
A.2.5.2.1.2	Feeding current	36
A.2.5.2.1.3	Loop and ring trip detection.....	36
A.2.5.2.1.4	Ringing current sending	36
A.2.5.2.1.5	Private meter pulses	36
A.2.5.2.1.6	Codec testing.....	37

A.2.5.2.1.7	Digit reception	37
A.2.5.2.2	Other inward tests	37
A.2.5.2.2.1	Dial tone test	37
A.2.5.3	ISDN BA testing	37
A.2.5.3.1	ISDN BA line testing	37
A.2.5.3.2	ISDN BA line termination testing	37
A.2.5.3.2.1	Loopbacks	37
A.2.5.3.2.2	Activation and deactivation of lines	38
A.2.5.3.3	ISDN BA line circuit testing	38
A.2.5.3.3.1	Power feed	38
A.2.5.4	ISDN PRA testing	38
A.2.5.4.1	ISDN PRA line testing	38
A.2.5.4.2	ISDN PRA line termination testing	38
A.2.5.5	ISDN BA and PRA quick tests	38
A.2.5.6	Connection of external test systems	38
Annex B (normative): Test categories		39
B.1	Electrical measurement tests	39
B.2	Dialled digit test	40
B.3	Dial tone test	41
B.4	Subscriber private meter pulses test	42
B.5	Ringing test	42
B.6	Test to line circuit	43
B.7	ISDN loopback test	44
B.8	ISDN quick test	45
Annex C (normative): Test termination		47
C.1	Termination of uncontrolled tests	47
C.2	Termination of controlled tests	47
Annex D (normative): Test result notification		49
Annex E (normative): Additional requirements on the test action performer		50
E.1	Indication of supported tests	50
E.2	Indication of unsuccessful test requests	50
Annex F (informative): Task Information Base (TIB)		51
F.1	Description of the service	51
F.2	Components of service (TIB A)	51
F.3	Management function list (TIB B)	52
Annex G (informative): Description of management functions		53
G.1	Model for the test function	53
G.1.1	Environment	53
G.1.2	Uncontrolled tests	53
G.1.3	Controlled tests	54
G.2	Functional model	55
G.2.1	Test initiation	55
G.2.2	Test scheduling	55
G.2.3	Reporting of test results	56
G.2.4	Test suspension and resumption	57

G.2.5	Test termination	57
Annex H (informative):	Message flows.....	58
Annex J (informative):	Bibliography.....	61
History		62

Intellectual Property Rights

IPRs essential or potentially essential to the present document may have been declared to ETSI. The information pertaining to these essential IPRs, if any, is publicly available for **ETSI members and non-members**, and can be found in ETR 314: "*Intellectual Property Rights (IPRs); Essential, or potentially Essential, IPRs notified to ETSI in respect of ETSI standards*", which is available **free of charge** from the ETSI Secretariat. Latest updates are available on the ETSI Web server (<http://www.etsi.fr/ipr> or <http://www.etsi.org/ipr>).

Pursuant to the ETSI Interim IPR Policy, no investigation, including IPR searches, has been carried out by ETSI. No guarantee can be given as to the existence of other IPRs not referenced in ETR 314 (or the updates on the ETSI Web server) which are, or may be, or may become, essential to the present document.

Foreword

This European Standard (Telecommunications series) has been produced by ETSI Technical Committee Signalling Protocols and Switching (SPS), and is now submitted for the Voting phase of the ETSI standards Two-step Approval Procedure.

The present document is part 1 of a multi-part document covering the Q3 interface at the Local Exchange (LE) for line and circuit testing of analogue and ISDN subscriber lines, as identified below:

Part 1: "Q3 interface specification";

Part 2: "Managed Object Conformance Statement (MOCS) proforma specification".

Proposed national transposition dates	
Date of latest announcement of this EN (doa):	3 months after ETSI publication
Date of latest publication of new National Standard or endorsement of this EN (dop/e):	6 months after doa
Date of withdrawal of any conflicting National Standard (dow):	6 months after doa

Introduction

Line and circuit testing of analogue and ISDN lines is part of a management activity which is performed by the operator in order to detect failure conditions and to bring the customer access back to its normal state of operation whenever a deviation occurs.

A customer access is considered as being that part of the local network which extends from the network termination equipment up to and including the exchange termination.

Here, only these parts of the activity are covered which are related directly to that part of the customer access which extends from the LE to the network termination equipment. An ISDN access extends to but does not include the T reference point. An analogue access extends to and may include the Customer Premise Equipment (CPE) (see figure 1).

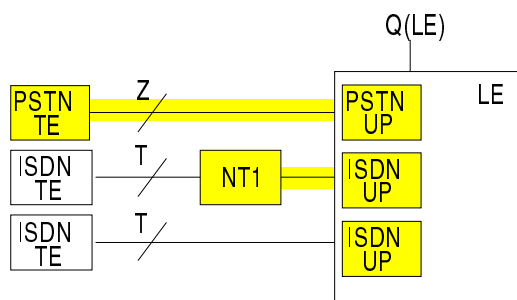

NOTE: Shaded areas are subject to line and circuit testing. User ports represent the different configurations for Line Circuit (LC), Line Termination (LT), Exchange Termination (ET) and Network Termination (NT). The option of ISDN access without remote NT1 is valid for ISDN BA only.

Figure 1: Scope of line and circuit testing

The present document details only those functions and management information model components which are required for line and circuit testing. However, the use of other components which may be applicable from other specifications is not precluded. In this case, combined applications incorporating line and circuit test specific and more generic aspects would result.

1 Scope

The present document specifies the Q3 interface between an Local Exchange (LE) and the Telecommunications Management Network (TMN) for the support of line and circuit test functions for analogue and ISDN lines which are connected directly to a LE.

The focus of the present document is on defining an object model based on the existing standards ETS 300 378-1 [3] and ITU-T Recommendation X.745 [20]. The add-ons, modifications and restrictions to these standards are specified which are necessary to adapt the object model to a LE. Existing protocols are used where possible. The definition of Operations System (OS) functionality is outside the scope of the present document.

2 References

The following documents contain provisions which, through reference in this text, constitute provisions of the present document.

- References are either specific (identified by date of publication, edition number, version number, etc.) or non-specific.
- For a specific reference, subsequent revisions do not apply.
- For a non-specific reference, subsequent revisions do apply.
- A non-specific reference to an ETS shall also be taken to refer to later versions published as an EN with the same number.

- [1] I-ETS 300 291 (1995): "Network Aspects (NA); Functional specification of Customer Administration (CA) on the Operations System/Network Element (OS/NE) interface".
- [2] ETS 300 324-1: "Signalling Protocols and Switching (SPS); V interfaces at the digital Local Exchange (LE); V5.1 interface for the support of Access Network (AN); Part 1: V5.1 interface specification".
- [3] ETS 300 378-1 (1995): "Signalling Protocols and Switching (SPS); Q3 interface at the Access Network (AN) for fault and performance management of V5 interfaces and associated customer profiles; Part 1: Q3 interface specification".
- [4] CCITT Recommendation M.3010 (1992): "Principles for a telecommunications management network".
- [5] CCITT Recommendation M.3100 (1992): "Generic network information model".
- [6] ITU-T Recommendation M.3603: "Application of maintenance principles to ISDN basic rate access".
- [7] ITU-T Recommendation M.3604: "Application of maintenance principles to ISDN primary rate access".
- [8] ITU-T Recommendation Q.543 (1993): "Digital exchange performance design objectives".
- [9] ITU-T Recommendation Q.811 (1993): "Lower layer protocol profiles for the Q3 interface".
- [10] ITU-T Recommendation Q.812 (1993): "Upper layer protocol profiles for the Q3 interface".
- [11] CCITT Recommendation X.208 (1988): "Specification of Abstract Syntax Notation One (ASN.1)".
- [12] CCITT Recommendation X.720 | ISO/IEC 10165-1: "Information technology - Open systems interconnection - Structure of management information: Management information model".
- [13] CCITT Recommendation X.721 | ISO/IEC 10165-2: "Information technology - Open systems interconnection - Structure of management information: Definition of management information".

- [14] CCITT Recommendation X.730 | ISO/IEC 10164-1: "Information technology - Open systems interconnection - Systems management: Object management function".
- [15] CCITT Recommendation X.731 | ISO/IEC 10164-2: "Information technology - Open systems interconnection - Systems management: State management function".
- [16] CCITT Recommendation X.732 | ISO/IEC 10164-3: "Information technology - Open systems interconnection - Systems management: Attributes for representing relationships".
- [17] CCITT Recommendation X.734 | ISO/IEC 10164-5: "Information technology - Open systems interconnection - Systems management: Event report management function".
- [18] CCITT Recommendation X.735 | ISO/IEC 10164-6: "Information technology - Open systems interconnection - Systems management: Log control functions".
- [19] ITU-T Recommendation X.737 | ISO/IEC 10164-14: "Information technology - Open systems interconnection - Systems management: Confidence and diagnostic test function".
- [20] ITU-T Recommendation X.745 | ISO/IEC 10164-12: "Information technology - Open systems interconnection - Systems management: Test management function".
- [21] ITU-T Recommendation X.746 | ISO/IEC 10164-15: "Information technology - Open systems interconnection - Systems management: Scheduling function".

3 Definitions and abbreviations

3.1 Definitions

For the purposes of the present document, the following definitions apply:

Access Network (AN): See ETS 300 324-1 [2].

activation-deactivation of the line: See subclause A.2.5.

cable pair identification tone: See subclause A.2.5.

capacitance measurement: See subclause A.2.5.

Codec testing: See subclause A.2.5.

dial pulse test: See subclause A.2.5.

dial tone test: See subclause A.2.5.

digit reception: See subclause A.2.5.

dry loop: See subclause A.2.5.

Dual Tone Multi-Frequency (DTMF) dialling test: See subclause A.2.5.

feeding current: See subclause A.2.5.

feeding voltage: See subclause A.2.5.

foreign voltage: See subclause A.2.5.

insulation resistance measurement: See subclause A.2.5.

line circuit testing: See subclause A.2.5.

line testing: See subclause A.2.5.

Local Exchange (LE): See ETS 300 324-1 [2].

loop and ring trip detection: See subclause A.2.5.

loop resistance measurement: See subclause A.2.5.

loopback 1 (line termination loopback): See subclause A.2.5.

loopback 2, 2₁ and 1A (NT1 loopbacks): See subclause A.2.5.

monitoring of the line with mark tone: See subclause A.2.5.

monitoring of the line: See subclause A.2.5.

Operations System (OS): See CCITT Recommendation M.3010 [4].

power feed: See subclause A.2.5.

private meter pulses: See subclause A.2.5.

register recall button test: See subclause A.2.5.

subscriber private metering: See subclause A.2.5.

3.2 Abbreviations

For the purpose of the present document, the following abbreviations apply:

AC	Alternating Current
AN	Access Network
ASN.1	Abstract Syntax Notation One (see CCITT Recommendation X.208 [11])
BA	Basic Access
CMIP	Common Management Information Protocol
CPE	Customer Premise Equipment
DC	Direct Current
DTMF	Dual Tone Multi-Frequency
ET	Exchange Termination
ID	Identity, identifier
ISDN	Integrated Services Digital Network
LC	Line Circuit
LE	Local Exchange
LT	Line Termination
M/C	Mandatory/Conditional
MORT	Managed Object Referring to Test
NE	Network Element
NT	Network Termination
OS	Operations System
PRA	Primary Rate Access
PSTN	Public Switched Telephone Network
RDN	Relative Distinguished Name
REG	Regenerator
SPM	Subscriber Private Meter
TARR	Test Action Request Receiver
TIB	Task Information Base
TMN	Telecommunication Management Network
TO	Test Object

4 Information model diagrams

The entity relationship diagram is given in subclause 4.1 and the inheritance hierarchy (is-a relationships) and naming hierarchy (containment relationships) are given in subclauses 4.2 and 4.3, respectively.

4.1 Entity relationship diagram

Figure 2 shows the various entities related to line and circuit testing at the LE. They extend the information model described in I-ETS 300 291 [1], which specifies management information describing the various user port aspects.

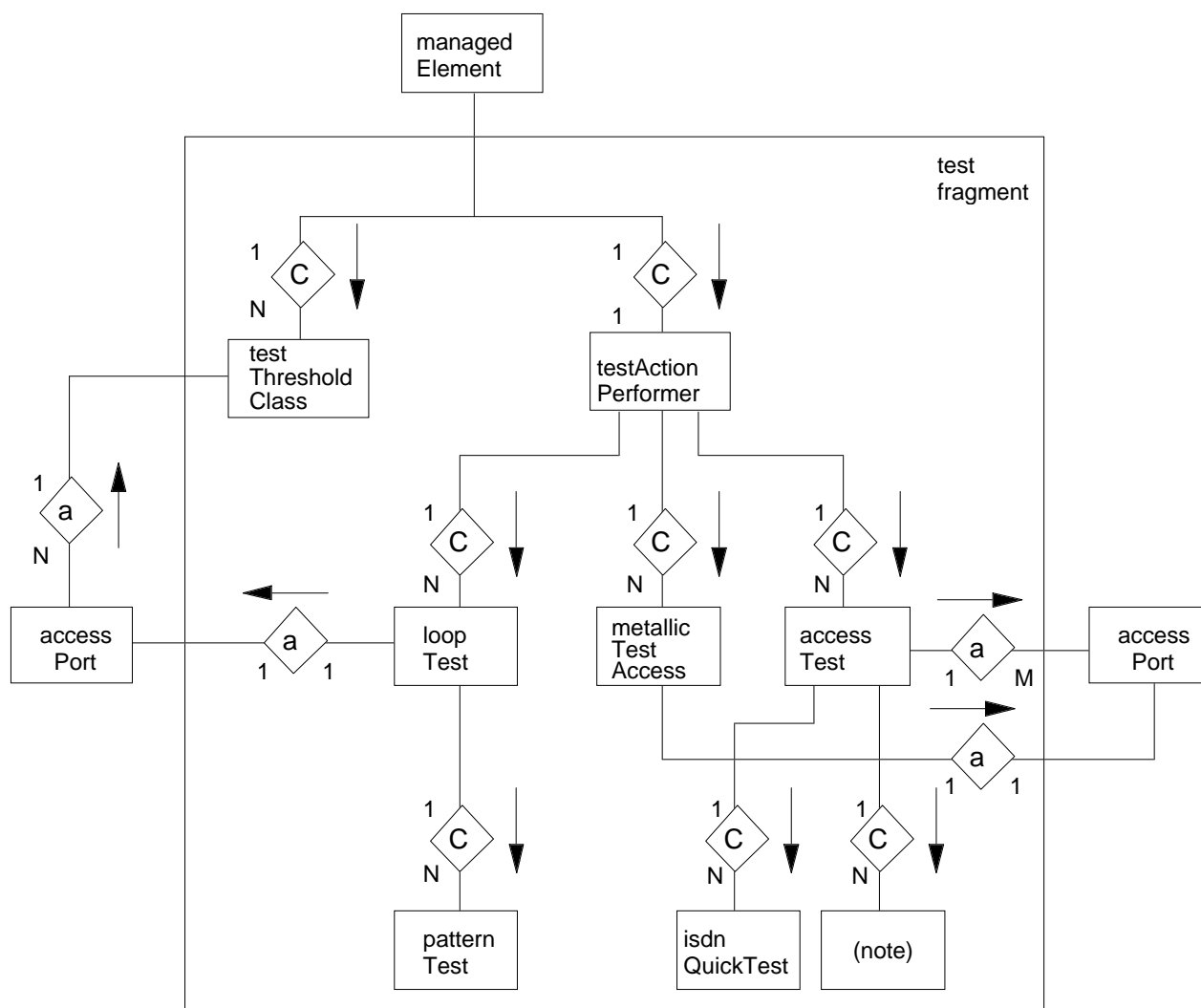

NOTE: Other specific test object classes are defined in ETS 300 378-1 [3].

Figure 2: Entity relationship diagram - test fragment

4.1.1 Line testing and line circuit testing

Test requests from the OS are sent as Common Management Information Protocol (CMIP) `testRequestControlled` or `testRequestUncontrolled` action to an instance of `testActionPerformer`. In this model, all controlled tests are delegated by instances of `testActionPerformer` to instances of subclasses of `testObject`, i.e. when receiving a test request the `testActionPerformer` automatically creates the required instances of these classes. Further instances of subclasses of `testObject` are created if further delegation of the performance of the test is required. This creation is achieved by sending additional `testRequestControlled` actions, the `testSessionId` parameter is used to identify in which access test instance the new tests should be contained. All instances of these subclasses of `testObject` exist only for the duration of their delegated operations. Details of the mechanism how to transmit test requests to `testActionPerformer` and how test results are generated are described in ITU-T Recommendation X.745 [20].

Management information related to uncontrolled tests can be found in annex B.

Controlled testing is initially delegated to an instance of `accessTest` or to an instance of `loopTest` or to an instance of `metallicTestAccess`. Each instance of `loopTest` or `accessTest` or `metallicTestAccess` is contained in an instance of `testActionPerformer`.

The object class `loopTest` is used to set up loopbacks for the user port to which it is associated by an attribute. If patterns are to be injected and compared within the LE as part of the loopback test, then this is delegated to an instance of `patternTest` which is contained in the delegating instance of `loopTest`.

The object class `accessTest` has all specific non-loopback tests allocated to it. It has an attribute which specifies one or a list of user ports which are to be tested.

If external test systems are used for line testing, the `metallicTestAccess` allows to connect it to each subscriber line (outbound or bridged) and to each line circuit (inbound) of the LE. The implementation of the metallic test access is outside the scope of this standard.

The creation of an instance of `accessTest` represents a test session and permits test access to lines or line circuits during which a number of different tests can be performed. These delegated tests are handled by specific contained test objects. Each contained test object triggers the specific test on one or more user ports which are specified in `accessTest`.

Electrical measurements, such as voltage, capacitance and resistance, are delegated to instances of `electricalMeasurementTest`. Dialed digit tests, dial tone tests and other tests (in particular those involving sending meter pulses to the line, cable pair identification tone and ringing) are triggered by the creation of instances of `dialedDigitTest`, `dialToneTest`, `spmPulses`, `cablePairIdTone` and `ringing`, respectively. The dry loop condition is set up by instances of `dryLoopTest`. The inward line circuit tests are delegated to instances of `testToLineCircuit`. The `voiceAccessTest` allows for the provision of those test which involve the establishment of a voice connection with the line under test. A quick check of an ISDN access is represented by a `isdnQuickTest` object.

The object class `testThresholdClass` can be used to modify predefined test thresholds via the Q3 interface.

4.1.2 The testResultNotifications of the tests

The sending time, the information contents and the number of `testResultNotifications` sent per test request are not restricted. It is a matter up to the LE implementation. If the `testResultNotification` contains results whose testing time has importance, they shall be ordered in the ASN.1 sequence oldest first.

4.2 Inheritance hierarchy

Figure 3 traces the inheritance from the highest level object "CCITT Recommendation X.721:1992":top to the managed objects defined in the present document.

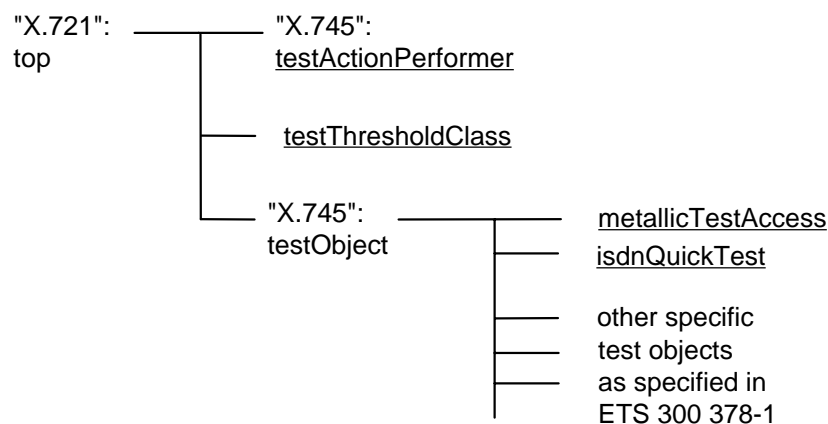

NOTE: Only classes which are underlined may be instantiated.

Figure 3: Inheritance hierarchy

4.3 Naming hierarchy

Figure 4 shows the naming (i.e. containment) relationships for the LE's managed objects associated with line and circuit testing.

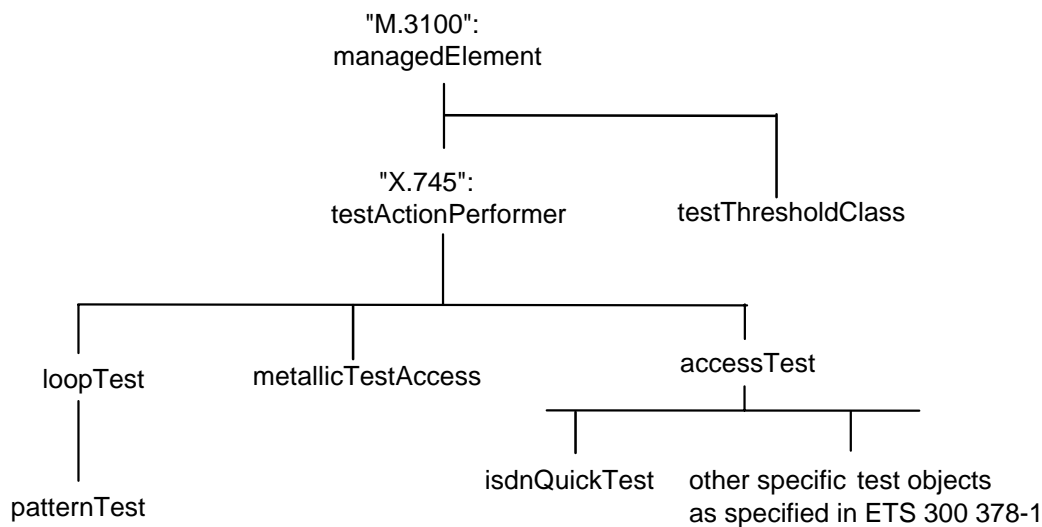

Figure 4: Naming hierarchy

5 Information model description

This clause provides a high-level informal description of the management information model for line and circuit testing in the LE.

Subclause 5.1 contains a brief description for each object class or package used in the model as far as it is not described in the reference documents. The description covers:

- the purpose of the object class or package;
- the attributes defined for the object class or package;
- the contents of the event reports defined in the present document;
- the relationship of the object class to other object classes;
- the applicability of these packages.

Attributes which are common to several object classes are described in subclause 5.2. Subclause 5.3 describes actions which are common to several object classes in the information model. Subclause 5.4 describes the common aspects of the notifications used in the information model.

5.1 Description of object classes

5.1.1 Access port fragment

In this fragment the following object classes are used. They are used in the test operations to identify the MORTs. They are defined in I-ETS 300 291 [1]:

- "I-ETS 300 291":analogueAccess;
- "I-ETS 300 291":basicRateAccess;
- "I-ETS 300 291":primaryRateAccess.

5.1.2 Support fragment

5.1.2.1 Event report management

Event reporting management functions shall be used to establish and control the discrimination and the forwarding of event reports to other open systems. The management information related to event reporting is defined in CCITT Recommendation X.734 [17].

5.1.2.2 Log control function

Log control functions may be used to store event reports and local system notifications into logs and to control this log process. The management information related to log control is defined in CCITT Recommendation X.735 [18].

5.1.3 Test fragment

The following classes are used for controlled testing. Management information related to uncontrolled tests can be found in annex C of the present document.

5.1.3.1 Access test (accessTest)

Instances of the class accessTest represent configurations and conditions for testing the line and line circuit. The class is a specialization of the testObject class defined in ITU-T Recommendation X.745 [20].

In addition to the inherited attributes, it has the attributes given in table 1.

Table 1

Name	M/C	Value set
"X.737":testConditions	M	single
waitTime	M	single
"X.745":mORTs	M	set
"X.737":testConditions:		indicates the action to be taken if the port is busy and if a call is attempted during testing.
waitTime:		indicates the wait time if the testConditions attribute indicates a wait if busy.

5.1.3.2 Dialed digit test (dialedDigitTest)

Instances of the class dialedDigitTest represent a dialed digit tests. The class is a specialization of the testObject class defined in ITU-T Recommendation X.745 [20].

In addition to the inherited attributes, it has the attributes given in table 2.

Table 2

Name	M/C	Value set
numberOfDigits	M	single
numberOfDigits:		indicates the number of digits for the test.

5.1.3.3 Dial tone test (dialToneTest)

Instances of the class dialToneTest represent a dial tone tests. The class is a specialization of the testObject class defined in ITU-T Recommendation X.745 [20].

In addition to the inherited attributes, it has the attributes given in table 3.

Table 3

Name	M/C	Value set
offHookSimulation	M	single
requestedResultType	M	single
iterations	M	single
offHookSimulation:		indicates how off-hook is to be simulated i.e. loop calling or earth calling.
requestedResultType:		indicates whether a test result should be a pass or a fail.
iterations:		indicates the number of iterations for a test.

5.1.3.4 Electrical measurement test (electricalMeasurementTest)

Instances of the class electricalMeasurementTest represent electrical measurements. The class is a specialization of the testObject class defined in ITU-T Recommendation X.745 [20].

In addition to the inherited attributes, it has the attributes given in table 4.

Table 4

Name	M/C	Value set
electricalMeasurementTestToBePerformed	M	single
requestedResultType	M	single
electricalMeasurementTestToBePerformed:		indicates the types of electrical measurements.
requestedResultType:		indicates whether a test result should be a pass or a fail or a measured value.

5.1.3.5 Subscriber Private Meter (SPM) pulses (spmPulses)

Instances of the class spmPulses represent subscriber private meter pulses which can be applied to a line. The class is a specialization of the testObject class defined in ITU-T Recommendation X.745 [20].

In addition to the inherited attributes, it has the attributes given in table 5.

Table 5

Name	M/C	Value set
spmPulsesNo	M	single
spmPulseNo:		indicates the number of SPM pulses which shall be applied.

5.1.3.6 Cable pair identification tone (cablePairIdTone)

Instances of the class cablePairIdTone represent identification tone which can be applied to a line. The class is a specialization of the testObject class defined in ITU-T Recommendation X.745 [20].

5.1.3.7 Ringing (ringing)

Instances of the class ringing represent ringing current which can be applied to a line. The class is a specialization of the testObject class defined in ITU-T Recommendation X.745 [20].

In addition to the inherited attributes, it has the attributes given in table 6.

Table 6

Name	M/C	Value set
ring	M	single
ring:		indicates for how long ringing is to be applied.

5.1.3.8 Test to line circuit (testToLineCircuit)

Instances of the class testToLineCircuit represent tests which can be applied to a line circuit. The class is a specialization of the testObject class defined in ITU-T Recommendation X.745 [20].

5.1.3.9 Dry Loop (dryLoop)

This object class is instantiated when it is required to disconnect the line from the line circuit. This condition is called "dry loop". After a dry loop is established, tests may be performed on the line outside the influence of the Q3 interface, until normal conditions are re-established.

5.1.3.10 Loop test (loopTest)

Instances of the class loopTest represent loopbacks which are used for testing. The class is a specialization of the testObject class defined in ITU-T Recommendation X.745 [20].

In addition to the inherited attributes, it has the attributes given in table 7.

Table 7

Name	M/C	Value set
"X.737":testConditions	M	single
waitTime	M	single
"X.745":mORTs	M	set
loopbackDuration	M	single
loopbackPosition	M	single
loopbackChannel	M	single
"X.737":testConditions: waitTime: loopbackDuration: loopbackPosition: loopbackChannel:		indicates the action to be taken if the port is busy and if a call is attempted during testing. indicates the wait time if the testConditions attribute indicates a wait if busy. indicates the duration of the loopback. indicates the location of the loopback. indicates the type of loopback.

5.1.3.11 Pattern test (patternTest)

Instances of the class patternTest represent the generation and comparison of patterns used for testing. The class is a specialization of the testObject class defined in ITU-T Recommendation X.745 [20].

In addition to the inherited attributes, it has the attributes given in table 8.

Table 8

Name	M/C	Value set
"X.737":loopbackResults	M	single
"X.737":testPattern	M	single
"X.737":errorRatioReportType	M	single
"X.737":loopbackResults: "X.737":testPattern: "X.737":errorRatioReportType:		contains the test results of a loopback test. contains the data units used to generate the test traffic indicates in what form the error ratio is to be reported

5.1.3.12 Voice access test (voiceAccessTest)

Instances of the class voiceAccessTest represent these tests which involve the monitoring of the line. The class is a specialization of the testObject class defined in ITU-T Recommendation X.745 [20].

In addition to the inherited attributes, it has the attributes given in table 9.

Table 9

Name	M/C	Value set
monitorSpeak	M	single
ringBackNo	M	single
monitorSpeak: ringBackNo:		indicates whether the line is to be monitored or if speech can be injected and whether or not a mark tone is used while monitoring. indicates the number for ring-back.

5.1.3.13 Metallic test access (metallicTestAccess)

Instances of the class `metallicTestAccess` represent the connection to a system external test system. The class is a specialization of the `testObject` class defined in ITU-T Recommendation X.745 [20].

In addition to the inherited attributes, it has the attributes given in table 10.

Table 10

Name	M/C	Value set
"X.745":mORTs	M	single
mtaTimeoutPeriod	M	single
mtaMsg	M	single
proposedMTA	M	single
"X.737":testConditions	M	single
waitTime	M	single
typeOfLine	C	single
mtaTimeoutPeriod:	indicates the timeout period of a metallic test access connection.	
mtaMsg:	indicates the return value of the test request.	
proposedMTA:	indicates the metallic test access measurement interface.	
"X.737":testConditions:	indicates the action to be taken if the port is busy and if a call is attempted during testing.	
waitTime:	indicates the wait time if the testConditions attribute indicates a wait if busy.	
typeOfLine:	indicates the type of line: inbound, outbound, bridged	

5.1.3.14 Test threshold class administration (testThresholdClass)

Instances of the class `testThresholdClass` represent the provisionable threshold values for line testing in the context of LE. The class is a specialization of the top class defined in ITU-T Recommendation X.721 [13].

In addition to the inherited attributes, it has the attributes given in table 11.

Table 11

Name	M/C	Value set
testThresholdClassId	RDN	single
capacitanceThreshold	C	single
resistanceThreshold	C	single
acVoltageThreshold	C	single
dcVoltageThreshold	C	single
dialSpeedThreshold	C	single
pulseNoPulseRatio	C	single
capacitanceThreshold:	indicates the thresholds for capacitance testing.	
resistanceThreshold:	indicates the thresholds for resistance testing.	
acVoltageThreshold:	indicates the thresholds for AC voltage testing.	
dcVoltageThreshold:	indicates the thresholds for DC voltage testing.	
dialSpeedThreshold:	indicates the thresholds for dial speed testing.	
pulseNoPulseRatio:	indicates the thresholds for pulse no pulse ratio.	

5.1.3.15 ISDN quick test (isdnQuickTest)

Instances of the class isdnQuickTest represent a quick test of ISDN BA or PRA. The class is a specialization of the testObject class defined in ITU-T Recommendation X.745 [20].

In addition to the inherited attributes, it has the attributes given in table 12.

Table 12

Name	M/C	Value set
"X.745":mORTs	M	single
isdnQuickTestToBePerformed	M	single
requestedResultType	M	single
isdnQuickTestToBePerformed:	indicates the types of quick test to be performed.	
requestedResultType:	indicates whether the test should be a pass or a fail or a measured value.	

5.2 Definition of attributes

This subclause provides the description of all generic attributes used within this information model. The following generic attributes have been identified and their definition can be found within the appropriate standards mentioned in the text:

- Relative Distinguished Name (RDN);
- state attributes;
- relationship attributes.

The attributes specific to this information model are already defined within the object class descriptions.

5.2.1 Relative distinguished name

The semantics of the RDN attribute type are specified in CCITT Recommendation X.720 [12]. This attribute type is used to identify an instance of a managed object uniquely within the scope of its immediate superior in the management information tree. This is modelled as a single-valued attribute type:

Value type:	identifier, graphic string or integer;
Inherent properties:	the value shall be unique within the scope of superior managed object instance;
Permitted operations:	get only;
Implicit relations:	the object instance is contained in the superior managed object instance;
Specification properties:	this attribute type may be used for naming all object classes defined in the present document.

5.2.2 State attributes

State related attributes of managed objects in this information model comprise the generic state model as defined by CCITT Recommendation X.731 [15] and every specific state attribute type related only to object classes defined in the present document.

5.2.2.1 Operational state (operationalState)

The semantics of the operationalState attribute are specified in the operational state attribute in CCITT Recommendation X.731 [15]. The syntax of the operationalState attribute is specified in the operational state attribute in CCITT Recommendation X.721 [13].

5.2.2.2 Administrative state (administrativeState)

The semantics of the administrativeState attribute are specified in the administrative state attribute in CCITT Recommendation X.731 [15]. The syntax of the administrativeState attribute is specified in the administrative state attribute in CCITT Recommendation X.721 [13].

5.2.2.3 Availability status (availabilityStatus)

The semantics of the availabilityStatus attribute are specified in the availability status attribute in CCITT Recommendation X.731 [15]. The syntax of the availabilityStatus attribute is specified in the availability status attribute in CCITT Recommendation X.721 [13].

5.2.3 Relationship attributes

Relationship related attributes of managed objects within the scope of this ETS comprise the generic relationship model as defined by CCITT Recommendation X.732 [16].

The following relationships are used in this ETS:

- group relationship;
- peer relationship.

5.3 Actions description

In addition to the inherited actions, the actions performed on the various object classes are indicated in table 13.

Table 13

Actions	Defined in object class
loopbackSelect	loopTest
loopbackSelect: is used to alter the conditions of a loopback.	

5.4 Notifications description

The following generic notifications are utilised:

- object creation according to CCITT Recommendations X.721 [13] and X.730 [14];
- object deletion according to CCITT Recommendations X.721 [13] and X.730 [14];
- attribute value change according to CCITT Recommendations X.721 [13] and X.730 [14];
- state change according to CCITT Recommendations X.721 [13] and X.731 [15];
- relationship change according to CCITT Recommendations X.721 [13] and X.732 [16];
- test result according to ITU-T Recommendation X.745 [20].

The additionalInformation field of the test result notification is used to carry the detailed measurement results for the test where it is applied. No specific notifications are utilized.

6 Formal object class definitions

This clause gives the formal definitions of the managed object classes, name bindings, general packages, behaviours, attributes, actions and notifications.

6.1 Definitions of object classes

This subclause specifies the object classes for all of the managed objects used in the management information model. These object classes are either defined here or by reference to other specifications. Classes of managed objects which are defined elsewhere and which are only used for containment are not included, but are identified by the name bindings for the classes specified here.

6.1.1 Access port fragment

In this fragment the following object classes are used. They are used in the test operations to identify the MORTs. They are defined in I-ETS 300 291 [1]:

- "I-ETS 300 291":analogueAccess;
- "I-ETS 300 291":basicRateAccess;
- "I-ETS 300 291":primaryRateAccess.

6.1.2 Support fragment

The following classes which are defined in CCITT Recommendation X.721 [13] may be instantiated:

- "CCITT Recommendation X.721:1992":attributeValueChangeRecord;
- "CCITT Recommendation X.721:1992":eventForwardingDiscriminator;
- "CCITT Recommendation X.721:1992":log.

The following classes which are defined in ITU-T Recommendation X.745 [20] may be instantiated:

- "ITU-T Recommendation X.745:1993":schedulingConflictRecord;
- "ITU-T Recommendation X.745:1993":testActionPerformer;
- "ITU-T Recommendation X.745:1993":testResultsRecord.

6.1.3 Test fragment

The following classes which are required for the testing of lines and line circuits are defined in ETS 300378-1 [3]. They may all be instantiated:

- "ETS 300378-1:1995":accessTest;
- "ETS 300378-1:1995":dialledDigitTest;
- "ETS 300378-1:1995":dialToneTest;
- "ETS 300378-1:1995":electricalMeasurementTest;
- "ETS 300378-1:1995":spmPulses;
- "ETS 300378-1:1995":cablePairIdTone;
- "ETS 300378-1:1995":ringing;
- "ETS 300378-1:1995":testToLineCircuit;

- "ETS 300378-1:1995":dryLoop;
- "ETS 300378-1:1995":loopTest;
- "ETS 300378-1:1995":patternTest;
- "ETS 300378-1:1995":voiceAccessTest.

The classes defined in the following subclauses may also be instantiated:

6.1.3.1 ISDN quick test

```
isdnQuickTest MANAGED OBJECT CLASS
DERIVED FROM "ITU-T Recommendation X.745":testObject;
CHARACTERIZED BY
"ITU-T Recommendation X.745":MORTsPackage,
isdnQuickTestPkg PACKAGE
  BEHAVIOUR
    isdnQuickTestPkgBehaviour BEHAVIOUR
  DEFINED AS "The ISDN quick test is only performed given that the containing accessTest
  object instance exists and that it is in the testing state, as defined in ITU-T
  Recommendation X.745 [20] for the MORT(s) to which the test is to be applied. The
  isdnQuickTestToBePerformed attribute defines which quick tests are to be performed. The
  appropriate testOutcome shall be set to 'pass' only, if all test steps performed by the quick
  test were successful. If requested, detailed error reasons will be returned in the
  isdnQuickTestResult parameter carried in the test result notification. If a requested
  isdnQuickTest could not be executed by the LE because it is not supported, the LE shall generate
  the appropriate specific error indicating the not supported test. In case of multiple MORTs
  testing the additionalInformation field of the test result notification shall contain the
  results for each MORT under test. When all MORTs passed the tests, the testOutcome field of the
  test result notification contains the value 'pass'. In case at least one MORT test fails, the
  testOutcome field of the test result notification shall contain the value 'fail'. The
  requestedResultType is used to control the test result notification. Its three Boolean
  parameters define whether the MORTs which passed and/or those which failed and/or the measured
  values are to be reported.";;
  ATTRIBUTES
    isdnQuickTestToBePerformed DEFAULT VALUE ASN1LELTTypeModule.defaultIsdnQuickTestToBePerformed
      GET-REPLACE,
    "ETS 300378-1":requestedResultType
      DEFAULT VALUE ASN1FPANTypeModule.defaultRequestedResultType
      GET-REPLACE;
  NOTIFICATIONS
    "ITU-T Recommendation X.745":testResultNotification isdnQuickTestResult;;;
REGISTERED AS {managedObjectClass 1};
```

6.1.3.2 Metallic test access

```
metallicTestAccess MANAGED OBJECT CLASS
DERIVED FROM "ITU-T Recommendation X.745":testObject;
CHARACTERIZED BY
"ITU-T Recommendation X.745":mORTsPackage,
metallicTestAccessPkg PACKAGE
  BEHAVIOUR
    metallicTestAccessPkgBehaviour BEHAVIOUR
  DEFINED AS "The test establishes a physical connection between an instance of MORT and a
  measurement interface of an external test system.
  The OS identifies the measurement interface in parameter numberOfMTA, which is included in the
  information syntax of testRequestControlledAction.
  In case the measurement interface is not available for any reason, the NE automatically tries to
  connect the MORT to an alternative measurement interface.
  In both cases, the attribute proposedMTA indicates the measurement interface where the MORT is
  physically connected to.
  The attribute mtaMsg contains the return value of a successful connection.
  The connection will be released after the time defined by attribute mtaTimeoutPeriod. In this
  case, all test related resources are released, the instance of metallicTestAccess is implicitly
  deleted, and an objectDeletionNotification is generated. Setting the attribute mtaTimeoutPeriod
  extends the connection time by the indicated value.";;
  ATTRIBUTES
    mtaTimeoutPeriod DEFAULT VALUE ASN1LELTTypeModule.defaultMTAtimeoutPeriod GET-REPLACE,
    mtaMsg GET,
    proposedMTA GET;
  NOTIFICATIONS
    "ITU-T Recommendation X.721":objectDeletion;;;
CONDITIONAL PACKAGES
  "ETS 300378-1":testEnvironmentConditionsPackage PRESENT IF "an instance supports it",
  mtaLinePackage PRESENT IF "the metallic test access is a two wire interface.";
REGISTERED AS {managedObjectClass 2};
```

6.1.3.3 Test threshold class

```
testThresholdClass MANAGED OBJECT CLASS
DERIVED FROM "ITU-T Recommendation X.721":top;
CHARACTERIZED BY
  testThresholdClassPkg PACKAGE
  BEHAVIOUR
  testThresholdClassPkgBehaviour BEHAVIOUR
  DEFINED AS "When a passed/not passed result is requested, provisionable threshold values are
  used, unless the test request contains threshold values which override the provisioned
  thresholds. After the termination of that test the provisioned thresholds will be restored.
  Provisionable thresholds are default thresholds for tests which can be modified via the Q3
  interface. For each type of test it is possible to specify a number of different thresholds.
  Each of these thresholds may be assigned to a particular group of thresholds, so-called
  threshold classes.
  Access ports may be associated with one of these threshold classes, e.g. by using the
  supportedByObjectList attribute.";;
  ATTRIBUTES
  testThresholdClassId GET,
  capacitanceThreshold DEFAULT VALUE ASN1LELTTypeModule.defaultCapacitanceThreshold GET-REPLACE,
  resistanceThreshold DEFAULT VALUE ASN1LELTTypeModule.defaultResistanceThreshold GET-REPLACE,
  acVoltageThreshold DEFAULT VALUE ASN1LELTTypeModule.defaultAcVoltageThreshold GET-REPLACE,
  dcVoltageThreshold DEFAULT VALUE ASN1LELTTypeModule.defaultDcVoltageThreshold GET-REPLACE,
  dialSpeedThreshold DEFAULT VALUE ASN1LELTTypeModule.defaultDialSpeedThreshold GET-REPLACE,
  pulseNoPulseRatio DEFAULT VALUE ASN1LELTTypeModule.defaultPulseNoPulseRatio GET-REPLACE;
REGISTERED AS {managedObjectClass 3};
```

6.2 Name bindings

6.2.1 Test fragment

6.2.1.1 ISDN quick test

```
isdnQuickTest-accessTest NAME BINDING
  SUBORDINATE OBJECT CLASS isdnQuickTest AND SUBCLASSES;
  NAMED BY SUPERIOR OBJECT CLASS "ETS 300378-1":accessTest AND SUBCLASSES;
  WITH ATTRIBUTE "ITU-T Recommendation X.745":testObjectId;
  DELETE;
REGISTERED AS {nameBinding 1};
```

6.2.1.2 Metallic test access

```
metallicTestAccess-testActionPerformer NAME BINDING
  SUBORDINATE OBJECT CLASS metallicTestAccess AND SUBCLASSES;
  NAMED BY SUPERIOR OBJECT CLASS "ITU-T Recommendation X.745":testActionPerformer AND SUBCLASSES;
  WITH ATTRIBUTE "ITU-T Recommendation X.745":testObjectId;
  DELETE;
REGISTERED AS {nameBinding 2};
```

6.2.1.3 Test threshold class

```
testThresholdClass-managedElement NAME BINDING
  SUBORDINATE OBJECT CLASS testThresholdClass AND SUBCLASSES;
  NAMED BY SUPERIOR OBJECT CLASS "ITU-T Recommendation M.3100:1995":managedElement AND SUBCLASSES;
  WITH ATTRIBUTE testThresholdClassId;
  DELETE;
  CREATE;
REGISTERED AS {nameBinding 3};
```

6.3 Definition of packages

6.3.1 Metallic test access line package

```
mtaLinePackage PACKAGE
  BEHAVIOUR
  mtaLinePackageBehaviour BEHAVIOUR
  DEFINED AS "The package mtaLinePackage is instantiated if the metallic test access supports a
  two wire interface. The attribute typeOfLine identifies the direction of the connection, inbound
  or outbound or bridged. Setting the attribute typeOfLine switches the direction of the metallic
  test access.";;
  ATTRIBUTES
  typeOfLine GET-REPLACE;
REGISTERED AS {package 1};
```

6.4 Definition of attributes

6.4.1 AC voltage threshold

```
acVoltageThreshold ATTRIBUTE
  WITH ATTRIBUTE SYNTAX ASN1LELTTypeModule.AcVoltageThreshold;
  MATCHES FOR EQUALITY;
  BEHAVIOUR
  acVoltageThresholdBehaviour BEHAVIOUR
  DEFINED AS "This attribute specifies the thresholds for AC voltage testing.";;
REGISTERED AS {attribute 1};
```

6.4.2 Capacitance threshold

```
capacitanceThreshold ATTRIBUTE
  WITH ATTRIBUTE SYNTAX ASN1LELTTypeModule.CapacitanceThreshold;
  MATCHES FOR EQUALITY;
  BEHAVIOUR
  capacitanceThresholdBehaviour BEHAVIOUR
  DEFINED AS "This attribute specifies the thresholds for capacitance testing.";;
REGISTERED AS {attribute 2};
```

6.4.3 DC voltage threshold

```
dcVoltageThreshold ATTRIBUTE
  WITH ATTRIBUTE SYNTAX ASN1LELTTypeModule.DcVoltageThreshold;
  MATCHES FOR EQUALITY;
  BEHAVIOUR
  dcVoltageThresholdBehaviour BEHAVIOUR
  DEFINED AS "This attribute specifies the thresholds for DC voltage testing.";;
REGISTERED AS {attribute 3};
```

6.4.4 Dial speed threshold

```
dialSpeedThreshold ATTRIBUTE
  WITH ATTRIBUTE SYNTAX ASN1LELTTypeModule.DialSpeedThreshold;
  MATCHES FOR EQUALITY;
  BEHAVIOUR
  dialSpeedThresholdBehaviour BEHAVIOUR
  DEFINED AS "This attribute specifies the thresholds for testing the dial speed.";;
REGISTERED AS {attribute 4};
```

6.4.5 ISDN quick test

```

isdnQuickTestToBePerformed ATTRIBUTE
  WITH ATTRIBUTE SYNTAX ASN1LELTTypeModule.IsdnQuickTestToBePerformed;
  MATCHES FOR EQUALITY;
  BEHAVIOUR
  isdnQuickTestToBePerformedBehaviour BEHAVIOUR
  DEFINED AS "This attribute specifies which types of quick tests are to be performed.";;
REGISTERED AS {attribute 5};

```

6.4.6 Metallic test access message

```

mtaMsg ATTRIBUTE
  WITH ATTRIBUTE SYNTAX ASN1LELTTypeModule.MtaMsg;
  MATCHES FOR EQUALITY;
  BEHAVIOUR
  mtaMsgBehaviour BEHAVIOUR
  DEFINED AS "This attribute specifies the return value of a metallic test access connection.
Possible values of a successful connection to the metallic test access are:
- analogueFree           the analogueAccess is in the idle state
- analogueOccupied       the analogueAccess is in the busy state
- analogueOccupiedNotUsed the analogueAccess is in a blocked state because of a permanent
off-hook situation (blocked permanent)
- analogueBlocked        the analogueAccess is in a blocked state because of administrative
or maintenance reasons or due to a transient line fault
- isdnAccess              successful connection of a basicRateAccess to the metallic test
access

In case of a not successful connection of the MORT to the metallic test access, the attribute
mtaMsg is included in the generated independent test invocation error, having one of the
following values:
- error                   not successful connection to the metallic test access due to a general error
situation, that is not represented by one of the specific errors described
below
- testing                 the MORT is already busy testing via MTA
- mTAoccupied            all measurement interfaces that would be accessible by the MORT are occupied
- noAccess-noSub         the MORT exists as physical access, but has no subscriber assigned to it
- noAccess-hdh           the MORT is an access using higher digital hierarchy, that does not support
the metallic test access connection
- noAccess-aconc         the MORT is connected to an analogue access concentrator, that does not
support the metallic test access connection
- notAccessible          the metallic test access is temporarily not accessible (e.g. internal
testbus busy by another test than MTA)
- noAccess-nuc           the MORT is part of a nailed-up connection
- noAccess-any           the MORT is part of an equipment, that does not support the connection to
the metallic test access due to any reason.";;
REGISTERED AS {attribute 6};

```

6.4.7 Metallic test access timeout period

```

mtaTimeoutPeriod ATTRIBUTE
  WITH ATTRIBUTE SYNTAX ASN1LELTTypeModule.MTAtimeoutPeriod;
  MATCHES FOR EQUALITY;
  BEHAVIOUR
  mtaTimeoutPeriodBehaviour BEHAVIOUR
  DEFINED AS "This attribute specifies the time of a metallic test access connection.";;
REGISTERED AS {attribute 7};

```

6.4.8 Proposed metallic test access

```

proposedMTA ATTRIBUTE
  WITH ATTRIBUTE SYNTAX ASN1LELTTypeModule.NumberOfMTA;
  MATCHES FOR EQUALITY;
  BEHAVIOUR
  proposedMTABehaviour BEHAVIOUR
  DEFINED AS "This attribute identifies the measurement interface, where the MORT is connected
  to.";;
REGISTERED AS {attribute 8};

```

6.4.9 Pulse no pulse ratio

```

pulseNoPulseRatio ATTRIBUTE
  WITH ATTRIBUTE SYNTAX ASN1LELTTypeModule.PulseNoPulseRatio;
  MATCHES FOR EQUALITY;
  BEHAVIOUR
  pulseNoPulseRatioBehaviour BEHAVIOUR
  DEFINED AS "This attribute specifies the threshold for testing the pulse no pulse ratio.";;
REGISTERED AS {attribute 9};

```

6.4.10 Resistance threshold

```

resistanceThreshold ATTRIBUTE
  WITH ATTRIBUTE SYNTAX ASN1LELTTypeModule.ResistanceThreshold;
  MATCHES FOR EQUALITY;
  BEHAVIOUR
  resistanceThresholdBehaviour BEHAVIOUR
  DEFINED AS "This attribute specifies the thresholds for resistance testing.";;
REGISTERED AS {attribute 10};

```

6.4.11 Test threshold class ID

```

testThresholdClassId ATTRIBUTE
  WITH ATTRIBUTE SYNTAX ASN1LELTTypeModule.NameType;
  MATCHES FOR EQUALITY;
  BEHAVIOUR
  testThresholdClassId BEHAVIOUR
  DEFINED AS "This attribute specifies the RDN of the objects.";;
REGISTERED AS {attribute 11};

```

6.4.12 Type of line

```

typeOfLine ATTRIBUTE
  WITH ATTRIBUTE SYNTAX ASN1LELTTypeModule.TypeOfLine;
  MATCHES FOR EQUALITY;
  BEHAVIOUR
  typeOfLineBehaviour BEHAVIOUR
  DEFINED AS "This attribute specifies the switched direction of the measurement interface in case
  of a two wire interface.";;
REGISTERED AS {attribute 12};

```

6.5 Definition of actions

No new actions are contained in the present document.

6.6 Definition of notifications

No new notifications are contained in the present document.

6.7 Definition of parameters

```

isdnQuickTestResult PARAMETER
  CONTEXT Test-ASN1Module.TestResultInfo.additionalInformation;
  WITH SYNTAX ASN1LELTTypeModule.IsdnQuickTestResult;
  BEHAVIOUR
  isdnQuickTestResult BEHAVIOUR

```

```
    DEFINED AS "The isdnQuickTestResult parameter is carried in the test result notification
    testResultInfo additionalInformation.";;
REGISTERED AS {parameter 1};

isdnQuickTestUncontrolledRequest PARAMETER
    CONTEXT Test-ASN1Module.TestRequestUncontrolledInfo.testCategoryInformation;
    WITH SYNTAX ASN1LELTTypeModule.IsdnQuickTestUncontrolledRequestType;
    BEHAVIOUR
    isdnQuickTestUncontrolledRequestBehaviour BEHAVIOUR
    DEFINED AS "The isdnQuickTestUncontrolledRequest parameter is used to request one of a set of
    possible ISDN tests, as layer 1 activation, loop back test, power feeding test and function
    test.";;
REGISTERED AS {parameter 2};

isdnQuickTestUncontrolledResult PARAMETER
    CONTEXT Test-ASN1Module.TestRequestUncontrolledResult.additionalInformation;
    WITH SYNTAX ASN1LELTTypeModule.IsdnQuickTestResult;
    BEHAVIOUR
    isdnQuickTestUncontrolledResultBehaviour BEHAVIOUR
    DEFINED AS "The isdnQuickTestUncontrolledResult parameter contains the result of previously
    requested ISDN quick tests and is carried in the additional information field of the
    uncontrolled test response. The way, how the test results are achieved is implementation
    specific, the function test e.g. may be implemented as a sequence of the other test
    functions.";;
REGISTERED AS {parameter 3};

numberOfMTA PARAMETER
    CONTEXT Test-ASN1Module.TestRequestControlledInfo.testCategoryInformation;
    WITH SYNTAX ASN1LELTTypeModule.NumberOfMTA;
    BEHAVIOUR
    numberOfMTABehaviour BEHAVIOUR
    DEFINED AS "The numberOfMTA parameter is used to request a metallic test access connection at
    the measurement interface identified by NumberOfMTA. The definition of a naming scheme is not
    part of this standard and up to the implementation.";;
REGISTERED AS {parameter 4};
```

6.8 ASN.1 defined types module

```

ASN1LELTTypeModule {ccitt(0) identified-organization(4) etsi(0) lineTestManagement(1006)
                    informationModel(0) asn1Module(2) asn1TypeModule(0)}

DEFINITIONS IMPLICIT TAGS ::=

BEGIN -- EXPORTS everything

IMPORTS
-- ETS 300378 [3]
    MORT,
    RequestedResultType,
    DefaultRequestedResultType
FROM ASN1FPANTypeModule {ccitt(0) identified-organization(4) etsi(0) v5AnFPManagement(378)
                        informationModel(0) asn1Module(2) asn1TypeModule(0)}
-- ITU-T Recommendation M.3100 [5]
    NameType
FROM ASN1DefinedTypesModule {ccitt recommendation m gnm(3100) informationModel(0)
                             asn1Modules(2) asn1DefinedTypesModule(0)}
-- ITU-T Recommendation X.745 [20]
    ActualStartTime,
    ActualStopTime,
    TestOutcome,
    Timespec,
    TestRequestUncontrolledInfo,
    TestRequestUncontrolledResult
FROM Test-ASN1Module { joint-iso-ccitt ms(9) function(2) part12(12) asn1Module(2) 0 }
-- ITU-T Recommendation X.737 [19]
    TestConditions
FROM TestCategories-ASN1Module {joint-iso-ccitt ms(9) function(2) part14(14) asn1Module(2) 1}
;

informationModel          OBJECT IDENTIFIER ::= {ccitt(0) identified-organization(4) etsi(0)
                                                lineTestManagement(1006)
                                                informationModel(0)}

managedObjectClass       OBJECT IDENTIFIER ::= {informationModel managedObjectClass(3)}
package                  OBJECT IDENTIFIER ::= {informationModel package(4)}
nameBinding              OBJECT IDENTIFIER ::= {informationModel nameBinding(6)}
attribute                OBJECT IDENTIFIER ::= {informationModel attribute(7)}
parameter                OBJECT IDENTIFIER ::= {informationModel parameter(11)}

AcVoltage                ::= Range (0..250000) -- milli Volt

AcVoltageThreshold       ::= SEQUENCE {
    acaEarth              [1] AcVoltage      OPTIONAL,
    acbEarth              [2] AcVoltage      OPTIONAL,
    acab                  [3] AcVoltage      OPTIONAL}

Capacitance              ::= Range (0..10000) -- nano Farad

CapacitanceThreshold     ::= SEQUENCE {
    caEarth               [1] Capacitance    OPTIONAL,
    cbEarth               [2] Capacitance    OPTIONAL,
    cabUpperLimit        [3] Capacitance    OPTIONAL,
    cabLowerLimit        [4] Capacitance    OPTIONAL}

DcVoltage                ::= Range (0..150000) -- milli Volt

DcVoltageThreshold       ::= SEQUENCE {
    dcaEarth              [1] DcVoltage      OPTIONAL,
    dcbEarth              [2] DcVoltage      OPTIONAL,
    dcab                  [3] DcVoltage      OPTIONAL}

defaultAcVoltageThreshold AcVoltageThreshold ::= {acaEarth:250000,
                                                acbEarth:250000,
                                                acab:250000}

```

```

defaultCapacitanceThreshold      CapacitanceThreshold ::= {caEarth:0,
                             cbEarth:0,
                             cabUpperLimit:10000,
                             cabLowerLimit:0}

defaultDcVoltageThreshold        DcVoltageThreshold ::= {dcaEarth:150000,
                             dcbEarth:150000,
                             dcab:150000}

defaultDialSpeedThreshold        DialSpeedThreshold ::= {dialSpeedUpperLimit:255,
                             dialSpeedLowerLimit:0}

defaultIsdnQuickTestToBePerformed IsdnQuickTestToBePerformed ::= functionTest

defaultMTATimeoutPeriod          MTATimeoutPeriod ::= minutes : 5

defaultPulseNoPulseRatio        PulseNoPulseRatio ::= {pulseNoPulseRatioUpperLimit:100,
                             pulseNoPulseRatioLowerLimit:0}

defaultResistanceThreshold       ResistanceThreshold ::= {raEarth:milliOhm:0,
                             rbEarth:milliOhm:0,
                             rabUpperLimit:kiloOhm:100000,
                             rabLowerLimit:milliOhm:0,
                             rLoop:milliOhm:0,
                             rEarth:milliOhm:0}

DialSpeed                        ::= Range (0..255) -- x 0,1 Hz

DialSpeedThreshold               ::= SEQUENCE {
    dialSpeedUpperLimit [1] DialSpeed      OPTIONAL,
    dialSpeedLowerLimit [2] DialSpeed      OPTIONAL}

FunctionTestResult               ::= ENUMERATED {
    noFailure                (0),
    activationLayer1Failure (1),
    ntLoopFailure            (2),
    leLoopFailure            (3),
    dtrLoopFailure           (4),
    powerFeedingFailure      (5),
    alarmCheckFailure        (6),
    leLoopAndPowerFeedingFailure (7)...}

IsdnQuickTestResult              ::= SET OF SEQUENCE{
    mORT                    [0] MORT,
    realStartTime           [1] ActualStartTime      OPTIONAL,
    realStopTime            [2] ActualStopTime       OPTIONAL,
    layer1Activation         [3] Layer1ActivationResult OPTIONAL,
    loopBackTest            [4] LoopBackQuickTestResult OPTIONAL,
    powerFeedingTest        [5] PowerFeedingTestResult OPTIONAL,
    functionTest            [6] FunctionTestResult   OPTIONAL,
    testOutcome              [7] TestOutcome         OPTIONAL}

IsdnQuickTestToBePerformed       ::= ENUMERATED {
    layer1Activation        (0),
    loopBackTest            (1),
    powerFeedingTest        (2),
    functionTest            (3)...}

IsdnQuickTestUncontrolledRequestType ::= SEQUENCE {
    isdnQuickTestToBePerformed [1] IsdnQuickTestToBePerformed,
    requestedResultType        [2] RequestedResultType,
    testConditions              [3] TestConditions OPTIONAL,
    waitTime                    [4] INTEGER OPTIONAL
    -- waitTime has importance only if TestConditions are set
    -- to waitIfBusy.

Layer1ActivationResult           ::= ENUMERATED {
    noFailure                (0),
    activationLayer1Failure (1)...}

```

```

LoopBackQuickTestResult ::= ENUMERATED {
    noFailure                (0),
    ntLoopFailure            (1),
    leLoopFailure            (2)...}

MtaMsg ::= ENUMERATED {
    error                    (0),
    analogueFree             (1),
    analogueOccupied         (2),
    analogueOccupiedNotUsed (3),
    analogueBlocked          (4),
    testing                  (5),
    mTAoccupied              (6),
    noAccess-noSub           (7),
    noAccess-hdh             (8),
    noAccess-aconc           (9),
    notAccessible            (10),
    noAccess-nuc             (11),
    isdnAccess               (12),
    noAccess-any             (13)...}

MTAtimeoutPeriod ::= Timespec

NumberOfMTA ::= INTEGER

PowerFeedingTestResult ::= ENUMERATED {
    noFailure                (0),
    shortCircuit             (1),
    neError                  (2)...}

PulseNoPulseRatio ::= SEQUENCE {
    pulseNoPulseRatioUpperLimit [1] Ratio OPTIONAL,
    pulseNoPulseRatioLowerLimit [2] Ratio OPTIONAL}

Range ::= INTEGER

Ratio ::= Range (0..100) -- percentage

Resistance ::= CHOICE {
    milliOhm                Range (0..100000),
    ohm                     Range (0..100000),
    kiloOhm                 Range (0..100000)}

ResistanceThreshold ::= SEQUENCE {
    raEarth                 [1] Resistance OPTIONAL,
    rbEarth                 [2] Resistance OPTIONAL,
    rabUpperLimit           [3] Resistance OPTIONAL,
    rabLowerLimit           [4] Resistance OPTIONAL,
    rLoop                   [5] Resistance OPTIONAL,
    rEarth                  [6] Resistance OPTIONAL}

TypeOfLine ::= ENUMERATED {
    inbound                 (0),
    outbound                (1),
    bridged                 (2)...}

END -- of ASN1LELTTypeModule

```

7 Protocol requirements

Protocol suites for the Q3 interface are specified in ITU-T Recommendations Q.811 [9] and Q.812 [10]. No specific requirements are identified.

Annex A (normative): Requirements and specification of parameters for access port tests

It is not mandatory to implement test requirements and functionalities described in the present document, but if any test is required to be managed via the Q3 interface on the LE, it shall be modelled as described in the relevant subclause(s) of the present document.

A.1 General test requirements

These are the general requirements for the test management of access ports via the Q3 interface of an LE.

A.1.1 Scheduled testing

The Q3 interface provides the functionality to control scheduling of tests in the LE, if the scheduling functionality is implemented in the LE.

A.1.2 Test capability

Information about which tests the LE is able to perform is required at the Q3 interface. The manager should be able to retrieve information about the test capabilities of an LE. If the OS is requesting the execution of a non-existing test, then the LE shall reply with an error message.

A.2 Access port test requirements

These are the requirements for line and circuit testing of analogue and ISDN subscriber lines managed via the Q3 interface of an LE.

Further complex test procedures may be operator dependant. These procedures may involve the execution of simple tests or other procedures such as subscriber assisted tests described in this subclause.

A.2.1 Access port test management functions

Whenever a test request is sent by the manager to the LE, the following information may be associated to it, as given in table A.1.

Table A.1: Possible test request parameters and values

Parameter	Value
type of tests and/or procedures	see list of test requirement description
scheduling of test	start time, stop time
ID of access ports under test	list of 1 or N access port object instances involved in the test
type of result	any conceivable combination among three possible results: passed, not passed, values

If one of the parameters is not permitted in the relevant test request, it shall be ignored by the LE.

If the LE is not able to manage one of the parameters listed above, a notification shall be emitted to the manager indicating the error cause.

A.2.2 Test scheduling

The following tests are suitable for scheduled tests:

- foreign voltage and current measurement;
- capacitance measurement;
- insulation resistance measurement;
- all line circuit tests;
- dial tone test;
- loopback test;
- ISDN quick test.

The following requirements are valid for scheduling:

- routine tests shall have lower priority than on-demand test and normal traffic;
- the test result shall indicate those ports which have not been tested due to any reason;
- it shall be possible to specify the start time and the stop time of the whole test sequence;
- it shall be possible to specify the test interval between the start of consecutive test sequences (e.g. daily, weekly).

The information model for scheduling and test repetition shall be based on already existing models specified in ITU-T Recommendation X.746 [21].

A.2.3 Test result management

The result for a test request shall be reported on a per test and per port basis. These reports are controlled by a combination of the following three Boolean conditions:

- a) pass: if TRUE send a result report if the port passed the test (the testOutcome field of the additional information parameter of the test result notification in ITU-T Recommendation X.745 [20] contains the value "pass");
- b) not passed: if TRUE send a result report only if the port did not pass the test (in this case the testOutcome field of the additional information parameter of the test result notification in ITU-T Recommendation X.745 [20] contains one of the following values: "fail", "inconclusive", "timed out" or "premature termination");
- c) measured values: if TRUE send the measured values (for that tests producing values as result).

These Boolean values shall be combined by means of the logical operator AND in order to determine when the result is to be sent.

EXAMPLE: When the following combination is used:

pass = FALSE;

not passed = TRUE;

values = TRUE,

the expected result contains the list of measured values for such ports that have not passed the test.

A.2.4 Test threshold management

When a passed/not passed result is requested, provisionable threshold values are used, unless the test request contains threshold values which override the provisioned thresholds. After the termination of that test the provisioned thresholds shall be restored.

Provisionable thresholds are default thresholds for tests which can be modified via the Q3 interface. For each type of test it shall be possible to specify a number of different thresholds. Each of these thresholds shall be assigned to a particular group of thresholds, so-called threshold classes. Access ports may be associated with one of these threshold classes.

A.2.5 Test requirements description

This subclause deals with requirements for line testing purposes. It is subdivided into PSTN line tests and PSTN inward tests; ISDN BA testing and ISDN PRA testing.

Accuracy and range of measurements are out of the scope of the present document.

A.2.5.1 PSTN line testing

In general, line testing requires that a certain line condition is established (e.g. off-hook or a line termination), then a test is performed and after the test the line is restored to its normal condition. In some cases, not all of these steps are under the control of the Q3 interface (e.g. where the test action is carried out by craft personnel), and so a test function may include all, or only some of these steps. The dry loop test, for example, is concerned only with disconnecting a line from the line circuit. In this case, the actual test conduction and the observation of the test outcome are assumed to be controlled separately.

In the following, subscriber assisted and voice connection mean that an operator gives instructions to the subscriber on how to perform a test. The subscriber returns the result back to the operator, when applicable.

A.2.5.1.1 Foreign voltage or current

It is required to check for the presence of foreign voltage or foreign current on the line.

This test is performed by disconnecting the line from the line circuit and measuring foreign voltage or foreign current between a/b, a/E or b/E. Both AC and DC voltage measurement are required. The manager may select one or more of these measurements. Results shall be passed, not passed and/or the values. Units are V (Volt) or A (Ampere).

A.2.5.1.2 Capacitance measurement

It is required to measure the capacitance on the line.

This test is performed by disconnecting the line from the line circuit and measuring the capacitance between a/b, a/E or b/E. The manager may select one or more of these measurements. Results shall be passed, not passed and/or the values. Units are F (Farad).

A.2.5.1.3 Insulation resistance measurement

It is required to measure the insulation resistance.

This test is performed by disconnecting the line from the line circuit and measuring the insulation resistance between a/b, a/Earth, b/Earth, aToBattery or bToBattery (both polarities are possible). The manager may select one or more of these measurements. Results shall be passed, not passed and/or the values. Units are Ω (Ohm).

A.2.5.1.4 Loop resistance measurement

It is required to measure the loop resistance during off-hook.

The loop resistance between a/b (both polarities are possible) is measured during off-hook. The manager may select one or both measurements. Results shall be passed, not passed and/or the values. Subscriber assistance may be required. Units are Ω (Ohm).

A.2.5.1.5 Dial pulse test

It is required to check the proper operation of the subscriber terminal.

The subscriber is requested to dial one or more digits: it is required to verify that the correct sequence of dialled digits is received by the LE. Results shall be passed, not passed and/or the values. The reported values are number of pulses, average make and break duration.

A.2.5.1.6 DTMF dialling test

It is required to check the proper operation of the subscriber terminal.

The subscriber is requested to dial one or more digits. It is required to verify that the correct sequence of digits is received by the LE in normal operation. Results shall be: passed, not passed and/or values for dialled digits, tone levels, tone frequencies, pulse length. Units are: dBm (decibel relative to 1 milliwatt), Hz (Hertz), s (seconds).

A.2.5.1.7 Subscriber private meter testing

It is required to check the subscriber's private meter.

The LE sends a specified number of metering pulses to the subscriber. The private meter at the customer premises should then step the same number of pulses. As a result, a comparison is made at the manager between subscriber answer and the notification from the LE about the number of pulses sent. The result parameter is number of pulses.

A.2.5.1.8 Ring subscriber

It is required to check the proper operation of the subscriber terminal.

The test is carried out by applying the ring signal and checking the answer of the subscriber. When off-hook is detected (both during the ringing tone itself or during the silent interval), no ringing current shall be sent anymore, according to the limits described in ITU-T Recommendation Q.543 [8]. The digital exchange performance design objectives are:

- a) < 100 ms (mean value);
- b) < 150 ms (95 % value).

A.2.5.1.9 Monitoring of the line

It is required that the operator may either listen into the line with or without sending a mark tone, or listen and speak.

A.2.5.1.10 Cable pair identification tone

It is required to assist the identification of cable pairs in the field, by generating a trace tone at the LE side. The tone shall continue until it is stopped by a manager command or after a timeout.

A.2.5.1.11 Dry loop

It is required to disconnect the line from the line circuit. This condition is called "dry loop". After a dry loop is established, tests may be performed on the line outside the influence of the Q3 interface, until normal conditions are re-established.

a and b wires are disconnected from the line circuit leaving them in an open circuit state. The subscriber line shall remain in dry loop condition until re-connected by a manager command or after a timeout.

A.2.5.1.12 Register recall button test

It is required to check the proper operation of the register recall button of the subscriber terminal.

The subscriber is requested to press the button. The pulse break time is then checked for acceptability. Results shall be passed/not passed.

A.2.5.1.13 Ring back procedure

The installer at the subscriber site may initiate a test procedure by dialling a special ring back code to the LE. The LE shall then initiate the ring back procedure. If during this procedure line or line circuit tests are required those already defined in the present document shall be applied.

A.2.5.2 PSTN inward tests

A.2.5.2.1 Line circuit testing

PSTN line circuit test results shall be reported as passed/not passed covering all circuit tests in a global way, in order to identify the replaceable units.

If the LE is able to provide the relevant information, the manager may be notified about which test failed and the related measured values. Even if the LE supports this information, the management application still requires a pass/fail (passed/not passed) result.

In the following detailed requirements are described. This list is not exhaustive, and new items may be added in the future.

Thresholds for result comparison are specific to the line card implementation and the manager is not required to manage (both reading and setting) them.

A.2.5.2.1.1 Feeding voltage

Feeding voltage between a and b wires shall be measured.

A.2.5.2.1.2 Feeding current

Feeding current between a and b wires shall be measured.

A.2.5.2.1.3 Loop and ring trip detection

It is checked whether the line circuit is able to detect a loop (i.e. an off-hook) with both normal and reversed polarity, while the line circuit busy or idle (busy means ongoing call on the line). The ring trip detection is carried out by applying the ring signal and simulating the answer of the subscriber. When off-hook simulation is detected (during the ringing tone itself or during the silent interval), the ringing current shall be stopped immediately, according to the limits described in ITU-T Recommendation Q.543 [8]:

- a) < 100 ms (mean value);
- b) < 150 ms (95 % value).

A.2.5.2.1.4 Ringing current sending

The ringing current shall be measured at the line side of the line circuit.

A.2.5.2.1.5 Private meter pulses

The duration and the level of private meter pulses shall be tested.

A.2.5.2.1.6 Codec testing

The analogue to digital and the digital to analogue conversion shall be tested including hybrid functionality.

A.2.5.2.1.7 Digit reception

The line circuit is tested to check whether it receives a hexadecimal digit. The test shall be performed with both normal and reversal polarities.

A.2.5.2.2 Other inward tests

A.2.5.2.2.1 Dial tone test

An off-hook condition is simulated in the LE. It shall be checked whether the dial tone appears at the LC termination or not.

A.2.5.3 ISDN BA testing

A.2.5.3.1 ISDN BA line testing

If copper wires are used, the following line tests as defined for PSTN lines shall be carried out:

- foreign voltage;
- current measurement;
- capacitance measurement;
- insulation resistance measurement (only normal polarity is possible);
- dry loop.

A.2.5.3.2 ISDN BA line termination testing

A.2.5.3.2.1 Loopbacks

Generally, a loopback is set up to test the integrity of the devices and the line between two points, by applying a known signal (pattern) on one side and checking whether the signal received is the same as the sent one. The input signal may be applied either by a device embedded in the network element which contains the port (or related line) under test, or by an external equipment. In the latter case, it is required that a loopback is set up without signal generation.

According to ITU-T Recommendation M.3603 [6], the terminology for ISDN BA loopbacks is:

- loopback 1: complete Line Termination (LT) loopback;
- loopback 1A: Regenerator (REG) loopback;
- loopback 2: complete NT1 loopback;
- loopback 2₁: B1, B2, NT1 loopback.

The NT1 may be located either within or outside the LE (see figure 1).

All the loopbacks mentioned above may be applied in connection with either an LE internal equipment or an external equipment to inject and detect a test pattern. The line under test is activated and a loopback is established.

The manager shall be notified whether the loopback is set up or not.

If the pattern injection and detection equipment are under the control of the manager via the Q3 interface, pattern injection and detection shall be initiated after the set up of the loopback. The pattern may be injected at a particular point and detected either at the same point or at another one. The received pattern shall be compared with the sent one and the result shall be reported as passed, not passed and/or bit error rate.

A.2.5.3.2.2 Activation and deactivation of lines

It is required to check the capability for activating and deactivating the line under test.

A.2.5.3.3 ISDN BA line circuit testing

A.2.5.3.3.1 Power feed

It is required to measure the feeding voltage between a and b wires provided by the line circuit. The voltage between a and b shall be measured in order to verify the proper operation of the power feeding of the NT1. The reported result shall be passed/not passed.

A.2.5.4 ISDN PRA testing

A.2.5.4.1 ISDN PRA line testing

Not applicable.

A.2.5.4.2 ISDN PRA line termination testing

Set up of loopbacks at the LT (loopback 1), at the regenerator (if more than one regenerator is installed, it shall be the one which is closest to the line termination; loopback 1A) and at the NT1 (loopback 2) shall be possible.

According to ITU-T Recommendation M.3604 [7], the terminology for ISDN PRA loopbacks is:

- loopback 1: complete LT loopback;
- loopback 1A: REG loopback;
- loopback 2: complete NT1 loopback.

A.2.5.5 ISDN BA and PRA quick tests

In order to perform a quick test of the basic functionality of an ISDN BA or PRA it shall be possible to apply a certain set of tests on the ISDN line. This includes the following tests:

- layer 1 activation (in case of an ISDN BA: test on the capability to activate the layer 1; in case of an ISDN PRA: test on the presence of an active layer 1);
- loop back test;
- power feeding test;
- function test.

If the ISDN quick test function is implemented in the LE it shall be possible to invoke this quick test via the Q3 interface.

A.2.5.6 Connection of external test systems

For external test systems used for line testing, a metallic test access shall be provided to each subscriber line (outbound) and to each line circuit (inbound) of the LE. It shall be possible to connect the test system to the outbound or inbound line and to disconnect it via the Q3 interface of the LE.

Annex B (normative): Test categories

This annex specifies the test categories for all tests in a LE which are invoked by the uncontrolled test request as defined in ITU-T Recommendation X.745 [20].

B.1 Electrical measurement tests

Test category name

Electrical Measurement Tests

Test category purpose

The purpose of tests of this category is measurement of electrical parameters.

Possible tests according to the ASN.1 definition of electricalMeasurementTest, e.g.:

- foreign voltage;
- foreign current;
- capacitance;
- resistance.

MORT requirements

The test invocation involves one object class (analogueAccess or basicRateAccess as defined in I-ETS 300 291-1 [1]), which represents the access port under test. One or more object instances can be involved in the test.

Associated object requirements

There are no associated object classes.

Test environment

Tests of this category are outward tests or inward tests.

Tests of this category do not require customer assistance.

Test request service type

"ITU-T Recommendation X.745:1993":testRequestUncontrolledAction.

Specific errors

"ITU-T Recommendation X.745:1993":noSuchMORT;

"ITU-T Recommendation X.745:1993":mORTNotAvailable;

"ITU-T Recommendation X.745:1993":mistypedTestCategoryInformation.

Test category information parameter

The electricalMeasurementTestUncontrolledRequest parameter as content of the test category information field in the information syntax of "ITU-T Recommendation X.745:1993":testRequestUncontrolledAction.

Uncontrolled test response additional information parameter

The electricalMeasurementTestUncontrolledResult parameter as content of the additionalInformation field in the reply syntax of "ITU-T Recommendation X.745:1993":testRequestUncontrolledAction.

B.2 Dialed digit test

Test category name

Dialed Digit Test

Test category purpose

The purpose of tests of this category is to check the proper operation of the subscriber equipment's (pulse or DTMF) dialling. Possible tests according to the ASN.1 definition of dialedDigitTest, e.g.:

- dial pulse test;
- DTMF dialling test;
- register recall button test.

MORT requirements

The test invocation involves one object class (analogueAccess as defined in I-ETS 300 291-1 [1]), which represents the line being measured. Only one object instances can be involved in the test;

Associated object requirements

There are no associated object classes.

Test environment

Tests of this test category are outward tests.

Tests of this category require customer assistance.

Test request service type

"ITU-T Recommendation X.745:1993":testRequestUncontrolledAction.

Specific errors

"ITU-T Recommendation X.745:1993":noSuchMORT;

"ITU-T Recommendation X.745:1993":mORTNotAvailable;

"ITU-T Recommendation X.745:1993":mistypedTestCategoryInformation.

Test category information parameter

The dialedDigitTestUncontrolledRequest parameter as content of the test category information field in the information syntax of "ITU-T Recommendation X.745:1993":testRequestUncontrolledAction.

Uncontrolled test response additional information parameter

The dialedDigitTestUncontrolledResult parameter as content of the additionalInformation field in the reply syntax of "ITU-T Recommendation X.745:1993":testRequestUncontrolledAction.

B.3 Dial tone test

Test category name

Dial Tone Test

Test category purpose

The purpose of tests of this category is to check the ability of the line circuit to detect an off-hook and to check the provision of the dial tone from the LE.

Possible tests according to the ASN.1 definition of dialToneTest:

- dial tone test.

MORT requirements

The test invocation involves one object class (analogueAccess as defined in I-ETS 300 291-1 [1]), which represents the line being measured. One or more object instances can be involved in the test;

Associated object requirements:

There are no associated object classes.

Test environment

Tests of this test category are inward tests. They are performed with disconnected line.

Tests of this category do not require customer assistance.

Test request service type

"ITU-T Recommendation X.745:1993":testRequestUncontrolledAction.

Specific errors

"ITU-T Recommendation X.745:1993":noSuchMORT;

"ITU-T Recommendation X.745:1993":mORTNotAvailable;

"ITU-T Recommendation X.745:1993":mistypedTestCategoryInformation.

Test category information parameter

The dialToneTestUncontrolledRequest parameter as content of the test category information field in the information syntax of "ITU-T Recommendation X.745:1993":testRequestUncontrolledAction.

Uncontrolled test response additional information parameter

The dialToneTestUncontrolledResult parameter as content of the additionalInformation field in the reply syntax of "ITU-T Recommendation X.745:1993":testRequestUncontrolledAction.

B.4 Subscriber private meter pulses test

Test category name

SPM Pulses Test

Test category purpose

The purpose of tests of this category is to check the cable and equipment in the customer's premises by sending SPM pulses to the private meter of the subscriber.

Possible tests according to the ASN.1 definition of spmPulses test:

- subscriber private meter testing.

MORT requirements

The test invocation involves one object class (analogueAccess as defined in I-ETS 300 291-1 [1]), which represents the line being measured. One or more object instances can be involved in the test.

Associated object requirements

There are no associated object classes.

Test environment

Tests of this test category are outward tests. They are performed with the line connected to the line circuit or with disconnected line.

Tests of this category either require customer assistance or assist an operator's craftsman in detecting an error in the field.

Test request service type

"ITU-T Recommendation X.745:1993":testRequestUncontrolledAction.

Specific errors

"ITU-T Recommendation X.745:1993":noSuchMORT;

"ITU-T Recommendation X.745:1993":mORTNotAvailable;

"ITU-T Recommendation X.745:1993":mistypedTestCategoryInformation.

Test category information parameter

The spmPulsesTestUncontrolledRequest parameter as content of the test category information field in the information syntax of "ITU-T Recommendation X.745:1993":testRequestUncontrolledAction.

Uncontrolled test response additional information parameter

None.

B.5 Ringing test

Test category name

Ringing Test

Test category purpose

The purpose of tests of this category is to check the cable and equipment in the customer's premises by applying ringing to the subscriber.

Possible tests according to the ASN.1 definition of ringing test:

ringing test.

MORT requirements

The test invocation involves one object class (analogueAccess as defined in I-ETS 300 291-1 [1]), which represents the line being measured. One or more object instances can be involved in the test;

Associated object requirements

There are no associated object classes.

Test environment

Tests of this test category are outward tests. They are performed with the line connected to the line circuit or with disconnected line.

Tests of this category either require customer assistance or assist an operator's craftsman in detecting an error in the field.

Test request service type

"ITU-T Recommendation X.745:1993":testRequestUncontrolledAction.

Specific errors

"ITU-T Recommendation X.745:1993":noSuchMORT;

"ITU-T Recommendation X.745:1993":mORTNotAvailable;

"ITU-T Recommendation X.745:1993":mistypedTestCategoryInformation.

Test category information parameter

The ringingTestUncontrolledRequest parameter as content of the test category information field in the information syntax of "ITU-T Recommendation X.745:1993":testRequestUncontrolledAction.

Uncontrolled test response additional information parameter

None.

B.6 Test to line circuit

Test category name

Test To Line Circuit

Test category purpose

The purpose of tests of this category is to check the ability of the inward test to provide or detect certain signals or feeding voltage. The test comprises of a set of possible tests, which are predefined in the NE and performed all together, e.g.:

- feeding voltage;

- feeding current;
- loop detection and ring trip detection;
- ringing current sending;
- private meter pulse generator test;
- Codec testing;
- digit reception.

MORT requirements

The test invocation involves one object class (analogueAccess or basicRateAccess as defined in I-ETS 300 291-1 [1]), as under test, which represents the line being measured. One or more object instances can be involved in the test.

Associated object requirements

There are no associated object classes.

Test environment

Tests of this test category are inward tests. They are performed with disconnected line.

Tests of this category do not require customer assistance.

Test request service type

"ITU-T Recommendation X.745:1993":testRequestUncontrolledAction.

Specific errors

"ITU-T Recommendation X.745:1993":noSuchMORT;

"ITU-T Recommendation X.745:1993":mORTNotAvailable;

"ITU-T Recommendation X.745:1993":mistypedTestCategoryInformation.

Test category information parameter

The testToLineCircuitUncontrolledRequest parameter as content of the test category information field in the information syntax of "ITU-T Recommendation X.745:1993":testRequestUncontrolledAction;

Uncontrolled test response additional information parameter

The testToLineCircuitUncontrolledResult parameter as content of the additionalInformation field in the reply syntax of "ITU-T Recommendation X.745:1993":testRequestUncontrolledAction;

B.7 ISDN loopback test

Test category name

ISDN Loopback Test

Test category purpose:

The purpose of tests of this category is to perform an internal loop test for ISDN basic or primary rate accesses. Possible tests according to the ASN.1 definition of iSDNLoopTest:

- loopback test.

MORT requirements

The test invocation involves one object class (basicRateAccess or primaryRateAccess as defined in I-ETS 300 291-1 [1]), which represents the line being measured. One or more object instances can be involved in the test.

Associated object requirements

There are no associated object classes.

Test environment

Tests of this test category are outward tests.

Tests of this category do not require customer assistance.

Test request service type

"ITU-T Recommendation X.745:1993":testRequestUncontrolledAction.

Specific errors

"ITU-T Recommendation X.745:1993":noSuchMORT;

"ITU-T Recommendation X.745:1993":mORTNotAvailable;

"ITU-T Recommendation X.745:1993":mistypedTestCategoryInformation.

Test category information parameter

The loopBackTestUncontrolledRequest parameter as content of the test category information field in the information syntax of "ITU-T Recommendation X.745:1993":testRequestUncontrolledAction.

Uncontrolled test response additional information parameter

The loopBackTestUncontrolledResult parameter as content of the additionalInformation field in the reply syntax of "ITU-T Recommendation X.745:1993":testRequestUncontrolledAction.

B.8 ISDN quick test

Test category name

ISDN Quick Test

Test category purpose

The purpose of tests of this category is to check the proper operation of certain functionalities of the subscriber equipment. Possible tests according to the ASN.1 definition IsdnQuickTestUncontrolledRequestType are:

- layer 1 activation;
- loop back test;
- power feeding test;
- function test.

MORT requirements

The test invocation involves one object class (basicRateAccess or primaryRateAccess as defined in I-ETS 300 291 [1]), which represents the line being tested. One or more object instances can be involved in the test.

Associated object requirements

There are no associated object classes.

Test environment

Tests of this test category are outward and inward tests. They do not require customer assistance.

Test request service type

"ITU-T Recommendation X.745:1993":testRequestUncontrolledAction.

Specific errors

"ITU-T Recommendation X.745:1993":noSuchMORT;

"ITU-T Recommendation X.745:1993":mORTNotAvailable;

"ITU-T Recommendation X.745:1993":mistypedTestCategoryInformation.

Test category information parameter

The isdnQuickTestUncontrolledRequest parameter as content of the test category information field in the information syntax of "ITU-T Recommendation X.745:1993":testRequestUncontrolledAction.

Uncontrolled test response additional information parameter

The isdnQuickTestUncontrolledResult parameter as content of the additionalInformation field in the reply syntax of "ITU-T Recommendation X.745:1993":testRequestUncontrolledAction.

Annex C (normative): Test termination

As specified in ITU-T Recommendation X.745 [20] a test may terminate spontaneously or by request. In the following subclauses, guidelines are given on termination of line and circuit tests.

C.1 Termination of uncontrolled tests

Uncontrolled tests terminate spontaneously,

- upon completion of the test; or
- upon fault situations; or
- upon the fulfilment of predefined criteria.

These predefined criteria and some specific fault situations are specified by the test category. The final test results or test failure response shall be returned using the test request uncontrolled action response message.

C.2 Termination of controlled tests

Controlled tests shall terminate depending on the test invocation:

One-step test

A one-step test is specified by one or more tests being invoked by a single test request controlled action. The request specifies a new access test object together with the test object(s) representing the specific test(s) to be performed.

A one-step test shall terminate spontaneously,

- upon completion of the test or
- upon fault situations or
- upon the fulfilment of predefined criteria.

These predefined criteria and some specific fault situations shall be specified by the test category or TO class. The final test results shall be returned using one or more controlled test result notifications. A test failure response shall be returned in the test request controlled action response or be contained in result notifications.

Before completion of the requested tests a one-step test may be terminated by a test terminate action directed to the test action performer which received the test request. The tests are identified in termination requests using the test invocation id. All TO(s) identified by the test shall be terminated otherwise an error shall be returned. The tests that have been terminated successfully as a result of this termination request shall be returned in the action response. In case an error occurs during test termination, the agent shall respond with a test termination error.

Test session

A test session is invoked by a test request controlled action which specifies a new access test object without any contained specific test objects. Subsequently, one or more other test requests are given which specify the specific tests to be performed within the already existing test session.

Test sessions shall be terminated by a test terminate action directed to the test action performer which received the test request. Test sessions may terminate spontaneously in case of fault situations or due to a time out specified in the test request. In case specific tests represented by contained test objects are invoked for this test session, these tests shall also be terminated. Test sessions are identified in termination requests using the test session id or the corresponding list of test invocation id(s). If a test session id is provided in the termination request, test invocations identified by the session shall be terminated in a best effort fashion. If a test invocation id is provided in the termination request, all TO(s)

identified by the test shall be terminated otherwise an error shall be returned. In the response to the termination request, the list of all test invocations that have been terminated as a result of this request shall be returned.

Specific controlled tests invoked during a test session shall terminate spontaneously or may be terminated by a test terminate action before completion of the test. Requirements are the same as for one-step tests.

Aborting tests

Controlled tests may also be aborted by deleting all TO(s) related by the same test invocation identifier. Test objects accepting deletion requests shall not emit any further test result reports. Where available it is recommended that the Scope parameter include all TOs with the same Test invocation identifier and that the Filter parameter select TOs with the same Test invocation identifier. If an abort request results in the deletion of some, but not all, TOs with the same test invocation identifier, the test becomes indeterminate. In this case, it is recommended to terminate the test by subsequent attempts to delete the surviving test objects. Yet, it may depend on the specific implementation how to resolve this situation.

Termination sequence

When a controlled test or test session is terminated the TO(s) of the test or test session will execute a termination sequence which may include issuing test result reports and performing any necessary cleanup including ending the test activity of MORT(s) and associated object(s). Successfully terminating a test or a test session implies that all the TO(s) of the test or test session are deleted automatically. If a result report is issued and the test outcome has not been concluded then the test outcome shall indicate a value of premature termination. The temporal order in which the termination sequence(s) are carried out is system specific and not defined by the test.

Annex D (normative): Test result notification

As specified in ITU-T Recommendation X.745 [20] test results of controlled tests may be emitted as notifications from the TO. The results are provided by one or more notifications.

- 1) A result notification shall contain the test invocation identifier of the test.
- 2) If present in the test request the test session identifier and the associated object identifier shall also be present in the result notification. They may be used for the correlation of test results.
- 3) The additional information identifier shall be present in the notification if specified in the behaviour of a specific test.
- 4) The MORTs identifier shall be present if not included in the test specific additional information field.
- 5) The test outcome parameter shall be included in the result notification to indicate the completion of a test. In case a TO is sending more than one test result notification during the execution of a test then the test outcome parameter also indicates that the TO is sending no more reports for the execution of the test. The parameter shall not be included in intermediate result notifications. It may take one of the following values: pass, fail, inconclusive, timed-out or premature termination, indicating the overall outcome of the test. In addition, notifications may contain specific test outcome information pertinent to the type of test.

The use of further generic information of the test result notification is left up to the implementation.

Annex E (normative): Additional requirements on the test action performer

This annex contains additional requirements on the implementation of the test action performer which detail the generic capabilities specified in ITU-T Recommendation X.745 [20].

E.1 Indication of supported tests

It shall be possible to retrieve the line and circuit test capabilities of an agent system. For this purpose, the `testActionPerformer` object class specified in ITU-T Recommendation X.745 [20] shall support the following packages:

- `supportedTOClassesPackage`, if controlled tests are supported; and
- `supportedUncontrolledTestsPackage`, if uncontrolled tests are supported.

Supported controlled tests are identified by a set of object identifiers of their related TO classes. Supported uncontrolled tests are identified by a set of object identifiers of their respective uncontrolled request parameter.

On receipt of a test request indicating a controlled test not supported by the agent system an independent or related test invocation error shall be generated. On receipt of a test request indicating a not supported uncontrolled test a mistyped test category information error shall be generated in the agent system.

E.2 Indication of unsuccessful test requests

The response to a not successful line or circuit test request shall contain a failure indication and information pertaining to the failure. According to ITU-T Recommendation X.745 [20] these failures shall be reported as specific errors.

Annex F (informative): Task Information Base (TIB)

F.1 Description of the service

Line and circuit testing is part of a management activity which is performed by the operator in order to detect failure conditions and to bring the subscriber access back to its normal state of operation whenever a deviation occurs. A customer access is considered as being that part of the local network which extends from the network termination equipment up to and including the exchange termination.

In this annex, only the parts of the activities are covered which are directly related to that part of the subscriber access which extends from the LE to the network termination equipment. An ISDN access extends to but does not include the T reference point. An analogue access extends to and may include the CPE.

F.2 Components of service (TIB A)

a) Failure detection

Observe or supervise the subscriber access and collect relevant data in order to detect failures or degradation. Perform continuous or periodic checks of the system functions.

b) Failure information

Send alarms and event reports from the NE to TMN with failure information related to subscriber access.

c) Failure localisation

Receive failure information from NEs which may be generated by performing tests and measurements on subscriber access. Initiate additional fault localisation procedures and receive information from these procedures.

d) Fault correction

Replace faulty access port equipment with working replacements.

e) Verification

Apply the appropriate tests and measurements to the replaced component before bringing it back to service.

f) Restoration

Restore the component to service.

F.3 Management function list (TIB B)

a) Request status

TMN requests NE to send the current status information related to the access port.

b) Set service state

TMN directs NE to place a access port in a specified service state, e.g. in service (available for use), standby (not for normal use), out of service (unavailable for use).

c) Alarm report

NE notifies TMN of alarm information concerning access ports.

d) Start line or circuit test

TMN directs NE to start an on-demand or a periodic test of the subscriber line or access port.

e) Stop line or circuit test

TMN directs NE to stop an on-demand or a periodic test of the subscriber line or access port.

f) Set test conditions

TMN directs NE to assign parameters, modes and thresholds to tests and measurements of the subscriber line or access port.

g) Apply test signals

TMN directs NE to send test signals to the terminating equipment or to the line circuit, e.g. ringing signals, dial pulses, meter pulses.

h) Remove test signals

TMN directs NE to remove the test signal sent by the apply function.

i) Connect external test equipment

TMN directs NE to connect the customer line or access port to an external test equipment.

j) Disconnect external test equipment

TMN directs NE to disconnect the subscriber line or access port from a previously connected external test equipment.

k) Request test results

TMN requests NE to report intermediate or final results from a test applied to a subscriber line or an access port.

l) Test result report

NE sends the results of a test applied to a subscriber line or an access port to TMN.

Annex G (informative): Description of management functions

Management functions related to testing are defined in ITU-T Recommendation X.745 [20]. No specific functions are defined in the context of line and circuit testing at the LE.

G.1 Model for the test function

G.1.1 Environment

In general, the execution of a test as defined in ITU-T Recommendation X.745 [20] involves two entities: a managing process (*test conductor*) that initiates the test, and an agent process (*test performer*) that executes the test on request by the test conductor.

Figure G.1 illustrates the principle structure of a test invocation, showing only a subset of possible protocol exchanges and does not show managed objects.

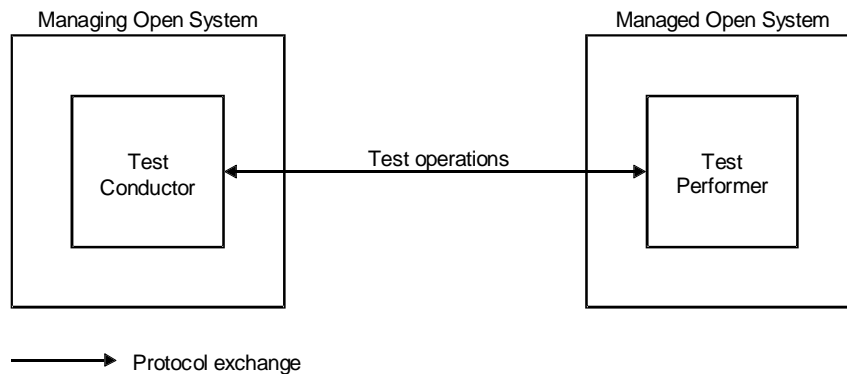

Figure G.1: Test model

The test performer sends a test request to a managed object, which has functionality to receive and respond to such requests. Such functionality is called the Test Action Request Receiver (TARR) functionality. Managed objects which refer to functionalities that are the subjects of tests, MORTs, are identified in test requests. Each test shall involve one or more MORT. The TARR functionality is part of a managed object, the test action performer, which exists expressly for the purpose of receiving test requests.

A test is *uncontrolled* or *controlled*. The general test behaviour is documented by a test category.

G.1.2 Uncontrolled tests

An uncontrolled test is one which is not subject to monitoring or control. Test results are provided in one or more replies to the test request. For uncontrolled tests, the span of test invocation is from the time of the initiation request to the time at which the final response is returned. An uncontrolled test is modelled by using MORT(s) and a test action performer. Figure G.2 depicts an example of an uncontrolled test.

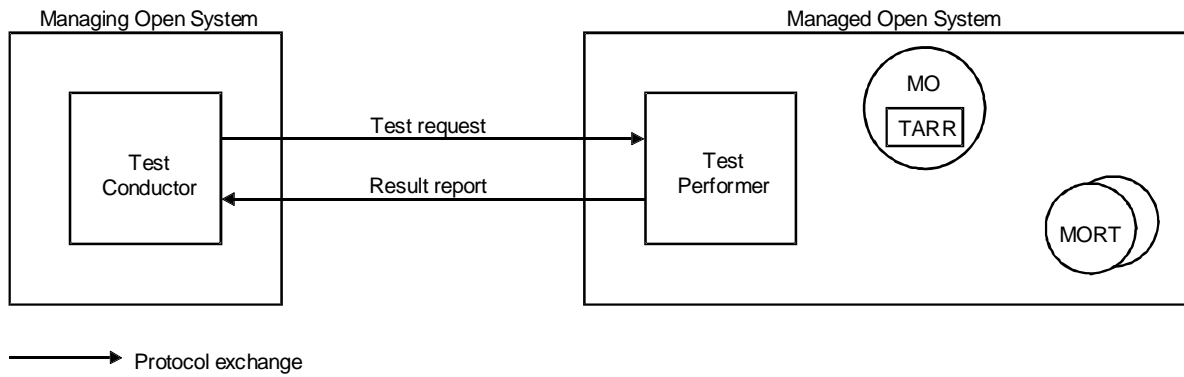

Figure G.2: Example of an uncontrolled test

G.1.3 Controlled tests

A controlled test is one for which one or more Test Objects, TO(s), having the same value for the test invocation identifier attribute are created for the purpose of monitoring and control. The TO(s) of a controlled test are instantiated as a consequence of a single test request. Results of the test are made available as attribute values of the TO(s) and/or are returned via notifications issued by the TO(s). The test result notifications may be sent to any open system as event reports. The test results may also be stored as test result records by instantiating an appropriate log in the test performer.

A controlled test is modelled by using TO(s), MORT(s), and a managed object with TARR functionality. Figure G.3 depicts an example of a controlled test.

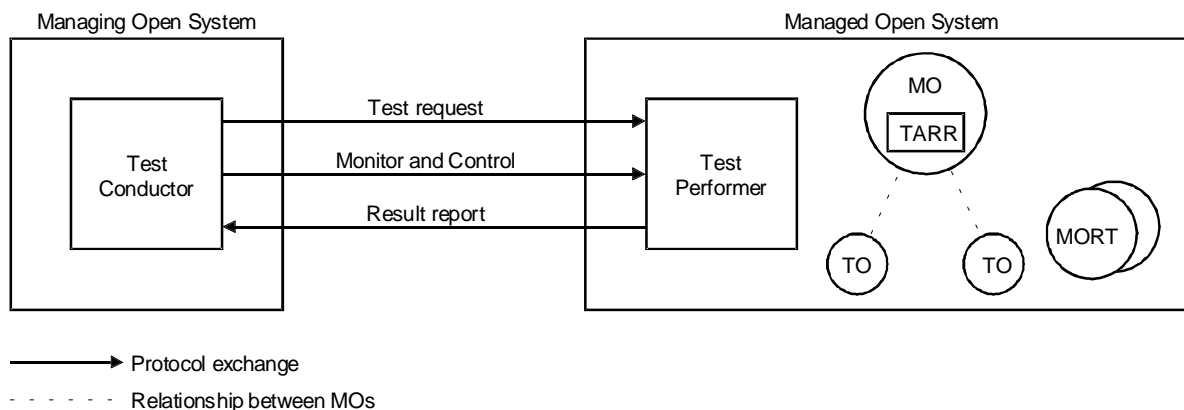

Figure G.3: Example of a controlled test

TO(s) hold information pertaining to the test. A single test request may create any number of TO(s). Relationships may exist between TO(s) and the behaviour of one TO may depend upon the behaviour of other TO(s). The name of the TO may be assigned by either the test conductor or the test performer. The test performer assigns the test invocation identifier which identifies the test invocation.

Requests to suspend, resume or terminate a controlled test are directed to the test action performer. The affected TO(s) are identified using either a test invocation identifier or a test session identifier. Requests to abort a test, if permitted, may be directed to the TO(s). The specification of the test may include the conditions under which it will be executed, suspended, resumed and terminated. These conditions may be controlled by either a scheduling mechanism, the status of a MORT or detection of a specific event.

G.2 Functional model

G.2.1 Test initiation

The request by the test conductor to the test performer to initiate the test(s) specifies the test input information and may include the following:

- the identification of MORT(s);
- test category specific input information;
- a timeout period;
- the identity of one or more associated objects;
- a test session identifier.

For controlled tests, a test conductor may also:

- indicate whether one or more tests are being requested;
- supply the classes and, optionally, names of required TO(s);
- include information about initial attribute values for the TO(s).

For uncontrolled tests, a response to a successful test request will contain test results. For controlled tests, a successful response will contain the distinguished names of the TO(s), their test invocation identifier(s), and optionally, initial attribute values. A failure response will contain a failure indication and information pertaining to the failure.

The TOs created as a result of a controlled test request may be independent tests or part of one related test. An independent test request initiates multiple (one or more) tests each comprised of a single TO. A related test request initiates a single test comprised of more than one related TO. A single controlled test request may initiate one related test, or one or more independent tests. A controlled test with only one TO is always an independent test.

G.2.2 Test scheduling

The test conductor may provide a time window in which it would like a TO to execute. If the test performer can schedule TO execution within this time window it will return a successful confirmation and may provide an actual (or expected) start and stop time for the TO, as measured or predicted by the test performer. The test performer may report any changes in the actual start and stop times. If the actual start or stop time does not match with the requested start or stop time the TO shall cease execution (if executing) and emit a scheduling conflict notification.

Figure G.4 shows examples of the scheduling model. Example 1 in figure G.4 illustrates the concept of the request window. Example 2 of figure G.4 illustrates the use of a Timeout period for a test.

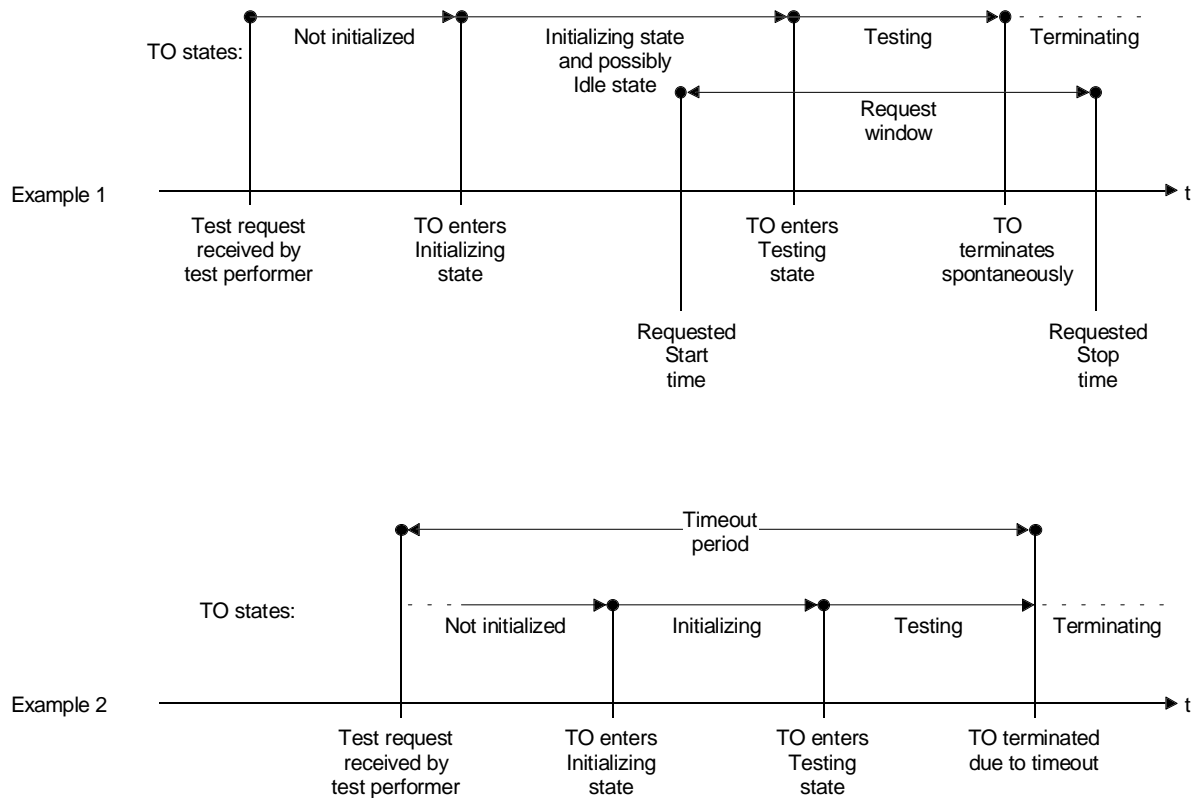

Figure G.4: Test scheduling examples

G.2.3 Reporting of test results

For uncontrolled tests, the results of the test are reported in one or more confirmations to the test request. The final confirmation indicates that the test was completed and shall contain the test outcome parameter. The test outcome parameter shall not be present in confirmations other than the final one. This parameter may take one of the following values: pass, fail, inconclusive, timed-out or premature termination. The interpretation of this parameter is contingent on the type of test that was requested. In addition, confirmations may contain information pertinent to the type of test. If the test outcome indicates fail, the confirmation primitive may contain parameters indicating the nature of the problem and proposed repair actions.

For controlled tests, the test conductor may directly retrieve the results from the TO by reading appropriate attribute values (solicited), or results may be emitted as notifications (unsolicited) from the TO.

In the case of unsolicited reporting the results are provided by one or more notifications from a TO. A result notification shall contain the test invocation identifier of the test. The test session identifier shall also be present if present in the test request. The TO shall indicate that it is sending no more reports for an execution of a test by including the test outcome parameter in a report. Result reports may contain any other information in accord with the specification of the notifications for the TO.

G.2.4 Test suspension and resumption

Only a controlled test may be suspended or resumed by a test suspend/resume request directed to the test action performer. Successfully suspending or resuming a test implies that all the TO(s) of the test are suspended/resumed. Tests are identified in suspend/resume requests using either a test invocation id or a test session id.

If a test session id is provided in the suspend/resume request, test invocations identified by the session shall be suspended/resumed in a best effort fashion. If a test invocation id is provided in the suspend/resume request, all TO(s) identified by the test shall be suspended/resumed, otherwise an error shall be returned.

In the response to the suspend/resume request, the list of all test invocations that have been suspended/resumed as a result of this request shall be returned.

When a test is suspended all the TO(s) for the test are set to the suspended state. The TO definitions determine if the normal operating state of the MORT(s) is restored during suspension. When a test is resumed the TO definition determines at what point in the test life cycle the test will be resumed. The TO test states are returned in the confirmation of the resumption request.

G.2.5 Test termination

A test may terminate spontaneously or by request. Both uncontrolled and controlled tests may terminate spontaneously, either upon the completion of the test or upon abnormal conditions (including scheduling conflicts for controlled tests). Only controlled tests may be terminated by a test terminate request or aborted by deleting all TO(s) related by the same test invocation identifier.

Spontaneous termination occurs upon the fulfilment of predefined criteria or a fault situation. These predefined criteria and some specific fault situations shall be specified by the test category or TO class. For uncontrolled tests, the final test results or test failure response shall be returned.

A controlled test may be terminated by a test terminate request. Successfully terminating a test implies that all the TO(s) of the test are terminated. Tests are identified in termination requests using either a test invocation id or a test session id.

If a test session id is provided in the termination request, test invocations identified by the session shall be terminated in a best effort fashion. If a test invocation id is provided in the termination request, all TO(s) identified by the test shall be terminated otherwise an error shall be returned.

In the response to the termination request, the list of all test invocations that have been terminated as a result of this request shall be returned.

When a test is terminated the TO(s) of the test will execute a termination sequence which may include issuing test result reports and performing any necessary cleanup including ending the test activity of MORT(s) and Associated object(s). If a result report is issued and the test outcome has not been concluded then the test outcome shall indicate a value of premature termination. The temporal order in which the termination sequence(s) are carried out is system specific and not defined by the test.

A controlled test may be aborted by deleting all the TO(s) with that test invocation identifier. Test objects accepting deletion requests shall not emit any further test result reports.

Annex H (informative): Message flows

In the following figures the principles of the message flows are introduced as examples.

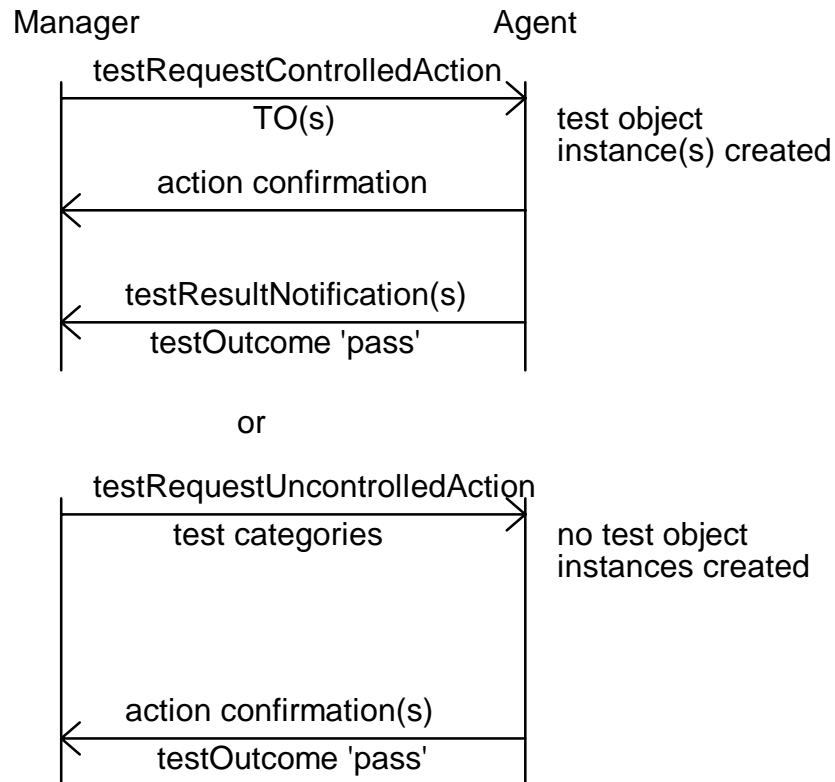

Figure H.1: The simple cases: a successful on-demand test

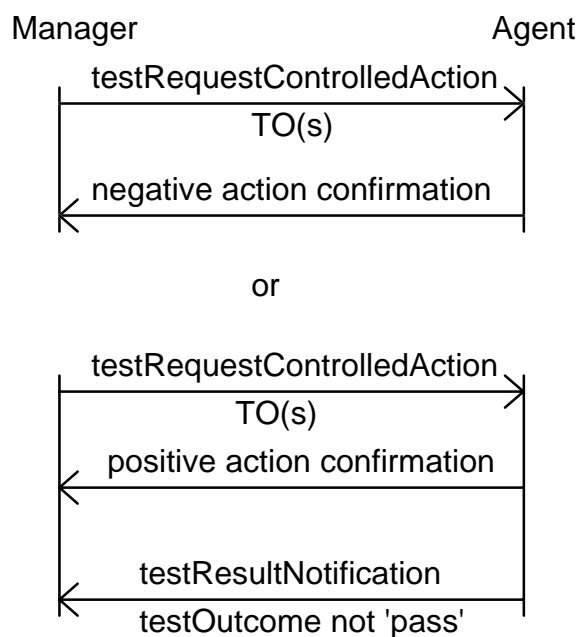

Figure H.2: Any failed test

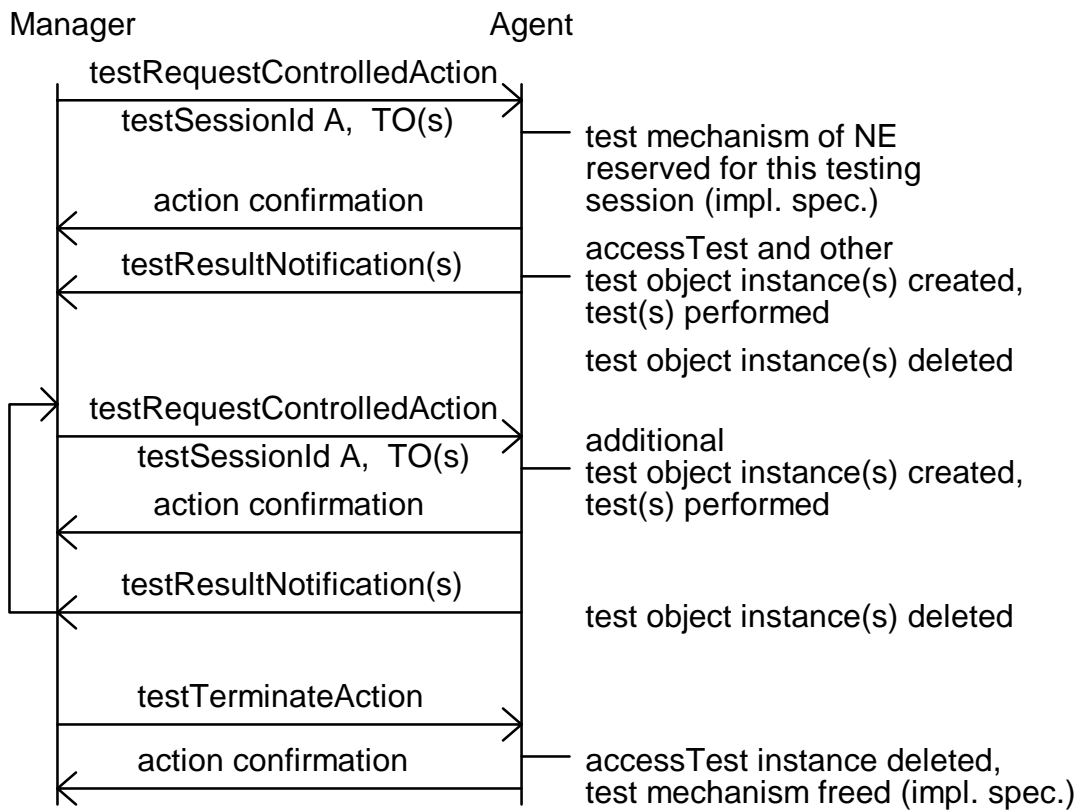

Figure H.3: A test session

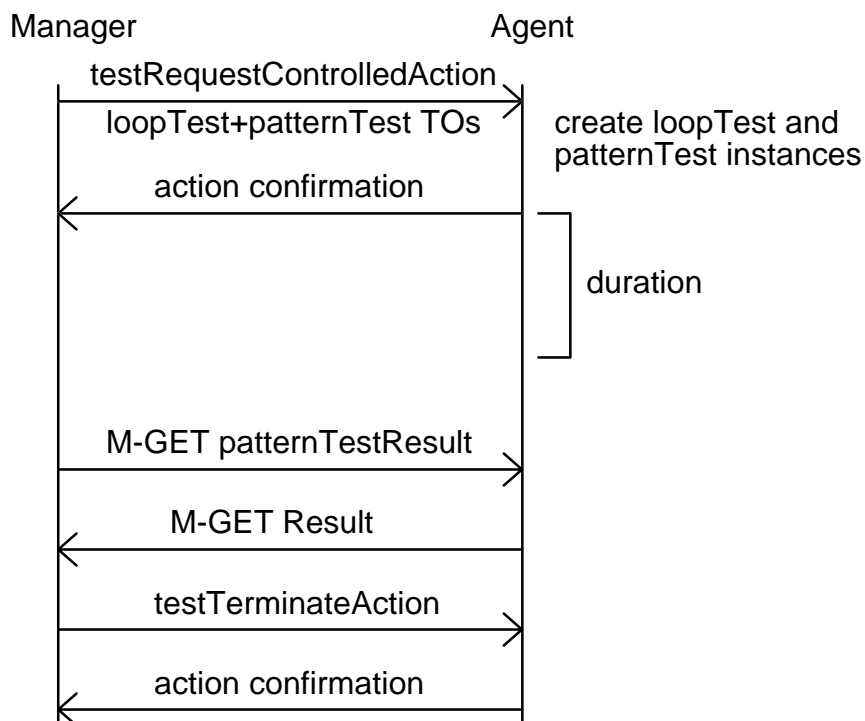

Figure H.4: Internal Pattern Injection

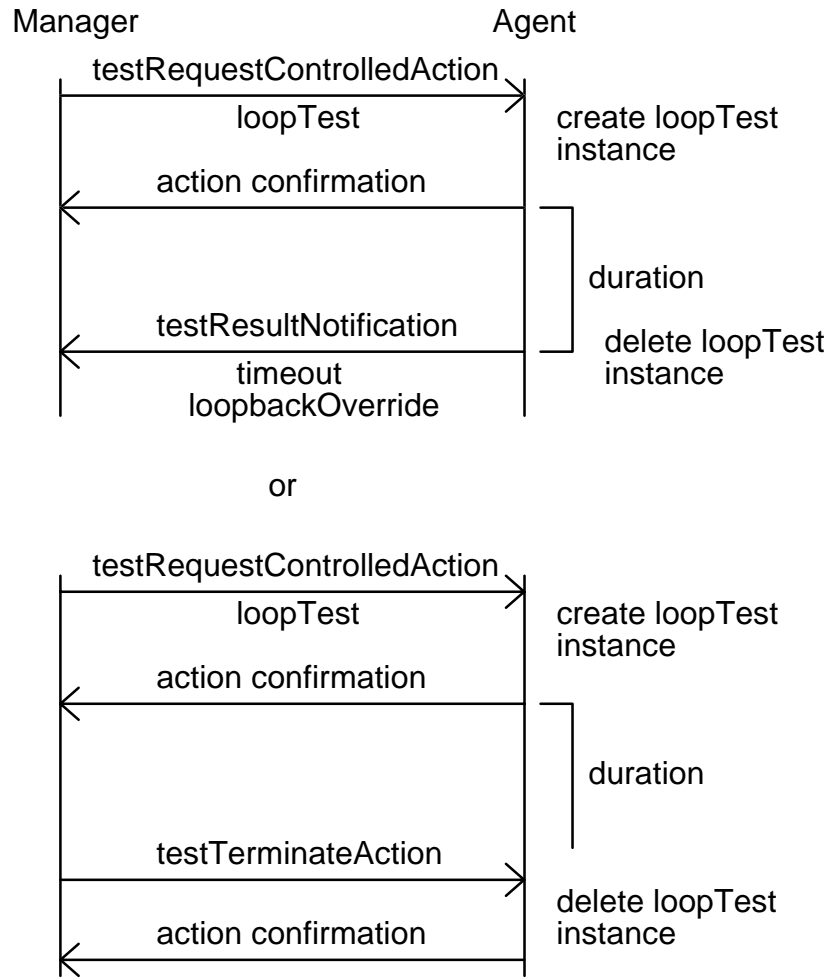

Figure H.5: External Pattern Injection

Annex J (informative): Bibliography

The following material, though not specifically referenced in the body of the present document, gives supporting information.

- CCITT Recommendation I.601 (1988): "General maintenance principles of ISDN subscriber access and subscriber installation".
- CCITT Recommendation X.722 | ISO/IEC 10165-4: "Information technology - Open systems interconnection - Structure of management information: Guidelines for the definition of managed objects".
- CCITT Recommendation X.733 | ISO/IEC 10164-4: "Information technology - Open systems interconnection - Systems management: Alarm reporting function".
- CEPT Recommendation T/S 54-07 E (1982): "Analogue subscriber line tests and measurements".
- CEPT Recommendation T/S 54-08 E (1987): "ISDN subscriber access and installation maintenance".
- ETR 008 (1990): "Network Aspects (NA); The method for the characterisation of the machine-machine interfaces utilised by a Telecommunications Management Network (TMN)".
- ETR 037 (1992): "Network Aspects (NA); Telecommunications Management Network (TMN); Objectives, principle, concepts and reference configurations".
- ETR 046 (1992): "Network Aspects (NA); Telecommunications management networks modelling guidelines".
- ETR 047 (1992): "Network Aspects (NA); Telecommunications Management Network (TMN); Management services".
- ETR 048 (1992): "Network Aspects (NA); Telecommunications Management Network (TMN); Management services prose descriptions".
- ETR 078 (1993): "Maintenance: Telecommunications management network; TMN interface specification methodology [CCITT Recommendation -M.3020 (1992)]".
- ETR 080 (1993): "Transmission and Multiplexing (TM); Integrated Services Digital Network (ISDN) basic rate access - Digital transmission system on metallic local lines".
- ETS 300 150 (1992): "Transmission and Multiplexing (TM); Protocol suites for Q interfaces for management of transmission systems".
- ETS 300 233 (1994): "Integrated Services Digital Network (ISDN); Access digital section for ISDN primary rate".
- ETS 300 297 (1995): "Integrated Services Digital Network (ISDN); Access digital section for ISDN basic access".
- ETS 300 347-1 (1994): "Signalling Protocols and Switching (SPS); V interfaces at the digital Local Exchange (LE); V5.2 interface for the support of Access Network (AN); Part 1: V5.2 interface specification".
- ETS 300 379-1 (1995): "Signalling Protocols and Switching (SPS); Q3 interface at the Local Exchange (LE) for fault and performance management of V5 interfaces and associated customer profiles; Part 1: Q3 interface specification".

History

Document history				
V1.1.4	February 1997	Public Enquiry	PE 9726:	1997-02-28 to 1997-06-27
V1.2.1	May 1998	Vote	V 9830:	1998-05-18 to 1998-07-31