

ETSI EN 300 718-1 V2.1.1 (2018-01)



**Avalanche Beacons operating at 457 kHz;
Transmitter-receiver systems;
Part 1: Harmonised Standard for access to radio spectrum**

Reference

REN/ERM-TG28-512-1

Keywords

harmonised standard, radio, testing

ETSI

650 Route des Lucioles
F-06921 Sophia Antipolis Cedex - FRANCE

Tel.: +33 4 92 94 42 00 Fax: +33 4 93 65 47 16

Siret N° 348 623 562 00017 - NAF 742 C
Association à but non lucratif enregistrée à la
Sous-Préfecture de Grasse (06) N° 7803/88

Important notice

The present document can be downloaded from:

<http://www.etsi.org/standards-search>

The present document may be made available in electronic versions and/or in print. The content of any electronic and/or print versions of the present document shall not be modified without the prior written authorization of ETSI. In case of any existing or perceived difference in contents between such versions and/or in print, the only prevailing document is the print of the Portable Document Format (PDF) version kept on a specific network drive within ETSI Secretariat.

Users of the present document should be aware that the document may be subject to revision or change of status.

Information on the current status of this and other ETSI documents is available at

<https://portal.etsi.org/TB/ETSIDeliverableStatus.aspx>

If you find errors in the present document, please send your comment to one of the following services:

<https://portal.etsi.org/People/CommiteeSupportStaff.aspx>

Copyright Notification

No part may be reproduced or utilized in any form or by any means, electronic or mechanical, including photocopying and microfilm except as authorized by written permission of ETSI.

The content of the PDF version shall not be modified without the written authorization of ETSI.

The copyright and the foregoing restriction extend to reproduction in all media.

© ETSI 2018.

All rights reserved.

DECT™, **PLUGTESTS™**, **UMTS™** and the ETSI logo are trademarks of ETSI registered for the benefit of its Members.

3GPP™ and **LTE™** are trademarks of ETSI registered for the benefit of its Members and of the 3GPP Organizational Partners.

oneM2M logo is protected for the benefit of its Members.

GSM® and the GSM logo are trademarks registered and owned by the GSM Association.

Contents

Intellectual Property Rights	5
Foreword.....	5
Modal verbs terminology.....	6
1 Scope	7
2 References	7
2.1 Normative references	7
2.2 Informative references.....	7
3 Definitions, symbols and abbreviations	8
3.1 Definitions.....	8
3.2 Symbols.....	8
3.3 Abbreviations	9
4 Technical requirements specifications	9
4.1 Environmental profile.....	9
4.2 Conformance requirements for transmitters	9
4.2.1 Modulation and carrier keying.....	9
4.2.1.1 Definition	9
4.2.1.2 Method of measurement.....	9
4.2.1.3 Limits	9
4.2.2 Frequency error.....	10
4.2.2.1 Definition	10
4.2.2.2 Method of measurement.....	10
4.2.2.3 Limits	10
4.2.3 Output field strength (H-field).....	10
4.2.3.1 Definition	10
4.2.3.2 Method of measurement.....	10
4.2.3.3 Limits	10
4.2.3.3.1 Minimum transmitted field.....	10
4.2.3.3.2 Maximum transmitted field	10
4.2.4 Transmitter spurious emissions.....	11
4.2.4.1 Definition	11
4.2.4.2 Radiated H-field.....	11
4.2.4.2.1 Method of measurement (< 30 MHz).....	11
4.2.4.2.2 Limits	11
4.2.4.3 Effective radiated power	11
4.2.4.3.1 Method of measurement (≥ 30 MHz).....	11
4.2.4.3.2 Limits	12
4.3 Conformance requirements for receivers parameters	12
4.3.1 Receiver sensitivity.....	12
4.3.1.1 Definition	12
4.3.1.2 Method of measurement.....	12
4.3.1.3 Limits	13
4.3.2 Receiver spurious emissions	13
4.3.2.1 Definition	13
4.3.2.2 Radiated H-field.....	13
4.3.2.2.1 Method of measurement (< 30 MHz).....	13
4.3.2.2.2 Limits	13
4.3.2.3 Effective radiated power	13
4.3.2.3.1 Method of measurement (≥ 30 MHz).....	13
4.3.2.3.2 Limits	14
4.3.3 Receiver blocking	14
5 Test conditions, power sources and ambient temperatures	15
5.1 Normal and extreme test conditions	15
5.2 External test power source.....	15
5.3 Normal test conditions.....	15

5.3.1	Normal temperature and humidity	15
5.3.2	Normal test voltage	15
5.4	Extreme test conditions	15
5.4.1	Extreme temperatures	15
5.4.2	Extreme test voltages	16
5.4.2.1	General requirement	16
5.4.2.2	Procedure for tests at extreme temperatures	16
5.5	Measurement uncertainty	16
Annex A (informative):	Relationship between the present document and the essential requirements of Directive 2014/53/EU	17
Annex B (normative):	Test sites and general arrangements for measurements involving the use of radiated fields	18
B.1	General	18
B.1.1	Normal test signals	18
B.1.2	Test fixture	18
B.1.3	Measuring receiver	18
B.2	Outdoor test site	19
B.2.1	General requirements	19
B.2.2	Standard position	19
B.3	Test antenna	20
B.3.1	Below 30 MHz	20
B.3.2	Above 30 MHz	20
B.4	Substitution antenna	20
B.4.1	General	20
B.4.2	Optional additional indoor site	21
B.5	Guidance on the use of radiation test sites	22
B.5.1	General	22
B.5.2	Measuring distance	22
B.5.3	Test antenna	22
B.5.4	Substitution antenna	22
B.5.5	Artificial antenna	22
B.5.6	Auxiliary cables	22
B.6	Further optional alternative indoor test site using an anechoic chamber	23
B.6.1	General	23
B.6.2	Example of the construction of a shielded anechoic chamber	23
B.6.3	Influence of parasitic reflections in anechoic chambers	23
B.6.4	Calibration of the shielded RF anechoic chamber	24
Annex C (normative):	Spurious limits, radiated H-field at 10 m distances	26
Annex D (informative):	E-fields in the near field at low frequencies	27
Annex E (informative):	Change history	30
History		31

Intellectual Property Rights

Essential patents

IPRs essential or potentially essential to the present document may have been declared to ETSI. The information pertaining to these essential IPRs, if any, is publicly available for **ETSI members and non-members**, and can be found in ETSI SR 000 314: "*Intellectual Property Rights (IPRs); Essential, or potentially Essential, IPRs notified to ETSI in respect of ETSI standards*", which is available from the ETSI Secretariat. Latest updates are available on the ETSI Web server (<https://ipr.etsi.org/>).

Pursuant to the ETSI IPR Policy, no investigation, including IPR searches, has been carried out by ETSI. No guarantee can be given as to the existence of other IPRs not referenced in ETSI SR 000 314 (or the updates on the ETSI Web server) which are, or may be, or may become, essential to the present document.

Trademarks

The present document may include trademarks and/or tradenames which are asserted and/or registered by their owners. ETSI claims no ownership of these except for any which are indicated as being the property of ETSI, and conveys no right to use or reproduce any trademark and/or tradename. Mention of those trademarks in the present document does not constitute an endorsement by ETSI of products, services or organizations associated with those trademarks.

Foreword

This Harmonised European Standard (EN) has been produced by ETSI Technical Committee Electromagnetic compatibility and Radio spectrum Matters (ERM).

The present document has been prepared under the Commission's standardisation request C(2015) 5376 final [i.2] to provide one voluntary means of conforming to the essential requirements of Directive 2014/53/EU on the harmonisation of the laws of the Member States relating to the making available on the market of radio equipment and repealing Directive 1999/5/EC [i.1].

Once the present document is cited in the Official Journal of the European Union under that Directive, compliance with the normative clauses of the present document given in table A.1 confers, within the limits of the scope of the present document, a presumption of conformity with the corresponding essential requirements of that Directive and associated EFTA regulations.

The present document is part 1 of a multi-part deliverable covering avalanche beacons operating at 457 kHz transmitter-receiver systems, as identified below:

Part 1: "**Harmonised Standard for access to radio spectrum**";

Part 2: "Harmonised Standard for features for emergency services".

National transposition dates	
Date of adoption of this EN:	18 December 2017
Date of latest announcement of this EN (doa):	31 March 2018
Date of latest publication of new National Standard or endorsement of this EN (dop/e):	30 September 2018
Date of withdrawal of any conflicting National Standard (dow):	30 September 2019

Modal verbs terminology

In the present document "**shall**", "**shall not**", "**should**", "**should not**", "**may**", "**need not**", "**will**", "**will not**", "**can**" and "**cannot**" are to be interpreted as described in clause 3.2 of the [ETSI Drafting Rules](#) (Verbal forms for the expression of provisions).

"**must**" and "**must not**" are **NOT** allowed in ETSI deliverables except when used in direct citation.

1 Scope

The present document specifies technical characteristics and methods of measurements for avalanche beacons operating at 457 kHz transmitter-receiver systems.

NOTE: The relationship between the present document and essential requirements of article 3.2 of Directive 2014/53/EU [i.1] is given in annex A.

2 References

2.1 Normative references

References are specific, identified by date of publication and/or edition number or version number. Only the cited version applies.

Referenced documents which are not found to be publicly available in the expected location might be found at <https://docbox.etsi.org/Reference/>.

NOTE: While any hyperlinks included in this clause were valid at the time of publication, ETSI cannot guarantee their long term validity.

The following referenced documents are necessary for the application of the present document.

- [1] CISPR 16-1-1 (2015): "Specification for radio disturbance and immunity measuring apparatus and methods - Part 1-1: Radio disturbance and immunity measuring apparatus - Measuring apparatus".
- [2] CISPR 16-1-4 (2010): "Part 1-4: Radio disturbance and immunity measuring apparatus - Antennas and test sites for radiated disturbance measurements".
- [3] CISPR 16-1-5 (2014): "Specification for radio disturbance and immunity measuring apparatus and methods; Part 1-5: Radio disturbance and immunity measuring apparatus - Antenna calibration sites and reference test sites for 5 MHz to 18 GHz".
- [4] ETSI EN 300 718-2 (V2.1.1) (01-2018): "Avalanche Beacons operating at 457 kHz; Transmitter-receiver systems; Part 2: Harmonised Standard for features for emergency services".

2.2 Informative references

References are either specific (identified by date of publication and/or edition number or version number) or non-specific. For specific references, only the cited version applies. For non-specific references, the latest version of the referenced document (including any amendments) applies.

NOTE: While any hyperlinks included in this clause were valid at the time of publication, ETSI cannot guarantee their long term validity.

The following referenced documents are not necessary for the application of the present document but they assist the user with regard to a particular subject area.

- [i.1] Directive 2014/53/EU of the European Parliament and of the Council of 16 April 2014 on the harmonisation of the laws of the Member States relating to the making available on the market of radio equipment and repealing Directive 1999/5/EC.
- [i.2] Commission Implementing Decision C(2015) 5376 final of 4.8.2015 on a standardisation request to the European Committee for Electrotechnical Standardisation and to the European Telecommunications Standards Institute as regards radio equipment in support of Directive 2014/53/EU of the European Parliament and of the Council.
- [i.3] ITU Radio Regulations (2012), Appendix 1 (REV.WRC-12): "Classification of emissions and necessary bandwidths".

[i.4] ETSI TR 100 028 (all parts): "Electromagnetic compatibility and Radio spectrum Matters (ERM); Uncertainties in the measurement of mobile radio equipment characteristics".

3 Definitions, symbols and abbreviations

3.1 Definitions

For the purposes of the present document, the following terms and definitions apply:

avalanche beacons: portable radio systems used for locating avalanche victims, for the purpose of direct rescue

NOTE: I.e. for rescue by comrades not buried by the avalanche.

artificial antenna: tuned reduced-radiating dummy load equal to the nominal impedance specified by the manufacturer

conducted measurements: measurements which are made using a direct connection to the equipment under test

E-field: electric component of the field measured as voltage per unit length

environmental profile: range of environmental conditions under which equipment within the scope of the present document is required to comply with the provisions of the present document

H-field: magnetic component of the field measured as current per unit length

H-field test antenna: electrically screened loop or equivalent antenna, with which the magnetic component of the field can be measured

integral antenna: antenna designed as an indispensable part of the equipment, with or without the use of an antenna connector

radiated measurements: measurements which involve the absolute measurement of a radiated field

(S + N)/N: ratio, expressed in Decibels, between the sum of the wanted signal plus the noise floor and the noise floor

3.2 Symbols

For the purposes of the present document, the following abbreviations apply:

A1A Class of emission

NOTE: See ITU Radio Regulations [i.3].

E Electrical field strength
E_o Reference electrical field strength

NOTE: See annex B.

f Frequency
H Magnetic field strength
H_o Reference magnetic field strength

NOTE: See annex B.

N Newton
P Power
R Distance
R_o Reference distance

NOTE: See annex B.

t Time
Z Wave impedance

l Wavelength

NOTE: See annex B.

3.3 Abbreviations

For the purposes of the present document, the following abbreviations apply:

RF Radio Frequency

4 Technical requirements specifications

4.1 Environmental profile

The technical requirements of the present document apply under the environmental profile for operation of the equipment, which shall be declared by the manufacturer. The equipment shall comply with all the technical requirements of the present document which are identified as applicable in annex A at all times when operating within the boundary limits of the declared operational environmental profile.

4.2 Conformance requirements for transmitters

4.2.1 Modulation and carrier keying

4.2.1.1 Definition

The modulation is the method for generating the RF carrier. The carrier keying defines the on and off times for a non-continuous carrier.

4.2.1.2 Method of measurement

The carrier keying shall be measured by means of an oscilloscope connected to a suitable coil antenna. The measurements shall be done under normal as well as under extreme test conditions.

4.2.1.3 Limits

The modulation shall be of type A1A, i.e. double sideband amplitude modulation with no modulating auxiliary carrier, as used for telegraphy.

The carrier keying shall be as shown in figure 1:

- on time: 70 ms minimum;
- off time: 400 ms minimum;
- period: 1 000 ms \pm 300 ms (on time plus off time).

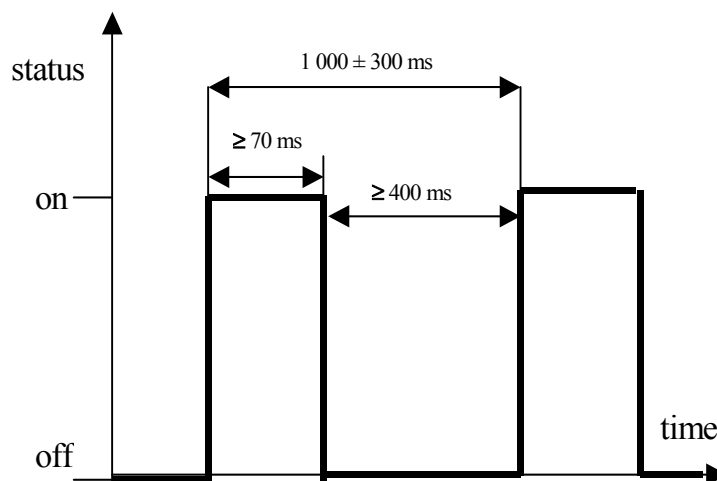

Figure 1

4.2.2 Frequency error

4.2.2.1 Definition

The frequency error of the transmitter system is the difference between the measured carrier frequency and the nominal carrier frequency.

4.2.2.2 Method of measurement

The carrier frequency shall be measured by means of a test fixture (see annex B, clause B.1.2). The measurements shall be done under normal as well as under extreme test conditions as defined in clause 5.

4.2.2.3 Limits

The frequency error shall not exceed ± 80 Hz at 457 kHz.

4.2.3 Output field strength (H-field)

4.2.3.1 Definition

The H-field is measured in the direction of maximum field strength under specified conditions of measurement.

4.2.3.2 Method of measurement

The H-field produced by the equipment shall be measured on the axis of the transmitting antenna at distances of 10 m on an outdoor test site (see annex B).

4.2.3.3 Limits

4.2.3.3.1 Minimum transmitted field

The minimum transmitted field strength at 457 kHz shall not be lower than -6 dB μ A/m ($0,5$ μ A/m) at a distance of 10 m.

4.2.3.3.2 Maximum transmitted field

The maximum transmitted field strength at 457 kHz shall not exceed 7 dB μ A/m ($2,23$ μ A/m) at a distance of 10 m.

4.2.4 Transmitter spurious emissions

4.2.4.1 Definition

Spurious emissions are emissions at frequencies other than those of the carrier and sidebands associated with normal modulation. The level of spurious emissions shall be measured at normal conditions as their effective radiated power or field strength radiated by the cabinet and the integral antenna.

4.2.4.2 Radiated H-field

4.2.4.2.1 Method of measurement (< 30 MHz)

The field strength shall be measured for frequencies below 30 MHz. The equipment under test shall be measured at a distance of 10 m on an outdoor test site. The test antenna shall be a calibrated shielded magnetic field antenna. The equipment under test and test antenna shall be arranged as stated in annex B, clause B.2.

The equipment under test shall be switched on in transmit mode (see clause 4.2). The measuring receiver shall be tuned over the frequency range 9 kHz to 30 MHz, except for the frequency band ± 20 kHz from the frequency on which the transmitter is intended to operate.

At each frequency at which a spurious signal is detected the equipment under test and the test antenna shall be rotated until maximum field strength is indicated on the measuring receiver. This level shall be noted.

The limits are quoted in dB μ A or dB μ A/m, so it is necessary to reduce the reading as explained in annex D for measuring equipment calibrated in dB μ V or dB μ V/m.

4.2.4.2.2 Limits

Radiated emissions below 30 MHz shall not exceed the generated H-field at 10 m given in table 2.

Table 2

State	Frequency $9 \text{ kHz} \leq f < 10 \text{ MHz}$	Frequency $10 \text{ MHz} \leq f < 30 \text{ MHz}$
Transmit	27 dB μ A/m descending 3 dB/oct	-3,5 dB μ A/m

A graphical representation is shown in annex C, figure C.1.

4.2.4.3 Effective radiated power

4.2.4.3.1 Method of measurement (≥ 30 MHz)

On a test site, selected from annex B, the equipment shall be placed at the specified height on a non-conducting support and in the position closest to normal use as declared by the manufacturer.

The test antenna shall be oriented for vertical polarization. The output of the test antenna shall be connected to a measuring receiver.

The equipment shall be switched on in transmit mode, and the measuring receiver shall be tuned over the frequency range 30 MHz to 1 000 MHz.

At each frequency at which a spurious component is detected, the test antenna shall be raised and lowered through the specified range of heights until a maximum signal level is detected on the measuring receiver.

The equipment shall then be rotated through 360° in the horizontal plane, until the maximum signal level is detected by the measuring receiver.

The maximum signal level detected by the measuring receiver shall be noted.

The substitution antenna shall be oriented for vertical polarization and calibrated for the frequency of the spurious component detected.

The frequency of the calibrated signal generator shall be set to the frequency of the spurious component detected. The input attenuator setting of the measuring receiver shall be adjusted in order to increase the sensitivity of the measuring receiver, if necessary.

The test antenna shall be raised and lowered through the specified range of heights to ensure that the maximum signal is received.

When a test site according to clause B.3 is used, there is no need to vary the height of the antenna.

The input signal to the substitution antenna shall be adjusted until an equal or a known related level to that detected from the transmitter is obtained on the measuring receiver.

The input signal to the substitution antenna shall be recorded as a power level and corrected for any change of input attenuator setting of the measuring receiver.

The measurement shall be repeated with the test antenna and the substitution antenna oriented for horizontal polarization.

The measure of the effective radiated power of the spurious components is the larger of the two power levels recorded for each spurious component at the input to the substitution antenna, corrected for the gain of the substitution antenna if necessary.

4.2.4.3.2 Limits

The power of any radiated emission shall not exceed the values given in table 3.

Table 3

State	47 MHz to 74 MHz 87,5 MHz to 118 MHz 174 MHz to 230 MHz 470 MHz to 862 MHz	Other frequencies between 30 to 1 000 MHz
Operating	4 nW	250 nW

4.3 Conformance requirements for receivers parameters

4.3.1 Receiver sensitivity

4.3.1.1 Definition

The maximum usable sensitivity of the receiver is the minimum level of the signal (H-field strength) at the nominal frequency of the receiver which, when applied to the receiver input with normal test modulation (see clause 4.2.1.3), produces either of the following:

- a (S + N)/N ratio of 6 dB, measured at the terminals of the electroacoustic transducer for beacons with an acoustic signal indication;
- an unambiguous optical indication of a received beacon signal for beacons with optical signal indication.

4.3.1.2 Method of measurement

For beacons with an acoustic indicator, the terminals of the transducer shall be made accessible for the purposes of the present document.

A test signal at a carrier frequency equal to the nominal frequency of the receiver, modulated by the normal test modulation (see clause 4.2) shall be applied in the best coupling position, i.e. when the antenna rod is parallel to the lines of the magnetic field. An audio frequency load and a measuring instrument for measuring the S/N ratio shall be connected to the terminals of the electroacoustic transducer.

The level of the test signal shall be adjusted until a $(S + N)/N$ ratio of 6 dB is obtained. The $(S + N)/N$ ratio is measured flat over a bandwidth of 20 kHz. The field strength at the receiver shall be measured by a substitution method. Under these conditions, the level of the test signal at the input is the value of the reference maximum usable sensitivity which shall be recorded.

For beacons providing optical indication, the level of the test signal shall be adjusted until an unambiguous indication of the presence of a transmitter is obtained. The field strength at the receiver shall be measured by a substitution method. Under these conditions, the level of the test signal at the input is the value of the reference maximum usable sensitivity which shall be recorded.

4.3.1.3 Limits

The appropriate indication shall be achieved for a field strength not higher than 80 nA/m at a frequency of 457 kHz.

4.3.2 Receiver spurious emissions

4.3.2.1 Definition

The level of spurious emissions shall be measured at normal conditions as their effective radiated power or field strength radiated by the cabinet and the integral antenna.

4.3.2.2 Radiated H-field

4.3.2.2.1 Method of measurement (< 30 MHz)

The field strength shall be measured for frequencies below 30 MHz. The equipment under test shall be measured at a distance of 10 m on an outdoor test site. The test antenna shall be a calibrated shielded magnetic field antenna. The equipment under test and test antenna shall be arranged as stated in annex B, clause B.1.

The equipment under test shall be switched on in receive mode. The measuring receiver shall be tuned over the frequency range 9 kHz to 30 MHz.

At each frequency at which a spurious signal is detected the equipment under test and the test antenna shall be rotated until maximum field strength is indicated on the measuring receiver. This level shall be noted.

The limits are quoted in dB μ A or dB μ A/m, so it is necessary to reduce the reading as explained in annex D for measuring equipment calibrated in dB μ V or dB μ V/m.

4.3.2.2.2 Limits

Radiated emissions below 30 MHz shall not exceed the generated H-field at 10 m given in table 4.

Table 4

State	Frequency 9 kHz \leq f < 10 MHz	Frequency 10 MHz \leq f < 30 MHz
Receive	6 dB μ A/m descending 3 dB/oct	-24,5 dB μ A/m

A graphical representation is shown in annex C, figure C.1.

4.3.2.3 Effective radiated power

4.3.2.3.1 Method of measurement (\geq 30 MHz)

On a test site, selected from annex B, the equipment shall be placed at the specified height on a non-conducting support and in the position closest to normal use as declared by the manufacturer.

The test antenna shall be oriented for vertical polarization. The output of the test antenna shall be connected to a measuring receiver.

The equipment shall be switched on in receive mode, and the measuring receiver shall be tuned over the frequency range 30 MHz to 1 000 MHz.

At each frequency at which a spurious component is detected, the test antenna shall be raised and lowered through the specified range of heights until a maximum signal level is detected on the measuring receiver.

The equipment shall then be rotated through 360° in the horizontal plane, until the maximum signal level is detected by the measuring receiver.

The maximum signal level detected by the measuring receiver shall be noted.

The substitution antenna shall be oriented for vertical polarization and calibrated for the frequency of the spurious component detected.

The frequency of the calibrated signal generator shall be set to the frequency of the spurious component detected. The input attenuator setting of the measuring receiver shall be adjusted in order to increase the sensitivity of the measuring receiver, if necessary.

The test antenna shall be raised and lowered through the specified range of heights to ensure that the maximum signal is received.

When a test site according to clause B.3 is used, there is no need to vary the height of the antenna.

The input signal to the substitution antenna shall be adjusted until an equal or a known related level to that detected from the receiver is obtained on the measuring receiver.

The input signal to the substitution antenna shall be recorded as a power level and corrected for any change of input attenuator setting of the measuring receiver.

The measurement shall be repeated with the test antenna and the substitution antenna oriented for horizontal polarization.

The measure of the effective radiated power of the spurious components is the larger of the two power levels recorded for each spurious component at the input to the substitution antenna, corrected for the gain of the substitution antenna if necessary.

4.3.2.3.2 Limits

The power of any radiated emission shall not exceed the values given in table 5.

Table 5

State	30 MHz to 1 000 MHz
Operating	2 nW

4.3.3 Receiver blocking

Receiver blocking is not applicable for avalanche beacons, due to propagation physics (i.e. magnetic).

The operating range of avalanche beacons is very small, typically 60 m (the minimum range to be compliant to the standard is about 40 m).

Avalanche beacons use magnetic antennas. They operate in the near field (the transition near field / far field is at $\lambda/2\pi = 104$ m).

In the near field the magnetic field strength varies with $1/r^3$; therefore avalanche beacons receiver intrinsically need to handle large signal strength ratios: 60 m / 1 m correspond to a dynamic range of 106 dB at least.

This is tested indirectly with clause 4.4.2 of ETSI EN 300 718-2 [4] "Changes in the received signal".

5 Test conditions, power sources and ambient temperatures

5.1 Normal and extreme test conditions

Type testing shall be made under normal test conditions, and also, where stated, under extreme test conditions.

The test conditions and procedures shall be as specified in clauses 5.2 to 5.4.

5.2 External test power source

During type tests, the power source of the equipment shall be replaced by an external test power source capable of producing normal and extreme test voltages as specified in clauses 5.3.2 and 5.4.2. The internal impedance of the external test power source shall be low enough for its effect on the test results to be negligible. For the purpose of the tests, the voltage of the external test power source shall be measured at the input terminals of the equipment.

The non-grounded terminal of the batteries shall be disconnected, but batteries shall be left in place. The external test power source shall be suitably de-coupled and applied as close to the equipment battery terminals as practicable. The power leads shall be as short as practicable and properly dressed. For radiated measurements fully charged internal batteries should be used. The batteries used should be as supplied or recommended by the manufacturer.

During tests the external test power source voltages shall be within a tolerance $\pm 1\%$ relative to the voltage at the beginning of each test.

5.3 Normal test conditions

5.3.1 Normal temperature and humidity

The normal temperature and humidity conditions for tests shall be any convenient combination of temperature and humidity within the following ranges:

- temperature: $+15^{\circ}\text{C}$ to $+35^{\circ}\text{C}$;
- relative humidity: 20 % to 75 %.

When it is impracticable to carry out tests under these conditions, a note to this effect, stating the ambient temperature and relative humidity during the tests, shall be added to the test report.

5.3.2 Normal test voltage

The normal test voltage shall be declared by the manufacturer. The values shall be stated in the test report.

5.4 Extreme test conditions

5.4.1 Extreme temperatures

The extreme operating and storage temperatures used for the tests shall be those declared by the manufacturer for the equipment.

The equipment shall be able to operate correctly in the temperature range from -20 to $+45^{\circ}\text{C}$ and shall be stored without damage in the temperature range from -25 to $+70^{\circ}\text{C}$.

5.4.2 Extreme test voltages

5.4.2.1 General requirement

The extreme test voltages shall be declared by the manufacturer.

5.4.2.2 Procedure for tests at extreme temperatures

Before measurements are made the equipment shall have reached thermal balance in the test chamber.

The equipment shall be switched off during the temperature stabilizing period.

In the case of equipment containing temperature stabilization circuits designed to operate continuously, the temperature stabilization circuits shall be switched on for 15 minutes after thermal balance has been obtained, and the equipment shall then meet the specified requirements.

If the thermal balance is not checked by measurements, a temperature stabilizing period of at least one hour, or such period as may be decided by the accredited test laboratory, shall be allowed. The sequence of measurements shall be chosen, and the humidity content in the test chamber shall be controlled so that excessive condensation does not occur.

5.5 Measurement uncertainty

The interpretation of the results recorded in a test report for the measurements described in the present document shall be as follows:

- the measured value related to the corresponding limit will be used to decide whether an equipment meets the requirements of the present document;
- the value of the measurement uncertainty for the measurement of each parameter shall be included in the test report;
- the recorded value of the measurement uncertainty shall be, for each measurement, equal to or less than the figures in table 6.

Table 6

Parameter	Uncertainty
RF frequency	$\pm 1 \times 10^{-6}$
Radiated emission of transmitter, valid up to 1 GHz (Substitution method)	± 2 dB
Radiated emission of transmitter, valid up to 1 GHz (direct measurement, using calibrated antennas)	± 6 dB
Temperature	± 1 °C
Humidity	± 5 %
Transmitted H field at a distance of 10 m	$\pm 0,1$ μ A/m
Carrier keying times	± 3 ms
NOTE: For the test methods according to the present document the uncertainty figures are valid to a confidence level of 95 % calculated according to the methods described in the ETSI TR 100 028 [i.4].	

For the test methods, according to the present document, the measurement uncertainty figures shall be calculated and shall correspond to an expansion factor (coverage factor) $k = 1,96$ or $k = 2$ (which provide confidence levels of respectively 95 % and 95,45 % in the case where the distributions characterizing the actual measurement uncertainties are normal (Gaussian)). Principles for the calculation of measurement uncertainty are contained in ETSI TR 100 028-2 [i.4], annex D.

Table 6 is based on such expansion factors.

Annex A (informative): Relationship between the present document and the essential requirements of Directive 2014/53/EU

The present document has been prepared under the Commission's standardisation request C(2015) 5376 final [i.2] to provide one voluntary means of conforming to the essential requirements of Directive 2014/53/EU on the harmonisation of the laws of the Member States relating to the making available on the market of radio equipment and repealing Directive 1999/5/EC [i.1].

Once the present document is cited in the Official Journal of the European Union under that Directive, compliance with the normative clauses of the present document given in table A.1 confers, within the limits of the scope of the present document, a presumption of conformity with the corresponding essential requirements of that Directive and associated EFTA regulations.

Table A.1: Relationship between the present document and the essential requirements of Directive 2014/53/EU

Harmonised Standard ETSI EN 300 718-1					
Requirement				Requirement Conditionality	
No	Description	Essential requirements of Directive	Clause(s) of the present document	U/C	Condition
1	Modulation and carrier keying	3.2	4.2.1	U	
2	Frequency error	3.2	4.2.2	U	
3	Maximum output field strength	3.2	4.2.3	U	
4	Transmitter spurious emissions	3.2	4.2.4	U	
5	Receiver Sensitivity	3.2	4.3.1	U	
6	Receiver spurious emissions	3.2	4.3.2	U	

Key to columns:

Requirement:

No A unique identifier for one row of the table which may be used to identify a requirement.

Description A textual reference to the requirement.

Essential requirements of Directive

Identification of article(s) defining the requirement in the Directive.

Clause(s) of the present document

Identification of clause(s) defining the requirement in the present document unless another document is referenced explicitly.

Requirement Conditionality:

U/C Indicates whether the requirement is unconditionally applicable (U) or is conditional upon the manufacturer's claimed functionality of the equipment (C).

Condition Explains the conditions when the requirement is or is not applicable for a requirement which is classified "conditional".

Presumption of conformity stays valid only as long as a reference to the present document is maintained in the list published in the Official Journal of the European Union. Users of the present document should consult frequently the latest list published in the Official Journal of the European Union.

Other Union legislation may be applicable to the product(s) falling within the scope of the present document.

Annex B (normative): Test sites and general arrangements for measurements involving the use of radiated fields

B.1 General

B.1.1 Normal test signals

Tests on the transmitter shall be performed with the equipment switched on in the normal transmit mode.

For tests on the receiver, the test signal shall be an A1A signal modulated as indicated in clause 4.2.1.

B.1.2 Test fixture

The test fixture shall couple to the generated electromagnetic field from the equipment under test without disturbing the operation of the said device. The test fixture shall be provided with a 50 Ω standard connector, where the generated field can be sampled.

NOTE: A test fixture may be provided by the manufacturer to enable extreme temperature measurements to be made, where applicable.

The test laboratory shall calibrate the test fixture by carrying out the required field measurements at normal temperatures at the prescribed test site and then by repeating the same measurements on the equipment under test using the test fixture for all identified frequency components.

The test fixture is only required for extreme temperature measurements and shall be calibrated only with the equipment under test.

B.1.3 Measuring receiver

The term "measuring receiver" refers to a selective voltmeter or a spectrum analyser. The bandwidth of the measuring receiver shall be according to CISPR 16-1 [1], [2] and [3]. The quasi-peak detector for the measuring receiver shall be applied, see table B.1.

Table B.1

Frequency (f)	Detector type	Bandwidth
$9 \text{ kHz} \leq f < 150 \text{ kHz}$	Quasi-peak	200 Hz to 300 Hz
$150 \text{ kHz} \leq f < 30 \text{ MHz}$	Quasi-peak	9 kHz to 10 kHz
$30 \text{ MHz} \leq f \leq 1\,000 \text{ MHz}$	Quasi-peak	100 kHz to 120 kHz

B.2 Outdoor test site

B.2.1 General requirements

The outdoor test site shall be on a reasonably level surface or ground. For measurements at frequencies below 30 MHz no artificial ground plane shall be used. For measurements at frequencies 30 MHz and above, a conducting ground plane of at least 5 m diameter shall be provided at one point on the site. In the middle of this ground plane, a non-conducting support, capable of rotation through 360° in the horizontal plane, shall be used to support the test sample in its standard position, at 1 m above the ground plane, with the exception of equipment with floor standing antenna. For this equipment, the antenna shall be raised, on a non-conducting support, 100 mm above the turntable, the point(s) of contact being consistent with normal use. The test site shall be large enough to allow the erection of a measuring or transmitting antenna at a distance of 10 m or optionally 30 m. The distance actually used shall be recorded with the results of the tests carried out on the site.

Sufficient precautions shall be taken to ensure that reflections from extraneous objects adjacent to the site do not degrade the measurements results.

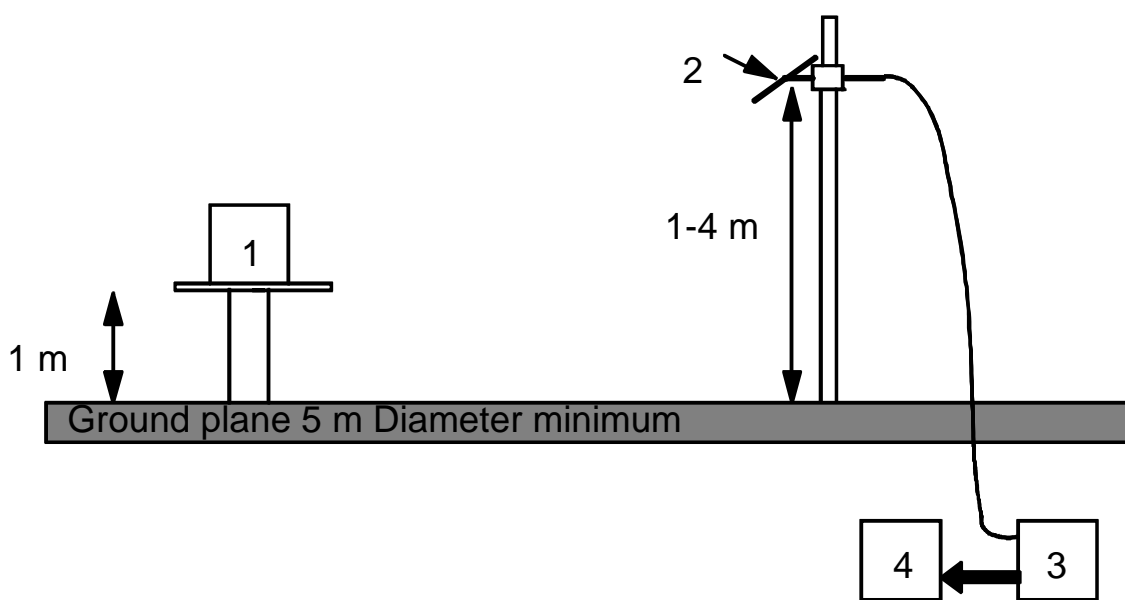

Figure B.1

B.2.2 Standard position

The standard position in all test sites, except for equipment which is intended to be worn on a person, shall be as follows:

- for equipment with an integral antenna, it shall be placed in the position closest to normal use as declared by the manufacturer;
- for equipment with a rigid external antenna, the antenna shall be vertical;
- for equipment with non-rigid external antenna, the antenna shall be extended vertically upwards by a non-conducting support.

For equipment intended to be worn close to the body or hand held, the non-conducting support may, at the request of the manufacturer be replaced with a simulated man, if appropriate. The use of the simulated man shall be stated in the test report.

The simulated man shall consist of an acrylic tube, filled with salt water (1,5 grams NaCl per litre of distilled water). The tube shall have a length of $1,7\text{ m} \pm 0,1\text{ m}$ and an internal diameter of $300\text{ mm} \pm 5\text{ mm}$ with side wall thickness of $1,5\text{ mm} \pm 0,5\text{ mm}$.

To reduce the weight of the simulated man it may be possible to use an alternative tube which has a hollow centre of 200 mm maximum diameter.

The sample shall be fixed to the surface of the simulated man, at the appropriate height for the equipment.

B.3 Test antenna

B.3.1 Below 30 MHz

A calibrated loop antenna shall be used to detect the field strength from the test sample. The antenna shall be supported in the vertical plane and be rotated about a vertical axis. The lowest point of the loop shall be 1 m above ground level.

B.3.2 Above 30 MHz

The test antenna is used to detect the radiation from both the test sample and the substitution antenna, when the site is used for radiation measurements. Where necessary, it is used as a transmitting antenna, when the site is used for the measurement of receiver characteristics.

This antenna is mounted on a support such as to allow the antenna to be used in either horizontal or vertical polarization and for the height of its centre above ground to be varied over the range 1 m to 4 m. Preferably a test antenna with pronounced directivity should be used. The size of the test antenna along the measurement axis shall not exceed 20 % of the measuring distance.

For receiver and transmitter radiation measurements, the test antenna is connected to a measuring receiver, capable of being tuned to any frequency under investigation and of measuring accurately the relative levels of signals at its input.

B.4 Substitution antenna

B.4.1 General

When measuring in the frequency range up to 1 GHz the substitution antenna shall be a $\lambda/2$ dipole, resonant at the operating frequency, or a shortened dipole, calibrated to the $\lambda/2$ dipole. The centre of this antenna shall coincide with the reference point of the test sample it has replaced. This reference point shall be the volume centre of the sample when its antenna is mounted inside the cabinet, or the point where an external antenna is connected to the cabinet.

The distance between the lower extremity of the dipole and the ground shall not be less than 0,3 m.

The substitution antenna shall be connected to a calibrated signal generator when the site is used for spurious radiation measurements and transmitter effective radiated power measurements. The substitution antenna shall be connected to a calibrated measuring receiver when the site is used for the measurement of receiver sensitivity.

The signal generator and the receiver shall operate at the frequencies under investigation and shall be connected to the antenna through suitable matching and balancing networks.

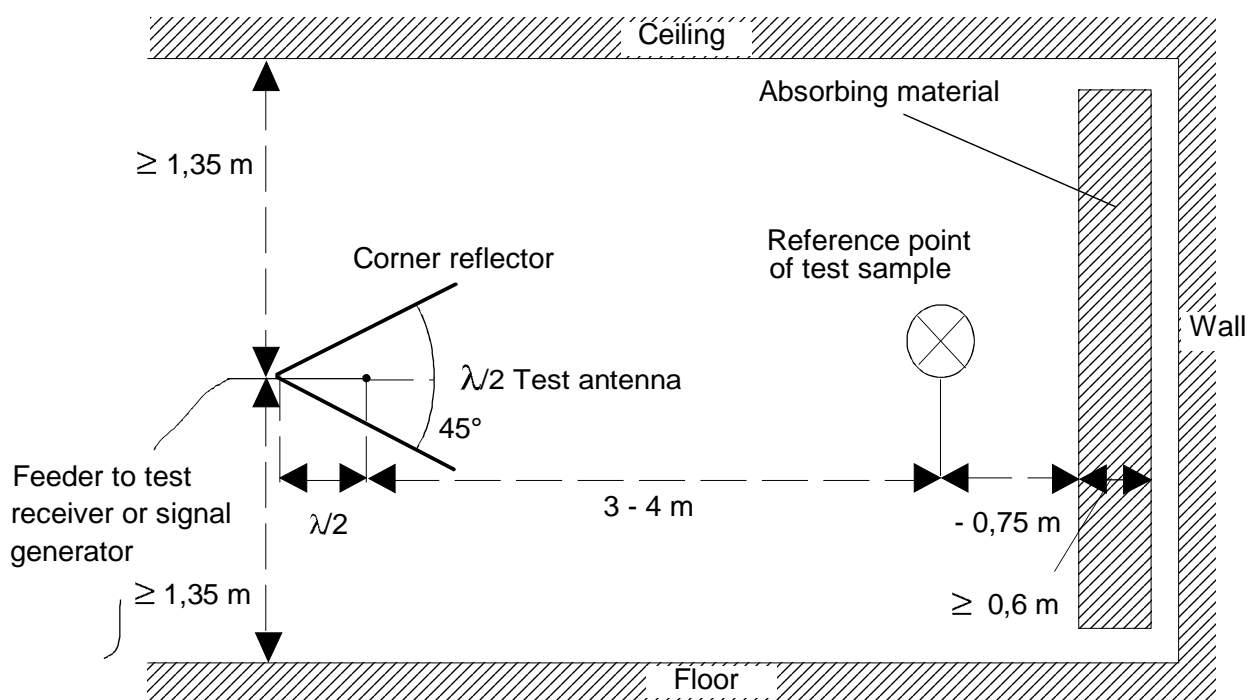

Figure B.2: Indoors site arrangement (shown for horizontal polarization)

B.4.2 Optional additional indoor site

When the frequency of the signals being measured is greater than 80 MHz, use may be made of an indoor test site. If this alternative site is used, this shall be recorded in the test report.

The measurement site may be a laboratory room with a minimum area of 6 m by 7 m and at least 2,7 m in height.

Apart from the measuring apparatus and the operator, the room shall be as free as possible from reflecting objects other than the walls, floor and ceiling.

The potential reflections from the wall behind the equipment under test are reduced by placing a barrier of absorbent material in front of it. The corner reflector around the test antenna is used to reduce the effect of reflections from the opposite wall and from the floor and ceiling, in the case of horizontally polarized measurements. Similarly, the corner reflector reduces the effects of reflections from the sidewalls for vertically polarized measurements. For the lower part of the frequency range (below approximately 175 MHz), no corner reflector or absorbent barrier is needed. For practical reasons, the $\lambda/2$ antenna in figure B.2 may be replaced by an antenna of constant length, provided that this length is between $\lambda/4$ and λ at the frequency of measurement, and the sensitivity of the measuring system is sufficient. In the same way, the distance of $\lambda/2$ to the apex may be varied.

The test antenna, measuring receiver, substitution antenna and calibrated signal generator are used in a way similar to that of the general method. To ensure that errors are not caused by the propagation path approaching the point at which phase cancellation between the direct and the remaining reflected signals occurs, the substitution antenna shall be moved through a distance of $\pm 0,1$ m in the direction of the test antenna as well as in the two directions perpendicular to this first direction.

If these changes of distance cause a signal change of greater than 2 dB, the test sample should be re-sited until a change of less than 2 dB is obtained.

B.5 Guidance on the use of radiation test sites

B.5.1 General

For measurements involving the use of radiated fields, use may be made of a test site in conformity with the requirements of clause B.1. When using such a test site, the following conditions should be observed to ensure consistency of measuring results.

B.5.2 Measuring distance

Evidence indicates that the measuring distance is not critical and does not significantly affect the measuring results, provided that the distance is not less than $\lambda/2$ at the frequency of measurement, and that the precautions described in this annex are observed. Measurements at low frequencies and distances less than $\lambda/2$ are considered in the present document and shall be followed. Measuring distances of 3 m, 5 m, 10 m and 30 m are in common use in European test laboratories. Measurements at distances different to 10 m need to have a correction factor added to give a resultant at 10 m so that comparison with the limit is possible. The correction factor used shall be stated in the test report.

B.5.3 Test antenna

Different types of test antenna may be used, since performing substitution measurements reduces the effect of the errors on the measuring results.

Height variation of the test antenna over a range of 1 m to 4 m is essential in order to find the point at which the radiation is maximum.

Height variation of the test antenna may not be necessary at the lower frequencies below approximately 100 MHz.

B.5.4 Substitution antenna

Variations in the measuring results may occur with the use of different types of substitution antenna at the lower frequencies below approximately 80 MHz. Where a shortened dipole antenna is used at these frequencies, details of the type of antenna used should be included with the results of the tests carried out on the test site. Correction factors shall be taken into account when shortened dipole antennas are used.

B.5.5 Artificial antenna

The dimensions of the artificial antenna used during radiated measurements should be small in relation to the sample under test.

Where possible, a direct connection should be used between the artificial antenna and the test sample. In cases where it is necessary to use a connecting cable, precautions should be taken to reduce the radiation from this cable by, for example, the use of ferrite cores or double-screened cables.

B.5.6 Auxiliary cables

The position of auxiliary cables (power supply and microphone cables, etc.) which are not adequately de-coupled, may cause variations in the measurement results. In order to get reproducible results, cables and wires of auxiliaries should be arranged vertically downwards (through a hole in the non-conducting support), or as specified in the technical documentation supplied with the equipment.

Care shall be taken to ensure that test cables do not adversely affect the measuring result.

B.6 Further optional alternative indoor test site using an anechoic chamber

B.6.1 General

For radiation measurements, when test frequency of the signals being measured is greater than 30 MHz, use may be made of an indoor test site being a well-shielded anechoic chamber simulating a free space environment. If such a chamber is used, this shall be recorded in the test report.

The test antenna, measuring receiver, substitution antenna and calibrated signal generator are used in a way similar to that of the general method, clause B.1. In the range 30 MHz to 100 MHz, some additional calibration may be necessary.

An example of a typical measurement site may be an electrically shielded anechoic chamber being 10 m long, 5 m broad and 5 m high. Walls and ceiling should be coated with RF absorbers of 1 m height. The base should be covered with absorbing material 1 m thick, and a wooden floor, capable of carrying test equipment and operators. The construction of the anechoic chamber is described in the following clauses.

B.6.2 Example of the construction of a shielded anechoic chamber

Free-field measurements can be simulated in a shielded measuring chamber where the walls are coated with RF absorbers. Figure B.3 shows the requirements for shielding loss and wall return loss of such a room. As dimensions and characteristics of usual absorber materials are critical below 100 MHz (height of absorbers < 1 m, reflection attenuation < 20 dB) such a room is more suitable for measurements above 100 MHz. Figure B.4 shows the construction of an anechoic shielded measuring chamber having a base area of 5 m by 10 m and a height of 5 m.

Ceilings and walls are coated with pyramidal formed RF absorbers approximately 1 m high. The base is covered with absorbers forming a non-conducting sub-floor or with special ground floor absorbers. The available internal dimensions of the room are 3 m × 8 m × 3 m, so that a maximum measuring distance of 5 m length in the middle axis of this room is available.

At 100 MHz the measuring distance can be extended up to a maximum of 2λ .

The floor absorbers reduce floor reflections so that the antenna height need not be changed and floor reflection influences need not be considered.

All measuring results can therefore be checked with simple calculations and the measurement uncertainties have the smallest possible values due to the simple measuring configuration.

B.6.3 Influence of parasitic reflections in anechoic chambers

For free-space propagation in the far field condition the correlation $E = E_0 (R_0/R)$ is valid for the dependence of the field strength E on the distance R , whereby E_0 is the reference field strength in the reference distance R_0 .

It is useful to use this correlation for comparison measurements, as all constants are eliminated with the ratio and neither cable attenuation, nor antenna mismatch, or antenna dimensions are of importance.

Deviations from the ideal curve can be seen easily if the logarithm of the above equation is used, because the ideal correlation of field strength and distance can then be shown as a straight line and the deviations occurring in practice are clearly visible. This indirect method more readily shows the disturbances due to reflections and is far less problematical than the direct measurement of reflection attenuation.

With an anechoic chamber of the dimensions suggested in clause B.4 at low frequencies up to 100 MHz, there are no far field conditions and therefore reflections are stronger so that careful calibration is necessary; in the medium frequency range from 100 MHz to 1 GHz the dependence of the field strength on the distance meets the expectations very well.

B.6.4 Calibration of the shielded RF anechoic chamber

Careful calibration of the chamber shall be performed over the range 30 MHz to 1 GHz.

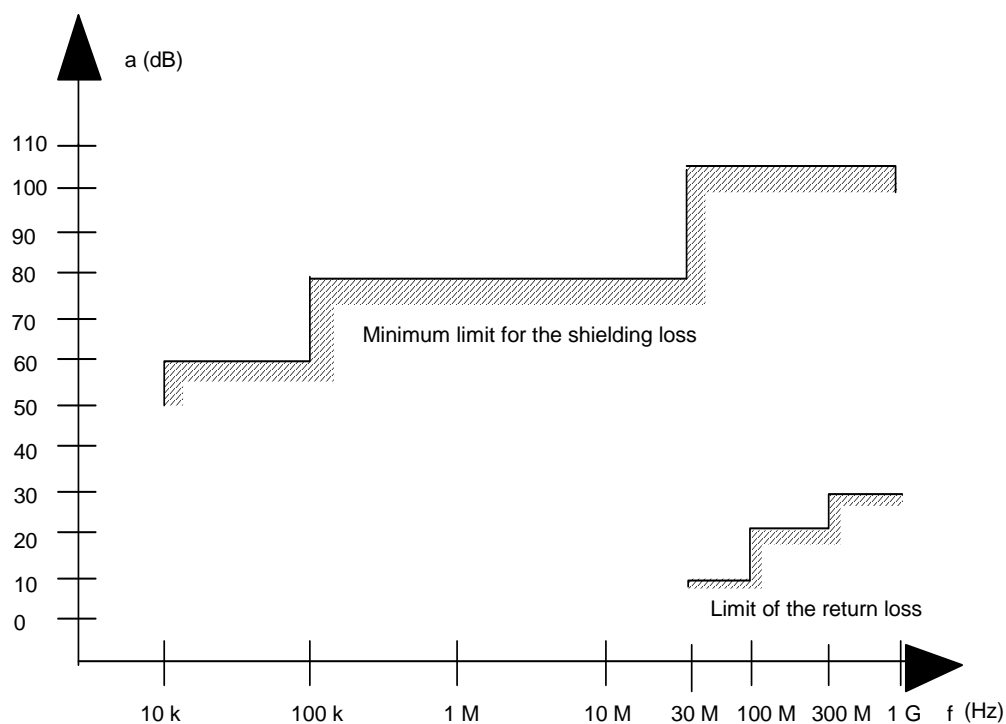
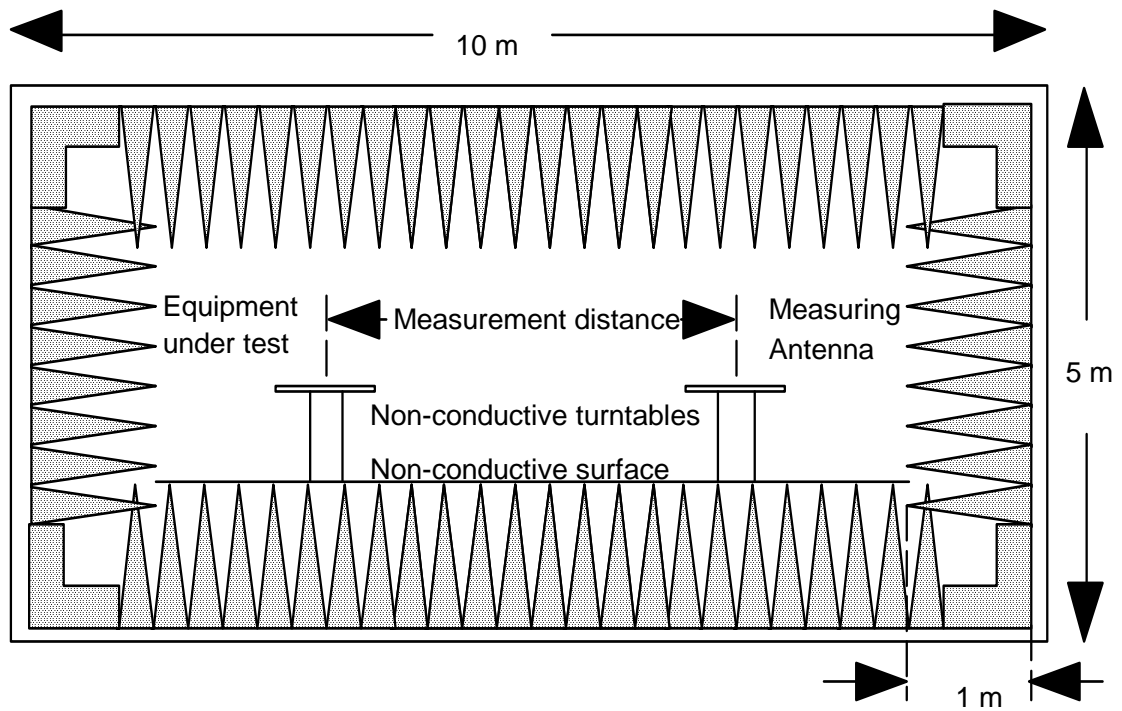

Figure B.3: Specification for shielding and reflections



Ground plan

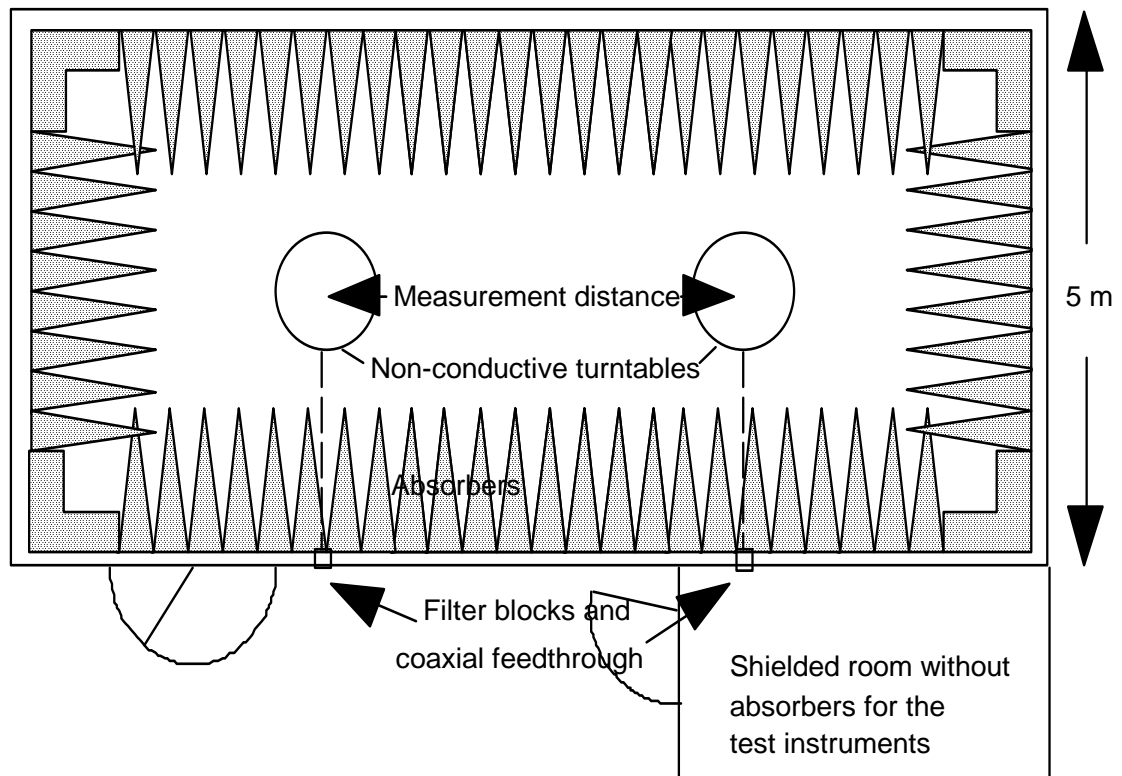

Figure B.4: Example of construction of an anechoic-shielded chamber

Annex C (normative):
Spurious limits, radiated H-field at 10 m distances

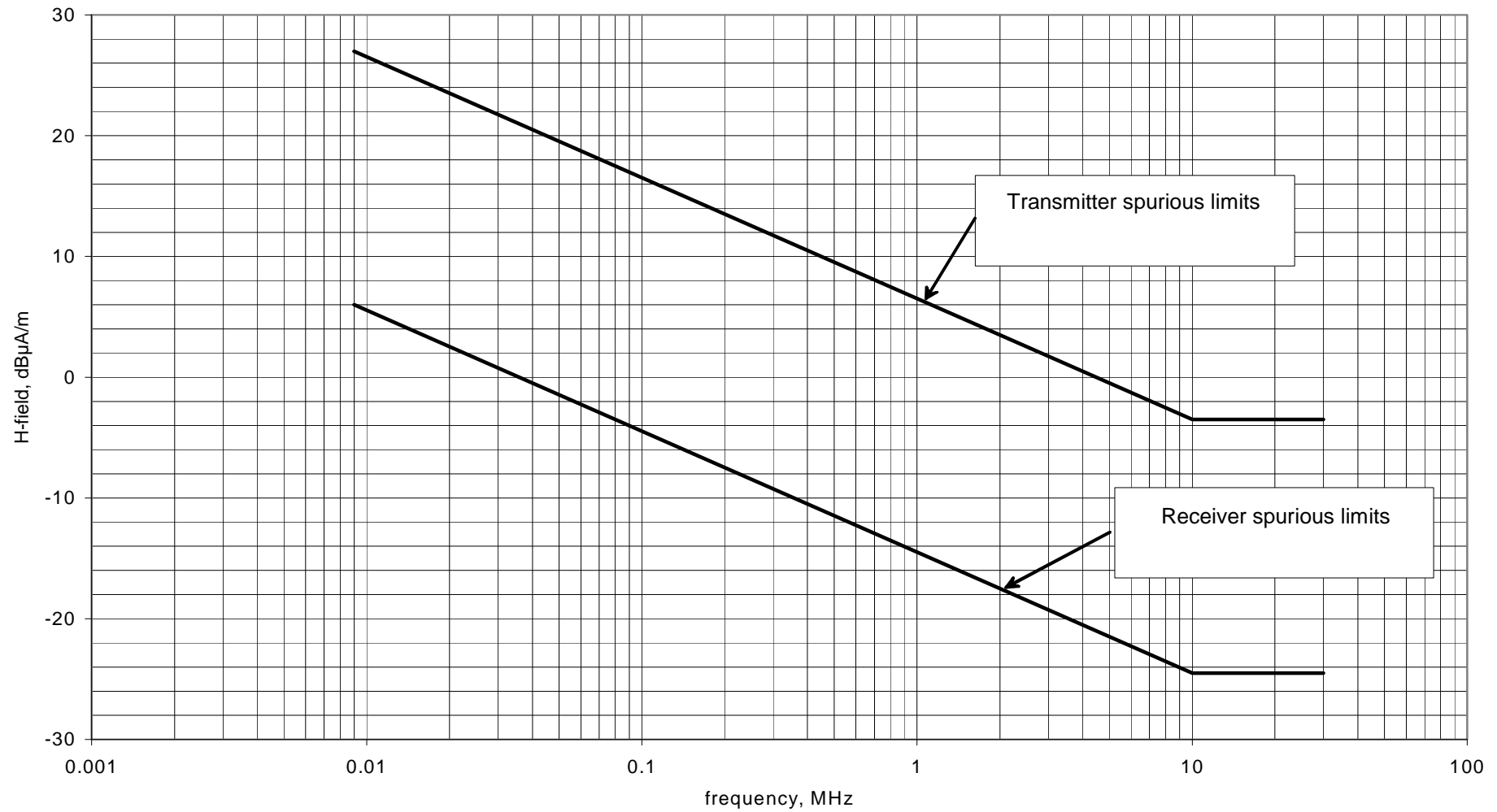

Figure C.1

Annex D (informative): E-fields in the near field at low frequencies

E-field at low frequencies is often in the near field and it is in reality only possible to measure with the shielded loop antenna; in this case there is also a relation between the E-field and the H-field by the wave impedance Z . In the near field the wave impedance is highly dependent on the type of radiating antenna (loop or open end wire) and the wavelength. If the power density at a certain distance is the same for a H-field and an E-field generated signal, the following calculation can be made:

In the direction of maximum power in the near field, the power density S is:

$$S = \frac{E^2}{Z_e} = H_e^2 Z_e = H_m^2 Z_m \quad (\text{D.1})$$

where:

- S = power density;
- E = electrical field generated by an E-field antenna at distance d ;
- H_e = magnetic field generated by an E-field antenna at distance d ;
- H_m = magnetic field generated by a H-field antenna at distance d ;
- Z_e = wave impedance of a field generated by an E-field antenna at distance d ;
- Z_m = wave impedance of a field generated by an H-field antenna at distance d .

$$Z_m = Z_0 2\pi \frac{d}{\lambda} \text{ if } d < \frac{\lambda}{2\pi} \quad (\text{near field}) \quad (\text{D.2})$$

$$Z_e = Z_0 \frac{\lambda}{2\pi d} \text{ if } d < \frac{\lambda}{2\pi} \quad (\text{near field}) \quad (\text{D.3})$$

Equation (D.1) gives:

$$H_e = H_m \sqrt{\frac{Z_m}{Z_e}} \quad (\text{A/m}) \quad (\text{D.4})$$

Equations (D.2) and (D.3) into (D.4) give:

$$H_e = H_m \frac{2\pi d}{\lambda} = H_m \frac{2\pi d f_c}{300} \quad (\text{D.5})$$

where f_c is the carrier frequency in MHz.

For $2\pi d/\lambda = 1$, $d = 10\text{m}$ and $f_c = 4,78$ MHz, and using equation (D.5), this gives:

$$H_e = H_m \frac{f_c}{4,78} \quad (\text{f in MHz}) \quad (\text{D.6})$$

For $2\pi d/\lambda < 1$ if $f_c < 4,78$ MHz then equation (D.5) is valid, (i.e. near field).

For $2\pi d/\lambda > 1$ if $f_c > 4,78$ MHz then $H_e = H_m$, (i.e. far field).

The method allows an electric generated E-field to be measured as a magnetic generated H-field by adding a correction factor derived from (D.6).

For a graphical representation of the correction factor, see figure D.1.

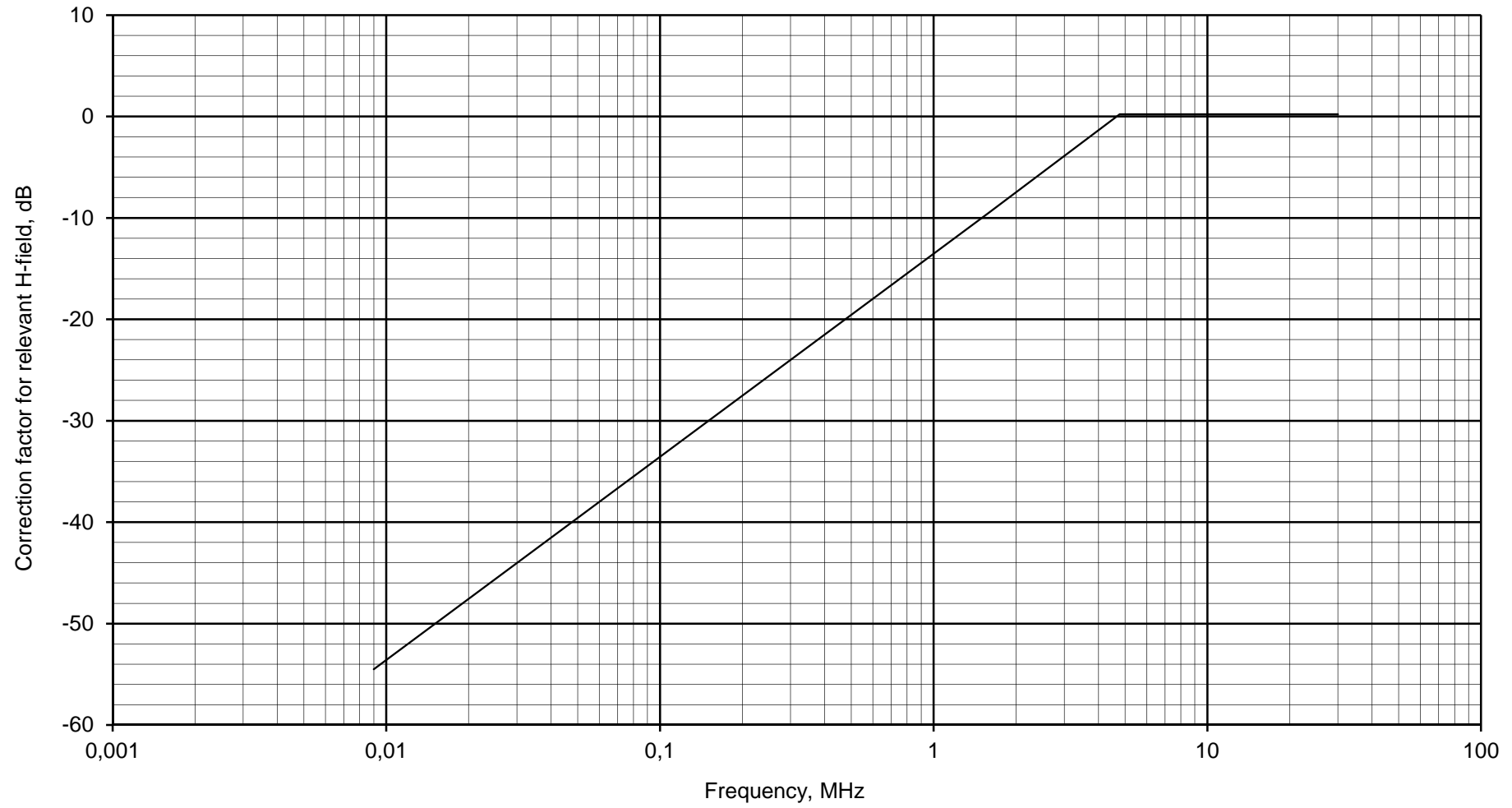

Figure D.1

Annex E (informative): Change history

Version	Information about changes
2.1.1	Receiver sensitivity was added

History

Document history		
Edition 1	March 1997	Publication as ETSI ETS 300 718
V1.1.1	January 1999	Publication as ETSI TS 100 718 (Historical)
V1.2.1	May 2001	Publication
V2.1.0	September 2017	EN Approval Procedure AP 20171217: 2017-09-18 to 2017-12-18
V2.1.1	January 2018	Publication