

Final draft **ETSI EN 300 452** V1.2.1 (2001-02)

---

*European Standard (Telecommunications series)*

**Access and Terminals (AT);  
Special quality voice bandwidth  
4-wire analogue leased line (A4S);  
Connection characteristics  
and network interface presentation**

---



---

**Reference**

REN/AT-010005

---

**Keywords**

ONP, leased line

**ETSI**

650 Route des Lucioles  
F-06921 Sophia Antipolis Cedex - FRANCE

---

Tel.: +33 4 92 94 42 00 Fax: +33 4 93 65 47 16

Siret N° 348 623 562 00017 - NAF 742 C  
Association à but non lucratif enregistrée à la  
Sous-Préfecture de Grasse (06) N° 7803/88

---

**Important notice**

Individual copies of the present document can be downloaded from:

<http://www.etsi.org>

The present document may be made available in more than one electronic version or in print. In any case of existing or perceived difference in contents between such versions, the reference version is the Portable Document Format (PDF). In case of dispute, the reference shall be the printing on ETSI printers of the PDF version kept on a specific network drive within ETSI Secretariat.

Users of the present document should be aware that the document may be subject to revision or change of status. Information on the current status of this and other ETSI documents is available at <http://www.etsi.org/tb/status/>

If you find errors in the present document, send your comment to:  
editor@etsi.fr

---

**Copyright Notification**

No part may be reproduced except as authorized by written permission.  
The copyright and the foregoing restriction extend to reproduction in all media.

© European Telecommunications Standards Institute 2001.  
All rights reserved.

# Contents

|  |           |
|--|-----------|
| Intellectual Property Rights .....                                 | 5         |
| Foreword.....  | 5         |
| Introduction.....  | 5         |
| 1 Scope.....   | 6         |
| 2 References.....  | 6         |
| 3 Definitions and abbreviations.....                               | 7         |
| 3.1 Definitions .....  | 7         |
| 3.2 Abbreviations.....   | 7         |
| 4 Requirements and tests .....                                     | 8         |
| 4.1 Connection characteristics .....                               | 8         |
| 4.1.1 Tabulation of connection characteristics .....               | 8         |
| 4.1.2 Overall loss.....  | 8         |
| 4.1.3 Loss/frequency distortion .....                              | 9         |
| 4.1.4 Transmission signals.....                                    | 9         |
| 4.1.4.1 Maximum mean input power .....                             | 9         |
| 4.1.4.2 Maximum instantaneous power.....                           | 10        |
| 4.1.4.3 Maximum signal power at 10 Hz bandwidth.....               | 10        |
| 4.1.4.4 Maximum input power outside the voice band.....            | 10        |
| 4.1.5 Transmission delay .....                                     | 10        |
| 4.1.6 Group-delay distortion .....                                 | 11        |
| 4.1.7 Variation of overall loss with time.....                     | 12        |
| 4.1.7.1 Amplitude hits.....  | 12        |
| 4.1.7.2 Other variations .....                                     | 12        |
| 4.1.8 Random circuit noise.....                                    | 12        |
| 4.1.9 Impulsive noise.....   | 12        |
| 4.1.10 Phase jitter .....  | 12        |
| 4.1.11 Distortion.....   | 13        |
| 4.1.11.1 Quantizing distortion .....                               | 13        |
| 4.1.11.2 Total distortion .....                                    | 13        |
| 4.1.12 Single tone interference.....                               | 13        |
| 4.1.13 Frequency error.....  | 13        |
| 4.1.14 Harmonic distortion .....                                   | 13        |
| 4.2 Interface presentation .....                                   | 13        |
| 4.2.1 Connector specification.....                                 | 14        |
| 4.2.2 Hardwired presentation .....                                 | 14        |
| 4.2.3 Return loss.....   | 14        |
| 4.2.4 Power feeding.....   | 15        |
| 4.3 Safety.....  | 15        |
| 4.4 Overvoltage.....   | 15        |
| 4.5 ElectroMagnetic Compatibility (EMC) .....                      | 15        |
| 4.6 Availability .....   | 15        |
| <b>Annex A (normative): Test methods .....</b>                     | <b>16</b> |
| A.1 General.....   | 16        |
| A.1.1 Equipment connection.....                                    | 16        |
| A.1.2 Reference impedance.....                                     | 16        |
| A.1.3 Measurement frequency.....                                   | 16        |
| A.2 Test Methods .....   | 17        |
| A.2.1 Overall loss .....   | 17        |
| A.2.2 Loss/frequency distortion and maximum mean input power ..... | 18        |
| A.2.3 Transmission delay.....                                      | 19        |
| A.2.4 Group delay distortion.....                                  | 19        |

|  |   |           |
|--|---|-----------|
| A.2.5  | Amplitude hits.....                       | 20        |
| A.2.6  | Random circuit noise.....                 | 21        |
| A.2.7  | Impulsive noise.....                      | 21        |
| A.2.8  | Phase jitter.....                         | 22        |
| A.2.9  | Total distortion.....                     | 23        |
| A.2.10   | Single tone interference.....             | 23        |
| A.2.11   | Frequency error.....                      | 24        |
| A.2.12   | Harmonic distortion.....                  | 24        |
| A.2.13   | Maximum instantaneous power.....          | 25        |
| A.2.14   | Return loss.....                          | 26        |
| A.2.15   | Power feeding.....                        | 27        |
| <b>Annex B (informative): Weighted return loss measurements .....</b>      |   | <b>28</b> |
| B.1  | Introduction.....                         | 28        |
| B.2  | Weighting function.....                   | 28        |
| B.2.1  | Calculation (trapezoidal rule).....       | 28        |
| B.2.2  | Calculation (tabulated data).....         | 29        |
| <b>Annex C (informative): Overall loss and quantizing distortion .....</b> |   | <b>30</b> |
| C.1  | Introduction.....                         | 30        |
| C.2  | Overall loss.....                         | 31        |
| C.3  | Quantizing distortion.....                | 32        |
| <b>Annex D (informative): Availability .....</b>                           |   | <b>33</b> |
| D.1  | General.....                              | 33        |
| D.1.1  | Unavailability.....                       | 33        |
| D.1.2  | Availability.....                         | 33        |
| D.2  | Definition of unavailability periods..... | 33        |
| D.3  | Availability figures.....                 | 35        |
| <b>Annex E (informative): Bibliography.....</b>                            |   | <b>36</b> |
| History.....   |   | 37        |

---

## Intellectual Property Rights

IPRs essential or potentially essential to the present document may have been declared to ETSI. The information pertaining to these essential IPRs, if any, is publicly available for **ETSI members and non-members**, and can be found in ETSI SR 000 314: "*Intellectual Property Rights (IPRs); Essential, or potentially Essential, IPRs notified to ETSI in respect of ETSI standards*", which is available from the ETSI Secretariat. Latest updates are available on the ETSI Web server (<http://www.etsi.org/ipr>).

Pursuant to the ETSI IPR Policy, no investigation, including IPR searches, has been carried out by ETSI. No guarantee can be given as to the existence of other IPRs not referenced in ETSI SR 000 314 (or the updates on the ETSI Web server) which are, or may be, or may become, essential to the present document.

---

## Foreword

This European Standard (Telecommunications series) has been produced by ETSI Technical Committee Access and Terminals (AT), and is now submitted for the ETSI standards One-step Approval Procedure.

The present document resulted from a mandate from the Commission of the European Community (CEC) to provide standards for support of the Directive on Open Network Provision (ONP) of leased lines (92/44/EEC).

There is another standard directly related to the present document:

EN 300 453: "Access and Terminals (AT); Ordinary and Special quality voice bandwidth 4-wire analogue leased lines (A4O and A4S); Terminal equipment interface".

The present document is based on information from ITU-T Recommendations and ETSI publications and the relevant documents are quoted where appropriate.

| <b>Proposed national transposition dates</b>   |                                 |
|--|---------------------------------|
| Date of latest announcement of this EN (doa):  | 3 months after ETSI publication |
| Date of latest publication of new National Standard or endorsement of this EN (dop/e): | 6 months after doa              |
| Date of withdrawal of any conflicting National Standard (dow):                         | 6 months after doa              |

---

## Introduction

The Council Directive on the application of ONP to used lines (92/44/EEC) (see annex E), concerns the harmonization of conditions for open and efficient access to, and use of, the leased lines provided over public telecommunications networks and the availability throughout the European Union (EU) of a minimum set of leased lines with harmonized technical characteristics.

The consequence of the Directive is that telecommunications organizations within the EU shall make available a set of leased lines within and between points in these countries with specified connection characteristics and specified interfaces. Under the Directive 91/263/EEC (see annex E), later replaced by 98/13/EC (see annex E), terminal equipment for connection to these leased lines was required to fulfil certain essential requirements.

The present version of the present document has been produced to introduce some necessary changes.

ITU-T Recommendation M.1020 (see annex E) was used as the basis for the connection characteristics.

---

# 1 Scope

The present document specifies the technical requirements and test principles for the connection characteristics and the physical and electrical characteristics (except safety, overvoltage and EMC aspects) of the network interface presentation of special quality, voice bandwidth, 4-wire, analogue leased lines, provided as part of the minimum set under the Council Directive on the application of Open Network Provision (ONP) to leased lines (92/94/EEC) (see annex E).

A connection is presented via interfaces at Network Termination Points (NTPs) and includes any equipment that may provide the NTP. Signals between terminal equipments are subject to impairments during their transfer over the connection. The limits to these impairments are stated in the present document although in practice the overall performance may be considerably better.

The leased line provides access to the voice bandwidth (300 Hz to 3 400 Hz) with no restrictions on the use of the frequencies. The requirements of the present document have been chosen primarily for the transmission of data between terminal equipments without equalizers although there is no restriction on the use of the leased line for other types of traffic.

The present document is applicable for leased lines, including part time leased lines, for which the establishment or release does not require any protocol exchange or other intervention at the NTP.

The tests specified in the present document cannot be carried out, nor can performance be monitored by the leased line provider, while the leased line is in service, i.e. carrying user's traffic. Thus the tests are designed for bringing into and returning into service although there is no obligation to perform these tests each time the leased line is brought into or returned into service.

The present document covers the physical, mechanical and electrical characteristics of the network interface and specifies the conformance tests for the connection characteristics and network interface. Some of the tests described in the present document are not designed to be applied to the interface of an installed leased line; such tests may be applied to equipment of the kind used to provide the interface.

The present document does not include details concerning the implementation of the tests nor does it include information on any regulations concerning testing.

---

# 2 References

The following documents contain provisions which, through reference in this text, constitute provisions of the present document.

- References are either specific (identified by date of publication, edition number, version number, etc.) or non-specific.
- For a specific reference, subsequent revisions do not apply.
- For a non-specific reference, the latest version applies.

- [1] ITU-T Recommendation O.71 (1988): "Impulsive noise measuring equipment for telephone-type circuits".
- [2] ITU-T Recommendation O.81 (1988): "Group-delay measuring equipment for telephone-type circuits".
- [3] ITU-T Recommendation O.91 (1988): "Phase jitter measuring equipment for telephone-type circuits".
- [4] ITU-T Recommendation O.95 (1988): "Phase and amplitude hit counters for telephone-type circuits".
- [5] ITU-T Recommendation O.132 (1988): "Quantizing distortion measuring equipment using a sinusoidal test signal".

- [6] CENELEC EN 28877 (1989): "Information processing systems - Interface connector and contact assignments for ISDN basic access interface located at reference points S and T".
- [7] ITU-T Recommendation O.41 (1994): "Psophometer for use on telephone-type circuits".
- [8] ETSI EN 300 453: "Access and Terminals (AT); Ordinary and Special quality voice bandwidth 4-wire analogue leased lines (A4O and A4S); Terminal equipment interface".

---

## 3 Definitions and abbreviations

### 3.1 Definitions

For the purposes of the present document, the following terms and definitions apply:

**group delay:** measure of the propagation time through the leased line. For a given frequency it is equal to the first derivative of the phase shift through the leased line, measured in radians, with respect to the angular frequency measured in radians per second

**group delay distortion:** difference between group delay at a given frequency and minimum group delay, in the frequency band of interest

**leased lines:** telecommunications facilities provided by a public telecommunication network that provide defined transmission characteristics between network termination points and that do not include switching functions that the user can control, (e.g. on-demand switching)

**Network Termination Point (NTP):** all physical connections and their technical access specifications which form part of the public telecommunications network and are necessary for access to and efficient communication through that public network

**reference impedance  $Z_R$ :** this is 600  $\Omega$ . See also clause A.1.2

**terminal equipment:** equipment intended to be connected to the public telecommunication network; i.e.:

- to be connected directly to the termination of a public telecommunication network; or
- to interwork with a public telecommunication network being connected directly or indirectly to the termination of a public telecommunication network,

in order to send, process, or receive information

**voice bandwidth:** band of frequencies over the range 300 Hz to 3 400 Hz

### 3.2 Abbreviations

For the purposes of the present document, the following abbreviations apply:

|        |   |
|--------|---|
| $a$    | Return loss in dB   |
| $a(f)$ | Return loss at frequency $f$ in dB  |
| $a_w$  | Weighted return loss in dB  |
| $A(f)$ | Return loss at frequency $f$ expressed as a ratio                                     |
| A4S    | Special quality voice bandwidth 4-wire analogue leased line                           |
| ADPCM  | Adaptive Differential Pulse Coded Modulation  |
| EMC    | ElectroMagnetic Compatibility   |
| $f$    | frequency   |
| NTP    | Network Termination Point   |
| ONP    | Open Network Provision  |
| qdu    | quantizing distortion unit  |
| rms    | root mean square  |
| RX     | Receive is a signal input at either the leased line interface or the test equipment   |
| TX     | Transmit is a signal output at either the leased line interface or the test equipment |

$Z_R$ 

Reference impedance

## 4 Requirements and tests

### 4.1 Connection characteristics

The special quality voice bandwidth 4-wire analogue leased line is a bidirectional line, configured point-to-point, nominally covering the voice bandwidth. The connection is, in general, symmetrical, i.e. each direction of transmission has the same nominal characteristics, although the actual values are independent.

#### 4.1.1 Tabulation of connection characteristics

The parameters defining the characteristics of the connection are given in table 1. These characteristics define the service offered.

**Table 1: Network performance characteristics**

| Description  | Nature   | Reference clause |
|--|--|------------------|
| Overall loss   | $0 \leq \text{overall loss} \leq 13 \text{ dB}$                          | 4.1.2            |
| Loss/frequency distortion  | table 2, figure 1  | 4.1.3            |
| Transmission signals   |  | 4.1.4            |
| - maximum mean input power   | -13 dBm  | 4.1.4.1          |
| - maximum instantaneous power  | 0 dBm  | 4.1.4.2          |
| - signal power in a 10 Hz bandwidth  | no requirement   | 4.1.4.3          |
| - maximum input power outside voice band   | no requirement   | 4.1.4.4          |
| Transmission delay   |  | 4.1.5            |
| - terrestrial (for distance G in kilometres)   | $< (15 + 0,01 G) \text{ ms}$   |                  |
| - via satellite  | $< 350 \text{ ms}$   |                  |
| Group delay distortion   | table 3, figure 2  | 4.1.6            |
| Variation of overall loss with time  |  | 4.1.7            |
| - amplitude hits   | $\leq 10$ in a 15 minute period  | 4.1.7.1          |
| - other variations   | $\pm 4 \text{ dB}$ of that at 1 020 Hz                                   | 4.1.7.2          |
| Random circuit noise   | $< -41 \text{ dBm0p}$ (see note)   | 4.1.8            |
| Impulsive noise  | $\leq 18$ peaks $\geq -21 \text{ dBm0}$ in a 15 minute period (see note) | 4.1.9            |
| Phase jitter   | $\leq 10^\circ$ peak to peak   | 4.1.10           |
| Total distortion   |  | 4.1.11           |
| - quantizing distortion  | $\leq 3 \text{ qdu}$ ; no ADPCM  | 4.1.11.1         |
| - total distortion   | $> 28 \text{ dB}$ signal to distortion ratio                             | 4.1.11.2         |
| Single tone interference   | $\leq -44 \text{ dBm0}$ (see note)                                       | 4.1.12           |
| Frequency error  | $\leq \pm 5 \text{ Hz}$  | 4.1.13           |
| Harmonic distortion  | $\geq 25 \text{ dB}$ below fundamental                                   | 4.1.14           |
| NOTE: Where the output relative level is not defined, an alternative value is specified in the reference clause. |  |                  |

#### 4.1.2 Overall loss

**Requirement:** The overall loss, including long term variations, presented to a signal frequency of 1 020 Hz sent at a power level of -13 dBm in each direction of transmission with the line terminated in  $600 \Omega$  at each end shall be in the range:

$$0 \leq \text{overall loss} \leq 13 \text{ dB.}$$

NOTE: The overall loss in each direction can be different.

**Test:** The test shall be conducted according to clause A.2.1.



### 4.1.3 Loss/frequency distortion

**Requirement:** The overall loss relative to that defined in clause 4.1.2 above for the connection, presented to a signal sent at a power level of -13 dBm with the line terminated in 600  $\Omega$  at each end shall lie between the limits given in table 2 and figure 1.

Below 300 Hz and above 3 600 Hz the relative loss shall not be less than -2 dB and 0 dB respectively, but is otherwise unspecified.

**Table 2: Limits for loss of the circuit relative to that at 1 020 Hz**

| Upper limit             |              |                  | Lower limit             |              |                  |
|-------------------------|--------------|------------------|-------------------------|--------------|------------------|
| Point<br>(see figure 1) | Frequency Hz | Relative loss dB | Point<br>(see figure 1) | Frequency Hz | Relative loss dB |
| A                       | 300          | 6                | G                       | 500          | -2               |
| B                       | 500          | 6                | H                       | 500          | -1               |
| C                       | 500          | 3                | I                       | 2 800        | -1               |
| D                       | 2 800        | 3                | J                       | 2 800        | -2               |
| E                       | 2 800        | 6                | K                       | 3 600        | -2               |
| F                       | 3 000        | 6                | L                       | 3 600        | 0                |

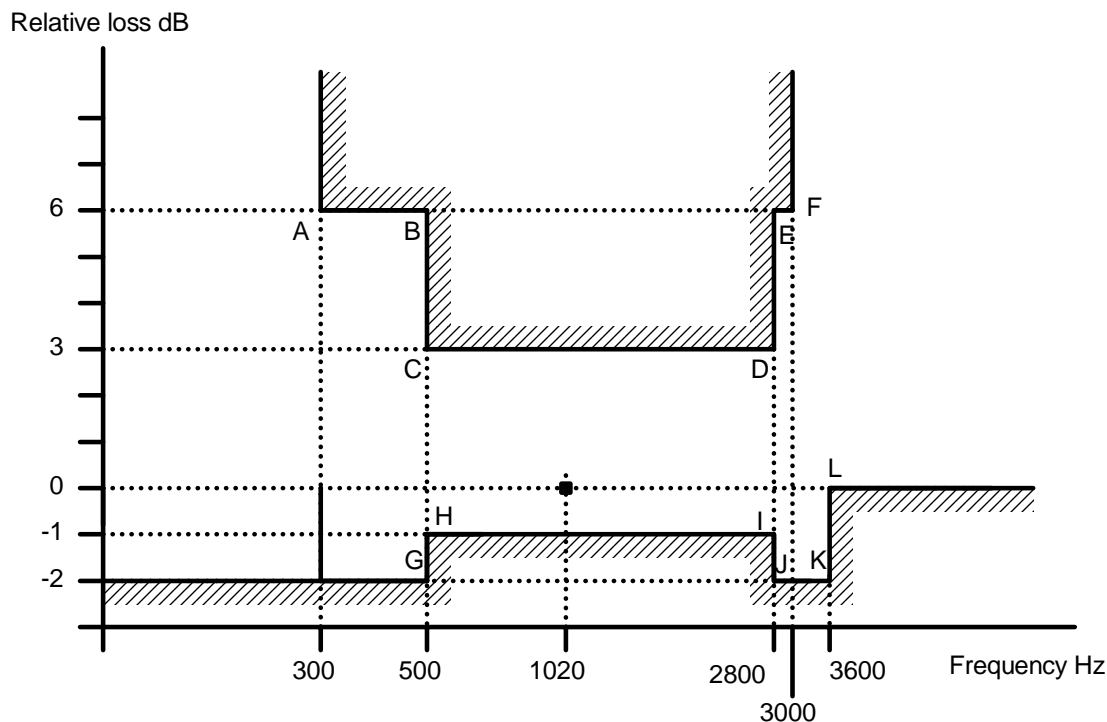

**Figure 1: Limits for overall loss of the circuit relative to that at 1 020 Hz**

**Test:** The test shall be conducted according to clause A.2.2.

### 4.1.4 Transmission signals

#### 4.1.4.1 Maximum mean input power

**Requirement:** The leased line shall be capable of carrying any signal presented at the input with a one minute mean power level of -13 dBm within a voice bandwidth of 300 Hz to 3 400 Hz with the line terminated in 600  $\Omega$  at each end.

**Test:** The test shall be conducted according to clause A.2.2.

#### 4.1.4.2 Maximum instantaneous power

**Requirement:** The leased line shall be capable of carrying a signal at the input having a maximum value equal to an instantaneous power which is 13 dB above the mean value of -13 dBm (i.e. 0 dBm).

NOTE: This value is based upon a provisional ITU-T value. See ITU-T Recommendation V.2 (see annex E).

**Test:** The test shall be conducted according to clause A.2.13.

#### 4.1.4.3 Maximum signal power at 10 Hz bandwidth

There is no requirement for maximum power in a 10 Hz bandwidth.

NOTE: However, there is a corresponding requirement on the terminal equipment specified in EN 300 453 [8].

#### 4.1.4.4 Maximum input power outside the voice band

NOTE: The leased line interface is not suitable for the handling of signals below 300 Hz and above 3 400 Hz. Out of band signals from the terminal equipment are limited to avoid trouble in the network (see terminal equipment interface requirement in EN 300 453 [8]).

### 4.1.5 Transmission delay

**Requirement:** The requirement depends upon whether satellite transmission is involved in the connection or not:

- 1) a) for connections where satellite transmission is not involved the one way end-to-end delay shall be less than  $(15 + 0,01 G)$  ms, where G is the geographical distance in kilometres, as shown in figure 2; or

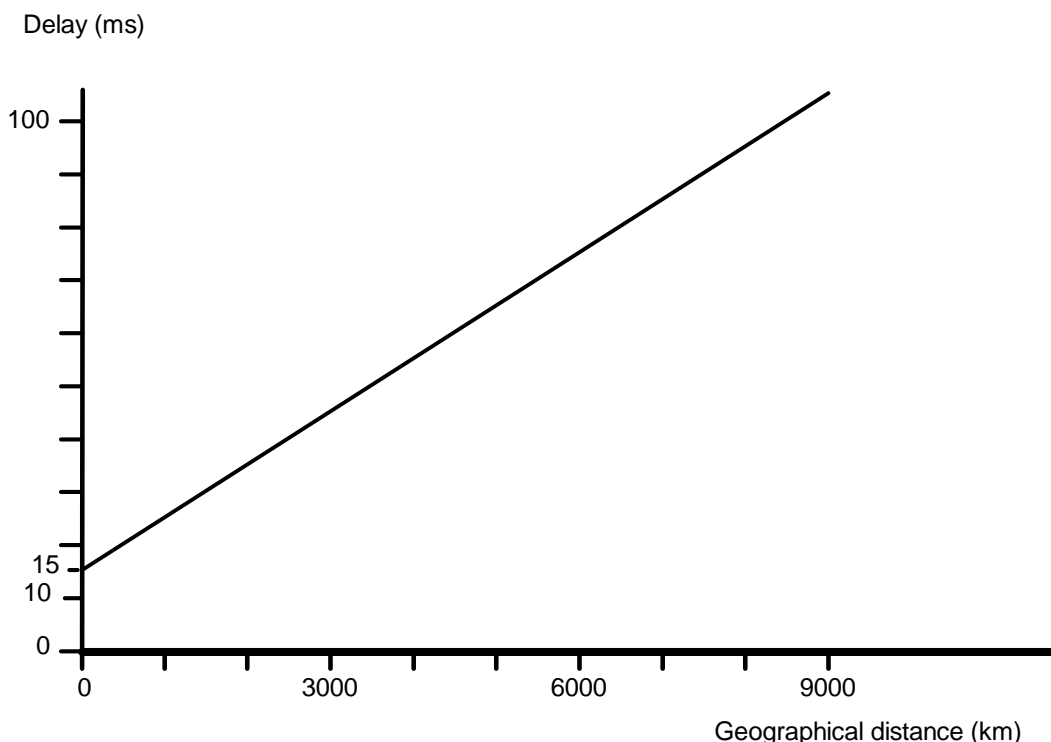

**Figure 2: Upper limit of delay**

- b) for connections where satellite transmission is involved the one way end-to-end delay shall be less than 350 ms.

NOTE: Requirements a) and b) are based on annex A.2 and A.3 of ITU-T Recommendation G.114 (see annex E), with suitable adjustment to requirement a) to allow for the possible use of loaded cable.

**Test:** The test shall be conducted according to clause A.2.3.

#### 4.1.6 Group-delay distortion

**Requirement:** The connection shall conform to the limits for group delay distortion given in table 3 and figure 3 in which the limiting values over the frequency band are expressed as values relative to the minimum measured group delay in the 500 Hz to 2 800 Hz frequency band.

NOTE: Figure 3 is based on figure 2 of ITU-T Recommendation M.1020 (see annex E).

**Table 3: Limits for group delay relative to the minimum measured group delay in the 500 Hz to 2 800 Hz band**

| Upper limit             |              |                           |
|-------------------------|--------------|---------------------------|
| Point<br>(see figure 3) | Frequency Hz | Group delay distortion ms |
| A                       | 500          | 3,0                       |
| B                       | 600          | 3,0                       |
| C                       | 600          | 1,5                       |
| D                       | 1 000        | 1,5                       |
| E                       | 1 000        | 0,5                       |
| F                       | 2 600        | 0,5                       |
| G                       | 2 600        | 3,0                       |
| H                       | 2 800        | 3,0                       |

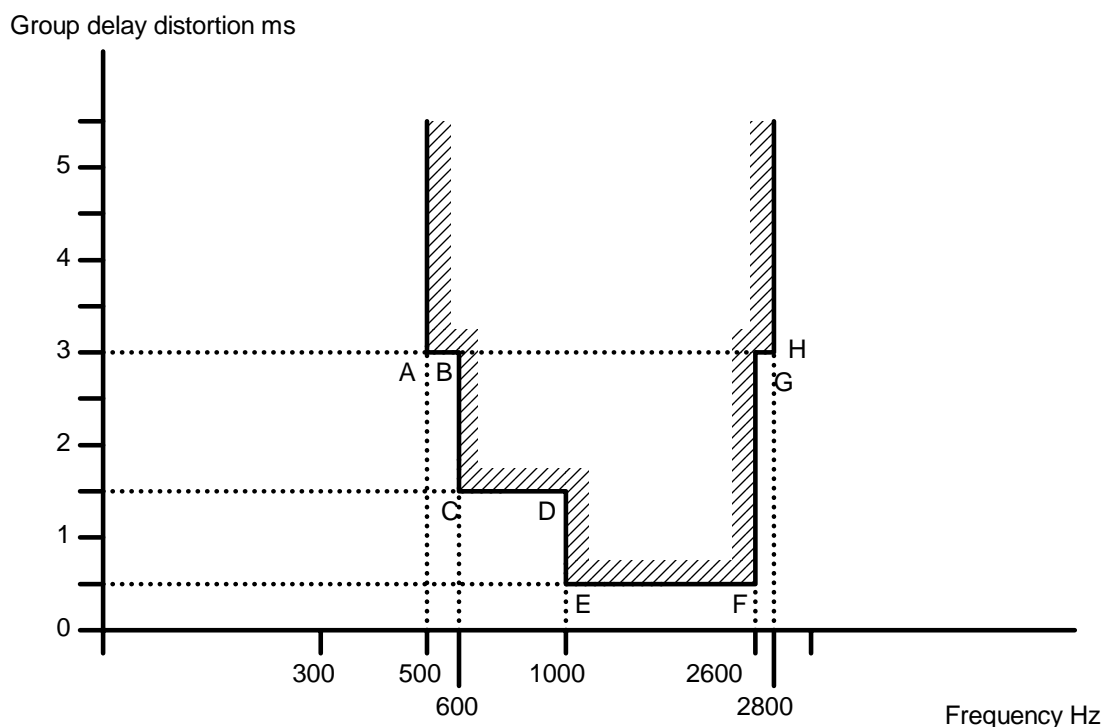

**Figure 3: Limits for group delay relative to the minimum measured group delay in the 500 Hz to 2 800 Hz band**

**Test:** The test shall be conducted according to clause A.2.4.

## 4.1.7 Variation of overall loss with time

### 4.1.7.1 Amplitude hits

**Requirement:** When measurements are made using an instrument complying with ITU-T Recommendation O.95 [4] with the send level set at -13 dBm at a frequency of 1 020 Hz, the number of amplitude hits greater than  $\pm 2$  dB shall not exceed 10 in any 15 minute measuring period.

NOTE: Phase or amplitude hits are defined as sudden positive or negative changes in phase or amplitude of an observed test signal which exceed a specified threshold and persist for a period of time greater than a specified duration.

**Test:** The test shall be conducted according to clause A.2.5.

### 4.1.7.2 Other variations

**Requirement:** For a particular implementation variations with time of the overall loss at 1 020 Hz (including daily and seasonal variations but excluding amplitude hits) shall not exceed  $\pm 4$  dB variation from the value established by the test for overall loss, see clause 4.1.2. Any such variation shall not result in an overall loss greater than the maximum specified in clause 4.1.2.

**Test:** There is no test for this but the record of the results of successive tests of overall loss may be used to check compliance. The test shall be conducted according to clause A.2.1.

## 4.1.8 Random circuit noise

**Requirement:** The level of the psophometric noise power at the output of the leased line shall be less than -41 dBm<sub>0p</sub>. In order that this parameter can be tested, the leased line provider should declare the planned value of the output relative level of the leased line.

Where the output relative level either is not, or cannot be, declared by the leased line provider, the psophometrically weighted random circuit noise level shall be 28 dB below a received test signal which is sent at a level of -13 dBm at a frequency of 1 020 Hz into the far end of the leased line.

**Test:** The test shall be conducted according to clause A.2.6.

### 4.1.9 Impulsive noise

**Requirement:** With an input signal level of -13 dBm applied at a frequency of 1 020 Hz to the input of the leased line, there shall not be more than 18 impulsive noise peaks exceeding a threshold level of -21 dBm<sub>0</sub> within a period of 15 minutes. In order that this parameter can be tested, the leased line provider should declare the planned value of the output relative level of the leased line.

Where the output relative level either is not, or cannot be, declared by the leased line provider, the threshold level shall be 8 dB below the received signal level. Thus, if a signal level of -13 dBm is applied at the input and the line loss is 13 dB then the received signal level will be -26 dBm and the threshold for impulsive noise peaks will be -34 dBm.

**Test:** The test shall be conducted according to clause A.2.7.

### 4.1.10 Phase jitter

**Requirement:** The phase jitter shall be less than or equal to 10° peak-to-peak when measured at a frequency of 1 020 Hz.

**Test:** The test shall be conducted according to clause A.2.8.

## 4.1.11 Distortion

### 4.1.11.1 Quantizing distortion

**Requirement:** The quantizing distortion shall not exceed 3 quantizing distortion unit (qdu). Moreover, Adaptive Differential Pulse Coded Modulation (ADPCM) systems shall not be used.

**NOTE:** In some cases (e.g. international leased lines spanning several transit countries, particular network configurations), an allocation of 4 qdu may be needed.

**Test:** There is no test. This requirement shall be checked by calculation using information from the network plans.

### 4.1.11.2 Total distortion

**Requirement:** With a power level of -13 dBm applied at a frequency of 1 020 Hz to the input of the leased line, the signal to total distortion ratio shall be greater than 28 dB.

**Test:** The test shall be conducted according to clause A.2.9.

## 4.1.12 Single tone interference

**Requirement:** The power level of single tone interference in the band 300 Hz to 3 400 Hz shall not exceed -44 dBm<sub>0</sub>, that is 3 dB less than the permitted noise power level (see clause 4.1.8). In order that this parameter can be tested, the leased line provider should declare the planned value of the output relative level of the leased line.

Where the output relative level either is not, or cannot be, declared by the leased line provider, the power level of any single tone shall be 31 dB below a received test signal which is sent at a level of -13 dBm at a frequency of 1 020 Hz into the far end of the leased line.

**Test:** The test shall be conducted according to clause A.2.10.

## 4.1.13 Frequency error

**Requirement:** The frequency error introduced by the connection shall be less than or equal to  $\pm 5$  Hz when measured at a frequency of 1 020 Hz.

**Test:** The test shall be conducted according to clause A.2.11.

## 4.1.14 Harmonic distortion

**Requirement:** When a 700 Hz test frequency of -13 dBm is injected at the input of the leased line, the level of any individual harmonic frequency at the output shall be at least 25 dB below the received level of the fundamental frequency.

**Test:** The test shall be conducted according to clause A.2.12.

## 4.2 Interface presentation

The physical connection arrangements shall normally be by a socket as specified in clause 4.2.1; however at the specific request of the user the connection arrangements specified in clause 4.2.2 shall be provided.

### 4.2.1 Connector specification

**Requirement:** The network interface shall provide an 8-contact socket of the type specified in EN 28877 [6] and with contact assignments as specified in table 4.

**Table 4: Contact assignment**

| Contact | Network interface |
|---------|-------------------|
| 1       | Unused            |
| 2       | Unused            |
| 3 & 6   | Receive pair      |
| 4 & 5   | Transmit pair     |
| 7       | Unused            |
| 8       | Unused            |

NOTE: The transmit pair is the output from the network interface. The receive pair is the input to the network interface as shown in figure 4. Where the terms "output" and "input" are used without qualification in the present document, they refer to the network interface.

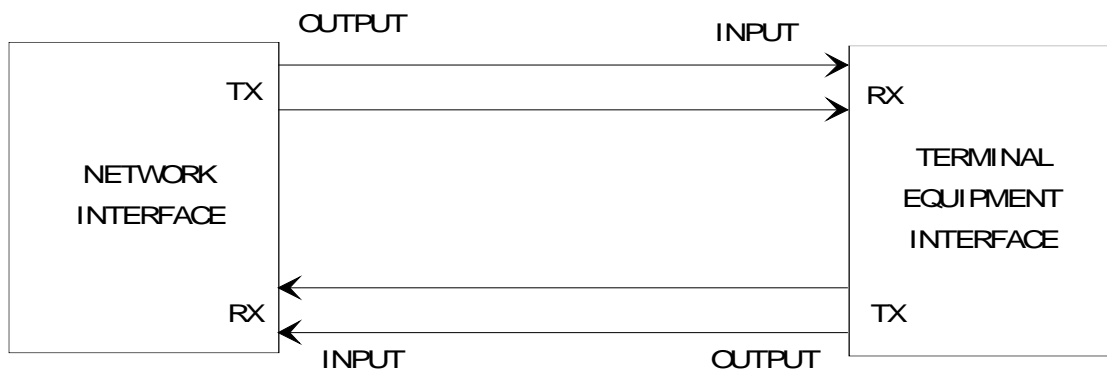

**Figure 4: Leased line configuration conventions**

**Test:** There shall be a visual inspection that the socket is of the correct type. The contact assignments are tested indirectly through the tests in annex A.

### 4.2.2 Hardwired presentation

**Requirement:** The network interface shall provide a set of connection contacts (e.g. an insulation displacement connector or a screw terminal block) to which solid conductors with wire diameters in the range 0,4 mm to 0,6 mm may be connected. The leased line provider shall provide information on the configuration of the connection contacts used for each leased line interface.

**Test:** There shall be a visual inspection that both the connection method provided suitable for taking solid conductors as defined in the requirement and that information on the configuration is provided.

NOTE: All subsequent tests are carried out via the appropriate connection method.

### 4.2.3 Return loss

**Requirement:** The return loss presented by the network interface against the reference impedance, when the far end interface of the connection is terminated by the reference impedance, shall either be:

- greater than 6 dB over the frequency range 300 Hz to 3 400 Hz when measured with a voltage equivalent to a signal power level at the input to the leased line of -13 dBm at 1 020 Hz; or
- if the return loss is not greater than 6 dB at all frequencies, then the weighted return loss against the reference impedance shall be greater than 6 dB over the frequency range 300 Hz to 3 400 Hz, when measured with a voltage equivalent to a signal power at the input to the leased line of -13 dBm at 1 020 Hz.

The weighted return loss  $a_w$  shall be given by:

$$a_w = 3,85 - 10 \log \left[ \int_{300}^{3400} \frac{A(f)}{f} df \right] \text{ dB}$$

where  $A(f) = 10^{-a(f)/10}$ ; and

$a(f)$  is the measured return loss at frequency  $f$  expressed in dB.

**Test:** The test shall be conducted according to clause A.2.14.

#### 4.2.4 Power feeding

**Requirement:** The network interface shall not feed power to the terminal equipment interface and shall not require power from the terminal equipment interface.

**Test:** The test for power output from the network interface shall be conducted according to clause A.2.15. The test for the requirement not to support power feeding from the terminal interface is tested indirectly through the various tests of annex A since no power is supplied over the network interface from the test equipment.

### 4.3 Safety

Requirements for safety are outside the scope of the present document.

Safety standards are published by CENELEC.

NOTE 1: An example of such a CENELEC product safety standard is EN 60950 (see annex E).

NOTE 2: For safety categories of interfaces, see EG 201 212 (see annex E). This document is also available from CENELEC as ROBT-002.

### 4.4 Overvoltage

Overvoltage aspects are outside the scope of the present document.

### 4.5 ElectroMagnetic Compatibility (EMC)

EMC requirements are outside the scope of the present document.

### 4.6 Availability

There is no requirement on availability under the present document.

NOTE 1: Annex D provides information about availability values for analogue leased lines.

NOTE 2: At present some leased line providers include availability performance, defined on an individual basis as a quality of service parameter, as part of the contracted supply conditions for their leased line offerings.

---

## Annex A (normative): Test methods

### A.1 General

This annex describes the test principles to be used to determine the compliance of a leased line connection and network interface presentation against the requirements of the present document.

It is outside the scope of this annex to identify the specific details of the implementation of the tests.

Details of test equipment accuracy and the specification tolerance of the test devices are not included in all cases. Where such details are provided, they shall be complied with, but the way they are expressed shall not constrain the method of implementing the test.

NOTE: Attention is drawn to the issue of measurement uncertainty which may be addressed in future documents. Not all the required test results make allowance for spurious events during testing (e.g. errors due to EMC effects), which may make it necessary to repeat a test.

The test configurations given do not imply a specific realization of the test equipment or test arrangement, or the use of specific test devices. However any test configuration used shall provide those test conditions specified under "interface state", "stimulus" and "monitor" for each individual test.

The test equipment shall be a device, or group of devices, that is capable of generating a stimulus signal conforming to the present document and capable of monitoring the receive signal from the network interface.

#### A.1.1 Equipment connection

The leased line interface may be supplied with either a socket or a set of contacts suitable for termination of solid conductors. Testing shall be performed at the socket or contact points as this is the point at which compliance with the present document is required.

#### A.1.2 Reference impedance

Where the test defines the use of the reference impedance ( $Z_R$ ), this shall be a non-reactive resistance of  $600 \Omega \pm 0,25 \%$ .

#### A.1.3 Measurement frequency

Many of the requirements specify a test signal frequency of 1 020 Hz. Where this is the case, the specified reference frequency tolerance shall be -7 Hz to +2 Hz (range 1 013 Hz to 1 022 Hz).



## A.2 Test Methods

### A.2.1 Overall loss

**Requirement:** Clauses 4.1.2 and 4.1.7.2.

**Purpose:** To determine the overall loss of the leased line.

**Test configuration:** A test sender is connected to one interface of the leased line. A level meter is connected to the far end interface of the leased line which is terminated in the reference impedance. See figure A.1.

The test is repeated in the other direction.

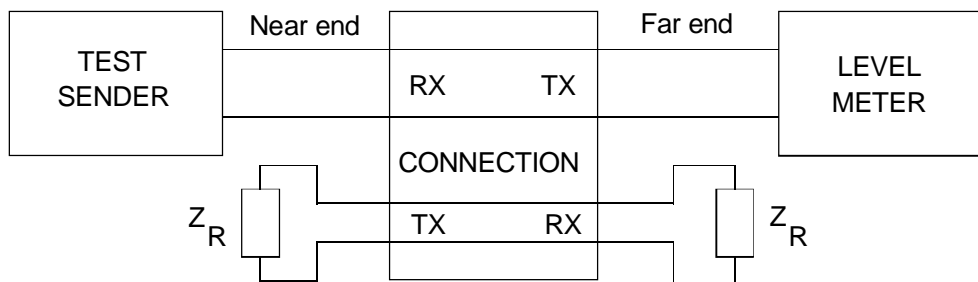

**Figure A.1: Overall loss**

**Connection state:** Available.

**Stimulus:** The test sender, with an impedance of  $600 \Omega$ , is set to send a signal frequency of  $1\,020 \text{ Hz}$  into a load impedance consisting of the reference impedance at a power level of  $-13 \text{ dBm}$ . The load impedance is then disconnected and the signal applied to one interface of the leased line.

**Monitor:** The power level is measured at the far end of the leased line with a terminating impedance of  $600 \Omega$ .

**Result:** The overall loss, which is the difference between  $-13 \text{ dBm}$  and the measured output power, shall be as defined in clause 4.1.2.

**NOTE:** For the purposes of checking the requirement of clause 4.1.7.2 the test result may be recorded every time the test is performed during the lifetime of the leased line and the record checked for deviation from the limits set in clause 4.1.7.2.

## A.2.2 Loss/frequency distortion and maximum mean input power

**Requirement:** Clauses 4.1.3 and 4.1.4.1.

**Purpose:** To check the loss/frequency distortion of the leased line over the bandwidth 300 Hz to 3 600 Hz. This test also serves to check the requirement for maximum mean input power handling capacity of the leased line interface over the bandwidth 300 Hz to 3 400 Hz.

**Test configuration:** A test sender, with an impedance of 600  $\Omega$ , is connected to one interface of the leased line. A level meter is connected to the far end interface of the leased line which is terminated in 600  $\Omega$ . See figure A.2.

The test is repeated in the other direction.

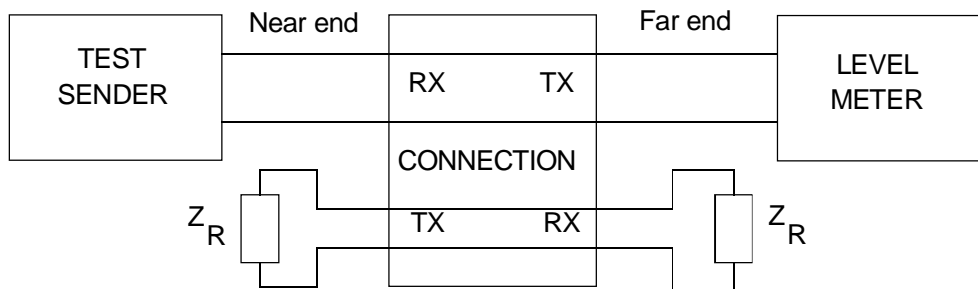

**Figure A.2: Loss/frequency distortion and maximum mean input power**

**Connection state:** Available.

**Stimulus:** The test sender, with an impedance of 600  $\Omega$ , is set to send a signal at a number of frequencies within the range 300 Hz to 3 600 Hz into a load impedance of 600  $\Omega$  at a power level of -13 dBm. At each frequency in turn the load impedance is disconnected and the signal applied to one interface of the leased line.

**Monitor:** The power level is measured at the far end of the leased line with a terminating impedance of 600  $\Omega$ .

**Result:** Relative to the received level measured in clause A.2.1 the received levels at other frequencies shall be within the limits defined by table 2 and figure 1.

## A.2.3 Transmission delay

**Requirement:** Clause 4.1.5.

**Purpose:** To check the transmission delay of the leased line.

**NOTE:** This test describes general principles only. Test equipment for the performance of the test may not be readily available and therefore special implementations may be needed.

**Test configuration:** See figure A.3.

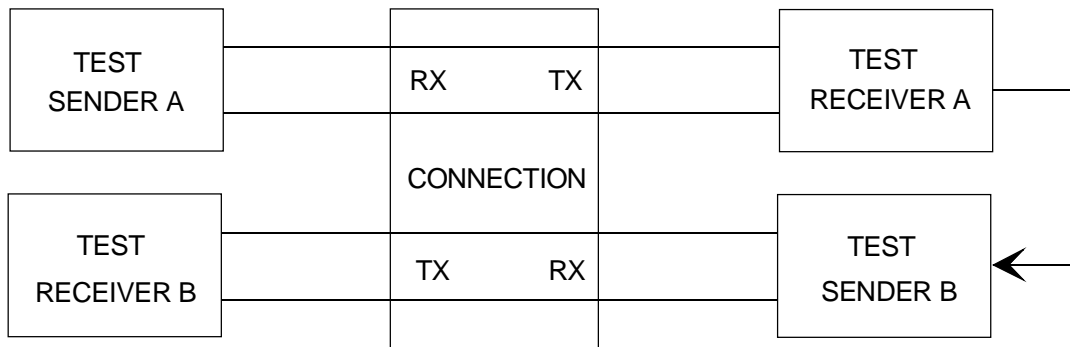

**Figure A.3: Measurement of transmission delay**

**Connection state:** Available.

**Stimulus:** Test sender A shall send a distinctive signal within the bandwidth of the leased line. Test sender B shall commence transmission of a distinctive signal at a known time after the receipt of the test signal from test sender A.

**Monitor:** The delay between test sender A commencing transmission of the signal and the receipt of the signal returned to test receiver B.

**Result:** The transmission delay of the leased line calculated from the measurements shall be less than the limits specified in clause 4.1.5.

## A.2.4 Group delay distortion

**Requirement:** Clause 4.1.6.

**Purpose:** To check the group delay distortion of the leased line.

**Test configuration:** A measuring set, to the specification of ITU-T Recommendation O.81 [2], is connected with the transmitter at one end of the connection to be measured, which may include the return connection, and the receiver is connected to the other end of the connection. Figure A.4 illustrates the case where the test is performed on one direction of transmission.

The test is repeated in the other direction.

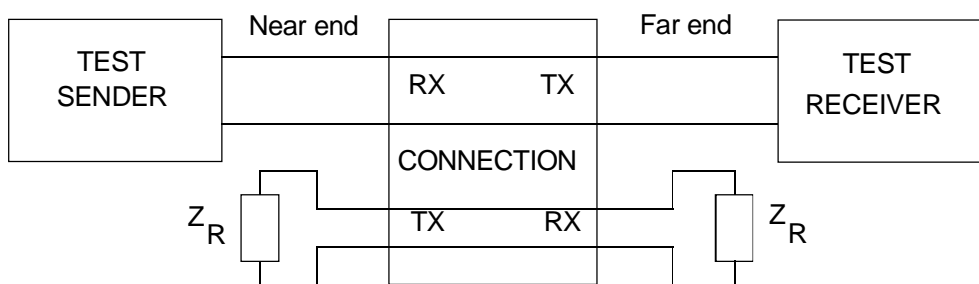

**Figure A.4: Group delay distortion**

- Connection state:** Available.
- Stimulus:** Modulated, identified, reference and measurement frequency signal, as described in ITU-T Recommendation O.81 [2].
- Monitor:** The group delay.
- Result:** The group delay shall be within the range specified in clause 4.1.6.

## A.2.5 Amplitude hits

- Requirement:** Clause 4.1.7.1.
- Purpose:** To check the leased line for amplitude hits.
- Test configuration:** Performed using an instrument complying with ITU-T Recommendation O.95 [4].

The transmitter (test sender) is connected to one interface of the circuit under test, which may include a return connection, and the receiver is connected to the other interface. See figure A.5.

The test is repeated in the other direction.

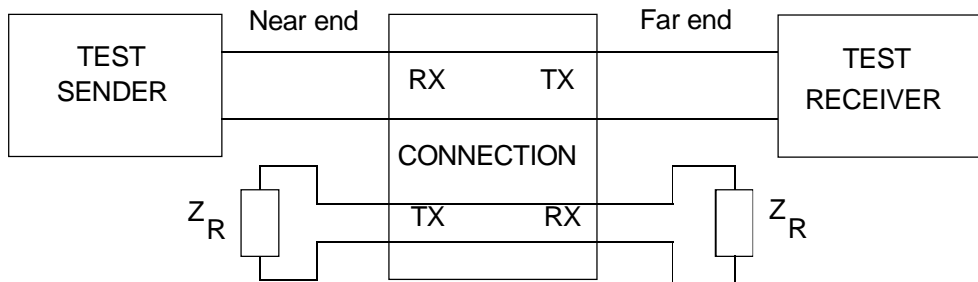

**Figure A.5: Variation of loss with time, amplitude hits**

- Connection state:** Available.
- Stimulus:** The transmitter, with an impedance of 600  $\Omega$ , is set to send at a power level of -13 dBm at a frequency of 1 020 Hz.
- Monitor:** The number of amplitude hits greater than  $\pm 2$  dB with a duration of 4 ms or greater for a period of 15 minutes. Slow amplitude changes, as defined in ITU-T Recommendation O.95 [4], shall not be counted.
- Result:** The number of amplitude hits shall be within the limits specified in clause 4.1.7.1.

## A.2.6 Random circuit noise

**Requirement:** Clause 4.1.8.

**Purpose:** To measure the random circuit noise of the leased line connection.

**Test configuration:** Performed using a psophometer complying with ITU-T Recommendation O.41 [7].

With the far end interface of the leased line terminated with the reference impedance, the psophometer is connected to the near end interface. See figure A.6.

The test is repeated in the other direction.

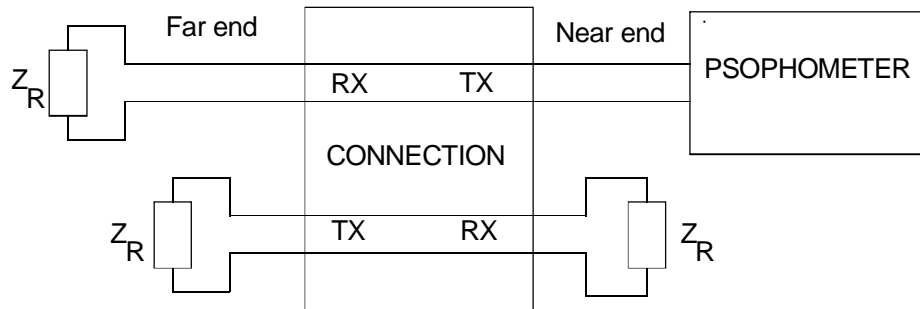

**Figure A.6: Random circuit noise**

**Connection state:** Available.

**Stimulus:** None.

**Monitor:** The psophometrically weighted noise signal across the 600  $\Omega$  termination at the near end interface of the leased line.

**NOTE:** The psophometer terminates the near end of the line with its own internal 600  $\Omega$  termination.

**Result:** The readings obtained shall be within the limits specified in clause 4.1.8.

## A.2.7 Impulsive noise

**Requirement:** Clause 4.1.9.

**Purpose:** To check the impulsive noise performance of the leased line connection.

**Test configuration:** Performed using an instrument complying with ITU-T Recommendation O.71 [1].

With the far end of the leased line connected to the impulsive noise measuring equipment and the threshold of the measuring equipment adjusted to -21 dBm0 or, where the output relative level is not declared, 8 dB below the received signal level. The test sender is connected to the near end of the leased line. See figure A.7.

The test is repeated in the other direction.

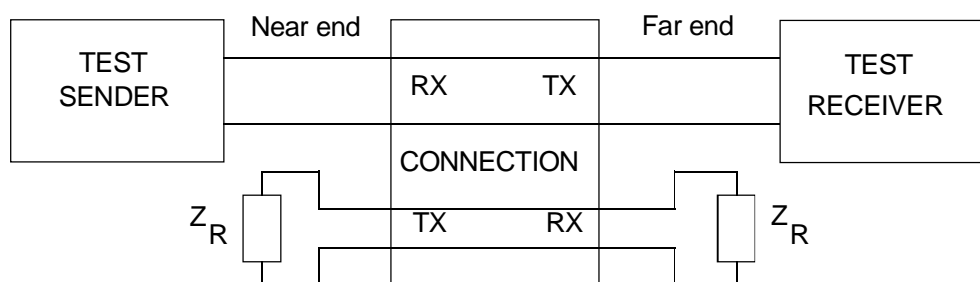

**Figure A.7: Impulsive noise**

- Connection state:** Available.
- Stimulus:** The test sender is set to send a signal at 1 020 Hz at a power level of -13 dBm.
- Monitor:** The number of impulsive noise peaks exceeding the threshold in a 15-minute measurement period.
- Result:** The number of impulsive noise peaks exceeding the threshold shall be less than the limit specified in clause 4.1.9.

## A.2.8 Phase jitter

- Requirement:** Clause 4.1.10.
- Purpose:** To check the phase jitter performance of the leased line.
- Test configuration:** Performed with an instrument complying with ITU-T Recommendation O.91 [3].

The phase jitter measuring equipment is connected to the leased line interfaces as shown in figure A.8.

The test is repeated in the other direction.

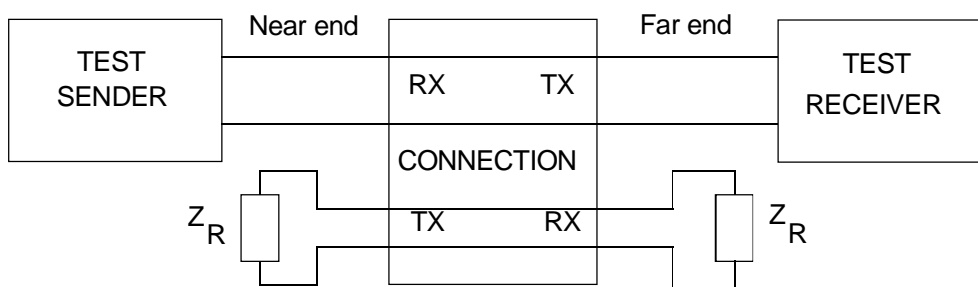

**Figure A.8: Phase jitter**

- Connection state:** Available.
- Stimulus:** A test signal as specified in ITU-T Recommendation O.91 [3].
- Monitor:** The jitter in degrees peak-to-peak.
- Result:** The jitter shall not exceed the limit specified in clause 4.1.10.

## A.2.9 Total distortion

**Requirement:** Clause 4.1.11.2.

**Purpose:** To check the total distortion of the leased line.

**Test configuration:** Performed using a distortion measuring equipment using a sinusoidal test signal complying with ITU-T Recommendation O.132 [5]. See figure A.9.

The test is repeated in the other direction.

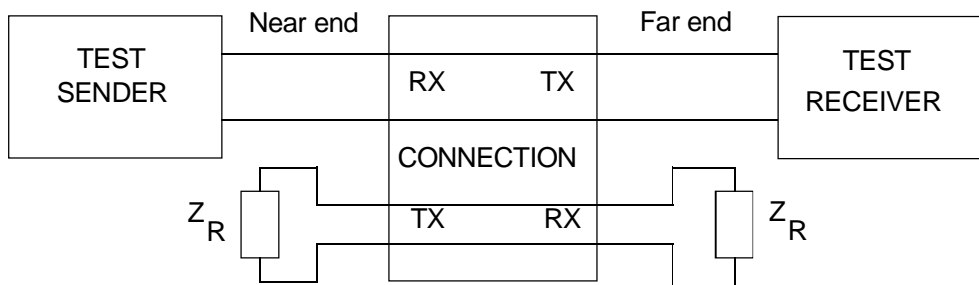

**Figure A.9: Total distortion**

**Connection state:** Available.

**Stimulus:** A test signal complying with ITU-T Recommendation O.132 [5] is applied to one interface of the circuit under test at a level of -13 dBm and a frequency of 1 020 Hz.

**Monitor:** The signal to distortion ratio when measured with the 1 000 Hz to 1 025 Hz test signal reject filter.

**Result:** The measuring equipment receiver shall indicate a total distortion power level below the power level of the received signal as specified in clause 4.1.11.2.

## A.2.10 Single tone interference

**Requirement:** Clause 4.1.12.

**Purpose:** To check the single tone interference performance of the leased line.

**Test configuration:** With the far end interface terminated in the reference impedance, a selective level meter with an input impedance of 600  $\Omega$  is connected to the near end interface. See figure A.10.

The test is repeated in the other direction.

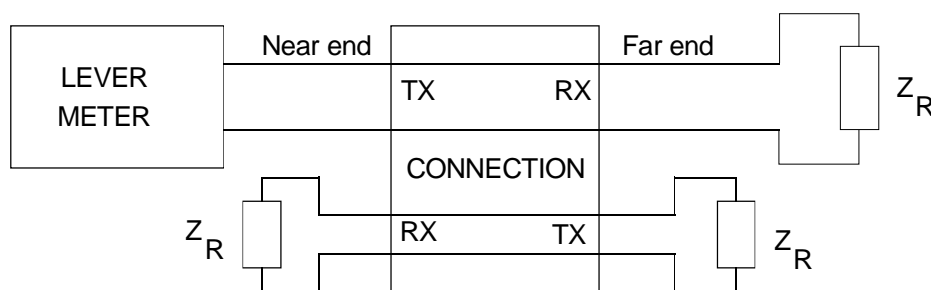

**Figure A.10: Single tone interference**

**Connection state:** Available.

**Stimulus:** None.

**Monitor:** The frequency band 300 Hz to 3 400 Hz is scanned with a bandwidth of 30 Hz.

**Result:** No single tone shall exceed the limits specified in clause 4.1.12.

## A.2.11 Frequency error

**Requirement:** Clause 4.1.13.

**Purpose:** To check the frequency error performance of the leased line.

**Test configuration:** A test sender is connected to one interface of the leased line. A frequency counter is connected to the other interface of the leased line with the line terminated in  $600\ \Omega$ . See figure A.11.

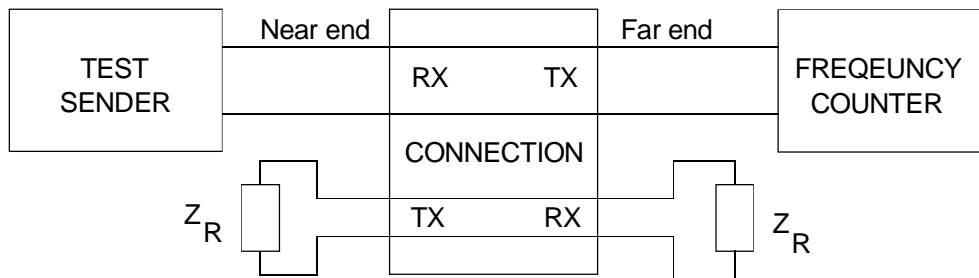

**Figure A.11: Frequency error**

**Connection state:** Available.

**Stimulus:** The test sender, with an impedance of  $600\ \Omega$ , is set to send a signal at a frequency of  $1\ 020\ \text{Hz}$  into a load impedance of  $600\ \Omega$ , at a level of  $-13\ \text{dBm}$ . The load impedance is then disconnected and the signal applied to one interface of the leased line.

**Monitor:** The signal frequency at the output of the leased line.

**Result:** The difference between the measured signal frequency and the input frequency shall be within the limits of  $\pm 5\ \text{Hz}$ .

## A.2.12 Harmonic distortion

**Requirement:** Clause 4.1.14.

**Purpose:** To measure the harmonic distortion performance of the leased line. The test uses a test signal frequency of  $700\ \text{Hz}$ .

**NOTE:** The frequency of  $700\ \text{Hz}$  is chosen because it gives the fundamental and the first three harmonics conveniently spaced within the voice bandwidth.

**Test configuration:** A test sender is connected to one interface of the leased line. A selective level meter or suitable equivalent is connected to the other interface of the leased line. See figure A.12.

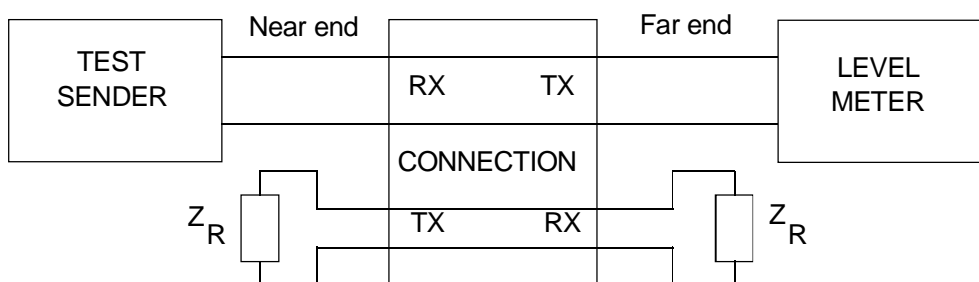

**Figure A.12: Harmonic distortion**

**Connection state:** Available.



- Stimulus:** The test sender, with an impedance of  $600\ \Omega$ , is set to send a signal at a frequency of 700 Hz into an impedance of  $600\ \Omega$  at a level of -13 dBm. The impedance is then disconnected and the signal applied to one interface of the line.
- Monitor:** The received power in  $600\ \Omega$  measured by the level meter at the far end of the line at the fundamental frequency of 700 Hz and at the three harmonic frequencies of 1 400 Hz, 2 100 Hz and 2 800 Hz.
- Result:** The received power level of the harmonics of the test signal shall be at least 25 dB below the received level of the test signal.

## A.2.13 Maximum instantaneous power

- Requirement:** Clause 4.1.4.2.
- Purpose:** To verify that the leased line can carry a signal corresponding to the peak value of a 0 dBm signal at the input. A sine wave of 1 020 Hz, at a level equivalent to 0 dBm, is transmitted into the leased line for a duration of no more than 100 ms. There should be no clipping at the output.
- Test configuration:** See figure A.13.

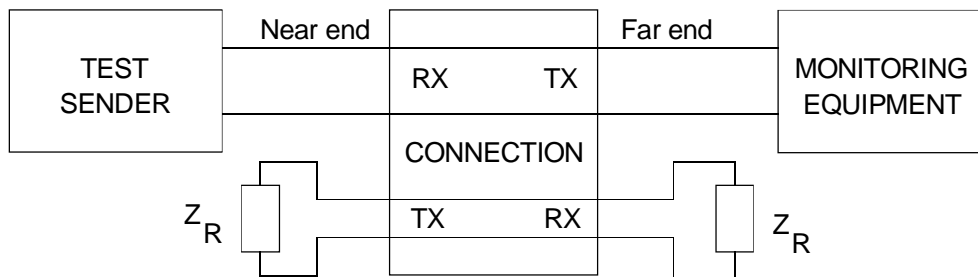

**Figure A.13: Maximum instantaneous power**

- Connection state:** Available.
- Stimulus:** The test sender, with an impedance of  $600\ \Omega$ , is set to send a sine wave of frequency 1 020 Hz, at a level of 0 dBm, into the input of the leased line, with a duration of no more than 100 ms.
- Monitor:** The signal across a termination impedance of  $600\ \Omega$  at the far end of the leased line.
- Result:** There shall be no clipping of the signal at the output of the leased line.

## A.2.14 Return loss

**Requirement:** Clause 4.2.3.

**Purpose:** To measure the return loss of both the input and output ports of the leased line with respect to the reference impedance  $Z_R$ .

**Test configuration:** The leased line interface is connected as shown in figure A.14.

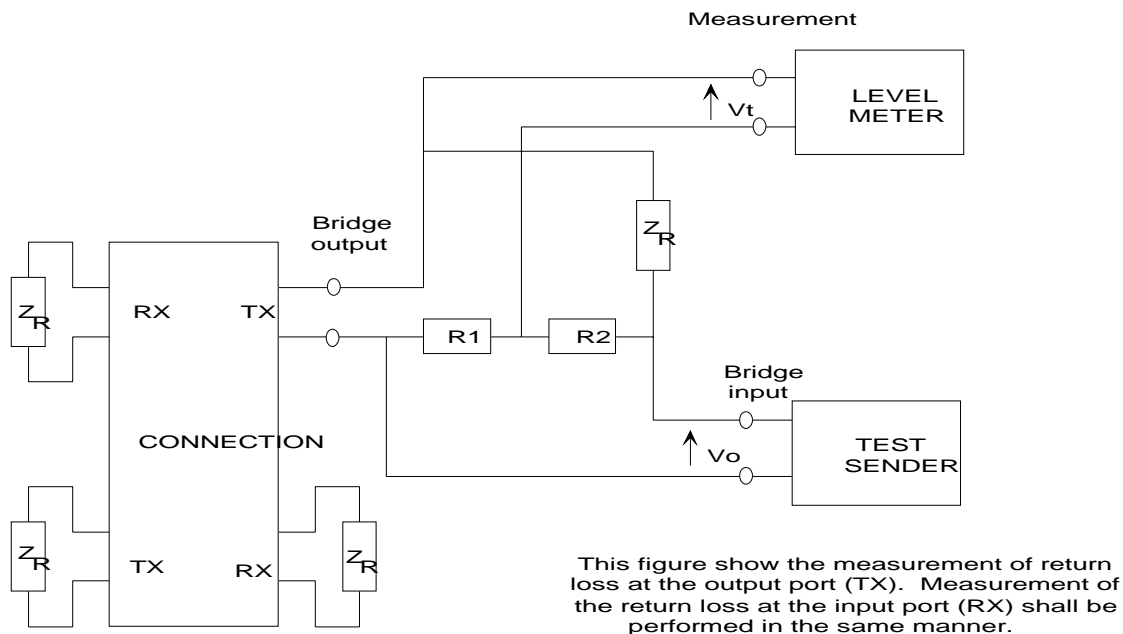

$R1 = R2$ ; between  $100 \Omega$  and  $800 \Omega$ , preferably  $600 \Omega$ , matched to better than  $0,2 \%$ .  
 Test sender output impedance  $< 10 \Omega$ .

**Figure A.14: Return loss**

**Connection state:** Available.

**Stimulus:** A sinusoidal signal with a constant voltage is applied to the input of the bridge at various frequencies between  $300 \text{ Hz}$  and  $3\,400 \text{ Hz}$ . The constant voltage is that required to give a power level of  $-13 \text{ dBm}$  at  $1\,020 \text{ Hz}$  into a reference impedance connected to the output of the bridge. Each measurement frequency shall be spaced by not more than one third of an octave from the next frequency of measurement.

**Monitor:** The level of voltages  $V_o$  and  $V_t$  with, in turn, both the leased line input and output connected to the output of the bridge, as shown in figure A.14.

**Result:** For both the input and output ports of the leased line, either the return loss  $a(f)$  or the weighted return loss  $\alpha_w$  shall meet the requirement of clause 4.2.3 across the frequency range; where:

$$a(f) = 20 \log \left| \frac{V_o}{2V_t} \right| \text{ is the measured return loss at frequency } f ,$$

$$\alpha_w = 3,85 - 10 \log \left[ \int_{300}^{3400} \frac{A(f)}{f} df \right] \text{ dB , and}$$

$$A(f) = 10^{-a(f)/10}$$

where  $V_o$  is the test signal level; and

$V_t$  is the level measured across the bridge.

Information on the application of the weighting function is given in annex B.

## A.2.15 Power feeding

**Requirement:** Clause 4.2.4.

**Purpose:** To verify that the leased line is not designed for power feeding by measuring the output current from the leased line into an impedance of 300  $\Omega$ .

**Test configuration:** See figure A.15. The termination at the far end of the leased line is undefined.

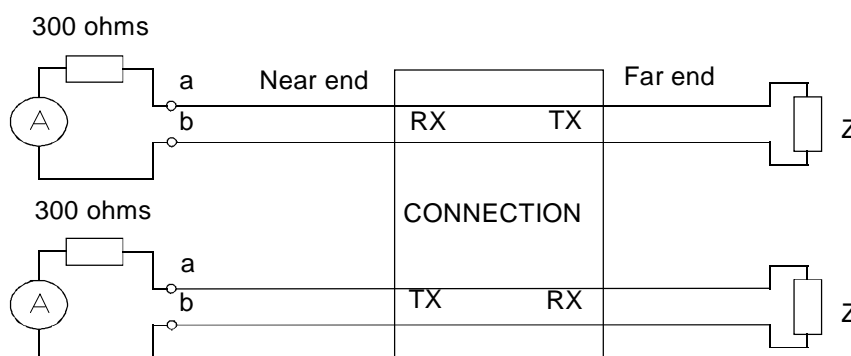

**Figure A.15: Power feeding**

**Connection state:** Available.

**Stimulus:** None.

**Monitor:** The current through each resistance of 300  $\Omega$ .

**Result:** The current through each resistance shall be less than 1 mA.

## Annex B (informative): Weighted return loss measurements

### B.1 Introduction

The use of a weighted return loss measurement is allowed within the present document because a fixed return loss is difficult to meet in some situations. Such situations include long local ends to leased lines and short local ends to leased lines in tandem with loaded cable. The definition of a complex reference impedance solves the problem for long local ends but in the case of lines containing loaded cable the situation is worse. The problem results from the behaviour of the impedance of loaded cable near to the cut-off frequency and it is for this reason that the weighting function has been introduced into the requirement to give more weight to the lower frequencies.

### B.2 Weighting function

Limitations are placed on the impedance of the leased line interface in order to control trans-hybrid loss in the terminal equipment. A weighting function which relates to trans-hybrid loss and which is relatively convenient to use is provided for the determination of echo loss in ITU-T Recommendation G.122 (see annex E); this weighting function can also be used for the determination of the weighted return loss.

The weighted return loss  $a_w$  is derived from the integral of the power transfer characteristic,  $A(f)$ , weighted by a negative slope of 3 dB per octave, starting at 300 Hz and extending to 3 400 Hz as follows:

$$a_w = 3,85 - 10 \log \left[ \int_{300}^{3400} \frac{A(f)}{f} df \right] \text{ dB} \quad (1)$$

where:  $A(f) = 10^{-a(f)/10}$ ; and

$a(f)$  is the measured return loss at frequency  $f$  expressed in dB.

#### B.2.1 Calculation (trapezoidal rule)

In order to calculate the weighted return loss, the weighting function can be approximated by choosing measurement frequencies that are equidistant on a log-frequency scale and using the trapezoidal rule, as described in annex B of ITU-T Recommendation G.122 (see annex E). Thus if equidistant measurement frequencies are chosen on a log-frequency scale and the measurement frequencies are spaced by no more than one third of an octave, then the weighted return loss  $a_w$  can be represented by:

$$a_w = -10 \log \left[ \frac{1}{N} \left( \frac{A_0}{2} + A_1 + A_2 + A_3 + \dots + A_{N-1} + \frac{A_N}{2} \right) \right] \quad (2)$$

where:  $N+1$  is the number of measurement frequencies;

$A_n = 10^{-a(f_n)/10}$ , for  $n$  from 0 to  $N$ ; and

$a(f_n)$  is the measured return loss at frequency  $f_n$  expressed in dB.

## B.2.2 Calculation (tabulated data)

Where the loss/frequency data are only available at  $N+1$  discrete frequencies, which are non-uniformly spaced on a log-frequency scale, an approximation to the formula for weighted return loss  $a_w$  can be given by:

$$a_w = 3,24 - 10 \log \sum_{n=1}^N (A_n + A_{n-1}) (\log f_n - \log f_{n-1}) \quad (3)$$

where:  $N+1$  is the number of measurement frequencies;

$$A_n = 10^{-a(f_n)/10}, \text{ for } n \text{ from } 0 \text{ to } N; \text{ and}$$

$a(f_n)$  is the measured return loss at frequency  $f_n$  expressed in dB.

NOTE 1: The approximation involved is to assume that within the sub-band  $f_{n-1}$  to  $f_n$ , the power ratio is constant and has the value  $A(f) = (A_n + A_{n-1}) / 2$ .

NOTE 2: The constant 3,24 in the approximate formula arises from a combination of the constant 3,85 in the definition and other constants produced by the approximation.

The sum of product terms may be conveniently calculated as illustrated by the following example and table B.1.

EXAMPLE: Weighted return loss =  $3,24 - 10 \log (0,5050) = 6,21$  dB

**Table B.1: Example of calculation of weighted return loss**

| n | f (Hz)<br>(1) | log f <sub>n</sub><br>(2) | log f <sub>n</sub> -<br>log f <sub>n-1</sub><br>(3) | measured<br>return loss<br>(4) | A <sub>n</sub><br>(5) | A <sub>n</sub> +<br>A <sub>n-1</sub><br>(6) | (3) x (6)<br>(7) |
|---|---------------|---------------------------|---|--------------------------------|-----------------------|---|------------------|
| 0 | 300           | 2,477                     |   | 5,00                           | 0,316                 |   |                  |
| 1 | 500           | 2,699                     | 0,222   | 6,00                           | 0,251                 | 0,567                                       | 0,1259           |
| 2 | 800           | 2,903                     | 0,204   | 8,00                           | 0,158                 | 0,410                                       | 0,0836           |
| 3 | 1 000         | 3,000                     | 0,097   | 7,00                           | 0,200                 | 0,358                                       | 0,0347           |
| 4 | 1 500         | 3,176                     | 0,176   | 6,00                           | 0,251                 | 0,451                                       | 0,0794           |
| 5 | 2 000         | 3,301                     | 0,125   | 6,00                           | 0,251                 | 0,502                                       | 0,0628           |
| 6 | 2 500         | 3,398                     | 0,097   | 6,00                           | 0,251                 | 0,502                                       | 0,0487           |
| 7 | 3 000         | 3,477                     | 0,079   | 5,80                           | 0,263                 | 0,514                                       | 0,0407           |
| 8 | 3 400         | 3,531                     | 0,054   | 5,60                           | 0,275                 | 0,538                                       | 0,0293           |
|   |               |                           |   |                                |                       | Total                                       | 0,5050           |

## Annex C (informative): Overall loss and quantizing distortion

### C.1 Introduction

The purpose of this annex is to provide information for the user on the factors that affect the overall loss and quantizing distortion on a leased line. This annex is given for information only and is not a normative part of the standard. This information is provided because the performance of a leased line is highly dependent on the methods of provision used within the public network and is not related to the distance between the NTPs on the customer's premises.

In many cases the leased lines provided in conformance to the present document will provide a level of performance much better than that specified within the present document. Where the actual performance available from a leased line offered under the ONP minimum set does not satisfy the needs of the user, the leased line provider may be able to provide an alternative more suitable type of leased line. Users are advised to discuss with the leased line provider the suitability of a particular leased line for their intended application.

Figure C.1 shows some of the different means by which analogue leased lines may be provided. In most cases, all NTPs on the customer's premises are connected back to the network operators local exchange premises in a star configuration (see note). This local loop is normally provided using copper pairs and may be the main source of loss. In some cases the local loop may use radio technology or fibre optic cables, in which case the transmission would be digital.

**NOTE:** Leased lines are normally provided from the premises that provides the local exchange for the switched network, although the leased lines will not normally be routed through the local exchange switch. In many cases these premises will house special transmission equipment for the connection of the leased lines to other parts of the public network.

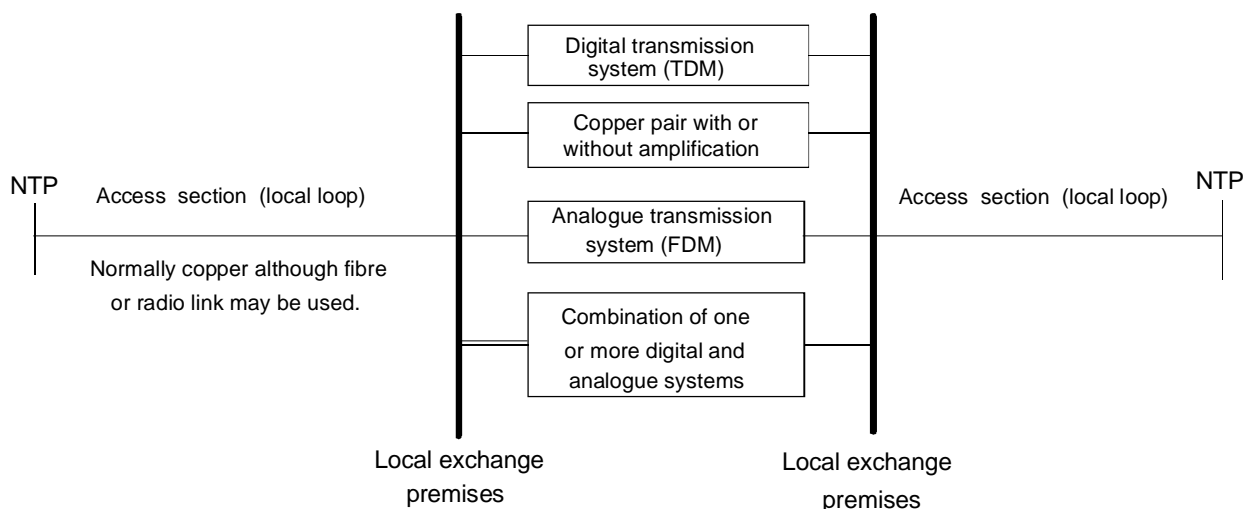

**Figure C.1: Means of providing analogue leased lines**

The means of transmission between the local exchange premises may be one or more of the following:

- digital transmission on optical fibre, copper cable or microwave radio links, using Time Division Multiplexing (TDM);
- analogue transmission on copper cable or microwave radio using Frequency Division Multiplexing (FDM);
- analogue transmission on copper cable without multiplexing, with or without amplification.

In general, the trend is for the analogue transmission equipment in the public networks to be replaced by digital equipment, although it will be a number of years before all the analogue transmission equipment has been withdrawn.

## C.2 Overall loss

The overall loss of a leased line is frequently of great importance in determining the suitability of a leased line for a particular application. The overall loss can, however, vary significantly between installations due to various factors such as the distance of the termination points of the leased line from the local exchange premises and the general practices adopted by the specific network provider.

The range of losses specified within the minimum set of analogue leased line standards encompasses what is generally available from leased line providers, where the leased lines have been supplied in accordance with the general practice of the network providers.

In most cases it is not the geographical distance between the ends of the leased line which determines the overall loss, but the different components from which the leased line is constructed. Normally the main contributor to loss is the copper pair that provides the local loop, whose loss is distance dependent and may be up to some 10 dB, which would equate to a distance of 10 km to 15 km depending on the type of cable. Thus a leased line between two adjacent customers premises may have a high loss in some circumstances. This is shown in figure C.2.

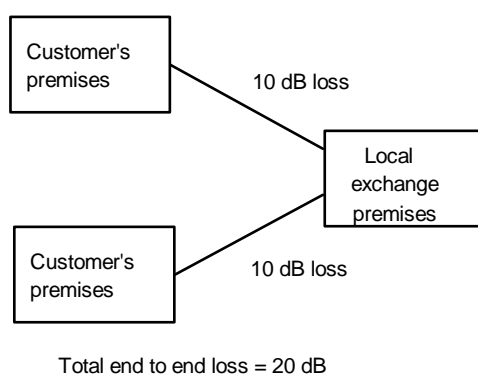

**Figure C.2: Example of a short ordinary quality leased line with high loss**

The loss between the local exchange premises will be distance dependent only if copper cables without amplification are used. If an analogue or digital transmission system is used, this system will normally introduce a fixed and distance independent loss. Such systems will almost always be used for international leased lines and will frequently be used for long distance national leased lines.

This information shows why a leased line between two closely spaced NTPs that are both at some distance from the local exchange premises may have considerably greater loss than an international leased line between NTPs that are close to the local exchange premises (e.g. in a city centre). An example of a long international leased line with low loss is given in figure C.3.

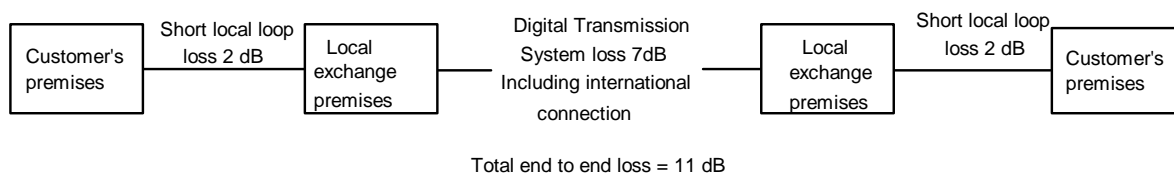

**Figure C.3: Example of a long international leased line with low loss**

## C.3 Quantizing distortion

Quantizing distortion, is the distortion of a signal that results either from the process of conversion from an analogue to digital form or the conversion between different digital forms. Quantizing distortion is measured in quantizing distortion units where one unit is defined as the distortion that arises from a conversion from analogue to the normal form of digital encoding in fixed networks (64 kbit/s PCM) and back.

Where there is a need to maximize the number of circuits that can be carried in a given transmission medium, lower bit rates than 64 kbit/s may be used for each circuit, but with the introduction of higher levels of quantizing distortion.

The limit for quantizing distortion is specified at 7,5 qdu (including one ADPCM conversion) for the ordinary quality leased lines and 3 qdu for the special quality leased lines (although in some cases 4 qdu may be required). Figure C.4 shows an example of how the qdus may be build up within a leased line; the leased line standards do not, however, allocate the qdus to a particular portion of the leased line.

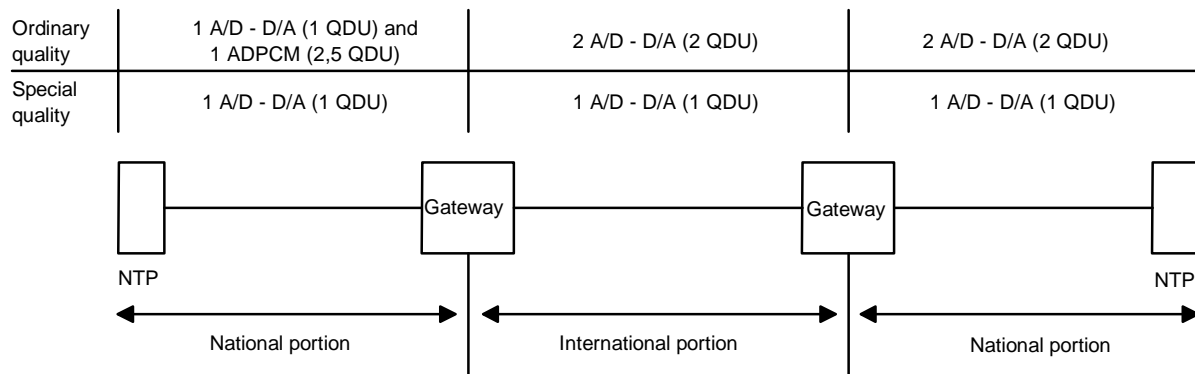

**Figure C.4: Example allocation of qdu for ordinary and special quality leased lines**



---

## Annex D (informative): Availability

### D.1 General

This annex is given for information only and is not a normative part of the present document.

The availability of a leased line should be assessed over a long period of time and cannot be measured using a single test. ITU-T Recommendation M.1016 (see annex E) proposes that any observation period should be three calendar months. For the purpose of observing availability, the following terms should be considered.

#### D.1.1 Unavailability

$$\text{Unavailability} = \frac{\sum \text{Unavailability periods}}{\text{Observation period}}$$

(with unavailability generally expressed as a percentage).

#### D.1.2 Availability

$$\text{Availability} = \frac{\text{Observation period} - \sum \text{Unavailability periods}}{\text{Observation period}}$$

(with availability generally expressed as a percentage).

---

## D.2 Definition of unavailability periods

The ITU-T, within ITU-T Recommendation M.1016 (see annex E), defines an assessment procedure based on fault reports made by users, and planned interruptions, which unacceptably disrupt the user's service.

ITU-T Recommendation M.1016 (see annex E) specifies three conditions which should be taken into account when assessing the availability performance of international leased circuits:

- faults, as reported by the user and confirmed by tests and investigations carried out by the leased line provider;
- impairments to normal service, as reported by the user, where the user chooses to continue to use the leased line in a degraded condition;
- planned interruptions to service to enable, for example, permanent repair work to be carried out, maintenance routines to be performed.

Figures D.1 and D.2 determine if, and how, unavailability periods are to be included in the assessment procedure; these principles are as specified in tables A-1 and A-2 of ITU-T Recommendation M.1016 (see annex E).

For the purpose of these tables the following definitions of impaired service report and fault report apply:

**impaired service report:** The condition reported by the user where the perceived performance of the leased line is degraded but the user has decided that the leased line can still be used.

**fault report:** The condition reported by the user where the user has decided that the leased line is unusable.

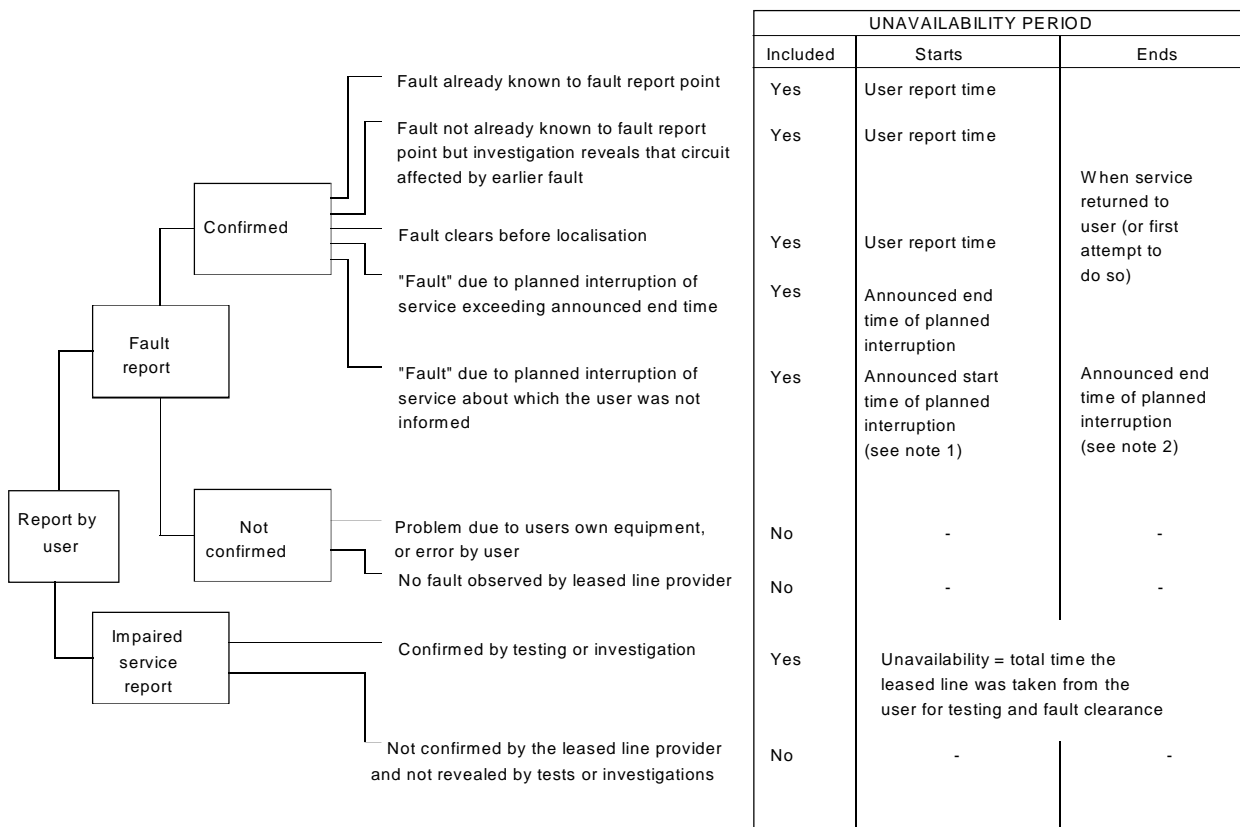

NOTE 1: If the announced start time is not known to the fault report point, the user report time should be used.

NOTE 2: If the announced end time is not known to the fault report point, the time the service is returned to the user (or first attempt to do so) should be used.

Figure D.1: Unavailability periods as a result of fault reports

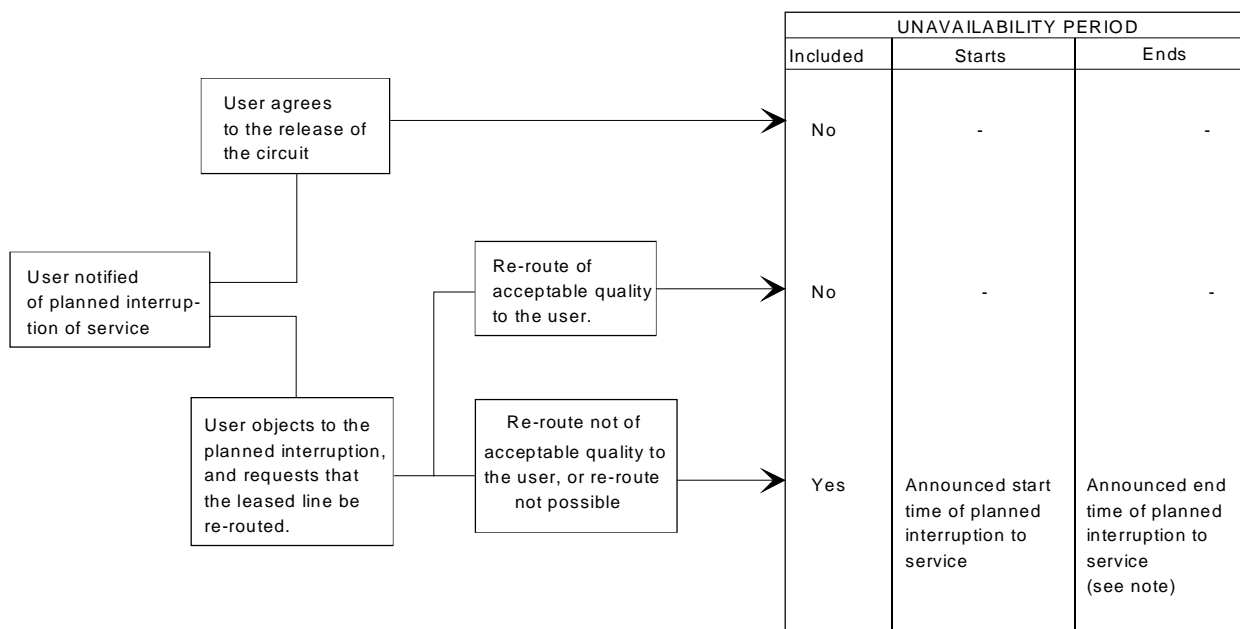

NOTE: For fault reports which are received because the announced fault time is exceeded (see figure D.1).

Figure D.2: Unavailability periods as a result planned interruptions of service

If a circuit is unavailable at the beginning of the observation period, the fault or planned interruption of service causing the unavailability is not taken into consideration. However, unavailability is deemed to start at the beginning of the observation period.

If a circuit is unavailable at the end of the observation period, the fault or planned interruption of service causing the unavailability is taken into consideration. The unavailability is deemed to end at the end of the observation period.

---

## D.3 Availability figures

At the time of publication, there are no International or European standards defining requirements for availability for analogue leased lines.

The figures given in table D.1 give some indication of the availability for analogue leased lines; they are based on values given for 2 048 kbit/s digital path elements between customer premises for terrestrial connections up to 5 500 km and satellite connections with access lines of up to 1 375 km. Therefore they should be regarded only as an indication of the availability of analogue leased lines. In practice the availability figures may be considerably better.

**Table D.1: Availability figures**

| Terrestrial |            | Satellite |            |
|-------------|------------|-----------|------------|
| mean        | worst case | mean      | worst case |
| 97,3 %      | 94,7 %     | undefined | 97,0 %     |

The mean value is the average for all the leased lines of an operator; the worst case value is the value that no leased line should exceed (i.e. be worse than this figure). Customers who require enhanced availability should discuss their particular requirements with the leased line provider.

---

## Annex E (informative): Bibliography

- Council Directive 91/263/EEC of 29 April 1991 on the approximation of the laws of Member States concerning telecommunications terminal equipment, including the mutual recognition of their conformity.
- Council Directive 92/44/EEC of 5 June 1992 on the application of Open Network Provision to leased lines.
- Directive 98/13/EC of the European Parliament and of the Council of 12 February 1998 relating to telecommunications terminal equipment and satellite earth station equipment, including the mutual recognition of their conformity.
- ITU-T Recommendation M.1016 (1988): "Assessment of the service availability performance of international leased circuits".
- ITU-T Recommendation M.1020 (1993): "Characteristics of Special Quality International Leased Circuits with Special Bandwidth Conditioning".
- ITU-T Recommendation V.2 (1988): "Power levels for data transmission over telephone lines".
- ITU-T Recommendation G.114 (2000): "One-way transmission time".
- ITU-T Recommendation G.122 (1993): "Influence of national systems on stability, talker echo, and listener echo in international connections".
- CENELEC EN 60950: "Safety of information technology equipment".
- ETSI EG 201 212: "Electrical safety; Classification of interfaces for equipment to be connected to telecommunication networks". This document is also available from CENELEC as ROBT-002.

---

## History

| <b>Document history</b> |               |  |
|-------------------------|---------------|--|
| Edition 1               | March 1996    | Publication as ETS 300 452   |
| V1.2.1                  | February 2001 | One-step Approval Procedure OAP 20010629: 2001-02-28 to 2001-06-29 |
|                         |               |  |
|                         |               |  |
|                         |               |  |