

EN 300 429 V1.2.1 (1998-04)

European Standard (Telecommunications series)

Digital Video Broadcasting (DVB); Framing structure, channel coding and modulation for cable systems

European Broadcasting Union



Union Européenne de Radio-Télévision

DVB
Digital Video
Broadcasting



Reference

REN/JTC-DVB-71 (3z000ioo.PDF)

Keywords

DVB, digital, video, broadcasting, cable, MPEG,
TV

ETSI

Postal address

F-06921 Sophia Antipolis Cedex - FRANCE

Office address

650 Route des Lucioles - Sophia Antipolis
Valbonne - FRANCE
Tel.: +33 4 92 94 42 00 Fax: +33 4 93 65 47 16
Siret N° 348 623 562 00017 - NAF 742 C
Association à but non lucratif enregistrée à la
Sous-Préfecture de Grasse (06) N° 7803/88

Internet

secretariat@etsi.fr
<http://www.etsi.fr>
<http://www.etsi.org>

Copyright Notification

No part may be reproduced except as authorized by written permission.
The copyright and the foregoing restriction extend to reproduction in all media.

© European Telecommunications Standards Institute 1998.
© European Broadcasting Union 1998.
All rights reserved.

Contents

Intellectual Property Rights.....	4
Foreword	4
1 Scope.....	5
2 References.....	5
3 Symbols and abbreviations	5
3.1 Symbols	5
3.2 Abbreviations.....	6
4 Cable System concept	6
4.1 Baseband interfacing and sync.....	8
4.2 Sync 1 inversion and randomization	8
4.3 Reed-Solomon (RS) coder	8
4.4 Convolutional interleaver.....	8
4.5 Byte to m-tuple conversion	8
4.6 Differential encoding	8
4.7 Baseband shaping	8
4.8 QAM modulation and physical interface	8
4.9 Cable receiver	8
5 MPEG-2 transport layer	8
6 Framing structure	9
7 Channel coding	10
7.1 Randomization for spectrum shaping.....	10
7.2 Reed-Solomon coding.....	11
7.3 Convolutional interleaving.....	11
8 Byte to symbol mapping	12
9 Modulation.....	13
Annex A (normative): Baseband filter characteristics	17
Annex B (informative): Transparency of cable networks	18
Annex C (informative): Bibliography.....	19
History	20

Intellectual Property Rights

IPRs essential or potentially essential to the present document may have been declared to ETSI. The information pertaining to these essential IPRs, if any, is publicly available for **ETSI members and non-members**, and can be found in ETR 314: "*Intellectual Property Rights (IPRs); Essential, or potentially Essential, IPRs notified to ETSI in respect of ETSI standards*", which is available **free of charge** from the ETSI Secretariat. Latest updates are available on the ETSI Web server (<http://www.etsi.fr/ipr>).

Pursuant to the ETSI Interim IPR Policy, no investigation, including IPR searches, has been carried out by ETSI. No guarantee can be given as to the existence of other IPRs not referenced in ETR 314 (or the updates on <http://www.etsi.fr/ipr>) which are, or may be, or may become, essential to the present document.

Foreword

This European Standard (Telecommunications series) has been produced by the Joint Technical Committee (JTC) of the European Broadcasting Union (EBU), Comité Européen de Normalisation ELECTrotechnique (CENELEC) and the European Telecommunications Standards Institute (ETSI).

NOTE: The EBU/ETSI JTC was established in 1990 to co-ordinate the drafting of standards in the specific field of broadcasting and related fields. Since 1995 the JTC became a tripartite body by including in the Memorandum of Understanding also CENELEC, which is responsible for the standardization of radio and television receivers. The EBU is a professional association of broadcasting organizations whose work includes the co-ordination of its members' activities in the technical, legal, programme-making and programme-exchange domains. The EBU has active members in about 60 countries in the European broadcasting area; its headquarters is in Geneva *.

* European Broadcasting Union
 CH-1218 GRAND SACONNEX (Geneva)
 Switzerland
 Tel: +41 22 717 21 11
 Fax: +41 22 717 24 81

Digital Video Broadcasting (DVB) Project

Founded in September 1993, the DVB Project is a market-led consortium of public and private sector organizations in the television industry. Its aim is to establish the framework for the introduction of MPEG-2 based digital television services. Now comprising over 200 organizations from more than 25 countries around the world, DVB fosters market-led systems, which meet the real needs, and economic circumstances, of the consumer electronics and the broadcast industry.

National transposition dates	
Date of adoption of this EN:	17 April 1998
Date of latest announcement of this EN (doa):	31 July 1998
Date of latest publication of new National Standard or endorsement of this EN (dop/e):	31 January 1999
Date of withdrawal of any conflicting National Standard (dow):	31 January 1999

1 Scope

The present document only adds 128 and 256 QAM to the specification.

The present document describes the framing structure, channel coding and modulation (denoted "the System" for the purposes of the present document) for a digital multi-programme television distribution by cable. The aim of the present document is to present a harmonized transmission standard for cable and satellite, based on the MPEG-2 System Layer ISO/IEC 13818-1 [1], with the addition of appropriate Forward Error Correction (FEC) technique.

This System can be used transparently with the modulation/channel coding system used for digital multi-programme television by satellite (see EN 300 421 [3]). The System is based on Quadrature Amplitude Modulation (QAM). It allows for 16, 32, 64, 128 or 256-QAM constellations.

The System FEC is designed to improve Bit Error Ratio (BER) from 10^{-4} to a range, 10^{-10} to 10^{-11} , ensuring "Quasi Error Free" (QEF) operation with approximately one uncorrected error event per transmission hour.

2 References

References may be made to:

- a) specific versions of publications (identified by date of publication, edition number, version number, etc.), in which case, subsequent revisions to the referenced document do not apply; or
- b) all versions up to and including the identified version (identified by "up to and including" before the version identity); or
- c) all versions subsequent to and including the identified version (identified by "onwards" following the version identity); or
- d) publications without mention of a specific version, in which case the latest version applies.

A non-specific reference to an ETS shall also be taken to refer to later versions published as an EN with the same number.

- [1] ISO/IEC 13818-1: "Coding of moving pictures and associated audio".
 - [2] IEEE Trans. Comm. Tech., COM-19, pp. 772-781, (October 1971) Forney, G.D.: "Burst-correcting codes for the classic bursty channel".
 - [3] EN 300 421: "Digital Video Broadcasting (DVB); Framing structure, channel coding and modulation for 11/12 GHz satellite services".
-

3 Symbols and abbreviations

3.1 Symbols

For the purposes of the present document, the following symbols apply:

α	Roll-off factor
A_k, B_k	Most Significant Bits at the output of the Byte to m-tuple converter
f_0	Channel centre frequency
f_N	Nyquist frequency
$g(x)$	RS code generator polynomial
HEX	Hexadecimal
I	Interleaving depth (bytes)
I, Q	In-phase, Quadrature phase components of the modulated signal
j	Branch index
k	Number of bytes mapped into n symbols

m	Power of 2 ^m -level QAM: 4,5,6,7,8 for 16-QAM, 32-QAM, 64-QAM, 128-QAM, 256-QAM respectively
M	Convolutional interleaver branch depth for j = 1, M = N/I
n	Number of symbols mapped from k bytes
N	Error protected frame length [bytes]
p(x)	RS field generator polynomial
r _m	In-band ripple (dB)
R	Randomized sequence
R _s	Symbol rate corresponding to the bilateral Nyquist bandwidth of the modulated signal
R _u	Useful bit rate after MPEG-2 transport multiplexer
R _{u'}	Bit rate after RS outer coder
q	Number of bits: 2,3,4,5,6 for 16-QAM, 32-QAM, 64-QAM, 128-QAM, 256-QAM respectively
T	Number of bytes which can be corrected in RS error protected packet
T _s	Symbol period

3.2 Abbreviations

For the purposes of the present document, the following abbreviations apply:

BB	Baseband
BER	Bit Error Ratio
DTVC	Digital Television by Cable
FEC	Forward Error Correction
FIFO	First In First Out
IF	Intermediate Frequency
IRD	Integrated Receiver Decoder
LSB	Least Significant Bit
MPEG	Moving Pictures Experts Group
MSB	Most Significant Bit
MUX	Multiplex
PDH	Plesiochronous Digital Hierarchy
PRBS	Pseudo Random Binary Sequence
QAM	Quadrature Amplitude Modulation
QEF	Quasi Error Free
RF	Radio Frequency
RS	Reed-Solomon
SMATV	Satellite Master Antenna Television
TDM	Time Division Multiplex
TV	Television

4 Cable System concept

The cable System shall be defined as the functional block of equipment performing the adaptation of the baseband TV signals to the cable channel characteristics (see figure 1). In the cable head-end, the following TV baseband signal sources can be considered:

- satellite signal(s);
- contribution link(s);
- local program source(s).

The processes in the following subclauses shall be applied as shown in figure 1.

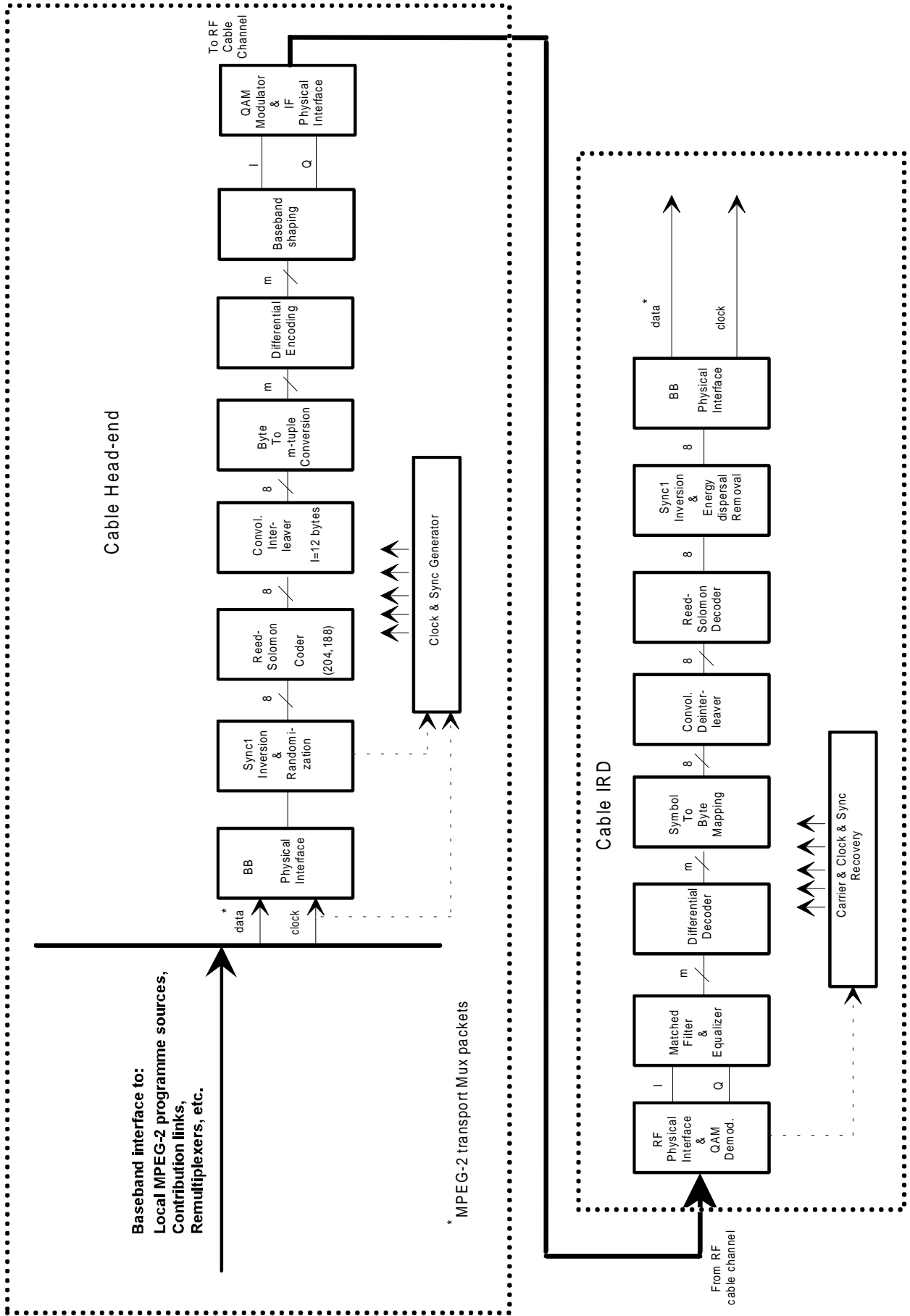

Figure 1: Conceptual block diagram of elements at the cable head-end and receiving site

4.1 Baseband interfacing and sync

This unit shall adapt the data structure to the format of the signal source. The framing structure shall be in accordance with MPEG-2 transport layer including sync bytes.

NOTE: Interfaces are not part of the present document.

4.2 Sync 1 inversion and randomization

This unit shall invert the Sync 1 byte according to the MPEG-2 framing structure, and randomizes the data stream for spectrum shaping purposes.

4.3 Reed-Solomon (RS) coder

This unit shall apply a shortened Reed-Solomon (RS) code to each randomized transport packet to generate an error-protected packet. This code shall also be applied to the Sync byte itself.

4.4 Convolutional interleaver

This unit shall perform a depth $I = 12$ convolutional interleaving of the error-protected packets. The periodicity of the sync bytes shall remain unchanged.

4.5 Byte to m-tuple conversion

This unit shall perform a conversion of the bytes generated by the interleaver into QAM symbols.

4.6 Differential encoding

In order to get a rotation-invariant constellation, this unit shall apply a differential encoding of the two Most Significant Bits (MSBs) of each symbol.

4.7 Baseband shaping

This unit performs mapping from differentially encoded m-tuples to I and Q signals and a square-root raised cosine filtering of the I and Q signals prior to QAM modulation.

4.8 QAM modulation and physical interface

This unit performs QAM modulation. It is followed by interfacing the QAM modulated signal to the Radio Frequency (RF) cable channel.

4.9 Cable receiver

A System receiver shall perform the inverse signal processing, as described for the modulation process above, in order to recover the baseband signal.

5 MPEG-2 transport layer

The MPEG-2 Transport Layer is defined in ISO/IEC 13818-1 [1]. The Transport Layer for MPEG-2 data is comprised of packets having 188 bytes, with one byte for synchronization purposes, three bytes of header containing service identification, scrambling and control information, followed by 184 bytes of MPEG-2 or auxiliary data.

6 Framing structure

The framing organization shall be based on the MPEG-2 transport packet structure. The System framing structure is shown on figure 2.

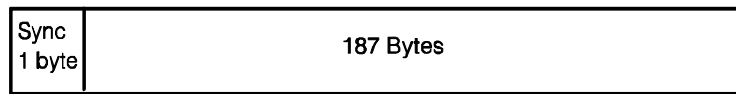

Figure 2a) MPEG-2 transport MUX packet

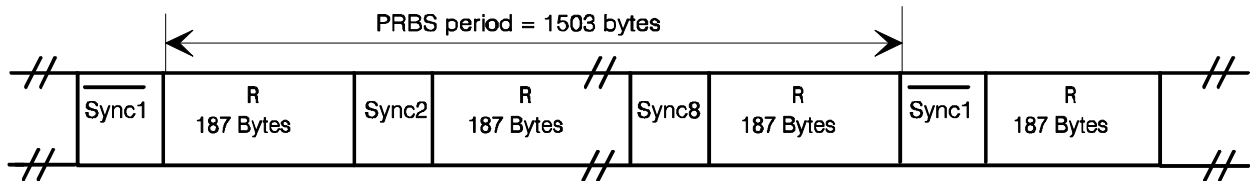

Figure 2b) Randomized transport packets: Sync bytes and Randomized Sequence R

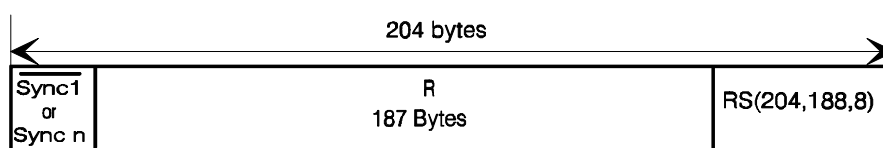

Figure 2c) Reed-Solomon RS(204,188, T=8) error protected packet

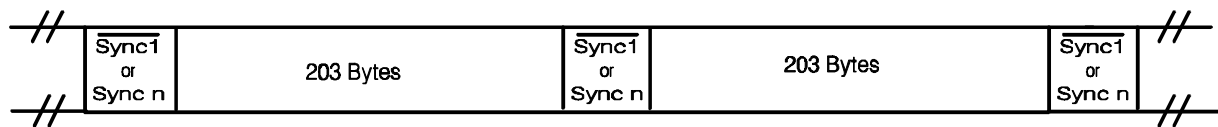

Figure 2d) Interleaved Frames; Interleaving depth I=12 bytes

$\overline{\text{Sync1}}$ = not randomized complemented sync byte
 Sync n = not randomized sync byte, n = 2, 3, ..., 8

Figure 2: Framing structure

7 Channel coding

To achieve the appropriate level of error protection required for cable transmission of digital data, a FEC based on Reed-Solomon encoding shall be used. In contrast to the Baseline System for satellite described in ETS 300 421 [3], no convolutional coding shall be applied to cable transmission. Protection against burst errors shall be achieved by the use of byte interleaving.

7.1 Randomization for spectrum shaping

The System input stream shall be organized in fixed length packets (see figure 2), following the MPEG-2 transport multiplexer. The total packet length of the MPEG-2 transport MUX packet is 188 bytes. This includes 1 sync-word byte (i.e. 47_{HEX}). The processing order at the transmitting side shall always start from the MSB (i.e. 0) of the sync word-byte (i.e. 01000111).

In order to comply with the System for satellite in ETS 300 421 [3] and to ensure adequate binary transitions for clock recovery, the data at the output of the MPEG-2 transport multiplex shall be randomized in accordance with the configuration depicted in figure 3.

The polynomial for the Pseudo Random Binary Sequence (PRBS) generator shall be:

$$1 + X^{14} + X^{15}$$

Loading of the sequence "10010101000000" into the PRBS registers, as indicated in figure 3, shall be initiated at the start of every eight transport packets. To provide an initialization signal for the descrambler, the MPEG-2 sync byte of the first transport packet in a group of eight packets shall be bitwise inverted from 47_{HEX} to B8_{HEX}.

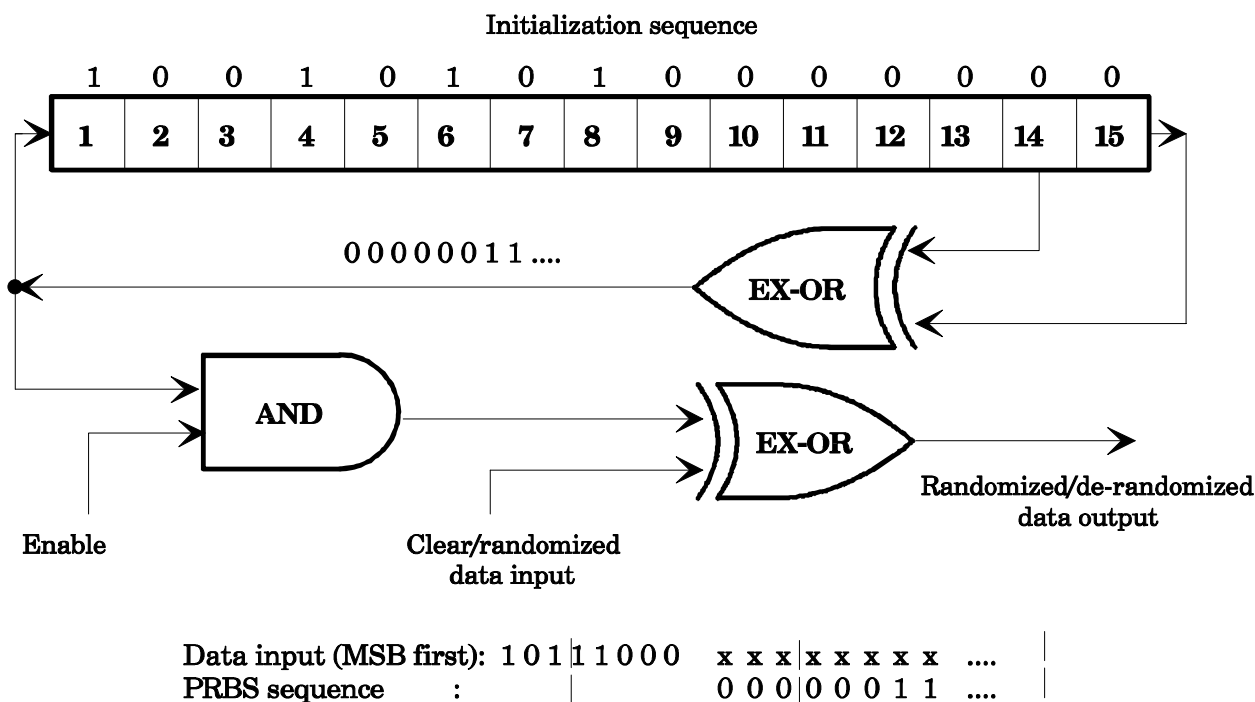

Figure 3: Scrambler/descrambler schematic diagram

The first bit at the output of the PRBS generator shall be applied to the first bit of the first byte following the inverted MPEG-2 sync byte (i.e. B8_{HEX}). To aid other synchronization functions, during the MPEG-2 sync bytes of the subsequent 7 transport packets, the PRBS generation continues, but its output shall be disabled, leaving these bytes unrandomized. The period of the PRBS sequence shall therefore be 1 503 bytes.

The randomization process shall be active also when the modulator input bit-stream is non-existent, or when it is non-compliant with the MPEG-2 transport stream format (i.e. 1 sync byte + 187 packet bytes). This is to avoid the emission of an unmodulated carrier from the modulator.

7.2 Reed-Solomon coding

Following the energy dispersal randomization process, systematic shortened Reed-Solomon encoding shall be performed on each randomized MPEG-2 transport packet, with $T = 8$. This means that 8 erroneous bytes per transport packet can be corrected. This process adds 16 parity bytes to the MPEG-2 transport packet to give a codeword (204,188).

NOTE: RS coding shall also be applied to the packet sync byte, either non-inverted (i.e. 47_{HEX}) or inverted (i.e. $B8_{\text{HEX}}$).

Code Generator Polynomial: $g(x) = (x+\lambda^0)(x+\lambda^1)(x+\lambda^2) \dots (x+\lambda^{15})$, where $\lambda = 02_{\text{HEX}}$

Field Generator Polynomial: $p(x) = x^8 + x^4 + x^3 + x^2 + 1$

The shortened Reed-Solomon code shall be implemented by appending 51 bytes, all set to zero, before the information bytes at the input of a (255,239) encoder; after the coding procedure these bytes are discarded.

7.3 Convolutional interleaving

Following the scheme of figure 4, convolutional interleaving with depth $I = 12$ shall be applied to the error protected packets (see figure 2c). This results in an interleaved frame (see figure 2d).

The convolutional interleaving process shall be based on the Forney approach (see Burst-correcting codes for the classic bursty channel in IEEE Trans. Comm. Tech., COM-19 [2]) which is compatible with the Ramsey type III approach, with $I = 12$. The Interleaved Frame shall be composed of overlapping error protected packets and shall be delimited by MPEG-2 sync bytes (preserving the periodicity of 204 bytes).

The interleaver may be composed of $I = 12$ branches, cyclically connected to the input byte-stream by the input switch. Each branch shall be a First In First Out (FIFO) shift register, with depth (M_j) cells (where $M = 17 = N/I$, $N = 204 =$ error protected frame length, $I = 12 =$ interleaving depth, $j =$ branch index). The cells of the FIFO shall contain 1 byte, and the input and output switches shall be synchronized.

For synchronization purposes, the sync bytes and the inverted sync bytes shall be always routed into the branch "0" of the interleaver (corresponding to a null delay).

NOTE: The deinterleaver is similar, in principle, to the interleaver, but the branch indexes are reversed (i.e. $j = 0$ corresponds to the largest delay). The deinterleaver synchronization can be carried out by routing the first recognized sync byte into the "0" branch.

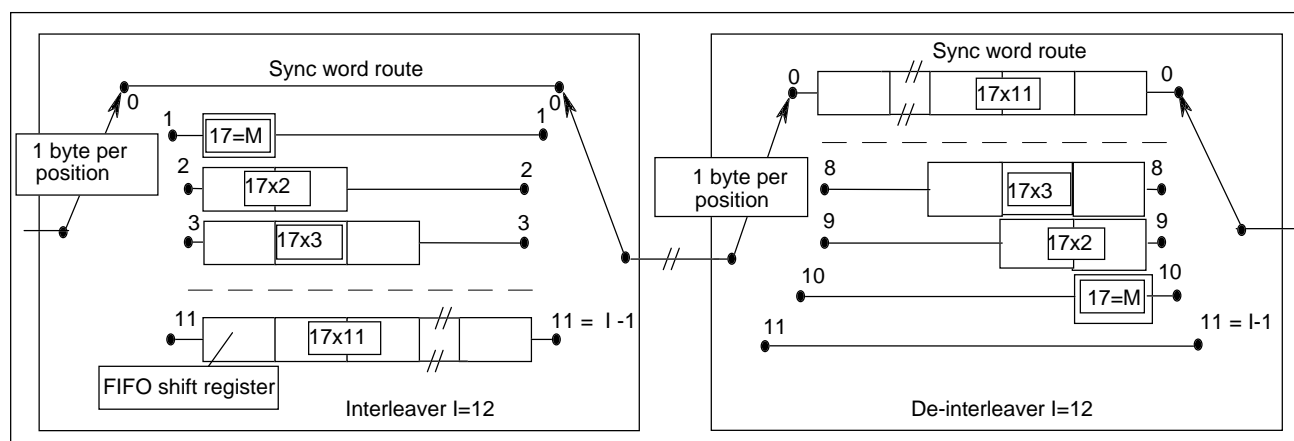

Figure 4: Conceptual diagram of the convolutional interleaver and de-interleaver

8 Byte to symbol mapping

After convolutional interleaving, an exact mapping of bytes into symbols shall be performed. The mapping shall rely on the use of byte boundaries in the modulation system.

In each case, the MSB of symbol Z shall be taken from the MSB of byte V. Correspondingly, the next significant bit of the symbol shall be taken from the next significant bit of the byte. For the case of 2^m -QAM modulation, the process shall map k bytes into n symbols, such that:

$$8k = n \times m$$

The process is illustrated for the case of 64-QAM (where $m = 6$, $k = 3$ and $n = 4$) in figure 5:

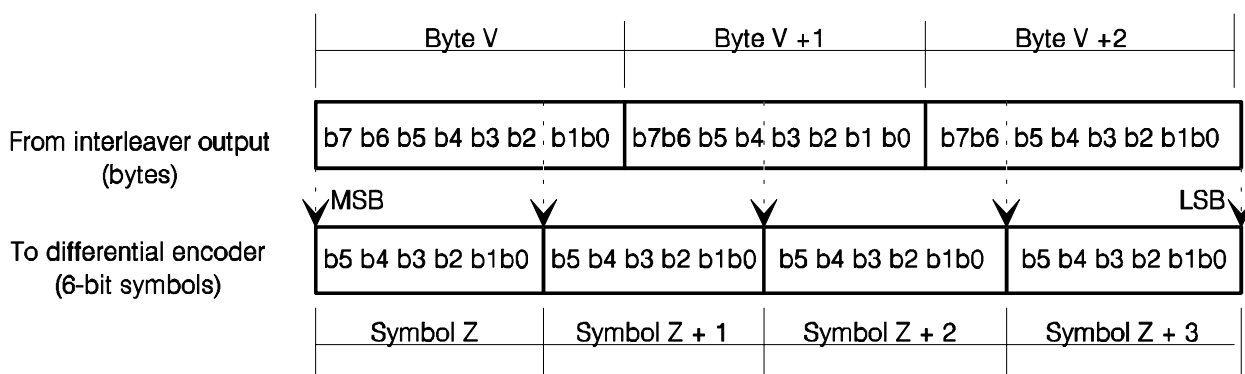

NOTE 1: b0 shall be understood as being the Least Significant Bit (LSB) of each byte or m-tuple.

NOTE 2: In this conversion, each byte results in more than one m-tuple, labelled Z, Z+1, etc. with Z being transmitted before Z+1.

Figure 5: Byte to m-tuple conversion for 64-QAM

The two most significant bits of each symbol shall then be differentially coded in order to obtain a $\pi/2$ rotation-invariant QAM constellation. The differential encoding of the two MSBs shall be given by the following Boolean expression:

$$I_k = \overline{(A_k \oplus B_k)} \cdot (A_k \oplus I_{k-1}) + (A_k \oplus B_k) \cdot (A_k \oplus Q_{k-1})$$

$$Q_k = \overline{(A_k \oplus B_k)} \cdot (B_k \oplus Q_{k-1}) + (A_k \oplus B_k) \cdot (B_k \oplus I_{k-1})$$

NOTE: For the above Boolean expression " \oplus " denotes the EXOR function, "+" denotes the logical OR function, "." denotes the logical AND function and the overbar denotes inversion.

Figure 6 gives an example of implementation of byte to symbol conversion.

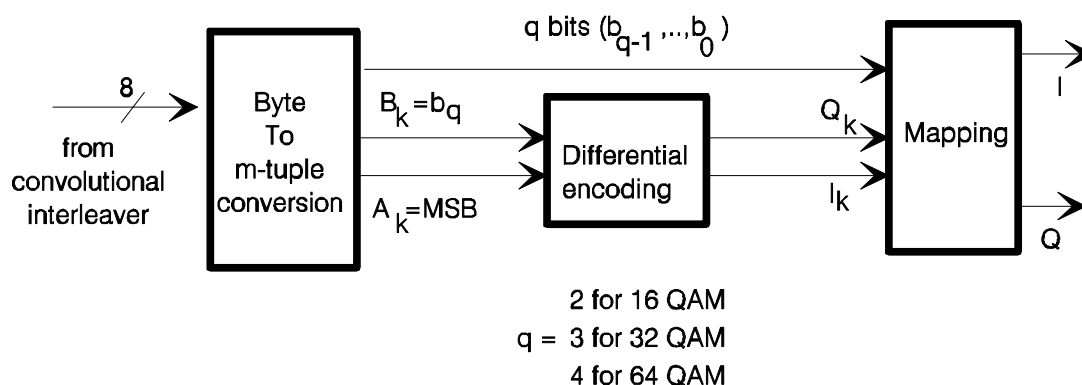

Figure 6: Example implementation of the byte to m-tuple conversion and the differential encoding of the two MSBs

9 Modulation

The modulation of the System shall be Quadrature Amplitude Modulation (QAM) with 16, 32, 64, 128 or 256 points in the constellation diagram.

The System constellation diagrams for 16-QAM, 32-QAM and 64-QAM are given in figure 7. The System constellation diagrams for 128-QAM and 256-QAM are given in figure 8. These constellation diagrams represent the signal transmitted in the cable system.

As shown in figure 7, the constellation points in Quadrant 1 shall be converted to Quadrants 2, 3 and 4 by changing the two MSB (i.e. I_k and Q_k) and by rotating the q LSBs according to the following rule given in table 1:

Table1: Conversion of constellation points of quadrant 1 to other quadrants of the constellation diagram given in figure 7

Quadrant	MSBs	LSBs rotation
1	00	
2	10	$+\pi/2$
3	11	$+\pi$
4	01	$+3\pi/2$

Receivers shall support at least 64-QAM modulation.

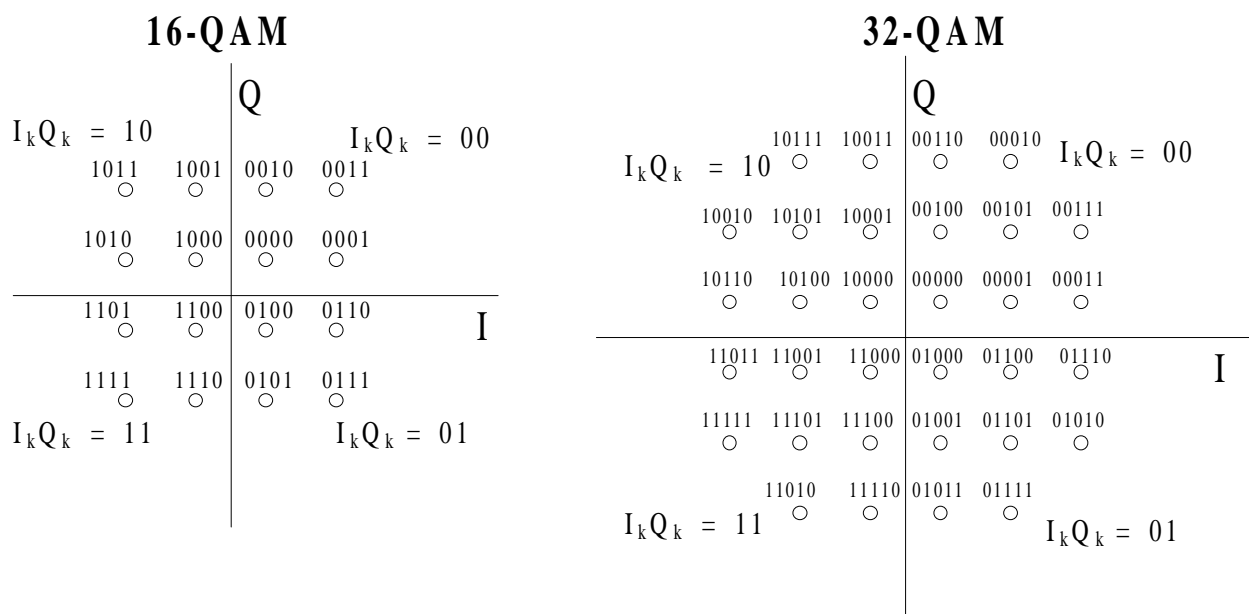

64-QAM

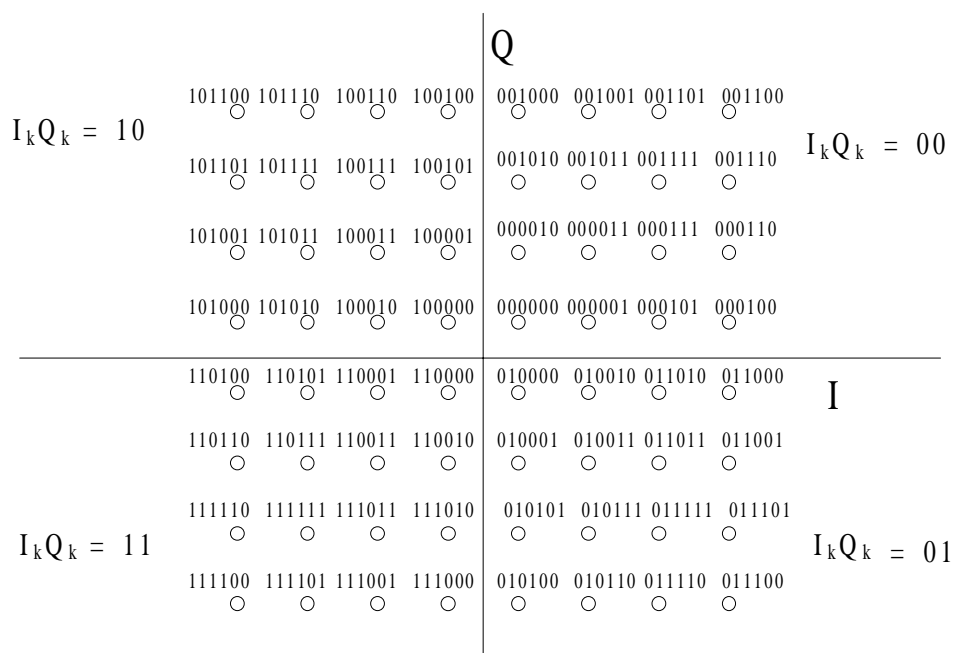

$I_k Q_k$ are the two MSBs in each quadrant

Figure 7: Constellation diagrams for 16-QAM, 32-QAM and 64-QAM

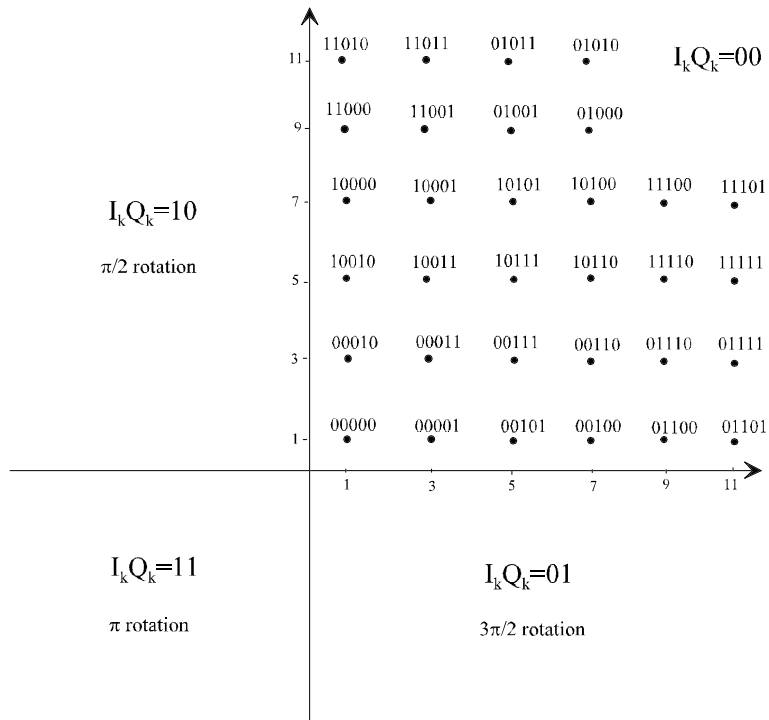

256 QAM

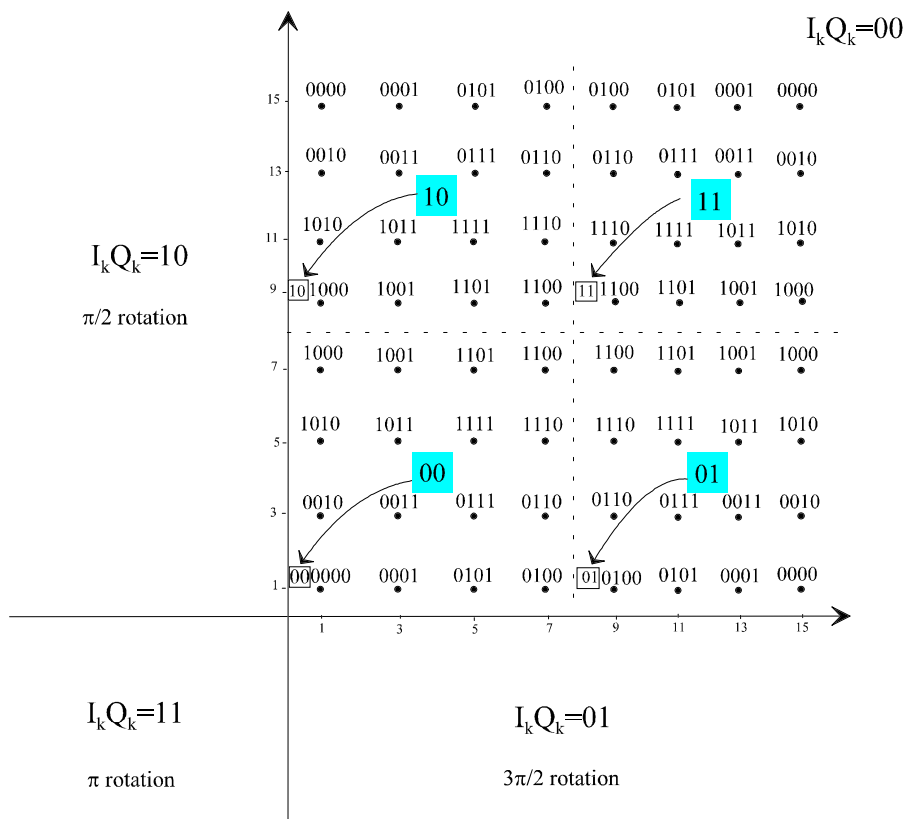

Figure 8: Constellation diagrams for 128-QAM and 256-QAM

Prior to modulation, the I and Q signals shall be square-root raised cosine filtered. The roll-off factor shall be 0,15.

Examples of transparent cable transmissions are given in table B.1.

The square-root raised cosine filter shall have a theoretical function defined by the following expression:

$$H(f) = 1 \text{ for } |f| < f_N(1 - \alpha)$$

$$H(f) = \left\{ \frac{1}{2} + \frac{1}{2} \sin \frac{\pi}{2f_N} \left[\frac{f_N - |f|}{\alpha} \right] \right\}^{\frac{1}{2}} \text{ for } f_N(1 - \alpha) \leq |f| \leq f_N(1 + \alpha)$$

$$H(f) = 0 \text{ for } |f| > f_N(1 + \alpha)$$

where

$$f_N = \frac{1}{2T_S} = \frac{R_S}{2} \text{ is the Nyquist frequency and roll-off factor } \alpha = 0,15.$$

The transmitter filter characteristic is given in annex A.

Annex A (normative): Baseband filter characteristics

The template given in figure A.1 shall be used as a minimum requirement for hardware implementation of the Nyquist filter. This template takes into account not only the design limitations of the digital filter, but also the artefacts coming from the analogue processing components of the System (e.g. D/A conversion, analogue filtering, etc.).

The value of in-band ripple r_m in the pass-band up to $0,85 f_N$ as well as at the Nyquist frequency f_N shall be lower than 0,4 dB. The out-band rejection shall be greater than 43 dB.

The filter shall be phase linear with the group delay ripple $\leq 0,1 T_s$ (ns) up to f_N

where, $T_s = 1/R_s$ is the symbol period.

NOTE: The values for in-band ripple and out of band rejection given in this annex are subject to further study.

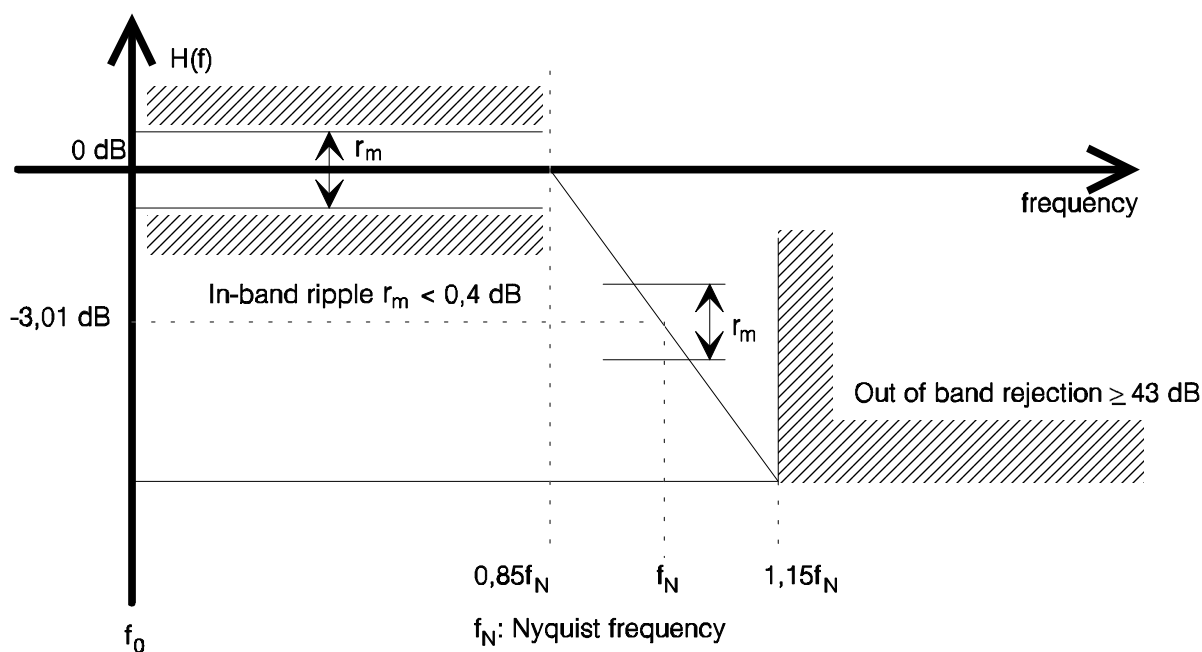

Figure A.1: Half-Nyquist baseband filter amplitude characteristics

Annex B (informative): Transparency of cable networks

In order to achieve a transparent re-transmission of different services on cable systems, the limitations imposed by the System for cable transmission in 8 MHz cable channel bandwidth should be taken into account. With a roll-off factor of 0,15, the theoretical maximum symbol rate in an 8 MHz channel is 6,96 MBaud.

Table B.1 of this annex gives examples of the wide range of possible cable symbol rates and occupied bandwidths for different useful bit rates considering 16-QAM, 32-QAM and 64-QAM constellations.

For full transparency, the same useful bit rate (**excluding** RS coding) should be used on the contributing system and the cable network for secondary distribution.

In the upper part of table B.1, an example of a transparent transmission of the satellite rate of 38,1 Mbit/s, which may be potentially used by many existing satellites (EN 300 421 [3]), is given. This bit rate can be re-transmitted very efficiently in an 8 MHz cable channel by using 64-QAM. A bit rate compatible with terrestrial Plesiochronous Digital Hierarchy (PDH) networks can be re-transmitted in an 8 MHz channel by using 32-QAM.

As shown in the lower part of table B.1, network performance limitations, service requirements (e.g. additional data/audio services), characteristics of the primary distribution system (e.g. satellite, fibre) or other constraints may lead to different usages of the System to appropriately suit various applications.

NOTE: Examples of satellite useful bit rates R_u are taken from EN 300 421 [3].

Table B.1: Examples of useful bit rates R_u and total bit rates $R_{u'}$ for transparent re-transmission and spectrum efficient use on cable networks

Useful bit rate R_u (MPEG-2 transport layer) [Mbit/s]	Total bit rate $R_{u'}$ incl. RS(204,188) [Mbit/s]	Cable symbol rate [MBaud]	Occupied bandwidth [MHz]	Modulation scheme
38,1	41,34	6,89	7,92	64-QAM
31,9	34,61	6,92	7,96	32-QAM
25,2	27,34	6,84	7,86	16-QAM
31,672 PDH	34,367	6,87	7,90	32-QAM
18,9	20,52	3,42	3,93	64-QAM
16,0	17,40	3,48	4,00	32-QAM
12,8	13,92	3,48	4,00	16-QAM
9,6	10,44	1,74	2,00	64-QAM
8,0	8,70	1,74	2,00	32-QAM
6,4	6,96	1,74	2,00	16-QAM

Annex C (informative): Bibliography

For the purposes of the present document, the following informative references apply:

- DTVB 1190/DTVC 38, 3rd revised version, February 1994 (Contribution from DTVC), document: "Specification of modulation, channel coding and framing structure for the Baseline System for digital multi-programme television by cable".
- DTVB 1110/GT V4/MOD 252/ DTVC 18, 7th revised version, January 1994 (Contribution from V4/MOD-B), document: "Specification of the "Baseline modulation/channel coding system" for digital multi-programme television by satellite".
- DVB-TM 1189/DTVC 37 (Contribution from Task Force DTVC), document: "Potential applications of the System for Digital multi-programme Television by Cable".
- GT V4/MOD 247 document, Jézéquel, P.Y., Veillard, J: "Introduction of Digital Television in cable networks".
- Reimers, U. NAB'93, document GT V4/MOD 249: "The European perspectives on Digital Television Broadcasting".

History

Document history		
Edition 1	December 1994	Publication as ETS 300 429
V1.1.2	August 1997	Publication
V1.2.1	December 1997	One-step Approval Procedure OAP 9815: 1997-12-12 to 1998-04-10
V1.2.1	April 1998	Publication