

Final draft **ETSI EN 300 422-3** V2.1.0 (2016-12)



**HARMONISED EUROPEAN STANDARD**

**Wireless Microphones;  
Audio PMSE up to 3 GHz;  
Part 3: Class C Receivers;  
Harmonised Standard covering the essential requirements  
of article 3.2 of Directive 2014/53/EU**

---

Reference

DEN/ERM-TG17-23

---

Keywords

harmonised standard, PMSE, radio MIC

**ETSI**

650 Route des Lucioles  
F-06921 Sophia Antipolis Cedex - FRANCE

Tel.: +33 4 92 94 42 00 Fax: +33 4 93 65 47 16

Siret N° 348 623 562 00017 - NAF 742 C  
Association à but non lucratif enregistrée à la  
Sous-Préfecture de Grasse (06) N° 7803/88

---

**Important notice**

The present document can be downloaded from:  
<http://www.etsi.org/standards-search>

The present document may be made available in electronic versions and/or in print. The content of any electronic and/or print versions of the present document shall not be modified without the prior written authorization of ETSI. In case of any existing or perceived difference in contents between such versions and/or in print, the only prevailing document is the print of the Portable Document Format (PDF) version kept on a specific network drive within ETSI Secretariat.

Users of the present document should be aware that the document may be subject to revision or change of status. Information on the current status of this and other ETSI documents is available at  
<https://portal.etsi.org/TB/ETSIDeliverableStatus.aspx>

If you find errors in the present document, please send your comment to one of the following services:  
<https://portal.etsi.org/People/CommiteeSupportStaff.aspx>

---

**Copyright Notification**

No part may be reproduced or utilized in any form or by any means, electronic or mechanical, including photocopying and microfilm except as authorized by written permission of ETSI.

The content of the PDF version shall not be modified without the written authorization of ETSI.  
The copyright and the foregoing restriction extend to reproduction in all media.

© European Telecommunications Standards Institute 2016.  
All rights reserved.

**DECT™**, **PLUGTESTS™**, **UMTS™** and the ETSI logo are Trade Marks of ETSI registered for the benefit of its Members.  
**3GPP™** and **LTE™** are Trade Marks of ETSI registered for the benefit of its Members and of the 3GPP Organizational Partners.  
**GSM®** and the GSM logo are Trade Marks registered and owned by the GSM Association.

# Contents

Intellectual Property Rights .....	7
Foreword.....	7
Modal verbs terminology.....	7
Executive summary .....	8
Introduction .....	8
1 Scope .....	9
2 References .....	10
2.1 Normative references .....	10
2.2 Informative references.....	10
3 Definitions, symbols and abbreviations .....	11
3.1 Definitions.....	11
3.2 Symbols.....	14
3.3 Abbreviations .....	14
4 Technical requirements specifications .....	15
4.1 Radio microphone .....	15
4.2 In ear monitoring.....	15
4.3 Tour Guide Systems .....	15
4.4 Wireless Multichannel Audio Systems.....	15
4.5 Environmental profile.....	16
5 Testing for compliance with technical requirements.....	16
5.1 Presentation of equipment for testing purposes.....	16
5.1.1 Introduction.....	16
5.1.2 Choice of model for testing .....	17
5.1.3 Definitions of alignment and switching ranges.....	17
5.1.4 Choice of frequencies .....	17
5.1.5 Testing of single channel equipment .....	17
5.1.6 Testing of two channel equipment.....	18
5.1.7 Testing of multi-channel equipment (more than two channels).....	18
5.1.8 Testing of equipment without a permanent external RF port.....	18
5.1.8.1 General .....	18
5.1.8.2 Equipment with a permanent internal RF port .....	18
5.1.8.3 Equipment with a temporary RF port.....	18
5.2 Mechanical and electrical design.....	18
5.2.1 General.....	18
5.2.2 Physical Controls .....	18
5.2.3 Performance testing with integral antenna.....	18
5.2.4 Marking (equipment identification).....	19
6 Test conditions, power sources and ambient conditions .....	19
6.1 Normal and extreme test conditions .....	19
6.2 Test power source.....	19
6.3 Normal test conditions.....	19
6.3.1 Normal temperature and humidity.....	19
6.3.2 Normal test power source voltage.....	20
6.3.2.1 Mains voltage.....	20
6.3.2.2 Other power sources.....	20
6.4 Extreme test conditions .....	20
6.4.1 Extreme temperatures .....	20
6.4.1.1 General .....	20
6.4.1.2 Procedures for tests at extreme temperatures .....	20
6.4.2 Extreme test power source voltages.....	20
6.4.2.1 Mains voltage.....	20
6.4.2.2 Other power sources.....	20

7	General conditions.....	21
7.1	Normal test modulation.....	21
7.1.1	Analogue systems.....	21
7.1.2	Digital systems.....	22
7.1.3	WMAS.....	22
7.2	Artificial antenna.....	22
7.2.1	General.....	22
7.3	Test fixture.....	22
7.3.1	General.....	22
7.4	Test site and general arrangements for radiated measurements.....	23
7.4.1	Introduction.....	23
7.5	Modes of operation of the transmitter.....	23
7.5.1	General.....	23
7.6	Arrangement for test signals at the input of the transmitter.....	23
7.6.1	General.....	23
8	Methods of measurement and limits for transmitter parameters.....	23
8.1	Frequency stability.....	23
8.1.1	Method of measurement (analogue).....	23
8.1.2	Method of measurement (digital).....	24
8.1.3	Limit.....	24
8.2	Rated output power.....	24
8.2.1	Method of measurement for equipment without integral antenna.....	24
8.2.2	Method of measurement for equipment with integral antenna.....	24
8.2.2.1	Method of measurement under normal test conditions.....	24
8.2.3	Limit.....	25
8.3	Necessary bandwidth.....	25
8.3.1	General.....	25
8.3.2	Necessary Bandwidth (BN) for Analogue Systems.....	25
8.3.2.1	Method of Measurement.....	25
8.3.2.2	Limits.....	26
8.3.3	Necessary Bandwidth (BN) for Digital Systems.....	26
8.3.3.1	Method of Measurement.....	26
8.3.3.2	Limits.....	28
8.3.4	Necessary Bandwidth (BN) for WMAS.....	29
8.3.4.1	Applicability.....	29
8.3.4.2	Method of measurement.....	29
8.3.4.3	Limits.....	30
8.3.5	Bandwidth measurement procedure for PMSE operation in 2,4 GHz to 2,4835 GHz.....	31
8.3.5.1	Applicability.....	31
8.3.5.2	Definition.....	31
8.3.5.3	Limits.....	31
8.3.5.4	Conformance.....	31
8.3.5.4.1	Test conditions.....	31
8.3.5.4.2	Test method.....	31
8.3.6	Transmitter Unwanted Emissions in the Out-of-band Domain Alternative Measurement Procedure.....	32
8.3.6.1	Applicability.....	32
8.3.6.2	Definition.....	32
8.3.6.3	Limit.....	32
8.3.6.4	Conformance.....	33
8.3.6.4.1	Test conditions.....	33
8.3.6.4.2	Test method.....	33
8.4	Spurious emissions.....	35
8.4.1	Definition.....	35
8.4.2	Method of measurement.....	35
8.4.3	Limits.....	35
8.4.4	Measuring receiver.....	35
8.5	Transmitter intermodulation distortion.....	36
8.5.1	Definition.....	36
8.5.2	Method of measurement.....	36
8.5.3	Limits.....	37

9	Receiver.....	37
9.1	Spurious emissions.....	37
9.1.1	Definitions.....	37
9.1.2	Method of measuring the power level in a specified load.....	38
9.1.3	Method of measuring the effective radiated power of the enclosure.....	38
9.1.4	Method of measuring the effective radiated power.....	38
9.1.5	Limits.....	39
9.2	Receiver sensitivity.....	39
9.2.1	Definition.....	39
9.2.2	Method of measurement.....	39
9.2.3	Limits.....	40
9.3	Receiver adjacent channel selectivity.....	40
9.3.1	Definition.....	40
9.3.2	Method of measurement.....	40
9.3.3	Limits.....	41
9.4	Receiver blocking.....	41
9.4.1	Definition.....	41
9.4.2	Method of measurement.....	41
9.4.3	Limits.....	41
10	Measurement uncertainty.....	41
<b>Annex A (informative):</b>	<b>Relationship between the present document and the essential requirements of Directive 2014/53/EU.....</b>	<b>43</b>
<b>Annex B (normative):</b>	<b>Measurement of Necessary Bandwidth (B) for analogue systems.....</b>	<b>44</b>
B.1	Test configuration for measurement of the Necessary Bandwidth (B) for analogue systems; see figure B.1.....	44
<b>Annex C (normative):</b>	<b>Radiated measurement.....</b>	<b>45</b>
C.1	Test sites and general arrangements for measurements involving the use of radiated fields.....	45
C.1.1	General.....	45
C.1.2	Anechoic chamber.....	45
C.1.3	Anechoic chamber with a conductive ground plane.....	46
C.1.4	Open Area Test Site (OATS).....	47
C.1.5	Test antenna.....	48
C.1.6	Substitution antenna.....	48
C.1.7	Measuring antenna.....	49
C.1.8	Stripline arrangement.....	49
C.1.8.1	General.....	49
C.1.8.2	Description.....	49
C.1.8.3	Calibration.....	49
C.1.8.4	Mode of use.....	49
C.2	Guidance on the use of radiation test sites.....	49
C.2.1	General.....	49
C.2.2	Verification of the test site.....	49
C.2.3	Preparation of the DUT.....	50
C.2.4	Power supplies to the DUT.....	50
C.2.5	Volume control setting for analogue speech tests.....	50
C.2.6	Range length.....	50
C.2.7	Site preparation.....	51
C.3	Coupling of signals.....	51
C.3.1	General.....	51
C.3.2	Data signals.....	51
C.3.3	Speech and analogue signals.....	52
C.3.3.0	General.....	52
C.3.3.1	Acoustic coupler description.....	52
C.3.3.2	Calibration.....	52
C.4	Standard test position.....	52

C.5	Test fixture .....	53
C.5.1	General .....	53
C.5.2	Description .....	53
C.5.3	Calibration .....	54
C.5.4	Mode of use .....	54
<b>Annex D (informative):</b>	<b>Additional receiver parameters identified under article 3.2 of Directive 2014/53/EU .....</b>	<b>55</b>
<b>Annex E (informative):</b>	<b>Application form for wireless microphone testing.....</b>	<b>56</b>
E.1	Introduction .....	56
E.1.1	Description .....	56
E.1.2	Notice .....	56
E.2	Transmitter intermodulation distortion.....	56
E.2.1	General .....	56
E.2.2	Definition .....	56
E.2.3	Method of measurement .....	56
E.2.4	Limits .....	56
E.2.5	Settings and results .....	56
E.3	Receiver Sensitivity.....	57
E.3.1	General .....	57
E.3.2	Definition .....	57
E.3.3	Method of measurement .....	57
E.3.4	Limits .....	57
E.3.5	Settings and results .....	57
E.4	Receiver Adjacent Channel Power Selectivity.....	58
E.4.1	General .....	58
E.4.2	Definition .....	58
E.4.3	Method of measurement .....	58
E.4.4	Limits .....	58
E.4.5	Settings and results .....	58
E.5	Receiver blocking.....	59
E.5.1	General .....	59
E.5.2	Definition .....	59
E.5.3	Method of measurement .....	59
E.5.4	Limits .....	59
E.5.5	Settings and results .....	59
<b>Annex F (informative):</b>	<b>Bibliography.....</b>	<b>60</b>
<b>Annex G (informative):</b>	<b>Change History .....</b>	<b>61</b>
History .....		62

---

## Intellectual Property Rights

IPRs essential or potentially essential to the present document may have been declared to ETSI. The information pertaining to these essential IPRs, if any, is publicly available for **ETSI members and non-members**, and can be found in ETSI SR 000 314: "*Intellectual Property Rights (IPRs); Essential, or potentially Essential, IPRs notified to ETSI in respect of ETSI standards*", which is available from the ETSI Secretariat. Latest updates are available on the ETSI Web server (<https://ipr.etsi.org>).

Pursuant to the ETSI IPR Policy, no investigation, including IPR searches, has been carried out by ETSI. No guarantee can be given as to the existence of other IPRs not referenced in ETSI SR 000 314 (or the updates on the ETSI Web server) which are, or may be, or may become, essential to the present document.

---

## Foreword

This final draft Harmonised European Standard (EN) has been produced by ETSI Technical Committee Electromagnetic compatibility and Radio spectrum Matters (ERM), and is now submitted for the Vote phase of the ETSI standards EN Approval Procedure.

The present document has been prepared under the Commission's standardisation request C(2015) 5376 final [i.16] to provide one voluntary means of conforming to the essential requirements of Directive 2014/53/EU on the harmonisation of the laws of the Member States relating to the making available on the market of radio equipment and repealing Directive 1999/5/EC [i.12].

Once the present document is cited in the Official Journal of the European Union under that Directive, compliance with the normative clauses of the present document given in table A.1 confers, within the limits of the scope of the present document, a presumption of conformity with the corresponding essential requirements of that Directive and associated EFTA regulations.

The present document is part 3 of a multi-part deliverable. Full details of the entire series can be found in part 1 [i.17].

<b>Proposed national transposition dates</b>	
Date of latest announcement of this EN (doa):	3 months after ETSI publication
Date of latest publication of new National Standard or endorsement of this EN (dop/e):	6 months after doa
Date of withdrawal of any conflicting National Standard (dow):	18 months after doa

---

## Modal verbs terminology

In the present document "**shall**", "**shall not**", "**should**", "**should not**", "**may**", "**need not**", "**will**", "**will not**", "**can**" and "**cannot**" are to be interpreted as described in clause 3.2 of the [ETSI Drafting Rules](#) (Verbal forms for the expression of provisions).

"**must**" and "**must not**" are **NOT** allowed in ETSI deliverables except when used in direct citation.

---

## Executive summary

With the introduction of Directive 2014/53/EU [i.12], this multi-part deliverable has been reformatted into multiple parts to accommodate the different types of equipment represented, i.e. different receivers for audio Programme Making and Special Events (PMSE) and Assistive Listening Devices (ALD). The present document covers Class C receivers.

The present document seeks to improve spectrum efficiency and has introduced new technology to assist in maximizing the use of available spectrum.

The present document seeks to provide a platform for Wideband Multichannel Audio Systems (WMAS).

Although the present document covers spectrum up to 3 GHz, it should be emphasized that multi-channel audio PMSE systems used in professional productions are best suited to spectrum under 2 GHz for reasons of propagation and body interaction. Further information on audio PMSE is available in ECC Report 204 [i.13].

---

## Introduction

With the introduction of Directive 2014/53/EU [i.12], receiver parameters are now included and the removal of the 9 kHz lower limit has brought inductive loop systems and receivers into this multi-part deliverable. Inductive loop transmitters are covered within ETSI EN 303 340 [i.18] along with test receivers; hearing aids containing inductive loop receivers (often referred to as T coil) are now covered in ETSI EN 300 422-4 [i.20]. The frequency range of the present document has been reduced to accommodate inductive loop receivers.

The present document is a testing standard based on spectrum utilization parameters and does not include performance characteristics that may be required by the user nor requirements for interfacing equipment.

This multi-part deliverable was originated in 1991 when Assistive Listening Devices (ALD) were a very small part of the Radio Microphone Industry; in recent years major advances in both the volume and functionality of ALDs has caused a rethink in how to best present the testing regime in a clear and concise manner. After a number of discussions the present document covers audio PMSE as Parts 1, 2, and 3 and ALDs as Part 4.

Systems including assistive listening devices (Aids for the handicapped) with analogue or digital modulations and operating in the range 863 MHz to 865 MHz may be tested to either the present document or to ETSI EN 301 357 [i.1] with due consideration of power and operating frequency.

ALDs may in some cases require stereo transmission to present both left and right audio information to the wearer. For that reason, devices that transmit information to the hearing impaired may require two channel operation. It is expected that two or more channel devices will be tested separately when determining bandwidth and associated measurements. Channels may involve the use of two separate frequencies or wider bandwidth.

Since the initial adoption of ETSI I-ETS 300 422 [i.2] there has been the introduction of further types of equipment into the market - cordless headphones/loudspeakers, Low power Band II and consumer in-ear monitoring. These are low power wideband systems that have some characteristics in common with radio microphones but are not compatible with multichannel radio microphones. This equipment is covered by ETSI EN 301 357 [i.1] and annex 10 of CEPT/ERC/REC 70-03 [i.6].

Additional standards or specifications may be required for equipment:

- 1) intended to interface to Public Networks, e.g. PSTN. This facility may be subjected to regulatory conditions;  
or
- 2) other relevant radio standards.



# 1 Scope

The present document specifies the technical characteristics and methods of measurement for the following types of equipment:

- 1) Assistive Listening Devices;
- 2) Radio Microphones;
- 3) In-ear Monitoring Systems;
- 4) WMAS (Wireless Multichannel Audio Systems);
- 5) Tour Guide Systems;

with Class C receivers which have significantly reduced performance requirements with respect to sensitivity, adjacent channel selectivity, and receiver blocking compared to those with Class A receivers. It does not necessarily include all the characteristics that may be required by a user, nor does it necessarily represent the optimum performance achievable. Equipment with Class C receivers will support the operation of fewer wireless audio channels in a given amount of spectrum than Class A or Class B receivers.

The present document applies to equipment operating on radio frequencies up to 3 GHz (as shown in table 1) using analogue, digital and hybrid (using both analogue and digital) modulation.

The maximum power recommended for equipment covered by this multi-part deliverable is 250 mW for radio microphones and 10 mW for ALDs.

An exception to this are the Public Hearing Aids defined in the CEPT Report 004 [i.7] and subsequent ECC [i.9] and EC Decisions [i.8] on the ex ERMES band (169,4 MHz to 169,8125 MHz) where 500 mW is defined.

The present document covers the essential requirements of article 3.2 of Directive 2014/53/EU under the conditions identified in annex A. The present document also covers radio microphones used in the 863 MHz to 865 MHz band, with a maximum power of 10 mW.

Electromagnetic Compatibility (EMC) requirements are covered by ETSI EN 301 489-9 [i.4].

National regulations on:

- 1) maximum power output;
- 2) licensing status;

will take precedence or those detailed in the latest version of:

- EC Decision 2005/928/EC [i.9];
- ECC/DEC/(05)02 [i.10];
- the EC SRD Decision [i.8]; or
- CEPT/ERC/REC 70-03 [i.6], annex 10 (see <http://www.erodocdb.dk/>);
- EC Decision 2014/641/EU [i.11].

Unless otherwise stated in the EC SRD Decision, ECC Decision or National Interfaces, Radio Microphones can be subject to individual licence.

**Table 1: Radiocommunications service frequency bands**

Radiocommunications service frequency bands	
Transmit	up to 3 000 MHz
Receive	up to 3 000 MHz

---

## 2 References

### 2.1 Normative references

References are specific, identified by date of publication and/or edition number or version number. Only the cited version applies.

Referenced documents which are not found to be publicly available in the expected location might be found at <https://docbox.etsi.org/Reference/>.

NOTE: While any hyperlinks included in this clause were valid at the time of publication, ETSI cannot guarantee their long term validity.

The following referenced documents are necessary for the application of the present document.

- [1] IEC 60244-13:1991: "Methods of measurement for radio transmitters - Part 13: Performance characteristics for FM sound broadcasting".

### 2.2 Informative references

References are either specific (identified by date of publication and/or edition number or version number) or non-specific. For specific references, only the cited version applies. For non-specific references, the latest version of the referenced document (including any amendments) applies.

NOTE: While any hyperlinks included in this clause were valid at the time of publication, ETSI cannot guarantee their long term validity.

The following referenced documents are not necessary for the application of the present document but they assist the user with regard to a particular subject area.

- [i.1] ETSI EN 301 357: "ElectroMagnetic Compatibility and Radio Spectrum Matters (ERM); Technical characteristics and test methods for analogue cordless wideband audio devices using integral antennas operating in the CEPT recommended 863 MHz to 865 MHz frequency range".
- [i.2] ETSI I-ETS 300 422: "Electromagnetic compatibility and Radio spectrum Matters (ERM); Wireless Audio PMSE up to 3 GHz".
- [i.3] Recommendation ITU-R BS.559-2: "Objective measurement of radio-frequency protection ratios in LF, MF, and HF broadcasting".
- [i.4] ETSI EN 301 489-9: "Electromagnetic compatibility and Radio spectrum Matters (ERM); Electromagnetic Compatibility (EMC) standard for radio equipment and services; Part 9: Specific conditions for wireless microphones, similar Radio Frequency (RF) audio link equipment, cordless audio and in-ear monitoring devices".
- [i.5] ETSI TR 102 273: "Electromagnetic compatibility and Radio spectrum Matters (ERM); Improvement on Radiated Methods of Measurement (using test site) and evaluation of the corresponding measurement uncertainties".
- [i.6] CEPT/ERC/REC 70-03: "Relating to the use of Short Range Devices (SRD)".
- [i.7] CEPT Report 004: "Report from CEPT to the European Commission in response to the Mandate to review the frequency band 169,4 - 169,8 MHz".
- [i.8] Commission Decision 2006/771/EC of 9 November 2006 on harmonisation of the radio spectrum for use by short-range devices.
- [i.9] EC Decision 2005/928/EC: "Commission Decision of 20 December 2005 on the harmonisation of the 169,4-169,8125 MHz frequency band in the Community", OJ L 344, 27.12.2005, p. 47-51.
- [i.10] ECC/DEC/(05)02: "ECC Decision of 18 March 2005 on the use of the Frequency Band 169,4-169,8125 MHz".

- [i.11] Commission Implementing Decision of 1 September 2014 on harmonised technical conditions of radio spectrum use by wireless audio programme making and special events equipment in the Union (notified under document C(2014) 6011) (Text with EEA relevance) (2014/641/EU).
- [i.12] Directive 2014/53/EU of the European Parliament and of the Council of 16 April 2014 on the harmonisation of the laws of the Member States relating to the making available on the market of radio equipment and repealing Directive 1999/5/EC.
- [i.13] ECC Report 204: "Spectrum Use and future requirements for PMSE".
- [i.14] Recommendation ITU-R SM.2152 (09-2009): "Definitions of Software Defined Radio (SDR) and Cognitive Radio System (CRS)".
- [i.15] ETSI EG 203 336: "Electromagnetic compatibility and Radio spectrum Matters (ERM); Guide for the selection of technical parameters for the production of Harmonised Standards covering article 3.1(b) and article 3.2 of Directive 2014/53/EU".
- [i.16] Commission Implementing Decision C(2015) 5376 final of 4.8.2015 on a standardisation request to the European Committee for Electrotechnical Standardisation and to the European Telecommunications Standards Institute as regards radio equipment in support of Directive 2014/53/EU of the European Parliament and of the Council.
- [i.17] ETSI EN 300 422-1: "Wireless Microphones; Audio PMSE up to 3 GHz; Part 1: Class A Receivers; Harmonised Standard covering the essential requirements of article 3.2 of Directive 2014/53/EU".
- [i.18] ETSI EN 303 340: "Digital Terrestrial TV Broadcast Receivers; Harmonised Standard covering the essential requirements of article 3.2 of Directive 2014/53/EU".
- [i.19] Void.
- [i.20] ETSI EN 300 422-4: "Wireless Microphones; Audio PMSE up to 3 GHz; Part 4: Assistive Listening Devices including personal sound amplifiers and inductive systems up to 3 GHz; Harmonised Standard covering the essential requirements of article 3.2 of Directive 2014/53/EU".
- [i.21] ANSI C63.5: "American National Standard for Electromagnetic Compatibility - Radiated Emission Measurements in Electromagnetic Interference (EMI) Control - Calibration of Antennas (9 kHz to 40 GHz)".
- [i.22] European Commission: "The 'Blue Guide' on the implementation of EU products rules 2016 (2016/C 272/01)".
- [i.23] ETSI TR 100 028 (all parts): "Electromagnetic compatibility and Radio spectrum Matters (ERM); Uncertainties in the measurement of mobile radio equipment characteristics".

---

## 3 Definitions, symbols and abbreviations

### 3.1 Definitions

For the purposes of the present document, the following terms and definitions apply:

**alignment range:** frequency range over which the receiver and the transmitter can be programmed and/or re-aligned to operate without any physical change of components other than programmable read only memories supplied by the manufacturer or the manufacturer's nominee, crystals, and frequency setting elements

**antenna port:** port, where a radio frequency antenna is connected to equipment

**audio limiting threshold:** audio input or output level at which the transmitter audio limiter action may be said to commence

NOTE: It is specified with any accessible variable gain controls set according to the manufacturer's instructions, with a sinusoidal input signal of 500 Hz.

**audio PMSE:** inclusive description consisting of radio microphones, in ear monitoring systems, audio links

**base station equipment:** radio and/or ancillary equipment intended for operation at a fixed location and powered directly or indirectly

**body worn transmitter:** radio microphone that can be attached to the human body

NOTE: The microphone is attached to the transmitter via cable; the antenna radiation characteristics are affected by the human body.

**class of emission:** set of characteristics of an emission, designated by standard symbols, e.g. type of modulation of the main carrier, modulating signal, type of information to be transmitted, and also, if appropriate, any additional signal characteristics

**conducted measurements:** measurements that are made using a direct connection to the device under test (DUT)

**confidence level:** probability of the accumulated error of a measurement being within the stated range of uncertainty of measurement

**C-PMSE:** cognitive PMSE is built of a Cognitive Radio System (CRS) based on Recommendation ITU-R SM.2152 [i.14] and designed for the purpose and the specific requirements of PSME applications

**C-PMSE system:** constituted out of information acquisition and C-PMSE

**digital modulation:** any modulation scheme with discrete constellation points (e.g. FSK, PSK)

**enclosure port:** physical boundary of the apparatus through which electromagnetic fields may radiate or impinge

NOTE: In the case of integral antenna equipment, this port is inseparable from the antenna port.

**frequency stability:** spontaneous and/or environmentally caused frequency change within a given time interval

**hand held microphone:** radio microphone which can be held and operated in the human hand

NOTE: The microphone is directly attached to the transmitter; the antenna radiation characteristics are less affected by the human body than body worn equipment.

**hybrid systems:** combination of analogue and digital processing and modulation techniques

**in ear monitor (IEM):** body worn miniature receiver with earpieces for personal monitoring of single- or dual-channel sound

**integral antenna:** antenna, with or without a connector, designed as, and declared as by the manufacturer, an indispensable part of the equipment

**integral microphone:** microphone, designed as, and declared as by the manufacturer, an indispensable fixed part of the equipment

**mean power (of a radio transmitter):** average power supplied to the antenna transmission line by a transmitter during an interval of time sufficiently long compared with the lowest frequency encountered in the modulation taken under normal operating conditions

**mobile equipment:** receiver, transmitter or transmitter/receiver (transceiver) intended for installation and use in a vehicle, and powered by the main battery of the vehicle

**necessary bandwidth:** for a given class of emission, the width of the frequency band which is just sufficient to ensure the transmission of information at the rate and with the quality required under specified conditions

**out-of-band emission:** emission on a frequency or frequencies immediately outside the necessary bandwidth which results from the modulation process, but excluding spurious emissions

**personal hearing aid system:** radio communication system comprising of a transmitter, which can be handheld, on a table or around the neck of a hearing impaired person and one or more receivers, where each receiver can have wired or inductive connection to a hearing aid

**port:** any connection point on or within the device under test (DUT) intended for the connection of cables to or from that equipment

**portable equipment:** radio and/or ancillary equipment intended for portable (e.g. handheld) operation, powered by its own integral battery

**public hearing aid system:** broadcast radio communication system comprising one transmitter (up to 500 mW in the band 169,4 MHz to 169,8125 MHz), which is installed at a fixed location in a large auditorium

EXAMPLE: In a church or theatre and one or more receivers, where each receiver can have wired or inductive connection to a hearing aid.

NOTE: May be subject to an individual licence.

**radiated measurements:** measurements that involve the absolute measurement of a radiated electromagnetic field

**Radio Frequency (RF) port:** any connection point on or within the DUT intended for the connection of RF cables

NOTE: RF ports are treated as 50  $\Omega$  connection points unless otherwise specified by the manufacturer.

**radio receiver:** item of electronic equipment designed to receive electromagnetic radio frequency emissions

**rated output power:** mean power which the transmitter delivers at its antenna port under the manufacturer's specified conditions of operation

NOTE: For the purposes of the present document this is quoted as erp below 1 GHz and eirp above 1 GHz.

**receiver adjacent channel selectivity:** measure of the capability of the receiver to operate satisfactorily in the presence of an unwanted signal, which differs in frequency from the wanted signal by an amount equal to the channel separation declared by the manufacturer

**receiver blocking:** measure of the capability of the receiver to receive a wanted modulated signal without exceeding a given degradation due to the presence of an unwanted input signal at any frequencies other than those of the spurious responses or the adjacent channels or bands

**receiver co-channel rejection:** measure of the capability of a receiver to receive a wanted signal, without exceeding a given degradation, due to the presence of an unwanted signal, both signals being at the nominal frequency of the receiver

**receiver sensitivity:** ability to receive a wanted signal at low input power level while providing a pre-determined level of performance.

**spurious emissions:** emission on a frequency or frequencies which are outside the necessary bandwidth and the level of which may be reduced without affecting the corresponding transmission of information

EXAMPLE: Spurious emissions include harmonic emissions, parasitic emissions, intermodulation products and frequency conversion products but exclude out of band emissions.

**switching range:** maximum frequency range over which the receiver or the transmitter can be operated without hardware or software modifications

**transmitter intermodulation distortion (IMD):** non-linear operation which occurs when at least two signals on different frequencies are injected into a transmitter resulting in at least third order intermodulation product

**transmitter intermodulation performance:** measure of the capability of the transmitter to inhibit the generation of signals in its nonlinear elements caused by presence of the wanted signal and an interfering signal reaching the transmitter via the antenna

**transmitter intermodulation ratio:** ratio of the power of the intermodulation product to the wanted signal, when an interference signal is injected into the antenna connector at a specific power level lower than that of the mean power of the wanted signal

**Wireless Multichannel Audio Systems (WMAS):** wireless audio transmission systems using broadband transmission technique for microphone and in-ear monitor systems, and other multichannel audio PMSE use

## 3.2 Symbols

For the purposes of the present document, the following symbols apply:

ac	alternating current
AF	Audio Frequency
B	declared channel Bandwidth

NOTE: See table 2.

$\lambda$	wavelength in metres
$\Omega$	ohm
$\mu\text{F}$	microfarad
$\mu\text{W}$	microwatt
dB	decibel; logarithmic unit to express ratio between two quantities
dBA	A-weighted power quantity
dBc	power quantity relative to carrier power level
dBm	power quantity relative to 1 mW
$f_{\text{BLK}}$	frequency of blocker signal
$f_{\text{c}}$	centre frequency
$f_{\text{INT}}$	frequency of interferer signal
$f_{\text{TOI}}$	frequency of third order intermodulation product
$f_{\text{w}}$	wanted frequency
GHz	gigahertz
kHz	kilohertz
MHz	megahertz
mW	milliwatt
nW	nanowatt

## 3.3 Abbreviations

For the purposes of the present document, the following abbreviations apply:

ALD	Assistive Listening Device
BER	Bit Error Rate
BN	Necessary Bandwidth
BW	BandWidth
CEPT	Commission of European Post and Telecommunications
dc	direct current
DUT	Device Under Test
ECC	Electronic Communications Committee
eirp	equivalent isotropically radiated power
EMC	ElectroMagnetic Compatibility
emf	electromagnetic field
ERMES	European Radio MESSage System
erp	effective radiated power
IEC	International Electrotechnical Commission
IEM	In Ear Monitor system
IMD	InterModulation Distortion
ITU-R	International Telecommunication Union – Radiocommunication Sector
LF	Low Frequency
lim	limiting
NF	Noise Figure
OATS	Open Area Test Site
PMSE	Program Making and Special Events
PSTN	Public Switched Telephone Network
PWMS	Professional Wireless Microphone Systems
R	distance
RBW	Resolution Bandwidth
RF	Radio Frequency
RMS	Root Mean Square
Rx	Receiver

SINAD	Ratio of (Signal + Noise + Distortion) to (Noise + Distortion)
SRD	Short Range Device
TOI	Third Order Intermodulation
Tx	Transmitter
Tx-IMD	Transmitter intermodulation distortion
VBW	Video BandWidth
VSWR	Voltage Standing Wave Ratio
WMAS	Wireless Multichannel Audio Systems

## 4 Technical requirements specifications

### 4.1 Radio microphone

Radio microphones are used to provide a high quality, short range, wireless link for use in audio performance for professional use in broadcasting, concerts, etc. The radio part of the transmitter and receiver shall be made up exclusively from equipment that has been approved according to the present document.

Other equipment that may be connected to radio microphones shall fulfil the standards applicable to that equipment (if any).

### 4.2 In ear monitoring

In ear monitoring equipment is used by stage and studio performers to receive personal fold back (monitoring) of the performance. This can be just their own voice or a complex mix of sources. The bandwidth requirement of professional in ear monitoring equipment is similar to those of radio microphones but normally uses a stereo signal.

The radio part of the transmitter and receiver shall be made up exclusively from equipment that has been approved according to the present document.

Other equipment that may be connected to in ear monitoring equipment shall fulfil the standards applicable to that equipment (if any).

### 4.3 Tour Guide Systems

Tour guide wireless systems are used for guided tours of a city, museum, business facilities, etc. A tour guide system consists of a low power wireless transmitter and several headset or headset-connected receivers depending on the number of persons participating in the tour. The wireless transmitter can utilize a built-in or external microphone. The radio section of the transmitter and receiver shall comply with the requirements of the present document.

Other equipment that may be connected to tour guide equipment shall fulfil the standards applicable to that equipment (if any).

### 4.4 Wireless Multichannel Audio Systems

Wireless Multichannel Audio Systems (WMAS) are broadband systems that provide multi-channel audio transmission capabilities, operating within bands that are specifically allocated to PMSE and in accordance with national regulations. WMAS might also operate in other bands where broadband transmissions are permitted.

One example of a WMAS application would be a multi-channel In-Ear Monitoring (IEM) system in which multiple audio channels are transmitted over a single broadband radio frequency (RF) channel to several receivers, each of which could select one or more of the audio channels for reproduction.

Broadband multi-channel systems inherently occupy a wider bandwidth than a narrowband single channel transmitter. In order to justify consuming this additional bandwidth, these systems should be designed to deliver high spectral efficiency.

Spectral efficiency is defined as the number of audio links transmitted per MHz of occupied spectrum. The use of a television channel as a bandwidth unit is not assumed. Television broadcasting channels currently have various bandwidths ranging from 6 MHz to 8 MHz in different countries, and might have other bandwidths in the future. Furthermore, audio PMSE systems also operate in other bands in addition to the broadcast bands. No dependency on bits/Hz or audio quality is assumed, since wireless multichannel audio systems might be designed with various combinations of transmission parameters in accordance with particular goals for audio quality, robustness, working range, etc.

A WMAS is required to have at least one mode, defined as the Standard Mode, which supports a minimum of three audio links per MHz, defined as:

$N_{\text{audio channels}} = B/1 \text{ MHz} \times 3$  where  $N_{\text{audio channels}}$  = number of audio channels and  $B$  = occupied bandwidth in Hz

Examples: for a 6 MHz television channel,  $N = 18$  channels, for a 7 MHz television channel,  $N = 21$  channels, and for an 8 MHz television channel,  $N = 24$  channels. For a hypothetical 10 MHz RF channel,  $N = 30$  channels.

The particular realization of this mode is not specified in the present document and is left to the manufacturer's discretion. In addition, the WMAS may also offer other modes according to the manufacturer's specific goals such as higher or lower audio quality, greater or lesser robustness, and greater or lesser working range.

Other equipment that may be connected to WMAS equipment shall fulfil the standards applicable to that equipment (if any).

## 4.5 Environmental profile

The technical requirements of the present document apply under the environmental profile for operation of the equipment, which shall be declared by the manufacturer. The equipment shall comply with all the technical requirements of the present document which are identified as applicable in annex A at all times when operating within the boundary limits of the declared operational environmental profile.

# 5 Testing for compliance with technical requirements

## 5.1 Presentation of equipment for testing purposes

### 5.1.1 Introduction

All equipment submitted for testing shall fulfil the requirements of the present document on all channels over which it is intended to operate.

For radio microphones that may use a variety of audio capsules, the manufacturer shall supply the test sample with an audio test fixture, to substitute the audio capsule with suitable input and output impedance.

The test report shall state the channel bandwidth(s) within which the equipment is designed to operate, but with a maximum of 200 kHz below 1 GHz and a maximum of 600 kHz above 1 GHz. WMAS may use a bandwidth of up to 20 MHz (see table 2).

For analogue systems, the test report shall state the audio input limiting threshold (see clause 7.1.1).

The test report shall also supply all relevant interface information to allow:

- direct current (dc) power connection;
- RF connection;
- audio connection;
- the bandwidth and audio limiting of the transmitter; and
- the setting of any input audio level controls for normal operation. The manufacturer shall specify the settings of any other controls necessary to avoid invalidating the test measurements.



Besides the technical documentation, the manufacturer shall also supply an operating manual and software, if necessary, for the device(s) (in order that the test engineer shall operate the equipment in accordance with the manufacturer's instructions).

**Table 2: Channel bandwidth**

Declared channel Bandwidth (B)	Designation
50 kHz	L
75 kHz	M
100 kHz	P
150 kHz	Q
200 kHz	R
250 kHz	S
300 kHz	T
400 kHz	U
600 kHz	V
other up to 20 MHz (for WMAS)	Z

### 5.1.2 Choice of model for testing

The manufacturer shall supply one or more production model(s) of the equipment, including all antenna(s) designed for the equipment, and that are required to be covered by the testing.

The equipment tested shall be representative of the performance of the corresponding production models.

If approval or compliance is given on the basis of tests on a preliminary model, the corresponding production models shall be identical in all respects with the preliminary model tested. For a model with more than one antenna the device shall not exceed the maximum declared power.

In the case of radio microphone equipment without a permanent external RF port, see clause 5.1.8.

### 5.1.3 Definitions of alignment and switching ranges

The alignment range is defined as the frequency range over which the receiver and the transmitter can be programmed and/or re-aligned to operate without any physical change of components other than:

- programmable read only memories supplied by the manufacturer or the manufacturer's nominee;
- crystals;
- frequency setting elements (for the receiver and transmitter). These elements shall not be accessible to the end user and shall be declared by the manufacturer in the application form.

The switching range is the maximum frequency range over which the receiver or the transmitter can be operated without hardware or software modifications.

The manufacturer shall, when submitting equipment for test, state the alignment ranges for the receiver and transmitter. The manufacturer shall also state the switching range of the receiver and the transmitter (which may differ).

### 5.1.4 Choice of frequencies

The frequencies for testing shall be chosen by the manufacturer.

### 5.1.5 Testing of single channel equipment

Full tests shall be carried out on an RF channel closest to the centre frequency of the alignment range on one sample of the equipment.

## 5.1.6 Testing of two channel equipment

One sample shall be submitted to enable full tests to be carried out on the highest frequency and the lowest frequency of the switching range.

## 5.1.7 Testing of multi-channel equipment (more than two channels)

One sample of the equipment shall be submitted to enable tests to be carried out on three RF channels. The closest centre frequency of the switching range of the sample shall correspond to the closest centre frequency of the alignment range.

Full tests shall be carried out on a frequency closest to the centre frequency, and at the lowest and highest frequencies of the switching range.

## 5.1.8 Testing of equipment without a permanent external RF port

### 5.1.8.1 General

To facilitate relative measurements, use may be made of a test fixture as described in clause 7.3, or the equipment may be supplied with a permanent internal or temporary internal/external RF port.

### 5.1.8.2 Equipment with a permanent internal RF port

The way to access a permanent internal RF port shall be stated by the manufacturer with the aid of a diagram. The fact that use has been made of a permanent internal RF port shall be recorded in the test report.

### 5.1.8.3 Equipment with a temporary RF port

The manufacturer shall submit two sets of equipment to the test laboratory, one fitted with a temporary 50  $\Omega$  RF connector with the antenna disconnected and the other with the antenna connected. Each equipment shall be used for the appropriate tests.

The way the temporary RF port is implemented shall be stated by the manufacturer with the aid of a diagram. The fact that use has been made of the temporary RF port to facilitate measurements shall be stated in the test report. The addition of a temporary RF port should not influence the performance of the DUT.

## 5.2 Mechanical and electrical design

### 5.2.1 General

The equipment submitted by the manufacturer shall be designed, constructed and manufactured in accordance with sound engineering practice, and with the aim of minimizing harmful interference to other equipment and services and promoting efficient spectrum use.

For further information please refer to the Blue Guide [i.22].

### 5.2.2 Physical Controls

Manufacturers shall use their best endeavour to ensure that the end user is unable to modify the equipment in a way which would affect the radio frequency performance of the system.

### 5.2.3 Performance testing with integral antenna

Approval of equipment with integral antenna only applies to that equipment together with the antenna originally supplied by the manufacturer for conformance testing.

## 5.2.4 Marking (equipment identification)

Information on marking can be found in the Blue Guide [i.22].

---

# 6 Test conditions, power sources and ambient conditions

## 6.1 Normal and extreme test conditions

Tests shall be made under normal test conditions, and also, where stated, under extreme test conditions.

The test conditions and procedures shall be as specified in clause 6.2 to clause 6.4.2.

## 6.2 Test power source

During tests the power source of the equipment shall be replaced by a test power source, capable of producing normal and extreme test voltages as specified in clauses 6.3.2 and 6.4.2. The internal impedance of the test power source shall be low enough for its effect on the test results to be negligible. For the purpose of the tests, the voltage of the power source shall be measured at the input terminals of the equipment.

For battery operated equipment, the battery should be removed and the test power source shall be suitably decoupled and applied as close to the equipment battery terminals as practicable. For radiated measurements any external power leads should be arranged so as not to affect the measurements. If necessary (or the DUT fails the test) the external power supply may be replaced with the equipment's own internal batteries at the required voltage, and this shall be stated on the test report.

Where equipment contains a non-removable rechargeable battery, the battery shall be fully charged before use and used for the purpose of the testing. The battery status shall be monitored and shall never fall into a low battery condition.

If the equipment is provided with a power cable or power socket, the test voltage shall be that measured at the point of connection of the power cable to the equipment.

During tests the power source voltages shall be within a tolerance of  $< \pm 1$  % relative to the voltage at the beginning of each test. The value of this tolerance can be critical for certain measurements. Using a smaller tolerance provides a better uncertainty value for these measurements. If internal batteries are used, at the end of each test the voltage shall be within a tolerance of  $< \pm 1$  % relative to the voltage at the beginning of each test.

## 6.3 Normal test conditions

### 6.3.1 Normal temperature and humidity

The normal temperature and humidity conditions for tests shall be any convenient combination of temperature and humidity within the following ranges:

- temperature: +15 °C to +35 °C;
- relative humidity: 20 % to 75 %.

When it is impracticable to carry out the tests under the conditions stated above, a note to this effect, stating the actual temperature and relative humidity during the tests, shall be added to the test report.

## 6.3.2 Normal test power source voltage

### 6.3.2.1 Mains voltage

The normal test voltage for equipment to be connected to the mains shall be the nominal mains voltage. For the purpose of the present document, the nominal voltage shall be the declared mains voltage, or any of the declared mains voltages, for which the equipment was designed.

The frequency of the test power source corresponding to the alternating current (ac) mains shall be between 49 Hz and 51 Hz.

### 6.3.2.2 Other power sources

For operation from other power sources or types of battery (primary or secondary), the normal test voltage shall be that declared by the equipment manufacturer and approved by the test laboratory. The values shall be stated in the test report.

## 6.4 Extreme test conditions

### 6.4.1 Extreme temperatures

#### 6.4.1.1 General

For tests at extreme temperatures, measurements shall be made in accordance with the procedures specified in clause 6.4.1.2, at -10 °C and +45 °C.

#### 6.4.1.2 Procedures for tests at extreme temperatures

Before measurements are made, the equipment shall have reached thermal balance in the test chamber. The equipment shall be switched off during the temperature stabilizing period. If the thermal balance is not checked by measurements, a temperature stabilizing period of at least one hour shall be allowed.

The sequence of measurements shall be chosen and the humidity content in the test chamber shall be controlled so that excessive condensation does not occur.

Before tests at the higher temperatures, the equipment shall be placed in the test chamber and left until thermal balance is attained. The equipment shall then be switched on for one minute in the transmit condition, after which the equipment shall meet the specified requirements.

For tests at the lower extreme temperature, the equipment shall be left in the test chamber until thermal balance is attained, then switched to the standby or receive condition for one minute after which the equipment shall meet the specified requirements.

### 6.4.2 Extreme test power source voltages

#### 6.4.2.1 Mains voltage

The extreme test voltages for equipment to be connected to an ac mains source shall be the nominal mains voltage +10 %.

#### 6.4.2.2 Other power sources

For equipment using other power sources, or capable of being operated from a variety of power sources, the extreme test voltages shall be those agreed between the equipment manufacturer and the testing laboratory and shall be recorded with the results.

## 7 General conditions

### 7.1 Normal test modulation

#### 7.1.1 Analogue systems

For normal test modulation, the audio frequency shall be a sinusoidal tone of 500 Hz, set at an input level to the transmitter 8 dB below the audio limiting threshold as defined in clause 3.1.

For the purpose of determining the transmitter necessary bandwidth, coloured noise according to Recommendation ITU-R BS.559-2 [i.3] shall be used, according to the method laid down in clause 8.3.2.1. The resulting spectral distribution is shown in figure 1. This noise may be generated by a white noise source followed by a passive filter shown in figure 2.

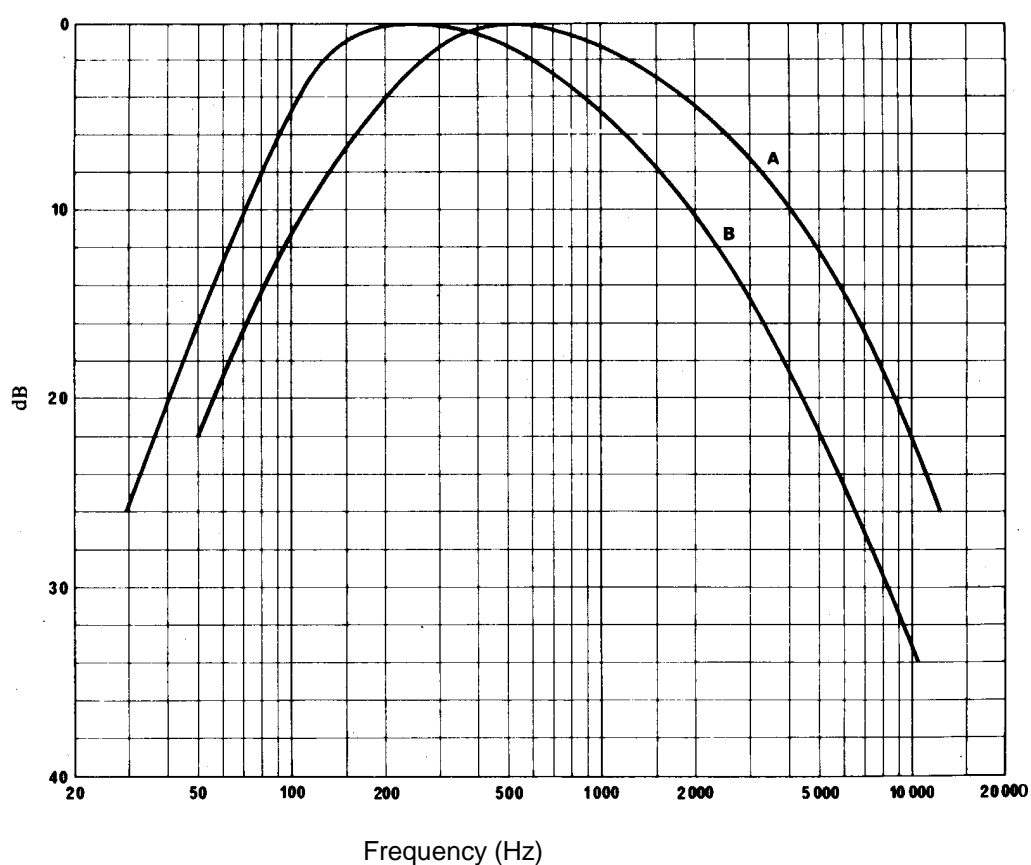

NOTE 1: Curve A = Frequency spectrum of standardized noise (measured with one-third octave filters).

NOTE 2: Curve B = Frequency response characteristics of filter circuit.

**Figure 1: Spectral distribution for determining transmitter necessary bandwidth**

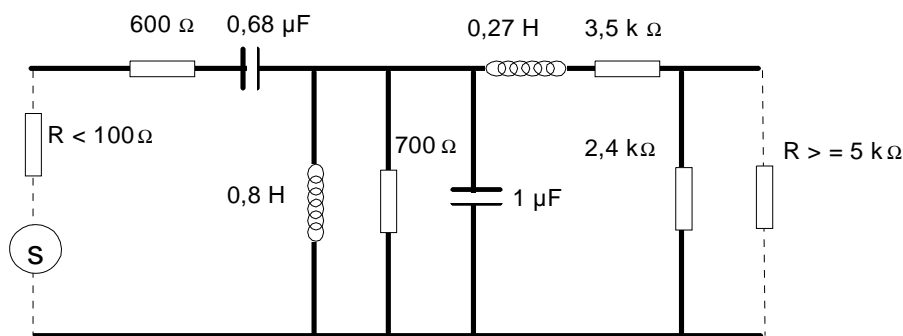

Figure 2: Filter circuit

## 7.1.2 Digital systems

All measurements shall be carried out with analogue input and output signals. AF-filter circuit for analogue test setup shall not be used.

The manufacturer shall declare and provide to the test house digital/analogue and analogue/digital interfaces if necessary.

The test signal shall be applied at 1 kHz, with nominal level declared by the manufacturer. In all cases the mask defined in clause 8.3.3.2 shall not be exceeded.

## 7.1.3 WMAS

All measurements shall be carried out with analogue input and output signals. The manufacturer shall provide to the test house digital/analogue and analogue/digital interfaces if necessary.

The test signal shall be applied at 1 kHz, with nominal level declared by the manufacturer. In all cases the mask defined in clause 8.3.4.3 shall not be exceeded.

## 7.2 Artificial antenna

### 7.2.1 General

Where applicable, tests shall be carried out using an artificial antenna that shall be a substantially non-reactive non-radiating load of 50 Ω. The return loss measured at the 50 Ω connector shall be  $\geq 20$  dB at the operating frequency of the DUT and  $\geq 14$  dB at any measured unwanted frequency outside this band.

## 7.3 Test fixture

### 7.3.1 General

The manufacturer may be required to supply a test fixture suitable to allow relative measurements to be made on the submitted sample.

In all cases, the test fixture shall provide:

- a connection to an external power supply;
- an audio interface either by direct connection or by an acoustic coupler.

In addition, the test fixture for integral antenna equipment shall contain a radio frequency coupling device associated with an integral antenna equipment for coupling the integral antenna to an RF port at the working frequencies of the DUT. This allows certain measurements to be performed using the conducted measurement methods. Only relative measurements may be performed and only those at or near frequencies for which the test fixture has been calibrated.

The performance characteristics of the test fixture shall be agreed upon with the test laboratory and shall conform to the following basic parameters:

- the circuitry associated with the RF coupling shall contain no active or non-linear devices;
- the coupling loss shall not influence the measuring results;
- the coupling loss shall be independent of the position of the test fixture and be unaffected by the proximity of surrounding objects or people;
- the coupling loss shall be reproducible when the DUT is removed and replaced;
- the coupling loss shall remain substantially constant when the environmental conditions are varied.

## 7.4 Test site and general arrangements for radiated measurements

### 7.4.1 Introduction

For guidance on radiation test sites, see annex C. Detailed descriptions of the radiated measurement arrangements are included in annex C.

## 7.5 Modes of operation of the transmitter

### 7.5.1 General

For the purpose of the measurements according to the present document there should preferably be a facility to operate the transmitter in an unmodulated state or in a Tx test mode. The method of achieving an unmodulated carrier frequency or special types of modulation patterns or a Tx test mode may also be decided by agreement between the manufacturer and the testing laboratory. It shall be described in the test report. It may involve suitable temporary internal modifications of the DUT. If it is not possible to provide an unmodulated carrier then this shall be stated in the test report.

## 7.6 Arrangement for test signals at the input of the transmitter

### 7.6.1 General

For the purpose of the present document, the transmitter audio frequency modulation signal shall be supplied by a generator at the correct impedance applied at the connections of the stated audio input, unless otherwise stated.

---

## 8 Methods of measurement and limits for transmitter parameters

### 8.1 Frequency stability

#### 8.1.1 Method of measurement (analogue)

The carrier frequency shall be measured (in the absence of modulation) with the transmitter connected to an artificial antenna (see clause 7.2). A transmitter without an RF port may be placed in a test fixture (see clause 7.3) connected to an artificial antenna. The measurement shall be made under normal test conditions (see clause 6.3), and extreme test conditions (clause 6.4.1 and clause 6.4.2 applied simultaneously). The measured value shall be compared with the nominal value.

Radio microphones that also include an RF port for use with other external antennas shall be tested using this port.

## 8.1.2 Method of measurement (digital)

In the case of transmitters that are capable of producing an unmodulated carrier, the measurement method in clause 8.1.1 can apply, alternatively, the mean of two frequency measurements taken at the same level on the upper and lower sides of the modulation envelope shall be taken as the measurement.

In case of transmitters that are not capable of producing an unmodulated carrier, the mean of two frequency measurements taken at the same level on the upper and lower sides of the emitted spectrum mask shall be taken as the measurement.

The measured value shall be compared with the nominal value. In case of a transceiver the DUT shall be set in a Tx test mode (for WMAS see clause 8.3.4.2, step 1).

## 8.1.3 Limit

The frequency error shall not exceed 20 parts per million for frequencies below 1 GHz, 15 parts per million between 1 GHz and 2 GHz, and 10 ppm above 2 GHz.

For the measurement uncertainty, see clause 10.

## 8.2 Rated output power

### 8.2.1 Method of measurement for equipment without integral antenna

This clause applies to equipment with a permanent RF port.

The transmitter shall be operated at its maximum RF output power and connected to an artificial antenna (see clause 7.2) and the power delivered to this artificial antenna shall be measured. In case of a transceiver the DUT shall be set in a Tx test mode (for WMAS see clause 8.3.4.2, step 1).

The measurements shall be made under normal test conditions (see clause 6.3), and extreme test conditions (clause 6.4.1 and clause 6.4.2 applied simultaneously).

### 8.2.2 Method of measurement for equipment with integral antenna

#### 8.2.2.1 Method of measurement under normal test conditions

On a test site, the sample shall be placed on the support in the following position:

- for equipment with an internal antenna, it shall stand vertically, with that axis vertical which is closest to vertical in normal use;
- for equipment with a rigid external antenna, the antenna shall be vertical;
- for equipment with a non-rigid external antenna, the antenna shall be extended vertically upwards by a non-conducting support.

The transmitter shall be switched on, with modulation, and the test receiver shall be tuned to the frequency of the signal being measured. In case of a transceiver the DUT shall be set in a Tx test mode (for WMAS see clause 8.3.4.2, step 1). The test antenna shall be oriented for vertical polarization and shall be raised or lowered through the specified height range until a maximum signal level is detected on the test receiver.

The transmitter shall be rotated horizontally through 360° until the highest maximum signal is received.

NOTE: This maximum may be a lower value than the value obtainable at heights outside the specified limits.



The transmitter shall be replaced by a substitution antenna and the test antenna raised or lowered as necessary to ensure that the maximum signal is still received. The input signal to the substitution antenna shall be adjusted in level until an equal or a known related level to that detected from the transmitter is obtained in the test receiver.

The carrier power is equal to the power supplied to the substitution antenna, increased by the known relationship if necessary.

The measurement shall be repeated for any alternative antenna supplied by the manufacturer.

A check shall be made in the horizontal plane of polarization to ensure that the value obtained above is the maximum. If larger values are obtained, this fact shall be recorded in the test report.

### 8.2.3 Limit

The measured value shall be within +20 % and -50 % of the manufacturer's declared rated output power.

For the measurement uncertainty, see clause 10.

## 8.3 Necessary bandwidth

### 8.3.1 General

The necessary bandwidth of the transmitter shall be measured under the conditions laid down in clause 8.3.2 to clause 8.3.5 as appropriate.

### 8.3.2 Necessary Bandwidth (BN) for Analogue Systems

#### 8.3.2.1 Method of Measurement

The arrangement of test equipment as shown in figure B.1 shall be used. Note that the noise meter conforms to (quasi peak) without weighting filter (flat).

With the Low Frequency (LF) audio signal generator set to 500 Hz, the audio input level to the DUT shall be adjusted to 8 dB below the limiting threshold (-8 dB (lim)) as declared by the manufacturer.

The corresponding audio output level from the demodulator shall be measured and recorded.

The input impedance of the noise meter shall be sufficiently high to avoid more than 0,1 dB change in input level when the meter is switched between input and output.

The audio input level shall be increased by 20 dB, i.e. to +12 dB (lim), and the corresponding change in output level shall be measured.

It shall be checked that the audio output level has increased by  $\leq 10$  dB.

If this condition is not met, the initial audio input level shall be increased from -8 dB (lim) in 1 dB steps until the above condition is fulfilled, and the input level recorded in the test report. This level replaces the value derived from the manufacturer's declaration and is defined as -8 dB (lim).

Measure the input level at the transmitter required to give +12 dB (lim).

The LF generator shall be replaced with the weighted noise source to Recommendation ITU-R BS.559-2 [i.3], band-limited to 15 kHz as described in IEC 60244-13 [1], and the level shall be adjusted such that the measured input to the transmitter corresponds to +12 dB (lim).

If the transmitter incorporates any ancillary coding or signalling channels (e.g. pilot-tones), these shall be enabled prior to any spectral measurements.

If the transmitter incorporates more than one audio input, e.g. stereo systems, the second and subsequent channels shall be simultaneously driven from the same noise source, attenuated to a level of -6 dB (lim).

The transmitter RF output spectrum shall be measured, using a spectrum analyser with the following settings:

- centre frequency:  $f_c$ : Transmitter (Tx) nominal frequency;
- dispersion (Span):  $f_c - 1 \text{ MHz}$  to  $f_c + 1 \text{ MHz}$ ;
- Resolution BandWidth (RBW): 1 kHz;
- Video BandWidth (VBW): 1 kHz;
- detector: Peak hold.

### 8.3.2.2 Limits

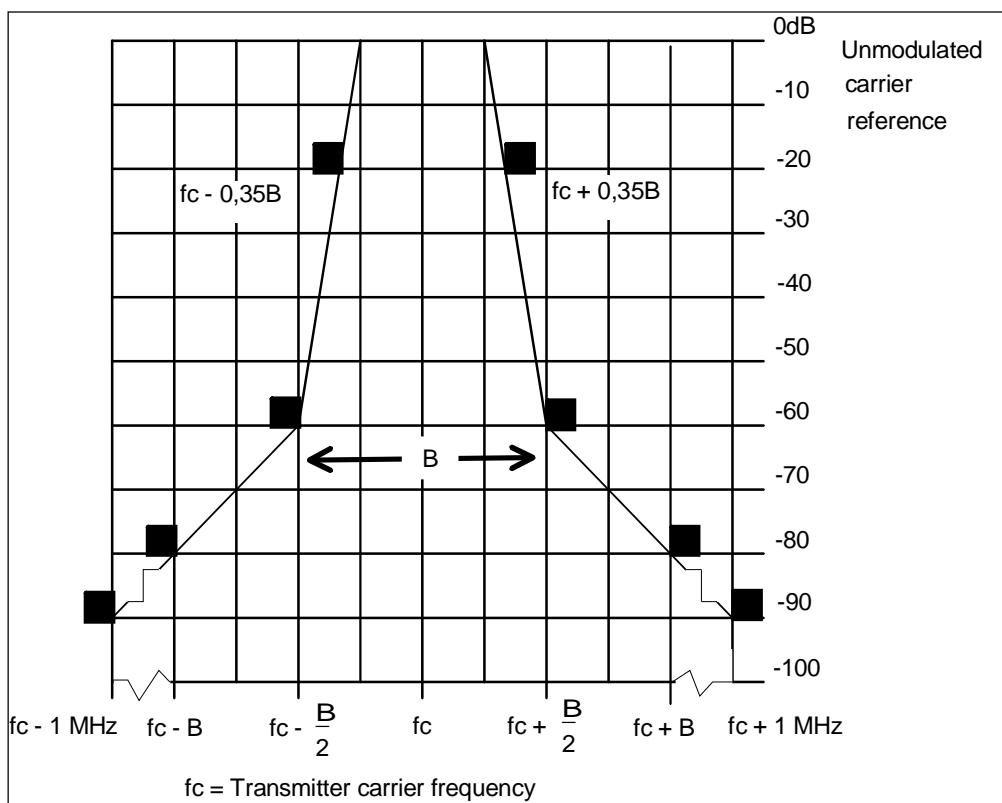

**Figure 3: Spectrum mask for analogue systems in all bands**

Figure 3 shows the spectrum mask for all analogue systems in the band. The -90 dBc point shall be  $\pm 1 \text{ MHz}$  from  $f_c$  measured with an average detector. To comply, a measured value shall fall below the mask limit as shown in figure 3.

## 8.3.3 Necessary Bandwidth (BN) for Digital Systems

### 8.3.3.1 Method of Measurement

Principal Spectrum Mask measuring method for digital transmitters:

- Spectrum mask below 1 GHz, see figure 4; for the spectrum mask above 1 GHz, see figure 5.

NOTE: This parameter also includes the limits for spectral components within the out-of-band region.

The transmitter shall be modulated with the test signals defined in clause 7.1.2. In any case the mask shall not be exceeded.

- Step 1: Measure the "Carrier Power" with the spectrum analyser setup:
  - Centre Frequency =  $f_c$

- Span = Zero span
- Detector = RMS
- Trace Mode = Average
- RBW&VBW =  $5 \times B$
- Sweep time  $\geq 2$  s
- Step 2: Measure the "Maximum Relative Level (dBc) at Specified Carrier Offsets" with the following spectrum analyser setup:
  - Centre Frequency =  $f_c$
  - Span  $\geq 5 \times B$
  - Detector = RMS
  - Trace Mode = Peak Hold
  - RBW&VBW = 1 kHz
  - Sweep time  $\geq 2$  s

## Limits:

- Step 3: Measure the "transmitter wide band noise floor":
  - The measurement of transmitter broad band noise floor shall be carried out according to clause 8.3.2.1.
- Step 3a: Measure the "lower frequency transmitter wide band noise floor":
  - Start Frequency =  $f_c - 5 \times B$   
Stop Frequency =  $f_c - 1,75 \times B$
  - Detector = RMS
  - Trace Mode = Average
  - RBW&VBW = 1 kHz
  - Sweep time = 2 s per 200 kHz
- Step 3b: Measure the "upper frequency transmitter wide band noise floor":
  - Start Frequency =  $f_c + 1,75 \times B$   
Stop Frequency =  $f_c + 5 \times B$
  - Detector = RMS
  - Trace Mode = Average
  - RBW&VBW = 1 kHz
  - Sweep time = 2 s per 200 kHz

Both spectrum ranges shall be measured.

## Limits:

- The spectrum mask for digital systems shall not be exceeded. See figure 4 for systems operating below 2 GHz and figure 5 for systems operating above 2 GHz.

### 8.3.3.2 Limits

The transmitter output spectrum shall be within the mask defined in figure 4.

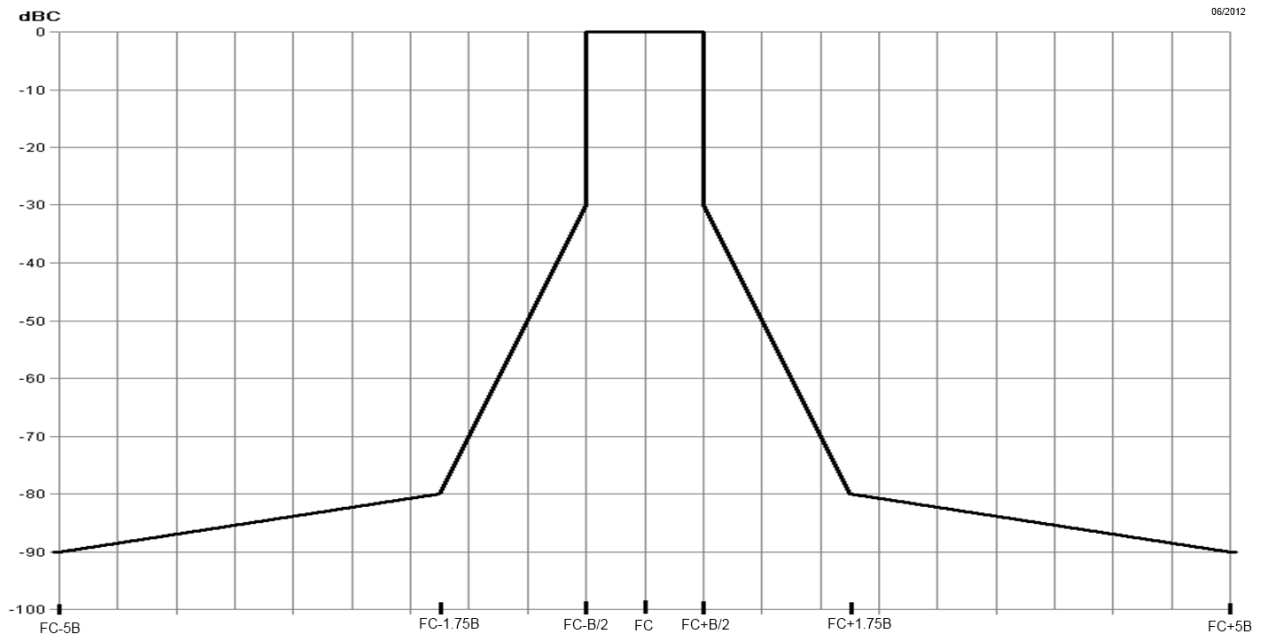

Figure 4: Spectrum mask for digital systems below 2 GHz

For the measurement uncertainty, see clause 10. The -90 dBc point shall be  $FC \pm 5B$  from  $fc$  measured with an average detector.

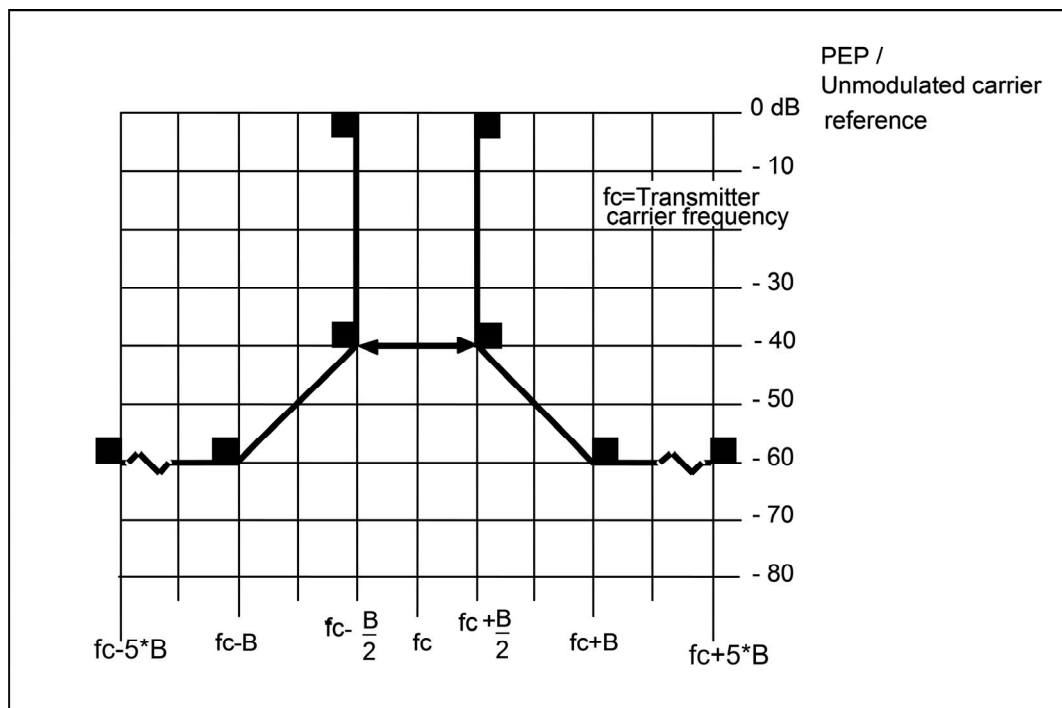

Figure 5: Spectrum mask for digital systems above 2 GHz

## 8.3.4 Necessary Bandwidth (BN) for WMAS

### 8.3.4.1 Applicability

This clause is not applicable for operation in the 2 400 MHz to 2 483,5 MHz band. Use the alternative procedure in clause 8.3.5 instead.

### 8.3.4.2 Method of measurement

The transmitter RF output spectrum shall be measured, using a spectrum analyser with the specified settings. The arrangement of test equipment as shown in figure 6 shall be used. The path loss of the connection between DUT and spectrum analyser shall be considered for determining the maximum output power.

The transmitter of the device under test shall be set in a Tx transmission test mode with the following characteristics:

- maximum output power;
- continuous transmission;
- generated by a random sequence of bits;
- set test mode to the operating mode with maximum crest factor.

If there are different operating modes using transmit signals with different crest factors, the manufacturer shall declare the operating mode with maximum crest factor to use for the following test procedure:

#### Step 1:

- Centre frequency =  $f_c$
- Span =  $10 \times B$
- RBW (Resolution Bandwidth)  $\geq B$  (occupied system bandwidth)
- VBW (Video Bandwidth)  $\geq RBW$
- Detector = RMS
- Trace mode = Max Hold
- Measurement time  $\geq 60$  s
- Sweep time  $\leq$  measurement time

Setting an active measurement marker to PEAK after waiting the specified measurement time gives the maximum output power  $P_{out}$ , which is limited to +23 dBm.

The maximum output power  $P_{out}$  is used as reference (0 dBc) for the measurement of the peak transmit mask.

The operational bandwidth (B) of the system is set according to manufacturer's declaration or spectrum allocation.

The transmitter of the device under test shall be set in a typical operating mode but transmitting with maximum output power, as shown in figure 6 with Audio source and Audio sink.

A 1 kHz audio test signal, at the manufacturer's declared input level, shall be applied to that device of the measurement setup which serves as audio source. A second device is used for receiving the audio test signal and provides the possibility to pass it to an audio output.

The transmit mask shall be measured with the following analyser settings:

#### Step 2:

- Centre frequency =  $f_c$
- Span =  $10 \times B$

- RBW = 100 kHz
- VBW  $\geq$  RBW
- Detector = Max Peak
- Trace mode = Max Hold
- Measurement time  $\geq$  60 s
- Sweep time  $\leq$  measurement time

Measurement setup:

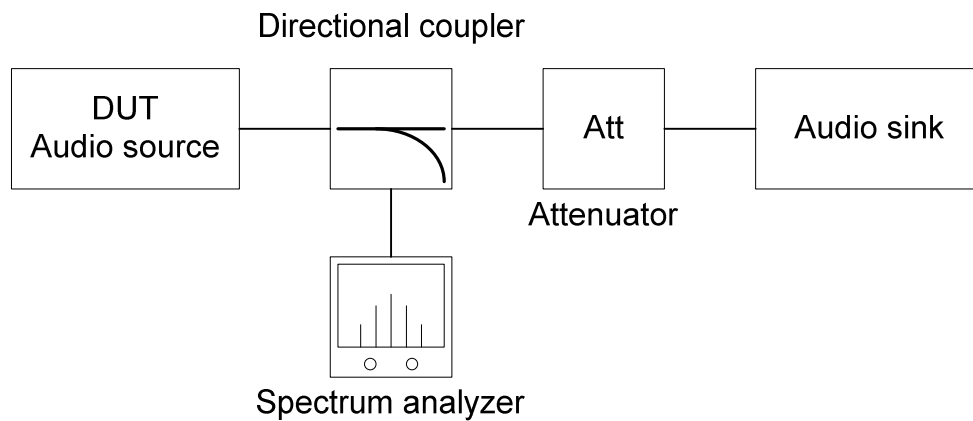

Figure 6: Measurement setup for WMAS

### 8.3.4.3 Limits

Figure 7 shows the limits of the transmit spectrum mask. In any case this mask shall not be exceeded.

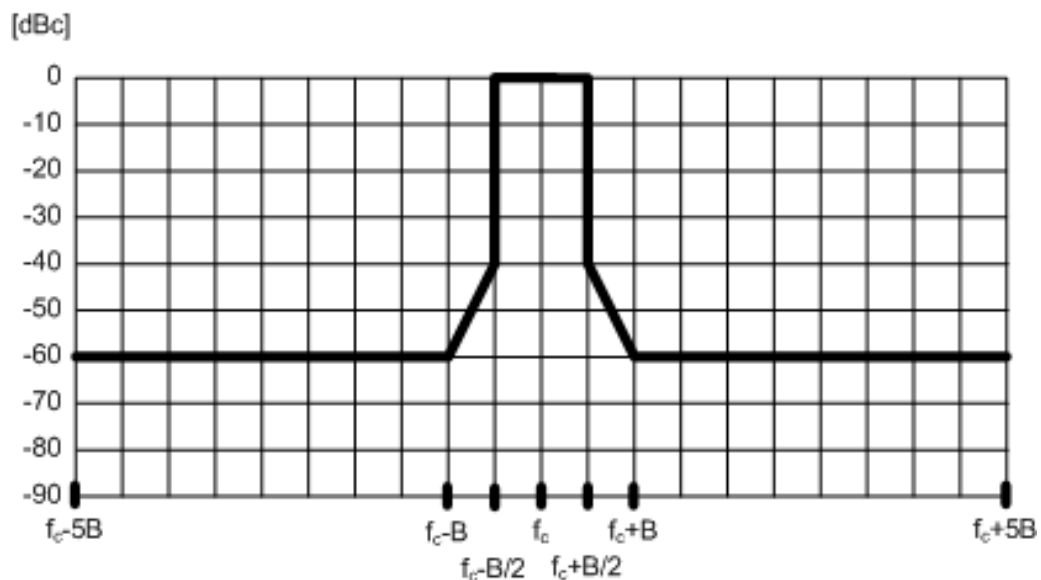

Figure 7: Spectrum mask for WMAS

## 8.3.5 Bandwidth measurement procedure for PMSE operation in 2,4 GHz to 2,4835 GHz

### 8.3.5.1 Applicability

This procedure can be used for PMSE devices operating in the 2,4 GHz to 2,4835 GHz band.

### 8.3.5.2 Definition

The Occupied Channel Bandwidth is the bandwidth that contains 99 % of the power of the signal.

### 8.3.5.3 Limits

The Occupied Channel Bandwidth shall fall completely within the band given in clause 8.3.5.4.

### 8.3.5.4 Conformance

#### 8.3.5.4.1 Test conditions

See clause 6 for the test conditions. These measurements shall only be performed at normal test conditions.

In case of conducted measurements on smart antenna systems (equipment with multiple transmit chains) measurements need only to be performed on one of the active transmit chains (antenna outputs).

The measurement shall be performed only on the lowest and the highest frequency within the stated frequency range. The frequencies on which the tests were performed shall be recorded.

If the equipment can operate with different Nominal Channel Bandwidths (e.g. 20 MHz and 40 MHz), then each channel bandwidth shall be tested separately.

#### 8.3.5.4.2 Test method

##### 8.3.5.4.2.1 Conducted measurement

The measurement procedure shall be as follows:

##### **Step 1:**

Connect the DUT to the spectrum analyser and use the following settings:

- Centre Frequency: The centre frequency of the channel under test
- Resolution BW: ~ 1 % of the span without going below 1 %
- Video BW:  $3 \times \text{RBW}$
- Frequency Span:  $2 \times \text{Nominal Channel Bandwidth}$  (e.g. 40 MHz for a 20 MHz channel)
- Detector Mode: RMS
- Trace Mode: Max Hold
- Sweep time: 1 s

##### **Step 2:**

Wait for the trace to stabilize.

Find the peak value of the trace and place the analyser marker on this peak.

**Step 3:**

Use the 99 % bandwidth function of the spectrum analyser to measure the Occupied Channel Bandwidth of the DUT. This value shall be recorded.

NOTE: Make sure that the power envelope is sufficiently above the noise floor of the analyser to avoid the noise signals above and below the power envelope being taken into account by this measurement.

**8.3.5.4.2.2 Radiated measurement**

This method shall only be used for integral antenna equipment that does not have a temporary antenna connector(s) provided.

The test set up and the applicable measurement procedures described in annex C shall be used.

The test procedure is as described under clause 8.3.5.4.2.1.

**8.3.6 Transmitter Unwanted Emissions in the Out-of-band Domain Alternative Measurement Procedure****8.3.6.1 Applicability**

This procedure applies to devices operating in the 2,4 GHz to 2,4835 GHz band.

**8.3.6.2 Definition**

Transmitter unwanted emissions in the out-of-band domain are emissions when the equipment is in Transmit mode, on frequencies immediately outside the necessary bandwidth which results from the modulation process, but excluding spurious emissions.

**8.3.6.3 Limit**

The transmitter unwanted emissions in the out-of-band domain but outside the allocated band, shall not exceed the values provided by the mask in figure 8.

NOTE: Within the 2 400 MHz to 2 483,5 MHz band, the Out-of-band emissions are fulfilled by compliance with the Occupied Channel Bandwidth requirement in clause 8.3.5.4.

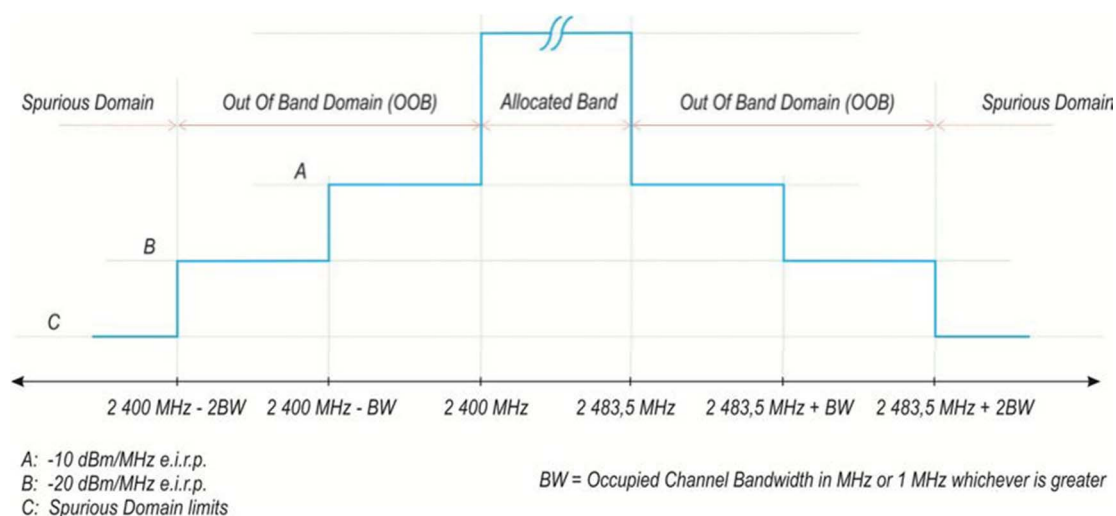

**Figure 8: Transmit mask**



### 8.3.6.4 Conformance

#### 8.3.6.4.1 Test conditions

See clause 6 for the test conditions.

These measurements shall only be performed at normal test conditions.

For equipment using wide band modulation, the measurement shall be performed at the lowest and the highest channel on which the equipment can operate. These frequencies shall be recorded.

The equipment shall be configured to operate at its highest output power.

If the equipment can operate with different Nominal Channel Bandwidths (e.g. 20 MHz and 40 MHz), then each channel bandwidth shall be tested separately.

#### 8.3.6.4.2 Test method

##### 8.3.6.4.2.1 Conducted measurement

The applicable mask is defined by the measurement results from the tests performed under clause 8.3.5.4 (Occupied Channel Bandwidth).

The Out-of-band emissions within the different horizontal segments of the mask provided in figure 8 shall be measured using the steps below. This method assumes the spectrum analyser is equipped with the Time Domain Power option.

##### Step 1:

- Connect the DUT to the spectrum analyser and use the following settings:
  - Centre Frequency: 2 484 MHz
  - Span: 0 Hz
  - Resolution BW: 1 MHz
  - Video BW: 3 MHz
  - Detector Mode: RMS
  - Trace Mode: Max Hold
  - Sweep Mode: Continuous
  - Sweep Points: Sweep Time [s] / (1  $\mu$ s) or 5 000 whichever is greater
  - Trigger Mode: Video trigger

NOTE 1: In case video triggering is not possible, an external trigger source may be used.

- Sweep Time: > 120 % of the duration of the longest burst detected during the measurement of the RF Output Power

##### Step 2 (segment 2 483,5 MHz to 2 483,5 MHz + B):

- Adjust the trigger level to select the transmissions with the highest power level.
- For frequency hopping equipment operating in a normal hopping mode, the different hops will result in signal bursts with different power levels. In this case the burst with the highest power level shall be selected.
- Set a window (start and stop lines) to match with the start and end of the burst and in which the RMS power shall be measured using the Time Domain Power function.

- Select RMS power to be measured within the selected window and note the result which is the RMS power within this 1 MHz segment (2 483,5 MHz to 2 484,5 MHz). Compare this value with the applicable limit provided by the mask.
- Increase the centre frequency in steps of 1 MHz and repeat this measurement for every 1 MHz segment within the range 2 483,5 MHz to 2 483,5 MHz + B. The centre frequency of the last 1 MHz segment shall be set to 2 483,5 MHz + B - 0,5 MHz (which means this may partly overlap with the previous 1 MHz segment).

**Step 3 (segment 2 483,5 MHz + B to 2 483,5 MHz + 2B):**

- Change the centre frequency of the analyser to 2 484 MHz + B and perform the measurement for the first 1 MHz segment within range 2 483,5 MHz + B to 2 483,5 MHz + 2B. Increase the centre frequency in 1 MHz steps and repeat the measurements to cover this whole range. The centre frequency of the last 1 MHz segment shall be set to 2 483,5 MHz + 2B - 0,5 MHz (which means this may partly overlap with the previous 1 MHz segment).

**Step 4 (segment 2 400 MHz - B to 2 400 MHz):**

- Change the centre frequency of the analyser to 2 399,5 MHz and perform the measurement for the first 1 MHz segment within range 2 400 MHz - B to 2 400 MHz. Reduce the centre frequency in 1 MHz steps and repeat the measurements to cover this whole range. The centre frequency of the last 1 MHz segment shall be set to 2 400 MHz - B + 0,5 MHz (which means this may partly overlap with the previous 1 MHz segment).

**Step 5 (segment 2 400 MHz - 2B to 2 400 MHz - B):**

- Change the centre frequency of the analyser to 2 399,5 MHz - B and perform the measurement for the first 1 MHz segment within range 2 400 MHz - 2B to 2 400 MHz - B. Reduce the centre frequency in 1 MHz steps and repeat the measurements to cover this whole range. The centre frequency of the last 1 MHz segment shall be set to 2 400 MHz - 2B + 0,5 MHz (which means this may partly overlap with the previous 1 MHz segment).

**Step 6:**

- In case of conducted measurements on equipment with a single transmit chain, the declared antenna assembly gain "G" in dBi shall be added to the results for each of the 1 MHz segments and compared with the limits provided by the mask given in figure 8. If more than one antenna assembly is intended for this power setting, the antenna with the highest gain shall be considered.
- In case of conducted measurements on smart antenna systems (equipment with multiple transmit chains), the measurements need to be repeated for each of the active transmit chains. The declared antenna assembly gain "G" in dBi for a single antenna shall be added to these results. If more than one antenna assembly is intended for this power setting, the antenna with the highest gain shall be considered. Comparison with the applicable limits shall be done using any of the options given below:
  - Option 1: the results for each of the transmit chains for the corresponding 1 MHz segments shall be added. The additional beamforming gain "Y" in dB shall be added as well and the resulting values compared with the limits provided by the mask given in figure 8.
  - Option 2: the limits provided by the mask given in figure 8 shall be reduced by  $10 \times \log_{10}(A_{ch})$  and the additional beamforming gain "Y" in dB. The results for each of the transmit chains shall be individually compared with these reduced limits.

NOTE 2:  $A_{ch}$  refers to the number of active transmit chains.

It shall be recorded whether the equipment complies with the mask provided in figure 8.

#### 8.3.6.4.2.2 Radiated measurement

This method shall only be used for integral antenna equipment that does not have a temporary antenna connector(s) provided.

The test set up and the applicable measurement procedures described in annex C shall be used.

The test procedure is as described under clause 8.3.6.4.2.1.

## 8.4 Spurious emissions

### 8.4.1 Definition

See clause 3.1.

### 8.4.2 Method of measurement

On a test site, the sample shall be placed at the specified height on a non-conducting support. The transmitter shall be operated at the power as specified under clause 8.2, delivered to the antenna (see clause 5.1.1).

Radiation of any spurious components shall be detected by the test antenna and receiver, over the frequency range specified below, excluding the 250 % (out of band region) band of frequencies centred on the channel on which the transmitter is intended to operate.

NOTE: The 250 % (out of band region) exclusion is covered by measurements carried out in clauses 8.3.2, 8.3.3, and 8.3.4.

The measuring receiver, as defined in table 4, shall be tuned over the frequency range 25 MHz to 4 GHz for equipment operating on frequencies below 1 GHz or in the frequency range of 25 MHz to 12,75 GHz for equipment operating on frequencies above 1 GHz.

At each frequency at which a component is detected, the sample shall be rotated to obtain maximum response and the effective radiated power of that component determined by a substitution measurement.

The measurement shall be repeated with the test antenna in the orthogonal polarization plane.

If the transmitter allows for standby operation, the tests shall be repeated with the transmitter in standby mode.

### 8.4.3 Limits

**Table 3: Limits for spurious emissions**

State	Frequency		
	47 MHz to 74 MHz 87,5 MHz to 137 MHz 174 MHz to 230 MHz 470 MHz to 862 MHz	Other Frequencies below 1 000 MHz	Frequencies above 1 000 MHz
Operation	4 nW	250 nW	1 µW
Standby	2 nW	2 nW	20 nW

Measured values for equipment in each frequency band shall fall below the values given in table 3.

### 8.4.4 Measuring receiver

The term measuring receiver refers to either a selective voltmeter or a spectrum analyser. The bandwidth of the measuring receiver is given in table 4.

**Table 4: Reference bandwidth**

Frequency being measured	Measuring receiver bandwidth
25 MHz to 30 MHz	9 kHz to 10 kHz
30 MHz to 1 000 MHz	100 kHz to 120 kHz
> 1 000 MHz	1 MHz

## 8.5 Transmitter intermodulation distortion

### 8.5.1 Definition

**Transmitter intermodulation distortion (IMD)** originates from non-linearities in electronic circuits when at least two signals on different frequencies are injected at the transmitter side resulting in at least third order intermodulation products.

For the purposes of the present document, transmitter intermodulation distortion (Tx-IMD) measurements consider only third order intermodulation (TOI) products at the transmitter side caused by the carrier frequency of DUT and an injected interfering frequency. These products are defined by:

$$f_{\text{TOI}} = 2 \times f_w \pm f_{\text{INT}} \text{ and } f_{\text{TOI}} = 2 \times f_{\text{INT}} \pm f_w \quad (1)$$

with:

- $f_{\text{TOI}}$  = frequency of third order intermodulation product
- $f_w$  = carrier frequency of DUT
- $f_{\text{INT}}$  = frequency of interferer

Tx-IMD is given in output power of TOI products relative to transmitter output power [dBc]. The manufacturer shall declare the transmitter intermodulation distortion value.

### 8.5.2 Method of measurement

Transmitter intermodulation distortion is measured with a conducted measurements setup (see figure 9). For transmitters with an internal or permanently attached antenna a temporary 50  $\Omega$  port may be used for conducted measurements.

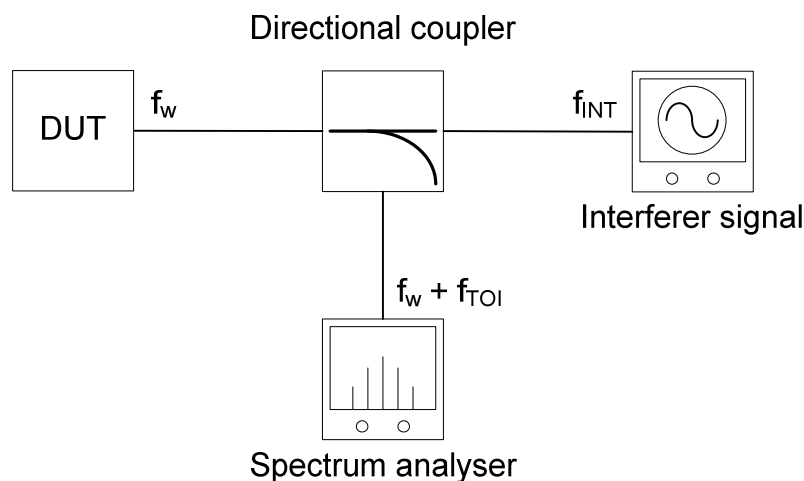

**Figure 9: Measurement setup for Tx-IMD**

The transmitter (DUT) shall be set in typical operation mode with carrier frequency in the middle of its tuning band. If DUT supports different Tx modes (e. g. output power, output linearity), Tx-IMD measurements shall be repeated for each mode. If a transceiver is tested, the DUT shall be set in a Tx transmission test mode (for WMAS see clause 8.3.4.2, step 1).

The interferer signal shall be a continuous wave signal with its centre frequency set to  $f_{\text{INT}} = f_w \pm f_{\text{offset}}$  with:

- $2 \times B \leq f_{\text{offset}} \leq \text{half of tuning band}$  (for WMAS).
- $5 \text{ MHz} \leq f_{\text{offset}} \leq 10 \text{ MHz}$  (for others).

One frequency  $f_{\text{offset}}$  shall be chosen from the above given range for all Tx intermodulation measurements. The power level of the interferer signal shall be -30 dB with respect to the output power of the DUT measured at the output port of the DUT. The path loss of the connection between interferer source and DUT shall be considered for determining the output power of the interferer signal.

Tx-IMD shall be measured with the following analyser settings:

- Centre frequency =  $(f_w + f_{\text{TOI}}) / 2$
- Span >  $|f_w - f_{\text{TOI}}| + 2 \times B$
- RBW:  $\text{span}/4 \geq \text{RBW} \geq B$
- VBW  $\geq$  RBW
- Detector = RMS
- Trace mode = Average
- Sweep count > 10
- Sweep time = AUTO
- Measurement time > sweep count times sweep time

The analyser's reference level shall be set according to the signal power at  $f_w$ .

The measurement shall be repeated for each of the four possible intermodulation frequencies ( $f_{\text{TOI}}$ ) to find the highest level of the Tx-IMD products.

### 8.5.3 Limits

The maximum resulting IMD product shall be at least 40 dB below the output power of the DUT.

## 9 Receiver

### 9.1 Spurious emissions

#### 9.1.1 Definitions

Spurious emissions from the receiver or receiver combiner are radio frequency emissions at any frequency, generated by the equipment, antenna amplifier, down converters or active filters.

The manufacturer shall provide a representative sample of the receiver system. The level of spurious emissions shall be measured by either:

- a) the power level from an external RF port; and  
their effective radiated power when radiated by the cabinet and structure of the equipment (cabinet radiation);  
or
- b) their effective radiated power when radiated by the cabinet and the integral antenna, in the case of hand-portable equipment fitted with such an antenna and no external RF port.

### 9.1.2 Method of measuring the power level in a specified load

This method applies only to equipment with an external RF port.

The external RF port of the receiver under test shall be connected to a measuring receiver (see clause 8.4.4). The receiver under test shall be switched on. In the case of a transceiver under test like WMAS, it shall be set in a Rx test mode with maximum Rx gain. The measuring receiver shall be tuned over the frequency range 25 MHz to 4 GHz for equipment operating on frequencies below 1 GHz, or in the frequency range of 25 MHz to 12,75 GHz for equipment operating on frequencies above 1 GHz.

At each frequency at which a spurious component is detected, the power level shall be recorded as the spurious level delivered into the specified load.

### 9.1.3 Method of measuring the effective radiated power of the enclosure

This method applies only to equipment with an external RF port.

On a test site, as described in annex C, the equipment shall be placed at the specified height on a non-conducting support and in the position closest to normal use as declared by the manufacturer. The receiver antenna connector shall be connected to an artificial antenna (see clause 7.2). The test antenna shall be oriented for vertical polarization and the length of the test antenna shall be chosen to correspond to the instantaneous frequency of the measuring receiver (see clause 8.4.4). The output of the test antenna shall be connected to a measuring receiver. The receiver shall be switched on and the measuring receiver shall be tuned over the frequency range as specified in clause 9.1.2. At each frequency at which a spurious component is detected, the test antenna shall be raised and lowered through the specified range of height until a maximum signal level is detected by the measuring receiver. When a test site according to clause C.1.1 is used, there is no need to vary the height of the antenna. The receiver shall then be rotated through 360° in the horizontal plane until the maximum signal level is detected by the measuring receiver. The maximum signal level detected by the measuring receiver shall be noted.

The receiver shall be replaced by a substitution antenna as defined in clause C.1.5.

The substitution antenna shall be oriented for vertical polarization and the length of the substitution antenna shall be adjusted to correspond to the frequency of the spurious component detected.

The substitution antenna shall be connected to a calibrated signal generator.

The frequency of the calibrated signal generator shall be set to the frequency of the spurious component detected.

The input attenuator setting of the measuring receiver shall be adjusted in order to increase the sensitivity of the measuring receiver, if necessary.

The test antenna shall be raised and lowered through the specified range of height to ensure that the maximum signal is received. The input signal to the substitution antenna shall be adjusted to the level that produces a level detected by the measuring receiver, that is equal to the level noted while the spurious component was measured, corrected for the change of input attenuator setting of the measuring receiver. The input level to the substitution antenna shall be recorded as power level, corrected for the change of input attenuator setting of the measuring receiver.

The measurement shall be repeated with the test antenna and the substitution antenna oriented for horizontal polarization.

The measure of the effective radiated power of the spurious components is the larger of the two power levels recorded for each spurious component at the input to the substitution antenna, corrected for the gain of the antenna if necessary.

### 9.1.4 Method of measuring the effective radiated power

This method applies only to equipment with an integral antenna.

The method of measurement shall be performed according to clause 9.1.3, except that the receiver input shall be connected to the integral antenna and not to an artificial antenna.

## 9.1.5 Limits

The power of the spurious emissions shall not exceed the limits of table 5.

**Table 5: Limits for receiver spurious emissions**

Receivers and idle/standby transmitters	-57 dBm	$9 \text{ kHz} \leq f \leq 1 \text{ GHz}$
	-47 dBm	$1 \text{ GHz} < f$

For the measurement uncertainty, see clause 10.

## 9.2 Receiver sensitivity

### 9.2.1 Definition

Receiver sensitivity is the ability to receive a wanted signal at low input power level while providing a pre-determined level of performance. Receiver sensitivity is defined as:

$$R_{\text{sensitivity}} = \text{thermal noise floor} + 10 \times \log(B) + \text{NF} + \text{SNR}_{\text{needed}} \quad (2)$$

with:

- NF = noise figure of the receiver in [dB];
- B = declared channel bandwidth in [Hz];
- $\text{SNR}_{\text{needed}}$  = minimum needed signal-to-noise ratio for a given technology / operation mode in [dB].

The manufacturer shall declare receiver sensitivity.

### 9.2.2 Method of measurement

Receiver sensitivity is measured as a conducted measurement (see figure 10).

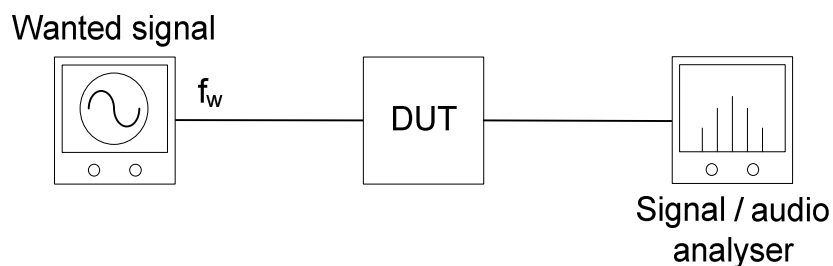

**Figure 10: Measurement setup for Rx sensitivity**

A signal generator shall be connected with the antenna port of the DUT. The audio output port of the DUT shall be connected to a signal or audio analyser using an AF filter, e.g. 22 Hz to 22 kHz. Losses of the combining networks shall be considered for determining the power level of the wanted signal.

The wanted signal shall be generated with a 1 kHz sinusoidal audio test signal modulated at the manufacturer's declared reference of 100 % modulation level for analogue systems. For digital systems the test signal shall be set at 6 dB below full scale. The wanted RF signal  $f_w$  shall be set to a carrier frequency in the middle of DUT's tuning band and its power level shall be reduced to that power level, which fulfils minimum performance criterion. Minimum performance criterion is 30 dB SINAD at DUT's audio output port for a measurement time  $\geq 10$  s without any dropouts or time outs in the measurement routine. Alternatively, a compatible transmitter / transceiver in combination with an attenuator may be used to generate the minimum power level of the wanted signal. If the receiver supports more than one mode of operation, receiver sensitivity shall be measured with its standard mode, which shall be declared by the manufacturer.

The manufacturer shall declare the minimum adjusted power level  $P_{\min}$  of  $f_w$ , which meets the minimum performance criterion, to a precision of 1 dB. This is the receiver sensitivity after bandwidth correction and shall be used as the reference for the receiver adjacent channel selectivity measurement in clause 9.3.

If the DUT is equipped with Rx diversity, it shall be measured in the configuration declared by the manufacturer.

### 9.2.3 Limits

Receiver sensitivity shall be  $-70 \text{ dBm} < R_{X_{\text{sensitivity}}} \leq -50 \text{ dBm}$ .

## 9.3 Receiver adjacent channel selectivity

### 9.3.1 Definition

The adjacent channel selectivity for the purposes of the present document is a measure of the capability of the receiver to operate satisfactorily in the presence of an unwanted signal on the next usable channel. It is given as ratio of unwanted signal output power to wanted signal output power in [dB].

The receiver adjacent channel selectivity is obtained by measuring the signal-to-noise and distortion ratio (SINAD) at the audio output port of the receiver.

### 9.3.2 Method of measurement

The manufacturer shall declare the receiver adjacent channel selectivity and the intended channel separation. The adjacent channel is the next usable channel above or below the operating channel.

Receiver adjacent channel selectivity is measured with a conducted measurements setup (see figure 11).

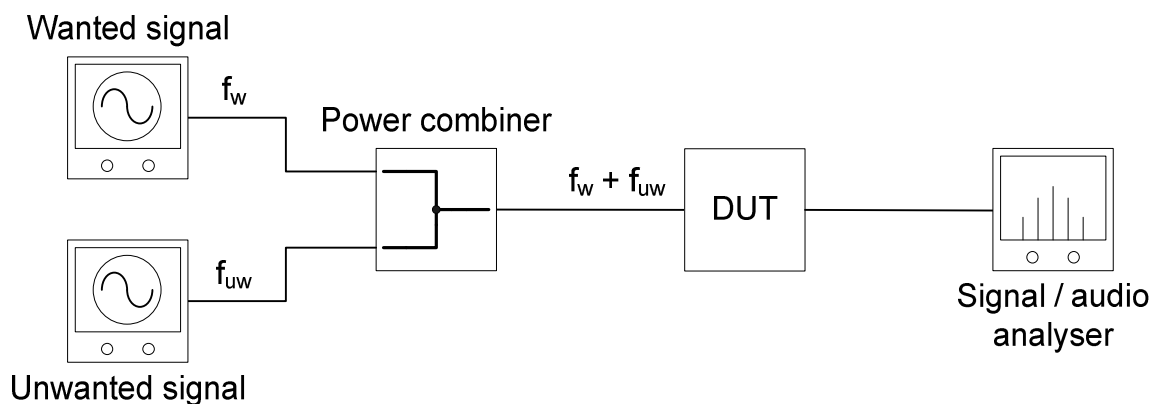

**Figure 11: Measurement setup for receiver adjacent channel selectivity**

Two signal generators shall be connected via a combining network to the antenna port of the DUT. The audio output port of the DUT shall be connected to a signal or audio analyser. Losses of the combining networks shall be considered for determining the power level of the unwanted signal.

The wanted signal shall be generated according to clause 9.2.2, but with an output power 3 dB above  $R_{X_{\text{sensitivity}}}$ .

The unwanted signal shall be an unmodulated carrier adjusted to the first adjacent channel centre frequency above the wanted channel as declared by the manufacturer. Its initial output power level shall be equal to the RF power level of the wanted signal relating to the DUT's antenna port. Both signals shall be fed into the antenna port of the DUT via a combining network. The audio output port of the DUT shall be connected to a signal or audio analyser. Losses of the combining networks shall be considered for determining the correct power levels.

The power level of the unwanted signal shall then be increased to the maximum level, at which the given minimum performance criterion according to clause 9.2.2. is met. The ratio of that power level of the unwanted signal to the power level of the wanted signal gives receiver adjacent channel selectivity in [dB].

The measurements shall be repeated with the first adjacent channel centre frequency below the wanted channel.



If the DUT is equipped with Rx diversity, it shall be measured in the configuration declared by the manufacturer.

### 9.3.3 Limits

Receiver adjacent channel selectivity shall be at least 15 dB.

## 9.4 Receiver blocking

### 9.4.1 Definition

The receiver blocking is a measure of the capability of the receiver to receive a wanted modulated signal without exceeding a given degradation due to the presence of an unwanted input signal at any offset frequency in the range between  $3 \times B$  and the receiver's tuning band. It is given as ratio of blocker signal output power to wanted signal output power in [dB].

The receiver blocking is obtained by measuring the signal-to-noise and distortion ratio (SINAD) at the audio output port of the receiver.

The manufacturer shall declare the receiver blocking category.

### 9.4.2 Method of measurement

Receiver blocking is measured with a conducted measurements setup (see figure 11).

The wanted signal shall be generated according to clause 9.2.2, but with an output power 3 dB above  $R_{X_{\text{sensitivity}}}$ .

The blocker signal shall be an unmodulated carrier adjusted to a centre frequency at  $f_w \pm f_{\text{offset}}$  with  $f_{\text{offset}} = n \times B$  where  $n = 3, 5, 10, \text{ and } 25$ .

Its initial output power level shall be less than the RF power level of the wanted signal at the DUT's antenna port.

The power level of the blocker signal shall then be increased to the maximum level, at which the given minimum performance criterion according to clause 9.2.2 is met. The ratio of that power level of the blocker signal to the power level of the wanted signal gives receiver blocking in [dB].

If the DUT is equipped with Rx diversity, it shall be measured in the configuration declared by the manufacturer.

### 9.4.3 Limits

Receiver blocking, for any frequency within the specified ranges, shall be at least 20 dB.

---

## 10 Measurement uncertainty

The accumulated measurement uncertainties of the test system in use for the parameters to be measured shall not exceed those given in table 6. This is in order to ensure that the measurements remain within an acceptable standard.

Uncertainty values for the RF parameters are valid to 1 GHz unless otherwise stated.

**Table 6: Measurement uncertainty**

Parameter	Uncertainty
RF frequency	$\pm 1 \times 10^{-7}$
Audio Output power	$\pm 0,5$ dB
Radiated RF power	$\pm 6$ dB
Conducted RF power Variations using a test fixture	$\pm 0,75$ dB
Maximum frequency deviation:	
– within 300 Hz and 6 kHz of audio frequency	$\pm 5$ %
– within 6 kHz and 25 kHz of audio frequency	$\pm 3$ dB
Deviation limitation	$\pm 5$ %
Radiated emission of transmitter, Valid up to 12,75 GHz	$\pm 6$ dB
Radiated emission of receiver, Valid up to 12,75 GHz	$\pm 6$ dB

For the test methods, according to the present document the uncertainty figures below 1 GHz shall be calculated according to the methods described in the ETSI TR 100 028 [i.23] and shall correspond to an expansion factor (coverage factor)  $k = 1,96$  or  $k = 2$  (which provide confidence levels of respectively 95 % and 95,45 % in case where the distributions characterizing the actual measurement uncertainties are normal (Gaussian)).

The particular expansion factor used for the evaluation of the measurement uncertainty shall be stated.

## Annex A (informative): Relationship between the present document and the essential requirements of Directive 2014/53/EU

The present document has been prepared under the Commission's standardisation request C(2015) 5376 final [i.16] to provide one voluntary means of conforming to the essential requirements of Directive 2014/53/EU on the harmonisation of the laws of the Member States relating to the making available on the market of radio equipment and repealing Directive 1999/5/EC [i.12].

Once the present document is cited in the Official Journal of the European Union under that Directive, compliance with the normative clauses of the present document given in table A.1 confers, within the limits of the scope of the present document, a presumption of conformity with the corresponding essential requirements of that Directive, and associated EFTA regulations.

**Table A.1: Relationship between the present document  
and the essential requirements of Directive 2014/53/EU**

Harmonised Standard ETSI EN 300 422-3				
Requirement			Requirement Conditionality	
No	Description	Reference: Clause No	U/C	Condition
1	RF Output Power	8.2	U	
2	Necessary bandwidth transmitter	8.3.2	C	For analogue equipment
3	Necessary bandwidth transmitter	8.3.3	C	For digital equipment
4	Necessary bandwidth transmitter	8.3.4	C	For WMAS equipment
5	Necessary bandwidth transmitter	8.3.5	C	For PMSE
6	Spurious emissions transmitter	8.4	U	
7	Transmitter intermodulation distortion	8.5	U	
8	Spurious emissions receiver	9.1	U	
9	Receiver sensitivity	9.2	U	
10	Receiver adjacent channel selectivity	9.3	U	
11	Receiver Blocking	9.4	U	

### Key to columns:

#### Requirement:

**No** A unique identifier for one row of the table which may be used to identify a requirement.

**Description** A textual reference to the requirement.

**Clause Number** Identification of clause(s) defining the requirement in the present document unless another document is referenced explicitly.

#### Requirement Conditionality:

**U/C** Indicates whether the requirement is unconditionally applicable (U) or is conditional upon the manufacturer's claimed functionality of the equipment (C).

**Condition** Explains the conditions when the requirement is or is not applicable for a requirement which is classified "conditional".

Presumption of conformity stays valid only as long as a reference to the present document is maintained in the list published in the Official Journal of the European Union. Users of the present document should consult frequently the latest list published in the Official Journal of the European Union.

Other Union legislation may be applicable to the product(s) falling within the scope of the present document.

## Annex B (normative): Measurement of Necessary Bandwidth (B) for analogue systems

### B.1 Test configuration for measurement of the Necessary Bandwidth (B) for analogue systems; see figure B.1

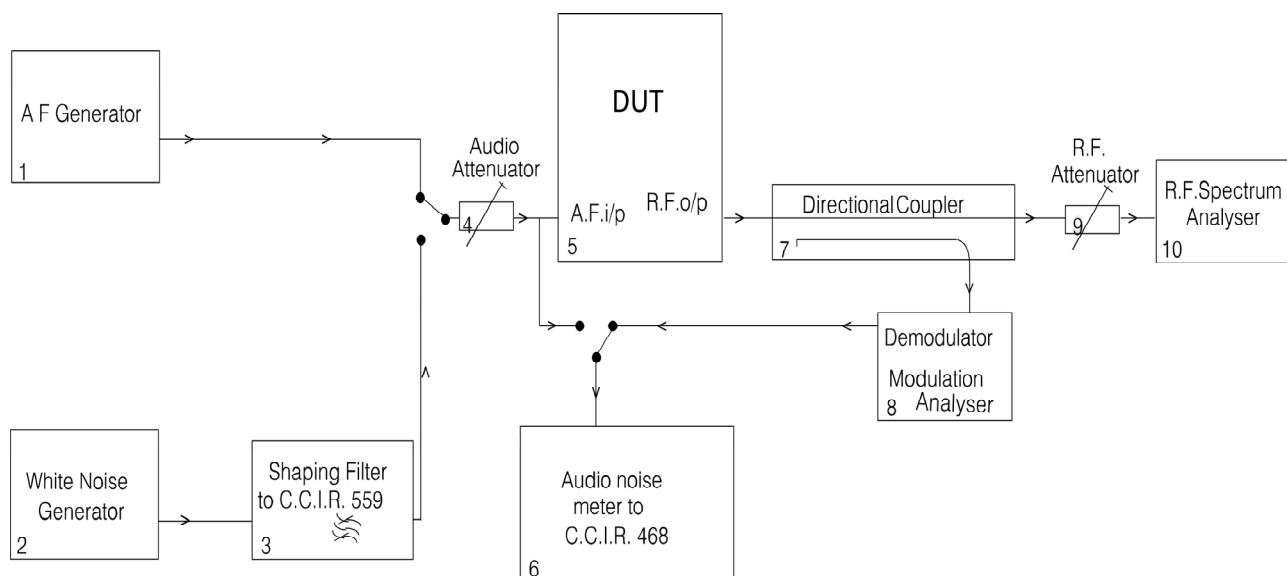

NOTE: If the DUT incorporates ancillary coding or signalling channels, for example, pilot tone, etc. these should be switched on prior to measuring the transmitter RF output spectrum.

**Figure B.1**

## Annex C (normative): Radiated measurement

### C.1 Test sites and general arrangements for measurements involving the use of radiated fields

#### C.1.1 General

This clause introduces three most commonly available test sites, an anechoic chamber, an anechoic chamber with a ground plane and an Open Area Test Site (OATS), which may be used for radiated tests. These test sites are generally referred to as free field test sites. Both absolute and relative measurements can be performed in these sites. Where absolute measurements are to be carried out, the chamber should be verified. A detailed verification procedure is described in the relevant parts of ETSI TR 102 273 [i.5] or equivalent.

NOTE: To ensure reproducibility and tractability of radiated measurements only these test sites should be used in measurements in accordance with the present document.

#### C.1.2 Anechoic chamber

An anechoic chamber is an enclosure, usually shielded, whose internal walls, floor and ceiling are covered with radio absorbing material, normally of the pyramidal urethane foam type. The chamber usually contains an antenna support at one end and a turntable at the other. A typical anechoic chamber is shown in figure C.1.

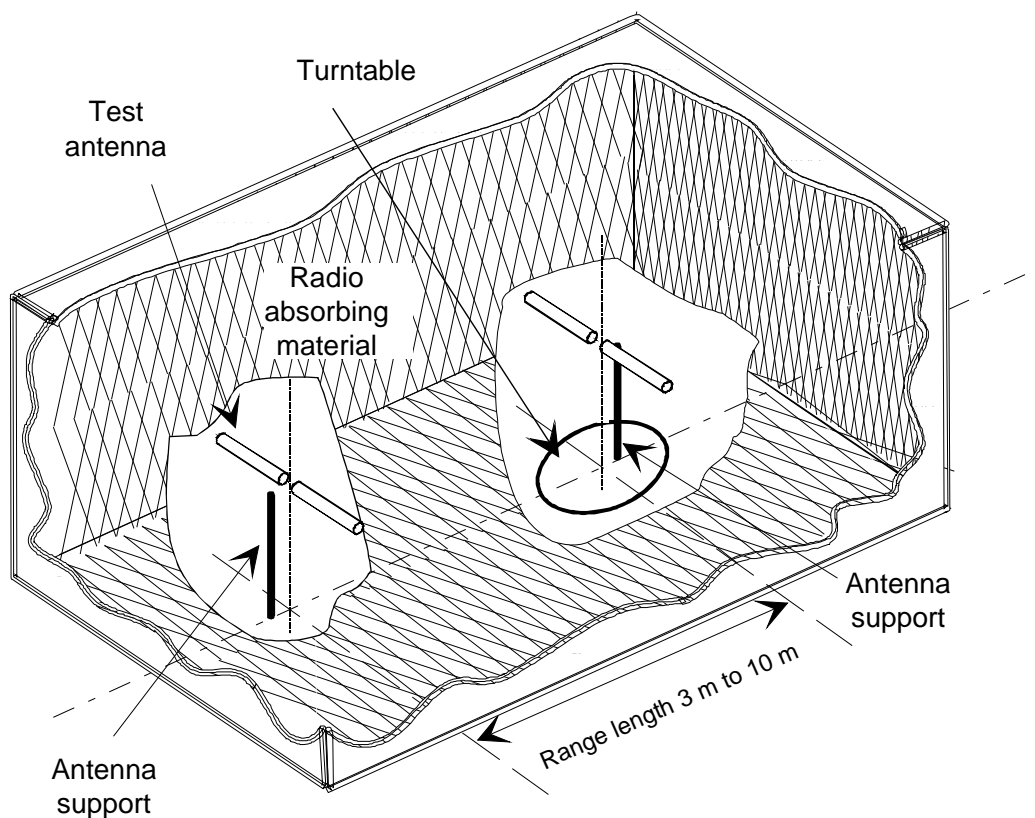

**Figure C.1: A typical anechoic chamber**

The chamber shielding and radio absorbing material work together to provide a controlled environment for testing purposes. This type of test chamber attempts to simulate free space conditions.

The shielding provides a test space, with reduced levels of interference from ambient signals and other outside effects, whilst the radio absorbing material minimizes unwanted reflections from the walls and ceiling which can influence the measurements. In practice it is relatively easy for shielding to provide high levels (80 dB to 140 dB) of ambient interference rejection, normally making ambient interference negligible.

A turntable is capable of rotation through 360° in the horizontal plane and it is used to support the test sample (DUT) at a suitable height (e.g. 1 m) above the ground plane. The chamber shall be large enough to allow the measuring distance of at least 3 m or  $2(d_1+d_2)^2 / \lambda$  (m), whichever is greater (see clause C.2.7). The distance used in actual measurements shall be recorded with the test results.

The anechoic chamber generally has several advantages over other test facilities. There is minimal ambient interference, minimal floor, ceiling and wall reflections and it is independent of the weather. It does however have some disadvantages which include limited measuring distance and limited lower frequency usage due to the size of the pyramidal absorbers. To improve low frequency performance, a combination structure of ferrite tiles and urethane foam absorbers is commonly used.

All types of emission, sensitivity and immunity testing can be carried out within an anechoic chamber without limitation.

### C.1.3 Anechoic chamber with a conductive ground plane

An anechoic chamber with a conductive ground plane is an enclosure, usually shielded, whose internal walls and ceiling are covered with radio absorbing material, normally of the pyramidal urethane foam type. The floor, which is metallic, is not covered and forms the ground plane. The chamber usually contains an antenna mast at one end and a turntable at the other. A typical anechoic chamber with a conductive ground plane is shown in figure C.2.

This type of test chamber attempts to simulate an ideal Open Area Test Site whose primary characteristic is a perfectly conducting ground plane of infinite extent.

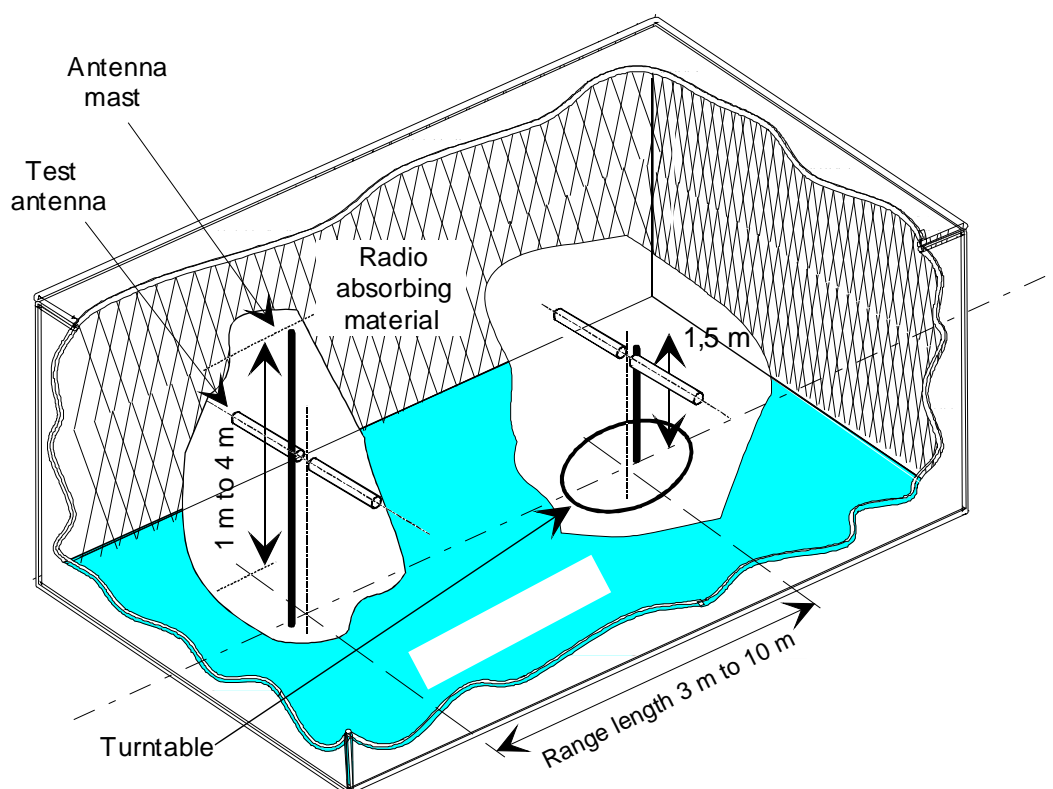

**Figure C.2: A typical anechoic chamber with a conductive ground plane**

In this facility the ground plane creates the wanted reflection path, such that the signal received by the receiving antenna is the sum of the signals from both the direct and reflected transmission paths. This creates a unique received signal level for each height of the transmitting antenna (or DUT) and the receiving antenna above the ground plane.

The antenna mast provides a variable height facility (from 1 m to 4 m) so that the position of the test antenna can be optimized for maximum coupled signal between antennas or between a DUT and the test antenna.

A turntable is capable of rotation through 360° in the horizontal plane and it is used to support the test sample (DUT) at a specified height, usually 1,5 m above the ground plane. The chamber shall be large enough to allow the measuring distance of at least 3 m or  $2(d_1+d_2)^2 / \lambda$  (m), whichever is greater (see clause C.2.7). The distance used in actual measurements shall be recorded with the test results.

Emission testing involves firstly "peaking" the field strength from the DUT by raising and lowering the receiving antenna on the mast (to obtain the maximum constructive interference of the direct and reflected signals from the DUT) and then rotating the turntable for a "peak" in the azimuth plane. At this height of the test antenna on the mast, the amplitude of the received signal is noted. Secondly the DUT is replaced by a substitution antenna (positioned at the DUT's phase or volume centre) which is connected to a signal generator. The signal is again "peaked" and the signal generator output adjusted until the level, noted in stage one, is again measured on the receiving device.

Receiver sensitivity tests over a ground plane also involve "peaking" the field strength by raising and lowering the test antenna on the mast to obtain the maximum constructive interference of the direct and reflected signals, this time using a measuring antenna which has been positioned where the phase or volume centre of the DUT will be during testing. A transform factor is derived. The test antenna remains at the same height for stage two, during which the measuring antenna is replaced by the DUT. The amplitude of the transmitted signal is reduced to determine the field strength level at which a specified response is obtained from the DUT.

### C.1.4 Open Area Test Site (OATS)

An Open Area Test Site comprises a turntable at one end and an antenna mast of variable height at the other end above a ground plane which, in the ideal case, is perfectly conducting and of infinite extent. In practice, whilst good conductivity can be achieved, the ground plane size has to be limited. A typical Open Area Test Site is shown in figure C.3.

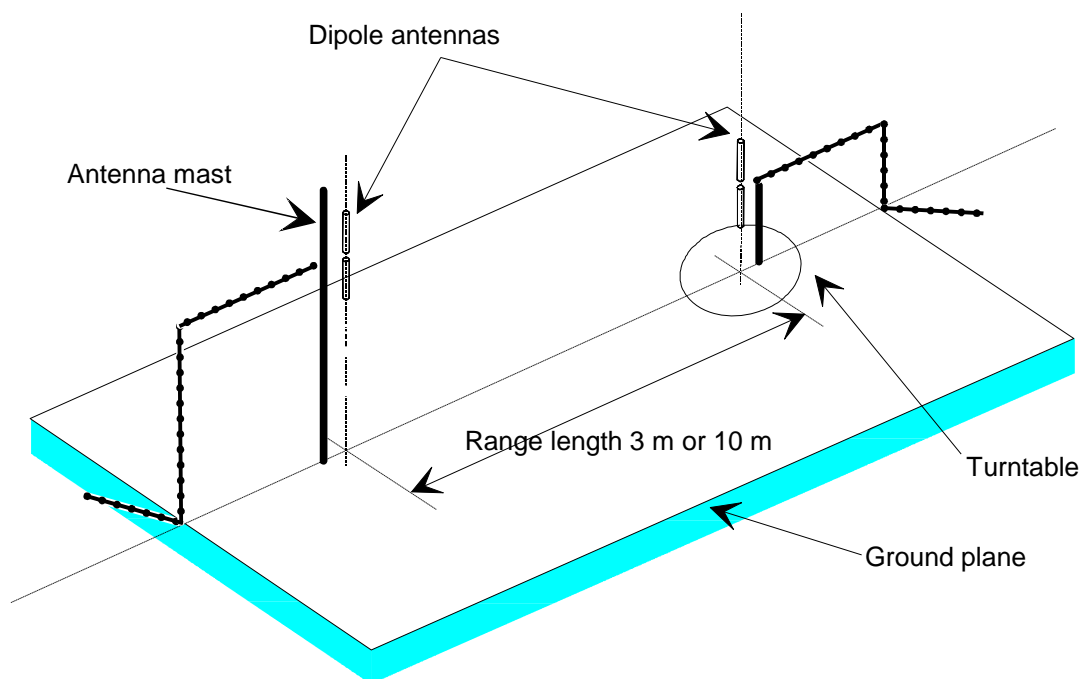
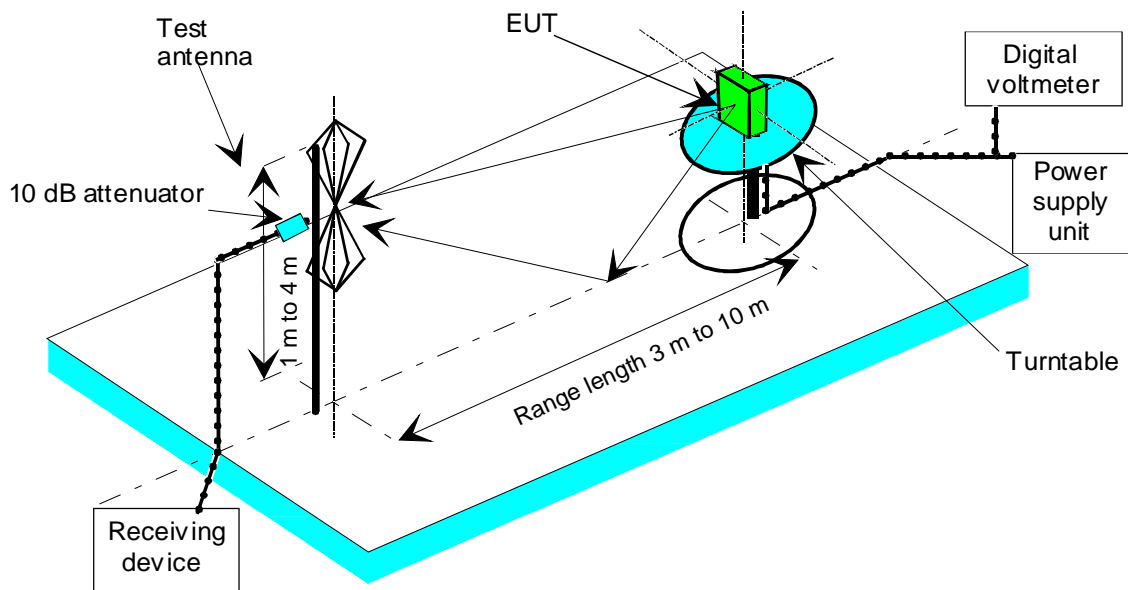

**Figure C.3: A typical Open Area Test Site**

The ground plane creates a wanted reflection path, such that the signal received by the receiving antenna is the sum of the signals received from the direct and reflected transmission paths. The phasing of these two signals creates a unique received level for each height of the transmitting antenna (or DUT) and the receiving antenna above the ground plane.

Site qualification concerning antenna positions, turntable, measurement distance and other arrangements are same as for anechoic chamber with a ground plane. In radiated measurements an OATS is also used by the same way as anechoic chamber with a ground plane.

Typical measuring arrangement common for ground plane test sites is presented in the figure C.4.



**Figure C.4: Measuring arrangement on ground plane test site (OATS set-up for spurious emission testing)**

### C.1.5 Test antenna

A test antenna is always used in radiated test methods. In emission tests (i.e. frequency error, effective radiated power, spurious emissions and adjacent channel power) the test antenna is used to detect the field from the DUT in one stage of the measurement and from the substitution antenna in the other stage. When the test site is used for the measurement of receiver characteristics (i.e. sensitivity and various immunity parameters) the antenna is used as the transmitting device.

The test antenna should be mounted on a support capable of allowing the antenna to be used in either horizontal or vertical polarization which, on ground plane sites (i.e. anechoic chambers with ground planes and Open Area Test Sites), should additionally allow the height of its centre above the ground to be varied over the specified range (usually 1 m to 4 m).

In the frequency band 30 MHz to 1 000 MHz, dipole antennas (constructed in accordance with ANSI C63.5 [i.21] are generally recommended). For frequencies of 80 MHz and above, the dipoles should have their arm lengths set for resonance at the frequency of test. Below 80 MHz, shortened arm lengths are recommended. For spurious emission testing, however, a combination of bicones and log periodic dipole array antennas (commonly termed "log periodics") could be used to cover the entire 30 MHz to 1 000 MHz band. Above 1 000 MHz, waveguide horns are recommended although, again, log periodics could be used.

NOTE: The gain of a horn antenna is generally expressed relative to an isotropic radiator.

### C.1.6 Substitution antenna

The substitution antenna is used to replace the DUT for tests in which a transmitting parameter (i.e. frequency error, effective radiated power, spurious emissions and adjacent channel power) is being measured. For measurements in the frequency band 30 MHz to 1 000 MHz, the substitution antenna should be a dipole antenna (constructed in accordance with ANSI C63.5 [i.21] is generally recommended). For frequencies of 80 MHz and above, the dipoles should have their arm lengths set for resonance at the frequency of test. Below 80 MHz, shortened arm lengths are recommended. For measurements above 1 000 MHz, a waveguide horn is recommended. The centre of this antenna should coincide with either the phase centre or volume centre.



## C.1.7 Measuring antenna

The measuring antenna is used in tests on a DUT in which a receiving parameter (i.e. sensitivity and various immunity tests) is being measured. Its purpose is to enable a measurement of the electric field strength in the vicinity of the DUT. For measurements in the frequency band 30 MHz to 1 000 MHz, the measuring antenna should be a dipole antenna (constructed in accordance with ANSI C63.5 [i.21] is generally recommended). For frequencies of 80 MHz and above, the dipoles should have their arm lengths set for resonance at the frequency of test. Below 80 MHz, shortened arm lengths are recommended. The centre of this antenna should coincide with either the phase centre or volume centre (as specified in the test method) of the DUT.

## C.1.8 Stripline arrangement

### C.1.8.1 General

The stripline arrangement is a RF coupling device for coupling the integral antenna of an equipment to a 50  $\Omega$  radio frequency terminal. This allows the radiated measurements to be performed without an open air test site but in a restricted frequency range. Absolute or relative measurements can be performed; absolute measurements require a calibration of the stripline arrangement.

### C.1.8.2 Description

The stripline is made of three highly conductive sheets forming part of a transmission line which allows the equipment under test to be placed within a known electric field. They shall be sufficiently rigid to support the equipment under test.

### C.1.8.3 Calibration

The aim of calibration is to establish at any frequency a relationship between the voltage applied by the signal generator and the field strength at the designated test area inside the stripline.

### C.1.8.4 Mode of use

The stripline arrangement may be used for all radiated measurements within its calibrated frequency range.

The method of measurement is the same as the method using an open air test site with the following change. The stripline arrangement input socket is used instead of the test antenna.

---

## C.2 Guidance on the use of radiation test sites

### C.2.1 General

This clause details procedures, test equipment arrangements and verification that should be carried out before any of the radiated test are undertaken. These schemes are common to all types of test sites described in annex C.

### C.2.2 Verification of the test site

No test should be carried out on a test site which does not possess a valid certificate of verification. The verification procedures for the different types of test sites described in annex C (i.e. anechoic chamber, anechoic chamber with a ground plane and Open Area Test Site) are given in ETSI TR 102 273 [i.5] or equivalent.

### C.2.3 Preparation of the DUT

The manufacturer should supply information about the DUT covering the operating frequency, polarization, supply voltage(s) and the reference face. Additional information, specific to the type of DUT should include, where relevant, carrier power, channel separation, whether different operating modes are available (e.g. high and low power modes) and if operation is continuous or is subject to a maximum test duty cycle (e.g. 1 minute on, 4 minutes off).

Where necessary, a mounting bracket of minimal size should be available for mounting the DUT on the turntable. This bracket should be made from low conductivity, low relative dielectric constant (i.e. less than 1,5) material(s) such as expanded polystyrene, balsa wood, etc.

### C.2.4 Power supplies to the DUT

All tests should be performed using power supplies wherever possible, including tests on DUT designed for battery-only use. In all cases, power leads should be connected to the DUT's supply terminals (and monitored with a digital voltmeter) but the battery should remain present, electrically isolated from the rest of the equipment, possibly by putting tape over its contacts.

The presence of these power cables can, however, affect the measured performance of the DUT. For this reason, they should be made to be "transparent" as far as the testing is concerned. This can be achieved by routing them away from the DUT and down to the either the screen, ground plane or facility wall (as appropriate) by the shortest possible paths. Precautions should be taken to minimize pick-up on these leads (e.g. the leads could be twisted together, loaded with ferrite beads at 0,15 m spacing or otherwise loaded).

### C.2.5 Volume control setting for analogue speech tests

Unless otherwise stated, in all receiver measurements for analogue speech the receiver volume control where possible, should be adjusted to give at least 50 % of the rated audio output power. In the case of stepped volume controls, to volume control should be set to the first step that provides an output power of at least 50 % of the rated audio output power. This control should not be readjusted between normal and extreme test conditions in tests.

### C.2.6 Range length

The range length for all these types of test facility should be adequate to allow for testing in the far-field of the DUT i.e. it should be equal to or exceed:

$$\frac{2(d_1 + d_2)^2}{\lambda} \quad (\text{C.1})$$

where:

$d_1$ : is the largest dimension of the DUT/dipole after substitution (m);

$d_2$ : is the largest dimension of the test antenna (m);

$\lambda$ : is the test frequency wavelength (m).

It should be noted that in the substitution part of this measurement, where both test and substitution antennas are half wavelength dipoles, this minimum range length for far-field testing would be:

$$2\lambda$$

It should be noted in the test report when either of these conditions is not met so that the additional measurement uncertainty can be incorporated into the results.

NOTE 1: **For the fully anechoic chamber**, no part of the volume of the DUT should, at any angle of rotation of the turntable, fall outside the "quiet zone" of the chamber at the nominal frequency of the test.

NOTE 2: The "quiet zone" is a volume within the anechoic chamber (without a ground plane) in which a specified performance has either been proven by test, or is guaranteed by the designer/manufacture. The specified performance is usually the reflectivity of the absorbing panels or a directly related parameter (e.g. signal uniformity in amplitude and phase). It should be noted however that the defining levels of the quiet zone tend to vary.

NOTE 3: **For the anechoic chamber with a ground plane**, a full height scanning capability, i.e. 1 m to 4 m, should be available for which no part of the test antenna should come within 1 m of the absorbing panels. For both types of Anechoic Chamber, the reflectivity of the absorbing panels should not be worse than -5 dB.

NOTE 4: **For both the anechoic chamber with a ground plane and the Open Area Test Site**, no part of any antenna should come within 0,25 m of the ground plane at any time throughout the tests. Where any of these conditions cannot be met, measurements should not be carried out.

## C.2.7 Site preparation

The cables for both ends of the test site should be routed horizontally away from the testing area for a minimum of 2 m (unless, in the case both types of anechoic chamber, a back wall is reached) and then allowed to drop vertically and out through either the ground plane or screen (as appropriate) to the test equipment. Precautions should be taken to minimize pick up on these leads (e.g. dressing with ferrite beads, or other loading). The cables, their routing and dressing should be identical to the verification set-up.

NOTE: For ground reflection test sites (i.e. anechoic chambers with ground planes and Open Area Test Sites) which incorporate a cable drum with the antenna mast, the 2 m requirement may be impossible to comply with.

Calibration data for all items of test equipment should be available and valid. For test, substitution and measuring antennas, the data should include gain relative to an isotropic radiator (or antenna factor) for the frequency of test. Also, the VSWR of the substitution and measuring antennas should be known.

The calibration data on all cables and attenuators should include insertion loss and VSWR throughout the entire frequency range of the tests. All VSWR and insertion loss figures should be recorded in the log book results sheet for the specific test.

Where correction factors/tables are required, these should be immediately available.

For all items of test equipment, the maximum errors they exhibit should be known along with the distribution of the error e.g.:

- cable loss:  $\pm 0,5$  dB with a rectangular distribution;
- measuring receiver: 1,0 dB (standard deviation) signal level accuracy with a Gaussian error distribution.

At the start of measurements, system checks should be made on the items of test equipment used on the test site.

---

## C.3 Coupling of signals

### C.3.1 General

The presence of leads in the radiated field may cause a disturbance of that field and lead to additional measurement uncertainty. These disturbances can be minimized by using suitable coupling methods, offering signal isolation and minimum field disturbance (e.g. optical and acoustic coupling).

### C.3.2 Data signals

Isolation can be provided by the use of optical, ultra-sonic or infra-red means. Field disturbance can be minimized by using a suitable fibre optic connection. Ultra-sonic or infra-red radiated connections require suitable measures for the minimization of ambient noise.

## C.3.3 Speech and analogue signals

### C.3.3.0 General

Where an audio output socket is not available an acoustic coupler should be used.

When using the acoustic coupler, care should be exercised that possible ambient noise does not influence the test result.

### C.3.3.1 Acoustic coupler description

The acoustic coupler comprises a plastic funnel, an acoustic pipe and a microphone with a suitable amplifier. The materials used to fabricate the funnel and pipe should be of low conductivity and of low relative dielectric constant (i.e. less than 1,5):

- The acoustic pipe should be long enough to reach from the DUT to the microphone which should be located in a position that will not disturb the RF field. The acoustic pipe should have an inner diameter of about 6 mm and a wall thickness of about 1,5 mm and should be sufficiently flexible so as not to hinder the rotation of the turntable.
- The plastic funnel should have a diameter appropriate to the size of the loudspeaker in the DUT, with soft foam rubber glued to its edge, it should be fitted to one end of the acoustic pipe and the microphone should be fitted to the other end. It is very important to fix the centre of the funnel in a reproducible position relative to the DUT, since the position of the centre has a strong influence on the frequency response that will be measured. This can be achieved by placing the DUT in a close fitting acoustic mounting jig, supplied by the manufacturer, of which the funnel is an integral part.
- The microphone should have a response characteristic flat within 1 dB over a frequency range of 50 Hz to 20 kHz, a linear dynamic range of at least 50 dB. The sensitivity of the microphone and the receiver audio output level should be suitable to measure a signal to noise ratio of at least 40 dB at the nominal audio output level of the DUT. Its size should be sufficiently small to couple to the acoustic pipe.
- The frequency correcting network should correct the frequency response of the acoustic coupler so that the acoustic SINAD measurement is valid.

### C.3.3.2 Calibration

The aim of the calibration of the acoustic coupler is to determine the acoustic SINAD ratio which is equivalent to the SINAD ratio at the receiver output.

---

## C.4 Standard test position

The standard position in all test sites, except the stripline arrangement, for equipment which is not intended to be worn on a person, including hand-held equipment, shall be on a non-conducting support with an  $\epsilon_r$  as close as possible to one, height 1,5 m, capable of rotating about a vertical axis through the equipment. The standard position of the equipment shall be the following:

- a) for equipment with an internal antenna, it shall be placed in the position closest to normal use as declared by the manufacturer;
- b) for equipment with a rigid external antenna, the antenna shall be vertical;
- c) for equipment with a non-rigid external antenna, the antenna shall be extended vertically upwards by a non-conducting support.

Equipment which is intended to be worn on a person may be tested using a simulated man as support.

The simulated man comprises a rotatable acrylic tube filled with salt water, placed on the ground.

The container shall have the following dimensions:

- Height:  $1,7 \pm 0,1$  m;
- Inside diameter:  $300 \pm 5$  mm;
- Sidewall thickness:  $5 \pm 0,5$  mm.

The container shall be filled with a salt (NaCl) solution of 1,5 g per litre of distilled water.

The equipment shall be fixed to the surface of the simulated man, at the appropriate height for the equipment.

NOTE: To reduce the weight of the simulated man it may be possible to use an alternative tube which has a hollow centre of 220 mm maximum diameter.

In the stripline arrangement the equipment under test or the substitution antenna is placed in the designated test area in the normal operational position, relative to the applied field, on a pedestal made of a low dielectric material (dielectric constant less than 2).

---

## C.5 Test fixture

### C.5.1 General

The test fixture is only needed for the assessment of integral antenna equipment.

### C.5.2 Description

The test fixture is a radio frequency coupling device associated with an integral antenna equipment for coupling the integral antenna to a  $50 \Omega$  radio frequency terminal at the working frequencies of the equipment under test. This allows certain measurements to be performed using the conducted measurement methods. Only relative measurements may be performed and only those at or near frequencies for which the test fixture has been calibrated.

In addition, the test fixture may provide:

- a) a connection to an external power supply;
- b) in the case of assessment of speech equipment, an audio interface either by direct connection or by an acoustic coupler.

In the case of non-speech equipment, the test fixture can also provide the suitable coupling means e.g. for the data output.

The test fixture shall normally be provided by the manufacturer.

The performance characteristics of the test fixture shall be approved by the testing laboratory and shall conform to the following basic parameters:

- a) the coupling loss shall not be greater than 30 dB;
- b) a coupling loss variation over the frequency range used in the measurement which does not exceed 2 dB;
- c) circuitry associated with the RF coupling shall contain no active or non-linear devices;
- d) the VSWR at the  $50 \Omega$  socket shall not be more than 1,5 over the frequency range of the measurements;
- e) the coupling loss shall be independent of the position of the test fixture and be unaffected by the proximity of surrounding objects or people. The coupling loss shall be reproducible when the equipment under test is removed and replaced;
- f) the coupling loss shall remain substantially constant when the environmental conditions are varied.

The characteristics and calibration shall be included in the test report.

### C.5.3 Calibration

The calibration of the test fixture establishes a relationship between the output of the signal generator and the field strength applied to the equipment placed in the test fixture.

The calibration is valid only at a given frequency and for a given polarization of the reference field.

The actual set-up used depends on the type of the equipment (e.g. data, speech, etc.).

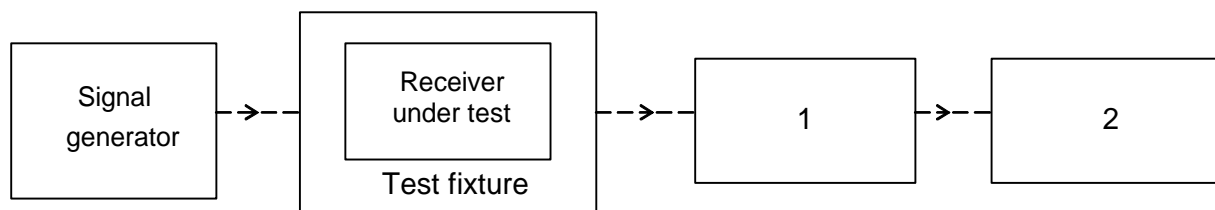

NOTE 1: Coupling device, e.g. AF load/acoustic coupler (in the case of speech equipment).

NOTE 2: Device for assessing the performance, e.g. distortion factor/audio level meter, BER measuring device, etc.

**Figure C.5: Measuring arrangement for calibration**

Method of calibration:

- a) Measure the sensitivity expressed as a field strength, as specified in the present document and note the value of this field strength in dB $\mu$ V/m and the polarization used.
- b) Place the receiver in the test fixture which is connected to the signal generator. The level of the signal generator producing:
  - a SINAD of 20 dB;
  - a bit error ratio of 0,01; or
  - a message acceptance ratio of 80 %, as appropriate;
 shall be noted.

The calibration of the test fixture is the relationship between the field strength in dB $\mu$ V/m and the signal generator level in dB $\mu$ V emf. This relationship is expected to be linear.

### C.5.4 Mode of use

The test fixture may be used to facilitate some of the measurements in the case of equipment having an integral antenna.

It is used in particular for the measurement of the radiated carrier power and usable sensitivity expressed as a field strength under the extreme conditions.

For the transmitter measurements calibration is not required as relative measuring methods are used.

For the receiver measurements calibration is necessary as absolute measurements are used.

To apply the specified wanted signal level expressed in field strength, convert it into the signal generator level (emf) using the calibration of the test fixture. Apply this value to the signal generator.

## Annex D (informative): Additional receiver parameters identified under article 3.2 of Directive 2014/53/EU

Table D.1 lists receiver parameter defined in ETSI EG 203 336 [i.15] under article 3.2 of Directive 2014/53/EU [i.12] but not implemented in the present document due to the stated reasons.

**Table D.1: Receiver parameter**

<b>Receiver parameter</b>	<b>Comment</b>
Receiver co-channel rejection	This is not appropriate for a PMSE system which is a 100 % duty cycle transmission and cannot operate co-channel with other transmissions.
Receiver spurious response rejection	New parameter for the present document which is currently partly covered in EMC Standard ETSI EN 301 489-9 [i.4].
Receiver radio-frequency intermodulation	Audio PMSE as a 100 % duty cycle application with multiple RF channels in simultaneous operation uses frequency planning to avoid undesired interaction between transmissions, e.g. up to 100 or more.
Receiver dynamic range	Currently insufficient information is available with regard to audio PMSE receivers. A testing campaign will need to be developed. In some cases the dynamic range can be altered by software; e.g., WMAS; and it is not currently clear if this test would be applicable to PMSE. Further investigation is underway.
Reciprocal mixing	New parameter which is not included in the present document as it is not currently clear if this test would be applicable to PMSE. Further investigation is underway.

---

## Annex E (informative): Application form for wireless microphone testing

### E.1 Introduction

#### E.1.1 Description

The form contained in this annex may be used by the manufacturer to comply with the requirement contained in clause 8.5, clause 9.2, clause 9.3 and clause 9.4 to provide the necessary information about the results of testing the equipment.

It contains product information as well as other information which might be required to define which configurations are to be tested, which tests are to be performed as well the test conditions.

This application form should form an integral part of the test report.

#### E.1.2 Notice

Notwithstanding the provisions of the copyright clause related to the text of the present document, ETSI grants that users of the present document may freely reproduce the application form pro forma in this annex so that it can be used for its intended purposes and may further publish the completed application form.

---

### E.2 Transmitter intermodulation distortion

#### E.2.1 General

This procedure may be carried out by either the manufacturer or Test House at a single frequency in the middle of the stated frequency range.

#### E.2.2 Definition

See clause 8.5.1.

#### E.2.3 Method of measurement

See clause 8.5.2.

#### E.2.4 Limits

See clause 8.5.3.

#### E.2.5 Settings and results

To be repeated for every Tx mode. See table E.1.



Table E.1: Transmitter IMD Data

Setting	Value
Tx Mode	
$f_w$ = carrier frequency of DUT	
$f_{INT}$ = frequency of interferer	
$f_{offset}$	
Centre frequency = $(f_w + f_{TOI}) / 2$	
Span > $ f_w - f_{TOI}  + 2 \times B$	
RBW: $span/4 \geq RBW \geq B$	
VBW $\geq$ RBW	
Detector = RMS	RMS
Trace mode = Average	Average
Sweep count > 10	
Sweep time = AUTO	AUTO
Measurement time > sweep count times sweep time	
<b>Results</b>	<b>Tx-IMD (dBc)</b>
$f_{TOI} = 2 \times f_w + f_{INT}$	
$f_{TOI} = 2 \times f_w - f_{INT}$	
(columns to be inserted if required)	
$f_{TOI} = 2 \times f_{INT} + f_w$	
$f_{TOI} = 2 \times f_{INT} - f_w$	
<b>Comments</b>	
<b>Equipment used</b>	
Date	

---

## E.3 Receiver Sensitivity

### E.3.1 General

This procedure may be carried out by either the manufacturer or Test House at a single frequency in the middle of the stated frequency range.

### E.3.2 Definition

See clause 9.2.1.

### E.3.3 Method of measurement

See clause 9.2.2.

### E.3.4 Limits

See clause 9.2.3.

### E.3.5 Settings and results

See table E.2.

Table E.2: Receiver Sensitivity Data

Setting	Value
Criteria	SINAD = 30 dB minimum
f <sub>1</sub> = frequency of DUT low	MHz
f <sub>2</sub> = frequency of DUT mid	MHz
f <sub>3</sub> = frequency of DUT high	MHz
<b>Results</b>	<b>Sensitivity</b>
@f <sub>1</sub>	dBm
@f <sub>2</sub>	
@f <sub>3</sub>	
<b>Class</b>	A, B, or C
<b>Comments</b>	
<b>Equipment used</b>	
<b>Date</b>	

## E.4 Receiver Adjacent Channel Power Selectivity

### E.4.1 General

This procedure may be carried out by either the manufacturer or Test House at a single frequency in the middle of the stated frequency range.

### E.4.2 Definition

See clause 9.3.1.

### E.4.3 Method of measurement

See clause 9.3.2.

### E.4.4 Limits

See clause 9.3.3.

### E.4.5 Settings and results

See table E.3.

Table E.3: Receiver Adjacent Channel Selectivity Data

Setting	Value
Criteria	SINAD = 30 dB minimum
f <sub>1</sub> = frequency of DUT	MHz
Channel spacing	kHz
Sensitivity + 3 dB	dBm
Audio level	
<b>Results</b>	<b>Adjacent Channel Power Selectivity</b>
@f <sub>1</sub> + channel spacing	dB
<b>Class</b>	A, B or C
<b>Comments</b>	
<b>Equipment used</b>	
<b>Date</b>	

## E.5 Receiver blocking

### E.5.1 General

This procedure may be carried out by either the manufacturer or Test House at a single frequency in the middle of the stated frequency range.

### E.5.2 Definition

See clause 9.4.1.

### E.5.3 Method of measurement

See clause 9.4.2.

### E.5.4 Limits

See clause 9.4.3.

### E.5.5 Settings and results

See table E.4.

**Table E.4: Receiver Blocking Data**

Setting	Value
Criteria	SINAD = 30 dB minimum
$f_1$ = frequency of DUT	MHz
B	kHz
Sensitivity + 3 dB	dBm
Audio level	
<b>Results</b>	<b>Adjacent Channel Power Selectivity</b>
@ $f_1 + 3 \times B$	dB
@ $f_1 - 3 \times B$	dB
@ $f_1 + 5 \times B$	dB
@ $f_1 - 5 \times B$	dB
@ $f_1 + 10 \times B$	dB
@ $f_1 - 10 \times B$	dB
@ $f_1 + 25 \times B$	dB
@ $f_1 - 25 \times B$	dB
<b>Class</b>	A, B or C
<b>Comments</b>	
<b>Equipment used</b>	
<b>Date</b>	

---

## Annex F (informative): Bibliography

- ETSI TR 102 215: "Electromagnetic compatibility and Radio spectrum Matters (ERM); Recommended approach, and possible limits for measurement uncertainty for the measurement of radiated electromagnetic fields above 1 GHz".
- ETSI EN 300 454-1: "Electromagnetic compatibility and Radio spectrum Matters (ERM); Wide band audio links; Part 1: Technical characteristics and test methods".
- ETSI TR 102 546: "Electromagnetic compatibility and Radio spectrum Matters (ERM); Technical characteristics for professional wireless microphone systems (PWMS); System reference document".
- ETSI TR 102 801 (V1.1.1) (03-2015): "Electromagnetic compatibility and Radio spectrum Matters (ERM); Methods, parameters and test procedures for cognitive interference mitigation techniques for use by PMSE devices (Programme Making and Special Events)".
- CENELEC EN 62209-1: "Human exposure to radio frequency fields from hand-held and body-mounted wireless communication devices - Human models, instrumentation, and procedures - Part 1: Procedure to determine the specific absorption rate (SAR) for hand-held devices used in close proximity to the ear (frequency range of 300 MHz to 3 GHz)".
- CENELEC EN 62209-2: "Human exposure to radio frequency fields from hand-held and body-mounted wireless communication devices - Human models, instrumentation, and procedures - Part 2: Procedure to determine the specific absorption rate (SAR) for wireless communication devices used in close proximity to the human body (frequency range of 30 MHz to 6 GHz)".
- ETSI EN 300 422-2: "Wireless Microphones; Audio PMSE up to 3 GHz; Part 2: Class B Receivers; Harmonised Standard covering the essential requirements of article 3.2 of Directive 2014/53/EU".

---

## Annex G (informative): Change History

Version	Information about changes
2.1.1	First published version covering Directive 2014/53/EU. Major changes are: <ul style="list-style-type: none"><li>• Change 1: inclusion of receiver parameters</li><li>• Change 2: inclusion of WMAS</li><li>• Change 3: bandwidth measurement procedure for PMSE operation in 2,4 GHz to 2,4835 GHz</li></ul>

---

## History

<b>Document history</b>				
V2.0.0	May 2016	EN Approval Procedure	AP 20160821:	2016-05-23 to 2016-08-22
V2.1.0	December 2016	Vote	V 20170212:	2016-12-14 to 2017-02-13