

EN 300 417-4-1 V1.1.2 (1998-11)

European Standard (Telecommunications series)

Transmission and Multiplexing (TM); Generic requirements of transport functionality of equipment; Part 4-1: Synchronous Digital Hierarchy (SDH) path layer functions



Reference

REN/TM 01015-4-1 (3v109idc.PDF)

Keywords

SDH, transmission, interface

ETSI

Postal address

F-06921 Sophia Antipolis Cedex - FRANCE

Office address

650 Route des Lucioles - Sophia Antipolis
Valbonne - FRANCE
Tel.: +33 4 92 94 42 00 Fax: +33 4 93 65 47 16
Siret N° 348 623 562 00017 - NAF 742 C
Association à but non lucratif enregistrée à la
Sous-Préfecture de Grasse (06) N° 7803/88

Internet

secretariat@etsi.fr
<http://www.etsi.org>

Copyright Notification

No part may be reproduced except as authorized by written permission.
The copyright and the foregoing restriction extend to reproduction in all media.

© European Telecommunications Standards Institute 1998.
All rights reserved.

Contents

Intellectual Property Rights.....	8
Foreword.....	8
1 Scope.....	10
2 References.....	10
3 Definitions, abbreviations and symbols.....	11
3.1 Definitions.....	11
3.2 Abbreviations.....	11
3.3 Symbols and diagrammatic conventions.....	15
3.4 Introduction.....	15
4 VC-4 Path Layer Functions.....	16
4.1 VC-4 Layer Connection Function S4_C.....	20
4.1.1 SNC Protection.....	22
4.2 VC-4 Layer Trail Termination Functions.....	23
4.2.1 VC-4 Layer Trail Termination Source S4_TT_So.....	23
4.2.2 VC-4 Layer Trail Termination Sink S4_TT_Sk.....	25
4.3 VC-4 Layer Adaptation Functions.....	28
4.3.1 VC-4 Layer to P4x Layer Adaptation Source S4/P4x_A_So.....	28
4.3.2 VC-4 Layer to P4x Layer Adaptation Sink S4/P4x_A_Sk.....	31
4.3.3 VC-4 Layer to P4e Layer Adaptation Source S4/P4e_A_So.....	33
4.3.4 VC-4 Layer to P4e Layer Adaptation Sink S4/P4e_A_Sk.....	35
4.3.5 VC-4 Layer to VC-3, VC-2, VC-12, and VC-11 Layer Compound Adaptation Source Function S4/SX_A_So.....	37
4.3.5.1 VC-4 Layer to TUG Adaptation Source Function S4/TUG_A_So.....	39
4.3.5.2 TUG Termination Source Function TUG_T_So.....	41
4.3.5.3 TUG to VC-3 Layer Adaptation Source Function TUG/S3_A_So/K.0.0.....	42
4.3.5.4 TUG to VC-2 Layer Adaptation Source Function TUG/S2_A_So/K.L.0.....	44
4.3.5.5 TUG to VC-12 Layer Adaptation Source Function TUG/S12_A_So/K.L.M.....	47
4.3.5.6 TUG to VC-11 Layer Adaptation Source Function TUG/S11*_A_So/K.L.M.....	50
4.3.6 VC-4 Layer to VC-3, VC-2, VC-12, and VC-11 Layer Compound Adaptation Sink Function S4/SX_A_Sk.....	53
4.3.6.1 VC-4 Layer to TUG Adaptation Sink Function S4/TUG_A_Sk.....	55
4.3.6.2 TUG Termination Sink Function TUG_T_Sk.....	57
4.3.6.3 TUG to VC-3 Layer Adaptation Sink Function TUG/S3_A_Sk/K.0.0.....	58
4.3.6.4 TUG to VC-2 Layer Adaptation Sink Function TUG/S2_A_Sk.....	60
4.3.6.5 TUG to VC-12 Layer Adaptation Sink Function TUG/S12_A_Sk/K.L.M.....	62
4.3.6.6 TUG to VC-11 Layer Adaptation Sink Function TUG/S11*_A_Sk/K.L.M.....	64
4.3.7 VC-4 Layer to P0s Layer Adaptation Source S4/P0s_A_So.....	66
4.3.8 VC-4 Layer to P0s Layer Adaptation Sink S4/P0s_A_Sk.....	68
4.3.9 VC-4 Layer to DQDB Layer Adaptation Source S4/DQDB_A_So.....	69
4.3.10 VC-4 Layer to DQDB Layer Adaptation Sink S4/DQDB_A_Sk.....	72
4.3.11 VC-4 Layer to TSS1 Adaptation Source S4/TSS1_A_So.....	75
4.3.12 VC-4 Layer to TSS1 Adaptation Sink S4/TSS1_A_Sk.....	76
4.3.13 VC-4 Layer to ATM Virtual Path Layer Compound Adaptation Source function S4/Avp_A_So.....	77
4.3.14 VC-4 Layer to ATM Virtual Path Layer Compound Adaptation Sink function S4/Avp_A_Sk.....	77
4.3.15 VC-4 Layer Clock Adaptation Source S4-LC_A_So.....	77
4.4 VC-4 Layer Monitoring Functions.....	77
4.4.1 VC-4 Layer Non-intrusive Monitoring Function S4m_TT_Sk.....	77
4.4.2 VC-4 Layer Supervisory-Unequipped Termination Source S4s_TT_So.....	80
4.4.3 VC-4 Layer Supervisory-unequipped Termination Sink S4s_TT_Sk.....	82
4.5 VC-4 Layer Trail Protection Functions.....	85
4.5.1 VC-4 Trail Protection Connection Functions S4P_C.....	85
4.5.1.1 VC-4 Layer 1+1 uni-directional Protection Connection Function S4P1+1u_C.....	85
4.5.1.2 VC-4 Layer Protection bi-directional Connection Function S4P1+1b_C.....	87
4.5.2 VC-4 Layer Trail Protection Trail Termination Functions.....	89

4.5.2.1	VC-4 Protection Trail Termination Source S4P_TT_So.....	89
4.5.2.2	VC-4 Protection Trail Termination Sink S4P_TT_Sk.....	90
4.5.3	VC-4 Layer Linear Trail Protection Adaptation Functions.....	91
4.5.3.1	VC-4 trail to VC-4 trail Protection Layer Adaptation Source S4/S4P_A_So.....	91
4.5.3.2	VC-4 trail to VC-4 trail Protection Layer Adaptation Sink S4/S4P_A_Sk.....	92
4.6	VC-4 Tandem Connection Sublayer Functions.....	93
4.6.1	VC-4 Tandem Connection Trail Termination Source function (S4D_TT_So).....	93
4.6.2	VC-4 Tandem Connection Trail Termination Sink function (S4D_TT_Sk).....	96
4.6.3	VC-4 Tandem Connection to VC-4 Adaptation Source function (S4D/S4_A_So).....	101
4.6.4	VC-4 Tandem Connection to VC-4 Adaptation Sink function (S4D/S4_A_Sk).....	102
4.6.5	VC-4 Tandem Connection Non-intrusive Monitoring Trail Termination Sink function (S4Dm_TT_Sk).....	103
5	VC-3 Path Layer Functions.....	106
5.1	VC-3 Layer Connection Function S3_C.....	109
5.1.1	SNC Protection.....	111
5.2	VC-3 Layer Trail Termination Functions.....	112
5.2.1	VC-3 Layer Trail Termination Source S3_TT_So.....	112
5.2.2	VC-3 Layer Trail Termination Sink S3_TT_Sk.....	114
5.3	VC-3 Layer Adaptation Functions.....	117
5.3.1	VC-3 Layer to P31x Layer Adaptation Source S3/P31x_A_So.....	117
5.3.2	VC-3 Layer to P31x Layer Adaptation Sink S3/P31x_A_Sk.....	120
5.3.3	VC-3 Layer to P31e Layer Adaptation Source S3/P31e_A_So.....	122
5.3.4	VC-3 Layer to P31e Layer Adaptation Sink S3/P31e_A_Sk.....	124
5.3.5	VC-3 Layer to P0s Layer Adaptation Source S3/P0s_A_So.....	126
5.3.6	VC-3 Layer to P0s Layer Adaptation Sink S3/P0s_A_Sk.....	128
5.3.7	VC-3 Layer to TSS3 Adaptation Source S3/TSS3_A_So.....	129
5.3.8	VC-3 Layer to TSS3 Adaptation Sink S3/TSS3_A_Sk.....	130
5.3.9	VC-3 Layer to ATM Virtual Path Layer Compound Adaptation Source function S3/Avp_A_So.....	131
5.3.10	VC-3 Layer to ATM Virtual Path Layer Compound Adaptation Sink function S3/Avp_A_Sk.....	131
5.3.11	VC-3 Layer Clock Adaptation Source S3-LC_A_So.....	131
5.4	VC-3 Layer Monitoring Functions.....	131
5.4.1	VC-3 Layer Non-intrusive Monitoring Function S3m_TT_Sk.....	131
5.4.2	VC-3 Layer Supervisory-Unequipped Termination Source S3s_TT_So.....	134
5.4.3	VC-3 Layer Supervisory-unequipped Termination Sink S3s_TT_Sk.....	136
5.5	VC-3 Layer Trail Protection Functions.....	139
5.5.1	VC-3 Trail Protection Connection Functions S3P_C.....	139
5.5.1.1	VC-3 Layer 1+1 uni-directional Protection Connection Function S3P1+1u_C.....	139
5.5.1.2	VC-3 Layer bi-directional Protection Connection Function S3P1+1b_C.....	141
5.5.2	VC-3 Layer Trail Protection Trail Termination Functions.....	143
5.5.2.1	VC-3 Protection Trail Termination Source S3P_TT_So.....	143
5.5.2.2	VC-3 Protection Trail Termination Sink S3P_TT_Sk.....	144
5.5.3	VC-3 Layer Linear Trail Protection Adaptation Functions.....	145
5.5.3.1	VC-3 trail to VC-3 trail Protection Layer Adaptation Source S3/S3P_A_So.....	145
5.5.3.2	VC-3 trail to VC-3 trail Protection Layer Adaptation Sink S3/S3P_A_Sk.....	146
5.6	VC-3 Tandem Connection Sublayer Functions.....	147
5.6.1	VC-3 Tandem Connection Trail Termination Source function (S3D_TT_So).....	147
5.6.2	VC-3 Tandem Connection Trail Termination Sink function (S3D_TT_Sk).....	150
5.6.3	VC-3 Tandem Connection to VC-3 Adaptation Source function (S3D/S3_A_So).....	155
5.6.4	VC-3 Tandem Connection to VC-3 Adaptation Sink function (S3D/S3_A_Sk).....	156
5.6.5	VC-3 Tandem Connection Non-intrusive Monitoring Trail Termination Sink function (S3Dm_TT_Sk).....	157
6	VC-2 Path Layer Functions.....	160
6.1	VC-2 Layer Connection Function S2_C.....	164
6.1.1	SNC Protection.....	166
6.2	VC-2 Layer Trail Termination Functions.....	167
6.2.1	VC-2 Layer Trail Termination Source S2_TT_So.....	167
6.2.2	VC-2 Layer Trail Termination Sink S2_TT_Sk.....	169
6.3	VC-2 Layer Adaptation Functions.....	171
6.3.1	VC-2 Layer to TSS4 Adaptation Source S2/TSS4_A_So.....	171

6.3.2	VC-2 Layer to TSS4 Adaptation Sink S2/TSS4_A_Sk.....	172
6.3.3	VC-2 Layer to ATM Virtual Path Layer Compound Adaptation Source function S2/Avp_A_So.....	173
6.3.4	VC-2 Layer to ATM Virtual Path Layer Compound Adaptation Sink function S2/Avp_A_Sk.....	173
6.3.5	VC-2 Layer Clock Adaptation Source S2-LC_A_So.....	173
6.4	VC-2 Layer Monitoring Functions.....	173
6.4.1	VC-2 Layer Non-intrusive Monitoring Function S2m_TT_Sk.....	173
6.4.2	VC-2 Layer Supervisory-Unequipped Termination Source S2s_TT_So.....	176
6.4.3	VC-2 Layer Supervisory-unequipped Termination Sink S2s_TT_Sk.....	178
6.5	VC-2 Layer Trail Protection Functions.....	180
6.5.1	VC-2 Trail Protection Connection Functions S2P_C.....	180
6.5.1.1	VC-2 Layer 1+1 uni-directional Protection Connection Function S2P1+1u_C.....	180
6.5.1.2	VC-2 Layer 1+1 dual ended Protection Connection Function S2P1+1b_C.....	182
6.5.2	VC-2 Layer Trail Protection Trail Termination Functions.....	184
6.5.2.1	VC-2 Protection Trail Termination Source S2P_TT_So.....	184
6.5.2.2	VC-2 Protection Trail Termination Sink S2P_TT_Sk.....	185
6.5.3	VC-2 Layer Linear Trail Protection Adaptation Functions.....	186
6.5.3.1	VC-2 trail to VC-2 trail Protection Layer Adaptation Source S2/S2P_A_So.....	186
6.5.3.2	VC-2 trail to VC-2 trail Protection Layer Adaptation Sink S2/S2P_A_Sk.....	187
6.6	VC-2 Tandem Connection Sublayer Functions.....	188
6.6.1	VC-2 Tandem Connection Trail Termination Source function (S2D_TT_So).....	188
6.6.2	VC-2 Tandem Connection Trail Termination Sink function (S2D_TT_Sk).....	191
6.6.3	VC-2 Tandem Connection to VC-2 Adaptation Source function (S2D/S2_A_So).....	195
6.6.4	VC-2 Tandem Connection to VC-2 Adaptation Sink function (S2D/S2_A_Sk).....	196
6.6.5	VC-2 Tandem Connection Non-intrusive Monitoring Trail Termination Sink function (S2Dm_TT_Sk).....	197
7	VC-12 Path Layer Functions.....	200
7.1	VC-12 Layer Connection Function S12_C.....	204
7.1.1	SNC Protection.....	206
7.2	VC-12 Trail Termination Functions.....	207
7.2.1	VC-12 Trail Termination Source S12_TT_So.....	207
7.2.2	VC-12 Trail Termination Sink S12_TT_Sk.....	209
7.3	VC-12 Adaptation Functions.....	211
7.3.1	VC-12 to P12x Adaptation Source S12/P12x_A_So.....	211
7.3.2	VC-12 to P12x Adaptation Sink S12/P12x_A_Sk.....	214
7.3.3	VC-12 to P12s Adaptation Source S12/P12s_A_So.....	216
7.3.3.1	Type 1 VC-12 to P12s Adaptation Source S12/P12s-b_A_So.....	216
7.3.3.2	Type 2 VC-12 to P12s Adaptation Source S12/P12s-a_A_So.....	219
7.3.4	VC-12 to P12s Adaptation Sink S12/P12s_A_Sk.....	221
7.3.4.1	Type 1 VC-12 to P12s Adaptation Sink S12/P12s-x_A_Sk.....	221
7.3.4.2	Type 2 VC-12 to P12s Adaptation Sink S12/P12s-b_A_Sk.....	223
7.3.4.3	Type 3 VC-12 to P12s Adaptation Sink S12/P12s-a_A_Sk.....	226
7.3.5	VC-12 to P0-31c Adaptation Source S12/P0-31c_A_So.....	228
7.3.6	VC-12 to P0-31c Adaptation Sink S12/P0-31c_A_Sk.....	230
7.3.7	VC-12 Layer to TSS4 Adaptation Source S12/TSS4_A_So.....	232
7.3.8	VC-12 Layer to TSS4 Adaptation Sink S12/TSS4_A_Sk.....	233
7.3.9	VC-12 Layer to ATM Virtual Path Layer Compound Adaptation Source function S12/Avp_A_So.....	234
7.3.10	VC-12 Layer to ATM Virtual Path Layer Compound Adaptation Sink function S12/Avp_A_Sk.....	234
7.3.11	VC-12 Layer Clock Adaptation Source S12-LC_A_So.....	234
7.4	VC-12 Layer Monitoring Functions.....	235
7.4.1	VC-12 Layer Non-intrusive Monitoring Function S12m_TT_Sk.....	235
7.4.2	VC-12 Layer Supervisory-Unequipped Termination Source S12s_TT_So.....	238
7.4.3	VC-12 Layer Supervisory-unequipped Termination Sink S12s_TT_Sk.....	240
7.5	VC-12 Layer Trail Protection Functions.....	242
7.5.1	VC-12 Trail Protection Connection Functions S12P_C.....	242
7.5.1.1	VC-12 Layer 1+1 uni-directional Protection Connection Function S12P1+1u_C.....	242
7.5.1.2	VC-12 Layer 1+1 dual ended Protection Connection Function S12P1+1b_C.....	244
7.5.2	VC-12 Layer Trail Protection Trail Termination Functions.....	246
7.5.2.1	VC-12 Protection Trail Termination Source S12P_TT_So.....	246
7.5.2.2	VC-12 Protection Trail Termination Sink S12P_TT_Sk.....	247
7.5.3	VC-12 Layer Linear Trail Protection Adaptation Functions.....	248

7.5.3.1	VC-12 trail to VC-12 trail Protection Layer Adaptation Source S12/S12P_A_So.....	248
7.5.3.2	VC-12 trail to VC-12 trail Protection Layer Adaptation Sink S12/S12P_A_Sk.....	249
7.6	VC-12 Tandem Connection Sublayer Functions.....	250
7.6.1	VC-12 Tandem Connection Trail Termination Source function (S12D_TT_So)	250
7.6.2	VC-12 Tandem Connection Trail Termination Sink function (S12D_TT_Sk)	253
7.6.3	VC-12 Tandem Connection to VC-12 Adaptation Source function (S12D/S12_A_So)	257
7.6.4	VC-12 Tandem Connection to VC-12 Adaptation Sink function (S12D/S12_A_Sk).....	258
7.6.5	VC-12 Tandem Connection Non-intrusive Monitoring Trail Termination Sink function (S12Dm_TT_Sk).....	259
8	VC-4-4c Path Layer Functions.....	262
Annex A (informative): Jitter/wander in justification processes.....		263
A.1	VC-n phase accuracy/timing error/jitter/wander	263
A.2	VC-n pointer processor introduced phase error measurement.....	263
A.3	SDH/PDH and PDH/PDH mapping introduced phase error measurement.....	266
Annex B (informative): SDH/PDH interconnection examples.....		267
Annex C (informative): Interaction between 2 Mbit/s and VC-12 signals for the case of byte synchronous mapping		269
Annex D (informative): Examples of linear trail and SNC protection models.....		271
Annex E (informative): VC-3 to 44 736 Mbit/s adaptation functions		274
E.1	VC-3 Layer to P32x Layer Adaptation Source S3/P32x_A_So	274
E.2	VC-3 Layer to P32x Layer Adaptation Sink S3/P32x_A_Sk	277
Annex F (informative): VC-11 Path Layer Functions.....		279
F.1	VC-11 Layer Connection Function S11_C.....	283
F.1.1	SNC Protection	285
F.2	VC-11 Trail Termination Functions	286
F.2.1	VC-11 Trail Termination Source S11_TT_So.....	286
F.2.2	VC-11 Trail Termination Sink S11_TT_Sk.....	288
F.3	VC-11 Adaptation Functions	290
F.3.1	VC-11 to P11x Adaptation Source S11/P11x_A_So.....	290
F.3.2	VC-11 to P11x Adaptation Sink S11/P11x_A_Sk.....	293
F.3.3	VC-11 Layer to TSS4 Adaptation Source S11/TSS4_A_So.....	295
F.3.4	VC-11 Layer to TSS4 Adaptation Sink S11/TSS4_A_Sk	296
F.3.5	VC-11 Layer Clock Adaptation Source S11-LC_A_So.....	297
F.4	VC-11 Layer Monitoring Functions	297
F.4.1	VC-11 Layer Non-intrusive Monitoring Function S11m_TT_Sk.....	297
F.4.2	VC-11 Layer Supervisory-Unequipped Termination Source S11s_TT_So	300
F.4.3	VC-11 Layer Supervisory-unequipped Termination Sink S11s_TT_Sk.....	302
F.5	VC-11 Layer Trail Protection Functions	304
F.5.1	VC-11 Trail Protection Connection Functions S11P_C	304
F.5.1.1	VC-11 Layer uni-directional Protection Connection Function S11P1+1u_C.....	304
F.5.1.2	VC-11 Layer 1+1 dual ended Protection Connection Function S11P1+1b_C	306
F.5.2	VC-11 Layer Trail Protection Trail Termination Functions	308
F.5.2.1	VC-11 Protection Trail Termination Source S11P_TT_So.....	308
F.5.2.2	VC-11 Protection Trail Termination Sink S11P_TT_Sk	309
F.5.3	VC-11 Layer Linear Trail Protection Adaptation Functions.....	310
F.5.3.1	VC-11 trail to VC-11 trail Protection Layer Adaptation Source S11/S11P_A_So	310
F.5.3.2	VC-11 trail to VC-11 trail Protection Layer Adaptation Sink S11/S11P_A_Sk	311

F.6	VC-11 Tandem Connection Sublayer Functions	312
F.6.1	VC-11 Tandem Connection Trail Termination Source function (S11D_TT_So).....	312
F.6.2	VC-11 Tandem Connection Trail Termination Sink function (S11D_TT_Sk).....	315
F.6.3	VC-11 Tandem Connection to VC-11 Adaptation Source function (S11D/S11_A_So).....	319
F.6.4	VC-11 Tandem Connection to VC-11 Adaptation Sink function (S11D/S11_A_Sk).....	320
F.6.5	VC-11 Tandem Connection Non-intrusive Monitoring Trail Termination Sink function (S11Dm_TT_Sk)	321
	Bibliography	324
	History	325

Intellectual Property Rights

IPRs essential or potentially essential to the present document may have been declared to ETSI. The information pertaining to these essential IPRs, if any, is publicly available for **ETSI members and non-members**, and can be found in SR 000 314: "*Intellectual Property Rights (IPRs); Essential, or potentially Essential, IPRs notified to ETSI in respect of ETSI standards*", which is available **free of charge** from the ETSI Secretariat. Latest updates are available on the ETSI Web server (<http://www.etsi.org/ipr>).

Pursuant to the ETSI IPR Policy, no investigation, including IPR searches, has been carried out by ETSI. No guarantee can be given as to the existence of other IPRs not referenced in SR 000 314 (or the updates on the ETSI Web server) which are, or may be, or may become, essential to the present document.

Foreword

This European Standard (Telecommunications series) has been produced by ETSI Technical Committee Transmission and Multiplexing (TM).

The present document is one of a family of documents that has been produced in order to provide inter-vendor and inter-operator compatibility of Synchronous Digital Hierarchy (SDH) equipment.

The present document is part 4-1 of a multi-part EN covering the Generic requirements of transport functionality of equipment, as identified below:

Part 1-1: "Generic processes and performance".

Part 1-2: "General information about Implementation Conformance Statement (ICS) proforma".

Part 1-3 "Generic processes and performance; Abstract Test Suite (ATS)".

Part 2-1: "Synchronous Digital Hierarchy (SDH) and Plesiochronous Digital Hierarchy (PDH) physical section layer functions".

Part 2-2: "Synchronous Digital Hierarchy (SDH) and Plesiochronous Digital Hierarchy (PDH) physical section layer functions; Implementation Conformance Statement (ICS) proforma specification".

Part 2-3: "Synchronous Digital Hierarchy (SDH) and Plesiochronous Digital Hierarchy (PDH) physical section layer functions; Abstract Test Suite (ATS)".

Part 3-1: "Synchronous Transport Module-N (STM-N) regenerator and multiplex section layer functions".

Part 3-2: "Synchronous Transport Module-N (STM-N) regenerator and multiplex section layer functions; Implementation Conformance Statement (ICS) proforma specification".

Part 3-3: "Synchronous Transport Module-N (STM-N) regenerator and multiplex section layer functions; Abstract Test Suite (ATS)".

Part 4-1: "Synchronous Digital Hierarchy (SDH) path layer functions".

Part 4-2: "Synchronous Digital Hierarchy (SDH) path layer functions; Implementation Conformance Statement (ICS) proforma specification".

Part 4-3: "Synchronous Digital Hierarchy (SDH) path layer functions; Abstract Test Suite (ATS)".

Part 5-1: "Plesiochronous Digital Hierarchy (PDH) path layer functions".

Part 5-2: "Plesiochronous Digital Hierarchy (PDH) path layer functions; Implementation Conformance Statement (ICS) proforma specification".

Part 5-3: "Plesiochronous Digital Hierarchy (PDH) path layer functions; Abstract Test Suite (ATS)".

Part 6-1: "Synchronization layer functions".

Part 6-2: "Synchronization layer functions; Implementation Conformance Statement (ICS) proforma specification".

Part 6-3: "Synchronization layer functions; Abstract Test Suite (ATS)".

Part 7-1: "Auxiliary layer functions".

Part 7-2: "Auxiliary layer functions; Implementation Conformance Statement (ICS) proforma specification".

Part 7-3: "Auxiliary layer functions; Abstract Test Suite (ATS)".

Parts 2 to 7 specify the layers and their atomic functions.

NOTE 1: The present document does not currently address configuration management.

NOTE 2: The SDH radio equipment functional blocks are addressed by ETSI WG TM4.

Various of the above parts have previously been published as parts of ETS 300 417.

They have been converted to parts of EN 300 417 without technical changes, but some editorial changes have been necessary (e.g. references). In particular:

- Parts 2-1 and 3-2 have been modified to take account of editorial errors present in edition 1.
- Part 1-1 has had its title change of to align with other parts published at a later date.

Also note that in the meantime parts 8-1, 8-2 and 8-3 have been stopped.

Transposition dates	
Date of adoption:	4 April 1997
Date of latest announcement of this EN (doa):	30 September 1997
Date of latest publication of new National Standard or endorsement of this EN (dop/e):	31 March 1998
Date of withdrawal of any conflicting National Standard (dow):	31 March 1998

1 Scope

The present document specifies a library of basic building blocks and a set of rules by which they are combined in order to describe transport functionality of equipment. The library comprises the functional building blocks needed to completely specify the generic functional structure of the European Transmission Hierarchies. Equipment which is compliant with the present document shall be describable as an interconnection of a subset of these functional blocks contained within the present document. The interconnections of these blocks shall obey the combination rules given. The generic functionality is described in EN 300 417-1-1 [6].

2 References

The following documents contain provisions which, through reference in this text, constitute provisions of the present document.

- References are either specific (identified by date of publication, edition number, version number, etc.) or non-specific.
- For a specific reference, subsequent revisions do not apply.
- For a non-specific reference, the latest version applies.
- A non-specific reference to an ETS shall also be taken to refer to later versions published as an EN with the same number.

- [1] ETS 300 147: "Transmission and Multiplexing (TM); Synchronous Digital Hierarchy (SDH); Multiplexing structure".
- [2] ETS 300 166 (1993): "Transmission and Multiplexing (TM); Physical and electrical characteristics of hierarchical digital interfaces for equipment using the 2 048 kbit/s - based plesiochronous or synchronous digital hierarchies".
- [3] ETS 300 167: "Transmission and Multiplexing (TM); Functional characteristics of 2 048 kbit/s interfaces".
- [4] ETS 300 216: "Network Aspects (NA); Metropolitan Area Network (MAN); Physical layer convergence procedure for 155,520 Mbit/s".
- [5] ETS 300 337: "Transmission and Multiplexing (TM); Generic frame structures for the transport of various signals (including Asynchronous Transfer Mode (ATM) cells and Synchronous Digital Hierarchy (SDH) elements) at the ITU-T Recommendation G.702 hierarchical rates of 2 048 kbit/s, 34 368 kbit/s and 139 264 kbit/s".
- [6] EN 300 417-1-1: "Transmission and Multiplexing (TM); Generic requirements of transport functionality of equipment; Part 1-1: Generic processes and performance".
- [7] EN 300 417-3-1: "Transmission and Multiplexing (TM); Generic requirements of transport functionality of equipment; Part 3-1: Synchronous Transport Module-N (STM-N) regenerator and multiplex section layer functions".
- [8] EN 300 417-6-1: "Transmission and Multiplexing (TM); Generic requirements of transport functionality of equipment; Part 6-1: Synchronization distribution layer functions".
- [9] ITU-T Recommendation G.823: "The control of jitter and wander within digital networks which are based on the 2 048 kbit/s hierarchy".
- [10] IEEE Standard 802.6: "Information technology-Telecommunications and information exchange between systems-Local and metropolitan area networks-Specific requirements-Part 6: Distributed Queue Dual Bus (DQDB) access method and physical layer specifications".
- [11] ITU-T Recommendation O.151: "Error performance measuring equipment operating at the primary rate and above".

[12] ITU-T Recommendation O.181: "Equipment to assess error performance on STM-N interfaces".

3 Definitions, abbreviations and symbols

3.1 Definitions

The functional definitions are described in EN 300 417-1-1 [6].

3.2 Abbreviations

For the purposes of the present document, the following abbreviations apply:

A	Adaptation function
AcSL	Accepted Signal Label
AcTI	Accepted Trace Identifier
ADM	Add-Drop Multiplexer
AI	Adapted Information
AIS	Alarm Indication Signal
AP	Access Point
APId	Access Point Identifier
APS	Automatic Protection Switch
ARCH	ARCHitecture
ATM	Asynchronous Transfer Mode
AU	Administrative Unit
AUG	Administrative Unit Group
AU-n	Administrative Unit, level n
Avp	ATM virtual path
BER	Bit Error Ratio
BIP	Bit Interleaved Parity
BIP-N	Bit Interleaved Parity, width N
C	Connection function
CI	Characteristic Information
CK	ClocK
CLR	CLeaR
CM	Connection Matrix
CP	Connection Point
CRC	Cyclic Redundancy Check
CS	Clock Source
D	Data
DCC	Data Communications Channel
DEC	DECrement
DEG	DEGraded
DEGM	DEGraded Monitor period
DEGTHR	DEGraded THreshold
DS	Defect Second
DSTATUS	Data STATUS
DTYPE	Data TYPE
EBC	Errored Block Count
ECC	Embedded Communications Channel
ECC(x)	Embedded Communications Channel, layer x
EDC	Error Detection Code
EDCV	Error Detection Code Violation
EMF	Equipment Management Function
EQ	EQuipment
ES	Electrical Section
ES	Errored Second
EXER	EXERcise

EXTCMD	EXTernal CoMmanD
ExTI	Expected Trace Identifier
F_B	Far-end Block
FAS	Frame Alignment Signal
FOP	Failure Of Protocol
FORCEDN	FORCE Down
FS	Frame Start signal
FSw	Forced Switch
HEC	Header Error Control
HO	Hold Off (used in HOTime)
HOB	Head Of Bus
HOVC	Higher Order Virtual Container
HP	Higher order Path
ID	IDentifier
IF	In Frame state
IM	In Multiframe state
INC	INCrement
incAIS	incoming AIS
LC	Link Connection
LO	Lockout Of protection
LOA	Loss Of Alignment; generic for LOF, LOM, LOP
LOF	Loss Of Frame
LOM	Loss Of Multiframe
LOP	Loss Of Pointer
LOS	Loss Of Signal
LOVC	Lower Order Virtual Container
LSS	Loss of Sequence Structure
LSTATUS	Link STATUS
LTC	Loss of Tandem Connection
MC	Matrix Connection
MCF	Message Communications Function
MDT	Mean Down Time
mei	maintenance event information
MFAS	Multi Frame Alignment Signal
MFS	Multi-Frame Start
MI	Management Information
MO	Managed Object
MON	MONitored
MP	Management Point
MS	Multiplex Section
MS1	STM-1 Multiplex Section
MS16	STM-16 Multiplex Section
MS4	STM-4 Multiplex Section
MSB	Most Significant Bit
MSOH	Multiplex Section OverHead
MSP	Multiplex Section Protection
MSPG	Multiplex Section Protection Group
MSw	Manual Switch
MTIE	Mean Time Interval Error
N.C.	Not Connected
N_B	Near-end Block
N1[x][y]	bit x (x=7,8) of byte N1 in frame y (y=1..76)
N2[x][y]	bit x (x=7,8) of byte N2 in frame y (y=1..76)
NC	Network Connection
NCI	No CRC-4 multiframe Indication
NDF	New Data Flag
NE	Network Element
NMON	Not MONitored
NNI	Network Node Interface
NU	National Use (bits, bytes)

NUx	National Use, bit rate order x
OAM	Operation, Administration and Management
ODI	Outgoing Defect Indication
OEI	Outgoing Error Indication
OF	Outgoing Far-end
OF_B	Outgoing Far-end VC Block
OFS	Out of Frame Second
OH	OverHead
ON	Outgoing Near-end
OOF	Out Of Frame state
OOM	Out Of Multiframe state
OPER	OPERation
OS	Optical Section
OSF	Outgoing Signal Fail
OSI(x)	Open Systems Interconnection, layer x
OW	Order Wire
P	Protection
P_A	Protection Adaptation
P_C	Protection Connection
P_TT	Protection Trail Termination
P0_31c	1 984 kbit/s layer
P0s	synchronous 64 kbit/s layer
P11x	1 544 kbit/s layer (transparent)
P12s	2 048 kbit/s PDH path layer with synchronous 125 µs frame structure according to ETS 300 167 [12]
P12x	2 048 kbit/s layer (transparent)
P22e	8 448 kbit/s PDH path layer with 4 plesiochronous 2 048 kbit/s
P22x	8 448 kbit/s layer (transparent)
P31e	34 368 kbit/s PDH path layer with 4 plesiochronous 8 448 kbit/s
P31s	34 368 kbit/s PDH path layer with synchronous 125 µs frame structure according to ETS 300 337 [13]
P31x	34 368 kbit/s layer (transparent)
P32x	44 736 kbit/s layer (transparent)
P4e	139 264 kbit/s PDH path layer with 4 plesiochronous 34 368 kbit/s
P4s	139 264 kbit/s PDH path layer with synchronous 125 µs frame structure according to ETS 300 337 [13]
P4x	139 264 kbit/s layer (transparent)
PDH	Plesiochronous Digital Hierarchy
PJE	Pointer Justification Event
PLM	PayLoad Mismatch
PM	Performance Monitoring
Pn	Plesiochronous signal, level n
POH	Path OverHead
ppm	part per million
PRBS	Pseudo Random Binary Sequence
PRC	Primary Reference Clock
PROT	PROTection
PS	Protection Switching
PSC	Protection Switch Count
PTR	PoinTeR
QOS	Quality Of Service
RD	ReaD
RDI	Remote Defect Indicator
REI	Remote Error Indicator
RFI	Remote Failure Indicator
RI	Remote Information
RP	Remote Point
RS	Regenerator Section
RS1	STM-1 Regenerator Section
RS16	STM-16 Regenerator Section

RS4	STM-4 Regenerator Section
RSOH	Regenerator Section OverHead
RxSL	Received Signal Label
RxTI	Received Trace identifier
S11	VC-11 path layer
S11D	VC-11 tandem connection sublayer
S11P	VC-11 protection sublayer
S12	VC-12 path layer
S12D	VC-12 tandem connection sublayer
S12P	VC-12 protection sublayer
S2	VC-2 path layer
S2D	VC-2 tandem connection sublayer
S2P	VC-2 protection sublayer
S3	VC-3 path layer
S3D	VC-3 tandem connection sublayer
S3P	VC-3 protection sublayer
S4	VC-4 path layer
S4-4c	contiguous concatenated VC-4-4c path layer
S4D	VC-4 tandem connection sublayer
S4P	VC-4 protection sublayer
SASE	Stand-Alone Synchronization Equipment
SD	synchronization distribution layer, Signal Degrade
SDH	Synchronous Digital Hierarchy
SEC	SDH Equipment Clock
SF	Signal Fail
Sk	Sink
SNC	Sub-Network Connection
SNC/I	Inherently monitored Sub-Network Connection protection
SNC/N	Non-intrusively monitored Sub-Network Connection protection
SNC/S	Sublayer monitored Sub-Network Connection protection
So	Source
SOH	Section OverHead
SPRING	Shared Protection RING
SR	Selected Reference
SSD	Server Signal Degrade
SSF	Server Signal Fail
SSM	Synchronization Status Message
SSU	Synchronization Supply Unit
STM	Synchronous Transport Module
STM-N	Synchronous Transport Module, level N
SW	SWitching
TC	Tandem Connection
TCn	Tandem Connection level n
TCP	Termination Connection Point
TI	Timing Information
TI	Trace Identifier
TIM	Trace Identifier Mismatch
TIMdis	Trace Identifier Mismatch disable
TM	Transmission_Medium, Transmission & Multiplexing
TMN	Telecommunications Management Network
TP	Timing Point
TPmode	Termination Point mode
TS	Time Slot
TSD	Trail Signal Degrade
TSE	Test Signal Error
TSF	Trail Signal Fail
TSS	Test Signal Structure
TT	Trail Termination function
TTI	Trail Trace Identifier
TTs	Trail Termination supervisory function

TU	Tributary Unit
TUG	Tributary Unit Group
TxTI	Transmitted Trace Identifier
UNEQ	UNEQuipped
UNI	User Network Interface
UOF	Under/Over Flow
USR	USeR channels
VC	Virtual Container
VC-n	Virtual Container, level n
W	Working
WR	WRite
WTR	Wait To Restore

3.3 Symbols and diagrammatic conventions

The symbols and diagrammatic conventions are described in EN 300 417-1-1 [6].

3.4 Introduction

The atomic and some compound functions used in the SDH Path Layers are defined below (clause 4 onwards).

4 VC-4 Path Layer Functions

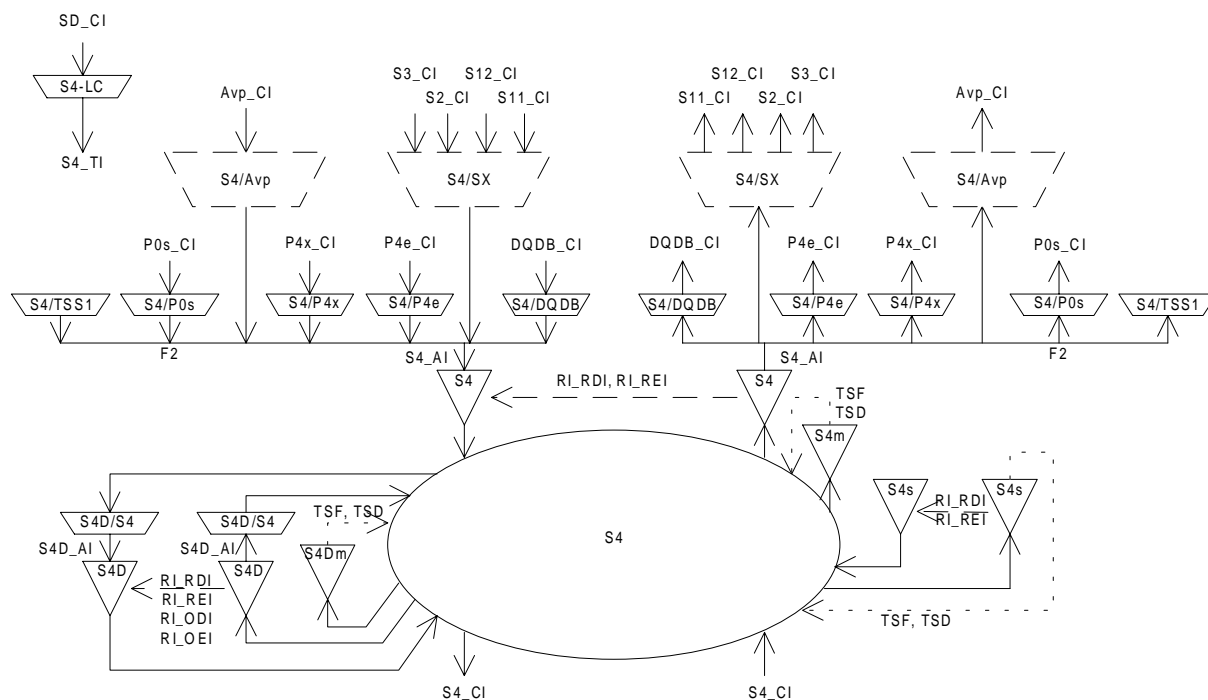

Figure 1: VC-4 Path layer atomic functions

VC-4 Layer CP

The CI at this point is octet structured with an 125 μ s frame (see figure 2). Its format is characterized as S4_AI plus the VC-4 trail termination overhead in the J1, B3, and G1 locations as defined in ETS 300 147 [1] or as an unequipped signal as defined in EN 300 417-1-1 [6], subclause 7.2. For the case the signal has passed the tandem connection sublayer, S4_CI has defined VC-4 tandem connection trail termination overhead in location N1.

NOTE 1: N1 will be undefined when the signal S4_CI has not been processed in a tandem connection adaptation and trail termination function. N1 is all "0"s in a (supervisory) unequipped VC-4 signal.

VC-4 Layer AP

The AI at this point is octet structured with an 125 μ s frame (see figure 2). It represents adapted client layer information comprising 2 340 bytes of client layer information, the signal label byte C2, and 2 bytes F3 and H4 of client specific information combined with an 1 byte user channel F2. For the case the signal has passed the trail protection sublayer, S4_AI has defined APS bits (1 to 4) in byte K3.

NOTE 2: Bits 1 to 4 of byte K3 will be undefined when the signal S4_AI has not been processed in a trail protection connection function S4P_C.

NOTE 3: Bits 5 to 8 of byte K3 are reserved for future international standardization. Currently, their values are undefined.

NOTE 4: Bytes F2 and F3 will be undefined when the adaptation functions sourcing these bytes are not present in the network element.

NOTE 5: Byte H4 will be undefined when the VC-4 transports a 140 Mbit/s, an ATM signal, or a Test Signal Structure (TSS1).

A VC-4 comprises one of the following payloads:

- a 139 264 kbit/s signal asynchronous mapped into a C-4;
- a TUG-structured signal;
- an ATM 149 760 kbit/s cell stream signal;
- a DQDB 149 888 kbit/s signal;
- a Test Signal Structure (TSS1).

Figure 1 shows that more than one adaptation function exists in the S4 layer that can be connected to one S4 access point. For such case, a subset of these adaptation source functions is allowed to be activated together, but only one adaptation source function may have access to a specific (TU) timeslot. Access to the same (TU) timeslot by other adaptation source functions shall be denied. In contradiction with the source direction, adaptation sink functions may be activated all together. This may cause faults (e.g. cLOP) to be detected and reported. To prevent this an adaptation sink function can be deactivated.

NOTE 6: If one adaptation function only is connected to the AP, it will be activated. If one or more other functions are connected to the same AP accessing the same (TU) timeslot, one out of the set of functions will be active.

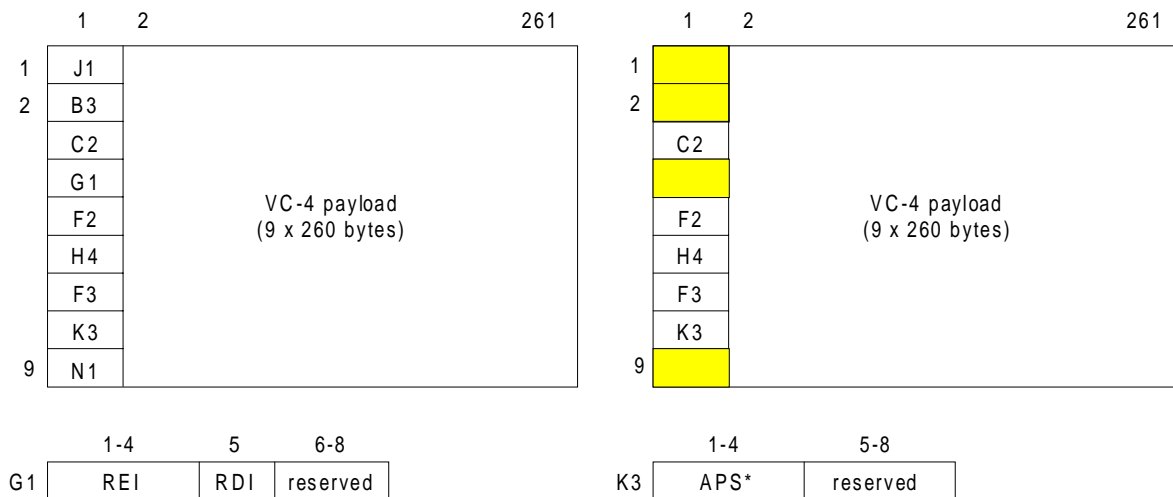

Figure 2: S4_CI_D (left) and S4_AI_D (right)

NOTE 7: The APS signal has not been defined; a multiframed APS signal might be required.

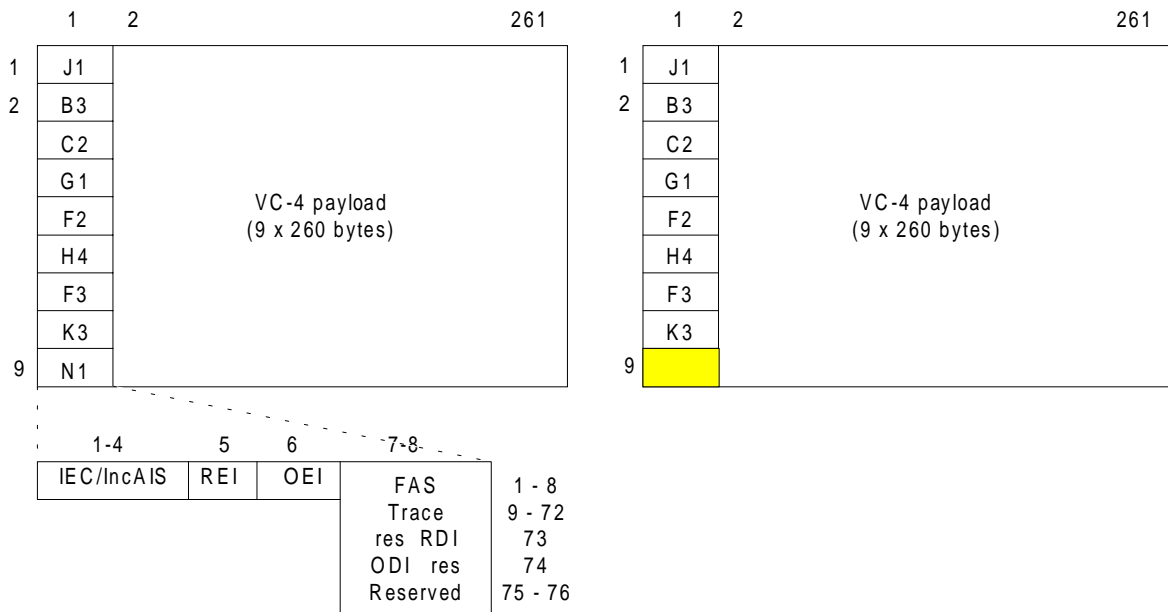

Figure 3: S4_CI_D (left) with defined N1 and S4D_AI_D (right)

Figure 4 shows the trail protection sublayer atomic functions added to (a subset of) the layer atomic functions presented in figure 1. It should be noted that the S4/P0s_A function can be absent, or connected before or after the protection functions S4P_C. When connected before S4P_C the transport of the user channel signal is not protected, otherwise it is protected.

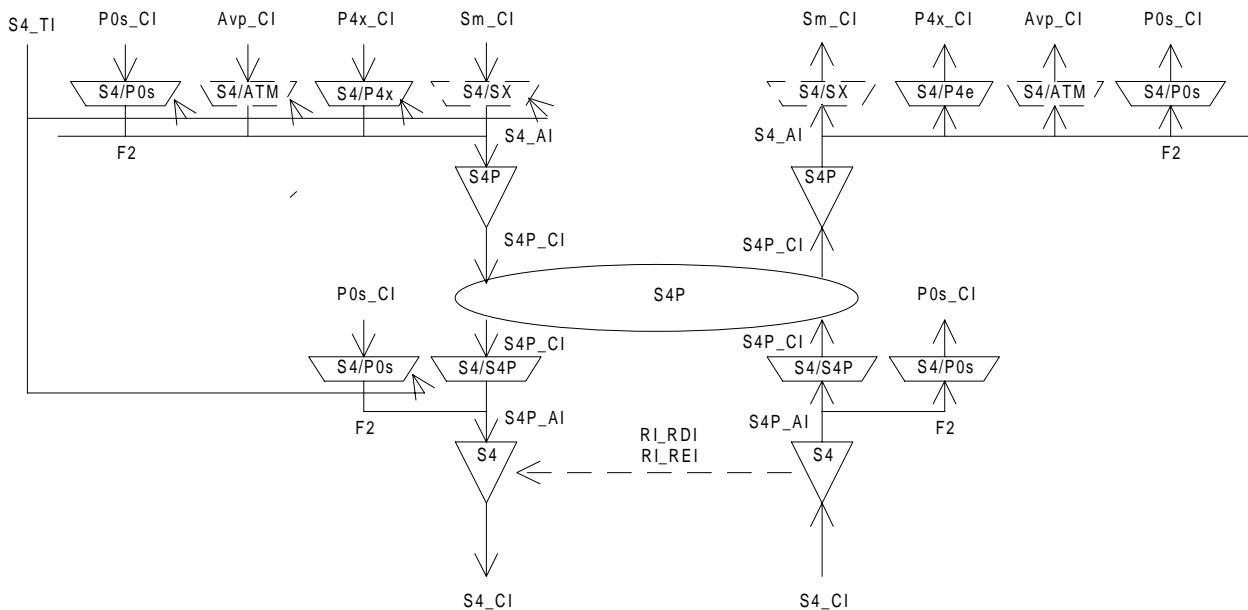

Figure 4: VC-4 Layer Trail Protection atomic functions

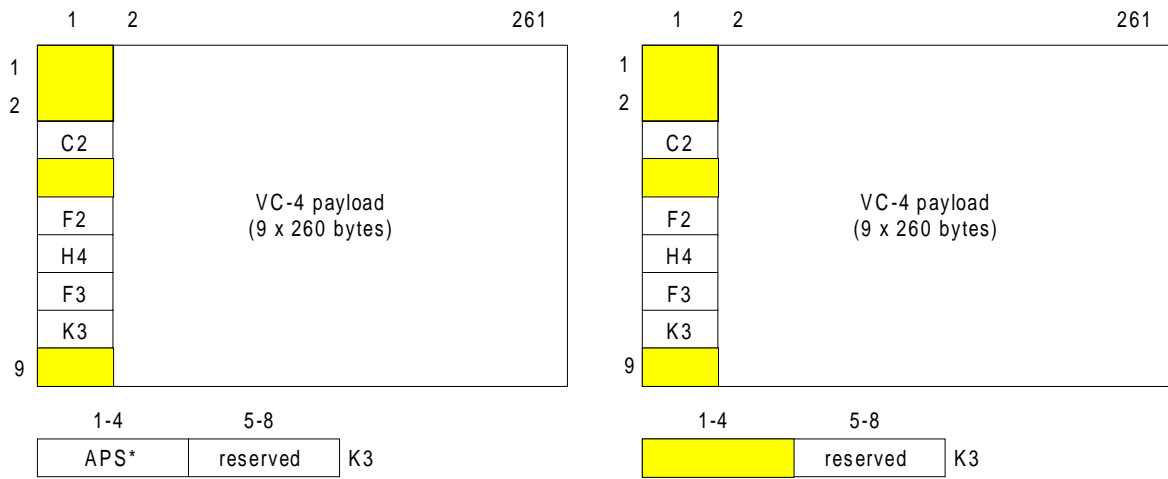

Figure 5: S4P_AI_D (left) and S4P_CI_D (right) signals

4.1 VC-4 Layer Connection Function S4_C

Symbol:

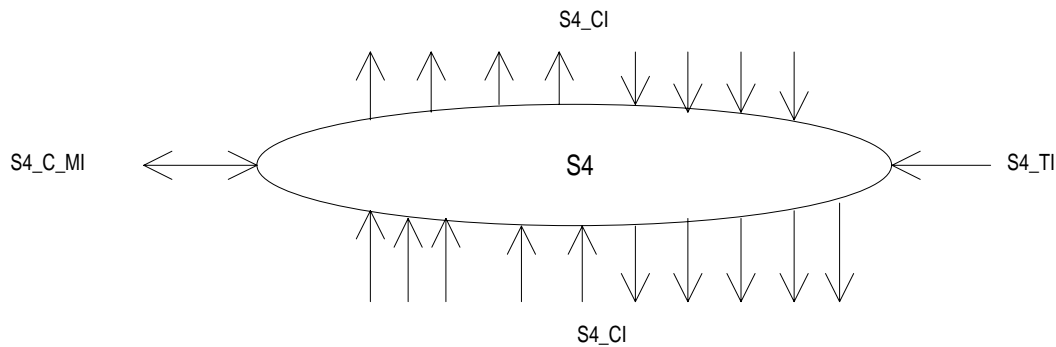

Figure 6: S4_C symbol

Interfaces:

Table 1: S4_C input and output signals

Input(s)	Output(s)
per S4_CI, n x for the function: S4_CI_D S4_CI_CK S4_CI_FS S4_CI_SSF S4_AI_TSF S4_AI_TSD	per S4_CI, m x per function: S4_CI_D S4_CI_CK S4_CI_FS S4_CI_SSF
1 x per function: S4_TI_CK S4_TI_FS	
per input and output connection point: S4_C_MI_ConnectionPortIds	
per matrix connection: S4_C_MI_ConnectionType S4_C_MI_Directionality	
per SNC protection group: S4_C_MI_PROTtype S4_C_MI_OPERtype S4_C_MI_WTRtime S4_C_MI_HOtime S4_C_MI_EXTCMD	
NOTE: Protection status reporting signals are for further study.	

Processes:

In the S4_C function VC-4 Layer Characteristic Information is routed between input (termination) connection points ((T)CPs) and output (T)CPs by means of matrix connections. (T)CPs may be allocated within a protection group.

NOTE 1: Neither the number of input/output signals to the connection function, nor the connectivity is specified in the present document. That is a property of individual network elements.

Figure 1 present a subset of the atomic functions that can be connected to this VC-4 connection function: VC-4 trail termination functions, VC-4 non-intrusive monitor trail termination sink function, VC-4 unequipped-supervisory trail termination functions, VC-4 tandem connection trail termination and adaptation functions. In addition, adaptation functions in the VC-4 server (i.e. STM-N multiplex section) layers will be connected to this VC-4 connection function.

Routing: The function shall be able to connect a specific input with a specific output by means of establishing a matrix connection between the specified input and output. It shall be able to remove an established matrix connection.

Each (matrix) connection in the S4_C function shall be characterized by the:

Type of connection	unprotected, 1+1 protected (SNC/I, SNC/N, or SNC/S protection);
Traffic direction	unidirectional, bi-directional;
Input and output connection points	set of connection point identifiers (refer to EN 300 417-1-1 [6], subclause 3.3.6).

NOTE 2: Broadcast connections are handled as separate connections to the same input CP.

Provided no protection switching action is activated/required the following changes to (the configuration of) a connection shall be possible without disturbing the CI passing the connection:

- addition and removal of protection;
- addition and removal of connections to/from a broadcast connection;
- change between operation types;
- change of WTR time;
- change of Hold-off time.

Unequipped VC generation: The function shall generate an unequipped VC signal, as specified in EN 300 417-1-1 [6], subclause 7.2.

Defects: None.

Consequent Actions:

If an output of this function is not connected to one of its inputs, the function shall connect the unequipped VC-4 (with valid frame start (FS) and SSF = false) to the output.

Defect Correlations: None.

Performance Monitoring: None.

4.1.1 SNC Protection

SNC protection: The function may provide the option to establish protection groups between a number of (T)CPs (EN 300 417-1-1 [6], subclauses 9.4.1 and 9.4.2) to perform the VC-4 linear (sub)network connection protection process for 1+1 protection architectures (refer to EN 300 417-1-1 [6], subclause 9.2). The SNC protection process shall perform the bridge and selector functionality as presented in figure 49 of EN 300 417-1-1 [6]. In the sink direction, the signal output at the normal reference point can be the signal received via either the working connection or the protection connection; this is determined by the SF,SD conditions (relayed via CI_SSF or AI_TSF/AI_TSD signals), and the external commands. In the source direction, the working output is connected to the associated normal input. The protection output is also connected to the normal input.

NOTE: The function does not support virtual concatenated VC-4 signal (VC-4-Xc) SNC protection. Refer for VC-4-Xc definition to ETS 300 147 [1].

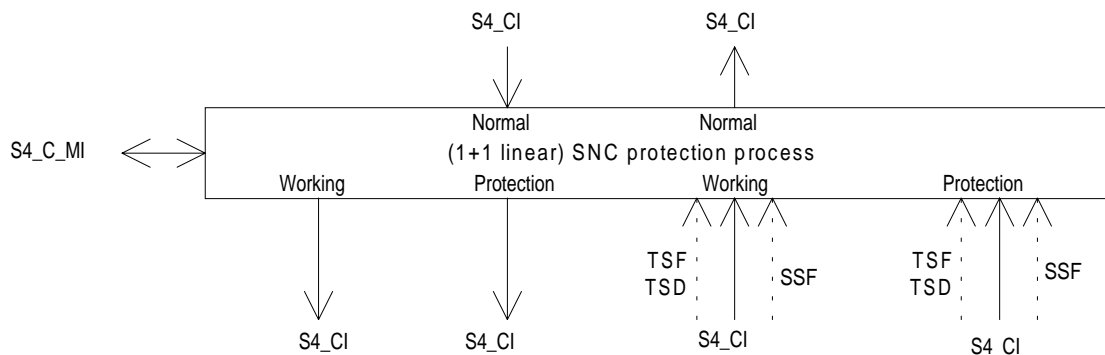

Figure 7: 1+1 SNC protection process (SNC/I, SNC/N, SNC/S)

SNC Protection Operation: The SNC protection process shall operate as specified in EN 300 417-3-1 [7] annex A, according the following characteristics:

Table 2: SNC protection parameters

Parameter	Value options
Architecture type (ARCHtype)	1 + 1
Switching type (SWtype)	uni-directional
Operation type (OPERType)	revertive, non-revertive
APS signal (APSmode)	false
Wait-To-Restore time (WTRtime)	in the order of 5-12 minutes
Switch time	≤ 50 ms
Hold-off time (HOtime)	0 to 10 seconds in steps of the order of 100 ms
Protection type (PROTtype)	SNC/I, SNC/N, SNC/S
Signal switch conditions:	SF = SSF (SNC/I), SF = TSF (SNC/N, SNC/S), SD = TSD (SNC/N, SNC/S)
External commands (EXTCMD)	(revertive operation) LO, FSw-#1, MSw-#1, CLR (non-revertive operation) LO or FSw, FSw-#, MSw-#, CLR (i = 0, 1)
Extra traffic (EXTRAtraffic)	false
SFpriority, SDpriority	high

In the sink case of a protection connection the source of the connection is determined by the SF (and SD) signals associated with each of the two inputs to the connection and the possible external switch requests. The set of SF and SD signals used, is controlled by the protection type setting.

4.2 VC-4 Layer Trail Termination Functions

4.2.1 VC-4 Layer Trail Termination Source S4_TT_So

Symbol:

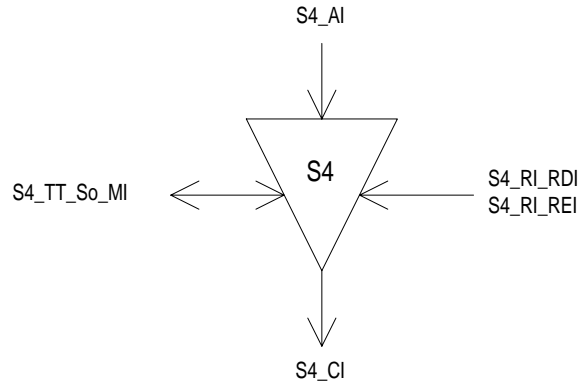

Figure 8: S4_TT_So symbol

Interfaces:

Table 3: S4_TT_So input and output signals

Input(s)	Output(s)
S4_AI_D	S4_CI_D
S4_AI_CK	S4_CI_CK
S4_AI_FS	S4_CI_FS
S4_RI_RDI	
S4_RI_REI	
S4_TT_So_MI_TxTI	

Processes:

This function adds error monitoring and status overhead bytes to the S4_AI (containing payload (or client layer) independent overhead of 3 bytes per frame) presented at its input to form the VC4 layer Characteristic Information. The processing of the trail termination overhead bytes is defined as follows:

J1: In this byte the function shall insert the Transmitted Trail Trace Identifier TxTI. Its format is described in EN 300 417-1-1 [6], subclause 7.1.

B3: In this byte the function shall insert the BIP-8 EDC with even bit parity. Each bit n of current B3 is computed to provide even parity over the n^{th} bit of every byte in the previous frame of the Characteristic Information S4_CI, i.e. B3 is calculated over the entire previous VC-4. Further reference is provided in EN 300 417-1-1 [6], subclause 7.3.

G1: This byte is set to represent the status of the associated S4_TT_Sk. Its format is defined in figure 2.

G1[1-4]: The signal value applied at RI_REI shall be inserted in the VC-4 REI, bits 1 to 4 of byte G1. The coding shall be as follows:

Table 4: G1[1-4] coding

Number of BIP-8 violations conveyed via RI_REI	G1[1]	G1[2]	G1[3]	G1[4]
0	0	0	0	0
1	0	0	0	1
2	0	0	1	0
3	0	0	1	1
4	0	1	0	0
5	0	1	0	1
6	0	1	1	0
7	0	1	1	1
8	1	0	0	0

G1[5]: Bit 5 of byte G1, a RDI indication, shall be set to "1" on activation of S4_RI_RDI within 250 µs, determined by the associated S4_TT_Sk function, and set to "0" within 250 µs on clearing of S4_RI_RDI.

G1[6-8]: The value of the bits 6 to 8 of byte G1 is undefined.

Defects: None.

Consequent Actions: None.

Defect Correlations: None.

Performance Monitoring: None.

4.2.2 VC-4 Layer Trail Termination Sink S4_TT_Sk

Symbol:

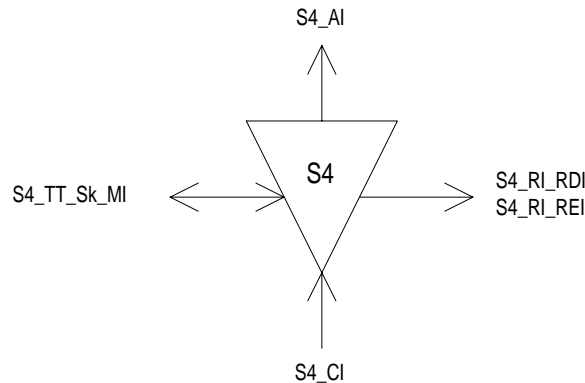

Figure 9: S4_TT_Sk symbol

Interfaces:

Table 5: S4_TT_Sk input and output signals

Input(s)	Output(s)
S4_CI_D	S4_AI_D
S4_CI_CK	S4_AI_CK
S4_CI_FS	S4_AI_FS
S4_CI_SSF	S4_AI_TSF
	S4_AI_TSD
S4_TT_Sk_MI_TPmode	S4_TT_Sk_MI_cTIM
S4_TT_Sk_MI_SSF_Reported	S4_TT_Sk_MI_cUNEQ
S4_TT_Sk_MI_ExtI	S4_TT_Sk_MI_cDEG
S4_TT_Sk_MI_RDI_Reported	S4_TT_Sk_MI_cRDI
S4_TT_Sk_MI_DEGTHR	S4_TT_Sk_MI_cSSF
S4_TT_Sk_MI_DEGM	S4_TT_Sk_MI_AcTI
S4_TT_Sk_MI_1second	S4_RI_RDI
S4_TT_Sk_MI_TIMdis	S4_RI_REI
S4_TT_Sk_MI_ExtImode	S4_TT_Sk_MI_pN_EBC
	S4_TT_Sk_MI_pF_EBC
	S4_TT_Sk_MI_pN_DS
	S4_TT_Sk_MI_pF_DS

Processes:

This function monitors VC-4 for errors, and recovers the trail termination status. It extracts the payload independent overhead bytes (J1, B3, C2, G1) from the VC-4 layer Characteristic Information:

J1: The Received Trail Trace Identifier RxTI shall be recovered from the J1 byte and shall be made available as AcTI for network management purposes. The application and acceptance and mismatch detection process shall be performed as specified in EN 300 417-1-1 [6], subclauses 7.1 and 8.2.1.3.

B3: Even bit parity shall be computed for each bit n of every byte of the preceding VC-4 and compared with bit n of B3 recovered from the current frame (n=1 to 8 inclusive). A difference between the computed and recovered B3 values shall be taken as evidence of an errored block (nN_B).

G1[1-4], G1[5]: The information carried in the G1 byte (REI, RDI) shall be extracted to enable single ended maintenance of a bi-directional Trail (Path). The REI (nF_B) shall be used to monitor the error performance of the other direction of transmission, and the RDI (bit 5) shall be used to provide information as to the status of the remote receiver. A "1" indicates a Remote Defect Indication state, while a "0" indicates the normal, working state. The application process shall be performed as specified in EN 300 417-1-1 [6], subclause 7.4.2 (REI), 7.4.11 and 8.2 (RDI).

G1[6-8]: The value in the bits 6 to 8 of byte G1 shall be ignored.

Table 6: G1[1-4] code interpretation

G1[1]	G1[2]	G1[3]	G1[4]	REI code interpretation [# errored blocks]
0	0	0	0	0
0	0	0	1	1
0	0	1	0	1
0	0	1	1	1
0	1	0	0	1
0	1	0	1	1
0	1	1	0	1
0	1	1	1	1
1	0	0	0	1
1	0	0	1	0
1	0	1	0	0
1	0	1	1	0
1	1	0	0	0
1	1	0	1	0
1	1	1	0	0
1	1	1	1	0

C2: The information in the C2 byte shall be extracted to allow unequipped VC defect detection.

Defects:

The function shall detect for dDEG, dRDI, dUNEQ and dTIM defects according the specification in EN 300 417-1-1 [6], subclause 8.2.1.

Consequent Actions:

aAIS	←	dUNEQ or dTIM
aTSF	←	CI_SSF or dUNEQ or dTIM
aRDI	←	CI_SSF or dUNEQ or dTIM
aTSD	←	dDEG
aREI	←	"#EDCV"

On declaration of aAIS the function shall output all-ONES signal within 250 µs; on clearing of aAIS the function shall output normal data within 250 µs.

Defect Correlations:

cUNEQ	←	dUNEQ and MON
cTIM	←	dTIM and (not dUNEQ) and MON
cDEG	←	dDEG and (not dTIM) and MON
cRDI	←	dRDI and (not dUNEQ) and (not dTIM) and MON and RDI_Reported
cSSF	←	CI_SSF and MON and SSF_Reported

Performance Monitoring:

The performance monitoring process shall be performed as specified in EN 300 417-1-1 [6], subclauses 8.2.4 through 8.2.7.

pN_DS ← aTSF or dEQ

pF_DS ← dRDI

pN_EBC ← Σ nN_B

pF_EBC ← Σ nF_B

4.3 VC-4 Layer Adaptation Functions

4.3.1 VC-4 Layer to P4x Layer Adaptation Source S4/P4x_A_So

Symbol:

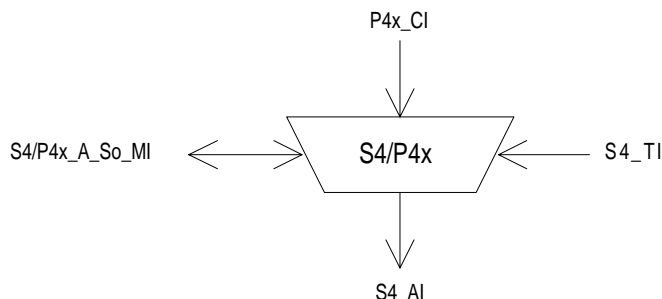

Figure 10: S4/P4x_A_So symbol

Interfaces:

Table 7: S4/P4x_A_So input and output signals

Input(s)	Output(s)
P4x_CI_D	S4_AI_D
P4x_CI_CK	S4_AI_CK
S4_TI_CK	S4_AI_FS
S4_TI_FS	
S4/P4x_A_So_MI_Active	

Processes:

This function maps a 139 264 kbit/s information stream into a VC-4 payload using bit stuffing and adds bytes C2 and H4. It takes P4x_CI, a bit-stream with a rate of 139 264 kbit/s ± 15 ppm, present at its input and inserts it into the synchronous container-4 having a capacity of 2 340 bytes and the justification frame as defined in ETS 300 147 [1] and depicted in figure 12.

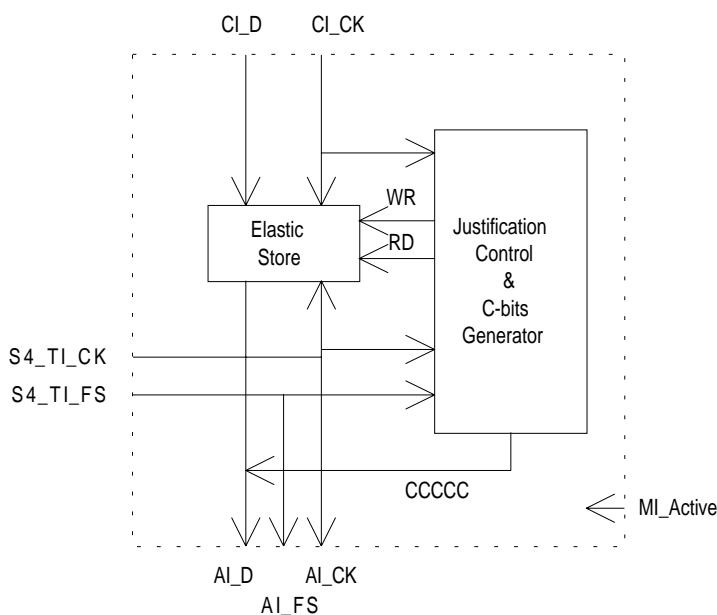
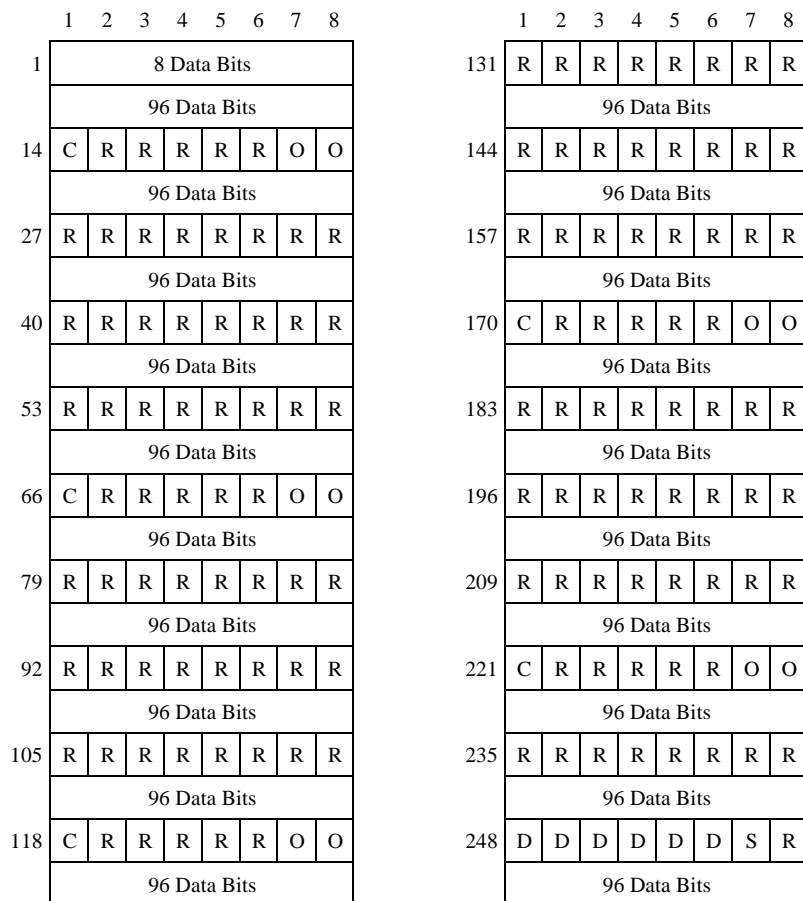

Figure 11: main processes within S4/P4x_A_So



Legend: D = Data Bit, R = Fixed Stuff Bit, O = O-Bit, S = Justification Opportunity Bit, C = Justification Control Bit

Figure 12: Asynchronous mapping of P4x_CI (139 264 kbit/s) showing one row of the nine-row Container-4 structure

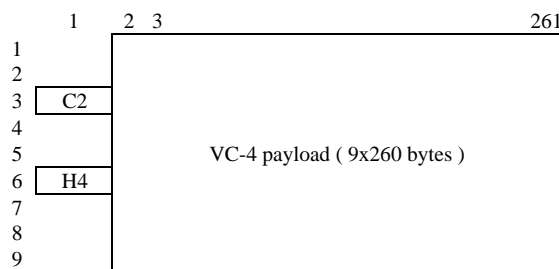

Figure 13: S4/P4x_AI_So_D

Frequency justification and bitrate adaptation: The function shall provide an elastic store (buffer) process (see figure 11). The data signal shall be written into the buffer under control of the associated input clock. The data shall be read out of the buffer and written onto the I and S bits under control of the VC-4 clock, frame position (S4_TI), and justification decisions.

The justification decisions determine the phase error introduced by the S4/P4x_A_So function. The amount of this phase error can be measured at the physical interfaces by monitoring the justification control bits C (see figure 12).

Each justification decision results in a corresponding positive justification action. Upon a positive justification action, the reading of 1 data bit shall be cancelled once and no data are written at the justification opportunity bit S. If no justification action is to be performed, data shall be written onto S.

NOTE: A requirement for maximum introduced phase error cannot be defined until a reference path is defined from which the requirements for network elements can be deduced.

Buffer size: In the presence of jitter as specified by ITU-T Recommendation G.823 [9] and a frequency within the range 139 264 kbit/s \pm 15 ppm, this justification process shall not introduce any errors. Any step in frequency within this range shall not cause any errors.

C bits: Justification control generation: The function shall generate the justification control (C) bits according the specification in ETS 300 147 [1]. It shall insert the justification control bits in the appropriate C bit positions.

Two bytes of payload specific POH information, bytes C2 and H4, shall be added to container-4 to form the VC-4 AI and a fixed Frame Start (FS) shall be generated.

H4: The value of H4 byte is undefined.

C2: In this byte the function shall insert code "0001 0010" (Asynchronous mapping of 139 264 kbit/s into the Container-4) as defined in ETS 300 147 [1].

O bits: The value of the O bits is undefined.

R bits: The value of an R bits is undefined.

Activation: The function shall access the access point when it is activated (MI_Active is true). Otherwise, it shall not access the access point.

Defects: None.

An elastic store under/overflow defect (dUOF) is for further study.

Consequent Actions: None.

Defect Correlations: None.

Performance Monitoring: None.

4.3.2 VC-4 Layer to P4x Layer Adaptation Sink S4/P4x_A_Sk

Symbol:

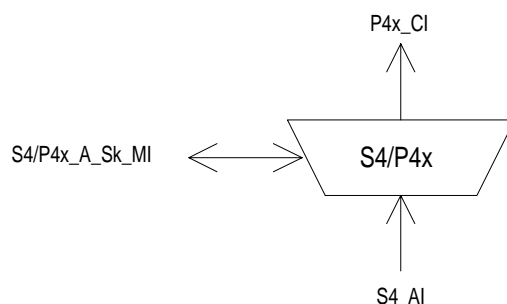

Figure 14: S4/P4x_A_Sk symbol

Interfaces:

Table 8: S4/P4x_A_Sk input and output signals

Input(s)	Output(s)
S4_AI_D	P4x_CI_D
S4_AI_CK	P4x_CI_CK
S4_AI_FS	S4/P4x_A_Sk_MI_cPLM
S4_AI_TSF	S4/P4x_A_Sk_MI_AcSL
S4/P4x_A_Sk_MI_Active	

Processes:

The function recovers plesiochronous P4x Characteristic Information (139 264 kbit/s \pm 15 ppm) from the synchronous container-4 (having a frequency accuracy within \pm 4,6 ppm) according to ETS 300 147 [1], and monitors the reception of the correct payload signal type.

C2: The function shall compare the content of the accepted C2 byte with the expected value code "0001 0010" (Asynchronous mapping of 139 264 kbit/s into the Container-4) as a check on consistency between the provisioning operation at each end. The application and acceptance and mismatch detection process shall be as specified in EN 300 417-1-1 [6], subclauses 7.2 and 8.1.2.

H4: The value in the H4 byte shall be ignored.

O bits: The value in the O bits shall be ignored.

R bits: The value in the R bits shall be ignored.

C bits: *Justification control interpretation:* The function shall perform justification control interpretation specified by ETS 300 147 [1] to recover the 139 264 kbit/s signal from the VC-4. If the majority of the C bits is "0" the S bit shall be taken as a data bit, otherwise (majority of C bits is "1") S bit shall be taken as a justification bit and consequently ignored.

Smoothing & jitter limiting process: The function shall provide for a clock smoothing and elastic store (buffer) process. The 139 264 kbit/s data signal shall be written into the buffer under control of the associated (gapped) input clock (with a frequency accuracy within \pm 4,6 ppm). The data signal shall be read out of the buffer under control of a smoothed (equally spaced) 139 264 kHz \pm 15 ppm clock (the rate is determined by the 140 Mbit/s signal at the input of the remote S4/P4x_A_So). The residual jitter caused by pointer adjustments and bit justifications (measured at the 139 264 kbit/s interface) shall be within the limits specified in subclause 11.3.1.2 of EN 300 417-1-1 [6].

Buffer size: In the presence of jitter as specified by subclause 11.3.1.2 of EN 300 417-1-1 [6] and a frequency within the range 139 264 kbit/s \pm 15 ppm, this justification process shall not introduce any errors.

Following a step in frequency of the P4x signal transported by the S4_AI (for example due to reception of P4x CI from a new P4x_TT_So at the far end or removal of all-ONEs (AIS) signal with a frequency offset) there will be a maximum recovery time of X seconds after which this process shall not generate any bit errors.

The value of X is for further study; a value of 1 second has been proposed.

Activation: The function shall perform the operation specified above when it is activated (MI_Active is true). Otherwise, it shall transmit the all-ONEs signal at its output (CI_D) and not report its status via the management point.

Defects: The function shall detect for dPLM defect according the specification in EN 300 417-1-1 [6], subclause 8.2.1.

Consequent Actions:

aAIS ← AI_TSF or dPLM

On declaration of the aAIS the function shall output an all-ONEs (AIS) signal in the P4x_CI_D within 250 µs; on clearing of aAIS the function shall output normal data within 250 µs. The P4x_CI_CK during the all-ONEs signal shall be within 139 264 kHz ± 15 ppm.

Defect Correlations:

cPLM ← dPLM and (not AI_TSF)

Performance Monitoring: None.

4.3.3 VC-4 Layer to P4e Layer Adaptation Source S4/P4e_A_So

Symbol:

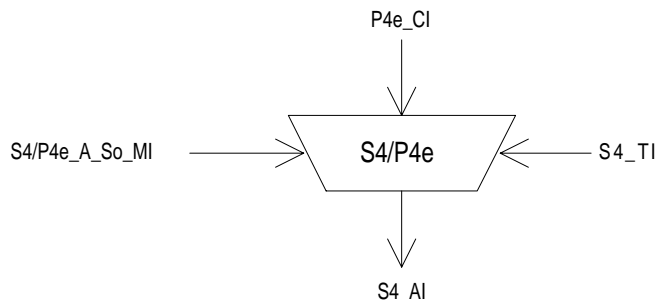

Figure 15: S4/P4e_A_So symbol

Interfaces:

Table 9: S4/P4e_A_So input and output signals

Input(s)	Output(s)
P4e_CI_D	S4_AI_D
P4e_CI_CK	S4_AI_CK
S4_TI_CK	S4_AI_FS
S4_TI_FS	
S4/P4e_A_So_MI_Active	

Processes:

This function maps a 139 264 kbit/s information stream into a VC-4 payload using bit stuffing and adds bytes C2 and H4. It takes P4e_CI, a bit-stream with a rate of 139 264 kbit/s \pm 15 ppm, present at its input and inserts it into the synchronous container C4 having a capacity of 2 340 bytes and the justification frame as defined in ETS 300 147 [1] and depicted in figure 12.

Frequency justification and bitrate adaptation: The function shall provide an elastic store (buffer) process (see figure 11). The data signal shall be written into the buffer under control of the associated input clock. The data shall be read out of the buffer and written onto the I and S bits under control of the VC-4 clock, frame position (S4_TI), and justification decisions.

The justification decisions determine the phase error introduced by the S4/P4e_A_So function. The amount of this phase error can be measured at the physical interfaces by monitoring the justification control bits C (see figure 12).

Each justification decision results in a corresponding positive justification action. Upon a positive justification action, the reading of 1 data bit shall be cancelled once an no data are written at the justification opportunity bit S. If no positive justification action is to be performed, data shall be written onto S.

NOTE: A requirement for maximum introduced phase error cannot be defined until a reference path is defined from which the requirements for network elements can be deduced.

Buffer size: In the presence of jitter as specified by ITU-T Recommendation G.823 [9] and a frequency within the range 139 264 kbit/s \pm 15 ppm, this justification process shall not introduce any errors. Any step in frequency within this range shall not cause any errors.

C bits: *Justification control generation:* The function shall generate the justification control (C) bits according the specification in ETS 300 147 [1]. It shall insert the justification control bits in the appropriate C bit positions.

Two bytes of payload specific POH information, bytes C2 and H4, shall be added to container-4 to form the VC-4 AI and a fixed Frame Start (FS) shall be generated.

H4: The value of H4 byte is undefined.

C2: In this byte the function shall insert code "0001 0010" (Asynchronous mapping of 139 264 kbit/s into the Container-4) as defined in ETS 300 147 [1].

O bits: The value of the O bits is undefined.

R bits: The value of an R bit is undefined.

Activation: The function shall access the access point when it is activated (MI_Active is true). Otherwise, it shall not access the access point.

Defects: None.

An elastic store under/overflow defect (dUOF) is for further study.

Consequent Actions: None.

Defect Correlations: None.

Performance Monitoring: None.

4.3.4 VC-4 Layer to P4e Layer Adaptation Sink S4/P4e_A_Sk

Symbol:

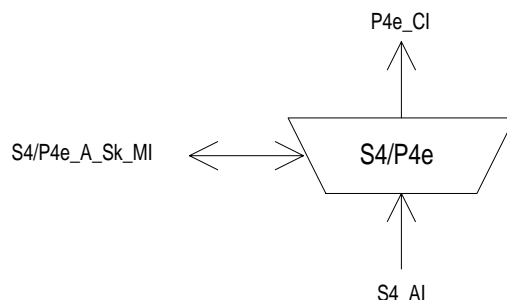

Figure 16: S4/P4e_A_Sk symbol

Interfaces:

Table 10: S4/P4e_A_Sk input and output signals

Input(s)	Output(s)
S4_AI_D	P4e_CI_D
S4_AI_CK	P4e_CI_CK
S4_AI_FS	P4e_CI_FS
S4_AI_TSF	P4e_CI_SSF
S4/P4e_A_Sk_MI_Active	S4/P4e_A_Sk_MI_cPLM
S4/P4e_A_Sk_MI_AIS_Reported	S4/P4e_A_Sk_MI_AcSL
	S4/P4e_A_Sk_MI_cLOF
	S4/P4e_A_Sk_MI_cAIS

Processes:

The function recovers plesiochronous P4e Characteristic Information (139 264 kbit/s \pm 15 ppm) from the synchronous container-4 according to ETS 300 147 [1], and monitors the reception of the correct payload signal type, and recovers P4e frame start reference (FS) from the received signal.

C2: The function shall compare the content of the accepted C2 byte with the expected value code "0001 0010" (Asynchronous mapping of 139 264 kbit/s into the Container-4) as a check on consistency between the provisioning operation at each end. The application and acceptance and mismatch detection process shall be as specified in EN 300 417-1-1 [6], subclauses 7.2 and 8.1.2.

H4: The value in the H4 byte shall be ignored.

O bits: The value in the O bits shall be ignored.

R bits: The value in the R bits shall be ignored.

C bits: Justification control interpretation: The function shall perform justification control interpretation according ETS 300 147 [1] to recover the 139 264 kbit/s signal from the VC-4. If the majority of the C bits is "0" the S bit shall be taken as a data bit, otherwise (majority of C bits is "1") S bit shall be taken as a justification bit and consequently ignored.

Smoothing & jitter limiting process: The function shall provide for a clock smoothing and elastic store (buffer) process. The 139 264 kbit/s data signal shall be written into the buffer under control of the associated (gapped) input clock. The data signal shall be read out of the buffer under control of a smoothed (equally spaced) 139 264 kHz \pm 15 ppm clock (the rate is determined by the 140 Mbit/s signal at the input of the remote S4/P4e_A_So). The residual jitter caused by pointer adjustments and bit justifications (measured at the 139 264 kbit/s interface) shall be within the limits specified in subclause 11.3.1.2 of EN 300 417-1-1 [6].

Buffer size: In the presence of jitter as specified by subclause 11.3.1.2 of EN 300 417-1-1 [6] and a frequency within the range 139 264 kbit/s \pm 15 ppm, this justification process shall not introduce any errors.

Following a step in frequency of the P4e signal transported by the S4_AI (for example due to reception of P4e CI from a new P4e_TT_So at the far end or removal of all-ONEs (AIS) signal with a frequency offset) there will be a maximum recovery time of X seconds after which this process shall not generate any bit errors.

The value of X is for further study; a value of 1 second has been proposed.

Activation: The function shall perform the operation specified above when it is activated (MI_Active is true). Otherwise, it shall transmit the all-ONEs signal at its output (CI_D) and not report its status via the management point.

Frame alignment: The function shall perform the frame alignment of the 139 264 kbit/s signal to recover the frame start information FS. Loss of frame alignment shall be assumed to have taken place when four consecutive frame alignment signals have been incorrectly received in their predicted positions.

When frame alignment is assumed to be lost, the frame alignment device shall decide that such alignment has effectively been recovered when it detects the presence of three consecutive frame alignment signals.

The frame alignment device having detected the appearance of a single correct frame alignment signal, shall begin a new search for the frame alignment signal when it detects the absence of the frame alignment signal in one of the two following frames.

Defects:

The function shall detect for dPLM defect according the specification in EN 300 417-1-1 [6], subclause 8.2.1.

The function shall detect a loss of frame defect (dLOF) when four consecutive frame alignment signals have been incorrectly received in their predicted positions. When frame alignment is lost, the dLOF defect shall be cleared when three consecutive frame alignment signals are detected.

The function shall detect an AIS defect (dAIS) according the specification in subclause 8.2.1.7 of EN 300 417-1-1 [6], with X = 5, Y = 2 928, Z = 6.

Consequent Actions:

aSSF ← dPLM or dLOF or dAIS or AI_TSF

aAIS ← dPLM or dLOF or dAIS or AI_TSF

On declaration of the aAIS the function shall output an all-ONEs (AIS) signal in the P4e_CI_D within 250 µs; on clearing of aAIS the function shall output normal data within 250 µs. The P4e_CI_CK during the all-ONEs signal shall be within 139 264 kHz ± 15 ppm.

Defect Correlations:

cPLM ← dPLM and (not AI_TSF)

cAIS ← dAIS and (not dPLM) and (not AI_TSF) and AIS_Reported

cLOF ← dLOF and (not dAIS) and (not dPLM)

Performance Monitoring: None.

4.3.5 VC-4 Layer to VC-3, VC-2, VC-12, and VC-11 Layer Compound Adaptation Source Function S4/SX_A_So

Symbol:

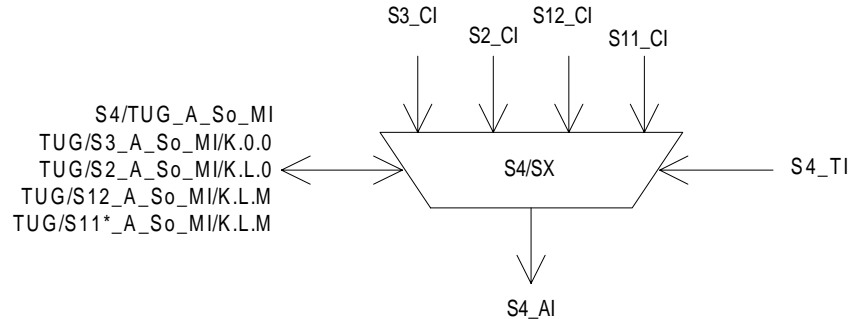

Figure 17: S4/SX_A_So symbol

Interfaces:

Table 11: S4/SX_A_So input and output signals

Input(s)	Output(s)
S4/TUG_A_So_MI S4_TI	S4_AI
maximum 3 inputs: S3_CI TUG/S3_A_So_MI/K.0.0	
maximum 21 inputs: S2_CI TUG/S2_A_So_MI/K.L.0	
maximum 63 inputs: S12_CI TUG/S12_A_So_MI/K.L.M	
maximum 63 inputs: S11_CI TUG/S11*_A_So_MI/K.L.M	

Processes:

The S4/SX_A_So compound function provides adaptation from the VC-3/2/12/11 layers to the VC-4 layer. This process is performed by a combination of several atomic functions as shown in figure 18. The S4/TUG_A_So function performs the VC-4 layer specific signal label and multiframe processing, while the TUG/S3_A_So, TUG/S2_A_So, TUG/S12_A_So and TUG/S11*_A_So functions perform the lower order VC specific frequency justification and bitrate adaptation. Each of these TUG/Sm_A_So functions is characterized by the K.L.M parameters, which define the number of the TU within the VC-4 the function has access to (TU numbering scheme according to EN 300 417-1-1 [6], subclause 3.3.5). According to the TUG multiplex structures supported by the NE, a variety of possible combinations of these TUG/Sm_A_So functions exists. Table 12 lists all possible TUG/Sm_A_So functions within a S4/SX_A_So compound functions.

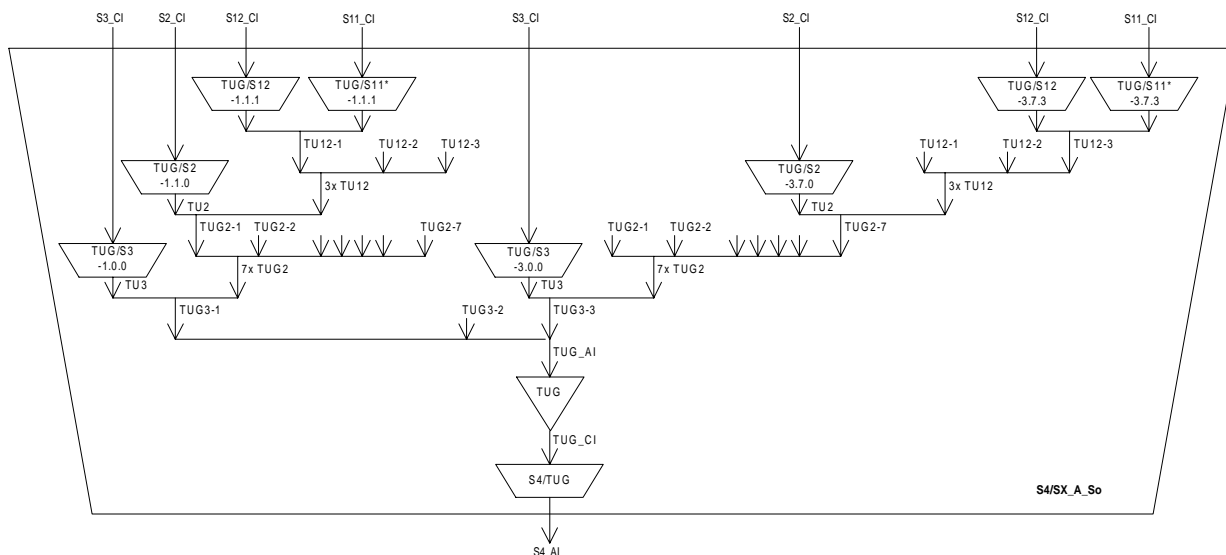

Figure 18: S4/SX_A_So compound function with set of S4/Sm_A_So atomic functions

Table 12: Possible TUG/Sm_A_So functions of a S4/SX_A_So compound function

Atomic function	TU-3/TUG-3 number K	TU-2/TUG-2 number L	TU-12 number M
TUG/S3_A_So/K.0.0	1..3	-	-
TUG/S2_A_So/K.L.0	1..3	1..7	-
TUG/S12_A_So/K.L.M	1..3	1..7	1..3
TUG/S11*_A_So/ K.L.M	1..3	1..7	1..3

For specific implementations only a subset of these TUG/Sm_A_So functions may be used (e.g. a terminal multiplexer with fixed 2 Mbit/s access has 63 TUG/S12_A_So functions). If a flexible TUG multiplex structure is supported, several TUG/Sm_A_So functions may have access to the same TU timeslot. For such case, only one of these adaptation source functions is allowed to be activated. This is controlled by the equipment management function by activating/deactivating the functions according to the configured TUG multiplex structure.

NOTE 1: The S4/TUG_A_So, TUG_T_So and TUG/Sm_A_So (m = 3, 2, 12, 11*) defined in the following subclauses can only be used in a S4/Sm_A_So compound function. These functions can not be used as stand alone functions.

NOTE 2: The TUG is a virtual sub-layer only applicable in a S4/SX_A compound function.

NOTE 3: The number of TUG/Sm_A (m=3, 2, 12, 11*) functions that is active shall completely fill the VC4 payload.

4.3.5.1 VC-4 Layer to TUG Adaptation Source Function S4/TUG_A_So

Symbol:

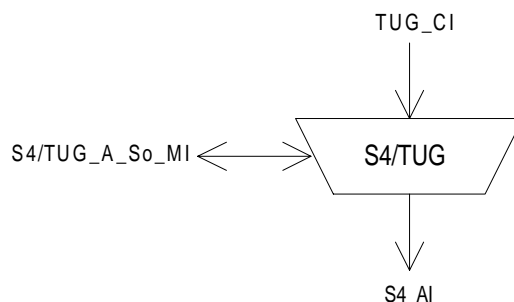

Figure 19: S4/TUG_A_So symbol

Interfaces:

Table 13: S4/TUG_A_So input and output signals

Input(s)	Output(s)
TUG_CI_D	S4_AI_D
TUG_CI_CK	S4_AI_CK
TUG_CI_FS	S4_AI_FS
TUG_CI_MFS	
S4/TUG_A_So_MI_Active	
S4/TUG_A_So_MI_TU3_1	
S4/TUG_A_So_MI_TU3_2	
S4/TUG_A_So_MI_TU3_3	

NOTE 1: The S4/TUG_A_So functions can only be used in a S4/SX_A_So compound function. It can not be used as a standalone function.

Processes:

The function adds two payload specific bytes C2 and H4 to the VC-4 POH and fixed stuff (R0) bytes to the VC-4 payload (see figure 21). The fixed stuff bytes R1, R2 and R3 are added depending on the TUG multiplex structure.

NOTE 2: The fixed stuff bytes (R0, R1, R2, R3) are undefined.

C2: In this byte the function shall insert code "0000 0010" (TUG structure) as defined in ETS 300 147 [1].

H4: If the TUG structure consists of TU-3s only (MI_TU3_1 is true and MI_TU3_2 is true and MI_TU3_3 is true), the value of H4 is undefined. Otherwise, the value of the multiframe indicator byte H4 shall be set as specified by ETS 300 147 [1], 500 μ s TU multiframe sequence, and aligned with TUG_CI_MFS.

The TU multiframe indicator is defined in bits 7 and 8 of byte H4. Bits 1 to 6 of byte H4 have no defined purpose. For backward compatibility, bits 3 and 4 of byte H4 shall be set to "1". Bits 1, 2, 5, and 6 of byte H4 are reserved for future international standardization and shall have their content set to "1" in the interim.

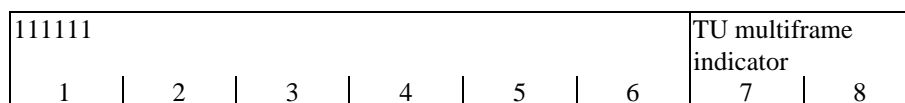

Figure 20: TU multiframe indicator byte H4

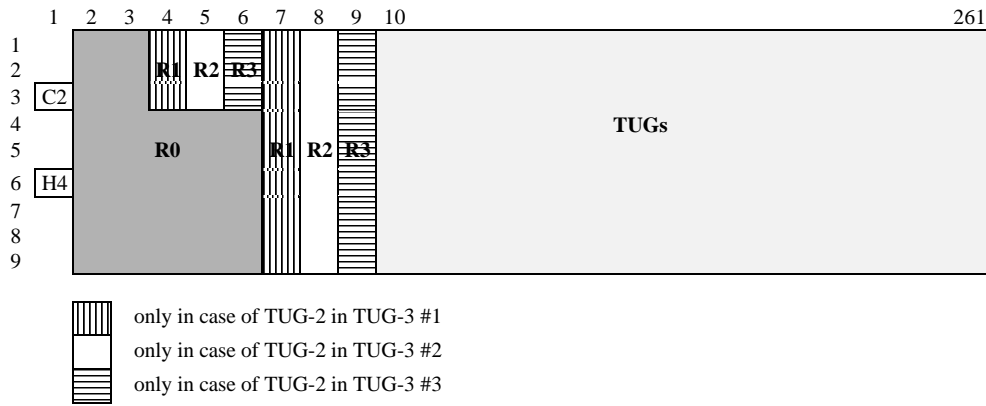

Figure 21: VC-4 payload (TUGs and fixed stuff "R" bytes)

Fixed Stuff bytes: The R0 bytes are always added. The R1 bytes are added if the TUG-3-1 contains TUG-2s (MI_TU3_1 is false). The R2 bytes are added if the TUG-3-2 contains TUG-2s (MI_TU3_2 is false). The R3 bytes are added if the TUG-3-3 contains TUG-2s (MI_TU3_3 is false).

Activation: The function shall access the access point when it is activated (MI_Active is true). Otherwise, it shall not access the access point.

Defects: None.

Consequent Actions: None.

Defect Correlations: None.

Performance Monitoring: None.

4.3.5.2 TUG Termination Source Function TUG_T_So

Symbol:

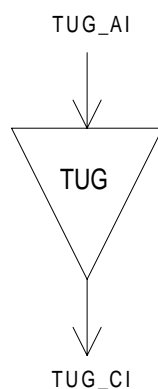

Figure 22: TUG_T_So symbol

Interfaces:

Table 14: TUG_T_So input and output signals

Input(s)	Output(s)
TUG_AI_D	TUG_CI_D
TUG_AI_CK	TUG_CI_CK
TUG_AI_FS	TUG_CI_FS
TUG_AI_MFS	TUG_CI_MFS

NOTE: The TUG_T_So functions can only be used in a S4/SX_A_So compound function. It can not be used as a standalone function.

Processes: None.

Defects: None.

Consequent Actions: None.

Defect Correlations: None.

Performance Monitoring: None.

4.3.5.3 TUG to VC-3 Layer Adaptation Source Function TUG/S3_A_So/K.0.0

Symbol:

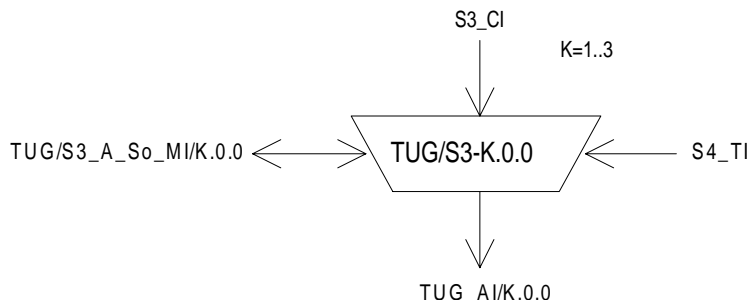

Figure 23: TUG/S3_A_So/K.0.0 symbol

Interfaces:

Table 15: TUG/S3_A_So input and output signals

Input(s)	Output(s)
S3_CI_D	TUG_AI_D
S3_CI_CK	TUG_AI_CK
S3_CI_FS	TUG_AI_FS
S3_CI_SSF	
S4_TI_CK	
S4_TI_FS	
TUG/S3_A_So_MI_Active	

NOTE 1: The TUG/S3_A_So functions can only be used in a S4/SX_A_So compound function. It can not be used as a standalone function.

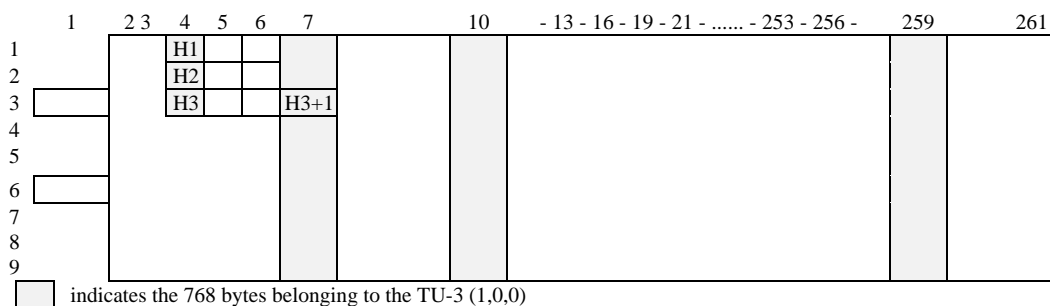

Figure 24: TUG_AI_D/1.0.0 signal

Processes:

This function provides frequency justification and bitrate adaptation for a VC-3 signal, represented by a nominally (765 x 64) = 48 960 kbit/s information stream with a frequency accuracy within ±4,6 ppm and the related frame phase, to be multiplexed into a VC-4 signal via a TU-3.

NOTE 2: Degraded performance may be observed when interworking with SONET equipment having a ±20 ppm network element clock source.

The frame phase of the VC-3 is coded in the related TU-3 pointer. Frequency justification, if required, is performed by pointer adjustments. The accuracy of this coding process is specified below. Refer to annex A.

Frequency justification and bitrate adaptation: The function shall provide an elastic store (buffer) process. The data and frame start signals shall be written into the buffer under control of the associated input clock. The data and frame start signals shall be read out of the buffer under control of the VC-4 clock, frame position, and justification decision.

The justification decisions determine the phase error introduced by the TUG/S3_A_So function. The amount of this phase error can be measured at the physical interfaces by monitoring the TU-3 pointer actions. An example is given in clause A.2.

Each justification decision results in a corresponding negative/positive justification action. Upon a positive justification action, the reading of 8 data bits shall be cancelled once and no data are written at the justification opportunity position H3+1. Upon a negative justification action, an extra 8 data bits shall be read out once into the justification opportunity position H3.

NOTE 3: A requirement for maximum introduced phase error cannot be defined until a reference path is defined from which the requirements for network elements can be deduced. Such a requirement would also limit excessive phase error caused by pointer processors under fixed frequency offset conditions.

Buffer size: For further study.

The TU-3 pointer is carried in 2 bytes of payload specific OH in each container frame. The TU-3 pointer is aligned in the VC-4 payload in fixed position relative to the VC-4 frame. The TU-3 pointer points to the begin of the VC-3 frame within the VC-4. The format of the TU-3 pointer and its location in the frame are defined in ETS 300 147 [1].

H1, H2: *Pointer generation:* The function shall generate the TU-3 pointer as is described in EN 300 417-1-1 [6], annex A: Pointer Generation. It shall insert the pointer in the appropriate H1, H2 positions with the SS field set to 10 to indicate TU-3.

TU-3 timeslot: The adaptation source function has access to a specific TU-3 of the TUG access point. The TU-3 is defined by the parameter K (K=1..3).

Activation: The function shall access the access point when it is activated (MI_Active is true). Otherwise, it shall not access the access point.

Defects: None.

Consequent Actions:

aAIS ← CI_SSF

On declaration of aAIS the function shall output an all-ONEs signal within 250 µs; on clearing of aAIS the function shall output normal data within 250 µs.

NOTE 4: If CI_SSF is not connected (when connected to a S3_TT_So), CI_SSF is assumed to be false.

Defect Correlation: None.

Performance Monitoring: None.

4.3.5.4 TUG to VC-2 Layer Adaptation Source Function TUG/S2_A_So/K.L.0

Symbol:

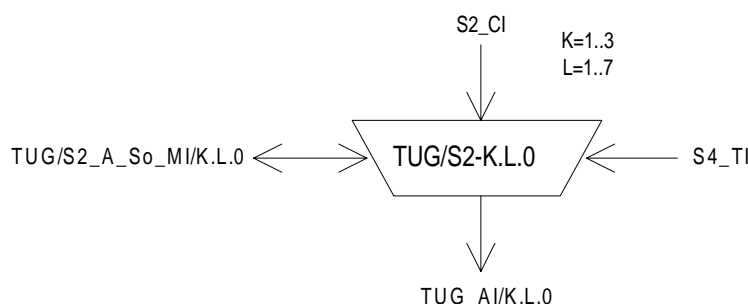

Figure 25: TUG/S2_A_So/K.L.0 symbol

Interfaces:

Table 16: TUG/S2_A_So input and output signals

Input(s)	Output(s)
S2_CI_D	TUG_AI_D
S2_CI_CK	TUG_AI_CK
S2_CI_FS	TUG_AI_FS
S2_CI_SSF	TUG_AI_MFS
S4_TI_CK	
S4_TI_FS	
S4_TI_MFS	
TUG/S2_A_So_MI_Active	

NOTE 1: The TUG/S2_A_So functions can only be used in a S4/SX_A_So compound function. It can not be used as a standalone function.

Processes:

This function provides frequency justification and bitrate adaptation for a VC-2 signal, represented by a nominally $(428 \times 64/4) = 6\,848$ kbit/s information stream with a frequency accuracy within $\pm 4,6$ ppm and the related frame phase, to be multiplexed into a VC-4 signal via a TU-2.

NOTE 2: Degraded performance may be observed when interworking with SONET equipment having a ± 20 ppm network element clock source.

The (500 μ s) frame phase of the VC-2 is coded in the related TU-2 pointer. Frequency justification, if required, is performed by pointer adjustments. The accuracy of this coding process is specified below. Refer to annex A.

Frequency justification and bitrate adaptation: The function shall provide an elastic store (buffer) process. The data and frame start signals shall be written into the buffer under control of the associated input clock. The data and frame start signals shall be read out of the buffer under control of the VC-4 clock, frame position, and justification decision.

The justification decisions determine the phase error introduced by the TUG/S2_A_So function. The amount of this phase error can be measured at the physical interfaces by monitoring the TU-2 pointer actions. An example is given in clause A.2.

Each justification decision results in a corresponding negative/positive justification action. Upon a positive justification action, the reading of 8 data bits shall be cancelled once and no data are written at the justification opportunity position V3+1 (see figure 26). Upon a negative justification action, an extra 8 data bits shall be read out once into the justification opportunity position V3.

NOTE 3: A requirement for maximum introduced phase error cannot be defined until a reference path is defined from which the requirements for network elements can be deduced. Such a requirement would also limit excessive phase error caused by pointer processors under fixed frequency offset conditions.

The TU-2 pointer is carried in bytes V1 and V2 of payload specific OH once per 500 μs multiframe (see figure 26). The TU-2 pointer is aligned in the VC-4 payload in fixed positions relative to the VC-4 frame and multiframe. The format of the TU-2 pointer and its location in the frame/multiframe are defined in ETS 300 147 [1].

Buffer size: For further study.

V1, V2: Pointer generation: The function shall generate the TU-2 pointer as is described in EN 300 417-1-1 [6], annex A: Pointer Generation. It shall insert the pointer in the appropriate V1, V2 positions with the SS field set to 00 to indicate TU-2.

NOTE 4: The byte V4 is undefined.

The configured TU structure is coded as follows:

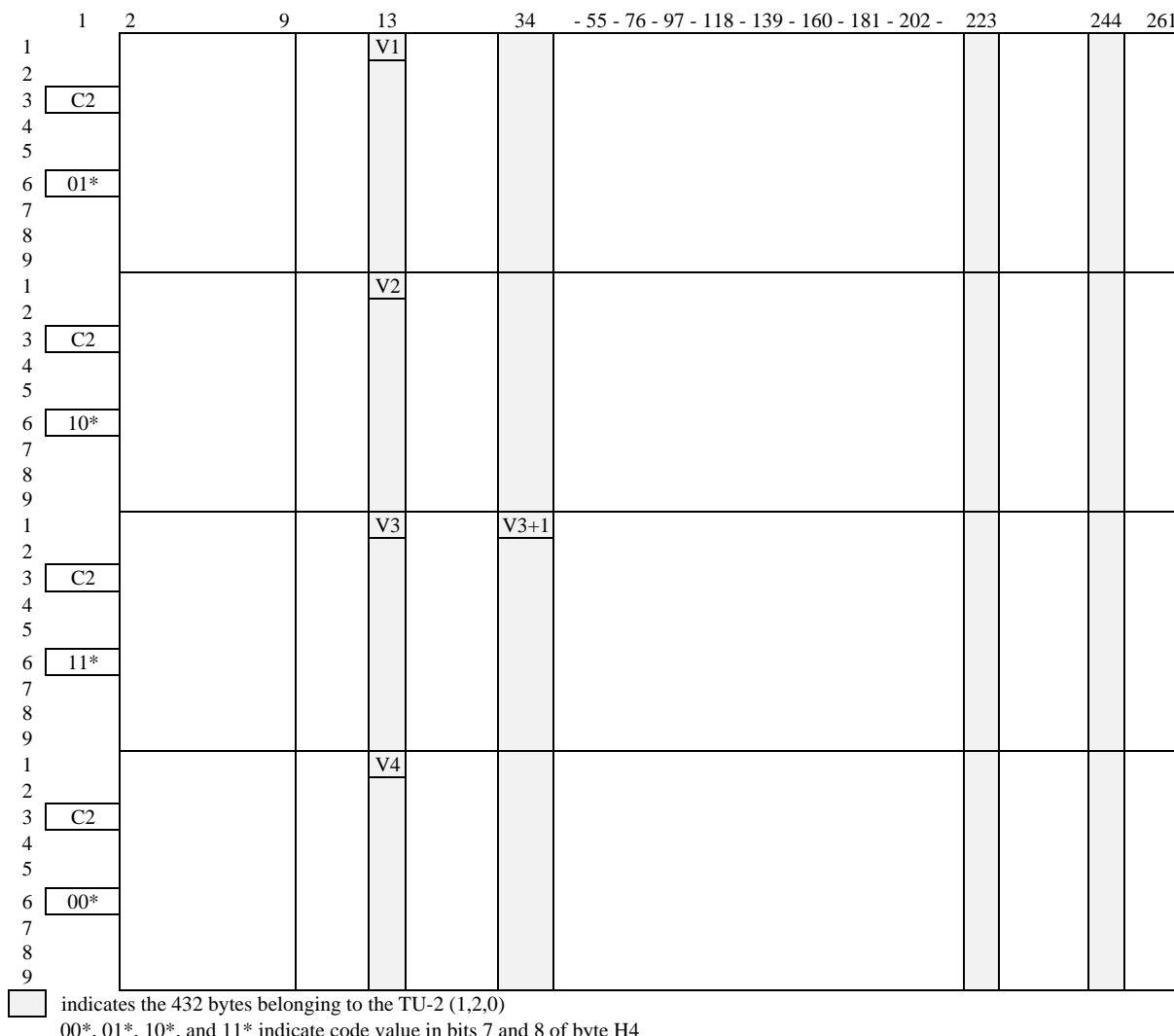

Figure 26: TUG_AI_D/1.2.0 signal

TU-2 timeslot: The adaptation source function has access to a specific TU-2 of the TUG access point. The TU-2 is defined by the parameters K and L (K=1..3, L=1..7).

Activation: The function shall access the access point when it is activated (MI_Active is true). Otherwise, it shall not access the access point.

Defects: None.

Consequent Actions:

aAIS ← CI_SSF

On declaration of aAIS the function shall output an all ONEs signal within 1 000 µs; on clearing of aAIS the function shall output normal data within 1 000 µs.

NOTE 5: If CI_SSF is not connected (when connected to a S2_TT_So), CI_SSF is assumed to be false.

Defect Correlations: None.

Performance Monitoring: None.

4.3.5.5 TUG to VC-12 Layer Adaptation Source Function TUG/S12_A_So/K.L.M

Symbol:

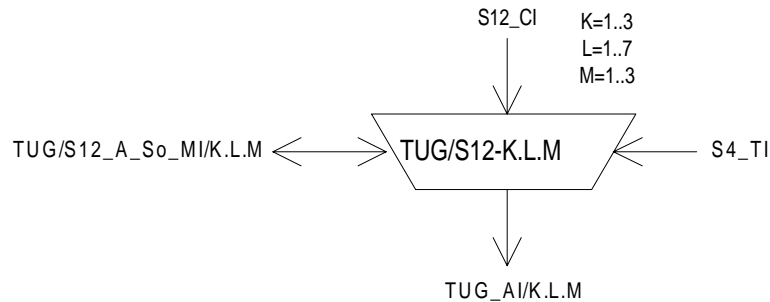

Figure 27: TUG/S12_A_So/K.L.M symbol

Interfaces:

Table 17: TUG/S12_A_So input and output signals

Input(s)	Output(s)
S12_CI_D	TUG_AI_D
S12_CI_CK	TUG_AI_CK
S12_CI_FS	TUG_AI_FS
S12_CI_SSF	
S4_TI_CK	
S4_TI_FS	
S4_TI_MFS	
TUG/S12_A_So_MI_Active	

NOTE 1: The TUG/S12_A_So functions can only be used in a S4/SX_A_So compound function. It can not be used as a standalone function.

Processes:

This function provides frequency justification and bitrate adaptation for a VC-12 signal, represented by a nominally $(140 \times 64/4) = 2\,240$ kbit/s information stream with a frequency accuracy within $\pm 4,6$ ppm and the related frame phase, to be multiplexed into a VC-4 signal via a TU-12.

NOTE 2: Degraded performance may be observed when interworking with SONET equipment having a ± 20 ppm network element clock source.

The (500 μ s) frame phase of the VC-12 is coded in the related TU-12 pointer. Frequency justification, if required, is performed by pointer adjustments. The accuracy of this coding process is specified below. Refer to annex A.

Frequency justification and bitrate adaptation: The function shall provide an elastic store (buffer) process. The data and frame start signals shall be written into the buffer under control of the associated input clock. The data and frame start signals shall be read out of the buffer under control of the VC-4 clock, frame position, and justification decision.

The justification decisions determine the phase error introduced by the TUG/S12_A_So function. The amount of this phase error can be measured at the physical interfaces by monitoring the TU-12 pointer actions. An example is given in clause A.2.

Each justification decision results in a corresponding negative/positive justification action. Upon a positive justification action, the reading of 8 data bits shall be cancelled once and no data are written at the justification opportunity position V3+1 (see figure 28). Upon a negative justification action, an extra 8 data bits shall be read out once into the justification opportunity position V3.

NOTE 3: A requirement for maximum introduced phase error cannot be defined until a reference path is defined from which the requirements for network elements can be deduced. Such a requirement would also limit excessive phase error caused by pointer processors under fixed frequency offset conditions.

Buffer size: For further study.

The TU-12 pointer is carried in bytes V1 and V2 of payload specific OH per 500 μs multiframe (see figure 28). The TU-12 pointer is aligned in the VC-4 payload in fixed positions relative to the VC-4 frame and multiframe. The format of the TU-12 pointer and its location in the frame/multiframe are defined in ETS 300 147 [1].

V1, V2: *Pointer generation*: The function shall generate the TU-12 pointer as is described in EN 300 417-1-1 [6], annex A: Pointer Generation. It shall insert the pointer in the appropriate V1, V2 positions with the SS field set to 10 to indicate TU-12.

NOTE 4: The byte V4 is undefined.

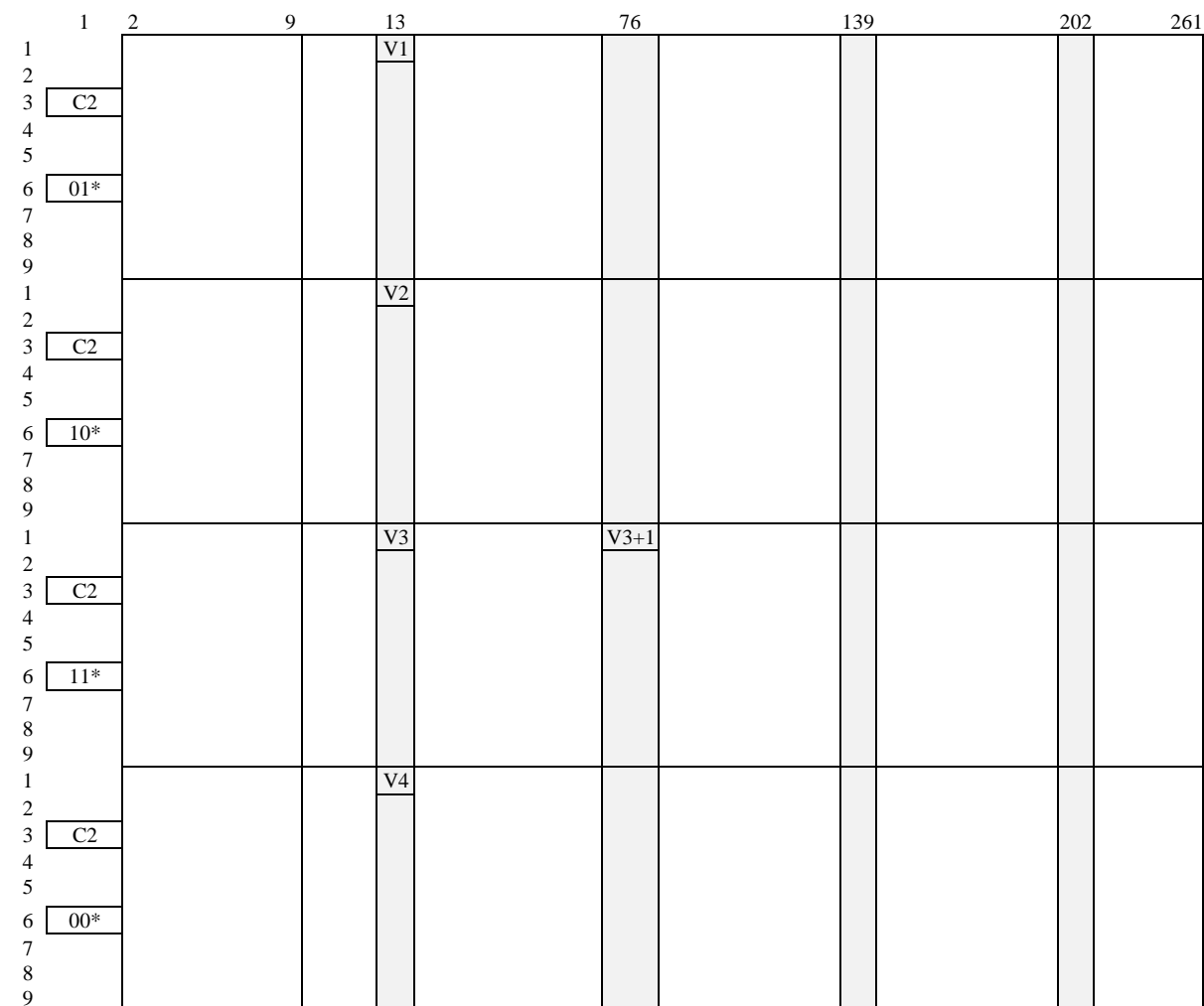

□ indicates the 144 bytes belonging to the TU-12 (1,2,1)
 00*, 01*, 10*, and 11* indicate code value in bits 7 and 8 of byte H4

Figure 28: TUG_AI_D/1.2.1 signal

TU-12 timeslot: The adaptation source function has access to a specific TU-12 of the TUG access point. The TU-12 is defined by the parameters K, L and M (K=1..3, L=1..7, M=1..3).

Activation: The function shall access the access point when it is activated (MI_Active is true). Otherwise, it shall not access the access point.

Defects: None.

Consequent Actions:

aAIS ← CI_SSF

On declaration of aAIS the function shall output an all-ONEs signal within 1 000 µs; on clearing of aAIS the function shall output normal data within 1 000 µs.

NOTE 5: If CI_SSF is not connected (when connected to a S12_TT_So), CI_SSF is assumed to be false.

Defect Correlations: None.

Performance Monitoring: None.

4.3.5.6 TUG to VC-11 Layer Adaptation Source Function TUG/S11*_A_So/K.L.M

Symbol:

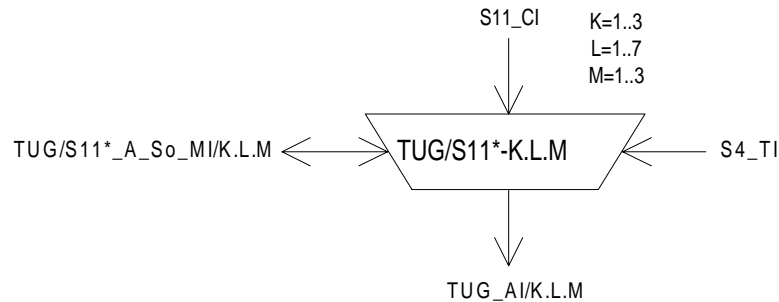

Figure 29: TUG/S11*_A_So/K.L.M symbol

Interfaces:

Table 18: TUG/S11*_A_So input and output signals

Input(s)	Output(s)
S11_CI_D	TUG_AI_D
S11_CI_CK	TUG_AI_CK
S11_CI_FS	TUG_AI_FS
S11_CI_SSF	
S4_TI_CK	
S4_TI_FS	
S4_TI_MFS	
TUG/S11*_A_So_MI_Active	

NOTE 1: The TUG/S11*_A_So functions can only be used in a S4/SX_A_So compound function. It can not be used as a standalone function.

Processes:

This function provides frequency justification and bitrate adaptation for a VC-11 signal, represented by a nominally $(104 \times 64/4) = 1\,664$ kbit/s information stream with a frequency accuracy within $\pm 4,6$ ppm and the related frame phase, to be multiplexed into a VC-4 signal. The VC-11 is transported within a TU-12; 9 bytes of fixed stuff (see figure 30) are added per 125 μ s to the VC-11 as specified by ETS 300 147 [1] to map the VC-11 into the TU-12 payload.

NOTE 2: Mapping a VC-11 into a TU-12 allows the VC-11 signal to be transported in a VC-12 based network (via S12_C and TUG/S12_A functions) and to non-intrusively monitor this VC-11 by means of a VC-12 non-intrusive monitor (S12m_TT_Sk). The S4/S11*_A function will be used at the junction of VC-11 and VC-12 networks.

NOTE 3: Degraded performance may be observed when interworking with SONET equipment having a ± 20 ppm network element clock source.

The (500 μ s) frame phase of the VC-11 is coded in the related TU-12 pointer. Frequency justification, if required, is performed by pointer adjustments. The accuracy of this coding process is specified below. Refer to annex A.

Frequency justification and bitrate adaptation: The function shall provide an elastic store (buffer) process. The data and frame start signals shall be written into the buffer under control of the associated input clock. The data and frame start signals shall be read out of the buffer under control of the VC-4 clock, frame position, and justification decision.

The justification decisions determine the phase error introduced by the TUG/S11*_A_So function. The amount of this phase error can be measured at the physical interfaces by monitoring the TU-12 pointer actions. An example is given in clause A.2.

Each justification decision results in a corresponding negative/positive justification action. Upon a positive justification action, the reading of 8 data bits shall be cancelled once and no data are written at the justification opportunity position V3+1 (see figure 30). Upon a negative justification action, an extra 8 data bits shall be read out once into the justification opportunity position V3.

NOTE 4: A requirement for maximum introduced phase error cannot be defined until a reference path is defined from which the requirements for network elements can be deduced. Such a requirement would also limit excessive phase error caused by pointer processors under fixed frequency offset conditions.

Buffer size: For further study.

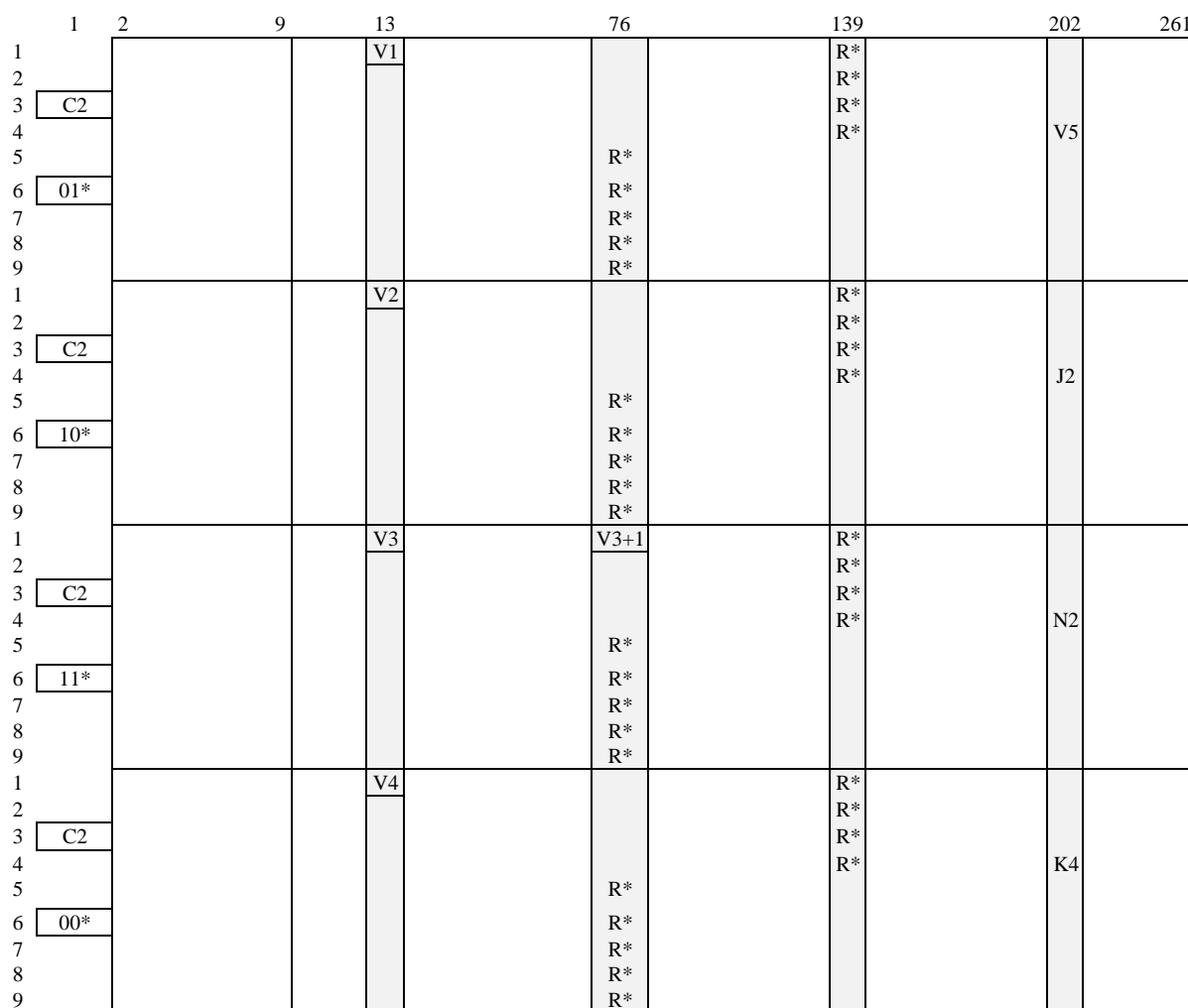

 indicates the 144 bytes belonging to the TU-12 (1,2,1)
 00*, 01*, 10*, and 11* indicate code value in bits 7 and 8 of byte H4

R* indicates fixed stuff with even parity

The positions of the V5, J2, N2, K4 and R^ bytes is relative to the position of the VC-11 in the TU-12. The start of the VC-11 (V5 byte) is defined by the TU-12 pointer.

Figure 30: TUG_AI_D/1.2.1 signal

The TU-12 pointer is carried in bytes V1 and V2 of payload specific OH per 500 μs multiframe (see figure 28). The TU-12 pointer is aligned in the VC-4 payload in fixed positions relative to the VC-4 frame and multiframe. The format of the TU-12 pointer and its location in the frame/multiframe are defined in ETS 300 147 [1].

V1, V2: Pointer generation: The function shall generate the TU-12 pointer as is described in EN 300 417-1-1 [6], annex A: Pointer Generation. It shall insert the pointer in the appropriate V1, V2 positions with the SS field set to 10 to indicate TU-12.

NOTE 5: The byte V4 is undefined.

TU-12 timeslot: The adaptation source function has access to a specific TU-12 of the TUG access point. The TU-12 is defined by the parameters K, L and M (K=1..3, L=1..7, M=1..3).

Activation: The function shall access the access point when it is activated (MI_Active is true). Otherwise, it shall not access the access point.

Defects: None.

Consequent Actions:

aAIS ← CI_SSF

On declaration of aAIS the function shall output an all-ONES signal within 1 000 µs; on clearing of aAIS the function shall output normal data within 1 000 µs.

NOTE 6: if CI_SSF is not connected (when connected to a S11_TT_So), CI_SSF is assumed to be false.

Defect Correlations: None.

Performance Monitoring: None.

4.3.6 VC-4 Layer to VC-3, VC-2, VC-12, and VC-11 Layer Compound Adaptation Sink Function S4/SX_A_Sk

Symbol:

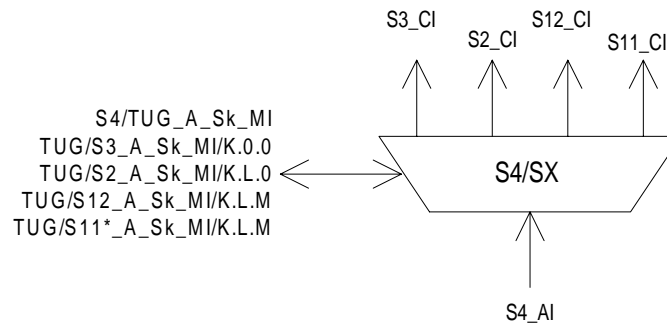

Figure 31: S4/TUG_A_Sk symbol

Interfaces:

Table 19: S4/TUG_A_Sk input and output signals

Input(s)	Output(s)
S4_AI	S4/TUG_A_Sk_MI
S4/TUG_A_Sk_MI	maximum 3 outputs: S3_CI TUG/S3_A_Sk_MI/K.0.0
maximum 3 inputs: TUG/S3_A_Sk_MI/K.0.0	maximum 21 outputs: S2_CI TUG/S2_A_Sk_MI/K.L.0
maximum 21 inputs: TUG/S2_A_Sk_MI/K.L.0	maximum 63 outputs: S12_CI TUG/S12_A_Sk_MI/K.L.M
maximum 63 inputs: TUG/S12_A_Sk_MI/K.L.M	maximum 63 outputs: S11_CI TUG/S11*_A_Sk_MI/K.L.M
maximum 63 inputs: TUG/S11*_A_Sk_MI/K.L.M	

Processes:

The S4/SX_A_Sk compound function provides adaptation from the VC-4 layer to the VC-3/2/12/11 layers. This process is performed by a combination of several atomic functions as shown in figure 32. The S4/TUG_A_Sk function performs the VC-4 layer specific signal label and multiframe processing, while the TUG/S3_A_Sk, TUG/S2_A_Sk, TUG/S12_A_Sk and TUG/S11*_A_Sk functions perform the lower order VC specific frequency justification and bitrate adaptation. Each of these TUG/Sm_A_Sk functions is characterized by the K.L.M parameters, which define the number of the TU within the VC-4 the function has access to (TU numbering scheme according to EN 300 417-1-1 [6], subclause 3.3.5). According to the TUG multiplex structures supported by the NE, a variety of possible combinations of these TUG/Sm_A_Sk functions exists. Table 20 lists all possible TUG/Sm_A_Sk functions within a S4/SX_A_Sk compound functions.

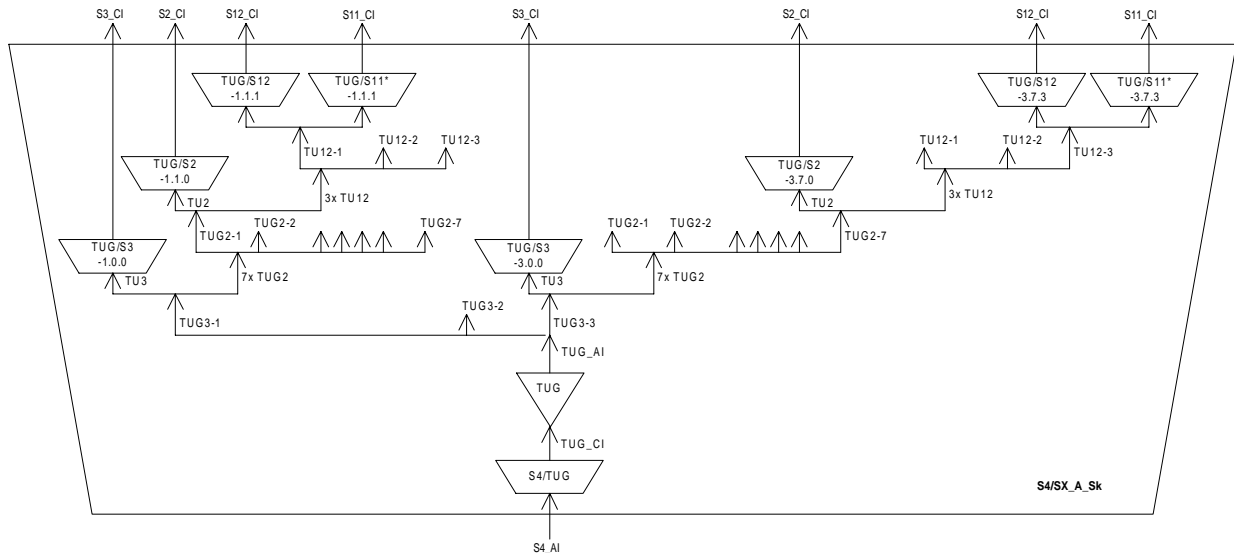

Figure 32: S4/SX_A_Sk compound function with set of S4/Sm_A_Sk atomic functions

Table 20: Possible TUG/Sm_A_Sk functions of a S4/SX_A_Sk compound function

Atomic function	TU-3/TUG-3 number K	TU-2/TUG-2 number L	TU-12 number M
TUG/S3_A_Sk/K.0.0	1..3	0	0
TUG/S2_A_Sk/K.L.0	1..3	1..7	0
TUG/S12_A_Sk/K.L.M	1..3	1..7	1..3
TUG/S11*_A_Sk/K.L.M	1..3	1..7	1..3

For specific implementations only a subset of these TUG/Sm_A_Sk functions may be used (e.g. a terminal multiplexer with fixed 2 Mbit/s access has 63 TUG/S12_A_Sk functions). If a flexible TUG multiplex structure is supported, several TUG/Sm_A_Sk functions may have access to the same TU timeslot. In contradiction with the source direction, adaptation sink functions may be activated all together. This will presumably cause faults (e.g. cLOP) to be detected and reported. To prevent this an adaptation sink function can be deactivated. This is controlled by the equipment management function by activating/deactivating the functions according to the configured TUG multiplex structure.

NOTE 1: The S4/TUG_A_Sk, TUG_T_Sk and TUG/Sm_A_Sk (m = 3, 2, 12, 11*) defined in the following subclauses can only be used in a S4/Sm_A_Sk compound function. These functions can not be used as stand alone functions.

NOTE 2: The TUG is a virtual sub-layer only applicable in a S4/SX_A compound function.

4.3.6.1 VC-4 Layer to TUG Adaptation Sink Function S4/TUG_A_Sk

Symbol:

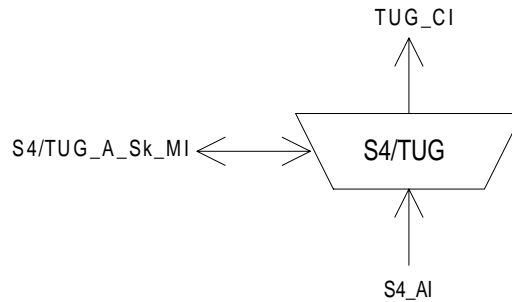

Figure 33: S4/TUG_A_Sk symbol

Interfaces:

Table 21: S4/TUG_A_Sk input and output signals

Input(s)	Output(s)
S4_AI_D	TUG_CI_D
S4_AI_CK	TUG_CI_CK
S4_AI_FS	TUG_CI_FS
S4_AI_TSF	TUG_CI_MFS
S4/TUG_A_Sk_MI_Active	TUG_CI_SSF_TUG2
S4/TUG_A_Sk_MI_TU3_only	TUG_CI_SSF_TU3
	S4/TUG_A_Sk_MI_cPLM
	S4/TUG_A_Sk_MI_cLOM

NOTE: The S4/TUG_A_Sk functions can only be used in a S4/SX_A_Sk compound function. It can not be used as a standalone function.

Processes:

The function monitors two payload specific bytes C2 and H4 of the VC-4 POH.

C2: The function shall compare the content of the accepted C2 byte with the expected value code "0000 0010" (TUG structure) as a check on consistency between the provisioning operation at each end. The application, acceptance and mismatch detection processes are described in EN 300 417-1-1 [6], subclauses 7.2 and 8.1.2.

H4: If the TUG structure consists of TU-3s only (MI_TU3_only is true), the value of H4 byte shall be ignored. Otherwise, the function shall recover the 500 μs (multi)frame start phase performing multi-frame alignment on bits 7 and 8 of byte H4. Out-of-multiframe (OOM) shall be assumed once when an error is detected in the H4 bit 7 and 8 sequence. Multiframe alignment shall be assumed to be recovered, and the In-Multiframe state (IM) shall be entered, when in four consecutive VC-4 frames an error free H4 sequence is found.

Activation: The function shall perform the operation specified above when it is activated (MI_Active is true). Otherwise, it shall activate the SSF signals at its output (CI_SSF_TU3 and CI_SSF_TUG2) and not report its status via the management point.

Defects:

The function shall detect for the dPLM defect according EN 300 417-1-1 [6], subclause 8.2.1.

If the multiframe alignment process is in the OOM state and the H4 multiframe is not recovered within X ms, a dLOM defect shall be declared. Once in a dLOM state, this state shall be exited when the multiframe is recovered (multiframe alignment process enter the IM state). X shall be a value in the range 1 ms to 5 ms. X is not configurable.

Consequent Actions:

aSSF_TU3 ← dPLM or AI_TSF

aSSF_TUG2 ← dPLM or dLOM or AI_TSF

Defect Correlations:

cPLM ← dPLM

cLOM ← dLOM and (not AI_TSF) and (not dPLM)

Performance Monitoring: None.

4.3.6.2 TUG Termination Sink Function TUG_T_Sk

Symbol:

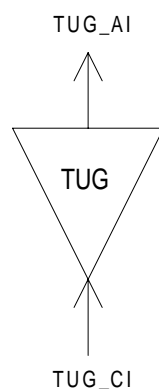

Figure 34: TUG_T_Sk symbol

Interfaces:

Table 22: TUG_T_Sk input and output signals

Input(s)	Output(s)
TUG_CI_D	TUG_AI_D
TUG_CI_CK	TUG_AI_CK
TUG_CI_FS	TUG_AI_FS
TUG_CI_SSF_TUG2	TUG_AI_TSF_TUG2
TUG_CI_SSF_TU3	TUG_AI_TSF_TU3

NOTE: The TUG_T_Sk functions can only be used in a S4/SX_A_Sk compound function. It can not be used as a standalone function.

Processes: None.

Defects: None.

Consequent Actions:

aTSF_TUG2 ← CI_SSF_TUG2

aTSF_TU3 ← CI_SSF_TU3

Defect Correlations: None.

Performance Monitoring: None.

4.3.6.3 TUG to VC-3 Layer Adaptation Sink Function TUG/S3_A_Sk/K.0.0

Symbol:

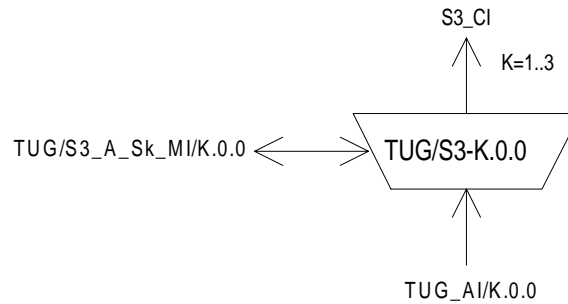

Figure 35: TUG/S3_A_Sk/K.0.0 symbol

Interfaces:

Table 23: TUG/S3_A_Sk input and output signals

Input(s)	Output(s)
TUG_AI_D	S3_CI_D
TUG_AI_CK	S3_CI_CK
TUG_AI_FS	S3_CI_FS
TUG_AI_TSF_TU3	S3_CI_SSF
TUG/S3_A_Sk_MI_AIS_Reported	TUG/S3_A_Sk_MI_cLOP
TUG/S3_A_Sk_MI_Active	TUG/S3_A_Sk_MI_cAIS

NOTE: The TUG/S3_A_Sk functions can only be used in a S4/SX_A_Sk compound function. It can not be used as a standalone function.

Processes:

This function recovers the VC-3 data with frame phase information from a TU-3.

H1, H2: *TU-3 pointer interpretation:* The function shall perform TU-3 pointer interpretation as specified in annex B of EN 300 417-1-1 [6] to recover the VC-3 frame phase within a TU-3 of a VC-4.

TU-3 timeslot: The adaptation sink function has access to a specific TU-3 of the TUG access point. The TU-3 is defined by the parameter K (K=1..3).

Activation: The function shall perform the operation specified above when it is activated (MI_Active is true). Otherwise, it shall transmit the all-ONES signal at its output (CI_D) and not report its status via its management point.

Defects:

The function shall detect for dAIS and dLOP defects according to the algorithm described under the pointer interpreter process in EN 300 417-1-1 [6], annex B, Pointer Interpretation.

Consequent Actions:

aAIS ← dAIS or dLOP or AI_TSF_TU3

aSSF ← dAIS or dLOP or AI_TSF_TU3

On declaration of aAIS the function shall output an all-ONEs (AIS) signal within 250 µs; on clearing of aAIS the function shall output the recovered data within 250 µs.

Defect Correlations:

cAIS ← dAIS and (not AI_TSF_TU3) and AIS_Reported

cLOP ← dLOP and (not AI_TSF_TU3)

Performance Monitoring: None.

4.3.6.4 TUG to VC-2 Layer Adaptation Sink Function TUG/S2_A_Sk

Symbol:

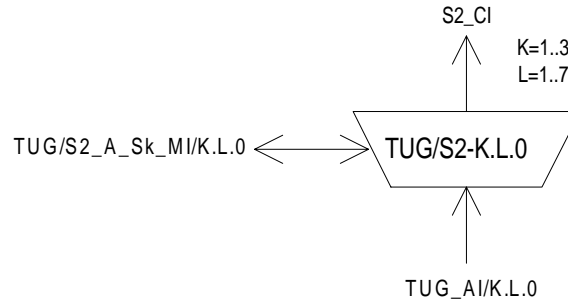

Figure 36: TUG/S2_A_Sk/K.L.0 symbol

Interfaces:

Table 24: TUG/S2_A_Sk input and output signals

Input(s)	Output(s)
TUG_AI_D	S2_CI_D
TUG_AI_CK	S2_CI_CK
TUG_AI_FS	S2_CI_FS
TUG_AI_TSF_TUG2	S2_CI_SSF
TUG/S2_A_Sk_MI_AIS_Reported	TUG/S2_A_Sk_MI_cLOP
TUG/S2_A_Sk_MI_Active	TUG/S2_A_Sk_MI_cAIS

NOTE: The TUG/S2_A_Sk functions can only be used in a S4/SX_A_Sk compound function. It can not be used as a standalone function.

Processes:

This function recovers VC-2 data with frame phase information from a TU-2.

V1, V2: *TU-2 pointer interpretation:* The function shall perform TU-2 pointer interpretation as specified in annex B of EN 300 417-1-1 [6] to recover the VC-2 frame phase within a TU-2 of a VC-4.

Defects:

The function shall detect for dAIS and dLOP defect according the algorithm described under the pointer interpreter process in EN 300 417-1-1 [6], annex B, Pointer Interpretation.

TU-2 timeslot: The adaptation sink function has access to a specific TU-2 of the TUG access point. The TU-2 is defined by the parameters K and L (K=1..3, L=1..7).

Activation: The function shall perform the operation specified above when it is activated (MI_Active is true). Otherwise, it shall transmit the all-ONEs signal at its output (CI_D) and not report its status via its management point.

Consequent Actions:

aAIS ← dAIS or dLOP or AI_TSF_TUG2

aSSF ← dAIS or dLOP or AI_TSF_TUG2

On declaration of aAIS the function shall output all-ONES signal within 1 000 µs; on clearing of aAIS the function shall output the recovered data within 1 000 µs.

Defect Correlations:

cAIS ← dAIS and (not AI_TSF_TUG2) and AIS_Reported

cLOP ← dLOP and (not AI_TSF_TUG2)

Performance Monitoring: None.

4.3.6.5 TUG to VC-12 Layer Adaptation Sink Function TUG/S12_A_Sk/K.L.M

Symbol:

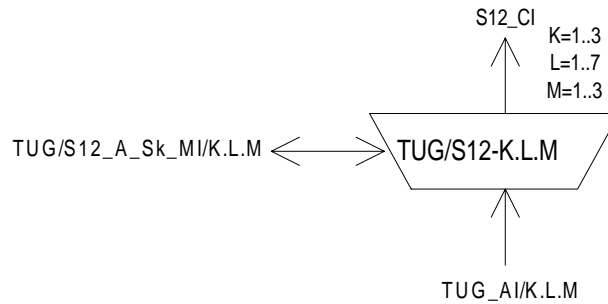

Figure 37: TUG/S12_A_Sk/K.L.M symbol

Interfaces:

Table 25: TUG/S12_A_Sk input and output signals

Input(s)	Output(s)
TUG_AI_D	S12_CI_D
TUG_AI_CK	S12_CI_CK
TUG_AI_FS	S12_CI_FS
TUG_AI_TSF_TUG2	S12_CI_SSF
TUG/S12_A_Sk_MI_AIS_Reported	TUG/S12_A_Sk_MI_cLOP
TUG/S12_A_Sk_MI_Active	TUG/S12_A_Sk_MI_cAIS

NOTE: The TUG/S12_A_Sk functions can only be used in a S4/SX_A_Sk compound function. It can not be used as a standalone function.

Processes:

This function recovers VC-12 data with frame phase information from a TU-12.

V1, V2: *TU-12 pointer interpretation:* The function shall perform TU-12 pointer interpretation as specified in annex B of EN 300 417-1-1 [6] to recover the VC-12 frame phase within a TU-12 of a VC-4.

TU-12 timeslot: The adaptation sink function has access to a specific TU-12 of the TUG access point. The TU-12 is defined by the parameters K, L and M (K=1..3, L=1..7, M=1..3).

Activation: The function shall perform the operation specified above when it is activated (MI_Active is true). Otherwise, it shall transmit the all-ONES signal at its output (CI_D) and not report its status via its management point.

Defects:

The function shall detect for dAIS and dLOP defect according the algorithm described under the pointer interpreter process in EN 300 417-1-1 [6], annex B, Pointer Interpretation.

Consequent Actions:

aAIS ← dAIS or dLOP or AI_TSF_TUG2

aSSF ← dAIS or dLOP or AI_TSF_TUG2

On declaration of aAIS the function shall output all ONEs signal within 1 000 µs; on clearing of aAIS the function shall output the recovered data within 1 000 µs.

Defect Correlations:

cAIS ← dAIS and (not AI_TSF_TUG2) and AIS_Reported

cLOP ← dLOP and (not AI_TSF_TUG2)

Performance Monitoring: None.

4.3.6.6 TUG to VC-11 Layer Adaptation Sink Function TUG/S11*_A_Sk/K.L.M

Symbol:

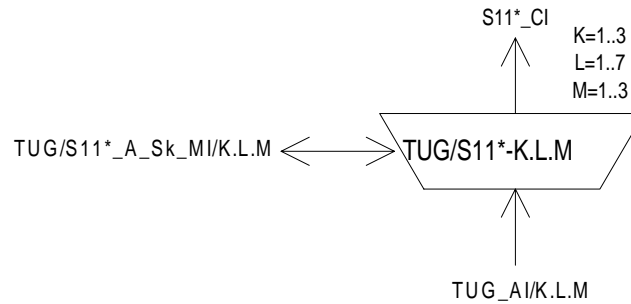

Figure 38: TUG/S11*_A_Sk symbol

Interfaces:

Table 26: TUG/S11*_A_Sk input and output signals

Input(s)	Output(s)
TUG_AI_D	S11_CI_D
TUG_AI_CK	S11_CI_CK
TUG_AI_FS	S11_CI_FS
TUG_AI_TSF_TUG2	S11_CI_SSF
TUG/S11*_A_Sk_MI_AIS_Reported	TUG/S11*_A_Sk_MI_cLOP
TUG/S11*_A_Sk_MI_Active	TUG/S11*_A_Sk_MI_cAIS

NOTE: The TUG/S11*_A_Sk functions can only be used in a S4/SX_A_Sk compound function. It can not be used as a standalone function.

Processes:

This function recovers VC-11 data with frame phase information from a TU-12.

V1, V2: *TU-12 pointer interpretation:* The function shall perform TU-12 pointer interpretation as specified in annex B of EN 300 417-1-1 [6] to recover the VC-11 frame phase within a TU-12 of a VC-4.

TU-12 timeslot: The adaptation sink function has access to a specific TU-12 of the TUG access point. The TU-12 is defined by the parameters K, L and M (K=1..3, L=1..7, M=1..3).

Activation: The function shall perform the operation specified above when it is activated (MI_Active is true). Otherwise, it shall transmit the all-ONEs signal at its output (CI_D) and not report its status via its management point.

Defects:

The function shall detect for dAIS and dLOP defect according the algorithm described under the pointer interpreter process in EN 300 417-1-1 [6], annex B, Pointer Interpretation.

Consequent Actions:

aAIS ← dAIS or dLOP or AI_TSF_TUG2

aSSF ← dAIS or dLOP or AI_TSF_TUG2

On declaration of aAIS the function shall output all ONEs signal within 1 000 µs; on clearing of aAIS the function shall output the recovered data within 1 000 µs.

Defect Correlations:

cAIS ← dAIS and (not AI_TSF_TUG2) and AIS_Reported

cLOP ← dLOP and (not AI_TSF_TUG2)

Performance Monitoring: None.

4.3.7 VC-4 Layer to P0s Layer Adaptation Source S4/P0s_A_So

Symbol:

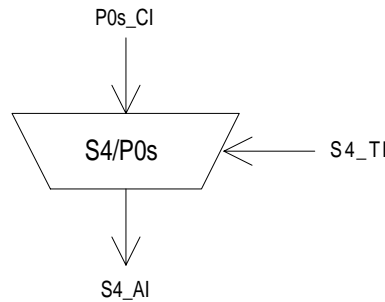

Figure 39: S4/P0s_A_So symbol

Interfaces:

Table 27: S4/P0s_A_So input and output signals

Input(s)	Output(s)
P0s_CI_D P0s_CI_CK P0s_CI_FS S4_TI_CK S4_TI_FS	S4_AI_D

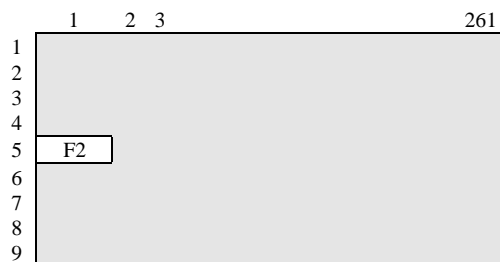

Figure 40: S4/ P0s_AI_D signal

Processes:

This function provides the multiplexing of a 64 kbit/s information stream into the S4_AI using slip buffering. It takes P0s_CI, defined in ETS 300 166 [2] as an octet structured bit-stream with a synchronous bit rate of 64 kbit/s, present at its input and inserts it into the VC-4 POH byte F2 as defined in ETS 300 147 [1] and depicted in figure 2.

NOTE: Any frequency deviation between the 64 kbit/s signal and the associated VC-4 signal leads to octet slips.

Frequency justification and bitrate adaptation: The function shall provide an elastic store (slip buffer) process. The data signal shall be written into the buffer under control of the associated input clock. The data shall be read out of the buffer under control of the VC-4 clock, frame position (S4_TI), and justification decisions.

Each justification decision results in a corresponding negative/positive justification (slip) action. Upon a positive justification (slip) action, the reading of one 64 kbit/s octet (8 bits) shall be cancelled once. Upon a negative justification (slip) action, the same 64 kbit/s octet (8 bits) shall be read out a second time.

Buffer size: The elastic store (slip buffer) shall accommodate at least 18 μ s of wander without introducing errors.

Defects: None.

Consequent Actions: None.

Defect Correlations: None.

Performance Monitoring: None.

4.3.8 VC-4 Layer to P0s Layer Adaptation Sink S4/P0s_A_Sk

Symbol:

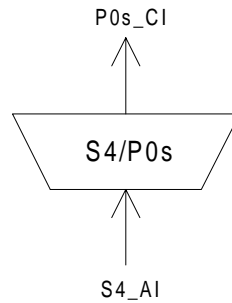

Figure 41: S4/P0s_A_Sk symbol

Interfaces:

Table 28: S4/P0s_A_Sk input and output signals

Input(s)	Output(s)
S4_AI_D	P0s_CI_D
S4_AI_CK	P0s_CI_CK
S4_AI_FS	P0s_CI_FS
S4_AI_TSF	P0s_CI_SSF

Processes:

The function extracts the path user channel byte F2 from the VC-4 layer Characteristic Information. The recovered byte provides a 64 kbit/s channel for the client (user).

Data latching and smoothing process: The function shall provide a data latching and smoothing function. Each 8-bit octet received shall be written and latched into a data store under the control of the VC-4 signal clock. The eight data bits shall then be read out of the store using a nominal 64 kHz clock which may be derived directly from the incoming STM-N signal clock (e.g. 155 520 kHz divided by a factor of $2\,430 \times N$).

Defects: None.

Consequent Actions:

aSSF ← AI_TSF

aAIS ← AI_TSF

On declaration of aAIS the function shall output an all-ONEs (AIS) signal - complying to the frequency limits for this signal (a bit rate in range 64 kbit/s \pm 100 ppm) - within 1 ms; on clearing of aAIS the function shall output normal data within 1 ms.

Defect Correlations: None.

Performance Monitoring: None.

4.3.9 VC-4 Layer to DQDB Layer Adaptation Source S4/DQDB_A_So

Symbol:

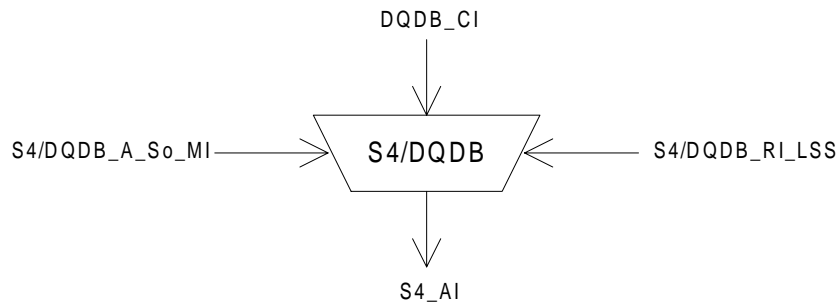

Figure 42: S4/DQDB_A_So symbol

Interfaces:

Table 29: S4/DQDB_A_So input and output signals

Input(s)	Output(s)
DQDB_CI_D	S4_AI_D
DQDB_CI_DTYPE	S4_AI_CK
DQDB_CI_DSTATUS	S4_AI_FS
DQDB_CI_CK	
DQDB_CI_FS	
DQDB_CI_SSF	
S4/DQDB_RI_LSS	
S4/DQDB_A_So_MI_Active	

Processes:

This function provides the mapping of a DQDB slots into VC-4 and it also adds the bytes F2, H4 and F3 of specific client information. The frequency accuracy of the DQDB signal is within $\pm 4,6$ ppm.

The convergence procedure for transfer of Distributed Queue Dual Bus (DQDB) slots using Synchronous Digital Hierarchy at 155,520 Mbit/s is defined in the ETS 300 216 [4].

The DQDB slots are located horizontally (by row) in the VC-4 payload capacity with the slot boundaries aligned with the VC-4 octet boundaries. Because the VC-4 payload capacity is not an integer multiple of the DQDB slot length (53 octets), a slot is allowed to cross the VC-4 boundary.

In figure 43 is represented the mapping of DQDB_CI (Slots and Management Octets) in the VC-4.

The adaptation function make use of a dedicated input signal, DQDB_CI_DTYPE to identify the boundary of the slot (first octet), the M1 and M2 management octets in the incoming DQDB_CI_D stream. The additional signal DQDB_CI_DSTATUS provides an indication to the atomic function that the DQDB_CI_D is either VALID or INVALID. These signals represent the services provided by the Physical Layer at Each Service Access point to the DQDB layer defined in IEEE Standard 802.6 [10], clause 4.

Figure 45 shows the DQDB slot format. The slot payload of 48 octets shall be scrambled before mapping in the VC-4 frame. The scrambler operates for a duration of the 48 octet slot payload. Operation is suspended and the scrambler state is retained at all other times. A self-synchronous scrambler with generator polynomial $x^{43}+1$ shall be used. An eight bit pattern shall be added (module 2) to the HCS field of the slot header in order to improve slot delineation procedure in the sink direction. The bit pattern shall be "01010101".

In addition, in the source direction, slot boundary indication shall be provided on a 125 μ s basis by use of six bit field in the H4 octet.

The DQDB Management octets M1 and M2 are carried in the F2 and F3 octets of VC-4. Two bytes of payload specific POH information, bytes C2 and H4, shall be added to container-4 to form the S4 AI and a fixed Frame Start (FS) shall be generated.

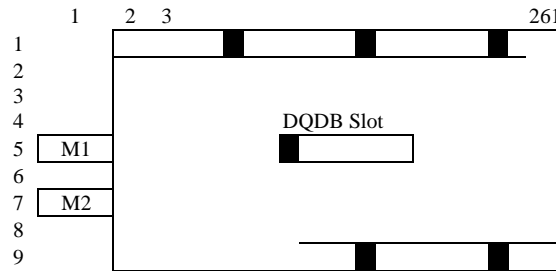

Figure 43: Mapping of DQDB_CI (Slots and Management octet) in the VC-4 structure

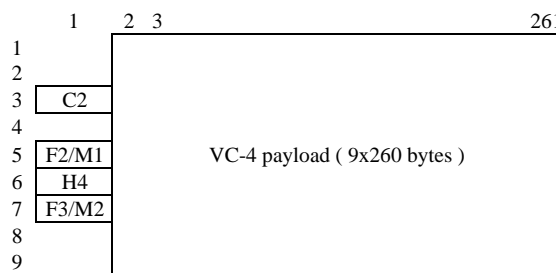

Figure 44: S4/DQDB_AI_So_D

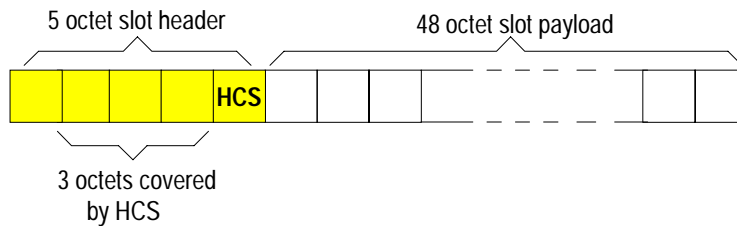

Figure 45: DQDB slot format

H4: The H4 byte carries the slot boundary information and the Link Status Signal (LSS) as depicted in figure 46. The bits 1 and 2 are used for the LSS code as described in IEEE Standard 802.6 [10], subclause 11.3.2. This signal is used to communicate information about the status of the transmission link between two adjacent DQDB nodes. The LSS codes are shown in table 30.

Link Status Signal		Slot Offset Indicator					
1	2	3	4	5	6	7	8

Figure 46: Position indicator (H4) coding

Table 30: Link Status Signal (LSS) codes

LSS Code	LSS name	Link Status
00	Connected rx_link_dn	Received link connected
11	rx_link_dn	Received link down, no input or forced down
01	rx_link_up	Received link up
10	Hob_incapable	Lack of upstream head of bus capability

Bit 3 to 8 of the H4 octet form the slot offset indicator. The slot offset indicator shall contain a binary number indicating the offset in octets between the H4 octet and the first slot boundary following the H4 octet. The valid range of the slot offset indicator value shall be 0 to 52.

C2: In this byte the function shall insert code "0001 0100" which indicates an IEEE Standard 802.6 [10] payload as defined in ETS 300 147 [1].

F2 and F3: These two octets are used to carry the DQDB Layer management information octets (M1 and M2) which are described in IEEE Standard 802.6 [10], subclause 10.1. M1 and M2 octets are generated at the Head Of Bus node as described in IEEE Standard 802.6 [10], subclause 4.2, and are operated on each DQDB node management protocol entity inside the DQDB layer as described in sections 5.4.3.2., 10.2 and 10.3, There need be no correlation between TYPE=0 or TYPE=1 octets and the M1 or M2 octets.

Activation: The function shall access the access point when it is activated (MI_Active is true). Otherwise, it shall not access the access point.

Defects: None.

Consequent Actions:

Continuous octets marked as INVALID (DQDB_CI_DSTATUS=INVALID) or no octet received from the DQDB layer cause void slot to be generated and mapped into the VC-4 payload. A void slot is defined as a 53 octets each with default code of "0000 0000".

Defect Correlations: None.

Performance Monitoring: None.

4.3.10 VC-4 Layer to DQDB Layer Adaptation Sink S4/DQDB_A_Sk

Symbol:

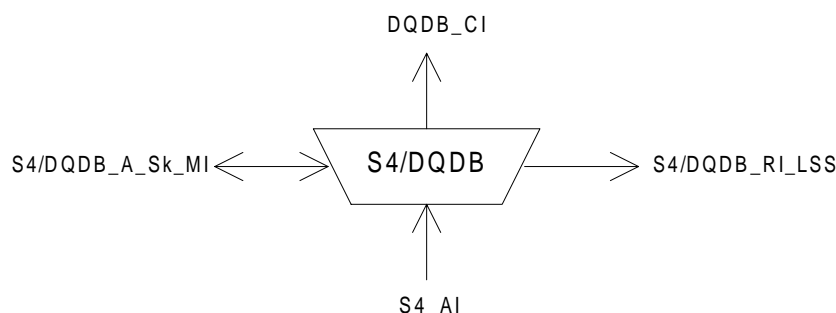

Figure 47: S4/DQDB_A_Sk symbol

Interfaces:

Table 31: S4/DQDB_A_Sk input and output signals

Input(s)	Output(s)
S4_AI_D	DQDB_CI_D
S4_AI_CK	DQDB_CI_CK
S4_AI_FS	DQDB_CI_FS
S4_AI_TSF	DQDB_CI_DTYPE
S4/DQDB_A_Sk_MI_FORCE_DN	DQDB_CI_DSTATUS
S4/DQDB_A_Sk_MI_HOB	DQDB_CI_LSTATUS
S4/DQDB_A_Sk_MI_Active	DQDB_CI_TMARK
	DQDB_CI_SSF
	S4/DQDB_RI_LSS
	S4/DQDB_A_Sk_MI_cPLM
	S4/DQDB_A_Sk_MI_cLSD
	S4/DQDB_A_Sk_MI_AcSL

Processes:

The function recovers DQDB Characteristic Information from the synchronous container-4 as specified in the ETS 300 216 [4].

Slot delineation shall be achieved using either the H4 octet slot offset indicator method or the HCS method.

When using the HCS method, slot boundaries are derived within the VC-4 payload using the correlation between the 3 slot header octets that are protected by the HCS, and the slot header HCS octet itself. The Header Check sequence method, similar to the Header Error Control (HEC) method used for ATM cell delineation, is described in details in ETS 300 216 [4] subclause 5.6.1.1.2.

When using the H4 octet slot offset indicator method, the H4 slot offset indicator value provides slot boundary indication. As the VC-4 payload capacity is not an integer multiple of the DQDB slot length, the received H4 slot offset indicator value in two consecutive VC-4s shall be expected to increase by 45 modulo 53. A H4 slot offset indicator value out of range shall be regarded as an unexpected slot offset indicator value. The H4 slot delineation method is described in detail in ETS 300 216 [4] subclause 5.6.1.1.1.

Following slot delineation, the bit pattern "0101 0101" is subtracted (equal to add modulo 2) from the HCS field of the slot headers and the slot payload shall be descrambled. The de-scrambler operates for the duration of the assumed slot payload according to the derived slot delineation. A self-synchronous scrambler with generator polynomial $x^{43}+1$ shall be used. Operation is suspended and the descrambler state is retained at all other times.

The Sink adaptation function make use of a dedicated output signal, DQDB_CI_DTYPE to indicate the boundary of the slot (first octets), the M1 and M2 management octets in DQDB_CI_D stream sent to the DQDB layer. The additional signal DQDB_CI_DSTATUS provides an indication to the DQDB layer that the DQDB_CI_D is either VALID or INVALID.

In addition the Sink adaptation function shall provide to the DQDB layer a 125 μ s timing information (DQDB_CI_TMARK) and the operational state of the transmission link (DQDB_CI_LSTATUS) between two adjacent DQDB node.

These signals represent the services provided by the Physical Layer at Each Service Access point to the DQDB layer defined in IEEE Standard 802.6 [10] clause 4.

C2: The function shall compare the content of the accepted C2 byte with the expected value code "0001 0100" (Man (DQDB) mapping, IEEE Standard 802.6 [10]) as a check on consistency between the provisioning operation at each end. The application and acceptance and mismatch process are described in EN 300 417-1-1 [6], subclauses 7.2 and 8.1.2.

H4: The bits 1 and 2 are recovered and processed to generate the outgoing LSS as reported in table 30. When using the H4 slot offset indicator method, the H4 slot offset indicator values (bits 3-8) provides slot boundary indication.

F2 and F3: These two octets are used to carry the DQDB Layer management information octets (M1 and M2) which are described in IEEE Standard 802.6 [10], subclause 10.1. These octets shall be sent to the DQDB layer without any processing in the atomic function.

Activation: The function shall perform the operation specified above when it is activated (MI_Active is true). Otherwise, it shall transmit the all-ONEs signal at its output (CI_D) and not report its status via the management point.

Defects:

The function shall detect for Loss of Slot Delineation defect (dLSD) according the specification in ETS 300 216 [4] subclause 5.6.1.2.

The function shall detect for dPLM defect according the specification in EN 300 417-1-1 [6], subclause 8.2.1.

Consequent Actions:

aSSF ← AI_TSF or dPLM or dLSD

The sink adaptation function shall generate the outgoing LSS (DQDB_RI_LSS) and the Link Status indication (DQDB_CI_LSTATUS) according to the Link Status Signal Operation Table defined in table 4. The operations table determines the status of the transmission link according to the VC-4 layer state (SSF), the incoming LSS and the Physical Layer Connection State Machine (PLCSM) control.

Table 32: Link Status Signal (LSS) operations table

VC-4 Layer state	INPUT		OUTPUT	
	PLCSM Control	Incoming LSS	DQDB_CI_LSTATUS	Outgoing LSS DQDB_RI_LSS
Not aSSF	Normal	connected	UP	connected
Not aSSF	Normal	rx_link_up	UP	connected
Not aSSF	Normal	rx_link_dn/ hob_incapable	DOWN	rx_link_up
aSSF	Normal	Do not Care	DOWN	rx_link_dn
Do not Care	FORCE_DN	Do not Care	DOWN	rx_link_dn

If aSSF it is no declared this function shall send to the DQDB layer the DQDB slots and DQDB Management octet marked as VALID.

If aSSF is declared, the function shall send to the DQDB layer a DQDB_CI_LSTATUS indication equal DOWN. If the DQDB node is capable to perform Head Of Bus operation (DQDB_MI_HOB=true), this function shall send to the DQDB layer EMPTY slot and EMPTY DQDB management octet (M1 and M2). If it is not capable this function shall send to the DQDB layer octets marked as INVALID and the outgoing LSS code equal to hob_incapable irrespective of the incoming LSS code.

Defect Correlations:

cPLM	←	dPLM and (not AI_TSF)
cLSD	←	dLSD and (not AI_TSF) and (not dPLM)

Performance Monitoring: None.

4.3.11 VC-4 Layer to TSS1 Adaptation Source S4/TSS1_A_So

Symbol:

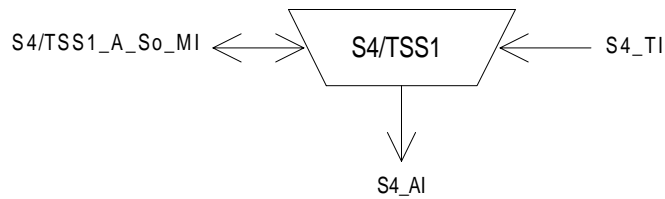

Figure 48: S4/TSS1_A_So symbol

Interfaces:

Table 33: S4/TSS1_A_So input and output signals

Input(s)	Output(s)
S4_TI_CK	S4_AI_D
S4_TI_FS	S4_AI_CK
S4/TSS1_A_So_MI_Active	S4_AI_FS

Processes:

This function maps a VC-4 synchronous Test Signal Structure TSS1 PRBS stream as described in ITU-T Recommendation O.181 [12] into a VC-4 payload and adds the C2 and H4 bytes. It creates a 2^{23} PRBS with timing derived from the S4_TI_Ck and maps it without justification bits into the whole of the synchronous container-4 having a capacity of 2 340 as depicted in figure 49. The PRBS is a sequence which repeats itself over a period which is not an exact multiple of the capacity available in the container-4 frame. Therefore the start of the sequence will move relative to the start of the container-4 frame over time.

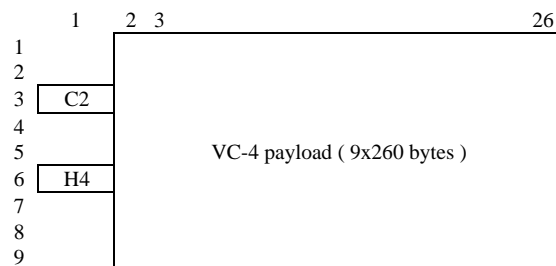

Figure 49: S4/TSS1_AI_So_D

H4: The value of H4 byte is undefined.

C2: In this byte the function shall insert code "1111 1110" (TSS1 in the Container-4) as defined in ETS 300 147 [1].

Activation: The function shall access the access point when it is activated (MI_Active is true). Otherwise, it shall not access the access point.

Defects: None.

Consequent Actions: None.

Defect Correlations: None.

Performance Monitoring: None.

4.3.12 VC-4 Layer to TSS1 Adaptation Sink S4/TSS1_A_Sk

Symbol:

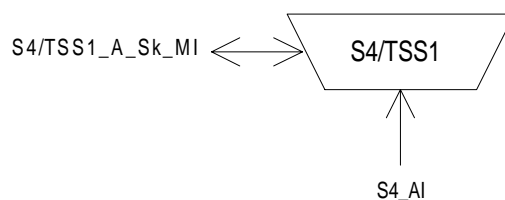

Figure 50: S4/TSS1_A_Sk symbol

Interfaces:

Table 34: S4/TSS1_A_Sk input and output signals

Input(s)	Output(s)
S4_AI_D	S4/TSS1_A_Sk_MI_cPLM
S4_AI_CK	S4/TSS1_A_Sk_MI_cLSS
S4_AI_FS	S4/TSS1_A_Sk_MI_AcSL
S4_AI_TSF	S4/TSS1_A_Sk_MI_pN_TSE
S4/TSS1_A_Sk_MI_Active	
S4/TSS1_A_Sk_MI_1second	

Processes:

The function recovers a TSS1 2^{23} PRBS test sequence as defined in ITU-T Recommendation O.181 [12] from the synchronous container-4 (having a frequency accuracy within $\pm 4,6$ ppm) and monitors the reception of the correct payload signal type and the presence of test sequence errors (TSE) in the PRBS sequence.

C2: The function shall compare the content of the recovered C2 byte (RxSL) expected value code "1111 1110" (TSS1 into the Container-4) as a check on consistency between the provisioning operation at each end. The application and acceptance and mismatch process shall be as specified in EN 300 417-1-1 [6], subclauses 7.2 and 8.1.2.

H4: The value in the H4 byte shall be ignored.

Error monitoring: Test sequence errors are bit errors in the TSS data stream and shall be detected whenever the PRBS detector is in lock and the received data bit does not match the expected value.

Activation: The function shall perform the operation specified above when it is activated (MI_Active is true). Otherwise, it shall not report its status via the management point.

Defects:

The function shall detect for dPLM defect according the specification in EN 300 417-1-1 [6], subclause 8.2.1.

The function shall detect for loss of PRBS lock (dLSS) according to the criteria defined in ITU-T Recommendation O.151 [11], subclause 2.6.

Consequent Actions: None.

Defect Correlations:

cPLM ← dPLM and (not AI_TSF)

cLSS ← dLSS and (not AI_TSF)

Performance Monitoring:

pN_TSE ← Sum of Test Sequence Errors (TSE) within one second period.

4.3.13 VC-4 Layer to ATM Virtual Path Layer Compound Adaptation Source function S4/Avp_A_So

The specification of this function is addressed in EN 301 163-2-1.

4.3.14 VC-4 Layer to ATM Virtual Path Layer Compound Adaptation Sink function S4/Avp_A_Sk

The specification of this function is addressed in EN 301 163-2-1.

4.3.15 VC-4 Layer Clock Adaptation Source S4-LC_A_So

Refer to EN 300 417-6-1 [8].

4.4 VC-4 Layer Monitoring Functions

4.4.1 VC-4 Layer Non-intrusive Monitoring Function S4m_TT_Sk

Symbol:

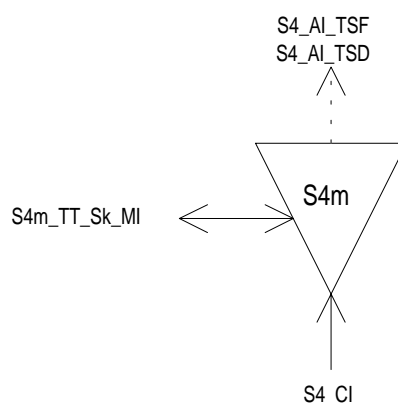

Figure 51: S4m_TT_Sk symbol

Interfaces:

Table 35: S4m_TT_Sk input and output signals

Input(s)	Output(s)
S4_CI_D	S4_AI_TSF
S4_CI_CK	S4_AI_TSD
S4_CI_FS	S4m_TT_Sk_MI_cTIM
S4_CI_SSF	S4m_TT_Sk_MI_cUNEQ
S4m_TT_Sk_MI_TPmode	S4m_TT_Sk_MI_cDEG
S4m_TT_Sk_MI_SSF_Reported	S4m_TT_Sk_MI_cRDI
S4m_TT_Sk_MI_ExtI	S4m_TT_Sk_MI_cSSF
S4m_TT_Sk_MI_RDI_Reported	S4m_TT_Sk_MI_AcTI
S4m_TT_Sk_MI_DEGTHR	S4m_TT_Sk_MI_pN_EBC
S4m_TT_Sk_MI_DEGM	S4m_TT_Sk_MI_pF_EBC
S4m_TT_Sk_MI_ExtImode	S4m_TT_Sk_MI_pN_DS
S4m_TT_Sk_MI_1second	S4m_TT_Sk_MI_pF_DS
S4m_TT_Sk_MI_TIMdis	

Processes:

NOTE 1: This non-intrusive monitor trail termination sink function has no associated source function.

This function monitors VC-4 for errors, and recovers the trail termination status. It extracts the payload independent overhead bytes (J1, B3, G1, C2) from the VC-4 layer Characteristic Information:

J1: The Received Trail Trace Identifier RxTI shall be recovered from the J1 byte and shall be made available as AcTI for network management purposes. The application and acceptance and mismatch detection process shall be performed as specified in EN 300 417-1-1 [6], subclauses 7.1 and 8.2.1.3.

B3: Even bit parity is computed for each bit n of every byte of the preceding VC-4 and compared with bit n of B3 recovered from the current frame (n=1 to 8 inclusive). A difference between the computed and recovered B3 values is taken as evidence of an errored block (nN_B).

G1[1-4], G1[5]: The information carried in the G1 byte (REI, RDI) shall be extracted to enable single ended maintenance of a bi-directional Trail (Path). The REI (nF_B) shall be used to monitor the error performance of the other direction of transmission, and the RDI (bit 5) shall be used to provide information as to the status of the remote receiver. A "1" indicates a Remote Defect Indication state, while a "0" indicates the normal, working state. The application process shall be performed as specified in EN 300 417-1-1 [6], subclauses 7.4.2 (REI), 7.4.11 and 8.2 (RDI).

Table 36: G1[1-4] code interpretation

G1[1]	G1[2]	G1[3]	G1[4]	REI code interpretation [#errored blocks]
0	0	0	0	0
0	0	0	1	1
0	0	1	0	1
0	0	1	1	1
0	1	0	0	1
0	1	0	1	1
0	1	1	0	1
0	1	1	1	1
1	0	0	0	1
1	0	0	1	0
1	0	1	0	0
1	0	1	1	0
1	1	0	0	0
1	1	0	1	0
1	1	1	0	0
1	1	1	1	0

C2: The information in the C2 byte shall be extracted to allow unequipped VC and VC-AIS defect detection.

G1[6-8]: The value in the bits 6 to 8 of byte G1 shall be ignored.

Defects:

The detection and removal conditions and processes for dDEG, dRDI, dUNEQ and dTIM defects shall be as specified by EN 300 417-1-1 [6], subclause 8.2.1 with the condition "aSSF" read as "aSSF or VC dAIS". To use the function within e.g. a tandem connection, it shall be possible to disable the trace id mismatch detection (TIMdis).

NOTE 2: Presumably, in such case the VC Trace Id. will be unknown to the tandem connection operator.

VC AIS:

The function shall detect for an AIS condition by monitoring the VC PSL for code "1111 1111". If 5 consecutive frames contain the "1111 1111" pattern in byte C2 a dAIS defect shall be detected. dAIS shall be cleared if in 5 consecutive frames any pattern other than the "1111 1111" is detected in byte C2.

NOTE 3: Equipment designed prior to the present document may be able to perform VC-AIS detection either as specified above interpreting "frames" as "samples (not necessary consecutive frames)", or by a comparison of the accepted signal label with the all-ONES pattern. If the accepted signal label is equal to all-ONES, VC-AIS defect is detected. If the accepted signal label is not equal to all-ONES, VC-AIS defect is cleared.

Consequent actions:

aTSF ← CI_SSF or dAIS or dUNEQ or dTIM

aTSD ← dDEG

Defect Correlations:

cUNEQ ← dUNEQ and MON

cTIM ← dTIM and (not dUNEQ) and MON

cDEG ← dDEG and (not dTIM) and MON

cRDI ← dRDI and (not dUNEQ) and (not dTIM) and MON and RDI_Reported

cSSF ← (CI_SSF or dAIS) and MON and SSF_Reported

Performance Monitoring:

The performance monitoring process shall be performed as specified in EN 300 417-1-1 [6], subclauses 8.2.4 through 8.2.7.

pN_DS ← aTSF or dEQ

pF_DS ← dRDI

pN_EBC ← Σ nN_B

pF_EBC ← Σ nF_B

NOTE 4: pF_DS/pF_EBC represent the performance of the total trail while pN_DS/pN_EBC represents only part of the trail up to the point of the non-intrusive monitor.

4.4.2 VC-4 Layer Supervisory-Unequipped Termination Source S4s_TT_So

Symbol:

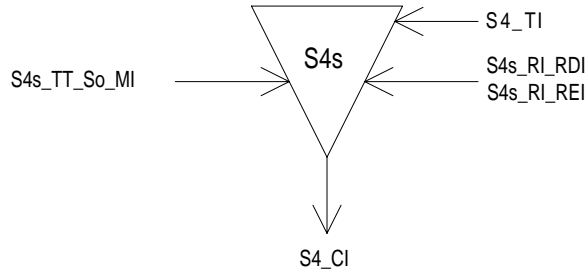

Figure 52: S4s_TT_So symbol

Interfaces:

Table 37: S4s_TT_So input and output signals

Input(s)	Output(s)
S4s_RI_RDI	S4_CI_D
S4s_RI_REI	S4_CI_CK
S4_TI_CK	S4_CI_FS
S4_TI_FS	
S4s_TT_So_MI_TxTI	

Processes:

This function generates error monitoring and status overhead bytes to an undefined VC-4. The processing of the trail termination overhead bytes is defined as follows:

J1: In this byte the function shall insert the Transmitted Trail Trace Identifier TxTI. Its format is described in EN 300 417-1-1 [6], subclause 7.1.

B3: In this byte the function shall insert the BIP-8 EDC with even bit parity. Each bit *n* of current B3 is computed to provide even parity over the *n*th bits of every byte in the previous frame of the Characteristic Information S4_CI, i.e., B3 is calculated over the entire previous VC-4. Further reference is provided in EN 300 417-1-1 [6], subclause 7.3.

C2: In this byte the function shall insert code "0000 0000" (unequipped VC or supervisory-unequipped VC) as defined in subclause 7.2 of EN 300 417-1-1 [6] and ETS 300 147 [1].

G1: This byte is set to represent the status of the associated S4s_TT_Sk. Its format is defined in the figure 2.

G1[1-4]: The signal value applied at RI_REI shall be inserted in the VC-4 REI, bits 1 to 4 of byte G1. The coding shall be as follows:

Table 38: G1[1-4] coding

Number of BIP-8 violations conveyed via RI_REI	G1[1]	G1[2]	G1[3]	G1[4]
0	0	0	0	0
1	0	0	0	1
2	0	0	1	0
3	0	0	1	1
4	0	1	0	0
5	0	1	0	1
6	0	1	1	0
7	0	1	1	1
8	1	0	0	0

G1[5]: Bit 5 of byte G1, a RDI indication, shall be set to "1" on activation of the S4s_RI_RDI within 250 μ s, determined by the associated S4s_TT_Sk function and set to "0" within 250 μ s on the S4s_RI_RDI removal.

G1[6-8]: The value of the bits 6 to 8 of byte G1 is undefined.

N1: In the byte the function shall insert code "0000 0000" (unequipped tandem connection) as defined in subclause 7.2 of EN 300 417-1-1 [6].

Other VC-4 bytes: The function shall generate the other VC-4 bytes and bits. Their content is undefined.

Defects: None.

Consequent Actions: None.

Defect Correlations: None.

Performance Monitoring: None.

4.4.3 VC-4 Layer Supervisory-unequipped Termination Sink S4s_TT_Sk

Symbol:

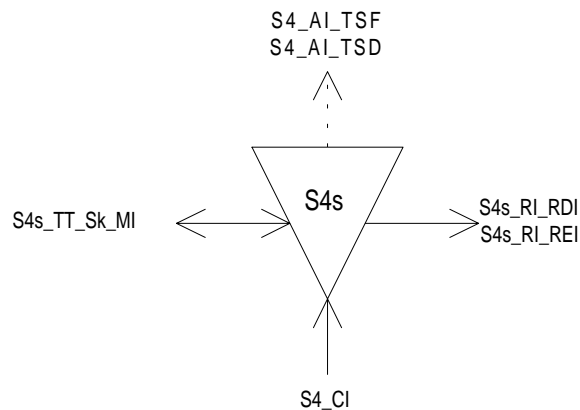

Figure 53: S4s_TT_Sk symbol

Interfaces:

Table 39: S4s_TT_Sk input and output signals

Input(s)	Output(s)
S4_CI_D	S4_AI_TSF
S4_CI_CK	S4_AI_TSD
S4_CI_FS	S4s_TT_Sk_MI_cTIM
S4_CI_SSF	S4s_TT_Sk_MI_cUNEQ
S4s_TT_Sk_MI_TPmode	S4s_TT_Sk_MI_cDEG
S4s_TT_Sk_MI_SSF_Reported	S4s_TT_Sk_MI_cRDI
S4s_TT_Sk_MI_ExtI	S4s_TT_Sk_MI_cSSF
S4s_TT_Sk_MI_RDI_Reported	S4s_TT_Sk_MI_AcTI
S4s_TT_Sk_MI_DEGTHR	S4s_RI_RDI
S4s_TT_Sk_MI_DEGM	S4s_RI_REI
S4s_TT_Sk_MI_1second	S4s_TT_Sk_MI_pN_EBC
S4s_TT_Sk_MI_TIMdis	S4s_TT_Sk_MI_pF_EBC
S4s_TT_Sk_MI_ExtImode	S4s_TT_Sk_MI_pN_DS
	S4s_TT_Sk_MI_pF_DS

Processes:

This function monitors VC-4 for errors, and recovers the trail termination status as defined in ETS 300 147 [1]. It extracts the payload independent overhead bytes (J1, B3, G1, C2) from the VC-4 layer Characteristic Information:

J1: The Received Trail Trace Identifier RxTI shall be recovered from the J1 byte and shall be made available as AcTI for network management purposes. The application and acceptance and mismatch detection process shall be as specified in EN 300 417-1-1 [6], subclauses 7.1 and 8.2.1.3.

B3: Even bit parity shall be computed for each bit n of every byte of the preceding VC-4 and compared with bit n of B3 recovered from the current frame (n=1 to 8 inclusive) A difference between the computed and recovered B3 values shall be taken as evidence of an errored block (nN_B).

G1[1-4], G1[5]: The information carried in the G1 byte (REI, RDI) shall be extracted to enable single ended maintenance of a bi-directional Trail (Path). The REI (nF_B) shall be used to monitor the error performance of the other direction of transmission, and the RDI (bit 5) shall be used to provide information as to the status of the remote receiver. A "1" indicates a Remote Defect Indication state, while a "0" indicates the normal, working state. The application process shall be performed as specified in EN 300 417-1-1 [6], subclauses 7.4.2 (REI), 7.4.11 and 8.2 (RDI).

G1[6-8]: The value in the bits 6 to 8 of byte G1 shall be ignored.

Table 40: G1[1-4] code interpretation

G1[1]	G1[2]	G1[3]	G1[4]	REI code interpretation [# errored blocks]
0	0	0	0	0
0	0	0	1	1
0	0	1	0	1
0	0	1	1	1
0	1	0	0	1
0	1	0	1	1
0	1	1	0	1
0	1	1	1	1
1	0	0	0	1
1	0	0	1	0
1	0	1	0	0
1	0	1	1	0
1	1	0	0	0
1	1	0	1	0
1	1	1	0	0
1	1	1	1	0

C2: The information in the C2 byte shall be extracted to allow unequipped VC defect detection.

Defects:

The function shall detect for dDEG, dRDI, dUNEQ and dTIM defects according the specifications in EN 300 417-1-1 [6], subclause 8.2.1.

Consequent Actions:

aTSF ← CI_SSF or dTIM
aTSD ← dDEG
aRDI ← CI_SSF or dTIM
aREI ← "#EDCV"

NOTE: dUNEQ can not be used to activate aTSF and aRDI; an expected supervisory-unequipped signal will have the signal label set to all-0's, causing a continuous detection of dUNEQ. If an unequipped VC comes in, dTIM will be activated and can serve as a trigger for aTSF/aRDI instead of dUNEQ.

Defect Correlations:

cUNEQ	←	MON and dTIM and (AcTI = all "0"s) and dUNEQ
cTIM	←	MON and dTIM and not (dUNEQ and AcTI = all "0"s)
cDEG	←	MON and (not dTIM) and dDEG
cRDI	←	MON and (not dTIM) and dRDI and RDI_reported
cSSF	←	MON and CI_SSF and SSF_Reported

Performance Monitoring:

The performance monitoring process shall be performed as specified in EN 300 417-1-1 [6], subclause 8.2.4 through 8.2.7.

pN_DS	←	aTSF or dEQ
pF_DS	←	dRDI
pN_EBC	←	Σ nN_B
pF_EBC	←	Σ nF_B

4.5 VC-4 Layer Trail Protection Functions

4.5.1 VC-4 Trail Protection Connection Functions S4P_C

4.5.1.1 VC-4 Layer 1+1 uni-directional Protection Connection Function S4P1+1u_C

Symbol:

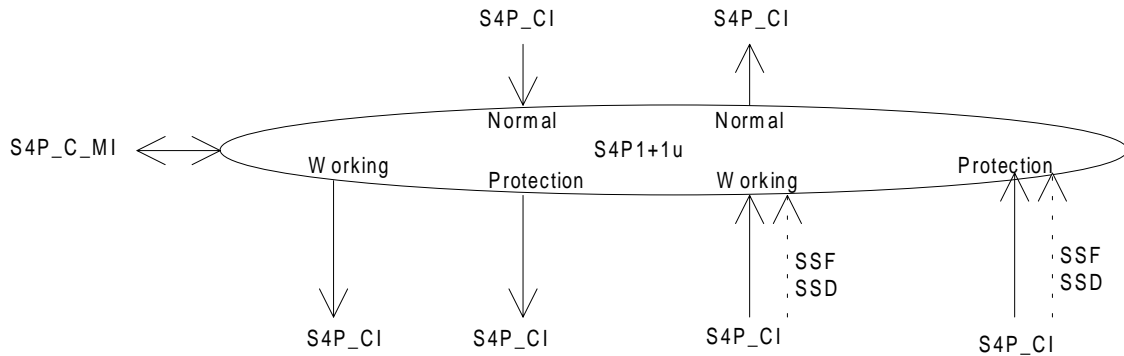

Figure 54: S4P1+1u_C symbol

Interfaces:

Table 41: S4P1+1u_C input and output signals

Input(s)	Output(s)
for connection points W and P: S4P_CI_D S4P_CI_CK S4P_CI_FS S4P_CI_SSF S4P_CI_SSD	for connection points W and P: S4P_CI_D S4P_CI_CK S4P_CI_FS
for connection point N: S4P_CI_D S4P_CI_CK S4P_CI_FS	for connection point N: S4P_CI_D S4P_CI_CK S4P_CI_FS S4P_CI_SSF
S4P_C_MI_OPERType S4P_C_MI_WTRTime S4P_C_MI_HOTime S4P_C_MI_EXTCMD	
NOTE: Protection status reporting signals are for further study.	

Processes:

The function performs the VC-4 linear trail protection process for 1+1 protection architecture with uni-directional switching; refer to EN 300 417-1-1 [6], subclause 9.2. It performs the bridge and selector functionality as presented in figure 49 of EN 300 417-1-1 [6]. In the sink direction, the signal output at the normal reference point can be the signal received via either the associated working path or the protection path; this is determined by the SF,SD conditions (relayed via CI_SSF,CI_SSD signals), and the external commands. In the source direction, the working output is connected to the associated normal input. The protection output is also connected to the normal input.

Provided no protection switching action is activated/required the following changes to (the configuration of) a trail shall be possible without disturbing the CI passing the trail:

- change between operation types;
- change of WTR and HO times.

Operation: The VC trail protection process shall operate as specified in EN 300 417-3-1 [7], annex A, according the following characteristics:

Table 42: Trail protection parameters

Parameter	Value options
architecture type (ARCHtype)	1 + 1
switching type (SWtype)	uni-directional
operation type (OPERtype)	revertive, non-revertive
APS signal (APSmode)	false
Wait-To-Restore time (WTRtime)	in the order of 5-12 minutes
Switch time	≤ 50 ms
Hold-off time (HOtime)	0 to 10 seconds in steps of the order of 100 ms
Protection type (PROTtype)	trail
Signal switch conditions:	SF = SSF (originated as AI_TSF) SD = SSD (originated as AI_TSD)
External commands (EXTCMD)	(revertive operation) LO, FSw-#1, MSw-#1, CLR (non-revertive operation) LO or FSw, FSw-#i, MSw-#i, CLR (i=0,1)
Extra traffic (EXTRAtraffic)	false
SFpriority, SDpriority	high

Defects: None.

Consequent Actions: None.

Defect Correlations: None.

Performance Monitoring: None.

4.5.1.2 VC-4 Layer Protection bi-directional Connection Function S4P1+1b_C

Symbol:

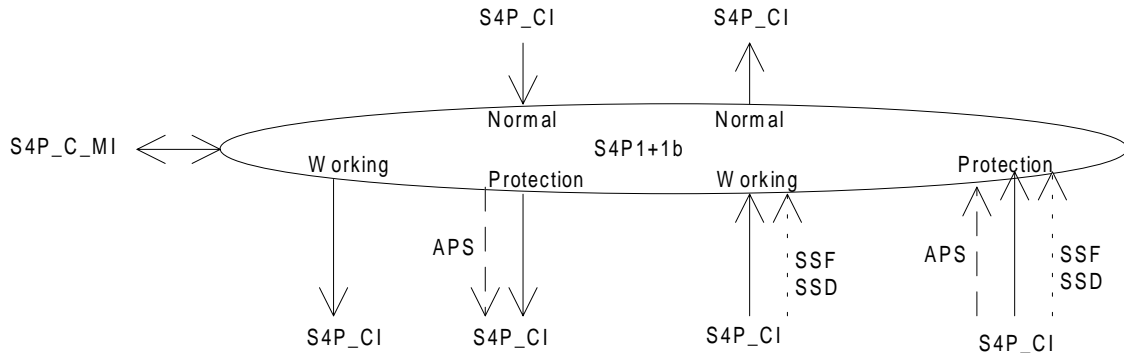

Figure 55: S4P1+1b_C symbol

Interfaces:

Table 43: S4P1+1b_C input and output signals

Input(s)	Output(s)
for connection points W and P: S4P_CI_D S4P_CI_CK S4P_CI_FS S4P_CI_SSF S4P_CI_SSD	for connection points W and P: S4P_CI_D S4P_CI_CK S4P_CI_FS
for connection point N: S4P_CI_D S4P_CI_CK S4P_CI_FS	for connection point N: S4P_CI_D S4P_CI_CK S4P_CI_FS S4P_CI_SSF
for connection point P: S4P_CI_APS	for connection point P: S4P_CI_APS
S4P_C_MI_OPERType S4P_C_MI_WTRTime S4P_C_MI_HOTime S4P_C_MI_EXTCMD	
NOTE: Protection status reporting signals are for further study.	

Processes:

The function performs the VC-4 linear trail protection process for 1+1 protection architecture with bi-directional switching; refer to EN 300 417-1-1 [6], subclause 9.2. It performs the bridge and selector functionality as presented in figure 49 of EN 300 417-1-1 [6]. In the sink direction, the signal output at the normal reference point can be the signal received via either the associated working path or the protection path; this is determined by the SF,SD conditions (relayed via CI_SSF,CI_SSD signals), and the external commands. In the source direction, the working output is connected to the associated normal input. The protection output is also connected to the normal input.

Provided no protection switching action is activated/required the following changes to (the configuration of) a trail shall be possible without disturbing the CI passing the trail:

- change between operation types;
- change of WTR and HO times.

VC Trail Protection Operation: The VC trail protection process shall operate as specified in EN 300 417-3-1 [7], annex A, according the following characteristics:

Table 44: Trail protection parameters

Parameter	Value options
Architecture type (ARCHtype)	1 + 1
Switching type (SWtype)	bi-directional
Operation type (OPERType)	revertive, non-revertive
APS signal (APSmode)	true
Wait-To-Restore time (WTRtime)	in the order of 5-12 minutes
Switch time	≤ 50 ms
Hold-off time (HOtime)	0 to 10 seconds in steps of the order of 100 ms
Protection type (PROTtype)	trail
Signal switch conditions:	SF = SSF (originated as AI_TSF) SD = SSD (originated as AI_TSD)
External commands (EXTCMD)	(revertive operation) LO, FSw-#1, MSw-#1, CLR (non-revertive operation) LO or FSw, FSw-#i, MSw-#i, EXER-#i, CLR (i=0,1)
Extra traffic (EXTRAtraffic)	false
SFpriority, SDpriority	high
NOTE:	The VC-4 APS signal definition is for further study.

Defects:	None.
Consequent Actions:	None.
Defect Correlations:	None.
Performance Monitoring:	None.

4.5.2 VC-4 Layer Trail Protection Trail Termination Functions

4.5.2.1 VC-4 Protection Trail Termination Source S4P_TT_So

Symbol:

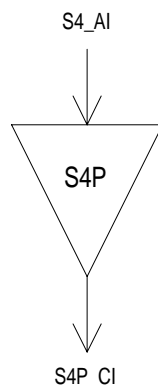

Figure 56: S4P_TT_So symbol

Interfaces:

Table 45: S4P_TT_So input and output signals

Input(s)	Output(s)
S4_AI_D	S4P_CI_D
S4_AI_CK	S4P_CI_CK
S4_AI_FS	S4P_CI_FS

Processes:

No information processing is required in the S4P_TT_So, the S4_AI at its output is identical to the S4P_CI at its input.

Defects: None.

Consequent Actions: None.

Defect Correlations: None.

Performance Monitoring: None.

4.5.2.2 VC-4 Protection Trail Termination Sink S4P_TT_Sk

Symbol:

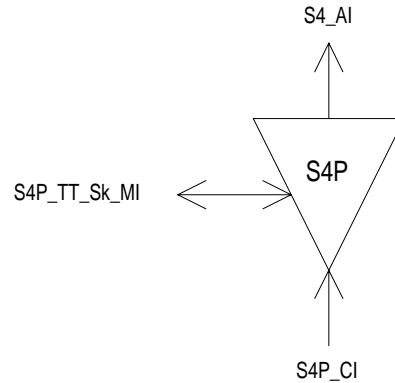

Figure 57: S4P_TT_Sk symbol

Interfaces:

Table 46: S4P_TT_Sk input and output signals

Input(s)	Output(s)
S4P_CI_D	S4_AI_D
S4P_CI_CK	S4_AI_CK
S4P_CI_FS	S4_AI_FS
S4P_CI_SSF	S4_AI_TSF
S4P_TT_Sk_MI_SSF_Reported	S4P_TT_Sk_MI_cSSF

Processes:

The S4P_TT_Sk function reports, as part of the S4 layer, the state of the protected VC-4 trail. In case all trails are unavailable the S4P_TT_Sk reports the signal fail condition of the protected trail.

Defects: None.

Consequent Actions:

aTSF ← CI_SSF

Defect Correlations:

cSSF ← CI_SSF and SSF_Reported

Performance Monitoring: None.

4.5.3 VC-4 Layer Linear Trail Protection Adaptation Functions

4.5.3.1 VC-4 trail to VC-4 trail Protection Layer Adaptation Source S4/S4P_A_So

Symbol:

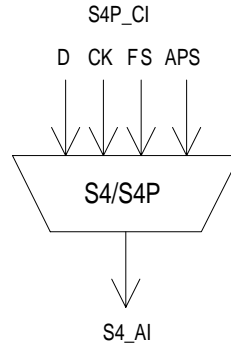

Figure 58: S4/S4P_A_So symbol

Interfaces:

Table 47: S4/S4P_A_So input and output signals

Input(s)	Output(s)
S4P_CI_D	S4_AI_D
S4P_CI_CK	S4_AI_CK
S4P_CI_FS	S4_AI_FS
S4P_CI_APS	

Processes:

The function shall multiplex the S4 APS signal and S4 data signal onto the S4 access point.

K3[1-4]: The insertion of the VC-APS signal is for further study. This process is required only for the protection path.

Defects: None.

Consequent actions: None.

Defect Correlations: None.

Performance Monitoring: None.

4.5.3.2 VC-4 trail to VC-4 trail Protection Layer Adaptation Sink S4/S4P_A_Sk

Symbol:

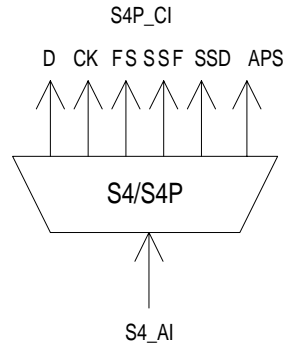

Figure 59: S4/S4P_A_Sk symbol

Interfaces:

Table 48: S4/S4P_A_Sk input and output signals

Input(s)	Output(s)
S4_AI_D	S4P_CI_D
S4_AI_CK	S4P_CI_CK
S4_AI_FS	S4P_CI_FS
S4_AI_TSF	S4P_CI_SSF
S4_AI_TSD	S4P_CI_SSD
	S4P_CI_APS (for Protection signal only)

Processes:

The function shall extract and output the S4P_CI_D signal from the S4_AI_D signal.

K3[1-4]: The extraction and persistency processing of the VC-APS signal is for further study. This process is required only for the protection path.

Defects: None.

Consequent actions:

aSSF ← AI_TSF

aSSD ← AI_TSD

Defect Correlations: None.

Performance Monitoring: None.

4.6 VC-4 Tandem Connection Sublayer Functions

4.6.1 VC-4 Tandem Connection Trail Termination Source function (S4D_TT_So)

Symbol:

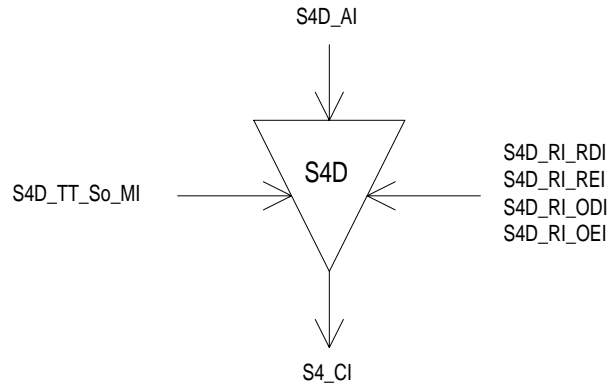

Figure 60: S4D_TT_So symbol

Interfaces:

Table 49: S4D_TT_So input and output signals

Input(s)	Output(s)
S4D_AI_D	S4_CI_D
S4D_AI_CK	S4_CI_CK
S4D_AI_FS	S4_CI_FS
S4D_AI_SF	
S4D_RI_RDI	
S4D_RI_REI	
S4D_RI_ODI	
S4D_RI_OEI	
S4D_TT_So_MI_TxTI	

Processes:

N1[8][73]: The function shall insert the TC RDI code within 1 multiframe (9,5 ms) after the RDI request generation (RI_RDI) in the tandem connection trail termination sink function. It ceases TC RDI code insertion within 1 multiframe (9,5 ms) after the TC RDI request has cleared.

NOTE: N1[x][y] refers to bit x (x = 7,8) of byte N1 in frame y (y=1..76) of the 76 frame multiframe. This multiframe is 9,5 ms long.

N1[5]: The function shall insert the RI_REI value in the REI bit in the following frame.

N1[7][74]: The function shall insert the ODI code within 1 multiframe (9,5 ms) after the ODI request generation (RI_ODI) in the tandem connection trail termination sink function. It ceases ODI code insertion at the first opportunity after the ODI request has cleared.

N1[6]: The function shall insert the RI_OEI value in the OEI bit in following frame.

N1[7-8]: The function shall insert in the multiframe N1[7-8] channel:

- the Frame Alignment Signal (FAS) "1111 1111 1111 1110" in FAS bits in frames 1 to 8;
- the TC trace identifier, received via MI_TxTI, in the TC-TI bits in frames 9 to 72;

- the TC RDI (N1[8][73]) and ODI (N1[7][74]) signals; and
- all-0s in the six reserved bits in frames 73 to 76.

N1[1-4]: Even BIP-8 shall be computed for each bit n of every byte of the preceding VC-4 including B3 and compared with byte B3 recovered from the current frame. A difference between the computed and recovered BIP-8 values shall be taken as evidence of one or more errors in the computation block, and shall be inserted in bits 1 to 4 of byte N1 (see figure 61 and table 50). If AI_SF is true, code "1110" shall be inserted in bits 1 to 4 of byte N1 instead of the number of incoming BIP-8 violations.

NOTE: Zero BIP-8 violations detected in the tandem connection incoming signal shall be coded with a non-all-ZEROs IEC code. This allows this IEC field to be used at the TC tail end as differentiator between TC incoming unequipped VC and unequipped TC.

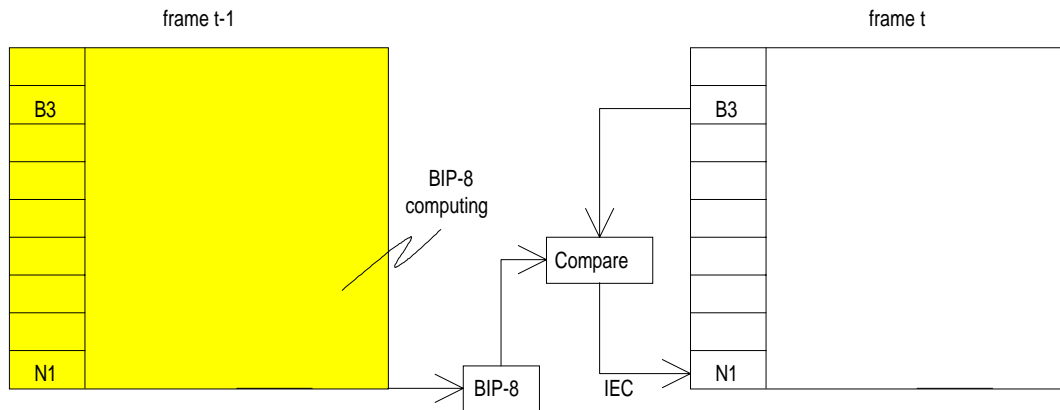

Figure 61: TC IEC computing and insertion

Table 50: IEC code generation

Number of BIP-8 violations	N1[1]	N1[2]	N1[3]	N1[4]
1	0	0	0	1
2	0	0	1	0
3	0	0	1	1
4	0	1	0	0
5	0	1	0	1
6	0	1	1	0
7	0	1	1	1
8	1	0	0	0
0	1	0	0	1

B3: The function shall compensate the VC4 BIP8 (in B3) according the following rule:

Since the BIP-8 parity check is taken over the VC (including N1), writing into N1 at the S4D_TT_So will affect the VC-4 path parity calculation. Unless this is compensated for, a device which monitors VC-4 path parity within the Tandem Connection (e.g., a non-intrusive monitor) may incorrectly count errors. The BIP-8 parity bits should always be consistent with the current state of the VC. Therefore, whenever N1 is written, BIP-8 shall be modified to compensate for the change in the N1 value. Since the BIP-8 value in a given frame reflects a parity check over the previous frame (including the BIP-8 bits in that frame), the changes made to the BIP-8 bits in the previous frame shall also be considered in the compensation of BIP-8 for the current frame. Therefore, the following equation shall be used for BIP-8 compensation:

$$B3[i]'(t) = B3[i](t-1) \oplus B3[i]'(t-1) \oplus N1[i](t-1) \oplus N1[i]'(t-1) \oplus B3[i](t)$$

Where:

B3[i] = the existing B3[i] value in the incoming signal

B3[i]' = the new (compensated) B3[i] value

N1[i] = the existing N1[i] value in the incoming signal

$N1[i]'$ = the new value written into the $N1[i]$ bit
 \oplus = exclusive OR operator
 t = the time of the current frame
 $t-1$ = the time of the previous frame

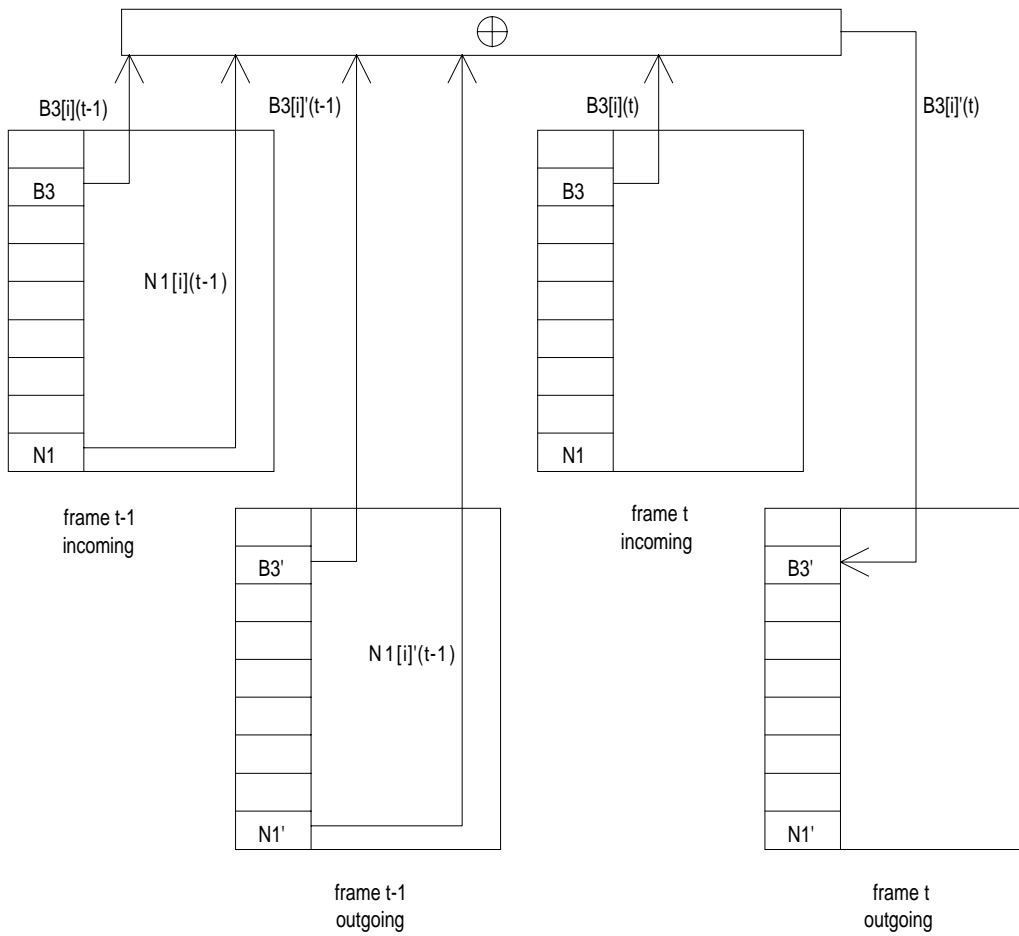

Figure 62: B3[i], i=1..8 compensating process

- Defects:** None.
- Consequent Actions:** None.
- Defect Correlations:** None.
- Performance Monitoring:** None.

4.6.2 VC-4 Tandem Connection Trail Termination Sink function (S4D_TT_Sk)

Symbol:

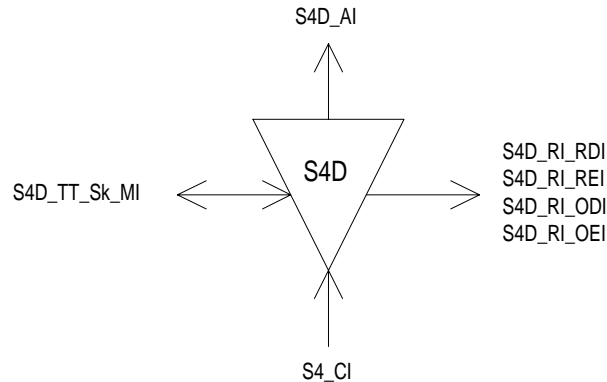

Figure 63: S4D_TT_Sk symbol

Interfaces:

Table 51: S4D_TT_Sk input and output signals

Input(s)	Output(s)
S4_CI_D	S4D_AI_D
S4_CI_CK	S4D_AI_CK
S4_CI_FS	S4D_AI_FS
S4_CI_SSF	S4D_AI_TSF
S4D_TT_Sk_MI_ExTI	S4D_AI_TSD
S4D_TT_Sk_MI_SSF_Reported	S4D_AI_OSF
S4D_TT_Sk_MI_RDI_Reported	S4D_TT_Sk_MI_cLTC
S4D_TT_Sk_MI_ODI_Reported	S4D_TT_Sk_MI_cTIM
S4D_TT_Sk_MI_TIMdis	S4D_TT_Sk_MI_cUNEQ
S4D_TT_Sk_MI_DEGM	S4D_TT_Sk_MI_cDEG
S4D_TT_Sk_MI_DEGTHR	S4D_TT_Sk_MI_cRDI
S4D_TT_Sk_MI_1second	S4D_TT_Sk_MI_cSSF
S4D_TT_Sk_MI_TPmode	S4D_TT_Sk_MI_cODI
	S4D_TT_Sk_MI_AcTI
	S4D_RI_RDI
	S4D_RI_REI
	S4D_RI_ODI
	S4D_RI_OEI
	S4D_TT_Sk_MI_pN_EBC
	S4D_TT_Sk_MI_pF_EBC
	S4D_TT_Sk_MI_pN_DS
	S4D_TT_Sk_MI_pF_DS
	S4D_TT_Sk_MI_pON_EBC
	S4D_TT_Sk_MI_pOF_EBC
	S4D_TT_Sk_MI_pON_DS
	S4D_TT_Sk_MI_pOF_DS

Processes:

TC EDC violations: Even bit parity shall be computed for each bit n of every byte of the preceding VC-4 and compared with bit n of B3 recovered from the current frame (n=1 to 8 inclusive). A difference between the computed and recovered B3 values shall be taken as evidence of one or more errors in the computation block. The magnitude (absolute value) of the difference between this calculated number of errors and the number of errors written into the IEC (see table 52) at the trail termination source shall be used to determine the error performance of the tandem connection for each transmitted VC-4 (see figure 64). If this magnitude of the difference is one or more, an errored TC block is detected (nN_B). If one or more errors were detected in the computation block, an errored VC block (nON_B) shall be declared.

NOTE 1: The B3 data and the IEC read in the current frame both apply to the previous frame.

Table 52: IEC code interpretation

N1[1]	N1[2]	N1[3]	N1[4]	IEC code interpretation
0	0	0	0	0 errors
0	0	0	1	1 error
0	0	1	0	2 errors
0	0	1	1	3 errors
0	1	0	0	4 errors
0	1	0	1	5 errors
0	1	1	0	6 errors
0	1	1	1	7 errors
1	0	0	0	8 errors
1	0	0	1	0 errors
1	0	1	0	0 errors
1	0	1	1	0 errors
1	1	0	0	0 errors
1	1	0	1	0 errors
1	1	1	0	0 errors
1	1	1	1	0 errors

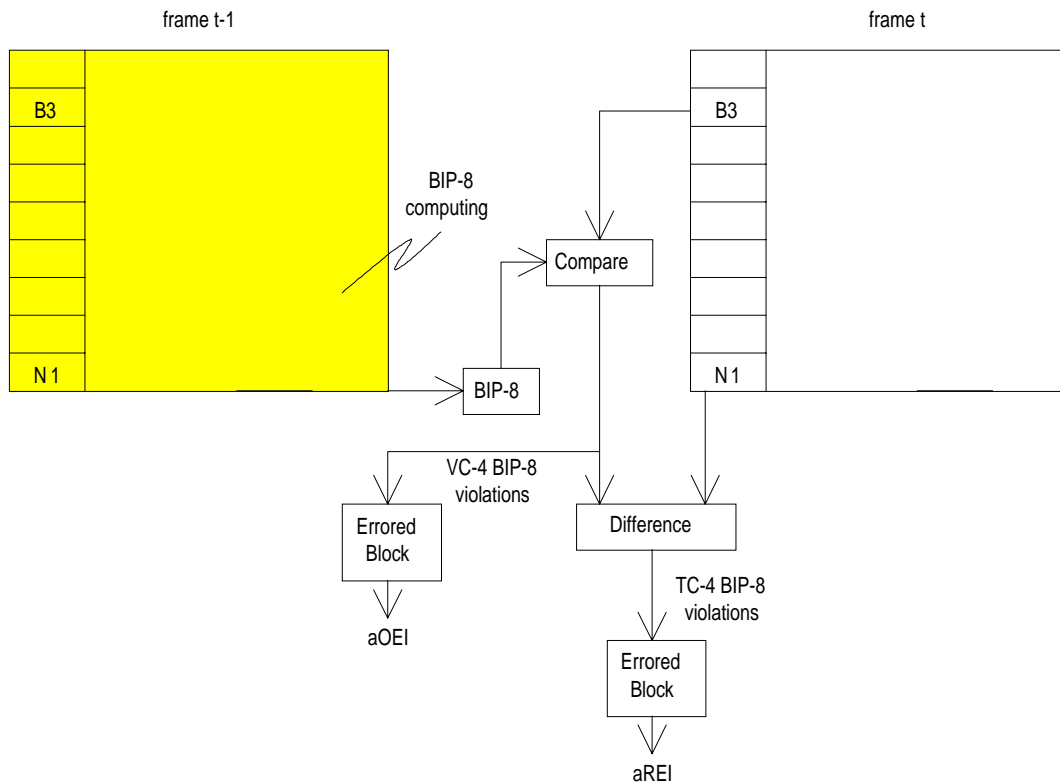

Figure 64: TC-4 and VC-4 BIP-8 computing and comparison

N1[1-4]: The function shall extract the Incoming Error Code (IEC). It shall accept the received code without further processing.

N1[7-8][9-72]: The Received Trail Trace Identifier RxTI shall be recovered from the tandem connection trail trace identifier overhead and shall be made available as AcTI for network management purposes. The application and acceptance process shall be performed as specified in EN 300 417-1-1 [6], subclauses 7.1 and 8.2.1.3. The mismatch detection process shall be as specified below.

The trace identifier process in this function is required to support "mode 1" (EN 300 417-1-1 [6], subclause 7.1) operation only. "Old" tandem connection equipment does not exist.

N1[1-4]: The function shall extract the Incoming AIS code.

N1[5], N1[8][73]: The information carried in the REI, RDI bits in byte N1 shall be extracted to enable single ended maintenance of a bi-directional tandem connection Trail. The REI (nF_B) shall be used to monitor the error performance of the other direction of transmission, and the RDI shall be used to provide information as to the status of the remote receiver. A "1" indicates a Remote Defect Indication state, while a "0" indicates the normal, working state. The application process shall be performed as specified in EN 300 417-1-1 [6], subclauses 7.4.2 (REI), 7.4.11 and 8.2 (RDI).

N1[6], N1[7][74]: The information carried in the OEI, ODI bits in byte N1 shall be extracted to enable single ended (intermediate) maintenance of a the VC-4 egressing the tandem connection Trail. The OEI (nOF_B) shall be used to monitor the error performance of the other direction of transmission, and the ODI shall be used to provide information as to the status of the remote receiver. A "1" indicates a Outgoing Defect Indication state, while a "0" indicates the normal, working state. The application process shall be performed equivalent to the remote maintenance case, as specified in EN 300 417-1-1 [6], subclauses 7.4.2 (REI/OEI), 7.4.11 and 8.2 (RDI/ODI).

N1[7-8]: *Multiframe alignment:* The function shall perform a multiframe alignment on bits 7 and 8 of byte N1 to recover the TTI, RDI, and ODI signals transported within the multiframe bits. The multiframe alignment shall be found by searching for the pattern "1111 1111 1111 1110" within the bits 7 and 8 of byte N1. The signal shall be continuously checked with the presumed multiframe start position for the alignment.

Frame alignment is deemed to have been lost (entering Out Of Multiframe (OOM) state) when two consecutive FAS are detected in error (i.e. ≥ 1 error in each FAS).

Frame alignment is deemed to have been recovered (entering In Multiframe (IM) state) when one non-errored FAS is found.

N1: The function shall terminate N1 channel by inserting an all-ZEROs pattern.

B3: The function shall compensate the VC-4 BIP8 in byte B3 according the algorithm defined in S4D_TT_So.

Defects:

TC Unequipped (dUNEQ):

The function shall detect for an unequipped Tandem Connection (UNEQ) condition by monitoring byte N1 for code "00000000". The unequipped defect (dUNEQ) shall be detected if five consecutive VC-n frames contain the "0000 0000" pattern in byte N1. The dUNEQ defect shall be cleared if in five consecutive VC-n frames any pattern other than the "0000 0000" is detected in byte N1.

TC Loss of Tandem Connection (dLTC):

The function shall detect for the presence/absence of the tandem connection overhead in the byte N1 by evaluating the multiframe alignment signal in bits 7 and 8 of byte N1. The loss of tandem connection defect (dLTC) shall be detected if the multiframe alignment process is in the OOM state. The dLTC shall be cleared if the multiframe alignment process is in the IM state.

TC Connectivity (Trace Identifier) (dTIM):

The function shall detect for a TC misconnection condition by monitoring the TC trace identifier. The Trace Identifier Mismatch defect (dTIM) shall be detected and cleared within a maximum period of 1 s in the absence of bit errors.

The defect detection process and its operation during the presence of bit errors is for further study.

The defect shall be suppressed during the receipt of SSF.

It shall be possible to disable the trace identifier mismatch defect detection (TIMdis).

TC Signal Degrade (dDEG):

The function shall detect for a TC signal degrade defect condition by monitoring for TC BIP-8 violations. The algorithm shall be according subclause 8.2.1.4 of EN 300 417-1-1 [6].

TC Remote Defect (dRDI):

The function shall detect for a TC remote defect indication defect condition by monitoring the TC RDI signal. The algorithm shall be according subclause 8.2.1.5 of EN 300 417-1-1 [6].

TC Remote Outgoing VC Defect (dODI):

The function shall detect for a TC remote outgoing VC defect indication defect condition by monitoring the TC ODI signal. The algorithm shall be according subclause 8.2.1.5 of EN 300 417-1-1 [6].

Incoming AIS (dIncAIS):

The function shall detect for a tandem connection incoming AIS condition by monitoring the IEC bits in byte N1 for code "1110". If 5 consecutive frames contain the "1110" pattern in the IEC bits a dIncAIS defect shall be detected. dIncAIS shall be cleared if in 5 consecutive frames any pattern other than the "1110" is detected in the IEC bits.

NOTE 2: Bits 1 to 4 of byte N1 support two applications: conveying the incoming error information (see table 52) and conveying the incoming AIS information to the TC tail end. Codes 0000 to 1101, 1111 represent IncAIS is false, code 1110 represents IncAIS is true.

Consequent Actions:

The function shall perform the following consequent actions (refer to subclause 8.2.2 of EN 300 417-1-1 [6]):

aAIS	←	dUNEQ or dTIM or dLTC
aTSF	←	CI_SSF or dUNEQ or dTIM or dLTC
aTSD	←	dDEG
aRDI	←	CI_SSF or dUNEQ or dTIM or dLTC
aREI	←	nN_B
aODI	←	CI_SSF or dUNEQ or dTIM or dIncAIS or dLTC
aOEI	←	nON_B
aOSF	←	CI_SSF or dUNEQ or dTIM or dLTC or dIncAIS

The function shall insert the all-ONEs (AIS) signal within 250 μ s after AIS request generation (aAIS), and cease the insertion within 250 μ s after the AIS request has cleared.

Defect Correlations:

The function shall perform the following defect correlations (refer to subclause 8.2.3 of EN 300 417-1-1 [6]):

cUNEQ	←	MON and dUNEQ
cLTC	←	MON and (not dUNEQ) and dLTC
cTIM	←	MON and (not dUNEQ) and (not dLTC) and dTIM
cDEG	←	MON and (not dTIM) and (not dLTC) and dDEG
cSSF	←	MON and CI_SSF and SSF_reported
cRDI	←	MON and (not dUNEQ) and (not dTIM) and (not dLTC) and dRDI and RDI_Reported
cODI	←	MON and (not dUNEQ) and (not dTIM) and (not dLTC) and dODI and ODI_Reported

Performance Monitoring:

The following TC error performance parameters shall be counted for each 1-second period (refer to subclauses 8.2.4 to 8.2.7 of EN 300 417-1-1 [6]):

pN_DS	←	aTSF or dEQ
pF_DS	←	dRDI
pN_EBC	←	ΣnN_B
pF_EBC	←	ΣnF_B
pON_DS	←	aODI or dEQ
pOF_DS	←	dODI
pON_EBC	←	ΣnON_B
pOF_EBC	←	ΣnOF_B

pN_EBC and pN_DS do not represent the actual performance monitoring support within an equipment. For that, these pN_DS/pN_EBC signals shall be connected to performance monitoring functions within the element management function. Similar for the far-end signals pF_EBC and pF_DS and for pON_EBC/pON_DS, pOF_EBC/pOF_DS.

4.6.3 VC-4 Tandem Connection to VC-4 Adaptation Source function (S4D/S4_A_So)

Symbol:

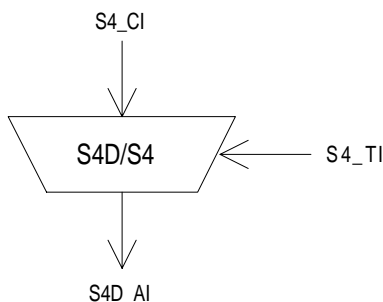

Figure 65: S4D/S4_A_So symbol

Interfaces:

Table 53: S4D/S4_A_So input and output signals

Input(s)	Output(s)
S4_CI_D	S4D_AI_D
S4_CI_CK	S4D_AI_CK
S4_CI_FS	S4D_AI_FS
S4_CI_SSF	S4D_AI_SF
S4_TI_CK	

Processes:

NOTE 1: The function has no means to verify the existence of a tandem connection within the incoming signal. Nested tandem connections are not supported.

The function shall replace the incoming Frame Start (CI_FS) signal by a local generated one (i.e. enter "holdover") if an all-ONEs (AIS) VC is received (i.e. if CI_SSF is TRUE).

NOTE 2: This replacement of the (invalid) incoming frame start signal result in the generation of a valid pointer in the MSn/S4_A_So function; SSF = true signal is not passed through via S4D_TT_So to the MSn/S4_A_So.

NOTE 3: The local frame start is generated with the S4_TI timing.

Defects: None.

Consequent Actions:

AI_SF ← CI_SSF

Defect Correlations: None.

Performance Monitoring: None.

4.6.4 VC-4 Tandem Connection to VC-4 Adaptation Sink function (S4D/S4_A_Sk)

Symbol:

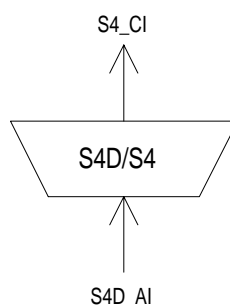

Figure 66: S4D/S4_A_Sk symbol

Interfaces:

Table 54: S4D/S4_A_Sk input and output signals

Input(s)	Output(s)
S4D_AI_D	S4_CI_D
S4D_AI_CK	S4_CI_CK
S4D_AI_FS	S4_CI_FS
S4D_AI_OSF	S4_CI_SSF

Processes:

The function shall restore the invalid frame start condition (i.e. output aSSF = true) if that existed at the ingress of the tandem connection.

NOTE: In addition, the invalid frame start condition is activated on a tandem connection connectivity defect condition that causes all-ONES (AIS) insertion in the S4D_TT_Sk.

Defects: None.

Consequent Actions:

aAIS ← AI_OSF

aSSF ← AI_OSF

The function shall insert the all-ONES (AIS) signal within 250 μs after AIS request generation (aAIS), and cease the insertion within 250 μs after the AIS request has cleared.

Defect Correlations: None.

Performance Monitoring: None.

4.6.5 VC-4 Tandem Connection Non-intrusive Monitoring Trail Termination Sink function (S4Dm_TT_Sk)

Symbol:

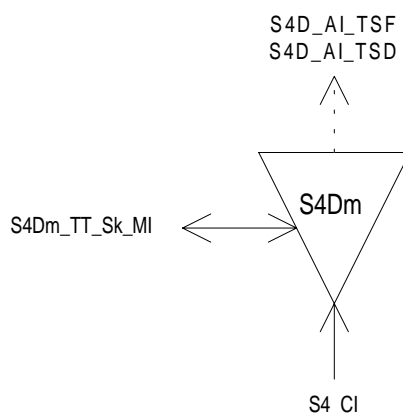

Figure 67: S4Dm_TT_Sk symbol

Interfaces:

Table 55: S4Dm_TT_Sk input and output signals

Input(s)	Output(s)
S4_CI_D	S4D_AI_TSF
S4_CI_CK	S4D_AI_TSD
S4_CI_FS	S4D_TT_Sk_MI_cLTC
S4_CI_SSF	S4D_TT_Sk_MI_cTIM
S4D_TT_Sk_MI_ExTI	S4D_TT_Sk_MI_cUNEQ
S4D_TT_Sk_MI_SSF_Reported	S4D_TT_Sk_MI_cDEG
S4D_TT_Sk_MI_RDI_Reported	S4D_TT_Sk_MI_cRDI
S4D_TT_Sk_MI_ODI_Reported	S4D_TT_Sk_MI_cSSF
S4D_TT_Sk_MI_TIMdis	S4D_TT_Sk_MI_cODI
S4D_TT_Sk_MI_DEGM	S4D_TT_Sk_MI_AcTI
S4D_TT_Sk_MI_DEGTHR	S4D_TT_Sk_MI_pN_EBC
S4D_TT_Sk_MI_1second	S4D_TT_Sk_MI_pF_EBC
S4D_TT_Sk_MI_TPmode	S4D_TT_Sk_MI_pN_DS
	S4D_TT_Sk_MI_pF_DS
	S4D_TT_Sk_MI_pOF_EBC
	S4D_TT_Sk_MI_pOF_DS

Processes:

This function can be used to perform the following:

- 1) single ended maintenance of the TC by monitoring at an intermediate node, using remote information (RDI,REI);
- 2) aid in fault localization within TC trail by monitoring near-end defects;
- 3) monitoring of VC performance at TC egressing point (except for connectivity defects before the TC) using remote outgoing information (ODI,OEI);
- 4) performing non-intrusive monitor function within SNC/S protection.

TC EDC violations: Even bit parity shall be computed for each bit n of every byte of the preceding VC-4 and compared with bit n of B3 recovered from the current frame ($n=1$ to 8 inclusive). A difference between the computed and recovered B3 values shall be taken as evidence of one or more errors in the computation block. The magnitude (absolute value) of the difference between this calculated number of errors and the number of errors written into the IEC (see table 52) at the trail termination source shall be used to determine the error performance of the tandem connection for each transmitted VC-4 (see figure 64). If this magnitude of the difference is one or more, an errored TC block is detected (nN_B). If one or more errors were detected in the computation block, an errored VC block (nON_B) shall be declared. Refer to S4D_TT_Sk.

N1[1-4]: The function shall extract the Incoming Error Code (IEC). It shall accept the received code without further processing.

N1[7-8][9-72]: The Received Trail Trace Identifier RxTI shall be recovered from the tandem connection trail trace identifier overhead and shall be made available as AcTI for network management purposes. The application and acceptance process shall be performed as specified in EN 300 417-1-1 [6], subclauses 7.1 and 8.2.1.3. The mismatch detection process shall be as specified below.

The trace identifier process in this function is required to support "mode 1" (EN 300 417-1-1 [6], subclause 7.1) operation only. "Old" tandem connection equipment does not exist.

N1[5], N1[8][73]: The information carried in the REI, RDI bits in byte N1 shall be extracted to enable single ended maintenance of a bi-directional tandem connection Trail. The REI (nF_B) shall be used to monitor the error performance of the other direction of transmission, and the RDI shall be used to provide information as to the status of the remote receiver. A "1" indicates a Remote Defect Indication state, while a "0" indicates the normal, working state. The application process shall be performed as specified in EN 300 417-1-1 [6], subclause 7.4.2 (REI), subclause 7.4.11 and 8.2 (RDI).

N1[6], N1[7][74]: The information carried in the OEI, ODI bits in byte N1 shall be extracted to enable single ended (intermediate) maintenance of a the VC-4 egressing the tandem connection Trail. The OEI (nOF_B) shall be used to monitor the error performance of the other direction of transmission, and the ODI shall be used to provide information as to the status of the remote receiver. A "1" indicates a Outgoing Defect Indication state, while a "0" indicates the normal, working state. The application process shall be performed equivalent to the remote maintenance case, as specified in EN 300 417-1-1 [6], subclause 7.4.2 (REI/OEI), subclause 7.4.11 and 8.2 (RDI/ODI).

N1[7-8]: *Multiframe alignment:* The function shall perform a multiframe alignment on bits 7 and 8 of byte N1 to recover the TTI, RDI, and ODI signals transported within the multiframe bits. The multiframe alignment shall be found by searching for the pattern "1111 1111 1111 1110" within the bits 7 and 8 of byte N1. The signal shall be continuously checked with the presumed multiframe start position for the alignment.

Frame alignment is deemed to have been lost (entering Out Of Multiframe (OOM) state) when two consecutive FAS are detected in error (i.e. ≥ 1 error in each FAS). Frame alignment is deemed to have been recovered (entering In Multiframe (IM) state) when one non-errored FAS is found.

Defects:

TC Unequipped (dUNEQ):

The function shall detect for an unequipped Tandem Connection (UNEQ) condition by monitoring byte N1 for code "00000000". The unequipped defect (dUNEQ) shall be detected if five consecutive VC- n frames contain the "0000 0000" pattern in byte N1. The dUNEQ defect shall be cleared if in five consecutive VC- n frames any pattern other than the "0000 0000" is detected in byte N1.

TC Loss of Tandem Connection (dLTC):

The function shall detect for the presence/absence of the tandem connection overhead in the byte N1 by evaluating the multiframe alignment signal in bits 7 and 8 of byte N1. The loss of tandem connection defect (dLTC) shall be detected if the multiframe alignment process is in the OOM state. The dLTC shall be cleared if the multiframe alignment process is in the IM state.

TC Connectivity (Trace Identifier) (dTIM):

The function shall detect for a TC misconnection condition by monitoring the TC trace identifier. The Trace Identifier Mismatch defect (dTIM) shall be detected and cleared within a maximum period of 1 s in the absence of bit errors.

The defect detection process and its operation during the presence of bit errors is for further study.

The defect shall be suppressed during the receipt of SSF.

It shall be possible to disable the trace identifier mismatch defect detection (TIMdis).

TC Signal Degrade (dDEG):

The function shall detect for a TC signal degrade defect condition by monitoring for TC BIP-8 violations. The algorithm shall be according subclause 8.2.1.4 of EN 300 417-1-1 [6].

TC Remote Defect (dRDI):

The function shall detect for a TC remote defect indication defect condition by monitoring the TC RDI signal. The algorithm shall be according subclause 8.2.1.5 of EN 300 417-1-1 [6].

TC Remote Outgoing VC Defect (dODI):

The function shall detect for a TC remote outgoing VC defect indication defect condition by monitoring the TC ODI signal. The algorithm shall be according subclause 8.2.1.5 of EN 300 417-1-1 [6].

Consequent Actions:

aTSF ← CI_SSF or dUNEQ or dTIM or dLTC
 aTSD ← dDEG

Defect Correlations:

The function shall perform the following defect correlations (refer to subclause 8.2.3 of EN 300 417-1-1 [6]):

cUNEQ ← MON and dUNEQ
 cLTC ← MON and (not dUNEQ) and dLTC
 cTIM ← MON and (not dUNEQ) and (not dLTC) and dTIM
 cDEG ← MON and (not dTIM) and (not dLTC) and dDEG
 cSSF ← MON and CI_SSF and SSF_reported
 cRDI ← MON and (not dUNEQ) and (not dTIM) and (not dLTC) and dRDI and RDI_reported
 cODI ← MON and (not dUNEQ) and (not dTIM) and (not dLTC) and dODI and ODI_Reported

Performance Monitoring:

The following TC error performance parameters shall be counted for each 1 second period (refer to subclauses 8.2.4 to 8.2.7 of EN 300 417-1-1 [6]):

pN_DS ← aTSF or dEQ
 pF_DS ← dRDI
 pN_EBC ← ΣnN_B
 pF_EBC ← ΣnF_B
 pOF_DS ← dODI
 pOF_EBC ← ΣnOF_B

5 VC-3 Path Layer Functions

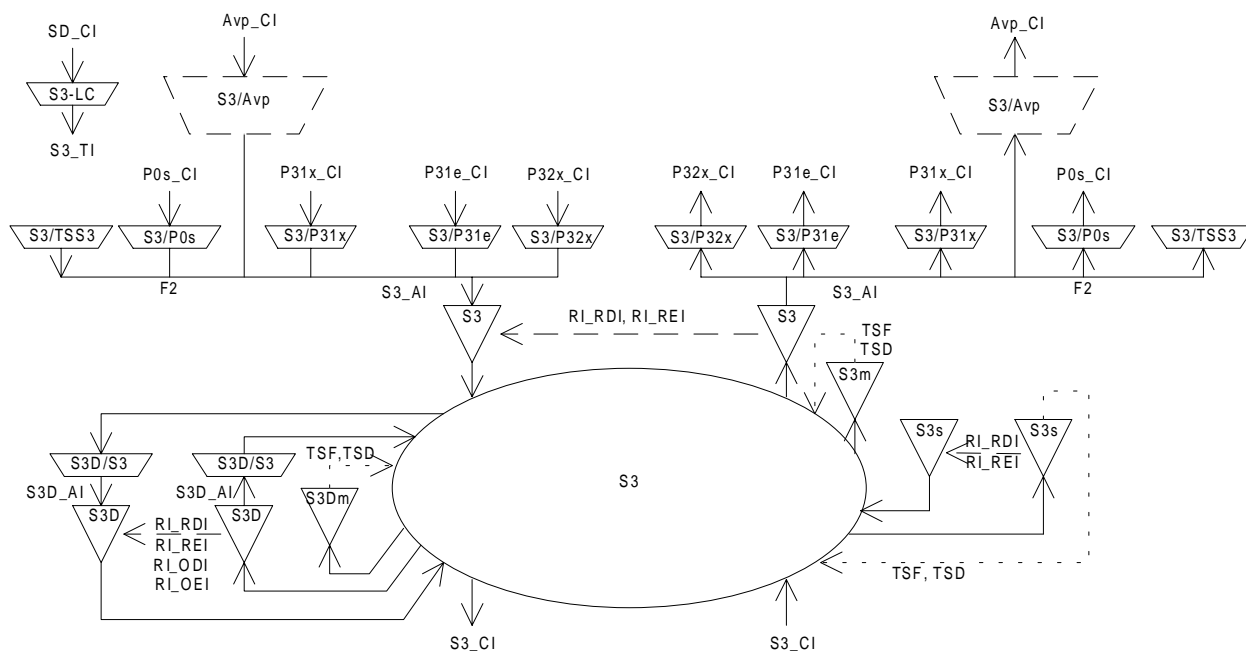

Figure 68: VC-3 path layer atomic functions

VC-3 Layer CP

The CI at this point is octet structured with an 125 μ s frame (see figure 69). Its format is characterized as S3_AI plus the VC-3 trail termination overhead in the J1, B3, and G1 locations as defined in ETS 300 147 [1] or as an unequipped signal as defined in EN 300 417-1-1 [6], subclause 7.2. For the case the signal has passed the tandem connection sublayer, S3_CI has defined VC-3 tandem connection trail termination overhead in location N1.

NOTE 1: N1 will be undefined when the signal S3_CI has not been processed in a tandem connection adaptation and trail termination function. N1 is all-"0"s in a (supervisory-) unequipped VC-3 signal.

VC-3 Layer AP

The AI at this point is octet structured with an 125 μ s frame (see figure 69). It represents adapted client layer information comprising 756 bytes of client layer information, the signal label byte C2, and two bytes F3 and H4 of client specific information combined with an 1 byte user channel F2. For the case the signal has passed the trail protection sublayer, S3_AI has defined APS bits (1 to 4) in byte K3.

NOTE 2: Bits 1 to 4 of byte K3 will be undefined when the signal S3_AI has not been processed in a trail protection connection function S3P_C.

NOTE 3: Bits 5 to 8 of byte K3 are reserved for future international standardization. Currently, their values are undefined.

NOTE 4: Bytes F2 and F3 will be undefined when the adaptation functions sourcing these bytes are not present in the network element.

NOTE 5: Byte H4 will be undefined.

A VC-3 comprises one of the following payloads:

- a 34 368 kbit/s signal asynchronous mapped into a Container-3;
- an ATM 48 384 kbit/s cell stream signal;
- a 44 736 kbit/s signal asynchronous mapped into a Container-3;
- a Test Signal Structure (TSS3).

Figure 68 shows that more than one adaptation function exists in the S3 layer that can be connected to one S3 access point. For such case, a subset of these adaptation source functions is allowed to be activated together, but only one adaptation source function may have access to a specific timeslot. Access to the same timeslot by other adaptation source functions shall be denied. In contradiction with the source direction, adaptation sink functions may be activated all together. This may cause faults (e.g. cLOP) to be detected and reported. To prevent this an adaptation sink function can be deactivated.

NOTE 6: If one adaptation function only is connected to the AP, it will be activated. If one or more other functions are connected to the same AP accessing the same timeslot, one out of the set of functions will be active.

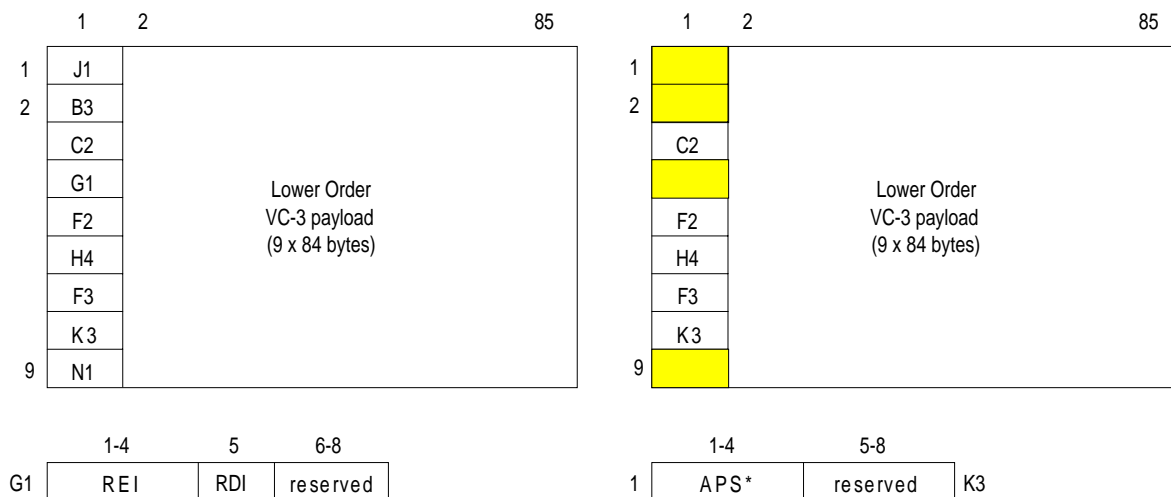

Figure 69: S3_CI_D (left) and S3_AI_D (right)

NOTE 7: The APS signal has not been defined; a multiframed APS signal might be required.

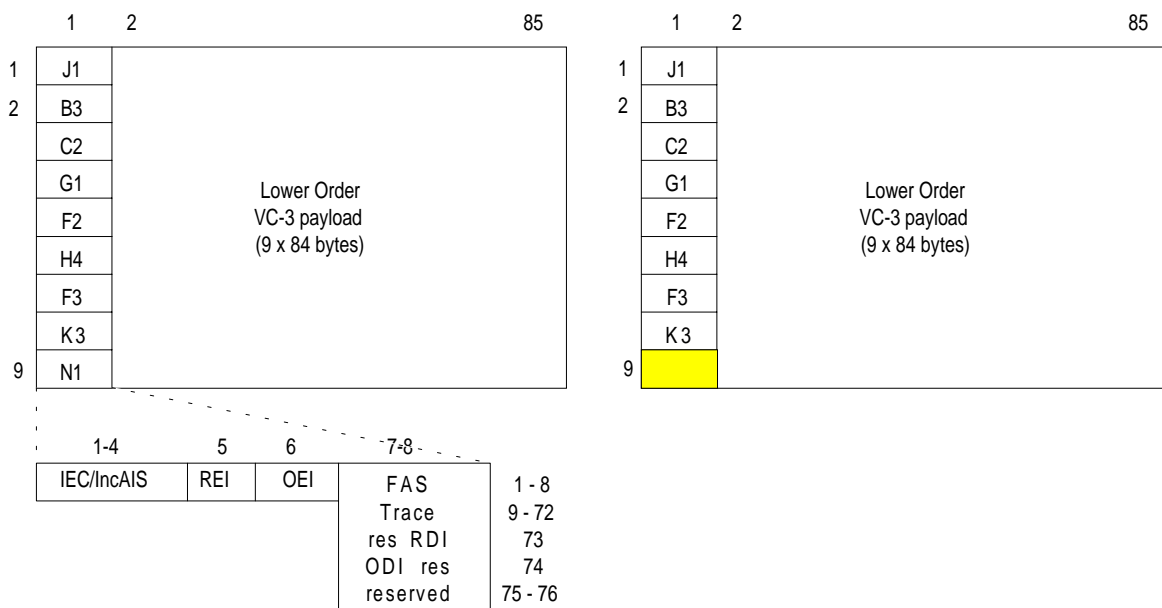

Figure 70: S3_CI_D (left) with defined N1 and S3D_AI_D (right)

Figure 71 shows the trail protection sublayer atomic functions added to (a subset of) the layer atomic functions presented in figure 68. It should be noted that the S3/P0s_A function can be absent, or connected before or after the protection functions S3P_C. When connected before S3P_C the transport of the user channel signal is not protected, otherwise it is protected.

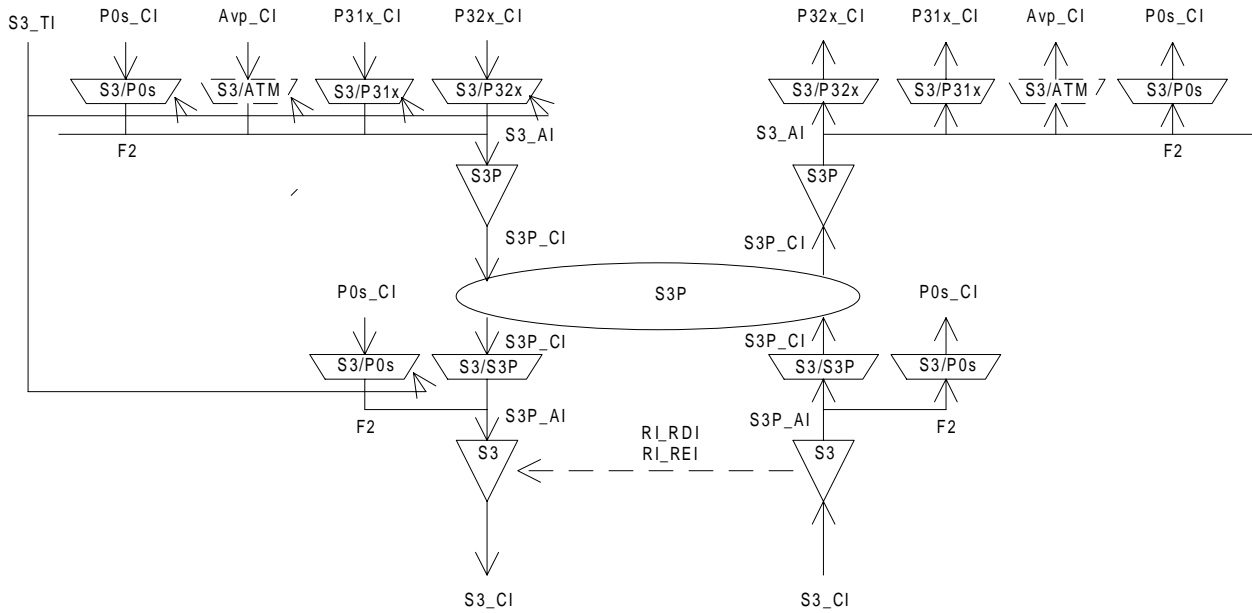

Figure 71: VC-3 Layer Trail Protection atomic functions

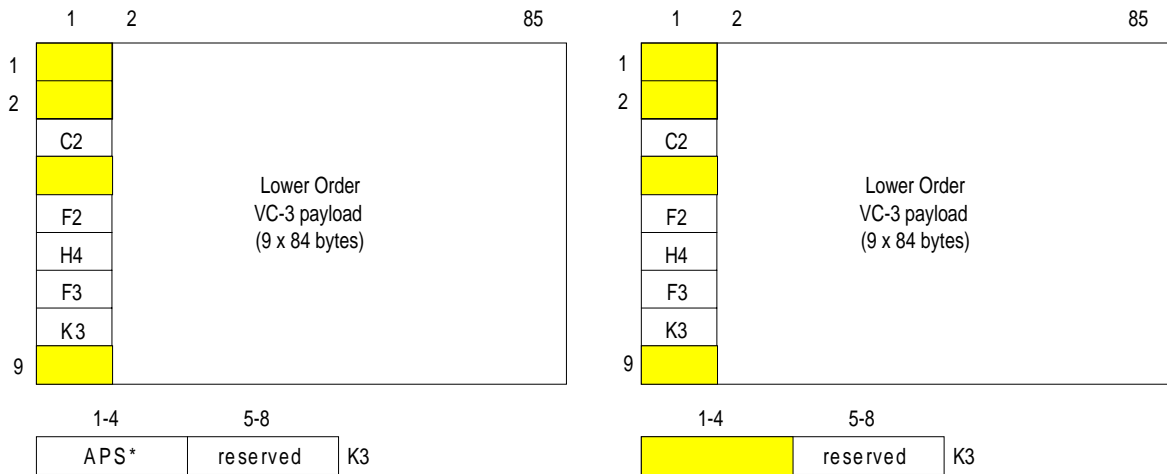

Figure 72: S3P_AI_D (left) and S3P_CI_D (right) signals

5.1 VC-3 Layer Connection Function S3_C

Symbol:

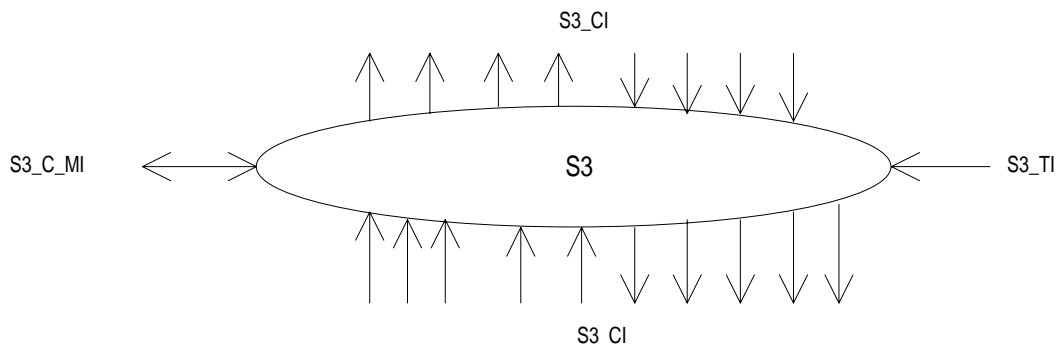

Figure 73: S3_C symbol

Interfaces:

Table 56: S3_C input and output signals

Input(s)	Output(s)
per S3_CI, n x for the function: S3_CI_D S3_CI_CK S3_CI_FS S3_CI_SSF S3_AI_TSF S3_AI_TSD 1 x per function: S3_TI_CK S3_TI_FS per input and output connection point: S3_C_MI_ConnectionPortIds per matrix connection: S3_C_MI_ConnectionType S3_C_MI_Directionality per SNC protection group: S3_C_MI_PROTtype S3_C_MI_OPERtype S3_C_MI_WTRtime S3_C_MI_HOtime S3_C_MI_EXTCMD	per S3_CI, m x per function: S3_CI_D S3_CI_CK S3_CI_FS S3_CI_SSF NOTE: Protection status reporting signals are for further study.

Processes:

In the S3_C function VC-3 Layer Characteristic Information is routed between input (termination) connection points ((T)CPs) and output (T)CPs by means of matrix connections. (T)CPs may be allocated within a protection group.

NOTE 1: Neither the number of input/output signals to the connection function, nor the connectivity is specified in the present document. That is a property of individual network elements.

Figure 68 present a subset of the atomic functions that can be connected to this VC-3 connection function: VC-3 trail termination functions, VC-3 non-intrusive monitor trail termination sink function, VC-3 unequipped-supervisory trail termination functions, VC-3 tandem connection trail termination and adaptation functions. In addition, adaptation functions in the VC-3 server (e.g. S4, P4s) layers will be connected to this VC-3 connection function.

Routing:

The function shall be able to connect a specific input with a specific output by means of establishing a matrix connection between the specified input and output. It shall be able to remove an established matrix connection.

Each (matrix) connection in the S3_C function shall be characterized by the:

Type of connection	unprotected, 1+1 protected (SNC/I, SNC/N, or SNC/S protection)
Traffic direction	unidirectional, bi-directional
Input and output connection points	set of connection point identifiers (refer to EN 300 417-1-1 [6], subclause 3.3.6)

NOTE 2: Broadcast connections are handled as separate connections to the same input CP.

Provided no protection switching action is activated/required the following changes to (the configuration of) a connection shall be possible without disturbing the CI passing the connection:

- addition and removal of protection;
- addition and removal of connections to/from a broadcast connection;
- change between operation types;
- change of WTR time;
- change of Hold-off time.

Unequipped VC generation:

The function shall generate an unequipped VC signal, as specified in EN 300 417-1-1 [6], subclause 7.2.

Defects: None.

Consequent Actions:

If an output of this function is not connected to one of its inputs, the function shall connect the unequipped VC-3 (with valid frame start (FS) and SSF = false) to the output.

Defect Correlations: None.

Performance Monitoring: None.

5.1.1 SNC Protection

SNC protection: The function may provide the option to establish protection groups between a number of (T)CPs (EN 300 417-1-1 [6], subclause 9.4.1 and subclause 9.4.2) to perform the VC-3 linear (sub)network connection protection process for 1+1 protection architectures (refer to EN 300 417-1-1 [6], subclause 9.2). The SNC protection process shall perform the bridge and selector functionality as presented in figure 49 of EN 300 417-1-1 [6]. In the sink direction, the signal output at the normal reference point can be the signal received via either the working connection or the protection connection; this is determined by the SF,SD conditions (relayed via CI_SSF or AI_TSF/AI_TSD signals), and the external commands. In the source direction, the working output is connected to the associated normal input. The protection output is also connected to the normal input.

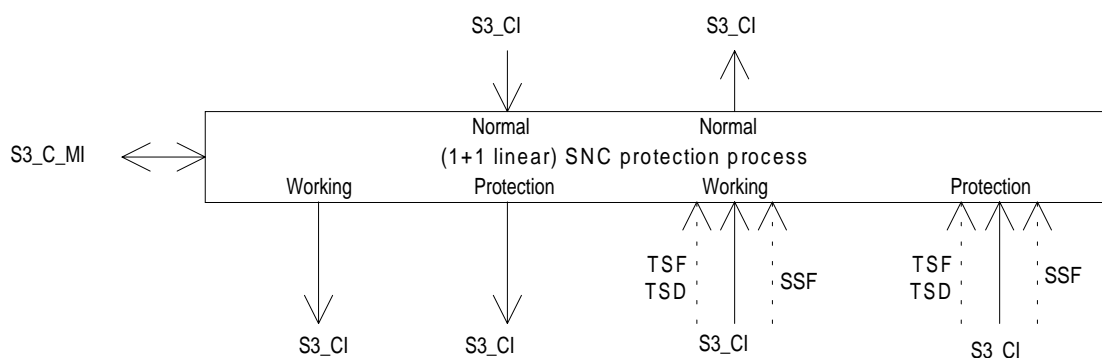

Figure 74: VC-3 1+1 SNC protection process (SNC/I, SNC/N, SNC/S)

SNC Protection Operation: The SNC protection process shall operate as specified in EN 300 417-3-1 [7] annex A, according the following characteristics:

Table 57: SNC protection parameters

Parameter	Value options
architecture type (ARCHtype)	1 + 1
switching type (SWtype)	uni-directional
operation type (OPERType)	revertive, non-revertive
APS signal (APSmode)	false
Wait-To-Restore time (WTRtime)	in the order of 5-12 minutes
Switch time	≤ 50 ms
Hold-off time (HOtime)	0 to 10 seconds in steps of the order of 100 ms
Protection type (PROTtype)	SNC/I, SNC/N, SNC/S
Signal switch conditions:	SF = SSF (SNC/I), SF = TSF (SNC/N, SNC/S), SD = TSD (SNC/N, SNC/S)
External commands (EXTMND)	(revertive operation) LO, FSw-#1, MSw-#1, CLR (non-revertive operation) LO or FSw, FSw-#i, MSw-#i, CLR (i = 0, 1)
Extra traffic (EXTRAtraffic)	false
SFpriority, SDpriority	high

In the sink case of a protection connection the source of the connection is determined by the SF (and SD) signals associated with each of the two inputs to the connection and the possible external switch requests. The set of SF and SD signals used, is controlled by the protection type setting.

5.2 VC-3 Layer Trail Termination Functions

5.2.1 VC-3 Layer Trail Termination Source S3_TT_So

Symbol:

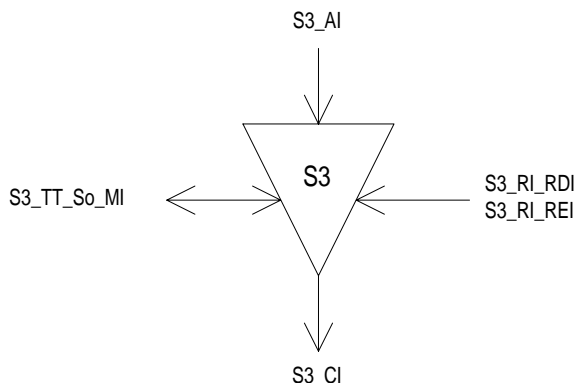

Figure 75: S3_TT_So symbol

Interfaces:

Table 58: S3_TT_So input and output signals

Input(s)	Output(s)
S3_AI_D	S3_CI_D
S3_AI_CK	S3_CI_CK
S3_AI_FS	S3_CI_FS
S3_RI_RDI	
S3_RI_REI	
S3_TT_So_MI_TxTI	

Processes:

This function adds error monitoring and status overhead bytes to the S3_AI (containing payload (or client layer) independent overhead of 3 bytes per frame) presented at its input to form the VC4 layer Characteristic Information. The processing of the trail termination overhead bytes is defined as follows:

J1:

In this byte the function shall insert the Transmitted Trail Trace Identifier TxTI. Its format is described in EN 300 417-1-1 [6], subclause 7.1.

B3:

In this byte the function shall insert the BIP-8 EDC with even bit parity. Each bit *n* of current B3 is computed to provide even parity over the *n*th bit of every byte in the previous frame of the Characteristic Information S3_CI, i.e. B3 is calculated over the entire previous VC-3. Further reference is provided in EN 300 417-1-1 [6], subclause 7.3.

G1:

This byte is set to represent the status of the associated S3_TT_Sk. Its format is defined in figure 69.

G1[1-4]:

The signal value applied at RI_REI shall be inserted in the VC-3 REI, bits 1 to 4 of byte G1. The coding shall be as follows:

Table 59: G1[1-4] coding

Number of BIP-8 violations conveyed via RI_REI	G1[1]	G1[2]	G1[3]	G1[4]
0	0	0	0	0
1	0	0	0	1
2	0	0	1	0
3	0	0	1	1
4	0	1	0	0
5	0	1	0	1
6	0	1	1	0
7	0	1	1	1
8	1	0	0	0

G1[5]:

Bit 5 of byte G1, a RDI indication, shall be set to "1" on activation of S3_RI_RDI within 250 μ s, determined by the associated S3_TT_Sk function, and set to "0" within 250 μ s on clearing of S3_RI_RDI.

G1[6-8]:

The value of the bits 6 to 8 of byte G1 is undefined.

Defects: None.

Consequent Actions: None.

Defect Correlations: None.

Performance Monitoring: None.

5.2.2 VC-3 Layer Trail Termination Sink S3_TT_Sk

Symbol:

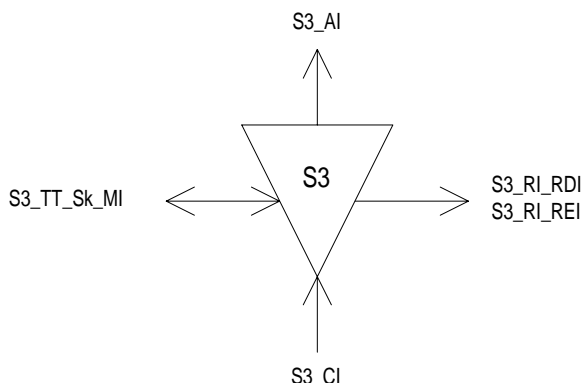

Figure 76: S3_TT_Sk symbol

Interfaces:

Table 60: S3_TT_Sk input and output signals

Input(s)	Output(s)
S3_CI_D	S3_AI_D
S3_CI_CK	S3_AI_CK
S3_CI_FS	S3_AI_FS
S3_CI_SSF	S3_AI_TSF
	S3_AI_TSD
S3_TT_Sk_MI_TPmode	S3_TT_Sk_MI_cTIM
S3_TT_Sk_MI_SSF_Reported	S3_TT_Sk_MI_cUNEQ
S3_TT_Sk_MI_ExtI	S3_TT_Sk_MI_cDEG
S3_TT_Sk_MI_RDI_Reported	S3_TT_Sk_MI_cRDI
S3_TT_Sk_MI_DEGTHR	S3_TT_Sk_MI_cSSF
S3_TT_Sk_MI_DEGM	S3_TT_Sk_MI_AcTI
S3_TT_Sk_MI_1second	S3_RI_RDI
S3_TT_Sk_MI_TIMdis	S3_RI_REI
S3_TT_Sk_MI_ExtImode	S3_TT_Sk_MI_pN_EBC
	S3_TT_Sk_MI_pF_EBC
	S3_TT_Sk_MI_pN_DS
	S3_TT_Sk_MI_pF_DS

Processes:

This function monitors VC-3 for errors, and recovers the trail termination status. It extracts the payload independent overhead bytes (J1, B3, C2, G1) from the VC-3 layer Characteristic Information:

J1:

The Received Trail Trace Identifier RxTI shall be recovered from the J1 byte and shall be made available as AcTI for network management purposes. The application and acceptance and mismatch detection process shall be performed as specified in EN 300 417-1-1 [6], subclauses 7.1 and 8.2.1.3.

B3:

Even bit parity is computed for each bit n of every byte of the preceding VC-3 and compared with bit n of B3 recovered from the current frame (n=1 to 8 inclusive). A difference between the computed and recovered B3 values is taken as evidence of an errored block (nN_B).

G1[1-4], G1[5]:

The information carried in the G1 byte (REI, RDI) shall be extracted to enable single ended maintenance of a bi-directional Trail (Path). The REI (nF_B) shall be used to monitor the error performance of the other direction of transmission, and the RDI (bit 5) shall be used to provide information as to the status of the remote receiver. A "1" indicates a Remote Defect Indication state, while a "0" indicates the normal, working state. The application process shall be performed as specified in EN 300 417-1-1 [6], subclauses 7.4.2 (REI), 7.4.11 and 8.2 (RDI).

G1[6-8]:

The value in the bits 6 to 8 of byte G1 shall be ignored.

Table 61: G1[1-4] code interpretation

G1[1]	G1[2]	G1[3]	G1[4]	REI code interpretation [# errored blocks]
0	0	0	0	0
0	0	0	1	1
0	0	1	0	1
0	0	1	1	1
0	1	0	0	1
0	1	0	1	1
0	1	1	0	1
0	1	1	1	1
1	0	0	0	1
1	0	0	1	0
1	0	1	0	0
1	0	1	1	0
1	1	0	0	0
1	1	0	1	0
1	1	1	0	0
1	1	1	1	0

C2:

The information in the C2 byte shall be extracted to allow unequipped VC defect detection.

Defects:

The function shall detect for dDEG, dRDI, dUNEQ and dTIM defects according the specification in EN 300 417-1-1 [6], subclause 8.2.1.

Consequent Actions:

aAIS ← dUNEQ or dTIM

aTSF ← CI_SSF or dUNEQ or dTIM

aRDI ← CI_SSF or dUNEQ or dTIM

aTSD ← dDEG

aREI ← "#EDCV"

On declaration of aAIS the function shall output all-ONES signal within 250 µs; on clearing of aAIS the function shall output normal data within 250 µs.

Defect Correlations:

cUNEQ ← dUNEQ and MON

cTIM ← dTIM and (not dUNEQ) and MON

cDEG ← dDEG and (not dTIM) and MON

cRDI ← dRDI and (not dUNEQ) and (not dTIM) and MON and RDI_Reported

cSSF ← CI_SSF and MON and SSF_Reported

Performance Monitoring:

The performance monitoring process shall be performed as specified in EN 300 417-1-1 [6], subclause 8.2.4 through 8.2.7.

pN_DS ← aTSF or dEQ

pF_DS ← dRDI

pN_EBC ← Σ nN_B

pF_EBC ← Σ nF_B

5.3 VC-3 Layer Adaptation Functions

5.3.1 VC-3 Layer to P31x Layer Adaptation Source S3/P31x_A_So

Symbol:

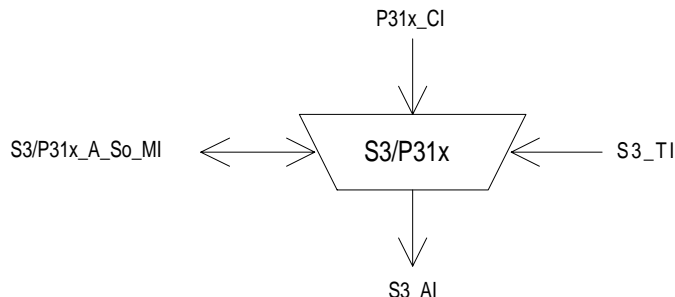

Figure 77: S3/P31x_A_So symbol

Interfaces:

Table 62: S3/P31x_A_So input and output signals

Input(s)	Output(s)
P31x_CI_D P31x_CI_CK S3_TI_CK S3_TI_FS S3/P31x_A_So_MI_Active	S3_AI_D S3_AI_CK S3_AI_FS

Processes:

This function maps a 34 368 kbit/s information stream into a VC-3 payload using bit stuffing and adds bytes C2 and H4. It takes P31x_CI, a bit-stream with a rate of 34 368 kbit/s ± 20 ppm, present at its input and inserts it into the synchronous container-3 having a capacity of 756 bytes and the justification frame as defined in ETS 300 147 [1] and depicted in figures 79 and 80.

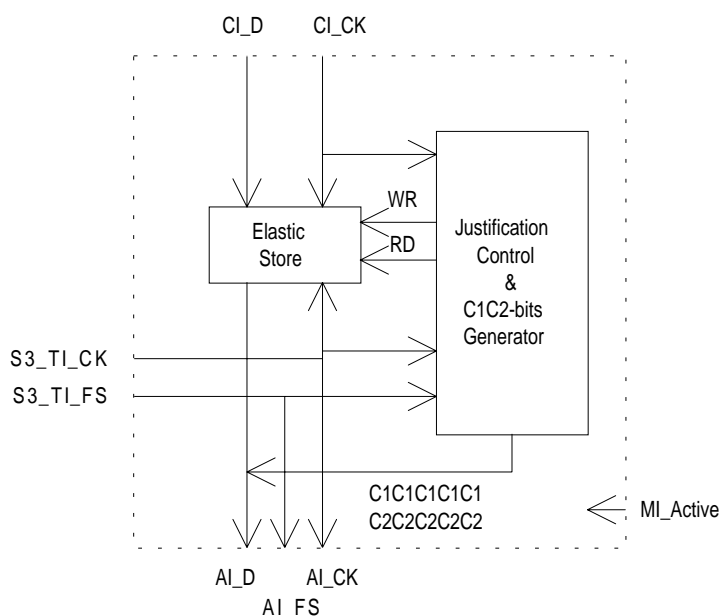

Figure 78: main processes within S3/P31x_A_So

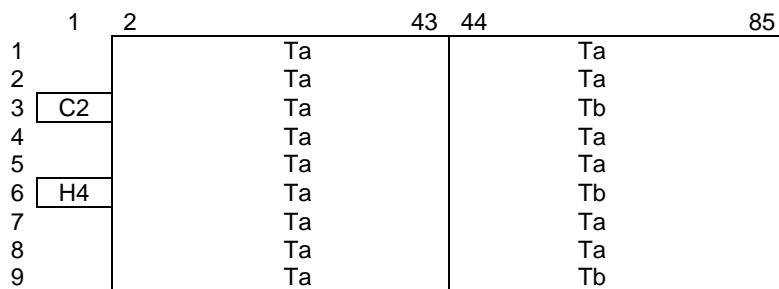
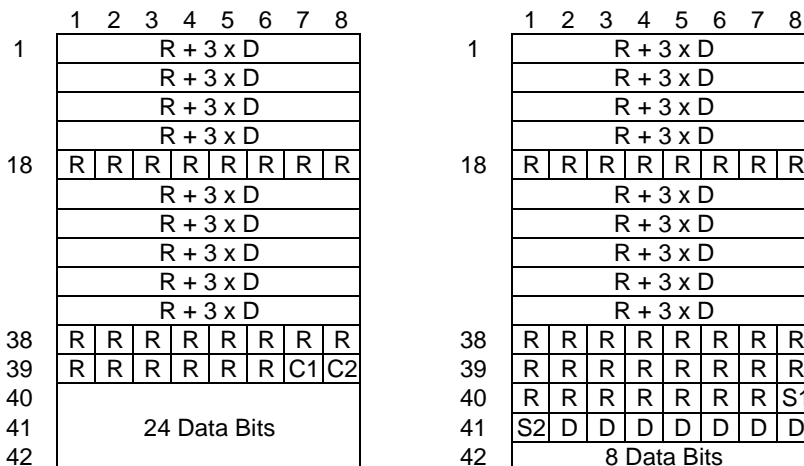

Figure 79: S3/P31x_AI_D



Legend: D = Data Bit, R = Fixed Stuff Bit, S1,S2 = Justification Opportunity Bit, C1,C2 = Justification Control Bit



Figure 80: Ta (left) and Tb (right) of S3/P31x_AI_D

Frequency justification and bitrate adaptation:

The function shall provide an elastic store (buffer) process (see figure 78). The data signal shall be written into the buffer under control of the associated input clock. The data shall be read out of the buffer and written onto the D, S1, S2 bits under control of the VC-3 clock, frame position (S3_TI), and justification decisions.

The justification decisions determine the phase error introduced by the S3/P31x_A_So function. The amount of this phase error can be measured at the physical interfaces by monitoring the justification control bits C1C2 (see figure 80). An example is given in clause A.3.

Each justification decision results in a corresponding positive or negative justification action. Upon a positive justification action, the reading of 1 data bit shall be cancelled once and no data are written at the justification opportunity bit S2 and no data are written onto S1. Upon a negative justification action, 1 extra data bit shall be read once and written onto the justification opportunity bit S1 and data shall be written onto S2. If neither a positive nor a negative justification action is to be performed, either no data shall be written onto S1 and data shall be written onto S2, or vice versa.

NOTE 1: A requirement for maximum introduced phase error cannot be defined until a reference path is defined from which the requirements for network elements can be deduced.

Buffer size:

In the presence of jitter as specified by ITU-T Recommendation G.823 [9] and a frequency within the range 34 368 kbit/s \pm 20 ppm, this justification process shall not introduce any errors. Any step in frequency within this range shall not cause any errors.

C1C2 bits:*Justification control generation:*

The function shall generate the justification control (C1C2) bits according the specification in ETS 300 147 [1]. It shall insert the justification control bits in the appropriate C1C2 bit positions.

Two bytes of payload specific POH information, bytes C2 and H4, shall be added to container-3 to form the VC-3 AI and a fixed Frame Start (FS) shall be generated.

H4: The value of H4 byte is undefined.

C2: In this byte the function shall insert code "0000 0100" (Asynchronous mapping of 34 368 kbit/s into the Container-3) as defined in ETS 300 147 [1].

NOTE 2: The mapping of 44 736 kbit/s into VC-3 as well as the mapping of 34 368 kbit/s into VC-3 have the same signal label.

R bits: The value of an R bit is undefined.

Activation:

The function shall access the access point when it is activated (MI_Active is true). Otherwise, it shall not access the access point.

Defects: None.

An elastic store under/overflow defect (dUOF) is for further study.

Consequent Actions: None.

Defect Correlations: None.

Performance Monitoring: None.

5.3.2 VC-3 Layer to P31x Layer Adaptation Sink S3/P31x_A_Sk

Symbol:

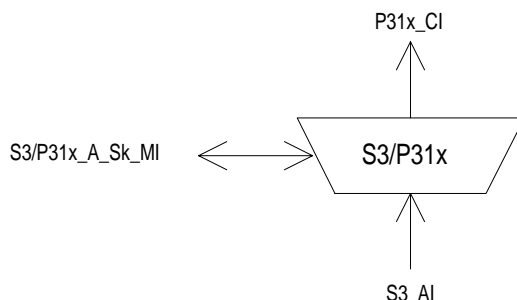

Figure 81: S3/P31x_A_Sk symbol

Interfaces:

Table 63: S3/P31x_A_Sk input and output signals

Input(s)	Output(s)
S3_AI_D	P31x_CI_D
S3_AI_CK	P31x_CI_CK
S3_AI_FS	P31x_CI_SSF
S3_AI_TSF	S3/P31x_A_Sk_MI_cPLM
S3/P31x_A_Sk_MI_Active	S3/P31x_A_Sk_MI_AcSL

Processes:

The function recovers plesiochronous P31x Characteristic Information (34 368 kbit/s \pm 20 ppm) from the synchronous container C-3 (having a frequency accuracy within \pm 4,6 ppm) according to ETS 300 147 [1], and monitors the reception of the correct payload signal type.

C2:

The function shall compare the content of the accepted C2 byte with the expected value code "0000 0100" (Asynchronous mapping of 34 368 kbit/s into the Container-3) as a check on consistency between the provisioning operation at each end. The application and acceptance and mismatch detection process shall be as specified in EN 300 417-1-1 [6], subclauses 7.2 and 8.1.2.

NOTE 1: The mapping of 44 736 kbit/s into VC-3 as well as the mapping of 34 368 kbit/s into VC-3 have the same signal label. Consequently, it is not possible to check consistent adaptation function provisioning at each end between these two mappings.

H4: The value in the H4 byte shall be ignored.

R bits: The value in the R bits shall be ignored.

C1C2 bits: Justification control interpretation:

The function shall perform justification control interpretation specified by ETS 300 147 [1] to recover the 34 368 kbit/s signal from the VC-3. If the majority of the C1 bits is "0" the S1 bit shall be taken as a data bit, otherwise (majority of C1 bits is "1") S1 bit shall be taken as a justification bit and consequently ignored. If the majority of the C2 bits is "0" S2 bit shall be taken as a data bit, otherwise (majority of C2 bits is "1") S2 bit shall be taken as a justification bit and consequently ignored.

NOTE 2: A negative justification is effectuated if the majority of C1 bits and the majority of C2 bits is "0". A positive justification is effectuated if the majority of the C1 bits and the majority of C2 bits is "1". The other combinations (C1 majority is "0" and C2 majority is "1", or C1 majority is "1" and C2 majority is "0") do not result in an actual justification.

Smoothing & jitter limiting process:

The function shall provide for a clock smoothing and elastic store (buffer) process. The 34 368 kbit/s data signal shall be written into the buffer under control of the associated (gapped) input clock (with a frequency accuracy within $\pm 4,6$ ppm). The data signal shall be read out of the buffer under control of a smoothed (equally spaced) 34 368 kHz ± 20 ppm clock (the rate is determined by the 34 Mbit/s signal at the input of the remote S3/P31x_A_So). The residual jitter caused by pointer adjustments and bit justifications (measured at the 34 368 kbit/s interface) shall be within the limits specified in subclause 11.3.1.2 of EN 300 417-1-1 [6].

Buffer size:

In the presence of jitter as specified by subclause 11.3.1.2 of EN 300 417-1-1 [6] and a frequency within the range 34 368 kbit/s ± 20 ppm, this justification process shall not introduce any errors.

Following a step in frequency of the P31x signal transported by the S3_AI (for example due to reception of P31x CI from a new P31x_TT_So at the far end or removal of all-ONEs (AIS) signal with a frequency offset) there will be a maximum recovery time of X seconds after which this process shall not generate any bit errors.

The value of X is for further study; a value of 1 second has been proposed.

Activation:

The function shall perform the operation specified above when it is activated (MI_Active is true). Otherwise, it shall transmit the all-ONEs signal at its output (CI_D) and not report its status via the management point.

Defects:

The function shall detect for dPLM defect according the specification in EN 300 417-1-1 [6], subclause 8.2.1.

Consequent Actions:

aSSF \leftarrow AI_TSF or dPLM

aAIS \leftarrow AI_TSF or dPLM

On declaration of the aAIS the function shall output an all-ONEs (AIS) signal in the P31x_CI_D within 250 μ s; on clearing of aAIS the function shall output normal data within 250 μ s. The P31x_CI_CK during the all-ONEs signal shall be within 34 368 kHz ± 20 ppm.

Defect Correlations:

cPLM \leftarrow dPLM and (not AI_TSF)

Performance Monitoring: None.

5.3.3 VC-3 Layer to P31e Layer Adaptation Source S3/P31e_A_So

Symbol:

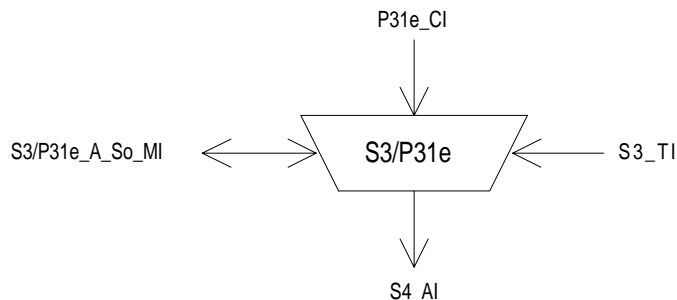

Figure 82: S3/P31e_A_So symbol

Interfaces:

Table 64: S3/P31e_A_So input and output signals

Input(s)	Output(s)
P31e_CI_D	S3_AI_D
P31e_CI_CK	S3_AI_CK
S3_TI_CK	S3_AI_FS
S3_TI_FS	
S3/P31e_A_So_MI_Active	

Processes:

This function maps a 34 368 kbit/s information stream into a VC-3 payload using bit stuffing and adds bytes C2 and H4. It takes P31e_CI, a bit-stream with a rate of 34 368 kbit/s \pm 20 ppm, present at its input and inserts it into the synchronous container-3 having a capacity of 756 bytes and the justification frame as defined in ETS 300 147 [1] and depicted in figures 79 and 80.

Frequency justification and bitrate adaptation:

The function shall provide an elastic store (buffer) process (see figure 78). The data signal shall be written into the buffer under control of the associated input clock. The data shall be read out of the buffer under control of the VC-3 clock, frame position (S3_TI), and justification decisions.

The justification decisions determine the phase error introduced by the S3/P31e_A_So function. The amount of this phase error can be measured at the physical interfaces by monitoring the justification control bits C1C2 (see figure 80). An example is given in clause A.3.

Each justification decision results in a corresponding positive or negative justification action. Upon a positive justification action, the reading of 1 data bit shall be cancelled once and no data are written at the justification opportunity bit S2 and no data are written onto S1. Upon a negative justification action, 1 extra data bit shall be read once and written onto the justification opportunity bit S1 and data shall be written onto S2. If neither a positive nor a negative justification action is to be performed, either no data shall be written onto S1 and data shall be written onto S2, or vice versa.

NOTE: A requirement for maximum introduced phase error cannot be defined until a reference path is defined from which the requirements for network elements can be deduced.

Buffer size:

In the presence of jitter as specified by ITU-T Recommendation G.823 [9] and a frequency within the range 34 368 kbit/s \pm 20 ppm, this justification process shall not introduce any errors. Any step in frequency within this range shall not cause any errors.

C1C2 bits:*Justification control generation:*

The function shall generate the justification control (C1C2) bits according the specification in ETS 300 147 [1]. It shall insert the justification control bits in the appropriate C1C2 bit positions.

Two bytes of payload specific POH information, bytes C2 and H4, shall be added to container-4 to form the VC-3 AI and a fixed Frame Start (FS) shall be generated.

H4: The value of H4 byte is undefined.

C2: In this byte the function shall insert code "0001 0010" (Asynchronous mapping of 34 368 kbit/s into the Container-3) as defined in ETS 300 147 [1].

R bits: The value of an R bit is undefined.

Activation:

The function shall access the access point when it is activated (MI_Active is true). Otherwise, it shall not access the access point.

Defects: None.

An elastic store under/overflow defect (dUOF) is for further study.

Consequent Actions: None.

Defect Correlations: None.

Performance Monitoring: None.

5.3.4 VC-3 Layer to P31e Layer Adaptation Sink S3/P31e_A_Sk

Symbol:

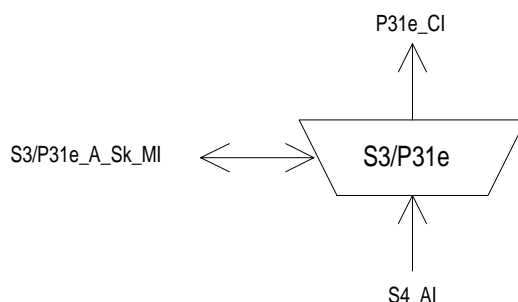

Figure 83: S3/P31e_A_Sk symbol

Interfaces:

Table 65: S3/P31e_A_Sk input and output signals

Input(s)	Output(s)
S3_AI_D	P31e_CI_D
S3_AI_CK	P31e_CI_CK
S3_AI_FS	P31e_CI_FS
S3_AI_TSF	P31e_CI_SSF
S3/P31e_A_Sk_MI_Active	S3/P31e_A_Sk_MI_cPLM
S3/P31e_A_Sk_MI_AIS_Reported	S3/P31e_A_Sk_MI_AcSL
	S3/P31e_A_Sk_MI_cLOF
	S3/P31e_A_Sk_MI_cAIS

Processes:

The function recovers plesiochronous P31e Characteristic Information (34 368 kbit/s \pm 20 ppm) from the synchronous container C-3 according to ETS 300 147 [1], and monitors the reception of the correct payload signal type, and recovers P31e frame start reference (FS) from the received signal.

C2:

The function shall compare the content of the accepted C2 byte with the expected value code "0000 0100" (Asynchronous mapping of 34 368 kbit/s into the Container-3) as a check on consistency between the provisioning operation at each end. The application and acceptance and mismatch detection process shall be as specified in EN 300 417-1-1 [6], subclauses 7.2 and 8.1.2.

H4: The value in the H4 byte shall be ignored.

R bits: The value in the R bits shall be ignored.

C1C2 bits: Justification control interpretation:

The function shall perform justification control interpretation according ETS 300 147 [1] to recover the 34 368 kbit/s signal from the VC-3. If the majority of the C1 bits is "0" the S1 bit shall be taken as a data bit, otherwise (majority of C1 bits is "1") S1 bit shall be taken as a justification bit and consequently ignored. If the majority of the C2 bits is "0" S2 bit shall be taken as a data bit, otherwise (majority of C2 bits is "1") S2 bit shall be taken as a justification bit and consequently ignored.

NOTE: A negative justification is effectuated if the majority of C1 bits and the majority of C2 bits is "0". A positive justification is effectuated if the majority of the C1 bits and the majority of C2 bits is "1". The other combinations (C1 majority is "0" and C2 majority is "1", or C1 majority is "1" and C2 majority is "0") do not result in an actual justification.

Smoothing & jitter limiting process:

The function shall provide for a clock smoothing and elastic store (buffer) process. The 34 368 kbit/s data signal shall be written into the buffer under control of the associated (gapped) input clock. The data signal shall be read out of the buffer under control of a smoothed (equally spaced) 34 368 kHz \pm 20 ppm clock (the rate is determined by the 34 Mbit/s signal at the input of the remote S3/P31e_A_So). The residual jitter caused by pointer adjustments and bit justifications (measured at the 34 368 kbit/s interface) shall be within the limits specified in subclause 11.3.1.2 of EN 300 417-1-1 [6].

Buffer size:

In the presence of jitter as specified by subclause 11.3.1.2 of EN 300 417-1-1 [6] and a frequency within the range 34 368 kbit/s \pm 20 ppm, this justification process shall not introduce any errors.

Following a step in frequency of the P31e CI (for example due to reception of P31e CI from a new P31e_TT_So at the far end or removal of all-ONEs (AIS) signal with a frequency offset) there will be a maximum recovery time of X seconds after which this process shall not generate any bit errors.

The value of X is for further study; a value of 1 second has been proposed.

Activation: The function shall perform the operation specified above when it is activated (MI_Active is true). Otherwise, it shall transmit the all-ONEs signal at its output (CI_D) and not report its status via the management point.

Frame alignment: The function shall perform the frame alignment of the 34 368 kbit/s signal to recover the frame start information FS. Loss of frame alignment shall be assumed to have taken place when four consecutive frame alignment signals have been incorrectly received in their predicted positions.

When frame alignment is assumed to be lost, the frame alignment device shall decide that such alignment has effectively been recovered when it detects the presence of three consecutive frame alignment signals.

The frame alignment device having detected the appearance of a single correct frame alignment signal, shall begin a new search for the frame alignment signal when it detects the absence of the frame alignment signal in one of the two following frames.

Defects:

The function shall detect for dPLM defect according the specification in EN 300 417-1-1 [6], subclause 8.2.1.

The function shall detect a loss of frame defect (dLOF) when four consecutive frame alignment signals have been incorrectly received in their predicted positions. When frame alignment is lost, the dLOF defect shall be cleared when three consecutive frame alignment signals are detected.

The function shall detect an AIS defect (dAIS) according the specification in subclause 8.2.1.7 of EN 300 417-1-1 [6], with X = 4, Y = 1 536, Z = 5.

Consequent Actions:

aSSF \leftarrow dPLM or dLOF or dAIS or AI_TSF

aAIS \leftarrow dPLM or dLOF or dAIS or AI_TSF

On declaration of the aAIS the function shall output an all-ONEs (AIS) signal in the P31e_CI_D within 250 μ s; on clearing of aAIS the function shall output normal data within 250 μ s. The P31e_CI_CK during the all-ONEs signal shall be within 34 368 kHz \pm 20 ppm.

Defect Correlations:

cPLM \leftarrow dPLM and (not AI_TSF)

cAIS \leftarrow dAIS and (not dPLM) and (not AI_TSF) and AIS_Reported

cLOF \leftarrow dLOF and (not dAIS) and (not dPLM)

Performance Monitoring: None.

5.3.5 VC-3 Layer to P0s Layer Adaptation Source S3/P0s_A_So

Symbol:

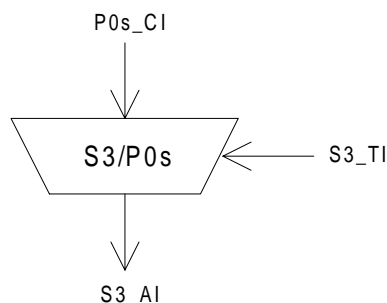

Figure 84: S3/P0s_A_So symbol

Interfaces:

Table 66: S3/P0s_A_So input and output signals

Input(s)	Output(s)
P0s_CI_D P0s_CI_CK P0s_CI_FS S3_TI_CK S3_TI_FS	S3_AI_D

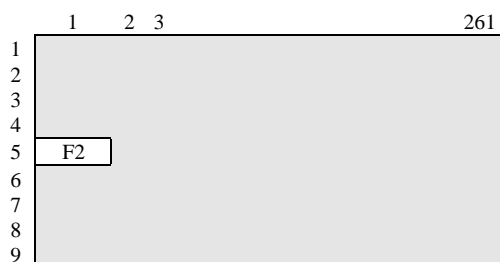

Figure 85: S3/ P0s_AI_D signal

Processes:

This function provides the multiplexing of a 64 kbit/s information stream into the S3_AI using slip buffering. It takes P0s_CI, defined in ETS 300 166 [2] as an octet structured bit-stream with a synchronous bit rate of 64 kbit/s, present at its input and inserts it into the VC-3 POH byte F2 as defined in ETS 300 147 [1] and depicted in figure 69.

NOTE: Any frequency deviation between the 64 kbit/s signal and the associated VC-3 signal leads to octet slips.

Frequency justification and bitrate adaptation:

The function shall provide an elastic store (slip buffer) process. The data signal shall be written into the buffer under control of the associated input clock. The data shall be read out of the buffer under control of the VC-3 clock, frame position (S3_TI), and justification decisions.

Each justification decision results in a corresponding negative/positive justification action. Upon a positive justification (slip) action, the reading of one 64 kbit/s octet (8 bits) shall be cancelled once. Upon a negative justification (slip) action, the same 64 kbit/s octet (8 bits) shall be read out a second time.

Buffer size:

The elastic store (slip buffer) shall accommodate at least 18 μ s of wander without introducing errors.

Defects: None.

Consequent Actions: None.

Defect Correlations: None.

Performance Monitoring: None.

5.3.6 VC-3 Layer to P0s Layer Adaptation Sink S3/P0s_A_Sk

Symbol:

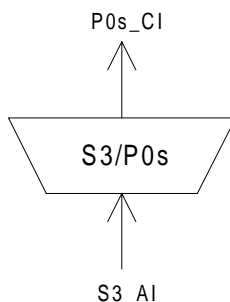

Figure 86: S3/P0s_A_Sk symbol

Interfaces:

Table 67: S3/P0s_A_Sk input and output signals

Input(s)	Output(s)
S3_AI_D	P0s_CI_D
S3_AI_CK	P0s_CI_CK
S3_AI_FS	P0s_CI_FS
S3_AI_TSF	P0s_CI_SSF

Processes:

The function extracts the path user channel byte F2 from the VC-3 layer Characteristic Information. The recovered byte provides a 64 kbit/s channel for the client (user).

Data latching and smoothing process: The function shall provide a data latching and smoothing function. Each 8-bit octet received shall be written and latched into a data store under the control of the VC-3 signal clock. The eight data bits shall then be read out of the store using a nominal 64 kHz clock which may be derived directly from the incoming STM-N signal clock (e.g. 155 520 kHz divided by a factor of $2\,430 \times N$).

Defects: None.

Consequent Actions:

aSSF ← AI_TSF

aAIS ← AI_TSF

On declaration of aAIS the function shall output an all-ONES (AIS) signal - complying to the frequency limits for this signal (a bit rate in range $64\text{ kbit/s} \pm 100\text{ ppm}$) - within 1 ms; on clearing of aAIS the function shall output normal data within 1 ms.

Defect Correlations: None.

Performance Monitoring: None.

5.3.7 VC-3 Layer to TSS3 Adaptation Source S3/TSS3_A_So

Symbol:

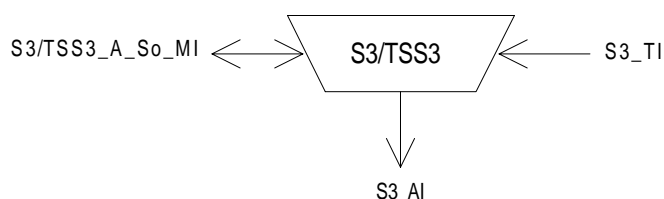

Figure 87: S3/TSS3_A_So symbol

Interfaces:

Table 68: S3/TSS3_A_So input and output signals

Input(s)	Output(s)
S3_TI_CK	S3_AI_D
S3_TI_FS	S3_AI_CK
S3/TSS3_A_So_MI_Active	S3_AI_FS

Processes:

This function maps a VC-3 synchronous Test Signal Structure TSS3 PRBS stream as described in ITU-T Recommendation O.181 [12] into a VC-3 payload and adds the C2 and H4 bytes. It creates a 2^{23} PRBS with timing derived from the S3_TI_Ck and maps it without justification bits into the whole of the synchronous container-3 having a capacity of 756 bytes as depicted in figure 88. The PRBS is a sequence which repeats itself over a period which is not an exact multiple of the capacity available in the container-3 frame. Therefore the start of the sequence will move relative to the start of the container-3 frame over time.

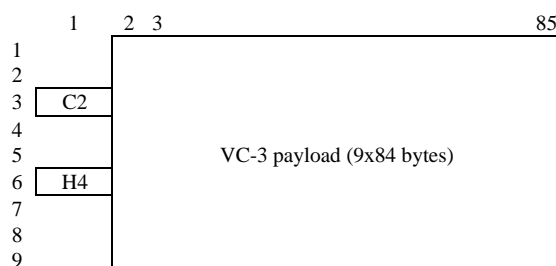

Figure 88: S3/TSS3_AI_So_D

H4: The value of H4 byte is undefined.

C2: In this byte the function shall insert code "1111 1110" (TSS3 in the Container-3) as defined in ETS 300 147 [1].

Activation: The function shall access the access point when it is activated (MI_Active is true). Otherwise, it shall not access the access point.

Defects: None.

Consequent Actions: None.

Defect Correlations: None.

Performance Monitoring: None.

5.3.8 VC-3 Layer to TSS3 Adaptation Sink S3/TSS3_A_Sk

Symbol:

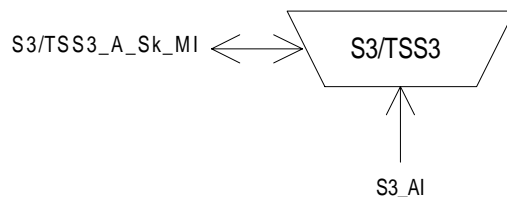

Figure 89: S3/TSS3_A_Sk symbol

Interfaces:

Table 69: S3/TSS3_A_Sk input and output signals

Input(s)	Output(s)
S3_AI_D	S3/TSS3_A_Sk_MI_cPLM
S3_AI_CK	S3/TSS3_A_Sk_MI_cLSS
S3_AI_FS	S3/TSS3_A_Sk_MI_AcSL
S3_AI_TSF	S3/TSS3_A_Sk_MI_pN_TSE
S3/TSS3_A_Sk_MI_Active	
S3/TSS3_A_Sk_MI_1second	

Processes:

The function recovers a TSS3 2^{23} PRBS test sequence as defined in ITU-T Recommendation O.181 [12] from the synchronous container-3 (having a frequency accuracy within $\pm 4,6$ ppm) and monitors the reception of the correct payload signal type and the presence of test sequence errors (TSE) in the PRBS sequence.

C2: The function shall compare the content of the recovered C2 byte (RxSL) expected value code "1111 1110" (TSS3 into the Container-3) as a check on consistency between the provisioning operation at each end. The application and acceptance and mismatch process shall be as specified in EN 300 417-1-1 [6], subclauses 7.2 and 8.1.2.

H4: The value in the H4 byte shall be ignored.

Error monitoring: Test sequence errors are bit errors in the TSS data stream and shall be detected whenever the PRBS detector is in lock and the received data bit does not match the expected value.

Activation: The function shall perform the operation specified above when it is activated (MI_Active is true). Otherwise, it shall not report its status via the management point.

Defects:

The function shall detect for dPLM defect according the specification in EN 300 417-1-1 [6], subclause 8.2.1.

The function shall detect for loss of PRBS lock (dLSS) according to the criteria defined in ITU-T Recommendation O.151 [11], subclause 2.6.

Consequent Actions: None.

Defect Correlations:

cPLM ← dPLM and (not AI_TSF)

cLSS ← dLSS and (not AI_TSF)

Performance Monitoring:

pN_TSE ← Sum of Test Sequence Errors (TSE) within one second period.

5.3.9 VC-3 Layer to ATM Virtual Path Layer Compound Adaptation Source function S3/Avp_A_So

The specification of this function is addressed in EN 301 163-2-1.

5.3.10 VC-3 Layer to ATM Virtual Path Layer Compound Adaptation Sink function S3/Avp_A_Sk

The specification of this function is addressed in EN 301 163-2-1.

5.3.11 VC-3 Layer Clock Adaptation Source S3-LC_A_So

Refer to EN 300 417-6-1 [8].

5.4 VC-3 Layer Monitoring Functions

5.4.1 VC-3 Layer Non-intrusive Monitoring Function S3m_TT_Sk

Symbol:

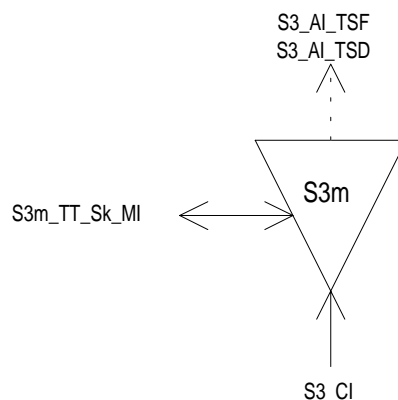

Figure 90: S3m_TT_Sk symbol

Interfaces:

Table 70: S3m_TT_Sk input and output signals

Input(s)	Output(s)
S3_CI_D	S3_AI_TSF
S3_CI_CK	S3_AI_TSD
S3_CI_FS	S3m_TT_Sk_MI_cTIM
S3_CI_SSF	S3m_TT_Sk_MI_cUNEQ
S3m_TT_Sk_MI_TPmode	S3m_TT_Sk_MI_cDEG
S3m_TT_Sk_MI_SSF_Reported	S3m_TT_Sk_MI_cRDI
S3m_TT_Sk_MI_ExTI	S3m_TT_Sk_MI_cSSF
S3m_TT_Sk_MI_RDI_Reported	S3m_TT_Sk_MI_AcTI
S3m_TT_Sk_MI_DEGTHR	S3m_TT_Sk_MI_pN_EBC
S3m_TT_Sk_MI_DEGM	S3m_TT_Sk_MI_pF_EBC
S3m_TT_Sk_MI_ExTImode	S3m_TT_Sk_MI_pN_DS
S3m_TT_Sk_MI_1second	S3m_TT_Sk_MI_pF_DS
S3m_TT_Sk_MI_TIMdis	

Processes:

NOTE 1: This non-intrusive monitor trail termination sink function has no associated source function.

This function monitors VC-3 for errors, and recovers the trail termination status. It extracts the payload independent overhead bytes (J1, B3, G1, C2) from the VC-3 layer Characteristic Information:

J1: The Received Trail Trace Identifier RxTI shall be recovered from the J1 byte and shall be made available as AcTI for network management purposes. The application and acceptance and mismatch detection process shall be performed as specified in EN 300 417-1-1 [6], subclauses 7.1 and 8.2.1.3.

B3: Even bit parity is computed for each bit n of every byte of the preceding VC-3 and compared with bit n of B3 recovered from the current frame (n=1 to 8 inclusive). A difference between the computed and recovered B3 values is taken as evidence of an errored block (nN_B).

G1[1-4], G1[5]: The information carried in the G1 byte (REI, RDI) shall be extracted to enable single ended maintenance of a bi-directional Trail (Path). The REI (nF_B) shall be used to monitor the error performance of the other direction of transmission, and the RDI (bit 5) shall be used to provide information as to the status of the remote receiver. A "1" indicates a Remote Defect Indication state, while a "0" indicates the normal, working state. The application process shall be performed as specified in EN 300 417-1-1 [6], subclauses 7.4.2 (REI), 7.4.11 and 8.2 (RDI).

Table 71: G1[1-4] code interpretation

G1[1]	G1[2]	G1[3]	G1[4]	REI code interpretation [# errored blocks]
0	0	0	0	0
0	0	0	1	1
0	0	1	0	1
0	0	1	1	1
0	1	0	0	1
0	1	0	1	1
0	1	1	0	1
0	1	1	1	1
1	0	0	0	1
1	0	0	1	0
1	0	1	0	0
1	0	1	1	0
1	1	0	0	0
1	1	0	1	0
1	1	1	0	0
1	1	1	1	0

C2: The information in the C2 byte shall be extracted to allow unequipped VC and VC-AIS defect detection.

G1[6-8]: The value in the bits 6 to 8 of byte G1 shall be ignored.

Defects:

The detection and removal conditions and processes for dDEG, dRDI, dUNEQ and dTIM defects shall be as specified by EN 300 417-1-1 [6], subclause 8.2.1 with the condition "aSSF" read as "aSSF or VC dAIS". To use the function within e.g. a tandem connection, it shall be possible to disable the trace id mismatch detection (TIMdis).

NOTE 2: Presumably, in such case the VC Trace Id. will be unknown to the tandem connection operator.

VC AIS:

The function shall detect for an AIS condition by monitoring the VC PSL for code "1111 1111". If 5 consecutive frames contain the "1111 1111" pattern in byte C2 a dAIS defect shall be detected. dAIS shall be cleared if in 5 consecutive frames any pattern other than the "1111 1111" is detected in byte C2.

NOTE 3: Equipment designed prior to the present document may be able to perform VC-AIS detection either as specified above interpreting "frames" as "samples (not necessary consecutive frames)", or by a comparison of the accepted signal label with the all-ONES pattern. If the accepted signal label is equal to all-ONES, VC-AIS defect is detected. If the accepted signal label is not equal to all-ONES, VC-AIS defect is cleared.

Consequent actions:

aTSF ← CI_SSF or dAIS or dUNEQ or dTIM

aTSD ← dDEG

Defect Correlations:

cUNEQ ← dUNEQ and MON

cTIM ← dTIM and (not dUNEQ) and MON

cDEG ← dDEG and (not dTIM) and MON

cRDI ← dRDI and (not dUNEQ) and (not dTIM) and MON and RDI_Reported

cSSF ← (CI_SSF or dAIS) and MON and SSF_Reported

Performance Monitoring:

The performance monitoring process shall be performed as specified in EN 300 417-1-1 [6], subclause 8.2.4 through 8.2.7.

pN_DS ← aTSF or dEQ

pF_DS ← dRDI

pN_EBC ← Σ nN_B

pF_EBC ← Σ nF_B

NOTE 4: pF_DS/pF_EBC represent the performance of the total trail while pN_DS/pN_EBC represents only part of the trail up to the point of the non-intrusive monitor.

5.4.2 VC-3 Layer Supervisory-Unequipped Termination Source S3s_TT_So

Symbol:

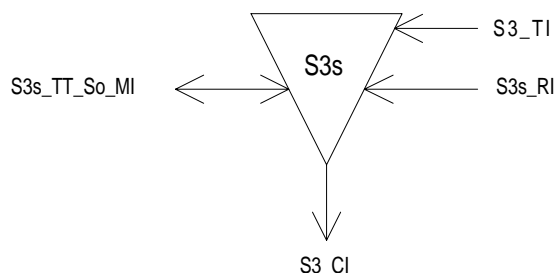

Figure 91: S3s_TT_So symbol

Interfaces:

Table 72: S3s_TT_So input and output signals

Input(s)	Output(s)
S3s_RI_RDI	S3_CI_D
S3s_RI_REI	S3_CI_CK
S3_TI_CK	S3_CI_FS
S3_TI_FS	
S3s_TT_So_MI_TxTI	

Processes:

This function generates error monitoring and status overhead bytes to an undefined VC-3. The processing of the trail termination overhead bytes is defined as follows:

J1: In this byte the function shall insert the Transmitted Trail Trace Identifier TxTI. Its format is described in EN 300 417-1-1 [6], subclause 7.1.

B3: In this byte the function shall insert the BIP-8 EDC with even bit parity. Each bit n of current B3 is computed to provide even parity over the n th bits of every byte in the previous frame of the Characteristic Information S3_CI, i.e., B3 is calculated over the entire previous VC-3. Further reference is provided in EN 300 417-1-1 [6], subclause 7.3.

C2: In this byte the function shall insert code "0000 0000" (unequipped VC or supervisory-unequipped VC) as defined in subclause 7.2 of EN 300 417-1-1 [6] and ETS 300 147 [1].

G1: This byte is set to represent the status of the associated S3s_TT_Sk. Its format is defined in the figure 69.

G1[1-4]: The signal value applied at RI_REI shall be inserted in the VC-3 REI, bits 1 to 4 of byte G1. The coding shall be as follows:

Table 73: G1[1-4] coding

Number of BIP-8 violations conveyed via RI_REI	G1[1]	G1[2]	G1[3]	G1[4]
0	0	0	0	0
1	0	0	0	1
2	0	0	1	0
3	0	0	1	1
4	0	1	0	0
5	0	1	0	1
6	0	1	1	0
7	0	1	1	1
8	1	0	0	0

G1[5]: Bit 5 of byte G1, a RDI indication, shall be set to "1" on activation of the S3s_RI_RDI within 250 μ s, determined by the associated S3s_TT_Sk function and set to "0" within 250 μ s on the S3s_RI_RDI removal.

G1[6-8]: The value of the bits 6 to 8 of byte G1 is undefined.

N1: In the byte the function shall insert code "0000 0000" (unequipped tandem connection) as defined in subclause 7.2 of EN 300 417-1-1 [6].

Other VC-3 bytes:

The function shall generate the other VC-3 bytes and bits. Their content is undefined.

Defects: None.

Consequent Actions: None.

Defect Correlations: None.

Performance Monitoring: None.

5.4.3 VC-3 Layer Supervisory-unequipped Termination Sink S3s_TT_Sk

Symbol:

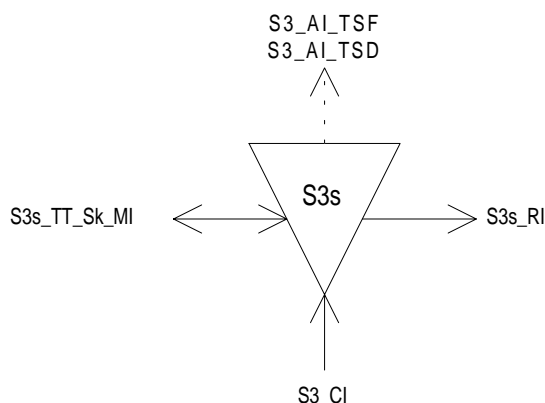

Figure 92: S3s_TT_Sk symbol

Interfaces:

Table 74: S3s_TT_Sk input and output signals

Input(s)	Output(s)
S3_CI_D	S3_AI_TSF
S3_CI_CK	S3_AI_TSD
S3_CI_FS	S3s_TT_Sk_MI_cTIM
S3_CI_SSF	S3s_TT_Sk_MI_cUNEQ
	S3s_TT_Sk_MI_cDEG
S3s_TT_Sk_MI_TPmode	S3s_TT_Sk_MI_cRDI
S3s_TT_Sk_MI_SSF_Reported	S3s_TT_Sk_MI_cSSF
S3s_TT_Sk_MI_ExtI	S3s_TT_Sk_MI_AcTI
S3s_TT_Sk_MI_RDI_Reported	S3s_RI_RDI
S3s_TT_Sk_MI_DEGTHR	S3s_RI_REI
S3s_TT_Sk_MI_DEGM	S3s_TT_Sk_MI_pN_EBC
S3s_TT_Sk_MI_ExtImode	S3s_TT_Sk_MI_pF_EBC
S3s_TT_Sk_MI_1second	S3s_TT_Sk_MI_pN_DS
S3s_TT_Sk_MI_TIMdis	S3s_TT_Sk_MI_pF_DS

Processes:

This function monitors VC-3 for errors, and recovers the trail termination status as defined in ETS 300 147 [1]. It extracts the payload independent overhead bytes (J1, B3, G1, C2) from the VC-3 layer Characteristic Information:

J1: The Received Trail Trace Identifier RxTI shall be recovered from the J1 byte and shall be made available as AcTI for network management purposes. The application and acceptance and mismatch detection process shall be as specified in EN 300 417-1-1 [6], subclauses 7.1 and 8.2.1.3.

B3: Even bit parity shall be computed for each bit n of every byte of the preceding VC-3 and compared with bit n of B3 recovered from the current frame (n = 1 to 8 inclusive). A difference between the computed and recovered B3 values shall be taken as evidence of an errored block (nN_B).

G1[1-4], G1[5]: The information carried in the G1 byte (REI, RDI) shall be extracted to enable single ended maintenance of a bi-directional Trail (Path). The REI (nF_B) shall be used to monitor the error performance of the other direction of transmission, and the RDI (bit 5) shall be used to provide information as to the status of the remote receiver. A "1" indicates a Remote Defect Indication state, while a "0" indicates the normal, working state. The application process shall be performed as specified in EN 300 417-1-1 [6], subclauses 7.4.2 (REI), 7.4.11 and 8.2 (RDI).

G1[6-8]: The value in the bits 6 to 8 of byte G1 shall be ignored.

Table 75: G1[1-4] code interpretation

G1[1]	G1[2]	G1[3]	G1[4]	REI code interpretation [# errored blocks]
0	0	0	0	0
0	0	0	1	1
0	0	1	0	1
0	0	1	1	1
0	1	0	0	1
0	1	0	1	1
0	1	1	0	1
0	1	1	1	1
1	0	0	0	1
1	0	0	1	0
1	0	1	0	0
1	0	1	1	0
1	1	0	0	0
1	1	0	1	0
1	1	1	0	0
1	1	1	1	0

C2: The information in the C2 byte shall be extracted to allow unequipped VC defect detection.

Defects:

The function shall detect for dDEG, dRDI, dUNEQ and dTIM defects according the specifications in EN 300 417-1-1 [6], subclause 8.2.1.

Consequent Actions:

aTSF ← CI_SSF or dTIM
aTSD ← dDEG
aRDI ← CI_SSF or dTIM
aREI ← "#EDCV"

NOTE: dUNEQ can not be used to activate aTSF and aRDI; an expected supervisory-unequipped signal will have the signal label set to all-0's, causing a continuous detection of dUNEQ. If an unequipped VC comes in, dTIM will be activated and can serve as a trigger for aTSF/aRDI instead of dUNEQ.

Defect Correlations:

cUNEQ ← MON and dTIM and (AcTI = all "0"s) and dUNEQ
cTIM ← MON and dTIM and not (dUNEQ and AcTI = all "0"s)
cDEG ← MON and (not dTIM) and dDEG
cRDI ← MON and (not dTIM) and dRDI and RDI_Reported
cSSF ← MON and CI_SSF and SSF_Reported

Performance Monitoring:

The performance monitoring process shall be performed as specified in EN 300 417-1-1 [6], subclause 8.2.4 through 8.2.7.

pN_DS ← aTSF or dEQ

pF_DS ← dRDI

pN_EBC ← ΣnN_B

pF_EBC ← ΣnF_B

5.5 VC-3 Layer Trail Protection Functions

5.5.1 VC-3 Trail Protection Connection Functions S3P_C

5.5.1.1 VC-3 Layer 1+1 uni-directional Protection Connection Function S3P1+1u_C

Symbol:

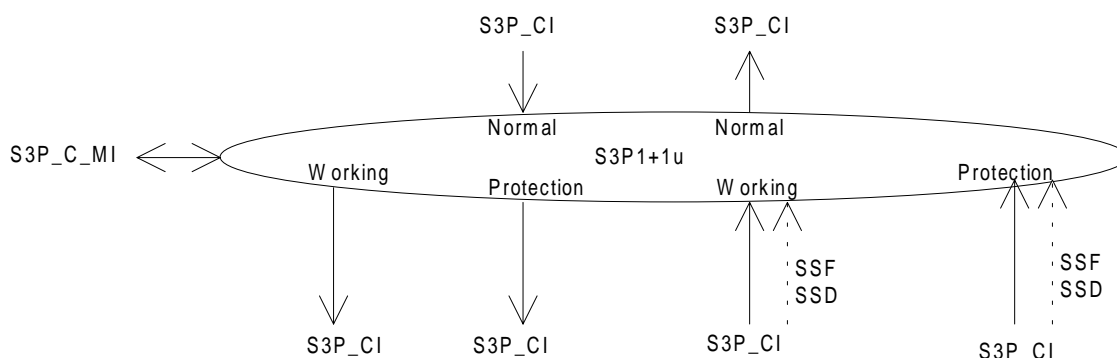

Figure 93: S3P1+1u_C symbol

Interfaces:

Table 76: S3P1+1u_C input and output signals

Input(s)	Output(s)
for connection points W and P: S3P_CI_D S3P_CI_CK S3P_CI_FS S3P_CI_SSF S3P_AI_SSD	for connection points W and P: S3P_CI_D S3P_CI_CK S3P_CI_FS
for connection point N: S3P_CI_D S3P_CI_CK S3P_CI_FS	for connection point N: S3P_CI_D S3P_CI_CK S3P_CI_FS S3P_CI_SSF
S3P_C_MI_OPERType S3P_C_MI_WTRTime S3P_C_MI_HOTime S3P_C_MI_EXTCMD	
NOTE: Protection status reporting signals are for further study.	

Processes:

The function performs the VC-3 linear trail protection process for 1+1 protection architecture with single ended switching; refer to EN 300 417-1-1 [6], subclause 9.2. It performs the bridge and selector functionality as presented in figure 49 of EN 300 417-1-1 [6]. In the sink direction, the signal output at the normal reference point can be the signal received via either the associated working path or the protection path; this is determined by the SF,SD conditions (relayed via CI_SSF,CI_SSD signals), and the external commands. In the source direction, the working output is connected to the associated normal input. The protection output is also connected to the normal input.

Provided no protection switching action is activated/required the following changes to (the configuration of) a trail shall be possible without disturbing the CI passing the trail:

- change between operation types;
- change of WTR and HO times.

Operation:

The VC trail protection process shall operate as specified in EN 300 417-3-1 [7], annex A, according the following characteristics:

Table 77: Trail protection parameters

Parameter	Value options
architecture type (ARCHtype)	1 + 1
switching type (SWtype)	uni-directional
operation type (OPERtype)	revertive, non-revertive
APS signal (APSmode)	false
Wait-To-Restore time (WTRtime)	in the order of 5-12 minutes
Switch time	≤ 50 ms
Hold-off time (HOtime)	0 to 10 seconds in steps of the order of 100 ms
Protection type (PROTtype)	trail
Signal switch conditions:	SF = SSF (originated as AI_TSF) SD = SSD (originated as AI_TSD)
External commands (EXTCMD)	(revertive operation) LO, FSw-#1, MSw-#1, CLR (non-revertive operation) LO, FSw-#i, MSw-#i, CLR (i=0,1)
Extra traffic (EXTRAtraffic)	false
SFpriority, SDpriority	high

Defects:	None.
Consequent Actions:	None.
Defect Correlations:	None.
Performance Monitoring:	None.

5.5.1.2 VC-3 Layer bi-directional Protection Connection Function S3P1+1b_C

Symbol:

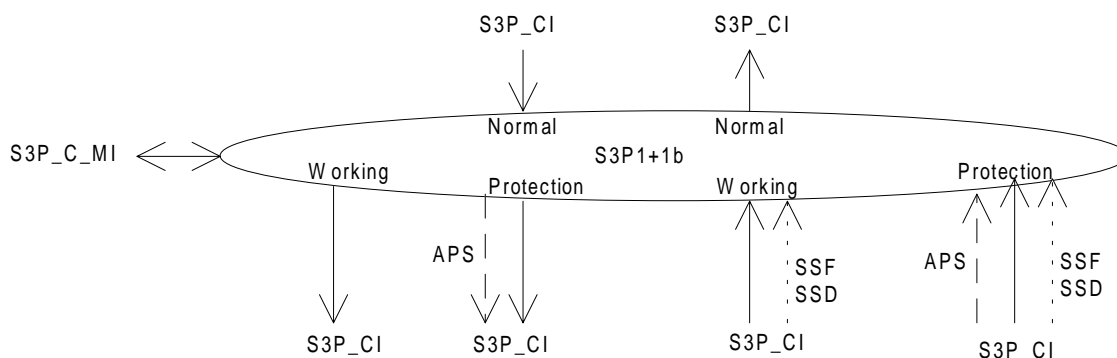

Figure 94: S3P1+1b_C symbol

Interfaces:

Table 78: S3P1+1b_C input and output signals

Input(s)	Output(s)
for connection points W and P: S3P_CI_D S3P_CI_CK S3P_CI_FS S3P_CI_SSF S3P_CI_SSD	for connection points W and P: S3P_CI_D S3P_CI_CK S3P_CI_FS
for connection point N: S3P_CI_D S3P_CI_CK S3P_CI_FS	for connection point N: S3P_CI_D S3P_CI_CK S3P_CI_FS S3P_CI_SSF
for connection point P: S3P_CI_APS	for connection point P: S3P_CI_APS
S3P_C_MI_OPERType S3P_C_MI_WTRTime S3P_C_MI_HOTime S3P_C_MI_EXTCMD	NOTE: Protection status reporting signals are for further study.

Processes:

The function performs the VC-3 linear trail protection process for 1+1 protection architecture with bi-directional switching; refer to EN 300 417-1-1 [6], subclause 9.2. It performs the bridge and selector functionality as presented in figure 49 of EN 300 417-1-1 [6]. In the sink direction, the signal output at the normal reference point can be the signal received via either the associated working path or the protection path; this is determined by the SF,SD conditions (relayed via CI_SSF,CI_SSD signals), and the external commands. In the source direction, the working output is connected to the associated normal input. The protection output is also connected to the normal input.

Provided no protection switching action is activated/required the following changes to (the configuration of) a trail shall be possible without disturbing the CI passing the trail:

- change between operation types;
- change of WTR and HO times.

Operation:

The VC trail protection process shall operate as specified in EN 300 417-3-1 [7], annex A, according the following characteristics:

Table 79: Trail protection parameters

Parameter	Value options
architecture type (ARCHtype)	1 + 1
switching type (SWtype)	bi-directional
operation type (OPERtype)	revertive, non-revertive
APS signal (APSmode)	true
Wait-To-Restore time (WTRtime)	in the order of 5-12 minutes
Switch time	≤ 50 ms
Hold-off time (HOfime)	0 to 10 seconds in steps of the order of 100 ms
Protection type (PROTtype)	trail
Signal switch conditions:	SF = SSF (originated as AI_TSF) SD = SSD (originated as AI_TSD)
External commands (EXTCMD)	(revertive operation) LO, FSw-#1, MSw-#1, CLR (non-revertive operation) LO or FSw, FSw-#i, MSw-#i, EXER-#i, CLR (i=0,1)
Extra traffic (EXTRAtraffic)	false
SFpriority, SDpriority	high
NOTE: The VC-3 APS signal definition is for further study.	

Defects: None.

Consequent Actions: None.

Defect Correlations: None.

Performance Monitoring: None.

5.5.2 VC-3 Layer Trail Protection Trail Termination Functions

5.5.2.1 VC-3 Protection Trail Termination Source S3P_TT_So

Symbol:

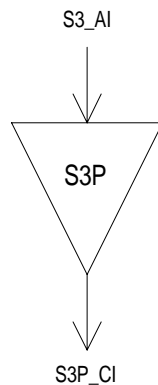

Figure 95: S3P_TT_So symbol

Interfaces:

Table 80: S3P_TT_So input and output signals

Input(s)	Output(s)
S3P_AI_D	S3P_CI_D
S3P_AI_CK	S3P_CI_CK
S3P_AI_FS	S3P_CI_FS

Processes:

No information processing is required in the S3P_TT_So, the S3_AI at its output is identical to the S3P_CI at its input.

Defects: None.

Consequent Actions: None.

Defect Correlations: None.

Performance Monitoring: None.

5.5.2.2 VC-3 Protection Trail Termination Sink S3P_TT_Sk

Symbol:

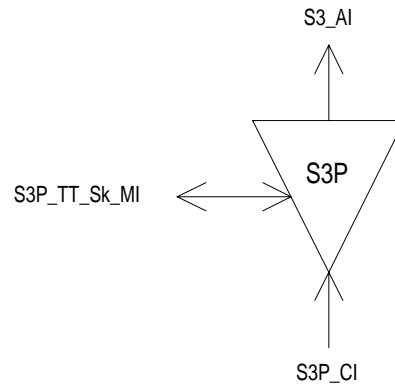

Figure 96: S3P_TT_Sk symbol

Interfaces:

Table 81: S3P_TT_Sk input and output signals

Input(s)	Output(s)
S3P_CI_D	S3_AI_D
S3P_CI_CK	S3_AI_CK
S3P_CI_FS	S3_AI_FS
S3P_CI_SSF	S3_AI_TSF
S3P_TT_Sk_MI_SSF_Reported	S3P_TT_Sk_MI_cSSF

Processes:

The S3P_TT_Sk function reports, as part of the S3 layer, the state of the protected VC-3 trail. In case all trails are unavailable the S3P_TT_Sk reports the signal fail condition of the protected trail.

Defects: None.

Consequent Actions:

aTSF ← CI_SSF

Defect Correlations:

cSSF ← CI_SSF and SSF_Reported

Performance Monitoring: None.

5.5.3 VC-3 Layer Linear Trail Protection Adaptation Functions

5.5.3.1 VC-3 trail to VC-3 trail Protection Layer Adaptation Source S3/S3P_A_So

Symbol:

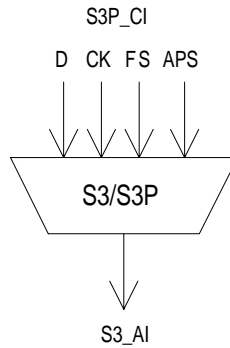

Figure 97: S3/S3P_A_So symbol

Interfaces:

Table 82: S3/S3P_A_So input and output signals

Input(s)	Output(s)
S3P_CI_D	S3_AI_D
S3P_CI_CK	S3_AI_CK
S3P_CI_FS	S3_AI_FS
S3P_CI_APS	

Processes:

The function shall multiplex the S3 APS signal and S3 data signal onto the S3 access point.

K3[1-4]: The insertion of the VC-APS signal is for further study. This process is required only for the protection path.

Defects: None.

Consequent actions: None.

Defect Correlations: None.

Performance Monitoring: None.

5.5.3.2 VC-3 trail to VC-3 trail Protection Layer Adaptation Sink S3/S3P_A_Sk

Symbol:

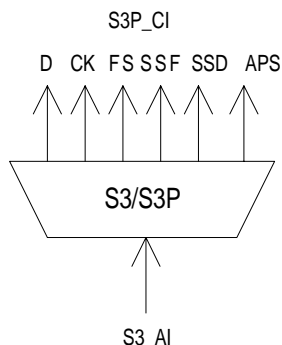

Figure 98: S3/S3P_A_Sk symbol

Interfaces:

Table 83: S3/S3P_A_Sk input and output signals

Input(s)	Output(s)
S3_AI_D	S3P_CI_D
S3_AI_CK	S3P_CI_CK
S3_AI_FS	S3P_CI_FS
S3_AI_TSF	S3P_CI_SSF
S3_AI_TSD	S3P_CI_SSD
	S3P_CI_APS (for Protection signal only)

Processes:

The function shall extract and output the S3P_CI_D signal from the S3_AI_D signal.

K3[1-4]: The extraction and persistency processing of the VC-APS signal is for further study. This process is required only for the protection section.

Defects: None.

Consequent actions:

aSSF ← AI_TSF

aSSD ← AI_TSD

Defect Correlations: None.

Performance Monitoring: None.

5.6 VC-3 Tandem Connection Sublayer Functions

5.6.1 VC-3 Tandem Connection Trail Termination Source function (S3D_TT_So)

Symbol:

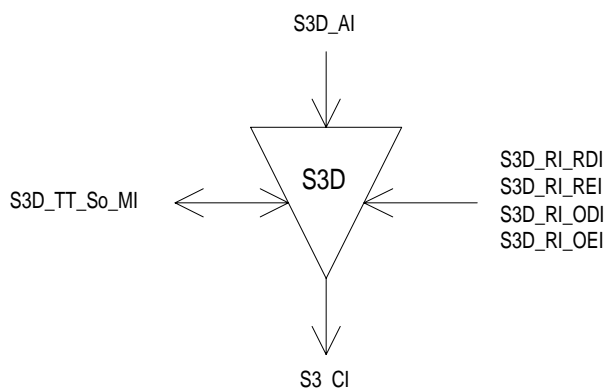

Figure 99: S3D_TT_So symbol

Interfaces:

Table 84: S3D_TT_So input and output signals

Input(s)	Output(s)
S3D_AI_D	S3_CI_D
S3D_AI_CK	S3_CI_CK
S3D_AI_FS	S3_CI_FS
S3D_AI_SF	
S3D_RI_RDI	
S3D_RI_REI	
S3D_RI_ODI	
S3D_RI_OEI	
S3D_TT_So_MI_TxTI	

Processes:

N1[8][73]: The function shall insert the TC RDI code within 1 multiframe (9,5 ms) after the RDI request generation (RI_RDI) in the tandem connection trail termination sink function. It ceases TC RDI code insertion within 1 multiframe (9,5 ms) after the TC RDI request has cleared.

NOTE 1: N1[x][y] refers to bit x (x = 7,8) of byte N1 in frame y (y=1..76) of the 76 frame multiframe. This multiframe is 9,5 ms long.

N1[5]: The function shall insert the RI_REI value in the REI bit in the following frame.

N1[7][74]: The function shall insert the ODI code within 1 multiframe (9,5 ms) after the ODI request generation (RI_ODI) in the tandem connection trail termination sink function. It ceases ODI code insertion at the first opportunity after the ODI request has cleared.

N1[6]: The function shall insert the RI_OEI value in the OEI bit in following frame.

N1[7-8]: The function shall insert in the multiframed N1[7-8] channel:

- the Frame Alignment Signal (FAS) "1111 1111 1111 1110" in FAS bits in frames 1 to 8;
- the TC trace identifier, received via MI_TxTI, in the TC-TI bits in frames 9 to 72;

- the TC RDI (N1[8][73]) and ODI (N1[7][74]) signals; and
- all-0s in the six reserved bits in frames 73 to 76.

N1[1-4]: Even BIP-8 shall be computed for each bit n of every byte of the preceding VC-3 including B3 and compared with byte B3 recovered from the current frame. A difference between the computed and recovered BIP-8 values shall be taken as evidence of one or more errors in the computation block, and shall be inserted in bits 1 to 4 of byte N1 (see figure 61 and table 50). If AI_SF is true, code "1110" shall be inserted in bits 1 to 4 of byte N1 instead of the number of incoming BIP-8 violations.

NOTE 2: Zero BIP-8 violations detected in the tandem connection incoming signal shall be coded with a non-all-ZEROS IEC code. This allows this IEC field to be used at the TC tail end as differentiator between TC incoming unequipped VC and unequipped TC.

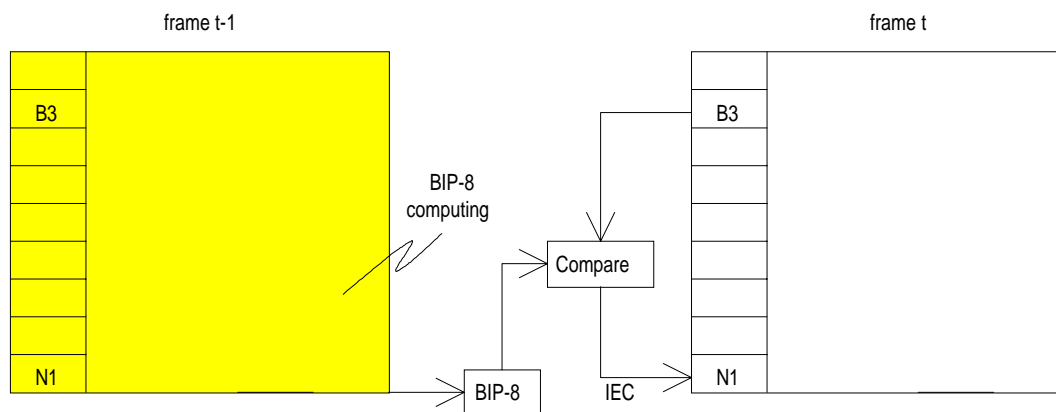

Figure 100: TC IEC computing and insertion

Table 85: IEC code generation

Number of BIP-8 violations	N1[1]	N1[2]	N1[3]	N1[4]
1	0	0	0	1
2	0	0	1	0
3	0	0	1	1
4	0	1	0	0
5	0	1	0	1
6	0	1	1	0
7	0	1	1	1
8	1	0	0	0
0	1	0	0	1

B3: The function shall compensate the VC4 BIP8 (in B3) according the following rule:

Since the BIP-8 parity check is taken over the VC (including N1), writing into N1 at the S3D_TT_So will affect the VC-3 path parity calculation. Unless this is compensated for, a device which monitors VC-3 path parity within the Tandem Connection (e.g., a non-intrusive monitor) may incorrectly count errors. The BIP-8 parity bits should always be consistent with the current state of the VC. Therefore, whenever N1 is written, BIP-8 shall be modified to compensate for the change in the N1 value. Since the BIP-8 value in a given frame reflects a parity check over the previous frame (including the BIP-8 bits in that frame), the changes made to the BIP-8 bits in the previous frame shall also be considered in the compensation of BIP-8 for the current frame. Therefore, the following equation shall be used for BIP-8 compensation:

$$B3[i]'(t) = B3[i](t-1) \oplus B3[i]'(t-1) \oplus N1[i](t-1) \oplus N1[i]'(t-1) \oplus B3[i](t)$$

Where:

B3[i] = the existing B3[i] value in the incoming signal;

B3[i]' = the new (compensated) B3[i] value;

$N1[i]$ = the existing $N1[i]$ value in the incoming signal;

$N1[i]'$ = the new value written into the $N1[i]$ bit;

\oplus = exclusive OR operator;

t = the time of the current frame;

$t-1$ = the time of the previous frame.

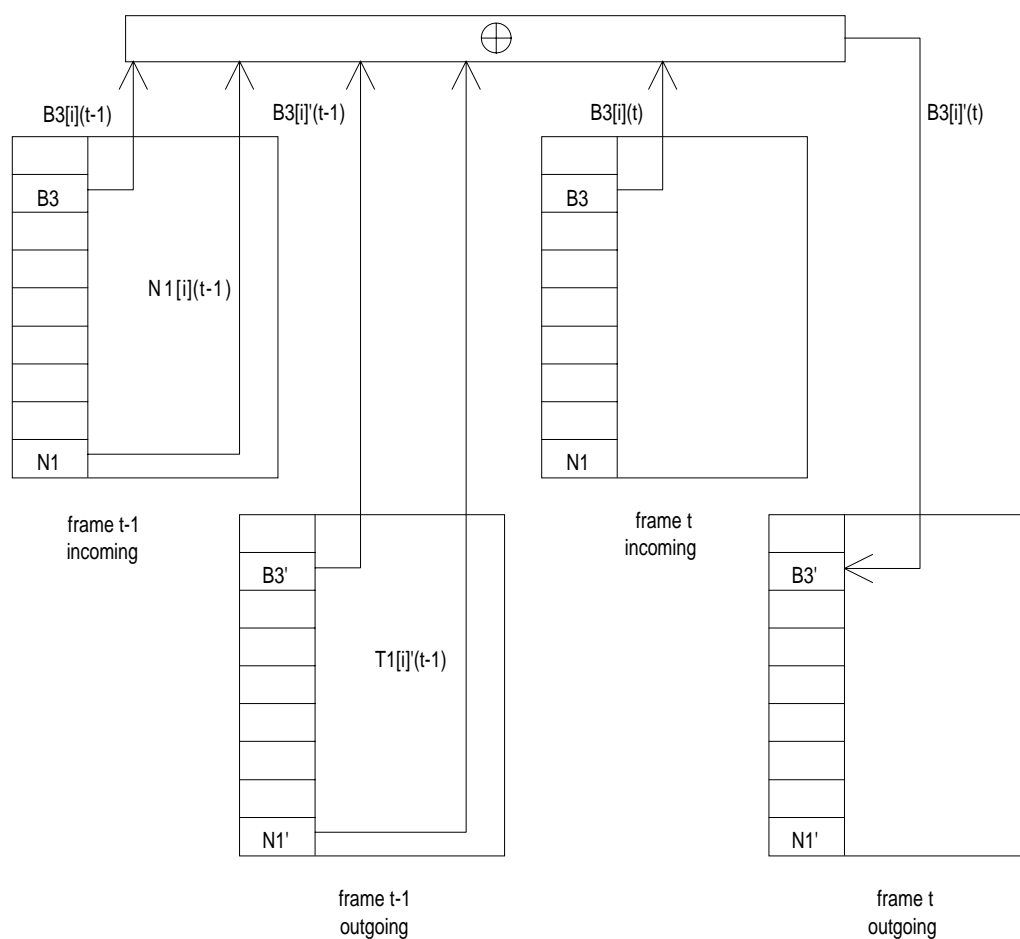

Figure 101: $B3[i]$, $i=1..8$ compensating process

Defects: None.

Consequent Actions: None.

Defect Correlations: None.

Performance Monitoring: None.

5.6.2 VC-3 Tandem Connection Trail Termination Sink function (S3D_TT_Sk)

Symbol:

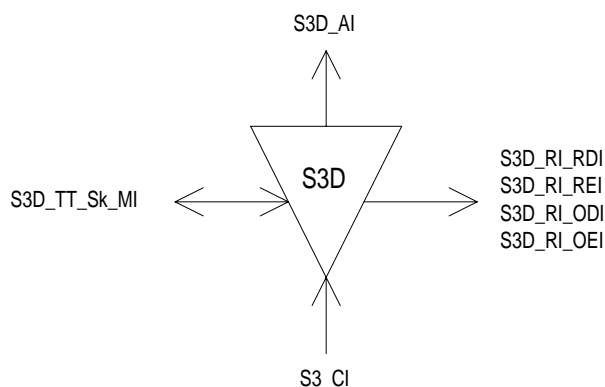

Figure 102: S3D_TT_Sk symbol

Interfaces:

Table 86: S3D_TT_Sk input and output signals

Input(s)	Output(s)
S3_CI_D	S3D_AI_D
S3_CI_CK	S3D_AI_CK
S3_CI_FS	S3D_AI_FS
S3_CI_SSF	S3D_AI_TSF
S3D_TT_Sk_MI_ExTI	S3D_AI_TSD
S3D_TT_Sk_MI_SSF_Reported	S3D_AI_OSF
S3D_TT_Sk_MI_RDI_Reported	S3D_TT_Sk_MI_cLTC
S3D_TT_Sk_MI_ODI_Reported	S3D_TT_Sk_MI_cTIM
S3D_TT_Sk_MI_TIMdis	S3D_TT_Sk_MI_cUNEQ
S3D_TT_Sk_MI_DEGM	S3D_TT_Sk_MI_cDEG
S3D_TT_Sk_MI_DEGTHR	S3D_TT_Sk_MI_cRDI
S3D_TT_Sk_MI_1second	S3D_TT_Sk_MI_cSSF
S3D_TT_Sk_MI_TPmode	S3D_TT_Sk_MI_cODI
	S3D_TT_Sk_MI_AcTI
	S3D_RI_RDI
	S3D_RI_REI
	S3D_RI_ODI
	S3D_RI_OEI
	S3D_TT_Sk_MI_pN_EBC
	S3D_TT_Sk_MI_pF_EBC
	S3D_TT_Sk_MI_pN_DS
	S3D_TT_Sk_MI_pF_DS
	S3D_TT_Sk_MI_pON_EBC
	S3D_TT_Sk_MI_pOF_EBC
	S3D_TT_Sk_MI_pON_DS
	S3D_TT_Sk_MI_pOF_DS

Processes:

TC EDC violations: Even bit parity shall be computed for each bit n of every byte of the preceding VC-3 and compared with bit n of B3 recovered from the current frame (n = 1 to 8 inclusive). A difference between the computed and recovered B3 values shall be taken as evidence of one or more errors in the computation block. The magnitude (absolute value) of the difference between this calculated number of errors and the number of errors written into the IEC (see table 52) at the trail termination source shall be used to determine the error performance of the tandem connection for each transmitted VC-3 (see figure 103). If this magnitude of the difference is one or more, an errored TC block is detected (nN_B). If one or more errors were detected in the computation block, an errored VC block (nON_B) shall be declared.

NOTE 1: The B3 data and the IEC read in the current frame both apply to the previous frame.

Table 87: IEC code interpretation

N1[1]	N1[2]	N1[3]	N1[4]	IEC code interpretation
0	0	0	0	0 errors
0	0	0	1	1 error
0	0	1	0	2 errors
0	0	1	1	3 errors
0	1	0	0	4 errors
0	1	0	1	5 errors
0	1	1	0	6 errors
0	1	1	1	7 errors
1	0	0	0	8 errors
1	0	0	1	0 errors
1	0	1	0	0 errors
1	0	1	1	0 errors
1	1	0	0	0 errors
1	1	0	1	0 errors
1	1	1	0	0 errors
1	1	1	1	0 errors

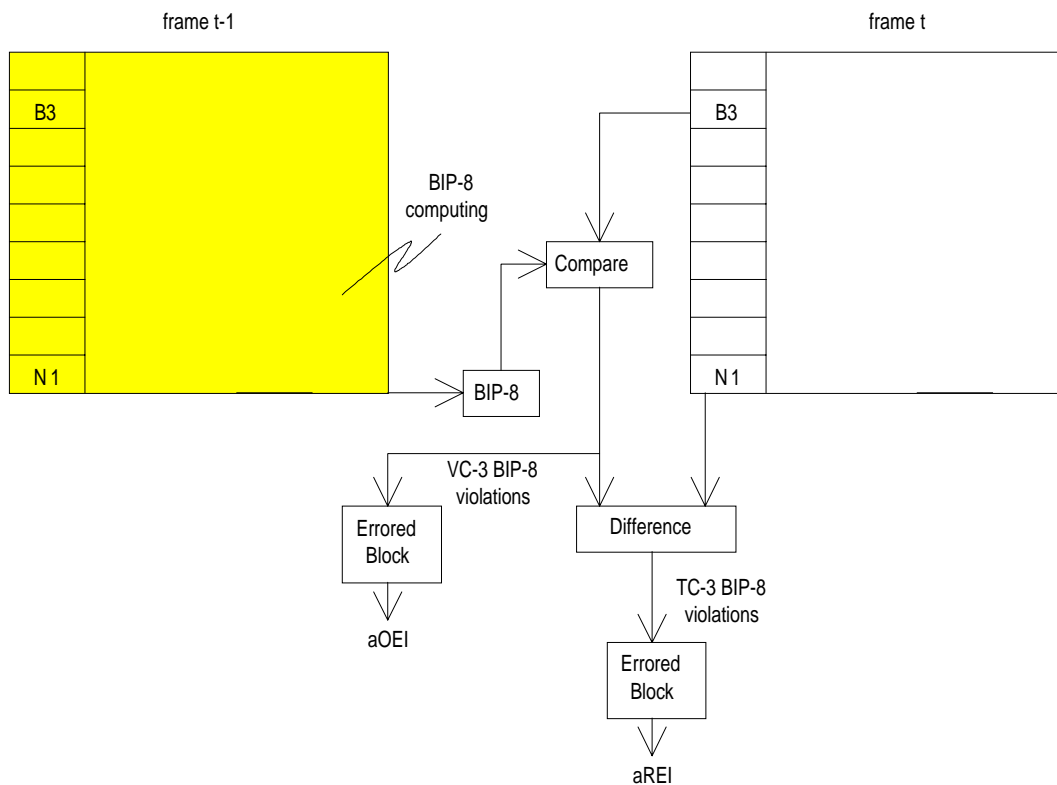

Figure 103: TC-3 and VC-3 BIP-8 computing and comparison

N1[1-4]: The function shall extract the Incoming Error Code (IEC). It shall accept the received code without further processing.

N1[7-8][9-72]: The Received Trail Trace Identifier RxTI shall be recovered from the tandem connection trail trace identifier overhead and shall be made available as AcTI for network management purposes. The application and acceptance process shall be performed as specified in EN 300 417-1-1 [6], subclauses 7.1 and 8.2.1.3. The mismatch detection process shall be as specified below.

The trace identifier process in this function is required to support "mode 1" (EN 300 417-1-1 [6], subclause 7.1) operation only. "Old" tandem connection equipment does not exist.

N1[1-4]: The function shall extract the Incoming AIS code.

N1[5], N1[8][73]: The information carried in the REI, RDI bits in byte N1 shall be extracted to enable single ended maintenance of a bi-directional tandem connection Trail. The REI (nF_B) shall be used to monitor the error performance of the other direction of transmission, and the RDI shall be used to provide information as to the status of the remote receiver. A "1" indicates a Remote Defect Indication state, while a "0" indicates the normal, working state. The application process shall be performed as specified in EN 300 417-1-1 [6], subclauses 7.4.2 (REI), 7.4.11 and 8.2 (RDI).

N1[6], N1[7][74]: The information carried in the OEI, ODI bits in byte N1 shall be extracted to enable single ended (intermediate) maintenance of a the VC-3 egressing the tandem connection Trail. The OEI (nOF_B) shall be used to monitor the error performance of the other direction of transmission, and the ODI shall be used to provide information as to the status of the remote receiver. A "1" indicates a Outgoing Defect Indication state, while a "0" indicates the normal, working state. The application process shall be performed equivalent to the remote maintenance case, as specified in EN 300 417-1-1 [6], subclauses 7.4.2 (REI/OEI), 7.4.11 and 8.2 (RDI/ODI).

N1[7-8]: Multiframe alignment:

The function shall perform a multiframe alignment on bits 7 and 8 of byte N1 to recover the TTI, RDI, and ODI signals transported within the multiframe bits. The multiframe alignment shall be found by searching for the pattern "1111 1111 1111 1110" within the bits 7 and 8 of byte N1. The signal shall be continuously checked with the presumed multiframe start position for the alignment.

Frame alignment is deemed to have been lost (entering Out Of Multiframe (OOM) state) when two consecutive FAS are detected in error (i.e. ≥ 1 error in each FAS).

Frame alignment is deemed to have been recovered (entering In Multiframe (IM) state) when one non-errored FAS is found.

N1: The function shall terminate N1 channel by inserting an all-ZEROs pattern.

B3: The function shall compensate the VC-3 BIP8 in byte B3 according the algorithm defined in S3D_TT_So.

Defects:

TC Unequipped (dUNEQ):

The function shall detect for an unequipped Tandem Connection (UNEQ) condition by monitoring byte N1 for code "00000000". The unequipped defect (dUNEQ) shall be detected if five consecutive VC-n frames contain the "0000 0000" pattern in byte N1. The dUNEQ defect shall be cleared if in five consecutive VC-n frames any pattern other than the "0000 0000" is detected in byte N1.

TC Loss of Tandem Connection (dLTC):

The function shall detect for the presence/absence of the tandem connection overhead in the byte N1 by evaluating the multiframe alignment signal in bits 7 and 8 of byte N1. The loss of tandem connection defect (dLTC) shall be detected if the multiframe alignment process is in the OOM state. The dLTC shall be cleared if the multiframe alignment process is in the IM state.

TC Connectivity (Trace Identifier) (dTIM):

The function shall detect for a TC misconnection condition by monitoring the TC trace identifier. The Trace Identifier Mismatch defect (dTIM) shall be detected and cleared within a maximum period of 1 s in the absence of bit errors.

The defect detection process and its operation during the presence of bit errors is for further study.

The defect shall be suppressed during the receipt of SSF.

It shall be possible to disable the trace identifier mismatch defect detection (TIMdis).

TC Signal Degrade (dDEG):

The function shall detect for a TC signal degrade defect condition by monitoring for TC BIP-8 violations. The algorithm shall be according subclause 8.2.1.4 of EN 300 417-1-1 [6].

TC Remote Defect dRDI):

The function shall detect for a TC remote defect indication defect condition by monitoring the TC RDI signal. The algorithm shall be according subclause 8.2.1.5 of EN 300 417-1-1 [6].

TC Remote Outgoing VC Defect (dODI):

The function shall detect for a TC remote outgoing VC defect indication defect condition by monitoring the TC ODI signal. The algorithm shall be according subclause 8.2.1.5 of EN 300 417 1-1 [1].

Incoming AIS (dIncAIS):

The function shall detect for a tandem connection incoming AIS condition by monitoring the IEC bits in byte N1 for code "1110". If 5 consecutive frames contain the "1110" pattern in the IEC bits a dIncAIS defect shall be detected. dIncAIS shall be cleared if in 5 consecutive frames any pattern other than the "1110" is detected in the IEC bits.

NOTE 2: Bits 1 to 4 of byte N1 support two applications: conveying the incoming error information (see table 52) and conveying the incoming AIS information to the TC tail end. Codes 0000 to 1101, 1111 represent IncAIS is false, code 1110 represents IncAIS is true.

Consequent Actions:

The function shall perform the following consequent actions (refer to subclause 8.2.2 of EN 300 417-1-1 [6]):

aAIS	←	dUNEQ or dTIM or dLTC
aTSF	←	CI_SSF or dUNEQ or dTIM or dLTC
aTSD	←	dDEG
aRDI	←	CI_SSF or dUNEQ or dTIM or dLTC
aREI	←	"errored TC block, where block is 1 VC-3 tandem connection frame (125 μs)"
aODI	←	CI_SSF or dUNEQ or dTIM or dIncAIS or dLTC
aOEI	←	"errored VC block, where block is 1 VC-3 frame (125 μs)"
aOSF	←	CI_SSF or dUNEQ or dTIM or dLTC or dIncAIS

The function shall insert the all-ONES (AIS) signal within 250 μs after AIS request generation (aAIS), and cease the insertion within 250 μs after the AIS request has cleared.

Defect Correlations:

The function shall perform the following defect correlations (refer to subclause 8.2.3 of EN 300 417-1-1 [6]):

cUNEQ	←	MON and dUNEQ
cLTC	←	MON and (not dUNEQ) and dLTC
cTIM	←	MON and (not dUNEQ) and (not dLTC) and dTIM
cDEG	←	MON and (not dTIM) and (not dLTC) and dDEG

cSSF	←	MON and CI_SSF and SSF_Reported
cRDI	←	MON and (not dUNEQ) and (not dTIM) and (not dLTC) and dRDI and RDI_Reported
cODI	←	MON and (not dUNEQ) and (not dTIM) and (not dLTC) and dODI and ODI_Reported

Performance Monitoring:

The following TC error performance parameters shall be counted for each 1 second period (refer to subclauses 8.2.4 to 8.2.7 of EN 300 417-1-1 [6]):

pN_DS	←	aTSF or dEQ
pF_DS	←	dRDI
pN_EBC	←	ΣnN_B
pF_EBC	←	ΣnF_B
pON_DS	←	aODI or dEQ
pOF_DS	←	dODI
pON_EBC	←	ΣnON_B
pOF_EBC	←	ΣnOF_B

pN_EBC and pN_DS does not represent the actual performance monitoring support within an equipment. For that, these pN_DS/pN_EBC signals shall be connected to performance monitoring functions within the element management function. Similar for the far-end signals pF_EBC and pF_DS, and for pON_EBC/pON_DS, pOF_EBC/pOF_DS.

5.6.3 VC-3 Tandem Connection to VC-3 Adaptation Source function (S3D/S3_A_So)

Symbol:

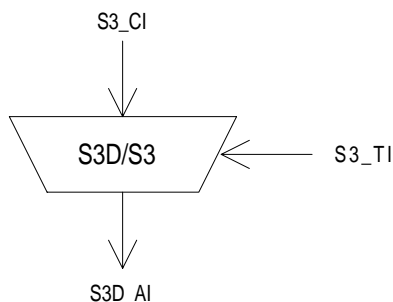

Figure 104: S3D/S3_A_So symbol

Interfaces:

Table 88: S3D/S3_A_So input and output signals

Input(s)	Output(s)
S3_CI_D S3_CI_CK S3_CI_FS S3_CI_SSF S3_TI_CK	S3D_AI_D S3D_AI_CK S3D_AI_FS S3D_AI_SF

Processes:

NOTE 1: The function has no means to verify the existence of a tandem connection within the incoming signal. Nested tandem connections are not supported.

The function shall replace the incoming Frame Start (CI_FS) signal by a local generated one (i.e. enter "holdover") if an all-ONES (AIS) VC is received (i.e. if CI_SSF is TRUE).

NOTE 2: This replacement of the (invalid) incoming frame start signal result in the generation of a valid pointer in the MSn/S3_A_So function; SSF = true signal is not passed through via S3D_TT_So to the MSn/S3_A_So.

NOTE 3: The local frame start is generated with the S3_TI timing.

Defects: None.

Consequent Actions:

AI_SF ← CI_SSF

Defect Correlations: None.

Performance Monitoring: None.

5.6.4 VC-3 Tandem Connection to VC-3 Adaptation Sink function (S3D/S3_A_Sk)

Symbol:

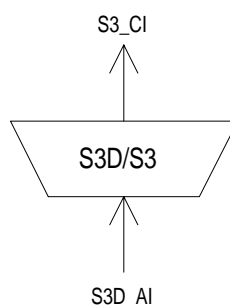

Figure 105: S3D/S3_A_Sk symbol

Interfaces:

Table 89: S3D/S3_A_Sk input and output signals

Input(s)	Output(s)
S3D_AI_D	S3_CI_D
S3D_AI_CK	S3_CI_CK
S3D_AI_FS	S3_CI_FS
S3D_AI_OSF	S3_CI_SSF

Processes:

The function shall restore the invalid frame start condition (i.e. output aSSF = true) if that existed at the ingress of the tandem connection.

NOTE: In addition, the invalid frame start condition is activated on a tandem connection connectivity defect condition that causes all-ONES (AIS) insertion in the S3D_TT_Sk.

Defects: None.

Consequent Actions:

aAIS ← AI_OSF

aSSF ← AI_OSF

The function shall insert the all-ONES (AIS) signal within 250 μs after AIS request generation (aAIS), and cease the insertion within 250 μs after the AIS request has cleared.

Defect Correlations: None.

Performance Monitoring: None.

5.6.5 VC-3 Tandem Connection Non-intrusive Monitoring Trail Termination Sink function (S3Dm_TT_Sk)

Symbol:

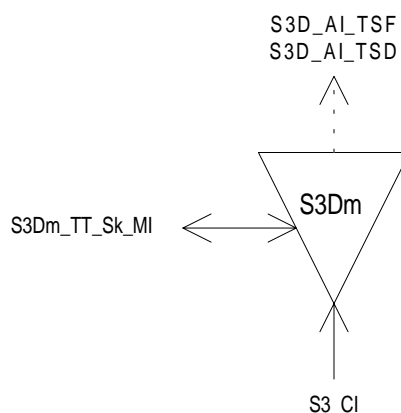

Figure 106: S3Dm_TT_Sk symbol

Interfaces:

Table 90: S3Dm_TT_Sk input and output signals

Input(s)	Output(s)
S3_CI_D	S3D_AI_TSF
S3_CI_CK	S3D_AI_TSD
S3_CI_FS	S3D_TT_Sk_MI_cLTC
S3_CI_SSF	S3D_TT_Sk_MI_cTIM
S3D_TT_Sk_MI_ExTI	S3D_TT_Sk_MI_cUNEQ
S3D_TT_Sk_MI_SSF_Reported	S3D_TT_Sk_MI_cDEG
S3D_TT_Sk_MI_RDI_Reported	S3D_TT_Sk_MI_cRDI
S3D_TT_Sk_MI_ODI_Reported	S3D_TT_Sk_MI_cSSF
S3D_TT_Sk_MI_TIMdis	S3D_TT_Sk_MI_cODI
S3D_TT_Sk_MI_DEGM	S3D_TT_Sk_MI_AcTI
S3D_TT_Sk_MI_DEGTHR	S3D_TT_Sk_MI_pN_EBC
S3D_TT_Sk_MI_1second	S3D_TT_Sk_MI_pF_EBC
S3D_TT_Sk_MI_TPmode	S3D_TT_Sk_MI_pN_DS
	S3D_TT_Sk_MI_pF_DS
	S3D_TT_Sk_MI_pOF_EBC
	S3D_TT_Sk_MI_pOF_DS

Processes:

This function can be used to perform the following:

- 1) single ended maintenance of the TC by monitoring at an intermediate node, using remote information (RDI,REI);
- 2) aid in fault localization within TC trail by monitoring near-end defects;
- 3) monitoring of VC performance at TC egressing point(except for connectivity defects before the TC) using remote outgoing information (ODI,OEI);
- 4) performing non-intrusive monitor function within SNC/S protection.

TC EDC violations: Even bit parity shall be computed for each bit n of every byte of the preceding VC-3 and compared with bit n of B3 recovered from the current frame (n = 1 to 8 inclusive). A difference between the computed and recovered B3 values shall be taken as evidence of one or more errors in the computation block. The magnitude (absolute value) of the difference between this calculated number of errors and the number of errors written into the IEC

(see table 52) at the trail termination source shall be used to determine the error performance of the tandem connection for each transmitted VC-3 (see figure 103). If this magnitude of the difference is one or more, an errored TC block is detected (nN_B). If one or more errors were detected in the computation block, an errored VC block (nON_B) shall be declared. Refer to S3D_TT_Sk.

N1[1-4]: The function shall extract the Incoming Error Code (IEC). It shall accept the received code without further processing.

N1[7-8][9-72]: The Received Trail Trace Identifier RxTI shall be recovered from the tandem connection trail trace identifier overhead and shall be made available as AcTI for network management purposes. The application and acceptance process shall be performed as specified in EN 300 417-1-1 [6], subclauses 7.1 and 8.2.1.3. The mismatch detection process shall be as specified below. The trace identifier process in this function is required to support "mode 1" (EN 300 417-1-1 [6], subclause 7.1) operation only. "Old" tandem connection equipment does not exist.

N1[5], N1[8][73]: The information carried in the REI, RDI bits in byte N1 shall be extracted to enable single ended maintenance of a bi-directional tandem connection Trail. The REI (nF_B) shall be used to monitor the error performance of the other direction of transmission, and the RDI shall be used to provide information as to the status of the remote receiver. A "1" indicates a Remote Defect Indication state, while a "0" indicates the normal, working state. The application process shall be performed as specified in EN 300 417-1-1 [6], subclauses 7.4.2 (REI), 7.4.11 and 8.2 (RDI).

N1[6], N1[7][74]: The information carried in the OEI, ODI bits in byte N1 shall be extracted to enable single ended (intermediate) maintenance of a the VC-3 egressing the tandem connection Trail. The OEI (nOF_B) shall be used to monitor the error performance of the other direction of transmission, and the ODI shall be used to provide information as to the status of the remote receiver. A "1" indicates a Outgoing Defect Indication state, while a "0" indicates the normal, working state. The application process shall be performed equivalent to the remote maintenance case, as specified in EN 300 417-1-1 [6], subclauses 7.4.2 (REI/OEI), 7.4.11 and 8.2 (RDI/ODI).

N1[7-8]: *Multiframe alignment:*

The function shall perform a multiframe alignment on bits 7 and 8 of byte N1 to recover the TTI, RDI, and ODI signals transported within the multiframe bits. The multiframe alignment shall be found by searching for the pattern "1111 1111 1111 1110" within the bits 7 and 8 of byte N1. The signal shall be continuously checked with the presumed multiframe start position for the alignment.

Frame alignment is deemed to have been lost (entering Out Of Multiframe (OOM) state) when two consecutive FAS are detected in error (i.e. ≥ 1 error in each FAS).

Frame alignment is deemed to have been recovered (entering In Multiframe (IM) state) when one non-errored FAS is found.

Defects:

TC Unequipped (dUNEQ):

The function shall detect for an unequipped Tandem Connection (UNEQ) condition by monitoring byte N1 for code "00000000". The unequipped defect (dUNEQ) shall be detected if five consecutive VC-n frames contain the "0000 0000" pattern in byte N1. The dUNEQ defect shall be cleared if in five consecutive VC-n frames any pattern other than the "0000 0000" is detected in byte N1.

TC Loss of Tandem Connection (dLTC):

The function shall detect for the presence/absence of the tandem connection overhead in the byte N1 by evaluating the multiframe alignment signal in bits 7 and 8 of byte N1. The loss of tandem connection defect (dLTC) shall be detected if the multiframe alignment process is in the OOM state. The dLTC shall be cleared if the multiframe alignment process is in the IM state.

TC Connectivity (Trace Identifier) (dTIM):

The function shall detect for a TC misconnection condition by monitoring the TC trace identifier. The Trace Identifier Mismatch defect (dTIM) shall be detected and cleared within a maximum period of 1 s in the absence of bit errors.

The defect detection process and its operation during the presence of bit errors is for further study.

The defect shall be suppressed during the receipt of SSF.

It shall be possible to disable the trace identifier mismatch defect detection (TIMdis).

TC Signal Degrade (dDEG):

The function shall detect for a TC signal degrade defect condition by monitoring for TC BIP-8 violations. The algorithm shall be according subclause 8.2.1.4 of EN 300 417-1-1 [6].

TC Remote Defect (dRDI):

The function shall detect for a TC remote defect indication defect condition by monitoring the TC RDI signal. The algorithm shall be according subclause 8.2.1.5 of EN 300 417-1-1 [6].

TC Remote Outgoing VC Defect (dODI):

The function shall detect for a TC remote outgoing VC defect indication defect condition by monitoring the TC ODI signal. The algorithm shall be according subclause 8.2.1.5 of EN 300 417-1-1 [6].

Consequent Actions:

aTSF ← CI_SSF or dUNEQ or dTIM or dLTC
 aTSD ← dDEG

Defect Correlations:

The function shall perform the following defect correlations (refer to subclause 8.2.3 of EN 300 417-1-1 [6]):

cUNEQ ← MON and dUNEQ
 cLTC ← MON and (not dUNEQ) and dLTC
 cTIM ← MON and (not dUNEQ) and (not dLTC) and dTIM
 cDEG ← MON and (not dTIM) and (not dLTC) and dDEG
 cSSF ← MON and CI_SSF and SSF_Reported
 cRDI ← MON and (not dUNEQ) and (not dTIM) and (not dLTC) and dRDI and RDI_Reported
 cODI ← MON and (not dUNEQ) and (not dTIM) and (not dLTC) and dODI and ODI_Reported

Performance Monitoring:

The following TC error performance parameters shall be counted for each 1-second period (refer to subclauses 8.2.4 to 8.2.7 of EN 300 417-1-1 [6]):

pN_DS ← aTSF or dEQ
 pF_DS ← dRDI
 pN_EBC ← ΣnN_B
 pF_EBC ← ΣnF_B
 pOF_DS ← dODI
 pOF_EBC ← ΣnOF_B

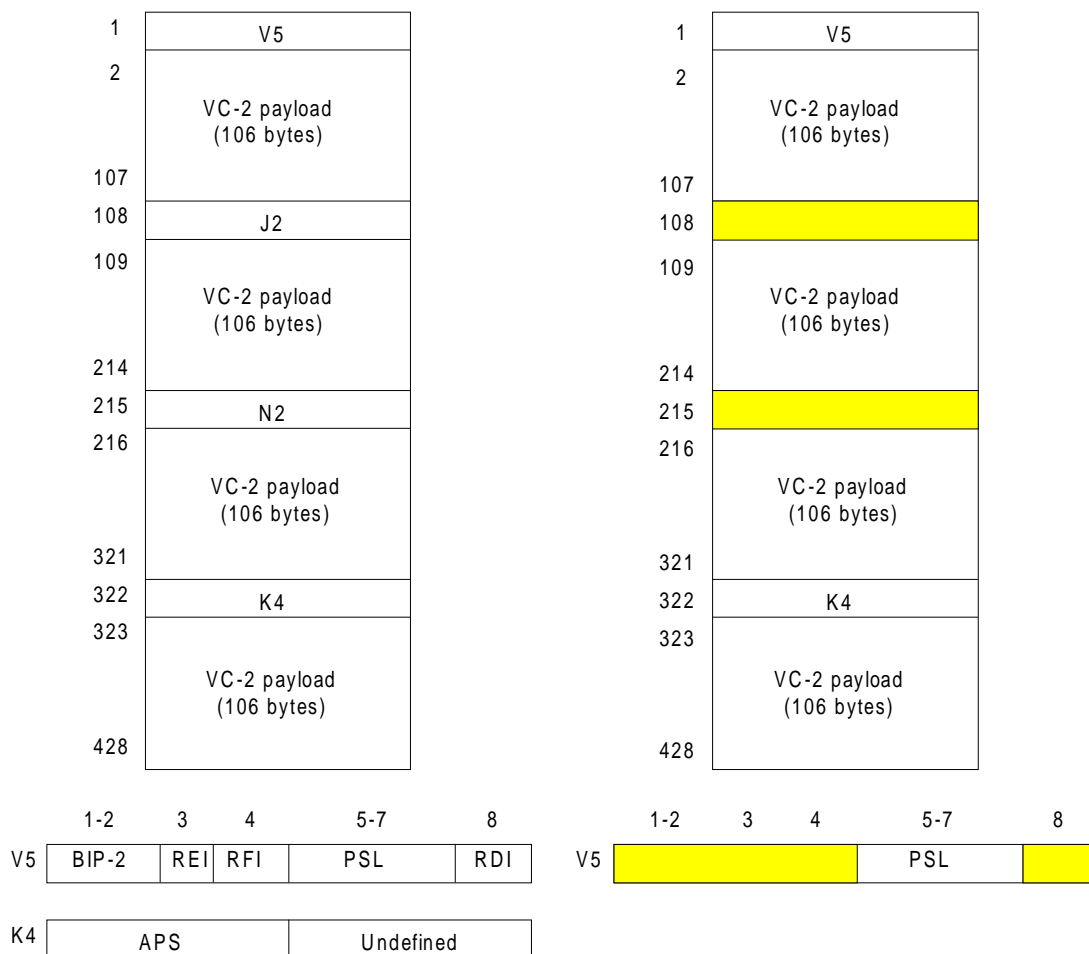

Figure 108: S2_CI_D (left) and S2_AI_D (right)

NOTE 6: The APS signal has not been defined; a multiframed APS signal might be required. The RFI signal is not supported within ETSI.

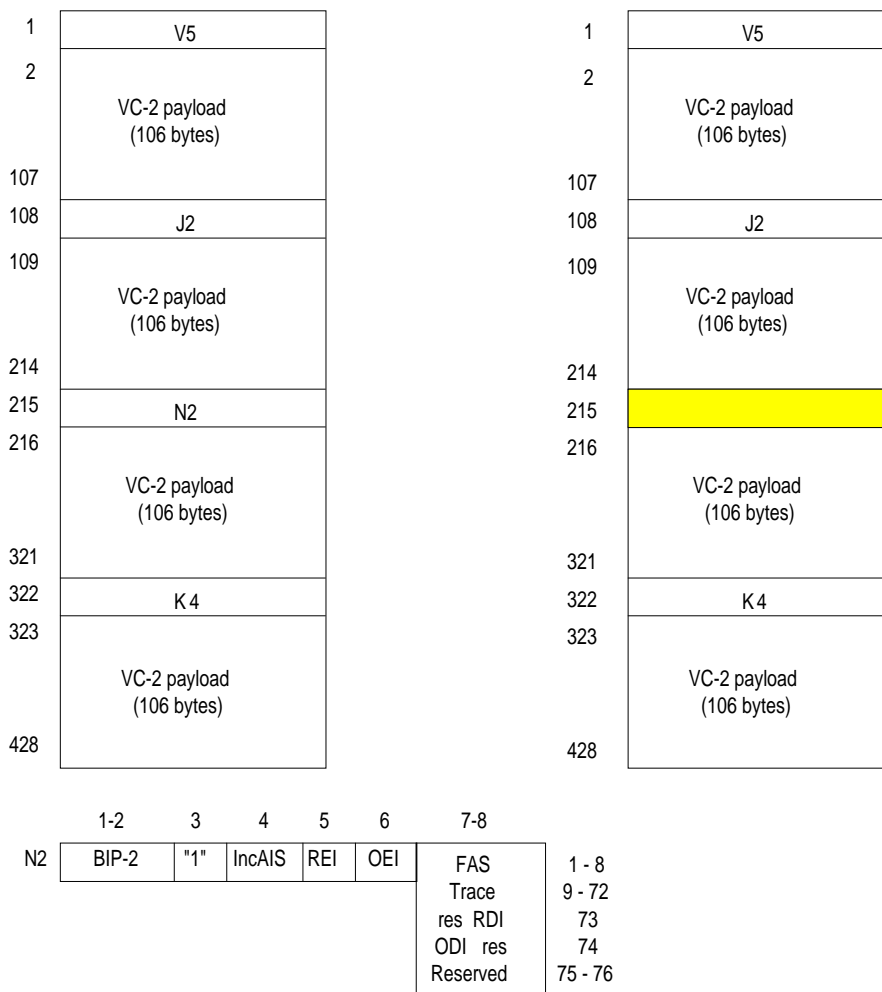

Figure 109: S2_CI_D (left) with defined N2 and S2D_AI_D (right)

Figure 110 shows the trail protection sublayer atomic functions added to (a subset of) the layer atomic functions presented in figure 107.

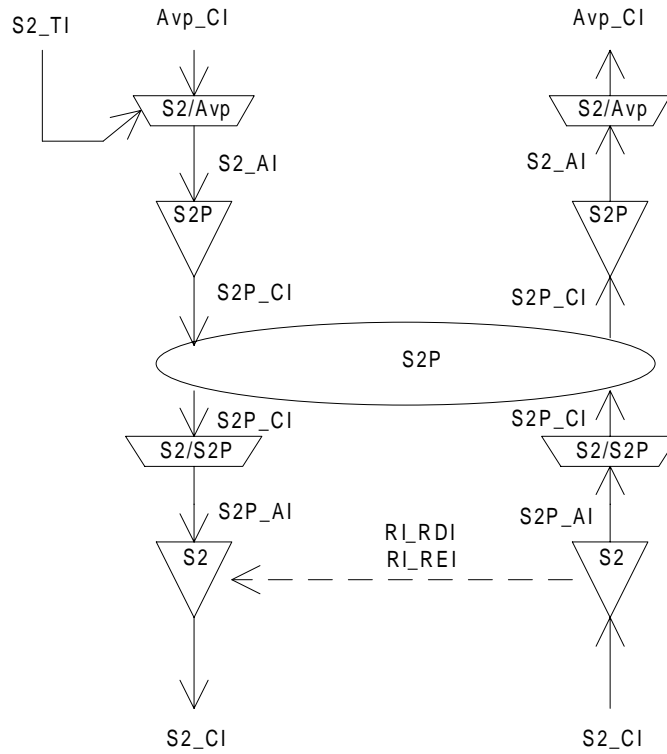

Figure 110: VC-2 Layer Trail Protection atomic functions

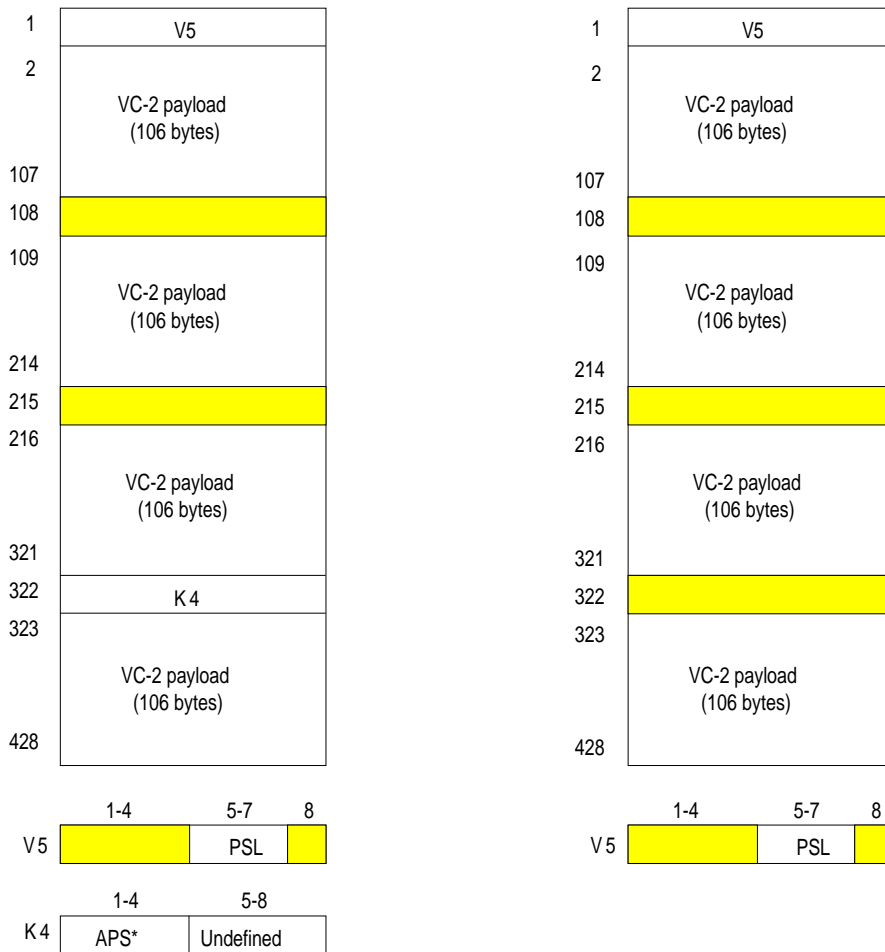

Figure 111: S2P_AI_D (left) and S2P_CI_D (right)

6.1 VC-2 Layer Connection Function S2_C

Symbol:

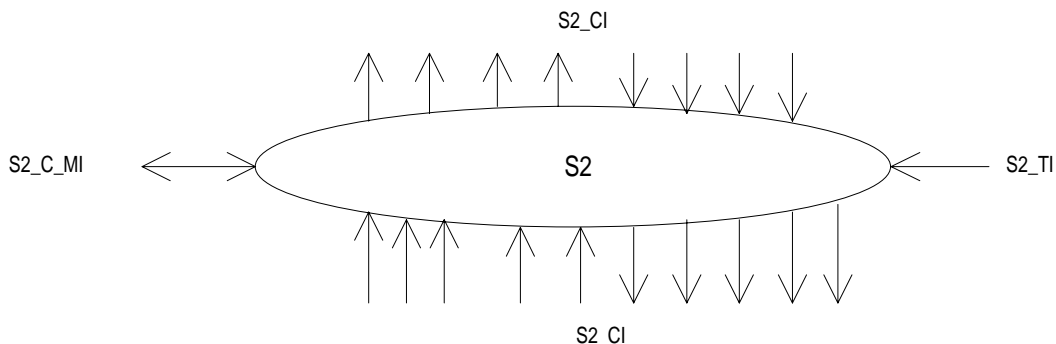

Figure 112: S2_C symbol

Interfaces:

Table 91: S2_C input and output signals

Input(s)	Output(s)
per S2_CI, n x for the function: S2_CI_D S2_CI_CK S2_CI_FS S2_CI_SSF S2_AI_TSF S2_AI_TSD	per S2_CI, m x per function: S2_CI_D S2_CI_CK S2_CI_FS S2_CI_SSF
1 x per function: S2_TI_CK S2_TI_FS	
per input and output connection point: S2_C_MI_ConnectionPortIds	
per matrix connection: S2_C_MI_ConnectionType S2_C_MI_Directionality	
per SNC protection group: S2_C_MI_PROTtype S2_C_MI_OPERtype S2_C_MI_WTRtime S2_C_MI_HOtime S2_C_MI_EXTCMD	
NOTE: Protection status reporting signals are for further study.	

Processes:

In the S2_C function VC-2 Layer Characteristic Information is routed between input (termination) connection points ((T)CPs) and output (T)CPs by means of matrix connections. (T)CPs may be allocated within a protection group.

NOTE 1: Neither the number of input/output signals to the connection function, nor the connectivity is specified in the present document. That is a property of individual network elements.

Figure 107 present a subset of the atomic functions that can be connected to this VC-2 connection function: VC-2 trail termination functions, VC-2 non-intrusive monitor trail termination sink function, VC-2 unequipped-supervisory trail termination functions, VC-2 tandem connection trail termination and adaptation functions. In addition, adaptation functions in the VC-2 server (e.g. VC-4, P4s) layers will be connected to this VC-2 connection function.

Routing:

The function shall be able to connect a specific input with a specific output by means of establishing a matrix connection between the specified input and output. It shall be able to remove an established matrix connection.

Each (matrix) connection in the S2_C function shall be characterized by the:

Type of connection:	unprotected, 1+1 protected (SNC/I, SNC/N or SNC/S protection)
Traffic direction:	unidirectional, bi-directional
Input and output connection points:	set of connection point identifiers (refer to EN 300 417-1-1 [6], subclause 3.3.6)

NOTE 2: Broadcast connections are handled as separate connections to the same input CP.

Provided no protection switching action is activated/required the following changes to (the configuration of) a connection shall be possible without disturbing the CI passing the connection:

- addition and removal of protection;
- addition and removal of connections to/from a broadcast connection;
- change between operation types;
- change of WTR time;
- change of Hold-off time.

Unequipped VC generation:

The function shall generate an unequipped VC signal, as specified in EN 300 417-1-1 [6], subclause 7.2.

Defects: None.

Consequent Actions:

If an output of this function is not connected to one of its inputs, the function shall connect the unequipped VC-2 (with valid frame start (FS) and SSF = false) to the output.

Defect Correlations: None.

Performance Monitoring: None.

6.1.1 SNC Protection

SNC protection: The function may provide the option to establish protection groups between a number of (T)CPs (see EN 300 417-1-1 [6], subclause 9.4.1 and subclause 9.4.2) to perform the VC-2 linear (sub)network connection protection process for 1+1 protection architectures (refer to EN 300 417-1-1 [6], subclause 9.2). The SNC protection process shall perform the bridge and selector functionality as presented in figure 49 of EN 300 417-1-1 [6]. In the sink direction, the signal output at the normal reference point can be the signal received via either the working connection or the protection connection; this is determined by the SF,SD conditions (relayed via CI_SSF or AI_TSF/AI_TSD signals), and the external commands. In the source direction, the working output is connected to the associated normal input. The protection output is also connected to the normal input.

NOTE: The function does not support virtual concatenated VC-2 signal (VC-2-mc) SNC protection. Refer for VC-2-mc definition to ETS 300 147 [1].

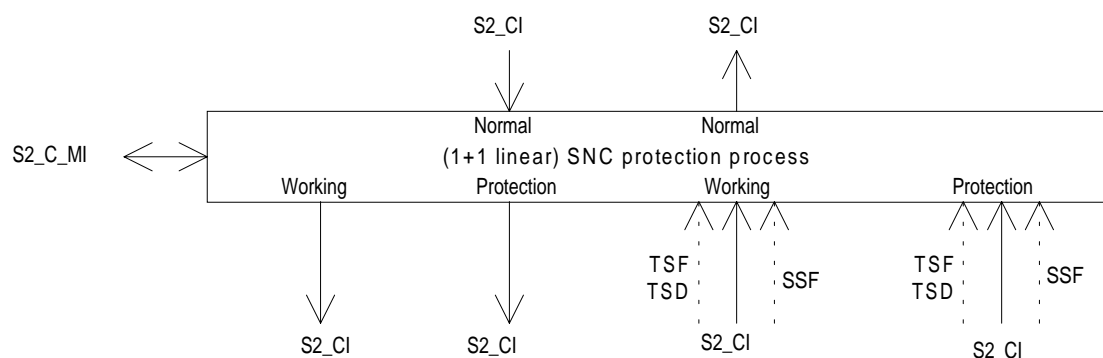

Figure 113: VC-2 1+1 SNC protection process (SNC/I, SNC/N, SNC/S)

SNC Protection Operation: The SNC protection process shall operate as specified in EN 300 417-3-1 [7], annex A, according the following characteristics:

Table 92: SNC protection parameters

Parameter	Value options
architecture type (ARCHtype)	1 + 1
switching type (SWtype)	uni-directional
operation type (OPERtype)	revertive, non-revertive
APS signal (APSmode)	false
Wait-To-Restore time (WTRtime)	in the order of 5 to 12 minutes
Switch time	≤ 50 ms
Hold-off time (HOtime)	0 to 10 seconds in steps of the order of 100 ms
Protection type (PROtype)	SNC/I, SNC/N, SNC/S
Signal switch conditions:	SF = SSF (SNC/I), SF = TSF (SNC/N, SNC/S), SD = TSD (SNC/N, SNC/S)
External commands (EXTMND)	(revertive operation) LO, FSw-#1, MSw-#1, CLR (non-revertive operation) LO or FSw, FSw-#, MSw-#, CLR (i = 0, 1)
Extra traffic (EXTRAtraffic)	false
SFpriority, SDpriority	high

In the sink case of a protection connection the source of the connection is determined by the SF (and SD) signals associated with each of the two inputs to the connection and the possible external switch requests. The set of SF and SD signals used, is controlled by the protection type setting.

6.2 VC-2 Layer Trail Termination Functions

6.2.1 VC-2 Layer Trail Termination Source S2_TT_So

Symbol:

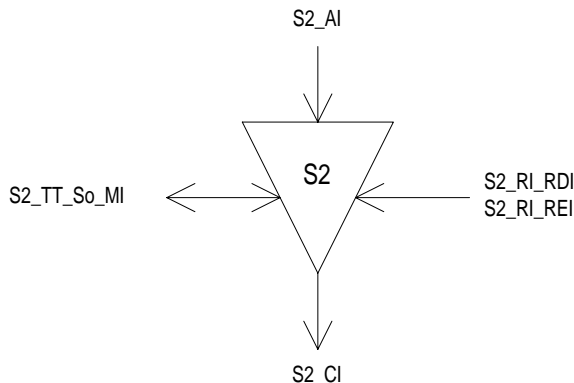

Figure 114: S2_TT_So symbol

Interfaces:

Table 93: S2_TT_So input and output signals

Input(s)	Output(s)
S2_AI_D	S2_CI_D
S2_AI_CK	S2_CI_CK
S2_AI_FS	S2_CI_FS
S2_RI_RDI	
S2_RI_REI	
S2_TT_So_MI_TxTI	

Processes:

This function adds error monitoring and status and control overhead bits to the S2_AI as defined in ETS 300 147 [1]. The processing of the trail overhead is defined as follows:

J2: In this byte the function shall insert the Transmitted Trail Trace Identifier TxTI. Its format is described in EN 300 417-1-1 [6], subclause 7.1.

V5[3]: The signal value applied at RI_REI shall be inserted in the VC-2 REI, bit 3 of byte V5. The coding shall be as follows:

Table 94: V5[3] coding

Number of BIP-2 violations conveyed via RI_REI	V5[3]
0	0
1	1
2	1

V5[8]: Bit 8 of byte V5, a RDI indication, shall be set to "1" on activation of S2_RI_RDI within 1 000 µs, determined by the associated S2_TT_Sk function, and set to "0" within 1 000 µs on clearing of S2_RI_RDI.

V5[1-2]: In these bits the function shall insert the BIP-2 EDC with even bit parity. Each bit of current bits 1 or 2 is computed to provide even parity over the associated (odd and even) bits of every byte in the previous frame of the Characteristic Information S2_CI, i.e., bits 1 and 2 are calculated over the entire previous VC-2. Further reference is provided in EN 300 417-1-1 [6], subclause 7.3.

K4[5-8]: The value of the bits 5 to 8 of byte K4 is undefined.

Defects: None.

Consequent Actions: None.

Defect Correlations: None.

Performance Monitoring: None.

6.2.2 VC-2 Layer Trail Termination Sink S2_TT_Sk

Symbol:

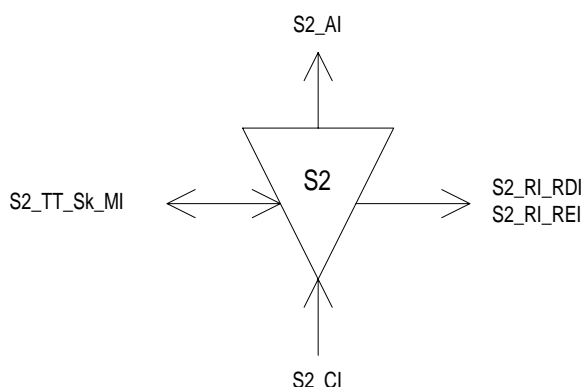

Figure 115: S2_TT_Sk symbol

Interfaces:

Table 95: S2_TT_Sk input and output signals

Input(s)	Output(s)
S2_CI_D	S2_AI_D
S2_CI_CK	S2_AI_CK
S2_CI_FS	S2_AI_FS
S2_CI_SSF	S2_AI_TSF
	S2_AI_TSD
S2_TT_Sk_MI_TPmode	S2_TT_Sk_MI_cTIM
S2_TT_Sk_MI_SSF_Reported	S2_TT_Sk_MI_cUNEQ
S2_TT_Sk_MI_ExtI	S2_TT_Sk_MI_cDEG
S2_TT_Sk_MI_RDI_Reported	S2_TT_Sk_MI_cRDI
S2_TT_Sk_MI_DEGTHR	S2_TT_Sk_MI_cSSF
S2_TT_Sk_MI_DEGM	S2_TT_Sk_MI_AcTI
S2_TT_Sk_MI_1second	S2_RI_RDI
S2_TT_Sk_MI_TIMdis	S2_RI_REI
S2_TT_Sk_MI_ExtImode	S2_TT_Sk_MI_pN_EBC
	S2_TT_Sk_MI_pN_DS
	S2_TT_Sk_MI_pF_EBC
	S2_TT_Sk_MI_pF_DS

Processes:

This function monitors VC-2 for errors, and recovers the trail termination status. It extracts the payload independent overhead bytes/bits (J2, V5[1-2], V5[3], V5[5-7], V5[8]) from the VC-2 layer Characteristic Information:

J2: The Received Trail Trace Identifier RxTI shall be recovered from the J2 byte and shall be made available as AcTI for network management purposes. The application and acceptance and mismatch detection process shall be performed as specified in EN 300 417-1-1 [6], subclauses 7.1 and 8.2.1.3.

V5[1-2]: Even bit parity is computed for each bit pair of every byte of the preceding VC-2 including V5 and compared with bit 1 and 2 of V5 recovered from the current frame. A difference between the computed and recovered BIP-2 values is taken as evidence of an errored block (nN_B).

V5[3], V5[8]: The information carried in the bits 3 and 8 of the V5 byte (REI, RDI) shall be extracted to enable single ended maintenance of a bi-directional Trail (Path). The REI (nF_B) shall be used to monitor the error performance of the other direction of transmission, and the RDI (bit 8) shall be used to provide information as to the status of the remote receiver. A "1" indicates a Remote Defect Indication state, while a "0" indicates the normal, working state. The

application process shall be performed as specified in EN 300 417-1-1 [6], subclauses 7.4.2 (REI), 7.4.11 and 8.2 (RDI).

K4[5-8]: The value in the bits 5 to 8 of byte K4 shall be ignored.

Table 96: V5[3] code interpretation

V5[3]	REI code interpretation
0	0 errored blocks
1	1 errored block

V5[5-7]: The information in bits 5 to 7 of byte V5 shall be extracted to allow unequipped VC defect detection.

Defects:

The function shall detect for dDEG, dRDI, dUNEQ and dTIM defects according the specification in EN 300 417-1-1 [6], subclause 8.2.1.

Consequent Actions:

aAIS	←	dUNEQ or dTIM
aTSF	←	CI_SSF or dUNEQ or dTIM
aRDI	←	CI_SSF or dUNEQ or dTIM
aTSD	←	dDEG
aREI	←	"#EDCV"

On declaration of aAIS the function shall output all-ONES signal within 1 000 μ s; on clearing of aAIS the function shall output normal data within 1 000 μ s.

Defect Correlations:

cUNEQ	←	dUNEQ and MON
cTIM	←	dTIM and (not dUNEQ) and MON
cDEG	←	dDEG and (not dTIM) and MON
cRDI	←	dRDI and (not dUNEQ) and (not dTIM) and MON and RDI_Reported
cSSF	←	CI_SSF and MON and SSF_Reported

Performance Monitoring:

The performance monitoring process shall be performed as specified in EN 300 417-1-1 [6], subclause 8.2.4 through 8.2.7.

pN_DS	←	aTSF or dEQ
pF_DS	←	dRDI
pN_EBC	←	Σ nN_B
pF_EBC	←	Σ nF_B

6.3 VC-2 Layer Adaptation Functions

6.3.1 VC-2 Layer to TSS4 Adaptation Source S2/TSS4_A_So

Symbol:

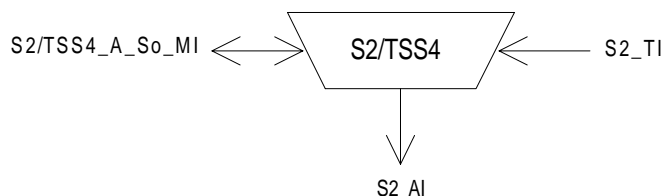

Figure 116: S2/TSS4_A_So symbol

Interfaces:

Table 97: S2/TSS4_A_So input and output signals

Input(s)	Output(s)
S2_TI_CK	S2_AI_D
S2_TI_FS	S2_AI_CK
S2/TSS4_A_So_MI_Active	S2_AI_FS

Processes:

This function maps a VC-2 synchronous Test Signal Structure TSS4 PRBS stream as described in ITU-T Recommendation O.181 [12] into a VC-2 payload and adds the bits V5[5-7] bytes. It creates a 2^{15} PRBS with timing derived from the S2_TI_Ck and maps it without justification bits into the whole of the synchronous container-2 having a capacity of 424 bytes. The PRBS is a sequence which repeats itself over a period which is not an exact multiple of the capacity available in the container-2 frame. Therefore the start of the sequence will move relative to the start of the container-2 frame over time.

Three bits of payload specific POH information, V5[5-7], shall be added to container-2 to form the VC-2 AI and a fixed Frame Start (FS) shall be generated.

V5[5-7]: In these bits the function shall insert code "110" (TSS4 into the Container-2) as defined in ETS 300 147 [1].

Activation:

The function shall access the access point when it is activated (MI_Active is true). Otherwise, it shall not access the access point.

Defects: None.

Consequent Actions: None.

Defect Correlations: None.

Performance Monitoring: None.

6.3.2 VC-2 Layer to TSS4 Adaptation Sink S2/TSS4_A_Sk

Symbol:

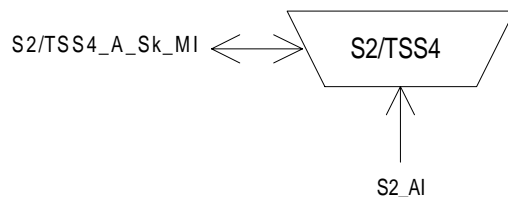

Figure 117: S2/TSS4_A_Sk symbol

Interfaces:

Table 98: S2/TSS4_A_Sk input and output signals

Input(s)	Output(s)
S2_AI_D	S2/TSS4_A_Sk_MI_cPLM
S2_AI_CK	S2/TSS4_A_SK_MI_cLSS
S2_AI_FS	S2/TSS4_A_Sk_MI_AcSL
S2_AI_TSF	S2/TSS4_A_Sk_MI_pN_TSE
S2/TSS4_A_Sk_MI_Active	
S2/TSS4_A_Sk_MI_1second	

Processes:

The function recovers a TSS4 2¹⁵ PRBS test sequence as defined in ITU-T Recommendation O.181 [12] from the synchronous container-2 (having a frequency accuracy within $\pm 4,6$ ppm) and monitors the reception of the correct payload signal type and the presence of test sequence errors (TSE) in the PRBS sequence.

V5[5-7]: The function shall compare the content of the accepted bits 5 to 7 of byte V5 with the expected value code "110" (TSS4 into the Container-2) as a check on consistency between the provisioning operation at each end. The application and acceptance and mismatch detection process shall be as specified in EN 300 417-1-1 [6], subclauses 7.2 and 8.1.2.

Error monitoring: Test sequence errors are bit errors in the TSS data stream and shall be detected whenever the PRBS detector is in lock and the received data bit does not match the expected value.

Activation:

The function shall perform the operation specified above when it is activated (MI_Active is true). Otherwise, it shall not report its status via the management point.

Defects:

The function shall detect for dPLM defect according the specification in EN 300 417-1-1 [6], subclause 8.2.1.

The function shall detect for loss of PRBS lock (dLSS) according to the criteria defined in ITU-T Recommendation O.151 [11], subclause 2.6.

Consequent Actions: None.

Defect Correlations:

cPLM ← dPLM and (not AI_TSF)
 cLSS ← dLSS and (not AI_TSF)

Performance Monitoring:

pN_TSE ← Sum of Test Sequence Errors (TSE) within one second period.

6.3.3 VC-2 Layer to ATM Virtual Path Layer Compound Adaptation Source function S2/Avp_A_So

For further study.

6.3.4 VC-2 Layer to ATM Virtual Path Layer Compound Adaptation Sink function S2/Avp_A_Sk

For further study.

6.3.5 VC-2 Layer Clock Adaptation Source S2-LC_A_So

Refer to EN 300 417-6-1 [8].

6.4 VC-2 Layer Monitoring Functions

6.4.1 VC-2 Layer Non-intrusive Monitoring Function S2m_TT_Sk

Symbol:

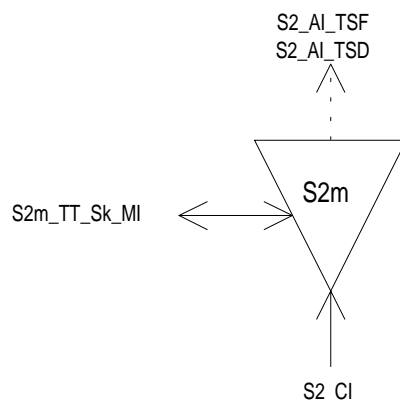

Figure 118: S2m_TT_Sk symbol

Interfaces:

Table 99: S2m_TT_Sk input and output signals

Input(s)	Output(s)
S2_CI_D	S2_AI_TSF
S2_CI_CK	S2_AI_TSD
S2_CI_FS	S2m_TT_Sk_MI_cTIM
S2_CI_SSF	S2m_TT_Sk_MI_cUNEQ
S2m_TT_Sk_MI_TPmode	S2m_TT_Sk_MI_cDEG
S2m_TT_Sk_MI_SSF_Reported	S2m_TT_Sk_MI_cRDI
S2m_TT_Sk_MI_ExtI	S2m_TT_Sk_MI_cSSF
S2m_TT_Sk_MI_RDI_Reported	S2m_TT_Sk_MI_AcTI
S2m_TT_Sk_MI_DEGTHR	S2m_TT_Sk_MI_pN_EBC
S2m_TT_Sk_MI_DEGM	S2m_TT_Sk_MI_pF_EBC
S2m_TT_Sk_MI_ExtImode	S2m_TT_Sk_MI_pN_DS
S2m_TT_Sk_MI_1second	S2m_TT_Sk_MI_pF_DS
S2m_TT_Sk_MI_TIMdis	

Processes:

NOTE 1: This non-intrusive monitor trail termination sink function has no associated source function.

This function monitors VC-2 for errors, and recovers the trail termination status. It extracts the payload independent overhead bytes/bits (J2, V5[1-2], V5[3], V5[5-7], V5[8]) from the VC-2 layer Characteristic Information:

J2: The Received Trail Trace Identifier RxTI shall be recovered from the J2 byte and shall be made available as AcTI for network management purposes. The application and acceptance and mismatch detection process shall be performed as specified in EN 300 417-1-1 [6], subclauses 7.1 and 8.2.1.3.

V5[1-2]: Even bit parity is computed for each bit pair of every byte of the preceding VC-2 including V5 and compared with bit 1 and 2 of V5 recovered from the current frame. A difference between the computed and recovered BIP-2 values is taken as evidence of an errored block (nN_B).

V5[3], V5[8]: The information carried in the bits 3 and 8 of the V5 byte (REI, RDI) shall be extracted to enable single ended maintenance of a bi-directional Trail (Path). The REI (nF_B) shall be used to monitor the error performance of the other direction of transmission, and the RDI (bit 8) shall be used to provide information as to the status of the remote receiver. A "1" indicates a Remote Defect Indication state, while a "0" indicates the normal, working state. The application process shall be performed as specified in EN 300 417-1-1 [6], subclauses 7.4.2 (REI), 7.4.11 and 8.2 (RDI).

K4[5-8]: The value in the bits 5 to 8 of byte K4 shall be ignored.

Table 100: V5[3] code interpretation

V5[3]	REI code interpretation
0	0 errored blocks
1	1 errored block

V5[5-7]: The information in bits 5 to 7 of byte V5 shall be extracted to allow unequipped VC defect detection.

Defects:

The detection and removal conditions and processes for dDEG, dRDI, dUNEQ and dTIM defects shall be as specified by EN 300 417-1-1 [6], subclause 8.2.1 with the condition "aSSF" read as "aSSF or VC dAIS". To use the function within e.g. a tandem connection, it shall be possible to disable the trace id mismatch detection (TIMdis).

NOTE 2: Presumably, in such case the VC Trace Id. will be unknown to the tandem connection operator.

VC AIS:

The function shall detect for an AIS VC (VC-AIS) condition by monitoring the VC PSL for code "111". If 5 consecutive frames contain the "111" pattern in bits 5 to 7 of byte V5 a dAIS defect shall be detected. dAIS shall be cleared if in 5 consecutive frames any pattern other than the "111" is detected in bits 5 to 7 of byte V5.

NOTE 3: Equipment designed prior to the present document may be able to perform VC-AIS detection either as specified above interpreting "frames" as "samples (not necessary consecutive frames)", or by a comparison of the accepted signal label with the all-ONEs pattern. If the accepted signal label is equal to all-ONEs, VC-AIS defect is detected. If the accepted signal label is not equal to all-ONEs, VC-AIS defect is cleared.

Consequent actions:

aTSF ← CI_SSF or dAIS or dUNEQ or dTIM

aTSD ← dDEG

Defect Correlations:

cUNEQ ← dUNEQ and MON

cTIM ← dTIM and (not dUNEQ) and MON

cDEG ← dDEG and (not dTIM) and MON

cRDI ← dRDI and (not dUNEQ) and (not dTIM) and MON and RDI_Reported

cSSF ← (CI_SSF or dAIS) and MON and SSF_Reported

Performance Monitoring:

The performance monitoring process shall be performed as specified in EN 300 417-1-1 [6], subclause 8.2.4 through 8.2.7.

pN_DS ← aTSF or dEQ

pF_DS ← dRDI

pN_EBC ← Σ nN_B

pF_EBC ← Σ nF_B

NOTE 4: pF_DS/pF_EBC represent the performance of the total trail while pN_DS/pN_EBC represents only part of the trail up to the point of the non-intrusive monitor.

6.4.2 VC-2 Layer Supervisory-Unequipped Termination Source S2s_TT_So

Symbol:

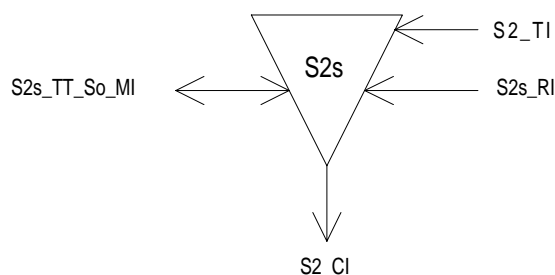

Figure 119: S2s_TT_So symbol

Interfaces:

Table 101: S2s_TT_So input and output signals

Input(s)	Output(s)
S2s_RI_RDI	S2_CI_D
S2s_RI_REI	S2_CI_CK
S2_TI_CK	S2_CI_FS
S2_TI_FS	
S2s_TT_So_MI_TxTI	

Processes:

This function generates error monitoring and status overhead bytes to an undefined VC-2. The processing of the trail termination overhead bytes is defined as follows:

J2: In this byte the function shall insert the Transmitted Trail Trace Identifier TxTI. Its format is described in EN 300 417-1-1 [6], subclause 7.1.

V5[3]: The signal value applied at RI_REI shall be inserted in the VC-2 REI, bit 3 of byte V5. The coding shall be as follows:

Table 102: V5[3] coding

Number of BIP-2 violations conveyed via RI_REI	V5[3]
0	0
1	1
2	1

V5[8]: Bit 8 of byte V5, a RDI indication, shall be set to "1" on activation of S2s_RI_RDI within 1 000 µs, determined by the associated S2s_TT_Sk function, and set to "0" within 1 000 µs on clearing of S2s_RI_RDI.

V5[5-7]: In this byte the function shall insert code "000" (unequipped VC or supervisory-unequipped VC) as defined in subclause 7.2 of EN 300 417-1-1 [6] and ETS 300 147 [1].

V5[1-2]: In these bits the function shall insert the BIP-2 EDC with even bit parity. Each bit of current bits 1 or 2 is computed to provide even parity over the associated (odd and even) bits of every byte in the previous frame of the Characteristic Information S2_CI, i.e., bits 1 and 2 are calculated over the entire previous VC-2. Further reference is provided in EN 300 417-1-1 [6], subclause 7.3.

K4[5-8]: The value of the bits 5 to 8 of byte K4 is undefined.

N2: In this byte the function shall insert code "0000 0000" (unequipped tandem connection) as defined in subclause 7.2 of EN 300 417-1-1 [6].

Other VC-2 bytes:

The function shall generate the other VC-2 bytes and bits. Their content is undefined (i.e. bits are set to either a value of "0" or "1").

Defects: None.

Consequent Actions: None.

Defect Correlations: None.

Performance Monitoring: None.

6.4.3 VC-2 Layer Supervisory-unequipped Termination Sink S2s_TT_Sk

Symbol:

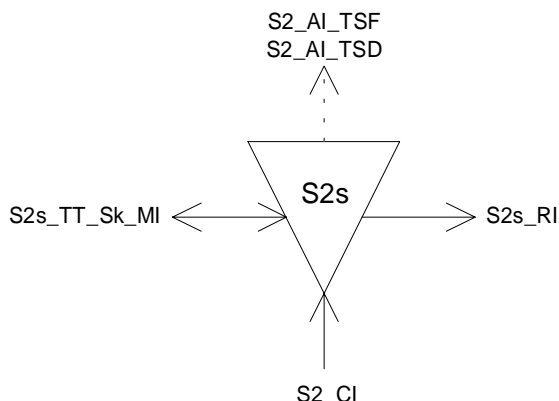

Figure 120: S2s_TT_Sk symbol

Interfaces:

Table 103: S2s_TT_Sk input and output signals

Input(s)	Output(s)
S2_CI_D	S2_AI_TSF
S2_CI_CK	S2_AI_TSD
S2_CI_FS	S2s_TT_Sk_MI_cTIM
S2_CI_SSF	S2s_TT_Sk_MI_cUNEQ
S2s_TT_Sk_MI_TPmode	S2s_TT_Sk_MI_cDEG
S2s_TT_Sk_MI_SSF_Reported	S2s_TT_Sk_MI_cRDI
S2s_TT_Sk_MI_ExTI	S2s_TT_Sk_MI_cSSF
S2s_TT_Sk_MI_RDI_Reported	S2s_TT_Sk_MI_AcTI
S2s_TT_Sk_MI_DEGTHR	S2s_RI_RDI
S2s_TT_Sk_MI_DEGM	S2s_RI_REI
S2s_TT_Sk_MI_1second	S2s_TT_Sk_MI_pN_EBC
S2s_TT_Sk_MI_TIMdis	S2s_TT_Sk_MI_pF_EBC
S2s_TT_Sk_MI_ExTImode	S2s_TT_Sk_MI_pN_DS
	S2s_TT_Sk_MI_pF_DS

Processes:

This function monitors VC-2 for errors, and recovers the trail termination status. It extracts the payload independent overhead bytes/bits (J2, V5[1-2], V5[3], V5[5-7], V5[8]) from the VC-2 layer Characteristic Information:

J2: The Received Trail Trace Identifier RxTI shall be recovered from the J2 byte and shall be made available as AcTI for network management purposes. The application and acceptance and mismatch detection process shall be performed as specified in EN 300 417-1-1 [6], subclauses 7.1 and 8.2.1.3.

V5[1-2]: Even bit parity is computed for each bit pair of every byte of the preceding VC-2 including V5 and compared with bit 1 and 2 of V5 recovered from the current frame. A difference between the computed and recovered BIP-2 values is taken as evidence of an errored block (nN_B).

V5[3], V5[8]: The information carried in the bits 3 and 8 of the V5 byte (REI, RDI) shall be extracted to enable single ended maintenance of a bi-directional Trail (Path). The REI (nF_B) shall be used to monitor the error performance of the other direction of transmission, and the RDI (bit 8) shall be used to provide information as to the status of the remote receiver. A "1" indicates a Remote Defect Indication state, while a "0" indicates the normal, working state. The application process shall be performed as specified in EN 300 417-1-1 [6], subclauses 7.4.2 (REI), 7.4.11 and 8.2 (RDI).

K4[5-8]: The value of the bits 5 to 8 of byte K4 shall be ignored.

Table 104: V5[3] code interpretation

V5[3]	REI code interpretation
0	0 errored blocks
1	1 errored block

V5[5-7]: The information in bits 5 to 7 of byte V5 shall be extracted to allow unequipped VC defect detection.

Defects:

The function shall detect for dDEG, dRDI, dUNEQ and dTIM defects according the specifications in EN 300 417-1-1 [6], subclause 8.2.1.

Consequent Actions:

aTSF ← CI_SSF or dTIM
 aTSD ← dDEG
 aRDI ← CI_SSF or dTIM
 aREI ← "#EDCV"

NOTE: dUNEQ can not be used to activate aTSF and aRDI; an expected supervisory-unequipped signal will have the signal label set to all-0s, causing a continuous detection of dUNEQ. If an unequipped VC comes in, dTIM will be activated and can serve as a trigger for aTSF/aRDI instead of dUNEQ.

Defect Correlations:

cUNEQ ← MON and dTIM and (AcTI = all "0"s) and dUNEQ
 cTIM ← MON and dTIM and not (dUNEQ and AcTI = all "0"s)
 cDEG ← MON and (not dTIM) and dDEG
 cRDI ← MON and (not dTIM) and dRDI and RDI_Reported
 cSSF ← MON and CI_SSF and SSF_Reported

Performance Monitoring:

The performance monitoring process shall be performed as specified in EN 300 417-1-1 [6], subclause 8.2.4 through 8.2.7.

pN_DS ← aTSF or dEQ
 pF_DS ← dRDI
 pN_EBC ← Σ nN_B
 pF_EBC ← Σ nF_B

6.5 VC-2 Layer Trail Protection Functions

6.5.1 VC-2 Trail Protection Connection Functions S2P_C

6.5.1.1 VC-2 Layer 1+1 uni-directional Protection Connection Function S2P1+1u_C

Symbol:

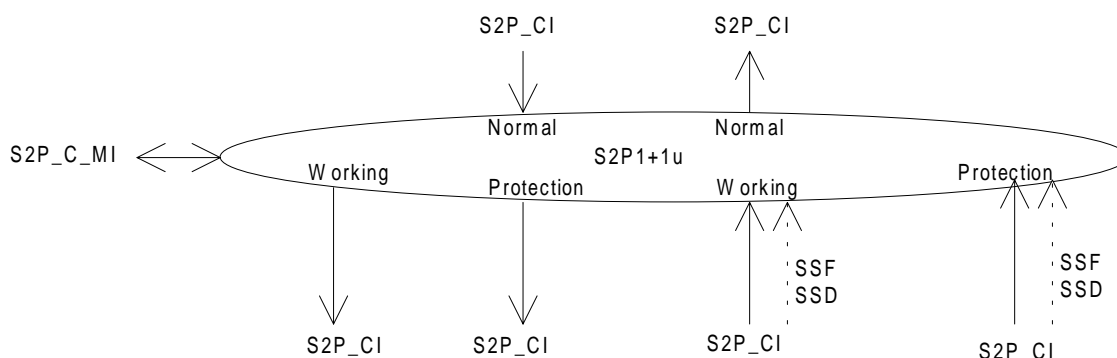

Figure 121: S2P1+1u_C symbol

Interfaces:

Table 105: S2P1+1u_C input and output signals

Input(s)	Output(s)
for connection points W and P: S2P_CI_D S2P_CI_CK S2P_CI_FS S2P_CI_SSF S2P_AI_SSD	for connection points W and P: S2P_CI_D S2P_CI_CK S2P_CI_FS
for connection point N: S2P_CI_D S2P_CI_CK S2P_CI_FS S2P_C_MI_OPERType S2P_C_MI_WTRTime S2P_C_MI_HOTime S2P_C_MI_EXTCMD	for connection point N: S2P_CI_D S2P_CI_CK S2P_CI_FS S2P_CI_SSF NOTE: protection status reporting signals are for further study.

Processes:

The function performs the VC-2 linear trail protection process for 1+1 protection architectures with uni-directional switching; refer to EN 300 417-1-1 [6], subclause 9.2. It performs the bridge and selector functionality as presented in figure 49 of EN 300 417-1-1 [6]. In the sink direction, the signal output at the normal reference point can be the signal received via either the associated working path or the protection path; this is determined by the SF,SD conditions (relayed via CI_SSF,CI_SSD signals), and the external commands. In the source direction, the working output is connected to the associated normal input. The protection output is also connected to the normal input.

Provided no protection switching action is activated/required the following changes to (the configuration of) a trail shall be possible without disturbing the CI passing the trail:

- change between operation types;
- change of WTR and HO times.

Operation:

The VC trail protection process shall operate as specified in EN 300 417-3-1 [7], annex A, according the following characteristics:

Table 106: Trail protection parameters

Parameter	Value options
architecture type (ARCHtype)	1 + 1
switching type (SWtype)	uni-directional
operation type (OPERtype)	revertive, non-revertive
APS signal (APSmode)	false
Wait-To-Restore time (WTRtime)	in the order of 5-12 minutes
Switch time	≤ 50 ms
Hold-off time (HOtime)	0 to 10 seconds in steps of the order of 100 ms
Protection type (PROTtype)	trail
Signal switch conditions:	SF = SSF (originated as AI_TSF) SD = SSD (originated as AI_TSD)
External commands (EXTCMD)	(revertive operation) LO, FSw-#1, MSw-#1, CLR (non-revertive operation) LO or FSw, FSw-#i, MSw-#i, CLR (i=0,1)
Extra traffic (EXTRAtraffic)	false
SFpriority, SDpriority	high

Defects: None.

Consequent Actions: None.

Defect Correlations: None.

Performance Monitoring: None.

6.5.1.2 VC-2 Layer 1+1 dual ended Protection Connection Function S2P1+1b_C

Symbol:

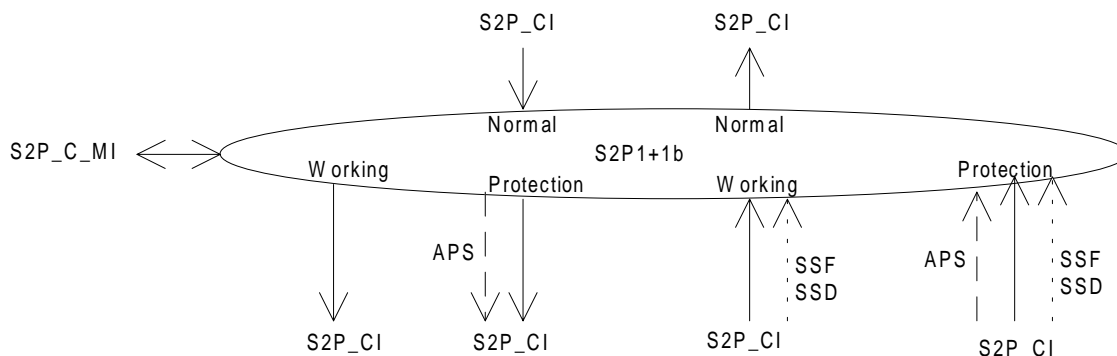

Figure 122: S2P1+1b_C symbol

Interfaces:

Table 107: S2P1+1b_C input and output signals

Input(s)	Output(s)
for connection points W and P: S2P_CI_D S2P_CI_CK S2P_CI_FS S2P_CI_SSF S2P_CI_SSD	for connection points W and P: S2P_CI_D S2P_CI_CK S2P_CI_FS
for connection point N: S2P_CI_D S2P_CI_CK S2P_CI_FS	for connection point N: S2P_CI_D S2P_CI_CK S2P_CI_FS S2P_CI_SSF
for connection point P: S2P_CI_APS S2P_C_MI_OPERType S2P_C_MI_WTRTime S2P_C_MI_HOTime S2P_C_MI_EXTCMD	for connection point P: S2P_CI_APS NOTE: protection status reporting signals are for further study.

Processes:

The function performs the VC-2 linear trail protection process for 1+1 protection architecture with bi-directional switching; refer to EN 300 417-1-1 [6], subclause 9.2. It performs the bridge and selector functionality as presented in figure 49 of EN 300 417-1-1 [6]. In the sink direction, the signal output at the normal reference point can be the signal received via either the associated working path or the protection path; this is determined by the SF,SD conditions (relayed via CI_SSF,CI_SSD signals), and the external commands. In the source direction, the working output is connected to the associated normal input. The protection output is also connected to the normal input.

Provided no protection switching action is activated/required the following changes to (the configuration of) a trail shall be possible without disturbing the CI passing the trail:

- change between operation types;
- change of WTR and HO times.

Operation:

The VC trail protection process shall operate as specified in EN 300 417-3-1 [7], annex A, according the following characteristics:

Table 108: Trail protection parameters

Parameter	Value options
architecture type (ARCHtype)	1 + 1
switching type (SWtype)	bi-directional
operation type (OPERtype)	revertive, non-revertive
APS signal (APSmode)	true
Wait-To-Restore time (WTRtime)	in the order of 5 to 12 minutes
Switch time	≤ 50 ms
Hold-off time (HOtime)	0 to 10 seconds in steps of the order of 100 ms
Protection type (PROTtype)	trail
Signal switch conditions:	SF = SSF (originated as AI_TSF) SD = SSD (originated as AI_TSD)
External commands (EXTCMD)	(revertive operation) LO, FSw-#1, MSw-#1, CLR (non-revertive operation) LO or FSw, FSw-#i, MSw-#i, EXER-#i, CLR (i=0,1)
Extra traffic (EXTRAtraffic)	false
SFpriority, SDpriority	high

NOTE: The VC-2 APS signal definition is for further study.

Defects:	None.
Consequent Actions:	None.
Defect Correlations:	None.
Performance Monitoring:	None.

6.5.2 VC-2 Layer Trail Protection Trail Termination Functions

6.5.2.1 VC-2 Protection Trail Termination Source S2P_TT_So

Symbol:

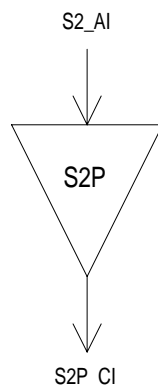

Figure 123: S2P_TT_So symbol

Interfaces:

Table 109: S2P_TT_So input and output signals

Input(s)	Output(s)
S2P_AI_D	S2P_CI_D
S2P_AI_CK	S2P_CI_CK
S2P_AI_FS	S2P_CI_FS

Processes:

No information processing is required in the S2P_TT_So, the S2_AI at its output is identical to the S2P_CI at its input.

Defects: None.

Consequent Actions: None.

Defect Correlations: None.

Performance Monitoring: None.

6.5.2.2 VC-2 Protection Trail Termination Sink S2P_TT_Sk

Symbol:

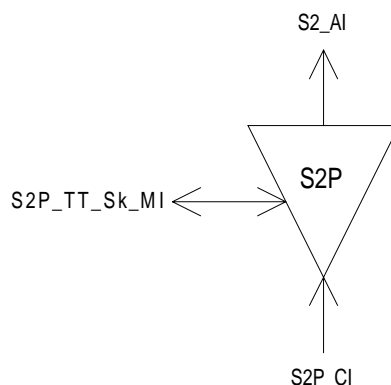

Figure 124: S2P_TT_Sk symbol

Interfaces:

Table 110: S2P_TT_Sk input and output signals

Input(s)	Output(s)
S2P_CI_D	S2_AI_D
S2P_CI_CK	S2_AI_CK
S2P_CI_FS	S2_AI_FS
S2P_CI_SSF	S2_AI_TSF
S2P_TT_Sk_MI_SSF_Reported	S2P_TT_Sk_MI_cSSF

Processes:

The S2P_TT_Sk function reports, as part of the S2 layer, the state of the protected VC-2 trail. In case all trails are unavailable the S2P_TT_Sk reports the signal fail condition of the protected trail.

Defects: None.

Consequent Actions:

aTSF ← CI_SSF

Defect Correlations:

cSSF ← CI_SSF and SSF_Reported

Performance Monitoring: None.

6.5.3 VC-2 Layer Linear Trail Protection Adaptation Functions

6.5.3.1 VC-2 trail to VC-2 trail Protection Layer Adaptation Source S2/S2P_A_So

Symbol:

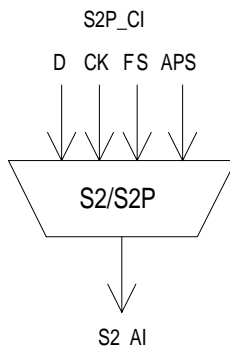

Figure 125: S2/S2P_A_Sk symbol

Interfaces:

Table 111: S2/S2P_A_So input and output signals

Input(s)	Output(s)
S2P_CI_D	S2_AI_D
S2P_CI_CK	S2_AI_CK
S2P_CI_FS	S2_AI_FS
S2P_CI_APS	

Processes:

The function shall multiplex the S2 APS signal and S2 data signal onto the S2 access point.

K4[1-4]: The insertion of the VC-APS signal is for further study. This process is required only for the protection path.

Defects: None.

Consequent actions: None.

Defect Correlations: None.

Performance Monitoring: None.

6.5.3.2 VC-2 trail to VC-2 trail Protection Layer Adaptation Sink S2/S2P_A_Sk

Symbol:

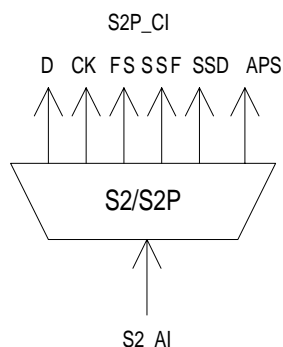

Figure 126: S2/S2P_A_Sk symbol

Interfaces:

Table 112: S2/S2P_A_Sk input and output signals

Input(s)	Output(s)
S2_AI_D	S2P_CI_D
S2_AI_CK	S2P_CI_CK
S2_AI_FS	S2P_CI_FS
S2_AI_TSF	S2P_CI_SSF
S2_AI_TSD	S2P_CI_SSD
	S2P_CI_APS (for Protection signal only)

Processes:

The function shall extract and output the S2P_CI_D signal from the S2_AI_D signal.

K4[1-4]: The extraction and persistency processing of the VC-APS signal is for further study. This process is required only for the protection path.

Defects: None.

Consequent actions:

aSSF ← AI_TSF

aSSD ← AI_TSD

Defect Correlations: None.

Performance Monitoring: None.

6.6 VC-2 Tandem Connection Sublayer Functions

6.6.1 VC-2 Tandem Connection Trail Termination Source function (S2D_TT_So)

Symbol:

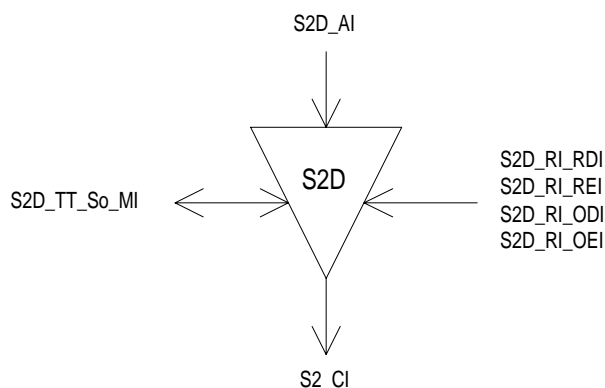

Figure 127: S2D_TT_So symbol

Interfaces:

Table 113: S2D_TT_So input and output signals

Input(s)	Output(s)
S2D_AI_D	S2_CI_D
S2D_AI_CK	S2_CI_CK
S2D_AI_FS	S2_CI_FS
S2D_AI_SF	
S2D_RI_RDI	
S2D_RI_REI	
S2D_RI_ODI	
S2D_RI_OEI	
S2D_TT_So_MI_TxTI	

Processes:

N2[8][73]: The function shall insert the TC RDI code within 1 multiframe (38 ms) after the RDI request generation (aRDI) in the tandem connection trail termination sink function. It ceases TC RDI code insertion within 1 multiframe (38 ms) after the RDI request has cleared.

NOTE: N2[x][y] refers to bit x (x = 7,8) of byte N2 in frame y (y = 1..76) of the 76 frame multiframe. This multiframe is 38 ms long since N2 appears in the low order path overhead once each four STM-N frames.

N2[3]: The function shall insert a "1" in this bit.

N2[4]: The function shall insert an incoming AIS code in this bit. If AI_SF is true this bit will be set to the value "1", otherwise value "0" shall be inserted.

N2[5]: The function shall insert the RI_REI value in the REI bit in the following frame.

N2[7][74]: The function shall insert the ODI code at the first opportunity after the ODI request generation (RI_ODI) in the tandem connection trail termination sink function. It ceases ODI code insertion at the first opportunity after the ODI request has cleared.

N2[6]: The function shall insert the RI_OEI value in the OEI bit in the following frame.

N2[7-8]: The function shall insert in the multiframed N2[7-8] channel:

- the Frame Alignment Signal (FAS) "1111 1111 1111 1110" in FAS bits in frames 1 to 8;
- the TC trace identifier, received via MI_TxTI, in the TC-TI bits in frames 9 to 72;
- the TC RDI (N2[8][73]) and ODI (N2[7][74]) signals; and
- all-0s in the six reserved bits in frames 73 to 76.

N2[1-2]: The function shall calculate a BIP2 over the VC-2, and insert this value in TC BIP2 in the next frame (see figure 128).

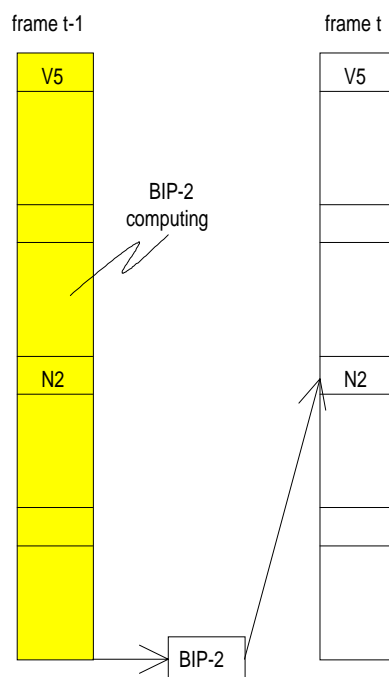

Figure 128: TC BIP-2 computing and insertion

V5[1-2]: The function shall compensate the VC12 BIP2 (in bits 1 and 2 of byte V5) according the following rule:

Since the BIP-2 parity check is taken over the VC (including N2), writing into N2 at the S2D_TT_So will affect the VC-2 path parity calculation. Unless this is compensated for, a device which monitors VC-2 path parity within the Tandem Connection (e.g., a non-intrusive monitor) may incorrectly count errors. The BIP-2 parity bits should always be consistent with the current state of the VC. Therefore, whenever N2 is written, BIP-2 shall be modified to compensate for the change in the N2 value. Since the BIP-2 value in a given frame reflects a parity check over the previous frame (including the BIP-2 bits in that frame), the changes made to the BIP-2 bits in the previous frame shall also be considered in the compensation of BIP-2 for the current frame. Therefore, the following equation shall be used for BIP-2 compensation:

$$\begin{aligned}
 V5[1]'(t) &= V5[1](t-1) \\
 &\oplus V5[1]'(t-1) \\
 &\oplus N2[1](t-1) \oplus N2[3](t-1) \oplus N2[5](t-1) \oplus N2[7](t-1) \\
 &\oplus N2[1]'(t-1) \oplus N2[3]'(t-1) \oplus N2[5]'(t-1) \oplus N2[7]'(t-1) \\
 &\oplus V5[1](t)
 \end{aligned}$$

$$\begin{aligned}
 V5[2]'(t) &= V5[2](t-1) \\
 &\oplus V5[2]'(t-1) \\
 &\oplus N2[2](t-1) \oplus N2[4](t-1) \oplus N2[6](t-1) \oplus N2[8](t-1) \\
 &\oplus N2[2]'(t-1) \oplus N2[4]'(t-1) \oplus N2[6]'(t-1) \oplus N2[8]'(t-1) \\
 &\oplus V5[2](t)
 \end{aligned}$$

Where:

$V5[i]$ = the existing $V5[i]$ value in the incoming signal

$V5[i]'$ = the new (compensated) $V5[i]$ value

$N2[i]$ = the existing $N2[i]$ value in the incoming signal

$N2[i]'$ = the new value written into the $N2[i]$ bit

\oplus = exclusive OR operator

t = the time of the current frame

$t-1$ = the time of the previous frame

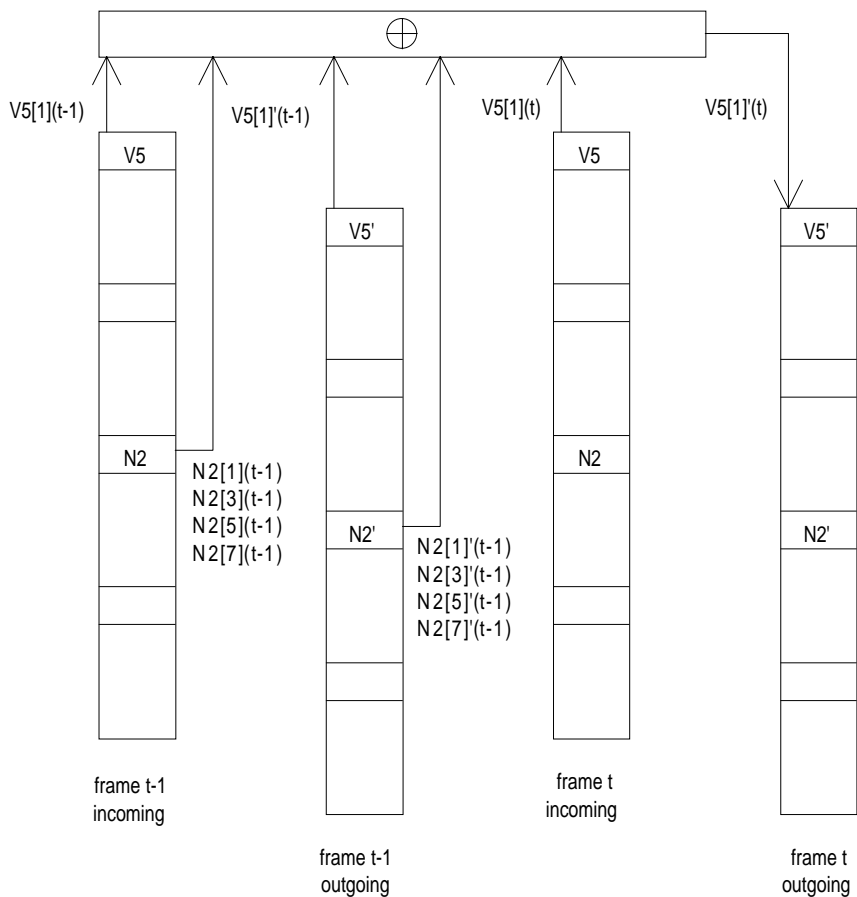

Figure 129: V5[1] compensating process

Defects: None.

Consequent Actions: None.

Defect Correlations: None.

Performance Monitoring: None.

6.6.2 VC-2 Tandem Connection Trail Termination Sink function (S2D_TT_Sk)

Symbol:

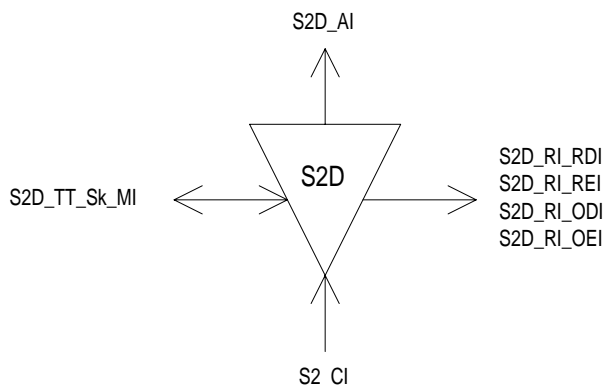

Figure 130: S2D_TT_Sk symbol

Interfaces:

Table 114: S2D_TT_Sk input and output signals

Input(s)	Output(s)
S2_CI_D	S2D_AI_D
S2_CI_CK	S2D_AI_CK
S2_CI_FS	S2D_AI_FS
S2_CI_SSF	S2D_AI_TSF
S2D_TT_Sk_MI_ExTI	S2D_AI_TSD
S2D_TT_Sk_MI_SSF_Reported	S2D_AI_OSF
S2D_TT_Sk_MI_RDI_Reported	S2D_TT_Sk_MI_cLTC
S2D_TT_Sk_MI_ODI_Reported	S2D_TT_Sk_MI_cTIM
S2D_TT_Sk_MI_TIMdis	S2D_TT_Sk_MI_cUNEQ
S2D_TT_Sk_MI_DEGM	S2D_TT_Sk_MI_cDEG
S2D_TT_Sk_MI_DEGTHR	S2D_TT_Sk_MI_cRDI
S2D_TT_Sk_MI_1second	S2D_TT_Sk_MI_cSSF
S2D_TT_Sk_MI_TPmode	S2D_TT_Sk_MI_cODI
	S2D_TT_Sk_MI_AcTI
	S2D_RI_RDI
	S2D_RI_REI
	S2D_RI_ODI
	S2D_RI_OEI
	S2D_TT_Sk_MI_pN_EBC
	S2D_TT_Sk_MI_pF_EBC
	S2D_TT_Sk_MI_pN_DS
	S2D_TT_Sk_MI_pF_DS
	S2D_TT_Sk_MI_pON_EBC
	S2D_TT_Sk_MI_pOF_EBC
	S2D_TT_Sk_MI_pON_DS
	S2D_TT_Sk_MI_pOF_DS

Processes:

N2[1-2]: Even BIP-2 is computed for each bit pair of every byte of the preceding VC-2 including V5 and N2 and compared with bit 1 and 2 of V5 and N2 recovered from the current frame (see figure 131). A difference between the computed and recovered BIP-2 values is taken as evidence of an errored block (nN_B) in the computation block.

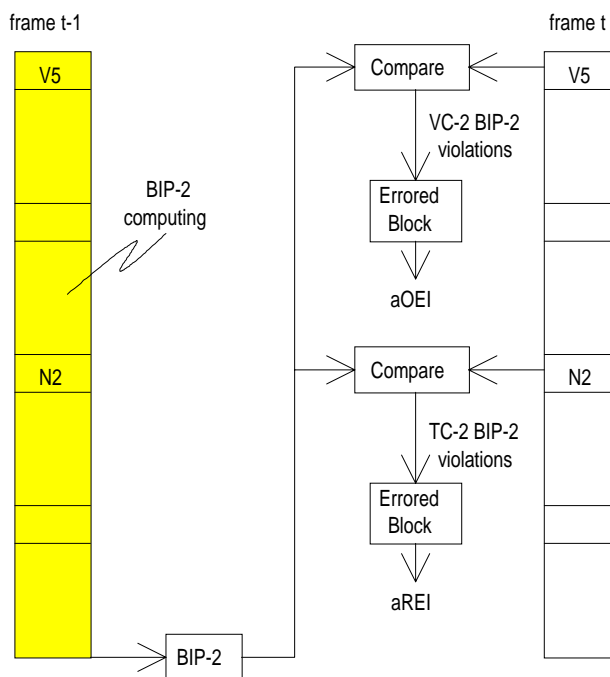

Figure 131: TC-2 and VC-2 BIP-2 computing and comparison

N2[7-8][9-72]: The Received Trail Trace Identifier RxTI shall be recovered from the tandem connection trail trace identifier overhead and shall be made available as AcTI for network management purposes. The application and acceptance process shall be performed as specified in EN 300 417-1-1 [6], subclauses 7.1 and 8.2.1.3. The mismatch detection process shall be as specified below.

The trace identifier process in this function is required to support "mode 1" (EN 300 417-1-1 [6], subclause 7.1) operation only. "Old" tandem connection equipment does not exist.

N2[4]: The function shall extract the Incoming AIS code.

N2[5], N2[8][73]: The information carried in the REI, RDI bits in byte N2 shall be extracted to enable single ended maintenance of a bi-directional tandem connection Trail. The REI (nF_B) shall be used to monitor the error performance of the other direction of transmission, and the RDI shall be used to provide information as to the status of the remote receiver. A "1" indicates a Remote Defect Indication state, while a "0" indicates the normal, working state. The application process shall be performed as specified in EN 300 417-1-1 [6], subclauses 7.4.2 (REI), 7.4.11 and 8.2 (RDI).

N2[6], N2[7][74]: The information carried in the OEI, ODI bits in byte N2 shall be extracted to enable single ended (intermediate) maintenance of a the VC-12 egressing the tandem connection Trail. The OEI (nOF_B) shall be used to monitor the error performance of the other direction of transmission, and the ODI shall be used to provide information as to the status of the remote receiver. A "1" indicates a Outgoing Defect Indication state, while a "0" indicates the normal, working state. The application process shall be performed equivalent to the remote maintenance case, as specified in EN 300 417-1-1 [6], subclause 7.4.2 (REI/OEI), subclause 7.4.11 and 8.2 (RDI/ODI).

N2[7-8]: Multiframe alignment:

The function shall perform a multiframe alignment on bits 7 and 8 of byte N2 to recover the TTI, RDI, and ODI signals transported within the multiframe bits. The multiframe alignment shall be found by searching for the pattern "1111 1111 1111 1110" within the bits 7 and 8 of byte N2. The signal shall be continuously checked with the presumed multiframe start position for the alignment.

Frame alignment is deemed to have been lost (entering Out Of Multiframe (OOM) state) when two consecutive FAS are detected in error (i.e. ≥ 1 error in each FAS);

Frame alignment is deemed to have been recovered (entering In Multiframe (IM) state) when one non-errored FAS is found.

V5[1-2]: Even BIP-2 is computed for each bit pair of every byte of the preceding VC-2 including V5 and compared with bit 1 and 2 of V5 recovered from the current frame. A difference between the computed and recovered BIP-2 values is taken as evidence of an errored block (nON_B) in the computation block.

N2: The function shall terminate N2 channel by inserting an all-ZEROs pattern.

V5[1-2]: The function shall compensate the VC12 BIP2 in bits 1 and 2 of byte V5 according the algorithm defined in S2D_TT_So.

Defects:

TC Unequipped (dUNEQ):

The function shall detect for an unequipped Tandem Connection (UNEQ) condition by monitoring byte N2 for code "00000000". The unequipped defect (dUNEQ) shall be detected if five consecutive VC-n frames contain the "0000 0000" pattern in byte N2. The dUNEQ defect shall be cleared if in five consecutive VC-n frames any pattern other than the "0000 0000" is detected in byte N2.

TC Loss of Tandem Connection (dLTC):

The function shall detect for the presence/absence of the tandem connection overhead in the byte N2 by evaluating the multiframe alignment signal in bits 7 and 8 of byte N2. The loss of tandem connection defect (dLTC) shall be detected if the multiframe alignment process is in the OOM state. The dLTC shall be cleared if the multiframe alignment process is in the IM state.

TC Connectivity (Trace Identifier) (dTIM):

The function shall detect for a TC misconnection condition by monitoring the TC trace identifier. The Trace Identifier Mismatch defect (dTIM) shall be detected and cleared within a maximum period of 1 s in the absence of bit errors.

The defect detection process and its operation during the presence of bit errors is for further study.

The defect shall be suppressed during the receipt of SSF.

It shall be possible to disable the trace identifier mismatch defect detection (TIMdis).

TC Signal Degrade (dDEG):

The function shall detect for a TC signal degrade defect condition by monitoring for TC BIP2 violations. The algorithm shall be according subclause 8.2.1.4 of EN 300 417-1-1 [6].

TC Remote Defect (dRDI):

The function shall detect for a TC remote defect indication defect condition by monitoring the TC RDI signal. The algorithm shall be according subclause 8.2.1.5 of EN 300 417-1-1 [6].

TC Remote Outgoing VC Defect (dODI):

The function shall detect for a TC remote outgoing VC defect indication defect condition by monitoring the TC ODI signal. The algorithm shall be according subclause 8.2.1.5 of EN 300 417-1-1 [6].

Incoming AIS (dIncAIS):

The function shall detect for a tandem connection incoming AIS condition by monitoring bit 4 in byte N2 for code "1". If 5 consecutive frames contain the value "1" in bit 4 a dIncAIS defect shall be detected. dIncAIS shall be cleared if in 5 consecutive frames value "0" is detected in bit 4 of byte N2.

Consequent Actions:

The function shall perform the following consequent actions (refer to subclause 8.2.2 of EN 300 417-1-1 [6]):

aAIS	←	dUNEQ or dTIM or dLTC
aTSF	←	CI_SSF or dUNEQ or dTIM or dLTC
aTSD	←	dDEG

aRDI	←	CI_SSF or dUNEQ or dTIM or dLTC
aREI	←	nN_B
aODI	←	CI_SSF or dUNEQ or dTIM or dIncAIS or dLTC
aOEI	←	nON_B
aOSF	←	CI_SSF or dUNEQ or dTIM or dLTC or dIncAIS

The function shall insert the all-ONEs (AIS) signal within 1 ms after AIS request generation (aAIS), and cease the insertion within 1 ms after the AIS request has cleared.

Defect Correlations:

The function shall perform the following defect correlations (refer to subclause 8.2.3 of EN 300 417-1-1 [6]):

cUNEQ	←	MON and dUNEQ
cLTC	←	MON and (not dUNEQ) and dLTC
cTIM	←	MON and (not dUNEQ) and (not dLTC) and dTIM
cDEG	←	MON and (not dTIM) and (not dLTC) and dDEG
cSSF	←	MON and CI_SSF and SSF_Reported
cRDI	←	MON and (not dUNEQ) and (not dTIM) and (not dLTC) and dRDI and RDI_Reported
cODI	←	MON and (not dUNEQ) and (not dTIM) and (not dLTC) and dODI and ODI_Reported

Performance Monitoring:

The following TC error performance parameters shall be counted for each 1-second period (refer to subclauses 8.2.4 to 8.2.7 of EN 300 417-1-1 [6]):

pN_DS	←	aTSF or dEQ
pF_DS	←	dRDI
pN_EBC	←	ΣnN_B
pF_EBC	←	ΣnF_B
pON_DS	←	aODI
pOF_DS	←	dODI
pON_EBC	←	ΣnON_B
pOF_EBC	←	ΣnOF_B

pN_EBC and pN_DS does not represent the actual performance monitoring support within an equipment. For that, these pN_DS/pN_EBC signals shall be connected to performance monitoring functions within the element management function. Similar for the far-end signals pF_EBC and pF_DS and for pON_EBC/pON_DS, pOF_EBC/pOF_DS.

6.6.3 VC-2 Tandem Connection to VC-2 Adaptation Source function (S2D/S2_A_So)

Symbol:

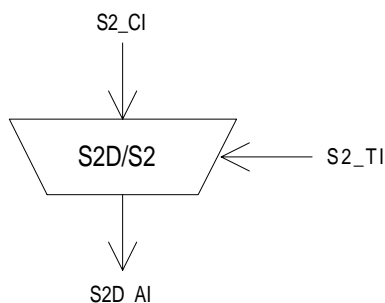

Figure 132: S2D/S2_A_So symbol

Interfaces:

Table 115: S2D/S2_A_Sk input and output signals

Input(s)	Output(s)
S2_CI_D	S2D_AI_D
S2_CI_CK	S2D_AI_CK
S2_CI_FS	S2D_AI_FS
S2_CI_SSF	S2D_AI_SF
S2_TI_CK	

Processes:

NOTE 1: The function has no means to verify the existence of a tandem connection within the incoming signal. Nested tandem connections are not supported.

The function shall replace the incoming Frame Start (CI_FS) signal by a local generated one (i.e. enter "holdover") if an all-ONEs (AIS) VC is received (i.e. if CI_SSF is TRUE).

NOTE 2: This replacement of the (invalid) incoming frame start signal result in the generation of a valid pointer in e.g. the S4/S2_A_So function; SSF = true signal is not passed through via S2D_TT_So to the S4/S2_A_So.

NOTE 3: The local frame start is generated with the S2_TI timing.

Defects: None.

Consequent Actions:

AI_SF ← CI_SSF

Defect Correlations: None.

Performance Monitoring: None.

6.6.4 VC-2 Tandem Connection to VC-2 Adaptation Sink function (S2D/S2_A_Sk)

Symbol:

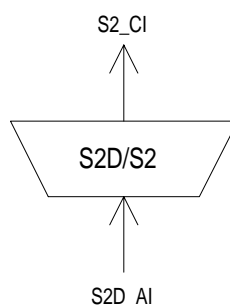

Figure 133: S2D/S2_A_Sk symbol

Interfaces:

Table 116: S2D/S2_A_Sk input and output signals

Input(s)	Output(s)
S2D_AI_D	S2_CI_D
S2D_AI_CK	S2_CI_CK
S2D_AI_FS	S2_CI_FS
S2D_AI_OSF	S2_CI_SSF

Processes:

The function shall restore the invalid frame start condition (i.e. output aSSF = true) if that existed at the ingress of the tandem connection.

NOTE: In addition, the invalid frame start condition is activated on a tandem connection connectivity defect condition that causes all-ONEs (AIS) insertion in the S2D_TT_Sk.

Defects: None.

Consequent Actions:

aAIS ← AI_OSF

aSSF ← AI_OSF

The function shall insert the all-ONEs (AIS) signal within 1 ms after AIS request generation (aAIS), and cease the insertion within 1 ms after the AIS request has cleared.

Defect Correlations: None.

Performance Monitoring: None.

6.6.5 VC-2 Tandem Connection Non-intrusive Monitoring Trail Termination Sink function (S2Dm_TT_Sk)

Symbol:

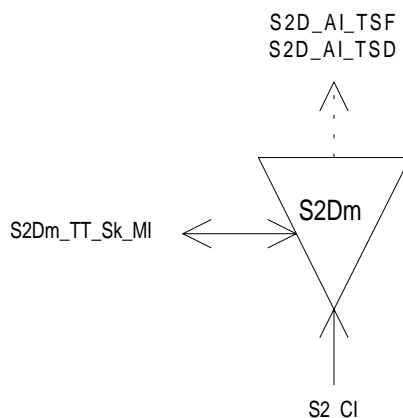

Figure 134: S2Dm_TT_Sk symbol

Interfaces:

Table 117: S2Dm_TT_Sk input and output signals

Input(s)	Output(s)
S2D_CI_D	S2D_AI_TSF
S2D_CI_CK	S2D_AI_TSD
S2D_CI_FS	S2D_TT_Sk_MI_cLTC
S2D_CI_SSF	S2D_TT_Sk_MI_cTIM
S2D_TT_Sk_MI_ExtI	S2D_TT_Sk_MI_cUNEQ
S2D_TT_Sk_MI_SSF_Reported	S2D_TT_Sk_MI_cDEG
S2D_TT_Sk_MI_RDI_Reported	S2D_TT_Sk_MI_cRDI
S2D_TT_Sk_MI_ODI_Reported	S2D_TT_Sk_MI_cSSF
S2D_TT_Sk_MI_TIMdis	S2D_TT_Sk_MI_cODI
S2D_TT_Sk_MI_DEGM	S2D_TT_Sk_MI_AcTI
S2D_TT_Sk_MI_DEGTHR	S2D_TT_Sk_MI_pN_EBC
S2D_TT_Sk_MI_1second	S2D_TT_Sk_MI_pF_EBC
S2D_TT_Sk_MI_TPmode	S2D_TT_Sk_MI_pN_DS
	S2D_TT_Sk_MI_pF_DS
	S2D_TT_Sk_MI_pOF_EBC
	S2D_TT_Sk_MI_pOF_DS

Processes:

This function can be used to perform the following:

- 1) single ended maintenance of the TC by monitoring at an intermediate node, using remote information (RDI,REI);
- 2) aid in fault localization within TC trail by monitoring near-end defects;
- 3) monitoring of VC performance at TC egressing point(except for connectivity defects before the TC) using remote outgoing information (ODI,OEI);
- 4) performing non-intrusive monitor function within SNC/S protection.

N2[1-2]: Even BIP-2 is computed for each bit pair of every byte of the preceding VC-2 including V5 and N2 and compared with bits 1 and 2 of V5 and N2 recovered from the current frame (see figure 128). A difference between the computed and recovered BIP-2 values is taken as evidence of an errored block (nN_B) in the computation block. Refer to S2D_TT_Sk.

N2[7-8][9-72]: The Received Trail Trace Identifier RxTI shall be recovered from the tandem connection trail trace identifier overhead and shall be made available as AcTI for network management purposes. The application and acceptance process shall be performed as specified in EN 300 417-1-1 [6], subclauses 7.1 and 8.2.1.3. The mismatch detection process shall be as specified below.

The trace identifier process in this function is required to support "mode 1" (EN 300 417-1-1 [6], subclause 7.1) operation only. "Old" tandem connection equipment does not exist.

N2[4]: The function shall ignore the bit.

N2[5], N2[8][73]: The information carried in the REI, RDI bits in byte N2 shall be extracted to enable single ended maintenance of a bi-directional tandem connection Trail. The REI (nF_B) shall be used to monitor the error performance of the other direction of transmission, and the RDI shall be used to provide information as to the status of the remote receiver. A "1" indicates a Remote Defect Indication state, while a "0" indicates the normal, working state. The application process shall be performed as specified in EN 300 417-1-1 [6], subclauses 7.4.2 (REI), 7.4.11 and 8.2 (RDI).

N2[6], N2[7][74]: (nOF_B). The information carried in the OEI, ODI bits in byte N2 shall be extracted to enable single ended (intermediate) maintenance of a the VC-2 egressing the tandem connection Trail. The OEI (nOF_B) shall be used to monitor the error performance of the other direction of transmission, and the ODI shall be used to provide information as to the status of the remote receiver. A "1" indicates a Outgoing Defect Indication state, while a "0" indicates the normal, working state. The application process shall be performed equivalent to the remote maintenance case, as specified in EN 300 417-1-1 [6], subclause 7.4.2 (REI/OEI), subclause 7.4.11 and subclause 8.2 (RDI/ODI).

N2[7-8]: *Multiframe alignment:*

The function shall perform a multiframe alignment on bits 7 and 8 of byte N2 to recover the TTI, RDI, and ODI signals transported within the multiframe bits. The multiframe alignment shall be found by searching for the pattern "1111 1111 1111 1110" within the bits 7 and 8 of byte N2. The signal shall be continuously checked with the presumed multiframe start position for the alignment.

Frame alignment is deemed to have been lost (entering Out Of Multiframe (OOM) state) when two consecutive FAS are detected in error (i.e. ≥ 1 error in each FAS).

Frame alignment is deemed to have been recovered (entering In Multiframe (IM) state) when one non-errored FAS is found.

Defects:

TC Unequipped (dUNEQ):

The function shall detect for an unequipped Tandem Connection (UNEQ) condition by monitoring byte N2 for code "00000000". The unequipped defect (dUNEQ) shall be detected if five consecutive VC-n frames contain the "0000 0000" pattern in byte N2. The dUNEQ defect shall be cleared if in five consecutive VC-n frames any pattern other than the "0000 0000" is detected in byte N2.

TC Loss of Tandem Connection (dLTC):

The function shall detect for the presence/absence of the tandem connection overhead in the byte N2 by evaluating the multiframe alignment signal in bits 7 and 8 of byte N2. The loss of tandem connection defect (dLTC) shall be detected if the multiframe alignment process is in the OOM state. The dLTC shall be cleared if the multiframe alignment process is in the IM state.

TC Connectivity (Trace Identifier) (dTIM):

The function shall detect for a TC mis-connection condition by monitoring the TC trace identifier. The Trace Identifier Mismatch defect (dTIM) shall be detected and cleared within a maximum period of 1 s in the absence of bit errors.

The defect detection process and its operation during the presence of bit errors is for further study.

The defect shall be suppressed during the receipt of SSF.

It shall be possible to disable the trace identifier mismatch defect detection (TIMdis).

TC Signal Degrade (dDEG):

The function shall detect for a TC signal degrade defect condition by monitoring for TC BIP2 violations. The algorithm shall be according subclause 8.2.1.4 of EN 300 417-1-1 [6].

TC Remote Defect (dRDI):

The function shall detect for a TC remote defect indication defect condition by monitoring the TC RDI signal. The algorithm shall be according subclause 8.2.1.5 of EN 300 417-1-1 [6].

TC Remote Outgoing VC Defect (dODI):

The function shall detect for a TC remote outgoing VC defect indication defect condition by monitoring the TC ODI signal. The algorithm shall be according subclause 8.2.1.5 of EN 300 417-1-1 [6].

Consequent Actions:

aTSF ← CI_SSF or dUNEQ or dTIM or dLTC
aTSD ← dDEG

Defect Correlations:

The function shall perform the following defect correlations (refer to subclause 8.2.3 of EN 300 417-1-1 [6]):

cUNEQ ← MON and dUNEQ
cLTC ← MON and (not dUNEQ) and dLTC
cTIM ← MON and (not dUNEQ) and (not dLTC) and dTIM
cDEG ← MON and (not dTIM) and (not dLTC) and dDEG
cSSF ← MON and CI_SSF and SSF_Reported
cRDI ← MON and (not dUNEQ) and (not dTIM) and (not dLTC) and dRDI and RDI_Reported
cODI ← MON and (not dUNEQ) and (not dTIM) and (not dLTC) and dODI and ODI_Reported

Performance Monitoring:

The following TC error performance parameters shall be counted for each 1 second period (refer to subclauses 8.2.4 to 8.2.7 of EN 300 417-1-1 [6]):

pN_DS ← aTSF or dEQ
pF_DS ← dRDI
pN_EBC ← ΣnN_B
pF_EBC ← ΣnF_B
pOF_DS ← dODI
pOF_EBC ← ΣnOF_B

pN_EBC and pN_DS does not represent the actual performance monitoring support within an equipment. For that, these pN_DS/pN_EBC signals shall be connected to performance monitoring functions within the element management function. Similar for the far-end signals pF_EBC and pF_DS and for pOF_EBC/pOF_DS.

adaptation source function may have access to a specific timeslot. Access to the same timeslot by other adaptation source functions shall be denied. In contradiction with the source direction, adaptation sink functions may be activated all together. This may cause faults (e.g. cLOP) to be detected and reported. To prevent this an adaptation sink function can be deactivated.

NOTE 4: If one adaptation function only is connected to the AP, it will be activated. If one or more other functions are connected to the same AP accessing the same timeslot, one out of the set of functions will be active.

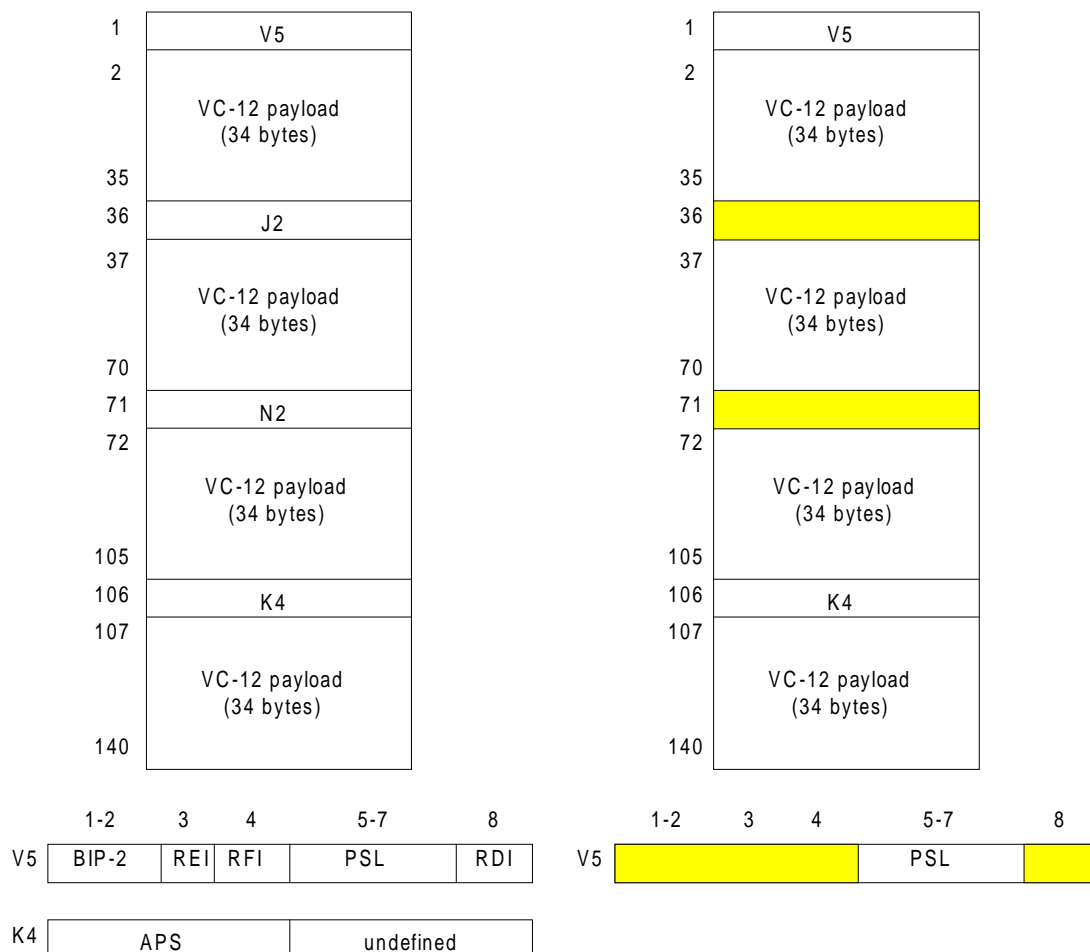

Figure 136: S12_CI_D (left) and S12_AI_D (right)

NOTE 5: The APS signal has not been defined; a multiframed APS signal might be required.

NOTE 6: The RFI signal is not supported within ETSI.

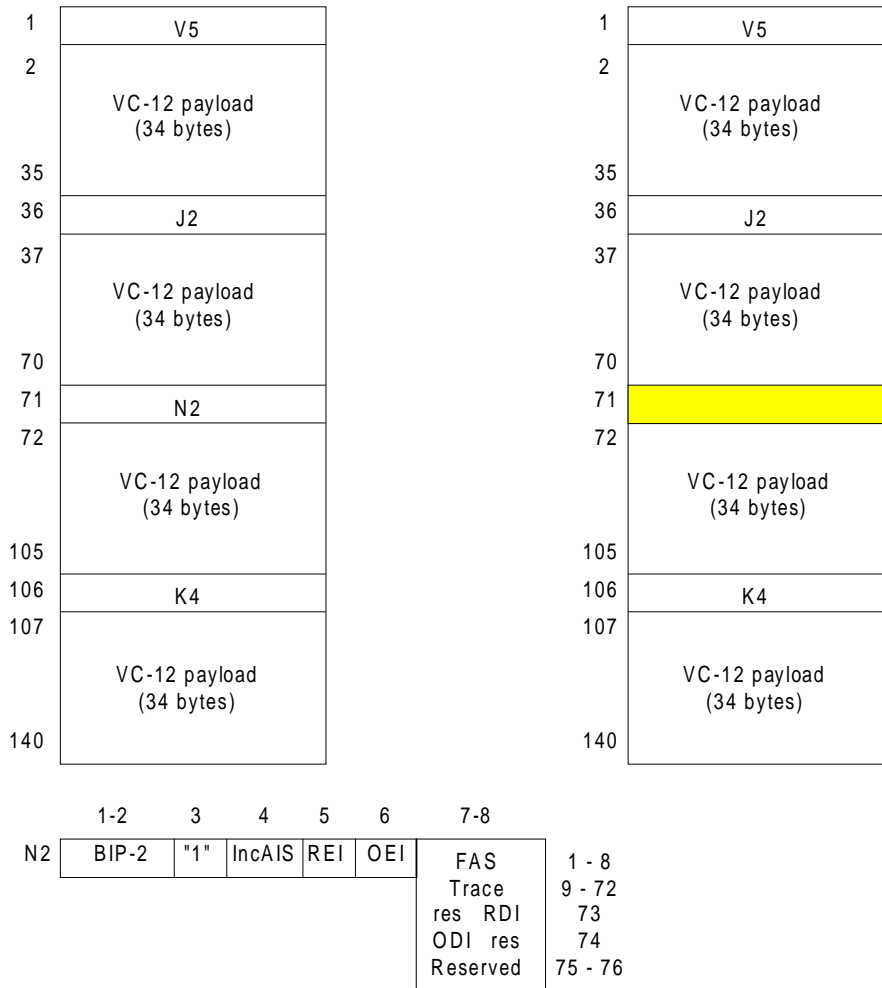

Figure 137: S12_CI_D (left) with defined N2 and S12D_AI_D (right)

Figure 138 shows the trail protection sublayer atomic functions added to (a subset of) the layer atomic functions presented in figure 135.

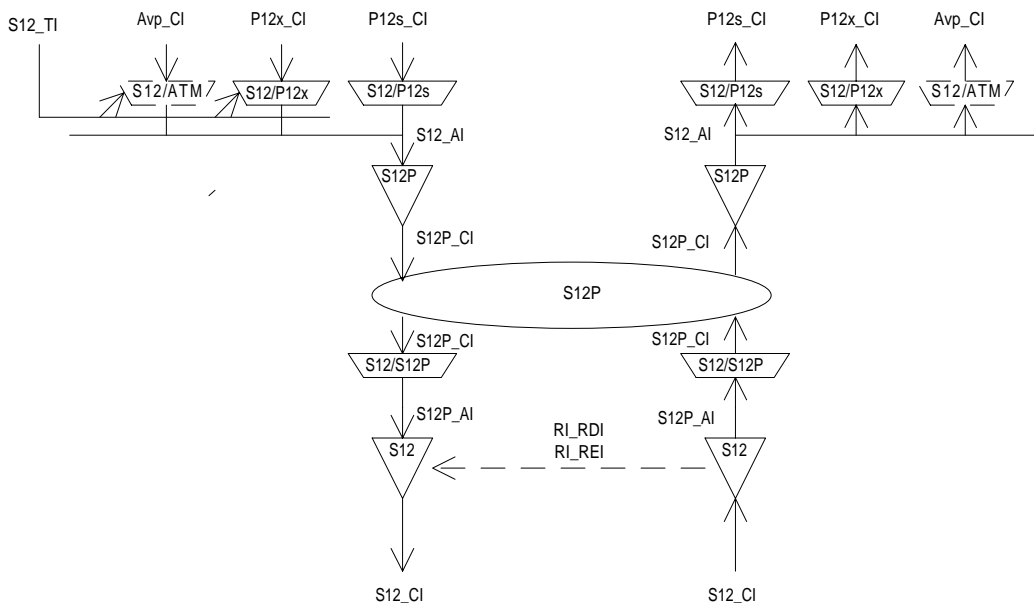

Figure 138: VC-12 Layer Trail Protection atomic functions

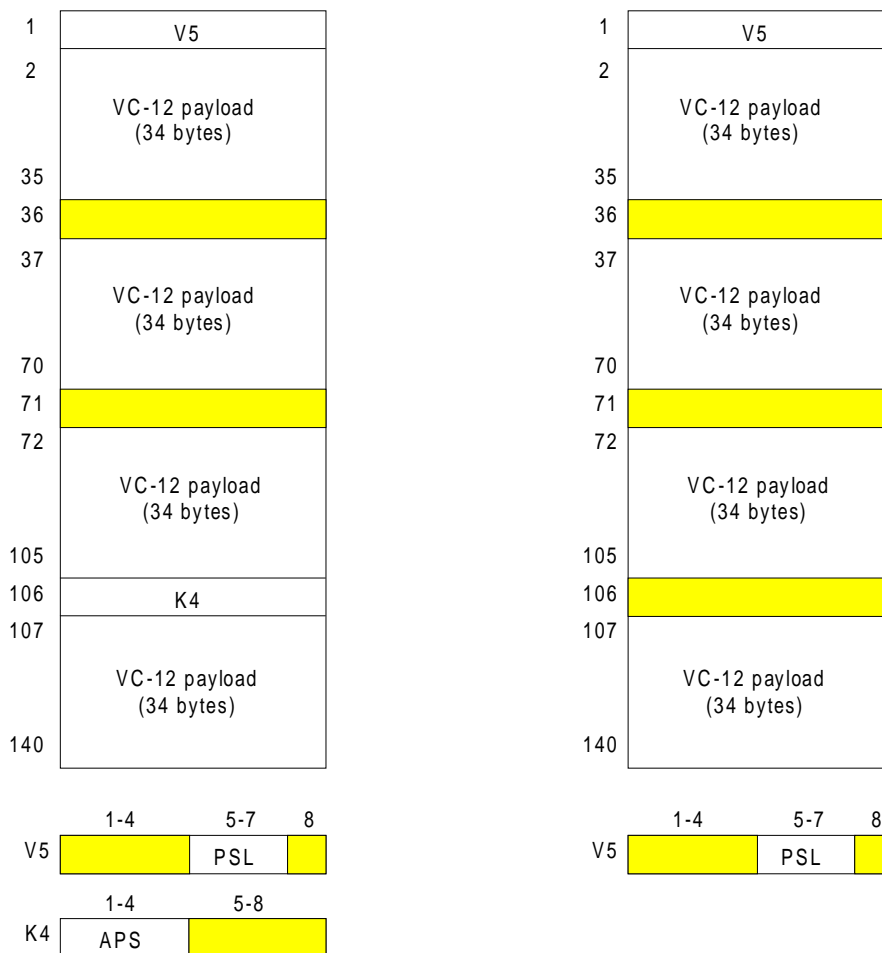

Figure 139: S12P_AI_D (left) and S12P_CI_D (right)

7.1 VC-12 Layer Connection Function S12_C

Symbol:

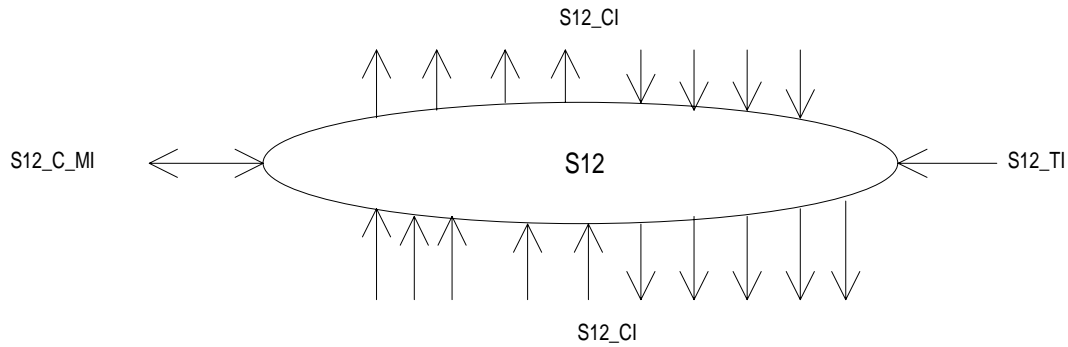

Figure 140: S12_C symbol

Interfaces:

Table 118: S12_C input and output signals

Input(s)	Output(s)
per S12_CI, n x for the function: S12_CI_D S12_CI_CK S12_CI_FS S12_CI_SSF S12_AI_TSF S12_AI_TSD	per S12_CI, m x per function: S12_CI_D S12_CI_CK S12_CI_FS S12_CI_SSF
1 x per function: S12_TI_CK S12_TI_FS	
per input and output connection point: S12_C_MI_ConnectionPortIds	
per matrix connection: S12_C_MI_ConnectionType S12_C_MI_Directionality	
per SNC protection group: S12_C_MI_PROTtype S12_C_MI_OPERtype S12_C_MI_WTRtime S12_C_MI_HOtime S12_C_MI_EXTCMD	
NOTE: Protection status reporting signals are for further study.	

Processes:

In the S12_C function VC-12 Layer Characteristic Information is routed between input (termination) connection points ((T)CPs) and output (T)CPs by means of matrix connections. (T)CPs may be allocated within a protection group.

NOTE 1: Neither the number of input/output signals to the connection function, nor the connectivity is specified in the present document. That is a property of individual network elements.

Figure 135 present a subset of the atomic functions that can be connected to this VC-12 connection function: VC-12 trail termination functions, VC-12 non-intrusive monitor trail termination sink function, VC-12 unequipped-supervisory trail termination functions, VC-12 tandem connection trail termination and adaptation functions. In addition, adaptation functions in the VC-12 server (e.g. VC-4, P31s, P4s) layers will be connected to this VC-12 connection function.

Routing:

The function shall be able to connect a specific input with a specific output by means of establishing a matrix connection between the specified input and output. It shall be able to remove an established matrix connection.

Each (matrix) connection in the S12_C function shall be characterized by the:

Type of connection:	unprotected, 1 + 1 protected (SNC/I, SNC/N or SNC/S protection)
Traffic direction:	unidirectional, bi-directional
Input and output connection points:	set of connection point identifiers (refer to EN 300 417-1-1 [6], subclause 3.3.6)

NOTE 2: Broadcast connections are handled as separate connections to the same input CP.

Provided no protection switching action is activated/required the following changes to (the configuration of) a connection shall be possible without disturbing the CI passing the connection:

- addition and removal of protection;
- addition and removal of connections to/from a broadcast connection;
- change between operation types;
- change of WTR time;
- change of Hold-off time.

Unequipped VC generation:

The function shall generate an unequipped VC signal, as specified in EN 300 417-1-1 [6], subclause 7.2.

Defects: None.

Consequent Actions:

If an output of this function is not connected to one of its inputs, the function shall connect the unequipped VC-12 (with valid frame start (FS) and SSF = false) to the output.

Defect Correlations: None.

Performance Monitoring: None.

7.1.1 SNC Protection

SNC protection:

The function may provide the option to establish protection groups between a number of (T)CPs (EN 300 417-1-1 [6], subclauses 9.4.1 and 9.4.2) to perform the VC-12 linear (sub)network connection protection process for 1+1 protection architectures (refer to EN 300 417-1-1 [6], subclause 9.2). The SNC protection process shall perform the bridge and selector functionality as presented in figure 49 of EN 300 417-1-1 [6]. In the sink direction, the signal output at the normal reference point can be the signal received via either the working connection or the protection connection; this is determined by the SF,SD conditions (relayed via CI_SSF or AI_TSF/AI_TSD signals), and the external commands. In the source direction, the working output is connected to the associated normal input. The protection output is also connected to the normal input.

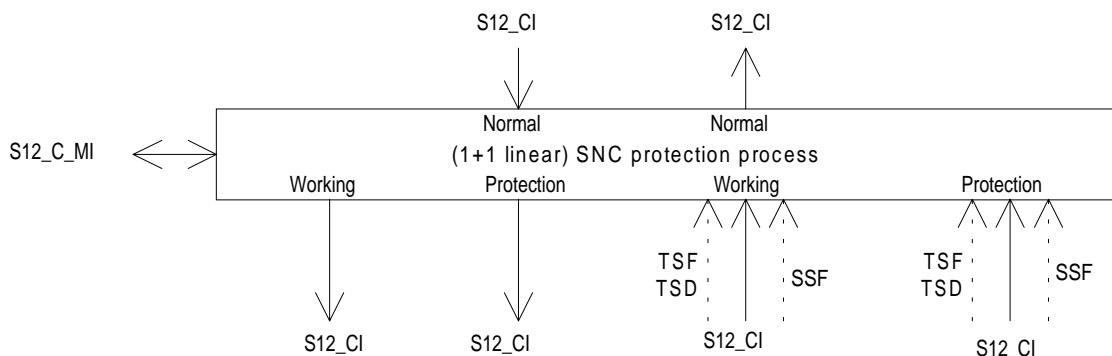

Figure 141: VC-12 1+1 SNC protection process (SNC/I, SNC/N, SNC/S)

SNC Protection Operation:

The SNC protection process shall operate as specified in EN 300 417-3-1 [7] annex A, according the following characteristics:

Table 119: SNC protection parameters

Parameter	Value options
architecture type (ARCHtype)	1 + 1
switching type (SWtype)	uni-directional
operation type (OPERType)	revertive, non-revertive
APS signal (APSmode)	false
Wait-To-Restore time (WTRtime)	in the order of 5 to 12 minutes
Switch time	≤ 50 ms
Hold-off time (HOtime)	0 to 10 seconds in steps of the order of 100 ms
Protection type (PROTtype)	SNC/I, SNC/N, SNC/S
Signal switch conditions:	SF = SSF (SNC/I), SF = TSF (SNC/N, SNC/S), SD = TSD (SNC/N, SNC/S)
External commands (EXTMND)	(revertive operation) LO, FSw-#1, MSw-#1, CLR (non-revertive operation) LO or FSw, FSw-#, MSw-#, CLR (i = 0, 1)
Extra traffic (EXTRAtraffic)	false
SFpriority, SDpriority	high

In the sink case of a protection connection the source of the connection is determined by the SF (and SD) signals associated with each of the two inputs to the connection and the possible external switch requests. The set of SF and SD signals used, is controlled by the protection type setting.

7.2 VC-12 Trail Termination Functions

7.2.1 VC-12 Trail Termination Source S12_TT_So

Symbol:

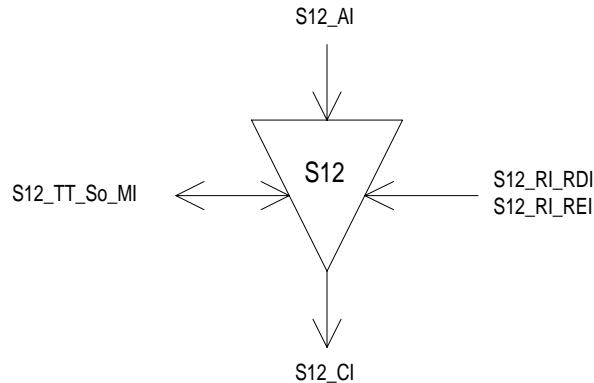

Figure 142: S12_TT_So symbol

Interfaces:

Table 120: S12_TT_So input and output signals

Input(s)	Output(s)
S12_AI_D	S12_CI_D
S12_AI_CK	S12_CI_CK
S12_AI_FS	S12_CI_FS
S12_RI_RDI	
S12_RI_REI	
S12_TT_So_MI_TxTI	

Processes:

This function adds error monitoring and status and control overhead bits to the S12_AI as defined in ETS 300 147 [1]. The processing of the trail overhead is defined as follows:

J2: In this byte the function shall insert the Transmitted Trail Trace Identifier TxTI. Its format is described in EN 300 417-1-1 [6], subclause 7.1.

V5[3]: The signal value applied at RI_REI shall be inserted in the VC-12 REI, bit 3 of byte V5. The coding shall be as follows:

Table 121: V5[3] coding

Number of BIP-2 violations conveyed via RI_REI	V5[3]
0	0
1	1
2	1

V5[8]: Bit 8 of byte V5, a RDI indication, shall be set to "1" on activation of S12_RI_RDI within 1 000 µs, determined by the associated S12_TT_Sk function, and set to "0" within 1 000 µs on clearing of S12_RI_RDI.

V5[1-2]: In these bits the function shall insert the BIP-2 EDC with even bit parity. Each bit of current bits 1 or 2 is computed to provide even parity over the associated (odd and even) bits of every byte in the previous frame of the

Characteristic Information S12_CI, i.e., bits 1 and 2 are calculated over the entire previous VC-12. Further reference is provided in EN 300 417-1-1 [6], subclause 7.3.

K4[5-8]: The value of the bits 5 to 8 of byte K4 is undefined.

Defects: None.

Consequent Actions: None.

Defect Correlations: None.

Performance Monitoring: None.

7.2.2 VC-12 Trail Termination Sink S12_TT_Sk

Symbol:

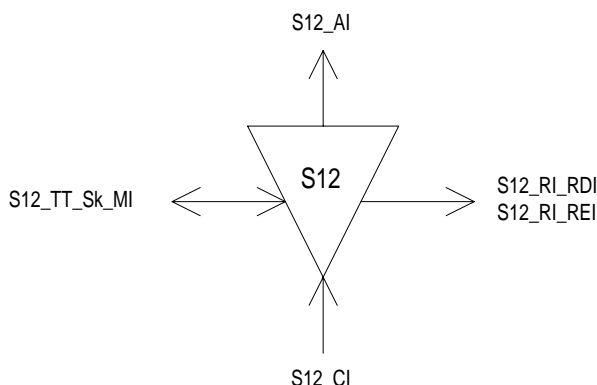

Figure 143: S12_TT_Sk symbol

Interfaces:

Table 122: S12_TT_Sk input and output signals

Input(s)	Output(s)
S12_CI_D	S12_AI_D
S12_CI_CK	S12_AI_CK
S12_CI_FS	S12_AI_FS
S12_CI_SSF	S12_AI_TSF
	S12_AI_TSD
S12_TT_Sk_MI_TPmode	S12_TT_Sk_MI_cTIM
S12_TT_Sk_MI_SSF_Reported	S12_TT_Sk_MI_cUNEQ
S12_TT_Sk_MI_ExtI	S12_TT_Sk_MI_cDEG
S12_TT_Sk_MI_RDI_Reported	S12_TT_Sk_MI_cRDI
S12_TT_Sk_MI_DEGTHR	S12_TT_Sk_MI_cSSF
S12_TT_Sk_MI_DEGM	S12_TT_Sk_MI_AcTI
S12_TT_Sk_MI_1second	S12_RI_RDI
S12_TT_Sk_MI_TIMdis	S12_RI_REI
S12_TT_Sk_MI_ExtImode	S12_TT_Sk_MI_pN_EBC
	S12_TT_Sk_MI_pN_DS
	S12_TT_Sk_MI_pF_EBC
	S12_TT_Sk_MI_pF_DS

Processes:

This function monitors VC-12 for errors, and recovers the trail termination status. It extracts the payload independent overhead bytes/bits (J2, V5[1-2], V5[3], V5[5-7], V5[8]) from the VC-12 layer Characteristic Information:

J2: The Received Trail Trace Identifier RxTI shall be recovered from the J2 byte and shall be made available as AcTI for network management purposes. The application and acceptance and mismatch detection process shall be performed as specified in EN 300 417-1-1 [6], subclauses 7.1 and 8.2.1.3.

V5[1-2]: Even bit parity is computed for each bit pair of every byte of the preceding VC-12 including V5 and compared with bit 1 and 2 of V5 recovered from the current frame. A difference between the computed and recovered BIP-2 values is taken as evidence of an errored block (nN_B).

V5[3], V5[8]: The information carried in the bits 3 and 8 of the V5 byte (REI, RDI) shall be extracted to enable single ended maintenance of a bi-directional Trail (Path). The REI (nF_B) shall be used to monitor the error performance of the other direction of transmission, and the RDI (bit 8) shall be used to provide information as to the status of the remote receiver. A "1" indicates a Remote Defect Indication state, while a "0" indicates the normal, working state. The

application process shall be performed as specified in EN 300 417-1-1 [6], subclause 7.4.2 (REI), subclause 7.4.11 and subclause 8.2 (RDI).

K4[5-8]: The value in the bits 5 to 8 of byte K4 shall be ignored.

Table 123: V5[3] code interpretation

V5[3]	REI code interpretation
0	0 errored blocks
1	1 errored block

V5[5-7]: The information in bits 5 to 7 of byte V5 shall be extracted to allow unequipped VC defect detection.

Defects:

The function shall detect for dDEG, dRDI, dUNEQ and dTIM defects according the specification in EN 300 417-1-1 [6], subclause 8.2.1.

Consequent Actions:

aAIS	←	dUNEQ or dTIM
aTSF	←	CI_SSF or dUNEQ or dTIM
aRDI	←	CI_SSF or dUNEQ or dTIM
aTSD	←	dDEG
aREI	←	"#EDCV"

On declaration of aAIS the function shall output all-ONES signal within 1 000 μ s; on clearing of aAIS the function shall output normal data within 1 000 μ s.

Defect Correlations:

cUNEQ	←	dUNEQ and MON
cTIM	←	dTIM and (not dUNEQ) and MON
cDEG	←	dDEG and (not dTIM) and MON
cRDI	←	dRDI and (not dUNEQ) and (not dTIM) and MON and RDI_Reported
cSSF	←	CI_SSF and MON and SSF_Reported

Performance Monitoring:

The performance monitoring process shall be performed as specified in EN 300 417-1-1 [6], subclause 8.2.4 through 8.2.7.

pN_DS	←	aTSF or dEQ
pF_DS	←	dRDI
pN_EBC	←	Σ nN_B
pF_EBC	←	Σ nF_B

7.3 VC-12 Adaptation Functions

7.3.1 VC-12 to P12x Adaptation Source S12/P12x_A_So

Symbol:

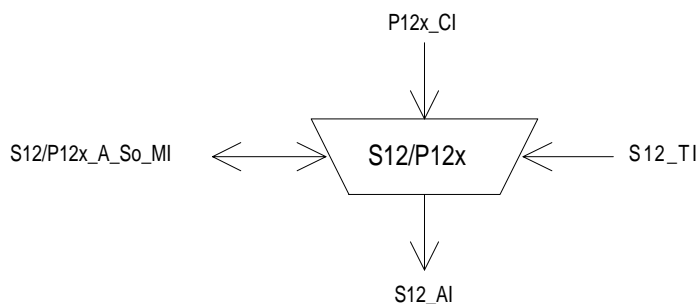

Figure 144: S12/P12x_A_So symbol

Interfaces:

Table 124: S12/P12x_A_So input and output signals

Input(s)	Output(s)
P12x_CI_D	S12_AI_D
P12x_CI_CK	S12_AI_CK
S12_TI_CK	S12_AI_FS
S12_TI_FS	
S12/P12x_A_So_MI_Active	

Processes:

This function maps a 2 048 kbit/s information stream into a VC-12 payload using bit stuffing and adds bits 5 to 7 of byte V5. It takes P12x_CI, a bit-stream with a rate of 2 048 kbit/s \pm 50 ppm, present at its input and inserts it into the synchronous container-12 having a capacity of 136 bytes and the justification frame as defined in ETS 300 147 [1] and depicted in figure 145.

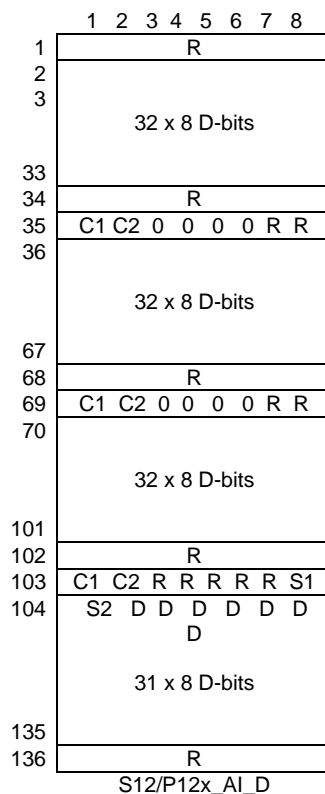

Legend: D = Data Bit, R = Fixed Stuff,
 S1,S2 = Justification Opportunity Bit, C1,C2 = Justification Control Bit

Figure 145: 2 Mbit/s asynchronous mapped into a Container-12 (using bit justification)

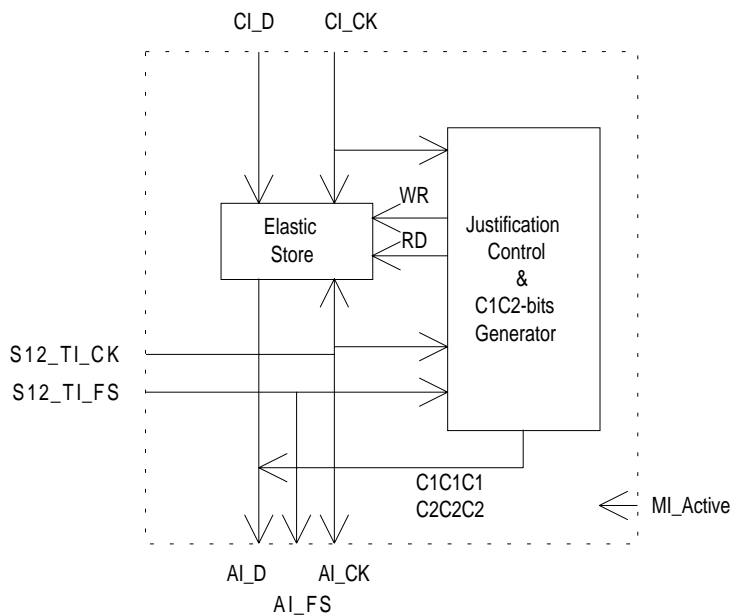

Figure 146: main processes within S12/P12x_A_So

Frequency justification and bit rate adaptation:

The function shall provide an elastic store (buffer) process (see figure 146). The data signal shall be written into the buffer under control of the associated input clock. The data shall be read out of the buffer and written onto the D, S1, S2 bits under control of the VC-12 clock, frame position (S12_TI), and justification decisions.

The justification decisions determine the phase error introduced by the S12/P12x_A_So function. The amount of this phase error can be measured at the physical interfaces by monitoring the justification control bits C1C2 (see figure 145). An example is given in clause A.3.

Each justification decision results in a corresponding positive or negative justification action. Upon a positive justification action, the reading of 1 data bit shall be cancelled once and no data are written at the justification opportunity bit S2 and no data are written onto S1. Upon a negative justification action, 1 extra data bit shall be read once and written onto the justification opportunity bit S1 and data shall be written onto S2. If neither a positive nor a negative justification action is to be performed, either no data shall be written onto S1 and data shall be written onto S2, or vice versa.

NOTE: A requirement for maximum introduced phase error cannot be defined until a reference path is defined from which the requirements for network elements can be deduced.

Buffer size:

In the presence of jitter as specified by ITU-T Recommendation G.823 [9] and a frequency within the range 2 048 kbit/s \pm 50 ppm, this justification process shall not introduce any errors. Any step in frequency within this range shall not cause any errors.

C1C2 bits: *Justification control generation:*

The function shall generate the justification control (C1,C2) bits according the specification in ETS 300 147 [1]. It shall insert the justification control bits in the appropriate C1C2 bit positions.

Three bits of payload specific POH information, V5[5-7], shall be added to container-12 to form the VC-12 AI and a fixed Frame Start (FS) shall be generated.

V5[5-7]: In these bits the function shall insert code "010" (Asynchronous mapping of 2 048 kbit/s into the Container-12) as defined in ETS 300 147 [1].

O bits: The value of the O bits is undefined.

R bits: The value of an R bit is undefined.

Activation:

The function shall access the access point when it is activated (MI_Active is true). Otherwise, it shall not access the access point.

Defects: None.

An elastic store under/overflow defect (dUOF) is for further study.

Consequent Actions: None.

Defect Correlations: None.

Performance Monitoring: None.

7.3.2 VC-12 to P12x Adaptation Sink S12/P12x_A_Sk

Symbol:

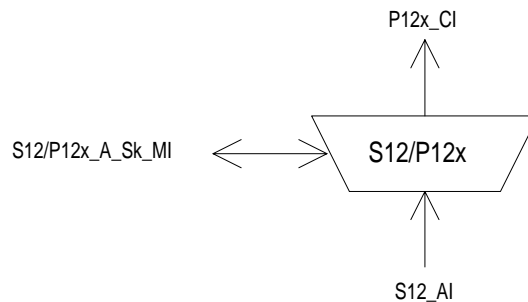

Figure 147: S12/P12x_A_Sk symbol

Interfaces:

Table 125: S12/P12x_A_Sk input and output signals

Input(s)	Output(s)
S12_AI_D	P12x_CI_D
S12_AI_CK	P12x_CI_CK
S12_AI_FS	P12x_CI_SSF
S12_AI_TSF	S12/P12x_A_Sk_MI_cPLM
S12/P12x_A_Sk_MI_Active	S12/P12x_A_Sk_MI_AcSL

Processes:

The function recovers plesiochronous P12x Characteristic Information (2 048 kbit/s \pm 50 ppm) from the synchronous container-12 with a frequency accuracy within \pm 4,6 ppm according to ETS 300 147 [1], and monitors the reception of the correct payload signal type.

V5[5-7]: The function shall compare the content of the accepted bits 5 to 7 of byte V5 with the expected value code "010" (Asynchronous mapping of 2 048 kbit/s into the Container-12) as a check on consistency between the provisioning operation at each end. The application and acceptance and mismatch detection process shall be as specified in EN 300 417-1-1 [6], subclauses 7.2 and 8.1.2.

R bits: The value in the R bits shall be ignored.

O bits: The value in the O bits shall be ignored.

C1C2 bits: Justification control interpretation:

The function shall perform justification control interpretation according ETS 300 147 [1] to recover the 2 048 kbit/s signal from the VC-12. If the majority of the C1 bits is "0" the S1 bit shall be taken as a data bit, otherwise (majority of C1 bits is "1") S1 bit shall be taken as a justification bit and consequently ignored. If the majority of the C2 bits is "0" S2 bit shall be taken as a data bit, otherwise (majority of C2 bits is "1") S2 bit shall be taken as a justification bit and consequently ignored.

NOTE: A negative justification is effectuated if the majority of C1 bits and the majority of C2 bits is "0". A positive justification is effectuated if the majority of the C1 bits and the majority of C2 bits is "1". The other combinations (C1 majority is "0" and C2 majority is "1", or C1 majority is "1" and C2 majority is "0") do not result in an actual justification.

Smoothing & jitter limiting process:

The function shall provide for a clock smoothing and elastic store (buffer) process. The 2 048 kbit/s data signal shall be written into the buffer under control of the associated (gapped) input clock with a frequency accuracy within $\pm 4,6$ ppm. The data signal shall be read out of the buffer under control of a smoothed (equally spaced) 2 048 kHz ± 50 ppm clock (the rate is determined by the 2 Mbit/s signal at the input of the remote S12/P12x_A_So). The residual jitter caused by pointer adjustments and bit justifications (measured at the 2 048 kbit/s interface) shall be within the limits specified in subclause 11.3.1.2 of EN 300 417-1-1 [6].

Buffer size:

In the presence of jitter as specified by subclause 11.3.1.2 of EN 300 417-1-1 [6] and a frequency within the range 2 048 kbit/s ± 50 ppm, this justification process shall not introduce any errors.

Following a step in frequency of the P12x signal transported by the S12_AI (for example due to reception of P12x_CI from a new P12x_TT_So at the far end or removal of all-ONEs (AIS) signal with a frequency offset) there will be a maximum recovery time of X seconds after which this process shall not generate any bit errors.

The value of X is for further study; a value of 1 second has been proposed.

Activation:

The function shall perform the operation specified above when it is activated (MI_Active is true). Otherwise, it shall transmit the all-ONEs signal at its output (CI_D) and not report its status via the management point.

Defects:

The function shall detect for dPLM defect according the specification in EN 300 417-1-1 [6], subclause 8.2.1.

Consequent Actions:

aSSF ← AI_TSF or dPLM

aAIS ← AI_TSF or dPLM

On declaration of the aAIS the function shall output an all-ONEs (AIS) signal in the P12x_CI_D within 1 000 μ s; on clearing of aAIS the function shall output normal data within 1 000 μ s. The P12x_CI_CK during the all-ONEs signal shall be within 2 048 kHz ± 50 ppm.

Defect Correlations:

cPLM ← dPLM and (not AI_TSF)

Performance Monitoring: None.

7.3.3 VC-12 to P12s Adaptation Source S12/P12s_A_So

Two types of S12/P12s_A_So functions are defined:

- type 1 for byte synchronous mapped P12s_CI: S12/P12s-b_A_So;
- type 2 for asynchronous mapped P12s_CI: S12/P12s-a_A_So.

7.3.3.1 Type 1 VC-12 to P12s Adaptation Source S12/P12s-b_A_So

Symbol:

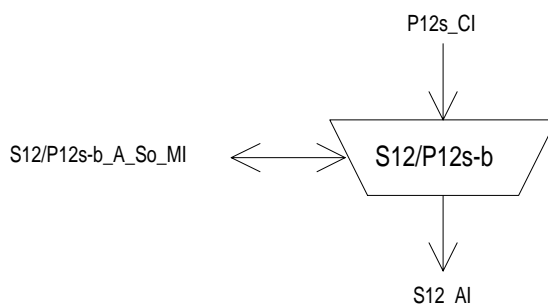

Figure 148: S12/P12s-b_A_So symbol

Interfaces:

Table 126: S12/P12s-b_A_So input and output signals

Input(s)	Output(s)
P12s_CI_D	S12_AI_D
P12s_CI_CK	S12_AI_CK
P12s_CI_FS	S12_AI_FS
P12s_CI_SSF	
S12/P12s-b_A_So_MI_Active	

Processes:

This function byte-synchronously maps a synchronous octet structured 2 048 kbit/s information stream into a VC-12 payload and adds bits 5 to 7 of byte V5. It takes P12s_CI, a bit-stream with a rate of 2 048 kbit/s \pm 4,6 ppm (nominally locked to a PRC), present at its input and inserts it into the synchronous container-12 having a capacity of 136 bytes and a frame as defined in ETS 300 147 [1] and depicted in figure 149.

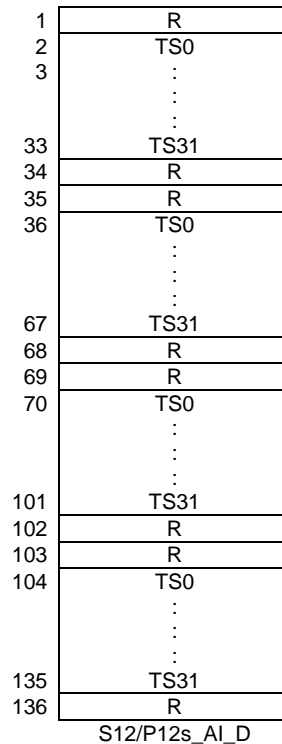

Legend: R = Fixed Stuff, TS = Time Slot (of structured 2 048 kbit/s signal)

Figure 149: 2 048 kbit/s byte synchronous mapping into Container 12

Bitrate adaptation:

The function shall provide for a (35/32) clock multiplier process taking P12s_CI_CK as input to generate the VC-12 clock signal S12_AI_CK (see figure 150).

The function shall provide for a buffer process. The data and frame start signals shall be written into the buffer under control of the associated input clock. The data and frame start signals shall be read out of the buffer under control of the VC-12 clock. No data shall be read out of the buffer at the VC-12 POH byte positions (see figure 136) and fixed stuff "R" byte positions (see figure 149).

The function shall convert the P12s frame start signal (P12s_CI_FS) identifying TS0 position into a VC-12 frame start signal (S12_AI_FS) identifying V5 byte position.

Buffer size:

The length of the buffer shall be such that the above process shall not introduce errors.

NOTE: Contrary to the asynchronous mapping, this byte-synchronous mapping process locks the VC-12 to the 2 Mbit/s signal's bitrate and frame phase. Frequency and/or phase differences between the 2 Mbit/s signal (mapped into the VC-12 signal) and the network element clock (TI_CK) generated within the synchronization distribution layer are accommodated via TU-12 pointer adjustments.

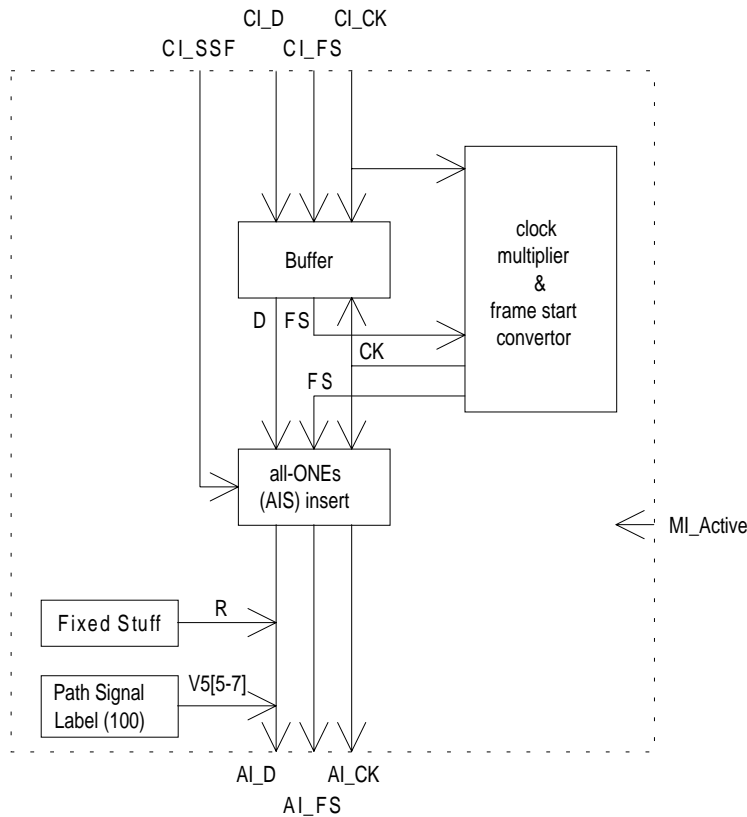

Figure 150: main processes within S12/P12s_A_So

Three bits of payload specific POH information, V5[5-7], shall be added to container-12 to form the VC-12 AI and a fixed Frame Start (FS) shall be generated.

V5[5-7]: In these bits the function shall insert code "100" (byte-synchronous mapping of 2 048 kbit/s into the Container-12) as defined in ETS 300 147 [1].

R bits: The value of an R bit is undefined.

Activation:

The function shall access the access point when it is activated (MI_Active is true). Otherwise, it shall not access the access point.

Defects: None.

Consequent Actions:

aAIS ← CI_SSF

On declaration of the aAIS the function shall output an all-ONES (AIS) signal within the bytes carrying TS0 to TS31: with a frequency accuracy of $\pm 4,6$ ppm - and an associating VC-12 frame start signal within 250 μ s; on clearing of aAIS the function shall output normal data within 250 μ s.

Defect Correlations: None.

Performance Monitoring: None.

7.3.3.2 Type 2 VC-12 to P12s Adaptation Source S12/P12s-a_A_So

Symbol:

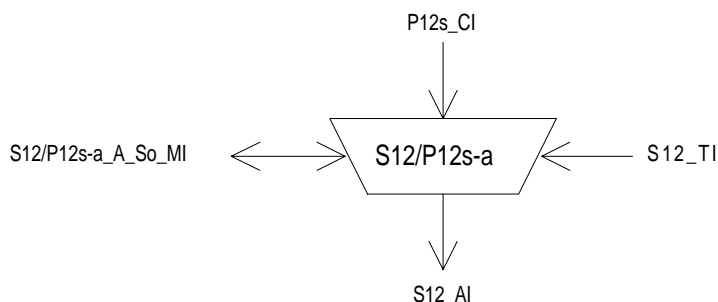

Figure 151: S12/P12s-a_A_So symbol

Interfaces:

Table 127: S12/P12s-a_A_So input and output signals

Input(s)	Output(s)
P12s_CI_D	S12_AI_D
P12s_CI_CK	S12_AI_CK
S12_TI_CK	S12_AI_FS
S12_TI_FS	
S12/P12s-a_A_So_MI_Active	

Processes:

This function maps a 2 048 kbit/s information stream into a VC-12 payload using bit stuffing and adds bits 5 to 7 of byte V5. It takes P12s_CI, present at its input, and inserts it into the synchronous container-12 having a capacity of 136 bytes and the justification frame as defined in ETS 300 147 [1] and depicted in figure 145.

Frequency justification and bit rate adaptation:

The function shall provide an elastic store (buffer) process (see figure 146). The data signal shall be written into the buffer under control of the associated input clock. The data shall be read out of the buffer and written onto the D, S1, S2 bits under control of the VC-12 clock, frame position (S12_TI), and justification decisions.

The justification decisions determine the phase error introduced by the S12/P12s-a_A_So function. The amount of this phase error can be measured at the physical interfaces by monitoring the justification control bits C1C2 (see figure 145). An example is given in clause A.3.

Each justification decision results in a corresponding positive or negative justification action. Upon a positive justification action, the reading of 1 data bit shall be cancelled once and no data are written at the justification opportunity bit S2 and no data are written onto S1. Upon a negative justification action, 1 extra data bit shall be read once and written onto the justification opportunity bit S1 and data shall be written onto S2. If neither a positive nor a negative justification action is to be performed, either no data shall be written onto S1 and data shall be written onto S2, or vice versa.

NOTE: A requirement for maximum introduced phase error cannot be defined until a reference path is defined from which the requirements for network elements can be deduced.

Buffer size:

In the presence of jitter as specified by ITU-T Recommendation G.823 [9] and a frequency within the range 2 048 kbit/s \pm 50 ppm, this justification process shall not introduce any errors. Any step in frequency within this range shall not cause any errors.

C1C2 bits: *Justification control generation:*

The function shall generate the justification control (C1,C2) bits according the specification in ETS 300 147 [1]. It shall insert the justification control bits in the appropriate C1C2 bit positions.

Three bits of payload specific POH information, V5[5-7], shall be added to container-12 to form the VC-12 AI and a fixed Frame Start (FS) shall be generated.

V5[5-7]: In these bits the function shall insert code "010" (Asynchronous mapping of 2 048 kbit/s into the Container-12) as defined in ETS 300 147 [1].

O bits: The value of the O bits is undefined.

R bits: The value of an R bit is undefined.

Activation:

The function shall access the access point when it is activated (MI_Active is true). Otherwise, it shall not access the access point.

Defects: None.

An elastic store under/overflow defect (dUOF) is for further study.

Consequent Actions: None.

Defect Correlations: None.

Performance Monitoring: None.

7.3.4 VC-12 to P12s Adaptation Sink S12/P12s_A_Sk

Three types of S12/P12s_A_Sk functions are defined:

- type 1 when the recovered byte synchronously mapped P12s_CI is passed through the P12s layer towards another server layer (e.g. E12, P22e): S12/P12s-x_A_So;
- type 2 when the recovered byte synchronously mapped P12s_CI is terminated in the P12s layer. In this case, an additional frame phase recovery process is required: S12/P12s-b_A_Sk;
- type 3 when the recovered asynchronously mapped P12s_CI is terminated in the P12s layer. In this case, an additional frame phase recovery process is required: S12/P12s-a_A_Sk.

7.3.4.1 Type 1 VC-12 to P12s Adaptation Sink S12/P12s-x_A_Sk

Symbol:

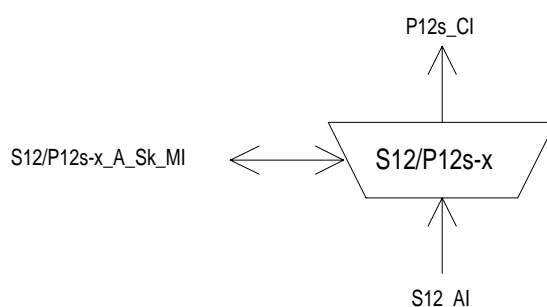

Figure 152: S12/P12s-x_A_Sk symbol

Interfaces:

Table 128: S12/P12s-x_A_Sk input and output signals

Input(s)	Output(s)
S12_AI_D	P12s_CI_D
S12_AI_CK	P12s_CI_CK
S12_AI_FS	P12s_CI_SSF
S12_AI_TSF	S12/P12s-x_A_Sk_MI_cPLM
S12/P12s-x_A_Sk_MI_Active	S12/P12s-x_A_Sk_MI_AcSL

Processes:

The function recovers byte-synchronous mapped P12s Characteristic Information (2 048 kbit/s \pm 4,6 ppm) from the synchronous container-12 with a frequency accuracy within \pm 4,6 ppm according to ETS 300 147 [1], and monitors the reception of the correct payload signal type.

V5[5-7]: The function shall compare the content of the accepted bits 5 to 7 of byte V5 with the expected value code "100" (byte-synchronous mapping of 2 048 kbit/s into the Container-12) as a check on consistency between the provisioning operation at each end. The application and acceptance and mismatch detection process shall be as specified in EN 300 417-1-1 [6], subclauses 7.2 and 8.1.2.

Smoothing & jitter limiting process:

The function shall provide for a clock smoothing and elastic store (buffer) process. The 2 048 kbit/s data signal shall be written into the buffer under control of the associated (gapped) input clock with a frequency accuracy within \pm 4,6 ppm. The data signal shall be read out of the buffer under control of a smoothed (equally spaced) 2 048 kHz \pm 4,6 ppm clock (the rate is determined by the 2 Mbit/s signal at the input of the remote S12/P12s_A_So). The residual jitter caused by pointer adjustments (measured at the 2 048 kbit/s interface) shall be within the limits specified in subclause 11.3.1.2 of EN 300 417-1-1 [6].

Buffer size:

In the presence of jitter as specified by subclause 11.3.1.2 of EN 300 417-1-1 [6] and a frequency within the range $2\,048\text{ kbit/s} \pm 4,6\text{ ppm}$, this justification process shall not introduce any errors.

Following a step in frequency of the P12s_CI signal transported by the S12_AI (for example due to reception of P12s_CI from a new P12s_TT_So at the far end or removal of all-ONEs (AIS) signal with a frequency offset) there will be a maximum recovery time of X seconds after which this process shall not generate any bit errors.

The value of X is for further study; a value of 1 second has been proposed.

Activation:

The function shall perform the operation specified above when it is activated (MI_Active is true). Otherwise, it shall transmit the all-ONEs signal at its output (CI_D) and not report its status via the management point.

R bits: The value in the R bits shall be ignored.

Defects:

The function shall detect for dPLM defect according the specification in EN 300 417-1-1 [6], subclause 8.2.1.

Consequent Actions:

aSSF ← AI_TSF or dPLM

aAIS ← AI_TSF or dPLM

On declaration of the aAIS the function shall output an all-ONEs (AIS) signal in the P12s_CI_D within $250\ \mu\text{s}$; on clearing of aAIS the function shall output normal data within $250\ \mu\text{s}$. The P12s_CI_CK during the all-ONEs signal shall be within $2\,048\text{ kHz} \pm 50\text{ ppm}$.

Defect Correlations:

cPLM ← dPLM and (not AI_TSF)

Performance Monitoring: None.

7.3.4.2 Type 2 VC-12 to P12s Adaptation Sink S12/P12s-b_A_Sk

Symbol:

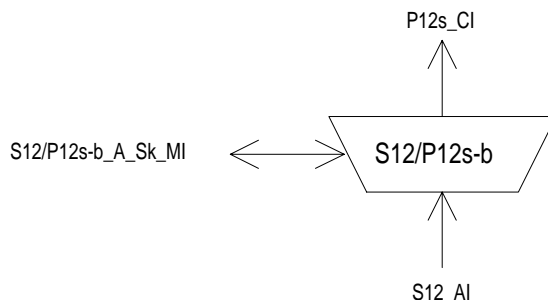

Figure 153: S12/P12s-b_A_Sk symbol

Interfaces:

Table 129: S12/P12s-b_A_Sk input and output signals

Input(s)	Output(s)
S12_AI_D	P12s_CI_D
S12_AI_CK	P12s_CI_CK
S12_AI_FS	P12s_CI_SSF
S12_AI_TSF	P12s_CI_FS
	P12s_CI_MFS
S12/P12s-b_A_Sk_MI_Active	S12/P12s-b_A_Sk_MI_cPLM
S12/P12s-b_A_Sk_MI_AIS_Reported	S12/P12s-b_A_Sk_MI_AcSL
S12/P12s-b_A_Sk_MI_CRC4mode	S12/P12s-b_A_Sk_MI_cAIS
	S12/P12s-b_A_Sk_MI_cLOF
	S12/P12s-b_A_Sk_MI_NCI

Processes:

The function recovers byte-synchronous mapped P12s Characteristic Information (2 048 kbit/s \pm 4,6 ppm) from the synchronous container-12 with a frequency accuracy within \pm 4,6 ppm according to ETS 300 147 [1], and monitors the reception of the correct payload signal type. It recovers the frame (and CRC4 multiframe) phase of the 2 048 kbit/s signal.

V5[5-7]: The function shall compare the content of the accepted bits 5 to 7 of byte V5 with the expected value code "100" (byte-synchronous mapping of 2 048 kbit/s into the Container-12) as a check on consistency between the provisioning operation at each end. The application and acceptance and mismatch detection process shall be as specified in EN 300 417-1-1 [6], subclauses 7.2 and 8.1.2.

Smoothing & jitter limiting process:

The function shall provide for a clock smoothing and elastic store (buffer) process. The 2 048 kbit/s data signal shall be written into the buffer under control of the associated (gapped) input clock with a frequency accuracy within \pm 4,6 ppm. The data signal shall be read out of the buffer under control of a smoothed (equally spaced) 2 048 kHz \pm 4,6 ppm clock (the rate is determined by the 2 Mbit/s signal at the input of the remote S12/P12s_A_So). The residual jitter caused by pointer adjustments (measured at the 2 048 kbit/s interface) shall be within the limits specified in subclause 11.3.1.2 of EN 300 417-1-1 [6].

Buffer size:

In the presence of jitter as specified by subclause 11.3.1.2 of EN 300 417-1-1 [6] and a frequency within the range 2 048 kbit/s \pm 4,6 ppm, this justification process shall not introduce any errors.

Following a step in frequency of the P12s_CI signal transported by the S12_AI (for example due to reception of P12s_CI from a new P12s_TT_So at the far end or removal of all-ONEs (AIS) signal with a frequency offset) there will be a maximum recovery time of X seconds after which this process shall not generate any bit errors.

The value of X is for further study; a value of 1 second has been proposed.

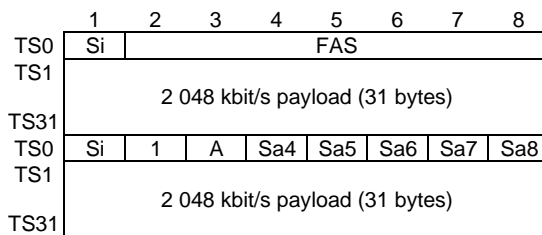

Figure 154: P12s_CI_D (without CRC-4 multiframe)

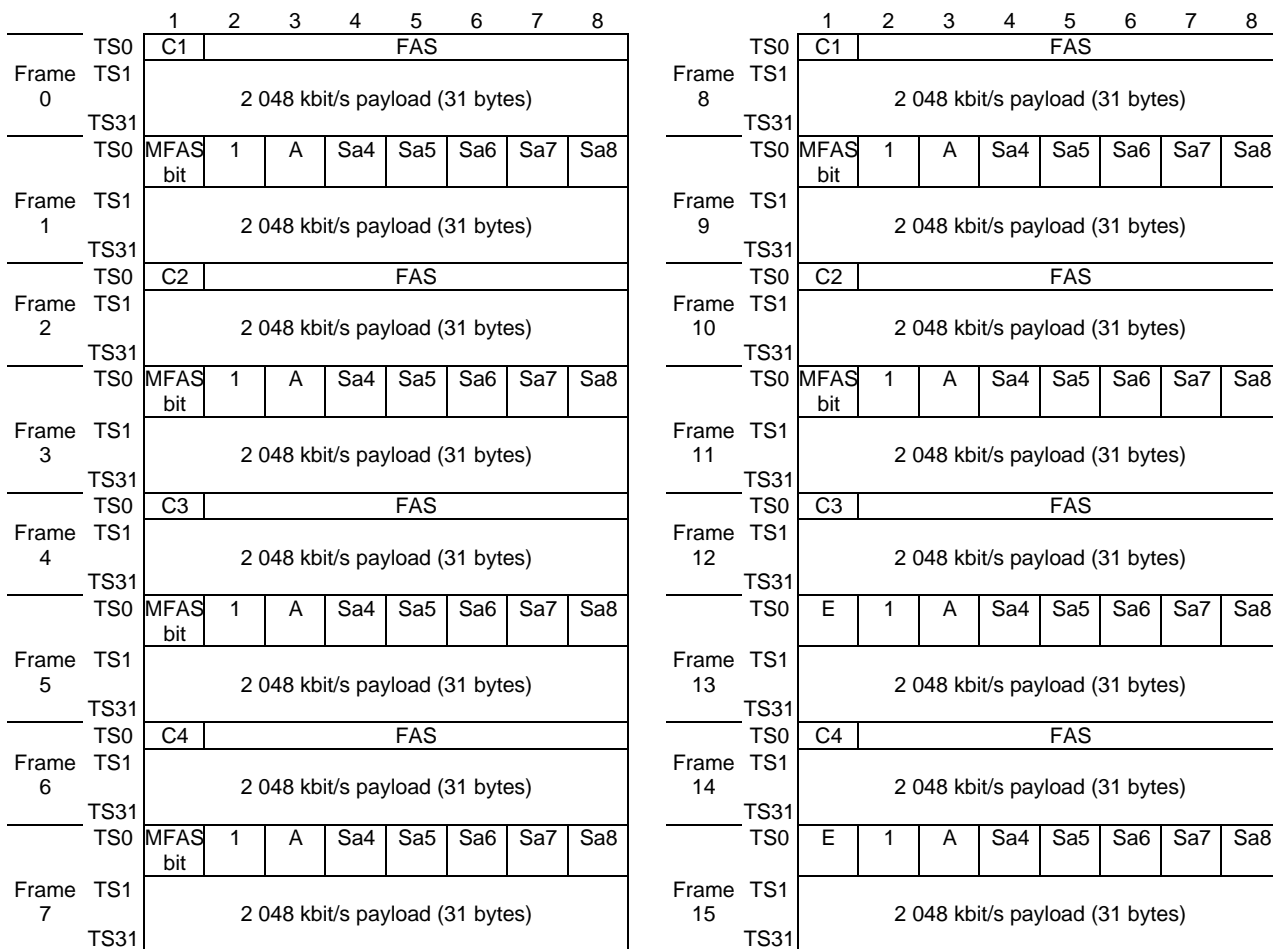

Figure 155: P12s_CI_D (with CRC-4 multiframe)

Basic frame and CRC-4 Multiframe alignment:

The function shall recover the (250 μs) basic frame and (2 ms) CRC-4 multiframe phase evaluating the timeslots in the VC-12 (see figure 149). The process shall operate as specified in ETS 300 167 [14]. Either the manual, or the automatic, or both manual and automatic interworking modes shall be supported.

NOTE: The frame alignment process in ETS 300 167 [14] is under study.

Activation:

The function shall perform the operation specified above when it is activated (MI_Active is true). Otherwise, it shall transmit the all-ONEs signal at its output (CI_D) and not report its status via the management point.

Defects:

The function shall detect for dPLM defect according the specification in EN 300 417-1-1 [6], subclause 8.2.1.

The function shall detect dLOF defect as specified in ETS 300 167 [14].

The function shall clear dLOF defect as specified in ETS 300 167 [14].

The function shall report NCI status in the automatic CRC-4 interworking mode as specified by ETS 300 167 [14].

The dAIS defect shall be detected specified by EN 300 417-1-1 [6], subclause 8.2.1.7 for 2 Mbit/s, with X = 2, Y = 512, Z = 3.

Consequent Actions:

aSSF ← dPLM or dAIS or dLOF

aAIS ← dPLM or dAIS or dLOF

On declaration of the aAIS the function shall output an all-ONEs (AIS) signal in the P12s_CL_D within 250 µs; on clearing of aAIS the function shall output normal data within 250 µs.

Defect Correlations:

cPLM ← dPLM and (not AI_TSF)

cAIS ← dAIS and (not dPLM) and (not AI_TSF) and AIS_Reported

cLOF ← dLOF and (not dAIS) and (not dPLM) and (not AI_TSF)

Performance Monitoring: None.

7.3.4.3 Type 3 VC-12 to P12s Adaptation Sink S12/P12s-a_A_Sk

Symbol:

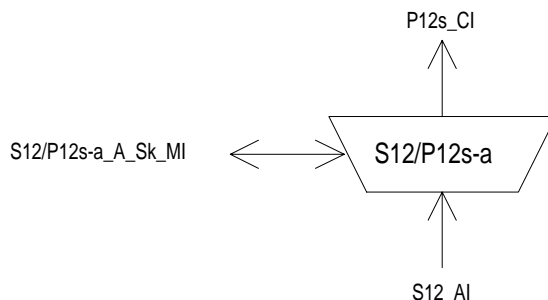

Figure 156: S12/P12s-a_A_Sk symbol

Interfaces:

Table 130: S12/P12s-a_A_Sk input and output signals

Input(s)	Output(s)
S12_AI_D	P12s_CI_D
S12_AI_CK	P12s_CI_CK
S12_AI_FS	P12s_CI_SSF
S12_AI_TSF	P12s_CI_FS
	P12s_CI_MFS
S12/P12s-a_A_Sk_MI_Active	S12/P12s-a_A_Sk_MI_cPLM
S12/P12s-a_A_Sk_MI_AIS_Reported	S12/P12s-a_A_Sk_MI_AcSL
S12/P12s-a_A_Sk_MI_CRC4mode	S12/P12s-a_A_Sk_MI_cAIS
	S12/P12s-a_A_Sk_MI_cLOF
	S12/P12s-a_A_Sk_MI_NCI

Processes:

The function recovers asynchronous mapped P12s Characteristic Information from the synchronous container-12 according to ETS 300 147 [1], and monitors the reception of the correct payload signal type. It recovers the frame (and CRC4 multiframe) phase of the 2 048 kbit/s signal.

V5[5-7]: The function shall compare the content of the accepted bits 5 to 7 of byte V5 with the expected value code "010" (Asynchronous mapping of 2 048 kbit/s into the Container-12) as a check on consistency between the provisioning operation at each end. The application and acceptance and mismatch detection process shall be as specified in EN 300 417-1-1 [6], subclauses 7.2 and 8.1.2.

R bits: The value in the R bits shall be ignored.

O bits: The value in the O bits shall be ignored.

C1C2 bits: Justification control interpretation:

The function shall perform justification control interpretation according ETS 300 147 [1] to recover the 2 048 kbit/s signal from the VC-12. If the majority of the C1 bits is "0" the S1 bit shall be taken as a data bit, otherwise (majority of C1 bits is "1") S1 bit shall be taken as a justification bit and consequently ignored. If the majority of the C2 bits is "0" S2 bit shall be taken as a data bit, otherwise (majority of C2 bits is "1") S2 bit shall be taken as a justification bit and consequently ignored.

NOTE 1: A negative justification is effectuated if the majority of C1 bits and the majority of C2 bits is "0". A positive justification is effectuated if the majority of the C1 bits and the majority of C2 bits is "1". The other combinations (C1 majority is "0" and C2 majority is "1", or C1 majority is "1" and C2 majority is "0") do not result in an actual justification.

Smoothing & jitter limiting process:

The function shall provide for a clock smoothing and elastic store (buffer) process. The 2 048 kbit/s data signal shall be written into the buffer under control of the associated (gapped) input clock with a frequency accuracy within ± 50 ppm. The data signal shall be read out of the buffer under control of a smoothed (equally spaced) 2 048 kHz ± 50 ppm clock (the rate is determined by the 2 Mbit/s signal at the input of the remote S12/P12s-a_A_So or S12/P12x_A_So). The residual jitter caused by pointer adjustments and bit justifications (measured at the 2 048 kbit/s interface) shall be within the limits specified in subclause 11.3.1.2 of EN 300 417-1-1 [6].

Buffer size:

In the presence of jitter as specified by subclause 11.3.1.2 of EN 300 417-1-1 [6] and a frequency within the range 2 048 kbit/s ± 50 ppm, this justification process shall not introduce any errors.

Following a step in frequency of the P12s signal transported by the S12_AI (for example due to reception of P12s_CI from a new P12s_TT_So at the far end or removal of all-ONEs (AIS) signal with a frequency offset) there will be a maximum recovery time of X seconds after which this process shall not generate any bit errors.

The value of X is for further study; a value of 1 second has been proposed.

Basic frame and CRC-4 Multiframe alignment:

The function shall recover the (250 μ s) basic frame and (2 ms) CRC-4 multiframe phase evaluating the D-bits and S1, S2 bits according to the justification control interpretation process in the VC-12 (see figure 145). The process shall operate as specified in ETS 300 167 [14]. Either the manual, or the automatic, or both manual and automatic interworking modes shall be supported.

NOTE 2: The frame alignment process in ETS 300 167 [14] is under study.

Activation:

The function shall perform the operation specified above when it is activated (MI_Active is true). Otherwise, it shall transmit the all-ONEs signal at its output (CI_D) and not report its status via the management point.

Defects:

The function shall detect for dPLM defect according the specification in EN 300 417-1-1 [6], subclause 8.2.1.

The function shall detect dLOF defect as specified in ETS 300 167 [14].

The function shall clear dLOF defect as specified in ETS 300 167 [14].

The function shall report NCI status in the automatic CRC-4 interworking mode as specified by ETS 300 167 [14].

Consequent Actions:

aSSF \leftarrow dPLM or dAIS or dLOF

aAIS \leftarrow dPLM or dAIS or dLOF

On declaration of the aAIS the function shall output an all-ONEs (AIS) signal in the P12s_CI_D within 250 μ s; on clearing of aAIS the function shall output normal data within 250 μ s.

Defect Correlations:

cPLM \leftarrow dPLM and (not AI_TSF)

cAIS \leftarrow dAIS and (not dPLM) and (not AI_TSF) and AIS_Reported

cLOF \leftarrow dLOF and (not dAIS) and (not dPLM) and (not AI_TSF)

Performance Monitoring: None.

7.3.5 VC-12 to P0-31c Adaptation Source S12/P0-31c_A_So

Symbol:

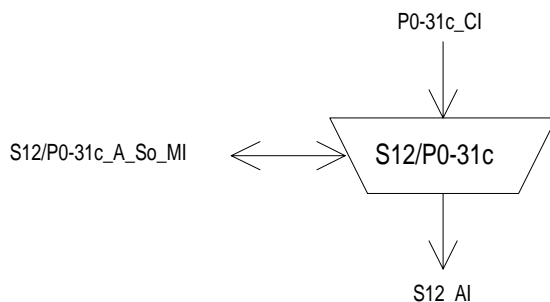

Figure 157: S12/P0-31c_A_So symbol

Interfaces:

Table 131: S12/P0-31c_A_So input and output signals

Input(s)	Output(s)
P0-31c_CI_D	S12_AI_D
P0-31c_CI_CK	S12_AI_CK
P0-31c_CI_FS	S12_AI_FS
P0-31c_CI_SSF	
S12/P0-31c_A_So_MI_Active	

Processes:

This function byte-synchronously maps 31 bytes representing any combination of 64 kbit/s channels as a 1 984 kbit/s byte structured information stream into a VC-12 payload and adds bits 5 to 7 of byte V5. It takes P0-31c_CI, a bit-stream with a rate of 1 984 kbit/s \pm 4,6 ppm (nominally locked to a PRC), present at its input and inserts it into the synchronous container C12 having a capacity of 136 bytes and a frame as defined in ETS 300 147 [1] and depicted in figure 158.

Bitrate adaptation:

The function shall provide for a (35/31) clock multiplier process taking P0-31c_CI_CK as input to generate the VC-12 clock signal S12_AI_CK.

The function shall provide for a buffer process. The data and frame start signals shall be written into the buffer under control of the associated input clock. The data and frame start signals shall be read out of the buffer under control of the VC-12 clock. No data shall be read out of the buffer at the VC-12 POH byte positions (see figure 136) and fixed stuff "R" byte positions (see figure 158).

The function shall convert the P0-31c frame start signal (P0-31c_CI_FS) identifying TS1 position into a VC-12 frame start signal (S12_AI_FS) identifying V5 byte position.

Buffer size:

The length of the buffer shall be such that the above process shall not introduce errors.

NOTE 1: Contrary to the asynchronous mapping, this byte-synchronous mapping process locks the VC-12 to the 31 x 64 kbit/s signal's bit rate and frame phase. Frequency and/or phase differences between the 1 984 kbit/s signal (mapped into the VC-12 signal) and the network element clock (TI_CK) generated within the synchronization distribution layer are accommodated via TU-12 pointer adjustments.

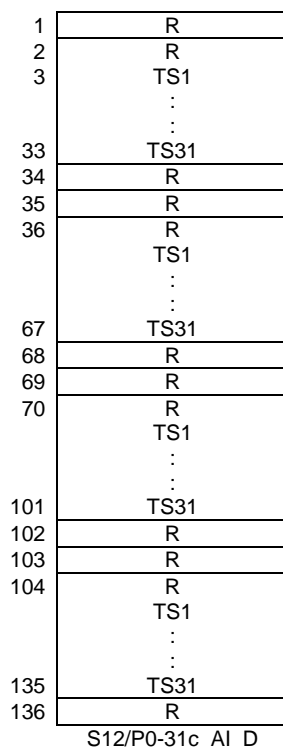

Legend: R = Fixed Stuff, TS = Time Slot (of structured 2 048 kbit/s signal)

Figure 158: 1 984 kbit/s byte synchronous mapping into Container 12

Three bits of payload specific POH information, V5[5-7], shall be added to container-12 to form the VC-12 AI and a fixed Frame Start (FS) shall be generated.

V5[5-7]: In these bits the function shall insert code "100" (byte-synchronous mapping of 2 048 kbit/s into the Container-12) as defined in ETS 300 147 [1].

NOTE 2: The same signal label code is allocated for the byte-synchronous mapping of a 2 048 kbit/s signal and a 1 984 kbit/s signal into a VC-12.

R bits: The value of an R bit is undefined.

Activation:

The function shall access the access point when it is activated (MI_Active is true). Otherwise, it shall not access the access point.

Defects: None.

Consequent Actions:

aAIS ← CI_SSF

On declaration of the aAIS the function shall output an all-ONES (AIS) signal within the bytes carrying TS1 to TS31 - with a frequency accuracy of $\pm 4,6$ ppm - and an associating VC-12 frame start signal within 250 μ s; on clearing of aAIS the function shall output normal data within 250 μ s.

Defect Correlations: None.

Performance Monitoring: None.

7.3.6 VC-12 to P0-31c Adaptation Sink S12/P0-31c_A_Sk

Symbol:

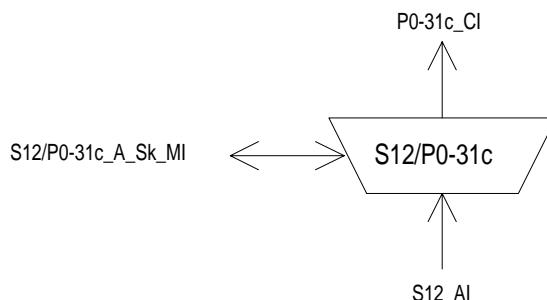

Figure 159: S12/P0-31c_A_Sk symbol

Interfaces:

Table 132: S12/P0-31c_A_Sk input and output signals

Input(s)	Output(s)
S12_AI_D	P0-31c_CI_D
S12_AI_CK	P0-31c_CI_CK
S12_AI_FS	P0-31c_CI_SSF
S12_AI_TSF	P0-31c_CI_FS
S12/P0-31c_A_Sk_MI_Active	S12/P0-31c_A_Sk_MI_cPLM
	S12/P0-31c_A_Sk_MI_AcSL

Processes:

This function recovers 31 bytes representing any combination of 64 kbit/s channels as a 31 bytes per frame structured synchronous bit-stream with a rate of 1 984 kbit/s from byte synchronous mapping in VC-12 as specified by ETS 300 147 [1], and monitors the reception of the correct payload signal type.

V5[5-7]: The function shall compare the content of the accepted bits 5 to 7 of byte V5 with the expected value code "100" (byte-synchronous mapping of 2 048 kbit/s into the Container-12) as a check on consistency between the provisioning operation at each end. The application and acceptance and mismatch process shall be as specified in EN 300 417-1-1 [6], subclauses 7.2 and 8.1.2.

Smoothing & jitter limiting process:

The function shall provide for a clock smoothing and elastic store (buffer) process. The 1 984 kbit/s data signal shall be written into the buffer under control of the associated (gapped) input clock. The data signal shall be read out of the buffer under control of a smoothed (equally spaced) 1 984 kHz \pm 4,6 ppm clock (the rate is determined by the 1 984 kbit/s signal at the input of the remote S12/P0-31c_A_So). The residual jitter caused by pointer adjustments (measured at the 2 048 kbit/s interface) shall be within the limits specified in subclause 11.3.1.2 of EN 300 417-1-1 [6].

Buffer size:

In the presence of jitter as specified by subclause 11.3.1.2 of EN 300 417-1-1 [6] and a frequency within the range 1 984 kbit/s \pm 4,6 ppm, this justification process shall not introduce any errors.

Following a step in frequency of the P0-31c signal transported by the S12_AI (for example due to reception of P0-31c CI from a new P0-31c_TT_So at the far end or removal of all-ONES (AIS) signal with a frequency offset) there will be a maximum recovery time of X seconds after which this process shall not generate any bit errors.

The value of X is for further study; a value of 1 second has been proposed.

Frame phase:

The function shall extract from the VC-12 frame phase the 1 984 kbit/s signal (8 kHz) frame phase.

Activation:

The function shall perform the operation specified above when it is activated (MI_Active is true). Otherwise, it shall transmit the all-ONEs signal at its output (CI_D) and not report its status via the management point.

R bits: The value in the R bits shall be ignored.

Defects:

The function shall detect for dPLM defect according the specification in EN 300 417-1-1 [6], subclause 8.2.1.

Consequent Actions:

aSSF ← AI_TSF or dPLM

aAIS ← AI_TSF or dPLM

On declaration of the aAIS the function shall output an all-ONEs (AIS) signal in the P0-31c_CI_D within 250 μ s; on clearing of aAIS the function shall output normal data within 250 μ s. The P0-31c_CI_CK during the all-ONEs signal shall be within 1 984 kHz \pm 4,6 ppm.

Defect Correlations:

cPLM ← dPLM and (not AI_TSF)

Performance Monitoring: None.

7.3.7 VC-12 Layer to TSS4 Adaptation Source S12/TSS4_A_So

Symbol:

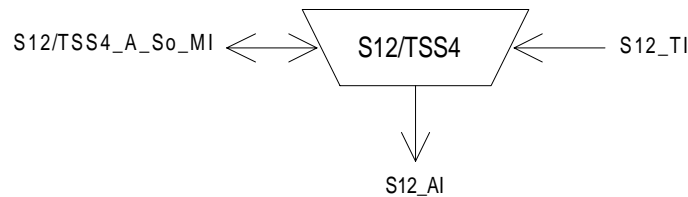

Figure 160: S12/TSS4_A_So symbol

Interfaces:

Table 133: S12/TSS4_A_So input and output signals

Input(s)	Output(s)
S12_TI_CK	S12_AI_D
S12_TI_FS	S12_AI_CK
S12/TSS4_A_So_MI_Active	S12_AI_FS

Processes:

This function maps a VC-12 synchronous Test Signal Structure TSS4 PRBS stream as described in ITU-T Recommendation O.181 [12] into a VC-12 payload and adds the bits V5[5-7] bytes. It creates a 2^{15} PRBS with timing derived from the S12_TI_Ck and maps it without justification bits into the whole of the synchronous container-12 having a capacity of 136 bytes. The PRBS is a sequence which repeats itself over a period which is not an exact multiple of the capacity available in the container-12 frame. Therefore the start of the sequence will move relative to the start of the container-12 frame over time.

Three bits of payload specific POH information, V5[5-7], shall be added to container-12 to form the VC-12 AI and a fixed Frame Start (FS) shall be generated.

V5[5-7]: In these bits the function shall insert code "110" (TSS4 into the Container-12) as defined in ETS 300 147 [1].

Activation:

The function shall access the access point when it is activated (MI_Active is true). Otherwise, it shall not access the access point.

Defects: None.

Consequent Actions: None.

Defect Correlations: None.

Performance Monitoring: None.

7.3.8 VC-12 Layer to TSS4 Adaptation Sink S12/TSS4_A_Sk

Symbol:

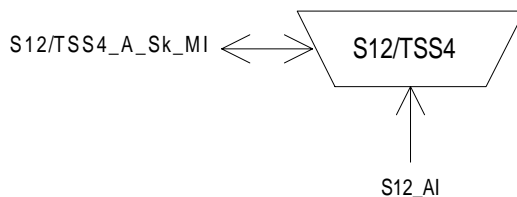

Figure 161: S12/TSS4_A_Sk symbol

Interfaces:

Table 134: S12/TSS4_A_Sk input and output signals

Input(s)	Output(s)
S12_AI_D	S12/TSS4_A_Sk_MI_cPLM
S12_AI_CK	S12/TSS4_A_SK_MI_cLSS
S12_AI_FS	S12/TSS4_A_Sk_MI_AcSL
S12_AI_TSF	S12/TSS4_A_Sk_MI_pN_TSE
S12/TSS4_A_Sk_MI_Active	
S12/TSS4_A_Sk_MI_1second	

Processes:

The function recovers a TSS4 2¹⁵ PRBS test sequence as defined in ITU-T Recommendation O.181 [12] from the synchronous container-12 (having a frequency accuracy within $\pm 4,6$ ppm) and monitors the reception of the correct payload signal type and the presence of test sequence errors (TSE) in the PRBS sequence.

V5[5-7]: The function shall compare the content of the accepted bits 5 to 7 of byte V5 with the expected value code "110" (TSS4 into the Container-12) as a check on consistency between the provisioning operation at each end. The application and acceptance and mismatch detection process shall be as specified in EN 300 417-1-1 [6], subclauses 7.2 and 8.1.2.

Error monitoring:

Test sequence errors are bit errors in the TSS data stream and shall be detected whenever the PRBS detector is in lock and the received data bit does not match the expected value.

Activation:

The function shall perform the operation specified above when it is activated (MI_Active is true). Otherwise, it shall not report its status via the management point.

Defects:

The function shall detect for dPLM defect according the specification in EN 300 417-1-1 [6], subclause 8.2.1.

The function shall detect for loss of PRBS lock (dLSS) according to the criteria defined in ITU-T Recommendation O.151 [11], subclause 2.6.

Consequent Actions: None.

Defect Correlations:

cPLM ← dPLM and (not AI_TSF)
 cLSS ← dLSS and not (AI_TSF)

Performance Monitoring:

pN_TSE ← Sum of Test Sequence Errors (TSE) within one second period.

7.3.9 VC-12 Layer to ATM Virtual Path Layer Compound Adaptation Source function S12/Avp_A_So

The specification of this function is addressed in EN 301 163-2-1.

7.3.10 VC-12 Layer to ATM Virtual Path Layer Compound Adaptation Sink function S12/Avp_A_Sk

The specification of this function is addressed in EN 301 163-2-1.

7.3.11 VC-12 Layer Clock Adaptation Source S12-LC_A_So

Refer to EN 300 417-6-1 [8].

7.4 VC-12 Layer Monitoring Functions

7.4.1 VC-12 Layer Non-intrusive Monitoring Function S12m_TT_Sk

Symbol:

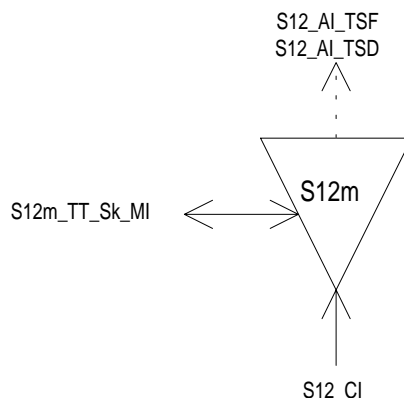

Figure 162: S12m_TT_Sk symbol

Interfaces:

Table 135: S12m_TT_Sk input and output signals

Input(s)	Output(s)
S12_CI_D	S12_AI_TSF
S12_CI_CK	S12_AI_TSD
S12_CI_FS	S12m_TT_Sk_MI_cTIM
S12_CI_SSF	S12m_TT_Sk_MI_cUNEQ
S12m_TT_Sk_MI_TPmode	S12m_TT_Sk_MI_cDEG
S12m_TT_Sk_MI_SSF_Reported	S12m_TT_Sk_MI_cRDI
S12m_TT_Sk_MI_ExtI	S12m_TT_Sk_MI_cSSF
S12m_TT_Sk_MI_RDI_Reported	S12m_TT_Sk_MI_AcTI
S12m_TT_Sk_MI_DEGTHR	S12m_TT_Sk_MI_pN_EBC
S12m_TT_Sk_MI_DEGM	S12m_TT_Sk_MI_pF_EBC
S12m_TT_Sk_MI_ExtImode	S12m_TT_Sk_MI_pN_DS
S12m_TT_Sk_MI_1second	S12m_TT_Sk_MI_pF_DS
S12m_TT_Sk_MI_TIMdis	

Processes:

NOTE 1: This non-intrusive monitor trail termination sink function has no associated source function.

This function monitors VC-12 for errors, and recovers the trail termination status. It extracts the payload independent overhead bytes/bits (J2, V5[1-2], V5[3], V5[5-7], V5[8]) from the VC-12 layer Characteristic Information:

J2: The Received Trail Trace Identifier RxTI shall be recovered from the J2 byte and shall be made available as AcTI for network management purposes. The application and acceptance and mismatch detection process shall be performed as specified in EN 300 417-1-1 [6], subclauses 7.1 and 8.2.1.3.

V5[1-2]: Even bit parity is computed for each bit pair of every byte of the preceding VC-12 including V5 and compared with bit 1 and 2 of V5 recovered from the current frame. A difference between the computed and recovered BIP-2 values is taken as evidence of an errored block (nN_B).

V5[3], V5[8]: The information carried in the bits 3 and 8 of the V5 byte (REI, RDI) shall be extracted to enable single ended maintenance of a bi-directional Trail (Path). The REI (nF_B) shall be used to monitor the error performance of the other direction of transmission, and the RDI (bit 8) shall be used to provide information as to the status of the remote

receiver. A "1" indicates a Remote Defect Indication state, while a "0" indicates the normal, working state. The application process shall be performed as specified in EN 300 417-1-1 [6], subclauses 7.4.2 (REI), 7.4.11 and 8.2 (RDI).

Table 136: V5[3] code interpretation

V5[3]	REI code interpretation
0	0 errored blocks
1	1 errored block

V5[5-7]: The information in bits 5 to 7 of byte V5 shall be extracted to allow unequipped VC defect detection.

K4[5-8]: The value in the bits 5 to 8 of byte K4 shall be ignored.

Defects:

The detection and removal conditions and processes for dDEG, dRDI, dUNEQ and dTIM defects shall be as specified by EN 300 417-1-1 [6], subclause 8.2.1 with the condition "aSSF" read as "aSSF or VC dAIS". To use the function within e.g. a tandem connection, it shall be possible to disable the trace id mismatch detection (TIMdis).

NOTE 2: Presumably, in such case the VC Trace Id. will be unknown to the tandem connection operator.

VC AIS:

The function shall detect for an AIS VC (VC-AIS) condition by monitoring the VC PSL for code "111". If 5 consecutive frames contain the "111" pattern in bits 5 to 7 of byte V5 a dAIS defect shall be detected. dAIS shall be cleared if in 5 consecutive frames any pattern other than the "111" is detected in bits 5 to 7 of byte V5.

NOTE 3: Equipment designed prior to the present document may be able to perform VC-AIS detection either as specified above interpreting "frames" as "samples (not necessary consecutive frames)", or by a comparison of the accepted signal label with the all-ONEs pattern. If the accepted signal label is equal to all-ONEs, VC-AIS defect is detected. If the accepted signal label is not equal to all-ONEs, VC-AIS defect is cleared.

Consequent actions:

aTSF ← CI_SSF or dAIS or dUNEQ or dTIM

aTSD ← dDEG

Defect Correlations:

cUNEQ ← dUNEQ and MON

cTIM ← dTIM and (not dUNEQ) and MON

cDEG ← dDEG and (not dTIM) and MON

cRDI ← dRDI and (not dUNEQ) and (not dTIM) and MON and RDI_Reported

cSSF ← (CI_SSF or dAIS) and MON and SSF_Reported

Performance Monitoring:

The performance monitoring process shall be performed as specified in EN 300 417-1-1 [6], subclause 8.2.4 through 8.2.7.

pN_DS ← aTSF or dEQ

pF_DS ← dRDI

pN_EBC ← Σ nN_B

pF_EBC ← Σ nF_B

NOTE 4: pF_DS/pF_EBC represent the performance of the total trail while pN_DS/pN_EBC represents only part of the trail up to the point of the non-intrusive monitor.

7.4.2 VC-12 Layer Supervisory-Unequipped Termination Source S12s_TT_So

Symbol:

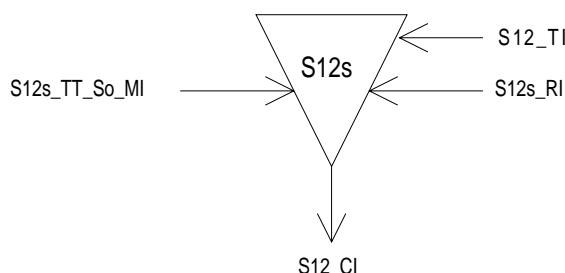

Figure 163: S12s_TT_So symbol

Interfaces:

Table 137: S12s_TT_So input and output signals

Input(s)	Output(s)
S12s_RI_RDI	S12_CI_D
S12s_RI_REI	S12_CI_CK
S12_TI_CK	S12_CI_FS
S12_TI_FS	
S12s_TT_So_MI_TxTI	

Processes:

This function generates error monitoring and status overhead bytes to an undefined VC-12. The processing of the trail termination overhead bytes is defined as follows:

J2: In this byte the function shall insert the Transmitted Trail Trace Identifier TxTI. Its format is described in EN 300 417-1-1 [6], subclause 7.1.

V5[3]: The signal value applied at RI_REI shall be inserted in the VC-12 REI, bit 3 of byte V5. The coding shall be as follows:

Table 138: V5[3] coding

Number of BIP-2 violations conveyed via RI_REI	V5[3]
0	0
1	1
2	1

V5[8]: Bit 8 of byte V5, a RDI indication, shall be set to "1" on activation of S12s_RI_RDI within 1 000 μ s, determined by the associated S12s_TT_Sk function, and set to "0" within 1 000 μ s on clearing of S12s_RI_RDI.

V5[5-7]: In this byte the function shall insert code "000" (unequipped VC or supervisory-unequipped VC) as defined in subclause 7.1 of EN 300 417-1-1 [6] and ETS 300 147 [1].

V5[1-2]: In these bits the function shall insert the BIP-2 EDC with even bit parity. Each bit of current bits 1 or 2 is computed to provide even parity over the associated (odd and even) bits of every byte in the previous frame of the Characteristic Information S12_CI, i.e., bits 1 and 2 are calculated over the entire previous VC-12. Further reference is provided in EN 300 417-1-1 [6], subclause 7.3.

K4[5-8]: The value of the bits 5 to 8 of byte K4 is undefined.

N2: In this byte the function shall insert code "0000 0000" (unequipped tandem connection) as defined in subclause 7.1 of EN 300 417-1-1 [6].

Other VC-12 bytes:

The function shall generate the other VC-12 bytes and bits. Their content is undefined (i.e. bits are set to either a value of "0" or "1").

Defects:	None.
Consequent Actions:	None.
Defect Correlations:	None.
Performance Monitoring:	None.

7.4.3 VC-12 Layer Supervisory-unequipped Termination Sink S12s_TT_Sk

Symbol:

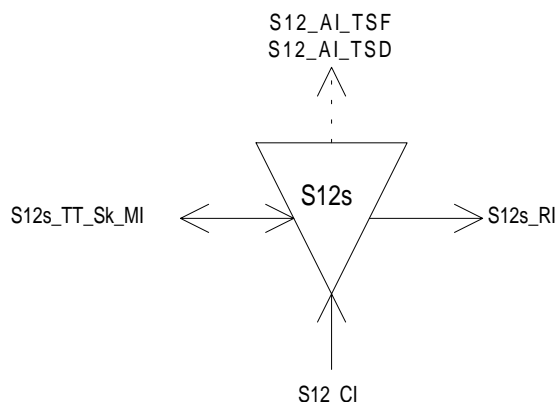

Figure 164: S12s_TT_Sk symbol

Interfaces:

Table 139: S12s_TT_Sk input and output signals

Input(s)	Output(s)
S12_CI_D	S12_AI_TSF
S12_CI_CK	S12_AI_TSD
S12_CI_FS	S12s_TT_Sk_MI_cTIM
S12_CI_SSF	S12s_TT_Sk_MI_cUNEQ
	S12s_TT_Sk_MI_cDEG
S12s_TT_Sk_MI_TPmode	S12s_TT_Sk_MI_cRDI
S12s_TT_Sk_MI_SSF_Reported	S12s_TT_Sk_MI_cSSF
S12s_TT_Sk_MI_ExtI	S12s_TT_Sk_MI_AcTI
S12s_TT_Sk_MI_RDI_Reported	S12s_RI_RDI
S12s_TT_Sk_MI_DEGTHR	S12s_RI_REI
S12s_TT_Sk_MI_DEGM	S12s_TT_Sk_MI_pN_EBC
S12s_TT_Sk_MI_1second	S12s_TT_Sk_MI_pF_EBC
S12s_TT_Sk_MI_TIMdis	S12s_TT_Sk_MI_pN_DS
S12s_TT_Sk_MI_ExtImode	S12s_TT_Sk_MI_pF_DS

Processes:

This function monitors VC-12 for errors, and recovers the trail termination status. It extracts the payload independent overhead bytes/bits (J2, V5[1-2], V5[3], V5[5-7], V5[8]) from the VC-12 layer Characteristic Information:

J2: The Received Trail Trace Identifier RxTI shall be recovered from the J2 byte and shall be made available as AcTI for network management purposes. The application and acceptance and mismatch detection process shall be performed as specified in EN 300 417-1-1 [6], subclauses 7.1 and 8.2.1.3.

V5[1-2]: Even bit parity is computed for each bit pair of every byte of the preceding VC-12 including V5 and compared with bit 1 and 2 of V5 recovered from the current frame. A difference between the computed and recovered BIP-2 values is taken as evidence of an errored block (nN_B).

V5[3], V5[8]: The information carried in the bits 3 and 8 of the V5 byte (REI, RDI) shall be extracted to enable single ended maintenance of a bi-directional Trail (Path). The REI (nF_B) shall be used to monitor the error performance of the other direction of transmission, and the RDI (bit 8) shall be used to provide information as to the status of the remote receiver. A "1" indicates a Remote Defect Indication state, while a "0" indicates the normal, working state. The application process shall be performed as specified in EN 300 417-1-1 [6], subclauses 7.4.2 (REI), 7.4.11 and 8.2 (RDI).

Table 140: V5[3] code interpretation

V5[3]	REI code interpretation
0	0 errored blocks
1	1 errored block

V5[5-7]: The information in bits 5 to 7 of byte V5 shall be extracted to allow unequipped VC defect detection.

K4[5-8]: The value of the bits 5 to 8 of byte K4 shall be ignored.

Defects:

The function shall detect for dDEG, dRDI, dUNEQ and dTIM defects according the specifications in EN 300 417-1-1 [6], subclause 8.2.1.

Consequent Actions:

aTSF ← CI_SSF or dTIM

aTSD ← dDEG

aRDI ← CI_SSF or dTIM

aREI ← "#EDCV"

NOTE: dUNEQ can not be used to activate aTSF and aRDI; an expected supervisory-unequipped signal will have the signal label set to all-0's, causing a continuous detection of dUNEQ. If an unequipped VC comes in, dTIM will be activated and can serve as a trigger for aTSF/aRDI instead of dUNEQ.

Defect Correlations:

cUNEQ ← MON and dTIM and (AcTI = all "0"s) and dUNEQ

cTIM ← MON and dTIM and not (dUNEQ and AcTI = all "0"s)

cDEG ← MON and (not dTIM) and dDEG

cRDI ← MON and (not dTIM) and dRDI and RDI_Reported

cSSF ← MON and CI_SSF and SSF_Reported

Performance Monitoring:

The performance monitoring process shall be performed as specified in EN 300 417-1-1 [6], subclause 8.2.4 through 8.2.7.

pN_DS ← aTSF or dEQ

pF_DS ← dRDI

pN_EBC ← Σ nN_B

pF_EBC ← Σ nF_B

7.5 VC-12 Layer Trail Protection Functions

7.5.1 VC-12 Trail Protection Connection Functions S12P_C

7.5.1.1 VC-12 Layer 1+1 uni-directional Protection Connection Function S12P1+1u_C

Symbol:

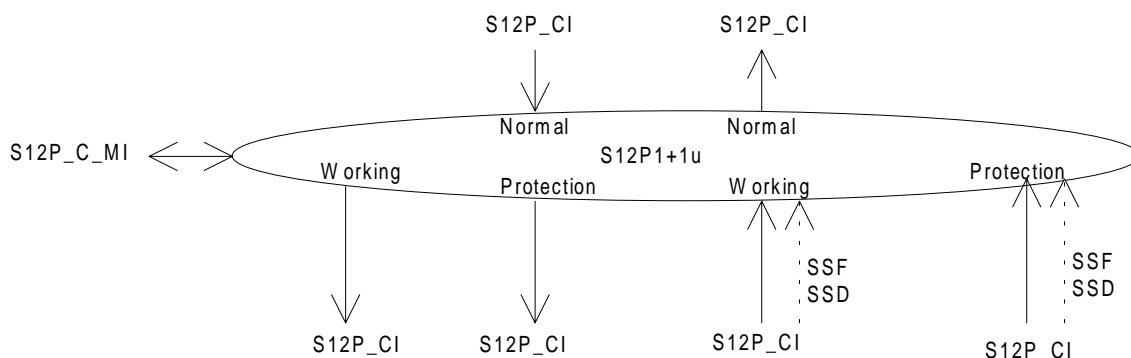

Figure 165: S12P1+1u_C symbol

Interfaces:

Table 141: S12P1+1u_C input and output signals

Input(s)	Output(s)
for connection points W and P: S12P_CI_D S12P_CI_CK S12P_CI_FS S12P_CI_SSF S12P_CI_SSD	for connection points W and P: S12P_CI_D S12P_CI_CK S12P_CI_FS
for connection point N: S12P_CI_D S12P_CI_CK S12P_CI_FS	for connection point N: S12P_CI_D S12P_CI_CK S12P_CI_FS S12P_CI_SSF
S12P_C_MI_OPERType S12P_C_MI_WTRTime S12P_C_MI_HOTime S12P_C_MI_EXTCMD	
NOTE: Protection status reporting signals are for further study.	

Processes:

The function performs the VC-12 linear trail protection process for 1+1 protection architectures with uni-directional switching; refer to EN 300 417-1-1 [6], subclause 9.2. It performs the bridge and selector functionality as presented in figure 49 of EN 300 417-1-1 [6]. In the sink direction, the signal output at the normal reference point can be the signal received via either the associated working path or the protection path; this is determined by the SF,SD conditions (relayed via CI_SSF,CI_SSD signals), and the external commands. In the source direction, the working output is connected to the associated normal input. The protection output is also connected to the normal input.

Provided no protection switching action is activated/required the following changes to (the configuration of) a trail shall be possible without disturbing the CI passing the trail:

- change between operation types;
- change of WTR and HO times.

Operation:

The VC trail protection process shall operate as specified in EN 300 417-3-1 [7], annex A, according the following characteristics:

Table 142: Trail protection parameters

Parameter	Value options
architecture type (ARCHtype)	1 + 1
switching type (SWtype)	uni-directional
operation type (OPERtype)	revertive, non-revertive
APS signal (APSmode)	false
Wait-To-Restore time (WTRtime)	in the order of 5 to 12 minutes
Switch time	≤ 50 ms
Hold-off time (HOtime)	0 to 10 seconds in steps of the order of 100 ms
Protection type (PROTtype)	trail
Signal switch conditions:	SF = SSF (originated as AI_TSF) SD = SSD (originated as AI_TSD)
External commands (EXTCMD)	(revertive operation) LO, FSw-#1, MSw-#1, CLR (non-revertive operation) LO or FSw, FSw-#i, MSw-#i, CLR (i=0,1)
Extra traffic (EXTRAtraffic)	false
SFpriority, SDpriority	high

Defects:	None.
Consequent Actions:	None.
Defect Correlations:	None.
Performance Monitoring:	None.

7.5.1.2 VC-12 Layer 1+1 dual ended Protection Connection Function S12P1+1b_C

Symbol:

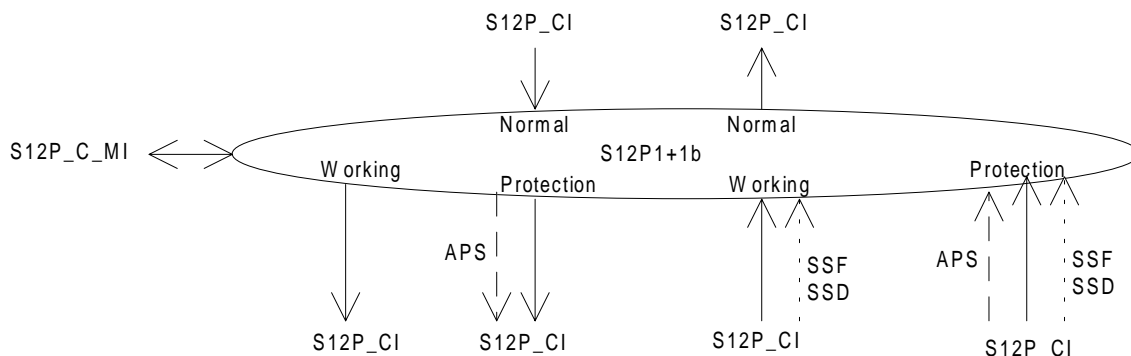

Figure 166: S12P1+1b_C symbol

Interfaces:

Table 143: S12P1+1b_C input and output signals

Input(s)	Output(s)
for connection points W and P: S12P_CI_D S12P_CI_CK S12P_CI_FS S12P_CI_SSF S12P_CI_SSD	for connection points W and P: S12P_CI_D S12P_CI_CK S12P_CI_FS
for connection point N: S12P_CI_D S12P_CI_CK S12P_CI_FS	for connection point N: S12P_CI_D S12P_CI_CK S12P_CI_FS S12P_CI_SSF
for connection point P: S12P_CI_APS	for connection point P: S12P_CI_APS
S12P_C_MI_OPERType S12P_C_MI_WTRTime S12P_C_MI_HOTime S12P_C_MI_EXTCMD	
NOTE: Protection status reporting signals are for further study.	

Processes:

The function performs the VC-12 linear trail protection process for 1+1 protection architecture with bi-directional switching; refer to EN 300 417-1-1 [6], subclause 9.2. It performs the bridge and selector functionality as presented in figure 49 of EN 300 417-1-1 [6]. In the sink direction, the signal output at the normal reference point can be the signal received via either the associated working path or the protection path; this is determined by the SF,SD conditions (relayed via CI_SSF,CI_SSD signals), and the external commands. In the source direction, the working output is connected to the associated normal input. The protection output is also connected to the normal input.

Provided no protection switching action is activated/required the following changes to (the configuration of) a trail shall be possible without disturbing the CI passing the trail:

- change between operation types;
- change of WTR and HO times.

Operation:

The VC trail protection process shall operate as specified in EN 300 417-3-1 [7], annex A, according the following characteristics:

Table 144: Trail protection parameters

Parameter	Value options
architecture type (ARCHtype)	1 + 1
switching type (SWtype)	bi-directional
operation type (OPERtype)	revertive, non-revertive
APS signal (APSmode)	true
Wait-To-Restore time (WTRtime)	in the order of 5 to 12 minutes
Switch time	≤ 50 ms
Hold-off time (Hotime)	0 to 10 seconds in steps of the order of 100 ms
Protection type (PROTtype)	trail
Signal switch conditions:	SF = SSF (originated as AI_TSF) SD = SSD (originated as AI_TSD)
External commands (EXTCMD)	(revertive operation) LO, FSw-#1, MSw-#1, CLR (non-revertive operation) LO or FSw, FSw-#i, MSw-#i, EXER-#i, CLR (i=0,1)
Extra traffic (EXTRAtraffic)	false
SFpriority, SDpriority	high

NOTE: The VC-12 APS signal definition is for further study.

Defects:	None.
Consequent Actions:	None.
Defect Correlations:	None.
Performance Monitoring:	None.

7.5.2 VC-12 Layer Trail Protection Trail Termination Functions

7.5.2.1 VC-12 Protection Trail Termination Source S12P_TT_So

Symbol:

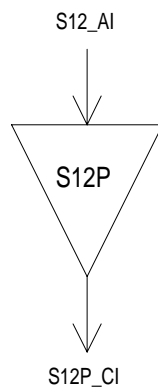

Figure 167: S12P_TT_So symbol

Interfaces:

Table 145: S12P_TT_So input and output signals

Input(s)	Output(s)
S12P_AI_D	S12P_CI_D
S12P_AI_CK	S12P_CI_CK
S12P_AI_FS	S12P_CI_FS

Processes:

No information processing is required in the S12P_TT_So, the S12_AI at its output is identical to the S12P_CI at its input.

Defects: None.

Consequent Actions: None.

Defect Correlations: None.

Performance Monitoring: None.

7.5.2.2 VC-12 Protection Trail Termination Sink S12P_TT_Sk

Symbol:

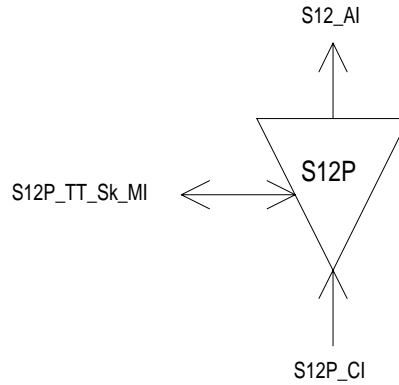

Figure 168: S12P_TT_Sk symbol

Interfaces:

Table 146: S12P_TT_Sk input and output signals

Input(s)	Output(s)
S12P_CI_D	S12_AI_D
S12P_CI_CK	S12_AI_CK
S12P_CI_FS	S12_AI_FS
S12P_CI_SSF	S12_AI_TSF
S12P_TT_Sk_MI_SSF_Reported	S12P_TT_Sk_MI_cSSF

Processes:

The S12P_TT_Sk function reports, as part of the S12 layer, the state of the protected VC-12 trail. In case all trails are unavailable the S12P_TT_Sk reports the signal fail condition of the protected trail.

Defects: None.

Consequent Actions:

aTSF ← CI_SSF

Defect Correlations:

cSSF ← CI_SSF and SSF_Reported

Performance Monitoring: None.

7.5.3 VC-12 Layer Linear Trail Protection Adaptation Functions

7.5.3.1 VC-12 trail to VC-12 trail Protection Layer Adaptation Source S12/S12P_A_So

Symbol:

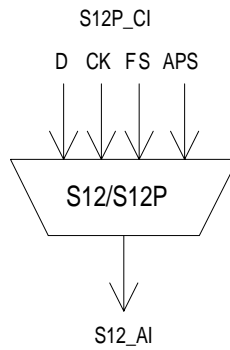

Figure 169: S12/S12P_A_Sk symbol

Interfaces:

Table 147: S12/S12P_A_So input and output signals

Input(s)	Output(s)
S12P_CI_D	S12_AI_D
S12P_CI_CK	S12_AI_CK
S12P_CI_FS	S12_AI_FS
S12P_CI_APS	

Processes:

The function shall multiplex the S12 APS signal and S12 data signal onto the S12 access point.

K4[1-4]: The insertion of the VC-APS signal is for further study. This process is required only for the protection path.

Defects: None.

Consequent actions: None.

Defect Correlations: None.

Performance Monitoring: None.

7.5.3.2 VC-12 trail to VC-12 trail Protection Layer Adaptation Sink S12/S12P_A_Sk

Symbol:

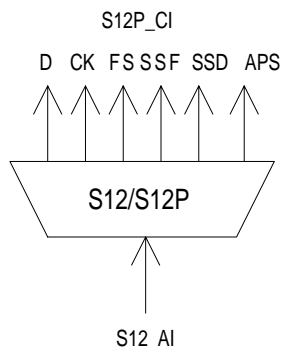

Figure 170: S12/S12P_A_Sk symbol

Interfaces:

Table 148: S12/S12P_A_Sk input and output signals

Input(s)	Output(s)
S12_AI_D	S12P_CI_D
S12_AI_CK	S12P_CI_CK
S12_AI_FS	S12P_CI_FS
S12_AI_TSF	S12P_CI_SSF
S12_AI_TSD	S12P_CI_SSD
	S12P_CI_APS (for Protection signal only)

Processes:

The function shall extract and output the S12P_CI_D signal from the S12_AI_D signal.

K4[1-4]: The extraction and persistency processing of the VC-APS signal is for further study. This process is required only for the protection path.

Defects: None.

Consequent actions:

aSSF ← AI_TSF

aSSD ← AI_TSD

Defect Correlations: None.

Performance Monitoring: None.

7.6 VC-12 Tandem Connection Sublayer Functions

7.6.1 VC-12 Tandem Connection Trail Termination Source function (S12D_TT_So)

Symbol:

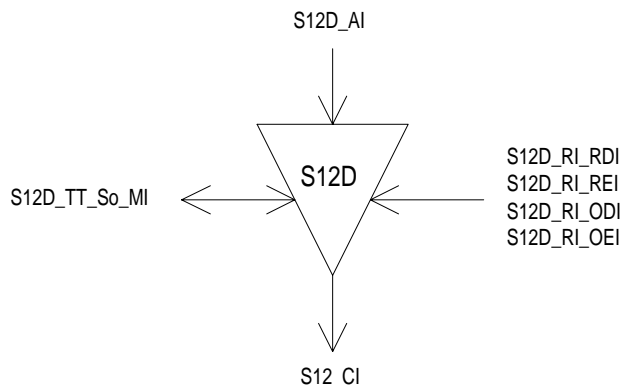

Figure 171: S12D_TT_So symbol

Interfaces:

Table 149: S12D_TT_So input and output signals

Input(s)	Output(s)
S12D_AI_D	S12_CI_D
S12D_AI_CK	S12_CI_CK
S12D_AI_FS	S12_CI_FS
S12D_AI_SF	
S12D_RI_RDI	
S12D_RI_REI	
S12D_RI_ODI	
S12D_RI_OEI	
S12D_TT_So_MI_TxTI	

Processes:

N2[8][73]: The function shall insert the TC RDI code within 1 multiframe (38 ms) after the RDI request generation (aRDI) in the tandem connection trail termination sink function. It ceases TC RDI code insertion within 1 multiframe (38 ms) after the RDI request has cleared.

NOTE: N2[x][y] refers to bit x (x = 7,8) of byte N2 in frame y (y=1..76) of the 76 frame multiframe. This multiframe is 38 ms long since N2 appears in the low order path overhead once each four STM-N frames.

N2[3]: The function shall insert a "1" in this bit.

N2[4]: The function shall insert an incoming AIS code in this bit. If AI_SF is true this bit will be set to the value "1", otherwise value "0" shall be inserted.

N2[5]: The function shall insert the RI_REI value in the REI bit in the following frame.

N2[7][74]: The function shall insert the ODI code at the first opportunity after the ODI request generation (RI_ODI) in the tandem connection trail termination sink function. It ceases ODI code insertion at the first opportunity after the ODI request has cleared.

N2[6]: The function shall insert the RI_OEI value in the OEI bit in the following frame.

N2[7-8]: The function shall insert in the multiframed N2[7-8] channel:

- the Frame Alignment Signal (FAS) "1111 1111 1111 1110" in FAS bits in frames 1 to 8;
- the TC trace identifier, received via MI_TxTI, in the TC-TI bits in frames 9 to 72;
- the TC RDI (N2[8][73]) and ODI (N2[7][74]) signals; and
- all-0s in the six reserved bits in frames 73 to 76.

N2[1-2]: The function shall calculate a BIP2 over the VC-12, and insert this value in TC BIP2 in the next frame (see figure 172).

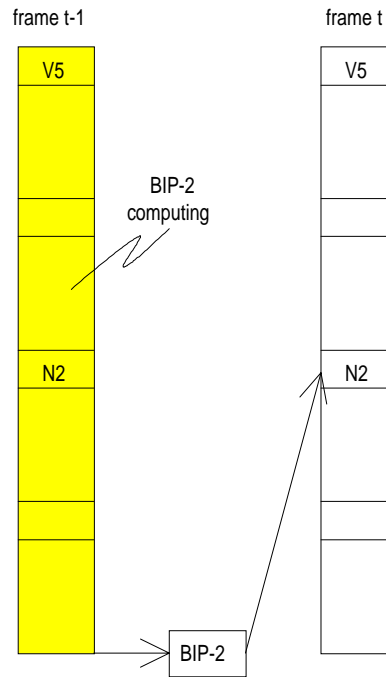

Figure 172: TC BIP-2 computing and insertion

V5[1-2]: The function shall compensate the VC12 BIP2 (in bits 1 and 2 of byte V5) according the following rule:

Since the BIP-2 parity check is taken over the VC (including N2), writing into N2 at the S12D_TT_So will affect the VC-12 path parity calculation. Unless this is compensated for, a device which monitors VC-12 path parity within the Tandem Connection (e.g., a non-intrusive monitor) may incorrectly count errors. The BIP-2 parity bits should always be consistent with the current state of the VC. Therefore, whenever N2 is written, BIP-2 shall be modified to compensate for the change in the N2 value. Since the BIP-2 value in a given frame reflects a parity check over the previous frame (including the BIP-2 bits in that frame), the changes made to the BIP-2 bits in the previous frame shall also be considered in the compensation of BIP-2 for the current frame. Therefore, the following equation shall be used for BIP-2 compensation:

$$\begin{aligned}
 V5[1]'(t) &= V5[1](t-1) \\
 &\oplus V5[1]'(t-1) \\
 &\oplus N2[1](t-1) \oplus N2[3](t-1) \oplus N2[5](t-1) \oplus N2[7](t-1) \\
 &\oplus N2[1]'(t-1) \oplus N2[3]'(t-1) \oplus N2[5]'(t-1) \oplus N2[7]'(t-1) \\
 &\oplus V5[1](t)
 \end{aligned}$$

$$\begin{aligned}
 V5[2]'(t) &= V5[2](t-1) \\
 &\oplus V5[2]'(t-1) \\
 &\oplus N2[2](t-1) \oplus N2[4](t-1) \oplus N2[6](t-1) \oplus N2[8](t-1) \\
 &\oplus N2[2]'(t-1) \oplus N2[4]'(t-1) \oplus N2[6]'(t-1) \oplus N2[8]'(t-1) \\
 &\oplus V5[2](t)
 \end{aligned}$$

Where:

$V5[i]$ = the existing $V5[i]$ value in the incoming signal

$V5[i]'$ = the new (compensated) $V5[i]$ value

$N2[i]$ = the existing $N2[i]$ value in the incoming signal

$N2[i]'$ = the new value written into the $N2[i]$ bit

\oplus = exclusive OR operator

t = the time of the current frame

$t-1$ = the time of the previous frame

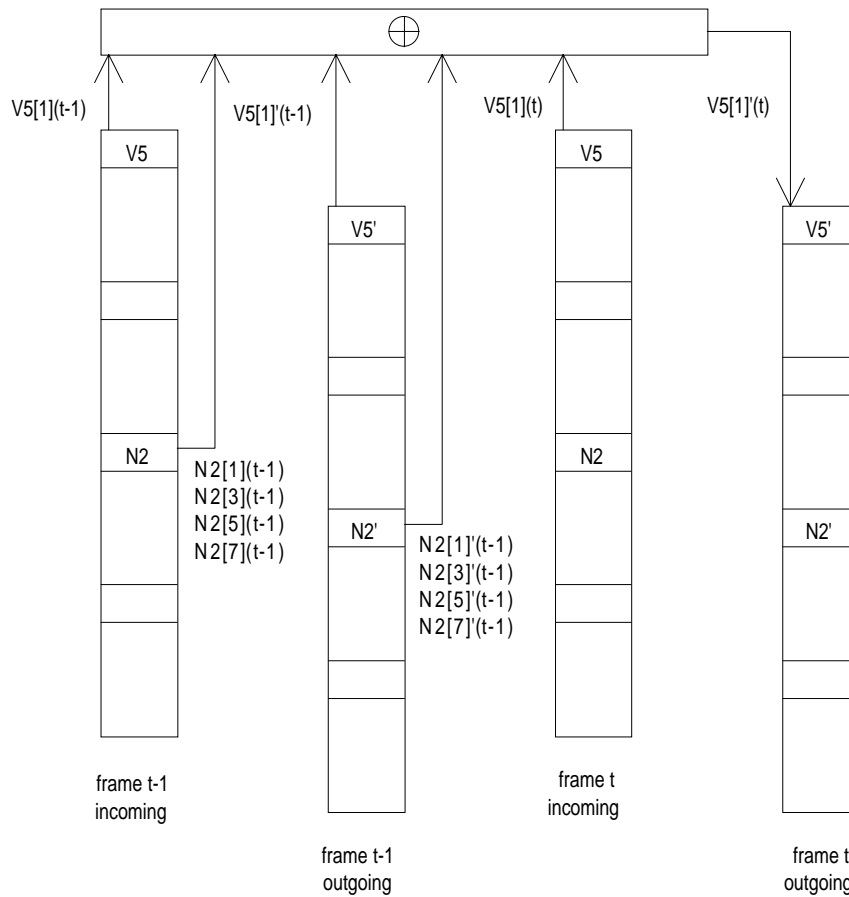

Figure 173: V5[1] compensating process

- Defects:** None.
- Consequent Actions:** None.
- Defect Correlations:** None.
- Performance Monitoring:** None.

7.6.2 VC-12 Tandem Connection Trail Termination Sink function (S12D_TT_Sk)

Symbol:

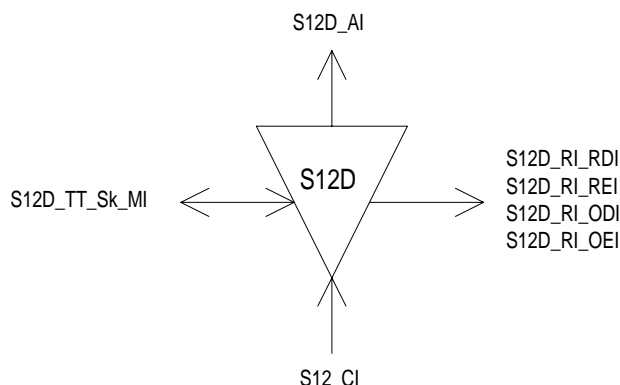

Figure 174: S12D_TT_Sk symbol

Interfaces:

Table 150: S12D_TT_Sk input and output signals

Input(s)	Output(s)
S12_CI_D	S12D_AI_D
S12_CI_CK	S12D_AI_CK
S12_CI_FS	S12D_AI_FS
S12_CI_SSF	S12D_AI_TSF
S12D_TT_Sk_MI_ExTI	S12D_AI_TSD
S12D_TT_Sk_MI_SSF_Reported	S12D_AI_OSF
S12D_TT_Sk_MI_RDI_Reported	S12D_TT_Sk_MI_cLTC
S12D_TT_Sk_MI_ODI_Reported	S12D_TT_Sk_MI_cTIM
S12D_TT_Sk_MI_TIMdis	S12D_TT_Sk_MI_cUNEQ
S12D_TT_Sk_MI_DEGM	S12D_TT_Sk_MI_cDEG
S12D_TT_Sk_MI_DEGTHR	S12D_TT_Sk_MI_cRDI
S12D_TT_Sk_MI_1second	S12D_TT_Sk_MI_cSSF
S12D_TT_Sk_MI_TPmode	S12D_TT_Sk_MI_cODI
	S12D_TT_Sk_MI_AcTI
	S12D_RI_RDI
	S12D_RI_REI
	S12D_RI_ODI
	S12D_RI_OEI
	S12D_TT_Sk_MI_pN_EBC
	S12D_TT_Sk_MI_pF_EBC
	S12D_TT_Sk_MI_pN_DS
	S12D_TT_Sk_MI_pF_DS
	S12D_TT_Sk_MI_pON_EBC
	S12D_TT_Sk_MI_pOF_EBC
	S12D_TT_Sk_MI_pON_DS
	S12D_TT_Sk_MI_pOF_DS

Processes:

N2[1-2]: Even BIP-2 is computed for each bit pair of every byte of the preceding VC-12 including V5 and N2 and compared with bit 1 and 2 of V5 and N2 recovered from the current frame (see figure 175). A difference between the computed and recovered BIP-2 values is taken as evidence of an errored block (nN_B) in the computation block.

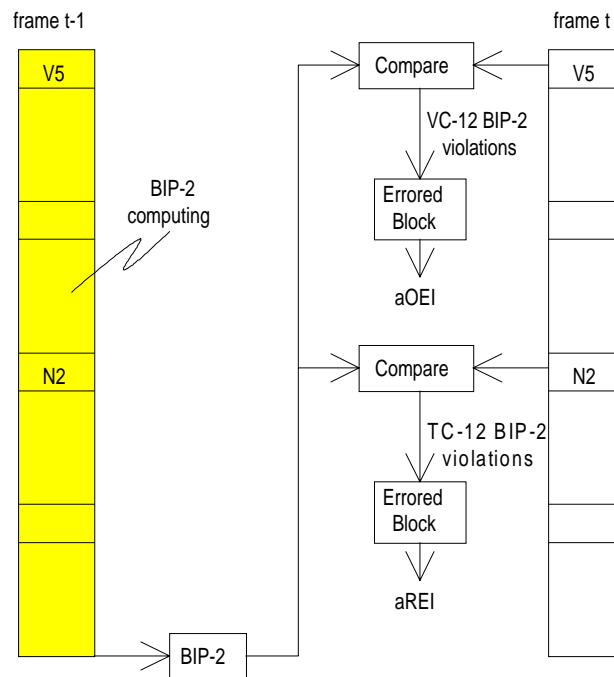

Figure 175: TC-12 and VC-12 BIP-2 computing and comparison

N2[7-8][9-72]: The Received Trail Trace Identifier RxTI shall be recovered from the tandem connection trail trace identifier overhead and shall be made available as AcTI for network management purposes. The application and acceptance process shall be performed as specified in EN 300 417-1-1 [6], subclauses 7.1 and 8.2.1.3. The mismatch detection process shall be as specified below.

The trace identifier process in this function is required to support "mode 1" (EN 300 417-1-1 [6], subclause 7.1) operation only. "Old" tandem connection equipment does not exist.

N2[4]: The function shall extract the Incoming AIS code.

N2[5], N2[8][73]: The information carried in the REI, RDI bits in byte N2 shall be extracted to enable single ended maintenance of a bi-directional tandem connection Trail. The REI (nF_B) shall be used to monitor the error performance of the other direction of transmission, and the RDI shall be used to provide information as to the status of the remote receiver. A "1" indicates a Remote Defect Indication state, while a "0" indicates the normal, working state. The application process shall be performed as specified in EN 300 417-1-1 [6], subclauses 7.4.2 (REI), 7.4.11 and 8.2 (RDI).

N2[6], N2[7][74]: The information carried in the OEI, ODI bits in byte N2 shall be extracted to enable single ended (intermediate) maintenance of a the VC-12 egressing the tandem connection Trail. The OEI (nOF_B) shall be used to monitor the error performance of the other direction of transmission, and the ODI shall be used to provide information as to the status of the remote receiver. A "1" indicates a Outgoing Defect Indication state, while a "0" indicates the normal, working state. The application process shall be performed equivalent to the remote maintenance case, as specified in EN 300 417-1-1 [6], subclauses 7.4.2 (REI/OEI), 7.4.11 and 8.2 (RDI/ODI).

N2[7-8]: *Multiframe alignment:*

The function shall perform a multiframe alignment on bits 7 and 8 of byte N2 to recover the TTI, RDI, and ODI signals transported within the multiframe bits. The multiframe alignment shall be found by searching for the pattern "1111 1111 1111 1110" within the bits 7 and 8 of byte N2. The signal shall be continuously checked with the presumed multiframe start position for the alignment.

Frame alignment is deemed to have been lost (entering Out Of Multiframe (OOM) state) when two consecutive FAS are detected in error (i.e. ≥ 1 error in each FAS);

Frame alignment is deemed to have been recovered (entering In Multiframe (IM) state) when one non-errored FAS is found.

V5[1-2]: Even BIP-2 is computed for each bit pair of every byte of the preceding VC-12 including V5 and compared with bit N°1 and 2 of V5 recovered from the current frame. A difference between the computed and recovered BIP-2 values is taken as evidence of an errored block (nON_B) in the computation block.

N2: The function shall terminate N2 channel by inserting an all-ZEROs pattern.

V5[1-2]: The function shall compensate the VC12 BIP2 in bits 1 and 2 of byte V5 according the algorithm defined in S12D_TT_So.

Defects:

TC Unequipped (dUNEQ):

The function shall detect for an unequipped Tandem Connection (UNEQ) condition by monitoring byte N2 for code "00000000". The unequipped defect (dUNEQ) shall be detected if five consecutive VC-n frames contain the "0000 0000" pattern in byte N2. The dUNEQ defect shall be cleared if in five consecutive VC-n frames any pattern other than the "0000 0000" is detected in byte N2.

TC Loss of Tandem Connection (dLTC):

The function shall detect for the presence/absence of the tandem connection overhead in the byte N2 by evaluating the multiframe alignment signal in bits 7 and 8 of byte N2. The loss of tandem connection defect (dLTC) shall be detected if the multiframe alignment process is in the OOM state. The dLTC shall be cleared if the multiframe alignment process is in the IM state.

TC Connectivity (Trace Identifier) (dTIM):

The function shall detect for a TC mis-connection condition by monitoring the TC trace identifier. The Trace Identifier Mismatch defect (dTIM) shall be detected and cleared within a maximum period of 1 s in the absence of bit errors.

The defect detection process and its operation during the presence of bit errors is for further study.

The defect shall be suppressed during the receipt of SSF.

It shall be possible to disable the trace identifier mismatch defect detection (TIMdis).

TC Signal Degrade (dDEG):

The function shall detect for a TC signal degrade defect condition by monitoring for TC BIP2 violations. The algorithm shall be according subclause 8.2.1.4 of EN 300 417-1-1 [6].

TC Remote Defect (dRDI):

The function shall detect for a TC remote defect indication defect condition by monitoring the TC RDI signal. The algorithm shall be according subclause 8.2.1.5 of EN 300 417-1-1 [6].

TC Remote Outgoing VC Defect (dODI):

The function shall detect for a TC remote outgoing VC defect indication defect condition by monitoring the TC ODI signal. The algorithm shall be according subclause 8.2.1.5 of EN 300 417-1-1 [6].

Incoming AIS (dIncAIS):

The function shall detect for a tandem connection incoming AIS condition by monitoring bit 4 in byte N2 for code "1". If 5 consecutive frames contain the value "1" in bit 4 a dIncAIS defect shall be detected. dIncAIS shall be cleared if in 5 consecutive frames value "0" is detected in bit 4 of byte N2.

Consequent Actions:

The function shall perform the following consequent actions (refer to subclause 8.2.2 of EN 300 417-1-1 [6]):

aAIS	←	dUNEQ or dTIM or dLTC
aTSF	←	CI_SSF or dUNEQ or dTIM or dLTC
aTSD	←	dDEG
aRDI	←	CI_SSF or dUNEQ or dTIM or dLTC
aREI	←	nN_B
aODI	←	CI_SSF or dUNEQ or dTIM or dIncAIS or dLTC
aOEI	←	nON_B
aOSF	←	CI_SSF or dUNEQ or dTIM or dLTC or dIncAIS

The function shall insert the all-ONES (AIS) signal within 1 ms after AIS request generation (aAIS), and cease the insertion within 1 ms after the AIS request has cleared.

Defect Correlations:

The function shall perform the following defect correlations (refer to subclause 8.2.3 of EN 300 417-1-1 [6]):

cUNEQ	←	MON and dUNEQ
cLTC	←	MON and (not dUNEQ) and dLTC
cTIM	←	MON and (not dUNEQ) and (not dLTC) and dTIM
cDEG	←	MON and (not dTIM) and (not dLTC) and dDEG
cSSF	←	MON and CI_SSF and SSF_Reported
cRDI	←	MON and (not dUNEQ) and (not dTIM) and (not dLTC) and dRDI and RDI_Reported
cODI	←	MON and (not dUNEQ) and (not dTIM) and (not dLTC) and dODI and ODI_Reported

Performance Monitoring:

The following TC error performance parameters shall be counted for each 1-second period (refer to subclauses 8.2.4 to 8.2.7 of EN 300 417-1-1 [6]):

pN_DS	←	aTSF or dEQ
pF_DS	←	dRDI
pN_EBC	←	ΣnN_B
pF_EBC	←	ΣnF_B
pON_DS	←	aODI
pOF_DS	←	dODI
pON_EBC	←	ΣnON_B
pOF_EBC	←	ΣnOF_B

pN_EBC and pN_DS does not represent the actual performance monitoring support within an equipment. For that, these pN_DS/pN_EBC signals shall be connected to performance monitoring functions within the element management function. Similar for the far-end signals pF_EBC and pF_DS, and for pON_EBC/pON_DS and pOF_EBC/pOF_DS.

7.6.3 VC-12 Tandem Connection to VC-12 Adaptation Source function (S12D/S12_A_So)

Symbol:

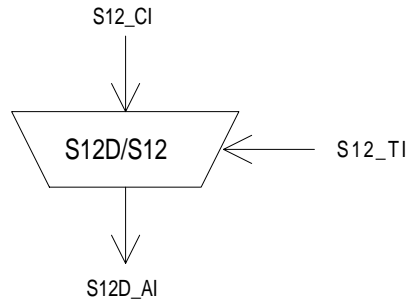

Figure 176: S12D/S12_A_So symbol

Interfaces:

Table 151: S12D/S12_A_So input and output signals

Input(s)	Output(s)
S12_CI_D	S12D_AI_D
S12_CI_CK	S12D_AI_CK
S12_CI_FS	S12D_AI_FS
S12_CI_SSF	S12D_AI_SF
S12_TI_CK	

Processes:

NOTE 1: The function has no means to verify the existence of a tandem connection within the incoming signal. Nested tandem connections are not supported.

The function shall replace the incoming Frame Start (CI_FS) signal by a local generated one (i.e. enter "holdover") if an all-ONES (AIS) VC is received (i.e. if CI_SSF is TRUE).

NOTE 2: This replacement of the (invalid) incoming frame start signal result in the generation of a valid pointer in e.g. the S4/S12_A_So function; SSF = true signal is not passed through via S12D_TT_So to the S4/S12_A_So.

NOTE 3: The local frame start is generated with the S12_TI timing.

Defects: None.

Consequent Actions:

AI_SF ← CI_SSF

Defect Correlations: None.

Performance Monitoring: None.

7.6.4 VC-12 Tandem Connection to VC-12 Adaptation Sink function (S12D/S12_A_Sk)

Symbol:

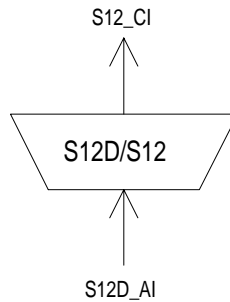

Figure 177: S12D/S12_A_Sk symbol

Interfaces:

Table 152: S12D/S12_A_Sk input and output signals

Input(s)	Output(s)
S12D_AI_D	S12_CI_D
S12D_AI_CK	S12_CI_CK
S12D_AI_FS	S12_CI_FS
S12D_AI_OSF	S12_CI_SSF

Processes:

The function shall restore the invalid frame start condition (i.e. output aSSF = true) if that existed at the ingress of the tandem connection.

NOTE: In addition, the invalid frame start condition is activated on a tandem connection connectivity defect condition that causes all-ONES (AIS) insertion in the S12D_TT_Sk.

Defects: None.

Consequent Actions:

aAIS ← AI_OSF

aSSF ← AI_OSF

The function shall insert the all-ONES (AIS) signal within 1 ms after AIS request generation (aAIS), and cease the insertion within 1 ms after the AIS request has cleared.

Defect Correlations: None.

Performance Monitoring: None.

7.6.5 VC-12 Tandem Connection Non-intrusive Monitoring Trail Termination Sink function (S12Dm_TT_Sk)

Symbol:

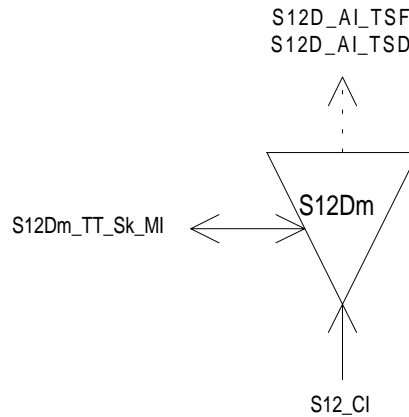

Figure 178: S12Dm_TT_Sk symbol

Interfaces:

Table 153: S12Dm_TT_Sk input and output signals

Input(s)	Output(s)
S12_CI_D	S12D_AI_TSF
S12_CI_CK	S12D_AI_TSD
S12_CI_FS	S12D_TT_Sk_MI_cLTC
S12_CI_SSF	S12D_TT_Sk_MI_cTIM
S12D_TT_Sk_MI_ExTI	S12D_TT_Sk_MI_cUNEQ
S12D_TT_Sk_MI_SSF_Reported	S12D_TT_Sk_MI_cDEG
S12D_TT_Sk_MI_RDI_Reported	S12D_TT_Sk_MI_cRDI
S12D_TT_Sk_MI_ODI_Reported	S12D_TT_Sk_MI_cSSF
S12D_TT_Sk_MI_TIMdis	S12D_TT_Sk_MI_cODI
S12D_TT_Sk_MI_DEGM	S12D_TT_Sk_MI_AcTI
S12D_TT_Sk_MI_DEGTHR	S12D_TT_Sk_MI_pN_EBC
S12D_TT_Sk_MI_1second	S12D_TT_Sk_MI_pF_EBC
S12D_TT_Sk_MI_TPmode	S12D_TT_Sk_MI_pN_DS
	S12D_TT_Sk_MI_pF_DS
	S12D_TT_Sk_MI_pOF_EBC
	S12D_TT_Sk_MI_pOF_DS

Processes:

This function can be used to perform the following:

- 1) single ended maintenance of the TC by monitoring at an intermediate node, using remote information (RDI,REI);
- 2) aid in fault localization within TC trail by monitoring near-end defects;
- 3) monitoring of VC performance at TC egressing point (except for connectivity defects before the TC) using remote outgoing information (ODI,OEI);
- 4) performing non-intrusive monitor function within SNC/S protection.

N2[1-2]: Even BIP-2 is computed for each bit pair of every byte of the preceding VC-12 including V5 and N2 and compared with bits 1 and 2 of V5 and N2 recovered from the current frame (see figure 172). A difference between the computed and recovered BIP-2 values is taken as evidence of an errored block (nN_B) in the computation block. Refer to S12D_TT_Sk.

N2[7-8][9-72]: The Received Trail Trace Identifier RxTI shall be recovered from the tandem connection trail trace identifier overhead and shall be made available as AcTI for network management purposes. The application and acceptance process shall be performed as specified in EN 300 417-1-1 [6], subclauses 7.1 and 8.2.1.3. The mismatch detection process shall be as specified below.

The trace identifier process in this function is required to support "mode 1" (EN 300 417-1-1 [6], subclause 7.1) operation only. "Old" tandem connection equipment does not exist.

N2[4]: The function shall ignore this bit.

N2[5], N2[8][73]: The information carried in the REI, RDI bits in byte N2 shall be extracted to enable single ended maintenance of a bi-directional tandem connection Trail. The REI (nF_B) shall be used to monitor the error performance of the other direction of transmission, and the RDI shall be used to provide information as to the status of the remote receiver. A "1" indicates a Remote Defect Indication state, while a "0" indicates the normal, working state. The application process shall be performed as specified in EN 300 417-1-1 [6], subclauses 7.4.2 (REI), 7.4.11 and 8.2 (RDI).

N2[6], N2[7][74]: (nOF_B). The information carried in the OEI, ODI bits in byte N2 shall be extracted to enable single ended (intermediate) maintenance of a the VC-12 egressing the tandem connection Trail. The OEI (nOF_B) shall be used to monitor the error performance of the other direction of transmission, and the ODI shall be used to provide information as to the status of the remote receiver. A "1" indicates a Outgoing Defect Indication state, while a "0" indicates the normal, working state. The application process shall be performed equivalent to the remote maintenance case, as specified in EN 300 417-1-1 [6], subclauses 7.4.2 (REI/OEI), 7.4.11 and 8.2 (RDI/ODI).

N2[7-8]: Multiframe alignment:

The function shall perform a multiframe alignment on bits 7 and 8 of byte N2 to recover the TTI, RDI, and ODI signals transported within the multiframe bits. The multiframe alignment shall be found by searching for the pattern "1111 1111 1111 1110" within the bits 7 and 8 of byte N2. The signal shall be continuously checked with the presumed multiframe start position for the alignment.

Frame alignment is deemed to have been lost (entering Out Of Multiframe (OOM) state) when two consecutive FAS are detected in error (i.e. ≥ 1 error in each FAS); Frame alignment is deemed to have been recovered (entering In Multiframe (IM) state) when one non-errored FAS is found.

Defects:

TC Unequipped (dUNEQ):

The function shall detect for an unequipped Tandem Connection (UNEQ) condition by monitoring byte N2 for code "00000000". The unequipped defect (dUNEQ) shall be detected if five consecutive VC-n frames contain the "0000 0000" pattern in byte N2. The dUNEQ defect shall be cleared if in five consecutive VC-n frames any pattern other than the "0000 0000" is detected in byte N2.

TC Loss of Tandem Connection (dLTC):

The function shall detect for the presence/absence of the tandem connection overhead in the byte N2 by evaluating the multiframe alignment signal in bits 7 and 8 of byte N2. The loss of tandem connection defect (dLTC) shall be detected if the multiframe alignment process is in the OOM state. The dLTC shall be cleared if the multiframe alignment process is in the IM state.

TC Connectivity (Trace Identifier) (dTIM):

The function shall detect for a TC mis-connection condition by monitoring the TC trace identifier. The Trace Identifier Mismatch defect (dTIM) shall be detected and cleared within a maximum period of 1 s in the absence of bit errors.

The defect detection process and its operation during the presence of bit errors is for further study. The defect shall be suppressed during the receipt of SSF. It shall be possible to disable the trace identifier mismatch defect detection (TIMdis).

TC Signal Degrade (dDEG):

The function shall detect for a TC signal degrade defect condition by monitoring for TC BIP2 violations. The algorithm shall be according subclause 8.2.1.4 of EN 300 417-1-1 [6].

TC Remote Defect (dRDI):

The function shall detect for a TC remote defect indication defect condition by monitoring the TC RDI signal. The algorithm shall be according subclause 8.2.1.5 of EN 300 417-1-1 [6].

TC Remote Outgoing VC Defect (dODI):

The function shall detect for a TC remote outgoing VC defect indication defect condition by monitoring the TC ODI signal. The algorithm shall be according subclause 8.2.1.5 of EN 300 417-1-1 [6].

Consequent Actions:

aTSF ← CI_SSF or dUNEQ or dTIM or dLTC
 aTSD ← dDEG

Defect Correlations:

The function shall perform the following defect correlations (refer to subclause 8.2.3 of EN 300 417-1-1 [6]):

cUNEQ ← MON and dUNEQ
 cLTC ← MON and (not dUNEQ) and dLTC
 cTIM ← MON and (not dUNEQ) and (not dLTC) and dTIM
 cDEG ← MON and (not dTIM) and (not dLTC) and dDEG
 cSSF ← MON and CI_SSF and SSF_Reported
 cRDI ← MON and (not dUNEQ) and (not dTIM) and (not dLTC) and dRDI and RDI_Reported
 cODI ← MON and (not dUNEQ) and (not dTIM) and (not dLTC) and dODI and ODI_Reported

Performance Monitoring:

The following TC error performance parameters shall be counted for each 1 second period (refer to subclauses 8.2.4 to 8.2.7 of EN 300 417-1-1 [6]):

pN_DS ← aTSF or dEQ
 pF_DS ← dRDI
 pN_EBC ← ΣnN_B
 pF_EBC ← ΣnF_B
 pOF_DS ← dODI
 pOF_EBC ← ΣnOF_B

8 VC-4-4c Path Layer Functions

The applicability of this path layer within ETSI is for further study in ETSI WG TM1.

Annex A (informative): Jitter/wander in justification processes

A.1 VC-n phase accuracy/timing error/jitter/wander

Bit rate adaptation (stuffing), i.e. pointer justification events, generate timing errors. The timing errors result from three basic parameters:

- the accuracy of the phase detector initiating the justification events (the threshold spacing);
- the time period between the point in time where the decision is made to adjust the pointer and the point in time where the PJE is actually realized; and
- the pointer step width.

The threshold spacing gives rise to low frequency wander not resulting in PJE's. The corresponding frequency spectrum is arbitrary.

Pointer adjustments are changing (correcting) the phase error, in the case of VC-m ($m = 3, 2, 12, 11$) by an 8 UI step, and give rise to jitter (low frequency spectrum).

As the TU-3 (TU-2/12/11) pointer can be changed only at points in time spaced 125 (500) μs , this pointer adjustment related jitter is enlarged by the delayed realization of the PJE with respect to the actually threshold crossing event. This additional jitter component is characterized by a very small amplitude and a very low frequency spectrum (i.e. it is practically negligible).

PJE sequences depend on the implementation of the justification decision process and the frequency/phase relationships of the incoming and outgoing signals.

A.2 VC-n pointer processor introduced phase error measurement

This annex describes how the phase error introduced by pointer processing in the S4/S3_A_So function can be measured. The method described allows very accurate measurement of the phase behaviour of the tributary (VC-3) because:

- a) the clock of the multiplex signal is regular;
- b) the time slots allocated to the tributary are fixed;
- c) the phase shift of the tributary relative to the multiplex signal is exactly defined by the stuffing indication.

The figure below shows the measurement set-up to determine the phase error introduced by the adaptation source functions. This example refers to the phase error introduced by an S4/S3_A_So function; equivalent measurements are possible for other adaptation functions.

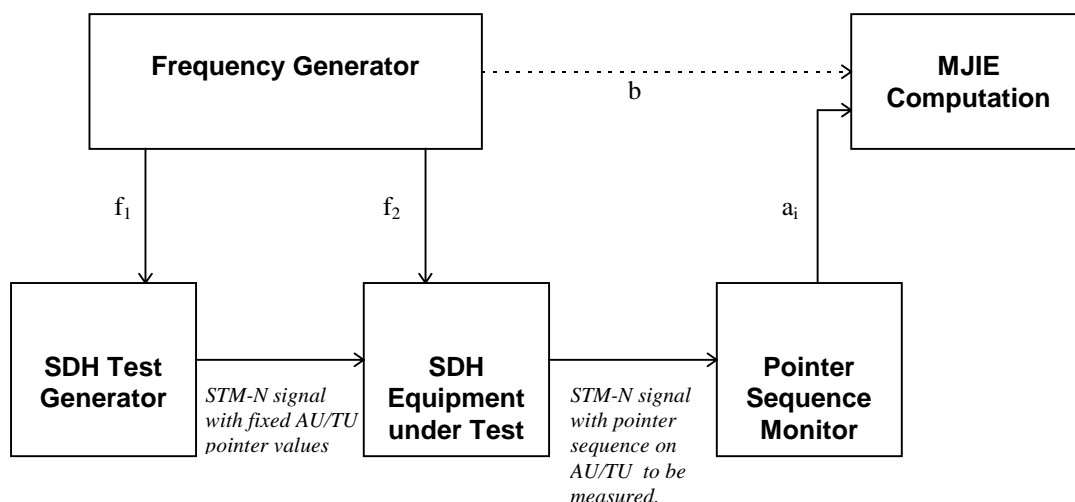

Figure A.1: Test Set-up to Measure Phase Errors (MJIE)

The **SDH test generator** is synchronized by a clock frequency f_1 and generates an STM-N test signal comprising a VC-4 and a VC-3. The VC-4 and the VC-3 have a fixed phase with respect to the STM-N signal, i.e. no pointer adjustments occur.

The SDH equipment under test receives the incoming STM-N signal from the SDH test generator and demultiplexes the VC-4 from the AU-4 and the VC-3 out of the VC-4/TU-3. The VC-3 is then mapped into a TU-3/VC-4 synchronized to the frequency f_2 . The VC-4 is then mapped into an outgoing STM-N signal which is also synchronized to f_2 .

A frequency difference between f_1 and f_2 causes a continuously increasing phase difference between incoming and outgoing VC-3. The amount of this phase shift during one frame period T ($T = 125 \mu\text{s}$) of the outgoing STM-N is b .

$$b = T \times \Delta f / f_2 \quad \text{where } \Delta f = (f_1 - f_2)$$

In order to prevent buffer overflow/underflow in the S4/S3_A_So (to limit the phase difference) negative/positive stuffing is performed. This is observable by monitoring the TU-3 pointers in the outgoing STM-N signal. A change of a TU-3 pointer value by 1 (i.e. a pointer justification event), results in a phase shift of the outgoing VC-3 by one VC-3 byte. As there are 765 VC-3 bytes per frame the amount of the phase shift is $T/765$.

The **pointer sequence monitor** synchronizes to the outgoing STM-N signal and monitors the TU-3 pointers in each frame. For each frame a corresponding value a_i is output to the MJIE computation block. The value of a_i is zero if in the i^{th} frame no pointer adjustment occurs. The value of a_i is $T/765$ if in the i^{th} frame the pointer value is incremented. The value of a_i is $-T/765$ if in the i^{th} frame the pointer value is decremented.

Starting at time t_0 the MJIE computation block calculates the differences $(a_i - b)$ at the times $t_i = t_0 + (i \times T)$. The results are accumulated giving values for each t_i :

$$c_i = \sum_{j=1}^{i} (a_j - b)$$

The measurement time T_m continues at least until $T_m > f_2 / \Delta f \times T$. This correlates to a minimum upper limit for i of $f_2 / \Delta f$.

The maximum difference calculated from each pair of c_i is the MJIE and represents the maximum phase error observed. The MJIE computation is summarized in the following figure:

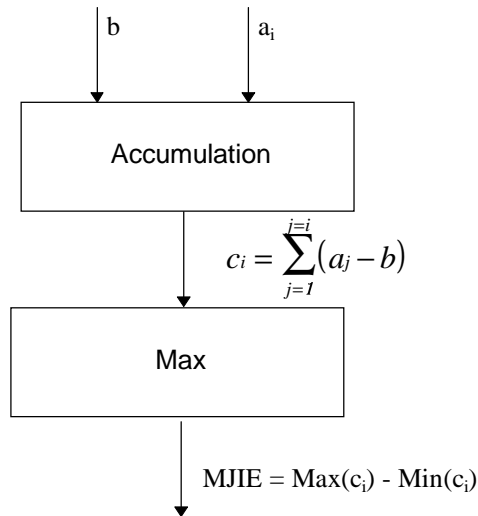

Figure A.2: Unweighted MJIE Computation

Due to different accumulation properties of networks for low frequency and high frequency phase distortions (jitter and wander) the frequency distribution of the phase distortions may be of interest. In this case the sequence of c_i values may be filtered by a digital filter. In the case of a first order low pass filter the sequence of c_i will be transformed into a sequence of e_i by the following equation:

$$e_i = (D \times c_i) + ((D-1) \times e_{(i-1)}) \text{ where } D \text{ is a constant corresponding to the cut-off frequency and } e_0 = 0$$

A value of $D = 1/32$ corresponds to a corner frequency close to 10 Hz and would therefore deliver the wander components of the phase distortions. The corresponding MJIE computation is summarized in the following figure:

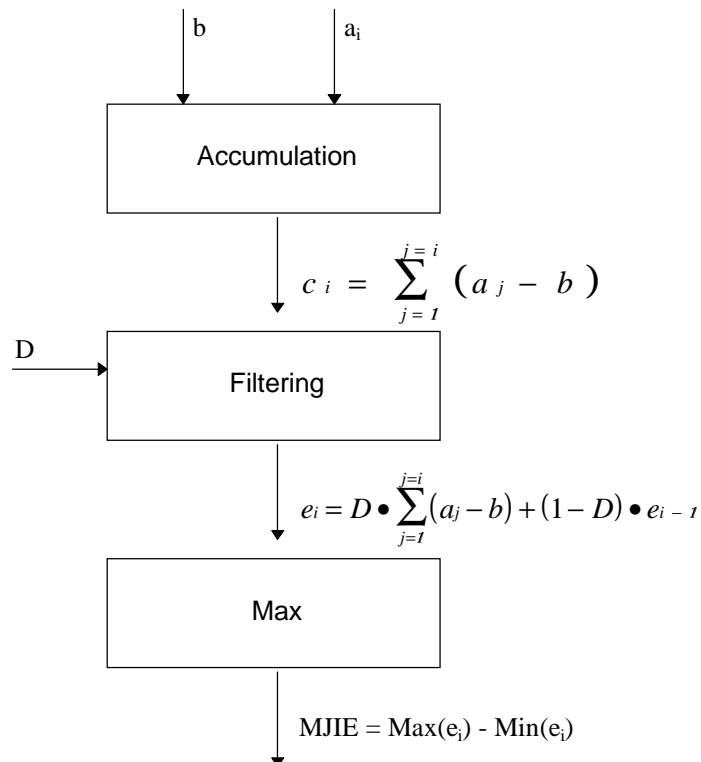

Figure A.3: Weighted MJIE Computation

A.3 SDH/PDH and PDH/PDH mapping introduced phase error measurement

For further study.

Annex B (informative): SDH/PDH interconnection examples

For the bitrate 139 264 kbit/s, three different types of signals are defined:

- P4e: This is a multiplexed signal with 34 368 kbit/s tributaries of the PDH. It may be used in transmultiplex application SDH \leftrightarrow PDH.
- P4s: A multiplex signal which transports clients such as SDH TUs or ATM VP signals. It may be used for transporting signals of SDH or ATM over PDH.
- P4x: A signal with the aforementioned bitrate and with undefined content. The signals P4e and P4s are a subset of the possible P4x signals (see figure B.4).

The reason for defining this set of signals is to cover the following combinations of atomic functions:

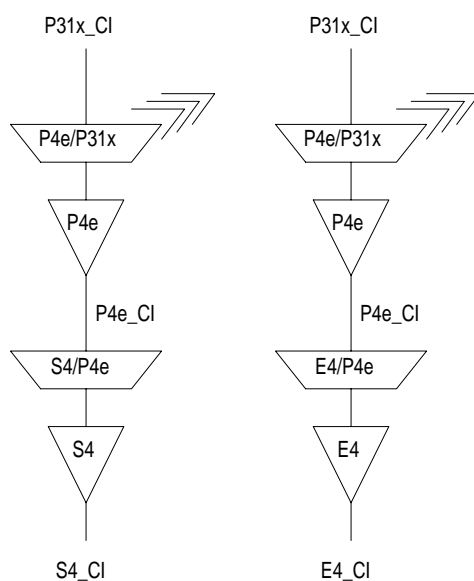

Figure B.1

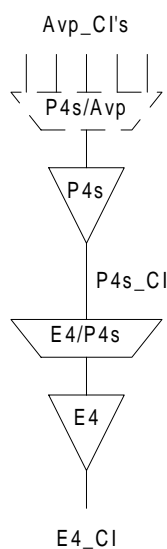

Figure B.2

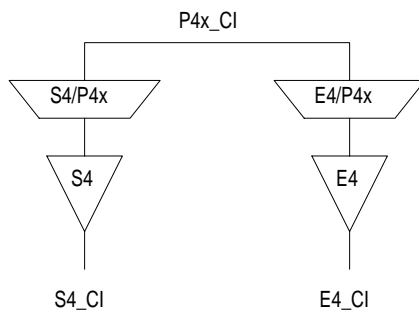

Figure B.3

A combination of atomic functions processing P4e, P4s, or P4x different to the combinations shown above may cause formal or physical problems.

The aforementioned applies similar to the signals of the plesiochronous layers P31 (P31e, P31s, P31x) and P22 (P22e, P22x).

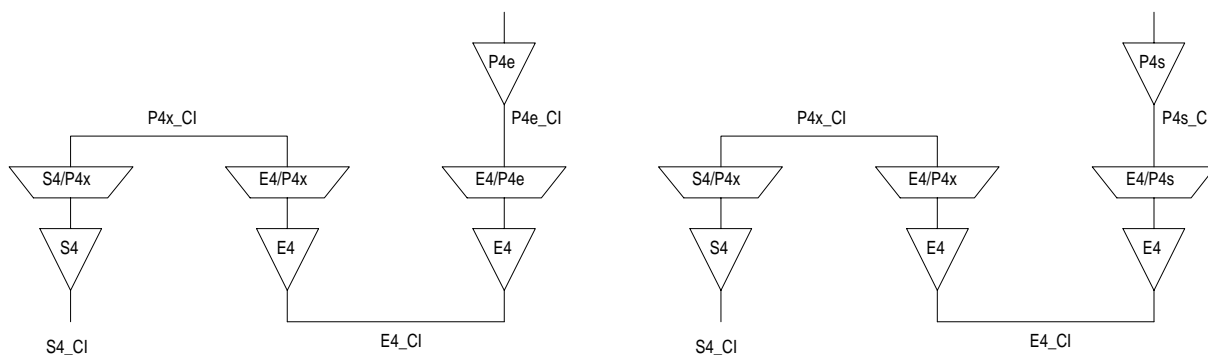

Figure B.4

Annex C (informative): Interaction between 2 Mbit/s and VC-12 signals for the case of byte synchronous mapping

Byte synchronous mappings into SDH VC signals introduce a dependency between the PDH signal and the SDH VC signal on clearing of a defect condition. Two examples are described in this annex.

- 1) For the case a 2 Mbit/s intra-station signal is mapped byte synchronous into a VC-12 an interaction between the 2 Mbit/s and VC-12 signal is present.
- 2) For the case a byte synchronous mapped 1 984 kbit/s signal into a VC-12 outputs the SDH network via a 2 Mbit/s section signal an interaction between the VC-12 and the 2 Mbit/s section signal carrying the 1 984 kbit/s signal is present.

It should be noted that practically the dependency can be neglected; for the majority of the time a signal is transported free of defects.

Example 1: direction 2 Mbit/s → VC-12

A 2 Mbit/s dLOS, dLOF, or dAIS defect state change (absence to presence, presence to absence) may lead to bit error detection (BIP-2) in the VC-12 path. I.e. one or two (severely) errored second(s) may be detected.

In a byte synchronization mapping the VC-12 is locked to the 2 Mbit/s signal; byte V5 is placed 2 bytes above TS0. If a phase jump occurs at the 2 Mbit/s signal the VC-12 will follow that. Consequently, the 2 Mbit/s and VC-12 layers are not independent during byte synchronization mapping modes.

NOTE: TU-12 pointer increments and decrements will forward phase changes that are not phase jumps, but are build up gradually over time (due to e.g. a frequency difference).

The mentioned phase jumps will occur due to the insertion/removal of the all-ONEs (AIS) signal with its free-running AIS clock on the mentioned defect conditions. When 2 Mbit/s all-ONEs (AIS) signal is byte synchronization mapped in the VC-12 the (clock and frame) phase relation with the incoming 2 Mbit/s is lost. Entering this condition can be done without introducing a VC-12 phase jump if the TU-12 pointer starts flywheeling. Returning from this condition will almost certainly cause a VC-12 phase jump due to:

- the 2 Mbit/s frame returns with a different phase;
- the difference in AIS and 2 Mbit/s clock frequencies;
- the recentering of the elastic store to prevent excessive pointer adjustments after re-establishment of the 2 Mbit/s - VC-12 relation.

This VC-12 phase jump will be communicated to the far-end VC-12 termination function via NDFs in the TU-12 pointer. NDF propagation takes between ≈ 0 to 2 frames per TU pointer processor (PP). I.e. there is a large probability that the TU-12 pointer received at the far-end VC-12 termination will be out of phase with the VC-12 itself for one or more frames. The calculation of BIP-2 violations in the VC-12 termination sink will, as such, detect violations. This results in the declaration of errored seconds and signalling of some background block errors. Depending on the number of TU PPs to pass, a VC-12 defect (e.g. trace identifier mismatch) may be detected. This results in declaration of severely errored second(s).

Example 2: direction VC-12 → 2 Mbit/s

A TU12dAIS, TU12dLOP, S12dTIM, or S12dPLM defect condition change may lead to 2 Mbit/s frame phase jump. This results in one (or two) (severely) errored seconds.

If the VC-12 suffers a phase jump, the 2 Mbit/s signal will follow that. This is unexpected when TS0 itself is not transported via SDH (byte synchronization 1 984 kbit/s mapping), but generated at the SDH/PDH boundary. I.e. the 2 Mbit/s path is not including the SDH network.

Consequently, the 2 Mbit/s and VC-12 layers are not independent during byte synchronization mapping of 1 984 kbit/s.

The mentioned phase jumps will occur due to the insertion/removal of the all-ONEs (AIS) signal with its free-running AIS clock on the mentioned defect conditions:

When a TU/VC-12 defect condition is detected and the VC-12 did not transport TS0 (i.e. byte synchronization 1 984 kbit/s mapping), a 2 Mbit/s framed AIS will be generated (all-ONEs in TS1 to TS31 and valid TS0) with an independent AIS clock. For similar reasons as above the removal of the AIS insertion will cause a 2 Mbit/s frame phase jump in the outgoing 2 Mbit/s signal. The receiving network element will detect the out-of-frame (LOF) condition and reframes on it in presumably 9 or 10 frames. This causes a few CRC4 violations to be detected. The dLOF and CRC4 violation conditions will result in 2 Mbit/s (severely) errored second declaration.

Annex D (informative): Examples of linear trail and SNC protection models

Figures D.1 to D.6 show connectivity examples of atomic functions associated with linear trail and SNC protection.

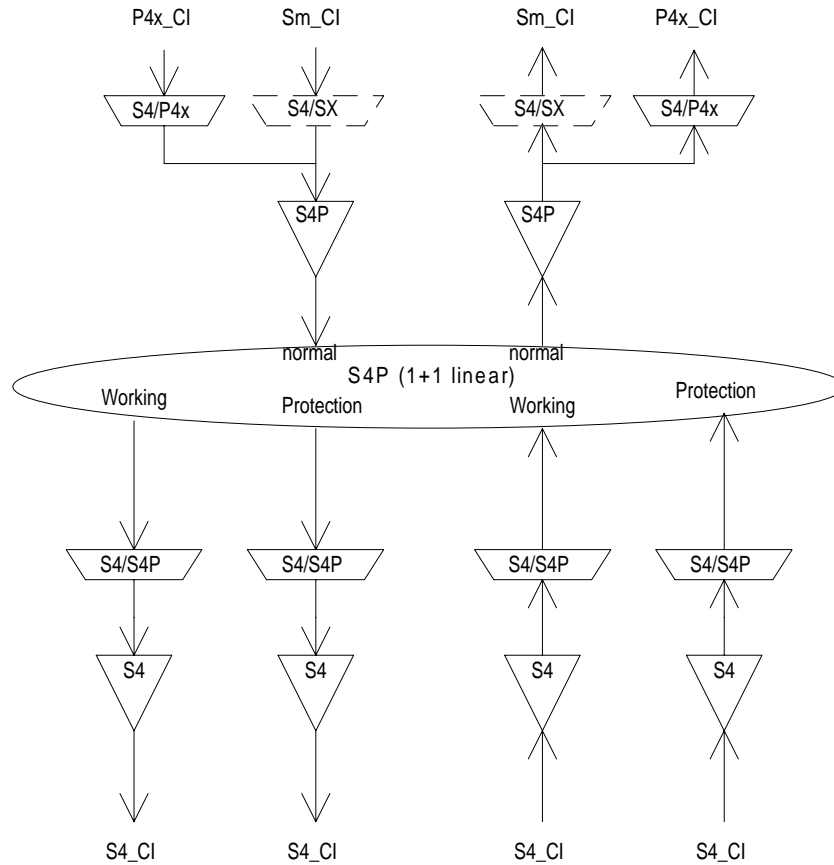

Figure D.1: 1+1 VC-4 Linear Trail Protection model (example)

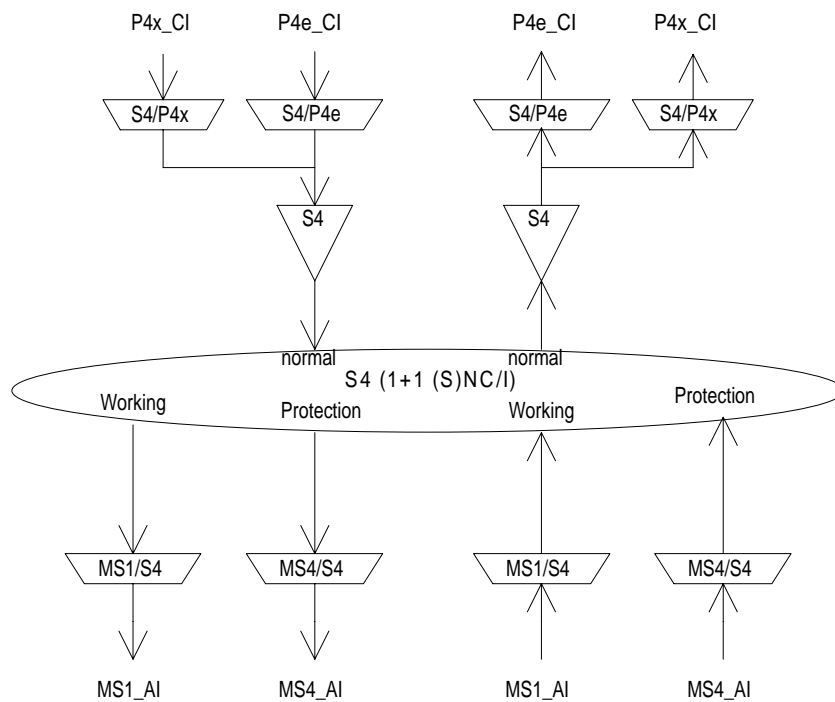

Figure D.2: 1+1 VC-4 SNC/I protection model within a network element terminating the VC-4 path (example)

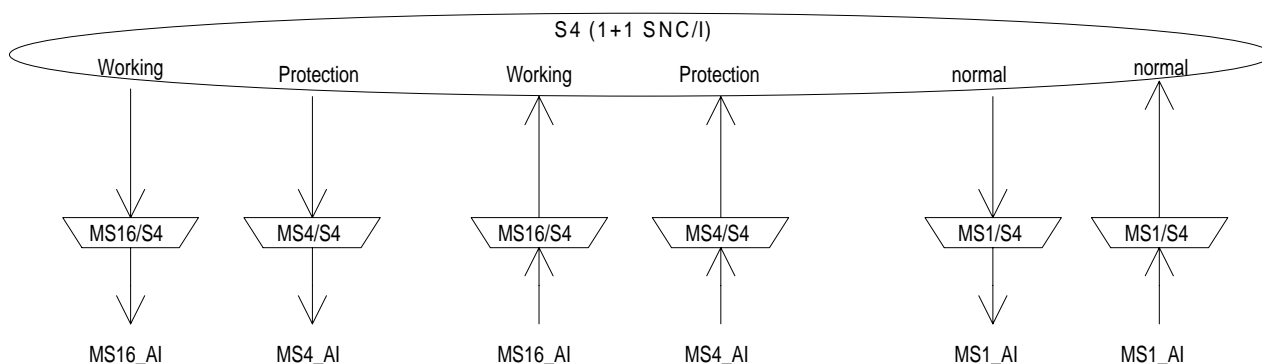

Figure D.3: 1+1 VC-4 SNC/I protection model within a network element passing through the VC-4 signal (example)

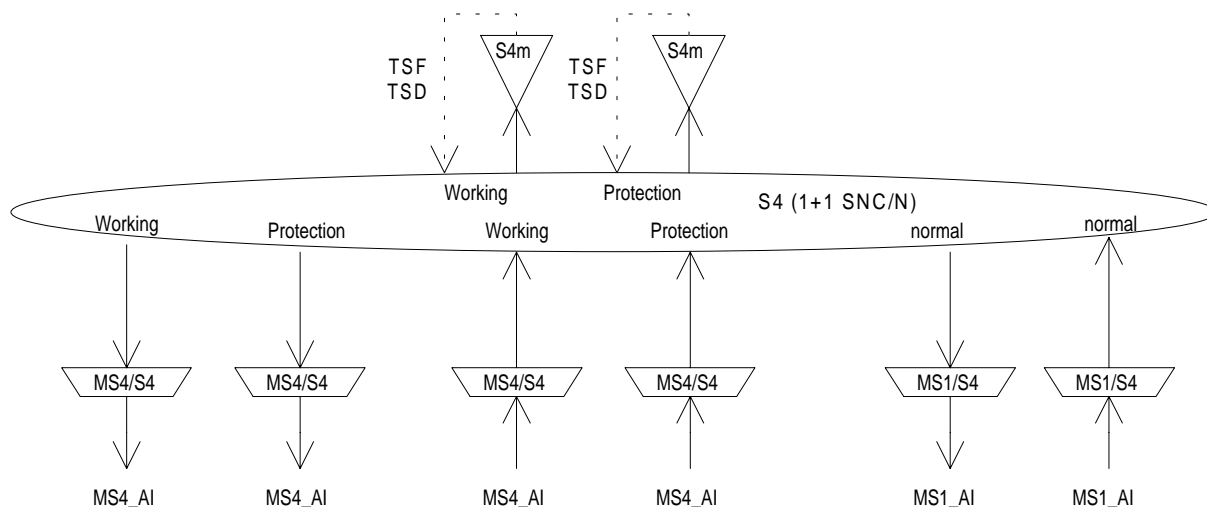

Figure D.4: 1+1 VC-4 SNC/N protection model within a network element passing through the VC-4 signal (example)

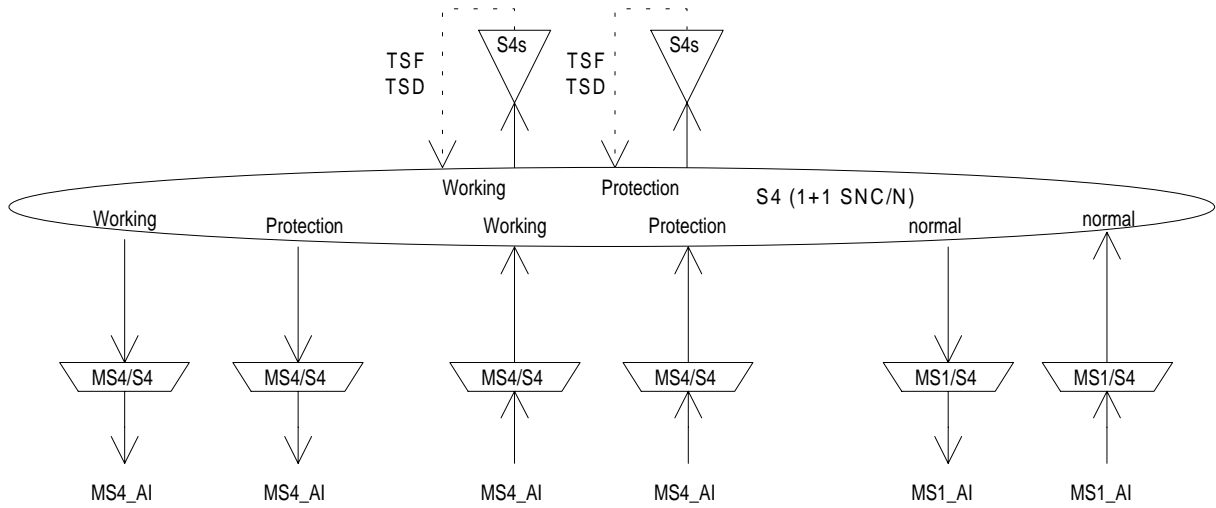

Figure D.5: 1+1 VC-4 SNC/N protection model for a supervisory-unequipped signal within a network element passing through the VC-4 signal (example)

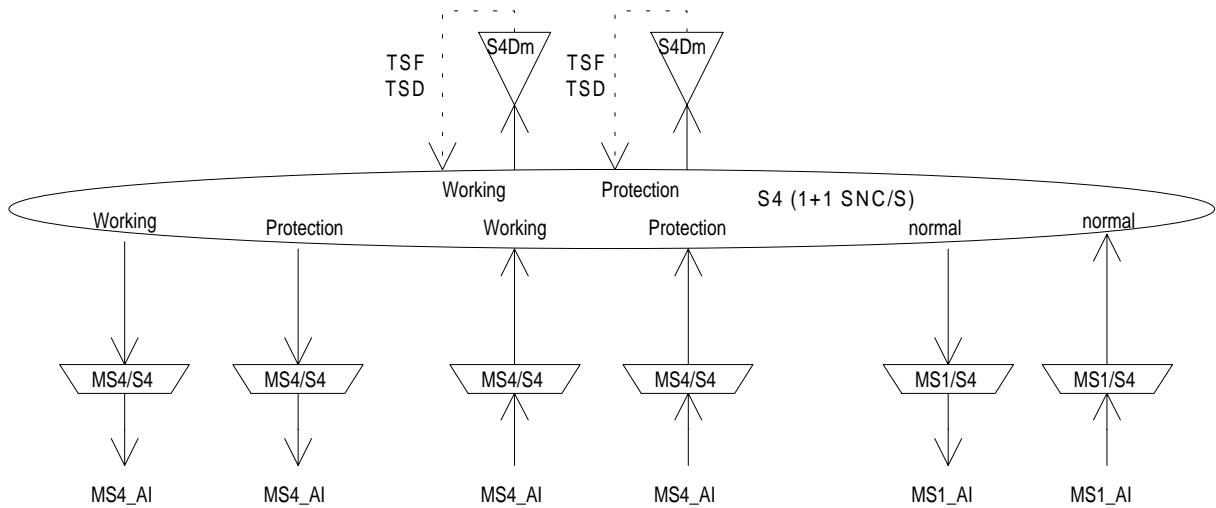

Figure D.6: 1+1 VC-4 tandem connection SNC/S protection model within a network element passing through the VC-4 tandem connection (TC4) signal (example)

Annex E (informative): VC-3 to 44 736 Mbit/s adaptation functions

E.1 VC-3 Layer to P32x Layer Adaptation Source S3/P32x_A_So

Symbol:

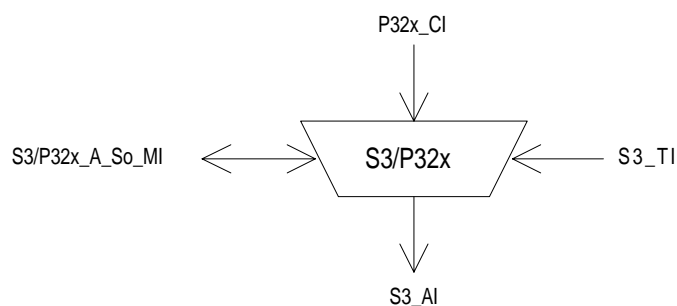

Figure E.1: S3/P32x_A_So symbol

Interfaces:

Table E.1: S3/P32x_A_So input and output signals

Input(s)	Output(s)
P32x_CI_D	S3_AI_D
P32x_CI_CK	S3_AI_CK
S3_TI_CK	S3_AI_FS
S3_TI_FS	
S3/P32x_A_So_MI_Active	

Processes:

This function maps a 44 736 kbit/s information stream into a VC-3 payload using bit stuffing and adds bytes C2 and H4. It takes P32x_CI, a bit-stream with a rate of 44 736 kbit/s \pm 20 ppm, present at its input and inserts it into the synchronous container-3 having a capacity of 756 bytes and the justification frame as defined in ETS 300 147 [1] and depicted in figures E.3 and E.4.

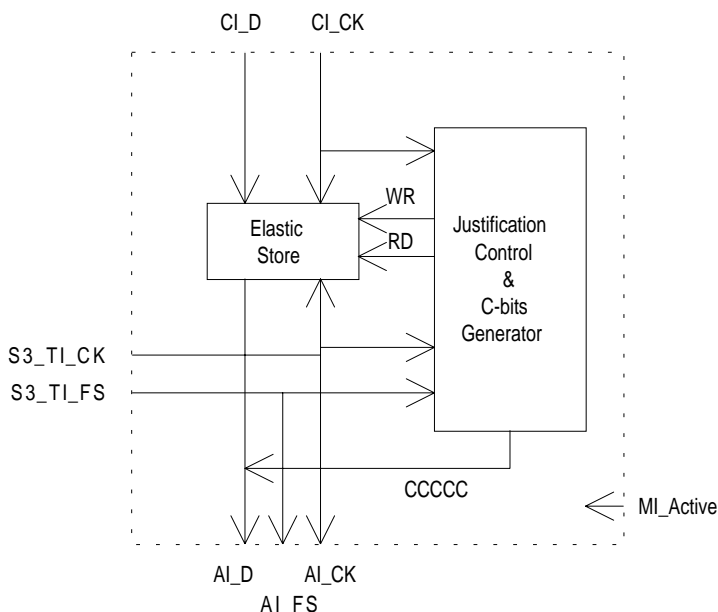

Figure E.2: main processes within S3/P32x_A_So



Figure E.3: S3/P32x_AI_D

Legend: D = Data Bit, R = Fixed Stuff Bit, O = O-Bit, S = Justification Opportunity Bit, C = Justification Control Bit

8 x R	8 x R	RRC D D D D D	8 x D	200 x D	8 x R	CCRRRRRRR	8 x D	200 x D	8 x R	CCRROORS	8 x D	200 x D
-------	-------	---------------	-------	---------	-------	-----------	-------	---------	-------	----------	-------	---------

Legend:
 R Fixed stuff bit
 D Data bit
 O Overhead bit
 C Justification control bit
 S Justification opportunity bit

Figure E.4: Asynchronous mapping of P32x_CI (44 736kbit/s) showing one row of the nine-row container-3 structure

Frequency justification and bitrate adaptation:

The function shall provide an elastic store (buffer) process (see figure E.2). The data signal shall be written into the buffer under control of the associated input clock. The data shall be read out of the buffer and written onto the D and S bits under control of the VC-3 clock, frame position (S3_TI), and justification decisions.

The justification decisions determine the phase error introduced by the S3/P32x_A_So function. The amount of this phase error can be measured at the physical interfaces by monitoring the justification control bits C (see figure E.4). An example is given in clause A.3.

Each justification decision results in a corresponding positive justification action. Upon a positive justification action, the reading of 1 data bit shall be cancelled once and no data are written at the justification opportunity bit S. If no justification action is to be performed, data shall be written onto S.

NOTE 1: A requirement for maximum introduced phase error cannot be defined until a reference path is defined from which the requirements for network elements can be deduced.

Buffer size:

In the presence of jitter as specified by ITU-T Recommendation G.823 [9] and a frequency within the range 34 368 kbit/s \pm 20 ppm, this justification process shall not introduce any errors. Any step in frequency within this range shall not cause any errors.

C bits: Justification control generation:

The function shall generate the justification control (C) bits according the specification in ETS 300 147 [1]. It shall insert the justification control bits in the appropriate C bit positions.

Two bytes of payload specific POH information, bytes C2 and H4, shall be added to container-3 to form the VC-3 AI and a fixed Frame Start (FS) shall be generated.

H4: The value of H4 byte is undefined.

C2: In this byte the function shall insert code "0000 0100" (Asynchronous mapping of 44 736 kbit/s into the Container-3) as defined in ETS 300 147 [1].

NOTE 2: The mapping of 44 736 kbit/s into VC-3 as well as the mapping of 34 368 kbit/s into VC-3 have the same signal label.

O bits: The value of the O bits is undefined.

R bits: The value of an R bit is undefined.

Activation:

The function shall access the access point when it is activated (MI_Active is true). Otherwise, it shall not access the access point.

Defects: None.

An elastic store under/overflow defect (dUOF) is for further study.

Consequent Actions: None.

Defect Correlations: None.

Performance Monitoring: None.

E.2 VC-3 Layer to P32x Layer Adaptation Sink S3/P32x_A_Sk

Symbol:

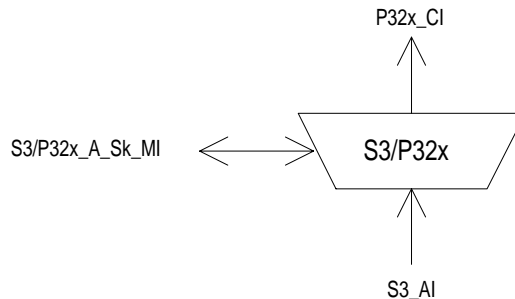

Figure E.5: S3/P32x_A_Sk symbol

Interfaces:

Table E.2: S3/P32x_A_Sk input and output signals

Input(s)	Output(s)
S3_AI_D	P32x_CI_D
S3_AI_CK	P32x_CI_CK
S3_AI_FS	P32x_CI_SSF
S3_AI_TSF	S3/P32x_A_Sk_MI_cPLM
S3/P32x_A_Sk_MI_Active	S3/P32x_A_Sk_MI_AcSL

Processes:

The function recovers plesiochronous P32x Characteristic Information (44 736 kbit/s \pm 20 ppm) from the synchronous container-3 (having a frequency accuracy within \pm 4,6 ppm) according to ETS 300 147 [1], and monitors the reception of the correct payload signal type.

C2: The function shall compare the content of the accepted C2 byte with the expected value code "0000 0100" (Asynchronous mapping of 44 736 kbit/s into the Container-3) as a check on consistency between the provisioning operation at each end. The application and acceptance and mismatch detection process shall be as specified in EN 300 417-1-1 [6], subclauses 7.2 and 8.1.2.

NOTE: The mapping of 44 736 kbit/s into VC-3 as well as the mapping of 34 368 kbit/s into VC-3 have the same signal label. Consequently, it is not possible to check consistent adaptation function provisioning at each end between these two mappings.

H4: The value in the H4 byte shall be ignored.

R bits: The value in the R bits shall be ignored.

O bits: The value in the O bits shall be ignored.

C bits: Justification control interpretation:

The function shall perform justification control interpretation specified by ETS 300 147 [1] to recover the 44 736 kbit/s signal from the VC-3. If the majority of the C bits is "0" the S bit shall be taken as a data bit, otherwise (majority of C bits is "1") S bit shall be taken as a justification bit and consequently ignored.

Smoothing & jitter limiting process

The function shall provide for a clock smoothing and elastic store (buffer) process. The 44 736 kbit/s data signal shall be written into the buffer under control of the associated (gapped) input clock (with a frequency accuracy within \pm 4,6 ppm). The data signal shall be read out of the buffer under control of a smoothed (equally spaced)

44 736 kHz \pm 20 ppm clock (the rate is determined by the 45 Mbit/s signal at the input of the remote S3/P32x_A_So). The residual jitter caused by pointer adjustments and bit justifications (measured at the 44 736 kbit/s interface) shall be within the limits specified in subclause 11.3.1.2 of EN 300 417-1-1 [6].

Buffer size:

In the presence of jitter as specified by subclause 11.3.1.2 of EN 300 417-1-1 [6] and a frequency within the range 44 736 kbit/s \pm 20 ppm, this justification process shall not introduce any errors.

Following a step in frequency of the P32x signal transported by the S3_AI (for example due to reception of P32x CI from a new P32x_TT_So at the far end or removal of all-ONEs (AIS) signal with a frequency offset) there will be a maximum recovery time of X seconds after which this process shall not generate any bit errors.

The value of X is for further study; a value of 1 second has been proposed.

Activation:

The function shall perform the operation specified above when it is activated (MI_Active is true). Otherwise, it shall transmit the all-ONEs signal at its output (CI_D) and not report its status via the management point.

Defects:

The function shall detect for dPLM defect according the specification in EN 300 417-1-1 [6], subclause 8.2.1.

Consequent Actions:

aSSF \leftarrow AI_TSF or dPLM

aAIS \leftarrow AI_TSF or dPLM

On declaration of the aAIS the function shall output an all-ONEs (AIS) signal in the P32x_CI_D within 250 μ s; on clearing of aAIS the function shall output normal data within 250 μ s. The P32x_CI_CK during the all-ONEs signal shall be within 34 368 kHz \pm 20 ppm.

Defect Correlations:

cPLM \leftarrow dPLM and (not AI_TSF)

Performance Monitoring: None.

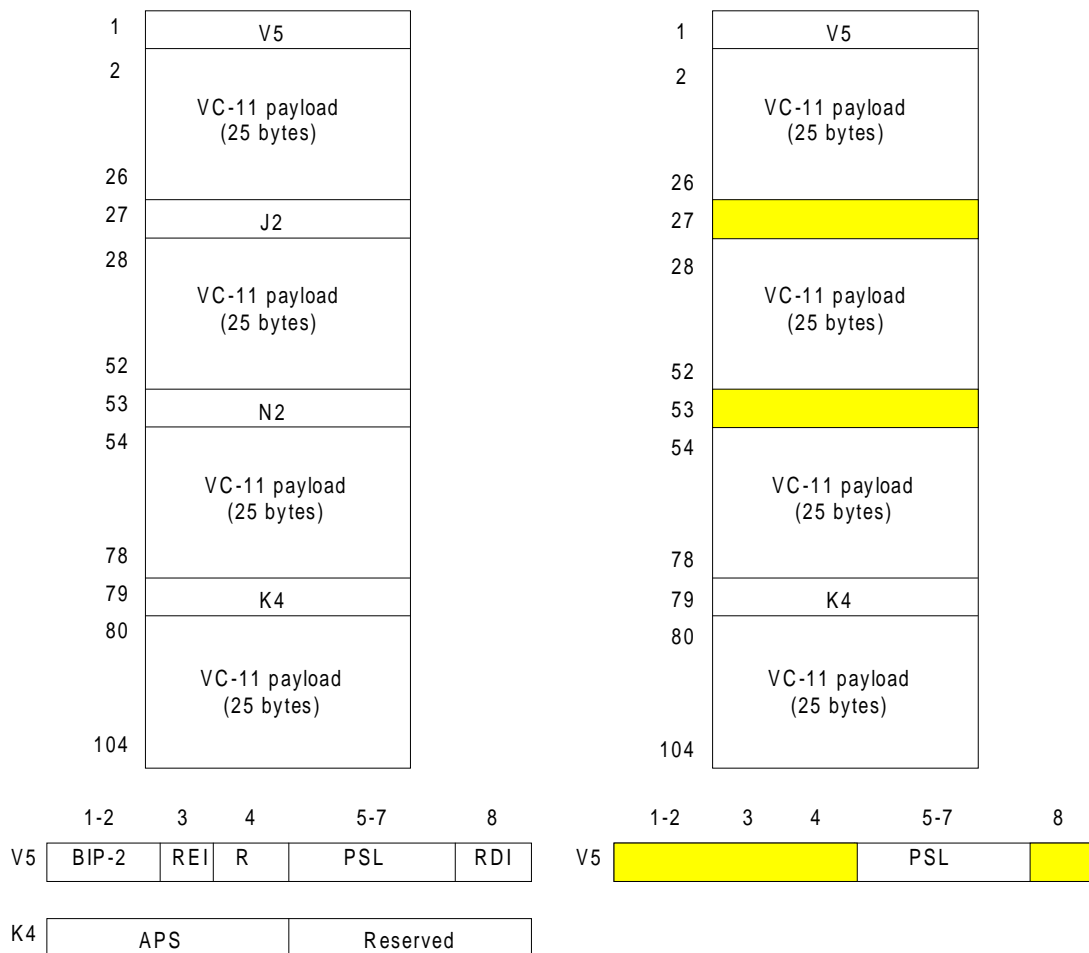

Figure F.2: S11_CI_D (left) and S11_AI_D (right)

NOTE 5: The APS signal has not been defined; a multiframed APS signal might be required. The RFI signal is not supported within ETSI.

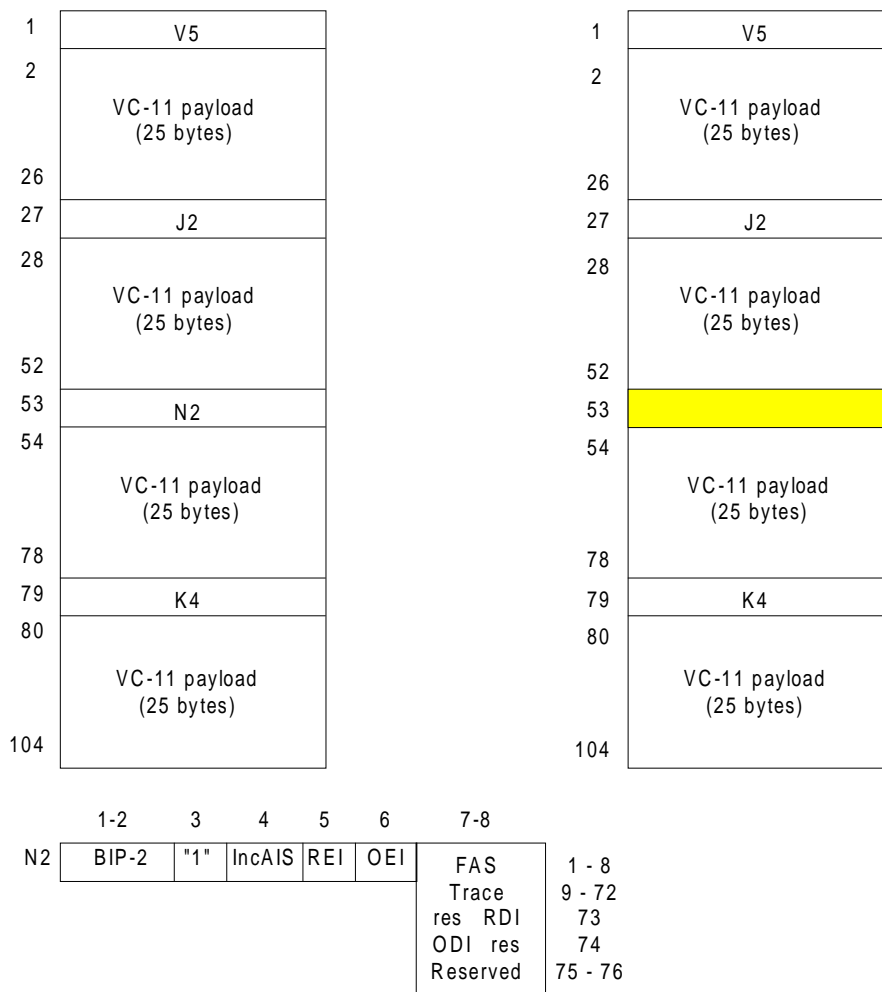

Figure F.3: S11_CI_D (left) with defined N2 and S11D_AI_D (right)

Figure F.4 shows the trail protection sublayer atomic functions added to (a subset of) the layer atomic functions presented in figure F.1.

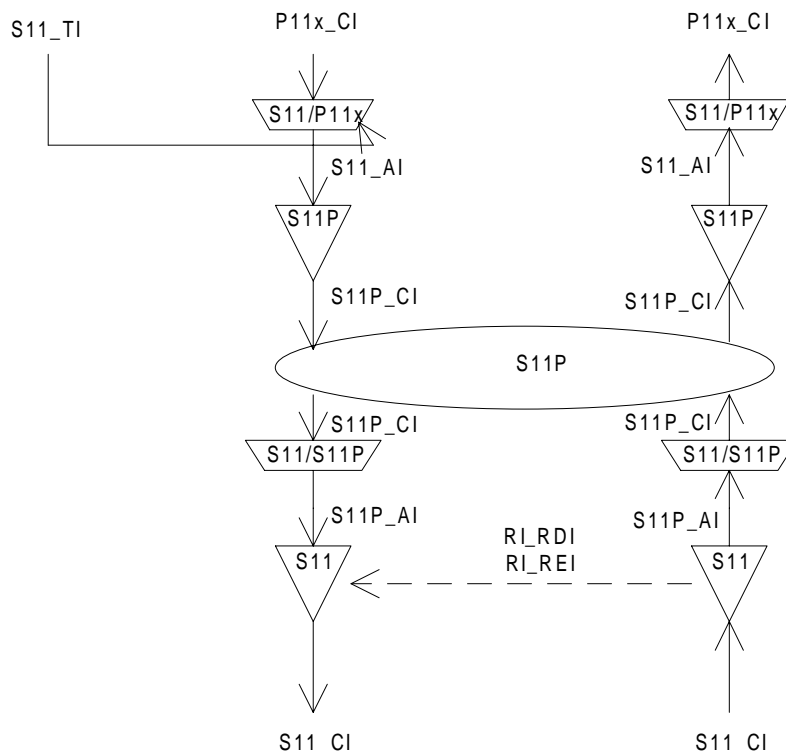

Figure F.4: VC-11 Layer Trail Protection atomic functions

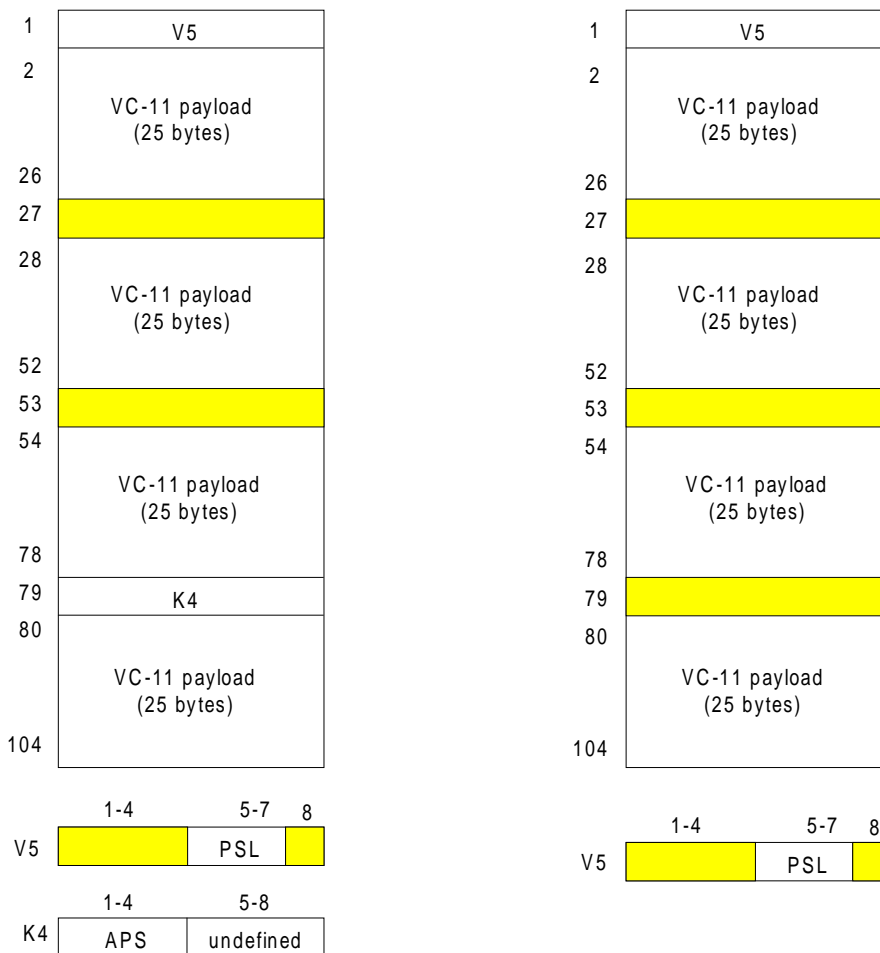

Figure F.5: S11P_AI_D (left) and S11P_CI_D (right)

F.1 VC-11 Layer Connection Function S11_C

Symbol:

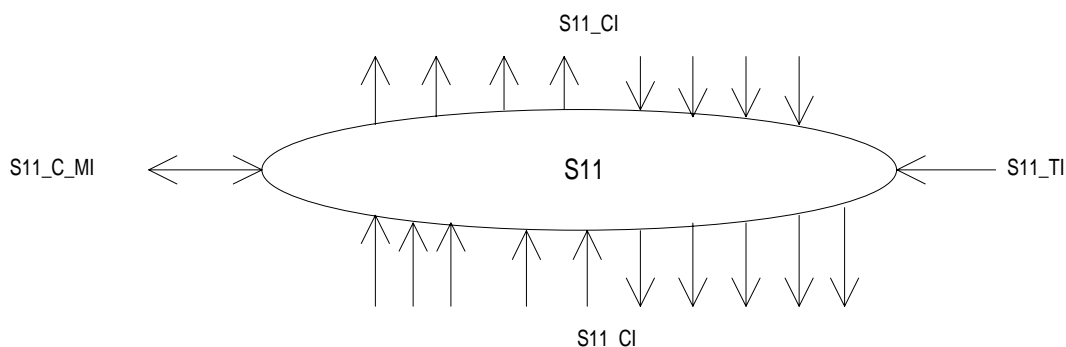

Figure F.6: S11_C symbol

Interfaces:

Table F.1: S11_C input and output signals

Input(s)	Output(s)
per S11_CI, n x for the function: S11_CI_D S11_CI_CK S11_CI_FS S11_CI_SSF S11_AI_TSF S11_AI_TSD 1 x per function: S11_TI_CK S11_TI_FS per input and output connection point: S11_C_MI_ConnectionPortIds per matrix connection: S11_C_MI_ConnectionType S11_C_MI_Directionality per SNC protection group: S11_C_MI_PROTtype S11_C_MI_OPERtype S11_C_MI_WTRtime S11_C_MI_HOtime S11_C_MI_EXTCMD	per S11_CI, m x per function: S11_CI_D S11_CI_CK S11_CI_FS S11_CI_SSF
NOTE: Protection status reporting signals are for further study.	

Processes:

In the S11_C function VC-11 Layer Characteristic Information is routed between input (termination) connection points ((T)CPs) and output (T)CPs by means of matrix connections. (T)CPs may be allocated within a protection group.

NOTE 1: Neither the number of input/output signals to the connection function, nor the connectivity is specified in the present document. That is a property of individual network elements.

Figure F.1 presents a subset of the atomic functions that can be connected to this VC-11 connection function: VC-11 trail termination functions, VC-11 non-intrusive monitor trail termination sink function, VC-11 unequipped-supervisory trail termination functions, VC-11 tandem connection trail termination and adaptation functions. In addition, adaptation functions in the VC-11 server (e.g. VC-4, P31s, P4s) layers will be connected to this VC-11 connection function.

Routing:

The function shall be able to connect a specific input with a specific output by means of establishing a matrix connection between the specified input and output. It shall be able to remove an established matrix connection.

Each (matrix) connection in the S11_C function shall be characterized by the:

Type of connection:	unprotected, 1+1 protected (SNC/I, SNC/N or SNC/S protection)
Traffic direction:	unidirectional, bi-directional
Input and output connection points:	set of connection point identifiers (refer to EN 300 417-1-1 [6], subclause 3.3.6)

NOTE 2: Broadcast connections are handled as separate connections to the same input CP.

Provided no protection switching action is activated/required the following changes to (the configuration of) a connection shall be possible without disturbing the CI passing the connection:

- addition and removal of protection;
- addition and removal of connections to/from a broadcast connection;
- change between operation types;
- change of WTR time;
- change of Hold-off time.

Unequipped VC generation:

The function shall generate an unequipped VC signal, as specified in EN 300 417-1-1 [6], subclause 7.2.

Defects: None.

Consequent Actions:

If an output of this function is not connected to one of its inputs, the function shall connect the unequipped VC-11 (with valid frame start (FS) and SSF = false) to the output.

Defect Correlations: None.

Performance Monitoring: None.

F.1.1 SNC Protection

SNC protection:

The function may provide the option to establish protection groups between a number of (T)CPs (EN 300 417-1-1 [6], subclauses 9.4.1 and 9.4.2) to perform the VC-11 linear (sub)network connection protection process for 1+1 protection architectures (refer to EN 300 417-1-1 [6], subclause 9.2). The SNC protection process shall perform the bridge and selector functionality as presented in figure 49 of EN 300 417-1-1 [6]. In the sink direction, the signal output at the normal reference point can be the signal received via either the working connection or the protection connection; this is determined by the SF,SD conditions (relayed via CI_SSF or AI_TSF/AI_TSD signals), and the external commands. In the source direction, the working output is connected to the associated normal input. The protection output is also connected to the normal input.

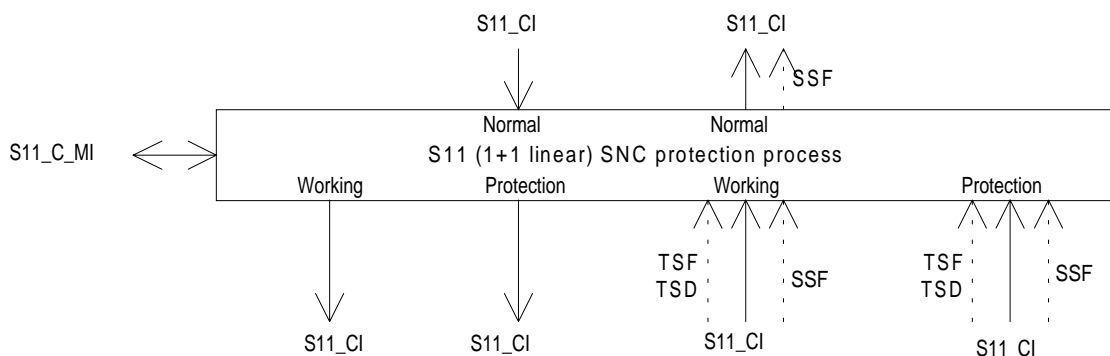

Figure F.7: VC-11 1+1 SNC protection process (SNC/I, SNC/N, SNC/S)

SNC Protection Operation:

The SNC protection process shall operate as specified in EN 300 417-3-1 [7], annex A, according the following characteristics:

Table F.2: SNC protection parameters

Parameter	Value options
architecture type (ARCHtype)	1 + 1
switching type (SWtype)	uni-directional
operation type (OPERtype)	revertive, non-revertive
APS signal (APSmode)	false
Wait-To-Restore time (WTRtime)	in the order of 5 to 12 minutes
Switch time	≤ 50 ms
Hold-off time (HOfime)	0 to 10 seconds in steps of the order of 100 ms
Protection type (PROTtype)	SNC/I, SNC/N, SNC/S
Signal switch conditions:	SF = SSF (SNC/I), SF = TSF (SNC/N,SNC/S), SD = TSD (SNC/N, SNC/S)
External commands (EXTCMD)	(revertive operation) LO, FSw-#1, MSw-#1, CLR (non-revertive operation) LO or FSw, FSw-#i, MSw-#i, CLR (i = 0, 1)
Extra traffic (EXTRAtraffic)	false
SFpriority, SDpriority	high

In the sink case of a protection connection the source of the connection is determined by the SF (and SD) signals associated with each of the two inputs to the connection and the possible external switch requests. The set of SF and SD signals used, is controlled by the protection type setting.

F.2 VC-11 Trail Termination Functions

F.2.1 VC-11 Trail Termination Source S11_TT_So

Symbol:

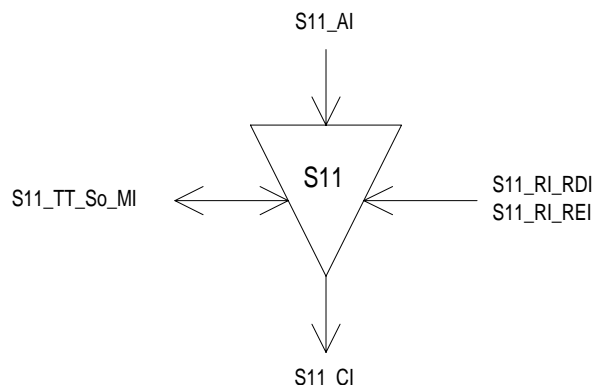

Figure F.8: S11_TT_So symbol

Interfaces:

Table F.3: S11_TT_So input and output signals

Input(s)	Output(s)
S11_AI_D	S11_CI_D
S11_AI_CK	S11_CI_CK
S11_AI_FS	S11_CI_FS
S11_RI_RDI	
S11_RI_REI	
S11_TT_So_MI_TxTI	

Processes:

This function adds error monitoring and status and control overhead bits to the S11_AI as defined in ETS 300 147 [1]. The processing of the trail overhead is defined as follows:

J2: In this byte the function shall insert the Transmitted Trail Trace Identifier TxTI. Its format is described in EN 300 417-1-1 [6], subclause 7.1.

V5[3]: The signal value applied at RI_REI shall be inserted in the VC-11 REI, bit 3 of byte V5. The coding shall be as follows:

Table F.4: V5[3] coding

Number of BIP-2 violations conveyed via RI_REI	V5[3]
0	0
1	1
2	1

V5[8]: Bit 8 of byte V5, a RDI indication, shall be set to "1" on activation of S11_RI_RDI within 1 000 µs, determined by the associated S11_TT_Sk function, and set to "0" within 1 000 µs on clearing of S11_RI_RDI.

V5[1-2]: In these bits the function shall insert the BIP-2 EDC with even bit parity. Each bit of current bits 1 or 2 is computed to provide even parity over the associated (odd and even) bits of every byte in the previous frame of the Characteristic Information S11_CI, i.e., bits 1 and 2 are calculated over the entire previous VC-11. Further reference is provided in EN 300 417-1-1 [6], subclause 7.3.

K4[5-8]: The value of the bits 5 to 8 of byte K4 is undefined.

Defects: None.

Consequent Actions: None.

Defect Correlations: None.

Performance Monitoring: None.

F.2.2 VC-11 Trail Termination Sink S11_TT_Sk

Symbol:

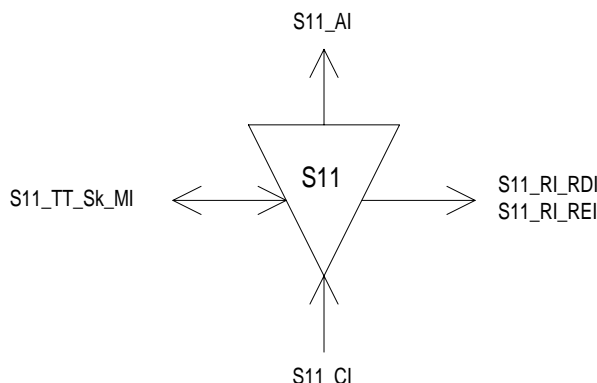

Figure F.9: S11_TT_Sk symbol

Interfaces:

Table F.5: S11_TT_Sk input and output signals

Input(s)	Output(s)
S11_CI_D	S11_AI_D
S11_CI_CK	S11_AI_CK
S11_CI_FS	S11_AI_FS
S11_CI_SSF	S11_AI_TSF
	S11_AI_TSD
S11_TT_Sk_MI_TPmode	S11_TT_Sk_MI_cTIM
S11_TT_Sk_MI_SSF_Reported	S11_TT_Sk_MI_cUNEQ
S11_TT_Sk_MI_ExTI	S11_TT_Sk_MI_cDEG
S11_TT_Sk_MI_RDI_Reported	S11_TT_Sk_MI_cRDI
S11_TT_Sk_MI_DEGTHR	S11_TT_Sk_MI_cSSF
S11_TT_Sk_MI_DEGM	S11_TT_Sk_MI_AcTI
S11_TT_Sk_MI_1second	S11_RI_RDI
S11_TT_Sk_MI_TIMdis	S11_RI_REI
S11_TT_Sk_MI_ExTI mode	S11_TT_Sk_MI_pN_EBC
	S11_TT_Sk_MI_pN_DS
	S11_TT_Sk_MI_pF_EBC
	S11_TT_Sk_MI_pF_DS

Processes:

This function monitors VC-11 for errors, and recovers the trail termination status. It extracts the payload independent overhead bytes/bits (J2, V5[1-2], V5[3], V5[5-7], V5[8]) from the VC-11 layer Characteristic Information:

J2: The Received Trail Trace Identifier RxTI shall be recovered from the J2 byte and shall be made available as AcTI for network management purposes. The application and acceptance and mismatch detection process shall be performed as specified in EN 300 417-1-1 [6], subclauses 7.1 and 8.2.1.3.

V5[1-2]: Even bit parity is computed for each bit pair of every byte of the preceding VC-11 including V5 and compared with bit 1 and 2 of V5 recovered from the current frame. A difference between the computed and recovered BIP-2 values is taken as evidence of an errored block (nN_B).

V5[3], V5[8]: The information carried in the bits 3 and 8 of the V5 byte (REI, RDI) shall be extracted to enable single ended maintenance of a bi-directional Trail (Path). The REI (nF_B) shall be used to monitor the error performance of the other direction of transmission, and the RDI (bit 8) shall be used to provide information as to the status of the remote receiver. A "1" indicates a Remote Defect Indication state, while a "0" indicates the normal, working state. The application process shall be performed as specified in EN 300 417-1-1 [6], subclauses 7.4.2 (REI), 7.4.11 and 8.2 (RDI).

K4[5-8]: The value in the bits 5 to 8 of byte K4 shall be ignored.

Table F.6: V5[3] code interpretation

V5[3]	REI code interpretation
0	0 errored blocks
1	1 errored block

V5[5-7]: The information in bits 5 to 7 of byte V5 shall be extracted to allow unequipped VC defect detection.

Defects:

The function shall detect for dDEG, dRDI, dUNEQ and dTIM defects according the specification in EN 300 417-1-1 [6], subclause 8.2.1.

Consequent Actions:

aAIS	←	dUNEQ or dTIM
aTSF	←	CI_SSF or dUNEQ or dTIM
aRDI	←	CI_SSF or dUNEQ or dTIM
aTSD	←	dDEG
aREI	←	"#EDCV"

On declaration of aAIS the function shall output all-ONES signal within 1 000 μ s; on clearing of aAIS the function shall output normal data within 1 000 μ s.

Defect Correlations:

cUNEQ	←	dUNEQ and MON
cTIM	←	dTIM and (not dUNEQ) and MON
cDEG	←	dDEG and (not dTIM) and MON
cRDI	←	dRDI and (not dUNEQ) and (not dTIM) and MON and RDI_Reported
cSSF	←	CI_SSF and MON and SSF_Reported

Performance Monitoring:

The performance monitoring process shall be performed as specified in EN 300 417-1-1 [6], subclause 8.2.4 through 8.2.7.

pN_DS	←	aTSF or dEQ
pF_DS	←	dRDI
pN_EBC	←	Σ nN_B
pF_EBC	←	Σ nF_B

F.3 VC-11 Adaptation Functions

F.3.1 VC-11 to P11x Adaptation Source S11/P11x_A_So

Symbol:

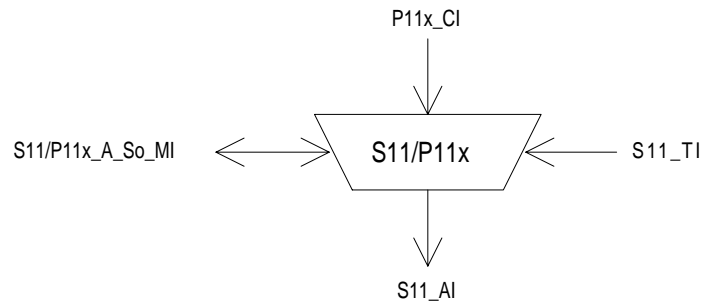

Figure F.10: S11/P11x_A_So symbol

Interfaces:

Table F.7: S11/P11x_A_So input and output signals

Input(s)	Output(s)
P11x_CI_D P11x_CI_CK S11_TI_CK S11_TI_FS S11/P11x_A_So_MI_Active	S11_AI_D S11_AI_CK S11_AI_FS

Processes:

This function maps a 1 544 kbit/s information stream into a VC-11 payload using bit stuffing and adds bits 5 to 7 of byte V5. It takes P11x_CI, a bit-stream with a rate of 1 544 kbit/s \pm 50 ppm, present at its input and inserts it into the synchronous container-11 having a capacity of 100 bytes and the justification frame as defined in ETS 300 147 [1] and depicted in figure F.11.

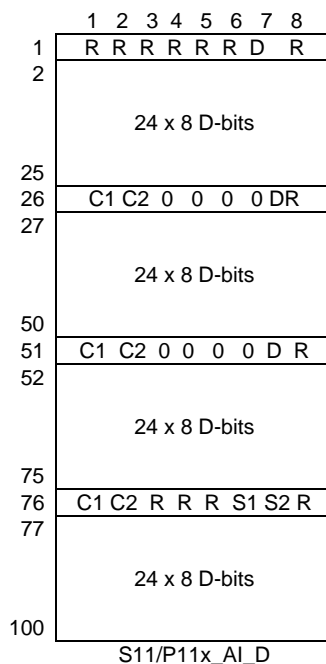

Legend: D = Data Bit, R = Fixed Stuff,
 S1,S2 = Justification Opportunity Bit, C1,C2 = Justification Control Bit

Figure F.11: 1.5 Mbit/s asynchronous mapped into a Container-11 (using bit justification)

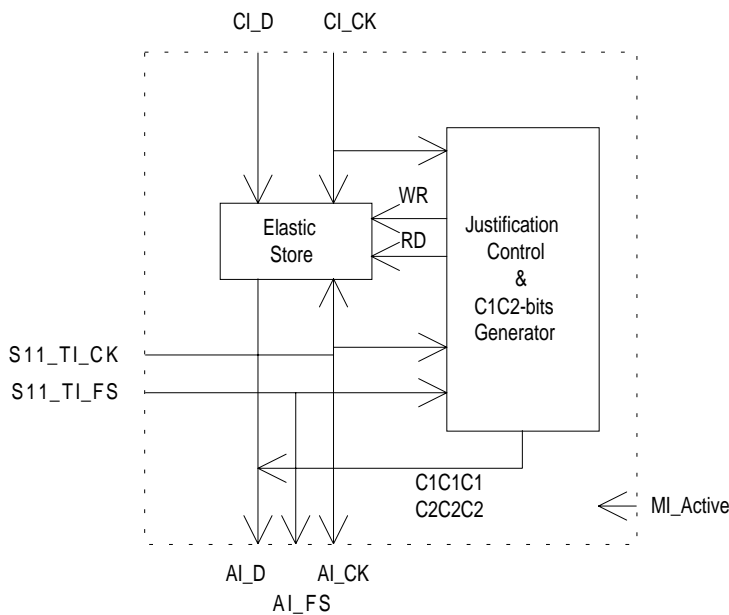

Figure F.12: main processes within S11/P11x_A_So

Frequency justification and bitrate adaptation:

The function shall provide an elastic store (buffer) process (see figure F.12). The data signal shall be written into the buffer under control of the associated input clock. The data shall be read out of the buffer and written onto the D, S1, S2 bits under control of the VC-11 clock, frame position (S11_TI), and justification decisions.

The justification decisions determine the phase error introduced by the S11/P11x_A_So function. The amount of this phase error can be measured at the physical interfaces by monitoring the justification control bits C1C2 (see figure F.11). An example is given in clause A.3.

Each justification decision results in a corresponding positive or negative justification action. Upon a positive justification action, the reading of 1 data bit shall be cancelled once an no data are written at the justification opportunity bit S2 and no data are written onto S1. Upon a negative justification action, 1 extra data bit shall be read once and written onto the justification opportunity bit S1 and data shall be written onto S2. If neither a positive nor a negative justification action is to be performed, either no data shall be written onto S1 and data shall be written onto S2, or vice versa.

NOTE: A requirement for maximum introduced phase error cannot be defined until a reference path is defined from which the requirements for network elements can be deduced.

Buffer size:

In the presence of jitter as specified by ITU-T Recommendation G.823 [9] and a frequency within the range $1\,544\text{ kbit/s} \pm 50\text{ ppm}$, this justification process shall not introduce any errors. Any step in frequency within this range shall not cause any errors.

C1C2 bits: *Justification control generation:*

The function shall generate the justification control (C1,C2) bits according the specification in ETS 300 147 [1]. It shall insert the justification control bits in the appropriate C1C2 bit positions.

Three bits of payload specific POH information, V5[5-7], shall be added to Container-11 to form the VC-11 AI and a fixed Frame Start (FS) shall be generated.

V5[5-7]: In these bits the function shall insert code "010" (Asynchronous mapping of 1 544 kbit/s into the Container-11) as defined in ETS 300 147 [1].

O bits: The value of the O bits is undefined.

R bits: The value of an R bits is undefined.

Activation:

The function shall access the access point when it is activated (MI_Active is true). Otherwise, it shall not access the access point.

Defects: None.

An elastic store under/overflow defect (dUOF) is for further study.

Consequent Actions: None.

Defect Correlations: None.

Performance Monitoring: None.

F.3.2 VC-11 to P11x Adaptation Sink S11/P11x_A_Sk

Symbol:

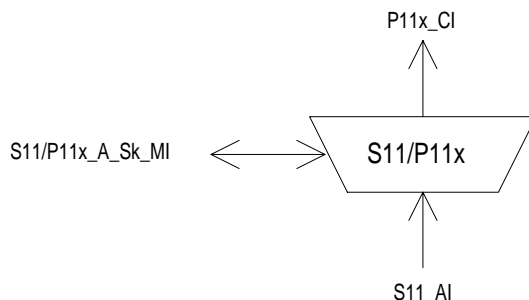

Figure F.13: S11/P11x_A_Sk symbol

Interfaces:

Table F.8: S11/P11x_A_Sk input and output signals

Input(s)	Output(s)
S11_AI_D	P11x_CI_D
S11_AI_CK	P11x_CI_CK
S11_AI_FS	P11x_CI_SSF
S11_AI_TSF	S11/P11x_A_Sk_MI_cPLM
S11/P11x_A_Sk_MI_Active	S11/P11x_A_Sk_MI_AcSL

Processes:

The function recovers plesiochronous P11x Characteristic Information (1 544 kbit/s \pm 50 ppm) from the synchronous container C-11 with a frequency accuracy within \pm 4,6 ppm according to ETS 300 147 [1], and monitors the reception of the correct payload signal type.

V5[5-7]: The function shall compare the content of the accepted bits 5 to 7 of byte V5 with the expected value code "010" (Asynchronous mapping of 1 544 kbit/s into the Container-11) as a check on consistency between the provisioning operation at each end. The application and acceptance and mismatch detection process shall be as specified in EN 300 417-1-1 [6], subclauses 7.2 and 8.1.2.

R bits: The value in the R bits shall be ignored.

O bits: The value in the O bits shall be ignored.

C1C2 bits: *Justification control interpretation:*

The function shall perform justification control interpretation according ETS 300 147 [1] to recover the 1 544 kbit/s signal from the VC-11. If the majority of the C1 bits is "0" the S1 bit shall be taken as a data bit, otherwise (majority of C1 bits is "1") S1 bit shall be taken as a justification bit and consequently ignored. If the majority of the C2 bits is "0" S2 bit shall be taken as a data bit, otherwise (majority of C2 bits is "1") S2 bit shall be taken as a justification bit and consequently ignored.

NOTE: A negative justification is effectuated if the majority of C1 bits and the majority of C2 bits is "0". A positive justification is effectuated if the majority of the C1 bits and the majority of C2 bits is "1". The other combinations (C1 majority is "0" and C2 majority is "1", or C1 majority is "1" and C2 majority is "0") do not result in an actual justification.

Smoothing & jitter limiting process:

The function shall provide for a clock smoothing and elastic store (buffer) process. The 1 544 kbit/s data signal shall be written into the buffer under control of the associated (gapped) input clock with a frequency accuracy within $\pm 4,6$ ppm. The data signal shall be read out of the buffer under control of a smoothed (equally spaced) 1 544 kHz ± 50 ppm clock (the rate is determined by the 2 Mbit/s signal at the input of the remote S11/P11x_A_So). The residual jitter caused by pointer adjustments and bit justifications (measured at the 1 544 kbit/s interface) shall be within the limits specified in subclause 11.3.1.2 of EN 300 417-1-1 [6].

Buffer size:

In the presence of jitter as specified by subclause 11.3.1.2 of EN 300 417-1-1 [6] and a frequency within the range 1 544 kbit/s ± 50 ppm, this justification process shall not introduce any errors.

Following a step in frequency of the P11x signal transported by the S11_AI (for example due to reception of P11x CI from a new P11x_TT_So at the far end or removal of all-ONEs (AIS) signal with a frequency offset) there will be a maximum recovery time of X seconds after which this process shall not generate any bit errors.

The value of X is for further study; a value of 1 second has been proposed.

Activation:

The function shall perform the operation specified above when it is activated (MI_Active is true). Otherwise, it shall transmit the all-ONEs signal at its output (CI_D) and not report its status via the management point.

Defects:

The function shall detect for dPLM defect according the specification in EN 300 417-1-1 [6], subclause 8.2.1.

Consequent Actions:

aSSF ← AI_TSF or dPLM

aAIS ← AI_TSF or dPLM

On declaration of the aAIS the function shall output an all-ONEs (AIS) signal in the P11x_CI_D within 1 000 μ s; on clearing of aAIS the function shall output normal data within 1 000 μ s. The P11x_CI_CK during the all-ONEs signal shall be within 1 544 kHz ± 50 ppm.

Defect Correlations:

cPLM ← dPLM and (not AI_TSF)

Performance Monitoring: None.

F.3.3 VC-11 Layer to TSS4 Adaptation Source S11/TSS4_A_So

Symbol:

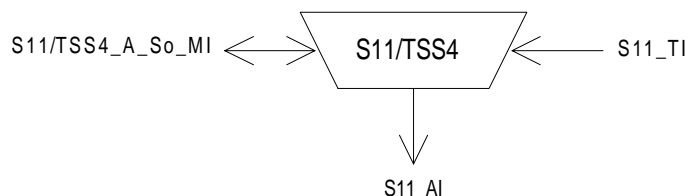

Figure F.14: S11/TSS4_A_So symbol

Interfaces:

Table F.9: S11/TSS4_A_So input and output signals

Input(s)	Output(s)
S11_TI_CK	S11_AI_D
S11_TI_FS	S11_AI_CK
S11/TSS4_A_So_MI_Active	S11_AI_FS

Processes:

This function maps a VC-11 synchronous Test Signal Structure TSS4 PRBS stream as described in ITU-T Recommendation O.181 [12] into a VC-11 payload and adds the bits V5[5-7] bytes. It creates a 2^{15} PRBS with timing derived from the S11_TI_Ck and maps it without justification bits into the whole of the synchronous container-11 having a capacity of 100 bytes. The PRBS is a sequence which repeats itself over a period which is not an exact multiple of the capacity available in the container-11 frame. Therefore the start of the sequence will move relative to the start of the container-11 frame over time.

Three bits of payload specific POH information, V5[5-7], shall be added to container-11 to form the VC-11 AI and a fixed Frame Start (FS) shall be generated.

V5[5-7]: In these bits the function shall insert code "110" (TSS4 into the Container-11) as defined in ETS 300 147 [1].

Activation:

The function shall access the access point when it is activated (MI_Active is true). Otherwise, it shall not access the access point.

Defects: None.

Consequent Actions: None.

Defect Correlations: None.

Performance Monitoring: None.

F.3.4 VC-11 Layer to TSS4 Adaptation Sink S11/TSS4_A_Sk

Symbol:

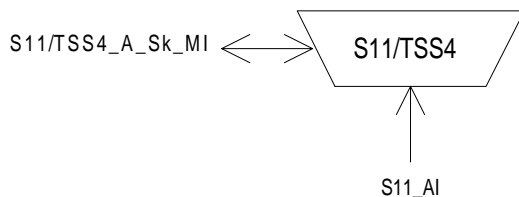

Figure F.15: S11/TSS4_A_Sk symbol

Interfaces:

Table F.10: S11/TSS4_A_Sk input and output signals

Input(s)	Output(s)
S11_AI_D	S11/TSS4_A_Sk_MI_cPLM
S11_AI_CK	S11/TSS4_A_Sk_MI_cLSS
S11_AI_FS	S11/TSS4_A_Sk_MI_AcSL
S11_AI_TSF	S11/TSS4_A_Sk_MI_pN_TSE
S11/TSS4_A_Sk_MI_Active	
S11/TSS4_A_Sk_MI1second	

Processes:

The function recovers a TSS4 2^{15} PRBS test sequence as defined in ITU-T Recommendation O.181 [12] from the synchronous container-11 (having a frequency accuracy within $\pm 4,6$ ppm) and monitors the reception of the correct payload signal type and the presence of test sequence errors (TSE) in the PRBS sequence.

V5[5-7]: The function shall compare the content of the accepted bits 5 to 7 of byte V5 with the expected value code "110" (TSS4 into the Container-12) as a check on consistency between the provisioning operation at each end. The application and acceptance and mismatch detection process shall be as specified in EN 300 417-1-1 [6], subclauses 7.2 and 8.1.2.

Error monitoring: Test sequence errors are bit errors in the TSS data stream and shall be detected whenever the PRBS detector is in lock and the received data bit does not match the expected value.

Activation:

The function shall perform the operation specified above when it is activated (MI_Active is true). Otherwise, it shall not report its status via the management point.

Defects:

The function shall detect for dPLM defect according the specification in EN 300 417-1-1 [6], subclause 8.2.1.

The function shall detect for loss of PRBS lock (dLSS) according to the criteria defined in ITU-T Recommendation O.151 [11], subclause 2.6.

Consequent Actions: None.

Defect Correlations:

cPLM ← dPLM and (not AI_TSF)

cLSS ← dLSS and (not AI_TSF)

Performance Monitoring:

pN_TSE ← Sum of Test Sequence Errors (TSE) within one second period.

F.3.5 VC-11 Layer Clock Adaptation Source S11-LC_A_So

Refer to EN 300 417-6-1 [8].

F.4 VC-11 Layer Monitoring Functions

F.4.1 VC-11 Layer Non-intrusive Monitoring Function S11m_TT_Sk

Symbol:

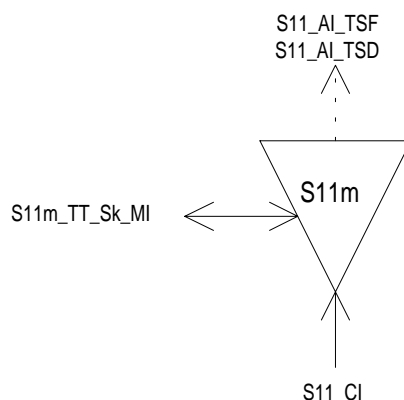

Figure F.16: S11m_TT_Sk symbol

Interfaces:

Table F.11: S11m_TT_Sk input and output signals

Input(s)	Output(s)
S11_CI_D	S11_AI_TSF
S11_CI_CK	S11_AI_TSD
S11_CI_FS	S11m_TT_Sk_MI_cTIM
S11_CI_SSF	S11m_TT_Sk_MI_cUNEQ
S11m_TT_Sk_MI_TPmode	S11m_TT_Sk_MI_cDEG
S11m_TT_Sk_MI_SSF_Reported	S11m_TT_Sk_MI_cRDI
S11m_TT_Sk_MI_ExtI	S11m_TT_Sk_MI_cSSF
S11m_TT_Sk_MI_RDI_Reported	S11m_TT_Sk_MI_AcTI
S11m_TT_Sk_MI_DEGTHR	S11m_TT_Sk_MI_pN_EBC
S11m_TT_Sk_MI_DEGM	S11m_TT_Sk_MI_pF_EBC
S11m_TT_Sk_MI_ExtImode	S11m_TT_Sk_MI_pN_DS
S11m_TT_Sk_MI_1second	S11m_TT_Sk_MI_pF_DS
S11m_TT_Sk_MI_TIMdis	

Processes:

NOTE 1: this non-intrusive monitor trail termination sink function has no associated source function.

This function monitors VC-11 for errors, and recovers the trail termination status. It extracts the payload independent overhead bytes/bits (J2, V5[1-2], V5[3], V5[5-7], V5[8]) from the VC-11 layer Characteristic Information:

J2: The Received Trail Trace Identifier RxTI shall be recovered from the J2 byte and shall be made available as AcTI for network management purposes. The application and acceptance and mismatch detection process shall be performed as specified in EN 300 417-1-1 [6], subclauses 7.1 and 8.2.1.3.

V5[1-2]: Even bit parity is computed for each bit pair of every byte of the preceding VC-11 including V5 and compared with bit 1 and 2 of V5 recovered from the current frame. A difference between the computed and recovered BIP-2 values is taken as evidence of an errored block (nN_B).

V5[3], V5[8]: The information carried in the bits 3 and 8 of the V5 byte (REI, RDI) shall be extracted to enable single ended maintenance of a bi-directional Trail (Path). The REI (nF_B) shall be used to monitor the error performance of the other direction of transmission, and the RDI (bit 8) shall be used to provide information as to the status of the remote receiver. A "1" indicates a Remote Defect Indication state, while a "0" indicates the normal, working state. The application process shall be performed as specified in EN 300 417-1-1 [6], subclauses 7.4.2 (REI), 7.4.11 and 8.2 (RDI).

Table F.12: V5[3] code interpretation

V5[3]	REI code interpretation
0	0 errored blocks
1	1 errored block

V5[5-7]: The information in bits 5 to 7 of byte V5 shall be extracted to allow unequipped VC defect detection.

K4[5-8]: The value in the bits 5 to 8 of byte K4 shall be ignored.

Defects:

The detection and removal conditions and processes for dDEG, dRDI, dUNEQ and dTIM defects shall be as specified by EN 300 417-1-1 [6], subclause 8.2.1 with the condition "aSSF" read as "aSSF or VC dAIS". To use the function within e.g. a tandem connection, it shall be possible to disable the trace id mismatch detection (TIMdis).

NOTE 2: Presumably, in such case the VC Trace Id. will be unknown to the tandem connection operator.

VC AIS:

The function shall detect for an AIS VC (VC-AIS) condition by monitoring the VC PSL for code "111". If 5 consecutive frames contain the "111" pattern in bits 5 to 7 of byte V5 a dAIS defect shall be detected. dAIS shall be cleared if in 5 consecutive frames any pattern other than the "111" is detected in bits 5 to 7 of byte V5.

NOTE 3: Equipment designed prior to the present document may be able to perform VC-AIS detection either as specified above interpreting "frames" as "samples (not necessary consecutive frames)", or by a comparison of the accepted signal label with the all-ONEs pattern. If the accepted signal label is equal to all-ONEs, VC-AIS defect is detected. If the accepted signal label is not equal to all-ONEs, VC-AIS defect is cleared.

Consequent actions:

aTSF ← CI_SSF or dAIS or dUNEQ or dTIM

aTSD ← dDEG

Defect Correlations:

cUNEQ ← dUNEQ and MON

cTIM ← dTIM and (not dUNEQ) and MON

cDEG ← dDEG and (not dTIM) and MON

cRDI ← dRDI and (not dUNEQ) and (not dTIM) and MON and RDI_Reported

cSSF ← (CI_SSF or dAIS) and MON and SSF_Reported

Performance Monitoring:

The performance monitoring process shall be performed as specified in EN 300 417-1-1 [6], subclause 8.2.4 through 8.2.7.

pN_DS ← aTSF or dEQ

pF_DS ← dRDI

pN_EBC ← ΣnN_B

pF_EBC ← ΣnF_B

NOTE 4: pF_DS/pF_EBC represent the performance of the total trail while pN_DS/pN_EBC represents only part of the trail up to the point of the non-intrusive monitor.

F.4.2 VC-11 Layer Supervisory-Unequipped Termination Source S11s_TT_So

Symbol:

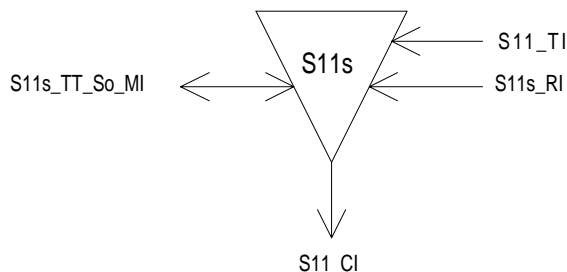

Figure F.17: S11s_TT_So symbol

Interfaces:

Table F.13: S11s_TT_So input and output signals

Input(s)	Output(s)
S11s_RI_RDI	S11_CI_D
S11s_RI_REI	S11_CI_CK
S11_TI_CK	S11_CI_FS
S11_TI_FS	
S11s_TT_So_MI_TxTI	

Processes:

This function generates error monitoring and status overhead bytes to an undefined VC-11. The processing of the trail termination overhead bytes is defined as follows:

J2: In this byte the function shall insert the Transmitted Trail Trace Identifier TxTI. Its format is described in EN 300 417-1-1 [6], subclause 7.1.

V5[3]: The signal value applied at RI_REI shall be inserted in the VC-11 REI, bit 3 of byte V5. The coding shall be as follows:

Table F.14: V5[3] coding

Number of BIP-2 violations conveyed via RI_REI	V5[3]
0	0
1	1
2	1

V5[8]: Bit 8 of byte V5, a RDI indication, shall be set to "1" on activation of S11s_RI_RDI within 1 000 µs, determined by the associated S11s_TT_Sk function, and set to "0" within 1 000 µs on clearing of S11s_RI_RDI.

V5[5-7]: In this byte the function shall insert code "000" (unequipped VC or supervisory-unequipped VC) as defined in subclause 7.2 of EN 300 417-1-1 [6] and ETS 300 147 [1].

V5[1-2]: In these bits the function shall insert the BIP-2 EDC with even bit parity. Each bit of current bits 1 or 2 is computed to provide even parity over the associated (odd and even) bits of every byte in the previous frame of the Characteristic Information S11_CI, i.e., bits 1 and 2 are calculated over the entire previous VC-11. Further reference is provided in EN 300 417-1-1 [6], subclause 7.3.

K4[5-8]: The value of the bits 5 to 8 of byte K4 is undefined.

N2: In this byte the function shall insert code "0000 0000" (unequipped tandem connection) as defined in subclause 7.2 of EN 300 417-1-1 [6].

Other VC-11 bytes:

The function shall generate the other VC-11 bytes and bits. Their content is undefined (i.e. bits are set to either a value of "0" or "1").

Defects: None.

Consequent Actions: None.

Defect Correlations: None.

Performance Monitoring: None.

F.4.3 VC-11 Layer Supervisory-unequipped Termination Sink S11s_TT_Sk

Symbol:

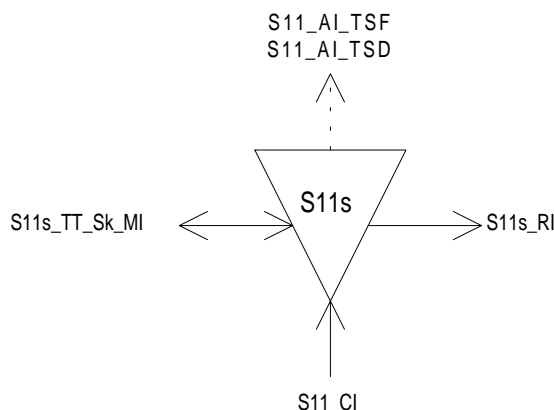

Figure F.18: S11s_TT_Sk symbol

Interfaces:

Table F.15: S11s_TT_Sk input and output signals

Input(s)	Output(s)
S11_CI_D	S11_AI_TSF
S11_CI_CK	S11_AI_TSD
S11_CI_FS	S11s_TT_Sk_MI_cTIM
S11_CI_SSF	S11s_TT_Sk_MI_cUNEQ
	S11s_TT_Sk_MI_cDEG
S11s_TT_Sk_MI_TPmode	S11s_TT_Sk_MI_cRDI
S11s_TT_Sk_MI_SSF_Reported	S11s_TT_Sk_MI_cSSF
S11s_TT_Sk_MI_ExtI	S11s_TT_Sk_MI_AcTI
S11s_TT_Sk_MI_RDI_Reported	S11s_RI_RDI
S11s_TT_Sk_MI_DEGTHR	S11s_RI_REI
S11s_TT_Sk_MI_DEGM	S11s_TT_Sk_MI_pN_EBC
S11s_TT_Sk_MI_1second	S11s_TT_Sk_MI_pF_EBC
S11s_TT_Sk_MI_TIMdis	S11s_TT_Sk_MI_pN_DS
S11s_TT_Sk_MI_ExtImode	S11s_TT_Sk_MI_pF_DS

Processes:

This function monitors VC-11 for errors, and recovers the trail termination status. It extracts the payload independent overhead bytes/bits (J2, V5[1-2], V5[3], V5[5-7], V5[8]) from the VC-11 layer Characteristic Information:

J2: The Received Trail Trace Identifier RxTI shall be recovered from the J2 byte and shall be made available as AcTI for network management purposes. The application and acceptance and mismatch detection process shall be performed as specified in EN 300 417-1-1 [6], subclauses 7.1 and 8.2.1.3.

V5[1-2]: Even bit parity is computed for each bit pair of every byte of the preceding VC-11 including V5 and compared with bit 1 and 2 of V5 recovered from the current frame. A difference between the computed and recovered BIP-2 values is taken as evidence of an errored block (nN_B).

V5[3], V5[8]: The information carried in the bits 3 and 8 of the V5 byte (REI, RDI) shall be extracted to enable single ended maintenance of a bi-directional Trail (Path). The REI (nF_B) shall be used to monitor the error performance of the other direction of transmission, and the RDI (bit 8) shall be used to provide information as to the status of the remote receiver. A "1" indicates a Remote Defect Indication state, while a "0" indicates the normal, working state. The application process shall be performed as specified in EN 300 417-1-1 [6], subclauses 7.4.2 (REI), 7.4.11 and 8.2 (RDI).

Table F.16: V5[3] code interpretation

V5[3]	REI code interpretation
0	0 errored blocks
1	1 errored block

V5[5-7]: The information in bits 5 to 7 of byte V5 shall be extracted to allow unequipped VC defect detection.

K4[5-8]: The value of the bits 5 to 8 of byte K4 shall be ignored.

Defects:

The function shall detect for dDEG, dRDI, dUNEQ and dTIM defects according the specifications in EN 300 417-1-1 [6], subclause 8.2.1.

Consequent Actions:

aTSF ← CI_SSF or dTIM

aTSD ← dDEG

aRDI ← CI_SSF or dTIM

aREI ← "#EDCV"

NOTE: dUNEQ can not be used to activate aTSF and aRDI; an expected supervisory-unequipped signal will have the signal label set to all-0's, causing a continuous detection of dUNEQ. If an unequipped VC comes in, dTIM will be activated and can serve as a trigger for aTSF/aRDI instead of dUNEQ.

Defect Correlations:

cUNEQ ← MON and dTIM and (AcTI = all "0"s) and dUNEQ

cTIM ← MON and dTIM and not (dUNEQ and AcTI = all "0"s)

cDEG ← MON and (not dTIM) and dDEG

cRDI ← MON and (not dTIM) and dRDI and RDI_Reported

cSSF ← MON and CI_SSF and SSF_Reported

Performance Monitoring:

The performance monitoring process shall be performed as specified in EN 300 417-1-1 [6], subclause 8.2.4 through 8.2.7.

pN_DS ← aTSF or dEQ

pF_DS ← dRDI

pN_EBC ← Σ nN_B

pF_EBC ← Σ nF_B

F.5 VC-11 Layer Trail Protection Functions

F.5.1 VC-11 Trail Protection Connection Functions S11P_C

F.5.1.1 VC-11 Layer uni-directional Protection Connection Function S11P1+1u_C

Symbol:

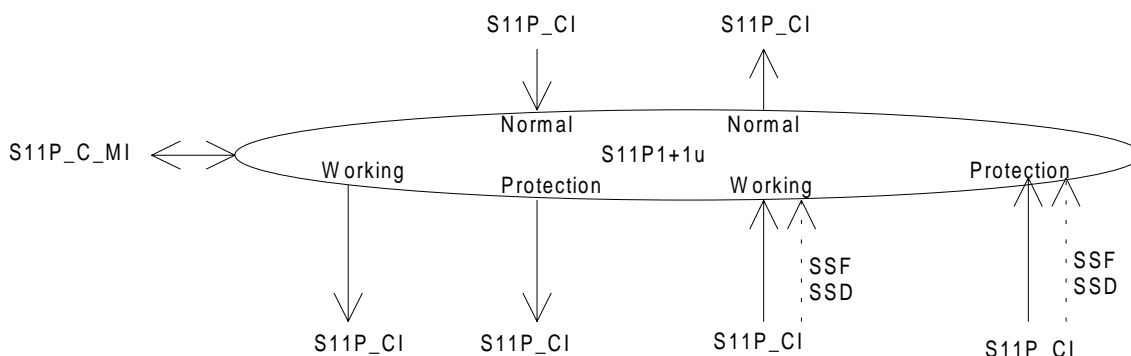

Figure F.19: S11P1+1u_C symbol

Interfaces:

Table F.17: S11P_C input and output signals

Input(s)	Output(s)
for connection points W and P: S11P_CI_D S11P_CI_CK S11P_CI_FS S11P_CI_SSF S11P_AI_SSD	for connection points W and P: S11P_CI_D S11P_CI_CK S11P_CI_FS S11P_CI_SSF
for connection point N: S2P_CI_D S2P_CI_CK S2P_CI_FS	for connection point N: S2P_CI_D S2P_CI_CK S2P_CI_FS S2P_CI_SSF
S11P_C_MI_OPERType S11P_C_MI_WTRTime S11P_C_MI_HOTime S11P_C_MI_EXTCMD	
NOTE: Protection status reporting signals are for further study.	

Processes:

The function performs the VC-11 linear trail protection process for 1+1 protection architectures with uni-directional switching; refer to EN 300 417-1-1 [6], subclause 9.2. It performs the bridge and selector functionality as presented in figure 49 of EN 300 417-1-1 [6]. In the sink direction, the signal output at the normal reference point can be the signal received via either the associated working path or the protection path; this is determined by the SF,SD conditions (relayed via CI_SSF,CI_SSD signals), and the external commands. In the source direction, the working output is connected to the associated normal input. The protection output is also connected to the normal input.

Provided no protection switching action is activated/required the following changes to (the configuration of) a trail shall be possible without disturbing the CI passing the trail:

- change between operation types;
- change of WTR and HO times.

Operation:

The VC trail protection process shall operate as specified in EN 300 417-3-1 [7], annex A, according the following characteristics:

Table F.18: Trail protection parameters

Parameter	Value options
architecture type (ARCHtype)	1 + 1
switching type (SWtype)	uni-directional
operation type (OPERtype)	revertive, non-revertive
APS signal (APSmode)	false
Wait-To-Restore time (WTRtime)	in the order of 5 to 12 minutes
Switch time	≤ 50 ms
Hold-off time (HOtime)	0 to 10 seconds in steps of the order of 100 ms
Protection type (PROTtype)	trail
Signal switch conditions:	SF = SSF (originated as AI_TSF) SD = SSD (originated as AI_TSD)
External commands (EXTCMD)	(revertive operation) LO, FSw-#1, MSw-#1, CLR (non-revertive operation) LO or FSw, FSw-#i, MSw-#i, CLR (i=0,1)
Extra traffic (EXTRAtraffic)	false
SFpriority, SDpriority	high

Defects:	None.
Consequent Actions:	None.
Defect Correlations:	None.
Performance Monitoring:	None.

F.5.1.2 VC-11 Layer 1+1 dual ended Protection Connection Function S11P1+1b_C

Symbol:

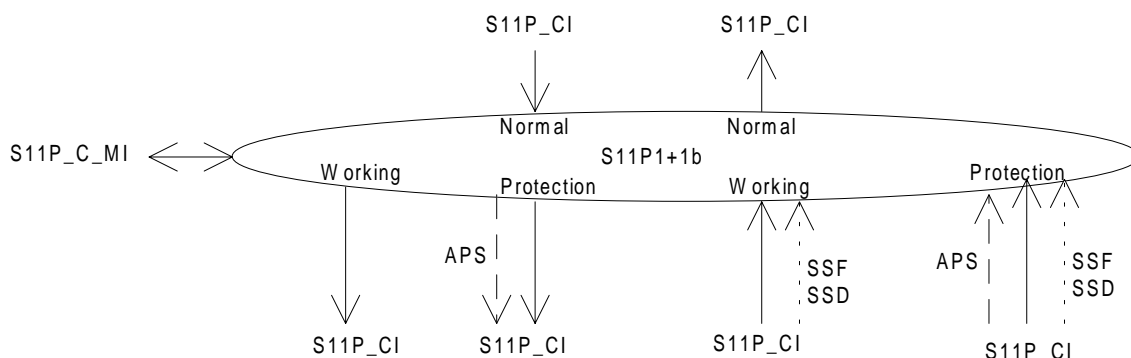

Figure F.20: S11P1+1b_C symbol

Interfaces:

Table F.19: S11P1+1b_C input and output signals

Input(s)	Output(s)
for connection points W and P: S11P_CI_D S11P_CI_CK S11P_CI_FS S11P_CI_SSF S11P_CI_SSD	for connection points W and P: S11P_CI_D S11P_CI_CK S11P_CI_FS
for connection point N: S11P_CI_D S11P_CI_CK S11P_CI_FS	for connection point N: S11P_CI_D S11P_CI_CK S11P_CI_FS S11P_CI_SSF
for connection point P: S11P_CI_APS	for connection point P: S11P_CI_APS
S11P_C_MI_OPERType S11P_C_MI_WTRTime S11P_C_MI_HOTime S11P_C_MI_EXTCMD	NOTE: Protection status reporting signals are for further study.

Processes:

The function performs the VC-11 linear trail protection process for 1+1 protection architecture with bi-directional switching; refer to EN 300 417-1-1 [6], subclause 9.2. It performs the bridge and selector functionality as presented in figure 49 of EN 300 417-1-1 [6]. In the sink direction, the signal output at the normal reference point can be the signal received via either the associated working path or the protection path; this is determined by the SF,SD conditions (relayed via CI_SSF,CI_SSD signals), and the external commands. In the source direction, the working output is connected to the associated normal input. The protection output is also connected to the normal input.

Provided no protection switching action is activated/required the following changes to (the configuration of) a trail shall be possible without disturbing the CI passing the trail:

- change between operation types;
- change of WTR and HO times.

Operation:

The VC trail protection process shall operate as specified in EN 300 417-3-1 [7], annex A, according the following characteristics:

Table F.20: Trail protection parameters

Parameter	Value options
architecture type (ARCHtype)	1 + 1
switching type (SWtype)	bi-directional
operation type (OPERtype)	revertive, non-revertive
APS signal (APSmode)	true
Wait-To-Restore time (WTRtime)	in the order of 5 to 12 minutes
Switch time	≤ 50 ms
Hold-off time (HOfime)	0 to 10 seconds in steps of the order of 100 ms
Protection type (PROTtype)	trail
Signal switch conditions:	SF = SSF (originated as AI_TSF) SD = SSD (originated as AI_TSD)
External commands (EXTMND)	(revertive operation) LO, FSw-#1, MSw-#1, CLR (non-revertive operation) LO or FSw, FSw-#i, MSw-#i, EXER-#i, CLR (i=0,1)
Extra traffic (EXTRAtraffic)	false
SFpriority, SDpriority	high

NOTE: The VC-11 APS signal definition is for further study.

Defects:	None.
Consequent Actions:	None.
Defect Correlations:	None.
Performance Monitoring:	None.

F.5.2 VC-11 Layer Trail Protection Trail Termination Functions

F.5.2.1 VC-11 Protection Trail Termination Source S11P_TT_So

Symbol:

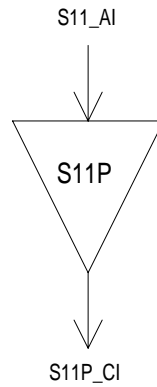

Figure F.21: S11P_TT_So symbol

Interfaces:

Table F.21: S11P_TT_So input and output signals

Input(s)	Output(s)
S11P_AI_D	S11P_CI_D
S11P_AI_CK	S11P_CI_CK
S11P_AI_FS	S11P_CI_FS

Processes:

No information processing is required in the S11P_TT_So, the S11_AI at its output is identical to the S11P_CI at its input.

Defects: None.

Consequent Actions: None.

Defect Correlations: None.

Performance Monitoring: None.

F.5.2.2 VC-11 Protection Trail Termination Sink S11P_TT_Sk

Symbol:

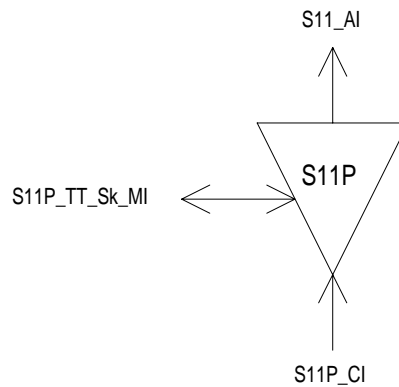

Figure F.22: S11P_TT_Sk symbol

Interfaces:

Table F.22: S11P_TT_Sk input and output signals

Input(s)	Output(s)
S11P_CI_D	S11_AI_D
S11P_CI_CK	S11_AI_CK
S11P_CI_FS	S11_AI_FS
S11P_CI_SSF	S11_AI_TSF
S11P_TT_Sk_MI_SSF_Reported	S11P_TT_Sk_MI_cSSF

Processes:

The S11P_TT_Sk function reports, as part of the S11 layer, the state of the protected VC-11 trail. In case all trails are unavailable the S11P_TT_Sk reports the signal fail condition of the protected trail.

Defects: None.

Consequent Actions:

aTSF ← CI_SSF

Defect Correlations:

cSSF ← CI_SSF and SSF_Reported

Performance Monitoring: None.

F.5.3 VC-11 Layer Linear Trail Protection Adaptation Functions

F.5.3.1 VC-11 trail to VC-11 trail Protection Layer Adaptation Source S11/S11P_A_So

Symbol:

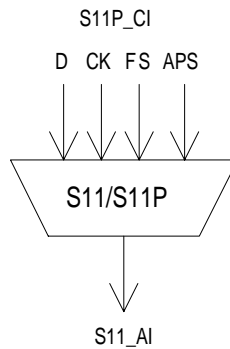

Figure F.23: S11/S11P_A_Sk symbol

Interfaces:

Table F.23: S11/S11P_A_So input and output signals

Input(s)	Output(s)
S11P_CI_D	S11_AI_D
S11P_CI_CK	S11_AI_CK
S11P_CI_FS	S11_AI_FS
S11P_CI_APS	

Processes:

The function shall multiplex the S11 APS signal and S11 data signal onto the S11 access point.

K4[1-4]: The insertion of the VC-APS signal is for further study. This process is required only for the protection path.

Defects: None.

Consequent actions: None.

Defect Correlations: None.

Performance Monitoring: None.

F.5.3.2 VC-11 trail to VC-11 trail Protection Layer Adaptation Sink S11/S11P_A_Sk

Symbol:

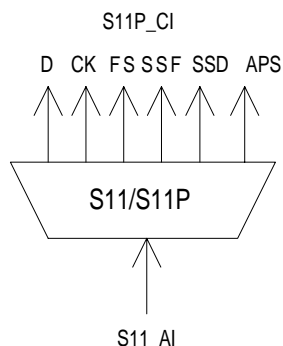

Figure F.24: S11/S11P_A_Sk symbol

Interfaces:

Table F.24: S11/S11P_A_Sk input and output signals

Input(s)	Output(s)
S11_AI_D	S11P_CI_D
S11_AI_CK	S11P_CI_CK
S11_AI_FS	S11P_CI_FS
S11_AI_TSF	S11P_CI_SSF
S11_AI_TSD	S11P_CI_SSD
	S11P_CI_APS (for Protection signal only)

Processes:

The function shall extract and output the S11P_CI_D signal from the S11_AI_D signal.

K4[1-4]: The extraction and persistency processing of the VC-APS signal is for further study. This process is required only for the protection path.

Defects: None.

Consequent actions:

aSSF ← AI_TSF

aSSD ← AI_TSD

Defect Correlations: None.

Performance Monitoring: None.

F.6 VC-11 Tandem Connection Sublayer Functions

F.6.1 VC-11 Tandem Connection Trail Termination Source function (S11D_TT_So)

Symbol:

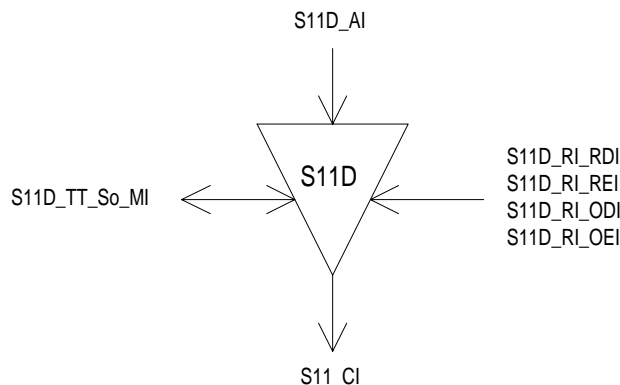

Figure F.25: S11D_TT_So symbol

Interfaces:

Table F.25: S11D_TT_So input and output signals

Input(s)	Output(s)
S11D_AI_D	S11_CI_D
S11D_AI_CK	S11_CI_CK
S11D_AI_FS	S11_CI_FS
S11D_AI_SF	
S11D_RI_RDI	
S11D_RI_REI	
S11D_RI_ODI	
S11D_RI_OEI	
S11D_TT_So_MI_TxTI	

Processes:

N2[8][73]: The function shall insert the TC RDI code within 1 multiframe (38 ms) after the RDI request generation (aRDI) in the tandem connection trail termination sink function. It ceases TC RDI code insertion within 1 multiframe (38 ms) after the RDI request has cleared.

NOTE: N2[x][y] refers to bit x (x = 7,8) of byte N2 in frame y (y=1..76) of the 76 frame multiframe. This multiframe is 38 ms long since N2 appears in the low order path overhead once each four STM-N frames.

N2[3]: The function shall insert a "1" in this bit.

N2[4]: The function shall insert an incoming AIS code in this bit. If AI_SF is true this bit will be set to the value "1", otherwise value "0" shall be inserted.

N2[5]: The function shall insert the RI_REI value in the REI bit in the following frame.

N2[7][74]: The function shall insert the ODI code at the first opportunity after the ODI request generation (RI_ODI) in the tandem connection trail termination sink function. It ceases ODI code insertion at the first opportunity after the ODI request has cleared.

N2[6]: The function shall insert the RI_OEI value in the OEI bit in the following frame.

N2[7-8]: The function shall insert in the multiframe N2[7-8] channel:

- the Frame Alignment Signal (FAS) "1111 1111 1111 1110" in FAS bits in frames 1 to 8;
- the TC trace identifier, received via MI_TxTI, in the TC-TI bits in frames 9 to 72;
- the TC RDI (N2[8][73]) and ODI (N2[7][74]) signals; and
- all-0s in the six reserved bits in frames 73 to 76.

N2[1-2]: The function shall calculate a BIP2 over the VC-11, and insert this value in TC BIP2 in the next frame (see figure F.26).

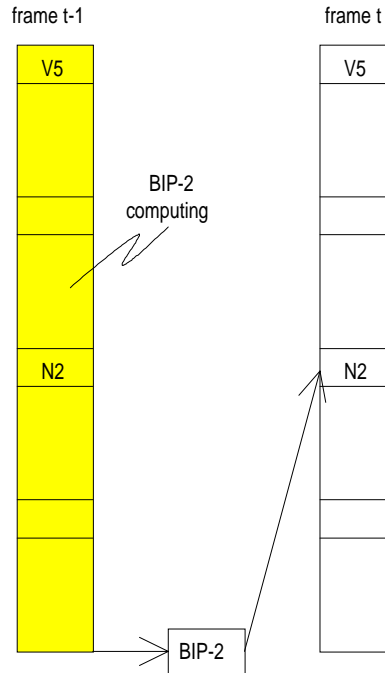

Figure F.26: TC BIP-2 computing and insertion

V5[1-2]: The function shall compensate the VC11 BIP2 (in bits 1 and 2 of byte V5) according the following rule:

Since the BIP-2 parity check is taken over the VC (including N2), writing into N2 at the S11D_TT_So will affect the VC-11 path parity calculation. Unless this is compensated for, a device which monitors VC-11 path parity within the Tandem Connection (e.g., a non-intrusive monitor) may incorrectly count errors. The BIP-2 parity bits should always be consistent with the current state of the VC. Therefore, whenever N2 is written, BIP-2 shall be modified to compensate for the change in the N2 value. Since the BIP-2 value in a given frame reflects a parity check over the previous frame (including the BIP-2 bits in that frame), the changes made to the BIP-2 bits in the previous frame shall also be considered in the compensation of BIP-2 for the current frame. Therefore, the following equation shall be used for BIP-2 compensation:

$$\begin{aligned}
 V5[1]'(t) &= V5[1](t-1) \\
 &\oplus V5[1]'(t-1) \\
 &\oplus N2[1](t-1) \oplus N2[3](t-1) \oplus N2[5](t-1) \oplus N2[7](t-1) \\
 &\oplus N2[1]'(t-1) \oplus N2[3]'(t-1) \oplus N2[5]'(t-1) \oplus N2[7]'(t-1) \\
 &\oplus V5[1](t)
 \end{aligned}$$

$$\begin{aligned}
 V5[2]'(t) &= V5[2](t-1) \\
 &\oplus V5[2]'(t-1) \\
 &\oplus N2[2](t-1) \oplus N2[4](t-1) \oplus N2[6](t-1) \oplus N2[8](t-1) \\
 &\oplus N2[2]'(t-1) \oplus N2[4]'(t-1) \oplus N2[6]'(t-1) \oplus N2[8]'(t-1) \\
 &\oplus V5[2](t)
 \end{aligned}$$

Where:

V5[i] = the existing V5[i] value in the incoming signal

$V5[i]'$ = the new (compensated) $V5[i]$ value

$N2[i]$ = the existing $N2[i]$ value in the incoming signal

$N2[i]'$ = the new value written into the $N2[i]$ bit

\oplus = exclusive OR operator

t = the time of the current frame

$t-1$ = the time of the previous frame

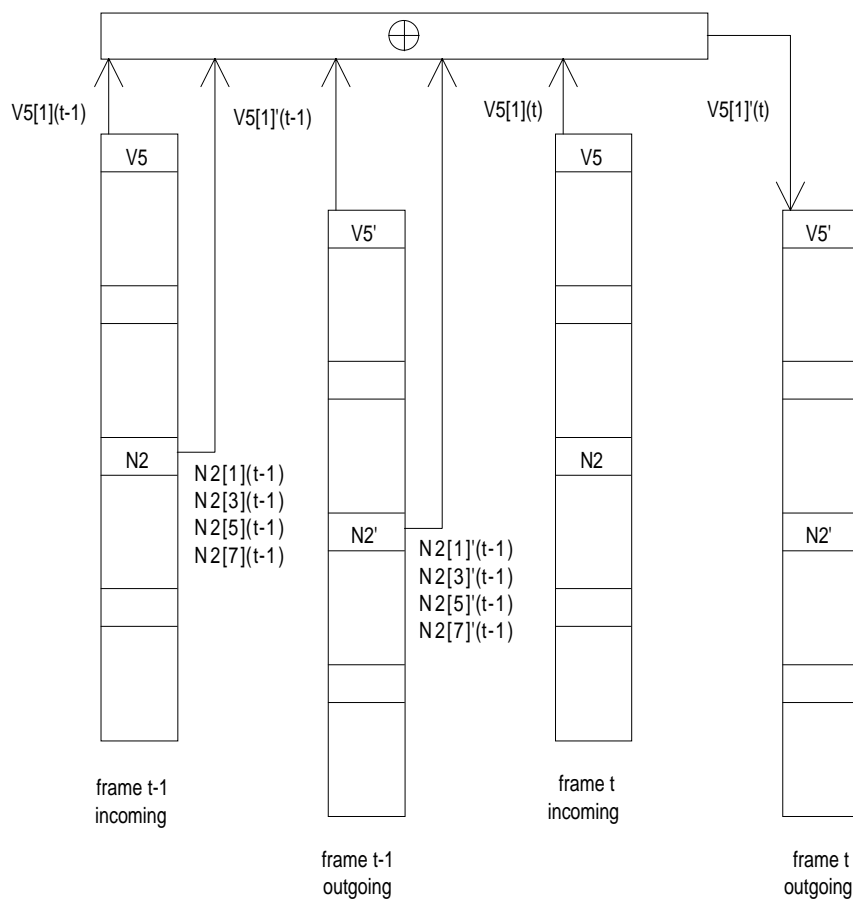

Figure F.27: V5[1] compensating process

Defects: None.

Consequent Actions: None.

Defect Correlations: None.

Performance Monitoring: None.

F.6.2 VC-11 Tandem Connection Trail Termination Sink function (S11D_TT_Sk)

Symbol:

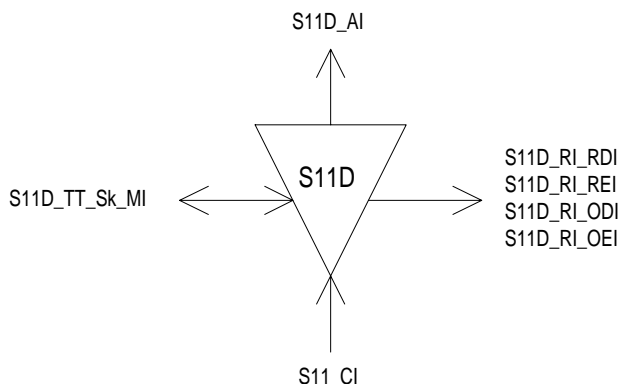

Figure F.28: S11D_TT_Sk symbol

Interfaces:

Table F.26: S11D_TT_Sk input and output signals

Input(s)	Output(s)
S11_CI_D	S11D_AI_D
S11_CI_CK	S11D_AI_CK
S11_CI_FS	S11D_AI_FS
S11_CI_SSF	S11D_AI_TSF
S11D_TT_Sk_MI_ExtI	S11D_AI_TSD
S11D_TT_Sk_MI_SSF_Reported	S11D_AI_OSF
S11D_TT_Sk_MI_RDI_Reported	S11D_TT_Sk_MI_cLTC
S11D_TT_Sk_MI_ODI_Reported	S11D_TT_Sk_MI_cTIM
S11D_TT_Sk_MI_TIMdis	S11D_TT_Sk_MI_cUNEQ
S11D_TT_Sk_MI_DEGM	S11D_TT_Sk_MI_cDEG
S11D_TT_Sk_MI_DEGTHR	S11D_TT_Sk_MI_cRDI
S11D_TT_Sk_MI_1second	S11D_TT_Sk_MI_cSSF
S11D_TT_Sk_MI_TPmode	S11D_TT_Sk_MI_cODI
	S11D_TT_Sk_MI_AcTI
	S11D_RI_RDI
	S11D_RI_REI
	S11D_RI_ODI
	S11D_RI_OEI
	S11D_TT_Sk_MI_pN_EBC
	S11D_TT_Sk_MI_pF_EBC
	S11D_TT_Sk_MI_pN_DS
	S11D_TT_Sk_MI_pF_DS
	S11D_TT_Sk_MI_pON_EBC
	S11D_TT_Sk_MI_pOF_EBC
	S11D_TT_Sk_MI_pON_DS
	S11D_TT_Sk_MI_pOF_DS

Processes:

N2[1-2]: Even BIP-2 is computed for each bit pair of every byte of the preceding VC-11 including V5 and N2 and compared with bit 1 and 2 of V5 and N2 recovered from the current frame (see figure F.29). A difference between the computed and recovered BIP-2 values is taken as evidence of an errored block (nN_B) in the computation block.

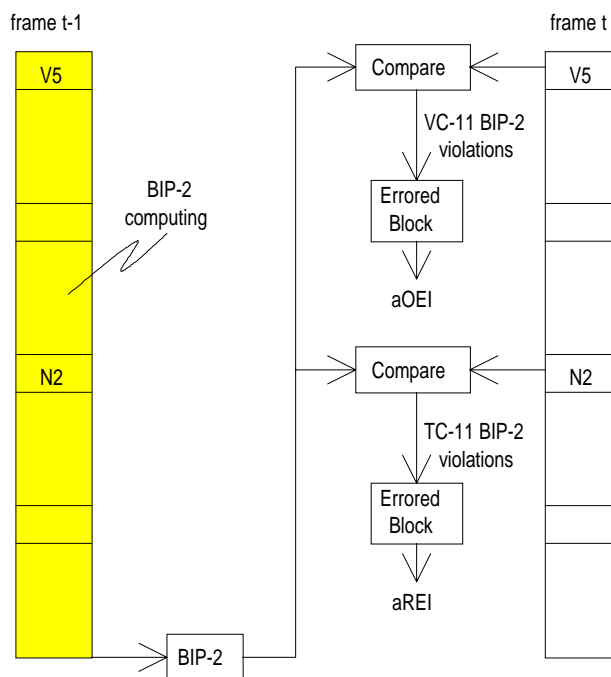

Figure F.29: TC-11 and VC-11 BIP-2 computing and comparison

N2[7-8]: The Received Trail Trace Identifier RxTI shall be recovered from the tandem connection trail trace identifier overhead and shall be made available as AcTI for network management purposes. The application and acceptance process shall be performed as specified in EN 300 417-1-1 [6], subclauses 7.1 and 8.2.1.3. The mismatch detection process shall be as specified below.

The trace identifier process in this function is required to support "mode 1" (EN 300 417-1-1 [6], subclause 7.1) operation only. "Old" tandem connection equipment does not exist.

N2[4]: The function shall extract the Incoming AIS code.

N2[5], N2[8][73]: The information carried in the REI, RDI bits in byte N2 shall be extracted to enable single ended maintenance of a bi-directional tandem connection Trail. The REI (nF_B) shall be used to monitor the error performance of the other direction of transmission, and the RDI shall be used to provide information as to the status of the remote receiver. A "1" indicates a Remote Defect Indication state, while a "0" indicates the normal, working state. The application process shall be performed as specified in EN 300 417-1-1 [6], subclauses 7.4.2 (REI), 7.4.11 and 8.2 (RDI).

N2[6], N2[7][74]: The information carried in the OEI, ODI bits in byte N2 shall be extracted to enable single ended (intermediate) maintenance of a the VC-12 egressing the tandem connection Trail. The OEI (nOF_B) shall be used to monitor the error performance of the other direction of transmission, and the ODI shall be used to provide information as to the status of the remote receiver. A "1" indicates a Outgoing Defect Indication state, while a "0" indicates the normal, working state. The application process shall be performed equivalent to the remote maintenance case, as specified in EN 300 417-1-1 [6], subclauses 7.4.2 (REI/OEI), 7.4.11 and 8.2 (RDI/ODI).

N2[7-8]: *Multiframe alignment:*

The function shall perform a multiframe alignment on bits 7 and 8 of byte N2 to recover the TTI, RDI, and ODI signals transported within the multiframe bits. The multiframe alignment shall be found by searching for the pattern "1111 1111 1111 1110" within the bits 7 and 8 of byte N2. The signal shall be continuously checked with the presumed multiframe start position for the alignment.

Frame alignment is deemed to have been lost (entering Out Of Multiframe (OOM) state) when two consecutive FAS are detected in error (i.e. ≥ 1 error in each FAS).

Frame alignment is deemed to have been recovered (entering In Multiframe (IM) state) when one non-errored FAS is found.

V5[1-2]: Even BIP-2 is computed for each bit pair of every byte of the preceding VC-11 including V5 and compared with bit 1 and 2 of V5 recovered from the current frame. A difference between the computed and recovered BIP-2 values is taken as evidence of an errored block (nON_B) in the computation block.

N2: The function shall terminate N2 channel by inserting an all-ZEROs pattern.

V5[1-2]: The function shall compensate the VC11 BIP2 in bits 1 and 2 of byte V5 according the algorithm defined in S11D_TT_So.

Defects:

TC Unequipped (dUNEQ):

The function shall detect for an unequipped Tandem Connection (UNEQ) condition by monitoring byte N2 for code "00000000". The unequipped defect (dUNEQ) shall be detected if five consecutive VC-n frames contain the "0000 0000" pattern in byte N2. The dUNEQ defect shall be cleared if in five consecutive VC-n frames any pattern other than the "0000 0000" is detected in byte N2.

TC Loss of Tandem Connection (dLTC):

The function shall detect for the presence/absence of the tandem connection overhead in the byte N2 by evaluating the multiframe alignment signal in bits 7 and 8 of byte N2. The loss of tandem connection defect (dLTC) shall be detected if the multiframe alignment process is in the OOM state. The dLTC shall be cleared if the multiframe alignment process is in the IM state.

TC Connectivity (Trace Identifier) (dTIM):

The function shall detect for a TC mis-connection condition by monitoring the TC trace identifier. The Trace Identifier Mismatch defect (dTIM) shall be detected and cleared within a maximum period of 1 s in the absence of bit errors.

The defect detection process and its operation during the presence of bit errors is for further study.

The defect shall be suppressed during the receipt of SSF.

It shall be possible to disable the trace identifier mismatch defect detection (TIMdis).

TC Signal Degrade (dDEG):

The function shall detect for a TC signal degrade defect condition by monitoring for TC BIP2 violations. The algorithm shall be according subclause 8.2.1.4 of EN 300 417-1-1 [6].

TC Remote Defect (dRDI):

The function shall detect for a TC remote defect indication defect condition by monitoring the TC RDI signal. The algorithm shall be according subclause 8.2.1.5 of EN 300 417-1-1 [6].

TC Remote Outgoing VC Defect (dODI):

The function shall detect for a TC remote outgoing VC defect indication defect condition by monitoring the TC ODI signal. The algorithm shall be according subclause 8.2.1.5 of EN 300 417-1-1 [6].

Incoming AIS (dIncAIS):

The function shall detect for a tandem connection incoming AIS condition by monitoring bit 4 in byte N2 for code "1". If 5 consecutive frames contain the value "1" in bit 4 a dIncAIS defect shall be detected. dIncAIS shall be cleared if in 5 consecutive frames value "0" is detected in bit 4 of byte N2.

Consequent Actions:

The function shall perform the following consequent actions (refer to subclause 8.2.2 of EN 300 417-1-1 [6]):

aAIS	←	dUNEQ or dTIM or dLTC
aTSF	←	CI_SSF or dUNEQ or dTIM or dLTC
aTSD	←	dDEG
aRDI	←	CI_SSF or dUNEQ or dTIM or dLTC
aREI	←	nN_B
aODI	←	CI_SSF or dUNEQ or dTIM or dIncAIS or dLTC
aOEI	←	nON_B
aOSF	←	CI_SSF or dUNEQ or dTIM or dLTC or dIncAIS

The function shall insert the all-ONES (AIS) signal within 1 ms after AIS request generation (aAIS), and cease the insertion within 1 ms after the AIS request has cleared.

Defect Correlations:

The function shall perform the following defect correlations (refer to subclause 8.2.3 of EN 300 417-1-1 [6]):

cUNEQ	←	MON and dUNEQ
cLTC	←	MON and (not dUNEQ) and dLTC
cTIM	←	MON and (not dUNEQ) and (not dLTC) and dTIM
cDEG	←	MON and (not dTIM) and (not dLTC) and dDEG
cSSF	←	MON and CI_SSF and SSF_Reported
cRDI	←	MON and (not dUNEQ) and (not dTIM) and (not dLTC) and dRDI and RDI_Reported
cODI	←	MON and (not dUNEQ) and (not dTIM) and (not dLTC) and dODI and ODI_Reported

Performance Monitoring:

The following TC error performance parameters shall be counted for each 1 second period (refer to subclauses 8.2.4 to 8.2.7 of EN 300 417-1-1 [6]):

pN_DS	←	aTSF or dEQ
pF_DS	←	dRDI
pN_EBC	←	ΣnN_B
pF_EBC	←	ΣnF_B
pON_DS	←	aODI
pOF_DS	←	dODI
pON_EBC	←	ΣnON_B
pOF_EBC	←	ΣnOF_B

pN_EBC and pN_DS does not represent the actual performance monitoring support within an equipment. For that, these pN_DS/pN_EBC signals shall be connected to performance monitoring functions within the element management function. Similar for the far-end signals pF_EBC and pF_DS, and for pON_EBC/pON_DS, pOF_EBC/pOF_DS.

F.6.3 VC-11 Tandem Connection to VC-11 Adaptation Source function (S11D/S11_A_So)

Symbol:

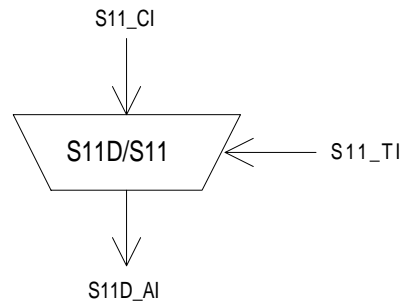

Figure F.30: S11D/S11_A_So symbol

Interfaces:

Table F.27: S11D/S11_A_Sk input and output signals

Input(s)	Output(s)
S11_CI_D	S11D_AI_D
S11_CI_CK	S11D_AI_CK
S11_CI_FS	S11D_AI_FS
S11_CI_SSF	S11D_AI_SF
S11_TI_CK	

Processes:

NOTE 1: The function has no means to verify the existence of a tandem connection within the incoming signal. Nested tandem connections are not supported.

The function shall replace the incoming Frame Start (CI_FS) signal by a local generated one (i.e. enter "holdover") if an all-ONEs (AIS) VC is received (i.e. if CI_SSF is TRUE).

NOTE 2: This replacement of the (invalid) incoming frame start signal result in the generation of a valid pointer in e.g. the S4/S11_A_So function; SSF = true signal is not passed through via S11D_TT_So to the S4/S11_A_So.

NOTE 3: The local frame start is generated with the S12_TI timing.

Defects: None.

Consequent Actions:

AI_SF ← CI_SSF

Defect Correlations: None.

Performance Monitoring: None.

F.6.4 VC-11 Tandem Connection to VC-11 Adaptation Sink function (S11D/S11_A_Sk)

Symbol:

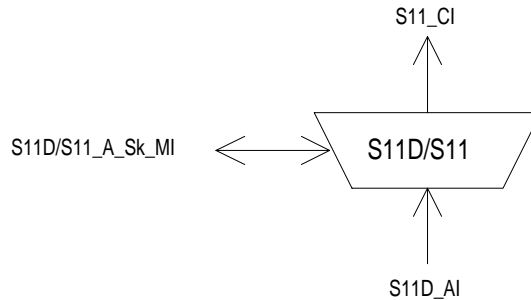

Figure F.31: S11D/S11_A_Sk symbol

Interfaces:

Table F.28: S11D/S11_A_Sk input and output signals

Input(s)	Output(s)
S11D_AI_D	S11_CI_D
S11D_AI_CK	S11_CI_CK
S11D_AI_FS	S11_CI_FS
S11D_AI_OSF	S11_CI_SSF

Processes:

The function shall restore the invalid frame start condition (i.e. output aSSF = true) if that existed at the ingress of the tandem connection.

NOTE: In addition, the invalid frame start condition is activated on a tandem connection connectivity defect condition that causes all-ONES (AIS) insertion in the S11D_TT_Sk.

Defects: None.

Consequent Actions:

aAIS ← AI_OSF

aSSF ← AI_OSF

The function shall insert the all-ONES (AIS) signal within 1 ms after AIS request generation (aAIS), and cease the insertion within 1 ms after the AIS request has cleared.

Defect Correlations: None.

Performance Monitoring: None.

F.6.5 VC-11 Tandem Connection Non-intrusive Monitoring Trail Termination Sink function (S11Dm_TT_Sk)

Symbol:

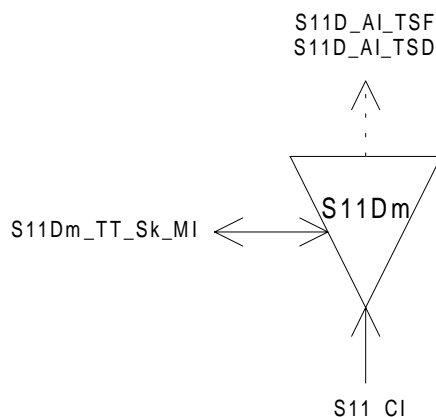

Figure F.32: S11Dm_TT_Sk symbol

Interfaces:

Table F.29: S11Dm_TT_Sk input and output signals

Input(s)	Output(s)
S11D_CI_D	S11D_AI_TSF
S11D_CI_CK	S11D_AI_TSD
S11D_CI_FS	S11D_TT_Sk_MI_cLTC
S11D_CI_SSF	S11D_TT_Sk_MI_cTIM
S11D_TT_Sk_MI_ExTI	S11D_TT_Sk_MI_cUNEQ
S11D_TT_Sk_MI_SSF_Reported	S11D_TT_Sk_MI_cDEG
S11D_TT_Sk_MI_RDI_Reported	S11D_TT_Sk_MI_cRDI
S11D_TT_Sk_MI_ODI_Reported	S11D_TT_Sk_MI_cSSF
S11D_TT_Sk_MI_TIMdis	S11D_TT_Sk_MI_cODI
S11D_TT_Sk_MI_DEGM	S11D_TT_Sk_MI_AcTI
S11D_TT_Sk_MI_DEGTHR	S11D_TT_Sk_MI_pN_EBC
S11D_TT_Sk_MI_1second	S11D_TT_Sk_MI_pF_EBC
S11Dm_TT_Sk_MI_TPmode	S11D_TT_Sk_MI_pN_DS
	S11D_TT_Sk_MI_pF_DS
	S11D_TT_Sk_MI_pOF_EBC
	S11D_TT_Sk_MI_pOF_DS

Processes:

This function can be used to perform the following:

- 1) single ended maintenance of the TC by monitoring at an intermediate node, using remote information (RDI,REI);
- 2) aid in fault localization within TC trail by monitoring near-end defects;
- 3) monitoring of VC performance at TC egressing point(except for connectivity defects before the TC) using remote outgoing information (ODI,OEI);
- 4) performing non-intrusive monitor function within SNC/S protection.

N2[1-2]: Even BIP-2 is computed for each bit pair of every byte of the preceding VC-11 including V5 and N2 and compared with bits 1 and 2 of V5 and N2 recovered from the current frame (see figure F.26). A difference between the computed and recovered BIP-2 values is taken as evidence of an errored block (nN_B) in the computation block. Refer to S11D_TT_Sk.

N2[7-8][9-72]: The Received Trail Trace Identifier RxTI shall be recovered from the tandem connection trail trace identifier overhead and shall be made available as AcTI for network management purposes. The application and acceptance process shall be performed as specified in EN 300 417-1-1 [6], subclauses 7.1 and 8.2.1.3. The mismatch detection process shall be as specified below.

The trace identifier process in this function is required to support "mode 1" (EN 300 417-1-1 [6], subclause 7.1) operation only. "Old" tandem connection equipment does not exist.

N2[5], N2[8][73]: The information carried in the REI, RDI bits in byte N2 shall be extracted to enable single ended maintenance of a bi-directional tandem connection Trail. The REI (nF_B) shall be used to monitor the error performance of the other direction of transmission, and the RDI shall be used to provide information as to the status of the remote receiver. A "1" indicates a Remote Defect Indication state, while a "0" indicates the normal, working state. The application process shall be performed as specified in EN 300 417-1-1 [6], subclauses 7.4.2 (REI), 7.4.11 and 8.2 (RDI).

N2[6], N2[7][74]: (nOF_B). The information carried in the OEI, ODI bits in byte N2 shall be extracted to enable single ended (intermediate) maintenance of a the VC-11 egressing the tandem connection Trail. The OEI (nOF_B) shall be used to monitor the error performance of the other direction of transmission, and the ODI shall be used to provide information as to the status of the remote receiver. A "1" indicates a Outgoing Defect Indication state, while a "0" indicates the normal, working state. The application process shall be performed equivalent to the remote maintenance case, as specified in EN 300 417-1-1 [6], subclauses 7.4.2 (REI/OEI), 7.4.11 and 8.2 (RDI/ODI).

N2[7-8]: *Multiframe alignment:*

The function shall perform a multiframe alignment on bits 7 and 8 of byte N2 to recover the TTI, RDI, and ODI signals transported within the multiframe bits. The multiframe alignment shall be found by searching for the pattern "1111 1111 1111 1110" within the bits 7 and 8 of byte N2. The signal shall be continuously checked with the presumed multiframe start position for the alignment.

Frame alignment is deemed to have been lost (entering Out Of Multiframe (OOM) state) when two consecutive FAS are detected in error (i.e. ≥ 1 error in each FAS).

Frame alignment is deemed to have been recovered (entering In Multiframe (IM) state) when one non-errored FAS is found.

Defects:

TC Unequipped (dUNEQ):

The function shall detect for an unequipped Tandem Connection (UNEQ) condition by monitoring byte N2 for code "00000000". The unequipped defect (dUNEQ) shall be detected if five consecutive VC-n frames contain the "0000 0000" pattern in byte N2. The dUNEQ defect shall be cleared if in five consecutive VC-n frames any pattern other than the "0000 0000" is detected in byte N2.

TC Loss of Tandem Connection (dLTC):

The function shall detect for the presence/absence of the tandem connection overhead in the byte N2 by evaluating the multiframe alignment signal in bits 7 and 8 of byte N2. The loss of tandem connection defect (dLTC) shall be detected if the multiframe alignment process is in the OOM state. The dLTC shall be cleared if the multiframe alignment process is in the IM state.

TC Connectivity (Trace Identifier) (dTIM):

The function shall detect for a TC mis-connection condition by monitoring the TC trace identifier. The Trace Identifier Mismatch defect (dTIM) shall be detected and cleared within a maximum period of 1 s in the absence of bit errors.

The defect detection process and its operation during the presence of bit errors is for further study.

The defect shall be suppressed during the receipt of SSF.

It shall be possible to disable the trace identifier mismatch defect detection (TIMdis).

TC Signal Degrade (dDEG):

The function shall detect for a TC signal degrade defect condition by monitoring for TC BIP2 violations. The algorithm shall be according subclause 8.2.1.4 of EN 300 417-1-1 [6].

TC Remote Defect (dRDI):

The function shall detect for a TC remote defect indication defect condition by monitoring the TC RDI signal. The algorithm shall be according subclause 8.2.1.5 of EN 300 417-1-1 [6].

TC Remote Outgoing VC Defect (dODI):

The function shall detect for a TC remote outgoing VC defect indication defect condition by monitoring the TC ODI signal. The algorithm shall be according subclause 8.2.1.5 of EN 300 417-1-1 [6].

Consequent Actions:

aTSF ← CI_SSF or dUNEQ or dTIM or dLTC
 aTSD ← dDEG

Defect Correlations:

The function shall perform the following defect correlations (refer to subclause 8.2.3 of EN 300 417-1-1 [6]):

cUNEQ ← MON and dUNEQ
 cLTC ← MON and (not dUNEQ) and dLTC
 cTIM ← MON and (not dUNEQ) and (not dLTC) and dTIM
 cDEG ← MON and (not dTIM) and (not dLTC) and dDEG
 cSSF ← MON and CI_SSF and SSF_Reported
 cRDI ← MON and (not dUNEQ) and (not dTIM) and (not dLTC) and dRDI and RDI_Reported
 cODI ← MON and (not dUNEQ) and (not dTIM) and (not dLTC) and dODI and ODI_Reported

Performance Monitoring:

The following TC error performance parameters shall be counted for each 1-second period (refer to subclauses 8.2.4 to 8.2.7 of EN 300 417-1-1 [6]):

pN_DS ← aTSF or dEQ
 pF_DS ← dRDI
 pN_EBC ← ΣnN_B
 pF_EBC ← ΣnF_B
 pOF_DS ← dODI
 pOF_EBC ← ΣnOF_B

pN_EBC and pN_DS does not represent the actual performance monitoring support within an equipment. For that, these pN_DS/pN_EBC signals shall be connected to performance monitoring functions within the element management function. Similar for the far-end signals pF_EBC and pF_DS and for pOF_EBC/pOF_DS.

Bibliography

- ITU-T Recommendation G.707: "Network node interface for the Synchronous Digital Hierarchy (SDH)".
- EN 300 417-5-1: "Transmission and Multiplexing (TM); Generic requirements of transport functionality of equipment; Part 5-1: PDH path layer functions".
- ITU-T Recommendation G.751 (1988): "Digital multiplex equipments operating at the third order bit rate of 34 368 kbit/s and the fourth order bit rate of 139 264 kbit/s and using positive justification".

History

Document history		
Edition 1	April 1997	Publication as ETS 300 417-4-1
V1.1.2	November 1998	Publication (Converted to EN 300 417-4-1)