

ETSI EN 300 396-4 V1.3.1 (2006-05)

European Standard (Telecommunications series)

Terrestrial Trunked Radio (TETRA); Technical requirements for Direct Mode Operation (DMO); Part 4: Type 1 repeater air interface



Reference

REN/TETRA-08079-4

Keywords

TETRA, DMO, protocol, radio, air interface

ETSI

650 Route des Lucioles
F-06921 Sophia Antipolis Cedex - FRANCE

Tel.: +33 4 92 94 42 00 Fax: +33 4 93 65 47 16

Siret N° 348 623 562 00017 - NAF 742 C
Association à but non lucratif enregistrée à la
Sous-Préfecture de Grasse (06) N° 7803/88

Important notice

Individual copies of the present document can be downloaded from:

<http://www.etsi.org>

The present document may be made available in more than one electronic version or in print. In any case of existing or perceived difference in contents between such versions, the reference version is the Portable Document Format (PDF). In case of dispute, the reference shall be the printing on ETSI printers of the PDF version kept on a specific network drive within ETSI Secretariat.

Users of the present document should be aware that the document may be subject to revision or change of status. Information on the current status of this and other ETSI documents is available at

<http://portal.etsi.org/tb/status/status.asp>

If you find errors in the present document, please send your comment to one of the following services:

http://portal.etsi.org/chaicor/ETSI_support.asp

Copyright Notification

No part may be reproduced except as authorized by written permission.
The copyright and the foregoing restriction extend to reproduction in all media.

© European Telecommunications Standards Institute 2006.
All rights reserved.

DECTTM, **PLUGTESTS**TM and **UMTS**TM are Trade Marks of ETSI registered for the benefit of its Members.
TIPHONTM and the **TIPHON logo** are Trade Marks currently being registered by ETSI for the benefit of its Members.
3GPPTM is a Trade Mark of ETSI registered for the benefit of its Members and of the 3GPP Organizational Partners.

Contents

| | |
|---|----|
| Intellectual Property Rights | 10 |
| Foreword..... | 10 |
| 1 Scope | 11 |
| 2 References | 11 |
| 3 Definitions and abbreviations..... | 12 |
| 3.1 Definitions | 12 |
| 3.2 Abbreviations | 15 |
| 4 Overview of protocol..... | 16 |
| 4.1 General | 16 |
| 4.2 The DM channel..... | 18 |
| 4.3 DM call procedures for operation with a type 1 DM-REP | 19 |
| 4.3.1 Constraints on the frame structure | 20 |
| 4.3.2 Setting up a call | 20 |
| 4.3.2.1 Call set-up without presence check..... | 21 |
| 4.3.2.2 Call set-up with presence check..... | 22 |
| 4.3.3 Changeover in a call | 22 |
| 4.3.4 Pre-emption of a DM call | 23 |
| 4.3.5 Terminating a call..... | 24 |
| 4.3.6 DM short data call | 24 |
| 4.3.6.1 Unacknowledged short data message..... | 24 |
| 4.3.6.2 Acknowledged short data message | 25 |
| 5 DM-MS layer 3 service description for operation with a type 1 DM-REP..... | 26 |
| 5.1 Introduction | 26 |
| 5.2 Services offered..... | 26 |
| 5.3 Primitive description | 26 |
| 5.4 Parameter description..... | 26 |
| 5.5 States for DMCC-SAP | 26 |
| 6 DM-MS layer 3 protocol for operation with a type 1 DM-REP..... | 27 |
| 6.1 Introduction | 27 |
| 6.1.1 DMCC protocol states | 27 |
| 6.2 Circuit mode calls..... | 27 |
| 6.2.1 Procedures for call set-up without presence check | 27 |
| 6.2.1.1 Outgoing call..... | 27 |
| 6.2.1.2 Incoming call..... | 28 |
| 6.2.1.3 Temporary group address..... | 28 |
| 6.2.2 Procedures for call set-up with presence check | 28 |
| 6.2.2.1 Outgoing call..... | 28 |
| 6.2.2.2 Incoming call..... | 28 |
| 6.2.3 Usage of DM-OCCUPIED PDU | 28 |
| 6.2.3.1 Sending of DM-OCCUPIED PDU by master DM-MS..... | 28 |
| 6.2.3.2 Late entry by slave DM-MS..... | 28 |
| 6.2.4 Procedures during occupation..... | 29 |
| 6.2.4.1 Master DM-MS | 29 |
| 6.2.4.2 Slave DM-MS | 29 |
| 6.2.4.3 Transmitting Party Number Identification (TPNI)..... | 29 |
| 6.2.5 Procedures during reservation..... | 29 |
| 6.2.5.1 Master DM-MS | 29 |
| 6.2.5.2 Slave DM-MS | 30 |
| 6.2.5.3 Pre-emption of short data sent as a transaction within a circuit mode call..... | 30 |
| 6.2.6 Procedures to set up a new call by pre-emption..... | 30 |
| 6.3 Short Data Service (SDS) procedures | 30 |
| 6.3.1 Sending short data..... | 30 |
| 6.3.1.1 Sending short data on a free channel..... | 30 |

| | | |
|-----------|--|----|
| 6.3.1.1.1 | Sending unacknowledged short data on a free channel | 30 |
| 6.3.1.1.2 | Sending acknowledged short data on a free channel | 31 |
| 6.3.1.2 | Sending short data by pre-emption..... | 31 |
| 6.3.1.3 | Sending short data during circuit mode transmission..... | 31 |
| 6.3.1.4 | Sending short data as a transaction within a circuit mode call..... | 31 |
| 6.3.2 | Receiving short data..... | 31 |
| 6.3.2.1 | Receiving unacknowledged short data..... | 31 |
| 6.3.2.2 | Receiving acknowledged short data..... | 31 |
| 6.3.3 | Additional addressing | 32 |
| 6.3.4 | Extended error protection | 32 |
| 6.3.5 | SDS-TL service in DMO | 32 |
| 6.4 | Usage of DMA-UNITDATA primitive..... | 32 |
| 6.5 | General procedures..... | 32 |
| 6.5.1 | Usage restriction type and validity time | 32 |
| 7 | DM-MS layer 2 service description for operation with a type 1 DM-REP | 33 |
| 7.1 | Introduction | 33 |
| 7.2 | Layer 2 architecture..... | 33 |
| 7.3 | Service descriptions..... | 33 |
| 7.3.1 | Services at the DMA-SAP | 33 |
| 7.3.1.1 | Services provided to layer 3..... | 33 |
| 7.3.1.2 | Service primitives at the DMA-SAP..... | 34 |
| 7.3.2 | Services at the DMC-SAP | 34 |
| 7.3.2.1 | Services provided to layer 3..... | 34 |
| 7.3.2.2 | Service primitives at the DMC-SAP | 34 |
| 7.3.2.2.1 | DMC-CONFIGURE primitive | 34 |
| 7.3.2.2.2 | DMC-REPORT primitive..... | 34 |
| 7.3.3 | Services at the DMD-SAP | 34 |
| 7.3.3.1 | Services provided to the U-plane application..... | 34 |
| 7.3.3.2 | Service primitives at the DMD-SAP..... | 34 |
| 7.4 | Parameter listing..... | 35 |
| 8 | DM-MS layer 2 protocol for operation with a type 1 DM-REP..... | 35 |
| 8.1 | Introduction | 35 |
| 8.1.1 | Functions of lower MAC | 35 |
| 8.1.2 | Functions of upper MAC | 35 |
| 8.2 | Interface between lower and upper MAC..... | 36 |
| 8.2.1 | Logical channels defined at the DMV-SAP..... | 36 |
| 8.2.2 | Service primitives at the DMV-SAP..... | 36 |
| 8.2.3 | PDU mapping of the logical channels at the DMV-SAP | 36 |
| 8.2.4 | Scrambling mechanism..... | 36 |
| 8.2.5 | PDU error detection..... | 37 |
| 8.2.6 | Modes of operation | 37 |
| 8.3 | Basic capabilities of the physical layer..... | 37 |
| 8.3.1 | DM-MS capabilities..... | 37 |
| 8.3.1.1 | DM only and dual mode capable MS operation..... | 37 |
| 8.3.1.2 | Dual watch capable MS operation | 38 |
| 8.3.1.2.1 | Full Dual Watch Mobile Station (F-DW-MS)..... | 38 |
| 8.3.1.2.2 | Idle Dual Watch Mobile Station (I-DW-MS)..... | 38 |
| 8.4 | Usage of DM channel with type 1 DM-REP | 38 |
| 8.4.1 | Definition of DM channel..... | 39 |
| 8.4.1.1 | DM channel arrangement..... | 39 |
| 8.4.1.2 | DM channel operation..... | 39 |
| 8.4.2 | DM-MAC states..... | 40 |
| 8.4.2.1 | DM-MAC state definitions | 40 |
| 8.4.2.2 | DM-MS channel surveillance procedures | 40 |
| 8.4.2.2.1 | Initial determination of DM channel state | 40 |
| 8.4.2.2.2 | Fast call set-up surveillance in idle mode..... | 41 |
| 8.4.2.2.3 | DM-MS channel surveillance at call set-up..... | 41 |
| 8.4.2.3 | Master DM-MS channel maintenance procedures during a call | 41 |
| 8.4.2.4 | Slave DM-MS channel maintenance procedures during a call..... | 42 |
| 8.4.2.4.1 | Slave MS channel maintenance during call transaction | 42 |

| | | |
|------------|---|----|
| 8.4.2.4.2 | Slave MS signal quality measurement during call transaction | 42 |
| 8.4.2.4.3 | Slave MS channel maintenance during reservation | 42 |
| 8.4.3 | Criteria for changing DM-MAC state | 42 |
| 8.4.3.1 | Criteria for changing DM-MAC state for master DM-MS | 42 |
| 8.4.3.2 | Criteria for changing DM-MAC state for slave DM-MS | 43 |
| 8.4.3.3 | Criteria for changing DM-MAC state for idle DM-MS | 43 |
| 8.4.4 | DM-MS channel monitoring procedures | 43 |
| 8.4.4.1 | DM channel during initial call set-up and new call transaction by current master MS | 43 |
| 8.4.4.2 | DM channel during call set-up with presence check | 43 |
| 8.4.4.3 | DM channel in occupation during a circuit mode call | 44 |
| 8.4.4.4 | DM channel in reservation during a circuit mode call | 44 |
| 8.4.4.5 | DM channel in occupation during an SDS call | 44 |
| 8.4.4.6 | DM channel usage during pre-emption signalling | 45 |
| 8.4.4.7 | DM channel usage during timing change request signalling | 45 |
| 8.4.5 | Transmission of layer 3 messages by DM-MAC | 45 |
| 8.4.5.1 | Transmission of C-plane messages by DM-MAC | 45 |
| 8.4.5.2 | Transmission of U-plane messages by DM-MAC | 46 |
| 8.4.6 | Transmission of layer 2 messages generated by DM-MAC | 46 |
| 8.4.7 | General DM-MAC procedures | 46 |
| 8.4.7.1 | DM-MAC repeat transmissions | 46 |
| 8.4.7.2 | DM-MAC frame countdown procedure | 46 |
| 8.4.7.3 | Use of timers | 46 |
| 8.4.7.4 | Linearization | 46 |
| 8.4.7.5 | Fragmentation | 47 |
| 8.4.7.6 | Fill bit indication | 47 |
| 8.4.7.7 | Selection of pseudo address | 47 |
| 8.4.7.8 | Slot flag indication | 47 |
| 8.4.7.9 | Requests bitmap | 47 |
| 8.4.7.10 | DM aspects of dual watch operation | 48 |
| 8.4.7.10.1 | Full and idle dual watch operation | 48 |
| 8.4.7.10.2 | DM aspects of full dual watch operation | 48 |
| 8.4.7.10.3 | DM aspects of idle dual watch operation | 49 |
| 8.4.7.11 | Air interface encryption | 49 |
| 8.4.7.12 | Channel A or B operation | 49 |
| 8.4.7.13 | Sending short data as a transaction within a circuit mode call | 49 |
| 8.4.7.14 | SDS time remaining | 49 |
| 8.4.7.15 | Timing change procedure | 49 |
| 8.4.7.16 | Timing change at changeover or pre-emption | 49 |
| 8.5 | MAC procedures for transfer of signalling messages | 50 |
| 8.5.1 | Formation of MAC PDU | 50 |
| 8.5.2 | Addressing | 50 |
| 8.5.2.1 | Transmission of message | 50 |
| 8.5.2.1.1 | Addressing in synchronization burst | 50 |
| 8.5.2.1.2 | Addressing in normal burst | 50 |
| 8.5.2.2 | Reception of message | 51 |
| 8.5.3 | Use of air interface encryption | 51 |
| 8.5.4 | Fragmentation and reconstruction | 52 |
| 8.5.4.1 | Fragmentation | 52 |
| 8.5.4.2 | Reconstruction | 53 |
| 8.5.5 | Fill bit addition and deletion | 53 |
| 8.5.6 | Transmission and reception of messages by layer 2 | 53 |
| 8.5.6.1 | Transmission of message | 54 |
| 8.5.6.2 | Reception of message | 55 |
| 8.5.7 | Random access protocol | 56 |
| 8.5.7.1 | Introduction | 56 |
| 8.5.7.2 | Procedures for master DM-MS | 56 |
| 8.5.7.2.1 | Indicating frames available for requests | 56 |
| 8.5.7.2.2 | Monitoring frames available for requests | 57 |
| 8.5.7.2.3 | Response to pre-emption or changeover request | 57 |
| 8.5.7.2.4 | Response to timing change request | 58 |
| 8.5.7.3 | Procedures for requesting DM-MS | 58 |
| 8.5.7.3.1 | Preparing for random access | 58 |

| | | |
|-----------|---|----|
| 8.5.7.3.2 | First transmission of request..... | 58 |
| 8.5.7.3.3 | Valid access slots..... | 58 |
| 8.5.7.3.4 | Waiting for response..... | 58 |
| 8.5.7.3.5 | Subsequent transmission of request..... | 59 |
| 8.5.7.3.6 | Abandoning random access attempt..... | 59 |
| 8.6 | MAC procedures in traffic mode..... | 59 |
| 8.6.1 | Introduction..... | 59 |
| 8.6.2 | Criteria for transmission and reception of traffic..... | 59 |
| 8.6.3 | Change of U-plane mode..... | 59 |
| 8.6.3.1 | Call set-up without presence check..... | 59 |
| 8.6.3.1.1 | Outgoing call..... | 59 |
| 8.6.3.1.2 | Incoming call..... | 60 |
| 8.6.3.2 | Call set-up with presence check..... | 60 |
| 8.6.3.2.1 | Outgoing call..... | 60 |
| 8.6.3.2.2 | Incoming call..... | 60 |
| 8.6.3.3 | Late entry..... | 60 |
| 8.6.3.4 | End of traffic transmission..... | 60 |
| 8.6.3.4.1 | Master DM-MS..... | 60 |
| 8.6.3.4.2 | Slave DM-MS..... | 61 |
| 8.6.4 | Exchange of information at the DMD-SAP..... | 61 |
| 8.6.5 | Stealing from circuit mode capacity..... | 61 |
| 9 | DM-REP layer 2 protocol for a type 1 DM-REP..... | 61 |
| 9.1 | Introduction..... | 61 |
| 9.1.1 | Functions of lower MAC..... | 61 |
| 9.1.2 | Functions of upper MAC..... | 62 |
| 9.2 | Interface between lower and upper MAC..... | 62 |
| 9.3 | Basic capabilities of the DM-REP physical layer..... | 62 |
| 9.4 | Usage of DM channel..... | 63 |
| 9.4.1 | DM-REP operation..... | 63 |
| 9.4.1.1 | Channel structure..... | 63 |
| 9.4.1.2 | Channel synchronization..... | 63 |
| 9.4.2 | DM-REP states..... | 63 |
| 9.4.2.1 | DM-REP state definitions..... | 64 |
| 9.4.2.2 | DM-REP channel surveillance procedures..... | 64 |
| 9.4.2.2.1 | DM-REP channel surveillance when idle on a channel in unknown or free state (i.e. in state 0 or 1)..... | 64 |
| 9.4.2.2.2 | DM-REP channel surveillance when idle on a busy channel (i.e. in state 2)..... | 65 |
| 9.4.2.2.3 | DM-REP channel surveillance when idle at DM-MS call set-up..... | 65 |
| 9.4.2.3 | DM-REP channel maintenance when active during a call..... | 66 |
| 9.4.3 | Criteria for changing DM-REP state..... | 66 |
| 9.4.3.1 | Criteria for changing DM-REP state for active DM-REP..... | 66 |
| 9.4.3.2 | Criteria for changing DM-REP state for idle DM-REP..... | 67 |
| 9.4.4 | DM-REP channel monitoring procedures..... | 68 |
| 9.4.4.1 | DM channel during call set-up with presence check..... | 68 |
| 9.4.4.2 | DM channel in occupation during a circuit mode call..... | 69 |
| 9.4.4.3 | DM channel in reservation during a circuit mode call..... | 69 |
| 9.4.4.4 | DM channel in occupation during an SDS call..... | 69 |
| 9.4.4.5 | DM channel following pre-emption or changeover acceptance..... | 70 |
| 9.4.4.6 | DM channel following timing change announcement..... | 70 |
| 9.4.5 | DM-REP presence signal..... | 71 |
| 9.4.5.1 | Channel free..... | 71 |
| 9.4.5.2 | Channel in occupation..... | 72 |
| 9.4.5.3 | Channel in reservation..... | 72 |
| 9.4.6 | DM-REP linearization..... | 73 |
| 9.5 | DM-REP procedures for re-transmission of signalling messages..... | 73 |
| 9.5.1 | Re-transmission of signalling messages received from the master DM-MS..... | 74 |
| 9.5.1.1 | Re-transmission of master DM-MS signalling messages received in a DSB..... | 74 |
| 9.5.1.1.1 | General procedures..... | 74 |
| 9.5.1.1.2 | Re-transmission of DM-SETUP or DM-SETUP PRES message..... | 74 |
| 9.5.1.1.3 | Re-transmission of DM-SDS DATA or DM-SDS UDATA message..... | 75 |
| 9.5.1.1.4 | Re-transmission of other messages in a DSB when not using multi-slot regeneration..... | 76 |

| | | |
|-----------|---|----|
| 9.5.1.1.5 | Re-transmission of other messages in a DSB during traffic transmission with multi-slot regeneration | 76 |
| 9.5.1.2 | Re-transmission of master DM-MS signalling messages received in a DNB | 76 |
| 9.5.1.2.1 | Call transaction without multi-slot regeneration | 76 |
| 9.5.1.2.2 | Call transaction with multi-slot regeneration..... | 77 |
| 9.5.1.3 | Regeneration of missing repetitions on the slave link..... | 77 |
| 9.5.2 | Re-transmission of signalling messages received from a slave DM-MS | 78 |
| 9.5.2.1 | General procedures..... | 78 |
| 9.5.2.2 | Re-transmission of response messages from a slave DM-MS..... | 78 |
| 9.5.2.3 | Re-transmission of random access request..... | 79 |
| 9.5.3 | DM-REP signalling mechanisms | 79 |
| 9.5.3.1 | Frame countdown procedure..... | 79 |
| 9.5.3.2 | Fill bit addition and deletion | 80 |
| 9.5.3.3 | Null PDU | 80 |
| 9.5.3.4 | Air interface encryption | 80 |
| 9.5.3.5 | Timing change procedure..... | 80 |
| 9.5.3.6 | Random access procedures for DM-REP..... | 80 |
| 9.6 | DM-REP procedures in traffic mode..... | 81 |
| 9.6.1 | Introduction..... | 81 |
| 9.6.2 | Change of U-plane mode | 81 |
| 9.6.2.1 | Set-up without presence check..... | 81 |
| 9.6.2.1.1 | Switching into traffic mode | 81 |
| 9.6.2.1.2 | Link establishment failure | 81 |
| 9.6.2.2 | Set-up with presence check..... | 82 |
| 9.6.2.3 | End of traffic transmission | 82 |
| 9.6.3 | DM-REP traffic operation when active in traffic mode..... | 82 |
| 9.6.3.1 | Reception of TCH and STCH on the master link..... | 82 |
| 9.6.3.2 | Re-transmission of TCH and STCH on the slave link..... | 83 |
| 9.6.3.2.1 | Call transaction without multi-slot regeneration | 83 |
| 9.6.3.2.2 | Call transaction with multi-slot regeneration..... | 84 |
| 10 | PDU descriptions..... | 84 |
| 10.1 | Layer 2 PDUs sent in DSB | 84 |
| 10.1.1 | DMAC-SYNC PDU | 84 |
| 10.1.2 | DPRES-SYNC PDU | 85 |
| 10.2 | Layer 2 PDUs sent in DNB | 86 |
| 10.3 | Layer 2 information element coding | 86 |
| 10.3.1 | Addressing for URT = 0010 ₂ | 86 |
| 10.3.2 | Addressing for URT = 0011 ₂ | 87 |
| 10.3.3 | Addressing for URT = 0100 ₂ or 0101 ₂ | 87 |
| 10.3.4 | Addressing for URT = 0110 ₂ | 87 |
| 10.3.5 | Channel state..... | 87 |
| 10.3.6 | Channel usage..... | 88 |
| 10.3.7 | Maximum DM-MS power class..... | 88 |
| 10.3.8 | M-DMO flag..... | 88 |
| 10.3.9 | MNI of DM-REP | 88 |
| 10.3.10 | Number of validity time units | 89 |
| 10.3.11 | Presence signal dual watch synchronization flag..... | 89 |
| 10.3.12 | Repeater operating modes..... | 89 |
| 10.3.13 | Spacing of uplink..... | 90 |
| 10.3.14 | Two-frequency repeater flag..... | 90 |
| 10.3.15 | Usage restriction type (URT)..... | 90 |
| 10.3.16 | Validity time unit..... | 91 |
| 10.3.17 | Value of DT254 | 91 |
| 10.3.18 | Values of DN232 and DN233..... | 91 |
| 10.4 | Messages generated by layer 2 | 92 |
| 10.5 | Layer 3 PDUs..... | 92 |
| 10.6 | Message dependent elements coding..... | 92 |
| 10.7 | DM-SDU elements coding | 93 |
| 11 | Radio aspects of DM-MS for operation with a type 1 DM-REP..... | 93 |
| 11.1 | Introduction | 93 |

| | | |
|--|--|------------|
| 11.2 | Modulation | 93 |
| 11.3 | Radio transmission and reception..... | 93 |
| 11.3.1 | Introduction..... | 93 |
| 11.3.2 | Frequency bands and channel arrangement | 93 |
| 11.3.3 | Reference test planes | 93 |
| 11.3.4 | Transmitter characteristics | 94 |
| 11.3.5 | Receiver characteristics | 94 |
| 11.3.6 | Transmitter/receiver performance..... | 94 |
| 11.4 | Radio sub-system synchronization | 94 |
| 11.4.1 | Introduction..... | 94 |
| 11.4.2 | Definitions and general requirements for synchronization of DM-MSs | 94 |
| 11.4.3 | Timebase counters | 95 |
| 11.4.4 | Requirements for the frequency reference source of DM mobiles | 95 |
| 11.4.5 | Requirements for the synchronization of a slave DM mobile..... | 95 |
| 11.4.6 | Synchronization requirements for a master MS operating on channel B in frequency efficient mode..... | 95 |
| 11.5 | Channel coding and scrambling | 95 |
| 11.6 | Channel multiplexing for DM operation through a type 1 DM-REP | 95 |
| 11.7 | Radio sub-system link control | 96 |
| 12 | Radio aspects of a type 1 DM-REP | 96 |
| 12.1 | Introduction | 96 |
| 12.2 | Modulation | 96 |
| 12.3 | Radio transmission and reception..... | 96 |
| 12.3.1 | Introduction..... | 96 |
| 12.3.2 | Frequency bands and channel arrangement | 96 |
| 12.3.3 | Reference test planes | 96 |
| 12.3.4 | Transmitter characteristics | 96 |
| 12.3.4.1 | Output power..... | 96 |
| 12.3.4.2 | Power classes | 97 |
| 12.3.4.3 | Unwanted conducted emissions | 97 |
| 12.3.4.3.1 | Definitions..... | 97 |
| 12.3.4.3.2 | Unwanted emissions close to the carrier | 97 |
| 12.3.4.3.3 | Unwanted emissions far from the carrier..... | 97 |
| 12.3.4.3.4 | Unwanted emissions during the Linearization CHannel (LCH)..... | 97 |
| 12.3.4.3.5 | Unwanted emissions in the non-transmit state | 97 |
| 12.3.4.4 | Unwanted radiated emissions..... | 97 |
| 12.3.4.5 | Radio frequency tolerance..... | 97 |
| 12.3.4.6 | RF output power time mask | 98 |
| 12.3.4.7 | Transmitter intermodulation attenuation | 98 |
| 12.3.5 | Receiver characteristics | 98 |
| 12.3.6 | Transmitter/receiver performance..... | 98 |
| 12.4 | Radio sub-system synchronization | 98 |
| 12.4.1 | Introduction..... | 98 |
| 12.4.2 | Definitions and general requirements for synchronization | 98 |
| 12.4.3 | Timebase counters | 98 |
| 12.4.4 | Requirements for the frequency reference source of a type 1 DM-REP | 99 |
| 12.4.5 | Requirements for the synchronization of a type 1 DM-REP | 99 |
| 12.5 | Channel coding and scrambling | 99 |
| 12.6 | Channel multiplexing for a type 1 DM-REP | 99 |
| 12.7 | Radio sub-system link control | 99 |
| Annex A (normative): Timers and constants in DM-MS and DM-REP | | 100 |
| A.1 | Layer 3 timers in DM-MS | 100 |
| A.2 | Layer 3 constants in DM-MS | 100 |
| A.3 | Layer 2 timers in DM-MS | 101 |
| A.4 | Layer 2 constants in DM-MS | 101 |
| A.5 | Maximum number of frame transmissions by DM-MAC..... | 102 |
| A.6 | Layer 2 timers in DM-REP | 103 |

| | |
|--|------------|
| A.7 Layer 2 constants in DM-REP..... | 104 |
| Annex B (normative): SDS-TL use in DMO..... | 105 |
| Annex C (informative): Bibliography..... | 106 |
| History | 107 |

Intellectual Property Rights

IPRs essential or potentially essential to the present document may have been declared to ETSI. The information pertaining to these essential IPRs, if any, is publicly available for **ETSI members and non-members**, and can be found in ETSI SR 000 314: "*Intellectual Property Rights (IPRs); Essential, or potentially Essential, IPRs notified to ETSI in respect of ETSI standards*", which is available from the ETSI Secretariat. Latest updates are available on the ETSI Web server (<http://webapp.etsi.org/IPR/home.asp>).

Pursuant to the ETSI IPR Policy, no investigation, including IPR searches, has been carried out by ETSI. No guarantee can be given as to the existence of other IPRs not referenced in ETSI SR 000 314 (or the updates on the ETSI Web server) which are, or may be, or may become, essential to the present document.

Foreword

This European Standard (Telecommunications series) has been produced by ETSI Technical Committee Terrestrial Trunked Radio (TETRA).

The present document is part 4 of a multi-part deliverable covering the Technical Requirements for Direct Mode Operation (DMO), as identified below:

- Part 1: "General network design";
- Part 2: "Radio aspects";
- Part 3: "Mobile Station to Mobile Station (MS-MS) Air Interface (AI) protocol";
- Part 4: "Type 1 repeater air interface";**
- Part 5: "Gateway air interface";
- Part 6: "Security";
- Part 7: "Type 2 repeater air interface";
- Part 8: "Protocol Implementation Conformance Statement (PICS) proforma specification";
- Part 10: "Managed Direct Mode Operation (M-DMO)".

NOTE: Part 8 of this multi-part deliverable is of status "historical" and will not be updated according to this version of the standard.

| National transposition dates | |
|--|-----------------|
| Date of adoption of this EN: | 28 April 2006 |
| Date of latest announcement of this EN (doa): | 31 July 2006 |
| Date of latest publication of new National Standard or endorsement of this EN (dop/e): | 31 January 2007 |
| Date of withdrawal of any conflicting National Standard (dow): | 31 January 2007 |

1 Scope

The multi-part deliverable EN 300 396 defines the TERrestrial Trunked RADio (TETRA) Direct Mode Operation (DMO). It specifies the basic air interface, the inter-working between Direct Mode (DM) groups via repeaters, and inter-working with the TETRA Voice plus Data (V+D) system via gateways. It also specifies the security aspects in TETRA DMO, and the intrinsic services that are supported in addition to the basic bearer and teleservices.

This part applies to the TETRA DMO Repeater (DM-REP) air interface and contains the specifications of the physical, Data Link Layer (DLL) and the network layer according to the ISO model.

The specifications contained herein apply to a DM-REP as a stand-alone unit supporting a single call on the air interface (type 1 DM-REP). They also cover the operation of a Direct Mode Mobile Station (DM-MS) with a type 1 DM-REP.

NOTE 1: The specifications for a Direct Mode Repeater/Gateway (DM-REP/GATE) combined implementation are provided in EN 300 396-5 [5], together with the specifications for a Direct Mode Gateway (DM-GATE).

NOTE 2: The specifications for a DM-REP as a stand-alone unit supporting two calls on the air interface (type 2 DM-REP) are provided in EN 300 396-7 [7].

The protocol for a DM-MS operating with a type 1 DM-REP is specified in clauses 5 through 8, 10 and 11. Much of this protocol is defined in the form of a "delta document" relative to the specifications provided in EN 300 396-2 [2] and EN 300 396-3 [3] for direct MS-MS operation. These clauses define where the protocol in EN 300 396-2 [2] and EN 300 396-3 [3] applies without change, or where it applies with the specified amendments, replacements or additions. Where no reference to EN 300 396-2 [2] or EN 300 396-3 [3] exists, the clause should be regarded as independent.

The protocol for the DM-REP is specified in clauses 9 and 12.

The normative annex mainly specifies the parameter values used in the protocol.

2 References

The following documents contain provisions which, through reference in this text, constitute provisions of the present document.

- References are either specific (identified by date of publication and/or edition number or version number) or non-specific.
- For a specific reference, subsequent revisions do not apply.
- For a non-specific reference, the latest version applies.

Referenced documents which are not found to be publicly available in the expected location might be found at <http://docbox.etsi.org/Reference>.

- [1] ETSI ETS 300 396-1: "Terrestrial Trunked Radio (TETRA); Technical requirements for Direct Mode Operation (DMO); Part 1: General network design".
- [2] ETSI EN 300 396-2: "Terrestrial Trunked Radio (TETRA); Technical requirements for Direct Mode Operation (DMO); Part 2: Radio aspects".
- [3] ETSI EN 300 396-3: "Terrestrial Trunked Radio (TETRA); Technical requirements for Direct Mode Operation (DMO); Part 3: Mobile Station to Mobile Station (MS-MS) Air Interface (AI) protocol".
- [4] ETSI EN 300 392-2: "Terrestrial Trunked Radio (TETRA); Voice plus Data (V+D); Part 2: Air Interface (AI)".
- [5] ETSI EN 300 396-5: "Terrestrial Trunked Radio (TETRA); Technical requirements for Direct Mode Operation (DMO); Part 5: Gateway air interface".

- [6] ETSI EN 300 396-6: "Terrestrial Trunked Radio (TETRA); Direct Mode Operation (DMO); Part 6: Security".
- [7] ETSI EN 300 396-7: "Terrestrial Trunked Radio (TETRA); Technical requirements for Direct Mode Operation (DMO); Part 7: Type 2 repeater air interface".
- [8] ETSI EN 300 396-10: "Terrestrial Trunked Radio (TETRA); Technical requirements for Direct Mode Operation (DMO); Part 10: Managed Direct Mode Operation (M-DMO)".

3 Definitions and abbreviations

3.1 Definitions

For the purposes of the present document, the following terms and definitions apply:

call: complete sequence of related call transactions between DM-MSs using the repeater protocol

NOTE: There are two types of call, individual call or group call. An individual call is a complete sequence of related call transactions between two DM-MSs. A group call is a complete sequence of related call transactions involving two or more DM-MSs. The number of participants in a group call is not fixed. Participants may join (late entry) and leave an ongoing call. For calls without presence check there is no guaranty that anyone is listening.

call transaction: all of the functions associated with a complete unidirectional transmission of information

NOTE: A call is made up of one or more sequential call transactions.

called user application: user application which receives an incoming call

calling user application: user application which initiates an outgoing call

changeover: within a call, the process of effecting a transfer of the master role (and hence transmitting MS) at the end of one call transaction so that another can commence

Direct Mode Operation (DMO): mode of simplex operation where mobile subscriber radio units may communicate using radio frequencies which may be monitored by, but which are outside the control of, the TETRA TMO network

NOTE: Direct Mode Operation is performed without intervention of any base station.

Direct Mode Call Control (DMCC): layer 3 entity responsible for setting up and maintaining a call in DMO

DM channel: specific grouping of timeslots in the DM multiplex structure related to a particular DM RF carrier (i.e. DM frequency) or to a pair of duplex-spaced RF carriers

NOTE: Duplex-spaced RF carriers are used for operation with a type 1B or type 2 DM-REP or a type 1B DM-REP/GATE.

Direct Mode Mobile Station (DM-MS): physical grouping that contains all of the mobile equipment that is used to obtain TETRA DM services

NOTE: A DM-MS may have one of three roles in the present document:

- **master:** if the DM-MS is either active in a call transaction transmitting traffic or control data, or is reserving the channel by means of channel reservation signalling;
- **slave:** if the DM-MS is receiving traffic and/or signalling in a call;
- **idle:** if the DM-MS is not in a call.

Direct Mode GATEway (DM-GATE): device that provides gateway connectivity between DM-MS(s) and the TETRA TMO network

NOTE: The gateway provides the interface between TETRA DMO and TETRA TMO. A gateway may provide only the gateway function (DM-GATE) or may provide the functions of both a DM repeater and a DM gateway during a call (DM-REP/GATE).

Direct Mode REpeater (DM-REP): device that operates in TETRA DMO and provides a repeater function to enable two or more DM-MSs to extend their coverage range

NOTE 1: It may be either a type 1 DM-REP, capable of supporting only a single call on the air interface, or a type 2 DM-REP, capable of supporting two calls on the air interface. A type 1 DM-REP may operate on either a single RF carrier (type 1A DM-REP) or a pair of duplex-spaced RF carriers (type 1B DM-REP). A type 2 DM-REP operates on a pair of duplex-spaced RF carriers.

NOTE 2: A repeater may have one of two roles:

- **active:** if the repeater is active in a call transaction receiving and transmitting traffic and/or signalling messages.
- **idle:** if the repeater is not in a call.

Dual Mode switchable Mobile Station (DU-MS): MS that is capable of operating in TETRA DMO or in TETRA TMO one mode at a time

NOTE: Only one mode can be selected at any given time and the MS is not capable of monitoring a DM RF carrier while in TMO or a TMO channel while in DMO.

Dual Watch Mobile Station (DW-MS): MS that is either full dual watch MS (F-DW-MS) or idle dual watch MS (I-DW-MS)

NOTE: When idle, the MS periodically monitors both the DM RF carrier and the TMO control channel. If the MS is performing full dual watch, it is also capable of periodically monitoring the TMO control channel while in a DM call and a DM RF carrier while in a TMO call. Alternatively the MS may perform idle dual watch, in which case it need not be capable of monitoring the TMO control channel while involved in a DM activity (e.g. call) or a DM RF carrier while involved in a TMO activity (e.g. call).

frequency efficient mode: mode of operation where two independent DM communications are supported on a single RF carrier or a pair of duplex-spaced RF carriers for operation with a type 2 DM-REP

NOTE: Frequency efficient mode is not applicable to transactions through a type 1 DM-REP.

Full Dual Watch Mobile Station (F-DW-MS): MS that is capable of both TETRA DMO and TETRA TMO and capable of monitoring the DM RF carrier while in a TMO service and a TMO control channel while in a DM service

NOTE: When idle, the MS periodically monitors both the DM RF carrier and the TMO control channel. The MS is also capable of periodically monitoring the TMO control channel while in a DM call and a DM RF carrier while in a TMO call.

gateway: DM-GATE or DM-REP/GATE

NOTE: Generic term which describes either a pure DM-GATE or a combined implementation with a repeater (DM-REP/GATE).

Idle Dual Watch Mobile Station (I-DW-MS): MS that is capable of both TETRA DMO and TETRA TMO and when idle capable of periodically monitoring both modes

NOTE: When idle, the MS periodically monitors both the DM RF carrier and the TMO control channel. The MS need not be capable of monitoring the TMO control channel while involved in a DM activity (e.g. call) or a DM RF carrier while involved in a TMO activity (e.g. call).

logical channel: any distinct data path

NOTE: Logical channels are considered to operate between logical endpoints.

master link: communication link used for transmissions between master DM-MS and DM-REP

Medium Access Control (MAC) block: unit of information transferred between the upper MAC and lower MAC for a particular logical channel

NOTE: Logical channels are e.g. SCH/F or STCH. The lower MAC performs channel coding for insertion into the appropriate physical slot or half slot.

normal mode: mode of operation where only one DM communication is supported on an RF carrier or a pair of duplex-spaced RF carriers for operation with a type 1B DM-REP or type 1B DM-REP/GATE

occupation: time where a call transaction is in progress on a channel

pre-emption: transfer of the master role to the requested DM-MS

NOTE: This process may occur within a call during occupation, or to set-up a new call during either occupation or reservation.

presence signal: message transmitted by a DM-REP or a gateway in order to indicate its presence on an RF carrier

Radio Frequency carrier (RF carrier): radio frequency channel

NOTE: This is a specified portion of the RF spectrum. In DMO, the RF carrier separation is 25 kHz.

random access: procedure used to avoid clashes when requesting permission from the current master to use the DM channel

NOTE: The request of the DM channel usage may be issued by any DM-MS that wishes to transmit traffic or short data either during occupation or reservation period.

recent user: DM-MS that was master of the call transaction immediately prior to the current master's call transaction in a call

recent user priority: service which gives the recent user a preferred access to request transmission when the current master is ceasing its call transaction in a group call

NOTE: This service is controlled by the current master.

reservation: time where a "channel reservation" signal is present on the channel

short data service: data service providing both user-defined short messages and predefined 16-bit messages

simplex: mode of working in which information can be transferred in both directions but not at the same time

slave link: communication link used for transmissions between the DM-REP and slave or idle DM-MSs

surveillance: process of determining the current state of the DM RF carrier when in idle mode

Trunked Mode Operation (TMO): mode of operation where MSs communicate via the TETRA V+D air interface which is controlled by the TETRA Switching and Management Infrastructure (SwMI)

NOTE: This is also called V+D operation. The abbreviation "TMO" is used in the present document to pair with the abbreviation "DMO" instead of the abbreviation "V+D". "TMO" abbreviation is not used in EN 300 392-1 and EN 300 392-2 [4].

type 1 call: call using the protocol defined in the present document

NOTE 1: There are two varieties of type 1 call:

- **type 1A call:** which is a call through a type 1A DM-REP;
- **type 1B call:** which is a call using the protocol for operation with a type 1B DM-REP.

NOTE 2: A DM-MS may make a type 1B call through a type 1B DM-REP. It may also make a type 1B call through a type 2 DM-REP if permitted by the DM-REP.

type 1 DM-REP: DM repeater that supports normal mode operation on the air interface

NOTE 1: There are two varieties of type 1 DM-REP:

- **type 1A DM-REP:** which operates on a single RF carrier;
- **type 1B DM-REP:** which operates on a pair of duplex-spaced RF carriers, one used as the "uplink" from DM-MSs to the DM-REP and the other used as the "downlink" from the DM-REP to DM-MSs.

NOTE 2: The protocol for operation with a type 1 DM-REP (either a type 1A or a type 1B DM-REP) is based on the protocol for normal mode in EN 300 396-3 [3].

type 2 call: call using the protocol defined in EN 300 396-7 [7]

NOTE: A DM-MS may make a type 2 call only through a type 2 DM-REP.

type 2 DM-REP: DM repeater that is capable of supporting frequency efficient mode operation on the air interface

NOTE: A type 2 DM-REP operates on a pair of duplex-spaced RF carriers, one used as the "uplink" from DM-MSs to the DM-REP and the other used as the "downlink" from the DM-REP to DM-MSs. The protocol for type 2 calls through a type 2 DM-REP is based on the protocol for frequency efficient mode in EN 300 396-3 [3]. (A type 2 DM-REP may also optionally offer type 1B calls using the protocol defined in the present document).

3.2 Abbreviations

For the purposes of the present document, the following abbreviations apply:

| | |
|-------------|--|
| CRC | Cyclic Redundancy Check |
| DCC | Direct mode Colour Code |
| DLB | Direct mode Linearization Burst |
| DLL | Data Link Layer |
| DM | Direct Mode |
| DMA | Direct mode MAC A (see note 1) |
| DMC | Direct mode MAC C (see note 1) |
| DMCC | Direct Mode Call Control entity |
| DMD | Direct mode MAC D (see note 1) |
| DM-GATE | Direct Mode-GATEway |
| DM-MS | Direct Mode-Mobile Station |
| DMO | Direct Mode Operation |
| DM-REP | Direct Mode-REPeater |
| DM-REP/GATE | Direct Mode-REPeater/GATEway |
| DM-SDU | SDU from layer 3 |
| DMV | Direct mode MAC Virtual (see note 1) |
| DNB | Direct mode Normal Burst |
| DO-MS | Direct mode Only-Mobile Station |
| DSB | Direct mode Synchronization Burst |
| DU-MS | DUal mode (Trunked Mode / Direct Mode) switchable Mobile Station |
| DW-MS | Dual Watch-Mobile Station |
| EDSI | Encrypted DMO Short data Identity |
| EG | Economy Group (see note 2) |
| FEC | Forward Error Correction |
| F-DW-MS | Full-Dual Watch-Mobile Station |
| I-DW-MS | Idle-Dual Watch-Mobile Station |
| LCH | Linearization CHannel |
| MAC | Medium Access Control |
| MCCH | Main Control CHannel |
| MNI | Mobile Network Identity |
| mod | modulo (base for counting) |
| MS | Mobile Station |
| PDU | Protocol Data Unit |
| PL | Physical Layer |

| | |
|--------|--|
| RF | Radio Frequency |
| RSSI | Radio Signal Strength Indication |
| SAP | Service Access Point |
| SCCH | Secondary Control CHannel |
| SCH | Signalling CHannel |
| SDS | Short Data Service |
| SDS-TL | SDS-Transport Layer |
| SDU | Service Data Unit |
| SSI | Short Subscriber Identity |
| STCH | Stealing CHannel |
| SwMI | Switching and Management Infrastructure |
| TCH | Traffic CHannel |
| TMO | Trunked Mode Operation |
| TN | Timeslot Number |
| TPNI | Transmitting Party Number Identification |
| TSI | TETRA Subscriber Identity |
| TVP | Time Variant Parameter |
| URT | Usage Restriction Type |

NOTE 1: Used with service primitives or service access points.

NOTE 2: Different Economy Groups exist, e.g. Economy Group 2 is called EG2.

4 Overview of protocol

4.1 General

TETRA DMO using a DM repeater (DM-REP) offers the possibility to support DM communications over an enhanced coverage area from that typically achieved in direct MS-MS operation.

A DM-REP re-transmits information received from one DM-MS to other DM-MS(s) over the DM air interface. It normally performs de-encoding and re-encoding operations on the DM-MS transmission bits prior to regeneration in order to improve BER performance.

The DM-REP may optionally generate a presence signal. The purpose of this signal is to inform any DM-MSs monitoring the RF carrier (i.e. frequency) that the DM-REP is now present and available for service.

The DM-REP is specifically addressed by a DM-MS if the DM-MS wishes the DM-REP to support a call, by inclusion of the repeater address within the call set-up messages. When a DM-REP is supporting a call, the recipient DM-MSs receive the signalling and traffic via the DM-REP.

NOTE 1: The present document does not support operation in which some DM-MSs receive a call via the DM-REP while other DM-MSs receive that call directly from the calling DM-MS.

In order to operate with a DM-REP, a DM-MS needs to implement some additional protocol procedures not needed for direct MS-MS operation. The additional procedures for operation with a type 1 DM-REP are described in the present document; the additional procedures for operation with a type 2 DM-REP are described in EN 300 396-7 [7].

The following types of DM-REP are standardized for DMO:

Type 1: single-call regenerating repeater:

A type 1 DM-REP can support only one call at a time. There are two varieties of type 1 DM-REP:

- a) A type 1A DM-REP conducts transmit and receive operations on a single RF carrier, re-transmitting bursts received from a DM-MS during one timeslot to other DM-MS(s) in a different timeslot.
- b) A type 1B DM-REP is similar to a type 1A DM-REP except that it uses a pair of duplex-spaced RF carriers, one as an "uplink" from DM-MSs to the DM-REP (RF carrier f_1) and the other as the "downlink" from the DM-REP to DM-MSs (RF carrier f_2).

The protocol for operation with a type 1 DM-REP (either a type 1A or a type 1B DM-REP) is based on the protocol for normal mode in EN 300 396-3 [3].

Type 2: two-call regenerating repeater:

A type 2 DM-REP is capable of supporting two simultaneous calls on the air interface. It uses a pair of duplex-spaced RF carriers, one as an "uplink" from DM-MSs to the DM-REP (RF carrier f_1) and the other as the "downlink" from the DM-REP to DM-MSs (RF carrier f_2). The protocol for operation with a type 2 DM-REP is based on the protocol for frequency efficient mode in EN 300 396-3 [3].

NOTE 2: In the present document, the term "normal mode" is used in the description of the protocol with a type 1 DM-REP. Similarly, in EN 300 396-7 [7], the term "frequency efficient mode" is used in the description of the protocol with a type 2 DM-REP. These terms are used for compatibility with EN 300 396-3 [3], since the type 1 DM-REP air interface supports a single call at a time (as for normal mode in EN 300 396-3 [3]) whereas the type 2 DM-REP air interface supports two calls at a time (as for frequency efficient mode in EN 300 396-3 [3]). However it should be noted that the efficiency of frequency usage with a type 1A DM-REP is actually the same as with a type 2 DM-REP i.e. the efficiency of frequency usage with one call on one RF carrier is the same as with two calls on two RF carriers.

The method of selection of the appropriate DM RF carrier(s) is not standardized in the present document.

Both type 1 and type 2 DM-REPs are primarily layer 2 devices comprising a Physical Layer (PL) (layer 1) and a Data Link Layer (DLL) (layer 2). The protocol stack applicable to either type 1 or type 2 DM-REPs is shown in figure 1.

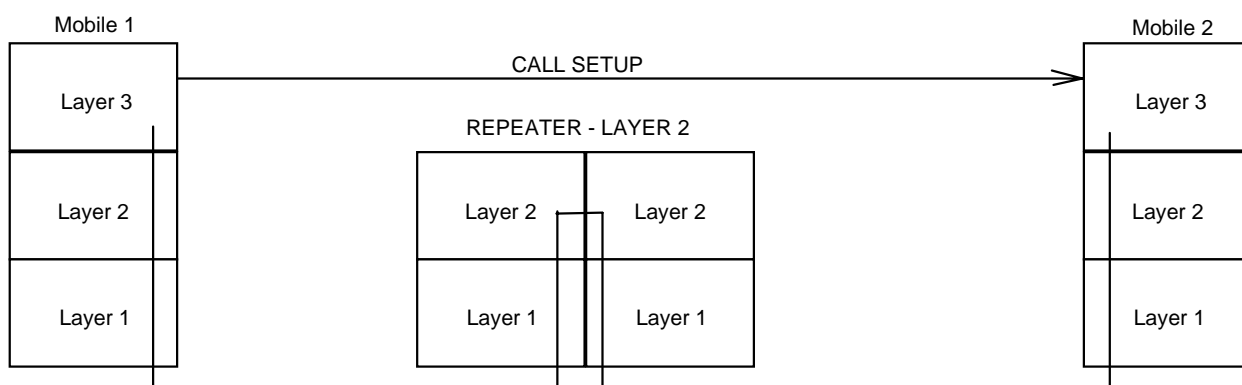

Figure 1: Protocol stack of DM-REP

It is optional for a DM-MS to support operation with a DM-REP. If a DM-MS supports operation with a DM-REP then it may support operation with one or more of the following: a type 1A DM-REP, a type 1B DM-REP or a type 2 DM-REP.

NOTE 3: There are some differences in the DM-MS procedures between operation with a type 1A DM-REP, type 1B DM-REP and type 2 DM-REP. The differences between operation with a type 1A DM-REP and type 1B DM-REP are basically only the RF differences resulting from the use of one or two RF carriers. However there are protocol differences between operation with a type 1 DM-REP and type 2 DM-REP.

A DM-REP needs more physical capabilities than those needed for a DM-MS. As described in clause 9.3, a type 1 DM-REP is required to switch from DM transmit to receive, and from DM receive to transmit, between contiguous timeslots.

NOTE 4: A type 2 DM-REP is required to be capable of frequency full duplex operation (see EN 300 396-7 [7]). However, frequency full duplex capability is not required for a type 1 DM-REP.

This part of the present document covers only the operation of a type 1 DM-REP (either a type 1A or a type 1B DM-REP) and the operation of a DM-MS with a type 1 DM-REP (either a type 1A or a type 1B DM-REP).

The operation of a type 2 DM-REP and the operation of a DM-MS with a type 2 DM-REP are described in EN 300 396-7 [7].

NOTE 5: Frequency planners should be aware that the present document provides no mandatory support for direct DM-MS to DM-MS operation as per EN 300 396-3 [3] on the same frequency as the uplink of a type 1B DM-REP where such DM-MS would not be detected by DM-MS using the DM-REP.

The remainder of this clause contains an introduction to the protocol for operation with a type 1 DM-REP (either a type 1A or a type 1B DM-REP).

4.2 The DM channel

A DM channel can be perceived as being in one of three states:

- free, where there is no activity on the channel (or, in the case where a DM-REP provides a signal indicating its presence, when this presence signal indicates that the channel is free);
- occupied, where a call transaction is in progress on the channel;
- reserved, where a "channel reservation" signal is present on the channel.

The actions and procedures followed by a DM-MS wishing to make a call through a DM-REP vary depending on the state of the channel.

When the channel is free, it is available for use by any DM-MS which can tune to that channel.

When a DM channel is occupied in a call through a DM-REP, a master DM-MS transmits signalling in DM Synchronization Bursts (DSBs) in frames 6, 12 and 18, and transmits traffic in DM Normal Bursts (DNBs) in frames 1 to 17 on the "master link". The information received by the DM-REP in a particular frame and timeslot on the "master link" is then decoded, error corrected and re-transmitted in the appropriate frame and timeslot on the "slave link".

NOTE 1: All communications between the master DM-MS and the DM-REP are conducted on the "master link". All communications between slave DM-MS(s) and the DM-REP are conducted on the "slave link".

When a DM channel is reserved in a call through a DM-REP, it has been in use for a call transaction in a group or individual call. The master DM-MS for that call transaction transmits DSBs in frames 6, 12 and 18 on the master link with parameters indicating the fact that the channel is reserved, for which group or individual it is being reserved, and for how long the channel may continue to be reserved. This information is re-transmitted by the DM-REP on the slave link. A DM channel may become reserved after the conclusion of each call transaction, in which case it normally stays reserved until either a changeover of the master role has been successfully achieved or until the channel reservation timer of the master DM-MS has expired.

For TETRA DMO through a type 1 DM-REP, timing synchronization between master DM-MS and DM-REP participating in a call is handled in a similar way as for basic DMO described in EN 300 396-3 [3]. However, in the case of operation through a type 1 DM-REP, the slave DM-MSs are synchronized to the DM-REP transmission timing on the slave link. This means that the master DM-MS provides the timing synchronization for the call. The DM-REP follows the master's timing and the slaves follow the DM-REP's timing.

The type 1 DM-REP provides the frequency synchronization. If the type 1 DM-REP has been generating the presence signal, the first master DM-MS aligns its frequency reference to the DM-REP prior to sending the initial call set-up messages. If the presence signal or other suitable DM-REP signalling has not been received sufficiently recently, the master DM-MS uses its own frequency reference to generate the transmission frequency for the initial call set-up messages. The master DM-MS then aligns its frequency reference to the DM-REP transmissions and maintains that alignment while it is master.

The slave DM-MSs align their frequency references to the DM-REP transmissions and, at changeover, the new master DM-MS generates the transmission frequency using this alignment.

NOTE 2: For operation with a type 1A DM-REP, a DM-MS aligns its transmission frequency with the frequency received from the DM-REP. For operation with a type 1B DM-REP, a DM-MS aligns its frequency reference to the DM-REP transmissions on the downlink RF carrier and then uses that reference when transmitting on the uplink RF carrier.

4.3 DM call procedures for operation with a type 1 DM-REP

The procedures and sequences given in the following clauses are intended to illustrate possible scenarios and the mechanisms which the protocol may take in those circumstances for DM-MS operation with a type 1 DM-REP (either a type 1A or a type 1B DM-REP). The procedures presented here are not exhaustive and are not intended to show every possible scenario.

Type 1 DM-REPs can support only one call at a time. The procedures for operation with a type 1B DM-REP are similar to the procedures for a type 1A DM-REP except that:

- for a type 1A DM-REP, all transmissions (on both the master link and slave link) are sent on the selected DM RF carrier;
- for a type 1B DM-REP, transmissions by DM-MSs (on both the master link and slave link) are sent on the appropriate DM uplink RF carrier f_1 ; transmissions from the DM-REP to DM-MSs (on both the master link and slave link) are sent on the associated DM downlink RF carrier f_2 .

The diagrams represent operation with either a type 1A DM-REP or a type 1B DM-REP.

Abbreviations are used in the diagrams to represent Protocol Data Units (PDUs) sent within the protocol. The actual message types are as follows:

cn ≡ DM-CONNECT;
 cnk ≡ DM-CONNECT ACK;
 occ ≡ DM-OCCUPIED;
 pa ≡ DM-PRE ACCEPT (sent in DSB);
 par ≡ DM-PRE ACCEPT + DM-RELEASE (sent in DNB);
 prq ≡ DM-PREEMPT;
 rsv ≡ DM-RESERVED;
 sdk ≡ DM-SDS ACK (or first fragment if fragmented);
 sdo ≡ DM-SDS OCCUPIED;
 sds ≡ DM-SDS DATA (or first fragment if fragmented);
 sdu ≡ DM-SDS UDATA (or first fragment if fragmented);
 su ≡ DM-SETUP;
 sup ≡ DM-SETUP PRES;
 txa ≡ DM-TX ACCEPT;
 txc ≡ DM-TX CEASED;
 txr ≡ DM-TX REQUEST.

Other abbreviations used are:

rps, representing the DM-REP presence signal;
 tc, representing traffic transmission;
 lch, representing slots available for linearization;
 p?, representing slots available for pre-emption requests; and
 sd, representing continuation fragments of DM-SDS UDATA or DM-SDS DATA.

NOTE: In all cases an abbreviation with a (') indicates a repeated transmission generated by the DM-REP which may take place on either the master link or slave link.

The DM-REP presence signal is a message sent by the DM-REP during calls. It may also optionally be sent on a free channel to indicate to receiving DM-MSs that the DM-REP is switched on and within range. It includes the DM-REP's 10-bit repeater address and may indicate which DM-MSs are permitted to use that DM-REP.

When a DM-MS makes a call through a DM-REP, it includes the DM-REP's 10-bit repeater address within the set-up message. It needs to know the correct repeater address before making the call, either by prior arrangement or by receiving the DM-REP presence signal. It also needs to know the repeater type (i.e. type 1A, type 1B or type 2).

4.3.1 Constraints on the frame structure

For DMO through a type 1 DM-REP the entire protocol procedure is based on a fixed frame structure and a knowledge of the current position (in time) within this structure. As shown in EN 300 396-2 [2], clause 4.5.1, the essential building blocks of the DMO structure are the frame which comprises four timeslots, and the multiframe which comprises 18 frames. For type 1 DM-REP operation the master and slave link frame boundaries are offset in time, such that the beginning of the frame *n* on the master link occurs 3 timeslots duration before the beginning of the corresponding frame *n* on the slave link.

In order to facilitate the DMO protocol through a type 1 DM-REP, a number of constraints are placed on this structure, in terms of what can be transmitted in any particular slot during a call:

- frame 18 is always used for synchronization purposes, and carries a DSB in both slots 1 and 3;
- frames 6 and 12 carry occupation information in a DSB in slot 3, and may carry traffic in a DNB in slot 1;
- frames 6 and 12 carry reservation information in a DSB in slots 1 and 3;
- pre-emption signalling is permitted, during occupation, in slot 3 of slave link frames 2, 5, 8, 11, 14 and 17; the DM-REP then re-transmits the pre-emption message to the current master DM-MS in slot 3 of master link frames 4, 7, 10, 13, 16 or 1 respectively;
- linearization, which is carried out in a DM Linearization Burst (DLB), may be permitted in slot 3 of frame 3 during a call;
- during occupation, frames 1 to 17 usually carry traffic in slot 1 (in a DNB);
- frames 1, 7 and 13 of the master link may carry a DM-REP presence signal in a DSB in slot 3.

4.3.2 Setting up a call

In DMO through a type 1 DM-REP there are two options for call set-up: a set-up without presence checking whereby transmission commences without explicit knowledge of the presence of any receiving DM-MS(s), and set-up with presence checking whereby a specific acknowledgement is sought before transmission commences. In both cases the calling DM-MS monitors the slave link in order to determine that the DM-REP has successfully received and re-transmitted the messages.

4.3.2.1 Call set-up without presence check

For group (point-to-multipoint) and individual (point-to-point) calls a set-up without presence check is the most basic mode of setting up a call in a DM channel. Figure 2 illustrates this procedure.

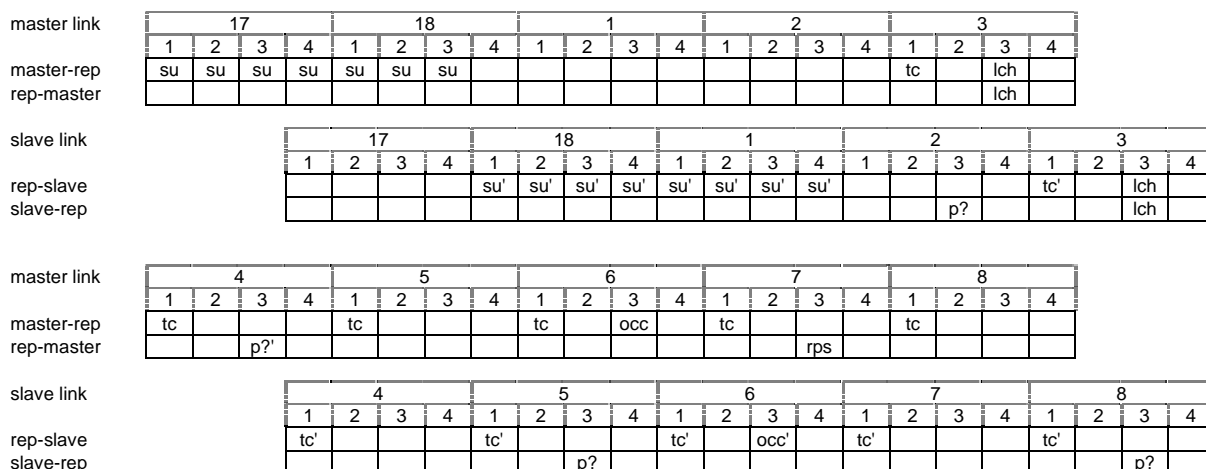

Figure 2: Call sequence for set-up without presence check through type 1 DM-REP

After following the procedures given in clause 8.4.2 to ascertain the state of the channel, provided the channel is found to be in the state "free", the calling DM-MS may linearize its transmitter. It then establishes the channel synchronization and simultaneously its role as "master" by transmitting a sequence of call set-up messages on the master link. These are sent in an appropriate number of frames, using the DSB structure as given in EN 300 396-2 [2], clause 9.4.3. These synchronization bursts contain frame count information, which defines their position in the timing structure of the 18-frame cyclic multiframe structure. In the example shown in figure 2, 7 synchronization bursts ("su" in the figure) are sent containing frame count information defining their position in frames 17 and 18 of the master link.

The master DM-MS then listens for the synchronization bursts to be re-transmitted by the DM-REP on the slave link in order to confirm that its signalling to the DM-REP was successful. The DM-REP may transmit in a different number of frames from the number used by the master DM-MS. However, in this example, it sends synchronization bursts in 2 frames giving a total of 8 bursts.

The master DM-MS then transmits traffic ("tc" in the figure) using the DNB structure, as given in EN 300 396-2 [2], clause 9.4.3, in the next available frame that in this example is frame 3 of the master link.

Figure 2 also illustrates the position of slots which are allocated to allow pre-emption requests to be made ("p?" in the figure), the slots available for linearization ("lch" in the figure), and the synchronization bursts indicating occupation of the channel ("occ" in the figure) which occur in slot 3 of frames 6, 12 and 18 following the initial synchronization.

In this example, pre-emption opportunities occur in slot 3 of frames 2, 5 and 8 on the slave link. A pre-emption request made in slot 3 of frame 2 on the slave link would have been re-transmitted 5 slots later in slot 3 of frame 4 on the master link.

Figure 2 also shows the transmission of the DM-REP presence signal in slot 3 of frame 7 on the master link. (This slot would have been used for the re-transmission of a pre-emption request from a slave if such a request had been received in slot 3 of frame 5 on the slave link).

In order to change over the talker (or sender) in a call, the master DM-MS first indicates that its call transaction has come to an end, using a transmit ceased message ("txc" in figure 4). This message is sent at least twice in slot 1 of consecutive frames on the master link and using the same burst format (i.e. DNB) as for normal traffic. These messages are subsequently re-transmitted by the DM-REP on the slave link (txc'). Recipients of the call listening to the slave link are therefore aware of the termination of that call transaction and can then apply to the master, through the DM-REP, to continue the call with a new call transaction. The changeover request message ("txr" in the figure) in this example is sent by a requesting DM-MS in the next available slot 3 on the slave link following reception of the txc'. This changeover request message is re-transmitted by the DM-REP in the appropriate frame on the master link.

On receipt of a valid changeover request (txr'), the master then surrenders the channel to the successful applicant using a series of changeover acknowledgement messages ("txa" in the figure). On transmission of the changeover acknowledgement messages on the master link, the master then becomes a slave and has no further responsibility for the channel. On receipt of the repeated changeover acknowledgement message (txa'), the requester transmits a sequence of set-up messages in synchronization bursts ("su" in the figure) on the master link using in this case the same frame and slot timing as the previous master. The action of sending the sequence of set-up messages effects the call changeover with the requester becoming the new master for the next call transaction.

The frame numbering in figure 4 has been chosen arbitrarily as an example but, in this illustration, the first traffic burst of the new master would take place in frame 5 (not shown in the figure) on the master link.

NOTE: The procedure for changeover when operating with a DM-REP takes longer than for direct MS-MS operation (see EN 300 396-3 [3]). Therefore MS designers may wish to consider means by which the operational effects of these delays can be alleviated. This may apply also to other call set-up procedures when operating with a DM-REP.

4.3.4 Pre-emption of a DM call

During a DM call through a type 1 DM-REP, a DM-MS, who may or may not be involved in the current call, may wish to access the DM channel for a priority reason such as an emergency. In this case a mechanism for pre-empting the already occupied channel exists. This is illustrated in figure 5.

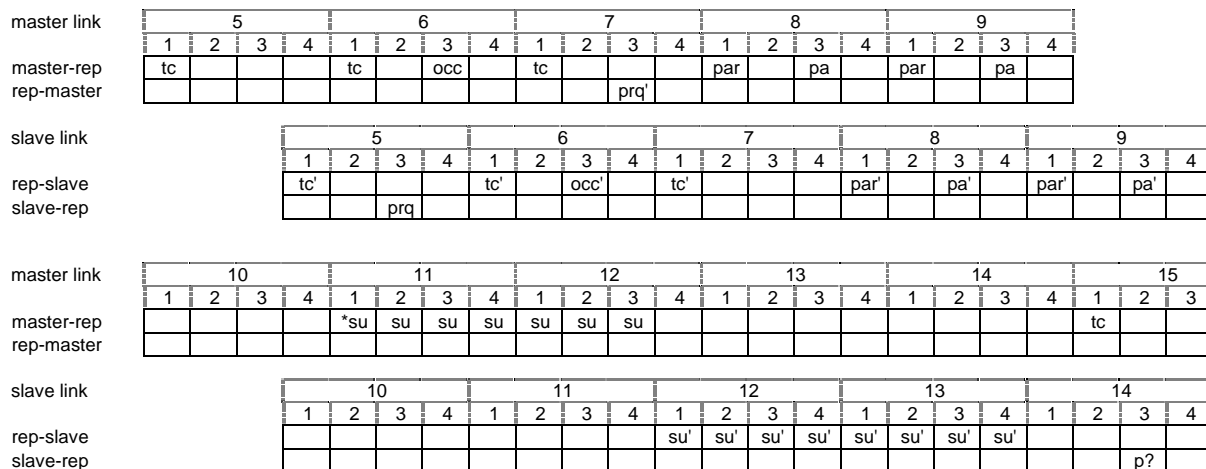

NOTE: * indicates start of transmissions by new master DM-MS.

Figure 5: Call sequence for pre-emption of call through type 1 DM-REP (no collisions)

The first master sequence in figure 5 shows normal progress of a call through a type 1 DM-REP, with traffic bursts in slot 1 of each frame (1 to 17) on the master link being re-transmitted by the DM-REP on the slave link. A DM-MS wishing to use the channel would, if not participating in the call, have had to first determine the state of the channel and in this illustration would have identified that the ongoing call is a type 1 call being transmitted through a DM-REP. The pre-empting DM-MS would then have synchronized to the DM-REP transmissions on the slave link and in the process determined the timing state of the channel, including the slave link frame and slot numbers.

To effect the pre-emption, the DM-MS transmits a pre-emption request message ("prq" in the figure) at an appropriate position in the slave link frame structure. During occupation, pre-emption is allowed only in slot 3 of slave link frames 2, 5, 8, 11, 14 and 17. When the master successfully decodes the repeated pre-emption request on the master link, assuming it is a valid request, it announces that the channel has been pre-empted to both the pre-empting DM-MS and the other DM-MSs, which were involved in the ongoing call. This announcement is by means of the pre-emption acknowledgement message ("par" and "pa" in the figure) sent on the master link and subsequently repeated on the slave link. Having issued the pre-emption acknowledgement messages the master ceases its role and relinquishes the channel.

The successful pre-emptor now transmits set-up messages to the DM-REP using the master link for the new call, with a new group or individual addressee, and becomes master for the initial transaction of this new call. In this example the traffic transmissions begin in slot 1 of frame 15 on the master link.

NOTE: In this example, the pre-empting DM-MS has not included a timing adjustment indication within the pre-emption request and so, in the new call set-up, it adopts the timing reference and frame numbering used by the old master DM-MS.

4.3.5 Terminating a call

At the end of a call transaction, the master DM-MS sends transmit ceased messages (as usual) and then provides reservation DSBs in frames 6, 12 and 18; these messages are re-transmitted by the DM-REP on the slave link. If the channel reservation timer expires without either a changeover of the master role having occurred or the master DM-MS resuming traffic transmission then the master DM-MS stops sending reservation DSBs and the call ends.

Alternatively, the master DM-MS may terminate the call prematurely by sending channel release messages (DM-RELEASE PDU). The DM-REP re-transmits these messages on the slave link.

4.3.6 DM short data call

4.3.6.1 Unacknowledged short data message

A DM-MS wishing to send an unacknowledged short data message through a type 1 DM-REP follows the procedures to ascertain the state of the channel. Provided that the channel is found to be in the state "free" the DM-MS may linearize its transmitter. It then establishes the channel synchronization and simultaneously its role as "master" by transmitting a sequence of DM-SDS UDATA message headers on the master link, in an appropriate number of frames, using the DSB structure. The DM-SDS UDATA message headers contain frame count information, which defines their position in the timing structure of the 18-frame cyclic multiframe structure. In the example shown in figure 6, 7 synchronization bursts ("sdu" in the figure) are sent containing frame count information defining their position in frames 17 and 18.

The master DM-MS then listens for the DM-SDS UDATA message headers to be re-transmitted by the DM-REP on the slave link in order to confirm that its signalling to the DM-REP was successful. The DM-REP may transmit in a different number of frames from the number used by the master DM-MS. However, in this example, it sends synchronization bursts in 2 frames giving a total of 8 bursts.

The master DM-MS then transmits the remaining parts of the short data message ("sd" in the figure), without repetition and using the DNB structure, in slot 1 of the following frames. In this example the remaining parts of the message occupy two slots and are sent in frames 3 and 4.

For reliability, the master DM-MS may repeat the complete message transmission immediately (without re-checking that the channel is free), and starting again with DSBs. In this example there is one message repetition, with the DSBs sent in frames 5 and 6; the two DNBs (not shown in the figure) are sent in frames 9 and 10.

Figure 6 also illustrates where pre-emption signalling is permitted during an SDS transmission.

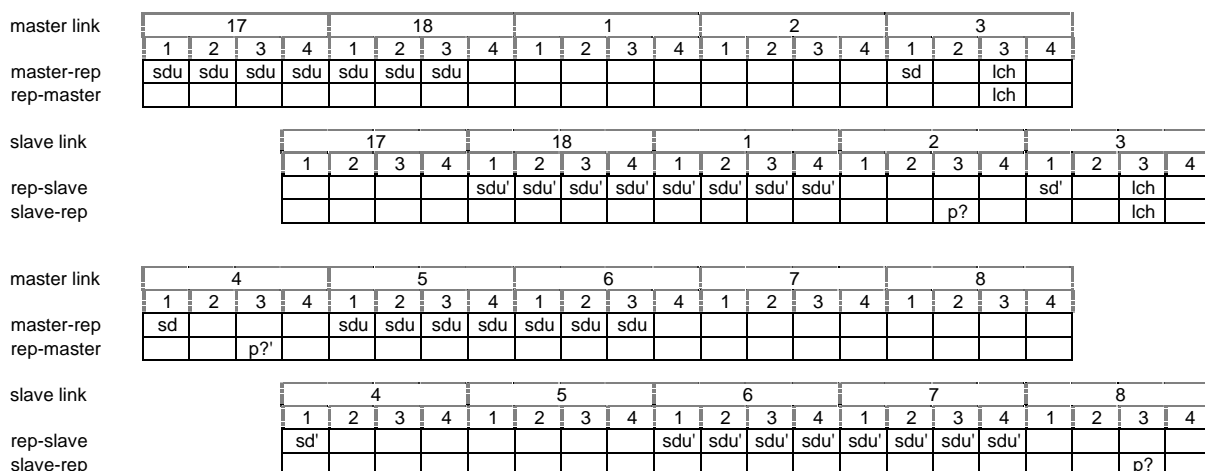

Figure 6: Call sequence for SDS (for unacknowledged data) through type 1 DM-REP

4.3.6.2 Acknowledged short data message

When sending short data to an individual DM-MS, the calling DM-MS may request an acknowledgement from the called DM-MS. Figure 7 illustrates the procedure for an acknowledged short data message comprising the DM-SDS DATA message headers followed by three DNBs.

The procedure starts in a similar manner to an unacknowledged short data message, but the DM-SDS DATA message headers request an acknowledgement from the receiving slave DM-MS. The slave DM-MS sends the acknowledgement following the receipt of the last burst containing data. In this example the slave DM-MS sends SDS acknowledgement DSBs ("sdk" in the figure) in slots 1 and 3 of frames 6 and 7 of the slave link. The acknowledgement is re-transmitted by the DM-REP to the master DM-MS in the appropriate frames on the master link, in this case frames 8 and 9.

NOTE 1: In this example, the receiving slave DM-MS may linearize its transmitter in slot 3 of slave link frame 3. It therefore does not need to use slot 1 of slave link frame 6 for linearization, so sends the first transmission of its acknowledgement DSB in that slot.

NOTE 2: The short data occupation signalling DSBs which usually occur in slot 3 of frames 6, 12 and 18 following the initial synchronization are only sent during data message transmission and not during the acknowledgement period.

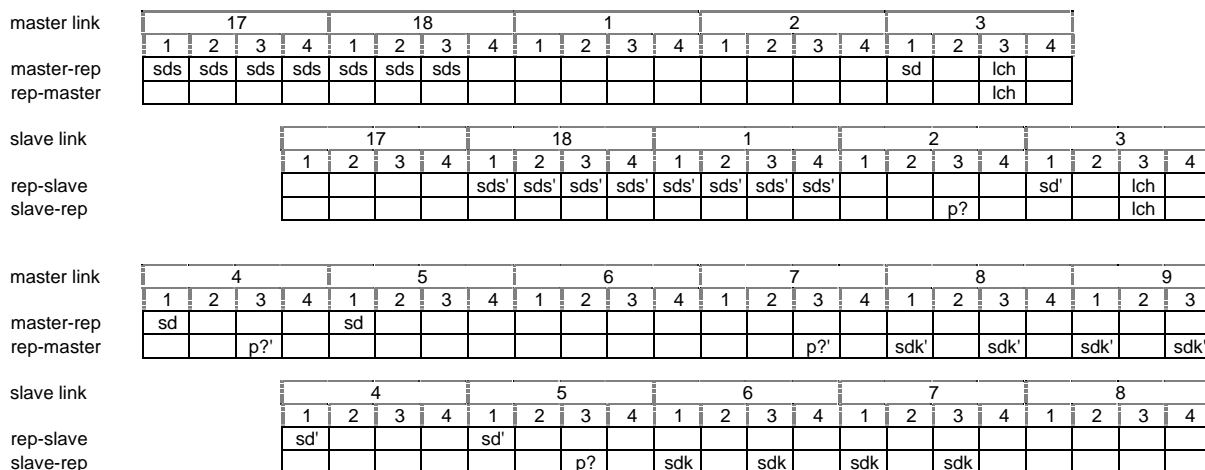

Figure 7: Call sequence for SDS (for acknowledgement without data) through type 1 DM-REP

5 DM-MS layer 3 service description for operation with a type 1 DM-REP

5.1 Introduction

This clause describes the services that may be offered by the DM-MS's Direct Mode Call Control (DMCC) entity to the user application for operation with a type 1 DM-REP (either a type 1A or a type 1B DM-REP). The service description is described in terms of primitives and their parameters.

The definition of the DMCC-SAP does not imply any specific implementation, but is rather used for the description of the protocol model. In the following clauses the word "shall" is used to describe the DMCC-SAP and the service primitives and parameters for traceability reasons in the protocol model, but they are not testable. The following description also does not imply any specific implementation.

NOTE: In an implementation, additional parameters may be included in the primitives in order to exchange additional information between the user application and the DMCC.

5.2 Services offered

EN 300 396-3 [3], clause 5.2 shall apply.

5.3 Primitive description

EN 300 396-3 [3], clause 5.3 shall apply.

NOTE 1: The DMCC-SETUP, DMCC-SDS DATA and DMCC-SDS UNITDATA primitives in EN 300 396-3 [3] contain a "communication type" parameter. This parameter enables the user application to specify, when within range of a DM-REP, whether the DM-REP function is required for the call - thereby invoking operation according to the present document or according to EN 300 396-7 [7], or not required for the call - thereby invoking operation according to EN 300 396-3 [3] or EN 300 396-5 [5].

NOTE 2: The "called party TSI" parameter in request primitives refers to the called DM-MS(s), not to the DM-REP. Similarly, the "calling party TSI" parameter in indication primitives refers to the calling DM-MS, not to the DM-REP.

5.4 Parameter description

EN 300 396-3 [3], clause 5.4 shall apply with the following differences:

- i) parameter "release cause" may have the following additional possible values:
 - link to DM-REP not established or failed (indication only);
 - transmit authorization lost (indication only);
- ii) parameter "SDS transfer result" may have the following additional possible value:
 - link to DM-REP not established or failed.
- iii) Parameter "report" may have the following additional possible value:
 - transmit authorization lost.

5.5 States for DMCC-SAP

EN 300 396-3 [3], clause 5.5 shall apply.

6 DM-MS layer 3 protocol for operation with a type 1 DM-REP

6.1 Introduction

This clause describes the layer 3 protocol for a DM-MS operating with a type 1 DM-REP (either a type 1A or a type 1B DM-REP). The layer 3 protocol is performed by the Direct Mode Call Control (DMCC) entity.

The DMCC entity performs the layer 3 functions for both circuit mode calls and short data messages (user-defined short messages and pre-coded status). The DMCC protocol when operating with a DM-REP is similar to the protocol defined in EN 300 396-3 [3], clause 6. The differences are detailed in clauses 6.2 and 6.3.

NOTE 1: The present document covers only type 1 DM-REP operation i.e. operation in which the DM-REP can support only one call at a time on the RF carrier (or pair of duplex-spaced RF carriers for a type 1B DM-REP). Therefore references to frequency efficient mode in EN 300 396-3 [3], clause 6 do not apply to transactions via a type 1 DM-REP.

NOTE 2: For direct DM-MS to DM-MS operation the procedures in EN 300 396-3 [3] apply, even if a DM-REP is currently occupying the DM channel. Similarly for operation via a gateway the procedures in EN 300 396-5 [5] apply, even if a DM-REP is currently occupying the DM channel.

6.1.1 DMCC protocol states

EN 300 396-3 [3], clause 6.1.1 shall apply.

6.2 Circuit mode calls

The DMCC protocol for circuit mode calls when operating with a DM-REP is similar to the protocol defined in EN 300 396-3 [3], clause 6.2 but with the following differences:

- i) A call may fail because the layer 2 in the calling DM-MS does not see its call set-up message re-transmitted by the DM-REP on the slave link. This is regarded as a failure of link establishment to the DM-REP.
- ii) A circuit mode call in progress may fail if the layer 2 in the calling DM-MS reports that the link to the DM-REP has been lost during the occupation or reservation period.

The differences are detailed in the following clauses.

6.2.1 Procedures for call set-up without presence check

6.2.1.1 Outgoing call

If use of the DM-REP is restricted due to URT, see clause 6.5.1, then the DMCC shall issue a DMCC-RELEASE indication to the user application with "transmit authorization lost".

Otherwise EN 300 396-3 [3], clause 6.2.1.1 shall apply except that the final paragraph of main text (i.e. "Otherwise, if the DMCC receives ...") shall be replaced with the following text:

Otherwise, if the DMCC receives a DMA-REPORT indication reporting that the DM-SETUP PDU has been transmitted then it shall wait for a further DMA-REPORT indication from layer 2 indicating the status of the link to the DM-REP:

- If the DMCC receives a DMA-REPORT indication reporting failure of link establishment to the DM-REP then it shall issue a DMCC-CONFIGURE request for lower layer traffic configuration and shall immediately send the DM-RELEASE PDU. It shall then either send the DM-SETUP PDU again or otherwise issue a DMCC-RELEASE indication to the user application (indicating "link to DM-REP not established or failed") and return to state IDLE. The DMCC shall attempt the call set-up for up to a maximum of DN304 times or until successful.

- Otherwise, if the DMCC receives a DMA-REPORT indication reporting successful link establishment to the DM-REP (or that the link to the DM-REP was already known to be available) then it shall enter state CALL ACTIVE TX OCCUPATION (following the procedures for a master DM-MS during occupation), inform the user application with a DMCC-SETUP confirm, issue a DMC-CONFIGURE request for lower layer traffic configuration and start timer DT311.

6.2.1.2 Incoming call

EN 300 396-3 [3], clause 6.2.1.2 shall apply.

6.2.1.3 Temporary group address

EN 300 396-3 [3], clause 6.2.1.3 shall apply.

6.2.2 Procedures for call set-up with presence check

6.2.2.1 Outgoing call

If use of the DM-REP is restricted due to URT, see clause 6.5.1, then the DMCC shall issue a DMCC-RELEASE indication to the user application with "transmit authorization lost".

Otherwise EN 300 396-3 [3], clause 6.2.2.1 shall apply except that the final indented paragraph (i.e. "If timer DT303 expires ...") shall be replaced with the following text:

- If timer DT303 expires, the DMCC shall send the DM-RELEASE PDU. Then, if DN303 or DN304 has not been reached (see below), the DMCC shall send the DM-SETUP PRES PDU again. Otherwise it shall issue a DMCC-RELEASE indication to the user application (indicating "called party is not reachable" or "link to DM-REP not established or failed" as appropriate) and shall return to state IDLE.
- If layer 2 reports that it has received a free channel presence signal from the DM-REP (DMC-REPORT indication) then the DMCC shall stop timer DT303. Then, if DN303 or DN304 has not been reached (see below), the DMCC shall send the DM-SETUP PRES PDU again. Otherwise it shall issue a DMCC-RELEASE indication to the user application (indicating "called party is not reachable" or "link to DM-REP not established or failed" as appropriate) and shall return to state IDLE.
- If use of the DM-REP becomes restricted (due to validity time expiring or receipt of a presence signal with validity time = 0, see clause 6.5.1), then the DMCC shall remain in the same state but abandon the call set-up at the next opportunity (i.e. DT303 expiry, or receipt of DM-CONNECT or DM-DISCONNECT PDU) by taking the call release path in the corresponding procedure. The release cause reported in the DMCC-RELEASE indication to the user application at that time should be "transmit authorization lost".
- If the DMCC has received a DMA-REPORT indication from layer 2 reporting successful link establishment to the DM-REP (or that the link to the DM-REP was already known to be available) then it shall attempt the call set-up for up to a maximum of DN303 times or until successful. Otherwise the DMCC shall attempt the call set-up for up to a maximum of DN304 times or until successful.

6.2.2.2 Incoming call

EN 300 396-3 [3], clause 6.2.2.2 shall apply.

6.2.3 Usage of DM-OCCUPIED PDU

6.2.3.1 Sending of DM-OCCUPIED PDU by master DM-MS

EN 300 396-3 [3], clause 6.2.3.1 shall apply.

6.2.3.2 Late entry by slave DM-MS

EN 300 396-3 [3], clause 6.2.3.2 shall apply.

6.2.4 Procedures during occupation

6.2.4.1 Master DM-MS

A master DM-MS sending circuit mode traffic shall obey the procedures in EN 300 396-3 [3], clause 6.2.4.1 bullet a) to d). It shall also obey the following procedures:

- e) If layer 2 reports that the link to the DM-REP has failed (DMC-REPORT indication) then the DMCC shall send a DM-RELEASE PDU to the called DM-MS(s), stop timer DT311, inform the user application with a DMCC-RELEASE indication and return to state IDLE.
- f) If layer 2 reports that it has received a free channel presence signal from the DM-REP (DMC-REPORT indication) then the DMCC shall stop timer DT311, inform the user application with a DMCC-RELEASE indication and return to state IDLE.
- g) If use of the DM-REP becomes restricted (due to validity time expiring or receipt of a presence signal with validity time = 0, see clause 6.5.1), then, unless already sending a DM-RELEASE PDU or a DM-PRE ACCEPT PDU, the DMCC shall send a DM-RELEASE PDU indicating "transmit authorization lost", stop timer DT311, inform the user application with a DMCC-RELEASE indication and return to state IDLE. In the case that it is already sending a DM-TX CEASED PDU, the DMCC shall send a DM-RELEASE PDU after the DM-TX CEASED to terminate the call.

6.2.4.2 Slave DM-MS

EN 300 396-3 [3], clause 6.2.4.2 shall apply with the following addition to procedure h) 1) when waiting for a response from the master to a valid pre-emption for continuation of the ongoing call:

- If use of the DM-REP becomes restricted (due to validity time expiring or receipt of a presence signal with validity time = 0, see clause 6.5.1), then: if there has been no response from layer 2, the DMCC shall indicate to layer 2 that no further random access transmissions are permitted for the outstanding request; the DMCC shall remain in the same state itself but abandon the pre-emption at the next opportunity (i.e. receipt of DM-PRE ACCEPT or DM-REJECT PDU, or receipt of DMA-REPORT indication). Where applicable the reason reported in the DMCC-REPORT indication to the user application at that time should be "transmit authorization lost". In the case of receiving DM-PRE ACCEPT the DMCC shall inform the user application with a DMCC-REPORT indication and return to state IDLE.

6.2.4.3 Transmitting Party Number Identification (TPNI)

EN 300 396-3 [3], clause 6.2.4.3 shall apply.

6.2.5 Procedures during reservation

6.2.5.1 Master DM-MS

During the reservation period, a master DM-MS shall obey the procedures in EN 300 396-3 [3], clause 6.2.5.1 bullet a) to h). It shall also obey the following procedures:

- j) If layer 2 reports that the link to the DM-REP has failed (DMC-REPORT indication) then the DMCC shall send a DM-RELEASE PDU to the called DM-MS(s), inform the user application with a DMCC-RELEASE indication and return to state IDLE.
- k) If layer 2 reports that it has received a free channel presence signal from the DM-REP (DMC-REPORT indication) then the DMCC shall inform the user application with a DMCC-RELEASE indication and return to state IDLE.
- l) If use of the DM-REP becomes restricted (due to validity time expiring or receipt of a presence signal with validity time = 0, see clause 6.5.1), then, unless already sending a DM-RELEASE PDU, a DM-PRE ACCEPT PDU or a DM-TX ACCEPT PDU, the DMCC shall send a DM-RELEASE PDU indicating "transmit authorization lost", stop timer DT311, inform the user application with a DMCC-RELEASE indication and return to state IDLE.

6.2.5.2 Slave DM-MS

EN 300 396-3 [3], clause 6.2.5.2 shall apply with the following addition to procedure a) when waiting for a response from the master to a request to transmit in the ongoing call:

- If use of the DM-REP becomes restricted (due to validity time expiring or receipt of a presence signal with validity time = 0, see clause 6.5.1), then: if there has been no response from layer 2, the DMCC shall indicate to layer 2 that no further random access transmissions are permitted for the outstanding request; the DMCC shall remain in the same state itself but abandon the changeover at the next opportunity (i.e. receipt of DM-TX ACCEPT or DM-REJECT PDU, or receipt of DMA-REPORT indication). Where applicable the reason reported in the DMCC-REPORT indication to the user application at that time should be "transmit authorization lost". In the case of receiving DM-TX ACCEPT the DMCC shall inform the user application with a DMCC-REPORT indication and return state IDLE.

6.2.5.3 Pre-emption of short data sent as a transaction within a circuit mode call

EN 300 396-3 [3], clause 6.2.5.3 shall apply.

6.2.6 Procedures to set up a new call by pre-emption

EN 300 396-3 [3], clause 6.2.6 shall apply.

6.3 Short Data Service (SDS) procedures

The DMCC protocol for the SDS when operating with a DM-REP is similar to the protocol defined in EN 300 396-3 [3], clause 6.3 except that a transaction may fail if the layer 2 in the calling DM-MS does not see the short data DSB re-transmitted by the DM-REP on the slave link.

6.3.1 Sending short data

6.3.1.1 Sending short data on a free channel

6.3.1.1.1 Sending unacknowledged short data on a free channel

EN 300 396-3 [3], clause 6.3.1.1.1 shall apply except that a DM-MS shall not initiate a transfer if use of the DM-REP is restricted due to URT, see clause 6.5.1 and with the following differences:

- i) The indented paragraph (i.e. "If the DMCC receives a DMA-REPORT indication reporting that the DM-SDS UDATA PDU has been transmitted ...") shall be replaced with the following text:
 - If the DMCC receives DMA-REPORT indication(s) reporting that either:
 - the DM-SDS UDATA PDU has not been completely sent because of failure of link establishment to the DM-REP; or
 - the DM-SDS UDATA PDU has been completely sent without fragmentation, but that link establishment to the DM-REP may have failed,
 then it shall either send the DM-SDS UDATA PDU again, URT permitting, (see note 1) or otherwise issue a DMCC-SDS REPORT indication to the user application reporting the failure and return to state IDLE. The DMCC shall attempt the short data transmission for up to a maximum of DN317 times or until successful.
 - Otherwise, if the DMCC receives a DMA-REPORT indication reporting that the DM-SDS UDATA PDU has been transmitted the required number of times, it shall either:
 - inform the user application using a DMCC-SDS REPORT indication with parameter "short data transfer completed" and return to state IDLE; or

- if using the alternative method 2 described in 6.3.1.1.1 of EN 300 396-3 [3], send the DM-SDS UDATA PDU again.

NOTE 1: The DMCC may choose to delay re-sending the DM-SDS UDATA PDU in case there may be a temporary propagation problem - except in the case of short data sent as a transaction within a circuit mode call.

NOTE 2: The alternative method 2 may give some advantage to the sending DM-MS in the case of temporary propagation problems. It may also give some advantage to other DM-MSs in the case when the sending DM-MS perceives failure of link establishment to the DM-REP when the DM-REP actually received the SDS set-up DSBs, since it may reduce the time for which the channel is wasted and cannot be pre-empted.

6.3.1.1.2 Sending acknowledged short data on a free channel

EN 300 396-3 [3], clause 6.3.1.1.2 shall apply except that a DM-MS shall not initiate a transfer if use of the DM-REP is restricted due to URT, see clause 6.5.1 and the final indented paragraph (i.e. "If timer DT316 expires ...") shall be replaced with the following text:

- If timer DT316 expires then, if DN316 or DN317 has not been reached (see below), the DMCC shall send the DM-SDS DATA PDU again, URT permitting, (without indicating "immediate retransmission" in the DMA-UNITDATA request). Otherwise it shall issue a DMCC-SDS REPORT indication to the user application (with parameter "failed transfer" or "link to DM-REP not established" as appropriate) and shall return to state IDLE.
- If the DMCC has received a DMA-REPORT indication from layer 2 reporting successful link establishment to the DM-REP (or that the link to the DM-REP was already known to be available) then it shall attempt the short data transmission up to a maximum of DN316 times if no acknowledgement has been received. Otherwise the DMCC shall attempt the short data transmission for up to a maximum of DN317 times or until successful.

6.3.1.2 Sending short data by pre-emption

EN 300 396-3 [3], clause 6.3.1.2 shall apply except that a DM-MS shall not initiate the transfer if use of the DM-REP is restricted due to URT, see clause 6.5.1.

6.3.1.3 Sending short data during circuit mode transmission

EN 300 396-3 [3], clause 6.3.1.3 shall apply.

6.3.1.4 Sending short data as a transaction within a circuit mode call

EN 300 396-3 [3], clause 6.3.1.4 shall apply except that point d) of clause 6.3.1.4.3 shall be replaced with the following text:

- d) after completion of the short data transfer (other than in the case of being pre-empted or failure of DM-REP link establishment) then, instead of returning to state IDLE, the DMCC shall enter state CALL ACTIVE TX RESERVATION as a master DM-MS during reservation and shall follow the procedures defined in clause 6.2.5.1.

6.3.2 Receiving short data

6.3.2.1 Receiving unacknowledged short data

EN 300 396-3 [3], clause 6.3.2.1 shall apply.

6.3.2.2 Receiving acknowledged short data

EN 300 396-3 [3], clause 6.3.2.2 shall apply.

6.3.3 Additional addressing

EN 300 396-3 [3], clause 6.3.3 shall apply.

6.3.4 Extended error protection

EN 300 396-3 [3], clause 6.3.4 shall apply.

6.3.5 SDS-TL service in DMO

EN 300 396-3 [3], clause 6.3.5 shall apply.

6.4 Usage of DMA-UNITDATA primitive

EN 300 396-3 [3], clause 6.4 shall apply.

6.5 General procedures

6.5.1 Usage restriction type and validity time

The usage restriction type (URT), addressing for URT and validity time elements are passed from layer 2 to layer 3 using DMC-REPORT indication in the "presence signal information" parameter, when received in the DM-REP presence signal.

If "usage restriction type" = 0000₂ (no restrictions), then this places no restrictions on the DM-MS using the DM-REP.

If "usage restriction type" = 0001₂ (restricted by prior arrangement), then the DM-MS shall only use the DM-REP if by configuration or otherwise it knows that it is permitted to use the DM-REP.

If "usage restriction type" = 0010₂ to 0110₂, then the DM-MS shall use the address information as defined in 10.3 to determine when it is permitted to use of the DM-REP follows:

- if the address information corresponds to one of its addresses and the validity time is non-zero, then the use of the DM-REP by the DM-MS should not be restricted for the specified validity time; the DM-MS should start or restart a validity time timer and when this expires the use of the DM-REP by the DM-MS should be restricted;
- if the address information corresponds to one of its addresses and the validity time is zero, then the use of the DM-REP by the DM-MS should be restricted immediately;
- if the address information does not correspond to any of its addresses, then there should be no change to the restriction on the DM-MS using the DM-REP.

If the use of the DM-REP by the DM-MS becomes restricted then any transaction that it is attempting to set up shall be abandoned cleanly and any ongoing transaction that it initiated shall be cleared down as described in the earlier parts of this clause 6. While restricted the DM-MS shall not initiate any new transactions through the DM-REP, however it is permitted to receive incoming transactions, including responding to acknowledged transactions when it is individually addressed, and it is permitted to pre-empt DM-REP transactions to initiate a transaction not involving the DM-REP.

Prior to receiving usage restriction type and validity time from a specific DM-REP, if the DM-MS is configured to use that DM-REP or it receives signalling messages from the DM-REP addressed to itself, the DM-MS may assume that there are no restrictions on its use of the DM-REP, unless configured to assume that its use is restricted prior to receipt of a presence signal.

NOTE: The DM-REP should not ignore messages from DM-MS based on URT and validity time in any way that prevents DM-MS from clearing down transactions cleanly or pre-empting transactions.

7 DM-MS layer 2 service description for operation with a type 1 DM-REP

7.1 Introduction

This clause describes the services offered by the DM-MS's layer 2 to its layer 3 for operation with a type 1 DM-REP (either a type 1A or a type 1B DM-REP). The service description is described in terms of Service Access Points (SAPs), primitives and their parameters.

The internal boundaries between the layers and sub-layers described herein are not testable and do not imply any specific implementation, but are rather used for the description of the protocol model. In the following clauses the word "shall" is used with SAPs, service primitives and parameters for traceability reasons in the protocol model, but again those SAPs and primitives are not testable. The following description also does not imply any specific implementation.

NOTE: In an implementation, additional parameters may be included in the primitives in order to exchange additional information between layer 3 and layer 2.

7.2 Layer 2 architecture

EN 300 396-3 [3], clause 7.2 shall apply.

7.3 Service descriptions

7.3.1 Services at the DMA-SAP

7.3.1.1 Services provided to layer 3

EN 300 396-3 [3], clause 7.3.1.1 shall apply except that the seventh and eighth paragraphs (i.e. "The signalling service offered ..." and "If the random access protocol is used ...") shall be replaced with the following text:

The signalling service offered by layer 2 to layer 3 shall be an unacknowledged service except for call set-up messages or when the random access protocol is used. Layer 2 receives a DMA-UNITDATA request primitive from layer 3, transmits the message (in one or more MAC blocks) sending it the appropriate number of times, and then reports to layer 3 when the message has been sent. Acknowledgements and retransmissions are under the control of layer 3.

For call set-up messages for circuit mode calls and short data messages, layer 2 is responsible for checking and reporting whether or not the link to the DM-REP has been established (or reporting if the link to the DM-REP was already known to be available). The repeated message on the slave link is regarded as an implicit layer 2 acknowledgement from the DM-REP to the master DM-MS. For a call set-up, the layer 2 in the master DM-MS receives a DMA-UNITDATA request primitive from layer 3 and transmits the message (or first fragment) sending it the appropriate number of times. In the protocol description, it is assumed that layer 2 reports to layer 3 both when the message has been sent and when the status of the link to the DM-REP is known. Retransmissions, and acknowledgements from the called DM-MS, are under the control of layer 3.

NOTE 1: For a call set-up sent after a successful pre-emption or changeover procedure, layer 2 may assume that the link to the DM-REP is already known to be available without looking for the repeated message on the slave link. However, in the protocol description, it is assumed that layer 2 still issues the additional report to layer 3.

For messages other than call set-up messages, layer 2 always assumes that the link to the DM-REP is available and there is no additional report issued to layer 3.

NOTE 2: When sending more than one transmission of a DM-SDS UDATA message then, for the repetitions (i.e. after the first complete transmission), layer 2 may assume that the link to the DM-REP is already known to be available without looking for the repeated DSB on the slave link. Note however that this applies only when layer 2 sends more than one transmission of a DM-SDS UDATA message as a result of a single DMA-UNITDATA request primitive; if layer 3 issues multiple DMA-UNITDATA request primitives for the same DM-SDS UDATA message (see clause 6.3.1.1.1) then layer 2 needs to check whether the link to the DM-REP has been established when sending the first transmission relating to each DMA-UNITDATA request primitive.

NOTE 3: For a fragmented DM-SDS DATA message, layer 2 reports when the status of the link to the DM-REP is known and then after complete transmission of the message (i.e. after transmission of the DMAC-END). In the layer 3 procedure for acknowledged short data, timer DT316 is measured from the latter report.

If the random access protocol is used (i.e. for pre-emption and changeover requests), layer 2 is responsible for sending retries until a response is received or the access attempt fails.

7.3.1.2 Service primitives at the DMA-SAP

EN 300 396-3 [3], clause 7.3.1.2 shall apply.

7.3.2 Services at the DMC-SAP

7.3.2.1 Services provided to layer 3

EN 300 396-3 [3], clause 7.3.2.1 shall apply.

7.3.2.2 Service primitives at the DMC-SAP

7.3.2.2.1 DMC-CONFIGURE primitive

EN 300 396-3 [3], clause 7.3.2.2.1 shall apply except that the DMC-CONFIGURE request primitive may have additional conditional parameters "repeater address" and "type of repeater".

NOTE: The "repeater address" and "type of repeater" parameters in the DMC-CONFIGURE request primitive configure layer 2 with the 10-bit repeater address and with information about the repeater type (i.e. type 1A, type 1B or type 2).

7.3.2.2.2 DMC-REPORT primitive

EN 300 396-3 [3], clause 7.3.2.2.2 shall apply except that the DMC-REPORT indication is used to issue two additional types of report on the status of the channel, not required for direct MS-MS operation:

- it is used to indicate to the higher layers when layer 2 is receiving a DM-REP presence signal from a DM-REP that the DM-MS is permitted to use;
- it is used, during a circuit mode call, for the layer 2 in the master DM-MS to report to layer 3 that the link to the DM-REP has failed.

7.3.3 Services at the DMD-SAP

7.3.3.1 Services provided to the U-plane application

EN 300 396-3 [3], clause 7.3.3.1 shall apply.

7.3.3.2 Service primitives at the DMD-SAP

EN 300 396-3 [3], clause 7.3.3.2 and the related clauses shall apply.

7.4 Parameter listing

EN 300 396-3 [3], clause 7.4 and the related clauses shall apply with the following differences:

- i) Clause 7.4.29, parameter "report" at the DMA-SAP may indicate the following additional possible occurrences:
 - successful link establishment to DM-REP (or link to DM-REP already known to be available);
 - failure of link establishment to DM-REP.

NOTE: The "communication type" parameter in the DMA-UNITDATA request primitive for a call set-up message enables layer 3 to specify whether the DM-REP function is required for the call - thereby invoking operation according to the present document or according to EN 300 396-7 [7], or not required for the call - thereby invoking operation according to EN 300 396-3 [3] or EN 300 396-5 [5].

8 DM-MS layer 2 protocol for operation with a type 1 DM-REP

8.1 Introduction

ETS 300 396-1 [1], clause 5 provides a brief overview of the general architecture and a description of all layers within the DMO protocol including the functionality of the Data Link Layer (DLL). This clause describes in detail the layer 2 protocol and defines the operation of the DLL in a DM-MS operating with a type 1 DM-REP (either a type 1A or a type 1B DM-REP).

NOTE 1: The procedures for operation with a type 1B DM-REP are similar to the procedures for operation with a type 1A DM-REP except that, for a type 1A DM-REP, all transmissions are sent on the selected DM RF carrier whereas, for a type 1B DM-REP, transmissions by DM-MSs are sent on the appropriate DM "uplink" RF carrier f_1 and transmissions from the DM-REP to DM-MSs are sent on the associated (duplex-spaced) DM "downlink" RF carrier f_2 .

A type 1A DM-REP can support a single call on the selected DM RF carrier. A type 1B DM-REP can support only a single call on the pair of RF carriers (f_1 and f_2).

NOTE 2: Since a type 1 DM-REP supports only a single call on the air interface, the protocol for operation with a type 1 DM-REP is based on the protocol for normal mode in EN 300 396-3 [3].

NOTE 3: The methods of slot usage are different in the case of a type 2 DM-REP. The procedures for operation with a type 2 DM-REP are described in EN 300 396-7 [7].

The DLL in the DM-MS is divided into two sub-layers: the upper MAC and the lower MAC.

8.1.1 Functions of lower MAC

EN 300 396-3 [3], clause 8.1.1 shall apply.

See clause 11 for specific details of the lower MAC functionality.

8.1.2 Functions of upper MAC

EN 300 396-3 [3], clause 8.1.2 shall apply.

The functions of the upper MAC are described in this clause.

8.2 Interface between lower and upper MAC

EN 300 396-3 [3], clause 8.2 shall apply.

8.2.1 Logical channels defined at the DMV-SAP

EN 300 396-3 [3], clause 8.2.1 shall apply.

8.2.2 Service primitives at the DMV-SAP

EN 300 396-3 [3], clause 8.2.2 shall apply.

8.2.3 PDU mapping of the logical channels at the DMV-SAP

EN 300 396-3 [3], clause 8.2.3 shall apply.

8.2.4 Scrambling mechanism

The scrambling method applied in TETRA DMO is defined in EN 300 396-2 [2], clause 8.2.5, and is based on a "seed" - the DM Colour Code (DCC).

The DCC for SCH/F, STCH and TCH shall be a 30-bit sequence $e(1)$, $e(2)$, ..., $e(30)$, generated as an algorithmic combination of the "source address" element and the 6 least significant bits of the 10-bit "repeater address" element. The coding order shall be as follows:

- $e(1)$ = 6th last bit of the repeater address;
- $e(2)$ = 5th last bit of the repeater address;
- ...etc.
- $e(6)$ = least significant bit of the repeater address;
- $e(7)$ = most significant bit of source address;
- ...etc.
- $e(30)$ = least significant bit of source address.

The colour code for STCH or TCH shall be derived from the "repeater address" and "source address" elements in the DMAC-SYNC PDU that carried the DM-SETUP, DM-CONNECT ACK or DM-OCCUPIED message for the current traffic transmission. The colour code for SCH/F shall be derived from the "repeater address" and "source address" elements in the DMAC-SYNC PDU that initiated the fragmentation; this may apply to DM-SDS UDATA, DM-SDS DATA and DM-SDS ACK messages.

NOTE: The "source address" element may contain either a true SSI or a pseudo SSI; the algorithmic combination described above applies in either case. This colour code applies for both transmission to the DM-REP and reception from the DM-REP.

When element "air interface encryption state" is set to 01_2 (security class DM-2-C) in the DMAC-SYNC PDU, the addressing information is encrypted except the 10-bit repeater address; see clause 8.5.3. The following parameters shall be used for the generation of the DCC:

- the "repeater address" element; and
- the Encrypted DMO Short Identity (EDSI) appropriate to the current slot (see EN 300 396-6 [6]). The EDSI is an encrypted version of the source address from the DMAC-SYNC PDU that carried the DM-SETUP, DM-CONNECT ACK or DM-OCCUPIED message for the current traffic transmission, or from the DMAC-SYNC PDU that initiated the fragmentation. The EDSI changes from one slot to the next, because it is derived using the Time Variant Parameter (TVP) for that slot, so the DCC also changes for each traffic or SCH/F slot.

The scrambling sequence is generated from the 30-bit DCC and is applied within the lower MAC to all logical channels, except for the SCH/S and SCH/H of the DSB. SCH/S and SCH/H of the DSB are subjected to the same scrambling but, in their case, all 30 bits of the DCC are set equal to zero.

8.2.5 PDU error detection

EN 300 396-3 [3], clause 8.2.5 shall apply.

8.2.6 Modes of operation

EN 300 396-3 [3], clause 8.2.6 and the related clauses shall apply.

8.3 Basic capabilities of the physical layer

8.3.1 DM-MS capabilities

The following clauses describe the capabilities required of DM-MSs for operation with a type 1 DM-REP. DM-MSs are classified as either DM only DO-MS, dual mode capable DU-MS or dual watch capable DW-MS (F-DW-MS or I-DW-MS).

8.3.1.1 DM only and dual mode capable MS operation

For operation with a type 1A DM-REP, a DO-MS or DU-MS shall be capable of either transmitting or receiving (i.e. simplex mode operation) on a single DM RF carrier.

For operation with a type 1B DM-REP, a DO-MS or DU-MS shall be capable of either transmitting on one DM RF carrier (the "uplink" frequency f_1 from DM-MSs to the DM-REP) or receiving on a different DM RF carrier (the "downlink" frequency f_2 from the DM-REP to DM-MSs), in two-frequency simplex mode.

In either case, the DO-MS or DU-MS shall be capable of switching between DM transmit and receive within one timeslot duration, approximately 14 ms.

A DO-MS or DU-MS shall be capable of transmitting in all four timeslots of at least two consecutive frames.

If a DO-MS or DU-MS which is operating as a master MS invites timing change requests then it shall be capable of adjusting its current transmit timing reference in accordance with the procedures defined in clause 8.4.7.15, with an accuracy of within ± 2 symbol durations.

NOTE: A DW-MS which is operating as a master MS is permitted to adjust its transmit timing reference if appropriate, in steps of not greater than 1/4 symbol duration. The rate of adjustment should not be greater than 1/4 symbol per multiframe duration.

A DO-MS or DU-MS shall be capable of adjusting its transmission frequency as defined in clause 11.

8.3.1.2 Dual watch capable MS operation

8.3.1.2.1 Full Dual Watch Mobile Station (F-DW-MS)

A F-DW-MS shall support the appropriate operations described in clause 8.3.1.1 and in addition shall be capable of switching between operating on the selected DM channel frequency and the TMO channel frequency within 0,5 of a timeslot duration (approximately 7 ms). This is illustrated in figure 8.

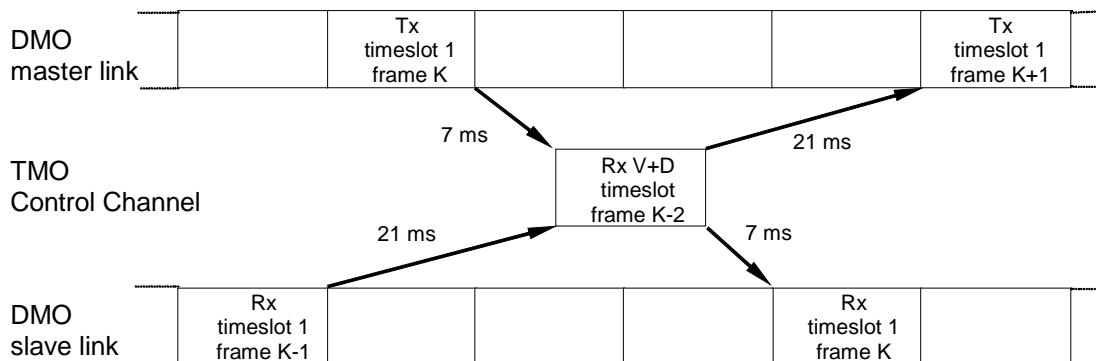

Figure 8: Full Dual watch timing on type 1 DM-REP

8.3.1.2.2 Idle Dual Watch Mobile Station (I-DW-MS)

EN 300 396-3 [3], clause 8.3.1.2.2 shall apply.

8.4 Usage of DM channel with type 1 DM-REP

A DM channel may be perceived as being in any one of three states, i.e. free, occupied or reserved.

When the DM channel is in occupation or reservation, there is a timing structure which is divided into multiframes, frames and timeslots. In the channel free condition, no overlying DM timing reference exists other than that which may be provided by a DM-REP presence signal or implicitly provided by an external network.

In DM-REP operation:

- all communications between the DM-REP and the master DM-MS, on the master link, shall use the master link's slot and frame numbering;
- all communications between the DM-REP and slave or idle DM-MSs, on the slave link, shall use the slave link's slot and frame numbering.

For operation with a type 1 DM-REP, the slot and frame numbering on the slave link lags three timeslots behind the master link's slot and frame numbering.

For operation with a type 1A DM-REP, all transmissions are sent on the selected DM RF carrier. This applies to both master link and slave link transmissions.

For operation with a type 1B DM-REP, all transmissions from the DM-REP to DM-MSs are sent on the selected DM downlink RF carrier f_2 . All transmissions by DM-MSs are sent on the associated (duplex-spaced) DM uplink RF carrier f_1 . This applies to both master link and slave link transmissions.

8.4.1 Definition of DM channel

8.4.1.1 DM channel arrangement

For operation with a type 1A DM-REP, a DM channel exists on a single RF carrier. During occupation and reservation it is divided, in time, into master link timeslots and slave link timeslots. As shown in figure 9, two timeslots are allocated primarily for the master link and two timeslots primarily for the slave link. Each timeslot lasts 14,167 ms. The end of one master link timeslot and the beginning of the other are separated in time by one timeslot duration. The slave link timeslots are similarly arranged. Time on the DM channel is further divided into frames and multiframe, each frame equal to 4 timeslots duration and each multiframe equal to 18 frames duration (see EN 300 396-2 [2], clause 9 for further details).

For operation with a type 1B DM-REP, the same arrangement shall apply except that transmissions by DM-MSs are sent on the uplink RF carrier f_1 whereas transmissions from the DM-REP to DM-MSs are sent on the downlink RF carrier f_2 .

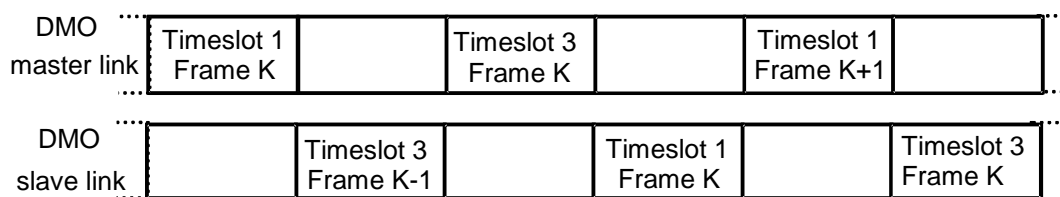

Figure 9: Master link / slave link arrangement on type 1 DM-REP

8.4.1.2 DM channel operation

A DM-MS wishing to begin a type 1 call, and having determined that the selected DM RF carrier is free, shall begin master MS operation on the master link.

When a DM-MS first becomes master on a free channel, it shall define the DM timing reference including slot and frame numbering. This includes the case where the DM-REP has been generating a presence signal on the selected channel.

- If the master is not performing full dual watch then the DM timing reference (including slot and frame numbering) may be chosen arbitrarily.

NOTE 1: For example, the master may choose to define the frame numbering such that its final repetitions of the call set-up message are sent in frame 18 of the master link.

Or, if the DM-REP has been providing a free-carrier presence signal on the selected channel, the master may choose a DM timing reference based on the timing defined by the DM-REP presence signal. This applies particularly if the "presence signal dual watch synchronization flag" in the presence signal was set to 1, indicating that the DM-REP considers that the presence signal was sent using the dual watch synchronization (see also clause 9.4.5.1, note 5). If using the timing from the DM-REP presence signal, the master should set the master link's slot and frame numbering three timeslots ahead of the numbering received in slave link DM-REP presence signals (unless the DM-MS is using a type 2 DM-REP to make a type 1B call, in which case it should set the master link's slot and frame numbering 29 timeslots behind the numbering received in slave link DM-REP presence signals).

- If the master is performing full dual watch then it shall define the slot boundaries and the slot and frame numbering so that timeslot 1 of frame K of the master link occurs 9,5 timeslot durations before TMO downlink timeslot J of frame K, where timeslot J is the TMO receive timeslot (normally timeslot 1). This timing shall be achieved with an accuracy of within ± 2 symbol durations. The DM channel timing is illustrated in figure 8. Refer also to clause 8.4.7.10.

NOTE 2: The TMO receive timeslot used in this procedure is the downlink slot of the appropriate common control channel i.e. Main Control CHannel (MCCH) or common Secondary Control CHannel (SCCH). The DM-MS should not align the DM slot numbering with a TMO assigned channel.

When the DM-MS first becomes master on a free channel, and if the DM-REP has been providing a presence signal on the selected channel, then the DM-MS should take its initial frequency synchronization from the presence signal. If the DM-MS has not received a presence signal (or other suitable signalling) from the DM-REP sufficiently recently then it shall use its own frequency reference to generate the transmission frequency. In either case, the DM-MS then aligns its frequency synchronization to the DM-REP transmissions as defined in clause 11.

NOTE 3: Frequency efficient mode is not supported for transactions through a type 1 DM-REP. DM-MSs are not precluded from using the RF carrier in frequency efficient mode for direct MS-MS calls when the DM-REP is in idle mode between calls. Note however that there is no procedure for pre-empting a frequency efficient direct MS-MS call in order to make a normal mode call (such as a call through a type 1 DM-REP) so use of this option will stop DM-REP operation until the RF carrier is completely free.

8.4.2 DM-MAC states

The MAC layer of the DM-MS is responsible for monitoring activity on a selected DM RF carrier in order to determine the current perceived state of that RF carrier and to receive any signalling messages addressed to itself (i.e. addressed to its individual address or to one of its group addresses). Accurate DM channel state information is essential if a DM-MS is to employ the correct signalling and monitoring procedures when it is in a call or if it wishes to use fast call set-up. The perceived DM channel state combined with the current DM-MS mode of operation shall be used to update the DM-MAC state model.

NOTE: For operation with a type 1B DM-REP, the DM-MS determines the perceived state of the selected DM downlink RF carrier f_2 .

8.4.2.1 DM-MAC state definitions

EN 300 396-3 [3], clause 8.4.2.1 shall apply except that frequency efficient mode is not valid for transactions through a type 1 DM-REP.

8.4.2.2 DM-MS channel surveillance procedures

EN 300 396-3 [3], clause 8.4.2.2 shall apply.

NOTE: For operation with a type 1B DM-REP, the DM-MS performs the channel surveillance procedures on the selected DM downlink RF carrier f_2 .

8.4.2.2.1 Initial determination of DM channel state

8.4.2.2.1.1 Initial determination of state of carrier

EN 300 396-3 [3], clause 8.4.2.2.1.1 shall apply.

NOTE: The DM-MS is permitted to implement a signal strength threshold where it need not regard the channel as busy (i.e. occupied or reserved) or re-enter state "MS idle - state of channel unknown" as a result of receiving DSBs below that threshold. For example, the signal strength threshold may be set to the receiver sensitivity level. However, if the received DSBs contain the repeater address of the DM-REP used by the DM-MS, the DM-MS should not try to make a call through the DM-REP while the DM-REP is active.

8.4.2.2.1.2 Determination of state of one DM channel when other DM channel is busy

Frequency efficient mode is not valid for transactions through a type 1 DM-REP.

8.4.2.2.2 Fast call set-up surveillance in idle mode

EN 300 396-3 [3], clause 8.4.2.2.2 shall apply.

8.4.2.2.2.1 Fast call set-up surveillance when idle on a free carrier

EN 300 396-3 [3], clause 8.4.2.2.2.1 shall apply with the following difference:

NOTE: A DM-MS is permitted to implement a signal strength threshold where the DM-MS need not regard the channel as occupied or reserved by other users as a result of receiving DSBs (i.e. DMAC-SYNC or DPRES-SYNC PDUs) below that threshold. For example, the signal strength threshold may be set to the receiver sensitivity level. However, if the received DSBs contain the repeater address of the DM-REP used by the DM-MS, the DM-MS should not try to make a call through the DM-REP while the DM-REP is active.

8.4.2.2.2.2 Fast call set-up surveillance when idle on a carrier that is not free

EN 300 396-3 [3], clause 8.4.2.2.2.2 shall apply with the following differences:

- i) in the case of an occupied or reserved channel, a DM-MS conducting fast call set-up surveillance may monitor timeslot 1 of frame 18 instead of timeslot 3 of frame 18;
- ii) frequency efficient mode is not valid for transactions through a type 1 DM-REP.

8.4.2.2.3 DM-MS channel surveillance at call set-up

EN 300 396-3 [3], clause 8.4.2.2.3 shall apply with the following differences:

- i) The procedure for a retransmission of DM-SETUP PRES by the DMCC and for a non-immediate retransmission of DM-SDS DATA shall apply also for a retransmission of DM-SETUP or DM-SDS UDATA by the DMCC (i.e. for a retransmission by the DMCC after layer 2 has reported failure of link establishment to the DM-REP).

NOTE 1: For a retransmission of DM-SDS UDATA by the DMCC after perceived failure of link establishment to the DM-REP, the DM-MAC should use the same channel timing as for the previous attempt if the "SDS time remaining" from the previous attempt has not yet expired. This is in case the DM-REP actually received the SDS set-up DSBs and is still waiting for signalling on the old channel timing. This principle may also be used for other retransmissions after call set-up failure.

NOTE 2: Frequency efficient mode is not valid for transactions through a type 1 DM-REP.

NOTE 3: A DM-MS is permitted to implement a signal strength threshold where the DM-MS need not regard the channel as occupied or reserved by other users as a result of receiving DSBs (i.e. DMAC-SYNC or DPRES-SYNC PDUs) below that threshold. For example, the signal strength threshold may be set to the receiver sensitivity level. However, if the received DSBs contain the repeater address of the DM-REP used by the DM-MS, the DM-MS should not try to make a call through the DM-REP while the DM-REP is active.

8.4.2.3 Master DM-MS channel maintenance procedures during a call

During a circuit mode call, if the master DM-MS receives a presence signal from the DM-REP indicating that the channel is free (see note 1), then the master DM-MAC shall issue a DMC-REPORT indication to the higher layers reporting that it has received a free channel presence signal from the DM-REP the DM-MS is permitted to use. (The DMCC then leaves the call without signalling.)

Otherwise if a time DT225 elapses without receipt of a DSB in timeslot 3 of master link frames 1, 7 or 13 containing:

- a random access request addressed to itself; or
- a presence signal from the DM-REP indicating that the channel is occupied or reserved,

then the master DM-MAC shall issue a DMC-REPORT indication to the higher layers reporting that the link to the DM-REP has failed. (The DMCC then sends a DM-RELEASE message, which the DM-MAC transmits before becoming idle.)

NOTE 1: This procedure applies on reception of a presence signal from the DM-REP indicating that the channel is free, irrespective of the setting of the "master/slave link flag".

During channel reservation, if the master DM-MAC receives signalling messages on the DM channel indicating that the channel has become occupied by other users then it may give up its call. If so the DM-MAC shall inform the higher layers using the DMC-REPORT indication and shall begin idle mode operating procedures.

NOTE 2: During occupation and reservation, the master DM-MS monitors for a DSB in timeslot 3 of master link frames 1, 7 and 13 for link maintenance purposes, as defined above (i.e. timer DT225). It also uses DSBs received from the DM-REP to re-align its frequency synchronization, as defined in clause 11.

8.4.2.4 Slave DM-MS channel maintenance procedures during a call

A slave DM-MS operating either in signalling or traffic mode on a DM channel may conduct the following or equivalent channel surveillance procedures on the slave link.

8.4.2.4.1 Slave MS channel maintenance during call transaction

EN 300 396-3 [3], clause 8.4.2.4.1 shall apply.

8.4.2.4.2 Slave MS signal quality measurement during call transaction

EN 300 396-3 [3], clause 8.4.2.4.2 shall apply except that the slave MS estimates the success rate of decoding the relevant signalling messages received in timeslot 3 of slave link frames 6 and 12 and timeslot 1 or 3 of slave link frame 18.

8.4.2.4.3 Slave MS channel maintenance during reservation

EN 300 396-3 [3], clause 8.4.2.4.3 shall apply.

8.4.3 Criteria for changing DM-MAC state

8.4.3.1 Criteria for changing DM-MAC state for master DM-MS

EN 300 396-3 [3], clause 8.4.3.1 shall apply except that frequency efficient mode does not apply to transactions through a type 1 DM-REP.

The DM-MAC shall also change the current state condition if the following occurs:

- the DM-MS receives a presence signal from the DM-REP used for the call, indicating a channel state change.

8.4.3.2 Criteria for changing DM-MAC state for slave DM-MS

EN 300 396-3 [3], clause 8.4.3.2 shall apply except that frequency efficient mode does not apply to transactions through a type 1 DM-REP.

Additionally, the DM-MAC shall change the current state condition if the following occurs:

- the DM-MS receives a presence signal from the DM-REP used for the call, indicating a channel state change.

8.4.3.3 Criteria for changing DM-MAC state for idle DM-MS

EN 300 396-3 [3], clause 8.4.3.3 shall apply.

Additionally, the DM-MAC shall change the current state condition if the following occurs:

- the DM-MS receives a DM-REP presence signal indicating that the channel is occupied or reserved;
- the DM-MS receives a DM-REP presence signal indicating that the channel is free then:
 - if the channel is currently perceived as being occupied or reserved in a call through that DM-REP then the receiving DM-MS shall change the perceived DM channel state to free;
 - if the channel is currently perceived as being occupied or reserved in a call not involving that DM-REP then the receiving DM-MS shall not change the perceived DM channel state.

8.4.4 DM-MS channel monitoring procedures

A DM-MS in idle mode shall monitor the DM RF carrier in order to keep an up-to-date record of the perceived state of the channel and to receive any call set-up messages addressed to itself; see clause 8.4.2.2. The following clauses define the DM-MS monitoring requirements for operation with a type 1 DM-REP when the DM-MS is master or slave in a call or when it is attempting random access.

NOTE 1: If the protocol requires the DM-MS to transmit in any of the monitoring slots specified in this clause, the transmission takes precedence over the monitoring requirement.

NOTE 2: For operation with a type 1A DM-REP, the DM-MS performs the channel monitoring procedures on the selected DM RF carrier. For operation with a type 1B DM-REP, the DM-MS performs the channel monitoring procedures on the selected DM downlink RF carrier f_2 .

8.4.4.1 DM channel during initial call set-up and new call transaction by current master MS

For the initiation of a new call (or during reservation if the current master MS begins a new call transaction) the master MS shall, following the transmission of the last DSB containing the DMAC-SYNC PDU on the master link, monitor the slave link in order to detect the successful re-transmission of its call set-up signalling by the DM-REP; see also clause 8.5.6. Monitoring of the repeated call set-up signalling on the slave link shall take place within the immediately following DN232 or DN233 frames on the slave link.

NOTE: It is not required that the master MS is able to monitor the first transmission of the DMAC-SYNC PDU on the slave link.

8.4.4.2 DM channel during call set-up with presence check

For a circuit mode call set-up with presence check, the master MS shall monitor timeslot 1 and 3 on the master link for a DSB in the frames allocated for acknowledgements sent from the called MS via the DM-REP.

For a circuit mode call set-up with presence check, after transmission of DM-CONNECT messages, the called MS shall monitor timeslot 1 and 3 on the slave link for a DSB in the frames allocated for acknowledgements sent from the master MS via the DM-REP.

8.4.4.3 DM channel in occupation during a circuit mode call

A master MS during an active call transaction shall monitor timeslot 3 of frames 1, 4, 7, 10, 13 and 16 on the master link for a DSB containing pre-emption or timing change request signalling sent from a slave MS via the DM-REP, or for a DSB containing a DM-REP presence signal.

NOTE: The master MS is not required to monitor timeslot 3 during the transmission of the DM-TX CEASED message at the end of circuit mode occupation.

A slave MS during channel occupation should monitor and attempt to decode the DNB transmitted in timeslot 1 of frames 1 to 17 (see clause 8.6.2).

A slave MS during channel occupation shall monitor and attempt to decode a DSB containing occupation or other signalling in timeslot 3 of slave link frames 6, 12 and 18. A temporary exception to this requirement is if a dual watching slave MS is receiving a fragmented message or attempting random access on the TMO system.

8.4.4.4 DM channel in reservation during a circuit mode call

Following the end of a call transaction the master MS shall monitor timeslot 3 on the master link for a DSB containing transmit request, timing change request or pre-emption request signalling sent from a slave MS via the DM-REP, or for a DSB containing a DM-REP presence signal. The master MS shall conduct this monitoring in all master link frames except:

- frame 3; and
- those frames in which it is transmitting channel reservation or other signalling; and
- those frames corresponding to re-transmission on the master link of slave link frames which are precluded by the "requests bitmap" (see clause 8.5.7.2.2).

A slave MS during reservation shall monitor and attempt to decode a DSB in timeslot 1 or 3 (or both) at least every two frames. Monitoring of timeslot 3 of frame 3 does not contribute to fulfilling this requirement. The monitoring shall include timeslot 1 or 3 of frames 6, 12 and 18 in each multiframe.

NOTE: This monitoring is needed, for example, so that the slave MS can receive reservation signalling and so that it can determine when a new call transaction has begun or detect a timing change announcement or new call pre-emption acceptance or call release.

A temporary exception to this requirement is if a dual watching slave MS is receiving a fragmented message or attempting random access on the TMO system. If the MS has not performed the required monitoring then, if the reservation period ends and the DM-MS did not receive any further signalling for the DM call after the TMO activity, the DM-MS shall enter state "MS idle - state of channel unknown".

A slave MS wishing to become the new master on the channel shall, following the transmission of the transmit request message on the slave link, monitor timeslot 1 and 3 in the following frames on the slave link (except timeslot 3 of linearization frames, or when sending a retransmission) for a DSB indicating the result of the request; refer to clause 8.5.7.

8.4.4.5 DM channel in occupation during an SDS call

EN 300 396-3 [3], clause 8.4.4.4 shall apply, except that the first and second paragraphs (i.e. 'During SDS transmissions the master ...' and 'For SDS transmissions that require ...') shall be replaced by the following text:

During SDS transmissions the master MS shall monitor timeslot 3 of frames 1, 4, 7, 10, 13 and 16 on the master link for a DSB carrying pre-emption request signalling sent from a slave MS via the DM-REP, or for a DSB containing a DM-REP presence signal.

For SDS transmissions that require an acknowledgement, the master MS shall monitor timeslots 1 and 3 on the master link in those frames assigned for acknowledgement messages sent from the called MS via the DM-REP.

8.4.4.6 DM channel usage during pre-emption signalling

A DM-MS following the transmission of a request to pre-empt the channel shall monitor timeslots 1 and 3 in the following frames on the slave link (except timeslot 3 of linearization frames, or when sending a retransmission) to determine the result of the pre-emption request

The response to the pre-emption request may be sent by the master using either a DSB or a DNB with slot flag set; refer to clause 8.5.7.

8.4.4.7 DM channel usage during timing change request signalling

A slave MS following the transmission of a request for timing change shall monitor timeslots 1 and 3 in the following frames on the slave link (except timeslot 3 of linearization frames, or when sending a retransmission) to determine the result of the timing change request; refer to clause 8.5.7.

However, if in occupation, the actual timing change shall not occur before the end of the current call transaction.

8.4.5 Transmission of layer 3 messages by DM-MAC

NOTE: For operation with a type 1A DM-REP, the DM-MS transmits on the selected DM RF carrier. For operation with a type 1B DM-REP, the DM-MS transmits on the uplink RF carrier f_1 .

8.4.5.1 Transmission of C-plane messages by DM-MAC

EN 300 396-3 [3], clause 8.4.5.1 shall apply with the following differences:

- i) Whenever the DM-MS is sending a DM-SETUP or DM-SETUP PRES message, or a DM-SDS UDATA or DM-SDS DATA message starting with DSBs, it shall transmit the DSB in all four timeslots in each of the signalling frames except in the final signalling frame where timeslot 4 shall not be used. When the DM-MS is sending DM-SETUP PRES for a new call, or a non-fragmented DM-SDS DATA message as a new call, it shall transmit the DSBs in at least two frames rather than in at least three frames. When the master DM-MS is sending a DM-SETUP, DM-SETUP PRES, DM-SDS UDATA or DM-SDS DATA message for continuation of an ongoing call, it shall transmit the DSBs in at least one frame, rather than generally at least two frames and in certain cases three frames. In all the cases mentioned in this paragraph the master shall ensure that the final frame it uses for transmitting DSBs is neither frame 2 nor frame 3.

NOTE: The reason for the master not ending its transmissions in frame 2 or frame 3 is so that the subsequent DM-REP transmissions do not end up in only frames 2 and 3 or frames 3 and 4, as these may not be seen by DW-MS.

- ii) When transmitting DM-CONNECT, the DM-MAC shall send the message in more than one frame if the first transmission of the message is in timeslot 3 (i.e. if the DM-MAC did not send the message in timeslot 1 in the first transmission frame). When transmitting DM-DISCONNECT, the DM-MAC should send the message in more than one frame if the first transmission of the message is in timeslot 3.
- iii) When transmitting DM-RELEASE, the DM-MAC shall send the message in timeslot 1 in at least two frames. It shall also send the message, using a DSB, in each corresponding timeslot 3 unless it is sending DM-PRE ACCEPT or this is a linearization frame. After a failure of link establishment to the DM-REP, the DM-MAC shall choose the initial value of the "frame countdown" element to ensure that it sends the DM-RELEASE message in timeslot 3 in at least two frames.
- iv) For a call set-up without presence check, the transmission of DM-OCCUPIED by the master DM-MS does not start until after the completion of the DM-REP's re-transmissions of the DM-SETUP message on the slave link. The option to send DM-OCCUPIED in timeslots 2 and 4 does not apply for operation with a type 1A DM-REP.
- v) Following the transmission of the DSBs for a fragmented DM-SDS UDATA or DM-SDS DATA message, the timing of the next fragment shall be as defined in clause 8.5.4.1.

- vi) When transmitting DM-SDS ACK, the DM-MAC shall normally send the DSB in more than one frame if the first transmission of the DSB is in timeslot 3. The exception occurs if the DM-MAC did not receive the DMAC-END PDU terminating a fragmented DM-SDS DATA message, in which case it sends the DM-SDS ACK in only one frame; see clause 8.5.6.2 f).
- vii) Channel B operation is not valid.

8.4.5.2 Transmission of U-plane messages by DM-MAC

During channel occupation, a master DM-MAC on receiving a DMD-UNITDATA request from the U-plane application shall perform the procedures as defined in clause 8.6.4.

8.4.6 Transmission of layer 2 messages generated by DM-MAC

EN 300 396-3 [3], clause 8.4.6 shall apply except that channel B operation and frequency efficient operation are not valid, and the option to send DM-RESERVED and DM-SDS OCCUPIED in timeslots 2 and 4 does not apply for operation with a type 1A DM-REP.

NOTE: The note in EN 300 396-3 [3], clause 8.4.6.3 applies (except that frequency efficient operation is not valid); i.e. it is recommended that, when an MS becomes master, it sets the "timing flag" element to 1 to invite timing change requests, unless it is itself performing dual watch. This recommendation applies even if the MS sets the "dual watch synchronization flag" element to 1, based on information from the previous master or from the DM-REP presence signal.

8.4.7 General DM-MAC procedures

8.4.7.1 DM-MAC repeat transmissions

EN 300 396-3 [3], clause 8.4.7.1 shall apply. The minimum and maximum numbers of transmission frames for messages sent using the frame countdown mechanism are given in annex A.

8.4.7.2 DM-MAC frame countdown procedure

EN 300 396-3 [3], clause 8.4.7.2 shall apply.

8.4.7.3 Use of timers

The DM-MAC shall use a set of timers e.g. to determine how long it should wait for a response to a random access message. The timers are listed in annex A.

8.4.7.4 Linearization

A DM-MS wishing to begin a call may, after determining that the selected channel is free, linearize its transmitter in the time just prior to sending the call set-up signalling.

NOTE 1: A DM-MS is not permitted to linearize on a free channel at other times, unless it can linearize without transmitting on the channel.

During circuit mode occupation and reservation, a master MS may linearize in timeslot 3 of frame 3 of any multiframe on the master link.

During circuit mode occupation, a slave MS (or idle MS) may only conduct linearization in frame 3 of the slave link if permitted by the master MS. The DM-MAC in the master MS shall, in order to enable transmitter linearization to be conducted on the DM channel, permit the use of timeslot 3 of frame 3 of the slave link for linearization, by setting the "LCH in frame 3 flag" equal to 1 in the call set-up and occupation signalling.

NOTE 2: Linearization is not permitted during the call set-up signalling. This restriction includes the time for any DM-CONNECT/DISCONNECT and DM-CONNECT ACK messages (except for the called MS - refer to the last two paragraphs of this clause).

If linearization is permitted then it may be performed in timeslot 3 of frame 3 of the slave link after the completion of the frame countdown for the transmissions of the DM-SETUP or DM-CONNECT ACK message on the slave link.

NOTE 3: The requirement on the master DM-MS to permit linearization during circuit mode occupation may be relaxed for some types of call in future editions of the present document. Therefore, recipients have to check the setting of the "LCH in frame 3 flag".

During reservation, a slave MS (or idle MS) may conduct linearization in timeslot 3 of frame 3 of any multiframe on the slave link.

During short data occupation, a master MS may conduct linearization in timeslot 3 of master link frame 3 if timeslot 1 of master link frame 3 is an SCH/F slot. Also, for a DM-SDS DATA message, it may conduct linearization in timeslot 3 of master link frame 3 if timeslot 1 of master link frame 2 was an SCH/F slot.

During short data occupation, a slave MS (or idle MS) may conduct linearization in timeslot 3 of slave link frame 3 if timeslot 1 of slave link frame 3 is an SCH/F slot (as indicated by the "number of SCH/F slots" element in the SDS call set-up DSBs) - except that, for a DM-SDS UDATA message, the MS shall not conduct linearization in the slave link frame containing the final SCH/F slot. Also, the MS may conduct linearization in timeslot 3 of slave link frame 3 if timeslot 1 of slave link frame 4 will be an SCH/F slot.

When a called MS sends a response to a non-fragmented message (received in slave link frame X and containing "frame countdown" element F), the called MS may linearize its transmitter in timeslot 1 of slave link frame $(X+F) \bmod 18 + 1$. When a called MS sends a response to a fragmented message, the called MS may linearize its transmitter in timeslot 1 of the slave link frame following the slave link frame that contained the DMAC-END PDU.

When a called MS sends a response to a non-fragmented message, and if the message was received only in timeslot 4 of the slave link frame containing "frame countdown" element set to 0, then the called MS may linearize its transmitter in timeslot 2 of the next slave link frame (before transmission in timeslot 3).

NOTE 4: For operation with a type 1A DM-REP, the DM-MS linearizes on the selected DM RF carrier. For operation with a type 1B DM-REP, the DM-MS linearizes on the uplink RF carrier f_1 .

8.4.7.5 Fragmentation

EN 300 396-3 [3], clause 8.4.7.5 shall apply.

8.4.7.6 Fill bit indication

EN 300 396-3 [3], clause 8.4.7.6 shall apply.

8.4.7.7 Selection of pseudo address

EN 300 396-3 [3], clause 8.4.7.7 shall apply.

8.4.7.8 Slot flag indication

EN 300 396-3 [3], clause 8.4.7.8 shall apply.

8.4.7.9 Requests bitmap

In order that a master MS may conduct dual watch operation or some form of battery economy mode during channel reservation the DM-MAC may dictate which slave link frames, in addition to those allocated for pre-emption, may be used for random access messages e.g. DM-TX REQUEST messages. The DM-MAC shall using an 8-bit element indicate in which frames a slave MS may send a random access message on the slave link. The 8-bit element used shall relate to frames 1, 4, 7, 9, 10, 13, 15 and 16 of the slave link.

8.4.7.10 DM aspects of dual watch operation

8.4.7.10.1 Full and idle dual watch operation

EN 300 396-3 [3], clause 8.4.7.10.1 shall apply.

8.4.7.10.2 DM aspects of full dual watch operation

8.4.7.10.2.1 Model of operation for full dual watch

EN 300 396-3 [3], clause 8.4.7.10.2.1 shall apply except that the list of DM frames not normally available for TMO reception shall be replaced by the following list of DM frames:

- slot 3 of master link frames 6, 12 and 18 (used for occupation/reservation signalling);
- slot 3 of slave link frames 6 and 12 (used for repeated occupation/reservation signalling);

NOTE: A slave or idle MS may monitor slot 1 of slave link frame 18 instead of monitoring slot 3 of slave link frame 18.

- slot 3 of master link frames 1, 4, 7, 10, 13 and 16 (used for repeated pre-emption signalling or the DM-REP presence signal);
- slot 3 of master link frame 3 (used for linearization); and
- slot 3 of slave link frame 3 (used for linearization).

8.4.7.10.2.2 Dual watch synchronization for full dual watch

The dual watch synchronization defines the frame and slot alignment between the TMO control channel and the DM channel. For the purposes of dual watch synchronization, only the Main Control Channel (MCCH) or a common Secondary Control Channel (SCCH) are considered as TMO control channels.

For full dual watch operation the DM channel synchronization with respect to the appropriate TMO downlink control channel shall be as follows (see also clause 8.4.1.2):

- slot 1 of the master link shall lead the appropriate TMO downlink slot by 9,5 slot durations;
- slot 1 of the slave link shall lead the appropriate TMO downlink slot by 6,5 slot durations.

Figure 10 illustrates the dual watch synchronization for full dual watch when there is a DM call ongoing. The DM channel abbreviations are as defined in clause 4.3. It is assumed in this scenario that the MS is monitoring the TMO MCCH (i.e. slot 1) and that the SwMI has assigned energy economy mode EG2. TMO downlink slot 1 in "awake" frames are denoted as "rx".

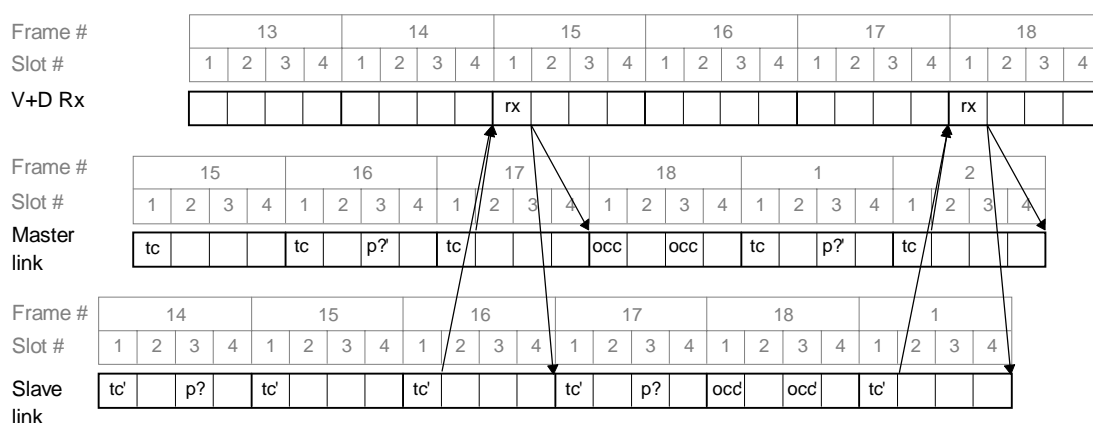

Figure 10: Illustration of dual watch synchronization

When the DM channel is being used by a non-dual-watching master MS, timing adjustment may be requested by slave MSs to achieve the dual watch synchronization (see clauses 8.4.7.15 and 8.4.7.16). Timing adjustment shall not be used to align the DM channel with a TMO assigned channel.

8.4.7.10.2.3 Dual watch precedence rules for full dual watch

EN 300 396-3 [3], clause 8.4.7.10.2.3 shall apply.

NOTE: DM requirements for a master MS to monitor the slave link in order to detect the re-transmission of its call set-up signalling by the DM-REP may take precedence over TMO dual watch reception.

8.4.7.10.3 DM aspects of idle dual watch operation

8.4.7.10.3.1 Model of operation for idle dual watch

EN 300 396-3 [3], clause 8.4.7.10.3.1 shall apply.

8.4.7.10.3.2 Dual watch precedence rules for idle dual watch

EN 300 396-3 [3], clause 8.4.7.10.3.2 shall apply.

8.4.7.11 Air interface encryption

EN 300 396-3 [3], clause 8.4.7.11 shall apply.

8.4.7.12 Channel A or B operation

When the DM-MAC sends a DMAC-SYNC PDU, it shall set the "A/B channel usage" element to indicate "channel A, normal mode".

The DM-MAC shall not attempt to use channel A in normal mode while a frequency efficient mode call is ongoing and shall not attempt to pre-empt an ongoing frequency efficient mode call.

8.4.7.13 Sending short data as a transaction within a circuit mode call

EN 300 396-3 [3], clause 8.4.7.13 shall apply.

8.4.7.14 SDS time remaining

EN 300 396-3 [3], clause 8.4.7.14 shall apply with the following difference:

- i) The DM-MS shall include an allowance of DN233 frames within the "SDS time remaining" for the DM-REP's re-transmission of the short data DSBs on the slave link.

8.4.7.15 Timing change procedure

EN 300 396-3 [3], clause 8.4.7.15 shall apply with the following difference:

- i) After the transmission of the requisite number of DM-TX CEASED or DM-TIMING ACK messages, the master MS shall transmit the first DM-RESERVED messages using the new timing reference in timeslots 1 and 3 of the two frames following the next frame. There is a delay of one frame in order to avoid possible collision with the re-transmission of the DM-TX CEASED or DM-TIMING ACK messages on the slave link. The option in EN 300 396-3 [3] to send DM-RESERVED in timeslot 2 and/or timeslot 4 does not apply for operation with a type 1 DM-REP.

8.4.7.16 Timing change at changeover or pre-emption

EN 300 396-3 [3], clause 8.4.7.16 shall apply.

8.5 MAC procedures for transfer of signalling messages

8.5.1 Formation of MAC PDU

EN 300 396-3 [3], clause 8.5.1 shall apply. The usage of PDU elements specific to DM-REP operation is described in clause 10. See also clause 8.5.2.

For direct MS-MS operation using the protocol defined in EN 300 396-3 [3], the only MAC PDU that can be carried in a synchronization burst (DSB) is the DMAC-SYNC PDU. The DMAC-SYNC PDU is used also by DM-MSs operating with a DM-REP.

For DM-REP operation, an additional MAC PDU may be sent in a DSB. This is the DM-REP presence signal, the DPRES-SYNC PDU, which may be generated by the DM-REP. The DM-REP presence signal comprises layer 2 elements only; refer to clause 10 for a description of the PDU. The contents of the DPRES-SYNC PDU are visible to the DM-MAC in any DM-MS that receives it, irrespective of the setting of the "master/slave link flag".

For operation with a DM-REP, the same MAC PDUs may be sent within the normal burst (DNB) as for direct MS-MS operation.

8.5.2 Addressing

For operation with a DM-REP, the MAC header in the SCH/H block of a DMAC-SYNC PDU shall contain the 10-bit repeater address, a 24-bit MNI, a 24-bit destination SSI and a 24-bit source SSI. The MAC header in a DMAC-DATA PDU shall contain a 24-bit MNI and a 24-bit destination SSI, and may contain a 24-bit source SSI. The source and destination address elements in a message refer to the address of the source DM-MS and destination DM-MS(s) respectively, as for direct MS-MS operation.

8.5.2.1 Transmission of message

8.5.2.1.1 Addressing in synchronization burst

EN 300 396-3 [3], clause 8.5.2.1.1 shall apply, with the following additions.

For operation with a DM-REP, the master DM-MAC shall set the "communication type" element to 01₂ in the DMAC-SYNC PDU and shall include the correct 10-bit repeater address in the SCH/H block. These values of "communication type" and "repeater address" element shall be re-transmitted by the DM-REP on the slave link. If a slave DM-MS sends a signalling message to the master DM-MS, it shall use the same "communication type" and "repeater address" elements in the DMAC-SYNC PDU.

NOTE: As defined above, when the master DM-MS makes a call through a DM-REP, it must include the correct 10-bit repeater address within the DMAC-SYNC PDU. The DM-MS needs to know the correct repeater address before making the call, either by prior arrangement or by receiving the DM-REP presence signal. (The DM-MS also needs to know the repeater type i.e. type 1A, type 1B or type 2.)

For a transmission by a master DM-MS, the master DM-MAC shall set the "master/slave link flag" to 1 in the DMAC-SYNC PDU and shall use the master link's slot and frame numbering. When the DM-REP re-transmits the message on the slave link, it sets the "master/slave link flag" to 0 and uses the slave link's slot and frame numbering.

For a transmission by a slave DM-MS, the slave DM-MAC shall set the "master/slave link flag" to 0 in the DMAC-SYNC PDU and shall use the slave link's slot and frame numbering. When the DM-REP re-transmits the message on the master link, it sets the "master/slave link flag" to 1 and uses the master link's slot and frame numbering.

8.5.2.1.2 Addressing in normal burst

EN 300 396-3 [3], clause 8.5.2.1.2 shall apply, with the following additions.

Normal bursts are only ever sent following a synchronization burst, which defines the repeater address and information about the purpose of the normal burst. Therefore those MAC PDUs that are sent in normal bursts do not include either a "communication type" element, "repeater address" element or "master/slave link flag".

The synchronization burst also defines the link type and slot numbering for that link. Then any following normal bursts for that link shall be sent only in slot 1 of frames 1 to 17 according to that slot and frame numbering. Thus normal bursts on the master link shall only ever be sent in slot 1 of frames 1 to 17 in the master link's slot and frame numbering; and normal bursts on the slave link shall only ever be sent in slot 1 of frames 1 to 17 in the slave link's slot and frame numbering.

8.5.2.2 Reception of message

EN 300 396-3 [3], clause 8.5.2.2 shall apply with the following differences:

- i) If the master DM-MS receives a DMAC-SYNC PDU with "master/slave link flag" set to 0 then it shall ignore that message (even if it is addressed by the message) except that, during call set-up for a circuit mode call or short data transmission, the master DM-MAC shall (when required) use the repeated call set-up message on the slave link to deduce the success of its link establishment to the DM-REP. Refer to clause 8.4.4.1 and clause 8.5.6.
- ii) If a slave or idle DM-MS receives a DMAC-SYNC PDU with "master/slave link flag" set to 1 then it shall ignore that message for the purposes of the procedures for the transfer of signalling messages. The DM-MAC shall not pass the message to layer 3 (nor assume a start of fragmentation) even if it is addressed by the message.

NOTE 1: Note however that, after reception of a DMAC-SYNC PDU on the master link, a slave DM-MS no longer regards the channel as free; refer to clause 8.4.2. Also, for operation with a type 1A DM-REP, the slave DM-MS may choose to modify its channel monitoring procedure to increase the probability of receiving the message when it is repeated on the slave link.

NOTE 2: The procedures defined in i) and ii) on reception of a DMAC-SYNC PDU contrast with the procedures on reception of a DPRES-SYNC PDU for which DM-MSs accept the message irrespective of the setting of the "master/slave link flag"; see clause 8.5.1.

8.5.3 Use of air interface encryption

EN 300 396-3 [3], clause 8.5.3 shall apply for "air interface encryption state" = 00₂ and 10₂ and 11₂.

"Air interface encryption state" = 01₂ shall only be used if the DM-MS knows (by prior arrangement or equivalent) that the DM-REP holds the appropriate air interface encryption information.

NOTE: In order to function correctly, the DM-REP needs to be able to process the source address, message type and message-dependent elements in the DMAC-SYNC and DMAC-DATA PDUs. For "air interface encryption state" = 01₂, these elements are encrypted. Therefore the DM-REP needs to hold the appropriate air interface encryption information. Also the encryption key numbers for all DM-MSs using a particular DM-REP must be co-ordinated so that the encryption key numbering is unique for that DM-REP.

8.5.4 Fragmentation and reconstruction

8.5.4.1 Fragmentation

EN 300 396-3 [3], clause 8.5.4.1 shall apply with the following differences for method 1):

- i) When sending a fragmented DM-SDS DATA or DM-SDS UDATA message, the master DM-MAC shall send the first fragment in DMAC-SYNC PDUs in the usual way, but using the master link. So it shall set the "fragmentation flag" to indicate start of fragmentation and the "number of SCH/F slots" element to indicate the number of following fragments ($n + 1$), and shall use the frame countdown mechanism to indicate when the repetitions of the DMAC-SYNC have been completed. Then, if the link to the DM-REP is not already known to be available, the master DM-MAC shall monitor the slave link looking for its DMAC-SYNC PDU to be re-transmitted by the DM-REP.
 - If the master DM-MAC receives a re-transmission on the slave link (or if it already knew that the link to the DM-REP was available) then it shall start to send the n DMAC-FRAG PDUs and the DMAC-END PDU on SCH/F on the master link, in consecutive slot 1 of frames 1 to 17 and without repetition. If the frame containing the master's final transmission of the DMAC-SYNC PDU was master link frame X , then the master shall send the first DMAC-FRAG PDU (or DMAC-END PDU) in slot 1 of master link frame $Y = (X + DN233) \bmod 18 + 1$ (if Y is in the range 1 to 17) or otherwise in slot 1 of master link frame 1. The master DM-MAC shall then continue to follow the procedure defined in EN 300 396-3 [3], clause 8.5.4.1.

NOTE 1: DN233 is the number of frames in which the DM-REP transmits the DMAC-SYNC PDU on the slave link. For example, if $DN233 = 2$, and if the master DM-MAC sends its final DMAC-SYNC in master link frame 18, then it starts transmitting SCH/F in slot 1 of master link frame 3.

For correct operation of the short data protocol, it is essential that the master DM-MAC assumes the same value of DN233 as the DM-REP. The master DM-MAC may use the frame countdown element in the re-transmitted DSB received on the slave link to deduce the value of DN233 being used by the DM-REP. For example, it is recommended that the DM-MAC confirms this value if it has not received the value in a DM-REP presence signal.

- Otherwise, if the master DM-MAC does not receive a re-transmission on the slave link then:
 - for a DM-SDS DATA message, the DM-MAC shall continue to transmit the message as defined above (and shall look for a response DM-SDS ACK in the usual way); however, it shall issue a DMA-REPORT indication to the DMCC reporting the perceived failure of link establishment to the DM-REP;
 - for a DM-SDS UDATA message, the DM-MAC shall abort the short data transmission (sending a Null PDU instead of the first DMAC-FRAG PDU or DMAC-END PDU and then ceasing transmission) and shall issue a DMA-REPORT indication to the DMCC reporting that the message has not been completely sent because of failure of link establishment to the DM-REP.

NOTE 2: Thus, in this case, for a DM-SDS UDATA message, the DM-MAC aborts the short data transmission. Whereas, for a DM-SDS DATA message, the DM-MAC continues to transmit the message. Since the DM-MS has not received a re-transmission on the slave link, it cannot align its frequency reference to the DM-REP's transmissions so it continues to use the frequency that it used for the DSBs (see clause 11). Therefore, if the DM-MS sent the DSBs using its own internal frequency reference, the DM-REP may not be able to receive the DNBs even if it actually received the DSBs since the DM-REP expects the DNBs to be aligned to the DM-REP's frequency reference.

- ii) If repeating transmission of an unacknowledged data message, the DM-MAC need not transmit in slot 1 of the first transmission frame.

NOTE 3: This allows the DM-MS to choose to look on the slave link for the re-transmission of its DMAC-END. (Receipt of the DMAC-END on the slave link implies that the DM-REP has received and re-transmitted the entire DM-SDU, since the DM-REP stops re-transmission if it fails to decode any of the SCH/F slots.)

- iii) When sending a fragmented DM-SDS ACK message, the slave DM-MAC shall use the slave link. It shall follow the procedure defined in EN 300 396-3 [3], clause 8.5.4.1 - sending the DMAC-SYNC PDU the appropriate number of times and then sending the DMAC-END PDU in slot 1 of the slave link frame following the frame with "frame countdown" element set to 00_2 . However, the slave DM-MAC shall choose its initial "frame countdown" value such that the frame with "frame countdown" element set to 00_2 is neither slave link frame 15 nor slave link frame 17.

8.5.4.2 Reconstruction

EN 300 396-3 [3], clause 8.5.4.2 shall apply, with the following differences for a DM-MS that supports reconstruction:

- i) When receiving a fragmented DM-SDS DATA or DM-SDS UDATA message, where the DMAC-SYNC PDU indicating start of fragmentation was received in frame X of the slave link and contained "frame countdown" element F, the slave DM-MAC shall look for the first DMAC-FRAG/DMAC-END in slot 1 of slave link frame $Y = (X+F+1) \bmod 18 + 1$ (if Y is in the range 1 to 17) or otherwise in slot 1 of slave link frame 1. The slave DM-MAC shall then continue to follow the procedure defined in EN 300 396-3 [3], clause 8.5.4.2.
- ii) When receiving a fragmented DM-SDS DATA or DM-SDS UDATA message: on receipt of a DMAC-END PDU, the DM-MAC shall check that it has received the number of SCH/F slots indicated by the "number of SCH/F slots" element S from the DMAC-SYNC PDU i.e. that it received S - 1 DMAC-FRAG PDUs before receiving the DMAC-END PDU. If the received number of SCH/F slots matches the "number of SCH/F slots" element then the DM-MAC shall deliver the reconstructed DM-SDU to layer 3 using a DMA-UNITDATA indication primitive. If the received number of SCH/F slots does not match the "number of SCH/F slots" element then the DM-MAC shall discard the message (without an indication to layer 3).

When receiving a fragmented DM-SDS ACK message, the master DM-MAC shall obey the procedure defined in EN 300 396-3 [3], clause 8.5.4.2 without amendment. (So, if the DMAC-SYNC PDU indicating start of fragmentation was received in frame X of the master link and contained "frame countdown" element F, the master DM-MAC shall look for the DMAC-END in slot 1 of master link frame $Y = (X+F) \bmod 18 + 1$ (if Y is in the range 1 to 17) or otherwise in slot 1 of master link frame 1.)

8.5.5 Fill bit addition and deletion

EN 300 396-3 [3], clause 8.5.5 shall apply.

8.5.6 Transmission and reception of messages by layer 2

When the DM-MAC receives a DMA-UNITDATA request primitive from layer 3, it shall use its current state and the message type parameter to decide how to send the message:

- a) For the initiation of a new call, or for a retransmission of DM-SETUP, DM-SETUP PRES or DM-SDS UDATA after set-up failure or a non-immediate retransmission of DM-SDS DATA, the DM-MAC shall check whether the channel is free (as defined in clause 8.4.2) before transmitting the DM-SETUP, DM-SETUP PRES, DM-SDS UDATA or DM-SDS DATA message.

NOTE 1: These are the only cases when the DM-MAC is required to check whether the channel is free before transmitting.

NOTE 2: As defined in clause 6.3.1.1.1, layer 3 may issue multiple DMA-UNITDATA request primitives for the same DM-SDS UDATA message. The DM-MAC treats each of the DMA-UNITDATA request primitives as a request for a separate transaction. Therefore the DM-MAC needs to check whether the channel is free before sending the first transmission relating to each DMA-UNITDATA request primitive.

After sending the DSB the appropriate number of times, the DM-MAC shall look for the repeated DSB on the slave link, regarding a received DSB as an implicit layer 2 acknowledgement from the DM-REP to itself.

The DM-MAC shall issue a DMA-REPORT indication to layer 3 reporting when the message has been sent the appropriate number of times. It shall issue another DMA-REPORT indication reporting whether or not the link to the DM-REP has been established (i.e. whether or not it saw its call set-up DSB repeated at least once on the slave link).

If the DM-MAC is unable to send the message because the channel becomes busy then it shall report the failure to layer 3 with a single DMA-REPORT indication.

- b) For a call continuation after changeover, or for a call set-up after pre-emption, the DM-MAC shall transmit the DM-SETUP, DM-SETUP PRES, DM-SDS DATA or DM-SDS UDATA message, timing its transmission using the "frame countdown" element from the received DM-TX ACCEPT or DM-PRE ACCEPT.

The DM-MAC may assume that the link to the DM-REP is already known to be available, without looking for the repeated call set-up DSB on the slave link. However, according to the protocol model, it still issues two DMA-REPORT indications to layer 3: one to report that the message has been sent the appropriate number of times and another to report that the link to the DM-REP was already known to be available.

- c) If the DM-MS is already a master, the DM-MAC may transmit the message and shall use the appropriate burst(s). For example, this may apply to DM-SETUP, DM-SETUP PRES, DM-SDS DATA, DM-SDS UDATA, DM-OCCUPIED, DM-TX CEASED, DM-RELEASE, DM-TX ACCEPT, DM-PRE ACCEPT, DM-REJECT and DM-INFO messages.

If the master DM-MS re-starts transmission during reservation, the DM-MAC transmits the DM-SETUP, DM-SETUP PRES, DM-SDS DATA or DM-SDS UDATA message without re-checking that the channel is free. However, it shall check the DM-REP link, looking for the repeated DSB on the slave link and shall issue two DMA-REPORT indications to layer 3: one to report that the message has been sent the appropriate number of times and another to report whether or not the link to the DM-REP has been re-established.

For other message types, the DM-MAC does not check whether the message is re-transmitted on the slave link. It shall issue a single DMA-REPORT indication when the message has been sent the appropriate number of times.

- d) If the DM-MS is the master and the message is a DM-CONNECT ACK, the DM-MAC shall transmit the message using the DSB and timing the transmission using the "frame countdown" element from the invoking DM-CONNECT.

The DM-MAC does not check whether the message is re-transmitted on the slave link. It shall issue a single DMA-REPORT indication when the message has been sent the appropriate number of times.

- e) If the DM-MS is not the master and the message is a response to a message from the master (i.e. the message is DM-CONNECT, DM-DISCONNECT, DM-SDS ACK or DM-REJECT), the DM-MAC shall transmit the message as a slave, timing the transmission using the "frame countdown" element from the invoking message.

The DM-MAC does not check whether the message is re-transmitted on the master link. It shall issue a single DMA-REPORT indication when the message has been sent the appropriate number of times.

- f) If the message is a DM-PREEMPT or DM-TX REQUEST, the DM-MAC shall use the random access protocol for sending the message. In the random access protocol, the DM-MAC sends retries until a response is received or the access attempt fails. The random access protocol is described in clause 8.5.7.

This clause describes the transmission of messages other than random access messages.

8.5.6.1 Transmission of message

EN 300 396-3 [3], clause 8.5.6.1 shall apply with the following differences:

- i) Note (re transmitting DM-SETUP) does not apply.
- ii) For a fragmented message, the "frame countdown" element refers only to repetitions of the DMAC-SYNC PDU. The timing of the first DMAC-FRAG PDU (or DMAC-END PDU) shall be as defined in clause 8.5.4.1.

For operation with a DM-REP, transmissions by the master DM-MS use the master link's slot and frame numbering; transmissions by a slave DM-MS use the slave link's slot and frame numbering.

NOTE: For operation with a type 1A DM-REP, the DM-MS transmits on the selected DM RF carrier. For operation with a type 1B DM-REP, the DM-MS transmits on the uplink RF carrier f_1 .

8.5.6.2 Reception of message

NOTE 1: For operation with a type 1A DM-REP, the DM-MS receives on the selected DM RF carrier. For operation with a type 1B DM-REP, the DM-MS receives on the selected downlink RF carrier f_2 .

The recipient DM-MAC may use the "frame countdown" element F in received messages in several ways:

a) Suppression of duplicates:

EN 300 396-3 [3], clause 8.5.6.2 a) shall apply.

b) Delaying switch into traffic mode:

When the DM-MS receives a message indicating that it should change into traffic mode (i.e. DM-SETUP or DM-CONNECT ACK), it shall use the timing defined in clause 8.6.3.

c) Timing of set-up signalling for pre-emption or changeover:

When the DM-MS receives a DM-PRE ACCEPT or DM-TX ACCEPT message (received in frame X of the slave link), giving it permission to send call set-up signalling or a short data message, the DM-MAC shall use the "frame countdown" element F from the DM-PRE ACCEPT or DM-TX ACCEPT to deduce when the set-up DSBs can be sent without risking message collision.

In normal cases, the DM-MS which becomes the new master after a successful pre-emption or changeover shall adopt the state of the timing counters currently in use on the master link. This requires an increase of three timeslots relative to the state of the slot and frame counters currently indicated by the DM-REP on the slave link (i.e. counter TN shall be incremented three times). Then the transmission of the set-up DSBs shall start in either master link frame $(X+F+1) \bmod 18 + 1$ or master link frame $(X+F+2) \bmod 18 + 1$.

The exception occurs if the DM-MS requested a timing change within its DM-PREEMPT or DM-TX REQUEST message. Then, on becoming the new master, it shall adopt the state of the timing counters currently in use on the master link and then modify those counters again to give the required timing adjustment.

d) Timing of immediate SDS retransmission:

EN 300 396-3 [3], clause 8.5.6.2 d) shall apply.

NOTE 2: The timings given refer to reception of the DM-SDS ACK as repeated on the master link, and then retransmission of the DM-SDS DATA message on the master link.

e) Timing of response to message from master:

EN 300 396-3 [3], clause 8.5.6.2 e) shall apply.

NOTE 3: The timings given refer to reception of the master's message as repeated on the slave link (in slave link frame X), and then transmission of the response on the slave link (with the first response DSB(s) sent in slave link frame $(X+F) \bmod 18 + 1$).

NOTE 4: As in EN 300 396-3 [3], the responding DM-MS may linearize in slot 1 of slave link frame $(X+F) \bmod 18 + 1$. It may also be permitted to linearize in slot 2 of that frame; see clause 8.4.7.4.

When sending a fragmented DM-SDS ACK message, the slave DM-MAC shall choose its initial "frame countdown" value such that the frame with "frame countdown" element set to 00_2 is neither slave link frame 15 nor slave link frame 17.

f) Timing of response to fragmented message from master:

For a fragmented message headed by the DMAC-SYNC PDU, the "frame countdown" element F refers only to the DMAC-SYNC. This then indicates where the first DMAC-FRAG PDU (or DMAC-END PDU) may be expected, as specified in clause 8.5.4.2.

The procedure for timing the response to a fragmented DM-SDS DATA message shall be as described in EN 300 396-3 [3], clause 8.5.6.2 f).

NOTE 5: The timings given refer to reception of the master's message as repeated on the slave link, and then transmission of the response on the slave link.

When sending a fragmented DM-SDS ACK message, the slave DM-MAC shall choose its initial "frame countdown" value such that the frame with "frame countdown" element set to 00₂ is neither slave link frame 15 nor slave link frame 17.

g) Timing of DM-CONNECT ACK:

EN 300 396-3 [3], clause 8.5.6.2 g) shall apply.

NOTE 6: The timings given refer to reception of the DM-CONNECT as repeated on the master link, and then transmission of the DM-CONNECT ACK message on the master link.

Points e) and f) above define when the first transmission of a response message must be sent. According to the protocol description, it is assumed that, when the DM-MS has received a DM-SDS DATA message addressed to itself, and if layer 3 does not immediately return a response DM-SDS ACK, then the DM-MAC shall issue a DMC-REPORT indication primitive as a prompt to layer 3 in time to allow transmission in the correct slot(s).

8.5.7 Random access protocol

8.5.7.1 Introduction

EN 300 396-3 [3], clause 8.5.7.1 shall apply, with the following additions.

For operation with a DM-REP, a requesting slave DM-MS sends its random access message on the slave link in an appropriate slot 3. When the DM-REP receives a random access message, it simply repeats the random access message on the master link; it does not send any form of interim response to the slave. It is the responsibility of the master DM-MS to decide whether to accept the request and then to send a response (on the master link). The DM-REP then repeats the response on the slave link.

For operation with a type 1 DM-REP, the usual numbering for pre-emption slots as slot 3 of frames 2, 5, 8, 11, 14 and 17 (and additional request slots as slot 3 of frames 1, 4, 7, 9, 10, 13, 15 and 16) still applies to the slave link. However, from the perception of the master DM-MAC, there is generally a two-frame delay relative to the numbering for direct DM-MS operation. For example, a pre-emption request sent in slot 3 of slave link frame 5 is repeated in slot 3 of master link frame 7. (Exceptions are requests sent in slot 3 of slave link frames 1, 4, 10 and 16; these are repeated in slot 3 of master link frames 4, 7, 13 and 1 respectively, thereby avoiding collision with the master DM-MS's linearization and reservation signalling.)

8.5.7.2 Procedures for master DM-MS

8.5.7.2.1 Indicating frames available for requests

When the DM-MAC transmits DM-SETUP, DM-CONNECT ACK and DM-OCCUPIED messages, it shall set the "pre-emption flag" to indicate that slot 3 of frames 2, 5, 8, 11, 14 and 17 on the slave link is available for random access requests (e.g. pre-emption requests) during the occupation period.

NOTE: This requirement may be relaxed for some types of call in future editions of the present document.

When the master DM-MAC transmits DM-TX CEASED and DM-RESERVED, it shall set the "requests flag" and "changeover requests flag" to indicate that random access requests may be sent, unless it has already received and is accepting a pre-emption or changeover request or is changing the channel timing. If random access requests are invited then the master DM-MAC shall also set the "requests bitmap" element to indicate whether random access requests may be sent on the slave link in slot 3 of frames 1, 4, 7, 9, 10, 13, 15 and 16 during the reservation period (in addition to the pre-emption slots). It shall allow random access requests on the slave link in slot 3 of frames 1, 4, 10 and 16, since this does not impose any additional monitoring requirements on itself. It should also allow random access requests on the slave link in slot 3 of frames 7, 9, 13 and 15 unless it may be performing dual watch or battery economy procedures in master link frames 9, 11, 15 or 17 respectively.

8.5.7.2.2 Monitoring frames available for requests

During occupation for a circuit mode call, the master DM-MAC shall monitor slot 3 of frames 1, 4, 7, 10, 13 and 16 on the master link for pre-emption or timing change requests addressed to itself.

NOTE 1: The master DM-MAC is not required to monitor slot 3 during the transmission of the DM-TX CEASED message at the end of circuit mode occupation.

During channel reservation, the master DM-MAC shall monitor slot 3 of frames 1, 4, 7, 10, 13 and 16 on the master link, looking for pre-emption, timing change or changeover requests addressed to itself. It shall also monitor the following slots for pre-emption, timing change or changeover requests addressed to itself:

- if, in the requests bitmap, the master DM-MAC allowed requests on the slave link in slot 3 of frame 7 then it shall monitor slot 3 of frame 9 on the master link;
- if, in the requests bitmap, the master DM-MAC allowed requests on the slave link in slot 3 of frame 9 then it shall monitor slot 3 of frame 11 on the master link;
- if, in the requests bitmap, the master DM-MAC allowed requests on the slave link in slot 3 of frame 13 then it shall monitor slot 3 of frame 15 on the master link;
- if, in the requests bitmap, the master DM-MAC allowed requests on the slave link in slot 3 of frame 15 then it shall monitor slot 3 of frame 17 on the master link.

When sending SCH/F for a fragmented DM-SDS UDATA or DM-SDS DATA message, and in the following two frames for a DM-SDS DATA message, the master DM-MAC shall monitor slot 3 of frames 1, 4, 7, 10, 13 and 16 on the master link for pre-emption requests addressed to itself.

NOTE 2: If the protocol requires the DM-MS to transmit in any of the monitoring slots specified in this clause, the transmission takes precedence over the monitoring requirement.

8.5.7.2.3 Response to pre-emption or changeover request

EN 300 396-3 [3], clause 8.5.7.2.3 shall apply with the following differences:

- i) In a), the time limit for first transmission of the response in short data occupation shall be 8 frame durations instead of 6.
- ii) After accepting a pre-emption or changeover request, the DM-MS shall stop being master (as defined in EN 300 396-3 [3], clause 8.5.7.2.3), and starts to receive on the slave link. In normal cases, the DM-MS should expect the slot and frame numbering on the slave link to run exactly three timeslots behind the slot and frame numbering that it has been using on the master link. The exception occurs if the requesting DM-MS included a "timing adjustment" element in its DM-PREEMPT or DM-TX REQUEST message. Then the old master should expect the timing on the slave link to be modified also according to the "timing adjustment" element.
- iii) In procedure b), if the master DM-MS sends the DM-REJECT message in slot 3 during circuit mode occupation, it may use master link frames 2, 5, 8, 9, 11, 14, 15 or 17.

NOTE: References in EN 300 396-3 [3], clause 8.5.7.2.3 to transmission by the master DM-MAC in "slot 1" or "slot 3" refer to slot and frame numbering on the master link.

8.5.7.2.4 Response to timing change request

EN 300 396-3 [3], clause 8.5.7.2.4 shall apply with the following difference:

- If the master DM-MS sends the DM-TIMING ACK message in slot 3 during circuit mode occupation, it may use master link frames 2, 5, 8, 9, 11, 14, 15 or 17.

NOTE: References in EN 300 396-3 [3], clause 8.5.7.2.4 to transmission by the master DM-MAC in "slot 1" or "slot 3" refer to slot and frame numbering on the master link.

8.5.7.3 Procedures for requesting DM-MS

This clause defines the procedures for a requesting DM-MS to make a random access attempt during a call through a type 1 DM-REP.

8.5.7.3.1 Preparing for random access

EN 300 396-3 [3], clause 8.5.7.3.1 shall apply.

NOTE: The expression "slot 3 of frames 2, 5, 8, 11, 14 and 17" refers to slot and frame numbering on the slave link. Also, the slots and frames defined by the "requests bitmap" element refer to slot and frame numbering on the slave link.

8.5.7.3.2 First transmission of request

EN 300 396-3 [3], clause 8.5.7.3.2 shall apply.

8.5.7.3.3 Valid access slots

EN 300 396-3 [3], clause 8.5.7.3.3 shall apply with the following differences in the third indented paragraph (i.e. "During short data occupation ..."):

- i) The expression "those frames in which the master intends to send SCH/F in slot 1" refers to the expected SCH/F slots as re-transmitted by the DM-REP on the slave link.
- ii) The requesting DM-MS may also (optionally) regard slot 3 of the frame preceding the first SCH/F slot as a "valid access slot", if that frame is slave link frame 2, 5, 8, 11, 14 or 17.
- iii) For a DM-SDS UDATA message, the requesting DM-MS shall not regard either slot 3 of the slave link frame containing the final SCH/F slot or slot 3 of the slave link frame preceding the final SCH/F slot as "valid access slots".

NOTE 1: The expression "slot 3 of frames 2, 5, 8, 11, 14 and 17" in EN 300 396-3 [3], clause 8.5.7.3.3 refers to slot and frame numbering on the slave link. Also, the slots and frames defined by the "requests bitmap" element refer to slot and frame numbering on the slave link.

NOTE 2: If requests are permitted during circuit mode occupation, the "valid access slots" as defined may be used after the completion of the frame countdown for the transmissions of the DM-SETUP or DM-CONNECT ACK message on the slave link.

8.5.7.3.4 Waiting for response

EN 300 396-3 [3], clause 8.5.7.3.4 shall apply with the following difference:

- For a request sent in slot 3 of slave link frame 1, 4, 10 or 16, the time-out waiting for a random access response shall be increased by 1 frame duration i.e. text "time DT211" shall be replaced by text "time DT211 plus 1 frame duration" and text "time DT212" shall be replaced by text "time DT212 plus 1 frame duration". (For requests sent in frames other than slave link frames 1, 4, 10 and 16, text "time DT211" and text "time DT212" apply without amendment.)

NOTE: References in EN 300 396-3 [3], clause 8.5.7.3.4 to monitoring slot 1 and slot 3 of the following frames for a response refer to slot and frame numbering on the slave link.

8.5.7.3.5 Subsequent transmission of request

EN 300 396-3 [3], clause 8.5.7.3.5 shall apply.

8.5.7.3.6 Abandoning random access attempt

EN 300 396-3 [3], clause 8.5.7.3.6 shall apply with the following difference:

- i) Criterion f) for ceasing attempting random access shall be replaced by the following criterion:
 - f) The user application indicates that the random access attempt is to be abandoned, or the DMCC has indicated that no further random access transmissions are permitted for the current attempt and no response has been received.

NOTE: In note 1 in [3], if the current master re-starts transmission, the DM-MAC may continue a pre-emption or timing change random access attempt after the frame countdown for the transmissions of the DM-SETUP or DM-CONNECT ACK message on the slave link; or it may continue a pre-emption random access attempt after the frame countdown for the transmissions of the short data DSBs on the slave link.

8.6 MAC procedures in traffic mode

8.6.1 Introduction

EN 300 396-3 [3], clause 8.6.1 shall apply.

NOTE: References in EN 300 396-3 [3], clause 8.6 to transmission by the master DM-MAC in slot 1 of a particular frame refer to the slot and frame numbering on the master link. References to reception by a slave DM-MAC in slot 1 of a particular frame refer to the slot and frame numbering on the slave link.

8.6.2 Criteria for transmission and reception of traffic

EN 300 396-3 [3], clause 8.6.2 shall apply, with the following additional procedure.

After starting to receive traffic, a slave DM-MAC may remain in traffic mode, processing TCH and STCH received on the slave link in slot 1 of frames 1 to 17, until one of cases 1) to 5) occurs or one of the following cases 6) or 7) occurs:

- 6) it receives a presence signal from the DM-REP used for the call, indicating that the channel is reserved;
- 7) it receives a presence signal from the DM-REP used for the call, indicating that the channel is free.

In case 6), the DM-MAC shall report to the higher layers that the channel is now in reservation (using the DMC-REPORT indication primitive). In case 7), the DM-MAC shall report to the higher layers that the call has been lost.

8.6.3 Change of U-plane mode

8.6.3.1 Call set-up without presence check

8.6.3.1.1 Outgoing call

At call set-up (or for a call continuation), the DMCC issues a DM-SETUP message in a DMA-UNITDATA request primitive. If the channel is available, the DM-MAC shall become master and shall send the message the appropriate number of times on the master link using the frame countdown mechanism to indicate the number of frames in which the message is being repeated. The DM-MAC shall issue a DMA-REPORT indication to the DMCC reporting when the PDU has been transmitted the appropriate number of times, and then another DMA-REPORT indication reporting the perceived success or failure of the link establishment to the DM-REP (or reporting that the link to the DM-REP was already known to be available); refer to clause 8.5.6. The master DM-MAC shall then switch to traffic mode. If the frame containing the master's final transmission of the DM-SETUP message was master link frame X, then the master DM-MAC shall start sending traffic (TCH and/or STCH) in slot 1 of master link frame $Y = (X + DN232) \bmod 18 + 1$ (if Y is in the range 1 to 17) or otherwise in slot 1 of master link frame 1.

NOTE 1: DN232 is the number of frames in which the DM-REP transmits the DM-SETUP message on the slave link. For example, if DN232 = 2, and if the master DM-MAC sends its final DM-SETUP in master link frame 18, then it starts transmitting traffic in slot 1 of master link frame 3.

For correct operation of air interface encryption of TCH and STCH, it is essential that the master DM-MAC assumes the same value of DN232 as the DM-REP. The master DM-MAC may use the frame countdown element in the re-transmitted DSB received on the slave link to deduce the value of DN232 being used by the DM-REP. For example, it is recommended that the DM-MAC confirms this value if it has not received the value in a DM-REP presence signal.

NOTE 2: The DM-MAC switches into traffic mode even if the link establishment to the DM-REP failed. In this case the DMCC then issues a DM-RELEASE message, to be sent on STCH and in DSBs as appropriate.

8.6.3.1.2 Incoming call

On receipt of a DM-SETUP message on the slave link for one of its addresses, received in slave link frame X and with "frame countdown" element set to F, and if the DMCC issues a DMC-CONFIGURE request primitive, a slave DM-MAC shall assume that traffic will start on the slave link in slot 1 of slave link frame $Y = (X+F+1) \bmod 18 + 1$ (if Y is in the range 1 to 17) or otherwise in slot 1 of slave link frame 1.

8.6.3.2 Call set-up with presence check

8.6.3.2.1 Outgoing call

At call set-up (or for a call continuation), the DMCC issues a DM-SETUP PRES message. If the channel is available, the DM-MAC shall send the message the appropriate number of times, as master. It shall issue a DMA-REPORT indication to the DMCC reporting when the PDU has been transmitted the appropriate number of times, and then another DMA-REPORT indication reporting the perceived success or failure of the link establishment to the DM-REP (or reporting that the link to the DM-REP was already known to be available). It shall then wait for a response from the addressed DM-MS.

The master DM-MAC's switch into traffic mode is timed from the transmission of the DM-CONNECT ACK message. If the DMCC issues a DM-CONNECT ACK then the DM-MAC shall send the message the appropriate number of times using DSBs and using the frame countdown mechanism to indicate the number of frames in which the message is being repeated. The timing of the switch into traffic mode shall be as defined in EN 300 396-3 [3], clause 8.6.3.2.1. I.e. the master DM-MAC shall switch to traffic mode in the master link frame following the master link frame with "frame countdown" element set to zero - sending traffic (TCH and/or STCH) in slot 1 of that master link frame (if it is in the range 1 to 17) or otherwise in slot 1 of master link frame 1.

8.6.3.2.2 Incoming call

After receiving a DM-SETUP PRES message, the addressed slave DM-MS sends DM-CONNECT or DM-DISCONNECT on the slave link; refer to clause 6. This message shall be sent the appropriate number of times. After sending DM-CONNECT, the DM-MAC procedure on receipt of a DM-CONNECT ACK message for the call shall be as defined in EN 300 396-3 [3], clause 8.6.3.2.2. I.e. for a DM-CONNECT ACK message received in slave link frame X and with "frame countdown" element set to F, the slave DM-MAC shall assume that traffic will start in slot 1 of slave link frame $Y = (X+F) \bmod 18 + 1$ (if Y is in the range 1 to 17) or otherwise in slot 1 of slave link frame 1.

8.6.3.3 Late entry

EN 300 396-3 [3], clause 8.6.3.3 shall apply.

8.6.3.4 End of traffic transmission

8.6.3.4.1 Master DM-MS

EN 300 396-3 [3], clause 8.6.3.4.1 shall apply.

8.6.3.4.2 Slave DM-MS

EN 300 396-3 [3], clause 8.6.3.4.2 shall apply.

8.6.4 Exchange of information at the DMD-SAP

EN 300 396-3 [3], clause 8.6.4 shall apply.

8.6.5 Stealing from circuit mode capacity

EN 300 396-3 [3], clause 8.6.5 shall apply.

9 DM-REP layer 2 protocol for a type 1 DM-REP

9.1 Introduction

As described in clause 4, a DM-REP comprises only a Physical Layer (PL) and Data Link Layer (DLL). This clause describes the operation of the DLL in a type 1 DM-REP - either a type 1A DM-REP or a type 1B DM-REP.

NOTE 1: The procedures for a type 1B DM-REP are similar to the procedures for a type 1A DM-REP except that, for a type 1A DM-REP, all transmissions are sent on the selected DM RF carrier whereas, for a type 1B DM-REP, transmissions by DM-MSs are sent on the appropriate DM "uplink" RF carrier f_1 and transmissions from the DM-REP to DM-MSs are sent on the associated (duplex-spaced) DM "downlink" RF carrier f_2 .

A type 1A DM-REP can support a single call on the selected DM RF carrier. A type 1B DM-REP can support only a single call on the pair of RF carriers (f_1 and f_2).

NOTE 2: The methods of slot usage are different in the case of a type 2 DM-REP. The procedures for a type 2 DM-REP are described in EN 300 396-7 [7].

NOTE 3: This clause defines only the procedures specific to the DM-REP functions. (If the DM-REP has a handset attached then the equipment is in essence a combined DM-REP and terminating mobile.)

The DLL in the DM-REP is divided into two sub-layers: the upper MAC and the lower MAC.

9.1.1 Functions of lower MAC

The lower MAC in the DM-REP provides the following services to the upper MAC:

- transfer of MAC PDUs into suitable PL bursts in accordance with the appropriate timeslot;
- choice of preamble and training sequence corresponding to the slot flag value and vice versa;
- signal strength measurement (RSSI);
- channel coding and scrambling:
 - Cyclic Redundancy Check (CRC) calculation;
 - Forward Error Correction (FEC) and interleaving of MAC blocks;
 - scrambling and de-scrambling of MAC blocks.

See clause 12 for specific details of the lower MAC functionality.

9.1.2 Functions of upper MAC

The principal functions of the upper MAC in the DM-REP are as follows:

- reception of signalling messages from the master DM-MS, on the master link, and regeneration and re-transmission of the received message on the slave link;
- reception of traffic from the master DM-MS, on the master link, and re-transmission of that traffic on the slave link;
- reception of signalling messages from slave DM-MSs, on the slave link, and regeneration and re-transmission of the received message on the master link;
- maintaining the frame and multiframe structure;
- determination of the DM channel state;
- transmission of the DM-REP presence signal.

The functions of the upper MAC in the DM-REP are described in this clause.

9.2 Interface between lower and upper MAC

The procedures defined for a DM-MS in EN 300 396-3 [3], clause 8.2 shall apply also for a DM-REP, with the following differences:

- i) In figure 25 and table 18, there is no functionality above the upper MAC for a DM-REP.
- ii) Clause 8.2.4 (scrambling mechanism) shall be replaced by the definition given in clause 8.2.4 of the present document.

NOTE: The scrambling mechanism for SCH/F, STCH and TCH is based on the "repeater address" element and the layer 2 "source address" element from the appropriate DMAC-SYNC PDU, as defined in clause 8.2.4, where the "source address" element contains the SSI or pseudo SSI of the DM-MS that originated the message. This colour code applies both when the DM-REP receives on one link (i.e. master link or slave link), and then again when it re-transmits on the other link (i.e. slave link or master link respectively).

- iii) In clause 8.2.6.1.1, "Idle mode" for the DM-REP shall be defined as follows.
 - The DM-REP shall operate in idle mode when it is not currently involved in a call. The DM-REP in idle mode shall monitor the appropriate RF channel in order to determine the current state of the channel and to receive any new signalling messages addressed to itself (i.e. with its address as the 10-bit "repeater address" element in the DMAC-SYNC PDU).

9.3 Basic capabilities of the DM-REP physical layer

A type 1A DM-REP shall be capable of either transmitting or receiving (i.e. simplex mode operation) on a single DM RF carrier.

A type 1B DM-REP shall be capable of either transmitting on one DM RF carrier (the selected "downlink" frequency f_2 from the DM-REP to DM-MSs) or receiving on a different DM RF carrier (the associated "uplink" frequency f_1 from DM-MSs to the DM-REP), using frequency half duplex operation i.e. two-frequency simplex mode.

In either case, the DM-REP shall be capable of switching from DM transmit to receive, and from DM receive to transmit, between contiguous slots i.e. within the guard + ramping + PA linearization time.

NOTE: This timing requirement applies only to the actual switching. The DM-REP is not required to be able to decode and process a message between contiguous slots. When the DM-REP switches from receive to transmit between contiguous slots, the message to be transmitted was received by the DM-REP at least one slot earlier.

The DM-REP shall be capable of transmitting in all four timeslots of at least four consecutive frames.

9.4 Usage of DM channel

9.4.1 DM-REP operation

9.4.1.1 Channel structure

A type 1A DM-REP can support a single call on the selected DM RF carrier. A type 1B DM-REP can support a single call on the pair of duplex-spaced RF carriers (f_1 and f_2).

When the DM-REP is idle (i.e. when it is not supporting a call) and the channel is perceived as free, the DM-REP may transmit a presence signal announcing its presence.

During calls that use the DM-REP, the DM-REP receives signalling messages and traffic from the master DM-MS and shall re-transmit that information to the called slave DM-MSs. It also may receive signalling messages from slave DM-MSs, in which case it re-transmits those messages to the master DM-MS.

During calls, communications between the DM-REP and the master DM-MS shall use the master link's slot and frame numbering. Communications between the DM-REP and slave DM-MSs shall use the slave link's slot and frame numbering, which lags three timeslots behind the master link's slot and frame numbering. For each link, the call is conducted primarily in timeslots 1 and 3 in each frame according to that link's slot and frame numbering (except for call set-up messages, which may use all four timeslots).

For a type 1A DM-REP, transmissions by both the DM-REP and DM-MSs are sent on the selected DM RF carrier. This applies to both master link and slave link transmissions.

For a type 1B DM-REP, transmissions from the DM-REP to DM-MSs are sent on the selected DM downlink RF carrier f_2 whereas transmissions by DM-MSs are sent on the associated uplink RF carrier f_1 . This applies to both master link and slave link transmissions.

9.4.1.2 Channel synchronization

The DM-REP provides the frequency synchronization. If the DM-REP has been generating the presence signal then, at the start of a new call on a free carrier, the master DM-MS takes its initial frequency synchronization from the presence signal. If a presence signal (or other suitable signalling) from the DM-REP has not been received sufficiently recently, the master DM-MS uses its own frequency reference to generate the transmission frequency for the initial call set-up messages. In either case, the DM-REP shall use its own frequency reference when transmitting. The DM-REP then maintains the frequency, as defined in clause 12, and the master and slave DM-MSs follow the DM-REP.

During calls that use the DM-REP:

- the DM-REP shall adopt and follow the slot timing defined by the current master DM-MS (though with different slot and frame numbering for slave link transmissions);
- the DM-REP shall use the same frequency for both master link and slave link transmissions;
- the DM-REP shall use the same power level for both master link and slave link transmissions.

9.4.2 DM-REP states

The DM-REP shall monitor activity on the appropriate DM RF carrier in order to determine the current state of the channel and to receive any signalling messages addressed to itself (i.e. with its address as the "repeater address" element in the DMAC-SYNC PDU).

When the DM-REP receives a MAC PDU, it may decode and use any of the elements that are visible at layer 2 (including the "message type" element and the message-dependent elements). For example, it shall use received layer 2 elements to decide whether and how to re-transmit the message, to adapt its monitoring procedures and to update its state model.

NOTE: The DM-REP may decode and use any of the elements that are visible at layer 2, irrespective of whether it is addressed by the message.

9.4.2.1 DM-REP state definitions

The following states are defined for the DM-REP, based on its own activity and the current state of the channel. These shall be used to determine which procedure the DM-REP follows at any point in time.

0) DM-REP idle - state of channel unknown

The DM-REP is currently operating in idle mode and does not know the state of the channel. This state applies at the following times:

- following initial power-up in direct mode or when the DM-REP has just been switched into direct mode operation or when the user has just selected a different DM channel; or
- when required or allowed by the protocol e.g. following expiry of inactivity timer DT257.

1) DM-REP idle - channel free

The DM-REP is currently operating in idle mode on a channel which is perceived as free i.e. no activity is detected on the channel (except possible detection of other DM-REP or gateway presence signals indicating that the channel is free).

2) DM-REP idle - channel busy (i.e. occupied or reserved)

a) DM-REP idle - channel occupied

The DM-REP is currently operating in idle mode on a channel which is perceived as being occupied i.e. signalling or traffic information not addressed to the DM-REP is detected on the channel, or other activity is detected on the channel.

b) DM-REP idle - channel reserved

The DM-REP is currently operating in idle mode on a channel which is perceived as being reserved i.e. channel reservation signalling not addressed to the DM-REP is detected on the channel.

3) DM-REP active in channel occupation or reservation

a) DM-REP active in channel occupation

The DM-REP is in active mode, re-transmitting traffic and/or signalling in a call transaction. This may be either a circuit mode traffic transmission or a short data transmission (DM-SDS UDATA or DM-SDS DATA).

b) DM-REP active in channel reservation

The DM-REP is in active mode, intermittently re-transmitting signalling during a reservation period.

9.4.2.2 DM-REP channel surveillance procedures

A DM-REP shall conduct channel surveillance procedures on the appropriate DM RF carrier in order to determine its current state.

9.4.2.2.1 DM-REP channel surveillance when idle on a channel in unknown or free state (i.e. in state 0 or 1)

When in idle mode on a channel whose state is unknown or on a free channel, the DM-REP shall perform the following channel surveillance:

- a) A type 1A DM-REP should continuously monitor the selected DM RF carrier (except when it is transmitting its DM-REP presence signal or linearizing) in order to detect any DSBs present and, when signal strength and channel conditions permit, decode any layer 2 information available.
- b) A type 1B DM-REP should continuously monitor the uplink RF carrier f_1 in order to detect any DSBs present and, when signal strength and channel conditions permit, decode any layer 2 information available, except that it need not perform this monitoring when it is transmitting its DM-REP presence signal or linearizing (or when it is monitoring the downlink RF carrier f_2 - see note 1).

NOTE 1: As defined above, an idle type 1B DM-REP is required to monitor the uplink RF carrier f_1 . This is so that it can receive DM-MS call set-up signalling messages containing its own repeater address. The DM-REP may also choose to periodically monitor the downlink RF carrier f_2 . For example, this would be useful if the DM-REP transmits the presence signal periodically on a free carrier and direct MS-MS operation may be used on RF carrier f_2 (in which case periodic monitoring of RF carrier f_2 would enable the DM-REP to detect a direct MS-MS call and cease transmission of the presence signal). Also it may be appropriate if another DM-REP or DM-REP/GATE may be using the same RF carriers in the same area.

Continuous monitoring of the RF carrier means that the DM-REP shall sample the RF carrier at a sufficient rate so that the presence of a DSB may be determined.

In the case where a DSB is detected the DM-REP shall, dependent upon the content, enter the appropriate mode of operation and update its state model, see clause 9.4.3.2; see also note 2.

NOTE 2: A DM-REP is permitted to implement a signal strength threshold where the DM-REP need not regard the channel as busy as a result of receiving DSBs (i.e. DMAC-SYNC or DPRES-SYNC PDUs) below that threshold. For example, the signal strength threshold may be set to the receiver sensitivity level.

In the case where the channel state is unknown, if no DSBs other than free-channel presence signals are detected for 19 consecutive frame durations, then the DM-REP may regard the channel as free.

NOTE 3: In the absence of DSBs the DM-REP may choose to conduct additional channel surveillance procedures, e.g. signal strength measurements, in order to determine whether the RF carrier is free and available for use.

9.4.2.2.2 DM-REP channel surveillance when idle on a busy channel (i.e. in state 2)

When in idle mode on a busy channel, the DM-REP channel surveillance shall monitor timeslot 3 at least every two frames. Monitoring of timeslot 3 of frame 3 does not contribute to fulfilling this requirement. The monitoring shall include timeslot 3 of frames 6, 12 and 18.

The DM-REP shall change the perceived DM channel state from its current state if it detects DSB(s) which indicate that the channel state has changed, see clause 9.4.3.2.

NOTE 1: If an idle DM-REP detects DSB(s) which indicate that the DM channel is busy (i.e. occupied or reserved) then it should assume that the DM channel is still occupied or reserved until it receives DSB(s) which indicate that the channel state has changed or until the appropriate timer expires (e.g. DT257, reservation time remaining or SDS time remaining). See clause 9.4.3.2.

NOTE 2: A type 1A DM-REP performs the specified monitoring on the selected DM RF carrier.

A type 1B DM-REP should perform the specified monitoring on the appropriate RF carrier. For example, if the DM-REP detected the downlink RF carrier f_2 as becoming busy then it should perform the monitoring on f_2 ; if it detected the uplink RF carrier f_1 as becoming busy then it may perform the monitoring on either f_1 or f_2 as appropriate.

9.4.2.2.3 DM-REP channel surveillance when idle at DM-MS call set-up

If the DM-REP is in idle mode and receives a call set-up message (i.e. a DM-SETUP or DM-SETUP PRES message or a DM-SDS UDATA or DM-SDS DATA DSB) containing its own 10-bit repeater address then:

- a) if the channel surveillance procedures described in clauses 9.4.2.2.1 and 9.4.2.2.2 indicate that the channel was busy then the DM-REP should ignore the message (see note 3); or
- b) if the channel surveillance procedures indicate that the channel was free or in unknown state then the DM-REP may accept the call set-up (see note 4):
 - if accepting the call set-up, the DM-REP shall enter active mode and shall re-transmit the signalling information and any traffic relating to the call; or
 - if not accepting the call set-up, the DM-REP shall ignore the message (remaining in idle mode).

NOTE 1: The DM-REP conducts the channel surveillance procedures while it is in idle mode i.e. prior to receipt of the call set-up message.

NOTE 2: A type 1A DM-REP receives the call set-up message on the selected DM RF carrier.

A type 1B DM-REP receives the call set-up message on the uplink RF carrier f_1 . The type 1B DM-REP regards the channel as being free only if its channel surveillance procedures indicate that the uplink RF carrier f_1 was free and (if performing channel surveillance on the downlink RF carrier f_2) that the downlink RF carrier f_2 is also free.

NOTE 3: As defined in note 2 of clause 9.4.2.2.1, the DM-REP is permitted to implement a signal strength threshold where it need not regard the channel as busy as a result of receiving DSBs below that threshold. Also, under some circumstances, the DM-REP is not precluded from accepting a call set-up even if it perceived the channel as being busy e.g. if the new call is an emergency call. If using this option, the DM-REP may choose to monitor the channel more frequently than specified in clause 9.4.2.2.2 and may look for DSBs sent using different slot timings.

NOTE 4: The DM-REP may perform validity checks on the elements in the MAC header of the call set-up message before deciding whether to accept the call set-up. For example, it may perform checks on the source and/or destination address (if visible).

9.4.2.3 DM-REP channel maintenance when active during a call

When the DM-REP is in active mode during a call, the DM-REP shall monitor the DM channel as defined in clause 9.4.4.

If, during circuit mode occupation, a time DT256 elapses without receipt of a DM-OCCUPIED message for the call then the DM-REP shall assume that the call has been lost and shall enter idle mode.

If, during channel reservation, a time DT258 elapses without receipt of a DM-RESERVED message for the call then the DM-REP shall assume that the call has been lost and shall enter idle mode.

In the case of expiry of timer DT256 or timer DT258, the DM-REP shall then either assume the channel is free and send the DM-REP presence signal, indicating that the DM channel is free, which causes receiving DM-MSs to release the call, or shall assume the state of the channel is unknown.

When the DM-REP is in active mode during a call, if it receives signalling messages on the channel indicating that the channel has become occupied by other users (e.g. by DM-MSs not using the DM-REP) then it may enter idle mode.

9.4.3 Criteria for changing DM-REP state

9.4.3.1 Criteria for changing DM-REP state for active DM-REP

When the DM-REP is active on a DM channel it shall, based upon the signalling received on the channel, update its state model accordingly. It shall change the current state condition if one of the following occurs:

- a) The DM-REP receives and re-transmits a channel state change command from the current master DM-MS i.e. a message indicating a change of channel state (e.g. the end of channel occupation or start or end of channel reservation, or a new call pre-emption acceptance or call release).
- b) The DM-REP is active in channel reservation, and a time corresponding to the "reservation time remaining" element from the last received DM-TX CEASED or DM-RESERVED message has elapsed since receipt of that message.
- c) The DM-REP is required to abandon a call set-up with presence check by the time-out procedure described in clause 9.6.2.2 (timer DT250).
- d) The DM-REP is required to relinquish a call by one of the procedures described in clause 9.4.2.3.
- e) The DM-REP is required to relinquish a call by the time-out procedure described in clause 9.4.4.5 (timer DT252).

- f) The DM-REP is active in short data occupation, and a time corresponding to the "SDS time remaining" element from the last received DM-SDS DATA, DM-SDS UDATA or DM-SDS OCCUPIED DSB has elapsed since receipt of that DSB.

In case a), the DM-REP shall not change state until the master DM-MS's frame countdown for the channel state change command message has expired.

9.4.3.2 Criteria for changing DM-REP state for idle DM-REP

When the DM-REP is idle on a DM channel it shall, based upon the signalling received on the channel, update its state model accordingly. It shall change the current state condition if one of the following occurs:

- a) The DM-REP receives a DSB but the message type cannot be decrypted or the SYNC PDU type or message type is not understood.
- The DM-REP shall enter (or remain in) state "DM-REP idle - channel occupied".
- b) The DM-REP receives and re-transmits a call set-up message (i.e. a DM-SETUP or DM-SETUP PRES message or a DM-SDS UDATA or DM-SDS DATA DSB) containing its own 10-bit repeater address.
- The DM-REP shall enter state "DM-REP active in channel occupation".
- c) The DM-REP receives a call set-up or DM-OCCUPIED message not addressed to itself, or a DM-CONNECT ACK or DM-SDS OCCUPIED message.
- The DM-REP shall enter (or remain in) state "DM-REP idle - channel occupied".
- d) The DM-REP receives a message from a call it is not involved in indicating reservation e.g. DM-TX CEASED or DM-RESERVED with "reservation time remaining" > 0.
- The DM-REP shall enter (or remain in) state "DM-REP idle - channel reserved".
- e) The DM-REP receives a message indicating end of a call it is not involved in e.g. DM-RESERVED with "reservation time remaining" = 0 sent in a frame 6, 12 or 18, or DM-RELEASE.
- At the end of a normal mode call, the DM-REP shall enter (or remain in) state "DM-REP idle - channel free". At the end of a frequency efficient mode call, the DM-REP shall enter state "DM-REP idle - state of channel unknown" unless it able to follow the states of both channel A and channel B independently.
- f) The DM-REP receives an acceptance of changeover or pre-emption within an ongoing call.
- The DM-REP shall enter (or remain in) state "DM-REP idle - channel reserved", with a "reservation time remaining" of 000011_2 (1 multiframe) measured relative to the final repetition of the acceptance message (i.e. frame countdown = 0).
- g) The DM-REP receives an acceptance of pre-emption for a new call for another DM-MS, sent by the current master.
- The DM-REP regards the pre-emption acceptance as being the end of the current call so the DM-REP shall enter (or remain in) state "DM-REP idle - channel free".
- h) The DM-REP is idle on a free channel, or the state of the channel is unknown, and the DM-REP receives a response message sent by a slave or a random access message or a DM-REJECT message.
- The DM-MAC shall either enter (or remain in) state "DM-REP idle - state of channel unknown" or enter state "DM-REP idle - channel busy".
- j) The DM-REP is idle in channel occupation or reservation, and a time DT257 has elapsed without receipt of a DSB from the current or new master (or a DSB where the message type cannot be decrypted or the SYNC PDU type or message type is not understood).
- The DM-MAC shall either enter state "DM-REP idle – state of channel unknown" or enter state "DM-REP idle - channel free".

- k) The DM-REP is idle in channel reservation, and a time corresponding to the "reservation time remaining", either from the last received DM-TX CEASED or DM-RESERVED message, or assumed on receipt of an acceptance of changeover or pre-emption within an ongoing call, has elapsed since receipt of that message.

The DM-REP shall enter state "DM-REP idle – channel free".

- l) The DM-REP is idle in short data occupation, and a time corresponding to the "SDS time remaining" element from the last received DM-SDS DATA, DM-SDS UDATA or DM-SDS OCCUPIED DSB has elapsed since receipt of that DSB.

The DM-REP shall enter state "DM-REP idle – channel free".

- m) The DM-REP receives a presence signal from another DM-REP or a gateway indicating that the channel is not free.
- n) The DM-REP receives a presence signal from another DM-REP or a gateway indicating that the channel is free then:
- if the channel is currently perceived as being busy in a call involving the transmitting DM-REP or gateway then the receiving DM-REP shall change the perceived DM channel state to free;
 - if the channel is currently perceived as being busy in a call not involving the transmitting DM-REP or gateway then the receiving DM-MS shall not change the perceived DM channel state.

9.4.4 DM-REP channel monitoring procedures

A DM-REP in idle mode shall monitor the appropriate DM RF carrier(s) in order to keep an up-to-date record of the perceived state of the channel and to receive any call set-up messages containing its own 10-bit repeater address; refer to clause 9.4.2.2.

The following clauses define the minimum monitoring requirements when the DM-REP is in active mode repeating signalling and/or traffic, after reception and re-transmission of call set-up messages containing its own repeater address. The methods for the re-transmission of received messages and traffic are defined in clauses 9.5 and 9.6 respectively.

NOTE 1: The channel monitoring procedures apply only when practicable. In case of conflict of requirements, transmission requirements may take precedence over monitoring requirements (in which case the DM-REP monitors as specified, but only in those slots for which there is no conflict).

NOTE 2: For a type 1A DM-REP, the channel monitoring procedures refer to the selected DM RF carrier. For a type 1B DM-REP, they refer to the uplink RF carrier f_1 .

9.4.4.1 DM channel during call set-up with presence check

For a circuit mode call set-up with presence check, after re-transmission of the DM-SETUP PRES messages on the slave link, the DM-REP shall monitor as follows (except when it is transmitting):

- a) it shall monitor slots 1 and 3 of the slave link for DSBs containing DM-CONNECT or DM-DISCONNECT messages sent by the called DM-MS; and
- b) it shall monitor slots 1 and 3 of the master link for DSBs containing DM-CONNECT ACK or DM-RELEASE messages sent by the master DM-MS.

The DM-REP shall perform this monitoring until it receives a DM-CONNECT ACK or DM-RELEASE message from the master DM-MS (plus any repetitions within the master DM-MS's frame countdown) or until a time DT250 has elapsed. Refer also to clause 9.6.2.2.

NOTE: The DM-REP may stop the monitoring specified in a) above when it has received a DM-CONNECT or DM-DISCONNECT message from the called DM-MS (plus any repetitions within the called DM-MS's frame countdown).

9.4.4.2 DM channel in occupation during a circuit mode call

When active during occupation for a circuit mode call, the DM-REP shall monitor as follows:

- a) The DM-REP shall monitor slot 1 of frames 1 to 17 on the master link for DNBs containing TCH or STCH. The timings for switching in and out of traffic mode are defined in clause 9.6.2.
- b) The DM-REP shall monitor slot 1 of frame 18 on the master link for a DSB sent by the master DM-MS. It shall also monitor for DSBs in slot 3 of all master link frames except those in which it is transmitting to the master DM-MS or linearizing. For example, the master DM-MS may send a DM-OCCUPIED message in frames 6, 12 and 18; or it may send a DM-PRE ACCEPT, DM-TIMING ACK, DM-TX CEASED or DM-RELEASE message in any frame.
- c) The DM-REP shall monitor slot 3 of the pre-emption frames on the slave link (i.e. slave link frames 2, 5, 8, 11, 14 and 17) for DSBs carrying pre-emption or timing change requests containing its own repeater address.

Following the re-transmission on the master link of a pre-emption or timing change request, the DM-REP shall continue to monitor slots 1 and 3 in the following master link frames, as defined in procedures a) and b) above, to determine the result of the request.

9.4.4.3 DM channel in reservation during a circuit mode call

When active during reservation, the DM-REP shall monitor as follows:

- a) The DM-REP shall monitor slot 1 of all frames on the master link, and slot 3 of all frames on the master link except those in which it is either transmitting to the master DM-MS or linearizing, looking for DSBs. For example, the master DM-MS may send:
 - a DM-RESERVED or DM-RELEASE message for the call; or
 - a call set-up message indicating that it is re-starting transmission (to send either circuit mode traffic or short data); or
 - a response to a pre-emption, timing change or changeover request.

NOTE: Improved operation may be achieved in detecting that the current master DM-MS is re-starting transmission if the DM-REP also monitors slots 2 and 4 on the master link when practicable. (The "master/slave link flag" indicates whether a received DSB was sent on the master link or slave link.)

- b) The DM-REP shall monitor slot 3 of the pre-emption frames on the slave link (i.e. slave link frames 2, 5, 8, 11, 14 and 17), and also slot 3 of the slave link frames indicated as valid for random access in the master DM-MS's "requests bitmap", looking for DSBs carrying pre-emption, timing change or changeover requests containing its own repeater address.

Following the re-transmission on the master link of a pre-emption, timing change or changeover request, the DM-REP shall continue to monitor slots 1 and 3 in the following master link frames, as defined in procedure a) above, to determine the result of the request.

9.4.4.4 DM channel in occupation during an SDS call

When active during a short data transaction (i.e. while the "SDS time remaining" element indicates a positive value), the DM-REP shall monitor as follows:

- a) After receiving and re-transmitting a DMAC-SYNC PDU indicating a fragmented DM-SDS UDATA or DM-SDS DATA message, the DM-REP shall monitor slot 1 of frames 1 to 17 on the master link for DNBs containing SCH/F until it receives and re-transmits the DMAC-END PDU or a DMAC-DATA PDU (e.g. a Null PDU) or fails to decode one of the SCH/F slots.

It shall then revert to monitoring for DSBs in slot 1 of all frames on the master link (except any frames in which it is transmitting). For example, the master DM-MS may send a DM-PRE ACCEPT message or a call set-up message indicating that it is re-starting transmission.

NOTE: In the case of a fragmented DM-SDS UDATA message, the DM-REP may enter idle mode if it receives a Null PDU from the master DM-MS when it has not re-transmitted a DM-PREEMPT message on the master link during the current short data message.

- b) The DM-REP shall monitor for DSBs in slot 1 of frame 18 on the master link and slot 3 of all frames on the master link (except any slots in which the DM-REP is transmitting or linearizing). For example, the master DM-MS may send a DM-SDS OCCUPIED message in frames 6, 12 and 18; or it may send a DM-PRE ACCEPT message in any frame.
- c) During the SCH/F frames for a fragmented DM-SDS UDATA or DM-SDS DATA message, and in the preceding frame, the DM-REP shall monitor slot 3 of the pre-emption frames on the slave link (i.e. slave link frames 2, 5, 8, 11, 14 and 17) for DSBs carrying pre-emption requests containing its own repeater address.
- d) After transmission of a non-fragmented DM-SDS DATA message on the slave link, or after transmission of the last SCH/F slot of a fragmented DM-SDS DATA message, the DM-REP shall monitor slots 1 and 3 of the slave link for DSBs until it receives a DM-SDS ACK or DM-REJECT message from the called DM-MS (plus any repetitions within the called DM-MS's frame countdown) or until a time DT251 has elapsed. If the received DSB indicates a fragmented DM-SDS ACK message then the DM-REP shall monitor for the final fragment (DMAC-END PDU on SCH/F, carried in a DNB) using the timing defined in clause 9.5.2.2.

If the DM-REP failed to decode one of the SCH/F slots in a fragmented DM-SDS DATA message then, unless it has received a DM-PRE ACCEPT or call set-up DSB in the interim time, it shall look for a response DSB in slots 1 and 3 of the slave link frame following the slave link frame that would have contained the last SCH/F slot (as indicated by the "number of SCH/F slots" element from the master DM-MS's DMAC-SYNC PDU).

Following the re-transmission on the master link of a pre-emption request, the DM-REP shall continue to obey all the procedures a) to d) above until it receives a DM-PRE ACCEPT message from the master DM-MS. (The DM-PRE ACCEPT message, if sent, will be in a DSB.)

9.4.4.5 DM channel following pre-emption or changeover acceptance

After receiving and re-transmitting a DM-PRE ACCEPT or DM-TX ACCEPT message from the master DM-MS, the DM-REP shall continue to monitor master link slots 1 and 3 during the master DM-MS's frame countdown and shall re-transmit any received messages on the slave link.

After the frame countdown for a DM-TX ACCEPT message, or for a DM-PRE ACCEPT message accepting a pre-emption within the ongoing call, the DM-REP shall then monitor the master link in all four slots of the following frames looking for call set-up DSBs (for a circuit mode call transaction or short data message) from the new master DM-MS. If the DM-REP does not receive a call set-up DSB within a time DT252 then it shall enter idle mode and may send the DM-REP presence signal, indicating that the channel is free, which causes receiving DM-MSs to release the call.

After the frame countdown for a DM-PRE ACCEPT message accepting a new call pre-emption, the DM-REP shall enter idle mode and shall perform the idle mode channel surveillance procedures.

NOTE: After entering idle mode, if the DM-REP receives call set-up signalling containing its own 10-bit repeater address then it may accept the call set-up (provided that it has not seen the channel become busy in the interim time).

9.4.4.6 DM channel following timing change announcement

After receiving and re-transmitting a DM-TIMING ACK or DM-TX CEASED message containing "timing change announced" element set to 1, the DM-REP shall continue to monitor the master link using the old timing reference during the master DM-MS's frame countdown and shall re-transmit any received messages on the slave link. It shall then monitor the master link in slots 1 and 3 of the following frames, using the new timing reference, looking for DSBs from the master DM-MS e.g. containing DM-RESERVED messages.

9.4.5 DM-REP presence signal

9.4.5.1 Channel free

As an option, the DM-REP may transmit a presence signal - the DPRES-SYNC PDU - periodically on the channel during the time when the DM-REP is otherwise idle and the channel is perceived by the DM-REP as being free. If used on a free channel, the presence signal shall be sent in a DSB, in all four slots of DN253 consecutive frames on the slave link, using the "frame countdown" element to indicate the number of frames in which the message is being repeated.

However, if the DM-REP observes a channel change from busy to free (e.g. at the end of the frame countdown for a transmitted or received DM-RELEASE message or if it detects the end of circuit mode reservation or SDS occupation) and if, within the following time DT255, it wishes to transmit a presence signal then it shall choose an integer R randomly from the range DN254 to DN255 (using a uniform distribution) and plan to start sending the presence signal after R frame durations. During the intervening time, the DM-REP shall continue to monitor the DM RF carrier(s) and if it detects a DSB that causes a change of DM-MAC state then it shall not transmit a presence signal on this occasion.

The following exception applies in the case of a new call pre-emption acceptance. If the DM-REP observes a channel change from busy to free as the result of a new call pre-emption acceptance (i.e. at the end of the frame countdown for a transmitted or received DM-PRE ACCEPT message with "new call pre-emption" set to 1) and if, within the following time DT259, it wishes to transmit a presence signal then the DM-REP shall choose an integer R randomly from the range DN254 + 8 to DN255 + 8 (using a uniform distribution) and plan to start sending the presence signal after R frame durations. During the intervening time, the DM-REP shall continue to monitor the DM RF carrier(s) and if it detects a DSB that causes a change of DM-MAC state then it shall not transmit a presence signal on this occasion.

The minimum interval between each sequence of transmissions shall correspond to time DT253 and the maximum interval shall correspond to time DT254 (see note 1). The structure of the presence signal shall be as defined in clause 10.

NOTE 1: If the presence signal is used on a free channel, it is recommended that the DM-REP sends the signal at irregular intervals. This is in order to avoid repeated collisions if more than one DM-REP or gateway is sending presence signals on the channel.

If regular transmission of the free-channel presence signal is required in an application, this may be achieved by setting DT253 equal to DT254.

NOTE 2: Transmission of the free-channel presence signal is optional. In an implementation, it is recommended that the DM-REP is capable of sending the free-channel presence signal - though it may be disabled in an application by setting DT253 and DT254 to 0.

NOTE 3: Intervals DT253 and DT254 are measured from the start of one sequence of transmissions until the start of the next sequence of transmissions.

NOTE 4: If a type 1B DM-REP is capable of frequency full duplex operation, and if it detects call set-up signalling while it is transmitting the free-channel presence signal, then it may stop transmitting the presence signal irrespective of the frame countdown value.

The DM-REP presence signal indicates to receiving DM-MSs that a DM-REP with the specified address is switched on and within range. It may also indicate which DM-MSs are permitted to use that DM-REP.

The presence signal need not be used as the timing reference when a DM-MS makes a call through the DM-REP. For example, the DM-REP's slot timing may be unsuitable for the DM-MS's dual watch operation. It is the responsibility of a DM-MS that becomes master on a free channel to define the timing reference including the slot timing and the slot and frame numbering. Therefore, when monitoring the channel in idle mode, the DM-REP should be prepared to receive DSBs at any time.

NOTE 5: If the DM-REP sends the presence signal on a free channel, it may choose to use a DM timing reference based on the timing of a previous call. This applies particularly if the signalling in the previous call indicated use of the dual watch synchronization. See also clause 8.4.1.2, note 1.

9.4.5.2 Channel in occupation

When active in circuit mode occupation or during the SCH/F frames for a short data message:

- a) if the DM-REP did not receive a random access message in slot 3 of slave link frame 5 then it shall send a presence signal, indicating occupation, in slot 3 of master link frame 7;
- b) if the DM-REP did not receive a random access message in slot 3 of slave link frame 11 then it shall send a presence signal, indicating occupation, in slot 3 of master link frame 13;
- c) if the DM-REP did not receive a random access message in slot 3 of slave link frame 17 then it shall send a presence signal, indicating occupation, in slot 3 of master link frame 1;
- d) if the DM-REP did not receive a DSB from the master DM-MS in slot 1 of master link frame 18 or slot 3 of master link frames 6, 12 or 18 then it may send a presence signal, indicating occupation, in the corresponding slot on the slave link;
- e) if the DM-REP received a DM-OCCUPIED or DM-SDS OCCUPIED message from the master DM-MS in slot 1 of master link frame 18 or slot 3 of master link frames 6, 12 or 18 then, if appropriate, it is not precluded from sending a presence signal, indicating occupation, in the corresponding slot on the slave link instead of re-transmitting the master DM-MS's message (e.g. if it needs to update the validity time for DM-MSs on the channel).

NOTE 1: DM-REP designers should note that a receiving slave DM-MS switches out of traffic mode if a time DT221 elapses without receipt of a DM-OCCUPIED message for the call (see clause 8.6). Also a DM-MS cannot join a call by late entry upon reception of the presence signal. Therefore frequent use of procedure e) is not recommended.

When the DM-REP receives a message from the master DM-MS in slot 1 (e.g. DM-TX CEASED or DM-RELEASE), the DM-REP should not send the presence signal in slot 3 during the master DM-MS's transmissions i.e. during the master DM-MS's frame countdown. This is in order to avoid a collision with the master DM-MS's message. It also enables the DM-REP to monitor the channel in order to receive the master DM-MS's signalling.

The active DM-REP may send the DM-REP presence signal during occupation in those timeslots not used within the call.

Also a type 1B DM-REP, after receiving a call set-up DSB from a master DM-MS (on the uplink RF carrier f_1), may send the presence signal indicating occupation (on the downlink RF carrier f_2) until it starts to re-transmit the master DM-MS's set-up message on the slave link.

NOTE 2: This method may be used if the type 1B DM-REP chooses to indicate as soon as possible that the channel is now busy, thereby preventing other DM-MSs from sending call set-up signalling. For an alternative possible method, see note 2 of clauses 9.5.1.1.2 and 9.5.1.1.3.

9.4.5.3 Channel in reservation

When active in channel reservation:

- a) if the DM-REP did not receive a random access message in slot 3 of slave link frame 4 or 5 then it shall send a presence signal, indicating reservation, in slot 3 of master link frame 7;
- b) if the DM-REP did not receive a random access message in slot 3 of slave link frame 10 or 11 then it shall send a presence signal, indicating reservation, in slot 3 of master link frame 13;
- c) if the DM-REP did not receive a random access message in slot 3 of slave link frame 16 or 17 then it shall send a presence signal, indicating reservation, in slot 3 of master link frame 1;
- d) if the DM-REP did not receive a DSB from the master DM-MS in slot 1 or 3 of master link frames 6, 12 or 18 then it may send a presence signal, indicating reservation, in the corresponding slot on the slave link;
- e) if the DM-REP received a DM-RESERVED message from the master DM-MS in slot 1 or 3 of master link frames 6, 12 or 18 then, if appropriate, it is not precluded from sending a presence signal, indicating reservation, in the corresponding slot on the slave link instead of re-transmitting the master DM-MS's message (e.g. if it needs to update the validity time for DM-MSs on the channel).

When the DM-REP receives a message from the master DM-MS in slot 1 (e.g. DM-RELEASE), the DM-REP should not send the presence signal in slot 3 during the master DM-MS's transmissions i.e. during the master DM-MS's frame countdown. This is in order to avoid a collision with the master DM-MS's message. It also enables the DM-REP to monitor the channel in order to receive the master DM-MS's signalling.

The active DM-REP may send the DM-REP presence signal during channel reservation in those timeslots not used within the call.

9.4.6 DM-REP linearization

When the channel is perceived as free, the DM-REP may linearize its transmitter at any time (but not more frequently than once per multiframe).

When active during circuit mode occupation or reservation, the DM-REP may linearize in timeslot 3 of frame 3 of either the slave link or the master link.

NOTE 1: The linearization opportunities during circuit mode occupation may be restricted for some types of call in future editions of the present document.

When active during short data occupation, the DM-REP may linearize in timeslot 3 of frame 3 of either the master link or the slave link as follows:

- It may linearize in timeslot 3 of frame 3 of the master link, if timeslot 1 of frame 3 is an SCH/F slot (as indicated by the "number of SCH/F slots" element in the SDS call set-up DSBs). Also, for a DM-SDS DATA message, it may linearize in timeslot 3 of master link frame 3 if timeslot 1 of master link frame 2 was an SCH/F slot.
- It may linearize in timeslot 3 of slave link frame 3 if timeslot 1 of slave link frame 3 is an SCH/F slot - except that, for a DM-SDS UDATA message, it shall not linearize in the slave link frame containing the final SCH/F slot. Also, it may linearize in timeslot 3 of slave link frame 3 if timeslot 1 of slave link frame 4 will be an SCH/F slot.

If, for any reason, the DM-REP is not adequately linearized at a time when other procedures in this clause require it to transmit on the DM channel then the DM-REP may linearize its transmitter in the time just prior to sending the signalling; or, alternatively, it may use the first designated transmission slot for linearization instead of sending the required signalling in that slot.

NOTE 2: For example, for some modes of operation, if the DM-REP does not send the presence signal periodically on a free channel, it may not be appropriate for the DM-REP to keep linearized on a free channel. Then the DM-REP may use one of the procedures in the above paragraph when it needs to transmit.

NOTE 3: The DM-REP may linearize during the repetitions of the master DM-MS's call set-up message. This applies even for a type 1A DM-REP since, after the DM-REP has received one of the call set-up messages, there is no problem if the DM-REP's linearization collides with the master's repetitions.

NOTE 4: A type 1A DM-REP linearizes on the selected DM RF carrier. A type 1B DM-REP linearizes on the downlink RF carrier f_2 .

9.5 DM-REP procedures for re-transmission of signalling messages

The procedures in this clause define the re-transmission functions for the DM-REP. The DM-REP receives signalling messages and traffic sent by the master DM-MS on the master link and re-transmits that information on the slave link to the slave DM-MSs. It may also receive signalling messages from slave DM-MSs, in which case it re-transmits those messages to the master DM-MS.

NOTE: For a type 1A DM-REP, the re-transmission procedures apply to reception and re-transmission on the selected DM RF carrier. Whereas, for a type 1B DM-REP, the re-transmission procedures apply to reception on the appropriate uplink RF carrier f_1 and re-transmission on the downlink RF carrier f_2 .

9.5.1 Re-transmission of signalling messages received from the master DM-MS

9.5.1.1 Re-transmission of master DM-MS signalling messages received in a DSB

9.5.1.1.1 General procedures

When the DM-REP receives a DMAC-SYNC PDU on the master link (i.e. with "master/slave link flag" set to 1), containing "communication type" element 01_2 and its own 10-bit repeater address, it shall decide whether to re-transmit the message on the slave link as follows:

- The DM-REP may accept and re-transmit a call set-up message (DM-SETUP, DM-SETUP PRES, DM-SDS DATA or DM-SDS UDATA) for a new circuit mode call or short data transmission if permitted by the channel surveillance procedures described in clause 9.4.2.2.
- For a call set-up message (DM-SETUP, DM-SETUP PRES, DM-SDS DATA or DM-SDS UDATA) following a changeover or pre-emption within the ongoing call, or if the current master DM-MS re-starts transmission during the reservation period, the DM-REP shall re-transmit the message.
- During a call set-up with presence check, the DM-REP shall re-transmit DM-CONNECT ACK or DM-RELEASE messages received from the master DM-MS.
- When the DM-REP is active in channel occupation or reservation, it shall re-transmit all valid messages received from the master DM-MS. For example, the re-transmitted message may be DM-OCCUPIED, DM-TX CEASED, DM-RELEASE, DM-PRE ACCEPT, DM-TX ACCEPT, DM-REJECT, DM-TIMING ACK, DM-RESERVED or DM-SDS OCCUPIED.
- For messages received at other times, the DM-REP should ignore the message.

If the DM-REP re-transmits the message, it shall set the "master/slave link flag" to 0 and shall use the slave link's slot and frame numbering. It shall use the appropriate procedure as defined in the following clauses.

When re-transmitting DM-SETUP, DM-SETUP PRES, DM-SDS DATA and DM-SDS UDATA messages, the DM-REP shall regenerate new values for the "frame countdown", "slot number" and "frame number" elements in the DMAC-SYNC PDU as defined below. When re-transmitting DM-TX CEASED and DM-RELEASE messages for a call transaction with multi-slot interleaving, the DM-REP may regenerate new values for the "frame number" element. For other messages, the DM-REP re-transmits the "frame countdown", "slot number" and "frame number" elements without any change from the values set by the master DM-MS (unless it regenerates missing repetitions - see clause 9.5.1.3). When re-transmitting DM-SDS DATA and DM-SDS UDATA messages, the DM-REP shall regenerate new values for the "SDS time remaining" element in the DMAC-SYNC PDU as defined below. When re-transmitting DM-SDS OCCUPIED, the DM-REP shall leave the value of "SDS time remaining" unchanged.

When re-transmitting DM-SETUP, DM-SETUP PRES, DM-CONNECT ACK, DM-OCCUPIED and DM-RESERVED messages, the DM-REP shall set the "power class" element to its own power level and shall set the "power control flag" appropriately.

All elements shall remain unchanged from the values set by the master DM-MS except for the "master/slave link flag" and the "frame countdown", "slot number", "frame number", "power class", "power control flag" and "SDS time remaining" elements (and the TVP element if the DM-REP needs to re-encrypt the message as defined in clauses 9.5.1.1.5 and 9.5.1.3).

9.5.1.1.2 Re-transmission of DM-SETUP or DM-SETUP PRES message

For a DM-SETUP or DM-SETUP PRES message, and if the DM-REP received the master DM-MS's message in master link frame X and with "frame countdown" element set to F , then it shall re-transmit the message in all four slots (see note 1) of DN232 frames on the slave link, using the "frame countdown" element in the re-transmitted messages to indicate how many more transmission frames remain. The first required transmission frame (see note 2) on the slave link shall be slave link frame $(X+F-1) \bmod 18 + 1$; those transmissions shall contain "frame countdown" element set to DN232-1. The final transmission frame on the slave link shall be slave link frame $(X+F-2+DN232) \bmod 18 + 1$, and those transmissions shall contain "frame countdown" element set to 0. The procedure for entering traffic mode shall then be as defined in clause 9.6.2. See also clause 9.6.3.

NOTE 1: If the DM-REP received the master DM-MS's message only in slot 3 of the frame with $F = 0$ then it need not transmit in the immediately following slot 1 on the slave link, but should then transmit in slots 2, 3 and 4.

NOTE 2: As defined above, the first required transmission frame on the slave link is slave link frame $(X+F-1) \bmod 18 + 1$. This is the first valid transmission frame for a type 1A DM-REP, in order to avoid collision with the master DM-MS's repeat transmissions. However, if a type 1B DM-REP's value of DN232 is less than 4 then the DM-REP may start the re-transmissions on the slave link earlier (though subject to the usual maximum of four transmission frames).

So, if a type 1B DM-REP receives the master DM-MS's message with "frame countdown" element F greater than 0, or in slot 1 of the frame with $F = 0$, then it may start the re-transmissions on the slave link V frames early (where $V+DN232$ does not exceed 4). The DM-REP uses the normal frame countdown mechanism over the $V+DN232$ transmission frames on the slave link, implemented so that the first re-transmission(s) in slave link frame $(X+F-V-1) \bmod 18 + 1$ contain "frame countdown" element set to $DN232+V-1$ and (as usual) the final re-transmissions in slave link frame $(X+F-2+DN232) \bmod 18 + 1$ contain "frame countdown" element set to 0. The DM-REP may start transmission part of the way through slave link frame $(X+F-V-1) \bmod 18 + 1$.

9.5.1.1.3 Re-transmission of DM-SDS DATA or DM-SDS UDATA message

For a DM-SDS DATA or DM-SDS UDATA message, and if the DM-REP received the master DM-MS's DMAC-SYNC PDU in master link frame X and with "frame countdown" element set to F , then it shall re-transmit the DMAC-SYNC PDU in all four slots (see note 1) of DN233 frames on the slave link, using the "frame countdown" element in the re-transmitted DMAC-SYNC PDUs to indicate how many more transmission frames remain. The first required transmission frame (see note 2) on the slave link shall be slave link frame $(X+F-1) \bmod 18 + 1$; those transmissions shall contain "frame countdown" element set to $DN233-1$. The final transmission frame on the slave link shall be slave link frame $(X+F-2+DN233) \bmod 18 + 1$, and those transmissions shall contain "frame countdown" element set to 0.

NOTE 1: If the DM-REP received the master DM-MS's DMAC-SYNC PDU only in slot 3 of the frame with $F = 0$ then it need not transmit in the immediately following slot 1 on the slave link, but should then transmit in slots 2, 3 and 4.

NOTE 2: As defined above, the first required transmission frame on the slave link is slave link frame $(X+F-1) \bmod 18 + 1$. This is the first valid transmission frame for a type 1A DM-REP, in order to avoid collision with the master DM-MS's repeat transmissions. However, if a type 1B DM-REP's value of DN233 is less than 4 then the DM-REP may start the re-transmissions on the slave link earlier (though subject to the usual maximum of four transmission frames).

So, if a type 1B DM-REP receives the master DM-MS's DMAC-SYNC PDU with "frame countdown" element F greater than 0, or in slot 1 of the frame with $F = 0$, then it may start the re-transmissions on the slave link V frames early (where $V+DN233$ does not exceed 4). The DM-REP uses the normal frame countdown mechanism over the $V+DN233$ transmission frames on the slave link, implemented so that the first re-transmission(s) in slave link frame $(X+F-V-1) \bmod 18 + 1$ contain "frame countdown" element set to $DN233+V-1$ and (as usual) the final re-transmissions in slave link frame $(X+F-2+DN233) \bmod 18 + 1$ contain "frame countdown" element set to 0. The DM-REP may start transmission part of the way through slave link frame $(X+F-V-1) \bmod 18 + 1$.

If the DMAC-SYNC PDU contained "fragmentation flag" set to 0 then the re-transmission of the short data message is now complete.

If the DMAC-SYNC PDU contained "fragmentation flag" set to 1 then the DM-REP shall expect the master DM-MS to start sending SCH/F in slot 1 of master link frame $Y = (X+F+DN233) \bmod 18 + 1$ (if Y is in the range 1 to 17) or otherwise in slot 1 of master link frame 1. It shall re-transmit each SCH/F slot once, in the corresponding slot 1 on the slave link, until it receives and re-transmits the DMAC-END PDU or a DMAC-DATA PDU (e.g. a Null PDU) or fails to decode one of the SCH/F slots. The "corresponding slot 1 on the slave link" lags three slots behind slot 1 of the master link.

The DM-REP shall use the same value of "SDS time remaining" in its first frame of DMAC-SYNC PDU transmissions as the master DM-MS used in its last frame of DMAC-SYNC PDU transmissions (as these have the same frame number) and it shall decrement "SDS time remaining" in subsequent frames.

9.5.1.1.4 Re-transmission of other messages in a DSB when not using multi-slot regeneration

This clause applies at all times during a call except during traffic transmission for TCH/4,8 or TCH/2,4 with interleaving depth $N = 4$ or 8 if the DM-REP is performing traffic regeneration.

NOTE 1: Thus this clause applies during a short data transaction, or during a circuit mode call transaction for TCH/S, TCH/7,2 or TCH/4,8 or TCH/2,4 with $N = 1$. It applies also during a circuit mode call transaction for TCH/4,8 or TCH/2,4 with $N = 4$ or 8 if the DM-REP is not performing traffic regeneration before re-transmission on the slave link. It applies during a call set-up with presence check after the re-transmission of the DM-SETUP PRES messages. And it applies during all reservation periods.

Each time any message other than DM-SETUP, DM-SETUP PRES, DM-SDS DATA and DM-SDS UDATA is received from the master DM-MS in a DMAC-SYNC PDU, the DM-REP shall re-transmit the DMAC-SYNC PDU in the corresponding slot on the slave link i.e. without changing the slot and frame numbers set by the master DM-MS (see note 2). The DM-REP shall also leave the "frame countdown" element unchanged. Thus it shall change only the setting of the "master/slave link flag" (and the "power class" and "power control flag" for a DM-CONNECT ACK, DM-OCCUPIED or DM-RESERVED message).

NOTE 2: When appropriate, the DM-REP is not precluded from sending the presence signal, indicating occupation, instead of re-transmitting a DM-OCCUPIED or DM-SDS OCCUPIED message on the slave link (e.g. if it needs to update the validity time for DM-MSs on the channel). For DM-OCCUPIED this applies also in clause 9.5.1.1.5. Similarly, the DM-REP is not precluded from sending the presence signal, indicating reservation, instead of re-transmitting a DM-RESERVED message on the slave link.

9.5.1.1.5 Re-transmission of other messages in a DSB during traffic transmission with multi-slot regeneration

This clause applies during circuit mode traffic transmission for TCH/4,8 or TCH/2,4 with interleaving depth $N = 4$ or 8 if the DM-REP is performing traffic regeneration (i.e. decoding and re-encoding the traffic before re-transmission on the slave link).

NOTE 1: Traffic regeneration by the DM-REP is optional. Note that the DM-REP cannot provide traffic regeneration for $N = 4$ and 8 for air-interface encrypted calls unless it is able to perform decryption and re-encryption.

When a DM-TX CEASED or DM-RELEASE message is received from the master DM-MS in a DMAC-SYNC PDU, the DM-REP should delay the re-transmission on the slave link by $N - 1$ traffic frames (except in the case of a pre-emption acceptance), modifying the "frame number" element appropriately. If the message was air-interface encrypted then the DM-REP shall re-encrypt the message, modifying the TVP element appropriately.

NOTE 2: The delay of $N - 1$ traffic frames is in addition to the usual three-slot delay of the slave link relative to the master link.

See also note 2 in clause 9.5.1.2.2.

For other messages received from the master DM-MS in a DMAC-SYNC PDU, the DM-REP should re-transmit the DMAC-SYNC PDU in the corresponding slot on the slave link (i.e. without changing the slot and frame numbers set by the master DM-MS).

9.5.1.2 Re-transmission of master DM-MS signalling messages received in a DNB

Refer to clause 9.6.3 for the DM-REP procedures for the re-transmission of the master DM-MS's circuit mode traffic.

9.5.1.2.1 Call transaction without multi-slot regeneration

This clause applies during a short data transaction, or during a circuit mode call transaction for TCH/S, TCH/7,2 or TCH/4,8 or TCH/2,4 with $N = 1$. It applies also for TCH/4,8 or TCH/2,4 with $N = 4$ or 8 if the DM-REP is not performing traffic regeneration before re-transmission on the slave link.

For signalling messages received from the master DM-MS in a normal burst (DNB), the DM-REP shall decode and error correct the PDU. It shall then re-encode the PDU, without changing any element values from the values set by the master DM-MS, and shall re-transmit it in the corresponding slot 1 on the slave link. For STCH, it shall use the same half slot as in the master DM-MS's transmission.

9.5.1.2.2 Call transaction with multi-slot regeneration

This clause applies during a circuit mode call transaction for TCH/4,8 or TCH/2,4 with $N = 4$ or 8 if the DM-REP is performing traffic regeneration before re-transmission on the slave link.

When a U-plane signalling message is received from the master DM-MS (i.e. a DMAC-U-SIGNAL PDU), the DM-REP shall delay the re-transmission on the slave link by $N - 1$ traffic frames, re-encrypting the message if it was air-interface encrypted.

NOTE 1: The delay of $N - 1$ traffic frames is in addition to the usual three-slot delay of the slave link relative to the master link.

This additional delay is defined so that the DM-REP re-transmits the U-plane data stream on the slave link with the U-plane signalling in the same position as when the master DM-MS transmitted it on the master link. This position may be important if the U-plane signalling is carrying end-to-end encryption synchronization.

The need for the procedure arises because the de-interleaving process causes the circuit mode data to be delayed by $N - 1$ traffic frames relative to the U-plane signalling. The receiving DM-MS's procedure takes account of the relative delay over the air interface if the DM-REP does not de-interleave the traffic before re-transmission on the slave link. The DM-REP needs to compensate for the additional relative delay introduced by its de-interleaving and re-interleaving of the traffic.

For a DM-PRE ACCEPT message received from the master DM-MS in a DMAC-DATA PDU, the DM-REP should re-transmit the message in the corresponding slot 1 on the slave link (i.e. without additional delay).

When a DM-TX CEASED or DM-RELEASE message is received from the master DM-MS in a DMAC-DATA PDU, the DM-REP should delay the re-transmission on the slave link by $N - 1$ traffic frames (except in the case of a pre-emption acceptance), re-encrypting the message if it was air-interface encrypted.

NOTE 2: The delay of $N - 1$ traffic frames is in addition to the usual three-slot delay of the slave link relative to the master link.

This additional delay is defined because the DM-TX CEASED or DM-RELEASE PDU terminates the traffic transmission. Therefore the DM-REP should normally ensure that it has been able to issue $N - 1$ slots containing tail bits (zeros) to the lower MAC at the end of the circuit mode data transmission before sending the transaction termination PDU. These tail bits are needed to complete the interleaving of the circuit mode data that has been received from the master DM-MS.

For other C-plane signalling messages received from the master DM-MS in a normal burst, the DM-REP may either re-transmit the message in the corresponding slot 1 on the slave link or delay the re-transmission by $N - 1$ traffic frames (re-encrypting the message if it was air-interface encrypted).

9.5.1.3 Regeneration of missing repetitions on the slave link

NOTE: The procedures in this clause are optional. Note that the DM-REP cannot regenerate missing repetitions for air-interface encrypted calls unless it is able to perform decryption and re-encryption.

If not using these options then, for messages other than DM-SETUP and DM-SETUP PRES, and DM-SDS DATA and DM-SDS UDATA DSBs, the DM-REP re-transmits each PDU received from the master DM-MS only once, in the appropriate slot on the slave link.

If the DM-REP receives a DM-TIMING ACK message with "timing change announced" element set to 1, or a DM-CONNECT ACK, DM-TX CEASED, DM-RELEASE, DM-PRE ACCEPT or DM-TX ACCEPT message from the master DM-MS, and then fails to decode a slot 1 or a slot 3 during the master DM-MS's frame countdown for the message, the DM-REP may (optionally) regenerate a missing repetition of the message in the appropriate slot(s) on the slave link. If it does so then it shall set the "slot number", "frame number" and "frame countdown" elements appropriately. Also, if the message was air-interface encrypted then the DM-REP shall re-encrypt the message, modifying the TVP element if sending a DSB.

During circuit mode occupation, if the DM-REP does not receive a DSB from the master DM-MS in slot 1 of master link frame 18 or slot 3 of master link frame 6, 12 or 18, then the DM-REP may (optionally) regenerate a DM-OCCUPIED message in the corresponding slot on the slave link, using the elements from the master DM-MS's last DM-OCCUPIED message. During channel reservation, if the DM-REP does not receive a DSB from the master DM-MS in slot 1 or 3 of master link frame 6, 12 or 18, then the DM-REP may (optionally) regenerate a DM-RESERVED message in the corresponding slot on the slave link, using the elements from the master DM-MS's last DM-RESERVED message. In either case, it shall set the "slot number" and "frame number" elements appropriately (in addition to the "power class" and "power control flag"). In the case of DM-RESERVED, it shall set the "reservation time remaining" appropriately. Also, if the message was air-interface encrypted then the DM-REP shall re-encrypt the message, modifying the TVP element appropriately.

9.5.2 Re-transmission of signalling messages received from a slave DM-MS

9.5.2.1 General procedures

If the DM-REP is active in a call, and it receives a DMAC-SYNC PDU on the slave link (i.e. with "master/slave link flag" set to 0) containing "communication type" element 01_2 and its own 10-bit repeater address, then it shall (in most cases) repeat that message on the master link, setting the "master/slave link flag" to 1 and using the master link's slot and frame numbering.

The only messages that may be sent by a slave DM-MS are:

- responses to a message from the master i.e. DM-CONNECT, DM-DISCONNECT, DM-REJECT and DM-SDS ACK; and
- random access messages i.e. DM-TIMING REQUEST, DM-TX REQUEST and DM-PREEMPT.

The methods for re-transmission of these messages by the DM-REP are defined in clauses 9.5.2.2 and 9.5.2.3.

When re-transmitting a DMAC-SYNC PDU from a slave DM-MS, the DM-REP shall change the "frame number" element to the master link frame number, as defined below. It shall re-transmit the "slot number" element unchanged for the principal re-transmission (though, for a slave response message, it may sometimes regenerate missing re-transmissions in other slots - see clause 9.5.2.2).

All elements other than the "master/slave link flag" and "frame number" elements (and the "slot number" and "frame countdown" elements if regenerating missing re-transmissions) shall remain unchanged from the values set by the slave DM-MS.

9.5.2.2 Re-transmission of response messages from a slave DM-MS

If the DM-REP is active during a call set-up with presence check or during a short data transaction then, each time a response DMAC-SYNC PDU is received from the slave DM-MS, the DM-REP shall re-transmit the DMAC-SYNC PDU on the master link, setting the "master/slave link flag" to 1 and the "frame number" element to the master link frame number. For a DMAC-SYNC PDU received in slot S of slave link frame X , the DM-REP shall re-transmit the DMAC-SYNC PDU in slot S of master link frame $(X+1) \bmod 18 + 1$.

If the DM-REP receives a response DMAC-SYNC PDU from the slave DM-MS, and then fails to decode a slot 1 or a slot 3 during the slave DM-MS's frame countdown, the DM-REP may (optionally) regenerate a missing repetition of the DMAC-SYNC PDU in the appropriate slot(s) on the master link. If it does so then it shall set the "slot number", "frame number" and "frame countdown" elements appropriately. Also, if the message was air-interface encrypted then the DM-REP shall re-encrypt the message, modifying the TVP element appropriately.

NOTE 1: The DM-REP cannot regenerate missing repetitions for air-interface encrypted calls unless it is able to perform decryption and re-encryption.

If the slave DM-MS's DMAC-SYNC PDU contained "fragmentation flag" set to 1 (i.e. if this is a fragmented DM-SDS ACK message), with "frame countdown" element set to F , then the DM-REP shall expect the slave DM-MS to send the SCH/F slot in slot 1 of slave link frame $(X+F) \bmod 18 + 1$. The DM-REP shall re-transmit the SCH/F slot once, in slot 1 of master link frame $(X+F+2) \bmod 18 + 1$.

NOTE 2: The slave DM-MS is required to choose its initial frame countdown value so that neither frame $(X+F) \bmod 18 + 1$ nor frame $(X+F+2) \bmod 18 + 1$ is a frame 18.

9.5.2.3 Re-transmission of random access request

If the DM-REP is active in a call and it receives a random access request (i.e. DM-TIMING REQUEST, DM-TX REQUEST or DM-PREEMPT) in a slot 3 on the slave link, containing "communication type" element 01_2 and its own 10-bit repeater address, then the DM-REP should repeat the request on the master link except in the cases described below. It shall transmit the request once, in the appropriate slot 3 on the master link, setting the "master/slave link flag" to 1 and the "frame number" element to the master link frame number. The frame for transmission of the request on the master link shall be as defined in table 1.

Table 1: Frame for DM-REP re-transmission of random access message on master link

| Reception frame on slave link | Transmission frame on master link |
|-------------------------------|-----------------------------------|
| 1 | 4 |
| 2 | 4 |
| 4 | 7 |
| 5 | 7 |
| 7 | 9 |
| 8 | 10 |
| 9 | 11 |
| 10 | 13 |
| 11 | 13 |
| 13 | 15 |
| 14 | 16 |
| 15 | 17 |
| 16 | 1 |
| 17 | 1 |

In most cases, this results in a delay of 5 slots relative to direct MS-MS operation. However, this delay is increased to 9 slots for a request received in slave link frame 1, 4, 10 or 16 in order to avoid the frames in which the master DM-MS may be linearizing or sending reservation messages.

If, according to the above algorithm, the DM-REP has two requests to be sent in master link frame 1, 4, 7 or 13 then the DM-REP shall transmit the higher priority request (or, for equal priority requests, the first received request) and shall discard the other request.

The DM-REP shall also refrain from repeating a request on the master link in the following cases:

- a) if it has already received a DM-PRE ACCEPT, DM-TX ACCEPT or DM-RELEASE message from the current master DM-MS; or
- b) if it chooses to perform addressing checks on the request and finds that the request is not addressed to the current master DM-MS; or
- c) if the current master DM-MS is sending set-up signalling for a new call transaction.

9.5.3 DM-REP signalling mechanisms

9.5.3.1 Frame countdown procedure

For messages other than call set-up DSBs, the DM-REP normally re-transmits the received "frame countdown" element unchanged on the other link.

For DM-SETUP and DM-SETUP PRES messages, the DM-REP transmits the message in multiple frames on the slave link (at least DN232 frames). For DM-SDS DATA and DM-SDS UDATA messages, the DM-REP transmits the DSB in multiple frames on the slave link (at least DN233 frames). In each case, it shall set the "frame countdown" element appropriately. The "frame countdown" element shall indicate how many more transmission frames remain following the current slave link frame. The DM-REP shall decrement the "frame countdown" element by 1 for each frame in which the message is sent. When the "frame countdown" element = 0 this shall indicate that this is the last frame containing this information.

9.5.3.2 Fill bit addition and deletion

The procedures defined for a DM-MS in EN 300 396-3 [3], clauses 8.5.5.1 and 8.5.5.2 shall apply also for a DM-REP.

9.5.3.3 Null PDU

The procedures defined for a DM-MS in EN 300 396-3 [3], clause 8.5.5.3 shall apply also for a DM-REP.

9.5.3.4 Air interface encryption

For a message received with "air interface encryption state" = 10_2 or 11_2 , the DM-REP may re-transmit the message (and any associated traffic or SCH/F) without needing to decrypt the information content.

NOTE 1: If the DM-REP is unable to perform decryption and re-encryption then it cannot provide traffic regeneration for interleaving depth $N = 4$ or 8 (or regenerate missing repetitions) for air-interface encrypted calls.

NOTE 2: In the case of a message received with "air interface encryption state" = 11_2 , if the DM-REP is able to perform decryption then it may choose to decrypt the "destination address" element for use in deciding whether to re-transmit the message.

For a message received with "air interface encryption state" = 01_2 :

- if the DM-REP is unable to perform the decryption then it shall ignore the message;
- if the DM-REP is able to perform decryption then it may re-transmit the message if appropriate. The DM-REP shall decrypt at least the encrypted layer 2 elements (i.e. the addressing information, message type and message-dependent elements) for use as required e.g. for scrambling and de-scrambling, for message re-transmission and for updating its state model.

9.5.3.5 Timing change procedure

If the DM-REP receives and re-transmits a DM-TIMING ACK, DM-TX CEASED, DM-TX ACCEPT or DM-PRE ACCEPT message containing "timing change announced" element set to 1, then it shall expect the announced timing to be used on the master link in master link frame Z and onwards - where frame Z is the first master link frame following the end of the slave link frame containing the re-transmitted DM-TIMING ACK, DM-TX CEASED, DM-TX ACCEPT or DM-PRE ACCEPT message(s) with "frame countdown" element equal to 0. After receipt of a DMAC-SYNC PDU from the master DM-MS using the new timing reference, the DM-REP shall use that new timing reference also for transmission and reception of messages on the slave link.

9.5.3.6 Random access procedures for DM-REP

The random access procedures for the DM-REP comprise the following three aspects:

- a) When active during circuit mode occupation and reservation, and when transmitting SCH/F for a fragmented DM-SDS UDATA or DM-SDS DATA message (and in the preceding frame), the DM-REP monitors slot 3 of the appropriate frames on the slave link for random access requests containing its own repeater address. Refer to clause 9.4.4.
- b) On reception of a random access request on the slave link, containing its own repeater address, the DM-REP normally repeats the request on the master link. It transmits the request once, in the appropriate slot 3 on the master link, as defined in clause 9.5.2.

- c) It is the responsibility of the master DM-MS to decide whether to accept a random access request and then to send the response. If the DM-REP receives a DM-PRE ACCEPT, DM-TX ACCEPT, DM-REJECT or DM-TIMING ACK from the master DM-MS in slot 1 or slot 3 on the master link then it re-transmits the message on the slave link, as defined in clause 9.5.1.

9.6 DM-REP procedures in traffic mode

9.6.1 Introduction

During traffic transmission in DM, the master DM-MS transmits traffic TCH or stealing channel STCH in slot 1 of frames 1 to 17 on the master link. The DM-REP re-transmits this information in the appropriate slot 1 on the slave link.

In the case of STCH, the DM-REP decodes and processes the information in the PDU (in addition to re-transmitting the PDU on the slave link). In particular, for C-plane stealing, the DM-REP uses appropriate layer 2 information from DM-TX CEASED, DM-RELEASE and DM-PRE ACCEPT messages. For example, the DM-REP uses the "frame countdown" element from DM-TX CEASED and DM-RELEASE messages to decide when to switch out of traffic mode; it should record the "requests bitmap" from DM-TX CEASED messages for use during reservation; and it should use any timing adjustment information included within DM-TX CEASED and DM-PRE ACCEPT messages.

During traffic transmission, slot 3 of frames 1 to 17 and slots 1 and 3 of frame 18 are used for synchronization and signalling purposes e.g. occupation messages and pre-emption requests; refer to clauses 9.4 and 9.5. This clause describes the DM-REP's procedures for the transfer of TCH and STCH.

See clause 9.2 for the configuration of the lower MAC in synchronization, signalling and traffic mode.

9.6.2 Change of U-plane mode

9.6.2.1 Set-up without presence check

9.6.2.1.1 Switching into traffic mode

For a call set-up (or call continuation) without presence check, and if accepting the call set-up, the DM-REP shall re-transmit the master DM-MS's DM-SETUP message on the slave link, as defined in clause 9.5.1, and shall then switch into traffic mode. If the DM-REP received the master DM-MS's DM-SETUP message in master link frame X and with "frame countdown" element set to F, it shall expect the master DM-MS to start traffic transmission in slot 1 of master link frame $Y = (X+F+DN232) \bmod 18 + 1$ (if Y is in the range 1 to 17) or otherwise in slot 1 of master link frame 1. The DM-REP shall expect the traffic type defined by the "circuit mode type" element from the DM-SETUP message.

9.6.2.1.2 Link establishment failure

When the DM-REP has received a master DM-MS's DM-SETUP message and has re-transmitted it on the slave link, the master DM-MS may sometimes wrongly perceive that the link establishment to the DM-REP failed, in which case it immediately sends the DM-RELEASE message in slot 1 and slot 3 in at least two frames. As usual, the DM-REP re-transmits any received DM-RELEASE messages on the slave link. However, if the master DM-MS has not aligned its frequency reference to the DM-REP's transmissions, the DM-REP may not be able to receive the DM-RELEASE messages in DNBs in slot 1 whereas it may be able to receive the DM-RELEASE messages in slot 3 where they are sent in DSBs. Slave DM-MSs are not required to monitor all slot 3's. Therefore, if the transmissions of the DM-RELEASE message did not include a frame 6, 12 or 18 and the channel remains free, it is recommended that the DM-REP transmits the free-channel presence signal in the next occurring slave link frames 6, 12 or 18, using the timing of the failed call. This assists slave (and idle) DM-MSs in perceiving the end of the failed call.

NOTE: It is also recommended that the DM-REP uses a similar procedure in general after receiving DM-RELEASE messages - except in the case of a pre-emption acceptance. Thus, if the DM-RELEASE message is not related to a pre-emption acceptance and the transmissions of the DM-RELEASE message did not include a frame 6, 12 or 18 and the channel remains free, it is recommended that the DM-REP transmits the free-channel presence signal in the next occurring slave link frame 6, 12 or 18, using the timing of the old call. This assists idle DM-MSs in perceiving the end of the call.

9.6.2.2 Set-up with presence check

For a call set-up (or call continuation) with presence check, and if accepting the call set-up, the DM-REP shall re-transmit the master DM-MS's DM-SETUP PRES message on the slave link, as defined in clause 9.5.1. It shall then monitor for a response (DM-CONNECT or DM-DISCONNECT) from the called DM-MS in slots 1 and 3 of the following frames of the slave link and for a DM-CONNECT ACK or DM-RELEASE message from the master DM-MS in slots 1 and 3 of the master link.

- On receipt of DM-CONNECT or DM-DISCONNECT message(s) from the called DM-MS, the DM-REP shall re-transmit the message(s) on the master link, as defined in clause 9.5.2.
- On receipt of DM-CONNECT ACK message(s) from the master DM-MS, the DM-REP shall re-transmit the message(s) in the corresponding slot(s) on the slave link, as defined in clause 9.5.1. Then, if the DM-REP received the master DM-MS's DM-CONNECT ACK message in master link frame X and with "frame countdown" element set to F, it shall expect the master DM-MS to start traffic transmission in slot 1 of master link frame $Y = (X+F) \bmod 18 + 1$ (if Y is in the range 1 to 17) or otherwise in slot 1 of master link frame 1. The DM-REP shall expect the traffic type defined by the "circuit mode type" element from the DM-CONNECT ACK message.
- On receipt of DM-RELEASE message(s) from the master DM-MS, the DM-REP shall re-transmit the message(s) in the corresponding slot(s) on the slave link, as defined in clause 9.5.1. At the end of the frame countdown for the DM-RELEASE message, the DM-REP shall enter idle mode (and may send the DM-REP presence signal indicating that the channel is free).
- If the DM-REP does not receive a DM-CONNECT ACK or DM-RELEASE message from the master DM-MS within a time DT250 following its last transmission of the DM-SETUP PRES message on the slave link then the DM-REP shall assume that the call set-up has failed and shall enter idle mode. The DM-REP shall either assume the channel is free and send the DM-REP presence signal indicating that the channel is free, or shall assume that the state of the channel is unknown.

9.6.2.3 End of traffic transmission

At the end of traffic transmission, the master DM-MS sends the DM-TX CEASED or DM-RELEASE message at least twice on the master link; after each reception, the DM-REP shall re-transmit the message in the appropriate slot on the slave link, as defined in clause 9.5.1.

On receipt of a DM-TX CEASED or DM-RELEASE message from the master DM-MS, received in master link frame X and with "frame countdown" element set to F, the DM-REP shall switch out of traffic receive mode at the end of master link frame $(X+F-1) \bmod 18 + 1$. It shall switch out of traffic transmit mode as follows:

- at the end of slave link frame $(X+F-1) \bmod 18 + 1$, if not performing multi-slot traffic regeneration; or
- at the end of the frame countdown for the re-transmission of the DM-TX CEASED or DM-RELEASE messages on the slave link, if performing multi-slot traffic regeneration (see clause 9.5.1.2.2).

The DM-REP shall also switch out of traffic mode if one of the following occurs:

- 1) it receives a DM-RESERVED message for the call; or
- 2) the channel surveillance procedures defined in clause 9.4.2.3 indicate that channel reception from the master DM-MS has been lost (timer DT256) or that the channel has become occupied by other users.

In case 1), the DM-REP shall assume that the DM channel is now in reservation for the call. In case 2), the DM-REP shall assume that the call has been lost; see also clause 9.4.2.3.

9.6.3 DM-REP traffic operation when active in traffic mode

9.6.3.1 Reception of TCH and STCH on the master link

When active in traffic mode, the DM-REP shall attempt to receive slot 1 of frames 1 to 17 on the master link, expecting TCH and/or STCH.

The training sequence in each slot shall indicate whether stealing has occurred.

For normal training sequence 1, the DM-REP shall assume that the slot contains only TCH.

For normal training sequence 2, the DM-REP shall assume that the first half slot contains STCH and shall decode (and error correct) that STCH. The MAC PDU type indicates whether the first half slot was stolen for C-plane signalling (DMAC-DATA PDU) or for U-plane signalling (DMAC-U-SIGNAL PDU). The DM-REP shall inspect the "second half slot stolen flag" in the MAC header to discover whether the second half slot is also stolen. Also, for a DMAC-DATA PDU, the DM-REP shall store appropriate layer 2 information from DM-TX CEASED, DM-RELEASE and DM-PRE ACCEPT messages and shall update its channel state model.

If the first half slot is not decoded successfully then the DM-REP designer should choose an appropriate method for processing the second half of the slot e.g. attempting to interpret the second half slot as STCH.

If the second half slot is not stolen, the DM-REP shall assume that the second half slot contains TCH.

If the second half slot is stolen, the DM-REP shall interpret the second half slot as STCH and shall decode (and error correct) that STCH. The MAC PDU type indicates whether the second half slot was stolen for C-plane signalling (DMAC-DATA or DMAC-END PDU) or for U-plane signalling (DMAC-U-SIGNAL PDU). For a DMAC-DATA PDU, the DM-REP shall store appropriate layer 2 information from DM-TX CEASED, DM-RELEASE and DM-PRE ACCEPT messages and shall update its channel state model.

9.6.3.2 Re-transmission of TCH and STCH on the slave link

For TCH/S and for TCH/4,8 and TCH/2,4 with $N = 1$, traffic regeneration (i.e. channel decoding and re-encoding) may be performed by the DM-REP, allowing error correction before re-transmission on the slave link. Traffic regeneration may also be performed by the DM-REP for TCH/4,8 and TCH/2,4 with $N = 4$ or 8 ; however, note that the DM-REP cannot provide traffic regeneration for $N = 4$ or 8 for air-interface encrypted calls unless it is able to perform decryption and re-encryption.

NOTE: In cases where the DM-REP does not provide traffic regeneration, the DM-REP may still accept and re-transmit the call. However the error performance may be reduced.

In all cases STCH shall be decoded and re-encoded before re-transmission on the slave link.

9.6.3.2.1 Call transaction without multi-slot regeneration

This clause applies during a circuit mode call transaction for TCH/S, TCH/7,2 or TCH/4,8 or TCH/2,4 with $N = 1$. It applies also for TCH/4,8 or TCH/2,4 with $N = 4$ or 8 if the DM-REP is not decoding and re-encoding the traffic before re-transmission on the slave link.

The DM-REP shall re-transmit the TCH and/or STCH in the corresponding slot 1 on the slave link (using the same normal training sequence as it received on the master link). The "corresponding slot 1 on the slave link" lags three slots behind slot 1 of the master link. For STCH, the DM-REP shall use the same half slot as in the master DM-MS's transmission.

If a first or second half slot was not decoded successfully then the DM-REP designer should choose an appropriate method for transmission in the slave link's first or second half slot respectively e.g. re-transmitting the same bit stream as the DM-REP received (i.e. type 5 bits received before de-scrambling and decoding, as described in EN 300 396-2 [2], clause 8.2.1).

If the DM-REP did not receive data on the master link in slot 1 of a frame in the range 1 to 17 then the DM-REP designer should choose an appropriate method for transmission in the corresponding slot 1 on the slave link e.g. filling the slot with two stolen half slots each containing the C-plane Null PDU.

9.6.3.2.2 Call transaction with multi-slot regeneration

This clause applies during a circuit mode call transaction for TCH/4,8 or TCH/2,4 with $N = 4$ or 8 if the DM-REP is decoding and re-encoding the traffic before re-transmission on the slave link.

The DM-REP shall re-transmit the TCH and/or STCH in the appropriate slot 1 on the slave link:

- For TCH, when the DM-REP's upper MAC has received a slot of de-interleaved and decoded circuit mode data from the lower MAC, it shall re-issue that circuit mode data to the lower MAC so that the re-transmission of the data starts in the corresponding slot 1 on the slave link. If the data was air-interface encrypted then the upper MAC shall re-encrypt it before issuing it to the lower MAC.

NOTE 1: The re-encryption is needed because the de-interleaving process causes the re-transmitted user traffic to be delayed by $N - 1$ traffic frames relative to the master DM-MS's transmission. (This delay is in addition to the usual three-slot delay of the slave link relative to the master link.)

- For STCH, the DM-REP shall re-transmit the PDU in the appropriate slot 1 on the slave link, as defined in clause 9.5.1.2.2. It shall use the same half slot as in the master DM-MS's transmission.

NOTE 2: For example, the DM-REP delays U-plane signalling by $N - 1$ traffic frames (in addition to the usual three-slot delay of the slave link relative to the master link). This delay is specified so that the DM-REP re-transmits the U-plane data stream on the slave link with the U-plane signalling in the same position as when the master DM-MS transmitted it on the master link.

The DM-REP also delays DM-TX CEASED and DM-RELEASE messages by $N - 1$ traffic frames (except in the case of a pre-emption acceptance), enabling it to issue $N - 1$ slots containing tail bits to its lower MAC before re-transmitting the transaction termination messages.

10 PDU descriptions

This clause describes the PDUs which apply to the DM air interface layers 2 and 3 for operation with a DM-REP.

10.1 Layer 2 PDUs sent in DSB

10.1.1 DMAC-SYNC PDU

EN 300 396-3 [3], clause 9.1.1 shall apply.

Additionally the following applies:

- Element "communication type" shall be set to 01_2 . This shall apply for both the master link and slave link, and for signalling both to and from the DM-REP.
- The "master/slave link flag" shall be included and shall be set to indicate whether the PDU is being sent on the master link or the slave link.
- For a PDU sent on the master link, the "slot number" and "frame number" elements shall be set using the master link's slot and frame numbering. For a PDU sent on the slave link, the "slot number" and "frame number" elements shall be set using the slave link's slot and frame numbering.
- For operation with a type 1 DM-REP, element "A/B channel usage" shall be set to 00_2 .
- The 10-bit "repeater address" element shall be included within the SCH/H block.

10.1.2 DPRES-SYNC PDU

The DPRES-SYNC PDU is transmitted by the DM-REP using the 60 available bits of the logical channel SCH/S and the 124 available bits of the logical channel SCH/H. Its purpose is to announce the presence of the DM-REP to MSs on the DM channel. Its content shall be as given in tables 2 and 3.

Table 2: DM-REP DPRES-SYNC PDU contents in SCH/S

| Information element | Length | Type | Remark |
|---|--------|------|---|
| System code | 4 | M | |
| SYNC PDU type | 2 | M | Value 01 ₂ indicates DPRES-SYNC PDU. |
| Communication type | 2 | M | Set to 00 ₂ for some cases of managed direct mode operation; see EN 300 396-10 [8]. Set to 01 ₂ when sent by a DM-REP (note 1). Set to 10 ₂ or 11 ₂ when sent by a gateway; see EN 300 396-5 [5] for the gateway presence signal. |
| M-DMO flag | 1 | M | |
| Reserved | 2 | C | Always present when sent by a DM-REP. Default value = 00 ₂ |
| Two-frequency repeater flag | 1 | C | Always present when sent by a DM-REP |
| Repeater operating modes | 2 | C | Always present when sent by a DM-REP. Set to 00 ₂ when sent by a type 1 DM-REP. |
| Spacing of uplink | 6 | C | Included if two-frequency repeater flag = 1 |
| Reserved | 6 | C | Included if two-frequency repeater flag = 0. Default value = 000000 ₂ . |
| Master/slave link flag | 1 | M | |
| Channel usage | 2 | M | Set to 00 ₂ when sent by a type 1 DM-REP. |
| Channel state | 2 | M | |
| Slot number | 2 | M | |
| Frame number | 5 | M | |
| Power class | 3 | M | Note 2. |
| Power control flag | 1 | M | Note 2. |
| Reserved | 1 | M | Default value = 0. |
| Frame countdown | 2 | M | |
| Reserved | 2 | C | Included if channel state = 00 ₂ . Default value = 00 ₂ . |
| Priority level | 2 | C | Included if channel state ≠ 00 ₂ . Note 2. |
| Reserved | 6 | C | Always present when sent by a DM-REP. Default value = 000000 ₂ . |
| Values of DN232 and DN233 | 4 | C | Always present when sent by a DM-REP. |
| Value of DT254 | 3 | C | Always present when sent by a DM-REP. |
| Presence signal dual watch synchronization flag | 1 | C | Included if master/slave link flag = 0. |
| Reserved | 1 | C | Included if master/slave link flag = 1. |
| Reserved | 5 | C | Always present when sent by a DM-REP. Default value = 00000 ₂ . |
| NOTE 1: Following the communication type element, the following elements in the DPRES-SYNC PDU are shown in this table only if relevant to the presence signal sent by a DM-REP i.e. if communication type = 01 ₂ . Similarly, conditions for the presence of the following elements are shown only for communication type 01 ₂ . | | | |
| NOTE 2: The power class, power control flag and priority level are message dependent elements in EN 300 396-3 [3]. See EN 300 396-3 [3], clause 9.6 for their definition. | | | |

Table 3: DM-REP DPRES-SYNC PDU contents in SCH/H

| Information element | Length | Type | Remark |
|---|--------|------|---|
| Repeater address | 10 | C | Always present when sent by a DM-REP. |
| MNI of DM-REP | 24 | C | Always present when sent by a DM-REP. |
| Validity time unit | 2 | M | |
| Number of validity time units | 6 | C | Included if validity time unit $\neq 11_2$. |
| Reserved | 6 | C | Included if validity time unit = 11_2 . Default value = 000000_2 . |
| Maximum DM-MS power class | 3 | M | |
| Reserved | 1 | M | Default value = 0. |
| Usage restriction type (URT) | 4 | M | |
| Addressing for URT = 0010_2 | 24 | C | Included if URT = 0010_2 . This element contains an MNI. |
| Addressing for URT = 0011_2 | 48 | C | Included if URT = 0011_2 . This element contains one TSI. |
| Addressing for URT = 0100_2 or 0101_2 | 72 | C | Included if URT = 0100_2 or 0101_2 . This element contains one TSI and one SSI. |
| Addressing for URT = 0110_2 | 72 | C | Included if URT = 0110_2 . This element contains three SSIs. |
| Proprietary | 72 | C | Included if URT = 0111_2 . The proprietary element is available for proprietary uses. Its use and structure are not defined in the present document. |
| Reserved | 72 | C | Included if URT = 0000_2 or 0001_2 . Default value = all zeros. |
| Reserved | 48 | C | Included if URT = 0010_2 . Default value = all zeros. |
| Reserved | 24 | C | Included if URT = 0011_2 . Default value = all zeros. |
| Reserved | 2 | C | Always present when sent by a DM-REP. Default value = 00_2 . |

10.2 Layer 2 PDUs sent in DNB

EN 300 396-3 [3], clause 9.2 shall apply.

10.3 Layer 2 information element coding

EN 300 396-3 [3], clause 9.3 shall apply with the following clarification.

The value of System code, see EN 300 396-3 [3], clause 9.3.29, used by DM-MS and DM-REP that comply with the present document shall be 1101_2 .

The following clauses shall also apply.

10.3.1 Addressing for URT = 0010_2

The addressing for URT = 0010_2 element contains a single 24-bit mobile network identity (MNI). DM-MSs with this MNI are permitted to initiate transactions and continue ongoing transactions through the DM-REP for the indicated validity time.

10.3.2 Addressing for $URT = 0011_2$

The addressing for $URT = 0011_2$ element contains a single 48-bit TSI. This is the TSI of a group of DM-MSs (for a group TSI) or an individual DM-MS (for an individual TSI) that is permitted to use the DM-REP. DM-MSs with an address corresponding to this TSI (either an individual or group address) are permitted to initiate transactions and continue ongoing transactions through the DM-REP for the indicated validity time.

NOTE: The 48-bit TSI comprises a 24-bit MNI followed by a 24-bit SSI.

10.3.3 Addressing for $URT = 0100_2$ or 0101_2

The addressing for $URT = 0100_2$ or 0101_2 element contains one 48-bit TSI and one 24-bit SSI.

The first TSI shall be generated by receiving DM-MSs using the MNI for SSI 1 element and SSI 1.

Then a TSI shall be generated from SSI 2 as follows:

- for $URT = 0100_2$ a TSI shall be generated from SSI 2 using the MNI for SSI 1;
- for $URT = 0101_2$ a TSI shall be generated from SSI 2 using the MNI of DM-REP element from the SCH/H block.

DM-MSs with an address corresponding to one of these two TSIs (either an individual or group address) are permitted to initiate transactions and continue ongoing transactions through the DM-REP for the indicated validity time.

| Information element | Length | Value | Remark |
|---------------------|--------|-------|--------|
| MNI for SSI 1 | 24 | | |
| SSI 1 | 24 | | |
| SSI 2 | 24 | | |

10.3.4 Addressing for $URT = 0110_2$

The addressing for $URT = 0110_2$ element contains three 24-bit SSIs. For each SSI, a TSI shall be generated by receiving DM-MSs using the MNI of DM-REP element from the SCH/H block. DM-MSs with an address corresponding to one of these three TSIs (either an individual or group address) are permitted to initiate transactions and continue ongoing transactions through the DM-REP for the indicated validity time.

| Information element | Length | Value | Remark |
|---------------------|--------|-------|--------|
| SSI 1 | 24 | | |
| SSI 2 | 24 | | |
| SSI 3 | 24 | | |

10.3.5 Channel state

The channel state element indicates the current state of the channel on which the presence signal is being sent, as defined by the channel usage element.

When the channel usage element is set to 00_2 the channel state element applies to the complete carrier. When the channel usage element is set to 01_2 or 10_2 the channel state element applies only to the indicated DM channel (i.e. channel A or channel B).

| Information element | Length | Value | Remark |
|---------------------|--------|--------|--------------------------|
| Channel state | 2 | 00_2 | Channel free |
| | | 01_2 | Channel in occupation |
| | | 10_2 | Channel in reservation |
| | | 11_2 | Used in EN 300 396-5 [5] |

10.3.6 Channel usage

The channel usage element indicates the DM channel on which the presence signal is being sent (i.e. channel A or channel B). It may also indicate that the presence signal applies to the complete carrier.

| Information element | Length | Value | Remark |
|---------------------|--------|-----------------|--|
| Channel usage | 2 | 00 ₂ | Presence signal applies to the carrier i.e. - channel A active in normal mode; or - presence signal sent on a free carrier |
| | | 01 ₂ | Channel A, frequency efficient mode |
| | | 10 ₂ | Channel B |
| | | 11 ₂ | Reserved |

10.3.7 Maximum DM-MS power class

The maximum DM-MS power class element specifies the maximum power class that may be used by a DM-MS whose use of the DM-REP is permitted by this PDU. When using the DM-REP, the DM-MS shall transmit at this power class or lower.

NOTE: This implies a requirement for switchable power classes under protocol control.

| Information element | Length | Value | Remark |
|---------------------------|--------|------------------|-------------------------------------|
| Maximum DM-MS power class | 3 | 000 ₂ | Null value (i.e. power not defined) |
| | | 001 ₂ | Power class 1 |
| | | 010 ₂ | Power class 2 |
| | | 011 ₂ | Power class 3 |
| | | 100 ₂ | Power class 4 |
| | | 101 ₂ | Power class 5 |
| | | 110 ₂ | Reserved |
| | | 111 ₂ | Reserved |

10.3.8 M-DMO flag

The M-DMO flag indicates whether the presence signal relates to managed direct mode operation (see EN 300 396-10 [8]) or to normal DM-REP operation as defined in the present document or in EN 300 396-7 [7].

| Information element | Length | Value | Remark |
|---------------------|--------|-------|---|
| M-DMO flag | 1 | 0 | Not a managed direct mode presence signal |
| | | 1 | Managed direct mode presence signal |

10.3.9 MNI of DM-REP

The MNI of DM-REP element contains the mobile network identity of the DM-REP.

If the DM-REP does not have an MNI (or if it does not wish to broadcast its MNI), the MNI of DM-REP element shall still be present; the DM-REP shall set it to the all ones MNI (all bits set to 1₂) as a null value. If using the all ones MNI, the DM-REP shall not set the URT to either 0101₂ or 0110₂.

10.3.10 Number of validity time units

The number of validity time units element indicates the validity time for use of the DM-REP by a DM-MS whose use of the DM-REP is permitted by this PDU.

The DM-MS shall use the value from the most recently received PDU permitting it to use the DM-REP. This shall apply even if it results in the DM-MS reducing its validity time. If the number of validity time units is set to 0 then this withdraws permission to use the DM-REP.

NOTE: A DM-MS's validity time is not affected by receipt of a presence signal if it is not addressed by the usage restrictions in that presence signal.

| Information element | Length | Value | Remark |
|-------------------------------|--------|-------|-----------------------------------|
| Number of validity time units | 6 | any | Multiplies the validity time unit |

10.3.11 Presence signal dual watch synchronization flag

The presence signal dual watch synchronization flag indicates whether the DM-REP considers that this presence signal is being sent using the dual watch synchronization appropriate for operation with this type of DM-REP. The DM-REP may have deduced this from previous signalling sent by DM-MSs or by other means.

The presence signal dual watch synchronization flag may indicate only an assumption by the DM-REP. The DM-REP may set the flag to 1 even if it has only an approximate view of the dual watch synchronization or based on information that may not necessarily be accurate.

The presence signal dual watch synchronization flag is provided only for guidance to DM-MSs, particularly to those DM-MSs that are not performing dual watch. When a non-dual-watching DM-MS makes a call on a free carrier, it may use the presence signal dual watch synchronization flag to decide whether to choose a DM timing reference based on the timing defined by the presence signal.

| Information element | Length | Value | Remark |
|---|--------|-------|---|
| Presence signal dual watch synchronization flag | 1 | 0 | No information provided about the dual watch synchronization |
| | | 1 | DM-REP considers that this presence signal is sent using the dual watch synchronization |

10.3.12 Repeater operating modes

The repeater operating modes element indicates whether a DM-MS operating with the DM-REP may make type 1 or type 2 calls.

| Information element | Length | Value | Remark |
|--------------------------|--------|-----------------|--|
| Repeater operating modes | 2 | 00 ₂ | Type 1 DM-REP; DM-MSs may make only type 1 calls |
| | | 01 ₂ | Type 2 DM-REP; DM-MSs may make only type 2 calls |
| | | 10 ₂ | Type 2 DM-REP; DM-MSs may make either type 1B or type 2 calls (see note 1) |
| | | 11 ₂ | Reserved |

NOTE 1: If a DM-MS makes a type 1B call through a type 2 DM-REP then, for the duration of that call, the DM-MSs and the DM-REP use the procedures defined in the present document - obeying the procedures for operation with a type 1B DM-REP (except that the DM-REP should continue to set the "repeater operating modes" element to 10₂ when it sends the presence signal).

The procedures for type 2 calls are defined in EN 300 396-7 [7].

NOTE 2: There is no procedure for a DM-MS to pre-empt a type 2 call in order to make a normal mode call. Therefore a DM-MS cannot pre-empt a type 2 call in order to make a type 1B call.

10.3.13 Spacing of uplink

The spacing of uplink element indicates the frequency of the DM uplink RF carrier f_1 from DM-MSs to a two-frequency DM-REP relative to the selected DM downlink RF carrier f_2 from the DM-REP to DM-MSs (i.e. the frequency on which the presence signal is being sent).

The spacing of uplink element comprises two sub-elements. The first defines the duplex spacing, and the second defines whether f_1 is above or below f_2 .

| Information element | Length | Value | Remark |
|--------------------------|--------|--------------------|-------------------------------------|
| Duplex spacing | 5 | 00000 ₂ | Reserved |
| | | 00001 ₂ | 1,6 MHz |
| | | 00010 ₂ | 4,5 MHz |
| | | 00011 ₂ | 8 MHz |
| | | 00100 ₂ | 10 MHz |
| | | 00101 ₂ | 18 MHz |
| | | 00110 ₂ | 30 MHz |
| | | 00111 ₂ | 39 MHz |
| | | 01000 ₂ | 45 MHz |
| | | others | Reserved |
| Normal/reverse operation | 1 | 0 | $f_1 = f_2 + \text{duplex spacing}$ |
| | | 1 | $f_1 = f_2 - \text{duplex spacing}$ |

10.3.14 Two-frequency repeater flag

The two-frequency repeater flag indicates whether the DM-REP is operating on one DM RF carrier or on a pair of duplex-spaced DM RF carriers.

| Information element | Length | Value | Remark |
|-----------------------------|--------|-------|--|
| Two-frequency repeater flag | 1 | 0 | One DM RF carrier (i.e. type 1A DM-REP) |
| | | 1 | Pair of duplex-spaced DM RF carriers (i.e. type 1B or type 2 DM-REP) |

10.3.15 Usage restriction type (URT)

The usage restriction type element indicates the type of restrictions on which DM-MSs are permitted to attempt to use the DM-REP.

| Information element | Length | Value | Remark |
|------------------------------|--------|-------------------|--|
| Usage restriction type (URT) | 4 | 0000 ₂ | No restrictions (i.e. open) |
| | | 0001 ₂ | Restricted by prior arrangement (i.e. use of this DM-REP is available only by prior arrangement) |
| | | 0010 ₂ | Restricted to single MNI |
| | | 0011 ₂ | Restricted to single address (TSI) |
| | | 0100 ₂ | Restricted to 2 addresses (TSI + SSI) |
| | | 0101 ₂ | Restricted to 2 addresses (TSI + SSI) |
| | | 0110 ₂ | Restricted to 3 addresses (SSIs) |
| | | 0111 ₂ | Available for proprietary uses |
| | | others | Reserved |

10.3.16 Validity time unit

The validity time unit element may indicate the time unit used for the validity time. Alternatively, value 11₂ indicates that the validity time is not currently restricted for use of the DM-REP by a DM-MS whose use of the DM-REP is permitted by this PDU.

The DM-MS shall use the validity time from the most recently received PDU permitting it to use the DM-REP. This shall apply even if it results in the DM-MS reducing its validity time.

NOTE: A DM-MS's validity time is not affected by receipt of a presence signal if it is not addressed by the usage restrictions in that presence signal.

| Information element | Length | Value | Remark |
|---------------------|--------|-----------------|------------------------------|
| Validity time unit | 2 | 00 ₂ | Multiframe |
| | | 01 ₂ | 60 multiframe |
| | | 10 ₂ | 3600 multiframe |
| | | 11 ₂ | Validity time not restricted |

10.3.17 Value of DT254

The value of DT254 element indicates the value of the DM-REP's timer DT254.

NOTE 1: DT254 is the maximum interval between sequences of transmissions of the DM-REP presence signal on a free carrier. This element may be used by DM-MSs in algorithms for deciding when they have gone out of range of the DM-REP.

NOTE 2: The DM-REP is not precluded from using a value of DT254 not represented by the "value of DT254" element. If it does so then it should set the "value of DT254" element to indicate the next represented value of DT254 above the actual value.

| Information element | Length | Value | Remark |
|---------------------|--------|------------------|------------------------------------|
| Value of DT254 | 3 | 000 ₂ | Value of timer DT254 not indicated |
| | | 001 ₂ | 2 multiframe duration |
| | | 010 ₂ | 5 multiframe duration |
| | | 011 ₂ | 10 multiframe duration |
| | | 100 ₂ | 15 multiframe duration |
| | | 101 ₂ | 20 multiframe duration |
| | | 110 ₂ | 30 multiframe duration |
| | | 111 ₂ | 60 multiframe duration |

10.3.18 Values of DN232 and DN233

The values of DN232 and DN233 element indicates the values of the layer 2 constants DN232 and DN233 that are being used by the DM-REP. The element comprises two sub-elements, the first indicating the value of DN232 and the second indicating the value of DN233.

A DM-MS shall use the values of DN232 and DN233 from the DM-REP's presence signal in preference to the values given by configuration (or the default values).

NOTE: DN232 is the number of frames in which the DM-REP transmits a DM-MS's DM-SETUP or DM-SETUP PRES message on the slave link. DN233 is the number of frames in which it transmits a DM-MS's short data DSB on the slave link.

| Information element | Length | Value | Remark |
|---------------------|--------|-----------------|-----------|
| Value of DN232 | 2 | 00 ₂ | Reserved |
| | | 01 ₂ | DN232 = 2 |
| | | 10 ₂ | DN232 = 3 |
| | | 11 ₂ | DN232 = 4 |
| Value of DN233 | 2 | 00 ₂ | Reserved |
| | | 01 ₂ | DN233 = 2 |
| | | 10 ₂ | DN233 = 3 |
| | | 11 ₂ | DN233 = 4 |

10.4 Messages generated by layer 2

EN 300 396-3 [3], clause 9.4 shall apply.

10.5 Layer 3 PDUs

EN 300 396-3 [3], clause 9.5 shall apply.

10.6 Message dependent elements coding

EN 300 396-3 [3], clause 9.6 shall apply with the following differences:

- i) When the master DM-MS transmits DM-SETUP, DM-SETUP PRES, DM-CONNECT ACK, DM-OCCUPIED and DM-RESERVED messages on the master link, it shall set the "power class" element to its own power level and shall set the "power control flag" to 0.

When the DM-REP sends the presence signal, and when it re-transmits DM-SETUP, DM-SETUP PRES, DM-CONNECT ACK, DM-OCCUPIED and DM-RESERVED messages on the slave link, it shall set the "power class" element to its own power level and shall set the "power control flag" to enable or disable DM-MS power control procedures as appropriate. As in EN 300 396-3 [3], clause 9.6.9, the "power control flag" indicates whether or not power control by slave and idle DM-MSs is permitted by the DM-REP. When operating with a DM-REP, the master DM-MS also may perform power control if permitted by the DM-REP's most recent setting of the "power control flag" (i.e. if the "power control flag" was set to 1 in the most recently received DM-REP presence signal or in the call set-up messages re-transmitted by the DM-REP on the slave link).

- ii) When a non-dual-watching DM-MS makes a call, it may set the "dual watch synchronization flag" to 1 if it is using a DM timing reference based on the timing defined by a presence signal in which the "presence signal dual watch synchronization flag" was set to 1.

A DM-REP may use the "dual watch synchronization flag" to decide whether to choose a DM timing reference based on the timing of a previous call when sending the presence signal on a free carrier.

- iii) In the case of a type 1 call through a DM-REP (i.e. a call with element "communication type" set to 01₂ and element "A/B channel usage" set to 00₂), "two-frequency call flag" indicates whether the master DM-MS assumes that this is a type 1A or type 1B call.

NOTE: If the "two-frequency call flag" is set to 1 then a DM-MS receiving on the downlink needs to know the duplex spacing (and whether f_1 is above or below f_2) before it can transmit on the uplink, either by receiving the presence signal or by prior arrangement.

Similarly, if a DM-MS receives the message on the uplink (i.e. if it receives the message as sent by the master DM-MS on the master link), it needs to know the duplex spacing (and whether f_1 is above or below f_2) in order to be able to identify the frequency of the downlink.

10.7 DM-SDU elements coding

EN 300 396-3 [3], clause 9.7 shall apply with the following difference:

- The release cause element may take an additional value as shown in table 4.

Table 4: Release cause element

| Information element | Length | Value | Remark |
|---------------------|--------|---|--|
| Release cause | 4 | 0000 ₂ to 0110 ₂ | As defined in EN 300 396-3 [3] |
| | | 0111 ₂ | Link to DM-REP not established or failed |
| | | 1000 ₂ to 1100 ₂ | Used in EN 300 396-5 [5] |
| | | 1101 ₂ | Transmit authorization lost |
| | | 1110 ₂ | Used in EN 300 396-5 [5] |
| | | 1111 ₂ | The reason for the release cause is given in the release cause extension element |

11 Radio aspects of DM-MS for operation with a type 1 DM-REP

11.1 Introduction

This clause details the radio aspects of DM-MS operation with a type 1 DM-REP.

11.2 Modulation

EN 300 396-2 [2], clause 5 shall apply.

11.3 Radio transmission and reception

11.3.1 Introduction

EN 300 396-2 [2], clause 6.1 shall apply.

11.3.2 Frequency bands and channel arrangement

DM-MSs may only transmit and receive in those channels allocated for TETRA DMO. For operation with a type 1A DM-REP, all transmission and reception takes place on a single selected DM RF carrier. For operation with a type 1B DM-REP, transmissions by the DM-MS are sent on the appropriate "uplink" RF carrier f_1 while transmissions from the DM-REP are received on the associated (duplex-spaced) "downlink" RF carrier f_2 .

Dual Watch Mobile Stations (DW-MSs) and Dual Mode Mobile Stations (DU-MSs) shall also be able to transmit and receive within TETRA Voice plus Data (TMO) channels.

The TETRA DM RF carrier separation (i.e. channel spacing) shall be 25 kHz.

11.3.3 Reference test planes

EN 300 396-2 [2], clause 6.3 shall apply.

11.3.4 Transmitter characteristics

EN 300 396-2 [2], clause 6.4 shall apply.

11.3.5 Receiver characteristics

EN 300 396-2 [2], clause 6.5 shall apply.

11.3.6 Transmitter/receiver performance

EN 300 396-2 [2], clause 6.6 shall apply.

11.4 Radio sub-system synchronization

11.4.1 Introduction

EN 300 396-2 [2], clause 7.1 shall apply.

11.4.2 Definitions and general requirements for synchronization of DM-MSs

In communication through a type 1 DM-REP, the DM-REP provides the frequency synchronization reference. All DM-MSs, including the "master" DM-MS, synchronize in frequency to the DM-REP transmissions. For a type 1A DM-REP, the transmissions take place on the selected DM RF carrier. For a type 1B DM-REP, transmissions from the DM-REP are sent on the "downlink" RF carrier f_2 .

A DM-MS which initiates a call defines the initial frequency and timing synchronization. If the DM-REP has been sending signalling on the selected RF carrier, the master DM-MS should take its initial frequency synchronization from this signalling. Otherwise it shall use its own internal free-running reference to generate the carrier as specified in EN 300 396-2 [2], clause 7.2.

NOTE 1: Even when the master DM-MS has chosen to synchronize in frequency to the DM-REP prior to sending the call set-up messages, it need not adopt the slot timing or slot and frame numbering defined by the signalling messages from the DM-REP.

At the beginning of a call, the master DM-MS shall transmit its call set-up messages in DSBs. The master DM-MS shall then synchronize in frequency to the DM-REP using the DSBs transmitted by the DM-REP. It shall maintain this frequency synchronization using the DSBs transmitted periodically by the DM-REP. When synchronizing to the DM-REP, the master DM-MS should meet the requirements for the frequency synchronization of a slave DM-MS as specified in EN 300 396-2 [2], clause 7.5.

When the master DM-MS perceives that its transmissions are not adequately synchronized in frequency to the DM-REP's transmissions, it should perform the necessary correction before its next transmitted burst.

NOTE 2: Thus, when the DM-MS perceives that its transmissions are not adequately synchronized in frequency to the DM-REP's transmissions, it performs the complete correction immediately (to within the accuracy specified in EN 300 396-2 [2], clause 7.5).

This includes the case when the DM-MS used its own internal reference to generate the carrier when sending the call set-up DSBs. For example, if the DM-MS is making a call set-up without presence check or sending a fragmented short data message, and it receives its call set-up DSB repeated on the slave link by the DM-REP, then it corrects its frequency synchronization before starting to send the DNBs; or, if it is making a call set-up with presence check, it corrects its frequency synchronization before sending the DM-CONNECT ACK messages.

The DSBs transmitted by the DM-REP at the start of a call and at intervals during the call shall be used by the slave DM-MSs to synchronize themselves in terms of frequency and time, and to maintain synchronization. The DM-MS shall align its burst transmission in time to the timeslots received from the DM-REP, as specified in clause 11.4.5. It shall also generate the transmission RF carrier using a frequency reference which has been synchronized to the carrier frequency received from the DM-REP, as specified in clause 11.4.5.

The timebase of a DM-MS shall continuously count quarter symbols, symbols, timeslots and frames, independently of whether the DM-MS is transmitting or not (see clause 11.4.3). A slave DM-MS is said to be fully time synchronized if all of its timebase counters run synchronously, within a specified tolerance to those of the DM-REP.

NOTE 3: The master DM-MS does not re-align its transmission timing when it receives DSBs from the DM-REP (since the DM-REP follows the slot timing used by the master DM-MS).

The timing information contained in the SCH/S transmitted by the DM-REP in the DSB shall refer to the slot and frame number at which the DSB is transmitted. Upon reception of an SCH/S, the slave DM-MS shall use this timing information to set its slot and frame counters.

In normal cases (see note 4) a slave DM-MS which becomes the new master DM-MS after a changeover or pre-emption has been carried out successfully shall adopt the state of the timing counters used by the previous master DM-MS. The transition point at which changeover occurs shall be at a timeslot boundary.

NOTE 4: An exception may be the case where a timing change request has been included within the changeover or pre-emption request.

The DM-MS taking over the master role shall continue to maintain its frequency synchronization to the DM-REP via the DSBs received from the DM-REP.

11.4.3 Timebase counters

EN 300 396-2 [2], clause 7.3 shall apply.

11.4.4 Requirements for the frequency reference source of DM mobiles

EN 300 396-2 [2], clause 7.4 shall apply.

11.4.5 Requirements for the synchronization of a slave DM mobile

EN 300 396-2 [2], clause 7.5 shall apply except that references to the master DM-MS shall be replaced by references to the type 1 DM-REP.

NOTE: For operation with a type 1B DM-REP, transmissions by DM-MSs are sent on the "uplink" RF carrier f_1 .

11.4.6 Synchronization requirements for a master MS operating on channel B in frequency efficient mode

Channel B operation is not valid for operation with a type 1 DM-REP. Therefore EN 300 396-2 [2], clause 7.6 shall not apply for operation with a type 1 DM-REP.

11.5 Channel coding and scrambling

EN 300 396-2 [2], clause 8 shall apply.

11.6 Channel multiplexing for DM operation through a type 1 DM-REP

EN 300 396-2 [2], clause 9 shall apply with the following differences:

- i) In clause 9.3.1, for operation with a type 1A DM-REP, all DM-MSs in a call shall transmit and receive on the same RF carrier. For operation with a type 1B DM-REP, all DM-MSs in a call shall transmit on the "uplink" RF carrier f_1 and receive on the "downlink" RF carrier f_2 .

- ii) In clause 9.4.1, for operation with a type 1A DM-REP, a DM physical channel is defined as a single RF carrier. For operation with a type 1B DM-REP, a DM physical channel is defined as a pair of duplex-spaced RF carriers (f_1 as the "uplink" with f_2 as the associated "downlink"). Two timeslots per frame are used primarily for the master link and the other two timeslots per frame are used primarily for the slave link.
- iii) The following addition shall also apply to clause 9:
 - The start of the multiframe and frame on the slave link shall occur 3 timeslot durations after the start of the corresponding multiframe and frame on the master link.

11.7 Radio sub-system link control

EN 300 396-2 [2], clause 10 shall apply with the following difference:

- Adaptive DM-MS RF power control shall be optional for operation through a type 1 DM-REP for both master and slave DM-MSs. The power reduction mechanism is outside the scope of the present document.

12 Radio aspects of a type 1 DM-REP

12.1 Introduction

This clause details the radio aspects of the type 1 DM-REP.

12.2 Modulation

EN 300 396-2 [2], clause 5 shall apply.

12.3 Radio transmission and reception

12.3.1 Introduction

EN 300 396-2 [2], clause 6.1 shall apply.

12.3.2 Frequency bands and channel arrangement

DM-REP equipment may only transmit and receive in those channels allocated for TETRA DM use. For a type 1A DM-REP, all transmission and reception takes place on a single selected DM RF carrier. For a type 1B DM-REP, transmissions by the DM-MSs are received on the appropriate "uplink" RF carrier f_1 while transmissions from the DM-REP are sent on the associated (duplex-spaced) "downlink" RF carrier f_2 .

The TETRA DM RF carrier separation (i.e. channel spacing) shall be 25 kHz.

12.3.3 Reference test planes

EN 300 396-2 [2], clause 6.3 shall apply.

12.3.4 Transmitter characteristics

12.3.4.1 Output power

EN 300 396-2 [2], clause 6.4.1 shall apply.

12.3.4.2 Power classes

The DM-REP nominal power shall be, according to its class, as defined in table 5.

Table 5: Nominal power of DM-REP transmitters

| Power class | Nominal power |
|-------------|------------------------|
| 1 (30 W) | 45 dBm |
| 1L (17,5 W) | 42,5 dBm |
| 2 (10 W) | 40 dBm |
| 2L (5,6 W) | 37,5 dBm |
| 3 (3 W) | 35 dBm |
| 3L (1,8 W) | 32,5 dBm |
| 4 (1 W) | 30 dBm |
| 4L (0,56 W) | 27,5 dBm |
| 5 | not defined for DM-REP |
| 5L | not defined for DM-REP |

12.3.4.3 Unwanted conducted emissions

12.3.4.3.1 Definitions

EN 300 396-2 [2], clause 6.4.3.1 shall apply.

12.3.4.3.2 Unwanted emissions close to the carrier

EN 300 396-2 [2], clause 6.4.3.2 shall apply.

12.3.4.3.3 Unwanted emissions far from the carrier

These unwanted emissions are emissions (discrete, wideband noise, modulated or un-modulated) occurring at offsets equal to, or greater than, 100 kHz from the carrier frequency, measured in the frequency range 9 kHz to 4 GHz.

12.3.4.3.3.1 Discrete spurious

EN 300 396-2 [2], clause 6.4.3.3.1 shall apply.

12.3.4.3.3.2 Wideband noise

EN 300 396-2 [2], clause 6.4.3.3.2 shall apply.

The wideband noise limits for a DM-REP with nominal power level = 30 W (class 1) shall be as for a DM-REP with nominal power level = 10 W (class 2).

12.3.4.3.4 Unwanted emissions during the Linearization Channel (LCH)

EN 300 396-2 [2], clause 6.4.3.4 shall apply.

12.3.4.3.5 Unwanted emissions in the non-transmit state

EN 300 396-2 [2], clause 6.4.3.5 shall apply.

12.3.4.4 Unwanted radiated emissions

EN 300 396-2 [2], clause 6.4.4 shall apply.

12.3.4.5 Radio frequency tolerance

The radio frequency tolerance for DM-REPs is defined in clause 12.4.4.

12.3.4.6 RF output power time mask

EN 300 396-2 [2], clause 6.4.6 shall apply.

A type 1A DM-REP may be required to receive in slots on the transmit frequency during the non-active transmit state. In this situation the equipment shall meet the receiver sensitivity specifications.

12.3.4.7 Transmitter intermodulation attenuation

EN 300 396-2 [2], clause 6.4.7 shall apply.

12.3.5 Receiver characteristics

EN 300 396-2 [2], clause 6.5 shall apply.

12.3.6 Transmitter/receiver performance

EN 300 396-2 [2], clause 6.6 shall apply.

12.4 Radio sub-system synchronization

12.4.1 Introduction

EN 300 396-2 [2], clause 7.1 shall apply.

12.4.2 Definitions and general requirements for synchronization

The DM-REP shall synchronize itself in terms of time to the initial call set-up transmissions from a master DM-MS. Moreover, the DM-REP shall use the timing information contained in the SCH/S transmitted by the master DM-MS to set its slot and frame counters.

The DM-REP shall in its turn transmit DSBs on the slave link to enable timing synchronization of the slave DM-MSs. The timing information contained in the SCH/S transmitted by the DM-REP shall refer to the slot and frame number at which the DSB is transmitted.

NOTE 1: The frame numbering is different on the master and slave links and the DM-REP therefore uses the frame numbering system of the slave link when transmitting its DSBs on that link.

The DM-REP shall generate the transmission carrier using its own internal frequency reference.

NOTE 2: This includes the DM-REP's transmissions of the initial call set-up messages from the master DM-MS, even when the master DM-MS used its own frequency reference to generate the transmission RF carrier. The master DM-MS then synchronizes in frequency to the DM-REP using the DSBs transmitted by the DM-REP. See also clause 11.4.2.

The timebase of a DM-REP shall continuously count quarter symbols, symbols, timeslots and frames, in accordance with EN 300 396-2 [2], clause 7.3, independently of whether the DM-REP is transmitting or not.

12.4.3 Timebase counters

EN 300 396-2 [2], clause 7.3 shall apply.

12.4.4 Requirements for the frequency reference source of a type 1 DM-REP

EN 300 396-2 [2], clause 7.4 shall apply.

NOTE: Under many operational circumstances it may be preferable that the DM-REP uses a frequency reference source of sufficient accuracy such that the RF carrier frequency is more accurate than $\pm 1,0$ kHz e.g. ± 500 Hz.

12.4.5 Requirements for the synchronization of a type 1 DM-REP

The DM-REP shall generate the transmission RF carrier using its own internal frequency reference.

The following requirement for timebase accuracy shall be met by the DM-REP for a transmission period of one multiframe duration following initial synchronization to a master DM-MS. This requirement shall be achieved at receive signal levels greater than or equal to 3 dB below the reference sensitivity:

- whenever the DM-REP transmits signalling while a call is ongoing, its burst timing shall be accurate to within 1/2 symbol period compared to signals received from the master DM-MS.

The following requirement for the timebase shall be met by the DM-REP for the time period following one multiframe duration after initial synchronization until the end of the call:

- whenever the DM-REP transmits signalling while a call is ongoing, its burst timing shall be accurate to within 1/4 symbol period compared to signals received from the master DM-MS.

The signals received from the master DM-MS shall be averaged over sufficient time so that errors due to noise, interference or Doppler spread are minimized.

12.5 Channel coding and scrambling

EN 300 396-2 [2], clause 8 shall apply.

12.6 Channel multiplexing for a type 1 DM-REP

EN 300 396-2 [2], clause 9 shall apply with the following differences:

- i) In clause 9.3.1, a type 1A DM-REP shall transmit and receive on the same RF carrier. A type 1B DM-REP shall receive on the "uplink" RF carrier f_1 and transmit on the "downlink" RF carrier f_2 .
- ii) In clause 9.4.1, for a type 1A DM-REP, a DM physical channel is defined as a single RF carrier. For a type 1B DM-REP, a DM physical channel is defined as a pair of duplex-spaced RF carriers (f_1 as the "uplink" with f_2 as the associated "downlink"). Two timeslots per frame are used primarily for the master link and the other two timeslots per frame are used primarily for the slave link.
- iii) The following addition shall also apply to clause 9:
 - The start of the multiframe and frame on the slave link shall occur 3 timeslot durations after the start of the corresponding multiframe and frame on the master link.

12.7 Radio sub-system link control

EN 300 396-2 [2], clause 10 shall apply.

A DM-REP shall always transmit at its nominal power according to clauses 12.3.4.1 and 12.3.4.2.

Annex A (normative): Timers and constants in DM-MS and DM-REP

This annex lists the timers and constants in a DM-MS when operating with a type 1 DM-REP.

Where indicated, a value should be chosen by the MS designer from within the specified range. For other timers and constants, a default value is specified and the value of these timers and constants shall be configurable within the DM-MS.

This annex also lists the timers and constants in the DM-REP. The values of these timers and constants shall be configurable within the DM-REP or, if specified, chosen by the gateway designer. Suggested default values are given.

A.1 Layer 3 timers in DM-MS

| | |
|-------|--|
| DT303 | Time-out waiting for response to DM-SETUP PRES. Value to be chosen by MS designer. Suggested value = 550 ms. |
| DT307 | Time-out waiting for response to DM-CONNECT. Value to be chosen by MS designer. Suggested value = 450 ms. |
| DT311 | Call transaction timer. Value to be chosen by MS designer or given by configuration. Suggested maximum value = 300 seconds. |
| DT314 | Time-out for reporting SDS failure after sending DM-PRE ACCEPT. Value to be chosen by MS designer. Suggested value = 600 ms. |
| DT316 | Time-out waiting for response to DM-SDS DATA. Value to be chosen by MS designer. Suggested value = 650 ms. |

A.2 Layer 3 constants in DM-MS

| | |
|-------|---|
| DN303 | Maximum number of attempts to send DM-SETUP PRES if no response received. MS designer choice from the range 1 to 3. |
| DN304 | Maximum number of attempts to send DM-SETUP or DM-SETUP PRES if link establishment to the DM-REP has failed. MS designer choice from the range 1 to 3. |
| DN314 | Number of transmissions of DM-SDS UDATA. Value may be chosen by MS designer (or may be message dependent) from the range 1 to 6. |
| DN315 | Maximum number of attempts to send DM-SDS DATA if negative response received. MS designer choice from the range 2 to 6. |
| DN316 | Maximum number of attempts to send DM-SDS DATA if no response received. MS designer choice from the range 1 to 4. |
| DN317 | Maximum number of attempts to send DM-SDS UDATA or DM-SDS DATA if link establishment to the DM-REP has failed. MS designer choice from the range 1 to 3. |

A.3 Layer 2 timers in DM-MS

| | |
|-------|--|
| DT204 | Time-out for increased surveillance after receiving gateway signalling. Value to be chosen by MS designer. Minimum value = 2 x DT264 if the gateway's value of DT264 has been received. Minimum value = 2 x 60 multiframe durations if the gateway's value of DT264 has not been received. |
| DT205 | Time when randomization is required for call set-up after channel becomes free. Default value = 18 frame durations. |
| DT206 | Time when longer randomization is required for call set-up after new call pre-emption acceptance. Value to be chosen by MS designer. Minimum value = 9 frame durations. |
| DT207 | Inactivity time-out for idle DM-MS in channel occupation or reservation. Default value = 90 frame durations. |
| DT210 | Time allowed by master for response to DM-SDS DATA before sending DM-PRE ACCEPT. Default value = 6 frame durations. Minimum value 4 frame durations, maximum value = 7 frame durations. Should be at least one more frame duration than DN210 in any slave DM-MS the master can send DM-SDS DATA to. |
| DT211 | Time-out waiting for random access response (circuit mode occupation or reservation). Default value = 5 frame durations. Minimum value = 5 frame durations. |
| DT212 | Time-out waiting for random access response (short data occupation). Default value = 11 frame durations. Minimum value = 11 frame durations. |
| DT213 | Random access time-out. MS designer choice from the range 2 to 60 multiframe durations. |
| DT214 | Validity time-out when attempting random access. Default value = 36 frame durations. |
| DT215 | Random access time-out for emergency message. Value to be chosen by MS designer from the range 2 to 60 multiframe durations or given by configuration. |
| DT221 | Inactivity time-out for slave DM-MS in channel occupation or reservation. Default value = 90 frame durations. |
| DT225 | Inactivity time-out on link from DM-REP for master DM-MS in circuit mode call. Default value = 90 frame durations. |

A.4 Layer 2 constants in DM-MS

| | |
|-------|---|
| DN204 | Minimum randomization for call set-up after channel becomes free. Default value = 1. |
| DN205 | Maximum randomization for call set-up after channel becomes free. Default value = 8. |
| DN206 | Minimum randomization for non-immediate retransmission of call set-up. Default value = 8. |
| DN207 | Maximum randomization for non-immediate retransmission of call set-up. Default value = 12. |

| | |
|-------|--|
| DN210 | Maximum number of frames containing slave's response DSB. Default value = 3. Minimum value 1, maximum value 4 |
| DN212 | Number of SCH/F slots of DM-SDS DATA that may be sent before pre-emption acceptance. Default value = 2. Maximum value = 8 - DT210 (expressed in frames). |
| DN213 | Maximum number of non-emergency random access transmissions. Default value = 8. |
| DN215 | Maximum number of emergency random access transmissions. Default value = 16. |
| DN232 | Number of frames in which the master DM-MS expects the DM-REP to transmit its DM-SETUP or DM-SETUP PRES message on the slave link. Minimum value = 2. Maximum value = 4. Default value = 2 if value not received in DM-REP presence signal. |
| DN233 | Number of frames in which the master DM-MS expects the DM-REP to transmit the DSB heading a DM-SDS UDATA or DM-SDS DATA message on the slave link. Minimum value = 2. Maximum value = 4. Default value = 2 if value not received in DM-REP presence signal. |

NOTE: DN232 and DN233 apply to both DM-MS and DM-REP. For correct operation of the short data protocol and the air interface encryption methods, it is essential that the master DM-MS uses the same values of DN232 and DN233 as the DM-REP, see notes in 8.5.4.1 and 8.6.3.1.1.

A.5 Maximum number of frame transmissions by DM-MAC

Table A.1 shows the minimum and maximum number of frames in which each message may be sent by the DM-MAC in the source DM-MS when using the frame countdown mechanism.

Table A.1: Number of frame transmissions by DM-MAC

| Message type | Minimum to maximum number of frames in which message may be sent |
|--------------------|---|
| DM-SETUP | 2 to 4 for new call set-up 1 to 4 for continuation of ongoing call |
| DM-SETUP PRES | 2 to 4 for new call set-up 1 to 4 for continuation of ongoing call |
| DM-CONNECT | 1 to DN210 |
| DM-DISCONNECT | 1 to DN210 |
| DM-CONNECT ACK | 1 to 4 |
| DM-TX CEASED | 2 to 4 |
| DM-RELEASE | 2 to 4 |
| DM-TX ACCEPT | 2 to 4 |
| DM-PRE ACCEPT | 2 to 4 |
| DM-REJECT | 1 to 4 |
| DM-TIMING ACK | 1 to 4 during occupation 1 to 4 during reservation for rejection 2 to 4 during reservation for acceptance |
| DM-SDS DATA (DSB) | 2 to 4 for new call set-up 1 to 4 for continuation of ongoing call |
| DM-SDS UDATA (DSB) | 2 to 4 for new call set-up 1 to 4 for continuation of ongoing call |
| DM-SDS ACK (DSB) | 1 to DN210 |
| NOTE: | The numbers of frames in which each message is sent may be set by the MS designer, or otherwise the MS designer may choose to allow some or all of the values to be configurable. |

A.6 Layer 2 timers in DM-REP

- DT250 DM-REP time-out during call set-up with presence check.
Default value = 14 frame durations.
- DT251 DM-REP time-out waiting for response to DM-SDS DATA on slave link.
Default value = 5 frame durations.
- DT252 DM-REP time-out waiting for call set-up signalling after pre-emption or changeover.
Default value = 9 frame durations.
- DT253 Minimum interval between transmissions of DM-REP presence signal on a free carrier.
Value to be chosen by DM-REP designer or given by configuration.
- DT254 Maximum interval between transmissions of DM-REP presence signal on a free carrier.
Maximum value = 60 multiframe durations.
Value to be chosen by DM-REP designer or given by configuration.
A value of 0 indicates that the DM-REP does not transmit the presence signal periodically on a free carrier.
- DT255 Time when randomization is required for transmission by DM-REP after channel becomes free.
Default value = 18 frame durations.
- DT256 Inactivity time-out for active DM-REP in channel occupation.
Default value = 120 frame durations.
- DT257 Inactivity time-out for idle DM-REP in channel occupation or reservation.
Default value = 90 frame durations.
- DT258 Inactivity time-out for active DM-REP in channel reservation.
Default value = 120 frame durations.

DT259 Time when longer randomization is required for transmission after new call pre-emption acceptance.
Value to be chosen by DM-REP designer.
Minimum value = 9 frame durations.

A.7 Layer 2 constants in DM-REP

DN232 Number of frames in which the DM-REP transmits a DM-MS's DM-SETUP or DM-SETUP PRES message on the slave link.
Minimum value = 2.
Maximum value = 4.
Default value = 2.

DN233 Number of frames in which the DM-REP transmits the DSB heading a DM-MS's DM-SDS UDATA or DM-SDS DATA message on the slave link.
Minimum value = 2.
Maximum value = 4.
Default value = 2.

NOTE: DN232 and DN233 apply to both DM-REP and DM-MS. For correct operation of the short data protocol and the air interface encryption methods, it is essential that the DM-REP uses the same values of DN232 and DN233 as the master DM-MS, see notes in 8.5.4.1 and 8.6.3.1.1.

DN253 Number of frames in which the DM-REP transmits the free-channel presence signal.
DM-REP designer choice from the range 2 to 4.

DN254 Minimum randomization by DM-REP for transmission after channel becomes free.
Default value = 1.

DN255 Maximum randomization by DM-REP for transmission after channel becomes free.
Default value = 8.

Annex B (normative): SDS-TL use in DMO

EN 300 396-3 [3], annex E shall apply.

Annex C (informative): Bibliography

ETSI EN 300 392-1: "Terrestrial Trunked Radio (TETRA); Voice plus Data (V+D); Part 1: General network design".

History

| Document history | | |
|-------------------------|---------------|---|
| V1.2.1 | October 2000 | Publication as TS 100 396-4 |
| V1.2.1 | December 2000 | Publication |
| V1.3.0 | December 2005 | One-step Approval Procedure OAP 20060428: 2005-12-28 to 2006-04-28 |
| V1.3.1 | May 2006 | Publication |
| | | |