

Draft **ETSI EN 300 392-3-10** V1.2.0 (2019-08)



**Terrestrial Trunked Radio (TETRA);
Voice plus Data (V+D);
Part 3: Interworking at the Inter-System Interface (ISI);
Sub-part 10: General design, PSS1 over E.1**

ReferenceREN/TCCE-03258

Keywordsmanagement, mobility, TETRA

ETSI

650 Route des Lucioles
F-06921 Sophia Antipolis Cedex - FRANCE

Tel.: +33 4 92 94 42 00 Fax: +33 4 93 65 47 16

Siret N° 348 623 562 00017 - NAF 742 C
Association à but non lucratif enregistrée à la
Sous-Préfecture de Grasse (06) N° 7803/88

Important notice

The present document can be downloaded from:

<http://www.etsi.org/standards-search>

The present document may be made available in electronic versions and/or in print. The content of any electronic and/or print versions of the present document shall not be modified without the prior written authorization of ETSI. In case of any existing or perceived difference in contents between such versions and/or in print, the only prevailing document is the print of the Portable Document Format (PDF) version kept on a specific network drive within ETSI Secretariat.

Users of the present document should be aware that the document may be subject to revision or change of status.

Information on the current status of this and other ETSI documents is available at

<https://portal.etsi.org/TB/ETSIDeliverableStatus.aspx>

If you find errors in the present document, please send your comment to one of the following services:

<https://portal.etsi.org/People/CommiteeSupportStaff.aspx>

Copyright Notification

No part may be reproduced or utilized in any form or by any means, electronic or mechanical, including photocopying and microfilm except as authorized by written permission of ETSI.

The content of the PDF version shall not be modified without the written authorization of ETSI.

The copyright and the foregoing restriction extend to reproduction in all media.

© ETSI 2019.

All rights reserved.

DECT™, **PLUGTESTS™**, **UMTS™** and the ETSI logo are trademarks of ETSI registered for the benefit of its Members.

3GPP™ and **LTE™** are trademarks of ETSI registered for the benefit of its Members and of the 3GPP Organizational Partners.

oneM2M™ logo is a trademark of ETSI registered for the benefit of its Members and of the oneM2M Partners.

GSM® and the GSM logo are trademarks registered and owned by the GSM Association.

Contents

Intellectual Property Rights	5
Foreword.....	5
Modal verbs terminology.....	7
1 Scope	8
2 References	8
2.1 Normative references	8
2.2 Informative references.....	9
3 Definition of terms, symbols and abbreviations.....	9
3.1 Terms.....	9
3.2 Symbols.....	11
3.3 Abbreviations	11
4 Usage of Private Signalling System 1 (PSS1) for TETRA	12
4.1 PSS1 Functionality	12
4.2 Protocol stack for signalling information	12
4.3 Generic Functional Protocol (GFP).....	13
4.4 Protocol stack for user information	13
4.5 User information encoding at the ISI	14
5 ISI Generic Functional Protocol (ISI GFP).....	14
5.1 Protocol model	14
5.2 Services provided by the protocol model entities.....	15
5.3 Addressing and Message Content	16
5.3.1 PSS1 Message Content	16
5.3.1.1 PISN Addressing.....	16
5.3.1.2 Basic PSS1 Parameter Content	17
5.3.1.3 Facility Information Element Parameter Content.....	18
5.3.2 Transport of ISI APDUs	19
5.3.2.1 General.....	19
5.3.2.2 PSS1 Messages Used for Call related Services.....	19
5.3.2.3 PSS1 Messages Used for Call Independent Services	20
5.4 Procedures	21
5.4.1 General.....	21
5.4.2 Connection Initiation	21
5.4.2.1 Call Independent Signalling.....	21
5.4.2.2 Call Related Signalling	22
5.4.3 Transport of ISI APDUs in PSS1 FACILITY.....	23
5.4.4 Transport of ISI Group Call Signalling.....	23
5.4.4.1 SwMI Roles for Group Call	23
5.4.4.1.1 Definition of SwMI Roles for Group Call.....	23
5.4.4.1.2 Requirements on the originating SwMI.....	23
5.4.4.1.3 Requirements on the group home SwMI	24
5.4.4.1.4 Requirements on the controlling SwMI.....	24
5.4.4.1.5 Requirements on the participating SwMI	24
5.4.4.2 Binding Rules.....	25
5.4.4.3 Sequences.....	26
5.4.5 Transport of ISI Individual Call Signalling	28
5.4.5.1 SwMI Roles for Individual Call	28
5.4.5.2 Requirements on the originating SwMI	28
5.4.5.3 Requirements on the destination SwMI	28
5.4.5.4 Call Restoration.....	29
5.4.5.5 Binding Rules.....	29
5.4.5.6 Sequences.....	30
5.4.6 Error Handling	31
5.4.7 Call Release	35

5.4.7.1	Release of a Call Independent Connection.....	35
5.4.7.2	Release of a Call Related Connection	35
5.5	ISI GFP requirements and operation definition.....	37
5.6	Segmentation Service Element (SSE)	37
5.6.1	Procedures.....	37
5.6.2	Requirements for procedures	38
5.6.2.1	Requirements for the segmentation procedure	38
5.6.2.2	Requirements for the re-assembly procedure	38
5.6.3	Segment encoding.....	39
5.7	Co-ordinationFunction	39
Annex A (informative): PSS1 Message Content		41
A.1	Maximum length of an ISI APDU or a SSE segment encoded in a facility information element	41
A.2	Example of the encoding of an ANF-ISIMM MIGRATION RESPONSE PDU in an ISI Invoke APDU in a PSS1 FACILITY PDU	41
Annex B (informative): Bibliography		43
Annex C (informative): Change requests		44
History		45

Intellectual Property Rights

Essential patents

IPRs essential or potentially essential to normative deliverables may have been declared to ETSI. The information pertaining to these essential IPRs, if any, is publicly available for **ETSI members and non-members**, and can be found in ETSI SR 000 314: "*Intellectual Property Rights (IPRs); Essential, or potentially Essential, IPRs notified to ETSI in respect of ETSI standards*", which is available from the ETSI Secretariat. Latest updates are available on the ETSI Web server (<https://ipr.etsi.org/>).

Pursuant to the ETSI IPR Policy, no investigation, including IPR searches, has been carried out by ETSI. No guarantee can be given as to the existence of other IPRs not referenced in ETSI SR 000 314 (or the updates on the ETSI Web server) which are, or may be, or may become, essential to the present document.

Trademarks

The present document may include trademarks and/or tradenames which are asserted and/or registered by their owners. ETSI claims no ownership of these except for any which are indicated as being the property of ETSI, and conveys no right to use or reproduce any trademark and/or tradename. Mention of those trademarks in the present document does not constitute an endorsement by ETSI of products, services or organizations associated with those trademarks.

Foreword

This draft European Standard (EN) has been produced by ETSI Technical Committee TETRA and Critical Communications Evolution (TCCE), and is now submitted for the combined Public Enquiry and Vote phase of the ETSI standards EN Approval Procedure.

The present document is part 3, sub-part 10 of a multi-part deliverable covering the Terrestrial Trunked Radio (TETRA); Voice plus Data (V+D), as identified below:

Part 1: "General network design";

Part 2: "Air Interface (AI)";

Part 3: "Interworking at the Inter-System Interface (ISI)":

Sub-part 1: "General design";

Sub-part 2: "Additional Network Feature Individual Call (ANF-ISIIC)";

Sub-part 3: "Additional Network Feature Group Call (ANF-ISIGC)";

Sub-part 4: "Additional Network Feature Short Data Service (ANF-ISISDS)";

Sub-part 5: "Additional Network Feature for Mobility Management (ANF-ISIMM)";

Sub-part 6: "Speech format implementation for circuit mode transmission";

Sub-part 7: "Speech Format Implementation for Packet Mode Transmission";

Sub-part 8: "Generic Speech Format Implementation";

Sub-part 9: "Transport layer independent, General design";

Sub-part 10: "General design, PSS1 over E.1";

Sub-part 11: "General design, SIP/IP";

Sub-part 12: "Transport layer independent Additional Network Feature Individual Call (ANF-ISIIC)";

Sub-part 13: "Transport layer independent Additional Network Feature Group Call (ANF-ISIGC)";

Sub-part 14: "Transport layer independent Additional Network Feature Short Data Service (ANF-ISISDS)";

Sub-part 15: Transport layer independent Additional Network Feature, Mobility Management (ANF-ISIMM)";

Part 4: "Gateways basic operation";

Part 5: "Peripheral Equipment Interface (PEI)";

Part 7: "Security";

Part 9: "General requirements for supplementary services";

Part 10: "Supplementary services stage 1";

Part 11: "Supplementary services stage 2";

Part 12: "Supplementary services stage 3";

Part 13: "SDL model of the Air Interface (AI)";

Part 14: "Protocol Implementation Conformance Statement (PICS) proforma specification";

Part 15: "TETRA frequency bands, duplex spacings and channel numbering";

Part 16: "Network Performance Metrics";

Part 17: "TETRA V+D and DMO specifications";

Part 18: "Air interface optimized applications";

Part 19: "Interworking between TETRA and Broadband systems".

NOTE 1: Part 3, sub-parts 6 and 7 (Speech format implementation), part 4, sub-part 3 (Data networks gateway), part 10, sub-part 15 (Transfer of control), part 13 (SDL) and part 14 (PICS) of this multi-part deliverable are in status "historical" and are not maintained.

NOTE 2: Some parts are also published as Technical Specifications such as ETSI TS 100 392-2 and those may be the latest version of the document.

The present document is based on ETSI EN 300 392-3-1 [i.2]. The main differences are:

- General information about ISI is included in ETSI EN 300 392-3-9 [2].
- Information about ISI APDU to PSS1 message mapping is added.
- Signalling sequences are added.

For all subparts in the TETRA specification ETSI EN 300 392-3, "Interworking at the Inter-System Interface (ISI)", the terms ISI and TETRA ISI are equivalent.

Proposed national transposition dates	
Date of latest announcement of this EN (doa):	3 months after ETSI publication
Date of latest publication of new National Standard or endorsement of this EN (dop/e):	6 months after doa
Date of withdrawal of any conflicting National Standard (dow):	6 months after doa

Modal verbs terminology

In the present document "**shall**", "**shall not**", "**should**", "**should not**", "**may**", "**need not**", "**will**", "**will not**", "**can**" and "**cannot**" are to be interpreted as described in clause 3.2 of the [ETSI Drafting Rules](#) (Verbal forms for the expression of provisions).

"**must**" and "**must not**" are **NOT** allowed in ETSI deliverables except when used in direct citation.

1 Scope

The present document defines the transport of the Inter-System Interface (ISI) using PSS1 as transport layer. It specifies:

- the PSS1 signalling used for transport of ISI APDUs; and
- the general protocol mechanism, called ISI Mediation Function which coordinates the communication between TETRA systems.

The ISI Mediation Function applies to any TETRA Switching and Management Infrastructure (SwMI) which supports the ISI.

2 References

2.1 Normative references

References are either specific (identified by date of publication and/or edition number or version number) or non-specific. For specific references, only the cited version applies. For non-specific references, the latest version of the referenced document (including any amendments) applies.

Referenced documents which are not found to be publicly available in the expected location might be found at <https://docbox.etsi.org/Reference/>.

NOTE 1: While any hyperlinks included in this clause were valid at the time of publication, ETSI cannot guarantee their long term validity.

NOTE 2: Note that for the TETRA standards, the reference is always to a European Standard (ETSI EN 300 xxx) if such has been published, but the latest version of that standard can be either an EN or a Technical Specification (ETSI TS 100 xxx), even if this is not visible in the reference list.

The following referenced documents are necessary for the application of the present document.

- [1] ETSI EN 300 392-3-8: "Terrestrial Trunked Radio (TETRA); Voice plus Data (V+D); Part 3: Interworking at the Inter-System Interface (ISI); Sub-part 8: Generic Speech Format Implementation".
- [2] ETSI EN 300 392-3-9: "Terrestrial Trunked Radio (TETRA); Voice plus Data (V+D); Part 3: Interworking at the Inter-System Interface (ISI); Sub-part 9: Transport layer independent, General design".
- [3] ETSI EN 300 392-3-12: "Terrestrial Trunked Radio (TETRA); Voice plus Data (V+D); Part 3: Interworking at the Inter-System Interface (ISI); Sub-part 12: Transport layer independent Additional Network Feature Individual Call (ANF-ISIIC)".
- [4] ETSI EN 300 392-3-13: "Terrestrial Trunked Radio (TETRA); Voice plus Data (V+D); Part 3: Interworking at the Inter-System Interface (ISI); Sub-part 13: Transport layer independent Additional Network Feature Group Call (ANF-ISIGC)".
- [5] Void.
- [6] Void.
- [7] ETSI ETS 300 402-1: "Integrated Services Digital Network (ISDN); Digital Subscriber Signalling System No. one (DSS1) protocol; Data link layer; Part 1: General aspects [ITU-T Recommendation Q.920 (1993), modified]".
- [8] ETSI ETS 300 402-2: "Integrated Services Digital Network (ISDN); Digital Subscriber Signalling System No. one (DSS1) protocol; Data link layer; Part 2: General protocol specification [ITU-T Recommendation Q.921 (1993), modified]".

- [9] ISO/IEC 11572: "Information technology -- Telecommunications and information exchange between systems -- Private Integrated Services Network -- Circuit mode bearer services -- Inter-exchange signalling procedures and protocol".
- [10] ISO/IEC 11582: "Information technology -- Telecommunications and information exchange between systems -- Private Integrated Services Network -- Generic functional protocol for the support of supplementary services -- Inter-exchange signalling procedures and protocol".
- [11] Recommendation ITU-T G.704: "Synchronous frame structures used at 1544, 6312, 2048, 8448 and 44 736 kbit/s hierarchical levels".
- [12] Recommendation ITU-T Q.931: "ISDN user-network interface layer 3 specification for basic call control".
- [13] Void.
- [14] ISO/IEC 11571: "Information technology -- Telecommunications and information exchange between systems -- Private Integrated Services Networks -- Addressing".

2.2 Informative references

References are either specific (identified by date of publication and/or edition number or version number) or non-specific. For specific references, only the cited version applies. For non-specific references, the latest version of the referenced document (including any amendments) applies.

NOTE 1: While any hyperlinks included in this clause were valid at the time of publication, ETSI cannot guarantee their long term validity.

NOTE 2: Note that for the TETRA standards, the reference is always to a European Standard (ETSI EN 300 xxx) if such has been published, but the latest version of that standard can be either an EN or a Technical Specification (ETSI TS 100 xxx), even if this is not visible in the reference list.

The following referenced documents are not necessary for the application of the present document but they assist the user with regard to a particular subject area.

- [i.1] Recommendation ITU-T X.229: "Remote Operations: Protocol specification".
- [i.2] ETSI EN 300 392-3-1: "Terrestrial Trunked Radio (TETRA); Voice plus Data (V+D); Part 3: Interworking at the Inter-System Interface (ISI); Sub-part 1: General design".

3 Definition of terms, symbols and abbreviations

3.1 Terms

For the purposes of the present document, the terms given in ISO/IEC 11582 [10] and the following apply:

call independent: property of information which is conveyed between SwMIs on a signalling connection which is not related to an audio call

call independent signalling connection: signalling connection established between ANF-ISI entities located in different Switching and Management Infrastructures is not related to audio calls

co-ordination Function: entity which provides co-ordination between different ANF-ISI entities, ROSE, SSE and GFT Control for different TETRA basic and supplementary services

destination SwMI: Switching and Management Infrastructure where the receiving ANF-ISI entity is located (in the context of a single one-way exchange of information between two ANF-ISI entities located in different Switching and Management Infrastructures)

Generic Functional Transport Control (GFT Control) entity: entity that exists within a Switching and Management Infrastructure and provides a range of services to the ANF-ISI entities and ROSE via the co-ordination Function

NOTE: The services are defined in clause 6 of ISO/IEC 11582 [10].

group attached SwMI: Switching and Management Infrastructure different from the home SwMI of the group considered in which at least one individual subscriber member of the group is attached to that group

Group TETRA Subscriber Identity (GTSD): TETRA Subscriber Identity assigned to a group

home SwMI: Switching and Management Infrastructure in which the subscription of a given user is registered

NOTE: That user is defined as being a subscriber (see below the definition of that term).

invocation: action taken by the user or by the service provider to execute a specific service function within real time

ISI Mediation Function: entity which provides to different ANF-ISI entities the services that are not supported by the transport layer protocol

Location Area (LA): area within radio coverage of a base station or group of base stations within which a Mobile Station (MS) is allowed to operate

Mobile Network Identity (MNI): identity that uniquely identifies the SwMI

NOTE: It consists of the Mobile Country Code (MCC) and the Mobile Network Code (MNC).

Mobile Station (MS): physical grouping that contains all of the mobile equipment that is used to obtain TETRA services

NOTE: By definition, a mobile station contains at least one Mobile Radio Stack (MRS).

originating SwMI: in the context of a TETRA call, Switching and Management Infrastructure where the calling user is registered (which implies that this user is located in that SwMI) or Switching and Management Infrastructure which originates a Call independent signalling connection

PISN number: number that unambiguously identifies the addressed PINX or an addressable entity associated with that PINX as defined in ISO/IEC 11571 [14]

segmentation: act of generating two or more PDUs derived from one ISI PDU

semi-permanent connection: logical connection between two network nodes (SwMIs)

service user: abstract representation of the totality of those entities in a single system that makes use of a service through a single access point

Short Subscriber Identity (SSI): network specific portion of a TSI

NOTE: A SSI is only unique within one TETRA sub-domain (one TETRA network).

source SwMI: Switching and Management Infrastructure where the sending ANF-ISI entity is located (in the context of a single one-way exchange of information between two ANF-ISI entities located in different Switching and Management Infrastructures)

subscriber: user of a telecommunication service, based on a contract with the provider of the service

NOTE 1: The subscriber may be an individual or a group: in the first case it is identified by an ITSI, in the second, by a GTSI.

NOTE 2: The individual subscriber is able to access an SwMI either through a MS or Line Station.

supplementary service: service which modifies or supplements a basic bearer service or a basic teleservice

NOTE: A supplementary service cannot be offered to a customer as a stand-alone service. It should be offered in combination with a bearer service or a teleservice.

Switching and Management Infrastructure (SwMI): all of the TETRA equipment for a Voice plus Data (V+D) network

terminating SwMI: in the context of a TETRA call, Switching and Management Infrastructure where the called user is registered (which implies that this user is located in that SwMI) or Switching and Management Infrastructure which terminates a Call independent signalling connection

TETRA Subscriber Identity (TSI): global TETRA network address that is to identify an individual or a group subscriber within the domain of all TETRA networks

user: entity using the services of a telecommunications network via an externally accessible service access point

NOTE: An individual user may be a person or an application process.

user information: TETRA coded speech

visited SwMI: TETRA network which MNI is not equal to the user's or the group's MNI

3.2 Symbols

Void.

3.3 Abbreviations

For the purposes of the present document, the following abbreviations apply:

ANF	Additional Network Feature
ANF-ISI	all Additional Network Features of the Inter-System Interface
APDU	Application Protocol Data Unit
ASN.1	Abstract Syntax Notation One
C	Conditional
E.1	E-carrier signal level 1, 2 048 kbit/s
ECMA	European Computer Manufacturers Association
GFP	Generic Functional Protocol
GFT	Generic Functional Transport
GTSI	Group TETRA Subscriber Identity
HDLC	High-level Data Link Control
ISI	Inter-System Interface
ISIIC	Inter System Interface Individual Call
ISIGC	Inter System Interface Group Call
ISIMM	Inter System Interface Mobility Management
ISISDS	Inter System Interface Short Data Service
ISISS	Inter System Interface Supplementary Services
ISSI	Individual Short Subscriber Identity
ITSI	Individual TETRA Subscriber Identity
LAPD	Link Access Procedure for the D-Channel
M	Mandatory
MCC	Mobile Country Code
MM	Mobility Management
MNC	Mobile Network Code
MNI	Mobile Network Identity
MRS	Mobile Radio Stack
MS	Mobile Station
NFE	Network Facility Extension
O	Optional
PC	Protocol Control
PDU	Protocol Data Unit
PINX	Private Integrated Network eXchange
PISN	Private Integrated Services Network
PSS1	Private Signalling System 1
ROSE	Remote Operation Service Element
SDL	Specification and Description Language
SDS	Short Data Service
SSE	Segmentation Service Element

SSI	Short Subscriber Identity
SwMI	TETRA Switching and Management Infrastructure
TSI	TETRA Subscriber Identity
TX	Transmit
V+D	Voice plus Data

4 Usage of Private Signalling System 1 (PSS1) for TETRA

4.1 PSS1 Functionality

The TETRA ISI application can use the PSS1 protocol stack for interconnecting Private Integrated Network eXchanges (PINXs) to form Private Integrated Services Network (PISN). PSS1 is the ISO term; the PSS1 protocol is also known, informally, as QSIG, generic term created by the European Computer Manufacturers Association (ECMA) which developed most of the signalling protocols comprised in the PSS1 protocol.

TETRA uses the standard functionalities defined for PSS1:

- signalling for the support of circuit-mode basic services (see note);
- Generic Functional Protocol (GFP) originally defined for the support of supplementary services.

NOTE: The definition of PSS1 basic call is in ISO/IEC 11572 [9].

4.2 Protocol stack for signalling information

Figure 4.1 shows how the protocols for TETRA ANF, which apply at the ISI, are built on top of the PSS1 protocol stack. The ISI APDU is used to convey ANF-ISI Protocol Data Units (PDU). The definition of ISI APDUs and the handling of ISI APDUs in ETSI EN 300 392-3-9 [2] is a subset of the ROSE protocol description [i.1] and are treated as ROSE APDUs in the PSS1 messages.

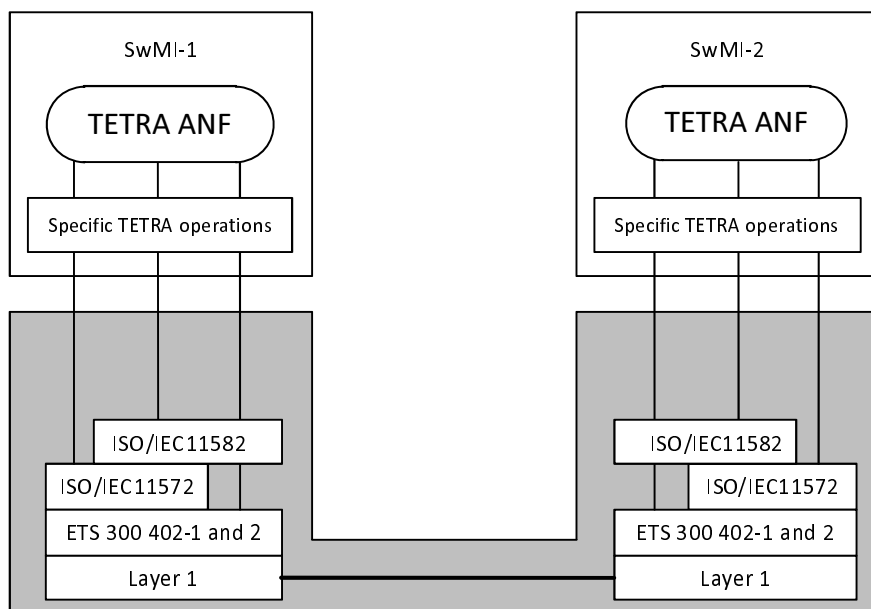

NOTE: Layer 2 protocol depends on the type of the inter-connection.

Figure 4.1: PSS1 protocol stack for TETRA

The protocol stack shown in figure 4.1 is for signalling information exchange on the common signalling channel i.e. D-channel. LAPD framing as defined in ETSI ETS 300 402-1 [7] and ETSI ETS 300 402-2 [8] and E.1, refer to Recommendation ITU-T G.704 [11], common signalling channel 16 shall be used. Protocol stack for user information exchange is presented in clause 4.4.

4.3 Generic Functional Protocol (GFP)

The GFP as defined in ISO/IEC 11582 [10] shall be used for all TETRA ANFs of the ISI (ANF-ISI).

ISI operations shall be used to convey ANF-ISI information in Facility information elements, as described in clause 5. These Facility information elements shall be included in PSS1 messages in accordance with ISO/IEC 11582 [10]. The specification given in clause 7.1.1.1 of ISO/IEC 11582 [10] as to when an SwMI can send a PSS1 FACILITY message at the earliest shall be understood as follows:

- such message can be sent by a receiving SwMI after it has sent a PSS1 CALL PROCEEDING message (following reception of a PSS1 SETUP message);
- such message can be sent by a source SwMI after it has received one of the following PSS1 messages: FACILITY, PROGRESS, ALERTING, CONNECT.

When the call independent signalling connection is used, it shall be connection oriented.

NOTE: This is in line with the choice made for the definition of all existing supplementary services of the PSS1 protocols.

4.4 Protocol stack for user information

Call control manages transportation of user information e.g. TETRA coded speech on B_Q channels as presented in figure 4.2. In this protocol stack the E.1 channels are 64 kbit/s channels supporting unrestricted digital information, refer to Recommendation ITU-T G.704 [11].

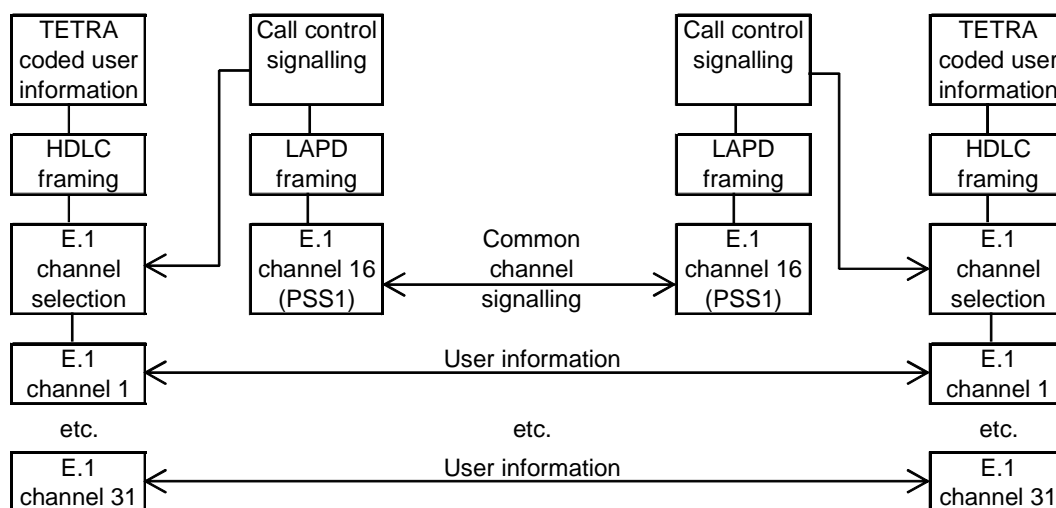

Figure 4.2: User information protocol stack

For speech transmission the TETRA coded user information is speech frames that shall be carried in an B_Q channel using HDLC frames, refer to ETSI EN 300 392-3-8 [1], annex B. The call control negotiates the B_Q channel for each call instance and locally select the negotiated B_Q channel. The mapping between TETRA ISI channels and B_Q channels is defined in ETSI EN 300 392-3-8 [1], annex A. Call control signalling (ETSI EN 300 392-3-12 [3] and ETSI EN 300 392-3-13 [4]), LAPD framing (ETSI ETS 300 402-1 [7] and ETSI ETS 300 402-2 [8]) and E.1 common signalling channel 16 are presented in figure 4.1 for call control.

All or a sub-set of B_Q channels 1 to 15 and 17 to 31 shall be considered to be available for user information transport as negotiated at the PSS1 connection negotiation. It can be assumed that the B_Q channels are physically connected at the same time as the LAPD connection is set-up on the common control channel and there shall be no additional E.1 channel set-up signalling at the link layer.

4.5 User information encoding at the ISI

Whether in a group call or in an individual call, the user information shall be sent over ISI user information connections, which will be considered as B_Q channels by the PSS1 protocols used to establish these calls.

It has been assumed that these connections will be digital, their standard data rate being 64 kbit/s.

Clause 4.4 presents the protocol stack for user information transport and its relation to the call control.

5 ISI Generic Functional Protocol (ISI GFP)

5.1 Protocol model

The TETRA ISI over E.1 is based on the PSS1 protocols stack in order to enable the interconnection of SwMIs through a PISN. Signalling needs for TETRA ISI operation, which are not directly supported by PSS1 basic call protocols, are provided by ISI Mediation Function.

The ISI Mediation Function does not by itself control sending of any ANF-ISI PDUs but rather provides a means to convey them.

Figure 5.1 shows the conceptual model of the ISI GFP. The generic ISI Mediation Function includes a Call Control function, a Coordination Function, ROSE (implementing the PDU Identification service), a Segmentation Service (for segmentation of messages) and the Generic Functional Transport Control (implementing the Connection Service).

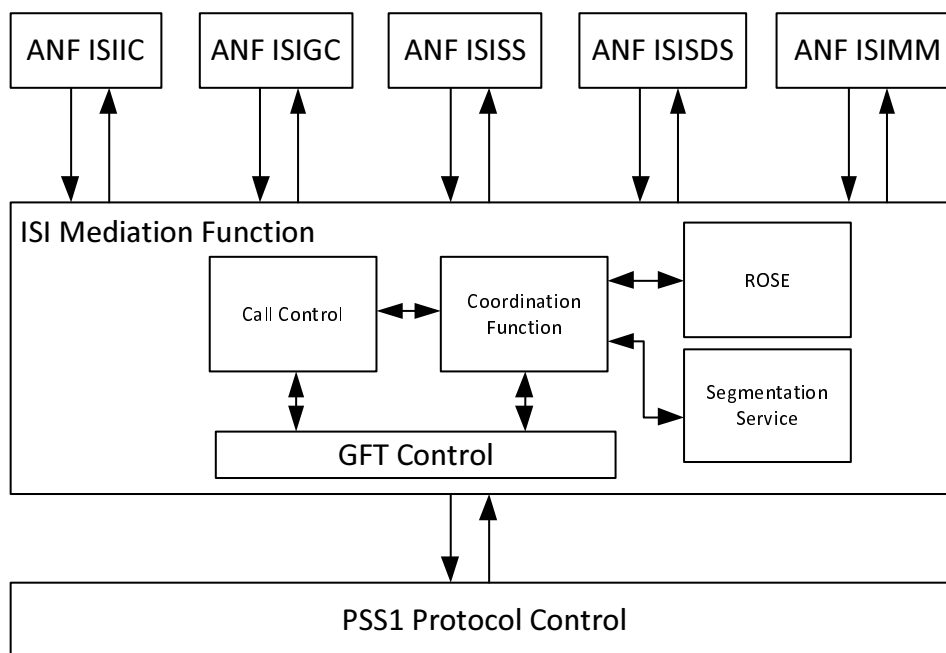

ROSE: Remote Operation Service
 SSE: Segmentation Service
 GFT: Generic Functional Transport

Figure 5.1: Protocol model of the ISI Generic Functional Protocol

The entities PSS1 Protocol Control (PC), Generic Functional Transport Control (GFT Control), Co-ordination Function, Call Control and ROSE shall exist in any E.1 based SwMI which supports the ISI. The existence in a SwMI of the other entities shown on figure 5.1 shall depend on the ANF-ISIs supported by this SwMI.

5.2 Services provided by the protocol model entities

ANF entities (i.e. ANF-ISIIC, ANF-ISIGC, ANF-ISISDS, ANF-ISISS and ANF-ISIMM entities) use the services of the ROSE entity via the Coordination Function in order to convey ANF-ISI PDUs between TETRA networks.

ISI Application Protocol Data Units (ISI APDUs) are carried inside the Facility information elements, as described in clause 4.3. These Facility information elements shall be included in PSS1 messages in accordance with ISO/IEC 11582 [10].

The ISI APDUs shall be those specified in ETSI EN 300 392-3-9 [2]. As ROSE is used as network protocol in Facility information elements the ISI APDUs are treated as ROSE APDUs in the PSS1 messages.

If an ISI APDU is call independent and its length exceeds its possible maximum, the Coordination Function shall address it to the Segmentation Service Element (SSE) so that this ISI APDU can be transparently transported in spite of its length (see clause 5.6). The same shall apply for a call related ISI APDU with a length exceeding its possible maximum provided that it does not have to be sent in a specific PSS1 basic call message.

ROSE and SSE shall use the connection oriented services of GFT Control as defined in clause 6.7.1 of ISO/IEC 11582 [10], via the Coordination Function. GFT Control in turn shall use the PSS1 Protocol Control (PC) services as defined in clause 6.8 of ISO/IEC 11582 [10]. GFT control provides services to establish and release of Call independent signalling connections and also transport services for the carriage of call related or call independent ISI APDUs between different PINXs. The corresponding PISN protocols are defined in clauses 7.1 and 7.3 of ISO/IEC 11582 [10]. The interaction between ROSE users (ISI-ANFs), ROSE itself, SSE and GFT Control is co-ordinated by the Coordination Function.

ANF-ISIIC and ANF-ISIGC use PC services for sending PSS1 call messages over PISN as defined in ISO/IEC 11572 [9]. They also use the extensions of PC services and the connection oriented services of GFT Control together with the services of ROSE and of the Coordination Function to convey their PDUs, as defined in ISO/IEC 11582 [10] to convey ISI APDUs. The ANF-ISIIC and ANF-ISIGC PDUs carry either:

- complementary TETRA call information, in PSS1 basic call messages; or
- TETRA call related messages, in PSS1 FACILITY messages.

ANF-ISIMM and ANF-ISISDS also use the extensions of PC services and the connection oriented services of GFT Control together with the services of ROSE and of the Coordination Function to convey their PDUs, as defined in ISO/IEC 11582 [10]. However the procedures which apply for the transport of the ISI APDUs conveying their PDUs are the connection oriented call independent procedures defined in clause 7.3 of ISO/IEC 11582 [10].

NOTE 1: No PSS1 call related procedures, as defined in clause 7.1 of ISO/IEC 11582 [10], apply for transmitting the ISI APDUs conveying the ANF-ISIMM PDUs because all MM information is TETRA call independent and no need has been found to send any of that exchanged between SwMIs (over their ISIs) as PISN user information (i.e. using a B_Q channel, possibly more, as transmission channel for the ANF-ISIMM PDUs). Similarly for ANF-ISISDS, no need has been found to send any of the SDS information exchanged between SwMIs (over their ISIs) as PISN user information (i.e. using a B_Q channel, possibly more, as transmission channel for the ANF-ISISDS PDUs): i.e. although from a formal point of view the sending of SDS messages can be considered as a TETRA call (in taking the definition of a call as being the instance of a basic service and considering that SDS is a TETRA basic service), the decision has been taken not to establish any PISN call to convey SDS information over the ISI.

NOTE 2: According to the definition of the connection oriented call independent procedures in ISO/IEC 11582 [10], ISI APDUs conveying call independent ANF-ISI PDUs (e.g. ANF-ISIMM or ANF-ISISDS PDUs) may be sent in the PSS1 messages which establish the related call independent signalling connection.

ANF-ISISS uses the same services as ANF-ISIMM and ANF-ISISDS for its call independent procedures. It uses the connection oriented services of GFT Control and the related extensions of PC services, both as defined in ISO/IEC 11582 [10], for its call related procedures.

NOTE 3: The latter statement implies that ANF-ISISS uses the signalling connections of either ANF-ISIIC or ANF-ISIGC for its call related procedure.

5.3 Addressing and Message Content

5.3.1 PSS1 Message Content

5.3.1.1 PISN Addressing

When PINXs are connected together within a Private Integrated Services Network (PISN) then according to ISO/IEC 11572 [9] the Called party number and Calling Party Number are used to route the PSS1 messages between the source and the destination PINX possibly via one or several transit PINX(s). Each TETRA SwMI shall in that case be assigned at least one PISN number.

PSS1 SETUP messages shall include a PISN number of with the source SwMI as Calling Party Number and a PISN number of the destination SwMI PISN numbers as Called Party Number.

If a call is forward switched the PISN number of the forward switching SwMI (i.e. source SwMI of second PSS1 SETUP message) shall be included as Calling Party Number in the PSS1 SETUP message between the forward switching SwMI and the terminating SwMI (i.e. destination SwMI of the second PSS1 SETUP message).

The PISN numbers to address the correct PINX of another TETRA network can be obtained as follows:

- received inside a TETRA PDU in some previous message exchange (more precisely, the PISN number will have been received in ANF-ISIMM in relation to the migration of the MS; or
- defined by a routing table on the basis of the SwMI MNI.

The PISN numbers defined above shall always correspond to SwMIs or SwMI entities, and never to any TETRA subscriber. A TETRA individual subscriber shall be addressed using its ITSI and a TETRA group using its GTSI. This ITSI or GTSI shall thus have to be included in the ANF-ISI PDUs whenever needed.

NOTE: If there is a semi-permanent E1 connection between two TETRA SwMIs, the use of the PISN numbers of Calling Party Number and Called Party Number information elements are not applicable for routing purposes. However the information elements have to be always present in PSS1 Setup message.

5.3.1.2 Basic PSS1 Parameter Content

The following rules shall apply for information elements of the PSS1 SETUP message:

- The sending complete information element shall always be included (no overlap sending supported).
- No progress indicator information element shall be included.
- The numbering plan identification shall be equal to either private numbering plan or unknown.
- No presentation or screening indicators shall be included (i.e. the calling party information element shall not include octet 3a).
- Calling party and Called party subaddresses shall not be included.
- Low layer or high layer compatibility information elements shall not be included.

For call related signalling connections the following applies:

- The bearer capability information element shall be encoded with information transfer capability code equal to unrestricted digital information, and an information transfer rate code equal to 64 kbit/s.
- The BQ channel indication information element shall indicate the selected channel.

For call independent signalling connections the following applies:

- The Bearer capacity element of PSS1 SETUP message shall contain the values in as defined in ISO/IEC 11582 [10], clause 11.3.1.
- The Channel identification element of the PSS1 SETUP message shall contain the information as defined in ISO/IEC 11582 [10], clause 11.3.2.

The following rules shall apply for the information elements of the PSS1 CONNECT message:

- The Connected number element shall not be included.
- The Progress indicator element shall not be included.
- The Channel indication element shall not be included.

Table 5.1 shows an example PSS1 parameters used in a PSS1 SETUP message for a call related connection. The column header "M/O/" indicates which of the corresponding information elements and other components are Mandatory (M), which are Optional (O) from a PSS1 point of view. When used for conveying of ISI APDUs all parameters are mandatory.

The PSS1 element Sending complete shall be present and shall always indicate that the Called Party number is complete as overlap sending is not supported between SwMIs.

The Network Protocol Profile parameter is omitted as described in ISO/IEC 11582 [10], clause 7.1.2.3 as the definition of the ISI APDU specification is a true subset of a ROSE APDU specification.

The Interpretation APDU is omitted as it is expected that the peer applications are supporting the same set of Service APDUs.

Table 5.1: Example of facility information element in a PSS1 SETUP message

PSS1 SETUP message		M/O/C
Protocol discriminator		M
Call reference		M
Message type		M
Sending complete		O (note 1)
Bearer capability		M
Channel Identification		M
Calling party number		M (note 2)
Called party number		M (note 3)
facility information element		
Identifier	M	1
Length	M	1
Protocol profile (Networking Extensions)	M	1
Network Facility Extension	M	8 (note 4)
sourceEntity	M	1
destinationEntity	M	1
END of NFE		
Service APDU: ISI APDU or SSE Segment		
END of facility information element		
END of PSS1 SETUP message		

NOTE 1:	Even though the Sending Complete is an optional parameter (from PSS1 point of view) it shall be present when used for ISI.
NOTE 2:	The calling party number will be a PISN number in the range of numbers allocated to the source SwMI.
NOTE 3:	The called party number will be a PISN number in the range of numbers allocated to the destination SwMI.
NOTE 4:	The length of 8 octets is indicated in the table for the NFE information as the destinationEntity and the sourceEntity data elements both contain the value endPINX.

5.3.1.3 Facility Information Element Parameter Content

The ISI operation tetraIsiMessage shall be included in PSS1 Facility information elements in accordance with clause 7.1.2.1 of ISO/IEC 11582 [10] for call related connections, or clause 7.3.3.4 of the same standard (ISO/IEC 11582 [10]) for call independent connections.

Each such Facility information element shall always include a **Network Facility Extension (NFE)**.

According to ISO/IEC 11582 [10] PINX addresses in NFE element are used to route the Facility elements carried in PSS1 messages to correct end PINX. As each TETRA SwMI through which the ISI PDU is transferred is considered as the destination PINX the destinationEntity and sourceEntity data elements of the Network Facility Extension (NFE) shall have the value corresponding to endPINX.

The sourceEntity and destinationEntity data elements of the argument of the ISI operation tetraIsiMessage shall have the value corresponding to the invoking/invoked ANF.

The **Network Protocol Profile** field shall not be included to the PSS1 Facility information element unless the PSS1 message is segmented and SSE APDU used, see clause 5.6.2. ROSE is the default Network Protocol Profile as described in ISO/IEC 11582 [10], clause 7.1.2.3.

The **Linked Identifier** of the Facility information element field is omitted.

Table 5.2 shows an example of a Facility information element in a PSS1 FACILITY message, whether the connection is call related or call independent.

Table 5.2: Example of Facility Information Element in a PSS1 FACILITY message

PSS1 FACILITY message	M/O	Length	Note
Protocol discriminator	M	1	
Call reference	M	3	
Message type	M	1	
Facility information element			
Identifier	M	1	
Length	M	1	
Protocol profile (Networking Extensions)	M	1	
Network Facility Extension	M	8	1
sourceEntity	M	1	
destinationEntity	M	1	
END of NFE			
Service APDU: ISI APDU or SSE Segment			
END of facility information element			
END of PSS1 FACILITY message			

NOTE: The length of 8 octets indicated in the table for the NFE information as the destinationEntity and the sourceEntity data elements both contain the value endPINX.

5.3.2 Transport of ISI APDUs

5.3.2.1 General

No Interpretation APDU shall be included together with any APDU of the ISI operation tetraIsiMessage included in PSS1 messages.

All call related ISI APDUs shall be transported using a call related signalling connection. A call related signalling connection cannot be shared between different calls.

All call independent ISI APDUs shall be transported using a call independent signalling connection as defined in clause 5.3.2.3.

5.3.2.2 PSS1 Messages Used for Call related Services

The procedures for establishment of the call related signalling connection defined in ISO/IEC 11572 [9] shall be followed. For transport of additional information ISO/IEC 11582 [10] shall be followed. The SwMI which starts to establish the signalling connection shall be called source SwMI. The source SwMI may or may not be the originating SwMI. The SwMI to which that connection is established shall be called destination SwMI. The destination SwMI may or may not be the terminating SwMI.

The PSS1 SETUP message initiating a call related connection for a call related service (ISIIC or ISIGC) shall contain the first ISI APDU for the ISI call in question in the Facility information element.

The PSS1 CALL PROCEEDING shall be sent by the destination SWMI to acknowledge the PSS1 SETUP message.

NOTE 1: ISO/IEC 11572 [9] in clause 10.1.2 describes that PSS1 ALERTING or PSS1 CONNECT as the first response to PSS1 SETUP shall not cause a protocol error. For a PSS1 connection for ISI call related services this is not acceptable.

The source SwMI shall send PSS1 CONNECT ACKNOWLEDGEMENT message to acknowledge the PSS1 CONNECT message.

During the establishment of the call related signalling connection ANF-ISI PDUs may be conveyed in the following PSS1 messages:

- PSS1 SETUP
- PSS1 FACILITY
- PSS1 ALERTING (only used for ISIIC)
- PSS1 CONNECT

NOTE 2: Specification as to when a SwMI can send a PSS1 FACILITY at the earliest is defined in clause 4.3.

For the call setup procedures related to ISIIC and ISIGC see clause 5.4.

All subsequent call related ISI APDUs during the call maintenance phase for the same ISI call until the release of the call shall be transported in Facility information elements of PSS1 messages as defined in clause 7.1 of ISO/IEC 11582 [10] (using the signalling connection established for the corresponding call, by ANF-ISIIC, if the call is an individual call, or by ANF-ISIGC, if the call is a group call).

For the detailed procedures for sending subsequent ISI APDUs, see clause 5.4.3.

The originating or the terminating SwMI may decide to clear a call related signalling connection already established.

When the originating or the terminating SwMI decide to clear such connection, it shall do so according to clause 10.2 of ISO/IEC 11572 [9]. PSS1 DISCONNECT message may be sent with or without a ANF-ISI PDU.

For clearing the call related signalling connection ANF-ISI PDUs may be conveyed in the following PSS1 messages:

- PSS1 DISCONNECT
- PSS1 RELEASE
- PSS1 RELEASE COMPLETE

NOTE 3: Clause 10.2.2 Exception conditions of ISO/IEC 11572 [9] define call clearing conditions where a PSS1 DISCONNECT is not the first clearing message sent. For the detailed procedures for sending call disconnection, see clause 5.4.7.

5.3.2.3 PSS1 Messages Used for Call Independent Services

The procedures to establish a call independent signalling connection are based on those defined in clause 7.3 of ISO/IEC 11582 [10]. The SwMI which starts to establish the signalling connection shall be called the source SwMI. The source SwMI may or may not be the originating SwMI. The SwMI to which that connection is established shall be called the destination SwMI. The destination SwMI may or may not be the terminating SwMI.

The PSS1 SETUP message initiating a connection for a call independent service (e.g. ISIMM or ISISD) shall contain the first ISI APDU for the ISI service in question in the Facility information element.

During the establishment of a call independent signalling connection ANF-ISI PDUs may be conveyed in the following PSS1 messages:

- PSS1 SETUP
- PSS1 CONNECT

A SwMI may use a call independent signalling connection already established, notably to respond to a request TETRA PDU received from the other SwMI or for sending a request TETRA PDU to that SwMI related to the same ISI service session. To send subsequent ANF-ISI messages PSS1 FACILITY messages can be sent by the source or the destination ANF ISI entities.

The source or the destination SwMI may decide to clear a call independent signalling connection already established. However when such a connection has only recently been established, the destination SwMI should avoid to clear it, leaving the decision to do it to the source SwMI.

When the source or the destination SwMI decide to clear such connection, it shall do so according to clauses 7.3.1.6 and 7.3.1.7 of ISO/IEC 11582 [10].

For clearing the call independent signalling connection the following PSS1 messages are used:

- PSS1 RELEASE
- PSS1 RELEASE COMPLETE

Call independent ANF-ISI PDUs are not conveyed in the PSS1 call release messages.

NOTE: Clauses 7.3.1.1 and 7.3.1.2 of ISO/IEC 11582 [10] define call clearing conditions where a PSS1 RELEASE COMPLETE message is the first clearing message sent:

- when the PSS1 SETUP message is invalid or cannot be accepted by the PINX receiving it (clause 7.3.1.1) - a PSS1 RELEASE COMPLETE message is then sent by the PINX which has received the PSS1 SETUP message;
- when the PINX sending the PSS1 SETUP message has not received any response from the next PINX within a given time (clause 7.3.1.2) - a PSS1 RELEASE COMPLETE message is then sent by the PINX which has sent the PSS1 SETUP message.

5.4 Procedures

5.4.1 General

The following clauses will describe the procedures for connection initiation, conveying ANF-ISI PDUs and release of connections between SwMIs using the services in the ISI Mediation Function.

5.4.2 Connection Initiation

5.4.2.1 Call Independent Signalling

When initiating a call independent signalling connection between two SwMIs the initial ISI APDU is sent in PSS1 SETUP without selecting any B_Q channel for user information. The destination SwMI, if it supports the indicated ANF-ISI service, shall acknowledge the connection by sending PSS1 CALL PROCEEDING and PSS1 CONNECT. Optionally the destination SwMI may send an ISI APDU in PSS1 CONNECT.

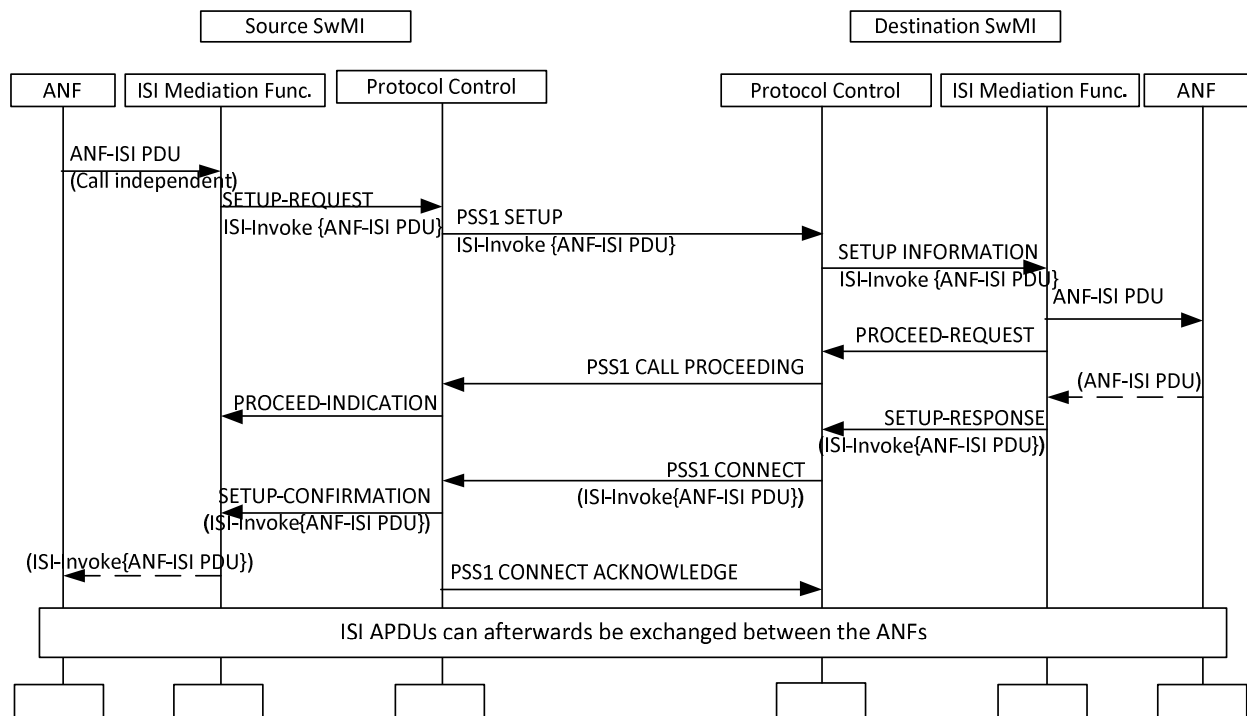

Figure 5.2: Establishment of call independent signalling connection

The transport layer shall not act on the content of the ISI APDU, but solely on orders from the ISI Mediation Function.

Subsequent ISI APDUs for call independent services are sent in PSS1 FACILITY.

If either the destination or the source SwMI decides to clear the call independent signalling connection during the establishment, it shall do so according to clause 7.3.1 of ISO/IEC 11582 [10].

5.4.2.2 Call Related Signalling

When initiating a call related signalling connection between two SwMI the initial ISI APDU is sent in PSS1 SETUP after the ISI Mediation function has selected a B_Q channel for TETRA speech transmission. The further signalling sequence is dependent on the call type.

In the case of call collision because two adjacent PISN nodes (including possibly the SwMIs involved in the call establishment or restoration) attempt both to seize the same B_Q channel the procedure defined in ISO/IEC 11572 [9] for call collision shall apply.

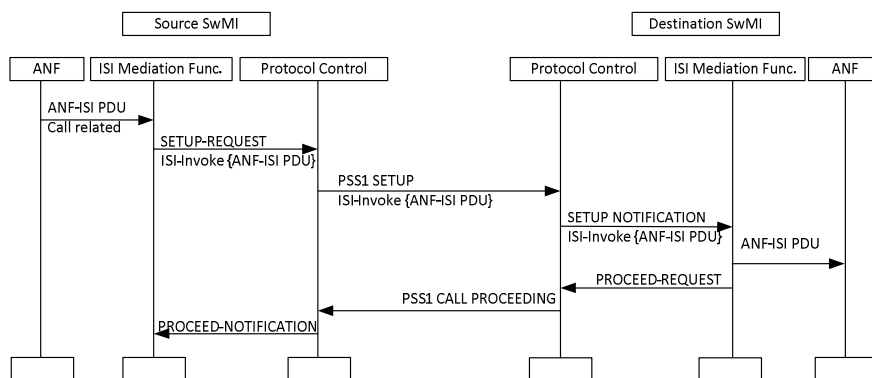

Figure 5.3: Establishment of call related connection

5.4.3 Transport of ISI APDUs in PSS1 FACILITY

This is common for call related signalling and call independent signalling.

Depending on the signalling needs of the ANF-ISI entity either the originating/source SwMI who has set up the signalling connection or the destination/terminating SwMI can send one or several ANF-ISI PDUs in sequence in PSS1 FACILITY messages towards the other SwMI.

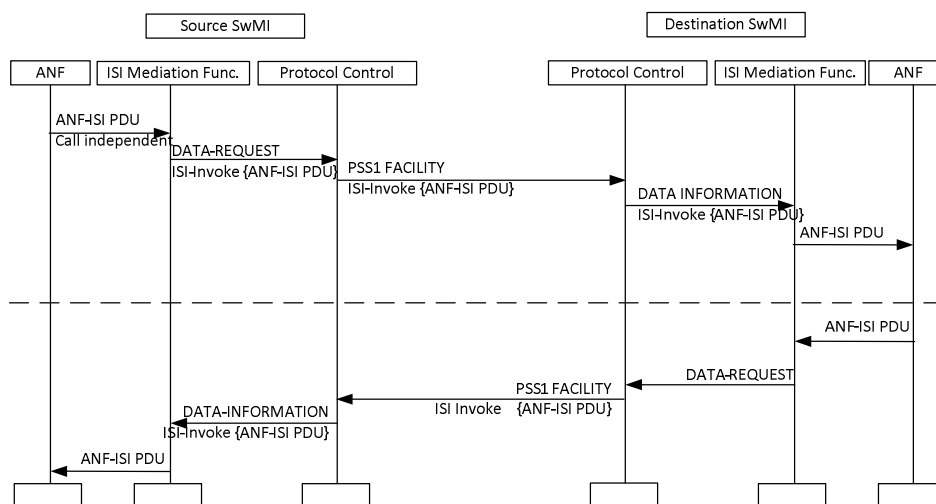

Figure 5.4: Sending of ISI APDUs within an established connection

5.4.4 Transport of ISI Group Call Signalling

5.4.4.1 SwMI Roles for Group Call

5.4.4.1.1 Definition of SwMI Roles for Group Call

For definitions of roles in relation to Group Call please see the ANF-ISIGC [4]. This clause will focus on the PSS1 messages to be used in different situations.

5.4.4.1.2 Requirements on the originating SwMI

When the originating SwMI ANF-ISIGC initiates a group call it shall request the Mediation Function to initiate a connection oriented call related connection for sending a group call set-up request. The Mediation Function and the Protocol Control Function shall support call related establishment and clearing procedures as for an originating PINX, as specified in ISO/IEC 11572 [9], clause 10.5.

NOTE 1: The originating SwMI might be a group home SwMI or a group visited SwMI as well as a linking controlling SwMI or a linking participating SwMI.

NOTE 2: If the originating SwMI is the home SwMI or the linking controlling SwMI the call may initiate call related connections to several participating SwMIs, see clause 5.4.4.1.3.

The content of the PSS1 SETUP message is defined in clause 5.3.1.2.

5.4.4.1.3 Requirements on the group home SwMI

In the group home SwMI the Protocol Control Function and the Mediation Function shall be able to receive a request for a connection oriented call related connection (PSS1 SETUP) for a group call. The imbedded ISI APDU shall be forwarded to the ANF-ISIGC.

If the group home SwMI ANF-ISIGC entity accepts the group call request and it is the controlling SwMI, it will act as described for the controlling SwMI (clause 5.4.4.1.4).

If the group home SwMI ANF-ISIGC entity cannot accept the incoming group call, it shall request the ISI Mediation Function to release of the call related connection established by the originating SwMI (see ETSI EN 300 392-3-13 [4]).

If the group home SwMI is not the controlling SwMI and the call is to be re-routed then the group home SwMI ANF-ISIGC entity shall request the ISI Mediation Function to release of the call related connection established by the originating SwMI (see ETSI EN 300 392-3-13 [4]).

When the ANF ISIGC entity determines to release a group call request the ISI APDU shall be included PSS1 RELEASE COMPLETE message and sent to the originating SwMI when no PSS1 message previously has been sent in response to the PSS1 SETUP message. Otherwise the ISI APDU shall be included in a PSS1 DISCONNECT message. The following rules shall apply for the cause information element of the PSS1 DISCONNECT or PSS1 RELEASE COMPLETE message:

- the location area shall be set to private network serving the local user;
- the cause value shall be set to normal, unspecified when the call is to be re-routed.

5.4.4.1.4 Requirements on the controlling SwMI

The controlling SwMI ANF-ISIGC entity shall use the Protocol Control Function and the Mediation Function for call establishment and call clearing procedures as for an originating and/or terminating PINX, as specified in ISO/IEC 11572 [9] with the exception that PSS1 ALERTING is not sent for group calls.

If the call originates from a SwMI not equal to the controlling SwMI and the controlling SwMI accepts the call the controlling SwMI shall acknowledge the received PSS1 call request. If the call originates within the controlling SwMI or (another) foreign SwMI has to be included in the call, the controlling SwMI shall establish a connection oriented call related connection to those participating SwMIs with a PSS1 SETUP. The content of the information elements of the PSS1 SETUP is described in clause 5.3.1.2.

The controlling SwMI shall release the call related connection to the originating SwMI when the controlling SwMI cannot accept the incoming group call. A PSS1 RELEASE COMPLETE message shall be sent to the originating SwMI when no PSS1 message previously has been sent in response to the PSS1 SETUP message. Otherwise a PSS1 DISCONNECT message is sent. The following rules shall apply for the cause information element of the PSS1 DISCONNECT or PSS1 RELEASE COMPLETE message:

- the location area shall be set to private network serving the local user.

5.4.4.1.5 Requirements on the participating SwMI

At reception of PSS1 SETUP with a group call request, the Mediation Function in a participating SwMI shall invoke an ANF-ISIGC entity. The Protocol Control Function and the Mediation Function in a participating SwMI shall support call establishment and call clearing procedures as for a terminating PINX, as specified in ISO/IEC 11572 [9]. When the participating SwMI Mediation Function accepts the selected information channel, it shall send PSS1 CALL PROCEEDING towards the controlling SwMI.

The participating SwMI shall release the call related connection to the controlling SwMI when the participating SwMI cannot accept the incoming group call. A PSS1 RELEASE COMPLETE message shall be sent to the controlling SwMI when no PSS1 message previously has been sent in response to the PSS1 SETUP message. Otherwise a PSS1 DISCONNECT message is sent. The following rules shall apply for the cause information element of the PSS1 DISCONNECT or PSS1 RELEASE COMPLETE message:

- the location area shall be set to private network serving the local user.

5.4.4.2 Binding Rules

The following rules shall be followed when sending ISIGC APDUs:

- ISI-ORIGINATING SETUP PDU can be sent in PSS1 SETUP, PSS1 CONNECT or PSS1 FACILITY message.
- ISI SETUP INITIATE PDU can be sent in PSS1 SETUP, PSS1 CONNECT, PSS1 DISCONNECT or PSS1 FACILITY message.
- ISI-SETUP ACKNOWLEDGE PDU can be sent in a PSS1 CONNECT or PSS1 FACILITY message.
- ISI CONNECT PDU shall be sent in PSS1 FACILITY message.
- ISI DELAY can be sent in a PSS1 CONNECT or in a PSS1 FACILITY message.
- ISI INFO PDU shall be sent in PSS1 CONNECT message when sent by the controlling SwMI to originating SwMI.
- ISI INFO PDU shall be sent in PSS1 FACILITY message in all other cases.
- The following messages shall only be sent in PSS1 FACILITY messages:
 - ISI TX DEMAND PDU.
 - ISI TX GRANTED PDU.
 - ISI TX CEASED PDU.
 - ISI TX INTERRUPT PDU.
 - ISI TX WAIT PDU.
 - ISI TX CONTINUE PDU.
 - ISI-RESOURCE PDU.
 - ISI-RESOURCE RESPONSE PDU.
 - ISI-POLL USER PDU.
 - ISI-POLL RESPONSE PDU.
- ISI-REJECT PDU shall be sent in PSS1 DISCONNECT when sent by the group home SwMI or the linking controlling SwMI.
- ISI REJECT PDU can be sent in the PSS1 DISCONNECT or PSS1 RELEASE COMPLETE message when sent by a participating SwMI.
- ISI DISCONNECT PDU can be sent in the PSS1 DISCONNECT or PSS1 FACILITY message.
- ISI RELEASE PDU can be sent in the PSS1 DISCONNECT, PSS1 FACILITY or PSS1 RELEASE message.

5.4.4.3 Sequences

For group calls initiated by the ANF ISIGC the basic call signalling is controlled by the Mediation Function. The initial call control PSS1 SETUP message, which is used to establish the call related signalling connection, is sent as described figure 5.3. All subsequent ISI APDUs until the ISI SETUP ACKNOWLEDGEMENT is sent in PSS1 FACILITY PDUs:

- When the call is originated from a SwMI which is not the controlling SwMI the ISI SETUP INITIATE and ISI SETUP ACKNOWLEDGEMENT are sent in PSS1 FACILITY PDUs followed by an empty PSS1 CONNECT.
- When the call is originated from the controlling SwMI then ISI SETUP ACKNOWLEDGEMENT is sent in PSS1 CONNECT.

PSS1 FACILITY message can be sent before PSS1 CONNECT message to carry ANF-ISIGC PDUs as described in clause 5.4.4.2. PSS1 CONNECT ACKNOWLEDGE is always sent as a response to PSS1 CONNECT. ISI CONNECT PDU shall be sent only after PSS1 CONNECT ACKNOWLEDGE message has been sent/received to guarantee that the E.1 speech channels have been already connected.

All subsequent ISIGC APDUs for the active call are sent in PSS1 FACILITY as described in clause 5.4.3 until the call related connection is to be released by sending PSS1 DISCONNECT message.

NOTE: The signalling sequence depends on the origination of the call. The two possible sequences are shown in the following MSCs.

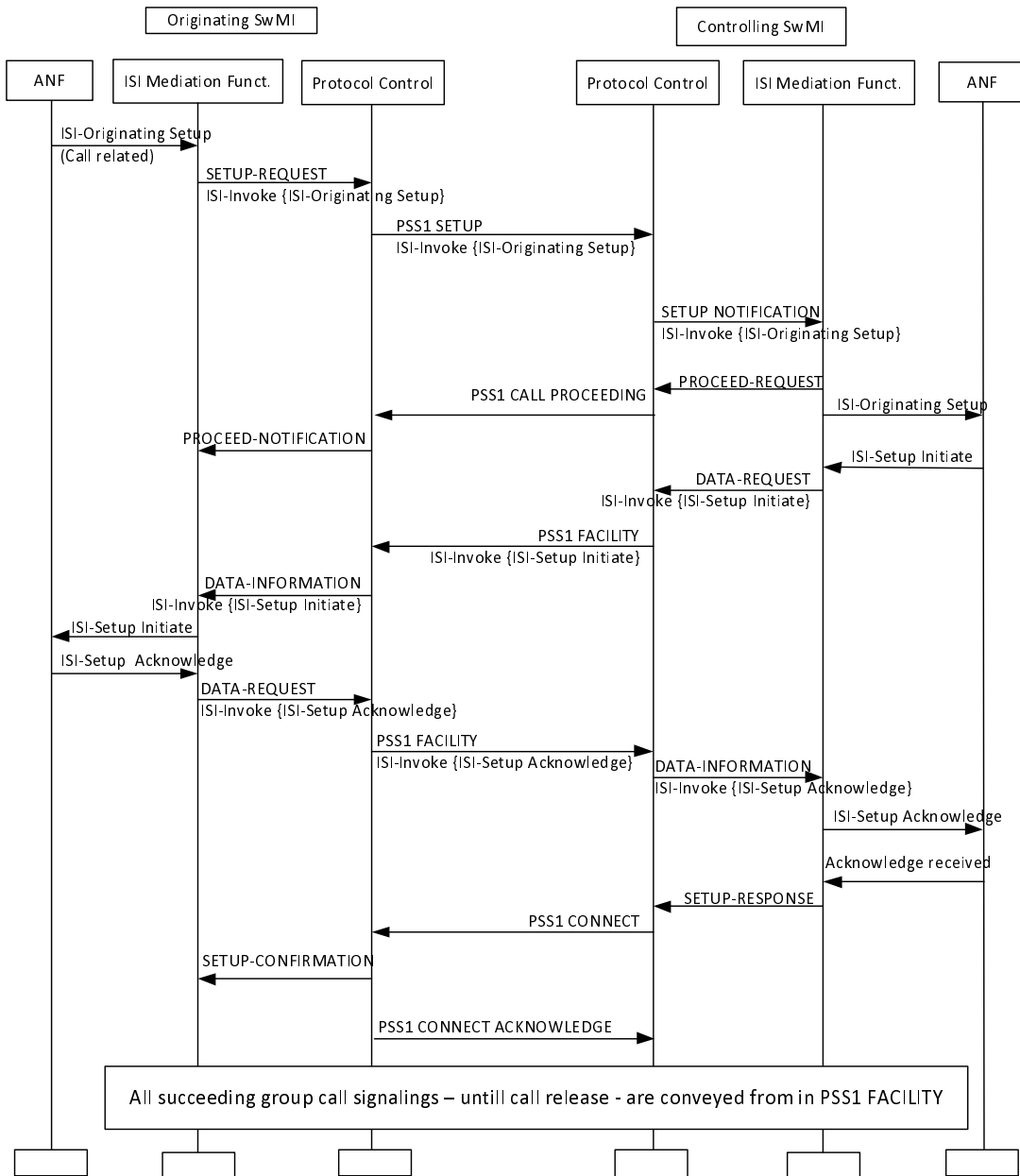

Figure 5.5: Establishment of a Group Call from an Originating Non-controlling SwMI

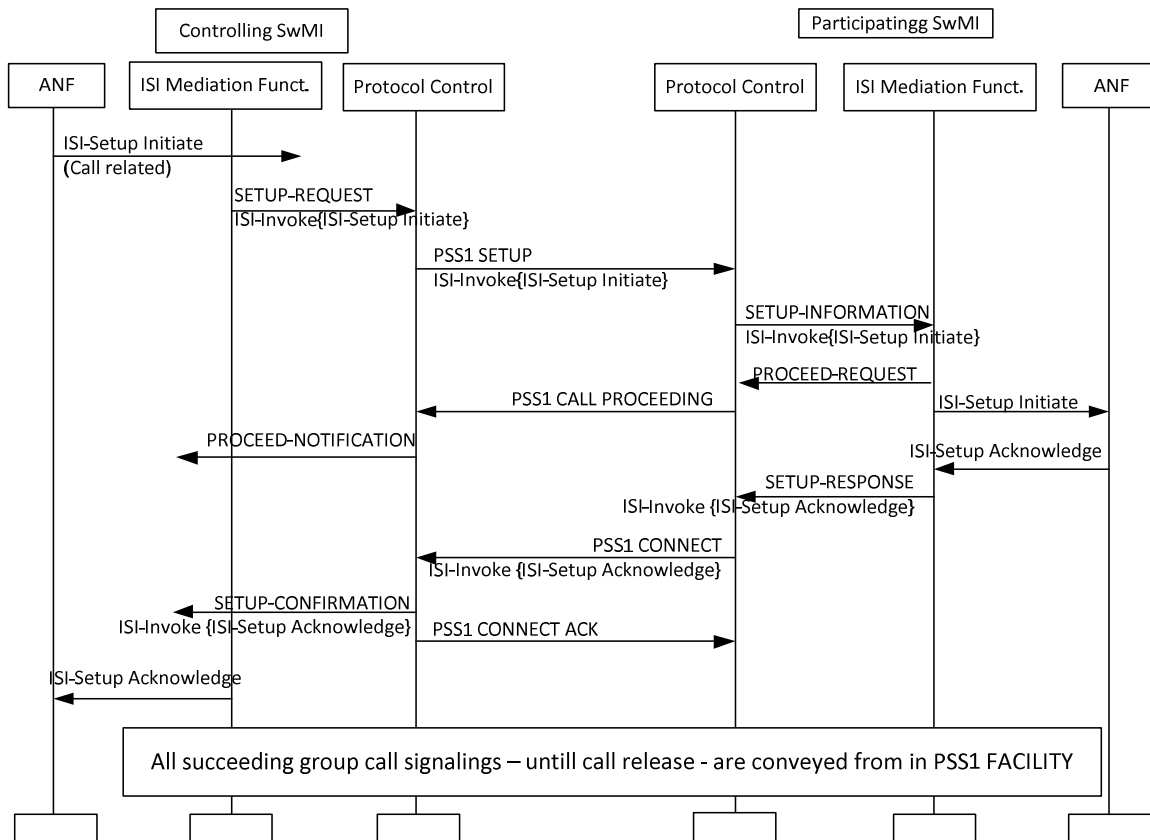

Figure 5.6: Establishment of a Group Call from an Originating Controlling SwMI or Group Call Originating from Another Originating SwMI

5.4.5 Transport of ISI Individual Call Signalling

5.4.5.1 SwMI Roles for Individual Call

For definitions of roles in relation to Individual Call please see the ANF-ISIIC [3]. This clause will focus on the PSS1 messages to be used in different situations.

5.4.5.2 Requirements on the originating SwMI

When an individual call is initiated towards an individual subscriber located in another SwMI the ANF-ISIIC entity shall request the Mediation Function to establish a connection oriented call related connection for sending an individual call set-up request in PSS1 SETUP message to the destination SwMI of the call. The invoked Mediation Function shall support call establishment and call clearing procedures for an originating PINX, as specified in ISO/IEC 11572 [9].

If the destination SwMI informs the originating SwMI that the call shall be re-routed to another SwMI (the originating SwMI or another SwMI), the originating SwMI ANF-ISIIC shall request the Mediation Function to disconnect the call towards destination SwMI by sending PSS1 DISCONNECT. The originating SwMI ANF-ISIIC may initiate a new call related connection to send call setup towards the new destination SwMI.

5.4.5.3 Requirements on the destination SwMI

The Mediation Function in a destination SwMI shall invoke ANF-ISIIC when receiving an individual call setup request in PSS1 SETUP. The Mediation Function shall support call establishment and call clearing procedures for a terminating PINX, as specified in ISO/IEC 11572 [9].

If the destination SwMI cannot accept the call, it shall release the established connection. A PSS1 RELEASE COMPLETE message shall be sent when no PSS1 message previously has been sent in response to the PSS1 SETUP message. Otherwise a PSS1 DISCONNECT message is sent.

If the destination SwMI is not the terminating SwMI (because the called party has migrated from the home SwMI to a third SwMI), and it is determined that the call shall be forward switched, then the destination SwMI ANF-ISIIC shall act as a source SwMI towards the terminating SwMI and request the ISI Mediation Function to establish a connection oriented call related connection and forward the ISI call request to the terminating SwMI in a PSS1 SETUP PDU.

5.4.5.4 Call Restoration

In case a new connection is required for an individual call restoration (after migration) the ANF-ISIIC will request the Mediation Function to establish a connection oriented call related connection for sending of an ISI-CALL RESTORE PREPARE PDU to the new SwMI. For that connection the Mediation Function shall support call establishment and call clearing procedures for an originating PINX as specified in ISO/IEC 11572 [9].

If the new SwMI does not support the ANF-ISIIC general call restoration procedure the ISI Return Error APDU with the cause corresponding to "requestNotSupported" shall be sent in a message clearing the PSS1 connection.

The message clearing the PSS1 connection shall be either:

- a PSS1 RELEASE COMPLETE message if PSS1 CALL PROCEEDING has not yet been sent; or
- a PSS1 DISCONNECT message.

5.4.5.5 Binding Rules

The following rules apply to the source and the destination SwMI for each connection.

NOTE: A call can include several connections if the call is forward switched or the call has been restored after an MS migration.

The following rules apply to the originating/source SwMI when sending ISIIC APDUs:

- ISI-SETUP PDU shall be sent in a PSS1 SETUP message.
- The following messages shall only be sent in a PSS1 FACILITY message before PSS1 ALERTING or PSS1 CONNECT:
 - ISI-CALL PROCEEDING.
- The following messages shall only be sent in a PSS1 FACILITY message after PSS1 CONNECT ACKNOWLEDGEMENT:
 - ISI-QUEUING.
 - ISI-RESOURCE.
 - ISI-CONNECT ACKNOWLEDGE.
 - ISI TX GRANTED.
 - ISI TX CEASED IN ORIGINATING SwMI.
 - ISI TX INTERRUPT.
 - ISI TX WAIT.
 - ISI TX CONTINUE IN ORIGINATING SwMI.
 - ISI-INFO DEMAND.
 - ISI-INFO REPLY.
 - ISI-PATH CALL RESTORE PREPARE.
 - ISI-END CALL RESTORE PREPARE.
- ISI-DISCONNECT shall be sent in a PSS1 DISCONNECT.

The following rules shall apply to by the destination/terminating SwMI when sending ISIIC APDUs:

- ISI-PROGRESS PDU shall be sent in a PSS1 PROGRESS message.
- ISI-ALERTING PDU shall be sent in a PSS1 ALERTING message.
- ISI-CONNECT PDU and ISI CALL RESTORE PREPARED PDU shall be sent in a PSS1 CONNECT message.
- ISI-CALL RESTORATION PDU shall be sent in a PSS1 CONNECT message if PSS1 CONNECT has not yet been sent, otherwise it shall be sent in a PSS1 FCILITY message.
- The following messages can only be sent in a PSS1 FACILITY message before PSS1 ALERTING or PSS1 CONNECT:
 - ISI-CALL PROCEEDING PDU.
 - ISI-REDIRECT PDU.
 - ISI-SETUP PROLONGATION PDU.
- The following messages can only be sent after PSS1ALERTING and before PSS1 CONNECT:
 - ISI-THROUGH ALERTING PDU.
- The following messages can only be sent in PSS1 FACILITY after PSS1 CONNECT:
 - ISI-RESOURCE RESPONSE.
 - ISI TX DEMAND PDU
 - ISI TX CEASED IN TERMINATING SwMI PDU.
 - ISI TX INTERRUPT PDU.
 - ISI TX WAIT PDU.
 - ISI TX CONTINUE IN TERMINATING SwMI PDU.
 - ISI-INFO DEMAND PDU.
 - ISI INFO REPLY PDU.
 - ISI-PATH CALL RESTORE PREPARE PDU.
 - ISI-END CALL RESTORE PRAPARE PDU.
 - ISI-SIMULTANEOUS MIGRATION PDU.
 - ISI-THROUGH CONNECT PDU.
- ISI-DISCONNECT shall be sent in a PSS1 DISCONNECT.

5.4.5.6 Sequences

For individual calls initiated by the ANF ISIIC the basic call setup is controlled by the Mediation Function. The initial call control PSS1 SETUP message to establish the call related signalling connection is sent as described in figure 5.3.

PSS1 FACILITY message can be sent before PSS1 CONNECT message to carry ANF-ISIIC PDUs as described in clause 5.4.5.5. PSS1 CONNECT ACKNOWLEDGE is always sent as a response to PSS1 CONNECT.

After PSS1CONNECT/CONNECT ACKNOWLEDGE is sent, all subsequent ISIGC APDUs for the active call are sent in PSS1 FACILITY as described in clause 5.4.3 until the call related connection is to be released by sending PSS1 DISCONNECT message.

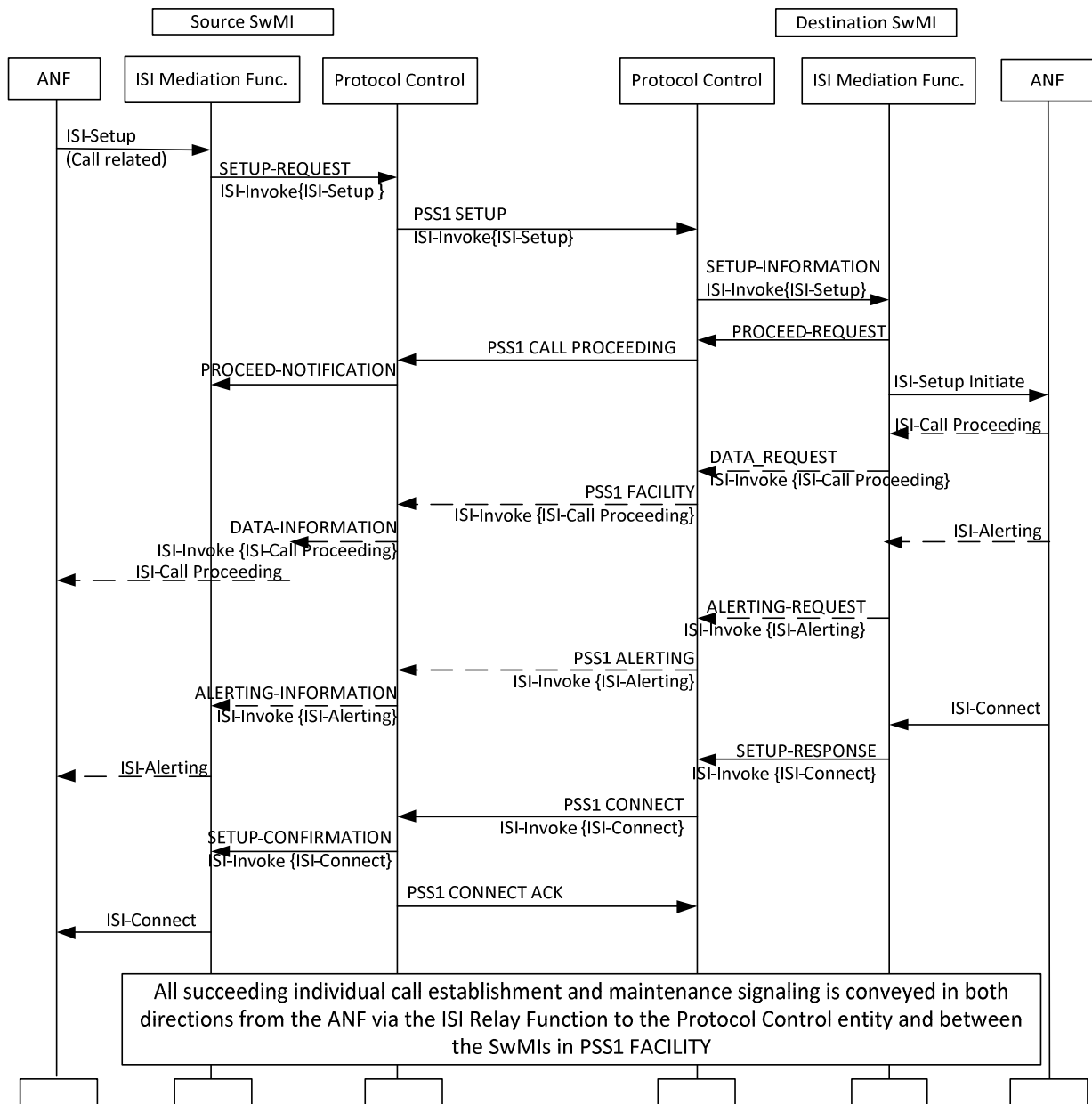

Figure 5.7: Individual Call Establishment Signalling

5.4.6 Error Handling

Both the ISI Mediation function and the ANF entity can reject an ISI APDU for the reasons described in clauses 7.4.2 or 7.4.3 in ETSI EN 300 392-3-9 [2]. The ISI-Reject or ISI-ReturnError can be sent in:

- PSS1 FACILITY (if the signalling connection shall be maintained);
- PSS1 DISCONNECT (for call related connections after PSS1 CALL PROCEEDING is sent/received);
- PSS1 RELEASE (for call independent connections where the PSS1 CALL PROCEEDING has been sent/received);
- PSS1 RELEASE COMPLETE (if PSS1 PROCEEDING message has NOT been sent).

If either of the SwMIs decides to clear the connection, it shall do so according to clause 10.2 of ISO/IEC 11572 [9] for call related connections and according to clause 7.3.1.7 of ISO/IEC 11582 [10] for call independent connection.

SwMI shall also support handling of protocol error conditions as specified in clause 9.2 of clause ISO/IEC 11572 [9] and clause 7.3.1.10 of ISO/IEC 11582 [10] and signalling carriage mechanism reset procedures as specified in clause 11.1 of ISO/IEC 11572 [9].

Figure 5.8 shows an example where the ISI-Invoke ID is not unique. The ISI-Invoke ID is checked by the ISI Mediation Function before the ISI PDU is presented to the ANF entity. The Mediation Function rejects the call request with an ISI-Reject with the cause 'duplicateInvocation' and requests the Protocol Control function to release the call. As no PSS1 CALL PROCEEDING has been sent the call is released with a PSS1 RELEASE COMPLETE. The sequence is valid for both Call related and call independent connections.

How the ISI Mediation Function in the originating/source SwMI is informing the ANF entity is manufacturer specific.

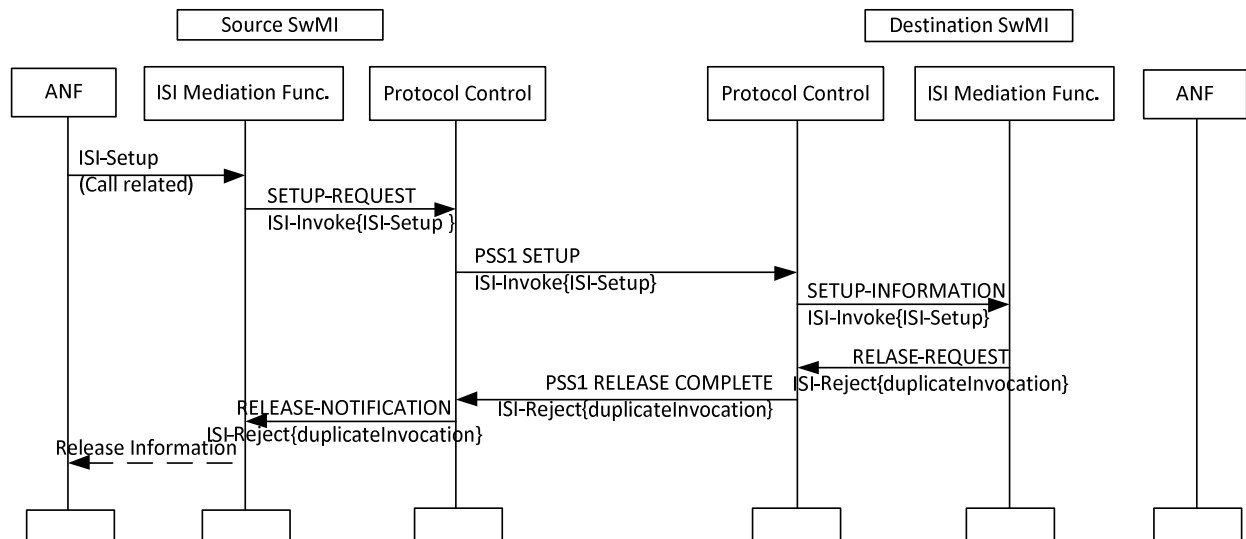

Figure 5.8: Error Detected, InvokeID not Unique

Figure 5.9 shows the example for a call related connection, where the destination SwMI ANF-ISIIC does not accept the individual call request. This could be because of an invalid information element. The ISI Mediation Function does not check the ISI PDU content but forwards it to the ANF entity and respond on the SETUP-INFORMATION by requesting the Protocol Control function to send PSS1 CALL PROCEEDING. When the ANF entity (in this case ANDF-ISIIC) checks the content of the received ISI PDU it might detect a malformed or invalid information element and rejects the ISI PDU with the reject cause 'invalidInfoElement' and a request to release the connection. The ISI Mediation Function requests the Protocol Control function to initiate a connection release by a DISCONNECT-REQUEST. The connection release is completed by the originating/source SwMI ISI Mediation Function.

NOTE: A malformed initial ISI PDU will always lead to release of the connection as it is not possible to send the initiating ISI PDU in other than a PSS1 SETUP message.

How the ISI Mediation Function in the originating/source SwMI is informing the ANF entity is manufacturer specific.

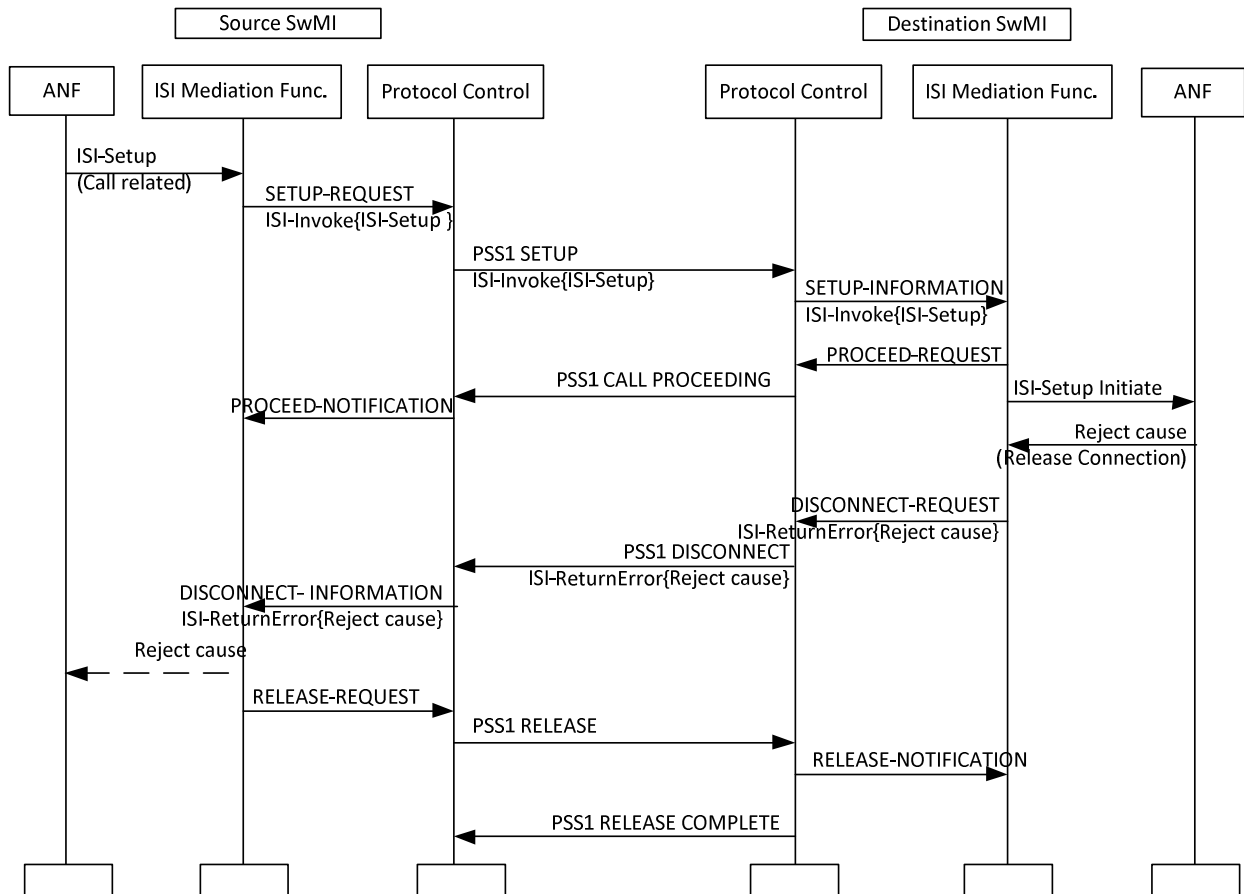

Figure 5.9: Error Detected, Invalid Information Element

If the invalid information element is detected by a call independent service ANF and the ANF requests release of the connection, the ISI Mediation function shall request the Protocol Control to include the ISI-ReturnError in PSS1 RELEASE instead of PSS1 DISCONNECT. Figure 5.10 shows an example of an ISI-ReturnError sent from a call independent ANF entity.

How the ISI Mediation Function in the originating/source SwMI is informing the ANF entity is manufacturer.

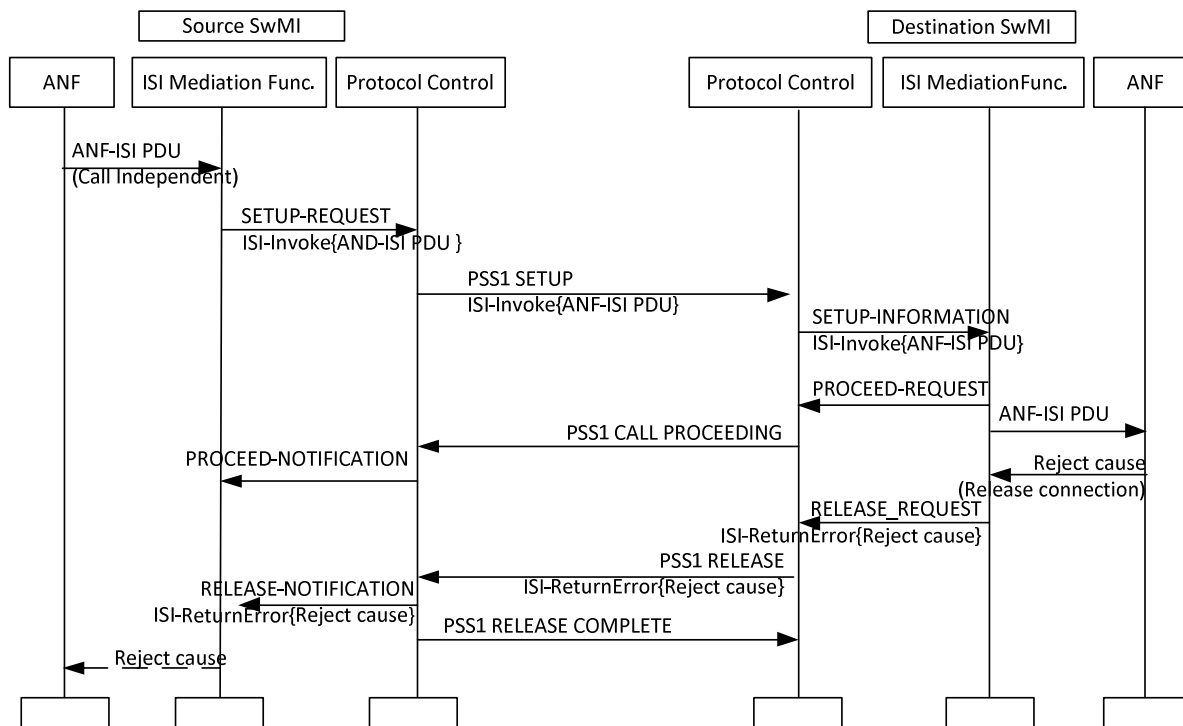

Figure 5.10: Error Detected by Call Independent ANF entity

If a SwMI ANF detects invalid content of an ISI PDU but wants to preserve the connection, the ANF entity shall inform the ISI Mediation Function about this. The ISI Mediation Function shall then convey the ISI-ReturnError PDU in a PSS1 FACILITY message. The procedure is independent of the connection type and the originator of the malformed ISI PDU. Figure 5.11 shows an example of the destination SwMI receiving a malformed ISI PDU.

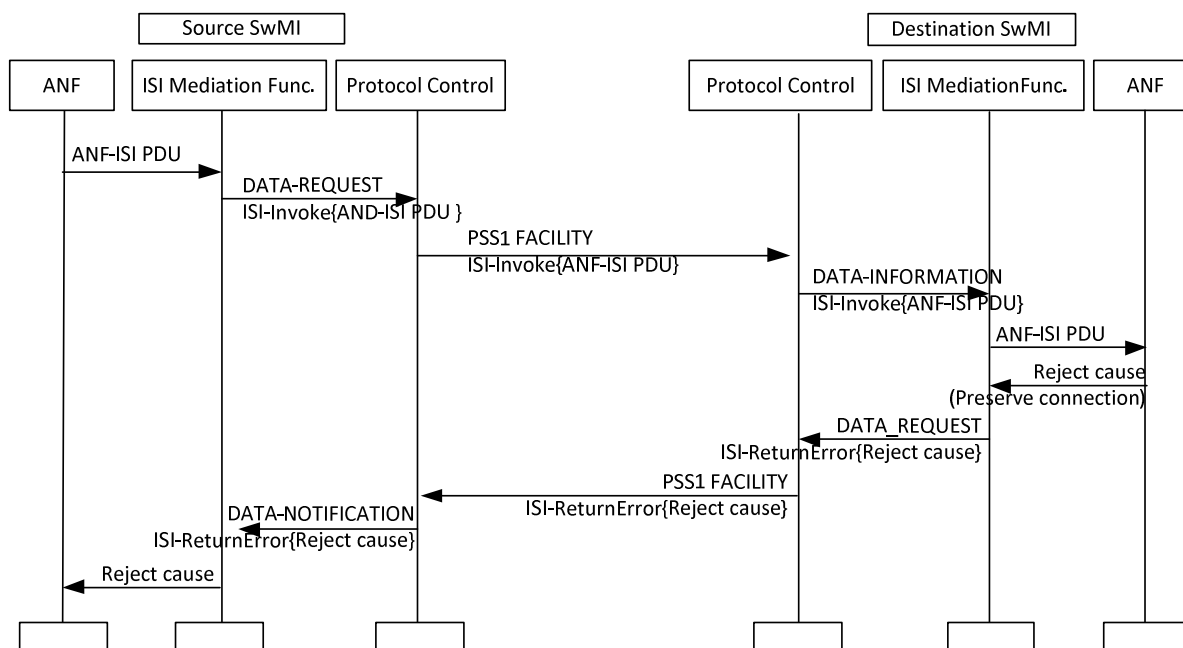

Figure 5.11: Error Detected During an Active Call

If the destination SwMI ANF detects that it cannot provide the service requested, it shall send an ISI PDU with indication of the service limitation. The ISI PDU may be included in PSS1 FACILITY, a PSS1 DISCONNECT or a PSS1 RELEASE dependent whether the connection shall be maintained or the connection shall be released.

5.4.7 Call Release

5.4.7.1 Release of a Call Independent Connection

Either SwMI can release a call independent connection at any time. For call independent connection the PSS1 release messages does not contain any ANF related information other than an ISI-ReturnError or an ISI-Reject as described in clause 5.4.6. For communication where no ISI-ReturnError or an ISI-Reject is invoked the connection is terminated after the last ISI APDU has been exchanged.

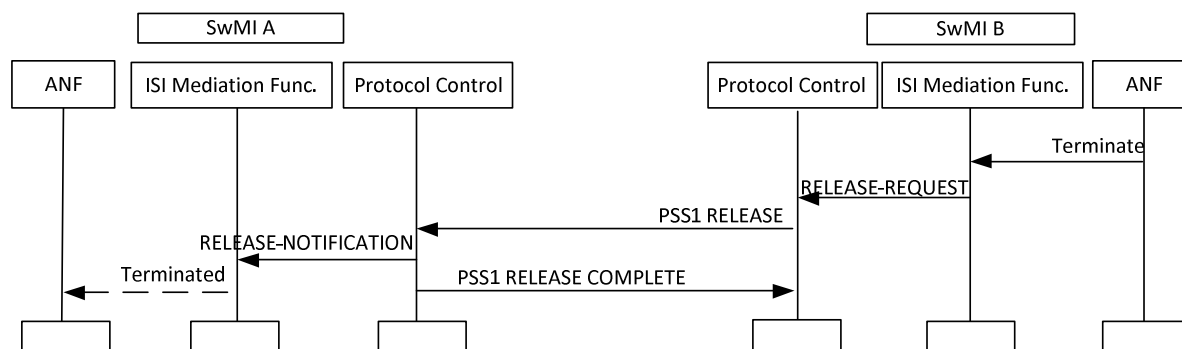

Figure 5.12: Termination of a Call Independent Connection

5.4.7.2 Release of a Call Related Connection

A call related connection is released when the ISI call is released either by one of the call participants or by the SwMI (e.g. as a result of a timeout).

For a group call or an individual call the destination SwMI rejecting the call in the call establishment phase shall send ISI-Reject in a PSS1 DISCONNECT message to the source SwMI.

Figure 5.13 shows the example where an individual call request is rejected by the ANF-ISIIC. This might be caused by the impossibility to route the call or the destination SwMI ANF ISIIC does not support the requested call type (e.g. direct setup).

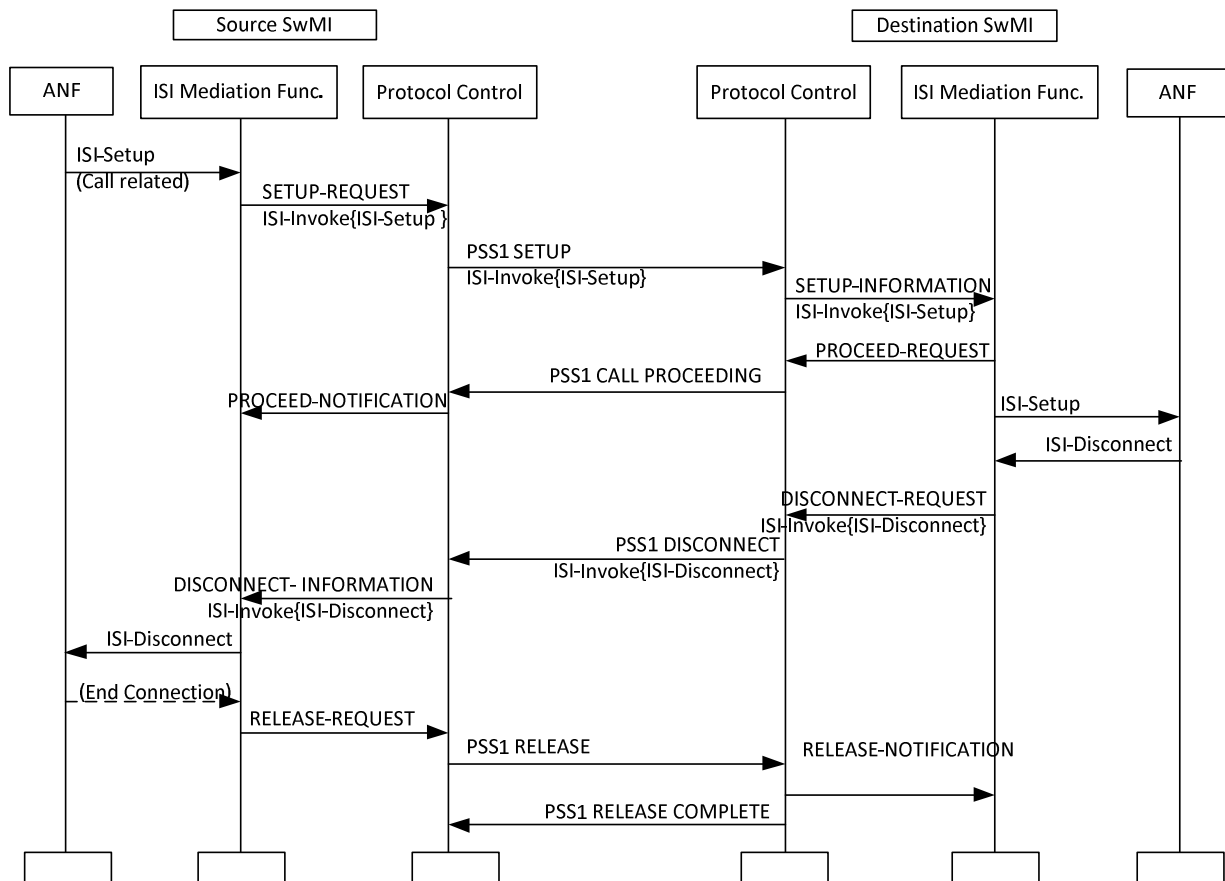

Figure 5.13: Call Establishment Rejected by the ANF Entity

For an individual call the SwMI requesting call termination shall include the ISI DISCONNECT in PSS1 DISCONNECT to the other SwMI.

For a group call the controlling SwMI requesting termination of the call shall send ISI RELEASE in PSS1 DISCONNECT to the participating SwMI(s). If a participating SwMI wants to leave the group call it shall send ISI DISCONNECT in PSS1 DISCONNECT to the controlling SwMI. The controlling SwMI shall complete the disconnection of the call towards the requesting participating SwMI and include the ISI-RELEASE PDU in PSS1 RELEASE.

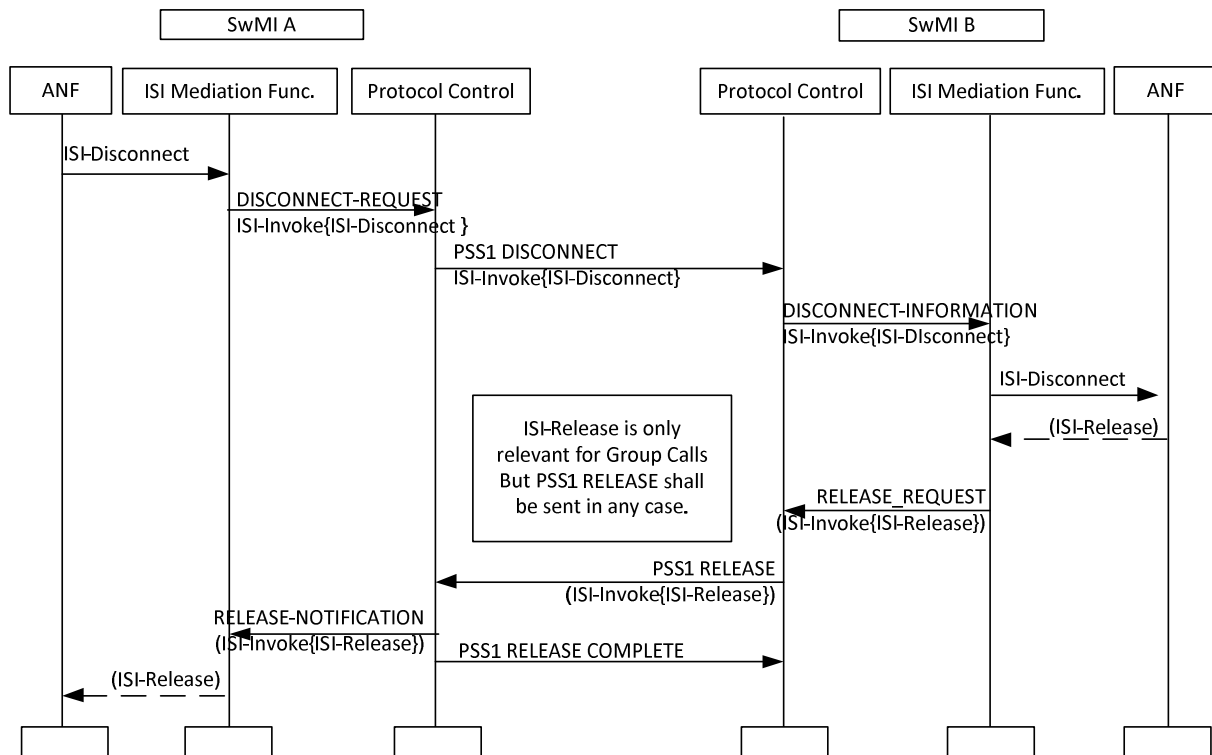

Figure 5.14: Termination of a Call Related Connection

5.5 ISI GFP requirements and operation definition

The ISI GFP requirements and operation definition is described in ETSI EN 300 392-3-9 [2] (ISI General Design, Common). Only the PSS1 specific requirements are described in this clause.

The protocol defined in ETSI EN 300 392-3-9 [2] shall apply for each E.1 based SwMI entity, with the exception of:

- the value of the InvokeIdType shall lie in the range (-32 768 to 32 767).

5.6 Segmentation Service Element (SSE)

5.6.1 Procedures

SSE shall take ISI APDUs divide them into segments which fit into a single facility information element and send these segments in SSE APDUs to the peer SSE. The peer SSE shall re-assemble the original ISI APDU and deliver it to the destination entity.

The length of a segment is related to the maximum length of a facility information element (which is 255 octets, see clause 11.3.3 of ISO/IEC 11582 [10]) and it depends on the maximum length of a PSS1 PDU. As a result, the segment length varies - see clause A.1. The procedures for segmentation and re-assembly are based on the segmentation and re-assembly procedures defined in annex ZA of ISO/IEC 11572 [9].

NOTE: According to the requirements defined in clause 5.2 for the Co-ordination Function to address an ISI APDU to SSE, segmentation procedures will not be applied to an ISI APDU:

- which fits into a single facility information element; or
- which has to be sent in a specific PSS1 basic call message.

5.6.2 Requirements for procedures

5.6.2.1 Requirements for the segmentation procedure

Once the first segment has been transmitted to GFT Control, then all remaining segments of that message shall be sent in order, before any other ISI APDU (segmented or not). After sending a segment, the timer T1 shall be started and before it expires the subsequent segment shall be sent. Only failure conditions (e.g. GFT Control failure or timer T1 time-out) shall cause the transmission of a segmented ISI APDU to be aborted.

The ISI message identifier field in the segmented message shall identify the ISI APDU to which the segment belongs; this identifier is uniquely defined by SSE and it is not related to the invokeId included in the ISI APDU.

The remaining segments field of the segmented message information element shall indicate how many more segments are to be sent.

The octet order of the segmented ISI APDU shall be preserved regardless of segment boundary.

The protocol timer definition in table 5.3 shall apply for the segmentation procedures.

Table 5.3: Timer definition for segmentation procedure

Timer number	Timer value	Cause for start	Normally terminated	Action to be taken when timer expires	Status
T1	Max. 100 ms	Message segment sent	Subsequent segment message sent	Transmission of the segmented ISI APDU aborted	Mandatory

5.6.2.2 Requirements for the re-assembly procedure

The re-assembly function on receiving a segment in which the remaining segments field is not set to zero (last segment of a segmented ISI APDU) shall save the segment contents and shall start a timer T2.

NOTE: This timer T2 is used to prevent the re-assembly function waiting indefinitely to receive the next message segment.

SSE shall be able to re-assemble received segments of any size.

When receiving an invalid segment, SSE shall discard this segment and send the incomplete message to the ISI Mediation Function. A Reject APDU or an ISI-ReturnError APDU with the value IncompleteTetraPDU shall also be sent to the source SwMI.

An invalid segment could be one of the following:

- segment in which the number of remaining segment field of the segmented message has a value which is not one less than the value of the previously received segment;
- segment which is not the first segment of a segmented ISI APDU with an identifier value different from that in the previously received segment.

On expiry of timer T2, the re-assembly function shall send any saved segment to ISI Mediation Function and inform it at the same time that the transmitted message is incomplete. The re-sending of the ISI APDU is an implementation matter.

The protocol timer definition in table 5.4 shall apply for the re-assembly procedures.

Table 5.4: Timer definition for re-assembly procedure

Timer number	Timer value	Cause for start	Normally terminated	Action to be taken when timer expires	Status
T2	Max. 200 ms	Message segment received	Last message segment received	Send message to ISI Mediation Function with error handling	Mandatory

5.6.3 Segment encoding

SSE segment shall be included in a (PSS1) facility information element as defined in clause 11.3.3 of ISO/IEC 11582 [10], with a new type of Service APDU: the SSE APDU, the definition of the information element network protocol profile, in table 29 of ISO/IEC 11582 [10]) being correspondingly superseded with that in table 5.5, in order to add a new value for that information element, allowing to indicate that the service APDU included in the (PSS1) facility information element is a SSE APDU.

Table 5.5: Network protocol profile

```

Network-Protocol-Profile-definition
{ccitt (0) identified-organization (4) etsi (0) tetra(392) network-protocol-profile-definition(1)}
DEFINITIONS ::=
BEGIN
EXPORTS NetworkProtocolProfile;
NetworkProtocolProfile ::= [18] IMPLICIT INTEGER
    {
        acse(19)
        dse (32)
        tetraSse(39) } (0..254)
END -- of Network Protocol Profile definition

```

Obviously, only one SSE APDU can be included in the service APDU of the facility information element. The protocol profile value of this facility information element shall be set to Networking Extensions and the NFE shall be included with the same data elements values which would have applied for sending the ISI APDU if it had been possible to send it without segmenting it.

A SSE APDU shall comprise ASN.1 type as defined in table 5.6.

Table 5.6: ASN.1 definition of SSE APDU

```

Sse-Apdu-definition
{ccitt (0) identified-organization (4) etsi (0) tetra(392) sse-apdu(2)}
DEFINITIONS ::=
BEGIN
EXPORTS SseApdu
SseApdu ::= [39] IMPLICIT OCTET STRING
END -- of SSE APDU definition

```

The structure of the octet string included in a SSE APDU shall be as defined in table 5.7.

Table 5.7: Structure of SSE APDU

Information element	Length	Type	C/O/M	Remark
ISI message identifier	8	1	M	Identifies the ISI APDU the segment belongs to (see note 1).
Remaining segments	8	1	M	Indicates how many segments follow (see note 2).
Data		1	M	Segment of the ISI APDU (see note 3).
NOTE 1: The message identifier is assigned by the sending SSE. It shall be unique on that signalling connection and can be reused when the transfer of the respective ISI APDU has been completed.				
NOTE 2: The counter provides a means to verify the proper transmission of the ISI APDU. It shall count down to 0, thus indicating the last segment.				
NOTE 3: To generate this information element, SSE shall simply consider the ISI APDU as a bit string.				

5.7 Co-ordinationFunction

The Co-ordination Function provides co-ordination between GFT Control, the different ANF-ISI entities, ROSE and SSE. This co-ordination includes the delivery of information received from the GFT Control to its destination entity ANF-ISI entity. It also includes the allocation of the ISI Invoke identifier for each new connection request initiated by an ANF-ISI.

NOTE: Since the same ISI operation (defined in ETSI EN 300 392-3-9 [2], table 1) is used by all ANF-ISI entities, the allocation of the ISI Invoke identifier has to be common to all those entities: only the Co-ordination Function can do it.

The Co-ordination Function also supports the handling of unrecognized and erroneous ISI APDUs by generating ISI-Reject and ISI-ReturnError APDUs as specified in clauses 7.4.3 and 7.4.4 of ETSI EN 300 392-3-9 [2].

Annex A (informative): PSS1 Message Content

A.1 Maximum length of an ISI APDU or a SSE segment encoded in a facility information element

The maximum length of an ISI APDU or a SSE segment is related to the maximum length of a facility information element (which is 257 octets - see clause 11.3.3 of ISO/IEC 11582 [10]) and it depends also on the maximum length provided for by PSS1 segmentation (see annex ZA of ISO/IEC 11572 [9]). The minimum length of the PSS1 PDU ensured by this segmentation is 260 octets.

In order to encode an ISI APDU in a PSS1 SETUP message, up to 58 octets may be used for the encoding of the PSS1 message (although it is highly unlikely that the PISN of the called SwMI or that of the source SWMI will ever need 21 octets) and 14 for the encoding of the facility information element. Of the two length limits of 260 octets per PSS1 message and 257 octets per facility information element, the more stringent in that case is the first one. It would result in the need to limit the length of an ISI APDU sent in a PSS1 SETUP message to 188 octets.

NOTE: If the PISN of the called SwMI and that of the source SWMI are each encoded with less than 21 octets, the limit length of an ISI APDU sent in a PSS1 SETUP message will be increased accordingly.

In order to encode an ISI APDU in a PSS1 FACILITY message, 5 octets are used for the encoding of the PSS1 message and 11 for the encoding of the facility information element. Of the two length limits of 260 octets per PSS1 message and 257 octets per facility information element, the more stringent in that case is the first one. It results in the maximum length of an ISI APDU being 244 octets in that case, that of a SSE segment being 241 octets.

A.2 Example of the encoding of an ANF-ISIMM MIGRATION RESPONSE PDU in an ISI Invoke APDU in a PSS1 FACILITY PDU

Table A.1 shows an example of encoding the ANF-ISIMM MIGRATION RESPONSE PDU in a PSS1 FACILITY PDU in a call independent connection.

Table A.1: Example of encoding an ANF-ISIMM MIGRATION RESPONSE PDU in an ISI Invoke APDU in a PSS1 FACILITY PDU

PSS1 FACILITY PDU	Definition of the value	Value
Protocol discriminator	Recommendation ITU-T Q.931 [12]	00001000 ₂
Call reference	call reference = 4	00000100 ₂
Message type	FACILITY	01100010 ₂
Facility Information Element		
Information element identifier	facility	00011100 ₂
Length	length = 39	00100111 ₂
Protocol profile	Networking extension	10011111 ₂
Network Facility Extension		
sourceEntity	Context specific-constructed-tag 10	10101010 ₂
	Length = 6	00000110 ₂
	Context specific-primitive-tag 0	10000000 ₂
	length = 1	00000001 ₂
	endPINX	00000000 ₂

destinationEntity	Context specific-primitive-tag 2	10000010 ₂
	length = 1	00000001 ₂
	endPINX	00000000 ₂

END of NFE**Service APDU: ISI INVOKE**

	Context specific-constructed-invoke APDU	10100001 ₂
	Length = 28	00011100 ₂
Invokeld	Universal-integer tag 2	00000010 ₂
	length = 1	00000001 ₂
	arbitrary value = 6	00000110 ₂
OperationValue	universal-object identifier tag 6	00000110 ₂
	length = 5	00000101 ₂
	encoding of { 0 4 0 392 0}	00000100 ₂
		00000000 ₂
		10000011 ₂
		00001000 ₂
		00000000 ₂

ARGUMENT tetralSiMessage

Sequence	Universal constructed sequence	00110000 ₂
	Length = 17	00010001 ₂
SourceEntity	Context specific-primitive-tag 0	10000000 ₂
	length = 1	00000001 ₂
	ANF-ISIMM	00000010 ₂
DestinationEntity	Context specific-primitive-tag 1	10000001 ₂
	length = 1	00000001 ₂
	ANF-ISIMM	00000010 ₂

tetralSiMessage

	Context specific-primitive-tag 2	10000010 ₂
	Length = 9	00001001 ₂
PDU Type	Migration Response	001110 ₂
ANF-ISIMM invoke id	arbitrary value: 1	0000000000000001 ₂
ISSI	arbitrary value: 010524 ₁₆	000000000010101001000100 ₂
Migration type	migration	00 ₂
Pre-defined profile set reference(s)	set no 1, 2 and 3 supported	1110000000000000 ₂
Recovery	No recovery	0 ₂
	padding	0000000 ₂

END of tetralSiMessage**END of ARGUMENT****END of Service APDU****END of Information Element****END of PSS1 FACILITY PDU**

Annex B (informative): Bibliography

- ETSI EN 300 392-1: "Terrestrial Trunked Radio (TETRA); Voice plus Data (V+D); Part 1: General network design".
- ETSI EN 300 392-2: "Terrestrial Trunked Radio (TETRA); Voice plus Data (V+D); Part 2: Air Interface (AI)".
- ETSI EN 300 392-7: "Terrestrial Trunked Radio (TETRA); Voice plus Data (V+D); Part 7: Security".
- ETSI EN 300 392-9: "Terrestrial Trunked Radio (TETRA); Voice plus Data (V+D); Part 9: General requirements for supplementary services".
- Recommendation ITU-T X.690: "Information technology - ASN.1 encoding rules: Specification of Basic Encoding Rules (BER), Canonical Encoding Rules (CER) and Distinguished Encoding Rules (DER)".
- Recommendation ITU-T X.219: "Remote Operations: Model, notation and service definition".

Annex C (informative): Change requests

The present document includes change requests as presented in table C.1.

Table C.1: Change requests

No	CR vers.	Standard Version	Clauses affected	Title	CR Status
01	01	1.1.2	Foreword, 2.1, 2.2, 4.2, 4.4, 5.2, 5.4.4.1.3, 5.4.6, 5.5, 5.7	Correction to references	WG3 approved 190327

History

Document history		
V1.1.1	May 2018	Publication as ETSI TS 100 392-3-10
V1.2.0	August 2019	EN Approval Procedure AP 20191113: 2019-08-15 to 2019-11-13