

Draft **ETSI EN 300 390** V2.1.0 (2015-12)



**Land Mobile Service;
Radio equipment intended for the transmission of data
(and speech) and using an integral antenna;
Harmonised Standard covering the essential requirements
of article 3.2 of the Directive 2014/53/EU**

Reference

REN/ERM-TGDMMR-347

Keywords

antenna, data, mobile, PMR, radio, speech,
transmission

ETSI

650 Route des Lucioles
F-06921 Sophia Antipolis Cedex - FRANCE

Tel.: +33 4 92 94 42 00 Fax: +33 4 93 65 47 16

Siret N° 348 623 562 00017 - NAF 742 C
Association à but non lucratif enregistrée à la
Sous-Préfecture de Grasse (06) N° 7803/88

Important notice

The present document can be downloaded from:
<http://www.etsi.org/standards-search>

The present document may be made available in electronic versions and/or in print. The content of any electronic and/or print versions of the present document shall not be modified without the prior written authorization of ETSI. In case of any existing or perceived difference in contents between such versions and/or in print, the only prevailing document is the print of the Portable Document Format (PDF) version kept on a specific network drive within ETSI Secretariat.

Users of the present document should be aware that the document may be subject to revision or change of status. Information on the current status of this and other ETSI documents is available at
<http://portal.etsi.org/tb/status/status.asp>

If you find errors in the present document, please send your comment to one of the following services:
<https://portal.etsi.org/People/CommitteeSupportStaff.aspx>

Copyright Notification

No part may be reproduced or utilized in any form or by any means, electronic or mechanical, including photocopying and microfilm except as authorized by written permission of ETSI.

The content of the PDF version shall not be modified without the written authorization of ETSI.
The copyright and the foregoing restriction extend to reproduction in all media.

© European Telecommunications Standards Institute 2015.
All rights reserved.

DECT™, **PLUGTESTS™**, **UMTS™** and the ETSI logo are Trade Marks of ETSI registered for the benefit of its Members.
3GPP™ and **LTE™** are Trade Marks of ETSI registered for the benefit of its Members and of the 3GPP Organizational Partners.
GSM® and the GSM logo are Trade Marks registered and owned by the GSM Association.

Contents

Intellectual Property Rights	7
Foreword.....	7
Modal verbs terminology.....	7
1 Scope	8
2 References	8
2.1 Normative references	8
2.2 Informative references.....	9
3 Definitions, symbols and abbreviations	9
3.1 Definitions.....	9
3.2 Symbols.....	11
3.3 Abbreviations	11
4 General and operational requirements.....	11
4.1 General	11
4.1.1 Environmental profile	11
4.1.2 Choice of model for testing	11
4.1.2.0 General	11
4.1.2.1 Auxiliary test equipment	12
4.1.2.2 Declarations by the supplier.....	12
4.2 Mechanical and electrical design.....	12
4.2.1 General.....	12
4.2.2 Controls	12
4.2.3 Transmitter shut-off facility.....	12
4.3 Marking.....	12
4.4 Testing using bit streams or messages.....	12
4.5 Measuring continuous mode equipment.....	12
4.6 Measuring discontinuous mode equipment	12
4.7 Constant and non-constant envelope modulation	12
4.8 Combined full bandwidth analogue speech/full bandwidth digital equipment.....	13
5 Test conditions, power sources and ambient temperatures	14
5.1 Normal and extreme test conditions	14
5.2 Test power source.....	14
5.3 Normal test conditions.....	14
5.3.1 Normal temperature and humidity	14
5.3.2 Normal test power source	14
5.3.2.1 Mains voltage.....	14
5.3.2.2 Regulated lead-acid battery power sources used on vehicles.....	14
5.3.2.3 Other power sources.....	15
5.4 Extreme test conditions	15
5.4.1 Extreme temperatures	15
5.4.2 Extreme test source voltages.....	15
5.4.2.1 Mains voltage.....	15
5.4.2.2 Regulated lead-acid battery power sources used on vehicles.....	15
5.4.2.3 Power sources using other types of batteries.....	15
5.4.2.4 Other power sources.....	15
5.5 Procedure for tests at extreme temperatures.....	15
5.5.0 Thermal balance.....	15
5.5.1 Procedure for equipment designed for continuous transmission.....	16
5.5.2 Procedure for equipment designed for intermittent transmission	16
6 General conditions of measurement	16
6.1 Normal test signals (wanted and unwanted signals).....	16
6.1.0 General.....	16
6.1.1 Signals for bit stream measurements	16
6.1.2 Signals for messages.....	17
6.2 Artificial antenna.....	17

6.3	Test sites and general arrangements for radiated measurements	17
6.4	Transmitter automatic shut-off facility	17
6.5	Modes of operation of the transmitter	17
6.6	Encoder for receiver measurements	18
6.7	Transceiver data interface	18
6.8	Arrangements for test signals at the input of the receiver via a test fixture or a test antenna	18
6.9	Facilities for access	18
6.9.1	Analogue access	18
6.9.2	Points for bit stream measurement	18
6.9.3	Coupling arrangements	19
6.9.3.0	General	19
6.9.3.1	Arrangements for measurements with continuous bit streams	19
6.9.3.2	Arrangements for measurements with messages	19
6.10	Receiver mute or squelch facility	19
7	Technical characteristics of the transmitter	19
7.0	General	19
7.1	Frequency error	19
7.1.0	General	19
7.1.1	Definition	19
7.1.2	Method of measurement	20
7.1.3	Limits	20
7.2	Effective radiated power	20
7.2.0	General	20
7.2.1	Definition	21
7.2.2	Method of measurement	21
7.2.2.0	General	21
7.2.2.1	Maximum effective radiated power under normal test conditions	21
7.2.2.2	Average effective radiated power under normal test conditions	22
7.2.2.3	Method of measurements of maximum and average effective radiated power under extreme test conditions	23
7.2.3	Limits	23
7.2.3.1	Effective radiated power under normal test conditions	23
7.2.3.2	Effective radiated power under extreme test conditions	24
7.3	Adjacent and alternate channel power	24
7.3.0	General	24
7.3.1	Definition	24
7.3.2	Method of measurement	24
7.3.3	Limits	25
7.4	Radiated unwanted emissions in the spurious domain	26
7.4.0	General	26
7.4.1	Definition	26
7.4.2	Method of measurement	26
7.4.3	Limits	28
7.5	Transmitter attack time	28
7.5.0	General	28
7.5.1	Definition	28
7.5.2	Method of measurement	29
7.5.3	Limits	29
7.6	Transmitter release time	29
7.6.0	General	29
7.6.1	Definition	29
7.6.2	Method of measurement	29
7.6.3	Limits	30
7.7	Transient behaviour of the transmitter	30
7.7.0	General	30
7.7.1	Definitions	30
7.7.2	Timings, frequencies and powers	31
7.7.3	Methods of measurement	35
7.7.3.0	General	35
7.7.3.1	Time and frequency domain analysis measurements	35
7.7.3.2	Test arrangement and characteristics of the test discriminator	36

7.7.3.3	Adjacent channel transient power measurements.....	36
7.7.3.4	Characteristics of the adjacent channel transient power measuring device.....	37
7.7.4	Limits.....	37
7.7.4.1	Time domain analysis of power and frequency.....	37
7.7.4.2	Adjacent channel transient power	38
8	Technical characteristics of the receiver	38
8.1	Average usable sensitivity (field strength, data or messages)	38
8.1.1	Definition.....	38
8.1.2	Method of measurement with continuous bit streams under normal test conditions	38
8.1.3	Method of measurement with continuous bits streams under extreme test conditions	40
8.1.4	Method of measurement with messages under normal test conditions	40
8.1.5	Method of measurement with messages under extreme test conditions.....	42
8.1.6	Reference for degradation measurements	43
8.1.6.1	Definition	43
8.1.6.2	Procedures for measurements using the test fixture	43
8.1.6.3	Procedures for measurements on a test site.....	43
8.1.7	Limits.....	43
8.2	Error behaviour at high input levels	44
8.2.1	Definition.....	44
8.2.2	Method of measurement with continuous bit streams.....	45
8.2.3	Method of measurement with messages	45
8.2.4	Limits.....	45
8.3	Co-channel rejection.....	46
8.3.1	Definition.....	46
8.3.2	Method of measurement with continuous bit streams.....	46
8.3.3	Method of measurement with messages	47
8.3.4	Limits.....	48
8.4	Adjacent channel selectivity.....	48
8.4.1	Definition.....	48
8.4.2	Method of measurement with continuous bit streams.....	48
8.4.3	Method of measurement with messages	49
8.4.4	Limits.....	50
8.5	Spurious response rejection.....	50
8.5.0	General.....	50
8.5.1	Definition.....	51
8.5.2	Introduction to the method of measurement	51
8.5.3	Measurement arrangement.....	52
8.5.4	Method of the search over the limited frequency range with continuous bit streams	53
8.5.5	Method of the search over the limited frequency range with messages.....	53
8.5.6	Method of measurement with continuous bit streams.....	54
8.5.7	Method of measurement with messages	55
8.5.8	Limits.....	56
8.6	Intermodulation response rejection	56
8.6.0	General.....	56
8.6.1	Definition.....	56
8.6.2	Method of measurement with continuous bit streams.....	56
8.6.3	Method of measurement with messages	57
8.6.4	Limits.....	58
8.7	Blocking or desensitization	58
8.7.0	General.....	58
8.7.1	Definition.....	58
8.7.2	Method of measurement with continuous bit streams.....	59
8.7.3	Method of measurement with messages	60
8.7.4	Limits.....	61
8.8	Spurious radiations	61
8.8.0	General.....	61
8.8.1	Definition.....	61
8.8.2	Method of measurement	62
8.8.3	Limits.....	63
9	Testing for compliance with technical requirements.....	63

9.1	Test conditions, power supply and ambient temperatures	63
9.2	Interpretation of the measurement results	64
Annex A (normative):	Relationship between the present document and the essential requirements of Directive 2014/53/EU	65
Annex B (normative):	Radiated measurement.....	67
B.1	Test sites and general arrangements for measurements involving the use of radiated fields	67
B.1.0	General	67
B.1.1	Anechoic chamber	67
B.1.2	Anechoic chamber with a conductive ground plane	68
B.1.3	Open Area Test Site (OATS)	69
B.1.4	Test antenna.....	70
B.1.5	Substitution antenna	70
B.1.6	Measuring antenna	71
B.2	Guidance on the use of radiation test sites	71
B.2.0	General	71
B.2.1	Verification of the test site	71
B.2.2	Preparation of the EUT.....	71
B.2.3	Power supplies to the EUT	71
B.2.4	Volume control setting for analogue speech tests	71
B.2.5	Range length.....	72
B.2.6	Site preparation	72
B.3	Coupling of signals.....	73
B.3.0	General	73
B.3.1	Data signals	73
B.4	Test fixture	73
B.4.1	Description	73
B.4.2	Calibration.....	74
B.4.3	Mode of use.....	74
Annex C (normative):	Specification for some particular measurement arrangements.....	75
C.1	Power measuring receiver specification.....	75
C.1.0	General	75
C.1.1	IF filter	75
C.1.2	Attenuation indicator.....	76
C.1.3	RMS value indicator.....	76
C.1.4	Oscillator and amplifier.....	76
C.2	Spectrum analyser specification.....	76
C.2.1	Adjacent and alternate channel power measurement.....	76
C.2.2	Unwanted emissions measurement.....	77
C.3	Integrating and power summing device	77
History	78

Intellectual Property Rights

IPRs essential or potentially essential to the present document may have been declared to ETSI. The information pertaining to these essential IPRs, if any, is publicly available for **ETSI members and non-members**, and can be found in ETSI SR 000 314: "*Intellectual Property Rights (IPRs); Essential, or potentially Essential, IPRs notified to ETSI in respect of ETSI standards*", which is available from the ETSI Secretariat. Latest updates are available on the ETSI Web server (<http://ipr.etsi.org>).

Pursuant to the ETSI IPR Policy, no investigation, including IPR searches, has been carried out by ETSI. No guarantee can be given as to the existence of other IPRs not referenced in ETSI SR 000 314 (or the updates on the ETSI Web server) which are, or may be, or may become, essential to the present document.

Foreword

This draft Harmonised European Standard (EN) has been produced by ETSI Technical Committee Electromagnetic compatibility and Radio spectrum Matters (ERM), and is now submitted for the combined Public Enquiry and Vote phase of the ETSI standards EN Approval Procedure.

The present document has been prepared in reply to the Commission's standardisation request Commission Implementing Decision C(2015) 5376 final of 04.08.2015 to provide a means of conforming to the essential requirements of Directive 2014/53/EU on the harmonisation of the laws of the Member States relating to the making available on the market of radio equipment.

Once the present document is cited in the Official Journal of the European Union under that Directive, compliance with the normative clauses of the present document given in table A.1 confers, within the limits of the scope of the present document, a presumption of conformity with the corresponding essential requirements of that Directive, and associated EFTA regulations.

Proposed national transposition dates	
Date of latest announcement of this EN (doa):	3 months after ETSI publication
Date of latest publication of new National Standard or endorsement of this EN (dop/e):	6 months after doa
Date of withdrawal of any conflicting National Standard (dow):	18 months after doa

Modal verbs terminology

In the present document "**shall**", "**shall not**", "**should**", "**should not**", "**may**", "**need not**", "**will**", "**will not**", "**can**" and "**cannot**" are to be interpreted as described in clause 3.2 of the [ETSI Drafting Rules](#) (Verbal forms for the expression of provisions).

"**must**" and "**must not**" are **NOT** allowed in ETSI deliverables except when used in direct citation.

1 Scope

The present document covers the technical requirements for radio transmitters and receivers used in stations in the Private Mobile Radio (PMR) service.

It applies to use in the land mobile service, operating on radio frequencies between 30 MHz and 1 GHz, with channel separations of 12,5 kHz, 20 kHz and 25 kHz, intended for data or speech and data.

Table 1: Radiocommunications service frequency bands

Radiocommunications service frequency bands	
Transmit	30 MHz to 1 000 MHz
Receive	30 MHz to 1 000 MHz

It applies to equipment for continuous and/or discontinuous transmission.

The equipment comprises a transmitter and associated encoder and modulator and/or a receiver and associated demodulator and decoder.

The present document also applies to combined analogue and digital radio equipment using an integral antenna and intended for the transmission of data and/or speech.

The present document is complementary to ETSI EN 300 113 [i.5], which covers radio equipment with an internal or external RF connector.

In the cases of:

- combined full bandwidth analogue/full bandwidth digital equipment, if the analogue part of the equipment has already been measured according to ETSI EN 300 296 [6];
- equipment which has already been measured according to the present document, and is remeasured with an add-on device, using another type of modulation without affecting any other characteristics of the equipment;

only some of the requirements of the present document apply. These requirements are given in clause 4.8.

2 References

2.1 Normative references

References are either specific (identified by date of publication and/or edition number or version number) or non-specific. For specific references, only the cited version applies. For non-specific references, the latest version of the referenced document (including any amendments) applies.

Referenced documents which are not found to be publicly available in the expected location might be found at <http://docbox.etsi.org/Reference>.

NOTE: While any hyperlinks included in this clause were valid at the time of publication, ETSI cannot guarantee their long term validity.

The following referenced documents are necessary for the application of the present document.

- [1] Void.
- [2] Void.
- [3] ANSI C63.5 (2006): "American National Standard for Calibration of Antennas Used for Radiated Emission Measurements in Electro Magnetic Interference".
- [4] ETSI TR 100 028 (V1.4.1) (12-2001) (all parts): "Electromagnetic compatibility and Radio spectrum Matters (ERM); Uncertainties in the measurement of mobile radio equipment characteristics".

- [5] Recommendation ITU-T O.153 (10-1992): "Basic parameters for the measurement of error performance at bit rates below the primary rate".
- [6] ETSI EN 300 296 (V2.1.0) (12-2015): "Land Mobile Service; Radio equipment using integral antennas intended primarily for analogue speech; Harmonised Standard covering the essential requirements of article 3.2 of the Directive 2014/53/EU".
- [7] ETSI TR 100 028-2 (V1.4.1) (12-2001): "Electromagnetic compatibility and Radio spectrum Matters (ERM); Uncertainties in the measurement of mobile radio equipment characteristics; Part 2".

2.2 Informative references

References are either specific (identified by date of publication and/or edition number or version number) or non-specific. For specific references, only the cited version applies. For non-specific references, the latest version of the referenced document (including any amendments) applies.

NOTE: While any hyperlinks included in this clause were valid at the time of publication, ETSI cannot guarantee their long term validity.

The following referenced documents are not necessary for the application of the present document but they assist the user with regard to a particular subject area.

- [i.1] ETSI TR 102 273 (V1.2.1) (all parts): "Electromagnetic compatibility and Radio spectrum Matters (ERM); Improvement on Radiated Methods of Measurement (using test site) and evaluation of the corresponding measurement uncertainties".
- [i.2] Directive 2014/53/EU of the European Parliament and of the Council of 16 April 2014 on the harmonisation of the laws of the Member States relating to the making available on the market of radio equipment and repealing Directive 1999/5/EC.

NOTE: Article 3.2 and article 10.8.

- [i.3] Commission Implementing Decision C(2015) 5376 final of 04.08.2015: Commission Implementing Decision on a standardisation request to the European Committee for Electrotechnical Standardisation and to the European Telecommunications Standards Institute as regards radio equipment in support of Directive 2014/53/EU of the European Parliament and of the Council.
- [i.4] ETSI EN 300 793 (V1.1.1): "Electromagnetic compatibility and Radio spectrum Matters (ERM); Land mobile service; Presentation of equipment for type testing".
- [i.5] ETSI EN 300 113 (V2.1.0): "Land Mobile Service; Radio equipment intended for the transmission of data (and/or speech) using constant or non-constant envelope modulation and having an antenna connector; Harmonised Standard covering the essential requirements of article 3.2 of the Directive 2014/53/EU".

3 Definitions, symbols and abbreviations

3.1 Definitions

For the purposes of the present document, the following terms and definitions apply:

adjacent channels: channel offset from the wanted channel by the channel spacing (see figure 1)

alternate channels: two channels offset from the wanted channel by double the channel spacing (see figure 1)

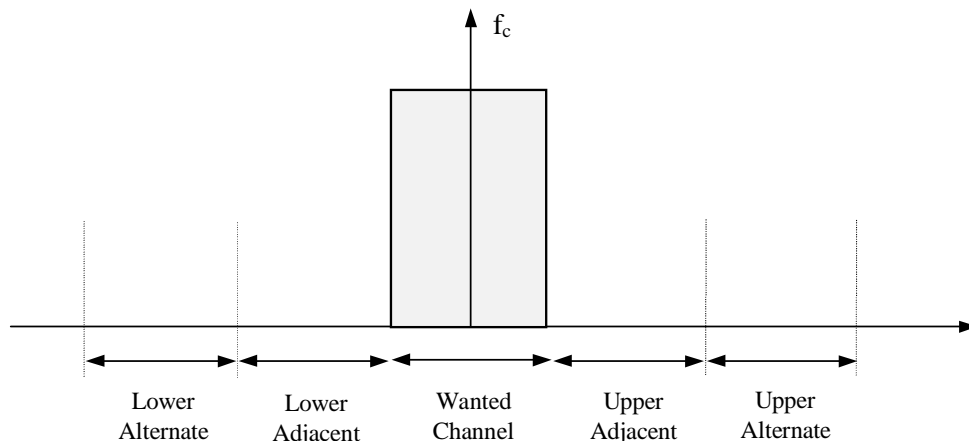

Figure 1: Adjacent and alternate channel definitions

bit: binary digit

block: smallest quantity of information sent over the radio channel. A constant number of useful bits are always sent together with the corresponding redundancy bits

constant envelope angle modulation: either phase modulation (G3) or frequency modulation (F3)

integral antenna: antenna designed to be connected to the equipment without the use of a 50 Ω external connector and considered to be part of the equipment

NOTE: An integral antenna may be fitted internally or externally to the equipment.

message: user data to be transferred in one or more packets in a session

packet: one block or a contiguous stream of blocks sent by one (logical) transmitter to one particular receiver or one particular group of receivers

session: set of inter-related exchanges of packets occupying one or several windows or parts thereof (if applicable)

NOTE: It corresponds to a complete interactive procedure for interchanging data between users, comprising initiation, data transmission and termination procedures. The session can be short (e.g. two packets) or long (e.g. one full page of text).

switching range (sr): maximum frequency range, as specified by the supplier, over which the receiver or the transmitter can be operated within the alignment range without reprogramming or realignment

transmission (physical): one or several packets transmitted between power on and power off of a particular transmitter

window: set of inter-related transmissions resulting from the action of the "initiating transmitter", and limited in time by an appropriate access protocol and corresponding occupation rules

Types of measurements:

conducted measurements: measurements which are made using a direct RF connection to the equipment under test

radiated measurements: measurements which involve the absolute measurement of a radiated field

Types of station:

base station: equipment fitted with an antenna connector, for use with an external antenna and intended for use in a fixed location

mobile station: mobile equipment fitted with an antenna connector, for use with an external antenna, normally used in a vehicle or as a transportable station

handportable station: equipment either fitted with an antenna connector or an integral antenna, or both, normally used on a stand-alone basis, to be carried on a person or held in the hand

3.2 Symbols

For the purposes of the present document, the following symbols apply:

Ω	ohm
dB	decibel
dBm	dB relative to 1 mW
D-M0, D-M1	signals defined in clause 6.1.1

NOTE: The symbols relating to transients and timings are defined in clause 7.7.1.

3.3 Abbreviations

For the purposes of the present document, the following abbreviations apply:

CSP	Channel Separation
CW	Continues Wave
dBc	dB relative to the carrier power
DC	Direct Current
EC	European Commission
emf	electro-motive force
EUT	Equipment Under Test
FSK	Frequency Shift Keying
IF	Intermediate Frequency
OATS	Open Area Test Site
PLL	Phase Locked Loop
PMR	Private Mobile Radio
RBW	Resolution Bandwidth
RF	Radio Frequency
Rx	Receiver
sr	switching range
Tx	Transmitter
VSWR	Voltage Standing Wave Ratio

4 General and operational requirements

4.1 General

4.1.1 Environmental profile

The technical requirements of the present document apply under the environmental profile for operation of the equipment, which shall be declared by the supplier, but as a minimum, shall be that specified in the test conditions contained in the present document.

4.1.2 Choice of model for testing

4.1.2.0 General

Stand-alone equipment shall be complete with any ancillary equipment needed for testing.

If an equipment has several optional features, considered not to affect the RF parameters, then the tests need only be performed on the equipment configured with the combination of features considered to be the most complex.

The performance of the equipment to be tested shall be representative of the performance of the corresponding production model.

Guidance on the presentation of equipment is also given in ETSI EN 300 793 [i.4].

4.1.2.1 Auxiliary test equipment

All necessary test signal sources, setting up instructions and other product information shall be made available with the equipment to be tested.

4.1.2.2 Declarations by the supplier

All necessary setting up instructions and other product information shall be made available with the equipment to be tested, in accordance with article 10.8 of Directive 2014/53/EU [i.2].

Equipment may be designed to fulfil the requirements of one or more ENs.

4.2 Mechanical and electrical design

4.2.1 General

The equipment should be designed, constructed and manufactured in accordance with good engineering practice, and with the aim of minimizing harmful interference to other equipment and services.

4.2.2 Controls

Those controls, which if maladjusted, might increase the interfering potentialities of the equipment shall not be accessible for adjustment by the user.

4.2.3 Transmitter shut-off facility

When a timer for an automatic shut-off facility is operative, at the moment of the time-out the transmitter shall automatically be switched off (the re-activation of the transmitter shall reset the timer).

A shut-off facility shall be inoperative for the duration of the measurements unless it has to remain operative to protect the equipment. If the shut-off facility is left operative the status of the equipment shall be indicated.

4.3 Marking

The equipment shall be marked in a visible place. This marking should be legible, tamperproof and durable.

The marking shall be in accordance with EC Directives and/or CEPT decisions or recommendations as appropriate.

4.4 Testing using bit streams or messages

The supplier may elect to have the equipment tested using bit streams or messages. It should be noted that the methods of measurement using messages are usually more time consuming.

4.5 Measuring continuous mode equipment

In the case of measurements performed on equipment designed to operate only in continuous mode, requirements such as "equipment shall be set in continuous mode" shall be interpreted as "equipment shall be used in its normal transmission mode (in this case, the continuous mode)".

4.6 Measuring discontinuous mode equipment

When it is specified that the transmission shall be continuous for the duration of the measurement(s), the transmitter under test shall be set to operate in continuous mode. If this is not possible, the measurements shall be carried out in a period shorter than the duration of the transmitted burst. It may be necessary to extend the duration of the burst.

When measurements are made in discontinuous mode, the reported values can be average values. This averaging shall be made using a set of measurements, each of these measurements being made during a burst or a part of it.

4.7 Constant and non-constant envelope modulation

Constant envelope angle modulation systems can be measured following the measurement procedure either for constant envelope angle modulation equipment or for non-constant envelope modulation equipment.

Non-constant envelope modulation systems shall always be measured following the measurement procedure for non-constant envelope modulation equipment.

NOTE: Both modulation types may be continuous or non-continuous.

In both cases, the type of measurement procedure used shall be reported in the test report.

4.8 Combined full bandwidth analogue speech/full bandwidth digital equipment

Equipment may be designed to fulfil the requirements of one or more standards.

In the case of combined full bandwidth analogue speech/full bandwidth digital equipment, if the analogue part of the equipment has already been measured according to ETSI EN 300 296 [6], only the following additional tests shall be performed:

- 7.3 Adjacent channel power.
- 7.4 Unwanted emissions in the spurious domain.
- 7.5 Transmitter attack time (if applicable).
- 7.6 Transmitter release time (if applicable).
- 7.7 Transient behaviour of the transmitter.
- 8.1 Average usable sensitivity (field strength, data or messages).
- 8.2 Error behaviour at high input levels.
- 8.3 Co-channel rejection.
- 8.4 Adjacent channel selectivity.
- 8.8 Spurious radiations.

More precisely, the measurement of the spurious emissions should be performed when equipment, previously measured to ETSI EN 300 296 [6], is being measured to the present document with an add-on data unit. If the equipment has been originally combined for analogue and digital operation, the measurement of the spurious emissions need not to be performed again if the data port(s) (and the data circuits/modules) were active while making this measurement for the test ETSI EN 300 296 [6].

In the case where equipment has already been measured according to the present document and is to be measured again with an add-on data unit using another type of modulation without affecting any other characteristic of the equipment, only the following additional tests shall be performed:

- 7.3 Adjacent channel power.
- 7.4 Unwanted emissions in the spurious domain.
- 8.1 Maximum usable sensitivity (data or messages, conducted).
- 8.1 Average usable sensitivity (field strength, data or messages).
- 8.2 Error behaviour at high input levels.
- 8.3 Co-channel rejection.
- 8.4 Adjacent channel selectivity.
- 8.8 Spurious radiations.

The above mentioned tests shall be performed on one piece of equipment tuned to a frequency in the centre of the band.

In the case where data is transmitted simultaneously together with analogue speech, the speech part of the equipment is tested according to ETSI EN 300 296 [6] and it shall also be checked that the data does not cause the adjacent channel power and spurious emissions to fall outside the appropriate limits.

5 Test conditions, power sources and ambient temperatures

5.1 Normal and extreme test conditions

Testing shall be performed under normal test conditions, and also, where stated, under extreme test conditions.

The test conditions and procedures shall be as specified in clauses 5.2 to 5.5.

5.2 Test power source

During testing the power source of the equipment shall be replaced by a test power source capable of producing normal and extreme test voltages as specified in clauses 5.3.2 and 5.4.2. The internal impedance of the test power source shall be low enough for its effect on the test results to be negligible. For the purpose of tests, the voltage of the power source shall be measured at the input terminals of the equipment.

If the equipment is provided with a permanently connected power cable, the test voltage shall be that measured at the point of connection of the power cable to the equipment.

For battery operated equipment the battery shall be removed and the test power source shall be applied as close to the battery terminals as practicable.

During tests of DC powered equipment the power source voltages shall be maintained within a tolerance of $< \pm 1$ % relative to the voltage at the beginning of each test. The value of this tolerance is critical for power measurements. Using a smaller tolerance will provide better measurement uncertainty values.

5.3 Normal test conditions

5.3.1 Normal temperature and humidity

The normal temperature and humidity conditions for tests shall be any convenient combination of temperature and humidity within the following ranges:

- temperature: $+15$ °C to $+35$ °C;
- relative humidity: 20 % to 75 %.

When it is impracticable to carry out the tests under these conditions, a note to this effect, stating the ambient temperature and relative humidity during the tests, shall be added to the test report.

5.3.2 Normal test power source

5.3.2.1 Mains voltage

The normal test voltage for equipment to be connected to the mains shall be the nominal mains voltage. For the purpose of the present document, the nominal voltage shall be the declared voltage or any of the declared voltages for which the equipment was designed.

The frequency of the test power source corresponding to the ac mains shall be between 49 Hz and 51 Hz.

5.3.2.2 Regulated lead-acid battery power sources used on vehicles

When the radio equipment is intended for operation from the usual types of regulated lead-acid battery power source used on vehicles the normal test voltage shall be 1,1 times the nominal voltage of the battery (for nominal voltages of 6 V and 12 V, these are 6,6 V and 13,2 V respectively).

5.3.2.3 Other power sources

For operation from other power sources or types of battery (primary or secondary), the normal test voltage shall be that declared by the equipment supplier.

5.4 Extreme test conditions

5.4.1 Extreme temperatures

For tests at extreme temperatures, measurements shall be made in accordance with the procedures specified in clause 5.5, at the upper and lower temperatures of the following range:

- -20 °C to +55 °C.

For the purpose of the note to table 1a, clause 7.1.3 an additional reduced extreme temperature range of 0 °C to +30 °C shall be used when the equipment is not able to fulfil the requirements of table 1a over the extreme temperature range of -20 °C to +55 °C.

Test reports shall state the temperature range used.

5.4.2 Extreme test source voltages

5.4.2.1 Mains voltage

The extreme test voltage for equipment to be connected to an ac mains source shall be the nominal mains voltage $\pm 10\%$.

5.4.2.2 Regulated lead-acid battery power sources used on vehicles

When the equipment is intended for operation from the usual types of regulated lead-acid battery power sources used on vehicles the extreme test voltages shall be 1,3 and 0,9 times the nominal voltage of the battery (for a nominal voltage of 6 V, these are 7,8 V and 5,4 V respectively and for a nominal voltage of 12 V, these are 15,6 V and 10,8 V respectively).

5.4.2.3 Power sources using other types of batteries

The lower extreme test voltages for equipment with power sources using batteries shall be as follows:

- for the nickel metal-hydride, leclanché or lithium type: 0,85 times the nominal battery voltage;
- for the mercury or nickel-cadmium type: 0,9 times the nominal battery voltage.

No upper extreme test voltages apply.

In the case where no upper extreme test voltage is applicable, the corresponding four extreme test conditions are:

- V_{\min}/T_{\min} , V_{\min}/T_{\max} ;
- $(V_{\max} = \text{nominal})/T_{\min}$, $(V_{\max} = \text{nominal})/T_{\max}$.

5.4.2.4 Other power sources

For equipment using other power sources, or capable of being operated from a variety of power sources, the extreme test voltages shall be those declared by the equipment supplier.

5.5 Procedure for tests at extreme temperatures

5.5.0 Thermal balance

Before measurements are made the equipment shall have reached thermal balance in the test chamber. The equipment shall be switched off during the temperature stabilizing period.

In the case of equipment containing temperature stabilization circuits designed to operate continuously, the temperature stabilization circuits may be switched on for 15 minutes after thermal balance has been obtained, and the equipment shall then meet the specified requirements. For such equipment the supplier shall provide for the power source circuit feeding the crystal oven (if any) to be independent of the power source for the rest of the equipment.

If the thermal balance is not checked by measurements, a temperature stabilizing period of at least one hour, or a longer period as may be decided by the testing laboratory, shall be allowed. The sequence of measurements shall be chosen, and the humidity content in the test chamber shall be controlled so that excessive condensation does not occur.

5.5.1 Procedure for equipment designed for continuous transmission

If the supplier states that the equipment is designed for continuous transmission, the test procedure shall be as follows.

Before tests at the upper extreme temperature, the equipment shall be placed in the test chamber, and left until thermal balance is attained. The equipment shall then be switched on in the transmit condition for a period of half an hour, after which the equipment shall meet the specified requirements.

Before tests at the lower extreme temperature, the equipment shall be left in the test chamber until thermal balance is attained, then switched to the standby or receive condition for a period of one minute, after which the equipment shall meet the specified requirements.

5.5.2 Procedure for equipment designed for intermittent transmission

If the supplier states that the equipment is designed for intermittent transmission, the test procedure shall be as follows.

Before tests at the upper extreme temperature, the equipment shall be placed in the test chamber and left until thermal balance is attained. The equipment shall then be switched on for one minute in the transmit condition, followed by four minutes in the receive condition, after which the equipment shall meet the specified requirements.

For tests at the lower extreme temperature, the equipment shall be left in the test chamber until thermal balance is attained, then switched to the standby or receive condition for one minute, after which the equipment shall meet the specified requirements.

6 General conditions of measurement

6.1 Normal test signals (wanted and unwanted signals)

6.1.0 General

The wanted signals for methods of measurement with bit streams and messages are defined in clauses 6.1.1 and 6.1.2 respectively.

The signal A-M3 is used as an unwanted signal for methods of measurement with either bit streams or messages for measurements such as co-channel rejection (clause 8.3) and adjacent channel selectivity (clause 8.4). It shall be as follows:

- signal A-M3, consisting of an RF signal, modulated by an audio frequency signal of 1 kHz with a deviation of 12 % of the channel separation.

6.1.1 Signals for bit stream measurements

When the equipment is designed to transmit continuous bit streams (e.g. data, facsimile, image transmission, digital speech) the normal test signal shall be as follows:

- signal D-M0, consisting of an infinite series of 0-bits;
- signal D-M1, consisting of an infinite series of 1-bits;
- signal D-M2, consisting of a pseudorandom bit sequence of at least 511 bits according to Recommendation ITU-T O.153 [5];
- signal D-M2', this is the same type as D-M2, but the pseudorandom bit sequence is independent of D-M2 (perhaps identical with D-M2 but started at a different point of time).

Applying an infinite series of 0 bits or 1 bits does not normally produce the typical bandwidth. Signal D-M2 is designed to produce a good approximation of the typical bandwidth.

6.1.2 Signals for messages

When the equipment is intended to be tested using messages, the normal test signal shall be trains of correctly coded bits or messages.

The normal test signals and modulations shall be obtained as follows:

- signal D-M3, corresponding to single bursts, used for measurements using the up-down method, triggered either manually or by an automatic testing system. This will provide the "normal test signal" as required (e.g. clause 8.3.3 step d));
- signal D-M4, consisting of correctly coded signals, messages transmitted sequentially, one by one, without gaps between them.

D-M3 is used for receiver methods of measurement with messages where there is a need to transmit single messages a number of times (e.g. 20 times, see "normal test signal" in step e) of clauses 8.3.3, 8.4.3, 8.5.7, 8.6.3 and 8.7.3). The corresponding normal test modulation shall be agreed between the supplier and the test laboratory.

The test signal D-M4 is used for transmitter methods of measurement such as adjacent channel power (clause 7.3) and radiated unwanted emissions (clause 7.4).

The test signal D-M4 shall be that signal, as agreed between the supplier and the test laboratory which produces the greatest radio frequency occupied bandwidth.

The encoder, which is associated with the transmitter, shall be capable of supplying the normal test modulation for D-M3, and the test signal D-M4, which should have continuous modulation for the duration of the measurements, if possible.

Details of D-M3 and D-M4 shall be included in the test report.

6.2 Artificial antenna

Tests on the transmitter requiring the use of the test fixture shall be carried out with a substantially non-reactive non-radiating load of 50 Ω connected to the test fixture terminals.

6.3 Test sites and general arrangements for radiated measurements

For guidance on radiation test sites see annex B. Detailed descriptions of the radiated measurement arrangements are included in this annex.

6.4 Transmitter automatic shut-off facility

When a timer for an automatic shut-off facility is operative, at the moment of the time-out the transmitter shall automatically be switched off (the re-activation of the transmitter shall reset the timer).

A shut-off facility shall be inoperative for the duration of the measurements unless it has to remain operative to protect the equipment. If the shut-off facility is left operative the status of the equipment shall be indicated.

6.5 Modes of operation of the transmitter

For the purpose of the measurements according to the present document, there should preferably be a facility to operate the transmitter unmodulated.

The method of obtaining an unmodulated carrier or special types of modulation patterns shall be described in test reports.

It may involve suitable temporary internal modifications of the equipment under test. For instance in the case of direct Frequency Shift Keying (FSK), a means to continuously transmit a sequence D-M0 containing only "zeros" and a sequence D-M1 containing only "ones" is desirable.

6.6 Encoder for receiver measurements

Whenever needed and in order to facilitate measurements on the receiver, an encoder for the data system shall accompany the model submitted, together with details of the normal modulation process. The encoder is used to modulate a signal generator for use as a test signal source.

In the case of equipment unable to operate with continuous bit streams, the encoder shall be capable of operation in a repetitive mode, with intervals between each message that are not less than the reset time of the receiver.

Complete details of all codes and code format(s) used shall be given.

6.7 Transceiver data interface

Equipment that does not integrate the keyboard and display used for normal operation shall provide a V.24/V.28 interface (preferably) or other suitable interfaces.

Variation in the level of the input signals, within the specified limits for that interface, shall have no measurable influence on the characteristics of the signals on the radio path.

6.8 Arrangements for test signals at the input of the receiver via a test fixture or a test antenna

Sources of test signals for application to the receiver via a test fixture (clause B.4) or a test antenna (clause B.1.4) shall be connected in such a way that the impedance presented to the test fixture or the test antenna is 50 Ω . This requirement shall be met irrespective of whether one or more signals using a combining network are applied to the receiver simultaneously.

The levels of the test signals shall be expressed in terms of the emf at the output of the source prior to connection to the appropriate input connector.

The effects of any intermodulation products and noise produced in the test signal sources shall be negligible.

6.9 Facilities for access

6.9.1 Analogue access

In order to simplify the measurements in clause 8.5 (spurious response rejection), temporary access to a point where the amplitude of the analogue output of the RF part can be measured should be provided, e.g. Intermediate Frequency (IF) output or the demodulated subcarrier point may be provided for the equipment to be tested. This access can be used to determine or verify the frequency where a spurious response is expected.

6.9.2 Points for bit stream measurement

It is recognized that it is not always possible to measure the air interface bit stream. The supplier shall define the points at which the equipment shall be tested in order to make the measurements on bit streams according to clauses 7 and 8.

Figure 2 is presented as an example for clarification only.

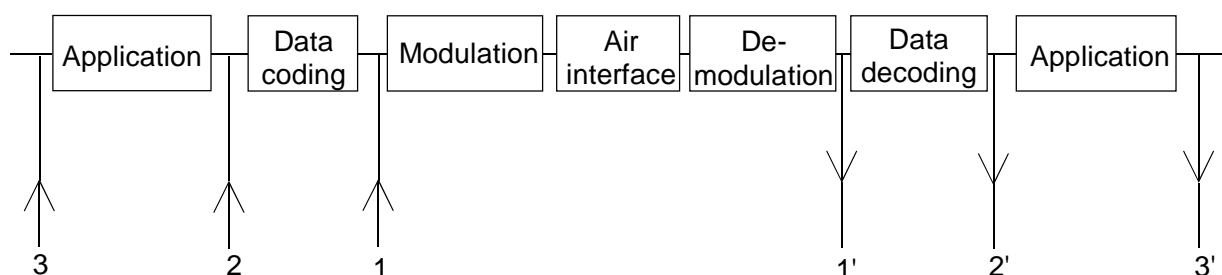

Figure 2: Test points for bit stream measurements

It should be noted that the closer the access point is located to the air interface (figure 2), a fewer number of variants may have to be tested because the measurement is less application dependent.

The tests shall be performed by use of corresponding points (1,1' or 2,2' or 3,3').

The points used shall be recorded in the test report.

6.9.3 Coupling arrangements

6.9.3.0 General

Arrangements shall be made by the supplier to couple the unit to be tested to the test equipment by a method which does not affect the radiated field (e.g. acoustic, ultra sonic or optic) and according to clauses 6.9.3.1 and 6.9.3.2.

6.9.3.1 Arrangements for measurements with continuous bit streams

For the measurements of the receiver on a test site, arrangements to couple the unit to be tested to the bit error ratio measuring device shall be available (clause 6.9.2).

Furthermore, the supplier may also provide another facility to give access to the analogue information (clause 6.9.1).

6.9.3.2 Arrangements for measurements with messages

For the measurements of the receiver on a test site, arrangements to couple the unit to be tested to the bit error observation device (or to an operator) shall be available.

Furthermore, the supplier shall also provide another facility to give access to the analogue information (clause 6.9.1).

6.10 Receiver mute or squelch facility

If the receiver is equipped with a mute or squelch circuit, this shall be made inoperative for the duration of the tests.

7 Technical characteristics of the transmitter

7.0 General

When performing transmitter tests on equipment designed for intermittent operation, the specified maximum transmit time shall not be exceeded.

7.1 Frequency error

7.1.0 General

This measurement need not be carried out if this parameter has been measured according to the requirements of ETSI EN 300 296 [6].

This measurement is made if the equipment is capable of producing an unmodulated carrier. Otherwise the adjacent channel power shall also be measured under extreme test conditions and the limits given in clause 7.3.3 shall be met.

7.1.1 Definition

The frequency error of the transmitter is the difference between the measured carrier frequency in the absence of modulation and the nominal frequency of the transmitter.

7.1.2 Method of measurement

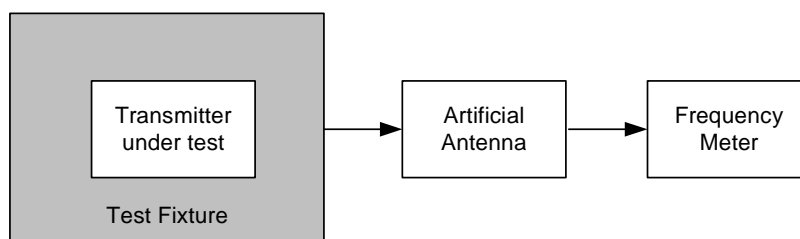

Figure 3: Measurement arrangement

The equipment shall be placed in a test fixture (clause B.4) connected to the artificial antenna (clause 6.2). The carrier frequency shall be measured in the absence of modulation.

The measurement shall be made under normal test conditions (clause 5.3) and repeated under extreme test conditions (clauses 5.4.1 and 5.4.2 applied simultaneously).

7.1.3 Limits

The frequency error shall not exceed the values given in table 1a under normal, extreme or any intermediate set of conditions.

For practical reasons the measurements shall be performed only under normal and extreme test conditions as stated in clause 5.1.

Table 1a: Frequency error

Channel separation (kHz)	Frequency error limit (kHz)				
	below 47 MHz	47 to 137 MHz	above 137 to 300 MHz	above 300 to 500 MHz	above 500 to 1 000 MHz
20 and 25	±0,60	±1,35	±2,00	±2,00	±2,50 (note)
12,5	±0,60	±1,00	±1,50	±1,50 (note)	No value specified

NOTE: For handportable stations having integral power supplies, these limits only apply to the reduced extreme temperature range 0 °C to + 30 °C. However for the full extreme temperature conditions (clause 5.4.1), exceeding the reduced extreme temperature range above, the following frequency error limits apply:

- ±2,50 kHz between 300 MHz and 500 MHz;
- ±3,00 kHz between 500 MHz and 1 000 MHz.

7.2 Effective radiated power

7.2.0 General

This measurement need not be carried out if this parameter has already been measured according to the requirements of ETSI EN 300 296 [6].

Administrations may state the maximum value for the maximum effective radiated power of transmitters; this can be a condition for issuing the licence.

If the equipment is designed to operate with different carrier powers, the rated maximum effective radiated power for each level or range of levels shall be declared by the supplier. The power adjustment control shall not be accessible to the user.

The requirements of the present document shall be met for all power levels at which the transmitter is intended to operate. For practical reasons measurements shall be performed only at the lowest and the highest power level at which the transmitter is intended to operate.

7.2.1 Definition

For the purpose of this measurement, the maximum effective radiated power is defined as the effective radiated power in the direction of maximum field strength under specific conditions of measurement.

The rated maximum effective radiated power is the maximum effective radiated power declared by the supplier.

The average effective radiated power is defined as the average of the effective radiated power measured in 8 directions.

The rated average effective radiated power shall also be declared by the supplier.

7.2.2 Method of measurement

7.2.2.0 General

The measurements shall be made under normal test conditions, clause 5.3, and extreme test conditions, clauses 5.4.1 and 5.4.2 applied simultaneously.

7.2.2.1 Maximum effective radiated power under normal test conditions

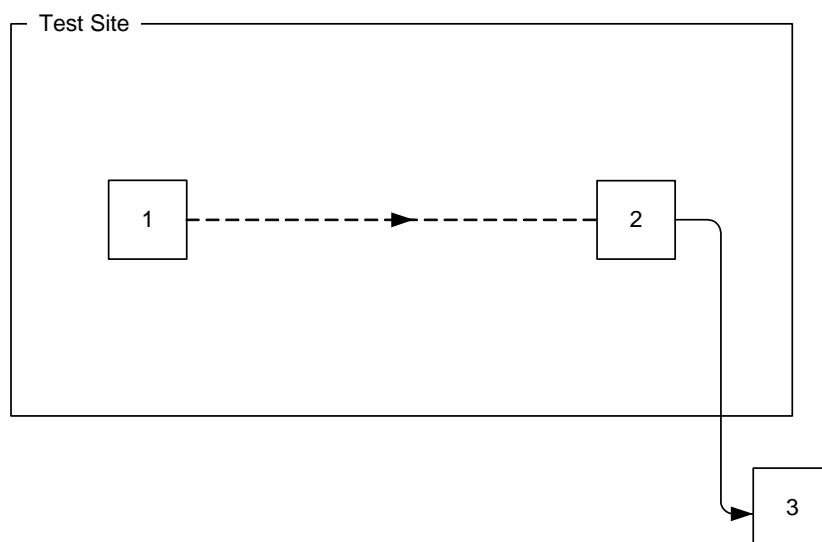

- 1: Transmitter under test.
- 2: Test antenna.
- 3: Spectrum analyser or selective voltmeter (test receiver).

Figure 4: Measurement arrangement

- a) A test site, selected from annex B, which fulfils the requirements of the specified frequency range of this measurement shall be used. The measurement arrangement of figure 3 shall be used. The test antenna shall be orientated initially for vertical polarization unless otherwise stated.

The transmitter under test shall be mounted in a normal installation and switched on preferably in the absence of modulation.

- b) The spectrum analyser or selective voltmeter shall be tuned to the transmitter carrier frequency. The test antenna shall be raised or lowered through the specified height range until the maximum signal level is detected on the spectrum analyser or selective voltmeter.
- c) The transmitter shall be rotated through 360° around a vertical axis until a higher or the "highest" maximum signal is received.
- d) The test antenna shall be raised or lowered again through the specified height range until a maximum is obtained. This level shall be recorded. (This maximum may be a lower value than the value obtainable at heights outside the specified limits).

The test antenna may not need to be raised or lowered if the measurement is carried out on a test site according to clause B.1.1.

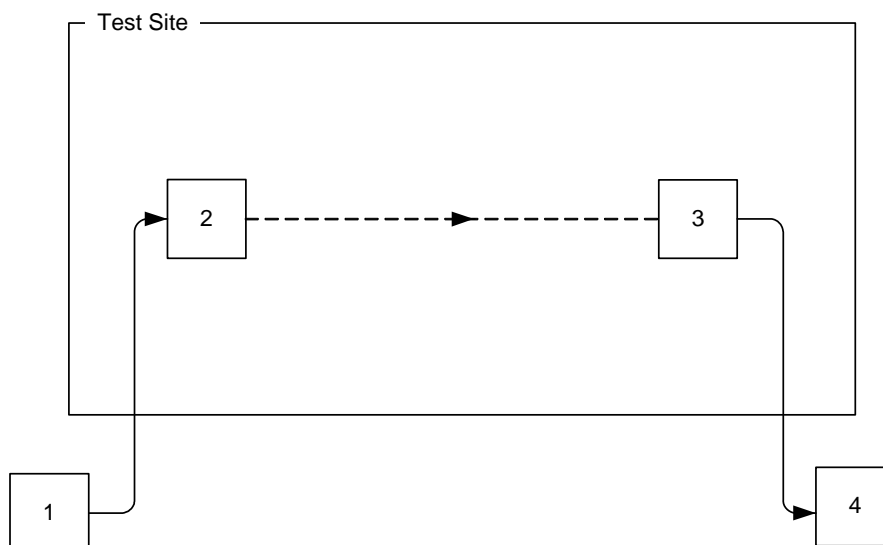

- 1: Signal generator.
 2: Substitution antenna.
 3: Test antenna.
 4: Spectrum analyser or selective voltmeter (test receiver).

Figure 5: Measurement arrangement

- e) Using measurement arrangement of figure 5 the substitution antenna shall replace the transmitter antenna in the same position and in vertical polarization. The frequency of the signal generator shall be adjusted to the transmitter carrier frequency. The test antenna shall be raised or lowered as necessary to ensure that the maximum signal is still received.

The test antenna may not need to be raised or lowered if the measurement is carried out on a test site according to clause B.1.1.

The input signal to the substitution antenna shall be adjusted in level until an equal or a known related level to that detected from the transmitter is obtained in the test receiver.

The value of the maximum effective radiated power of the equipment under test is equal to the power supplied by the signal generator, increased by the known relationship if necessary and after corrections due to the gain of the substitution antenna and the cable loss between the signal generator and the substitution antenna.

- f) Steps b) to e) above shall be repeated with the test antenna and the substitution antenna orientated for horizontal polarization.
- g) The maximum effective radiated power of the equipment under test shall be expressed as the higher of the two values found in step e).

7.2.2.2 Average effective radiated power under normal test conditions

- a) The procedures in steps b) to e) described in clause 7.2.2.1 shall be repeated, except that in step c) the transmitter shall be rotated through 8 positions, 45° apart, starting at the position corresponding to maximum effective radiated power (clause 7.2.2.1 step g)).
- b) The average effective radiated power corresponding to the eight measured values is given by:

$$\text{average radiated power} = \frac{\sum_{n=1}^{n=8} P_n}{8}$$

where P_n is the power corresponding to each position.

7.2.2.3 Method of measurements of maximum and average effective radiated power under extreme test conditions

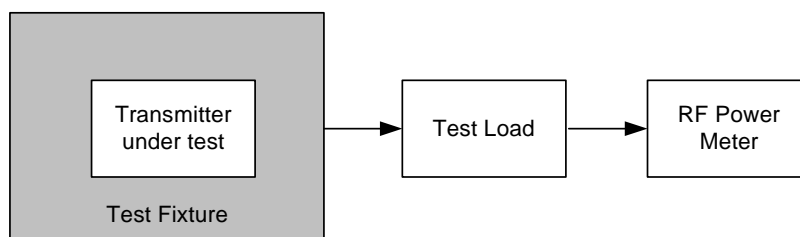

Figure 6: Measurement arrangement

- The measurement shall also be performed under extreme test conditions. Due to the impossibility of repeating the above measurement on a test site under extreme temperature conditions, only a relative measurement is performed, using the test fixture (clause B.4) and the measurement arrangement of figure 6.
- The power delivered to the test load is measured under normal and extreme test conditions, and the difference in dB is recorded. This difference is algebraically added to the average effective radiated power under normal test conditions, in order to obtain the average effective radiated power under extreme test conditions.
- A similar calculation will provide the maximum effective radiated power.
- Additional uncertainties can occur under extreme test conditions due to the calibration of the test fixture.

7.2.3 Limits

7.2.3.1 Effective radiated power under normal test conditions

The maximum effective radiated power under normal test conditions shall be within d_f of the rated maximum effective radiated power.

The average effective radiated power under normal test conditions shall be within d_f of the rated average effective radiated power.

The allowance for the characteristics of the equipment ($\pm 1,5$ dB) shall be combined with the actual measurement uncertainty in order to provide d_f , as follows:

$$d_f^2 = d_m^2 + d_e^2;$$

where:

- d_m is the actual measurement uncertainty;
- d_e is the allowance for the equipment ($\pm 1,5$ dB);
- d_f is the final difference.

All values shall be expressed in linear terms.

In all cases the actual measurement uncertainty shall comply with clause 9.

Furthermore, the maximum effective radiated power shall not exceed the maximum value allowed by the administrations.

Example of the calculation of d_f :

- $d_m = 6$ dB (value acceptable, as indicated in the table of maximum uncertainties, table 8);
= 3,98 in linear terms;
- $d_e = 1,5$ dB (fixed value for all equipment fulfilling the requirements of the present document);

= 1,41 in linear terms;

$$d_f^2 = [3,98]^2 + [1,41]^2;$$

therefore $d_f = 4,22$ in linear terms, or 6,25 dB.

This calculation shows that in this case d_f is in excess of 0,25 dB compared to d_m , the actual measurement uncertainty (6 dB).

7.2.3.2 Effective radiated power under extreme test conditions

The variation of power due to the change of temperature and voltage for the measurements under extreme test conditions shall not exceed +2 dB or -3 dB (the measurements shall be performed using the test fixture).

7.3 Adjacent and alternate channel power

7.3.0 General

This measurement shall be carried out even if the equipment has been tested to the requirements of ETSI EN 300 296 [6].

7.3.1 Definition

The adjacent channel power is that part of the total power output of a transmitter under defined conditions of modulation, which falls within a specified passband centred on the nominal frequency of either of the adjacent channels. This power is the sum of the mean power produced by the modulation, hum and noise of the transmitter.

It is specified either as the ratio expressed in decibels of the carrier power to the adjacent channel power or as the absolute value of the power in the adjacent channel.

7.3.2 Method of measurement

The adjacent channel power may be measured with a power measuring receiver which conforms with the requirements given in annex C.

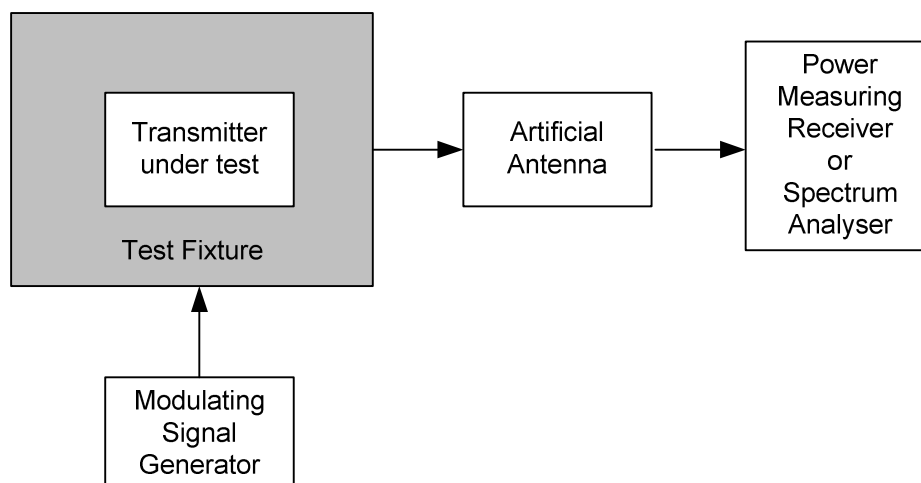

Figure 7: Measurement arrangement

- The transmitter under test shall be placed in the test fixture (clause B.4) connected via the artificial antenna (clause 6.2) to a power measuring receiver calibrated to measure rms power level. The level at the receiver input shall be within its allowed limit. The transmitter shall be operated at the maximum carrier power level available.
- With the transmitter unmodulated, the tuning of the power measuring receiver shall be adjusted so that a maximum response is obtained. This is the 0 dB response point. The power measuring receiver attenuator setting and the reading of the meter shall be recorded.

- c) The tuning of the power measuring receiver shall be adjusted away from the carrier so that its -6 dB response nearest to the transmitter carrier frequency is located at a displacement from the nominal frequency of the carrier as given in table 2 for the adjacent channel.

Table 2: Frequency displacement

Channel separation (kHz)	Specified necessary bandwidth (kHz)	Adjacent channel displacement of the -6 dB point from the nominal carrier frequency (kHz)	Alternate channel displacement of the -6 dB point from the nominal carrier frequency (kHz)
12,5	8,5	8,25	20,75
20	14	13	33
25	16	17	42

The same result may be obtained by tuning the power measuring receiver (point D2 in figure C.2) to the nominal frequency of the adjacent channel, if it has been suitably calibrated.

- d) The transmitter shall be modulated by the test signal D-M2 or D-M4 as appropriate (clause 6.1).
- e) The power measuring receiver variable attenuator shall be adjusted to obtain the same meter reading as in step b) or a known relation to it. This value shall be recorded.
- f) The ratio of adjacent channel power to carrier power is the difference between the attenuator settings in steps b) and e), corrected for any differences in the reading of the meter. Alternatively the absolute value of the adjacent channel power may be calculated from the above ratio and the transmitter carrier power.
- g) Steps c) to f) shall be repeated with the power measuring receiver tuned to the other side of the carrier.
- h) The test shall be repeated for the alternate channels.
- i) For the purpose of equipment which is not capable of producing an unmodulated carrier (clause 7.1), the measurement shall be repeated under extreme test conditions (clauses 5.4.1 and 5.4.2 applied simultaneously).

Alternatively, if a spectrum analyser is being used (see clause C.2) that is capable of measuring rms adjacent channel power automatically, the adjacent channel power (in dB) may be measured directly with the transmitter modulated by normal test signal D-M2 or D-M4, according to clause 6.1. The spectrum analyser shall use a measurement method without frequency weighting and shall not use an accelerated method. The adjacent channel power ratio is the value of the measurement results showing the smallest difference between the power in the pass-band and the power in either adjacent channel.

For automated spectrum analyser measurements the following settings shall be used:

- resolution bandwidth: 500 Hz.
- video bandwidth: 5 000 Hz.
- video average: off.
- detector mode: rms.

Up to 100 individual reading may be averaged, however video average shall not be used.

7.3.3 Limits

For channel separations of 20 kHz and 25 kHz, the adjacent channel power shall not exceed a value of 70,0 dB below the carrier power of the transmitter without the need to be below 0,20 μ W. For channel separations of 12,5 kHz, the adjacent channel power shall not exceed a value of 60,0 dB below the transmitter carrier power without the need to be below 0,20 μ W.

In the case where the equipment is not capable of producing an unmodulated carrier, these measurements shall also be performed under extreme test conditions. Under extreme test conditions, the measured adjacent channel power shall not exceed:

- 65 dB below the carrier for equipment with channel separations of 20 kHz and 25 kHz; and

- 55 dB for channel separations of 12,5 kHz;

without the need to be below 0,20 μ W.

7.4 Radiated unwanted emissions in the spurious domain

7.4.0 General

This measurement need not be carried out on equipment which is simultaneously submitted for approval to the requirements of ETSI EN 300 296 [6] and of the present document, if the data part is operational while making the corresponding test in ETSI EN 300 296 [6].

7.4.1 Definition

Spurious emissions are emissions at frequencies, other than those of the carrier and sidebands associated with normal modulation, radiated by the antenna and by the cabinet of the transmitter.

They are specified as the radiated power of any discrete signal.

7.4.2 Method of measurement

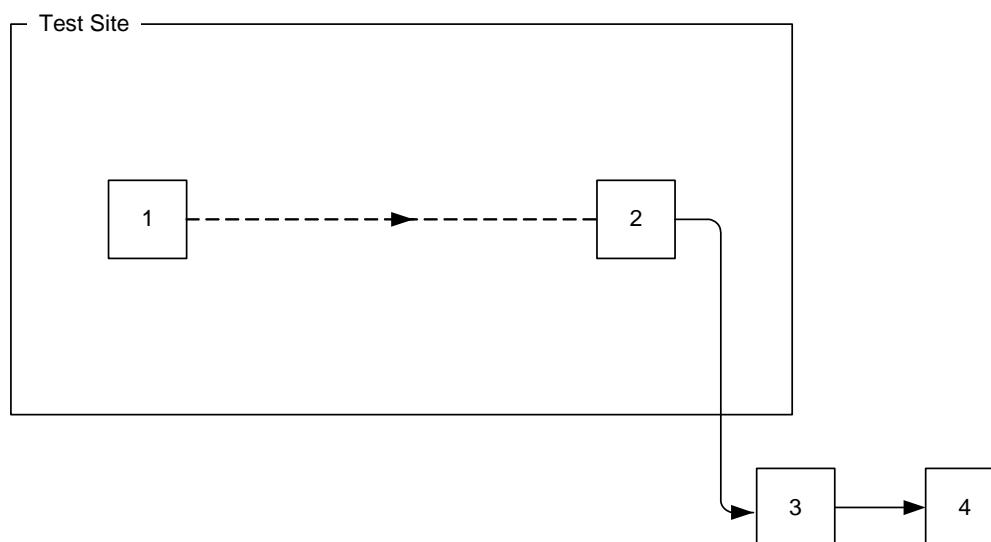

- 1: Transmitter under test.
- 2: Test antenna.
- 3: High "Q" (notch) or high pass filter.
- 4: Spectrum analyser or selective voltmeter (test receiver).

Figure 8: Measurement arrangement

- a) A test site, fulfilling the requirements of annex B over the specified frequency range of this measurement shall be used. The test antenna shall be orientated initially for vertical polarization and connected to a spectrum analyser or a selective voltmeter, through a suitable filter to avoid overloading of the spectrum analyser or selective voltmeter. The bandwidth of the spectrum analyser or selective voltmeter shall be between 10 kHz and 100 kHz, set to a suitable value to correctly perform the measurement.

For the measurement of spurious emissions below the second harmonic of the carrier frequency the filter used shall be a high "Q" (notch) filter centred on the transmitter carrier frequency and attenuating this signal by at least 30 dB.

For the measurement of spurious emissions at and above the second harmonic of the carrier frequency the filter used shall be a high pass filter with a stop band rejection exceeding 40 dB. The cut-off frequency of the high pass filter shall be approximately 1,5 times the transmitter carrier frequency.

The transmitter under test shall be placed on the support in its standard position and shall be switched on without modulation.

If an unmodulated carrier cannot be obtained then the measurements shall be made with the transmitter modulated by the test signal D-M2 or D-M4 as appropriate (clause 6.1) in which case this fact shall be recorded in the test report.

- b) The radiation of any spurious emission shall be detected by the test antenna and spectrum analyser or selective voltmeter over the frequency range 30 MHz to 4 GHz, except for the channel on which the transmitter is intended to operate and its adjacent channels. In addition, for equipment operating on frequencies above 470 MHz, measurements shall be repeated over the frequency range 4 GHz to 12,75 GHz. The frequency of each spurious emission detected shall be recorded. If the test site is disturbed by interference coming from outside, this qualitative search may be performed in a screened room, with a reduced distance between the transmitter and the test antenna.
- c) At each frequency at which an emission has been detected, the spectrum analyser or selective voltmeter shall be tuned and the test antenna shall be raised or lowered through the specified height range until the maximum signal level is detected on the spectrum analyser or selective voltmeter.
- d) The transmitter shall be rotated through 360° around a vertical axis, until a higher maximum signal is received.
- e) The test antenna shall be raised or lowered again through the specified height range until a maximum is obtained. This signal level shall be recorded.

The test antenna may not need to be raised or lowered if the measurement is carried out on a test site according to clause B.1.1.

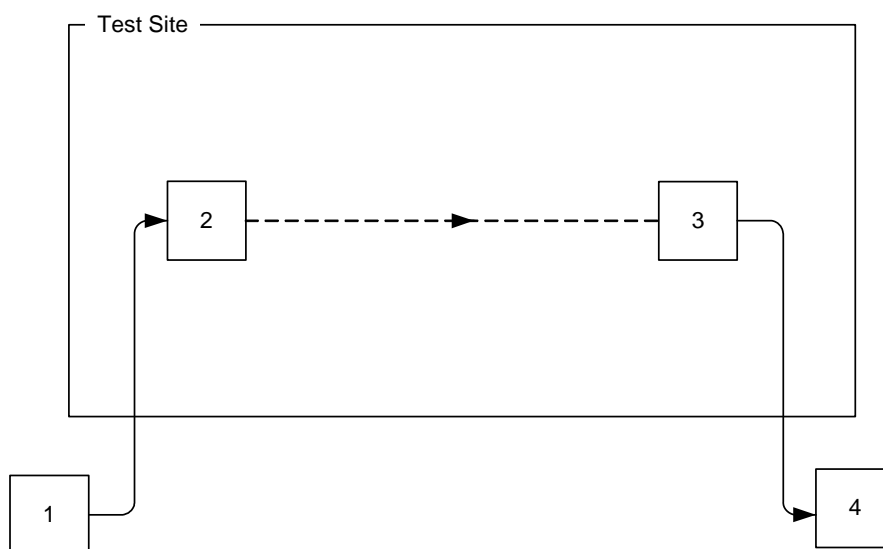

- 1: Signal generator.
- 2: Substitution antenna.
- 3: Test antenna.
- 4: Spectrum analyser or selective voltmeter (test receiver).

Figure 9: Measurement arrangement

- f) Using the measurement arrangement of figure 9, the substitution antenna shall replace the transmitter antenna in the same position and in vertical polarization. It shall be connected to the signal generator.
- g) At each frequency at which an emission has been detected, the signal generator, substitution antenna and spectrum analyser or selective voltmeter shall be tuned to the emission frequency. The test antenna shall be raised or lowered through the height range until the maximum signal level is detected on the spectrum analyser or selective voltmeter.

The test antenna may not need to be raised or lowered if the measurement is carried out on a test site according to clause B.1.1.

The level of the signal generator giving the same signal level on the spectrum analyser or selective voltmeter as in item e) above shall be recorded. This value, after corrections due to the gain of the substitution antenna and the cable loss between the signal generator and the substitution antenna, is the radiated spurious emission at this frequency.

The resolution bandwidth of the measuring instrument shall be the smallest bandwidth available which is greater than the spectral width of the spurious component being measured.

- h) Steps c) to g) above shall be repeated with the test antenna orientated for horizontal polarization.
- i) Steps c) to h) above shall be repeated with the transmitter in stand-by condition if this option is available.

7.4.3 Limits

The power of any radiated spurious emission shall not exceed the values given in table 3a.

Table 3a: Radiated spurious emissions

Frequency range	Tx operating	Tx standby
30 MHz to 1 GHz	0,25 μ W (-36,0 dBm)	2,0 nW (-57,0 dBm)
above 1 to 12,75 GHz	1,00 μ W (-30,0 dBm)	20,0 nW (-47,0 dBm)

The reference bandwidths used shall be as stated in tables 3b and 3c.

Table 3b: Reference bandwidths to be used for the measurement of spurious emission

Frequency range	RBW
30 MHz to 1 GHz	100 kHz
1 GHz to 12,75 GHz	1 MHz

Table 3c: Reference bandwidths to be used close to the wanted emission

Frequency offset from carrier	RBW
250 % of the CSP to 100 kHz	1 kHz
100 kHz to 500 kHz	10 kHz

7.5 Transmitter attack time

7.5.0 General

This measurement does not apply to transmitters intended for continuous transmission only.

7.5.1 Definition

The transmitter attack time (t_a) is the time which elapses between the initiation of the "transmitter on" function (Tx_{on}) and:

- a) the moment when the transmitter output power has reached a level 1 dB below or 1,5 dB above the steady state power (P_c) and maintains a level within +1,5 dB/-1 dB from P_c thereafter as seen on the measuring equipment or in the power plot as a function of time; or
- b) the moment after which the frequency of the carrier always remains within ± 1 kHz of its steady state frequency (F_c) as seen on the measuring equipment or the frequency plot as a function of time;

whichever occurs later (clause 7.7.2, figures 10 and 11).

The measured value of t_a is t_{am} ; its limit is t_{al} .

The choice of conditions for b), above, is made in order to make the method of measurement easier to perform and to have good repeatability. Normally under these conditions, the frequency of the carrier will be within the frequency tolerance of the steady state (df_c), a few ms after the end of the attack time as defined in b) above.

7.5.2 Method of measurement

The measurement procedure shall be as follows:

- a) The transmitter under test shall be placed in the test fixture connected to a RF detector and to a test discriminator via a matched test load. The attenuation of the test load shall be chosen in such a way that the input of the test discriminator is protected against overload and the limiter amplifier of the test discriminator operates correctly in the limiting range as soon as the transmitter carrier power (before attenuation) exceeds 1 mW.

A dual trace storage oscilloscope (or a transient recorder) records the amplitude transient from the detector on a logarithmic scale and the frequency transient from the discriminator.

A trigger device may be required to ensure that the start of the sweep of the oscilloscope timebase occurs the instant at which the "transmitter on" function is initiated.

The measuring arrangement is shown in figure 13 of clause 7.7.3.2.

A spectrum analyser and a test discriminator/storage oscilloscope can also be used.

- b) The traces of the oscilloscope shall be calibrated in power and frequency (y-axis) and in time (x-axis), using the signal generator.
- c) The transmitter attack time shall be measured by direct reading on the oscilloscope while the transmitter is preferably unmodulated.

7.5.3 Limits

The time t_{am} (measured transmitter attack time) shall not exceed t_{al} (the attack time limit) of 25 ms.

7.6 Transmitter release time

7.6.0 General

This measurement does not apply to transmitters intended for continuous transmission only.

7.6.1 Definition

The transmitter release time (t_r) is the time which elapses between the initiation of the "transmitter off" function ($T_{x_{off}}$) and the moment when the transmitter output power has reduced to a level 50 dB below the steady state power (P_c) and remains below this level thereafter as seen on the measuring equipment or in the power plot as a function of time (clause 7.7.2, figure 12).

The measured value of t_r is t_{rm} ; its limit is t_{rl} .

7.6.2 Method of measurement

The measurement procedure shall be as follows:

- a) The transmitter under test shall be placed in the test fixture connected to a RF detector and to a test discriminator via a matched test load. The attenuation of the test load shall be chosen in such a way that the input of the test discriminator is protected against overload and the limiter amplifier of the test discriminator operates correctly in the limiting range as long as the transmitter carrier power (before attenuation) exceeds 1 mW.

A dual trace storage oscilloscope (or a transient recorder) records the amplitude transient from the detector on a logarithmic scale and the frequency transient from the discriminator. A trigger device may be required to ensure that the start of the sweep of the oscilloscope timebase occurs the instant at which the "transmitter off" function is initiated. If the transmitter possesses an automatic powering down facility (e.g. in the case of fixed length message transmission), it may replace the trigger device for starting the sweep of the oscilloscope.

The measuring arrangement is shown in figure 13 of clause 7.7.3.2.

A spectrum analyser and a test discriminator/storage oscilloscope can also be used as shown in figure 13.

- b) The traces of the oscilloscope shall be calibrated in power and frequency (y-axis) and in time (x-axis) by replacing the transmitter and test load by the signal generator.
- c) The transmitter release time shall be measured by direct reading on the oscilloscope while the transmitter is preferably unmodulated.

7.6.3 Limits

The time t_{tm} (measured transmitter release time) shall not exceed t_{tl} (the release time limit) of 20 ms.

7.7 Transient behaviour of the transmitter

7.7.0 General

Limitations of the transmitter attack and release times (clauses 7.5 and 7.6) are intended to improve the spectrum efficiency. The attack and release times can also be used to allow the definition of the timings in the protocols.

The measurements of transient behaviour are intended to ensure that the transmitter will not cause harmful interference in the other channels when the operating frequency is outside the tolerance of the steady state (df_e).

The method of measurement results in particular in:

- the drawing of plots of "carrier power as a function of time" and "carrier frequency as a function of time";
- the evaluation of the slopes of those plots between predetermined points;
- the measurement of the transient power in the adjacent channels.

This measurement does not apply to transmitters intended for continuous transmission only.

7.7.1 Definitions

The transient behaviour of the transmitter is defined as the time-dependency of transmitter frequency, power and adjacent channel transmitter power when the RF output power is switched on and off.

The following powers, frequencies, frequency tolerances and transient times are specified:

- P_o rated power;
- P_c steady state power;
- P_a adjacent channel transient power. This is the transient power falling into the adjacent channels due to switching the transmitter on and off (clause 7.7.3.3);
- F_o nominal carrier frequency;
- F_c steady state carrier frequency;
- df frequency difference (relative to F_c) or frequency error (absolute) (clause 7.1.1) of the transmitter;
- df_e limit of the frequency error (df) in the steady state (clause 7.1.3);
- df_0 limit of the frequency difference (df) equal to 1 kHz; if it is impossible to switch off the transmitter modulation one half channel separation is added;
- df_c limit of the frequency difference (df) during the transient, equal to one half channel separation; while the frequency difference is less than df_c , the carrier frequency remains within the boundaries of the allocated channel; if it is impossible to switch off the transmitter modulation another half channel separation is added;

$T_{x_{on}}$ time at which the final irrevocable logic decision to power on the transmitter is taken. If an access point is unavailable then the time after which the carrier power exceeds ($P_c - 50$ dB) may be taken. This fact shall be recorded in the test report.

The power starts to rise somewhere between $T_{x_{on}}$ and t_{on} (RF-power on).

t_{on} time when the carrier power, exceeds $P_c - 30$ dB;

t_p period of time starting at t_{on} and finishing when the power reaches $P_c - 6$ dB;

t_{am} transmitter attack time as defined in clause 7.5.1;

t_{al} limit of t_{am} as given in clause 7.5.3;

$T_{x_{off}}$ time at which the final irrevocable logic decision to power off the transmitter is taken. If an access point is unavailable then the time after which the carrier power remains below ($P_c - 3$ dB) may be taken. This fact shall be recorded in the test report;

The power starts to decrease somewhere between $T_{x_{off}}$ and the moment when $P_c - 6$ dB is reached (RF-power off).

t_{off} time when the carrier power falls below $P_c - 30$ dB;

t_d period of time starting when the power falls below $P_c - 6$ dB and finishing at t_{off} ;

t_{rm} transmitter release time as defined in clause 7.6.1, after which the power remains below $P_c - 50$ dB;

t_{rl} limit of t_{rm} as given in clause 7.6.3.

If use is made of a synthesizer and/or a PLL system, for determining the transmitter frequency, then the transmitter shall be inhibited when synchronization is absent or in the case of PLL, when the loop system is not locked.

7.7.2 Timings, frequencies and powers

Figures 10, 11 and 12 represent the timings, frequencies and powers as defined in clauses 7.5.1, 7.6.1 and 7.7.1.

The corresponding limits are given in clauses 7.5.3, 7.6.3 and 7.7.4.

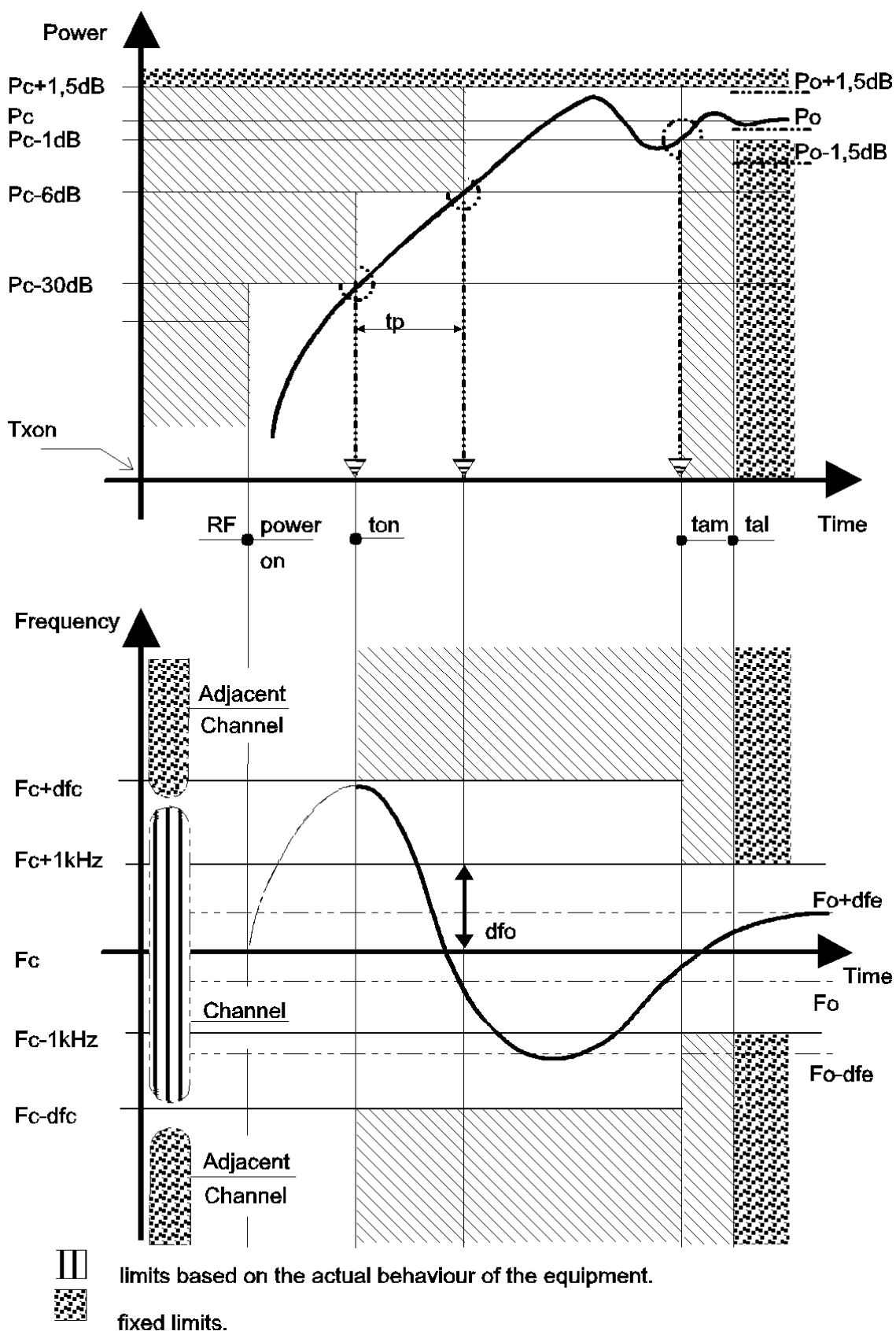

Figure 10: Transmitter attack time according to clause 7.5.1 a) and transient behaviour during switch-on (case where the attack time is given by the behaviour of the power rise)

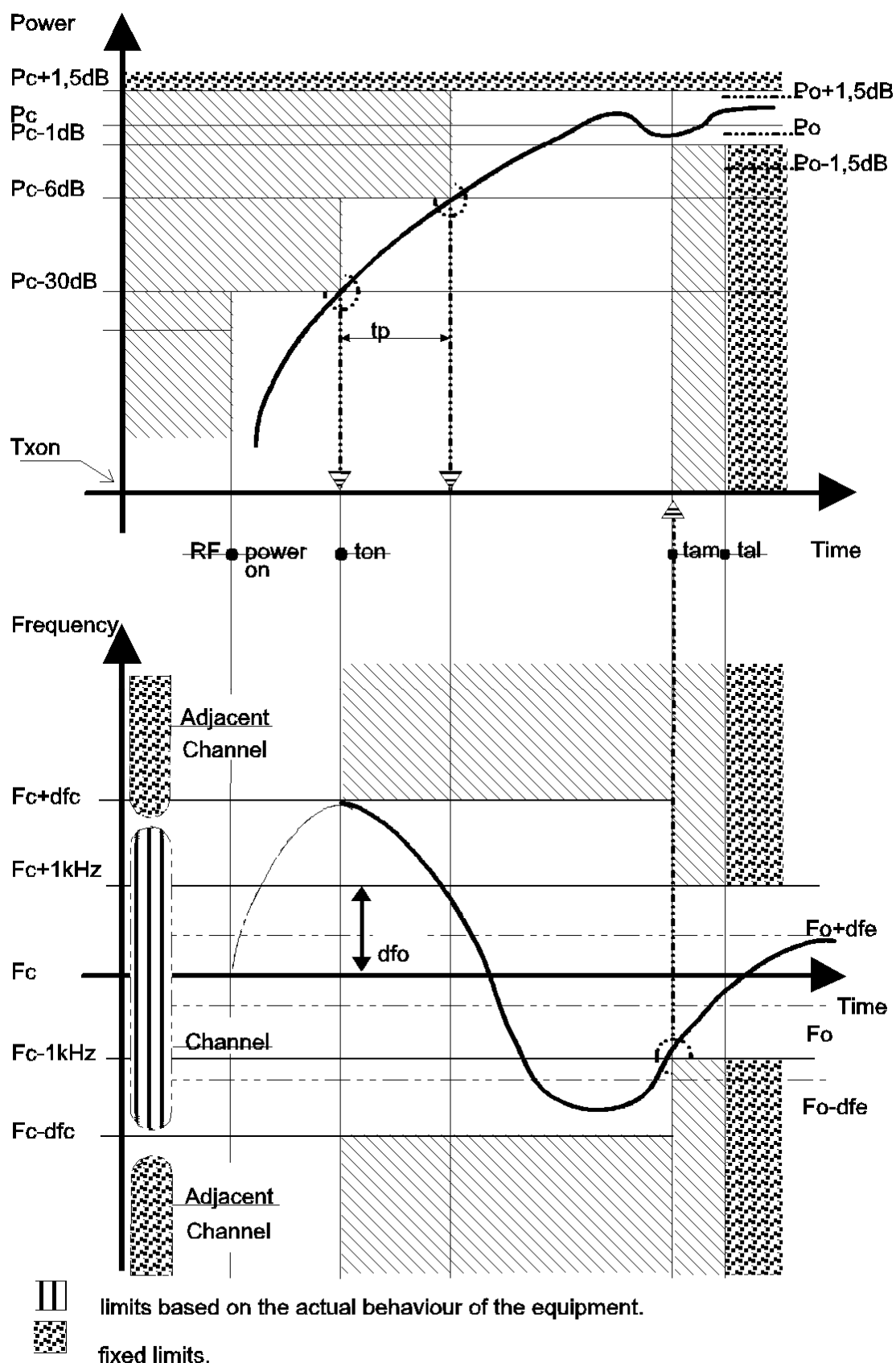

Figure 11: Transmitter attack time according to clause 7.5.1 b) and transient behaviour during switch-on (case where the attack time is given by the behaviour of the frequency)

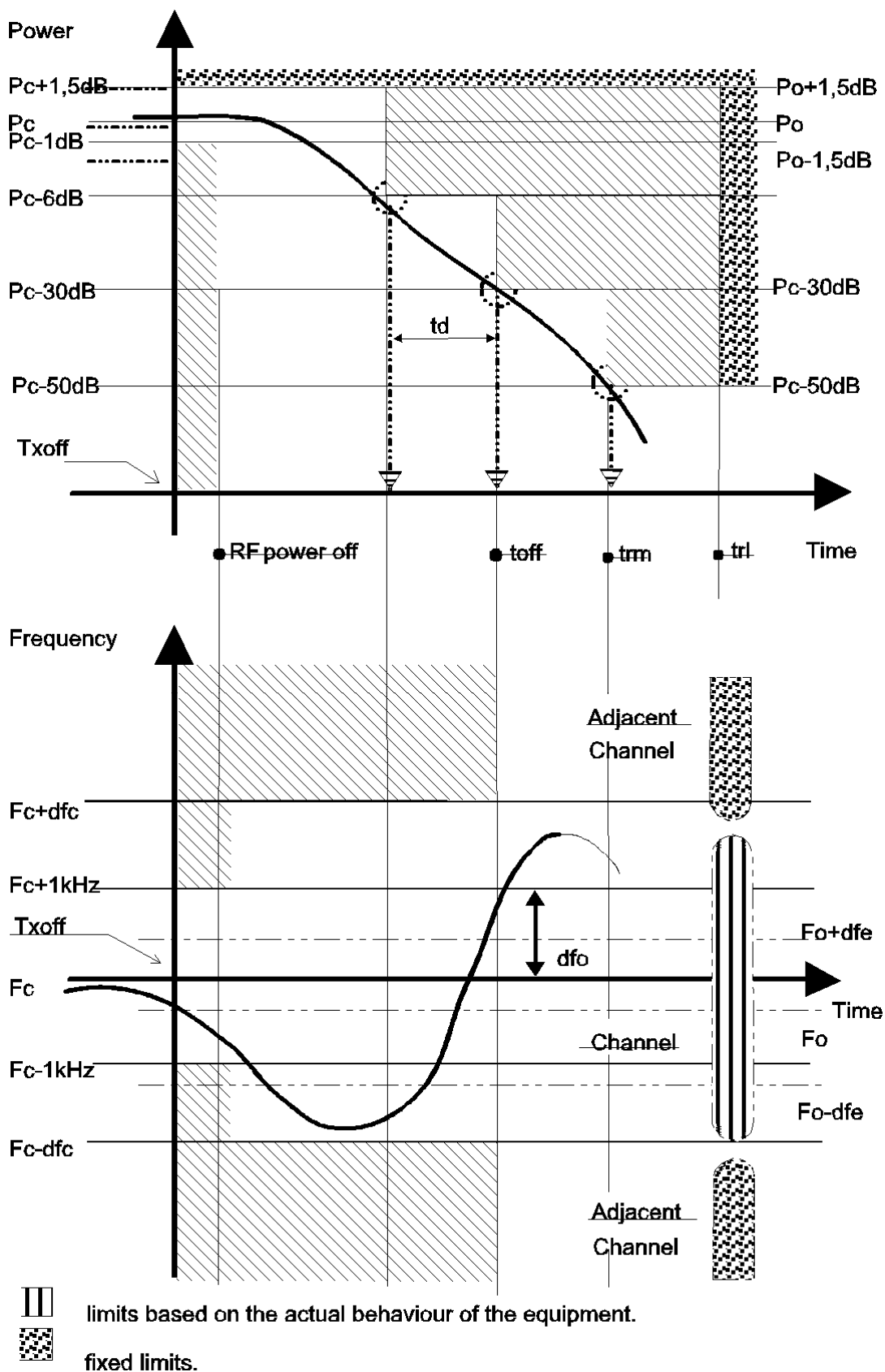

Figure 12: Transmitter release time according to clause 7.6.1 and transient behaviour, during switch-off

7.7.3 Methods of measurement

7.7.3.0 General

The transmitter shall be placed in the test fixture (clause B.4).

The transient timings (switch on/switch off) and the frequency differences occurring during these periods of time can be measured by means of a spectrum analyser and a test discriminator which meets the requirements indicated in clause 7.7.3.2. The corresponding limits are given in clause 7.7.4.

The power impairing the operation on the adjacent channels can be measured using an appropriate transient power measuring device which meets the requirements of clause 7.7.3.4.

7.7.3.1 Time and frequency domain analysis measurements

The measurement shall be performed with the transmitter unmodulated if possible. If the transmitter cannot be operated unmodulated, the measurement shall be performed with modulation and this fact shall be recorded in the test report.

The transmitter under test shall be placed in the test fixture and connected to the test set-up as shown in figure 13.

The calibration of the test set-up shall be checked. The output of the test fixture shall be connected to the input of the spectrum analyser and test discriminator via a power splitter and attenuator(s).

The attenuation of the power attenuators shall be chosen in such a way that the input of the test equipment is protected against overload and that the limiter amplifier of the test discriminator operates correctly in the limiting range when the power conditions of clause 7.7.1 are reached.

The spectrum analyser is set to measure and display power as a function of time ("zero span mode").

The test discriminator shall be calibrated. This may be carried out by feeding RF voltages from a signal generator with defined frequency differences from the nominal frequency of the transmitter.

By appropriate means, a triggering pulse is generated for the test equipment when the Tx_{on} function or the Tx_{off} function are activated.

The "RF power on" and the "RF power off" can be monitored.

The voltage occurring at the test discriminator output shall be recorded as a function of time in correspondence with the power level on a storage device or a transient recorder. This voltage is a measure of the frequency difference. The elapsed periods of time during the frequency transient can be measured using the time base of the storage device. The output of the test discriminator is valid only after t_{on} and before t_{off} .

7.7.3.2 Test arrangement and characteristics of the test discriminator

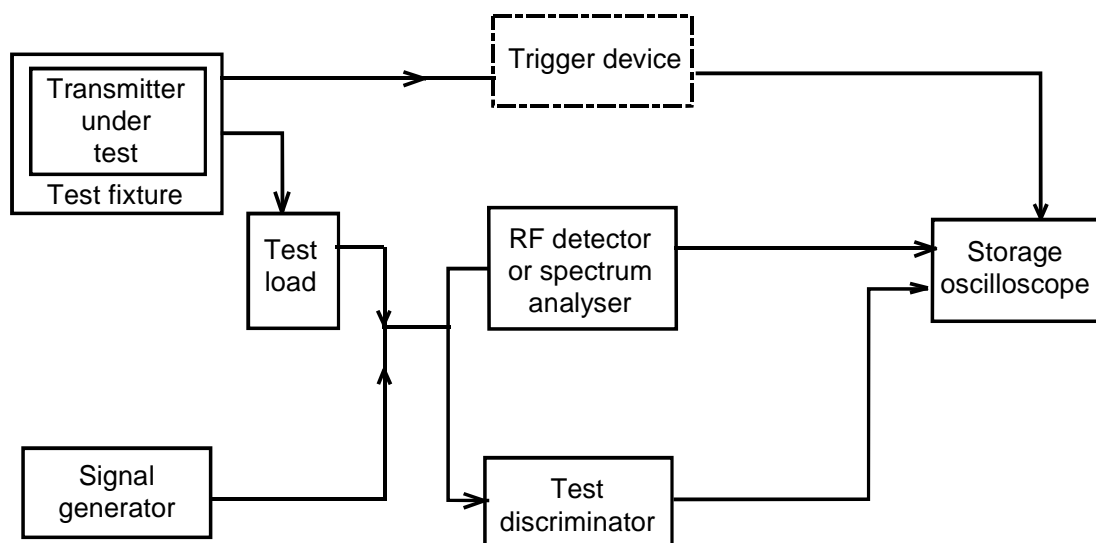

Figure 13: Test arrangement for transient behaviour of transmitter power and frequency, including transmitter attack and release time

The test discriminator may consist of a mixer and a local oscillator (providing the auxiliary frequency) used to convert the transmitter frequency to be measured into the frequency fed to the (broadband) limiter amplifier and the associated broadband discriminator:

- the test discriminator shall be sensitive enough to measure input signals down to $P_c - 30$ dB;
- the test discriminator shall be fast enough to display the frequency deviations (approximately 100 kHz/100 μ s);
- the test discriminator output shall be dc coupled.

7.7.3.3 Adjacent channel transient power measurements

The transmitter under test shall be placed in the test fixture (clause B.4) and connected via the power attenuator to the "adjacent channel transient power measuring device" as described in clause 7.7.3.4, so that the level at its input shall be between zero and -10 dBm when the transmitter power is P_c .

- a) The transmitter shall preferably be unmodulated and operated at the maximum power level available under normal test conditions. If an unmodulated carrier cannot be obtained this fact shall be recorded in the test report.
- b) The tuning of the "transient power measuring device" shall be adjusted so that a maximum response is obtained. This is the 0 dBc reference level.
- c) The tuning of the "transient power measuring device" shall be adjusted away from the carrier so that its -6 dB response nearest to the transmitter carrier frequency is located at a displacement from the nominal carrier frequency as given in table 4.

Table 4: Frequency displacement

Channel separation (kHz)	Displacement (kHz)
12,5	8,25
20	13
25	17

- d) The transmitter shall be switched on.

- e) The spectrum analyser shall be used to record the first 35 ms of the envelope of the transient power as a function of time. The peak envelope transient power shall be recorded in dBc.
- f) The transmitter shall be switched off.
- g) The spectrum analyser shall be used to record the first 35 ms of the envelope of the transient power as a function of time. The peak envelope transient power shall be recorded in dBc.
- h) Steps c) to g) shall be repeated with the "transient power measuring device" tuned to the other side of the carrier.
- i) The transient power in the adjacent channel during the attack and release times is the dBc value corresponding to the highest of the four powers recorded for the adjacent channels in steps e) and g).

7.7.3.4 Characteristics of the adjacent channel transient power measuring device

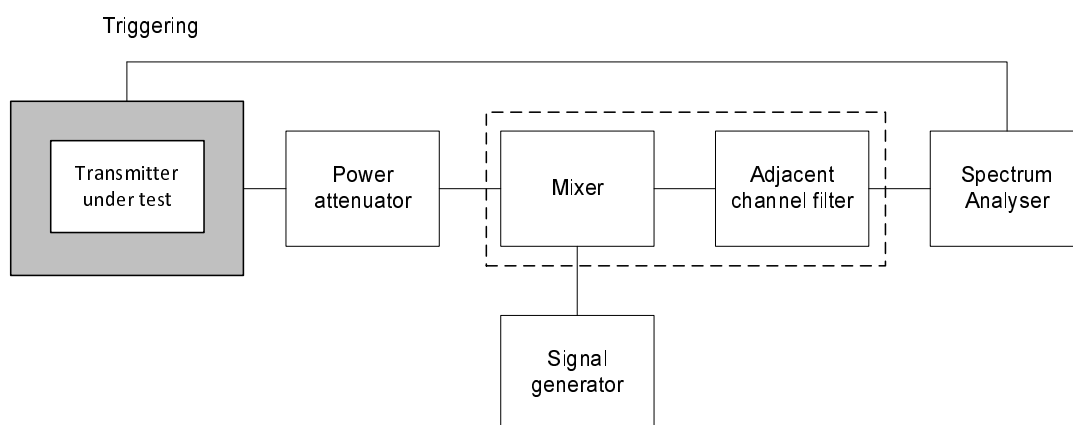

Figure 14: Adjacent channel transient power measuring device measurement arrangement

The adjacent channel transient power measuring device shall be as follows:

- mixer: 50 Ω balanced diode mixer; with an appropriate local oscillator level, for example +7 dBm;
- adjacent channel filter: matched to 50 Ω (annex C);
- spectrum analyser: 100 kHz bandwidth, peak detection, or power/time measurement provision.

7.7.4 Limits

7.7.4.1 Time domain analysis of power and frequency

The plots of carrier power and carrier frequency as a function of time, covering in an appropriate way the transients, shall be included in the test report.

At any time when the carrier power is above the steady-state power (P_c) -30 dB, the carrier frequency shall remain within half a channel separation (df_c) from the steady carrier frequency (F_c).

The slopes of the plots corresponding to both attack and release times, shall be such that:

- $t_p \geq 0,20$ ms and $t_d \geq 0,20$ ms, for attack and release time (clause 7.7.1);
- between the P_c -30 dB point and the P_c -6 dB point, both in the case of attack and release time, the sign of the slope shall not change.

7.7.4.2 Adjacent channel transient power

The transient power, in the adjacent channels shall not exceed a value of:

- 60,0 dB below the carrier power of the transmitter (dBc) without the need to be below 2 μ W (-27,0 dBm) for channel separations of 20 and 25 kHz;
- 50,0 dBc without the need to be below 2 μ W (-27 dBm), for a channel separation of 12,5 kHz.

8 Technical characteristics of the receiver

8.1 Average usable sensitivity (field strength, data or messages)

8.1.1 Definition

The average usable sensitivity (data) expressed as field strength is the average field strength, expressed in dB μ V/m, produced by a carrier at the nominal frequency of the receiver, modulated with the normal test signal (clause 6.1) which will, without interference, produce after demodulation a data signal with a specified bit error ratio or a specified successful message ratio. The specified bit error ratio is 10^{-2} . The specified successful message ratio is 80 %. The average is calculated from 8 measurements of field strength where the receiver is rotated in 45° increments starting at an arbitrary orientation.

NOTE: The average usable sensitivity mostly differs only by a small amount from the maximum usable sensitivity to be found in a particular direction. This is due to the properties of the averaging process as used in the formula in clauses 8.1.2 step i) and 8.1.4 step i). For instance, an error not exceeding 1,2 dB can be found if the sensitivity is equal in seven directions and is extremely poor in the eighth direction. For the same reason the starting direction (or angle) can be selected randomly.

8.1.2 Method of measurement with continuous bit streams under normal test conditions

Arrangements shall be made by the supplier to couple the equipment under test to the bit error measuring device by a method which does not affect the radiated field (also clause 6.9.3.1).

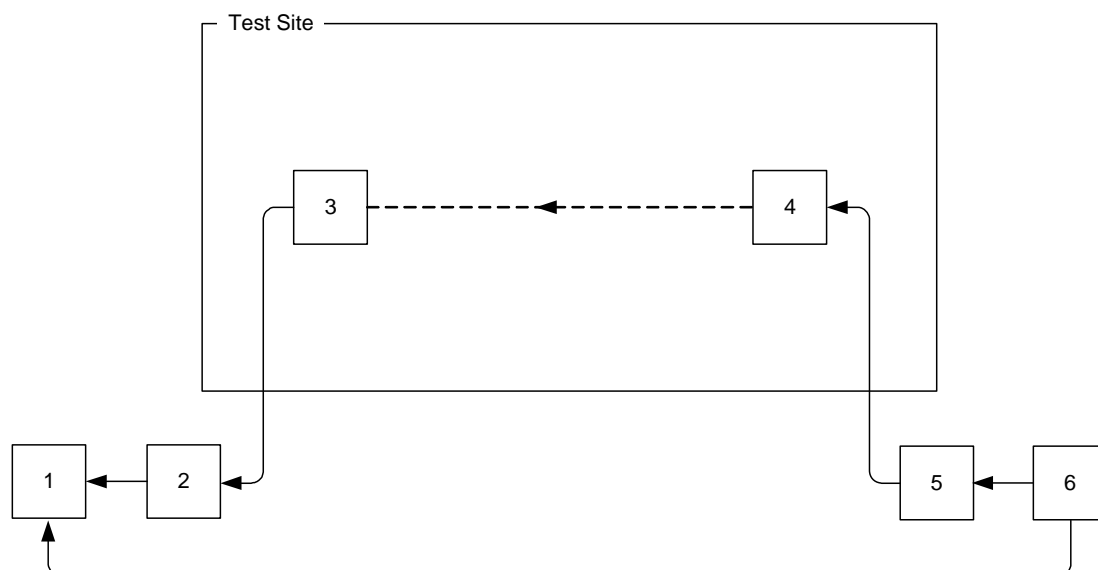

- 1: Bit error measuring test set.
- 2: Photo detector/acoustic coupler.
- 3: Receiver under test.
- 4: Test antenna.
- 5: Signal generator.
- 6: Bit stream generator.

Figure 15: Measurement arrangement

A test site which fulfils the requirements of annex B for the specified frequency range of this measurement shall be used. The test antenna shall be orientated for vertical polarization or for the polarization in which the equipment under test is intended to operate.

The equipment under test shall be placed on the support in its standard position and in a random orientation. The raw bit stream produced by the receiver shall be monitored, preferably via a photo detector or an acoustic coupler (clause B.3) in order to avoid disturbing the electromagnetic field in the vicinity of the equipment:

- a) A signal generator shall be connected to the test antenna.
The signal generator shall be at the nominal frequency of the receiver and shall have the normal test signal D-M2 (clause 6.1).
- b) The bit pattern of the modulating signal shall be compared to the bit pattern provided by the receiver after demodulation, in order to obtain the bit error ratio.
- c) The level of the signal generator shall be adjusted until a bit error ratio of approximately 10^{-1} is obtained.
- d) The test antenna shall be raised or lowered through the specified height range to find the lowest bit error ratio.
The test antenna may not need to be raised or lowered if a test site according to clause B.1.2 is used, or if the ground floor reflection can effectively be eliminated.
- e) The level of the signal generator shall be re-adjusted until a bit error ratio of 10^{-2} is obtained.
- f) The minimum signal generator level from step d) shall be recorded.
- g) Steps c) to f) shall be repeated for the remaining seven positions of the receiver 45° apart.
- h) The eight field strengths X_n ($n = 1..8$) in $\mu\text{V}/\text{m}$ corresponding to the levels of the signal generator recorded above shall be calculated and recorded.

- j) The average usable sensitivity expressed as field strength E_{mean} (dB μ V/m) is given by:

$$E_{mean} = 20 \log \left(\sqrt{\frac{8}{\sum_{n=1}^{n=8} \frac{1}{X_n^2}}} \right)$$

where X_n represents each of the eight field strengths calculated in step h).

- k) The reference direction is defined as the direction at which the maximum sensitivity (i.e. corresponding to the minimum field strength recorded during the measurement) occurred during the eight position measurement.

The corresponding direction, height (where applicable) and this reference field strength value shall be recorded.

8.1.3 Method of measurement with continuous bits streams under extreme test conditions

Using the test fixture in the measurement arrangement of figure 16, the measurement of the average usable sensitivity with continuous bit streams shall also be performed under extreme test conditions.

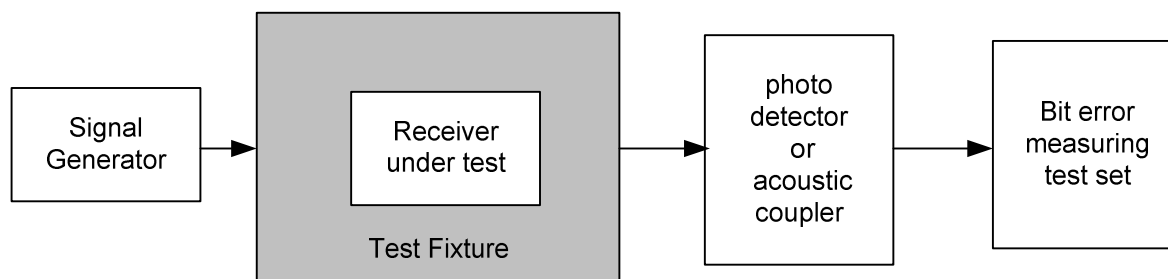

Figure 16: Measurement arrangement

The test signal input level providing a bit error ratio of 10^{-2} shall be determined under extreme and under normal test conditions and the difference in dB shall be calculated. This difference shall be added to the average usable sensitivity to radiated fields expressed in dB μ V/m, as calculated in clause 8.1.2 step i), under normal test conditions, to obtain the sensitivity under extreme test conditions.

8.1.4 Method of measurement with messages under normal test conditions

Arrangements shall be made by the supplier to couple the equipment under test to the message measuring device by a method which does not affect the radiated field (clause 6.9.3.2).

A test site which fulfils the requirements for the specified frequency range of this measurement shall be used. The test antenna shall be orientated for vertical polarization or for the polarization in which the equipment under test is intended to operate.

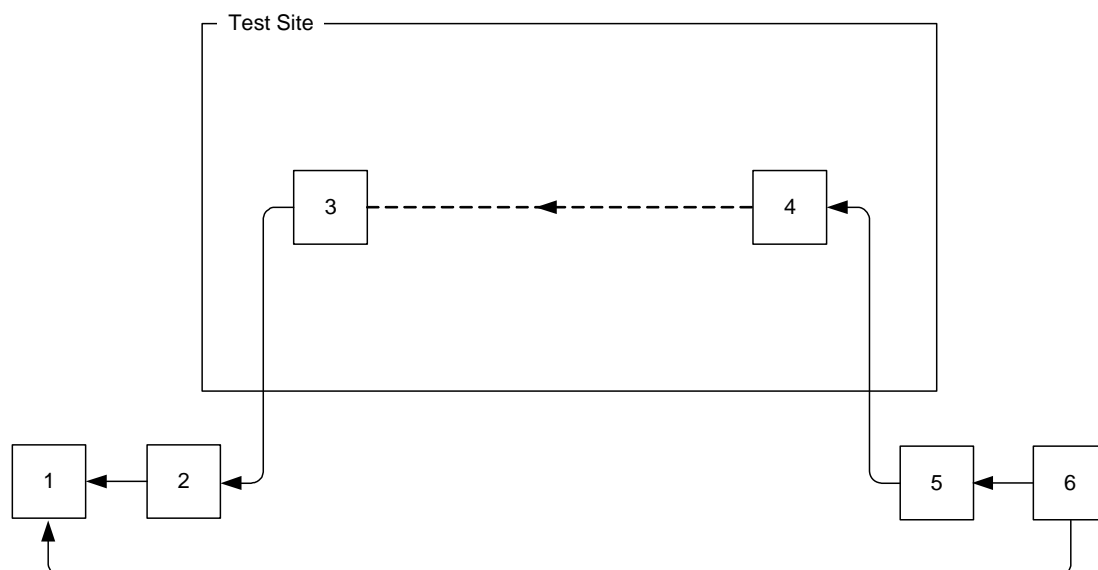

- 1: Message measuring test set.
- 2: Photo detector/acoustic coupler.
- 3: Receiver under test.
- 4: Test antenna.
- 5: Signal generator.
- 6: Message generator.

Figure 17: Measurement arrangement

The equipment under test shall be placed on the support in its standard position and in a random orientation. A message measuring device shall be coupled to the receiver, preferably via a photo detector or an acoustic coupler (clause B.3) in order to avoid disturbing the electromagnetic field in the vicinity of the equipment:

- a) A signal generator shall be connected to the test antenna.

The signal generator shall be at the nominal frequency of the receiver and shall have the normal test modulation (clause 6.1).

- b) The level of the signal generator shall be adjusted until a successful message ratio of less than 10 % is obtained.

- c) The test antenna shall be raised or lowered through the specified height range to find the maximum successful message ratio.

The test antenna may not need to be raised or lowered if a test site according to clause B.1.1 is used, or if the ground floor reflection can effectively be eliminated.

The level of the test signal shall be re-adjusted to produce the successful message ratio specified in step b).

- d) The minimum signal generator level from step c) shall be recorded.
- e) The normal test signal shall be transmitted repeatedly whilst observing in each case whether or not a message is successfully received.

The level of the test signal shall be increased by 2 dB for each occasion that a message is not successfully received.

The procedure shall be continued until three consecutive messages are successfully received.

This level as the minimum signal generator level in this direction shall be recorded.

- f) The level recorded in step e) shall be reduced by 1 dB and the new value shall also be recorded.

The normal test signal (clause 6.1) shall then be transmitted 20 times. In each case, if a message is not successfully received, the level shall be increased by 1 dB and the new value recorded.

If a message is successfully received, the level shall not be changed until three consecutive messages have been successfully received.

In this case, the level shall be reduced by 1 dB and the new value recorded.

No signal level shall be recorded unless preceded by a change in level.

The average of the values recorded corresponds to the successful message ratio of 80 %. It shall be used to calculate the field strength associated with each position in step h).

- g) Steps b) to f) above shall be repeated for the remaining seven positions (45° apart) of the receiver.
- h) The eight field strengths X_n ($n = 1..8$) in $\mu\text{V}/\text{m}$ corresponding to the above average values shall be calculated and recorded.
- i) The average usable sensitivity expressed as field strength E_{mean} ($\text{dB}\mu\text{V}/\text{m}$) is given by:

$$E_{\text{mean}} = 20 \log \left(\sqrt{\frac{8}{\sum_{n=1}^{n=8} \frac{1}{X_n^2}}} \right)$$

where X_n represents each of the eight field strengths calculated in step h).

- j) The reference direction is defined as the direction at which the maximum sensitivity (i.e. corresponding to the minimum field strength recorded during the measurement) occurred during the eight position measurement.

The corresponding direction, height (where applicable) and this reference field strength value shall be recorded.

8.1.5 Method of measurement with messages under extreme test conditions

Using the test fixture in the measurement arrangement of figure 18, the measurement of the average usable sensitivity with messages shall also be performed under extreme test conditions.

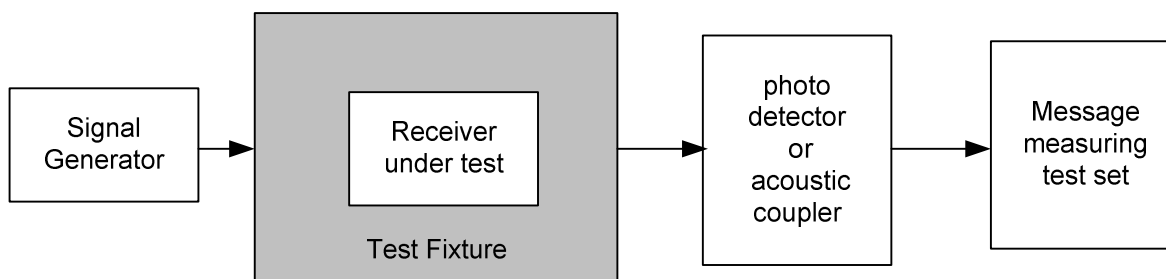

Figure 18: Measurement arrangement

The test signal input level providing a successful message ratio of 80 % shall be determined under extreme and under normal test conditions and the difference in dB shall be calculated. This difference shall be added to the average usable sensitivity to radiated fields expressed in $\text{dB}\mu\text{V}/\text{m}$, as calculated in clause 8.1.4 step i), under normal test conditions, to obtain the sensitivity under extreme test conditions.

8.1.6 Reference for degradation measurements

8.1.6.1 Definition

Degradation measurements are those measurements which are made on the receiver to establish the degradation of the performance of the receiver due to the presence of (an) unwanted (interfering) signal(s). For such measurements, the level of the wanted signal shall be adjusted to a level which is 3 dB above the limit of the average usable sensitivity, according to the category of the equipment, and expressed as field strength.

Degradation measurements fall into two categories:

- a) Those carried out on a test site (clauses 8.5, 8.7 and B.1).
- b) Those carried out using a test fixture (clauses 8.2, 8.3, 8.4, 8.6 and B.4).

The test fixture is only used for those tests where the difference in frequency between the wanted and the unwanted test signals is very small in relation to the actual frequency, so that the coupling loss is the same for the wanted and unwanted test signals fed into the test fixture.

8.1.6.2 Procedures for measurements using the test fixture

The test fixture is coupled to the signal generators via a combining network to provide the wanted and unwanted test input signals to the receiver in the test fixture. It is necessary, therefore, to establish the output level of the wanted test signal from the signal generator that results in a signal at the receiver (in the test fixture) which corresponds with the average usable sensitivity (field strength) as specified in clause 8.1.7.

This test output level from the signal generator for the wanted test signal is then used for all the receiver measurements using the test fixture.

The method for determining the test output level from the signal generator is as follows:

- a) The actual average usable sensitivity of the receiver, measured in accordance with clauses 8.1.2 step i) or 8.1.4 step i) and expressed as a field strength, shall be used.
- b) The difference between the appropriate limit of the average usable sensitivity specified in clause 8.1.7, and this actual average usable sensitivity (step a)), expressed in dB, is recorded.
- c) The receiver is then mounted in the test fixture.

The signal generator providing the wanted input signal is coupled to the test fixture via a combining network. All other input ports of the combining network are terminated in 50 Ω loads.

For continuous bit streams, the output level from the signal generator with normal test signal D-M2 (clause 6.1) is adjusted so that a bit error ratio of 10^{-2} is obtained. This output level is then increased by an amount equal to the difference expressed in dB calculated in clause 8.1.6.2 step b).

For messages, the output level from the signal generator with normal test modulation (clause 6.1) is adjusted so that the successful message ratio of 80 % is obtained. This output level is then increased by an amount equal to the difference expressed in dB calculated in clause 8.1.6.2 step b).

The output level of the signal generator is defined as being the level equivalent to the limit of the average usable sensitivity, for the category of equipment used, expressed as a field strength (clause 8.1.7).

8.1.6.3 Procedures for measurements on a test site

When measurements are carried out on a test site, the wanted and unwanted signals shall be calibrated in terms of dB μ V/m at the location of the equipment under test.

8.1.7 Limits

For the average usable sensitivity limits, four categories of equipment are defined as follows:

- category A: equipment having an integral antenna fully within the case;

- category B: equipment having an extractable or fixed integral antenna, with an antenna length not exceeding 20 cm external to the case;
- category C: equipment having an extractable or fixed integral antenna, with an antenna length exceeding 20 cm external to the case;
- category D: equipment not covered by category A, B or C.

Under normal test conditions for categories A, B and D, the average usable sensitivity shall not exceed the field strength values shown in tables 5a and 5b.

Table 5a: Sensitivity limits for categories A and D

Frequency band (MHz)	Average usable sensitivity in dB relative to 1 µV/m
30 to 400	27,0
> 400 to 750	28,5
> 750 to 1 000	30,0

Table 5b: Sensitivity limits for category B

Frequency band (MHz)	Average usable sensitivity in dB relative to 1 µV/m
30 to 130	18,0
> 130 to 300	19,5
> 300 to 440	21,5
> 440 to 600	23,5
> 600 to 800	25,5
> 800 to 1 000	28,0

For category C the following limits shall apply under normal conditions:

- at frequencies greater than 375 MHz the limits shall be as specified in table 5b;
- at frequencies less than or equal to 375 MHz, a correction factor K shall be subtracted from the specified field strengths in table 5b. K shall be calculated as:

$$K = 20 \log_{10} \frac{l + 20}{40}$$

where l is the length of the external part of the antenna in cm.

This correction only applies if the antenna length in cm external to the case is less than $(15\,000/f_0 - 20)$ in cm, where f_0 is the frequency in MHz.

For all categories of equipment, add 6 dB to the limit under normal test conditions to obtain the limit under extreme test conditions.

8.2 Error behaviour at high input levels

8.2.1 Definition

The performance at high input levels (noise free operation) is defined by the bit error ratio (continuous bit stream) or the number of messages lost or corrupted at levels significantly above the maximum usable sensitivity.

8.2.2 Method of measurement with continuous bit streams

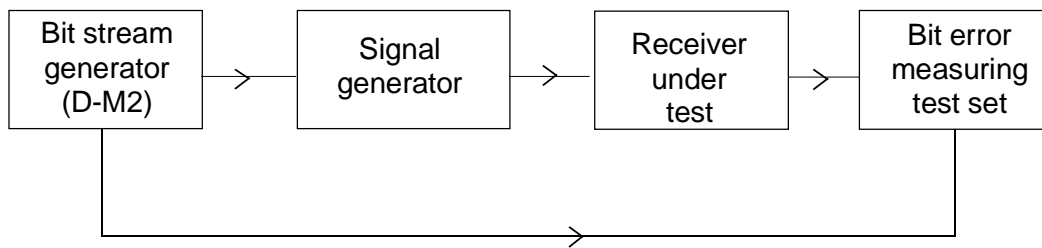

Figure 19: Measurement arrangement

- a) The receiver shall be placed in the test fixture (clause B.4).

An input signal with a frequency equal to the nominal frequency of the receiver, modulated by the normal test signal D-M2 (clause 6.1.1) shall be applied to the input of the test fixture.

- b) The bit pattern of the modulating signal shall be compared to the bit pattern obtained from the receiver after demodulation.
- c) The input signal shall be adjusted to a level of 30 dB above the level of the wanted signal for the degradation measurements (clause 8.1.6).
- d) The number of errors that occur at the data output terminals or at a special measuring terminal of the receiver, during a period of 3 minutes, shall be counted.
- e) The measurement shall be repeated with the input signal to the test fixture at a level of 100 dB above the level of the wanted signal for the degradation measurements (clause 8.1.6).

8.2.3 Method of measurement with messages

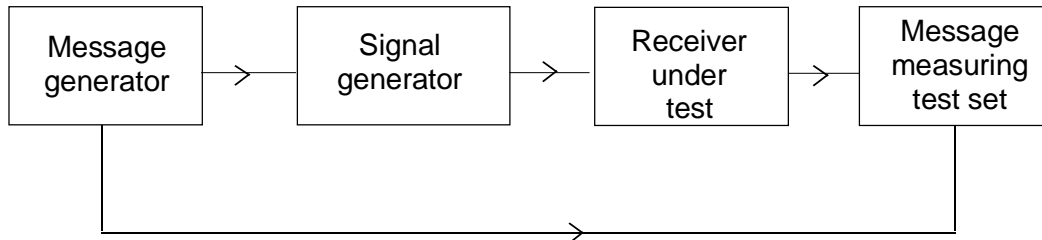

Figure 20: Measurement arrangement

- a) The receiver shall be placed in the test fixture (clause B.4).

A signal of carrier frequency equal to the nominal frequency of the receiver and modulated with the normal test signal (clause 6.1.2) in accordance with the instructions of the supplier (and approved by the testing laboratory) shall be applied to the input of the test fixture.

- b) The input signal of the receiver is adjusted to a level of 30 dB above the level of the wanted signal for the degradation measurements (clause 8.1.6).
- c) The normal test signal shall be transmitted 100 times whilst observing in each case whether or not a message is successfully received.
- d) The number of occasions when a message is not successfully received shall be recorded.
- e) The measurement shall be repeated with the input signal to the test fixture at a level of 100 dB above the wanted signal for the degradation measurements (clause 8.1.6).

8.2.4 Limits

The bit error ratio (continuous bit streams) shall not exceed 10^{-4} .

The number of messages not correctly received (lost or corrupted) shall not exceed 1.

8.3 Co-channel rejection

8.3.1 Definition

The co-channel rejection is a measure of the capability of the receiver to receive a wanted modulated signal without exceeding a given degradation due to the presence of an unwanted modulated signal, both signals being at the nominal frequency of the receiver.

8.3.2 Method of measurement with continuous bit streams

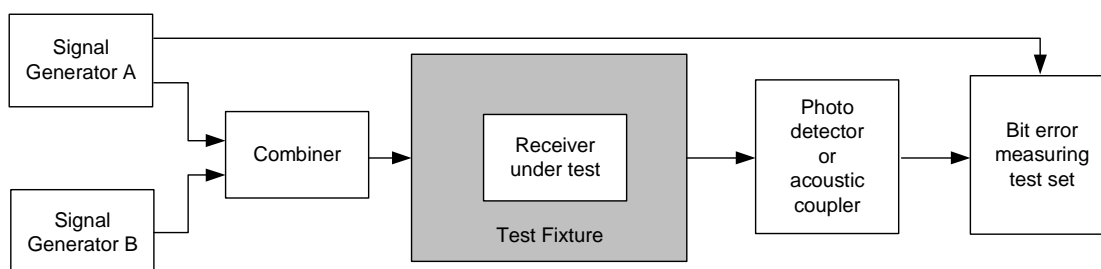

Figure 21: Measurement arrangement

- a) The receiver shall be placed in the test fixture (clause B.4).

Two signal generators A and B shall be connected to the test fixture via a combining network. The wanted signal, provided by signal generator A, shall be at the nominal frequency of the receiver and shall have the normal test signal D-M2 (clause 6.1.1).

The unwanted signal, provided by signal generator B, shall be modulated with signal A-M3 (see clause 6.1).

Both input signals shall be at the nominal frequency of the receiver under test.

- b) Initially the unwanted signal shall be switched off (maintaining the output impedance). The level of the wanted signal from generator A shall be adjusted to a level which is 3 dB above the level equivalent to the limit of the average usable sensitivity, for the category of equipment used, expressed as a field strength (clauses 8.1.6 and 8.1.7).
- c) The unwanted signal from generator B shall then be switched on, and its level shall be adjusted until a bit error ratio of approximately 10^{-1} is obtained.
- d) The normal test signal D-M2 shall be transmitted whilst observing the bit error ratio.
- e) The level of the unwanted signal shall be reduced in steps of 1 dB until a bit error ratio of 10^{-2} or better is obtained. The level of the unwanted signal shall then be recorded.
- f) For each frequency of the unwanted signal, the co-channel rejection ratio shall be expressed as the ratio, in dB, of the level of the unwanted signal to the level of the wanted signal. This ratio shall be recorded.
- g) The measurement shall be repeated for displacements of the unwanted signal of $\pm 12\%$ of the channel separation.
- h) The co-channel rejection of the equipment under test shall be expressed as the lowest of the three values expressed in dB, calculated in step f).

The value of the co-channel rejection ratio, expressed in dB, is generally negative (therefore, for example, -12 dB is lower than -8 dB).

8.3.3 Method of measurement with messages

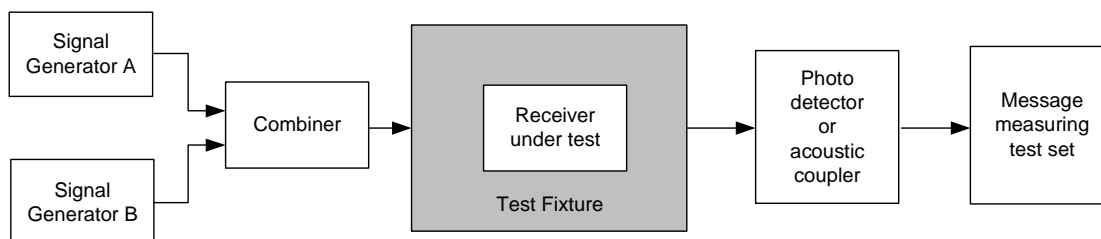

Figure 22: Measurement arrangement

- a) The receiver shall be placed in the test fixture (clause B.4).

Two signal generators A and B shall be connected to the test fixture via a combining network.

The wanted signal, provided by signal generator A, shall be at the nominal frequency of the receiver and shall have the normal test modulation (clause 6.1.2).

The unwanted signal, provided by signal generator B, shall be modulated with signal A-M3 (clause 6.1).

Both input signals shall be at the nominal frequency of the receiver under test.

- b) Initially, the unwanted signal shall be switched off (maintaining the output impedance).

The level of the wanted signal from generator A shall be adjusted to a level which is 3 dB above the level equivalent to the limit of the average usable sensitivity, for the category of equipment used, expressed as a field strength (clauses 8.1.6 and 8.1.7) test.

- c) The unwanted signal from signal generator B shall then be switched on and its level shall be adjusted until a successful message ratio of less than 10 % is obtained.

- d) The normal test signal (clause 6.1.2) shall be transmitted repeatedly whilst observing in each case whether or not a message is successfully received.

The level of the unwanted signal shall be reduced by 2 dB for each occasion that a message is not successfully received.

The procedure shall be continued until three consecutive messages are successfully received.

The level of the input signal shall then be recorded.

- e) The level of the unwanted signal shall be increased by 1 dB and the new value recorded.

The normal test signal (see clause 6.1.2) shall then be transmitted 20 times. In each case, if a message is not successfully received the level of the unwanted signal shall be reduced by 1 dB and the new value recorded.

If a message is successfully received the level of the unwanted signal shall not be changed until three consecutive messages have been successfully received.

In this case the unwanted signal shall be increased by 1 dB and the new value recorded.

No level of the unwanted signal shall be recorded unless preceded by a change in level.

The average of the values recorded in steps d) and e) (which provides the level corresponding to the successful message ratio of 80 %) shall be recorded.

- f) For each frequency of the unwanted signal, the co-channel rejection ratio shall be expressed as the ratio, in dB, of the average level recorded in step e) to the level of the wanted signal. This ratio shall be recorded.

- g) The measurement shall be repeated for displacements of the unwanted signal of $\pm 12\%$ of the channel separation.

- h) The co-channel rejection ratio of the equipment under test shall be expressed as the lowest of the three values expressed in dB, calculated in step f).

The value of the co-channel rejection ratio, expressed in dB, is generally negative (therefore, for example, -12 dB is lower than -8 dB).

8.3.4 Limits

The value of the co-channel rejection ratio, expressed in dB, at any frequency of the unwanted signal within the specified range, shall be between:

- -8,0 dB and 0 dB for channel separations of 20 kHz and 25 kHz;
- -12,0 dB and 0 dB for a channel separation of 12,5 kHz.

8.4 Adjacent channel selectivity

8.4.1 Definition

The adjacent channel selectivity is a measure of the capability of the receiver to receive a wanted modulated signal without exceeding a given degradation due to the presence of an unwanted signal which differs in frequency from the wanted signal by an amount equal to the adjacent channel separation for which the equipment is intended.

8.4.2 Method of measurement with continuous bit streams

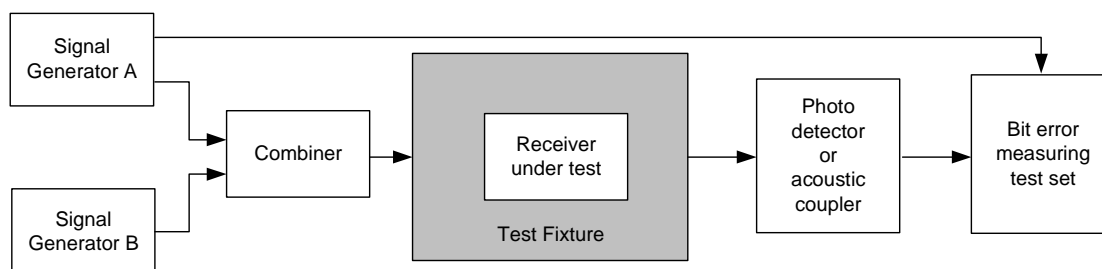

Figure 23: Measurement arrangement

- a) The receiver shall be placed in the test fixture (clause B.4).

Two signal generators A and B shall be connected to the test fixture via a combining network.

The wanted signal, provided by signal generator A, shall be at the nominal frequency of the receiver and shall have the normal test signal D-M2 (clause 6.1.1).

The unwanted signal, provided by signal generator B, shall be modulated with signal A-M3 (clause 6.1) and shall be at the frequency of the channel immediately above that of the wanted signal.

- b) Initially the unwanted signal shall be switched off (maintaining the output impedance).

The level of the wanted signal from generator A shall be adjusted to a level which is 3 dB above the level equivalent to the limit of the average usable sensitivity, for the category of equipment used, expressed as a field strength (clauses 8.1.6 and 8.1.7).

- c) The unwanted signal from generator B shall then be switched on; its level shall be adjusted until a bit error ratio of approximately 10^{-1} is obtained.
- d) The normal test signal D-M2 shall be transmitted whilst observing the bit error ratio.
- e) The level of the unwanted signal shall be reduced in steps of 1 dB until a bit error ratio of 10^{-2} or better is obtained. The level of the unwanted signal shall then be recorded.

- f) For each adjacent channel, the selectivity shall be expressed as the ratio in dB of the level of the unwanted signal to the level of the wanted signal. This ratio shall be recorded.

It shall then be converted back into field strengths of the unwanted signals at the receiver location and expressed in $\text{dB}\mu\text{V/m}$.

- g) The measurement shall be repeated with the unwanted signal at the frequency of the channel below that of the wanted signal.
- h) The adjacent channel selectivity of the equipment under test shall be expressed as the lower of the two values measured in the upper and lower adjacent channel (step f)).
- i) Unless analogue measurements were made according to ETSI EN 300 296 [6], in which case the adjacent channel selectivity shall be measured at normal test conditions only, the measurement shall be repeated under extreme test conditions (clauses 5.4.1 and 5.4.2 applied simultaneously), with the level of the wanted signal adjusted to a level which is 3 dB above the level equivalent to the limit of the average usable sensitivity (under extreme test conditions), for the category of equipment used, expressed as a field strength (clauses 8.1.6 and 8.1.7).

NOTE: This is a valid procedure, because the degradation of adjacent channel selectivity at extreme test conditions is known by the analogue measurement results.

8.4.3 Method of measurement with messages

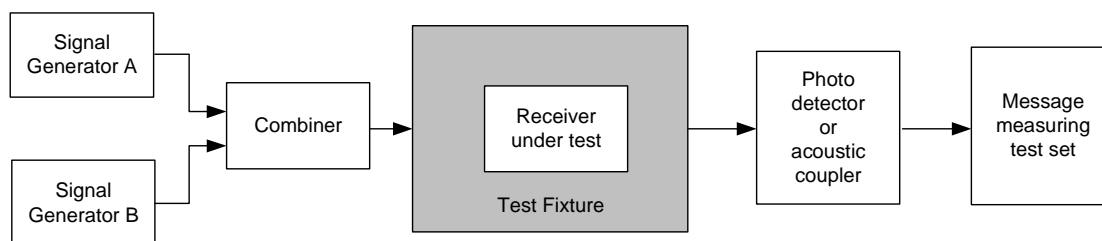

Figure 24: Measurement arrangement

- a) The receiver shall be placed in the test fixture (clause B.4).

Two signal generators, A and B, shall be connected to the test fixture via a combining network.

The wanted signal, provided by signal generator A, shall be at the nominal frequency of the receiver and shall have normal test modulation (clause 6.1.2).

The unwanted signal, provided by signal generator B, shall be modulated with signal A-M3 (clause 6.1) and shall be at the frequency of the channel immediately above that of the wanted signal.

- b) Initially the unwanted signal shall be switched off (maintaining the output impedance).

The level of the wanted signal from generator A shall be adjusted to a level which is 3 dB above the level equivalent to the limit of the average usable sensitivity, for the category of equipment used, expressed as a field strength (clauses 8.1.6 and 8.1.7).

- c) The unwanted signal from generator B shall then be switched on, and its level shall be adjusted until a successful message ratio of less than 10 % is obtained.

- d) The normal test signal (clause 6.1.2) shall be transmitted repeatedly whilst observing in each case whether or not a message is successfully received.

The level of the unwanted signal shall be reduced by 2 dB for each occasion that a message is not successfully received. The procedure shall be continued until three consecutive messages are successfully received. The level of the input signal shall then be recorded.

- e) The level of the unwanted signal shall be increased by 1 dB and the new value recorded.

The normal test signal (clause 6.1.2) shall then be transmitted 20 times. In each case, if a message is not successfully received the level of the unwanted signal shall be reduced by 1 dB and the new value recorded.

If a message is successfully received, the level of the unwanted signal shall not be changed until three consecutive messages have been successfully received. In this case the unwanted signal shall be increased by 1 dB and the new value recorded.

No level of the unwanted signal shall be recorded unless preceded by a change in level.

The average of the values recorded in steps d) and e) (which provides the level corresponding to the successful message ratio of 80 %) shall be recorded.

- f) For each adjacent channel, the selectivity shall be expressed as the ratio in dB of the average level recorded in step e) to the level of the wanted signal. This value shall be recorded.

It shall then be converted back into field strengths of the unwanted signals at the receiver location and expressed in dB μ V/m.

- g) The measurement shall be repeated with the unwanted signal at the frequency of the channel below that of the wanted signal.
- h) The adjacent channel selectivity of the equipment under test shall be expressed as the lower of the two values measured in the upper and lower adjacent channel (step f)).
- i) Unless analogue measurements were made according to ETSI EN 300 296 [6], in which case the adjacent channel selectivity shall be measured at normal test conditions only, the measurement shall be repeated under extreme test conditions (clauses 5.4.1 and 5.4.2 applied simultaneously), with the level of the wanted signal adjusted to a level which is 3 dB above the level equivalent to the limit of the average usable sensitivity (under extreme test conditions), for the category of equipment used, expressed as a field strength (clauses 8.1.6 and 8.1.7).

8.4.4 Limits

The adjacent channel selectivity of the equipment shall be such that under the specified test conditions, the given degradation shall not be exceeded for levels of the unwanted signal up to those given in table 6.

Table 6: Adjacent channel selectivity

Channel separation (kHz)	Adjacent channel selectivity limit (dB μ V/m)			
	Unwanted frequencies ≤ 68 MHz		Unwanted frequencies > 68 MHz	
	Normal test conditions	Extreme test conditions	Normal test conditions	Extreme test conditions
20 and 25	75	65	$38,3 + 20 \log_{10}(f)$	$28,3 + 20 \log_{10}(f)$
12,5	65	55	$28,3 + 20 \log_{10}(f)$	$18,3 + 20 \log_{10}(f)$

NOTE: f is the value of the carrier frequency expressed in MHz.

8.5 Spurious response rejection

8.5.0 General

Spurious responses may occur at all frequencies throughout the frequency spectrum and the requirements of the present document shall be met for all frequencies. However, for practical reasons the measurements for testing shall be performed as specified in the present document. More specifically, this method of measurement is not intended to capture all spurious responses but selects those that have a high probability of being present. However, in a limited frequency range close to the nominal frequency of the receiver, it has been considered impossible to determine the probability of a spurious response and therefore a search shall be performed over this limited frequency range. This method provides a high degree of confidence that the equipment also meets the requirements at frequencies not being measured.

This measurement need not be carried out if this parameter has been measured according to the requirements of ETSI EN 300 296 [6].

8.5.1 Definition

The spurious response rejection is a measure of the capability of the receiver to receive a wanted modulated signal without exceeding a given degradation due to the presence of an unwanted modulated signal at any other frequency at which a response is obtained.

8.5.2 Introduction to the method of measurement

To determine the frequencies at which spurious responses can occur the following calculations shall be made:

- a) calculation of the "limited frequency range":

The limited frequency range is defined as the frequency of the local oscillator signal (f_{LO}) applied to the first mixer of the receiver plus or minus the sum of the intermediate frequencies (f_{I1}, \dots, f_{In}) and a half of the switching range (sr) of the receiver.

Hence the frequency f_L of the limited frequency range is:

$$f_{LO} - \sum_{j=1}^{j=n} f_{Ij} - \frac{sr}{2} \leq f_l \leq f_{LO} + \sum_{j=1}^{j=n} f_{Ij} + \frac{sr}{2}$$

- b) calculation of frequencies outside the limited frequency range:

A calculation of the frequencies at which spurious responses can occur outside the range determined in a) is made for the remainder of the frequency range of interest, as appropriate, clause 8.5.6 step g) and clause 8.5.7 step g).

The frequencies outside the limited frequency range are equal to the harmonics of the frequency of the local oscillator signal (f_{LO}) applied to the first mixer of the receiver plus or minus the first intermediate frequency (f_{I1}) of the receiver.

Hence, the frequencies of these spurious responses are $nf_{LO} \pm f_{I1}$, where n is an integer greater than or equal to 2.

The measurement of the first image response of the receiver shall initially be made to verify the calculation of spurious response frequencies.

For calculations a) and b), the supplier shall state the frequency of the receiver, the frequency of the local oscillator signal (f_{LO}) applied to the first mixer of the receiver, the intermediate frequencies (f_{I1} , f_{I2} , etc.), and the switching range (sr) of the receiver.

8.5.3 Measurement arrangement

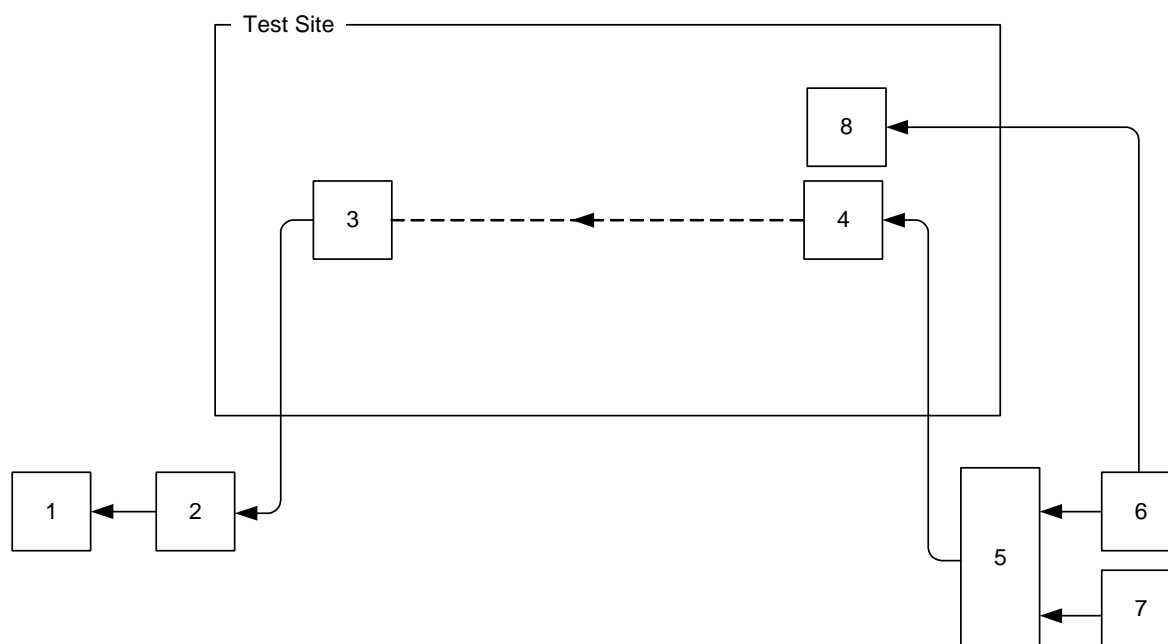

- 1: Bit error or message measuring test set.
- 2: Photo detector/acoustic coupler.
- 3: Receiver under test.
- 4: Wide band test antenna.
- 5: Combining network (used only when one antenna is used).
- 6: Signal generator A.
- 7: Signal generator B.
- 8: Test antenna for the wanted signal (clause 8.5.3 step e)).

Figure 25: Measurement arrangement

- a) A test site corresponding to that for the measurement of the average usable sensitivity shall be used (clause 8.1).
- b) The height of the wide band test antenna and the direction (angle) of the equipment under test shall be positioned as indicated in clauses 8.1.2, 8.1.4 and 8.1.6.
- c) During the course of the measurement it may be necessary to radiate high powers in a broad frequency range, and care should be taken to avoid the signals causing interference to existing services that may be operating in the neighbourhood.
- d) In the presence of a reflective ground plane, the height of the wide band test antenna has to be altered to optimize the reflections from the ground plane. This cannot be done simultaneously for two different frequencies.

If vertical polarization is used, the ground floor reflection can be effectively eliminated by the use of an appropriate monopole located directly on the ground plane (rod antenna).

- e) In case the wide band test antenna does not cover the necessary frequency range, alternatively two different and sufficiently decoupled antennas may be used.
- f) The equipment under test shall be placed on the support in its standard position and in the reference direction as indicated in clauses 8.1.2, 8.1.4 and 8.1.6.

8.5.4 Method of the search over the limited frequency range with continuous bit streams

The measurement shall be performed as follows, using the measurement arrangement of clause 8.5.3:

- a) Two signal generators, A and B, shall be connected to the wide band test antenna via a combining network, where appropriate, or alternatively to two different antennas in accordance with clause 8.5.3 step e).

The wanted signal, provided by signal generator A, shall be at the nominal frequency of the receiver and shall have the normal test signal D-M2 (clause 6.1).

The unwanted signal, provided by signal generator B, shall be modulated with a frequency of 400 Hz at a level producing a deviation of ± 5 kHz.

- b) Initially, the unwanted signal shall be switched off (maintaining the output impedance).

The level of the wanted signal from signal generator A shall be adjusted to a level which is 3 dB above the level of the limit of the average usable sensitivity, for the category of equipment used, expressed as a field strength (clauses 8.1.6 and 8.1.7).

- c) The unwanted signal from generator B shall then be switched on and its level shall be adjusted to provide a field strength which is at least 10 dB above, but close to, the limit of the spurious response rejection (clause 8.5.8) measured at the receiver location, even when on some types of test sites the level of the unwanted signal varies considerably with the frequency due to ground reflections.

The frequency of the unwanted signal shall be varied in increments of 10 kHz over the limited frequency range (clause 8.5.2 a)) and over the frequencies in accordance with the calculations outside of this frequency range (clause 8.5.2 b)).

- d) The normal test signal D-M2 shall then be transmitted whilst observing the bit error ratio.
- e) If the bit error ratio is better than 10^{-2} , then no spurious response effects have been detected and the search shall be continued on the next increment of frequency.
- f) If the bit error ratio is worse than 10^{-2} then a spurious response effect has been detected and the search shall be continued on the next increment of frequency.
- g) The frequency of any spurious response detected during the search, and the antenna position and its height shall be recorded for the use in measurements in accordance with clause 8.5.6.

8.5.5 Method of the search over the limited frequency range with messages

The measurement shall be performed as follows, using the measurement arrangement of clause 8.5.3:

- a) Two signal generators, A and B, shall be connected to the wide band test antenna via a combining network, where appropriate, or alternatively to two different antennas in accordance with clause 8.5.3 step e).

The wanted signal, provided by signal generator A, shall be at the nominal frequency of the receiver and shall have normal test modulation (clause 6.1.2).

The unwanted signal, provided by signal generator B, shall be modulated with a frequency of 400 Hz at a level producing a deviation of ± 5 kHz.

- b) Initially the unwanted signal shall be switched off (maintaining the output impedance).

The level of the wanted signal from generator A shall be adjusted to a level which is 3 dB above the level of the limit of the average usable sensitivity, for the category of equipment used, expressed as a field strength (clauses 8.1.6 and 8.1.7).

- c) The unwanted signal from generator B shall then be switched on and its level shall be adjusted to provide a field strength which is at least 10 dB above, but close to, the limit of the spurious response rejection (clause 8.5.8) measured at the receiver location, even when on some types of test sites the level of the unwanted signal varies considerably with the frequency due to ground reflections.

The frequency of the unwanted signal shall be varied in increments of 10 kHz over the limited frequency range (clause 8.5.2 a)) and over the frequencies in accordance with calculations outside of this frequency range (clause 8.5.2 b)).

- d) The normal test signal (clause 6.1.2) shall be transmitted repeatedly whilst observing in each case whether or not a message is successfully received.
- e) If the successful message ratio is higher than 80 %, then no spurious response effects have been detected and the search shall be continued on the next increment of frequency.
- f) If three consecutive successful messages cannot be received then a spurious response effect has been detected and the search shall be continued on the next increment of frequency.
- g) The frequency of any spurious response detected during the search, and the antenna position and its height shall be recorded for the use in measurements in accordance with clause 8.5.7.

8.5.6 Method of measurement with continuous bit streams

At each frequency where a spurious response has been found, within and outside the limited frequency range, the measurement shall be performed as follows:

- a) The measurement arrangement is identical to that in clause 8.5.4.

The wanted signal, provided by signal generator A, shall be at the nominal frequency of the receiver and shall have the normal test signal D-M2 (clause 6.1.1).

The unwanted signal, provided by signal generator B, shall be modulated with a frequency of 400 Hz with a deviation of 12 % of the channel separation and shall be at the frequency of that spurious response being considered.

- b) Initially the unwanted signal shall be switched off (maintaining the output impedance).

The level of the wanted signal from signal generator A shall be adjusted to a level which is 3 dB above the level of the limit of the average usable sensitivity (clause 8.1.6), for the category of equipment used (clause 8.1.7), expressed in field strength when measured at the receiver location.

- c) The unwanted signal from generator B shall then be switched on and its level shall be adjusted until a bit error ratio of approximately 10^{-1} is obtained.
- d) The normal test signal D-M2 shall then be transmitted whilst observing the bit error ratio.
- e) The level of the unwanted signal shall be reduced in steps of 1 dB until a bit error ratio of 10^{-2} or better is obtained. The level of the unwanted signal shall then be recorded.
- f) The frequency of the unwanted signal shall be stepped up and down in increments of 20 % of the channel separation and steps c) to e) shall be repeated until the lowest level recorded in step e) is obtained.

For each frequency, the spurious response rejection shall be expressed, as the level in dB μ V/m of the field strength of the unwanted signal at the receiver location, corresponding to the lowest value recorded during this step.

- g) The measurement shall be repeated at all spurious response frequencies found during the search over the limited frequency range, clauses 8.5.2 and 8.5.4, and at frequencies calculated for the remainder of the spurious response frequencies in the frequency range $f_{RX}/3,2$ or 30 MHz, whichever is higher, to $3,2 \times f_{RX}$, where f_{RX} is the nominal frequency of the receiver, with the antenna position and height recorded in clause 8.5.4 step g) if appropriate.
- h) The spurious response rejection of the equipment under test shall be expressed as the level in dB μ V/m of the field strength of the unwanted signal, at the receiver location, corresponding to the lowest value recorded in step f).

8.5.7 Method of measurement with messages

At each frequency where a spurious response has been found, within and outside the limited frequency range, the measurement shall be performed as follows:

- a) The measurement arrangement is identical to that in clause 8.5.5.

The wanted signal, provided by signal generator A, shall be at the nominal frequency of the receiver and shall have normal test modulation (clause 6.1.2).

The unwanted signal, provided by signal generator B, shall be modulated with a frequency of 400 Hz with a deviation of 12 % of the channel separation and shall be at the frequency of that spurious response being considered.

- b) Initially the unwanted signal shall be switched off (maintaining the output impedance).

The level of the wanted signal from signal generator A shall be adjusted to a level which is 3 dB above the level of the limit of the average usable sensitivity (clause 8.1.6), for the category of equipment used (clause 8.1.7), expressed in field strength when measured at the receiver location.

- c) The unwanted signal from generator B shall then be switched on and its level shall be adjusted until a successful message ratio of less than 10 % is obtained.

- d) The normal test signal (see clause 6.1.2) shall be transmitted repeatedly whilst observing in each case whether or not a message is successfully received.

The level of the unwanted signal shall be reduced by 2 dB for each occasion that a message is not successfully received.

The procedure shall be continued until three consecutive messages are successfully received.

The level of the input signal shall then be recorded.

- e) The level of the unwanted signal shall be increased by 1 dB and the new value recorded.

The normal test signal (see clause 6.1.2) shall then be transmitted 20 times. In each case, if a message is not successfully received, the level of the unwanted signal shall be reduced by 1 dB and the new value recorded.

If a message is successfully received the level of the unwanted signal shall not be changed until three consecutive messages have been successfully received.

In this case the unwanted signal shall be increased by 1 dB and the new value recorded.

No level of the unwanted signal level shall be recorded unless preceded by a change in level.

The average of the values recorded in steps d) and e) (which provides the level corresponding to the successful message ratio of 80 %) shall be recorded.

- f) The frequency of the unwanted signal shall be stepped up and down in increments of 20 % of the channel separation and steps d) and e) shall be repeated until the lowest average level recorded in step e) is obtained.

For each frequency, the spurious response rejection shall be expressed as the level in dB μ V/m of the field strength of the unwanted signal at the receiver location, corresponding to the lowest value recorded during this step.

- g) The measurement shall be repeated at all spurious response frequencies found during the search over the limited frequency range, clauses 8.5.2 and 8.5.5, and at frequencies calculated for the remainder of the spurious response frequencies in the frequency range $f_{RX}/3,2$ or 30 MHz, whichever is higher, to $3,2 \times f_{RX}$, where f_{RX} is the nominal frequency of the receiver, with the antenna position and height recorded in clause 8.5.5 step g) if appropriate.

- h) The spurious response rejection of the equipment under test shall be expressed as the level in dB μ V/m of the field strength of the unwanted signal, at the receiver location, corresponding to the lowest value recorded in step f).

8.5.8 Limits

The spurious response rejection of the equipment shall be such that under the specified test conditions, the given degradation shall not be exceeded for levels of the unwanted signal up to:

- 75 dB μ V/m for unwanted signal frequencies \leq 68 MHz;
- $(38,3 + 20 \log_{10} f)$ dB μ V/m for unwanted signal frequencies $>$ 68 MHz, where f is the value of the frequency of the carrier expressed in MHz.

8.6 Intermodulation response rejection

8.6.0 General

This measurement need not be carried out if this parameter has been measured according to the requirements of ETSI EN 300 296 [6].

8.6.1 Definition

The intermodulation response rejection is a measure of the capability of the receiver to receive a wanted modulated signal, without exceeding a given degradation due to the presence of two or more unwanted signals with a specific frequency relationship to the wanted signal frequency.

8.6.2 Method of measurement with continuous bit streams

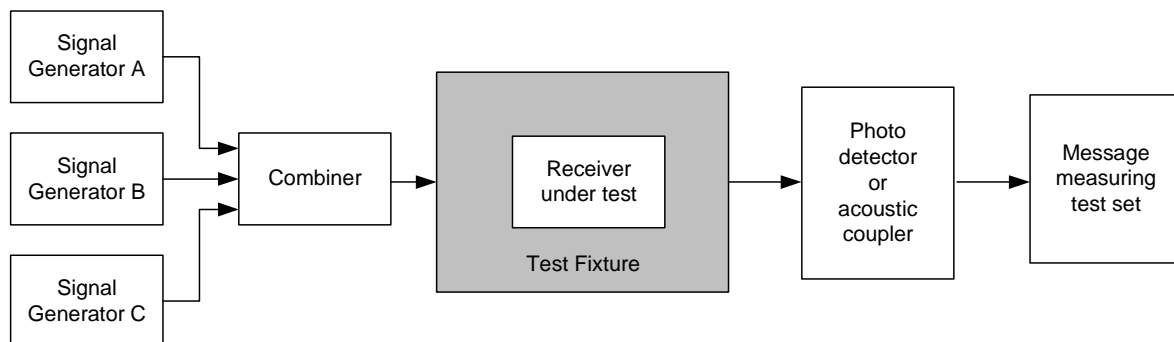

Figure 26: Measurement arrangement

- a) The receiver shall be placed in the test fixture (clause B.4).

Three signal generators, A, B and C, shall be connected to the test fixture via a combining network.

The wanted signal, provided by signal generator A, shall be at the nominal frequency of the receiver and shall have normal test signal D-M2 (clause 6.1.1).

The first unwanted signal, provided by signal generator B, shall be unmodulated and adjusted to a frequency 50 kHz above the nominal frequency of the receiver.

The second unwanted signal, provided by signal generator C, shall be modulated with signal A-M3 (clause 6.1) and adjusted to a frequency 100 kHz above the nominal frequency of the receiver.

- b) Initially, the unwanted signals shall be switched off (maintaining the output impedances).

The level of the wanted signal from generator A shall be adjusted to a level which is 3 dB above the level equivalent to the limit of the average usable sensitivity, for the category of equipment used, expressed as a field strength (clauses 8.1.6 and 8.1.7).

- c) The two unwanted signals from signal generators B and C shall then be switched on. Their levels shall be maintained equal and shall be adjusted until a bit error ratio of 10^{-1} or worse is obtained.
- d) The test signal D-M2 shall then be transmitted whilst observing the bit error ratio.

- e) The level of the unwanted signals shall be reduced in steps of 1 dB until a bit error ratio of 10^{-2} or better is obtained. The level of the unwanted signals shall then be recorded.
- f) For each configuration of the unwanted signals, the intermodulation response rejection shall be expressed as the ratio, in dB, of the level of the unwanted signals to the level of the wanted signal. This ratio shall be recorded.

It shall then be converted back into field strength of the unwanted signals at the receiver location and expressed in dB μ V/m.

- g) The measurements shall be repeated with the unwanted signal generator B at the frequency 50 kHz below that of the wanted signal and the frequency of the unwanted signal generator C at the frequency 100 kHz below that of the wanted signal.
- h) The intermodulation response rejection of the equipment under test shall be expressed as the lower of the two values calculated in step f).

8.6.3 Method of measurement with messages

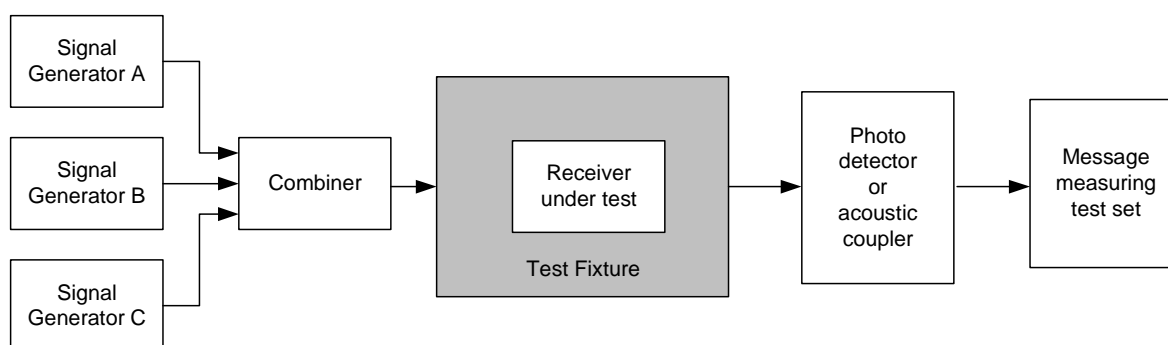

Figure 27: Measurement arrangement

- a) The receiver shall be placed in the test fixture (clause B.4).
Three signal generators, A, B and C, shall be connected to the test fixture via a combining network.
The wanted signal, provided by signal generator A, shall be at the nominal frequency of the receiver and shall have normal test modulation (clause 6.1.2).
The first unwanted signal, provided by signal generator B, shall be unmodulated and adjusted to a frequency 50 kHz above the nominal frequency of the receiver.
The second unwanted signal, provided by signal generator C, shall be modulated with signal A-M3 (clause 6.1) and adjusted to a frequency 100 kHz above the nominal frequency of the receiver.
- b) Initially, the unwanted signals shall be switched off (maintaining the output impedances).
The level of the wanted signal from generator A shall be adjusted to a level which is 3 dB above the level equivalent to the limit of the average usable sensitivity, for the category of equipment used, expressed as a field strength (clauses 8.1.6 and 8.1.7).
- c) The two unwanted signals from signal generators B and C shall then be switched on. Their levels shall be maintained equal and shall be adjusted until a successful message ratio of less than 10 % is obtained.
- d) The normal test signal (clause 6.1.2) shall be transmitted repeatedly whilst observing in each case whether or not a message is successfully received.
The level of the unwanted signals shall be reduced by 2 dB for each occasion that a message is not successfully received.
The procedure shall be continued until three consecutive messages are successfully received. The level of the input signals shall then be recorded.
- e) The level of the unwanted signals shall be increased by 1 dB and the new value recorded.

The normal test signal (clause 6.1.2) shall then be transmitted 20 times. In each case, if a message is not successfully received, the level of the unwanted signals shall be reduced by 1 dB and the new value recorded.

If a message is successfully received, the input level of the unwanted signals shall not be changed until three consecutive messages have been successfully received. In this case the level of the unwanted signals shall be increased by 1 dB and the new value recorded.

No level of the unwanted signals shall be recorded unless preceded by a change in level.

The average of the values recorded in steps d) and e) (which provides the level corresponding to the successful message ratio of 80 %) shall be recorded.

- f) For each configuration of the unwanted signals, the intermodulation response rejection shall be expressed as the ratio in dB of the average level recorded in step e) to the level of the wanted signal. This ratio shall be recorded.

It shall then be converted back into field strength of the unwanted signals at the receiver location and expressed in dB μ V/m.

- g) The measurement shall be repeated with the unwanted signal generator B at the frequency 50 kHz below that of the wanted signal and the frequency of the unwanted signal generator C at the frequency 100 kHz below that of the wanted signal.
- h) The intermodulation response rejection of the equipment under test shall be expressed as the lower of the two values calculated in step f).

8.6.4 Limits

The intermodulation response rejection of the equipment shall be such that under the specified test conditions, the given degradation shall not be exceeded for levels of the unwanted signal up to:

- 70 dB μ V/m for unwanted frequencies \leq 68 MHz;
- $(33,3 + 20 \log_{10} f)$ dB μ V/m for unwanted frequencies $>$ 68 MHz, where f is the value of the frequency of the carrier expressed in MHz.

8.7 Blocking or desensitization

8.7.0 General

This measurement need not be carried out if this parameter has been measured according to the requirements of ETSI EN 300 296 [6].

8.7.1 Definition

Blocking is a measure of the capability of the receiver to receive a wanted modulated signal without exceeding a given degradation due to the presence of an unwanted signal at any frequencies other than those of the spurious responses or the adjacent channels.

8.7.2 Method of measurement with continuous bit streams

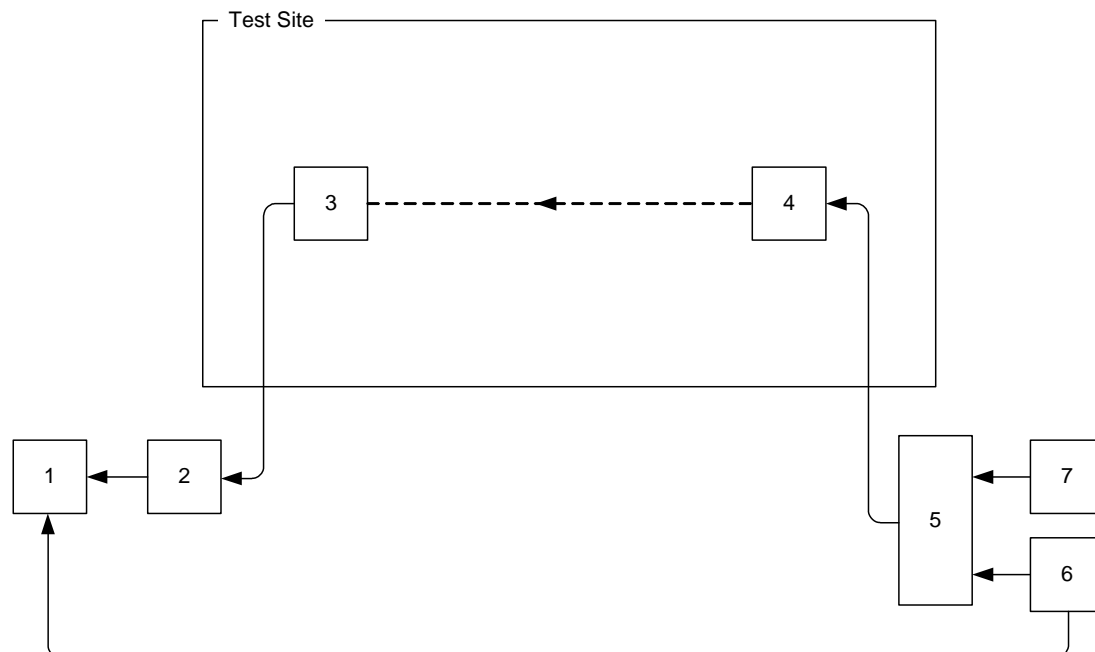

- 1: Bit error measuring test set.
- 2: Photo detector/acoustic coupler.
- 3: Receiver under test.
- 4: Wide band test antenna.
- 5: Combining network.
- 6: Signal generator A.
- 7: Signal generator B.

Figure 28: Measurement arrangement

A test site corresponding to that for the measurement of the average usable sensitivity shall be used (clause 8.1).

The equipment under test shall be placed on the support in its standard position and in the reference direction (clause 8.1.2 step k) and the measurement shall be performed as follows:

- a) Two signal generators, A and B, shall be connected to the wide band test antenna via a combining network.

The wanted signal, provided by signal generator A, shall be at the nominal frequency of the receiver and shall have normal test signal D-M2 (clause 6.1.1).

The unwanted signal, provided by signal generator B, shall be unmodulated and shall be at a frequency from 1 MHz to 10 MHz away from the nominal frequency of the receiver.

For practical reasons the measurements shall be carried out at frequencies of the unwanted signal at approximately ± 1 MHz, ± 2 MHz, ± 5 MHz and ± 10 MHz, avoiding those frequencies at which spurious responses occur (clause 8.5).
- b) Initially the unwanted signal shall be switched off (maintaining the output impedance).

The level of the wanted signal from generator A shall be adjusted to a level which is 3 dB above the level of the limit of the average usable sensitivity, for the category of equipment used, expressed as a field strength (clauses 8.1.6 and 8.1.7).
- c) The unwanted signal from generator B shall then be switched on and its level shall be adjusted until a bit error ratio of approximately 10^{-1} is obtained.
- d) The normal test signal D-M2 shall then be transmitted whilst observing the bit error ratio.

- e) The level of the unwanted signal shall be reduced in steps of 1 dB until a bit error ratio of 10^{-2} or better is obtained. The level of the unwanted signal shall then be recorded.
- f) For each frequency, the blocking or desensitization shall be expressed as the level in dB μ V/m of the field strength of the unwanted signal at the receiver location. This value shall be recorded.
- g) The measurement shall be repeated for all the frequencies defined in step a).
- h) The blocking or desensitization of the equipment under test shall be expressed as the level in dB μ V/m of the field strength of the unwanted signal, at the receiver location, corresponding to the lowest value recorded in step f).

8.7.3 Method of measurement with messages

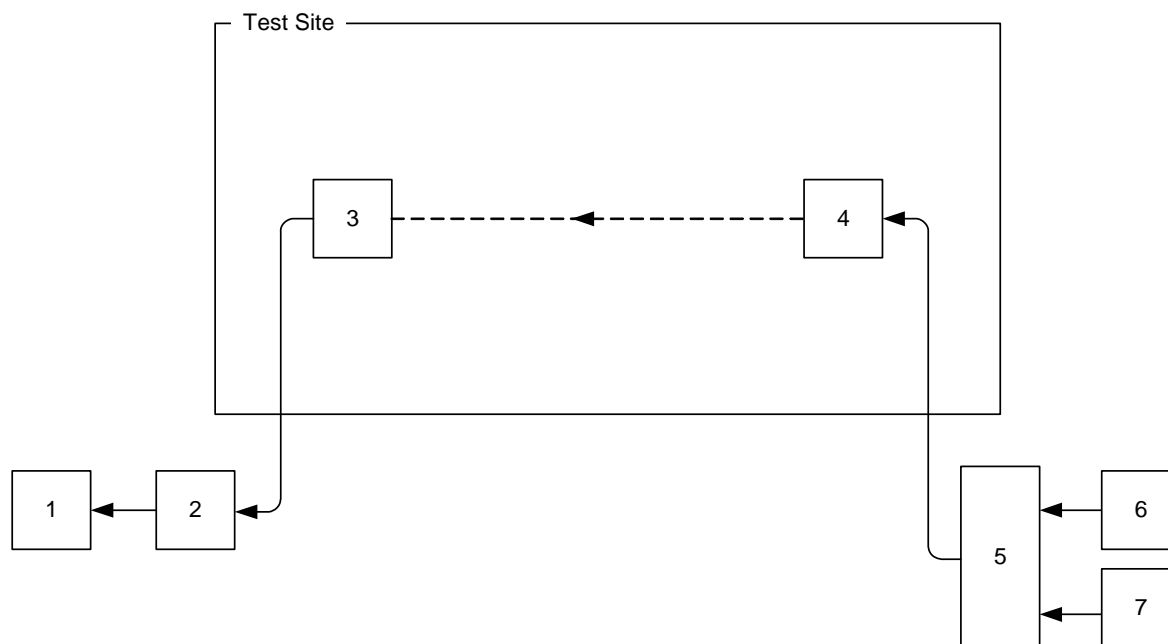

- 1: Message measuring test set.
- 2: Photo detector/acoustic coupler.
- 3: Receiver under test.
- 4: Wide band test antenna.
- 5: Combining network.
- 6: Signal generator A.
- 7: Signal generator B.

Figure 29: Measurement arrangement

A test site corresponding to that for the measurement of the average usable sensitivity shall be used (clause 8.1).

The equipment under test shall be placed on the support in its standard position and in the reference direction (clause 8.1.4 step k)) and the measurement shall be performed as follows:

- a) Two signal generators A and B shall be connected to the wide band test antenna via a combining network.
The wanted signal, provided by signal generator A, shall be at the nominal frequency of the receiver and shall have normal test modulation (clause 6.1.2).
The unwanted signal, provided by signal generator B, shall be unmodulated and shall be at a frequency from 1 MHz to 10 MHz away from the nominal frequency of the receiver.
For practical reasons the measurements shall be carried out at frequencies of the unwanted signal at approximately ± 1 MHz, ± 2 MHz, ± 5 MHz and ± 10 MHz, avoiding those frequencies at which spurious responses occur (clause 8.5).
- b) Initially, the unwanted signal shall be switched off (maintaining the output impedance).

The level of the wanted signal from generator A shall be adjusted to a level which is 3 dB above the level of the limit of the average usable sensitivity, for the category of equipment used, expressed as a field strength (clauses 8.1.6 and 8.1.7).

- c) The unwanted signal from generator B shall then be switched on and its level shall be adjusted until a successful message ratio of less than 10 % is obtained.
- d) The normal test signal (clause 6.1.2) shall be transmitted repeatedly whilst observing in each case whether or not a message is successfully received.

The level of the unwanted signal shall be reduced by 2 dB for each occasion that a message is not successfully received.

The procedure shall be continued until three consecutive messages are successfully received.

The level of the input signal shall then be recorded.

- e) The level of the unwanted signal shall be increased by 1 dB and the new value recorded.

The normal test signal (clause 6.1.2) shall then be transmitted 20 times. In each case if a message is not successfully received, the level of the unwanted signal shall be reduced by 1 dB and the new value recorded.

If a message is successfully received the level of the unwanted signal shall not be changed until three consecutive messages have been successfully received.

In this case the unwanted signal level shall be increased by 1 dB and the new value recorded.

No level of the unwanted signal shall be recorded unless preceded by a change in level.

The average of the values recorded in steps d) and e) (which provides the level corresponding to the successful message ratio of 80 %) shall be recorded.

- f) For each frequency, the blocking or desensitization shall be expressed as the level in dB μ V/m of the field strength of the unwanted signal at the receiver location, corresponding to the average value recorded in step e). For each frequency, the level shall be recorded.
- g) The measurement shall be repeated for all the frequencies defined in step a).
- h) The blocking or desensitization of the equipment under test shall be expressed as the level in dB μ V/m of the field strength of the unwanted signal, at the receiver location, corresponding to the lowest value recorded in step f).

8.7.4 Limits

The blocking level, for any frequency within the specified ranges, shall be:

- ≥ 89 dB μ V/m for unwanted frequencies ≤ 68 MHz;
- $\geq (52,3 + 20 \log_{10} f)$ dB μ V/m for unwanted frequencies > 68 MHz, where f is the value of the frequency of the carrier expressed in MHz.

8.8 Spurious radiations

8.8.0 General

This measurement need not to be carried out on equipment which is simultaneously submitted for approval to the requirements of ETSI EN 300 296 [6] and of the present document, if the data part is operational while making the corresponding test in ETSI EN 300 296 [6].

8.8.1 Definition

Spurious radiations from the receiver are components at any frequency radiated by the equipment and its antenna.

They are specified as the radiated power of any discrete signal.

8.8.2 Method of measurement

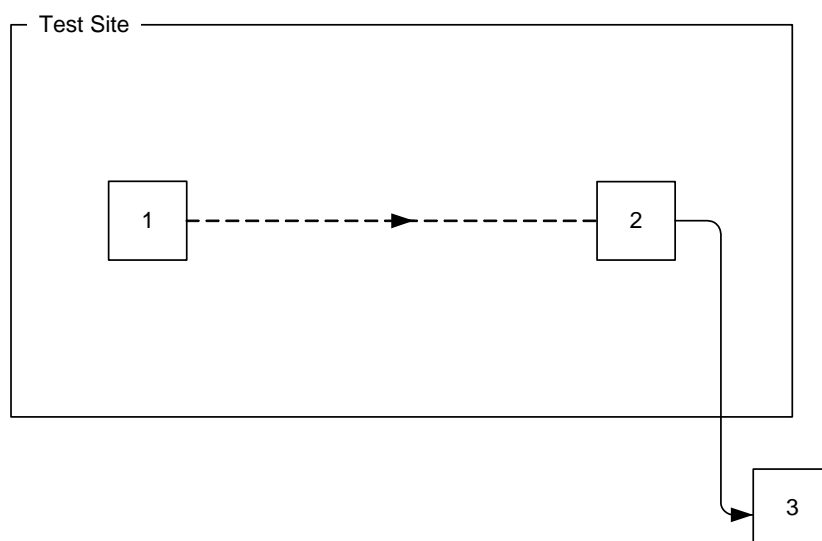

- 1: Receiver under test.
 2: Test antenna.
 3: Spectrum analyser or selective voltmeter.

Figure 30: Measurement arrangement

- a) A test site which fulfils the requirements of the specified frequency range of this measurement shall be used. The test antenna shall be orientated for vertical polarization and connected to a spectrum analyser or a selective voltmeter. The resolution bandwidth of the spectrum analyser or selective voltmeter shall be the smallest bandwidth available which is greater than the spectral width of the spurious component being measured.
- b) The receiver under test shall be placed on the support in its standard position. The radiation of any spurious component shall be detected by the test antenna and the spectrum analyser or selective voltmeter over the frequency range 30 MHz to 4 GHz. In addition, for equipment operating on frequencies above 470 MHz, measurements shall be repeated over the frequency range 4 GHz to 12,75 GHz.

The frequency of each spurious component shall be recorded. If the test site is disturbed by radiation coming from outside, this qualitative search may be performed in a screened room with reduced distance between the receiver under test and the test antenna.

- c) At each frequency at which a component has been detected, the spectrum analyser or selective voltmeter shall be tuned and the test antenna shall be raised or lowered through the specified height range until the maximum signal level is detected on the spectrum analyser or selective voltmeter.
- d) The receiver shall be rotated through 360° about a vertical axis, until a higher maximum signal is received.
- e) The test antenna shall be raised or lowered again through the specified height range until a maximum signal is obtained. This signal level shall be recorded.

The test antenna may not need to be raised or lowered if the measurement is carried out on a test site according to clause B.1.1.

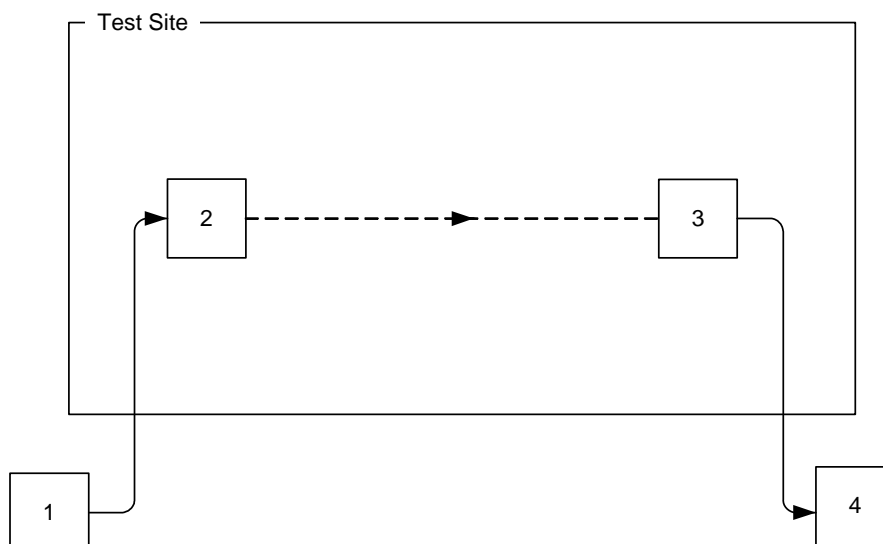

- 1: Signal generator.
 2: Substitution antenna.
 3: Test antenna.
 4: Spectrum analyser or selective voltmeter (test receiver).

Figure 31: Measurement arrangement

- f) Using the measurement arrangement in figure 31, the substitution antenna shall replace the receiver antenna in the same position and in vertical polarization. It shall be connected to the signal generator.
- g) For each frequency at which a component has been detected, the signal generator and spectrum analyser or selective voltmeter shall be tuned and the test antenna shall be raised or lowered through the specified height range until the maximum signal level is detected on the spectrum analyser or selective voltmeter.

The test antenna may not need to be raised or lowered if the measurement is carried out on a test site according to clause B.1.1.

The level of the signal generator giving the same signal level on the spectrum analyser or selective voltmeter as in step e) above shall be recorded. This value, after correction due to the gain of the substitution antenna and the cable loss between the signal generator and the substitution antenna, is the radiated spurious component at this frequency.

- h) Measurements of step b) to step g) shall be repeated with the test antenna orientated in horizontal polarization.

8.8.3 Limits

The power of any spurious radiation shall not exceed the values given in table 7.

Table 7: Radiated components

Frequency range	Limit
30 MHz to 1 GHz	2,0 nW (-57,0 dBm)
above 1 GHz to 12,75 GHz	20,0 nW (-47,0 dBm)

9 Testing for compliance with technical requirements

9.1 Test conditions, power supply and ambient temperatures

Tests defined in the present document shall be carried out at representative points within the boundary limits of the declared operational environmental profile which, as a minimum, shall be that specified in the test conditions contained in the present document.

As technical performance varies subject to environmental conditions, tests shall be carried out under a sufficient variety of environmental conditions as specified in the present document to give confidence of compliance for the affected technical requirements.

9.2 Interpretation of the measurement results

The interpretation of the results recorded in a test report for the measurements described in the present document shall be as follows:

- the measured value related to the corresponding limit will be used to decide whether an equipment meets the requirements of the present document;
- the value of the measurement uncertainty for the measurement of each parameter shall be included in the test report;
- the recorded value of the measurement uncertainty shall be, for each measurement, equal to or lower than the figures in table 8.

For the test methods, according to the present document, the measurement uncertainty figures shall be calculated and shall correspond to an expansion factor (coverage factor) $k = 1,96$ or $k = 2$ (which provide confidence levels of respectively 95 % and 95,45 % in the case where the distributions characterizing the actual measurement uncertainties are normal (Gaussian)). Principles for the calculation of measurement uncertainty are contained in ETSI TR 100 028 [4], in particular in annex D of ETSI TR 100 028-2 [7].

Table 8 is based on such expansion factors.

Table 8: Maximum measurement uncertainty

Parameter	Uncertainty (note 1)
RF frequency	$\pm 1 \times 10^{-7}$
Radiated RF power	± 6 dB
Conducted RF power variations using a test fixture	$\pm 0,75$ dB
Adjacent channel power	± 5 dB
Sensitivity	± 3 dB
Two-signal measurement, valid to 4 GHz (using a test fixture)	± 4 dB
Two-signal measurements using radiated fields (notes)	± 6 dB
Three-signal measurement (using a test fixture)	± 3 dB
Radiated emission of transmitter, valid to 12,75 GHz	± 6 dB
Radiated emission of receiver, valid to 12,75 GHz	± 6 dB
Transmitter transient attack time	± 20 %
Transmitter transient release time	± 20 %
Transmitter transient frequency	± 250 Hz
NOTE 1: Valid up to 1 GHz unless otherwise stated.	
NOTE 2: For blocking and spurious response rejection measurements.	

Annex A (normative): Relationship between the present document and the essential requirements of Directive 2014/53/EU

The present document has been prepared in reply to the Commission's standardisation request Commission Implementing Decision C(2015) 5376 final of 04.08.2015 to provide a means of conforming to the essential requirements of Directive 2014/53/EU on the harmonisation of the laws of the Member States relating to the making available on the market of radio equipment.

Once the present document is cited in the Official Journal of the European Union under that Directive, compliance with the normative clauses of the present document given in table A.1 confers, within the limits of the scope of the present document, a presumption of conformity with the corresponding essential requirements of that Directive, and associated EFTA regulations.

Table A.1: Relationship between the present document and the essential requirements of Directive 2014/53/EU

Harmonised Standard ETSI EN 300 390				
The following requirements are relevant to the presumption of conformity under the article 3.2 of Directive 2014/53/EU [i.2]				
Requirement			Requirement Conditionality	
No	Description	Reference: Clause No	U/C	Condition
1	Transmitter frequency error	7.1	C	Note 1 & Note 2
2	Transmitter effective radiated power	7.2	C	Note 1
3	Transient adjacent and alternate channel power	7.3	U	
4	Transmitter unwanted emissions in the spurious domain	7.4	C	Note 4
5	Transmitter attack time	7.5	C	Note 3
6	Transmitter release time	7.6	C	Note 3
7	Transient behaviour of the transmitter	7.7	C	Note 3
8	Receiver average useable sensitivity (field strength)	8.1	U	
9	Receiver error behaviour at high input levels	8.2	U	
10	Receiver co-channel rejection	8.3	U	
11	Receiver adjacent channel selectivity	8.4	U	
12	Receiver spurious response rejection	8.5	C	Note 1
13	Receiver intermodulation response rejection	8.6	C	Note 1
14	Receiver blocking or desensitization	8.7	C	Note 1
17	Receiver spurious radiations	8.8	C	Note 4
NOTE 1: Not required if already tested to ETSI EN 300 296 [6].				
NOTE 2: Only applies to equipment capable of producing an unmodulated carrier.				
NOTE 3: Not required for equipment intended for continuous transmission.				
NOTE 4: Not required if performance is evaluated as part of parallel testing to ETSI EN 300 296 [6].				

Key to columns:

Requirement:

- No** A unique identifier for one row of the table which may be used to identify a requirement.
- Description** A textual reference to the requirement.
- Clause Number** Identification of clause(s) defining the requirement in the present document unless another document is referenced explicitly.

Requirement Conditionality:

- U/C** Indicates whether the requirement shall be unconditionally applicable (U) or is conditional upon the suppliers claimed functionality of the equipment (C).
- Condition** Explains the conditions when the requirement shall or shall not be applicable for a requirement which is classified "conditional".

Presumption of conformity stays valid only as long as a reference to the present document is maintained in the list published in the Official Journal of the European Union. Users of the present document should consult frequently the latest list published in the Official Journal of the European Union.

Other Union legislation may be applicable to the product(s) falling within the scope of the present document.

Annex B (normative): Radiated measurement

B.1 Test sites and general arrangements for measurements involving the use of radiated fields

B.1.0 General

This annex introduces three most commonly available test sites, an Anechoic Chamber, an Anechoic Chamber with a ground plane and an Open Area Test Site (OATS), which may be used for radiated tests. These test sites are generally referred to as free field test sites. Both absolute and relative measurements can be performed in these sites. Where absolute measurements are to be carried out, the chamber should be verified. A detailed verification procedure is described in ETSI TR 102 273 [i.1] relevant parts 2, 3 and 4.

NOTE: To ensure reproducibility and traceability of radiated measurements only these test sites should be used in measurements in accordance with the present document.

B.1.1 Anechoic chamber

An anechoic chamber is an enclosure, usually shielded, whose internal walls, floor and ceiling are covered with radio absorbing material, normally of the pyramidal urethane foam type. The chamber usually contains an antenna support at one end and a turntable at the other. A typical anechoic chamber is shown in figure B.1.

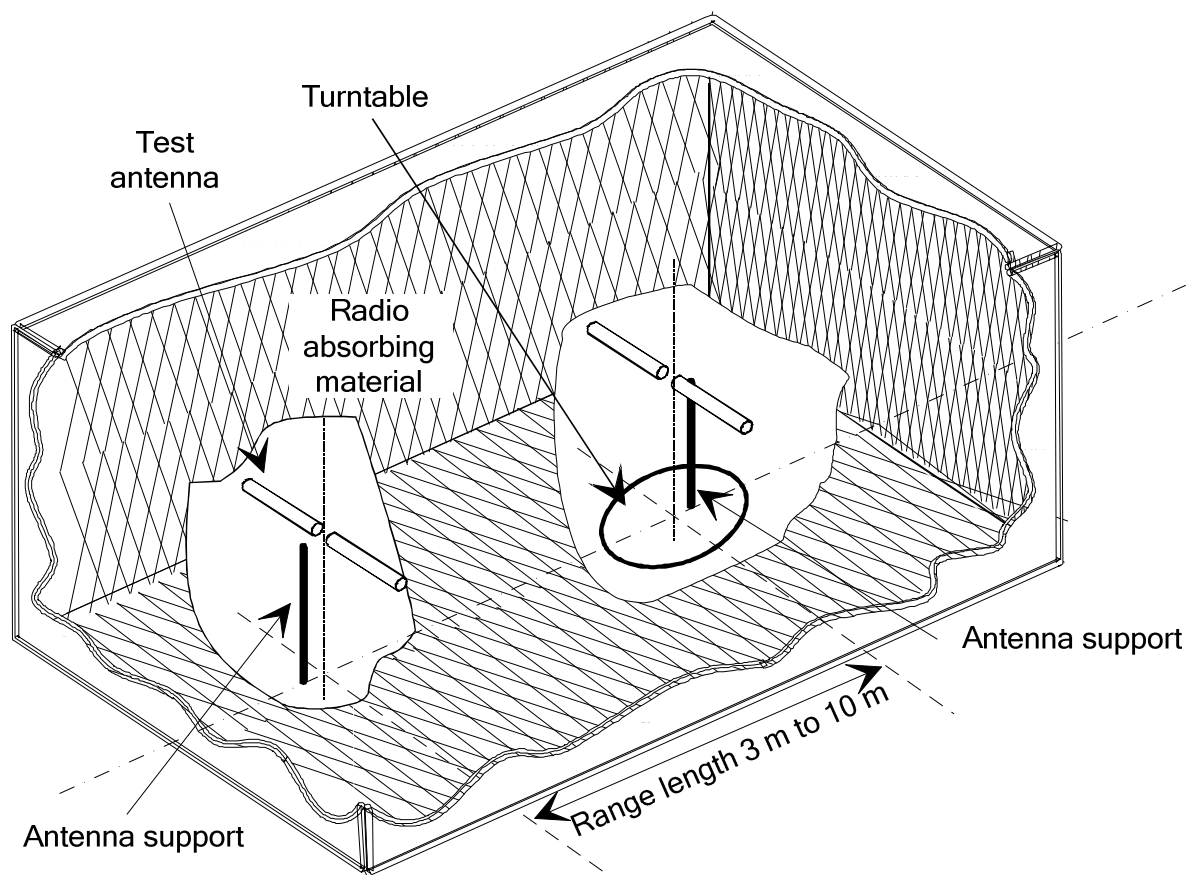

Figure B.1: A typical anechoic chamber

The chamber shielding and radio absorbing material work together to provide a controlled environment for testing purposes. This type of test chamber attempts to simulate free space conditions.

The shielding provides a test space, with reduced levels of interference from ambient signals and other outside effects, whilst the radio absorbing material minimizes unwanted reflections from the walls and ceiling which can influence the measurements. In practice it is relatively easy for shielding to provide high levels (80 dB to 140 dB) of ambient interference rejection, normally making ambient interference negligible.

A turntable is capable of rotation through 360° in the horizontal plane and it is used to support the test sample (EUT) at a suitable height (e.g. 1 m) above the ground plane. The chamber shall be large enough to allow the measuring distance of at least 3 m or $2(d_1 + d_2)^2/\lambda$ (m), whichever is greater (see clause B.2.5). The distance used in actual measurements shall be recorded with the test results.

The anechoic chamber generally has several advantages over other test facilities. There is minimal ambient interference, minimal floor, ceiling and wall reflections and it is independent of the weather. It does however have some disadvantages which include limited measuring distance and limited lower frequency usage due to the size of the pyramidal absorbers. To improve low frequency performance, a combination structure of ferrite tiles and urethane foam absorbers is commonly used.

All types of emission, sensitivity and immunity testing can be carried out within an Anechoic Chamber without limitation.

B.1.2 Anechoic chamber with a conductive ground plane

An anechoic chamber with a conductive ground plane is an enclosure, usually shielded, whose internal walls and ceiling are covered with radio absorbing material, normally of the pyramidal urethane foam type. The floor, which is metallic, is not covered and forms the ground plane. The chamber usually contains an antenna mast at one end and a turntable at the other. A typical anechoic chamber with a conductive ground plane is shown in figure B.2.

This type of test chamber attempts to simulate an ideal Open Area Test Site whose primary characteristic is a perfectly conducting ground plane of infinite extent.

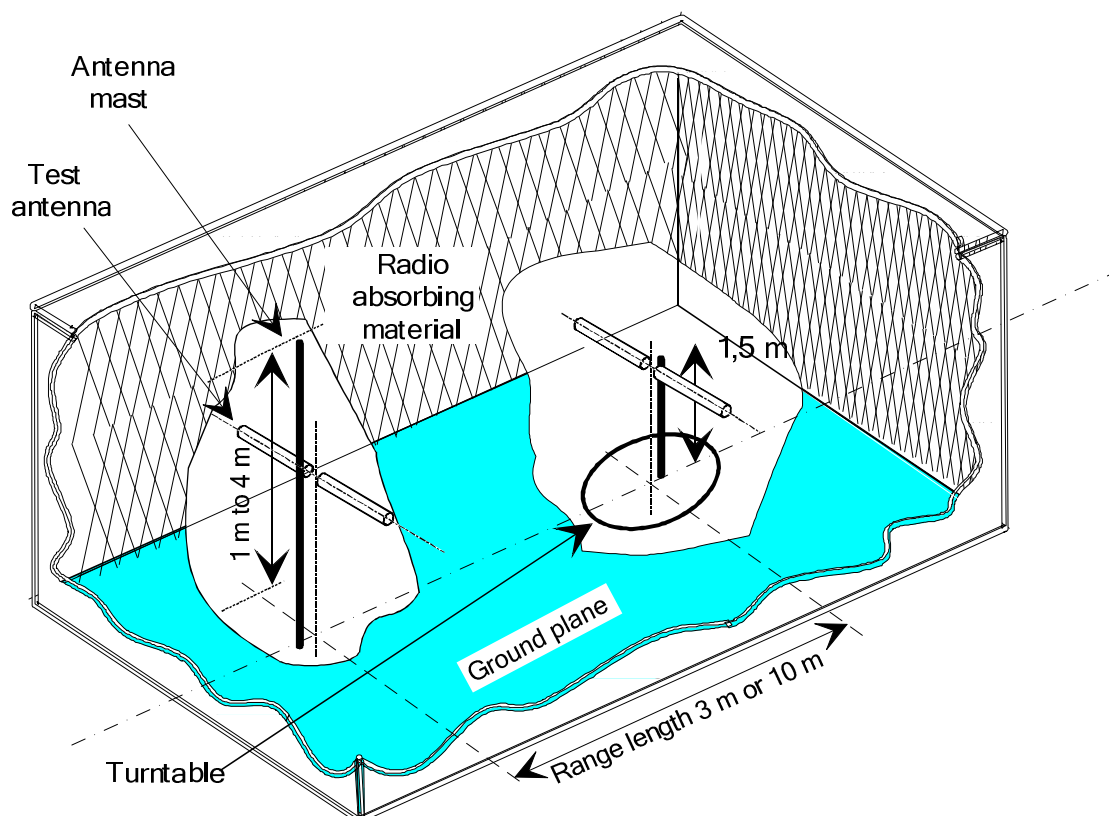

Figure B.2: A typical anechoic chamber with a conductive ground plane

In this facility the ground plane creates the wanted reflection path, such that the signal received by the receiving antenna is the sum of the signals from both the direct and reflected transmission paths. This creates a unique received signal level for each height of the transmitting antenna (or EUT) and the receiving antenna above the ground plane.

The antenna mast provides a variable height facility (from 1 to 4 metres) so that the position of the test antenna can be optimized for maximum coupled signal between antennas or between a EUT and the test antenna.

A turntable is capable of rotation through 360° in the horizontal plane and it is used to support the test sample (EUT) at a specified height, usually 1,5 metres above the ground plane. The chamber shall be large enough to allow the measuring distance of at least 3 m or $2(d_1 + d_2)/\lambda$ (m), whichever is greater (see clause B.2.5). The distance used in actual measurements shall be recorded with the test results.

Emission testing involves firstly "peaking" the field strength from the EUT by raising and lowering the receiving antenna on the mast (to obtain the maximum constructive interference of the direct and reflected signals from the EUT) and then rotating the turntable for a "peak" in the azimuth plane. At this height of the test antenna on the mast, the amplitude of the received signal is noted. Secondly the EUT is replaced by a substitution antenna (positioned at the EUT's phase or volume centre) which is connected to a signal generator. The signal is again "peaked" and the signal generator output adjusted until the level, noted in stage one, is again measured on the receiving device.

Receiver sensitivity tests over a ground plane also involve "peaking" the field strength by raising and lowering the test antenna on the mast to obtain the maximum constructive interference of the direct and reflected signals, this time using a measuring antenna which has been positioned where the phase or volume centre of the EUT will be during testing. A transform factor is derived. The test antenna remains at the same height for stage two, during which the measuring antenna is replaced by the EUT. The amplitude of the transmitted signal is reduced to determine the field strength level at which a specified response is obtained from the EUT.

B.1.3 Open Area Test Site (OATS)

An Open Area Test Site comprises a turntable at one end and an antenna mast of variable height at the other end above a ground plane which, in the ideal case, is perfectly conducting and of infinite extent. In practice, while good conductivity can be achieved, the ground plane size has to be limited. A typical Open Area Test Site is shown in figure B.3.

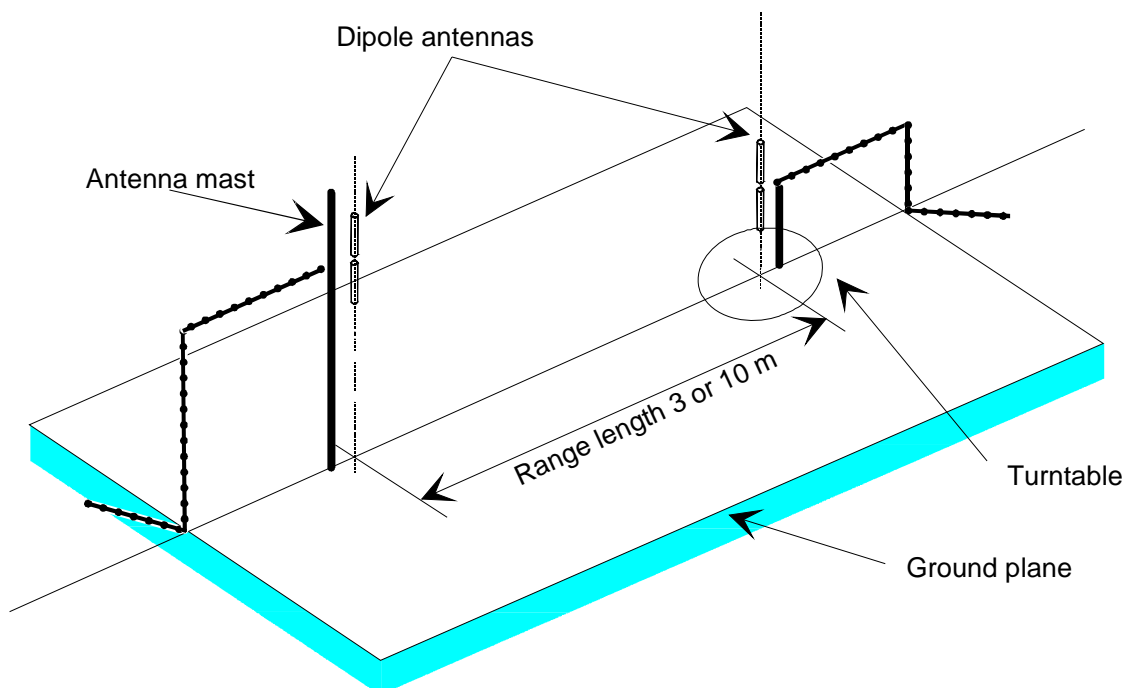

Figure B.3: A typical Open Area Test Site

The ground plane creates a wanted reflection path, such that the signal received by the receiving antenna is the sum of the signals received from the direct and reflected transmission paths. The phasing of these two signals creates a unique received level for each height of the transmitting antenna (or EUT) and the receiving antenna above the ground plane.

Site qualification concerning antenna positions, turntable, measurement distance and other arrangements are same as for anechoic chamber with a ground plane. In radiated measurements an OATS is also used by the same way as anechoic chamber with a ground plane.

Typical measuring arrangement common for ground plane test sites is presented in the figure B.4.

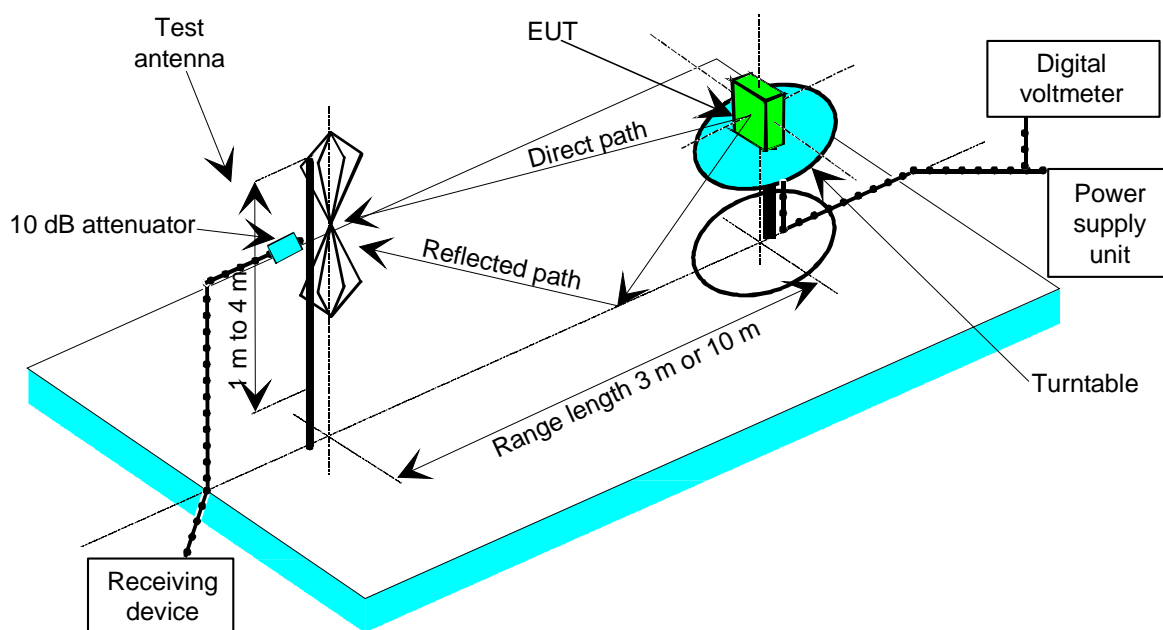

Figure B.4: Measuring arrangement on ground plane test site (OATS set-up for spurious emission testing)

B.1.4 Test antenna

A test antenna is always used in radiated test methods. In emission tests (i.e. frequency error, effective radiated power, spurious emissions and adjacent channel power) the test antenna is used to detect the field from the EUT in one stage of the measurement and from the substitution antenna in the other stage. When the test site is used for the measurement of receiver characteristics (i.e. sensitivity and various immunity parameters) the antenna is used as the transmitting device.

The test antenna should be mounted on a support capable of allowing the antenna to be used in either horizontal or vertical polarization which, on ground plane sites (i.e. Anechoic Chambers with ground planes and Open Area Test Sites), should additionally allow the height of its centre above the ground to be varied over the specified range (usually 1 to 4 metres).

In the frequency band 30 MHz to 1 000 MHz, dipole antennas (constructed in accordance with ANSI C63.5 [3]) are generally recommended. For frequencies of 80 MHz and above, the dipoles should have their arm lengths set for resonance at the frequency of test. Below 80 MHz, shortened arm lengths are recommended. For spurious emission testing, however, a combination of biconical antennas (commonly termed "bicones") and log periodic dipole array antennas (commonly termed "log periodics") could be used to cover the entire 30 MHz to 1 000 MHz band. Above 1 000 MHz, waveguide horns are recommended although, again, log periodics could be used.

NOTE: The gain of a horn antenna is generally expressed relative to an isotropic radiator.

B.1.5 Substitution antenna

The substitution antenna is used to replace the EUT for tests in which a transmitting parameter (i.e. frequency error, effective radiated power, spurious emissions and adjacent channel power) is being measured. For measurements in the frequency band 30 MHz to 1 000 MHz, the substitution antenna should be a dipole antenna (constructed in accordance with ANSI C63.5 [3]). For frequencies of 80 MHz and above, the dipoles should have their arm lengths set for resonance at the frequency of test. Below 80 MHz, shortened arm lengths are recommended. For measurements above 1 000 MHz, a waveguide horn is recommended. The centre of this antenna should coincide with either the phase centre or volume centre.

B.1.6 Measuring antenna

The measuring antenna is used in tests on a EUT in which a receiving parameter (i.e. sensitivity and various immunity tests) is being measured. Its purpose is to enable a measurement of the electric field strength in the vicinity of the EUT. For measurements in the frequency band 30 MHz to 1 000 MHz, the measuring antenna should be a dipole antenna (constructed in accordance with ANSI C63.5 [3]). For frequencies of 80 MHz and above, the dipoles should have their arm lengths set for resonance at the frequency of test. Below 80 MHz, shortened arm lengths are recommended. The centre of this antenna should coincide with either the phase centre or volume centre (as specified in the test method) of the EUT.

B.2 Guidance on the use of radiation test sites

B.2.0 General

This clause details procedures, test equipment arrangements and verification that should be carried out before any of the radiated test are undertaken. These schemes are common to all types of test sites described in annex B.

B.2.1 Verification of the test site

No test should be carried out on a test site which does not possess a valid certificate of verification. The verification procedures for the different types of test sites described in annex B (i.e. Anechoic Chamber, Anechoic Chamber with a ground plane and Open Area Test Site) are given in ETSI TR 102 273 [i.1] parts 2, 3 and 4, respectively.

B.2.2 Preparation of the EUT

The supplier should supply information about the EUT covering the operating frequency, polarization, supply voltage(s) and the reference face. Additional information, specific to the type of EUT should include, where relevant, carrier power, channel separation, whether different operating modes are available (e.g. high and low power modes) and if operation is continuous or is subject to a maximum test duty cycle (e.g. 1 minute on, 4 minutes off).

Where necessary, a mounting bracket of minimal size should be available for mounting the EUT on the turntable. This bracket should be made from low conductivity, low relative dielectric constant (i.e. less than 1,5) material(s) such as expanded polystyrene, balsawood, etc.

B.2.3 Power supplies to the EUT

All tests should be performed using power supplies wherever possible, including tests on EUT designed for battery-only use. In all cases, power leads should be connected to the EUT's supply terminals (and monitored with a digital voltmeter) but the battery should remain present, electrically isolated from the rest of the equipment, possibly by putting tape over its contacts.

The presence of these power cables can, however, affect the measured performance of the EUT. For this reason, they should be made to be "transparent" as far as the testing is concerned. This can be achieved by routing them away from the EUT and down to the either the screen, ground plane or facility wall (as appropriate) by the shortest possible paths. Precautions should be taken to minimize pick-up on these leads (e.g. the leads could be twisted together, loaded with ferrite beads at 0,15 metre spacing or otherwise loaded).

B.2.4 Volume control setting for analogue speech tests

Unless otherwise stated, in all receiver measurements for analogue speech the receiver volume control where possible, should be adjusted to give at least 50 % of the rated audio output power. In the case of stepped volume controls, the volume control should be set to the first step that provides an output power of at least 50 % of the rated audio output power. This control should not be readjusted between normal and extreme test conditions in tests.

B.2.5 Range length

The range length for all these types of test facility should be adequate to allow for testing in the far-field of the EUT i.e. it should be equal to or exceed:

$$\frac{2(d_1 + d_2)^2}{\lambda}$$

Where:

- d_1 is the largest dimension of the EUT/dipole after substitution (m);
- d_2 is the largest dimension of the test antenna (m);
- λ is the test frequency wavelength (m).

It should be noted that in the substitution part of this measurement, where both test and substitution antennas are half wavelength dipoles, this minimum range length for far-field testing would be:

$$2\lambda$$

It should be noted in test reports when either of these conditions is not met so that the additional measurement uncertainty can be incorporated into the results.

NOTE 1: For the fully anechoic chamber, no part of the volume of the EUT should, at any angle of rotation of the turntable, fall outside the "quiet zone" of the chamber at the nominal frequency of the test.

NOTE 2: The "quiet zone" is a volume within the Anechoic Chamber (without a ground plane) in which a specified performance has either been proven by test, or is guaranteed by the supplier. The specified performance is usually the reflectivity of the absorbing panels or a directly related parameter (e.g. signal uniformity in amplitude and phase). It should be noted however that the defining levels of the quiet zone tend to vary.

NOTE 3: For the anechoic chamber with a ground plane, a full height scanning capability, i.e. 1 to 4 metres, should be available for which no part of the test antenna should come within 1 metre of the absorbing panels. For both types of Anechoic Chamber, the reflectivity of the absorbing panels should not be worse than -5 dB.

NOTE 4: For both the anechoic chamber with a ground plane and the Open Area Test Site, no part of any antenna should come within 0,25 metre of the ground plane at any time throughout the tests. Where any of these conditions cannot be met, measurements should not be carried out.

B.2.6 Site preparation

The cables for both ends of the test site should be routed horizontally away from the testing area for a minimum of 2 metres (unless, in the case both types of anechoic chamber, a back wall is reached) and then allowed to drop vertically and out through either the ground plane or screen (as appropriate) to the test equipment. Precautions should be taken to minimize pick up on these leads (e.g. dressing with ferrite beads, or other loading). The cables, their routing and dressing should be identical to the verification set-up.

NOTE: For ground reflection test sites (i.e. anechoic chambers with ground planes and Open Area Test Sites) which incorporate a cable drum with the antenna mast, the 2 metres requirement may be impossible to comply with.

Calibration data for all items of test equipment should be available and valid. For test, substitution and measuring antennas, the data should include gain relative to an isotropic radiator (or antenna factor) for the frequency of test. Also, the VSWR of the substitution and measuring antennas should be known.

The calibration data on all cables and attenuators should include insertion loss and VSWR throughout the entire frequency range of the tests. All VSWR and insertion loss figures should be recorded in the log book results sheet for the specific test.

Where correction factors/tables are required, these should be immediately available.

For all items of test equipment, the maximum errors they exhibit should be known along with the distribution of the error e.g.:

- cable loss: $\pm 0,5$ dB with a rectangular distribution;
- measuring receiver: 1,0 dB (standard deviation) signal level accuracy with a Gaussian error distribution.

At the start of measurements, system checks should be made on the items of test equipment used on the test site.

B.3 Coupling of signals

B.3.0 General

The presence of leads in the radiated field may cause a disturbance of that field and lead to additional measurement uncertainty. These disturbances can be minimized by using suitable coupling methods, offering signal isolation and minimum field disturbance (e.g. optical and acoustic coupling).

B.3.1 Data signals

Isolation can be provided by the use of optical, ultrasonic or infra-red means. Field disturbance can be minimized by using a suitable fibre optic connection. ultrasonic or infra-red radiated connections require suitable measures for the minimization of ambient noise.

B.4 Test fixture

B.4.1 Description

The test fixture is a radio frequency coupling device associated with an integral antenna equipment for coupling the integral antenna to a 50Ω radio frequency terminal at the working frequencies of the equipment under test. This allows certain measurements to be performed using the conducted measurement methods. Only relative measurements may be performed and only those at or near frequencies for which the test fixture has been calibrated.

In addition, the test fixture shall provide:

- a) a connection to an external power supply;
- b) an audio interface either by direct connection or by an acoustic coupler.

The test fixture normally shall be provided by the manufacturer.

The performance characteristics of the test fixture shall conform to the following basic parameters:

- a) the coupling loss shall not be greater than 30 dB;
- b) a coupling loss variation over the frequency range used in the measurement which does not exceed 2 dB;
- c) circuitry associated with the RF coupling shall contain no active or non linear devices;
- d) the VSWR at the 50Ω socket shall not be greater than 1,5 over the frequency range of the measurements;
- e) the coupling loss shall be independent of the position of the test fixture and be unaffected by the proximity of surrounding objects or people. The coupling loss shall be reproducible when the equipment under test is removed and replaced;
- f) the coupling loss shall remain substantially constant when the environmental conditions are varied.

In the case of measurements to be performed by a third party, the performance characteristics of the test fixture shall be approved by the testing laboratory.

The characteristics and calibration shall be included in test reports.

B.4.2 Calibration

The calibration of the test fixture establishes a relationship between the output of the signal generator and the field strength applied to the equipment inside the test fixture.

The calibration is valid **only** at a given frequency and for a given polarization of the reference field.

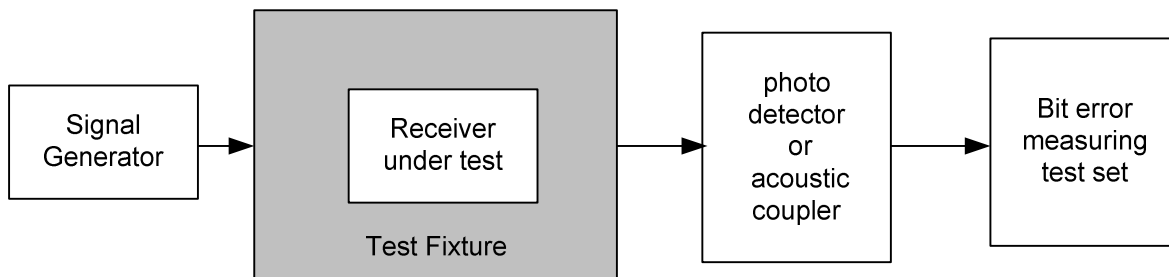

Figure B.5: Measuring arrangement for calibration

- a) Using the method described in clause 8.1.2 or 8.1.4, measure the sensitivity expressed as field strength, and note the value of this field strength in dB μ V/m and the polarization used.
- b) The receiver is now placed in the test fixture which is connected to the signal generator. The level of the signal generator producing a until a bit error ratio of 10^{-2} or a successful message ratio of 80 % shall be noted.
- c) The calibration of the test fixture is thus the linear relationship between the field strength in dB μ V/m and the signal generator level in dB μ V emf or dBm.

B.4.3 Mode of use

For the transmitter measurements calibration is not required.

For the receiver measurements calibration is necessary.

To apply the specified wanted signal level expressed in field strength, convert it into the signal generator level (emf) using the calibration of the test fixture. Apply this value with the signal generator.

Annex C (normative): Specification for some particular measurement arrangements

C.1 Power measuring receiver specification

C.1.0 General

The power measuring receiver consists of a mixer, an IF filter, an oscillator, an amplifier, a variable attenuator and a root mean squared (rms) value indicator.

Instead of the variable attenuator with the rms value indicator it is also possible to use a rms voltmeter calibrated in dB. The technical characteristics of the power measuring receiver are given in clauses C.1.1 to C.1.4.

An alternative measuring method shall consist in using, in place of the IF filter and the rms voltmeter calibrated in dB, a spectrum analyser with a resolution bandwidth of 100 Hz and integrating the power of all the 100 Hz sub-band measurements, over a total bandwidth of $\pm D2$ (see table C.1).

Spectrum analyser should use the rms measurement mode.

C.1.1 IF filter

The IF filter shall be within the limits of the selectivity characteristic of figure C.1.

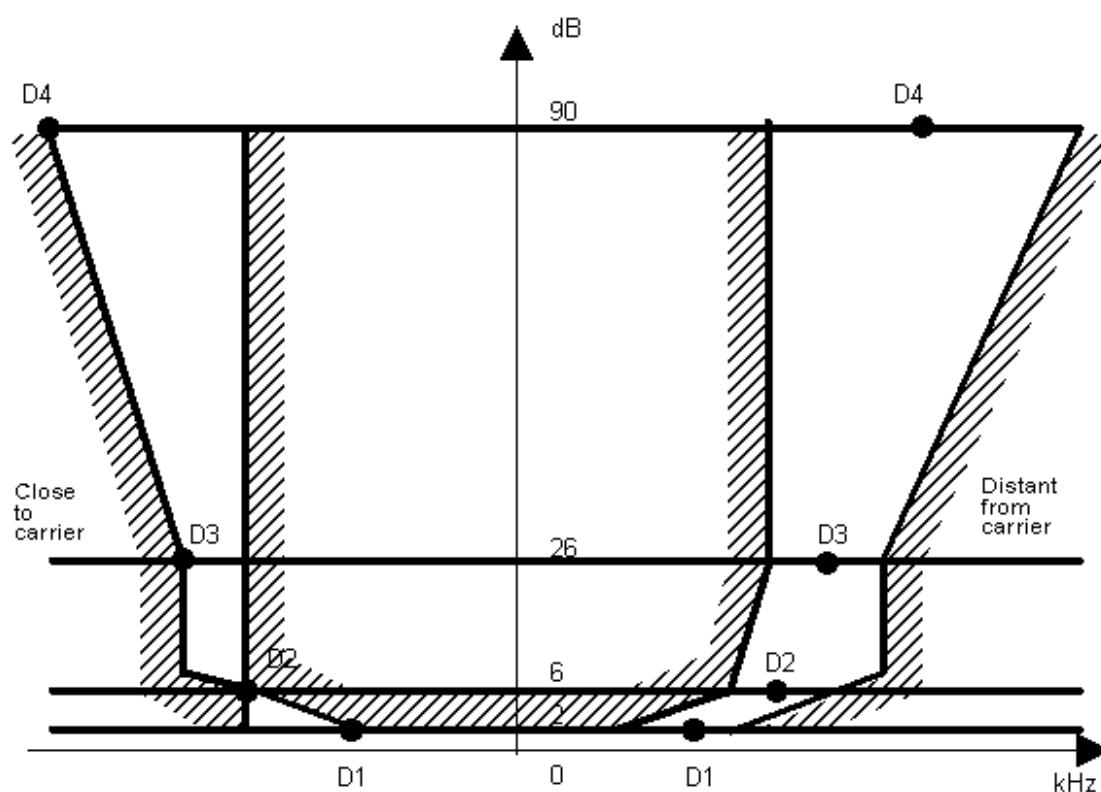

Figure C.1: IF filter

Depending on the channel separation, the selectivity characteristic shall keep the frequency separations from the nominal centre frequency of the adjacent channel as stated in table C.1.

Table C.1: Selectivity characteristic

Channel separation (kHz)	Frequency separation of filter curve from nominal centre frequency of adjacent channel (kHz)			
	D1	D2	D3	D4
12,5	3	4,25	5,5	9,5
20	4	7,0	8,25	12,25
25	5	8,0	9,25	13,25

Depending on the channel separation, the attenuation points shall not exceed the tolerances as stated in tables C.2 and C.3.

Table C.2: Attenuation points close to carrier

Channel separation (kHz)	Tolerances range (kHz)			
	D1	D2	D3	D4
12,5	+1,35	±0,1	-1,35	-5,35
20	+3,1	±0,1	-1,35	-5,35
25	+3,1	±0,1	-1,35	-5,35

Table C.3: Attenuation points distant from the carrier

Channel separation (kHz)	Tolerance range (kHz)			
	D1	D2	D3	D4
12,5	±2,0	±2,0	±2,0	+2,0 -6,0
20	±3,0	±3,0	±3,0	+3,0 -7,0
25	±3,5	±3,5	±3,5	+3,5 -7,5

The minimum attenuation of the filter, outside the 90 dB attenuation points, shall be greater than or equal to 90 dB.

C.1.2 Attenuation indicator

The attenuation indicator shall have a minimum range of 80 dB and a reading accuracy of 1 dB. With a view to future regulations, an attenuation of 90 dB or more is recommended.

C.1.3 RMS value indicator

The instrument shall accurately indicate non-sinusoidal signals in a ratio of up to 10:1 between peak value and rms value.

C.1.4 Oscillator and amplifier

The oscillator and the amplifier shall be designed in such a way that the measurement of the adjacent channel power of a low-noise unmodulated transmitter, whose self-noise has a negligible influence on the measurement result, yields a measured value of ≤ -90 dB for channel separations of 20 kHz and 25 kHz and of ≤ -80 dB for a channel separation of 12,5 kHz, referred to the carrier of the oscillator.

C.2 Spectrum analyser specification

C.2.1 Adjacent and alternate channel power measurement

The characteristics of the spectrum analyser shall meet at least the following requirements:

- the reading accuracy of the frequency marker shall be within ± 100 Hz;

- the accuracy of relative amplitude measurements shall be within $\pm 3,5$ dB.

It shall be possible to adjust the spectrum analyser to allow the separation on its screen of two equal amplitude components with a frequency difference of 200 Hz.

For statistically distributed modulations, the spectrum analyser and the integrating device (when appropriate) needs to allow determination of the power spectral density (energy per time and bandwidth), which has to be integrated over the bandwidth in question. It shall be possible to sum the effective power of all discrete components, the spectral power density and the noise power in the selected bandwidth and to measure this as a ratio relative to the carrier power.

The spectrum analyser should have a dynamic range greater than 90 dB and the average phase noise in the adjacent channels shall be such that measurement of adjacent channel power is not limited by phase noise. In order to confirm this, the selected measurement technique for clause 7.4.2 shall be used to measure the adjacent channel power with a CW signal source with phase noise of less than -120 dBc/Hz in the centre of the adjacent channel. The following performance shall be achieved:

- the maximum adjacent channel power observed with these conditions shall not exceed -70 dBc;
- the maximum alternate channel power measured with these conditions shall not exceed -80 dBc.

NOTE: A resolution bandwidth of 500 Hz may be used for this measurement as an alternative to the usual 100 Hz to reduce measurement time.

C.2.2 Unwanted emissions measurement

The specification shall include the following requirements.

It shall be possible, using a resolution bandwidth of 1 kHz, to measure the amplitude of a signal, or noise at a level 3 dB or more above the noise level of the spectrum analyser, as displayed on the screen, to an accuracy of ± 2 dB in the presence of the wanted signal.

The accuracy of relative amplitude measurements shall be within ± 1 dB.

For statistically distributed modulations, the spectrum analyser and the integrating device (when appropriate) shall allow determination of the real spectral power density (energy per time and bandwidth), which has to be integrated over the bandwidth in question.

C.3 Integrating and power summing device

The integrating and power summing device is connected to the video output of the spectrum analyser, referred to in clause C.2.

It shall be possible to sum the effective power of all discrete components, the spectral power density and the noise power in the selected bandwidth and to measure this as a ratio relative to the carrier power.

The position and the width of the integration range selected can be indicated on the spectrum analyser by brightening the trace.

History

Document history		
Edition 1	February 1996	Publication as ETSI ETS 300 390
Edition	June 1996	Publication as ETSI ETS 300 390 Corrigendum 1
Edition 1	March 1997	Publication as ETSI ETS 300 390 Amendment 1
V1.1.1	August 1999	Publication as ETSI EN 300 390 part 2
V1.2.1	September 2000	Publication as ETSI EN 300 390 part 1
V2.1.0	December 2015	EN Approval Procedure AP 20160320: 2015-12-21 to 2016-03-21