



**Technical characteristics and methods of measurement
for equipment for generation, transmission
and reception of Digital Selective Calling (DSC)
in the maritime MF, MF/HF and/or VHF mobile service;
Part 2: Class A DSC**

Reference

REN/ERM-TGMAR-593

Keywords

DSC, GMDSS, maritime, radio

ETSI

650 Route des Lucioles
F-06921 Sophia Antipolis Cedex - FRANCE

Tel.: +33 4 92 94 42 00 Fax: +33 4 93 65 47 16

Siret N° 348 623 562 00017 - NAF 742 C
Association à but non lucratif enregistrée à la
Sous-Préfecture de Grasse (06) N° 7803/88

Important notice

The present document can be downloaded from:

<http://www.etsi.org/standards-search>

The present document may be made available in electronic versions and/or in print. The content of any electronic and/or print versions of the present document shall not be modified without the prior written authorization of ETSI. In case of any existing or perceived difference in contents between such versions and/or in print, the prevailing version of an ETSI deliverable is the one made publicly available in PDF format at www.etsi.org/deliver.

Users of the present document should be aware that the document may be subject to revision or change of status.

Information on the current status of this and other ETSI documents is available at

<https://portal.etsi.org/TB/ETSIDeliverableStatus.aspx>

If you find errors in the present document, please send your comment to one of the following services:

<https://portal.etsi.org/People/CommiteeSupportStaff.aspx>

Copyright Notification

No part may be reproduced or utilized in any form or by any means, electronic or mechanical, including photocopying and microfilm except as authorized by written permission of ETSI.

The content of the PDF version shall not be modified without the written authorization of ETSI.

The copyright and the foregoing restriction extend to reproduction in all media.

© ETSI 2019.

All rights reserved.

DECT™, **PLUGTESTS™**, **UMTS™** and the ETSI logo are trademarks of ETSI registered for the benefit of its Members.

3GPP™ and **LTE™** are trademarks of ETSI registered for the benefit of its Members and of the 3GPP Organizational Partners.

oneM2M™ logo is a trademark of ETSI registered for the benefit of its Members and of the oneM2M Partners.

GSM® and the GSM logo are trademarks registered and owned by the GSM Association.

Contents

Intellectual Property Rights	6
Foreword.....	6
Modal verbs terminology.....	6
1 Scope	7
2 References	7
2.1 Normative references	7
2.2 Informative references.....	8
3 Definition of terms, symbols and abbreviations.....	8
3.1 Terms.....	8
3.2 Symbols.....	10
3.3 Abbreviations	10
4 Controls and Indicators in Class A DSC Equipment.....	10
4.1 Visual indication	10
5 Technical requirements	11
5.1 Facilities for DSC transmission and reception	11
5.1.1 Multi-frequency distress alert attempts and watch receiver capabilities (MF/HF)	11
5.1.2 Watch receiver capabilities (VHF)	11
5.2 Remote alarms.....	11
5.3 Galvanic isolation.....	11
5.4 Manuals	11
6 Automated and Non-Automated Procedure Requirements in Class A DSC Equipment	11
6.1 Introduction	11
6.2 Non-automated features	12
6.2.0 General.....	12
6.2.1 DSC Message Composition	12
6.2.2 Transmission of DSC messages and prioritized wait.....	13
6.2.3 Alarms	14
6.3 Standby.....	14
6.4 Sending distress automated procedure	15
6.4.1 Procedure.....	15
6.4.2 Tasks.....	17
6.4.3 Display.....	17
6.4.3.0 General Display Requirements.....	17
6.4.3.1 Examples of sending distress procedure displays on VHF equipment.....	18
6.4.4 Dedicated distress button sub procedure.....	19
6.4.5 Transmission of the alert attempt.....	20
6.4.6 Updating position.....	20
6.4.7 Handling received DSC Messages.....	20
6.4.8 Alarms	20
6.4.9 Determining Subsequent communications.....	21
6.4.10 Automated tuning	21
6.4.11 Cancelling the Distress Alert	21
6.4.11.0 General Requirements.....	21
6.4.11.1 Examples of cancel-distress displays on VHF equipment.....	22
6.4.12 Acknowledgments	23
6.4.13 Termination.....	23
6.4.14 Warnings.....	23
6.5 Receiving distress automated procedure	23
6.5.1 Procedure	23
6.5.2 Tasks.....	25
6.5.3 Display	25
6.5.3.0 General Display Requirements.....	25
6.5.3.1 Examples of received distress procedure displays on VHF equipment.....	26

6.5.4	Handling received DSC Messages.....	27
6.5.5	Alarms	27
6.5.6	Determining Subsequent communications.....	27
6.5.7	Automated tuning	27
6.5.8	Acknowledgments	28
6.5.9	Sending Relays and Acknowledgments.....	28
6.5.10	Termination.....	28
6.5.11	Warnings.....	28
6.5.12	Handling events from man overboard devices (VHF only)	29
6.5.12.1	General	29
6.5.12.2	Display and tasks	29
6.5.12.3	Handling received DSC messages pertinent to the procedure.....	30
6.6	Sending non-distress automated procedure	31
6.6.1	Procedure	31
6.6.2	Tasks	31
6.6.3	Display	32
6.6.3.0	General Display Requirements.....	32
6.6.3.1	Examples of sending non-distress procedures displays on VHF equipment	33
6.6.4	Handling received DSC Messages	33
6.6.5	Alarms	33
6.6.6	Automated tuning	33
6.6.7	Delayed Acknowledgements	34
6.6.8	Termination.....	34
6.6.9	Warnings.....	34
6.7	Receiving non-distress automated procedure	34
6.7.1	Procedure	34
6.7.2	Tasks	36
6.7.3	Display	36
6.7.3.0	General Display Requirements.....	36
6.7.3.1	Examples of receiving non-distress procedures displays on VHF equipment.....	37
6.7.4	Handling received DSC messages	38
6.7.5	Alarms	38
6.7.6	Automated tuning	38
6.7.7	Acknowledgments	39
6.7.8	Termination.....	39
6.7.9	Warnings.....	39
6.8	Communications automated procedure	40
6.8.1	Procedure	40
6.8.2	Tasks	40
6.8.3	Display	40
6.8.4	Handling received DSC Messages	40
6.8.5	Tuning of the general receiver and transmitter	40
6.8.6	Termination.....	41
6.9	Multiple automated procedures and parallel event handling	41
6.9.1	Procedure	41
6.9.2	Tasks.....	41
6.9.3	Examples of multiple procedure screens	42
Annex A (normative): DSC Message Composition		43
A.1	Default values.....	43
A.2	The default DROBOSE.....	44
A.3	Allowable non-distress DSC message parameters	44
Annex B (normative): Radius-Centre point conversion and rounding algorithm		45
B.1	Radius-centre point conversion.....	45
B.2	Rounding	46
B.3	Special cases for either form of area data entry	46

Annex C (normative):	Automated Non-Distress Channel/Frequency Selection Algorithm.....	47
C.0	General	47
C.1	VHF.....	47
C.2	HF.....	47
Annex D (normative):	Alarms.....	48
D.1	Alarm specifications.....	48
D.2	Alarming with critical errors	49
D.3	Default alarm sounds.....	49
D.4	Other alarm sounds.....	50
History	51

Intellectual Property Rights

Essential patents

IPRs essential or potentially essential to normative deliverables may have been declared to ETSI. The information pertaining to these essential IPRs, if any, is publicly available for **ETSI members and non-members**, and can be found in ETSI SR 000 314: "*Intellectual Property Rights (IPRs); Essential, or potentially Essential, IPRs notified to ETSI in respect of ETSI standards*", which is available from the ETSI Secretariat. Latest updates are available on the ETSI Web server (<https://ipr.etsi.org/>).

Pursuant to the ETSI IPR Policy, no investigation, including IPR searches, has been carried out by ETSI. No guarantee can be given as to the existence of other IPRs not referenced in ETSI SR 000 314 (or the updates on the ETSI Web server) which are, or may be, or may become, essential to the present document.

Trademarks

The present document may include trademarks and/or tradenames which are asserted and/or registered by their owners. ETSI claims no ownership of these except for any which are indicated as being the property of ETSI, and conveys no right to use or reproduce any trademark and/or tradename. Mention of those trademarks in the present document does not constitute an endorsement by ETSI of products, services or organizations associated with those trademarks.

Foreword

This draft European Standard (EN) has been produced by ETSI Technical Committee Electromagnetic compatibility and Radio spectrum Matters (ERM), and is now submitted for the combined Public Enquiry and Vote phase of the ETSI standards EN Approval Procedure.

The present document is part 2 of a multi-part deliverable. Full details of the entire series can be found in part 1 [i.1].

The present document covers the operator interfaces and operating system for Class A DSC equipment.

Proposed national transposition dates	
Date of latest announcement of this EN (doa):	3 months after ETSI publication
Date of latest publication of new National Standard or endorsement of this EN (dop/e):	6 months after doa
Date of withdrawal of any conflicting National Standard (dow):	18 months after doa

Modal verbs terminology

In the present document "**shall**", "**shall not**", "**should**", "**should not**", "**may**", "**need not**", "**will**", "**will not**", "**can**" and "**cannot**" are to be interpreted as described in clause 3.2 of the [ETSI Drafting Rules](#) (Verbal forms for the expression of provisions).

"**must**" and "**must not**" are **NOT** allowed in ETSI deliverables except when used in direct citation.

1 Scope

The present document states the minimum requirements for equipment to be used for generation, transmission and reception of Class A Digital Selective Calling (DSC) for use on board ships.

DSC is intended to be used in the Medium Frequency (MF), High Frequency (HF) and Very High Frequency (VHF) bands of the Maritime Mobile Service (MMS), for both distress, safety and general communications.

The present document is part 2 of a multi-part deliverable that covers the requirements to be fulfilled by equipment that is either integrated with a transmitter and/or a receiver or equipment that is a stand-alone DSC terminal and has the following class of DSC:

- Class A: includes all the facilities defined in annex 1 of Recommendation ITU-R M.493-15 [3] and complies with the IMO Global Maritime Distress and Safety System (GMDSS) carriage requirements for MF/HF installations and/or VHF installations.

These requirements include the relevant provisions of the ITU Radio Regulations [2] and Recommendation ITU-R M.493-15 [3], the International Convention for the Safety Of Life At Sea (SOLAS) [1], and the relevant resolutions of the International Maritime Organization (IMO) [4].

2 References

2.1 Normative references

References are either specific (identified by date of publication and/or edition number or version number) or non-specific. For specific references, only the cited version applies. For non-specific references, the latest version of the referenced document (including any amendments) applies.

Referenced documents which are not found to be publicly available in the expected location might be found at <https://docbox.etsi.org/Reference/>.

NOTE: While any hyperlinks included in this clause were valid at the time of publication, ETSI cannot guarantee their long term validity.

The following referenced documents are necessary for the application of the present document.

- [1] "International Convention for the Safety of Life at Sea (SOLAS)", 1974.
- [2] ITU Radio Regulations (2016).
- [3] Recommendation ITU-R M.493-15 (01/2019): "Digital selective-calling system for use in the maritime mobile service".
- [4] IMO resolution MSC.97(73), section 14.6.4: "Adoption of the International Code of Safety for High-Speed Craft, 2000 (2000 HSC Code)".

2.2 Informative references

References are either specific (identified by date of publication and/or edition number or version number) or non-specific. For specific references, only the cited version applies. For non-specific references, the latest version of the referenced document (including any amendments) applies.

NOTE: While any hyperlinks included in this clause were valid at the time of publication, ETSI cannot guarantee their long term validity.

The following referenced documents are not necessary for the application of the present document but they assist the user with regard to a particular subject area.

- [i.1] ETSI EN 300 338-1: "Technical characteristics and methods of measurement for equipment for generation, transmission and reception of Digital Selective Calling (DSC) in the maritime MF, MF/HF and/or VHF mobile service; Part 1: Common requirements".
- [i.2] MSC 302(87): "Adoption of performance standards for bridge alert management".
- [i.3] IEC 61924-2 (Edition 1): "Maritime navigation and radiocommunication equipment and systems -- integrated navigation systems -- Part 2: Modular structure for INS -- operational and performance requirements, methods of testing and required test results" (including IEC 61924-2 Corrigendum 1 November 2013).
- [i.4] ETSI EN 300 338-6: "Technical characteristics and methods of measurement for equipment for generation, transmission and reception of Digital Selective Calling (DSC) in the maritime MF, MF/HF and/or VHF mobile service; Part 6: Class M DSC".
- [i.5] Recommendation ITU-R M.541-10: "Operational procedures for the use of digital selective-calling equipment in the maritime mobile service".
- [i.6] Recommendation ITU-R M.585-7: "Assignment and use of identities in the maritime mobile service".

3 Definition of terms, symbols and abbreviations

3.1 Terms

For the purposes of the present document, the terms given in ETSI EN 300 338-1 [i.1] and the following apply:

acknowledged: when the objective of the initial DSC message has been achieved

active: automated procedure which has control of the general receiver and transmitter and is thus able to engage in subsequent communications and receive DSC messages on both the watch receiver and general receiver

automated procedure: set of actions necessary to complete the objective of an initiating DSC message or non DSC communication event

NOTE 1: Four DSC automated procedures are designed to process these. They are the receiving of distress DSC messages, the receiving of non-distress DSC messages, the sending of distress DSC alert attempts and the sending of non-distress DSC messages. In addition a fifth procedure is designed to handle non DSC communication events.

NOTE 2: These automated procedures are called:

- Received distress automated procedure.
- Sending distress automated procedure.
- Received non-distress automated procedure.
- Sending non-distress automated procedure.

- Communications automated procedure.

closed loop operation: MOB devices supporting closed loop can be programmed to transmit either an individual distress relay call (subsequent communication 126) to a vessel or group distress relay call to a group of vessels as described in Recommendation ITU-R M.493-15 [3]

NOTE: Acknowledgement of these calls is possible.

default: value selected or an action taken by the equipment software in the absence of any operator input

distress DSC message: DSC message or acknowledgement containing the distress information

distress event: unique distress situation identified by two (VHF) or three (MF/HF) parameters of the distress information; the MMSI of the vessel in distress and the nature of distress and on MF/HF the mode of subsequent communication

engaged: equipment that is busy handling an automated procedure

factory default: default value that is set by the manufacturer such that the field or behaviour is defined prior to any operator intervention

general receiver: receiver part of the transceiver used for the reception of all subsequent communications and on HF the reception of DSC acknowledgements on the duplex DSC channels

NOTE: It is important to distinguish this unit from the watch receiver.

information characters: set of symbols in a DSC message that contains the items of interest for the recipient and is used to compute the ECC symbol that terminates the message

NOTE: These symbols are repeated in the DX/RX time diversity pattern.

initial DSC message: DSC message that starts an automated procedure

non-distress DSC message: DSC messages or acknowledgments that do not have the format specifier or category of "distress"

objective: intent of the DSC message either to establish subsequent communications or request information

on hold: automated procedure which does not have access to the transmitter and general receiver and therefore cannot engage in subsequent communications and is only able to receive DSC messages on the watch receiver

open loop operation: MOB device is in a state where it transmits distress alerts (Recommendation ITU-R M.493-15 [3])

operator options: any choices the operator can make while the automated procedure is engaged

parallel event handling: background process of handling a received DSC message that is not pertinent to the active automated procedure

pertinent to the automated procedure: DSC messages that have something to do with the procedure and are therefore "handled" by the procedure

NOTE: A DSC message is pertinent to an automated procedure if the set of information characters in the DSC message has the correct values.

pertinent to the station: any DSC message that would start an automated procedure if the transceiver were in standby

self-terminating alarm: short alarm that stops by itself without operator intervention

NOTE: The purpose of this alarm is to inform the operator that a DSC message is received but it does not require his immediate attention.

symbol (as part of the DSC sentence): term used to describe the 7 binary bits of a 10 bit DSC word that have the information content

toggle (between automated procedures): ability to make one automated procedure active assuring that all other procedures go on hold

top level: items, buttons, or functions are present and visible without requiring any action by the operator (such as scrolling, opening up menus, or removing any obscuring covers, etc.)

two-tone alarm: alarm consisting of a repetition of the 2 200 Hz frequency for 250 ms followed by a 1 300 Hz frequency for 250 ms

NOTE: This alarm is used for the initiation of the received distress DSC automated procedure.

urgency alarm: alarm consisting of a repetition of the 2 200 Hz frequency for 250 ms followed by 250 ms period of silence

NOTE: This alarm is used for the initiation of the received non-distress DSC automated procedure when the category of the initiating DSC message is "urgency".

watch receiver: separate receiver in DSC radios that continuously monitors the DSC distress frequencies on MF/HF, 2 187,5 kHz on MF, and channel 70 on VHF

NOTE: On MF/HF it is sometimes referred to as the scanning receiver.

word (as part of the DSC sentence): 10 binary bits that make up the coded entities of a transmitted DSC message

NOTE: The 10 bits consist of a 7 bit "symbol" that gives the information content and 3 bit error check that gives the number of 0 binary bits in the 7 bit symbol.

3.2 Symbols

Void.

3.3 Abbreviations

For the purposes of the present document, the abbreviations given in ETSI EN 300 338-1 [i.1] and the following apply:

ALE	Automatic Linking Exchange
DROBOSE	Distress Relay On Behalf Of Someone Else
MOB	Man Over Board
NBDP	Narrow Band Direct Printing

4 Controls and Indicators in Class A DSC Equipment

4.1 Visual indication

Any visual display of the information content shall be clearly legible under all ambient light conditions.

The display shall be large enough to hold enough information from the active procedure to safely guide the operator through operator options in any engaged DSC procedure (distress or non-distress). It shall at any time hold information on how to instantly recall any waiting procedure, or put any active procedure on hold.

The amount of information to display simultaneously on the display shall correspond to the information that can be written in plain text with a minimum of 160 characters, each character having a minimum height of 3,5 mm, and a nominal character width/height ratio of 0,7.

Where logic flows and procedural guidance, expressed by graphical symbols, have an advantage over text, this shall be allowed. Any graphical symbols shall be clearly defined in the operation manual.

All DSC displays at all operating positions shall comply with these requirements.

5 Technical requirements

5.1 Facilities for DSC transmission and reception

5.1.1 Multi-frequency distress alert attempts and watch receiver capabilities (MF/HF)

The equipment shall either:

- be capable of receiving DSC messages on all distress frequencies (except for the transmit frequency in use) whilst the distress alert is being transmitted; or
- be able to complete the multi-frequency distress alert attempt within 1 minute and then be capable of receiving DSC messages on all frequencies used in that multi-frequency attempt.

5.1.2 Watch receiver capabilities (VHF)

The watchkeeping receiver part of the DSC equipment shall be designed for continuous operation on channel 70 but the receiver need not operate when the transmitter is in use on that channel.

5.2 Remote alarms

The equipment shall be provided with facilities for connecting remote alarms as recommended in Chapter IV/6.6, regulation X/3 of the SOLAS Convention [1] and IMO resolution MSC.97 (73), section 14.6.4 [4].

5.3 Galvanic isolation

No exposed metallic part of the equipment shall cause any terminal of the source of electrical energy to be earthed.

5.4 Manuals

Maintenance or service manuals shall be available and shall contain:

- If the equipment is so constructed that fault diagnosis and repair is practicable down to component level, the maintenance instructions shall include full circuit diagrams, component layouts and components parts lists.
- If the equipment contains modules in which fault diagnosis and repair down to component level is not practicable, the maintenance instructions shall contain sufficient information to enable localization and replacement of the defective module.

6 Automated and Non-Automated Procedure Requirements in Class A DSC Equipment

6.1 Introduction

This clause covers the minimum level of software automation, operational simplicity, and interface consistency requirements for shipborne fixed installations using class A Digital Selective Calling equipment as specified in Recommendation ITU-R M.493-15 [3], annexes 1, 3 and 4.

Perhaps the most important issue concerns an implied expectation for the use of the terminology "automated procedure" as used in the present document to appear in the user interface. The terminology "automated procedure" describes the set of algorithms that are used to encapsulate all the activities necessary to perform multitasking, DSC, and non DSC communication events. The operator does not need to know anything about the existence of automated procedures in order to operate a radio that makes use of these algorithms. Though the present document refers to items such as the "Sending Distress Automated Procedure" such language shall not appear on the user interface of the equipment.

The primary purpose of DSC signalling is to provide the means to set-up subsequent communications between vessels and/or coast stations. A call may be considered as being the total duration from the start of the DSC signalling until the end of the subsequent communications, and the automated procedure is terminated.

The operational functionality described in this part has the objective of not disturbing any ongoing call. Furthermore, the equipment shall assist the operator by providing simple audible indication of a received DSC call whilst the equipment is engaged, and provide a facility to manage activation amongst initiated automated procedures.

6.2 Non-automated features

6.2.0 General

This clause describes the features of the equipment that are necessary to assure compliance to the ITU-R DSC functionality standards and support a smoother operation of the automation algorithms, but are not directly related to the automation algorithms.

6.2.1 DSC Message Composition

The equipment shall provide factory default values for all non-distress DSC messages as specified in Recommendation ITU-R M.493-15 [3], annex 3 and summarized in figure A.1 for all parameters where the operator has the option to select or enter more than one value and has not already done so.

The default values for the Distress Relay On Behalf Of Someone Else (DROBOSE) shall be as given in table A.1.

The default values for the operator-composed distress alert shall be the default distress alert as specified in the sent distress automated procedure.

A destination MMSI that does not have at least 9 digits entered is invalid.

The MMSI "unknown" indicator shall only be able to be used for the MMSI of the vessel in distress when composing a DROBOSE.

No DSC message shall be able to be sent that has an invalid parameter.

For simplicity of the user interface:

- a) the DSC message composition interface shall be such that the operator needs no user manual to initiate the desired DSC message;
- b) it shall require a maximum of two keystrokes, button pushes or menu actions plus the entry or selection of a destination MMSI and working channel (where appropriate) for the operator to send the default (routine individual) DSC message from standby;
- c) parameter descriptions and terms shall be provided in plain language;
- d) all parameters of the DSC message that do not require an operator choice shall be entered automatically;
- e) guidance and/or prompting shall be provided for the entry of any necessary parameters of the DSC message if these parameters and/or their values are not plainly visible from context or on the display.

For data entry:

- a) the equipment shall only allow the operator to compose and send DSC messages that are compliant with the latest version of Recommendation ITU-R M.493-15 [3];
- b) acknowledgements shall be automatically composed by the equipment and user options for these acknowledgements are provided by the automated procedures;
- c) the equipment shall provide the operator with the choice of specifying the geographic area parameters as either a circle of radius "r" about a centre point or the traditional latitude-longitude Mercator box and northwest corner point or about a centre point;
- d) the equipment shall convert and round the radius-centre point entry according to the algorithm given in annex B;
- e) the equipment shall provide an automatic determination of the channel and or frequencies of subsequent communication according to the algorithm given in Recommendation ITU-R M.493-15 [3], annex 3 and summarized in annex C.

The automated channel selection shall be able to be overridden.

It shall not be possible to select a distress channel for subsequent communications for DSC messages of priority routine.

The equipment shall automatically set the dot pattern length to 20 bits for all transmitted DSC messages on VHF, and on MF/HF all DSC messages addressed to a coast station and all individual acknowledgements with format specifiers 120 and 123.

Furthermore MF/HF equipment shall automatically set the dot pattern length to 200 bits for all transmitted DSC messages for:

- distress alerts;
- distress acknowledgements;
- distress relays addressed to a geographic area;
- distress relay acknowledgements addressed to all ships;
- all calls addressed to a ship station other than messages addressed to a coast station or all individual acknowledgements with format specifiers 120 and 123.

6.2.2 Transmission of DSC messages and prioritized wait

If the channel is free after the transmitter has powered up, the transmission shall begin immediately. If the channel is not free, and the DSC message is a distress alert, the alert shall be transmitted as soon as the channel becomes free or after 10 seconds on MF or HF or 1 second on VHF, whichever occurs first. (The 10 seconds and 1 second values are approximate average times for HF and VHF DSC messages, respectively.) For all other DSC messages, the equipment shall wait for the channel to become free and then the equipment shall delay transmission of the DSC message for a specified wait time.

The specified wait time shall depend upon the message type and priority. Distress DSC messages (except for alerts), urgency, safety, routine and test DSC messages shall wait one, two, three, and four "fixed" units of time plus a random addition described below, respectively, before attempting to transmit. Transmission occurs if and only if the channel is still free after this wait time has elapsed, otherwise the process is repeated.

The fixed "unit" of time shall be 100 ms on MF and HF and 50 ms on VHF. The randomly generated component shall be some positive integer with resolution in milliseconds between zero and the fixed interval. The random component serves as a tie-breaker when multiple DSC messages of the same priority and type are waiting to be transmitted. The randomly generated part of the wait time shall be recomputed for every transmission attempt.

For example, on HF, the random interval would be some positive integer of milliseconds between 0 ms and 100 ms, for example, 56 ms. Thus the wait time for a routine DSC message in this example would be 456 ms the first attempt. If the channel was once again busy after the wait time expired, the new wait time might be 417 ms the second attempt, etc.

6.2.3 Alarms

Alarms shall have both a visual and aural component.

Any alarm that initiates for the purpose of getting the operator's attention shall provide the reason for and means to terminate the alarm.

Alarms shall be initiated for the reasons given in table D.1.

The means to terminate the alarms are given in table D.1.

The "two-tone" and "urgency-sound" alarms shall not be able to be disabled.

The default aural alarms are given by table D.2.

Some alarm tones may be customized by the operator as shown in table D.2.

6.3 Standby

NOTE: Standby is the state of the equipment when it is not engaged in a communications or DSC automated procedure. The state of the equipment is considered engaged whether the automated procedure is active or on hold.

The following functions and or information shall be visible to the operator at top level while in standby:

- a) the station MMSI;
- b) the latest position of the vessel;
- c) the UTC time of that position;
- d) the dedicated distress button;
- e) a clearly labelled means to compose a distress alert prior to sending distinct from the dedicated distress button;
- f) a clearly labelled means to compose/send a non-distress DSC message;
- g) a clearly labelled means to compose/send a DROBOSE.

The following setup options shall be available with the following factory defaults:

- a) the option to send medical transport DSC messages: set to off;
- b) the option to send neutral crafts DSC messages: set to off;
- c) the option to auto acknowledge polling DSC messages: set to on;
- d) the option to auto acknowledge test DSC messages: set to on;
- e) the option to auto acknowledge position request DSC messages: set to off;
- f) the option to auto acknowledge individually addressed, non-distress DSC messages: set to on (see clause 6.7.7);
- g) the option on MF/HF equipment to set the maximum distance for sounding a two-tone alarm that does not self-terminate upon initiation of a received distress automated procedure to some value greater than or equal to 500 nautical miles that includes "never self-terminate": set to 500 nautical miles;
- h) the option to set the no activity timeout to exit any non-automated procedure activity to some value that includes no timeout: set to 10 min;
- i) the option to set the no activity timeout of non-distress DSC automated procedures to some value that includes no timeout: set to 15 min;
- j) the option to set the no activity timeout of received distress DSC automated procedures to some value that includes no timeout: set to no timeout;

- k) that there is no option to set any timeout of the unacknowledged sending distress automated procedure;
- l) the option to set the maximum amount of simultaneous automated procedure (applies only to equipment that supports more than the required minimum of seven);
- m) the option to set the no activity timeout of communications automated procedures to some value in the range [10 seconds to 10 min]: set 30 seconds;
- n) the option to enable automatic channel or frequency change: set to on.

A record of the DSC activity shall be available containing the following information which shall be able to be displayed:

- a) the UTC time and date of reception;
- b) on MF/HF the frequency of reception;
- c) the information content of the DSC message;
- d) a minimum of the twenty most recently received distress DSC messages; a single or multi frequency alert attempt shall be recorded as a single DSC message with an indication of how many of the alerts in the attempt were received. DSC alerts received on the same frequency within a period of 60 seconds (MF/HF) and 5 seconds (VHF) shall be considered part of the same distress alert attempt. On MF/HF consecutive alerts received on different frequencies within a period of 60 seconds shall be considered a multi frequency attempt. In both cases, the information characters assimilated by the automated procedure handling the distress alerts shall be the recorded information characters. In other words, if any errors in the information characters of a received alert are corrected by the reception of other alerts within the attempt, only the corrected version shall be recorded;
- e) a minimum of the twenty most recently sent DSC messages, where a distress alert attempt is recorded as a single message;
- f) a minimum of the twenty most recently received non-distress DSC messages.

6.4 Sending distress automated procedure

6.4.1 Procedure

The sending distress automated procedure results when the operator presses the dedicated distress button to send a distress alert attempt. An informative schematic of the outline of the automated procedure is given in figure 1.

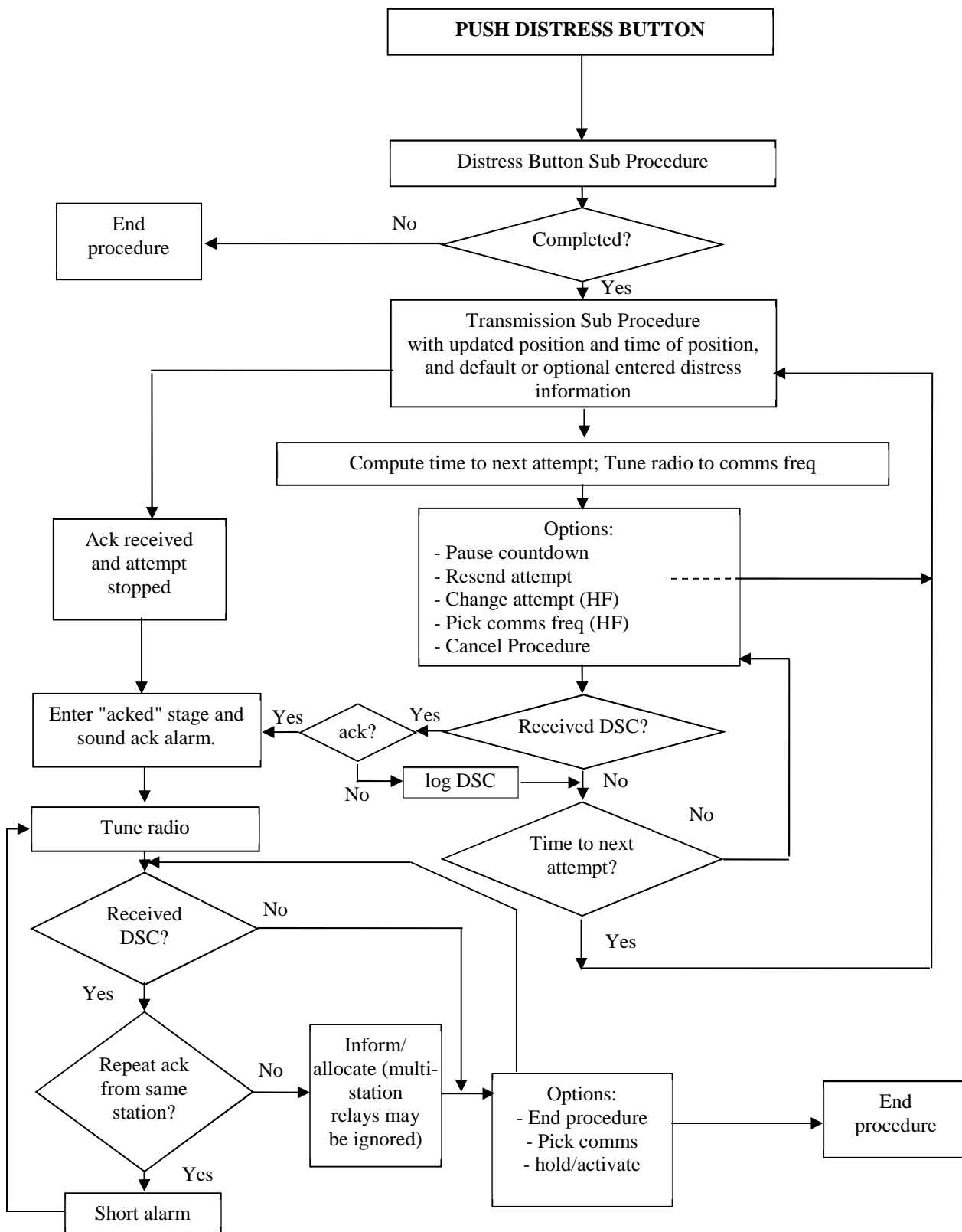

Figure 1: Sending distress procedure

6.4.2 Tasks

The radio shall follow the sending distress automated procedure as shown in figure 1 complying with the automated procedures as defined in Recommendation ITU-R M.493-15 [3], annex 4.

The sending distress automated procedure shall handle the following events:

- a) the distress button sub procedure;
- b) previous to the procedure being acknowledged:
 - 1) on HF the setting of the watch receiver to scan all six distress frequencies (if not already doing so);
 - 2) the transmission of the alert attempt;
 - 3) calculating the time to an automated resending of the attempt (random, between 3,5 min and 4,5 min);
 - 4) tuning to the subsequent communication frequency (upon conclusion of the attempt);
 - 5) waiting for the reception of a distress alert acknowledgement;
 - 6) logging all other received DSC messages assuring they do not disrupt the procedure;
 - 7) retransmission of the alert attempt occurs after the calculated resend timer expires (3);
 - 8) providing the valid operator options which are:
 - i) pausing the countdown to automated resending;
 - ii) resending the alert attempt, with the last entered other parameters, using the dedicated DISTRESS button;
 - iii) cancelling the alert attempt;
 - iv) selecting amongst the six frequencies of subsequent communications (HF only);
- c) after reception of the acknowledgement:
 - 1) stopping the automatic resending of the alert attempt;
 - 2) transmitting any remaining single alert of the attempt to completion;
 - 3) allocating received DSC messages not pertinent to the procedure to their appropriate automated procedures or initiating its own procedure on hold; and
 - 4) providing the valid operator options which are:
 - i) selecting amongst the six frequencies of subsequent communications (HF only);
 - ii) activate or place the procedure on hold; and
 - iii) terminating the automated procedure.

6.4.3 Display

6.4.3.0 General Display Requirements

During the sending distress automated procedure the radio shall display the following items and/or information as appropriate at top level:

- 1) the fact one is engaged in sending a distress;
- 2) the time remaining to the next automated resending of the attempt (prior to acknowledgement);
- 3) the elapsed time since receiving the distress alert acknowledgement (after acknowledgment);

- 4) indicate whether the procedure is on hold or is active (after acknowledgement);
- 5) the distress information;
- 6) a warning before the automated resending of the attempt in case engaged in traffic;
- 7) the frequency of subsequent communication (HF only);
- 8) the frequencies on which the alerts are sent (HF only);
- 9) the MMSI of the sender of the distress acknowledgement;
- 10) the sub-stages of the procedure:
 - a) transmitting;
 - b) waiting for acknowledgement;
 - c) alert acknowledged;
 - d) waiting for a free channel; and
- 11) the valid operator options.

6.4.3.1 Examples of sending distress procedure displays on VHF equipment

Figure 1a shows a set of examples of windows that could appear on a display screen during a sending distress automated procedure at various stages during the event. The first figure is what might appear after the operator holds down the dedicated distress button for 3 or more seconds. The second figure shows the window after the alert attempt has completed. The procedure is waiting for a distress alert acknowledgement and the radio is tuned for distress traffic on channel 16. The operator has several options; to cancel the alert, resend the alert before the auto-resend timeout, pause the countdown to the auto-resending, and to look at detailed information about the sent alert. The "info" shall contain, at minimum, the distress information. Note there is no option to "abort" the alert; the operator shall go through the cancel procedure. The third figure is 4 minutes later. There may have been voice traffic but no authority has acknowledged the alert. The next figure is 2 seconds later and now the EUT is warning the operator that the distress alert will be automatically resent in 9 seconds. The operator could press the pause button to stop the countdown (perhaps there is voice traffic) at which time the button would say "resume" or something like that. The fifth figure shows the retransmission of the alert and the sixth figure a short time later after the transmission has finished. Note the different time to the auto resend in the fifth figure. In the seventh figure the distress alert acknowledgement has been received. An alarm would sound that needs manual termination, and the text bar indicating the alarm information would likely flash or provide some other visual alarm signal. The eighth figure shows the acknowledged procedure. Note the operator options have changed and the procedure is still tuned for distress traffic. At this point, the DSC phase has accomplished its purpose and linked the vessel in distress to assistance/authorities. Until the procedure is terminated, the procedure remains.

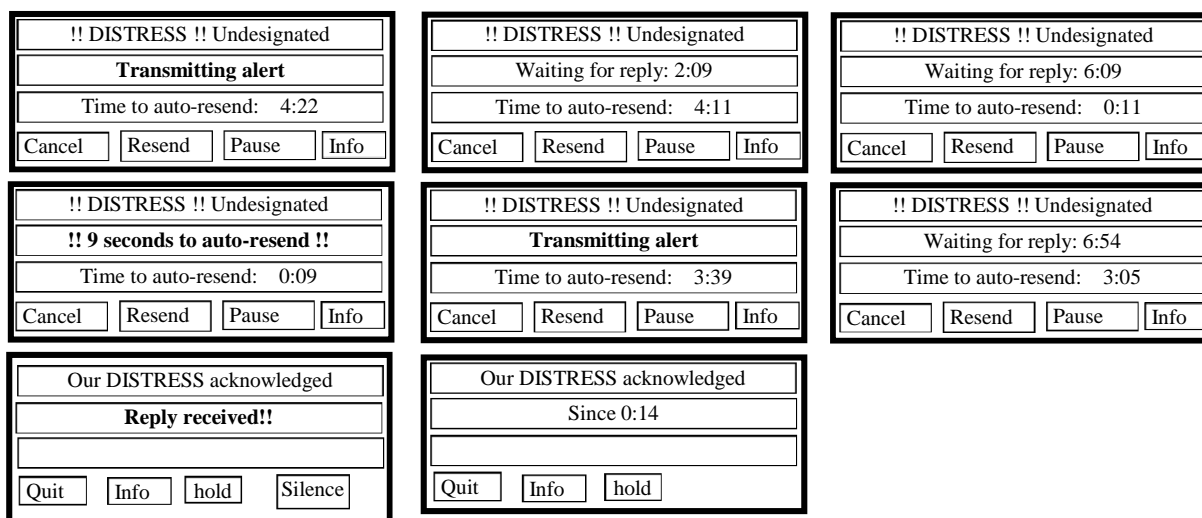

Figure 1a: Example "windows" of the sending distress automated procedure at various stages

The above examples are only examples. They show one means of providing the **minimum** required information. The layout, method, and choice of text are up to the manufacturer.

6.4.4 Dedicated distress button sub procedure

The dedicated distress button shall be used for the following purposes in the following manner:

- a) use of the dedicated distress button is required to initiate the sending distress automated procedure;
- b) the dedicated distress button shall be used exclusively for initiating the sending distress automated procedure;
- c) use of the dedicated distress button after entering parameters of the alert attempt via a menu or equivalent shall initiate the sending distress automated procedure with the alert attempt as composed by the operator;
- d) use of the dedicated distress button without entering parameters of the alert attempt via a menu or equivalent shall initiate the sending distress automated procedure with the default alert attempt. The default alert attempt is given by the following:
 - 1) undesignated nature of distress;
 - 2) the latest position of the vessel;
 - 3) the UTC time of that position;
 - 4) radio telephone for subsequent communication;
 - 5) on HF the multi frequency attempt using all six frequencies.

Use of the dedicated distress button without entering parameters of the alert attempt via a menu or equivalent shall initiate the sending distress automated procedure with the default alert attempt regardless of the state of the radio, except when the radio is already engaged in the sending distress automated procedure.

The distress button sub procedure of the sending distress automated procedure shall be as follows:

- a) lifting or opening of the lid or cover permanently attached to the equipment by, for example, hinges. This is ACTION 1;
- b) pressing and holding the distress button (ACTION 2) while:
 - i) displaying the seconds remaining to transmission of the attempt starting at three; and
 - ii) invoking an intermittent audio and intermittent visual alarm once each second;

- c) stopping the procedure if the distress button is released before the 3 seconds have elapsed (when releasing the button the radio shall return to its previous state);
- d) when the 3 seconds have elapsed regardless of whether the button is continued to be held down or released completes ACTION 2 and the alert attempt is started;
- e) sounding a steady tone of two second duration after ACTION 2 has completed and displaying a visual indication that the distress alert attempt has been sent.

6.4.5 Transmission of the alert attempt

The transmission sub procedure of the sending distress automated procedure shall be as follows:

- a) the appropriate frequencies for transmission shall be determined from the selected frequencies;
- b) on VHF it is always channel 70 and thus always a single frequency attempt;
- c) on MF it is always 2 187,5 kHz and thus always a single frequency attempt;
- d) for an HF single frequency attempt a frequency is chosen from a list of six possible frequencies (default all six) previously set up by the operator during equipment installation. Each time the attempt is automatically (or manually) repeated the next frequency in the list is used until all frequencies are utilized at which time the cycle repeats;
- e) for an HF multi frequency attempt a list of three to six frequencies (2 MHz and 8 MHz mandatory, default all six) previously set up by the operator is utilized. The multi frequency attempt is completed when a distress alert has been transmitted on each of the frequencies in the list. (There shall be no more than a three second delay between transmissions of each alert in the multi-frequency attempt);
- f) the transmission starts on the appropriate frequency;
- g) the countdown to the next automated resending of the attempt is started;
- h) if a distress acknowledgement is received the attempt shall cease after completion of any ongoing distress alert within the attempt;
- i) if a single frequency attempt, five alerts shall be sent without a break between alerts;
- j) if a single frequency attempt, the extended position information shall be sent on only the 5th alert;
- k) if a multi frequency attempt, the extended position information shall be sent on each alert.

6.4.6 Updating position

When a distress alert attempt is resent it shall update the position and UTC time of position information.

6.4.7 Handling received DSC Messages

Prior to acknowledgment of the sending distress automated procedure only the distress acknowledgement describing the same distress event is pertinent to the procedure. All other DSC messages shall be ignored and only recorded in the log.

After the sending distress automated procedure has been acknowledged all DSC messages describing the same distress event are pertinent to the procedure. Of these DSC messages, all ships, group, and area distress relays may be ignored. DSC messages not pertinent to the procedure shall be allocated to the appropriate automated procedure or initiate their own automated procedure on hold.

6.4.8 Alarms

The reception of the first distress alert acknowledgement pertinent to the procedure shall sound a distress acknowledgement alarm. Any subsequent acknowledgement shall only sound the self-terminating alarm.

6.4.9 Determining Subsequent communications

On VHF it is always channel 16.

On MF it is always 2 182,0 kHz (radiotelephony) or 2 174,5 kHz (data).

On HF the frequency is given by:

- a) the distress telephony frequency in the band used for a single frequency distress alert attempt; or
- b) prior to acknowledgement the distress telephony frequency in the 8 MHz band if a multi-frequency distress alert attempt;
- c) after reception or the sending of a distress alert acknowledgment the distress telephony frequency in the band of the sent or received distress DSC message.

The channel set is given by the mode of subsequent communication.

6.4.10 Automated tuning

Automatic tuning to the subsequent communications frequency or channel shall occur after transmission of the first distress alert attempt.

On HF the operator shall have at least a 10 seconds warning prior to an automated resending of the alert attempt where the operator may pause the resending in case engaged in traffic.

Upon reception of the first distress alert acknowledgement, the tuning shall occur after the manual silencing of the alarm.

Subsequent acknowledgements from the same source demanding changes in subsequent communication frequencies shall occur automatically.

Subsequent acknowledgments from a different source shall indicate to the operator by some means that a change in frequency is requested, however, in the absence of any operator action, the tuning shall not occur.

6.4.11 Cancelling the Distress Alert

6.4.11.0 General Requirements

The distress cancel procedure consists of the cancel operation on all bands utilized by the distress alert attempts (on VHF and MF there is only one cancel operation whereas on MF/HF there may be up to six). The cancel operation consists of a DSC cancel (a self-addressed distress alert acknowledgement) followed by a voice cancel on the corresponding frequency of subsequent communication. The phrase "voice cancel" refers to the part of the cancel done over the subsequent communication frequencies whether it is by radio telephony or on MF and MF/HF by data.

Cancellation of a distress alert shall only be possible prior to acknowledgement.

Selection of the cancellation option during the sending of a distress alert attempt shall stop the transmission as soon as possible but only after any ongoing distress alert within the distress alert attempt is completed.

Upon selection of the cancel option the equipment should provide an explanation of the cancel procedure, and for HF the frequencies requiring cancellation shall be indicated to the operator.

The radio shall prompt the operator to confirm continuing with the cancel, or to abort the cancel procedure. If the latter is selected the sending distress automated procedure will be resumed.

If the user confirms the distress cancel then:

- 1) if the distress alert was sent on VHF, transmit the distress cancel on channel 70;
- 2) if the distress alert was sent on MF, transmit the distress cancel on 2 187,5 kHz;
- 3) if the distress alert was sent on HF, transmit the distress cancel on the DSC distress frequencies of all bands that were used for the HF distress alerts.

After the transmission of all of the self-addressed distress alert acknowledgment, the operator shall be given the subsequent communication options to "voice cancel" by either telephony or data (telex).

If telephony is selected the general receiver and transmitter shall in a sequence automatically be tuned to the subsequent communication frequency for all channels the cancel distress DSC call have been transmitted on. For each channel the operator shall be prompted to make the voice cancellation and the appropriate text for the voice cancellation shall be displayed. The operator shall acknowledge the voice cancel on each channel before the equipment is tuned to the next communication frequency.

In case data was selected for "voice cancel" the general receiver and transmitter shall in a sequence automatically be tuned to the subsequent communication frequency for all channels the cancel distress DSC call have been transmitted on, and automatically send the cancel.

Frequencies that have been cancelled shall be indicated.

On HF once any single channel is cancelled, the operator shall be unable to exit the cancel procedure until all utilized channels have been cancelled.

Completion of the cancellation shall place the sending distress automated procedure in the acknowledged state.

The radio shall display to the operator the stages of the cancellation procedure such as "waiting for the operator to proceed" or equivalent, "transmitting the DSC cancel" or equivalent, "radio tuned for the voice cancel", or equivalent, "cancel procedure done" or equivalent.

6.4.11.1 Examples of cancel-distress displays on VHF equipment

Figure 1b shows a set of examples of windows that could appear on a display screen during a sending distress automated procedure when the cancel operation is done. The first figure shows the sent distress procedure after the transmission. The operator presses the cancel button. The second figure shows the warning with the option to continue or to back out. The operator chooses to continue. The third figure shows the start option which still gives the operator the option to back out. The operator selects start. The fourth figure shows the DSC phase of the cancel (the self-addressed distress acknowledgement) which lasts only about 0,7 seconds on VHF. The fifth figure shows the start of the voice cancel which provides a brief explanation to the operator. The only choice is to proceed, and in the sixth figure the EUT provides the text of the voice cancel message that the operator can read. Upon completion of the voice cancel, the operator returns to the distress procedure in its acknowledged state, still tuned to channel 16. Note that the operator does have the option to repeat the procedure (perhaps instructed to do so by a coast station). That action would bring the operator back to the fourth figure. However, once the finish option is selected, no further DSC cancels can be sent. The seventh figure shows the return to the sending distress procedure, now in its acknowledged state. Further communications may continue.

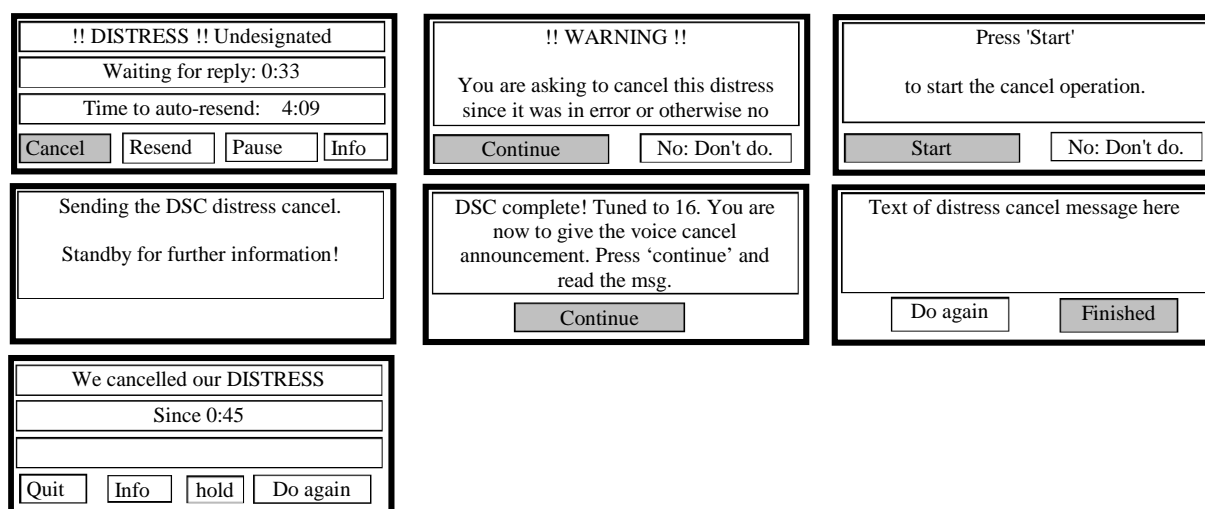

Figure 1b: Example "windows" of the cancel distress procedure at various stages

The above examples are only examples. They show one means of providing the **minimum** required information. The layout, method, and choice of text are up to the manufacturer.

6.4.12 Acknowledgments

The procedure shall be considered acknowledged upon reception of the first distress alert acknowledgement concerning the same distress event.

6.4.13 Termination

Prior to acknowledgement the procedure cannot be terminated either by the operator or the equipment; it may only be cancelled by an operator initiative.

After acknowledgment, the procedure is terminated manually or by an imposed automatic timeout (not required). However, if such an automatic timeout is provided, at least 10 seconds prior to termination a visual and aural warning that automatic termination is about to occur shall be displayed with the option to stop the termination.

6.4.14 Warnings

The procedure shall provide warnings for those reasons provided in Recommendation ITU-R M.493-15 [3], annex 4. The operator shall have the option to go back to the stage of the procedure where the action was taken that caused the warning.

6.5 Receiving distress automated procedure

6.5.1 Procedure

The receiving distress automated procedure is initiated either by the reception of the first multi-station distress DSC message of a distress event, the reception of the first individually addressed distress DSC message of a distress event, or the sending of a DROBOSE. An informative schematic of the outline of the automated procedure is given in figure 2.

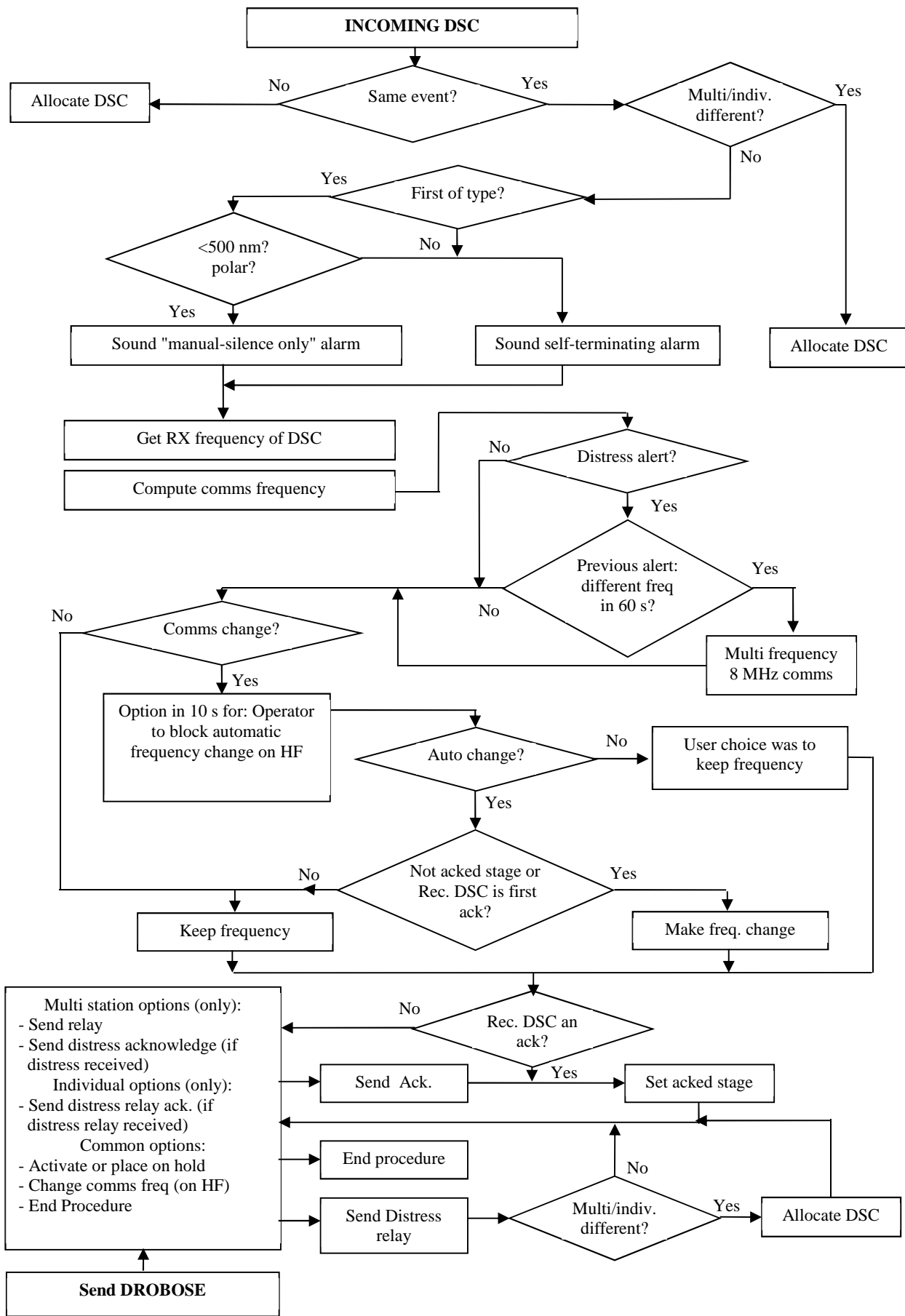

Figure 2: Receiving distress procedure

6.5.2 Tasks

The radio shall follow the received distress automated procedure as shown in figure 2 complying with the automated procedures as defined in Recommendation ITU-R M.493-15 [3], annex 4.

The received distress automated procedure shall handle the following events:

- a) the sounding of the appropriate alarms for DSC messages pertinent to the procedure;
- b) allocating all DSC messages pertinent to the station but not the procedure to their own procedures or initiating their own procedure;
- c) on HF keeping track of the frequencies of reception;
- d) on HF appropriate tuning to the frequency and mode of subsequent communication and providing at least a 10 seconds warning if that tuning involves a change from the current tuning and the option to pause the tuning;
- e) on HF scanning all 6 distress frequencies;
- f) watching for the distress event acknowledgement or recognizing the self-cancel;
- g) providing the operator with the option to:
 - 1) send a relay;
 - 2) send a distress acknowledgement (when and if a distress alert has been received);
 - 3) send a distress relay acknowledgement (when and if a distress relay has been received);
 - 4) on HF to change the frequency of subsequent communication;
 - 5) ability to activate or place the procedure on hold;
 - 6) end the procedure.

6.5.3 Display

6.5.3.0 General Display Requirements

During the received distress automated procedure the radio shall display or make available to the operator the following items and/or information:

- a) the fact one is engaged in receiving a distress;
- b) the elapsed time since the procedure started (prior to acknowledgment);
- c) the elapsed time since acknowledgement (after acknowledgment);
- d) indicate whether the procedure is on hold or is active;
- e) the latest distress information (MMSI of vessel in distress, nature of distress, position, time of position, comms);
- f) the type (alert, relay, alert acknowledgement, relay acknowledgement), sender, and intended destination (individual, area, all ships) of the latest received DSC message;
- g) at least a 10 seconds warning before any automated change in communications frequencies are invoked in case engaged in traffic;
- h) the frequency of subsequent communication (HF only);
- i) the frequencies on which the DSC messages have been received (HF only);
- j) displaying the valid user options;

- k) the ability to display information about the history of at least the received DSC messages pertinent to the procedure; and
- l) the sub-stages of the procedure which are:
 - 1) waiting to send acknowledgement;
 - 2) transmitting;
 - 3) waiting for acknowledgement;
 - 4) cancelled;
 - 5) acknowledged;
 - 6) waiting for a free channel.

At top level the elapsed time, the stage of the automated procedure, and operator options shall be displayed.

6.5.3.1 Examples of received distress procedure displays on VHF equipment

Figure 2a shows a set of examples of windows that could appear on a display screen during a received distress automated procedure at various stages during the event. The first figure shows the reception of the distress alert where the operator shall silence the two-tone alarm. The display concerning the alarm text should also be flashing or providing some type of visual alarm. The second figure shows the procedure after silencing the alarm. The procedure indicates that channel 16 is open for traffic and that it is waiting for a distress alert acknowledgement. The third figure shows the reception of a distress relay concerning this distress event. An alarm sounds, but it is self-terminating. The message shall still provide a means to silence it and it shall flash or provide some type of visual alarm. The operator can press "info" to view the details of the latest received DSC message pertinent to this event. The fourth figure shows the procedure after the alarm terminates. The procedure is still waiting for the DSC acknowledgement and is still tuned to channel 16. The fifth figure shows the reception of a repeat distress alert attempt by the vessel in distress. This attempt could have happened automatically or been done by the operator on the vessel in distress. However, this time only the self-terminating alarm sounds. The sixth figure shows continuation of the procedure after the alarm terminates. The seventh figure shows the reception of the distress alert acknowledgement. This time the alarm shall be manually silenced. The eighth figure shows the received distress procedure upon silencing the alarm. The DSC phase is done. Note that the operator has the option to exit the procedure, place it on hold, or get further information at any time during the event.

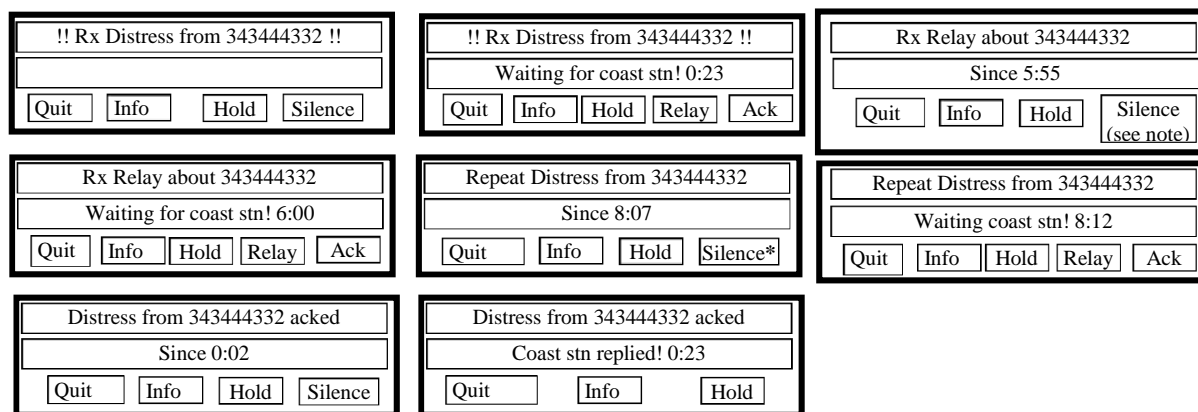

NOTE: This alarm self terminates in 1 second. After this, the option shall disappear.

Figure 2a: Example "windows" of the received distress automated procedure

The above examples are only examples. They show one means of providing the **minimum** required information. The layout, method, and choice of text are up to the manufacturer.

6.5.4 Handling received DSC Messages

DSC messages pertinent to the station but not the procedure shall be allocated to the appropriate automated procedure or initiate their own automated procedure on hold.

DSC messages that are pertinent to the procedure are all DSC messages concerning the same distress event. If the MMSI is unknown, DSC messages that are pertinent to the procedure are all DSC messages that have the same distress information (nature of distress and subsequent communication - allow updated position and time). However, individually addressed DSC messages shall initiate their own automated procedures on hold if engaged in a received distress procedure handling multi-station (for example, all ships, area) addressed DSC messages or vice versa.

6.5.5 Alarms

In a given procedure, only the reception of the initial DSC message and the DSC message that first acknowledges the procedure shall sound an alarm unique to the DSC message type (with the two-tone sound reserved for the distress alert or relay if it initiates the procedure) which shall be manually silenced.

All subsequent DSC messages that are pertinent to the procedure shall sound the self-terminating alarm.

6.5.6 Determining Subsequent communications

On VHF it is always channel 16.

On MF it is either 2 182,0 kHz (voice) or 2 174,5 kHz (data).

On HF the frequency band is given by:

- a) the frequency band of a single frequency distress alert attempt, relay, distress alert acknowledgement, and relay acknowledgment;
- b) the 8 MHz band if a multi-frequency distress alert attempt is received. A distress alert attempt is considered to be multi-frequency if two consecutive distress alerts are received on two different frequencies within a period of 1 minute. This rule applies even if neither of the two distress alerts were received on the 8 MHz band;
- c) the channel set is given by the mode of subsequent communication;
- d) the band of subsequent communication given in (c) shall be used as the default DSC band for any subsequent distress DSC messages sent by the operator.

6.5.7 Automated tuning

The tuning to the subsequent communication frequencies as determined in clause 6.5.6 shall occur automatically upon reception of a distress DSC message in the following manner:

- a) on HF the operator shall have a 10 seconds warning prior any tuning if the new subsequent frequency is different from the current selected frequency;
- b) the operator shall be able to pause the tuning in case engaged in traffic or accept the tuning;
- c) prior to acknowledgement, the tuning to the new frequency shall occur in the absence of any operator action. If automatic channel or frequency change has been switched off, the radio shall remain on the current channel or frequency and prompt the user to accept the channel change. There shall be no change until manually accepted;
- d) after acknowledgment the tuning to the new frequency shall only occur if the operator requests it (note that the procedure is not yet acknowledged until after the first acknowledgement starts the alarm).

6.5.8 Acknowledgments

The procedure handling all-ships and area distress DSC messages and distress alerts shall be considered acknowledged upon reception of the first distress alert acknowledgement or all ships distress relay acknowledgement.

A distress alert acknowledgement sent by the vessel in distress shall be recognized as a self-cancel.

The procedure handling a received individually addressed distress relay shall be considered acknowledged when the operator first transmits the corresponding individually addressed distress relay acknowledgement to the sender.

The procedure handling a distress relay sent to an individual station shall be considered acknowledged when the first corresponding individually addressed distress relay acknowledgement is received from that station.

6.5.9 Sending Relays and Acknowledgments

On HF the operator shall always have the option to send a distress relay to a coast station.

The operator shall not have the option to send a distress relay acknowledgement until an individual distress relay request has been received.

The operator shall not have the option to send a distress alert acknowledgement until a distress alert has been received.

Once the option to send any of the distress DSC messages (distress relay, distress alert acknowledgement, distress relay acknowledgement) referenced above becomes available, the options shall remain available until the procedure is terminated.

The procedure shall automatically compose the distress DSC messages referenced above except:

- a) the distress relay where the operator shall have the option to select the addressing mode and address where the default shall be individual and on MF/HF the communications mode; and
- b) in a procedure handling an individually addressed relay or relay acknowledgement, the operator shall have the option to send an all ships relay acknowledgement in addition to the default individual relay acknowledgement even though this DSC message is typically forbidden to be sent by ship stations. (Note that it is only possible to send an individually addressed distress relay acknowledgement upon reception of an individually addressed relay).

On HF the operator shall have the option to override the default band of the DSC message and send the distress DSC messages (distress relay, distress alert acknowledgement, distress relay acknowledgement) referenced above on any one of the six distress channels.

6.5.10 Termination

The procedure can be terminated manually or by the automated timeout. At least 10 seconds prior to automated termination, a visual and discrete aural warning shall be displayed with the option to stop the automatic termination.

If the procedure is terminated manually by the user then integrated equipment may revert to the channel or frequency that was previously selected before the DSC procedure.

6.5.11 Warnings

The procedure shall provide warnings for those reasons provided in Recommendation ITU-R M.493-15 [3], annex 4. The operator shall have the option to go back to the stage of the procedure where the action was taken that caused the warning.

6.5.12 Handling events from man overboard devices (VHF only)

6.5.12.1 General

Receiving an individual distress relay call with the subsequent communication field set to 100 shall be handled in separate procedures unless the call is received from an MOB device (Self-ID is recognized as man overboard according to Recommendation ITU-R M.585-6 [i.6]).

In the case of an event triggered by MOB devices (open loop, closed loop individual or group operation) then multiple alerts from different MOB devices (open loop, closed loop individual or group operation) should be handled as one event and within the same automated procedure.

In the following the mentioned calls:

- individual distress relay;
- individual distress relay acknowledgement;
- group distress relays;
- group distress relay acknowledgement;

are all assumed to be with the subsequent communication field set to 126 [3].

6.5.12.2 Display and tasks

Within the automated procedure handling multiple MOB events:

- a) the following extended information shall be available:
 - 1) obtain a list of at least 20 handled MOB devices from which calls have been received;
 - 2) for each of the devices it shall be possible to determine:
 - i) whether or not the device is active or acknowledged;
 - ii) if the device is in individual closed loop operation, group closed loop operation or open loop operation state;
 - iii) the last updated distress information (identity of MOB device, position, time of position) received from the device;
 - iv) the elapsed time since the first call (open loop or closed loop) was received for the device (prior to acknowledgment);
 - v) the elapsed time since acknowledgement was issued or received for the device (after acknowledgment);
- b) the operator shall (for each MOB device) be provided with the options to:
 - 1) send a relay;
 - 2) send an individual distress relay acknowledgement (when and if only an individual distress relay has been received and a distress alert has not been received);
 - 3) send a group distress relay acknowledgement (when and after a group distress relay has been received and a distress alert has not been received);
 - 4) send a distress acknowledgement (when and after a distress alert has been received).

Appropriate warnings shall be displayed when attempting to acknowledge an MOB device, because this will cease the continuation of periodic transmission of DSC calls from the MOB device [i.4].

As with other VHF DSC distress alerts, DSC acknowledgments to open loop MOB device alerts are normally only sent by coast stations, or under direction of a coast station. However, the recovery vessel may send a DSC acknowledgment message if the person in the water has been recovered [i.5].

All MOB devices (acknowledged or not) within the list defined in clause 6.5.12.2 shall remain in the procedure until the procedure is terminated or they have been automatically purged as described in clause 6.5.12.3.

6.5.12.3 Handling received DSC messages pertinent to the procedure

The EUT shall keep track of acknowledgements of the individual MOB devices and indicate this accordingly in the automated procedure. In addition to the individual distress relay acknowledgement sent from the EUT the reception of one of the following calls for an MOB device shall indicate its acknowledged state:

- distress acknowledgement;
- group distress relay acknowledgement;
- self-cancel [i.4].

The automated procedure handling of MOB triggered events is the same as described in clause 6.9.

6.6 Sending non-distress automated procedure

6.6.1 Procedure

The sending non-distress automated procedure results when the operator selects to transmit a DSC message that does not contain the distress information. It also results when an acknowledgement to a sending non-distress automated procedure that has been prematurely terminated is received ("an acknowledgement one quit waiting for"). An informative schematic of the outline of the automated procedure is given in figure 3.

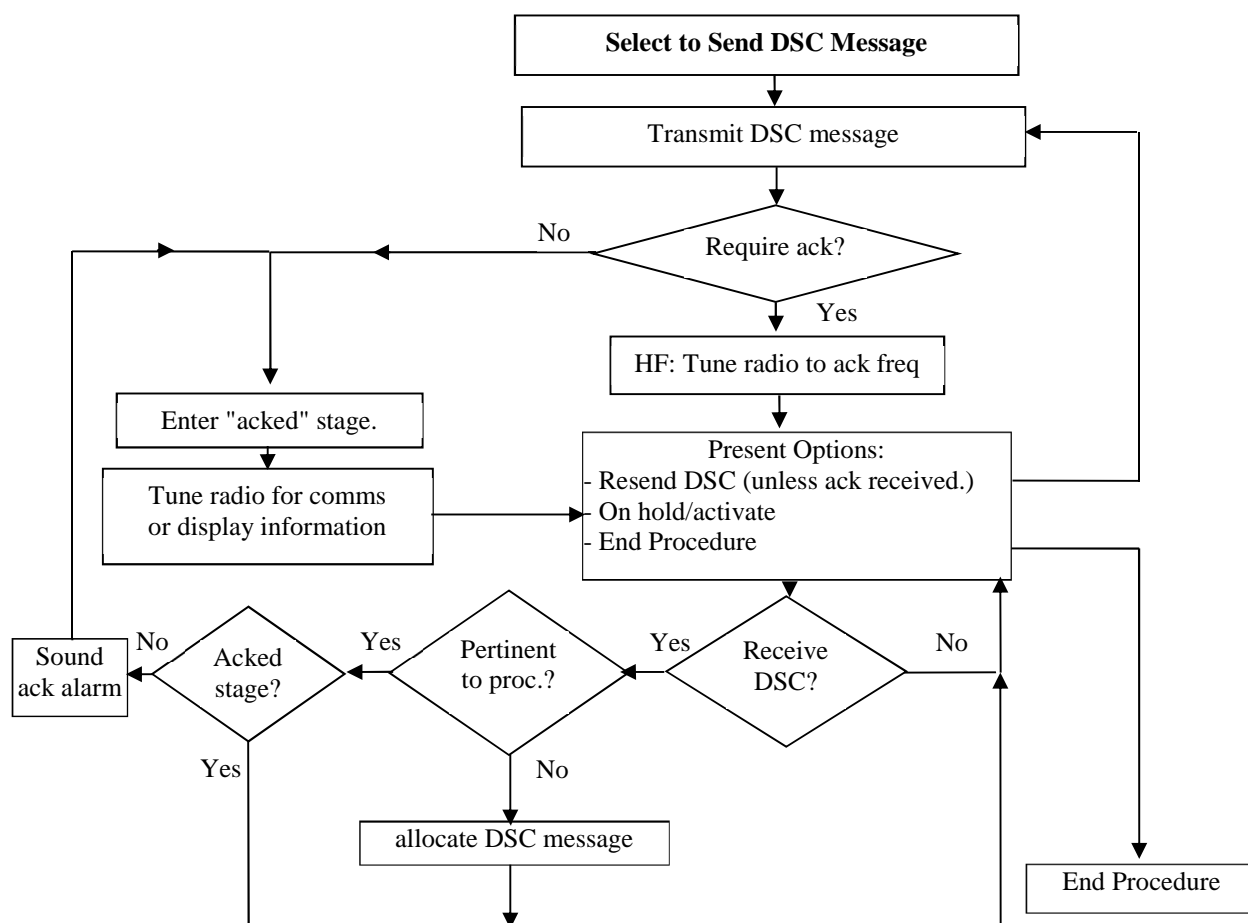

Figure 3: Sending non-distress automated procedure

6.6.2 Tasks

The radio shall follow the sending non-distress automated procedure as shown in figure 3 complying with the automated procedures as defined in Recommendation ITU-R M.493-15 [3], annex 4.

The sending non-distress automated procedure shall handle the following events:

- a) prior to acknowledgement:
 - 1) the transmission of the composed/selected DSC message;
 - 2) if the DSC message demands no acknowledgment setting the procedure to acknowledged;
 - 3) if the DSC message demands an acknowledgement:
 - i) on HF tuning the general receiver to the frequency of the DSC acknowledgement if required;
 - ii) waiting for the acknowledgement and alarming when received;

- iii) allocating any received DSC message not pertinent to the procedure to their appropriate procedure or initiating their own procedure on hold;
 - iv) providing the valid operator options which are:
 - resend the initial DSC message;
 - activate or place the procedure on hold;
 - terminate the procedure;
- b) upon reception of the acknowledgement or being set to acknowledged:
- 1) tuning the general receiver and transmitter to the frequency of subsequent communication or displaying the requested information;
 - 2) ignoring any received DSC message pertinent to the procedure since it is a duplicate;
 - 3) allocating any received DSC message not pertinent to the procedure to the appropriate procedure or initiating their own procedure on hold; and
 - 4) providing the valid operator options which are:
 - i) resend the initial DSC message if it requires no acknowledgement;
 - ii) activate or place the procedure on hold;
 - iii) terminate the procedure.

6.6.3 Display

6.6.3.0 General Display Requirements

During the sending non-distress automated procedure the radio shall display or make available to the operator the following items and/or information:

- a) the fact one is engaged in sending a non-distress DSC message;
- b) the elapsed time since sending the initial DSC message (prior to acknowledgement); or
- c) the elapsed time since being acknowledged (once acknowledged or considered acknowledged);
- d) the information content of the initial DSC message sent which is:
 - 1) the type of DSC message (description);
 - 2) the priority of the DSC message;
 - 3) the destination;
 - 4) the means of subsequent communication or purpose;
 - 5) the frequencies of subsequent communication if any;
 - 6) on HF the frequency of the sent DSC message;
 - 7) whether or not the DSC message requires an acknowledgement;
- e) if acknowledged, the information content of the acknowledgement which is:
 - 1) the means of subsequent communication or the requested information;
 - 2) if appropriate the mode/frequency change or unable to comply and reason;
 - 3) the frequencies of subsequent communication if any;
 - 4) on HF the frequency of the acknowledgement;

- f) the valid operator options; and
- g) the sub-stages of the procedure which are:
 - 1) waiting for free channel;
 - 2) transmitting;
 - 3) waiting for acknowledgement;
 - 4) linked for communications.

At top level the elapsed time, the stage of the automated procedure, and operator options shall be displayed.

6.6.3.1 Examples of sending non-distress procedures displays on VHF equipment

Figure 3a shows a set of examples of windows that could appear on a display screen during a sending non-distress procedure. The examples below show windows for a routine call (1 to 4), group call (5 and 6), and an urgency call (7 and 8).

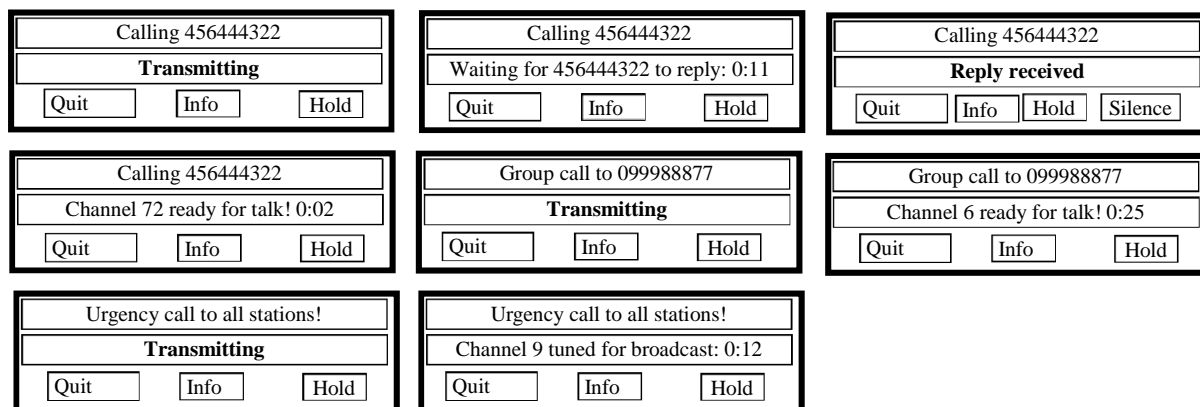

Figure 3a: Example "windows" of the sending non-distress procedures

6.6.4 Handling received DSC Messages

DSC messages pertinent to the station but not the procedure shall be allocated to the appropriate automated procedure or initiate their own automated procedure on hold.

DSC messages that are pertinent to the procedure are acknowledgements to the initial DSC message.

6.6.5 Alarms

The reception of the first acknowledgement pertinent to the procedure shall sound the appropriate acknowledgement alarm as specified in tables D.1 and D.2.

Any subsequent acknowledgement may be ignored as only individually addressed non-distress DSC messages have acknowledgements.

6.6.6 Automated tuning

On HF, DSC messages using the duplex DSC channels requiring acknowledgements shall tune the general receiver to the anticipated frequency of the DSC acknowledgement.

If the DSC message requires subsequent communications, the general receiver and transmitter shall be tuned to the frequencies given in the acknowledgement upon reception of the "able to comply" acknowledgement.

If the acknowledgement received is "unable to comply" the radio shall not tune to the originally proposed channel or frequency.

If the acknowledgement received is "able to comply" but proposes a new working frequency that is not available the radio shall not tune to the proposed frequency, but inform the operator that he has to make a new call request to the called station.

If no acknowledgement is required the transmitter shall be tuned to the frequency of subsequent communications given by the initial DSC message.

6.6.7 Delayed Acknowledgements

If an acknowledgement to a sending non-distress automated procedure is received after the procedure has been prematurely terminated, the automated procedure shall initiate itself recreating the initial DSC message based upon the acknowledgement. The procedure shall inform the operator that "an acknowledgement the equipment quit waiting for" has been received. If the acknowledging station changed the frequency or communication mode, the original values will not be known but shall be assumed to be that present in the acknowledgement. If the acknowledging station responded with "unable to comply" all the original communication information will be unknown in which case the initial DSC message shall be assumed to have been radiotelephone on any legal frequency.

6.6.8 Termination

Termination is done manually or by the automated timeout. At least 10 seconds prior to automated termination, a visual and discrete aural warning shall be displayed with the option to stop the automatic termination.

If the procedure is terminated manually by the user then integrated equipment may revert to the channel or frequency that was previously selected before the DSC procedure.

6.6.9 Warnings

The procedure shall provide warnings for those reasons provided in Recommendation ITU-R M.493-15 [3], annex 4. The operator shall have the option to go back to the stage of the procedure where the action was taken that caused the warning.

6.7 Receiving non-distress automated procedure

6.7.1 Procedure

The received non-distress automated procedure results when a DSC message is received that does not contain the distress information and is not an acknowledgement. An informative schematic of the outline of the automated procedure is given in figure 4.

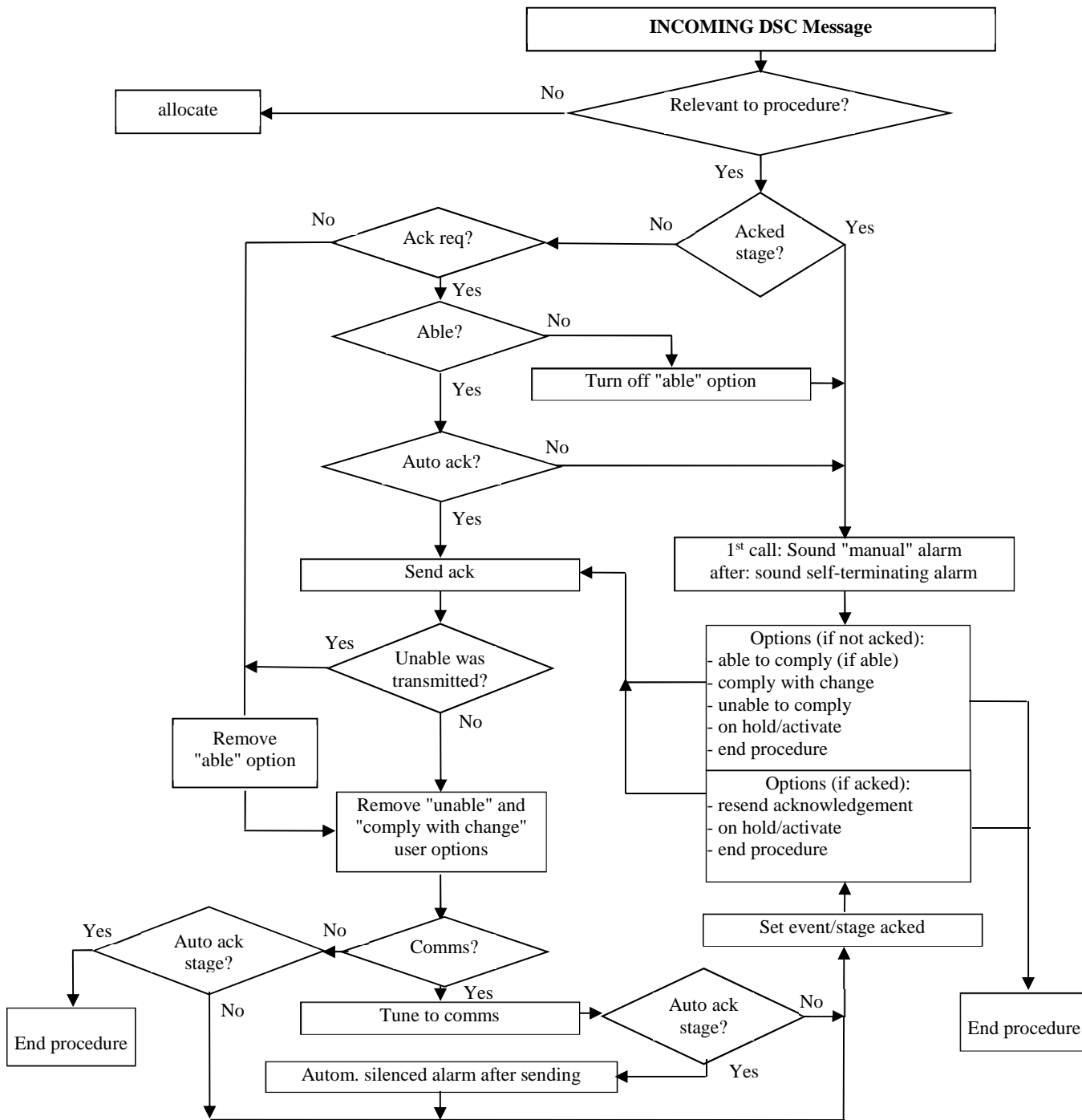

Figure 4: Receiving non-distress procedure

6.7.2 Tasks

The radio shall follow the received distress automated procedure as shown in the figure 4 complying with the automated procedures as defined in Recommendation ITU-R M.493-15 [3], annex 4.

The received non-distress automated procedure shall handle the following events:

- a) sound the appropriate alarms at the appropriate times for DSC messages pertinent to the procedure;
- b) allocate DSC messages pertinent to the station but not the procedure to the appropriate automated procedure or initiate their own automated procedure on hold;
- c) denote the procedure as acknowledged if the DSC message requires no acknowledgement;
- d) provide and compose the acknowledgement options as dictated by the initial DSC message;
- e) on HF tune the transmitter to the appropriate DSC frequency for any selected acknowledgement if an acknowledgement is required;
- f) tune the general receiver and transmitter to the frequencies of subsequent communications when and if required;
- g) provide the operator with the option to:
 - 1) prior to acknowledgment:
 - i) comply if able;
 - ii) comply with mode or frequency change if there are communications;
 - iii) unable to comply;
 - iv) ability to activate or place the procedure on hold;
 - v) end the procedure;
 - 2) after acknowledgement or being considered acknowledged:
 - i) resend the acknowledgment (after sending the first acknowledgment);
 - ii) ability to activate or place the procedure on hold;
 - iii) end the procedure.

6.7.3 Display

6.7.3.0 General Display Requirements

During the received non-distress automated procedure the radio shall display or make available to the operator the following items and/or information:

- a) the fact one is engaged in receiving a non-distress DSC message;
- b) the elapsed time since the procedure started (prior to acknowledgment); or
- c) the elapsed time since acknowledgement (after acknowledgment);
- d) indicate whether the procedure is on hold or is active;
- e) at least a 10 seconds warning before any automated change in communications frequencies are invoked in case engaged in traffic;

- f) the information content of the received DSC message:
 - 1) priority (category);
 - 2) the sender;
 - 3) to whom the DSC message was sent (format and MMSI or area);
 - 4) means of subsequent communication or the requested or sent information;
 - 5) frequencies and mode of subsequent communication (if any);
 - 6) on HF the frequency of the DSC message;
 - 7) whether or not the DSC message requires an acknowledgement;
- g) the information content of any acknowledgment sent:
 - 1) priority;
 - 2) the destination;
 - 3) the communication mode and frequencies, or unable to comply and reason or info;
 - 4) on HF the frequency of the acknowledgment;
- h) displaying the valid user options; and
- i) the sub-stages of the procedure which are:
 - 1) waiting to send acknowledgement;
 - 2) transmitting;
 - 3) acknowledged;
 - 4) waiting for a free channel.

At top level the elapsed time, the stage of the automated procedure, and operator options shall be displayed.

6.7.3.1 Examples of receiving non-distress procedures displays on VHF equipment

Figure 5 shows a set of examples of windows that could appear on a display screen during a received non-distress procedure. The examples below show windows for a received routine call, group call, and an urgency call.

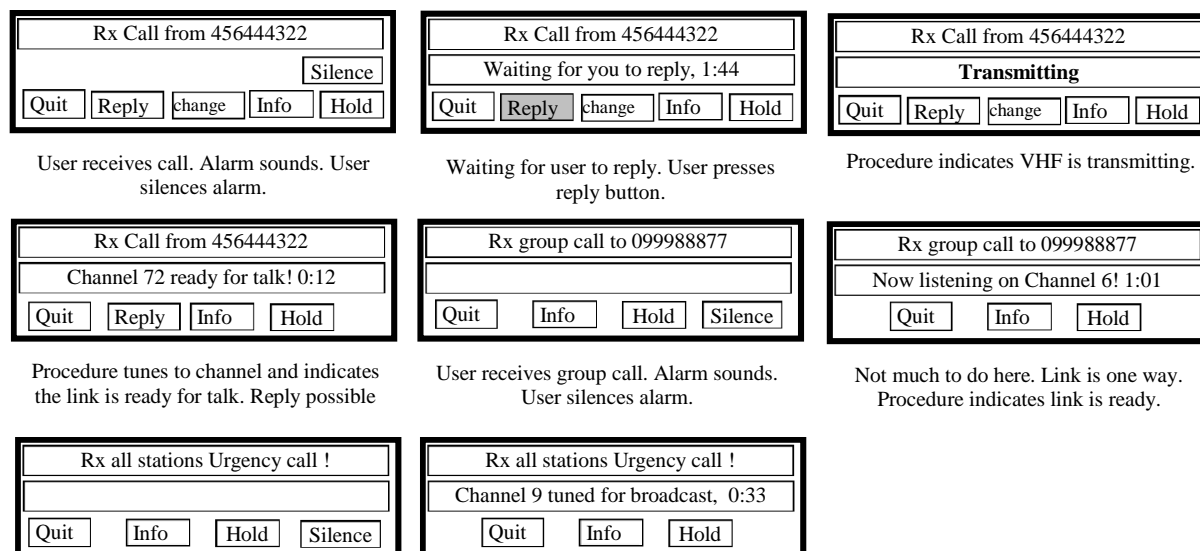

Figure 5: Example "windows" of the received non-distress procedures

6.7.4 Handling received DSC messages

DSC messages pertinent to the station but not the procedure shall be allocated to the appropriate automated procedure or initiate their own automated procedure on hold.

DSC messages that are pertinent to the procedure are repeats of the initial DSC message.

6.7.5 Alarms

When auto acknowledging position, poll and test DSC messages no alarm shall sound.

When auto acknowledging individually addressed DSC messages requesting subsequent communications, an alarm shall sound and be terminated as specified in tables D.1 and D.2, but the alarm shall be delayed until after transmission of the acknowledgement.

When auto acknowledging is not involved, an alarm shall sound and be terminated as specified in tables D.1 and D.2.

All repeat initial DSC messages shall sound the self-terminating alarm.

6.7.6 Automated tuning

DSC messages requiring acknowledgements shall determine the frequency of the DSC acknowledgement based upon the frequency of the received DSC message. If the channel of the DSC message cannot be determined, the acknowledgment shall be sent on the same frequency as the original DSC message was received (HF only).

If the DSC message requires subsequent communications, the general receiver and transmitter shall be tuned to the frequencies of the subsequent communications given in the acknowledgement if acknowledgments are requested. Otherwise the general receiver shall be tuned to the frequency of subsequent communication given by the initial DSC message:

- the operator shall have a 10 seconds warning prior to any tuning if the new subsequent frequency is different from the current;
- the operator shall be able to pause the tuning or accept the tuning;
- if automatic channel or frequency change has been switched off, the radio shall remain on the current channel or frequency and prompt the user to accept the channel change. There shall be no change until manually accepted.

6.7.7 Acknowledgments

Acknowledgment options shall only be provided if the initial DSC message requests an acknowledgement and the acknowledgment option is possible. For example, the "able to comply" option is not possible for an individually addressed DSC message requesting telephony but providing no subsequent communication frequency information. Only the "comply with mode/frequency change" and "unable to comply" options are possible.

In the case of a received individual call requesting telephony, the radio shall be capable of identifying if the requested working frequency identified in the call is available in the equipment:

- If this frequency is available the radio shall display the call details and compose an "Able to comply" acknowledgement which shall only be transmitted manually. Switching to the frequency identified shall only be performed after a manual "Able to comply" acknowledgement has been transmitted.
- If this frequency is not available the radio shall display the call details and compose an "Unable to comply" acknowledgement with 104 as the first telecommand and 108 as the second telecommand. This acknowledgement may be automatic.

The "able to comply" option shall only require a single action by the operator to respond (e.g. lifting the handset). The operator shall not be required to compose any elements of this acknowledgement.

The "comply with mode/frequency change" option shall require that the operator be able to enter/select frequencies and/or channels and on HF between voice and data modes before sending. The operator shall not be required to compose any other elements of this acknowledgement.

The "unable to comply" option shall require that the operator select one of the 10 reasons (telecommand 2 symbols, 101 does not apply to ship stations) specified in Recommendation ITU-R M.493-15 [3] for being unable to comply (default "no reason given") before sending. In the case of a position request, the option shall only require a single action by the operator to send, and the procedure shall indicate non-compliance by filling the position and time information with the no information character.

If an acknowledgement is resent by the operator it shall be identical to the first acknowledgment. It shall not be possible to further edit the content.

6.7.8 Termination

When auto acknowledging position, poll and test DSC messages the procedure shall self-terminate after sending the acknowledgement.

When sending an "unable to comply" acknowledgement the procedure shall terminate after completing the transmission.

In all other cases, termination is done manually or by the automated timeout. At least 10 seconds prior to automated termination, a visual and discrete aural warning shall be displayed with the option to stop the automatic termination.

If the procedure is terminated manually by the user then integrated equipment may revert to the channel or frequency that was previously selected before the DSC procedure.

6.7.9 Warnings

The procedure shall provide warnings for those reasons provided in Recommendation ITU-R M.493-15 [3], annex 4. The operator shall have the option to go back to the stage of the procedure where the action was taken that caused the warning.

6.8 Communications automated procedure

6.8.1 Procedure

The communications automated procedure results when the operator engages in communications established by non DSC means. The procedure is initiated when the operator chooses to monitor a channel for non DSC traffic or non DSC traffic is initiated by the reception of an appropriate signal. (Note that the details in design of the automated procedure might depend upon the type of non DSC traffic being monitored. For example, the non DSC traffic may be initiated by the reception of an NBDP signal).

The critical purpose of this simple procedure is to assure that received DSC messages do not interrupt ongoing communications in the same manner that they do not disrupt any of the ongoing automated procedures handling DSC messages.

6.8.2 Tasks

The communications automated procedure shall handle the following events:

- a) received DSC messages pertinent to the station shall be allocated to the appropriate automated procedure or initiate their own automated procedure on hold;
- b) tune the general receiver and transmitter to the frequencies of communication;
- c) provide the operator with the option to:
 - 1) terminate the procedure;
 - 2) toggle between activating and placing the procedure on hold;
 - 3) provide any other options necessary for the traffic mode being handled.

6.8.3 Display

During the communications automated procedure the equipment shall display or make available to the operator the following items and/or information:

- a) the fact one is engaged in a communications procedure;
- b) indication of whether the procedure is on hold or is active;
- c) the frequencies and or channels of communication (only applies for non-integrated DSC equipment);
- d) the operator options;
- e) the station MMSI;
- f) the latest known position of the vessel and the origin of the position (manual, automatic, etc.);
- g) the UTC time of that position.

6.8.4 Handling received DSC Messages

All received DSC messages pertinent to the station shall be allocated to the appropriate automated procedure or initiate their own automated procedure on hold.

6.8.5 Tuning of the general receiver and transmitter

The procedure shall automatically tune the general receiver and transmitter to the frequencies of the selected channel.

6.8.6 Termination

The procedure may either be terminated manually or via an automatic timeout.

6.9 Multiple automated procedures and parallel event handling

6.9.1 Procedure

This clause describes the handling of received DSC messages that are pertinent to the station while the radio is engaged.

6.9.2 Tasks

If the radio is engaged in handling an automated procedure (except for an unacknowledged sending distress automated procedure), received DSC messages that are pertinent to the station but not the currently active automated procedure:

- a) are allocated to an existing automated procedure on hold; or
- b) shall initiate their own automated procedure on hold.

Only one automated procedure can be active at a time (since there is only one transmitter and general receiver in addition to the watch receiver) thus any action to activate an automated procedure on hold places the currently active automated procedure on hold.

Automated procedures on hold shall behave identical to active procedures except they do not have control of the transmitter and general receiver thus:

- a) the only operator options which are available are those that do not require use of the transmitter or general receiver such as to terminate or activate the automated procedure;
- b) any subsequent tunings of the transmitter and general receiver that would occur if the procedure were active upon reception of a DSC message appropriate to the procedure shall not occur until the procedure is activated by the operator;
- c) the display of automated procedures on hold may be requested by a simple button press or selection, and may be represented by an appropriately named list, labelled icons, or equivalent in order to minimize space requirements;
- d) all other features, including handling of the alarms and full display of information at the request of the operator, remain.

The operator shall be able to activate any displayed automated procedure on hold selected from the list in c) by a single action (a button press or selection) unless the currently active procedure is transmitting.

If the only remaining automated procedures present on the equipment are inactive or on hold, and there are automated procedures handling test, polling, or position requests and these procedures are setup to auto acknowledge, the equipment shall successively perform the auto acknowledgement and terminate these procedures.

The radio shall provide sufficient memory or capacity to be able to handle a minimum of seven simultaneous automated procedures including a reserve of one. If the equipment can handle more than the required minimum, the equipment shall provide a setup option where the operator can set the value to seven (or any other value the equipment is capable of handling). This option is only required for equipment that can handle more than the minimum. When the equipment maximum is exceeded by one and the reserve procedure is started, the equipment shall generate a warning stating that an automated procedure needs to be terminated or equivalent, though this new procedure and all the previous automated procedures shall still function normally. At this time, the operator shall be prevented from starting any automated procedure except for the sending one's own distress. If the operator does not elect to terminate an automated procedure, the reception of an additional automated procedure shall result in the automatic termination of an existing automated procedure.

The automatic and immediate termination of an automated procedure should be based upon age and priority.

6.9.3 Examples of multiple procedure screens

Figure 6 shows a set of examples of windows displaying multiple procedures. In this case one area of the screen is dedicated to displaying the active procedure and a list of current procedures is navigated by up/down arrow keys. In the first figure the received distress procedure is shown. The procedure is unacknowledged, and upon activating this procedure the EUT automatically tunes the subsequent communication channel to 16. The second figure shows the result of pressing the "up arrow". The received distress procedure goes on hold and our sending non-distress procedure becomes active. Note that 555444322 has not responded yet. The default is for 555444322 to auto acknowledge, but it may not happen because 555444322 is out of range or engaged in another communication event and has not gotten around to acknowledging your call. The third figure shows the result of pressing the "up arrow" key one more time. The sending non-distress procedure goes on hold and the listed received non-distress procedure which happens to be a group call becomes active. The channel of subsequent communication automatically tunes to channel 6 and one can join in the voice traffic of that group. Of course the operator missed any traffic associated with that procedure while the procedure was on hold.

The fourth figure shows what might happen if 555444322 acknowledges our individual call while another procedure is active. The "procedure list bar" might flash as the alarm sounds indicating it needs attention, or a popup message could be displayed. In either case the operator shall be presented with the reason for and means of silencing the alarm so one does not have to activate the procedure. In this case the operator opted to press the down arrow to activate the indicated procedure. The fifth figure shows the result and the operator can now silence the alarm while "in" the procedure.

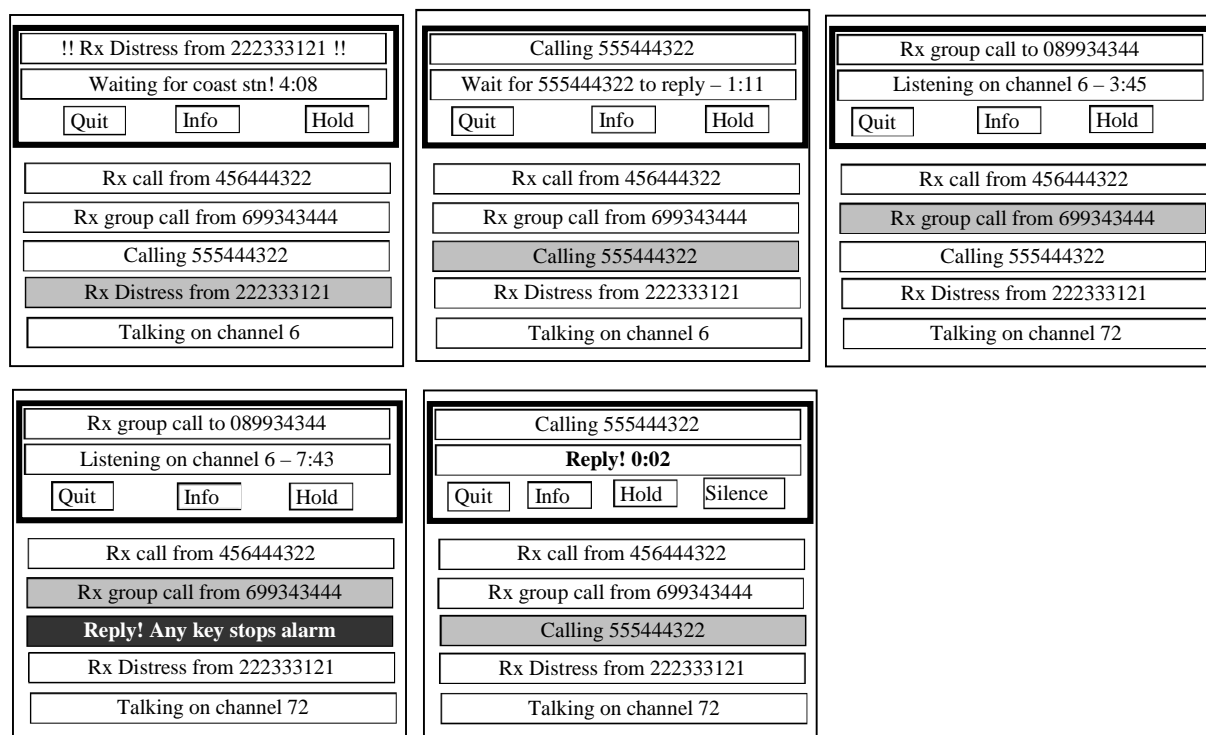

NOTE 1: The manufacturer has in this example provided the hold function separately allowing the user to view an inactive procedure without putting the current active procedure on hold.

NOTE 2: The "procedure buttons" could very well be physical buttons that are not part of the screen, similar to many older telephones. How the manufacturer chooses to handle the browsing of the multiple procedures is not specified by the present document.

Figure 6

Annex A (normative): DSC Message Composition

A.1 Default values

When default parameters are necessary, the factory default values shall be as shown in figure A.1.

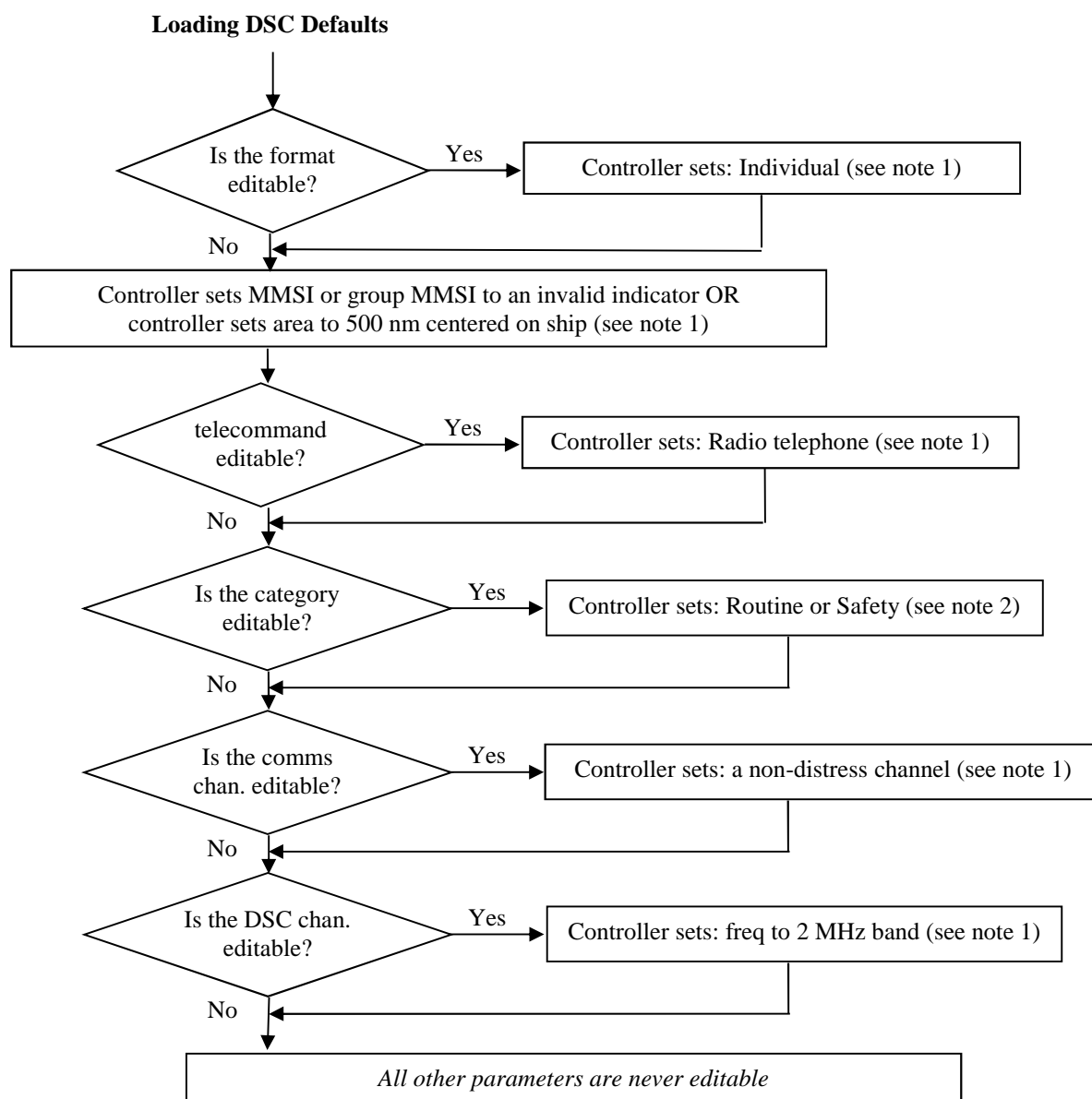

NOTE 1: Only if the parameter has not already been set by the operator.

NOTE 2: The default is "routine" if allowed (it is not allowed for area or all ships messages), otherwise the default is "safety". This default is to be reset (the most recently entered value shall be overwritten) when the operator selects the option to compose a non-distress DSC message at some later time.

Figure A.1: Loading DSC defaults

A.2 The default DROBOSE

Table A.1: Default DROBOSE

vessel in distress MMSI	Format (see note)	Nature	Distress comms	position	UTC time of position
unknown	individual	undesigned	phone	unknown	unknown

NOTE: The destination MMSI shall be some invalid indicator.

The MMSI of the vessel in distress, format, nature and position shall be reset when the operator selects the option to compose the DROBOSE at some later time.

A.3 Allowable non-distress DSC message parameters

The radio shall provide the operator only with the ability to send non-distress DSC messages with the parameter combinations as given by table 4 in the latest Recommendation ITU-R M.493-15 [3]. For convenience, the allowable parameter combinations for the various message types for non-distress DSC messages are summarized in table A.2.

Parameters in **bold** type are fixed for that DSC message type and when composing that message type, the fixed parameters shall not be able to be edited by the operator.

Table A.2: Allowable parameter combinations

Message type	Format (note 1)	Category	Telecommand	Frequency message
General priority	Individual Area (note 2), All-ships (note 3)	Safety urgency	Phone, HF: NBDP	Comms freq (note 5)
Individual routine	Individual	Routine	Phone, HF: NBDP	Comms freq (note 5)
Group DSC	Group	Routine	Phone, HF: NBDP	Comms freq (note 5)
Position request	Individual	Safety	Position request	No info
Test	Individual	Safety	Test	No info
Medical Transport (note 4)	Area (note 2), All-ships (note 3)	Urgency	Phone, HF: NBDP	Comms freq (note 5)
Neutral Craft (note 4)	Area (note 2), All-ships (note 3)	Urgency	Phone, HF: NBDP	Comms freq (note 5)

NOTE 1: The ability to enter/select an appropriate address for the individual, area, and group formats is also necessary.

NOTE 2: MF/HF only.

NOTE 3: VHF only.

NOTE 4: The Medical Transport and Neutral Craft DSC messages shall only be available as a setup option. In the factory defaults, these DSC messages shall not be available.

NOTE 5: On MF/HF the communications options are the duplex and simplex radio phone and NBDP channels/frequencies. On VHF the communication options are the applicable voice channels in Appendix 18 of the Radio Regulations [2]. A broadcast option is also permissible. For individually addressed DSC messages, there is also the option of letting the other station decide. When directed to a coast station the radio shall let the coast station decide the working frequencies. On MF/HF the ship station shall provide position information in place of the frequency message. On VHF the ship station may put the "no information" characters in the frequency message.

Annex B (normative): Radius-Centre point conversion and rounding algorithm

B.1 Radius-centre point conversion

The Mercator box specification coded into the DSC message shall be the minimum sized box that encompasses the entire circle as illustrated in figure B.1.

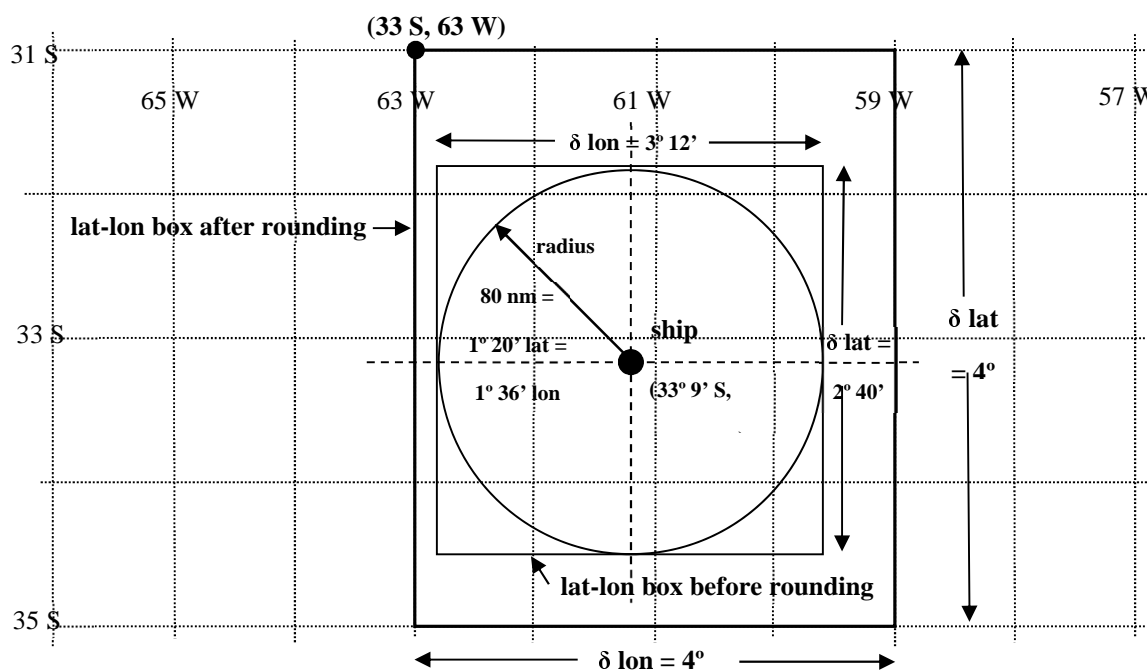

Figure B.1: Circle-radius to lat-lon box

The centre point, radius to northwest corner point, latitude-longitude Mercator box conversion shall take the following steps. The situation shown in figure B.1, a radius of 80 nautical miles centered on the point $(33^{\circ} 9' S, 61^{\circ} 10' W)$ is used as an example in the conversion algorithm below as an illustration:

- Define the centre point as given by the latitude - longitude point (θ, λ) : $(33^{\circ} 9' S, 61^{\circ} 10' W)$.
- The radius shall be converted to units of latitude ϕ : (80 nautical miles = $1^{\circ} 20'$ latitude).
- The equivalent value in units of longitude shall be given by: $\gamma = \phi / \cos\theta$, where θ is the latitude of the centre point: $1^{\circ} 36'$ longitude = $1^{\circ} 20'$ latitude / $\cos(33^{\circ} 9')$. If the longitude exceeds $49^{\circ} 00'$, the longitude shall be truncated to that value since the maximum box width in the DSC sentence is 99° .
- The dimensions of the Mercator box before rounding shall be given by $(2\phi, 2\gamma)$: $(2^{\circ} 40', 3^{\circ} 12')$.
- The northwest corner point of the Mercator box before rounding shall be given by moving the centre point latitude north by the radius distance ϕ and the centre point longitude west by the radius distance γ : $(33^{\circ} 9' S + 1^{\circ} 20' N, 61^{\circ} 10' W + 1^{\circ} 36' W) = (31^{\circ} 49' S, 62^{\circ} 46' W)$.

B.2 Rounding

If the enhanced geographic position expansion option is not used, the northwest corner point and Mercator box dimensions shall be rounded. The rounding shall take place as follows:

- a) The northwest corner point latitude shall be moved northward to the nearest whole degree latitude and the longitude shall be moved westward to the nearest whole degree longitude.
- b) $31^{\circ} 49'S$ becomes $31^{\circ} S$, a movement of $49'N$ and $62^{\circ} 46'W$ becomes $63^{\circ} W$, a movement of $14'W$.
- c) The northward and westward movements needed to round the northwest corner point to whole degrees shall be added to the latitude height and longitude width of the Mercator box: ($2^{\circ} 40' + 49'$, $3^{\circ} 12' + 14'$) = ($3^{\circ} 29'$, $3^{\circ} 26'$).
- d) The final dimensions of the Mercator box shall be rounded upward to the nearest whole degree: (4° , 4°).

B.3 Special cases for either form of area data entry

- a) If the final northwest corner point via either entry method exceeds $90^{\circ}N$ it shall be truncated to $90^{\circ}N$ and the latitude height of the Mercator box shall be adjusted accordingly.
- b) If the final southern extent of the Mercator box via either entry method exceeds $90^{\circ}S$ the latitude height shall be truncated so that it reaches $90^{\circ}S$.
- c) If the final longitudinal dimension exceeds 99° , the dimension shall be truncated to 99° .
- d) If the final latitudinal dimension exceeds 99° , the dimension shall be truncated to 99° .

Annex C (normative): Automated Non-Distress Channel/Frequency Selection Algorithm

C.0 General

Automated subsequent communications channel selection provides a default channel for the operator for non-distress DSC messages requiring subsequent communications based upon a simple algorithm. It shall be applied in the absence of any other specialized means of an automated communication setup, such as HF Automatic Linking Exchange (ALE).

C.1 VHF

The equipment shall assist the operator by suggesting a suitable inter-ship channel as defined in appendix 18 of the ITU Radio Regulations [2].

- a) Channel 16 shall not be used as a default for routine category DSC messages.
- b) If the DSC message is directed toward ship stations, a simplex channel shall be used (for example channel 6).
- c) DSC messages directed toward a coast station shall let the coast station decide (position or all 126 seconds in the frequency parameters of the DSC message).
- d) Any automatically proposed channel or list of channels may be established as an operator or configuration option.

C.2 HF

The equipment shall assist the operator by suggesting a suitable inter-ship channel as defined in appendix 17 of the ITU Radio Regulations [2].

On HF one has several bands of simplex and duplex frequencies for both voice or analogue signals (3 000 Hz bandwidth) and data signals (500 Hz bandwidth):

- a) The distress channels shall not be used for routine category DSC messages.
- b) The band of the communication channel shall be in the band of the DSC message.
- c) The set of 3 000 Hz analogue channels shall be chosen for voice communications.
- d) The set of 500 Hz data (NBDP) channels shall be chosen for data modes such as NBDP.
- e) DSC messages addressed to coast station destinations shall let the coast station decide (position in the frequency parameters of the DSC message).
- f) DSC messages addressed to ship station destinations shall use the simplex set of channels.
- g) DSC messages directed to a group or an area shall use the broadcast mode (126 seconds for the TX frequency in the frequency parameters of the DSC message).
- h) On HF the band of the communication channel shall be in the band of the DSC message.
- i) On HF the telephony channel set shall be chosen for voice communications.

The automated channel/frequency selection shall be able to be overridden (which will be necessary to select a distress channel for subsequent communications).

Annex D (normative): Alarms

D.1 Alarm specifications

Table D.1 summarizes the alarm characteristics required by the radio. The "**Event**" is the reason for the alarm. The "**sound**" specifies the default audio character of the alarm whose detailed characteristics are specified in table D.2. The "**increase**" specifies whether or not the alarm shall increase in volume over the first 10 seconds. The "**shutdown**" specifies whether the alarm shall be terminated manually (man), may be silenced automatically (auto), or automatically if the situation causing the alarm is corrected (corr). Manual silencing of alarms is always an option. The "**when aural required**" column specifies the conditions under which the aural alarm is mandatory.

It is assumed in table D.1 that any references to received DSC messages refer only to messages implicitly or explicitly addressed to the station.

Table D.1: Alarm characteristics

Event	Sound	Increase	Shutdown see note 3	When aural is required
Initiating a received distress automated procedure (note 1)	two-tone	Yes	Man	Only if within 500 nm of the vessel in distress or if from north of 70°N or south of 70°S otherwise alarm self-terminates
Acknowledging a received distress automated procedure (note 1)	Distress ack	No	Man	Only if within 500 nm of the vessel in distress or if from north of 70°N or south of 70°S otherwise alarm self-terminates
Acknowledging a sent distress automated procedure (note 1)	distress ack	No	Man	Always
rx DSC message not pertinent to unacknowledged sent distress automated procedure	silence	Does Not Apply	Does Not Apply	DSC message is only logged, no alarm of any type is required
Initiating a received urgency non-distress automated procedure	Urgency alarm	Yes	Man	Always when the priority of the non-distress DSC message is (distress - note 2) or urgency
Acknowledging a sent urgency non-distress automated procedure	Urgency ack alarm	No	Man	Always when the priority of the non-distress DSC message is (distress - note 2) or urgency
Initiating all other priority non-distress automated procedures (note 1)	routine alarm	Yes	Auto	When the priority of the non-distress DSC message is safety, routine, ships business, or unknown
Acknowledging all other priority sent non-distress automated procedures	routine ack alarm	No	Auto	When the priority of the non-distress DSC message is safety, routine, ships business, or unknown
rx DSC message pertinent to an ongoing automated procedure	Self-terminating alarm	No	Auto	Always
Auto termination of procedures; too many procedures	Discrete	No	Auto	Always
No own MMSI	Warning	No	Auto	Only on equipment power up
Automatic positioning ceases	Warning	No	Man/corr	Only if configured for auto position updating and info has not been received for 10 minutes
Position older than 4 hours	Warning	No	Man	At all times the situation is satisfied

Event	Sound	Increase	Shutdown see note 3	When aural is required
Position older than 23,5 hours	Warning	No	Man	Only if older than 4 hr alarm has been silenced
Pressing the dedicated distress button	Count	No	—	At all times the situation is satisfied

NOTE 1: Only when the event occurs due to the reception of a DSC message.

NOTE 2: The "distress priority" has been a source of great confusion. It is not a distress alert but a non-distress DSC message with the priority "distress" which is no longer allowed in the latest version of Recommendation ITU-R M.493-15 [3]. The distress priority non-distress DSC message has no distress information, is sent as a single DSC message on a single frequency, and all subsequent communication information is given explicitly in the message. Like any other non-distress DSC message in the old recommendation, it could be addressed to an individual, a group, an area, or all ships and have one of several possible telecommands.

NOTE 3: Shutdown of alarms may also be achieved by means of an external interface to an Integrated Communications System (ICS) [i.2] and [i.3].

D.2 Alarming with critical errors

If an automated procedure is initiated by a DSC message with critical errors (errors in the information symbols such that the procedure cannot take any action such as generating acknowledgements) the alarm shall self-terminate. The sound of the alarm shall be that it would have had if the DSC message were received without critical errors. The alarm specified in table D.1 (perhaps requiring manual termination) shall be delayed until that time the reception of subsequent or repeat DSC messages allows the procedure to correct the critical errors.

D.3 Default alarm sounds

The accuracy of the tones and durations specified in the table are not critical since they are for the human ear and not electronic detection. Nevertheless, the error shall not be more than 5 % in frequency and time. The waveforms may be sinusoidal, square, triangular, sawtooth, or any other form as long as the fundamental tone is clearly recognizable.

The two-tone and "urgency" alarms of table D.2 shall initially be of a power that is clearly distinguishable, but not interfere with, radiotelephone communications. If not manually cancelled within 10 seconds, the power shall start to rise to a level of at least 80 dB(A) within the next 10 seconds at a distance of 1 m from the equipment.

The "count" alarm of table D.2 shall have a power level of at least 80 dB(A) at a distance of 1 m from the equipment.

All other alarms (clause D.4) shall be of an audio level (or of a final level when appropriate) that is clearly distinguishable, but not interfere with, radiotelephone communications.

The operator shall be unable to neither customize the two-tone, distress acknowledgment, urgency and urgency acknowledgment alarms of table D.2 nor use these alarms for other purposes. Alarms for other purposes are specified in clause D.4.

Table D.2: Non configurable alarm sounds

Fixed Alarm sounds	Frequency (Hz)		Duration (ms)	
	Tone 1	Tone 2	Tone 1	Tone 2
two-tone (see note)	2 200	1 300	250	250
distress ack (see note)	2 200	1 300	500	500
Urgency (see note)	2 200	Silence	250	250
urgency ack (see note)	2 200	Silence	500	500
count	2 000	Silence	500	500

NOTE: The two-tone, distress ack, urgency, and urgency ack alarms shall not be able to be customized. These alarms are continuously repeated until manually terminated.

D.4 Other alarm sounds

The manufacturer may implement alarm sounds for the following events:

- Routine calls and routine acknowledgement calls.
- Safety calls and safety acknowledgement calls.
- Warnings.
- Discrete alarms.
- Self-terminating alarms.

Alarms may be repeated as long as it is pertinent to the procedure, and awaiting user interaction (unhandled).

It is recommended the alarms are selected within an audible frequency range of 300 Hz to 3 300 kHz.

The manufacturer is encouraged to implement an option to disable alarms, except from those defined in table D.2.

History

Document history		
Edition 1	November 1995	Publication as ETSI ETS 300 338
V1.2.1	April 1999	Publication as ETSI EN 300 338
V1.3.1	February 2010	Publication
V1.4.1	February 2017	Publication
V1.5.0	October 2019	EN Approval Procedure AP 20191231: 2019-10-02 to 2019-12-31