



**Electromagnetic compatibility  
and Radio spectrum Matters (ERM);  
Short Range Devices (SRD);  
Radio equipment in the frequency range  
9 kHz to 25 MHz and inductive loop systems  
in the frequency range 9 kHz to 30 MHz;  
Part 1: Technical characteristics and test methods**

---

Reference

REN/ERM-TG28-0436

---

Keywords

radio, RFID, SRD, testing

**ETSI**

650 Route des Lucioles  
F-06921 Sophia Antipolis Cedex - FRANCE

Tel.: +33 4 92 94 42 00 Fax: +33 4 93 65 47 16

Siret N° 348 623 562 00017 - NAF 742 C  
Association à but non lucratif enregistrée à la  
Sous-Préfecture de Grasse (06) N° 7803/88

---

**Important notice**

The present document can be downloaded from:

<http://www.etsi.org>

The present document may be made available in electronic versions and/or in print. The content of any electronic and/or print versions of the present document shall not be modified without the prior written authorization of ETSI. In case of any existing or perceived difference in contents between such versions and/or in print, the only prevailing document is the print of the Portable Document Format (PDF) version kept on a specific network drive within ETSI Secretariat.

Users of the present document should be aware that the document may be subject to revision or change of status. Information on the current status of this and other ETSI documents is available at

<http://portal.etsi.org/tb/status/status.asp>

If you find errors in the present document, please send your comment to one of the following services:

[http://portal.etsi.org/chaicor/ETSI\\_support.asp](http://portal.etsi.org/chaicor/ETSI_support.asp)

---

**Copyright Notification**

No part may be reproduced or utilized in any form or by any means, electronic or mechanical, including photocopying and microfilm except as authorized by written permission of ETSI.

The content of the PDF version shall not be modified without the written authorization of ETSI.

The copyright and the foregoing restriction extend to reproduction in all media.

© European Telecommunications Standards Institute 2014.

All rights reserved.

**DECT™**, **PLUGTESTS™**, **UMTS™** and the ETSI logo are Trade Marks of ETSI registered for the benefit of its Members. **3GPP™** and **LTE™** are Trade Marks of ETSI registered for the benefit of its Members and of the 3GPP Organizational Partners.

**GSM®** and the GSM logo are Trade Marks registered and owned by the GSM Association.

# Contents

Intellectual Property Rights .....	7
Foreword.....	7
Modal verbs terminology.....	7
Introduction .....	8
1 Scope .....	9
2 References .....	10
2.1 Normative references .....	10
2.2 Informative references.....	11
3 Definitions, symbols and abbreviations .....	12
3.1 Definitions .....	12
3.2 Symbols.....	13
3.3 Abbreviations .....	14
4 Technical requirements specifications .....	15
4.1 General requirements .....	15
4.1.1 Receiver categorization.....	15
4.1.2 General performance criteria .....	15
4.1.3 General performance criteria for wireless power transfer (WPT) systems .....	15
4.2 Presentation of equipment for testing purposes.....	17
4.2.1 Choice of model for testing .....	17
4.2.2 Testing of equipment with alternative radiated H-field strengths .....	18
4.2.3 Testing of equipment that does not have an external 50 $\Omega$ RF connector (integral antenna equipment) .....	18
4.2.3.1 Equipment with an internal permanent or temporary antenna connector.....	18
4.2.3.2 Equipment with a temporary antenna connector.....	18
4.2.3.3 Wireless Power Transfer systems .....	18
4.2.4 On-site testing.....	18
4.3 Mechanical and electrical design.....	18
4.3.1 General.....	18
4.3.1.1 WPT .....	18
4.3.2 Controls .....	18
4.3.3 Transmitter shut-off facility.....	19
4.3.4 Receiver mute or squelch.....	19
4.3.5 Marking (equipment identification).....	19
4.3.5.1 Equipment identification .....	19
4.3.5.2 Equipment marking.....	19
4.4 Declarations by the provider .....	19
4.5 Auxiliary test equipment .....	19
4.6 Interpretation of the measurement results .....	19
5 Test conditions, power sources and ambient temperatures .....	20
5.1 Normal and extreme test conditions .....	20
5.2 Test power source.....	20
5.2.1 External test power source .....	20
5.2.2 Internal test power source .....	20
5.3 Normal test conditions.....	20
5.3.1 Normal temperature and humidity .....	20
5.3.2 Normal test power source .....	21
5.3.2.1 Mains voltage .....	21
5.3.2.2 Regulated lead-acid battery power sources .....	21
5.3.2.3 Other power sources.....	21
5.4 Extreme test conditions .....	21
5.4.1 Extreme temperatures .....	21
5.4.1.1 Procedure for tests at extreme temperatures.....	21

5.4.1.1.1	Procedure for equipment designed for continuous operation .....	21
5.4.1.1.2	Procedure for equipment designed for intermittent operation .....	21
5.4.1.2	Extreme temperature ranges .....	22
5.4.2	Extreme test source voltages .....	22
5.4.2.1	Mains voltage .....	22
5.4.2.2	Regulated lead-acid battery power sources .....	22
5.4.2.3	Power sources using other types of batteries .....	22
5.4.2.4	Other power sources .....	23
6	General conditions .....	23
6.1	Normal test signals and test modulation .....	23
6.1.1	Normal test signals for analogue speech .....	23
6.1.2	Normal test signals for data .....	23
6.2	Artificial antenna .....	23
6.2.1	Artificial antenna for inductive transmitters (non 50 $\Omega$ ) .....	23
6.2.2	Artificial antenna for transmitters with 50 $\Omega$ impedance connector .....	24
6.3	Test fixture .....	24
6.4	Test sites and general arrangements for radiated measurements .....	25
6.5	Modes of operation of the transmitter .....	25
6.6	Measuring receiver .....	25
7	Transmitter requirements .....	25
7.1	Transmitter definitions .....	26
7.1.1	The inductive loop coil transmitters .....	26
7.1.2	The large size loop transmitters .....	26
7.1.3	Other transmitters .....	26
7.1.4	Product Classes .....	26
7.2	Transmitter carrier output levels .....	30
7.2.1	H-field (radiated) .....	30
7.2.1.1	Definition .....	30
7.2.1.2	Methods of measurement .....	30
7.2.1.3	Limits .....	30
7.2.2	RF carrier current (Product Class 3 only) .....	32
7.2.2.1	Definition .....	32
7.2.2.2	Methods of measurement .....	32
7.2.2.3	Limits .....	32
7.2.3	Radiated E-field (Product Class 4 only) .....	32
7.2.3.1	Definition .....	32
7.2.3.2	Methods of measurement .....	32
7.2.3.3	Limits .....	33
7.3	Permitted range of operating frequencies .....	33
7.3.1	Definition .....	33
7.3.2	Method of measurement .....	33
7.3.3	Limits .....	33
7.4	Permitted frequency range of the modulation bandwidth .....	33
7.4.1	Definition .....	34
7.4.2	Method of measurement .....	34
7.4.3	Limits .....	34
7.5	Spurious domain emission limits .....	35
7.5.1	Definition .....	35
7.5.2	Conducted spurious emissions (Product class 3 only) .....	35
7.5.2.1	Methods of measurement (< 30 MHz) .....	35
7.5.2.2	Limits .....	35
7.5.2.3	Methods of measurement ( $\geq$ 30 MHz) .....	35
7.5.2.4	Limits .....	36
7.5.3	Radiated field strength .....	36
7.5.3.1	Methods of measurement (< 30 MHz) .....	36
7.5.3.2	Limits .....	36
7.5.4	Effective radiated power .....	36
7.5.4.1	Methods of measurement ( $\geq$ 30 MHz) .....	37
7.5.4.2	Limits .....	37
8	Receiver requirement .....	38

8.1	Adjacent channel selectivity - in band.....	38
8.1.1	Definition.....	38
8.1.2	Method of measurement.....	38
8.1.3	Limits.....	39
8.2	Blocking or desensitization (Receiver category 1 and 2 only).....	39
8.2.1	Definition.....	39
8.2.2	Methods of measurement.....	39
8.2.3	Limits.....	40
8.3	Receiver spurious radiation.....	40
8.3.1	Definition.....	41
8.3.2	Methods of measurement.....	41
8.3.3	Limits.....	41
8.3.3.1	Radiated emissions below 30 MHz.....	41
8.3.3.2	Radiated emissions above 30 MHz.....	41
9	Measurement uncertainty.....	41
10	Interpretation of results.....	42
10.1	Measurement uncertainty is equal to or less than maximum acceptable uncertainty.....	42
<b>Annex A (normative): Radiated measurement.....</b>		<b>43</b>
A.1	Test sites and general arrangements for measurements involving the use of radiated fields.....	43
A.1.1	Anechoic chamber.....	43
A.1.2	Anechoic chamber with a conductive ground plane.....	44
A.1.3	Open Area Test Site (OATS).....	45
A.1.3.1	Measurements below 30 MHz.....	46
A.1.3.2	Measurements above 30 MHz.....	46
A.1.4	Test antenna.....	47
A.1.5	Substitution antenna.....	48
A.1.6	Measuring antenna.....	48
A.2	Guidance on the use of radiation test sites.....	48
A.2.1	Verification of the test site.....	48
A.2.2	Preparation of the EUT.....	48
A.2.3	Power supplies to the EUT.....	48
A.2.4	Range length.....	49
A.2.4.1	Far-field length above 30 MHz.....	49
A.2.4.2	Near-field and Far-field length below 30 MHz.....	49
A.2.5	Site preparation.....	50
A.3	Coupling of signals.....	50
A.3.1	General.....	50
A.3.2	Data signals.....	50
A.4	Standard test position.....	50
A.5	Test fixture.....	51
A.5.1	Description.....	51
A.5.2	Calibration.....	52
A.5.3	Mode of use.....	52
A.6	Technical performance of the spectrum analyser.....	53
<b>Annex B (normative): H-field limit correction factor for generated E-fields.....</b>		<b>54</b>
<b>Annex C (normative): Customized loop antennas.....</b>		<b>55</b>
C.1	Product classes related to the antenna loop.....	55
C.1.1	Antenna loops below 1 MHz.....	55
C.1.2	Antenna loops above 1 MHz.....	56
<b>Annex D (informative): Test fixture for measuring inductive transmitter carrier and harmonic currents by use of an artificial antenna (Product Class 3 only).....</b>		<b>58</b>

<b>Annex E (informative):</b>	<b>E-fields in the near field at low frequencies.....</b>	<b>60</b>
<b>Annex F (normative):</b>	<b>H-field measurements and limits at 3 m and 30 m .....</b>	<b>61</b>
F.1	Limits for measurements at 30 m distance .....	61
F.2	Limits for measurements at 3 m distance .....	62
<b>Annex G (normative):</b>	<b>Transmitter emission levels and spectrum mask measurements.....</b>	<b>63</b>
<b>Annex H (normative):</b>	<b>Generic inductive loop limits in the frequency range 148,5 kHz to 30 MHz .....</b>	<b>66</b>
H.1	Introduction .....	66
H.2	Radiated H-field strength .....	66
H.2.1	Methods of measurements .....	66
H.2.2	Radiated H-field strength limit.....	66
H.2.2.1	Radiated total H-field and H-field density limits according to the measurements in clause H.2.1 indent a) .....	66
H.2.2.2	Radiated bandwidth and H-field density limits according to the measurements in clause H.2.1 indent b) .....	67
H.3	Other requirements .....	67
<b>Annex I (informative):</b>	<b>Determination and use of the measurement bandwidth.....</b>	<b>68</b>
<b>Annex J (informative):</b>	<b>Other limits.....</b>	<b>69</b>
<b>Annex K (informative):</b>	<b>Bibliography .....</b>	<b>70</b>
History	.....	71

---

## Intellectual Property Rights

IPRs essential or potentially essential to the present document may have been declared to ETSI. The information pertaining to these essential IPRs, if any, is publicly available for **ETSI members and non-members**, and can be found in ETSI SR 000 314: *"Intellectual Property Rights (IPRs); Essential, or potentially Essential, IPRs notified to ETSI in respect of ETSI standards"*, which is available from the ETSI Secretariat. Latest updates are available on the ETSI Web server (<http://ipr.etsi.org>).

Pursuant to the ETSI IPR Policy, no investigation, including IPR searches, has been carried out by ETSI. No guarantee can be given as to the existence of other IPRs not referenced in ETSI SR 000 314 (or the updates on the ETSI Web server) which are, or may be, or may become, essential to the present document.

---

## Foreword

This final draft European Standard (EN) has been produced by ETSI Technical Committee Electromagnetic compatibility and Radio spectrum Matters (ERM), and is now submitted for the Vote phase of the ETSI standards EN Approval Procedure.

The present document includes improvements to the previous version of the standard that take advantage of technical developments within the SRD industry.

The present document is part 1 of a multi-part deliverable covering Electromagnetic compatibility and Radio spectrum Matters (ERM); Short Range Devices (SRD); Radio equipment in the frequency range 9 kHz to 25 MHz and inductive loop systems in the frequency range 9 kHz to 30 MHz, as identified below:

**Part 1:** "Technical characteristics and test methods";

Part 2: "Harmonized EN covering the essential requirements of article 3.2 of the R&TTE Directive".

<b>Proposed national transposition dates</b>	
Date of latest announcement of this EN (doa):	3 months after ETSI publication
Date of latest publication of new National Standard or endorsement of this EN (dop/e):	6 months after doa
Date of withdrawal of any conflicting National Standard (dow):	6 months after doa

---

## Modal verbs terminology

In the present document "shall", "shall not", "should", "should not", "may", "may not", "need", "need not", "will", "will not", "can" and "cannot" are to be interpreted as described in clause 3.2 of the [ETSI Drafting Rules](#) (Verbal forms for the expression of provisions).

"must" and "must not" are **NOT** allowed in ETSI deliverables except when used in direct citation.

---

# Introduction

The present document has been prepared to:

- Enhance operating conditions for RFIDs in the 13,56 MHz Band with regard to high datarate wideband low level systems up to  $\pm 7$  MHz for ISO 14443 [i.9] type applications including NFC and secondly for higher operating range, narrowband high level modulation for ISO 15693 [i.10] and ISO 18000-3 [i.11] type systems.
- Include wireless inductive power transfer (WPT) systems.



---

# 1 Scope

The present document applies to the following Short Range Device major equipment types:

- 1) Generic Short range Devices including transmitters operating in the range from 9 kHz to 25 MHz; and
- 2) inductive loop transmitters operating from 9 kHz to 30 MHz including Radio Frequency Identification (RFID) and EAS operating in LF and HF ranges and for radio equipment including wireless power transfer (WPT) function in the same frequency range;
- 3) receivers of systems as defined by bullets 1 and 2.

These radio equipment types are capable of operating in the permitted frequency bands within the 9 kHz to 30 MHz range as specified in table 1:

- either with a Radio Frequency (RF) output connection and dedicated antenna or with an integral antenna;
- for all types of modulation;
- receivers of systems as defined by bullets 1 and 2.

Table 1 shows a list of the frequency bands as designated to Short Range Devices and the CEPT/ERC/REC 70-03 [i.1] as known at the date of publication of the present document.

When selecting parameters for new SRDs, which may have inherent safety of human life implications, manufacturers and users should pay particular attention to the potential for interference from other systems operating in the same or adjacent bands.

The present document covers fixed stations, mobile stations and portable stations. If a system includes transponders, these are measured together with the transmitter.

All types of modulation for radio devices are covered by the present document, provided the requirements of clause 7.3 are met.

The radio equipment, covered by the classification SRD is divided into several classes based on the maximum radiated magnetic field strength. The field strength designation in the present document is based on CEPT/ERC/REC 70-03 [i.1] and National SRD-frequency designations.

Three types of measuring methods are defined in the present document due to the varied nature of the antenna types for equipment used in this band. One method measures the RF carrier current, another measures the radiated H-field and the third conducted power.

The present document covers requirements for radiated emissions below as well as above 30 MHz.

Additional standards or specifications may be required for equipment such as that intended for connection to the Public Switched Telephone Network (PSTN).

**Table 1: Short Range Devices within the 9 kHz to 30 MHz permitted frequency bands**

	Frequency Bands/frequencies	Applications
Transmit and Receive	9 kHz to 90 kHz	Inductive devices, Generic use
Transmit and Receive	90 kHz to 119 kHz	Inductive devices, Generic use
Transmit and Receive	119 kHz to 140 kHz	Inductive devices, Generic use
Transmit and Receive	140 kHz to 148,5 kHz	Inductive devices, Generic use
Transmit and Receive	148,5 kHz to 5 MHz	Inductive devices, Generic use
Transmit and Receive	400 kHz to 600 kHz	RFID only
Transmit and Receive	5 kHz to 30 MHz	Inductive devices, Generic use
Transmit and Receive	3 155 kHz to 3 400 kHz	Inductive devices, Generic use
Transmit and Receive	4 234 kHz	Inductive devices, Railway applications
Transmit and Receive	4 516 kHz	Inductive devices, Railway applications
Transmit and Receive	6 765 kHz to 6 795 kHz	Inductive devices, Generic use
Transmit and Receive	7 400 kHz to 8 800 kHz	Inductive devices, Generic use
Transmit and Receive	10 200 kHz to 11,000 MHz	Inductive devices, Generic use
Transmit and Receive	11,810 MHz to 15,310 MHz	RFID only
Transmit and Receive	12,5 MHz to 20 MHz	Inductive devices, Wireless healthcare
Transmit and Receive	13,553 MHz to 13,567 MHz	Inductive devices, Generic use
Transmit and Receive	26,957 MHz to 27,283 MHz	Inductive devices, Generic use
Transmit and Receive	27,095 MHz	Inductive devices, Railway applications

NOTE 1: It should be noted that table 1 represents the most widely implemented position within the European Union and the CEPT countries, but it should not be assumed that all designated bands are available in all countries.

NOTE 2: In addition, it should be noted that other frequency bands may be available in a country within the frequency range 9 kHz to 30 MHz covered by the present document.

NOTE 3: On non-harmonized parameters, national administrations may impose certain conditions such as the type of modulation, frequency, channel/frequency separations, maximum transmitter radiated power, duty cycle, and the inclusion of an automatic transmitter shut-off facility, as a condition for the issue of an Individual Rights for use of spectrum or General Authorization, or as a condition for use under "licence exemption" as it is in most cases for Short Range Devices.

The present document covers fixed stations, mobile stations and portable stations.

Applications using Ultra-WideBand (UWB) technology are not covered by the present document.

---

## 2 References

References are either specific (identified by date of publication and/or edition number or version number) or non-specific. For specific references, only the cited version applies. For non-specific references, the latest version of the reference document (including any amendments) applies.

Referenced documents which are not found to be publicly available in the expected location might be found at <http://docbox.etsi.org/Reference>.

NOTE: While any hyperlinks included in this clause were valid at the time of publication, ETSI cannot guarantee their long term validity.

### 2.1 Normative references

The following referenced documents are necessary for the application of the present document.

- [1] ETSI TR 100 028 (all parts) (V1.4.1): "Electromagnetic compatibility and Radio spectrum Matters (ERM); Uncertainties in the measurement of mobile radio equipment characteristics".

## 2.2 Informative references

The following referenced documents are not necessary for the application of the present document but they assist the user with regard to a particular subject area.

- [i.1] CEPT/ERC/REC 70-03: "Relating to the use of Short Range Devices (SRD)".
- [i.2] Recommendation ITU-T O.153: "Basic parameters for the measurement of error performance at bit rates below the primary rate".
- [i.3] ANSI C63.5: "American National Standard for Electromagnetic Compatibility-Radiated Emission Measurements in Electromagnetic Interference (EMI) Control-Calibration of Antennas (9 kHz to 40 GHz)".
- [i.4] Directive 1999/5/EC of the European Parliament and of the Council of 9 March 1999 on radio equipment and telecommunications terminal equipment and the mutual recognition of their conformity (R&TTE Directive).
- [i.5] ETSI TR 102 273-2: "Electromagnetic compatibility and Radio spectrum Matters (ERM); Improvement on Radiated Methods of Measurement (using test site) and evaluation of the corresponding measurement uncertainties; Part 2: Anechoic chamber".
- [i.6] ETSI TR 102 273-3: "Electromagnetic compatibility and Radio spectrum Matters (ERM); Improvement on Radiated Methods of Measurement (using test site) and evaluation of the corresponding measurement uncertainties; Part 3: Anechoic chamber with a ground plane".
- [i.7] ETSI TR 102 273-4: "Electromagnetic compatibility and Radio spectrum Matters (ERM); Improvement on Radiated Methods of Measurement (using test site) and evaluation of the corresponding measurement uncertainties; Part 4: Open area test site".
- [i.8] ECC report 208: "Impact of RFID devices on radio services in the band 13.56 MHz".
- [i.9] ISO 14443: "Identification cards -- Contactless integrated circuit cards -- Proximity cards".
- [i.10] ISO 15693: "Information technology -- Radio frequency identification for item management -- Unique identification for RF tags".
- [i.11] ISO 18000-3: "Information technology -- Radio frequency identification for item management -- Part 3: Parameters for air interface communications at 13,56 MHz".
- [i.12] CISPR 16-2-3: "Specification for radio disturbance and immunity measuring apparatus and methods - Part 2-3: Methods of measurement of disturbances and immunity - Radiated disturbance measurements".
- [i.13] CENELEC EN 62311: "Assessment of electronic and electrical equipment related to human exposure restrictions for electromagnetic fields (0 Hz - 300 GHz)".
- [i.14] CENELEC EN 62479: "Assessment of the compliance of low power electronic and electrical equipment with the basic restrictions related to human exposure to electromagnetic fields (10 MHz to 300 GHz)".
- [i.15] CENELEC EN 55011: "Industrial, scientific and medical equipment - Radio-frequency disturbance characteristics - Limits and methods of measurement".
- [i.16] Void.
- [i.17] ETSI EN 300 220 (all parts): "Electromagnetic compatibility and Radio spectrum Matters (ERM); Short Range Devices (SRD); Radio equipment to be used in the 25 MHz to 1 000 MHz frequency range with power levels ranging up to 500 mW".
- [i.18] ETSI EN 300 440 (all parts): "Electromagnetic compatibility and Radio spectrum Matters (ERM); Short range devices; Radio equipment to be used in the 1 GHz to 40 GHz frequency range".

- [i.19] ETSI EN 301 489-1: "Electromagnetic compatibility and Radio spectrum Matters (ERM); ElectroMagnetic Compatibility (EMC) standard for radio equipment and services; Part 1: Common technical requirements".
- [i.20] ETSI EN 301 489-3: "Electromagnetic compatibility and Radio spectrum Matters (ERM); ElectroMagnetic Compatibility (EMC) standard for radio equipment and services; Part 3: Specific conditions for Short-Range Devices (SRD) operating on frequencies between 9 kHz and 246 GHz".
- [i.21] ETSI EN 301 489-17: "Electromagnetic compatibility and Radio spectrum Matters (ERM); ElectroMagnetic Compatibility (EMC) standard for radio equipment; Part 17: Specific conditions for Broadband Data Transmission Systems".
- [i.22] ETSI EN 300 328: "Electromagnetic compatibility and Radio spectrum Matters (ERM); Wideband transmission systems; Data transmission equipment operating in the 2,4 GHz ISM band and using wide band modulation techniques; Harmonized EN covering the essential requirements of article 3.2 of the R&TTE Directive".
- [i.23] ETSI EN 300 330: "ElectroMagnetic Compatibility and Radio Spectrum Matters (ERM); Short Range Devices (SRD); Radio equipment in the frequency range 9 kHz to 25 MHz and inductive loop systems in the frequency range 9 kHz to 30 MHz".
- [i.24] Recommendation ITU-T O.41: "Psophometer for use on telephone-type circuits".
- [i.25] Directive 2006/95/EC of the European Parliament and of the Council of 12 December 2006 on the harmonisation of the laws of Member States relating to Electrical Equipment designed for use within certain voltage limits (LVD).
- [i.26] ITU Radio Regulations.
- [i.27] Directive 2004/108/EC of the European Parliament and of the Council of 15 December 2004 on the approximation of the laws of the Member States relating to electromagnetic compatibility and repealing Directive 89/336/EEC Text with EEA relevance (EMCD).

---

## 3 Definitions, symbols and abbreviations

### 3.1 Definitions

For the purposes of the present document, the following terms and definitions apply:

**alarm:** use of radio communication or a sensing device for indicating alert information at a distant location

**artificial antenna:** tuned reduced-radiating dummy load equal to the nominal impedance specified by the provider

**assigned frequency band:** frequency band within which the device is authorized to operate

**battery:** receiving part of a WPT system, a combination a receiving coil and battery in one housing

**battery emulator:** receiving part of a WPT systems, which emulates the battery and the receiving coil

**charger:** stationary part of the Wireless Power Transfer (WPT) system supplying energy to a receiving part

**conducted measurements:** measurements which are made using a direct connection to the equipment under test

**customized antenna:** antenna built according to manufacturers' antenna design rules inside tested limits

**dedicated antenna:** removable antenna supplied and type tested with the radio equipment, designed as an indispensable part of the equipment

NOTE: The antenna has been designed or developed for one or more specific types of equipment. It is the combination of dedicated antenna and radio equipment that is expected to be compliant with the regulations.

**fixed station:** equipment intended for use in a fixed location

**H-field test antenna:** electrically screened loop or equivalent antenna, with which the magnetic component of the field can be measured

**identification system:** equipment consisting of a transmitter(s), receiver(s) (or a combination of the two) and an antenna(s) to identify objects by means of a transponder

**integral antenna:** antenna designed as a fixed part of the equipment, without the use of an external connector and as such which cannot be disconnected from the equipment by the user

**magnetic dipole moment:** product of (Number of coil turns)  $\times$  (coil area)  $\times$  (coil current)

NOTE: Air coils only.

**medical device:** any instrument, apparatus, appliance, software, material or other article, whether used alone or in combination, together with any accessories, including the software intended by its manufacturer to be used specifically for diagnostic and/or therapeutic purposes and necessary for its proper application, intended by the manufacturer to be used for human beings for the purpose of:

- diagnosis, prevention, monitoring, treatment or alleviation of disease;
- diagnosis, monitoring, treatment, alleviation of or compensation for an injury or handicap;
- investigation, replacement or modification of the anatomy or of a physiological process;
- control of conception;

and which does not achieve its principal intended action in or on the human body by pharmacological, immunological or metabolic means, but which may be assisted in its function by such means

**mobile station:** equipment normally installed in a vehicle

**portable station:** equipment intended to be carried, attached or implanted

**radiated measurements:** measurements which involve the absolute measurement of a radiated field

**receiving part:** receiving or second coil of a WPT system

**spurious emissions:** emissions on a frequency or frequencies which are outside the occupied bandwidth and the level of which may be reduced without affecting the corresponding transmission of information

**telecommand:** use of radio communication for the transmission of signals to initiate, modify or terminate functions of equipment at a distance

**telemetry:** use of radio communication for indicating or recording data at a distance

**transponder:** device that responds to an interrogation signal

**type designation:** providers' marking of the equipment

## 3.2 Symbols

For the purposes of the present document, the following symbols apply:

$\Omega$	ohm
A	loop antenna area
C	correction factor
E	electrical field strength
f	frequency
$f_C$	carrier frequency in Hz
H	magnetic field strength
H <sub>ef</sub>	H field-strength generated by an e-field antenna
H <sub>f</sub>	H-field-strength limit

$H_C$	carrier H-field strength
$H_S$	H-field-strength limit for radiated spurious emissions
$I_C$	transmitter carrier output current
$I_S$	transmitter spurious output current
$\lambda$	Wave length
$m$	magnetic dipole moment
$N$	number of turns for a loop antenna
$P$	Power
$t$	time

### 3.3 Abbreviations

For the purposes of the present document, the following abbreviations apply:

ASK	Amplitude Shift Keying
BER	Bit Error Margin
CEPT	Conférence Européenne des Postes et Télécommunications
CISPR	Comité International Spécial des Perturbations Radioélectriques
e.r.p.	effective radiated power
EAS	Electronic Article Surveillance
EC	European Community
EMC	ElectroMagnetic Compatibility
EMF/emf	ElectroMagnetic Field
ERC	European Radiocommunications Committee
EUT	Equipment Under Test
HF	High Frequency (range)
ISM	Industrial, Scientific and Medical
ITU-T	ITU-Telecommunication sector
LF	Low Frequency
ND	Noise and Distortion
NFC	Near Field Communication
NIA	Product of $N$ (the number of turns of the loop coil) $\times I$ (current in the loop coil) $\times A$ (the area of the loop coil antenna)
NRI	National Radio Interfaces
OATS	Open Area Test Site
PSTN	Public Switched Telephone Network
R&TTE	Radio and Telecommunications Terminal Equipment
RF	Radio Frequency
RFID	Radio Frequency IDentification
SND	Signal, Noise and Distortion
SND/ND	Signal, Noise and Distortion over Noise and Distortion
SRD	Short Range Device
TR	Technical Report
UWB	Ultra Wideband
VSWR	Voltage Standing Wave Ratio
WPT	Wireless Power Transfer

## 4 Technical requirements specifications

### 4.1 General requirements

#### 4.1.1 Receiver categorization

The product family of short range radio devices is divided into three receiver categories, see table 2, each having its own set of minimum performance criteria. This classification is based upon the impact on persons in case the equipment does not operate above the specified minimum performance level.

**Table 2**

Receiver categories	Relevant receiver clauses	Risk assessment of receiver performance
1	8.1, 8.2 and 8.3	Safety critical SRD communication media; i.e. for devices serving systems where failure may result in a physical risk to a person.
2	8.2 and 8.3	Function critical SRD communication media; i.e. when a failure to operate correctly causes loss of function but does not constitute a safety hazard.
3	8.3	Non-critical SRD communication media whose failure to operate correctly causes loss of function which can be overcome by parallel means.
NOTE: With reference to the present document manufacturers are recommended to declare the categorization of their devices in accordance with table 2, as relevant. In particular where an SRD which may have an inherent safety of human life implication, manufacturers and users should pay particular attention to the potential for interference from other systems operating in the same or adjacent bands.		

#### 4.1.2 General performance criteria

For the purpose of the receiver performance tests, the receiver will produce an appropriate output under normal conditions as indicated below:

- a SND/ND ratio of 20 dB, measured at the receiver output through a telephone psophometric weighting network as described in Recommendation ITU-T O.41 [i.24];
- after demodulation, a data signal with a bit error ratio of  $10^{-2}$ ; or
- after demodulation, a message acceptance ratio of 80 %.

Where the indicated performance cannot be achieved or if it is defined differently, the manufacturer shall declare and publish the performance criteria used to determine the performance of the receiver.

#### 4.1.3 General performance criteria for wireless power transfer (WPT) systems

For the purpose of the present document WPT systems are classified into three different groups according to table 3.

**Table 3: Distinction between WPT cases with regard to the communication technology**

Case	Applicable Directive(s)	Operating frequency range	Essential requirement		
			EMF	EMC	Radio
1	EMC-D and LVD/GPSD	ISM and non-ISM bands > 9 kHz	Applicable standard selected from OJ LVD List [i.25]	EN 55011 [i.15] Group 2 (or more specific CENELEC standard if applicable)	N/A
2	R&TTE-D	9 kHz < band < 30 MHz	EN 62311 [i.13] EN 62479 [i.14]	ETSI EN 301 489-1 [i.19] ETSI EN 301 489-3 [i.20]	ETSI EN 300 330 [i.23]
		30 MHz < band < 1 GHz			ETSI EN 300 220 [i.17]
		1 GHz < band < 40 GHz			ETSI EN 300 440 [i.18]
3	EMC-D (wireless charger part)	Rules for Case 1 apply			
	R&TTE-D (communication part)	Depends on the communication technology (e.g. Bluetooth -> ETSI EN 301 489-1 [i.19]/ ETSI EN 301 489-17 [i.21]; ETSI EN 300 328 [i.22])			

## WPT Cases:

Case 1: when the charging device operates without a data communication function between the charger and the charge receiving device, then the framework of the EMC Directive [i.27] and related EMC standards can define an adequate path for compliance.

Case 2: when a data communication function exists between the charger and the charge receiving device at the same frequency as the charging energy transfer, then additionally the R&TTE (SRD) framework and the present document can provide an adequate path for compliance.

Medical devices using WPT that require reverse compatibility with other medical devices placed on the market when earlier versions of the ETSI EN 300 330-2 (V1.6.1) [i.23] were harmonized, are allowed to have an operating mode in which they do not have to comply with the R&TTE (SRD) framework.

Case 3: when a data communication function exists between the charger and the charge receiving device at a different frequency to the charging energy transfer, then the R&TTE (SRD) framework and the related harmonized standard for radio equipment applicable to the frequency band/technology in use can be applied to the communications path whilst the framework of the EMC Directive [i.27] and related EMC standards can apply to the charger function as for Case 1 above.

The present document covers wireless power transfer systems according to Case 2 of the table 3, i.e. systems which consist of:

- 1) A power transmitter, with additional communication capability to control the charge function in conjunction with the receiving part. The power transmitter could also be named as charger.
- 2) A receiver, which supplies the received energy to a battery and performs a control/supervision function for the battery status and charge operation.

Both parts in combination are able to transmit and receive data in addition to the power transfer mode e.g. to control the battery status and to optimize the transfer mode.

Because of the close interaction between charger and battery the manufacturer shall provide all necessary parts for the presentation of equipment and for testing purposes. The description of the setup including the positioning and mechanical orientation of both parts shall be provided since this affects the radiated emissions. For using different batteries or power receiving parts with one charger, the manufacturer shall declare the typical and the worse case combinations with regard to radiated emissions and provide such combinations for testing.

In certain cases it may be not possible to provide the necessary samples of batteries due to unavailability. In these cases the manufacturer has to declare that the charger was developed based on certain batteries and such charger/battery combinations shall be provided for testing.

The provider shall declare for each possible operation or charging mode of the WPT system:

- a) charging mode/power transfer / system in resonance;



- b) communication mode (data transmission from and to the battery);
- c) such as communication and determination of the charging action e.g. to find the resonance frequency of the system or optimal charging parameters of the WPT systems.

Additional declarations to establish the appropriate test conditions:

- a) the mechanical setup;
- b) the mechanical orientation;
- c) the frequency ranges;
- d) the range of operating conditions including the duty cycle or pulsing operational parameter;
- e) power requirements.

The measurements itself shall be done on these actual set-up and operating conditions for each mode.

NOTE: If during the initial establishment of the charging mode, no or very low emission are occurring, this initialization mode can be declared as irrelevant for the test.

## 4.2 Presentation of equipment for testing purposes

Each equipment submitted for testing shall fulfil the requirements of the present document on all frequencies over which it is intended to operate.

The provider shall declare the frequency ranges, the range of operating conditions and power requirements as applicable, to establish the appropriate test conditions.

Additionally, technical documentation and operating manuals, sufficient to make the test, shall be supplied.

A test fixture for equipment with an integral antenna may be supplied by the provider (see clause 6.3). For equipment supplied without an antenna i.e. Product Class 3 as defined in clause 7.1.4, the provider will supply either a tuned reduced radiating load (see clause 6.2.1) or an artificial antenna as defined by annex E.

If an equipment is designed to operate with different transmitter radiated field strengths or power level, measurement of each transmitter parameter shall be performed, according to the present document, on samples of equipment defined in clause 4.2.1.

To simplify and harmonize the testing procedures between different testing laboratories, measurements shall be performed, according to the present document, on samples defined in clauses 4.2.1 to 4.2.4.

### 4.2.1 Choice of model for testing

The provider shall provide one or more samples of the equipment, as appropriate for testing.

Stand alone equipment shall be offered by the provider complete with any ancillary equipment needed for testing.

If an equipment has several optional features, considered not to affect the RF parameters then the tests need only to be performed on the equipment configured with that combination of features considered to be the most complex, as proposed by the provider and agreed by the test laboratory.

Where practicable, equipment offered for testing shall provide a 50  $\Omega$  connector for conducted RF power level measurements.

In the case of integral antenna equipment, if the equipment does not have an internal permanent 50  $\Omega$  connector then it is permissible to supply a second sample of the equipment with a temporary antenna connector fitted to facilitate testing, see clause 4.2.3.

The performance of the equipment submitted for testing shall be representative of the performance of the corresponding production model.

## 4.2.2 Testing of equipment with alternative radiated H-field strengths

If a family of equipment has alternative radiated field strengths provided by the use of separate power modules or add on stages, then these shall be declared by the provider. Each module or add on stage shall be tested in combination with the equipment. As a minimum, measurements of the radiated H-field strength and spurious emissions shall be performed for each combination and shall be stated in the test report.

## 4.2.3 Testing of equipment that does not have an external 50 $\Omega$ RF connector (integral antenna equipment)

### 4.2.3.1 Equipment with an internal permanent or temporary antenna connector

The means to access and/or implement the internal permanent or temporary antenna connector shall be stated by the provider with the aid of a diagram. The fact that use has been made of the internal antenna connection, or of a temporary connection, to facilitate measurements shall be recorded in the test report.

### 4.2.3.2 Equipment with a temporary antenna connector

The provider may submit one set of equipment with the normal antenna connected, to enable radiated measurements to be made. The provider shall attend the test laboratory at the conclusion of the radiated measurements, to disconnect the antenna and fit the temporary connector. The testing laboratory staff shall not connect or disconnect any temporary antenna connector.

Alternatively, the provider may submit two sets of equipment to the test laboratory, one fitted with a temporary antenna connector with the antenna disconnected and another equipment with the antenna connected. Each equipment shall be used for the appropriate tests. The provider shall declare that the two sets of equipment are identical in all aspects except for the antenna connector.

### 4.2.3.3 Wireless Power Transfer systems

The manufacturer has to submit the necessary parts (as charger and battery) for the test. The test shall be done in the worse case setup/mechanical arrangement.

## 4.2.4 On-site testing

In certain cases it may not be possible to provide representative samples of antennas and/or equipment due to physical constraints. In these cases equivalent measurements to the present document shall be made at a representative installation of the equipment (on-site).

## 4.3 Mechanical and electrical design

### 4.3.1 General

Transmitters and receivers may be individual or combination units.

#### 4.3.1.1 WPT

Transmitter (charger) and receiver (battery or battery emulator) shall be tested in combination and in the worse case charging setup with regard to radiated emissions.

### 4.3.2 Controls

Those controls which, if maladjusted, might increase the interfering potentialities of the equipment shall not be easily accessible to the user.

### 4.3.3 Transmitter shut-off facility

If the transmitter is equipped with an automatic transmitter shut-off facility, it should be made inoperative for the duration of the test.

### 4.3.4 Receiver mute or squelch

If the receiver is equipped with a mute, squelch or battery-saving circuit, this circuit shall be made inoperative for the duration of the tests.

### 4.3.5 Marking (equipment identification)

The equipment shall be marked in a visible place. This marking shall be legible and durable. Where this is not possible due to physical constraints, the marking shall be included in the users' manual.

#### 4.3.5.1 Equipment identification

The marking shall include as a minimum:

- the name of the manufacturer or his trade mark;
- the type designation; and
- receiver category, see clause 4.1.1.

#### 4.3.5.2 Equipment marking

The equipment shall be marked, where applicable, in accordance with the Directive 1999/5/EC [i.4]. Where this is not applicable the equipment shall be marked in accordance with the National Regulatory requirements.

## 4.4 Declarations by the provider

When submitting equipment for testing, the provider shall supply the necessary information required by the laboratory.

## 4.5 Auxiliary test equipment

All necessary test signal sources and set-up information shall accompany the equipment when it is submitted for testing.

## 4.6 Interpretation of the measurement results

The interpretation of the results recorded on the appropriate test report for the measurements described in the present document shall be as follows:

- the measured value relating to the corresponding limit shall be used to decide whether an equipment meets the requirements of the present document;
- the measurement uncertainty value for the measurement of each parameter shall be included in the test report;
- the recorded value of the measurement uncertainty shall, for each measurement, be equal to, or lower than, the figures in the table of measurement uncertainty (clause 9);
- for WPT systems, the measurement results relating to the corresponding limit and working mode of the system shall be recorded.

---

## 5 Test conditions, power sources and ambient temperatures

### 5.1 Normal and extreme test conditions

Testing shall be made under normal test conditions, and also, where stated, under extreme test conditions.

The test conditions and procedures shall be as specified in clauses 5.2 to 5.4.

### 5.2 Test power source

The equipment shall be tested using the appropriate test power source as specified in clauses 5.2.1 or 5.2.2. Where equipment can be powered using either external or internal power sources, then the equipment shall be tested using the external power source as specified in clause 5.2.1 then repeated using the internal power source as specified in clause 5.2.2.

The test power source used shall be stated in the test report.

#### 5.2.1 External test power source

During tests, the power source of the equipment shall be replaced by an external test power source capable of producing normal and extreme test voltages as specified in clauses 5.3.2 and 5.4.2. The internal impedance of the external test power source shall be low enough for its effect on the test results to be negligible. For the purpose of the tests, the voltage of the external test power source shall be measured at the input terminals of the equipment. The external test power source shall be suitably de-coupled as close to the equipment battery terminals as practicable. For radiated measurements any external power leads should be so arranged so as not to affect the measurements.

During tests the test power source voltages shall be within a tolerance of  $< \pm 1$  % relative to the voltage at the beginning of each test. The value of this tolerance can be critical for certain measurements. Using a smaller tolerance will provide a better uncertainty value for these measurements.

#### 5.2.2 Internal test power source

For radiated measurements on portable equipment with integral antenna, fully charged internal batteries should be used. The batteries used should be as supplied or recommended by the provider. If internal batteries are used, at the end of each test the voltage shall be within a tolerance of within 5 % relative to the voltage at the beginning of each test.

If appropriate, for conducted measurements or where a test fixture is used, an external power supply at the required voltage may replace the supplied or recommended internal batteries. This shall be stated on the test report.

### 5.3 Normal test conditions

#### 5.3.1 Normal temperature and humidity

The normal temperature and humidity conditions for tests shall be any convenient combination of temperature and humidity within the following ranges:

- temperature +15 °C to +35 °C;
- relative humidity 20 % to 75 %.

When it is impracticable to carry out tests under these conditions, a note to this effect, stating the ambient temperature and relative humidity during the tests, shall be added to the test report.

## 5.3.2 Normal test power source

### 5.3.2.1 Mains voltage

The normal test voltage for equipment to be connected to the mains shall be the nominal mains voltage. For the purpose of the present document, the nominal voltage shall be the declared voltage, or any of the declared voltages, for which the equipment was designed.

The frequency of the test power source corresponding to the ac mains shall be between 49 Hz and 51 Hz.

### 5.3.2.2 Regulated lead-acid battery power sources

When the radio equipment is intended for operation with the usual types of regulated lead-acid battery power source, the normal test voltage shall be 1,1 multiplied by the nominal voltage of the battery (e.g. 6 V, 12 V, etc.).

### 5.3.2.3 Other power sources

For operation from other power sources or types of battery (primary or secondary), the normal test voltage shall be that declared by the equipment provider and agreed by the test laboratory. Such values shall be stated in the test report.

## 5.4 Extreme test conditions

### 5.4.1 Extreme temperatures

#### 5.4.1.1 Procedure for tests at extreme temperatures

Before measurements are made the equipment shall have reached thermal balance in the test chamber. The equipment shall be switched off during the temperature stabilizing period.

In the case of equipment containing temperature stabilization circuits designed to operate continuously, the temperature stabilization circuits shall be switched on for 15 minutes after thermal balance has been obtained, and the equipment shall then meet the specified requirements.

If the thermal balance is not checked by measurements, a temperature stabilizing period of at least one hour, or such period as may be decided by the test laboratory, shall be allowed. The sequence of measurements shall be chosen, and the humidity content in the test chamber shall be controlled so that excessive condensation does not occur.

##### 5.4.1.1.1 Procedure for equipment designed for continuous operation

If the provider states that the equipment is designed for continuous operation, the test procedure shall be as follows:

- before tests at the upper extreme temperature the equipment shall be placed in the test chamber and left until thermal balance is attained. The equipment shall then be switched on in the transmit condition for a period of a half hour after which the equipment shall meet the specified requirements;
- for tests at the lower extreme temperature, the equipment shall be left in the test chamber until thermal balance is attained, then switched on for a period of one minute after which the equipment shall meet the specified requirements.

##### 5.4.1.1.2 Procedure for equipment designed for intermittent operation

If the provider states that the equipment is designed for intermittent operation, the test procedure shall be as follows:

- Before tests at the upper extreme temperature the equipment shall be placed in the test chamber and left until thermal balance is attained in the oven. The equipment shall then either:
  - transmit on and off according to the providers declared duty cycle for a period of five minutes; or

- if the provider's declared on period exceeds one minute, then transmit in the on condition for a period not exceeding one minute, followed by a period in the off or standby mode for four minutes; after which the equipment shall meet the specified requirements.
- For tests at the lower extreme temperature, the equipment shall be left in the test chamber until thermal balance is attained, then switched to the standby or receive condition for one minute after which the equipment shall meet the specified requirements.

#### 5.4.1.2 Extreme temperature ranges

For tests at extreme temperatures, measurements shall be made in accordance with the procedures specified in clause 5.4.1.1, at the upper and lower temperatures of one of the following ranges:

- Category I (General): -20 °C to +55 °C.
- Category II (Portable): -10 °C to +55 °C.
- Category III (Equipment for normal indoor use): 0 °C to +35 °C.

NOTE: The term "Equipment for normal indoor use" is taken to mean the minimum indoor temperature  $\geq 5$  °C.

For special applications, the manufacturer can specify wider temperature ranges than given as a minimum above. This shall be reflected in manufacturer's product literature.

The test report shall state which range is used.

### 5.4.2 Extreme test source voltages

#### 5.4.2.1 Mains voltage

The extreme test voltages for equipment to be connected to an ac mains source shall be the nominal mains voltage  $\pm 10$  %. For equipment operating over a range of mains voltages clause 5.4.2.4 applies.

#### 5.4.2.2 Regulated lead-acid battery power sources

When the radio equipment is intended for operation from the usual type of regulated lead-acid battery power sources the extreme test voltages shall be 1,3 and 0,9 multiplied by the nominal voltage of the battery (6 V, 12 V, etc.).

For float charge applications using "gel-cell" type batteries the extreme voltage shall be 1,15 and 0,85 multiplied by the nominal voltage of the declared battery voltage.

#### 5.4.2.3 Power sources using other types of batteries

The lower extreme test voltages for equipment with power sources using batteries other than lead-acid shall be as follows:

- For equipment with a battery indicator, the end point voltage as indicated.
- For equipment without a battery indicator the following end point voltages shall be used:
  - a) For the Leclanché or the lithium type of battery:
    - 0,85 multiplied by the nominal voltage of the battery.
  - b) For the nickel-cadmium type of battery:
    - 0,9 multiplied by the nominal voltage of the battery.
- For other types of battery or equipment, the lower extreme test voltage for the discharged condition shall be declared by the equipment provider.

The nominal voltage is considered to be the upper extreme test voltage in this case.

#### 5.4.2.4 Other power sources

For equipment using other power sources, or capable of being operated from a variety of power sources, the extreme test voltages shall be those agreed between the equipment provider and the test laboratory. This shall be recorded in the test report.

---

## 6 General conditions

### 6.1 Normal test signals and test modulation

The test modulating signal is a signal which modulates a carrier, is dependent upon the type of equipment under test and also the measurement to be performed. Modulation test signals only apply to products with an external modulation connector. For equipment without an external modulation connector, normal operating modulation shall be used.

#### 6.1.1 Normal test signals for analogue speech

Normal test signals for analogue speech are specified as follows:

- A-M1: a 1 000 Hz tone;
- A-M2: a 1 250 Hz tone.

For angle modulation, the normal level of the test signals A-M1 and A-M2 shall be adjusted to produce a deviation of 12 % of the channel separation or any lower value as declared by the provider as the normal operating level.

In the case of amplitude modulation, the normal modulation depth shall be 60 % or any lower value as declared by the provider. This shall be used as the normal level of operation and shall be stated in the test report.

#### 6.1.2 Normal test signals for data

Normal test signals for data are specified as follows:

- D-M2: A test signal representing a pseudo-random bit sequence of at least 511 bits in accordance with Recommendation ITU-T O.153 [i.2]. This sequence shall be continuously repeated. If the sequence cannot be continuously repeated, the actual method used shall be stated in the test report.
- D-M3: A test signal shall be agreed between the test laboratory and the provider in case selective messages are used and are generated or decoded within the equipment.  
The agreed test signal may be formatted and may contain error detection and correction.

For angle modulation, the normal level of the test signal D-M3 shall produce a deviation of 20 % of the channel separation or any other value as declared by the provider as the normal operating level.

In case of amplitude modulation, the modulation ratio shall be 60 %, or any value, as declared by the provider, as the normal operating level.

## 6.2 Artificial antenna

Where applicable, tests shall be carried out using an artificial antenna which shall simulate the actual antenna configuration specified by the provider.

### 6.2.1 Artificial antenna for inductive transmitters (non 50 $\Omega$ )

For measurements of inductive transmitters without a 50  $\Omega$  antenna impedance, a tuned reduced radiating load connected to the antenna connector shall be used as agreed with the test laboratory.

The impedance shall be equal to the nominal load of the equipment specified by the provider.

This method facilitates conducted measurements to be made of the following:

- transmitter carrier loop currents up to 30 MHz;
- transmitter spurious loop currents up to 30 MHz; and
- conducted spurious measurements in the range 30 MHz to 1 GHz.

The use of this non-50  $\Omega$  load during test shall be stated in the test report form.

## 6.2.2 Artificial antenna for transmitters with 50 $\Omega$ impedance connector

For measurements on transmitters with a normal 50  $\Omega$  antenna impedance, tests shall be carried out using an artificial antenna which shall be a substantially non-reactive non-radiating 50  $\Omega$  load connected to the antenna connector. The Voltage Standing Wave Ratio (VSWR) at the 50  $\Omega$  connector shall not be greater than 1,2 to 1 over the frequency range of the measurement.

This method may also facilitate conducted measurements to be made of the following:

- transmitter carrier loop currents up to 30 MHz;
- transmitter spurious loop currents up to 30 MHz; and
- conducted spurious measurements in the range 30 MHz to 1 GHz.

The use of 50  $\Omega$  load during test shall be stated in the test report form.

## 6.3 Test fixture

With equipment intended for use with an integral antenna, and not equipped with a 50  $\Omega$  RF output connector, a suitable test fixture shall be used as agreed with the test laboratory, where applicable.

This fixture is a RF coupling device for coupling the integral antenna to a 50  $\Omega$  RF terminal at the working frequencies of the equipment under test. This allows certain measurements to be performed using conducted measuring methods. The test fixture shall be calibrated with the equipment under test. The test fixture is normally only required for extreme temperature measurements. The test fixture shall be fully described by the provider. The test laboratory, where applicable shall calibrate the test fixture by carrying out the required field measurements at normal temperatures at the prescribed test site. Then the same measurements shall be repeated on the equipment under test using the test fixture for all identified frequency components.

In addition, the test fixture may provide:

- a connection to an external power supply;
- an audio interface either by direct connection or by an acoustic coupler;
- a connection to a data interface.

The performance characteristics of the test fixture shall be agreed upon with the test laboratory, where applicable and shall conform to the following basic parameters:

- the circuit associated with the RF coupling shall contain no active or non linear devices;
- the coupling loss shall not influence the measuring results;
- the coupling loss shall be independent of the position of the test fixture and be unaffected by the proximity of the surrounding objects or people;
- the coupling loss shall be reproducible when the equipment under test is removed and replaced;
- the coupling loss shall remain substantially constant when the environmental conditions are varied.



## 6.4 Test sites and general arrangements for radiated measurements

For guidance on radiation test sites, see annex A. Detailed descriptions of radiated measurement arrangements are included in annex A.

## 6.5 Modes of operation of the transmitter

For the purpose of the measurements according to the present document, there should preferably be a facility to operate the transmitter in an unmodulated state. The method of achieving an unmodulated carrier frequency or special types of modulation patterns may also be decided by agreement between the provider and the test laboratory. It shall be described in the test report. It may involve suitable temporary internal modifications of the equipment under test. If it is not possible to provide an unmodulated carrier then this shall be stated in the test report.

For transmitters using a continuous wideband swept carrier the measurement shall be made with the sweep on.

For the purpose of testing, the normal test signal, see clauses 6.1.1 and 6.1.2, shall be applied to the input of the transmitter under test with the normal input device disconnected (e.g. microphone).

## 6.6 Measuring receiver

The term "measuring receiver" refers to a selective voltmeter or a spectrum analyser. The bandwidth and detector type of the measuring receiver are given in table 4.

**Table 4**

Frequency: (f)	Detector type	Measurement receiver bandwidth	Spectrum analyser bandwidth
$9 \text{ kHz} \leq f < 150 \text{ kHz}$	Quasi Peak	200 Hz	300 Hz
$150 \text{ kHz} \leq f < 30 \text{ MHz}$	Quasi Peak	9 kHz	10 KHz
$30 \text{ MHz} \leq f \leq 1\,000 \text{ MHz}$	Quasi Peak	120 kHz	100 kHz
NOTE: For the measurement of the ranges $6,765 \text{ MHz} \leq f \leq 6,795 \text{ MHz}$ and $11,810 \text{ MHz} \leq f \leq 15,310 \text{ MHz}$ , the measurement bandwidth has to be 200 Hz respectively 300 Hz.			

Different bandwidth may be used if agreed with the test laboratory, for further guidance see annex I. The measurement bandwidth and any related calculations shall be stated in the test report.

---

# 7 Transmitter requirements

To meet the requirements of the present document, the transmitter shall be measured at the radiated H-field, conducted current or power level as declared by the provider.

Where the transmitter is designed with an adjustable carrier H-field or RF current, all parameters shall be measured using the highest output level as declared by the provider. The equipment shall then be adjusted to the lowest setting, as declared by the provider, and the spurious emissions measurement shall be repeated (see clause 7.4).

When making transmitter tests on equipment designed for intermittent operation, the duty cycle of the transmitter, as declared by the provider on the application form, shall not be exceeded. The actual duty cycle used shall be stated on the test report.

If the equipment is supplied with both a permanent 50  $\Omega$  antenna connector and a dedicated antenna, the full tests shall be carried out using the external connector and in addition:

- radiated H-field (see clause 7.2.1);
- spurious emissions (see clause 7.4 and annex A);

Tests shall be carried out with the dedicated antenna.

## 7.1 Transmitter definitions

Transmitters are divided into Product Classes (see clause 7.1.4) depending on the antenna type to be used. Product Class 2 and Product Class 3 transmitters may allow the customer to use his own loop antenna design based on the manufacturers design guidelines. The user's manual shall include the guidelines for the design of the antennas. These guidelines may be evaluated by the test laboratory as part of the test of the equipment and compared to actual radiated measurements.

### 7.1.1 The inductive loop coil transmitters

These transmitters are characterized by:

- a) the loop coil antenna area  $A$  shall be  $< 30 \text{ m}^2$ ;
- b) the length of any antenna loop element shall be  $< \frac{\lambda}{4} \text{ m}$  ( $< \frac{75}{f} \text{ m}$ , where  $f$  is in MHz) or  $< 30 \text{ m}$  whichever is shorter; (the loop element can be e.g. one side of a rectangular loop or a diameter of a circular antenna);
- c) antenna coil may have one or multiple turns.

### 7.1.2 The large size loop transmitters

These transmitters are characterized by:

- large loop antenna area  $A > 30 \text{ m}^2$ ;
- large loop antenna with one turn only;
- frequency range limited from 9 kHz to 135 kHz only.

### 7.1.3 Other transmitters

These transmitters are characterized as either:

- E-field transmitters; or
- loop antenna transmitters which do not meet the criteria in clauses 7.1.1 and 7.1.2.

### 7.1.4 Product Classes

The equipment is divided into Product Classes depending of the antenna type used. The Product Classes shall not be confused with Receiver Categories, see clause 4.1.1. The different antenna types are referencing CEPT/ERC/REC 70-03 [i.1], as implemented through National Radio Interfaces (NRI) and additional NRI as relevant.

The Product Classes according to table 5 are:

#### **Product Class 1:**

Inductive loop coil transmitter, tested with an antenna as either:

- an integral antenna (antenna type 1); or
- a dedicated antenna supplied with the equipment (antenna type 2).

The following restrictions apply to this product class:

- 9 kHz to 30 MHz frequency range;
- no customization of the antenna(s) in the field is allowed;
- loop antenna area  $< 30 \text{ m}^2$ ; and

- the length of any antenna loop element shall be  $< \frac{\lambda}{4}$  m, ( $< \frac{75}{f}$  m, where f is in MHz) or  $< 30$  m whichever is shorter.

The transmitter carrier output and spurious limits are given in clauses 7.2.1.3, 7.5.3.2 and 7.5.4.2 respectively.

Where a manufacturer provides a range of standard antennas, the equipment will be tested as Product Class 1 equipment, with the antenna(s) attached. The transmitter measurements shall be repeated for each such antenna.

### Product Class 2:

Inductive loop coil transmitter, allowing customization of the loop antenna in the field, see annex C.

Customization is only allowed according to the manufacturer's antenna design rules published in the equipment manual.

Product Class 2 equipment is tested as Product Class 1 with two representative antennas supplied with the equipment. The two antennas shall meet the manufacturer's design rules published in the equipment manual and shall have maximum and minimum loop area respectively. Both antennas shall have the maximum magnetic dipole moment as declared by the manufacturer. The following additional restrictions apply to this Product Class:

- 9 kHz to 30 MHz frequency range;
- loop antenna area  $< 30$  m<sup>2</sup>; and
- the length of any antenna loop element shall be  $< \frac{\lambda}{4}$  m, ( $< \frac{75}{f}$  m, where f is in MHz) or  $< 30$  m whichever is shorter.

The transmitter carrier output and spurious limits are given in clauses 7.2.1.3, 7.5.3.2 and 7.5.4.2 respectively.

In cases where it, due to size constraints, is not practical to ship and test a large antenna together with the equipment, the equipment is tested either:

- at an open test site together with a maximum and minimum size custom made antenna build by the manufacturer; or
- at a representative installation (on-site) according to clause 4.2.4.

### Product Class 3:

This Product Class is intended for use with customized large size loop antennas only. The loop coil transmitter is tested without an antenna by using an artificial antenna.

The following additional restrictions apply to this Product Class:

- 9 kHz to 135 kHz frequency range;
- loop antenna area  $> 30$  m<sup>2</sup>;
- single turn loop only.

The transmitter carrier output and spurious are limited by the maximum output loop current multiplied by the loop antenna area and shall comply with the radiated H-field limit given in clauses 7.2.1.3, 7.2.2.3, 7.5.2.2, 7.5.2.4 and 7.5.4.2. The manufacturer shall declare the maximum size of the loop in the users' manual.

### Product Class 4:

E-field transmitter, tested with each type of antenna to be used.

The transmitter carrier output and spurious limits are limited by the maximum generated E-field, measured as the equivalent H-field given in clauses 7.2.3.3 and 7.5.3.2 respectively.

An overview of the four Product Classes above is given in table 4.

**Product Class 5:**

This Product Class is intended for use with customized WPT systems. The charger or loop coil transmitter is tested in combination with the necessary counter part (battery/battery emulator).

Scenario 1: power transfer and data from the charger to the battery, in this case the charger shall be seen as a transmitter

Scenario 2: data transfer from the battery to the charger, in this case the power receiving coil of the battery shall be seen as transmitter.

The following additional restrictions apply to this Product Class:

- 9 kHz to 30 MHz frequency range;
- loop antenna area  $< 2 \text{ m}^2$ ;
- only to be tested and usable as a system in combination with charger and battery/Battery emulator.

The transmitter carrier output and spurious are limited in clauses 7.2.1.3, 7.5.3.2 and 7.5.4.2. The manufacturer shall declare the maximum size of the loop in the users' manual.

Table 5: Description of product classes

Product Class	Description of transmitter	Antenna to be tested	Frequency range	Loop antenna area	Length of antenna (= maximum dimension of the antenna)	Customization of antenna design allowed	Transmitter carrier output limits	Spurious emissions limits
1	Inductive loop coil transmitter	Integral antenna (antenna type 1) or dedicated antenna supplied with the equipment (antenna type 2); (see note 1)	9 kHz to 30 MHz	< 30 m <sup>2</sup>	< $\lambda/4$ (75 metres/f where f is in MHz) or < 30 m, whichever is shorter	No	H-field at 10 m (see clause 7.2.1.3)	H-field at 10 m (see clauses 7.5.3.2 and 7.5.4.2)
2	Inductive loop coil transmitter	Two representative antennas supplied with the equipment (see note 2)	9 kHz to 30 MHz	< 30 m <sup>2</sup> (see note 3)	< $\lambda/4$ (75 metres/f where f is in MHz) or < 30 m, whichever is shorter	Yes (see note 3)	H-field at 10 m (see clause 7.2.1.3)	H-field at 10 m (see clauses 7.5.3.2 and 7.5.4.2)
3	Customized, large size loop antennas only	Test without an antenna by using an artificial antenna	9 kHz to 135 kHz	> 30 m <sup>2</sup>	n.a.	Yes	Current in artificial antenna (see note 4 and clauses 7.2.1.3 and 7.2.2.3)	Current in artificial antenna (see note 4 and clauses 7.5.2.2 and 7.5.2.4)
4	E-field transmitter	Each type of antenna to be used	9 kHz to 30 MHz	n.a.	n.a.	n.a.	H-field at 10 m (see clause 7.2.3.3)	H-field at 10 m (see clauses 7.5.3.2 and 7.5.4.2)
5	WPT system	Test shall be performed with the WPT system, this includes the antenna of the charger and on the battery	9 kHz to 30 MHz	< 2 m <sup>2</sup>	n.a.	n.a.	H-field at 10 m (see clause 7.2.1.3)	H-field at 10 m (see clauses 7.5.3.2 and 7.5.4.2)

NOTE 1: Where a manufacturer provides a range of standard antennas, the equipment will be tested as Product Class 1 equipment, with the antenna(s) attached. The measurements shall be repeated for each antenna.

NOTE 2: The two antennas shall meet the manufacturer's design rules published in the equipment manual and shall have maximum and minimum loop areas respectively. Both antennas shall have the maximum magnetic dipole moment as declared by the manufacturer.

NOTE 3: Customization is only allowed according to the manufacturer's antenna design rules published in the equipment manual.

NOTE 4: ON-site measurements may be required.

NOTE 5: Wireless Power Transfer (WPT) Systems shall be tested in declared combination and all modes of operations (see clause 4.1.3).

NOTE 6: Only the frequency segments as described in table 6 are available - for SRDs including WPTs.

NOTE 7: In case of a device combining a WPT and communication function using the same antenna, the antenna provisions of Case 5 apply.

## 7.2 Transmitter carrier output levels

### 7.2.1 H-field (radiated)

#### 7.2.1.1 Definition

In the case of a transmitter with an integral or dedicated antenna, the radiated H-field is defined in the direction of maximum field strength under specified conditions of measurement.

#### 7.2.1.2 Methods of measurement

The measurements of the transmitter radiated H-field shall be made on an open field test site as specified in clause A.1.3. Any measured values shall be at least 6 dB above the ambient noise level.

The H-field produced by the equipment shall be measured at standard distance of 10 m. Where this is not practical, e.g. due to physical size of the equipment including the antenna or with use of special field cancelling antenna, then other distances may be used. When another distance is used, the distance used and the field strength value measured shall be stated in the test report. In this case, the measured value at actual test distance shall be extrapolated to 10 m according to annex F and these calculations shall be stated in the test report.

The H-field is measured with a shielded loop antenna connected to a measurement receiver. The measuring bandwidth and detector type of the measurement receiver shall be in accordance with clause 6.6.

The equipment under test shall operate where possible, with modulation. Where this is not possible, it shall be stated in the test report.

For transmitters using a continuous wideband swept carrier, the measurement shall be made with the sweep off. When it is not possible to turn the sweep off the measurements shall be made with the sweep on and this shall be stated in the test report.

The measurements are made under normal and extreme conditions. However, measurements at extreme temperatures are not required when tests can only be made at an open test site due to size constraints of the loop antenna, see clause A.1.3.

For measuring equipment calibrated in dB $\mu$ V/m, the reading should be reduced by 51,5 dB to be converted to dB $\mu$ A/m.

#### 7.2.1.3 Limits

The limits presented in the present document are the required field strengths to allow satisfactory operation of inductive systems.

The limit for a low level generic H-field strength is given in annex H.

The maximum H-field strengths for certain frequency bands are given in table 6. Field-strength limits of National Radio Interfaces (NRI) apply.

Regulatory information is available in CEPT/ERC/REC 70-03 [i.1], ECC report 208 [i.8] and where applicable ERC or ECC Decisions as implemented through National Radio Interfaces (NRI) and additional NRI as relevant.

Table 6: H-field limits at 10 m

Frequency range (MHz)	H-field strength limit ( $H_f$ ) dB $\mu$ A/m at 10 m (note 8)
$0,009 \leq f < 0,090$	72 descending 3 dB/oct above 0,03 MHz or according to note 1 (see note 5)
$0,09 \leq f < 0,119$	42
$0,119 \leq f < 0,135$	66 descending 3 dB/oct above 0,119 MHz or according to note 1 (see notes 3 and 5)
$0,135 \leq f < 0,140$	42
$0,140 \leq f < 0,1485$	37,7
$0,1485 \leq f < 30$	-5 (see note 4)
$0,315 \leq f < 0,600$	-5
$3,155 \leq f < 3,400$	13,5
4,234	9
4,516	7
$7,400 \leq f < 8,800$	9
$10,2 \leq f < 11,00$	9
$12,5 \leq f \leq 20$	-7
$6,765 \leq f \leq 6,795$ $13,553 \leq f \leq 13,567$ $26,957 \leq f \leq 27,283$	42 (see notes 3 and 9)
$13,410 \leq f \leq 13,553$ , $13,567 \leq f \leq 13,710$	9 (see note 6)
$13,110 \leq f \leq 13,410$ , $13,710 \leq f \leq 14,010$	-3,5 (see note 6)
$12,660 \leq f \leq 13,110$ , $14,010 \leq f \leq 14,460$	-10 (see note 6)
$11,810 \leq f \leq 12,660$ , $14,460 \leq f \leq 15,310$	-16 (see note 6)
$13,460 \leq f \leq 13,553$ , $13,567 \leq f \leq 13,660$	27 (see note 7)
$13,360 \leq f \leq 13,460$ , $13,660 \leq f \leq 13,760$	Linear transition from 27 to -3,5 (see note 7)
$13,110 \leq f \leq 13,360$ , $13,760 \leq f \leq 14,010$	-3,5 (see note 7)
$12,660 \leq f \leq 13,110$ , $14,010 \leq f \leq 14,460$	-5 (see note 7)
$13,553 \leq f \leq 13,567$	60 (see notes 2 and 3)
27,095	42
NOTE 1: For the frequency ranges 9 kHz to 135 kHz, the following additional restrictions apply to limits above 42 dB $\mu$ A/m: <ul style="list-style-type: none"> <li>- for loop coil antennas with an area <math>\geq 0,16</math> m<sup>2</sup> this table and table 5 with the antenna limitations apply;</li> <li>- for loop coil antennas with an area between 0,05 m<sup>2</sup> and 0,16 m<sup>2</sup> table 5 applies with a correction factor. The limit is: table value + <math>10 \times \log(\text{area}/0,16 \text{ m}^2)</math>;</li> <li>- for loop coil antennas with an area <math>&lt; 0,05</math> m<sup>2</sup> the limit is 10 dB below table 5.</li> </ul>	
NOTE 2: For RFID and EAS applications only.	
NOTE 3: Spectrum mask limit, see annex G.	
NOTE 4: For further information see annex H.	
NOTE 5: Limit is 42 dB $\mu$ A/m for the following spot frequencies: 60 kHz $\pm$ 250 Hz, 66,6 kHz $\pm$ 750 Hz, 75 kHz $\pm$ 250 Hz, 77,5 kHz $\pm$ 250 Hz, and 129,1 kHz $\pm$ 500 Hz.	
NOTE 6: Only in conjunction with spectrum mask, see clause G.3.	
NOTE 7: Only in conjunction with spectrum mask, see clause G.4.	
NOTE 8: The H-field strength limits ( $H_f$ ) in dB $\mu$ A/m at 10 m distance of a Wireless Power Transfer System in the declared working situations.	
NOTE 9: The frequency range 6,765 MHz - 6,795 MHz is not a harmonized ISM frequency band according article 5.138 of the ITU Radio Regulations [i.26]. For the decision scheme in table 3 only Case 2 may therefore be applicable in some countries.	

For calculation rules for limits at other measurement distances, see annex F.

## 7.2.2 RF carrier current (Product Class 3 only)

### 7.2.2.1 Definition

This applies to Product Class 3 only.

RF carrier current is defined as the current delivered to an artificial load under specified conditions of measurement. The manufacturer shall declare the maximum antenna loop size.

### 7.2.2.2 Methods of measurement

The transmitter shall be connected to an artificial antenna, see clause 6.2.1 and annex D. The RF current delivered to this artificial antenna during a transmission duty cycle shall be measured up to 30 MHz. The current shall be measured either by using:

- a calibrated current probe connected to a measuring receiver; or
- a derived output from a calibrated artificial antenna connected to a measuring receiver, see annex D.

The measuring bandwidth and detector type shall be in accordance with clause 6.6.

For transmitters using a continuous wideband swept carrier the measurement shall be made with the sweep off. Where this is not possible the measurements may be made with the sweep on. This shall be stated in the test report.

This method of measurement for the transmitter carrier current is used for Product Class 3 equipment operating at a frequency up to 135 kHz.

The measurements shall be made under normal and extreme test conditions, see clauses 5.3 and 5.4.

A detailed explanation of the relationship between the RF carrier current, antenna factor ( $N \times A$ ) and the equivalent generated H-field is given in annex C.

### 7.2.2.3 Limits

The limit for the RF carrier current multiplied with the antenna area for Product Class 3 Large size loop transmitters is given in table 7.

**Table 7: Limit for RF carrier current  $\times$  antenna area (for Product Class 3 only)**

Frequency range (MHz)	RF carrier current $\times$ antenna area, dBAm <sup>2</sup>
$0,009 \leq f < 0,135$	40 descending 3 dB/oct above 30 kHz (see note)
NOTE: Limit is 10 dBAm <sup>2</sup> for the following spot frequencies: 60 kHz $\pm$ 250 Hz, 75 kHz $\pm$ 250 Hz, 77,5 kHz $\pm$ 250 Hz and 129,1 kHz $\pm$ 500 Hz.	

## 7.2.3 Radiated E-field (Product Class 4 only)

### 7.2.3.1 Definition

The radiated E-field is defined as the E-field in the direction of maximum field strength under the specified conditions of measurement. This is defined for a transmitter with an integral antenna.

### 7.2.3.2 Methods of measurement

The transmitter radiated E-field is based on the equivalent H-field, measured at 10 m.

The H-field is measured with a shielded loop antenna connected to a measurement receiver. The measuring bandwidth and detector type of the measurement receiver shall be in accordance with clause 6.6.

For a detailed explanation of the relationship between E-field and H-field, see annex E.



### 7.2.3.3 Limits

In the frequency range 9 kHz to 4,78 MHz, the limits of  $H_{ef}$  follow the H-fields limits,  $H_f$ , as given in clause 7.2.1.3, table 4 with an additional correction factor C. The factor given below is specific for a 10 m measuring distance.

The limit  $H_{ef} = H_f + C$

where:

$$C = 20 \times \log (f_c / 4,78 \times 10^6) \text{ dB};$$

and where:

$f_c$  is the carrier frequency in Hz.

For a graphical representation of the correction factor C see annex B.

In the frequency range 4,78 MHz to 25 MHz limits are identical to the limits in clause 7.2.1.3, table 4, without any correction factor.

## 7.3 Permitted range of operating frequencies

### 7.3.1 Definition

The permitted range of operating frequencies is the frequency range over which the equipment is authorized to operate.

### 7.3.2 Method of measurement

The permitted range of operating frequencies, e.g. the distance (in kHz) between the minimum and maximum output frequencies at which the permitted spurious and out-of-band emission levels as specified in clause 7.5 are exceeded due to intentional emission from the radio transmitter shall be measured using the method shown in figure 1.

The measuring receiver may be a spectrum analyser, oscilloscope, selective power meter or any measuring receiver which is appropriate to perform the intended measurement of the EUT.

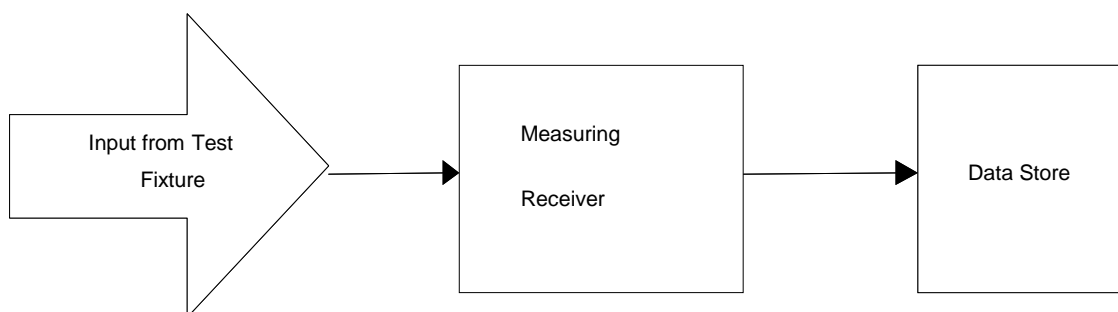

**Figure 1: Test set-up for measurement of the permitted range of operating frequencies**

### 7.3.3 Limits

The permitted range of operating frequency for intentional emissions shall be from 9 kHz to 30 MHz. Outside the permitted range of operating frequencies the unintentional emissions shall be reduced to the limits given in clause 7.5.

## 7.4 Permitted frequency range of the modulation bandwidth

The permitted frequency range of the modulation bandwidth shall be stated by the provider.

### 7.4.1 Definition

The frequency range of the modulation bandwidth contains all associated side bands above the following level:

- a) For carrier frequencies below 135 kHz:
  - 23 dB below the carrier, for RFID within the transmitter emission boundary of figure G.1, and for RFID and EAS systems within the transmitter mask of figures G.2, G.3 and G.4, see [i.12] or the appropriate spurious limit as defined in clause 7.5.
- b) For carrier frequencies in the range 135 kHz to 30 MHz:
  - 15 dB below the carrier or the appropriate spurious limit as defined in clause 7.5.

Where the assigned frequency band has been divided into sub-bands by the regulatory body, the above measuring levels and bandwidths apply inside these sub-bands.

For the modulation products of RFID and EAS systems, see annex G.

### 7.4.2 Method of measurement

The transmitter shall be connected to an artificial antenna or if the transmitter has an integral antenna a test fixture shall be used (see clause 6.3). The RF output of the equipment shall be connected to a spectrum analyser via a 50  $\Omega$  variable attenuator.

The transmitter shall be operated at the nominal carrier power or field strength measured under normal test conditions in clause 7.2. The attenuator shall be adjusted to an appropriate level displayed at the spectrum analyser screen.

The transmitter shall be modulated with standard test modulation (see clauses 6.1.1 and 6.1.2). If the equipment cannot be modulated externally, the internal modulation shall be used.

For transmitters using a continuous wideband swept carrier the measurement shall be made with the sweep on.

The output of the transmitter, with or without test fixture, shall be measured by using a spectrum analyser with a resolution bandwidth appropriate to accept all major side bands. The power level calibration of the spectrum analyser shall then be related to the power level or field strength measured in clause 7.2. The calculation will be used to calculate the absolute level of the sideband power.

The test laboratory shall ensure that the spectrum analyser's span is sufficiently wide enough to ensure that the carrier and all its major side bands are captured.

The frequency of the upper and lower points, where the displayed power envelope of the modulation including frequency drift is equal to the appropriate level defined in clause 7.3.1 is recorded as the modulation bandwidth.

The measurements shall be made during normal and extreme test conditions. During extreme test conditions, both extreme temperature and voltage apply simultaneously, (clauses 5.4.1 and 5.4.2 applied simultaneously).

### 7.4.3 Limits

The permitted range of the modulation bandwidth shall be within the assigned frequency band see table 1 or  $\pm 7,5$  % of the carrier frequency whichever is the smallest. For RFID and EAS Systems, the permitted modulation bandwidth shall be within the transmitter emission boundary of figures G.1, G.2, G.3 and G.4.

For further information, see CEPT/ERC/REC 70-03 [i.1] or ERC/ECC/CEPT Decisions as implemented through National Radio Interfaces (NRI) and additional NRI as relevant.

## 7.5 Spurious domain emission limits

### 7.5.1 Definition

Spurious domain emission limits are limits on emissions at frequencies other than those of the carrier and sidebands associated with normal test modulation (clause 6.1). The level of spurious emissions shall be measured at normal conditions (clause 5.3) as either:

- 1) a) their power or current level in an artificial antenna (conducted spurious emission); and
  - b) their effective radiated power or field strength when radiated by the cabinet and structure of the equipment (cabinet radiation); or
- 2) their effective radiated power or field strength when radiated by the cabinet and the integral antenna.

### 7.5.2 Conducted spurious emissions (Product class 3 only)

This clause refers to the requirements in clause 7.4.1; indent 1 a) and applies to Product Class 3 only.

#### 7.5.2.1 Methods of measurement (< 30 MHz)

The transmitter shall be connected to an artificial antenna according to clause 6.2.1. The measuring receiver shall be connected to the output of the artificial antenna and the current for both the carrier output and the spurious components shall be measured. For further details of the artificial antenna, see annex D.

The currents shall first be measured with the transmitter switched on (operation) and then repeated with the transmitter switched off (standby/idle).

The method for deriving the spurious current limit  $I_s$  is calculated by the following formula:

$$I_c - I_s = H_c - H_s$$

where:

- $I_s$  is the measured transmitter conducted spurious output current expressed in dB $\mu$ A;
- $I_c$  is the measured transmitter RF carrier output current expressed in dB $\mu$ A, see clause 7.2.2.3;
- $H_c$  is the radiated limit for the transmitter generated H-field expressed in dB $\mu$ A/m, see clause 7.2.1.3;
- $H_s$  is the radiated limit for transmitter generated H-field spurious expressed in dB $\mu$ A/m, see clause 7.5.3.2.

The term  $(H_c - H_s)$  in the above formula is the required attenuation in dBc of the spurious H-field. This requirement may vary with frequency due to varying limits with frequency.

The term  $(I_c - I_s)$  (in dB) is the attenuation in dB of the spurious current below the carrier current.

#### 7.5.2.2 Limits

Under normal test conditions the following condition shall be fulfilled:

$$(I_c - I_s) \geq (H_c - H_s)$$

#### 7.5.2.3 Methods of measurement ( $\geq$ 30 MHz)

The transmitter shall be connected to an artificial antenna according to clause 6.2.2. The spurious components are measured by means of a selective voltmeter connected to the output of the transmitter by means of an appropriate coupling device. For details of the artificial antenna, see annex D.

### 7.5.2.4 Limits

The power of any conducted spurious emission shall not exceed the values given in table 8.

**Table 8**

State	47 MHz to 74 MHz 87,5 MHz to 118 MHz 174 MHz to 230 MHz 470 MHz to 790 MHz	Other Frequencies between 30 MHz to 1 000 MHz
<b>Operating</b>	4 nW	250 nW
<b>Standby</b>	2 nW	2 nW

### 7.5.3 Radiated field strength

This clause refers to clause 7.5.1; indent 1 b) and 2).

#### 7.5.3.1 Methods of measurement (< 30 MHz)

This applies to all Product Classes.

The field strength shall be measured for frequencies below 30 MHz. The equipment under test shall be measured at a distance of 10 m on an outdoor test site. The test antenna shall be a calibrated shielded magnetic field antenna. The equipment under test and test antenna shall be arranged as stated in clause A.1.

For Product Class 3 the transmitter antenna connector of the equipment under test shall be connected to an artificial antenna (see clause 6.2) and the output connector terminated.

The equipment under test shall be switched on with normal modulation. The characteristics of the modulation signal used shall be stated on the test report. The measuring receiver shall be tuned over the frequency range 9 kHz to 30 MHz, except for the frequency band on which the transmitter is intended to operate.

At each frequency at which a relevant spurious signal is detected the equipment under test and the test antenna shall be rotated until maximum field strength is indicated on the measuring receiver. This level shall be noted.

If the transmitter can be operated in the standby mode, then the measurements shall be repeated in the standby mode.

For measuring equipment calibrated in dB $\mu$ V/m, the reading should be reduced by 51,5 dB to be converted to dB $\mu$ A/m.

#### 7.5.3.2 Limits

The radiated field strength of the spurious domain emissions below 30 MHz shall not exceed the generated H-field dB $\mu$ A/m at 10 m given in table 9.

**Table 9**

State	Frequency 9 kHz $\leq$ f < 10 MHz	Frequency 10 MHz $\leq$ f < 30 MHz
<b>Operating</b>	27 dB $\mu$ A/m at 9 kHz descending 3 dB/oct	-3,5 dB $\mu$ A/m
<b>Standby</b>	5,5 dB $\mu$ A/m at 9 kHz descending 3 dB/oct	-25 dB $\mu$ A/m

### 7.5.4 Effective radiated power

This clause refers to the requirements of clause 7.5.1 1) b) and 2).

### 7.5.4.1 Methods of measurement ( $\geq 30$ MHz)

This method applies to all Product Classes.

On an appropriate test site selected from annex A, the equipment shall be placed at the specified height on a non-conducting support and in the position closest to normal use as declared by the provider.

For Product Class 3 the transmitter antenna connector shall be connected to an artificial antenna (see clause 6.2).

The test antenna shall be oriented for vertical polarization. The output of the test antenna shall be connected to a measuring receiver.

The transmitter shall be switched on with normal modulation, and the measuring receiver shall be tuned over the frequency range 30 MHz to 1 000 MHz.

At each frequency at which a relevant spurious component is detected, the test antenna shall be raised and lowered through the specified range of heights until a maximum signal level is detected on the measuring receiver.

The transmitter shall then be rotated through  $360^\circ$  in the horizontal plane, until the maximum signal level is detected by the measuring receiver.

The maximum signal level detected by the measuring receiver shall be noted.

The substitution antenna shall be oriented for vertical polarization and calibrated for the frequency of the spurious component detected.

The frequency of the calibrated signal generator shall be set to the frequency of the spurious component detected. The input attenuator setting of the measuring receiver shall be adjusted in order to increase the sensitivity of the measuring receiver, if necessary.

The test antenna shall be raised and lowered through the specified range of heights to ensure that the maximum signal is received.

When a test site according to clause A.1.1 is used, there is no need to vary the height of the antenna.

The input signal to the substitution antenna shall be adjusted until an equal or a known related level to that detected from the transmitter is obtained on the measuring receiver.

The input signal to the substitution antenna shall be recorded as a power level and corrected for any change of input attenuator setting of the measuring receiver.

The measure of the effective radiated power of the spurious components is the larger of the two power levels recorded for each spurious component at the input to the substitution antenna, corrected for the gain of the substitution antenna if necessary.

If an unmodulated carrier cannot be obtained then the measurements shall be made with the transmitter modulated by the normal test signal (see clause 6.1.2) in which case this fact shall be recorded in the test report.

If standby mode is available, the measurements shall be repeated in that mode.

### 7.5.4.2 Limits

The power of any radiated emission shall not exceed the values given in table 10.

**Table 10**

State	47 MHz to 74 MHz 87,5 MHz to 118 MHz 174 MHz to 230 MHz 470 MHz to 790 MHz	Other frequencies between 30 MHz to 1 000 MHz
Operating	4 nW	250 nW
Standby	2 nW	2 nW

---

## 8 Receiver requirement

### 8.1 Adjacent channel selectivity - in band

This measurement is only required where a frequency plan with standard channel spacing is consistently used, for example at 27 MHz.

This measurement shall not be performed if:

- a) the transmitter cannot be switched off and the spacing between the transmit and the receiver frequency is less than ten times the declared receiver 3 dB bandwidth; or
- b) the transmitter and receiver are operating at the same frequency and the transmitter cannot be switched off as the carrier is used as receiver injection signal (e.g. for homodyne systems).

In the case where a) and/or b) above applies, this shall be stated in the test report.

#### 8.1.1 Definition

The adjacent channel selectivity is a measure of the capability of the receiver to operate satisfactorily in the presence of an unwanted signal that differs in frequency from the wanted signal by an amount equal to the adjacent channel separation for which the equipment is intended.

This requirement does not apply for tagging systems (e.g. RF identification, anti-theft, access control, location systems).

#### 8.1.2 Method of measurement

This measurement shall be conducted under normal conditions.

Two signal generators A and B shall be connected to the receiver via a combining network to the receiver either:

- a) via a test fixture or a test antenna to the receiver integral, dedicated or test antenna; or
- b) directly to the receiver permanent or temporary antenna connector.

The method of coupling to the receiver shall be stated in the test report.

Signal generator A shall be at the nominal frequency of the receiver, with normal modulation of the wanted signal. Signal generator B shall be unmodulated and shall be adjusted to the test frequency for the adjacent channel immediately above that of the wanted signal.

Initially signal generator B shall be switched off and using signal generator A with a signal level corresponding to the specified receiver sensitivity. The output level of generator A shall then be increased by 3 dB.

Signal generator B is then switched on and its level is adjusted until operation at the specified receiver sensitivity is obtained. This level shall be recorded.

The measurements shall be repeated with signal generator B adjusted to the test frequency on the adjacent channel immediately below the wanted signal.

The adjacent channel selectivity shall be recorded for the upper and lower adjacent channels as the ratio in dB of the unwanted signal to the level of the wanted signal.

This requirement does not apply for tagging systems (e.g. RF identification, anti-theft, access control, location systems).

### 8.1.3 Limits

The adjacent channel selectivity of the equipment under specified conditions shall not be less than stated in table 11.

**Table 11**

Receiver category	Channel spacing $\leq$ 25 kHz	Channel spacing $>$ 25 kHz
1	60 dB	70 dB

## 8.2 Blocking or desensitization (Receiver category 1 and 2 only)

### 8.2.1 Definition

Blocking is a measure of the capability of the receiver to receive a wanted modulated signal without exceeding a given degradation due to the presence of an unwanted input signal at any frequencies other than those of the receiver spurious responses and adjacent channel selectivity, see clause 8.1.

This requirement does not apply for tagging systems (e.g. RF identification, NFC devices, Smart Cards, anti-theft, access control, location systems).

### 8.2.2 Methods of measurement

The measurements below shall only be made for receiver category 1 and 2.

The measurement shall be conducted under normal conditions.

Two signal generators A and B shall be connected to the receiver via a combining network to the receiver either:

- a) via a test fixture or a test antenna coupling to the receiver integral, dedicated or test antenna; or
- b) directly to the receiver permanent or temporary antenna connector.

The method of coupling to the receiver shall be stated in the test report.

Signal generator A shall be at the nominal frequency of the receiver, with normal modulation of the wanted signal. Signal generator B shall be unmodulated and shall be adjusted to a test frequency as defined below.

Initially signal generator B shall be switched off and by using signal generator A with a signal level corresponding to the specified receiver sensitivity. The output level of generator A shall then be increased by 3 dB.

Signal generator B is then switched on and the level is adjusted until operation at the specified sensitivity is obtained. This level shall be recorded.

The frequency for generator B is defined by either a) or b) below whichever is greater:

- a) For the frequency range 9 kHz to  $<$  500 kHz, the measurements shall be at approximately +50 kHz, +100 kHz, +200 kHz, +300 kHz and +500 kHz from the highest receiver operating frequency + the 3 dB receiver bandwidth.  
The tests shall be repeated at approximately -50 kHz, -100 kHz, -200 kHz, -300 kHz and -500 kHz from the lowest receiver operating frequency - the 3 dB receiver bandwidth.

For the frequency range  $\geq$  500 kHz to 30 MHz, the measurements shall be at approximately +500 kHz, +1 MHz, +2 MHz and +5 MHz from the highest receiver operating frequency + the 3 dB receiver bandwidth. The tests shall be repeated at approximately -500 kHz, -1 MHz, -2 MHz and -5 MHz from the lowest receiver operating frequency - the 3 dB receiver bandwidth.

The manufacturer shall declare the receiver operating frequencies and 3 dB receiver bandwidth.

Or:

- b) The frequency for generator B is determined as an offset by using the upper and lower receiver operating frequencies plus or minus receiver 3 dB bandwidth times a multiplier, (N+1). The values for N are given in clause 8.2.3, table 12.

The upper and lower test frequencies for generator B are defined as follows:

- Upper test frequencies: Highest operating receiver frequency + (receiver 3 dB bandwidth) × (N+1).
- Lower test frequencies: Lowest operating receiver frequency - (receiver 3 dB bandwidth) × (N+1).

The manufacturer shall declare the receiver operating frequencies and 3 dB receiver bandwidth.

For systems with swept operating frequencies:

- Upper test frequencies: High end of sweep range + (receiver 3 dB bandwidth) × (N+1).
- Lower test frequencies: Low end of sweep range - (receiver 3 dB bandwidth) × (N+1).

The manufacturer shall declare the receiver operating frequencies, 3 dB receiver bandwidth and sweeping range.

The blocking or desensitization shall be recorded as the ratio in dB of lowest level of the unwanted signal (generator B) to the level of the wanted signal (generator A).

Generator B frequencies below 9 kHz are not defined and shall not be measured.

### 8.2.3 Limits

The blocking ratio, for any frequency within the specified ranges, shall not be less than the values given in table 12, except at frequencies on which spurious responses are found. The limit value is determined by a reference limit (Ref) multiplied by a correction factor depending of the appropriate receiver category.

This requirement does not apply for tagging systems.

**Table 12: Receiver blocking or desensitization limits**

Receiver Category	Generator B frequency offset, $ f_A - f_B $ , either by a) or b) whichever is greater (see note 3)			Limit (dB)
	a) per clause 8.2.2, indent a)		b) per clause 8.2.2, indent b)	
	$f_A < 500$ kHz	$f_A \geq 500$ kHz	value of N, see below	
1	For all offset frequencies	For all offset frequencies	2, 4, 8 and 20	Reference Limit (see note 1)
2	$\pm 100$ kHz	$\pm 500$ kHz	2	Reference Limit × 1/2 (see note 2)
	$\pm 200$ kHz	$\pm 1$ MHz	4	Reference Limit × 2/3 (see note 2)
	$\pm 300$ kHz	$\pm 2$ MHz	8	Reference Limit × 5/6 (see note 2)
	$\pm 500$ kHz	$\pm 5$ MHz	20	Reference Limit (see note 1)
NOTE 1: Reference limit (Ref) = 30 dB at 9 kHz increasing with 10 dB/decade to 65,2 dB at 30 MHz.				
NOTE 2: The limit is a fractional dB value of the reference limit.				
NOTE 3: Generator B frequencies below 9 kHz are not specified.				

### 8.3 Receiver spurious radiation

These requirements do not apply to receivers used in combination with permanently co-located transmitters continuously transmitting. Co-located is defined as < 3 m. In these cases the receivers will be tested together with the transmitter in operating mode (see clause 7.4).



### 8.3.1 Definition

Spurious radiation from receivers are emissions radiated from the antenna, the chassis and case of the receiver. It is specified as the radiated power of a discrete signal.

### 8.3.2 Methods of measurement

- 1) For radiation below 30 MHz, see clause 7.5.3.1.
- 2) For radiation at or above 30 MHz, see clause 7.5.4.1.

Convert reading by 51,5 dB for measuring equipment calibrated in dB $\mu$ V or dB $\mu$ V/m.

### 8.3.3 Limits

#### 8.3.3.1 Radiated emissions below 30 MHz

The spurious components below 30 MHz shall not exceed the generated H-field dB $\mu$ A/m values at 10 m according to table 13.

**Table 13: Receiver spurious radiation limits**

Frequency 9 kHz $\leq$ f < 10 MHz	Frequency 10 MHz $\leq$ f < 30 MHz
5,5 dB $\mu$ A/m at 9 kHz descending 3 dB/oct	-25 dB $\mu$ A/m

#### 8.3.3.2 Radiated emissions above 30 MHz

The measured values shall not exceed 2 nW.

---

## 9 Measurement uncertainty

The interpretation of the results recorded in the test report for the measurements described in the present document shall be as follows:

- the measured value related to the corresponding limit shall be used to decide whether an equipment meets the requirements of the present document;
- the value of the measurement uncertainty for the measurement of each parameter shall be separately included in the test report;
- the value of the measurement uncertainty shall be, for each measurement, equal to or lower than the figures given below:
  - RF frequency  $\pm 1 \times 10^{-7}$ .
  - RF power, conducted  $\pm 1$  dB.
  - RF power, radiated  $\pm 6$  dB.
  - Temperature  $\pm 1$  °C.
  - Humidity  $\pm 5$  %.

For the test methods, according to the present document the uncertainty figures shall be calculated according to the methods described in the ETSI TR 100 028 [1] and shall correspond to an expansion factor (coverage factor)  $k = 1,96$  or  $k = 2$  (which provide confidence levels of respectively 95 % and 95,45 % in case where the distributions characterizing the actual measurement uncertainties are normal (Gaussian)).

The measurement uncertainties given above are based on such expansion factors.

The particular expansion factor used for the evaluation of the measurement uncertainty shall be stated.

---

## 10 Interpretation of results

### 10.1 Measurement uncertainty is equal to or less than maximum acceptable uncertainty

The interpretation of the results when comparing measurement values with specification limits shall be as follows:

- a) When the measured value does not exceed the limit value the equipment under test meets the requirements of the present document.
- b) When the measured value exceeds the limit value the equipment under test does not meet the requirements of the present document.
- c) The measurement uncertainty calculated by the test technician carrying out the measurement should be recorded in the test report.
- d) The measurement uncertainty calculated by the test technician may be a maximum value for a range of values of measurement, or may be the measurement uncertainty for the specific measurement undertaken. The method used should be recorded in the test report.

## Annex A (normative): Radiated measurement

This annex is applicable to the assessment of data or equipment providing a specific response.

It covers test sites and methods to be used with integral antenna equipment or equipment having an antenna connector.

### A.1 Test sites and general arrangements for measurements involving the use of radiated fields

This annex introduces three most commonly available test sites, an anechoic chamber, an anechoic chamber with a ground plane and an Open Area Test Site (OATS), which may be used for radiated tests. These test sites are generally referred to as free field test sites. Both absolute and relative measurements can be performed in these sites. Where absolute measurements are to be carried out, the chamber should be verified. A detailed verification procedure is described in ETSI TR 102 273-2 [i.5], ETSI TR 102 273-3 [i.6] and ETSI TR 102 273-4 [i.7].

**NOTE:** To ensure reproducibility and tractability of radiated measurements only these test sites should be used in measurements in accordance with the present document.

#### A.1.1 Anechoic chamber

An anechoic chamber is an enclosure, usually shielded, whose internal walls, floor and ceiling are covered with radio absorbing material, normally of the pyramidal urethane foam type. The chamber usually contains an antenna support at one end and a turntable at the other. A typical anechoic chamber is shown in figure A.1.

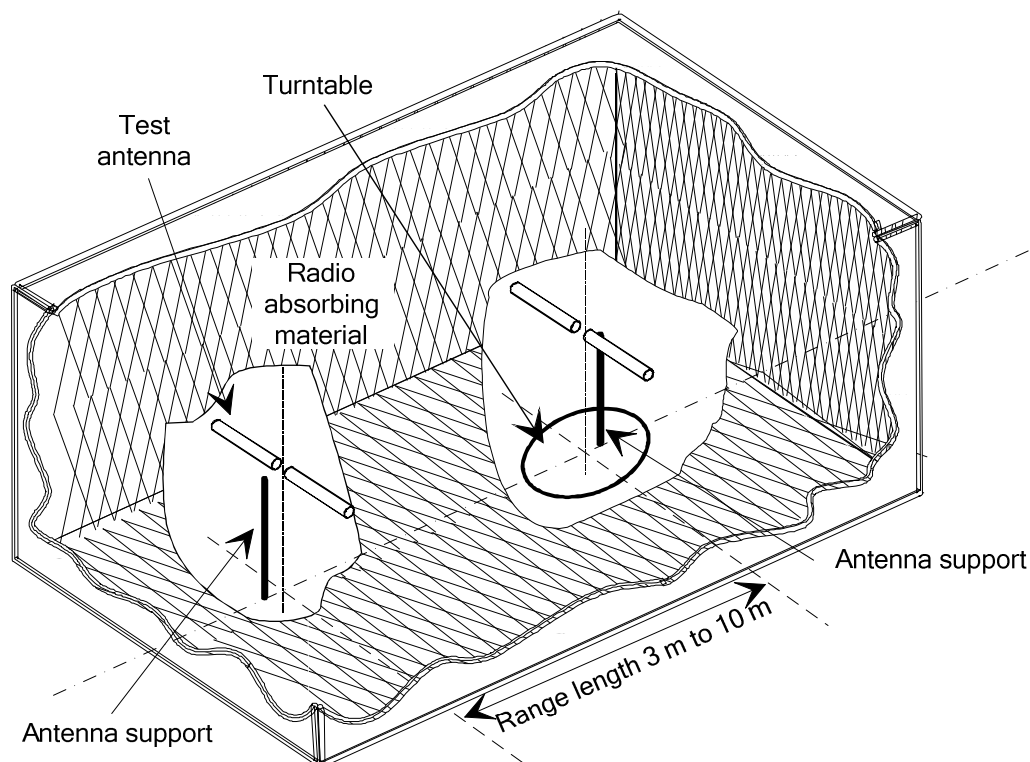

Figure A.1: A typical anechoic chamber

The chamber shielding and radio absorbing material work together to provide a controlled environment for testing purposes. This type of test chamber attempts to simulate free space conditions.

The shielding provides a test space, with reduced levels of interference from ambient signals and other outside effects, whilst the radio absorbing material minimizes unwanted reflections from the walls and ceiling which can influence the measurements. In practice it is relatively easy for shielding to provide high levels (80 dB to 140 dB) of ambient interference rejection, normally making ambient interference negligible.

A turntable is capable of rotation through 360° in the horizontal plane and it is used to support the test sample (EUT) at a suitable height (e.g. 1 m) above the ground plane. The chamber shall be large enough to allow the measuring distance of at least 3 m or  $2(d_1 + d_2)^2/\lambda$  (m), whichever is greater (see clause A.2.5). The distance used in actual measurements shall be recorded with the test results.

The anechoic chamber generally has several advantages over other test facilities. There is minimal ambient interference, minimal floor, ceiling and wall reflections and it is independent of the weather. It does however have some disadvantages which include limited measuring distance and limited lower frequency usage due to the size of the pyramidal absorbers. To improve low frequency performance, a combination structure of ferrite tiles and urethane foam absorbers is commonly used.

All types of emission, sensitivity and immunity testing can be carried out within an anechoic chamber without limitation.

## A.1.2 Anechoic chamber with a conductive ground plane

An anechoic chamber with a conductive ground plane is an enclosure, usually shielded, whose internal walls and ceiling are covered with radio absorbing material, normally of the pyramidal urethane foam type. The floor, which is metallic, is not covered and forms the ground plane. The chamber usually contains an antenna mast at one end and a turntable at the other. A typical anechoic chamber with a conductive ground plane is shown in figure A.2.

This type of test chamber attempts to simulate an ideal Open Area Test Site whose primary characteristic is a perfectly conducting ground plane of infinite extent.

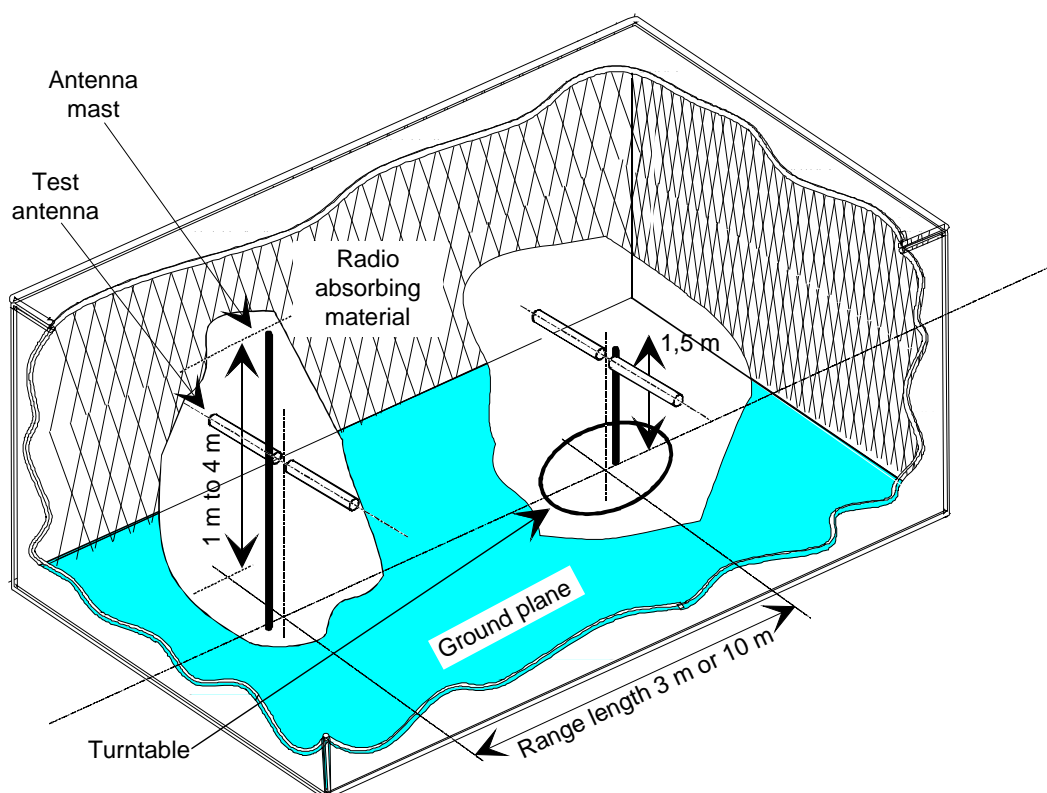

Figure A.2: A typical Anechoic Chamber with a conductive ground plane

In this facility the ground plane creates the wanted reflection path, such that the signal received by the receiving antenna is the sum of the signals from both the direct and reflected transmission paths. This creates a unique received signal level for each height of the transmitting antenna (or EUT) and the receiving antenna above the ground plane.

The antenna mast provides a variable height facility (from 1 m to 4 m) so that the position of the test antenna can be optimized for maximum coupled signal between antennas or between an EUT and the test antenna.

A turntable is capable of rotation through 360° in the horizontal plane and it is used to support the test sample (EUT) at a specified height, usually 1,5 m above the ground plane. The chamber shall be large enough to allow the measuring distance of at least 3 m or  $2(d_1 + d_2)^2/\lambda$  (m), whichever is greater (see clause A.2.4). The distance used in actual measurements shall be recorded with the test results.

Emission testing involves firstly "peaking" the field strength from the EUT by raising and lowering the receiving antenna on the mast (to obtain the maximum constructive interference of the direct and reflected signals from the EUT) and then rotating the turntable for a "peak" in the azimuth plane. At this height of the test antenna on the mast, the amplitude of the received signal is noted. Secondly the EUT is replaced by a substitution antenna (positioned at the EUT's phase or volume centre) which is connected to a signal generator. The signal is again "peaked" and the signal generator output adjusted until the level, noted in stage one, is again measured on the receiving device.

Receiver sensitivity tests over a ground plane also involve "peaking" the field strength by raising and lowering the test antenna on the mast to obtain the maximum constructive interference of the direct and reflected signals, this time using a measuring antenna which has been positioned where the phase or volume centre of the EUT will be during testing. A transform factor is derived. The test antenna remains at the same height for stage two, during which the measuring antenna is replaced by the EUT. The amplitude of the transmitted signal is reduced to determine the field strength level at which a specified response is obtained from the EUT.

### A.1.3 Open Area Test Site (OATS)

The OATS can be used for measurements in the range of 9 kHz to 1 000 MHz.

Measurements below 30 MHz shall be made according to clause A.1.3.1 and measurements above 30 MHz shall be made according to clause A.1.3.2.

An Open Area Test Site comprises a turntable at one end and an antenna mast of variable height at the other end. A typical OATS is shown in figure A.3.

In figure A.3, for measurements below 30 MHz the dipole antennas shall be replaced by loop antennas and as explained in clause A1.3.1.

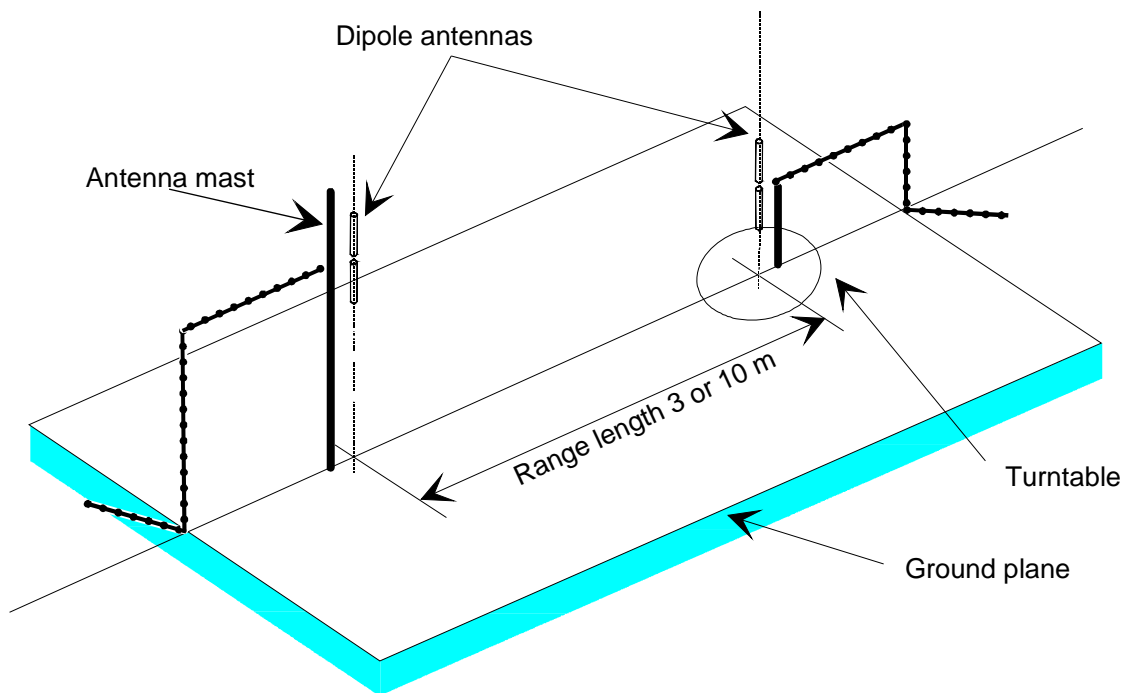

Figure A.3: A typical Open Area Test Site

### A.1.3.1 Measurements below 30 MHz

For measurements below 30 MHz tests may be made according to CISPR 16-2-3 [i.12]. The measurements are made with an inductive shielded loop test antenna, which reads the magnetic field (H-field) only. These measurements are valid for both the far-field and the near-field situations. In this case the OATS shall not have a ground plane with an electrical or magnetic conductive material.

Radiated emission test sites (OATS) below 30 MHz shall be free from metal objects, buried pipes, and any objects that can affect radiated measurements. An alternative test site that can demonstrate equivalence to a test site as described in the preceding paragraph shall be accepted for the purposes of the present document.

### A.1.3.2 Measurements above 30 MHz

An Open Area Test Site comprises a turntable at one end and an antenna mast of variable height at the other end above a ground plane, which in the ideal case, is perfectly conducting and of infinite extent. In practice, whilst good conductivity can be achieved, the ground plane size has to be limited. A typical OATS is shown in figure A.3.

The ground plane creates a wanted reflection path, such that the signal received by the receiving antenna is the sum of the signals received from the direct and reflected transmission paths. The phasing of these two signals creates a unique received level for each height of the transmitting antenna (or EUT) and the receiving antenna above the ground plane.

Site qualification concerning antenna positions, turntable, measurement distance and other arrangements are same as for anechoic chamber with a ground plane. In radiated measurements an OATS is also used by the same way as anechoic chamber with a ground plane.

Typical measuring arrangement common for ground plane test sites for spurious emission testing is presented in figure A.4.

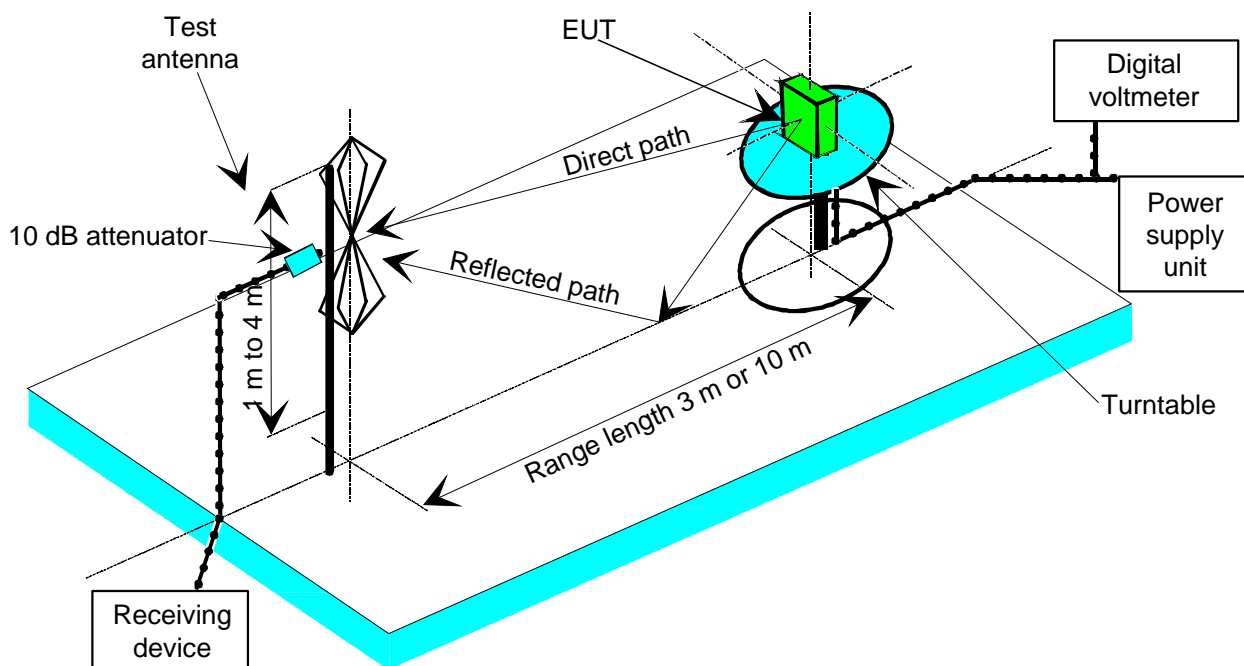

**Figure A.4: Measuring arrangement on ground plane test site (OATS set-up for spurious emission testing)**

## A.1.4 Test antenna

A test antenna is always used in radiated test methods. In emission tests (i.e. frequency error, effective radiated power, spurious emissions and adjacent sub-band power) the test antenna is used to detect the field from the EUT in one stage of the measurement and from the substitution antenna in the other stage. When the test site is used for the measurement of receiver characteristics (i.e. sensitivity and various immunity parameters) the antenna is used as the transmitting device.

The test antenna should be mounted on a support capable of allowing the antenna to be used in either horizontal or vertical polarization which, on ground plane sites (i.e. anechoic chambers with ground planes and Open Area Test Sites), should additionally allow the height of its centre above the ground to be varied over the specified range (usually 1 m to 4 m).

In the frequency range 9 kHz to 30 MHz, inductive shielded loop antennas according to CISPR 16-2-3 [i.12] are generally recommended. This test antenna method supports measurements in both the far-field and near-field.

In the frequency band 30 MHz to 1 000 MHz, dipole antennas (constructed in accordance with ANSI C63.5 [i.3] are generally recommended. For frequencies of 80 MHz and above, the dipoles should have their arm lengths set for resonance at the frequency of test. Below 80 MHz, shortened arm lengths are recommended. For spurious emission testing, however, a combination of bicones and log periodic dipole array antennas (commonly termed "log periodics") could be used to cover the entire 30 MHz to 1 000 MHz band. Above 1 000 MHz, waveguide horns are recommended although, again, log periodic could be used.

**NOTE:** The gain of a horn antenna is generally expressed relative to an isotropic radiator.

## A.1.5 Substitution antenna

The substitution antenna is used to replace the EUT for tests in which a transmitting parameter (i.e. frequency error, effective radiated power, spurious emissions and adjacent sub-band power) is being measured. For measurements in the frequency band 30 MHz to 1 000 MHz, the substitution antenna should be a dipole antenna (constructed in accordance with ANSI C63.5 [i.3]). For frequencies of 80 MHz and above, the dipoles should have their arm lengths set for resonance at the frequency of test. Below 80 MHz, shortened arm lengths are recommended. For measurements above 1 000 MHz, a waveguide horn is recommended. The centre of this antenna should coincide with either the phase centre or volume centre.

Below 30 MHz substitution measurements are not used as the radiated H-field is measured with a shielded loop antenna according to CISPR 16-2-3 [i.12].

## A.1.6 Measuring antenna

The measuring antenna is used in tests on an EUT in which a receiving parameter (i.e. sensitivity and various immunity tests) is being measured. Its purpose is to enable a measurement of the electric field strength in the vicinity of the EUT.

For measurements in the frequency band 30 MHz to 1 000 MHz, the measuring antenna should be a dipole antenna (constructed in accordance with ANSI C63.5 [i.3]). For frequencies of 80 MHz and above, the dipoles should have their arm lengths set for resonance at the frequency of test. Below 80 MHz, shortened arm lengths are recommended. The centre of this antenna should coincide with either the phase centre or volume centre (as specified in the test method) of the EUT.

For measurements on inductive loop systems operating below 30 MHz, the measurement antenna is a calibrated loop antenna.

---

## A.2 Guidance on the use of radiation test sites

This clause details procedures, test equipment arrangements and verification that should be carried out before any of the radiated tests are undertaken. These schemes are common to all types of test sites described in annex A.

### A.2.1 Verification of the test site

No test should be carried out on a test site which does not possess a valid certificate of verification. The verification procedures for the different types of test sites described in annex A (i.e. anechoic chamber, anechoic chamber with a ground plane and Open Area Test Site) are given in ETSI TR 102 273-2 [i.5], ETSI TR 102 273-3 [i.6] and ETSI TR 102 273-4 [i.7], respectively.

### A.2.2 Preparation of the EUT

The provider should supply information about the EUT covering the operating frequency, polarization, supply voltage(s) and the reference face. Additional information, specific to the type of EUT should include, where relevant, carrier power, sub-band separation, whether different operating modes are available (e.g. high and low power modes) and if operation is continuous or is subject to a maximum test duty cycle (e.g. 1 min on, 4 min off).

Where necessary, a mounting bracket of minimal size should be available for mounting the EUT on the turntable. This bracket should be made from low conductivity, low relative dielectric constant (i.e. less than 1,5) material(s) such as expanded polystyrene, balsa wood, etc.

### A.2.3 Power supplies to the EUT

All tests should be performed using power supplies wherever possible, including tests on EUT designed for battery-only use. In all cases, power leads should be connected to the EUT's supply terminals (and monitored with a digital voltmeter) but the battery should remain present, electrically isolated from the rest of the equipment, possibly by putting tape over its contacts.



The presence of these power cables can, however, affect the measured performance of the EUT. For this reason, they should be made to be "transparent" as far as the testing is concerned. This can be achieved by routing them away from the EUT and down to the either the screen, ground plane or facility wall (as appropriate) by the shortest possible paths. Precautions should be taken to minimize pick-up on these leads (e.g. the leads could be twisted together, loaded with ferrite beads at 0,15 m spacing or otherwise loaded).

## A.2.4 Range length

### A.2.4.1 Far-field length above 30 MHz

The range length for all these types of test facility should be adequate to allow for testing in the far-field of the EUT i.e. it should be equal to or exceed:

$$\frac{2(d_1 + d_2)^2}{\lambda}$$

where:

$d_1$  is the largest dimension of the EUT/dipole after substitution (m);

$d_2$  is the largest dimension of the test antenna (m);

$\lambda$  is the test frequency wavelength (m).

It should be noted that in the substitution part of this measurement, where both test and substitution antennas are half wavelength dipoles, this minimum range length for far-field testing would be:

$$2\lambda$$

It should be noted in the test report when either of these conditions is not met so that the additional measurement uncertainty can be incorporated into the results.

NOTE 1: For the fully anechoic chamber, no part of the volume of the EUT should, at any angle of rotation of the turntable, fall outside the "quiet zone" of the chamber at the nominal frequency of the test.

NOTE 2: The "quiet zone" is a volume within the anechoic chamber (without a ground plane) in which a specified performance has either been proven by test, or is guaranteed by the designer/manufacture. The specified performance is usually the reflectivity of the absorbing panels or a directly related parameter (e.g. signal uniformity in amplitude and phase). It should be noted however that the defining levels of the quiet zone tend to vary.

NOTE 3: For the anechoic chamber with a ground plane, a full height scanning capability, i.e. 1 m to 4 m, should be available for which no part of the test antenna should come within 1 m of the absorbing panels. For both types of Anechoic Chamber, the reflectivity of the absorbing panels should not be worse than -5 dB.

NOTE 4: For both the anechoic chamber with a ground plane and the Open Area Test Site, no part of any antenna should come within 0,25 m of the ground plane at any time throughout the tests. Where any of these conditions cannot be met, measurements should not be carried out.

### A.2.4.2 Near-field and Far-field length below 30 MHz

Inductive systems below 30 MHz can be measured both in the near-field and far-field regions at an open test site by means of a shielded loop antenna according to CISPR 16-2-3 [i.12].

The minimum measurement distance,  $d$  is determined by:

$$d \geq 3D$$

where  $D$  is the maximum dimension in metre of the inductive loop.

## A.2.5 Site preparation

The cables for both ends of the test site should be routed horizontally away from the testing area for a minimum of 2 m (unless, in the case both types of anechoic chamber, a back wall is reached) and then allowed to drop vertically and out through either the ground plane or screen (as appropriate) to the test equipment. Precautions should be taken to minimize pick up on these leads (e.g. dressing with ferrite beads, or other loading). The cables, their routing and dressing should be identical to the verification set-up.

NOTE: For ground reflection test sites (i.e. anechoic chambers with ground planes and Open Area Test Sites) which incorporate a cable drum with the antenna mast, the 2 m requirement may be impossible to comply with. In this case the cable routing should be described in the test report.

Calibration data for all items of test equipment should be available and valid. For test, substitution and measuring antennas, the data should include gain relative to an isotropic radiator (or antenna factor) for the frequency of test. Also, the VSWR of the substitution and measuring antennas should be known.

The calibration data on all cables and attenuators should include insertion loss and VSWR throughout the entire frequency range of the tests. All VSWR and insertion loss figures should be recorded in the log book results sheet for the specific test.

Where correction factors/tables are required, these should be immediately available.

For all items of test equipment, the maximum errors they exhibit should be known along with the distribution of the error e.g.:

- cable loss:  $\pm 0,5$  dB with a rectangular distribution;
- measuring receiver: 1,0 dB (standard deviation) signal level accuracy with a Gaussian error distribution.

At the start of measurements, system checks should be made on the items of test equipment used on the test site.

---

## A.3 Coupling of signals

### A.3.1 General

The presence of leads in the radiated field may cause a disturbance of that field and lead to additional measurement uncertainty. These disturbances can be minimized by using suitable coupling methods, offering signal isolation and minimum field disturbance (e.g. optical and acoustic coupling).

### A.3.2 Data signals

Isolation can be provided by the use of optical, ultrasonic or infrared means. Field disturbance can be minimized by using a suitable fibre optic connection. Ultra sonic or infrared radiated connections require suitable measures for the minimization of ambient noise.

---

## A.4 Standard test position

The standard position in all test sites, except the stripline arrangement, for equipment which is not intended to be worn on a person, including hand-held equipment, shall be on a non conducting support, height 1,5 m, capable of rotating about a vertical axis through the equipment. The standard position of the equipment shall be the following:

- a) for equipment with an internal antenna, it shall be placed in the position closest to normal use as declared by the provider;
- b) for equipment with a rigid external antenna, the antenna shall be vertical;

- c) for equipment with a non-rigid external antenna, the antenna shall be extended vertically upwards by a non-conducting support.

Equipment which is intended to be worn on a person may be tested using a simulated man as support. The simulated man comprises a rotatable acrylic tube filled with salt water, placed on the ground.

The container shall have the following dimensions:

- Height: 1,7 m  $\pm$  0,1 m.
- Inside diameter: 300 mm  $\pm$  5 mm.
- Sidewall thickness: 5 mm  $\pm$  0,5 mm.

The container shall be filled with a salt (NaCl) solution of 1,5 g per litre of distilled water.

The equipment shall be fixed to the surface of the simulated man, at the appropriate height for the equipment.

NOTE: To reduce the weight of the simulated man it may be possible to use an alternative tube which has a hollow centre of 220 mm maximum diameter.

In the stripline arrangement the equipment under test or the substitution antenna is placed in the designated test area in the normal operational position, relative to the applied field, on a pedestal made of a low dielectric material (dielectric constant less than 2).

---

## A.5 Test fixture

The test fixture is only needed for the assessment of integral antenna equipment.

### A.5.1 Description

The test fixture is a radio frequency coupling device associated with an integral antenna equipment for coupling the integral antenna to a 50  $\Omega$  radio frequency terminal at the working frequencies of the equipment under test. This allows certain measurements to be performed using the conducted measurement methods. Only relative measurements may be performed and only those at or near frequencies for which the test fixture has been calibrated.

In addition, the test fixture may provide:

- a) a connection to an external power supply;
- b) in the case of assessment of speech equipment, an audio interface either by direct connection or by an acoustic coupler.

In the case of non-speech equipment, the test fixture can also provide the suitable coupling means e.g. for the data output.

The test fixture shall normally be provided by the provider.

The performance characteristics of the test fixture shall be approved by the testing laboratory and shall conform to the following basic parameters:

- a) the coupling loss shall not be greater than 30 dB;
- b) a coupling loss variation over the frequency range used in the measurement which does not exceed 2 dB;
- c) circuitry associated with the RF coupling shall contain no active or non-linear devices;
- d) the VSWR at the 50  $\Omega$  socket shall not be more than 1,5 over the frequency range of the measurements;

- e) the coupling loss shall be independent of the position of the test fixture and be unaffected by the proximity of surrounding objects or people. The coupling loss shall be reproducible when the equipment under test is removed and replaced;
- f) the coupling loss shall remain substantially constant when the environmental conditions are varied.

The characteristics and calibration shall be included in the test report.

## A.5.2 Calibration

The calibration of the test fixture establishes a relationship between the output of the signal generator and the field strength applied to the equipment placed in the test fixture.

The calibration is valid only at a given frequency and for a given polarization of the reference field.

The actual set-up used depends on the type of the equipment (e.g. data, speech, etc.).

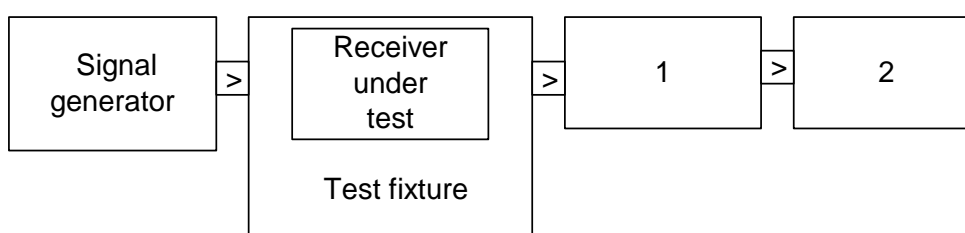

- 1) Coupling device.
- 2) Device for assessing the performance, e.g. distortion factor, BER measuring device, etc.

**Figure A.5: Measuring arrangement for calibration**

### Method of calibration:

- a) Measure the sensitivity expressed as a field strength, as specified in the present document and note the value of this field strength in dB $\mu$ V/m and the polarization used.
- b) Place the receiver in the test fixture, which is connected to the signal generator. The level of the signal generator producing:
  - a bit error ratio of 0,01; or
  - a message acceptance ratio of 80 %, as appropriate;
 shall be noted.

The calibration of the test fixture is the relationship between the field strength in dB $\mu$ V/m and the signal generator level in dB $\mu$ V emf. This relationship is expected to be linear.

## A.5.3 Mode of use

The test fixture may be used to facilitate some of the measurements in the case of equipment having an integral antenna.

It is used in particular for the measurement of the radiated carrier power and usable sensitivity expressed as a field strength under extreme conditions.

For the transmitter measurements calibration is not required as relative measuring methods are used.

For the receiver measurements calibration is necessary as absolute measurements are used.

To apply the specified wanted signal level expressed in field strength, convert it into the signal generator level using the calibration of the test fixture. Apply this value to the signal generator.

---

## A.6 Technical performance of the spectrum analyser

It shall be possible, using a resolution bandwidth of 1 kHz, to measure the amplitude of a signal or noise at a level 3 dB or more above the noise level of the spectrum analyser as displayed on the screen, to an accuracy of  $\pm 2$  dB in the presence of a signal separated in frequency by 10 kHz, at a level 90 dB above that of the signal to be measured.

The reading accuracy of the frequency marker shall be within  $\pm 2$  % of the sub-band separation.

The accuracy of relative amplitude measurements shall be within  $\pm 1$  dB.

It shall be possible to adjust the spectrum analyser to allow the separation, on the display, of two components with a frequency difference of 1 kHz.

Annex B (normative):  
H-field limit correction factor for generated E-fields

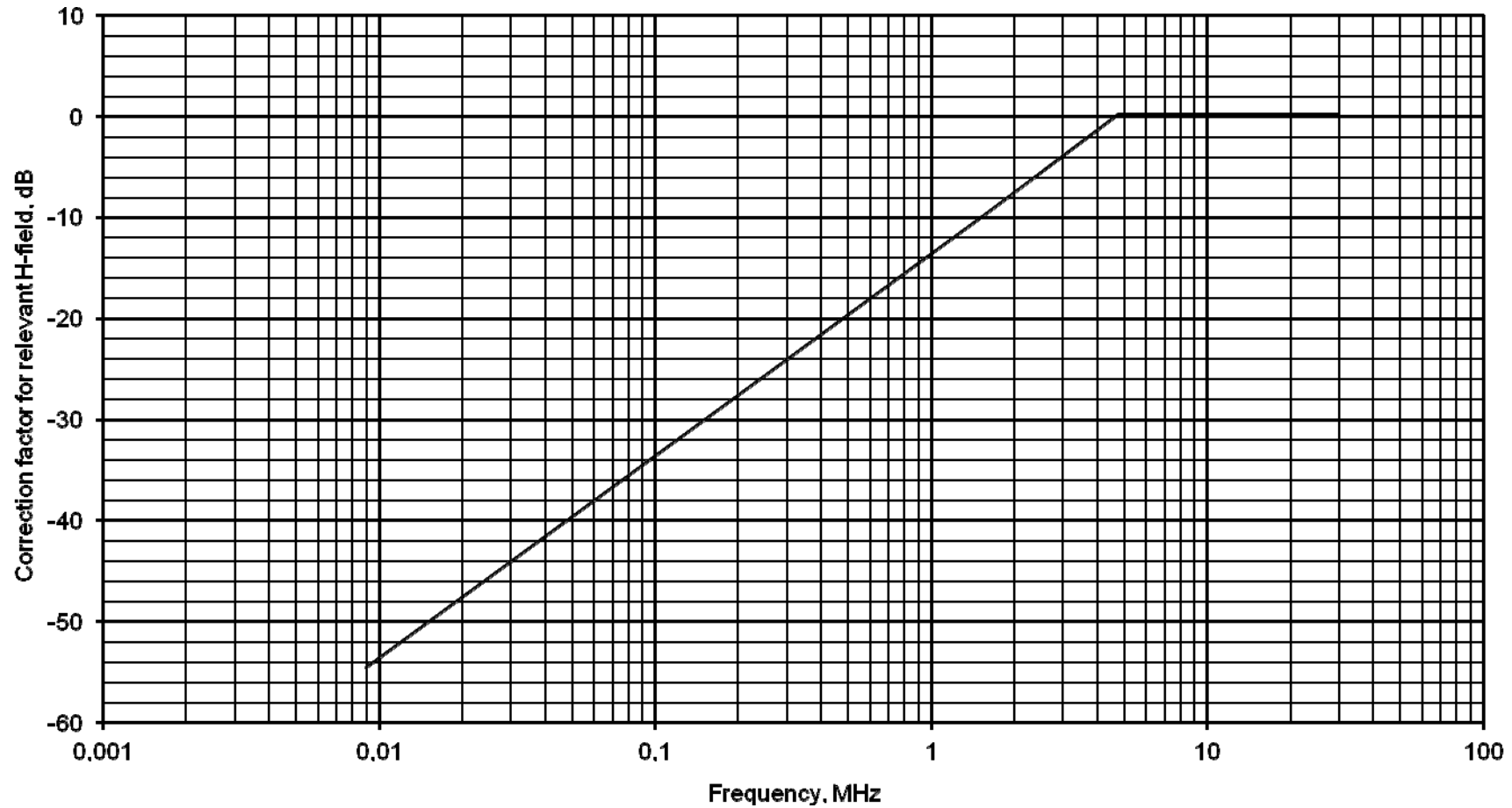

Figure B.1

## Annex C (normative): Customized loop antennas

### C.1 Product classes related to the antenna loop

The present document allows customization of loop antennas under the following restrictions:

- Product Class 1 is tested with an integral or dedicated antenna. No antenna customization allowed.
- Product Class 2 is restricted to loop antenna areas  $< 30 \text{ m}^2$  and a length of the antenna loop of less than  $\lambda/4$  or less than 30 m whichever is shorter.
- Product Class 2 equipment is tested with two representative maximum and minimum size loop antennas supplied by the manufacturer. Product Class 2 allows:
  - customization of the loop antenna according to the manufacturers design rules documented in the equipment manual.
- Product Class 3 is restricted to loop antenna sizes  $> 30 \text{ m}^2$ . The equipment is tested with an artificial antenna only:
  - allow customization of a single turn large loop.

The design formulas given under clauses C.1.1 and C.1.2 are given as guidelines only.

#### C.1.1 Antenna loops below 1 MHz

The radiated magnetic field  $H$  from a loop coil antenna in the near field is given by:

$$H = \frac{NIA}{2\pi d^3} \text{ A/m} \quad (\text{C.1})$$

where:

- $N$  is the number of turns of the loop coil antenna.
- $I$  is the current in Ampere in the loop coil antenna.
- $A$  is the area in  $\text{m}^2$  of the loop coil antenna.
- $d$  is the distance in metre from the transmitter.

The formula is valid at low frequencies under the following conditions:

- Length of the coil wire in m:  $l < \lambda / 2\pi$ .
- Distance from coil in m:  $d < \lambda / 2\pi$ .

The product of  $NIA$  is the magnetic dipole moment  $m$  of the coil.

The equation for the magnetic moment is:

$$m = NIA = H 2\pi d^3 \text{ (Am}^2\text{)} \quad (\text{C.2})$$

In the present document the reference measuring distances  $d$  are 10 m or 30 m.

If 10 m is inserted into (C.2):

$$m = NIA = H_{10} \times 6283 \text{ (Am}^2\text{)} \quad (\text{C.3})$$

where:

$H_{10}$  is the H-field limit at 10 m in A/m (see clause 7.1.1).

The equation is only valid up to 1 MHz.

For method of measurement for loop current into an artificial antenna, see annex D.

## C.1.2 Antenna loops above 1 MHz

For frequencies above 1 MHz the maximum dipole moment can be derived from:

$$P = \frac{8\mu_0\pi^3 m^2 f^4}{3c^3} \text{ (Werp)} \quad (\text{C.4})$$

where:

$\mu_0$  is the free space permeability;

$m$  is magnetic moment of the dipole antenna;

$c$  is the speed of light

$f$  is the frequency

Equation (C.4) after rearrangement:

$$m = NIA = \frac{1}{f^2} \sqrt{\frac{3c^3}{8\mu_0\pi^3} P} \text{ (Werp)} \quad (\text{C.5})$$

Above 1 MHz the NIA limit is determined by equation (C.5) and is descending with  $f^2$  or 12 dB/oct.

Below 1 MHz the NIA limit is determined by equation (C.3), see clause C.1.1.

Relevant e.r.p. limits are 250 nW, 2,5  $\mu$ W and 10 mW all e.r.p.

The corresponding  $N \times I \times A$  products are calculated in examples (C.6), (C.7) and (C.8):

For e.r.p. = 250 nW e.r.p. in (C.5):

$$NIA = \frac{0,255}{f^2} \text{ (A} \times \text{m}^2\text{)} \quad (\text{C.6})$$

For e.r.p. = 2,5  $\mu$ W e.r.p. in (C.5):

$$NIA = \frac{0,806}{f^2} \text{ (A} \times \text{m}^2\text{)} \quad (\text{C.7})$$



For e.r.p. = 10 mW e.r.p. in (C.5):

$$NIA = \frac{50,98}{f^2} (A \times m^2) \quad (C.8)$$

where the frequency  $f$  is in MHz in (C.6), (C.7) and (C.8).

For method of measurement for loop current into an artificial antenna, see annex D.

## Annex D (informative): Test fixture for measuring inductive transmitter carrier and harmonic currents by use of an artificial antenna (Product Class 3 only)

The artificial antenna is used for equipment with an antenna connector and submitted for testing without an antenna. The radiated fields for the carrier and spurious are proportional to the RF carrier and spurious currents. Therefore, measurements are made to determine the RF carrier and spurious currents in the artificial antenna.

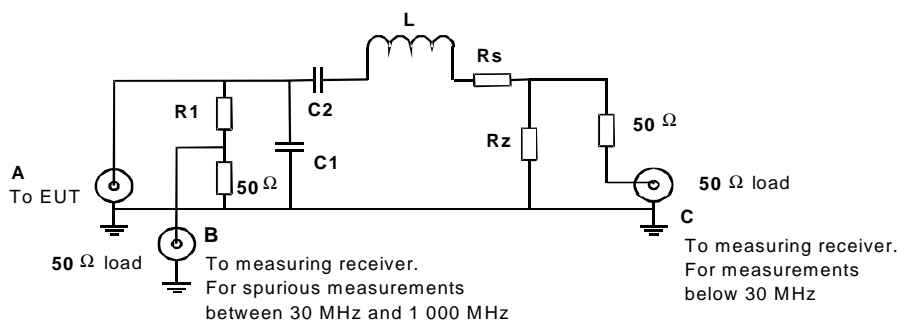

Figure D.1

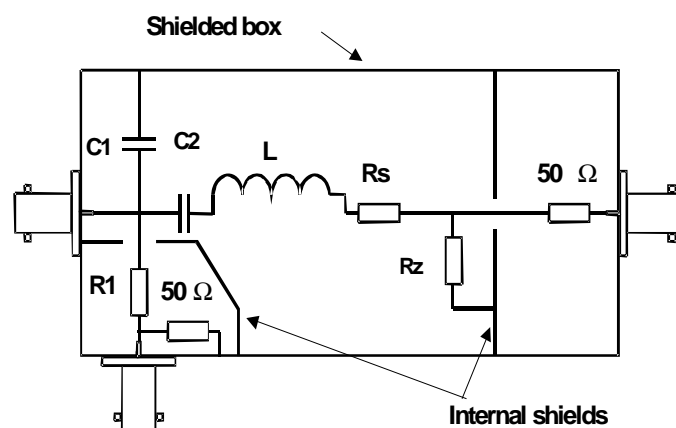

Figure D.2

An example of the mechanical layout and the equivalent electric circuit of the components is given in figures D.2 and D.1 respectively.

If the manufacturer uses several values of antenna inductance, two artificial antennas having maximum and minimum inductance  $L$  should be supplied as agreed with the test laboratory. This fact is stated in the test report.

$R_z$  is a low value non-reactive resistor. The voltage across  $R_z$  is proportional to the conducted carrier and spurious loop currents. These can be measured at connector C.

$R_s$  in combination with  $R_z$  ensures that the artificial antenna has the same  $Q$  as the actual loop antenna.

Resistor  $R1$  together with a  $50\ \Omega$  load resistor provides an attenuation of EUT output signal at connector B used for conducted spurious measurements between 30 MHz and 1 GHz. It is recommended that  $R1$  is  $> 200\ \Omega$ .

Capacitors C1, C2 are optional components together with L to be used as appropriate by the manufacturer to simulate the actual loop antenna configuration. Other possible configurations are shown in figure D.3.

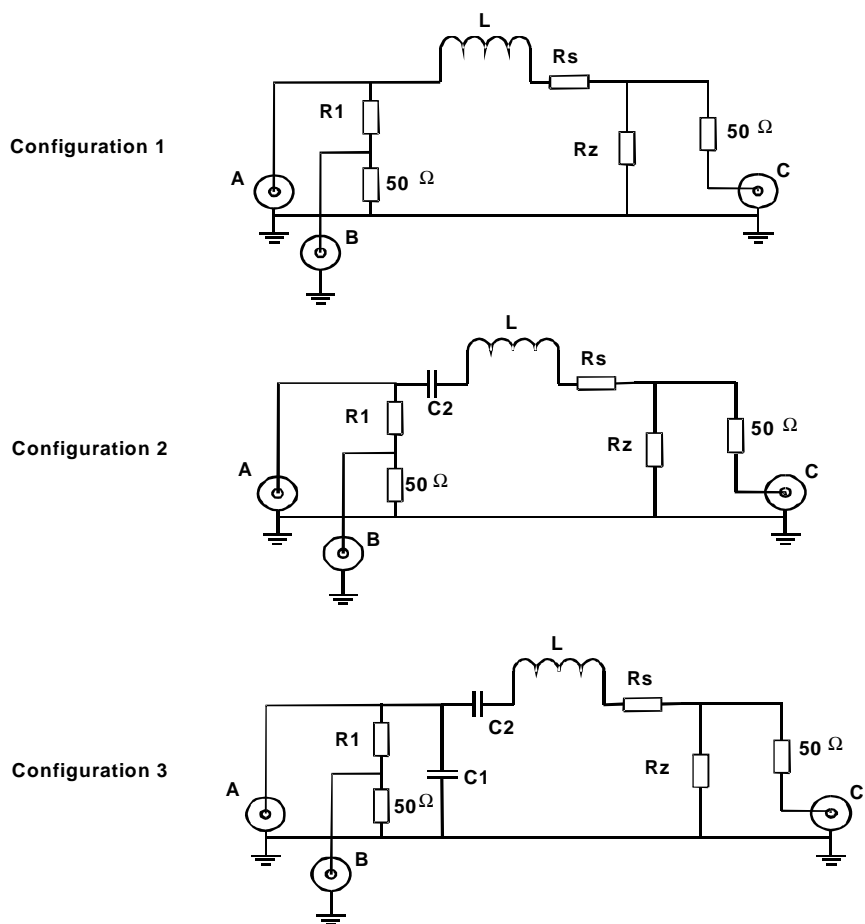

**Figure D.3**

The test fixture configuration used by the manufacturer is stated in the application and test report.

## Annex E (informative): E-fields in the near field at low frequencies

E-field at low frequencies is often in the near field and it is in reality only possible to measure the H-field component with the shielded loop antenna; in this case there is also a relation between the E-field and the H-field by the wave impedance  $Z$ . In the near field the wave impedance is highly dependent on the type of radiating antenna (loop or open end wire) and the wavelength. If the power density at a certain distance is the same for an H-field and an E-field generated signal, the following calculation can be made:

In the direction of maximum power in the near field, the power density  $S$  is:

$$S = \frac{E^2}{Z_e} = H_e^2 Z_e = H_m^2 Z_m \quad (\text{E.1})$$

where:

- $S$  = power density.
- $E$  = electrical field generated by an E-field antenna at distance  $d$ .
- $H_e$  = magnetic field generated by an E-field antenna at distance  $d$ .
- $H_m$  = magnetic field generated by an H-field antenna at distance  $d$ .
- $Z_e$  = wave impedance of a field generated by an E-field antenna at distance  $d$ .
- $Z_m$  = wave impedance of a field generated by an H-field antenna at distance  $d$ .

$$Z_m = Z_o 2\pi \frac{d}{\lambda} \text{ if } d < \frac{\lambda}{2\pi} \text{ (near field)} \quad (\text{E.2})$$

$$Z_e = Z_o \frac{\lambda}{2\pi d} \text{ if } d < \frac{\lambda}{2\pi} \text{ (near field)} \quad (\text{E.3})$$

Equation (E.1) gives:

$$H_e = H_m \sqrt{\frac{Z_m}{Z_e}} \text{ (A/m)} \quad (\text{E.4})$$

Equation (E.2) and (E.3) into (E.4) gives:

$$H_e = H_m \frac{2\pi d}{\lambda} = H_m \frac{2\pi d f_c}{300} \quad (\text{E.5})$$

where  $f_c$  is the carrier frequency in MHz.

For  $2\pi d/\lambda = 1$ ,  $d = 10$  and  $f_c = 4,78$  MHz, and using equation (E.5), this gives:

$$H_e = H_m \frac{f_c}{4,78} \text{ (f in MHz)} \quad (\text{E.6})$$

For  $2\pi d/\lambda < 1$  if  $f_c < 4,78$  MHz then equation (5) is valid, (i.e. near field).

For  $2\pi d/\lambda \geq 1$  if  $f_c > 4,78$  MHz then  $H_e = H_m$ , (i.e. far field).

The method allows an electric generated E-field to be measured as a magnetic generated H-field by adding a correction factor derived from (E.6).

For a graphical representation of the correction factor, see annex B.

## Annex F (normative): H-field measurements and limits at 3 m and 30 m

The present document allows field measurements to be made at other distances than 10 m. In this case, the appropriate H-field limit,  $H_x$ , for provider requested measurement distance,  $d_x$ , shall be determined by the provider. Both the requested measurement distance and the appropriate limit shall be stated in the Test Report.

The conversion of the H-field limits at 10 m to a new measurements distance is not trivial as the near-field to far-field boundary is changing with both frequency and distance. Different combinations of near/far-field and a maximum radiated field strength in either the coaxial or coplanar direction of the loop antenna the conversions of the H-field limits of the present document to 3 m or 30 m are discontinuous curves see clauses F.1 and F.2.

The conversion methods of this annex are only applicable if the maximum dimension of the loop coil is small in relation to the measurement distance.

### F.1 Limits for measurements at 30 m distance

The H-field limit at 30 m,  $H_{30m}$ , is determined by the following equation:

$$H_{30m} = H_{10m} + C_{30} \quad (\text{F.1})$$

where:

$H_{10m}$  is the H-field limit in  $\text{dB}\mu\text{A}/\text{m}$  at 10 m distance according to the present document; and

$C_{30}$  is a conversion factor in dB which is determined from figure F.1.

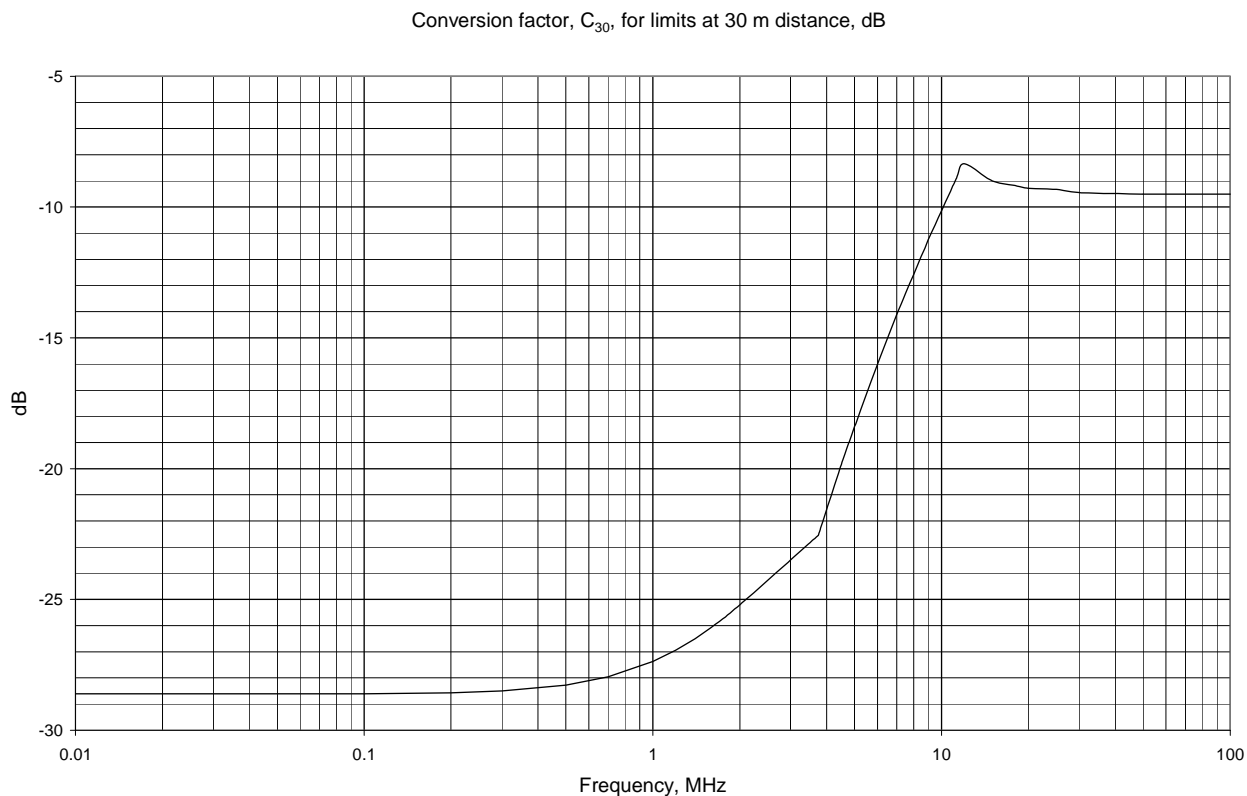

Figure F.1: Conversion factor  $C_{30}$  versus frequency

## F.2 Limits for measurements at 3 m distance

The H-field limit in dB $\mu$ A/m at 3 m,  $H_{3m}$ , is determined by the following equation:

$$H_{3m} = H_{10m} + C_3 \quad (\text{F.2})$$

where:

$H_{10m}$  is the H-field limit in dB $\mu$ A/m at 10 m distance according to the present document; and

$C_3$  is a conversion factor in dB determined from figure F.2.

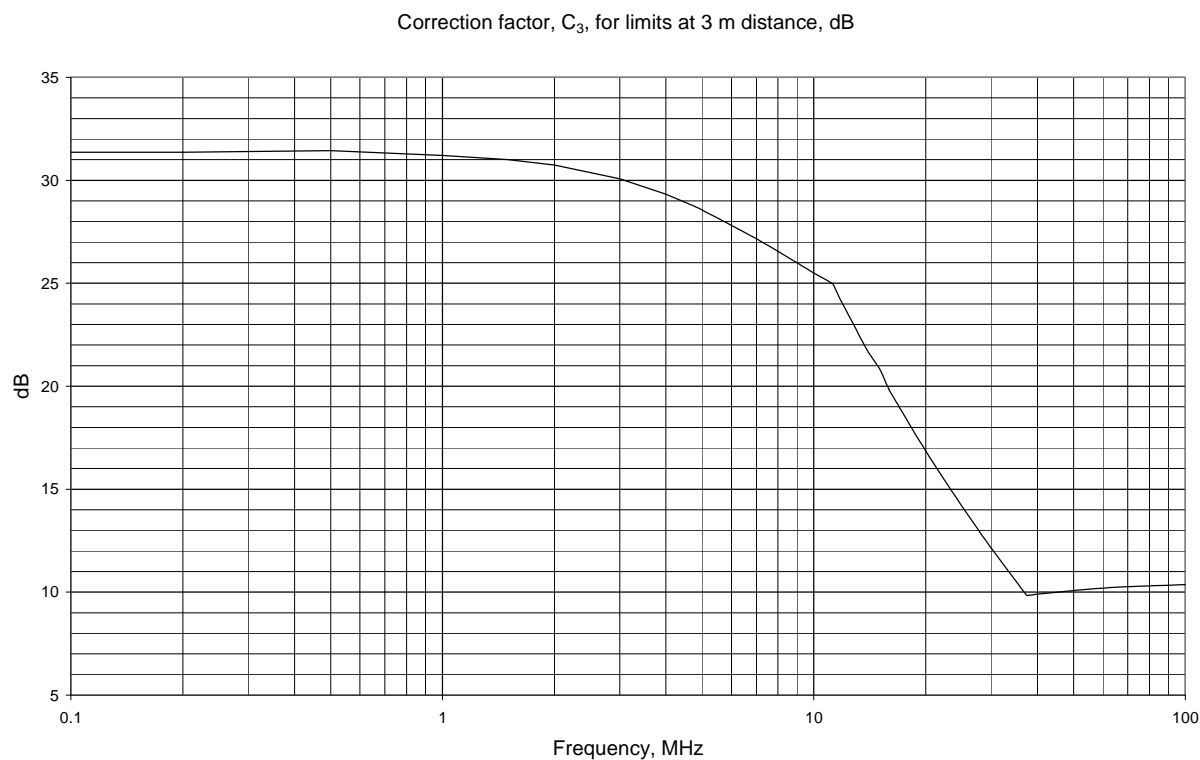
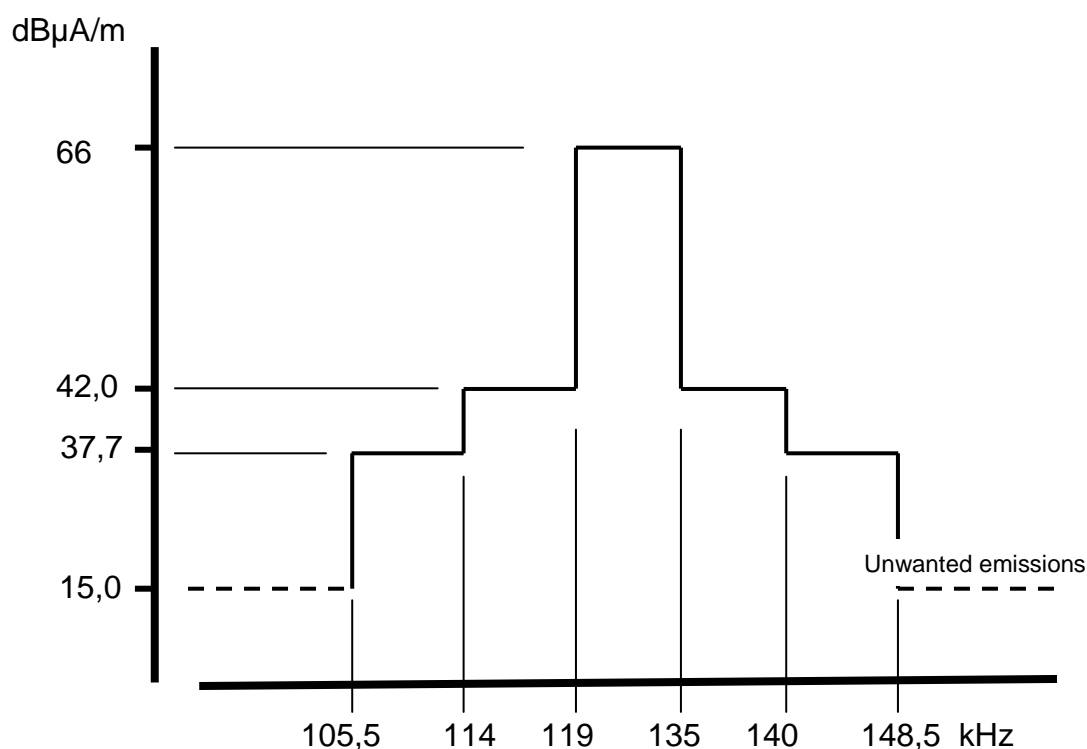

**Figure F.2: Conversion factor  $C_3$  versus frequency**

## Annex G (normative): Transmitter emission levels and spectrum mask measurements

The present document allows transmitter spectrum measurements to be made. The measurements may be relevant for SRDs operating between 9 kHz to 30 MHz.

The radiated spectrum mask shall be declared by the manufacturer, shall comply with the limits in table 4, clause 7.4.3 and figures G.1 and G.2. For further information, see the appropriate annex of CEPT/ERC/REC 70-03 [i.1] as implemented through National Radio Interfaces (NRI) and additional NRI as relevant.



NOTE: The limit at 129,1 kHz ± 500 Hz is maximum 42 dBμA/m at 10 m.

**Figure G.1: Emission boundary for LF RFID systems**

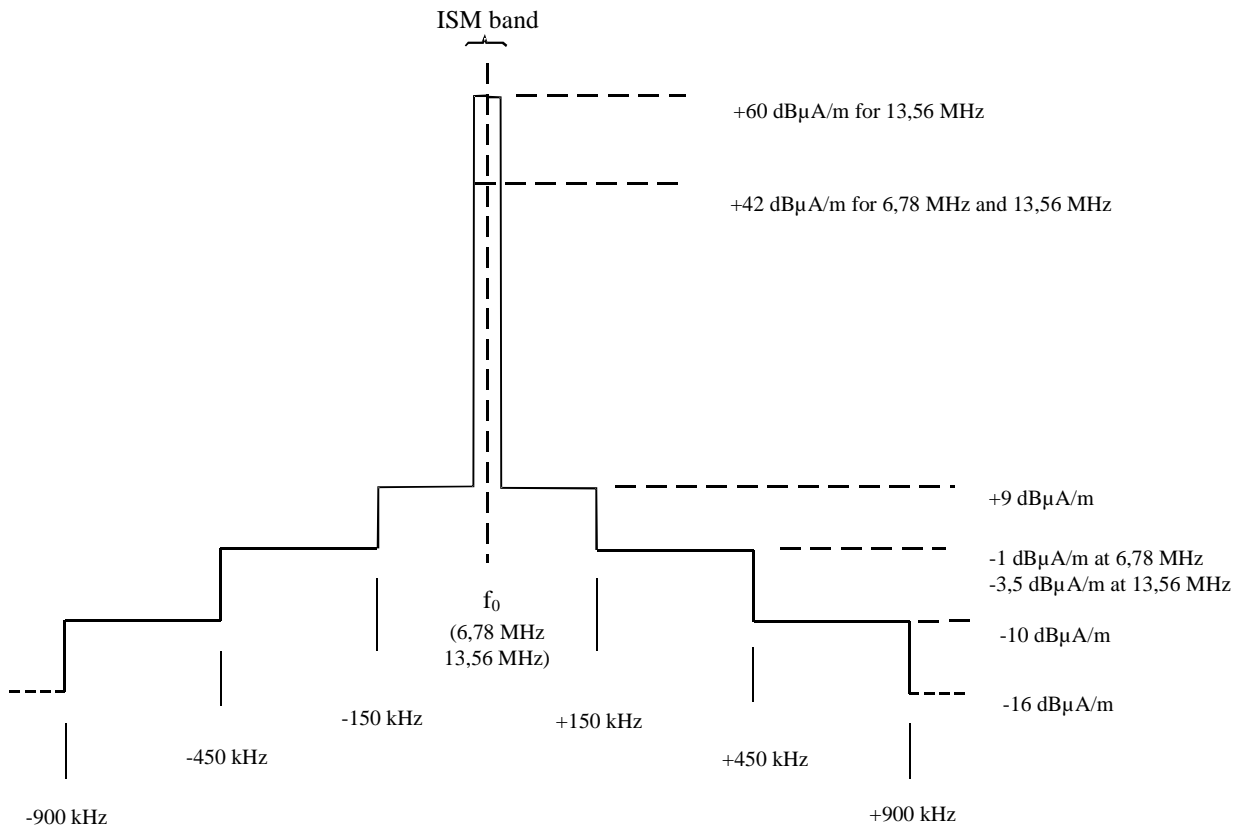

Figure G.2: Spectrum mask limit for RFIDs and EAS in the 6,78 MHz and 13,56 MHz range

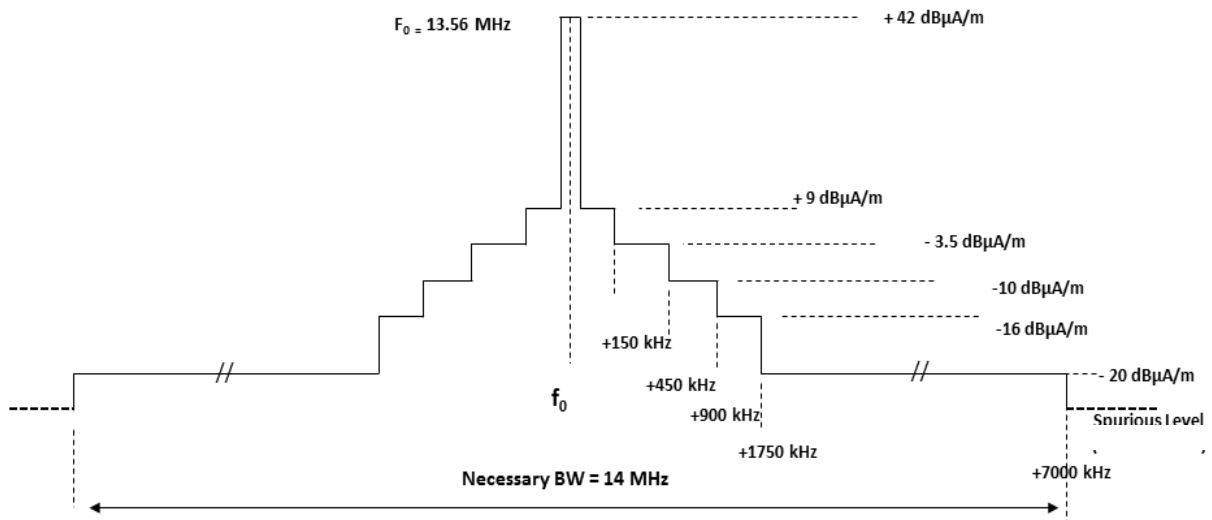

Figure G.3: Spectrum mask limit for wideband RFIDs in the 13,56 MHz range



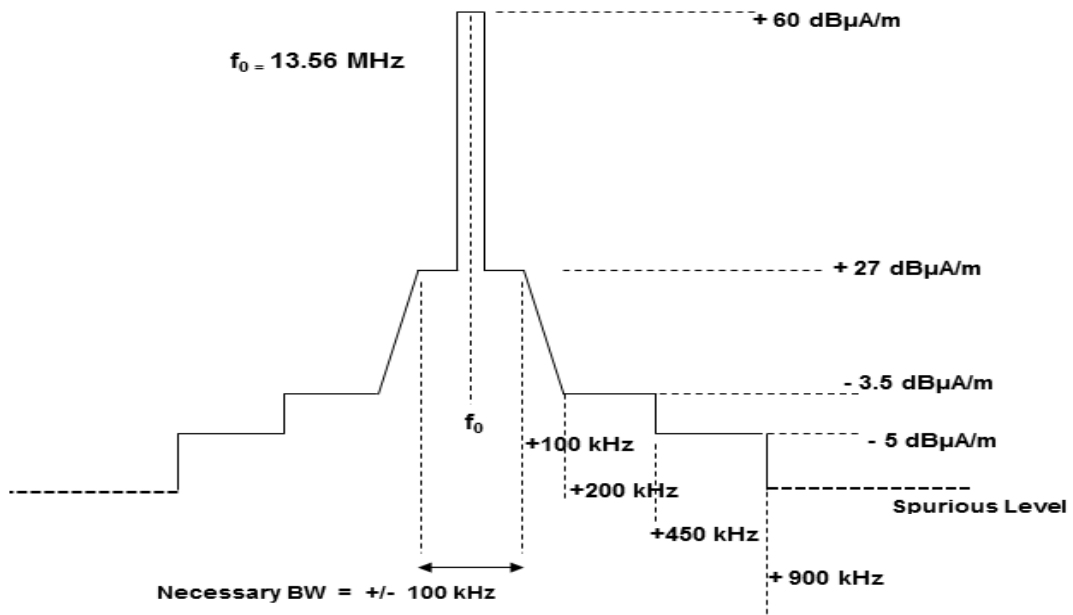

Figure G 4: Spectrum mask limit for narrowband RFIDs in the 13,56 MHz range

---

## Annex H (normative): Generic inductive loop limits in the frequency range 148,5 kHz to 30 MHz

### H.1 Introduction

The present annex provides additional information to the measurement of inductive systems at very low magnetic field-strength levels.

---

### H.2 Radiated H-field strength

#### H.2.1 Methods of measurements

The methods of measurements should be in accordance with clause 7.2.1.2 with the following additional provisions, either:

- a) For equipment where the transmitter modulation can be switched off, the following measurements apply:

- Step 1 The transmitter modulation is switched off and the H-field strength is measured at 10 m distance according to clause 7.2 of the present document by using quasi peak detector and a 10 kHz resolution bandwidth. The result is recorded in the test report as the total field strength.
- Step 2 The transmitter modulation is switched on and the bandwidth of the transmitter is measured in accordance with clauses 7.3.1 indent b) and 7.3.2. The result is recorded in the test report.
- Step 3 The frequency for maximum value of the spectrum is determined. The frequency is adjusted to the centre of the spectrum analyser screen.
- Step 4 The spectrum analyser span is changed to zero Hz and the detector is switched from quasi peak to positive peak. The measured result is recorded in the test report as the maximum H-field strength density.

Or:

- b) For equipment where the transmitter modulation cannot be switched off, the following measurements apply:

Steps 2 through 4 are conducted.

Step 1 is not relevant and cannot be conducted.

For H-field density measurements of the carrier for an ASK modulated transmitter operating in the range 400 kHz to 600 kHz, where the modulation cannot be switched off a 3 dB value can be subtracted from the measurement value.

#### H.2.2 Radiated H-field strength limit

##### H.2.2.1 Radiated total H-field and H-field density limits according to the measurements in clause H.2.1 indent a)

This limit applies for equipment where the transmitter modulation can be switched off.

Under normal and extreme test conditions (see clauses 5.3 and 5.4), the radiated transmitter H-field strength for clause H.2.1 indent a) should not exceed the limits for total field strength and field density given in tables H.1 and H.2.

**Table H.1: Radiated H-field strength and H-field density limits at 10 m distance**

Frequency range MHz	Total H-field strength at 10 m dB $\mu$ A/m	H-field strength density at 10 m in a 10 kHz resolution bandwidth dB $\mu$ A/m
0,1485 to 30,0	-5 (note 1)	-15 (note 2)

NOTE 1: Without transmitter modulation.  
NOTE 2: With transmitter modulation.

For RFID equipment operating in the frequency range 400 kHz to 600 kHz the following limit applies:

**Table H.2: Radiated H-field strength and H-field density limits at 10 m distance for RFID equipment**

Frequency range MHz	Total H-field strength at 10 m dB $\mu$ A/m	H-field strength density at 10 m in a 10 kHz resolution bandwidth dB $\mu$ A/m
0,400 to 0,600	-5 (note 1)	-8 (note 1)

NOTE 1: With transmitter modulation.  
NOTE 2: The transmitted bandwidth should not be less than 30 kHz.

### H.2.2.2 Radiated bandwidth and H-field density limits according to the measurements in clause H.2.1 indent b)

This limit applies for equipment where the transmitter modulation cannot be switched off.

Under normal and extreme test conditions (see clauses 5.3 and 5.4), the radiated transmitter H-field strength for clause H.2.1 indent b) should not exceed the limits for field density and bandwidth given in figure H.1.

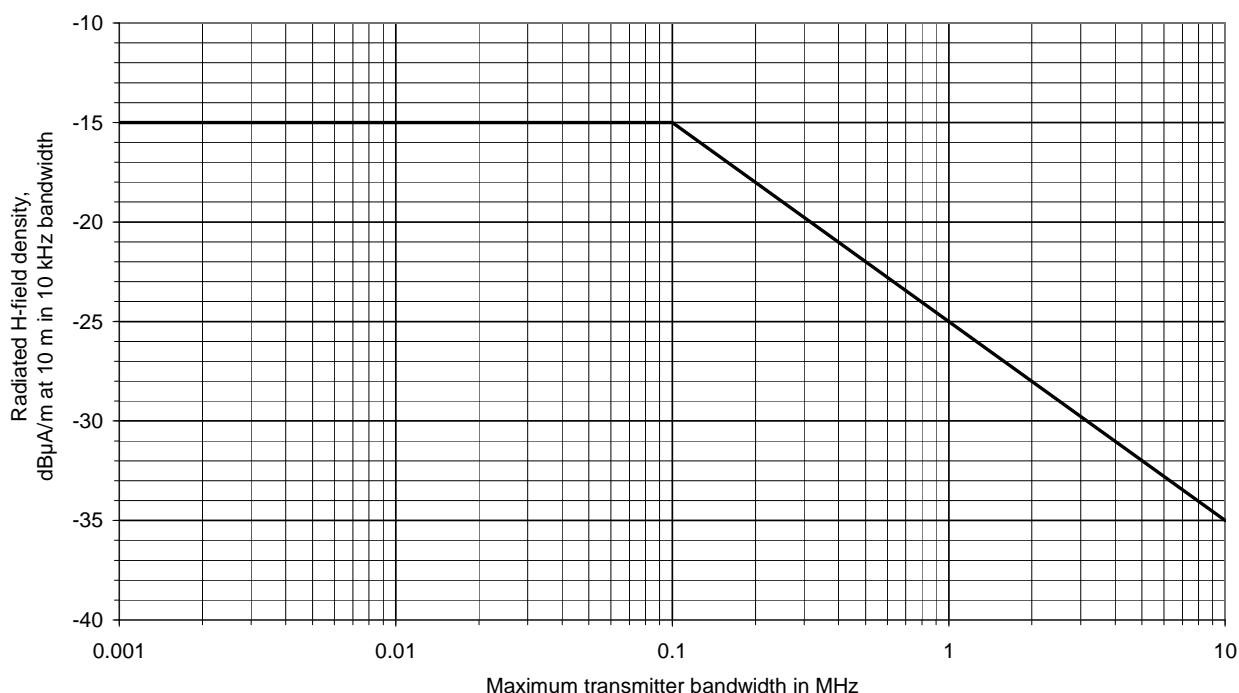
**Figure H.1: Radiated bandwidth and H-field density at 10 m distance**

## H.3 Other requirements

Other requirements should be in accordance with the present document.

---

## Annex I (informative): Determination and use of the measurement bandwidth

CISPR 16-2-3 [i.12] specifies a reference bandwidth for the measurement of unwanted emissions by measurement receivers and spectrum analysers.

The reference bandwidth ( $BW_{REFERENCE}$ ) cannot always be used as the measurement bandwidth ( $BW_{MEASUREMENT}$ ). This is particularly the case if the measurement is to be made for example on the slope of a spectrum mask or a receiver selectivity curve. In such situations the measurement should be made with a sufficiently low bandwidth in order not to distort the reading.

The actual measured value, A, should be referred back to the reference bandwidth by.

Either:

- a) Correcting the measured value, A, for any signal having a flat level spectrum with the following formula:

$$B = A + 10 \log \frac{BW_{REFERENCE}}{BW_{MEASURED}}$$

where:

- B is the measured level, A, transferred to the reference bandwidth.

Or:

- b) Use the measured value, A, directly if the measured spectrum is a discrete spectral line.

A discrete spectrum line is defined as a narrow peak with a level of at least 6 dB above the average level inside the measurement bandwidth.

---

## Annex J (informative): Other limits

Other limits are covered within this annex. National administrations should be consulted for approval prior for the use of these limits.

**Table J.1: Other limits**

<b>Frequency range (MHz)</b>	<b>H-field strength limit (<math>H_f</math>) dB<math>\mu</math>A/m at 10 m</b>
$0,135 \leq f < 1,0$	37,7 at 0,135 MHz descending 3 dB/oct
$1,0 \leq f < 4,642$	29 at 1,0 MHz descending 9 dB/oct
$4,642 \leq f < 30$	9

---

## Annex K (informative): Bibliography

- ERC Report 044 (1997): "Sharing between inductive systems and radiocommunication systems in the band 9 - 135 kHz".
- ERC Report 069: "Propagation model and interference range calculation for inductive systems 10 kHz - 30 MHz".
- ERC Report 074: "Compatibility between Radio Frequency Identification Devices (RFID) and the radioastronomy service at 13 MHz".
- ERC Report 092: "Sharing between inductive SRD systems and radio communication systems operating in the frequency band 10.2 - 11 MHz".
- ECC Report 001: "Compatibility between inductive LF and HF RFID transponder and other radio communications systems in the frequency ranges 135-148.5 kHz, 4.78-8.78 MHz and 11.56-15.56 MHz".
- ECC Report 007: "Compatibility between inductive LF RFID systems and radio communications systems in the frequency range 135-148.5 kHz".
- Council Directive 89/336/EEC of 3 May 1989 on the approximation of the laws of the Member States relating to electromagnetic compatibility.
- ERC Decision of 12 March 2001 on harmonised frequencies, technical characteristics and exemption from individual licensing of Short Range Devices used for inductive applications operating in the frequency bands 9 - 59.750 kHz, 59.750 - 60.250 kHz, 60.250 - 70 kHz, 70 - 119 kHz, 119 - 135 kHz; (ERC/DEC(01)13).
- ERC Decision of 12 March 2001 on harmonised frequencies, technical characteristics and exemption from individual licensing of Short Range Devices used for inductive applications operating in the frequency bands 6765 - 6795 kHz, 13.553 - 13.567 MHz; (ERC/DEC(01)14).
- ERC Decision of 12 March 2001 on harmonised frequencies, technical characteristics and exemption from individual licensing of Short Range Devices used for inductive applications operating in the frequency band 7400 - 8800 kHz (ERC/DEC(01)15).
- ERC Decision of 12 March 2001 on harmonised frequencies, technical characteristics and exemption from individual licensing of Short Range Devices used for inductive applications operating in the frequency band 26.957 - 27.283 MHz (ERC/DEC(01)16).
- Directive 98/34/EC of the European Parliament and of the Council of 22 June 1998 laying down a procedure for the provision of information in the field of technical standards and regulations.
- IEC 60489-3: "Methods of measurement for radio equipment used in the mobile services. Part 3: Receivers for A3E or F3E emissions".
- ETSI EG 201 399: "Electromagnetic compatibility and Radio spectrum Matters (ERM); A guide to the production of candidate Harmonized Standards for application under the R&TTE Directive".
- CENELEC EN 55022: "Information technology equipment - Radio disturbance characteristics - Limits and methods of measurement".

# History

<b>Document history</b>		
Edition 1	December 1994	Publication as ETSI I-ETS 300 330
Amendment 1	January 1997	Amendment 1 to 1 <sup>st</sup> Edition of ETSI I-ETS 300 330
V1.2.2	May 1999	Publication as ETSI EN 300 330
V1.3.1	June 2001	Publication
V1.3.2	December 2002	Publication
V1.5.1	April 2006	Publication
V1.7.1	February 2010	Publication
V1.8.0	June 2014	EN Approval Procedure                      AP 20141017:    2014-06-19 to 2014-10-17
V1.8.1	December 2014	Vote    V 20150220:    2014-12-22 to 2015-02-20