



**Short Range Devices (SRD);  
Radio equipment in the frequency range  
9 kHz to 25 MHz and inductive loop systems  
in the frequency range 9 kHz to 30 MHz;  
Harmonised Standard covering the essential requirements  
of article 3.2 of Directive 2014/53/EU**

---

Reference

REN/ERM-TG28-507

---

Keywords

harmonised standard, radio, RFID, SRD, testing

**ETSI**

650 Route des Lucioles  
F-06921 Sophia Antipolis Cedex - FRANCE

Tel.: +33 4 92 94 42 00 Fax: +33 4 93 65 47 16

Siret N° 348 623 562 00017 - NAF 742 C  
Association à but non lucratif enregistrée à la  
Sous-Préfecture de Grasse (06) N° 7803/88

---

**Important notice**

The present document can be downloaded from:  
<http://www.etsi.org/standards-search>

The present document may be made available in electronic versions and/or in print. The content of any electronic and/or print versions of the present document shall not be modified without the prior written authorization of ETSI. In case of any existing or perceived difference in contents between such versions and/or in print, the only prevailing document is the print of the Portable Document Format (PDF) version kept on a specific network drive within ETSI Secretariat.

Users of the present document should be aware that the document may be subject to revision or change of status. Information on the current status of this and other ETSI documents is available at  
<https://portal.etsi.org/TB/ETSIDeliverableStatus.aspx>

If you find errors in the present document, please send your comment to one of the following services:  
<https://portal.etsi.org/People/CommitteeSupportStaff.aspx>

---

**Copyright Notification**

No part may be reproduced or utilized in any form or by any means, electronic or mechanical, including photocopying and microfilm except as authorized by written permission of ETSI.

The content of the PDF version shall not be modified without the written authorization of ETSI.  
The copyright and the foregoing restriction extend to reproduction in all media.

© European Telecommunications Standards Institute 2016.  
All rights reserved.

**DECT™**, **PLUGTESTS™**, **UMTS™** and the ETSI logo are Trade Marks of ETSI registered for the benefit of its Members.  
**3GPP™** and **LTE™** are Trade Marks of ETSI registered for the benefit of its Members and of the 3GPP Organizational Partners.  
**GSM®** and the GSM logo are Trade Marks registered and owned by the GSM Association.

# Contents

Intellectual Property Rights .....	8
Foreword.....	8
Modal verbs terminology.....	8
Introduction .....	8
1 Scope .....	10
2 References .....	11
2.1 Normative references .....	11
2.2 Informative references.....	11
3 Definitions, symbols and abbreviations .....	12
3.1 Definitions.....	12
3.2 Symbols.....	13
3.3 Abbreviations .....	13
4 Technical requirements specifications .....	14
4.1 Environmental conditions.....	14
4.2 General .....	14
4.2.1 General performance criteria .....	14
4.2.2 Presentation of equipment for testing purposes .....	14
4.2.2.0 General .....	14
4.2.2.1 Choice of model for testing.....	15
4.2.2.2 Testing of equipment with alternative radiated H-field strengths .....	15
4.2.2.3 Testing of equipment that does not have an external 50 $\Omega$ RF connector (integral antenna equipment) .....	15
4.2.2.3.1 Equipment with an internal permanent or temporary antenna connector .....	15
4.2.2.3.2 Equipment with a temporary antenna connector .....	15
4.2.2.4 On-site testing .....	16
4.2.3 Mechanical and electrical design .....	16
4.2.3.1 General .....	16
4.2.3.2 Controls.....	16
4.2.3.3 Transmitter shut-off facility .....	16
4.2.3.4 Receiver mute or squelch .....	16
4.3 Transmitter conformance requirements.....	16
4.3.1 Permitted range of operating frequencies .....	16
4.3.1.1 Applicability.....	16
4.3.1.2 Description .....	16
4.3.1.3 Limits.....	16
4.3.1.4 Conformance.....	16
4.3.2 Operating frequency ranges .....	16
4.3.2.1 Applicability.....	16
4.3.2.2 Description .....	17
4.3.2.3 Limits.....	17
4.3.2.4 Conformance.....	17
4.3.3 Modulation bandwidth.....	17
4.3.3.1 Applicability.....	17
4.3.3.2 Description .....	17
4.3.3.3 Limits .....	17
4.3.3.4 Conformance.....	17
4.3.4 Transmitter H-field requirements .....	18
4.3.4.1 Applicability.....	18
4.3.4.2 Description .....	18
4.3.4.3 Limits.....	18
4.3.4.4 Conformance.....	19
4.3.5 Transmitter RF carrier current .....	19
4.3.5.1 Applicability.....	19
4.3.5.2 Description.....	19

4.3.5.3	Limits .....	19
4.3.5.4	Conformance .....	20
4.3.6	Transmitter radiated E-field .....	20
4.3.6.1	Applicability .....	20
4.3.6.2	Description .....	20
4.3.6.3	Limits .....	20
4.3.6.4	Conformance .....	20
4.3.7	Transmitter conducted spurious emissions .....	20
4.3.7.1	Applicability .....	20
4.3.7.2	Description .....	20
4.3.7.3	Limits .....	21
4.3.7.4	Conformance .....	21
4.3.8	Transmitter radiated spurious domain emission limits < 30 MHz .....	21
4.3.8.1	Applicability .....	21
4.3.8.2	Description .....	21
4.3.8.3	Limits .....	21
4.3.8.4	Conformance .....	21
4.3.9	Transmitter radiated spurious domain emission limits > 30 MHz .....	21
4.3.9.1	Applicability .....	21
4.3.9.2	Description .....	22
4.3.9.3	Limits .....	22
4.3.9.4	Conformance .....	22
4.3.10	Transmitter Frequency stability .....	22
4.3.10.1	Applicability .....	22
4.3.10.2	Description .....	22
4.3.10.3	Limits .....	22
4.3.10.4	Conformance .....	22
4.4	Receiver Conformance requirements .....	23
4.4.1	General .....	23
4.4.2	Receiver spurious emissions .....	23
4.4.2.1	Applicability .....	23
4.4.2.2	Description .....	23
4.4.2.3	Limits .....	23
4.4.2.4	Conformance .....	23
4.4.3	Adjacent channel selectivity .....	24
4.4.3.1	Applicability .....	24
4.4.3.2	Description .....	24
4.4.3.3	Limits .....	24
4.4.3.4	Conformance .....	24
4.4.4	Receiver blocking or desensitization .....	24
4.4.4.1	Applicability .....	24
4.4.4.2	Description .....	24
4.4.4.3	Limits .....	25
4.4.4.4	Conformance .....	25
5	Testing for compliance with technical requirements .....	25
5.1	Environmental conditions for testing .....	25
5.2	General conditions for testing .....	25
5.2.1	Product information .....	25
5.3	Normal and extreme test conditions .....	25
5.4	Test power source .....	26
5.4.0	General .....	26
5.4.1	External test power source .....	26
5.4.2	Internal test power source .....	26
5.5	Normal test conditions .....	26
5.5.1	Normal temperature and humidity .....	26
5.5.2	Normal test power source .....	26
5.5.2.1	Mains voltage .....	26
5.5.2.2	Regulated lead-acid battery power sources .....	27
5.5.2.3	Other power sources .....	27
5.6	Extreme test conditions .....	27
5.6.1	Extreme temperatures .....	27

5.6.1.1	Procedure for tests at extreme temperatures.....	27
5.6.1.1.0	General .....	27
5.6.1.1.1	Procedure for equipment designed for continuous operation .....	27
5.6.1.1.2	Procedure for equipment designed for intermittent operation .....	27
5.6.1.2	Extreme temperature ranges.....	28
5.6.2	Extreme test source voltages.....	28
5.6.2.1	Mains voltage .....	28
5.6.2.2	Regulated lead-acid battery power sources .....	28
5.6.2.3	Power sources using other types of batteries.....	28
5.6.2.4	Other power sources.....	28
5.7	Auxiliary test equipment .....	29
5.8	Normal test signals and test modulation.....	29
5.8.0	General.....	29
5.8.1	Normal test signals for analogue speech.....	29
5.8.2	Normal test signals for data .....	29
5.9	Artificial antenna.....	29
5.9.0	General.....	29
5.9.1	Artificial antenna for inductive transmitters (non 50 $\Omega$ ).....	29
5.9.2	Artificial antenna for transmitters with 50 $\Omega$ impedance connector.....	30
5.10	Test fixture .....	30
5.11	Test sites and general arrangements for radiated measurements .....	31
5.12	Measuring receiver .....	31
5.13	Measurement uncertainty .....	31
5.14	Interpretation of the measurement results .....	32
5.14.0	General.....	32
5.14.1	Measurement uncertainty is equal to or less than maximum acceptable uncertainty.....	32
6	Conformance methods of measurement for transmitters and receivers .....	32
6.1	Transmitter requirements .....	32
6.1.1	Transmitter definitions.....	32
6.1.2	Equipment Product Classes .....	33
6.1.3	Modes of operation of the transmitter.....	33
6.2	Conformance methods of measurement for transmitter .....	33
6.2.1	General.....	33
6.2.2	Operating frequency ranges .....	33
6.2.2.1	General .....	33
6.2.2.2	OFR measurement with spectrum analyser.....	34
6.2.3	Modulation bandwidth.....	34
6.2.4	Transmitter H-field .....	35
6.2.5	Transmitter RF carrier current .....	35
6.2.6	Transmitter radiated E-field.....	35
6.2.7	Transmitter conducted spurious emissions .....	35
6.2.7.1	Transmitter conducted spurious emissions < 30 MHz .....	35
6.2.7.2	Transmitter conducted spurious emissions $\geq$ 30 MHz .....	36
6.2.8	Transmitter radiated spurious domain emission limits < 30 MHz .....	36
6.2.9	Transmitter radiated spurious domain emission limits > 30 MHz .....	36
6.2.10	Transmitter Frequency stability under low voltage conditions.....	37
6.2.10.1	Test conditions .....	37
6.3	Conformance methods of measurement for receiver.....	37
6.3.1	Receiver spurious emissions .....	37
6.3.2	Adjacent channel selectivity .....	38
6.3.3	Receiver blocking or desensitization .....	38
6.3.3.1	Measurement for channelized, narrowband or broadband equipment.....	38
6.3.3.2	Measurement for tagging systems.....	39
<b>Annex A (informative):</b>	<b>Relationship between the present document and the essential requirements of Directive 2014/53/EU .....</b>	<b>40</b>
<b>Annex B (normative):</b>	<b>Transmitter definitions.....</b>	<b>42</b>
B.1	Transmitter definitions .....	42
B.1.0	General .....	42

B.1.1	The inductive loop coil transmitters .....	42
B.1.2	The large size loop transmitters .....	42
B.1.3	Other transmitters .....	42
B.2	Product Classes .....	42
B.2.0	General .....	42
B.2.1	Product Class 1 .....	43
B.2.2	Product Class 2 .....	43
B.2.3	Product Class 3 .....	43
B.2.4	Product Class 4 .....	44
<b>Annex C (normative):</b>	<b>Radiated measurement.....</b>	<b>46</b>
C.0	General .....	46
C.1	Test sites and general arrangements for measurements involving the use of radiated fields .....	46
C.1.0	Test sites .....	46
C.1.1	Anechoic chamber .....	46
C.1.2	Anechoic chamber with a conductive ground plane .....	47
C.1.3	Open Area Test Site (OATS) .....	49
C.1.3.0	General for OATS .....	49
C.1.3.1	Measurements below 30 MHz .....	49
C.1.3.2	Measurements above 30 MHz .....	49
C.1.4	Test antenna .....	50
C.1.5	Substitution antenna .....	51
C.1.6	Measuring antenna .....	51
C.2	Guidance on the use of radiation test sites .....	51
C.2.0	General .....	51
C.2.1	Verification of the test site .....	51
C.2.2	Preparation of the EUT .....	51
C.2.3	Power supplies to the EUT .....	52
C.2.4	Range length .....	52
C.2.4.1	Far-field length above 30 MHz .....	52
C.2.4.2	Near-field and Far-field length below 30 MHz .....	52
C.2.5	Site preparation .....	53
C.3	Coupling of signals .....	53
C.3.1	General .....	53
C.3.2	Data signals .....	53
C.4	Standard test position .....	54
C.5	Test fixture .....	54
C.5.0	Usage Test fixture .....	54
C.5.1	Description .....	54
C.5.2	Calibration .....	55
C.5.3	Mode of use .....	56
C.6	Technical performance of the spectrum analyser .....	56
<b>Annex D (normative):</b>	<b>H-field limit correction factor for generated E-fields.....</b>	<b>57</b>
<b>Annex E (normative):</b>	<b>Customized loop antennas.....</b>	<b>58</b>
E.1	Product classes related to the antenna loop .....	58
E.2	Antenna loops below 1 MHz .....	58
E.3	Antenna loops above 1 MHz .....	59
<b>Annex F (informative):</b>	<b>Artificial antenna for measuring inductive transmitter carrier and harmonic currents (Product Class 3 only).....</b>	<b>60</b>
<b>Annex G (informative):</b>	<b>E-fields in the near field at low frequencies.....</b>	<b>62</b>

<b>Annex H (normative):</b>	<b>H-field measurements and limits at 3 m and 30 m .....</b>	<b>64</b>
H.0	General .....	64
H.1	Limits for measurements at 30 m distance .....	64
H.2	Limits for measurements at 3 m distance .....	65
<b>Annex I (normative):</b>	<b>Transmitter emission levels and spectrum mask measurements.....</b>	<b>67</b>
<b>Annex J (normative):</b>	<b>Generic inductive loop limits in the frequency range 148,5 kHz to 30 MHz .....</b>	<b>70</b>
J.1	Introduction .....	70
J.2	Radiated H-field strength .....	70
J.2.1	Methods of measurements .....	70
J.2.2	Radiated H-field strength limit .....	70
J.2.2.1	Radiated total H-field and H-field density limits according to the measurements in clause J.2.1 indent a) .....	70
J.2.2.2	Radiated bandwidth and H-field density limits according to the measurements in clause J.2.1 indent b) .....	71
<b>Annex K (informative):</b>	<b>Determination and use of the measurement bandwidth.....</b>	<b>72</b>
<b>Annex L (informative):</b>	<b>Bibliography .....</b>	<b>73</b>
<b>Annex M (informative):</b>	<b>Change History .....</b>	<b>76</b>
History .....		77

---

## Intellectual Property Rights

IPRs essential or potentially essential to the present document may have been declared to ETSI. The information pertaining to these essential IPRs, if any, is publicly available for **ETSI members and non-members**, and can be found in ETSI SR 000 314: "*Intellectual Property Rights (IPRs); Essential, or potentially Essential, IPRs notified to ETSI in respect of ETSI standards*", which is available from the ETSI Secretariat. Latest updates are available on the ETSI Web server (<https://ipr.etsi.org>).

Pursuant to the ETSI IPR Policy, no investigation, including IPR searches, has been carried out by ETSI. No guarantee can be given as to the existence of other IPRs not referenced in ETSI SR 000 314 (or the updates on the ETSI Web server) which are, or may be, or may become, essential to the present document.

---

## Foreword

This final draft Harmonised European Standard (EN) has been produced by ETSI Technical Committee Electromagnetic compatibility and Radio spectrum Matters (ERM), and is now submitted for the Vote phase of the ETSI standards EN Approval Procedure.

The present document has been prepared under the Commission's standardisation request C(2015) 5376 final [i.11] to provide one voluntary means of conforming to the essential requirements of Directive 2014/53/EU on the harmonisation of the laws of the Member States relating to the making available on the market of radio equipment and repealing Directive 1999/5/EC [i.4].

Once the present document is cited in the Official Journal of the European Union under that Directive, compliance with the normative clauses of the present document given in table A.1 confers, within the limits of the scope of the present document, a presumption of conformity with the corresponding essential requirements of that Directive and associated EFTA regulations.

<b>Proposed national transposition dates</b>	
Date of latest announcement of this EN (doa):	3 months after ETSI publication
Date of latest publication of new National Standard or endorsement of this EN (dop/e):	6 months after doa
Date of withdrawal of any conflicting National Standard (dow):	18 months after doa

---

## Modal verbs terminology

In the present document "**shall**", "**shall not**", "**should**", "**should not**", "**may**", "**need not**", "**will**", "**will not**", "**can**" and "**cannot**" are to be interpreted as described in clause 3.2 of the [ETSI Drafting Rules](#) (Verbal forms for the expression of provisions).

"**must**" and "**must not**" are **NOT** allowed in ETSI deliverables except when used in direct citation.

---

## Introduction

The present document has been prepared to conform to the requirements of the new Radio Equipment Directive (RED) [i.4].

The present document is structured as follows:

- Clause 2 provides references.
- Clause 3 provides definitions, symbols and abbreviations.



- Clause 4 provides technical requirements specifications.
- Clause 5 provides the testing procedures for compliance with technical requirements.
- Clause 6 provides conformance methods of measurement for transmitters and receivers.
- Annex A (informative): Relationship between the present document and the essential requirements of Directive 2014/53/EU.
- Annex B (normative): Transmitter definitions.
- Annex C (normative): Radiated measurement.
- Annex D (normative): H-field limit correction factor for generated E-fields.
- Annex E (normative): Customized loop antennas.
- Annex F (informative): Artificial antenna for measuring inductive transmitter carrier and harmonic currents (Product Class 3 only).
- Annex G (informative): E-fields in the near field at low frequencies.
- Annex H (normative): H-field measurements and limits at 3 m and 30 m.
- Annex I (normative): Transmitter emission levels and spectrum mask measurements.
- Annex J (normative): Generic inductive loop limits in the frequency range 148,5 kHz to 30 MHz.
- Annex K (informative): Determination and use of the measurement bandwidth.
- Annex L (informative): Bibliography.
- Annex M (informative): Change History.

# 1 Scope

The present document specifies technical characteristics and methods of measurements for the following Short Range Device major equipment types:

- 1) Generic Short range Devices including transmitters and receivers operating in the range from 9 kHz to 25 MHz; and
- 2) inductive loop transmitters and receivers operating from 9 kHz to 30 MHz including Radio Frequency Identification (RFID), Near Field Communication (NFC) and Electronic Article Surveillance (EAS) operating in LF and HF ranges.

Also the present document covers fixed, mobile and portable stations.

NOTE: If a system includes transponders, these are measured together with the transmitter.

These radio equipment types are capable of operating in the permitted frequency bands within the 9 kHz to 30 MHz range as specified in table 1.

**Table 1: Short Range Devices within the 9 kHz to 30 MHz permitted frequency bands**

	Frequency Bands/frequencies	Applications
Transmit and Receive	9 kHz to 90 kHz	Inductive devices, Generic use
Transmit and Receive	90 kHz to 119 kHz	Inductive devices, Generic use
Transmit and Receive	119 kHz to 140 kHz	Inductive devices, Generic use
Transmit and Receive	140 kHz to 148,5 kHz	Inductive devices, Generic use
Transmit and Receive	148,5 kHz to 5 MHz	Inductive devices, Generic use
Transmit and Receive	400 kHz to 600 kHz	RFID only
Transmit and Receive	5 MHz to 30 MHz	Inductive devices, Generic use
Transmit and Receive	3 155 kHz to 3 400 kHz	Inductive devices, Generic use
Transmit and Receive	984 kHz to 7 484 kHz (Note 3, Centre frequency is 4 234 kHz)	Inductive devices, Railway applications
Transmit and Receive	4 516 kHz	Inductive devices, Railway applications
Transmit and Receive	6 765 kHz to 6 795 kHz	Inductive devices, Generic use
Transmit and Receive	7 400 kHz to 8 800 kHz	Inductive devices, Generic use
Transmit and Receive	10 200 kHz to 11,000 MHz	Inductive devices, Generic use
Transmit and Receive	11,810 MHz to 15,310 MHz (Centre frequency is 13,56 MHz)	RFID only
Transmit and Receive	12,5 MHz to 20 MHz	Inductive devices, Wireless healthcare
Transmit and Receive	13,553 MHz to 13,567 MHz	Inductive devices, Generic use
Transmit and Receive	26,957 MHz to 27,283 MHz	Inductive devices, Generic use
Transmit and Receive	27,090 MHz to 27,100 MHz	Inductive devices, Railway applications
NOTE 1: In addition, it should be noted that other frequency bands may be available in a country within the frequency range 9 kHz to 30 MHz.		
NOTE 2: On non-harmonised parameters, national administrations may impose certain conditions such as the type of modulation, frequency, channel/frequency separations, maximum transmitter radiated power, duty cycle, and the inclusion of an automatic transmitter shut-off facility, as a condition for the issue of an Individual Rights for use of spectrum or General Authorization, or as a condition for use under "licence exemption" as it is in most cases for Short Range Devices.		
NOTE 3: Transmitting only on receipt of a Balise/Eurobalise tele-powering signal from a train.		

The frequency ranges and limits of the present document are based on the European Commission Decision for SRDs [i.10], CEPT/ERC/REC 70-03 [i.1].

When selecting parameters for new SRDs, which may have inherent safety of human life implications, manufacturers and users should pay particular attention to the potential for interference from other systems operating in the same or adjacent bands.

The radio equipment, covered by the present document is divided into several classes which are dependent on the antenna used (see annex B). Three types of measuring methods are defined in the present document due to the varied nature of the antenna types for equipment used in this band. One method measures the RF carrier current, another measures the radiated H-field and the third conducted power.

The present document covers the essential requirements of article 3.2 of Directive 2014/53/EU [i.4] under the conditions identified in annex A.

---

## 2 References

### 2.1 Normative references

References are specific, identified by date of publication and/or edition number or version number. Only the cited version applies.

Referenced documents which are not found to be publicly available in the expected location might be found at <https://docbox.etsi.org/Reference/>.

NOTE: While any hyperlinks included in this clause were valid at the time of publication, ETSI cannot guarantee their long term validity.

The following referenced documents are necessary for the application of the present document.

- [1] Void.
- [2] CISPR 16-1-4:2010+AMD1:2012: "Specification for radio disturbance and immunity measuring apparatus and methods - Part 1-4: Radio disturbance and immunity measuring apparatus - Antennas and test sites for radiated disturbance measurements".

### 2.2 Informative references

References are either specific (identified by date of publication and/or edition number or version number) or non-specific. For specific references, only the cited version applies. For non-specific references, the latest version of the referenced document (including any amendments) applies.

NOTE: While any hyperlinks included in this clause were valid at the time of publication, ETSI cannot guarantee their long term validity.

The following referenced documents are not necessary for the application of the present document but they assist the user with regard to a particular subject area.

- [i.1] CEPT/ERC/REC 70-03: "Relating to the use of Short Range Devices (SRD)".
- [i.2] Recommendation ITU-T O.153: "Basic parameters for the measurement of error performance at bit rates below the primary rate".
- [i.3] ANSI C63.5: "American National Standard for Electromagnetic Compatibility-Radiated Emission Measurements in Electromagnetic Interference (EMI) Control-Calibration of Antennas (9 kHz to 40 GHz)".
- [i.4] Directive 2014/53/EU of the European Parliament and of the Council of 16 April 2014 on the harmonisation of the laws of the Member States relating to the making available on the market of radio equipment and repealing Directive 1999/5/EC Text with EEA relevance.
- [i.5] ETSI TR 102 273-2: "Electromagnetic compatibility and Radio spectrum Matters (ERM); Improvement on Radiated Methods of Measurement (using test site) and evaluation of the corresponding measurement uncertainties; Part 2: Anechoic chamber".
- [i.6] ETSI TR 102 273-3: "Electromagnetic compatibility and Radio spectrum Matters (ERM); Improvement on Radiated Methods of Measurement (using test site) and evaluation of the corresponding measurement uncertainties; Part 3: Anechoic chamber with a ground plane".
- [i.7] ETSI TR 102 273-4: "Electromagnetic compatibility and Radio spectrum Matters (ERM); Improvement on Radiated Methods of Measurement (using test site) and evaluation of the corresponding measurement uncertainties; Part 4: Open area test site".

- [i.8] Void.
- [i.9] ETSI TR 103 059 (V1.2.1): "Electromagnetic compatibility and Radio spectrum Matters (ERM); Short-Range Devices (SRD) for operation in the 13,56 MHz band; System Reference Document for Radio Frequency Identification (RFID) equipment".
- [i.10] Commission Decision 2013/752/EC on harmonisation of the radio spectrum for use by short-range devices as amended by subsequent Commission Decisions.
- [i.11] Commission Implementing Decision C(2015) 5376 final of 4.8.2015 on a standardisation request to the European Committee for Electrotechnical Standardisation and to the European Telecommunications Standards Institute as regards radio equipment in support of Directive 2014/53/EU of the European Parliament and of the Council.
- [i.12] Recommendation ITU-T O.41: "Psophometer for use on telephone-type circuits".
- [i.13] ITU Radio Regulations.
- [i.14] ETSI TR 100 028 (all parts) (V1.4.1) (12-2001): "Electromagnetic compatibility and Radio spectrum Matters (ERM); Uncertainties in the measurement of mobile radio equipment characteristics".

---

## 3 Definitions, symbols and abbreviations

### 3.1 Definitions

For the purposes of the present document, the following terms and definitions apply:

**artificial antenna:** tuned reduced-radiating dummy load equal to the nominal impedance specified by the manufacturer

**assigned frequency band:** frequency band within which the device is authorized to operate

**co-location:** assembly where Transmitter and Receiver contained in one case or unit

NOTE: Co-location is usually defined as < 3 m.

**conducted measurements:** measurements which are made using a direct connection to the equipment under test

**customized antenna:** antenna built according to manufacturers' antenna design rules inside tested limits

**dedicated antenna:** removable antenna supplied and type tested with the radio equipment, designed as an indispensable part of the equipment

NOTE: The antenna has been designed or developed for one or more specific types of equipment. It is the combination of dedicated antenna and radio equipment that is expected to be compliant with the regulations.

**fixed station:** equipment intended for use in a fixed location

**integral antenna:** antenna designed as a fixed part of the equipment, without the use of an external connector and as such which cannot be disconnected from the equipment by the user

**magnetic dipole moment:** product of (Number of coil turns)  $\times$  (coil area)  $\times$  (coil current)

NOTE: Air coils only.

**mobile station:** equipment normally installed in a vehicle

**portable station:** equipment intended to be carried, attached or implanted

**radiated measurements:** measurements which involve the absolute measurement of a radiated field

**spurious emissions:** emissions on a frequency or frequencies which are outside the occupied bandwidth and the level of which may be reduced without affecting the corresponding transmission of information

**tagging systems:** RFID, anti-theft, access control, location systems and NFC

NOTE: These kind of equipment consists of a transmitter(s), receiver(s) (or a combination of the two) and an antenna(s) to identify objects by means of a transponder.

**transponder:** device that responds to an interrogation signal

## 3.2 Symbols

For the purposes of the present document, the following symbols apply:

$\Omega$	ohm
A	loop antenna area
C	correction factor
E	electrical field strength
f	frequency
$f_A$	frequency generator A
$f_B$	frequency generator B
$f_C$	centre frequency of the OFR
$f_H$	highest frequency of the OFR
$f_L$	lowest frequency
$f_c$	carrier frequency in Hz
H	magnetic field strength
H <sub>ef</sub>	H field-strength generated by an e-field antenna
H <sub>f</sub>	H-field-strength limit
H <sub>c</sub>	carrier H-field strength
H <sub>s</sub>	H-field-strength limit for radiated spurious emissions
I <sub>c</sub>	transmitter carrier output current
I <sub>s</sub>	transmitter spurious output current
$\lambda$	Wave length
m	magnetic dipole moment
N	number of turns for a loop antenna
N <sub>B</sub>	variable defined in table 10 to calculate the frequency for RX-blocking test, see clause 6.3.3.1
NIA	Product of $N$ (the number of turns of the loop coil) $\times I$ (current in the loop coil) $\times A$ (the area of the loop coil antenna)
P	Power
t	time

## 3.3 Abbreviations

For the purposes of the present document, the following abbreviations apply:

ASK	Amplitude Shift Keying
BER	Bit Error Rate
CEPT	Conférence Européenne des Postes et Télécommunications
CISPR	Comité International Spécial des Perturbations Radioélectriques
e.r.p.	effective radiated power
EAS	Electronic Article Surveillance
EC	European Community
ECC	Electronic Communications Committee
EFTA	European Free Trade Association
EMC	ElectroMagnetic Compatibility
EMF/emf	ElectroMagnetic Field
ERC	European Radiocommunications Committee
EU	European Union

EUT	Equipment Under Test
HF	High Frequency (range)
ISM	Industrial, Scientific and Medical
ITU-T	ITU-Telecommunication sector
LF	Low Frequency
ND	Noise and Distortion
NFC	Near Field Communication
NRI	National Radio Interfaces
OATS	Open Area Test Site
OBW	Occupied BandWidth
OFR	Operating Frequency Range
R&TTE	Radio and Telecommunications Terminal Equipment
RF	Radio Frequency
RFID	Radio Frequency Identification
RMS	Root Mean Square
RX	Receiver
SND	Signal, Noise and Distortion
SND/ND	Signal, Noise and Distortion over Noise and Distortion
SRD	Short Range Device
TR	Technical Report
TX	Transmitter
VSWR	Voltage Standing Wave Ratio

---

## 4 Technical requirements specifications

### 4.1 Environmental conditions

The technical requirements of the present document apply under the environmental profile for operation of the equipment, which shall be declared by the manufacturer. The equipment shall comply with all the technical requirements of the present document which are identified as applicable in annex A at all times when operating within the boundary limits of the declared operational environmental profile. Normal and extreme tests conditions are defined in clauses 5.5 and 5.6.

### 4.2 General

#### 4.2.1 General performance criteria

For the purpose of the receiver performance tests, the receiver will produce an appropriate output under normal conditions as indicated below:

- a SND/ND ratio of 20 dB, measured at the receiver output through a telephone psophometric weighting network as described in Recommendation ITU-T O.41 [i.12];
- after demodulation, a data signal with a bit error ratio of  $10^{-2}$ ; or
- after demodulation, a message acceptance ratio of 80 %.

Where the indicated performance cannot be achieved or if it is defined differently, the manufacturer shall declare and publish the performance criteria used to determine the performance of the receiver.

#### 4.2.2 Presentation of equipment for testing purposes

##### 4.2.2.0 General

Each equipment submitted for testing shall fulfil the requirements of the present document on all frequencies over which it is intended to operate.

The manufacturer shall declare the frequency ranges, the range of operating conditions and power requirements as applicable, to establish the appropriate test conditions.

Additionally, technical documentation and operating manuals, sufficient to make the test, shall be supplied.

A test fixture for equipment with an integral antenna may be supplied by the manufacturer (see clause 5.10). For equipment supplied without an antenna i.e. Product Class 3 as defined in clause B.2, the manufacturer will supply either a tuned reduced radiating load (see clause 5.9.1 or an artificial antenna as defined by annex F).

To simplify and harmonise the testing procedures between different testing laboratories, measurements shall be performed, according to the present document, on samples defined in clauses 4.2.2.1 to 4.2.2.4.

#### 4.2.2.1 Choice of model for testing

The manufacturer shall provide one or more samples of the equipment, as appropriate for testing.

Stand alone equipment shall be offered by the manufacturer complete with any ancillary equipment needed for testing.

If an equipment has several optional features, considered not to affect the RF parameters then the tests need only to be performed on the equipment configured with that combination of features considered to be the most complex, as proposed by the manufacturer and agreed by the test laboratory.

Where practicable, equipment offered for testing shall provide a 50  $\Omega$  connector for conducted RF power level measurements.

In the case of integral antenna equipment, if the equipment does not have an internal permanent 50  $\Omega$  connector then it is permissible to supply a second sample of the equipment with a temporary antenna connector fitted to facilitate testing, see clause 4.2.2.3.

The performance of the equipment submitted for testing shall be representative of the performance of the corresponding production model.

#### 4.2.2.2 Testing of equipment with alternative radiated H-field strengths

If a family of equipment has alternative radiated field strengths provided by the use of separate power modules or add on stages, then these shall be declared by the manufacturer. Each module or add on stage shall be tested in combination with the equipment. As a minimum and on samples of equipment defined in clause 4.2.2.1, measurements of the radiated H-field strength and spurious emissions shall be performed for each combination and shall be stated in the test report.

#### 4.2.2.3 Testing of equipment that does not have an external 50 $\Omega$ RF connector (integral antenna equipment)

##### 4.2.2.3.1 Equipment with an internal permanent or temporary antenna connector

The means to access and/or implement the internal permanent or temporary antenna connector shall be stated by the manufacturer with the aid of a diagram. The fact that use has been made of the internal antenna connection, or of a temporary connection, to facilitate measurements shall be recorded in the test report.

##### 4.2.2.3.2 Equipment with a temporary antenna connector

The manufacturer may submit one set of equipment with the normal antenna connected, to enable radiated measurements to be made. The manufacturer shall attend the test laboratory at the conclusion of the radiated measurements, to disconnect the antenna and fit the temporary connector. The testing laboratory staff shall not connect or disconnect any temporary antenna connector.

Alternatively, the manufacturer may submit two sets of equipment to the test laboratory, one fitted with a temporary antenna connector with the antenna disconnected and another equipment with the antenna connected. Each equipment shall be used for the appropriate tests. The manufacturer shall declare that the two sets of equipment are identical in all aspects except for the antenna connector.

#### 4.2.2.4 On-site testing

In certain cases it may not be possible to provide representative samples of antennas and/or equipment due to physical constraints. In these cases equivalent measurements to the present document shall be made at a representative installation of the equipment (on-site).

### 4.2.3 Mechanical and electrical design

#### 4.2.3.1 General

Transmitters and receivers may be individual or combination units.

#### 4.2.3.2 Controls

Those controls which, if maladjusted, might increase the interfering potentialities of the equipment shall not be easily accessible to the user.

#### 4.2.3.3 Transmitter shut-off facility

If the transmitter is equipped with an automatic transmitter shut-off facility, it should be made inoperative for the duration of the test.

#### 4.2.3.4 Receiver mute or squelch

If the receiver is equipped with a mute, squelch or battery-saving circuit, this circuit shall be made inoperative for the duration of the tests.

## 4.3 Transmitter conformance requirements

### 4.3.1 Permitted range of operating frequencies

#### 4.3.1.1 Applicability

This applies to all EUT.

#### 4.3.1.2 Description

The permitted range of operating frequencies is the frequency range over which the equipment is authorized to operate.

#### 4.3.1.3 Limits

The permitted range of operating frequencies for intentional emissions shall be entirely within the frequency bands in table 1.

#### 4.3.1.4 Conformance

The permitted range of operating frequencies used by the EUT shall be declared by the manufacturer. The operating frequency range(s) will be tested considered under in clause 4.3.2.

### 4.3.2 Operating frequency ranges

#### 4.3.2.1 Applicability

This applies to all EUT.



#### 4.3.2.2 Description

The operating frequency range (OFR) is the frequency range over which the EUT is transmitting. The operating frequency range of the EUT is determined by the lowest ( $f_L$ ) and highest frequency ( $f_H$ ) as occupied by the power envelope.

With the centre frequency of the OFR as:  $f_C = (f_H + f_L)/2$ .

An EUT could have more than one operating frequency range.

#### 4.3.2.3 Limits

The operating frequency ranges for intentional emissions shall be entirely within the frequency bands in table 1.

#### 4.3.2.4 Conformance

The conformance tests for operating frequency ranges shall be as defined in clause 6.2.2 of the present document.

Conformance shall be established under test conditions to be declared by the manufacturer according to clause 4.1.

The interpretation of the results for the measurements uncertainty shall be as given in clause 5.13.

### 4.3.3 Modulation bandwidth

#### 4.3.3.1 Applicability

This applies to all EUT.

#### 4.3.3.2 Description

The modulation bandwidth contains all associated side bands above the following level:

- a) For carrier frequencies below 135 kHz:
  - 23 dB below the carrier, for RFID within the transmitter emission boundary of figure I.1, and for RFID and EAS systems within the transmitter mask of figures I.2, I.3 and I.4, see CISPR 16-1-4 [2] or the appropriate spurious limit as defined in clauses 4.3.7, 4.3.8, 4.3.9.
- b) For carrier frequencies in the range 135 kHz to 30 MHz:
  - 15 dB below the carrier or the appropriate spurious limit as defined in clauses 4.3.7, 4.3.8, 4.3.9.

#### 4.3.3.3 Limits

The modulation bandwidth shall be within the assigned frequency band see table 1 or  $\pm 7,5\%$  of the carrier frequency whichever is the smallest. For RFID and EAS Systems, the modulation bandwidth shall be within the transmitter emission boundary of figures I.1, I.2, I.3 and I.4.

For further information, see CEPT/ERC/REC 70-03 [i.1] or ERC/ECC/CEPT Decisions as implemented through National Radio Interfaces (NRI) and additional NRI as relevant.

#### 4.3.3.4 Conformance

The conformance tests for Operating frequency ranges of the modulation bandwidth shall be as defined in clause 6.2.3 of the present document.

Conformance shall be established under test conditions to be declared by the manufacturer according to clause 4.1.

The interpretation of the results for the measurements uncertainty shall be as given in clause 5.13.

## 4.3.4 Transmitter H-field requirements

### 4.3.4.1 Applicability

The Transmitter H-field requirements only applies for equipment under product class 1 and class 2 as defined in clause 6.1.2 and clause B.2.

### 4.3.4.2 Description

In the case of a transmitter with an integral or dedicated antenna, the radiated H-field is defined in the direction of maximum field strength under specified conditions of measurement.

### 4.3.4.3 Limits

The frequency ranges and limits of the present document are shown in table 2. The limits are based on the European Commission Decision for SRDs [i.10], CEPT/ERC/REC 70-03 [i.1].

**Table 2: H-field limits at 10 m**

Frequency range (MHz)	H-field strength limit ( $H_f$ ) dB $\mu$ A/m at 10 m or specified in mW e.r.p.
$0,009 \leq f < 0,090$	72 descending 3 dB/oct above 0,03 MHz or according to note 1 (see note 5)
$0,09 \leq f < 0,119$	42
$0,119 \leq f < 0,135$	66 descending 3 dB/oct above 0,119 MHz or according to note 1 (see notes 3 and 5)
$0,135 \leq f < 0,140$	42
$0,140 \leq f < 0,1485$	37,7
$0,1485 \leq f < 30$	-5 (see note 4)
$0,315 \leq f < 0,600$	-5
$3,155 \leq f < 3,400$	13,5
4,234	9 (see note 9)
4,516	7
$7,400 \leq f < 8,800$	9
$10,2 \leq f < 11,00$	9
$12,5 \leq f \leq 20$	-7
$6,765 \leq f \leq 6,795$	42 (see notes 3 and 7)
$26,957 \leq f \leq 27,283$	42 (see note 3)
$13,410 \leq f \leq 13,553$ , $13,567 \leq f \leq 13,710$	9 (see note 6)
$13,110 \leq f \leq 13,410$ , $13,710 \leq f \leq 14,010$	-3,5 (see note 6)
$12,660 \leq f \leq 13,110$ , $14,010 \leq f \leq 14,460$	-10 (see note 6)
$11,810 \leq f \leq 12,660$ , $14,460 \leq f \leq 15,310$	-16 (see note 6)
$13,460 \leq f \leq 13,553$ , $13,567 \leq f \leq 13,660$	27 (see note 6)
$13,360 \leq f \leq 13,460$ , $13,660 \leq f \leq 13,760$	Linear transition from 27 to -3,5 (see note 6)
$13,110 \leq f \leq 13,360$ , $13,760 \leq f \leq 14,010$	-3,5 (see note 6)
$12,660 \leq f \leq 13,110$ , $14,010 \leq f \leq 14,460$	-5 (see note 6)
$13,553 \leq f \leq 13,567$	42 (see note 3) or 60 (see notes 2 and 3)
27,095	42

Frequency range (MHz)	H-field strength limit ( $H_f$ ) dB $\mu$ A/m at 10 m or specified in mW e.r.p.
26,995, 27,045, 27,095, 27,145, 27,195 (see note 8)	100 mW
<p>NOTE 1: For the frequency ranges 9 kHz to 135 kHz, the following additional restrictions apply to limits above 42 dB<math>\mu</math>A/m:</p> <ul style="list-style-type: none"> <li>- for loop coil antennas with an area <math>\geq 0,16</math> m<sup>2</sup> this table and table B.1 with the antenna limitations apply;</li> <li>- for loop coil antennas with an area between 0,05 m<sup>2</sup> and 0,16 m<sup>2</sup> table B.1 applies with a correction factor. The limit is: table value + 10 <math>\times</math> log (area/0,16 m<sup>2</sup>);</li> <li>- for loop coil antennas with an area &lt; 0,05 m<sup>2</sup> the limit is 10 dB below table B.1.</li> </ul> <p>NOTE 2: For RFID (incl. NFC) and EAS applications only.</p> <p>NOTE 3: Spectrum mask limit, see annex I.</p> <p>NOTE 4: For further information see annex G.</p> <p>NOTE 5: Limit is 42 dB<math>\mu</math>A/m for the following spot frequencies: 60 kHz <math>\pm</math> 250 Hz, 66,6 kHz <math>\pm</math> 750 Hz, 75 kHz <math>\pm</math> 250 Hz, 77,5 kHz <math>\pm</math> 250 Hz, and 129,1 kHz <math>\pm</math> 500 Hz.</p> <p>NOTE 6: Only in conjunction with spectrum mask, see annex I.</p> <p>NOTE 7: The frequency range 6,765 MHz - 6,795 MHz is not a harmonised ISM frequency band according article 5.138 of the ITU Radio Regulations [i.13].</p> <p>NOTE 8: Center frequencies for channelized systems by using <math>\leq 10</math> kHz bandwidth.</p> <p>NOTE 9: The limit is valid in the range 984 kHz - 7 484 kHz for Transmitting only on receipt of a Balise/Eurobalise tele-powering signal from a train.</p>	

For calculation rules for limits at other measurement distances, see annex H.

#### 4.3.4.4 Conformance

The conformance tests for transmitter H-Field requirements shall be as defined in clause 6.2.4 of the present document.

Conformance shall be established under test conditions to be declared by the manufacturer according to clause 4.1.

The interpretation of the results for the measurements uncertainty shall be as given in clause 5.13.

#### 4.3.5 Transmitter RF carrier current

##### 4.3.5.1 Applicability

The transmitter RF carrier current applies to Product Class 3 only, as defined in clause 6.1.2 and clause B.2.

##### 4.3.5.2 Description

RF carrier current is defined as the current delivered to an artificial load under specified conditions of measurement. The manufacturer shall declare the maximum antenna loop size.

##### 4.3.5.3 Limits

The limit for the RF carrier current multiplied with the antenna area for Product Class 3 Large size loop transmitters is given in table 3.

**Table 3: Limit for RF carrier current  $\times$  antenna area (for Product Class 3 only)**

Frequency range (MHz)	RF carrier current $\times$ antenna area, dBAm <sup>2</sup>
$0,009 \leq f < 0,135$	40 descending 3 dB/oct above 30 kHz (see note)
<p>NOTE: Limit is 10 dBAm<sup>2</sup> for the following spot frequencies: 60 kHz <math>\pm</math> 250 Hz, 75 kHz <math>\pm</math> 250 Hz, 77,5 kHz <math>\pm</math> 250 Hz and 129,1 kHz <math>\pm</math> 500 Hz.</p>	

#### 4.3.5.4 Conformance

The conformance tests for transmitter RF carrier current shall be as defined in clause 6.2.5 of the present document. Conformance shall be established under test conditions to be declared by the manufacturer according to clause 4.1. The interpretation of the results for the measurements uncertainty shall be as given in clause 5.13.

### 4.3.6 Transmitter radiated E-field

#### 4.3.6.1 Applicability

The transmitter radiated E-field applies to Product Class 4 only, as defined in clause 6.1.2 and clause B.2.

#### 4.3.6.2 Description

The radiated E-field is defined as the E-field in the direction of maximum field strength under the specified conditions of measurement. This is defined for a transmitter with an integral antenna.

For a detailed explanation of the relationship between E-field and H-field, see annex G.

#### 4.3.6.3 Limits

In the frequency range 9 kHz to 4,78 MHz, the limits of  $H_{ef}$  follow the H-fields limits,  $H_f$ , as given in clause 4.3.4.3, table 2 with an additional correction factor C. The factor given below is specific for a 10 m measuring distance.

The limit  $H_{ef} = H_f + C$

where:

$$C = 20 \times \log (f_c / 4,78 \times 10^6) \text{ dB};$$

and where:

$f_c$  is the carrier frequency in Hz.

For a graphical representation of the correction factor C see annex D.

In the frequency range 4,78 MHz to 25 MHz limits are identical to the limits in clause 4.3.4.3, table 2, without any correction factor.

#### 4.3.6.4 Conformance

The conformance tests for Transmitter radiated E-field shall be as defined in clause 6.2.6 of the present document. Conformance shall be established under test conditions to be declared by the manufacturer according to clause 4.1. The interpretation of the results for the measurements uncertainty shall be as given in clause 5.13.

### 4.3.7 Transmitter conducted spurious emissions

#### 4.3.7.1 Applicability

This applies to Product Class 3 only (see clause 6.1.2) and their power or current level in an artificial antenna (conducted spurious emission).

#### 4.3.7.2 Description

Spurious domain emission limits are limits on emissions at frequencies other than those of the carrier and sidebands associated with normal test modulation (clause 5.8).

### 4.3.7.3 Limits

The limit for  $I_s$  will be derived from the below formula with the existing limits of  $H_c$  (see clause 4.3.4),  $H_g$  (see clause 4.3.8) and  $I_c$  (see clause 4.3.5).

$$(I_c - I_s) = (H_c - H_g)$$

**Table 4: Void**

### 4.3.7.4 Conformance

The conformance tests for Transmitter conducted spurious emissions shall be as defined in clause 6.2.7 of the present document.

Conformance shall be established under test conditions to be declared by the manufacturer according to clause 4.1.

The interpretation of the results for the measurements uncertainty shall be as given in clause 5.13.

## 4.3.8 Transmitter radiated spurious domain emission limits < 30 MHz

### 4.3.8.1 Applicability

This applies to all EUT.

### 4.3.8.2 Description

Spurious domain emission limits are limits on emissions at frequencies other than those of the carrier and sidebands associated (clauses 4.3.2 and 4.3.3) with normal test modulation (clause 5.8).

### 4.3.8.3 Limits

The radiated field strength of the spurious domain emissions below 30 MHz shall not exceed the generated H-field dB $\mu$ A/m at 10 m given in table 5.

**Table 5**

State	Frequency 9 kHz $\leq$ f < 10 MHz	Frequency 10 MHz $\leq$ f < 30 MHz
Operating	27 dB $\mu$ A/m at 9 kHz descending 3 dB/oct	-3,5 dB $\mu$ A/m
Standby	5,5 dB $\mu$ A/m at 9 kHz descending 3 dB/oct	-25 dB $\mu$ A/m

### 4.3.8.4 Conformance

The conformance tests for transmitter radiated spurious domain emission limits < 30 MHz shall be as defined in clause 6.2.8 of the present document.

Conformance shall be established under test conditions to be declared by the manufacturer according to clause 4.1.

The interpretation of the results for the measurements uncertainty shall be as given in clause 5.13.

## 4.3.9 Transmitter radiated spurious domain emission limits > 30 MHz

### 4.3.9.1 Applicability

This method applies to all EUT.

For Product Class 3 (see clause B.2) the transmitter antenna port shall be connected to an artificial antenna (see clause 5.9).

#### 4.3.9.2 Description

Spurious domain emission limits are limits on emissions at frequencies other than those of the carrier and sidebands associated with normal test modulation (clause 5.8).

#### 4.3.9.3 Limits

The power of any radiated emission shall not exceed the values given in table 6.

**Table 6**

State	47 MHz to 74 MHz 87,5 MHz to 118 MHz 174 MHz to 230 MHz 470 MHz to 790 MHz	Other frequencies between 30 MHz to 1 000 MHz
Operating	4 nW	250 nW
Standby	2 nW	2 nW

#### 4.3.9.4 Conformance

The conformance tests for transmitter radiated spurious domain emission limits > 30 MHz shall be as defined in clause 6.2.9 of the present document.

Conformance shall be established under test conditions to be declared by the manufacturer according to clause 4.1.

The interpretation of the results for the measurements uncertainty shall be as given in clause 5.13.

### 4.3.10 Transmitter Frequency stability

#### 4.3.10.1 Applicability

The frequency stability shall be applicable only for channelized systems where channel limits are defined.

#### 4.3.10.2 Description

The frequency stability under low voltage condition is the ability of the equipment to maintain its operating frequency and not produce emissions which exceed any relevant limit when the battery voltage falls below the lower extreme voltage level.

#### 4.3.10.3 Limits

The equipment shall either:

- a) remain in the Operating Channel without exceeding any applicable limits (e.g. Duty Cycle); or
- b) reduce its effective radiated power below the Spurious Emission limits without exceeding any applicable limits (e.g. Duty Cycle); or
- c) shut down, (e.g. no emission above EMC levels).

#### 4.3.10.4 Conformance

The conformance tests for Transmitter Frequency stability shall be as defined in clause 6.2.10 of the present document.

Conformance shall be established under test conditions to be declared by the manufacturer according to clause 4.1.

The interpretation of the results for the measurements uncertainty shall be as given in clause 5.13.

## 4.4 Receiver Conformance requirements

### 4.4.1 General

The required Receiver Conformance tests are defined in table 7.

**Table 7**

Technologies	Receiver spurious emission (clause 4.4.2)	Adjacent channel selectivity (clause 4.4.3)	Blocking or desensitization (clause 4.4.4)
tagging systems	yes	no (note 2)	no (note 1)
systems in the 27 MHz range	yes	Yes	yes
all others	yes	no (note 2)	yes

NOTE 1: Blocking or desensitization not needed because of the physical co-location of RX to TX in tagging systems where the RX and TX operate simultaneously. The TX signal is used for the RX baseband mixing. The TX signal at the RX input is about 90 dB above the receiver sensitivity or tagging signal level the receiver (see ETSI TR 103 059 [i.9], figure 8).  
Furthermore given the very short communication ranges for most applications (e.g. NFC, RFID), a given interference blocking signal will have to be about 90 dB higher as the transmitter signal at the transceiver antenna, which is unlikely to happen.

NOTE 2: This requirement can only be required where a frequency plan with standard channel spacing is consistently used, for example in the 27 MHz band.

### 4.4.2 Receiver spurious emissions

#### 4.4.2.1 Applicability

These requirements does not apply to receivers used in combination with permanently co-located transmitters continuously transmitting. In these cases the receivers will be tested together with the transmitter in operating mode (see clause 4.3.3).

#### 4.4.2.2 Description

Spurious radiation from receivers are emissions radiated from the antenna, the chassis and case of the receiver. It is specified as the radiated power of a discrete signal.

#### 4.4.2.3 Limits

The spurious components below 30 MHz shall not exceed the generated H-field dB $\mu$ A/m values at 10 m according to table 8.

**Table 8: Receiver spurious radiation limits**

Frequency 9 kHz $\leq$ f < 10 MHz	Frequency 10 MHz $\leq$ f < 30 MHz
5,5 dB $\mu$ A/m at 9 kHz descending 3 dB/oct	-25 dB $\mu$ A/m

The spurious components above 30 MHz measured values shall not exceed 2 nW.

#### 4.4.2.4 Conformance

The conformance tests for the receiver spurious emissions shall be as defined in clause 6.3.1 of the present document.

Conformance shall be established under test conditions to be declared by the manufacturer according to clause 4.1.

The interpretation of the results for the measurements uncertainty shall be as given in clause 5.13.

### 4.4.3 Adjacent channel selectivity

#### 4.4.3.1 Applicability

Only for channelized systems in the 27 MHz range, see table 7, clause 4.4.1.

This measurement is only required where a frequency plan with standard channel spacing is consistently used, for example at 27 MHz.

This measurement shall not be performed if:

- a) the transmitter cannot be switched off and the spacing between the transmit and the receiver frequency is less than ten times the declared receiver 3 dB bandwidth; or
- b) the transmitter and receiver are operating at the same frequency and the transmitter cannot be switched off as the carrier is used as receiver injection signal (e.g. for homodyne systems).

In the case where a) and/or b) above applies, this shall be stated in the test report.

This requirement does not apply for tagging systems (e.g. RF identification, anti-theft, access control, location systems).

The receiver selectivity applies only to channelized systems.

#### 4.4.3.2 Description

The receiver selectivity is a measure of the capability of the receiver to operate satisfactorily in the presence of an unwanted signal that differs in frequency from the wanted signal by an amount equal to the adjacent channel separation for which the equipment is intended.

#### 4.4.3.3 Limits

The receiver selectivity of the equipment under specified conditions shall not be less than stated in table 9.

**Table 9**

<b>Channel spacing <math>\leq</math> 25 kHz</b>	<b>Channel spacing <math>&gt;</math> 25 kHz</b>
60 dB	70 dB

#### 4.4.3.4 Conformance

The conformance tests for the receiver selectivity shall be as defined in clause 6.3.2 of the present document.

Conformance shall be established under test conditions to be declared by the manufacturer according to clause 4.1.

The interpretation of the results for the measurements uncertainty shall be as given in clause 5.13.

### 4.4.4 Receiver blocking or desensitization

#### 4.4.4.1 Applicability

Receiver blocking or desensitization is only applicable for channelized systems where channel definitions are used.

See also note 1 within table 7 in clause 4.4.1.

#### 4.4.4.2 Description

Blocking is a measure of the capability of the receiver to receive a wanted modulated signal without exceeding a given degradation due to the presence of an unwanted input signal at any frequencies other than those of the receiver spurious responses and receiver selectivity, see clause 4.4.3.



#### 4.4.4.3 Limits

The blocking ratio, for any frequency within the specified ranges, shall not be less than the values given in table 10, except at frequencies on which spurious responses are found. The limit value is determined by a reference limit (Ref) multiplied by a correction factor depending of the appropriate receiver category.

**Table 10: Receiver blocking or desensitization limits**

Generator B frequency offset, $ f_A - f_B $ , either by a) or b) whichever is greater (see note 3)			Limit (dB)
a) per clause 7.4, indent a)		b) per clause 7.4, indent b)	
$f_A < 500$ kHz	$f_A \geq 500$ kHz	value of $N_B$ , see below	
$\pm 100$ kHz	$\pm 500$ kHz	2	Reference Limit $\times 1/2$ (see note 2)
$\pm 200$ kHz	$\pm 1$ MHz	4	Reference Limit $\times 2/3$ (see note 2)
$\pm 300$ kHz	$\pm 2$ MHz	8	Reference Limit $\times 5/6$ (see note 2)
$\pm 500$ kHz	$\pm 5$ MHz	20	Reference Limit (see note 1)
NOTE 1: Reference limit (Ref) = 30 dB at 9 kHz increasing with 10 dB/decade to 65,2 dB at 30 MHz.			
NOTE 2: The limit is a fractional dB value of the reference limit.			
NOTE 3: Generator B frequencies below 9 kHz are not specified.			

#### 4.4.4.4 Conformance

The conformance test suite for the receiver selectivity shall be as defined in clause 6.3.3 of the present document.

Conformance shall be established under test conditions to be declared by the manufacturer according to clause 4.1.

The interpretation of the results for the measurements uncertainty shall be as given in clause 5.13.

---

## 5 Testing for compliance with technical requirements

### 5.1 Environmental conditions for testing

Tests defined in the present document shall be carried out at representative points within the boundary limits of the declared operational environmental profile.

Where technical performance varies subject to environmental conditions, tests shall be carried out under a sufficient variety of environmental conditions (within the boundary limits of the declared operational environmental profile) to give confidence of compliance for the affected technical requirements.

### 5.2 General conditions for testing

#### 5.2.1 Product information

When submitting equipment for testing, the manufacturer shall supply the necessary information required by the laboratory.

### 5.3 Normal and extreme test conditions

Testing shall be made under normal test conditions, and also, where stated, under extreme test conditions.

The test conditions and procedures shall be as specified in clauses 5.4 to 5.6.

## 5.4 Test power source

### 5.4.0 General

The equipment shall be tested using the appropriate test power source as specified in clauses 5.4.1 or 5.4.2. Where equipment can be powered using either external or internal power sources, then the equipment shall be tested using the external power source as specified in clause 5.4.1 then repeated using the internal power source as specified in clause 5.4.2.

The test power source used shall be stated in the test report.

### 5.4.1 External test power source

During tests, the power source of the equipment shall be replaced by an external test power source capable of producing normal and extreme test voltages as specified in clauses 5.5.2 and 5.6.2. The internal impedance of the external test power source shall be low enough for its effect on the test results to be negligible. For the purpose of the tests, the voltage of the external test power source shall be measured at the input terminals of the equipment. The external test power source shall be suitably de-coupled as close to the equipment battery terminals as practicable. For radiated measurements any external power leads should be so arranged so as not to affect the measurements.

During tests the test power source voltages shall be within a tolerance of  $< \pm 1$  % relative to the voltage at the beginning of each test. The value of this tolerance can be critical for certain measurements. Using a smaller tolerance will provide a better uncertainty value for these measurements.

### 5.4.2 Internal test power source

For radiated measurements on portable equipment with integral antenna, fully charged internal batteries should be used. The batteries used should be as supplied or recommended by the manufacturer. If internal batteries are used, at the end of each test the voltage shall be within a tolerance of within 5 % relative to the voltage at the beginning of each test.

If appropriate, for conducted measurements or where a test fixture is used, an external power supply at the required voltage may replace the supplied or recommended internal batteries. This shall be stated on the test report.

## 5.5 Normal test conditions

### 5.5.1 Normal temperature and humidity

The normal temperature and humidity conditions for tests shall be any convenient combination of temperature and humidity within the following ranges:

- temperature +15 °C to +35 °C;
- relative humidity 20 % to 75 %.

When it is impracticable to carry out tests under these conditions, a note to this effect, stating the ambient temperature and relative humidity during the tests, shall be added to the test report.

### 5.5.2 Normal test power source

#### 5.5.2.1 Mains voltage

The normal test voltage for equipment to be connected to the mains shall be the nominal mains voltage. For the purpose of the present document, the nominal voltage shall be the declared voltage, or any of the declared voltages, for which the equipment was designed.

The frequency of the test power source corresponding to the ac mains shall be between 49 Hz and 51 Hz.

### 5.5.2.2 Regulated lead-acid battery power sources

When the radio equipment is intended for operation with the usual types of regulated lead-acid battery power source, the normal test voltage shall be 1,1 multiplied by the nominal voltage of the battery (e.g. 6 V, 12 V, etc.).

### 5.5.2.3 Other power sources

For operation from other power sources or types of battery (primary or secondary), the normal test voltage shall be that declared by the equipment manufacturer and agreed by the test laboratory. Such values shall be stated in the test report.

## 5.6 Extreme test conditions

### 5.6.1 Extreme temperatures

#### 5.6.1.1 Procedure for tests at extreme temperatures

##### 5.6.1.1.0 General

Before measurements are made the equipment shall have reached thermal balance in the test chamber. The equipment shall be switched off during the temperature stabilizing period.

In the case of equipment containing temperature stabilization circuits designed to operate continuously, the temperature stabilization circuits shall be switched on for 15 minutes after thermal balance has been obtained, and the equipment shall then meet the specified requirements.

If the thermal balance is not checked by measurements, a temperature stabilizing period of at least one hour, or such period as may be decided by the test laboratory, shall be allowed. The sequence of measurements shall be chosen, and the humidity content in the test chamber shall be controlled so that excessive condensation does not occur.

##### 5.6.1.1.1 Procedure for equipment designed for continuous operation

If the manufacturer states that the equipment is designed for continuous operation, the test procedure shall be as follows:

- before tests at the upper extreme temperature the equipment shall be placed in the test chamber and left until thermal balance is attained. The equipment shall then be switched on in the transmit condition for a period of a half hour after which the equipment shall meet the specified requirements;
- for tests at the lower extreme temperature, the equipment shall be left in the test chamber until thermal balance is attained, then switched on for a period of one minute after which the equipment shall meet the specified requirements.

##### 5.6.1.1.2 Procedure for equipment designed for intermittent operation

If the manufacturer states that the equipment is designed for intermittent operation, the test procedure shall be as follows:

- Before tests at the upper extreme temperature the equipment shall be placed in the test chamber and left until thermal balance is attained in the oven. The equipment shall then either:
  - transmit on and off according to the manufacturers declared duty cycle for a period of five minutes; or
  - if the manufacturer's declared on period exceeds one minute, then transmit in the on condition for a period not exceeding one minute, followed by a period in the off or standby mode for four minutes; after which the equipment shall meet the specified requirements.
- For tests at the lower extreme temperature, the equipment shall be left in the test chamber until thermal balance is attained, then switched to the standby or receive condition for one minute after which the equipment shall meet the specified requirements.

### 5.6.1.2 Extreme temperature ranges

For tests at extreme temperatures, measurements shall be made in accordance with the procedures specified in clause 5.6.1.1, at the upper and lower temperatures of one of the following ranges:

- Category I (General): -20 °C to +55 °C.
- Category II (Portable): -10 °C to +55 °C.
- Category III (Equipment for normal indoor use): 0 °C to +35 °C.

NOTE: The term "Equipment for normal indoor use" is taken to mean the minimum indoor temperature  $\geq 5$  °C.

For special applications, the manufacturer can specify wider temperature ranges than given as a minimum above. This shall be reflected in manufacturer's product literature.

The test report shall state which range is used.

## 5.6.2 Extreme test source voltages

### 5.6.2.1 Mains voltage

The extreme test voltages for equipment to be connected to an ac mains source shall be the nominal mains voltage  $\pm 10$  %. For equipment operating over a range of mains voltages clause 5.5.2.3 applies.

### 5.6.2.2 Regulated lead-acid battery power sources

When the radio equipment is intended for operation from the usual type of regulated lead-acid battery power sources the extreme test voltages shall be 1,3 and 0,9 multiplied by the nominal voltage of the battery (6 V, 12 V, etc.).

For float charge applications using "gel-cell" type batteries the extreme voltage shall be 1,15 and 0,85 multiplied by the nominal voltage of the declared battery voltage.

### 5.6.2.3 Power sources using other types of batteries

The lower extreme test voltages for equipment with power sources using batteries other than lead-acid shall be as follows:

- For equipment with a battery indicator, the end point voltage as indicated.
- For equipment without a battery indicator the following end point voltages shall be used:
  - For the Leclanché or the lithium type of battery:
    - 0,85 multiplied by the nominal voltage of the battery.
  - For the nickel-cadmium type of battery:
    - 0,9 multiplied by the nominal voltage of the battery.
- For other types of battery or equipment, the lower extreme test voltage for the discharged condition shall be declared by the equipment manufacturer.

The nominal voltage is considered to be the upper extreme test voltage in this case.

### 5.6.2.4 Other power sources

- For equipment using other power sources, or capable of being operated from a variety of power sources, the extreme test voltages shall be those agreed between the equipment manufacturer and the test laboratory. This shall be recorded in the test report.

## 5.7 Auxiliary test equipment

All necessary test signal sources and set-up information shall accompany the equipment when it is submitted for testing.

## 5.8 Normal test signals and test modulation

### 5.8.0 General

The test modulating signal is a signal which modulates a carrier, is dependent upon the type of equipment under test and also the measurement to be performed. Modulation test signals only apply to products with an external modulation connector. For equipment without an external modulation connector, normal operating modulation shall be used.

### 5.8.1 Normal test signals for analogue speech

Normal test signals for analogue speech are specified as follows:

- A-M1: a 1 000 Hz tone;
- A-M2: a 1 250 Hz tone.

For angle modulation, the normal level of the test signals A-M1 and A-M2 shall be adjusted to produce a deviation of 12 % of the channel separation or any lower value as declared by the manufacturer as the normal operating level.

In the case of amplitude modulation, the normal modulation depth shall be 60 % or any lower value as declared by the manufacturer. This shall be used as the normal level of operation and shall be stated in the test report.

### 5.8.2 Normal test signals for data

Normal test signals for data are specified as follows:

- D-M2: A test signal representing a pseudo-random bit sequence of at least 511 bits in accordance with Recommendation ITU-T O.153 [i.2]. This sequence shall be continuously repeated. If the sequence cannot be continuously repeated, the actual method used shall be stated in the test report.
- D-M3: A test signal shall be agreed between the test laboratory and the manufacturer in case selective messages are used and are generated or decoded within the equipment.  
The agreed test signal may be formatted and may contain error detection and correction.

For angle modulation, the normal level of the test signal D-M3 shall produce a deviation of 20 % of the channel separation or any other value as declared by the manufacturer as the normal operating level.

In case of amplitude modulation, the modulation ratio shall be 60 %, or any value, as declared by the manufacturer, as the normal operating level.

## 5.9 Artificial antenna

### 5.9.0 General

Where applicable, tests shall be carried out using an artificial antenna which shall simulate the actual antenna configuration specified by the manufacturer.

### 5.9.1 Artificial antenna for inductive transmitters (non 50 $\Omega$ )

For measurements of inductive transmitters without a 50  $\Omega$  antenna impedance, a tuned reduced radiating load connected to the antenna connector shall be used as agreed with the test laboratory.

The impedance shall be equal to the nominal load of the equipment specified by the manufacturer.

This method facilitates conducted measurements to be made of the following:

- transmitter carrier loop currents up to 30 MHz;
- transmitter spurious loop currents up to 30 MHz; and
- conducted spurious measurements in the range 30 MHz to 1 GHz.

The use of this non-50  $\Omega$  load during test shall be stated in the test report form.

### 5.9.2 Artificial antenna for transmitters with 50 $\Omega$ impedance connector

For measurements on transmitters with a normal 50  $\Omega$  antenna impedance, tests shall be carried out using an artificial antenna which shall be a substantially non-reactive non-radiating 50  $\Omega$  load connected to the antenna connector. The Voltage Standing Wave Ratio (VSWR) at the 50  $\Omega$  connector shall not be greater than 1,2 to 1 over the frequency range of the measurement.

This method may also facilitate conducted measurements to be made of the following:

- transmitter carrier loop currents up to 30 MHz;
- transmitter spurious loop currents up to 30 MHz; and
- conducted spurious measurements in the range 30 MHz to 1 GHz.

The use of 50  $\Omega$  load during test shall be stated in the test report form.

## 5.10 Test fixture

With equipment intended for use with an integral antenna, and not equipped with a 50  $\Omega$  RF output connector, a suitable test fixture shall be used as agreed with the test laboratory, where applicable.

This fixture is a RF coupling device for coupling the integral antenna to a 50  $\Omega$  RF terminal at the working frequencies of the equipment under test. This allows certain measurements to be performed using conducted measuring methods. The test fixture shall be calibrated with the equipment under test. The test fixture is normally only required for extreme temperature measurements. The test fixture shall be fully described by the manufacturer. The test laboratory, where applicable shall calibrate the test fixture by carrying out the required field measurements at normal temperatures at the prescribed test site. Then the same measurements shall be repeated on the equipment under test using the test fixture for all identified frequency components.

In addition, the test fixture may provide:

- a connection to an external power supply;
- an audio interface either by direct connection or by an acoustic coupler;
- a connection to a data interface.

The performance characteristics of the test fixture shall be agreed upon with the test laboratory, where applicable and shall conform to the following basic parameters:

- the circuit associated with the RF coupling shall contain no active or non linear devices;
- the coupling loss shall not influence the measuring results;
- the coupling loss shall be independent of the position of the test fixture and be unaffected by the proximity of the surrounding objects or people;
- the coupling loss shall be reproducible when the equipment under test is removed and replaced;
- the coupling loss shall remain substantially constant when the environmental conditions are varied.

## 5.11 Test sites and general arrangements for radiated measurements

Detailed descriptions of radiated measurement arrangements are included in annex C.

## 5.12 Measuring receiver

The term "measuring receiver" refers to a selective voltmeter or a spectrum analyser. The bandwidth and detector type of the measuring receiver are given in table 11.

**Table 11**

Frequency: (f)	Detector type	Measurement receiver bandwidth	Spectrum analyser bandwidth
$9 \text{ kHz} \leq f < 150 \text{ kHz}$	Quasi Peak	200 Hz	300 Hz
$150 \text{ kHz} \leq f < 30 \text{ MHz}$	Quasi Peak	9 kHz	10 KHz
$30 \text{ MHz} \leq f \leq 1\,000 \text{ MHz}$	Quasi Peak	120 kHz	100 kHz
NOTE: For the measurement of the ranges $6,765 \text{ MHz} \leq f \leq 6,795 \text{ MHz}$ and $11,810 \text{ MHz} \leq f \leq 15,310 \text{ MHz}$ , the measurement bandwidth has to be 200 Hz respectively 300 Hz.			

Different bandwidth may be used if agreed with the test laboratory, for further guidance see annex K. The measurement bandwidth and any related calculations shall be stated in the test report.

## 5.13 Measurement uncertainty

The interpretation of the results recorded in the test report for the measurements described in the present document shall be as follows:

- the measured value related to the corresponding limit shall be used to decide whether an equipment meets the requirements of the present document;
- the value of the measurement uncertainty for the measurement of each parameter shall be separately included in the test report;
- the value of the measurement uncertainty shall be, for each measurement, equal to or less than the figures given below:
  - RF frequency  $\pm 1 \times 10^{-7}$ .
  - RF power, conducted  $\pm 1 \text{ dB}$ .
  - RF power, radiated  $\pm 6 \text{ dB}$ .
  - Temperature  $\pm 1 \text{ }^\circ\text{C}$ .
  - Humidity  $\pm 5 \%$ .

For the test methods, according to the present document the uncertainty figures shall be calculated according to the methods described in the ETSI TR 100 028 [i.14] and shall correspond to an expansion factor (coverage factor)  $k = 1,96$  or  $k = 2$  (which provide confidence levels of respectively 95 % and 95,45 % in case where the distributions characterizing the actual measurement uncertainties are normal (Gaussian)).

The measurement uncertainties given above are based on such expansion factors.

The particular expansion factor used for the evaluation of the measurement uncertainty shall be stated.

## 5.14 Interpretation of the measurement results

### 5.14.0 General

The interpretation of the results when comparing measurement values with specification limits shall be as follows:

- a) When the measured value does not exceed the limit value the equipment under test meets the requirements of the present document.
- b) When the measured value exceeds the limit value the equipment under test does not meet the requirements of the present document.
- c) The measurement uncertainty calculated by the test technician carrying out the measurement should be recorded in the test report.
- d) The measurement uncertainty calculated by the test technician may be a maximum value for a range of values of measurement, or may be the measurement uncertainty for the specific measurement undertaken. The method used should be recorded in the test report.

### 5.14.1 Measurement uncertainty is equal to or less than maximum acceptable uncertainty

The interpretation of the results when comparing measurement values with specification limits shall be as follows:

- a) When the measured value does not exceed the limit value the equipment under test meets the requirements of the present document.
- b) When the measured value exceeds the limit value the equipment under test does not meet the requirements of the present document.
- c) The measurement uncertainty calculated by the test technician carrying out the measurement should be recorded in the test report.
- d) The measurement uncertainty calculated by the test technician may be a maximum value for a range of values of measurement, or may be the measurement uncertainty for the specific measurement undertaken. The method used should be recorded in the test report.

---

## 6 Conformance methods of measurement for transmitters and receivers

### 6.1 Transmitter requirements

#### 6.1.1 Transmitter definitions

Transmitters are divided into Product Classes (see clause 6.1.2) depending on the antenna type to be used. Product Class 2 and Product Class 3 transmitters may allow the customer to use his own loop antenna design based on the manufacturers design guidelines. The user's manual shall include the guidelines for the design of the antennas. These guidelines may be evaluated by the test laboratory as part of the test of the equipment and compared to actual radiated measurements.

The transmitters are categorized into:

- inductive loop transmitter, details see clause B.1.1;
- large size loop transmitter, details see clause B.1.2;
- other transmitters, details see clause B.1.3.



## 6.1.2 Equipment Product Classes

The equipment is divided into Product Classes depending of the antenna type used. The Product Classes shall not be confused with Receiver Categories, see clause 4.4.1.

The product classes are in detailed described in clause B.2.

## 6.1.3 Modes of operation of the transmitter

For the purpose of the measurements according to the present document, there should preferably be a facility to operate the transmitter in an unmodulated state. The method of achieving an unmodulated carrier frequency or special types of modulation patterns may also be decided by agreement between the manufacturer and the test laboratory. It shall be described in the test report. It may involve suitable temporary internal modifications of the equipment under test. If it is not possible to provide an unmodulated carrier then this shall be stated in the test report.

For transmitters using a continuous wideband swept carrier the measurement shall be made with the sweep on.

For the purpose of testing, the normal test signal, see clauses 5.8.1 and 5.8.2, shall be applied to the input of the transmitter under test with the normal input device disconnected (e.g. microphone).

## 6.2 Conformance methods of measurement for transmitter

### 6.2.1 General

- Transmitter conformance requirements
- Permitted range of operating frequencies
- Permitted frequency range of the modulation bandwidth
- Transmitter H-field requirements
- Transmitter RF carrier current
- Transmitter radiated E-field
- Transmitter conducted spurious emissions
- radiated spurious domain emission limits < 30 MHz
- radiated spurious domain emission limits > 30 MHz
- Transmitter Frequency stability

### 6.2.2 Operating frequency ranges

#### 6.2.2.1 General

The measuring receiver may be a spectrum analyser, oscilloscope, selective power meter or any measuring receiver which is appropriate to perform the intended measurement of the EUT.

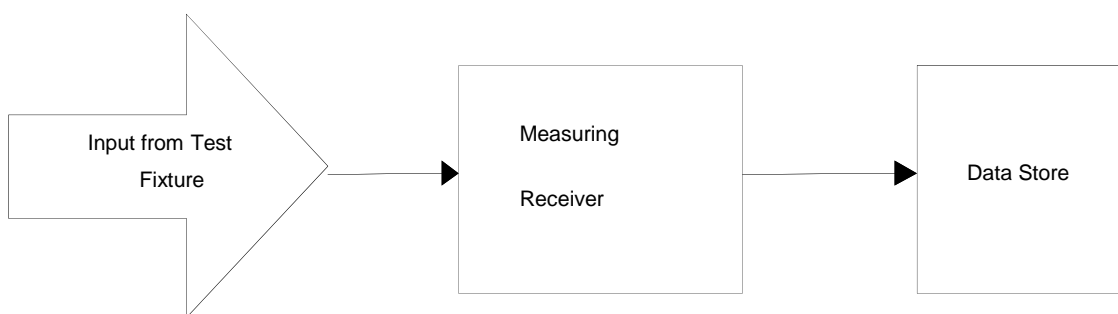

**Figure 1: Test set-up for measurement of the operating frequencies**

### 6.2.2.2 OFR measurement with spectrum analyser

The measurement antenna shall be placed at one point of the setup up. Alternatively, a current probe could be used.

A spectrum analyser with the following settings is used as measuring receiver in the test set-up:

- Start frequency: lower than the lower edge of the permitted frequency range.
- Stop frequency: higher than the upper edge of the permitted frequency range.
- Resolution Bandwidth: see table 11.
- Video Bandwidth:  $\geq$  Resolution Bandwidth.
- Detector mode: RMS.
- Display mode: Maxhold.

The 99 % OBW function shall be used to determine the operating frequency range:

- $f_H$  is determined.  $f_H$  is the frequency of the upper marker resulting from the OFR.
- $f_L$  is determined.  $f_L$  is the frequency of the lower marker resulting from the OFR.
- $f_c$  is the centre frequency.  $f_c = \frac{f_H + f_L}{2}$ .

Alternatively, the recorded results from the H-field measurement described in clause 6.2.4 may be used.

### 6.2.3 Modulation bandwidth

The transmitter shall be connected to an artificial antenna or if the transmitter has an integral antenna, a test fixture shall be used (see clause 5.10). The RF output of the equipment shall be connected to a spectrum analyser via a 50  $\Omega$  variable attenuator.

The transmitter shall be operated at the nominal carrier power or field strength measured under normal test conditions in clause 4.3.4. The attenuator shall be adjusted to an appropriate level displayed at the spectrum analyser screen.

The transmitter shall be modulated with standard test modulation (see clauses 5.8.1 and 5.8.2). If the equipment cannot be modulated externally, the internal modulation shall be used.

For transmitters using a continuous wideband swept carrier the measurement shall be made with the sweep on.

The output of the transmitter, with or without test fixture, shall be measured by using a spectrum analyser with a resolution bandwidth appropriate to accept all major side bands. The power level calibration of the spectrum analyser shall then be related to the power level or field strength measured in clause 4.3.3. The calculation will be used to calculate the absolute level of the sideband power.

The test laboratory shall ensure that the spectrum analyser's span is sufficiently wide enough to ensure that the carrier and all its major side bands are captured.

The frequency of the upper and lower points, where the displayed power envelope of the modulation including frequency drift is equal to the appropriate level defined in clause 4.3.3 is recorded as the modulation bandwidth.

## 6.2.4 Transmitter H-field

The measurements of the transmitter radiated H-field shall be made on an open field test site as specified in clause C.1.3. Any measured values shall be at least 6 dB above the ambient noise level.

The H-field produced by the equipment shall be measured at standard distance of 10 m. Where this is not practical, e.g. due to physical size of the equipment including the antenna or with use of special field cancelling antenna, then other distances may be used. When another distance is used, the distance used and the field strength value measured shall be stated in the test report. In this case, the measured value at actual test distance shall be extrapolated to 10 m according to annex H and these calculations shall be stated in the test report.

The H-field is measured with a shielded loop antenna connected to a measurement receiver. The measuring bandwidth and detector type of the measurement receiver shall be in accordance with clause 5.12.

The equipment under test shall operate where possible, with modulation. Where this is not possible, it shall be stated in the test report.

For transmitters using a continuous wideband swept carrier, the measurement shall be made with the sweep off. When it is not possible to turn the sweep off the measurements shall be made with the sweep on and this shall be stated in the test report.

For measuring equipment calibrated in dB $\mu$ V/m, the reading should be reduced by 51,5 dB to be converted to dB $\mu$ A/m.

## 6.2.5 Transmitter RF carrier current

The transmitter shall be connected to an artificial antenna, see clause 5.9 and annex F. The RF current delivered to this artificial antenna during a transmission duty cycle shall be measured up to 30 MHz. The current shall be measured either by using:

- a calibrated current probe connected to a measuring receiver; or
- a derived output from a calibrated artificial antenna connected to a measuring receiver, see annex F.

The measuring bandwidth and detector type shall be in accordance with clause 5.12.

For transmitters using a continuous wideband swept carrier the measurement shall be made with the sweep off. Where this is not possible the measurements may be made with the sweep on. This shall be stated in the test report.

A detailed explanation of the relationship between the RF carrier current, antenna factor ( $N \times A$ ) and the equivalent generated H-field is given in annex E.

## 6.2.6 Transmitter radiated E-field

The transmitter radiated E-field is based on the equivalent H-field, measured at 10 m.

The H-field is measured with a shielded loop antenna connected to a measurement receiver. The measuring bandwidth and detector type of the measurement receiver shall be in accordance with clause 5.12.

For a detailed explanation of the relationship between E-field and H-field, see annex G.

## 6.2.7 Transmitter conducted spurious emissions

### 6.2.7.1 Transmitter conducted spurious emissions < 30 MHz

The transmitter shall be connected to an artificial antenna according to clause 5.9.1. The measuring receiver shall be connected to the output of the artificial antenna and the current for both the carrier output and the spurious components shall be measured. For further details of the artificial antenna, see annex F.

The currents shall first be measured with the transmitter switched on (operation) and then repeated with the transmitter switched off (standby/idle).

The method for deriving the spurious current limit  $I_s$  is calculated by the following formula:

$$I_c - I_s = H_c - H_s$$

where:

- $I_s$  is the measured transmitter conducted spurious output current expressed in dB $\mu$ A;
- $I_c$  is the measured transmitter RF carrier output current expressed in dB $\mu$ A, see clause 4.3.5.3;
- $H_c$  is the radiated limit for the transmitter generated H-field expressed in dB $\mu$ A/m, see clause 4.3.4.3;
- $H_s$  is the radiated limit for transmitter generated H-field spurious expressed in dB $\mu$ A/m, see clause 4.3.8.3.

The term  $(H_c - H_s)$  in the above formula is the required attenuation in dBc of the spurious H -field. This requirement may vary with frequency due to varying limits with frequency.

The term  $(I_c - I_s)$  (in dB) is the attenuation in dB of the spurious current below the carrier current.

### 6.2.7.2 Transmitter conducted spurious emissions $\geq 30$ MHz

The transmitter shall be connected to an artificial antenna according to clause 5.9.2. The spurious components are measured by means of a selective voltmeter connected to the output of the transmitter by means of an appropriate coupling device. For details of the artificial antenna, see annex F.

### 6.2.8 Transmitter radiated spurious domain emission limits $< 30$ MHz

The field strength shall be measured for frequencies below 30 MHz. The equipment under test shall be measured at a distance of 10 m on an outdoor test site. The test antenna shall be a calibrated shielded magnetic field antenna. The equipment under test and test antenna shall be arranged as stated in clause C.1.

For Product Class 3 the transmitter antenna connector of the equipment under test shall be connected to an artificial antenna (see clause 5.9) and the output connector terminated.

The equipment under test shall be switched on with normal modulation. The characteristics of the modulation signal used shall be stated on the test report. The measuring receiver shall be tuned over the frequency range 9 kHz to 30 MHz, except for the frequency band on which the transmitter is intended to operate.

At each frequency at which a relevant spurious signal is detected the equipment under test and the test antenna shall be rotated until maximum field strength is indicated on the measuring receiver. This level shall be noted.

If the transmitter can be operated in the standby mode, then the measurements shall be repeated in the standby mode.

For measuring equipment calibrated in dB $\mu$ V/m, the reading should be reduced by 51,5 dB to be converted to dB $\mu$ A/m.

### 6.2.9 Transmitter radiated spurious domain emission limits $> 30$ MHz

For classes 1, 2 and 4 an appropriate test site selected from annex C shall be used. The equipment shall be placed at the specified height on a non-conducting support and in the position closest to normal use as declared by the manufacturer.

The test antenna shall be oriented for vertical polarization. The output of the test antenna shall be connected to a measuring receiver.

The transmitter shall be switched on with normal modulation, and the measuring receiver shall be tuned over the frequency range 30 MHz to 1 000 MHz.

At each frequency at which a relevant spurious component is detected, the test antenna shall be raised and lowered through the specified range of heights until a maximum signal level is detected on the measuring receiver.

The transmitter shall then be rotated through 360° in the horizontal plane, until the maximum signal level is detected by the measuring receiver.

The maximum signal level detected by the measuring receiver shall be noted.

The substitution antenna shall be oriented for vertical polarization and calibrated for the frequency of the spurious component detected.

The frequency of the calibrated signal generator shall be set to the frequency of the spurious component detected. The input attenuator setting of the measuring receiver shall be adjusted in order to increase the sensitivity of the measuring receiver, if necessary.

The test antenna shall be raised and lowered through the specified range of heights to ensure that the maximum signal is received.

When a test site according to clause C.1.1 is used, there is no need to vary the height of the antenna.

The input signal to the substitution antenna shall be adjusted until an equal or a known related level to that detected from the transmitter is obtained on the measuring receiver.

The input signal to the substitution antenna shall be recorded as a power level and corrected for any change of input attenuator setting of the measuring receiver.

The measure of the effective radiated power of the spurious components is the larger of the two power levels recorded for each spurious component at the input to the substitution antenna, corrected for the gain of the substitution antenna if necessary.

If an unmodulated carrier cannot be obtained then the measurements shall be made with the transmitter modulated by the normal test signal (see clause 5.8.2) in which case this fact shall be recorded in the test report.

If standby mode is available, the measurements shall be repeated in that mode.

## 6.2.10 Transmitter Frequency stability under low voltage conditions

### 6.2.10.1 Test conditions

- 1) The measurements shall be performed under normal test conditions.
- 2) The measurements shall be performed on Operatinat procedure.

#### **Step 1:**

Operation of the EUT shall be started, on Operating Frequency as declared by the manufacturer, with the appropriate test signal and with the EUT operating at nominal operating voltage.

The centre frequency of the transmitted signal shall be measured and noted.

#### **Step 2:**

The operating voltage shall be reduced by appropriate steps until the voltage reaches zero.

The centre frequency of the transmitted signal shall be measured and noted.

Any abnormal behaviour shall be noted.

## 6.3 Conformance methods of measurement for receiver

### 6.3.1 Receiver spurious emissions

- 1) For radiation below 30 MHz, the methods of measurements should be in accordance with clause 6.2.8.
- 2) For radiation at or above 30 MHz, the methods of measurements should be in accordance with clause 6.2.9.

Convert reading by 51,5 dB for measuring equipment calibrated in dB $\mu$ V or dB $\mu$ V/m.

## 6.3.2 Adjacent channel selectivity

This measurement shall be conducted under normal conditions. This measurement applies to channelized equipment only.

Two signal generators A and B shall be connected to the receiver via a combining network to the receiver either:

- a) via a test fixture or a test antenna to the receiver integral, dedicated or test antenna; or
- b) directly to the receiver permanent or temporary antenna connector.

The method of coupling to the receiver shall be stated in the test report.

Signal generator A shall be at the nominal frequency of the receiver, with normal modulation of the wanted signal. Signal generator B shall be unmodulated and shall be adjusted to the test frequency for the adjacent channel immediately above that of the wanted signal.

Initially signal generator B shall be switched off and using signal generator A with a signal level corresponding to the specified receiver sensitivity. The output level of generator A shall then be increased by 3 dB.

Signal generator B is then switched on and its level is adjusted until operation at the specified receiver sensitivity is obtained. This level shall be recorded.

The measurements shall be repeated with signal generator B adjusted to the test frequency on the adjacent channel immediately below the wanted signal.

The adjacent channel selectivity shall be recorded for the upper and lower adjacent channels as the ratio in dB of the unwanted signal to the level of the wanted signal.

## 6.3.3 Receiver blocking or desensitization

### 6.3.3.1 Measurement for channelized, narrowband or broadband equipment

The measurement shall be conducted under normal conditions.

Two signal generators A and B shall be connected to the receiver via a combining network to the receiver either:

- a) via a test fixture or a test antenna coupling to the receiver integral, dedicated or test antenna; or
- b) directly to the receiver permanent or temporary antenna connector.

The method of coupling to the receiver shall be stated in the test report.

Signal generator A shall be at the nominal frequency of the receiver, with normal modulation of the wanted signal. Signal generator B shall be unmodulated and shall be adjusted to a test frequency as defined below.

Initially signal generator B shall be switched off and by using signal generator A with a signal level corresponding to the specified receiver sensitivity. The output level of generator A shall then be increased by 3 dB.

Signal generator B is then switched on and the level is adjusted until operation at the specified sensitivity is obtained. This level shall be recorded.

The frequency for generator B is defined by either a) or b) below whichever is greater:

- a) For the frequency range 9 kHz to < 500 kHz, the measurements shall be at approximately +50 kHz, +100 kHz, +200 kHz, +300 kHz and +500 kHz from the highest receiver operating frequency + the 3 dB receiver bandwidth.  
The tests shall be repeated at approximately -50 kHz, -100 kHz, -200 kHz, -300 kHz and -500 kHz from the lowest receiver operating frequency - the 3 dB receiver bandwidth.

For the frequency range  $\geq$  500 kHz to 30 MHz, the measurements shall be at approximately +500 kHz, +1 MHz, +2 MHz and +5 MHz from the highest receiver operating frequency + the 3 dB receiver bandwidth.

The tests shall be repeated at approximately -500 kHz, -1 MHz, -2 MHz and -5 MHz from the lowest receiver operating frequency - the 3 dB receiver bandwidth.

The manufacturer shall declare the receiver operating frequencies and 3 dB receiver bandwidth.

Or:

- b) The frequency for generator B is determined as an offset by using the upper and lower receiver operating frequencies plus or minus receiver 3 dB bandwidth times a multiplier,  $(N_B+1)$ . The values for  $N_B$  are given in clause 4.4.4.3, table 10.

The upper and lower test frequencies for generator B are defined as follows:

- Upper test frequencies: Highest operating receiver frequency + (receiver 3 dB bandwidth)  $\times (N_B+1)$ .
- Lower test frequencies: Lowest operating receiver frequency - (receiver 3 dB bandwidth)  $\times (N_B+1)$ .

The manufacturer shall declare the receiver operating frequencies and 3 dB receiver bandwidth.

For systems with swept operating frequencies:

- Upper test frequencies: High end of sweep range + (receiver 3 dB bandwidth)  $\times (N_B+1)$ .
- Lower test frequencies: Low end of sweep range - (receiver 3 dB bandwidth)  $\times (N_B+1)$ .

The manufacturer shall declare the receiver operating frequencies, 3 dB receiver bandwidth and sweeping range.

The blocking or desensitization shall be recorded as the ratio in dB of lowest level of the unwanted signal (generator B) to the level of the wanted signal (generator A).

Generator B frequencies below 9 kHz are not defined and shall not be measured.

### 6.3.3.2 Measurement for tagging systems

The requirement for receiver blocking or desensitization does not apply for tagging systems (e.g. RF identification, anti-theft, access control, location systems) because of inherent receiver robustness.

NOTE: The reason is that tagging systems:

- a) contain co-located transmitter and receivers in one case and connected to the same antenna;
- b) simultaneously transmit and receive via the same antenna. The receiver operates reliably in presence of a 90 dB higher carrier without causing blocking, see ETSI TR 103 059 [i.9], figure 8.

## Annex A (informative): Relationship between the present document and the essential requirements of Directive 2014/53/EU

The present document has been prepared under the Commission's standardisation request C(2015) 5376 final [i.11] to provide one voluntary means of conforming to the essential requirements of Directive 2014/53/EU on the harmonisation of the laws of the Member States relating to the making available on the market of radio equipment and repealing Directive 1999/5/EC [i.4].

Once the present document is cited in the Official Journal of the European Union under that Directive, compliance with the normative clauses of the present document given in table A.1 confers, within the limits of the scope of the present document, a presumption of conformity with the corresponding essential requirements of that Directive and associated EFTA regulations.

**Table A.1: Relationship between the present document and the essential requirements of Directive 2014/53/EU**

Harmonised Standard ETSI EN 300 330				
Requirement			Requirement Conditionality	
No	Description	Reference: Clause No	U/C	Condition
1	Permitted range of operating frequencies	4.3.1	U	
2	Operating frequency ranges	4.3.2	U	
3	Modulation bandwidth	4.3.3	U	
4	Transmitter H-field requirements	4.3.4	C	Only for equipment under class 1 and class 2, in clause 6.1.2
5	Transmitter RF carrier current	4.3.5	C	Only for equipment under class 3 in clause 6.1.2
6	Transmitter radiated E-field	4.3.6	C	Only for equipment under class 4 in clause 6.1.2
7	Transmitter conducted spurious emissions	4.3.7	C	Only for equipment under class 3 in clause 6.1.2
8	Transmitter radiated spurious domain emission limits < 30 MHz	4.3.8	U	
9	Transmitter radiated spurious domain emission limits > 30 MHz	4.3.9	C	For equipment under class 1, 2 and 4 in clause 6.1.2
10	Transmitter Frequency stability	4.3.10	C	Only for channelized systems
11	Receiver spurious emissions	4.4.2	C	Does only apply to receivers which are not co-located with transmitters
12	Adjacent channel selectivity	4.4.3	C	Only for channelized systems in clause 4.4.1
13	Receiver blocking or desensitization	4.4.4	C	Not for tagging systems in clause 4.4.1

### Key to columns:

#### Requirement:

**No** A unique identifier for one row of the table which may be used to identify a requirement.

**Description** A textual reference to the requirement.

**Clause Number** Identification of clause(s) defining the requirement in the present document unless another document is referenced explicitly.

#### Requirement Conditionality:

**U/C** Indicates whether the requirement is unconditionally applicable (U) or is conditional upon the manufacturer's claimed functionality of the equipment (C).



**Condition** Explains the conditions when the requirement is or is not applicable for a requirement which is classified "conditional".

Presumption of conformity stays valid only as long as a reference to the present document is maintained in the list published in the Official Journal of the European Union. Users of the present document should consult frequently the latest list published in the Official Journal of the European Union.

Other Union legislation may be applicable to the product(s) falling within the scope of the present document.

---

## Annex B (normative): Transmitter definitions

### B.1 Transmitter definitions

#### B.1.0 General

Transmitters are divided into Product Classes (see clause 6.1.2) depending on the antenna type to be used. Product Class 2 and Product Class 3 transmitters may allow the customer to use his own loop antenna design based on the manufacturers design guidelines. The user's manual shall include the guidelines for the design of the antennas. These guidelines may be evaluated by the test laboratory as part of the test of the equipment and compared to actual radiated measurements.

#### B.1.1 The inductive loop coil transmitters

These transmitters are characterized by:

- a) the loop coil antenna area  $A$  shall be  $< 30 \text{ m}^2$ ;
- b) the length of any antenna loop element shall be  $< \frac{\lambda}{4} \text{ m}$  ( $< \frac{75}{f} \text{ m}$ , where  $f$  is in MHz) or  $< 30 \text{ m}$  whichever is shorter; (the loop element can be e.g. one side of a rectangular loop or a diameter of a circular antenna);
- c) antenna coil may have one or multiple turns.

#### B.1.2 The large size loop transmitters

These transmitters are characterized by:

- large loop antenna area  $A > 30 \text{ m}^2$ ;
- large loop antenna with one turn only;
- frequency range limited from 9 kHz to 135 kHz only.

#### B.1.3 Other transmitters

These transmitters are characterized as either:

- E-field transmitters; or
- loop antenna transmitters which do not meet the criteria in clauses B.1.1 and B.1.2.

---

## B.2 Product Classes

### B.2.0 General

The equipment is divided into Product Classes depending of the antenna type used. The Product Classes shall not be confused with Receiver Requirements, see clause 4.4. The different antenna types are referencing CEPT/ERC/REC 70-03 [i.1], as implemented through National Radio Interfaces (NRI) and additional NRI as relevant.

The Product Classes according to table B.1 are the following.

## B.2.1 Product Class 1

Inductive loop coil transmitter, tested with an antenna as either:

- an integral antenna (antenna type 1); or
- a dedicated antenna supplied with the equipment (antenna type 2).

The following restrictions apply to this product class:

- 9 kHz to 30 MHz frequency range;
- no customization of the antenna(s) in the field is allowed;
- loop antenna area < 30 m<sup>2</sup>; and
- the length of any antenna loop element shall be <  $\frac{\lambda}{4}$  m, (<  $\frac{75}{f}$  m, where f is in MHz) or < 30 m whichever is shorter.

The transmitter carrier output and spurious limits are given in clauses 4.3.7, 4.3.8 and 4.3.9 respectively.

Where a manufacturer provides a range of standard antennas, the equipment will be tested as Product Class 1 equipment, with the antenna(s) attached. The transmitter measurements shall be repeated for each such antenna.

## B.2.2 Product Class 2

Inductive loop coil transmitter, allowing customization of the loop antenna in the field, see annex B.

Customization is only allowed according to the manufacturer's antenna design rules published in the equipment manual.

Product Class 2 equipment is tested as Product Class 1 with two representative antennas supplied with the equipment. The two antennas shall meet the manufacturer's design rules published in the equipment manual and shall have maximum and minimum loop area respectively. Both antennas shall have the maximum magnetic dipole moment as declared by the manufacturer. The following additional restrictions apply to this Product Class:

- 9 kHz to 30 MHz frequency range;
- loop antenna area < 30 m<sup>2</sup>; and
- - the length of any antenna loop element shall be <  $\frac{\lambda}{4}$  m, (<  $\frac{75}{f}$  m, where f is in MHz) or < 30 m whichever is shorter.

The transmitter carrier output and spurious limits are given in clauses 4.3.4.3, 4.3.5.3, 4.3.8.3 and 4.3.9.3 respectively.

In cases where it, due to size constraints, is not practical to ship and test a large antenna together with the equipment, the equipment is tested either:

- at an open test site together with a maximum and minimum size custom made antenna build by the manufacturer; or
- at a representative installation (on-site) according to clause 4.2.2.4.

## B.2.3 Product Class 3

This Product Class is intended for use with customized large size loop antennas only. The loop coil transmitter is tested without an antenna by using an artificial antenna.

The following additional restrictions apply to this Product Class:

- 9 kHz to 135 kHz frequency range;

- loop antenna area  $> 30 \text{ m}^2$ ;
- single turn loop only.

The transmitter carrier output and spurious are limited by the maximum output loop current multiplied by the loop antenna area and shall comply with the radiated H-field limit given in clauses 4.3.4.3, 4.3.5.3, 4.3.8.3, 4.3.9.3 and 4.3.10.3. The manufacturer shall declare the maximum size of the loop in the users' manual.

## B.2.4 Product Class 4

E-field transmitter, tested with each type of antenna to be used.

The transmitter carrier output and spurious limits are limited by the maximum generated E-field, measured as the equivalent H-field given in clauses 4.3.4.3 and 4.3.8.3 respectively.

Table B.1: Description of product classes

Product Class	Description of transmitter	Antenna to be tested	Frequency range	Loop antenna area	Length of antenna (= maximum dimension of the antenna)	Customization of antenna design allowed	Transmitter carrier output limits	Spurious emissions limits
1	Inductive loop coil transmitter	Integral antenna (antenna type 1) or dedicated antenna supplied with the equipment (antenna type 2); (see note 1)	9 kHz to 30 MHz	< 30 m <sup>2</sup>	< $\lambda/4$ (75 metres/f where f is in MHz) or < 30 m, whichever is shorter	No	H-field at 10 m (see clause 4.3.4.3)	H-field at 10 m (see clauses 4.3.8.3 and 4.3.9.3)
2	Inductive loop coil transmitter	Two representative antennas supplied with the equipment (see note 2)	9 kHz to 30 MHz	< 30 m <sup>2</sup> (see note 3)	< $\lambda/4$ (75 metres/f where f is in MHz) or < 30 m, whichever is shorter	Yes (see note 3)	H-field at 10 m (see clause 4.3.4.3)	H-field at 10 m (see clauses 4.3.8.3 and 4.3.9.3)
3	Customized, large size loop antennas only	Test without an antenna by using an artificial antenna	9 kHz to 135 kHz	> 30 m <sup>2</sup>	n.a.	Yes	Current in artificial antenna (see note 4 and clauses 4.3.4.3 and 4.3.6.3)	Current in artificial antenna (see note 4 and clauses 4.3.7.3 and 4.3.19.3)
4	E-field transmitter	Each type of antenna to be used	9 kHz to 30 MHz	n.a.	n.a.	n.a.	H-field at 10 m (see clause 4.3.6.3)	H-field at 10 m (see clauses 4.3.8.3 and 4.3.9.3)

NOTE 1: Where a manufacturer provides a range of standard antennas, the equipment will be tested as Product Class 1 equipment, with the antenna(s) attached. The measurements shall be repeated for each antenna.

NOTE 2: The two antennas shall meet the manufacturer's design rules published in the equipment manual and shall have maximum and minimum loop areas respectively. Both antennas shall have the maximum magnetic dipole moment as declared by the manufacturer.

NOTE 3: Customization is only allowed according to the manufacturer's antenna design rules published in the equipment manual.

NOTE 4: ON-site measurements may be required.

---

## Annex C (normative): Radiated measurement

### C.0 General

This annex is applicable to the assessment of data or equipment providing a specific response.

It covers test sites and methods to be used with integral antenna equipment or equipment having an antenna connector.

---

### C.1 Test sites and general arrangements for measurements involving the use of radiated fields

#### C.1.0 Test sites

This annex introduces three most commonly available test sites, an anechoic chamber, an anechoic chamber with a ground plane and an Open Area Test Site (OATS), which may be used for radiated tests. These test sites are generally referred to as free field test sites. Both absolute and relative measurements can be performed in these sites. Where absolute measurements are to be carried out, the chamber should be verified. A detailed verification procedure is described in ETSI TR 102 273-2 [i.5], ETSI TR 102 273-3 [i.6] and ETSI TR 102 273-4 [i.7].

NOTE: To ensure reproducibility and tractability of radiated measurements only these test sites should be used in measurements in accordance with the present document.

#### C.1.1 Anechoic chamber

An anechoic chamber is an enclosure, usually shielded, whose internal walls, floor and ceiling are covered with radio absorbing material, normally of the pyramidal urethane foam type. The chamber usually contains an antenna support at one end and a turntable at the other. A typical anechoic chamber is shown in figure C.1.

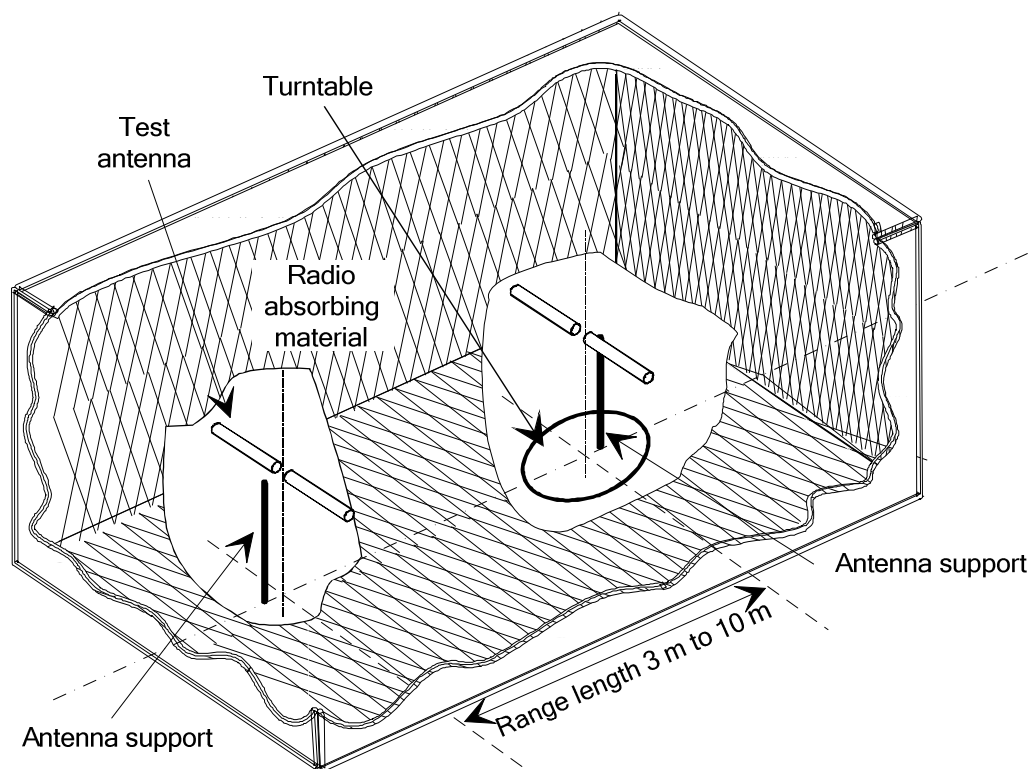

**Figure C.1: A typical anechoic chamber**

The chamber shielding and radio absorbing material work together to provide a controlled environment for testing purposes. This type of test chamber attempts to simulate free space conditions.

The shielding provides a test space, with reduced levels of interference from ambient signals and other outside effects, whilst the radio absorbing material minimizes unwanted reflections from the walls and ceiling which can influence the measurements. In practice it is relatively easy for shielding to provide high levels (80 dB to 140 dB) of ambient interference rejection, normally making ambient interference negligible.

A turntable is capable of rotation through  $360^\circ$  in the horizontal plane and it is used to support the test sample (EUT) at a suitable height (e.g. 1 m) above the ground plane. The chamber shall be large enough to allow the measuring distance of at least 3 m or  $2(d_1 + d_2)^2/\lambda$  (m), whichever is greater (see clause C.2.4). The distance used in actual measurements shall be recorded with the test results.

The anechoic chamber generally has several advantages over other test facilities. There is minimal ambient interference, minimal floor, ceiling and wall reflections and it is independent of the weather. It does however have some disadvantages which include limited measuring distance and limited lower frequency usage due to the size of the pyramidal absorbers. To improve low frequency performance, a combination structure of ferrite tiles and urethane foam absorbers is commonly used.

All types of emission, sensitivity and immunity testing can be carried out within an anechoic chamber without limitation.

## C.1.2 Anechoic chamber with a conductive ground plane

An anechoic chamber with a conductive ground plane is an enclosure, usually shielded, whose internal walls and ceiling are covered with radio absorbing material, normally of the pyramidal urethane foam type. The floor, which is metallic, is not covered and forms the ground plane. The chamber usually contains an antenna mast at one end and a turntable at the other. A typical anechoic chamber with a conductive ground plane is shown in figure C.2.

This type of test chamber attempts to simulate an ideal Open Area Test Site whose primary characteristic is a perfectly conducting ground plane of infinite extent.

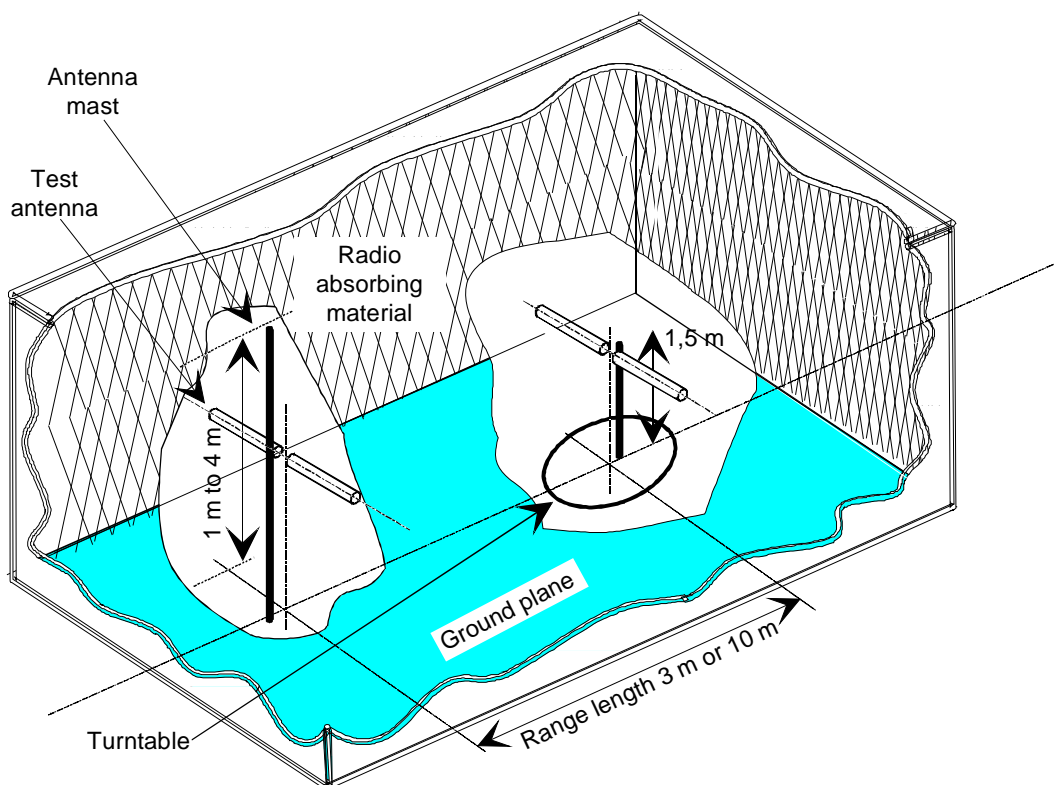

**Figure C.2: A typical Anechoic Chamber with a conductive ground plane**

In this facility the ground plane creates the wanted reflection path, such that the signal received by the receiving antenna is the sum of the signals from both the direct and reflected transmission paths. This creates a unique received signal level for each height of the transmitting antenna (or EUT) and the receiving antenna above the ground plane.

The antenna mast provides a variable height facility (from 1 m to 4 m) so that the position of the test antenna can be optimized for maximum coupled signal between antennas or between an EUT and the test antenna.

A turntable is capable of rotation through 360° in the horizontal plane and it is used to support the test sample (EUT) at a specified height, usually 1,5 m above the ground plane. The chamber shall be large enough to allow the measuring distance of at least 3 m or  $2(d_1 + d_2)^2/\lambda$  (m), whichever is greater (see clause C.2.4). The distance used in actual measurements shall be recorded with the test results.

Emission testing involves first "peaking" the field strength from the EUT by raising and lowering the receiving antenna on the mast (to obtain the maximum constructive interference of the direct and reflected signals from the EUT) and then rotating the turntable for a "peak" in the azimuth plane. At this height of the test antenna on the mast, the amplitude of the received signal is noted. Secondly the EUT is replaced by a substitution antenna (positioned at the EUT's phase or volume centre) which is connected to a signal generator. The signal is again "peaked" and the signal generator output adjusted until the level, noted in stage one, is again measured on the receiving device.

Receiver sensitivity tests over a ground plane also involve "peaking" the field strength by raising and lowering the test antenna on the mast to obtain the maximum constructive interference of the direct and reflected signals, this time using a measuring antenna which has been positioned where the phase or volume centre of the EUT will be during testing. A transform factor is derived. The test antenna remains at the same height for stage two, during which the measuring antenna is replaced by the EUT. The amplitude of the transmitted signal is reduced to determine the field strength level at which a specified response is obtained from the EUT.



## C.1.3 Open Area Test Site (OATS)

### C.1.3.0 General for OATS

The OATS can be used for measurements in the range of 9 kHz to 1 000 MHz.

Measurements below 30 MHz shall be made according to clause C.1.3.1 and measurements above 30 MHz shall be made according to clause C.1.3.2.

An Open Area Test Site comprises a turntable at one end and an antenna mast of variable height at the other end. A typical OATS is shown in figure C.3.

In figure C.3, for measurements below 30 MHz the dipole antennas shall be replaced by loop antennas and as explained in clause C.1.3.1.

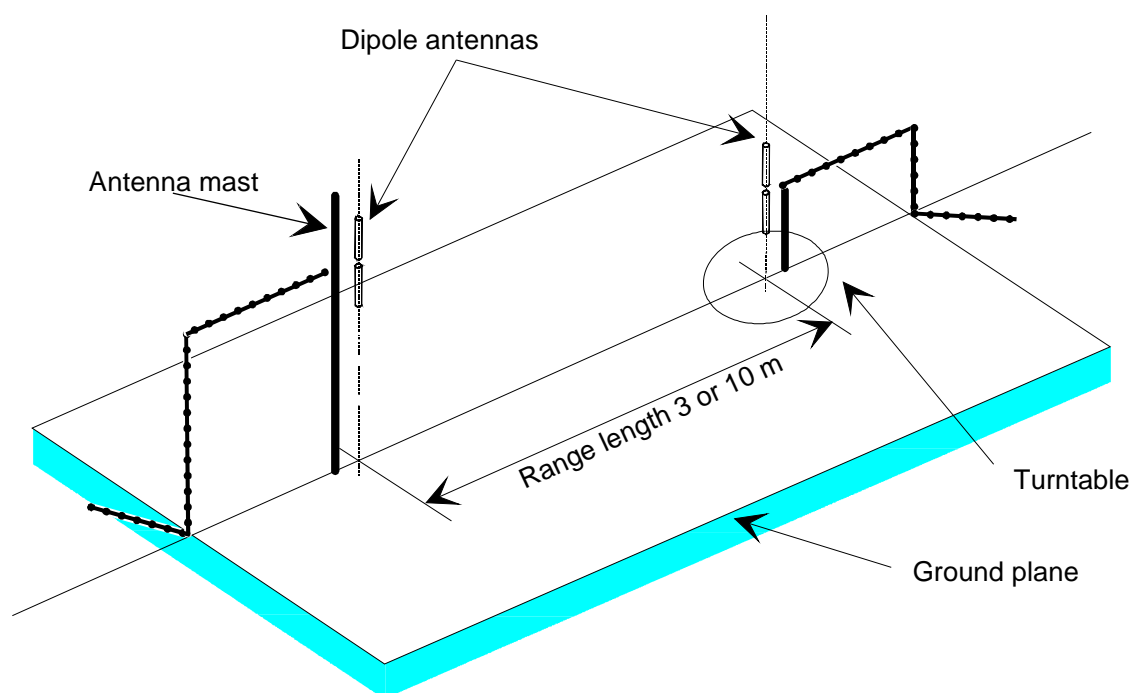

**Figure C.3: A typical Open Area Test Site**

### C.1.3.1 Measurements below 30 MHz

For measurements below 30 MHz tests may be made according to CISPR 16-1-4 [2]. The measurements are made with an inductive shielded loop test antenna, which reads the magnetic field (H-field) only. These measurements are valid for both the far-field and the near-field situations. In this case the OATS shall not have a ground plane with an electrical or magnetic conductive material.

Radiated emission test sites (OATS) below 30 MHz shall be free from metal objects, buried pipes, and any objects that can affect radiated measurements. An alternative test site that can demonstrate equivalence to a test site as described in the preceding paragraph shall be accepted for the purposes of the present document.

### C.1.3.2 Measurements above 30 MHz

An Open Area Test Site comprises a turntable at one end and an antenna mast of variable height at the other end above a ground plane, which in the ideal case, is perfectly conducting and of infinite extent. In practice, whilst good conductivity can be achieved, the ground plane size has to be limited. A typical OATS is shown in figure C.3.

The ground plane creates a wanted reflection path, such that the signal received by the receiving antenna is the sum of the signals received from the direct and reflected transmission paths. The phasing of these two signals creates a unique received level for each height of the transmitting antenna (or EUT) and the receiving antenna above the ground plane.

Site qualification concerning antenna positions, turntable, measurement distance and other arrangements are same as for anechoic chamber with a ground plane. In radiated measurements an OATS is also used by the same way as anechoic chamber with a ground plane.

Typical measuring arrangement common for ground plane test sites for spurious emission testing is presented in figure C.4.

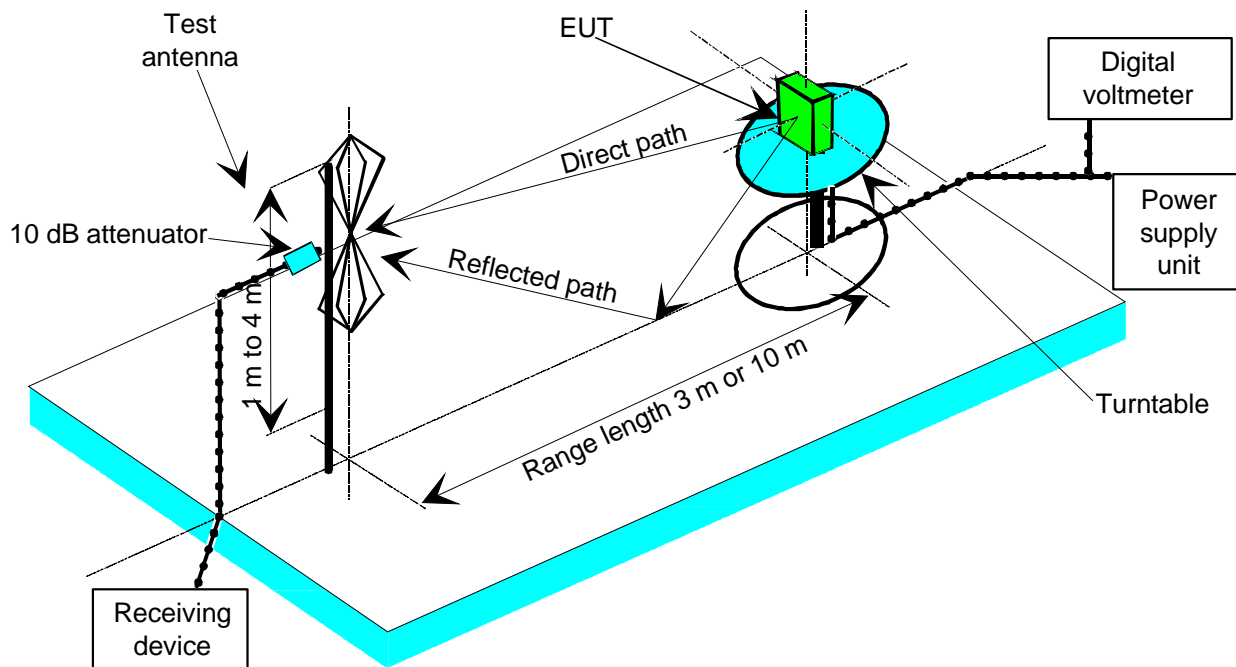

**Figure C.4: Measuring arrangement on ground plane test site (OATS set-up for spurious emission testing)**

### C.1.4 Test antenna

A test antenna is always used in radiated test methods. In emission tests (i.e. frequency error, effective radiated power, spurious emissions and adjacent sub-band power) the test antenna is used to detect the field from the EUT in one stage of the measurement and from the substitution antenna in the other stage. When the test site is used for the measurement of receiver characteristics (i.e. sensitivity and various immunity parameters) the antenna is used as the transmitting device.

The test antenna should be mounted on a support capable of allowing the antenna to be used in either horizontal or vertical polarization which, on ground plane sites (i.e. anechoic chambers with ground planes and Open Area Test Sites), should additionally allow the height of its centre above the ground to be varied over the specified range (usually 1 m to 4 m).

In the frequency range 9 kHz to 30 MHz, inductive shielded loop antennas according to CISPR 16-1-4 [2] are generally recommended. This test antenna method supports measurements in both the far-field and near-field.

In the frequency band 30 MHz to 1 000 MHz, dipole antennas (constructed in accordance with ANSI C63.5 [i.3]) are generally recommended. For frequencies of 80 MHz and above, the dipoles should have their arm lengths set for resonance at the frequency of test. Below 80 MHz, shortened arm lengths are recommended. For spurious emission testing, however, a combination of bicones and log periodic dipole array antennas (commonly termed "log periodics") could be used to cover the entire 30 MHz to 1 000 MHz band. Above 1 000 MHz, waveguide horns are recommended although, again, log periodic could be used.

NOTE: The gain of a horn antenna is generally expressed relative to an isotropic radiator.

## C.1.5 Substitution antenna

The substitution antenna is used to replace the EUT for tests in which a transmitting parameter (i.e. frequency error, effective radiated power, spurious emissions and adjacent sub-band power) is being measured. For measurements in the frequency band 30 MHz to 1 000 MHz, the substitution antenna should be a dipole antenna (constructed in accordance with ANSI C63.5 [i.3]). For frequencies of 80 MHz and above, the dipoles should have their arm lengths set for resonance at the frequency of test. Below 80 MHz, shortened arm lengths are recommended. For measurements above 1 000 MHz, a waveguide horn is recommended. The centre of this antenna should coincide with either the phase centre or volume centre.

Below 30 MHz substitution measurements are not used as the radiated H-field is measured with a shielded loop antenna according to CISPR 16-1-4 [2].

## C.1.6 Measuring antenna

The measuring antenna is used in tests on an EUT in which a receiving parameter (i.e. sensitivity and various immunity tests) is being measured. Its purpose is to enable a measurement of the electric field strength in the vicinity of the EUT.

For measurements in the frequency band 30 MHz to 1 000 MHz, the measuring antenna should be a dipole antenna (constructed in accordance with ANSI C63.5 [i.3]). For frequencies of 80 MHz and above, the dipoles should have their arm lengths set for resonance at the frequency of test. Below 80 MHz, shortened arm lengths are recommended. The centre of this antenna should coincide with either the phase centre or volume centre (as specified in the test method) of the EUT.

For measurements on inductive loop systems operating below 30 MHz, the measurement antenna is a calibrated loop antenna.

---

# C.2 Guidance on the use of radiation test sites

## C.2.0 General

This clause details procedures, test equipment arrangements and verification that should be carried out before any of the radiated tests are undertaken. These schemes are common to all types of test sites described in clause C.1.

## C.2.1 Verification of the test site

No test should be carried out on a test site which does not possess a valid certificate of verification. The verification procedures for the different types of test sites described in clause C.1 (i.e. anechoic chamber, anechoic chamber with a ground plane and Open Area Test Site) are given in ETSI TR 102 273-2 [i.5], ETSI TR 102 273-3 [i.6] and ETSI TR 102 273-4 [i.7], respectively.

## C.2.2 Preparation of the EUT

The manufacturer should supply information about the EUT covering the operating frequency, polarization, supply voltage(s) and the reference face. Additional information, specific to the type of EUT should include, where relevant, carrier power, sub-band separation, whether different operating modes are available (e.g. high and low power modes) and if operation is continuous or is subject to a maximum test duty cycle (e.g. 1 min on, 4 min off).

Where necessary, a mounting bracket of minimal size should be available for mounting the EUT on the turntable. This bracket should be made from low conductivity, low relative dielectric constant (i.e. less than 1,5) material(s) such as expanded polystyrene, balsa wood, etc.

## C.2.3 Power supplies to the EUT

All tests should be performed using power supplies wherever possible, including tests on EUT designed for battery-only use. In all cases, power leads should be connected to the EUT's supply terminals (and monitored with a digital voltmeter) but the battery should remain present, electrically isolated from the rest of the equipment, possibly by putting tape over its contacts.

The presence of these power cables can, however, affect the measured performance of the EUT. For this reason, they should be made to be "transparent" as far as the testing is concerned. This can be achieved by routing them away from the EUT and down to the either the screen, ground plane or facility wall (as appropriate) by the shortest possible paths. Precautions should be taken to minimize pick-up on these leads (e.g. the leads could be twisted together, loaded with ferrite beads at 0,15 m spacing or otherwise loaded).

## C.2.4 Range length

### C.2.4.1 Far-field length above 30 MHz

The range length for all these types of test facility should be adequate to allow for testing in the far-field of the EUT i.e. it should be equal to or exceed:

$$\frac{2(d_1 + d_2)^2}{\lambda} \quad (\text{C.1})$$

where:

$d_1$  is the largest dimension of the EUT/dipole after substitution (m);

$d_2$  is the largest dimension of the test antenna (m);

$\lambda$  is the test frequency wavelength (m).

It should be noted that in the substitution part of this measurement, where both test and substitution antennas are half wavelength dipoles, this minimum range length for far-field testing would be:

$$2\lambda$$

It should be noted in the test report when either of these conditions is not met so that the additional measurement uncertainty can be incorporated into the results.

NOTE 1: For the fully anechoic chamber, no part of the volume of the EUT should, at any angle of rotation of the turntable, fall outside the "quiet zone" of the chamber at the nominal frequency of the test.

NOTE 2: The "quiet zone" is a volume within the anechoic chamber (without a ground plane) in which a specified performance has either been proven by test, or is guaranteed by the designer/manufacture. The specified performance is usually the reflectivity of the absorbing panels or a directly related parameter (e.g. signal uniformity in amplitude and phase). It should be noted however that the defining levels of the quiet zone tend to vary.

NOTE 3: For the anechoic chamber with a ground plane, a full height scanning capability, i.e. 1 m to 4 m, should be available for which no part of the test antenna should come within 1 m of the absorbing panels. For both types of Anechoic Chamber, the reflectivity of the absorbing panels should not be worse than -5 dB.

NOTE 4: For both the anechoic chamber with a ground plane and the Open Area Test Site, no part of any antenna should come within 0,25 m of the ground plane at any time throughout the tests. Where any of these conditions cannot be met, measurements should not be carried out.

### C.2.4.2 Near-field and Far-field length below 30 MHz

Inductive systems below 30 MHz can be measured both in the near-field and far-field regions at an open test site by means of a shielded loop antenna according to CISPR 16-1-4 [2].

The minimum measurement distance,  $d$  is determined by:

$$d \geq 3D \quad (\text{C.2})$$

where  $D$  is the maximum dimension in metre of the inductive loop.

## C.2.5 Site preparation

The cables for both ends of the test site should be routed horizontally away from the testing area for a minimum of 2 m (unless, in the case both types of anechoic chamber, a back wall is reached) and then allowed to drop vertically and out through either the ground plane or screen (as appropriate) to the test equipment. Precautions should be taken to minimize pick up on these leads (e.g. dressing with ferrite beads, or other loading). The cables, their routing and dressing should be identical to the verification set-up.

NOTE: For ground reflection test sites (i.e. anechoic chambers with ground planes and Open Area Test Sites) which incorporate a cable drum with the antenna mast, the 2 m requirement may be impossible to comply with. In this case the cable routing should be described in the test report.

Calibration data for all items of test equipment should be available and valid. For test, substitution and measuring antennas, the data should include gain relative to an isotropic radiator (or antenna factor) for the frequency of test. Also, the VSWR of the substitution and measuring antennas should be known.

The calibration data on all cables and attenuators should include insertion loss and VSWR throughout the entire frequency range of the tests. All VSWR and insertion loss figures should be recorded in the log book results sheet for the specific test.

Where correction factors/tables are required, these should be immediately available.

For all items of test equipment, the maximum errors they exhibit should be known along with the distribution of the error e.g.:

- cable loss:  $\pm 0,5$  dB with a rectangular distribution;
- measuring receiver: 1,0 dB (standard deviation) signal level accuracy with a Gaussian error distribution.

At the start of measurements, system checks should be made on the items of test equipment used on the test site.

## C.3 Coupling of signals

### C.3.1 General

The presence of leads in the radiated field may cause a disturbance of that field and lead to additional measurement uncertainty. These disturbances can be minimized by using suitable coupling methods, offering signal isolation and minimum field disturbance (e.g. optical and acoustic coupling).

### C.3.2 Data signals

Isolation can be provided by the use of optical, ultrasonic or infrared means. Field disturbance can be minimized by using a suitable fibre optic connection. Ultra sonic or infrared radiated connections require suitable measures for the minimization of ambient noise.

---

## C.4 Standard test position

The standard position in all test sites, except the stripline arrangement, for equipment which is not intended to be worn on a person, including hand-held equipment, shall be on a non conducting support, height 1,5 m, capable of rotating about a vertical axis through the equipment. The standard position of the equipment shall be the following:

- a) for equipment with an internal antenna, it shall be placed in the position closest to normal use as declared by the manufacturer;
- b) for equipment with a rigid external antenna, the antenna shall be vertical;
- c) for equipment with a non-rigid external antenna, the antenna shall be extended vertically upwards by a non-conducting support.

Equipment which is intended to be worn on a person may be tested using a simulated man as support. The simulated man comprises a rotatable acrylic tube filled with salt water, placed on the ground.

The container shall have the following dimensions:

- Height: 1,7 m  $\pm$  0,1 m.
- Inside diameter: 300 mm  $\pm$  5 mm.
- Sidewall thickness: 5 mm  $\pm$  0,5 mm.

The container shall be filled with a salt (NaCl) solution of 1,5 g per litre of distilled water.

The equipment shall be fixed to the surface of the simulated man, at the appropriate height for the equipment.

NOTE: To reduce the weight of the simulated man it may be possible to use an alternative tube which has a hollow centre of 220 mm maximum diameter.

In the stripline arrangement the equipment under test or the substitution antenna is placed in the designated test area in the normal operational position, relative to the applied field, on a pedestal made of a low dielectric material (dielectric constant less than 2).

---

## C.5 Test fixture

### C.5.0 Usage Test fixture

The test fixture is only needed for the assessment of integral antenna equipment.

#### C.5.1 Description

The test fixture is a radio frequency coupling device associated with an integral antenna equipment for coupling the integral antenna to a 50  $\Omega$  radio frequency terminal at the working frequencies of the equipment under test. This allows certain measurements to be performed using the conducted measurement methods. Only relative measurements may be performed and only those at or near frequencies for which the test fixture has been calibrated.

In addition, the test fixture may provide:

- a) a connection to an external power supply;
- b) in the case of assessment of speech equipment, an audio interface either by direct connection or by an acoustic coupler.

In the case of non-speech equipment, the test fixture can also provide the suitable coupling means e.g. for the data output.

The test fixture shall normally be provided by the manufacturer.

The performance characteristics of the test fixture shall be approved by the testing laboratory and shall conform to the following basic parameters:

- a) the coupling loss shall not be greater than 30 dB;
- b) a coupling loss variation over the frequency range used in the measurement which does not exceed 2 dB;
- c) circuitry associated with the RF coupling shall contain no active or non-linear devices;
- d) the VSWR at the 50  $\Omega$  socket shall not be more than 1,5 over the frequency range of the measurements;
- e) the coupling loss shall be independent of the position of the test fixture and be unaffected by the proximity of surrounding objects or people. The coupling loss shall be reproducible when the equipment under test is removed and replaced;
- f) the coupling loss shall remain substantially constant when the environmental conditions are varied.

The characteristics and calibration shall be included in the test report.

## C.5.2 Calibration

The calibration of the test fixture establishes a relationship between the output of the signal generator and the field strength applied to the equipment placed in the test fixture.

The calibration is valid only at a given frequency and for a given polarization of the reference field.

The actual set-up used depends on the type of the equipment (e.g. data, speech, etc.).

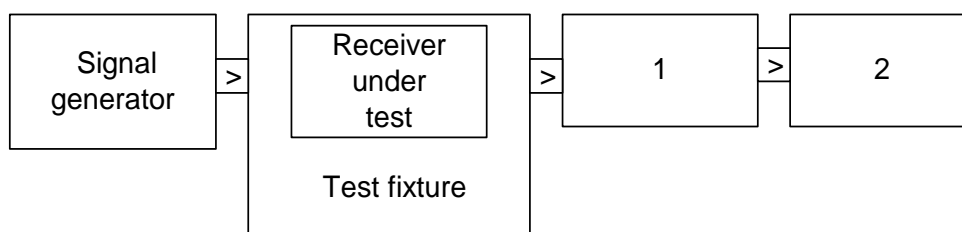

- 1) Coupling device.
- 2) Device for assessing the performance, e.g. distortion factor, BER measuring device, etc.

**Figure C.5: Measuring arrangement for calibration**

### Method of calibration:

- a) Measure the sensitivity expressed as a field strength, as specified in the present document and note the value of this field strength in dB $\mu$ V/m and the polarization used.
- b) Place the receiver in the test fixture, which is connected to the signal generator. The level of the signal generator producing:
  - a bit error ratio of 0,01; or
  - a message acceptance ratio of 80 %, as appropriate;
 shall be noted.

The calibration of the test fixture is the relationship between the field strength in dB $\mu$ V/m and the signal generator level in dB $\mu$ V emf. This relationship is expected to be linear.

### C.5.3 Mode of use

The test fixture may be used to facilitate some of the measurements in the case of equipment having an integral antenna.

It is used in particular for the measurement of the radiated carrier power and usable sensitivity expressed as a field strength under extreme conditions.

For the transmitter measurements calibration is not required as relative measuring methods are used.

For the receiver measurements calibration is necessary as absolute measurements are used.

To apply the specified wanted signal level expressed in field strength, convert it into the signal generator level using the calibration of the test fixture. Apply this value to the signal generator.

---

## C.6 Technical performance of the spectrum analyser

It shall be possible, using a resolution bandwidth of 1 kHz, to measure the amplitude of a signal or noise at a level 3 dB or more above the noise level of the spectrum analyser as displayed on the screen, to an accuracy of  $\pm 2$  dB in the presence of a signal separated in frequency by 10 kHz, at a level 90 dB above that of the signal to be measured.

The reading accuracy of the frequency marker shall be within  $\pm 2$  % of the sub-band separation.

The accuracy of relative amplitude measurements shall be within  $\pm 1$  dB.

It shall be possible to adjust the spectrum analyser to allow the separation, on the display, of two components with a frequency difference of 1 kHz.



Annex D (normative):  
H-field limit correction factor for generated E-fields

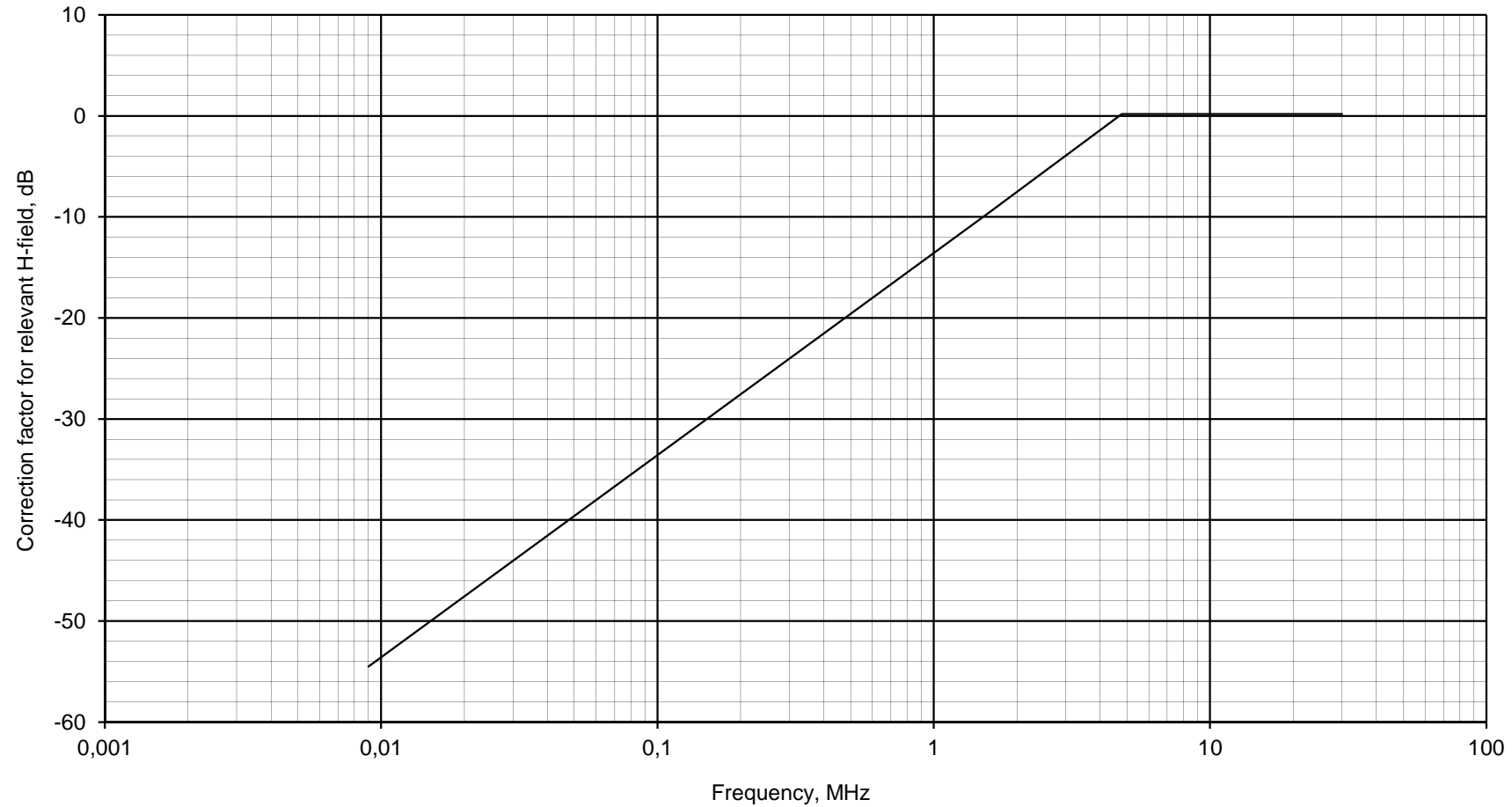

Figure D.1

---

## Annex E (normative): Customized loop antennas

### E.1 Product classes related to the antenna loop

The present document allows customization of loop antennas under the following restrictions:

- Product Class 1 is tested with an integral or dedicated antenna. No antenna customization allowed.
- Product Class 2 is restricted to loop antenna areas  $< 30 \text{ m}^2$  and a length of the antenna loop of less than  $\lambda/4$  or less than 30 m whichever is shorter.
- Product Class 2 equipment is tested with two representative maximum and minimum size loop antennas supplied by the manufacturer. Product Class 2 allows:
  - customization of the loop antenna according to the manufacturers design rules documented in the equipment manual.
- Product Class 3 is restricted to loop antenna sizes  $> 30 \text{ m}^2$ . The equipment is tested with an artificial antenna only:
  - allow customization of a single turn large loop.

The design formulas given under clauses E.2 and E.3 are given as guidelines only.

---

### E.2 Antenna loops below 1 MHz

The radiated magnetic field  $H$  from a loop coil antenna in the near field is given by:

$$H = \frac{NIA}{2\pi d^3} \text{ A/m} \quad (\text{E.1})$$

where:

- $N$  is the number of turns of the loop coil antenna.
- $I$  is the current in Ampere in the loop coil antenna.
- $A$  is the area in  $\text{m}^2$  of the loop coil antenna.
- $d$  is the distance in metre from the transmitter.

The formula is valid at low frequencies under the following conditions:

- Length of the coil wire in m:  $l < \lambda / 2\pi$ .
- Distance from coil in m:  $d < \lambda / 2\pi$ .

The product of  $NIA$  is the magnetic dipole moment  $m$  of the coil.

The equation for the magnetic moment is:

$$m = NIA = H 2\pi d^3 \text{ (Am}^2\text{)} \quad (\text{E.2})$$

In the present document the reference measuring distances  $d$  are 10 m or 30 m.

If 10 m is inserted into (E.2):

$$m = NIA = H_{10} \times 6283 \text{ (Am}^2\text{)} \quad (\text{E.3})$$

where:

$H_{10}$  is the H-field limit at 10 m in A/m (see clause 4.3.4).

The equation is only valid up to 1 MHz.

For method of measurement for loop current into an artificial antenna, see annex F.

---

## E.3 Antenna loops above 1 MHz

For frequencies above 1 MHz the maximum dipole moment can be derived from:

$$P = \frac{8\mu_0\pi^3 m^2 f^4}{3c^3} \text{ (Werp)} \quad (\text{E.4})$$

where:

$\mu_0$  is the free space permeability;

$m$  is magnetic moment of the dipole antenna;

$c$  is the speed of light;

$f$  is the frequency.

Equation (E.4) after rearrangement:

$$m = NIA = \frac{1}{f^2} \sqrt{\frac{3c^3}{8\mu_0\pi^3} P \text{ (Werp)}} \quad (\text{E.5})$$

Above 1 MHz the NIA limit is determined by equation (E.5) and is descending with  $f^2$  or 12 dB/oct.

Below 1 MHz the NIA limit is determined by equation (E.3), see clause E.2.

Relevant e.r.p. limits are 250 nW, 2,5  $\mu$ W and 10 mW all e.r.p.

The corresponding  $N \times I \times A$  products are calculated in examples (E.6), (E.7) and (E.8):

For e.r.p. = 250 nW e.r.p. in (E.5):

$$NIA = \frac{0,255}{f^2} \text{ (A} \times \text{m}^2\text{)} \quad (\text{E.6})$$

For e.r.p. = 2,5  $\mu$ W e.r.p. in (E.5):

$$NIA = \frac{0,806}{f^2} \text{ (A} \times \text{m}^2\text{)} \quad (\text{E.7})$$

For e.r.p. = 10 mW e.r.p. in (E.5):

$$NIA = \frac{50,98}{f^2} \text{ (A} \times \text{m}^2\text{)} \quad (\text{E.8})$$

where the frequency  $f$  is in MHz in (E.6), (E.7) and (E.8).

For method of measurement for loop current into an artificial antenna, see annex F.

## Annex F (informative): Artificial antenna for measuring inductive transmitter carrier and harmonic currents (Product Class 3 only)

The artificial antenna is used for equipment with an antenna connector and submitted for testing without an antenna. The radiated fields for the carrier and spurious are proportional to the RF carrier and spurious currents. Therefore, measurements are made to determine the RF carrier and spurious currents in the artificial antenna.

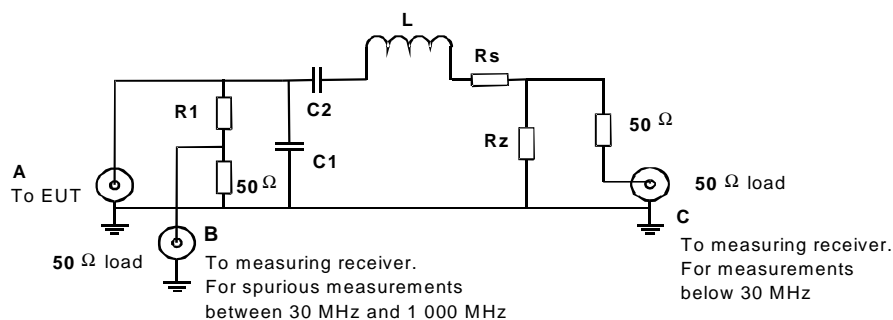

Figure F.1

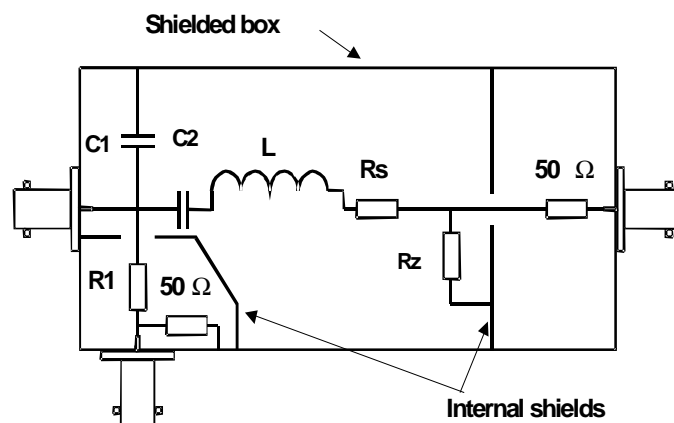

Figure F.2

An example of the mechanical layout and the equivalent electric circuit of the components is given in figures F.2 and F.1 respectively.

If the manufacturer uses several values of antenna inductance, two artificial antennas having maximum and minimum inductance  $L$  should be supplied as agreed with the test laboratory. This fact is stated in the test report.

$R_z$  is a low value non-reactive resistor. The voltage across  $R_z$  is proportional to the conducted carrier and spurious loop currents. These can be measured at connector C.

$R_s$  in combination with  $R_z$  ensures that the artificial antenna has the same  $Q$  as the actual loop antenna.

Resistor  $R_1$  together with a 50 Ω load resistor provides an attenuation of EUT output signal at connector B used for conducted spurious measurements between 30 MHz and 1 GHz. It is recommended that  $R_1$  is  $> 200 \Omega$ .

Capacitors  $C_1$  and  $C_2$  are optional components together with  $L$  to be used as appropriate by the manufacturer to simulate the actual loop antenna configuration. Other possible configurations are shown in figure F.3.

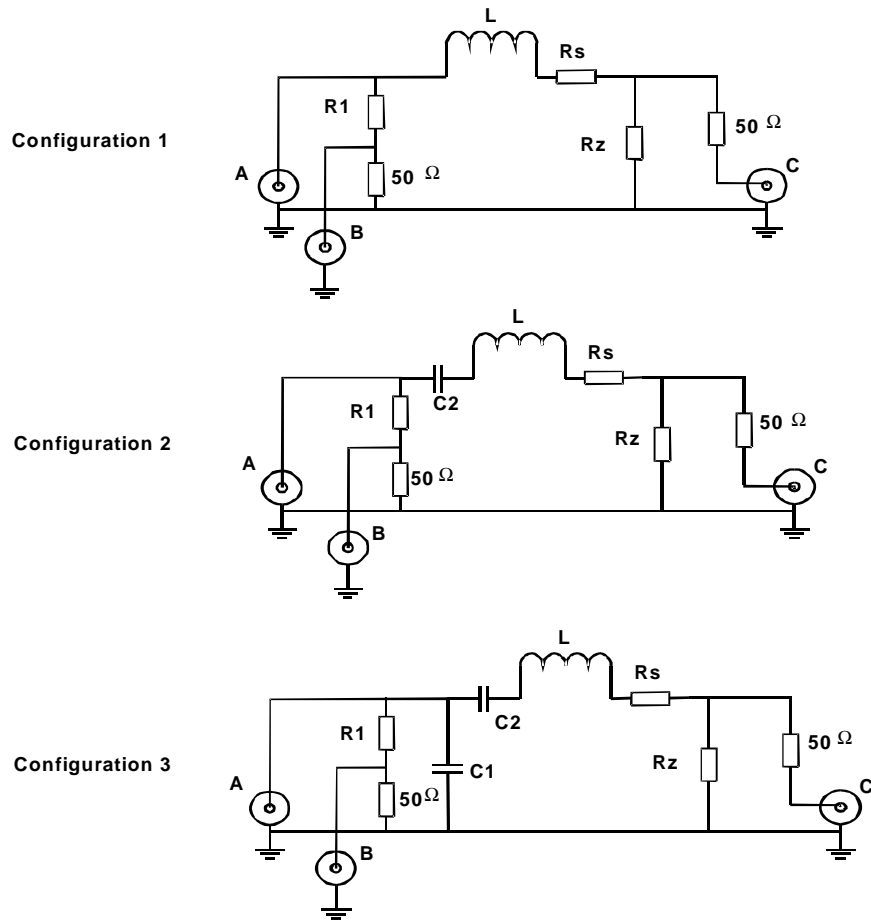
**Figure F.3**

The test fixture configuration used by the manufacturer is stated in the application and test report.

## Annex G (informative): E-fields in the near field at low frequencies

E-field at low frequencies is often in the near field and it is in reality only possible to measure the H-field component with the shielded loop antenna; in this case there is also a relation between the E-field and the H-field by the wave impedance  $Z$ . In the near field the wave impedance is highly dependent on the type of radiating antenna (loop or open end wire) and the wavelength. If the power density at a certain distance is the same for an H-field and an E-field generated signal, the following calculation can be made:

In the direction of maximum power in the near field, the power density  $S$  is:

$$S = \frac{E^2}{Z_e} = H_e^2 Z_e = H_m^2 Z_m \quad (\text{G.1})$$

where:

- $S$  = power density.
- $E$  = electrical field generated by an E-field antenna at distance  $d$ .
- $H_e$  = magnetic field generated by an E-field antenna at distance  $d$ .
- $H_m$  = magnetic field generated by an H-field antenna at distance  $d$ .
- $Z_e$  = wave impedance of a field generated by an E-field antenna at distance  $d$ .
- $Z_m$  = wave impedance of a field generated by an H-field antenna at distance  $d$ .

$$Z_m = Z_0 2\pi \frac{d}{\lambda} \text{ if } d < \frac{\lambda}{2\pi} \text{ (near field)} \quad (\text{G.2})$$

$$Z_e = Z_0 \frac{\lambda}{2\pi d} \text{ if } d < \frac{\lambda}{2\pi} \text{ (near field)} \quad (\text{G.3})$$

Equation (G.1) gives:

$$H_e = H_m \sqrt{\frac{Z_m}{Z_e}} \text{ (A/m)} \quad (\text{G.4})$$

Equations (G.2) and (G.3) into (G.4) give:

$$H_e = H_m \frac{2\pi d}{\lambda} = H_m \frac{2\pi d f_c}{300} \quad (\text{G.5})$$

where  $f_c$  is the carrier frequency in MHz.

For  $2\pi d/\lambda = 1$ ,  $d = 10$  m and  $f_c = 4,78$  MHz, and using equation (G.5), this gives:

$$H_e = H_m \frac{f_c}{4,78} \text{ (f in MHz)} \quad (\text{G.6})$$

For  $2\pi d/\lambda < 1$  if  $f_c < 4,78$  MHz then equation (G.5) is valid, (i.e. near field).

For  $2\pi d/\lambda \geq 1$  if  $f_c > 4,78$  MHz then  $H_e \approx H_m$ .

NOTE: Far field conditions like  $H_e = H_m$  and the wave impedance of a field  $Z_e = Z_m = 377 \Omega$  are valid for  $d \gg 5\lambda/2\pi$  if  $f_c \gg 23,86$  MHz.

The method allows an electric generated E-field to be measured as a magnetic generated H-field by adding a correction factor derived from (equation G.6).

For a graphical representation of the correction factor, see annex D.

---

## Annex H (normative): H-field measurements and limits at 3 m and 30 m

### H.0 General

The present document allows field measurements to be made at other distances than 10 m. In this case, the appropriate H-field limit,  $H_x$ , for manufacturer requested measurement distance,  $d_x$ , shall be determined by the manufacturer. Both the requested measurement distance and the appropriate limit shall be stated in the Test Report.

The conversion of the H-field limits at 10 m to a new measurements distance is not trivial as the near-field to far-field boundary is changing with both frequency and distance. Different combinations of near/far-field and a maximum radiated field strength in either the coaxial or coplanar direction of the loop antenna the conversions of the H-field limits of the present document to 3 m and 30 m are discontinuous curves see clauses H.1 and H.2.

The conversion methods of this annex are only applicable if the maximum dimension of the loop coil is small in relation to the measurement distance.

---

### H.1 Limits for measurements at 30 m distance

The H-field limit at 30 m,  $H_{30m}$ , is determined by the following equation:

$$H_{30m} = H_{10m} + C_{30} \quad (\text{H.1})$$

where:

$H_{10m}$  is the H-field limit in dB $\mu$ A/m at 10 m distance according to the present document; and

$C_{30}$  is a conversion factor in dB which is determined from figure H.1.



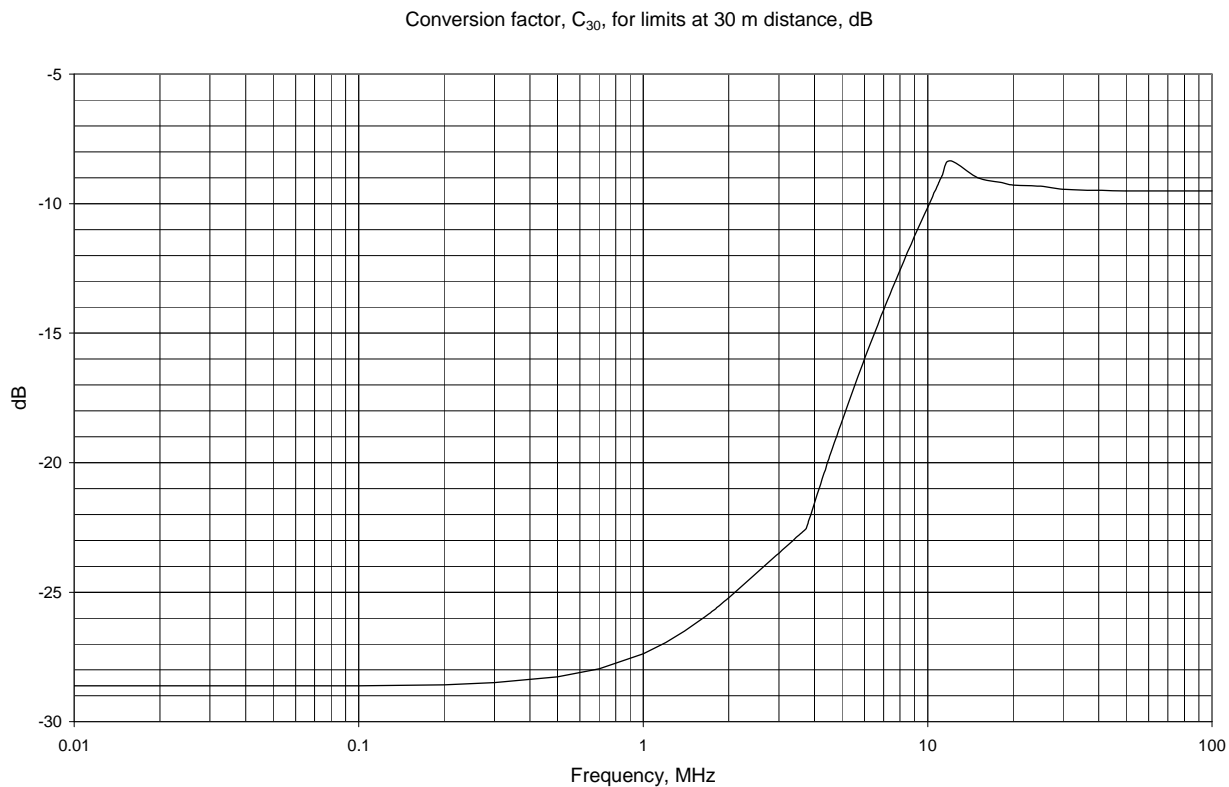

**Figure H.1: Conversion factor  $C_{30}$  versus frequency**

---

## H.2 Limits for measurements at 3 m distance

The H-field limit in dB $\mu$ A/m at 3 m,  $H_{3m}$ , is determined by the following equation:

$$H_{3m} = H_{10m} + C_3 \quad (\text{H.2})$$

where:

$H_{10m}$  is the H-field limit in dB $\mu$ A/m at 10 m distance according to the present document; and

$C_3$  is a conversion factor in dB determined from figure H.2.

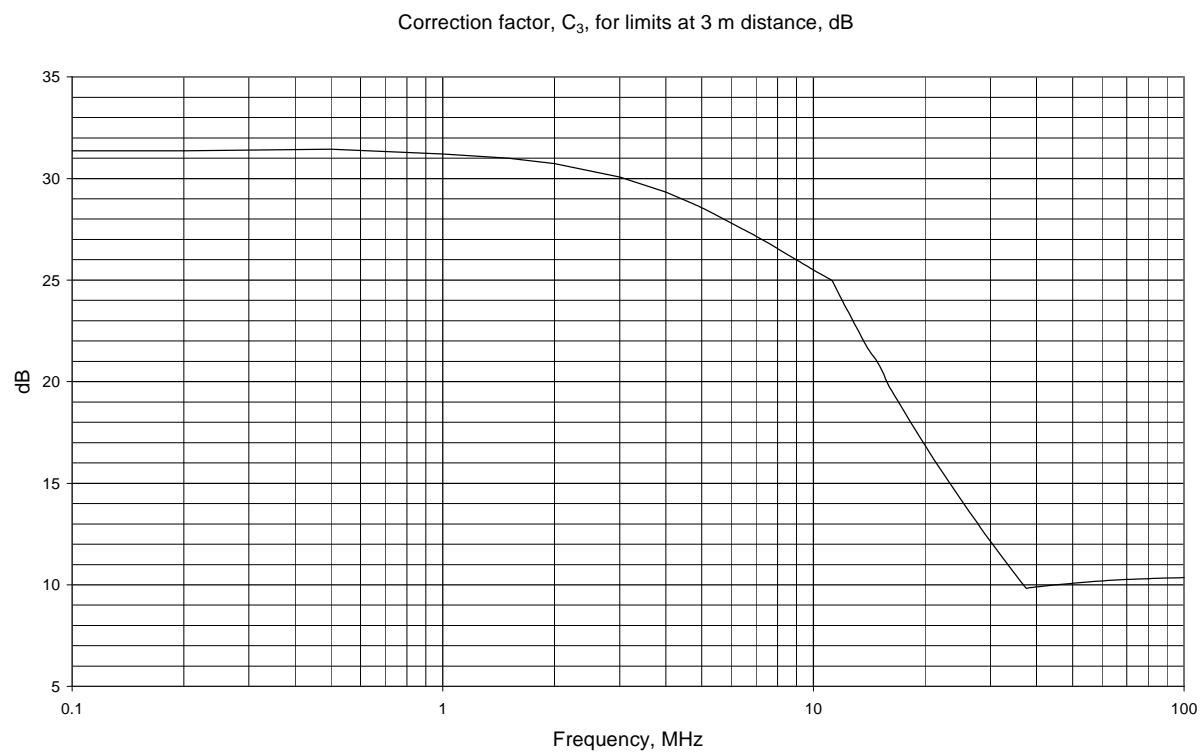
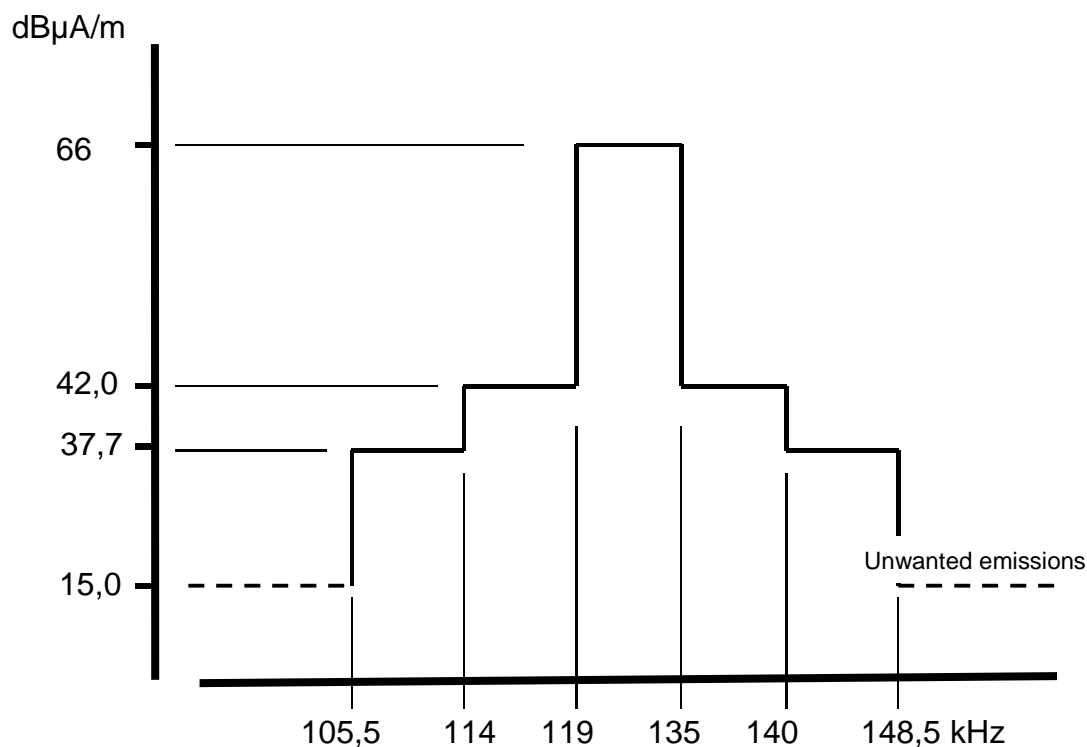

**Figure H.2: Conversion factor  $C_3$  versus frequency**

## Annex I (normative): Transmitter emission levels and spectrum mask measurements

The present document allows transmitter spectrum measurements to be made. The measurements may be relevant for SRDs operating between 9 kHz to 30 MHz.

The radiated spectrum mask shall be declared by the manufacturer, shall comply with the limits in table 10, clause 4.3.3.3 and figures I.1 and I.2. For further information, see the appropriate annex of CEPT/ERC/REC 70-03 [i.1] as implemented through National Radio Interfaces (NRI) and additional NRI as relevant.



NOTE: The limit at 129,1 kHz  $\pm$  500 Hz is maximum 42 dBμA/m at 10 m.

**Figure I.1: Emission boundary for LF RFID systems**

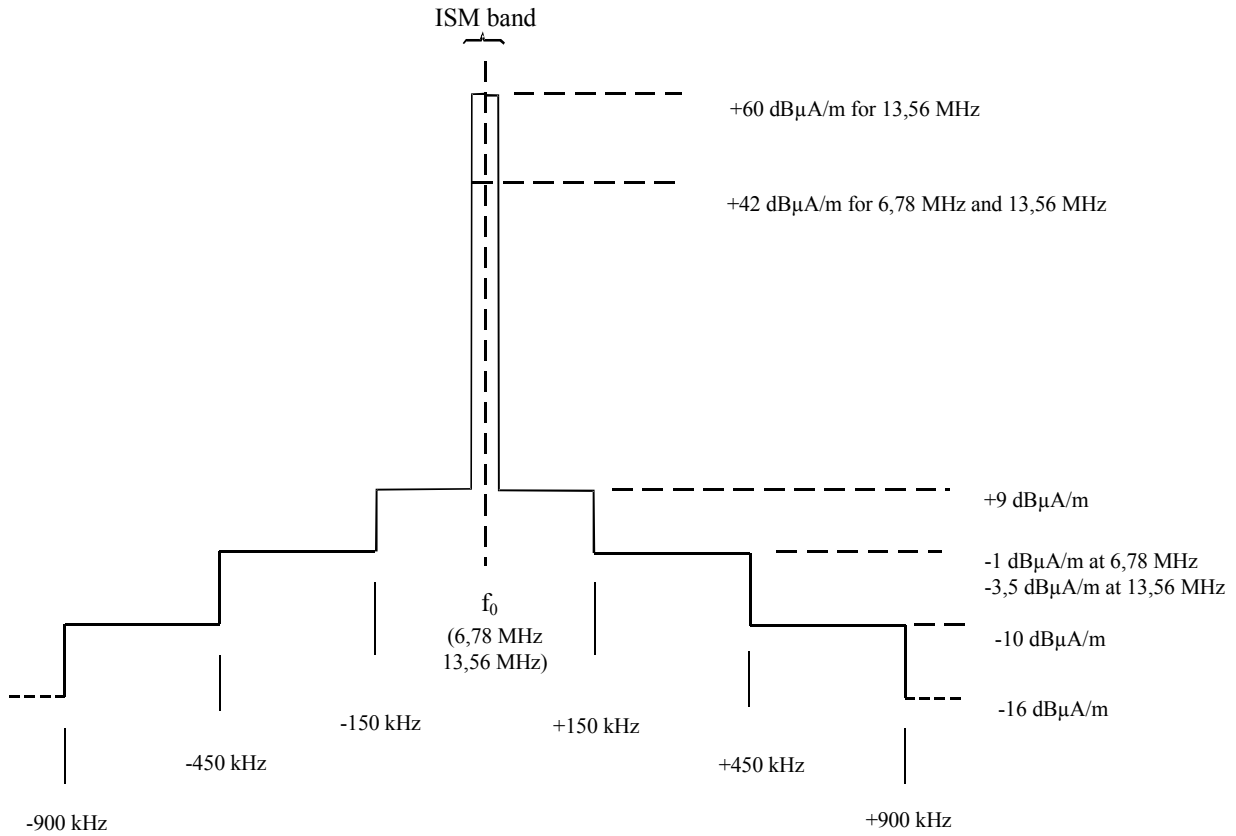

Figure I.2: Spectrum mask limit for RFIDs and EAS in the 6,78 MHz and 13,56 MHz range

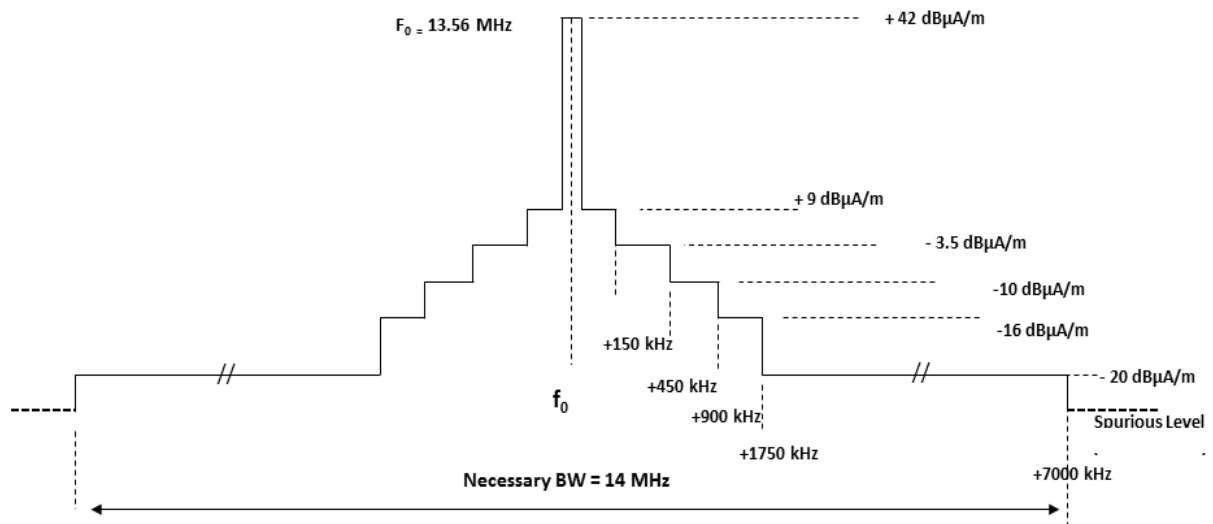

Figure I.3: Spectrum mask limit for wideband RFIDs (incl. NFC application) in the 13,56 MHz range

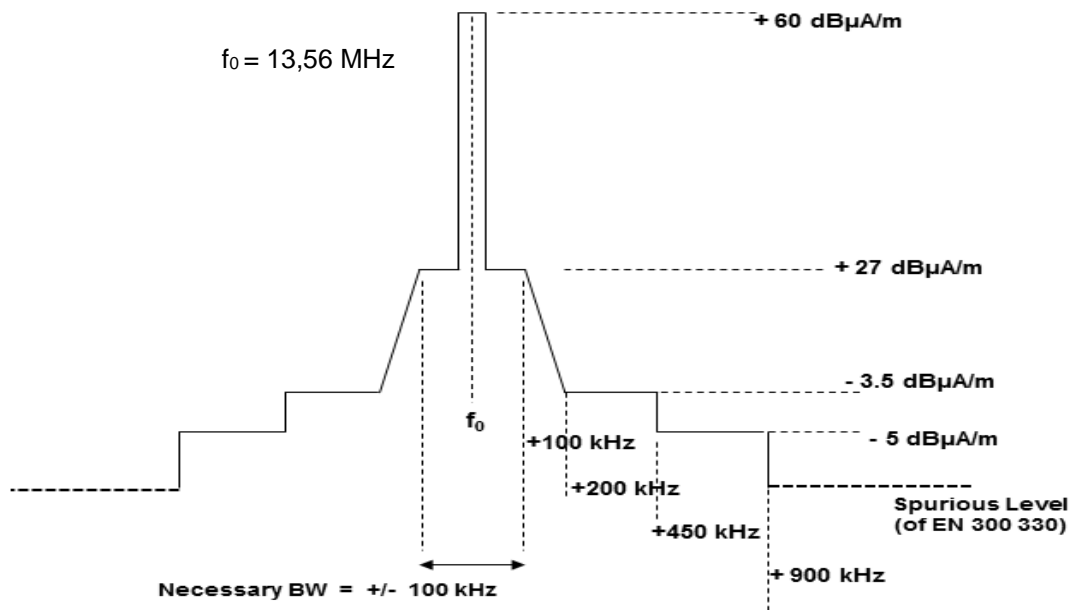

Figure I.4: Spectrum mask limit for narrowband RFIDs (incl. NFC application) in the 13,56 MHz range

---

# Annex J (normative): Generic inductive loop limits in the frequency range 148,5 kHz to 30 MHz

## J.1 Introduction

The present annex provides additional information to the measurement of inductive systems at very low magnetic field-strength levels.

---

## J.2 Radiated H-field strength

### J.2.1 Methods of measurements

The methods of measurements should be in accordance with clause 6.2.5 with the following additional provisions, either:

- a) For equipment where the transmitter modulation can be switched off, the following measurements apply:
  - Step 1 The transmitter modulation is switched off and the H-field strength is measured at 10 m distance according to clause 6.2.8 of the present document by using quasi peak detector and a 10 kHz resolution bandwidth. The result is recorded in the test report as the total field strength.
  - Step 2 The transmitter modulation is switched on and the bandwidth of the transmitter is measured in accordance with clauses 4.3.1 indent b) and 6.2.2 and 6.2.3. The result is recorded in the test report.
  - Step 3 The frequency for maximum value of the spectrum is determined. The frequency is adjusted to the centre of the spectrum analyser screen.
  - Step 4 The spectrum analyser span is changed to zero Hz and the detector is switched from quasi peak to positive peak. The measured result is recorded in the test report as the maximum H-field strength density.

Or

- b) For equipment where the transmitter modulation cannot be switched off, the following measurements apply:

Steps 2 through 4 are conducted.

Step 1 is not relevant and cannot be conducted.

For H-field density measurements of the carrier for an ASK modulated transmitter operating in the range 400 kHz to 600 kHz, where the modulation cannot be switched off a 3 dB value can be subtracted from the measurement value.

### J.2.2 Radiated H-field strength limit

#### J.2.2.1 Radiated total H-field and H-field density limits according to the measurements in clause J.2.1 indent a)

This limit applies for equipment where the transmitter modulation can be switched off.

Under normal and extreme test conditions (see clauses 5.5 and 5.6), the radiated transmitter H-field strength for clause J.2.1 indent a) should not exceed the limits for total field strength and field density given in tables J.1 and J.2.

**Table J.1: Radiated H-field strength and H-field density limits at 10 m distance**

Frequency range MHz	Total H-field strength at 10 m dB $\mu$ A/m	H-field strength density at 10 m in a 10 kHz resolution bandwidth dB $\mu$ A/m
0,1485 to 30,0	-5 (note 1)	-15 (note 2)
NOTE 1: Without transmitter modulation.		
NOTE 2: With transmitter modulation.		

For RFID equipment operating in the frequency range 400 kHz to 600 kHz the following limit applies:

**Table J.2: Radiated H-field strength and H-field density limits at 10 m distance for RFID equipment**

Frequency range MHz	Total H-field strength at 10 m dB $\mu$ A/m	H-field strength density at 10 m in a 10 kHz resolution bandwidth dB $\mu$ A/m
0,400 to 0,600	-5 (note 1)	-8 (note 1)
NOTE 1: With transmitter modulation.		
NOTE 2: The transmitted bandwidth should not be less than 30 kHz.		

### J.2.2.2 Radiated bandwidth and H-field density limits according to the measurements in clause J.2.1 indent b)

This limit applies for equipment where the transmitter modulation cannot be switched off.

Under normal and extreme test conditions (see clauses 5.5 and 5.6), the radiated transmitter H-field strength for clause J.2.1 indent b) should not exceed the limits for field density and bandwidth given in figure J.1.

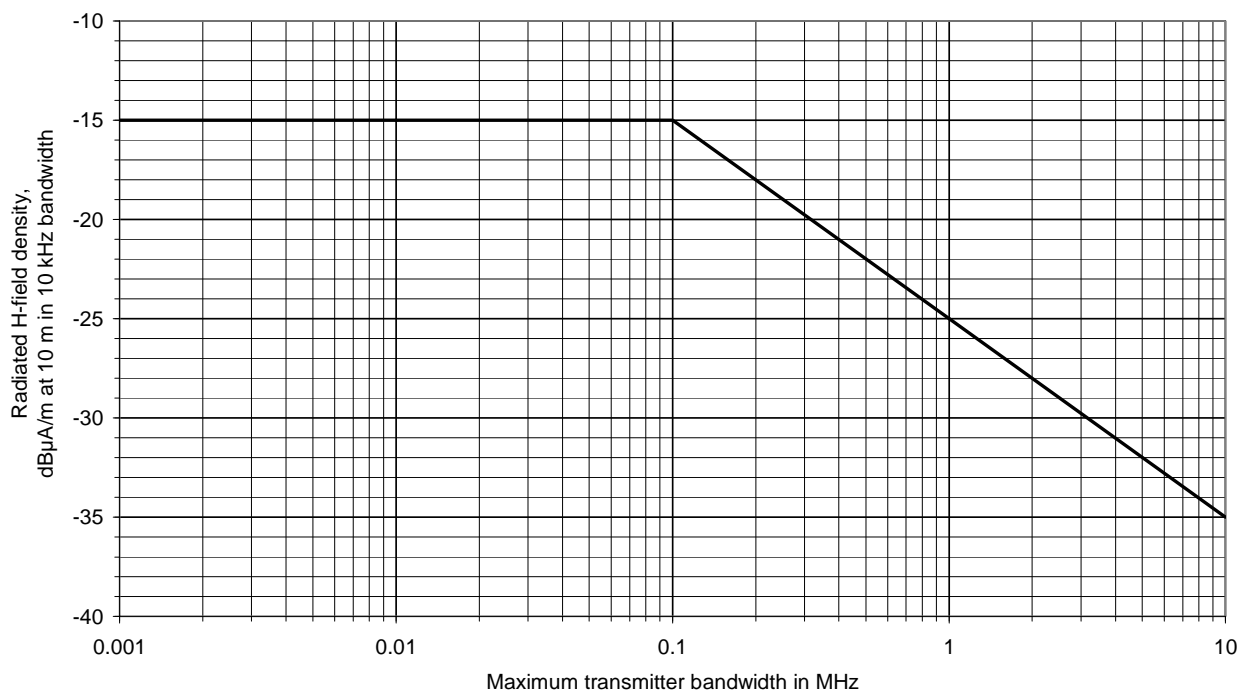
**Figure J.1: Radiated bandwidth and H-field density at 10 m distance**

---

## Annex K (informative): Determination and use of the measurement bandwidth

CISPR 16-1-4 [2] specifies a reference bandwidth for the measurement of unwanted emissions by measurement receivers and spectrum analysers.

The reference bandwidth ( $BW_{REFERENCE}$ ) cannot always be used as the measurement bandwidth ( $BW_{MEASUREMENT}$ ). This is particularly the case if the measurement is to be made for example on the slope of a spectrum mask or a receiver selectivity curve. In such situations the measurement should be made with a sufficiently low bandwidth in order not to distort the reading.

The actual measured value, A, should be referred back to the reference bandwidth by.

Either:

- a) Correcting the measured value, A, for any signal having a flat level spectrum with formula (K.1):

$$B = A + 10 \log \frac{BW_{REFERENCE}}{BW_{MEASURED}} \quad (\text{K.1})$$

where:

- B is the measured level, A, transferred to the reference bandwidth.

Or:

- b) Use the measured value, A, directly if the measured spectrum is a discrete spectral line.

A discrete spectrum line is defined as a narrow peak with a level of at least 6 dB above the average level inside the measurement bandwidth.



---

## Annex L (informative): Bibliography

- ERC Report 044 (1997): "Sharing between inductive systems and radio communication systems in the band-9 - 135 kHz".
- ERC Report 069: "Propagation model and interference range calculation for inductive systems 10 kHz - 30 MHz".
- ERC Report 074: "Compatibility between Radio Frequency Identification Devices (RFID) and the radio astronomy service at 13 MHz".
- ERC Report 092: "Sharing between inductive SRD systems and radio communication systems operating in the frequency band 10,2 - 11 MHz".
- ECC Report 001: "Compatibility between inductive LF and HF RFID transponder and other radio communications systems in the frequency ranges 135-148.5 kHz, 4.78-8.78 MHz and 11.56-15.56 MHz".
- ECC Report 007: "Compatibility between inductive LF RFID systems and radio communications systems in the frequency range 135-148.5 kHz".
- Council Directive 89/336/EEC of 3 May 1989 on the approximation of the laws of the Member States relating to electromagnetic compatibility.
- ERC Decision (ERC/DEC(01)13) of 12 March 2001 on harmonised frequencies, technical characteristics and exemption from individual licensing of Short Range Devices used for inductive applications operating in the frequency bands-9 - 59.750 kHz, 59.7-0 - 60.250 kHz, 60.2-0 - 70 kHz, -0 - 119 kHz, 1-9 - 135 kHz.
- ERC Decision (ERC/DEC(01)14) of 12 March 2001 on harmonised frequencies, technical characteristics and exemption from individual licensing of Short Range Devices used for inductive applications operating in the frequency bands 67-5 - 6795 kHz, 13.5-3 - 13.567 MHz.
- ERC Decision (ERC/DEC(01)15) of 12 March 2001 on harmonised frequencies, technical characteristics and exemption from individual licensing of Short Range Devices used for inductive applications operating in the frequency band 74-0 - 8800 kHz.
- ERC Decision (ERC/DEC(01)16) of 12 March 2001 on harmonised frequencies, technical characteristics and exemption from individual licensing of Short Range Devices used for inductive applications operating in the frequency band 26.9-7 - 27.283 MHz.
- Directive 98/34/EC of the European Parliament and of the Council of 22 June 1998 laying down a procedure for the provision of information in the field of technical standards and regulations.
- IEC 60489-3: "Methods of measurement for radio equipment used in the mobile services. Part 3: Receivers for A3E or F3E emissions".
- CENELEC EN 55022: "Information technology equipment-t - Radio disturbance characteristics - Limits and methods of measurement".
- ISO 14443: "Identification cards -- Contactless integrated circuit cards -- Proximity cards".
- ISO 15693: "Information technology -- Radio frequency identification for item management -- Unique identification for RF tags".
- ISO 18000-3: "Information technology -- Radio frequency identification for item management -- Part 3: Parameters for air interface communications at 13,56 MHz".
- CENELEC EN 62311: "Assessment of electronic and electrical equipment related to human exposure restrictions for electromagnetic fields (0 Hz - 300 GHz)".
- CENELEC EN 62479: "Assessment of the compliance of low power electronic and electrical equipment with the basic restrictions related to human exposure to electromagnetic fields (10 MHz to 300 GHz)".

- CENELEC EN 55011: "Industrial, scientific and medical equipment - Radio-frequency disturbance characteristics - Limits and methods of measurement".
- ETSI EN 300 220 (all parts): "Electromagnetic compatibility and Radio spectrum Matters (ERM); Short Range Devices (SRD); Radio equipment to be used in the 25 MHz to 1 000 MHz frequency range with power levels ranging up to 500 mW".
- ETSI EN 300 440 (all parts): "Electromagnetic compatibility and Radio spectrum Matters (ERM); Short range devices; Radio equipment to be used in the 1 GHz to 40 GHz frequency range".
- ETSI EN 301 489-1: "Electromagnetic compatibility and Radio spectrum Matters (ERM); ElectroMagnetic Compatibility (EMC) standard for radio equipment and services; Part 1: Common technical requirements".
- ETSI EN 301 489-3: "Electromagnetic compatibility and Radio spectrum Matters (ERM); ElectroMagnetic Compatibility (EMC) standard for radio equipment and services; Part 3: Specific conditions for Short-Range Devices (SRD) operating on frequencies between 9 kHz and 246 GHz".
- ETSI EN 301 489-17: "Electromagnetic compatibility and Radio spectrum Matters (ERM); ElectroMagnetic Compatibility (EMC) standard for radio equipment; Part 17: Specific conditions for Broadband Data Transmission Systems".
- ETSI EN 300 328: "Electromagnetic compatibility and Radio spectrum Matters (ERM); Wideband transmission systems; Data transmission equipment operating in the 2,4 GHz ISM band and using wide band modulation techniques; Harmonised EN covering the essential requirements of article 3.2 of the R&TTE Directive".
- Directive 2006/95/EC of the European Parliament and of the Council of 12 December 2006 on the harmonisation of the laws of Member States relating to Electrical Equipment designed for use within certain voltage limits (LVD).
- Directive 2004/108/EC of the European Parliament and of the Council of 15 December 2004 on the approximation of the laws of the Member States relating to electromagnetic compatibility and repealing Directive 89/336/EEC Text with EEA relevance (EMCD).
- Wired Science: "New RFID Tag could mean the end of Bar Codes".

NOTE: Available at: <http://www.wired.com/2010/03/rfid/>.

- ERC Report 44 (January 1997): "Sharing between inductive systems and radiocommunication systems in the band 9 - 135 kHz".
- ISO/IEC 14443-2: "Identification cards - Contactless integrated circuit(s) cards - Proximity cards - Part 2: Radio frequency power and signal interface".
- ISO/IEC 15693-1: "Identification cards - Contactless integrated circuit cards - Vicinity cards - Part 1: Physical characteristics".
- ISO/DIS 17367: "Supply chain applications of RFID - Product tagging".
- CEN EN 14803: "Identification and/or determination of the quantity of waste".
- FM(10)092 Annex 24: "Dynamic Evolution of RFID Market".
- Klaus Finkenzeller: "RFID Handbook", Chapter 5.1.11: "Selection of frequency for inductive coupled RFID systems", issue 2008, ISBN 978-3-446-41200-2.
- VDC Market Report: "RFID and related solutions".
- EETimes publishes an article about PolyIC: "Organic RFID breakthroughs detailed".

NOTE: Available at: [http://www.eetimes.com/document.asp?doc\\_id=1170339](http://www.eetimes.com/document.asp?doc_id=1170339).

- ISO/IEC 18000-3: "Information technology - Radio frequency identification for item management - Part 3: Parameters for air interface communications at 13,56 MHz".

- ISO/IEC 10536: "Identification cards - Contactless integrated circuit(s) cards".
- ISO/IEC TR 18047-3: "Information technology - Radio frequency identification device conformance test methods - Part 3: Test methods for air interface communications at 13,56 MHz".
- ISO/IEC 15693-3: "Identification cards - Contactless integrated circuit cards - Vicinity cards - Part 3: Anticollision and transmission protocol".
- ISO/IEC 10373-4: "Identification cards - Test methods - Part 4: Contactless integrated circuit cards".
- ISO/IEC 10373-6: "Identification cards - Test methods - Part 6: Proximity cards".
- ISO/IEC 10373-7: "Identification cards - Test methods - Part 7: Vicinity cards".
- ETSI EN 302 291: "Electromagnetic compatibility and Radio spectrum Matters (ERM); Short Range Devices (SRD); Close Range Inductive Data Communication equipment operating at 13,56 MHz".
- ISO/IEC 18092: "Information technology - Telecommunications and information exchange between systems - Near Field Communication - Interface and Protocol (NFCIP-1)".
- ECMA 340: "Near Field Communication Interface and Protocol (NFCIP-1)".
- ISO/IEC 18046 (parts 1 to 3): "Information technology - Radio frequency identification device performance test methods".
- ISO/IEC 18000-1: "Information technology - Radio frequency identification for item management - Part 1: Reference architecture and definition of parameters to be standardized".
- RFID report BnetzA: Measurements to characterize HF RFID signals and to determine the interference to the HF broadcast service: M66-17R0-SE24-at-13MHz-Test-Report.
- Liaison statement from ETSI-ERM to ECC WGSE #63 dated 2012-11-07, Doc. ECC/SE(13)016.
- M436: Standardisation Mandate To the European Standardisation Organization Organisations CEN, CENELEC and ETSI In The Field Of Information And Communication Technologies Applied To Radio Frequency (RFID And Systems).
- Summary for the 13.56 MHz RFID Measurement campaign (for BC).
- "Measuring Lean benefits using Radio Frequency Identification (RFID) technology".

NOTE: [http://www.rfidjournal.net/PDF\\_download/Lean\\_RFID\\_White\\_paper\\_final.pdf](http://www.rfidjournal.net/PDF_download/Lean_RFID_White_paper_final.pdf)

- ECC report 208: "Impact of RFID devices on radio services in the band 13.56 MHz".

## Annex M (informative): Change History

Version	Information about changes
1.8.1 for part 1 1.6.1 for part 2	<ul style="list-style-type: none"> <li>• Last publication as two-part HS under R&amp;TTE</li> <li>• Changes to former version 1.7.1 &amp; 1.5.1               <ul style="list-style-type: none"> <li>– To cover applications from EN 300 291 (Short Range Devices (SRD) Close Range Inductive Data Communication equipment operating at 13,56 MHz)</li> <li>– WPT applications &lt; 30 MHz</li> </ul> </li> </ul>
2.1.1	<ul style="list-style-type: none"> <li>• Revision for compliance with Directive 2014/53/EU</li> <li>• Single part HS</li> <li>• More detailed description of receiver spurious emission requirements</li> <li>• Exclusion of WPT equipment from the scope. For WPT application a new separate standard EN 303 417</li> </ul> <p>Removal of three diferent receiver classes, only one generic receiver limit is remaining</p>

# History

<b>Document history</b>		
Edition 1	December 1994	Publication as ETSI I-ETS 300 330
Amendment 1	January 1997	Amendment 1 to 1 <sup>st</sup> Edition of ETSI I-ETS 300 330
V1.2.2	May 1999	Publication as ETSI EN 300 330
V1.3.1/V1.1.1	June 2001	Publication as ETSI EN 300 330 part 1 and part 2
V1.3.2	December 2002	Publication as ETSI EN 300 330 part 1
V1.5.1/V1.3.1	April 2006	Publication as ETSI EN 300 330 part 1 and part 2
V1.7.1/V1.5.1	February 2010	Publication as ETSI EN 300 330 part 1 and part 2
V1.8.1/V1.6.1	March 2015	Publication as ETSI EN 300 330 part 1 and part 2
V2.1.0	May 2016	EN Approval Procedure AP 20160801: 2016-05-03 to 2016-08-01
V2.1.1	November 2016	Vote V 20170122: 2016-11-23 to 2017-01-23