

ETSI EN 300 152-1 V1.2.2 (2000-08)

European Standard (Telecommunications series)

**Electromagnetic compatibility and
Radio spectrum Matters (ERM);
Maritime Emergency Position Indicating
Radio Beacons (EPIRBs) intended for use on the frequency
121,5 MHz or the frequencies 121,5 MHz and 243 MHz
for homing purposes only;
Part 1: Technical characteristics and methods of measurement**

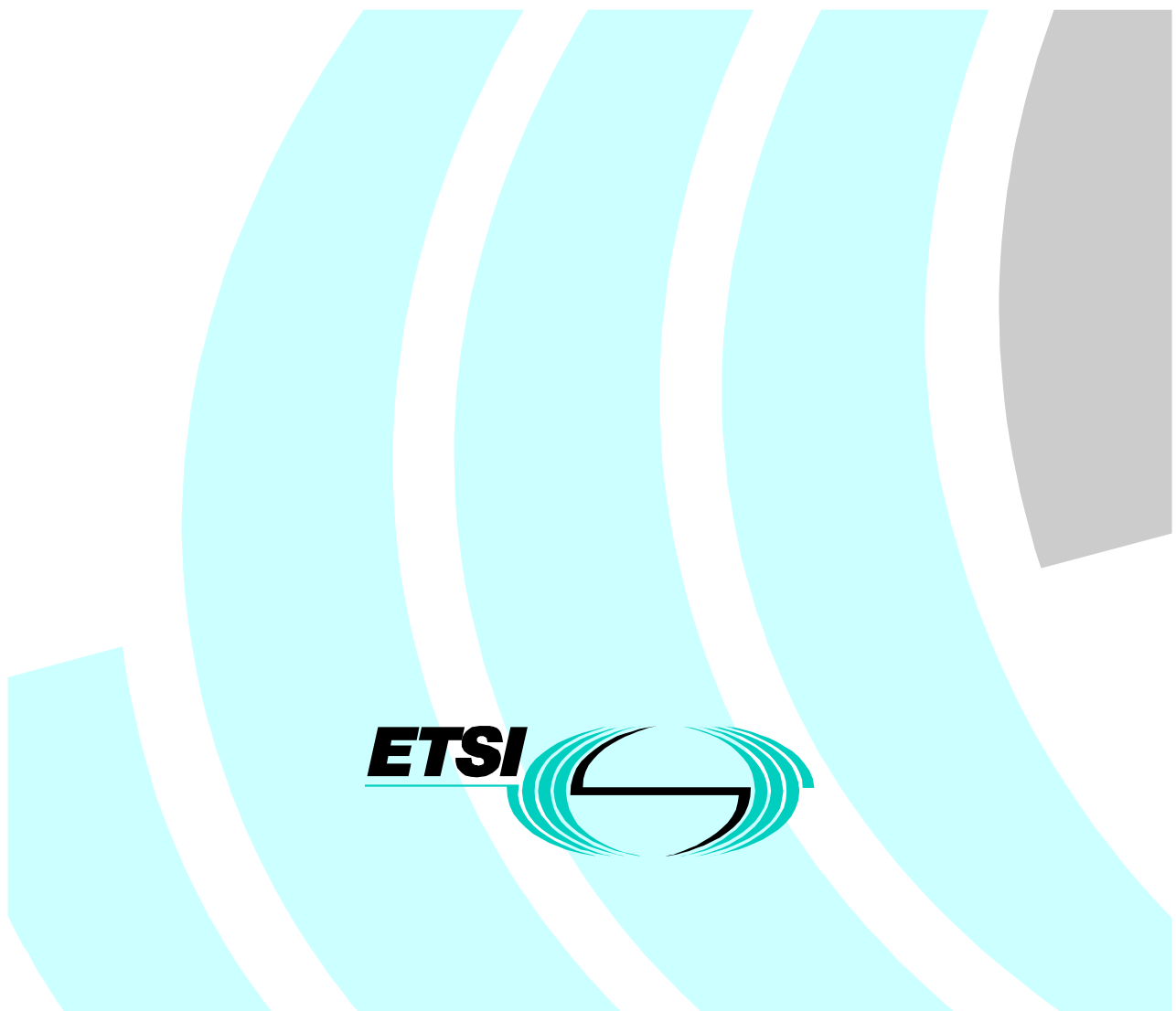

Reference

REN/ERM-RP01-036-1

Keywords

EPIRB, maritime, radio, SAR, testing

ETSI

650 Route des Lucioles
F-06921 Sophia Antipolis Cedex - FRANCE

Tel.: +33 4 92 94 42 00 Fax: +33 4 93 65 47 16

Siret N° 348 623 562 00017 - NAF 742 C
Association à but non lucratif enregistrée à la
Sous-Préfecture de Grasse (06) N° 7803/88

Important notice

Individual copies of the present document can be downloaded from:
<http://www.etsi.org>

The present document may be made available in more than one electronic version or in print. In any case of existing or perceived difference in contents between such versions, the reference version is the Portable Document Format (PDF). In case of dispute, the reference shall be the printing on ETSI printers of the PDF version kept on a specific network drive within ETSI Secretariat.

Users of the present document should be aware that the document may be subject to revision or change of status. Information on the current status of this and other ETSI documents is available at <http://www.etsi.org/tb/status/>

If you find errors in the present document, send your comment to:
editor@etsi.fr

Copyright Notification

No part may be reproduced except as authorized by written permission.
The copyright and the foregoing restriction extend to reproduction in all media.

© European Telecommunications Standards Institute 2000.
All rights reserved.

Contents

Intellectual Property Rights	6
Foreword	6
Introduction.....	6
1 Scope.....	7
2 References	7
3 Definitions, symbols and abbreviations.....	7
3.1 Definitions	7
3.2 Symbols.....	8
3.3 Abbreviations.....	8
4 General requirements.....	8
4.1 Construction	8
4.2 Controls	9
4.3 Indicators.....	9
4.4 Labelling.....	9
4.5 Requirements for conformity testing purposes.....	9
4.6 Power source	9
4.6.1 Battery requirements	9
4.6.2 Safety precautions	9
5 Technical requirements.....	10
5.1 EPIRB transmission characteristics	10
5.2 EPIRB power source.....	10
5.2.1 Battery requirements	10
6 General conditions of measurement.....	10
6.1 Test frequencies.....	10
6.2 Test fixture	10
6.3 Measurement uncertainty and interpretation of the measured results.....	11
6.3.1 Measurement uncertainty.....	11
6.3.2 Interpretation of the measurement results.....	11
6.4 Test conditions power sources and ambient temperatures	11
6.4.1 Normal and extreme test conditions	11
6.4.2 Test power source.....	11
6.5 Normal test conditions	12
6.5.1 Normal temperature and humidity.....	12
6.5.2 Normal test voltage	12
6.6 Extreme test conditions	12
6.6.1 Extreme temperatures.....	12
6.6.1.1 Procedure for tests at extreme temperatures	12
6.6.2 Extreme test voltages.....	12
6.6.2.1 Upper extreme test voltage.....	12
6.6.2.2 Lower extreme test voltage	12
7 Environmental tests	13
7.1 Introduction.....	13
7.2 Procedure	13
7.3 Performance check.....	13
7.4 Drop test.....	13
7.4.1 Definition	13
7.4.2 Test conditions	13
7.4.3 Method of measurement.....	13
7.4.4 Requirements.....	13
7.5 Temperature tests	14
7.5.1 Definition	14

7.5.2	Dry heat test	14
7.5.2.1	Method of measurement	14
7.5.2.2	Requirement.....	14
7.5.3	Damp heat test.....	14
7.5.3.1	Method of measurement	14
7.5.3.2	Requirement.....	14
7.5.4	Low temperature test	15
7.5.4.1	Method of measurement	15
7.5.4.2	Requirement.....	15
7.6	Vibration test.....	15
7.6.1	Definition	15
7.6.2	Method of measurement	15
7.6.3	Requirement	16
7.7	Corrosion test.....	16
7.7.1	Definition	16
7.7.2	Method of measurement	16
7.7.3	Requirements.....	16
7.8	Thermal shock test.....	17
7.8.1	Definition	17
7.8.2	Method of measurement	17
7.8.3	Requirements.....	17
7.9	Buoyancy test.....	17
7.9.1	Definition	17
7.9.2	Method of measurement	17
7.9.3	Requirements.....	17
7.10	Solar radiation test	17
7.10.1	Definition	17
7.10.2	Method of measurement	17
7.10.3	Requirements.....	18
7.11	Oil resistance test	18
7.11.1	Definition	18
7.11.2	Method of measurement	18
7.11.3	Requirements.....	18
7.12	Protection of the transmitter	19
7.12.1	Definition	19
7.12.2	Method of measurement	19
7.12.3	Requirement	19
8	Tests on radiation characteristics.....	19
8.1	Frequency error.....	19
8.1.1	Definition	19
8.1.2	Method of measurement	19
8.1.3	Limit	19
8.2	Modulation characteristics	19
8.2.1	Depth of modulation.....	19
8.2.1.1	Definition	19
8.2.2	Modulation duty-cycle.....	20
8.2.2.1	Definition	20
8.2.3	Method of measurement	20
8.2.4	Limits.....	20
8.2.5	Sweep characteristics.....	20
8.2.5.1	Sweep range.....	20
8.2.5.2	Sweep repetition rate	20
8.2.5.3	Method of measurement	21
8.2.5.4	Limits.....	21
8.3	Spectral carrier power ratio	21
8.3.1	Definition	21
8.3.2	Method of measurement	21
8.3.3	Limit	22
8.4	Maximum Effective Radiated Peak Envelope Power (ERPEP)	22
8.4.1	Definition.....	22

8.4.2	Method of measurement under normal test conditions	22
8.4.3	Method of measurement under extreme test conditions	23
8.4.4	Limit	23
8.5	Radiation produced by operation of the test facility	23
8.5.1	Definition	23
8.5.2	Method of measurement	23
8.5.3	Limit	23
8.6	Spurious emissions.....	23
8.6.1	Definition	23
8.6.2	Method of measurement	24
8.6.3	Limit	24
Annex A (normative): Radiated measurements.....		25
A.1	Test sites and general arrangements for measurements involving the use of radiated fields	25
A.1.1	Outdoor test site	25
A.1.2	Test antenna	25
A.1.3	Substitution antenna	26
A.1.4	Optional additional indoor site.....	26
A.2	Guidance on the use of radiation test sites	27
A.2.1	Measuring distance	27
A.2.2	Test antenna	27
A.2.3	Substitution antenna	27
A.2.4	Artificial antenna.....	28
A.2.5	Auxiliary cables	28
A.2.6	Acoustic measuring arrangement	28
A.3	Further optional alternative indoor test site using an anechoic chamber	28
A.3.1	Example of the construction of a shielded anechoic chamber.....	29
A.3.2	Influence of parasitic reflections in anechoic chambers.....	29
A.3.3	Calibration of the shielded anechoic chamber.....	30
A.4	Standard position.....	32
History.....		33

Intellectual Property Rights

IPRs essential or potentially essential to the present document may have been declared to ETSI. The information pertaining to these essential IPRs, if any, is publicly available for **ETSI members and non-members**, and can be found in ETSI SR 000 314: "*Intellectual Property Rights (IPRs); Essential, or potentially Essential, IPRs notified to ETSI in respect of ETSI standards*", which is available from the ETSI Secretariat. Latest updates are available on the ETSI Web server (<http://www.etsi.org/ipr>).

Pursuant to the ETSI IPR Policy, no investigation, including IPR searches, has been carried out by ETSI. No guarantee can be given as to the existence of other IPRs not referenced in ETSI SR 000 314 (or the updates on the ETSI Web server) which are, or may be, or may become, essential to the present document.

Foreword

This European Standard (Telecommunications series) has been prepared by ETSI Technical Committee Electromagnetic compatibility and Radio spectrum Matters (ERM).

The present document is part 1 of a multi-part EN covering the Electromagnetic compatibility and Radio spectrum Matters (ERM); Maritime Emergency Position Indicating Radio Beacons (EPIRBs) intended for use on the frequency 121,5 MHz or the frequencies 121,5 MHz and 243 MHz for homing purposes only, as identified below:

- Part 1: "Technical characteristics and methods of measurement";**
- Part 2: "Harmonized EN under article 3.2 of the R&TTE Directive";
- Part 3: "Harmonized EN under article 3.3e of the R&TTE Directive.

The present document lays down the minimum requirements for maritime Emergency Position Indicating Radio Beacons (EPIRBs) operating on certain frequencies, and incorporates the relevant provisions of the International Telecommunication Union (ITU) radio regulations and the relevant standards of the International Civil Aviation Organization (ICAO).

Every EN prepared by ETSI is a voluntary standard. The present document contains text concerning the type approval of the equipment to which it relates. This text should be considered only as guidance and does not make the present document mandatory.

Annex A to the present document is normative.

National transposition dates	
Date of latest announcement of this EN (doa):	31 October 2000
Date of latest publication of new National Standard or endorsement of this EN (dop/e):	30 April 2001
Date of withdrawal of any conflicting National Standard (dow):	30 April 2001

Introduction

The present document has been produced by ETSI in response to a mandate from the European Commission issued under Council Directive 98/34/EC [4] laying down a procedure for the provision of information in the field of technical standards and regulations.

1 Scope

The present document lays down the minimum requirements for maritime Emergency Position Indicating Radio Beacons (EPIRBs) operating on certain frequencies, and incorporates the relevant provisions of the International Telecommunication Union (ITU) radio regulations and the relevant standards of the International Civil Aviation Organization (ICAO).

EPIRBs are defined as stations in the maritime mobile service, the emissions of which are intended to facilitate search and rescue operations.

The EPIRBs described in the present document are intended only for transmission of radio signals on the frequency 121,5 MHz or the frequencies 121,5 MHz and 243 MHz for locating vessels and survival craft in distress.

The present document also applies to EPIRBs intended for very short range man-overboard location applications. For this application, both the radiated power and the length of time of operation are reduced to enable the equipment to be sufficiently small and light to be worn comfortably at all times.

2 References

The following documents contain provisions which, through reference in this text, constitute provisions of the present document.

- References are either specific (identified by date of publication, edition number, version number, etc.) or non-specific.
- For a specific reference, subsequent revisions do not apply.
- For a non-specific reference, the latest version applies.
- A non-specific reference to an ETS shall also be taken to refer to later versions published as an EN with the same number.

- [1] ITU-R Recommendation M.690-1: "Technical characteristics of emergency position-indicating radio beacons (EPIRBs) operating on the carrier frequencies of 121,5 MHz and 243 MHz".
- [2] ETSI ETR 028: "Radio Equipment and Systems (RES); Uncertainties in the measurement of mobile radio equipment characteristics".
- [3] ETSI ETR 273 (all parts): "Electromagnetic compatibility and Radio spectrum Matters (ERM); Improvement of radiated methods of measurement (using test sites) and evaluation of the corresponding measurement uncertainties".
- [4] Directive 98/34/EC of the European Parliament and of the Council of 22 June 1998 laying down a procedure for the provision of information in the field of technical standards and regulations.

3 Definitions, symbols and abbreviations

3.1 Definitions

For the purposes of the present document the following terms and definitions apply:

EPIRB station: station in the mobile service, the emissions of which are intended to facilitate search and rescue operations.

homing device: 121,5 MHz / 243 MHz beacon primarily intended for transmitting homing signals.

3.2 Symbols

For the purposes of the present document, the following symbols apply:

ϵ	permittivity
σ	Conductivity
λ	wavelength
dB	decibel
div	division
S	Siemens

3.3 Abbreviations

For the purposes of the present document, the following abbreviations apply:

EPIRB	Emergency Position Indicating Radio Beacon
ERPEP	Effective Radiated Peak Envelope Power
RF	Radio Frequency

4 General requirements

4.1 Construction

The manufacturer shall declare that compliance to the requirements of clause 4 is achieved and shall provide relevant documentation.

In all respects, the mechanical and electrical design and the construction and finish of the equipment shall conform with good engineering practice.

The equipment shall be designed to minimize the risk of internal and external damage during use or stowage.

The exterior of the equipment shall have no sharp edges or projections which could easily damage inflatable rafts or injure personnel.

The general construction and method of operation shall provide a high degree of proof against inadvertent operation due to magnetic influences, handling, stowage and transit, whilst still providing a simple means of operation in an emergency.

The equipment shall be portable, lightweight, and compact and be designed as one integral unit. The Emergency Position-Indicating Radiobeacon (EPIRB) shall derive its energy from a battery forming a part of the equipment and incorporate a permanently attached antenna which may be either fixed length or extendible.

The EPIRB may be fitted with a test facility by which the functioning of the transmitter and battery can be easily tested without the use of any external equipment.

The equipment shall be capable of being used by an unskilled person and only be capable of manual activation and deactivation.

The EPIRB shall be watertight and buoyant.

A substantial part of the equipment shall be of highly visible yellow or orange color to assist visual location.

The equipment shall not be unduly affected by sea water or oil and shall be resistant to deterioration by prolonged exposure to sunlight.

Necessary operating instructions shall be provided with the equipment.

4.2 Controls

The equipment shall be initially activated by the use of two simple, but independent mechanical actions, neither of which on its own shall activate the equipment. For equipment relating solely to man-overboard location applications, the second mechanical action may be replaced by an immersion sensor.

The equipment shall not be capable of automatic activation, except in the case of the second operation for man-overboard devices only.

Initial activation shall break a seal which shall not be replaceable by the user. This seal shall not be broken when using the test facility.

After activation it shall be simple to de-activate the equipment.

The switch which operates any test facility (subclause 4.1) shall be so designed that it returns automatically to the off-position when released.

4.3 Indicators

The equipment shall be provided with a visual indication that signals are being emitted.

4.4 Labelling

The equipment shall be provided with a label, or labels, permanently affixed to the exterior of the equipment, containing the following information:

- frequency or frequencies of operation of the equipment;
- serial number of the equipment;
- type designation of the equipment;
- adequate instructions to enable the equipment to be activated and de-activated;
- the type of battery as specified by the manufacturer of the EPIRB;
- a warning to the effect that the EPIRB should not be operated except in an emergency;
- the date on which the battery will need to be replaced. Simple means shall be provided for changing this date when the battery is replaced.

4.5 Requirements for conformity testing purposes

To assist the testing authority, complete technical and operational documentation shall be provided with the equipment.

4.6 Power source

4.6.1 Battery requirements

The type of battery and designation specified by the manufacturer for use in the equipment shall be clearly and indelibly marked on the equipment.

The battery shall be clearly and durably marked with the expiry date.

4.6.2 Safety precautions

Provisions shall be made for protecting the equipment from damage due to the accidental reversal of polarity of the battery.

5 Technical requirements

5.1 EPIRB transmission characteristics

When activated, the EPIRB shall transmit continuously on either the frequency 121,5 MHz or the frequencies 121,5 MHz and 243 MHz.

The class of emission shall be A3X as defined in ITU-R Recommendation M.690-1 [1]. However, the signal may include information of the identity of the ship. If included, this information should be transmitted automatically and shall not occupy more than 20 seconds in every 2 minutes of transmission.

5.2 EPIRB power source

5.2.1 Battery requirements

The battery provided as a power source shall be a primary battery and have sufficient capacity to operate the equipment for an uninterrupted period of at least 24 hours, or for man-overboard devices only, at least 6 hours, under all temperature conditions, (subclause 6.6), within the requirements of the present document.

6 General conditions of measurement

6.1 Test frequencies

For the purpose of conformity testing, the EPIRB shall be provided with the frequencies specified by the administration of the country in which the test is carried out. In the case of EPIRBs fitted with 121,5 MHz and 243 MHz, two frequencies are applicable and unless otherwise stated, tests shall be carried out on both frequencies.

6.2 Test fixture

The test fixture is a radio frequency coupling device with an integral antenna equipment for coupling the integral antenna to a 50 Ω radio frequency terminal at the working frequencies of the equipment under test. This allows certain measurements to be performed using the conducted measurement methods. Only relative measurements shall be performed and only those at or near frequencies for which the test fixture has been calibrated.

The test fixture normally shall be provided by the manufacturer.

The performance characteristics of the test fixture shall be approved by the testing laboratory and shall conform to the following basic parameters:

- a) the coupling loss shall not be greater than 30 dB;
- b) a coupling loss variation over the frequency range used in the measurement which does not exceed 2 dB;
- c) circuitry associated with the Radio Frequency (RF) coupling shall contain no active or non linear devices;
- d) the VSWR at the 50 Ω socket shall not be greater than 1,5 over the frequency range of the measurements;
- e) the coupling loss shall be independent of the position of the test fixture and be unaffected by the proximity of surrounding objects or people. The coupling loss shall be reproducible when the equipment under test is removed and replaced;
- f) the coupling loss shall remain substantially constant when the environmental conditions are varied.

Any connections provided on the equipment in order to facilitate relative measurements shall not affect the performance of the equipment, neither in the test fixture nor when making measurements involving the use of radiated fields.

The characteristics and calibration shall be included in the test report.

6.3 Measurement uncertainty and interpretation of the measured results

6.3.1 Measurement uncertainty

Table 1: Absolute measurement uncertainties: maximum values

Parameter	Maximum uncertainty
RF frequency	$\pm 1 \times 10^{-7}$
Radiated emission of transmitter	± 6 dB
Conducted RF power variations using a test fixture	$\pm 0,75$ dB
Modulation depth	± 5 %
Modulation duty cycle	± 5 %
Spectral carrier power ratio	$\pm 0,75$ dB
Audio frequency	± 5 %
Sweep repetition rate	± 5 %

6.3.2 Interpretation of the measurement results

The interpretation of the results recorded in a test report for the measurements described in the present document shall be as follows:

- the measured value related to the corresponding limit will be used to decide whether an equipment meets the requirements of the present document;
- the value of the measurement uncertainty for the measurement of each parameter shall be included in the test report;
- the recorded value of the measurement uncertainty shall be, for each measurement, equal to or lower than the figures in table 1.

For the test methods, according to the present document, the measurement uncertainty figures shall be calculated in accordance with ETR 028 [2] and shall correspond to an expansion factor (coverage factor) $k = 1,96$ or $k = 2$ (which provide confidence levels of respectively 95 % and 95,45 % in the case where the distributions characterizing the actual measurement uncertainties are normal (Gaussian)).

Table 1 is based on such expansion factors.

6.4 Test conditions power sources and ambient temperatures

6.4.1 Normal and extreme test conditions

Conformity testing shall be carried out under normal test conditions (subclause 6.5) and also where stated under extreme test conditions (subclauses 6.6.1 and 6.6.2 applied simultaneously).

6.4.2 Test power source

Where stated, the battery of the equipment shall be replaced by a test power source capable of producing normal (subclause 6.5.2) and extreme test voltages as specified in subclauses 6.6.2.1 and 6.6.2.2.

6.5 Normal test conditions

6.5.1 Normal temperature and humidity

Normal temperature and humidity conditions for tests shall be any convenient combination of temperature and humidity, within the following ranges:

- Temperature: +15°C to +35°C.
- Relative humidity: 20 % to 75 %.

6.5.2 Normal test voltage

The normal test voltage shall be determined in each case and shall be the voltage corresponding to the voltage which a fresh battery gives at normal temperature and humidity at a load equal to that of the equipment when activated.

6.6 Extreme test conditions

6.6.1 Extreme temperatures

For tests at extreme temperatures, measurements shall be made in accordance with the procedure specified in subclause 6.6.1.1 at the lower and upper temperatures of -20°C and +55°C respectively except when installed within other equipment subject to more stringent temperature requirements, in which case the more stringent requirements shall apply.

6.6.1.1 Procedure for tests at extreme temperatures

The equipment shall be switched off during the temperature stabilization period.

Before tests are carried out, the equipment shall have obtained thermal balance in the test chamber and have been activated for a period of 5 minutes.

The location of the equipment under test in the climatic chamber shall not substantially influence the power output or the power consumption of the equipment under test.

6.6.2 Extreme test voltages

6.6.2.1 Upper extreme test voltage

The upper extreme test voltage shall be determined in each case and shall be the voltage corresponding to the voltage which a fresh battery gives at the upper extreme temperature with a load equal to that of the equipment when activated.

6.6.2.2 Lower extreme test voltage

The lower extreme test voltage shall be determined in each case. The equipment fitted with a primary battery shall be placed in a climatic chamber and cooled to -20°C allowing a stabilization period of 2 hours. The equipment shall then be activated for a period of 24 hours, or 6 hours in the case of a man-overboard device. After this period the battery voltage shall be measured. This voltage shall be taken as the lower extreme test voltage and shall be measured before disconnecting the battery.

7 Environmental tests

7.1 Introduction

The requirements of clause 7 demonstrate that the equipment is capable of continuous operation under the conditions of various sea states, vibration, humidity and change of temperature likely to be experienced on a ship in which it is carried.

7.2 Procedure

Environmental tests shall be carried out before tests in respect of the other requirements in the present document are performed on the same equipment.

7.3 Performance check

The term performance check as used in the present document shall be taken to mean a check of:

- Frequency error: the carrier frequency 121,5 MHz shall be measured with the equipment placed in the test fixture (subclause 6.2). The frequency error shall not exceed $\pm 3,5$ kHz.
- Maximum effective radiated peak envelope power: the output power shall be measured with the equipment placed in the test fixture (subclause 6.2). The measured power corrected with the reference factor (subclause 8.4.3) shall be at least 75 mW, and in the case of man-overboard devices only, shall be at least 25 mW.

The performance check shall be carried out only under normal test conditions unless otherwise stated.

7.4 Drop test

7.4.1 Definition

The immunity against the effects of dropping is the ability of the equipment to maintain the specified mechanical and electrical performance after being subjected to a series of drops on a hard wooden test surface.

7.4.2 Test conditions

During the test, the equipment shall be fitted with a suitable set of batteries and antenna but it shall be switched off. The test shall be carried out under normal temperature and humidity conditions as detailed in subclause 6.5.1.

The hard wooden test surface shall consist of a piece of solid hard wood with a minimum thickness of 15 cm and a mass of at least 30 kilograms.

The height of the lowest part of the equipment under test, relative to the test surface at the moment of release, shall be 1 m.

Equipment shall be subjected to this test in the configuration as it is normally used in operational circumstances.

7.4.3 Method of measurement

The test shall consist of six drops, once on each face.

7.4.4 Requirements

Inspection for mechanical damage, both internal and external, shall be carried out after completion of tests. Any damage shall not impair the operation of the equipment. In particular, parts like knobs, switches and the antenna shall operate in the normal manner. The act of dropping shall not cause the equipment to operate.

7.5 Temperature tests

7.5.1 Definition

The immunity against the effects of temperature is the ability of the equipment to maintain the specified mechanical and electrical performance after the following tests have been carried out.

The maximum rate of raising or reducing the temperature of the chamber in which the equipment is being tested shall be 1°C/minute.

7.5.2 Dry heat test

7.5.2.1 Method of measurement

The equipment shall be placed in a chamber of normal room temperature. The temperature shall then be raised to and maintained at +70°C ($\pm 3^\circ\text{C}$) for a period of between 10 hours and 16 hours.

After this period any climatic control device provided in the equipment may be switched on and the chamber cooled to +55°C ($\pm 3^\circ\text{C}$). The cooling of the chamber shall be completed within 30 minutes.

The equipment shall then be activated and shall be kept working continuously for a period of 2 hours. The temperature of the chamber shall be maintained at +55°C ($\pm 3^\circ\text{C}$) during the 2 hours 30 minutes period. The equipment shall be subjected to a performance check during the last 30 minutes.

At the end of the test, and with the equipment still in the chamber, the chamber shall be brought to room temperature in not less than 1 hour. The equipment shall then be exposed to normal room temperature and humidity for not less than 3 hours before the next test is carried out.

7.5.2.2 Requirement

The requirement for the performance check shall be met.

7.5.3 Damp heat test

7.5.3.1 Method of measurement

The equipment shall be placed in a chamber at normal room temperature and humidity which, steadily, over a period 3 hours ($\pm 0,5$ hours), shall be heated from room temperature to +40°C ($\pm 3^\circ\text{C}$) and shall during this period be brought to a relative humidity of 93 % (± 2 %).

These conditions shall be maintained for a period of between 10 hours and 16 hours.

The equipment shall be activated 30 minutes later, and shall then be kept working continuously for a period of 2 hours.

The temperature and relative humidity of the chamber shall be maintained at +40°C ($\pm 3^\circ\text{C}$) and 93 % (± 2 %) during the 2 hours 30 minutes period. The equipment shall be subjected to a performance check during the last 30 minutes.

At the end of the test, and with the equipment still in the chamber, the chamber shall be brought to room temperature in not less than 1 hour. The equipment shall then be exposed to normal room temperature and humidity for not less than 3 hours, or until moisture has dispersed, whichever is longer, before the performance check is carried out.

7.5.3.2 Requirement

The requirement for the performance check shall be met.

7.5.4 Low temperature test

7.5.4.1 Method of measurement

The equipment shall be placed in a chamber at normal room temperature. The temperature shall be reduced to, and maintained at -30°C ($\pm 3^{\circ}\text{C}$) for a period of between 10 hours and 16 hours.

The chamber shall then be heated to -20°C ($\pm 3^{\circ}\text{C}$).

Any climatic control device provided in the equipment may be switched on. The action of the climatic control device and the heating of the chamber shall be completed within 25 minutes (± 5 minutes).

The temperature of the chamber shall be then maintained during a period of 2 hours.

The equipment shall be activated and subjected to a performance check during the last 30 minutes of the test.

At the end of the test, and with the equipment still in the chamber, the chamber shall be brought to room temperature in not less than 1 hour. The equipment shall then be exposed to normal room temperature for not less than 3 hours, or until moisture has dispersed, whichever is longer, before the next test is carried out.

Throughout the test the equipment shall be working normally.

7.5.4.2 Requirement

The requirement for the performance check shall be met.

7.6 Vibration test

7.6.1 Definition

The immunity against the effects of vibration is the ability of the equipment to maintain the specified mechanical and electrical performance when the following test is carried out.

7.6.2 Method of measurement

The equipment, complete with any shock absorbers which are part of it, shall be clamped to the vibration table by its normal means of support and in its normal attitude. The equipment may be suspended to compensate for weight not capable of being withstood by the vibration table.

Provision may be made to reduce or nullify any adverse effect on the equipment performance which could be caused by the presence of any electro-magnetic field due to the vibration unit.

The equipment shall be subjected to sinusoidal vertical vibration at all frequencies between:

- 2 Hz ($-0/+3$ Hz) and 13,2 Hz with an excursion of ± 1 mm ± 10 % (7 m/s² maximum acceleration at 13,2 Hz); and
- 13,2 Hz and 100 Hz with a constant maximum acceleration of 7 m/s².

The frequency sweep rate shall be slow enough to allow the detection of resonances in any part of the Equipment Under Test (EUT).

A resonance search shall be carried out during the vibration test. If any resonance of any part of any component is observed, the equipment shall be subjected to a vibration endurance test at each resonance frequency with the duration of not less than 2 hours at the vibration level specified above. The test shall be repeated with vibration in each of the mutual perpendicular direction in the horizontal plane.

A performance check of the EPIRB shall be carried out during and after the test. At the end of the test, the equipment shall be examined for any mechanical deterioration.

7.6.3 Requirement

The EPIRB shall not automatically activate during the vibration test.

The requirement for the performance check shall be met. No damage or mechanical deterioration shall be visible to the naked eye.

7.7 Corrosion test

This test need not be carried out if the manufacturer produces sufficient evidence that the components, materials etc. maintain their specified mechanical and electrical performance against the effects of corrosion.

7.7.1 Definition

The immunity against the effects of corrosion is the ability of the equipment to maintain the specified mechanical and electrical performance after the following test has been carried out.

7.7.2 Method of measurement

The equipment shall be placed in a chamber fitted with apparatus capable of spraying in the form of fine mist, such as would be produced by a spray gun, salt solution to the formula in table 2.

Table 2: Salt solution formula

sodium chloride	26,5	g	±10 %
magnesium chloride	2,5	g	±10 %
magnesium sulphate	3,3	g	±10 %
calcium chloride	1,1	g	±10 %
potassium chloride	0,73	g	±10 %
sodium bicarbonate	0,20	g	±10 %
sodium bromide	0,28	g	±10 %
plus distilled water to make the solution up to 1 l.			

Alternatively a 5 % sodium chloride (NaCl) solution may be used. The salt used for the test shall be high quality sodium chloride (NaCl) containing, when dry, not more than 0,1 % sodium iodide and not more than 0,3 % of total impurities.

Salt solution concentration shall be 5 % (±1 %) by weight. The solution shall be prepared by dissolving 5 parts ±1 by weight of salt in 95 parts by weight of distilled or de-mineralized water.

The pH value of the solution shall be between 6,5 and 7,2 at temperature of 20°C (±2°C). The pH value shall be maintained within this range during conditioning. For this purpose, diluted hydrochloric acid or sodium hydroxide may be used to adjust the pH value, provided that the concentration of NaCl remains within the prescribed limits. The pH value shall be measured when preparing each new batch of solution.

The spraying apparatus shall be such that the products of corrosion cannot mix with the salt solution contained within the spray reservoir.

The equipment shall be sprayed simultaneously on all its external surfaces with the salt solution for a period of 1 hour. This spraying shall be carried out 4 times with a storage period of 7 days; at 40°C (±2°C) after each spraying. The relative humidity during storage shall be maintained between 90 % and 95 %.

At the end of the total period the equipment shall be examined visually.

7.7.3 Requirements

There shall be no undue deterioration or corrosion of the metal parts, finishes, material, or component parts visible to the naked eye.

In the case of hermetically sealed equipment there shall be no evidence of moisture penetration.

7.8 Thermal shock test

7.8.1 Definition

The immunity against the effects of thermal shock is the ability of the equipment to maintain the specified mechanical and electrical performance after the following test has been carried out.

7.8.2 Method of measurement

The equipment shall be placed in an atmosphere of +65°C ($\pm 3^\circ\text{C}$) for 1 hour. It shall then be immersed in water at +20°C ($\pm 3^\circ\text{C}$) to a depth of 10 cm, measured from the highest point of the equipment to the surface of the water, for a period of 1 hour.

7.8.3 Requirements

No damage shall be visible to the naked eye and the equipment shall not show any sign of significant external damage or harmful penetration of water.

7.9 Buoyancy test

7.9.1 Definition

Buoyancy, expressed as a percentage, is its buoyant force divided by its gravity force.

7.9.2 Method of measurement

The EPIRB shall be submerged in calm fresh water.

One of the following methods of measurement shall be used:

- the buoyant force shall be measured when the EPIRB is totally submerged in fresh water. The buoyant force shall be then divided by the measured gravity force. The result shall be recorded; or
- the buoyancy may be calculated by dividing the volume of the unit above the waterline by the total volume of the EPIRB. The result shall be recorded.

7.9.3 Requirements

The value of buoyancy shall be at least 5 %.

7.10 Solar radiation test

This test need not be carried out if the manufacturer produces sufficient evidence that the components, materials etc. maintain their specified mechanical and electrical performance against the effects of continuous solar radiation.

7.10.1 Definition

The immunity against the effects of continuous solar radiation is the ability of the equipment to maintain the specified mechanical and electrical performance after the following test has been carried out.

7.10.2 Method of measurement

The equipment shall be placed on a suitable support and exposed continuously to a simulated solar radiation source (table 3) for 80 hours.

The intensity at the test point, which shall also include any radiation reflected from the test enclosure, shall be $1\ 120\ \text{W/m}^2 \pm 10\ \%$ with a spectral distribution given in table 3.

Table 3: Spectral distribution

Spectral Region	Ultra-violet B	Ultra-violet A	Visible			Infra-red
Bandwidth { μm }	0,28 to 0,32	0,32 to 0,40	0,40 to 0,52	0,52 to 0,64	0,64 to 0,78	0,78 to 3,00
Radiance { W/m^2 }	5	63	200	186	174	492
Tolerance {%}	± 35	± 25	± 10	± 10	± 10	± 10

NOTE: Radiation shorter than 0,30 μm reaching the earth's surface is insignificant.

7.10.3 Requirements

No damage shall be visible to the naked eye and the equipment shall not show any sign of significant external damage or harmful penetration of water.

7.11 Oil resistance test

This test need not be carried out if the manufacturer produces sufficient evidence that the components, materials etc. maintain their specified mechanical and electrical performance against the effects of corrosion.

7.11.1 Definition

The immunity against the effects of immersion in mineral oil is the ability of the equipment to maintain the specified mechanical and electrical performance after the following test has been carried out.

7.11.2 Method of measurement

The equipment shall be immersed horizontally for a period of 24 hours under a 100 mm head of mineral oil as specified below at normal room temperature.

- aniline point: 120°C;
- flash point: minimum 240°C;
- viscosity: 10 - 25 sST at 99°C.

The following oils may be used:

- ASTM Oil No. 1;
- ASTM Oil No. 5;
- ISO Oil No. 1.

7.11.3 Requirements

No sign of damage such as shrinking, cracking, swelling, dissolution or change of mechanical qualities of the EPIRB, including labelling, shall be visible to the naked eye.

7.12 Protection of the transmitter

7.12.1 Definition

When operating, the EPIRB transmitter shall not be damaged due to antenna mismatching.

7.12.2 Method of measurement

With the transmitter operating, the equipment shall be completely immersed in water for a period of 5 minutes. For equipment fitted with an extendible antenna, the test shall be carried out with the antenna fully extended, and repeated with the antenna fully retracted under normal test conditions.

7.12.3 Requirement

No damage shall be visible to the naked eye and the equipment shall not show any sign of significant external damage or harmful penetration of water, and the requirements of the performance check shall be met.

8 Tests on radiation characteristics

8.1 Frequency error

8.1.1 Definition

The frequency error is the difference between the measured carrier frequency and its nominal value (subclause 5.1).

8.1.2 Method of measurement

The carrier frequency shall be measured with the equipment placed in the test fixture (subclause 6.2). The measurement shall be made using the test power source (see subclause 6.4.2) under both normal and extreme test conditions.

8.1.3 Limit

The frequency error under both normal and extreme test conditions shall not exceed $\pm 3,5$ kHz for the frequency 121,5 MHz and ± 7 kHz for the frequency 243 MHz.

8.2 Modulation characteristics

8.2.1 Depth of modulation

8.2.1.1 Definition

The depth of modulation is calculated from the formula: $\frac{A - B}{A + B} \times 100 \%$

Where A and B are respectively the maximum and minimum value of the modulation envelope in figure 1.

8.2.2 Modulation duty-cycle

8.2.2.1 Definition

The modulation duty cycle is the ratio: $\frac{t_1}{t_2} \times 100 \%$ where t_1 is the duration of the positive half cycle of the audio modulation measured at the half amplitude points of the modulation envelope, and t_2 is the period of the fundamental of the audio modulation, in figure 1.

8.2.3 Method of measurement

The depth of modulation and the modulation duty cycle shall be measured with the EPIRB placed in the test fixture (see subclause 6.2). The emission is suitably applied to the input of a storage oscilloscope. A display of the type shown in figure 1 can be obtained on the storage oscilloscope. The modulation duty cycle and the depth of modulation are calculated as depicted in figure 1.

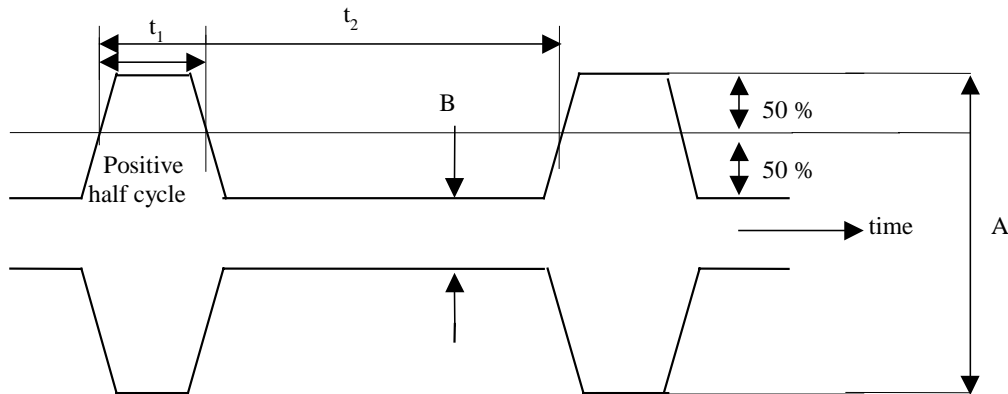

Figure 1

$$\text{Modulation depth: } \frac{A - B}{A + B} \times 100 \%$$

$$\text{Modulation duty cycle: } \frac{t_1}{t_2} \times 100 \%$$

NOTE: Low modulation duty cycle may occur by over-modulation.

8.2.4 Limits

The depth of modulation shall be at least 85 %.

The modulation duty cycle shall be between 33 % and 55 %.

8.2.5 Sweep characteristics

8.2.5.1 Sweep range

The audio sweep range is defined by the upper and lower frequencies with which the carrier is amplitude modulated.

8.2.5.2 Sweep repetition rate

The sweep repetition rate is defined as the rate at which the audio sweep is repeated.

8.2.5.3 Method of measurement

The sweep range and repetition rate shall be measured with the EPIRB placed in the test fixture (subclause 6.2). The emission shall be applied to the input of a suitable analyser. If a spectrum analyser is used, it shall be tuned to the emission centre frequency and with the following settings:

- Resolution bandwidth: 30 kHz;
- Frequency span: 0 Hz;
- Vertical scale: Linear.

The reference line shall be set as close to full scale deflection as practicable. The video output of the spectrum analyser shall be applied to the input of a digital storage oscilloscope. The oscilloscope shall have deep memory capability (in the order of 50 K samples) such that a complete sweep cycle can be captured without losing waveform detail.

8.2.5.4 Limits

The sweep shall be downwards (high frequency to low frequency).

The highest frequency shall not exceed 1 600 Hz.

The lowest frequency shall be greater than 300 Hz.

The total swept range shall be at least 700 Hz.

The sweep repetition rate shall be between 2 Hz and 4 Hz.

8.3 Spectral carrier power ratio

8.3.1 Definition

The spectral carrier power ratio is the ratio of the total power of the emission to the power centred on the carrier in a specified bandwidth, both measurements taken under normal modulated conditions.

8.3.2 Method of measurement

The measurement shall be performed under normal test conditions with the EPIRB placed in the test fixture (subclause 6.2).

To determine the total power, the emission is suitably applied to the input of a spectrum analyser with the following preferred settings:

- Resolution bandwidth: 10 kHz;
- Video filter: off;
- Scan time: 100 ms/division (div);
- Centre frequency: Carrier frequency as measured in subclause 8.1.

The total power is determined by noting the power measured from the amplitude reading on the spectrum analyser expressed in logarithmic form and adding it to the modulation duty cycle previously measured and converted to a figure in dB, i.e. $10 \log_{10}(\text{spectrum analyser power}) + 10 \log_{10}(t_1/t_2)$ using relevant units. (For the definition of t_1 and t_2 see figure 1).

To determine the power in the specified bandwidth, the preferred spectrum analyser settings are as follows:

- Resolution bandwidth: 60 Hz for 121,5 MHz EPIRB, 120 Hz for 243,0 MHz EPIRB;
- Video filter: off;
- Scan time: 10 sec/div;
- Centre frequency: Carrier frequency as measured in subclause 8.1.

The power in the specified bandwidth is determined from the amplitude reading on the spectrum analyser.

The difference between the total power and the power in the specified bandwidth in dB is the spectral carrier power ratio.

8.3.3 Limit

The spectral carrier power ratio shall be less than 5,2 dB for both 121,5 MHz and 243,0 MHz.

8.4 Maximum Effective Radiated Peak Envelope Power (ERPEP)

8.4.1 Definition

The maximum ERPEP is defined as the ERPEP in the direction of maximum field strength under specific conditions of measurement.

The peak envelope power is the average power supplied to the antenna transmission line by a transmitter during one radio cycle at the crest of the modulation envelope taken under normal operating conditions.

The measurements shall be made under normal test conditions and under extreme test conditions.

8.4.2 Method of measurement under normal test conditions

On a test site selected from annex A, the equipment shall be placed on the support and according to the requirements of clause A.4 for equipment intended to be worn on a person. The equipment shall then be activated.

The receiver shall be tuned to the transmitter carrier frequency. The test antenna shall be orientated for vertical polarization. The test antenna shall be raised or lowered through the specified range of heights until a maximum signal level is detected on the measuring receiver.

The transmitter shall be rotated through 360° around a vertical axis in order to find the direction of the maximum signal.

The maximum signal level detected by the measuring receiver shall be noted.

The transmitter shall be replaced by a substitution antenna as defined in annex A.

The substitution antenna shall be connected to a calibrated signal generator.

The frequency of the calibrated signal generator shall be adjusted to the transmit carrier frequency.

The input attenuator setting of the measuring receiver shall be adjusted in order to increase the sensitivity of the measuring receiver, if necessary.

The test antenna shall be raised or lowered through the specified range of heights to ensure that the maximum signal is received.

The input signal to the substitution antenna shall be adjusted to the level that produces a level detected by the measuring receiver that is equal to the level noted to that detected from the equipment under test corrected for the change in input attenuator setting of the measuring receiver.

The maximum ERPEP is equal to the power supplied by the signal generator, increased by the gain of the substitution antenna and corrected for the change in the attenuator.

8.4.3 Method of measurement under extreme test conditions

The equipment shall be placed in the test fixture connected to the artificial load with a means of measuring the power delivered to the load. The equipment shall be operated from the test power source (subclause 6.4.2).

The measurement shall be made under normal test conditions initially with the equipment on the support in the standard position (annex A or clause A.4 for equipment intended to be worn on a person) to enable a reference measurement to be made. This enables a reference factor to be determined. The measurement shall be repeated with the test fixture placed in the chamber under extreme test conditions (subclause 6.6).

8.4.4 Limit

The ERPEP shall be at least 75 mW.

For man-overboard devices only, the ERPEP shall be at least 25 mW.

8.5 Radiation produced by operation of the test facility

8.5.1 Definition

Radiation produced by operation of the test facility is the radiation at the nominal frequencies when the equipment is being tested.

8.5.2 Method of measurement

The EPIRB shall be with the switch in the test position.

The method of measurement described in subclause 8.4 shall be used, however, the test shall be performed at normal test conditions only.

The transmitter shall be rotated in all directions until the maximum radiation is detected.

8.5.3 Limit

The test facility provided to indicate the correct functioning of the EPIRB shall not produce an ERPEP greater than 25 nW.

8.6 Spurious emissions

8.6.1 Definition

Emission(s) on a frequency or frequencies which are outside the necessary bandwidth and the level of which may be reduced without affecting the corresponding transmission of information. Spurious emissions include harmonic emissions, parasitic emissions, intermodulation products, and frequency conversion products, but exclude out-of-band emissions.

8.6.2 Method of measurement

Spurious emissions shall be measured using a test site described in annex A.

The measurement shall be performed with the EPIRB in its standard position (annex A) and according to the requirements of clause A.4 for equipment intended to be worn on a person.

The method of measurement described in subclause 8.4 shall be used to search for spurious emissions in the frequency bands 108 MHz to 137 MHz, 156 MHz to 162 MHz, 406,0 MHz to 406,1 MHz and 450 MHz to 470 MHz.

The measuring receiver shall have a bandwidth of 100 kHz to 120 kHz.

The measurement shall only be performed under normal test conditions, the EPIRB being rotated until the maximum emission is detected.

8.6.3 Limit

The power of any spurious emission component shall not exceed 0,2 μ W.

Annex A (normative): Radiated measurements

A.1 Test sites and general arrangements for measurements involving the use of radiated fields

A.1.1 Outdoor test site

The outdoor test site shall be on a reasonably level surface or ground. At one point on the site, a ground plane of at least 5 m diameter shall be provided. In the middle of this ground plane, a non-conducting support, capable of rotation through 360° in the horizontal plane, shall be used to support the test sample at 1,5 m above the ground plane. The test site shall be large enough to allow the erection of a measuring or transmitting antenna at a distance of $\lambda/2$ or 3 m whichever is the greater. The distance actually used shall be recorded with the results of the tests carried out on the site.

Sufficient precautions shall be taken to ensure that reflections from extraneous objects adjacent to the site and ground reflections do not degrade the measurements results.

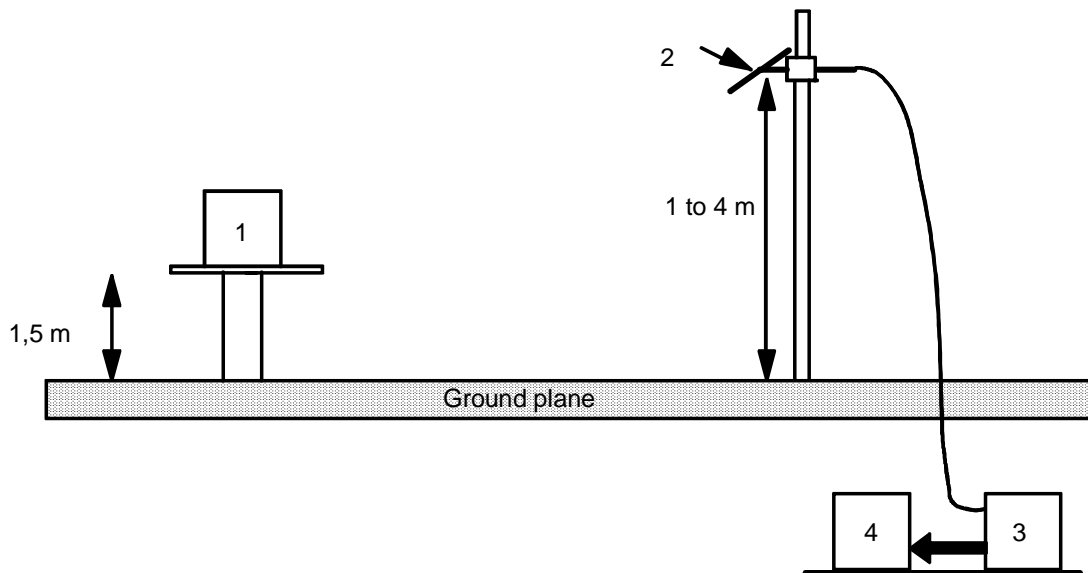

NOTE: Key:
 1 Equipment under test
 2 Test antenna
 3 High pass filter (necessary for strong fundamental Tx radiation)
 4 Spectrum analyser or measuring receiver

Figure A.1

A.1.2 Test antenna

The test antenna is used to detect the radiation from both the test sample and the substitution antenna, when the site is used for radiation measurements; where necessary, it is used as a transmitting antenna, when the site is used for the measurement of receiver characteristics.

This antenna is mounted on a support such as to allow the antenna to be used in either horizontal or vertical polarization and for the height of its centre above ground to be varied over the range 1 m to 4 m. Preferably a test antenna with pronounced directivity should be used. The size of the test antenna along the measurement axis shall not exceed 20 % of the measuring distance.

For receiver and transmitter radiation measurements, the test antenna is connected to a measuring receiver, capable of being tuned to any frequency under investigation and of measuring accurately the relative levels of signals at its input. For receiver radiated sensitivity measurements the test antenna is connected to a signal generator.

A.1.3 Substitution antenna

When measuring in the frequency range up to 1 GHz the substitution antenna shall be a $\lambda/2$ dipole, resonant at the frequency under consideration, or a shortened dipole, calibrated to the $\lambda/2$ dipole. When measuring in the frequency range above 4 GHz a horn radiator shall be used. For measurements between 1 GHz and 4 GHz either a $\lambda/2$ dipole or a horn radiator may be used. The centre of this antenna shall coincide with the reference point of the test sample it has replaced. This reference point shall be the volume centre of the sample when its antenna is mounted inside the cabinet, or the point where an external antenna is connected to the cabinet.

The distance between the lower extremity of the dipole and the ground shall be at least 0,3 m.

The substitution antenna shall be connected to a calibrated signal generator when the site is used for spurious radiation measurements and transmitter effective radiated power measurements. The substitution antenna shall be connected to a calibrated measuring receiver when the site is used for the measurement of receiver sensitivity.

The signal generator and the receiver shall be operating at the frequencies under investigation and shall be connected to the antenna through suitable matching and balancing networks.

NOTE: The gain of a horn antenna is generally expressed relative to an isotropic radiator.

A.1.4 Optional additional indoor site

When the frequency of the signals being measured is greater than 80 MHz, use may be made of an indoor site. If this alternative site is used, this shall be recorded in the test report.

The measurement site may be a laboratory room with a minimum area of 6 m by 7 m and at least 2,7 m in height.

Apart from the measuring apparatus and the operator, the room shall be as free as possible from reflecting objects other than the walls, floor and ceiling.

The potential reflections from the wall behind the equipment under test are reduced by placing a barrier of absorbent material in front of it. The corner reflector around the test antenna is used to reduce the effect of reflections from the opposite wall and from the floor and ceiling in the case of horizontally polarized measurements. Similarly, the corner reflector reduces the effects of reflections from the side walls for vertically polarized measurements. For the lower part of the frequency range (below approximately 175 MHz) no corner reflector or absorbent barrier is needed. For practical reasons, the $\lambda/2$ antenna in figure A.2 may be replaced by an antenna of constant length, provided that this length is between $\lambda/4$ and λ at the frequency of measurement and the sensitivity of the measuring system is sufficient. In the same way the distance of $\lambda/2$ to the apex may be varied.

The test antenna, measuring receiver, substitution antenna and calibrated signal generator are used in a way similar to that of the general method.

To ensure that errors are not caused by the propagation path approaching the point at which phase cancellation between direct and the remaining reflected signals occurs, the substitution antenna shall be moved through a distance of $\pm 0,1$ m in the direction of the test antenna as well as in the two directions perpendicular to this first direction.

If these changes of distance cause a signal change of greater than 2 dB, the test sample should be re-sited until a change of less than 2 dB is obtained.

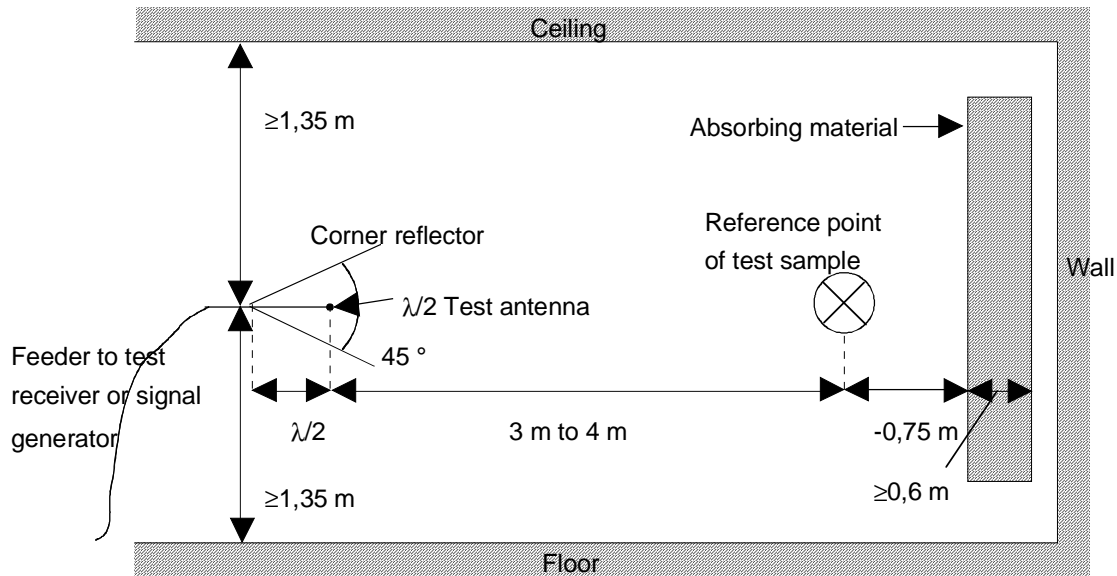

Figure A.2: Indoor site arrangement (shown for horizontal polarization)

A.2 Guidance on the use of radiation test sites

For measurements involving the use of radiated fields, use may be made of a test site in conformity with the requirements of clause A.1 of annex A. When using such a test site, the following conditions should be observed to ensure consistency of measuring results.

A.2.1 Measuring distance

Evidence indicates that the measuring distance is not critical and does not significantly affect the measuring results, provided that the distance is not less than $\lambda/2$ at the frequency of measurement, and the precautions described in annex A are observed. Measuring distances of 3 m, 5 m, 10 m and 30 m are in common use in European test laboratories.

A.2.2 Test antenna

Different types of test antenna may be used, since performing substitution measurements reduces the effect of the errors on the measuring results.

Height variation of the test antenna over a range of 1 m to 4 m is essential in order to find the point at which the radiation is a maximum.

Height variation of the test antenna may not be necessary at the lower frequencies below about 100 MHz.

A.2.3 Substitution antenna

Variations in the measuring results may occur with the use of different types of substitution antenna at the lower frequencies below about 80 MHz.

Where a shortened dipole antenna is used at these frequencies, details of the type of antenna used should be included with the results of the tests carried out on the site. Correction factors shall be taken into account when shortened dipole antennas are used.

A.2.4 Artificial antenna

The dimensions of the artificial antenna used during radiated measurements should be small in relation to the sample under test.

Where possible, a direct connection should be used between the artificial antenna and the test sample.

In cases where it is necessary to use a connecting cable, precautions should be taken to reduce the radiation from this cable by, for example, the use of ferrite cores or double screened cables.

A.2.5 Auxiliary cables

The position of auxiliary cables (power supply and microphone cables etc.) which are not adequately decoupled may cause variations in the measuring results. In order to get reproducible results, cables and wires of auxiliaries should be arranged vertically downwards (through a hole in the non conducting support).

A.2.6 Acoustic measuring arrangement

When carrying out measurements of the maximum usable sensitivity (radiated) of the receiver, the audio output shall be monitored by acoustically coupling the audio signal from the receiver loudspeaker/transducer to the test microphone. On the radiation test site all conducting materials shall be placed below the ground surface and the acoustic signal is conveyed from the receiver to the test microphone in a non-conducting acoustic pipe.

The acoustic pipe shall have an appropriate length. The acoustic pipe shall have an inner diameter of 6 mm and a wall thickness of 1,5 mm. A plastic funnel of a diameter corresponding to the receiver loudspeaker/transducer shall be attached to the receiver surface centred in front of the receiver loudspeaker/transducer. The plastic funnel shall be very soft at the attachment point to the receiver in order to avoid mechanical resonance. The narrow end of the plastic funnel shall be connected to the one end of the acoustic pipe and the test microphone to the other.

A.3 Further optional alternative indoor test site using an anechoic chamber

For radiation measurements when the frequency of the signals being measured is greater than 30 MHz, use may be made of an indoor site being a well-shielded anechoic chamber simulating free space environment. If such a chamber is used, this shall be recorded in the test report.

The test antenna, measuring receiver, substitution antenna and calibrated signal generator are used in a way similar to that of the general method, clause A.1. In the range between 30 MHz and 100 MHz some additional calibration may be necessary.

An example of a typical measurement site may be an electrically shielded anechoic chamber being 10 m long, 5 m broad and 5 m high.

Walls and ceiling should be coated with RF absorbers of 1 m height.

The base should be covered with absorbing material 1 m thick, and a wooden floor, able to carry test equipment and operators.

A measuring distance of 3 m to 5 m in the long middle axis of the chamber can be used for measurements up to 12,75 GHz.

The construction of the anechoic chamber is described in the following subclauses.

A.3.1 Example of the construction of a shielded anechoic chamber

Free-field measurements can be simulated in a shielded measuring chamber where the walls are coated with RF absorbers.

Figure A.3 shows the requirements for shielding loss and wall return loss of such a room.

As dimensions and characteristics of usual absorber materials are critical below 100 MHz (height of absorbers < 1 m, reflection attenuation < 20 dB) such a room is preferably suitable for measurements above 100 MHz.

Figure A.4 shows the construction of a shielded measuring chamber having a base area of 5 m by 10 m and a height of 5 m.

Ceilings and walls are coated with pyramidal formed absorbers approximately 1 m high. The base is covered with absorbers which are able to carry and which forms a sort of floor.

The available internal dimensions of the room are 3 m × 8 m × 3 m, so that a measuring distance of maximum 5 m length in the middle axis of this room is available.

At 100 MHz the measuring distance can be extended up to a maximum of 2 lambda.

The floor absorbers reject floor reflections so that the antenna height need not be changed and floor reflection influences need not be considered.

All measuring results can therefore be checked with simple calculations and the measuring tolerances have the smallest possible values due to the simple measuring configuration.

For special measurements it can be necessary to re-introduce floor reflections. Taking away the floor absorbers would mean a removal of approximately 24 m³ absorber material. Therefore the floor absorbers are covered with metal plates of metallic nets instead.

A.3.2 Influence of parasitic reflections in anechoic chambers

For free-space propagation in the far field condition the correlation $E = E_0 (R_0/R)$ is valid for the dependence of the field strength E on the distance R , whereby E_0 is the reference field strength in the reference distance R_0 .

It is useful to use just this correlation for comparison measurements, as all constants are eliminated with the ratio and neither cable attenuation nor antenna mismatch or antenna dimensions are of importance.

Deviations from the ideal curve can be seen easily if the logarithm of the above equation is used, because the ideal correlation of field strength and distance can then be shown as a straight line and the deviations occurring in practice are clearly visible. This indirect method shows the disturbances due to reflections more readily and is far less problematical than the direct measurement of reflection attenuation.

With an anechoic chamber of the dimensions suggested in clause A.3 at low frequencies up to 100 MHz there are no far field conditions, and therefore reflections are stronger so that careful calibration is necessary.

In the medium frequency range from 100 MHz to 1 GHz the dependence of the field strength on the distance meets the expectations very well.

In the frequency range of 1 GHz to 12,75 GHz, because more reflections will occur, the dependence of the field strength on the distance will not correlate so closely.

A.3.3 Calibration of the shielded anechoic chamber

Careful calibration of the chamber shall be performed over the range 30 MHz to 12,75 GHz.

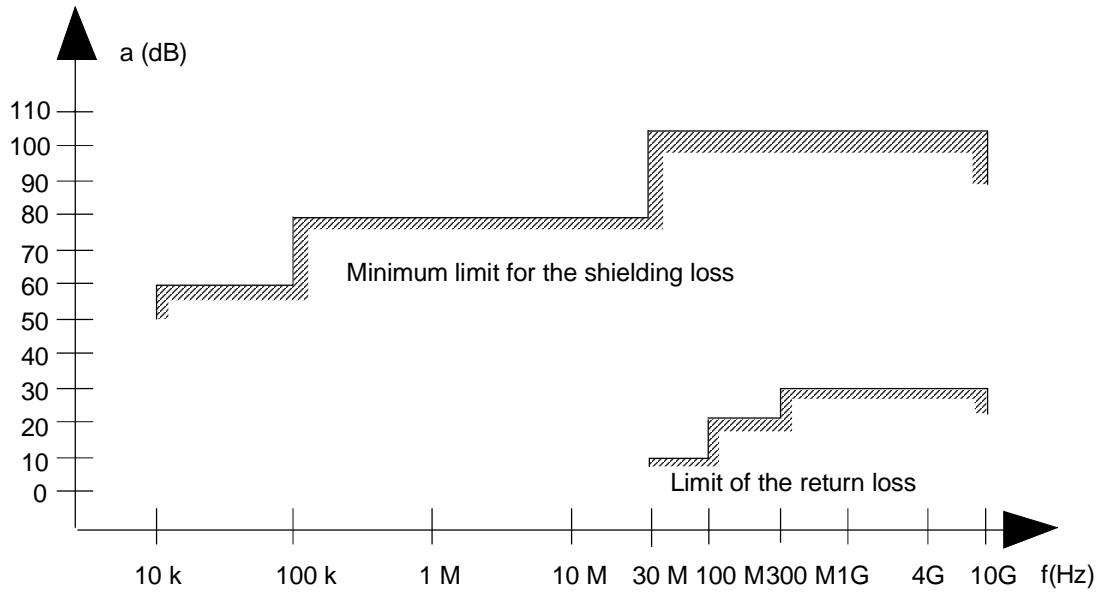
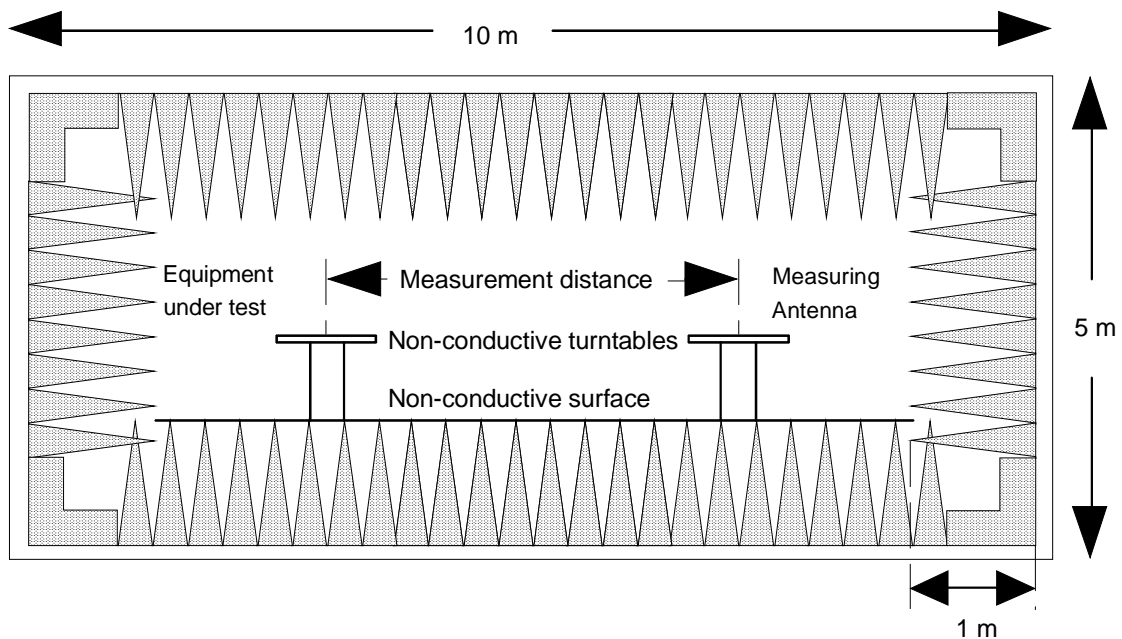

Figure A.3: Specifications for shielding and reflections



Ground plan

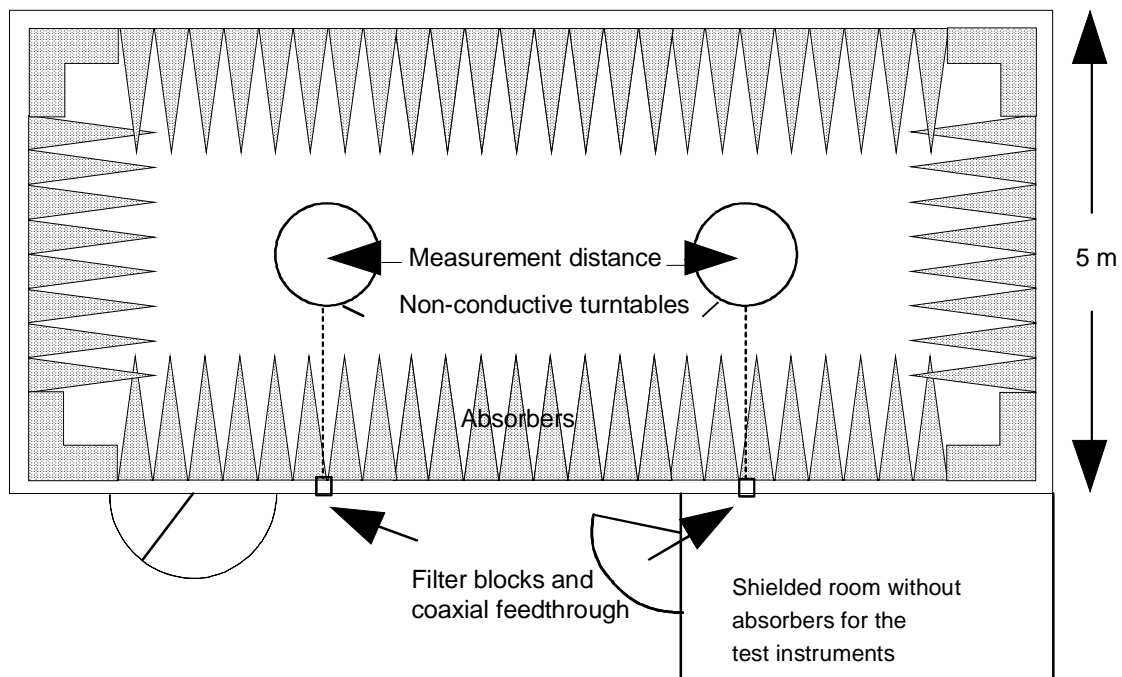

Figure A.4: Example of construction of an anechoic shielded chamber

A.4 Standard position

The standard position in all test sites, except the stripline arrangement, for equipment which is not intended to be worn on a person, including hand-held equipment, shall be on a non conducting support, height 1,5 m, capable of rotating about a vertical axis through the equipment. The standard position of the equipment shall be the following:

- a) for equipment with an internal antenna, it shall be placed in the position closest to normal use as declared by the manufacturer;
- b) for equipment with a rigid external antenna, the antenna shall be vertical;
- c) for equipment with a non-rigid external antenna, the antenna shall be extended vertically upwards by a non-conducting support.

Equipment which is intended to be worn on a person shall be tested using a salty man as support as described in ETR 273 [3] Part 7 Artificial human beings.

The simulated man comprises a rotatable acrylic tube filled with salt (NaCl) water with acrylic caps at both ends, placed on the ground.

The preferred dimensions of the container are:

- height: 1,7 m;
- outside diameter: 305 mm;
- sidewall thickness: 4,8 mm.

The container shall be filled with a salt (NaCl) solution of 1,49 g per litre of distilled water ($\sigma = 0,26 \text{ S/m}$, $\epsilon = 77$).

The equipment shall be fixed to the surface of the simulated man, at the appropriate height for the equipment.

NOTE: To reduce the weight of the simulated man it may be possible to use an alternative tube as described in ETR 273 [3].

History

Document history		
Edition 1	December 1991	Publication as ETS 300 152
V1.2.1	October 1999	Publication as EN 300 152
V1.2.2	August 2000	Publication as EN 300 152-1