



**Environmental Engineering (EE);
Power supply interface at the input to
telecommunications and datacom (ICT) equipment;
Part 2: Operated by -48 V direct current (dc)**

Reference

REN/EE-02016

Keywords

interface, power supply

ETSI

650 Route des Lucioles
F-06921 Sophia Antipolis Cedex - FRANCE

Tel.: +33 4 92 94 42 00 Fax: +33 4 93 65 47 16

Siret N° 348 623 562 00017 - NAF 742 C
Association à but non lucratif enregistrée à la
Sous-Préfecture de Grasse (06) N° 7803/88

Important notice

Individual copies of the present document can be downloaded from:

<http://www.etsi.org>

The present document may be made available in more than one electronic version or in print. In any case of existing or perceived difference in contents between such versions, the reference version is the Portable Document Format (PDF). In case of dispute, the reference shall be the printing on ETSI printers of the PDF version kept on a specific network drive within ETSI Secretariat.

Users of the present document should be aware that the document may be subject to revision or change of status. Information on the current status of this and other ETSI documents is available at

<http://portal.etsi.org/tb/status/status.asp>

If you find errors in the present document, please send your comment to one of the following services:

http://portal.etsi.org/chaicor/ETSI_support.asp

Copyright Notification

No part may be reproduced except as authorized by written permission.
The copyright and the foregoing restriction extend to reproduction in all media.

© European Telecommunications Standards Institute 2011.
All rights reserved.

DECT™, PLUGTESTS™, UMTS™ and the ETSI logo are Trade Marks of ETSI registered for the benefit of its Members.
3GPP™ and LTE™ are Trade Marks of ETSI registered for the benefit of its Members and
of the 3GPP Organizational Partners.
GSM® and the GSM logo are Trade Marks registered and owned by the GSM Association.

Contents

Intellectual Property Rights	5
Foreword.....	5
1 Scope	6
2 References	6
2.1 Normative references	7
2.2 Informative references.....	7
3 Definitions, symbols and abbreviations	7
3.1 Definitions.....	7
3.2 Symbols.....	8
3.3 Abbreviations	8
4 Requirements.....	9
4.1 Nominal voltage	9
4.2 Normal service voltage range at interface "A"	9
4.3 Abnormal service voltage range at interface "A"	10
4.3.1 Abnormal service voltage range under steady state conditions	10
4.3.2 Abnormal conditions: voltage variations, dips and short interruptions.....	10
4.3.3 Voltage transients	11
4.3.3.1 Voltage transient due to short-circuit and protective device clearance	11
4.3.3.2 Short voltage transient due to switching and lightning	11
4.3.4 Recovery from voltage transients	12
4.4 Voltage changes due to the regulation of the power supply	12
4.5 Power supply protection at interface "A"	12
4.6 Maximum current drain.....	12
4.7 Inrush Current on connection of interface "A"	13
4.7.1 Limits.....	13
4.7.2 Measurements	14
4.8 Conducted immunity requirements of the telecommunications equipment at interface "A": narrowband noise	15
4.9 Conducted emissions requirements of the telecommunications and datacom (ICT) equipment at interface "A"	17
5 Earthing and bonding	18
Annex A (normative): Identification of interface "A"	19
Annex B (informative): -60 V_{DC} systems	20
Annex C (informative): Guide for measuring inrush current and for transferring the recorded pulses onto the limit chart.....	21
C.1 Measurement	21
C.2 Pulse waveform transformation.....	21
C.3 Measurement of inrush current with filter capacitor current pulses	24
Annex D (informative): Test arrangements for the injection of electrical noise at interface "A"	27
Annex E (informative): Wideband noise.....	28
E.1 Emission of wideband noise.....	28
E.1.1 Assessment of wideband noise.....	28
E.2 How to calculate wideband emission	28
Annex F (informative): Protection dimensioning.....	32

Annex G (informative):	Effects of protective device operation transients in the power distribution	33
Annex H (informative):	Bibliography	34
History		35

Intellectual Property Rights

IPRs essential or potentially essential to the present document may have been declared to ETSI. The information pertaining to these essential IPRs, if any, is publicly available for **ETSI members and non-members**, and can be found in ETSI SR 000 314: "*Intellectual Property Rights (IPRs); Essential, or potentially Essential, IPRs notified to ETSI in respect of ETSI standards*", which is available from the ETSI Secretariat. Latest updates are available on the ETSI Web server (<http://ipr.etsi.org>).

Pursuant to the ETSI IPR Policy, no investigation, including IPR searches, has been carried out by ETSI. No guarantee can be given as to the existence of other IPRs not referenced in ETSI SR 000 314 (or the updates on the ETSI Web server) which are, or may be, or may become, essential to the present document.

Foreword

This final draft European Standard (EN) has been produced by ETSI Technical Committee Environmental Engineering (EE), and is now submitted for the Vote phase of the ETSI standards Two-step Approval Procedure.

The present document concerns the requirements for the interface between telecommunications and datacom (ICT) equipment and its power supply, and includes requirements relating to its stability and measurement. Various other references and detailed measurement and test arrangements are contained in informative annexes.

The present document is part 2 of a multi-part deliverable covering Environmental Engineering (EE); Power supply interface at the input to telecommunications and datacom (ICT) equipment, as identified below:

Part 1: "Operated by alternating current (ac) derived from direct current (dc) sources";

Part 2: "Operated by -48 V direct current (dc)";

Part 3-0: "Operated by rectified current source, alternating current source or direct current source up to 400 V, Sub-part 0: Overview";

Part 3-1: "Operated by rectified current source, alternating current source or direct current source up to 400 V; Sub-part 1: Direct current source up to 400 V";

Part 3-2: "Operated by rectified current source, alternating current source or direct current source up to 400 V; Sub-part 2: Alternating up to 400 V solution";

Part 3-3: "Operated by rectified current source, alternating current source or direct current source up to 400 V; Sub-part 3: Rectified current up to 400 V solution".

Proposed national transposition dates	
Date of latest announcement of this EN (doa):	3 months after ETSI publication
Date of latest publication of new National Standard or endorsement of this EN (dop/e):	6 months after doa
Date of withdrawal of any conflicting National Standard (dow):	6 months after doa

1 Scope

The present document contains requirements and measurements methods for the physical interface that is situated between the power supply system(s) and the power consuming telecommunications and datacom (ICT) equipment; this point is called interface "A" as defined in clause 4.

The purpose of the present document is to use a power supply system with the same characteristics for all telecommunications and datacom (ICT) equipment defined in the area of application:

- to facilitate inter working of different (types of) load units;
- to facilitate the standardization of telecommunications and datacom (ICT) equipment;
- to facilitate the installation, operation and maintenance in the same network of telecommunications and datacom (ICT) equipment and systems from different origins.

The present document aims at providing electrical compatibility between the power supply equipment and the power consuming telecommunications and datacom (ICT) equipment, and also between different system blocks connected to the same power supply.

The requirements are defined for:

- the output of the power supply equipment or power supply installation of telecommunications centres providing power at the interface "A";
- the power supply input of any type of telecommunications and datacom (ICT) equipment installed at telecommunication centres that are connected to interface "A" powered by DC;
- any type of telecommunications and datacom (ICT) equipment, installed in access networks and customers' premises, the DC interface "A" of which is also used by equipment requiring a supply to the present document.
- any type of telecommunication and datacom (ICT) equipment powered by DC, used in the fixed and mobile networks installed in different locations as building, shelter, street cabinet.

Disturbances on the power supply interface "A" relating to the continuous wave phenomena below 20 kHz are covered within the present document.

The present document does not cover safety requirements, they are covered by relevant safety standards.

The present document does not cover EMC requirements, they are covered by relevant EMC standards.

NOTE 1: The present document is applicable only to $-48 V_{DC}$ power supply interfaces. However, during a transitional period, other DC voltages may be used in existing installations. Annex B gives guidance on working in conjunction with existing $-60 V_{DC}$ supply systems.

NOTE 2: The DC voltage at interface "A" may be derived from the AC primary supply. The DC supply may incorporate a backup battery

2 References

References are either specific (identified by date of publication and/or edition number or version number) or non-specific. For specific references, only the cited version applies. For non-specific references, the latest version of the reference document (including any amendments) applies.

Referenced documents which are not found to be publicly available in the expected location might be found at <http://docbox.etsi.org/Reference>.

NOTE: While any hyperlinks included in this clause were valid at the time of publication, ETSI cannot guarantee their long term validity.

2.1 Normative references

The following referenced documents are necessary for the application of the present document.

- [1] CENELEC EN 60269-1: "Low-voltage fuses - Part 1: General requirements".
- [2] CENELEC EN 60934: "Circuit-breakers for equipment (CBE)".
- [3] ETSI EN 300 253: "Environmental Engineering (EE); Earthing and bonding of telecommunication equipment in telecommunication centres".
- [4] ITU-T Recommendation O.41: "Psophometer for use on telephone-type circuits".
- [5] CENELEC EN 61000-4-5: "Electromagnetic compatibility (EMC) - Part 4-5: Testing and measurement techniques - Surge immunity test".
- [6] IEC 60050-601: "International Electrotechnical Vocabulary. Chapter 601: Generation, transmission and distribution of electricity - General" (Area 826 "Electrical installations", section 826-11 "Voltages and currents").
- [7] CENELEC EN 61000-4-29: "Electromagnetic compatibility (EMC) -Part 4-29: Testing and measurement techniques -Voltage dips, short interruptions and voltage variations on d.c. input power port immunity tests".

2.2 Informative references

The following referenced documents are not necessary for the application of the present document but they assist the user with regard to a particular subject area.

- [i.1] ITU-T Recommendation Q.551: "Transmission characteristics of digital exchanges".
- [i.2] ITU-T Recommendation Q.552: "Transmission characteristics at 2-wire analogue interfaces of digital exchanges".
- [i.3] ITU-T Recommendation Q.553: "Transmission characteristics at 4-wire analogue interfaces of digital exchanges".
- [i.4] ITU-T Recommendation Q.554: "Transmission characteristics at digital interfaces of digital exchanges".
- [i.5] ETSI TR 100 283: "Environmental Engineering (EE); Transient voltages at Interface "A" on telecommunications direct current (dc) power distributions".
- [i.6] US Department of Defence MIL-STD-461E: "Requirements for the control of electromagnetic interference characteristics of subsystems and equipment".

3 Definitions, symbols and abbreviations

3.1 Definitions

For the purposes of the present document, the following terms and definitions apply:

abnormal service voltage range: range of steady-state voltage over which the equipment will not be expected to maintain normal service but will survive undamaged

customer premises: any location which is the sole responsibility of the customer

fully equipped equipment: configuration that corresponds to the maximum power consumption measured at $-48 V_{DC}$ with the equipment in operating conditions (e.g. not in standby mode)

NOTE: When there are several fully equipped configurations because of different combinations of possible boards, the configuration with the boards that gives the highest power consumption shall be considered.

interface "A": terminals at which the power supply is connected to the system block

NOTE 1: See also figure 1 and annex A.

NOTE 2: This is a functional definition and not an exact depiction of the physical location.

malfunction: termination of the normal service

maximum steady state input current (I_m): maximum steady state input current, stated by the manufacturer, for a fully equipped equipment under test connected to interface "A" at nominal voltage

nominal voltage: value of the voltage by which the electrical installation or part of the electrical installation is designated and identified [6]

normal operating voltage range: voltage range at interface "A" where the system operates most of the time, e.g. in general linked to battery floating voltage

normal service: service mode where telecommunications and datacom (ICT) equipment operates within its specification which includes a defined restart time after malfunction or full interruption

normal service voltage range: range of steady-state voltages over which the equipment will maintain normal service

operating voltage: value of the voltage under normal conditions, at a given instant and a given point of the system [6]

power supply: power source to which telecommunications equipment is intended to be connected

system block: functional group of equipment depending for its operation and performance on its connection to the same power supply

NOTE: A system block may consist of equipment or a functional group of equipment. Different examples of configurations at interface "A" are given in annex A.

telecommunication centre: location where telecommunications and datacom (ICT) equipment is installed and which is the sole responsibility of the operator

telecommunications and datacom equipment: Information and Communication Technology equipment (ICT)

3.2 Symbols

For the purposes of the present document, the following symbols apply:

I_t	instantaneous inrush current
I_m	maximum steady state input current
L	inductance of inductive element of LISN
R	resistance of resistive element of LISN
t	time
Z_c	capacitive impedance of immunity measurement circuit
Z_m	resistive impedance of immunity measurement circuit
μs	microsecond

3.3 Abbreviations

For the purposes of the present document, the following abbreviations apply:

AC	Alternating Current
DC	Direct Current

NOTE: Also when used as a suffix to units of measurement.

EMC	ElectroMagnetic Compatibility
-----	-------------------------------

EUT	Equipment Under Test
HOD	High-Ohmic Distributions
ICT	Information and Communication Technology
LISN	Line Impedance Stabilization Network
LOD	Low-Ohmic Distributions
RF	Radio Frequency
rms	root mean square

NOTE: Also when used as a suffix to units of measurement.

4 Requirements

The power supply interface, interface "A" of figure 1, is a physical point to which all the requirements are related.

This point is situated between the power supply system(s) and the power consuming telecommunications and datacom (ICT) equipment.

An example of a configuration in which interface "A" is identified is given in annex A.

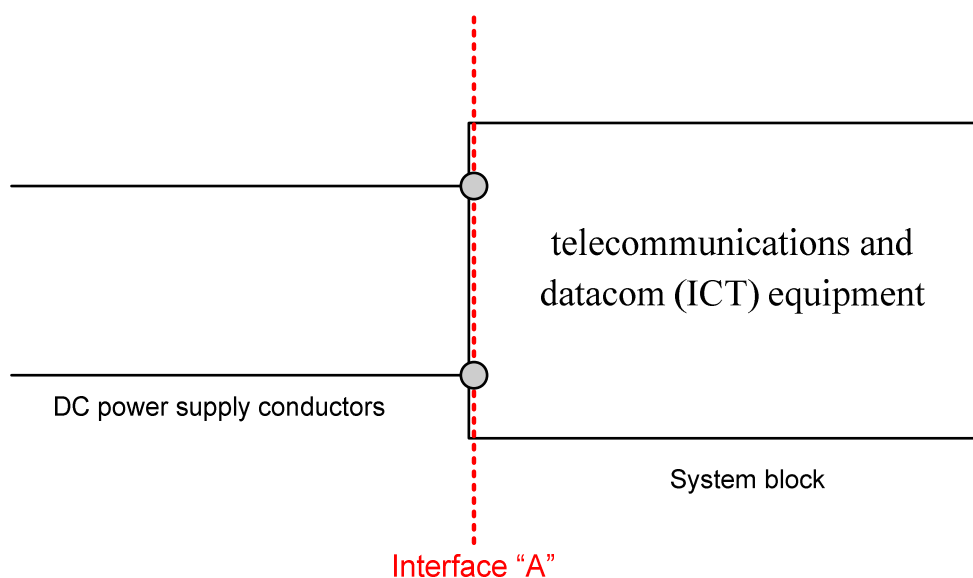

Figure 1: Identification of interface "A"

4.1 Nominal voltage

The interface and equipment shall be designated and identified by a nominal voltage.

The nominal voltage at interface "A" shall be $-48 V_{DC}$ (positive conductor is connected to earth as defined in EN 300 253 [3]).

NOTE: In most cases the nominal voltage of interface "A" is based on a 24 cell lead-acid battery.

4.2 Normal service voltage range at interface "A"

The normal service voltage range for the $-48 V_{DC}$ nominal supply at interface "A" shall be $-40,5 V_{DC}$ to $-57,0 V_{DC}$.

There shall be no degradation of service performance when telecommunication and datacom (ICT) equipment is operating at voltages within the normal service voltage range.

This requirement shall be verified by applying the following tests at interface "A".

The testing and measurement techniques are described in EN 61000-4-29 [7].

Table 1

Test level of Normal service voltage variation	Duration	Basic standard	Rise and fall time of voltage change	Performance criteria
From -40,5 V to -57,0 V	0,1 s	EN 61000-4-29 [7]	Between 1 μ s and 50 μ s on 100 Ω resistive load (see basic standard for test generator)	No degradation in the service performance during and after the test
From -57,0 V to -40,5 V	0,1 s			

In the case of telecommunication and datacom (ICT) equipment with power supply input redundancies (e.g. power supply 1 "PS1" and power supply 2 "PS2"), this test shall be performed at each power supply input at a time with and without the second power supply.

NOTE 1: The minimum voltage is based on the voltage drop in the distribution network and a battery cell end of discharge voltage.

NOTE 2: The voltages specified are measured at interface "A". It should be noted that if interface "A" is at any point other than the telecommunications equipment interface there will be a voltage drop between interface "A" and the equipment terminals.

NOTE 3: The operator can ask the manufacturer of telecommunications and datacom (ICT) equipment for any test made at nominal voltage -48 V to be repeated at the most common operating voltage within the normal operating voltage range e.g. -54,5 V for power consumption test.

4.3 Abnormal service voltage range at interface "A"

4.3.1 Abnormal service voltage range under steady state conditions

Telecommunications equipment operated at -48 V_{DC} shall not suffer any damage when subjected to the following voltage ranges:

Table 2

0,0 V _{DC}	to	-40,5 V _{DC} and
-57,0 V _{DC}	to	-60,0 V _{DC}

Following the restoration of the supply to the normal voltage range, the power conversion and management systems on the load side of interface "A" shall automatically restore normal service. The telecommunications and datacom (ICT) equipment shall then resume operation according to its specifications. The abnormal service voltage shall not lead to the disconnection of the power supply e.g. by causing circuit breakers, fuses or other such devices to operate.

NOTE: It is acceptable that the system may restart when the voltage is -40,5 V or greater within the nominal service voltage range and/or after a time delay.

4.3.2 Abnormal conditions: voltage variations, dips and short interruptions

Telecommunication equipment shall not suffer any damage when subject to the following abnormal voltage range that can be present at the interface "A".

Table 3

Voltage variation	Duration	Basic standard	Rise and fall time of voltage change	Performance criteria
From -40,5 V to -60,0 V and from -60 V to -40,5 V	0,1 s	EN 61000-4-29 [7]	Between 1 μ s and 50 μ s on 100 Ω resistive load (see basic standard)	Self restart to a normal service of the equipment without operator intervention after the test
From -57,0 V to 0,0 V and from 0,0 V to -57,0 V	0,1 s			

In the case of telecommunication and datacom (ICT) equipment with power supply input redundancies (e.g. power supply 1 and power supply 2), this test shall be performed at each power supply input at a time with and without the second power supply.

4.3.3 Voltage transients

4.3.3.1 Voltage transient due to short-circuit and protective device clearance

Voltage transients may occur at interface "A" when faults (e.g. short circuits) occur in the power distribution system. These transients are characterized by a voltage drop in the range: 0 V_{DC} to -40,5 V_{DC}, followed by an overvoltage often in excess of the maximum steady state abnormal service voltage range and dependent upon the power distribution up to interface "A" and the equipment connected to interface "A".

NOTE: TR 100 283 [i.5] provides guidance for the protection of telecommunications equipment from the transients.

4.3.3.2 Short voltage transient due to switching and lightning

The surge immunity performance of telecommunications and datacom (ICT) equipment against abnormal overvoltage shall be verified using the test procedure described below and the combination wave generator defined in the standard EN 61000-4-5 [5]. This generator can produce the pulse shape of 1,2 μ s-rise time/50 μ s-duration in open circuit and 8 μ s-rise time/20 μ s-duration in short circuit.

Tests with positive of power supply **connected** to ground shall be performed with the operating input voltage of -54 V accordingly with the following test specification.

Table 4

Transient level and test class	Pulse polarity	Coupling lines	Number of pulses	Pulse shape and impedance	Performance criteria	Comments
500 V surge (class 1)	Negative	Between positive and negative power supply poles	5	1,2 μ s-rise time/50 μ s-duration 2 Ω impedance	Telecommunications equipment operated within the normal service voltage range shall not be damaged Self restart to a normal service of the equipment without operator intervention after the test	The 0 V reference of the generator shall be connected to the positive pole of the power supply

Telecommunications and datacom (ICT) equipment with power supply input redundancies (e.g. power supply 1 and power supply 2) shall be tested applying the overvoltage at each power supply input at a time without the second power supply.

NOTE: In a -48 Vdc system having the positive pole connected to earth, only the negative polarity of the voltage transient following the clearance of an overcurrent protection device during a short-circuit condition is relevant.

4.3.4 Recovery from voltage transients

After the occurrence of a voltage transient, as described in clause 4.3.3, telecommunications equipment shall continue to function within its operational specification without requiring manual intervention.

In case of telecommunications and datacom (ICT) equipment with power supply input redundancies (e.g. power supply 1 and power supply 2), this test shall be performed at each power supply input at a time with and without the second power supply.

NOTE 1: The abnormal service should not lead to the disconnection of ICT equipment power supply units e.g. by causing circuit breakers, fuses and other such devices to operate.

NOTE 2: In sensitive equipment, momentary and temporary interruption of the service may occur as a result of such transients at interface "A". Lengthening of the interruption to service (equipment is not functioning as intended) due to the recovery of software should be declared in the test report (i.e. details about the service interruption).

NOTE 3: To prevent system malfunctioning additional arrangements concerning the power supply system may be necessary.

For example:

- Dual feeding system.
- High-Ohmic distribution system.
- Independent power distribution.

4.4 Voltage changes due to the regulation of the power supply

Telecommunications and datacom (ICT) equipment may be subjected to a voltage change at interface "A" as a result of regulation of the voltage by the power supply system e.g. end cell switching.

This test applies to the telecommunications and datacom (ICT) equipment connected to interface "A". The test can also be applied separately to each subpart of the equipment connected to the same interface "A".

This requirement can be verified applying the following test at the interface "A".

Table 5

Voltage variation	Change rate	Performance criteria
From -40,5 V to -57,0 V	Linear variation slope: between 3 V/ms and 7 V/ms	No degradation in the equipment functionality during and after the test
From -57,0 V to -40,5 V		

In case of telecommunications and datacom (ICT) equipment with power supply input redundancies (e.g. power supply 1 and power supply 2), this test shall be performed at each power supply input at a time with and without the second power supply.

4.5 Power supply protection at interface "A"

The power supply at interface "A" shall be protected by circuit breakers, fuses or equivalent devices.

NOTE: The energy content of the inrush current has also to be taken into account when specifying the power supply system up to interface "A".

4.6 Maximum current drain

Protection devices are defined for a rated current of 1,5 times I_m to avoid tripping in the normal service voltage range.

The maximum steady state current I_m is the current stated by the manufacturer, for a fully-equipped equipment at full load, connected to interface "A" at nominal voltage -48 V.

At 40,5 V, the current shall not be higher than 1,5 time I_m .

Table 6

Voltage (U)	Voltage variation	Performance criteria
-48 V		I_m value shall be measured and provided
From -54 V to -40,5 V	Linear variation slope: 1 V/min	The current used by the equipment shall be lower than 1,5 I_m
From -40,5 V to 0	Linear variation slope: 1 V/min	The current chart $I(U)$ characteristic used by the equipment shall be measured and provided

In case of telecommunications and datacom (ICT) equipment with power supply input redundancies (e.g. power supply 1 and power supply 2), these tests shall be performed at each power supply input at a time with and without the second power supply.

NOTE: Additional consideration should be taken for temperature variation and technology of the protection devices (see annex F).

4.7 Inrush Current on connection of interface "A"

4.7.1 Limits

The ratio of the instantaneous inrush current I_t to maximum steady state current I_m at interface "A", when the switch is closed within the normal service voltage range, shall not exceed the limits shown in figure 2.

The parameters are defined as follows:

- I_t : inrush current (magnitude of instantaneous value);
- I_m : maximum steady state input current for a fully-equipped equipment under test connected to interface "A", at nominal voltage.

The power generator for Inrush current test shall be in accordance with EN 61000-4-29 [7].

Performance criteria:

- Below 0,1 ms, the inrush current is not defined.
- Below 0,9 ms the I_t/I_m ratio shall be lower than 48.
- Above 1 ms : the curve corresponds to the maximum tripping limit of majority of existing protective devices.

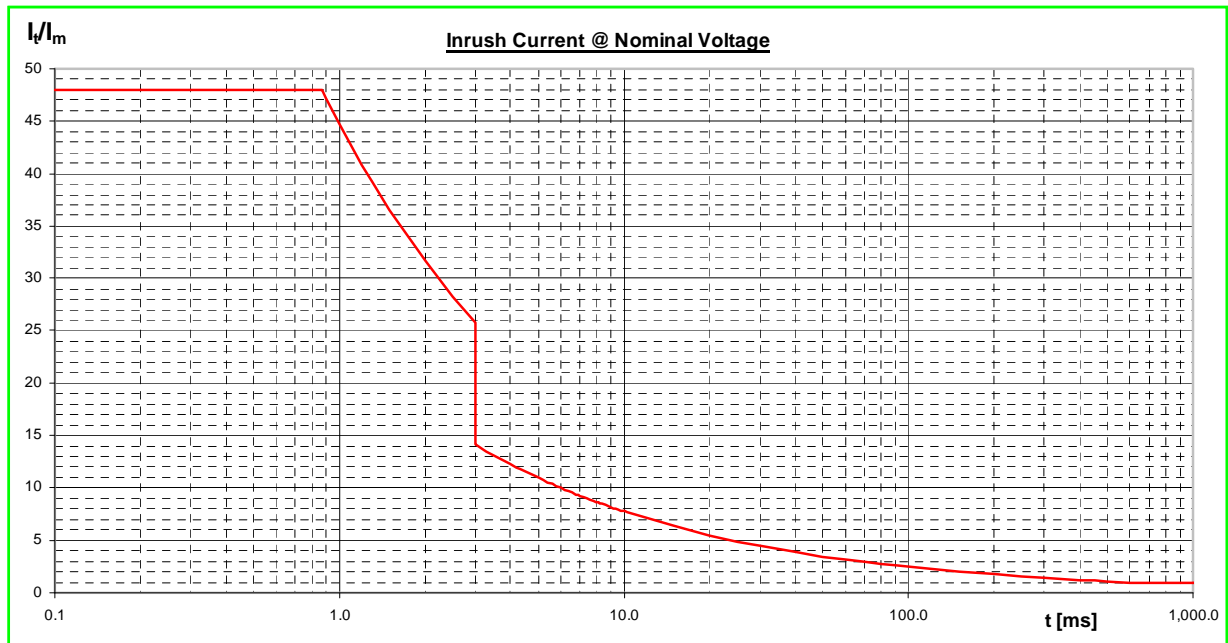

Figure 2: Maximum inrush current characteristics for telecommunications and datacom (ICT) equipment at nominal voltage and maximum load

NOTE 1: This graph is a combined graph for both fuses and (Hydraulic) Magnetic Circuit Breakers. Fuses according EN 60269-1 [1] (gG type), Magnetic Circuit Breakers according EN 60934 [2]. Annex F reports the rationale between maximum current and protection selection.

NOTE 2: The time axis refers to "pulse width". Annex C reports suggestion and explanation on the inrush measurement.

4.7.2 Measurements

The circuit for measuring the inrush current drawn by the equipment shall be as shown in figure 3. The test circuit is designed to operate with a single switch as shown.

NOTE: Small magnitude current pulses for charging RF filter capacitors should not be considered as the starting point of the inrush measurement. These pulses are not part of the inrush pulse but are before the inrush current pulse.

Annex C gives guidance on taking these measurements.

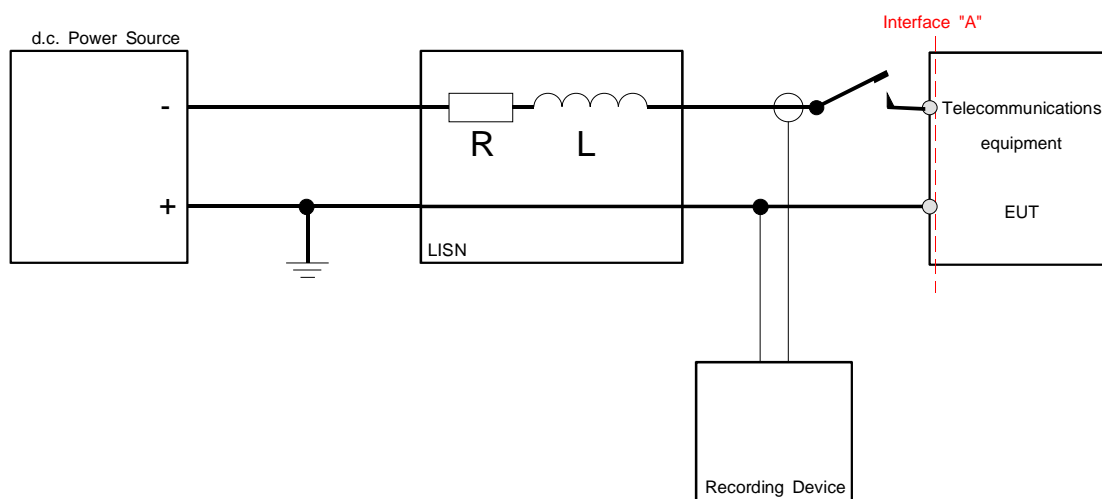

$$R \leq \frac{1V}{I_m (@54V)}$$

$$10\mu H \leq L \leq 20\mu H$$

NOTE 1: Resistance R includes the resistance of inductor L.

NOTE 2: The LISN could be the connecting cable (EUT to power supply), providing that the length has an inductance of 10 μ H to 20 μ H and an equivalent resistance.

NOTE 3: The intention of the LISN is to simulate a power network over which a voltage drop **not greater than 1 V** will appear in case of nominal current.

NOTE 4: While carrying out the surge current test, the voltage of the DC Power Source at the input of the LISN, as shown in figure 3, shall fall by no more than 2 V due to current limitation or internal impedance of the DC Power Source.

Figure 3: Inrush current test circuit for DC interfaces

4.8 Conducted immunity requirements of the telecommunications equipment at interface "A": narrowband noise

Conducted Immunity shall apply only at telecommunication equipment having analogue voice interface. Due to the nature of the interference, only analogue voice interface could be influenced by disturbing signals in the voice frequency range.

Performance criteria

The telecommunications equipment shall meet its specification when the level of narrowband noise at interface "A" does not exceed the limits shown in figure 4.

The values shown refer to the maximum bandwidths as given in table 7.

Table 7

Frequency range	Resolution bandwidth
25 Hz to 10 kHz	10 Hz
> 10 kHz to 20 kHz	200 Hz or 300 Hz

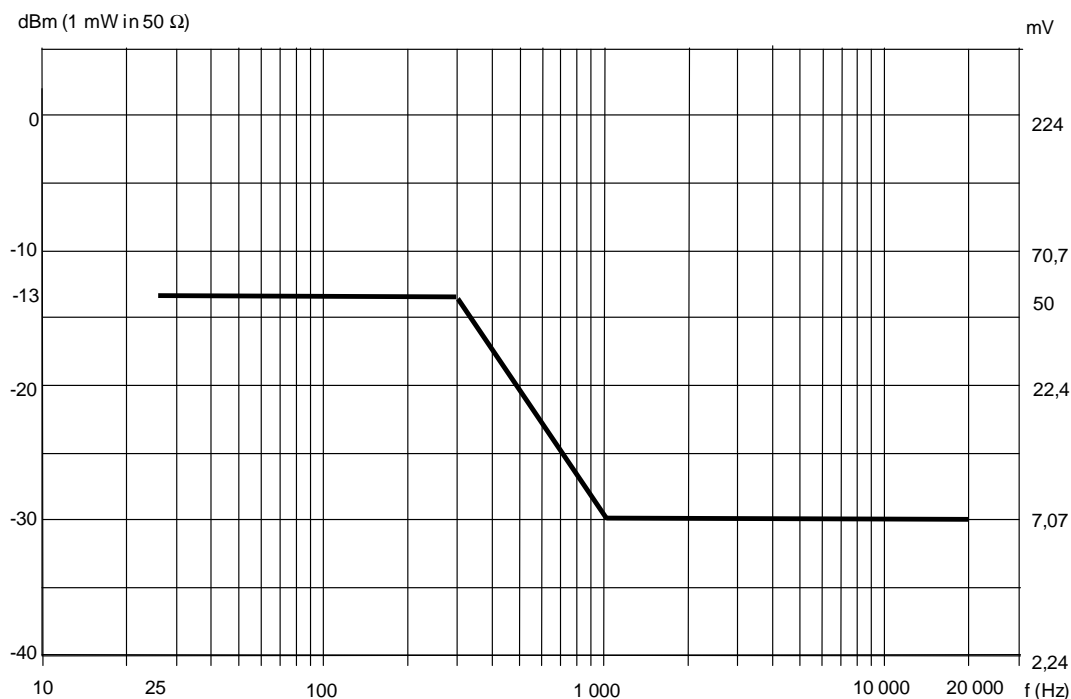

Figure 4: Immunity level of narrow-band noise at interface "A"

The recommended method of measurement is with a spectrum analyser having the bandwidths shown in table 7 for the relevant frequency ranges. The measuring circuit is shown in figure 5.

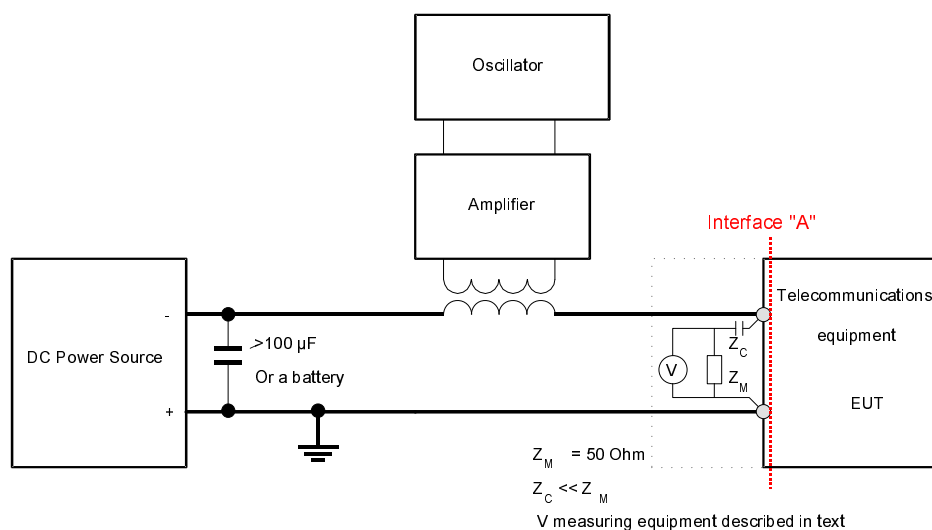

Figure 5: Example of a typical test arrangement for immunity measurement at interface "A"

Test conditions

When checking compliance to this requirement the rms value of the injected noise current shall be limited to 5 % of the actual DC current level. Compliance is achieved when the first of the following levels is reached:

- the maximum noise voltage value; or
- the maximum injected noise current level.

NOTE 1: The user should exercise extreme caution when working with the test arrangement shown in figure 5 as high energy levels can exist.

NOTE 2: Annex D gives an example of a test arrangement for the injection of noise at interface "A".

NOTE 3: The test should be limited for equipment with an input not higher than 10 A.

4.9 Conducted emissions requirements of the telecommunications and datacom (ICT) equipment at interface "A"

Conducted emission requirements shall not be applicable at equipment installed in outdoor location such as shelters and street cabinets. Due to the nature of the emitted noise this could be influenced only other equipment directly connected at the interface "A" present in the outdoor location.

Performance criteria

The maximum level of noise re-injected to the power supply system at interface "A" from the telecommunications and datacom (ICT) equipment is shown in figure 6.

The values shown refer to the bandwidths as given in table 8.

Table 8

Frequency range	Resolution bandwidth
25 Hz to 10 kHz	10 Hz
> 10 kHz to 20 kHz	200 Hz or 300 Hz

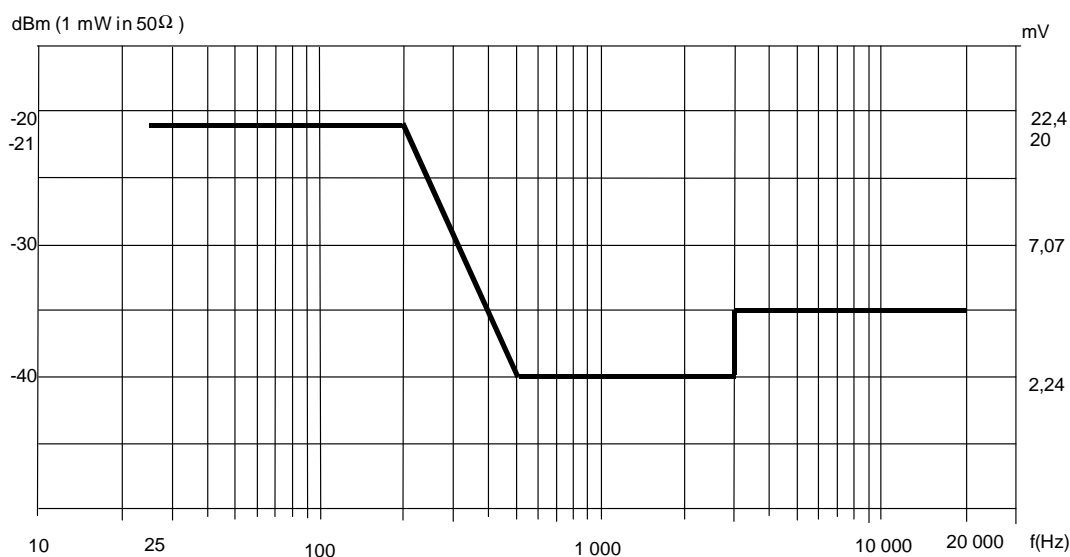
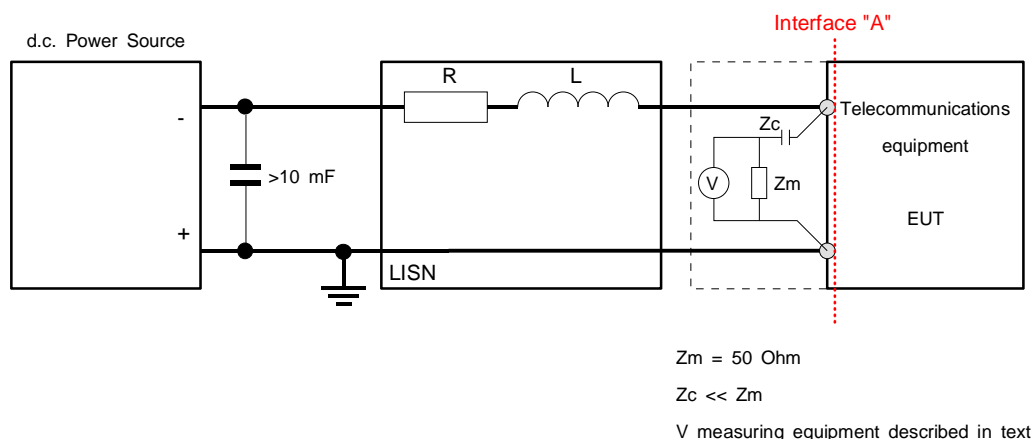

Figure 6: Maximum levels of narrowband noise

Test condition

The measurement shall be made with a spectrum analyser having the bandwidths shown in table 8 for the relevant frequency ranges.

The measurement circuit shall be as shown in figure 7. During the measurement the telecommunications and datacom (ICT) equipment shall be powered at the nominal voltage and operated at typical configuration under maximum power (watt level) operation.



$$R \leq \frac{1V}{I_m(@54V)}$$

$$10\mu H \leq L \leq 20\mu H$$

Figure 7: Measuring circuit for re-injected narrow-band and wide-band noise

NOTE 1: The user should exercise extreme caution when working with the test arrangement shown in figure 5 as high energy levels can exist.

NOTE 2: Resistance R includes the resistance of inductor L.

NOTE 3: The LISN could be the connecting cable (EUT to power supply), providing that the length has an inductance of 10 μ H to 20 μ H and an equivalent resistance.

NOTE 4: The intention of the LISN is to simulate a power network over which a voltage drop **not greater than** 1 V will appear in case of nominal current.

For telecommunications equipment fitted with analogue interfaces an evaluation of wideband noise amplitude in this frequency band can be calculated using the method detailed in annex E.

5 Earthing and bonding

Earthing and bonding of the telecommunications and datacom (ICT) equipment in telecommunications centres is covered by EN 300 253 [3].

Annex A (normative): Identification of interface "A"

Interface "A" is defined as the terminals at which the telecommunications and datacom (ICT) equipment is connected to the power supply distribution. This is shown in figure A.1.

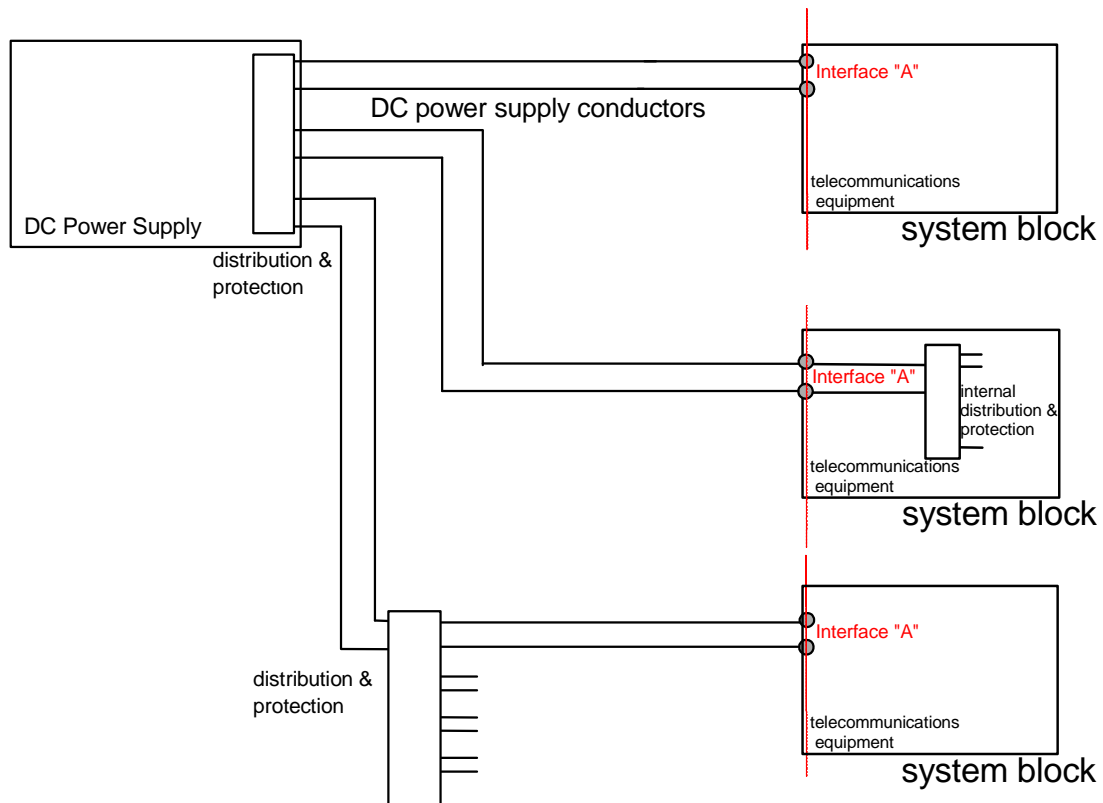

Figure A.1: Identification of interface "A" (three proposed examples)

Annex B (informative): -60 V_{DC} systems

When equipment is added to existing -60 V_{DC} systems the requirements given in table B.1, deviating from the requirements of the present document, may be used.

NOTE: This variation may be necessary due to established national practice which cannot be changed for a long period of time, for instance when an existing network structure is based on -60 V_{DC} power feeding.

Table B.1

Nominal value of the supply voltage	-60,0 V _{DC}		
Normal service voltage range at interface "A"	-50,0 V _{DC}	to	-72,0 V _{DC}
Abnormal service voltage range at interface "A"	0 V _{DC} -72,0 V _{DC}	to	-50,0 V _{DC} and -75,0 V _{DC}

Annex C (informative): Guide for measuring inrush current and for transferring the recorded pulses onto the limit chart

C.1 Measurement

- Use a storage oscilloscope, which can record values of di/dt of at least $10 \text{ A}/\mu\text{s}$.
- When measuring the DC supply, use a time base setting which enables readings of the pulse width to be taken at different current levels (figure C.1 reports a result of inrush pulse simulation measurement).
- Take several readings to ensure that the worst case value has been recorded.

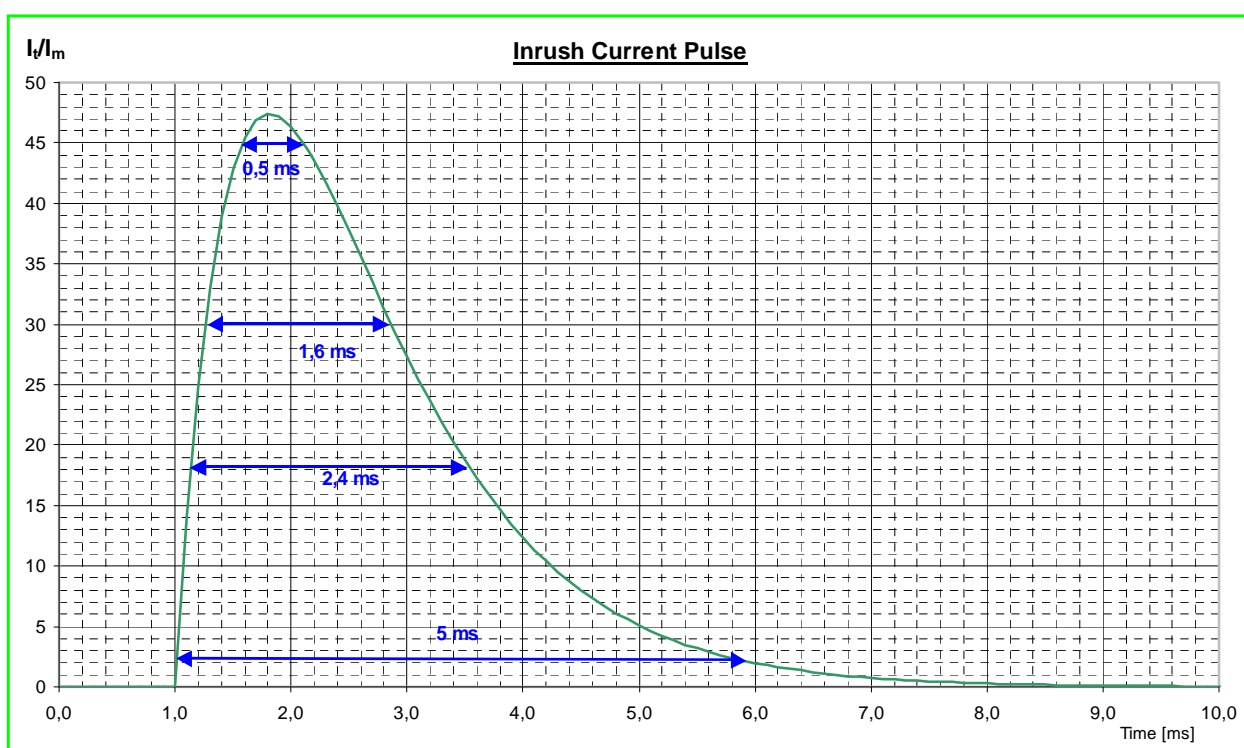

Figure C.1: Example of current pulse and associated measurements

C.2 Pulse waveform transformation

- For a single pulse from the DC system, proceed as follows:
 - measure the width of the current pulse at different levels;

NOTE 1: Small magnitude current pulses for charging RF filter capacitors should not be considered. Clause C.3 contains example oscillogram showing measurements of typical equipment RF capacitor charging current and inrush current pulses.

- plot the current ratios against their corresponding time values points onto the limit curve of figure 2;
- draw an interpolation curve between the plotted points.

- b) The interpolation curve should not cross the limit curve at any point. Use more points from the recorded pulse in critical areas where the interpolated curve has insufficient accuracy. Figure C.2 shows the DC pulse of figure C.1 transferred onto the limit chart of figure 2.

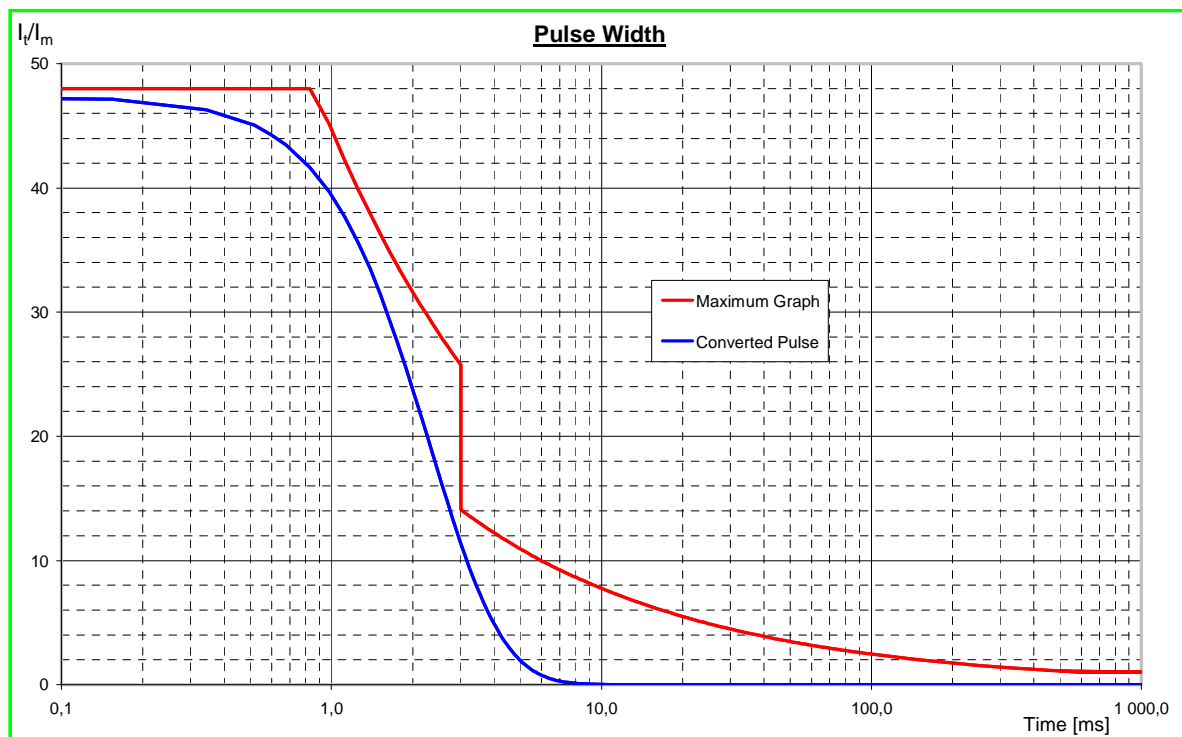

Figure C.2: Example of values for a typical inrush current ratio plotted against limit curve

NOTE 2: Occasionally, more than one inrush pulse may appear, due to special arrangements for limiting the amplitude of single pulses or because the load (telecommunications and datacom (ICT) equipment) starts in sequences. Under these conditions, the limit should be interpreted separately for each different start-up sequence where there is more than 1 second between each. The protective device in the distribution network should not operate.

- c) When from the load or from the limited amplitude of single pulses you have more than one inrush current this limit should be interpreted as shown in figure C.3 - the width obtained is the addition of the width of the individual pulses (e.g. 1,6 ms + 0,8 ms). This is depending of the frequency and the level of the impulses and practical from the time for demagnetisation of the anchor in the circuit breaker.

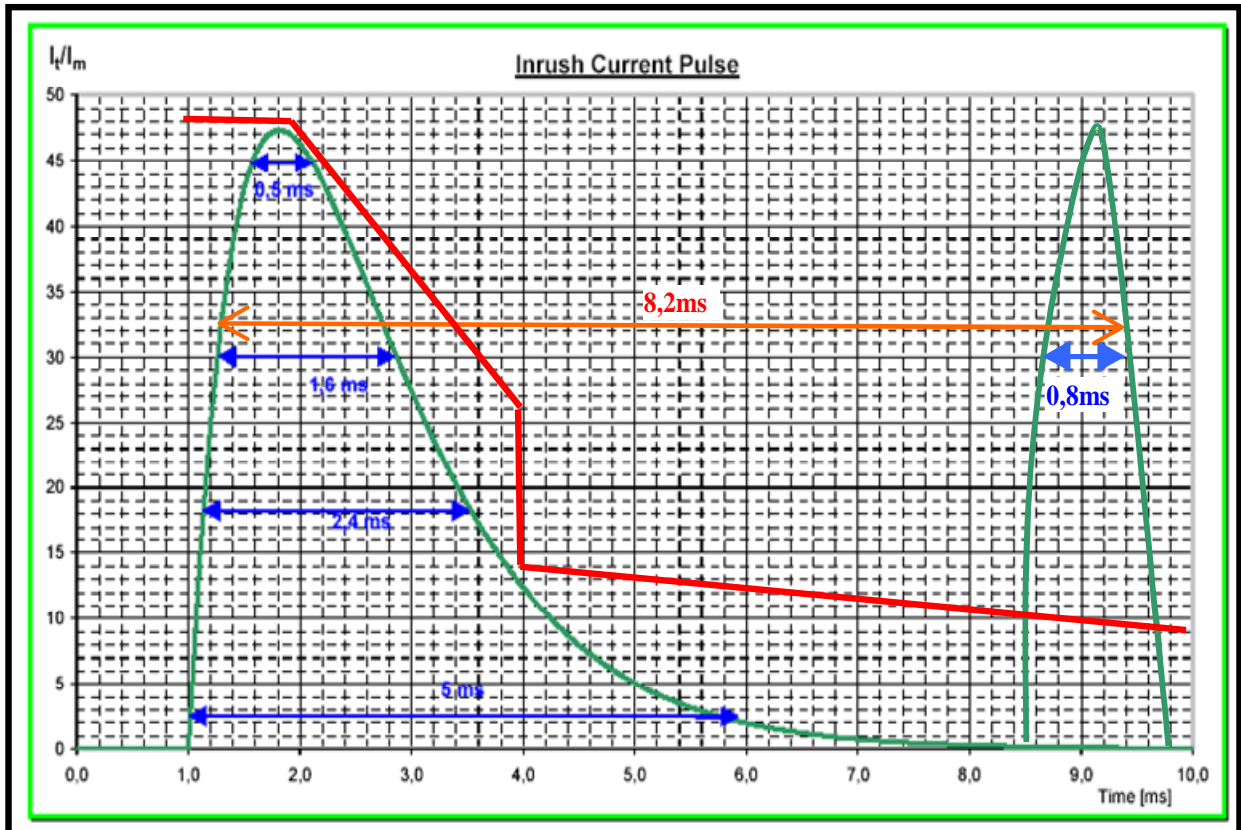
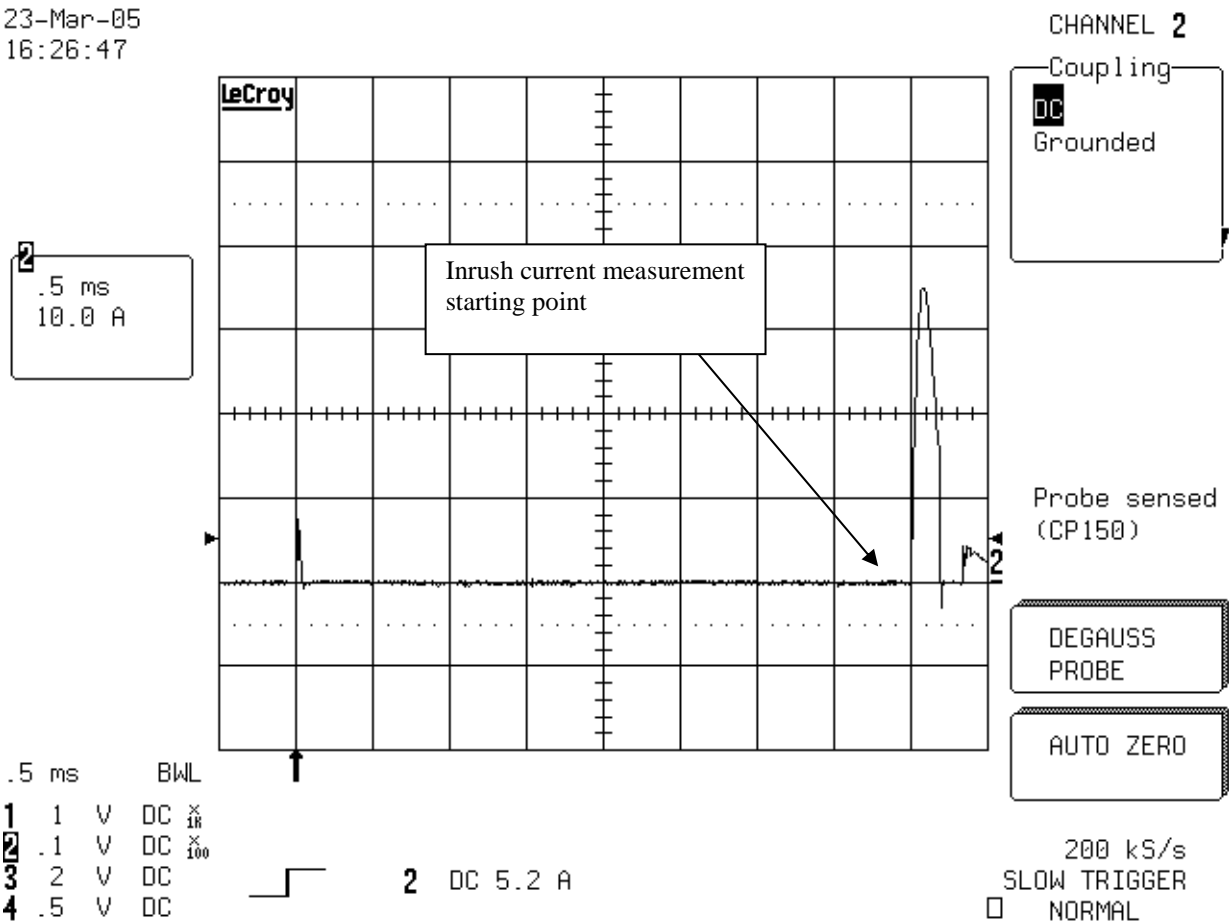

Figure C.3: The width obtained is the addition of the width of the individual pulses (1,6 ms + 0,8 ms)

C.3 Measurement of inrush current with filter capacitor current pulses

23-Mar-05
16:26:47



NOTE: In this example the inrush current measurement starting point is set at the beginning of the biggest pulse.

Figure C.4: Example of inrush current measurement with evidence of a pulse due to a filter capacitor

25-May-06
15:15:45

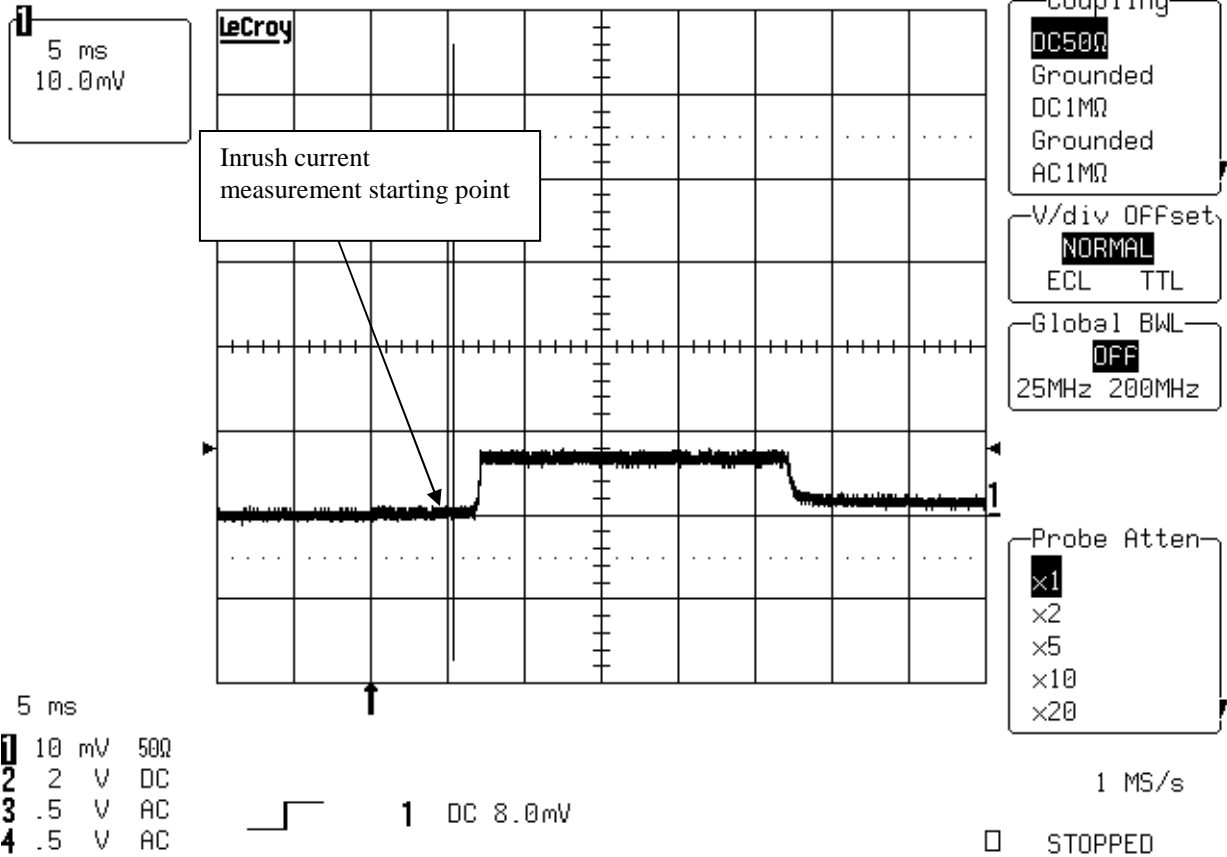

due to a filter capacitor

NOTE: In this example the inrush current measurement starting point is set at the beginning of the single pulse.

Figure C.5: Example of inrush current measurement with no evidence of a pulse

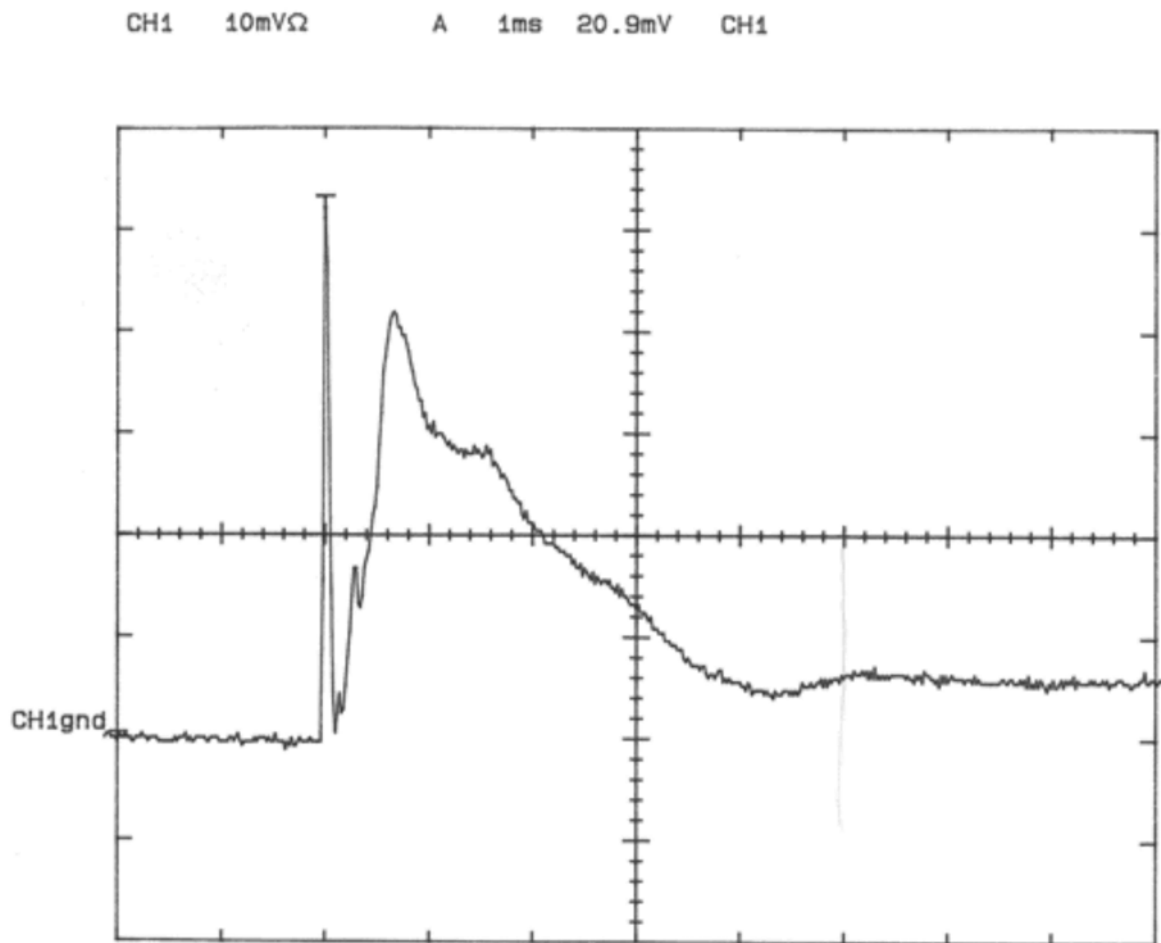

NOTE: In this example the inrush current measurement starting point is set at the beginning of the filter capacitor charging pulse.

Figure C.6: Example of inrush current measurement with no separation between the filter capacitor charging pulse and inrush current pulse (note time scale)

Annex D (informative): Test arrangements for the injection of electrical noise at interface "A"

- a) Clause 4.8 defines the maximum levels of noise, which may be present at interface "A". The method of injecting noise for testing purposes is not critical provided that the maximum levels in clause 4.8 for narrowband noise are not exceeded.
- b) The test configuration shown in figure 5 is an example of how noise may be injected at interface "A". Further details of this test may be found in MIL-STD-461E [i.6]. The required ratio $Z_c \ll Z_m$ is fulfilled with:

$$C = 10\,000\ \mu\text{F} \text{ and } |Z_{c, 25\ \text{Hz}}| = 640\ \text{m}\Omega.$$

Annex E (informative): Wideband noise

E.1 Emission of wideband noise

The maximum wideband noise levels should be as follows:

- a) 25 Hz to 5 kHz: $P_{\text{pso}}=0,08\mu\text{W}$ ($U_{\text{pso,eff}} = 2 \text{ mV}$ measured on 50Ω): (via ITU-T Weighting Filter for commercial telephone circuits);

NOTE: In ITU-T Recommendations Q.551 [i.1], Q.552 [i.2], Q.553 [i.3] and Q.554 [i.4] (digital exchanges) the analogue noise contribution is limited to 200 picowatts psophometrically weighted, corresponding to -67 dBm_p (reference 1 mW). This limitation may require dedicated precautions to reduce the reinjected noise on the DC distribution to a lower level (e.g. $0,4 \text{ mV}_{\text{pso,rms}}$).

- b) 25 Hz to 20 kHz: $U_{\text{rms}} = 20 \text{ mV}$: (flat/unweighted).

Both measurements should be made with a psophometer conforming to ITU-T Recommendation O.41 [4]. The measurement circuit should be as shown in figure 7. During the measurement the telecommunications and datacom (ICT) equipment should be powered at the nominal voltage ($-48 \text{ V}_{\text{DC}}$) of interface "A" and the rated load condition.

E.1.1 Assessment of wideband noise

Wideband (psophometric) noise can be measured or calculated using the guidance given in ITU-T Recommendation O.41 [4].

E.2 How to calculate wideband emission

The results of the measure of the noise emitted in the DC line obtained using the narrowband methods reported in clause 4.9.1 can be used to obtain the value of the wideband noise via a simple calculation.

The measurements should be made with a psophometer conforming to ITU-T Recommendation O.41 [4].

ITU-T Recommendation O.41 [4] contains the definition of the psophometric weighting filter.

The measured power is defined by this formula:

$$P_p = \frac{1}{(F_2 - F_1)} \int_{F_1}^{F_2} \frac{V^2(f)}{10^{-3} |Z_n(F_0)|} 10^{W(f)/10} df$$

P_p is the psophometric power $W(f)$ is the weighting filter of the psophometer with the limiting frequencies $F_1 = 16,66 \text{ Hz}$ and $F_2 = 6 \text{ kHz}$ as given in table E.1. $Z_n(F_0)$ is the input impedance of the instrument at the reference frequency F_0 . V is the unknown voltage to be measured.

The weighting filter is reported in table E.1 and shown in figure E.1.

Table E.1: Psophometric weight

Frequency (Hz)	Relative weight (dB)
16,66	-85,0
50	-63,0
100	-41,0
200	-21,0
300	-10,6
400	-6,3
500	-3,6
600	-2,0
700	-0,9
800	0,0
900	+0,6
1 000	+1,0
1 200	0,0
1 400	-0,9
1 600	-1,7
1 800	-2,4
2 000	-3,0
2 500	-4,2
3 000	-5,6
3 500	-8,5
4 000	-15,0
4 500	-25,0
5 000	-36,0
6 000	-43,0

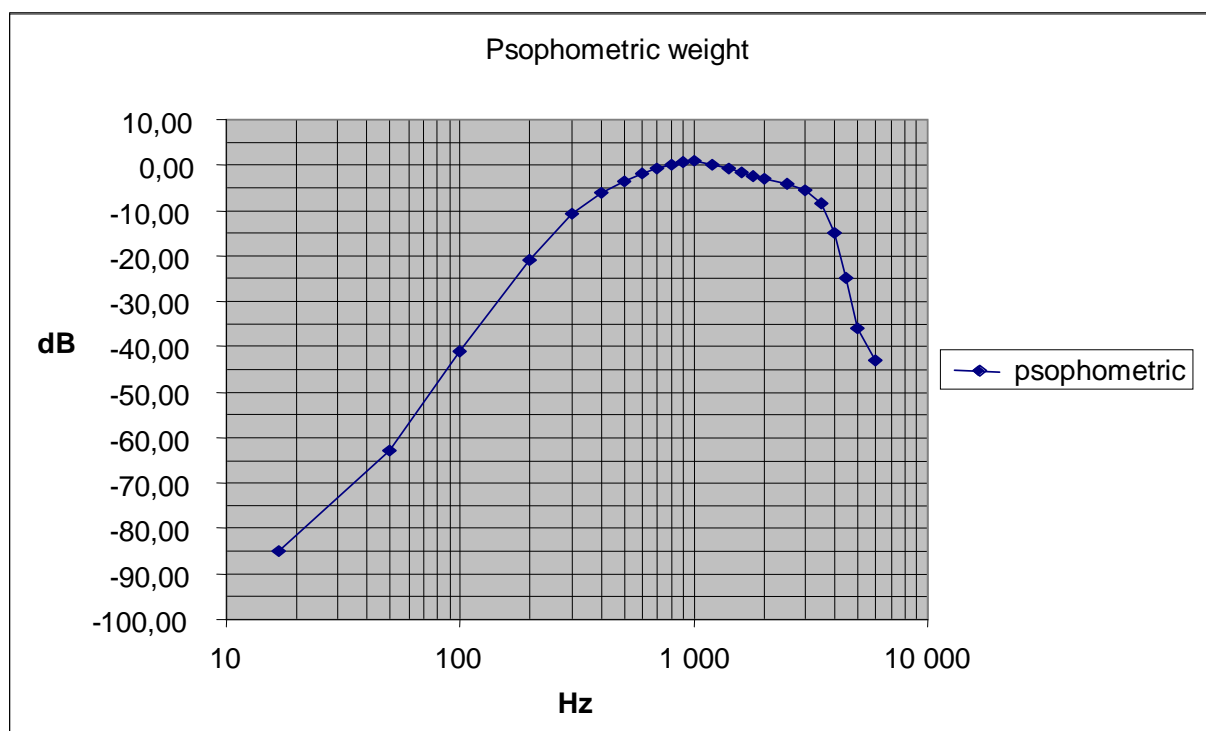

Figure E.1: Psophometric filter frequency response

Starting with measurements obtained from using the narrowband method it is possible to calculate the result of total power using the formula given above.

However, the calculation can be done using a simplified approximate method.

For example consider the measured noise shown in figure E.2.

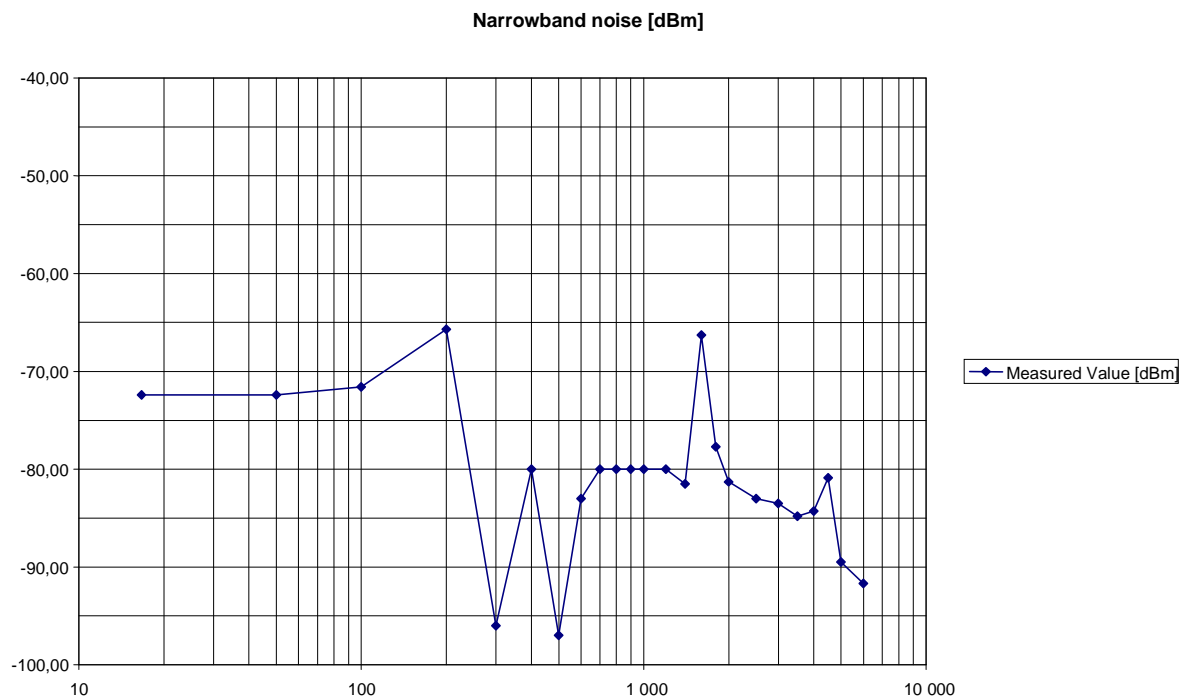

Figure E.2: Example of narrowband measure

In table format, the noise measured has the values reported in table E.2. The values are given at the frequency reported in table E.2. The simplified method considers only the noise and the weighting factor at some frequencies and substitutes the integral calculation of the formula with a simple sum.

With this assumption the formula is:

$$P_w = \sum 10^{(P_{noise}(f)+W(f))/10}$$

In this formula:

- $P_{noise}(f)$ is the value of the noise power in dBm at frequency f .
- $W(f)$ is the value of the weighting filter at frequency f in dB.
- P_w is the value of the wideband noise with the ITU-T Weighting Filter; P_w is expressed in mW.
- The unweighted noise can be calculated with the same method considering the weight equal to 0 dB.
- With the example of the noise of figure E.2 and applied the formula above result a value of wideband noise weighted of: 2,41436E-07 mW (-66 dBm) corresponding at 3,5 μ V.

Table E.2: Narrowband values

Frequency (Hz)	Measured Value (dBm)
16,66	-72,40
50	-72,40
100	-71,60
200	-65,70
300	-96,00
400	-80,00
500	-97,00
600	-83,00
700	-80,00
800	-80,00
900	-80,00
1 000	-80,00
1 200	-80,00
1 400	-81,50
1 600	-66,30
1 800	-77,70
2 000	-81,30
2 500	-83,00
3 000	-83,50
3 500	-84,80
4 000	-84,30
4 500	-80,90
5 000	-89,50
6 000	-91,70

Annex F (informative): Protection dimensioning

It is common practice to use fuses or circuit breakers in the DC network distribution with a sizing factor greater than 1,5 times I_m .

This takes into account:

- The maximum steady state current into interface "A" at minimum voltage of the normal service voltage range - 40,5 V (because at constant power, the current increase when the voltage at interface "A" decreases).
- The inrush current according to figure 2.
- Some margin with regards to temperature deviation, technology, ageing, delatch mechanism, etc.,: it is not recommended to load fuses and breakers with the rated trip current (e.g. 90 % or less).
- Equipment inrush current can cause circuit breaker mechanism to "de-latch" earlier than indicated by circuit-breaker time/current characteristic. After de-latching of the circuit-breakers the contacts will open even if the current falls to zero. De-latching performance should therefore be considered when selecting circuit breakers.

Annex G (informative): Effects of protective device operation transients in the power distribution

A protective device operation transient results from a low impedance fault to ground on the equipment side of a protective device (fuse or circuit breaker) connected to a power distribution bus. The bus voltage is reduced due to high current flowing to ground through the protective device and the short ground. When the protective device opens, the release energy stored in the inductance of the bus causes an initial high voltage overshoot of short duration, followed by a longer interval voltage overshoot that decays toward the steady state bus voltage.

In the present document, in clause 4.3 tests are defined to verify the susceptibility of the equipment when a short circuit or overload condition occurs on the power distribution bus.

The technique to reduce the effect propagation of a short circuit or overload condition on the power distribution bus (i.e. transient voltage dip at Interface A) is to isolate the fault. The fault isolation can be achieved using High-Ohmic Distributions (HOD) or Low-Ohmic Distributions (LOD).

In the HOD, the equipment and the subparts of the equipment, are connected separately to the battery with sufficient impedance. The high impedance can be achieved with long cables and in some cases additional resistors are installed. With this distribution the undervoltage effects are reduced on the other equipment connected to the battery.

In the LOD, the equipment and the subparts of the equipment are connected to the battery with as low impedance as possible and hold-up capacitors are installed at the power entrance point of the equipment, or equipment subparts, to reduce the undervoltage effects in case of short circuit of one of equipment.

Annex H (informative): Bibliography

- IEC 60664-1: "Insulation co-ordination for equipment within low voltage systems".
- IEC 60364-4-41: "Electrical installations of buildings - Part 4: Protection for safety - Chapter 41: Protection against electric shock".
- ETSI EN 300 386: "Electromagnetic compatibility and Radio spectrum Matters (ERM); Telecommunication network equipment; ElectroMagnetic Compatibility (EMC) requirements".
- ETSI EG 201 212: "Electrical safety; Classification of interfaces for equipment to be connected to telecommunication networks".
- CENELEC TR 62102: "Electrical Safety - Classification of interfaces for equipment to be connected to information and communications technology networks".
- CENELEC EN 50310: "Application of equipotential bonding and earthing in buildings with information technology equipment".
- CENELEC EN 60950-1: "Safety of information technology equipment".
- IEC 60950-1: "Information technology equipment - Safety - Part 1: General".
- CENELEC EN 41003: "Particular safety requirements for equipment to be connected to telecommunication networks and/or a cable distribution system".
- CENELEC EN 62368-1 Ed 1.0: Audio/Video: "Information and Communication Technology Equipment - Part 1: Safety requirements".
- Electropedia.org: Electropedia: "The World's Online Electrotechnical Vocabulary".

History

Document history		
Edition 1	September 1996	Publication as ETS 300 132-2
Corrigendum 1	December 1996	Corrigendum 1 of 1 st Edition of ETS 300 132-2
V2.1.1	January 2003	Publication (withdrawn)
V2.1.2	September 2003	Publication
V2.2.1	May 2007	Publication
V2.2.2	October 2007	Publication
V2.3.6	February 2011	Public Enquiry PE 20110609: 2011-02-09 to 2011-06-09
V2.4.6	October 2011	Vote V 20111209: 2011-10-10 to 2011-12-09