

ETSI TS 138 521-2 V19.2.0 (2026-04)



TECHNICAL SPECIFICATION

**5G;
NR;
User Equipment (UE) conformance specification;
Radio transmission and reception;
Part 2: Range 2 standalone
(3GPP TS 38.521-2 version 19.2.0 Release 19)**



Reference

RTS/TSGR-0538521-2vj20

Keywords

5G

ETSI

650 Route des Lucioles
F-06921 Sophia Antipolis Cedex - FRANCE

Tel.: +33 4 92 94 42 00 Fax: +33 4 93 65 47 16

Siret N° 348 623 562 00017 - APE 7112B
Association à but non lucratif enregistrée à la
Sous-Préfecture de Grasse (06) N° w061004871

Important notice

The present document can be downloaded from the
[ETSI Search & Browse Standards](#) application.

The present document may be made available in electronic versions and/or in print. The content of any electronic and/or print versions of the present document shall not be modified without the prior written authorization of ETSI. In case of any existing or perceived difference in contents between such versions and/or in print, the prevailing version of an ETSI deliverable is the one made publicly available in PDF format on [ETSI deliver](#) repository.

Users should be aware that the present document may be revised or have its status changed,
this information is available in the [Milestones listing](#).

If you find errors in the present document, please send your comments to
the relevant service listed under [Committee Support Staff](#).

If you find a security vulnerability in the present document, please report it through our
[Coordinated Vulnerability Disclosure \(CVD\)](#) program.

Notice of disclaimer & limitation of liability

The information provided in the present deliverable is directed solely to professionals who have the appropriate degree of experience to understand and interpret its content in accordance with generally accepted engineering or other professional standard and applicable regulations.

No recommendation as to products and services or vendors is made or should be implied.

No representation or warranty is made that this deliverable is technically accurate or sufficient or conforms to any law and/or governmental rule and/or regulation and further, no representation or warranty is made of merchantability or fitness for any particular purpose or against infringement of intellectual property rights.

In no event shall ETSI be held liable for loss of profits or any other incidental or consequential damages.

Any software contained in this deliverable is provided "AS IS" with no warranties, express or implied, including but not limited to, the warranties of merchantability, fitness for a particular purpose and non-infringement of intellectual property rights and ETSI shall not be held liable in any event for any damages whatsoever (including, without limitation, damages for loss of profits, business interruption, loss of information, or any other pecuniary loss) arising out of or related to the use of or inability to use the software.

Copyright Notification

No part may be reproduced or utilized in any form or by any means, electronic or mechanical, including photocopying and microfilm except as authorized by written permission of ETSI.

The content of the PDF version shall not be modified without the written authorization of ETSI.

The copyright and the foregoing restriction extend to reproduction in all media.

© ETSI 2026.
All rights reserved.

Intellectual Property Rights

Essential patents

IPRs essential or potentially essential to normative deliverables may have been declared to ETSI. The declarations pertaining to these essential IPRs, if any, are publicly available for **ETSI members and non-members**, and can be found in ETSI SR 000 314: "*Intellectual Property Rights (IPRs); Essential, or potentially Essential, IPRs notified to ETSI in respect of ETSI standards*", which is available from the ETSI Secretariat. Latest updates are available on the [ETSI IPR online database](#).

Pursuant to the ETSI Directives including the ETSI IPR Policy, no investigation regarding the essentiality of IPRs, including IPR searches, has been carried out by ETSI. No guarantee can be given as to the existence of other IPRs not referenced in ETSI SR 000 314 (or the updates on the ETSI Web server) which are, or may be, or may become, essential to the present document.

Trademarks

The present document may include trademarks and/or tradenames which are asserted and/or registered by their owners. ETSI claims no ownership of these except for any which are indicated as being the property of ETSI, and conveys no right to use or reproduce any trademark and/or tradename. Mention of those trademarks in the present document does not constitute an endorsement by ETSI of products, services or organizations associated with those trademarks.

DECT™, **PLUGTESTS™**, **UMTS™** and the ETSI logo are trademarks of ETSI registered for the benefit of its Members. **3GPP™**, **LTE™** and **5G™** logo are trademarks of ETSI registered for the benefit of its Members and of the 3GPP Organizational Partners. **oneM2M™** logo is a trademark of ETSI registered for the benefit of its Members and of the oneM2M Partners. **GSM®** and the GSM logo are trademarks registered and owned by the GSM Association.

Legal Notice

This Technical Specification (TS) has been produced by the ETSI 3rd Generation Partnership Project (3GPP).

The present document may refer to technical specifications or reports using their 3GPP identities. These shall be interpreted as being references to the corresponding ETSI deliverables.

The cross reference between 3GPP and ETSI identities can be found at [3GPP to ETSI numbering cross-referencing](#).

Modal verbs terminology

In the present document "**shall**", "**shall not**", "**should**", "**should not**", "**may**", "**need not**", "**will**", "**will not**", "**can**" and "**cannot**" are to be interpreted as described in clause 3.2 of the [ETSI Drafting Rules](#) (Verbal forms for the expression of provisions).

"**must**" and "**must not**" are **NOT** allowed in ETSI deliverables except when used in direct citation.

Contents

Intellectual Property Rights	2
Legal Notice	2
Modal verbs terminology.....	2
Foreword.....	17
1 Scope	18
2 References	18
3 Definitions, symbols and abbreviations	19
3.1 Definitions	19
3.2 Symbols.....	21
3.3 Abbreviations	23
4 General	24
4.1 Relationship between minimum requirements and test requirements	24
4.2 Applicability of minimum requirements	25
4.3 Specification suffix information.....	25
4.4 Test point analysis.....	26
4.5 Applicability and test coverage rules.....	26
5 Operating bands and channel arrangement.....	26
5.1 General	26
5.2 Operating bands.....	27
5.2A Operating bands for CA	27
5.2A.2 Void.....	27
5.2A.3 Inter-band CA	27
5.2D Operating bands for UL MIMO	27
5.2K Operating bands for simultaneous reception or transmission in multiple directions	28
5.3 UE Channel bandwidth	28
5.3.1 General.....	28
5.3.2 Maximum transmission bandwidth configuration	29
5.3.3 Minimum guardband and transmission bandwidth configuration.....	29
5.3.4 RB alignment	31
5.3.5 Channel bandwidth per operating band	31
5.3A UE Channel bandwidth for CA	31
5.3A.1 General.....	31
5.3A.2 Minimum guardband and transmission bandwidth configuration for CA	31
5.3A.3 RB alignment with different numerologies for CA.....	33
5.3A.4 UE channel bandwidth per operating band for CA.....	33
5.3D Channel bandwidth for UL MIMO.....	35
5.4 Channel arrangement.....	35
5.4.1 Channel spacing.....	35
5.4.1.1 Channel spacing for adjacent NR carriers	35
5.4.2 Channel raster	35
5.4.2.1 NR-ARFCN and channel raster.....	35
5.4.2.2 Channel raster to resource element mapping.....	36
5.4.2.3 Channel raster entries for each operating band	36
5.4.3 Synchronization raster	37
5.4.3.1 Synchronization raster and numbering.....	37
5.4.3.2 Synchronization raster to synchronization block resource element mapping.....	37
5.4.3.3 Synchronization raster entries for each operating band.....	37
5.4A Channel arrangement for CA.....	38
5.4A.1 Channel spacing for CA.....	38
5.5 Configurations	39
5.5A Configurations for CA.....	39
5.5A.1 Configurations for intra-band contiguous CA.....	39
5.5A.2 Configurations for intra-band non-contiguous CA	40

5.5A.3	Configurations for inter-band CA	44
5.5D	Configurations for UL MIMO	44
6	Transmitter characteristics	45
6.1	General	45
6.2	Transmit power	47
6.2.1	UE maximum output power	47
6.2.1.0	General	47
6.2.1.1	UE maximum output power - EIRP and TRP	48
6.2.1.1_1	UE maximum output power - EIRP and TRP (Rel16 and forward)	60
6.2.1.2	UE maximum output power - Spherical coverage	62
6.2.1.2_1	UE maximum output power - Spherical coverage (Rel16 and forward)	68
6.2.2	UE maximum output power reduction	69
6.2.2.0	General	69
6.2.2.3.1	UE maximum output power reduction for power class 1	70
6.2.2.3.2	UE maximum output power reduction for power class 2	71
6.2.2.3.3	UE maximum output power reduction for power class 3	72
6.2.2.3.4	UE maximum output power reduction for power class 4	73
6.2.2.3.5	UE maximum output power reduction for power class 5	73
6.2.2.3.6	UE maximum output power reduction for power class 6	73
6.2.2.3.7	UE maximum output power reduction for power class 7	73
6.2.2_1	UE maximum output power reduction enhancements	89
6.2.2_1.0	General	89
6.2.3	UE maximum output power with additional requirements	96
6.2.3.3.1	General	96
6.2.3.3.2	Void	97
6.2.3.3.3	A-MPR for NS_202	97
6.2.3.3.4	A-MPR for NS_203	98
6.2.3.3.5	[Reserved]	98
6.2.3.3.6	A-MPR for NS_205	98
6.2.4	Configured transmitted power	108
6.2.4_1	Configured transmitted power with Power Boost	109
6.2.5	UE maximum output power – EIRP with UL Gaps	111
6.2A	Transmit power for CA	115
6.2A.1	UE maximum output power for CA	115
6.2A.1.0	Minimum conformance requirements	115
6.2A.1.1	UE maximum output power - EIRP and TRP for CA	115
6.2A.1.1.1	UE maximum output power - EIRP and TRP for CA (2UL CA)	115
6.2A.1.1.2	UE maximum output power - EIRP and TRP for CA (3UL CA)	120
6.2A.1.1.3	UE maximum output power - EIRP and TRP for CA (4UL CA)	122
6.2A.1.1.4	UE maximum output power - EIRP and TRP for CA (5UL CA)	124
6.2A.1.1.5	UE maximum output power - EIRP and TRP for CA (6UL CA)	125
6.2A.1.1.6	UE maximum output power - EIRP and TRP for CA (7UL CA)	125
6.2A.1.1.7	UE maximum output power - EIRP and TRP for CA (8UL CA)	125
6.2A.1.2	UE maximum output power - Spherical coverage	126
6.2A.1.2.1	UE maximum output power - Spherical coverage for CA (2UL CA)	126
6.2A.1.2.2	UE maximum output power - Spherical coverage for CA (3UL CA)	130
6.2A.1.2.3	UE maximum output power - Spherical coverage for CA (4UL CA)	133
6.2A.1.2.4	UE maximum output power - Spherical coverage for CA (5UL CA)	135
6.2A.1.2.5	UE maximum output power - Spherical coverage for CA (6UL CA)	135
6.2A.1.2.6	UE maximum output power - Spherical coverage for CA (7UL CA)	136
6.2A.1.2.7	UE maximum output power - Spherical coverage for CA (8UL CA)	136
6.2A.2	UE maximum output power reduction for CA	136
6.2A.2.0	Minimum conformance requirements	136
6.2A.2.0.1	General	136
6.2A.2.0.2	Maximum output power reduction for power class 1	136
6.2A.2.0.3	Maximum output power reduction for power class 2	139
6.2A.2.0.4	Maximum output power reduction for power class 3	140
6.2A.2.0.5	Maximum output power reduction for power class 4	142
6.2A.2.0.6	Maximum output power reduction for power class 5	142
6.2A.2.0.7	Maximum output power reduction for power class 6	142
6.2A.2.1	UE maximum output power reduction for CA (2UL CA)	142

6.2A.2.2	UE maximum output power reduction for CA (3UL CA).....	165
6.2A.2.3	UE maximum output power reduction for CA (4UL CA).....	171
6.2A.2.4	UE maximum output power reduction for CA (5UL CA).....	178
6.2A.2.5	UE maximum output power reduction for CA (6UL CA).....	178
6.2A.2.6	UE maximum output power reduction for CA (7UL CA).....	178
6.2A.2.7	UE maximum output power reduction for CA (8UL CA).....	178
6.2A.3	UE maximum output power with additional requirements for CA.....	178
6.2A.3.0	Minimum conformance requirements	178
6.2A.3.0.1	General	178
6.2A.3.0.2	Void.....	179
6.2A.3.0.3	A-MPR for CA_NS_202	179
6.2A.3.0.4	A-MPR for CA_NS_203	179
6.2A.3.0.5	[Reserved]	180
6.2A.3.0.6	A-MPR for CA_NS_205	180
6.2A.3.1	UE maximum output power with additional requirements for CA (2UL CA).....	181
6.2A.3.2	UE maximum output power with additional requirements for CA (3UL CA).....	188
6.2A.3.3	UE maximum output power with additional requirements for CA (4UL CA).....	195
6.2A.3.4	UE maximum output power with additional requirements for CA (5UL CA).....	202
6.2A.3.5	UE maximum output power with additional requirements for CA (6UL CA).....	202
6.2A.3.6	UE maximum output power with additional requirements for CA (7UL CA).....	203
6.2A.3.7	UE maximum output power with additional requirements for CA (8UL CA).....	203
6.2A.4	Configured transmitted power for CA	203
6.2A.4.0	Minimum conformance requirements	203
6.2A.4.1	Configured transmitted power for CA (2UL CA)	204
6.2A.4.2	Configured transmitted power for CA (3UL CA)	204
6.2A.4.3	Configured transmitted power for CA (4UL CA)	204
6.2A.4.4	Configured transmitted power for CA (5UL CA)	204
6.2A.4.5	Configured transmitted power for CA (6UL CA)	204
6.2A.4.6	Configured transmitted power for CA (7UL CA)	204
6.2A.4.7	Configured transmitted power for CA (8UL CA)	205
6.2A.5	UE maximum output power - EIRP and TRP for CA (2UL CA) with UL Gaps.....	205
6.2D	Transmit power for UL MIMO	207
6.2D.1	UE maximum output power for UL MIMO.....	207
6.2D.1.0	General	207
6.2D.1.1	UE maximum output power - EIRP and TRP for UL MIMO	208
6.2D.1.2	UE maximum output power - Spherical coverage for UL MIMO	217
6.2D.2	UE maximum output power reduction for UL MIMO.....	220
6.2D.3	UE maximum output power with additional requirements for UL MIMO	233
6.2D.4	Configured transmitted power for UL MIMO	245
6.2K	Transmitter power for simultaneous transmission to multiple directions.....	245
6.2K.1	UE maximum output power for simultaneous transmission to multiple directions	245
6.2K.1.1	UE maximum output power - EIRP and TRP	246
6.2K.1.2	UE spherical coverage for simultaneous transmission to multiple directions	248
6.2K.2	UE maximum output power reduction for simultaneous transmission to multiple directions	248
6.2K.3	UE maximum output power with additional requirements for simultaneous transmission to multiple directions	249
6.2K.4	Configured transmitted power for simultaneous transmission to multiple directions.....	249
6.3	Output power dynamics.....	250
6.3.1	Minimum output power	250
6.3.2	Transmit OFF power.....	255
6.3.3	Transmit ON/OFF time mask	257
6.3.3.1	General	257
6.3.3.2	General ON/OFF time mask	257
6.3.3.3	Transmit power time mask for slot and short or long subslot boundaries.....	260
6.3.3.4	PRACH time mask.....	261
6.3.3.5	Void.....	265
6.3.3.6	SRS time mask	265
6.3.3.7	PUSCH-PUCCH and PUSCH-SRS time masks	269
6.3.3.8	Transmit power time mask for consecutive slot or long subslot transmission and short subslot transmission boundaries	270
6.3.3.9	Transmit power time mask for consecutive short subslot transmissions boundaries	270
6.3.4	Power control.....	270

6.3.4.1	General	270
6.3.4.2	Absolute power tolerance	270
6.3.4.3	Relative power tolerance	275
6.3.4.4	Aggregate power tolerance.....	284
6.3A	Output power dynamics for CA	288
6.3A.1	Minimum output power for CA	288
6.3A.1.0	Minimum conformance requirements	288
6.3A.1.1	Minimum output power for CA (2UL CA)	289
6.3A.1.2	Minimum output power for CA (3UL CA)	292
6.3A.1.3	Minimum output power for CA (4UL CA)	294
6.3A.1.4	Minimum output power for CA (5UL CA)	297
6.3A.1.5	Minimum output power for CA (6UL CA)	299
6.3A.1.6	Minimum output power for CA (7UL CA)	301
6.3A.1.7	Minimum output power for CA (8UL CA)	304
6.3A.2	Transmit OFF power for CA.....	306
6.3A.2.0	Minimum conformance requirements	306
6.3A.2.1	Void.....	307
6.3A.2.2	Void.....	307
6.3A.2.3	Void.....	307
6.3A.3	Transmit ON/OFF time mask for CA	307
6.3A.3.0	Minimum conformance requirements	307
6.3A.3.1	General ON/OFF time mask for CA	307
6.3A.3.1.1	General ON/OFF time mask for CA (2UL CA)	307
6.3A.3.1.2	General ON/OFF time mask for CA (3UL CA)	310
6.3A.3.1.3	General ON/OFF time mask for CA (4UL CA)	311
6.3A.3.1.4	General ON/OFF time mask for CA (5UL CA)	313
6.3A.3.1.5	General ON/OFF time mask for CA (6UL CA)	313
6.3A.3.1.6	General ON/OFF time mask for CA (7UL CA)	313
6.3A.3.1.7	General ON/OFF time mask for CA (8UL CA)	313
6.3A.4	Power control for CA.....	313
6.3A.4.1	General	313
6.3A.4.2	Absolute power tolerance for CA.....	313
6.3A.4.2.0	Minimum conformance requirements.....	313
6.3A.4.2.1	Absolute power tolerance for CA (2UL CA).....	314
6.3A.4.2.2	Absolute power tolerance for CA (3UL CA).....	316
6.3A.4.2.3	Absolute power tolerance for CA (4UL CA).....	317
6.3A.4.2.4	Absolute power tolerance for CA (5UL CA).....	319
6.3A.4.2.5	Absolute power tolerance for CA (6UL CA).....	321
6.3A.4.2.6	Absolute power tolerance for CA (7UL CA).....	323
6.3A.4.2.7	Absolute power tolerance for CA (8UL CA).....	325
6.3A.4.3	Relative power tolerance for CA.....	327
6.3A.4.3.0	Minimum conformance requirements.....	327
6.3A.4.3.1	Relative power tolerance for CA (2UL CA).....	328
6.3A.4.3.2	Relative power tolerance for CA (3UL CA).....	328
6.3A.4.3.3	Relative power tolerance for CA (4UL CA).....	328
6.3A.4.3.4	Relative power tolerance for CA (5UL CA).....	328
6.3A.4.3.5	Relative power tolerance for CA (6UL CA).....	328
6.3A.4.3.6	Relative power tolerance for CA (7UL CA).....	328
6.3A.4.3.7	Relative power tolerance for CA (8UL CA).....	328
6.3A.4.4	Aggregate power tolerance for CA	328
6.3A.4.4.0	Minimum conformance requirements.....	328
6.3A.4.4.1	Aggregate power tolerance for CA (2UL CA)	328
6.3A.4.4.2	Aggregate power tolerance for CA (3UL CA)	331
6.3A.4.4.3	Aggregate power tolerance for CA (4UL CA)	333
6.3A.4.4.4	Aggregate power tolerance for CA (5UL CA)	334
6.3A.4.4.5	Aggregate power tolerance for CA (6UL CA)	336
6.3A.4.4.6	Aggregate power tolerance for CA (7UL CA)	337
6.3A.4.4.7	Aggregate power tolerance for CA (8UL CA)	339
6.3D	Output power dynamics for UL MIMO	341
6.3D.0	General.....	341
6.3D.1	Minimum output power for UL MIMO	341
6.3D.2	Transmit OFF power for UL MIMO.....	344

6.3D.3	Transmit ON/OFF time mask for UL MIMO	346
6.3D.3.1	General ON/OFF time mask for UL MIMO	346
6.3D.3.2	Void.....	349
6.3D.3.3	Void.....	349
6.3D.3.4	Void.....	349
6.4	Transmit signal quality	349
6.4.1	Frequency error.....	349
6.4.2	Transmit modulation quality.....	351
6.4.2.1	Error vector magnitude	351
6.4.2.1_1	Error vector magnitude with Power Boost.....	358
6.4.2.2	Carrier leakage	360
6.4.2.3	In-band emissions	365
6.4.2.4	EVM equalizer spectrum flatness	379
6.4.2.5	EVM spectral flatness for pi/2 BPSK modulation	382
6.4.2.6	Phase continuity requirements for DMRS bundling	385
6.4A	Transmit signal quality for CA.....	390
6.4A.1	Frequency error for CA.....	390
6.4A.1.0	Minimum conformance requirements.....	390
6.4A.1.1	Frequency error for CA (2UL CA).....	390
6.4A.1.2	Frequency error for CA (3UL CA).....	392
6.4A.1.3	Frequency error for CA (4UL CA).....	393
6.4A.1.4	Frequency error for CA (5UL CA).....	394
6.4A.1.5	Frequency error for CA (6UL CA).....	396
6.4A.1.6	Frequency error for CA (7UL CA).....	398
6.4A.1.7	Frequency error for CA (8UL CA).....	399
6.4A.2	Transmit modulation quality for CA.....	402
6.4A.2.0	General.....	402
6.4A.2.1	Error vector magnitude for CA	402
6.4A.2.1.0	Minimum conformance requirements.....	402
6.4A.2.1.1	Error vector magnitude for CA (2UL CA)	402
6.4A.2.1.2	Error vector magnitude for CA (3UL CA)	405
6.4A.2.1.3	Error vector magnitude for CA (4UL CA)	408
6.4A.2.1.4	Error Vector magnitude for CA (5UL CA)	410
6.4A.2.1.5	Error Vector magnitude for CA (6UL CA)	413
6.4A.2.1.6	Error vector magnitude for CA (7UL CA)	416
6.4A.2.1.7	Error vector magnitude for CA (8UL CA)	419
6.4A.2.2	Carrier leakage for CA.....	422
6.4A.2.2.0	Minimum conformance requirements.....	422
6.4A.2.2.0.7	Carrier leakage for power class 6	423
6.4A.2.2.1	Carrier leakage for CA (2UL CA).....	424
6.4A.2.2.2	Carrier leakage for CA (3UL CA).....	426
6.4A.2.2.3	Carrier leakage for CA (4UL CA).....	428
6.4A.2.2.4	Carrier leakage for CA (5UL CA).....	429
6.4A.2.2.5	Carrier leakage for CA (6UL CA).....	431
6.4A.2.2.6	Carrier leakage for CA (7UL CA).....	432
6.4A.2.2.7	Carrier leakage for CA (8UL CA).....	433
6.4A.2.3	In-band emissions for CA	435
6.4A.2.3.0	Minimum conformance requirements.....	435
6.4A.2.3.1	In-band emissions for CA (2UL CA)	439
6.4A.2.3.2	In-band emissions for CA (3UL CA)	445
6.4A.2.3.3	In-band emissions for CA (4UL CA)	449
6.4A.2.3.4	In-band emissions for CA (5UL CA)	453
6.4A.2.3.5	In-band emissions for CA (6UL CA)	457
6.4A.2.3.6	In-band emissions for CA (7UL CA)	462
6.4A.2.3.7	In-band emissions for CA (8UL CA)	466
6.4A.2.4	EVM equalizer spectrum flatness for CA	470
6.4A.2.4.0	Minimum conformance requirements.....	470
6.4A.2.4.1	EVM equalizer spectrum flatness for CA (2UL CA)	470
6.4A.2.4.2	EVM equalizer spectrum flatness for CA (3UL CA)	473
6.4A.2.4.3	EVM equalizer spectrum flatness for CA (4UL CA)	475
6.4A.2.4.4	EVM equalizer spectrum flatness for CA (5UL CA)	477
6.4A.2.4.5	EVM equalizer spectrum flatness for CA (6UL CA)	479

6.4A.2.4.6	EVM equalizer spectrum flatness for CA (7UL CA)	481
6.4A.2.4.7	EVM equalizer spectrum flatness for CA (8UL CA)	483
6.4A.2.5	Void.....	485
6.4D	Transmit signal quality for UL MIMO.....	485
6.4D.0	General.....	485
6.4D.1	Frequency error for UL MIMO.....	485
6.4D.2	Transmit signal quality for UL MIMO	487
6.4D.2.1	Error vector magnitude for UL MIMO	487
6.4D.2.2	Carrier leakage for UL MIMO	490
6.4D.2.3	In-band emissions for UL MIMO	494
6.4D.2.4	EVM equalizer spectrum flatness for UL MIMO	504
6.4D.3	Time alignment error for UL MIMO	510
6.5	Output RF spectrum emissions.....	513
6.5.1	Occupied bandwidth	513
6.5.2	Out of band emission	516
6.5.2.1	Spectrum Emission Mask.....	516
6.5.2.1_1	Spectrum Emission Mask with Power Boost	519
6.5.2.2	Void.....	520
6.5.2.3	Adjacent channel leakage ratio	520
6.5.3	Spurious emissions	525
6.5.3.1	Transmitter Spurious emissions	525
6.5.3.1_1	Transmitter Spurious emissions with Power Boost.....	530
6.5.3.2	Spurious emission band UE co-existence	531
6.5.3.2_1	Spurious emission band UE co-existence with Power Boost	535
6.5.3.3	Additional spurious emissions	537
6.5.3.3_1	Additional spurious emissions with Power Boost	543
6.5A	Output RF spectrum emissions for CA.....	544
6.5A.1	Occupied bandwidth for CA	544
6.5A.1.0	Minimum conformance requirements	544
6.5A.1.1	Occupied bandwidth for CA (2UL CA)	544
6.5A.1.2	Occupied bandwidth for CA (3UL CA)	547
6.5A.1.3	Occupied bandwidth for CA (4UL CA)	548
6.5A.1.4	Occupied bandwidth for CA (5UL CA)	549
6.5A.1.5	Occupied bandwidth for CA (6UL CA)	550
6.5A.1.6	Occupied bandwidth for CA (7UL CA)	551
6.5A.1.7	Occupied bandwidth for CA (8UL CA)	552
6.5A.2	Out of band emission for CA	553
6.5A.2.1	Spectrum Emission Mask for CA.....	553
6.5A.2.1.0	Minimum conformance requirements.....	553
6.5A.2.1.1	Spectrum Emission Mask for CA (2UL CA).....	554
6.5A.2.1.2	Spectrum Emission Mask for CA (3UL CA).....	558
6.5A.2.1.3	Spectrum Emission Mask for CA (4UL CA).....	559
6.5A.2.1.4	Spectrum Emission Mask for CA (5UL CA).....	560
6.5A.2.1.5	Spectrum Emission Mask for CA (6UL CA).....	561
6.5A.2.1.6	Spectrum Emission Mask for CA (7UL CA).....	562
6.5A.2.1.7	Spectrum Emission Mask for CA (8UL CA).....	563
6.5A.2.2	Adjacent channel leakage ratio for CA	564
6.5A.2.2.0	Minimum conformance requirements.....	564
6.5A.2.2.1	Adjacent channel leakage ratio for CA (2UL CA)	565
6.5A.2.2.2	Adjacent channel leakage ratio for CA (3UL CA)	569
6.5A.2.2.3	Adjacent channel leakage ratio for CA (4UL CA)	570
6.5A.2.2.4	Adjacent channel leakage ratio for CA (5UL CA)	571
6.5A.2.2.5	Adjacent channel leakage ratio for CA (6UL CA)	572
6.5A.2.2.6	Adjacent channel leakage ratio for CA (7UL CA)	573
6.5A.2.2.7	Adjacent channel leakage ratio for CA (8UL CA)	574
6.5A.3	Spurious emissions for CA	575
6.5A.3.1	General spurious emissions for CA.....	575
6.5A.3.1.0	Minimum conformance requirements.....	575
6.5A.3.1.1	General spurious emissions for CA (2UL CA).....	575
6.5A.3.1.2	General spurious emissions for CA (3UL CA).....	580
6.5A.3.1.3	General spurious emissions for CA (4UL CA).....	580
6.5A.3.1.4	General spurious emissions for CA (5UL CA).....	581

6.5A.3.1.5	General spurious emissions for CA (6UL CA).....	581
6.5A.3.1.6	General spurious emissions for CA (7UL CA).....	582
6.5A.3.1.7	General spurious emissions for CA (8UL CA).....	582
6.5A.3.2	Spurious emission band UE co-existence for UL CA.....	583
6.5A.3.2.0	Minimum conformance requirements.....	583
6.5A.3.2.1	Spurious emission band UE co-existence for CA (2UL CA).....	584
6.5A.3.2.2	Spurious emission band UE co-existence for CA (3UL CA).....	588
6.5A.3.2.3	Spurious emission band UE co-existence for CA (4UL CA).....	589
6.5A.3.2.4	Spurious emission band UE co-existence for CA (5UL CA).....	589
6.5A.3.2.5	Spurious emission band UE co-existence for CA (6UL CA).....	590
6.5A.3.2.6	Spurious emission band UE co-existence for CA (7UL CA).....	591
6.5A.3.2.7	Spurious emission band UE co-existence for CA (8UL CA).....	591
6.5A.3.3	Additional spurious emissions for CA.....	592
6.5A.3.3.0	Minimum conformance requirements.....	592
6.5A.3.3.1	Additional spurious emissions for CA (2UL CA).....	593
6.5A.3.3.2	Additional spurious emissions for CA (3UL CA).....	599
6.5A.3.3.3	Additional spurious emissions for CA (4UL CA).....	600
6.5A.3.3.4	Additional spurious emissions for CA (5UL CA).....	600
6.5A.3.3.5	Additional spurious emissions for CA (6UL CA).....	601
6.5A.3.3.6	Additional spurious emissions for CA (7UL CA).....	601
6.5A.3.3.7	Additional spurious emissions for CA (8UL CA).....	602
6.5D	Output RF spectrum emissions for UL MIMO.....	603
6.5D.1	Occupied bandwidth for UL MIMO.....	603
6.5D.2	Out of band emission for UL MIMO.....	605
6.5D.2.1	Spectrum Emission Mask for UL MIMO.....	605
6.5D.2.2	Adjacent channel leakage ratio for UL MIMO.....	606
6.5D.3	Spurious emissions for UL MIMO.....	609
6.5D.3.1	Transmitter Spurious emissions for UL MIMO.....	609
6.5D.3.2	Spurious emission band UE co-existence for UL MIMO.....	610
6.5D.3.3	Additional spurious emissions for UL MIMO.....	610
6.6	Beam correspondence.....	611
6.6.0	General.....	611
6.6.1	Beam correspondence - EIRP.....	612
6.6.2	Enhanced Beam correspondence – EIRP.....	622
6.6.3	Beam Correspondence in RRC_INACTIVE and initial access.....	629
6.6A	Beam correspondence for CA.....	630
7	Receiver characteristics.....	630
7.1	General.....	630
7.2	Diversity characteristics.....	631
7.2M	Diversity characteristics for LP-WUR/WUS.....	631
7.3	Reference sensitivity.....	631
7.3.1	General.....	631
7.3.2	Reference sensitivity power level.....	631
7.3.4	EIS spherical coverage.....	640
7.3A	Reference sensitivity for CA.....	647
7.3A.1	General.....	647
7.3A.2	Reference sensitivity power level for CA.....	647
7.3A.2.0	Minimum Conformance Requirements.....	647
7.3A.2.0.1	Intra-band contiguous CA.....	647
7.3A.2.0.2	Intra-band non-contiguous CA.....	647
7.3A.2.0.3	Inter-band CA.....	648
7.3A.2.1	Reference sensitivity power level for CA (2DL CA).....	648
7.3A.2.2	Reference sensitivity power level for CA (3DL CA).....	653
7.3A.2.3	Reference sensitivity power level for CA (4DL CA).....	654
7.3A.2.4	Reference sensitivity power level for CA (5DL CA).....	654
7.3A.2.5	Reference sensitivity power level for CA (6DL CA).....	655
7.3A.2.6	Reference sensitivity power level for CA (7DL CA).....	655
7.3A.2.7	Reference sensitivity power level for CA (8DL CA).....	656
7.3A.3	EIS spherical coverage for DL CA.....	657
7.3A.3.0	Minimum Conformance Requirements.....	657
7.3A.3.0.1	Void.....	657

7.3A.3.0.2	Void.....	657
7.3A.3.0.3	EIS spherical coverage for inter-band CA.....	657
7.3A.3.1	EIS Spherical Coverage for Inter-band CA (2DL CA).....	657
7.3A.3.2	EIS Spherical Coverage for Inter-band CA (3DL CA).....	661
7.3A.3.3	EIS Spherical Coverage for Inter-band CA (4DL CA).....	661
7.3D	Reference sensitivity for UL MIMO.....	662
7.3K	Spherical coverage requirement for simultaneous reception from multiple directions.....	662
7.3K.1	Spherical coverage with two Angle of Arrivals (AoAs) with simultaneous reception from multiple directions.....	662
7.3K.1.0	General.....	662
7.3K.1.1	UE spherical coverage for simultaneous reception from multiple directions (2 AoAs).....	663
7.3M	Reference sensitivity for LP-WUR/WUS.....	666
7.3M.1	General.....	666
7.3M.2	Reference sensitivity power level for LP-WUS/WUR.....	667
7.3M.2.1	Test purpose.....	667
7.3M.2.2	Test applicability.....	667
7.3M.3	Void.....	667
7.3M.4	LP-WUR/WUS [sensitivity] spherical coverage.....	667
7.3M.4.1	Test purpose.....	668
7.3M.4.2	Test applicability.....	668
7.4	Maximum input level.....	668
7.4A	Maximum input level for CA.....	671
7.4A.0	Minimum Conformance Requirements.....	671
7.4A.0.1	Maximum input level for Intra-band contiguous CA.....	671
7.4A.0.2	Maximum input level for Intra-band non-contiguous CA.....	671
7.4A.0.3	Maximum input level for inter-band CA.....	671
7.4A.1	Maximum input level for CA (2DL CA).....	672
7.4A.2	Maximum input level for CA (3DL CA).....	675
7.4A.3	Maximum input level for CA (4DL CA).....	676
7.4A.4	Maximum input level for CA (5DL CA).....	676
7.4A.5	Maximum input level for CA (6DL CA).....	677
7.4A.6	Maximum input level for CA (7DL CA).....	677
7.4A.7	Maximum input level for CA (8DL CA).....	678
7.4D	Maximum input level for UL MIMO.....	678
7.5	Adjacent channel selectivity.....	678
7.5A	Adjacent channel selectivity for CA.....	684
7.5A.0	Minimum Conformance Requirements.....	684
7.5A.0.1	Adjacent channel selectivity for Intra-band contiguous CA.....	684
7.5A.0.2	Adjacent channel selectivity for Intra-band non-contiguous CA.....	686
7.5A.0.3	Adjacent channel selectivity for Inter-band CA.....	686
7.5A.1	Adjacent channel selectivity for CA (2DL CA).....	686
7.5A.2	Adjacent channel selectivity for CA (3DL CA).....	686
7.5A.3	Adjacent channel selectivity for CA (4DL CA).....	686
7.5A.4	Adjacent channel selectivity for CA (5DL CA).....	686
7.5A.5	Adjacent channel selectivity for CA (6DL CA).....	686
7.5A.6	Adjacent channel selectivity for CA (7DL CA).....	686
7.5A.7	Adjacent channel selectivity for CA (8DL CA).....	686
7.5D	Adjacent channel selectivity for UL MIMO.....	687
7.5M	Adjacent channel and subcarrier selectivity for LP-WUS/WUR.....	687
7.5M.1	General.....	687
7.5M.2	Adjacent channel selectivity for LP-WUS/WUR.....	687
7.5M.2.1	Test purpose.....	687
7.5M.2.2	Test applicability.....	687
7.5M.3	Adjacent subcarrier selectivity for LP-WUS/WUR.....	688
7.5M.3.1	Test purpose.....	688
7.5M.3.2	Test applicability.....	688
7.6	Blocking characteristics.....	689
7.6.1	General.....	689
7.6.2	In-band blocking.....	689
7.6.3	Void.....	695
7.6A	Blocking characteristics for CA.....	695
7.6A.1	General.....	695

7.6A.2	In-band blocking for CA.....	695
7.6A.2.0	Minimum Conformance Requirements.....	695
7.6A.2.0.1	In-band blocking for Intra-band contiguous CA.....	695
7.6A.2.0.2	In-band blocking for Intra-band non-contiguous CA.....	696
7.6A.2.0.3	In-band blocking for Inter-band CA.....	696
7.6A.2.1	In-band blocking for CA (2DL CA).....	696
7.6A.2.2	Void.....	699
7.6A.2.3	Void.....	699
7.6A.2.4	Void.....	699
7.6A.2.5	Void.....	699
7.6A.2.6	Void.....	699
7.6A.2.7	Void.....	699
7.6D	Blocking characteristics for UL MIMO.....	699
7.7	Void.....	699
7.8	Void.....	699
7.9	Spurious emissions.....	699
7.10	Void.....	702
Annex A (normative): Measurement channels.....		703
A.1	General.....	703
A.2	UL reference measurement channels.....	703
A.2.1	General.....	703
A.2.2	Void.....	703
A.2.3	Reference measurement channels for TDD.....	704
A.2.3.1	DFT-s-OFDM Pi/2-BPSK.....	705
A.2.3.2	DFT-s-OFDM QPSK.....	705
A.2.3.3	DFT-s-OFDM 16QAM.....	706
A.2.3.4	DFT-s-OFDM 64QAM.....	707
A.2.3.5	CP-OFDM QPSK.....	708
A.2.3.6	CP-OFDM 16QAM.....	708
A.2.3.7	CP-OFDM 64QAM.....	709
A.3	DL reference measurement channels.....	711
A.3.1	General.....	711
A.3.2	Void.....	713
A.3.3	DL reference measurement channels for TDD.....	713
A.3.3.1	General.....	713
A.3.3.2	FRC for receiver requirements for QPSK.....	713
A.3.3.3	FRC for receiver requirements for 16QAM.....	716
A.3.3.4	FRC for receiver requirements for 64QAM.....	716
A.3.3.5	FRC for receiver requirements for 256QAM.....	717
A.4	Void.....	719
A.5	OFDMA Channel Noise Generator (OCNG).....	719
A.5.1	OCNG Patterns for FDD.....	719
A.5.2	OCNG Patterns for TDD.....	719
A.5.2.1	OCNG TDD pattern 1: Generic OCNG TDD Pattern for all unused REs.....	719
A.6	FR2 RF tests with testability issues.....	719
A.6.1	FR2 RF tests with testability issues not related to Measurement Uncertainty (MU).....	720
Annex B (normative): Propagation conditions.....		721
B.0	No interference.....	721
Annex C (normative): Downlink Physical Channels.....		722
C.0	Downlink signal levels.....	722
C.1	General.....	723
C.2	Setup.....	723

C.3	Connection	724
C.3.0	Measurement of Transmitter Characteristics	724
C.3.1	Measurement of Receiver Characteristics	725
Annex D (normative):	Characteristics of the interfering signal	726
D.1	General	726
D.2	Interference signals.....	726
Annex E (normative):	Global In-Channel TX-Test	727
E.1	General	727
E.2	Signals and results	727
E.2.1	Basic principle.....	727
E.2.2	Output signal of the TX under test	727
E.2.3	Reference signal	727
E.2.4	Measurement results.....	728
E.2.5	Measurement points	728
E.3	Signal processing.....	728
E.3.1	Pre FFT minimization process.....	728
E.3.2	Timing of the FFT window	729
E.3.3	Post FFT equalisation.....	730
E.4	Derivation of the results	731
E.4.1	EVM.....	731
E.4.2	Averaged EVM	731
E.4.3	In-band emissions measurement.....	732
E.4.4	EVM equalizer spectrum flatness.....	734
E.4.5	Frequency error and Carrier leakage	735
E.4.6	EVM of Demodulation reference symbols (EVM _{DMRS})	735
E.4.6.1	1 st average for EVM _{DMRS}	736
E.4.6.2	Final average for EVM _{DMRS}	736
E.5	EVM and inband emissions for PUCCH.....	736
E.5.1	Basic principle.....	736
E.5.2	Output signal of the TX under test	736
E.5.3	Reference signal	736
E.5.4	Measurement results.....	737
E.5.5	Measurement points	737
E.5.6	Pre FFT minimization process.....	737
E.5.7	Timing of the FFT window	737
E.5.8	Post FFT equalisation.....	737
E.5.9	Derivation of the results	738
E.5.9.1	EVM _{PUCCH}	738
E.5.9.2	Averaged EVM _{PUCCH}	738
E.5.9.3	In-band emissions measurement	739
E.5.10	Modified signal under test.....	740
E.6	EVM for PRACH	742
E.6.1	Basic principle.....	742
E.6.2	Output signal of the TX under test	742
E.6.3	Reference signal	742
E.6.4	Measurement results.....	742
E.6.5	Measurement points	743
E.6.6	Pre FFT minimization process.....	743
E.6.7	Timing of the FFT window	743
E.6.8	Post FFT equalisation.....	744
E.6.9	Derivation of the results	744
E.6.9.1	EVM _{PRACH}	744
E.6.9.2	Averaged EVM _{PRACH}	745
E.6.10	Modified signal under test.....	745
E.6.11	Phase offset measurement for DMRS bundling	745

E.6.11.1	Measurement point	745
E.6.11.2	Symbols used	745
E.6.11.3	Modified test signal	745
E.6.11.4	Phase offset measurement.....	745
E.6.12	Void.....	746
E.7	EVM for dual transmit polarizations	746
E.7.1	General.....	746
E.7.2	MIMO Equalization (UL MIMO transmission).....	746
E.7.3	Maximum Ratio combining (Tx diversity transmission)	747
E.7.4	Layer processing.....	747

Annex F (normative): Measurement uncertainties and Test Tolerances749

F.1	Acceptable uncertainty of Test System (normative)	749
F.1.0	General	749
F.1.1	Measurement of test environments.....	749
F.1.2	Measurement of transmitter.....	749
F.1.3	Measurement of receiver	771
F.2	Interpretation of measurement results (normative)	774
F.3	Test Tolerance and Derivation of Test Requirements (informative).....	775
F.3.1	Measurement of test environments.....	775
F.3.2	Measurement of transmitter.....	775
F.3.3	Measurement of receiver	793
F.4	Uplink power window	796
F.4.1	Introduction	796
F.4.2	Setting the power window above a requirement.....	796
F.4.3	Setting the power window below a requirement	796
F.4.4	Setting the power window centred on a target value	796
F.8	FFS	797
F.9	FFS	797
F.10	FFS	797

Annex G (normative): Uplink Physical Channels798

G.0	Uplink Signal Levels	798
G.1	General	798
G.2	Set-up	798
G.3	Connection	798
G.3.0	Measurement of Transmitter Characteristics.....	798
G.3.1	Measurement of Receiver Characteristics	798

Annex H (normative): Statistical Testing.....799

H.1	General	799
H.2	Statistical testing of receiver characteristics.....	799
H.2.1	General	799
H.2.2	Mapping throughput to error ratio.....	799
H.2.3	Design of the test.....	800
H.2.4	Numerical definition of the pass fail limits	800
H.2.5	Pass fail decision rules	801
H.2.6	Theory to derive the pass fail limits (Informative).....	801
H.2.6.1	Numerical definition of the pass-fail limits	801
H.2.6.2	Simulation to derive the pass-fail limits for testing 95% throughput.....	802

Annex I: Void 804

Annex J (normative): Test applicability per permitted test method805

Annex K (normative):	EIRP, TRP, and EIS measurement procedures	806
K.1	Direct far field (DFF)	806
K.1.1	TX beam peak direction search	806
K.1.2	RX beam peak direction search	808
K.1.3	Peak EIRP measurement procedure	810
K.1.4	Peak EIS measurement procedure	811
K.1.5	EIRP spherical coverage	811
K.1.5.0	Tx Spherical Coverage Method	811
K.1.5.1	Tx Fast Spherical Coverage Method	812
K.1.5.1.1	Introduction	812
K.1.5.1.2	Description	812
K.1.5.1.3	Measurement uncertainties	812
K.1.6	EIS spherical coverage	812
K.1.6.0	Rx Spherical Coverage Method	812
K.1.6.1	Rx Fast Spherical Coverage Method	813
K.1.6.1.1	Introduction	813
K.1.6.1.2	Description	813
K.1.6.1.3	Measurement uncertainties	813
K.1.7	TRP measurement procedure	813
K.1.8	Blocking measurement procedure	814
K.1.9	Beam Correspondence tolerance procedure	814
K.1.11	RSRP(B) based RX beam peak search	815
K.1.11.1	Test procedure	815
K.1.12	Enhanced test method for EIRP measurements	816
K.1.12.1	Applicability of TPMI side condition method	817
K.1.12.2	TPMI side condition method Measurement uncertainties impact	817
K.2	Direct far field (DFF) simplification	817
K.2.1	TX beam peak direction search	817
K.2.2	RX beam peak direction search	817
K.2.3	Peak EIRP measurement procedure	817
K.2.4	Peak EIS measurement procedure	817
K.2.5	EIRP spherical coverage	817
K.2.6	EIS spherical coverage	818
K.2.7	TRP measurement procedure	818
K.2.8	Blocking measurement procedure	818
K.3	Indirect far field (IFF)	818
K.3.1	TX beam peak direction search	818
K.3.2	RX beam peak direction search	818
K.3.3	Peak EIRP measurement procedure	818
K.3.4	Peak EIS measurement procedure	818
K.3.5	EIRP spherical coverage	818
K.3.6	EIS spherical coverage	818
K.3.7	TRP measurement procedure	818
K.3.8	Blocking measurement procedure	818
K.4	Near field to far field transform (NFTF)	819
K.4.1	TX beam peak direction search	819
K.4.2	RX beam peak direction search	819
K.4.3	Peak EIRP measurement procedure	819
K.4.4	Peak EIS measurement procedure	819
K.4.5	EIRP spherical coverage	819
K.4.6	EIS spherical coverage	819
K.4.7	TRP measurement procedure	819
K.4.8	Blocking measurement procedure	820
Annex L (normative):	Void	821
Annex M:(normative) Measurement grids		822
M.1	Grid Types	822

M.2	Beam Peak Search Grid.....	824
M.2.1	UE Power classes	824
M.2.1.1	Power class 1 devices	824
M.2.1.2	Power class 2 devices	825
M.2.1.3	Power class 3 devices	825
M.2.1.4	Power class 4 devices	827
M.2.1.5	Power class 5 devices	827
M.2.1.6	Power class 6 devices	827
M.2.2	Coarse and fine measurement grids.....	827
M.3	Spherical Coverage Grid	831
M.3.1	EIRP spherical coverage	831
M.3.1.1	UE Power classes.....	831
M.3.1.1.1	Power class 1 devices.....	831
M.3.1.1.2	Power class 2 devices.....	832
M.3.1.1.3	Power class 3 devices.....	832
M.3.1.1.4	Power class 4 devices.....	833
M.3.1.1.5	Power class 5 devices.....	833
M.3.1.1.6	Power class 6 devices.....	833
clause M.3.2 EIS spherical coverage	833
M.3.2.1	UE Power classes.....	833
M.3.2.1.1	Power class 1 devices.....	833
M.3.2.1.2	Power class 2 devices.....	834
M.3.2.1.3	Power class 3 devices.....	834
M.3.2.1.4	Power class 4 devices.....	835
M.3.2.1.5	Power class 5 devices.....	835
M.3.2.1.6	Power class 6 devices.....	835
clause M.4 TRP Measurement Grid.....	835
M.4.1	UE Power Classes	835
M.4.1.1	Power class 1 devices	835
M.4.1.2	Power class 2 devices	836
M.4.1.3	Power class 3 devices	836
M.4.1.4	Power class 4 devices	838
M.4.1.5	Power class 5 devices	838
M.4.1.6	Power class 6 devices	838
M.4.2	TRP Integration for Constant Step Size Grid Type	839
M.4.2.1	TRP Integration using Weights.....	839
M.4.3	TRP Integration for Constant Density Grid Types	841
M.4.4	Interpolation at or near the Pole	841
M.4.5	TRP Grids for Spurious Emissions.....	842
Annex N (normative):	UE coordinate system	845
N.1	Reference coordinate system.....	845
N.2	Test conditions and angle definitions.....	846
N.3	DUT positioning guidelines	856
Annex O: Quality of the quiet zone validation.....	860	
O.1	General	860
O.2	Procedure to characterize the quality of the quiet zone for in-band/OOB for the permitted far field methods	860
O.2.1	Equipment used	861
O.2.2	Test frequencies	862
O.2.3	Reference measurements	862
O.2.4	Size of the quiet zone.....	862
O.2.5	Reference AUT positions.....	863
O.2.5.1	Distributed-axes system.....	863
O.2.5.2	Combined-axes system	864
O.2.6	Reference AUT orientations	865

O.2.6.1	Distributed-axes system	865
O.2.6.2	Combined-axes system	867
O.2.7	Quality of quiet zone measurement uncertainty calculations for TRP	868
O.2.8	Quality of quiet zone measurement uncertainty for EIRP/EIS	868
O.3	Procedure to characterize the spurious emissions quality of the quiet zone for the permitted far field methods	869
O.3.1	Equipment used	869
O.3.2	Test frequencies	869
O.3.3	Reference measurements	870
O.3.4	Size of the quiet zone	870
O.3.5	Reference AUT positions	870
O.3.5.1	Distributed-axes system	870
O.3.5.2	Combined-axes system	870
O.3.6	Reference AUT orientations	870
O.3.6.1	Distributed-axes system	870
O.3.6.2	Combined-axes system	872
O.3.7	Quality of quiet zone measurement uncertainty calculations for TRP	872
Annex P (normative): Modified MPR behaviour		873
P.1	Indication of modified MPR behaviour	873
Annex Q (normative): Difference of relative phase and power errors		875
Q.0	General	875
Q.1	Measurement Point	875
Q.2	Relative Phase Error Measurement	875
Q.2.1	Symbols used	875
Q.2.2	CFO (carrier frequency offset) correction	876
Q.2.3	Steps of the measurement method	876
Annex R (normative): Requirement metric for simultaneous reception from multiple directions		877
R.1	Spherical coverage grid for simultaneous reception or transmission in multiple directions	877
R.2	Probability to support 2AoA reception	877
R.3	Spherical coverage procedure for simultaneous multi-Rx reception	877
Annex S (informative): Change history		880
History	902

Foreword

This Technical Specification has been produced by the 3rd Generation Partnership Project (3GPP).

The contents of the present document are subject to continuing work within the TSG and may change following formal TSG approval. Should the TSG modify the contents of the present document, it will be re-released by the TSG with an identifying change of release date and an increase in version number as follows:

Version x.y.z

where:

- x the first digit:
 - 1 presented to TSG for information;
 - 2 presented to TSG for approval;
 - 3 or greater indicates TSG approved document under change control.
- y the second digit is incremented for all changes of substance, i.e. technical enhancements, corrections, updates, etc.
- z the third digit is incremented when editorial only changes have been incorporated in the document.

The present document is part 2 of a multi-part Technical Specification (TS) covering the New Radio (NR) User Equipment (UE) conformance specification, which is divided in the following parts:

3GPP TS 38.521-1 [13]: NR; User Equipment (UE) conformance specification; Radio transmission and reception; Part 1: Range 1 Standalone;

3GPP TS 38.521-2: NR; User Equipment (UE) conformance specification; Radio transmission and reception; Part 2: Range 2 Standalone;

3GPP TS 38.521-3 [14]: NR; User Equipment (UE) conformance specification; Radio transmission and reception; Part 3: Range 1 and Range 2 Interworking operation with other radios;

3GPP TS 38.521-4 [15]: NR; User Equipment conformance specification; Radio transmission and reception; Part 4: Performance;

3GPP TS 38.522 [16]: NR; User Equipment (UE) conformance specification; Applicability of radio transmission, radio reception and radio resource management test cases;

3GPP TS 38.533 [17]: NR; User Equipment (UE) conformance specification; Radio resource management (RRM);

1 Scope

The present document specifies the measurement procedures for the conformance test of the user equipment (UE) that contain RF characteristics for frequency Range 2 as part of the 5G-NR.

The requirements are listed in different clauses only if the corresponding parameters deviate. More generally, tests are only applicable to those mobiles that are intended to support the appropriate functionality. To indicate the circumstances in which tests apply, this is noted in the "*definition and applicability*" part of the test.

For example only Release 15 and later UE declared to support 5G-NR shall be tested for this functionality. In the event that for some tests different conditions apply for different releases, this is indicated within the text of the test itself.

2 References

The following documents contain provisions which, through reference in this text, constitute provisions of the present document.

- References are either specific (identified by date of publication, edition number, version number, etc.) or non-specific.
- For a specific reference, subsequent revisions do not apply.
- For a non-specific reference, the latest version applies. In the case of a reference to a 3GPP document (including a GSM document), a non-specific reference implicitly refers to the latest version of that document *in the same Release as the present document*.

- [1] 3GPP.TR 21.905: "Vocabulary for 3GPP Specifications".
- [2] 3GPP TS 38.101-1: "NR; User Equipment (UE) radio transmission and reception; Part 1: Range 1 Standalone".
- [3] 3GPP TS 38.101-2: "NR; User Equipment (UE) radio transmission and reception; Part 2: Range 2 Standalone".
- [4] 3GPP TS 38.101-3: "NR; User Equipment (UE) radio transmission and reception; Part 3: Range 1 and Range 2 Interworking operation with other radios".
- [5] 3GPP TR 38.810: "Study on test methods for New Radio".
- [6] ITU-R Recommendation M.1545: "Measurement uncertainty as it applies to test limits for the terrestrial component of International Mobile Telecommunications-2000".
- [7] ITU-R Recommendation SM.329: "Unwanted emissions in the spurious domain".
- [8] FCC 47 CFR Part 30: "UPPER MICROWAVE FLEXIBLE USE SERVICE, §30.202 Power limits".
- [9] 3GPP TS 38.211: "NR; Physical channels and modulation".
- [10] 3GPP TS 38.508-1: "5GS; User Equipment (UE) conformance specification; Part 1: Common test environment".
- [11] 3GPP TS 38.508-2: "5GS; User Equipment (UE) conformance specification; Part 2: Common Implementation Conformance Statement (ICS) proforma".
- [12] 3GPP TS 38.509: "5GS; Special conformance testing functions for User Equipment (UE)".
- [13] 3GPP TS 38.521-1: "NR; User Equipment (UE) conformance specification; Radio transmission and reception; Part 1: Range 1 Standalone".
- [14] 3GPP TS 38.521-3: "NR; User Equipment (UE) conformance specification; Radio transmission and reception; Part 3: Range 1 and Range 2 Interworking operation with other radios".

- [15] 3GPP TS 38.521-4: "NR; User Equipment conformance specification; Radio transmission and reception; Part 4: Performance".
- [16] 3GPP TS 38.522: "NR; User Equipment (UE) conformance specification; Applicability of radio transmission, radio reception and radio resource management test cases".
- [17] 3GPP TS 38.533: "NR; User Equipment (UE) conformance specification; Radio resource management (RRM)".
- [18] 3GPP TS 38.300: "NR; Overall description; Stage 2".
- [19] 3GPP TS 38.331: "NR; Radio Resource Control (RRC); Protocol specification".
- [20] 3GPP TR 38.903: "NR; Derivation of test tolerances and measurement uncertainty for User Equipment (UE) conformance tests".
- [21] 3GPP TR 38.905: "NR; Derivation of test points for radio transmission and reception conformance test cases".
- [22] 3GPP TS 38.213: "NR; Physical layer procedures for control".
- [23] 3GPP TS 38.214: "NR; Physical layer procedures for data".
- [24] 3GPP TS 38.215: "NR; Physical layer measurements".
- [25] 3GPP TS 38.133: "NR; Requirements for support of radio resource management".
- [26] 3GPP TS 38.306: "NR; User Equipment (UE) radio access capabilities".
- [27] IEEE Std 149: "IEEE Standard Test Procedures for Antennas", IEEE.
- [28] 3GPP TS 38.321: "NR; Medium Access Control (MAC) protocol specification".

3 Definitions, symbols and abbreviations

3.1 Definitions

For the purposes of the present document, the terms and definitions given in TR 21.905 [1] and the following apply. A term defined in the present document takes precedence over the definition of the same term, if any, in TR 21.905 [1].

Aggregated Channel Bandwidth: The RF bandwidth in which a UE transmits and receives multiple contiguously aggregated carriers.

Bidirectional spectrum: UL/DL common spectrum in which the UE supports the configuration of uplink or downlink CCs.

Beam correspondence: the ability of the UE to select a suitable beam for UL transmission based on DL measurements with or without relying on UL beam sweeping.

Carrier aggregation: Aggregation of two or more component carriers in order to support wider transmission bandwidths.

Carrier aggregation band: A set of one or more operating bands across which multiple carriers are aggregated with a specific set of technical requirements.

Carrier aggregation bandwidth class: A class defined by the aggregated transmission bandwidth configuration and maximum number of component carriers supported by a UE.

Carrier aggregation configuration: A combination of CA operating band(s) and CA bandwidth class(es) supported by a UE.

NOTE: Carriers aggregated in each band can be contiguous or non-contiguous.

Cumulative aggregated channel bandwidth: The cumulative aggregated channel bandwidth is defined as the frequency band from the lowest edge of the lowest CC to the upper edge of the highest CC of all UL and DL configured CCs.

EIRP(Link=TX beam peak direction, Meas=Link angle): measurement of the EIRP of the UE such that the measurement angle is aligned with the beam peak direction within an acceptable measurement error uncertainty. EIRP (indicator to be measured) can be replaced by Frequency, EVM, carrier Leakage, In-band emission and OBW.

EIRP(Link=Link angle, Meas=Link angle): measurement of the UE such that the link angle is aligned with the measurement angle. EIRP (indicator to be measured) can be replaced by EIS, Frequency, EVM, carrier Leakage, In-band emission and OBW.

EIRP(Link=Spherical coverage grid, Meas=Link angle): measurement of the EIRP spherical coverage of the UE such that the EIRP link and measurement angles are aligned with the directions along the spherical coverage grid within an acceptable measurement error uncertainty. Alternatively, the spherical coverage grid can be replaced by the beam peak search grid as the results from the beam peak search can be re-used for spherical coverage.

EIS (effective isotropic sensitivity): sensitivity for an isotropic directivity device equivalent to the sensitivity of the discussed device exposed to an incoming wave from a defined AoA

NOTE 1: The sensitivity is the minimum received power level at which specific requirement is met.

NOTE 2: Isotropic directivity is equal in all directions (i.e. 0 dBi).

EIS(Link=RX beam peak direction, Meas=Link angle): measurement of the EIS of the UE such that the measurement angle is aligned with the RX beam peak direction within an acceptable measurement error uncertainty.

Fallback group: Group of carrier aggregation bandwidth classes for which it is mandatory for a UE to be able to fallback to lower order CA bandwidth class configuration. It is not mandatory for a UE to be able to fallback to lower order CA bandwidth class configuration that belongs to a different fallback group.

FWA UE: A UE intended to be used in fixed wireless access scenario.

Handheld UE: A UE intended to be used in handheld scenario.

IBM (Independent Beam Management): A UE that supports inter-band CA with IBM selects its DL and UL beam(s) for all CCs in each configured band based on DL reference signals measurements made in that band.

Inter-band carrier aggregation: Carrier aggregation of component carriers in different operating bands.

NOTE: Carriers aggregated in each band can be contiguous or non-contiguous.

Intra-band contiguous carrier aggregation: Contiguous carriers aggregated in the same operating band.

Intra-band non-contiguous carrier aggregation: Non-contiguous carriers aggregated in the same operating band.

LP-WUS power boost: difference between the average power of LP-WUS REs (which occupy certain REs within a NR transmission bandwidth configuration) and the average power over all REs (from both LP-WUS and the NR carrier containing the LP-WUS REs)

Link angle: a DL-signal AoA from the view point of the UE, as described in Annex J. If the beam lock function is used to lock the UE beam(s), the link angle can become any arbitrary AoA once the beam lock has been activated.

Measurement angle: the angle of measurement of the desired metric from the view point of the UE, as described in Annex N.

radiated interface boundary: operating band specific radiated requirements reference point where the radiated requirements apply.

radiated requirements reference point: for the RF measurement setup, the radiated requirements reference point is located at the centre of the quiet zone. From the UE perspective the reference point is the input of the UE antenna array.

RedCap UE: The UE with reduced capabilities as defined in clause 4.2.21.1 from TS38.306 [26]

RX beam peak direction: direction where the maximum total component of RSRP and thus best total component of EIS is found.

Sub-block: This is one contiguous allocated block of spectrum for transmission and reception by the same UE. There may be multiple instances of sub-blocks within an RF bandwidth.

TRP(Link=TX beam peak direction, Meas=TRP grid): measurement of the TRP of the UE such that the measurement angles are aligned with the directions of the TRP grid points within an acceptable measurement uncertainty while the link angle is aligned with the TX beam peak direction

NOTE: For requirements based on EIRP/EIS, the radiated interface boundary is associated to the far-field region.

TX beam peak direction: direction where the maximum total component of EIRP is found.

UE transmission bandwidth configuration: Set of resource blocks located within the UE channel bandwidth which may be used for transmitting or receiving by the UE.

Vehicular UE: A UE embedded in a vehicle.

3.2 Symbols

For the purposes of the present document, the following symbols apply:

$\Delta EIRP_{BC}$	The beam correspondence tolerance, where $\Delta EIRP_{BC} = EIRP_2 - EIRP_1$
ΔF_{Global}	Granularity of the global frequency raster
ΔF_{Raster}	Band dependent channel raster granularity
Δf_{OOB}	Δ Frequency of Out Of Band emission
$\Delta MB_{P,n}$	Allowed relaxation to each, minimum peak EIRP and reference sensitivity due to support for multi-band operation, per band in a combination of supported bands
$\Delta MB_{S,n}$	Allowed relaxation to each, EIRP spherical coverage and EIS spherical coverage due to support for multi-band operation, per band in a combination of supported bands
ΔR_B	The starting frequency offset between the allocated RB and the measured non-allocated RB
ΔR_{IB}	Allowed reference sensitivity relaxation due to support for inter-band CA operation
ΔR_{IBC}	Allowed reference sensitivity relaxation due to support for intra-band contiguous CA operation
ΔR_{IBNC}	Allowed reference sensitivity relaxation due to support for intra-band non-contiguous CA operation
$\Delta R_{IB,P,n}$	Allowed relaxation to reference sensitivity due to support for inter-band CA operation, per band in a combination of supported bands
ΔT_{IB}	Allowed relaxation to EIRP requirements due to support for inter-band CA operation
$\Delta T_{IB,P,n}$	Allowed relaxation to peak EIRP requirements due to support for inter-band CA operation, per supported band in a combination.
$\Delta T_{IB,S,n}$	Allowed relaxation to EIRP spherical coverage due to support for inter-band CA operation, per supported band in a combination.
ΔT_{STxMP}	Allowed relaxation to EIRP requirements due to support for simultaneous transmission to multiple directions. ΔMPR_{STxMP} Allowed relaxation to MPR requirement due to support for simultaneous transmission to multiple directions, per each of indicated TCI states.
$\Delta R_{IB,S,n}$	Allowed relaxation to EIS spherical coverage due to support for inter-band CA operation, per band in a combination of supported bands
$\sum MB_P$	Total allowed relaxation to each, minimum peak EIRP and reference sensitivity due to support for multi-band operation, for all bands in a combination of supported bands
$\sum MB_S$	Total allowed relaxation to each, EIRP spherical coverage and EIS spherical coverage due to support for multi-band operation, for all bands in a combination of supported bands
$BW_{Channel}$	Channel bandwidth
$BW_{Channel_CA}$	Aggregated channel bandwidth, expressed in MHz.
BW_{GB}	$\max(BW_{GB,Channel(k)})$
$BW_{GB,Channel(k)}$	Minimum guardband defined in clause 5.3A.2 of carrier k
$BW_{interferer}$	Bandwidth of the interferer
$BW_{intraCA}$	Aggregated channel bandwidth for intra-band contiguous CA with or without contiguous RBs allocation and intra-band non-contiguous CA, expressed in MHz. $BW_{intraCA} = BW_{Channel_CA}$ in case of contiguous RBs allocation. $BW_{intraCA}$ is the frequency separation between the lower edge of the lowest allocated RB and the higher edge of the highest allocated RB in case of non-contiguous RBs allocation and intra-band non-contiguous CA.
$Ceil(x)$	Rounding upwards; $ceil(x)$ is the smallest integer such that $ceil(x) \geq x$
$EIRP_{max}$	The applicable maximum EIRP as specified in clause 6.2.1

EIRP ₁	The measured total EIRP based on the beam the UE chooses autonomously (corresponding beam) to transmit in the direction of the incoming DL signal, which is based on beam correspondence without relying on UL beam sweeping
EIRP ₂	The measured total EIRP based on the beam yielding highest EIRP in a given direction, which is based on beam correspondence with relying on UL beam sweeping
F _C	<i>RF reference frequency</i> for the carrier center on the channel raster, given in table 5.4.2.2-1
F _{C,block,high}	F _C of the highest transmitted/received carrier in a sub-block.
F _{C,block,low}	F _C of the lowest transmitted/received carrier in a sub-block.
F _{C,high}	The F _C of the highest carrier, expressed in MHz.
F _{C,low}	The F _C of the lowest carrier, expressed in MHz.
F _{DL,high}	The highest frequency of the downlink <i>operating band</i>
F _{DL,low}	The lowest frequency of the downlink <i>operating band</i>
F _{edge,block,high}	The upper sub-block edge, where $F_{\text{edge,block,high}} = F_{\text{C,block,high}} + F_{\text{offset,high}}$.
F _{edge,block,low}	The lower sub-block edge, where $F_{\text{edge,block,low}} = F_{\text{C,block,low}} - F_{\text{offset,low}}$.
F _{edge,high}	The upper edge of <i>Aggregated Channel Bandwidth</i> , expressed in MHz. $F_{\text{edge,high}} = F_{\text{C,high}} + F_{\text{offset,high}}$.
F _{edge,low}	The lower edge of <i>Aggregated Channel Bandwidth</i> , expressed in MHz. $F_{\text{edge,low}} = F_{\text{C,low}} - F_{\text{offset,low}}$.
F _{Interferer}	Frequency of the interferer
F _{Interferer (offset)}	Frequency offset of the interferer (between the center frequency of the interferer and the carrier frequency of the carrier measured)
F _{loffset}	Frequency offset of the interferer (between the center frequency of the interferer and the closest edge of the carrier measured)
Floor(x)	Rounding downwards; floor(x) is the greatest integer such that floor(x) ≤ x
F _{OOB}	The boundary between the NR out of band emission and spurious emission domains
F _{offset,high}	Frequency offset from F _{C,high} to the upper <i>UE RF Bandwidth edge</i> , or from F _{C,block,high} to the upper sub-block edge
F _{offset,low}	Frequency offset from F _{C,low} to the lower <i>UE RF Bandwidth edge</i> , or from F _{C,block,low} to the lower sub-block edge
F _{REF}	RF reference frequency
F _{REF-Offs}	Offset used for calculating F _{REF}
F _{UL,high}	The highest frequency of the uplink <i>operating band</i>
F _{UL,low}	The lowest frequency of the uplink <i>operating band</i>
F _{UL,Meas}	The sub-carrier frequency for which the equalizer coefficient is evaluated
F _{center}	The center frequency of an allocated block of PRBs
GB _{Channel}	Minimum guardband defined in clause 5.3.3, expressed in kHz
L _{CRB}	Transmission bandwidth which represents the length of a contiguous resource block allocation expressed in units of resources blocks
L _{CRB,Max}	Maximum number of RB for a given Channel bandwidth and sub-carrier spacing
Max()	The largest of given numbers
Min()	The smallest of given numbers
M _{PR_{f,c}}	Maximum output power reduction for carrier <i>f</i> of serving cell <i>c</i>
M _{PR_{narrow}}	Maximum output power reduction due to narrow PRB allocation
M _{PR_{WT}}	Maximum power reduction due to modulation orders, transmit bandwidth configurations, waveform types
NR _{ACLR}	NR ACLR
N _{RB}	Transmission bandwidth configuration, expressed in units of resource blocks
N _{RB,LP-WUS}	Number of RBs for LP-WUS
N _{RB,high}	Transmission bandwidth configurations according to Table 5.3.2-1 for the highest assigned component carrier in clause 5.3A.2
N _{RB,low}	Transmission bandwidth configurations according to Table 5.3.2-1 for the lowest assigned component carrier in clause 5.3A.2
N _{REF}	NR Absolute Radio Frequency Channel Number (NR-ARFCN)
N _{REF-Offs}	Offset used for calculating N _{REF}
n _{PRB}	Physical resource block number
P _{C_{MAX}}	The configured maximum UE output power
P _{C_{MAX},_{f,c}}	The configured maximum UE output power for carrier <i>f</i> of serving cell <i>c</i>
P _{int}	The intermediate power point as defined in Table 6.3.4.2.3-2
P _{Interferer}	Modulated mean power of the interferer
P _{max}	The maximum UE output power as specified in clause 6.2.1
P _{min}	The minimum UE output power as specified in clause 6.3.1
P _{PowerClass}	Nominal UE power class (i.e., no tolerance) as specified in clause 6.2.1
P _{RB}	The transmitted power per allocated RB, measured in dBm

$P_{TMAX,f,c}$	The measured total radiated power for carrier f of serving cell c
P_{UMAX}	The measured configured maximum UE output power
P_w	Power of a wanted DL signal
$P\text{-MPR}_{f,c}$	The Power Management UE Maximum Power Reduction for carrier f of serving cell c
RB_{start}	Indicates the lowest RB index of transmitted resource blocks
SCS_{high}	SCS for the highest assigned component carrier in clause 5.3A.2, expressed in kHz
SCS_{low}	SCS for the lowest assigned component carrier in clause 5.3A.2, expressed in kHz
SS_{REF}	SS block reference frequency position
TRP_{max}	The maximum TRP for the UE power class as specified in clause 6.2.1
$T(\Delta P)$	The tolerance $T(\Delta P)$ for applicable values of ΔP (values in dB)

3.3 Abbreviations

For the purposes of the present document, the abbreviations given in TR 21.905 [1] and the following apply. An abbreviation defined in the present document takes precedence over the definition of the same abbreviation, if any, in TR 21.905 [1].

ACLR	Adjacent Channel Leakage Ratio
ACS	Adjacent Channel Selectivity
ASCS	Adjacent Subcarrier selectivity
AoA	Angle of Arrival
A-MPR	Additional Maximum Power Reduction
BCS	Bandwidth Combination Set
BPSK	Binary Phase-Shift Keying
BS	Base Station
BW	Bandwidth
BWP	Bandwidth Part
CA	Carrier Aggregation
CABW	Cumulative Aggregated Channel Bandwidth
CA_{nX-nY}	Inter-band CA of component carrier(s) in one sub-block within Band nX and component carrier(s) in one sub-block within Band nY where nX and nY are the applicable NR <i>operating band</i>
CC	Component Carrier
CDF	Cumulative Distribution Function
CP-OFDM	Cyclic Prefix-OFDM
CW	Continuous Wave
DFT-s-OFDM	Discrete Fourier Transform-spread-OFDM
DL	Downlink
DM-RS	Demodulation Reference Signal
DTX	Discontinuous Transmission
DUT	Device Under Test
EIRP	Effective Isotropic Radiated Power
EIS	Effective Isotropic Sensitivity
EVM	Error Vector Magnitude
FR	Frequency Range
FWA	Fixed Wireless Access
GSCN	Global Synchronization Channel Number
IBB	In-band Blocking
IBM	Independent Beam Management
IDFT	Inverse Discrete Fourier Transformation
ITU-R	Radio communication Sector of the International Telecommunication Union
LP-WUR	Low Power-Wake Up Receiver
LP-WUS	Low Power-Wake Up Signal
LP-SS	Low Power-Synchronization Signal
LR	LP-WURMBW Measurement bandwidth defined for the protected band
MDR	Missed-detection rate
MPR	Allowed maximum power reduction
MR	Main Radio
NR	New Radio
NR/5GC	NR connected to 5GC
NR-ARFCN	NR Absolute Radio Frequency Channel Number
NS	Network Signalling
OCNG	OFDMA Channel Noise Generator

OOB	Out-of-band
OOK	On-Off keying
OTA	Over The Air
PRB	Physical Resource Block
P-MPR	Power Management Maximum Power Reduction
QAM	Quadrature Amplitude Modulation
RB	Resource Blocks
RedCap	Reduced Capability
REFSENS	Reference Sensitivity
RF	Radio Frequency
RIB	Radiated Interface Boundary
RMS	Root Mean Square (value)
RSRP	Reference Signal Receiving Power
Rx	Receiver
SCS	Subcarrier Spacing
SEM	Spectrum Emission Mask
SRS	Sounding Reference Symbol
SS	Synchronization Symbol / System Simulator
TDD	Time Division Duplex
TPC	Transmission Power Control
TRP	Total Radiated Power
Tx	Transmitter
UE	User Equipment
UL	Uplink
UL MIMO	Uplink Multiple Antenna transmission
ULFPTx	Uplink Full Power Transmission

4 General

4.1 Relationship between minimum requirements and test requirements

The TS 38.101-2 [3] is a Single-RAT specification for NR UE, covering RF characteristics and minimum performance requirements. Conformance to the TS 38.101-2 [3] is demonstrated by fulfilling the test requirements specified in the present document.

The Minimum Requirements given in TS 38.101-2 [3] make no allowance for measurement uncertainty (MU). The measurement uncertainty defines in TR 38.903 [20]. The present document defines test tolerances (TT). These test tolerances are individually calculated for each test. The test tolerances are used to relax the minimum requirements in the TS 38.101-2 [3] to create test requirements. For some requirements, including regulatory requirements, the test tolerance is set to zero.

The measurement results returned by the test system are compared - without any modification - against the test requirements as defined by various levels of "Shared Risk" principle as described below.

- a) Core specification value is not relaxed by any relaxation value (TT=0). For each single measurement, the probability of a borderline good UE being judged as FAIL equals the probability of a borderline bad UE being judged as PASS.
 - Test tolerances equal to 0 (TT=0) are considered in this specification.
- b) Core specification value is relaxed by a relaxation value (TT>0). For each single measurement, the probability of a borderline bad UE being judged as PASS is greater than the probability of a borderline good UE being judged as FAIL.
 - Test tolerances lower than measurement uncertainty and greater than 0 ($0 < TT < MU$) are considered in this specification.

- Test tolerances high up to measurement uncertainty ($TT = MU$) are considered in this specification which is also known as "Never fail a good DUT" principle.
- c) Core specification value is tightened by a stringent value ($TT < 0$). For each single measurement, the probability of a borderline good UE being judged as FAIL is greater than the probability of a borderline bad UE being judged as PASS.
- Test tolerances lower than 0 ($TT < 0$) are not considered in this specification.

The "Never fail a good DUT" and the "Shared Risk" principles are defined in Recommendation ITU R M.1545 [6].

4.2 Applicability of minimum requirements

- a) In TS 38.101-2 [3] the Minimum Requirements are specified as general requirements and additional requirements. Where the Requirement is specified as a general requirement, the requirement is mandated to be met in all scenarios.
- b) For specific scenarios for which an additional requirement is specified, in addition to meeting the general requirement, the UE is mandated to meet the additional requirements.
- c) The spurious emissions power requirements are for the long-term average of the power. For the purpose of reducing measurement uncertainty it is acceptable to average the measured power over a period of time sufficient to reduce the uncertainty due to the statistical nature of the signal.
- d) All the requirements for intra-band contiguous and non-contiguous CA apply under the assumption of the same slot format indicated by TDD-UL-DL-ConfigurationCommon and TDD-UL-DL-ConfigurationDedicated in the PCell and SCells for NR/5GC.

For FR2 intra-band CA configurations with multiple FR2 sub-blocks, where at least one of the sub-blocks is a contiguous CA configuration:

- if the field *partialFR2-FallbackRX-Req* is not present, the UE shall meet all applicable UE RF requirements for the highest order CA configuration and all associated fallback CA configurations;
- if the field *partialFR2-FallbackRX-Req* is present, for each FR2 intra-band CA configuration with multiple sub-blocks that the UE indicates support for explicitly in UE capability signalling: the in-gap UE RF requirements in clauses 7.5A, 7.5D, 7.6A, 7.6D apply as the equivalent requirements for the associated fallback CA configurations with the same number of sub-blocks, where at least one of the sub-blocks consists of a contiguous CA configuration. The UE shall meet all applicable UE RF requirements for fallback CA configurations with a lesser number of sub-blocks;
- regardless of the field *partialFR2-FallbackRX-Req*, the UE shall meet all DL out-of-gap requirements for all lower order fallback CA configurations.

4.3 Specification suffix information

Unless stated otherwise the following suffixes are used for indicating at 2nd level clause, shown in Table 4.3-1.

Table 4.3-1: Definition of suffixes

Clause suffix	Variant
None	Single Carrier
A	Carrier Aggregation (CA)
B	Dual-Connectivity (DC)
C	Supplement Uplink (SUL)
D	UL MIMO
K	Simultaneous reception or transmission in multiple directions
NOTE:	Suffix D in this specification represents either polarized UL MIMO or spatial UL MIMO. RF requirements are same. If UE supports both kinds of UL MIMO,

NOTE:	then RF requirements only need to be verified under either polarized or spatial UL MIMO. Suffix K applies to simultaneous reception or transmission with different TCI-states and different QCL-Type D reference signals across the TCI-states
-------	---

4.4 Test point analysis

The information on test point analysis and test point selection including number of test points for each test case is shown in TR 38.905 [21] clause 4.2.

4.5 Applicability and test coverage rules

The applicability and test coverage rules for NR/5GC and EN-DC capable devices shall include the following:

If a test case for a FR2 NR band in a device is tested in EN-DC mode for non-exceptional requirement as per TS 38.521-3 [14], it shall fulfil the coverage requirement for that test case for NR/5GC FR2 test requirements for that NR band and need not be retested.

5 Operating bands and channel arrangement

5.1 General

The channel arrangements presented in this clause are based on the operating bands and channel bandwidths defined in the present release of specifications.

NOTE: Other operating bands and channel bandwidths may be considered in future releases.

Requirements throughout the RF specifications are in many cases defined separately for different frequency ranges (FR). The frequency ranges in which NR can operate according to this version of the specification are identified as described in Table 5.1-1.

Table 5.1-1: Definition of frequency ranges

Frequency range designation	Corresponding frequency range
FR1	410 MHz – 7125 MHz
FR2	24250 MHz – 52600 MHz

This test specification covers FR2 operating bands.

For the purpose of derivation of Maximum Test System Uncertainty (MTSU) in Annex F, the frequency range FR2 is further divided into sub-ranges as shown in Table 5.1-2. These FR2 sub-ranges are also referred to as part of definition of test tolerance within the individual test cases.

Table 5.1-2: Definition of frequency sub-ranges

Frequency sub-range designation	Corresponding frequency range
FR2a	$23.45 \text{ GHz} \leq f < 32.125 \text{ GHz}$
FR2b	$32.125 \text{ GHz} \leq f < 40.8 \text{ GHz}$
FR2c ¹	$40.8 \text{ GHz} \leq f < 44.3 \text{ GHz}$
FR2d	$44.3 \text{ GHz} \leq f < 49.0 \text{ GHz}$
NOTE 1: MTSU/TT/relaxation for FR2c is applied to all over the frequency range of n259.	

5.2 Operating bands

NR is designed to operate in the FR2 operating bands defined in Table 5.2-1.

Table 5.2-1: NR operating bands in FR2

Operating Band	Uplink (UL) operating band BS receive UE transmit	Downlink (DL) operating band BS transmit UE receive	Duplex Mode
	F _{UL_low} – F _{UL_high}	F _{DL_low} – F _{DL_high}	
n257	26500 MHz – 29500 MHz	26500 MHz – 29500 MHz	TDD
n258	24250 MHz – 27500 MHz	24250 MHz – 27500 MHz	TDD
n259 ¹	39500 MHz – 43500 MHz	39500 MHz – 43500 MHz	TDD
n260	37000 MHz – 40000 MHz	37000 MHz – 40000 MHz	TDD
n261	27500 MHz – 28350 MHz	27500 MHz – 28350 MHz	TDD

NOTE 1: MTSU/TT/relaxation for FR2c is applied to all over the frequency range of n259.

5.2A Operating bands for CA

5.2A.1 Intra-band CA

NR intra-band contiguous and non-contiguous carrier aggregation is designed to operate in the operating bands defined in Table 5.2A.1-1, where all operating bands are within FR2.

Table 5.2A.1-1: Intra-band contiguous and non-contiguous CA operating bands in FR2

NR CA Band	NR Band (Table 5.2-1)
CA_n257	n257
CA_n258	n258
CA_n260	n260
CA_n261	n261

5.2A.2 Void

5.2A.3 Inter-band CA

NR inter-band carrier aggregation is designed to operate in the operating bands defined in Table 5.2A.2-1, where all operating bands are within FR2.

Beam management type is according to UE capability declaration *IE beamManagementType-r16*. The requirements in the following clauses are only applicable to inter-band CA with IBM type.

Table 5.2A.3-1: Inter-band CA operating bands in FR2

NR CA Band	NR Band (Table 5.2-1)
CA_n260-n261	n260, n261

5.2D Operating bands for UL MIMO

NR UL MIMO is designed to operate in the operating bands defined in Table 5.2D-1.

Table 5.2D-1: NR UL MIMO operating bands

UL MIMO operating band

(Table 5.2-1)
n257
n258
n259
n260
n261

5.2K Operating bands for simultaneous reception or transmission in multiple directions

Simultaneous reception or transmission in multiple directions is enabled for the bands defined in Table 5.2K-1.

Table 5.2K-1: NR bands for simultaneous reception or transmission in multiple directions

NR bands for simultaneous reception or transmission in multiple directions (Table 5.2-1)
n257
n258
n259
n260
n261

5.3 UE Channel bandwidth

5.3.1 General

The UE channel bandwidth supports a single NR RF carrier in the uplink or downlink at the UE. From a BS perspective, different UE channel bandwidths may be supported within the same spectrum for transmitting to and receiving from UEs connected to the BS. Transmission of multiple carriers to the same UE (CA) or multiple carriers to different UEs within the BS channel bandwidth can be supported.

From a UE perspective, the UE is configured with one or more BWP / carriers, each with its own UE channel bandwidth. The UE does not need to be aware of the BS channel bandwidth or how the BS allocates bandwidth to different UEs.

The placement of the UE channel bandwidth for each UE carrier is flexible but can only be completely within the BS channel bandwidth.

The relationship between the channel bandwidth, the guardband and the transmission bandwidth configuration is shown in Figure 5.3.1-1.

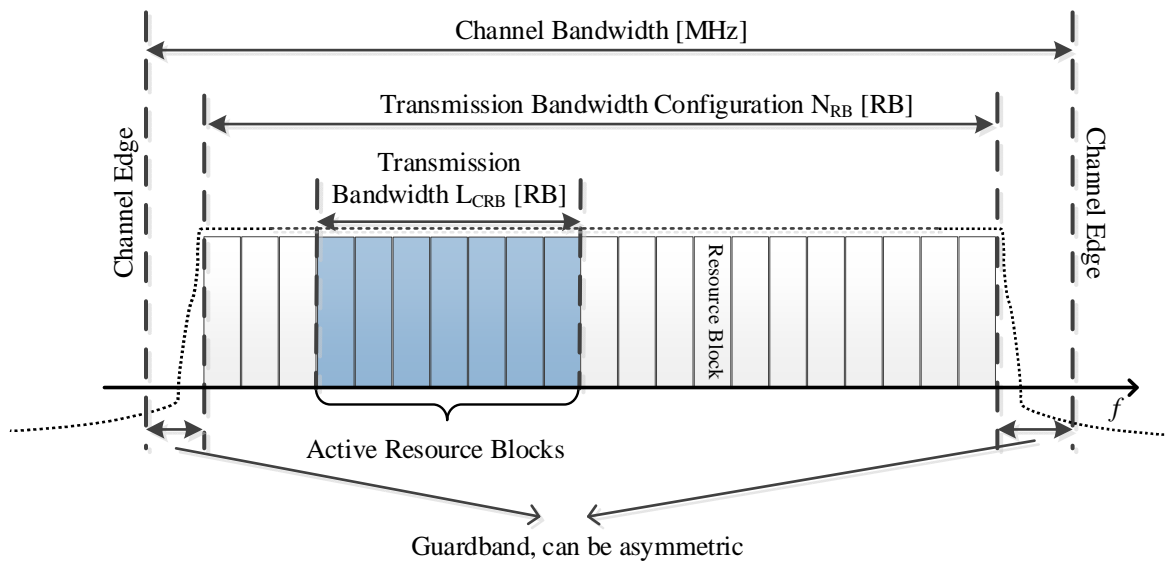

Figure 5.3.1-1: Definition of channel bandwidth and transmission bandwidth configuration for one NR channel

5.3.2 Maximum transmission bandwidth configuration

The maximum transmission bandwidth configuration N_{RB} for each UE channel bandwidth and subcarrier spacing is specified in Table 5.3.2-1

Table 5.3.2-1: Maximum transmission bandwidth configuration N_{RB}

SCS (kHz)	50 MHz	100 MHz	200 MHz	400 MHz
	N_{RB}	N_{RB}	N_{RB}	N_{RB}
60	66	132	264	N/A
120	32	66	132	264

5.3.3 Minimum guardband and transmission bandwidth configuration

The minimum guardband for each UE channel bandwidth and SCS is specified in Table 5.3.3-1.

Table 5.3.3-1: Minimum guardband for each UE channel bandwidth and SCS (kHz)

SCS (kHz)	50 MHz	100 MHz	200 MHz	400 MHz
60	1210	2450	4930	N/A
120	1900	2420	4900	9860

NOTE: The minimum guardbands have been calculated using the following equation: $GB_{channel} = (BW_{channel} \times 1000 \text{ (kHz)} - N_{RB} \times SCS \times 12) / 2 - SCS/2$, where N_{RB} are from Table 5.3.2-1 and $GB_{channel}$ expressed in kHz.

The minimum guardband of receiving BS SCS 240 kHz SS/PBCH block for each UE channel bandwidth is specified in table 5.3.3-2 for FR2.

Table: 5.3.3-2: Minimum guardband (kHz) of SCS 240 kHz SS/PBCH block

SCS (kHz)	100 MHz	200 MHz	400 MHz
240	3800	7720	15560

NOTE: The minimum guardband in Table 5.3.3-2 is applicable only when the SCS 240 kHz SS/PBCH block is received adjacent to the edge of the UE channel bandwidth within which the SS/PBCH block is located.

Figure 5.3.3-1: Void

The number of RBs configured in any channel bandwidth shall ensure that the minimum guardband specified in this clause is met.

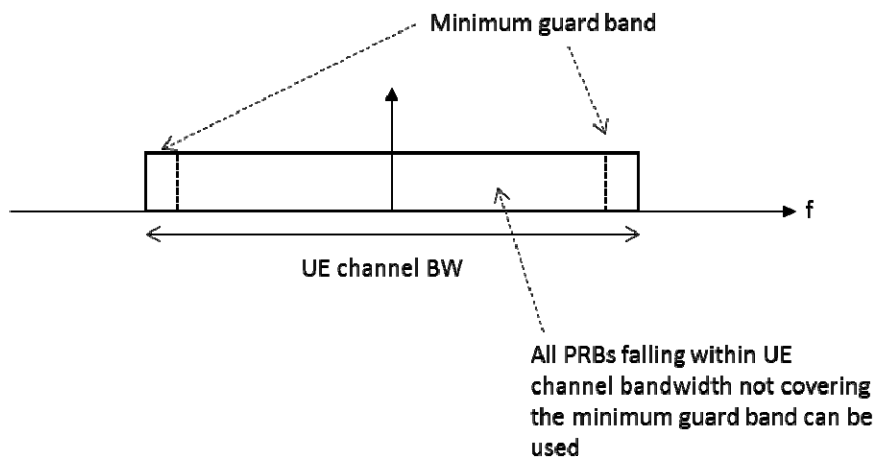

Figure 5.3.3-2: UE PRB utilization

In the case that multiple numerologies are multiplexed in the same symbol due to BS transmission of SSB, the minimum guardband on each side of the carrier is the guardband applied at the configured channel bandwidth for the numerology that is transmitted immediately adjacent to the guardband.

If multiple numerologies are multiplexed in the same symbol and the UE channel bandwidth is >200 MHz, the minimum guardband applied adjacent to 60 kHz SCS shall be the same as the minimum guardband defined for 120 kHz SCS for the same UE channel bandwidth.

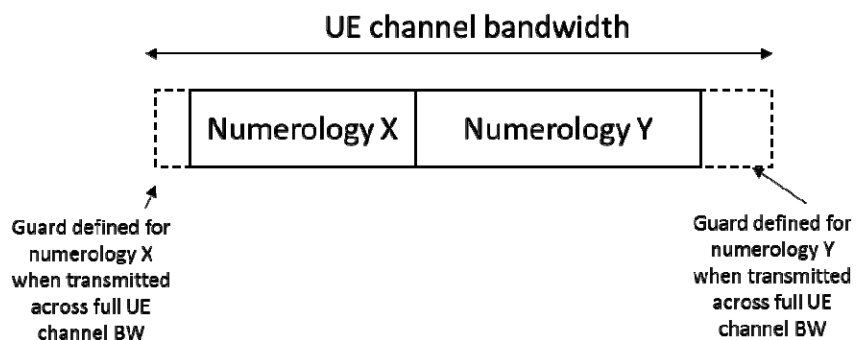

Figure 5.3.3-3: Guardband definition when transmitting multiple numerologies

NOTE: Figure 5.3.3-3 is not intended to imply the size of any guard between the two numerologies. Inter-numerology guardband within the carrier is implementation dependent.

5.3.4 RB alignment

For each numerology, its common resource blocks are specified in clause 4.4.4.3 in [9], and the starting point of its transmission bandwidth configuration on the common resource block grid for a given channel bandwidth is indicated by an offset to "Reference point A" in the unit of the numerology. The *UE transmission bandwidth configuration* is indicated by the higher layer parameter *carrierBandwidth* [19] and will fulfil the minimum UE guardband requirement specified in clause 5.3.3.

5.3.5 Channel bandwidth per operating band

The requirements in this specification apply to the combination of channel bandwidths, SCS and operating bands shown in Table 5.3.5-1. The transmission bandwidth configuration in Table 5.3.2-1 shall be supported for each of the specified channel bandwidths. The channel bandwidths are specified for both the Tx and Rx path.

Table 5.3.5-1: Channel bandwidths for each NR band

Operating band / SCS / UE channel bandwidth					
Operating band	SCS kHz	50 MHz	100 MHz	200 MHz	400 ² MHz
n257	60	Yes	Yes	Yes	N/A
	120	Yes	Yes	Yes	Yes
n258	60	Yes	Yes	Yes	N/A
	120	Yes	Yes	Yes	Yes
n259	60	Yes	Yes	Yes	N/A
	120	Yes	Yes	Yes	Yes
n260	60	Yes	Yes	Yes	N/A
	120	Yes	Yes	Yes	Yes
n261	60	Yes	Yes	Yes	N/A
	120	Yes	Yes	Yes	Yes

NOTE 1: For test configuration tables from the transmitter and receiver tests in Section 6 and 7 that refer to this table and indicate test SCS to use, if referenced SCS value is not supported by the UE in UL and/or DL, select the closest SCS supported by the UE in both UL and DL.

NOTE 2: This UE channel bandwidth is optional in this release of the specification.

5.3A UE Channel bandwidth for CA

5.3A.1 General

TBD

5.3A.2 Minimum guardband and transmission bandwidth configuration for CA

For intra-band contiguous carrier aggregation, *Aggregated Channel Bandwidth* and *Guard Bands* are defined as follows, see Figure 5.3A.2-1.

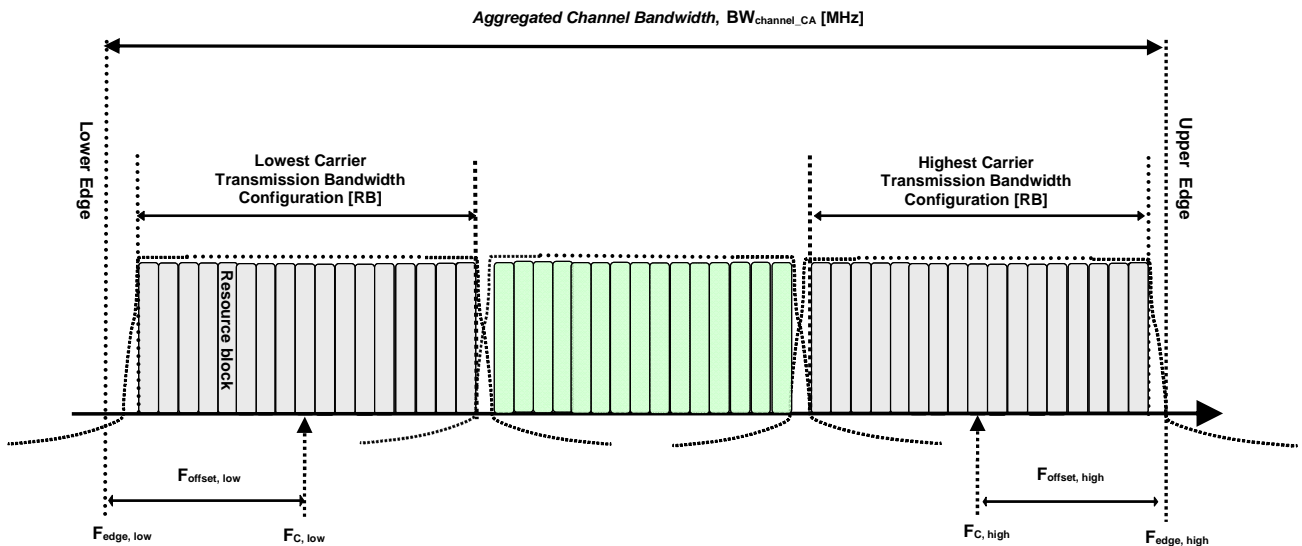

Figure 5.3A.2-1: Definition of *Aggregated Channel Bandwidth* for intra-band carrier aggregation

The *aggregated channel bandwidth*, $BW_{Channel_CA}$, is defined as

$$BW_{Channel_CA} = F_{edge,high} - F_{edge,low} \text{ (MHz)}.$$

The lower bandwidth edge $F_{edge,low}$ and the upper bandwidth edge $F_{edge,high}$ of the aggregated channel bandwidth are used as frequency reference points for transmitter and receiver requirements and are defined by

$$F_{edge,low} = F_{C,low} - F_{offset,low}$$

$$F_{edge,high} = F_{C,high} + F_{offset,high}$$

The lower and upper frequency offsets depend on the transmission bandwidth configurations of the lowest and highest assigned edge component carrier and are defined as

$$F_{offset,low} = (N_{RB,low} * 12 + 1) * SCS_{low} / 2 + BW_{GB} \text{ (MHz)}$$

$$F_{offset,high} = (N_{RB,high} * 12 - 1) * SCS_{high} / 2 + BW_{GB} \text{ (MHz)}$$

$$BW_{GB} = \max(BW_{GB,Channel(k)})$$

$N_{RB,low}$ and $N_{RB,high}$ are the transmission bandwidth configurations according to Table 5.3.2-1 for the lowest and highest assigned component carrier, SCS_{low} and SCS_{high} are the sub-carrier spacing for the lowest and highest assigned component carrier respectively. SCS_{low} , SCS_{high} , $N_{RB,low}$, $N_{RB,high}$, and $BW_{GB,Channel(k)}$ use the largest μ value among the subcarrier spacing configurations supported in the operating band for both of the channel bandwidths according to Table 5.3.5-1 and $BW_{GB,Channel(k)}$ is the minimum guard band for carrier k according to Table 5.3.3-1 for the said μ value.

For intra-band non-contiguous carrier aggregation *Sub-block Bandwidth* and *Sub-block edges* are defined as follows, see Figure 5.3A.2-2.

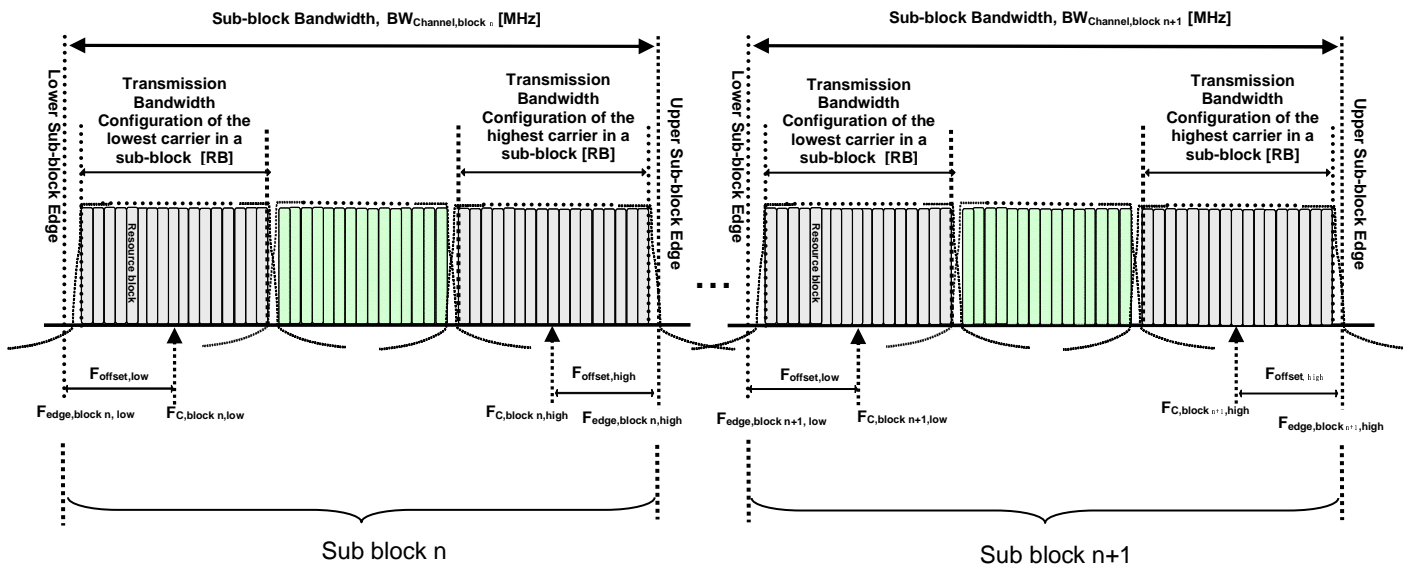

Figure 5.3A.2-2: Definition of sub-block bandwidth for intra-band non-contiguous spectrum

The lower sub-block edge of the Sub-block Bandwidth ($BW_{Channel,block}$) is defined as

$$F_{edge,block,low} = F_{C,block,low} - F_{offset,low}$$

The upper sub-block edge of the Sub-block Bandwidth is defined as

$$F_{edge,block,high} = F_{C,block,high} + F_{offset,high}$$

The Sub-block Bandwidth, $BW_{Channel,block}$, is defined as follows:

$$BW_{Channel,block} = F_{edge,block,high} - F_{edge,block,low} \text{ (MHz)}$$

The lower and upper frequency offsets $F_{offset,block,low}$ and $F_{offset,block,high}$ depend on the transmission bandwidth configurations of the lowest and highest assigned edge component carriers within a sub-block and are defined as

$$F_{offset,block,low} = (N_{RB,low} * 12 + 1) * SCS_{low} / 2 + BW_{GB} \text{ (MHz)}$$

$$F_{offset,block,high} = (N_{RB,high} * 12 - 1) * SCS_{high} / 2 + BW_{GB} \text{ (MHz)}$$

$$BW_{GB} = \max(BW_{GB,Channel(k)})$$

where $N_{RB,low}$ and $N_{RB,high}$ are the transmission bandwidth configurations according to Table 5.3.2-1 for the lowest and highest assigned component carrier within a sub-block, respectively. SCS_{low} , SCS_{high} , $N_{RB,low}$, $N_{RB,high}$, and $BW_{GB,Channel(k)}$ use the largest μ value among the subcarrier spacing configurations supported in the operating band for both of the channel bandwidths according to Table 5.3.5-1 and $BW_{GB,Channel(k)}$ is the minimum guard band for carrier k according to Table 5.3.3-1 for the said μ value. SCS_{low} and SCS_{high} are the sub-carrier spacing for the lowest and highest assigned component carrier within a sub-block, respectively.

The sub-block gap size between two consecutive sub-blocks W_{gap} is defined as

$$W_{gap} = F_{edge,block\ n+1,low} - F_{edge,block\ n,high} \text{ (MHz)}$$

5.3A.3 RB alignment with different numerologies for CA

TBD

5.3A.4 UE channel bandwidth per operating band for CA

For intra-band contiguous carrier aggregation, a carrier aggregation configuration is a single operating band supporting a carrier aggregation bandwidth class with associated bandwidth combination sets specified in clause 5.5A.1. For each

carrier aggregation configuration, requirements are specified for all aggregated channel bandwidths contained in a bandwidth combination set, UE can indicate support of several bandwidth combination sets per carrier aggregation configuration. The requirements are applicable only when Uplink CCs are configured within the frequency range between lower edge of lowest downlink component carrier and upper edge of highest downlink component carrier.

For intra-band non-contiguous downlink carrier aggregation, a carrier aggregation configuration is a single operating band supporting two or more sub-blocks, each supporting a carrier aggregation bandwidth class. The requirements are applicable only when Uplink CCs are configured within the frequency range between lower edge of lowest downlink component carrier and upper edge of highest downlink component carrier.

Frequency separation class specified in Table 5.3A.4-2 indicates the maximum frequency span between lower edge of lowest component carrier and upper edge of highest component carrier that UE can support per band in downlink or uplink respectively in non-contiguous intra-band operation.

The DL-only frequency spectrum is the width of UE frequency spectrum available to network to configure DL CCs only, and it extends on one-side of the bidirectional spectrum in contiguous manner with no frequency gap between the two. Frequency separation class for DL-only spectrum (F_{sd}) specified in Table 5.3A.4-3 and is declared per band. The frequency separation class for DL-only spectrum (F_{sd}) can be equal but not larger than the frequency separation (DL F_s). The combined downlink spectrum (DL $F_s + F_{sd}$) cannot exceed 2400 MHz. A UE may configure DL-only spectrum only if the combined downlink spectrum (DL $F_s + F_{sd}$) exceeds 1400 MHz. When a UE configures DL-only spectrum, it shall not expect a CC to be configured across the boundary between bidirectional spectrum and DL-only spectrum UE can support respectively.

For inter-band carrier aggregation, a carrier aggregation configuration is a combination of operating bands, each supporting a carrier aggregation bandwidth class.

Table 5.3A.4-1: CA bandwidth classes

NR CA bandwidth class	Aggregated channel bandwidth	Number of contiguous CC	Fallback group
A	$BW_{Channel} \leq 400$ MHz	1	1,2,3,4
B	$400 \text{ MHz} < BW_{Channel_CA} \leq 800$ MHz	2	1
C	$800 \text{ MHz} < BW_{Channel_CA} \leq 1200$ MHz	3	
D	$200 \text{ MHz} < BW_{Channel_CA} \leq 400$ MHz	2	2
E	$400 \text{ MHz} < BW_{Channel_CA} \leq 600$ MHz	3	
F	$600 \text{ MHz} < BW_{Channel_CA} \leq 800$ MHz	4	
G	$100 \text{ MHz} < BW_{Channel_CA} \leq 200$ MHz	2	
H	$200 \text{ MHz} < BW_{Channel_CA} \leq 300$ MHz	3	3
I	$300 \text{ MHz} < BW_{Channel_CA} \leq 400$ MHz	4	
J	$400 \text{ MHz} < BW_{Channel_CA} \leq 500$ MHz	5	
K	$500 \text{ MHz} < BW_{Channel_CA} \leq 600$ MHz	6	
L	$600 \text{ MHz} < BW_{Channel_CA} \leq 700$ MHz	7	
M	$700 \text{ MHz} < BW_{Channel_CA} \leq 800$ MHz	8	
O	$100 \text{ MHz} \leq BW_{Channel_CA} \leq 200$ MHz	2	4
P	$150 \text{ MHz} \leq BW_{Channel_CA} \leq 300$ MHz	3	
Q	$200 \text{ MHz} \leq BW_{Channel_CA} \leq 400$ MHz	4	
NOTE 1: Maximum supported component carrier bandwidths for fallback groups 1, 2, 3 and 4 are 400 MHz, 200 MHz, 100 MHz and 100 MHz respectively except for CA bandwidth class A.			
NOTE 2: It is mandatory for a UE to be able to fall back to lower order CA bandwidth class configuration within a fallback group. It is not mandatory for a UE to be able to fall back to lower order CA bandwidth class configuration that belongs to a different fallback group.			

Table 5.3A.4-2: Frequency separation classes for non-contiguous intra-band operation

Frequency separation class	Max. allowed frequency separation (F_s)
----------------------------	---

I	800 MHz
II	1200 MHz
III	F _s 1400 MHz
IV	1000 MHz
V	1600 MHz
VI	1800 MHz
VII	2000 MHz
VIII	2200 MHz
IX	2400 MHz
X	400 MHz
XI	600 MHz
NOTE 1: F _s values larger than 1400 MHz apply only to downlink frequency separation.	

Table 5.3A.4-3: Frequency separation classes for DL-only spectrum

Frequency separation class	Max. allowed frequency separation (F _{sd})
I	200 MHz
II	400 MHz
III	600 MHz
IV	800 MHz
V	1000 MHz
VI	1200 MHz

5.3D Channel bandwidth for UL MIMO

The requirements specified in clause 5.3 are applicable to UE supporting UL MIMO.

5.4 Channel arrangement

5.4.1 Channel spacing

5.4.1.1 Channel spacing for adjacent NR carriers

The spacing between carriers will depend on the deployment scenario, the size of the frequency block available and the channel bandwidths. The nominal channel spacing between two adjacent NR carriers is defined as following:

For NR operating bands with 60 kHz channel raster,

Nominal Channel spacing = $(BW_{\text{Channel}(1)} + BW_{\text{Channel}(2)})/2 + \{-20 \text{ kHz}, 0 \text{ kHz}, 20 \text{ kHz}\}$ for ΔF_{Raster} equals to 60 kHz

Nominal Channel spacing = $(BW_{\text{Channel}(1)} + BW_{\text{Channel}(2)})/2 + \{-40 \text{ kHz}, 0 \text{ kHz}, 40 \text{ kHz}\}$ for ΔF_{Raster} equals to 120 kHz

where $BW_{\text{Channel}(1)}$ and $BW_{\text{Channel}(2)}$ are the channel bandwidths of the two respective NR carriers. The channel spacing can be adjusted depending on the channel raster to optimize performance in a particular deployment scenario.

5.4.2 Channel raster

5.4.2.1 NR-ARFCN and channel raster

The global frequency raster defines a set of RF reference frequencies F_{REF} . The RF reference frequency is used in signalling to identify the position of RF channels, SS blocks and other elements.

The global frequency raster is defined for all frequencies from 0 to 100 GHz. The granularity of the global frequency raster is ΔF_{Global} .

RF reference frequency is designated by an NR Absolute Radio Frequency Channel Number (NR-ARFCN) in the range [2016667...3279165] on the global frequency raster. The relation between the NR-ARFCN and the RF reference frequency F_{REF} in MHz is given by the following equation, where $F_{\text{REF-Offs}}$ and $N_{\text{REF-Offs}}$ are given in Table 5.4.2.1-1 and N_{REF} is the NR-ARFCN

$$F_{\text{REF}} = F_{\text{REF-Offs}} + \Delta F_{\text{Global}} (N_{\text{REF}} - N_{\text{REF-Offs}})$$

Table 5.4.2.1-1: NR-ARFCN parameters for the global frequency raster

Frequency range (MHz)	ΔF_{Global} (kHz)	$F_{\text{REF-Offs}}$ (MHz)	$N_{\text{REF-Offs}}$	Range of N_{REF}
24250 – 100000	60	24250.08	2016667	2016667 – 3279165

The *channel raster* defines a subset of *RF reference frequencies* that can be used to identify the RF channel position in the uplink and downlink. The *RF reference frequency* for an RF channel maps to a resource element on the carrier. For each operating band, a subset of frequencies from the global frequency raster are applicable for that band and forms a channel raster with a granularity ΔF_{Raster} , which may be equal to or larger than ΔF_{Global} .

The mapping between the channel raster and corresponding resource element is given in clause 5.4.2.2. The applicable entries for each operating band are defined in clause 5.4.2.3

5.4.2.2 Channel raster to resource element mapping

The mapping between the RF reference frequency on channel raster and the corresponding resource element is given in Table 5.4.2.2-1 and can be used to identify the RF channel position. The mapping depends on the total number of RBs that are allocated in the channel and applies to both UL and DL. The mapping must apply to at least one numerology supported by the UE.

Table 5.4.2.2-1: Channel raster to resource element mapping

	$N_{\text{RB}} \bmod 2 = 0$	$N_{\text{RB}} \bmod 2 = 1$
Resource element index k	0	6
Physical resource block number n_{PRB}	$n_{\text{PRB}} = \left\lfloor \frac{N_{\text{RB}}}{2} \right\rfloor$	$n_{\text{PRB}} = \left\lfloor \frac{N_{\text{RB}}}{2} \right\rfloor$

k , n_{PRB} , N_{RB} are as defined in TS 38.211[9].

5.4.2.3 Channel raster entries for each operating band

The RF channel positions on the channel raster in each NR operating band are given through the applicable NR-ARFCN in Table 5.4.2.3-1, using the channel raster to resource element mapping in clause 5.4.2.2.

- For NR operating bands with 60 kHz channel raster above 24 GHz, $\Delta F_{\text{Raster}} = I \times \Delta F_{\text{Global}}$, where $I \in \{1, 2\}$. Every I^{th} NR-ARFCN within the operating band are applicable for the channel raster within the operating band and the step size for the channel raster in Table 5.4.2.3-1 is given as $\langle I \rangle$.
- In frequency bands with two ΔF_{Raster} , the higher ΔF_{Raster} applies to channels using only the SCS that is equal to the higher ΔF_{Raster} and the SSB SCS that is equal to or larger than the higher ΔF_{Raster} .

Table 5.4.2.3-1: Applicable NR-ARFCN per operating band

Operating Band	ΔF_{Raster} (kHz)	Uplink and Downlink Range of N_{REF} (First – $\langle \text{Step size} \rangle$ – Last)
n257	60	2054166 – $\langle 1 \rangle$ – 2104165
	120	2054167 – $\langle 2 \rangle$ – 2104165
n258	60	2016667 – $\langle 1 \rangle$ – 2070832
	120	2016667 – $\langle 2 \rangle$ – 2070831
n259	60	2270833 – $\langle 1 \rangle$ – 2337499
	120	2270833 – $\langle 2 \rangle$ – 2337499

n260	60	2229166 – <1> – 2279165
	120	2229167 – <2> – 2279165
n261	60	2070833 – <1> – 2084999
	120	2070833 – <2> – 2084999

5.4.3 Synchronization raster

5.4.3.1 Synchronization raster and numbering

The synchronization raster indicates the frequency positions of the synchronization block that can be used by the UE for system acquisition when explicit signalling of the synchronization block position is not present.

A global synchronization raster is defined for all frequencies. The frequency position of the SS block is defined as SS_{REF} with corresponding number GSCN. The parameters defining the SS_{REF} and GSCN for all the frequency ranges are in Table 5.4.3.1-1.

The resource element corresponding to the SS block reference frequency SS_{REF} is given in clause 5.4.3.2. The synchronization raster and the subcarrier spacing of the synchronization block are defined separately for each band.

Table 5.4.3.1-1: GSCN parameters for the global frequency raster

Frequency range	SS block frequency position SS_{REF}	GSCN	Range of GSCN
24250 – 100000 MHz	24250.08 MHz + N * 17.28 MHz, N = 0: 4383	22256+ N	22256 – 26639

5.4.3.2 Synchronization raster to synchronization block resource element mapping

The mapping between the synchronization raster and the corresponding resource element of the SS block is given in Table 5.4.3.2-1.

Table 5.4.3.2-1: Synchronization raster to SS block resource element mapping

Resource element index k	120
----------------------------	-----

k is the subcarrier number of SS/PBCH block defined in TS 38.211 [9] clause 7.4.3.1.

5.4.3.3 Synchronization raster entries for each operating band

The synchronization raster for each band is given in Table 5.4.3.3-1. The distance between applicable GSCN entries is given by the <Step size> indicated in Table 5.4.3.3-1.

Table 5.4.3.3-1: Applicable SS raster entries per operating band

NR Operating Band	SS Block SCS	SS Block pattern ¹	Range of GSCN (First – <Step size> – Last)
n257	120 kHz	Case D	22388 - <1> - 22558
	240 kHz	Case E	22390 - <2> - 22556
n258	120 kHz	Case D	22257 - <1> - 22443
	240 kHz	Case E	22258 - <2> - 22442
n259	120 kHz	Case D	23140 - <1> - 23369
	240 kHz	Case E	23142 - <2> - 23368
n260	120 kHz	Case D	22995 - <1> - 23166
	240 kHz	Case E	22996 - <2> - 23164
n261	120 kHz	Case D	22446 - <1> - 22492
	240 kHz	Case E	22446 - <2> - 22490

NOTE 1: SS Block pattern is defined in clause 4.1 in TS 38.213 [22].

5.4A Channel arrangement for CA

5.4A.1 Channel spacing for CA

For intra-band contiguous carrier aggregation with two or more component carriers, the nominal channel spacing between two adjacent NR component carriers is defined as the following unless stated otherwise:

For NR operating bands with 60kHz channel raster:

$$\text{Nominal channel spacing} = \left\lceil \frac{BW_{\text{Channel}(1)} + BW_{\text{Channel}(2)} - 2|GB_{\text{Channel}(1)} - GB_{\text{Channel}(2)}|}{0.06 * 2^{n+1}} \right\rceil 0.06 * 2^n \text{ [MHz]}$$

with

$$n = \mu_0 - 2$$

where $BW_{\text{Channel}(1)}$ and $BW_{\text{Channel}(2)}$ are the channel bandwidths of the two respective NR component carriers according to Table 5.3.2-1 with values in MHz, μ_0 is the largest μ value among the subcarrier spacing configurations supported in the operating band for both of the channel bandwidths according to Table 5.3.5-1, and $GB_{\text{Channel}(i)}$ is the minimum guardband for channel bandwidth i according to Table 5.3.3-1 for the said μ value, with μ as defined in TS 38.211 [9].

The channel spacing for intra-band contiguous carrier aggregation can be adjusted to any multiple of sub-carrier spacing less than the nominal channel spacing to optimize performance in a particular deployment scenario.

For intra-band non-contiguous carrier aggregation, the channel spacing between two NR component carriers in different sub-blocks shall be larger than the nominal channel spacing defined in this clause.

5.5 Configurations

5.5A Configurations for CA

5.5A.1 Configurations for intra-band contiguous CA

Table 5.5A.1-1: NR CA configurations, bandwidth combination sets, and fallback group defined for intra-band contiguous CA

NR CA configuration	Uplink CA configurations	BW _{Channel} (MHz)	BW _{Channel} (MHz)	BW _{Channel} (MHz)	BW _{Channel} (MHz)	BW _{Channel} (MHz)	BW _{Channel} (MHz)	BW _{Channel} (MHz)	BW _{Channel} (MHz)	BW _{Channel} (MHz)	Maximum aggregated BW (MHz)	BCS	Fallback group
CA_n257B	CA_n257B	50, 100, 200, 400	400								800	0	1
CA_n257E	CA_n257E	50, 100, 200,	200	200							600	0	2
CA_n257F	CA_n257F	50, 100, 200,	200	200	200						800	0	
CA_n257G	CA_n257G	50, 100	100								200	0	3
CA_n257H	CA_n257H	50, 100	100	100							300	0	
CA_n257I	CA_n257I	50, 100	100	100	100						400	0	
CA_n257J	CA_n257J	50, 100	100	100	100	100					500	0	
CA_n257K	CA_n257K	50, 100	100	100	100	100	100				600	0	
CA_n257L	CA_n257L	50, 100	100	100	100	100	100	100			700	0	
CA_n258D	CA_n258D	50, 100, 200	200								400	0	2
CA_n258E	CA_n258D CA_n258E	50, 100, 200	200	200							600	0	
CA_n258F	CA_n258D CA_n258E CA_n258F	50, 100, 200	200	200	200						800	0	3
CA_n258G	CA_n258G	50, 100	100								200	0	
CA_n258H	CA_n258G CA_n258H	50, 100	100	100							300	0	
CA_n258I	CA_n258G CA_n258H CA_n258I	50, 100	100	100	100						400	0	
CA_n258J	CA_n258G CA_n258H CA_n258I CA_n258J	50, 100	100	100	100	100					500	0	
CA_n258K	CA_n258G CA_n258H CA_n258I CA_n258J CA_n258K	50, 100	100	100	100	100	100				600	0	
CA_n258L	CA_n258G CA_n258H CA_n258I CA_n258J CA_n258K CA_n258L	50, 100	100	100	100	100	100	100			700	0	3
CA_n258M	CA_n258G CA_n258H CA_n258I CA_n258J CA_n258K CA_n258L CA_n258M	50, 100	100	100	100	100	100	100	100		800	0	
CA_n260B	CA_n260B	50, 100, 200, 400	400								800	0	1
CA_n260C	CA_n260B	50, 100,	400	400							1200	0	

NR CA configuration	Uplink CA configurations	BW _{Channel} (MHz)	BW _{Channel} (MHz)	BW _{Channel} (MHz)	BW _{Channel} (MHz)	BW _{Channel} (MHz)	BW _{Channel} (MHz)	BW _{Channel} (MHz)	BW _{Channel} (MHz)	BW _{Channel} (MHz)	Maximum aggregated BW (MHz)	BCS	Fall back group
		200, 400											
CA_n260E	CA_n260E	50, 100, 200	200	200							600	0	
CA_n260F	CA_n260F	50, 100, 200	200	200	200						800	0	
CA_n260G	CA_n260G	50, 100	100								200	0	3
CA_n260H	CA_n260H	50, 100	100	100							300	0	
CA_n260I	CA_n260I	50, 100	100	100	100						400	0	
CA_n260J	CA_n260J	50, 100	100	100	100	100					500	0	
CA_n260K	CA_n260K	50, 100	100	100	100	100	100				600	0	
CA_n260L	CA_n260L	50, 100	100	100	100	100	100	100			700	0	
CA_n260M	CA_n260M	50, 100	100	100	100	100	100	100	100		800	0	
CA_n261B	CA_n261B	50, 100, 200, 400	400								800	0	
CA_n261C	CA_n261C	50	400	400							850 ¹	0	
CA_n261D	CA_n261D	50, 100, 200	200								400	0	2
CA_n261E	CA_n261E	50, 100, 200	200	200							600	0	
CA_n261F	CA_n261F	50, 100, 200	200	200	200						800	0	
CA_n261G	CA_n261G	50, 100	100								200	0	3
CA_n261H	CA_n261H	50, 100	100	100							300	0	
CA_n261I	CA_n261I	50, 100	100	100	100						400	0	
CA_n261J	CA_n261J	50, 100	100	100	100	100					500	0	
CA_n261K	CA_n261K	50, 100	100	100	100	100	100				600	0	

NOTE 1: Void.
 NOTE 2: For the NR CA configuration with more than two component carriers, the bandwidths in a BCS which may introduce combinations more than requested unintentionally should be listed in a row separately.

5.5A.2 Configurations for intra-band non-contiguous CA

Configurations listed in this clause apply to downlink carrier aggregation only.

NOTE: Sub-blocks belonging to a CA configuration can be in any order. In other words certain CA configuration acronym includes all sub-block arrangements which have exactly the same sub-block set. As an example, CA_n260(2G-3O) denotes CA_n260(2O-2G-O), CA_n260(G-3O-G) etc. but these are not listed in tables separately.

Table 5.5A.2-1: NR CA configurations with single CA bandwidth class defined for intra-band non-contiguous CA

NR configuration	Uplink CA configurations	Sub-block	Sub-block	Sub-block	Sub-block	Sub-block	Sub-block	Sub-block	Sub-block	Sub-block	Σ(BW _{Channel,block}) (MHz)	BCS
CA_n257(2A)	-	n257A	n257A								800	0
CA_n260(2A)	-	n260A	n260A								800	0
CA_n260(3A)	-	n260A	n260A	n260A							1200	0
CA_n260(4A)	-	n260A	n260A	n260A	n260A						1600	0
CA_n261(2A)	-	n261A	n261A								800	0
CA_n261(3A)	-	n261A	n261A	n261A							800	0
CA_n261(4A)	-	n261A	n261A	n261A	n261A						800	0

NOTE 1: Void
 NOTE 2: Void
 NOTE 3: Void

NOTE 4: Channel bandwidth per operating band defined in Table 5.3.5-1.

NOTE 5: Void.

NOTE 6: Void.

NOTE 7: $\Sigma(BW_{\text{Channel,block}})$ denotes the maximum total bandwidth from the summation of the sub-block bandwidths and shall be less than the bandwidth of the operating band.

NOTE 8: Unless otherwise stated, BCS0 is referred in each constituent CA configuration.

Table 5.5A.2-2: NR CA configurations with multiple CA bandwidth classes defined for intra-band non-contiguous CA

CA configuration	Uplink CA configurations	Sub-block	Sub-block	Sub-block	Sub-block	Sub-block	Sub-block	Sub-block	$\Sigma(BW_{\text{Chann el, block}})$ (MHz)	BCS
CA_n260(A-I)	CA_n260I	n260A	CA_n260I						800	0
CA_n260(D-G)	CA_n260D CA_n260G	CA_n260D	CA_n260G						600	0
CA_n260(D-H)	CA_n260D CA_n260H	CA_n260D	CA_n260H						700	0
CA_n260(D-I)	CA_n260D CA_n260I	CA_n260D	CA_n260I						800	0
CA_n260(D-P)	CA_n260D CA_n260P	CA_n260D	CA_n260P						700	0
CA_n260(E-O)	CA_n260E CA_n260O	CA_n260O	CA_n260E						800	0
CA_n260(E-P)	CA_n260E CA_n260P	CA_n260E	CA_n260P						800	0
CA_n260(G-I)	CA_n260G CA_n260I	CA_n260G	CA_n260I						600	0
CA_n261(D-G)	CA_n261D CA_n261G	CA_n261D	CA_n261G						600	0
CA_n261(D-H)	CA_n261D CA_n261H	CA_n261D	CA_n261H						700	0
CA_n261(D-I)	CA_n261D CA_n261I	CA_n261D	CA_n261I						800	0
CA_n261(D-O)	CA_n261D	CA_n261D	CA_n261D						600	0

	CA_n261O	1D	1O							
CA_n261(D-P)	CA_n261D CA_n261P	CA_n26 1D	CA_n26 1P						700	0
CA_n261(D-Q)	CA_n261D CA_n261Q	CA_n26 1D	CA_n26 1Q						800	0
CA_n261(E-O)	CA_n261E CA_n261O	CA_n26 1E	CA_n26 1O						800	0
CA_n261(E-P)	CA_n261E CA_n261P	CA_n26 1E	CA_n26 1P						800	0
<p>NOTE 1: Void</p> <p>NOTE 2: Void</p> <p>NOTE 3: Unless otherwise stated, BCS0 is referred to, in each constituent CA configuration.</p> <p>NOTE 4: Void.</p> <p>NOTE 5: Void.</p> <p>NOTE 6: Void.</p> <p>NOTE 7: $\Sigma(BW_{\text{Channel,block}})$ denotes the maximum total bandwidth from the summation of the sub-block bandwidths and shall be less than the bandwidth of the operating band.</p> <p>NOTE 8: Channel bandwidth per operating band is defined in Table 5.3.5-1.</p> <p>NOTE 9: Configurations for intra-band contiguous CA are defined in Table 5.5A.1-1.</p> <p>NOTE 10: Configurations for intra-band non-contiguous CA are defined in Table 5.5A.2-1.</p>										

5.5A.3 Configurations for inter-band CA

Table 5.5A.3-1: NR CA configurations for inter-band CA

NR CA configuration	Uplink CA configuration	NR Band	Channel bandwidth (MHz) (NOTE 1)				Bandwidth combination set
			50	100	200	400	
CA_n260A- n261A	-	n260	50	100	200	400	0
		n261	50	100	200	400	

NOTE 1: The SCS of each channel bandwidth for NR band refers to Table 5.3.5-1.

5.5D Configurations for UL MIMO

The requirements specified in clause 5.5 are applicable to UE supporting UL MIMO.

6 Transmitter characteristics

6.1 General

Editor's note: Test configurations/environments that require new spherical scan shall be included in test procedure section and identifying such scenarios is currently FFS and owned by RAN5.

Unless otherwise stated, the transmitter characteristics are specified over the air (OTA) with a single or multiple transmit chains.

Unless otherwise stated, for power class 3 UEs, the beam correspondence side condition for SSB and CSI-RS specified in clause 6.6 shall apply to the transmission tests.

Unless otherwise stated, the UE min peak EIRP requirements and UE spherical coverage requirements specified in clause 6.2.1 does not apply to initial access and RRC_INACTIVE.

Transmitter requirements for CA operation apply only when the DMRS initialization parameters (including the case when the UE applies cell ID as DMRS scrambling ID) are different across all CCs. The UE may use higher MPR values outside this limitation.

Transmitter requirements for UL MIMO operation apply when the UE transmits on 2 ports on the same CDM group. The UE may use higher MPR values outside this limitation.

For Tx test cases the identified beam peak direction can be stored and reused for a device under test in various configurations/environments for the full duration of device testing as long as beam peak direction is the same.

Unless otherwise stated, Channel Bandwidth shall be prioritized in the selecting of test points. Subcarrier spacing shall be selected after Test Channel Bandwidth is selected.

Uplink RB allocations given in Table 6.1-1 and Table 6.1-2 are used throughout this section, unless otherwise stated by the test case.

The UE under test shall be pre-configured with UL Tx diversity schemes disabled to account for single polarization System Simulator (SS) in the test environment. The UE under test may transmit with dual polarization.

Transmitter requirements for simultaneous transmission to multiple directions apply to the power classes 1, 2, 5, and 6 only.

The requirements for 256 QAM apply to bands defined within the frequency spectrum range of 24.25 – 43.5 GHz for power classes 1, 2 and 5.

Table 6.1-1: Common Uplink Configuration for PC2, PC3, PC4, PC6 and PC7

Channel Bandwidth	SCS(kHz)	OFDM	RB allocation								Inner_Pa rtial2_Lef t	Inner_Pa rtial2_Rig ht
			Outer_Fu ll	Outer_xR B_Left (Note 6)	Outer_xR B_Right (Note 6)	Inner_Fu ll (Note 1)	Inner_xR B_Left (Note 6)	Inner_xR B_Right (Note 6)	Inner_Pa rtial_Left	Inner_Pa rtial_Rig ht		
50MHz	60	DFT-s	64@0	x@0	x@(6 6-x)	20@2 2 ³ 20@2 0 ⁴	x@22 3 x@1 ⁴	x@(4 4-x) ³ x@(6 5-x) ⁴	4@22 3 8@8 ⁴	4@40 3 8@50 4	6@6 ⁴	6@54 4
		CP	66@0	x@0	x@(6 6-x)	22@2 2	x@22 3 x@1 ⁴	x@(4 4-x) ³ x@(6 5-x) ⁴	4@22 3 7@7 ⁴	4@40 3 7@52 4	6@6 ⁴	6@54 4
120	DFT-s	DFT-s	32@0	x@0	x@(3 2-x)	10@1 1 ³ 10@1 0 ⁴	x@11 3 x@1 ⁴	x@(2 2-x) ³ @(31 -x) ⁴	4@11 3 4@4 ⁴	4@18 3 4@24 4	3@3 ⁴	3@26 4

		CP	32@0	x@0	x@(3 2-x)	11@1 1 ³ 10@1 0 ⁴	x@11 3 x@1 ⁴	x@(2 2-x) ³ x@(3 1-x) ⁴	4@11 3 4@4 ⁴	4@18 3 4@24 4	3@3 ⁴	3@26 4
100MHz	60	DFT-s	128@0	x@0	x@(1 32-x)	40@4 4 ³ 40@4 0 ⁴	x@44 3 x@1 ⁴	x@(8 8-x) ³ x@(1 31-x) ⁴	4@44 3 8@8 ⁴	4@84 3 8@11 6 ⁴	6@6 ⁴	6@12 0 ⁴
		CP	132@0	x@0	x@(1 32-x)	44@4 4	x@44 3 x@1 ⁴	x@(8 8-x) ³ x@(1 31-x) ⁴	4@44 3 7@7 ⁴	4@84 3 7@11 8 ⁴	6@6 ⁴	6@12 0 ⁴
	120	DFT-s	64@0	x@0	x@(6 6-x)	20@2 2 ³ 20@2 0 ⁴	x@22 3 x@1 ⁴	x@(4 4-x) ³ x@(6 5-x) ⁴	4@22 3 4@4 ⁴	4@40 3 4@58 4	3@3 ⁴	3@60 4
		CP	66@0	x@0	x@(6 6-x)	22@2 2	x@22 3 x@1 ⁴	x@(4 4-x) ³ x@(6 5-x) ⁴	4@22 3 4@4 ⁴	4@40 3 4@58 4	3@3 ⁴	3@60 4
200MHz 5	60	DFT-s	256@0	x@0	x@(2 64-x)	81@8 8 ³ 81@8 1 ⁴	x@88 3 x@1 ⁴	x@(1 76-x) ³ x@(2 63-x) ⁴	4@88 3 8@8 ⁴	4@17 2 ³ 8@24 8 ⁴	6@6 ⁴	6@25 2 ⁴
		CP	264@0	x@0	x@(2 64-x)	88@8 8	x@88 3 x@1 ⁴	x@(1 76-x) ³ x@(2 63-x) ⁴	4@88 3 7@7 ⁴	4@17 2 ³ 7@25 0 ⁴	6@6 ⁴	6@25 2 ⁴
	120	DFT-s	128@0	x@0	x@(1 32-x)	40@4 4 ³ 40@4 0 ⁴	x@44 3 x@1 ⁴	x@(8 8-x) ³ x@(1 31-x) ⁴	4@44 3 4@4 ⁴	4@84 3 4@12 4 ⁴	3@3 ⁴	3@12 6 ⁴
		CP	132@0	x@0	x@(1 32-x)	44@4 4	x@44 3 x@1 ⁴	x@(8 8-x) ³ x@(1 31-x) ⁴	4@44 3 4@4 ⁴	4@84 3 4@12 4 ⁴	3@3 ⁴	3@12 6 ⁴
400MHz 5	60	DFT-s	N/A	N/A	N/A	N/A	N/A	N/A	N/A	N/A	N/A	N/A
		CP	N/A	N/A	N/A	N/A	N/A	N/A	N/A	N/A	N/A	N/A
	120	DFT-s	256@0	x@0	x@(2 64-x)	64@6 6	x@66	x@(1 98-x)	4@66	4@19 4	N/A	N/A
		CP	264@0	x@0	x@(2 64-x)	66@6 6	x@66	x@(1 98-x)	4@66	4@19 4	N/A	N/A

Note 1: RB allocation is left aligned within inner region.
 Note 2: Inner_Full allocation is selected as the largest RB allocation within Region 1 inner allocation defined in 6.2.2.3.3; Inner_Partial_Left and Inner_Partial_Right are selected as partial allocation within Region 1 inner allocation which are not impacted by MPR_{narrow} defined in 6.2.2.3.3; Inner_Partial2_Left and Inner_Partial2_Right are selected as partial allocation within Region 1 inner allocation which are impacted by MPR_{narrow} defined in 6.2.2.3.3 when MPR_{narrow}=2 dB.
 Note 3: Applicable to Rel-15 PC3 devices which do not support *modifiedMPR-Behaviour* bit 0 capability (according to Annex P.1) and to Rel-15 and forward PC2 and PC4 devices.
 Note 4: Applicable to Rel-15 PC3 devices which supports *modifiedMPR-Behaviour* bit 0 capability (according to Annex P.1) and Rel-16 and forward PC3 devices.
 Note 5: The 200MHz and 400MHz bandwidths are not applicable to PC7 RedCap UEs.
 Note 6: In case of transform precoding, applicable only if $x = 2^{\alpha_2}, 3^{\alpha_3}, 5^{\alpha_5}$, where $\alpha_2, \alpha_3, \alpha_5$ is a set of non-negative integers.

Table 6.1-2: Common Uplink Configuration for PC1

Channel Bandwidth	SCS(kHz)	OFDM	RB allocation								Inner_Partial_Right	Inner_Partial2_Right
			Outer_Full	Outer_xRB_L	Outer_xRB_Right	Inner_Full_Region1	Inner_partial_Left	Inner_Partial_Right	Inner_Full_Region2	Inner_Partial		
60	60	DFT-s	64@0	x@0	x@(66-x)	20@2 2	16@2 2	16@2 8	32@1 6	16@8 8	16@4 2	6@54 ⁴

50MHz		CP	66@0	x@0	x@(66-x)	22@2	16@2	16@2	33@1	16@8	16@4	6@54 ⁴
	120	DFT-s	32@0	x@0	x@(32-x)	10@1	8@11	8@14	16@8	8@4	8@20	3@26 ⁴
		CP	32@0	x@0	x@(32-x)	11@1	8@11	8@14	16@8	8@4	8@20	3@26 ⁴
100MHz	60	DFT-s	128@0	x@0	x@(132-x)	40@4	16@4	16@7	64@3	16@8	16@108	6@120 ⁴
		CP	132@0	x@0	x@(132-x)	44@4	16@4	16@7	66@3	16@8	16@108	6@120 ⁴
	120	DFT-s	64@0	x@0	x@(66-x)	20@2	8@22	8@36	32@1	8@4	8@54	3@60 ⁴
		CP	66@0	x@0	x@(66-x)	22@2	8@22	8@36	33@1	8@4	8@54	3@60 ⁴
200MHz ⁵	60	DFT-s	256@0	x@0	x@(264-x)	81@8	16@8	16@160	128@64	16@8	16@240	6@252 ⁴
		CP	264@0	x@0	x@(264-x)	88@8	16@8	16@160	132@66	16@8	16@240	6@252 ⁴
	120	DFT-s	128@0	x@0	x@(132-x)	40@4	8@44	8@80	64@3	8@4	8@120	3@126 ⁴
		CP	132@0	x@0	x@(132-x)	44@4	8@44	8@80	66@3	8@4	8@120	3@126 ⁴
400MHz ⁵	60	DFT-s	N/A	N/A	N/A	N/A	N/A	N/A	N/A	N/A	N/A	N/A
		CP	N/A	N/A	N/A	N/A	N/A	N/A	N/A	N/A	N/A	N/A
	120	DFT-s	256@0	x@0	x@(264-x)	64@6	8@66	8@19	128@64	8@4	8@25	N/A
		CP	264@0	x@0	x@(264-x)	66@6	8@66	8@19	132@66	8@4	8@25	N/A

Note 1: RB allocation is left aligned within inner region 1 or inner region 2 as defined in clause 6.2.2.3.1.
 Note 2: Inner_Full allocation is selected as the largest RB allocation within Region 1 or Region 2 inner allocation defined in 6.2.2.3.1; Inner_partial_Left and Inner_partial_Right are selected as minimum allocation within Region 1 or Region 2 inner allocation which are not impacted by MPR_{narrow} defined in 6.2.2.3.1.
 Note 3: In case of transform precoding, applicable only if $x = 2^{\alpha_2} \cdot 3^{\alpha_3} \cdot 5^{\alpha_5}$, where $\alpha_2, \alpha_3, \alpha_5$ is a set of non-negative integers.

6.2 Transmit power

6.2.1 UE maximum output power

6.2.1.0 General

Note: Power classes are specified based on the assumption of certain UE types with specific device architectures. The UE types can be found in Table 6.2.1.0-1.

Table 6.2.1.0-1: Assumption of UE Types

UE Power class	UE type
1	Fixed wireless access (FWA) UE
2	Vehicular UE
3	Handheld UE
4	High power non-handheld UE
5	Fixed wireless access (FWA) UE
6	High Speed Train Roof-Mounted UE
7	RedCap UE
Note: Any power class can be used for Redcap type devices as long as the device can meet the core requirements that are applicable to Redcap devices as defined in clause 4.2.21.1 from TS38.306 [14]	

6.2.1.1 UE maximum output power - EIRP and TRP

Editor's note: The following aspects are either missing or not yet determined:

- **Measurement Uncertainties and Test Tolerances are FFS for power class other than 1, 3, 5, 6 and 7.**

6.2.1.1.1 Test purpose

To verify that the error of the UE maximum output power does not exceed the range prescribed by the specified nominal maximum output power and tolerance.

An excess maximum output power has the possibility to interfere to other channels or other systems. A small maximum output power decreases the coverage area.

6.2.1.1.2 Test applicability

This test case applies to all types of release 15 NR UEs.

This test case also applies to all types of release 16 and forward NR Power Class 1, Power Class 2 and Power Class 4 UEs.

This test case also applies to all types of release 16 and forward NR Power Class 3 UEs not supporting CSI-RS based or SSB-based enhanced beam correspondence.

This test case also applies to all types of release 17 and forward NR Power Class 7 UEs not supporting CSI-RS based or SSB-based enhanced beam correspondence.

6.2.1.1.3 Minimum conformance requirements

6.2.1.1.3.1 UE maximum output power for power class 1

The following requirements define the maximum output power radiated by the UE for any transmission bandwidth within the channel bandwidth for non-CA configuration, unless otherwise stated. The period of measurement shall be at least one sub frame (1ms). In case of initial access and RRC_INACTIVE, the cumulative period of measurement shall equal or exceed 1ms. The minimum output power values for EIRP are found in Table 6.2.1.1.3.1-1. The requirement is verified with the test metric of EIRP (Link=TX beam peak direction, Meas=Link angle).

Table 6.2.1.1.3.1-1: UE minimum peak EIRP for power class 1

Operating band	Min peak EIRP (dBm)
n257	40.0
n258	40.0
n260	38.0
n261	40.0
NOTE 1: Minimum peak EIRP is defined as the lower limit without tolerance	
NOTE 2: Minimum peak EIRP does not apply to initial access and RRC_INACTIVE.	

The maximum output power values for TRP and EIRP are found in Table 6.2.1.1.3.1-2 below. The maximum allowed EIRP is derived from regulatory requirements [8]. The requirements are verified with the test metrics of TRP (Link=TX beam peak direction, Meas=TRP grid) in beam locked mode and EIRP (Link=TX beam peak direction, Meas=Link angle).

Table 6.2.1.1.3.1-2: UE maximum output power limits for power class 1

Operating band	Max TRP (dBm)	Max EIRP (dBm)
n257	35	55
n258	35	55
n260	35	55
n261	35	55

The minimum EIRP at the 85th percentile of the distribution of radiated power measured over the full sphere around the UE is defined as the spherical coverage requirement and is found in Table 6.2.1.1.3.1-3 below. The requirement is verified with the test metric of EIRP (Link=Spherical coverage grid, Meas=Link angle).

Table 6.2.1.1.3.1-3: UE spherical coverage for power class 1

Operating band	Min EIRP at 85%-tile CDF (dBm)
n257	32.0
n258	32.0
n260	30.0
n261	32.0
NOTE 1: Minimum EIRP at 85%-tile CDF is defined as the lower limit without tolerance in RRC_CONNECTED.	
NOTE 2: The requirements in this table are verified only under normal temperature conditions as defined in TS 38.508-1 [10] clause 4.1.1.	
NOTE 3: Minimum EIRP at 85%-tile CDF is defined as the lower limit minus 2 dB in initial access and RRC_INACTIVE	

6.2.1.1.3.2 UE maximum output power for power class 2

The following requirements define the maximum output power radiated by the UE for any transmission bandwidth within the channel bandwidth for non-CA configuration, unless otherwise stated. The period of measurement shall be at least one sub frame (1ms). The minimum output power values for EIRP are found in Table 6.2.1.1.3.2-1. The requirement is verified with the test metric of EIRP (Link=TX beam peak direction, Meas=Link angle).

Table 6.2.1.1.3.2-1: UE minimum peak EIRP for power class 2

Operating band	Min peak EIRP (dBm)
n257	29
n258	29
n261	29
NOTE 1: Minimum peak EIRP is defined as the lower limit without tolerance	

The maximum output power values for TRP and EIRP are found in Table 6.2.1.1.3.2-2 below. The maximum allowed EIRP is derived from regulatory requirements [8]. The requirements are verified with the test metrics of TRP (Link=TX beam peak direction, Meas=TRP grid) in beam locked mode and EIRP (Link=TX beam peak direction, Meas=Link angle).

Table 6.2.1.1.3.2-2: UE maximum output power limits for power class 2

Operating band	Max TRP (dBm)	Max EIRP (dBm)
n257	23	43
n258	23	43
n261	23	43

The minimum EIRP at the 60th percentile of the distribution of radiated power measured over the full sphere around the UE is defined as the spherical coverage requirement and is found in Table 6.2.1.1.3.2-3 below. The requirement is verified with the test metric of EIRP (Link=Spherical coverage grid, Meas=Link angle).

Table 6.2.1.1.3.2-3: UE spherical coverage for power class 2

Operating band	Min EIRP at 60%-tile CDF (dBm)
n257	18.0
n258	18.0
n261	18.0

NOTE 1: Minimum EIRP at 60%-tile CDF is defined as the lower limit without tolerance
 NOTE 2: The requirements in this table are verified only under normal temperature conditions as defined in TS 38.508-1 [10] clause 4.1.1.

6.2.1.1.3.3 UE maximum output power for power class 3

The following requirements define the maximum output power radiated by the UE for any transmission bandwidth within the channel bandwidth for non-CA configuration, unless otherwise stated. The period of measurement shall be at least one sub frame (1ms). In case of initial access and RRC_INACTIVE, the cumulative period of measurement shall equal or exceed 1ms. The minimum output power values for EIRP are found in Table 6.2.1.1.3.3-1. The requirement is verified with the test metric of total component of EIRP (Link=TX beam peak direction, Meas=Link angle). The requirement for the UE which supports a single FR2 band is specified in Table 6.2.1.1.3.3-1. The requirement for the UE which supports multiple FR2 bands is specified in both Table 6.2.1.1.3.3-1 and Table 6.2.1.1.3.3-4 or Table 6.2.1.1.3.3-5.

Table 6.2.1.1.3.3-1: UE minimum peak EIRP for power class 3

Operating band	Min peak EIRP (dBm)
n257	22.4
n258	22.4
n259	18.7
n260	20.6
n261	22.4
NOTE 1: Minimum peak EIRP is defined as the lower limit without tolerance	
NOTE 2: Void	
NOTE 3: Minimum peak EIRP does not apply to initial access and RRC_INACTIVE.	

The maximum output power values for TRP and EIRP are found on the Table 6.2.1.1.3.3-2. The max allowed EIRP is derived from regulatory requirements [8]. The requirements are verified with the test metrics of TRP (Link=TX beam peak direction, Meas=TRP grid) in beam locked mode and the total component of EIRP (Link=TX beam peak direction, Meas=Link angle).

Table 6.2.1.1.3.3-2: UE maximum output power limits for power class 3

Operating band	Max TRP (dBm)	Max EIRP (dBm)
n257	23	43
n258	23	43
n259	23	43
n260	23	43
n261	23	43

The minimum EIRP at the 50th percentile of the distribution of radiated power measured over the full sphere around the UE is defined as the spherical coverage requirement and is found in Table 6.2.1.1.3.3-3 below. The requirement is verified with the test metric of the total component of EIRP, as defined in [5] (Link=Spherical coverage grid, Meas=Link angle). The requirement for the UE which supports a single FR2 band is specified in Table 6.2.1.1.3.3-3. The requirement for the UE which supports multiple FR2 bands is specified in both Table 6.2.1.1.3.3-3 and Table 6.2.1.1.3.3-4 or Table 6.2.1.1.3.3-5.

Table 6.2.1.1.3.3-3: UE spherical coverage for power class 3

Operating band	Min EIRP at 50%-tile CDF (dBm)
n257	11.5
n258	11.5
n259	5.8
n260	8
n261	11.5

NOTE 1: Minimum EIRP at 50 %-tile CDF is defined as the lower limit without tolerance in RRC_CONNECTED.
 NOTE 2: Void
 NOTE 3: The requirements in this table are verified only under normal temperature conditions as defined in TS 38.508-1 [10] clause 4.1.1.
 NOTE 4: Minimum EIRP at 50%-tile CDF is defined as the lower limit minus 2 dB in initial access and RRC_INACTIVE

For the UEs that support multiple FR2 bands, minimum requirement for peak EIRP and EIRP spherical coverage in Tables 6.2.1.1.3.3-1 and 6.2.1.1.3.3-3 shall be decreased per band, respectively, by the peak EIRP relaxation parameter $\Delta MB_{P,n}$ and EIRP spherical coverage relaxation parameter $\Delta MB_{S,n}$, as indicated in Table 6.2.1.1.3.3-4 to 6.2.1.1.3.3-5. For Rel-15 UE, each combination of supported bands $\Delta MB_{P,n}$ and $\Delta MB_{S,n}$ apply to each supported band n , such that the total relaxations, $\sum MB_P$ and $\sum MB_S$, across all supported bands shall not exceed the total value indicated in Table 6.2.1.1.3.3-4.

Table 6.2.1.1.3.3-4: UE multi-band relaxation factors for power class 3 (Rel-15)

Supported bands	$\sum MB_P$ (dB)	$\sum MB_S$ (dB)
n257, n258	≤ 1.3	≤ 1.25
n257, n260	$\leq 1.0^3$	$\leq 0.75^3$
n258, n260	$\leq 1.0^3$	$\leq 0.75^3$
n258, n261	≤ 1.0	≤ 1.25
n260, n261	0.0	$\leq 0.75^2$
n257, n261	0.0	0.0
n257, n258, n260	$\leq 1.7^3$	$\leq 1.75^3$
n257, n258, n261	≤ 1.7	≤ 1.75
n257, n260, n261	$\leq 0.5^3$	$\leq 1.25^3$
n258, n260, n261	$\leq 1.5^3$	$\leq 1.25^3$
n257, n258, n260, n261	$\leq 1.7^3$	$\leq 1.75^3$
NOTE 1: The requirements in this table are applicable to UEs which support only the indicated bands.		
NOTE 2: For supported bands n260 + n261, $\Delta MB_{S,n}$ is not applied for band n260.		
NOTE 3: For band n260, maximum applicable $\Delta MB_{S,n}$ is 0.4 dB and $\Delta MB_{P,n}$ is 0.75 dB.		
NOTE 4: For all bands except n260, the maximum applicable $\Delta MB_{P,n}$ and $\Delta MB_{S,n}$ is 0.75 dB.		

Table 6.2.1.1.3.3-5: UE multi-band relaxation factors for power class 3 (Rel-16 and forward)

Band	$\Delta MB_{P,n}$ (dB)	$\Delta MB_{S,n}$ (dB)
n257	0.7^3	0.7^3
n258	0.6	0.7
n259	0.5	0.4
n260	0.5^1	0.4^1
n261	$0.5^{2,4}$	0.7^4
Note 1: n260 peak and spherical relaxations are 0 dB for UE that exclusively supports n261+n260		
Note 2: n261 peak relaxation is 0 dB for UE that exclusively supports n261+n260		
Note 3: n257 peak and spherical relaxations are 0 dB for UE that exclusively supports n261+n257		
Note 4: n261 peak and spherical relaxations are 0 dB for UE that exclusively supports n261+n257		

6.2.1.1.3.4 UE maximum output power for power class 4

The following requirements define the maximum output power radiated by the UE for any transmission bandwidth within the channel bandwidth for non-CA configuration, unless otherwise stated. The period of measurement shall be at least one sub frame (1ms). The minimum output power values for EIRP are found in Table 6.2.1.1.3.4-1. The requirement is verified with the test metric of EIRP (Link=TX beam peak direction, Meas=Link angle).

Table 6.2.1.1.3.4-1: UE minimum peak EIRP for power class 4

Operating band	Min peak EIRP (dBm)
n257	34
n258	34
n260	31
n261	34
NOTE 1: Minimum peak EIRP is defined as the lower limit without tolerance	

The maximum output power values for TRP and EIRP are found in Table 6.2.1.1.3.4-2 below. The maximum allowed EIRP is derived from regulatory requirements [8]. The requirements are verified with the test metrics of TRP (Link=TX beam peak direction, Meas=TRP grid) in beam locked mode and EIRP (Link=TX beam peak direction, Meas=Link angle).

Table 6.2.1.1.3.4-2: UE maximum output power limits for power class 4

Operating band	Max TRP (dBm)	Max EIRP (dBm)
n257	23	43
n258	23	43
n260	23	43
n261	23	43

The minimum EIRP at the 20th percentile of the distribution of radiated power measured over the full sphere around the UE is defined as the spherical coverage requirement and is found in Table 6.2.1.1.3.4-3 below. The requirement is verified with the test metric of EIRP (Link=Spherical coverage grid, Meas=Link angle).

Table 6.2.1.1.3.4-3: UE spherical coverage for power class 4

Operating band	Min EIRP at 20%-tile CDF (dBm)
n257	25
n258	25
n260	19
n261	25
NOTE 1: Minimum EIRP at 20%-tile CDF is defined as the lower limit without tolerance	
NOTE 2: The requirements in this table are verified only under normal temperature conditions as defined in TS 38.508-1 [10] clause 4.1.1.	

6.2.1.1.3.5 UE maximum output power for power class 5

The following requirements define the maximum output power radiated by the UE for any transmission bandwidth within the channel bandwidth for non-CA configuration, unless otherwise stated. The period of measurement shall be at least one sub frame (1ms). In case of initial access and RRC_INACTIVE, the cumulative period of measurement shall equal or exceed 1ms. The minimum output power values for EIRP are found in Table 6.2.1.1.3.5-1. The requirement is verified with the test metric of EIRP (Link=TX beam peak direction, Meas=Link angle).

Table 6.2.1.1.3.5-1: UE minimum peak EIRP for power class 5

Operating band	Min peak EIRP (dBm)
n257	30
n258	30.4
NOTE 1: Minimum peak EIRP is defined as the lower limit without tolerance.	
NOTE 2: Minimum peak EIRP does not apply to initial access and RRC_INACTIVE.	

The maximum output power values for TRP and EIRP are found in Table 6.2.1.1.3.5-2 below. The maximum allowed EIRP is derived from regulatory requirements. The requirements are verified with the test metrics of TRP (Link=TX

beam peak direction, Meas=TRP grid) in beam locked mode and EIRP (Link=TX beam peak direction, Meas=Link angle).

Table 6.2.1.1.3.5-2: UE maximum output power limits for power class 5

Operating band	Max TRP (dBm)	Max EIRP (dBm)
n257	23	43
n258	23	43

The minimum EIRP at the 85th percentile of the distribution of radiated power measured over the full sphere around the UE is defined as the spherical coverage requirement and is found in Table 6.2.1.1.3.5-3 below. The requirement is verified with the test metric of EIRP (Link=Spherical coverage grid, Meas=Link angle).

Table 6.2.1.1.3.5-3: UE spherical coverage for power class 5

Operating band	Min EIRP at 85 %-tile CDF (dBm)
n257	22
n258	22.4

NOTE 1: Minimum EIRP at 85 %-tile CDF is defined as the lower limit without tolerance in RRC_CONNECTED.

NOTE 2: The requirements in this table are verified only under normal temperature conditions as defined in TS 38.508-1 [10] clause 4.1.1.

NOTE 3: Minimum EIRP at 85%-tile CDF is defined as the lower limit minus 2 dB in initial access and RRC_INACTIVE

For the UEs that support multiple FR2 bands, minimum requirement for peak EIRP and EIRP spherical coverage in Tables 6.2.1.5-1 and 6.2.1.5-3 shall be decreased per band, respectively, by the peak EIRP relaxation parameter $\Delta MB_{P,n}$ and EIRP spherical coverage relaxation parameter $\Delta MB_{S,n}$, as defined in Table 6.2.1.1.3.5-4.

Table 6.2.1.1.3.5-4: UE multi-band relaxation factors for power class 5

Band	$\Delta MB_{P,n}$ (dB)	$\Delta MB_{S,n}$ (dB)
n257	0.7	0.7
n258	0.7	0.7

6.2.1.1.3.6 UE maximum output power for power class 6

The following requirements define the maximum output power radiated by the UE for any transmission bandwidth within the channel bandwidth for non-CA configuration, unless otherwise stated. The period of measurement shall be at least one sub frame (1ms). The minimum output power values for EIRP are found in Table 6.2.1.1.3.6-1. The requirement is verified with the test metric of EIRP (Link=TX beam peak direction, Meas=Link angle).

Table 6.2.1.1.3.6-1: UE minimum peak EIRP for power class 6

Operating band	Min peak EIRP (dBm)
n257	30
n258	30.4
n261	30

NOTE 1: Minimum peak EIRP is defined as the lower limit without tolerance

The maximum output power values for TRP and EIRP are found in Table 6.2.1.1.3.6-2 below. The maximum allowed EIRP is derived from regulatory requirements [8]. The requirements are verified with the test metrics of TRP (Link=TX beam peak direction, Meas=TRP grid) in beam locked mode and EIRP (Link=TX beam peak direction, Meas=Link angle).

Table 6.2.1.1.3.6-2: UE maximum output power limits for power class 6

Operating band	Max TRP (dBm)	Max EIRP (dBm)
n257	23	43
n258	23	43
n261	23	43

The minimum EIRP measured over the spherical coverage evaluation areas specified below is defined as the spherical coverage requirement and is found in Table 6.2.1.1.3.6-3 below. UE spherical coverage evaluation areas are found in Table 6.2.1.1.3.6-3a below, by consisting of Area-1 and Area-2, in the reference coordinate system in Annex J.1. The requirement is verified with the test metric of EIRP (Link= Spherical coverage grid, Meas=Link angle).

Table 6.2.1.1.3.6-3: UE spherical coverage for power class 6

Operating band	Min EIRP over UE spherical coverage evaluation areas (dBm)
n257	20
n258	20.4
n261	20
NOTE 1: Minimum EIRP over UE spherical coverage evaluation areas is defined as the lower limit without tolerance.	
NOTE 2: The requirements in this table are verified only under normal temperature conditions as defined in TS 38.508-1 [10] clause 4.1.1.	
NOTE 3: The requirements in this table are applicable to FR2 PC6 UE with the network signalling <i>highSpeedMeasFlagFR2-r17</i> configured as <i>set2</i> .	

Table 6.2.1.1.3.6-3a: UE spherical coverage evaluation areas for power class 6

	θ range (degree)	ϕ range (degree)
Area-1	90 to 60	- 37.5 to + 37.5
Area-2	90 to 60	142.5 to 217.5
NOTE 1: When testing power class 6 UEs, DUT orientation can be determined according to the UE spherical coverage evaluation areas, not necessarily following default alignment in Figure J.1-2 or positioning guidelines in clause J.3.		
NOTE 2: High speed train deployment is expected to be w.r.t. the reference coordination system: $\theta = 90$ (degree) corresponds to the ground plane the train is running on, and $\phi = 0$ or 180 with $\theta = 90$ are the train track directions.		

For the UEs that support multiple FR2 bands, minimum requirement for peak EIRP and EIRP spherical coverage in Tables 6.2.1.1.3.6-1 and 6.2.1.1.3.6-3 shall be decreased per band, respectively, by the peak EIRP relaxation parameter $\Delta MB_{P,n}$ and EIRP spherical coverage relaxation parameter $\Delta MB_{S,n}$, as defined in Table 6.2.1.1.3.6-4.

Table 6.2.1.1.3.6-4: UE multi-band relaxation factors for power class 6

Band	$\Delta MB_{P,n}$ (dB)	$\Delta MB_{S,n}$ (dB)
n257	0.7	0.7
n258	0.7	0.7
n261	0.7	0.7

6.2.1.1.3.7 UE maximum output power for power class 7

The following requirements define the maximum output power radiated by the UE for any transmission bandwidth within the channel bandwidth for non-CA configuration, unless otherwise stated. The period of measurement shall be at least one sub frame (1ms). In case of initial access and RRC_INACTIVE, the cumulative period of measurement shall equal or exceed 1ms. The minimum output power values for EIRP are found in Table 6.2.1.1.3.7-1. The requirement is verified with the test metric of total component of EIRP (Link=TX beam peak direction, Meas=Link angle).

Table 6.2.1.1.3.7-1: UE minimum peak EIRP for power class 7

Operating band	Min peak EIRP (dBm)
n257	16.4
n258	16.4
n261	16.4
NOTE 1: Minimum peak EIRP is defined as the lower limit without tolerance	
NOTE 2: Void	
NOTE 3: Minimum peak EIRP does not apply to initial access and RRC_INACTIVE.	

The maximum output power values for TRP and EIRP are found on the Table 6.2.1.1.3.7-2. The max allowed EIRP is derived from regulatory requirements [8]. The requirements are verified with the test metrics of TRP (Link=TX beam peak direction, Meas=TRP grid) in beam locked mode and the total component of EIRP (Link=TX beam peak direction, Meas=Link angle).

Table 6.2.1.1.3.7-2: UE maximum output power limits for power class 7

Operating band	Max TRP (dBm)	Max EIRP (dBm)
n257	23	43
n258	23	43
n261	23	43

The minimum EIRP at the 50th percentile of the distribution of radiated power measured over the full sphere around the UE is defined as the spherical coverage requirement and is found in Table 6.2.1.1.3.7-3 below. The requirement is verified with the test metric of the total component of EIRP (Link=Beam peak search grids, Meas=Link angle).

Table 6.2.1.1.3.7-3: UE spherical coverage for power class 7

Operating band	Min EIRP at 50 %-tile CDF (dBm)
n257	5.5
n258	5.5
n261	5.5
NOTE 1: Minimum EIRP at 50 %-tile CDF is defined as the lower limit without tolerance in RRC_CONNECTED.	
NOTE 2: The requirements in this table are verified only under normal temperature conditions as defined in TS 38.508-1 [10] clause 4.1.1.	
NOTE 3: Minimum EIRP at 50%-tile CDF is defined as the lower limit minus 2 dB in initial access and RRC_INACTIVE	

For power class 7 UEs that support multiple FR2 bands, minimum requirement for peak EIRP and EIRP spherical coverage in Table 6.2.1.1.3.7-1 and Table 6.2.1.1.3.7-3 shall be decreased per band, respectively, by the peak EIRP relaxation parameter $\Delta MB_{P,n}$ and EIRP spherical coverage relaxation parameter $\Delta MB_{S,n}$, as defined for power class 3 in 6.2.1.1.3.3-5.

The normative reference for this requirement is TS 38.101-2 [3] clause 6.2.1.

6.2.1.1.4 Test description

6.2.1.1.4.1 Initial conditions

Initial conditions are a set of test configurations the UE needs to be tested in and the steps for the SS to take with the UE to reach the correct measurement state.

The initial test configurations consist of environmental conditions, test frequencies, and channel bandwidths based on NR operating bands specified in Table 5.3.5-1. All of these configurations shall be tested with applicable test

parameters for each channel bandwidth and subcarrier spacing, are shown in Table 6.2.1.1.4.1-1. The details of the uplink reference measurement channels (RMCs) are specified in Annexes A.2. Configurations of PDSCH and PDCCH before measurement are specified in Annex C.2.

Table 6.2.1.1.4.1-1: Test Configuration Table

Default Conditions					
Test Environment as specified in TS 38.508-1 [10] clause 4.1			Normal, TL, TH		
Test Frequencies as specified in TS 38.508-1 [10] clause 4.3.1			Low range, Mid Range, High range		
Test Channel Bandwidths as specified in TS 38.508-1 [10] clause 4.3.1			Lowest, 100 MHz, Highest		
Test SCS as specified in Table 5.3.5-1			120 kHz		
Test Parameters					
Test ID	ChBw (NOTE 2)	SCS	Downlink Configuration	Uplink Configuration	
		Default	-	Modulation	RB allocation (NOTE 1)
1	50			DFT-s-OFDM QPSK	Inner_Full for PC2, PC3 PC4, PC5, PC6 and PC7 Inner_Full_Region1 for PC1
2	100				
3	200				
4	400				
NOTE 1: The specific configuration of each RF allocation is defined in Table 6.1-1 for PC2, PC3, PC4, PC5, PC6 and PC7 or Table 6.1-2 for PC1.					
NOTE 2: The 200MHz and 400MHz bandwidths are not applicable to PC7 RedCap UEs					

1. Connection between SS and UE is shown in TS 38.508-1 [10] Annex A, Figure A.3.3.1.1 for TE diagram and Figure A.3.4.1.1 for UE diagram.
2. The parameter settings for the cell are set up according to TS 38.508-1 [10] clause 4.4.3.
3. Downlink signals are initially set up according to Annex C, and uplink signals according to Annex G.
4. The UL Reference Measurement channels are set according to Table 6.2.1.1.4.1-1.
5. Propagation conditions are set according to Annex B.0
6. Ensure the UE is in state RRC_CONNECTED with generic procedure parameters Connectivity NR, Connected without release On, Test Mode On and Test Loop Function On according to TS 38.508-1 [10] clause 4.5. Message contents are defined in clause 6.2.1.1.4.3

6.2.1.1.4.2 Test procedure

1. SS sends uplink scheduling information for each UL HARQ process via PDCCH DCI format 0_1 for C_RNTI to schedule the UL RMC according to Table 6.2.1.1.4.1-1. Since the UL has no payload and no loopback data to send the UE sends uplink MAC padding bits on the UL RMC. Messages to configure the appropriate uplink modulation in section 6.2.1.1.4.3.
- 1a. The side conditions for SSB-based and CSI-RS based L1-RSRP measurements are applied as per clause 6.6.1.3.3.1.1 for PC3 and 6.6.1.3.6.1.1 for PC7.
2. Set the UE in the Tx beam peak direction found with a 3D EIRP scan as performed in Annex K.1.1. Allow at least BEAM_SELECT_WAIT_TIME (NOTE 1) for the UE Tx beam selection to complete.
3. Send continuously uplink power control "up" commands in every uplink scheduling information to the UE; allow at least 200 msec starting from the first TPC command in this step to ensure that the UE transmits at its maximum output power. Allow at least BEAM_SELECT_WAIT_TIME (NOTE 1) for the UE Tx beam selection to complete.
4. SS activates the UE Beamlock Function (UBF) by performing the procedure as specified in TS 38.508-1 [10] clause 4.9.2 using condition Tx only.
5. Measure UE EIRP in the Tx beam peak direction in the channel bandwidth of the radio access mode according to the test configuration, which shall meet the requirements described in Tables 6.2.1.1.5-1 to 6.2.1.1.5-4. EIRP test

procedure is defined in Annex K.1.3. The measuring duration is one active uplink subframe. EIRP is calculated considering both polarizations, theta and phi.

6. Measure TRP of the transmitted signal for the assigned NR channel with a rectangular measurement filter with bandwidths according to Table 6.5.2.3.5-1. Total radiated power is measured according to TRP measurement procedure defined in Annex K.1.7 and measurement grid specified in Annex M.4. TRP is calculated considering both polarizations, theta and phi.
7. SS deactivates the UE Beamlock Function (UBF) by performing the procedure as specified in TS 38.508-1 [10] clause 4.9.3.

NOTE 1: The BEAM_SELECT_WAIT_TIME default value is defined in Annex K.

6.2.1.1.4.3 Message contents

Message contents are according to TS 38.508-1 [10] clause 4.6 with TRANSFORM_PRECODER_ENABLED condition in Table 4.6.3-118 PUSCH-Config.

6.2.1.1.5 Test requirement

The EIRP derived in step 5 and TRP derived in step 6 shall not exceed the values specified in Table 6.2.1.1.5-1 to Table 6.2.1.1.5-4.

Table 6.2.1.1.5-1: UE maximum output test requirements for power class 1

Operating band	Max TRP (dBm)	Max EIRP (dBm)	Min peak EIRP (dBm)
n257	35+TT	55	40.0-TT
n258	35+TT	55	40.0-TT
n260	35+TT	55	38.0-TT
n261	35+TT	55	40.0-TT

Table 6.2.1.1.5-1a: Test Tolerance (Max TRP for Power class 1)

Test Metric	FR2a	FR2b
Max device size \leq 30 cm	2.78 dB, NTC 2.94 dB, ETC	2.87 dB, NTC 3.03 dB, ETC

Table 6.2.1.1.5-1b: Test Tolerance (Min peak EIRP for Power class 1)

Test Metric	FR2a	FR2b
Max device size \leq 30 cm	3.12 dB, NTC 3.28 dB, ETC	3.12 dB, NTC 3.28 dB, ETC

Table 6.2.1.1.5-2: UE maximum output test requirements for power class 2

Operating band	Max TRP (dBm)	Max EIRP (dBm)	Min peak EIRP (dBm)
n257	23+TT	43	29-TT
n258	23+TT	43	29-TT
n260			
n261	23+TT	43	29-TT

Table 6.2.1.1.5-3: UE maximum output test requirements for power class 3 for single band UE

Operating band	Max TRP (dBm)	Max EIRP (dBm)	Min peak EIRP (dBm)
n257	23+TT	43	22.4-TT
n258	23+TT	43	22.4-TT
n259	23+TT	43	18.7-TT
n260	23+TT	43	20.6-TT
n261	23+TT	43	22.4-TT

Table 6.2.1.1.5-3a: UE maximum output test requirements for power class 3 for multi-band UE (Rel-15)

ID	Supported FR2 bands set	Test requirement (dB) (Note 1)				Maximum sum of MB _p , ΣMB _p (dB) (Note 3)	Comments
		n257	n258	n260	n261		
1	n257, n258	22.4-TT-MB _p	22.4-TT-MB _p			1.3	Maximum 0.75 dB relaxation allowed for each band
2	n257, n260	22.4-TT-MB _p		20.6-TT-MB _p		1.0	Maximum 0.75 dB relaxation allowed for each band
3	n258, n260		22.4-TT-MB _p	20.6-TT-MB _p		1.0	Maximum 0.75 dB relaxation allowed for each band
4	n258, n261		22.4-TT-MB _p		22.4-TT-MB _p	1.0	Maximum 0.75 dB relaxation allowed for each band
5	n260, n261			20.6-TT	22.4-TT	0.0	No relaxation factor allowed
6	n257, n258, n260	22.4-TT-MB _p	22.4-TT-MB _p	20.6-TT-MB _p		1.7	Maximum 0.75 dB relaxation allowed for each band
7	n257, n258, n261	22.4-TT-MB _p	22.4-TT-MB _p		22.4-TT-MB _p	1.7	Maximum 0.75 dB relaxation allowed for each band
8	n257, n260, n261	22.4-TT-MB _p		20.6-TT-MB _p	22.4-TT-MB _p	0.5	Maximum 0.75 dB relaxation allowed for each band
9	n258, n260, n261		22.4-TT-MB _p	20.6-TT-MB _p	22.4-TT-MB _p	1.5	Maximum 0.75 dB relaxation allowed for each band
10	n257, n258, n260, n261	22.4-TT-MB _p	22.4-TT-MB _p	20.6-TT-MB _p	22.4-TT-MB _p	1.7	Maximum 0.75 dB relaxation allowed for each band
11	n257, n261	22.4-TT			22.4-TT	0.0	No relaxation factor allowed

Note 1: MB_p is the Multi-band Relaxation factor declared by the UE for the tested band in table A.4.3.9-2 of TS38.508-2 [11]. This declaration shall fulfil the requirements in Table 6.2.1.1.3.3-4.
 Note 2: All UE supported bands needs to be tested to ensure the multi-band relaxation declaration is compliant
 Note 3: Max allowed sum of MB_p over all supported FR2 bands as defined in clause 6.2.1.1.3.3.
 Note 4: For a Rel-15 UE supporting FR2 bands set not defined in Table 6.2.1.1.3.3-4, Table 6.2.1.1.5-3d applies.

Table 6.2.1.1.5-3b: Test Tolerance (Max TRP for Power class 3)

Test Metric	FR2a	FR2b	FR2c
Max device size ≤ 30 cm	2.77 dB, NTC 2.91 dB, ETC	2.89 dB, NTC 3.04 dB, ETC	3.70 dB, NTC 3.78 dB, ETC

Table 6.2.1.1.5-3c: Test Tolerance (Min peak EIRP for Power class 3)

Test Metric	FR2a	FR2b	FR2c
-------------	------	------	------

Max device size ≤ 30 cm	2.99 dB, NTC 3.15 dB, ETC	2.99 dB, NTC 3.15 dB, ETC	3.80 dB, NTC 3.89 dB, ETC
-------------------------	------------------------------	------------------------------	------------------------------

Table 6.2.1.1.5-3d: UE maximum output test requirements for power class 3 (Rel-16 and forward)

ID	FR2 bands/set	Test requirement (dB) (Note 1)					Comments
		n257	n258	n259	n260	n261	
1	n257	22.4-TT- $\Delta MB_{P,n}$					
2	n258		22.4-TT- $\Delta MB_{P,n}$				
3	n259			18.7-TT- $\Delta MB_{P,n}$			
4	n260				20.6-TT- $\Delta MB_{P,n}$		
5	n261					22.4-TT- $\Delta MB_{P,n}$	
6	n257, n261	22.4-TT				22.4-TT	$\Delta MB_{P,n}$ relaxation is 0 dB
7	n260, n261				20.6-TT	22.4-TT	$\Delta MB_{P,n}$ relaxation is 0 dB

Note 1: $\Delta MB_{P,n}$ is the Multi-band Relaxation factor for the tested band. This shall fulfil the requirements in Table 6.2.1.1.3.3-5.

Table 6.2.1.1.5-4: UE maximum output power test requirements for power class 4

Operating band	Max TRP (dBm)	Max EIRP (dBm)	Min peak EIRP (dBm)
n257	23+TT	43	34-TT
n258	23+TT	43	34-TT
n260	23+TT	43	31-TT
n261	23+TT	43	34-TT

Table 6.2.1.1.5-5: UE maximum output power test requirements for power class 5

Operating band	Max TRP (dBm)	Max EIRP (dBm)	Min peak EIRP (dBm)
n257	23+TT	43	30.0-TT- $\Delta MB_{P,n}$
n258	23+TT	43	30.4-TT- $\Delta MB_{P,n}$

Note 1: $\Delta MB_{P,n} = 0$ for single band UE. For multi-band UEs, $\Delta MB_{P,n}$ is defined in table 6.2.1.1.3.5-4.

Table 6.2.1.1.5-5a: Test Tolerance (Max TRP for Power class 5)

Test Metric	FR2a
Max device size ≤ 30 cm	2.78 dB, NTC 2.94 dB, ETC

Table 6.2.1.1.5-5b: Test Tolerance (Min peak EIRP for Power class 5)

Test Metric	FR2a
Max device size ≤ 30 cm	3.12 dB, NTC 3.28 dB, ETC

Table 6.2.1.1.5-6: UE maximum output power test requirements for power class 6

Operating band	Max TRP (dBm)	Max EIRP (dBm)	Min peak EIRP (dBm)
n257, n261	23+TT	43	30.0-TT- $\Delta MB_{P,n}$

n258	23+TT	43	30.4-TT- $\Delta MB_{P,n}$
Note 1: $\Delta MB_{P,n} = 0$ for single band UE. For multi-band UEs, $\Delta MB_{P,n}$ is defined in table 6.2.1.1.3.5-4.			

Table 6.2.1.1.5-6a: Test Tolerance (Max TRP for Power class 6)

Test Metric	FR2a
Max device size ≤ 30 cm	2.78 dB, NTC 2.94 dB, ETC

Table 6.2.1.1.5-6b: Test Tolerance (Min peak EIRP for Power class 6)

Test Metric	FR2a
Max device size ≤ 30 cm	3.11 dB, NTC 3.27 dB, ETC

Table 6.2.1.1.5-7: UE maximum output power test requirements for power class 7

Operating band	Max TRP (dBm)	Max EIRP (dBm)	Min peak EIRP (dBm)
n257	23+TT	43	16.4-TT
n258	23+TT	43	16.4-TT
n261	23+TT	43	16.4-TT

Table 6.2.1.1.5-7a: UE maximum output test requirements for power class 7 (Rel-16 and forward)

ID	FR2 bands/set	Test requirement (dB) (Note 1)					Comments
		n257	n258	n259	n260	n261	
1	n257	16.4-TT- $\Delta MB_{P,n}$					
2	n258		16.4-TT- $\Delta MB_{P,n}$				
3	n261					16.4-TT- $\Delta MB_{P,n}$	
4	n257, n261	16.4-TT				16.4-TT	$\Delta MB_{P,n}$ relaxation is 0 dB

Note 1: $\Delta MB_{P,n}$ is the Multi-band Relaxation factor for the tested band. This shall fulfil the requirements in Table 6.2.1.1.3.3-5.

Table 6.2.1.1.5-7b: Test Tolerance (Max TRP for Power class 7)

Test Metric	FR2a
Max device size ≤ 30 cm	2.77 dB, NTC 2.91 dB, ETC

Table 6.2.1.1.5-7c: Test Tolerance (Min peak EIRP for Power class 7)

Test Metric	FR2a
Max device size ≤ 30 cm	2.99 dB, NTC 3.15 dB, ETC

6.2.1.1_1 UE maximum output power - EIRP and TRP (Rel16 and forward)

Editor's note: The following aspects are either missing or not yet determined:

- Same as in 6.2.1.1

6.2.1.1_1.1 Test purpose

Same as 6.2.1.1.1

6.2.1.1_1.2 Test applicability

This test case applies to all types of NR Power Class 3 UEs release 16 and forward supporting SSB-based or CSI-RS based enhanced beam correspondence.

This test case also applies to all types of release 17 and forward NR Power Class 7 UEs supporting SSB-based or CSI-RS based enhanced beam correspondence.

6.2.1.1_1.3 Minimum conformance requirements

Same as clause 6.2.1.1.3 including UE multi-band relaxation factors defined for Rel-16 and forward UEs supporting power class 3, power class 5, power class 6 or power class 7.

6.2.1.1_1.4 Test description

6.2.1.1_1.4.1 Initial conditions

Same as clauses 6.2.1.1.4.1 and 6.6.1.4.3.

6.2.1.1_1.4.2 Test procedure

The following cases are tested depending on UE capability:

1. Test procedure if *beamCorrespondenceWithoutUL-BeamSweeping* is NOT supported and *beamCorrespondenceSSB-based-r16* is supported:
 - 1.1 Same as clause 6.2.1.1.4.2 with the exception that step 6 is skipped and measurements shall be carried out using only side conditions defined in clause 6.6.2.3.1.3.1 for PC3.
 - 1.2 Skip to Step 7.
2. Test procedure if *beamCorrespondenceWithoutUL-BeamSweeping* is NOT supported, and *beamCorrespondenceCSI-RS-based-r16* is supported
 - 2.1 Same as clause 6.2.1.1.4.2 with the exception that step 6 is skipped and measurements shall be carried out using only side conditions defined in clause 6.6.2.3.1.3.2 for PC3.
 - 2.2 Skip to Step 7.
3. Test procedure if *beamCorrespondenceWithoutUL-BeamSweeping* is NOT supported, *beamCorrespondenceCSI-RS-based-r16* and *beamCorrespondenceSSB-based-r16* are supported
 - 3.1 Same as clause 6.2.1.1.4.2 with the exception that step 6 is skipped and measurements shall be carried out using only side conditions defined in clause 6.3.2.3.1.3.2 for PC3.
 - 3.2 Repeat clause 6.2.1.1.4.2 with step 6 skipped with Tx Beam Peak direction determined using the side conditions in clause 6.3.2.3.1.3.2 for PC3. Record the verdict (as this result will not be compared to test requirements in this test case but in a different one).
 - 3.3 Skip to Step 7.
4. Test procedure if *beamCorrespondenceWithoutUL-BeamSweeping* is supported and *beamCorrespondenceSSB-based-r16* is supported:
 - 4.1 Same as clause 6.2.1.1.4.2 with the exception that step 6 is skipped and measurements shall be carried out using only side conditions defined in clause 6.6.2.3.1.3.1 for PC3 and clause 6.6.2.3.4.3.1 for PC7.
 - 4.2 Skip to Step 7.

5. Test procedure if beamCorrespondenceWithoutUL-BeamSweeping is supported and beamCorrespondenceCSI-RS-based-r16 is supported:
 - 5.1 Same as clause 6.2.1.1.4.2 with the exception that step 6 is skipped and measurements shall be carried out using only side conditions defined in clause 6.6.2.3.1.3.2 for PC3 and clause 6.6.2.3.4.3.2 for PC7.
 - 5.2 Skip to Step 7.
6. Test procedure if beamCorrespondenceWithoutUL-BeamSweeping is supported, beamCorrespondenceCSI-RS-based-r16 and beamCorrespondenceSSB-based-r16 is supported
 - 6.1 Same as clause 6.2.1.1.4.2 with the exception that step 6 is skipped and measurements shall be carried out using only side conditions defined in clause 6.6.2.3.1.3.1 for PC3 and clause 6.6.2.3.4.3.1 for PC7.
 - 6.2 Repeat clause 6.2.1.1.4.2 with step 6 skipped with Tx Beam Peak direction determined using the side conditions in clause 6.6.2.3.1.3.2 for PC3 and clause 6.6.2.3.4.3.2 for PC7. Record the verdict (as this result will not be compared to test requirements in this test case but in a different one).
7. Set side conditions for SSB-based and CSI-RS based L1-RSRP measurements as per clause 6.6.1.3.3.1.1 for PC3 and clause 6.6.1.3.6.1.1 for PC7.
8. Send continuously uplink power control "up" commands in every uplink scheduling information to the UE; allow at least 200 msec starting from the first TPC command in this step to ensure that the UE transmits at its maximum output power. Allow at least BEAM_SELECT_WAIT_TIME (NOTE 1) for the UE Tx beam selection to complete.
9. SS activates the UE BeamlockFunction (UBF) by performing the procedure as specified in TS 38.508-1 [10] clause 4.9.2 using condition Tx only.
10. Measure TRP of the transmitted signal for the assigned NR channel with a rectangular measurement filter with bandwidths according to Table 6.5.2.3.5-1. Total radiated power is measured according to TRP measurement procedure defined in Annex K.1.7 and measurement grid specified in Annex M.4. TRP is calculated considering both polarizations, theta and phi.
11. SS deactivates the UE Beamlock Function (UBF) by performing the procedure as specified in TS 38.508-1 [10] clause 4.9.3.

NOTE 1: The BEAM_SELECT_WAIT_TIME default value is defined in Annex K.

6.2.1.1_1.4.3 Message contents

Same as clauses 6.2.1.1.4.3 and 6.6.1.4.3.

6.2.1.1_1.5 Test requirement

Same as clauses 6.2.1.1.5 including UE multi-band relaxation factors defined for Rel-16 and forward UEs supporting power class 3, power class 5, power class 6 or power class 7.

6.2.1.2 UE maximum output power - Spherical coverage

Editor's note: The following aspects are either missing or not yet determined:

- **Measurement Uncertainties and Test Tolerances are FFS for power class other than 1, 3, 5, 6 and 7.**

6.2.1.2.1 Test purpose

To verify that the spatial coverage of the UE in expected directions is acceptable.

6.2.1.2.2 Test applicability

This test case applies to all types of release 15 NR UEs.

This test case also applies to all types of release 16 and forward NR Power Class 1, Power Class 2 and Power Class 4 UEs.

This test case also applies to all types of release 16 and forward NR Power Class 3 UEs not supporting CSI-RS based or SSB-based enhanced beam correspondence. This test case also applies to all types of release 17 and forward NR Power Class 7 UEs not supporting CSI-RS based or SSB-based enhanced beam correspondence.

6.2.1.2.3 Minimum conformance requirements

Minimum conformance requirements are defined in clause 6.2.1.1.3.

6.2.1.2.4 Test description

6.2.1.2.4.1 Initial conditions

Initial conditions are a set of test configurations the UE needs to be tested in and the steps for the SS to take with the UE to reach the correct measurement state.

The initial test configurations consist of environmental conditions, test frequencies, and channel bandwidths based on NR operating bands specified in Table 5.3.5-1. All of these configurations shall be tested with applicable test parameters for each channel bandwidth and subcarrier spacing, are shown in Table 6.2.1.2.4.1-1. The details of the uplink reference measurement channels (RMCs) are specified in Annexes A.2. Configurations of PDSCH and PDCCH before measurement are specified in Annex C.2.

Table 6.2.1.2.4.1-1: Test Configuration Table

Default Conditions					
Test Environment as specified in TS 38.508-1 [10] clause 4.1			Normal		
Test Frequencies as specified in TS 38.508-1 [10] clause 4.3.1			Low range, Mid Range, High range		
Test Channel Bandwidths as specified in TS 38.508-1 [10] clause 4.3.1			Lowest, Highest		
Test SCS as specified in Table 5.3.5-1			120 kHz		
Test Parameters					
Test ID	ChBw	SCS	Downlink Configuration	Uplink Configuration	
		Default	-	Modulation	RB allocation (NOTE 1)
1	50			DFT-s-OFDM QPSK	Inner_Full for PC2, PC3, PC4, PC5, PC6 and PC7 Inner_Full_Region1 for PC1
2	100				
3	200				
4	400				
NOTE 1: The specific configuration of each RF allocation is defined in Table 6.1-1 for PC2, PC3, PC4, PC5, PC6 and PC7 or Table 6.1-2 for PC1.					

1. Connection between SS and UE is shown in TS 38.508-1 [10] Annex A, Figure A.3.3.1.1 for TE diagram and Figure A.3.4.1.1 for UE diagram.
2. The parameter settings for the cell are set up according to TS 38.508-1 [10] clause 4.4.3.
3. Downlink signals are initially set up according to Annex C, and uplink signals according to Annex G.
4. The UL Reference Measurement channels are set according to Table 6.2.1.2.4.1-1.
5. Propagation conditions are set according to Annex B.0.
6. Ensure the UE is in state RRC_CONNECTED with generic procedure parameters Connectivity NR, Connected without release On, Test Mode On and Test Loop Function On according to TS 38.508-1 [10] clause 4.5. Message contents are defined in clause 6.2.1.2.4.3

6.2.1.2.4.2 Test procedure

1. SS sends uplink scheduling information for each UL HARQ process via PDCCH DCI format 0_1 for C_RNTI to schedule the UL RMC according to Table 6.2.1.2.4.1-1. Since the UL has no payload and no loopback data to send the UE sends uplink MAC padding bits on the UL RMC. Messages to configure the appropriate uplink modulation in section 6.2.1.2.4.3.

- 1a. The side conditions for SSB-based and CSI-RS based L1-RSRP measurements are applied as per clause 6.6.1.3.3.1.1 for PC3 and 6.6.1.3.6.1.1 for PC7.
2. Send continuously uplink power control "up" commands in every uplink scheduling information to the UE; allow at least 200 msec to ensure that the UE transmits at its maximum output power. Allow at least BEAM_SELECT_WAIT_TIME (NOTE 1) for the UE Tx beam selection to complete.
3. Through its beam correspondence procedure, DUT refines its TX beam toward that direction depending on DUT's beam correspondence capability which shall match OEM declaration:
 - 3a If the DUT's beam correspondence capability `beamCorrespondenceWithoutUL-BeamSweeping` is supported, then DUT autonomously chooses the corresponding TX beam for PUSCH transmission using downlink reference signals to transmit in the direction of the incoming DL signal, which is based on beam correspondence without relying on UL beam sweeping;
 - 3b If the DUT's beam correspondence capability `beamCorrespondenceWithoutUL-BeamSweeping` is not present, then DUT chooses the TX beam for PUSCH transmission which is based on beam correspondence with relying on both DL measurements on downlink reference signals and network-assisted uplink beam sweeping:
 - 3b.1) DUT uses downlink reference signals to select proper RX beam and uses autonomous beam correspondence to select the TX beam.
 - 3b.2) SS configures M=8 SRS resources to DUT, with the field *spatialRelationInfo* omitted and the field usage set as 'beamManagement'. In case DUT supports less than 8 SRS resources, SS configures the number of SRS resources according to the maximum number of SRS resources indicated by UE capability signalling. Additionally, for codebook based PUSCH transmission, SS configures a semi-persistent SRS resource set with the field *usage* as 'codebook'.
 - 3b.3) Based on the TX beam autonomously selected by DUT, DUT chooses TX beams to transmit SRS-resources configured by SS.
 - 3b.4) Based on measurement of the received *beamManagement* SRS, SS chooses the best SRS beam and, if needed, updates the spatial relation information between the semi-persistent *codebook* SRS resources and the SS selected *beamManagement* SRS resource in the activation MAC CE of the semi-persistent SRS resource. The SS indicates in the SRS Resource Indicator (SRI) field in the scheduling grant for PUSCH, if present, the SRS resource within the semi-persistent SRS resource set whose spatial relation is linked to the best detected SRS beam.
 - 3b.5) DUT transmits PUSCH corresponding to the SRS resource indicated by the SRI.

For power class UEs other than PC6, steps 4 and 5 apply:

4. Measure UE EIRP value for each grid point according to the EIRP spherical coverage procedure defined in Annex K.1.5, and obtain a cumulative distribution function (CDF) of all EIRP dBm values. Alternatively, UE EIRP measurement for each grid point could be done according to Tx Fast spherical coverage procedure defined in Annex K.1.5.1. After a rotation, allow at least BEAM_SELECT_WAIT_TIME (NOTE 1) for UE to find the best beam to use. The measuring duration is one active uplink subframe. EIRP is calculated considering both polarizations, theta and phi.
5. Identify the EIRP dBm value corresponding to %-tile (UE power class dependent) value in the applicable test requirement table in section 6.2.1.2.5.

For power class 6 UEs, steps 6 and 7 apply:

6. Measure UE EIRP value for each grid point within the UE spherical coverage evaluation areas, Area-1 and Area-2, per Table 6.2.1.1.3.6-3a. After a rotation, allow at least BEAM_SELECT_WAIT_TIME (NOTE 1) for UE to find the best beam to use. The measuring duration is one active uplink subframe. EIRP is calculated considering both polarizations, theta and phi and EIRP needs to be recorded separately for both link polarizations EIRP(PolLink= θ), EIRP(PolLink= ϕ).
7. Identify the minimum EIRP dBm value corresponding to value in the applicable test requirement table in clause 6.2.1.2.5.

NOTE 1: The BEAM_SELECT_WAIT_TIME default value is defined in Annex K.

6.2.1.2.4.3 Message contents

Message contents are according to TS 38.508-1 [10] clause 4.6 with TRANSFORM_PRECODER_ENABLED condition in Table 4.6.3-118 PUSCH-Config.

6.2.1.2.5 Test requirement

The defined %-tile EIRP in measurement distribution derived in step 5 shall exceed the values specified in Table 6.2.1.2.5-1 to Table 6.2.1.2.5-4.

Table 6.2.1.2.5-1: UE spherical coverage for power class 1

Operating band	Min EIRP at 85%-tile CDF (dBm)
n257	32.0-TT
n258	32.0-TT
n260	30.0-TT
n261	32.0-TT

Table 6.2.1.2.5-1a: Test Tolerance (UE spherical coverage for Power class 1)

Test Metric	FR2a	FR2b
Max device size ≤ 30 cm	2.69 dB	2.69 dB

Table 6.2.1.2.5-2: UE spherical coverage for power class 2

Operating band	Min EIRP at 60%-tile CDF (dBm)
n257	18.0-TT
n258	18.0-TT
n260	
n261	18.0-TT

Table 6.2.1.2.5-3: UE spherical coverage for power class 3 for single band UE or multiband UE declaring MB_s = 0 in all FR2 bands

Operating band	Min EIRP at 50%-tile CDF (dBm)
n257	11.5-TT
n258	11.5-TT
n259	5.8-TT
n260	8-TT
n261	11.5-TT

Table 6.2.1.2.5-3a: UE spherical coverage for power class 3 for multi band UE declaring MB_s>0 in any FR2 band (Rel-15)

ID	Supported FR2 bands set	Test requirement (dB) (Note 1)				Maximum sum of MB _s , ∑MB _s (dB) (Note 3)	Comments
		n257	n258	n260	n261		
1	n257, n258	11.5-TT-MB _s	11.5-TT-MB _s			1.25	Maximum 0.75 dB relaxation allowed for each band
2	n257, n260	11.5-TT-MB _s		8-TT-MB _s		0.75	Maximum 0.4 dB relaxation allowed for n260 and 0.75 dB relaxation allowed for all other bands

3	n258, n260		11.5-TT-MB _s	8-TT-MB _s		0.75	Maximum 0.4 dB relaxation allowed for n260 and 0.75 dB relaxation allowed for all other bands
4	n258, n261		11.5-TT-MB _s		11.5-TT-MB _s	1.25	Maximum 0.75 dB relaxation allowed for each band
5	n260, n261			8-TT-MB _s	11.5-TT-MB _s	0.75	No relaxation allowed for n260 and 0.75 dB relaxation allowed for all other bands
6	n257, n258, n260	11.5-TT-MB _s	11.5-TT-MB _s	8-TT-MB _s		1.75	Maximum 0.4 dB relaxation allowed for n260 and 0.75 dB relaxation allowed for all other bands
7	n257, n258, n261	11.5-TT-MB _s	11.5-TT-MB _s		11.5-TT-MB _s	1.75	Maximum 0.75 dB relaxation allowed for each band
8	n257, n260, n261	11.5-TT-MB _s		8-TT-MB _s	11.5-TT-MB _s	1.25	Maximum 0.4 dB relaxation allowed for n260 and 0.75 dB relaxation allowed for all other bands
9	n258, n260, n261		11.5-TT-MB _s	8-TT-MB _s	11.5-TT-MB _s	1.25	Maximum 0.4 dB relaxation allowed for n260 and 0.75 dB relaxation allowed for all other bands
10	n257, n258, n260, n261	11.5-TT-MB _s	11.5-TT-MB _s	8-TT-MB _s	11.5-TT-MB _s	1.75	Maximum 0.4 dB relaxation allowed for n260 and 0.75 dB relaxation allowed for all other bands
<p>Note 1: MB_s is the Multiband Relaxation factor declared by the UE for the tested band in table A.4.3.9-3 of TS38.508-2 [11]. This declaration shall fulfil the requirements in Table 6.2.1.1.3.3-4.</p> <p>Note 2: All UE supported bands needs to be tested to ensure the multiband relaxation declaration is compliant</p> <p>Note 3: Max allowed sum of MB_s over all supported FR2 bands as defined in clause 6.2.1.1.3.3.</p> <p>Note 4: For a Rel-15 UE supporting FR2 bands set not defined in Table 6.2.1.1.3.3-4, Table 6.2.1.2.5-3c applies.</p>							

Table 6.2.1.2.5-3b: Test Tolerance (UE spherical coverage for Power class 3)

Test Metric	FR2a	FR2b	FR2c
Max device size ≤ 30 cm	2.69 dB	2.69 dB	3.50 dB

Table 6.2.1.2.5-3c: UE spherical coverage for power class 3 (Rel-16 and forward)

ID	FR2 bands/set	Test requirement (dB) (Note 1)					Comments
		n257	n258	n259	n260	n261	
1	n257	11.5-TT- ΔMB _{s,n}					
2	n258		11.5-TT- ΔMB _{s,n}				
3	n259			5.8-TT- ΔMB _{s,n}			
4	n260				8-TT- ΔMB _{s,n}		
5	n261					11.5-TT- ΔMB _{s,n}	
6	n257, n261	11.5-TT- ΔMB _{s,n}				11.5-TT- ΔMB _{s,n}	ΔMB _{s,n} relaxation is 0 dB

7	n260, n261				8-TT- $\Delta MB_{s,n}$	11.5-TT- $\Delta MB_{s,n}$	$\Delta MB_{s,n}$ relaxation is 0 dB for n260
Note 1: $\Delta MB_{s,n}$ is the Multiband Relaxation factor for the tested band. This shall fulfil the requirements in Table 6.2.1.1.3.3-5.							

Table 6.2.1.2.5-4: UE spherical coverage for power class 4

Operating band	Min EIRP at 20%-tile CDF (dBm)
n257	25
n258	25
n260	19
n261	25

Table 6.2.1.2.5-5: UE spherical coverage for power class 5

Operating band	Min EIRP at 85%-tile CDF (dBm)
n257	22.0-TT- $\Delta MB_{s,n}$
n258	22.4-TT- $\Delta MB_{s,n}$
Note 1: $\Delta MB_{s,n} = 0$ for single band UE. For multi-band UEs, $\Delta MB_{s,n}$ is defined in table 6.2.1.1.3.5-5.	

Table 6.2.1.2.5-5a: Test Tolerance (UE spherical coverage for Power class 5)

Test Metric	FR2a
Max device size \leq 30 cm	2.69 dB

Table 6.2.1.2.5-6: UE spherical coverage for power class 6

Operating band	Min EIRP at 85%-tile CDF (dBm)
n257, n261	20.0-TT- $\Delta MB_{s,n}$
n258	20.4-TT- $\Delta MB_{s,n}$
NOTE 1: $\Delta MB_{s,n} = 0$ for single band UE. For multi-band UEs, $\Delta MB_{s,n}$ is defined in table 6.2.1.1.3.6-4.	

Table 6.2.1.2.5-6a: Test Tolerance (UE spherical coverage for Power class 6)

Test Metric	FR2a
Max device size \leq 30 cm	3.11 dB

Table 6.2.1.2.5-7: UE spherical coverage for power class 7

Operating band	Min EIRP at 50 %-tile CDF (dBm)
n257	5.5
n258	5.5
n261	5.5
NOTE 1: Minimum EIRP at 50 %-tile CDF is defined as the lower limit without tolerance	
NOTE 2: The requirements in this table are verified only under normal temperature conditions as defined in TS 38.508-1 [10] clause 4.1.1.	

Table 6.2.1.2.5-7a: Test Tolerance (UE spherical coverage for Power class 7)

Test Metric	FR2a
Max device size \leq 30 cm	2.69 dB

Table 6.2.1.2.5-7b: UE spherical coverage for power class 7 (Rel-16 and forward)

ID	FR2 bands/set	Test requirement (dB) (Note 1)					Comments
		n257	n258	n259	n260	n261	
1	n257	5.5-TT- $\Delta MB_{s,n}$					
2	n258		5.5-TT- $\Delta MB_{s,n}$				
3	n261					5.5-TT- $\Delta MB_{s,n}$	
4	n257, n261	5.5-TT- $\Delta MB_{s,n}$				5.5-TT- $\Delta MB_{s,n}$	$\Delta MB_{s,n}$ relaxation is 0 dB
Note 1: $\Delta MB_{s,n}$ is the Multiband Relaxation factor for the tested band. This shall fulfil the requirements in Table 6.2.1.1.3.3-5.							

6.2.1.2_1 UE maximum output power - Spherical coverage (Rel16 and forward)

Editor's note: The following aspects are either missing or not yet determined:

- Same as in 6.2.1.2

6.2.1.2_1.1 Test purpose

Same as clause 6.2.1.2.1.

6.2.1.2_1.2 Test applicability

This test case applies to all types of NR UE release 16 and forward supporting either SSB-based or CSI-RS based enhanced beam correspondence without UL beam sweeping.

6.2.1.2_1.3 Minimum conformance requirements

Same as clause 6.2.1.2.3 including UE multi-band relaxation factors defined for Rel-16 and forward UEs supporting power class 3, power class 5, power class 6 or power class 7.

6.2.1.2_1.4 Test description

6.2.1.2_1.4.1 Initial conditions

Same as clause 6.2.1.2.4.1

6.2.1.2_1.4.2 Test procedure

The following cases are tested depending on UE capability:

1. Test procedure if *beamCorrespondenceWithoutUL-BeamSweeping* is NOT supported and *beamCorrespondenceSSB-based-r16* is supported:
 - 1.1 Same as clause 6.2.1.2.4.2 with the exception that measurements shall be carried out using only side conditions defined in clause 6.6.2.3.1.3.1 for PC3, clause 6.6.2.3.3.2.1 for PC6 and clause 6.6.2.3.4.3.1 for PC7.
 - 1.2 End test procedure.
2. Test procedure if *beamCorrespondenceWithoutUL-BeamSweeping* is NOT supported, and *beamCorrespondenceCSI-RS-based-r16* is supported
 - 2.1 Same as clause 6.2.1.2.4.2 with the exception that measurements shall be carried out using only side conditions defined in clause 6.6.2.3.1.3.2 for PC3, clause 6.6.2.3.3.2.2 for PC6 and clause 6.6.2.3.4.3.2 for PC7.

2.2 End test procedure.

3. Test procedure if beamCorrespondenceWithoutUL-BeamSweeping is supported and beamCorrespondenceSSB-based-r16 is supported:

3.1 Same as clause 6.2.1.2.4.2 with the exception that measurements shall be carried out using only side conditions defined in clause 6.6.2.3.1.3.1 for PC3, clause 6.6.2.3.3.2.1 for PC6 and clause 6.6.2.3.4.3.1 for PC7.

3.2 End test procedure.

4. Test procedure if beamCorrespondenceWithoutUL-BeamSweeping is supported and beamCorrespondenceCSI-RS-based-r16 is supported:

4.1 Same as clause 6.2.1.2.4.2 with the exception that step 7 is skipped and measurements shall be carried out using only side conditions defined in clause 6.6.2.3.1.3.2 for PC3, clause 6.6.2.3.3.2.2 for PC6 and clause 6.6.2.3.4.3.2 for PC7.

4.2 End test procedure.

6.2.1.2_1.4.3 Message contents

Same as clauses 6.2.1.2.4.3 and 6.6.1.4.3.

6.2.1.2_1.5 Test requirement

Same as clause 6.2.1.2.5 including UE multi-band relaxation factors defined for Rel-16 and forward UEs supporting power class 3, power class 5, power class 6 or power class 7.

6.2.2 UE maximum output power reduction

Editor's note: The following aspects are either missing or not yet determined:

- Measurement Uncertainties and Test Tolerances are FFS for power class other than 1, 3, 5, 6 and 7..
- Measurement grid for PC2/4 in Annex M.4 is FFS.
- How to deal with power classes reusing PC3 MPR requirements, especially those defined from Release 17 and forward, and then the relationship with 6.2.2_1 test is FFS.
- Declaration of the Multiband Relaxation factor for n259 is not defined in TS 38.508-2 [11].

6.2.2.0 General

The requirements in section 6.2.2 only apply when both UL and DL of a UE are configured for single CC operation, and they are of the same bandwidth. A UE may reduce its maximum output power due to modulation orders, transmit bandwidth configurations, waveform types and narrow allocations. This Maximum Power Reduction (MPR) is defined in subclauses below. The allowed MPR for SRS, PUCCH formats 0, 1, 3 and 4 shall be as specified for QPSK modulated DFT-s-OFDM of equivalent RB allocation. The allowed MPR for PUCCH format 2 shall be as specified for QPSK modulated CP-OFDM of equivalent RB allocation. When the maximum output power of a UE is modified by MPR, the power limits specified in clause 6.2.4 apply.

For a UE that is configured for single CC operation with different channel bandwidths in UL and DL, the requirements in section 6.2A.2 apply.

For all power classes, the waveform defined by BW = 100 MHz, SCS = 120 kHz, DFT-S-OFDM QPSK, 20RB23 is the reference waveform with 0 dB MPR and is used for the power class definition.

6.2.2.1 Test purpose

The number of RB identified in 6.2.2.3 is based on meeting the requirements for the maximum power reduction (MPR) due to Cubic Metric (CM).

6.2.2.2 Test applicability

The requirements of this test apply to all types of NR Power Class 2 and Power Class 4 UE release 15 and forward.

The requirements of this test apply to all types of NR Power Class 5 UE release 17 and forward.

The requirements of this test apply to all types of NR Power Class 3 UE release 15 and release 16 which doesn't support modified MPR behaviour bit 0 capability (according to Annex P.1).

The requirements of this test apply to all types of NR Power Class 7 UE release 17 and forward.

6.2.2.3 Minimum conformance requirements

6.2.2.3.1 UE maximum output power reduction for power class 1

For power class 1, MPR for contiguous allocations is defined as:

$$\text{MPR} = \max(\text{MPR}_{\text{WT}}, \text{MPR}_{\text{narrow}})$$

Where,

$\text{MPR}_{\text{narrow}} = 14.4 \text{ dB}$, when $\text{BW}_{\text{alloc, RB}} \leq 1.44 \text{ MHz}$, $\text{MPR}_{\text{narrow}} = 10 \text{ dB}$, when $1.44 \text{ MHz} < \text{BW}_{\text{alloc, RB}} \leq 10.8 \text{ MHz}$, where $\text{BW}_{\text{alloc, RB}}$ is the bandwidth of the RB allocation size.

MPR_{WT} is the maximum power reduction due to modulation orders, transmission bandwidth configurations listed in Table 5.3.2-1, and waveform types. MPR_{WT} is defined in Tables 6.2.2.3.1-1 and 6.2.2.3.1-2.

ΔMPR is due to phase noise for 256 QAM for all transmission bandwidth configurations and defined in Table 6.2.2.3.1-3.

Table 6.2.2.3.1-1: MPR_{WT} for power class 1, $\text{BW}_{\text{channel}} \leq 200 \text{ MHz}$

Modulation		MPR_{WT} (dB), $\text{BW}_{\text{channel}} \leq 200 \text{ MHz}$		
		Outer RB allocations	Inner RB allocations	
			Region 1	Region 2
DFT-s-OFDM	Pi/2 BPSK	≤ 5.5	0.0	≤ 3.0
	QPSK	≤ 6.5	0.0	≤ 3.0
	16 QAM	≤ 6.5	≤ 4.0	≤ 4.0
	64 QAM	≤ 6.5	≤ 5.0	≤ 5.0
	256 QAM ¹	≤ 9.5	≤ 8.0	≤ 8.0
CP-OFDM	QPSK	≤ 7.0	≤ 4.5	≤ 4.5
	16 QAM	≤ 7.0	≤ 5.5	≤ 5.5
	64 QAM	≤ 7.5	≤ 7.5	≤ 7.5
	256 QAM ¹	≤ 10.5	≤ 10.5	≤ 10.5

NOTE 1: Refer to clause 6.1 for 256 QAM applicability.

Table 6.2.2.3.1-2: MPR_{WT} for power class 1, $\text{BW}_{\text{channel}} = 400 \text{ MHz}$

Modulation		MPR_{WT} (dB), $\text{BW}_{\text{channel}} = 400 \text{ MHz}$		
		Outer RB allocations	Inner RB allocations	
			Region 1	Region 2
DFT-s-OFDM	Pi/2 BPSK	≤ 5.5	0.0	≤ 3.0
	QPSK	≤ 6.5	0.0	≤ 3.5
	16 QAM	≤ 6.5	≤ 4.5	≤ 4.5
	64 QAM	≤ 6.5	≤ 6.5	≤ 6.5
	256 QAM ¹	≤ 9.5	≤ 9.5	≤ 9.5
CP-OFDM	QPSK	≤ 7.0	≤ 5.0	≤ 5.0
	16 QAM	≤ 7.0	≤ 6.5	≤ 6.5
	64 QAM	≤ 9.0	≤ 9.0	≤ 9.0
	256 QAM ¹	≤ 12	≤ 12	≤ 12

NOTE 1: Refer to clause 6.1 for 256 QAM applicability.

Table 6.2.2.3.1-3: Δ MPR

Modulation		Band	Δ MPR (dB)
DFT-s-OFDM	256 QAM	n257, n258, n261	0.0
		n259, n260	1.0
CP-OFDM	256 QAM	n257, n258, n261	0.0
		n259, n260	1.0

Where the following parameters are defined to specify valid RB allocation ranges for the RB allocations regions in Tables 6.2.2.3.1-1 and 6.2.2.3.1-2:

N_{RB} is the maximum number of RBs for a given Channel bandwidth and sub-carrier spacing defined in Table 5.3.2-1.

$$RB_{end} = RB_{start} + L_{CRB} - 1$$

$$RB_{start,Low} = \text{Max}(1, \text{Floor}(L_{CRB}/2))$$

$$RB_{start,High} = N_{RB} - RB_{start,Low} - L_{CRB}$$

An RB allocation is an Outer RB allocation if

$$RB_{start} < RB_{start,Low} \text{ OR } RB_{start} > RB_{start,High} \text{ OR } L_{CRB} > \text{Ceil}(N_{RB}/2)$$

An RB allocation belonging to Table 6.2.2.3.1-1 is a Region 1 inner RB allocation if

$$RB_{start} \geq \text{Ceil}(1/3 N_{RB}) \text{ AND } RB_{end} < \text{Ceil}(2/3 N_{RB})$$

An RB allocation belonging to Table 6.2.2.3.1-2 is a Region 1 inner RB allocation if

$$RB_{start} \geq \text{Ceil}(1/4 N_{RB}) \text{ AND } RB_{end} < \text{Ceil}(3/4 N_{RB}) \text{ AND } L_{CRB} \leq \text{Ceil}(1/4 N_{RB})$$

An RB allocation is a Region 2 inner allocation if it is NOT an Outer allocation AND NOT a Region 1 inner allocation.

For the UE maximum output power modified by MPR, the power limits specified in clause 6.2.4 apply.

The normative reference for this requirement is TS 38.101-2 [3] clause 6.2.2.1.

6.2.2.3.2 UE maximum output power reduction for power class 2

For power class 2, MPR (except 256 QAM) as specified in clause 6.2.2.3.3 applies. For 256 QAM, MPR for contiguous allocations is defined as:

$$MPR = \max(MPR_{WT} + \Delta MPR, MPR_{narrow})$$

MPR_{narrow} as specified in clause 6.2.2.3.3 applies.

Δ MPR as specified in Table 6.2.2.3.1-3 applies.

MPR_{WT} is defined in Table 6.2.2.3.2-2 and Table 6.2.2.3.2-3. The RB allocation ranges for RB allocations as specified in clause 6.2.2.3.3 applies.

Table 6.2.2.3.2-1: Void**Table 6.2.2.3.2-2: MPR_{WT} for power class 2, $BW_{channel} \leq 200$ MHz**

Modulation		$MPR_{WT}, BW_{channel} \leq 200$ MHz	
		Inner RB allocations, Region 1	Edge RB allocations
DFT-s-OFDM	256 QAM ¹	≤ 8.0	≤ 8.5
CP-OFDM	256 QAM ¹	≤ 10.5	≤ 10.5

NOTE 1: Refer to clause 6.1 for 256 QAM applicability.

Table 6.2.2.3.2-3: MPR_{WT} for power class 2, BW_{channel} = 400 MHz

Modulation		MPR _{WT} , BW _{channel} = 400 MHz	
		Inner RB allocations, Region 1	Edge RB allocations
DFT-s-OFDM	256 QAM ¹	≤ 9.5	≤ 9.5
CP-OFDM	256 QAM ¹	≤ 12	≤ 12
NOTE 1: Refer to clause 6.1 for 256 QAM applicability.			

The normative reference for this requirement is TS 38.101-2 [3] clause 6.2.2.2.

6.2.2.3.3 UE maximum output power reduction for power class 3

For power class 3, MPR for contiguous allocations is defined as:

$$\text{MPR} = \max(\text{MPR}_{\text{WT}}, \text{MPR}_{\text{narrow}})$$

Where,

$\text{MPR}_{\text{narrow}} = 2.5$ dB, $\text{BW}_{\text{alloc, RB}} \leq 1.44$ MHz, and $0 \leq \text{RB}_{\text{start}} < \text{Ceil}(1/3 N_{\text{RB}})$ or $\text{Ceil}((2/3 N_{\text{RB}}) - \text{L}_{\text{CRB}}) \leq \text{RB}_{\text{start}} \leq N_{\text{RB}} - \text{L}_{\text{CRB}}$, where $\text{BW}_{\text{alloc, RB}}$ is the bandwidth of the RB allocation size.

MPR_{WT} is the maximum power reduction due to modulation orders, transmission bandwidth configurations listed in Table 5.3.2-1, and waveform types. MPR_{WT} is defined in Table 6.2.2.3.3-1 and Table 6.2.2.3.3-2.

Table 6.2.2.3.3-1: MPR_{WT} for power class 3, BW_{channel} ≤ 200 MHz

Modulation		MPR _{WT} , BW _{channel} ≤ 200 MHz	
		Inner RB allocations, Region 1	Edge RB allocations
DFT-s-OFDM	Pi/2 BPSK	0.0	≤ 2.0
	QPSK	0.0	≤ 2.0
	16 QAM	≤ 3.0	≤ 3.5
	64 QAM	≤ 5.0	≤ 5.5
CP-OFDM	QPSK	≤ 3.5	≤ 4.0
	16 QAM	≤ 5.0	≤ 5.0
	64 QAM	≤ 7.5	≤ 7.5

Table 6.2.2.3.3-2: MPR_{WT} for power class 3, BW_{channel} = 400 MHz

Modulation		MPR _{WT} , BW _{channel} = 400 MHz	
		Inner RB allocations, Region 1	Edge RB allocations
DFT-s-OFDM	Pi/2 BPSK	0.0	≤ 3.0
	QPSK	0.0	≤ 3.0
	16 QAM	≤ 4.5	≤ 4.5
	64 QAM	≤ 6.5	≤ 6.5
CP-OFDM	QPSK	≤ 5.0	≤ 5.0
	16 QAM	≤ 6.5	≤ 6.5
	64 QAM	≤ 9.0	≤ 9.0

Where the following parameters are defined to specify valid RB allocation ranges for RB allocations in Tables 6.2.2.3.3-1 and 6.2.2.3.3-2:

N_{RB} is the maximum number of RBs for a given Channel bandwidth and sub-carrier spacing defined in Table 5.3.2-1.

$$\text{RB}_{\text{end}} = \text{RB}_{\text{start}} + \text{L}_{\text{CRB}} - 1$$

An RB allocation belonging to Table 6.2.2.3.3-1 is a Region 1 inner RB allocation if

$$\text{RB}_{\text{start}} \geq \text{Ceil}(1/3 N_{\text{RB}}) \text{ AND } \text{RB}_{\text{end}} < \text{Ceil}(2/3 N_{\text{RB}})$$

An RB allocation belonging to Table 6.2.2.3.3-2 is a Region 1 inner RB allocation if

$$RB_{start} \geq \text{Ceil}(1/4 N_{RB}) \text{ AND } RB_{end} < \text{Ceil}(3/4 N_{RB}) \text{ AND } L_{CRB} \leq \text{Ceil}(1/4 N_{RB})$$

An RB allocation is an Edge allocation if it is NOT a Region 1 inner allocation.

The normative reference for this requirement is clause 6.2.2.3 in TS 38.101-2 [3] V16.1.0.

6.2.2.3.4 UE maximum output power reduction for power class 4

For power class 4, MPR specified in sub-clause 6.2.2.3.3 applies.

Table 6.2.2.3.4-1: Void

The normative reference for this requirement is TS 38.101-2 [3] clause 6.2.2.4.

6.2.2.3.5 UE maximum output power reduction for power class 5

For power class 5, MPR (except 256 QAM) specified in sub-clause 6.2.2.3.3 applies. MPR 256 QAM specified in sub-clause 6.2.2.3.2 applies.

The normative reference for this requirement is TS 38.101-2 [3] clause 6.2.2.5.

6.2.2.3.6 UE maximum output power reduction for power class 6

For power class 6, MPR specified in sub-clause 6.2.2.3.3 applies.

The normative reference for this requirement is TS 38.101-2 [3] clause 6.2.2.6

6.2.2.3.7 UE maximum output power reduction for power class 7

For power class 7, MPR specified in Table 6.2.2.3.3-1 applies.

The normative reference for this requirement is TS 38.101-2 [3] clause 6.2.2.7.

6.2.2.4 Test description

6.2.2.4.1 Initial conditions

Initial conditions are a set of test configurations the UE needs to be tested in and the steps for the SS to take with the UE to reach the correct measurement state.

The initial test configurations consist of environmental conditions, test frequencies, and channel bandwidths based on NR operating bands specified in Table 5.3.5-1. All of these configurations shall be tested with applicable test parameters for each channel bandwidth and subcarrier spacing, are shown in Table 6.2.2.4.1-1 to Table 6.2.2.4.1-9. The details of the uplink reference measurement channels (RMCs) are specified in Annexes A.2. Configurations of PDSCH and PDCCH before measurement are specified in Annex C.2.

Table 6.2.2.4.1-1: Test Configuration Table (Power Class 1, MPR_{narrow})

Default Conditions					
Test Environment as specified in TS 38.508-1 [10] clause 4.1			Normal, TL, TH		
Test Frequencies as specified in TS 38.508-1 [10] clause 4.3.1			Low range, High range		
Test Channel Bandwidths as specified in TS 38.508-1 [10] clause 4.3.1			Lowest and Highest		
Test SCS as specified in Table 5.3.5-1			Lowest, Highest		
Test Parameters					
Test ID	Freq	ChBw	SCS	Downlink Configuration	Uplink Configuration

		Default	Default	-	Modulation	RB allocation (NOTE 1)	
						SCS 60 kHz	SCS 120 kHz
1	Low				CP-OFDM 64 QAM	Outer_1RB_Left	Outer_1RB_Left
2	High				CP-OFDM 64 QAM	Outer_1RB_Right	Outer_1RB_Right
3	Low				CP-OFDM 64 QAM	3@0	2@0
4	High				CP-OFDM 64 QAM	3@N _{RB} -3	2@N _{RB} -2
5	Low				CP-OFDM 64 QAM	15@0	7@0
6	High				CP-OFDM 64 QAM	15@N _{RB} -15	7@N _{RB} -7

NOTE 1: The specific configuration of each RF allocation is defined in Table 6.1-2.

Table 6.2.2.4.1-2: Test Configuration Table (Power Class 1, MPR_{WT}, BW_{channel} ≤ 200 MHz)

Default Conditions							
Test Environment as specified in TS 38.508-1 [10] clause 4.1				Normal, TL, TH			
Test Frequencies as specified in TS 38.508-1 [10] clause 4.3.1				Low range, Mid range, High range			
Test Channel Bandwidths as specified in TS 38.508-1 [10] clause 4.3.1				Lowest and Highest supported channel bandwidth that ≤ 200 MHz			
Test SCS as specified in Table 5.3.5-1				Lowest, Highest			
Test Parameters							
Test ID	Freq	ChBw	SCS	Downlink Configuration	Uplink Configuration		
		Default	Default	-	Modulation	RB allocation (NOTE 1)	
						SCS 60 kHz	SCS 120 kHz
1	Low				DFT-s-OFDM PI/2 BPSK	16@0	8@0
2	High				DFT-s-OFDM PI/2 BPSK	16@N _{RB} -16	8@N _{RB} -8
3	Mid				DFT-s-OFDM PI/2 BPSK	Outer_Full	Outer_Full
4	Mid				DFT-s-OFDM QPSK	Inner_Full_Region2	Inner_Full_Region2
5	Low				DFT-s-OFDM QPSK	16@0	8@0
6	High				DFT-s-OFDM QPSK	16@N _{RB} -16	8@N _{RB} -8
7	Mid				DFT-s-OFDM QPSK	Outer_Full	Outer_Full
8	Mid				DFT-s-OFDM 16 QAM	Inner_Full_Region2	Inner_Full_Region2
9	Low				DFT-s-OFDM 16 QAM	16@0	8@0
10	High				DFT-s-OFDM 16 QAM	16@N _{RB} -16	8@N _{RB} -8
11	Mid				DFT-s-OFDM 16 QAM	Outer_Full	Outer_Full
12	Low				DFT-s-OFDM 64 QAM	16@0	8@0
13	High				DFT-s-OFDM 64 QAM	16@N _{RB} -16	8@N _{RB} -8
14	Mid				DFT-s-OFDM 64 QAM	Outer_Full	Outer_Full
15	Mid				DFT-s-OFDM 64 QAM	Inner_Full_Region2	Inner_Full_Region2
16	Mid				CP-OFDM QPSK	Inner_Full_Region2	Inner_Full_Region2
17	Low				CP-OFDM QPSK	16@0	8@0
18	High				CP-OFDM QPSK	16@N _{RB} -16	8@N _{RB} -8
19	Mid				CP-OFDM QPSK	Outer_Full	Outer_Full
20	Low				CP-OFDM 16 QAM	16@0	8@0
21	High				CP-OFDM 16 QAM	16@N _{RB} -16	8@N _{RB} -8
22	Mid				CP-OFDM 16 QAM	Outer_Full	Outer_Full
23	Mid				CP-OFDM 16 QAM	Inner_Full_Region2	Inner_Full_Region2
24	Low				CP-OFDM 64 QAM	16@0	8@0
25	High				CP-OFDM 64 QAM	16@N _{RB} -16	8@N _{RB} -8
26	Mid	CP-OFDM 64 QAM	Outer_Full	Outer_Full			

NOTE 1: The specific configuration of each RF allocation is defined in clause 6.1-2.

Table 6.2.2.4.1-3: Test Configuration Table (Power Class 1, MPR_{WT}, BW_{channel} = 400 MHz)

Default Conditions	
Test Environment as specified in TS 38.508-1 [10] clause 4.1	Normal, TL, TH
Test Frequencies as specified in TS 38.508-1 [10] clause 4.3.1	Low range, Mid range, High range

Test Channel Bandwidths as specified in TS 38.508-1 [10] clause 4.3.1				400 MHz		
Test SCS as specified in Table 5.3.5-1				120kHz		
Test Parameters						
Test ID	Freq	ChBw	SCS	Downlink Configuration	Uplink Configuration	
		Default	Default	-	Modulation	RB allocation (NOTE 1)
1	Low				DFT-s-OFDM PI/2 BPSK	8@0
2	High				DFT-s-OFDM PI/2 BPSK	8@N _{RB} -8
3	Mid				DFT-s-OFDM PI/2 BPSK	Outer_Full
4	Mid				DFT-s-OFDM PI/2 BPSK	Inner_Full_Region2
5	Mid				DFT-s-OFDM QPSK	Inner_Full_Region2
6	Low				DFT-s-OFDM QPSK	8@0
7	High				DFT-s-OFDM QPSK	8@N _{RB} -8
8	Mid				DFT-s-OFDM QPSK	Outer_Full
9	Mid				DFT-s-OFDM 16 QAM	Inner_Full_Region2
10	Low				DFT-s-OFDM 16 QAM	8@0
11	High				DFT-s-OFDM 16 QAM	8@N _{RB} -8
12	Mid				DFT-s-OFDM 16 QAM	Outer_Full
13	Low				DFT-s-OFDM 64 QAM	8@0
14	High				DFT-s-OFDM 64 QAM	8@N _{RB} -8
15	Mid				DFT-s-OFDM 64 QAM	Outer_Full
16	Mid				CP-OFDM QPSK	Inner_Full_Region2
17	Low				CP-OFDM QPSK	8@0
18	High				CP-OFDM QPSK	8@N _{RB} -8
19	Mid				CP-OFDM QPSK	Outer_Full
20	Low				CP-OFDM 16 QAM	8@0
21	High				CP-OFDM 16 QAM	8@N _{RB} -8
22	Mid				CP-OFDM 16 QAM	Outer_Full
23	Mid				CP-OFDM 16 QAM	Inner_Full_Region2
24	Low				CP-OFDM 64 QAM	8@0
25	High				CP-OFDM 64 QAM	8@N _{RB} -8
26	Mid	CP-OFDM 64 QAM	Outer_Full			
NOTE 1: The specific configuration of each RF allocation is defined in clause 6.1-2.						

Table 6.2.2.4.1-4: Void

Table 6.2.2.4.1-5: Void

Table 6.2.2.4.1-6: Void

Table 6.2.2.4.1-7: Test Configuration Table (Power Class 2, 3, 4, 5, 6 and 7, MPR_{narrow}, BW_{channel} ≤ 200 MHz)

Default Conditions	
Test Environment as specified in TS 38.508-1 [10] clause 4.1	Normal, TL, TH

Test Frequencies as specified in TS 38.508-1 [10] clause 4.3.1		Low range, High range													
Test Channel Bandwidths as specified in TS 38.508-1 [10] clause 4.3.1		Lowest and Highest supported channel bandwidth that ≤ 200 MHz													
Test SCS as specified in Table 5.3.5-1		Lowest, Highest													
Test Parameters															
Test ID	Freq	ChBw	SCS	Downlink Configuration	Uplink Configuration										
		Default	Default	-	<table border="1"> <tr> <th>Modulation</th> <th>RB allocation (NOTE 1)</th> </tr> <tr> <td>DFT-s-OFDM PI/2 BPSK</td> <td>Outer_1RB_Left</td> </tr> <tr> <td>DFT-s-OFDM PI/2 BPSK</td> <td>Outer_1RB_Right</td> </tr> <tr> <td>DFT-s-OFDM QPSK</td> <td>Outer_1RB_Left</td> </tr> <tr> <td>DFT-s-OFDM QPSK</td> <td>Outer_1RB_Right</td> </tr> </table>	Modulation	RB allocation (NOTE 1)	DFT-s-OFDM PI/2 BPSK	Outer_1RB_Left	DFT-s-OFDM PI/2 BPSK	Outer_1RB_Right	DFT-s-OFDM QPSK	Outer_1RB_Left	DFT-s-OFDM QPSK	Outer_1RB_Right
Modulation	RB allocation (NOTE 1)														
DFT-s-OFDM PI/2 BPSK	Outer_1RB_Left														
DFT-s-OFDM PI/2 BPSK	Outer_1RB_Right														
DFT-s-OFDM QPSK	Outer_1RB_Left														
DFT-s-OFDM QPSK	Outer_1RB_Right														
1	Low														
2	High														
3	Low														
4	High														
NOTE 1: The specific configuration of each RF allocation is defined in Table 6.1-1.															

Table 6.2.2.4.1-8: Test Configuration Table (Power Class 2, 3, 4, 5, 6 and 7, MPR_{WT}, BW_{channel} ≤ 200 MHz)

Default Conditions																																															
Test Environment as specified in TS 38.508-1 [10] clause 4.1		Normal, TL, TH																																													
Test Frequencies as specified in TS 38.508-1 [10] clause 4.3.1		Low range, Mid range, High range																																													
Test Channel Bandwidths as specified in TS 38.508-1 [10] clause 4.3.1		Lowest and Highest supported channel bandwidth that ≤ 200 MHz																																													
Test SCS as specified in Table 5.3.5-1		Lowest, Highest																																													
Test Parameters																																															
Test ID	Freq	ChBw	SCS	Downlink Configuration	Uplink Configuration																																										
		Default	Default	-	<table border="1"> <tr> <th>Modulation</th> <th>RB allocation (NOTE 1)</th> </tr> <tr> <td>DFT-s-OFDM PI/2 BPSK</td> <td>Outer_Full</td> </tr> <tr> <td>DFT-s-OFDM QPSK</td> <td>Outer_Full</td> </tr> <tr> <td>DFT-s-OFDM 16 QAM</td> <td>Inner_Full</td> </tr> <tr> <td>DFT-s-OFDM 16 QAM</td> <td>Outer_1RB_Left</td> </tr> <tr> <td>DFT-s-OFDM 16 QAM</td> <td>Outer_1RB_Right</td> </tr> <tr> <td>DFT-s-OFDM 16 QAM</td> <td>Outer_Full</td> </tr> <tr> <td>DFT-s-OFDM 64 QAM</td> <td>Inner_Full</td> </tr> <tr> <td>DFT-s-OFDM 64 QAM</td> <td>Outer_1RB_Left</td> </tr> <tr> <td>DFT-s-OFDM 64 QAM</td> <td>Outer_1RB_Right</td> </tr> <tr> <td>DFT-s-OFDM 64 QAM</td> <td>Outer_Full</td> </tr> <tr> <td>CP-OFDM QPSK</td> <td>Inner_Full</td> </tr> <tr> <td>CP-OFDM QPSK</td> <td>Outer_1RB_Left</td> </tr> <tr> <td>CP-OFDM QPSK</td> <td>Outer_1RB_Right</td> </tr> <tr> <td>CP-OFDM QPSK</td> <td>Outer_Full</td> </tr> <tr> <td>CP-OFDM 16 QAM</td> <td>Outer_1RB_Left</td> </tr> <tr> <td>CP-OFDM 16 QAM</td> <td>Outer_1RB_Right</td> </tr> <tr> <td>CP-OFDM 16 QAM</td> <td>Outer_Full</td> </tr> <tr> <td>CP-OFDM 64 QAM</td> <td>Outer_1RB_Left</td> </tr> <tr> <td>CP-OFDM 64 QAM</td> <td>Outer_1RB_Right</td> </tr> <tr> <td>CP-OFDM 64 QAM</td> <td>Outer_Full</td> </tr> </table>	Modulation	RB allocation (NOTE 1)	DFT-s-OFDM PI/2 BPSK	Outer_Full	DFT-s-OFDM QPSK	Outer_Full	DFT-s-OFDM 16 QAM	Inner_Full	DFT-s-OFDM 16 QAM	Outer_1RB_Left	DFT-s-OFDM 16 QAM	Outer_1RB_Right	DFT-s-OFDM 16 QAM	Outer_Full	DFT-s-OFDM 64 QAM	Inner_Full	DFT-s-OFDM 64 QAM	Outer_1RB_Left	DFT-s-OFDM 64 QAM	Outer_1RB_Right	DFT-s-OFDM 64 QAM	Outer_Full	CP-OFDM QPSK	Inner_Full	CP-OFDM QPSK	Outer_1RB_Left	CP-OFDM QPSK	Outer_1RB_Right	CP-OFDM QPSK	Outer_Full	CP-OFDM 16 QAM	Outer_1RB_Left	CP-OFDM 16 QAM	Outer_1RB_Right	CP-OFDM 16 QAM	Outer_Full	CP-OFDM 64 QAM	Outer_1RB_Left	CP-OFDM 64 QAM	Outer_1RB_Right	CP-OFDM 64 QAM	Outer_Full
Modulation	RB allocation (NOTE 1)																																														
DFT-s-OFDM PI/2 BPSK	Outer_Full																																														
DFT-s-OFDM QPSK	Outer_Full																																														
DFT-s-OFDM 16 QAM	Inner_Full																																														
DFT-s-OFDM 16 QAM	Outer_1RB_Left																																														
DFT-s-OFDM 16 QAM	Outer_1RB_Right																																														
DFT-s-OFDM 16 QAM	Outer_Full																																														
DFT-s-OFDM 64 QAM	Inner_Full																																														
DFT-s-OFDM 64 QAM	Outer_1RB_Left																																														
DFT-s-OFDM 64 QAM	Outer_1RB_Right																																														
DFT-s-OFDM 64 QAM	Outer_Full																																														
CP-OFDM QPSK	Inner_Full																																														
CP-OFDM QPSK	Outer_1RB_Left																																														
CP-OFDM QPSK	Outer_1RB_Right																																														
CP-OFDM QPSK	Outer_Full																																														
CP-OFDM 16 QAM	Outer_1RB_Left																																														
CP-OFDM 16 QAM	Outer_1RB_Right																																														
CP-OFDM 16 QAM	Outer_Full																																														
CP-OFDM 64 QAM	Outer_1RB_Left																																														
CP-OFDM 64 QAM	Outer_1RB_Right																																														
CP-OFDM 64 QAM	Outer_Full																																														
1	Mid																																														
2	Mid																																														
3	Mid																																														
4	Low																																														
5	High																																														
6	Mid																																														
7	Mid																																														
8	Low																																														
9	High																																														
10	Mid																																														
11	Mid																																														
12	Low																																														
13	High																																														
14	Mid																																														
15	Low																																														
16	High																																														
17	Mid																																														
18	Low																																														
19	High																																														
20	Mid																																														
NOTE 1: The specific configuration of each RF allocation is defined in Table 6.1-1.																																															

Table 6.2.2.4.1-8a: Test Configuration Table (Power Class 2, 3, 4, 5 and 6 MPR_{narrow}, BW_{channel} = 400 MHz)

Default Conditions	
Test Environment as specified in TS 38.508-1 [10] clause 4.1	Normal, TL, TH
Test Frequencies as specified in TS 38.508-1 [10] clause 4.3.1	Low range, High range
Test Channel Bandwidths as specified in TS 38.508-1 [10] clause 4.3.1	400 MHz

Test SCS as specified in Table 5.3.5-1				120 kHz		
Test Parameters						
Test ID	Freq	ChBw	SCS	Downlink Configuration	Uplink Configuration	
		Default	Default	N/A for Maximum Power Reduction (MPR) test case	Modulation	RB allocation (NOTE 1)
1	Low				DFT-s-OFDM PI/2 BPSK	Inner_1RB_Left
2	High				DFT-s-OFDM PI/2 BPSK	Inner_1RB_Right
3	Low				DFT-s-OFDM QPSK	Inner_1RB_Left
4	High				DFT-s-OFDM QPSK	Inner_1RB_Right
NOTE 1: The specific configuration of each RF allocation is defined in Table 6.1-1.						

Table 6.2.2.4.1-9: Test Configuration Table (Power Class 2, 3, 4, 5 and 6, MPR_{WT}, BW_{channel} = 400 MHz)

Default Conditions						
Test Environment as specified in TS 38.508-1 [10] clause 4.1				Normal, TL, TH		
Test Frequencies as specified in TS 38.508-1 [10] clause 4.3.1				Low range, Mid range, High range		
Test Channel Bandwidths as specified in TS 38.508-1 [10] clause 4.3.1				400 MHz		
Test SCS as specified in Table 5.3.5-1				120kHz		
Test Parameters						
Test ID	Freq	ChBw	SCS	Downlink Configuration	Uplink Configuration	
		Default	Default	-	Modulation	RB allocation (NOTE 1)
1	Low				DFT-s-OFDM PI/2 BPSK	Outer_1RB_Left
2	High				DFT-s-OFDM PI/2 BPSK	Outer_1RB_Right
3	Mid				DFT-s-OFDM PI/2 BPSK	Outer_Full
4	Low				DFT-s-OFDM QPSK	Outer_1RB_Left
5	High				DFT-s-OFDM QPSK	Outer_1RB_Right
6	Mid				DFT-s-OFDM QPSK	Outer_Full
7	Low				DFT-s-OFDM 16 QAM	Outer_1RB_Left
8	High				DFT-s-OFDM 16 QAM	Outer_1RB_Right
9	Mid				DFT-s-OFDM 16 QAM	Outer_Full
10	Low				DFT-s-OFDM 64 QAM	Outer_1RB_Left
11	High				DFT-s-OFDM 64 QAM	Outer_1RB_Right
12	Mid				DFT-s-OFDM 64 QAM	Outer_Full
13	Low				CP-OFDM QPSK	Outer_1RB_Left
14	High				CP-OFDM QPSK	Outer_1RB_Right
15	Mid				CP-OFDM QPSK	Outer_Full
16	Low				CP-OFDM 16 QAM	Outer_1RB_Left
17	High				CP-OFDM 16 QAM	Outer_1RB_Right
18	Mid				CP-OFDM 16 QAM	Outer_Full
19	Low				CP-OFDM 64 QAM	Outer_1RB_Left
20	High				CP-OFDM 64 QAM	Outer_1RB_Right
21	Mid				CP-OFDM 64 QAM	Outer_Full
NOTE 1: The specific configuration of each RF allocation is defined in Table 6.1-1.						

1. Connection between SS and UE is shown in TS 38.508-1 [10] Annex A, Figure A.3.3.1.1 for TE diagram and Figure A.3.4.1.1 for UE diagram.
2. The parameter settings for the cell are set up according to TS 38.508-1 [10] clause 4.4.3.
3. Downlink signals are initially set up according to Annex C, and uplink signals according to Annex G.
4. The UL Reference Measurement channels are set according to Table 6.2.2.4.1-1 to Table 6.2.2.4.1-9.
5. Propagation conditions are set according to Annex B.0

6. Ensure the UE is in state RRC_CONNECTED with generic procedure parameters Connectivity *NR*, Connected without release *On*, Test Mode *On* and Test Loop Function *On* according to TS 38.508-1 [10] clause 4.5. Message contents are defined in clause 6.2.2.4.3.

6.2.2.4.2 Test procedure

1. SS sends uplink scheduling information for each UL HARQ process via PDCCH DCI format 0_1 for C_RNTI to schedule the UL RMC according to Table 6.2.2.4.1-1 to Table 6.2.2.4.1-9. Since the UL has no payload and no loopback data to send the UE sends uplink MAC padding bits on the UL RMC.
2. Set the UE in the Tx beam peak direction found with a 3D EIRP scan as performed in Annex K.1.1. Allow at least BEAM_SELECT_WAIT_TIME (NOTE 1) for the UE Tx beam selection to complete.
3. Send continuously uplink power control "up" commands in every uplink scheduling information to the UE; allow at least 200ms for the UE to reach P_{UMAX} level. Allow at least BEAM_SELECT_WAIT_TIME (NOTE 1) for the UE Tx beam selection to complete.
4. SS activates the UE Beamlock Function (UBF) by performing the procedure as specified in TS 38.508-1 [10] clause 4.9.2 using condition Tx only.
5. Measure UE EIRP in the Tx beam peak direction in the channel bandwidth of the radio access mode according to the test configuration, which shall meet the requirements described in 6.2.2.5. EIRP test procedure is defined in Annex K.1.3. The measuring duration is one active uplink subframe. EIRP is calculated considering both polarizations, theta and phi.
6. SS deactivates the UE Beamlock Function (UBF) by performing the procedure as specified in TS 38.508-1 [10] clause 4.9.3.

NOTE 1: The BEAM_SELECT_WAIT_TIME default value is defined in Annex K.

NOTE 2: When switching to DFT-s-OFDM waveform, as specified in Table 6.2.2.4.1-1 to Table 6.2.2.4.1-9, send an NR RRCReconfiguration message according to TS 38.508-1 [10] clause 4.6.3 Table 4.6.3-118 PUSCH-Config with TRANSFORM_PRECODER_ENABLED condition.

6.2.2.4.3 Message contents

Message contents are according to TS 38.508-1 [10] clause 4.6.

6.2.2.5 Test requirement

The maximum output power, derived in step 5 shall be within the range prescribed by the nominal maximum output power and tolerance in following tables.

Table 6.2.2.5-1: UE Power Class test requirements for Power Class 1 (for Bands n257, n258, n261)

Test Configuration Table	Test ID	P _{Powerclass}	MPR _{f,c}	T(MPR _{f,c})	Lower limit (dBm)	Upper limit (dBm)
Table 6.2.2.4.1-1	1	40	14.4	7	18.6-TT	55
	2	40	14.4	7	18.6-TT	55
	3	40	10	5	25-TT	55
	4	40	10	5	25-TT	55
	5	40	10	5	25-TT	55
	6	40	10	5	25-TT	55
Table 6.2.2.4.1-2	1	40	5.5	5	29.5-TT	55
	2	40	5.5	5	29.5-TT	55
	3	40	5.5	5	29.5-TT	55
	4	40	3	2	35-TT	55
	5	40	6.5	5	28.5-TT	55
	6	40	6.5	5	28.5-TT	55
	7	40	6.5	5	28.5-TT	55
	8	40	4	3	33-TT	55
	9	40	6.5	5	28.5-TT	55
	10	40	6.5	5	28.5-TT	55
	11	40	6.5	5	28.5-TT	55
	12	40	6.5	5	28.5-TT	55
	13	40	6.5	5	28.5-TT	55
	14	40	6.5	5	28.5-TT	55
	15	40	5	4	31-TT	55
	16	40	4.5	4	31.5-TT	55
	17	40	7	5	28-TT	55
	18	40	7	5	28-TT	55
	19	40	7	5	28-TT	55
	20	40	7	5	28-TT	55
	21	40	7	5	28-TT	55
	22	40	7	5	28-TT	55
	23	40	5.5	5	29.5-TT	55
	24	40	7.5	5	27.5-TT	55
	25	40	7.5	5	27.5-TT	55
	26	40	7.5	5	27.5-TT	55
Table 6.2.2.4.1-3	1	40	5.5	5	29.5-TT	55
	2	40	5.5	5	29.5-TT	55
	3	40	5.5	5	29.5-TT	55
	4	40	3	2	35-TT	55
	5	40	3.5	3	33.5-TT	55
	6	40	6.5	5	28.5-TT	55
	7	40	6.5	5	28.5-TT	55
	8	40	6.5	5	28.5-TT	55
	9	40	4.5	4	31.5-TT	55
	10	40	6.5	5	28.5-TT	55
	11	40	6.5	5	28.5-TT	55
	12	40	6.5	5	28.5-TT	55
	13	40	6.5	5	28.5-TT	55
	14	40	6.5	5	28.5-TT	55
	15	40	6.5	5	28.5-TT	55
	16	40	5	4	31-TT	55
	17	40	7	5	28-TT	55
	18	40	7	5	28-TT	55
	19	40	7	5	28-TT	55
	20	40	7	5	28-TT	55
	21	40	7	5	28-TT	55
	22	40	7	5	28-TT	55
	23	40	6.5	5	28.5-TT	55
	24	40	9	5	26-TT	55
	25	40	9	5	26-TT	55
	26	40	9	5	26-TT	55

Table 6.2.2.5-1a: UE Power Class test requirements for Power Class 1 (for Bands n260)

Test Configuration Table	Test ID	P _{Powerclass}	MPR _{f,c}	T(MPR _{f,c})	Lower limit (dBm)	Upper limit (dBm)
Table 6.2.2.4.1-1	1	38	14.4	7	16.6-TT	55
	2	38	14.4	7	16.6-TT	55
	3	38	10	5	23-TT	55
	4	38	10	5	23-TT	55
	5	38	10	5	23-TT	55
	6	38	10	5	23-TT	55
Table 6.2.2.4.1-2	1	38	5.5	5	27.5-TT	55
	2	38	5.5	5	27.5-TT	55
	3	38	5.5	5	27.5-TT	55
	4	38	3	2	33-TT	55
	5	38	6.5	5	26.5-TT	55
	6	38	6.5	5	26.5-TT	55
	7	38	6.5	5	26.5-TT	55
	8	38	4	3	31-TT	55
	9	38	6.5	5	26.5-TT	55
	10	38	6.5	5	26.5-TT	55
	11	38	6.5	5	26.5-TT	55
	12	38	6.5	5	26.5-TT	55
	13	38	6.5	5	26.5-TT	55
	14	38	6.5	5	26.5-TT	55
	15	38	5	4	29-TT	55
	16	38	4.5	4	29.5-TT	55
	17	38	7	5	26-TT	55
	18	38	7	5	26-TT	55
	19	38	7	5	26-TT	55
	20	38	7	5	26-TT	55
	21	38	7	5	26-TT	55
	22	38	7	5	26-TT	55
	23	38	5.5	5	27.5-TT	55
	24	38	7.5	5	25.5-TT	55
	25	38	7.5	5	25.5-TT	55
	26	38	7.5	5	25.5-TT	55
Table 6.2.2.4.1-3	1	38	5.5	5	27.5-TT	55
	2	38	5.5	5	27.5-TT	55
	3	38	5.5	5	27.5-TT	55
	4	38	3	2	33-TT	55
	5	38	3.5	3	31.5-TT	55
	6	38	6.5	5	26.5-TT	55
	7	38	6.5	5	26.5-TT	55
	8	38	6.5	5	26.5-TT	55
	9	38	4.5	4	29.5-TT	55
	10	38	6.5	5	26.5-TT	55
	11	38	6.5	5	26.5-TT	55
	12	38	6.5	5	26.5-TT	55
	13	38	6.5	5	26.5-TT	55
	14	38	6.5	5	26.5-TT	55
	15	38	6.5	5	26.5-TT	55
	16	38	5	4	29-TT	55
	17	38	7	5	26-TT	55
	18	38	7	5	26-TT	55
	19	38	7	5	26-TT	55
	20	38	7	5	26-TT	55
	21	38	7	5	26-TT	55
	22	38	7	5	26-TT	55
	23	38	6.5	5	26.5-TT	55
	24	38	9	5	24-TT	55
	25	38	9	5	24-TT	55
	26	38	9	5	24-TT	55

Table 6.2.2.5-1b: Test Tolerance (Power class 1)

Test Metric	FR2a	FR2b
Max device size ≤ 30 cm	3.38 dB, NTC 3.56 dB, ETC	3.38 dB, NTC 3.56 dB, ETC

Table 6.2.2.5-2: UE Power Class test requirements for Power Class 2

Test Configuration Table	Test ID	P _{Powerclass}	MPR _{f,c}	T(MPR _{f,c})	Lower limit (dBm)	Upper limit (dBm)
Table 6.2.2.4.1-7	1	29	2.5	2	24.5-TT	43
	2	29	2.5	2	24.5-TT	43
	3	29	2.5	2	24.5-TT	43
	4	29	2.5	2	24.5-TT	43
Table 6.2.2.4.1-8	1	29	2	1.5	25.5-TT	43
	2	29	2	1.5	25.5-TT	43
	3	29	3	2	24-TT	43
	4	29	3.5	3	22.5-TT	43
	5	29	3.5	3	22.5-TT	43
	6	29	3.5	3	22.5-TT	43
	7	29	5	4	20-TT	43
	8	29	5.5	5	18.5-TT	43
	9	29	5.5	5	18.5-TT	43
	10	29	5.5	5	18.5-TT	43
	11	29	3.5	3	22.5-TT	43
	12	29	4	3	22-TT	43
	13	29	4	3	22-TT	43
	14	29	4	3	22-TT	43
	15	29	5	4	20-TT	43
	16	29	5	4	20-TT	43
	17	29	5	4	20-TT	43
	18	29	7.5	5	16.5-TT	43
	19	29	7.5	5	16.5-TT	43
	20	29	7.5	5	16.5-TT	43
Table 6.2.2.4.1-8a	1	29	2.5	2	24.5-TT	43
	2	29	2.5	2	24.5-TT	43
	3	29	2.5	2	24.5-TT	43
	4	29	2.5	2	24.5-TT	43
Table 6.2.2.4.1-9	1	29	3	2	24-TT	43
	2	29	3	2	24-TT	43
	3	29	3	2	24-TT	43
	4	29	3	2	24-TT	43
	5	29	3	2	24-TT	43
	6	29	3	2	24-TT	43
	7	29	4.5	4	20.5-TT	43
	8	29	4.5	4	20.5-TT	43
	9	29	4.5	4	20.5-TT	43
	10	29	6.5	5	17.5-TT	43
	11	29	6.5	5	17.5-TT	43
	12	29	6.5	5	17.5-TT	43
	13	29	5	4	20-TT	43
	14	29	5	4	20-TT	43
	15	29	5	4	20-TT	43
	16	29	6.5	5	17.5-TT	43
	17	29	6.5	5	17.5-TT	43
	18	29	6.5	5	17.5-TT	43
	19	29	9	5	15-TT	43
	20	29	9	5	15-TT	43
	21	29	9	5	15-TT	43

Table 6.2.2.5-3: UE Power Class test requirements for Power Class 3 (n257, 258, 261)

Test Configuration Table	Test ID	P _{Powerclass}	MPR _{i,c}	T(MPR _{i,c})	Lower limit (dBm)	Upper limit (dBm)
Table 6.2.2.4.1-7	1	22.4	2.5	2	17.9-TT-ΔMB _{P,n}	43
	2	22.4	2.5	2	17.9-TT-ΔMB _{P,n}	43
	3	22.4	2.5	2	17.9-TT-ΔMB _{P,n}	43
	4	22.4	2.5	2	17.9-TT-ΔMB _{P,n}	43
Table 6.2.2.4.1-8	1	22.4	2	1.5	18.9-TT-ΔMB _{P,n}	43
	2	22.4	2	1.5	18.9-TT-ΔMB _{P,n}	43
	3	22.4	3	2	17.4-TT-ΔMB _{P,n}	43
	4	22.4	3.5	3	15.9-TT-ΔMB _{P,n}	43
	5	22.4	3.5	3	15.9-TT-ΔMB _{P,n}	43
	6	22.4	3.5	3	15.9-TT-ΔMB _{P,n}	43
	7	22.4	5	4	13.4-TT-ΔMB _{P,n}	43
	8	22.4	5.5	5	11.9-TT-ΔMB _{P,n}	43
	9	22.4	5.5	5	11.9-TT-ΔMB _{P,n}	43
	10	22.4	5.5	5	11.9-TT-ΔMB _{P,n}	43
	11	22.4	3.5	3	15.9-TT-ΔMB _{P,n}	43
	12	22.4	4	3	15.4-TT-ΔMB _{P,n}	43
	13	22.4	4	3	15.4-TT-ΔMB _{P,n}	43
	14	22.4	4	3	15.4-TT-ΔMB _{P,n}	43
	15	22.4	5	4	13.4-TT-ΔMB _{P,n}	43
	16	22.4	5	4	13.4-TT-ΔMB _{P,n}	43
	17	22.4	5	4	13.4-TT-ΔMB _{P,n}	43
	18	22.4	7.5	5	9.9-TT-ΔMB _{P,n}	43
	19	22.4	7.5	5	9.9-TT-ΔMB _{P,n}	43
	20	22.4	7.5	5	9.9-TT-ΔMB _{P,n}	43
Table 6.2.2.4.1-8a	1	22.4	2.5	2	17.9-TT-ΔMB _{P,n}	43
	2	22.4	2.5	2	17.9-TT-ΔMB _{P,n}	43
	3	22.4	2.5	2	17.9-TT-ΔMB _{P,n}	43
	4	22.4	2.5	2	17.9-TT-ΔMB _{P,n}	43
Table 6.2.2.4.1-9	1	22.4	3	2	17.4-TT-ΔMB _{P,n}	43
	2	22.4	3	2	17.4-TT-ΔMB _{P,n}	43
	3	22.4	3	2	17.4-TT-ΔMB _{P,n}	43
	4	22.4	3	2	17.4-TT-ΔMB _{P,n}	43
	5	22.4	3	2	17.4-TT-ΔMB _{P,n}	43
	6	22.4	3	2	17.4-TT-ΔMB _{P,n}	43
	7	22.4	4.5	4	13.9-TT-ΔMB _{P,n}	43
	8	22.4	4.5	4	13.9-TT-ΔMB _{P,n}	43
	9	22.4	4.5	4	13.9-TT-ΔMB _{P,n}	43
	10	22.4	6.5	5	10.9-TT-ΔMB _{P,n}	43
	11	22.4	6.5	5	10.9-TT-ΔMB _{P,n}	43
	12	22.4	6.5	5	10.9-TT-ΔMB _{P,n}	43
	13	22.4	5	4	13.4-TT-ΔMB _{P,n}	43
	14	22.4	5	4	13.4-TT-ΔMB _{P,n}	43
	15	22.4	5	4	13.4-TT-ΔMB _{P,n}	43
	16	22.4	6.5	5	10.9-TT-ΔMB _{P,n}	43
	17	22.4	6.5	5	10.9-TT-ΔMB _{P,n}	43
	18	22.4	6.5	5	10.9-TT-ΔMB _{P,n}	43
	19	22.4	9	5	8.4-TT-ΔMB _{P,n}	43
	20	22.4	9	5	8.4-TT-ΔMB _{P,n}	43
	21	22.4	9	5	8.4-TT-ΔMB _{P,n}	43
Note 1:	ΔMB _{P,n} is the Multiband Relaxation factor declared by the UE for the tested band in table A.4.3.9-2 of TS38.508-2. This declaration shall fulfil the requirements in clause 6.2.1.1.3.3.					
Note 2:	All UE supported bands needs to be tested to ensure the multiband relaxation declaration is compliant.					
Note 3:	Max allowed sum of ΔMB _{P,n} over all supported FR2 bands as defined in clause 6.2.1.1.3.3.					
Note 4:	ΔMB _{P,n} is 0 for single band UE.					

Table 6.2.2.5-3a: UE Power Class test requirements for Power Class 3 (n260)

Test Configuration Table	Test ID	P ^{Powerclass}	MPR _{f,c}	T(MPR _{f,c})	Lower limit (dBm)	Upper limit (dBm)
Table 6.2.2.4.1-7	1	20.6	2.5	2	16.1-TT-ΔMB _{P,n}	43
	2	20.6	2.5	2	16.1-TT-ΔMB _{P,n}	43
	3	20.6	2.5	2	16.1-TT-ΔMB _{P,n}	43
	4	20.6	2.5	2	16.1-TT-ΔMB _{P,n}	43
Table 6.2.2.4.1-8	1	20.6	2	1.5	17.1-TT-ΔMB _{P,n}	43
	2	20.6	2	1.5	17.1-TT-ΔMB _{P,n}	43
	3	20.6	3	2	15.6-TT-ΔMB _{P,n}	43
	4	20.6	3.5	3	14.1-TT-ΔMB _{P,n}	43
	5	20.6	3.5	3	14.1-TT-ΔMB _{P,n}	43
	6	20.6	3.5	3	14.1-TT-ΔMB _{P,n}	43
	7	20.6	5	4	11.6-TT-ΔMB _{P,n}	43
	8	20.6	5.5	5	10.1-TT-ΔMB _{P,n}	43
	9	20.6	5.5	5	10.1-TT-ΔMB _{P,n}	43
	10	20.6	5.5	5	10.1-TT-ΔMB _{P,n}	43
	11	20.6	3.5	3	14.1-TT-ΔMB _{P,n}	43
	12	20.6	4	3	13.6-TT-ΔMB _{P,n}	43
	13	20.6	4	3	13.6-TT-ΔMB _{P,n}	43
	14	20.6	4	3	13.6-TT-ΔMB _{P,n}	43
	15	20.6	5	4	11.6-TT-ΔMB _{P,n}	43
	16	20.6	5	4	11.6-TT-ΔMB _{P,n}	43
	17	20.6	5	4	11.6-TT-ΔMB _{P,n}	43
	18	20.6	7.5	5	8.1-TT-ΔMB _{P,n}	43
	19	20.6	7.5	5	8.1-TT-ΔMB _{P,n}	43
	20	20.6	7.5	5	8.1-TT-ΔMB _{P,n}	43
Table 6.2.2.4.1-8a	1	20.6	2.5	2	16.1-TT-ΔMB _{P,n}	43
	2	20.6	2.5	2	16.1-TT-ΔMB _{P,n}	43
	3	20.6	2.5	2	16.1-TT-ΔMB _{P,n}	43
	4	20.6	2.5	2	16.1-TT-ΔMB _{P,n}	43
Table 6.2.2.4.1-9	1	20.6	3	2	15.6-TT-ΔMB _{P,n}	43
	2	20.6	3	2	15.6-TT-ΔMB _{P,n}	43
	3	20.6	3	2	15.6-TT-ΔMB _{P,n}	43
	4	20.6	3	2	15.6-TT-ΔMB _{P,n}	43
	5	20.6	3	2	15.6-TT-ΔMB _{P,n}	43
	6	20.6	3	2	15.6-TT-ΔMB _{P,n}	43
	7	20.6	4.5	4	12.1-TT-ΔMB _{P,n}	43
	8	20.6	4.5	4	12.1-TT-ΔMB _{P,n}	43
	9	20.6	4.5	4	12.1-TT-ΔMB _{P,n}	43
	10	20.6	6.5	5	9.1-TT-ΔMB _{P,n}	43
	11	20.6	6.5	5	9.1-TT-ΔMB _{P,n}	43
	12	20.6	6.5	5	9.1-TT-ΔMB _{P,n}	43
	13	20.6	5	4	11.6-TT-ΔMB _{P,n}	43
	14	20.6	5	4	11.6-TT-ΔMB _{P,n}	43
	15	20.6	5	4	11.6-TT-ΔMB _{P,n}	43
	16	20.6	6.5	5	9.1-TT-ΔMB _{P,n}	43
	17	20.6	6.5	5	9.1-TT-ΔMB _{P,n}	43
	18	20.6	6.5	5	9.1-TT-ΔMB _{P,n}	43
	19	20.6	9	5	6.6-TT-ΔMB _{P,n}	43
	20	20.6	9	5	6.6-TT-ΔMB _{P,n}	43
	21	20.6	9	5	6.6-TT-ΔMB _{P,n}	43
<p>Note 1: ΔMB_{P,n} is the Multiband Relaxation factor declared by the UE for the tested band in table A.4.3.9-2 of TS38.508-2. This declaration shall fulfil the requirements in clause 6.2.1.1.3.3.</p> <p>Note 2: All UE supported bands needs to be tested to ensure the multiband relaxation declaration is compliant.</p> <p>Note 3: Max allowed sum of ΔMB_{P,n} over all supported FR2 bands as defined in clause 6.2.1.1.3.3.</p> <p>Note 4: ΔMB_{P,n} is 0 for single band UE.</p>						

Table 6.2.2.5-3b: UE Power Class test requirements for Power Class 3 (n259)

Test Configuration Table	Test ID	P ^{Powerclass}	MPR _{f,c}	T(MPR _{f,c})	Lower limit (dBm)	Upper limit (dBm)
--------------------------	---------	-------------------------	--------------------	------------------------	-------------------	-------------------

Table 6.2.2.4.1-7	1	18.7	2.5	2	14.2-TT- $\Delta MB_{P,n}$	43
	2	18.7	2.5	2	14.2-TT- $\Delta MB_{P,n}$	43
	3	18.7	2.5	2	14.2-TT- $\Delta MB_{P,n}$	43
	4	18.7	2.5	2	14.2-TT- $\Delta MB_{P,n}$	43
Table 6.2.2.4.1-8	1	18.7	2	1.5	15.2-TT- $\Delta MB_{P,n}$	43
	2	18.7	2	1.5	15.2-TT- $\Delta MB_{P,n}$	43
	3	18.7	3	2	13.7-TT- $\Delta MB_{P,n}$	43
	4	18.7	3.5	3	12.2-TT- $\Delta MB_{P,n}$	43
	5	18.7	3.5	3	12.2-TT- $\Delta MB_{P,n}$	43
	6	18.7	3.5	3	12.2-TT- $\Delta MB_{P,n}$	43
	7	18.7	5	4	9.7-TT- $\Delta MB_{P,n}$	43
	8	18.7	5.5	5	8.2-TT- $\Delta MB_{P,n}$	43
	9	18.7	5.5	5	8.2-TT- $\Delta MB_{P,n}$	43
	10	18.7	5.5	5	8.2-TT- $\Delta MB_{P,n}$	43
	11	18.7	3.5	3	12.2-TT- $\Delta MB_{P,n}$	43
	12	18.7	4	3	11.7-TT- $\Delta MB_{P,n}$	43
	13	18.7	4	3	11.7-TT- $\Delta MB_{P,n}$	43
	14	18.7	4	3	11.7-TT- $\Delta MB_{P,n}$	43
	15	18.7	5	4	9.7-TT- $\Delta MB_{P,n}$	43
	16	18.7	5	4	9.7-TT- $\Delta MB_{P,n}$	43
	17	18.7	5	4	9.7-TT- $\Delta MB_{P,n}$	43
	18	18.7	7.5	5	6.2-TT- $\Delta MB_{P,n}$	43
	19	18.7	7.5	5	6.2-TT- $\Delta MB_{P,n}$	43
	20	18.7	7.5	5	6.2-TT- $\Delta MB_{P,n}$	43
Table 6.2.2.4.1-8a	1	18.7	2.5	2	14.2-TT- $\Delta MB_{P,n}$	43
	2	18.7	2.5	2	14.2-TT- $\Delta MB_{P,n}$	43
	3	18.7	2.5	2	14.2-TT- $\Delta MB_{P,n}$	43
	4	18.7	2.5	2	14.2-TT- $\Delta MB_{P,n}$	43
Table 6.2.2.4.1-9	1	18.7	3	2	13.7-TT- $\Delta MB_{P,n}$	43
	2	18.7	3	2	13.7-TT- $\Delta MB_{P,n}$	43
	3	18.7	3	2	13.7-TT- $\Delta MB_{P,n}$	43
	4	18.7	3	2	13.7-TT- $\Delta MB_{P,n}$	43
	5	18.7	3	2	13.7-TT- $\Delta MB_{P,n}$	43
	6	18.7	3	2	13.7-TT- $\Delta MB_{P,n}$	43
	7	18.7	4.5	4	10.2-TT- $\Delta MB_{P,n}$	43
	8	18.7	4.5	4	10.2-TT- $\Delta MB_{P,n}$	43
	9	18.7	4.5	4	10.2-TT- $\Delta MB_{P,n}$	43
	10	18.7	6.5	5	7.2-TT- $\Delta MB_{P,n}$	43
	11	18.7	6.5	5	7.2-TT- $\Delta MB_{P,n}$	43
	12	18.7	6.5	5	7.2-TT- $\Delta MB_{P,n}$	43
	13	18.7	5	4	9.7-TT- $\Delta MB_{P,n}$	43
	14	18.7	5	4	9.7-TT- $\Delta MB_{P,n}$	43
	15	18.7	5	4	9.7-TT- $\Delta MB_{P,n}$	43
	16	18.7	6.5	5	7.2-TT- $\Delta MB_{P,n}$	43
	17	18.7	6.5	5	7.2-TT- $\Delta MB_{P,n}$	43
	18	18.7	6.5	5	7.2-TT- $\Delta MB_{P,n}$	43
	19	18.7	9	5	4.7-TT- $\Delta MB_{P,n}$	43
	20	18.7	9	5	4.7-TT- $\Delta MB_{P,n}$	43
	21	18.7	9	5	4.7-TT- $\Delta MB_{P,n}$	43
<p>Note 1: $\Delta MB_{P,n}$ is the Multiband Relaxation factor declared by the UE for the tested band in table FFS of TS38.508-2. This declaration shall fulfil the requirements in clause 6.2.1.1.3.3.</p> <p>Note 2: All UE supported bands needs to be tested to ensure the multiband relaxation declaration is compliant.</p> <p>Note 3: Max allowed sum of $\Delta MB_{P,n}$ over all supported FR2 bands as defined in clause 6.2.1.1.3.3.</p> <p>Note 4: $\Delta MB_{P,n}$ is 0 for single band UE.</p>						

Table 6.2.2.5-3c: Test Tolerance (Power class 3)

Test Metric	FR2a	FR2b	FR2c
Max device size \leq 30 cm	3.24 dB, NTC 3.41 dB, ETC	3.24 dB, NTC 3.41 dB, ETC	4.12 dB, NTC 4.21, ETC

Table 6.2.2.5-4: UE Power Class test requirements for Power Class 4 (n257, 258, 261)

Test Configuration Table	Test ID	P _{Powerclass}	MPR _{f,c}	T(MPR _{f,c})	Lower limit (dBm)	Upper limit (dBm)
Table 6.2.2.4.1-7	1	34	2.5	2	29.5-TT	43
	2	34	2.5	2	29.5-TT	43
	3	34	2.5	2	29.5-TT	43
	4	34	2.5	2	29.5-TT	43
Table 6.2.2.4.1-8	1	34	2	1.5	30.5-TT	43
	2	34	2	1.5	30.5-TT	43
	3	34	3	2	29-TT	43
	4	34	3.5	3	27.5-TT	43
	5	34	3.5	3	27.5-TT	43
	6	34	3.5	3	27.5-TT	43
	7	34	5	4	25-TT	43
	8	34	5.5	5	23.5-TT	43
	9	34	5.5	5	23.5-TT	43
	10	34	5.5	5	23.5-TT	43
	11	34	3.5	3	27.5-TT	43
	12	34	4	3	27-TT	43
	13	34	4	3	27-TT	43
	14	34	4	3	27-TT	43
	15	34	5	4	25-TT	43
	16	34	5	4	25-TT	43
	17	34	5	4	25-TT	43
	18	34	7.5	5	1.5-TT	43
	19	34	7.5	5	1.5-TT	43
	20	34	7.5	5	1.5-TT	43
Table 6.2.2.4.1-8a	1	34	2.5	2	29.5-TT	43
	2	34	2.5	2	29.5-TT	43
	3	34	2.5	2	29.5-TT	43
	4	34	2.5	2	29.5-TT	43
Table 6.2.2.4.1-9	1	34	3	2	29-TT	43
	2	34	3	2	29-TT	43
	3	34	3	2	29-TT	43
	4	34	3	2	29-TT	43
	5	34	3	2	29-TT	43
	6	34	3	2	29-TT	43
	7	34	4.5	4	25.5-TT	43
	8	34	4.5	4	25.5-TT	43
	9	34	4.5	4	25.5-TT	43
	10	34	6.5	5	22.5-TT	43
	11	34	6.5	5	22.5-TT	43
	12	34	6.5	5	22.5-TT	43
	13	34	5	4	25-TT	43
	14	34	5	4	25-TT	43
	15	34	5	4	25-TT	43
	16	34	6.5	5	22.5-TT	43
	17	34	6.5	5	22.5-TT	43
	18	34	6.5	5	22.5-TT	43
	19	34	9	5	20-TT	43
	20	34	9	5	20-TT	43
	21	34	9	5	20-TT	43

Table 6.2.2.5-4a: UE Power Class test requirements for Power Class 4 (n260)

Test Configuration Table	Test ID	P _{Powerclass}	MPR _{f,c}	T(MPR _{f,c})	Lower limit (dBm)	Upper limit (dBm)
Table 6.2.2.4.1-7	1	31	2.5	2	26.5-TT	43
	2	31	2.5	2	26.5-TT	43
	3	31	2.5	2	26.5-TT	43
	4	31	2.5	2	26.5-TT	43
Table 6.2.2.4.1-8	1	31	2	1.5	27.5-TT	43

	2	31	2	1.5	27.5-TT	43
	3	31	3	2	26-TT	43
	4	31	3.5	3	24.5-TT	43
	5	31	3.5	3	24.5-TT	43
	6	31	3.5	3	24.5-TT	43
	7	31	5	4	22-TT	43
	8	31	5.5	5	20.5-TT	43
	9	31	5.5	5	20.5-TT	43
	10	31	5.5	5	20.5-TT	43
	11	31	3.5	3	24.5-TT	43
	12	31	4	3	24-TT	43
	13	31	4	3	24-TT	43
	14	31	4	3	24-TT	43
	15	31	5	4	22-TT	43
	16	31	5	4	22-TT	43
	17	31	5	4	22-TT	43
	18	31	7.5	5	18.5-TT	43
	19	31	7.5	5	18.5-TT	43
	20	31	7.5	5	18.5-TT	43
Table 6.2.2.4.1-8a	1	31	2.5	2	26.5-TT	43
	2	31	2.5	2	26.5-TT	43
	3	31	2.5	2	26.5-TT	43
	4	31	2.5	2	26.5-TT	43
Table 6.2.2.4.1-9	1	31	3	2	26-TT	43
	2	31	3	2	26-TT	43
	3	31	3	2	26-TT	43
	4	31	3	2	26-TT	43
	5	31	3	2	26-TT	43
	6	31	3	2	26-TT	43
	7	31	4.5	4	22.5-TT	43
	8	31	4.5	4	22.5-TT	43
	9	31	4.5	4	22.5-TT	43
	10	31	6.5	5	19.5-TT	43
	11	31	6.5	5	19.5-TT	43
	12	31	6.5	5	19.5-TT	43
	13	31	5	4	22-TT	43
	14	31	5	4	22-TT	43
	15	31	5	4	22-TT	43
	16	31	6.5	5	19.5-TT	43
	17	31	6.5	5	19.5-TT	43
	18	31	6.5	5	19.5-TT	43
	19	31	9	5	17-TT	43
	20	31	9	5	17-TT	43
	21	31	9	5	17-TT	43

Table 6.2.2.5-5: UE Power Class test requirements for Power Class 5 (n257) and Power Class 6 (n257, n261)

Test Configuration Table	Test ID	P _{Powerclass}	MPR _{f,c}	T(MPR _{f,c})	Lower limit (dBm)	Upper limit (dBm)
Table 6.2.2.4.1-7	1	30	2.5	2	25.5-TT-ΔMB _{P,n}	43
	2	30	2.5	2	25.5-TT-ΔMB _{P,n}	43
	3	30	2.5	2	25.5-TT-ΔMB _{P,n}	43
	4	30	2.5	2	25.5-TT-ΔMB _{P,n}	43
Table 6.2.2.4.1-8	1	30	2	1.5	26.5-TT-ΔMB _{P,n}	43
	2	30	2	1.5	26.5-TT-ΔMB _{P,n}	43
	3	30	3	2	25-TT-ΔMB _{P,n}	43
	4	30	3.5	3	23.5-TT-ΔMB _{P,n}	43
	5	30	3.5	3	23.5-TT-ΔMB _{P,n}	43
	6	30	3.5	3	23.5-TT-ΔMB _{P,n}	43
	7	30	5	4	21-TT-ΔMB _{P,n}	43
	8	30	5.5	5	19.5-TT-ΔMB _{P,n}	43
	9	30	5.5	5	19.5-TT-ΔMB _{P,n}	43

Test Configuration Table	Test ID	P _{Powerclass}	MPR _{f,c}	T(MPR _{f,c})	Lower limit (dBm)	Upper limit (dBm)
	10	30	5.5	5	19.5-TT-ΔMB _{P,n}	43
	11	30	3.5	3	23.5-TT-ΔMB _{P,n}	43
	12	30	4	3	23-TT-ΔMB _{P,n}	43
	13	30	4	3	23-TT-ΔMB _{P,n}	43
	14	30	4	3	23-TT-ΔMB _{P,n}	43
	15	30	5	4	21-TT-ΔMB _{P,n}	43
	16	30	5	4	21-TT-ΔMB _{P,n}	43
	17	30	5	4	21-TT-ΔMB _{P,n}	43
	18	30	7.5	5	17.5-TT-ΔMB _{P,n}	43
	19	30	7.5	5	17.5-TT-ΔMB _{P,n}	43
20	30	7.5	5	17.5-TT-ΔMB _{P,n}	43	
Table 6.2.2.4.1-8a	1	30	2.5	2	25.5-TT-ΔMB _{P,n}	43
	2	30	2.5	2	25.5-TT-ΔMB _{P,n}	43
	3	30	2.5	2	25.5-TT-ΔMB _{P,n}	43
	4	30	2.5	2	25.5-TT-ΔMB _{P,n}	43
Table 6.2.2.4.1-9	1	30	3	2	25-TT-ΔMB _{P,n}	43
	2	30	3	2	25-TT-ΔMB _{P,n}	43
	3	30	3	2	25-TT-ΔMB _{P,n}	43
	4	30	3	2	25-TT-ΔMB _{P,n}	43
	5	30	3	2	25-TT-ΔMB _{P,n}	43
	6	30	3	2	25-TT-ΔMB _{P,n}	43
	7	30	4.5	4	21.5-TT-ΔMB _{P,n}	43
	8	30	4.5	4	21.5-TT-ΔMB _{P,n}	43
	9	30	4.5	4	21.5-TT-ΔMB _{P,n}	43
	10	30	6.5	5	18.5-TT-ΔMB _{P,n}	43
	11	30	6.5	5	18.5-TT-ΔMB _{P,n}	43
	12	30	6.5	5	18.5-TT-ΔMB _{P,n}	43
	13	30	5	4	21-TT-ΔMB _{P,n}	43
	14	30	5	4	21-TT-ΔMB _{P,n}	43
	15	30	5	4	21-TT-ΔMB _{P,n}	43
	16	30	6.5	5	18.5-TT-ΔMB _{P,n}	43
	17	30	6.5	5	18.5-TT-ΔMB _{P,n}	43
	18	30	6.5	5	18.5-TT-ΔMB _{P,n}	43
	19	30	9	5	16-TT-ΔMB _{P,n}	43
	20	30	9	5	16-TT-ΔMB _{P,n}	43
	21	30	9	5	16-TT-ΔMB _{P,n}	43

Table 6.2.2.5-5a: UE Power Class test requirements for Power Class 5 and 6 (n258)

Test Configuration Table	Test ID	P _{Powerclass}	MPR _{r,c}	T(MPR _{r,c})	Lower limit (dBm)	Upper limit (dBm)
Table 6.2.2.4.1-7	1	30.4	2.5	2	25.9-TT-ΔMB _{P,n}	43
	2	30.4	2.5	2	25.9-TT-ΔMB _{P,n}	43
	3	30.4	2.5	2	25.9-TT-ΔMB _{P,n}	43
	4	30.4	2.5	2	25.9-TT-ΔMB _{P,n}	43
Table 6.2.2.4.1-8	1	30.4	2	1.5	26.9-TT-ΔMB _{P,n}	43
	2	30.4	2	1.5	26.9-TT-ΔMB _{P,n}	43
	3	30.4	3	2	25.4-TT-ΔMB _{P,n}	43
	4	30.4	3.5	3	23.9-TT-ΔMB _{P,n}	43
	5	30.4	3.5	3	23.9-TT-ΔMB _{P,n}	43
	6	30.4	3.5	3	23.9-TT-ΔMB _{P,n}	43
	7	30.4	5	4	21.4-TT-ΔMB _{P,n}	43
	8	30.4	5.5	5	19.9-TT-ΔMB _{P,n}	43
	9	30.4	5.5	5	19.9-TT-ΔMB _{P,n}	43
	10	30.4	5.5	5	19.9-TT-ΔMB _{P,n}	43
	11	30.4	3.5	3	23.9-TT-ΔMB _{P,n}	43
	12	30.4	4	3	23.4-TT-ΔMB _{P,n}	43
	13	30.4	4	3	23.4-TT-ΔMB _{P,n}	43
	14	30.4	4	3	23.4-TT-ΔMB _{P,n}	43
	15	30.4	5	4	21.4-TT-ΔMB _{P,n}	43

Test Configuration Table	Test ID	P _{Powerclass}	MPR _{f,c}	T(MPR _{f,c})	Lower limit (dBm)	Upper limit (dBm)
	16	30.4	5	4	21.4-TT-ΔMB _{P,n}	43
	17	30.4	5	4	21.4-TT-ΔMB _{P,n}	43
	18	30.4	7.5	5	17.9-TT-ΔMB _{P,n}	43
	19	30.4	7.5	5	17.9-TT-ΔMB _{P,n}	43
	20	30.4	7.5	5	17.9-TT-ΔMB _{P,n}	43
Table 6.2.2.4.1-8a	1	30.4	2.5	2	25.9-TT-ΔMB _{P,n}	43
	2	30.4	2.5	2	25.9-TT-ΔMB _{P,n}	43
	3	30.4	2.5	2	25.9-TT-ΔMB _{P,n}	43
	4	30.4	2.5	2	25.9-TT-ΔMB _{P,n}	43
Table 6.2.2.4.1-9	1	30.4	3	2	25.4-TT-ΔMB _{P,n}	43
	2	30.4	3	2	25.4-TT-ΔMB _{P,n}	43
	3	30.4	3	2	25.4-TT-ΔMB _{P,n}	43
	4	30.4	3	2	25.4-TT-ΔMB _{P,n}	43
	5	30.4	3	2	25.4-TT-ΔMB _{P,n}	43
	6	30.4	3	2	25.4-TT-ΔMB _{P,n}	43
	7	30.4	4.5	4	21.9-TT-ΔMB _{P,n}	43
	8	30.4	4.5	4	21.9-TT-ΔMB _{P,n}	43
	9	30.4	4.5	4	21.9-TT-ΔMB _{P,n}	43
	10	30.4	6.5	5	18.9-TT-ΔMB _{P,n}	43
	11	30.4	6.5	5	18.9-TT-ΔMB _{P,n}	43
	12	30.4	6.5	5	18.9-TT-ΔMB _{P,n}	43
	13	30.4	5	4	21.4-TT-ΔMB _{P,n}	43
	14	30.4	5	4	21.4-TT-ΔMB _{P,n}	43
	15	30.4	5	4	21.4-TT-ΔMB _{P,n}	43
	16	30.4	6.5	5	18.9-TT-ΔMB _{P,n}	43
	17	30.4	6.5	5	18.9-TT-ΔMB _{P,n}	43
	18	30.4	6.5	5	18.9-TT-ΔMB _{P,n}	43
	19	30.4	9	5	16.4-TT-ΔMB _{P,n}	43
	20	30.4	9	5	16.4-TT-ΔMB _{P,n}	43
	21	30.4	9	5	16.4-TT-ΔMB _{P,n}	43

Table 6.2.2.5-5c: Test Tolerance (Power class 5)

Test Metric	FR2a
Max device size ≤ 30 cm	3.38 dB, NTC 3.56 dB, ETC

Table 6.2.2.5-6: Test Tolerance (Power class 6)

Test Metric	FR2a
Max device size ≤ 30 cm	3.37 dB, NTC 3.54 dB, ETC

Table 6.2.2.5-7: UE Power Class test requirements for Power Class 7 (n257, n258, n261)

Test Configuration Table	Test ID	P _{Powerclass}	MPR _{f,c}	T(MPR _{f,c})	Lower limit (dBm)	Upper limit (dBm)
Table 6.2.2.4.1-7	1	16.4	2.5	2	11.9-TT-ΔMB _{P,n}	43
	2	16.4	2.5	2	11.9-TT-ΔMB _{P,n}	43
	3	16.4	2.5	2	11.9-TT-ΔMB _{P,n}	43
	4	16.4	2.5	2	11.9-TT-ΔMB _{P,n}	43
Table 6.2.2.4.1-8	1	16.4	2	1.5	12.9-TT-ΔMB _{P,n}	43
	2	16.4	2	1.5	12.9-TT-ΔMB _{P,n}	43
	3	16.4	3	2	11.4-TT-ΔMB _{P,n}	43
	4	16.4	3.5	3	9.9-TT-ΔMB _{P,n}	43
	5	16.4	3.5	3	9.9-TT-ΔMB _{P,n}	43

6	16.4	3.5	3	9.9-TT- $\Delta MB_{P,n}$	43
7	16.4	5	4	7.4-TT- $\Delta MB_{P,n}$	43
8	16.4	5.5	5	5.9-TT- $\Delta MB_{P,n}$	43
9	16.4	5.5	5	5.9-TT- $\Delta MB_{P,n}$	43
10	16.4	5.5	5	5.9-TT- $\Delta MB_{P,n}$	43
11	16.4	3.5	3	9.9-TT- $\Delta MB_{P,n}$	43
12	16.4	4	3	9.4-TT- $\Delta MB_{P,n}$	43
13	16.4	4	3	9.4-TT- $\Delta MB_{P,n}$	43
14	16.4	4	3	9.4-TT- $\Delta MB_{P,n}$	43
15	16.4	5	4	7.4-TT- $\Delta MB_{P,n}$	43
16	16.4	5	4	7.4-TT- $\Delta MB_{P,n}$	43
17	16.4	5	4	7.4-TT- $\Delta MB_{P,n}$	43
18	16.4	7.5	5	3.9-TT- $\Delta MB_{P,n}$	43
19	16.4	7.5	5	3.9-TT- $\Delta MB_{P,n}$	43
20	16.4	7.5	5	3.9-TT- $\Delta MB_{P,n}$	43

Note 1: $\Delta MB_{P,n}$ is the Multiband Relaxation factor declared by the UE for the tested band in table A.4.3.9-2 of TS38.508-2. This declaration shall fulfil the requirements in clause 6.2.1.1.3.7.

Note 2: All UE supported bands needs to be tested to ensure the multiband relaxation declaration is compliant.

Note 3: Max allowed sum of $\Delta MB_{P,n}$ over all supported FR2 bands as defined in clause 6.2.1.1.3.7.

Note 4: $\Delta MB_{P,n}$ is 0 for single band UE.

Table 6.2.2-5-7a: Test Tolerance (Power class 7)

Test Metric	FR2a
Max device size \leq 30 cm	3.24 dB, NTC 3.41 dB, ETC

6.2.2_1 UE maximum output power reduction enhancements

6.2.2_1.0 General

The requirements in section 6.2.2_1 only apply when both UL and DL of a UE are configured for single CC operation, and they are of the same bandwidth. A UE may reduce its maximum output power due to modulation orders, transmit bandwidth configurations, waveform types and narrow allocations. This Maximum Power Reduction (MPR) is defined in subclauses below. The allowed MPR for SRS, PUCCH formats 0, 1, 3 and 4, and PRACH shall be as specified for QPSK modulated DFT-s-OFDM of equivalent RB allocation. The allowed MPR for PUCCH format 2 shall be as specified for QPSK modulated CP-OFDM of equivalent RB allocation. When the maximum output power of a UE is modified by MPR, the power limits specified in clause 6.2.4 apply.

For a UE that is configured for single CC operation with different channel bandwidths in UL and DL, the requirements in section 6.2A.2 apply.

For all power classes, the waveform defined by BW = 100 MHz, SCS = 120 kHz, DFT-S-OFDM QPSK, 20RB23 is the reference waveform with 0 dB MPR and is used for the power class definition.

6.2.2_1.1 Test purpose

The number of RB identified in 6.2.2_1.3 is based on meeting the requirements for the maximum power reduction (MPR) due to Cubic Metric (CM).

6.2.2_1.2 Test applicability

The requirements of this test apply to all types of NR Power Class 3 UE release 15 and release 16 which supports *modifiedMPRbehaviour* bit 0 capability (according to Annex P.1)

The requirements of this test apply to all types of NR Power Class 3 UE release 17 and forward.

6.2.2_1.3 Minimum conformance requirements

6.2.2_1.3.1 Void

6.2.2_1.3.2 Void

6.2.2_1.3.3 UE maximum output power reduction for power class 3

For transmission bandwidth configuration less than or equal to 200MHz, and $0 \leq RB_{start} < \text{Ceil}(1/3 N_{RB})$ or $\text{Ceil}((2/3N_{RB}) - L_{CRB}) < RB_{start} \leq N_{RB} - L_{CRB}$:

- $MPR_{narrow} = 2.5$ dB, when $BW_{alloc,RB}$ is less than or equal to 1.44 MHz,
- $MPR_{narrow} = 2.0$ dB, when $1.44 \text{ MHz} < BW_{alloc,RB} \leq 4.32 \text{ MHz}$,
- otherwise $MPR_{narrow} = 0$ dB.

MPR_{WT} is the maximum power reduction due to modulation orders, transmission bandwidth configurations listed in Table 5.3.2-1, and waveform types. MPR_{WT} is defined in Table 6.2.2_1.3.3-1.

Table 6.2.2_1.3.3-1 MPR_{WT} for power class 3, $BW_{channel} \leq 200$ MHz

Modulation		$MPR_{WT}, BW_{channel} \leq 200$ MHz	
		Inner RB allocations, Region 1	Edge RB allocations
DFT-s-OFDM	Pi/2 BPSK	0.0	≤ 2.0
	QPSK	0.0	≤ 2.0
	16 QAM	≤ 3.0	≤ 3.5
	64 QAM	≤ 5.0	≤ 5.5
CP-OFDM	QPSK	≤ 3.5	≤ 4.0
	16 QAM	≤ 5.0	≤ 5.0
	64 QAM	≤ 7.5	≤ 7.5

Where the following parameters are defined to specify valid RB allocation ranges for RB allocations in Table 6.2.2_1.3.3-1:

- $RB_{Start,Low} = \max(1, L_{CRB})$, where $\max()$ indicates the largest value of all arguments.
- $RB_{Start,High} = N_{RB} - RB_{Start,Low} - L_{CRB}$,

An RB allocation belonging to table 6.2.2_1.3.3-1 is a Region 1 inner RB allocation if:

- $RB_{Start,Low} \leq RB_{Start} \leq RB_{Start,High}$, and $L_{CRB} \leq \text{ceil}(N_{RB}/3)$, where $\text{ceil}(x)$ is the smallest integer greater than or equal to x .

For transmission bandwidth configuration equal to 400MHz,

$MPR_{narrow} = 2.5$ dB, when $BW_{alloc,RB}$ is less than or equal to 1.44 MHz, and $0 \leq RB_{start} < \text{Ceil}(1/3 N_{RB})$ or $\text{Ceil}(2/3N_{RB}) \leq RB_{start} \leq N_{RB} - L_{CRB}$, where $BW_{alloc,RB}$ is the bandwidth of the RB allocation size.

MPR_{WT} is the maximum power reduction due to modulation orders, transmission bandwidth configurations listed in Table 5.3.2-1, and waveform types. MPR_{WT} is defined in Table 6.2.2_1.3.3-2.

Table 6.2.2_1.3.3-2 MPR_{WT} for power class 3, $BW_{channel} = 400$ MHz

Modulation		$MPR_{WT}, BW_{channel} = 400$ MHz	
		Inner RB allocations, Region 1	Edge RB allocations
DFT-s-OFDM	Pi/2 BPSK	0.0	≤ 3.0
	QPSK	0.0	≤ 3.0
	16 QAM	≤ 4.5	≤ 4.5
	64 QAM	≤ 6.5	≤ 6.5
CP-OFDM	QPSK	≤ 5.0	≤ 5.0
	16 QAM	≤ 6.5	≤ 6.5

	64 QAM	≤ 9.0	≤ 9.0
--	--------	-------	-------

Where the following parameters are defined to specify valid RB allocation ranges for RB allocations in Table 6.2.2_1.3.3-2:

N_{RB} is the maximum number of RBs for a given Channel bandwidth and sub-carrier spacing defined in Table 5.3.2-1.

$$RB_{end} = RB_{start} + L_{CRB} - 1$$

An RB allocation belonging to table 6.2.2_1.3.3-2 is a Region 1 inner RB allocation if

$$RB_{start} \geq \text{Ceil}(1/4 N_{RB}) \text{ AND } RB_{end} < \text{Ceil}(3/4 N_{RB}) \text{ AND } L_{CRB} \leq \text{Ceil}(1/4 N_{RB})$$

For all transmission bandwidth configurations, an RB allocation is an Edge allocation if it is NOT a Region 1 inner allocation.

The normative reference for this requirement is TS 38.101-2 [3] clause 6.2.2.3

6.2.2_1.3.4 Void

6.2.2_1.4 Test description

Same as in clause 6.2.2.1.4.1 with following exceptions: Instead of Tables 6.2.2.1.4.1-1 to 6.2.2.1.4.1-9 →use Tables 6.2.2_1.1.4.1-1 and 6.2.2_1.1.4.1-4

Table 6.2.2_1.4.1-1: Test Configuration Table (Power Class 3, MPR_{narrow} , $BW_{channel} \leq 200$ MHz)

Default Conditions						
Test Environment as specified in TS 38.508-1 [10] clause 4.1				Normal, TL, TH		
Test Frequencies as specified in TS 38.508-1 [10] clause 4.3.1				Low range, High range		
Test Channel Bandwidths as specified in TS 38.508-1 [10] clause 4.3.1				Lowest and Highest supported channel bandwidth that ≤ 200 MHz		
Test SCS as specified in Table 5.3.5-1				Lowest, Highest		
Test Parameters						
Test ID	Freq	ChBw	SCS	Downlink Configuration	Uplink Configuration	
					Modulation	RB allocation (NOTE 1)
		Default	Default	-		
1	Low				DFT-s-OFDM PI/2 BPSK	Outer_1RB_Left
2	High				DFT-s-OFDM PI/2 BPSK	Outer_1RB_Right
3	Low				DFT-s-OFDM QPSK	Outer_1RB_Left
4	High				DFT-s-OFDM QPSK	Outer_1RB_Right
5	Low				DFT-s-OFDM PI/2 BPSK	Inner_Partial2_Left
6	High				DFT-s-OFDM PI/2 BPSK	Inner_Partial2_Right
7	Low				DFT-s-OFDM QPSK	Inner_Partial2_Left
8	High				DFT-s-OFDM QPSK	Inner_Partial2_Right
NOTE 1: The specific configuration of each RF allocation is defined in Table 6.1-1.						

Table 6.2.2_1.4.1-2: Test Configuration Table (Power Class 3, MPR_{WT} , $BW_{channel} \leq 200$ MHz)

Default Conditions	
Test Environment as specified in TS 38.508-1 [10] clause 4.1	Normal, TL, TH
Test Frequencies as specified in TS 38.508-1 [10] clause 4.3.1	Low range, Mid range, High range
Test Channel Bandwidths as specified in TS 38.508-1 [10] clause 4.3.1	Lowest and Highest supported channel bandwidth that ≤ 200 MHz

Test SCS as specified in Table 5.3.5-1					Lowest, Highest	
Test Parameters						
Test ID	Freq	ChBw	SCS	Downlink Configuration	Uplink Configuration	
		Default	Default	-	Modulation	RB allocation (NOTE 1)
1	Mid				DFT-s-OFDM PI/2 BPSK	Outer_Full
2	Mid				DFT-s-OFDM QPSK	Outer_Full
3	Mid				DFT-s-OFDM 16 QAM	Inner_Full
4	Low				DFT-s-OFDM 16 QAM	Outer_1RB_Left
5	High				DFT-s-OFDM 16 QAM	Outer_1RB_Right
6	Mid				DFT-s-OFDM 16 QAM	Outer_Full
7	Mid				DFT-s-OFDM 64 QAM	Inner_Full
8	Low				DFT-s-OFDM 64 QAM	Outer_1RB_Left
9	High				DFT-s-OFDM 64 QAM	Outer_1RB_Right
10	Mid				DFT-s-OFDM 64 QAM	Outer_Full
11	Mid				CP-OFDM QPSK	Inner_Full
12	Low				CP-OFDM QPSK	Outer_1RB_Left
13	High				CP-OFDM QPSK	Outer_1RB_Right
14	Mid				CP-OFDM QPSK	Outer_Full
15	Low				CP-OFDM 16 QAM	Outer_1RB_Left
16	High				CP-OFDM 16 QAM	Outer_1RB_Right
17	Mid				CP-OFDM 16 QAM	Outer_Full
18	Low				CP-OFDM 64 QAM	Outer_1RB_Left
19	High				CP-OFDM 64 QAM	Outer_1RB_Right
20	Mid	CP-OFDM 64 QAM	Outer_Full			

NOTE 1: The specific configuration of each RF allocation is defined in Table 6.1-1.

Table 6.2.2_1.4.1-3: Test Configuration Table (Power Class 3, MPR_{narrow}, BWchannel = 400 MHz)

Default Conditions						
Test Environment as specified in TS 38.508-1 [10] clause 4.1					Normal, TL, TH	
Test Frequencies as specified in TS 38.508-1 [10] clause 4.3.1					Low range, High range	
Test Channel Bandwidths as specified in TS 38.508-1 [10] clause 4.3.1					400 MHz	
Test SCS as specified in Table 5.3.5-1					120 kHz	
Test Parameters						
Test ID	Freq	ChBw	SCS	Downlink Configuration	Uplink Configuration	
		Default	Default	N/A for Maximum Power Reduction (MPR) test case	Modulation	RB allocation (NOTE 1)
1	Low				DFT-s-OFDM PI/2 BPSK	Inner_1RB_Left
2	High				DFT-s-OFDM PI/2 BPSK	Inner_1RB_Right
3	Low				DFT-s-OFDM QPSK	Inner_1RB_Left
4	High				DFT-s-OFDM QPSK	Inner_1RB_Right

NOTE 1: The specific configuration of each RF allocation is defined in Table 6.1-1.

Table 6.2.2_1.4.1-4: Test Configuration Table (Power Class 3, MPR_{WT}, BWchannel = 400 MHz)

Default Conditions						
Test Environment as specified in TS 38.508-1 [10] clause 4.1					Normal, TL, TH	
Test Frequencies as specified in TS 38.508-1 [10] clause 4.3.1					Low range, Mid range, High range	
Test Channel Bandwidths as specified in TS 38.508-1 [10] clause 4.3.1					400 MHz	
Test SCS as specified in Table 5.3.5-1					120kHz	
Test Parameters						
Test ID	Freq	ChBw	SCS	Downlink Configuration	Uplink Configuration	
		Default	Default	-	Modulation	RB allocation (NOTE 1)

1	Low			DFT-s-OFDM PI/2 BPSK	Outer_1RB_Left
2	High			DFT-s-OFDM PI/2 BPSK	Outer_1RB_Right
3	Mid			DFT-s-OFDM PI/2 BPSK	Outer_Full
4	Low			DFT-s-OFDM QPSK	Outer_1RB_Left
5	High			DFT-s-OFDM QPSK	Outer_1RB_Right
6	Mid			DFT-s-OFDM QPSK	Outer_Full
7	Low			DFT-s-OFDM 16 QAM	Outer_1RB_Left
8	High			DFT-s-OFDM 16 QAM	Outer_1RB_Right
9	Mid			DFT-s-OFDM 16 QAM	Outer_Full
10	Low			DFT-s-OFDM 64 QAM	Outer_1RB_Left
11	High			DFT-s-OFDM 64 QAM	Outer_1RB_Right
12	Mid			DFT-s-OFDM 64 QAM	Outer_Full
13	Low			CP-OFDM QPSK	Outer_1RB_Left
14	High			CP-OFDM QPSK	Outer_1RB_Right
15	Mid			CP-OFDM QPSK	Outer_Full
16	Low			CP-OFDM 16 QAM	Outer_1RB_Left
17	High			CP-OFDM 16 QAM	Outer_1RB_Right
18	Mid			CP-OFDM 16 QAM	Outer_Full
19	Low			CP-OFDM 64 QAM	Outer_1RB_Left
20	High			CP-OFDM 64 QAM	Outer_1RB_Right
21	Mid			CP-OFDM 64 QAM	Outer_Full

NOTE 1: The specific configuration of each RF allocation is defined in Table 6.1-1.

6.2.2_1.5 Test requirement

The maximum output power, derived in step 5 shall be within the range prescribed by the nominal maximum output power and tolerance in following tables.

Table 6.2.2_1.5-1: UE Power Class test requirements for Power Class 3 (n257, 258, 261)

Test Configuration Table	Test ID	P _{Powerclass}	MPR _{f,c}	T(MPR _{f,c})	Lower limit (dBm)	Upper limit (dBm)
6.2.2_1.4.1-1	1	22.4	2.5	2	17.9-TT-ΔMB _{P,n}	43
	2	22.4	2.5	2	17.9-TT-ΔMB _{P,n}	43
	3	22.4	2.5	2	17.9-TT-ΔMB _{P,n}	43
	4	22.4	2.5	2	17.9-TT-ΔMB _{P,n}	43
	5	22.4	2	1.5	18.9-TT-ΔMB _{P,n}	43
	6	22.4	2	1.5	18.9-TT-ΔMB _{P,n}	43
	7	22.4	2	1.5	18.9-TT-ΔMB _{P,n}	43
	8	22.4	2	1.5	18.9-TT-ΔMB _{P,n}	43
6.2.2_1.4.1-2	1	22.4	2	1.5	18.9-TT-ΔMB _{P,n}	43
	2	22.4	2	1.5	18.9-TT-ΔMB _{P,n}	43
	3	22.4	3	2	17.4-TT-ΔMB _{P,n}	43
	4	22.4	3.5	3	15.9-TT-ΔMB _{P,n}	43
	5	22.4	3.5	3	15.9-TT-ΔMB _{P,n}	43
	6	22.4	3.5	3	15.9-TT-ΔMB _{P,n}	43
	7	22.4	5	4	13.4-TT-ΔMB _{P,n}	43
	8	22.4	5.5	5	11.9-TT-ΔMB _{P,n}	43
	9	22.4	5.5	5	11.9-TT-ΔMB _{P,n}	43
	10	22.4	5.5	5	11.9-TT-ΔMB _{P,n}	43
	11	22.4	3.5	3	15.9-TT-ΔMB _{P,n}	43
	12	22.4	4	3	15.4-TT-ΔMB _{P,n}	43
	13	22.4	4	3	15.4-TT-ΔMB _{P,n}	43
	14	22.4	4	3	15.4-TT-ΔMB _{P,n}	43
	15	22.4	5	4	13.4-TT-ΔMB _{P,n}	43
	16	22.4	5	4	13.4-TT-ΔMB _{P,n}	43
	17	22.4	5	4	13.4-TT-ΔMB _{P,n}	43
	18	22.4	7.5	5	9.9-TT-ΔMB _{P,n}	43
	19	22.4	7.5	5	9.9-TT-ΔMB _{P,n}	43
	20	22.4	7.5	5	9.9-TT-ΔMB _{P,n}	43
6.2.2_1.4.1-3	1	22.4	2.5	2	17.9-TT-ΔMB _{P,n}	43
	2	22.4	2.5	2	17.9-TT-ΔMB _{P,n}	43
	3	22.4	2.5	2	17.9-TT-ΔMB _{P,n}	43

6.2.2_1.4.1-4	4	22.4	2.5	2	17.9-TT- $\Delta MB_{P,n}$	43
	1	22.4	3	2	17.4-TT- $\Delta MB_{P,n}$	43
	2	22.4	3	2	17.4-TT- $\Delta MB_{P,n}$	43
	3	22.4	3	2	17.4-TT- $\Delta MB_{P,n}$	43
	4	22.4	3	2	17.4-TT- $\Delta MB_{P,n}$	43
	5	22.4	3	2	17.4-TT- $\Delta MB_{P,n}$	43
	6	22.4	3	2	17.4-TT- $\Delta MB_{P,n}$	43
	7	22.4	4.5	4	13.9-TT- $\Delta MB_{P,n}$	43
	8	22.4	4.5	4	13.9-TT- $\Delta MB_{P,n}$	43
	9	22.4	4.5	4	13.9-TT- $\Delta MB_{P,n}$	43
	10	22.4	6.5	5	10.9-TT- $\Delta MB_{P,n}$	43
	11	22.4	6.5	5	10.9-TT- $\Delta MB_{P,n}$	43
	12	22.4	6.5	5	10.9-TT- $\Delta MB_{P,n}$	43
	13	22.4	5	4	13.4-TT- $\Delta MB_{P,n}$	43
	14	22.4	5	4	13.4-TT- $\Delta MB_{P,n}$	43
	15	22.4	5	4	13.4-TT- $\Delta MB_{P,n}$	43
	16	22.4	6.5	5	10.9-TT- $\Delta MB_{P,n}$	43
	17	22.4	6.5	5	10.9-TT- $\Delta MB_{P,n}$	43
	18	22.4	6.5	5	10.9-TT- $\Delta MB_{P,n}$	43
	19	22.4	9	5	8.4-TT- $\Delta MB_{P,n}$	43
	20	22.4	9	5	8.4-TT- $\Delta MB_{P,n}$	43
21	22.4	9	5	8.4-TT- $\Delta MB_{P,n}$	43	

Note 1: $\Delta MB_{P,n}$ is the Multiband Relaxation factor declared by the UE for the tested band in table A.4.3.9-2 of TS38.508-2. This declaration shall fulfil the requirements in clause 6.2.1.1.3.3.

Note 2: All UE supported bands needs to be tested to ensure the multiband relaxation declaration is compliant.

Note 3: Max allowed sum of $\Delta MB_{P,n}$ over all supported FR2 bands as defined in clause 6.2.1.1.3.3.

Note 4: $\Delta MB_{P,n}$ is 0 for single band UE.

Table 6.2.2_1.5-2: UE Power Class test requirements for Power Class 3 (n260)

Test Configuration Table	Test ID	$P_{Powerclass}$	$MPR_{f,c}$	$T(MPR_{f,c})$	Lower limit (dBm)	Upper limit (dBm)
6.2.2_1.4.1-1	1	20.6	2.5	2	16.1-TT- $\Delta MB_{P,n}$	43
	2	20.6	2.5	2	16.1-TT- $\Delta MB_{P,n}$	43
	3	20.6	2.5	2	16.1-TT- $\Delta MB_{P,n}$	43
	4	20.6	2.5	2	16.1-TT- $\Delta MB_{P,n}$	43
	5	20.6	2	1.5	17.1-TT- $\Delta MB_{P,n}$	43
	6	20.6	2	1.5	17.1-TT- $\Delta MB_{P,n}$	43
	7	20.6	2	1.5	17.1-TT- $\Delta MB_{P,n}$	43
	8	20.6	2	1.5	17.1-TT- $\Delta MB_{P,n}$	43
6.2.2_1.4.1-2	1	20.6	2	1.5	17.1-TT- $\Delta MB_{P,n}$	43
	2	20.6	2	1.5	17.1-TT- $\Delta MB_{P,n}$	43
	3	20.6	3	2	15.6-TT- $\Delta MB_{P,n}$	43
	4	20.6	3.5	3	14.1-TT- $\Delta MB_{P,n}$	43
	5	20.6	3.5	3	14.1-TT- $\Delta MB_{P,n}$	43
	6	20.6	3.5	3	14.1-TT- $\Delta MB_{P,n}$	43
	7	20.6	5	4	11.6-TT- $\Delta MB_{P,n}$	43
	8	20.6	5.5	5	10.1-TT- $\Delta MB_{P,n}$	43
	9	20.6	5.5	5	10.1-TT- $\Delta MB_{P,n}$	43
	10	20.6	5.5	5	10.1-TT- $\Delta MB_{P,n}$	43
	11	20.6	3.5	3	14.1-TT- $\Delta MB_{P,n}$	43
	12	20.6	4	3	13.6-TT- $\Delta MB_{P,n}$	43
	13	20.6	4	3	13.6-TT- $\Delta MB_{P,n}$	43
	14	20.6	4	3	13.6-TT- $\Delta MB_{P,n}$	43
	15	20.6	5	4	11.6-TT- $\Delta MB_{P,n}$	43
	16	20.6	5	4	11.6-TT- $\Delta MB_{P,n}$	43
	17	20.6	5	4	11.6-TT- $\Delta MB_{P,n}$	43
	18	20.6	7.5	5	8.1-TT- $\Delta MB_{P,n}$	43
	19	20.6	7.5	5	8.1-TT- $\Delta MB_{P,n}$	43
	20	20.6	7.5	5	8.1-TT- $\Delta MB_{P,n}$	43
6.2.2_1.4.1-3	1	20.6	2.5	2	16.1-TT- $\Delta MB_{P,n}$	43
	2	20.6	2.5	2	16.1-TT- $\Delta MB_{P,n}$	43
	3	20.6	2.5	2	16.1-TT- $\Delta MB_{P,n}$	43

6.2.2_1.4.1-4	4	20.6	2.5	2	16.1-TT- $\Delta MB_{P,n}$	43
	1	20.6	3	2	15.6-TT- $\Delta MB_{P,n}$	43
	2	20.6	3	2	15.6-TT- $\Delta MB_{P,n}$	43
	3	20.6	3	2	15.6-TT- $\Delta MB_{P,n}$	43
	4	20.6	3	2	15.6-TT- $\Delta MB_{P,n}$	43
	5	20.6	3	2	15.6-TT- $\Delta MB_{P,n}$	43
	6	20.6	3	2	15.6-TT- $\Delta MB_{P,n}$	43
	7	20.6	4.5	4	12.1-TT- $\Delta MB_{P,n}$	43
	8	20.6	4.5	4	12.1-TT- $\Delta MB_{P,n}$	43
	9	20.6	4.5	4	12.1-TT- $\Delta MB_{P,n}$	43
	10	20.6	6.5	5	9.1-TT- $\Delta MB_{P,n}$	43
	11	20.6	6.5	5	9.1-TT- $\Delta MB_{P,n}$	43
	12	20.6	6.5	5	9.1-TT- $\Delta MB_{P,n}$	43
	13	20.6	5	4	11.6-TT- $\Delta MB_{P,n}$	43
	14	20.6	5	4	11.6-TT- $\Delta MB_{P,n}$	43
	15	20.6	5	4	11.6-TT- $\Delta MB_{P,n}$	43
	16	20.6	6.5	5	9.1-TT- $\Delta MB_{P,n}$	43
	17	20.6	6.5	5	9.1-TT- $\Delta MB_{P,n}$	43
	18	20.6	6.5	5	9.1-TT- $\Delta MB_{P,n}$	43
	19	20.6	9	5	6.6-TT- $\Delta MB_{P,n}$	43
	20	20.6	9	5	6.6-TT- $\Delta MB_{P,n}$	43
21	20.6	9	5	6.6-TT- $\Delta MB_{P,n}$	43	

Note 1: $\Delta MB_{P,n}$ is the Multiband Relaxation factor declared by the UE for the tested band in table A.4.3.9-2 of TS38.508-2. This declaration shall fulfil the requirements in clause 6.2.1.1.3.3.
 Note 2: All UE supported bands needs to be tested to ensure the multiband relaxation declaration is compliant.
 Note 3: Max allowed sum of $\Delta MB_{P,n}$ over all supported FR2 bands as defined in clause 6.2.1.1.3.3.
 Note 4: $\Delta MB_{P,n}$ is 0 for single band UE.

Table 6.2.2_1.5-3: Test Tolerance (Power class 3)

Test Metric	FR2a	FR2b	FR2c
Max device size \leq 30 cm	3.24 dB	3.24 dB	4.12 dB

Table 6.2.2_1.5-4: UE Power Class test requirements for Power Class 3 (n259)

Test Configuration Table	Test ID	$P_{Powerclass}$	$MPR_{f,c}$	$T(MPR_{f,c})$	Lower limit (dBm)	Upper limit (dBm)
6.2.2_1.4.1-1	1	18.7	2.5	2	14.2-TT- $\Delta MB_{P,n}$	43
	2	18.7	2.5	2	14.2-TT- $\Delta MB_{P,n}$	43
	3	18.7	2.5	2	14.2-TT- $\Delta MB_{P,n}$	43
	4	18.7	2.5	2	14.2-TT- $\Delta MB_{P,n}$	43
	5	18.7	2	1.5	15.2-TT- $\Delta MB_{P,n}$	43
	6	18.7	2	1.5	15.2-TT- $\Delta MB_{P,n}$	43
	7	18.7	2	1.5	15.2-TT- $\Delta MB_{P,n}$	43
	8	18.7	2	1.5	15.2-TT- $\Delta MB_{P,n}$	43
6.2.2_1.4.1-2	1	18.7	2	1.5	15.2-TT- $\Delta MB_{P,n}$	43
	2	18.7	2	1.5	15.2-TT- $\Delta MB_{P,n}$	43
	3	18.7	3	2	13.7-TT- $\Delta MB_{P,n}$	43
	4	18.7	3.5	3	12.2-TT- $\Delta MB_{P,n}$	43
	5	18.7	3.5	3	12.2-TT- $\Delta MB_{P,n}$	43
	6	18.7	3.5	3	12.2-TT- $\Delta MB_{P,n}$	43
	7	18.7	5	4	9.7-TT- $\Delta MB_{P,n}$	43
	8	18.7	5.5	5	8.2-TT- $\Delta MB_{P,n}$	43
	9	18.7	5.5	5	8.2-TT- $\Delta MB_{P,n}$	43
	10	18.7	5.5	5	8.2-TT- $\Delta MB_{P,n}$	43
	11	18.7	3.5	3	12.2-TT- $\Delta MB_{P,n}$	43
	12	18.7	4	3	11.7-TT- $\Delta MB_{P,n}$	43
	13	18.7	4	3	11.7-TT- $\Delta MB_{P,n}$	43
	14	18.7	4	3	11.7-TT- $\Delta MB_{P,n}$	43
	15	18.7	5	4	9.7-TT- $\Delta MB_{P,n}$	43
	16	18.7	5	4	9.7-TT- $\Delta MB_{P,n}$	43
	17	18.7	5	4	9.7-TT- $\Delta MB_{P,n}$	43

	18	18.7	7.5	5	6.2-TT- $\Delta MB_{P,n}$	43
	19	18.7	7.5	5	6.2-TT- $\Delta MB_{P,n}$	43
	20	18.7	7.5	5	6.2-TT- $\Delta MB_{P,n}$	43
6.2.2_1.4.1-3	1	18.7	2.5	2	14.2-TT- $\Delta MB_{P,n}$	43
	2	18.7	2.5	2	14.2-TT- $\Delta MB_{P,n}$	43
	3	18.7	2.5	2	14.2-TT- $\Delta MB_{P,n}$	43
	4	18.7	2.5	2	14.2-TT- $\Delta MB_{P,n}$	43
6.2.2_1.4.1-4	1	18.7	3	2	13.7-TT- $\Delta MB_{P,n}$	43
	2	18.7	3	2	13.7-TT- $\Delta MB_{P,n}$	43
	3	18.7	3	2	13.7-TT- $\Delta MB_{P,n}$	43
	4	18.7	3	2	13.7-TT- $\Delta MB_{P,n}$	43
	5	18.7	3	2	13.7-TT- $\Delta MB_{P,n}$	43
	6	18.7	3	2	13.7-TT- $\Delta MB_{P,n}$	43
	7	18.7	4.5	4	10.2-TT- $\Delta MB_{P,n}$	43
	8	18.7	4.5	4	10.2-TT- $\Delta MB_{P,n}$	43
	9	18.7	4.5	4	10.2-TT- $\Delta MB_{P,n}$	43
	10	18.7	6.5	5	7.2-TT- $\Delta MB_{P,n}$	43
	11	18.7	6.5	5	7.2-TT- $\Delta MB_{P,n}$	43
	12	18.7	6.5	5	7.2-TT- $\Delta MB_{P,n}$	43
	13	18.7	5	4	9.7-TT- $\Delta MB_{P,n}$	43
	14	18.7	5	4	9.7-TT- $\Delta MB_{P,n}$	43
	15	18.7	5	4	9.7-TT- $\Delta MB_{P,n}$	43
	16	18.7	6.5	5	7.2-TT- $\Delta MB_{P,n}$	43
	17	18.7	6.5	5	7.2-TT- $\Delta MB_{P,n}$	43
	18	18.7	6.5	5	7.2-TT- $\Delta MB_{P,n}$	43
	19	18.7	9	5	4.7-TT- $\Delta MB_{P,n}$	43
	20	18.7	9	5	4.7-TT- $\Delta MB_{P,n}$	43
	21	18.7	9	5	4.7-TT- $\Delta MB_{P,n}$	43
Note 1:	$\Delta MB_{P,n}$ is the Multiband Relaxation factor declared by the UE for the tested band in table A.4.3.9-2 of TS38.508-2. This declaration shall fulfil the requirements in clause 6.2.1.1.3.3.					
Note 2:	All UE supported bands needs to be tested to ensure the multiband relaxation declaration is compliant.					
Note 3:	Max allowed sum of $\Delta MB_{P,n}$ over all supported FR2 bands as defined in clause 6.2.1.1.3.3.					
Note 4:	$\Delta MB_{P,n}$ is 0 for single band UE.					

6.2.3 UE maximum output power with additional requirements

Editor's note: The following aspects are either missing or not yet determined:

- Measurement Uncertainties and Test Tolerances are FFS for power class other than 1, 3, 5 and 7..

6.2.3.1 Test purpose

Additional spectrum emission requirements can be signalled by the network to indicate that the UE shall also meet additional requirements in a specific deployment scenario. To meet these additional requirements, Additional Maximum Power Reduction (A-MPR) is allowed for the output power.

6.2.3.2 Test applicability

This test case applies to all types of NR UE release 15 and forward.

6.2.3.3 Minimum conformance requirements

6.2.3.3.1 General

Additional emission requirements can be signalled by the network. Each additional emission requirement is associated with a unique network signalling (NS) value indicated in RRC signalling by an NR frequency band number of the applicable operating band and an associated value in the field *additionalSpectrumEmission*. Throughout this specification, the notion of indication or signalling of an NS value refers to the corresponding indication of an NR frequency band number of the applicable operating band (the IE field *freqBandIndicatorNR*) and an associated value of *additionalSpectrumEmission* in the relevant RRC information elements.

To meet these additional requirements, additional maximum power reduction (A-MPR) is allowed for the maximum output power as specified in clause 6.2.1.1.3. Unless stated otherwise, an A-MPR of 0 dB shall be used.

Table 6.2.3.3.1-1 specifies the additional requirements with their associated network signalling values and the allowed A-MPR and applicable operating band(s) for each NS value. The mapping of NR frequency band numbers and values of the *additionalSpectrumEmission* to network signalling labels is specified in Table 6.2.3.3.1-2. Unless otherwise stated, the allowed total back off is maximum of A-MPR and MPR specified in clause 6.2.2.

Table 6.2.3.3.1-1: Additional maximum power reduction (A-MPR)

Network Signalling label	Requirements (subclause)	NR Band	Channel bandwidth (MHz)	Resources Blocks (N_{RB})	A-MPR (dB)
NS_200					N/A
NS_201 (NOTE 1)	6.5.3.3.3	n258			6.2.3.3.2
NS_202	6.5.3.3.3	n257, n258	50, 100, 200, 400	Table 5.3.2-1	6.2.3.3.3
NS_203	6.5.3.3.3	n258	50, 100, 200, 400	Table 5.3.2-1	6.2.3.3.4
NS_205	6.5.3.3.3	n257, n258	50, 100, 200, 400	Table 5.3.2-1	6.2.3.3.6
NOTE 1: NS_201 is obsolete, the associated additional spurious emission requirements are not applicable.					

Table 6.2.3.3.1-2: Mapping of Network Signalling label

NR Band	Value of <i>additionalSpectrumEmission</i> (NOTE 1)							
	0	1	2	3	4	5	6	7
n257	NS_200	NS_202	NS_205					
n258	NS_200	NS_201 ²	NS_202	NS_203	NS_205			
n260	NS_200							
n261	NS_200							
NOTE 1: <i>additionalSpectrumEmission</i> corresponds to an information element of the same name defined in sub-clause 6.3.2 of TS 38.331 [19].								
NOTE 2: NS_201 is obsolete, the associated additional spurious emission requirements are not applicable.								

The normative reference for this requirement is TS 38.101-2 [3] clause 6.2.3.1.

6.2.3.3.2 Void

6.2.3.3.2.1 Void

6.2.3.3.2.2 Void

6.2.3.3.2.3 Void

6.2.3.3.3 A-MPR for NS_202

The normative reference for this requirement is TS 38.101-2 [3] clause 6.2.3.3.

6.2.3.3.3.1 A-MPR for NS_202 for power class 1

For power class 1, A-MPR for NS_202 shall be 11.0 dB.

6.2.3.3.3.2 A-MPR for NS_202 for power class 2

For power class 2, A-MPR for NS_202 specified in clause 6.2.3.3.3.3 applies.

6.2.3.3.3.3 A-MPR for NS_202 for power class 3

For power class 3, A-MPR for NS_202 shall be 2.0 dB.

6.2.3.3.3.4 A-MPR for NS_202 for power class 4

For power class 4, A-MPR for NS_202 specified in clause 6.2.3.3.3.3 applies.

6.2.3.3.3.5 A-MPR for NS_202 for power class 5

For power class 5, A-MPR for NS_202 specified in clause 6.2.3.3.3.3 applies.

6.2.3.3.3.6 A-MPR for NS_202 for power class 6

For power class 6, A-MPR for NS_202 specified in clause 6.2.3.3.3.3 applies.

6.2.3.3.3.7 A-MPR for NS_202 for power class 7

For power class 7, A-MPR for NS_202 specified in clause 6.2.3.3.3.3 applies.

6.2.3.3.4 A-MPR for NS_203

6.2.3.3.4.1 A-MPR for NS_203 for power class 1

For power class 1, A-MPR for NS_203 shall be 3.0 dB if Offset frequency < BW_{channel} , 0.0 dB otherwise.
The Offset frequency is defined as the frequency from 24.25 GHz to the lower edge of the channel bandwidth.

6.2.3.3.4.2 A-MPR for NS_203 for power class 2

For power class 2, A-MPR for NS_203 specified in clause 6.2.3.3.4.3 applies.

6.2.3.3.4.3 A-MPR for NS_203 for power class 3

For power class 3, A-MPR for NS_203 shall be 0 dB.

6.2.3.3.4.4 A-MPR for NS_203 for power class 4

For power class 4, A-MPR for NS_203 specified in clause 6.2.3.3.4.3 applies.

The normative reference for this requirement is TS 38.101-2 [3] clause 6.2.3.4.

6.2.3.3.4.5 A-MPR for NS_203 for power class 5

For power class 6, AMPR for NS_203 specified in clause 6.2.3.3.4.3 applies.

6.2.3.3.4.6 A-MPR for NS_203 for power class 6

For power class 6, AMPR for NS_203 specified in clause 6.2.3.3.4.3 applies.

6.2.3.3.4.7 A-MPR for NS_203 for power class 7

For power class 7, A-MPR for NS_203 specified in clause 6.2.3.3.4.3 applies.

6.2.3.3.5 [Reserved]

6.2.3.3.6 A-MPR for NS_205

6.2.3.3.6.1 A-MPR for NS_205 for power class 1

For power class 1, A-MPR for NS_205 shall be 7.0 dB if offset frequency < BW_{channel} , 6.0 dB otherwise.

Offset frequency is defined as the frequency from the upper edge of the protected frequency range i.e. 24 GHz to the lower edge of the channel bandwidth.

6.2.3.3.6.2 A-MPR for NS_205 for power class 2

For power class 2, A-MPR for NS_205 specified in clause 6.2.3.6.3 applies.

6.2.3.3.6.3 A-MPR for NS_205 for power class 3

For power class 3, A-MPR for NS_205 shall be 2.0 dB if offset frequency < BW_{channel}, 0.0 dB otherwise.

Offset frequency is defined as the frequency from the upper edge of the protected frequency range i.e. 24 GHz to the lower edge of the channel bandwidth.

6.2.3.3.6.4 A-MPR for NS_205 for power class 4

For power class 4, A-MPR for NS_205 specified in clause 6.2.3.6.3 applies.

6.2.3.3.6.5 A-MPR for NS_205 for power class 5

For power class 5, A-MPR for NS_205 specified in clause 6.2.3.6.3 applies.

6.2.3.3.6.6 A-MPR for NS_205 for power class 6

For power class 6, A-MPR for NS_205 specified in clause 6.2.3.6.3 applies.

6.2.3.3.6.7 A-MPR for NS_205 for power class 7

For power class 7, A-MPR for NS_205 specified in clause 6.2.3.6.3 applies.

6.2.3.4 Test description

6.2.3.4.1 Initial conditions

Initial conditions are a set of test configurations the UE needs to be tested in and the steps for the SS to take with the UE to reach the correct measurement state.

The initial test configurations consist of environmental conditions, test frequencies, and channel bandwidths based on NR operating bands specified in Table 5.3.5-1. All of these configurations shall be tested with applicable test parameters for each channel bandwidth and subcarrier spacing, are shown in Table 6.2.3.4.1-2 to Table 6.2.3.4.1-6. The details of the uplink reference measurement channels (RMCs) are specified in Annexes A.2. Configurations of PDSCH and PDCCH before measurement are specified in Annex C.2.

Table 6.2.3.4.1-1: Void

Table 6.2.3.4.1-2: Test configuration table for NS_202

Initial Conditions		
Test Environment as specified in TS 38.508-1 [10] clause 4.1	Normal	
Test Frequencies as specified in TS 38.508-1 [10] clause 4.3.1	Low range, High range	
Test Channel Bandwidths as specified in TS 38.508-1 [10] clause 4.3.1	Highest	
Test SCS as specified in Table 5.3.5-1	120kHz	
Test Parameters		
Test ID	Downlink Configuration	Uplink Configuration

	-	Modulation	RB allocation (NOTE 1)
1 (NOTE 4)		DFT-s-OFDM QPSK	Inner_Full
2		DFT-s-OFDM QPSK	Inner_1RB for PC2, PC3, PC4, PC6 and PC7 Inner_Partial for PC1 (NOTE 2)
3 (NOTE 3)		DFT-s-OFDM 64QAM	Outer_Full

NOTE 1: The specific configuration of each RB allocation is defined in Table 6.1-1 for PC2, PC3 , PC4, PC6 and PC7 or Table 6.1-2 for PC1.
 NOTE 2: When testing Low range configure uplink RB to Inner_1RB_Left for PC2, PC3, PC4, PC6 and PC7 or Inner_Partial_Left_Region1 for PC1 and when testing High range configure uplink RB to Inner_1RB_Right for PC2, PC3, PC4, PC6 and PC7 or Inner_Partial_Right_Region1 for PC1.
 NOTE 3: Test ID only applicable to PC1.
 NOTE 4: Test ID only applicable to PC2, PC3, PC4, PC6 and PC7.

Table 6.2.3.4.1-3: Test configuration table for NS_203

Initial Conditions					
Test Environment as specified in TS 38.508-1 [10] clause 4.1			Normal		
Test Frequencies as specified in TS 38.508-1 [10] clause 4.3.1			Low range		
Test Channel Bandwidths as specified in TS 38.508-1 [10] clause 4.3.1			Highest		
Test SCS as specified in Table 5.3.5-1			120kHz		
Test Parameters					
Test ID	Frequency	Channel Bandwidth	Downlink Configuration	Uplink Configuration	
			-	Modulation	RB allocation (NOTE 1)
1	Default	Default		DFT-s-OFDM QPSK	Inner_Full
2	Default	Default		DFT-s-OFDM QPSK	Inner_1RB_Left for PC2, PC3, PC4, PC6 and PC7 Inner_Partial_Left_Region1 for PC1
3 (NOTE 2)	Low range + Channel Bandwidth (NOTE 3)	Default		DFT-s-OFDM QPSK	Inner_Partial_Left_Region1

NOTE 1: The specific configuration of each RB allocation is defined in Table 6.1-1 for PC2, PC3, PC4, PC6 and PC7 or Table 6.1-2 for PC1.
 NOTE 2: Test ID only applicable to PC1
 NOTE 3: Test frequencies for test ID 3 is specified in Table 6.2.3.4.1-4.

Table 6.2.3.4.1-4: NS_203 test ID3 test frequencies for NR operating band n258, SCS 120kHz and ΔF_{Raster} 120 kHz

CBW [MHz]	carrier Bandwidth [PRBs]	Range		Carrier centre [MHz]	Carrier centre [ARFCN]	point A [MHz]	absolute Frequency Point A [ARFCN]	offsetTo Carrier [Carrier PRBs]	SS block SCS [kHz]	GSCN	absolute FrequencySSB [ARFCN]	k_{SSB}	Offset Carrier CORESET#0 [RBs] Note 2	CORE SET#0 Index (Offset [RBs]) Note 1	offsetTo PointA (SIB1) [PRBs] Note 1
50	32	Downlink & Uplink	Low + CHBW	24325.08	2017917	24302.04	2017533	0	120	22260	2017819	11	1	0 (0)	2
100	66	Downlink & Uplink	Low + CHBW	24400.08	2019167	24352.56	2018375	0	120	22263	2018683	10	2	0 (0)	4
200	132	Downlink & Uplink	Low + CHBW	24550.08	2021667	24455.04	2020083	0	120	22269	2020411	8	3	0 (0)	6
400	264	Downlink & Uplink	Low + CHBW	24850.08	2026667	24660.00	2023499	0	120	22281	2023867	4	1	1 (4)	10

Note 1: The CORESET#0 Index and the associated CORESET#0 Offset refers to Table 13-8 in TS 38.213 [22]. The value of CORESET#0 Index is signalled in controlResourceSetZero (pdcch-ConfigSIB1) in the MIB. The offsetToPointA IE is expressed in units of resource blocks assuming 15 kHz subcarrier spacing for FR1 and 60 kHz subcarrier spacing for FR2.

Note 2: The parameter Offset Carrier CORESET#0 specifies the offset from the lowest subcarrier of the carrier and the lowest subcarrier of CORESET#0. It corresponds to the parameter $\Delta F_{\text{OffsetCORESET-0-Carrier}}$ in Annex C expressed in number of common RBs.

Table 6.2.3.4.1-5: [Reserved]

Table 6.2.3.4.1-6: Test configuration table for NS_205

Initial Conditions					
Test Environment as specified in TS 38.508-1 [10] subclause 4.1				Normal	
Test Frequencies as specified in TS 38.508-1 [10] subclause 4.3.1				Low range	
Test Channel Bandwidths as specified in TS 38.508-1 [10] subclause 4.3.1				Highest	
Test SCS as specified in Table 5.3.5-1				120kHz	
Test Parameters					
Test ID	Frequency	Channel Bandwidth	Downlink Configuration	Uplink Configuration	
				Modulation	RB allocation (NOTE 1)
1 ²	Default	Default		DFT-s-OFDM QPSK	Outer_Full

2 ²	Default	Default	DFT-s-OFDM QPSK	Inner_Partial_Left_Region1
3 ^{2,4}	Mid	Default	DFT-s-OFDM QPSK	Outer_Full
4 ^{2,4}	Mid	Default	DFT-s-OFDM QPSK	Inner_Partial_Left_Region1
5 ³	Default	Default	DFT-s-OFDM QPSK	Inner_Full
6 ³	Default	Default	DFT-s-OFDM QPSK	Inner_1RB_Left
7 ^{3,4}	Mid	Default	DFT-s-OFDM QPSK	Inner_Full
8 ^{3,4}	Mid	Default	DFT-s-OFDM QPSK	Inner_1RB_Left
<p>NOTE 1: The specific configuration of each RB allocation is defined in Table 6.1-1 for PC2, PC3, PC4, PC6 and PC7 or Table 6.1-2 for PC1.</p> <p>NOTE 2: The test ID applies to PC1.</p> <p>NOTE 3: The test ID applies to PC2, PC3, PC4, PC6 and PC7.</p> <p>NOTE 4: The test ID applies to band n258.</p>				

1. Connection between SS and UE is shown in TS 38.508-1 [10] Annex A, Figure A.3.3.1.1 for TE diagram and Figure A.3.4.1.1 for UE diagram.
2. The parameter settings for the cell are set up according to TS 38.508-1 [10] clause 4.4.3.
3. Downlink signals are initially set up according to Annex C, and uplink signals according to Annex G.
4. The DL and UL Reference Measurement channels are set according to Table 6.2.3.4.1-2 to Table 6.2.3.4.1-6.
5. Propagation conditions are set according to Annex B.0.
6. Ensure the UE is in state RRC_CONNECTED with generic procedure parameters Connectivity *NR*, Connected without release *On*, Test Mode *On* and Test Loop Function *On* according to TS 38.508-1 [10] clause 4.5. Message contents are defined in clause 6.2.3.4.3

6.2.3.4.2 Test procedure

1. SS sends uplink scheduling information for each UL HARQ process via PDCCH DCI format 0_1 for C_RNTI to schedule the UL RMC according to Table 6.2.3.4.1-2 to Table 6.2.3.4.1-3. Since the UL has no payload and no loopback data to send the UE sends uplink MAC padding bits on the UL RMC.
2. Set the UE in the Tx beam peak direction found with a 3D EIRP scan as performed in Annex K. Allow at least BEAM_SELECT_WAIT_TIME (NOTE 1) for the UE Tx beam selection to complete.
3. Send continuously uplink power control "up" commands in every uplink scheduling information to the UE; allow at least 200 msec starting from the first TPC command in this step to ensure that the UE transmits at its maximum output power. Allow at least BEAM_SELECT_WAIT_TIME (NOTE 1) for the UE Tx beam selection to complete.
4. SS activates the UE Beamlock Function (UBF) by performing the procedure as specified in TS 38.508-1 [10] clause 4.9.2 using condition Tx only.
5. Measure UE EIRP in the Tx beam peak direction in the channel bandwidth of the radio access mode according to the test configuration, which shall meet the requirements described in Table 6.2.3.5-5 to Table 6.2.3.5-24. EIRP test procedure is defined in Annex K. The measuring duration is one active uplink subframe. EIRP is calculated considering both polarizations, theta and phi.
6. SS deactivates the UE Beamlock Function (UBF) by performing the procedure as specified in TS 38.508-1 [10] clause 4.9.3.

NOTE 1: The BEAM_SELECT_WAIT_TIME default value is defined in Annex K.

6.2.3.4.3 Message contents

Message contents are according to TS 38.508-1 [10] clause 4.6, with the following exceptions for each network signalling value.

1. Information element *AdditionalSpectrumEmission* for NR can be set in SIB1 according to TS 38.331[19]. This exception indicates that the UE shall meet the additional spurious emission requirement for a specific deployment scenario.

Table 6.2.3.4.3-1: *AdditionalSpectrumEmission*: Additional spurious emissions test requirement

Derivation Path: TS 38.508-1 [10] clause 4.6.3, Table 4.6.3-1			
Information Element	Value/remark	Comment	Condition
<i>AdditionalSpectrumEmission</i>	1 (NS_202)	for band n257	
<i>AdditionalSpectrumEmission</i>	2 (NS_202)	for band n258	
<i>AdditionalSpectrumEmission</i>	3 (NS_203)	for band n258	
<i>AdditionalSpectrumEmission</i>	4 (NS_205)	for band n257	
<i>AdditionalSpectrumEmission</i>	5 (NS_205)	for band n258	

6.2.3.5 Test requirement

The UE EIRP derived in step 5 shall not exceed the values specified in Table 6.2.3.5-5 to Table 6.2.3.5-24.

Table 6.2.3.5-1: Void

Table 6.2.3.5-2: Void

Table 6.2.3.5-3: Void

Table 6.2.3.5-4: Void

Table 6.2.3.5-5: UE Power Class 1 test requirements (network signalling value "NS_202")

Band	Test ID	P _{Powerclass}	MPR _{f,c}	A- MPR _{f,c}	T(MAX(MPR _{f,c} , A-MPR _{f,c}))	Lower limit (dBm)	Upper limit (dBm)
n257, n258	2	40	0	11	7	22-TT	55
	3		6.5	11	7	22-TT	55

Table 6.2.3.5-6: UE Power Class 2 test requirements (network signalling value "NS_202")

Band	Test ID	P _{Powerclass}	MPR _{f,c}	A- MPR _{f,c}	T(MAX(MPR _{f,c} , A-MPR _{f,c}))	Lower limit (dBm)	Upper limit (dBm)
n257, n258	1	29	0	2	1.5	25.5-TT	43
	2		2.5	2	2	24.5-TT	43

Table 6.2.3.5-7: UE Power Class 3 test requirements (network signalling value "NS_202")

Band	Test ID	P _{Powerclass}	MPR _{f,c}	A- MPR _{f,c}	T(MAX(MPR _{f,c} , A-MPR _{f,c}))	Lower limit (dBm)	Upper limit (dBm)
n257, n258	1	22.4	0	2	1.5	18.9-TT- Δ MB _{P,n}	43
	2		2.5	2	2	17.9-TT- Δ MB _{P,n}	43

Note 1: Δ MB_{P,n} is the Multiband Relaxation factor for the tested band. This shall fulfil the requirements in Table 6.2.1.1.3.3-5.

Table 6.2.3.5-8: UE Power Class 4 test requirements (network signalling value "NS_202")

Band	Test ID	P _{Powerclass}	MPR _{f,c}	A- MPR _{f,c}	T(MAX(MPR _{f,c} , A-MPR _{f,c}))	Lower limit (dBm)	Upper limit (dBm)
n257, n258	1	34	0	2	1.5	30.5-TT	43
	2		2.5	2	2	29.5-TT	43

Table 6.2.3.5-9: UE Power Class 5 and 6 test requirements (network signalling value "NS_202")

Band	Test ID	P _{Powerclass}	MPR _{f,c}	A- MPR _{f,c}	T(MAX(MPR _{f,c} , A-MPR _{f,c}))	Lower limit (dBm)	Upper limit (dBm)
n257	1	30	0	2	1.5	26.5-TT- Δ MB _{P,n}	43
n258	2	30.4	2.5	2	2	25.9-TT- Δ MB _{P,n}	43

Note 1: Δ MB_{P,n} is the Multiband Relaxation factor for the tested band. This shall fulfil the requirements in Table 6.2.1.1.3.5-4 for PC5 and Table 6.2.1.1.3.6-4 for PC6.

Table 6.2.3.5-9a: UE Power Class 7 test requirements (network signalling value "NS_202")

Band	Test ID	P _{Powerclass}	MPR _{f,c}	A- MPR _{f,c}	T(MAX(MPR _{f,c} , A- MPR _{f,c}))	Lower limit (dBm)	Upper limit (dBm)
n257, n258	1	16.4	0	2	1.5	12.9-TT- Δ MB _{P,n}	43
	2		2.5	2	2	11.9-TT- Δ MB _{P,n}	43
Note 1: Δ MB _{P,n} is the Multiband Relaxation factor for the tested band. This shall fulfil the requirements in Table 6.2.1.1.3.3-5.							

Table 6.2.3.5-10: UE Power Class 1 test requirements (network signalling value "NS_203")

Band	Test ID	P _{Powerclass}	MPR _{f,c}	A- MPR _{f,c}	T(MAX(MPR _{f,c} , A- MPR _{f,c}))	Lower limit (dBm)	Upper limit (dBm)
n258	1	40	0	3	2	35-TT	55
	2		0	3	2	35-TT	55
	3		0	0	0	40-TT	55

Table 6.2.3.5-11: UE Power Class 2 test requirements (network signalling value "NS_203")

Band	Test ID	P _{Powerclass}	MPR _{f,c}	A- MPR _{f,c}	T(MAX(MPR _{f,c} , A- MPR _{f,c}))	Lower limit (dBm)	Upper limit (dBm)
n258	1	29	0	0	0	29-TT	43
	2		2.5	0	2	24.5-TT	43

Table 6.2.3.5-12: UE Power Class 3 test requirements (network signalling value "NS_203")

Band	Test ID	P _{Powerclass}	MPR _{f,c}	A- MPR _{f,c}	T(MAX(MPR _{f,c} , A- MPR _{f,c}))	Lower limit (dBm)	Upper limit (dBm)
n258	1	22.4	0	0	0	22.4-TT- Δ MB _{P,n}	43
	2		2.5	0	2	17.9-TT- Δ MB _{P,n}	43
Note 1: Δ MB _{P,n} is the Multiband Relaxation factor for the tested band. This shall fulfil the requirements in Table 6.2.1.1.3.3-5.							

Table 6.2.3.5-13: UE Power Class 4 test requirements (network signalling value "NS_203")

Band	Test ID	P _{Powerclass}	MPR _{f,c}	A- MPR _{f,c}	T(MAX(MPR _{f,c} , A- MPR _{f,c}))	Lower limit (dBm)	Upper limit (dBm)
n258	1	34	0	0	0	34-TT	43
	2		2.5	0	2	29.5-TT	43

Table 6.2.3.5-14: UE Power Class 5 and 6 test requirements (network signalling value "NS_203")

Band	Test ID	P _{Powerclass}	MPR _{f,c}	A- MPR _{f,c}	T(MAX(MPR _{f,c} , A- MPR _{f,c}))	Lower limit (dBm)	Upper limit (dBm)
n258	1	30.4	0	0	0	30.4-TT- Δ MB _{P,n}	43
	2	30.4	2.5	0	2	25.9-TT- Δ MB _{P,n}	43
Note 1: Δ MB _{P,n} is the Multiband Relaxation factor for the tested band. This shall fulfil the requirements in Table 6.2.1.1.3.5-4 for PC5 and Table 6.2.1.1.3.6-4 for PC6.							

Table 6.2.3.5-14a: UE Power Class 7 test requirements (network signalling value "NS_203")

Band	Test ID	P _{Powerclass}	MPR _{f,c}	A- MPR _{f,c}	T(MAX(MPR _{f,c} , A- MPR _{f,c}))	Lower limit (dBm)	Upper limit (dBm)
------	---------	-------------------------	--------------------	-----------------------	---	-------------------	-------------------

n258	1	16.4	0	0	0	16.4-TT- $\Delta MB_{P,n}$	43
	2		2.5	0	2	11.9-TT- $\Delta MB_{P,n}$	43
Note 1: $\Delta MB_{P,n}$ is the Multiband Relaxation factor for the tested band. This shall fulfil the requirements in Table 6.2.1.1.3.3-5.							

Table 6.2.3.5-15: Test Tolerance (Power class 3)

Test Metric	FR2a	FR2b
Max device size \leq 30 cm	3.24 dB	3.11 dB

Table 6.2.3.5-16: Test Tolerance (Power class 1)

Test Metric	FR2a
Max device size \leq 30 cm	3.38 dB

Table 6.2.3.5-17: Test Tolerance (Power class 5)

Test Metric	FR2a
Max device size \leq 30 cm	3.38 dB

Table 6.2.3.5-17a: Test Tolerance (Power class 6)

Test Metric	FR2a
Max device size \leq 30 cm	3.37 dB

Table 6.2.3.5-18: Test Tolerance (Power class 7)

Test Metric	FR2a
Max device size \leq 30 cm	3.24 dB

Table 6.2.3.5-19: UE Power Class 1 test requirements (network signalling value "NS_205")

Band	Test ID	P _{Powerclass}	MPR _{f,c}	A- MPR _{f,c}	T(MAX(MPR _{f,c} , A-MPR _{f,c}))	Lower limit (dBm)	Upper limit (dBm)
n257	1	40	6.5	6	5	28.5-TT	55
	2		0	6	5	29-TT	55
n258	1		6.5	7	5	28-TT	55
	2		0	7	5	28-TT	55
	3	6.5	6	5	28.5-TT	55	
	4	0	6	5	29-TT	55	

Table 6.2.3.5-20: UE Power Class 2 test requirements (network signalling value "NS_205")

Band	Test ID	P _{Powerclass}	MPR _{f,c}	A- MPR _{f,c}	T(MAX(MPR _{f,c} , A-MPR _{f,c}))	Lower limit (dBm)	Upper limit (dBm)
n257	5	29	0	0	0	29-TT	43
	6		2.5	0	2	24.5-TT	43
n258	5		0	2	1.5	25.5-TT	43
	6		2.5	2	2	24.5-TT	43
	7		0	0	0	29-TT	43
	8		2.5	0	2	24.5-TT	43

Table 6.2.3.5-21: UE Power Class 3 test requirements (network signalling value "NS_205")

Band	Test ID	P _{Powerclass}	MPR _{f,c}	A- MPR _{f,c}	T(MAX(MPR _{f,c} , A-MPR _{f,c}))	Lower limit (dBm)	Upper limit (dBm)
n257	5	22.4	0	0	0	22.4-TT- Δ MB _{P,n}	43
	6		2.5	0	2	17.9-TT- Δ MB _{P,n}	43
n258	5	22.4	0	2	1.5	18.9-TT- Δ MB _{P,n}	43
	6		2.5	2	2	17.9-TT- Δ MB _{P,n}	43
	7		0	0	0	22.4-TT- Δ MB _{P,n}	43
	8		2.5	0	2	17.9-TT- Δ MB _{P,n}	43

Note 1: Δ MB_{P,n} is the Multiband Relaxation factor for the tested band. This shall fulfil the requirements in Table 6.2.1.1.3.3-5.

Table 6.2.3.5-22: UE Power Class 4 test requirements (network signalling value "NS_205")

Band	Test ID	P _{Powerclass}	MPR _{f,c}	A- MPR _{f,c}	T(MAX(MPR _{f,c} , A-MPR _{f,c}))	Lower limit (dBm)	Upper limit (dBm)
n257	5	34	0	0	0	34-TT	43
	6		2.5	0	2	29.5-TT	43
n258	5	34	0	2	1.5	30.5-TT	43
	6		2.5	2	2	29.5-TT	43
	7		0	0	0	34-TT	43
	8		2.5	0	2	29.5-TT	43

Table 6.2.3.5-23: UE Power Class 5 and 6 test requirements (network signalling value "NS_205")

Band	Test ID	P _{Powerclass}	MPR _{f,c}	A- MPR _{f,c}	T(MAX(MPR _{f,c} , A-MPR _{f,c}))	Lower limit (dBm)	Upper limit (dBm)
n257	5	30	0	0	0	30-TT- Δ MB _{P,n}	43
	6		2.5	0	2	25.5-TT- Δ MB _{P,n}	43
n258	5	30.4	0	2	1.5	26.9-TT- Δ MB _{P,n}	43
	6		2.5	2	2	25.9-TT- Δ MB _{P,n}	43
	7		0	0	0	30.4-TT- Δ MB _{P,n}	43
	8		2.5	0	2	25.9-TT- Δ MB _{P,n}	43

Note 1: Δ MB_{P,n} is the Multiband Relaxation factor for the tested band. This shall fulfil the requirements in Table 6.2.1.1.3.5-4 for PC5 and 6.2.1.1.6-4 for PC6.

Table 6.2.3.5-24: UE Power Class 7 test requirements (network signalling value "NS_205")

Band	Test ID	P _{Powerclass}	MPR _{f,c}	A- MPR _{f,c}	T(MAX(MPR _{f,c} , A-MPR _{f,c}))	Lower limit (dBm)	Upper limit (dBm)
n257	5	16.4	0	0	0	16.4-TT- Δ MB _{P,n}	43
	6		2.5	0	2	11.9-TT- Δ MB _{P,n}	43
n258	5	16.4	0	2	1.5	12.9-TT- Δ MB _{P,n}	43
	6		2.5	2	2	11.9-TT- Δ MB _{P,n}	43

	7	0	0	0	16.4-TT- $\Delta MB_{P,n}$	43
	8	2.5	0	2	11.9-TT- $\Delta MB_{P,n}$	43
Note 1: $\Delta MB_{P,n}$ is the Multiband Relaxation factor for the tested band. This shall fulfil the requirements in Table 6.2.1.1.3.3-5.						

6.2.4 Configured transmitted power

6.2.4.1 Test purpose

To verify the UE configured transmitted power $P_{UMAX,f,c}$ is within the range defined prescribed by the specified nominal maximum output power and tolerance.

6.2.4.2 Test applicability

The requirements of this test are covered in test cases 6.2.1 Maximum output power, 6.2.2 Maximum output power reduction and 6.2.3 UE maximum output power with additional requirements to all types of NR UE release 15 and forward.

6.2.4.3 Minimum conformance requirements

The UE can configure its maximum output power. The configured UE maximum output power $P_{CMAX,f,c}$ for carrier f of a serving cell c is defined as that available to the reference point of a given transmitter branch that corresponds to the reference point of the higher-layer filtered RSRP measurement as specified in TS 38.215 [24].

The configured UE maximum output power $P_{CMAX,f,c}$ for carrier f of a serving cell c shall be set such that the corresponding measured peak EIRP $P_{UMAX,f,c}$ is within the following bounds

$$P_{Powerclass} + \Delta P_{IBE} - \text{MAX}(\text{MAX}(\text{MPR}_{f,c}, \text{A-MPR}_{f,c}), \Delta MB_{P,n}, \text{P-MPR}_{f,c}) - \text{MAX}\{\text{T}(\text{MAX}(\text{MPR}_{f,c}, \text{A-MPR}_{f,c})), \text{T}(\text{P-MPR}_{f,c})\} \leq P_{UMAX,f,c} \leq \text{EIRP}_{\max}$$

while the corresponding measured total radiated power $P_{TMAX,f,c}$ is bounded by

$$P_{TMAX,f,c} \leq \text{TRP}_{\max}$$

with $P_{Powerclass}$ the UE minimum peak EIRP as specified in sub-clause 6.2.1.1.3, EIRP_{\max} the applicable maximum EIRP as specified in sub-clause 6.2.1.1.3, $\text{MPR}_{f,c}$ as specified in sub-clause 6.2.2.3, $\text{A-MPR}_{f,c}$ as specified in sub-clause 6.2.3.3, $\Delta MB_{P,n}$ the peak EIRP relaxation as specified in section 6.2.1.1.3 and TRP_{\max} the maximum TRP for the UE power class as specified in sub-clause 6.2.1.1.3. ΔP_{IBE} is 1.0 dB if UE declares support for *mpr-PowerBoost-FR2-r16*, UL transmission is QPSK, $\text{MPR}_{f,c} = 0$ and when *NS_200* applies and the network configures the UE to operate with *mpr-PowerBoost-FR2-r16*, otherwise ΔP_{IBE} is 0.0 dB. The requirement is verified in beam peak direction.

maxUplinkDutyCycle-FR2 as defined in TS 38.306 [26] is a UE capability to facilitate electromagnetic power density exposure requirements. This UE capability is applicable to all FR2 power classes.

If the field of UE capability *maxUplinkDutyCycle-FR2* is present and the percentage of uplink symbols transmitted within any 1 s evaluation period is larger than *maxUplinkDutyCycle-FR2*, the UE follows the uplink scheduling and can apply $\text{P-MPR}_{f,c}$.

If the field of UE capability *maxUplinkDutyCycle-FR2* is absent, the compliance to electromagnetic power density exposure requirements are ensured by means of scaling down the power density or by other means.

$\text{P-MPR}_{f,c}$ is the power management maximum output power reduction. The UE shall apply $\text{P-MPR}_{f,c}$ for carrier f of serving cell c only for the cases described below. For UE conformance testing $\text{P-MPR}_{f,c}$ shall be 0 dB, except for the testing of UL gap for Tx power management, where $\text{P-MPR}_{f,c}$ may be non-zero dB.

- a) ensuring compliance with applicable electromagnetic power density exposure requirements and addressing unwanted emissions / self desense requirements in case of simultaneous transmissions on multiple RAT(s) for scenarios not in scope of 3GPP RAN specifications;

b) ensuring compliance with applicable electromagnetic power density exposure requirements in case of proximity detection is used to address such requirements that require a lower maximum output power.

NOTE 1: $P\text{-MPR}_{f,c}$ was introduced in the $P_{C\text{MAX},f,c}$ equation such that the UE can report to the gNB the available maximum output transmit power. This information can be used by the gNB for scheduling decisions.

NOTE 2: $P\text{-MPR}_{f,c}$ and *maxUplinkDutyCycle-FR2* may impact the maximum uplink performance for the selected UL transmission path.

NOTE 3: MPE P-MPR Reporting, as defined in TS 38.306 [26], is an optional UE capability to report $P\text{-MPR}_{f,c}$ when the reporting conditions configured by gNB are met. This UE capability is applicable to all FR2 power classes.

The tolerance $T(\Delta P)$ for applicable values of ΔP (values in dB) is specified in Table 6.2.4.3-1.

Table 6.2.4.3-1: $P_{U\text{MAX},f,c}$ tolerance

Operating Band	ΔP (dB)	Tolerance $T(\Delta P)$ (dB)
n257, n258, n259, n260, n261	$\Delta P = 0$	0
	$0 < \Delta P \leq 2$	1.5
	$2 < \Delta P \leq 3$	2.0
	$3 < \Delta P \leq 4$	3.0
	$4 < \Delta P \leq 5$	4.0
	$5 < \Delta P \leq 10$	5.0
	$10 < \Delta P \leq 15$	7.0
	$15 < \Delta P \leq X$	8.0
NOTE: X is the value such that $P_{U\text{MAX},f,c}$ lower bound, $P_{\text{Powerclass}} - \Delta P - T(\Delta P) = \text{minimum output power specified in clause 6.3.1.}$		

6.2.4.4 Test description

This test is covered by clause 6.2.1 Maximum output power, 6.2.2 Maximum output power reduction and 6.2.3 UE maximum output power with additional requirements.

6.2.4.5 Test requirements

This test is covered by clause 6.2.1 Maximum output power, 6.2.2 Maximum output power reduction and 6.2.3 UE maximum output power with additional requirements.

6.2.4_1 Configured transmitted power with Power Boost

Editor's note: **The following aspects are either missing or not yet determined:**

- **Measurement Uncertainties and Test Tolerances are FFS for power class 1, 2 and 4.**
- **The test case is incomplete for band n259.**

6.2.4_1.1 Test purpose

To verify the UE configured transmitted power $P_{U\text{MAX},f,c}$ is within the range defined prescribed by the specified nominal maximum output power and tolerance.

6.2.4_1.2 Test applicability

This test case applies to all types of NR UE release 16 and forward supporting *mpr-PowerBoost-FR2-r16* UE capability.

6.2.4_1.3 Minimum conformance requirements

Same as clause 6.2.4.3.

6.2.4_1.4 Test description

6.2.4_1.4.1 Initial conditions

Same as clause 6.2.1.1.4.1

6.2.4_1.4.2 Test procedure

1. SS sends uplink scheduling information for each UL HARQ process via PDCCH DCI format 0_1 for C_RNTI to schedule the UL RMC according to Table 6.2.1.1.4.1-1. Since the UL has no payload and no loopback data to send the UE sends uplink MAC padding bits on the UL RMC. Messages to configure the appropriate uplink modulation in section 6.2.4_1.4.3.
2. Set the UE in the Tx beam peak direction found with a 3D EIRP scan as performed in Annex K.1.1. Allow at least BEAM_SELECT_WAIT_TIME (NOTE 1) for the UE Tx beam selection to complete.
3. Send continuously uplink power control "up" commands in every uplink scheduling information to the UE; allow at least 200 msec starting from the first TPC command in this step to ensure that the UE transmits at its maximum output power. Allow at least BEAM_SELECT_WAIT_TIME (NOTE 1) for the UE Tx beam selection to complete.
4. SS activates the UE Beamlock Function (UBF) by performing the procedure as specified in TS 38.508-1 [10] clause 4.9.2 using condition Tx only.
5. Measure UE EIRP in the Tx beam peak direction in the channel bandwidth of the radio access mode according to the test configuration, which shall meet the requirements described in Tables 6.2.4_1.5-1 to 6.2.4_1.5-4. EIRP test procedure is defined in Annex K.1.3. The measuring duration is one active uplink subframe. EIRP is calculated considering both polarizations, theta and phi.
6. SS deactivates the UE Beamlock Function (UBF) by performing the procedure as specified in TS 38.508-1 [10] clause 4.9.3.

NOTE 1: The BEAM_SELECT_WAIT_TIME default value is defined in Annex K.

6.2.4_1.4.3 Message contents

Message contents are according to TS 38.508-1 [10] clause 4.6 with TRANSFORM_PRECODER_ENABLED condition in Table 4.6.3-118 PUSCH-Config with the following exceptions:

Table 6.2.4_1.4.3-1: ServinCellConfig

Derivation Path: TS 38.508-1 [5], Table 4.6.3-167			
Information Element	Value/remark	Comment	Condition
ServingCellConfig ::= SEQUENCE {			
uplinkConfig SEQUENCE {			
mpr-PowerBoost-FR2-r16	True		
}			
}			

6.2.4_1.5 Test requirement

The EIRP derived in step 5 shall not exceed the values specified in Table 6.2.4_1.5-1 to Table 6.2.4_1.5-4.

Table 6.2.4_1.5-1: UE maximum output test requirements for power class 1

Operating band	Max EIRP (dBm)	Min peak EIRP (dBm)
n257	55	41.0-TT
n258	55	41.0-TT
n260	55	39.0-TT
n261	55	41.0-TT

Table 6.2.4_1.5-2: UE maximum output test requirements for power class 2

Operating band	Max EIRP (dBm)	Min peak EIRP (dBm)
n257	43	30-TT
n258	43	30-TT
n260		
n261	43	30-TT

Table 6.2.4_1.5-3: UE maximum output test requirements for power class 3 for single band UE

Operating band	Max EIRP (dBm)	Min peak EIRP (dBm)
n257	43	23.4-TT
n258	43	23.4-TT
n260	43	21.6-TT
n261	43	23.4-TT

Table 6.2.4_1.5-3a: Test Tolerance (Min peak EIRP for Power class 3)

Test Metric	FR2a	FR2b
Max device size \leq 30 cm	2.99 dB (NTC) 3.15 (ETC)	2.99 dB (NTC) 3.15 (ETC)

Table 6.2.4_1.5-3b: UE maximum output test requirements for power class 3

ID	FR2 bands/set	Test requirement (dB) (Note 1)					Comments
		n257	n258	n259	n260	n261	
1	n257	23.4-TT- $\Delta MB_{P,n}$					
2	n258		23.4-TT- $\Delta MB_{P,n}$				
3	n259			19.7-TT- $\Delta MB_{P,n}$			
4	n260				21.6-TT- $\Delta MB_{P,n}$		
5	n261					23.4-TT- $\Delta MB_{P,n}$	
6	n257, n261	23.4-TT- $\Delta MB_{P,n}$				23.4-TT- $\Delta MB_{P,n}$	$\Delta MB_{P,n}$ relaxation is 0 dB
7	n260, n261				21.6-TT- $\Delta MB_{P,n}$	23.4-TT- $\Delta MB_{P,n}$	$\Delta MB_{P,n}$ relaxation is 0 dB

Note 1: $\Delta MB_{P,n}$ is the Multi-band Relaxation factor for the tested band. This shall fulfil the requirements in Table 6.2.1.1.3.3-5.

Table 6.2.4_1.5-4: UE maximum output power test requirements for power class 4

Operating band	Max EIRP (dBm)	Min peak EIRP (dBm)
n257	43	35-TT
n258	43	35-TT
n260	43	35-TT
n261	43	35-TT

6.2.5 UE maximum output power – EIRP with UL Gaps

Editor's note: This clause is complete for PC1, PC3. The following aspects are either missing or not yet determined:

- The test case is incomplete for band n259.
- Initial conditions are pending analysis for PC1, PC5 and PC7.

- Measurement Uncertainties and Test Tolerances are FFS for power class other than 1, 3.
- MU and TT is not finalized for PC3 extreme testing conditions-

6.2.5.1 Test purpose

The objective of this test is to determine the impact of UL-gaps on TX power management by measuring the EIRP with and without UL-Gaps configured.

6.2.5.2 Test applicability

This test case applies to all types of NR UEs release 17 and forward supporting *ul-GapFR2-r17* and *tdd-MPE-P-MPR-Reporting-r16*.

6.2.5.3 Minimum conformance requirements

The difference of the measured peak EIRP P_{UMAX,f,c_GAP_ON} when UL gap for TX power management is configured and activated, and the measured peak EIRP P_{UMAX,f,c_GAP_OFF} when UL gap is not configured or de-activated, shall meet the following requirement:

$$P_{UMAX,f,c_GAP_ON} - P_{UMAX,f,c_GAP_OFF} \geq \max((EIRP_{meas_peak} - 23) + 10 * \log_{10}(Z/20), 3)dB$$

where $EIRP_{meas_peak}$ is the measured UE peak EIRP with zero MPR/A-MPR/P-MPR as specified in clause 6.2.1 for the corresponding power class, and Z% is duty cycle of the reference measurement channel. P_{UMAX,f,c_GAP_ON} shall be measured outside of the UL gap symbol(s). The period of measurement shall be at least 4s. The requirement is verified with the test metric of EIRP (Link=TX beam peak direction, Meas=Link angle) and in the test Z is set to 20 when *maxUplinkDutyCycle-FR2* is less than 20 or not reported, and should be larger than *maxUplinkDutyCycle-FR2* when *maxUplinkDutyCycle-FR2* is equal to or greater than 20. The reference measurement channel is specified in Annex A.2.3.

When UL gap for Tx power management is configured and activated, the reported $P-MPR_{f,c}$ shall be less than 3dB. When UL gap for Tx power management is not configured and activated, UE shall set the P bit in PHR to 1 in the test when PHR is configured.

The normative reference for this requirement is TS 38.101-2 [3] clause 6.2.5.

NOTE 1: As mentioned in clause 6.2.4.3 - for UE conformance testing $P-MPR_{f,c}$ shall be 0 dB, except for the testing of UL gap for Tx power management, where $P-MPR_{f,c}$ may be non-zero dB – which is relevant to this test case

The UL gap patterns for TX power management are listed in Table 6.2.5.3-1 if UE supports the UL gap for Tx power management, and the UE shall support at least one of UL MGP#1 and UL MGP#3. All other UL MGPs are optional.

Table 6.2.5.3-1: UL Gap Pattern Configurations

	UL Gap Length (UGL) [ms]	UL gap repetition periodicity (UGRP) [ms]
UL MGP #0	1.0	20
UL MGP #1	1.0	40
UL MGP #2	0.5	160
UL MGP #3	0.125 when SCS of active UL BWP =120kHz 0.25 when SCS of active UL BWP =60kHz	5

An uplink gap consists of consecutive static UL slot(s) in one or more *TDD-UL-DL-Pattern* duration, starting from the first static UL slot of an UL gap repetition period. UGL is the aggregated length of consecutive UL slots used as the UL gap within an UL gap repetition period. That means, there can be a DL slot and/or special slot but no static UL slot between the two consecutive static UL slots within the UL gap length.

When an UL gap overlaps with an uplink transmission in NR serving cells in FR2 single CC or FR2 intra-band CA or FR2 inter-band CA where UE does not support *tx-Support-UL-GapFR2-r17*, then the UE is not required to conduct any transmission during the UL gap on the NR serving cells other than those listed in Clause 5.30 in TS 38.321 [28].

The normative reference for the above configurations is TS 38.133 [25] clause 9.1.11.

6.2.5.4 Test description

6.2.5.4.1 Initial conditions

Initial conditions are a set of test configurations the UE needs to be tested in and the steps for the SS to take with the UE to reach the correct measurement state.

The initial test configurations consist of environmental conditions, test frequencies, channel bandwidths and sub-carrier spacing based on NR operating bands specified in table 5.3.5-1. All of these configurations shall be tested with applicable test parameters for each combination of test channel bandwidth and sub-carrier spacing, and are shown in Table 6.2.2.4.1-1. The details of the uplink reference measurement channels (RMCs) are specified in Annexes A.2. Configurations of PDSCH and PDCCH before measurement are specified in Annex C.2.

Table 6.2.5.4.1-1: Test Configuration Table for power class 2, 3, 4 and 6

Default Conditions					
Test Environment as specified in TS 38.508-1 [10] clause 4.1			Normal, TL, TH		
Test Frequencies as specified in TS 38.508-1 [10] clause 4.3.1			Low range, Mid Range, High range		
Test Channel Bandwidths as specified in TS 38.508-1 [10] clause 4.3.1			Lowest, 100 MHz, Highest		
Test SCS as specified in Table 5.3.5-1			120 kHz		
Test Parameters					
Test ID	ChBw (NOTE 2)	SCS	Downlink Configuration	Uplink Configuration	
1	100	Default	-	Modulation	RB allocation (NOTE 1)
				DFT-s-OFDM QPSK	Inner_Full for PC2, PC3, PC4 and PC6
NOTE 1: The specific configuration of each RF allocation is defined in Table 6.1-1 for PC2, PC3, PC4, PC6 and PC7 or Table 6.1-2 for PC1.					
NOTE 2: The 200MHz and 400MHz bandwidths are not applicable to PC7 RedCap UEs					

1. Connect the SS to the UE antenna connectors as shown in TS 38.508-1 [10] Annex A, Figure A.3.1.2.1 for TE diagram and section A.3.2 for UE diagram.
2. The parameter settings for the cell are set up according to TS 38.508-1 [10] clause 4.4.3.
3. Downlink signals are initially set up according to TS 38.521-1 [2] Annex C.0, C.1, C.2, and uplink signals according to TS 38.521-1 [2] Annex G.0, G.1, G.2, G.3.0.
4. The UL Reference Measurement Channel is set according to Annex A.2.3-1 with the uplink duty cycle Z set to 20%.
5. Propagation conditions are set according to TS 38.521-1 [2] Annex B.0.
6. Ensure the UE is in State RRC_CONNECTED with generic procedure parameters Connectivity NR, Connected without release On, Test Mode On and Test Loop Function On according to TS 38.508-1 [10] clause 4.5. Message contents are defined in clause 6.2.5.4.3.

6.2.5.4.2 Test procedure

1. to schedule the UL RMC according to Table 6.2.1.1.4.1-1. Since the UL has no payload and no loopback data to send the UE sends uplink MAC padding bits on the UL RMC. Messages to configure the appropriate uplink modulation in section 6.2.1.1.4.3.
 - 1a. If the UE does not support beamCorrespondenceWithoutULBeamSweeping, the side conditions for SSB-based and CSI-RS based L1-RSRP measurements are applied as per Table 6.6.1.3.3.1.1-1 and Table 6.6.1.3.3.1.1-2 respectively.

2. Set the UE in the Tx beam peak direction found with a 3D EIRP scan as performed in Annex K.1.1. Allow at least BEAM_SELECT_WAIT_TIME (NOTE 1) for the UE Tx beam selection to complete.
3. Send continuously uplink power control "up" commands in every uplink scheduling information to the UE; allow at least 200 msec starting from the first TPC command in this step to ensure that the UE transmits at its maximum output power. Allow at least BEAM_SELECT_WAIT_TIME (NOTE 1) for the UE Tx beam selection to complete.
4. SS activates the UE Beamlock Function (UBF) by performing the procedure as specified in TS 38.508-1 [10] clause 4.9.2 using condition Tx only.

ACTIVATE Uplink Gaps

5. SS configures and activates UL-gaps via message contents defined in Table 6.2.5.4.3-1. P-MPR reporting is also enabled via the message contents defined in Table 6.2.5.4.3-2.
6. Measure UE EIRP in the Tx beam peak direction in the channel bandwidth of the radio access mode according to the test configuration. EIRP test procedure is defined in Annex K.1.3. The period of measurement shall be at least 4 seconds. EIRP is calculated considering both polarizations, theta and phi. Record this as peak EIRP P_{UMAX,f,c_GAP_ON}
7. SS detects and record the value within the P-MPR reports. Call this value P-MPR_{ULgapON}

DE-ACTIVATE Uplink Gaps

8. SS de-activates UL-gaps via message contents defined in Table 6.2.5.4.3-3.
9. Measure UE EIRP in the Tx beam peak direction in the channel bandwidth of the radio access mode according to the test configuration. EIRP test procedure is defined in Annex K.1.3. The period of measurement shall be at least 4 seconds. EIRP is calculated considering both polarizations, theta and phi. Record this value as peak EIRP P_{UMAX,f,c_GAP_OFF}
10. SS detects and record the value of the P bit within the PHR.
11. SS deactivates the UE Beamlock Function (UBF) by performing the procedure as specified in TS 38.508-1 [10] clause 4.9.3.
12. Compute the difference between P_{UMAX,f,c_GAP_ON} and P_{UMAX,f,c_GAP_OFF}

NOTE 1: The BEAM_SELECT_WAIT_TIME default value is defined in Annex K.

6.2.5.4.3 Message contents

Message contents are according to TS 38.508-1 [10] clause 4.6 with TRANSFORM_PRECODER_ENABLED condition in Table 4.6.3-118 PUSCH-Config and with the following exception

Table 6.2.5.4.3-1: UE UL-GapFR2-Config (FR2 UL-Gap Activation)

Derivation Path: TS 38.508-1 [6], Table 4.6.3-200B			
Information Element	Value/remark	Comment	Condition
UL-GapFR2-Config-r17 ::= CHOICE {			
Setup SEQUENCE {			
gapOffset-r17	0		
ugl-r17	ms1		
ugrp-r17	ms40		
}			

Table 6.2.5.4.3-2: PHR Config (P-MPR Report Activation)

Derivation Path: TS 38.508 [10], clause 4.6.3-104			
Information Element	Value/remark	Comment	Condition
PHR-Config ::= CHOICE {			
setup SEQUENCE {			
mpe-Reporting-FR2-r16:: CHOICE {			

Setup SEQUENCE {			
Mpe-ProhibitTimer-r16	[sf10]		
Mpe-Threshold-r16	dB3		
}			
}			
}			

Table 6.2.5.4.3-3: UE UL-GapFR2-Config (FR2 UL-Gap De-activation)

Derivation Path: TS 38.508 [10], clause 4.6.3-200BB			
Information Element	Value/remark	Comment	Condition
UL-GapFR2-Config-r17 ::= CHOICE {			
release			
}			

6.2.5.5 Test requirement

The difference between P_{UMAX,f,c_GAP_ON} and P_{UMAX,f,c_GAP_OFF} computed in Step 12 and the UE reported P-MPR_{ULgapON} and P-bit within PHR value in Steps 7 and 10 respectively shall meet the requirements defined in Table 6.2.5.5-1

Table 6.2.5.5-1: Test Requirements for EIRP with UL Gaps (for Power class 3)

Test Metric	Requirement
$P_{UMAX,f,c_GAP_ON} - P_{UMAX,f,c_GAP_OFF}$	$\geq \max((EIRP_{meas_peak} - 23 - TT_2) + 10 * \log_{10}(Z/20), 3)dB - TT_1$
P-MPR _{ULgapON}	< 3dB
P bit reported within PHR report (when UL-Gaps OFF)	1
NOTE 1: Z is the uplink duty cycle set within the test procedure	

Table 6.2.5.5-2: TT for EIRP with UL Gaps (for Power class 3)

TT term	Test Metric	FR2a	FR2b
TT ₁	$P_{UMAX,f,c_GAP_ON} - P_{UMAX,f,c_GAP_OFF}$	0.46 dB (NTC) [0.46 dB] (ETC)	0.46 dB (NTC) [0.46 dB] (ETC)
TT ₂	$EIRP_{meas_peak}$	2.99 dB (NTC) 3.15 dB (ETC)	2.99 dB (NTC) 3.15 dB (ETC)

6.2A Transmit power for CA

6.2A.1 UE maximum output power for CA

6.2A.1.0 Minimum conformance requirements

For downlink intra-band contiguous and non-contiguous carrier aggregation with a single uplink component carrier configured in the NR band, the maximum output power is specified in clause 6.2.1.1.3.

For uplink intra-band contiguous carrier aggregation for any CA bandwidth class, the maximum output power is specified in clause 6.2.1.1.3.

Power class 3 is default power class.

6.2A.1.1 UE maximum output power - EIRP and TRP for CA

6.2A.1.1.1 UE maximum output power - EIRP and TRP for CA (2UL CA)

Editor's note: The following aspects are either missing or not yet determined:

- Measurement Uncertainties and Test Tolerances are FFS for power class other than 1, 3, 5 and CA other than intra-band contiguous.

6.2A.1.1.1.1 Test purpose

To verify that the power of any UE emission shall not exceed specified level for the specified channel bandwidth for CA under the deployment scenarios where additional requirements are specified.

6.2A.1.1.1.2 Test applicability

This test case applies to all types of NR UE release 15 and forward that supports FR2 2UL CA.

For bandwidth class B, this test case is not testable due to lack of appropriate test points since there is no configuration satisfying MPR=0dB requirements in TS 38.101-2.

6.2A.1.1.1.3 Minimum conformance requirements

The minimum conformance requirements are defined in clause 6.2A.1.0.

6.2A.1.1.1.4 Test description

6.2A.1.1.1.4.1 Initial condition

Initial conditions are a set of test configurations the UE needs to be tested in and the steps for the SS to take with the UE to reach the correct measurement state.

The initial test configurations consist of environmental conditions, test frequencies, and channel bandwidths based on NR operating bands specified in clause 5.5A. All of these configurations shall be tested with applicable test parameters for each channel bandwidth and subcarrier spacing, are shown in Table 6.2A.1.1.1.4.1-1. The details of the uplink reference measurement channels (RMCs) are specified in Annexes A.2. Configurations of PDSCH and PDCCH before measurement are specified in Annex C.2.

Table 6.2A.1.1.1.4.1-1: Intra-band Contiguous CA Test Configuration Table

Default Conditions					
Test Environment as specified in TS 38.508-1 [10] clause 4.1			Normal, TL, TH (NOTE 2)		
Test Frequencies as specified in TS 38.508-1 [10] clause 4.3.1.2.3 for different CA bandwidth classes			Low and High range		
Test CC Combination setting (aggregated BW of the CA configuration) as specified in TS 38.508-1 [10] clause 4.3.1.2.3 for the CA Configuration across bandwidth combination sets supported by the UE			Highest aggregated BW of the CA configuration (≤ 400 MHz aggregated channel bandwidth)		
Test SCS as specified in Table 5.3.5-1			120 kHz		
Test Parameters					
CA Configuration / Aggregated BW			Downlink Configuration	Uplink Configuration	
Test ID	CC & Mapping (NOTE 4)	CBW (MHz)	RB allocation	Modulation	RB allocation (NOTE 1)
1	PCC/CC1	100	-	DFT-s-OFDM QPSK	Inner Full for PC2, PC3, PC4 and PC5 Inner_Full_Region1 for PC1
	SCC/CC2	100		-	-
2	PCC/CC1	200		DFT-s-OFDM QPSK	Inner Full for PC2, PC3, PC4 and PC5 Inner_Full_Region1 for PC1
	SCC/CC2	200		-	-

- NOTE 1: The specific configuration of each RF allocation is defined in Table 6.1-1 for PC2, PC3, PC4 and PC5 or Table 6.1-2 for PC1.
- NOTE 2: Test environment for UE Max TRP is normal only.
- NOTE 3: CA Configuration Test cumulative aggregated BW settings are checked separately for each CA Configuration, which applicable aggregated channel bandwidths are specified in Table 5.5A.1-1.
- NOTE 4: PCC/CCi and SCC/CCj means PCC is on component carrier CCi and SCC is on component carrier CCj, with CCi or CCj frequencies defined in TS38.508-1 [10].
- NOTE 5: Number of DL CCs shall be configured the same as number of UL CCs. The requirements are applicable as per 5.3A.4: *"The requirements are applicable only when Uplink CCs are configured within the frequency range between lower edge of lowest downlink component carrier and upper edge of highest downlink component carrier"*.

1. Connection between SS and UE is shown in TS 38.508-1 [10] Annex A, Figure A.3.3.1.1 for TE diagram and Figure A.3.4.1.1 for UE diagram.
2. The parameter settings for the cell are set up according to TS 38.508-1 [10] clause 4.4.3.
3. Downlink signals are initially set up according to Annex C, and uplink signals according to Annex G.
4. The UL Reference Measurement channels are set according to Table 6.2A.1.1.1.4.1-1.
5. Propagation conditions are set according to Annex B.0
6. Ensure the UE is in state RRC_CONNECTED with generic procedure parameters Connectivity *NR*, Connected without release *On*, Test Mode *On* and Test Loop Function *On* according to TS 38.508-1 [10] clause 4.5. Message contents are defined in clause 6.2A.1.1.1.4.3

6.2A.1.1.1.4.2 Test procedure

1. Configure SCC according to Annex C.0, C.1, C.2 for all downlink physical channels.
2. The SS shall configure SCC as per TS 38.508-1 [10] clause 5.5.1. Message contents are defined in clause 6.2A.1.1.1.4.3.
3. SS activates SCC by sending the activation MAC CE (Refer TS 38.321 [28], clauses 5.9, 6.1.3.10). Wait for at least 2 seconds (Refer TS 38.133[25], clause 9.3).
4. SS sends uplink scheduling information for each UL HARQ process via PDCCH DCI format 0_1 for C_RNTI to schedule the UL RMC according to Table 6.2A.1.1.1.4.1-1. Since the UL has no payload and no loopback data to send the UE sends uplink MAC padding bits on the UL RMC. Messages to configure the appropriate uplink modulation in section 6.2A.1.1.1.4.3.
5. Set the UE in the Tx beam peak direction found with a 3D EIRP scan as performed in Annex K.1.1. Allow at least BEAM_SELECT_WAIT_TIME (NOTE 1) for the UE Tx beam selection to complete.
6. Send continuously uplink power control "up" commands in every uplink scheduling information to the UE; allow at least 200 msec starting from the first TPC command in this step to ensure that the UE transmits at its maximum output power. Allow at least BEAM_SELECT_WAIT_TIME (NOTE 1) for the UE Tx beam selection to complete.
7. SS activates the UE Beamlock Function (UBF) by performing the procedure as specified in TS 38.508-1 [10] clause 4.9.2 using condition Tx only.
8. Measure UE EIRP in the Tx beam peak direction in the channel bandwidth of the radio access mode according to the test configuration, which shall meet the requirements described in Table 6.2A.1.1.1.5-1. EIRP test procedure is defined in Annex K.1.3. The measuring duration is one active uplink subframe. EIRP is calculated considering both polarizations, theta and phi.
9. Measure TRP of the transmitted signal for the assigned NR channel with a rectangular measurement filter with bandwidths according to Table 6.2A.1.1.1.5-1. Total radiated power is measured according to TRP measurement procedure defined in Annex K.1.7 and measurement grid specified in Annex M.4. TRP is calculated considering both polarizations, theta and phi.
10. SS deactivates the UE Beamlock Function (UBF) by performing the procedure as specified in TS 38.508-1 [10] clause 4.9.3.

NOTE 1: The BEAM_SELECT_WAIT_TIME default value is defined in Annex K.

6.2A.1.1.1.4.3 Message contents

Message contents are according to TS 38.508-1 [10] clause 4.6 with TRANSFORM_PRECODER_ENABLED condition in Table 4.6.3-118 PUSCH-Config.

6.2A.1.1.1.5 Test Requirements

The EIRP derived in step 8 and TRP derived in step 9 shall not exceed the values specified in Table 6.2A.1.1.1.5-1 to Table 6.2A.1.1.1.5-5.

Table 6.2A.1.1.1.5-1: Intra-band Contiguous CA UE maximum output test requirements for power class 1

UL CA configuration	Max TRP (dBm)	Max EIRP (dBm)	Min peak EIRP (dBm)
CA_n257D	35+TT	55	40-TT
CA_n257G	35+TT	55	40-TT
CA_n260D	35+TT	55	38-TT
CA_n260G	35+TT	55	38-TT
CA_n260O	35+TT	55	38-TT
CA_n261D	35+TT	55	40-TT
CA_n261G	35+TT	55	40-TT
CA_n261O	35+TT	55	40-TT

Table 6.2A.1.1.1.5-1a: Test Tolerance (Max TRP for Power class 1)

Test Metric	FR2a	FR2b
Max device size ≤ 30 cm	2.78 dB, NTC	2.87 dB, NTC
	2.94 dB, ETC	3.03 dB, ETC

Table 6.2A.1.1.1.5-1b: Test Tolerance (Min peak EIRP for Power class 1)

Test Metric	FR2a	FR2b
Max device size ≤ 30 cm	3.12 dB, NTC	3.12 dB, NTC
	3.28 dB, ETC	3.28 dB, ETC

Table 6.2A.1.1.1.5-2: Intra-band Contiguous CA UE maximum output test requirements for power class 2

UL CA configuration	Max TRP (dBm)	Max EIRP (dBm)	Min peak EIRP (dBm)
CA_n257D	23+TT	43	29-TT
CA_n257G	23+TT	43	29-TT
CA_n261D	23+TT	43	29-TT
CA_n261G	23+TT	43	29-TT
CA_n261O	23+TT	43	29-TT

Table 6.2A.1.1.1.5-3: Intra-band Contiguous CA UE maximum output test requirements for power class 3

UL CA configuration	Max TRP (dBm)	Max EIRP (dBm)	Min peak EIRP (dBm)
CA_n257D	23+TT	43	22.4-TT
CA_n257G	23+TT	43	22.4-TT
CA_n258D	23+TT	43	22.4-TT
CA_n258G	23+TT	43	22.4-TT
CA_n260D	23+TT	43	20.6-TT
CA_n260G	23+TT	43	20.6-TT
CA_n260O	23+TT	43	20.6-TT
CA_n261D	23+TT	43	22.4-TT
CA_n261G	23+TT	43	22.4-TT

CA_n261O	23+TT	43	22.4-TT
----------	-------	----	---------

Table 6.2A.1.1.1.5-3a: UE maximum output test requirements for power class 3 for multi band UE declaring MB_p>0 in any FR2 band

ID	Supported FR2 bands set	Test requirement (dB) (Note 1)				Maximum sum of MB _p , ΣMB _p (dB) (Note 3)	Comments
		CA_n257D/ G	CA_n258	CA_n260D/ G/O	CA_n261D/ G/O		
1	n257, n258	22.4-TT-MB _p				1.3	
2	n257, n260	22.4-TT-MB _p		20.6-TT-MB _p		1.0	
3	n258, n260			20.6-TT-MB _p		1.0	
4	n258, n261				22.4-TT-MB _p	1.0	
5	n260, n261					0.0	No relaxation factor allowed
6	n257, n258, n260	22.4-TT-MB _p		20.6-TT-MB _p		1.7	
7	n257, n258, n261	22.4-TT-MB _p			22.4-TT-MB _p	1.7	
8	n257, n260, n261	22.4-TT-MB _p		20.6-TT-MB _p	22.4-TT-MB _p	0.5	
9	n258, n260, n261			20.6-TT-MB _p	22.4-TT-MB _p	1.5	
10	n257, n258, n260, n261	22.4-TT-MB _p		20.6-TT-MB _p	22.4-TT-MB _p	1.7	

Note 1: MB_p is the Multiband Relaxation factor declared by the UE for the tested band in Table A.4.3.9-2 of TS38.508-2. This declaration shall fulfil the requirements in clause 6.2.1.1.3.3.

Note 2: All UE supported bands needs to be tested to ensure the multiband relaxation declaration is compliant

Note 3: Max allowed sum of MB_p over all supported FR2 bands as defined in clause 6.2.1.1.3.3

Table 6.2A.1.1.1.5-3b: Test Tolerance (Max TRP for Power class 3) (Aggregated BW ≤ 400MHz)

Test Metric	FR2a	FR2b
Max device size ≤ 30 cm	2.77 dB, NTC 2.91 dB, ETC	2.89 dB, NTC 3.04 dB, ETC

Table 6.2A.1.1.1.5-3c: Test Tolerance (Min peak EIRP for Power class 3) (Aggregated BW ≤ 400MHz)

Test Metric	FR2a	FR2b
Max device size ≤ 30cm	2.99 dB, NTC 3.15 dB, ETC	2.99 dB, NTC 3.15 dB, ETC

Table 6.2A.1.1.1.5-4: Intra-band Contiguous CA UE maximum output test requirements for power class 4

UL CA configuration	Max TRP (dBm)	Max EIRP (dBm)	Min peak EIRP (dBm)
CA_n257D	23+TT	43	34-TT
CA_n257G	23+TT	43	34-TT
CA_n260B	23+TT	43	31-TT
CA_n260D	23+TT	43	31-TT
CA_n260G	23+TT	43	31-TT
CA_n260O	23+TT	43	31-TT
CA_n261B	23+TT	43	34-TT
CA_n261D	23+TT	43	34-TT
CA_n261G	23+TT	43	34-TT
CA_n261O	23+TT	43	34-TT

Table 6.2A.1.1.1.5-5: Intra-band Contiguous CA UE maximum output power test requirements for power class 5

Operating band	Max TRP (dBm)	Max EIRP (dBm)	Min peak EIRP (dBm)
n257	23+TT	43	30.0-TT- Δ MB _{P,n}
n258	23+TT	43	30.4-TT- Δ MB _{P,n}
Note 1: Δ MB _{P,n} = 0 for single band UE. For multi-band UEs, Δ MB _{P,n} is defined in table 6.2.1.1.3.5-4.			

Table 6.2A.1.1.1.5-5a: Test Tolerance (Max TRP for Power class 5) (Aggregated BW ≤ 400MHz)

Test Metric	FR2a
Max device size ≤ 30 cm	2.78 dB, NTC 2.94 dB, ETC

Table 6.2A.1.1.1.5-5b: Test Tolerance (Min peak EIRP for Power class 5) (Aggregated BW ≤ 400MHz)

Test Metric	FR2a
Max device size ≤ 30 cm	3.12 dB, NTC 3.28 dB, ETC

6.2A.1.1.2 UE maximum output power - EIRP and TRP for CA (3UL CA)

Editor's note: The following aspects are either missing or not yet determined:

- Measurement Uncertainties and Test Tolerances are FFS for power class other than 1, 3, 5 and CA other than intra-band contiguous.

6.2A.1.1.2.1 Test purpose

To verify that the power of any UE emission shall not exceed specified level for the specified channel bandwidth for CA under the deployment scenarios where additional requirements are specified.

6.2A.1.1.2.2 Test applicability

This test case applies to all types of NR UE release 15 and forward that supports FR2 3UL CA.

For bandwidth class C and E, this test case is not testable due to lack of appropriate test points since there is no configuration satisfying MPR=0dB requirements in TS 38.101-2.

6.2A.1.1.2.3 Minimum conformance requirements

The minimum conformance requirements are defined in clause 6.2A.1.0.

6.2A.1.1.2.4 Test description

Same as in clause 6.2A.1.1.1.4 with following exceptions:

- Instead of Table 6.2A.1.1.1.4.1-1 → use Table 6.2A.1.1.2.4-1.
- Instead of Table 6.2A.1.1.1.5-1 → use Table 6.2A.1.1.2.5-1.

Table 6.2A.1.1.2.4-1: Test Configuration Table

Default Conditions	
Test Environment as specified in TS 38.508-1 [10] clause 4.1	Normal, TL, TH (NOTE 2)
Test Frequencies as specified in TS 38.508-1 [10] clause 4.3.1.2.3 for different CA bandwidth classes	Low and High range

Test CC Combination setting (aggregated BW of the CA configuration) as specified in TS 38.508-1 [10] clause 4.3.1.2.3 for the CA Configuration across bandwidth combination sets supported by the UE			Highest aggregated BW (≤ 400 MHz aggregated channel bandwidth)			
Test SCS as specified in Table 5.3.5-1			120 kHz			
Test Parameters						
CA Configuration / Aggregated BW			Downlink Configuration	Uplink Configuration		
Test ID	CC & Mapping (NOTE 4)	CBW (MHz)	RB allocation	Modulation	RB allocation (NOTE 1)	
1	PCC/CC1	100	-	DFT-s-OFDM QPSK	Inner Full for PC2, PC3, PC4 and 5 Inner_Full_Region1 for PC1	
	SCC/CC2	100		-	-	
	SCC/CC3	100		-	-	
NOTE 1: The specific configuration of each RF allocation is defined in Table 6.1-1 for PC2, PC3, PC4 and PC5 or Table 6.1-2 for PC1.						
NOTE 2: Test environment for UE Max TRP is normal only.						
NOTE 3: CA Configuration Test cumulative aggregated BW settings are checked separately for each CA Configuration, which applicable aggregated channel bandwidths are specified in Table 5.5A.1-1.						
NOTE 4: If the UE supports multiple CC Combinations in the CA Configuration with the same cumulative aggregated BW, only the combination with the lowest PCC ChBW is tested.						
NOTE 5: PCC/CCi and SCC/CCj means PCC is on component carrier CCi and SCC is on component carrier CCj, with CCi or CCj frequencies defined in TS38.508-1 [10].						
NOTE 6: Number of DL CCs shall be configured the same as number of UL CCs. The requirements are applicable as per 5.3A.4: "The requirements are applicable only when Uplink CCs are configured within the frequency range between lower edge of lowest downlink component carrier and upper edge of highest downlink component carrier".						

6.2A.1.1.2.5 Test Requirements

The EIRP derived in step 8 and TRP derived in step 9 shall not exceed the values specified in Table 6.2A.1.1.2.5-1 to 6.2A.1.1.2.5-5.

Table 6.2A.1.1.2.5-1: Intra-band Contiguous CA UE maximum output test requirements for power class 1

CA configuration	Max TRP (dBm)	Max EIRP (dBm)	Min peak EIRP (dBm)
CA_n257H	35+TT	55	40-TT
CA_n258H	35+TT	55	40-TT
CA_n260H	35+TT	55	38-TT

Table 6.2A.1.1.2.5-1a: Test Tolerance (Max TRP for Power class 1) (Aggregated BW ≤ 400 MHz)

Test Metric	FR2a	FR2b
Max device size ≤ 30 cm	2.78 dB, NTC 2.94 dB, ETC	2.87 dB, NTC 3.03 dB, ETC

Table 6.2A.1.1.2.5-1b: Test Tolerance (Min peak EIRP for Power class 1) (Aggregated BW ≤ 400 MHz)

Test Metric	FR2a	FR2b
Max device size ≤ 30 cm	3.12 dB, NTC 3.28 dB, ETC	3.12 dB, NTC 3.28 dB, ETC

Table 6.2A.1.1.2.5-3: Intra-band Contiguous CA UE maximum output test requirements for power class 3

CA configuration	Max TRP (dBm)	Max EIRP (dBm)	Min peak EIRP (dBm)
CA_n257H	23+TT	43	22.4-TT
CA_n258H	23+TT	43	22.4-TT
CA_n260H	23+TT	43	20.6-TT

Table 6.2A.1.1.2.5-3a: Test Tolerance (Max TRP for Power class 3) (Aggregated BW ≤ 400MHz)

Test Metric	FR2a	FR2b
Max device size ≤ 30 cm	2.77 dB, NTC 2.91 dB, ETC	2.89 dB, NTC 3.04 dB, ETC

Table 6.2A.1.1.2.5-3b: Test Tolerance (Min peak EIRP for Power class 3) (Aggregated BW ≤ 400MHz)

Test Metric	FR2a	FR2b
Max device size ≤ 30 cm	2.99 dB, NTC 3.15 dB, ETC	2.99 dB, NTC 3.15 dB, ETC

Table 6.2A.1.1.2.5-5: Intra-band Contiguous CA UE maximum output test requirements for power class 5

CA configuration	Max TRP (dBm)	Max EIRP (dBm)	Min peak EIRP (dBm)
CA_n257H	23+TT	43	30.0-TT-ΔMB _{P,n}
CA_n258H	23+TT	43	30.4-TT-ΔMB _{P,n}

Table 6.2A.1.1.2.5-5a: Test Tolerance (Max TRP for Power class 5) (Aggregated BW ≤ 400MHz)

Test Metric	FR2a
Max device size ≤ 30 cm	2.78 dB, NTC 2.94 dB, ETC

Table 6.2A.1.1.2.5-5b: Test Tolerance (Min peak EIRP for Power class 5) (Aggregated BW ≤ 400MHz)

Test Metric	FR2a
Max device size ≤ 30 cm	3.12 dB, NTC 3.28 dB, ETC

6.2A.1.1.3 UE maximum output power - EIRP and TRP for CA (4UL CA)

Editor's note: The following aspects are either missing or not yet determined:

- Measurement Uncertainties and Test Tolerances are FFS for power class other than 1, 3, 5 and CA other than intra-band contiguous.

6.2A.1.1.3.1 Test purpose

To verify that the power of any UE emission shall not exceed specified level for the specified channel bandwidth for CA under the deployment scenarios where additional requirements are specified.

6.2A.1.1.3.2 Test applicability

This test case applies to all types of NR UE release 15 and forward that supports FR2 4UL CA.

For bandwidth class F, this test case is not testable due to lack of appropriate test points since there is no configuration satisfying MPR=0dB requirements in TS 38.101-2.

6.2A.1.1.3.3 Minimum conformance requirements

The minimum conformance requirements are defined in clause 6.2A.1.0.

6.2A.1.1.3.4 Test description

Same as in clause 6.2A.1.1.1.4 with following exceptions:

- Instead of Table 6.2A.1.1.1.4.1-1 → use Table 6.2A.1.1.3.4-1.
- Instead of Table 6.2A.1.1.1.5-1 → use Table 6.2A.1.1.3.5-1.

Table 6.2A.1.1.3.4-1: Test Configuration Table

Default Conditions					
Test Environment as specified in TS 38.508-1 [10] clause 4.1			Normal, TL, TH (NOTE 2)		
Test Frequencies as specified in TS 38.508-1 [10] clause 4.3.1.2.3 for different CA bandwidth classes, and PCC and SCC are mapped onto physical frequencies according to Table 6.1-2			Low and High range		
Test CC Combination setting (cumulative aggregated BW of the CA configuration) as specified in TS 38.508-1 [10] clause 4.3.1.2.3 for the CA Configuration across bandwidth combination sets supported by the UE			Highest aggregated BW (≤ 400 MHz aggregated channel bandwidth)		
Test SCS as specified in Table 5.3.5-1			120 kHz		
Test Parameters					
CA Configuration / Aggregated BW			Downlink Configuration	Uplink Configuration	
Test ID	CC & Mapping (NOTE 4)	ChBw	RB allocation	Modulation	RB allocation (NOTE 1)
1	PCC/CC1	100	-	DFT-s-OFDM QPSK	Inner Full for PC2, PC3, PC4 and PC5 Inner_Full_Region1 for PC1
	SCC/CC2	100		-	-
	SCC/CC3	100		-	-
	SCC/CC4	100		-	-
NOTE 1: The specific configuration of each RF allocation is defined in Table 6.1-1 for PC2, PC3, PC4 and PC5 or Table 6.1-2 for PC1.					
NOTE 2: Test environment for UE Max TRP is normal only.					
NOTE 3: CA Configuration Test cumulative aggregated BW settings are checked separately for each CA Configuration, which applicable aggregated channel bandwidths are specified in Table 5.5A.1-1.					
NOTE 4: If the UE supports multiple CC Combinations in the CA Configuration with the same cumulative aggregated BW, only the combination with the lowest PCC ChBW is tested.					
NOTE 5: PCC/CCi and SCC/CCj means PCC is on component carrier CCi and SCC is on component carrier CCj, with CCi or CCj frequencies defined in TS38.508-1 [10].					
NOTE 6: Number of DL CCs shall be configured the same as number of UL CCs. The requirements are applicable as per 5.3A.4: "The requirements are applicable only when Uplink CCs are configured within the frequency range between lower edge of lowest downlink component carrier and upper edge of highest downlink component carrier".					

6.2A.1.1.3.5 Test Requirements

The EIRP derived in step 8 and TRP derived in step 9 shall not exceed the values specified in Table 6.2A.1.1.3.5-1 to Table 6.2A.1.1.3.5-5.

Table 6.2A.1.1.3.5-1: Intra-band Contiguous CA UE maximum output test requirements for power class 1

CA configuration	Max TRP (dBm)	Max EIRP (dBm)	Min peak EIRP (dBm)
CA_n257l	35+TT	55	40-TT
CA_n258l	35+TT	55	40-TT
CA_n260l	35+TT	55	38-TT

Table 6.2A.1.1.3.5-1a: Test Tolerance (Max TRP for Power class 1) (Aggregated BW ≤ 400MHz)

Test Metric	FR2a	FR2b
-------------	------	------

Max device size \leq 30 cm	2.78 dB, NTC 2.94 dB, ETC	2.87 dB, NTC 3.03 dB, ETC
------------------------------	------------------------------	------------------------------

Table 6.2A.1.1.3.5-1b: Test Tolerance (Min peak EIRP for Power class 1) (Aggregated BW \leq 400MHz)

Test Metric	FR2a	FR2b
Max device size \leq 30 cm	3.12 dB, NTC 3.28 dB, ETC	3.12 dB, NTC 3.28 dB, ETC

Table 6.2A.1.1.3.5-3: UE maximum output test requirements for power class 3

CA configuration	Max TRP (dBm)	Max EIRP (dBm)	Min peak EIRP (dBm)
CA_n257l	23+TT	43	22.4-TT
CA_n258l	23+TT	43	22.4-TT
CA_n260l	23+TT	43	20.6-TT

Table 6.2A.1.1.3.5-3a: Test Tolerance (Max TRP for Power class 3) (Aggregated BW \leq 400MHz)

Test Metric	FR2a	FR2b
Max device size \leq 30 cm	2.77 dB, NTC 2.91 dB, ETC	2.89 dB, NTC 3.04 dB, ETC

Table 6.2A.1.1.3.5-3b: Test Tolerance (Min peak EIRP for Power class 3) (Aggregated BW \leq 400MHz)

Test Metric	FR2a	FR2b
Max device size \leq 30 cm	2.99 dB, NTC 3.15 dB, ETC	2.99 dB, NTC 3.15 dB, ETC

Table 6.2A.1.1.3.5-5: Intra-band Contiguous CA UE maximum output test requirements for power class 5

CA configuration	Max TRP (dBm)	Max EIRP (dBm)	Min peak EIRP (dBm)
CA_n257H	23+TT	43	30.0-TT- Δ MB _{P,n}
CA_n258H	23+TT	43	30.4-TT- Δ MB _{P,n}

Table 6.2A.1.1.3.5-5a: Test Tolerance (Max TRP for Power class 5) (Aggregated BW \leq 400MHz)

Test Metric	FR2a
Max device size \leq 30 cm	2.78 dB, NTC 2.94 dB, ETC

Table 6.2A.1.1.3.5-5b: Test Tolerance (Min peak EIRP for Power class 5) (Aggregated BW \leq 400MHz)

Test Metric	FR2a
Max device size \leq 30 cm	3.12 dB, NTC 3.28 dB, ETC

6.2A.1.1.4 UE maximum output power - EIRP and TRP for CA (5UL CA)

6.2A.1.1.4.1 Test purpose

To verify that the error of the UE maximum output power does not exceed the range prescribed by the specified nominal maximum output power and tolerance.

An excess maximum output power has the possibility to interfere to other channels or other systems. A small maximum output power decreases the coverage area.

6.2A.1.1.4.2 Test applicability

The requirements in this test are not testable due to lack of appropriate test points since there's no configuration satisfying MPR=0dB requirements in RAN4.

No test case details are specified.

6.2A.1.1.5 UE maximum output power - EIRP and TRP for CA (6UL CA)

6.2A.1.1.5.1 Test purpose

To verify that the error of the UE maximum output power does not exceed the range prescribed by the specified nominal maximum output power and tolerance.

An excess maximum output power has the possibility to interfere to other channels or other systems. A small maximum output power decreases the coverage area.

6.2A.1.1.5.2 Test applicability

The requirements in this test are not testable due to lack of appropriate test points since there's no configuration satisfying MPR=0dB requirements in TS 38.101-2.

No test case details are specified.

6.2A.1.1.6 UE maximum output power - EIRP and TRP for CA (7UL CA)

6.2A.1.1.6.1 Test purpose

To verify that the error of the UE maximum output power does not exceed the range prescribed by the specified nominal maximum output power and tolerance.

An excess maximum output power has the possibility to interfere to other channels or other systems. A small maximum output power decreases the coverage area.

6.2A.1.1.6.2 Test applicability

The requirements in this test are not testable due to lack of appropriate test points since there's no configuration satisfying MPR=0dB requirements in TS 38.101-2.

No test case details are specified.

6.2A.1.1.7 UE maximum output power - EIRP and TRP for CA (8UL CA)

6.2A.1.1.7.1 Test purpose

To verify that the error of the UE maximum output power does not exceed the range prescribed by the specified nominal maximum output power and tolerance.

An excess maximum output power has the possibility to interfere to other channels or other systems. A small maximum output power decreases the coverage area.

6.2A.1.1.7.2 Test applicability

The requirements in this test are not testable due to lack of appropriate test points since there's no configuration satisfying MPR=0dB requirements in TS 38.101-2.

No test case details are specified.

6.2A.1.2 UE maximum output power - Spherical coverage

6.2A.1.2.1 UE maximum output power - Spherical coverage for CA (2UL CA)

Editor's note: The following aspects are either missing or not yet determined:

- Measurement Uncertainties and Test Tolerances are FFS for power class other than 1, 3, 5 and CA other than intra-band contiguous.

6.2A.1.2.1.1 Test purpose

To verify that the spatial coverage of the UE for CA in expected directions is acceptable.

6.2A.1.2.1.2 Test applicability

This test case applies to all types of NR UE release 15 and forward that supports FR2 2UL CA.

For bandwidth class B, this test case is not testable due to lack of appropriate test points since there is no configuration satisfying MPR=0dB requirements in TS 38.101-2.

6.2A.1.2.1.3 Minimum conformance requirements

The minimum conformance requirements are defined in clause 6.2A.1.0.

6.2A.1.2.1.4 Test description

6.2A.1.2.1.4.1 Initial condition

Initial conditions are a set of test configurations the UE needs to be tested in and the steps for the SS to take with the UE to reach the correct measurement state.

The initial test configurations consist of environmental conditions, test frequencies, and channel bandwidths based on NR operating bands specified in clause 5.5A. All of these configurations shall be tested with applicable test parameters for each channel bandwidth and subcarrier spacing, are shown in Table 6.2A.1.2.1.4.1-1. The details of the uplink reference measurement channels (RMCs) are specified in Annexes A.2. Configurations of PDSCH and PDCCH before measurement are specified in Annex C.2.

Table 6.2A.1.2.1.4.1-1: Intra-band Contiguous CA Test Configuration Table (single CC requirement)

Default Conditions					
Test Environment as specified in TS 38.508-1 [10] clause 4.1			Normal		
Test Frequencies as specified in TS 38.508-1 [10] clause 4.3.1.2.3 for different CA bandwidth classes			Low and High range		
Test CC Combination setting (aggregated BW of the CA configuration) as specified in TS 38.508-1 [10] clause 4.3.1.2.3 for the CA Configuration across bandwidth combination sets supported by the UE			Highest aggregated BW (\leq 400 MHz aggregated channel bandwidth)		
Test SCS as specified in Table 5.3.5-1			120 kHz		
Test Parameters					
CA Configuration / Aggregated BW			Downlink Configuration	Uplink Configuration	
Test ID	CC & Mapping (NOTE 4)	CBW (MHz)	RB allocation	Modulation	RB allocation (NOTE 1)
1	PCC/CC1	100	-	DFT-s-OFDM QPSK	Inner Full for PC2, PC3, PC4 and PC5 Inner_Full_Region1 for PC1
	SCC/CC2	100		-	-
2	PCC/CC1	200		DFT-s-OFDM QPSK	Inner Full for PC2, PC3, PC4 and PC5 Inner_Full_Region1 for PC1
	SCC/CC2	200		-	-

NOTE 1: The specific configuration of each RF allocation is defined in Table 6.1-1 for PC2, PC3, PC4 and PC5 or Table 6.1-2 for PC1.
NOTE 2: CA Configuration Test cumulative aggregated BW settings are checked separately for each CA Configuration, which applicable aggregated channel bandwidths are specified in Table 5.5A.1-1.
NOTE 3: If the UE supports multiple CC Combinations in the CA Configuration with the same cumulative aggregated BW, only the combination with the lowest PCC ChBW is tested.
NOTE 4: PCC/CCi and SCC/CCj means PCC is on component carrier CCi and SCC is on component carrier CCj, with CCi or CCj frequencies defined in TS38.508-1 [10].
NOTE 5: Number of DL CCs shall be configured the same as number of UL CCs. The requirements are applicable as per 5.3A.4: <i>"The requirements are applicable only when Uplink CCs are configured within the frequency range between lower edge of lowest downlink component carrier and upper edge of highest downlink component carrier"</i> .

1. Connection between SS and UE is shown in TS 38.508-1 [10] Annex A, Figure A.3.3.1.1 for TE diagram and Figure A.3.4.1.1 for UE diagram.
2. The parameter settings for the cell are set up according to TS 38.508-1 [10] clause 4.4.3.
3. Downlink signals for PCC are initially set up according to Annex C, and uplink signals according to Annex G.
4. The UL Reference Measurement channels are set according to Table 6.2A.1.2.1.4.1-1.
5. Propagation conditions are set according to Annex B.0
6. Ensure the UE is in state RRC_CONNECTED with generic procedure parameters Connectivity NR, Connected without release On, Test Mode On and Test Loop Function On according to TS 38.508-1 [10] clause 4.5. Message contents are defined in clause 6.2A.1.2.1.4.3

6.2A.1.2.1.4.2 Test procedure

1. Configure PCC and SCC according to Annex C.0, C.1, C.2 and Annex C.3.0 for all downlink physical channels.
2. The SS shall configure SCC as per TS 38.508-1 [10] clause 5.5.1 Procedure to configure SCC(s) for NR RF CA testing. Message contents are defined in clause 6.2A.1.2.1.4.3.
3. SS activates SCC by sending the activation MAC CE (Refer TS 38.321, clauses 5.9, 6.1.3.10). Wait for at least 2 seconds (Refer TS 38.133[25], clause 9.3).
4. SS sends uplink scheduling information for each UL HARQ process via PDCCH DCI format 0_1 for C_RNTI to schedule the UL RMC according to Table 6.2A.1.2.1.4.1-1. Since the UL has no payload and no loopback data to send the UE sends uplink MAC padding bits on the UL RMC. Messages to configure the appropriate uplink modulation in section 6.2A.1.2.1.4.3.
5. Set the UE in the Tx beam peak direction found with a 3D EIRP scan as performed in Annex K.1.1. Allow at least BEAM_SELECT_WAIT_TIME (NOTE 1) for the UE Tx beam selection to complete.
6. Send continuously uplink power control "up" commands in every uplink scheduling information to the UE; allow at least 200 msec to ensure that the UE transmits at its maximum output power. Allow at least BEAM_SELECT_WAIT_TIME (NOTE 1) for the UE Tx beam selection to complete.
7. Through its beam correspondence procedure, DUT refines its TX beam toward that direction depending on DUT's beam correspondence capability which shall match OEM declaration:
 - 7a If the DUT's beam correspondence capability beamCorrespondenceWithoutUL-BeamSweeping is supported, then DUT autonomously chooses the corresponding TX beam for PUSCH transmission using downlink reference signals to transmit in the direction of the incoming DL signal, which is based on beam correspondence without relying on UL beam sweeping;
 - 7b If the DUT's beam correspondence capability beamCorrespondenceWithoutUL-BeamSweeping is not present, then DUT chooses the TX beam for PUSCH transmission which is based on beam correspondence with relying on both DL measurements on downlink reference signals and network-assisted uplink beam sweeping:
 - 7b.1) DUT uses downlink reference signals to select proper RX beam and uses autonomous beam correspondence to select the TX beam.

7b.2) SS configures $M=8$ SRS resources to DUT, with the field *spatialRelationInfo* omitted and the field *usage* set as 'beamManagement'. In case DUT supports less than 8 SRS resources, SS configures the number of SRS resources according to the maximum number of SRS resources indicated by UE capability signalling. Additionally, for codebook based PUSCH transmission, SS configures a semi-persistent SRS resource set with the field *usage* as 'codebook'.

7b.3) Based on the TX beam autonomously selected by DUT, DUT chooses TX beams to transmit SRS-resources configured by SS.

7b.4) Based on measurement of the received *beamManagement* SRS, SS chooses the best SRS beam and, if needed, updates the spatial relation information between the semi-persistent *codebook* SRS resources and the SS selected *beamManagement* SRS resource in the activation MAC CE of the semi-persistent SRS resource. The SS indicates in the SRS Resource Indicator (SRI) field in the scheduling grant for PUSCH, if present, the SRS resource within the semi-persistent SRS resource set whose spatial relation is linked to the best detected SRS beam.

7b.5) DUT transmits PUSCH corresponding to the SRS resource indicated by the SRI.

8. Measure UE EIRP value for each grid point according to the EIRP spherical coverage procedure defined in Annex K.1.5.0, and obtain a cumulative distribution function (CDF) of all EIRP dBm values. Alternatively, UE EIRP measurement for each grid point could be done according to Tx Fast spherical coverage procedure defined in Annex K.1.5.1. After a rotation, allow at least BEAM_SELECT_WAIT_TIME (NOTE 1) for UE to find the best beam to use. The measuring duration is one active uplink subframe. EIRP is calculated considering both polarizations, theta and phi.
9. Identify the EIRP dBm value corresponding to %-tile (UE power class dependent) value in the applicable test requirement table in section 6.2A.1.2.1.5..

NOTE 1: The BEAM_SELECT_WAIT_TIME default value is defined in Annex K.

6.2A.1.2.1.4.3 Message contents

Message contents are according to TS 38.508-1 [10] clause 4.6 with TRANSFORM_PRECODER_ENABLED condition in Table 4.6.3-118 PUSCH-Config.

6.2A.1.2.1.5 Test requirement

The defined %-tile EIRP in measurement distribution derived in step 8 shall exceed the values specified in Table 6.2A.1.2.1.5-1 to Table 6.2A.1.2.1.5-5.

Table 6.2A.1.2.1.5-1: Intra-band Contiguous CA UE spherical coverage for power class 1

Operating band	Min EIRP at 85%-tile CDF (dBm)
CA_n257D	32.0-TT
CA_n257G	32.0-TT
CA_n260D	30.0-TT
CA_n260G	30.0-TT
CA_n260O	30.0-TT
CA_n261D	32.0-TT
CA_n261G	32.0-TT
CA_n261O	32.0-TT

Table 6.2A.1.2.1.5-2: Intra-band Contiguous CA UE spherical coverage for power class 2

Operating band	Min EIRP at 60%-tile CDF (dBm)
CA_n257D	18.0-TT
CA_n257G	18.0-TT
CA_n261D	18.0-TT
CA_n261G	18.0-TT
CA_n261O	18.0-TT

Table 6.2A.1.2.1.5-3: Intra-band Contiguous CA UE spherical coverage for power class 3 for single band UE or multiband UE declaring MB_s = 0 in all FR2 bands

Operating band	Min EIRP at 50 th -tile CDF (dBm)
CA_n257D	11.5-TT
CA_n257G	11.5-TT
CA_n258D	11.5-TT
CA_n258G	11.5-TT
CA_n260D	8-TT
CA_n260G	8-TT
CA_n260O	8-TT
CA_n261D	11.5-TT
CA_n261G	11.5-TT
CA_n261O	11.5-TT

Table 6.2A.1.2.1.5-3a: UE spherical coverage for power class 3 for multi band UE declaring MB_s>0 in any FR2 band

ID	Supported FR2 bands set	Test requirement (dB) (Note 1)				Maximum sum of MB _s , ΣMB _s (dB) (Note 3)	Comments
		CA_n257D /G	CA_n258	CA_n260D /G/O	CA_n261D /G/O		
1	n257, n258	11.5-TT-MB _s				1.25	
2	n257, n260	11.5-TT-MB _s		8-TT-MB _s		0.75	Maximum 0.4 dB relaxation allowed for n260
3	n258, n260			8-TT-MB _s		0.75	Maximum 0.4 dB relaxation allowed for n260
4	n258, n261				11.5-TT-MB _s	1.25	
5	n260, n261			8-TT-MB _s	11.5-TT-MB _s	0.75	No relaxation allowed for n260
6	n257, n258, n260	11.5-TT-MB _s		8-TT-MB _s		1.75	Maximum 0.4 dB relaxation allowed for n260
7	n257, n258, n261	11.5-TT-MB _s			11.5-TT-MB _s	1.75	
8	n257, n260, n261	11.5-TT-MB _s		8-TT-MB _s	11.5-TT-MB _s	1.25	Maximum 0.4 dB relaxation allowed for n260
9	n258, n260, n261			8-TT-MB _s	11.5-TT-MB _s	1.25	Maximum 0.4 dB relaxation allowed for n260
10	n257, n258, n260, n261	11.5-TT-MB _s		8-TT-MB _s	11.5-TT-MB _s	1.75	Maximum 0.4 dB relaxation allowed for n260

Note 1: MB_s is the Multiband Relaxation factor declared by the UE for the tested band in Table A.4.3.9-3 of TS38.508-2 [11]. This declaration shall fulfil the requirements in clause 6.2.1.1.3.3.

Note 2: All UE supported bands needs to be tested to ensure the multiband relaxation declaration is compliant

Note 3: Max allowed sum of MB_s over all supported FR2 bands as defined in clause 6.2.1.1.3.3

Table 6.2A.1.2.1.5-4: Intra-band Contiguous CA UE spherical coverage for power class 4

Operating band	Min EIRP at 20%-tile CDF (dBm)
CA_n257D	25-TT
CA_n257G	25-TT
CA_n260D	19-TT
CA_n260G	19-TT
CA_n260O	19-TT

CA_n261D	25-TT
CA_n261G	25-TT
CA_n261O	25-TT

Table 6.2A.1.2.1.5-5: Intra-band Contiguous UE spherical coverage for power class 5

Operating band	Min EIRP at 85%-tile CDF (dBm)
n257	22.0-TT- $\Delta\text{MB}_{s,n}$
n258	22.4-TT- $\Delta\text{MB}_{s,n}$
Note 1: $\Delta\text{MB}_{s,n} = 0$ for single band UE. For multi-band UEs, $\Delta\text{MB}_{s,n}$ is defined in table 6.2.1.1.3.5-5.	

Table 6.2A.1.2.1.5-6: Test Tolerance (Spherical coverage) (Aggregated BW \leq 400MHz)

Test Metric	FR2a	FR2b
IFF (Max device size \leq 30 cm)	2.69 dB	2.69 dB

6.2A.1.2.2 UE maximum output power - Spherical coverage for CA (3UL CA)

Editor's note: The following aspects are either missing or not yet determined:

- Measurement Uncertainties and Test Tolerances are FFS for power class other than 1, 3, 5 and CA other than intra-band contiguous.

6.2A.1.2.2.1 Test purpose

To verify that the spatial coverage of the UE for CA in expected directions is acceptable.

6.2A.1.2.2.2 Test applicability

This test case applies to all types of NR UE release 15 and forward that supports FR2 3UL CA.

For bandwidth class C and E, this test case is not testable due to lack of appropriate test points since there is no configuration satisfying MPR=0dB requirements in TS 38.101-2.

6.2A.1.2.2.3 Minimum conformance requirements

The minimum conformance requirements are defined in clause 6.2A.1.0.

6.2A.1.2.2.4 Test description

Same as in clause 6.2A.1.2.1.4 with following exceptions:

- Instead of Table 6.2A.1.2.1.4.1-1 \rightarrow use Table 6.2A.1.2.2.4-1.
- Instead of Table 6.2A.1.2.1.5-1 to 5 \rightarrow use Table 6.2A.1.2.2.5-1 to 5.

Table 6.2A.1.2.2.4-1: Intra-band Contiguous CA Test Configuration Table (single CC requirement)

Default Conditions	
Test Environment as specified in TS 38.508-1 [10] clause 4.1	Normal
Test Frequencies as specified in TS 38.508-1 [10] clause 4.3.1.2.3 for different CA bandwidth classes	Low and High range
Test CC Combination setting (aggregated BW of the CA configuration) as specified in TS 38.508-1 [10] clause 4.3.1.2.3 for the CA Configuration across bandwidth combination sets supported by the UE	Highest aggregated BW (\leq 400 MHz aggregated channel bandwidth)
Test SCS as specified in Table 5.3.5-1	120 kHz
Test Parameters	

CA Configuration / Aggregated BW			Downlink Configuration	Uplink Configuration	
Test ID	CC & Mapping (NOTE 4)	CBW (MHz)	RB allocation	Modulation	RB allocation (NOTE 1)
1	PCC/CC1	100	-	DFT-s-OFDM QPSK	Inner Full for PC2, PC3, PC4 and PC5 Inner_Full_Region1 for PC1
	SCC/CC2	100		-	-
	SCC/CC3	100		-	-

NOTE 1: The specific configuration of each RF allocation is defined in Table 6.1-1 for PC2, PC3, PC4 and PC5 or Table 6.1-2 for PC1.

NOTE 2: CA Configuration Test cumulative aggregated BW settings are checked separately for each CA Configuration, which applicable aggregated channel bandwidths are specified in Table 5.5A.1-1.

NOTE 3: If the UE supports multiple CC Combinations in the CA Configuration with the same cumulative aggregated BW, only the combination with the lowest PCC ChBW is tested.

NOTE 4: PCC/CCi and SCC/CCj means PCC is on component carrier CCi and SCC is on component carrier CCj, with CCi or CCj frequencies defined in TS38.508-1 [10].

NOTE 5: Number of DL CCs shall be configured the same as number of UL CCs. The requirements are applicable as per 5.3A.4: "The requirements are applicable only when Uplink CCs are configured within the frequency range between lower edge of lowest downlink component carrier and upper edge of highest downlink component carrier".

6.2A.1.2.2.5 Test requirement

The defined %-tile EIRP in measurement distribution derived in step 8 shall exceed the values specified in Table 6.2A.1.2.2.5-1 to Table 6.2A.1.2.2.5-5.

Table 6.2A.1.2.2.5-1: Intra-band Contiguous CA UE spherical coverage for power class 1

Operating band	Min EIRP at 85%-tile CDF (dBm)
CA_n257H	32.0-TT
CA_n260H	30.0-TT
CA_n260P	30.0-TT
CA_n261H	32.0-TT
CA_n261P	32.0-TT

Table 6.2A.1.2.2.5-2: Intra-band Contiguous CA UE spherical coverage for power class 2

Operating band	Min EIRP at 60%-tile CDF (dBm)
CA_n257H	18.0-TT
CA_n261H	18.0-TT
CA_n261P	18.0-TT

Table 6.2A.1.2.2.5-3: Intra-band Contiguous CA UE spherical coverage for power class 3 for single band UE or multiband UE declaring MB_s = 0 in all FR2 bands

Operating band	Min EIRP at 50%-tile CDF (dBm)
CA_n257H	11.5-TT
CA_n258H	11.5-TT
CA_n260H	8-TT
CA_n260P	8-TT
CA_n261H	11.5-TT
CA_n261P	11.5-TT

Table 6.2A.1.2.2.5-3a: UE spherical coverage for power class 3 for multi band UE declaring $MB_s > 0$ in any FR2 band

ID	Supported FR2 bands set	Test requirement (dB) (Note 1)				Maximum sum of MB_s , $\sum MB_s$ (dB) (Note 3)	Comments
		CA_n257H	CA_n258	CA_n260H /P	CA_n261H/P		
1	n257, n258	11.5-TT- MB_s				1.25	
2	n257, n260	11.5-TT- MB_s		8-TT- MB_s		0.75	Maximum 0.4 dB relaxation allowed for n260
3	n258, n260			8-TT- MB_s		0.75	Maximum 0.4 dB relaxation allowed for n260
4	n258, n261				11.5-TT- MB_s	1.25	
5	n260, n261			8-TT- MB_s	11.5-TT- MB_s	0.75	No relaxation allowed for n260
6	n257, n258, n260	11.5-TT- MB_s		8-TT- MB_s		1.75	Maximum 0.4 dB relaxation allowed for n260
7	n257, n258, n261	11.5-TT- MB_s			11.5-TT- MB_s	1.75	
8	n257, n260, n261	11.5-TT- MB_s		8-TT- MB_s	11.5-TT- MB_s	1.25	Maximum 0.4 dB relaxation allowed for n260
9	n258, n260, n261			8-TT- MB_s	11.5-TT- MB_s	1.25	Maximum 0.4 dB relaxation allowed for n260
10	n257, n258, n260, n261	11.5-TT- MB_s		8-TT- MB_s	11.5-TT- MB_s	1.75	Maximum 0.4 dB relaxation allowed for n260

Note 1: MB_s is the Multiband Relaxation factor declared by the UE for the tested band in Table A.4.3.9-3 of TS38.508-2 [11]. This declaration shall fulfil the requirements in clause 6.2.1.1.3.3.

Note 2: All UE supported bands needs to be tested to ensure the multiband relaxation declaration is compliant

Note 3: Max allowed sum of MB_s over all supported FR2 bands as defined in clause 6.2.1.1.3.3

Table 6.2A.1.2.2.5-4: Intra-band Contiguous CA UE spherical coverage for power class 4

Operating band	Min EIRP at 20%-tile CDF (dBm)
CA_n257H	25-TT
CA_n260H	19-TT
CA_n260P	19-TT
CA_n261H	25-TT
CA_n261P	25-TT

Table 6.2A.1.2.2.5-5: Intra-band Contiguous UE spherical coverage for power class 5

Operating band	Min EIRP at 85%-tile CDF (dBm)
n257	22.0-TT- $\Delta MB_{s,n}$
n258	22.4-TT- $\Delta MB_{s,n}$

Note 1: $\Delta MB_{s,n} = 0$ for single band UE. For multi-band UEs, $\Delta MB_{s,n}$ is defined in table 6.2.1.1.3.5-5.

Table 6.2A.1.2.2.5-6: Test Tolerance (Spherical coverage) (Aggregated BW \leq 400MHz)

Test Metric	FR2a	FR2b
IFF (Max device size \leq 30 cm)	2.69 dB	2.69 dB

6.2A.1.2.3 UE maximum output power - Spherical coverage for CA (4UL CA)

Editor's note: The following aspects are either missing or not yet determined:

- Measurement Uncertainties and Test Tolerances are FFS for power class other than 1, 3, 5 and CA other than intra-band contiguous.

6.2A.1.2.3.1 Test purpose

To verify that the spatial coverage of the UE for CA in expected directions is acceptable.

6.2A.1.2.3.2 Test applicability

This test case applies to all types of NR UE release 15 and forward that supports FR2 4UL CA.

For bandwidth class F, this test case is not testable due to lack of appropriate test points since there is no configuration satisfying MPR=0dB requirements in TS 38.101-2.

6.2A.1.2.3.3 Minimum conformance requirements

The minimum conformance requirements are defined in clause 6.2A.1.0.

6.2A.1.2.3.4 Test description

Same as in clause 6.2A.1.2.1.4 with following exceptions:

- Instead of Table 6.2A.1.2.1.4.1-1 → use Table 6.2A.1.2.3.4-1.
- Instead of Table 6.2A.1.2.1.5-1 to 5 → use Table 6.2A.1.2.3.5-1 to 5.

Table 6.2A.1.2.3.4-1: Intra-band Contiguous CA Test Configuration Table (single CC requirement)

Default Conditions					
Test Environment as specified in TS 38.508-1 [10] clause 4.1			Normal		
Test Frequencies as specified in TS 38.508-1 [10] clause 4.3.1.2.3 for different CA bandwidth classes			Low and High range		
Test CC Combination setting (cumulative aggregated BW of the CA configuration) as specified in TS 38.508-1 [10] clause 4.3.1.2.3 for the CA Configuration across bandwidth combination sets supported by the UE			Highest aggregated BW (≤ 400 MHz aggregated channel bandwidth)		
Test SCS as specified in Table 5.3.5-1			120 kHz		
Test Parameters					
CA Configuration / Aggregated BW			Downlink Configuration	Uplink Configuration	
Test ID	CC & Mapping (NOTE 4)	ChBw	RB allocation	Modulation	RB allocation (NOTE 1)
1	PCC/CC1	100	-	DFT-s-OFDM QPSK	Inner Full for PC2, PC3, PC4 and PC5 Inner_Full_Region1 for PC1
	SCC/CC2	100		-	-
	SCC/CC3	100		-	-
	SCC/CC4	100		-	-
NOTE 1: The specific configuration of each RF allocation is defined in Table 6.1-1 for PC2, PC3, PC4 and PC5 or Table 6.1-2 for PC1.					
NOTE 2: CA Configuration Test cumulative aggregated BW settings are checked separately for each CA Configuration, which applicable aggregated channel bandwidths are specified in Table 5.5A.1-1.					
NOTE 3: If the UE supports multiple CC Combinations in the CA Configuration with the same cumulative aggregated BW, only the combination with the lowest PCC ChBW is tested.					
NOTE 4: PCC/CCi and SCC/CCj means PCC is on component carrier CCi and SCC is on component carrier CCj, with CCi or CCj frequencies defined in TS38.508-1 [10].					
NOTE 5: Number of DL CCs shall be configured the same as number of UL CCs. The requirements are applicable as per 5.3A.4: "The requirements are applicable only when Uplink CCs are configured within the frequency range between lower edge of lowest downlink component carrier and upper edge of highest downlink component carrier".					

6.2A.1.2.3.5 Test requirement

The defined %-tile EIRP in measurement distribution derived in step 8 shall exceed the values specified in Table 6.2A.1.2.3.5-1 to Table 6.2A.1.2.3.5-5.

Table 6.2A.1.2.3.5-1: Intra-band Contiguous CA UE spherical coverage for power class 1

Operating band	Min EIRP at 85%-tile CDF (dBm)
CA_n257I	32.0-TT
CA_n260I	30.0-TT
CA_n260Q	30.0-TT
CA_n261I	32.0-TT
CA_n261Q	32.0-TT

Table 6.2A.1.2.3.5-2: Intra-band Contiguous CA UE spherical coverage for power class 2

Operating band	Min EIRP at 60%-tile CDF (dBm)
CA_n257I	32.0-TT
CA_n261I	32.0-TT
CA_n261Q	32.0-TT

Table 6.2A.1.2.3.5-3: Intra-band Contiguous CA UE spherical coverage for power class 3 for single band UE or multiband UE declaring MB_s = 0 in all FR2 bands

Operating band	Min EIRP at 50%-tile CDF (dBm)
CA_n257I	11.5-TT
CA_n258I	11.5-TT
CA_n260I	8-TT
CA_n260Q	8-TT
CA_n261I	11.5-TT
CA_n261Q	11.5-TT

Table 6.2A.1.2.3.5-3a: UE spherical coverage for power class 3 for multi band UE declaring MB_s>0 in any FR2 band

ID	Supported FR2 bands set	Test requirement (dB) (Note 1)				Maximum sum of MB _s , \sum MB _s (dB) (Note 3)	Comments
		CA_n257I	CA_n258	CA_n260I/Q	CA_n261I/Q		
1	n257, n258	11.5-TT-MB _s				1.25	
2	n257, n260	11.5-TT-MB _s		8-TT-MB _s		0.75	Maximum 0.4 dB relaxation allowed for n260
3	n258, n260			8-TT-MB _s		0.75	Maximum 0.4 dB relaxation allowed for n260
4	n258, n261				11.5-TT-MB _s	1.25	
5	n260, n261			8-TT-MB _s	11.5-TT-MB _s	0.75	No relaxation allowed for n260
6	n257, n258, n260	11.5-TT-MB _s		8-TT-MB _s		1.75	Maximum 0.4 dB relaxation allowed for n260
7	n257, n258, n261	11.5-TT-MB _s			11.5-TT-MB _s	1.75	
8	n257, n260, n261	11.5-TT-MB _s		8-TT-MB _s	11.5-TT-MB _s	1.25	Maximum 0.4 dB relaxation allowed for n260

9	n258, n260, n261			8-TT-MB _s	11.5-TT-MB _s	1.25	Maximum 0.4 dB relaxation allowed for n260
10	n257, n258, n260, n261	11.5-TT-MB _s		8-TT-MB _s	11.5-TT-MB _s	1.75	Maximum 0.4 dB relaxation allowed for n260
<p>Note 1: MB_s is the Multiband Relaxation factor declared by the UE for the tested band in Table A.4.3.9-3 of TS38.508-2 [11]. This declaration shall fulfil the requirements in clause 6.2.1.1.3.3.</p> <p>Note 2: All UE supported bands needs to be tested to ensure the multiband relaxation declaration is compliant</p> <p>Note 3: Max allowed sum of MB_s over all supported FR2 bands as defined in clause 6.2.1.1.3.3</p>							

Table 6.2A.1.2.3.5-4: Intra-band Contiguous CA UE spherical coverage for power class 4

Operating band	Min EIRP at 20%-tile CDF (dBm)
CA_n257I	25-TT
CA_n260I	19-TT
CA_n260Q	19-TT
CA_n261I	25-TT
CA_n261Q	25-TT

Table 6.2A.1.2.2.5-5: Intra-band Contiguous UE spherical coverage for power class 5

Operating band	Min EIRP at 85%-tile CDF (dBm)
n257	22.0-TT- Δ MB _{s,n}
n258	22.4-TT- Δ MB _{s,n}
Note 1: Δ MB _{s,n} = 0 for single band UE. For multi-band UEs, Δ MB _{s,n} is defined in table 6.2.1.1.3.5-5.	

Table 6.2A.1.2.3.5-6: Test Tolerance (Spherical coverage) (Aggregated BW \leq 400MHz)

Test Metric	FR2a	FR2b
IFF (Max device size \leq 30 cm)	2.69 dB	2.69 dB

6.2A.1.2.4 UE maximum output power - Spherical coverage for CA (5UL CA)**6.2A.1.2.4.1 Test purpose**

To verify that the spatial coverage of the UE for CA in expected directions is acceptable.

6.2A.1.2.4.2 Test applicability

The requirements in this test are not testable due to lack of appropriate test points since there's no configuration satisfying MPR=0dB requirements in TS 38.101-2.

No test case details are specified.

6.2A.1.2.5 UE maximum output power - Spherical coverage for CA (6UL CA)**6.2A.1.2.5.1 Test purpose**

To verify that the spatial coverage of the UE for CA in expected directions is acceptable.

6.2A.1.2.5.2 Test applicability

The requirements in this test are not testable due to lack of appropriate test points since there's no configuration satisfying MPR=0dB requirements in TS 38.101-2.

No test case details are specified.

6.2A.1.2.6 UE maximum output power - Spherical coverage for CA (7UL CA)

6.2A.1.2.6.1 Test purpose

To verify that the spatial coverage of the UE for CA in expected directions is acceptable.

6.2A.1.2.6.2 Test applicability

The requirements in this test are not testable due to lack of appropriate test points since there's no configuration satisfying MPR=0dB requirements in TS 38.101-2.

No test case details are specified.

6.2A.1.2.7 UE maximum output power - Spherical coverage for CA (8UL CA)

6.2A.1.2.7.1 Test purpose

To verify that the spatial coverage of the UE for CA in expected directions is acceptable.

6.2A.1.2.7.2 Test applicability

The requirements in this test are not testable due to lack of appropriate test points since there's no configuration satisfying MPR=0dB requirements in TS 38.101-2.

No test case details are specified.

6.2A.2 UE maximum output power reduction for CA

6.2A.2.0 Minimum conformance requirements

6.2A.2.0.1 General

The UE is defined to be configured for CA operation when it has at least one of UL or DL configured for CA. In CA operation, the UE may reduce its maximum output power due to higher order modulations and transmit bandwidth configurations. This Maximum Power Reduction (MPR) is defined in subclauses below. The allowed MPR for SRS, PUCCH formats 0, 1, 3 and 4, shall be as specified for QPSK modulated DFT-s-OFDM of equivalent RB allocation. The allowed MPR for PUCCH format 2, shall be as specified for QPSK modulated CP-OFDM of equivalent RB allocation.

When the maximum output power of a UE is modified by MPR, the power limits specified in clause 6.2A.4.0 apply.

The requirements in the following subclauses are only applicable to the following CA configurations:

- intra-band contiguous uplink CA, with the aggregated channel bandwidth up to 800 MHz.
- intra-band non-contiguous uplink CA with UL frequency separation no greater than 1400 MHz, and no more than 3 sub-blocks. A sub-block may consist of single CC or multiple contiguous CCs.
- In case the CA configuration consists of a single UL CC, MPR for contiguous UL CA applies and where necessary, $BW_{channel}$ shall be used as $BW_{channel_CA}$.

6.2A.2.0.2 Maximum output power reduction for power class 1

For power class 1, MPR for intra-band contiguous UL CA with contiguous allocations within the cumulative aggregated bandwidth is defined as:

$$MPR_{C_CA} = \max(MPR_{WT_C_CA} + \Delta MPR, MPR_{narrow})$$

Where,

$MPR_{narrow} = 14.4$ dB, when $BW_{alloc, RB}$ is less than or equal to 1.44 MHz, $MPR_{narrow} = 10$ dB, when $1.44 \text{ MHz} < BW_{alloc, RB} \leq 10.8$ MHz, where $BW_{alloc, RB}$ is the bandwidth of the RB allocation size.

$MPR_{WT_C_CA}$ is the maximum power reduction due to modulation orders, transmit bandwidth configurations, and waveform types. $MPR_{WT_C_CA}$ is defined in Table 6.2A.2.0.2-1.

ΔMPR for 256 QAM as specified in Table 6.2.2.3.1-3 applies.

Table 6.2A.2.0.2-1: Maximum power reduction ($MPR_{WT_C_CA}$) for UE power class 1

Waveform Type		Cumulative aggregated channel bandwidth			
		< 400 MHz	≥ 400 MHz and < 800 MHz	≥ 800 MHz and ≤ 1400 MHz	> 1400 MHz and ≤ 2400 MHz
DFT-s-OFDM	Pi/2 BPSK	≤ 5.5	≤ 7.7	≤ 8.2	≤ 8.7
	QPSK	≤ 6.5	≤ 8.7	≤ 9.7	≤ 9.7
	16 QAM	≤ 6.5	≤ 8.7	≤ 9.2	≤ 9.7
	64 QAM	≤ 9.0	≤ 10.7	≤ 11.2	≤ 11.7
	256 QAM ²	≤ 12.5	≤ 14.2	≤ 14.7	≤ 15.7
CP-OFDM	QPSK	≤ 6.5	≤ 8.7	≤ 8.7	≤ 9.7
	16 QAM	≤ 6.5	≤ 8.7	≤ 8.7	≤ 9.7
	64 QAM	≤ 9.0	≤ 10.7	≤ 11.2	≤ 11.7
	256 QAM ²	≤ 12.5	≤ 14.2	≤ 14.7	≤ 15.7

NOTE 1: (Void)
NOTE 2: Refer to clause 6.1 for 256 QAM applicability.

In case of a contiguous RB, DFT-s-BPSK or DFT-s-QPSK UL allocation in a single CC of a CA configuration with contiguous CCs, and whose cumulative aggregated BW ≤ 400 MHz, $MPR_{WT_C_CA}$ shall be derived instead as $\max(MPR_1, MPR_2)$, where:

MPR_1 shall be determined from Table 6.2.2.3.1-1 if CABW ≤ 200 MHz, from Table 6.2.2.3.1-2 if CABW > 200 MHz.

MPR_2 shall be determined from Table 6.2.2.3.1-1 if UL $BW_{channel_CA} \leq 200$ MHz, from Table 6.2.2.3.1-2 if UL $BW_{channel_CA} > 200$ MHz.

and assume all UL CCs use the same SCS for the purpose of determination of inner and outer RB allocations in Table 6.2.2.3.1-1 and Table 6.2.2.3.1-2:

N_{RB} shall be chosen as the sum of N_{RB} of all constituent UL CCs in the CA configuration.

L_{CRB} shall be chosen as $BW_{alloc, RB}$

RB_{start} shall be derived as: $RB_{start_allocatedCC} + N_{RB_unallocatedCC_low}$

$RB_{start_allocatedCC}$ is the index of the first allocated RB in the CC with allocation

$N_{RB_unallocatedCC_low}$ is the sum of N_{RB} in all UL CCs lower in frequency compared to the CC with allocation

When different waveform types exist across CCs, the requirement is set by the waveform type used in the configuration with the largest MPR_{C_CA} .

For intra-band contiguous UL CA with non-contiguous RB allocations, the following rule for MPR applies:

$$MPR = \max(MPR_{C_CA}, -10 \cdot A + 14.4)$$

Where:

$$A = N_{RB_alloc} / N_{RB_agg_C}$$

N_{RB_alloc} is the total number of allocated UL RBs

$N_{RB_agg_C}$ is the number of the aggregated RBs within the fully allocated cumulative aggregated channel bandwidth assuming lowest SCS among all configured CCs

For intra-band non-contiguous UL CA, the following rule for MPR applies:

$$MPR = \max(MPR_{NC_CA} + \Delta MPR, -10 * A + 14.4)$$

Where:

MPR_{NC_CA} is derived from table 6.2A.2.0.2-2

ΔMPR as specified in Table 6.2.2.3.1-3 applies.

$$A = N_{RB_alloc} / N_{RB_agg_C}$$

N_{RB_alloc} is the total number of allocated UL RBs

$N_{RB_agg_C}$ is the number of the aggregated RBs within the fully allocated cumulative aggregated channel bandwidth assuming lowest SCS among all configured CCs

Table 6.2A.2.0.2-2: MPR_{NC_CA} for UE power class 1

Waveform Type		Cumulative aggregated channel bandwidth (CABW)			
		< 400 MHz	≥ 400 MHz and < 800 MHz	≥ 800 MHz and ≤ 1400 MHz	> 1400 MHz and ≤ 2400 MHz
DFT-s-OFDM	Pi/2 BPSK	≤ 6	≤ 7.7	≤ 8.2	≤ 8.7
	QPSK	≤ 7	≤ 8.7	≤ 9.2	≤ 9.7
	16 QAM	≤ 7	≤ 8.7	≤ 9.2	≤ 9.7
	64 QAM	≤ 9.0	≤ 10.7	≤ 11.2	≤ 11.7
	256 QAM ¹	≤ 12.5	≤ 14.2	≤ 14.7	≤ 15.7
CP-OFDM	QPSK	≤ 7	≤ 8.7	≤ 9.2	≤ 9.7
	16 QAM	≤ 7	≤ 8.7	≤ 9.2	≤ 9.7
	64 QAM	≤ 9.0	≤ 10.7	≤ 11.2	≤ 11.7
	256 QAM ¹	≤ 12.5	≤ 14.2	≤ 14.7	≤ 15.7

NOTE 1: Refer to clause 6.1 for 256 QAM applicability.

When different waveform types exist across CCs, the requirement is set by the waveform type used in the configuration with the largest MPR_{NC_CA} . For inter-band carrier aggregation with uplink assigned to two NR bands, the MPR for each configured UL band in the UL CA band combination is:

$$MPR_{inter-band_CA} = \max(MPR_{SingleBand}, MPR_{PA-PA})$$

Where:

$MPR_{SingleBand}$ is the MPR specified in clause 6.2.2.1 for the allocation and modulation type in that band

MPR_{PA-PA} is MAX(MPR_1 , MPR_2), where MPR_1 and MPR_2 are specified per band combination in Table 6.2A.2.2.3-1 and applies only when both bands have non-zero power UL RB allocations, 0 dB otherwise.

Table 6.2A.2.2.3-1: MPR_{PA-PA} for Inter-band ULCA in FR2 for PC1

NR CA Band	MPR	Value (dB)	Condition
CA_n260A-n261A	MPR1	Max(0, 10 - 10*log ₁₀ (Max(1.0, L _{RB,min} *12*SCS/1e6)))	L _{RB,min} = Min (L _{RB,n260} , L _{RB,n261}), where L _{RB,n} is the number of non-zero power UL RBs in band 'n'
	MPR2	6.0 if condition satisfied, 0.0 otherwise	47.2 GHz ≤ 2*f _{n260} - f _{n261} ≤ 48.2 GHz Where f _n is any frequency inside the UL allocation in band 'n'

6.2A.2.0.3 Maximum output power reduction for power class 2

For power class 2, MPR (except 256 QAM) specified in sub-clause 6.2A.2.0.4 applies for intra-band contiguous UL CA and intra-band non-contiguous UL CA.

Table 6.2A.2.0.3-1: Void

For 256 QAM, for intra-band contiguous UL CA with contiguous allocations within the cumulative aggregated bandwidth, the following rule for MPR applies:

$$\text{MPR} = \text{MPR}_{\text{C_CA}} + \Delta\text{MPR}$$

$\text{MPR}_{\text{C_CA}}$ is defined in Table 6.2A.2.0.3-2. ΔMPR as specified in Table 6.2.2.3.1-3 applies.

Table 6.2A.2.0.3-2: Maximum power reduction ($\text{MPR}_{\text{C_CA}}$) for UE power class 2

		Cumulative aggregated channel bandwidth (CABW)			
		≤ 400 MHz	> 400 MHz and < 800 MHz	≥ 800 MHz and ≤ 1400 MHz	> 1400 MHz and ≤ 2400 MHz
DFT-s-OFDM	256 QAM ¹	≤ 12.5	≤ 14.2	≤ 14.7	≤ 15.7
CP-OFDM	256 QAM ¹	≤ 12.5	≤ 14.2	≤ 14.7	≤ 15.7

NOTE 1: Refer to clause 6.1 for 256QAM applicability.

For 256 QAM, for intra-band contiguous UL CA with non-contiguous RB allocations, the following rule for MPR applies:

$$\text{MPR} = \max(\text{MPR}_{\text{C_CA}} + \Delta\text{MPR}, -10 \cdot A + 7.0)$$

Where:

$$A = N_{\text{RB_alloc}} / N_{\text{RB_agg_C}}$$

$N_{\text{RB_alloc}}$ is the total number of allocated UL RBs

$N_{\text{RB_agg_C}}$ is the number of the aggregated RBs within the fully allocated cumulative aggregated channel bandwidth assuming lowest SCS among all configured CCs

For 256 QAM, for intra-band non-contiguous UL CA, the following rule for MPR applies:

$$\text{MPR} = \max(\text{MPR}_{\text{NC_CA}} + \Delta\text{MPR}, -8 \cdot A + 10.0)$$

Where:

$\text{MPR}_{\text{NC_CA}}$ is derived from table 6.2A.2.0.3-3.

$$A = N_{\text{RB_alloc}} / N_{\text{RB_agg_C}}$$

$N_{\text{RB_alloc}}$ is the total number of allocated UL RBs

$N_{\text{RB_agg_C}}$ is the number of the aggregated RBs within the fully allocated cumulative aggregated channel bandwidth assuming lowest SCS among all configured CCs.

Table 6.2A.2.0.3-3: $\text{MPR}_{\text{NC_CA}}$ for UE power class 2

		Cumulative aggregated channel bandwidth (CABW)			
		≤ 400 MHz	> 400 MHz and < 800 MHz	≥ 800 MHz and ≤ 1400 MHz	> 1400 MHz and ≤ 2400 MHz
DFT-s-OFDM	256 QAM ¹	≤ 12.5	≤ 14.2	≤ 14.7	≤ 15.7
CP-OFDM	256 QAM ¹	≤ 12.5	≤ 14.2	≤ 14.7	≤ 15.7

NOTE 1: Refer to clause 6.1 for 256 QAM applicability.

For inter-band carrier aggregation with uplink assigned to two NR bands, the MPR for each configured UL band in the UL CA band combination is:

$$MPR_{\text{inter-band_CA}} = \max(MPR_{\text{SingleBand}}, MPR_{\text{PA-PA}})$$

Where:

$MPR_{\text{SingleBand}}$ is the MPR specified in clause 6.2.2.3.2 for the allocation and modulation type in that band

$MPR_{\text{PA-PA}}$ is specified in Table 6.2A.2.0.3-4 and applies only when both bands have non-zero UL RB allocations, 0 dB otherwise.

Table 6.2A.2.0.3-4: $MPR_{\text{PA-PA}}$ for Inter-band ULCA in FR2 for PC2

NR CA Band	Value (dB)	Condition
CA_n257A-n259A	$\text{Max}(0, 6 - 10 \cdot \log_{10}(\text{Max}(1.0, L_{\text{RB,min}} \cdot 12 \cdot \text{SCS}/1\text{e}6)))$	$L_{\text{RB,min}} = \text{Min}(L_{\text{RB,n257}}, L_{\text{RB,n259}})$, where $L_{\text{RB,n}}$ is the number of non-zero power UL RBs in band 'n'

6.2A.2.0.4 Maximum output power reduction for power class 3

For power class 3, MPR for intra-band contiguous UL CA with contiguous allocations within the cumulative aggregated bandwidth is denoted as $MPR_{\text{C_CA}}$ and is defined in Table 6.2A.2.0.4-1.

Table 6.2A.2.0.4-1: Maximum power reduction ($MPR_{\text{C_CA}}$) for UE power class 3

		Cumulative aggregated bandwidth configuration (CABW)			
		≤ 400 MHz	> 400 MHz and < 800 MHz	≥ 800 MHz and ≤ 1400 MHz	> 1400 MHz and ≤ 2400 MHz
DFT-s-OFDM	Pi/2 BPSK	≤ 5.0	≤ 7.7	≤ 8.2	≤ 8.7
	QPSK	≤ 5.0	≤ 7.7	≤ 8.2	≤ 9.7
	16 QAM	≤ 6.5	≤ 8.7	≤ 9.3	≤ 9.7
	64 QAM	≤ 9.0	≤ 10.7	≤ 11.2	≤ 11.7
CP-OFDM	QPSK	≤ 5.0	≤ 7.5	≤ 8.0	≤ 9.7
	16 QAM	≤ 6.5	≤ 8.7	≤ 9.2	≤ 9.7
	64 QAM	≤ 9.0	≤ 10.7	≤ 11.2	≤ 11.7
NOTE 1: void.					

In case of a contiguous RB, DFT-s-BPSK or DFT-s-QPSK UL allocation in a single CC of a CA configuration with contiguous CCs, and whose cumulative aggregated BW ≤ 400 MHz, $MPR_{\text{C_CA}}$ shall be derived instead as $\text{MAX}(MPR_1, MPR_2)$, where:

MPR_1 shall be determined from Table 6.2.2.3.3-1 if CABW ≤ 200 MHz, from Table 6.2.2.3.3-2 if CABW > 200 MHz.

MPR_2 shall be determined from Table 6.2.2.3.3-1 if UL $BW_{\text{channel_CA}} \leq 200$ MHz, from Table 6.2.2.3.3-2 if UL $BW_{\text{channel_CA}} > 200$ MHz.

and assume all UL CCs use the same SCS for the purpose of determination of inner and outer RB allocations in Table 6.2.2.3.3-1 and Table 6.2.2.3.3-2:

N_{RB} shall be chosen as the sum of N_{RB} of all constituent UL CCs in the CA configuration.

L_{CRB} shall be chosen as $BW_{\text{alloc, RB}}$

RB_{start} shall be derived as: $RB_{\text{start_allocatedCC}} + N_{\text{RB_unallocatedCC_low}}$

$RB_{\text{start_allocatedCC}}$ is the index of the first allocated RB in the CC with allocation

$N_{\text{RB_unallocatedCC_low}}$ is the sum of N_{RB} in all UL CCs lower in frequency compared to the CC with allocation

When different waveform types exist across CCs, the requirement is set by the waveform type used in the configuration with the highest contiguous MPR.

For intra-band contiguous UL CA with non-contiguous RB allocations, the following rule for MPR applies:

$$MPR = \max(MPR_{\text{C_CA}}, -10 \cdot A + 7.0)$$

Where:

$$A = N_{RB_alloc} / N_{RB_agg_C}$$

N_{RB_alloc} is the total number of allocated UL RBs

$N_{RB_agg_C}$ is the number of the aggregated RBs within the fully allocated cumulative aggregated channel bandwidth assuming lowest SCS among all configured CCs

For intra-band non-contiguous UL CA, the following rule for MPR applies:

$$MPR = \max(MPR_{NC_CA}, -8 * A + 10.0)$$

Where:

MPR_{NC_CA} is derived from table 6.2A.2. 0.4-2

$$A = N_{RB_alloc} / N_{RB_agg_C}$$

N_{RB_alloc} is the total number of allocated UL RBs

$N_{RB_agg_C}$ is the number of the aggregated RBs within the fully allocated cumulative aggregated channel bandwidth assuming lowest SCS among all configured CCs

Table 6.2A.2.0.4-2: MPR_{NC_CA} for UE power class 3

		Cumulative aggregated channel bandwidth (CABW)			
		≤ 400 MHz	> 400 MHz and < 800 MHz	≥ 800 MHz and ≤ 1400 MHz	> 1400 MHz and ≤ 2400 MHz
DFT-s-OFDM	Pi/2 BPSK	≤ 5.5	≤ 7.7	≤ 8.2	≤ 8.7
	QPSK	≤ 6	≤ 7.7	≤ 8.2	≤ 8.7
	16 QAM	≤ 7	≤ 8.7	≤ 9.3	≤ 9.8
	64 QAM	≤ 9.0	≤ 10.7	≤ 11.2	≤ 11.7
CP-OFDM	QPSK	≤ 6	≤ 7.5	≤ 8.0	≤ 8.5
	16 QAM	≤ 7	≤ 8.7	≤ 9.2	≤ 9.7
	64 QAM	≤ 9.0	≤ 10.7	≤ 11.2	≤ 11.7

When different waveform types exist across CCs, the requirement is set by the waveform type used in the configuration with the largest MPR_{NC_CA} .

For inter-band carrier aggregation with uplink assigned to two NR bands, the MPR for each configured UL band in the UL CA band combination is:

$$MPR_{inter_band_CA} = \max(MPR_{SingleBand}, MPR_{PA-PA})$$

Where:

$MPR_{SingleBand}$ is the MPR specified in clause 6.2.2.3 for the allocation and modulation type in that band.

MPR_{PA-PA} is $\max(MPR1, MPR2)$, where $MPR1$ and $MPR2$ are specified per band combination in Table 6.2A.2.4.3-1 and applies only when both bands have non-zero power UL RB allocations, 0 dB otherwise.

Table 6.2A.2.0.4-3: MPR_{PA-PA} for Inter-band ULCA in FR2 for PC3

NR CA Band	MPR	Value (dB)	Condition
	MPR2	0.0	-
CA_n260A-n261A	MPR1	$\max(0, 6 - 10 * \log_{10}(\max(1.0, L_{RB,min} * 12 * SCS / 1e6)))$	$L_{RB,min} = \min(L_{RB,n260}, L_{RB,n261})$, where $L_{RB,n}$ is the number of non-zero power UL RBs in band 'n'
	MPR2	2.0 if condition satisfied, 0.0 otherwise	47.2 GHz ≤ $2 * f_{n260} - f_{n261}$ ≤ 48.2 GHz Where f_n is any frequency inside the UL allocation in band 'n'

6.2A.2.0.5 Maximum output power reduction for power class 4

For power class 4, MPR specified in sub-clause 6.2A.2.0.4 applies.

The normative reference for this requirement is TS 38.101-2 [3] clause 6.2A.2.

6.2A.2.0.6 Maximum output power reduction for power class 5

For power class 5, MPR (except 256 QAM) specified in sub-clause 6.2A.2.0.4 applies for intra-band contiguous UL CA and intra-band non-contiguous UL CA.

For 256 QAM, MPR specified in sub-clause 6.2A.2.0.3 applies for intra-band contiguous UL CA and intra-band non-contiguous UL CA.

For inter-band carrier aggregation with uplink assigned to two NR bands, MPR for each configured UL band in the UL CA band combination is:

$$MPR_{\text{inter-band_CA}} = \max(MPR_{\text{SingleBand}}, MPR_{\text{PA-PA}})$$

Where:

$MPR_{\text{SingleBand}}$ is the MPR specified in clause 6.2.2.3.5 for the allocation and modulation type in that band

$MPR_{\text{PA-PA}}$ is the maximum of the MPR values specified per band combination in Table 6.2A.2.0.6-1 and applies only when both bands have non-zero UL RB allocations, 0 dB otherwise.

Table 6.2A.2.0.6-1: $MPR_{\text{PA-PA}}$ for Inter-band CA in FR2 for PC5

NR CA Band	Value (dB)	Condition
CA_n257A-n259A	$\text{Max}(0, 6 - 10 \cdot \log_{10}(\text{Max}(1.0, L_{\text{RB,min}} \cdot 12 \cdot \text{SCS}/1\text{e6})))$	$L_{\text{RB,min}} = \text{Min}(L_{\text{RB,n257}}, L_{\text{RB,n259}})$, where $L_{\text{RB,n}}$ is the number of non-zero power UL RBs in band 'n'

The normative reference for this requirement is TS 38.101-2 [3] clause 6.2A.2.

6.2A.2.0.7 Maximum output power reduction for power class 6

For power class 6, MPR specified in sub-clause 6.2A.2.0.4 applies for intra-band contiguous UL CA and intra-band non-contiguous UL CA.

6.2A.2.1 UE maximum output power reduction for CA (2UL CA)

Editor's note: The following aspects are either missing or not yet determined:

- The UPLF test mode is applicable to UEs Release 16 and forward.
- This test case is incomplete for Power classes other than 1, 3, 5, 6 and CA other than intra-band contiguous.
- For a transition period until RAN#99, the stability and repeatability of test procedure with PHR (variant b) for Rel-15 UEs is under evaluation.
- Whether additional check is needed in the test procedure to ensure UE continues transmissions on the SCell is FFS
- Measurement Uncertainties and Test Tolerances are FFS for power class other than 1, 3, 5, 6 and CA other than intra-band contiguous.
- Measurement Uncertainties and Test Tolerances for intra-band contiguous CA supporting aggregated BW > 400MHz and intra-band non-contiguous CA are TBD.
- The test points for higher bandwidth classes with testability problem need an update to decrease the UL bandwidth until they become testable.

6.2A.2.1.1 Test purpose

The number of RB identified in 6.2.2.3 is based on meeting the requirements for the maximum power reduction (MPR) due to Cubic Metric (CM).

6.2A.2.1.2 Test applicability

The requirements of this test apply to all types of NR UE release 15 and forward supporting 2UL CA.

6.2A.2.1.3 Minimum conformance requirements

The normative reference for this requirement is TS 38.101-2 [3] clause 6.2A.2.

6.2A.2.1.4 Test description

6.2A.2.1.4.1 Initial conditions

Initial conditions are a set of test configurations the UE needs to be tested in and the steps for the SS to take with the UE to reach the correct measurement state.

The initial test configurations consist of environmental conditions, test frequencies, and CC combinations based on NR operating bands specified in clause 5.5A. All of these configurations shall be tested with applicable test parameters for each CA configuration and subcarrier spacing, are shown in Table 6.2A.2.1.4.1-1. The details of the uplink reference measurement channels (RMCs) are specified in Annexes A.2. Configurations of PDSCH and PDCCH before measurement are specified in Annex C.2.

Table 6.2A.2.1.4.1-1: Intra-band Contiguous UL CA Test Configuration Table (Power Class 1, MPR_{narrow})

Default Conditions						
Test Environment as specified in TS 38.508-1 [10] clause 4.1				Normal		
Test Frequencies as specified in TS 38.508-1 [10] clause 4.3.1.2.3 for different CA bandwidth classes				Refer to "Test frequency" column		
Test CC Combination setting (aggregated BW of the CA configuration) as specified in TS 38.508-1 [10] clause 4.3.1.2.3 for the CA Configuration across bandwidth combination sets supported by the UE				Highest aggregated channel bandwidth of the CA configuration		
Test SCS as specified in Table 5.3.5-1				120 kHz		
Test Parameters						
Test ID	CC & Mapping (NOTE 2)	ChBw(MHz)	Test frequency	DL RB allocation	UL Modulation	UL RB allocation (NOTE 1)
Default Test Settings for a CA_nXB, CA_nXD, CA_nXG, CA_nXO Configuration						
1	PCC/CC1	Default	Low	-	CP-OFDM 64QAM	Outer_1RB_Left
	SCC/CC2		Low		-	-
2	PCC/CC1		High		CP-OFDM 64QAM	Outer_1RB_Right
	SCC/CC2		High		-	-
3	PCC/CC1		Low		CP-OFDM 64QAM	7@0
	SCC/CC2		Low		-	-
4	PCC/CC1	High	CP-OFDM 64QAM	7@N _{RB} -7		
	SCC/CC2	High	-	-		
NOTE 1: The specific configuration of each RB allocation is defined in Table 6.1-2.						
NOTE 2: PCC/CC _i and SCC/CC _j means PCC is on component carrier CC _i and SCC is on component carrier CC _j , with CC _i or CC _j frequencies defined in TS38.508-1 [10].						

Table 6.2A.2.1.4.1-2: Intra-band Contiguous UL CA Test Configuration Table (Power Class 1, single CC MPR requirement)

Default Conditions						
Test Environment as specified in TS 38.508-1 [10] clause 4.1			Normal			
Test Frequencies as specified in TS 38.508-1 [10] clause 4.3.1.2.3 for different CA bandwidth classes			Low range, High range			
Test CC Combination setting (aggregated BW of the CA configuration) as specified in TS 38.508-1 [10] clause 4.3.1.2.3 for the CA Configuration across bandwidth combination sets supported by the UE			Highest aggregated channel bandwidth of the CA configuration			
Test SCS as specified in Table 5.3.5-1			120 kHz			
Test Parameters						
Test ID	CC & Mapping (NOTE 2)	ChBw(MHz)	Test frequency	DL RB allocation	UL Modulation	UL RB allocation
Default Test Settings for a CA_nXG, CA_nXO Configuration (Cumulative aggregated BWchannel <= 200MHz)						
1	PCC/CC1	Default	Default	-	DFT-s-OFDM Pi/2 BPSK	Outer_Full
	SCC/CC2				-	-
2	PCC/CC1	Default	Default	-	DFT-s-OFDM QPSK	Inner_Full_Region1
	SCC/CC2				-	-
Default Test Settings for a CA_nXD Configuration (Cumulative aggregated BWchannel <= 400MHz)						
1	PCC/CC1	Default	Default	-	DFT-s-OFDM Pi/2 BPSK	Outer_Full
	SCC/CC2				-	-
2	PCC/CC1	Default	Default	-	DFT-s-OFDM Pi/2 BPSK	Inner_Full_Region1
	SCC/CC2				-	-
3	PCC/CC1	Default	Default	-	DFT-s-OFDM QPSK	Inner_Full_Region1
	SCC/CC2				-	-
NOTE 1: The specific configuration of each RB allocation is defined in Table 6.1-2.						
NOTE 2: PCC/CCi and SCC/CCj means PCC is on component carrier CCi and SCC is on component carrier CCj, with CCi or CCj frequencies defined in TS38.508-1 [10].						
NOTE 3: DFT-s-OFDM Pi/2 BPSK test applies only for UEs which supports half Pi BPSK in FR1.						

Table 6.2A.2.1.4.1-3: Intra-band Contiguous UL CA Test Configuration Table (Power Class 1, MPR_C_CA)

Default Conditions						
Test Environment as specified in TS 38.508-1 [10] clause 4.1			Normal			
Test Frequencies as specified in TS 38.508-1 [10] clause 4.3.1.2.3 and 4.3.1.2.4 for different CA bandwidth classes			For intra-band contiguous CA: Mid range. For intra-band non-contiguous CA: FFS.			
Test CC Combination setting (aggregated BW of the CA configuration) as specified in TS 38.508-1 [10] clause 4.3.1.2.3 and 4.3.1.2.4 for the CA Configuration across bandwidth combination sets supported by the UE			Highest aggregated channel bandwidth of the CA configuration			
Test SCS as specified in Table 5.3.5-1			120 kHz			
Test Parameters						
Test ID	CC& Mapping (NOTE 2)	ChBw(MHz)	Test frequency	DL RB allocation	UL Modulation	UL RB allocation
Default Test Settings for a CA_nXB, CA_nXC_UL_nXB Configuration (800MHz <= Cumulative aggregated BWchannel <= 1400MHz)						
1	PCC/CC1	Default	Default	-	DFT-s-OFDM Pi/2 BPSK	Outer_Full
	SCC/CC2				DFT-s-OFDM Pi/2 BPSK	Outer_Full
2	PCC/CC1	Default	Default	-	DFT-s-OFDM QPSK	Outer_Full
	SCC/CC2				DFT-s-OFDM QPSK	Outer_Full

3	PCC/CC1				DFT-s-OFDM 16QAM	Outer_Full
	SCC/CC2				DFT-s-OFDM 16QAM	Outer_Full
4	PCC/CC1				CP-OFDM 16QAM	Outer_Full
	SCC/CC2				CP-OFDM 16QAM	Outer_Full
5	PCC/CC1				CP-OFDM 64QAM	Outer_Full
	SCC/CC2				CP-OFDM 64QAM	Outer_Full
Default Test Settings for a CA_nXD Configuration (400MHz <= Cumulative aggregated BWchannel < 800MHz)						
1	PCC/CC1	Default	Default	-	DFT-s-OFDM Pi/2 BPSK	Outer_Full
	SCC/CC2				DFT-s-OFDM Pi/2 BPSK	Outer_Full
2	PCC/CC1				CP-OFDM 16QAM	Outer_Full
	SCC/CC2				CP-OFDM 16QAM	Outer_Full
3	PCC/CC1				CP-OFDM 64QAM	Outer_Full
	SCC/CC2				CP-OFDM 64QAM	Outer_Full
Default Test Settings for a CA_nXB Configuration (400MHz <= Cumulative aggregated BWchannel < 800MHz)						
1	PCC/CC1	200MHz	Default	-	DFT-s-OFDM Pi/2 BPSK	Outer_Full
	SCC/CC2	400MHz			DFT-s-OFDM Pi/2 BPSK	Outer_Full
2	PCC/CC1	200MHz			CP-OFDM 16QAM	Outer_Full
	SCC/CC2	400MHz			CP-OFDM 16QAM	Outer_Full
3	PCC/CC1	200MHz			CP-OFDM 64QAM	Outer_Full
	SCC/CC2	400MHz			CP-OFDM 64QAM	Outer_Full
Default Test Settings for a CA_nXG, CA_nXO Configuration (Cumulative aggregated BWchannel < 400MHz)						
1	PCC/CC1	Default	Default	-	DFT-s-OFDM Pi/2 BPSK	Outer_Full
	SCC/CC2				DFT-s-OFDM Pi/2 BPSK	Outer_Full
2	PCC/CC1				CP-OFDM 16QAM	Outer_Full
	SCC/CC2				CP-OFDM 16QAM	Outer_Full
3	PCC/CC1				CP-OFDM 64QAM	Outer_Full
	SCC/CC2				CP-OFDM 64QAM	Outer_Full
Default Test Settings for a CA_nXD Configuration (Cumulative aggregated BWchannel < 400MHz)						
1	PCC/CC1	100MHz	Default	-	DFT-s-OFDM Pi/2 BPSK	Outer_Full
	SCC/CC2	200MHz			DFT-s-OFDM Pi/2 BPSK	Outer_Full
2	PCC/CC1	100MHz			CP-OFDM 16QAM	Outer_Full
	SCC/CC2	200MHz			CP-OFDM 16QAM	Outer_Full
3	PCC/CC1	100MHz			CP-OFDM 64QAM	Outer_Full
	SCC/CC2	200MHz			CP-OFDM 64QAM	Outer_Full
NOTE 1: The specific configuration of each RB allocation is defined in Table 6.1-2.						
NOTE 2: PCC/CCi and SCC/CCj means PCC is on component carrier CCi and SCC is on component carrier CCj, with CCi or CCj frequencies defined in TS38.508-1 [10].						

Table 6.2A.2.1.4.1-4: Intra-band Contiguous UL CA Test Configuration Table (Power Class 1, Non-contiguous allocation)

Default Conditions						
Test Environment as specified in TS 38.508-1 [10] clause 4.1				Normal		
Test Frequencies as specified in TS 38.508-1 [10] clause 4.3.1.2.3 and 4.3.1.2.4 for different CA bandwidth classes				For intra-band contiguous CA: Mid range. For intra-band non-contiguous CA: FFS.		
Test CC Combination setting (aggregated BW of the CA configuration) as specified in TS 38.508-1 [10] clause 4.3.1.2.3 and 4.3.1.2.4 for the CA Configuration across bandwidth combination sets supported by the UE				Highest aggregated channel bandwidth of the CA configuration		
Test SCS as specified in Table 5.3.5-1				120 kHz		
Test Parameters						
Test ID	CC & Mapping (NOTE 2)	ChBw(MHz)	Test frequency	DL RB allocation	UL Modulation	UL RB allocation
Default Test Settings for a CA_nXB, CA_nXD, CA_XG, CA_nXO Configuration						
1	PCC/CC1	Default	Default	-	CP-OFDM 64QAM	Outer_1RB_Left
	SCC/CC2				CP-OFDM 64QAM	Outer_1RB_Right
2	PCC/CC1	Default	Default	-	DFT-s-OFDM Pi/2 BPSK	[Outer_0.9_Left]
	SCC/CC2				DFT-s-OFDM Pi/2 BPSK	[Outer_0.9_Right]
3	PCC/CC1	Default	Default	-	DFT-s-OFDM Pi/2 QPSK	[Outer_0.9_Left]
	SCC/CC2				DFT-s-OFDM Pi/2 QPSK	[Outer_0.9_Right]
NOTE 1: The specific configuration of each RB allocation is defined in Table 6.1-2.						
NOTE 2: PCC/CCi and SCC/CCj means PCC is on component carrier CCi and SCC is on component carrier CCj, with CCi or CCj frequencies defined in TS38.508-1 [10].						
NOTE 3: Applicable to Rel-16 and forward UEs.						
NOTE 4: Applicable to Rel-15 UEs.						

Table 6.2A.2.1.4.1-5: Intra-band Contiguous UL CA Test Configuration Table (Power Class 2, 3, 4 and 5, 6, single CC MPR requirement)

Default Conditions						
Test Environment as specified in TS 38.508-1 [10] clause 4.1				Normal		
Test Frequencies as specified in TS 38.508-1 [10] clause 4.3.1.2.3 for different CA bandwidth classes				Low range, High range		
Test CC Combination setting (aggregated BW of the CA configuration) as specified in for the CA Configuration across bandwidth combination sets supported by the UE				Highest aggregated channel bandwidth of the CA configuration		
Test SCS as specified in Table 5.3.5-1				120 kHz		
Test Parameters						
Test ID	CC & Mapping (NOTE 2)	ChBw(MHz)	Test frequency	DL RB allocation	UL Modulation	UL RB allocation
Default Test Settings for a CA_nXG, CA_nXO Configuration (Cumulative aggregated BWchannel <= 200MHz)						
1	PCC/CC1	Default	Default	-	DFT-s-OFDM QPSK	Inner_Full
	SCC/CC2				-	-
2	PCC/CC1	Default	Default	-	DFT-s-OFDM QPSK	Outer_Full
	SCC/CC2				-	-
Default Test Settings for a CA_nXD Configuration (Cumulative aggregated BWchannel <= 400MHz)						
1	PCC/CC1	Default	Default	-	DFT-s-OFDM QPSK	Inner_Full
	SCC/CC2				-	-
2	PCC/CC1	Default	Default	-	DFT-s-OFDM QPSK	Outer_Full
	SCC/CC2				-	-

NOTE 1: The specific configuration of each RB allocation is defined in Table 6.1-1.
 NOTE 2: PCC/CCi and SCC/CCj means PCC is on component carrier CCi and SCC is on component carrier CCj, with CCi or CCj frequencies defined in TS38.508-1 [10].

Table 6.2A.2.1.4.1-6: Intra-band Contiguous UL CA Test Configuration Table (Power Class 2, 3, 4 and 5, 6, MPR_{C,CA})

Default Conditions						
Test Environment as specified in TS 38.508-1 [10] clause 4.1				Normal		
Test Frequencies as specified in TS 38.508-1 [10] clause 4.3.1.2.3 and 4.3.1.2.4 for different CA bandwidth classes				For intra-band contiguous CA: Mid range. For intra-band non-contiguous CA: FFS		
Test CC Combination setting (aggregated BW of the CA configuration) as specified in TS 38.508-1 [10] clause 4.3.1.2.3 and 4.3.1.2.4 for the CA Configuration across bandwidth combination sets supported by the UE				Highest aggregated channel bandwidth of the CA configuration		
Test SCS as specified in Table 5.3.5-1				120 kHz		
Test Parameters						
Test ID	CC & Mapping (NOTE 2)	ChBw(MHz)	Test frequency	DL RB allocation	UL Modulation	UL RB allocation
Default Test Settings for a CA_nXB, nXC_UL_nXB Configuration (800MHz <= Cumulative aggregated BWchannel <= 1400MHz)						
1	PCC/CC1	Default	Default	-	DFT-s-OFDM QPSK	Outer_Full
	SCC/CC2				DFT-s-OFDM QPSK	Outer_Full
2	PCC/CC1	Default	Default	-	DFT-s-OFDM 16QAM	Outer_Full
	SCC/CC2				DFT-s-OFDM 16QAM	Outer_Full
3	PCC/CC1	Default	Default	-	CP-OFDM QPSK	Outer_Full
	SCC/CC2				CP-OFDM QPSK	Outer_Full
4	PCC/CC1	Default	Default	-	CP-OFDM 16QAM	Outer_Full
	SCC/CC2				CP-OFDM 16QAM	Outer_Full
5	PCC/CC1	Default	Default	-	CP-OFDM 64QAM	Outer_Full
	SCC/CC2				CP-OFDM 64QAM	Outer_Full
Default Test Settings for a CA_nXD, CA_nXE_UL_nXD, CA_nXF_UL_nXD Configuration (400MHz <= Cumulative aggregated BWchannel < 800MHz)						
1	PCC/CC1	Default	Default	-	DFT-s-OFDM QPSK	Outer_Full
	SCC/CC2				DFT-s-OFDM QPSK	Outer_Full
2	PCC/CC1	Default	Default	-	CP-OFDM QPSK	Outer_Full
	SCC/CC2				CP-OFDM QPSK	Outer_Full
3	PCC/CC1	Default	Default	-	CP-OFDM 16QAM	Outer_Full
	SCC/CC2				CP-OFDM 16QAM	Outer_Full
4	PCC/CC1	Default	Default	-	CP-OFDM 64QAM	Outer_Full
	SCC/CC2				CP-OFDM 64QAM	Outer_Full
Default Test Settings for a CA_nXB Configuration (400MHz <= Cumulative aggregated BWchannel < 800MHz)						
1	PCC/CC1	200MHz	Default	-	DFT-s-OFDM QPSK	Outer_Full
	SCC/CC2	400MHz			DFT-s-OFDM QPSK	Outer_Full

2	PCC/CC1	200MHz			CP-OFDM QPSK	Outer_Full
	SCC/CC2	400MHz			CP-OFDM QPSK	Outer_Full
3	PCC/CC1	200MHz			CP-OFDM 16QAM	Outer_Full
	SCC/CC2	400MHz			CP-OFDM 16QAM	Outer_Full
4	PCC/CC1	200MHz			CP-OFDM 64QAM	Outer_Full
	SCC/CC2	400MHz			CP-OFDM 64QAM	Outer_Full
Default Test Settings for a CA_nXG, CA_nXO Configuration (Cumulative aggregated BWchannel < 400MHz)						
1	PCC/CC1	Default	Default	-	CP-OFDM QPSK	Outer_Full
	SCC/CC2				CP-OFDM QPSK	Outer_Full
2	PCC/CC1				CP-OFDM 16QAM	Outer_Full
	SCC/CC2				CP-OFDM 16QAM	Outer_Full
3	PCC/CC1				CP-OFDM 64QAM	Outer_Full
	SCC/CC2				CP-OFDM 64QAM	Outer_Full
Default Test Settings for a CA_nXD Configuration (Cumulative aggregated BWchannel < 400MHz)						
1	PCC/CC1	100MHz	Default	-	CP-OFDM QPSK	Outer_Full
	SCC/CC2	200MHz			CP-OFDM QPSK	Outer_Full
2	PCC/CC1	100MHz			CP-OFDM 16QAM	Outer_Full
	SCC/CC2	200MHz			CP-OFDM 16QAM	Outer_Full
3	PCC/CC1	100MHz			CP-OFDM 64QAM	Outer_Full
	SCC/CC2	200MHz			CP-OFDM 64QAM	Outer_Full
Default Test Settings for a CA_nX(D-A))_UL_nXD, CA_nX(A-G)_UL_nXG, CA_nX(A-O)_UL_nXO Configuration (800MHz <= Cumulative aggregated BWchannel <= 1400MHz)						
1	PCC/CC1	Default	Default	-	DFT-s-OFDM QPSK	Outer_Full
	SCC1/CC2				DFT-s-OFDM QPSK	Outer_Full
	Wgap				N/A	N/A
	SCC2/CC3				N/A	N/A
2	PCC/CC1				DFT-s-OFDM 16QAM	Outer_Full
	SCC1/CC2				DFT-s-OFDM 16QAM	Outer_Full
	Wgap				N/A	N/A
	SCC2/CC3				N/A	N/A
3	PCC/CC1				CP-OFDM QPSK	Outer_Full
	SCC1/CC2				CP-OFDM QPSK	Outer_Full
	Wgap				N/A	N/A
	SCC2/CC3				N/A	N/A
4	PCC/CC1				CP-OFDM 16QAM	Outer_Full
	SCC1/CC2				CP-OFDM 16QAM	Outer_Full
	Wgap				N/A	N/A
	SCC2/CC3				N/A	N/A

5	PCC/CC1				CP-OFDM 64QAM	Outer_Full
	SCC1/CC2				CP-OFDM 64QAM	Outer_Full
	Wgap				N/A	N/A
	SCC2/CC3				N/A	N/A
Default Test Settings for a CA_nX(D-A)_UL_nXD Configuration (400MHz <= Cumulative aggregated BWchannel <800MHz)						
1	PCC/CC1	200MHz	Default	-	DFT-s-OFDM QPSK	Outer_Full
	SCC1/CC2	200MHz			DFT-s-OFDM QPSK	Outer_Full
	Wgap	290MHz			N/A	N/A
	SCC2/CC3	100MHz			N/A	N/A
2	PCC/CC1	200MHz	Default	-	CP-OFDM QPSK	Outer_Full
	SCC1/CC2	200MHz			CP-OFDM QPSK	Outer_Full
	Wgap	290MHz			N/A	N/A
	SCC2/CC3	100MHz			N/A	N/A
3	PCC/CC1	200MHz	Default	-	CP-OFDM 16QAM	Outer_Full
	SCC1/CC2	200MHz			CP-OFDM 16QAM	Outer_Full
	Wgap	290MHz			N/A	N/A
	SCC2/CC3	100MHz			N/A	N/A
4	PCC/CC1	200MHz	Default	-	CP-OFDM 64QAM	Outer_Full
	SCC1/CC2	200MHz			CP-OFDM 64QAM	Outer_Full
	Wgap	290MHz			N/A	N/A
	SCC2/CC3	100MHz			N/A	N/A
Default Test Settings for a CA_nX(A-G)_UL_nXG, CA_nX(A-O)_UL_nXO Configuration (400MHz <= Cumulative aggregated BWchannel <800MHz)						
1	PCC/CC1	100MHz	Default	-	DFT-s-OFDM QPSK	Outer_Full
	SCC1/CC2	100MHz			DFT-s-OFDM QPSK	Outer_Full
	Wgap	390MHz			N/A	N/A
	SCC2/CC3	200MHz			N/A	N/A
2	PCC/CC1	100MHz	Default	-	CP-OFDM QPSK	Outer_Full
	SCC1/CC2	100MHz			CP-OFDM QPSK	Outer_Full
	Wgap	390MHz			N/A	N/A
	SCC2/CC3	200MHz			N/A	N/A
3	PCC/CC1	100MHz	Default	-	CP-OFDM 16QAM	Outer_Full
	SCC1/CC2	100MHz			CP-OFDM 16QAM	Outer_Full
	Wgap	390MHz			N/A	N/A
	SCC2/CC3	200MHz			N/A	N/A
4	PCC/CC1	100MHz	Default	-	c	Outer_Full
	SCC1/CC2	100MHz			CP-OFDM 64QAM	Outer_Full
	Wgap	390MHz			N/A	N/A
	SCC2/CC3	200MHz			N/A	N/A

Default Test Settings for a CA_nX(D-A)_UL_nXD Configuration (Cumulative aggregated BWchannel <400MHz)						
1	PCC/CC1	50MHz	Default	-	CP-OFDM QPSK	Outer_Full
	SCC1/CC2	200MHz			CP-OFDM QPSK	Outer_Full
	Wgap	90MHz			N/A	N/A
	SCC2/CC3	50MHz			N/A	N/A
2	PCC/CC1	50MHz			CP-OFDM 16QAM	Outer_Full
	SCC1/CC2	200MHz			CP-OFDM 16QAM	Outer_Full
	Wgap	90MHz			N/A	N/A
	SCC2/CC3	50MHz			N/A	N/A
3	PCC/CC1	50MHz			CP-OFDM 64QAM	Outer_Full
	SCC1/CC2	200MHz			CP-OFDM 64QAM	Outer_Full
	Wgap	90MHz			N/A	N/A
	SCC2/CC3	50MHz			N/A	N/A
Default Test Settings for a CA_nX(A-O)_UL_nXO Configuration (Cumulative aggregated BWchannel <400MHz)						
1					N/A	N/A
	SCC1/CC2	200MHz			N/A	N/A
	Wgap	90MHz			CP-OFDM QPSK	Outer_Full
	PCC/CC3	50MHz			CP-OFDM QPSK	Outer_Full
	SCC3/CC4	50MHz				
2	SCC1/CC2	200MHz			N/A	N/A
	Wgap	90MHz			N/A	N/A
	PCC/CC3	50MHz			CP-OFDM 16QAM	Outer_Full
	SCC3/CC4	50MHz			CP-OFDM 16QAM	Outer_Full
3	SCC1/CC2	200MHz			N/A	N/A
	Wgap	90MHz			N/A	N/A
	PCC/CC3	50MHz			CP-OFDM 64QAM	Outer_Full
	SCC3/CC4	50MHz			CP-OFDM 64QAM	Outer_Full
NOTE 1: The specific configuration of each RB allocation is defined in Table 6.1-1.						
NOTE 2: PCC/CCi and SCC/CCj means PCC is on component carrier CCi and SCC is on component carrier CCj, with CCi or CCj frequencies defined in TS38.508-1 [10].						

Table 6.2A.2.1.4.1-7: Intra-band Contiguous UL CA Test Configuration Table (Power Class 2, 3, 4 and 5, 6, Non-contiguous allocation)

Default Conditions	
Test Environment as specified in TS 38.508-1 [10] clause 4.1	Normal
Test Frequencies as specified in TS 38.508-1 [10] clause 4.3.1.2.3 for different CA bandwidth classes	Mid range
Test CC Combination setting (aggregated BW of the CA configuration) as specified in TS 38.508-1 [10] clause 4.3.1.2.3 for the CA Configuration across bandwidth combination sets supported by the UE	Highest aggregated channel bandwidth of the CA configuration
Test SCS as specified in Table 5.3.5-1	120 kHz
Test Parameters	

Test ID	CC & Mapping (NOTE 2)	ChBw(MHz)	Test frequency	DL RB allocation	UL Modulation	UL RB allocation
Default Test Settings for a CA_XG, CA_nXO Configuration (Cumulative aggregated BWchannel < 400MHz)						
1	PCC/CC1	Default	Default	-	DFT-s-OFDM QPSK	Outer_1RB_Left (Note 3) Outer_2RB_Left (Note 4)
	SCC/CC2				DFT-s-OFDM QPSK	Outer_1RB_Right (Note 3) Outer_2RB_Right (Note 4)
2	PCC/CC1				DFT-s-OFDM Pi/2 BPSK	[Outer_0.9_Left]
	SCC/CC2				DFT-s-OFDM Pi/2 BPSK	[Outer_0.9_Right]
3	PCC/CC1				DFT-s-OFDM Pi/2 QPSK	[Outer_0.9_Left]
	SCC/CC2				DFT-s-OFDM Pi/2 QPSK	[Outer_0.9_Right]
NOTE 1: The specific configuration of each RB allocation is defined in Table 6.1-1.						
NOTE 2: PCC/CCi and SCC/CCj means PCC is on component carrier CCi and SCC is on component carrier CCj, with CCi or CCj frequencies defined in TS38.508-1 [10].						
NOTE 3: Applicable to Rel-16 and forward UEs.						
NOTE 4: Applicable to Rel-15 UEs.						

1. Connection between SS and UE is shown in TS 38.508-1 [10] Annex A, Figure A.3.3.1.1 for TE diagram and Figure A.3.4.1.1 for UE diagram.
2. The parameter settings for the cell are set up according to TS 38.508-1 [10] clause 4.4.3.
3. Downlink signals are initially set up according to Annex C, and uplink signals according to Annex G.
4. The UL Reference Measurement channels are set according to Table 6.2A.2.1.4.1-1 to Table 6.2A.2.1.4.1-7.
5. Propagation conditions are set according to Annex B.0.
6. Ensure the UE is in state RRC_CONNECTED with generic procedure parameters Connectivity NR, Connected without release On, Test Mode On and Test Loop Function On according to TS 38.508-1 [10] clause 4.5. Message contents are defined in clause 6.2A.2.1.4.3.

6.2A.2.1.4.2 Test procedure

1. Configure SCC according to Annex C.0, C.1, C.2 and Annex C.3.0 for all downlink physical channels
2. The SS shall configure SCC as per TS 38.508-1 [10] clause 5.5.1 Procedure to configure SCC(s) for NR RF CA testing. Message contents are defined in clause 6.2A.2.1.4.3.
3. Apply the test step based on the 5G NR UE Release:
 - 3a. For Release 16 and forward 5G NR UEs supporting the UPLF test mode: SS applies a backoff on the PCell power by activating the UE Power Limit Function (UPLF). The ACTIVATE POWER LIMIT REQUEST procedure is performed as specified in TS 38.508-1 [10] clause 4.9.32 using TOTAL NR AGGREGATED BANDWIDTH and PCELL NR bandwidth as per Test CC Combination setting. UE shall transmit ACTIVATE POWER LIMIT RESPONSE to SS. Go to step 4.
 - 3b. For Release 15 5G NR UEs: No action.
 - 3c. For testing single CC MPR requirement: No action.
4. SS activates SCC by sending the activation MAC CE (Refer TS 38.321, clauses 5.9, 6.1.3.10). Wait for at least 2 seconds (Refer TS 38.133[25], clause 9.3).
5. SS sends uplink scheduling information for each UL HARQ process via PDCCH DCI format 0_1 for C_RNTI to schedule the UL RMC according to Table 6.2A.2.1.4.1-1 to Table 6.2A.2.1.4.1-7. Since the UL has no payload and no loopback data to send the UE sends uplink MAC padding bits on the UL RMC.

6. Set the UE in the Tx beam peak direction found with a 3D EIRP scan as performed in Annex K.1.1. Allow at least BEAM_SELECT_WAIT_TIME (NOTE 1) for the UE Tx beam selection to complete.
7. Apply the test step based on the 5G NR UE Release:
 - 7a. For Release 16 and forward 5G NR UEs: Send continuously uplink power control "up" commands in every uplink scheduling information to the UE; allow at least 200 msec starting from the first TPC command in this step to ensure that the UE transmits at its maximum output power. Allow at least BEAM_SELECT_WAIT_TIME (NOTE 1) for the UE Tx beam selection to complete.
 - 7b. For Release 15 5G NR UEs: Send uplink power control commands in uplink scheduling information to the UE per UL CC until the Power Headroom Report (PHR) from the UE for each UL CC is at the target value according to Table 6.2A.2.1.4.2-1; allow at least 200 ms for the UE to reach maximum output power. Allow at least BEAM_SELECT_WAIT_TIME (NOTE 1) for the UE Tx beam selection to complete.

Table 6.2A.2.1.4.2-1: Power target values per UL CC for test procedure using PHR

BW ratio (Note 1)	Xmax [dB] (Note 2)	Target PHR	Δ PHR [dB] (Note 3)	BW combination examples
1/2	3.0	POWER_HEADROOM_36 ($3 \leq \text{PH} < 4$)	1	2CC equal BW
1/3	4.8	POWER_HEADROOM_38 ($5 \leq \text{PH} < 6$)	1.2	2CC 50+100 MHz CC1
2/3	1.8	POWER_HEADROOM_35 ($2 \leq \text{PH} < 3$)	1.2	2CC 50+100 MHz CC2
1/5	7.0	POWER_HEADROOM_40 ($7 \leq \text{PH} < 8$)	1.0	2CC 50+200 MHz CC1
4/5	1.0	POWER_HEADROOM_34 ($1 \leq \text{PH} < 2$)	1.0	2CC 50+200 MHz CC2
1/9	9.5	POWER_HEADROOM_43 ($10 \leq \text{PH} < 11$)	1.5	2CC 50+400 MHz CC1
8/9	0.5	POWER_HEADROOM_34 ($1 \leq \text{PH} < 2$)	1.5	2CC 50+400 MHz CC2
Note 1: The BW ratio is the ratio of BW of the CC over the total Aggregated UL BW				
Note 2: Xmax = 10log(BW ratio)				
Note 3: Δ PHR is the worst case UE output power decrease due to Xmax and 1 dB reporting granularity of PHR according to TS38.133 [25].				

- 7c. For testing single CC MPR requirement: Send continuously uplink power control "up" commands in every uplink scheduling information to the UE; allow at least 200 msec starting from the first TPC command in this step to ensure that the UE transmits at its maximum output power. Allow at least BEAM_SELECT_WAIT_TIME (NOTE 1) for the UE Tx beam selection to complete.
8. SS activates the UE Beamlock Function (UBF) by performing the procedure as specified in TS 38.508-1 [10] clause 4.9.2 using condition Tx only.
9. Measure UE EIRP in the Tx beam peak direction in the accumulative aggregated channel bandwidth of the radio access mode according to the test configuration, which shall meet the requirements described in 6.2A.2.1.5. EIRP test procedure is defined in Annex K.1.3. The measuring duration is one active uplink subframe. EIRP is calculated considering both polarizations, theta and phi.
10. Apply the test step based on the 5G NR UE Release:
 - 10a. For Release 16 and forward 5G NR UEs supporting the UPLF test mode: SS deactivates the UE Power Limit Function (UPLF) by performing the DEACTIVATE POWER LIMIT REQUEST procedure as specified in TS 38.508-1 [10] clause 4.9.33.
 - 10b. For Release 15 5G NR UEs: No action.
 - 10c. For testing single CC MPR requirement: No action.
11. SS deactivates the UE Beamlock Function (UBF) by performing the procedure as specified in TS 38.508-1 [10] clause 4.9.3.

NOTE 1: The BEAM_SELECT_WAIT_TIME default value is defined in Annex K.

NOTE 2: When switching to DFT-s-OFDM waveform, as specified in Table 6.2A.2.1.4.1-1 to Table 6.2A.2.1.4.1-7, send an NR RRCReconfiguration message according to TS 38.508-1 [10] clause 4.6.3 Table 4.6.3-118 PUSCH-Config with TRANSFORM_PRECODER_ENABLED condition.

6.2A.2.1.4.3 Message contents

Message contents are according to TS 38.508-1 [10] clause 4.6 with the following exceptions for Release 15 5G NR UE.

Table 6.2A.2.1.4.3-1: PUSCH-PowerControl

Derivation Path: TS 38.508-1 [10], Table 4.6.3-120			
Information Element	Value/remark	Comment	Condition
PUSCH-PowerControl ::= SEQUENCE {			
p0-AlphaSets SEQUENCE (SIZE (1..maxNrofP0-PUSCH-AlphaSets)) OF SEQUENCE {	1 entry		
P0-PUSCH-AlphaSet[1] SEQUENCE {			
alpha	alpha0		
}			
}			
}			

Table 6.2A.2.1.4.3-2: PUSCH-ConfigCommon

Derivation Path: TS 38.508-1[10], Table 4.6.3-119			
Information Element	Value/remark	Comment	Condition
PUSCH-ConfigCommon ::= SEQUENCE {			
p0-NominalWithGrant	-4		50 MHz
p0-NominalWithGrant	-8		100 MHz
p0-NominalWithGrant	-10		200 MHz
p0-NominalWithGrant	-14		400 MHz
}			

Table 6.2A.2.1.4.3-3: BSR-Config (Rel-15 UE only)

Derivation Path: TS 38.508-1 [10], Table 4.6.3-7			
Information Element	Value/remark	Comment	Condition
BSR-Config ::= SEQUENCE {			
periodicBSR-Timer	infinity		
retxBSR-Timer	sf80		
logicalChannelSR-DelayTimer	Not present		
}			

6.2A.2.1.5 Test requirement

The EIRP derived in step 8 shall be within the range prescribed by the nominal maximum output power and tolerance in the applicable table from Table 6.2A.2.1.5-1 to Table 6.2A.2.1.5-17.

Table 6.2A.2.1.5-1: MPR requirements for Intra-band Contiguous UL CA (Power Class 1, MPR_{narrow})

Test ID	Band	Min peak EIRP (dBm)	MPR (dB)	T(MPR) (dB)	Lower limit (dBm)	Upper limit (dBm)
1	n257, n258, n261	40.0	14.4	[7.0]	[18.6]-TT	55
1	n260	38.0	14.4	[7.0]	[16.6]-TT	55
2	n257, n258, n261	40.0	14.4	[7.0]	[18.6]-TT	55
2	n260	38.0	14.4	[7.0]	[16.6]-TT	55
3	n257, n258, n261	40.0	10	[5]	[25.0]-TT	55
3	n260	38.0	10	[5]	[23.0]-TT	55
4	n257, n258, n261	40.0	10	[5]	[25.0]-TT	55
4	n260	38.0	10	[5]	[23.0]-TT	55

NOTE 1: TT for each band and accumulative aggregated bandwidth is specified in Table 6.2A.2.1.5-5.

Table 6.2A.2.1.5-2: MPR requirements for Intra-band Contiguous UL CA (Power Class 1, single CC MPR requirement)

Test ID	Band	Min peak EIRP (dBm)	MPR (dB)	T(MPR) (dB)	Lower limit (dBm)	Upper limit (dBm)
Test requirements for a CA_nXG, CA_nXO Configuration (Cumulative aggregated BWchannel <= 200MHz)						
1	n257, n258, n261	40.0	5.5	[5.0]	[29.5]-TT	55
1	n260	38.0	5.5	[5.0]	[27.5]-TT	55
2	n257, n258, n261	40.0	3.0	[2.0]	[35.0]-TT	55
2	n260	38.0	3.0	[2.0]	[33.0]-TT	55
Test requirements for a CA_nXD Configuration (Cumulative aggregated BWchannel <= 400MHz)						
1	n257, n258, n261	40.0	5.5	[5.0]	[29.5]-TT	55
1	n260	38.0	5.5	[5.0]	[27.5]-TT	55
2	n257, n258, n261	40.0	3.0	[2.0]	[35.0]-TT	55
2	n260	38.0	3.0	[2.0]	[33.0]-TT	55
3	n257, n258, n261	40.0	3.5	[3.0]	[33.5]-TT	55
3	n260	38.0	3.5	[3.0]	[31.5]-TT	55
NOTE 1: TT for each band and accumulative aggregated bandwidth is specified in Table 6.2A.2.1.5-5.						

Table 6.2A.2.1.5-3: MPR requirements for Intra-band Contiguous UL CA (Power Class 1, MPR_{C,CA})

Test ID	Band	Min peak EIRP (dBm)	MPR (dB)	T(MPR) (dB)	Lower limit (dBm)	Upper limit (dBm)
Test requirements for a CA_nXB, CA_nXC_UL_nXB Configuration (800MHz <= Cumulative aggregated BWchannel <= 1400MHz)						
1	n257, n258, n261	40.0	8.2	[5.0]	[26.8]-TT	55
1	n260	38.0	8.2	[5.0]	[24.8]-TT	55
2	n257, n258, n261	40.0	9.7	[5.0]	[25.3]-TT	55
2	n260	38.0	9.7	[5.0]	[23.3]-TT	55
3	n257, n258, n261	40.0	9.2	[5.0]	[25.8]-TT	55
3	n260	38.0	9.2	[5.0]	[23.8]-TT	55
4	n257, n258, n261	40.0	8.7	[5.0]	[26.3]-TT	55
4	n260	38.0	8.7	[5.0]	[24.3]-TT	55
5	n257, n258, n261	40.0	11.2	[7.0]	[21.8]-TT	55
5	n260	38.0	11.2	[7.0]	[19.8]-TT	55
Test requirements for a CA_nXD, CA_nXB Configuration (400MHz <= Cumulative aggregated BWchannel < 800MHz)						
1	n257, n258, n261	40.0	7.7	[5.0]	[27.3]-TT	55
1	n260	38.0	7.7	[5.0]	[25.3]-TT	55
2	n257, n258, n261	40.0	8.7	[5.0]	[26.3]-TT	55
2	n260	38.0	8.7	[5.0]	[24.3]-TT	55
3	n257, n258, n261	40.0	10.7	[7.0]	[22.3]-TT	55
3	n260	38.0	10.7	[7.0]	[20.3]-TT	55
Test requirements for a CA_nXG, CA_nXO, CA_nXD Configuration (Cumulative aggregated BWchannel < 400MHz)						

1	n257, n258, n261	40.0	5.5	[5.0]	[29.5]-TT	55
1	n260	38.0	5.5	[5.0]	[27.5]-TT	55
2	n257, n258, n261	40.0	6.5	[5.0]	[28.5]-TT	55
2	n260	38.0	6.5	[5.0]	[26.5]-TT	55
3	n257, n258, n261	40.0	9.0	[5.0]	[26.0]-TT	55
3	n260	38.0	9.0	[5.0]	[24.0]-TT	55
Test requirements for a CA_nX(D-G)_UL_nXD, CA_nX(D-G)_UL_nXG, CA_nX(D-O)_UL_nXD, CA_nX(D-O)_UL_nXO, CA_nX(D-H)_UL_nXD, CA_nX(D-P)_UL_nXD, CA_nX(E-O)_UL_nXO, CA_nX(D-I)_UL_nXD, CA_nX(D-Q)_UL_nXD, CA_nX(G-I)_UL_nXG Configuration (800MHz <= Cumulative aggregated BWchannel <= 1400MHz)						
1	n257, n258, n261	40.0	8.2	[5.0]	[26.8]-TT	55
1	n260	38.0	8.2	[5.0]	[24.8]-TT	55
2	n257, n258, n261	40.0	9.7	[5.0]	[25.3]-TT	55
2	n260	38.0	9.7	[5.0]	[23.3]-TT	55
3	n257, n258, n261	40.0	9.2	[5.0]	[25.8]-TT	55
3	n260	38.0	9.2	[5.0]	[23.8]-TT	55
4	n257, n258, n261	40.0	8.7	[5.0]	[26.3]-TT	55
4	n260	38.0	8.7	[5.0]	[24.3]-TT	55
5	n257, n258, n261	40.0	11.2	[7.0]	[21.8]-TT	55
5	n260	38.0	11.2	[7.0]	[19.8]-TT	55
Test requirements for a CA_nX(D-G)_UL_nXD, CA_nX(D-O)_UL_nXD, CA_nX(D-G)_UL_nXG, CA_nX(D-O)_UL_nXO, CA_nX(D-H)_UL_nXD, CA_nX(D-P)_UL_nXD, CA_nX(O-E)_UL_nXO, CA_nX(D-I)_UL_nXD, CA_nX(D-Q)_UL_nXD, CA_nX(G-I)_UL_nXG Configuration (400MHz <= Cumulative aggregated BWchannel <800MHz)						
1	n257, n258, n261	40.0	7.7	[5.0]	[27.3]-TT	55
1	n260	38.0	7.7	[5.0]	[25.3]-TT	55
2	n257, n258, n261	40.0	8.7	[5.0]	[26.3]-TT	55
2	n260	38.0	8.7	[5.0]	[24.3]-TT	55
3	n257, n258, n261	40.0	10.7	[7.0]	[22.3]-TT	55
3	n260	38.0	10.7	[7.0]	[20.3]-TT	55
Test requirements for a CA_nX(D-O)_UL_nXD, CA_nX(D-O)_UL_nXO Configuration (Cumulative aggregated BWchannel <400MHz)						
1	n257, n258, n261	40.0	5.5	[5.0]	[29.5]-TT	55
1	n260	38.0	5.5	[5.0]	[27.5]-TT	55
2	n257, n258, n261	40.0	6.5	[5.0]	[28.5]-TT	55
2	n260	38.0	6.5	[5.0]	[26.5]-TT	55
3	n257, n258, n261	40.0	9.0	[5.0]	[26.0]-TT	55
3	n260	38.0	9.0	[5.0]	[24.0]-TT	55

NOTE 1: TT for each band and accumulative aggregated bandwidth is specified in Table 6.2A.2.1.5-5.

Table 6.2A.2.1.5-4: MPR requirements for Intra-band Contiguous UL CA (Power Class 1, Non-contiguous allocation)

Test ID	Band	Min peak EIRP (dBm)	MPR (dB)	T(MPR) (dB)	Lower limit (dBm)	Upper limit (dBm)
Test requirements for a CA_nXB, CA_nXD, CA_XG, CA_nXO Configuration						
1	n257, n258, n261	40.0	[14.4]	[7.0]	[18.6] -TT	55
1	n260	38.0	[14.4]	[7.0]	[16.6] -TT	55
2	n257, n258, n261	FFS	FFS	FFS	FFS	FFS
2	n260	FFS	FFS	FFS	FFS	FFS
3	n257, n258, n261	FFS	FFS	FFS	FFS	FFS
3	n260	FFS	FFS	FFS	FFS	FFS
Test requirements for a CA_nX(D-G), CA_nX(D-O) Configuration						
1	n257, n258, n261	40.0	[14.4]	[7.0]	[18.6] -TT	55
1	n260	38.0	[14.4]	[7.0]	[16.6] -TT	55
2	n257, n258, n261	FFS	FFS	FFS	FFS	FFS
2	n260	FFS	FFS	FFS	FFS	FFS
3	n257, n258, n261	FFS	FFS	FFS	FFS	FFS
3	n260	FFS	FFS	FFS	FFS	FFS

NOTE 1: TT for each band and accumulative aggregated bandwidth is specified in Table 6.2A.2.1.5-5.

Table 6.2A.2.1.5-5: Test Tolerance (MPR for CA for Power class 1)

Test Metric	FR2a	FR2b
Max device size ≤ 30 cm	3.38 dB	3.38 dB

Table 6.2A.2.1.5-6: MPR requirements for Intra-band Contiguous UL CA (Power Class 2, single CC MPR requirement)

Test ID	Band	Min peak EIRP (dBm)	MPR (dB)	T(MPR) (dB)	Lower limit (dBm)	Upper limit (dBm)
Test requirements for a CA_nXG, CA_nXO Configuration (Cumulative aggregated BWchannel ≤ 200MHz)						
1	n257, n258, n261	29	0	0	29.0-TT	43
2	n257, n258, n261	29	2	[1.5]	[25.5]-TT	43
Test requirements for a CA_nXD Configuration (Cumulative aggregated BWchannel ≤ 400MHz)						
1	n257, n258, n261	29	0	0	29.0-TT	43
2	n257, n258, n261	29	3	[2.0]	[24.0]-TT	43

NOTE 1: TT for each band and accumulative aggregated bandwidth is specified in Table 6.2A.2.1.5-9.

Table 6.2A.2.1.5-7: MPR requirements for Intra-band Contiguous UL CA (Power Class 2, MPR_{C,CA})

Test ID	Band	Min peak EIRP (dBm)	MPR (dB)	T(MPR) (dB)	Lower limit (dBm)	Upper limit (dBm)
Test requirements for a CA_nXB, nXC_UL_nXB Configuration (800MHz ≤ Cumulative aggregated BWchannel ≤ 1400MHz)						
1	n257, n258, n261	29	8.2	[5.0]	[15.8]-TT	43
2	n257, n258, n261	29	9.3	[5.0]	[14.7]-TT	43
3	n257, n258, n261	29	8.0	[5.0]	[16.0]-TT	43
4	n257, n258, n261	29	9.2	[5.0]	[14.8]-TT	43
5	n257, n258, n261	29	11.2	[7.0]	[10.8]-TT	43
Test requirements for a CA_nXD, CA_nXB Configuration (400MHz ≤ Cumulative aggregated BWchannel < 800MHz)						
1	n257, n258, n261	29	7.7	[5.0]	[16.3]-TT	43
2	n257, n258, n261	29	7.5	[5.0]	[16.5]-TT	43

3	n257, n258, n261	29	8.7	[5.0]	[15.3]-TT	43
4	n257, n258, n261	29	10.7	[7.0]	[11.3]-TT	43
Test requirements for a CA_nXG, CA_nXO, CA_nXD Configuration (Cumulative aggregated BWchannel < 400MHz)						
1	n257, n258, n261	29	5	[4.0]	[20.0]-TT	43
2	n257, n258, n261	29	6.5	[5.0]	[17.5]-TT	43
3	n257, n258, n261	29	9	[5.0]	[15.0]-TT	43
Test requirements for a CA_nX(D-G))_UL_nXD, CA_nX(D-G)_UL_nXG, CA_nX(D-O)_UL_nXD, CA_nX(D-O)_UL_nXO, CA_nX(D-H)_UL_nXD, CA_nX(D-P)_UL_nXD, CA_nX(E-O)_UL_nXO, CA_nX(D-I)_UL_nXD, CA_nX(D-Q)_UL_nXD, CA_nX(G-I)_UL_nXG Configuration (800MHz <= Cumulative aggregated BWchannel <= 1400MHz)						
1	n257, n258, n261	29	8.2	[5.0]	[15.8]-TT	43
2	n257, n258, n261	29	9.3	[5.0]	[14.7]-TT	43
3	n257, n258, n261	29	8.0	[5.0]	[16.0]-TT	43
4	n257, n258, n261	29	9.2	[5.0]	[14.8]-TT	43
5	n257, n258, n261	29	11.2	[7.0]	[10.8]-TT	43
Test requirements for a CA_nX(D-G)_UL_nXD, CA_nX(D-O)_UL_nXD, CA_nX(D-G)_UL_nXG, CA_nX(D-O)_UL_nXO, CA_nX(D-H)_UL_nXD, CA_nX(D-P)_UL_nXD, CA_nX(O-E)_UL_nXO, CA_nX(D-I)_UL_nXD, CA_nX(D-Q)_UL_nXD, CA_nX(G-I)_UL_nXG Configuration (400MHz <= Cumulative aggregated BWchannel < 800MHz)						
1	n257, n258, n261	29	7.7	[5.0]	[16.3]-TT	43
2	n257, n258, n261	29	7.5	[5.0]	[16.5]-TT	43
3	n257, n258, n261	29	8.7	[5.0]	[15.3]-TT	43
4	n257, n258, n261	29	10.7	[7.0]	[11.3]-TT	43
Test requirements for a CA_nX(D-O)_UL_nXD, CA_nX(D-O)_UL_nXO Configuration (Cumulative aggregated BWchannel < 400MHz)						
1	n257, n258, n261	29	7.7	[5.0]	[16.3]-TT	43
2	n257, n258, n261	29	7.5	[5.0]	[16.5]-TT	43
3	n257, n258, n261	29	8.7	[5.0]	[15.3]-TT	43
NOTE 1: TT for each band and accumulative aggregated bandwidth is specified in Table 6.2A.2.1.5-9.						

Table 6.2A.2.1.5-8: MPR requirements for Intra-band Contiguous UL CA (Power Class 2, Non-contiguous allocation)

Test ID	Band	Min peak EIRP (dBm)	MPR (dB)	T(MPR) (dB)	Lower limit (dBm)	Upper limit (dBm)
Test requirements for a CA_nXB, CA_nXD, CA_XG, CA_nXO Configuration						
1	n257, n258, n261	29	7	[5.0]	[17.0]-TT	43
2	n257, n258, n261	FFS	FFS	FFS	FFS	FFS
3	n257, n258, n261	FFS	FFS	FFS	FFS	FFS
NOTE 1: TT for each band and accumulative aggregated bandwidth is specified in Table 6.2A.2.1.5-9.						

Table 6.2A.2.1.5-9: Test Tolerance (MPR for CA for Power class 2)

FFS

Table 6.2A.2.1.5-10: MPR requirements for Intra-band Contiguous UL CA (Power Class 3, single CC MPR requirement)

Test ID	Band	Min peak EIRP (dBm)	MPR (dB)	T(MPR) (dB)	Lower limit (dBm)	Upper limit (dBm)
Test requirements for a CA_nXG, CA_nXO Configuration (Cumulative aggregated BWchannel <= 200MHz)						
1	n257, n258, n261	22.4	0	0	22.4-TT	43
1	n260	20.6	0	0	20.6-TT	43
2	n257, n258, n261	22.4	2	1.5	18.9-TT	43
2	n260	20.6	2	1.5	17.1-TT	43
Test requirements for a CA_nXD Configuration (Cumulative aggregated BWchannel <= 400MHz)						
1	n257, n258, n261	22.4	0	0	22.4-TT	43
1	n260	20.6	0	0	20.6-TT	43
2	n257, n258, n261	22.4	3	2.0	17.4-TT	43
2	n260	20.6	3	2.0	15.6-TT	43
NOTE 1: TT for each band and accumulative aggregated bandwidth is specified in Table 6.2A.2.1.5-13.						

Table 6.2A.2.1.5-11: MPR requirements for Intra-band Contiguous UL CA (Power Class 3, MPR_{C_CA})

Test ID	Band	Min peak EIRP (dBm)	MPR (dB)	Lower limit for test procedure with UPLF test mode (variant a, Rel-16 and later)		Lower limit for test procedure with PHR (variant b, Rel-15 only)		Upper limit (dBm)
				T(MPR) (dB)	Lower limit (dBm)	T(MPR+ ΔPHR) (dB)	Lower limit PHR(dBm)	
Test requirements for a CA_nXB, nXC_UL_nXB Configuration (800MHz <= Cumulative aggregated BWchannel <= 1400MHz)								
1	n257, n258, n261	22.4	8.2	5.0	9.2-TT	5.0	9.2-ΔPHR-TT	43
1	n260	20.6	8.2	5.0	7.4-TT	5.0	7.4- ΔPHR-TT	43
2	n257, n258, n261	22.4	9.3	5.0	8.1-TT	5.0+2	6.1- ΔPHR-TT	43
2	n260	20.6	9.3	5.0	6.3-TT	5.0+2	4.3- ΔPHR-TT	43
3	n257, n258, n261	22.4	8.0	5.0	9.4-TT	5.0	9.4- ΔPHR-TT	43
3	n260	20.6	8.0	5.0	7.6-TT	5.0	7.6- ΔPHR-TT	43
4	n257, n258, n261	22.4	9.2	5.0	8.2-TT	5.0+2	6.2- ΔPHR-TT	43
4	n260	20.6	9.2	5.0	6.4-TT	5.0+2	4.4- ΔPHR-TT	43
5	n257, n258, n261	22.4	11.2	7.0	4.2-TT	7.0	4.2- ΔPHR-TT	43
5	n260	20.6	11.2	7.0	2.4-TT	7.0]	2.4- ΔPHR-TT	43
Test requirements for a CA_nXD, CA_nXE_UL_nXD, CA_nXF_UL_nXD, CA_nXB Configuration (Cumulative aggregated BWchannel < 800MHz)								
1	n257, n258, n261	22.4	7.7	5.0	9.7-TT	5.0	9.7- ΔPHR-TT	43
1	n260	20.6	7.7	5.0	7.9-TT	5.0	7.9- ΔPHR-TT	43
2	n257, n258, n261	22.4	7.5	5.0	9.9-TT	5.0	9.9- ΔPHR-TT	43
2	n260	20.6	7.5	5.0	8.1-TT	5.0	8.1- ΔPHR-TT	43
3	n257, n258, n261	22.4	8.7	5.0	8.7-TT	5.0	8.7- ΔPHR-TT	43
3	n260	20.6	8.7	5.0	6.9-TT	5.0	6.9- ΔPHR-TT	43
4	n257, n258, n261	22.4	10.7	7.0	4.7-TT	7.0	4.7- ΔPHR-TT	43
4	n260	20.6	10.7	7.0	2.9-TT	7.0	2.9- ΔPHR-TT	43

Test requirements for a CA_nXG, CA_nXO, CA_nXD Configuration (Cumulative aggregated BWchannel < 400MHz)								
1	n257, n258, n261	22.4	5	4.0	13.4-TT	4.0+1	12.4- ΔPHR-TT	43
1	n260	20.6	5	4.0	11.6-TT	4.0+1	10.6- ΔPHR-TT	43
2	n257, n258, n261	22.4	6.5	5.0	10.9-TT	5.0	10.9- ΔPHR-TT	43
2	n260	20.6	6.5	5.0	9.1-TT	5.0	9.1- ΔPHR-TT	43
3	n257, n258, n261	22.4	9	5.0	8.4-TT	5.0	8.4- ΔPHR-TT	43
3	n260	20.6	9	5.0	6.6-TT	5.0	6.6- ΔPHR-TT	43
Test requirements for a CA_nX(D-A)_UL_nXD, CA_nX(A-G)_UL_nXG, CA_nX(A-O)_UL_nXO Configuration (800MHz <= Cumulative aggregated BWchannel <= 1400MHz)								
1	n257, n258, n261	22.4	8.2	5.0	9.2-TT	5.0	9.2- ΔPHR-TT	43
1	n260	20.6	8.2	5.0	7.4-TT	5.0	7.4- ΔPHR-TT	43
2	n257, n258, n261	22.4	9.3	5.0	8.1-TT	5.0+2	6.1- ΔPHR-TT	43
2	n260	20.6	9.3	5.0	6.3-TT	5.0+2	4.3- ΔPHR-TT	43
3	n257, n258, n261	22.4	8.0	5.0	9.4-TT	5.0	9.4- ΔPHR-TT	43
3	n260	20.6	8.0	5.0	7.6-TT	5.0	7.6- ΔPHR-TT	43
4	n257, n258, n261	22.4	9.2	5.0	8.2-TT	5.0+2	6.2- ΔPHR-TT	43
4	n260	20.6	9.2	5.0	6.4-TT	5.0+2	4.4- ΔPHR-TT	43
5	n257, n258, n261	22.4	11.2	7.0	4.2-TT	7.0	4.2- ΔPHR-TT	43
5	n260	20.6	11.2	7.0	2.4-TT	7.0	2.4- ΔPHR-TT	43
Test requirements for a CA_nX(D-A)_UL_nXD, CA_nX(A-G)_UL_nXG, CA_nX(A-O) Configuration (Cumulative aggregated BWchannel < 800MHz)								
1	n257, n258, n261	22.4	7.7	[5.0]	9.7-TT	5.0	9.7- ΔPHR-TT	43
1	n260	20.6	7.7	[5.0]	7.9-TT	5.0	7.9- ΔPHR-TT	43
2	n257, n258, n261	22.4	7.5	[5.0]	9.9-TT	5.0	9.9- ΔPHR-TT	43
2	n260	20.6	7.5	[5.0]	8.1-TT	5.0	8.1- ΔPHR-TT	43
3	n257, n258, n261	22.4	8.7	[5.0]	8.7-TT	5.0	8.7- ΔPHR-TT	43
3	n260	20.6	8.7	[5.0]	6.9-TT	5.0	6.9- ΔPHR-TT	43
4	n257, n258, n261	22.4	10.7	[7.0]	4.7-TT	7.0	4.7- ΔPHR-TT	43
4	n260	20.6	10.7	[7.0]	2.9-TT	7.0	2.9- ΔPHR-TT	43
Test requirements for a CA_nX(D-A)_UL_nXD, CA_nX(A-O)_UL_nXO Configuration (Cumulative aggregated BWchannel < 400MHz)								
1	n257, n258, n261	22.4	5	4.0	13.4-TT	4.0+1	12.4- ΔPHR-TT	43
1	n260	20.6	5	4.0	11.6-TT	4.0+1	10.6- ΔPHR-TT	43
2	n257, n258, n261	22.4	6.5	5.0	10.9-TT	5.0	10.9- ΔPHR-TT	43
2	n260	20.6	6.5	5.0	9.1-TT	5.0	9.1- ΔPHR-TT	43
3	n257, n258, n261	22.4	9	5.0	8.4-TT	5.0	8.4- ΔPHR-TT	43
3	n260	20.6	9	5.0	6.6-TT	5.0	6.6- ΔPHR-TT	43

NOTE 1: TT for each band and accumulative aggregated bandwidth is specified in Table 6.2A.2.1.5-13.
 NOTE 2: ΔPHR is defined in Table 6.2A.2.1.4.2-1
 NOTE 3: test procedure with PHR (variant b)

Table 6.2A.2.1.5-12: MPR requirements for Intra-band Contiguous UL CA (Power Class 3, Non-contiguous allocation)

Test ID	Band	Min peak EIRP (dBm)	MPR (dB)	Lower limit for test procedure with UPLF test mode (variant a)		Lower limit for test procedure with PHR (variant b)		Upper limit (dBm)
				T(MPR) (dB)	Lower limit (dBm)	T(MPR+ΔPHR) (dB)	Lower limit PHR(dBm)	
Test requirements for a CA_nXB, CA_nXD, CA_XG, CA_nXO Configuration								
1	n257, n258, n261	22.4	7	[5.0]	[10.4]-TT	[5.0]	[10.4]-ΔPHR-TT	43
1	n260	20.6	7	[5.0]	[8.6]-TT	[5.0]	[8.6]-ΔPHR-TT	43
2	n257, n258, n261	FFS	FFS	FFS	FFS	FFS	FFS	FFS
2	n260	FFS	FFS	FFS	FFS	FFS	FFS	FFS
3	n257, n258, n261	FFS	FFS	FFS	FFS	FFS	FFS	FFS
3	n260	FFS	FFS	FFS	FFS	FFS	FFS	FFS

NOTE 1: TT for each band and accumulative aggregated bandwidth is specified in Table 6.2A.2.1.5-13.
 NOTE 2: ΔPHR is defined in Table 6.2A.2.1.4.2-1

Table 6.2A.2.1.5-13: Test Tolerance (MPR for CA for Power class 3) (Aggregated UL BW ≤ 400MHz)

Test Metric	FR2a	FR2b
Max device size ≤ 30 cm	3.24 dB	3.24 dB

Table 6.2A.2.1.5-14: MPR requirements for Intra-band Contiguous UL CA (Power Class 4, single CC MPR requirement)

Test ID	Band	Min peak EIRP (dBm)	MPR (dB)	T(MPR) (dB)	Lower limit (dBm)	Upper limit (dBm)
Test requirements for a CA_nXG, CA_nXO Configuration (Cumulative aggregated BWchannel ≤ 200MHz)						
1	n257, n258, n261	34	0	0	34.0-TT	43
1	n260	31	0	0	31.0-TT	43
2	n257, n258, n261	34	2	[1.5]	[30.5]-TT	43
2	n260	31	2	[1.5]	[27.5]-TT	43
Test requirements for a CA_nXD Configuration (Cumulative aggregated BWchannel ≤ 400MHz)						
1	n257, n258, n261	34	0	0	34.0-TT	43
1	n260	31	0	0	31.0-TT	43
2	n257, n258, n261	34	3	[2.0]	[29.0]-TT	43
2	n260	31	3	[2.0]	[26.0]-TT	43

NOTE 1: TT for each band and accumulative aggregated bandwidth is specified in Table 6.2A.2.1.5-17.

Table 6.2A.2.1.5-15: MPR requirements for Intra-band Contiguous UL CA (Power Class 4, MPR_{C_CA})

Test ID	Band	Min peak EIRP (dBm)	MPR (dB)	T(MPR) (dB)	Lower limit (dBm)	Upper limit (dBm)
Test requirements for a CA_nXB, nXC_UL_nXB Configuration (800MHz ≤ Cumulative aggregated BWchannel ≤ 1400MHz)						
1	n257, n258, n261	34	8.2	[5.0]	[20.8]-TT	43

1	n260	31	8.2	[5.0]	[17.8]-TT	43
2	n257, n258, n261	34	9.3	[5.0]	[19.7]-TT	43
2	n260	31	9.3	[5.0]	[16.7]-TT	43
3	n257, n258, n261	34	8.0	[5.0]	[21.0]-TT	43
3	n260	31	8.0	[5.0]	[18.0]-TT	43
4	n257, n258, n261	34	9.2	[5.0]	[19.8]-TT	43
4	n260	31	9.2	[5.0]	[16.8]-TT	43
5	n257, n258, n261	34	11.2	[7.0]	[15.8]-TT	43
5	n260	31	11.2	[7.0]	[12.8]-TT	43
Test requirements for a CA_nXD, CA_nXB Configuration (Cumulative aggregated BWchannel < 800MHz)						
1	n257, n258, n261	34	7.7	[5.0]	[21.3]-TT	43
1	n260	31	7.7	[5.0]	[18.3]-TT	43
2	n257, n258, n261	34	7.5	[5.0]	[21.5]-TT	43
2	n260	31	7.5	[5.0]	[18.5]-TT	43
3	n257, n258, n261	34	8.7	[5.0]	[20.3]-TT	43
3	n260	31	8.7	[5.0]	[17.3]-TT	43
4	n257, n258, n261	34	10.7	[7.0]	[16.3]-TT	43
4	n260	31	10.7	[7.0]	[13.3]-TT	43
Test requirements for a CA_nXG, CA_nXO, CA_nXD Configuration (Cumulative aggregated BWchannel < 400MHz)						
1	n257, n258, n261	34	5	[4.0]	[25.0]-TT	43
1	n260	31	5	[4.0]	[22.0]-TT	43
2	n257, n258, n261	34	6.5	[5.0]	[22.5]-TT	43
2	n260	31	6.5	[5.0]	[19.5]-TT	43
3	n257, n258, n261	34	9	[5.0]	[20.0]-TT	43
3	n260	31	9	[5.0]	[17.0]-TT	43
Test requirements for a CA_nX(D-G))_UL_nXD, CA_nX(D-G)_UL_nXG, CA_nX(D-O)_UL_nXD, CA_nX(D-O)_UL_nXO, CA_nX(D-H)_UL_nXD, CA_nX(D-P)_UL_nXD, CA_nX(E-O)_UL_nXO, CA_nX(D-I)_UL_nXD, CA_nX(D-Q)_UL_nXD, CA_nX(G-I)_UL_nXG Configuration (800MHz <= Cumulative aggregated BWchannel <= 1400MHz)						
1	n257, n258, n261	34	8.2	[5.0]	[20.8]-TT	43
1	n260	31	8.2	[5.0]	[17.8]-TT	43
2	n257, n258, n261	34	9.3	[5.0]	[19.7]-TT	43
2	n260	31	9.3	[5.0]	[16.7]-TT	43
3	n257, n258, n261	34	8.0	[5.0]	[21.0]-TT	43
3	n260	31	8.0	[5.0]	[18.0]-TT	43
4	n257, n258, n261	34	9.2	[5.0]	[19.8]-TT	43

4	n260	31	9.2	[5.0]	[16.8]-TT	43
5	n257, n258, n261	34	11.2	[7.0]	[15.8]-TT	43
5	n260	31	11.2	[7.0]	[12.8]-TT	43
Test requirements for a CA_nX(D-G)_UL_nXD, CA_nX(D-O)_UL_nXD, CA_nX(D-G)_UL_nXG, CA_nX(D-O)_UL_nXO, CA_nX(D-H)_UL_nXD, CA_nX(D-P)_UL_nXD, CA_nX(O-E)_UL_nXO, CA_nX(D-I)_UL_nXD, CA_nX(D-Q)_UL_nXD, CA_nX(G-I)_UL_nXG Configuration (Cumulative aggregated BWchannel < 800MHz)						
1	n257, n258, n261	34	7.7	[5.0]	[21.3]-TT	43
1	n260	31	7.7	[5.0]	[18.3]-TT	43
2	n257, n258, n261	34	7.5	[5.0]	[21.5]-TT	43
2	n260	31	7.5	[5.0]	[18.5]-TT	43
3	n257, n258, n261	34	8.7	[5.0]	[20.3]-TT	43
3	n260	31	8.7	[5.0]	[17.3]-TT	43
4	n257, n258, n261	34	10.7	[7.0]	[16.3]-TT	43
4	n260	31	10.7	[7.0]	[13.3]-TT	43
Test requirements for a CA_nX(D-O)_UL_nXD, CA_nX(D-O)_UL_nXO Configuration (Cumulative aggregated BWchannel < 400MHz)						
1	n257, n258, n261	34	5	[4.0]	[25.0]-TT	43
1	n260	31	5	[4.0]	[22.0]-TT	43
2	n257, n258, n261	34	6.5	[5.0]	[22.5]-TT	43
2	n260	31	6.5	[5.0]	[19.5]-TT	43
3	n257, n258, n261	34	9	[5.0]	[20.0]-TT	43
3	n260	31	9	[5.0]	[17.0]-TT	43
NOTE 1: TT for each band and accumulative aggregated bandwidth is specified in Table 6.2A.2.1.5-17.						

Table 6.2A.2.1.5-16: MPR requirements for Intra-band Contiguous UL CA (Power Class 4, Non-contiguous allocation)

Test ID	Band	Min peak EIRP (dBm)	MPR (dB)	T(MPR) (dB)	Lower limit (dBm)	Upper limit (dBm)
Test requirements for a CA_nXB, CA_nXD, CA_XG, CA_nXO Configuration						
1	n257, n258, n261	34	7	[5.0]	[22.0]-TT	43
1	n260	31	7	[5.0]	[19.0]-TT	43
2	n257, n258, n261	FFS	FFS	FFS	FFS	FFS
2	n260	FFS	FFS	FFS	FFS	FFS
3	n257, n258, n261	FFS	FFS	FFS	FFS	FFS
3	n260	FFS	FFS	FFS	FFS	FFS
NOTE 1: TT for each band and accumulative aggregated bandwidth is specified in Table 6.2A.2.1.5-17.						

Table 6.2A.2.1.5-17: Test Tolerance (MPR for CA for Power class 4)

FFS

Table 6.2A.2.1.5-18: MPR requirements for Intra-band Contiguous UL CA (Power Class 5, 6, single CC MPR requirement)

Test ID	Band	Min peak EIRP (dBm)	MPR (dB)	T(MPR) (dB)	Lower limit (dBm)	Upper limit (dBm)
---------	------	---------------------	----------	-------------	-------------------	-------------------

Test requirements for a CA_nXG, CA_nXO Configuration (Cumulative aggregated BWchannel <= 200MHz)						
1	n257	30	0	0	30-TT	43
1	n258	30.4	0	0	30.4-TT	43
2	n257	30	2	1.5	26.5-TT	43
2	n258	30.4	2	1.5	26.9-TT	43
Test requirements for a CA_nXD Configuration (Cumulative aggregated BWchannel <= 400MHz)						
1	n257	30	0	0	30-TT	43
1	n258	30.4	0	0	30.4-TT	43
2	n257	30	3	2.0	25-TT	43
2	n258	30.4	3	2.0	25.4-TT	43

NOTE 1: TT for each band and accumulative aggregated bandwidth is specified in Table 6.2A.2.1.5-13.

Table 6.2A.2.1.5-19: MPR requirements for Intra-band Contiguous UL CA (Power Class 5, 6, MPR_{C_CA})

Test ID	Band	Min peak EIRP (dBm)	MPR (dB)	Lower limit for test procedure with UPLF test mode (variant a, Rel-16 and later)		Lower limit for test procedure with PHR (variant b, Rel-15 only)		Upper limit (dBm)
				T(MPR) (dB)	Lower limit (dBm)	T(MPR+ ΔPHR) (dB)	Lower limit PHR(dBm)	
Test requirements for a CA_nXB, nXC_UL_nXB Configuration (800MHz <= Cumulative aggregated BWchannel <= 1400MHz)								
1	n257	30	8.2	5.0	16.8-TT	5.0	16.8-ΔPHR-TT	43
1	n258	30.4	8.2	5.0	17.2-TT	5.0	17.2-ΔPHR-TT	43
2	n257	30	9.3	5.0	15.7-TT	5.0+2	13.7-ΔPHR-TT	43
2	n258	30.4	9.3	5.0	16.1-TT	5.0+2	14.1-ΔPHR-TT	43
3	n257	30	8.0	5.0	17-TT	5.0	17-ΔPHR-TT	43
3	n258	30.4	8.0	5.0	17.4-TT	5.0	17.4-ΔPHR-TT	43
4	n257	30	9.2	5.0	15.8-TT	5.0+2	13.8-ΔPHR-TT	43
4	n258	30.4	9.2	5.0	16.2-TT	5.0+2	14.2-ΔPHR-TT	43
5	n257	30	11.2	7.0	11.8-TT	7.0	11.8-ΔPHR-TT	43
5	n258	30.4	11.2	7.0	12.2-TT	7.0	12.2-ΔPHR-TT	43
Test requirements for a CA_nXD, CA_nXE_UL_nXD, CA_nXF_UL_nXD, CA_nXB Configuration (Cumulative aggregated BWchannel < 800MHz)								
1	n257	30	7.7	5.0	17.3-TT	5.0	17.3-ΔPHR-TT	43
1	n258	30.4	7.7	5.0	17.7-TT	5.0	17.7-ΔPHR-TT	43
2	n257	30	7.5	5.0	17.5-TT	5.0	17.5-ΔPHR-TT	43
2	n258	30.4	7.5	5.0	17.9-TT	5.0	17.9-ΔPHR-TT	43
3	n257	30	8.7	5.0	16.3-TT	5.0	16.3-ΔPHR-TT	43
3	n258	30.4	8.7	5.0	16.7-TT	5.0	16.7-ΔPHR-TT	43
4	n257	30	10.7	7.0	12.3-TT	7.0	12.3-ΔPHR-TT	43
4	n258	30.4	10.7	7.0	12.7-TT	7.0	12.7-ΔPHR-TT	43
Test requirements for a CA_nXG, CA_nXO, CA_nXD Configuration (Cumulative aggregated BWchannel < 400MHz)								
1	n257	30	5	4.0	21-TT	4.0+1	20-ΔPHR-TT	43
1	n258	30.4	5	4.0	21.4-TT	4.0+1	20.4-ΔPHR-TT	43
2	n257	30	6.5	5.0	18.5-TT	5.0	18.5-ΔPHR-TT	43

2	n258	30.4	6.5	5.0	18.9-TT	5.0	18.9- Δ PHR-TT	43
3	n257	30	9	5.0	16-TT	5.0	16- Δ PHR-TT	43
3	n258	30.4	9	5.0	16.4-TT	5.0	16.4- Δ PHR-TT	43
Test requirements for a CA_nX(D-A)_UL_nXD, CA_nX(A-G)_UL_nXG, CA_nX(A-O)_UL_nXO Configuration (800MHz <= Cumulative aggregated BWchannel <= 1400MHz)								
1	n257	30	8.2	5.0	16.8-TT	5.0	16.8- Δ PHR-TT	43
1	n258	30.4	8.2	5.0	17.2-TT	5.0	17.2- Δ PHR-TT	43
2	n257	30	9.3	5.0	15.7-TT	5.0+2	13.7- Δ PHR-TT	43
2	n258	30.4	9.3	5.0	16.1-TT	5.0+2	14.1- Δ PHR-TT	43
3	n257	30	8.0	5.0	17-TT	5.0	17- Δ PHR-TT	43
3	n258	30.4	8.0	5.0	17.4-TT	5.0	17.4- Δ PHR-TT	43
4	n257	30	9.2	5.0	15.8-TT	5.0+2	13.8- Δ PHR-TT	43
4	n258	30.4	9.2	5.0	16.2-TT	5.0+2	14.2- Δ PHR-TT	43
5	n257	30	11.2	7.0	11.8-TT	7.0	11.8- Δ PHR-TT	43
5	n258	30.4	11.2	7.0	12.2-TT	7.0	12.2- Δ PHR-TT	43
Test requirements for a CA_nX(D-A)_UL_nXD, CA_nX(A-G)_UL_nXG, CA_nX(A-O) Configuration (Cumulative aggregated BWchannel < 800MHz)								
1	n257	30	7.7	5.0	17.3-TT	5.0	17.3- Δ PHR-TT	43
1	n258	30.4	7.7	5.0	17.7-TT	5.0	17.7- Δ PHR-TT	43
2	n257	30	7.5	5.0	17.5-TT	5.0	17.5- Δ PHR-TT	43
2	n258	30.4	7.5	5.0	17.9-TT	5.0	17.9- Δ PHR-TT	43
3	n257	30	8.7	5.0	16.3-TT	5.0	16.3- Δ PHR-TT	43
3	n258	30.4	8.7	5.0	16.7-TT	5.0	16.7- Δ PHR-TT	43
4	n257	30	10.7	7.0	12.3-TT	7.0	12.3- Δ PHR-TT	43
4	n258	30.4	10.7	7.0	12.7-TT	7.0	12.7- Δ PHR-TT	43
Test requirements for a CA_nX(D-A)_UL_nXD, CA_nX(A-O)_UL_nXO Configuration (Cumulative aggregated BWchannel < 400MHz)								
1	n257	30	5	4.0	21-TT	4.0+1	20- Δ PHR-TT	43
1	n258	30.4	5	4.0	21.4-TT	4.0+1	20.4- Δ PHR-TT	43
2	n257	30	6.5	5.0	18.5-TT	5.0	18.5- Δ PHR-TT	43
2	n258	30.4	6.5	5.0	18.9-TT	5.0	18.9- Δ PHR-TT	43
3	n257	30	9	5.0	16-TT	5.0	16- Δ PHR-TT	43
3	n258	30.4	9	5.0	16.4-TT	5.0	16.4- Δ PHR-TT	43

NOTE 1: TT for each band and accumulative aggregated bandwidth is specified in Table 6.2A.2.1.5-13.
NOTE 2: Δ PHR is defined in Table 6.2A.2.1.4.2-1
NOTE 3: test procedure with PHR (variant b)

Table 6.2A.2.1.5-20: MPR requirements for Intra-band Contiguous UL CA (Power Class 5, 6, Non-contiguous allocation)

Test ID	Band	Min peak EIRP (dBm)	MPR (dB)	Lower limit for test procedure with UPLF test mode (variant a)	Lower limit for test procedure with PHR (variant b)	Upper limit (dBm)
---------	------	---------------------	----------	--	---	-------------------

				T(MPR) (dB)	Lower limit (dBm)	T(MPR+ΔPHR) (dB)	Lower limit PHR(dBm)	
Test requirements for a CA_nXB, CA_nXD, CA_XG, CA_nXO Configuration								
1	n257	30	7	[5.0]	[18]-TT	[5.0]	[18]-ΔPHR -TT	43
1	n258	30.4	7	[5.0]	[18.4]-TT	[5.0]	[18.4]-ΔPHR -TT	43
2	n257	FFS	FFS	FFS	FFS	FFS	FFS	FFS
2	n258	FFS	FFS	FFS	FFS	FFS	FFS	FFS
3	n257	FFS	FFS	FFS	FFS	FFS	FFS	FFS
3	n258	FFS	FFS	FFS	FFS	FFS	FFS	FFS
NOTE 1: TT for each band and accumulative aggregated bandwidth is specified in Table 6.2A.2.1.5-13.								
NOTE 2: ΔPHR is defined in Table 6.2A.2.1.4.2-1								

Table 6.2A.2.1.5-21: Test Tolerance (MPR for CA for Power class 5) (Aggregated UL BW ≤ 400MHz)

Test Metric	FR2a
Max device size ≤ 30 cm	3.38 dB

Table 6.2A.2.1.5-22: Test Tolerance (MPR for CA for Power class 6) (Aggregated UL BW ≤ 400MHz)

Test Metric	FR2a
Max device size ≤ 30 cm	3.37 dB

6.2A.2.2 UE maximum output power reduction for CA (3UL CA)

Editor's note: The following aspects are either missing or not yet determined:

- The UPLF test mode is applicable to UEs Release 16 and forward.
- This test case is incomplete for Power classes 1, 2, 4 Release 15.
- For a transition period until RAN#99, the stability and repeatability of test procedure with PHR (variant b) for Rel-15 UEs is under evaluation.
- Whether additional check is needed in the test procedure to ensure UE continues transmissions on the SCell is FFS
- Measurement Uncertainties and Test Tolerances are FFS for power class 1, 2 and 4.
- Measurement Uncertainties and Test Tolerances for intra-band contiguous CA supporting aggregated BW > 400MHz and intra-band non-contiguous CA are TBD.
- The test points for higher bandwidth classes with testability problem need an update to decrease the UL bandwidth until they become testable.
- This test case is incomplete for intra-band non-contiguous CA

6.2A.2.2.1 Test purpose

The number of RB identified in 6.2.2.3 is based on meeting the requirements for the maximum power reduction (MPR) due to Cubic Metric (CM).

6.2A.2.2.2 Test applicability

The requirements of this test apply to all types of NR UE release 15 and forward supporting 3UL CA.

6.2A.2.2.3 Minimum conformance requirements

The normative reference for this requirement is TS 38.101-2 [3] clause 6.2A.2.

6.2A.2.2.4 Test description

6.2A.2.2.4.1 Initial conditions

Initial conditions are a set of test configurations the UE needs to be tested in and the steps for the SS to take with the UE to reach the correct measurement state.

The initial test configurations consist of environmental conditions, test frequencies, and CC combinations based on NR operating bands specified in clause 5.5A. All of these configurations shall be tested with applicable test parameters for each CA configuration and subcarrier spacing, are shown in Table 6.2A.2.1.4.1-1. The details of the uplink reference measurement channels (RMCs) are specified in Annexes A.2. Configurations of PDSCH and PDCCH before measurement are specified in Annex C.2.

Table 6.2A.2.2.4.1-1: Intra-band Contiguous UL CA Test Configuration Table (Power Class 1, MPR_{narrow})

FFS

Table 6.2A.2.2.4.1-2: Intra-band Contiguous UL CA Test Configuration Table (Power Class 1, single CC MPR requirement)

FFS

Table 6.2A.2.2.4.1-3: Intra-band Contiguous UL CA Test Configuration Table (Power Class 1, MPR_{C_CA})

FFS

Table 6.2A.2.2.4.1-4: Intra-band Contiguous UL CA Test Configuration Table (Power Class 1, Non-contiguous allocation)

FFS

Table 6.2A.2.2.4.1-5: Intra-band Contiguous UL CA Test Configuration Table (Power Class 2, 3 and 4, single CC MPR requirement)

Default Conditions						
Test Environment as specified in TS 38.508-1 [10] clause 4.1				Normal		
Test Frequencies as specified in TS 38.508-1 [10] clause 4.3.1.2.3 for different CA bandwidth classes				Low range, High range		
Test CC Combination setting (aggregated BW of the CA configuration) as specified in for the CA Configuration across bandwidth combination sets supported by the UE				Highest aggregated channel bandwidth of the CA configuration		
Test SCS as specified in Table 5.3.5-1				120 kHz		
Test Parameters						
Test ID	CC & Mapping (NOTE 2)	ChBw(MHz)	Test frequency	DL RB allocation	UL Modulation	UL RB allocation
Default Test Settings for a CA_nXH Configuration (Cumulative aggregated BWchannel <= 400MHz)						
1	PCC/CC1	Default	Default	-	DFT-s-OFDM QPSK	Inner_Full
	SCC/CC2				-	-
	SCC/CC3				-	-
2	PCC/CC1	Default	Default	-	DFT-s-OFDM QPSK	Outer_Full
	SCC/CC2				-	-
	SCC/CC3				-	-
NOTE 1: The specific configuration of each RB allocation is defined in Table 6.1-1.						
NOTE 2: PCC/CCi and SCC/CCj means PCC is on component carrier CCi and SCC is on component carrier CCj, with CCi or CCj frequencies defined in TS38.508-1 [10].						

Table 6.2A.2.2.4.1-6: Intra-band Contiguous UL CA Test Configuration Table (Power Class 2, 3 and 4, MPR_{C,CA})

Default Conditions						
Test Environment as specified in TS 38.508-1 [10] clause 4.1				Normal		
Test Frequencies as specified in TS 38.508-1 [10] clause 4.3.1.2.3 and 4.3.1.2.4 for different CA bandwidth classes				For intra-band contiguous CA: Mid range. For intra-band non-contiguous CA: FFS		
Test CC Combination setting (aggregated BW of the CA configuration) as specified in TS 38.508-1 [10] clause 4.3.1.2.3 and 4.3.1.2.4 for the CA Configuration across bandwidth combination sets supported by the UE				Highest aggregated channel bandwidth of the CA configuration		
Test SCS as specified in Table 5.3.5-1				120 kHz		
Test Parameters						
Test ID	CC & Mapping (NOTE 2)	ChBw(MHz)	Test frequency	DL RB allocation	UL Modulation	UL RB allocation
Default Test Settings for a CA_nXE, CA_nXF_UL_nXE Configuration (400MHz <= Cumulative aggregated BWchannel <= 800MHz)						
1	PCC/CC1				DFT-s-OFDM 16QAM	Outer_Full
	SCC1/CC2				DFT-s-OFDM 16QAM	Outer_Full
	SCC2/CC3				DFT-s-OFDM 16QAM	Outer_Full
2	PCC/CC1				CP-OFDM QPSK	Outer_Full
	SCC1/CC2				CP-OFDM QPSK	Outer_Full
	SCC2/CC3				CP-OFDM QPSK	Outer_Full
3	PCC/CC1				CP-OFDM 16QAM	Outer_Full
	SCC1/CC2				CP-OFDM 16QAM	Outer_Full
	SCC2/CC3				CP-OFDM 16QAM	Outer_Full
4	PCC/CC1				CP-OFDM 64QAM	Outer_Full
	SCC1/CC2				CP-OFDM 64QAM	Outer_Full
	SCC2/CC3				CP-OFDM 64QAM	Outer_Full
Default Test Settings for a CA_nXH Configuration (Cumulative aggregated BWchannel < 400MHz)						
1	PCC/CC1	Default	Default	-	CP-OFDM QPSK	Outer_Full
	SCC/CC2				CP-OFDM QPSK	Outer_Full
	SCC/CC3				CP-OFDM QPSK	Outer_Full
2	PCC/CC1				CP-OFDM 16QAM	Outer_Full
	SCC/CC2				CP-OFDM 16QAM	Outer_Full
	SCC/CC3				CP-OFDM 16QAM	Outer_Full
3	PCC/CC1				CP-OFDM 64QAM	Outer_Full
	SCC/CC2				CP-OFDM 64QAM	Outer_Full
	SCC/CC3				CP-OFDM 64QAM	Outer_Full
NOTE 1: The specific configuration of each RB allocation is defined in Table 6.1-1.						
NOTE 2: PCC/CC _i and SCC/CC _j means PCC is on component carrier CC _i and SCC is on component carrier CC _j , with CC _i or CC _j frequencies defined in TS38.508-1 [10].						

1. Connection between SS and UE is shown in TS 38.508-1 [10] Annex A, Figure A.3.3.1.1 for TE diagram and Figure A.3.4.1.1 for UE diagram.
2. The parameter settings for the cell are set up according to TS 38.508-1 [10] clause 4.4.3.
3. Downlink signals are initially set up according to Annex C, and uplink signals according to Annex G.
4. The UL Reference Measurement channels are set according to Table 6.2A.2.2.4.1-1 to Table 6.2A.2.2.4.1-6.
5. Propagation conditions are set according to Annex B.0.
6. Ensure the UE is in state RRC_CONNECTED with generic procedure parameters Connectivity *NR*, Connected without release *On*, Test Mode *On* and Test Loop Function *On* according to TS 38.508-1 [10] clause 4.5. Message contents are defined in clause 6.2A.2.2.4.3.

6.2A.2.2.4.2 Test procedure

1. Configure SCC according to Annex C.0, C.1, C.2 and Annex C.3.0 for all downlink physical channels
2. The SS shall configure SCC as per TS 38.508-1 [10] clause 5.5.1 Procedure to configure SCC(s) for NR RF CA testing. Message contents are defined in clause 6.2A.2.2.4.3.
3. Apply the test step based on the 5G NR UE Release:
 - 3a. For Release 16 and forward 5G NR UEs supporting the UPLF test mode: SS applies a backoff on the PCell power by activating the UE Power Limit Function (UPLF). The ACTIVATE POWER LIMIT REQUEST procedure is performed as specified in TS 38.508-1 [10] clause 4.9.32 using TOTAL NR AGGREGATED BANDWIDTH and PCELL NR bandwidth as per Test CC Combination setting. UE shall transmit ACTIVATE POWER LIMIT RESPONSE to SS. Go to step 4.
 - 3b. For Release 15 5G NR UEs: No action.
 - 3c. For testing single CC MPR requirement: No action.
4. SS activates SCC by sending the activation MAC CE (Refer TS 38.321, clauses 5.9, 6.1.3.10). Wait for at least 2 seconds (Refer TS 38.133[25], clause 9.3).
5. SS sends uplink scheduling information for each UL HARQ process via PDCCH DCI format 0_1 for C_RNTI to schedule the UL RMC according to Table 6.2A.2.2.4.1-1 to Table 6.2A.2.1.4.1-6. Since the UL has no payload and no loopback data to send the UE sends uplink MAC padding bits on the UL RMC.
6. Set the UE in the Tx beam peak direction found with a 3D EIRP scan as performed in Annex K.1.1. Allow at least BEAM_SELECT_WAIT_TIME (NOTE 1) for the UE Tx beam selection to complete.
7. Apply the test step based on the 5G NR UE Release:
 - 7a. For Release 16 and forward 5G NR UEs: Send continuously uplink power control "up" commands in every uplink scheduling information to the UE; allow at least 200 msec starting from the first TPC command in this step to ensure that the UE transmits at its maximum output power. Allow at least BEAM_SELECT_WAIT_TIME (NOTE 1) for the UE Tx beam selection to complete.
 - 7b. For Release 15 5G NR UEs: Send uplink power control commands in uplink scheduling information to the UE per UL CC until the Power Headroom Report (PHR) from the UE for each UL CC is at the target value according to Table 6.2A.2.2.4.2-1; allow at least 200 ms for the UE to reach maximum output power. Allow at least BEAM_SELECT_WAIT_TIME (NOTE 1) for the UE Tx beam selection to complete.

Table 6.2A.2.2.4.2-1: Power target values per UL CC for test procedure using PHR

FFS

- 7c. For testing single CC MPR requirement: Send continuously uplink power control "up" commands in every uplink scheduling information to the UE; allow at least 200 msec starting from the first TPC command in this step to ensure that the UE transmits at its maximum output power. Allow at least BEAM_SELECT_WAIT_TIME (NOTE 1) for the UE Tx beam selection to complete.

8. SS activates the UE Beamlock Function (UBF) by performing the procedure as specified in TS 38.508-1 [10] clause 4.9.2 using condition Tx only.
9. Measure UE EIRP in the Tx beam peak direction in the accumulative aggregated channel bandwidth of the radio access mode according to the test configuration, which shall meet the requirements described in 6.2A.2.1.5. EIRP test procedure is defined in Annex K.1.3. The measuring duration is one active uplink subframe. EIRP is calculated considering both polarizations, theta and phi.
10. Apply the test step based on the 5G NR UE Release:
 - 10a. For Release 16 and forward 5G NR UEs supporting the UPLF test mode: SS deactivates the UE Power Limit Function (UPLF) by performing the DEACTIVATE POWER LIMIT REQUEST procedure as specified in TS 38.508-1 [10] clause 4.9.33.
 - 10b. For Release 15 5G NR UEs: No action.
 - 10c. For testing single CC MPR requirement: No action.
11. SS deactivates the UE Beamlock Function (UBF) by performing the procedure as specified in TS 38.508-1 [10] clause 4.9.3.

NOTE 1: The BEAM_SELECT_WAIT_TIME default value is defined in Annex K.

NOTE 2: When switching to DFT-s-OFDM waveform, as specified in Table 6.2A.2.2.4.1-1 to Table 6.2A.2.2.4.1-6, send an NR RRCReconfiguration message according to TS 38.508-1 [10] clause 4.6.3 Table 4.6.3-118 PUSCH-Config with TRANSFORM_PRECODER_ENABLED condition.

6.2A.2.2.4.3 Message contents

Message contents are according to TS 38.508-1 [10] clause 4.6 with the following exceptions for Release 15 5G NR UE.

Table 6.2A.2.2.4.3-1: PUSCH-PowerControl

Derivation Path: TS 38.508-1 [10], Table 4.6.3-120			
Information Element	Value/remark	Comment	Condition
PUSCH-PowerControl ::= SEQUENCE {			
p0-AlphaSets SEQUENCE (SIZE (1..maxNrofP0-PUSCH-AlphaSets)) OF SEQUENCE {	1 entry		
P0-PUSCH-AlphaSet[1] SEQUENCE {			
alpha	alpha0		
}			
}			
}			

Table 6.2A.2.2.4.3-2: PUSCH-ConfigCommon

Derivation Path: TS 38.508-1[10], Table 4.6.3-119			
Information Element	Value/remark	Comment	Condition
PUSCH-ConfigCommon ::= SEQUENCE {			
p0-NominalWithGrant	-4		50 MHz
p0-NominalWithGrant	-8		100 MHz
p0-NominalWithGrant	-10		200 MHz
p0-NominalWithGrant	-14		400 MHz
}			

Table 6.2A.2.2.4.3-3: BSR-Config (Rel-15 UE only)

Derivation Path: TS 38.508-1 [10], Table 4.6.3-7			
Information Element	Value/remark	Comment	Condition
BSR-Config ::= SEQUENCE {			
periodicBSR-Timer	infinity		
retxBSR-Timer	sf80		

logicalChannelSR-DelayTimer	Not present		
}			

6.2A.2.2.5 Test requirement

The EIRP derived in step 8 shall be within the range prescribed by the nominal maximum output power and tolerance in the applicable table from Table 6.2A.2.2.5-1 to Table 6.2A.2.2.5-11.

Table 6.2A.2.2.5-1: MPR requirements for Intra-band Contiguous UL CA (Power Class 1, MPR_{narrow})

FFS

Table 6.2A.2.2.5-2: MPR requirements for Intra-band Contiguous UL CA (Power Class 1, single CC MPR requirement)

FFS

Table 6.2A.2.2.5-3: MPR requirements for Intra-band Contiguous UL CA (Power Class 1, MPR_{C_CA})

FFS

Table 6.2A.2.2.5-4: MPR requirements for Intra-band Contiguous UL CA (Power Class 1, Non-contiguous allocation)

FFS

Table 6.2A.2.2.5-5: Test Tolerance (MPR for CA for Power class 1)

FFS

Table 6.2A.2.2.5-6: MPR requirements for Intra-band Contiguous UL CA (Power Class 2, single CC MPR requirement)

FFS

Table 6.2A.2.2.5-7: MPR requirements for Intra-band Contiguous UL CA (Power Class 2, MPR_{C_CA})

FFS

Table 6.2A.2.2.5-8: MPR requirements for Intra-band Contiguous UL CA (Power Class 2, Non-contiguous allocation)

FFS

Table 6.2A.2.2.5-9: Test Tolerance (MPR for CA for Power class 2)

FFS

Table 6.2A.2.2.5-10: MPR requirements for Intra-band Contiguous UL CA (Power Class 3, single CC MPR requirement)

Test ID	Band	Min peak EIRP (dBm)	MPR (dB)	T(MPR) (dB)	Lower limit (dBm)	Upper limit (dBm)
Test requirements for a CA_nXH UL Configuration (Cumulative aggregated BWchannel <= 400MHz)						
1	n257, n258, n261	22.4	0	0	22.4-TT	43
1	n260	20.6	0	0	20.6-TT	43
2	n257, n258, n261	22.4	3	2.0	17.4-TT	43
2	n260	20.6	3	2.0	15.6-TT	43
NOTE 1: TT for each band and accumulative aggregated bandwidth is specified in Table 6.2A.2.1.5-13.						

Table 6.2A.2.2.5-11: MPR requirements for Intra-band Contiguous UL CA (Power Class 3, MPR_{C_CA})

Test ID	Band	Min peak EIRP (dBm)	MPR (dB)	Lower limit for test procedure with UPLF test mode (variant a, Rel-16 and later)		Lower limit for test procedure with PHR (variant b, Rel-15 only)			Upper limit (dBm)
				T(MPR) (dB)	Lower limit (dBm)	MPR + ΔPHR (dB)	T(MPR+ ΔPHR) (dB)	Lower limit PHR (dBm)	
Test requirements for a CA_nXE, nXF_UL_nXE Configuration (400MHz < Cumulative aggregated BWchannel < 800MHz)									
1	n257, n258, n261	22.4	8.7	5	8.7-MP _p -TT	9.9	5	7.5-MP _p -TT	43
1	n260	20.6	8.7	5	6.9-MP _p -TT	9.9	5	5.7-MP _p -TT	43
2	n257, n258, n261	22.4	7.5	5	9.9-MP _p -TT	8.7	5	8.7-MP _p -TT	43
2	n260	20.6	7.5	5	8.1-MP _p -TT	8.7	5	6.9-MP _p -TT	43
3	n257, n258, n261	22.4	8.7	5	8.7-MP _p -TT	9.9	5	7.5-MP _p -TT	43
3	n260	20.6	8.7	5	6.9-MP _p -TT	9.9	5	5.7-MP _p -TT	43
4	n257, n258, n261	22.4	10.7	7	4.7-MP _p -TT	11.9	7	3.5-MP _p -TT	43
4	n260	20.6	10.7	7	2.9-MP _p -TT	11.9	7	1.7-MP _p -TT	43
Test requirements for a CA_nXH, CA_nXI_UL_nXH, CA_nXJ_UL_nXH, CA_nXK_UL_nXH, CA_nXL_UL_nXH, CA_nXM_UL_nXH Configuration (Cumulative aggregated BWchannel ≤ 400MHz)									
1	n257, n258, n261	22.4	5	4	13.4-MP _p -TT	6.2	5	11.2-MP _p -TT	43
1	n260	20.6	5	4	11.6-MP _p -TT	6.2	5	9.4-MP _p -TT	43
2	n257, n258, n261	22.4	6.5	5	10.9-MP _p -TT	7.7	5	9.7-MP _p -TT	43
2	n260	20.6	6.5	5	9.1-MP _p -TT	7.7	5	7.9-MP _p -TT	43
3	n257, n258, n261	22.4	9	5	8.4-MP _p -TT	10.2	7	5.2-MP _p -TT	43
3	n260	20.6	9	5	6.6-MP _p -TT	10.2	7	3.4-MP _p -TT	43
NOTE 1: MBp is the Multiband Relaxation factor declared by the UE for the tested band in Table A.4.3.9-2 of TS 38.508-2. This declaration shall fulfil the requirements in clause 6.2.1.1.3.3.									
NOTE 2: ΔPHR is defined in Table 6.2A.2.1.4.2-1.									
NOTE 3: TT for each band and accumulative aggregated bandwidth is specified in Table 6.2A.2.1.5-13.									

6.2A.2.3 UE maximum output power reduction for CA (4UL CA)

Editor's note: The following aspects are either missing or not yet determined:

- The UPLF test mode is applicable to UEs Release 16 and forward.
- This test case is incomplete for Power classes 1, 2, 4 Release 15.
- For a transition period until RAN#99, the stability and repeatability of test procedure with PHR (variant b) for Rel-15 UEs is under evaluation.
- Whether additional check is needed in the test procedure to ensure UE continues transmissions on the SCell is FFS
- Measurement Uncertainties and Test Tolerances are FFS for power class 1, 2 and 4.
- Measurement Uncertainties and Test Tolerances for intra-band contiguous CA supporting aggregated BW > 400MHz and intra-band non-contiguous CA are TBD.
- The test points for higher bandwidth classes with testability problem need an update to decrease the UL bandwidth until they become testable.
- This test case is incomplete for intra-band non-contiguous CA

6.2A.2.3.1 Test purpose

The number of RB identified in 6.2.2.3 is based on meeting the requirements for the maximum power reduction (MPR) due to Cubic Metric (CM).

6.2A.2.3.2 Test applicability

The requirements of this test apply to all types of NR UE release 15 and forward supporting 3UL CA.

6.2A.2.3.3 Minimum conformance requirements

The normative reference for this requirement is TS 38.101-2 [3] clause 6.2A.2.

6.2A.2.3.4 Test description

6.2A.2.3.4.1 Initial conditions

Initial conditions are a set of test configurations the UE needs to be tested in and the steps for the SS to take with the UE to reach the correct measurement state.

The initial test configurations consist of environmental conditions, test frequencies, and CC combinations based on NR operating bands specified in clause 5.5A. All of these configurations shall be tested with applicable test parameters for each CA configuration and subcarrier spacing, are shown in Table 6.2A.2.1.4.1-1. The details of the uplink reference measurement channels (RMCs) are specified in Annexes A.2. Configurations of PDSCH and PDCCH before measurement are specified in Annex C.2.

Table 6.2A.2.3.4.1-1: Intra-band Contiguous UL CA Test Configuration Table (Power Class 1, MPR_{narrow})

FFS

Table 6.2A.2.3.4.1-2: Intra-band Contiguous UL CA Test Configuration Table (Power Class 1, single CC MPR requirement)

FFS

Table 6.2A.2.3.4.1-3: Intra-band Contiguous UL CA Test Configuration Table (Power Class 1, MPR_{C_CA})

FFS

Table 6.2A.2.3.4.1-4: Intra-band Contiguous UL CA Test Configuration Table (Power Class 1, Non-contiguous allocation)

FFS

Table 6.2A.2.3.4.1-5: Intra-band Contiguous UL CA Test Configuration Table (Power Class 2, 3 and 4, single CC MPR requirement)

Default Conditions						
Test Environment as specified in TS 38.508-1 [10] clause 4.1				Normal		
Test Frequencies as specified in TS 38.508-1 [10] clause 4.3.1.2.3 for different CA bandwidth classes				Low range, High range		
Test CC Combination setting (aggregated BW of the CA configuration) as specified in for the CA Configuration across bandwidth combination sets supported by the UE				Highest aggregated channel bandwidth of the CA configuration		
Test SCS as specified in Table 5.3.5-1				120 kHz		
Test Parameters						
Test ID	CC & Mapping (NOTE 2)	ChBw(MHz)	Test frequency	DL RB allocation	UL Modulation	UL RB allocation
Default Test Settings for a CA_nXH Configuration (Cumulative aggregated BWchannel <= 400MHz)						

1	PCC/CC1	Default	Default	-	DFT-s-OFDM QPSK	Inner_Full
	SCC/CC2				-	-
	SCC/CC3				-	-
	SCC/CC4				-	-
2	PCC/CC1	Default	Default	-	DFT-s-OFDM QPSK	Outer_Full
	SCC/CC2				-	-
	SCC/CC3				-	-
	SCC/CC4				-	-
NOTE 1: The specific configuration of each RB allocation is defined in Table 6.1-1.						
NOTE 2: PCC/CC _i and SCC/CC _j means PCC is on component carrier CC _i and SCC is on component carrier CC _j , with CC _i or CC _j frequencies defined in TS38.508-1 [10].						

Table 6.2A.2.3.4.1-6: Intra-band Contiguous UL CA Test Configuration Table (Power Class 2, 3 and 4, MPR_{C,CA})

Default Conditions						
Test Environment as specified in TS 38.508-1 [10] clause 4.1				Normal		
Test Frequencies as specified in TS 38.508-1 [10] clause 4.3.1.2.3 and 4.3.1.2.4 for different CA bandwidth classes				For intra-band contiguous CA: Mid range. For intra-band non-contiguous CA: FFS		
Test CC Combination setting (aggregated BW of the CA configuration) as specified in TS 38.508-1 [10] clause 4.3.1.2.3 and 4.3.1.2.4 for the CA Configuration across bandwidth combination sets supported by the UE				Highest aggregated channel bandwidth of the CA configuration		
Test SCS as specified in Table 5.3.5-1				120 kHz		
Test Parameters						
Test ID	CC & Mapping (NOTE 2)	ChBw(MHz)	Test frequency	DL RB allocation	UL Modulation	UL RB allocation
Default Test Settings for a CA_nXF Configuration (400MHz <= Cumulative aggregated BWchannel <= 800MHz)						
1	PCC/CC1				DFT-s-OFDM 16QAM	Outer_Full
	SCC1/CC2				DFT-s-OFDM 16QAM	Outer_Full
	SCC2/CC3				DFT-s-OFDM 16QAM	Outer_Full
	SCC3/CC4				DFT-s-OFDM 16QAM	Outer_Full
2	PCC/CC1				CP-OFDM QPSK	Outer_Full
	SCC1/CC2				CP-OFDM QPSK	Outer_Full
	SCC2/CC3				CP-OFDM QPSK	Outer_Full
	SCC3/CC4				CP-OFDM QPSK	Outer_Full
3	PCC/CC1				CP-OFDM 16QAM	Outer_Full
	SCC1/CC2				CP-OFDM 16QAM	Outer_Full
	SCC2/CC3				CP-OFDM 16QAM	Outer_Full
	SCC3/CC4				CP-OFDM 16QAM	Outer_Full
4	PCC/CC1				CP-OFDM 64QAM	Outer_Full
	SCC1/CC2				CP-OFDM 64QAM	Outer_Full
	SCC2/CC3				CP-OFDM 64QAM	Outer_Full
	SCC3/CC4				CP-OFDM 64QAM	Outer_Full
Default Test Settings for a CA_nXI Configuration (Cumulative aggregated BWchannel ≤ 400MHz)						

1	PCC/CC1	Default	Default	-	CP-OFDM QPSK	Outer_Full
	SCC/CC2				CP-OFDM QPSK	Outer_Full
	SCC2/CC3				CP-OFDM QPSK	Outer_Full
	SCC3/CC4				CP-OFDM QPSK	Outer_Full
2	PCC/CC1				CP-OFDM 16QAM	Outer_Full
	SCC/CC2				CP-OFDM 16QAM	Outer_Full
	SCC2/CC3				CP-OFDM 16QAM	Outer_Full
	SCC3/CC4				CP-OFDM 16QAM	Outer_Full
3	PCC/CC1				CP-OFDM 64QAM	Outer_Full
	SCC/CC2				CP-OFDM 64QAM	Outer_Full
	SCC2/CC3				CP-OFDM 64QAM	Outer_Full
	SCC3/CC4				CP-OFDM 64QAM	Outer_Full
<p>NOTE 1: The specific configuration of each RB allocation is defined in Table 6.1-1. NOTE 2: PCC/CC_i and SCC/CC_j means PCC is on component carrier CC_i and SCC is on component carrier CC_j, with CC_i or CC_j frequencies defined in TS38.508-1 [10].</p>						

1. Connection between SS and UE is shown in TS 38.508-1 [10] Annex A, Figure A.3.3.1.1 for TE diagram and Figure A.3.4.1.1 for UE diagram.
2. The parameter settings for the cell are set up according to TS 38.508-1 [10] clause 4.4.3.
3. Downlink signals are initially set up according to Annex C, and uplink signals according to Annex G.
4. The UL Reference Measurement channels are set according to Table 6.2A.2.3.4.1-1 to Table 6.2A.2.3.4.1-6.
5. Propagation conditions are set according to Annex B.0.
6. Ensure the UE is in state RRC_CONNECTED with generic procedure parameters Connectivity *NR*, Connected without release *On*, Test Mode *On* and Test Loop Function *On* according to TS 38.508-1 [10] clause 4.5. Message contents are defined in clause 6.2A.2.3.4.3.

6.2A.2.3.4.2 Test procedure

1. Configure SCC according to Annex C.0, C.1, C.2 and Annex C.3.0 for all downlink physical channels
2. The SS shall configure SCC as per TS 38.508-1 [10] clause 5.5.1 Procedure to configure SCC(s) for NR RF CA testing. Message contents are defined in clause 6.2A.2.2.4.3.
3. Apply the test step based on the 5G NR UE Release:
 - 3a. For Release 16 and forward 5G NR UEs supporting the UPLF test mode: SS applies a backoff on the PCell power by activating the UE Power Limit Function (UPLF). The ACTIVATE POWER LIMIT REQUEST procedure is performed as specified in TS 38.508-1 [10] clause 4.9.32 using TOTAL NR AGGREGATED BANDWIDTH and PCELL NR bandwidth as per Test CC Combination setting. UE shall transmit ACTIVATE POWER LIMIT RESPONSE to SS. Go to step 4.
 - 3b. For Release 15 5G NR UEs: No action.
 - 3c. For testing single CC MPR requirement: No action.
4. SS activates SCC by sending the activation MAC CE (Refer TS 38.321, clauses 5.9, 6.1.3.10). Wait for at least 2 seconds (Refer TS 38.133[25], clause 9.3).

5. SS sends uplink scheduling information for each UL HARQ process via PDCCH DCI format 0_1 for C_RNTI to schedule the UL RMC according to Table 6.2A.2.2.4.1-1 to Table 6.2A.2.1.4.1-6. Since the UL has no payload and no loopback data to send the UE sends uplink MAC padding bits on the UL RMC.
6. Set the UE in the Tx beam peak direction found with a 3D EIRP scan as performed in Annex K.1.1. Allow at least BEAM_SELECT_WAIT_TIME (NOTE 1) for the UE Tx beam selection to complete.
7. Apply the test step based on the 5G NR UE Release:
 - 7a. For Release 16 and forward 5G NR UEs: Send continuously uplink power control "up" commands in every uplink scheduling information to the UE; allow at least 200 msec starting from the first TPC command in this step to ensure that the UE transmits at its maximum output power. Allow at least BEAM_SELECT_WAIT_TIME (NOTE 1) for the UE Tx beam selection to complete.
 - 7b. For Release 15 5G NR UEs: Send uplink power control commands in uplink scheduling information to the UE per UL CC until the Power Headroom Report (PHR) from the UE for each UL CC is at the target value according to Table 6.2A.2.2.4.2-1; allow at least 200 ms for the UE to reach maximum output power. Allow at least BEAM_SELECT_WAIT_TIME (NOTE 1) for the UE Tx beam selection to complete.

Table 6.2A.2.3.4.2-1: Power target values per UL CC for test procedure using PHR

FFS

- 7c. For testing single CC MPR requirement: Send continuously uplink power control "up" commands in every uplink scheduling information to the UE; allow at least 200 msec starting from the first TPC command in this step to ensure that the UE transmits at its maximum output power. Allow at least BEAM_SELECT_WAIT_TIME (NOTE 1) for the UE Tx beam selection to complete.
8. SS activates the UE Beamlock Function (UBF) by performing the procedure as specified in TS 38.508-1 [10] clause 4.9.2 using condition Tx only.
9. Measure UE EIRP in the Tx beam peak direction in the accumulative aggregated channel bandwidth of the radio access mode according to the test configuration, which shall meet the requirements described in 6.2A.2.1.5. EIRP test procedure is defined in Annex K.1.3. The measuring duration is one active uplink subframe. EIRP is calculated considering both polarizations, theta and phi.
10. Apply the test step based on the 5G NR UE Release:
 - 10a. For Release 16 and forward 5G NR UEs supporting the UPLF test mode: SS deactivates the UE Power Limit Function (UPLF) by performing the DEACTIVATE POWER LIMIT REQUEST procedure as specified in TS 38.508-1 [10] clause 4.9.33.
 - 10b. For Release 15 5G NR UEs: No action.
 - 10c. For testing single CC MPR requirement: No action.
11. SS deactivates the UE Beamlock Function (UBF) by performing the procedure as specified in TS 38.508-1 [10] clause 4.9.3.

NOTE 1: The BEAM_SELECT_WAIT_TIME default value is defined in Annex K.

NOTE 2: When switching to DFT-s-OFDM waveform, as specified in Table 6.2A.2.2.4.1-1 to Table 6.2A.2.2.4.1-6, send an NR RRCReconfiguration message according to TS 38.508-1 [10] clause 4.6.3 Table 4.6.3-118 PUSCH-Config with TRANSFORM_PRECODER_ENABLED condition.

6.2A.2.3.4.3 Message contents

Message contents are according to TS 38.508-1 [10] clause 4.6 with the following exceptions for Release 15 5G NR UE.

Table 6.2A.2.3.4.3-1: PUSCH-PowerControl

Derivation Path: TS 38.508-1 [10], Table 4.6.3-120			
Information Element	Value/remark	Comment	Condition
PUSCH-PowerControl ::= SEQUENCE {			

p0-AlphaSets SEQUENCE (SIZE (1..maxNrofP0-PUSCH-AlphaSets)) OF SEQUENCE {	1 entry		
P0-PUSCH-AlphaSet[1] SEQUENCE {			
alpha	alpha0		
}			
}			

Table 6.2A.2.3.4.3-2: PUSCH-ConfigCommon

Derivation Path: TS 38.508-1[10], Table 4.6.3-119			
Information Element	Value/remark	Comment	Condition
PUSCH-ConfigCommon ::= SEQUENCE {			
p0-NominalWithGrant	-4		50 MHz
p0-NominalWithGrant	-8		100 MHz
p0-NominalWithGrant	-10		200 MHz
p0-NominalWithGrant	-14		400 MHz
}			

Table 6.2A.2.3.4.3-3: BSR-Config (Rel-15 UE only)

Derivation Path: TS 38.508-1 [10], Table 4.6.3-7			
Information Element	Value/remark	Comment	Condition
BSR-Config ::= SEQUENCE {			
periodicBSR-Timer	infinity		
retxBSR-Timer	sf80		
logicalChannelSR-DelayTimer	Not present		
}			

6.2A.2.3.5 Test requirement

The EIRP derived in step 8 shall be within the range prescribed by the nominal maximum output power and tolerance in the applicable table from Table 6.2A.2.2.5-1 to Table 6.2A.2.2.5-11.

Table 6.2A.2.3.5-1: MPR requirements for Intra-band Contiguous UL CA (Power Class 1, MPR_{narrow})

FFS

Table 6.2A.2.3.5-2: MPR requirements for Intra-band Contiguous UL CA (Power Class 1, single CC MPR requirement)

FFS

Table 6.2A.2.3.5-3: MPR requirements for Intra-band Contiguous UL CA (Power Class 1, MPR_{C_CA})

FFS

Table 6.2A.2.3.5-4: MPR requirements for Intra-band Contiguous UL CA (Power Class 1, Non-contiguous allocation)

FFS

Table 6.2A.2.3.5-5: Test Tolerance (MPR for CA for Power class 1)

FFS

Table 6.2A.2.3.5-6: MPR requirements for Intra-band Contiguous UL CA (Power Class 2, single CC MPR requirement)

Table 6.2A.2.3.5-7: MPR requirements for Intra-band Contiguous UL CA (Power Class 2, MPR_{C_CA})

FFS

Table 6.2A.2.3.5-8: MPR requirements for Intra-band Contiguous UL CA (Power Class 2, Non-contiguous allocation)

FFS

Table 6.2A.2.3.5-9: Test Tolerance (MPR for CA for Power class 2)

FFS

Table 6.2A.2.3.5-10: MPR requirements for Intra-band Contiguous UL CA (Power Class 3, single CC MPR requirement)

Test ID	Band	Min peak EIRP (dBm)	MPR (dB)	T(MPR) (dB)	Lower limit (dBm)	Upper limit (dBm)
Test requirements for a CA_nXH UL Configuration (Cumulative aggregated BWchannel <= 400MHz)						
1	n257, n258, n261	22.4	0	0	22.4-TT	43
1	n260	20.6	0	0	20.6-TT	43
2	n257, n258, n261	22.4	3	2.0	17.4-TT	43
2	n260	20.6	3	2.0	15.6-TT	43

NOTE 1: TT for each band and accumulative aggregated bandwidth is specified in Table 6.2A.2.1.5-13.

Table 6.2A.2.3.5-11: MPR requirements for Intra-band Contiguous UL CA (Power Class 3, MPR_{C_CA})

Test ID	Band	Min peak EIRP (dBm)	MPR (dB)	Lower limit for test procedure with UPLF test mode (variant a, Rel-16 and later)		Lower limit for test procedure with PHR (variant b, Rel-15 only)			Upper limit (dBm)
				T(MPR) (dB)	Lower limit (dBm)	MPR + ΔPHR (dB)	T(MPR+ ΔPHR) (dB)	Lower limit PHR (dBm)	
Test requirements for a CA_nXF Configuration (400MHz < Cumulative aggregated BWchannel < 800MHz)									
1	n257, n258, n261	22.4	8.7	5	8.7-MP _p -TT	9.7	5	7.7-MP _p -TT	43
1	n260	20.6	8.7	5	6.9-MP _p -TT	9.7	5	5.9-MP _p -TT	43
2	n257, n258, n261	22.4	7.5	5	9.9-MP _p -TT	8.5	5	8.9-MP _p -TT	43
2	n260	20.6	7.5	5	8.1-MP _p -TT	8.5	5	7.1-MP _p -TT	43
3	n257, n258, n261	22.4	8.7	5	8.7-MP _p -TT	9.7	5	7.7-MP _p -TT	43
3	n260	20.6	8.7	5	6.9-MP _p -TT	9.7	5	5.9-MP _p -TT	43
4	n257, n258, n261	22.4	10.7	7	4.7-MP _p -TT	11.7	7	3.7-MP _p -TT	43
4	n260	20.6	10.7	7	2.9-MP _p -TT	11.7	7	1.9-MP _p -TT	43
Test requirements for a CA_XI, CA_nXJ_UL_nXI, CA_nXK_UL_nXI, CA_nXL_UL_nXI, CA_nXM_UL_nXI (Cumulative aggregated BWchannel ≤ 400MHz)									
1	n257, n258, n261	22.4	5	4	13.4-MP _p -TT	6	5	11.4-MP _p -TT	43
1	n260	20.6	5	4	11.6-MP _p -TT	6	5	9.6-MP _p -TT	43
2	n257, n258, n261	22.4	6.5	5	10.9-MP _p -TT	7.5	5	9.9-MP _p -TT	43
2	n260	20.6	6.5	5	9.1-MP _p -TT	7.5	5	8.1-MP _p -TT	43
3	n257, n258, n261	22.4	9	5	8.4-MP _p -TT	10	5	7.4-MP _p -TT	43
3	n260	20.6	9	5	6.6-MP _p -TT	10	5	5.6-MP _p -TT	43

NOTE 1: MBp is the Multiband Relaxation factor declared by the UE for the tested band in Table A.4.3.9-2 of TS 38.508-2. This declaration shall fulfil the requirements in clause 6.2.1.1.3.3.
 NOTE 2: ΔPHR is defined in Table 6.2A.2.1.4.2-1.
 NOTE 3: TT for each band and accumulative aggregated bandwidth is specified in Table 6.2A.2.1.5-13.

6.2A.2.4 UE maximum output power reduction for CA (5UL CA)

FFS

6.2A.2.5 UE maximum output power reduction for CA (6UL CA)

FFS

6.2A.2.6 UE maximum output power reduction for CA (7UL CA)

FFS

6.2A.2.7 UE maximum output power reduction for CA (8UL CA)

FFS

6.2A.3 UE maximum output power with additional requirements for CA

6.2A.3.0 Minimum conformance requirements

6.2A.3.0.1 General

Additional emission requirements can be signalled by the network with network signalling value indicated by the field *additionalSpectrumEmission*. To meet these additional requirements, additional maximum power reduction (A-MPR) is allowed for the maximum output power as specified in clause 6.2A.1.0. Unless stated otherwise, an A-MPR of 0 dB shall be used. Unless otherwise stated, the allowed total back off is maximum of A-MPR and MPR specified in clause 6.2A.2.0.

For intra-band contiguous aggregation with the UE configured for transmissions on two serving cells, the maximum output power reduction specified in Table 6.2A.3.0.1-1 is allowed for all serving cells of the applicable uplink contiguous CA configurations.

Table 6.2A.3.0.1-1 specifies the additional requirements and allowed A-MPR with corresponding network signalling label and operating band. The mapping between network signalling labels and the *additionalSpectrumEmission* IE defined in TS 38.331 [13] is specified in Table 6.2A.3.0.1-2. Unless otherwise stated, the allowed total back off is maximum of A-MPR and MPR specified in clause 6.2A.2.0.

Table 6.2A.3.0.1-1: Additional maximum power reduction (A-MPR)

Network Signalling value	Requirements (clause)	NR Band	Channel bandwidth (MHz)	Resources Blocks (N_{RB})	A-MPR (dB)
CA_NS_200					N/A
CA_NS_201		n258			6.2A.3.0.2
CA_NS_202	6.5A.3.3.0	n257, n258			6.2A.3.0.3
CA_NS_203	6.5A.3.3.0	n258			6.2A.3.0.4
CA_NS_205	6.5A.3.3.0	n257, n258			6.2A.3.0.6
NOTE: CA_NS_201 is obsolete, the associated additional spurious emission requirements are not applicable.					

Table 6.2A.3.0.1-2: Value of *additionalSpectrumEmission*

NR Band	Value of <i>additionalSpectrumEmission</i> / NS number							
	0	1	2	3	4	5	6	7

n257	CA_NS_200	CA_NS_202	CA_NS_205				
n258	CA_NS_200	CA_NS_201	CA_NS_202	CA_NS_203	CA_NS_205		
n259	CA_NS_200						
n260	CA_NS_200						
n261	CA_NS_200						

NOTE 1: *additionalSpectrumEmission* corresponds to an information element of the same name defined in clause 6.3.2 of TS 38.331 [13].

NOTE 2: CA_NS_201 is obsolete, the associated additional spurious emission requirements are not applicable.

6.2A.3.0.2 Void

6.2A.3.0.3 A-MPR for CA_NS_202

6.2A.3.0.3.1 A-MPR for CA_NS_202 for power class 1

For intra-band contiguous UL CA with contiguous RB allocation, A-MPR for CA_NS_202 shall be 11.0 dB.

For intra-band contiguous UL CA with non-contiguous RB allocation or non-contiguous UL CA, A-MPR for CA_NS_202 shall be 13.0 dB if offset frequency < $BW_{intraCA}$, 11.0 dB otherwise.

- Offset frequency is defined as the frequency from the upper edge of the protected frequency range i.e. 24 GHz to the lower edge of the aggregated channel bandwidth of the configured UL CA.

6.2A.3.0.3.2 A-MPR for CA_NS_202 for power class 2

For intra-band contiguous CA, A-MPR for CA_NS_202 specified in sub-clause 6.2A.3.0.3.3 applies.

6.2A.3.0.3.3 A-MPR for CA_NS_202 for power class 3

For intra-band contiguous UL CA with contiguous RB allocation, A-MPR for CA_NS_202 shall be 5.0 dB if offset frequency < $BW_{intraCA}$, 2.0 dB otherwise.

For intra-band contiguous UL CA with non-contiguous RB allocation or non-contiguous UL CA, A-MPR for CA_NS_202 shall be 8.0 dB if offset frequency < $BW_{intraCA}$, 2.0 dB otherwise.

- Offset frequency is defined as the frequency from the upper edge of the protected frequency range i.e. 24 GHz to the lower edge of the aggregated channel bandwidth of the configured UL CA.

6.2A.3.0.3.4 A-MPR for CA_NS_202 for power class 4

For intra-band contiguous CA, A-MPR for CA_NS_202 specified in sub-clause 6.2A.3.0.3.3 applies.

6.2A.3.0.3.5 A-MPR for CA_NS_202 for power class 5

For intra-band contiguous CA, A-MPR for CA_NS_202 specified in sub-clause 6.2A.3.0.3.3 applies.

6.2A.3.0.3.6 A-MPR for CA_NS_202 for power class 6

For intra-band contiguous CA, A-MPR for CA_NS_202 specified in sub-clause 6.2A.3.0.3.3 applies.

6.2A.3.0.4 A-MPR for CA_NS_203

6.2A.3.0.4.1 A-MPR for CA_NS_203 for power class 1

For intra-band contiguous CA, A-MPR for CA_NS_203 shall be 6.5 dB, if Offset frequency < $BW_{Channel_CA}$ of the UL CA configuration, 0.0 dB, otherwise

The Offset frequency is defined as the frequency from 24.25 GHz to the lower edge of the lowest CC among the configured UL CA.

6.2A.3.0.4.2 A-MPR for CA_NS_203 for power class 2

For intra-band contiguous CA, A-MPR specified in sub-clause 6.2A.3.0.4.3 applies.

6.2A.3.0.4.3 A-MPR for CA_NS_203 for power class 3

For intra-band contiguous CA, A-MPR for CA_NS_203 shall be 2.5 dB, if Offset frequency $< BW_{\text{Channel_CA}}$ of the UL CA configuration, 0.0 dB otherwise.

The Offset frequency is defined as the frequency from 24.25 GHz to the lower edge of the lowest CC among the configured UL CA.

6.2A.3.0.4.4 A-MPR for CA_NS_203 for power class 4

For intra-band contiguous CA, A-MPR specified in sub-clause 6.2A.3.0.4.3 applies.

6.2A.3.0.4.5 A-MPR for CA_NS_203 for power class 5

For intra-band contiguous CA, A-MPR specified in sub-clause 6.2A.3.0.4.3 applies.

6.2A.3.0.4.6 A-MPR for CA_NS_203 for power class 6

For intra-band contiguous CA, A-MPR specified in sub-clause 6.2A.3.0.4.3 applies.

The normative reference for this requirement is TS 38.101-2 [3] clause 6.2A.3.

6.2A.3.0.5 [Reserved]

6.2A.3.0.6 A-MPR for CA_NS_205

6.2A.3.0.6.1 A-MPR for CA_NS_205 for power class 1

For intra-band contiguous UL CA with single contiguous RB allocation, A-MPR for CA_NS_205 shall be 9.0 dB if offset frequency $< BW_{\text{intraCA}}$, 6.0 dB otherwise.

For intra-band contiguous UL CA with non-contiguous RB allocation or non-contiguous UL CA, A-MPR for CA_NS_205 shall be 13.0 dB if offset frequency $< BW_{\text{intraCA}}$, 6.0 dB otherwise.

Offset frequency is defined as the frequency from the upper edge of the protected frequency range i.e. 24 GHz to the lower edge of the aggregated channel bandwidth of the configured UL CA.

6.2A.3.0.6.2 A-MPR for CA_NS_205 for power class 2

For UL CA, A-MPR for CA_NS_205 specified in sub-clause 6.2A.3.0.6.3 applies.

6.2A.3.0.6.3 A-MPR for CA_NS_205 for power class 3

For intra-band contiguous UL CA with single contiguous RB allocation, A-MPR for CA_NS_205 shall be 5.0 dB if offset frequency $< BW_{\text{intraCA}}$, 0.0 dB otherwise.

For intra-band contiguous UL CA with non-contiguous RB allocation or non-contiguous UL CA, A-MPR for CA_NS_205 shall be 8.0 dB if offset frequency $< BW_{\text{intraCA}}$, 0.0 dB otherwise.

Offset frequency is defined as the frequency from the upper edge of the protected frequency range i.e. 24 GHz to the lower edge of the aggregated carrier bandwidth of the configured UL CA.

6.2A.3.0.6.4 A-MPR for CA_NS_205 for power class 4

For UL CA, A-MPR for CA_NS_205 specified in sub-clause 6.2A.3.0.6.3 applies.

6.2A.3.0.6.5 A-MPR for CA_NS_205 for power class 5

For UL CA, A-MPR for CA_NS_205 specified in sub-clause 6.2A.3.0.6.3 applies.

6.2A.3.0.6.6 A-MPR for CA_NS_205 for power class 6

For UL CA, A-MPR for CA_NS_205 specified in sub-clause 6.2A.3.0.6.3 applies.

6.2A.3.1 UE maximum output power with additional requirements for CA (2UL CA)

Editor's note: The following aspects are either missing or not yet determined:

- The UPLF test mode is applicable to UEs Release 16 and forward.
- This test case is incomplete for Power classes other than 1, 3, 5, 6 and CA other than intra-band contiguous.
For a transition period until RAN#99, the stability and repeatability of test procedure with PHR (variant b) for Rel-15 UEs is under evaluation.
- Whether additional check is needed in the test procedure to ensure UE continues transmissions on the SCell is FFS
- Measurement Uncertainties and Test Tolerances are FFS for power class other than 1, 3, 5, 6 and CA other than intra-band contiguous.
- Measurement Uncertainties and Test Tolerances for intra-band contiguous CA supporting aggregated BW > 400MHz and intra-band non-contiguous CA are TBD.
- The test points for higher bandwidth classes with testability problem need an update to decrease the UL bandwidth until they become testable.

6.2A.3.1.1 Test purpose

Additional emission requirements for CA can be signalled by the network. Each additional emission requirement is associated with a unique network signalling (NS) value indicated in RRC signalling by an NR frequency band number of the applicable operating band and an associated value in the field *additionalSpectrumEmission*. Throughout this specification, the notion of indication or signalling of an NS value refers to the corresponding indication of an NR frequency band number of the applicable operating band, the IE *freqBandIndicatorNR* and an associated value of *additionalSpectrumEmission* in the relevant RRC information elements [6].

To meet the additional requirements, additional maximum power reduction (A-MPR) is allowed for the CA maximum output power as specified in Table 6.2A.1. Unless stated otherwise, the total reduction to UE maximum output power is $\max(\text{MPR}, \text{A-MPR})$ where MPR is defined in clause 6.2A.2.

6.2A.3.1.2 Test applicability

The requirements of this test apply to all types of NR UE release 15 and forward supporting 2UL CA.

6.2A.3.1.3 Minimum conformance requirements

The normative reference for this requirement is TS 38.101-2 [3] clause 6.2A.3.

6.2A.3.1.4 Test description

6.2A.3.1.4.1 Initial conditions

Initial conditions are a set of test configurations the UE needs to be tested in and the steps for the SS to take with the UE to reach the correct measurement state.

The initial test configurations consist of environmental conditions, test frequencies, and CC combinations based on NR operating bands specified in clause 5.5A. All of these configurations shall be tested with applicable test parameters for each CA configuration and subcarrier spacing, are shown in Table 6.2A.3.1.4.1-1 and Table 6.2A.3.1.4.1-4. The details

of the uplink reference measurement channels (RMCs) are specified in Annexes A.2. Configurations of PDSCH and PDCCH before measurement are specified in Annex C.2.

Table 6.2A.3.1.4.1-1: Test Configuration Table for CA_NS_202 (Power Class 1)

Initial Conditions				
Test Environment as specified in TS 38.508-1 [10] clause 4.1		Normal		
Test Frequencies as specified in TS 38.508-1 [10] clause 4.3.1.2.3 for different CA bandwidth classes		Low range, High range		
Test CC combination setting as specified in TS 38.508-1 [10] clause 4.3.1.2.3 for the CA Configuration across bandwidth combination sets supported by the UE.		Maximum aggregated BW (contiguous CA)		
Test SCS as specified in Table 5.3.5-1		120kHz		
Test Parameters				
Test ID	CC	Downlink Configuration	UL Modulation	UL RB allocation (NOTE 1)
1	PCC	-	DFT-s-OFDM QPSK	Outer_Full
	SCCs		DFT-s-OFDM QPSK	Outer_Full
2	PCC		DFT-s-OFDM 64QAM	Outer_Full
	SCCs		DFT-s-OFDM 64QAM	Outer_Full
NOTE 1: The specific configuration of each RB allocation is defined in Table 6.1-2 for PC1.				
NOTE 2: Number of DL CCs shall be configured the same as number of UL CCs. The requirements are applicable as per 5.3A.4: "The requirements are applicable only when Uplink CCs are configured within the frequency range between lower edge of lowest downlink component carrier and upper edge of highest downlink component carrier".				

Table 6.2A.3.1.4.1-1b: Test Configuration Table for CA_NS_202 (Power Class 2, 3, 4, 5, 6)

Initial Conditions				
Test Environment as specified in TS 38.508-1 [10] clause 4.1		Normal		
Test Frequencies as specified in TS 38.508-1 [10] clause 4.3.1.2.3 for different CA bandwidth classes		Low range, High range		
Test CC combination setting as specified in TS 38.508-1 [10] clause 4.3.1.2.3 for the CA Configuration across bandwidth combination sets supported by the UE.		Maximum aggregated BW (contiguous CA) with cumulative aggregated BW <= 400MHz		
Test SCS as specified in Table 5.3.5-1		120kHz		
Test Parameters				
Test ID	CC	Downlink Configuration	UL Modulation	UL RB allocation (NOTE 1)
1	PCC	-	DFT-s-OFDM QPSK	Inner_Full for PC2, PC3 PC4, PC5, PC6
	SCCs		-	-
NOTE 1: The specific configuration of each RB allocation is defined in Table 6.1-1 for PC2, PC3, PC4, PC5 and PC6.				
NOTE 2: Number of DL CCs shall be configured the same as number of UL CCs. The requirements are applicable as per 5.3A.4: "The requirements are applicable only when Uplink CCs are configured within the frequency range between lower edge of lowest downlink component carrier and upper edge of highest downlink component carrier".				

Table 6.2A.3.1.4.1-2: Test Configuration Table for CA_NS_203 (Power Class 1, 2, 3, 4, 5 and 6)

Initial Conditions	
Test Environment as specified in TS 38.508-1 [10] clause 4.1	Normal
Test Frequencies as specified in TS 38.508-1 [10] clause 4.3.1.2.3 for different CA bandwidth classes	Low range

Test CC combination setting as specified in TS 38.508-1 [10] clause 4.3.1.2.3 for the CA Configuration across bandwidth combination sets supported by the UE.		Maximum aggregated BW (contiguous CA) with cumulative aggregated BW <= 400MHz		
Test SCS as specified in Table 5.3.5-1		120kHz		
Test Parameters				
Test ID	CC	Downlink Configuration	UL Modulation	UL RB allocation (NOTE 1)
1	PCC	-	DFT-s-OFDM QPSK	Inner_Full for PC2, PC3 PC4, PC5, PC6 Inner_Full_Region1 for PC1
	SCCs		-	-
NOTE 1: The specific configuration of each RB allocation is defined in Table 6.1-1 for PC2, PC3, PC4, PC5, PC6 or Table 6.1-2 for PC1.				
NOTE 2: Number of DL CCs shall be configured the same as number of UL CCs. The requirements are applicable as per 5.3A.4: " <i>The requirements are applicable only when Uplink CCs are configured within the frequency range between lower edge of lowest downlink component carrier and upper edge of highest downlink component carrier</i> ".				

Table 6.2A.3.1.4.1-3: [Reserved]

Table 6.2A.3.1.4.1-4: Test Configuration Table for CA_NS_205 (Power class 1)

Initial Conditions				
Test Environment as specified in TS 38.508-1 [10] clause 4.1		Normal		
Test Frequencies as specified in TS 38.508-1 [10] clause 4.3.1.2.3 for different CA bandwidth classes		Low range		
Test CC combination setting as specified in TS 38.508-1 [10] clause 4.3.1.2.3 for the CA Configuration across bandwidth combination sets supported by the UE.		Maximum aggregated BW (contiguous CA) with cumulative aggregated BW >= 250MHz		
Test SCS as specified in Table 5.3.5-1		120kHz		
Test Parameters				
Test ID	CC	Downlink Configuration	UL Modulation	UL RB allocation (NOTE 1)
1	PCC	-	DFT-s-OFDM QPSK	Outer_Full
	SCCs		DFT-s-OFDM QPSK	Outer_Full
NOTE 1: The specific configuration of each RB allocation is defined in Table 6.1-2 for PC1.				
NOTE 2: Number of DL CCs shall be configured the same as number of UL CCs. The requirements are applicable as per 5.3A.4: " <i>The requirements are applicable only when Uplink CCs are configured within the frequency range between lower edge of lowest downlink component carrier and upper edge of highest downlink component carrier</i> ".				

1. Connection between SS and UE is shown in TS 38.508-1 [10] Annex A, Figure A.3.3.1.1 for TE diagram and Figure A.3.4.1.1 for UE diagram.
2. The parameter settings for the cell are set up according to TS 38.508-1 [10] clause 4.4.3.
3. Downlink signals are initially set up according to Annex C, and uplink signals according to Annex G.
4. The UL Reference Measurement channels are set according to Table 6.2A.3.1.4.1-1 to Table 6.2A.3.1.4.1-4.
5. Propagation conditions are set according to Annex B.0.
6. Ensure the UE is in state RRC_CONNECTED with generic procedure parameters Connectivity *NR*, Connected without release *On*, Test Mode *On* and Test Loop Function *On* according to TS 38.508-1 [10] clause 4.5. Message contents are defined in clause 6.2A.3.1.4.3.

6.2A.3.1.4.2 Test procedure

1. Configure SCC according to Annex C.0, C.1, C.2 and Annex C.3.0 for all downlink physical channels
2. The SS shall configure SCC as per TS 38.508-1 [10] clause 5.5.1 Procedure to configure SCC(s) for NR RF CA testing. Message contents are defined in clause 6.2A.3.1.4.3.
3. Apply the test step based on the 5G NR UE Release:
 - 3a. For Release 16 and forward 5G NR UEs supporting the UPLF test mode: SS applies a backoff on the PCell power by activating the UE Power Limit Function (UPLF). The ACTIVATE POWER LIMIT REQUEST procedure is performed as specified in TS 38.508-1 [10] clause 4.9.32 using TOTAL NR AGGREGATED BANDWIDTH and PCELL NR bandwidth as per Test CC Combination setting. UE shall transmit ACTIVATE POWER LIMIT RESPONSE to SS. Go to step 4.
 - 3b. For Release 15 5G NR UEs: No action.
 - 3c. For testing single CC A-MPR requirement: No action.
4. SS activates SCC by sending the activation MAC CE (Refer TS 38.321, clauses 5.9, 6.1.3.10). Wait for at least 2 seconds (Refer TS 38.133[25], clause 9.3).
5. SS sends uplink scheduling information for each UL HARQ process via PDCCH DCI format 0_1 for C_RNTI to schedule the UL RMC according to Table 6.2A.3.1.4.1-1 to Table 6.2A.3.1.4.1-4. Since the UL has no payload and no loopback data to send the UE sends uplink MAC padding bits on the UL RMC.
6. Set the UE in the Tx beam peak direction found with a 3D EIRP scan as performed in Annex K.1.1. Allow at least BEAM_SELECT_WAIT_TIME (NOTE 1) for the UE Tx beam selection to complete.
7. Apply the test step based on the 5G NR UE Release:
 - 7a. For Release 16 and forward 5G NR UEs: Send continuously uplink power control "up" commands in every uplink scheduling information to the UE; allow at least 200 msec starting from the first TPC command in this step to ensure that the UE transmits at its maximum output power. Allow at least BEAM_SELECT_WAIT_TIME (NOTE 1) for the UE Tx beam selection to complete.
 - 7b. For Release 15 5G NR UEs: Send uplink power control commands in uplink scheduling information to the UE per UL CC until the Power Headroom Report (PHR) from the UE for each UL CC is at the target value according to Table 6.2A.3.1.4.2-1; allow at least 200 ms for the UE to reach maximum output power. Allow at least BEAM_SELECT_WAIT_TIME (NOTE 1) for the UE Tx beam selection to complete.

Table 6.2A.3.1.4.2-1: Power target values per UL CC for test procedure using PHR

BW ratio (Note 1)	Xmax [dB] (Note 2)	Target PHR	Δ PHR [dB] (Note 3)	BW combination examples
1/2	3.0	POWER_HEADROOM_36 ($3 \leq \text{PH} < 4$)	1	2CC equal BW
1/3	4.8	POWER_HEADROOM_38 ($5 \leq \text{PH} < 6$)	1.2	2CC 50+100 MHz CC1
2/3	1.8	POWER_HEADROOM_35 ($2 \leq \text{PH} < 3$)	1.2	2CC 50+100 MHz CC2
1/5	7.0	POWER_HEADROOM_40 ($7 \leq \text{PH} < 8$)	1.0	2CC 50+200 MHz CC1
4/5	1.0	POWER_HEADROOM_34 ($1 \leq \text{PH} < 2$)	1.0	2CC 50+200 MHz CC2
1/9	9.5	POWER_HEADROOM_43 ($10 \leq \text{PH} < 11$)	1.5	2CC 50+400 MHz CC1
8/9	0.5	POWER_HEADROOM_34 ($1 \leq \text{PH} < 2$)	1.5	2CC 50+400 MHz CC2
Note 1: The BW ratio is the ratio of BW of the CC over the total Aggregated UL BW				
Note 2: Xmax = 10log(BW ratio)				
Note 3: Δ PHR is the worst case UE output power decrease due to Xmax and 1 dB reporting granularity of PHR according to TS38.133 [25].				

- 7c. For testing single CC A-MPR requirement: Send continuously uplink power control "up" commands in every uplink scheduling information to the UE; allow at least 200 msec starting from the first TPC command in this step to ensure that the UE transmits at its maximum output power. Allow at least BEAM_SELECT_WAIT_TIME (NOTE 1) for the UE Tx beam selection to complete.

8. SS activates the UE Beamlock Function (UBF) by performing the procedure as specified in TS 38.508-1 [10] clause 4.9.2 using condition Tx only.
9. Measure UE EIRP in the Tx beam peak direction in the accumulative aggregated channel bandwidth of the radio access mode according to the test configuration, which shall meet the requirements described in 6.2A.3.1.5. EIRP test procedure is defined in Annex K.1.3. The measuring duration is one active uplink subframe. EIRP is calculated considering both polarizations, theta and phi.
10. Apply the test step based on the 5G NR UE Release:
 - 10a. For Release 16 and forward 5G NR UEs supporting the UPLF test mode: SS deactivates the UE Power Limit Function (UPLF) by performing the DEACTIVATE POWER LIMIT REQUEST procedure as specified in TS 38.508-1 [10] clause 4.9.33.
 - 10b. For Release 15 5G NR UEs: No action.
 - 10c. For testing single CC A-MPR requirement: No action.
11. SS deactivates the UE Beamlock Function (UBF) by performing the procedure as specified in TS 38.508-1 [10] clause 4.9.3.

NOTE 1: The BEAM_SELECT_WAIT_TIME default value is defined in Annex K.

NOTE 2: When switching to DFT-s-OFDM waveform, as specified in Table 6.2A.3.1.4.1-1 to Table 6.2A.3.1.4.1-4, send an NR RRCReconfiguration message according to TS 38.508-1 [10] clause 4.6.3 Table 4.6.3-118 PUSCH-Config with TRANSFORM_PRECODER_ENABLED condition.

6.2A.3.1.4.3 Message contents

Message contents are according to TS 38.508-1 [10] clause 4.6 with the following exceptions for Release 15 5G NR UE.

Table 6.2A.3.1.4.3-1: PUSCH-PowerControl

Derivation Path: TS 38.508-1 [10], Table 4.6.3-120			
Information Element	Value/remark	Comment	Condition
PUSCH-PowerControl ::= SEQUENCE {			
p0-AlphaSets SEQUENCE (SIZE (1..maxNrofP0-PUSCH-AlphaSets)) OF SEQUENCE {	1 entry		
P0-PUSCH-AlphaSet[1] SEQUENCE {			
alpha	alpha0		
}			
}			
}			

Table 6.2A.3.1.4.3-2: PUSCH-ConfigCommon

Derivation Path: TS 38.508-1[10], Table 4.6.3-119			
Information Element	Value/remark	Comment	Condition
PUSCH-ConfigCommon ::= SEQUENCE {			
p0-NominalWithGrant	-4		50 MHz
p0-NominalWithGrant	-8		100 MHz
p0-NominalWithGrant	-10		200 MHz
p0-NominalWithGrant	-14		400 MHz
}			

Table 6.2A.3.1.4.3-3: BSR-Config (Rel-15 UE only)

Derivation Path: TS 38.508-1 [10], Table 4.6.3-7			
Information Element	Value/remark	Comment	Condition
BSR-Config ::= SEQUENCE {			
periodicBSR-Timer	infinity		
retxBSR-Timer	sf80		

logicalChannelSR-DelayTimer	Not present		
}			

6.2A.3.1.4.3.1 Message contents exceptions (network signalling value "CA_NS_202" on PCC and SCC)

Table 6.2A.3.1.4.3.1-1: AdditionalSpectrumEmission: Additional spurious emissions test requirement for "CA_NS_202"

Derivation Path: TS 38.508-1 [5] clause 4.6.3, Table 4.6.3-1 AdditionalSpectrumEmission			
Information Element	Value/remark	Comment	Condition
AdditionalSpectrumEmission	1 (CA_NS_202)		band n257
	2 (CA_NS_202)		band 258

6.2A.3.1.4.3.2 Message contents exceptions (network signalling value "CA_NS_203" on PCC and SCC)

Table 6.2A.3.1.4.3.2-1: AdditionalSpectrumEmission: Additional spurious emissions test requirement for "CA_NS_203"

Derivation Path: TS 38.508-1 [5] clause 4.6.3, Table 4.6.3-1 AdditionalSpectrumEmission			
Information Element	Value/remark	Comment	Condition
AdditionalSpectrumEmission	3 (CA_NS_203)		band n258

6.2A.3.1.4.3.3 [Reserved]

6.2A.3.1.4.3.4 Message contents exceptions (network signalling value "CA_NS_205" on PCC and SCC)

Table 6.2A.3.1.4.3.4-1: AdditionalSpectrumEmission: Additional spurious emissions test requirement for "CA_NS_205"

Derivation Path: TS 38.508-1 [5] clause 4.6.3, Table 4.6.3-1 AdditionalSpectrumEmission			
Information Element	Value/remark	Comment	Condition
AdditionalSpectrumEmission	4 (CA_NS_205)		band n257
	5 (CA_NS_205)		band n258

6.2A.3.1.5 Test requirement

The EIRP derived in step 9 shall be within the range prescribed by the nominal maximum output power and tolerance in the applicable table from Table 6.2A.3.1.5-1 to Table 6.2A.3.1.5-7.

Table 6.2A.3.1.5-0: Test Tolerance (A-MPR for CA) (Aggregated BW ≤ 400MHz)

Power Class	Test Metric	FR2a	FR2b
PC1	Max device size ≤ 30 cm	3.38 dB, NTC	3.38 dB, NTC
PC2	Max device size ≤ 30 cm	FFS	FFS
PC3	Max device size ≤ 30 cm	3.24 dB, NTC	3.24 dB, NTC
PC4	Max device size ≤ 30 cm	FFS	FFS
PC5	Max device size ≤ 30 cm	3.38 dB, NTC	-
PC6	Max device size ≤ 30 cm	3.37 dB, NTC	-

Table 6.2A.3.1.5-1: A-MPR requirements for CA_NS_202 (Power Class 1)

Test ID	Band	Min peak EIRP (dBm)	MPR (dB)	A-MPR (dB)	T(MAX(MPR, A-MPR)) (dB)	Lower limit (dBm)	Upper limit (dBm)
---------	------	---------------------	----------	------------	-------------------------	-------------------	-------------------

1	n257, n258	40.0	6.5~9.7	13.0	7.0	20-TT	55
2	n257, n258 (NOTE 2)	40.0	9~10.7	13.0	7.0	20-TT	55
2	n257, n258 (NOTE 3)	40.0	11.2	13.0	7.0	19.8-TT	55

NOTE 1: TT for each band and accumulative aggregated bandwidth is specified in Table 6.2A.3.1.5-0.
NOTE 2: Cumulative aggregated BW < 800MHz.
NOTE 3: Cumulative aggregated BW = 800MHz.

Table 6.2A.3.1.5-1b: A-MPR requirements for CA_NS_202 (Power Class 2)

Test ID	Band	Min peak EIRP (dBm)	MPR (dB)	A-MPR (dB)	T(MAX(MPR, A-MPR)) (dB)	Lower limit (dBm)	Upper limit (dBm)
1	n257, n258	29.0	0	2	1.5	25.5-TT	43

NOTE 1: TT for each band and accumulative aggregated bandwidth is specified in Table 6.2A.3.1.5-0.

Table 6.2A.3.1.5-1c: A-MPR requirements for CA_NS_202 (Power Class 3)

Test ID	Band	Min peak EIRP (dBm)	MPR (dB)	A-MPR (dB)	T(MAX(MPR, A-MPR)) (dB)	Lower limit (dBm)	Upper limit (dBm)
1	n257, n258	22.4	0	5	1.5	15.9-TT	43

NOTE 1: TT for each band and accumulative aggregated bandwidth is specified in Table 6.2A.3.1.5-0.

Table 6.2A.3.1.5-1d: A-MPR requirements for CA_NS_202 (Power Class 4)

Test ID	Band	Min peak EIRP (dBm)	MPR (dB)	A-MPR (dB)	T(MAX(MPR, A-MPR)) (dB)	Lower limit (dBm)	Upper limit (dBm)
1	n257, n258	34.0	0	2	1.5	30.5-TT	43

NOTE 1: TT for each band and accumulative aggregated bandwidth is specified in Table 6.2A.3.1.5-0.

Table 6.2A.3.1.5-1e: A-MPR requirements for CA_NS_202 (Power Class 5)

Test ID	Band	Min peak EIRP (dBm)	MPR (dB)	A-MPR (dB)	T(MAX(MPR, A-MPR)) (dB)	Lower limit (dBm)	Upper limit (dBm)
1	n257	30.0	0	2	1.5	26.5-TT	43
	n258	30.4	0	2	1.5	26.9-TT	43

NOTE 1: TT for each band and accumulative aggregated bandwidth is specified in Table 6.2A.3.1.5-0.

Table 6.2A.3.1.5-1f: A-MPR requirements for CA_NS_202 (Power Class 6)

Test ID	Band	Min peak EIRP (dBm)	MPR (dB)	A-MPR (dB)	T(MAX(MPR, A-MPR)) (dB)	Lower limit (dBm)	Upper limit (dBm)
1	n257	30.0	0	2	1.5	26.5-TT	43
	n258	30.4	0	2	1.5	26.9-TT	43

NOTE 1: TT for each band and accumulative aggregated bandwidth is specified in Table 6.2A.3.1.5-0.

Table 6.2A.3.1.5-2: A-MPR requirements for CA_NS_203 (Power Class 1)

Test ID	Band	Min peak EIRP (dBm)	MPR (dB)	A-MPR (dB)	T(MAX(MPR, A-MPR)) (dB)	Lower limit (dBm)	Upper limit (dBm)
1	n258	40.0	0	6.5	5.0	28.5-TT	55

NOTE 1: TT for each band and accumulative aggregated bandwidth is specified in Table 6.2A.3.1.5-0.

Table 6.2A.3.1.5-3: A-MPR requirements for CA_NS_203 (Power Class 2)

Test ID	Band	Min peak EIRP (dBm)	MPR (dB)	A-MPR (dB)	T(MAX(MPR, A-MPR)) (dB)	Lower limit (dBm)	Upper limit (dBm)
1	n258	29.0	0	2.5	2.0	24.5-TT	43

NOTE 1: TT for each band and accumulative aggregated bandwidth is specified in Table 6.2A.3.1.5-0.

Table 6.2A.3.1.5-4: A-MPR requirements for CA_NS_203 (Power Class 3)

Test ID	Band	Min peak EIRP (dBm)	MPR (dB)	A-MPR (dB)	T(MAX(MPR, A-MPR)) (dB)	Lower limit (dBm)	Upper limit (dBm)
1	n258	22.4	0	2.5	2.0	17.9-TT	43

NOTE 1: TT for each band and accumulative aggregated bandwidth is specified in Table 6.2A.3.1.5-0.

Table 6.2A.3.1.5-5: A-MPR requirements for CA_NS_203 (Power Class 4)

Test ID	Band	Min peak EIRP (dBm)	MPR (dB)	A-MPR (dB)	T(MAX(MPR, A-MPR)) (dB)	Lower limit (dBm)	Upper limit (dBm)
1	n258	34.0	0	2.5	2.0	29.5-TT	43

NOTE 1: TT for each band and accumulative aggregated bandwidth is specified in Table 6.2A.3.1.5-0.

Table 6.2A.3.1.5-6: A-MPR requirements for CA_NS_203 (Power Class 5)

Test ID	Band	Min peak EIRP (dBm)	MPR (dB)	A-MPR (dB)	T(MAX(MPR, A-MPR)) (dB)	Lower limit (dBm)	Upper limit (dBm)
1	n258	30.4	0	2.5	2.0	25.9-TT	43

NOTE 1: TT for each band and accumulative aggregated bandwidth is specified in Table 6.2A.3.1.5-0.

Table 6.2A.3.1.5-6a: A-MPR requirements for CA_NS_203 (Power Class 6)

Test ID	Band	Min peak EIRP (dBm)	MPR (dB)	A-MPR (dB)	T(MAX(MPR, A-MPR)) (dB)	Lower limit (dBm)	Upper limit (dBm)
1	n258	30.4	0	2.5	2.0	25.9-TT	43

NOTE 1: TT for each band and accumulative aggregated bandwidth is specified in Table 6.2A.3.1.5-0.

Table 6.2A.3.1.5-7: A-MPR requirements for CA_NS_205 (Power Class 1)

Test ID	Band	Min peak EIRP (dBm)	MPR (dB)	A-MPR (dB)	T(MAX(MPR, A-MPR)) (dB)	Lower limit (dBm)	Upper limit (dBm)
1	n257, n258 ²	40.0	6.5	9.0	5.0	26-TT	55

NOTE 1: TT for each band and accumulative aggregated bandwidth is specified in Table 6.2A.3.1.5-0.
NOTE 2: Cumulative aggregated BW >= 250MHz.

6.2A.3.2 UE maximum output power with additional requirements for CA (3UL CA)

Editor's note: The following aspects are either missing or not yet determined:

- The UPLF test mode is applicable to UEs Release 16 and forward.
- This test case is incomplete for Power classes other than 1, 3, 5 and CA other than intra-band contiguous.
- For a transition period until RAN#99, the stability and repeatability of test procedure with PHR (variant b) for Rel-15 UEs is under evaluation.

- Whether additional check is needed in the test procedure to ensure UE continues transmissions on the SCell is FFS
- Measurement Uncertainties and Test Tolerances are are FFS for power class other than 1, 3, 5 and CA other than intra-band contiguous.
- Measurement Uncertainties and Test Tolerances for intra-band contiguous CA supporting aggregated BW > 400MHz and intra-band non-contiguous CA are TBD.
- The test points for higher bandwidth classes with testability problem need an update to decrease the UL bandwidth until they become testable.

6.2A.3.2.1 Test purpose

Same as test purpose in 6.2A.3.1.1.

6.2A.3.2.2 Test applicability

The requirements of this test apply to all types of NR UE release 15 and forward supporting 3UL CA.

6.2A.3.2.3 Minimum conformance requirements

The normative reference for this requirement is TS 38.101-2 [3] clause 6.2A.3.

6.2A.3.2.4 Test description

6.2A.3.2.4.1 Initial conditions

Initial conditions are a set of test configurations the UE needs to be tested in and the steps for the SS to take with the UE to reach the correct measurement state.

The initial test configurations consist of environmental conditions, test frequencies, and CC combinations based on NR operating bands specified in clause 5.5A. All of these configurations shall be tested with applicable test parameters for each CA configuration and subcarrier spacing, are shown in Table 6.2A.3.2.4.1-1 and Table 6.2A.3.2.4.1-4. The details of the uplink reference measurement channels (RMCs) are specified in Annexes A.2. Configurations of PDSCH and PDCCH before measurement are specified in Annex C.2.

Table 6.2A.3.2.4.1-1: Test Configuration Table for CA_NS_202 (Power Class 1)

Initial Conditions				
Test Environment as specified in TS 38.508-1 [10] clause 4.1		Normal		
Test Frequencies as specified in TS 38.508-1 [10] clause 4.3.1.2.3 for different CA bandwidth classes		Low range, High range		
Test CC combination setting as specified in TS 38.508-1 [10] clause 4.3.1.2.3 for the CA Configuration across bandwidth combination sets supported by the UE.		Maximum aggregated BW (contiguous CA)		
Test SCS as specified in Table 5.3.5-1		120kHz		
Test Parameters				
Test ID	CC	Downlink Configuration	UL Modulation	UL RB allocation (NOTE 1)
1	PCC	-	DFT-s-OFDM QPSK	Outer_Full
	SCCs		DFT-s-OFDM QPSK	Outer_Full
2	PCC		DFT-s-OFDM 64QAM	Outer_Full
	SCCs		DFT-s-OFDM 64QAM	Outer_Full
NOTE 1: The specific configuration of each RB allocation is defined in Table 6.1-2 for PC1.				
NOTE 2: Number of DL CCs shall be configured the same as number of UL CCs. The requirements are applicable as per 5.3A.4: "The requirements are applicable only when Uplink CCs are configured within the frequency range between lower edge of lowest downlink component carrier and upper edge of highest downlink component carrier".				

Table 6.2A.3.2.4.1-1b: Test Configuration Table for CA_NS_202 (Power Class 2, 3, 4, 5)

Initial Conditions				
Test Environment as specified in TS 38.508-1 [10] clause 4.1		Normal		
Test Frequencies as specified in TS 38.508-1 [10] clause 4.3.1.2.3 for different CA bandwidth classes		Low range, High range		
Test CC combination setting as specified in TS 38.508-1 [10] clause 4.3.1.2.3 for the CA Configuration across bandwidth combination sets supported by the UE.		Maximum aggregated BW (contiguous CA) with cumulative aggregated BW <= 400MHz		
Test SCS as specified in Table 5.3.5-1		120kHz		
Test Parameters				
Test ID	CC	Downlink Configuration	UL Modulation	UL RB allocation (NOTE 1)
1	PCC	-	DFT-s-OFDM QPSK	Inner_Full for PC2, PC3 PC4, PC5
	SCCs	-	-	-
NOTE 1: The specific configuration of each RB allocation is defined in Table 6.1-1 for PC2, PC3, PC4, PC5.				
NOTE 2: Number of DL CCs shall be configured the same as number of UL CCs. The requirements are applicable as per 5.3A.4: " <i>The requirements are applicable only when Uplink CCs are configured within the frequency range between lower edge of lowest downlink component carrier and upper edge of highest downlink component carrier</i> ".				

Table 6.2A.3.2.4.1-2: Test Configuration Table for CA_NS_203 (Power Class 1, 2, 3, 4 and 5)

Initial Conditions				
Test Environment as specified in TS 38.508-1 [10] clause 4.1		Normal		
Test Frequencies as specified in TS 38.508-1 [10] clause 4.3.1.2.3 for different CA bandwidth classes		Low range		
Test CC combination setting as specified in TS 38.508-1 [10] clause 4.3.1.2.3 for the CA Configuration across bandwidth combination sets supported by the UE.		Maximum aggregated BW (contiguous CA) with cumulative aggregated BW <= 400MHz		
Test SCS as specified in Table 5.3.5-1		120kHz		
Test Parameters				
Test ID	CC	Downlink Configuration	UL Modulation	UL RB allocation (NOTE 1)
1	PCC	-	DFT-s-OFDM QPSK	Inner_Full for PC2, PC3, PC4 and PC5 Inner_Full_Region1 for PC1
	SCCs	-	-	-
NOTE 1: The specific configuration of each RB allocation is defined in Table 6.1-1 for PC2, PC3, PC4 or Table 6.1-2 for PC1.				
NOTE 2: Number of DL CCs shall be configured the same as number of UL CCs. The requirements are applicable as per 5.3A.4: " <i>The requirements are applicable only when Uplink CCs are configured within the frequency range between lower edge of lowest downlink component carrier and upper edge of highest downlink component carrier</i> ".				

Table 6.2A.3.2.4.1-3: [Reserved]

Table 6.2A.3.2.4.1-4: Test Configuration Table for CA_NS_205 (Power Class 1)

Initial Conditions	
Test Environment as specified in TS 38.508-1 [10] clause 4.1	Normal

Test Frequencies as specified in TS 38.508-1 [10] clause 4.3.1.2.3 for different CA bandwidth classes		Low range		
Test CC combination setting as specified in TS 38.508-1 [10] clause 4.3.1.2.3 for the CA Configuration across bandwidth combination sets supported by the UE.		Maximum aggregated BW (contiguous CA) with cumulative aggregated BW \geq 250MHz		
Test SCS as specified in Table 5.3.5-1		120kHz		
Test Parameters				
Test ID	CC	Downlink Configuration	UL Modulation	UL RB allocation (NOTE 1)
1	PCC	-	DFT-s-OFDM QPSK	Outer_Full
	SCCs		DFT-s-OFDM QPSK	Outer_Full
NOTE 1: The specific configuration of each RB allocation is defined in Table 6.1-1 for PC2, PC3, PC4 or Table 6.1-2 for PC1.				
NOTE 2: Number of DL CCs shall be configured the same as number of UL CCs. The requirements are applicable as per 5.3A.4: " <i>The requirements are applicable only when Uplink CCs are configured within the frequency range between lower edge of lowest downlink component carrier and upper edge of highest downlink component carrier</i> ".				

1. Connection between SS and UE is shown in TS 38.508-1 [10] Annex A, Figure A.3.3.1.1 for TE diagram and Figure A.3.4.1.1 for UE diagram.
2. The parameter settings for the cell are set up according to TS 38.508-1 [10] clause 4.4.3.
3. Downlink signals are initially set up according to Annex C, and uplink signals according to Annex G.
4. The UL Reference Measurement channels are set according to Table 6.2A.3.2.4.1-1 to Table 6.2A.3.2.4.1-4.
5. Propagation conditions are set according to Annex B.0.
6. Ensure the UE is in state RRC_CONNECTED with generic procedure parameters Connectivity *NR*, Connected without release *On*, Test Mode *On* and Test Loop Function *On* according to TS 38.508-1 [10] clause 4.5. Message contents are defined in clause 6.2A.3.2.4.3.

6.2A.3.2.4.2 Test procedure

1. Configure SCC according to Annex C.0, C.1, C.2 and Annex C.3.0 for all downlink physical channels
2. The SS shall configure SCC as per TS 38.508-1 [10] clause 5.5.1 Procedure to configure SCC(s) for NR RF CA testing. Message contents are defined in clause 6.2A.3.2.4.3.
3. Apply the test step based on the 5G NR UE Release:
 - 3a. For Release 16 and forward 5G NR UEs supporting the UPLF test mode: SS applies a backoff on the PCell power by activating the UE Power Limit Function (UPLF). The ACTIVATE POWER LIMIT REQUEST procedure is performed as specified in TS 38.508-1 [10] clause 4.9.32 using TOTAL NR AGGREGATED BANDWIDTH and PCELL NR bandwidth as per Test CC Combination setting. UE shall transmit ACTIVATE POWER LIMIT RESPONSE to SS. Go to step 4.
 - 3b. For Release 15 5G NR UEs: No action.
 - 3c. For testing single CC A-MPR requirement: No action.
4. SS activates SCC by sending the activation MAC CE (Refer TS 38.321, clauses 5.9, 6.1.3.10). Wait for at least 2 seconds (Refer TS 38.133[25], clause 9.3).
5. SS sends uplink scheduling information for each UL HARQ process via PDCCH DCI format 0_1 for C_RNTI to schedule the UL RMC according to Table 6.2A.3.2.4.1-1 to Table 6.2A.3.2.4.1-4. Since the UL has no payload and no loopback data to send the UE sends uplink MAC padding bits on the UL RMC.
6. Set the UE in the Tx beam peak direction found with a 3D EIRP scan as performed in Annex K.1.1. Allow at least BEAM_SELECT_WAIT_TIME (NOTE 1) for the UE Tx beam selection to complete.
7. Apply the test step based on the 5G NR UE Release:

- 7a. For Release 16 and forward 5G NR UEs: Send continuously uplink power control "up" commands in every uplink scheduling information to the UE; allow at least 200 msec starting from the first TPC command in this step to ensure that the UE transmits at its maximum output power. Allow at least BEAM_SELECT_WAIT_TIME (NOTE 1) for the UE Tx beam selection to complete.
- 7b. For Release 15 5G NR UEs: Send uplink power control commands in uplink scheduling information to the UE per UL CC until the Power Headroom Report (PHR) from the UE for each UL CC is at the target value according to Table 6.2A.3.2.4.2-1; allow at least 200 ms for the UE to reach maximum output power. Allow at least BEAM_SELECT_WAIT_TIME (NOTE 1) for the UE Tx beam selection to complete.

Table 6.2A.3.2.4.2-1: Power target values per UL CC for test procedure using PHR

FFS

- 7c. For testing single CC A-MPR requirement: Send continuously uplink power control "up" commands in every uplink scheduling information to the UE; allow at least 200 msec starting from the first TPC command in this step to ensure that the UE transmits at its maximum output power. Allow at least BEAM_SELECT_WAIT_TIME (NOTE 1) for the UE Tx beam selection to complete.
- 8. SS activates the UE Beamlock Function (UBF) by performing the procedure as specified in TS 38.508-1 [10] clause 4.9.2 using condition Tx only.
- 9. Measure UE EIRP in the Tx beam peak direction in the accumulative aggregated channel bandwidth of the radio access mode according to the test configuration, which shall meet the requirements described in 6.2A.3.2.5. EIRP test procedure is defined in Annex K.1.3. The measuring duration is one active uplink subframe. EIRP is calculated considering both polarizations, theta and phi.
- 10. Apply the test step based on the 5G NR UE Release:
 - 10a. For Release 16 and forward 5G NR UEs supporting the UPLF test mode: SS deactivates the UE Power Limit Function (UPLF) by performing the DEACTIVATE POWER LIMIT REQUEST procedure as specified in TS 38.508-1 [10] clause 4.9.33.
 - 10b. For Release 15 5G NR UEs: No action.
 - 10c. For testing single CC A-MPR requirement: No action.
- 11. SS deactivates the UE Beamlock Function (UBF) by performing the procedure as specified in TS 38.508-1 [10] clause 4.9.3.

NOTE 1: The BEAM_SELECT_WAIT_TIME default value is defined in Annex K.

NOTE 2: When switching to DFT-s-OFDM waveform, as specified in Table 6.2A.3.2.4.1-1 to Table 6.2A.3.2.4.1-4, send an NR RRCReconfiguration message according to TS 38.508-1 [10] clause 4.6.3 Table 4.6.3-118 PUSCH-Config with TRANSFORM_PRECODER_ENABLED condition.

6.2A.3.2.4.3 Message contents

Message contents are according to TS 38.508-1 [10] clause 4.6 with the following exceptions for Release 15 5G NR UE.

Table 6.2A.3.2.4.3-1: PUSCH-PowerControl

Derivation Path: TS 38.508-1 [10], Table 4.6.3-120			
Information Element	Value/remark	Comment	Condition
PUSCH-PowerControl ::= SEQUENCE {			
p0-AlphaSets SEQUENCE (SIZE (1..maxNrofP0-PUSCH-AlphaSets)) OF SEQUENCE {	1 entry		
P0-PUSCH-AlphaSet[1] SEQUENCE {			
alpha	alpha0		
}			
}			
}			

Table 6.2A.3.2.4.3-2: PUSCH-ConfigCommon

Derivation Path: TS 38.508-1[10], Table 4.6.3-119			
Information Element	Value/remark	Comment	Condition
PUSCH-ConfigCommon ::= SEQUENCE {			
p0-NominalWithGrant	-4		50 MHz
p0-NominalWithGrant	-8		100 MHz
p0-NominalWithGrant	-10		200 MHz
p0-NominalWithGrant	-14		400 MHz
}			

Table 6.2A.3.2.4.3-3: BSR-Config (Rel-15 UE only)

Derivation Path: TS 38.508-1 [10], Table 4.6.3-7			
Information Element	Value/remark	Comment	Condition
BSR-Config ::= SEQUENCE {			
periodicBSR-Timer	infinity		
retxBSR-Timer	sf80		
logicalChannelSR-DelayTimer	Not present		
}			

6.2A.3.2.4.3.1 Message contents exceptions (network signalling value "CA_NS_202" on PCC and SCC)

Table 6.2A.3.2.4.3.1-1: AdditionalSpectrumEmission: Additional spurious emissions test requirement for "CA_NS_202"

Derivation Path: TS 38.508-1 [5] clause 4.6.3, Table 4.6.3-1 AdditionalSpectrumEmission			
Information Element	Value/remark	Comment	Condition
AdditionalSpectrumEmission	1 (CA_NS_202)		band n257
	2 (CA_NS_202)		band 258

6.2A.3.2.4.3.2 Message contents exceptions (network signalling value "CA_NS_203" on PCC and SCC)

Table 6.2A.3.2.4.3.2-1: AdditionalSpectrumEmission: Additional spurious emissions test requirement for "CA_NS_203"

Derivation Path: TS 38.508-1 [5] clause 4.6.3, Table 4.6.3-1 AdditionalSpectrumEmission			
Information Element	Value/remark	Comment	Condition
AdditionalSpectrumEmission	3 (CA_NS_203)		band n258

6.2A.3.2.4.3.3 [Reserved]

6.2A.3.2.4.3.4 Message contents exceptions (network signalling value "CA_NS_205" on PCC and SCC)

Table 6.2A.3.2.4.3.4-1: AdditionalSpectrumEmission: Additional spurious emissions test requirement for "CA_NS_205"

Derivation Path: TS 38.508-1 [5] clause 4.6.3, Table 4.6.3-1 AdditionalSpectrumEmission			
Information Element	Value/remark	Comment	Condition
AdditionalSpectrumEmission	4 (CA_NS_205)		band n257
	5 (CA_NS_205)		band n258

6.2A.3.2.5 Test requirement

The EIRP derived in step 9 shall be within the range prescribed by the nominal maximum output power and tolerance in the applicable table from Table 6.2A.3.2.5-1 to Table 6.2A.3.2.5-6.

Table 6.2A.3.2.5-0: Test Tolerance (A-MPR for CA) (Aggregated BW ≤ 400MHz)

Power Class	Test Metric	FR2a	FR2b
PC1	Max device size ≤ 30 cm	3.38 dB, NTC	3.38 dB, NTC
PC2	Max device size ≤ 30 cm	FFS	FFS
PC3	Max device size ≤ 30 cm	3.24 dB, NTC	3.24 dB, NTC
PC4	Max device size ≤ 30 cm	FFS	FFS
PC5	Max device size ≤ 30 cm	3.38 dB, NTC	-

Table 6.2A.3.2.5-1: A-MPR requirements for CA_NS_202 (Power Class 1)

Test ID	Band	Min peak EIRP (dBm)	MPR (dB)	A-MPR (dB)	T(MAX(MPR, A-MPR)) (dB)	Lower limit (dBm)	Upper limit (dBm)
1	n257, n258	40.0	6.5~9.7	13.0	7.0	20-TT	55
2	n257, n258 (NOTE 2)	40.0	9~10.7	13.0	7.0	20-TT	55
2	n257, n258 (NOTE 3)	40.0	11.2	13.0	7.0	19.8-TT	55

NOTE 1: TT for each band and accumulative aggregated bandwidth is specified in Table 6.2A.3.2.5-0.
NOTE 2: Cumulative aggregated BW < 800MHz.
NOTE 3: 800MHz ≤ Cumulative aggregated BW < 1400MHz.

Table 6.2A.3.2.5-1b: A-MPR requirements for CA_NS_202 (Power Class 2)

Test ID	Band	Min peak EIRP (dBm)	MPR (dB)	A-MPR (dB)	T(MAX(MPR, A-MPR)) (dB)	Lower limit (dBm)	Upper limit (dBm)
1	n257, n258	29.0	0	2	1.5	25.5-TT	43

NOTE 1: TT for each band and accumulative aggregated bandwidth is specified in Table 6.2A.3.1.5-0.

Table 6.2A.3.2.5-1c: A-MPR requirements for CA_NS_202 (Power Class 3)

Test ID	Band	Min peak EIRP (dBm)	MPR (dB)	A-MPR (dB)	T(MAX(MPR, A-MPR)) (dB)	Lower limit (dBm)	Upper limit (dBm)
1	n257, n258	22.4	0	2	1.5	18.9-TT	43

NOTE 1: TT for each band and accumulative aggregated bandwidth is specified in Table 6.2A.3.1.5-0.

Table 6.2A.3.2.5-1d: A-MPR requirements for CA_NS_202 (Power Class 4)

Test ID	Band	Min peak EIRP (dBm)	MPR (dB)	A-MPR (dB)	T(MAX(MPR, A-MPR)) (dB)	Lower limit (dBm)	Upper limit (dBm)
1	n257, n258	34.0	0	5	1.5	27.5-TT	43

NOTE 1: TT for each band and accumulative aggregated bandwidth is specified in Table 6.2A.3.1.5-0.

Table 6.2A.3.2.5-1e: A-MPR requirements for CA_NS_202 (Power Class 5)

Test ID	Band	Min peak EIRP (dBm)	MPR (dB)	A-MPR (dB)	T(MAX(MPR, A-MPR)) (dB)	Lower limit (dBm)	Upper limit (dBm)
1	n257	30.0	0	2	1.5	26.5-TT	43
	n258	30.4	0	2	1.5	26.9-TT	43

NOTE 1: TT for each band and accumulative aggregated bandwidth is specified in Table 6.2A.3.1.5-0.

Table 6.2A.3.2.5-2: A-MPR requirements for CA_NS_203 (Power Class 1)

Test ID	Band	Min peak EIRP (dBm)	MPR (dB)	A-MPR (dB)	T(MAX(MPR, A-MPR)) (dB)	Lower limit (dBm)	Upper limit (dBm)
1	n258	40.0	0	6.5	5.0	28.5-TT	55

NOTE 1: TT for each band and accumulative aggregated bandwidth is specified in Table 6.2A.3.2.5-0.

Table 6.2A.3.2.5-3: A-MPR requirements for CA_NS_203 (Power Class 2)

Test ID	Band	Min peak EIRP (dBm)	MPR (dB)	A-MPR (dB)	T(MAX(MPR, A-MPR)) (dB)	Lower limit (dBm)	Upper limit (dBm)
1	n258	29.0	0	2.5	2.0	24.5-TT	43

NOTE 1: TT for each band and accumulative aggregated bandwidth is specified in Table 6.2A.3.2.5-0.

Table 6.2A.3.2.5-4: A-MPR requirements for CA_NS_203 (Power Class 3)

Test ID	Band	Min peak EIRP (dBm)	MPR (dB)	A-MPR (dB)	T(MAX(MPR, A-MPR)) (dB)	Lower limit (dBm)	Upper limit (dBm)
1	n258	22.4	0	2.5	2.0	17.9-TT	43

NOTE 1: TT for each band and accumulative aggregated bandwidth is specified in Table 6.2A.3.2.5-0.

Table 6.2A.3.2.5-5: A-MPR requirements for CA_NS_203 (Power Class 4)

Test ID	Band	Min peak EIRP (dBm)	MPR (dB)	A-MPR (dB)	T(MAX(MPR, A-MPR)) (dB)	Lower limit (dBm)	Upper limit (dBm)
1	n258	34.0	0	2.5	2.0	29.5-TT	43

NOTE 1: TT for each band and accumulative aggregated bandwidth is specified in Table 6.2A.3.2.5-0.

Table 6.2A.3.2.5-6: A-MPR requirements for CA_NS_203 (Power Class 5)

Test ID	Band	Min peak EIRP (dBm)	MPR (dB)	A-MPR (dB)	T(MAX(MPR, A-MPR)) (dB)	Lower limit (dBm)	Upper limit (dBm)
1	n258	30.4	0	2.5	2	25.9-TT	43

NOTE 1: TT for each band and accumulative aggregated bandwidth is specified in Table 6.2A.3.1.5-0.

Table 6.2A.3.2.5-7: A-MPR requirements for CA_NS_205 (Power Class 1)

Test ID	Band	Min peak EIRP (dBm)	MPR (dB)	A-MPR (dB)	T(MAX(MPR, A-MPR)) (dB)	Lower limit (dBm)	Upper limit (dBm)
1	n257, n258 ²	40.0	6.5	6.0	5.0	28.5-TT	55

NOTE 1: TT for each band and accumulative aggregated bandwidth is specified in Table 6.2A.3.1.5-0.
NOTE 2: Cumulative aggregated BW >= 250MHz.

6.2A.3.3 UE maximum output power with additional requirements for CA (4UL CA)

Editor's note: The following aspects are either missing or not yet determined:

- The UPLF test mode is applicable to UEs Release 16 and forward.
- This test case is incomplete for Power classes other than 1, 3, 5 and CA other than intra-band contiguous.
- For a transition period until RAN#99, the stability and repeatability of test procedure with PHR (variant b) for Rel-15 UEs is under evaluation.

- Whether additional check is needed in the test procedure to ensure UE continues transmissions on the SCell is FFS
- Measurement Uncertainties and Test Tolerances are FFS for power class other than 1, 3, 5 and CA other than intra-band contiguous.
- Measurement Uncertainties and Test Tolerances for intra-band contiguous CA supporting aggregated BW > 400MHz and intra-band non-contiguous CA are TBD.
- The test points for higher bandwidth classes with testability problem need an update to decrease the UL bandwidth until they become testable.

6.2A.3.3.1 Test purpose

Same as test purpose in 6.2A.3.1.1.

6.2A.3.3.2 Test applicability

The requirements of this test apply to all types of NR UE release 15 and forward supporting 4UL CA.

6.2A.3.3.3 Minimum conformance requirements

The normative reference for this requirement is TS 38.101-2 [3] clause 6.2A.3.

6.2A.3.3.4 Test description

6.2A.3.3.4.1 Initial conditions

Initial conditions are a set of test configurations the UE needs to be tested in and the steps for the SS to take with the UE to reach the correct measurement state.

The initial test configurations consist of environmental conditions, test frequencies, and CC combinations based on NR operating bands specified in clause 5.5A. All of these configurations shall be tested with applicable test parameters for each CA configuration and subcarrier spacing, are shown in Table 6.2A.3.3.4.1-1 and Table 6.2A.3.3.4.1-4. The details of the uplink reference measurement channels (RMCs) are specified in Annexes A.2. Configurations of PDSCH and PDCCH before measurement are specified in Annex C.2.

Table 6.2A.3.3.4.1-1: Test Configuration Table for CA_NS_202 (Power Class 1)

Initial Conditions				
Test Environment as specified in TS 38.508-1 [10] clause 4.1		Normal		
Test Frequencies as specified in TS 38.508-1 [10] clause 4.3.1.2.3 for different CA bandwidth classes		Low range, High range		
Test CC combination setting as specified in TS 38.508-1 [10] clause 4.3.1.2.3 for the CA Configuration across bandwidth combination sets supported by the UE.		Maximum aggregated BW (contiguous CA)		
Test SCS as specified in Table 5.3.5-1		120kHz		
Test Parameters				
Test ID	CC	Downlink Configuration	UL Modulation	UL RB allocation (NOTE 1)
1	PCC	-	DFT-s-OFDM QPSK	Outer_Full
	SCCs		DFT-s-OFDM QPSK	Outer_Full
2	PCC		DFT-s-OFDM 64QAM	Outer_Full
	SCCs		DFT-s-OFDM 64QAM	Outer_Full
NOTE 1: The specific configuration of each RB allocation is defined in Table 6.1-2 for PC1.				
NOTE 2: Number of DL CCs shall be configured the same as number of UL CCs. The requirements are applicable as per 5.3A.4: "The requirements are applicable only when Uplink CCs are configured within the frequency range between lower edge of lowest downlink component carrier and upper edge of highest downlink component carrier".				

Table 6.2A.3.3.4.1-1b: Test Configuration Table for CA_NS_202 (Power Class 2, 3, 4, 5)

Initial Conditions				
Test Environment as specified in TS 38.508-1 [10] clause 4.1		Normal		
Test Frequencies as specified in TS 38.508-1 [10] clause 4.3.1.2.3 for different CA bandwidth classes		Low range, High range		
Test CC combination setting as specified in TS 38.508-1 [10] clause 4.3.1.2.3 for the CA Configuration across bandwidth combination sets supported by the UE.		Maximum aggregated BW (contiguous CA) with cumulative aggregated BW <= 400MHz		
Test SCS as specified in Table 5.3.5-1		120kHz		
Test Parameters				
Test ID	CC	Downlink Configuration	UL Modulation	UL RB allocation (NOTE 1)
1	PCC	-	DFT-s-OFDM QPSK	Inner_Full for PC2, PC3 PC4, PC5
	SCCs	-	-	-
NOTE 1: The specific configuration of each RB allocation is defined in Table 6.1-1 for PC2, PC3, PC4, PC5. NOTE 2: Number of DL CCs shall be configured the same as number of UL CCs. The requirements are applicable as per 5.3A.4: "The requirements are applicable only when Uplink CCs are configured within the frequency range between lower edge of lowest downlink component carrier and upper edge of highest downlink component carrier".				

Table 6.2A.3.3.4.1-2: Test Configuration Table for CA_NS_203 (Power Class 1, 2, 3, 4, and 5)

Initial Conditions				
Test Environment as specified in TS 38.508-1 [10] clause 4.1		Normal		
Test Frequencies as specified in TS 38.508-1 [10] clause 4.3.1.2.3 for different CA bandwidth classes		Low range		
Test CC combination setting as specified in TS 38.508-1 [10] clause 4.3.1.2.3 for the CA Configuration across bandwidth combination sets supported by the UE.		Maximum aggregated BW (contiguous CA) with cumulative aggregated BW <= 400MHz		
Test SCS as specified in Table 5.3.5-1		120kHz		
Test Parameters				
Test ID	CC	Downlink Configuration	UL Modulation	UL RB allocation (NOTE 1)
1	PCC	-	DFT-s-OFDM QPSK	Inner_Full for PC2, PC3, PC4 and PC5 Inner_Full_Region1 for PC1
	SCCs	-	-	-
NOTE 1: The specific configuration of each RB allocation is defined in Table 6.1-1 for PC2, PC3, PC4 and PC5 or Table 6.1-2 for PC1. NOTE 2: Number of DL CCs shall be configured the same as number of UL CCs. The requirements are applicable as per 5.3A.4: "The requirements are applicable only when Uplink CCs are configured within the frequency range between lower edge of lowest downlink component carrier and upper edge of highest downlink component carrier".				

Table 6.2A.3.3.4.1-3: [Reserved]

Table 6.2A.3.3.4.1-4: Test Configuration Table for CA_NS_205 (Power Class 1)

Initial Conditions	
Test Environment as specified in TS 38.508-1 [10] clause 4.1	Normal

Test Frequencies as specified in TS 38.508-1 [10] clause 4.3.1.2.3 for different CA bandwidth classes		Low range		
Test CC combination setting as specified in TS 38.508-1 [10] clause 4.3.1.2.3 for the CA Configuration across bandwidth combination sets supported by the UE.		Maximum aggregated BW (contiguous CA) with cumulative aggregated BW \geq 250MHz		
Test SCS as specified in Table 5.3.5-1		120kHz		
Test Parameters				
Test ID	CC	Downlink Configuration	UL Modulation	UL RB allocation (NOTE 1)
1	PCC	-	DFT-s-OFDM QPSK	Outer_Full
	SCCs		DFT-s-OFDM QPSK	Outer_Full
NOTE 1: The specific configuration of each RB allocation is defined in Table 6.1-1 for PC2, PC3, PC4 or Table 6.1-2 for PC1.				
NOTE 2: Number of DL CCs shall be configured the same as number of UL CCs. The requirements are applicable as per 5.3A.4: " <i>The requirements are applicable only when Uplink CCs are configured within the frequency range between lower edge of lowest downlink component carrier and upper edge of highest downlink component carrier</i> ".				

1. Connection between SS and UE is shown in TS 38.508-1 [10] Annex A, Figure A.3.3.1.1 for TE diagram and Figure A.3.4.1.1 for UE diagram.
2. The parameter settings for the cell are set up according to TS 38.508-1 [10] clause 4.4.3.
3. Downlink signals are initially set up according to Annex C, and uplink signals according to Annex G.
4. The UL Reference Measurement channels are set according to Table 6.2A.3.3.4.1-1 to Table 6.2A.3.3.4.1-4.
5. Propagation conditions are set according to Annex B.0.
6. Ensure the UE is in state RRC_CONNECTED with generic procedure parameters Connectivity *NR*, Connected without release *On*, Test Mode *On* and Test Loop Function *On* according to TS 38.508-1 [10] clause 4.5. Message contents are defined in clause 6.2A.3.3.4.3.

6.2A.3.3.4.2 Test procedure

1. Configure SCC according to Annex C.0, C.1, C.2 and Annex C.3.0 for all downlink physical channels
2. The SS shall configure SCC as per TS 38.508-1 [10] clause 5.5.1 Procedure to configure SCC(s) for NR RF CA testing. Message contents are defined in clause 6.2A.3.3.4.3.
3. Apply the test step based on the 5G NR UE Release:
 - 3a. For Release 16 and forward 5G NR UEs supporting the UPLF test mode: SS applies a backoff on the PCell power by activating the UE Power Limit Function (UPLF). The ACTIVATE POWER LIMIT REQUEST procedure is performed as specified in TS 38.508-1 [10] clause 4.9.32 using TOTAL NR AGGREGATED BANDWIDTH and PCELL NR bandwidth as per Test CC Combination setting. UE shall transmit ACTIVATE POWER LIMIT RESPONSE to SS. Go to step 4.
 - 3b. For Release 15 5G NR UEs: No action.
 - 3c. For testing single CC A-MPR requirement: No action.
4. SS activates SCC by sending the activation MAC CE (Refer TS 38.321, clauses 5.9, 6.1.3.10). Wait for at least 2 seconds (Refer TS 38.133[25], clause 9.3).
5. SS sends uplink scheduling information for each UL HARQ process via PDCCH DCI format 0_1 for C_RNTI to schedule the UL RMC according to Table 6.2A.3.3.4.1-1 to Table 6.2A.3.3.4.1-4. Since the UL has no payload and no loopback data to send the UE sends uplink MAC padding bits on the UL RMC.
6. Set the UE in the Tx beam peak direction found with a 3D EIRP scan as performed in Annex K.1.1. Allow at least BEAM_SELECT_WAIT_TIME (NOTE 1) for the UE Tx beam selection to complete.
7. Apply the test step based on the 5G NR UE Release:

- 7a. For Release 16 and forward 5G NR UEs: Send continuously uplink power control "up" commands in every uplink scheduling information to the UE; allow at least 200 msec starting from the first TPC command in this step to ensure that the UE transmits at its maximum output power. Allow at least BEAM_SELECT_WAIT_TIME (NOTE 1) for the UE Tx beam selection to complete.
- 7b. For Release 15 5G NR UEs: Send uplink power control commands in uplink scheduling information to the UE per UL CC until the Power Headroom Report (PHR) from the UE for each UL CC is at the target value according to Table 6.2A.3.3.4.2-1; allow at least 200 ms for the UE to reach maximum output power. Allow at least BEAM_SELECT_WAIT_TIME (NOTE 1) for the UE Tx beam selection to complete.

Table 6.2A.3.3.4.2-1: Power target values per UL CC for test procedure using PHR

FFS

- 7c. For testing single CC A-MPR requirement: Send continuously uplink power control "up" commands in every uplink scheduling information to the UE; allow at least 200 msec starting from the first TPC command in this step to ensure that the UE transmits at its maximum output power. Allow at least BEAM_SELECT_WAIT_TIME (NOTE 1) for the UE Tx beam selection to complete.
- 8. SS activates the UE Beamlock Function (UBF) by performing the procedure as specified in TS 38.508-1 [10] clause 4.9.2 using condition Tx only.
- 9. Measure UE EIRP in the Tx beam peak direction in the accumulative aggregated channel bandwidth of the radio access mode according to the test configuration, which shall meet the requirements described in 6.2A.3.3.5. EIRP test procedure is defined in Annex K.1.3. The measuring duration is one active uplink subframe. EIRP is calculated considering both polarizations, theta and phi.
- 10. Apply the test step based on the 5G NR UE Release:
 - 10a. For Release 16 and forward 5G NR UEs supporting the UPLF test mode: SS deactivates the UE Power Limit Function (UPLF) by performing the DEACTIVATE POWER LIMIT REQUEST procedure as specified in TS 38.508-1 [10] clause 4.9.33.
 - 10b. For Release 15 5G NR UEs: No action.
 - 10c. For testing single CC A-MPR requirement: No action.
- 11. SS deactivates the UE Beamlock Function (UBF) by performing the procedure as specified in TS 38.508-1 [10] clause 4.9.3.

NOTE 1: The BEAM_SELECT_WAIT_TIME default value is defined in Annex K.

NOTE 2: When switching to DFT-s-OFDM waveform, as specified in Table 6.2A.3.3.4.1-1 to Table 6.2A.3.3.4.1-4, send an NR RRCReconfiguration message according to TS 38.508-1 [10] clause 4.6.3 Table 4.6.3-118 PUSCH-Config with TRANSFORM_PRECODER_ENABLED condition.

6.2A.3.3.4.3 Message contents

Message contents are according to TS 38.508-1 [10] clause 4.6 with the following exceptions for Release 15 5G NR UE.

Table 6.2A.3.3.4.3-1: PUSCH-PowerControl

Derivation Path: TS 38.508-1 [10], Table 4.6.3-120			
Information Element	Value/remark	Comment	Condition
PUSCH-PowerControl ::= SEQUENCE {			
p0-AlphaSets SEQUENCE (SIZE (1..maxNrofP0-PUSCH-AlphaSets)) OF SEQUENCE {	1 entry		
P0-PUSCH-AlphaSet[1] SEQUENCE {			
alpha	alpha0		
}			
}			
}			

Table 6.2A.3.3.4.3-2: PUSCH-ConfigCommon

Derivation Path: TS 38.508-1[10], Table 4.6.3-119			
Information Element	Value/remark	Comment	Condition
PUSCH-ConfigCommon ::= SEQUENCE {			
p0-NominalWithGrant	-4		50 MHz
p0-NominalWithGrant	-8		100 MHz
p0-NominalWithGrant	-10		200 MHz
p0-NominalWithGrant	-14		400 MHz
}			

Table 6.2A.3.3.4.3-3: BSR-Config (Rel-15 UE only)

Derivation Path: TS 38.508-1 [10], Table 4.6.3-7			
Information Element	Value/remark	Comment	Condition
BSR-Config ::= SEQUENCE {			
periodicBSR-Timer	infinity		
retxBSR-Timer	sf80		
logicalChannelSR-DelayTimer	Not present		
}			

6.2A.3.3.4.3.1 Message contents exceptions (network signalling value "CA_NS_202" on PCC and SCC)

Table 6.2A.3.3.4.3.1-1: AdditionalSpectrumEmission: Additional spurious emissions test requirement for "CA_NS_202"

Derivation Path: TS 38.508-1 [5] clause 4.6.3, Table 4.6.3-1 AdditionalSpectrumEmission			
Information Element	Value/remark	Comment	Condition
AdditionalSpectrumEmission	1 (CA_NS_202)		band n257
	2 (CA_NS_202)		band 258

6.2A.3.3.4.3.2 Message contents exceptions (network signalling value "CA_NS_203" on PCC and SCC)

Table 6.2A.3.3.4.3.2-1: AdditionalSpectrumEmission: Additional spurious emissions test requirement for "CA_NS_203"

Derivation Path: TS 38.508-1 [5] clause 4.6.3, Table 4.6.3-1 AdditionalSpectrumEmission			
Information Element	Value/remark	Comment	Condition
AdditionalSpectrumEmission	3 (CA_NS_203)		band n258

6.2A.3.3.4.3.3 [Reserved]

6.2A.3.3.4.3.4 Message contents exceptions (network signalling value "CA_NS_205" on PCC and SCC)

Table 6.2A.3.3.4.3.4-1: AdditionalSpectrumEmission: Additional spurious emissions test requirement for "CA_NS_205"

Derivation Path: TS 38.508-1 [5] clause 4.6.3, Table 4.6.3-1 AdditionalSpectrumEmission			
Information Element	Value/remark	Comment	Condition
AdditionalSpectrumEmission	4 (CA_NS_205)		band n257
	5 (CA_NS_205)		band n258

6.2A.3.3.5 Test requirement

The EIRP derived in step 9 shall be within the range prescribed by the nominal maximum output power and tolerance in the applicable table from Table 6.2A.3.3.5-1 to Table 6.2A.3.3.5-7.

Table 6.2A.3.3.5-0: Test Tolerance (A-MPR for CA) (Aggregated BW ≤ 400MHz)

Power Class	Test Metric	FR2a	FR2b
PC1	Max device size ≤ 30 cm	3.38 dB, NTC	3.38 dB, NTC
PC2	Max device size ≤ 30 cm	FFS	FFS
PC3	Max device size ≤ 30 cm	3.24 dB, NTC	3.24 dB, NTC
PC4	Max device size ≤ 30 cm	FFS	FFS
PC5	Max device size ≤ 30 cm	3.38 dB, NTC	-

Table 6.2A.3.3.5-1: A-MPR requirements for CA_NS_202 (Power Class 1)

Test ID	Band	Min peak EIRP (dBm)	MPR (dB)	A-MPR (dB)	T(MAX(MPR, A-MPR)) (dB)	Lower limit (dBm)	Upper limit (dBm)
1	n257, n258	40.0	6.5~9.7	13.0	7.0	20-TT	55
2	n257, n258 (NOTE 2)	40.0	9~10.7	13.0	7.0	20-TT	55
2	n257, n258 (NOTE 3)	40.0	11.2	13.0	7.0	19.8-TT	55

NOTE 1: TT for each band and accumulative aggregated bandwidth is specified in Table 6.2A.3.3.5-0.
NOTE 2: Cumulative aggregated BW < 800MHz.
NOTE 3: 800MHz ≤ Cumulative aggregated BW < 1400MHz.

Table 6.2A.3.3.5-1b: A-MPR requirements for CA_NS_202 (Power Class 2)

Test ID	Band	Min peak EIRP (dBm)	MPR (dB)	A-MPR (dB)	T(MAX(MPR, A-MPR)) (dB)	Lower limit (dBm)	Upper limit (dBm)
1	n257, n258	29.0	0	2	1.5	25.5-TT	43

NOTE 1: TT for each band and accumulative aggregated bandwidth is specified in Table 6.2A.3.1.5-0.

Table 6.2A.3.3.5-1c: A-MPR requirements for CA_NS_202 (Power Class 3)

Test ID	Band	Min peak EIRP (dBm)	MPR (dB)	A-MPR (dB)	T(MAX(MPR, A-MPR)) (dB)	Lower limit (dBm)	Upper limit (dBm)
1	n257, n258	22.4	0	5	1.5	15.9-TT	43

NOTE 1: TT for each band and accumulative aggregated bandwidth is specified in Table 6.2A.3.1.5-0.

Table 6.2A.3.3.5-1d: A-MPR requirements for CA_NS_202 (Power Class 4)

Test ID	Band	Min peak EIRP (dBm)	MPR (dB)	A-MPR (dB)	T(MAX(MPR, A-MPR)) (dB)	Lower limit (dBm)	Upper limit (dBm)
1	n257, n258	34.0	0	2	1.5	30.5-TT	43

NOTE 1: TT for each band and accumulative aggregated bandwidth is specified in Table 6.2A.3.1.5-0.

Table 6.2A.3.3.5-1e: A-MPR requirements for CA_NS_202 (Power Class 5)

Test ID	Band	Min peak EIRP (dBm)	MPR (dB)	A-MPR (dB)	T(MAX(MPR, A-MPR)) (dB)	Lower limit (dBm)	Upper limit (dBm)
1	n257	30.0	0	2	1.5	26.5-TT	43
	n258	30.4	0	2	1.5	26.9-TT	43

NOTE 1: TT for each band and accumulative aggregated bandwidth is specified in Table 6.2A.3.1.5-0.

Table 6.2A.3.3.5-2: A-MPR requirements for CA_NS_203 (Power Class 1)

Test ID	Band	Min peak EIRP (dBm)	MPR (dB)	A-MPR (dB)	T(MAX(MPR, A-MPR)) (dB)	Lower limit (dBm)	Upper limit (dBm)
1	n258	40.0	0	6.5	5.0	28.5-TT	55

NOTE 1: TT for each band and accumulative aggregated bandwidth is specified in Table 6.2A.3.3.5-0.

Table 6.2A.3.3.5-3: A-MPR requirements for CA_NS_203 (Power Class 2)

Test ID	Band	Min peak EIRP (dBm)	MPR (dB)	A-MPR (dB)	T(MAX(MPR, A-MPR)) (dB)	Lower limit (dBm)	Upper limit (dBm)
1	n258	29.0	0	2.5	2.0	24.5-TT	43

NOTE 1: TT for each band and accumulative aggregated bandwidth is specified in Table 6.2A.3.3.5-0.

Table 6.2A.3.3.5-4: A-MPR requirements for CA_NS_203 (Power Class 3)

Test ID	Band	Min peak EIRP (dBm)	MPR (dB)	A-MPR (dB)	T(MAX(MPR, A-MPR)) (dB)	Lower limit (dBm)	Upper limit (dBm)
1	n258	22.4	0	2.5	2.0	17.9-TT	43

NOTE 1: TT for each band and accumulative aggregated bandwidth is specified in Table 6.2A.3.3.5-0.

Table 6.2A.3.3.5-5: A-MPR requirements for CA_NS_203 (Power Class 4)

Test ID	Band	Min peak EIRP (dBm)	MPR (dB)	A-MPR (dB)	T(MAX(MPR, A-MPR)) (dB)	Lower limit (dBm)	Upper limit (dBm)
1	n258	34.0	0	2.5	2.0	29.5-TT	43

NOTE 1: TT for each band and accumulative aggregated bandwidth is specified in Table 6.2A.3.3.5-0.

Table 6.2A.3.3.5-6: A-MPR requirements for CA_NS_203 (Power Class 5)

Test ID	Band	Min peak EIRP (dBm)	MPR (dB)	A-MPR (dB)	T(MAX(MPR, A-MPR)) (dB)	Lower limit (dBm)	Upper limit (dBm)
1	n258	30.4	0	2.5	2	25.9-TT	43

NOTE 1: TT for each band and accumulative aggregated bandwidth is specified in Table 6.2A.3.1.5-0.

Table 6.2A.3.3.5-7: A-MPR requirements for CA_NS_205 (Power Class 1)

Test ID	Band	Min peak EIRP (dBm)	MPR (dB)	A-MPR (dB)	T(MAX(MPR, A-MPR)) (dB)	Lower limit (dBm)	Upper limit (dBm)
1	n257, n258 ²	40.0	6.5	6.0	5.0	28.5-TT	55

NOTE 1: TT for each band and accumulative aggregated bandwidth is specified in Table 6.2A.3.1.5-0.
NOTE 2: Cumulative aggregated BW >= 250MHz.

6.2A.3.4 UE maximum output power with additional requirements for CA (5UL CA)

FFS

6.2A.3.5 UE maximum output power with additional requirements for CA (6UL CA)

FFS

6.2A.3.6 UE maximum output power with additional requirements for CA (7UL CA)

FFS

6.2A.3.7 UE maximum output power with additional requirements for CA (8UL CA)

FFS

6.2A.4 Configured transmitted power for CA

6.2A.4.0 Minimum conformance requirements

A UE configured with carrier aggregation can configure its maximum output power for each uplink carrier f of activated serving cell c and its total configured output power P_{CMAX} . The definition of the configured UE maximum output power $P_{\text{CMAX},f,c}$ for each carrier f of a serving cell c is used for power headroom reporting for carrier f of serving cell c only and is in accordance with that specified in clause 6.2.4 with parameters MPR, A-MPR and P-MPR replaced with those specified below. The UE maximum configured power P_{CMAX} in a transmission occasion is determined by the UL grants for carriers f of all serving cells c with non-zero granted power in the respective reference point.

For uplink intra-band contiguous carrier aggregation, MPR is specified in clause 6.2A.2. P_{CMAX} is calculated under the assumption that power spectral density for each RB in each component carrier is same.

The configured UE maximum output power P_{CMAX} shall be set such that the corresponding measured total peak EIRP P_{UMAX} is within the following bounds

$$P_{\text{Powerclass}} - \text{MAX}(\text{MAX}(\text{MPR}, \text{A-MPR}) + \Delta\text{MB}_{\text{P,n}}, \text{P-MPR}) - \text{MAX}\{\text{T}(\text{MAX}(\text{MPR}, \text{A-MPR})), \text{T}(\text{P-MPR})\} \leq P_{\text{UMAX}} \leq \text{EIRP}_{\text{max}}$$

with $P_{\text{Powerclass}}$ the peak EIRP as specified in sub-clause 6.2A.1, EIRP_{max} the applicable maximum EIRP as specified in sub-clause 6.2A.1, MPR as specified in sub-clause 6.2A.2, A-MPR as specified in sub-clause 6.2A.3, $\Delta\text{MB}_{\text{P,n}}$ the peak EIRP relaxation as specified in clause 6.2.1, P-MPR the power management term for the UE as described in 6.2.4.

The measured configured power P_{UMAX} for carrier aggregation is defined as

$$P_{\text{UMAX}} = 10 \log_{10} \sum_{c,f(c)} p_{\text{UMAX},f,c}$$

where $p_{\text{UMAX},f,c}$ is the linear value of the measured power $P_{\text{UMAX},f,c}$ for carrier $f=f(c)$ of serving cell c . The measured total radiated power P_{TMAX} for carrier aggregation is defined as

$$P_{\text{TMAX}} = 10 \log_{10} \sum_{c,f(c)} p_{\text{TMAX},f,c}$$

where $p_{\text{TMAX},f,c}$ is the linear value of the measured total radiated power $P_{\text{TMAX},f,c}$ for carrier $f=f(c)$ of serving cell c . The total radiated power P_{TMAX} is bounded by

$$P_{\text{TMAX}} \leq \text{TRP}_{\text{max}}$$

where TRP_{max} the maximum TRP for the UE power class as specified in sub-clause 6.2A.1.

The tolerance $\text{T}(\Delta\text{P})$ for applicable values of ΔP (values in dB) is specified in Table 6.2A.4.0-1.

Table 6.2A.4.0-1: P_{UMAX} tolerance

Operating Band	ΔP (dB)	Tolerance $\text{T}(\Delta\text{P})$ (dB)
n257, n258, n260, n261	$\Delta\text{P} = 0$	0
	$0 < \Delta\text{P} \leq 2$	1.5
	$2 < \Delta\text{P} \leq 3$	2.0
	$3 < \Delta\text{P} \leq 4$	3.0
	$4 < \Delta\text{P} \leq 5$	4.0
	$5 < \Delta\text{P} \leq 10$	5.0

	$10 < \Delta P \leq 15$	7.0
	$15 < \Delta P \leq X$	8.0
NOTE: X is the value such that P_{umax} lower bound, $P_{\text{Powerclass}} - \Delta P - T(\Delta P)$ = minimum output power specified in clause 6.3A.1		

The normative reference for this requirement is TS 38.101-2 [3] clause 6.2A.4.

6.2A.4.1 Configured transmitted power for CA (2UL CA)

6.2A.4.1.1 Test purpose

To verify the UE measured configured maximum power P_{UMAX} is within the range defined prescribed by the specified nominal maximum output power and tolerance.

6.2A.4.1.2 Test applicability

The requirements of this test are covered in test cases 6.2A.1.1.1 UE maximum output power - EIRP and TRP for CA (2UL CA), 6.2A.2.1 Maximum output power reduction for CA (2UL CA) and 6.2A.3.1 UE maximum output power with additional requirements for CA (2UL CA) to all types of NR UE release 15 and forward supporting 2UL CA.

6.2A.4.1.3 Minimum conformance requirements

The minimum conformance requirements are defined in clause 6.2A.4.0.

6.2A.4.1.4 Test description

This test is covered by clause 6.2A.1.1.1 UE maximum output power - EIRP and TRP for CA (2UL CA), 6.2A.2.1 Maximum output power reduction for CA (2UL CA) and 6.2A.3.1 UE maximum output power with additional requirements for CA (2UL CA).

6.2A.4.1.5 Test requirements

This test is covered by clause 6.2A.1.1.1 UE maximum output power - EIRP and TRP for CA (2UL CA), 6.2A.2.1 Maximum output power reduction for CA (2UL CA) and 6.2A.3.1 UE maximum output power with additional requirements for CA (2UL CA).

6.2A.4.2 Configured transmitted power for CA (3UL CA)

FFS

6.2A.4.3 Configured transmitted power for CA (4UL CA)

FFS

6.2A.4.4 Configured transmitted power for CA (5UL CA)

FFS

6.2A.4.5 Configured transmitted power for CA (6UL CA)

FFS

6.2A.4.6 Configured transmitted power for CA (7UL CA)

FFS

6.2A.4.7 Configured transmitted power for CA (8UL CA)

FFS

6.2A.5 UE maximum output power - EIRP and TRP for CA (2UL CA) with UL Gaps

Editor's note: This clause is incomplete. The following aspects are either missing or not yet determined:

- Measurement Uncertainties and Test Tolerances are FFS

6.2A.5.1 Test purpose

The objective of this test is to determine the impact of UL-gaps on TX power management by measuring the EIRP with and without UL-Gaps configured for FR2 Carrier Aggregation.

6.2A.5.2 Test applicability

This test case applies to all types of NR UEs release 17 and forward supporting *ul-GapFR2-r17*, *tdd-MPE-P-MPR-Reporting-r16* and FR2 2UL CA.

For bandwidth class B, this test case is not testable due to lack of appropriate test points since there is no configuration satisfying MPR=0dB requirements in TS 38.101-2.

6.2A.5.3 Minimum conformance requirements

The difference of the measured peak EIRP $P_{UMAX_GAP_ON}$ for CA when UL gap for TX power management is configured and activated, and the measured peak EIRP $P_{UMAX_GAP_OFF}$ when UL gap is not configured or de-activated, shall meet the following requirement:

$$P_{UMAX_GAP_ON} - P_{UMAX_GAP_OFF} \geq \max((EIRP_{meas_peak} - 23) + 10 * \log_{10}(Z/20), 3)dB$$

where $EIRP_{meas_peak}$ is the measured UE peak EIRP with zero MPR/A-MPR/P-MPR in clause 6.2A.1 for the corresponding power class, and Z% is duty cycle of the reference measurement channel. P_{UMAX_f,c_GAP_ON} shall be measured outside of the UL gap symbol(s). The period of measurement shall be at least 4 seconds. The requirement is verified with the test metric of EIRP (Link=TX beam peak direction, Meas=Link angle) and in the test Z is set to 20 when *maxUplinkDutyCycle-FR2* is less than 20 or not reported, and should be larger than *maxUplinkDutyCycle-FR2* when *maxUplinkDutyCycle-FR2* is equal to or greater than 20, assuming all CCs share the same TX beam peak direction. The reference measurement channel is specified in Annex A.2.3.

When UL gap for Tx power management is configured and activated, the reported P-MPR_{f,c} shall be less than 3dB.

When UL gap for Tx power management is not configured and activated, UE shall set the P bit in PHR to 1 in the test when PHR is configured. P-bit is defined in TS 38.321 [28] clause 6.1.3.8 and 6.1.3.9.

NOTE 1: As mentioned in clause 6.2.4.3 - for UE conformance testing P-MPR_{f,c} shall be 0 dB, except for the testing of UL gap for Tx power management, where P-MPR_{f,c} may be non-zero dB – which is relevant to this test case

6.2A.5.4 Test description

6.2A.5.4.1 Initial condition

Initial conditions are a set of test configurations the UE needs to be tested in and the steps for the SS to take with the UE to reach the correct measurement state.

The initial test configurations consist of environmental conditions, test frequencies, and channel bandwidths based on NR operating bands specified in clause 5.5A. All of these configurations shall be tested with applicable test parameters for each channel bandwidth and subcarrier spacing, are shown in Table 6.2A.5.1.1.4.1-1. The details of the uplink reference measurement channels (RMCs) are specified in Annexes A.2. Configurations of PDSCH and PDCCH before measurement are specified in Annex C.2.

Table 6.2A.5.4.1-1: Intra-band Contiguous CA Test Configuration Table

Default Conditions					
Test Environment as specified in TS 38.508-1 [10] clause 4.1				Normal	
Test Frequencies as specified in TS 38.508-1 [10] clause 4.3.1.2.3 for different CA bandwidth classes				Low and High range	
Test CC Combination setting (aggregated BW of the CA configuration) as specified in TS 38.508-1 [10] clause 4.3.1.2.3 for the CA Configuration across bandwidth combination sets supported by the UE				Highest aggregated BW of the CA configuration (≤ 400 MHz aggregated channel bandwidth)	
Test SCS as specified in Table 5.3.5-1				120 kHz	
Test Parameters					
CA Configuration / Aggregated BW			Downlink Configuration	Uplink Configuration	
Test ID	CC & Mapping (NOTE 4)	CBW (MHz)	RB allocation	Modulation	RB allocation (NOTE 1)
1	PCC/CC1	100	-	DFT-s-OFDM QPSK	Inner Full for PC2, PC3 and PC4
	SCC/CC2	100		-	
NOTE 1: The specific configuration of each RF allocation is defined in Table 6.1-1 for PC2, PC3 and PC4 or Table 6.1-2 for PC1.					
NOTE 2: CA Configuration Test cumulative aggregated BW settings are checked separately for each CA Configuration, which applicable aggregated channel bandwidths are specified in Table 5.5A.1-1.					
NOTE 3: PCC/CC _i and SCC/CC _j means PCC is on component carrier CC _i and SCC is on component carrier CC _j , with CC _i or CC _j frequencies defined in TS38.508-1 [10].					
NOTE 4: Number of DL CCs shall be configured the same as number of UL CCs. The requirements are applicable as per 5.3A.4: <i>"The requirements are applicable only when Uplink CCs are configured within the frequency range between lower edge of lowest downlink component carrier and upper edge of highest downlink component carrier"</i> .					

1. Connection between SS and UE is shown in TS 38.508-1 [10] Annex A, Figure A.3.3.1.1 for TE diagram and Figure A.3.4.1.1 for UE diagram.
2. The parameter settings for the cell are set up according to TS 38.508-1 [10] clause 4.4.3.
3. Downlink signals are initially set up according to Annex C, and uplink signals according to Annex G.
4. The UL Reference Measurement channels are set according to Table 6.2A.1.1.1.4.1-1.
5. Propagation conditions are set according to Annex B.0
6. Ensure the UE is in state RRC_CONNECTED with generic procedure parameters Connectivity *NR*, Connected without release *On*, Test Mode *On* and Test Loop Function *On* according to TS 38.508-1 [10] clause 4.5. Message contents are defined in clause 6.2A.5.4.3.

6.2A.5.4.2 Test procedure

1. Configure SCC according to Annex C.0, C.1, C.2 for all downlink physical channels.
2. The SS shall configure SCC as per TS 38.508-1 [10] clause 5.5.1. Message contents are defined in clause 6.2A.5.4.3.
3. SS activates SCC by sending the activation MAC CE (Refer TS 38.321 [28], clauses 5.9, 6.1.3.10). Wait for at least 2 seconds (Refer TS 38.133[25], clause 9.3).
4. SS sends uplink scheduling information for each UL HARQ process via PDCCH DCI format 0_1 for C_RNTI to schedule the UL RMC according to Table 6.2A.1.1.1.4.1-1. Since the UL has no payload and no loopback data to send the UE sends uplink MAC padding bits on the UL RMC. Messages to configure the appropriate uplink modulation in clause 6.2A.5.4.3.
- 4a. If the UE does not support beamCorrespondenceWithoutULBeamSweeping, the side conditions for SSB-based and CSI-RS based L1-RSRP measurements are applied as per Table 6.6.1.3.3.1.1-1 and Table 6.6.1.3.3.1.1-2 respectively.
5. Set the UE in the Tx beam peak direction found with a 3D EIRP scan as performed in Annex K.1.1. Allow at least BEAM_SELECT_WAIT_TIME (NOTE 1) for the UE Tx beam selection to complete.

6. Send continuously uplink power control "up" commands in every uplink scheduling information to the UE; allow at least 200 msec starting from the first TPC command in this step to ensure that the UE transmits at its maximum output power. Allow at least BEAM_SELECT_WAIT_TIME (NOTE 1) for the UE Tx beam selection to complete.
7. SS activates the UE Beamlock Function (UBF) by performing the procedure as specified in TS 38.508-1 [10] clause 4.9.2 using condition Tx only.

ACTIVATE Uplink Gaps

8. SS configures and activates UL-gaps via message contents defined in Table 6.2.5.4.3-1. P-MPR reporting is also enabled via the message contents defined in Table 6.2.5.4.3-2.
9. Measure UE EIRP in the Tx beam peak direction in the channel bandwidth of the radio access mode according to the test configuration. EIRP test procedure is defined in Annex K.1.3. The period of measurement shall be at least 4 seconds. EIRP is calculated considering both polarizations, theta and phi. Record this as peak EIRP P_{UMAX,f,c_GAP_ON}
10. SS detects and record the value within the P-MPR reports. Call this value P-MPR_{ULgapON}

DE-ACTIVATE Uplink Gaps

11. SS de-activates UL-gaps via message contents defined in Table 6.2.5.4.3-3.
12. Measure UE EIRP in the Tx beam peak direction in the channel bandwidth of the radio access mode according to the test configuration. EIRP test procedure is defined in Annex K.1.3. The period of measurement shall be at least 4 seconds. EIRP is calculated considering both polarizations, theta and phi. Record this value as peak EIRP P_{UMAX,f,c_GAP_OFF}
13. SS detects and record the value of the P bit within the PHR.
14. SS deactivates the UE Beamlock Function (UBF) by performing the procedure as specified in TS 38.508-1 [10] clause 4.9.3.
15. Compute the difference between P_{UMAX,f,c_GAP_ON} and P_{UMAX,f,c_GAP_OFF}

NOTE 1: The BEAM_SELECT_WAIT_TIME default value is defined in Annex K.

6.2A.5.4.3 Message contents

The message contents are configured the same as clause 6.2.5.4.3

6.2A.5.5 Test Requirements

FFS

6.2D Transmit power for UL MIMO

6.2D.1 UE maximum output power for UL MIMO

6.2D.1.0 General

The requirements in the following clauses define the maximum output power radiated by the UE with *nrofSRS-Ports* set to 2, for any transmission bandwidth within the channel bandwidth for non-CA configuration, unless otherwise stated. MPR shall be applied as specified in clause 6.2D.2

For the maximum output power requirement for 2-layer UL MIMO operation, a UE shall be configured for 2-layer UL MIMO transmission as specified in Table 6.2D.1.0-1.

Table 6.2D.1.0-1: UL MIMO configuration

Transmission scheme	DCI format	Number of layers	TPMI index
---------------------	------------	------------------	------------

Codebook based uplink	DCI format 0_1	2	0
-----------------------	----------------	---	---

The maximum output power requirement for single layer transmission shall apply to a UE that supports ULFPTx feature and is configured for single layer transmission in its declared full power mode [22, TS 38.213] as specified in Table 6.2D.1.0-2.

Table 6.2D.1.0-2: PUSCH Configuration for uplink full power transmission (ULFPTx)

ULFPTx Mode	Transmission scheme	DCI format	Modulation	Number of layers	TPMI index
Mode-1	Codebook based uplink	DCI format 0_1	DFT-s-OFDM, CP-OFDM ¹	1	2
Mode-2	Codebook based uplink	DCI format 0_1	DFT-s-OFDM, CP-OFDM	1	0 or 1 ²
Mode-full power	Codebook based uplink	DCI format 0_1	DFT-s-OFDM, CP-OFDM	1	0,1
NOTE 1: For PUSCH configured with ULFPTxModes set to Mode-1, all requirements for 1-layer CP-OFDM based modulation in subsection 6.2D are assumed to be met if the requirement for 2-layer UL MIMO has been validated.					
NOTE 2: TPMI index selected shall be based upon the full power TPMI reported by the UE [22, TS 38.213].					

6.2D.1.1 UE maximum output power - EIRP and TRP for UL MIMO

Editor's note: The following aspects are either missing or not yet determined:

- No test points are defined for 2-layer UL MIMO since there is no configuration satisfying MPR=0dB requirements in RAN4.
- Measurement Uncertainties and Test Tolerances are FFS for power classes other than 1, 3 5 and 6.
- The test case is incomplete for band n259.
- Test Procedures for EIRP beam peak Extreme Conditions are FFS.

6.2D.1.1.1 Test purpose

To verify that the power of any UE emission shall not exceed specified level for the specified channel bandwidth for UL MIMO under the deployment scenarios where additional requirements are specified.

6.2D.1.1.2 Test applicability

This test case applies to all types of NR UE release 15 and forward that supports UL MIMO.

6.2D.1.1.3 Minimum conformance requirements

6.2D.1.1.3.1 UE maximum output power for UL MIMO for power class 1

The following requirements define the maximum output power radiated by the PC1 UE. Requirements apply to UEs when configured for 2-layer transmission as well as when configured for single layer uplink full power transmission (ULFPTx), with configuration per clause 6.2D.1.0.

The minimum peak EIRP requirements are found in Table 6.2D.1.1.3.1-1 below. The period of measurement shall be at least one sub frame (1ms). The requirement is verified with the test metric of EIRP (Link=TX beam peak direction, Meas=Link angle). Power class 1 UE is used for fixed wireless access (FWA).

Table 6.2D.1.1.3.1-1: UE minimum peak EIRP for UL MIMO for power class 1

Operating band	Min peak EIRP (dBm)
n257	40.0
n258	40.0
n260	38.0
n261	40.0
NOTE 1: Minimum peak EIRP is defined as the lower limit without tolerance.	

Table 6.2D.1.1.3.1-2: Void

The maximum output power values for TRP and EIRP are found in Table 6.2D.1.1.3.1-3 below for UE with UL MIMO. The maximum allowed EIRP is derived from regulatory requirements [8]. The requirements are verified with the test metrics of TRP (Link=TX beam peak direction, Meas=TRP grid) in beam locked mode and EIRP (Link=TX beam peak direction, Meas=Link angle).

Table 6.2D.1.1.3.1-3: UE maximum output power limits for UL MIMO for power class 1

Operating band	Max TRP (dBm)	Max EIRP (dBm)
n257	35	55
n258	35	55
n260	35	55
n261	35	55

The minimum EIRP at the 85th percentile of the distribution of radiated power measured over the full sphere around the UE with UL MIMO is defined as the spherical coverage requirement and is found in Table 6.2D.1.1.3.1-4 below. The requirement is verified with the test metric of EIRP (Link=Spherical coverage grid, Meas=Link angle).

Table 6.2D.1.1.3.1-4: UE spherical coverage for UL MIMO for power class 1

Operating band	Min EIRP at 85 %-tile CDF (dBm)
n257	32.0
n258	32.0
n260	30.0
n261	32.0

NOTE 1: Minimum EIRP at 85 %-tile CDF is defined as the lower limit without tolerance.

6.2D.1.1.3.2 UE maximum output power for UL MIMO for power class 2

The following requirements define the maximum output power radiated by the PC2 UE. Requirements apply to UEs when configured for 2-layer transmission as well as when configured for single layer uplink full power transmission (ULFPTx), with configuration per clause 6.2D.1.0.

The minimum peak EIRP requirements are found in Table 6.2D.1.1.3.2-1 below. The period of measurement shall be at least one sub frame (1ms). The requirement is verified with the test metric of EIRP (Link=TX beam peak direction, Meas=Link angle).

Table 6.2D.1.1.3.2-1: UE minimum peak EIRP for UL MIMO for power class 2

Operating band	Min peak EIRP (dBm)
n257	29
n258	29
n261	29

NOTE 1: Minimum peak EIRP is defined as the lower limit without tolerance.
NOTE 2: Min Peak EIRP refers to the total EIRP for the UL beams peaks.

The maximum output power values for TRP and EIRP are found in Table 6.2D.1.1.3.2-2 below. The maximum allowed EIRP is derived from regulatory requirements [8]. The requirements are verified with the test metrics of TRP (Link=TX beam peak direction, Meas=TRP grid) in beam locked mode and EIRP (Link=TX beam peak direction, Meas=Link angle).

Table 6.2D.1.1.3.2-2: UE maximum output power limits for UL MIMO for power class 2

Operating band	Max TRP (dBm)	Max EIRP (dBm)
n257	23	43

n258	23	43
n261	23	43

Table 6.2D.1.1.3.2-3: Void

The minimum EIRP at the 60th percentile of the distribution of radiated power measured over the full sphere around the UE is defined as the spherical coverage requirement and is found in Table 6.2D.1.1.3.2-4 below. The requirement is verified with the test metric of EIRP (Link=Spherical coverage grid, Meas=Link angle).

Table 6.2D.1.1.3.2-4: UE spherical coverage for UL MIMO for power class 2

Operating band	Min EIRP at 60 %-tile CDF (dBm)
n257	18.0
n258	18.0
n261	18.0
NOTE 1: Minimum EIRP at 60 %-tile CDF is defined as the lower limit without tolerance	

6.2D.1.1.3.3 UE maximum output power for UL MIMO for power class 3

The following requirements define the maximum output power radiated by the PC3 UE.. Requirements apply to UEs when configured for 2-layer transmission as well as when configured for single layer uplink full power transmission (ULFPTx), with configuration per clause 6.2D.1.0.

The minimum peak EIRP requirements are found in Table 6.2D.1.1.3.3-1 below. The period of measurement shall be at least one sub frame (1 ms). The requirement is verified with the test metric of EIRP (Link=TX beam peak direction, Meas=Link angle).

Table 6.2D.1.1.3.3-1: UE minimum peak EIRP for UL MIMO for power class 3

Operating band	Min peak EIRP (dBm)
n257	22.4
n258	22.4
n259	18.7
n260	20.6
n261	22.4
NOTE 1: Minimum peak EIRP is defined as the lower limit without tolerance.	
NOTE 2: Min Peak EIRP refers to the total EIRP for the UL beams peaks.	

The maximum output power values for TRP and EIRP are found in Table 6.2D.1.1.3.3-2 below. The maximum allowed EIRP is derived from regulatory requirements [8]. The requirements are verified with the test metrics of TRP (Link=TX beam peak direction, Meas=TRP grid) in beam locked mode and EIRP (Link=TX beam peak direction, Meas=Link angle).

Table 6.2D.1.1.3.3-2: UE maximum output power limits for UL MIMO for power class 3

Operating band	Max TRP (dBm)	Max EIRP (dBm)
n257	23	43
n258	23	43
n259	23	43
n260	23	43
n261	23	43

Table 6.2D.1.1.3.3-3: Void

The minimum EIRP at the 50th percentile of the distribution of radiated power measured over the full sphere around the UE is defined as the spherical coverage requirement and is found in Table 6.2D.1.1.3.3-4 below. The requirement is verified with the test metric of EIRP (Link=spherical coverage grid, Meas=Link angle).

Table 6.2D.1.1.3.3-4: UE spherical coverage for UL MIMO for power class 3

Operating band	Min EIRP at 50 %-tile CDF (dBm)
n257	11.5
n258	11.5
n259	5.8
n260	8
n261	11.5
NOTE 1: Minimum EIRP at 50 %-tile CDF is defined as the lower limit without tolerance	
NOTE 2: The requirements in this table are only applicable for UE which supports single band in FR2	

6.2D.1.1.3.4 UE maximum output power for UL MIMO for power class 4

The following requirements define the maximum output power radiated by the PC4 UE. Requirements apply to UEs configured for 2-layer transmission as well as UEs configured for single layer uplink full power transmission (ULFPTx), with configuration per clause 6.2D.1.0.

The minimum peak EIRP requirements are found in Table 6.2D.1.1.3.4-1 below. The period of measurement shall be at least one sub frame (1ms). The requirement is verified with the test metric of EIRP (Link=TX beam peak direction, Meas=Link angle).

Table 6.2D.1.1.3.4-1: UE minimum peak EIRP for UL MIMO for power class 4

Operating band	Min peak EIRP (dBm)
n257	34
n258	34
n260	31
n261	34
NOTE 1: Minimum peak EIRP is defined as the lower limit without tolerance.	
NOTE 2: Min Peak EIRP refers to the total EIRP for the UL beams peaks.	

The maximum output power values for TRP and EIRP are found in Table 6.2D.1.1.3.4-2 below. The maximum allowed EIRP is derived from regulatory requirements [8]. The requirements are verified with the test metrics of TRP (Link=TX beam peak direction, Meas=TRP grid) in beam locked mode and EIRP (Link=TX beam peak direction, Meas=Link angle).

Table 6.2D.1.1.3.4-2: UE maximum output power limits for UL MIMO for power class 4

Operating band	Max TRP (dBm)	Max EIRP (dBm)
n257	23	43
n258	23	43
n260	23	43
n261	23	43

Table 6.2D.1.1.3.4-3: Void

The minimum EIRP at the 20th percentile of the distribution of radiated power measured over the full sphere around the UE is defined as the spherical coverage requirement and is found in Table 6.2D.1.1.3.4-4 below. The requirement is verified with the test metric of EIRP (Link=Spherical coverage grid, Meas=Link angle).

Table 6.2D.1.1.3.4-4: UE spherical coverage for UL MIMO for power class 4

Operating band	Min EIRP at 20 %-tile CDF (dBm)
----------------	---------------------------------

n257	25
n258	25
n260	19
n261	25
NOTE 1: Minimum EIRP at 20 %-tile CDF is defined as the lower limit without tolerance	

The normative reference for this requirement is TS 38.101-2 [3] clause 6.2.1.

6.2D.1.1.3.5 UE maximum output power for UL MIMO for power class 5

The following requirements define the maximum output power radiated by the PC4 UE. Requirements apply to UEs configured for 2-layer transmission as well as UEs configured for single layer uplink full power transmission (ULFPTx), with configuration per clause 6.2D.1.0.

The minimum peak EIRP requirements are found in Table Table 6.2D.1.1.3.5-1 below. The period of measurement shall be at least one sub frame (1ms). The requirement is verified with the test metric of EIRP (Link=TX beam peak direction, Meas=Link angle). Power class 5 UE is used for fixed wireless access (FWA).

Table 6.2D.1.1.3.5-1: UE minimum peak EIRP for UL MIMO for power class 5

Operating band	Min peak EIRP (dBm)
n257	30
n258	30.4
NOTE 1: Minimum peak EIRP is defined as the lower limit without tolerance	

The maximum output power values for TRP and EIRP are found in Table Table 6.2D.1.1.3.5-2 below for UE with UL MIMO. The maximum allowed EIRP is derived from regulatory requirements. The requirements are verified with the test metrics of TRP (Link=TX beam peak direction, Meas=TRP grid) in beam locked mode and EIRP (Link=TX beam peak direction, Meas=Link angle).

Table 6.2D.1.1.3.5-2: UE maximum output power limits for UL MIMO for power class 5

Operating band	Max TRP (dBm)	Max EIRP (dBm)
n257	23	43
n258	23	43

The minimum EIRP at the 85th percentile of the distribution of radiated power measured over the full sphere around the UE with UL MIMO is defined as the spherical coverage requirement and is found in Table Table 6.2D.1.1.3.5-3 below. The requirement is verified with the test metric of EIRP (Link=Spherical coverage grid, Meas=Link angle).

Table 6.2D.1.1.3.5-3: UE spherical coverage for UL MIMO for power class 5

Operating band	Min EIRP at 85 %-tile CDF (dBm)
n257	22
n258	22.4
NOTE 1: Minimum EIRP at 85 %-tile CDF is defined as the lower limit without tolerance	

6.2D.1.1.3.6 UE maximum output power for UL MIMO for power class 6

The following requirements define the maximum output power radiated by the PC6 UE. Requirements apply to UEs configured for 2-layer transmission as well as UEs configured for single layer uplink full power transmission (ULFPTx), with configuration per clause 6.2D.1.0.

The minimum peak EIRP requirements are found in Table 6.2D.1.1.3.6-1 below. The period of measurement shall be at least one sub frame (1ms). The requirement is verified with the test metric of EIRP (Link=TX beam peak direction, Meas=Link angle).

Table 6.2D.1.1.3.6-1: UE minimum peak EIRP for UL MIMO for power class 6

Operating band	Min peak EIRP (dBm)
n257	30
n258	30.4
n261	30
NOTE 1: Minimum peak EIRP is defined as the lower limit without tolerance	

The maximum output power values for TRP and EIRP are found in Table 6.2D. 1.1.3.6-2 below for UE with UL MIMO. The maximum allowed EIRP is derived from regulatory requirements [8]. The requirements are verified with the test metrics of TRP (Link=TX beam peak direction, Meas=TRP grid) in beam locked mode and EIRP (Link=TX beam peak direction, Meas=Link angle).

Table 6.2D.1.1.3.6-2: UE maximum output power limits for UL MIMO for power class 6

Operating band	Max TRP (dBm)	Max EIRP (dBm)
n257	23	43
n258	23	43
n261	23	43

The minimum EIRP measured over the spherical coverage evaluation areas is defined as the spherical coverage requirement and is found in Table 6.2D. 1.1.3.6-3 below. UE spherical coverage evaluation areas are found in Table 6.2.1.1.3.6-3a in clause 6.2.1.1.3.6, by consisting of Area-1 and Area-2, in the reference coordinate system in Annex J.1. The requirement is verified with the test metric of EIRP (Link= Spherical coverage grid, Meas=Link angle).

Table 6.2D.1.1.3.6-3: UE spherical coverage for UL MIMO for power class 6

Operating band	Min EIRP over UE spherical coverage evaluation areas (dBm)
n257	20
n258	20.4
n261	20
NOTE 1: Minimum EIRP over UE spherical coverage evaluation areas is defined as the lower limit without tolerance.	
NOTE 2: The requirements in this table are verified only under normal temperature conditions as defined in TS 38.508-1 [10] clause 4.1.1.	
NOTE 3: The requirements in this table are applicable to FR2 PC6 UE with the network signalling <i>highSpeedMeasFlagFR2-r17</i> configured as <i>set2</i> .	

6.2D.1.1.4 Test description

6.2D.1.1.4.1 Initial conditions

Initial conditions are a set of test configurations the UE needs to be tested in and the steps for the SS to take with the UE to reach the correct measurement state.

The initial test configurations consist of environmental conditions, test frequencies, and channel bandwidths based on NR operating bands specified in Table 5.3.5-1. All of these configurations shall be tested with applicable test parameters for each channel bandwidth and subcarrier spacing, are shown in Table 6.2D.1.1.4.1-1 and Table 6.2D.1.1.4.1-2. The details of the uplink reference measurement channels (RMCs) are specified in Annexes A.2. Configurations of PDSCH and PDCCH before measurement are specified in Annex C.2.

Table 6.2D.1.1.4.1-1: Test Configuration Table for 2-layer UL MIMO

NOTE: No test points are defined since there is no configuration satisfying MPR=0dB requirements in RAN4.

Table 6.2D.1.1.4.1-2: Test Configuration Table for uplink full power transmission (ULFPTx)

Default Conditions					
Test Environment as specified in TS 38.508-1 [10] clause 4.1			Normal, TL, TH		
Test Frequencies as specified in TS 38.508-1 [10] clause 4.3.1			Low range, Mid Range, High range		
Test Channel Bandwidths as specified in TS 38.508-1 [10] clause 4.3.1			Lowest, 100 MHz, Highest		
Test SCS as specified in Table 5.3.5-1			120 kHz		
Test Parameters					
Test ID	ChBw	SCS	Downlink Configuration	Uplink Configuration	
		Default	N/A	Modulation	RB allocation (NOTE 1)
1	50			DFT-s-OFDM QPSK	Inner_Full for PC2, PC3, PC4 and PC6 Inner_Full_Region1 for PC1
2	100				
3	200				
4	400				
NOTE 1: The specific configuration of each RF allocation is defined in Table 6.1-1 for PC2, PC3, PC4 and PC6 or Table 6.1-2 for PC1.					

1. Connection between SS and UE is shown in TS 38.508-1 [10] Annex A, Figure A.3.3.1.1 for TE diagram and Figure A.3.4.1.1 for UE diagram.
2. The parameter settings for the cell are set up according to TS 38.508-1 [10] clause 4.4.3.
3. Downlink signals are initially set up according to Annex C, and uplink signals according to Annex G.
4. The UL Reference Measurement channels are set according to Table 6.2D.1.1.4.1-2.
5. Propagation conditions are set according to Annex B.0
6. Ensure the UE is in state RRC_CONNECTED with generic procedure parameters Connectivity NR, Connected without release On, Test Mode On and Test Loop Function On according to TS 38.508-1 [10] clause 4.5. Message contents are defined in clause 6.2D.1.1.4.3

6.2D.1.1.4.2 Test procedure

1. SS sends uplink scheduling information for each UL HARQ process via PDCCH DCI format 0_1 for C_RNTI to schedule the UL RMC according to Table 6.2D.1.1.4.1-2. The PDCCH DCI format 0_1 is specified with the condition ULFPTx_Mode1, ULFPTx_Mode2 or ULFPTx_ModeFull in 38.508-1 [5] clause 4.3.6.1.1.2 depending on UE reported capability. Message contents are according to TS 38.508-1 [5] clause 4.6.3 Table 4.6.3-118 with condition TRANSFORM_PRECODER_ENABLED. Since the UL has no payload and no loopback data to send the UE sends uplink MAC padding bits on the UL RMC. Messages to configure the appropriate uplink modulation in section 6.2D.1.1.4.3.
2. Set the UE in the Tx beam peak direction found with a 3D EIRP scan as performed in Annex K.1.1. Allow at least BEAM_SELECT_WAIT_TIME (NOTE 1) for the UE Tx beam selection to complete.
3. Send continuously uplink power control "up" commands in every uplink scheduling information to the UE; allow at least 200 msec starting from the first TPC command in this step to ensure that the UE transmits at its maximum output power. Allow at least BEAM_SELECT_WAIT_TIME (NOTE 1) for the UE Tx beam selection to complete.
4. SS activates the UE Beamlock Function (UBF) by performing the procedure as specified in TS 38.508-1 [10] clause 4.9.2 using condition Tx only.
5. Measure UE EIRP in the Tx beam peak direction in the channel bandwidth of the radio access mode according to the test configuration, which shall meet the requirements described in Tables 6.2D.1.1.5-1 to 6.2D.1.1.5-4. EIRP test procedure is defined in Annex K.1.3. The measuring duration is one active uplink subframe. EIRP is calculated considering both polarizations, theta and phi.

6. Measure TRP of the transmitted signal for the assigned NR channel with a rectangular measurement filter with bandwidths according to Table 6.5.2.3.5-1. Total radiated power is measured according to TRP measurement procedure defined in Annex K.1.7 and measurement grid specified in Annex M.4. TRP is calculated considering both polarizations, theta and phi.
7. SS deactivates the UE Beamlock Function (UBF) by performing the procedure as specified in TS 38.508-1 [10] clause 4.9.3.

NOTE 1: The BEAM_SELECT_WAIT_TIME default value is defined in Annex K.

6.2D.1.1.4.3 Message contents

Message contents are according to TS 38.508-1 [10] clause 4.6.

6.2D.1.1.5 Test requirement

The EIRP derived in step 4, TRP derived in step 5, and EIRP and TRP derived in step 8 shall not exceed the values specified in Table 6.2D.1.1.5-1 to Table 6.2D.1.1.5-4.

Table 6.2D.1.1.5-1: UE maximum output test requirements for power class 1

Operating band	Max TRP (dBm)	Max EIRP (dBm)	Min peak EIRP (dBm)
n257	35+TT	55	40.0-TT
n258	35+TT	55	40.0-TT
n260	35+TT	55	38.0-TT
n261	35+TT	55	40.0-TT

Table 6.2D.1.1.5-1a: Test Tolerance (Max TRP for Power class 1)

Test Metric	FR2a	FR2b
Max device size ≤ 30 cm	2.78 dB, NTC 2.94 dB, ETC	2.87 dB, NTC 3.03 dB, ETC

Table 6.2D.1.1.5-1b: Test Tolerance (Min peak EIRP for Power class 1)

Test Metric	FR2a	FR2b
Max device size ≤ 30 cm	3.12 dB, NTC 3.28 dB, ETC	3.12 dB, NTC 3.28 dB, ETC

Table 6.2D.1.1.5-2: UE maximum output test requirements for power class 2

Operating band	Max TRP (dBm)	Max EIRP (dBm)	Min peak EIRP (dBm)
n257	23+TT	43	29-TT
n258	23+TT	43	29-TT
n260			
n261	23+TT	43	29-TT

Table 6.2D.1.1.5-3: UE maximum output test requirements for power class 3

Operating band	Max TRP (dBm)	Max EIRP (dBm)	Min peak EIRP (dBm)
n257	23+TT	43	22.4-TT
n258	23+TT	43	22.4-TT
n260	23+TT	43	20.6-TT
n261	23+TT	43	22.4-TT

Table 6.2D.1.1.5-3a: Test Tolerance (Max TRP for Power class 3)

Test Metric	FR2a	FR2b	FR2c
-------------	------	------	------

Max device size \leq 30 cm	2.77 dB, NTC 2.91 dB, ETC	2.89 dB, NTC 3.04 dB, ETC	3.70 dB, NTC TBD dB, ETC
------------------------------	------------------------------	------------------------------	-----------------------------

Table 6.2D.1.1.5-3b: Test Tolerance (Min peak EIRP for Power class 3)

Test Metric	FR2a	FR2b	FR2c
Max device size \leq 30 cm	2.99 dB, NTC 3.15 dB, ETC	2.99 dB, NTC 3.15 dB, ETC	3.80 dB, NTC 3.89 dB, ETC

Table 6.2D.1.1.5-4: UE maximum output power test requirements for power class 4

Operating band	Max TRP (dBm)	Max EIRP (dBm)	Min peak EIRP (dBm)
n257	23+TT	43	34-TT
n258	23+TT	43	34-TT
n260	23+TT	43	31-TT
n261	23+TT	43	34-TT

Table 6.2D.1.1.5-5: UE maximum output power test requirements for power class 5

Operating band	Max TRP (dBm)	Max EIRP (dBm)	Min peak EIRP (dBm)
n257	23+TT	43	30.0-TT- Δ MB _{P,n}
n258	23+TT	43	30.4-TT- Δ MB _{P,n}

Note 1: Δ MB_{P,n} = 0 for single band UE. For multi-band UEs, Δ MB_{P,n} is defined in table 6.2.1.1.3.5-4.

Table 6.2D.1.1.5-5a: Test Tolerance (Max TRP for Power class 5)

Test Metric	FR2a
Max device size \leq 30 cm	2.78 dB, NTC 2.94 dB, ETC

Table 6.2D.1.1.5-5b: Test Tolerance (Min peak EIRP for Power class 5)

Test Metric	FR2a
Max device size \leq 30 cm	3.12 dB, NTC 3.28 dB, ETC

Table 6.2D.1.1.5-6: UE maximum output power test requirements for power class 6

Operating band	Max TRP (dBm)	Max EIRP (dBm)	Min peak EIRP (dBm)
n257	23+TT	43	30+TT
n258	23+TT	43	30.4+TT
n261	23+TT	43	30+TT

Table 6.2D.1.1.5-6a: Test Tolerance (Max TRP for Power class 6)

Test Metric	FR2a
Max device size \leq 30 cm	2.78 dB, NTC 2.94 dB, ETC

Table 6.2D.1.1.5-6b: Test Tolerance (Min peak EIRP for Power class 6)

Test Metric	FR2a
Max device size \leq 30 cm	3.11 dB, NTC 3.27 dB, ETC

6.2D.1.2 UE maximum output power - Spherical coverage for UL MIMO

Editor's note: The following aspects are either missing or not yet determined:

- No test points are defined for 2-layer UL MIMO since there is no configuration satisfying MPR=0dB requirements in RAN4.
- Measurement Uncertainties and Test Tolerances are FFS for power classes other than 1, 3 5 and 6.
- The test case is incomplete for band n259.

6.2D.1.2.1 Test purpose

To verify that the spatial coverage of the UE in expected directions is acceptable.

6.2D.1.2.2 Test applicability

This test case applies to all types of NR UE release 15 and forward that support beam correspondence without UL beam sweeping.

6.2D.1.2.3 Minimum conformance requirements

Minimum conformance requirements are defined in clause 6.2D.1.1.3.

6.2D.1.2.4 Test description

6.2D.1.2.4.1 Initial conditions

Initial conditions are a set of test configurations the UE needs to be tested in and the steps for the SS to take with the UE to reach the correct measurement state.

The initial test configurations consist of environmental conditions, test frequencies, and channel bandwidths based on NR operating bands specified in Table 5.3.5-1. All of these configurations shall be tested with applicable test parameters for each channel bandwidth and subcarrier spacing, are shown in Table 6.2D.1.2.4.1-1 and Table 6.2D.1.2.4.1-2. The details of the uplink reference measurement channels (RMCs) are specified in Annexes A.2. Configurations of PDSCH and PDCCH before measurement are specified in Annex C.2.

Table 6.2D.1.2.4.1-1: Test Configuration Table for 2-layer UL MIMO

NOTE: No test points are defined since there is no configuration satisfying MPR=0dB requirements in RAN4.

Table 6.2D.1.2.4.1-2: Test Configuration Table for uplink full power transmission (ULFPTx)

Default Conditions						
Test Environment as specified in TS 38.508-1 [10] clause 4.1				Normal		
Test Frequencies as specified in TS 38.508-1 [10] clause 4.3.1				Low range, Mid Range, High range		
Test Channel Bandwidths as specified in TS 38.508-1 [10] clause 4.3.1				Lowest, Highest		
Test SCS as specified in Table 5.3.5-1				120 kHz		
Test Parameters						
Test ID	ChBw	SCS	Downlink Configuration	Uplink Configuration		
		Default	N/A	Modulation	RB allocation (NOTE 1)	
1	50			DFT-s-OFDM QPSK	Inner_Full for PC2, PC3 and PC4	
2	100				Inner_Full_Region1 for PC1	
3	200					
4	400					
NOTE 1: The specific configuration of each RF allocation is defined in Table 6.1-1 for PC2, PC3 and PC4 or Table 6.1-2 for PC1.						

1. Connection between SS and UE is shown in TS 38.508-1 [10] Annex A, Figure A.3.3.1.1 for TE diagram and Figure A.3.4.1.1 for UE diagram.
2. The parameter settings for the cell are set up according to TS 38.508-1 [10] clause 4.4.3.
3. Downlink signals are initially set up according to Annex C.2 and TS 38.508-1 [10] clause 5.2.1.1.1, and uplink signals according to Annex G.0, G.1 and G.3.0.
4. The UL Reference Measurement channels are set according to Table 6.2D.1.2.4.1-2.
5. Propagation conditions are set according to Annex B.0.
6. Ensure the UE is in state RRC_CONNECTED with generic procedure parameters Connectivity *NR*, Connected without release *On*, Test Mode *On* and Test Loop Function *On* according to TS 38.508-1 [10] clause 4.5. Message contents are defined in clause 6.2D.1.2.4.3

6.2D.1.2.4.2 Test procedure

1. SS sends uplink scheduling information for each UL HARQ process via PDCCH DCI format 0_1 for C_RNTI to schedule the UL RMC according to Table 6.2D.1.2.4.1-2. The PDCCH DCI format 0_1 is specified with the condition ULFPTx_Mode1, ULFPTx_Mode2 or ULFPTx_ModeFull in 38.508-1 [5] clause 4.3.6.1.1.2 depending on UE reported capability. Message contents are according to TS 38.508-1 [5] clause 4.6.3 Table 4.6.3-118 with condition TRANSFORM_PRECODER_ENABLED. Since the UL has no payload and no loopback data to send the UE sends uplink MAC padding bits on the UL RMC. Messages to configure the appropriate uplink modulation in section 6.2D.1.2.4.3.
2. Set the UE in the Tx beam peak direction found with a 3D EIRP scan as performed in Annex K.1.1. Allow at least BEAM_SELECT_WAIT_TIME (NOTE 1) for the UE Tx beam selection to complete.
3. Send continuously uplink power control "up" commands in every uplink scheduling information to the UE; allow at least 200 msec to ensure that the UE transmits at its maximum output power. Allow at least BEAM_SELECT_WAIT_TIME (NOTE 1) for the UE Tx beam selection to complete.
4. Through its beam correspondence procedure, DUT refines its TX beam toward that direction depending on DUT's beam correspondence capability which shall match OEM declaration:
 - 4a If the DUT's beam correspondence capability beamCorrespondenceWithoutUL-BeamSweeping is supported, then DUT autonomously chooses the corresponding TX beam for PUSCH transmission using downlink reference signals to transmit in the direction of the incoming DL signal, which is based on beam correspondence without relying on UL beam sweeping;
 - 4b If the DUT's beam correspondence capability beamCorrespondenceWithoutUL-BeamSweeping is not present, then DUT chooses the TX beam for PUSCH transmission which is based on beam correspondence with relying on both DL measurements on downlink reference signals and network-assisted uplink beam sweeping:
 - 4b.1) DUT uses downlink reference signals to select proper RX beam and uses autonomous beam correspondence to select the TX beam.
 - 4b.2) SS configures M=8 SRS resources to DUT, with the field *spatialRelationInfo* omitted and the field usage set as 'beamManagement'. In case DUT supports less than 8 SRS resources, SS configures the number of SRS resources according to the maximum number of SRS resources indicated by UE capability signalling. Additionally, for codebook based PUSCH transmission, SS configures a semi-persistent SRS resource set with the field *usage* as 'codebook'.
 - 4b.3) Based on the TX beam autonomously selected by DUT, DUT chooses TX beams to transmit SRS-resources configured by SS.
 - 4b.4) Based on measurement of the received *beamManagement* SRS, SS chooses the best SRS beam and, if needed, updates the spatial relation information between the semi-persistent *codebook* SRS resources and the SS selected *beamManagement* SRS resource in the activation MAC CE of the semi-persistent SRS resource. The SS indicates in the SRS Resource Indicator (SRI) field in the scheduling grant for PUSCH, if present, the SRS resource within the semi-persistent SRS resource set whose spatial relation is linked to the best detected SRS beam.

4b.5) DUT transmits PUSCH corresponding to the SRS resource indicated by the SRI.

5. Measure UE EIRP value for each grid point according to the EIRP spherical coverage procedure defined in Annex K.1.5.0, and obtain a cumulative distribution function (CDF) of all EIRP dBm values. Alternatively, UE EIRP measurement for each grid point could be done according to Tx Fast spherical coverage procedure defined in Annex K.1.5.1. After a rotation, allow at least BEAM_SELECT_WAIT_TIME (NOTE 1) for UE to find the best beam to use. The measuring duration is one active uplink subframe. EIRP is calculated considering both polarizations, theta and phi.
6. Identify the EIRP dBm value corresponding to %-tile (UE power class dependent) value in the applicable test requirement table in section 6.2D.1.2.5.

NOTE 1: The BEAM_SELECT_WAIT_TIME default value is defined in Annex K.

6.2D.1.2.4.3 Message contents

Message contents are according to TS 38.508-1 [10] clause 4.6.

6.2D.1.2.5 Test requirement

The defined %-tile EIRP in measurement distribution derived in step 5 and step 6 shall exceed the values specified in Table 6.2D.1.2.5-1 to Table 6.2D.1.2.5-6.

Table 6.2D.1.2.5-1: UE spherical coverage for power class 1

Operating band	Min EIRP at 85%-tile CDF (dBm)
n257	32.0-TT
n258	32.0-TT
n260	30.0-TT
n261	32.0-TT

Table 6.2D.1.2.5-1a: Test Tolerance (UE spherical coverage for Power class 1)

Test Metric	FR2a	FR2b
Max device size \leq 30 cm	2.69 dB	2.69 dB

Table 6.2D.1.2.5-2: UE spherical coverage for power class 2

Operating band	Min EIRP at 60%-tile CDF (dBm)
n257	18.0-TT
n258	18.0-TT
n260	
n261	18.0-TT

Table 6.2D.1.2.5-3: UE spherical coverage for power class 3

Operating band	Min EIRP at 50%-tile CDF (dBm)
n257	11.5-TT
n258	11.5-TT
n259	5.8-TT
n260	8-TT
n261	11.5-TT

Table 6.2D.1.2.5-3b: Test Tolerance (UE spherical coverage for Power class 3)

Test Metric	FR2a	FR2b	FR2c
Max device size \leq 30 cm	2.69 dB	2.69 dB	TBD

Table 6.2D.1.2.5-4: UE spherical coverage for power class 4

Operating band	Min EIRP at 20%-tile CDF (dBm)
n257	25-TT
n258	25-TT
n260	19-TT
n261	25-TT

Table 6.2D.1.2.5-5: UE spherical coverage for power class 5

Operating band	Min EIRP at 85 %-tile CDF (dBm)
n257	22-TT
n258	22.4-TT

Table 6.2D.1.2.5-5a: Test Tolerance (UE spherical coverage for Power class 5)

Test Metric	FR2a
Max device size \leq 30 cm	2.69 dB

Table 6.2D.1.2.5-6: UE spherical coverage for power class 6

Operating band	Min EIRP over UE spherical coverage evaluation areas (dBm)
n257	20-TT
n258	20.4-TT
n261	20-TT

Table 6.2D.1.2.5-6a: Test Tolerance (UE spherical coverage for Power class 6)

Test Metric	FR2a
Max device size \leq 30 cm	3.11 dB

6.2D.2 UE maximum output power reduction for UL MIMO

Editor's note: The following aspects are either missing or not yet determined:

- Measurement Uncertainties and Test Tolerances are FFS for PC2 and PC4.
- The test requirement for PCs other than PC3, PC5 and PC6 is FFS.

6.2D.2.1 Test purpose

The number of RB identified in 6.2D.2.3 is based on meeting the requirements for the maximum power reduction (MPR) due to Cubic Metric (CM).

6.2D.2.2 Test applicability

This test case applies to all types of NR UE release 15 and forward supporting UL MIMO.

6.2D.2.3 Minimum conformance requirements

6.2D.2.3.1 UE maximum output power reduction for modulation / channel bandwidth for UL MIMO for power class 1

For UEs configured for 2-layer transmission as well as UEs configured for single layer uplink full power transmission (ULFPTx), the allowed Maximum Power Reduction (MPR) for the maximum output power in Table 6.2D.1.1.3.1-1 is specified in sub-clause 6.2.2.3.1. The requirements shall be met with configurations specified in sub-clause 6.2D.1.0.

For the UE maximum output power modified by MPR, the power limits specified in clause 6.2D.4 apply.

6.2D.2.3.2 UE maximum output power reduction for modulation / channel bandwidth for UL MIMO for power class 2

For UEs configured for 2-layer transmission as well as UEs configured for single layer uplink full power transmission (ULFPTx), the allowed Maximum Power Reduction (MPR) for the maximum output power in Table 6.2D.1.1.3.2-1 is specified in sub-clause 6.2.2.3.2. The requirements shall be met with configurations specified in sub-clause 6.2D.1.0.

For the UE maximum output power modified by MPR, the power limits specified in clause 6.2D.4 apply.

6.2D.2.3.3 UE maximum output power reduction for modulation / channel bandwidth for UL MIMO for power class 3

For UEs configured for 2-layer transmission as well as UEs configured for single layer uplink full power transmission (ULFPTx), the allowed Maximum Power Reduction (MPR) for the maximum output power in Table 6.2D.1.1.3.3-1 is specified in sub-clause 6.2.2.3.3. The requirements shall be met with configurations specified in sub-clause 6.2D.1.0.

For the UE maximum output power modified by MPR, the power limits specified in clause 6.2D.4 apply.

6.2D.2.3.4 UE maximum output power reduction for modulation / channel bandwidth for UL MIMO for power class 4

For UEs configured for 2-layer transmission as well as UEs configured for single layer uplink full power transmission (ULFPTx), the allowed Maximum Power Reduction (MPR) for the maximum output power in Table 6.2D.1.1.3.4-1 is specified in sub-clause 6.2.2.3.4. The requirements shall be met with configurations specified in sub-clause 6.2D.1.0.

For the UE maximum output power modified by MPR, the power limits specified in clause 6.2D.4 apply.

6.2D.2.3.5 UE maximum output power reduction for modulation / channel bandwidth for UL MIMO for power class 5

For UEs configured for 2-layer transmission as well as UEs configured for single layer uplink full power transmission (ULFPTx), the allowed Maximum Power Reduction (MPR) for the maximum output power in Table 6.2D.1.1.3.5-1 is specified in sub-clause 6.2.2.3.5. The requirements shall be met with configurations specified in sub-clause 6.2D.1.0.

For the UE maximum output power modified by MPR, the power limits specified in clause 6.2D.4 apply.

The normative reference for this requirement is TS 38.101-2 [3] clause 6.2D.2.

6.2D.2.3.6 UE maximum output power reduction for modulation / channel bandwidth for UL MIMO for power class 6

For UEs configured for 2-layer transmission as well as UEs configured for single layer uplink full power transmission (ULFPTx), the allowed Maximum Power Reduction (MPR) for the maximum output power in Table 6.2D.1.1.3.6-1 is specified in sub-clause 6.2.2.3.6. The requirements shall be met with configurations specified in sub-clause 6.2D.1.0.

For the UE maximum output power modified by MPR, the power limits specified in clause 6.2D.4 apply.

The normative reference for this requirement is TS 38.101-2 [3] clause 6.2D.2.

6.2D.2.4 Test description

6.2D.2.4.1 Initial condition

Same initial condition in clause 6.2.2.4.1, with following exceptions:

- Instead of Table 6.2.2.4.1-1 → use Table 6.2D.2.4.1-1.
- Instead of Table 6.2.2.4.1-2 → use Table 6.2D.2.4.1-2.

- Instead of Table 6.2.2.4.1-3 → use Table 6.2D.2.4.1-3.
- Instead of Table 6.2.2.4.1-7 → use Table 6.2D.2.4.1-4.
- Instead of Table 6.2.2.4.1-8 → use Table 6.2D.2.4.1-5.
- Instead of Table 6.2.2.4.1-9 → use Table 6.2D.2.4.1-6.

Table 6.2D.2.4.1-1: Test Configuration Table (Power Class 1, MPR_{narrow})

Default Conditions							
Test Environment as specified in TS 38.508-1 [10] clause 4.1				Normal, TL, TH			
Test Frequencies as specified in TS 38.508-1 [10] clause 4.3.1				Low range, High range			
Test Channel Bandwidths as specified in TS 38.508-1 [10] clause 4.3.1				Lowest and Highest			
Test SCS as specified in Table 5.3.5-1				Lowest, Highest			
Test Parameters							
Test ID	Freq	ChBw	SCS	Downlink Configuration	Uplink Configuration		
					Modulation	RB allocation (NOTE 1)	
		Default	Default	-		SCS 60 kHz	SCS 120 kHz
1	Low				CP-OFDM 64 QAM	Outer_1RB_Left	Outer_1RB_Left
2	High				CP-OFDM 64 QAM	Outer_1RB_Right	Outer_1RB_Right
3	Low				CP-OFDM 64 QAM	3@0	2@0
4	High				CP-OFDM 64 QAM	3@N _{RB} -3	2@N _{RB} -2
5	Low				CP-OFDM 64 QAM	15@0	7@0
6	High				CP-OFDM 64 QAM	15@N _{RB} -15	7@N _{RB} -7

NOTE 1: The specific configuration of each RF allocation is defined in Table 6.1-2.

Table 6.2D.2.4.1-2: Test Configuration Table (Power Class 1, MPR_{WT}, BW_{channel} ≤ 200 MHz)

Default Conditions							
Test Environment as specified in TS 38.508-1 [10] clause 4.1				Normal, TL, TH			
Test Frequencies as specified in TS 38.508-1 [10] clause 4.3.1				Low range, Mid range, High range			
Test Channel Bandwidths as specified in TS 38.508-1 [10] clause 4.3.1				Lowest and Highest supported channel bandwidth that ≤ 200 MHz			
Test SCS as specified in Table 5.3.5-1				Lowest, Highest			
Test Parameters							
Test ID	Freq	ChBw	SCS	Downlink Configuration	Uplink Configuration		
					Modulation	RB allocation (NOTE 1)	
		Default	Default	-		SCS 60 kHz	SCS 120 kHz
1	Mid				CP-OFDM QPSK	Inner_Full_Region2	Inner_Full_Region2
2	Low				CP-OFDM QPSK	16@0	8@0
3	High				CP-OFDM QPSK	16@N _{RB} -16	8@N _{RB} -8
4	Mid				CP-OFDM QPSK	Outer_Full	Outer_Full
5	Low				CP-OFDM 16 QAM	16@0	8@0
6	High				CP-OFDM 16 QAM	16@N _{RB} -16	8@N _{RB} -8
7	Mid				CP-OFDM 16 QAM	Outer_Full	Outer_Full
8	Mid				CP-OFDM 16 QAM	Inner_Full_Region2	Inner_Full_Region2
9	Low				CP-OFDM 64 QAM	16@0	8@0
10	High				CP-OFDM 64 QAM	16@N _{RB} -16	8@N _{RB} -8
11	Mid				CP-OFDM 64 QAM	Outer_Full	Outer_Full

12	Mid			CP-OFDM 64 QAM	Inner_Full	Inner_Full
NOTE 1: The specific configuration of each RF allocation is defined in clause 6.1-2.						

Table 6.2D.2.4.1-3: Test Configuration Table (Power Class 1, MPR_{WT}, BWchannel = 400 MHz)

Default Conditions						
Test Environment as specified in TS 38.508-1 [10] clause 4.1				Normal, TL, TH		
Test Frequencies as specified in TS 38.508-1 [10] clause 4.3.1				Low range, Mid range, High range		
Test Channel Bandwidths as specified in TS 38.508-1 [10] clause 4.3.1				400 MHz		
Test SCS as specified in Table 5.3.5-1				120kHz		
Test Parameters						
Test ID	Freq	ChBw	SCS	Downlink Configuration	Uplink Configuration	
		Default	Default	-	Modulation	RB allocation (NOTE 1)
1	Mid				CP-OFDM QPSK	Inner_Full_Region2
2	Low				CP-OFDM QPSK	8@0
3	High				CP-OFDM QPSK	8@N _{RB} -8
4	Mid				CP-OFDM QPSK	Outer_Full
5	Low				CP-OFDM 16 QAM	8@0
6	High				CP-OFDM 16 QAM	8@N _{RB} -8
7	Mid				CP-OFDM 16 QAM	Outer_Full
8	Mid				CP-OFDM 16 QAM	Inner_Full_Region2
9	Low				CP-OFDM 64 QAM	8@0
10	High				CP-OFDM 64 QAM	8@N _{RB} -8
11	Mid	CP-OFDM 64 QAM	Outer_Full			
NOTE 1: The specific configuration of each RF allocation is defined in clause 6.1-2.						

Table 6.2D.2.4.1-4: Test Configuration Table (Power Class 2, 3, 4, 5 and 6, MPR_{narrow}, BWchannel ≤ 200 MHz)

Default Conditions						
Test Environment as specified in TS 38.508-1 [10] clause 4.1				Normal, TL, TH		
Test Frequencies as specified in TS 38.508-1 [10] clause 4.3.1				Low range, High range		
Test Channel Bandwidths as specified in TS 38.508-1 [10] clause 4.3.1				Lowest and Highest supported channel bandwidth that ≤ 200 MHz t		
Test SCS as specified in Table 5.3.5-1				Lowest, Highest		
Test Parameters						
Test ID	Freq	ChBw	SCS	Downlink Configuration	Uplink Configuration	
		Default	Default	-	Modulation	RB allocation (NOTE 1)
1	Low				CP-OFDM QPSK	Outer_1RB_Left
2	High				CP-OFDM QPSK	Outer_1RB_Right
NOTE 1: The specific configuration of each RF allocation is defined in Table 6.1-1.						

Table 6.2D.2.4.1-5: Test Configuration Table (Power Class 2, 3, 4, 5 and 6, MPR_{WT}, BWchannel ≤ 200 MHz)

Default Conditions						
--------------------	--	--	--	--	--	--

Test Environment as specified in TS 38.508-1 [10] clause 4.1		Normal, TL, TH				
Test Frequencies as specified in TS 38.508-1 [10] clause 4.3.1		Low range, Mid range, High range				
Test Channel Bandwidths as specified in TS 38.508-1 [10] clause 4.3.1		Lowest and Highest supported channel bandwidth that \leq 200 MHz				
Test SCS as specified in Table 5.3.5-1		Lowest, Highest				
Test Parameters						
Test ID	Freq	ChBw	SCS	Downlink Configuration	Uplink Configuration	
		Default	Default	-	Modulation	RB allocation (NOTE 1)
1	Mid				CP-OFDM QPSK	Inner_Full
2	Low				CP-OFDM QPSK	Outer_1RB_Left
3	High				CP-OFDM QPSK	Outer_1RB_Right
4	Mid				CP-OFDM QPSK	Outer_Full
5	Mid				CP-OFDM 16 QAM	Inner_Full
6	Low				CP-OFDM 16 QAM	Outer_1RB_Left
7	High				CP-OFDM 16 QAM	Outer_1RB_Right
8	Mid				CP-OFDM 16 QAM	Outer_Full
9	Mid				CP-OFDM 64 QAM	Inner_Full
10	Low				CP-OFDM 64 QAM	Outer_1RB_Left
11	High				CP-OFDM 64 QAM	Outer_1RB_Right
12	Mid				CP-OFDM 64 QAM	Outer_Full
NOTE 1: The specific configuration of each RF allocation is defined in Table 6.1-1.						

Table 6.2D.2.4.1-6: Test Configuration Table (Power Class 2, 3, 4, 5 and 6, MPR_{WT}, BW_{channel} = 400 MHz)

Default Conditions						
Test Environment as specified in TS 38.508-1 [10] clause 4.1		Normal, TL, TH				
Test Frequencies as specified in TS 38.508-1 [10] clause 4.3.1		Low range, High range				
Test Channel Bandwidths as specified in TS 38.508-1 [10] clause 4.3.1		400 MHz				
Test SCS as specified in Table 5.3.5-1		120kHz				
Test Parameters						
Test ID	Freq	ChBw	SCS	Downlink Configuration	Uplink Configuration	
		Default	Default	-	Modulation	RB allocation (NOTE 1)
1	Low				CP-OFDM QPSK	Outer_1RB_Left
2	High				CP-OFDM QPSK	Outer_1RB_Right
3	Mid				CP-OFDM QPSK	Outer_Full
4	Low				CP-OFDM 16 QAM	Outer_1RB_Left
5	High				CP-OFDM 16 QAM	Outer_1RB_Right
6	Mid				CP-OFDM 16 QAM	Outer_Full
7	Low				CP-OFDM 64 QAM	Outer_1RB_Left
8	High				CP-OFDM 64 QAM	Outer_1RB_Right
9	Mid				CP-OFDM 64 QAM	Outer_Full
NOTE 1: The specific configuration of each RF allocation is defined in Table 6.1-1.						

Table 6.2D.2.4.1-7: Test Configuration Table for ULFP_{Tx} (Power Class 1, MPR_{narrow})

Default Conditions	
Test Environment as specified in TS 38.508-1 [10] clause 4.1	Normal, TL, TH
Test Frequencies as specified in TS 38.508-1 [10] clause 4.3.1	Low range, High range
Test Channel Bandwidths as specified in TS 38.508-1 [10] clause 4.3.1	Lowest and Highest
Test SCS as specified in Table 5.3.5-1	Lowest, Highest

Test Parameters							
Test ID	Freq	ChBw	SCS	Downlink Configuration	Uplink Configuration		
					Modulation	RB allocation (NOTE 1)	
		Default	Default	N/A for Maximum Power Reduction (MPR) test case		SCS 60 kHz	SCS 120 kHz
1	Low				CP-OFDM 64 QAM	Outer_1RB_Left	Outer_1RB_Left
2	High				CP-OFDM 64 QAM	Outer_1RB_Right	Outer_1RB_Right
3	Low				CP-OFDM 64 QAM	3@0	2@0
4	High				CP-OFDM 64 QAM	3@N _{RB} -3	2@N _{RB} -2
5	Low				CP-OFDM 64 QAM	15@0	7@0
6	High				CP-OFDM 64 QAM	15@N _{RB} -15	7@N _{RB} -7

NOTE 1: The specific configuration of each RF allocation is defined in Table 6.1-2.
 NOTE 2: Test IDs 1 ~ 6 with CP-OFDM modulation are not needed if PDCCH DCI format 0_1 indicates ULFPTx_Mode1.

Table 6.2D.2.4.1-8: Test Configuration Table for ULFPTx (Power Class 1, MPR_{WT}, BWchannel ≤ 200 MHz)

Default Conditions							
Test Environment as specified in TS 38.508-1 [10] clause 4.1				Normal, TL, TH			
Test Frequencies as specified in TS 38.508-1 [10] clause 4.3.1				Low range, Mid range, High range			
Test Channel Bandwidths as specified in TS 38.508-1 [10] clause 4.3.1				Lowest and Highest supported channel bandwidth that ≤ 200 MHz			
Test SCS as specified in Table 5.3.5-1				Lowest, Highest			
Test Parameters							
Test ID	Freq	ChBw	SCS	Downlink Configuration	Uplink Configuration		
					Modulation	RB allocation (NOTE 1)	
		Default	Default	N/A for Maximum Power Reduction (MPR) test case		SCS 60 kHz	SCS 120 kHz
1	Low				DFT-s-OFDM PI/2 BPSK	16@0	8@0
2	High				DFT-s-OFDM PI/2 BPSK	16@N _{RB} -16	8@N _{RB} -8
3	Mid				DFT-s-OFDM PI/2 BPSK	Outer_Full	Outer_Full
4	Mid				DFT-s-OFDM QPSK	Inner_Full_Region2	Inner_Full_Region2
5	Low				DFT-s-OFDM QPSK	16@0	8@0
6	High				DFT-s-OFDM QPSK	16@N _{RB} -16	8@N _{RB} -8
7	Mid				DFT-s-OFDM QPSK	Outer_Full	Outer_Full
8	Mid				DFT-s-OFDM 16 QAM	Inner_Full_Region2	Inner_Full_Region2
9	Low				DFT-s-OFDM 16 QAM	16@0	8@0
10	High				DFT-s-OFDM 16 QAM	16@N _{RB} -16	8@N _{RB} -8
11	Mid				DFT-s-OFDM 16 QAM	Outer_Full	Outer_Full
12	Low				DFT-s-OFDM 64 QAM	16@0	8@0
13	High				DFT-s-OFDM 64 QAM	16@N _{RB} -16	8@N _{RB} -8
14	Mid				DFT-s-OFDM 64 QAM	Outer_Full	Outer_Full
15	Mid				DFT-s-OFDM 64 QAM	Inner_Full_Region2	Inner_Full_Region2
16	Mid				CP-OFDM QPSK	Inner_Full_Region2	Inner_Full_Region2
17	Low				CP-OFDM QPSK	16@0	8@0
18	High				CP-OFDM QPSK	16@N _{RB} -16	8@N _{RB} -8
19	Mid				CP-OFDM QPSK	Outer_Full	Outer_Full
20	Low				CP-OFDM 16 QAM	16@0	8@0
21	High				CP-OFDM 16 QAM	16@N _{RB} -16	8@N _{RB} -8
22	Mid				CP-OFDM 16 QAM	Outer_Full	Outer_Full
23	Mid			CP-OFDM 16 QAM	Inner_Full_Region2	Inner_Full_Region2	

24	Low			CP-OFDM 64 QAM	16@0	8@0
25	High			CP-OFDM 64 QAM	16@N _{RB} -16	8@N _{RB} -8
26	Mid			CP-OFDM 64 QAM	Outer_Full	Outer_Full

NOTE 1: The specific configuration of each RF allocation is defined in clause 6.1-2.
 NOTE 2: Test IDs 16 ~ 26 with CP-OFDM modulation are not needed if PDCCH DCI format 0_1 indicates ULFPTx_Mode1.

Table 6.2D.2.4.1-9: Test Configuration Table for ULFPTx (Power Class 1, MPR_{WT}, BW_{channel} = 400 MHz)

Default Conditions						
Test Environment as specified in TS 38.508-1 [10] clause 4.1				Normal, TL, TH		
Test Frequencies as specified in TS 38.508-1 [10] clause 4.3.1				Low range, Mid range, High range		
Test Channel Bandwidths as specified in TS 38.508-1 [10] clause 4.3.1				400 MHz		
Test SCS as specified in Table 5.3.5-1				120kHz		
Test Parameters						
Test ID	Freq	ChBw	SCS	Downlink Configuration	Uplink Configuration	
		Default	Default	N/A for Maximum Power Reduction (MPR) test case	Modulation	RB allocation (NOTE 1)
1	Low				DFT-s-OFDM PI/2 BPSK	8@0
2	High				DFT-s-OFDM PI/2 BPSK	8@N _{RB} -8
3	Mid				DFT-s-OFDM PI/2 BPSK	Outer_Full
4	Mid				DFT-s-OFDM PI/2 BPSK	Inner_Full_Region2
5	Mid				DFT-s-OFDM QPSK	Inner_Full_Region2
6	Low				DFT-s-OFDM QPSK	8@0
7	High				DFT-s-OFDM QPSK	8@N _{RB} -8
8	Mid				DFT-s-OFDM QPSK	Outer_Full
9	Mid				DFT-s-OFDM 16 QAM	Inner_Full_Region2
10	Low				DFT-s-OFDM 16 QAM	8@0
11	High				DFT-s-OFDM 16 QAM	8@N _{RB} -8
12	Mid				DFT-s-OFDM 16 QAM	Outer_Full
13	Low				DFT-s-OFDM 64 QAM	8@0
14	High				DFT-s-OFDM 64 QAM	8@N _{RB} -8
15	Mid				DFT-s-OFDM 64 QAM	Outer_Full
16	Mid				CP-OFDM QPSK	Inner_Full_Region2
17	Low				CP-OFDM QPSK	8@0
18	High				CP-OFDM QPSK	8@N _{RB} -8
19	Mid				CP-OFDM QPSK	Outer_Full
20	Low				CP-OFDM 16 QAM	8@0
21	High				CP-OFDM 16 QAM	8@N _{RB} -8
22	Mid				CP-OFDM 16 QAM	Outer_Full
23	Mid				CP-OFDM 16 QAM	Inner_Full_Region2
24	Low				CP-OFDM 64 QAM	8@0
25	High				CP-OFDM 64 QAM	8@N _{RB} -8
26	Mid			CP-OFDM 64 QAM	Outer_Full	

NOTE 1: The specific configuration of each RF allocation is defined in clause 6.1-2.
 NOTE 2: Test IDs 16 ~ 26 with CP-OFDM modulation are not needed if PDCCH DCI format 0_1 indicates ULFPTx_Mode1.

Table 6.2D.2.4.1-10: Test Configuration Table for ULFPTx (Power Class 2, 3, 4, 5 and 6, MPR_{narrow}, BWchannel ≤ 200 MHz)

Default Conditions						
Test Environment as specified in TS 38.508-1 [10] clause 4.1				Normal, TL, TH		
Test Frequencies as specified in TS 38.508-1 [10] clause 4.3.1				Low range, High range		
Test Channel Bandwidths as specified in TS 38.508-1 [10] clause 4.3.1				Lowest and Highest supported channel bandwidth that ≤ 200 MHz		
Test SCS as specified in Table 5.3.5-1				Lowest, Highest		
Test Parameters						
Test ID	Freq	ChBw	SCS	Downlink Configuration	Uplink Configuration	
		Default	Default	N/A for Maximum Power Reduction (MPR) test case	Modulation	RB allocation (NOTE 1)
1	Low				DFT-s-OFDM PI/2 BPSK	Outer_1RB_Left
2	High				DFT-s-OFDM PI/2 BPSK	Outer_1RB_Right
3	Low				DFT-s-OFDM QPSK	Outer_1RB_Left
4	High				DFT-s-OFDM QPSK	Outer_1RB_Right
NOTE 1: The specific configuration of each RF allocation is defined in Table 6.1-1.						

Table 6.2D.2.4.1-11: Test Configuration Table for ULFPTx (Power Class 2, 3, 4, 5 and 6, MPR_{WT}, BWchannel ≤ 200 MHz)

Default Conditions						
Test Environment as specified in TS 38.508-1 [10] clause 4.1				Normal, TL, TH		
Test Frequencies as specified in TS 38.508-1 [10] clause 4.3.1				Low range, Mid range, High range		
Test Channel Bandwidths as specified in TS 38.508-1 [10] clause 4.3.1				Lowest and Highest supported channel bandwidth that ≤ 200 MHz		
Test SCS as specified in Table 5.3.5-1				Lowest, Highest		
Test Parameters						
Test ID	Freq	ChBw	SCS	Downlink Configuration	Uplink Configuration	
		Default	Default	N/A for Maximum Power Reduction (MPR) test case	Modulation	RB allocation (NOTE 1)
1	Mid				DFT-s-OFDM PI/2 BPSK	Outer_Full
2	Mid				DFT-s-OFDM QPSK	Outer_Full
3	Mid				DFT-s-OFDM 16 QAM	Inner_Full
4	Low				DFT-s-OFDM 16 QAM	Outer_1RB_Left
5	High				DFT-s-OFDM 16 QAM	Outer_1RB_Right
6	Mid				DFT-s-OFDM 16 QAM	Outer_Full
7	Mid				DFT-s-OFDM 64 QAM	Inner_Full
8	Low				DFT-s-OFDM 64 QAM	Outer_1RB_Left
9	High				DFT-s-OFDM 64 QAM	Outer_1RB_Right
10	Mid				DFT-s-OFDM 64 QAM	Outer_Full
11	Mid				CP-OFDM QPSK	Inner_Full
12	Low				CP-OFDM QPSK	Outer_1RB_Left
13	High				CP-OFDM QPSK	Outer_1RB_Right
14	Mid				CP-OFDM QPSK	Outer_Full
15	Low				CP-OFDM 16 QAM	Outer_1RB_Left
16	High				CP-OFDM 16 QAM	Outer_1RB_Right
17	Mid				CP-OFDM 16 QAM	Outer_Full
18	Low				CP-OFDM 64 QAM	Outer_1RB_Left
19	High				CP-OFDM 64 QAM	Outer_1RB_Right
20	Mid	CP-OFDM 64 QAM	Outer_Full			

NOTE 1: The specific configuration of each RF allocation is defined in Table 6.1-1.
 NOTE 2: Test IDs 11 ~ 20 with CP-OFDM modulation are not needed if PDCCH DCI format 0_1 indicates ULFPTx_Mode1.

Table 6.2D.2.4.1-12: Test Configuration Table for ULFPTx (Power Class 2, 3, 4, 5 and 6, MPR_{WT} , $BW_{channel} = 400$ MHz)

Default Conditions						
Test Environment as specified in TS 38.508-1 [10] clause 4.1			Normal, TL, TH			
Test Frequencies as specified in TS 38.508-1 [10] clause 4.3.1			Low range, High range			
Test Channel Bandwidths as specified in TS 38.508-1 [10] clause 4.3.1			400 MHz			
Test SCS as specified in Table 5.3.5-1			120kHz			
Test Parameters						
Test ID	Freq	ChBw	SCS	Downlink Configuration	Uplink Configuration	
		Default	Default	N/A for Maximum Power Reduction (MPR) test case	Modulation	RB allocation (NOTE 1)
1	Low				DFT-s-OFDM PI/2 BPSK	Outer_1RB_Left
2	High				DFT-s-OFDM PI/2 BPSK	Outer_1RB_Right
3	Mid				DFT-s-OFDM PI/2 BPSK	Outer_Full
4	Low				DFT-s-OFDM QPSK	Outer_1RB_Left
5	High				DFT-s-OFDM QPSK	Outer_1RB_Right
6	Mid				DFT-s-OFDM QPSK	Outer_Full
7	Low				DFT-s-OFDM 16 QAM	Outer_1RB_Left
8	High				DFT-s-OFDM 16 QAM	Outer_1RB_Right
9	Mid				DFT-s-OFDM 16 QAM	Outer_Full
10	Low				DFT-s-OFDM 64 QAM	Outer_1RB_Left
11	High				DFT-s-OFDM 64 QAM	Outer_1RB_Right
12	Mid				DFT-s-OFDM 64 QAM	Outer_Full
13	Low				CP-OFDM QPSK	Outer_1RB_Left
14	High				CP-OFDM QPSK	Outer_1RB_Right
15	Mid				CP-OFDM QPSK	Outer_Full
16	Low				CP-OFDM 16 QAM	Outer_1RB_Left
17	High				CP-OFDM 16 QAM	Outer_1RB_Right
18	Mid				CP-OFDM 16 QAM	Outer_Full
19	Low				CP-OFDM 64 QAM	Outer_1RB_Left
20	High				CP-OFDM 64 QAM	Outer_1RB_Right
21	Mid			CP-OFDM 64 QAM	Outer_Full	
NOTE 1: The specific configuration of each RF allocation is defined in Table 6.1-1. NOTE 2: Test IDs 13 ~ 21 with CP-OFDM modulation are not needed if PDCCH DCI format 0_1 indicates ULFPTx_Mode1.						

6.2D.2.4.2 Test procedure

1. SS sends uplink scheduling information for each UL HARQ process via PDCCH DCI format 0_1 for C_RNTI to schedule the UL RMC according to Table 6.2.2.4.1-1 to Table 6.2.2.4.1-9. Since the UL has no payload and no loopback data to send the UE sends uplink MAC padding bits on the UL RMC.
2. Set the UE in the Tx beam peak direction found with a 3D EIRP scan as performed in Annex K.1.1. Allow at least BEAM_SELECT_WAIT_TIME (NOTE 1) for the UE Tx beam selection to complete.
3. Send continuously uplink power control "up" commands in every uplink scheduling information to the UE; allow at least 200ms for the UE to reach P_{UMAX} level. Allow at least BEAM_SELECT_WAIT_TIME (Note 1) for the UE Tx beam selection to complete.
4. SS activates the UE Beamlock Function (UBF) by performing the procedure as specified in TS 38.508-1 [10] clause 4.9.2 using condition Tx only.
5. Measure UE EIRP in the Tx beam peak direction in the channel bandwidth of the radio access mode according to the test configuration, which shall meet the requirements described in 6.2.2.5. EIRP test procedure is defined in

Annex K.1.3. The measuring duration is one active uplink subframe. EIRP is calculated considering both polarizations, theta and phi.

6. SS deactivates the UE Beamlock Function (UBF) by performing the procedure as specified in TS 38.508-1 [10] clause 4.9.3.
7. If UE supports ULFPTx, repeat test steps 1~6 with UL RMC according to Table 6.2D.2.4.1-7 through Table 6.2D.2.4.1-12. The PDCCH DCI format 0_1 is specified with the condition ULFPTx_Mode1, ULFPTx_Mode2 or ULFPTx_ModeFull in 38.508-1 [5] clause 4.3.6.1.1.2 depending on UE reported capability. Message contents are according to TS 38.508-1 [5] clause 4.6.3 Table 4.6.3-118 with condition TRANSFORM_PRECODER_ENABLED.

NOTE 1: The BEAM_SELECT_WAIT_TIME default value is defined in Annex K.

NOTE 2: When switching to DFT-s-OFDM waveform, as specified in the test configuration table 6.2.2.4.1-1 to Table 6.2.2.4.1-9, send an NR RRCReconfiguration message according to TS 38.508-1 [10] clause 4.6.3 Table 4.6.3-118 PUSCH-Config with TRANSFORM_PRECODER_ENABLED condition.

6.2D.2.4.3 Message contents

Message contents are according to TS 38.508-1 [10] clause 4.6 ensuring Table 4.6.3-182 with condition 2TX_UL_MIMO.

6.2D.2.5 Test requirements

The maximum output power, derived in step 5 shall be within the range prescribed by the nominal maximum output power and tolerance in following tables.

Table 6.2D.2.5-1: UE Power Class test requirements for Power Class 1 (for Bands n257, n258, n261)

FFS

Table 6.2D.2.5-2: UE Power Class test requirements for Power Class 1 (for Bands n260)

FFS

Table 6.2D.2.5-3: UE Power Class test requirements for Power Class 2 (n257, 258, 261)

FFS

Table 6.2D.2.5-4: UE Power Class test requirements for Power Class 3 (n257, 258, 261)

Test Configuration Table	Test ID	BW (MHz)	P _{Powerclass}	MPR _{f,c}	T(MPR _{f,c})	Lower limit (dBm)	Upper limit (dBm)
Table 6.2D.2.4.1-4	1	<=200MHz	22.4	4.0	3	15.4-TT	43
		400MHz	22.4	5.0	4	13.4-TT	43
	2	<=200MHz	22.4	4.0	3	15.4-TT	43
		400MHz	22.4	5.0	4	13.4-TT	43
Table 6.2D.2.4.1-5	1	<=200MHz	22.4	3.5	3	15.9-TT	43
	2	<=200MHz	22.4	4.0	3	15.4-TT	43
	3	<=200MHz	22.4	4.0	3	15.4-TT	43
	4	<=200MHz	22.4	4.0	3	15.4-TT	43
	5	<=200MHz	22.4	5.0	4	13.4-TT	43
	6	<=200MHz	22.4	5.0	4	13.4-TT	43
	7	<=200MHz	22.4	5.0	4	13.4-TT	43
	8	<=200MHz	22.4	5.0	4	13.4-TT	43
	9	<=200MHz	22.4	7.5	5	11.9-TT	43
	10	<=200MHz	22.4	7.5	5	11.9-TT	43

Table 6.2D.2.4.1-6	11	<=200MHz	22.4	7.5	5	11.9-TT	43
	12	<=200MHz	22.4	7.5	5	11.9-TT	43
	1	400MHz	22.4	5	4	13.4-TT	43
	2	400MHz	22.4	5	4	13.4-TT	43
	3	400MHz	22.4	5	4	13.4-TT	43
	4	400MHz	22.4	6.5	5	10.9-TT	43
	5	400MHz	22.4	6.5	5	10.9-TT	43
	6	400MHz	22.4	6.5	5	10.9-TT	43
	7	400MHz	22.4	9	5	8.4-TT	43
	8	400MHz	22.4	9	5	8.4-TT	43
9	400MHz	22.4	9	5	8.4-TT	43	
Note 1:	Void.						
Note 2:	Void.						
Note 3:	Void.						
Note 4:	Void.						

Table 6.2D.2.5-5: UE Power Class test requirements for Power Class 3 (n260)

Test Configuration Table	Test ID	BW (MHz)	P _{Powerclass}	MPR _{r,c}	T(MPR _{r,c})	Lower limit (dBm)	Upper limit (dBm)
Table 6.2D.2.4.1-4	1	<=200MHz	20.6	4.0	3	13.6-TT	43
		400MHz	20.6	5.0	4	11.6-TT	43
	2	<=200MHz	20.6	4.0	3	13.6-TT	43
		400MHz	20.6	5.0	4	11.6-TT	43
Table 6.2D.2.4.1-5	1	<=200MHz	20.6	3.5	3	14.1-TT	43
	2	<=200MHz	20.6	4.0	3	13.6-TT	43
	3	<=200MHz	20.6	4.0	3	13.6-TT	43
	4	<=200MHz	20.6	4.0	3	13.6-TT	43
	5	<=200MHz	20.6	5.0	4	11.6-TT	43
	6	<=200MHz	20.6	5.0	4	11.6-TT	43
	7	<=200MHz	20.6	5.0	4	11.6-TT	43
	8	<=200MHz	20.6	5.0	4	11.6-TT	43
	9	<=200MHz	20.6	7.5	5	8.1-TT	43
	10	<=200MHz	20.6	7.5	5	8.1-TT	43
	11	<=200MHz	20.6	7.5	5	8.1-TT	43
	12	<=200MHz	20.6	7.5	5	8.1-TT	43
Table 6.2D.2.4.1-6	1	400MHz	20.6	5	4	11.6-TT	43
	2	400MHz	20.6	5	4	11.6-TT	43
	3	400MHz	20.6	5	4	11.6-TT	43
	4	400MHz	20.6	6.5	5	9.1-TT	43
	5	400MHz	20.6	6.5	5	9.1-TT	43
	6	400MHz	20.6	6.5	5	9.1-TT	43
	7	400MHz	20.6	9	5	6.6-TT	43
	8	400MHz	20.6	9	5	6.6-TT	43
	9	400MHz	20.6	9	5	6.6-TT	43
Note 1:	Void.						
Note 2:	Void.						
Note 3:	Void.						
Note 4:	Void.						

Table 6.2D.2.5-5a: Test Tolerance (Power class 3)

Test Metric	FR2a	FR2b	FR2c
Max device size ≤ 30 cm	3.24 dB, NTC 3.41 dB, ETC	3.24 dB, NTC 3.41 dB, ETC	TBD, NTC TBD, ETC

Table 6.2D.2.5-6: UE Power Class test requirements for Power Class 4 (for Bands n257, n258, n261)

FFS

Table 6.2D.2.5-7: UE Power Class test requirements for Power Class 4 (for Bands n260)

FFS

Table 6.2D.2.5-8: UE Power Class test requirements for Power Class 5 (n257)

Test Configuration Table	Test ID	BW (MHz)	P _{Powerclass}	MPR _{f,c}	T(MPR _{f,c})	Lower limit (dBm)	Upper limit (dBm)
Table 6.2D.2.4.1-4	1	<=200MHz	30	4.0	3	23-TT	43
		400MHz	30	5.0	4	21-TT	43
	2	<=200MHz	30	4.0	3	23-TT	43
		400MHz	30	5.0	4	21-TT	43
Table 6.2D.2.4.1-5	1	<=200MHz	30	3.5	3	23.5-TT	43
	2	<=200MHz	30	4.0	3	23-TT	43
	3	<=200MHz	30	4.0	3	23-TT	43
	4	<=200MHz	30	4.0	3	23-TT	43
	5	<=200MHz	30	5.0	4	21-TT	43
	6	<=200MHz	30	5.0	4	21-TT	43
	7	<=200MHz	30	5.0	4	21-TT	43
	8	<=200MHz	30	5.0	4	21-TT	43
	9	<=200MHz	30	7.5	5	17.5-TT	43
	10	<=200MHz	30	7.5	5	17.5-TT	43
	11	<=200MHz	30	7.5	5	17.5-TT	43
	12	<=200MHz	30	7.5	5	17.5-TT	43
Table 6.2D.2.4.1-6	1	400MHz	30	5	4	21-TT	43
	2	400MHz	30	5	4	21-TT	43
	3	400MHz	30	5	4	21-TT	43
	4	400MHz	30	6.5	5	18.5-TT	43
	5	400MHz	30	6.5	5	18.5-TT	43
	6	400MHz	30	6.5	5	18.5-TT	43
	7	400MHz	30	9	5	16-TT	43
	8	400MHz	30	9	5	16-TT	43
	9	400MHz	30	9	5	16-TT	43

Table 6.2D.2.5-8a: UE Power Class test requirements for Power Class 5 (n258)

Test Configuration Table	Test ID	BW (MHz)	P _{Powerclass}	MPR _{f,c}	T(MPR _{f,c})	Lower limit (dBm)	Upper limit (dBm)
Table 6.2D.2.4.1-4	1	<=200MHz	30.4	4.0	3	23.4-TT	43
		400MHz	30.4	5.0	4	21.4-TT	43
	2	<=200MHz	30.4	4.0	3	23.4-TT	43
		400MHz	30.4	5.0	4	21.4-TT	43
Table 6.2D.2.4.1-5	1	<=200MHz	30.4	3.5	3	23.9-TT	43
	2	<=200MHz	30.4	4.0	3	23.4-TT	43
	3	<=200MHz	30.4	4.0	3	23.4-TT	43
	4	<=200MHz	30.4	4.0	3	23.4-TT	43
	5	<=200MHz	30.4	5.0	4	21.4-TT	43
	6	<=200MHz	30.4	5.0	4	21.4-TT	43
	7	<=200MHz	30.4	5.0	4	21.4-TT	43
	8	<=200MHz	30.4	5.0	4	21.4-TT	43
	9	<=200MHz	30.4	7.5	5	17.9-TT	43
	10	<=200MHz	30.4	7.5	5	17.9-TT	43
	11	<=200MHz	30.4	7.5	5	17.9-TT	43
	12	<=200MHz	30.4	7.5	5	17.9-TT	43
Table 6.2D.2.4.1-6	1	400MHz	30.4	5	4	21.4-TT	43
	2	400MHz	30.4	5	4	21.4-TT	43
	3	400MHz	30.4	5	4	21.4-TT	43
	4	400MHz	30.4	6.5	5	18.9-TT	43
	5	400MHz	30.4	6.5	5	18.9-TT	43
	6	400MHz	30.4	6.5	5	18.9-TT	43
	7	400MHz	30.4	9	5	16.4-TT	43
	8	400MHz	30.4	9	5	16.4-TT	43

	9	400MHz	30.4	9	5	16.4-TT	43
--	---	--------	------	---	---	---------	----

Table 6.2D.2.5-8b: Test Tolerance (Power class 5)

Test Metric	FR2a
Max device size ≤ 30 cm	3.38 dB, NTC 3.56 dB, ETC

Table 6.2D.2.5-9: UE Power Class test requirements for Power Class 6 (for Bands n257, n261)

Test Configuration Table	Test ID	BW (MHz)	P _{Powerclass}	MPR _{f,c}	T(MPR _{f,c})	Lower limit (dBm)	Upper limit (dBm)
Table 6.2D.2.4.1-4	1	≤200MHz	30	4.0	3	23-TT	43
		400MHz	30	5.0	4	21-TT	43
	2	≤200MHz	30	4.0	3	23-TT	43
		400MHz	30	5.0	4	21-TT	43
Table 6.2D.2.4.1-5	1	≤200MHz	30	3.5	3	23.5-TT	43
	2	≤200MHz	30	4.0	3	23-TT	43
	3	≤200MHz	30	4.0	3	23-TT	43
	4	≤200MHz	30	4.0	3	23-TT	43
	5	≤200MHz	30	5.0	4	21-TT	43
	6	≤200MHz	30	5.0	4	21-TT	43
	7	≤200MHz	30	5.0	4	21-TT	43
	8	≤200MHz	30	5.0	4	21-TT	43
	9	≤200MHz	30	7.5	5	17.5-TT	43
	10	≤200MHz	30	7.5	5	17.5-TT	43
	11	≤200MHz	30	7.5	5	17.5-TT	43
	12	≤200MHz	30	7.5	5	17.5-TT	43
Table 6.2D.2.4.1-6	1	400MHz	30	5	4	21-TT	43
	2	400MHz	30	5	4	21-TT	43
	3	400MHz	30	5	4	21-TT	43
	4	400MHz	30	6.5	5	18.5-TT	43
	5	400MHz	30	6.5	5	18.5-TT	43
	6	400MHz	30	6.5	5	18.5-TT	43
	7	400MHz	30	9	5	16-TT	43
	8	400MHz	30	9	5	16-TT	43
	9	400MHz	30	9	5	16-TT	43

Table 6.2D.2.5-9a: UE Power Class test requirements for Power Class 6 (n258)

Test Configuration Table	Test ID	BW (MHz)	P _{Powerclass}	MPR _{f,c}	T(MPR _{f,c})	Lower limit (dBm)	Upper limit (dBm)
Table 6.2D.2.4.1-4	1	≤200MHz	30.4	4.0	3	23.4-TT	43
		400MHz	30.4	5.0	4	21.4-TT	43
	2	≤200MHz	30.4	4.0	3	23.4-TT	43
		400MHz	30.4	5.0	4	21.4-TT	43
Table 6.2D.2.4.1-5	1	≤200MHz	30.4	3.5	3	23.9-TT	43
	2	≤200MHz	30.4	4.0	3	23.4-TT	43
	3	≤200MHz	30.4	4.0	3	23.4-TT	43
	4	≤200MHz	30.4	4.0	3	23.4-TT	43
	5	≤200MHz	30.4	5.0	4	21.4-TT	43
	6	≤200MHz	30.4	5.0	4	21.4-TT	43
	7	≤200MHz	30.4	5.0	4	21.4-TT	43
	8	≤200MHz	30.4	5.0	4	21.4-TT	43
	9	≤200MHz	30.4	7.5	5	17.9-TT	43
	10	≤200MHz	30.4	7.5	5	17.9-TT	43
	11	≤200MHz	30.4	7.5	5	17.9-TT	43
	12	≤200MHz	30.4	7.5	5	17.9-TT	43
Table 6.2D.2.4.1-6	1	400MHz	30.4	5	4	21.4-TT	43
	2	400MHz	30.4	5	4	21.4-TT	43

3	400MHz	30.4	5	4	21.4-TT	43
4	400MHz	30.4	6.5	5	18.9-TT	43
5	400MHz	30.4	6.5	5	18.9-TT	43
6	400MHz	30.4	6.5	5	18.9-TT	43
7	400MHz	30.4	9	5	16.4-TT	43
8	400MHz	30.4	9	5	16.4-TT	43
9	400MHz	30.4	9	5	16.4-TT	43

Table 6.2D.2.5-9b: Test Tolerance (Power class 6)

Test Metric	FR2a
Max device size \leq 30 cm	3.37 dB

6.2D.3 UE maximum output power with additional requirements for UL MIMO

Editor's note: The following aspects are either missing or not yet determined:

- Measurement Uncertainties and Test Tolerances are FFS for power class other than 3, 5 and 6.

6.2D.3.1 Test purpose

Additional spectrum emission requirements can be signalled by the network to indicate that the UE shall also meet additional requirements in a specific deployment scenario. To meet these additional requirements, Additional Maximum Power Reduction (A-MPR) is allowed for the output power.

6.2D.3.2 Test applicability

This test case applies to all types of NR UE release 15 and forward supporting UL MIMO.

6.2D.3.3 Minimum conformance requirements

6.2D.3.3.1 UE maximum output power reduction with additional requirements for UL MIMO for power class 1

For UEs configured for 2-layer transmission as well as UEs configured for single layer uplink full power transmission (ULFPTx), the A-MPR values specified in clause 6.2.3.3 shall apply to the maximum output power specified in Table 6.2D.1.1.3.1-1. The requirements shall be met with the configurations specified in sub-clause 6.2D.1.0.

For the UE maximum output power modified by A-MPR, the power limits specified in clause 6.2D.4.3 apply.

6.2D.3.3.2 UE maximum output power reduction with additional requirements for UL MIMO for power class 2

For UEs configured for 2-layer transmission as well as UEs configured for single layer uplink full power transmission (ULFPTx), the A-MPR values specified in clause 6.2.3.3 shall apply to the maximum output power specified in Table 6.2D.1.1.3.2-1. The requirements shall be met with the configurations specified in clause 6.2D.1.0.

For the UE maximum output power modified by A-MPR, the power limits specified in clause 6.2D.4.3 apply.

6.2D.3.3.3 UE maximum output power reduction with additional requirements for UL MIMO for power class 3

For UEs configured for 2-layer transmission as well as UEs configured for single layer uplink full power transmission (ULFPTx), the A-MPR values specified in clause 6.2.3.3 shall apply to the maximum output power specified in Table 6.2D.1.1.3.3-1. The requirements shall be met with the configurations specified in clause 6.2D.1.0.

For the UE maximum output power modified by A-MPR, the power limits specified in clause 6.2D.4.3 apply.

6.2D.3.3.4 UE maximum output power reduction with additional requirements for UL MIMO for power class 4

For UEs configured for 2-layer transmission as well as UEs configured for single layer uplink full power transmission (ULFPTx), the A-MPR values specified in clause 6.2.3.3 shall apply to the maximum output power specified in Table 6.2D.1.1.3.4-1. The requirements shall be met with the configurations specified in clause 6.2D.1.0.

6.2D.3.3.5 UE maximum output power reduction with additional requirements for UL MIMO for power class 5

For UEs configured for 2-layer transmission as well as UEs configured for single layer uplink full power transmission (ULFPTx), the A-MPR values specified in clause 6.2.3.3 shall apply to the maximum output power specified in Table 6.2D.1.1.3.5-1. The requirements shall be met with the configurations specified in clause 6.2D.1.0.

6.2D.3.3.6 UE maximum output power reduction with additional requirements for UL MIMO for power class 6

For UEs configured for 2-layer transmission as well as UEs configured for single layer uplink full power transmission (ULFPTx), the A-MPR values specified in clause 6.2.3.3 shall apply to the maximum output power specified in Table 6.2D.1.1.3.6-1. The requirements shall be met with the configurations specified in clause 6.2D.1.0.

The normative reference for this requirement is TS 38.101-2 [3] clause 6.2D.3.

6.2D.3.4 Test description

6.2D.3.4.1 Initial conditions

Initial conditions are a set of test configurations the UE needs to be tested in and the steps for the SS to take with the UE to reach the correct measurement state.

The initial test configurations consist of environmental conditions, test frequencies, and channel bandwidths based on NR operating bands specified in Table 5.3.5-1. All of these configurations shall be tested with applicable test parameters for each channel bandwidth and subcarrier spacing, are shown in Table 6.2D.3.4.1-1 to Table 6.2D.3.4.1-4. The details of the uplink reference measurement channels (RMCs) are specified in Annexes A.2. Configurations of PDSCH and PDCCH before measurement are specified in Annex C.2.

Table 6.2D.3.4.1-1: Test configuration table for 2-layer UL-MIMO for NS_202

Initial Conditions			
Test Environment as specified in TS 38.508-1 [10] clause 4.1		Normal	
Test Frequencies as specified in TS 38.508-1 [10] clause 4.3.1		Low range, High range	
Test Channel Bandwidths as specified in TS 38.508-1 [10] clause 4.3.1		Highest	
Test SCS as specified in Table 5.3.5-1		120kHz	
Test Parameters			
Test ID	Downlink Configuration	Uplink Configuration	
	-	Modulation	RB allocation (NOTE 1)
1 (NOTE 4)		CP-OFDM QPSK	Inner_Full
2		CP-OFDM QPSK	Inner_1RB for PC2, PC3, PC4, PC5 and PC6 Inner_Partial for PC1 (NOTE 2)
3 (NOTE 3)		CP-OFDM 64QAM	Outer_Full

NOTE 1: The specific configuration of each RB allocation is defined in Table 6.1-1 for PC2, PC3, PC4 and PC6 or Table 6.1-2 for PC1.
 NOTE 2: When testing Low range configure uplink RB to Inner_1RB_Left for PC2, PC3, PC4 and PC6 or Inner_Partial_Left_Region1 for PC1 and when testing High range configure uplink RB to Inner_1RB_Right for PC2, PC3, PC4 and PC6 or Inner_Partial_Right_Region1 for PC1.
 NOTE 3: Test ID only applicable to PC1
 NOTE 4: Test ID only applicable to PC2, PC3, PC4 and PC6

Table 6.2D.3.4.1-2: Test configuration table for 2-layer UL-MIMO for NS_203

Initial Conditions					
Test Environment as specified in TS 38.508-1 [10] clause 4.1					Normal
Test Frequencies as specified in TS 38.508-1 [10] clause 4.3.1					Low range
Test Channel Bandwidths as specified in TS 38.508-1 [10] clause 4.3.1					Highest
Test SCS as specified in Table 5.3.5-1					120kHz
Test Parameters					
Test ID	Frequency	Channel Bandwidth	Downlink Configuration	Uplink Configuration	
			-	Modulation	RB allocation (NOTE 1)
1	Default	Default		CP-OFDM QPSK	Inner_Full
2	Default	Default		CP-OFDM QPSK	Inner_1RB_Left for PC2, PC3, PC4, PC5 and PC6 Inner_Partial for PC1 (NOTE 2)
3 (NOTE 2)	Low range + Channel Bandwidth	Default		CP-OFDM QPSK	Inner_Partial
NOTE 1: The specific configuration of each RB allocation is defined in Table 6.1-1 for PC2, PC3, PC4, PC5 and PC6 or Table 6.1-2 for PC1.					
NOTE 2: Test ID only applicable to PC1					

Table 6.2D.3.4.1-3: Test configuration table for ULFPTx for NS_202

Initial Conditions			
Test Environment as specified in TS 38.508-1 [10] clause 4.1			Normal
Test Frequencies as specified in TS 38.508-1 [10] clause 4.3.1			Low range, High range
Test Channel Bandwidths as specified in TS 38.508-1 [10] clause 4.3.1			Highest
Test SCS as specified in Table 5.3.5-1			120kHz
Test Parameters			
Test ID	Downlink Configuration	Uplink Configuration	
	-	Modulation	RB allocation (NOTE 1)
1 (NOTE 4)		DFT-s-OFDM QPSK	Inner_Full
2		DFT-s-OFDM QPSK	Inner_1RB for PC2, PC3, PC4, PC5 and PC6 Inner_Partial for PC1 (NOTE 2)
3 (NOTE 3)		DFT-s-OFDM 64QAM	Outer_Full
NOTE 1: The specific configuration of each RB allocation is defined in Table 6.1-1 for PC2, PC3, PC4, PC5 and PC6 or Table 6.1-2 for PC1.			
NOTE 2: When testing Low range configure uplink RB to Inner_1RB_Left for PC2, PC3, PC4, PC5 and PC6 or Inner_Partial_Left_Region1 for PC1 and when testing High range configure uplink RB to Inner_1RB_Right for PC2, PC3, PC4, PC5 and PC6 or Inner_Partial_Right_Region1 for PC1.			
NOTE 3: Test ID only applicable to PC1.			
NOTE 4: Test ID only applicable to PC2, PC3, PC4, PC5 and PC6.			

Table 6.2D.3.4.1-4: Test configuration table for ULFP Tx for NS_203

Initial Conditions					
Test Environment as specified in TS 38.508-1 [10] clause 4.1					Normal
Test Frequencies as specified in TS 38.508-1 [10] clause 4.3.1					Low range
Test Channel Bandwidths as specified in TS 38.508-1 [10] clause 4.3.1					Highest
Test SCS as specified in Table 5.3.5-1					120kHz
Test Parameters					
Test ID	Frequency	Channel Bandwidth	Downlink Configuration	Uplink Configuration	
			-	Modulation	RB allocation (NOTE 1)
1	Default	Default		DFT-s-OFDM QPSK	Inner_Full
2	Default	Default		DFT-s-OFDM QPSK	Inner_1RB_Left for PC2, PC3, PC4, PC5 and PC6 Inner_Partial for PC1 (NOTE 2)
3 (NOTE 2)	Low range + Channel Bandwidth	Default		DFT-s-OFDM QPSK	Inner_Partial
NOTE 1: The specific configuration of each RB allocation is defined in Table 6.1-1 for PC2, PC3, PC4, PC5 and PC6 or Table 6.1-2 for PC1.					
NOTE 2: Test ID only applicable to PC1					

Table 6.2D.3.4.1-5: [Reserved]

Table 6.2D.3.4.1-6: Test configuration table for NS_205

Initial Conditions					
Test Environment as specified in TS 38.508-1 [10] subclause 4.1					Normal
Test Frequencies as specified in TS 38.508-1 [10] subclause 4.3.1					Low range
Test Channel Bandwidths as specified in TS 38.508-1 [10] subclause 4.3.1					Highest
Test SCS as specified in Table 5.3.5-1					120kHz
Test Parameters					
Test ID	Frequency	Channel Bandwidth	Downlink Configuration	Uplink Configuration	
			-	Modulation	RB allocation (NOTE 1)
1 ²	Default	Default		DFT-s-OFDM QPSK	Outer_Full
2 ²	Default	Default		DFT-s-OFDM QPSK	Inner_Partial_Left_Region1
3 ^{2,4}	Mid	Default		DFT-s-OFDM QPSK	Outer_Full
4 ^{2,4}	Mid	Default		DFT-s-OFDM QPSK	Inner_Partial_Left_Region1
5 ³	Default	Default		DFT-s-OFDM QPSK	Inner_Full
6 ³	Default	Default		DFT-s-OFDM QPSK	Inner_1RB_Left
7 ^{3,4}	Mid	Default		DFT-s-OFDM QPSK	Inner_Full
8 ^{3,4}	Mid	Default		DFT-s-OFDM QPSK	Inner_1RB_Left
NOTE 1: The specific configuration of each RB allocation is defined in Table 6.1-1 for PC2, PC3, PC4, PC6 and PC7 or Table 6.1-2 for PC1.					
NOTE 2: The test ID applies to PC1.					
NOTE 3: The test ID applies to PC2, PC3, PC4, PC6 and PC7.					

NOTE 4: The test ID applies to band n258.

1. Connection between SS and UE is shown in TS 38.508-1 [10] Annex A, Figure A.3.3.1.1 for TE diagram and Figure A.3.4.1.1 for UE diagram.
2. The parameter settings for the cell are set up according to TS 38.508-1 [10] clause 4.4.3.
3. Downlink signals are initially set up according to Annex C, and uplink signals according to Annex G.
4. The DL and UL Reference Measurement channels are set according to Table 6.2D.3.4.1-1 to Table 6.2D.3.4.1-6.
5. Propagation conditions are set according to Annex B.0.
6. Ensure the UE is in state RRC_CONNECTED with generic procedure parameters Connectivity *NR*, Connected without release *On*, Test Mode *On* and Test Loop Function *On* according to TS 38.508-1 [10] clause 4.5. Message contents are defined in clause 6.2D.3.4.3

6.2D.3.4.2 Test procedure

1. SS sends uplink scheduling information for each UL HARQ process via PDCCH DCI format 0_1 for C_RNTI to schedule the UL RMC according to Table 6.2D.3.4.1-1 to Table 6.2D.3.4.1-2. Since the UL has no payload and no loopback data to send the UE sends uplink MAC padding bits on the UL RMC.
2. Set the UE in the Tx beam peak direction found with a 3D EIRP scan as performed in Annex K. Allow at least BEAM_SELECT_WAIT_TIME (NOTE 1) for the UE Tx beam selection to complete.
3. Send continuously uplink power control "up" commands in every uplink scheduling information to the UE; allow at least 200 msec starting from the first TPC command in this step to ensure that the UE transmits at its maximum output power. Allow at least BEAM_SELECT_WAIT_TIME (NOTE 1) for the UE Tx beam selection to complete.
4. SS activates the UE Beamlock Function (UBF) by performing the procedure as specified in TS 38.508-1 [10] clause 4.9.2 using condition Tx only.
5. Measure UE EIRP in the Tx beam peak direction in the channel bandwidth of the radio access mode according to the test configuration, which shall meet the requirements described in clause 6.2D.3.5-5 to 6.2D.3.5-24. EIRP test procedure is defined in Annex K. The measuring duration is one active uplink subframe. EIRP is calculated considering both polarizations, theta and phi.
6. SS deactivates the UE Beamlock Function (UBF) by performing the procedure as specified in TS 38.508-1 [10] clause 4.9.3.
7. If UE supports ULFPTx, repeat test steps 1~6 with UL RMC according to Table 6.2D.3.4.1-3 and 6.2D.3.4.1-4. The PDCCH DCI format 0_1 is specified with the condition ULFPTx_Mode1, ULFPTx_Mode2 or ULFPTx_ModeFull in 38.508-1 [5] clause 4.3.6.1.1.2 depending on UE reported capability. Message contents are according to TS 38.508-1 [5] clause 4.6.3 Table 4.6.3-118 with condition TRANSFORM_PRECODER_ENABLED.

NOTE 1: The BEAM_SELECT_WAIT_TIME default value is defined in Annex K.

6.2D.3.4.3 Message contents

Message contents are according to TS 38.508-1 [10] clause 4.6 ensuring Table 4.6.3-182 with condition 2TX_UL_MIMO, with the following exceptions for each network signalling value.

1. Information element *AdditionalSpectrumEmission* for NR can be set in SIB1 according to TS 38.331[19]. This exception indicates that the UE shall meet the additional spurious emission requirement for a specific deployment scenario.

Table 6.2D.3.4.3-1: *AdditionalSpectrumEmission*: Additional spurious emissions test requirement

Derivation Path: TS 38.508-1 [10] clause 4.6.3, Table 4.6.3-1			
Information Element	Value/remark	Comment	Condition

<i>AdditionalSpectrumEmission</i>	1 (NS_202)	for band n257	
<i>AdditionalSpectrumEmission</i>	2 (NS_202)	for band n258	
<i>AdditionalSpectrumEmission</i>	3 (NS_203)	for band n258	
<i>AdditionalSpectrumEmission</i>	4 (NS_205)	for band n257	
<i>AdditionalSpectrumEmission</i>	5 (NS_205)	for band n258	

6.2D.3.5 Test requirement

The UE EIRP derived in step 5 shall not exceed the values specified in Table 6.2D.3.5-1 to Table 6.2D.3.5-8. The UE EIRP derived in step 7 shall not exceed the values specified in Table 6.2D.3.5-9 to Table 6.2D.3.5-16.

Table 6.2D.3.5-1: UE Power Class 1 test requirements for 2-layer UL-MIMO (network signalling value "NS_202")

Band	Test ID	P _{Powerclass}	MPR _{f,c}	A- MPR _{f,c}	T(MAX(MPR _{f,c} , A- MPR _{f,c}))	Lower limit (dBm)	Upper limit (dBm)
n257, n258	2	40	4.5 ¹	11	7	22-TT	55
	3		5.0 ²				
NOTE 1 Applicable to BWchannel ≤ 200 MHz							
NOTE 2 Applicable to BWchannel = 400 MHz							

Table 6.2D.3.5-2: UE Power Class 2 test requirements for 2-layer UL-MIMO (network signalling value "NS_202")

Band	Test ID	P _{Powerclass}	MPR _{f,c}	A- MPR _{f,c}	T(MAX(MPR _{f,c} , A- MPR _{f,c}))	Lower limit (dBm)	Upper limit (dBm)
n257, n258	1	29	3.5 ¹	1	3.0 ¹	22.5-TT ¹	43
	2		5.0 ²				
NOTE 1 Applicable to BWchannel ≤ 200 MHz							
NOTE 2 Applicable to BWchannel = 400 MHz							

Table 6.2D.3.5-3: UE Power Class 3 test requirements for 2-layer UL-MIMO (network signalling value "NS_202")

Band	Test ID	P _{Powerclass}	MPR _{f,c}	A- MPR _{f,c}	T(MAX(MPR _{f,c} , A- MPR _{f,c}))	Lower limit (dBm)	Upper limit (dBm)
n257, n258	1	22.4	3.5 ¹	1	3.0 ¹	15.9 -TT ¹	43
	2		5.0 ²				
NOTE 1 Applicable to BWchannel ≤ 200 MHz							
NOTE 2 Applicable to BWchannel = 400 MHz							
NOTE 3: Void.							

Table 6.2D.3.5-4: UE Power Class 4 test requirements for 2-layer UL-MIMO (network signalling value "NS_202")

Band	Test ID	P _{Powerclass}	MPR _{f,c}	A- MPR _{f,c}	T(MAX(MPR _{f,c} , A- MPR _{f,c}))	Lower limit (dBm)	Upper limit (dBm)
n257, n258	1	34	3.5 ¹	1	3.0 ¹	27.5 -TT ¹	43
	2		5.0 ²				
NOTE 1 Applicable to BWchannel ≤ 200 MHz							
NOTE 2 Applicable to BWchannel = 400 MHz							

Table 6.2D.3.5-5: UE Power Class 1 test requirements for 2-layer UL-MIMO (network signalling value "NS_203")

Band	Test ID	P _{Powerclass}	MPR _{f,c}	A- MPR _{f,c}	T(MAX(MPR _{f,c} , A- MPR _{f,c}))	Lower limit (dBm)	Upper limit (dBm)
n258	1	40	4.5 ¹ 5.0 ²	3	4	31.5 - TT ¹ 31.0 - TT ²	55
	2		4.5 ¹ 5.0 ²	3	4	31.5 - TT ¹ 31.0 - TT ²	55
	3		4.5 ¹ 5.0 ²	0	4	31.5 - TT ¹ 31.0 - TT ²	55
NOTE 1 Applicable to BWchannel ≤ 200 MHz							
NOTE 2 Applicable to BWchannel = 400 MHz							

Table 6.2D.3.5-6: UE Power Class 2 test requirements for 2-layer UL-MIMO (network signalling value "NS_203")

Band	Test ID	P _{Powerclass}	MPR _{f,c}	A- MPR _{f,c}	T(MAX(MPR _{f,c} , A- MPR _{f,c}))	Lower limit (dBm)	Upper limit (dBm)
n258	1	29	3.5 ¹ 5.0 ²	0	3.0 ¹ 4.0 ²	22.5-TT ¹ 20.0-TT ²	43
	2		3.5 ¹ 5.0 ²	0	3.0 ¹ 4.0 ²	22.5-TT ¹ 20.0-TT ²	43
NOTE 1 Applicable to BWchannel ≤ 200 MHz							
NOTE 2 Applicable to BWchannel = 400 MHz							

Table 6.2D.3.5-7: UE Power Class 3 test requirements for 2-layer UL-MIMO (network signalling value "NS_203")

Band	Test ID	P _{Powerclass}	MPR _{f,c}	A- MPR _{f,c}	T(MAX(MPR _{f,c} , A- MPR _{f,c}))	Lower limit (dBm)	Upper limit (dBm)
n258	1	22.4	3.5 ¹ 5.0 ²	0	3.0 ¹ 4.0 ²	15.9-TT ¹ 13.4-TT ²	43
	2		3.5 ¹ 5.0 ²	0	3.0 ¹ 4.0 ²	15.9-TT ¹ 13.4-TT ²	43
NOTE 1 Applicable to BWchannel ≤ 200 MHz							
NOTE 2 Applicable to BWchannel = 400 MHz							
NOTE 3: Void.							

Table 6.2D.3.5-8: UE Power Class 4 test requirements for 2-layer UL-MIMO (network signalling value "NS_203")

Band	Test ID	P _{Powerclass}	MPR _{f,c}	A- MPR _{f,c}	T(MAX(MPR _{f,c} , A- MPR _{f,c}))	Lower limit (dBm)	Upper limit (dBm)
n258	1	34	3.5 ¹ 5.0 ²	0	3.0 ¹ 4.0 ²	27.5-TT ¹ 25-TT ²	43
	2		3.5 ¹ 5.0 ²	0	3.0 ¹ 4.0 ²	27.5-TT ¹ 25-TT ²	43
NOTE 1 Applicable to BWchannel ≤ 200 MHz							
NOTE 2 Applicable to BWchannel = 400 MHz							

Table 6.2D.3.5-9: UE Power Class 1 test requirements for ULFPTx (network signalling value "NS_202")

Band	Test ID	P _{Powerclass}	MPR _{f,c}	A- MPR _{f,c}	T(MAX(MPR _{f,c} , A- MPR _{f,c}))	Lower limit (dBm)	Upper limit (dBm)
n257, n258	2	40	0	11	7	22-TT	55
	3		6.5	11	7	22-TT	55

Table 6.2D.3.5-10: UE Power Class 2 test requirements for ULFP Tx (network signalling value "NS_202")

Band	Test ID	P _{Powerclass}	MPR _{f,c}	A- MPR _{f,c}	T(MAX(MPR _{f,c} , A- MPR _{f,c}))	Lower limit (dBm)	Upper limit (dBm)
n257, n258	1	29	0	1	1.5	26.5-TT	43
	2		0	1	1.5	26.5-TT	43

Table 6.2D.3.5-11 UE Power Class 3 test requirements for ULFP Tx (network signalling value "NS_202")

Band	Test ID	P _{Powerclass}	MPR _{f,c}	A- MPR _{f,c}	T(MAX(MPR _{f,c} , A- MPR _{f,c}))	Lower limit (dBm)	Upper limit (dBm)
n257, n258	1	22.4	0	1	1.5	19.2-TT	43
	2		0	1	1.5	19.2-TT	43
Note 1: Void.							

Table 6.2D.3.5-12: UE Power Class 4 test requirements for ULFP Tx (network signalling value "NS_202")

Band	Test ID	P _{Powerclass}	MPR _{f,c}	A- MPR _{f,c}	T(MAX(MPR _{f,c} , A- MPR _{f,c}))	Lower limit (dBm)	Upper limit (dBm)
n257, n258	1	34	0	1	1.5	31.5-TT	43
	2		0	1	1.5	31.5-TT	43

Table 6.2D.3.5-13: UE Power Class 1 test requirements for ULFP Tx (network signalling value "NS_203")

Band	Test ID	P _{Powerclass}	MPR _{f,c}	A- MPR _{f,c}	T(MAX(MPR _{f,c} , A- MPR _{f,c}))	Lower limit (dBm)	Upper limit (dBm)
n258	1	40	0	3	2	35-TT	55
	2		0	3	2	35-TT	55
	3		0	0	0	40-TT	55

Table 6.2D.3.5-14: UE Power Class 2 test requirements for ULFP Tx (network signalling value "NS_203")

Band	Test ID	P _{Powerclass}	MPR _{f,c}	A- MPR _{f,c}	T(MAX(MPR _{f,c} , A- MPR _{f,c}))	Lower limit (dBm)	Upper limit (dBm)
n258	1	29	0	0	0	29-TT	43
	2		0	0	0	29-TT	43

Table 6.2D.3.5-15: UE Power Class 3 test requirements for ULFP Tx (network signalling value "NS_203")

Band	Test ID	P _{Powerclass}	MPR _{f,c}	A- MPR _{f,c}	T(MAX(MPR _{f,c} , A- MPR _{f,c}))	Lower limit (dBm)	Upper limit (dBm)
n258	1	22.4	0	0	0	22.4-TT	43
	2		0	0	0	22.4-TT	43
Note 1: Void.							

Table 6.2D.3.5-16: UE Power Class 4 test requirements for ULFP Tx (network signalling value "NS_203")

Band	Test ID	P _{Powerclass}	MPR _{f,c}	A- MPR _{f,c}	T(MAX(MPR _{f,c} , A- MPR _{f,c}))	Lower limit (dBm)	Upper limit (dBm)

n258	1	34	0	0	0	34-TT	43
	2		0	0	0	34-TT	43

Table 6.2D.3.5-17: Test Tolerance (Power class 3)

Test Metric	FR2a	FR2b
Max device size ≤ 30 cm	3.24 dB	3.24 dB

Table 6.2D.3.5-18: UE Power Class 5 test requirements for 2-layer UL-MIMO (network signalling value "NS_202")

Band	Test ID	P _{Powerclass}	MPR _{f,c}	A- MPR _{f,c}	T(MAX(MPR _{f,c} , A-MPR _{f,c}))	Lower limit (dBm)	Upper limit (dBm)
n257	1	30	3.5 ¹	1	3.0 ¹	23.5 -TT ¹	43
	2		5.0 ²		4.0 ²	21 -TT ²	
n258	1	30.4	3.5 ¹	1	3.0 ¹	23.5 -TT ¹	43
	2		5.0 ²		4.0 ²	21 -TT ²	
NOTE 1 Applicable to BWchannel ≤ 200 MHz							
NOTE 2 Applicable to BWchannel = 400 MHz							

Table 6.2D.3.5-19: UE Power Class 5 test requirements for 2-layer UL-MIMO (network signalling value "NS_203")

Band	Test ID	P _{Powerclass}	MPR _{f,c}	A- MPR _{f,c}	T(MAX(MPR _{f,c} , A-MPR _{f,c}))	Lower limit (dBm)	Upper limit (dBm)
n257	1	30	3.5 ¹	1	3.0 ¹	23.5 -TT ¹	43
	2		5.0 ²		4.0 ²	21 -TT ²	
n258	1	30.4	3.5 ¹	1	3.0 ¹	23.5 -TT ¹	43
	2		5.0 ²		4.0 ²	21 -TT ²	
NOTE 1 Applicable to BWchannel ≤ 200 MHz							
NOTE 2 Applicable to BWchannel = 400 MHz							

Table 6.2D.3.5-20 UE Power Class 5 test requirements for ULFPTx (network signalling value "NS_202")

Band	Test ID	P _{Powerclass}	MPR _{f,c}	A- MPR _{f,c}	T(MAX(MPR _{f,c} , A-MPR _{f,c}))	Lower limit (dBm)	Upper limit (dBm)
n257	1	30	0	1	1.5	27.5-TT	43
	2		0		1.5	27.5-TT	
n258	1	30.4	0	1	1.5	27.9-TT	43
	2		0		1.5	27.9-TT	

Table 6.2D.3.5-21: UE Power Class 5 test requirements for ULFPTx (network signalling value "NS_203")

Band	Test ID	P _{Powerclass}	MPR _{f,c}	A- MPR _{f,c}	T(MAX(MPR _{f,c} , A-MPR _{f,c}))	Lower limit (dBm)	Upper limit (dBm)
n257	1	30	0	0	0	30-TT	43
	2		0		0	30-TT	
n258	1	30.4	0	0	0	30.4-TT	43
	2		0		0	30.4-TT	

--

Table 6.2D.3.5-22: Test Tolerance (Power class 5)

Test Metric	FR2a
Max device size ≤ 30 cm	3.38 dB

Table 6.2D.3.5-23: UE Power Class 6 test requirements for 2-layer UL-MIMO (network signalling value "NS_202")

Band	Test ID	P _{Powerclass}	MPR _{f,c}	A- MPR _{f,c}	T(MAX(MPR _{f,c} , A-MPR _{f,c}))	Lower limit (dBm)	Upper limit (dBm)
n257	1	30	3.5 ¹	1	3.0 ¹	23.5 -TT ¹	43
	2		5.0 ²		4.0 ²	21 -TT ²	
n258	1	30.4	3.5 ¹	1	3.0 ¹	23.5 -TT ¹	43
	2		5.0 ²		4.0 ²	21 -TT ²	
n257	1	30	3.5 ¹	1	3.0 ¹	23.9 -TT ¹	43
	2		5.0 ²		4.0 ²	21.4 -TT ²	
n258	1	30.4	3.5 ¹	1	3.0 ¹	23.9 -TT ¹	43
	2		5.0 ²		4.0 ²	21.4 -TT ²	

NOTE 1 Applicable to BWchannel ≤ 200 MHz
 NOTE 2 Applicable to BWchannel = 400 MHz

Table 6.2D.3.5-24: UE Power Class 6 test requirements for 2-layer UL-MIMO (network signalling value "NS_203")

Band	Test ID	P _{Powerclass}	MPR _{f,c}	A- MPR _{f,c}	T(MAX(MPR _{f,c} , A-MPR _{f,c}))	Lower limit (dBm)	Upper limit (dBm)
n257	1	30	3.5 ¹	1	3.0 ¹	23.5 -TT ¹	43
	2		5.0 ²		4.0 ²	21 -TT ²	
n258	1	30.4	3.5 ¹	1	3.0 ¹	23.5 -TT ¹	43
	2		5.0 ²		4.0 ²	21 -TT ²	
n257	1	30	3.5 ¹	1	3.0 ¹	23.9 -TT ¹	43
	2		5.0 ²		4.0 ²	21.4 -TT ²	
n258	1	30.4	3.5 ¹	1	3.0 ¹	23.9 -TT ¹	43
	2		5.0 ²		4.0 ²	21.4 -TT ²	

NOTE 1 Applicable to BWchannel ≤ 200 MHz
 NOTE 2 Applicable to BWchannel = 400 MHz

Table 6.2D.3.5-25 UE Power Class 6 test requirements for ULFPTx (network signalling value "NS_202")

Band	Test ID	P _{Powerclass}	MPR _{f,c}	A- MPR _{f,c}	T(MAX(MPR _{f,c} , A-MPR _{f,c}))	Lower limit (dBm)	Upper limit (dBm)
n257	1	30	0	1	1.5	27.5-TT	43
	2		0		1.5	27.5-TT	
n258	1	30.4	0	1	1.5	27.9-TT	43
	2		0		1.5	27.9-TT	

Table 6.2D.3.5-26: UE Power Class 6 test requirements for ULFPTx (network signalling value "NS_203")

Band	Test ID	P _{Powerclass}	MPR _{f,c}	A- MPR _{f,c}	T(MAX(MPR _{f,c} , A-MPR _{f,c}))	Lower limit (dBm)	Upper limit (dBm)
n257	1	30	0	0	0	30-TT	43
	2		0		0	30-TT	
n258	1	30.4	0	0	0	30.4-TT	43
	2		0		0	30.4-TT	

Table 6.2D.3.5-27: Test Tolerance (Power class 6)

Test Metric	FR2a
Max device size ≤ 30 cm	3.37 dB

Table 6.2D.3.5-28: UE Power Class 1 test requirements for ULFP Tx (network signalling value "NS_205")

Band	Test ID	P _{Powerclass}	MPR _{f,c}	A- MPR _{f,c}	T(MAX(MPR _{f,c} , A-MPR _{f,c}))	Lower limit (dBm)	Upper limit (dBm)
n257	1	40	6.5	6	5	28.5-TT	55
	2		0	6	5	29-TT	55
n258	1		6.5	7	5	28-TT	55
	2		0	7	5	28-TT	55
	3		6.5	6	5	28.5-TT	55
	4		0	6	5	29-TT	55

Table 6.2D.3.5-29: UE Power Class 2 test requirements for ULFP Tx (network signalling value "NS_205")

Band	Test ID	P _{Powerclass}	MPR _{f,c}	A- MPR _{f,c}	T(MAX(MPR _{f,c} , A-MPR _{f,c}))	Lower limit (dBm)	Upper limit (dBm)
n257	5	29	0	0	0	29-TT	43
	6		2.5	0	2	24.5-TT	43
n258	5		0	2	1.5	25.5-TT	43
	6		2.5	2	2	24.5-TT	43
	7		0	0	0	29-TT	43
	8		2.5	0	2	24.5-TT	43

Table 6.2D.3.5-30: UE Power Class 3 test requirements for ULFP Tx (network signalling value "NS_205")

Band	Test ID	P _{Powerclass}	MPR _{f,c}	A- MPR _{f,c}	T(MAX(MPR _{f,c} , A-MPR _{f,c}))	Lower limit (dBm)	Upper limit (dBm)
n257	5	22.4	0	0	0	22.4-TT-ΔMB _{P,n}	43
	6		2.5	0	2	17.9-TT-ΔMB _{P,n}	43
n258	5		0	2	1.5	18.9-TT-ΔMB _{P,n}	43
	6		2.5	2	2	17.9-TT-	43

					$\Delta MB_{P,n}$	
	7		0	0	0	22.4-TT- $\Delta MB_{P,n}$ 43
	8		2.5	0	2	17.9-TT- $\Delta MB_{P,n}$ 43

Note 1: $\Delta MB_{P,n}$ is the Multiband Relaxation factor for the tested band. This shall fulfil the requirements in Table 6.2.1.1.3.3-5.

Table 6.2D.3.5-31: UE Power Class 4 test requirements for ULFTx (network signalling value "NS_205")

Band	Test ID	P _{Powerclass}	MPR _{f,c}	A- MPR _{f,c}	T(MAX(MPR _{f,c} , A- MPR _{f,c}))	Lower limit (dBm)	Upper limit (dBm)
n257	5	34	0	0	0	34-TT	43
	6		2.5	0	2	29.5-TT	43
n258	5	34	0	2	1.5	30.5-TT	43
	6		2.5	2	2	29.5-TT	43
	7		0	0	0	34-TT	43
	8		2.5	0	2	29.5-TT	43

Table 6.2D.3.5-33: UE Power Class 5 and 6 test requirements for ULFTx (network signalling value "NS_205")

Band	Test ID	P _{Powerclass}	MPR _{f,c}	A- MPR _{f,c}	T(MAX(MPR _{f,c} , A- MPR _{f,c}))	Lower limit (dBm)	Upper limit (dBm)
n257	5	30	0	0	0	30-TT- $\Delta MB_{P,n}$	43
	6		2.5	0	2	25.5-TT- $\Delta MB_{P,n}$	43
n258	5	30.4	0	2	1.5	26.9-TT- $\Delta MB_{P,n}$	43
	6		2.5	2	2	25.9-TT- $\Delta MB_{P,n}$	43
	7		0	0	0	30.4-TT- $\Delta MB_{P,n}$	43
	8		2.5	0	2	25.9-TT- $\Delta MB_{P,n}$	43

Note 1: $\Delta MB_{P,n}$ is the Multiband Relaxation factor for the tested band. This shall fulfil the requirements in Table 6.2.1.1.3.5-4 for PC5 and 6.2.1.1.6-4 for PC6.

Table 6.2D.3.5-34: UE Power Class 7 test requirements for ULFTx (network signalling value "NS_205")

Band	Test ID	P _{Powerclass}	MPR _{f,c}	A- MPR _{f,c}	T(MAX(MPR _{f,c} , A- MPR _{f,c}))	Lower limit (dBm)	Upper limit (dBm)
------	---------	-------------------------	--------------------	-----------------------	---	-------------------	-------------------

n257	5	16.4	0	0	0	16.4-TT- $\Delta\text{MB}_{P,n}$	43	
	6		2.5	0	2	11.9-TT- $\Delta\text{MB}_{P,n}$	43	
n258	5		0	2	1.5	12.9-TT- $\Delta\text{MB}_{P,n}$	43	
	6		2.5	2	2	11.9-TT- $\Delta\text{MB}_{P,n}$	43	
	7		0	0	0	16.4-TT- $\Delta\text{MB}_{P,n}$	43	
	8		2.5	0	2	11.9-TT- $\Delta\text{MB}_{P,n}$	43	
Note 1: $\Delta\text{MB}_{P,n}$ is the Multiband Relaxation factor for the tested band. This shall fulfil the requirements in Table 6.2.1.1.3.3-5.								

6.2D.4 Configured transmitted power for UL MIMO

6.2D.4.1 Test purpose

To verify the UE transmitted power $P_{\text{UMAX},f,c}$ is within the range defined prescribed by the specified nominal maximum output power and tolerance.

6.2D.4.2 Test applicability

The requirements of this test are covered in test cases 6.2D.1 UE Maximum output power for UL MIMO, 6.2D.2 UE maximum output power reduction for UL MIMO and 6.2D.3 UE Maximum output power with additional requirements for UL MIMO to all types of NR UE release 15 and forward that supports UL MIMO.

6.2D.4.3 Minimum conformance requirements

For UEs configured for 2-layer transmission as well as UEs configured for single layer uplink full power transmission (ULFPTx), the configured maximum output power $P_{\text{CMAX},c}$ for serving cell c is defined as sum of all streams and is bound by limits set in section 6.2.4.

The normative reference for this requirement is TS 38.101-2 [3] clause 6.2D.4.

6.2D.4.4 Test description

This test is covered by clause 6.2D.1 UE Maximum output power for UL MIMO, 6.2D.2 UE maximum output power reduction for UL MIMO and 6.2D.3 UE Maximum output power with additional requirements for UL MIMO.

6.2D.4.5 Test requirements

This test is covered by clause 6.2D.1 UE Maximum output power for UL MIMO, 6.2D.2 UE maximum output power reduction for UL MIMO and 6.2D.3 UE Maximum output power with additional requirements for UL MIMO.

6.2K Transmitter power for simultaneous transmission to multiple directions

6.2K.1 UE maximum output power for simultaneous transmission to multiple directions

Editor's note: This clause is incomplete. The following aspects are either missing or not yet determined:

- Missing aspects described in 6.2.1.1
- Initial Conditions, Test Procedure and Message contents to be updated for measuring UEs configured for simultaneous transmission to multiple directions is FFS

6.2K.1.1 UE maximum output power - EIRP and TRP

Editor's note: This clause is incomplete. The following aspects are either missing or not yet determined:

- Need to update Test Procedure for transmission to multiple directions needs further analysis
- Measurement Uncertainties and Test Tolerances are FFS.

6.2K.1.1.1 Test purpose

Same as 6.2.1.1.1 for UEs configured for simultaneous transmission to multiple directions

6.2K.1.1.2 Test applicability

This test case applies to all types of release 18 and UE's supporting simultaneous transmission to multiple directions.

6.2K.1.1.3 Minimum conformance requirements

6.2K.1.1.3.1 UE maximum output power for power classes 1, 2, 5, and 6

Refer to 6.2.1.1.3 for Power Class 1, 2, 5, and 6

6.2K.1.1.4 Test description

6.2K.1.1.4.1 Initial conditions

Same as clauses 6.2.1.1.4.1 with additional details for UEs configured for simultaneous transmission to multiple directions being FFS.

6.2K.1.1.4.2 Test procedure

Same as clauses 6.2.1.1.4.2 with additional details for UEs configured for simultaneous transmission to multiple directions being FFS.

NOTE 1: The BEAM_SELECT_WAIT_TIME default value is defined in Annex K.

6.2K.1.1.4.3 Message contents

Same as clauses 6.2.1.1.4.3 with additional details for UEs configured for simultaneous transmission to multiple directions being FFS.

6.2K.1.1.5 Test requirement

The EIRP derived in step 5 and TRP derived in step 6 shall not exceed the values specified in Table 6.2.1.1.5-1 to Table 6.2K.1.1.5-4.

Table 6.2K.1.1.5-1: UE maximum output test requirements for power class 1

Operating band	Max TRP (dBm)	Max EIRP (dBm)	Min peak EIRP (dBm)
n257	35+TT	55	40.0-TT
n258	35+TT	55	40.0-TT
n260	35+TT	55	38.0-TT
n261	35+TT	55	40.0-TT

Table 6.2K.1.1.5-1a: Test Tolerance (Max TRP for Power class 1)

Test Metric	FR2a	FR2b
Max device size \leq 30 cm	TBD (NTC) TBD (ETC)	TBD (NTC) TBD (ETC)

Table 6.2K.1.1.5-1b: Test Tolerance (Min peak EIRP for Power class 1)

Test Metric	FR2a	FR2b
Max device size \leq 30 cm	TBD (NTC) TBD (ETC)	TBD (NTC) TBD (ETC)

Table 6.2K.1.1.5-2: UE maximum output test requirements for power class 2

Operating band	Max TRP (dBm)	Max EIRP (dBm)	Min peak EIRP (dBm)
n257	23+TT	43	29-TT
n258	23+TT	43	29-TT
n260			
n261	23+TT	43	29-TT

Table 6.2K.1.1.5-5: UE maximum output power test requirements for power class 5

Operating band	Max TRP (dBm)	Max EIRP (dBm)	Min peak EIRP (dBm)
n257	23+TT	43	30.0-TT- Δ MB _{P,n}
n258	23+TT	43	30.4-TT- Δ MB _{P,n}
Note 1: Δ MB _{P,n} = 0 for single band UE. For multi-band UEs, Δ MB _{P,n} is defined in table 6.2.1.1.3.5-4.			

Table 6.2K.1.1.5-5a: Test Tolerance (Max TRP for Power class 5)

Test Metric	FR2a
Max device size \leq 30 cm	TBD (NTC) TBD (ETC)

Table 6.2K.1.1.5-5b: Test Tolerance (Min peak EIRP for Power class 5)

Test Metric	FR2a
Max device size \leq 30 cm	TBD (NTC) TBD (ETC)

Table 6.2K.1.1.5-6: UE maximum output power test requirements for power class 6

Operating band	Max TRP (dBm)	Max EIRP (dBm)	Min peak EIRP (dBm)
n257, n261	23+TT	43	30.0-TT- Δ MB _{P,n}
n258	23+TT	43	30.4-TT- Δ MB _{P,n}
Note 1: Δ MB _{P,n} = 0 for single band UE. For multi-band UEs, Δ MB _{P,n} is defined in table 6.2.1.1.3.5-4.			

Table 6.2K.1.1.5-6a: Test Tolerance (Max TRP for Power class 6)

Test Metric	FR2a
Max device size \leq 30 cm	TBD (NTC) TBD (ETC)

Table 6.2K.1.1.5-6b: Test Tolerance (Min peak EIRP for Power class 6)

Test Metric	FR2a
Max device size \leq 30 cm	TBD (NTC) TBD (ETC)

6.2K.1.2 UE spherical coverage for simultaneous transmission to multiple directions

Editor's note: This clause is incomplete. The following aspects are either missing or not yet determined:

- Missing aspects described in 6.2.1.2
- Initial Conditions, Test Procedure and Message contents to be updated for measuring UEs configured for simultaneous transmission to multiple directions is FFS
- Test Requirement details and MU/TT are FFS

6.2K.1.2.1 Test purpose

Same as 6.2.1.2.1 for UEs configured for simultaneous transmission to multiple directions

6.2K.1.2.2 Test applicability

[This test case applies to all types of NR Power Class 3 UEs Release 18 and forward supporting simultaneous transmission to multiple directions.]

6.2K.1.2.3 Minimum conformance requirements

For UEs configured for simultaneous transmission to multiple directions, the maximum output power for each of indicated joint/UL TCI states is specified in clause 6.2.1.

The normative reference for this requirement is TS 38.101-2 [3] clause 6.2K.1.

6.2K.1.2.4 Test description

6.2K.1.2.4.1 Initial conditions

Same as clauses 6.2.1.2.4.1 with additional details for UEs configured for simultaneous transmission to multiple directions being FFS.

6.2K.1.2.4.2 Test procedure

Same as clauses 6.2.1.2.4.2 with additional details for UEs configured for simultaneous transmission to multiple directions being FFS.

NOTE 1: The BEAM_SELECT_WAIT_TIME default value is defined in Annex K.

6.2K.1.2.4.3 Message contents

Same as clauses 6.2.1.2.4.3 with additional details for UEs configured for simultaneous transmission to multiple directions being FFS.

6.2K.1.2.5 Test requirement

The maximum output power for each of indicated joint/UL TCI states is specified in clause 6.2.1.2.5. Any additional details are FFS.

6.2K.2 UE maximum output power reduction for simultaneous transmission to multiple directions

Editor's note: This clause is incomplete. The following aspects are either missing or not yet determined:

- Missing aspects described in 6.2.2.1
- Initial Conditions, Test Procedure and Message contents to be updated for measuring UEs configured for simultaneous transmission to multiple directions is FFS
- Test Requirement details and MU/TT are FFS

6.2K.2.1 Test purpose

Same as 6.2.2.1.1 for UEs configured for simultaneous transmission to multiple directions

6.2K.2.2 Test applicability

[This test case applies to all types of NR Power Class 3 UEs Release 18 and forward supporting simultaneous transmission to multiple directions.]

6.2K.2.3 Minimum conformance requirements

For UEs configured for simultaneous transmission to multiple directions, the maximum output power reduction for each of indicated joint/UL TCI states is specified in clause 6.2.2.

The normative reference for this requirement is TS 38.101-2 [3] clause 6.2K.2.

6.2K.2.4 Test description

6.2K.2.4.1 Initial conditions

Same as clauses 6.2.2.1.4.1 with additional details for UEs configured for simultaneous transmission to multiple directions being FFS.

6.2K.2.4.2 Test procedure

Same as clauses 6.2.2.1.4.2 with additional details for UEs configured for simultaneous transmission to multiple directions being FFS.

NOTE 1: The BEAM_SELECT_WAIT_TIME default value is defined in Annex K.

6.2K.2.4.3 Message contents

Same as clauses 6.2.2.1.4.3 with additional details for UEs configured for simultaneous transmission to multiple directions being FFS.

6.2K.2.5 Test requirement

The maximum output power shall be within the range prescribed by the nominal maximum output power and tolerance defined in FFS. The maximum output power for each of indicated joint/UL TCI states is specified in clause 6.2.2.5. Additional details are FFS.

6.2K.3 UE maximum output power with additional requirements for simultaneous transmission to multiple directions

Editor's note: This clause is incomplete. The following aspects are either missing or not yet determined:

- Missing aspects described in 6.2.3
- Initial Conditions, Test Procedure and Message contents to be updated for measuring UEs configured for simultaneous transmission to multiple directions is FFS
- Test Requirement details and MU/TT are FFS

For UEs configured for simultaneous transmission to multiple directions, the maximum output power with additional requirements for each of indicated joint/UL TCI states is specified in clause 6.2.3.

6.2K.4 Configured transmitted power for simultaneous transmission to multiple directions

Editor's note: This clause is incomplete. The following aspects are either missing or not yet determined:

- Test definition is FFS
- Initial Conditions, Test Procedure and Message contents to be updated for measuring UEs configured for simultaneous transmission to multiple directions is FFS
- Test Requirement details and MU/TT are FFS

A UE configured for simultaneous transmission to multiple directions can configure two maximum output powers. The configured UE maximum output power $P_{\text{CMAX},f,c,k}$ for each of joint/UL TCI states k ($k = 1, 2$) indicated for simultaneous transmission to multiple directions of carrier f and serving cell c is defined as that available to the reference point of a given transmitter branch that corresponds to the reference point of the higher-layer filtered RSRP measurement as specified in TS 38.215 [11].

The configured UE maximum output power $P_{\text{CMAX},f,c,k}$ shall be set such that the corresponding measured peak EIRP $P_{\text{UMAX},f,c,k}$ is within the following bounds

$$P_{\text{Powerclass}} + \Delta P_{\text{IBE}} - \text{MAX}(\text{MAX}(\text{MPR}_{f,c,k}, A - \text{MPR}_{f,c,k}), \Delta \text{MPR}_{\text{STxMP}} + \Delta \text{MB}_{P,n}, P - \text{MPR}_{f,c,k}) - \text{MAX}\{\text{T}(\text{MAX}(\text{MPR}_{f,c,k}, A - \text{MPR}_{f,c,k}), \Delta \text{MPR}_{\text{STxMP}}), \text{T}(P - \text{MPR}_{f,c,k})\} - \Delta T_{\text{STxMP}} \leq P_{\text{UMAX},f,c,k} \leq \text{EIRP}_{\text{max}}$$

and $P_{\text{UMAX},f,c}$, the corresponding measured peak EIRP for carrier f of a serving cell c , aggregated over all indicated joint/UL TCI states in a given direction, satisfies over all directions

$$P_{\text{UMAX},f,c} \leq \text{EIRP}_{\text{max}}$$

while the corresponding measured total radiated power $P_{\text{TMAX},f,c}$ is bounded by

$$P_{\text{TMAX},f,c} \leq \text{TRP}_{\text{max}}$$

with $P_{\text{Powerclass}}$ the UE minimum peak EIRP as specified in sub-clause 6.2K.1, EIRP_{max} the applicable maximum EIRP as specified in sub-clause 6.2.1, $\text{MPR}_{f,c,k}$ as specified in sub-clause 6.2K.2, $A - \text{MPR}_{f,c,k}$ as specified in sub-clause 6.2K.3, $\Delta \text{MB}_{P,n}$ the peak EIRP relaxation as specified in clause 6.2.1 and TRP_{max} the maximum TRP for the UE power class as specified in sub-clause 6.2.1. ΔP_{IBE} is 1.0 dB if UE declares support for *mpr-PowerBoost-FR2-r16*, UL transmission is QPSK, $\text{MPR}_{f,c} = 0$ and when NS_200 applies and the network configures the UE to operate with *mpr-PowerBoost-FR2-r16* otherwise ΔP_{IBE} is 0.0 dB. $\Delta \text{MPR}_{\text{STxMP}}$ is [3.0] dB if two TCI states are indicated for simultaneous transmission to multiple directions, 0.0 dB otherwise. ΔT_{STxMP} is specified in sub-clause 6.2K.1. The requirement is verified in beam peak direction for each of the indicated joint/UL TCI states.

$P - \text{MPR}_{f,c,k}$ is the power management maximum output power reduction $P - \text{MPR}_{f,c}$ for each of indicated joint/UL TCI states. $P - \text{MPR}_{f,c}$ is defined in clause 6.2.4.

The tolerance $\text{T}(\Delta P)$ for applicable values of ΔP (values in dB) is specified in Tables 6.2.4-1.

6.3 Output power dynamics

6.3.1 Minimum output power

Editor's note: The following aspects of the clause are for future consideration:

- Relaxation, Measurement Uncertainties and Test Tolerances are FFS for power class other than 1, 3, 5, 6 and 7.

6.3.1.1 Test purpose

To verify the UE's ability to transmit with a broadband output power below the value specified in the test requirement when the power is set to a minimum value.

6.3.1.2 Test applicability

This test case applies to all types of NR UE release 15 and forward.

6.3.1.3 Minimum conformance requirements

The minimum controlled output power of the UE is defined as the EIRP in the channel bandwidth for all transmit bandwidth configurations (resource blocks) when the power is set to a minimum value.

The minimum output power is defined as the mean power in at least one subframe (1ms).

6.3.1.3.1 Minimum output power for power class 1

For power class 1 UE, the minimum output power shall not exceed the values specified in Table 6.3.1.3.1-1 for each operating band supported. The minimum power is verified in beam locked mode with the test metric of EIRP (Link=TX beam peak direction, Meas=Link angle).

Table 6.3.1.3.1-1: Minimum output power for power class 1

Operating band	Channel bandwidth (MHz)	Minimum output power (dBm)	Measurement bandwidth (MHz)
n257, n258, n260, n261	50	4	47.58
	100	4	95.16
	200	4	190.20
	400	4	380.28

6.3.1.3.2 Minimum output power for power class 2, 3, and 4

The minimum output power shall not exceed the values specified in Table 6.3.1.3.2-1 for each operating band supported. The minimum power is verified in beam locked mode with the test metric of EIRP (Link=TX beam peak direction, Meas=Link angle).

Table 6.3.1.3.2-1: Minimum output power for power class 2, 3, and 4

Operating band	Channel bandwidth (MHz)	Minimum output power (dBm)	Measurement bandwidth (MHz)
n257, n258, n259, n260, n261	50	-13	47.58
	100	-13	95.16
	200	-13	190.20
	400	-13	380.28

NOTE 1: n260 is not applied for power class 2.

The normative reference for this requirement is TS 38.101-2 [3] clause 6.3.1.

6.3.1.3.3 Minimum output power for power class 5 and 6

The minimum output power shall not exceed the values specified in Table 6.3.1.3.3-1 for each operating band supported. The minimum power is verified in beam locked mode with the test metric of EIRP (Link=TX beam peak direction, Meas=Link angle).

Table 6.3.1.3.3-1: Minimum output power for power class 5 and 6

Operating band	Channel bandwidth (MHz)	Minimum output power (dBm)	Measurement bandwidth (MHz)
n257, n258, n261	50	-6	47.58
	100	-6	95.16
	200	-6	190.20
	400	-6	380.28

6.3.1.3.4 Minimum output power for power class 7

The minimum output power shall not exceed the values specified in Table 6.3.1.3.4-1 for each operating band supported. The minimum power is verified in beam locked mode with the test metric of EIRP (Link=TX beam peak direction, Meas=Link angle).

Table 6.3.1.3.4-1: Minimum output power for power class 7

Operating band	Channel bandwidth (MHz)	Minimum output power (dBm)	Measurement bandwidth (MHz)
n257, n258, n261	50	-13	47.58
	100	-13	95.16

6.3.1.4 Test description

6.3.1.4.1 Initial condition

Initial conditions are a set of test configurations the UE needs to be tested in and the steps for the SS to take with the UE to reach the correct measurement state.

The initial test configurations consist of environmental conditions, test frequencies, test channel bandwidths and sub-carrier spacing based on NR operating bands specified in Table 5.3.5-1. All of these configurations shall be tested with applicable test parameters for each combination of test channel bandwidth and sub-carrier spacing, and are shown in Table 6.3.1.4.1-1. The details of the uplink reference measurement channels (RMCs) are specified in Annex A.2. Configurations of PDSCH and PDCCH before measurement are specified in Annex C.2.

Table 6.3.1.4.1-1: Test Configuration Table

Initial Conditions			
Test Environment as specified in TS 38.508-1 [10] clause 4.1		Normal, TL, TH	
Test Frequencies as specified in TS 38.508-1 [10] clause 4.3.1		Low range, Mid range, High range	
Test Channel Bandwidths as specified in TS 38.508-1 [10] clause 4.3.1		Lowest, Mid, Highest	
Test SCS as specified in Table 5.3.5-1.		Highest	
Test Parameters			
Test ID	Downlink Configuration	Uplink Configuration	
		Modulation	RB allocation (NOTE 1)
1	-	DFT-s-OFDM QPSK	Outer_Full
NOTE 1: The specific configuration of each RB allocation is defined in Table 6.1-1 for PC2, PC3, PC4, PC5, PC6 and PC7 or Table 6.1-2 for PC1.			

1. Connection between SS and UE is shown in TS 38.508-1 [10] Annex A, Figure A.3.3.1.1 for TE diagram and Figure A.3.4.1.1 for UE diagram.
2. The parameter settings for the cell are set up according to TS 38.508-1 [10] clause 4.4.3.
3. Downlink signals are initially set up according to Annex C, and uplink signals according to Annex G.
4. The UL Reference Measurement Channel is set according to Table 6.3.1.4.1-1.
5. Propagation conditions are set according to Annex B.0.
6. Ensure the UE is in State RRC_CONNECTED with generic procedure parameters Connectivity *NR*, Connected without release *On*, Test Mode *On* and Test Loop Function *On* according to TS 38.508-1 [10] clause 4.5. Message contents are defined in clause 6.3.1.4.3.

6.3.1.4.2 Test procedure

1. SS sends uplink scheduling information for each UL HARQ process via PDCCH DCI format 0_1 for C_RNTI to schedule the UL RMC according to Table 6.3.1.4.1-1. Since the UE has no payload and no loopback data to send the UE sends uplink MAC padding bits on the UL RMC.
2. Set the UE in the Tx beam peak direction found with a 3D EIRP scan as performed in Annex K.1.1. Allow at least BEAM_SELECT_WAIT_TIME (NOTE 1) for the UE Tx beam selection to complete.
3. Send continuously uplink power control "down" commands in every uplink scheduling information to the UE; allow at least 200ms starting from the first TPC command in this step to ensure that the UE transmits at its

minimum output power. If UE is disconnected, repeat the test case. Optionally, send continuously uplink power control "down" commands in every uplink scheduling information to the UE until the UE EIRP measured by the test system is at a level just before the UE was disconnected. Allow at least BEAM_SELECT_WAIT_TIME (NOTE 1) for the UE Tx beam selection to complete.

4. SS activates the UE Beamlock Function (UBF) by performing the procedure as specified in TS 38.508-1 [10] clause 4.9.2 using condition Tx only.
5. Measure UE EIRP in the Tx beam peak direction in the measurement bandwidth specified in Table 6.3.1.5-1 and Table 6.3.1.5-2 for the specific channel bandwidth under test. EIRP test procedure is defined in Annex K.1.3. The measuring duration is at least one active subframe (1ms). EIRP is calculated considering both polarizations, theta and phi. For TDD, only slots consisting of only UL symbols are under test.
6. SS deactivates the UE Beamlock Function (UBF) by performing the procedure as specified in TS 38.508-1 [10] clause 4.9.3.

NOTE 1: The BEAM_SELECT_WAIT_TIME default value is defined in Annex K.

6.3.1.4.3 Message contents

Message contents are according to TS 38.508-1 [10] clause 4.6 with TRANSFORM_PRECODER_ENABLED condition in Table 4.6.3-118 PUSCH-Config.

6.3.1.5 Test requirement

The maximum EIRP, derived in step 5 shall not exceed the values specified in Table 6.3.1.5-1 to Table 6.3.1.5-5.

Table 6.3.1.5-1: Minimum output power for power class 1

Operating band	Channel bandwidth (MHz)	Minimum output power (dBm)	Measurement bandwidth (MHz)
n257, n258, n260, n261	50	4 +TT	47.58
	100	4 +TT	95.16
	200	4 +TT	190.20
	400	4 +TT	380.28

Table 6.3.1.5-1a: Test Tolerance Minimum output power for power class 1

Test Metric	FR2a	FR2b
Max device size \leq 30 cm	3.79 dB, NTC 3.95 dB, ETC	4.09 dB, NTC 4.25 dB, ETC

Table 6.3.1.5-2: Minimum output power for power class 3

Operating band	Channel bandwidth (MHz)	Minimum output power (dBm)	Test Tolerance TT (dB)	Measurement bandwidth (MHz)
n257, n258, n261	50	-13+TT	4.21 dB, NTC 4.37 dB, ETC	47.58
	100	-13+2.4+TT ¹	2.52 dB, NTC 2.68 dB, ETC	95.16
	200	-13+5.4+TT ¹	0.66 dB, NTC 0.82 dB, ETC	190.20
	400	-13+8.4+TT ¹	0 dB, NTC 0 dB, ETC	380.28
n260	50	-13+4.5+TT ¹	1.17 dB, NTC 1.33 dB, ETC	47.58
	100	-13+7.5+TT ¹	0 dB, NTC 0 dB, ETC	95.16
	200	-13+10.5+TT ¹	0 dB, NTC 0 dB, ETC	190.20

	400	$-13+13.5+TT^1$	0 dB, NTC 0 dB, ETC	380.28
n259	50	$-13+5.5+TT^1$	1.39 dB, NTC 1.48 dB, ETC	47.58
	100	$-13+8.5+TT^1$	0.06 dB, NTC 0.15 dB, ETC	95.16
	200	$-13+11.5+TT^1$	0 dB, NTC 0 dB, ETC	190.20
	400	$-13+14.5+TT^1$	0 dB, NTC 0 dB, ETC	380.28
NOTE 1: Core requirement cannot be tested due to testability issue and test requirement includes relaxation to achieve impact from test system noise to measurement result = 1.0 dB (Minimum requirement + relaxation).				

Table 6.3.1.5-2a: Minimum output power for power class 2 and 4

Operating band	Channel bandwidth (MHz)	Minimum output power (dBm)	Measurement bandwidth (MHz)
n257, n258, n260, n261	50	$-13+TBD+TT$	47.58
	100	$-13+TBD+TT$	95.16
	200	$-13+TBD+TT$	190.20
	400	$-13+TBD+TT$	380.28
NOTE 1: n260 is not applied for power class 2.			

Table 6.3.1.5-2b: Minimum output power for power class 6

Operating band	Channel bandwidth (MHz)	Minimum output power (dBm)	Test Tolerance TT (dB)	Measurement bandwidth (MHz)
n257, n258, n261	50	$-6 +TT$	3.66 dB, NTC 3.83 dB, ETC	47.58
	100	$-6 +TT$	3.84 dB, NTC 4.01 dB, ETC	95.16
	200	$-6 +TT$	4.17 dB, NTC 4.34 dB, ETC	190.20
	400	$-6+1.4+TT^1$	3.37 dB, NTC 3.54 dB, ETC	380.28
NOTE 1: Core requirement cannot be tested due to testability issue and test requirement includes relaxation to achieve impact from test system noise to measurement result = 1.0 dB (Minimum requirement + relaxation).				

Table 6.3.1.5-3: Minimum output power for power class 5

Operating band	Channel bandwidth (MHz)	Minimum output power (dBm)	Test Tolerance TT (dB)	Measurement bandwidth (MHz)
n257, n258	50	$-6+TT$	3.67 dB, NTC 3.84 dB, ETC	47.58
	100	$-6+TT$	3.85 dB, NTC 4.02 dB, ETC	95.16
	200	$-6+TT$	4.18 dB, NTC 4.35 dB, ETC	190.20
	400	$-6+1.4+TT^1$	3.38 dB, NTC 3.55 dB, ETC	380.28
NOTE 1: Core requirement cannot be tested due to testability issue and test requirement includes relaxation to achieve impact from test system noise to measurement result = 1.0 dB (Minimum requirement + relaxation).				

Table 6.3.1.5-4: Void

Table 6.3.1.5-5: Minimum output power for power class 7

Operating band	Channel bandwidth (MHz)	Minimum output power (dBm)	Test Tolerance TT (dB)	Measurement bandwidth (MHz)
n257, n258, n261	50	-13+TT	4.21	47.58
	100	-13+2.4+TT	2.52	95.16

6.3.2 Transmit OFF power

Editor's note: Following aspects are either missing or not yet determined otherwise:

- Measurement Uncertainties and Test Tolerances are FFS for power class other than PC1, PC3, PC5 and PC6.
- Measurement grid for PC2/4 in Annex M.4 is TBD.
- Test Procedure aspects for UE indicating *ul-GapFR2-r17* is FFS

6.3.2.1 Test purpose

To verify that the UE transmit OFF power is lower than the value specified in the test requirement.

An excess transmit OFF power potentially increases the Rise Over Thermal (RoT) and therefore reduces the cell coverage area for other UEs.

6.3.2.2 Test applicability

This test applies to all types of NR UE release 15 and forward.

6.3.2.3 Minimum conformance requirements

The transmit OFF power is defined as the TRP in the channel bandwidth when the transmitter is OFF. The transmitter is considered OFF when the UE is not allowed to transmit on any of its ports.

The transmit OFF power shall not exceed the values specified in Table 6.3.2.3-1 for each operating band supported. The requirement is verified with the test metric of TRP (Link=TX beam peak direction, Meas=TRP grid).

Table 6.3.2.3-1: Transmit OFF power

Operating band	Channel bandwidth / Transmit OFF power (dBm) / measurement bandwidth			
	50 MHz	100 MHz	200 MHz	400 MHz
n257, n258, n259, n260, n261	-35	-35	-35	-35
	47.58 MHz	95.16 MHz	190.20 MHz	380.28 MHz

For UE indicating *ul-GapFR2-r17*, UE shall meet OFF power requirement defined in this clause for the band for which UL transmission is stopped in the activated UL gap.

The normative reference for this requirement is TS 38.101-2 [3] clause 6.3.2.

6.3.2.4 Test description

6.3.2.4.1 Initial condition

Initial conditions are a set of test configurations the UE needs to be tested in and the steps for the SS to take with the UE to reach the correct measurement state.

The initial test configurations consist of environmental conditions, test frequencies, test channel bandwidths and sub-carrier spacing based on NR operating bands specified in Table 5.3.5-1. All of these configurations shall be tested with

applicable test parameters for each combination of test channel bandwidth and sub-carrier spacing, and are shown in Table 6.3.2.4.1-1. The details of the uplink reference measurement channels (RMCs) are specified in Annexes A.2. Configurations of PDSCH and PDCCH before measurement are specified in Annex C.2.

Table 6.3.2.4.1-1: Test Configuration Table

Initial Conditions				
Test Environment as specified in TS 38.508-1 [10] clause 4.1			Normal	
Test Frequencies as specified in TS 38.508-1 [10] clause 4.3.1			Low range, Mid range, High range	
Test Channel Bandwidths as specified in TS 38.508-1 [10] clause 4.3.1			Lowest	
Test SCS as specified in Table 5.3.5-1.			Highest	
Test Parameters				
Test ID	Downlink Configuration		Uplink Configuration	
	Modulation	RB allocation	Modulation	RB allocation
1	-	-	-	-

1. Connection between SS and UE is shown in TS 38.508-1 [10] Annex A Figure A.3.3.1.1 for TE diagram and Figure A.3.4.1.1 for UE diagram.
2. The parameter settings for the cell are set up according to TS 38.508-1 [10] clause 4.4.3.
3. Downlink signals are initially set up according to Annex C, and uplink signals according to Annex G.
4. The UL Reference Measurement Channels are set according to Table 6.3.2.4.1-1.
5. Propagation conditions are set according to Annex B.0.
6. Ensure the UE is in State RRC_CONNECTED with generic procedure parameters Connectivity NR, Connected without release On, Test Mode On and Test Loop Function On according to TS 38.508-1 [10] clause 4.5. Message contents are defined in clause 6.3.2.4.3.

6.3.2.4.2 Test procedure

Editor's note: Test Procedure aspects for UE indicating *ul-GapFR2-r17* is FFS

1. Set the UE in the Tx beam peak direction found with a 3D EIRP scan as performed in Annex K.1.1. Allow at least BEAM_SELECT_WAIT_TIME (NOTE) for the UE Tx beam selection to complete.
2. SS activates the UE Beamlock Function (UBF) by performing the procedure as specified in TS 38.508-1 [10] clause 4.9.2 using condition Tx only.
3. Measure UE TRP for the assigned NR channel with a rectangular measurement filter with bandwidths according to Table 6.3.2.5-1. Total radiated power is measured according to TRP measurement procedure defined in Annex K. TRP is calculated considering both polarizations, theta and phi.

NOTE: The BEAM_SELECT_WAIT_TIME default value is defined in Annex K.

6.3.2.4.3 Message contents

Message contents are according to TS 38.508-1 [10] clause 4.6.

6.3.2.5 Test requirement

The requirement for the transmit OFF power shall not exceed the values specified in Table 6.3.2.5-1.

Table 6.3.2.5-1: Transmit OFF power

Operating band	Channel bandwidth / Transmit OFF power (dBm) / measurement bandwidth			
	50 MHz	100 MHz	200 MHz	400 MHz
n257, n258, n261 ^{1,2}	-35+21.4	-35+24.4	-35+27.4	-35+30.4

	47.58 MHz	95.16 MHz	190.20 MHz	380.28 MHz
n260 ^{1,4}	-35+ 26.5	-35+ 29.5	-35+ 32.5	-35+ 35.5
	47.58 MHz	95.16 MHz	190.20 MHz	380.28 MHz
n259 ^{1,3}	-35+27.5	-35+30.5	-35+33.5	-35+36.5
	47.58 MHz	95.16 MHz	190.20 MHz	380.28 MHz
NOTE 1: Core requirement cannot be tested due to testability issue and test requirement includes relaxation to achieve impact from test system noise to measurement result = 1.0 dB (Minimum requirement + relaxation).				
NOTE 2: Relaxed test requirement is testable for PC6, PC5, PC3 and PC1.				
NOTE 3: Relaxed test requirement is testable for PC3.				
NOTE 4: Relaxed test requirement is testable for PC3 and PC1.				

6.3.3 Transmit ON/OFF time mask

6.3.3.1 General

The transmit ON/OFF time mask defines the transient period(s) allowed

- between transmit OFF power and transmit ON power symbols (transmit ON/OFF)
- between continuous ON-power transmissions when power change or RB hopping is applied.

In case of RB hopping, transition period is shared symmetrically.

Unless otherwise stated the minimum requirements in clause 6.5 apply also in transient periods.

The transmit ON/OFF time mask is defined as a directional requirement. The requirement is verified in beam locked mode at beam peak direction. The maximum allowed EIRP OFF power level is -30dBm at beam peak direction. The requirement is verified with the test metric of EIRP (Link=TX beam peak direction, Meas=Link angle).

In the following sub-clauses, following definitions apply:

- A slot transmission is a Type A transmission.
- A long subslot transmission is a Type B transmission with more than 2 symbols.
- A short subslot transmission is a Type B transmission with 1 or 2 symbols.

6.3.3.2 General ON/OFF time mask

Editor's note: The following aspects are either missing or not yet determined:

- **Measurement Uncertainty and Test Tolerances are FFS for power class 1, 2, 4 and 6.**
- **Measurement Uncertainty and Test Tolerances are FFS for band n259.**

6.3.3.2.1 Test purpose

To verify that the general ON/OFF time mask meets the requirements given in 6.3.3.2.5.

The transmit ON/OFF time mask defines the transient period(s) allowed

- between transmit OFF power and transmit ON power symbols (transmit ON/OFF)

Unless otherwise stated the minimum requirements in clause 6.5 apply also in transient periods.

Transmission of the wrong power increases interference to other channels, or increases transmission errors in the uplink channel.

6.3.3.2.2 Test applicability

This test case applies to all types of NR UE release 15 and forward.

6.3.3.2.3 Minimum conformance requirements

The transmit ON/OFF time mask is defined as a directional requirement. The requirement is verified in beam locked mode at beam peak direction. The maximum allowed EIRP OFF power level is -30dBm at beam peak direction. The requirement is verified with the test metric of EIRP (Link=TX beam peak direction, Meas=Link angle)

The general ON/OFF time mask defines the observation period allowed between transmit OFF and ON power. ON/OFF scenarios include: contiguous, and non-contiguous transmission, etc.

The OFF power measurement period is defined in a duration of at least one slot excluding any transient periods. The ON power is defined as the mean power over one slot excluding any transient period.

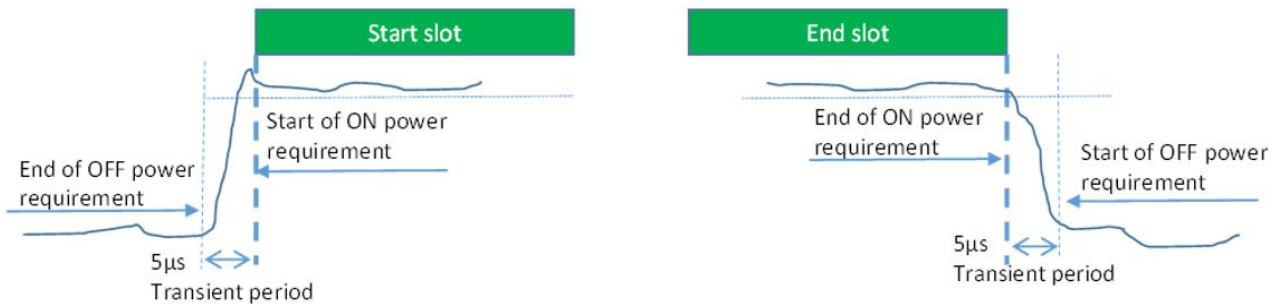

Figure 6.3.3.2.3-1: General ON/OFF time mask for NR UL transmission in FR2

The normative reference for this requirement is TS 38.101-2 [3] clause 6.3.3.2.

6.3.3.2.4 Test description

6.3.3.2.4.1 Initial condition

Initial conditions are a set of test configurations the UE needs to be tested in and the steps for the SS to take with the UE to reach the correct measurement state.

The initial test configurations consist of environmental conditions, test frequencies, test channel bandwidths and sub-carrier spacing based on NR operating bands specified in Table 5.2-1. All of these configurations shall be tested with applicable test parameters for each combination of test channel bandwidth and sub-carrier spacing, and are shown in Table 6.3.3.2.4.1-1. The details of the uplink reference measurement channels (RMCs) are specified in Annexes A.2. Configurations of PDSCH and PDCCH before measurement are specified in Annex C.2.

Table 6.3.3.2.4.1-1: Test Configuration Table

Initial Conditions			
Test Environment as specified in TS 38.508-1 [10] clause 4.1		Normal, TL, TH	
Test Frequencies as specified in TS 38.508-1 [10] clause 4.3.1		Low range, Mid range, High range	
Test Channel Bandwidths as specified in TS 38.508-1 [10] clause 4.3.1		Lowest, Mid, Highest	
Test SCS as specified in Table 5.3.5-1.		Highest	
Test Parameters			
Test ID	Downlink Configuration	Uplink Configuration	
		Modulation	RB allocation (NOTE 1)
1	-	DFT-s-OFDM QPSK	Inner_Full
NOTE 1: The specific configuration of each RB allocation is defined in Table 6.1-1 for PC2, PC3, PC4, PC6 and PC7 or Table 6.1-2 for PC1.			

1. Connection between SS and UE is shown in TS 38.508-1 [10] Annex A Figure A.3.3.1.1 for TE diagram and Figure A.3.4.1.1 for UE diagram.
2. The parameter settings for the cell are set up according to TS 38.508-1 [10] clause 4.4.3.

3. Downlink signals are initially set up according to Annex C, and uplink signals according to Annex G.
4. The UL Reference Measurement Channels are set according to Table 6.3.3.2.4.1-1.
5. Propagation conditions are set according to Annex B.0.
6. Ensure the UE is in State RRC_CONNECTED with generic procedure parameters Connectivity *NR*, Connected without release *On*, Test Mode *On* and Test Loop Function *On* according to TS 38.508-1 [10] clause 4.5. Message contents are defined in clause 6.3.3.2.4.3.

6.3.3.2.4.2 Test procedure

1. SS sends uplink scheduling information for each UL HARQ process via PDCCH DCI format 0_1 for C_RNTI to schedule the UL RMC according to Table 6.3.3.2.4.1-1. Since the UE has no payload and no loopback data to send the UE sends uplink MAC padding bits on the UL RMC. The UL assignment is such that the UE transmits on slot 37 for 60kHz SCS and on slot 74 for 120kHz SCS.
2. Set the UE in the Inband Tx beam peak direction found with a 3D EIRP scan as performed in Annex K.1.1. Allow at least BEAM_SELECT_WAIT_TIME (NOTE 1) for the UE Tx beam selection to complete.
3. Send continuously uplink power control "up" commands in every uplink scheduling information to the UE; allow at least 200 msec starting from the first TPC command in this step to ensure that the UE transmits at its maximum output power. Allow at least BEAM_SELECT_WAIT_TIME (NOTE 1) for the UE Tx beam selection to complete.
4. SS activates the UE Beamlock Function (UBF) by performing the procedure as specified in TS 38.508-1 [10] clause 4.9.2 using condition Tx only.
5. ON power sub test:
 - 5.1. For UE transmission ON power, measure UE EIRP in the Tx beam peak direction in the channel bandwidth of the radio access mode according to the test configuration, which shall meet the requirements described in Table 6.3.3.2.5-2. EIRP test procedure is defined in Annex K. The period of the measurement shall be one slot with PUSCH transmission. EIRP is calculated considering both polarizations, theta and phi. For TDD, only slots consisting of only UL symbols are under test.
6. OFF power sub test:
 - 6.1. For UE transmission OFF power, measure UE EIRP in the Tx beam peak direction in the channel bandwidth of the radio access mode according to the test configuration, which shall meet the requirements described in Table 6.3.3.2.5-1. EIRP test procedure is defined in Annex K.1.3. The period of the measurement shall be the slot prior to the PUSCH transmission, excluding a transient period of 5 μ s in the end of the slot and any DL periods. EIRP is calculated considering both polarizations, theta and phi.
 - 6.2. For UE transmission OFF power, measure UE EIRP in the Tx beam peak direction in the channel bandwidth of the radio access mode according to the test configuration, which shall meet the requirements described in Table 6.3.3.2.5-1. EIRP test procedure is defined in Annex K.1.3. The period of the measurement shall be the slot following the PUSCH transmission, excluding a transient period of 5 μ s at the beginning of the slot and any DL periods. EIRP is calculated considering both polarizations, theta and phi.
7. SS deactivates the UE Beamlock Function (UBF) by performing the procedure as specified in TS 38.508-1 [10] clause 4.9.3.

NOTE 1: The BEAM_SELECT_WAIT_TIME default value is defined in Annex K.

6.3.3.2.4.3 Message contents

Message contents are according to TS 38.508-1 [10] clause 4.6 with TRANSFORM_PRECODER_ENABLED condition in Table 4.6.3-118 PUSCH-Config.

Table 6.3.3.2.4.3-1: Void

Table 6.3.3.2.4.3-2: Void

Table 6.3.3.2.4.3-3: Void

6.3.3.2.5 Test requirement

The requirement for the EIRP measured in steps 5 and 6 of the test procedure shall not exceed the values specified in Table 6.3.3.2.5-1 and 6.3.3.2.5-2.

Table 6.3.3.2.5-1: Test requirement of OFF power of General ON/OFF time mask

	Channel bandwidth / minimum output power / measurement bandwidth			
	50 MHz	100 MHz	200 MHz	400 MHz
Transmit OFF power	$\leq -30+TT+R$ dBm			
Transmission OFF Measurement bandwidth	47.58 MHz	95.16 MHz	190.20 MHz	380.28 MHz
NOTE 1: Core requirement cannot be tested due to testability issue and test requirement includes relaxation to achieve impact from test system noise to measurement result = 1.0 dB (Minimum requirement + relaxation R).				
NOTE 2: Relaxation R is specified in Table 6.3.3.2.5-5.				
NOTE 3: TT = 0 dB.				

Table 6.3.3.2.5-2: Test requirement of ON power of General ON/OFF time mask

	Channel bandwidth / measurement bandwidth			
	50 MHz	100 MHz	200 MHz	400 MHz
Transmit ON power	Same as the EIRP requirements described in 6.2.1.1.5			
NOTE 1: Void.				

Table 6.3.3.2.5-3: Void

Table 6.3.3.2.5-4: Void

Table 6.3.3.2.5-5: Relaxation required for OFF power for PC1 and PC3 UEs

Operating band	50 MHz	100 MHz	200 MHz	400 MHz
n257, n258, n261	EIRP - 1 dB	EIRP + 2 dB	EIRP + 5 dB	EIRP + 8 dB
n260	EIRP + 2 dB	EIRP + 5 dB	EIRP + 8 dB	EIRP + 11 dB
NOTE 1: EIRP is measured value in the ON power sub test, and the unit is dBm.				

Table 6.3.3.2.5-6: Relaxation required for OFF power for PC6 UEs

FSS

6.3.3.3 Transmit power time mask for slot and short or long subslot boundaries

No test case details are specified. Current test procedures for time masks are based on power measurement in relatively long period compared with transient period. For time masks between 2 active time slots with different power level, the test procedure can't provide enough resolution to identify non-conformant UEs. Therefore the minimum requirement is not testable.

6.3.3.4 PRACH time mask

Editor's Notes: This clause is incomplete. The following aspects are either missing or not yet determined:

- Message contents are not complete
- Measurement uncertainty and Test tolerance are not complete
- Test requirements are not complete
- PRACH configuration index is not complete
- The further investigation is essential that how does beamforming affect the initial access procedure
- TP analysis is FFS.

6.3.3.4.1 Test purpose

To verify that the PRACH time mask meets the requirements given in 6.3.3.4.5.

The time mask for PRACH time mask defines the transient period(s) allowed between transmit OFF power and transmit ON power when transmitting the PRACH.

Transmission of the wrong power increases interference to other channels, or increases transmission errors in the uplink channel.

6.3.3.4.2 Test applicability

This test case applies to all types of NR UE release 15 and forward.

6.3.3.4.3 Minimum conformance requirements

The transmit ON/OFF time mask is defined as a directional requirement. The requirement is verified in beam locked mode at beam peak direction. The maximum allowed EIRP OFF power level is -30dBm at beam peak direction. The requirement is verified with the test metric of EIRP (Link=TX beam peak direction, Meas=Link angle).

The PRACH ON power is specified as the mean power over the PRACH measurement period excluding any transient periods as shown in Figure 6.3.3.4.3-1. The measurement period for different PRACH preamble format is specified in Table 6.3.3.4.3-1.

Table 6.3.3.4.3-1: PRACH ON power measurement period

Format	SCS	Measurement period
A ₁	60 kHz	0.035677 ms
	120 kHz	0.017839 ms
A ₂	60 kHz	0.071354 ms
	120 kHz	0.035677 ms
A ₃	60 kHz	0.107031 ms
	120 kHz	0.053516 ms
B ₁	60 kHz	0.035091 ms
	120 kHz	0.0175455 ms
B ₄	60 kHz	0.207617 ms
	120 kHz	0.103809 ms
A ₁ /B ₁	60 kHz	0.035677 ms for front X1 occasion 0.035091 ms for last occasion X1 = [2,5]
	120 kHz	0.017839 ms for front X1 occasion 0.017546 ms for last occasion X1 = [2,5]
A ₂ /B ₂	60 kHz	0.071354 ms for front X2 occasion 0.069596 ms for last occasion X2 = [1,2]
	120 kHz	0.035677 ms for front X2 occasion 0.034798 ms for last occasion X2 = [1,2]

A ₃ /B ₃	60 kHz	0.107031 ms for first occasion 0.104101 ms for second occasion
	120 kHz	0.053515 ms for first occasion 0.052050 ms for second occasion
C ₀	60 kHz	0.026758 ms
	120 kHz	0.013379 ms
C ₂	60 kHz	0.083333 ms
	120 kHz	0.0416667 ms
NOTE: For PRACH on PRACH occasion start from begin of 0ms or 0.5ms boundary, the measurement period will plus 0.032552μs		

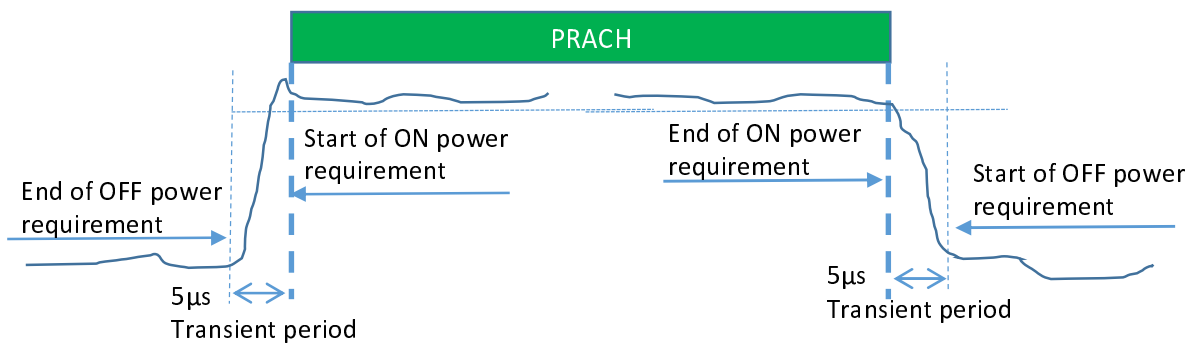

Figure 6.3.3.4.3-1: PRACH ON/OFF time mask

The normative reference for this requirement is TS 38.101-2 [3] clause 6.3.3.4.

6.3.3.4.4 Test description

6.3.3.4.4.1 Initial condition

Initial conditions are a set of test configurations the UE needs to be tested in and the steps for the SS to take with the UE to reach the correct measurement state.

The initial test configurations consist of environmental conditions, test frequencies, test channel bandwidths and sub-carrier spacing based on NR operating bands specified in Table 5.3.5-1. All of these configurations shall be tested with applicable test parameters for each combination of test channel bandwidth and sub-carrier spacing, and are shown in Table 6.3.3.4.4.1-1. The details of the uplink reference measurement channels (RMCs) are specified in Annexes A.2. Configurations of PDSCH and PDCCH before measurement are specified in Annex C.2.

Table 6.3.3.4.4.1-1: Test Configuration Table

Initial Conditions	
Test Environment as specified in TS 38.508-1 [10] clause 4.1	Normal, TL, TH
Test Frequencies as specified in TS 38.508-1 [10] clause 4.3.1	Mid range
Test Channel Bandwidths as specified in TS 38.508-1 [10] clause 4.3.1	Lowest, Mid, Highest
Test SCS as specified in Table 5.3.5-1	SCS defined in TS 38.211 [8] clause 6.3.3.2
PRACH preamble format	
PRACH Configuration Index	[0]

1. Connection between SS and UE is shown in TS 38.508-1 [10] Annex A, Figure A.3.3.1.1 for TE diagram and Figure A.3.4.1.1 for UE diagram.
2. The parameter settings for the cell are set up according to TS 38.508-1 [10] clause 4.4.3.
3. Downlink signals are initially set up according to Annex C, and uplink signals according to Annex G.

4. Propagation conditions are set according to Annex B.0.
5. Ensure the UE is in State RRC_CONNECTED with generic procedure parameters Connectivity NR, Connected without release On, Test Mode On and Test Loop Function On according to TS 38.508-1 [10] clause 4.5. Message contents are defined in clause 6.3.3.4.4.3.

6.3.3.4.4.2 Test procedure

1. Set the UE in the Tx beam peak direction found with a 3D EIRP scan as performed in Annex K.1.1. Allow at least BEAM_SELECT_WAIT_TIME (NOTE 1) for the UE Tx beam selection to complete.
2. The SS shall signal a Random Access Preamble ID via a PDCCH order to the UE and initiate a Non-contention based Random Access procedure.
3. The UE shall send the signalled preamble to the SS.
4. For UE transmission OFF power, measure UE EIRP in the Tx beam peak direction in the channel bandwidth of the radio access mode according to the test configuration, which shall meet the requirements described in Table 6.3.3.4.5-1. EIRP test procedure is defined in Annex K.1.3. The period of the measurement shall be the slot prior to the PRACH transmission, excluding a transient period of 5 μ s in the end of the slot and any DL periods. EIRP is calculated considering both polarizations, theta and phi.
5. For UE transmission ON power, measure UE EIRP in the Tx beam peak direction in the channel bandwidth of the radio access mode according to the test configuration, which shall meet the requirements described in Table 6.3.3.4.5-1. EIRP test procedure is defined in Annex K.1.3. The period of the measurement shall be the slot during the PRACH preamble transmission. EIRP is calculated considering both polarizations, theta and phi. For TDD, only slots consisting of only UL symbols are under test.
6. For UE transmission OFF power, measure UE EIRP in the Tx beam peak direction in the channel bandwidth of the radio access mode according to the test configuration, which shall meet the requirements described in Table 6.3.3.2.5-1. EIRP test procedure is defined in Annex K.1.3. The period of the measurement shall be the slot following the PUSCH transmission, excluding a transient period of 5 μ s at the beginning of the slot and any DL periods. EIRP is calculated considering both polarizations, theta and phi.

NOTE 1: The BEAM_SELECT_WAIT_TIME default value is defined in Annex K.

6.3.3.4.4.3 Message contents

Message contents are according to TS 38.508-1 [10] clause 4.6 with following exceptions:

Table 6.3.3.4.4.3-1: RACH-ConfigCommon: PRACH measurement

Derivation Path: TS 38.508-1[5], Table 4.6.3-128			
Information Element	Value/remark	Comment	Condition
RACH-ConfigCommon ::= SEQUENCE {			
rach-ConfigGeneric	RACH-ConfigGeneric		
totalNumberOfRA-Preambles	Not present		
ssb-perRACH-OccasionAndCB-PreamblesPerSSB CHOICE {			
one	n4		FR2
}			
groupBconfigured	Not present		
ra-ContentionResolutionTimer	sf64		
rsrp-ThresholdSSB	RSRP-Range		
rsrp-ThresholdSSB-SUL	Not present		
	RSRP-Range		SUL
prach-RootSequenceIndex CHOICE {			
l139	Set according to table 4.4.2-2 for the NR Cell.		PRACH Format A3
}			
msg1-SubcarrierSpacing	SubcarrierSpacing		
restrictedSetConfig	unrestrictedSet		

msg3-transformPrecoder	Not present	transform precoding is disabled for Msg3 PUSCH transmission and any PUSCH transmission scheduled with DCI format 0_0	
}			

Table 6.3.3.4.4.3-2: RACH-ConfigGeneric: PRACH measurement

Derivation Path: TS 38.508-1[5], Table 4.6.3-130			
Information Element	Value/remark	Comment	Condition
RACH-ConfigGeneric ::= SEQUENCE {			
prach-ConfigurationIndex	[TBD]	Unpaired Spectrum	PRACH Format A3
msg1-FDM	one		FR2
msg1-FrequencyStart	0		
zeroCorrelationZoneConfig	15		
preambleReceivedTargetPower	[TBD]		PRACH Format A3
preambleTransMax	n7		
powerRampingStep	dB0		
ra-ResponseWindow	sl20		
}			

Table 6.3.3.4.4.3-3: ServingCellConfigCommonSIB: PRACH measurement

Derivation Path: TS 38.508-1[5], Table 4.6.3-169			
Information Element	Value/remark	Comment	Condition
ServingCellConfigCommonSIB ::= SEQUENCE {			
ssb-PositionsInBurst SEQUENCE {			
inOneGroup	'1000 0000'B		
groupPresence	Not present		
}			
ss-PBCH-BlockPower	[TBD]		
}			

6.3.3.4.5 Test requirement

The requirement for the power measured in steps 4, 5 and 6 of the test procedure shall not exceed the values specified in Table 6.3.3.4.5-1.

Table 6.3.3.4.5-1: PRACH time mask

	Channel bandwidth / Output Power [dBm] / measurement bandwidth			
	50MHz	100MHz	200MHz	400MHz
Transmit OFF power	≤ -30+TT + R			
Transmission OFF Measurement bandwidth	47.58 MHz	95.16 MHz	190.20 MHz	380.28 MHz
Expected PRACH Transmission ON Measured power	FFS	FFS	FFS	FFS
ON power tolerance FFS	FFS	FFS	FFS	FFS
NOTE 1: Core requirement cannot be tested due to testability issue and test requirement includes relaxation to achieve impact from test system noise to measurement result = 1.0 dB (Minimum requirement + relaxation R).				
NOTE 2: Relaxation R is specified in Table 6.3.3.4.5-2.				

Table 6.3.3.4.5-2: Relaxations for OFF power for PC3 UEs

Operating band	50 MHz	100 MHz	200 MHz	400 MHz
n257, n258, n261	19.4 dB	22.4 dB	25.4 dB	28.4 dB
n260	21.5 dB	24.5 dB	27.5 dB	30.5 dB

Table 6.3.3.4.5-3: Relaxations for ON power

FFS

6.3.3.5 Void

6.3.3.6 SRS time mask

Editor's Notes: This clause is incomplete. The following aspects are either missing or not yet determined:

- TP analysis is FFS.
- Message contents are not complete
- Measurement uncertainty and Test tolerance are not complete

6.3.3.6.1 Test purpose

To verify that the SRS time mask meets the requirements given in 6.3.3.6.5.

The time mask for SRS time mask defines the transient period(s) allowed between transmit OFF power and transmit ON power when transmitting the SRS.

Transmission of the wrong power increases interference to other channels, or increases transmission errors in the uplink channel.

6.3.3.6.2 Test applicability

This test case applies to all types of NR UE release 15 and forward.

6.3.3.6.3 Minimum conformance requirements

In the case a single SRS transmission, the ON power is defined as the mean power over the symbol duration excluding any transient period; Figure 6.3.3.6.3-1.

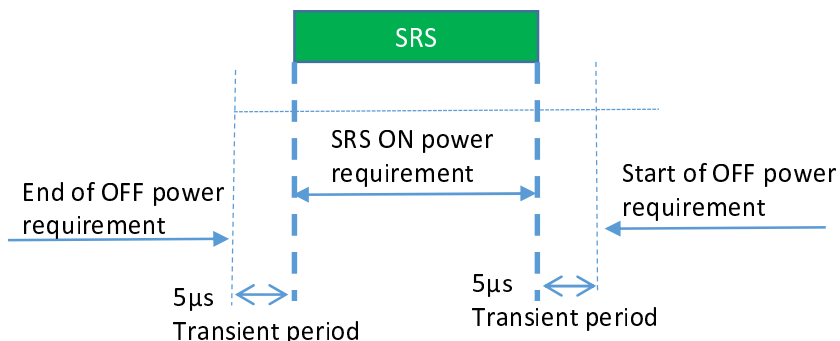

Figure 6.3.3.6.3-1: Single SRS time mask for NR UL transmission

In the case multiple consecutive SRS transmission, the ON power is defined as the mean power for each symbol duration excluding any transient period. See Figure 6.3.3.6.3-2.

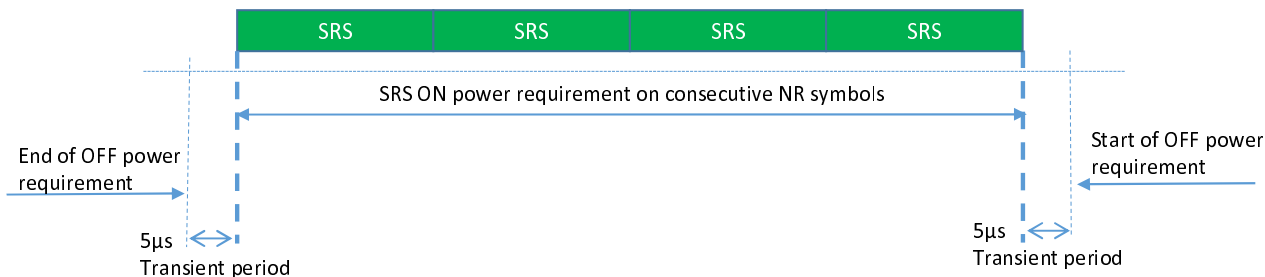

Figure 6.3.3.6.3-2: Consecutive SRS time mask for the case when no power change is required

When power change between consecutive SRS transmissions is required, then Figure 6.3.3.6-3 and Figure 6.3.3.6-4 apply.

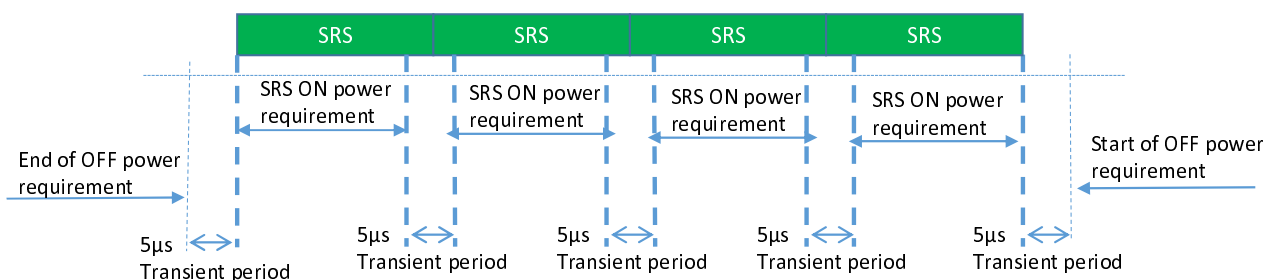

Figure 6.3.3.6.3-3: Consecutive SRS time mask for the case when power change is required and when 60kHz SCS is used in FR2

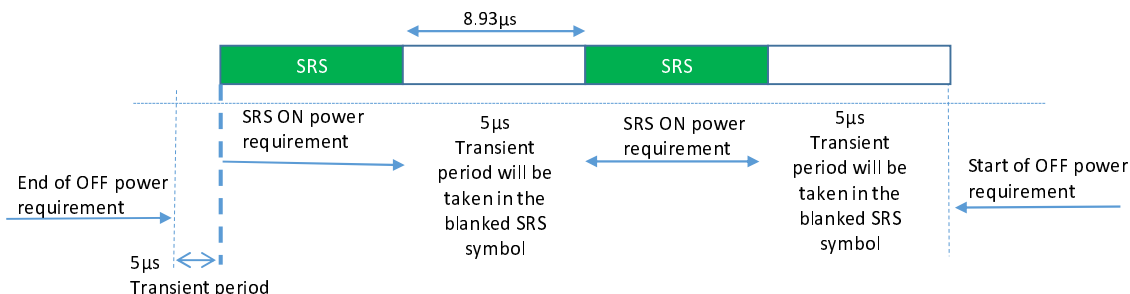

Figure 6.3.3.6.3-4: Consecutive SRS time mask for the case when power change is required and when 120kHz SCS is used in FR2

The normative reference for this requirement is TS 38.101-2 [3] clause 6.3.3.6.

6.3.3.6.4 Test description

6.3.3.6.4.1 Initial condition

Initial conditions are a set of test configurations the UE needs to be tested in and the steps for the SS to take with the UE to reach the correct measurement state.

The initial test configurations consist of environmental conditions, test frequencies, test channel bandwidths and sub-carrier spacing based on NR operating bands specified in Table 5.3.5-1. All of these configurations shall be tested with applicable test parameters for each combination of test channel bandwidth and sub-carrier spacing, and are shown in

Table 6.3.3.6.4.1-1. The details of the uplink reference measurement channels (RMCs) are specified in Annexes A.2. Configurations of PDSCH and PDCCH before measurement are specified in Annex C.2.

Table 6.3.3.6.4.1-1: Test Configuration Table

Initial Conditions	
Test Environment as specified in TS 38.508-1 [5] clause 4.1	FFS
Test Frequencies as specified in TS 38.508-1 [5] clause 4.3.1	FFS
Test Channel Bandwidths as specified in TS 38.508-1 [5] clause 4.3.1	FFS
Test SCS as specified in Table 5.3.5-1	FFS
SRS configuration	
c-SRS (SRS bandwidth configuration)	17 (64 RB for BW 50 MHz) 33 (132 RB for BW 100 MHz) 60 (264 RB for BW 200 MHz) for SCS 60 KHz
	9 (32 RB for BW 50 MHz) 17 (64 RB for BW 100 MHz) 33 (132 RB for BW 200 MHz) 60 (264 RB for BW 400 MHz) for SCS 120 KHz
b-SRS	0
b-hop	3
freqDomainPosition	0
SRS-PeriodicityAndOffset	sl40 for SCS 60 KHz
	sl80 for SCS 120 KHz
transmissionComb	n2
CombOffset	0
cyclicShift	0
startPosition	0
nrofSymbols	n1

1. Connection between SS and UE is shown in TS 38.508-1 [10] Annex A, Figure A.3.3.1.1 for TE diagram and Figure A.3.4.1.1 for UE diagram.
2. The parameter settings for the cell are set up according to TS 38.508-1 [10] clause 4.4.3.
3. Downlink signals are initially set up according to Annex C, and uplink signals according to Annex G.
4. Propagation conditions are set according to Annex B.0.
5. Ensure the UE is in State RRC_CONNECTED with generic procedure parameters Connectivity *NR*, Connected without release *On*, Test Mode *On* and Test Loop Function *On* according to TS 38.508-1 [10] clause 4.5. Message contents are defined in clause 6.3.3.6.4.3.

6.3.3.6.4.2 Test procedure

1. SS sends uplink scheduling information for each UL HARQ process via PDCCH DCI format 0_1 for C_RNTI to schedule the UL RMC according to Table 6.3.3.2.4.1-1. Since the UL has no payload and no loopback data to send the UE sends uplink MAC padding bits on the UL RMC. The UL assignment is such that the UE transmits on slot 16 for 60kHz SCS and on slot 32 for 120kHz SCS. PUSCH is transmitted in the first half of the frame.
2. Set the UE in the Tx beam peak direction found with a 3D EIRP scan as performed in Annex K.1.1. Allow at least BEAM_SELECT_WAIT_TIME (NOTE 1) for the UE Tx beam selection to complete.
3. Send continuously uplink power control "up" commands in every uplink scheduling information to the UE; allow at least 200ms starting from the first TPC command in this step for the UE to reach P_{UMAX} level. Allow at least BEAM_SELECT_WAIT_TIME (NOTE 1) for the UE Tx beam selection to complete.

4. SS activates the UE Beamlock Function (UBF) by performing the procedure as specified in TS 38.508-1 [10] clause 4.9.2 using condition Tx only.
5. ON power sub test:
 - 5.1. Measure UE EIRP of the transmitted SRS transmission in the Tx beam peak direction during 1 OFDM symbol. The SRS transmission in the second half of the frame is used for measurement since there is no PUSCH transmission before and after. EIRP test procedure is defined in Annex K. EIRP is calculated considering both polarizations, theta and phi.
6. OFF power sub test:
 - 6.1. For UE transmission OFF power, measure UE EIRP in the Tx beam peak direction in the channel bandwidth of the radio access mode according to the test configuration, which shall meet the requirements described in Table 6.3.3.2.5-1. The period of the measurement shall be the 13 OFDM symbols preceding the SRS symbol excluding a transient period of 5 μ s. EIRP test procedure is defined in Annex K.1.3. EIRP is calculated considering both polarizations, theta and phi.
 - 6.2. For UE transmission OFF power, measure UE EIRP in the Tx beam peak direction in the channel bandwidth of the radio access mode according to the test configuration, which shall meet the requirements described in Table 6.3.3.2.5-1. The period of the measurement shall be the slot following the SRS symbol excluding a transient period of 5 μ s. EIRP test procedure is defined in Annex K.1.3. EIRP is calculated considering both polarizations, theta and phi.
7. SS deactivates the UE Beamlock Function (UBF) by performing the procedure as specified in TS 38.508-1 [10] clause 4.9.3.

NOTE 1: The BEAM_SELECT_WAIT_TIME default value is defined in Annex K.

6.3.3.6.4.3 Message contents

Message contents are according to TS 38.508-1 [10] clause 4.6 with following exceptions:

Table 6.3.3.6.4.3-1: BWP-UplinkDedicated

Derivation Path: TS 38.508-1[5], Table 4.6.3-15			
Information Element	Value/remark	Comment	Condition
BWP-UplinkDedicated ::= SEQUENCE {			
srs-Config	SRS-Config in Table 6.3.3.6.4.3-2		
}			
Note: This message exception is only valid for the initial BWP and not for an additional BWP inside BWP-Uplink.			

Table 6.3.3.6.4.3-2: SRS-Config: SRS time mask measurement

Derivation Path: TS 38.508-1[5], Table 4.6.3-182			
Information Element	Value/remark	Comment	Condition
SRS-Config ::= SEQUENCE {			
srs-ResourceSetToAddModList SEQUENCE (SIZE(0..maxNrofSRS-ResourceSets)) OF SEQUENCE {	1 entry		
resourceType CHOICE {			
periodic SEQUENCE {			
}			
}			
}			
srs-ResourceToAddModList SEQUENCE (SIZE(1..maxNrofSRS-Resources)) OF SEQUENCE {	1 entry		
resourceMapping SEQUENCE {			
startPosition	0		
nrofSymbols	n1		
repetitionFactor	n1		
}			

freqHopping SEQUENCE {			
c-SRS			
	17 (64 RB for BW 50 MHz) 33 (132 RB for BW 100 MHz) 60 (264 RB for BW 200 MHz)		SCS 60 KHz
	9 (32 RB for BW 50 MHz) 17 (64 RB for BW 100 MHz) 33 (132 RB for BW 200 MHz) 60 (264 RB for BW 400 MHz)		SCS 120 KHz
b-SRS	0		
b-hop	3		
}			
resourceType CHOICE {			
periodic SEQUENCE {			
periodicityAndOffset-p CHOICE{			
sl40	36		SCS 60 KHz
sl80	72		SCS 120 KHz
}			
}			
}			
}			
}			

Condition	Explanation
SCS_60kHz	SCS=60kHz for SS/PBCH block
SCS_120kHz	SCS=120kHz for SS/PBCH block

6.3.3.6.5 Test requirement

The requirement for the power measured in steps 5 and 6 of the test procedure shall not exceed the values specified in Table 6.3.3.6.5-1 and 6.3.3.6.5-2.

Table 6.3.3.6.5-1: Test requirement of OFF power of SRS ON/OFF time mask

	Channel bandwidth / minimum output power / measurement bandwidth			
	50 MHz	100 MHz	200 MHz	400 MHz
Transmit OFF power	≤ -30+[TT+R] dBm			
Transmission OFF Measurement bandwidth	47.58 MHz	95.16 MHz	190.20 MHz	380.28 MHz
NOTE 1: Core requirement cannot be tested due to testability issue and test requirement includes relaxation to achieve impact from test system noise to measurement result = 1.0 dB (Minimum requirement + relaxation R). NOTE 2: Relaxation R is specified in Table FFS. NOTE 3: TT = FFS.				

Table 6.3.3.6.5-2: Test requirement of ON power of SRS ON/OFF time mask

	Channel bandwidth / measurement bandwidth			
	50 MHz	100 MHz	200 MHz	400 MHz
Transmit ON power	Same as the MPR requirements described in 6.2.2.5 for QPSK and Outer_Full allocation.			
NOTE 1: Void.				

6.3.3.7 PUSCH-PUCCH and PUSCH-SRS time masks

No test case details are specified. Current test procedures for time masks are based on power measurement in relatively long period compared with transient period. For time masks between 2 active time slots with different power level, the

test procedure can't provide enough resolution to identify non-conformant UEs. Therefore the minimum requirement is not testable.

6.3.3.8 Transmit power time mask for consecutive slot or long subslot transmission and short subslot transmission boundaries

No test case details are specified. Current test procedures for time masks are based on power measurement in relatively long period compared with transient period. For time masks between 2 active time slots with different power level, the test procedure can't provide enough resolution to identify non-conformant UEs. Therefore the minimum requirement is not testable.

6.3.3.9 Transmit power time mask for consecutive short subslot transmissions boundaries

No test case details are specified. Current test procedures for time masks are based on power measurement in relatively long period compared with transient period. For time masks between 2 active time slots with different power level, the test procedure can't provide enough resolution to identify non-conformant UEs. Therefore the minimum requirement is not testable.

6.3.4 Power control

6.3.4.1 General

The requirements on power control accuracy apply under normal conditions and are defined as a directional requirement. The requirements are verified in beam locked mode on beam peak direction.

6.3.4.2 Absolute power tolerance

Editor's note: The following aspects are either missing or not yet determined:

- Testing of extreme conditions for FR2 is FFS.
- UE transmitted power for PC 1, 2, 4, 5, 6 and 7 are FFS
- The reduction of the impact of DL MU by choosing $\alpha < 1$ is FFS.

6.3.4.2.1 Test purpose

To verify the UE's ability to transmit with a broadband output power below the value specified in the test requirement when the power is set to a minimum value.

To verify the ability of the UE transmitter to set its initial output power to a specific value at the start of a contiguous transmission or non-contiguous transmission with a long transmission gap, i.e. transmission gap is larger than 20 ms.

6.3.4.2.2 Test applicability

This test case applies to all types of NR UE release 15 and forward.

6.3.4.2.3 Minimum conformance requirements

The absolute power tolerance is the ability of the UE transmitter to set its initial output power to a specific value for the first sub-frame (1ms) at the start of a contiguous transmission or non-contiguous transmission with a transmission gap larger than 20 ms. The tolerance includes the channel estimation error RSRP estimate.

The minimum requirements specified in Table 6.3.4.2.3-1 apply in the power range bounded by the minimum output power as specified in sub-clause 6.3.1 (P_{\min}) and the maximum output power as specified in sub-clause 6.2.1.1 as minimum peak EIRP (P_{\max}). The intermediate power point ' P_{int} ' is defined in table 6.3.4.2.3-2.

Table 6.3.4.2.3-1: Absolute power tolerance

Power Range	Tolerance
$P_{int} \geq P \geq P_{min}$	± 14.0 dB
$P_{max} \geq P > P_{int}$	± 12.0 dB

Table 6.3.4.2.3-2: Intermediate power point

Power Parameter	Value
P_{int}	$P_{max} - 12.0$ dB

The normative reference for this requirement is TS 38.101-2 [3] clause 6.3.4.2.

6.3.4.2.4 Test description

6.3.4.2.4.1 Initial condition

Initial conditions are a set of test configurations the UE needs to be tested in and the steps for the SS to take with the UE to reach the correct measurement state.

The initial test configurations consist of environmental conditions, test frequencies, test channel bandwidths and sub-carrier spacing based on NR operating bands specified in Table 5.3.5-1. All of these configurations shall be tested with applicable test parameters for each combination of test channel bandwidth and sub-carrier spacing, and are shown in Table 6.3.4.2.4.1-1. The details of the uplink reference measurement channels (RMCs) are specified in Annexes A.2. Configurations of PDSCH and PDCCH before measurement are specified in Annex C.2.

Table 6.3.4.2.4.1-1: Test Configuration Table

Initial Conditions			
Test Environment as specified in TS 38.508-1 [10] clause 4.1		Normal	
Test Frequencies as specified in TS 38.508-1 [10] clause 4.3.1		Mid range	
Test Channel Bandwidths as specified in TS 38.508-1 [10] clause 4.3.1		50 MHz, 100 MHz, 200 MHz, 400 MHz (NOTE 2)	
Test SCS as specified in Table 5.3.5-1.		Highest	
Test Parameters			
Test ID	Downlink Configuration	Uplink Configuration	
		Modulation	RB allocation (NOTE 1)
1	-	DFT-s-OFDM QPSK	Inner_Full
NOTE 1: The specific configuration of each RB allocation is defined in Table 6.1-1 for PC2, PC3, PC4, PC6 and PC7 or Table 6.1-2 for PC1.			
NOTE 2: Test is required only for CBWs supported by the UE.			

1. Connection between SS and UE is shown in TS 38.508-1 [10] Annex A, Figure A.3.3.1.1 for TE diagram and Figure A.3.4.1.1 for UE diagram.
2. The parameter settings for the cell are set up according to TS 38.508-1 [10] clause 4.4.3.
3. Downlink signals are initially set up according to Annex C, and uplink signals according to Annex G.
4. The UL Reference Measurement Channel is set according to Table 6.3.4.2.4.1-1.
5. Propagation conditions are set according to Annex B.0.
6. Ensure the UE is in State RRC_CONNECTED with generic procedure parameters Connectivity *NR*, Connected without release *On*, Test Mode *On* and Test Loop Function *On* according to TS 38.508-1 [10] clause 4.5. Message contents are defined in clause 6.3.4.2.4.3.

6.3.4.2.4.2 Test procedure

1. SS sends uplink scheduling information via PDCCH DCI format 0_1 with TPC command 0dB for C_RNTI to schedule the UL RMC according to Table 6.3.4.2.4.1-1. Since the UE has no payload and no loopback data to send the UE sends uplink MAC padding bits on the UL RMC.
2. Set the UE in the Tx beam peak direction found with a 3D EIRP scan as performed in Annex K.1.1. Allow at least BEAM_SELECT_WAIT_TIME (NOTE 1) for the UE Tx beam selection to complete.
3. Configure the UE transmitted output power to test point 1 in section 6.3.4.2.4.3. Allow at least BEAM_SELECT_WAIT_TIME (NOTE 1) for the UE Tx beam selection to complete.
4. SS activates the UE Beamlock Function (UBF) by performing the procedure as specified in TS 38.508-1 [10] clause 4.9.2 using condition Tx only.
5. Measure UE EIRP of the first subframe in the Tx beam peak direction in the measurement bandwidth specified in Table 6.3.1.5-1 and Table 6.3.1.5-2 for the specific channel bandwidth under test. EIRP test procedure is defined in Annex K. The measuring duration is one active uplink subframe. EIRP is calculated considering both polarizations, theta and phi. For TDD slots with transient periods are not under test.
6. SS deactivates the UE Beamlock Function (UBF) by performing the procedure as specified in TS 38.508-1 [10] clause 4.9.3.
7. Repeat test steps 1~6 for measurement of test point 2~3. The timing of the execution between the two test points shall be larger than 20ms.

NOTE 1: The BEAM_SELECT_WAIT_TIME default value is defined in Annex K.

6.3.4.2.4.3 Message contents

Message contents are according to TS 38.508-1 [10] clause 4.6 with TRANSFORM_PRECODER_ENABLED condition in Table 4.6.3-118 PUSCH-Config and with following exceptions:

Table 6.3.4.2.4.3-1: PUSCH-ConfigCommon (Test point 1) for power class 3

Derivation Path: TS 38.508-1 [10], Table 4.6.3-119			
Information Element	Value/remark	Comment	Condition
PUSCH-ConfigCommon ::= SEQUENCE {			
p0-NominalWithGrant	-132		FR2a, 50MHz
	-134		FR2a, 100MHz
	-138		FR2a, 200MHz
	-140		FR2a, 400MHz
	-132		FR2b, 50MHz
	-134		FR2b, 100MHz
	-138		FR2b, 200MHz
	-140		FR2b, 400MHz
}			

Table 6.3.4.2.4.3-2: PUSCH-ConfigCommon (Test point 2) for power class 3

Derivation Path: TS 38.508-1 [10], Table 4.6.3-119			
Information Element	Value/remark	Comment	Condition
PUSCH-ConfigCommon ::= SEQUENCE {			
p0-NominalWithGrant	-108		FR2a, 50MHz

	-110		FR2a, 100MHz
	-114		FR2a, 200MHz
	-116		FR2a, 400MHz
	-110		FR2b, 50MHz
	-112		FR2b, 100MHz
	-116		FR2b, 200MHz
	-118		FR2b, 400MHz
}			

Table 6.3.4.2.4.3-3: PUSCH-PowerControl (Test point 3) for power class 3

Derivation Path: TS 38.508-1 [10], Table 4.6.3-119			
Information Element	Value/remark	Comment	Condition
PUSCH-ConfigCommon ::= SEQUENCE { p0-NominalWithGrant			
	-98		FR2a, 50MHz
	-102		FR2a, 100MHz
	-104		FR2a, 200MHz
	-106		FR2a, 400MHz
	-100		FR2b, 50MHz
	-104		FR2b, 100MHz
	-106		FR2b, 200MHz
	-108		FR2b, 400MHz
}			

Table 6.3.4.2.4.3-4: ServingCellConfigCommon

Derivation Path: 38.508-1[5], Table 4.6.3-168			
Information Element	Value/remark	Comment	Condition
ServingCellConfigCommon ::= SEQUENCE { ss-PBCH-BlockPower			
	4		SCS_120kHz
	7		SCS_240kHz
}			

Condition	Explanation
SCS_120kHz	SCS=120kHz for SS/PBCH block
SCS_240kHz	SCS=240kHz for SS/PBCH block

Table 6.3.4.2.4.3-5: PUSCH-PowerControl

Derivation Path: TS 38.508-1 [10], Table 4.6.3-120			
Information Element	Value/remark	Comment	Condition
PUSCH-PowerControl ::= SEQUENCE { tpc-Accumulation			
	disabled		
p0-AlphaSets SEQUENCE (SIZE (1..maxNrofP0-PUSCH-AlphaSets)) OF SEQUENCE {			
	1 entry		

P0-PUSCH-AlphaSet[1] SEQUENCE {			
alpha	alpha1		
}			
}			
}			

6.3.4.2.5 Test requirement

The measured EIRP in step 5 and 7 shall not to exceed the values specified in Table 6.3.4.2.5-1 to 6.3.4.2.5-3.

Table 6.3.4.2.5-1: Absolute power tolerance: test point 1 for power class 3

	Frequency range	Channel bandwidth / expected output power (dBm)			
		50 MHz	100 MHz	200 MHz	400 MHz
Expected Measured power	FR2a	-13.0	-12.0	-12.9	-12.8
	FR2b	-13.0	-12.0	-12.9	-12.8
Power tolerance (Note 2)		± (14+TT)dB			
Note 1: The higher power limit shall not exceed the Max EIRP defined in sub-clause 6.2.1.1.5.					
Note 2: Do not test lower limit.					

Table 6.3.4.2.5-2: Absolute power tolerance: test point 2 for power class 3

	Frequency range	Channel bandwidth / expected output power (dBm)			
		50 MHz	100 MHz	200 MHz	400 MHz
Expected Measured power	FR2a	11.0	12.0	11.1	11.2
	FR2b	9.0	10.0	9.1	9.2
Power tolerance (Note 2)		± (12+TT)dB			
Note 1: The lower power limit shall not exceed the minimum output power requirements defined in sub-clause 6.3.2.5, and the higher power limit shall not exceed the Max EIRP defined in sub-clause 6.2.1.1.5.					
Note 2: Do not test lower limit at CBW ≥ 200 MHz for FR2b					

Table 6.3.4.2.5-3: Absolute power tolerance: test point 3 for power class 3

	Frequency range	Channel bandwidth / expected output power (dBm)			
		50 MHz	100 MHz	200 MHz	400 MHz
Expected Measured power	FR2a	21.0	20.0	21.1	21.2
	FR2b	19.0	18.0	19.1	19.2
Power tolerance		± (12+TT)dB			
Note 1: The lower power limit shall not exceed the minimum output power requirements defined in sub-clause 6.3.2.5, and the higher power limit shall not exceed the Max EIRP defined in sub-clause 6.2.1.1.5.					

Table 6.3.4.2.5-4: Test Tolerance for power class 1, 2, 4

Test Metric	FR2a	FR2b
IFF (Max device size ≤ 30 cm)	Same as Table 6.3.1.5-3	Same as Table 6.3.1.5-3

Table 6.3.4.2.5-5: Test Tolerance for power class 3

Test Metric	NTC testing	ETC testing
IFF (Max device size ≤ 30 cm)	±8.16 dB	±8.52 dB

Table 6.3.4.2.5-6: Test Tolerance for power class 6

Test Metric	FR2a	FR2b
IFF (Max device size \leq 30 cm)	Same as Table 6.3.1.5-2b	Same as Table 6.3.1.5-2b

6.3.4.3 Relative power tolerance

Editor's note: This clause is incomplete. The following items are either missing or not yet determined:

- MU and TT are TBD
- Starting power at ramp up/ramp down/alternating sub-test is TBD (6.3.4.3 MU dependent)
- Testability of test points needs further analysis, based on MU outcome
- This test case has a testability issue due to narrow range for 1 dB TPC step core requirement and therefore testing is not recommended.

6.3.4.3.1 Test purpose

To verify the ability of the UE transmitter to set its output power in a target sub-frame relatively to the power of the most recently transmitted reference sub-frame if the transmission gap between these sub-frames is less than or equal to 20 ms.

6.3.4.3.2 Test applicability

This test case applies to all types of NR UE release 15 and forward.

6.3.4.3.3 Minimum conformance requirements

The minimum requirements specified in Table 6.3.4.3.3-1 apply when the power of the target and reference sub-frames are within the power range bounded by the minimum output power as defined in sub-clause 6.3.1 and P_{int} as defined in sub-clause 6.3.4.2. The minimum requirements specified in Table 6.3.4.3.3-2 apply when the power of the target and reference sub-frames are within the power range bounded by P_{int} as defined in sub-clause 6.3.4.2 and the measured P_{UMAX} as defined in sub-clause 6.2.4.

For a test pattern that is either a monotonically increasing or monotonically decreasing power sweep over the range specified for Tables 6.3.4.3.3-1 and 6.3.4.3.3-2, 3 exceptions are allowed for each of the test patterns. For these exceptions, the power tolerance limit is a maximum of ± 11.0 dB.

Table 6.3.4.3.3-1: Relative power tolerance, $P_{int} \geq P \geq P_{min}$

Power step ΔP (Up or down) (dB)	All combinations of PUSCH and PUCCH, PUSCH/PUCCH and SRS transitions between sub-frames, PRACH (dB)
$\Delta P < 2$	± 5.0
$2 \leq \Delta P < 3$	± 6.0
$3 \leq \Delta P < 4$	± 7.0
$4 \leq \Delta P < 10$	± 8.0
$10 \leq \Delta P < 15$	± 10.0
$15 \leq \Delta P$	± 11.0
NOTE: The requirements apply with <i>ue-BeamLockFunction</i> enabled.	

Table 6.3.4.3.3-2: Relative power tolerance, $P_{UMAX} \geq P > P_{int}$

Power step ΔP (Up or down) (dB)	All combinations of PUSCH and PUCCH, PUSCH/PUCCH and SRS transitions between sub-frames, PRACH (dB)
---	---

$\Delta P < 2$	± 3.0
$2 \leq \Delta P < 3$	± 4.0
$3 \leq \Delta P < 4$	± 5.0
$4 \leq \Delta P < 10$	± 6.0
$10 \leq \Delta P < 15$	± 8.0
$15 \leq \Delta P$	± 9.0
NOTE 1: The requirements apply with <i>ue-BeamLockFunction</i> enabled.	
NOTE 2: For PUSCH to PUSCH transitions with the allocated resource blocks fixed in frequency and no transmission gaps other than those generated by downlink subframes, guard periods: for a power step $\Delta P = 1$ dB, the relative power tolerance for transmission is ± 1.0 dB.	

The normative reference for this requirement is TS 38.101-2 [3] clause 6.3.4.3.

6.3.4.3.4 Test description

6.3.4.3.4.1 Initial conditions

Initial conditions are a set of test configurations the UE needs to be tested in and the steps for the SS to take with the UE to reach the correct measurement state.

The initial test configurations consist of environmental conditions, test frequencies, and channel bandwidths based on NR operating bands specified in Table 5.3.5-1. All of these configurations shall be tested with applicable test parameters for each channel bandwidth and subcarrier spacing, are shown in Table 6.3.4.3.4.1-1. The details of the uplink reference measurement channels (RMCs) are specified in Annexes A.2. Configurations of PDSCH and PDCCH before measurement are specified in Annex C.2.

Table 6.3.4.3.4.1-1: Test Configuration Table

Initial Conditions				
Test Environment as specified in TS 38.508-1 [10] clause 4.1			Normal	
Test Frequencies as specified in TS 38.508-1 [10] clause 4.3.1			Low Range	
Test Channel Bandwidths as specified in TS 38.508-1 [10] clause 4.3.1			100MHz	
Test SCS as specified in Table 5.3.5-1			Highest	
Test Parameters				
Ch BW	Downlink Configuration		Uplink Configuration	
	Modulation	RB Allocation	Modulation	RB allocation (NOTE 1)
100MHz	-		DFT-s-OFDM QPSK	See Table 6.3.4.3.5-1 See Table 6.3.4.3.5-2 See Table 6.3.4.3.5-3
Note 1: The starting resource block shall be RB# 44.				

1. Connection between SS and UE is shown in TS 38.508-1 [10] Annex A, Figure A.3.3.1.1 for TE diagram and Figure A.3.4.1.1 for UE diagram.
2. The parameter settings for the cell are set up according to TS 38.508-1 [10] clause 4.4.3.
3. Downlink signals are initially set up according to Annex C, and uplink signals according to Annex G.
4. The UL Reference Measurement channels are set according to Table 6.3.4.3.4.1-1.
5. Propagation conditions are set according to Annex B.0
6. Ensure the UE is in state RRC_CONNECTED with generic procedure parameters Connectivity NR, Connected without release On, Test Mode On and Test Loop Function On according to TS 38.508-1 [10] clause 4.5. Message contents are defined in clause 6.3.4.3.4.3

6.3.4.3.4.2 Test procedure

The procedure is separated in various subtests to verify different aspects of relative power control. The power patterns of the subtests are described in Figure 6.3.4.3.4.2-1 through Figure 6.3.4.3.4.2-3. The power patterns and corresponding sub frame numberings are derived from Table A.2.3-1.

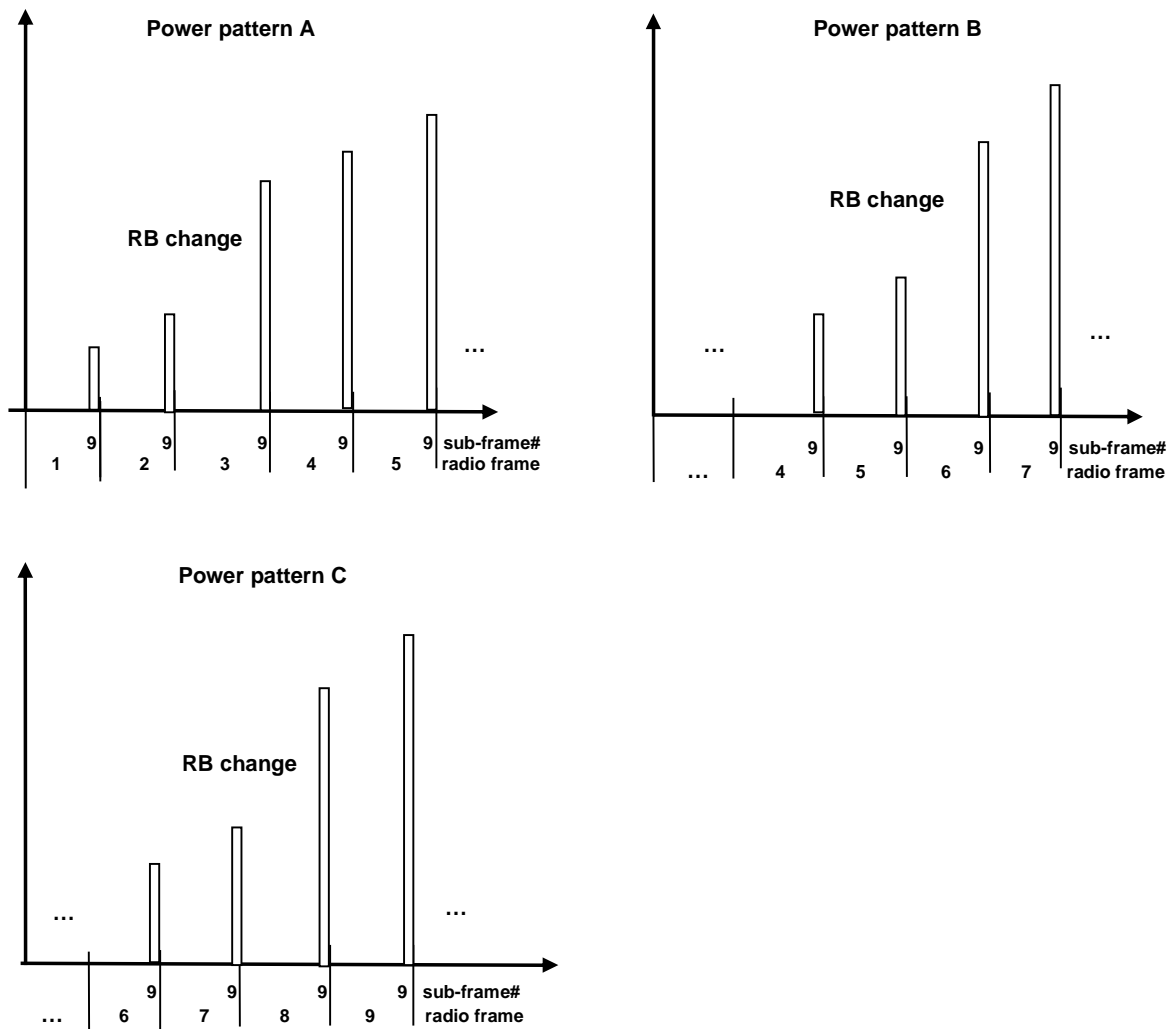

Figure 6.3.4.3.4.2-1: TDD ramping up test power patterns, SCS 60kHz

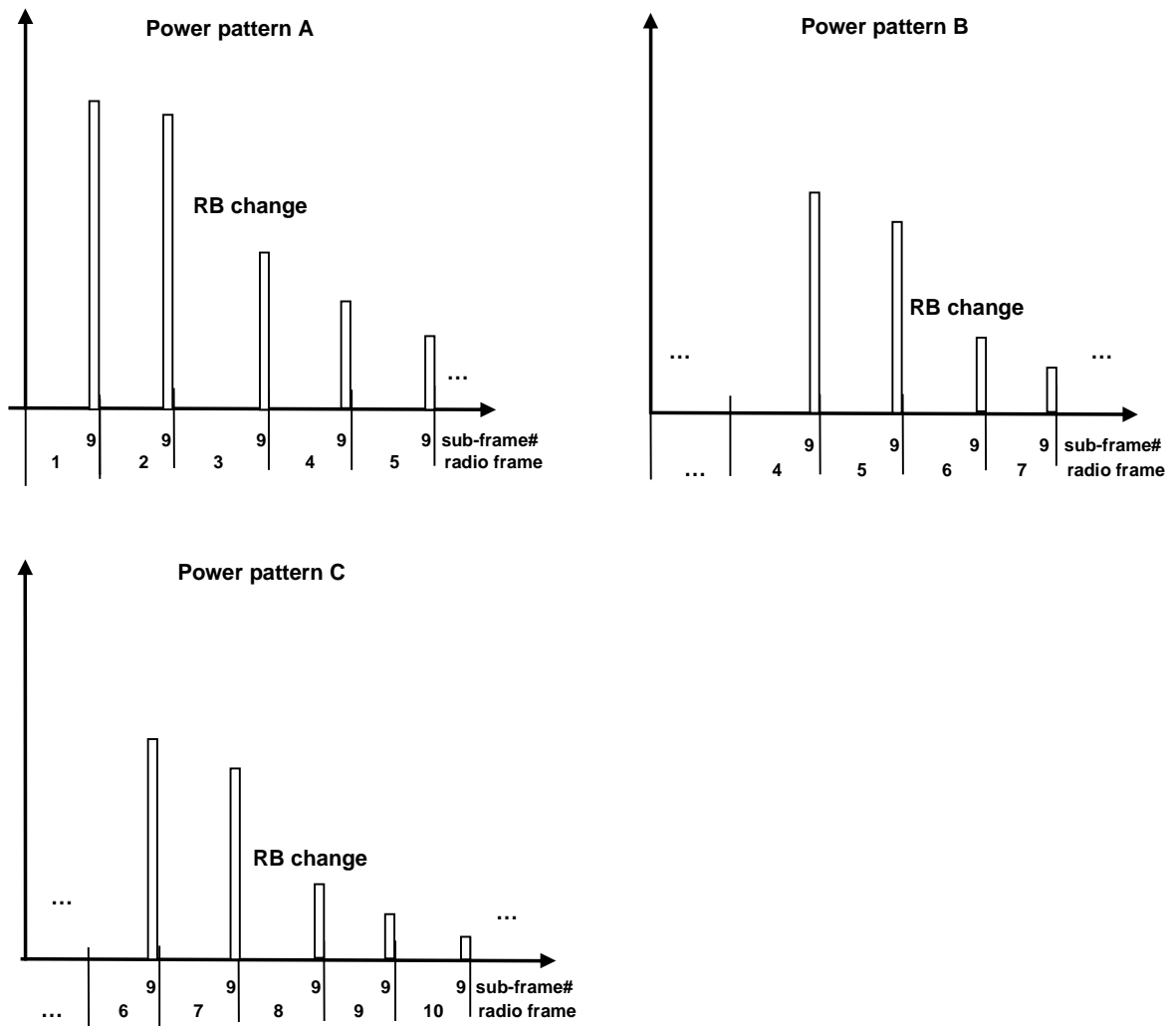

Figure 6.3.4.3.4.2-2: TDD ramping down test power patterns, SCS 60kHz

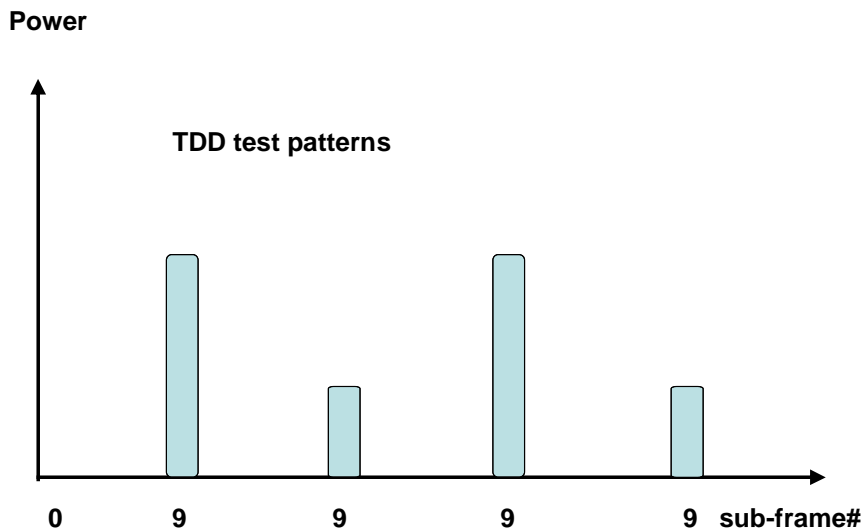

Figure 6.3.4.3.4.2-3: Alternating Test Power patterns, SCS 60kHz

1. Sub test: ramping up pattern

- 1.1 SS sends uplink scheduling information for each UL HARQ process via PDCCH DCI format 0_1 for C_RNTI to schedule the UL RMC according to Table 6.3.4.3.4.1-1. Since the UE has no payload and no loopback data to send the UE sends uplink MAC padding bits on the UL RMC.
- 1.2 Set the UE in the Tx beam peak direction found with a 3D EIRP scan as performed in Annex K.1.1. Allow at least BEAM_SELECT_WAIT_TIME (NOTE 1) for the UE Tx beam selection to complete.
- 1.3 Send the appropriate TPC commands in the uplink scheduling information to UE until the UE EIRP measured by the test system is within the Uplink power control window, defined as $+MU$ to $+(MU + \text{Uplink power control window size})$ dB of the target power level P_{min} , where:
 - P_{min} is the minimum output power according to clause 6.3.1.3.
 - MU is the test system uplink power measurement uncertainty and is specified in Table F.1.2-1 for the carrier frequency f and the channel bandwidth BW .
 - Uplink power control window size = 1dB (UE power step size) + 5dB (UE power step tolerance) + (Test system relative power measurement uncertainty), where, the UE power step tolerance is specified in TS 38.101-2 [3], Table 6.3.4.3-1 and is 5dB for 1dB power step size, and the Test system relative power measurement uncertainty is specified in Table F.1.2-1.

Allow at least BEAM_SELECT_WAIT_TIME (NOTE 1) for the UE Tx beam selection to complete.
- 1.4 SS activates the UE Beamlock Function (UBF) by performing the procedure as specified in TS 38.508-1 [10] clause 4.9.2 using condition Tx only.
- 1.5 Schedule the UE's PUSCH data transmission as described in Figure 6.3.4.3.4.2-1 (TDD) pattern A: Uplink RB allocation as defined in Table 6.3.4.3.5-1. On the PDCCH format 0_1 for the scheduling of the PUSCH the SS will transmit +1dB TPC commands over a sequence of 75 (NOTE 2) active uplink sub-frames to ensure that the UE reaches maximum power threshold. Note that the measurement need not be done continuously, provided that interruptions are whole numbers of frames, and TPC commands of 0dB are sent during the interruption.
- 1.6 Measure UE EIRP in the Tx beam peak direction in the channel bandwidth of the radio access mode according to the test configuration, to verify the UE relative power control meet test requirements in 6.3.4.3.5. EIRP test procedure is defined in Annex K.1.3. EIRP is calculated considering both polarizations,

theta and phi. Measurement of the power is not required in sub-frame after the mean power has exceeded the maximum power threshold. For power transients between sub-frames, transient periods of 40us between sub-frames are excluded. For ON/OFF or OFF/ON transients, transient periods of 20 us at the beginning of the sub-frames are excluded.

1.7 Repeat the subtest different pattern B, C to move the RB allocation change at different points in the pattern as described in Table 6.3.4.3.5-1 to force different UE power steps at various points in the power range.

1.8 SS deactivates the UE Beamlock Function (UBF) by performing the procedure as specified in TS 38.508-1 [10] clause 4.9.3.

2. Sub test: ramping down pattern

2.1 SS sends uplink scheduling information for each UL HARQ process via PDCCH DCI format 0_1 for C_RNTI to schedule the UL RMC according to Table 6.3.4.3.4.1-1. Since the UE has no payload and no loopback data to send the UE sends uplink MAC padding bits on the UL RMC.

2.2 Set the UE in the Tx beam peak direction found with a 3D EIRP scan as performed in Annex K.1.1. Allow at least BEAM_SELECT_WAIT_TIME (NOTE 1) for the UE Tx beam selection to complete.

2.3 Send the appropriate TPC commands in the uplink scheduling information to UE until the UE EIRP measured by the test system is within the Uplink power control window, defined as +MU to +(MU + Uplink power control window size) dB of the target power level P_{UMAX} , where:

- P_{UMAX} is the maximum output power according to clause 6.2.1.1.3.
- MU is the test system uplink power measurement uncertainty and is specified in Table F.1.2-1 for the carrier frequency f and the channel bandwidth BW.
- Uplink power control window size = 1dB (UE power step size) + 1dB (UE power step tolerance) + (Test system relative power measurement uncertainty), where, the UE power step tolerance is specified in TS 38.101-2 [3], Table 6.3.4.3-2 and is 1dB for 1dB power step size, and the Test system relative power measurement uncertainty is specified in Table F.1.2-1.

Allow at least BEAM_SELECT_WAIT_TIME (NOTE 1) for the UE Tx beam selection to complete.

2.4 SS activates the UE Beamlock Function (UBF) by performing the procedure as specified in TS 38.508-1 [10] clause 4.9.2 using condition Tx only.

2.5. Schedule the UE's PUSCH data transmission as described in Figure 6.3.4.3.4.2-2 (TDD) pattern A: Uplink RB allocation as defined in Table 6.3.4.3.5-2. On the PDCCH format 0_1 for the scheduling of the PUSCH the SS will transmit -1dB TPC commands over a sequence of 75 (NOTE 2) active uplink sub-frames to ensure that the UE reaches minimum power threshold. Note that the measurement need not be done continuously, provided that interruptions are whole numbers of frames, and TPC commands of 0dB are sent during the interruption.

2.6. Measure UE EIRP in the Tx beam peak direction in the channel bandwidth of the radio access mode according to the test configuration, to verify the UE relative power control meet test requirements in 6.3.4.3.5. EIRP test procedure is defined in Annex K.1.3. EIRP is calculated considering both polarizations, theta and phi. Measurement of the power is not required in sub-frame after the mean power has exceeded the maximum power threshold. For power transients between sub-frame, transient periods of 40us between sub-frame are excluded. For ON/OFF or OFF/ON transients, transient periods of 20 us at the beginning of the sub-frame are excluded.

2.7. Repeat the subtest different pattern B, C to move the RB allocation change at different points in the pattern as described in Table 6.3.4.3.5-2 to force different UE power steps at various points in the power range.

2.8 SS deactivates the UE Beamlock Function (UBF) by performing the procedure as specified in TS 38.508-1 [10] clause 4.9.3.

3. Sub test: alternating pattern

3.1 SS sends uplink scheduling information for each UL HARQ process via PDCCH DCI format 0_1 for C_RNTI to schedule the UL RMC according to Table 6.3.4.3.4.1-1. Since the UE has no payload and no loopback data to send the UE sends uplink MAC padding bits on the UL RMC. The initial uplink RB

allocation is defined as the smaller uplink RB allocation value specified in Table 6.3.4.3.4.1-1. The power level and RB allocation are reset for each sub-test.

- 3.2 Set the UE in the Tx beam peak direction found with a 3D EIRP scan as performed in Annex K.1.1. Allow at least BEAM_SELECT_WAIT_TIME (NOTE 1) for the UE Tx beam selection to complete.
- 3.3 Send the appropriate TPC commands in the uplink scheduling information to UE until the UE EIRP measured by the test system is within the Uplink power control window, defined as +MU to +(MU + Uplink power control window size) dB of the target power level 0 dBm, where:
 - MU is the test system uplink power measurement uncertainty and is specified in Table F.1.2-1 for the carrier frequency f and the channel bandwidth BW.
 - Uplink power control window size is same as defined in step 1.3.

Allow at least BEAM_SELECT_WAIT_TIME (NOTE 1) for the UE Tx beam selection to complete.
- 3.4 SS activates the UE Beamlock Function (UBF) by performing the procedure as specified in TS 38.508-1 [10] clause 4.9.2 using condition Tx only.
- 3.5. Schedule the UE's PUSCH data transmission as described in Figure 6.3.5.2.4.2-3 for 5 frames with an uplink RB allocation alternating pattern as defined in Table 6.3.4.3.5-3 while transmitting 0dB TPC command for PUSCH via the PDCCH.
- 3.6. Measure UE EIRP in the Tx beam peak direction in the channel bandwidth of the radio access mode according to the test configuration, to verify the UE relative power control meet test requirements in 6.3.4.3.5. EIRP test procedure is defined in Annex K.1.3. EIRP is calculated considering both polarizations, theta and phi. Measurement of the power is not required in sub-frame after the mean power has exceeded the maximum power threshold. For power transients between sub-frames, transient periods of 40us between sub-frames are excluded. For ON/OFF or OFF/ON transients, transient periods of 20 us at the beginning of the sub-frame are excluded.
- 3.7 SS deactivates the UE Beamlock Function (UBF) by performing the procedure as specified in TS 38.508-1 [10] clause 4.9.3.

NOTE 1: The BEAM_SELECT_WAIT_TIME default value is defined in Annex K.

NOTE 2: These numbers of TPC commands are given as examples. The actual number of TPC commands transmitted in these steps shall be enough to ensure that the UE reaches the relevant maximum or minimum power threshold in each step, as shown in Figure 6.3.4.3.4.2-1 through 6.3.4.3.4.2-3.

6.3.4.3.4.3 Message contents

Message contents are according to TS 38.508-1 [10] clause 4.6 with TRANSFORM_PRECODER_ENABLED condition in Table 4.6.3-118 PUSCH-Config.

6.3.4.3.5 Test requirement

Each UE power step measured in the test procedure 6.3.4.3.4.2 should satisfy the test requirements specified in Table 6.3.4.3.5-1 through 6.3.4.3.5-3.

For a test pattern that is either a monotonically increasing or monotonically decreasing power sweep over the range specified for Tables 6.3.4.3.3-1 and 6.3.4.3.3-2, 3 exceptions are allowed for each of the test patterns. For these exceptions, the power tolerance limit is a maximum of ± (11.0 + TT) dB. If there is an exception in the power step caused by the RB change for all test patterns (A, B, C) then fail the UE.

Table 6.3.4.3.5-1: Test Requirements Relative Power Tolerance for Transmission, channel BW 100MHz, SCS 60kHz, ramp up sub-test

Sub-test ID	Applicable sub-frames	Uplink RB allocation	TPC command	Expected power step size (Up) ΔP [dB]	Power step size range (Up) ΔP [dB]	PUSCH [dB]
-------------	-----------------------	----------------------	-------------	---------------------------------------	------------------------------------	------------

1	Sub-frames before RB change	105RBs	TPC=+1dB	1	$\Delta P \leq 1$ dB	1 +/- (1.0 + TT)
	RB change	105RBs to 128 RBs	TPC=+1dB	1.86	$\Delta P < 2$ dB	1.86 +/- (5.0 + TT) (NOTE 1) 1.86 +/- (3.0 + TT) (NOTE 2)
	Sub-frames after RB change	Fixed = 128	TPC=+1dB	1	$\Delta P \leq 1$ dB	1 +/- (1.0 + TT)
2	Sub-frames before RB change	90RBs	TPC=+1dB	1	$\Delta P \leq 1$ dB	1 +/- (1.0 + TT)
	RB change	90RBs to 128 RBs	TPC=+1dB	2.53	$2\text{dB} \leq \Delta P < 3\text{dB}$	2.53 +/- (6.0 + TT) (NOTE 1) 2.53 +/- (4.0 + TT) (NOTE 2)
	Sub-frames after RB change	Fixed = 128	TPC=+1dB	1	$\Delta P \leq 1$ dB	1 +/- (1.0 + TT)
3	Sub-frames before RB change	79RBs	TPC=+1dB	1	$\Delta P \leq 1$ dB	1 +/- (1.0 + TT)
	RB change	79RBs to 128 RBs	TPC=+1dB	3.10	$3\text{dB} \leq \Delta P < 4\text{dB}$	3,10 +/- (7.0 + TT) (NOTE 1) 3,10 +/- (5.0 + TT) (NOTE 2)
	Sub-frames after RB change	Fixed = 128RBs	TPC=+1dB	1	$\Delta P \leq 1$ dB	1 +/- (1.0 + TT)
4	Sub-frames before RB change	32RBs	TPC=+1dB	1	$\Delta P \leq 1$ dB	1 +/- (1.0 + TT)
	RB change	32RBs to 128 RBs	TPC=+1dB	7.02	$4\text{dB} \leq \Delta P < 10\text{dB}$	7.02 +/- (8.0 + TT) (NOTE 1) 7.02 +/- (6.0 + TT) (NOTE 2)
	Sub-frames after RB change	Fixed = 128	TPC=+1dB	1	$\Delta P \leq 1$ dB	1 +/- (1.0 + TT)
5	Sub-frames before RB change	7RBs	TPC=+1dB	1	$\Delta P \leq 1$ dB	1 +/- (1.0 + TT)
	RB change	7RBs to 128 RBs	TPC=+1dB	13.62	$10\text{dB} \leq \Delta P < 15\text{dB}$	13.62 +/- (10.0 + TT) (NOTE 1) 13.62 +/- (8.0 + TT) (NOTE 2)
	Sub-frames after RB change	Fixed = 128RBs	TPC=+1dB	1	$\Delta P \leq 1$ dB	1 +/- (1.0 + TT)
6	Sub-frames before RB change	1RB	TPC=+1dB	1	$\Delta P \leq 1$ dB	1 +/- (1.0 + TT)
	RB change	1RB to 128 RBs	TPC=+1dB	22.07	$15\text{dB} < \Delta P$	22.07 +/- (11.0 + TT) (NOTE 1) 22.07 +/- (9.0 + TT) (NOTE 2)
	Sub-frames after RB change	Fixed = 128	TPC=+1dB	1	$\Delta P \leq 1$ dB	1 +/- (1.0 + TT)

NOTE 1: Applicable if $P_{\text{int}} \geq P \geq P_{\text{min}}$.NOTE 2: Applicable if $P_{\text{UMAX}} \geq P > P_{\text{int}}$.NOTE 3: Applicable if $P_{\text{UMAX}} \geq P \geq P_{\text{min}}$. P_{min} as defined in sub-clause 6.3.1.

Table 6.3.4.3.5-2: Test Requirements Relative Power Tolerance for Transmission, channel BW 100MHz, SCS 60kHz, ramp down sub-test

Sub-test ID	Applicable sub-frames	Uplink RB allocation	TPC command	Expected power step size (Down) ΔP [dB]	Power step size range (Down)	PUSCH
					ΔP [dB]	[dB]
1	Sub-frames before RB change	128RBs	TPC=-1dB	1	$\Delta P \leq 1$ dB	1 +/- (1.0 + TT)
	RB change	128RBs to 105 RBs	TPC=-1dB	1.86	$\Delta P < 2$ dB	1.86 +/- (5.0 + TT) (NOTE 1) 1.86 +/- (3.0 + TT) (NOTE 2)
	Sub-frames after RB change	Fixed = 105	TPC=-1dB	1	$\Delta P \leq 1$ dB	1 +/- (1.0 + TT)
2	Sub-frames before RB change	128RBs	TPC=-1dB	1	$\Delta P \leq 1$ dB	1 +/- (1.0 + TT)
	RB change	128RBs to 90 RBs	TPC=-1dB	2.53	$2\text{dB} \leq \Delta P < 3\text{dB}$	2.53 +/- (6.0 + TT) (NOTE 1) 2.53 +/- (4.0 + TT) (NOTE 2)
	Sub-frames after RB change	Fixed = 90	TPC=-1dB	1	$\Delta P \leq 1$ dB	1 +/- (1.0 + TT)
3	Sub-frames before RB change	128RBs	TPC=-1dB	1	$\Delta P \leq 1$ dB	1 +/- (1.0 + TT)
	RB change	128RBs to 79 RBs	TPC=-1dB	3.10	$3\text{dB} \leq \Delta P < 4\text{dB}$	3,10 +/- (7.0 + TT) (NOTE 1) 3,10 +/- (5.0 + TT) (NOTE 2)
	Sub-frames after RB change	Fixed = 79RBs	TPC=-1dB	1	$\Delta P \leq 1$ dB	1 +/- (1.0 + TT)
4	Sub-frames before RB change	128RBs	TPC=-1dB	1	$\Delta P \leq 1$ dB	1 +/- (1.0 + TT)
	RB change	128RBs to 32 RBs	TPC=-1dB	7.02	$4\text{dB} \leq \Delta P < 10\text{dB}$	7.02 +/- (8.0 + TT) (NOTE 1) 7.02 +/- (6.0 + TT) (NOTE 2)
	Sub-frames after RB change	Fixed = 32	TPC=-1dB	1	$\Delta P \leq 1$ dB	1 +/- (1.0 + TT)
5	Sub-frames before RB change	128RBs	TPC=-1dB	1	$\Delta P \leq 1$ dB	1 +/- (1.0 + TT)
	RB change	128RBs to 7 RBs	TPC=-1dB	13.62	$10\text{dB} \leq \Delta P < 15\text{dB}$	13.62 +/- (10.0 + TT) (NOTE 1) 13.62 +/- (8.0 + TT) (NOTE 2)
	Sub-frames after RB change	Fixed = 7RBs	TPC=-1dB	1	$\Delta P \leq 1$ dB	1 +/- (1.0 + TT)
6	Sub-frames before RB change	128RB	TPC=-1dB	1	$\Delta P \leq 1$ dB	1 +/- (1.0 + TT)
	RB change	128RB to 1 RBs	TPC=-1dB	22.07	$15\text{dB} < \Delta P$	22.07 +/- (11.0 + TT) (NOTE 1) 22.07 +/- (9.0 + TT) (NOTE 2)

	Sub-frames after RB change	Fixed = 1	TPC=-1dB	1	$\Delta P \leq 1$ dB	1 +/- (1.0 + TT)
NOTE 1: Applicable if $P_{int} \geq P \geq P_{min}$.						
NOTE 2: Applicable if $P_{UMAX} \geq P > P_{int}$.						
NOTE 3: Applicable if $P_{UMAX} \geq P \geq P_{min}$. P_{min} as defined in sub-clause 6.3.1.						

Table 6.3.4.3.5-3: Test Requirements Relative Power Tolerance for Transmission, channel BW 100MHz, SCS 60kHz, alternating sub-test

Sub-test ID	Uplink RB allocation	TPC command	Expected power step size (Up/Down) ΔP [dB]	Power step size range (Up/Down) ΔP [dB]	PUSCH
					[dB]
1	Alternating 105 and 128	TPC=0dB	0.86	$\Delta P < 2$ dB	0.86 +/- (5.0 + TT) (NOTE 1) 0.86 +/- (3.0 + TT) (NOTE 2)
2	Alternating 79 and 128	TPC=0dB	2.10	2 dB $\leq \Delta P < 3$ dB	2.10 +/- (6.0 + TT) (NOTE 1) 2.10 +/- (4.0 + TT) (NOTE 2)
3	Alternating 64 and 128	TPC=0dB	3.01	3 dB $\leq \Delta P < 4$ dB	3.01 +/- (7.0 + TT) (NOTE 1) 3.01 +/- (5.0 + TT) (NOTE 2)
4	Alternating 32 and 128	TPC=0dB	6.02	4 dB $\leq \Delta P < 10$ dB	6.02 +/- (8.0 + TT) (NOTE 1) 6.02 +/- (6.0 + TT) (NOTE 2)
5	Alternating 7 and 128	TPC=0dB	12.62	10 dB $\leq \Delta P < 15$ dB	12.62 +/- (10.0 + TT) (NOTE 1) 12.62 +/- (8.0 + TT) (NOTE 2)
6	Alternating 1 and 128	TPC=0dB	21.07	15 dB $< \Delta P$	21.07 +/- (11.0 + TT) (NOTE 1) 21.07 +/- (9.0 + TT) (NOTE 2)
NOTE 1: Applicable if $P_{int} \geq P \geq P_{min}$.					
NOTE 2: Applicable if $P_{UMAX} \geq P > P_{int}$.					
NOTE 3: Applicable if $P_{UMAX} \geq P \geq P_{min}$. P_{min} as defined in sub-clause 6.3.1.					

6.3.4.4 Aggregate power tolerance

Editor's note: The following aspects are either missing or not yet determined:

- UE transmitted power for power class 1, 2, 4, 5, 6 and 7 is FFS.

6.3.4.4.1 Test purpose

To verify the ability of the UE transmitter to maintain its power during non-contiguous transmissions within 21ms in response to 0 dB commands with respect to the first UE transmission and all other power control parameters as specified in TS 38.213 [22] kept constant.

6.3.4.4.2 Test applicability

This test case applies to all types of NR UE release 15 and forward.

6.3.4.4.3 Minimum conformance requirements

The aggregate power control tolerance is the ability of the UE transmitter to maintain its power in a sub-frame (1 ms) non-contiguous transmissions within 21ms in response to 0 dB TPC commands with respect to the first UE transmission and all other power control parameters as specified in TS 38.213 [22] kept constant.

The minimum requirements specified in Table 6.3.4.4.3-1 apply when the power of the target and reference sub-frames are within the power range bounded by the minimum output power as defined in sub-clause 6.3.1 and P_{int} as defined in sub-clause 6.3.4.2. The minimum requirements specified in Table 6.3.4.4.3-2 apply when the power of the target and reference sub-frames are within the power range bounded by P_{int} as defined in sub-clause 6.3.4.2 and the maximum output power as specified in sub-clause 6.2.1.

Table 6.3.4.4.3-1: Aggregate power tolerance, $P_{\text{int}} \geq P \geq P_{\text{min}}$

TPC command	UL channel	Aggregate power tolerance within 21ms
0 dB	PUCCH	± 5.5 dB
0 dB	PUSCH	± 5.5 dB

Table 6.3.4.4.3-2: Aggregate power tolerance, $P_{\text{max}} \geq P > P_{\text{int}}$

TPC command	UL channel	Aggregate power tolerance within 21ms
0 dB	PUCCH	± 3.5 dB
0 dB	PUSCH	± 3.5 dB

The normative reference for this requirement is TS 38.101-2 [3] clause 6.3.4.4

6.3.4.4.4 Test description

6.3.4.4.4.1 Initial conditions

Initial conditions are a set of test configurations the UE needs to be tested in and the steps for the SS to take with the UE to reach the correct measurement state.

The initial test configurations consist of environmental conditions, test frequencies, test channel bandwidths and sub-carrier spacing based on NR operating bands specified in Table 5.3.5-1. All of these configurations shall be tested with applicable test parameters for each combination of test channel bandwidth and sub-carrier spacing, and are shown in Table 6.3.4.4.4.1-1 and Table 6.3.4.4.4.1-2. The details of the uplink reference measurement channels (RMCs) are specified in Annexes A.2. Configurations of PDSCH and PDCCH before measurement are specified in Annex C.2.

Table 6.3.4.4.4.1-1: Test Configuration Table: PUCCH subtest

Initial Conditions		
Test Environment as specified in TS 38.508-1 [10] clause 4.1		Normal
Test Frequencies as specified in TS 38.508-1 [10] clause 4.3.1		Mid range
Test Channel Bandwidths as specified in TS 38.508-1 [10] clause 4.3.1		Lowest, Mid and Highest
Test SCS as specified in Table 5.3.5-1		Highest
Test Parameters for Channel Bandwidths		
Test ID	Downlink Configuration	Uplink Configuration
	Modulation	RB allocation
1	CP-OFDM QPSK	Full RB (NOTE 1)
		PUCCH format = Format 1 Length in OFDM symbols = 14
NOTE 1: Full RB allocation shall be used per each SCS and channel BW as specified in Table 7.3.2.4.1-2.		

Table 6.3.4.4.4.1-2: Test Configuration Table: PUSCH subtest

Initial Conditions		
Test Environment as specified in TS 38.508-1 [10] clause 4.1		Normal
Test Frequencies as specified in TS 38.508-1 [10] clause 4.3.1		Mid range
Test Channel Bandwidths as specified in TS 38.508-1 [10] clause 4.3.1		Lowest, Mid and Highest
Test SCS as specified in Table 5.3.5-1		Highest
Test Parameters for Channel Bandwidths		
Test ID	Downlink Configuration	Uplink Configuration
	-	Modulation
1		RB allocation (NOTE 1)
		DFT-s-OFDM QPSK
		Inner_Full
NOTE 1: The specific configuration of each RB allocation is defined in Table 6.1-1 for PC2, PC3, PC4, PC6 and PC7 or Table 6.1-2 for PC1.		

1. Connection between SS and UE is shown in TS 38.508-1 [10] Annex A, Figure A.3.3.1.1 for TE diagram and Figure A.3.4.1.1 for UE diagram.
2. The parameter settings for the cell are set up according to TS 38.508-1 [10] clause 4.4.3.
3. Downlink signals are initially set up according to Annex C, and uplink signals according to Annex G.
4. For PUCCH subtest, the UL and DL Reference Measurement Channels are set according to Table 6.3.4.4.4.1-1. For PUSCH subtest, the UL Reference Measurement Channel is set according to Table 6.3.4.4.4.1-2.
5. Propagation conditions are set according to Annex B.0.
6. Ensure the UE is in State RRC_CONNECTED with generic procedure parameters Connectivity *NR*, Connected without release *On*, Test Mode *On* and Test Loop Function *On* according to TS 38.508-1 [10] clause 4.5. Message contents are defined in clause 6.3.4.4.4.3.

6.3.4.4.4.2 Test procedure

The procedure is separated in two subtests to verify PUCCH and PUSCH aggregate power control tolerance respectively. The uplink transmission patterns are described in Figure 6.3.4.4.4.2-1.

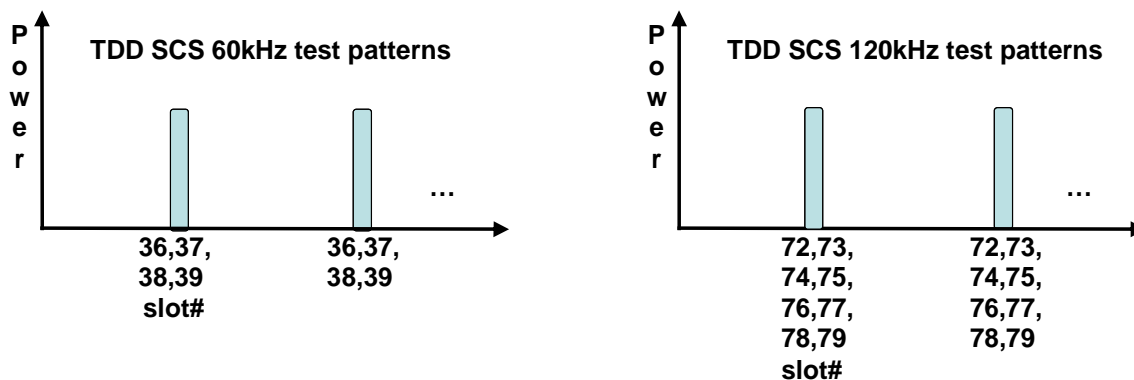

Figure 6.3.4.4.4.2-1: Test uplink transmission

1. PUCCH subtest:
 - 1.1. Set the UE in the Tx beam peak direction found with a 3D EIRP scan as performed in Annex K.1.1.
 - 1.2. SS activates the UE Beamlock Function (UBF) by performing the procedure as specified in TS 38.508-1 [10] clause 4.9.2 using condition Tx only.
 - 1.3. The SS transmits PDSCH via PDCCH DCI format 1_1 for C_RNTI to transmit the DL RMC according to Table 6.3.4.4.4.1-1. The SS sends downlink MAC padding bits on the DL RMC. The transmission of PDSCH will make the UE send uplink ACK/NACK using PUCCH. Send uplink power control commands for PUCCH to the UE using 1dB power step size to ensure that the UE output power measured by the test system is within P_W of the target power level specified in Table 6.3.4.4.4.2-1 according to the power class with power ID = 1. P_W is the power window according to Table 6.3.4.4.4.2-2 for the carrier frequency f and the channel bandwidth BW.
 - 1.4. Every 10 sub-frames (10ms) transmit to the UE downlink PDSCH MAC padding bits as well as 0 dB TPC command for PUCCH via the PDCCH to make the UE transmit ACK/NACK on the PUCCH for 1 sub-frame (1ms). The downlink transmission is scheduled in the appropriate slots to make the UE transmit PUCCH as described in Figure 6.3.4.4.4.2-1.
 - 1.5. Measure the UE EIRP of 3 consecutive PUCCH transmissions in the Tx beam peak direction of in the measurement bandwidth specified in Table 6.3.1.5-1 and Table 6.3.1.5-2 to verify the UE transmitted PUCCH power is maintained within 21ms. EIRP test procedure is defined in Annex K. EIRP is calculated considering both polarizations, theta and phi. For TDD slots with transient periods are not under test.
 - 1.6. SS deactivates the UE Beamlock Function (UBF) by performing the procedure as specified in TS 38.508-1 [10] clause 4.9.3.

1.7. Repeat test steps 1.2 to 1.6 for measurement for power ID = 2 in Table 6.3.4.4.4.2-1.

2. PUSCH subtest:

2.1. Set the UE in the Tx beam peak direction found with a 3D EIRP scan as performed in Annex K.1.1.

2.2. SS activates the UE Beamlock Function (UBF) by performing the procedure as specified in TS 38.508-1 [10] clause 4.9.2 using condition Tx only.

2.3. The SS sends uplink scheduling information via PDCCH DCI format 0_1 for C_RNTI to schedule the PUSCH. Since the UE has no payload and no loopback data to send the UE sends uplink MAC padding bits on the UL RMC. Send uplink power control commands for PUSCH to the UE using 1dB power step size to ensure that the UE output power measured by the test system is within P_w of the target power level specified in Table 6.3.4.4.4.2-1 according to the power class with power ID = 1. P_w is the power window according to Table 6.3.4.4.4.2-2 for the carrier frequency f and the channel bandwidth BW.

2.4. Every 10 sub-frames (10ms) schedule the UE's PUSCH data transmission for 1 sub-frame (1ms) and transmit 0 dB TPC command for PUSCH via the PDCCH to make the UE transmit PUSCH. The uplink transmission patterns are described in Figure 6.3.4.4.4.2-1.

2.5. Measure the UE EIRP of 3 consecutive PUSCH transmissions in the Tx beam peak direction of in the measurement bandwidth specified in Table 6.3.1.5-1 and Table 6.3.1.5-2 to verify the UE transmitted PUSCH power is maintained within 21ms. EIRP test procedure is defined in Annex K. EIRP is calculated considering both polarizations, theta and phi. For TDD slots with transient periods are not under test.

2.6. SS deactivates the UE Beamlock Function (UBF) by performing the procedure as specified in TS 38.508-1 [10] clause 4.9.3.

2.7. Repeat test steps 2.2 to 2.6 for measurement for power ID = 2 in Table 6.3.4.4.4.2-1.

Table 6.3.4.4.4.2-1: Parameters for Aggregate power tolerance

	Power ID	Unit	PC1	PC2	PC3	PC4	PC6
FR2a	1	dBm	TBD	TBD	1	TBD	TBD
	2	dBm	TBD	TBD	15	TBD	TBD
FR2b	1	dBm	TBD	TBD	6	TBD	TBD
	2	dBm	TBD	TBD	15	TBD	TBD

Table 6.3.4.4.4.2-2: Power Window (dB) for Aggregate Power tolerance for PUSCH and PUCCH

Power ID	PUCCH	PUSCH
1	7.4	7.4
2	5.4	3.4

6.3.4.4.4.3 Message contents

Message contents are according to TS 38.508-1 [10] clause 4.6 with TRANSFORM_PRECODER_ENABLED condition in Table 4.6.3-118 PUSCH-Config and with following exception:

Table 6.3.4.4.4.3-1: Physical layer parameters for DCI format 1_1 for PUCCH subtest

Derivation Path: TS 38.508-1 [10], Table 5.4.2.0-1		
Parameter	Value	Value in binary
PUCCH resource indicator	$PUCCH-ResourceId[8] = 7$ in pucch-ResourceSetID[1] as defined in TS 38.508-1 [10], Table 4.6.3-112 (Mapping as per Table 9.2.3-2 in TS 38.213 [22])	'111'B

6.3.4.4.5 Test requirement

The requirement for the power measurements made in step (1.5) and (2.5) of the test procedure shall not exceed the values specified in Table 6.3.4.4.5-1 and Table 6.3.4.4.5-2. The power measurement period shall be 1 sub-frame (1ms).

Table 6.3.4.4.5-1: Power control tolerance ($P_{int} \geq P \geq P_{min}$)

TPC command	UL channel	Test requirement measured power
0 dB	PUCCH	Given 3 power measurements in the pattern, the 2 nd , and later measurements shall be within $\pm(5.5\text{dB}+TT)$ of the 1 st measurement.
0 dB	PUSCH	Given 3 power measurements in the pattern, the 2 nd , and later measurements shall be within $\pm(5.5\text{dB}+TT)$ of the 1 st measurement.
Note 1: TT for each duplex, Sub-Carrier Spacing, frequency and channel bandwidth is specified in Table 6.3.4.4.5-3.		

Table 6.3.4.4.5-2: Power control tolerance ($P_{max} \geq P > P_{int}$)

TPC command	UL channel	Test requirement measured power
0 dB	PUCCH	Given 3 power measurements in the pattern, the 2 nd , and later measurements shall be within $\pm(3.5\text{dB}+TT)$ of the 1 st measurement.
0 dB	PUSCH	Given 3 power measurements in the pattern, the 2 nd , and later measurements shall be within $\pm(3.5\text{dB}+TT)$ of the 1 st measurement.
Note 1: TT for each duplex, Sub-Carrier Spacing, frequency and channel bandwidth is specified in Table 6.3.4.4.5-4.		

Table 6.3.4.4.5-3: Test Tolerance ($P_{int} \geq P \geq P_{min}$)

Test Metric	FR2a	FR2b
IFF (Max device size ≤ 30 cm)	0.26 dB	0.26 dB

Table 6.3.4.4.5-4: Test Tolerance ($P_{max} \geq P > P_{int}$)

Test Metric	FR2a	FR2b
IFF (Max device size ≤ 30 cm)	0.26 dB	0.26 dB

6.3A Output power dynamics for CA

6.3A.1 Minimum output power for CA

6.3A.1.0 Minimum conformance requirements

For intra-band contiguous carrier aggregation, the minimum controlled output power of the UE is defined as the transmit power of the UE per component carrier, i.e., EIRP in the channel bandwidth of each component carrier for all transmit bandwidth configurations (resource blocks), when the power on both component carriers are set to a minimum value.

The minimum output power is defined as the mean power in at least one subframe (1ms).

The minimum output power shall not exceed the values specified in Table 6.3A.1.0-1 and 6.3.A.1.0-2 for each operating band supported. The minimum power is verified in beam locked mode with the test metric of EIRP (Link=TX beam peak direction, Meas=Link angle).

Table 6.3A.1.0-1: Minimum output power for CA for power class 1

Operating band	Channel bandwidth (MHz)	Minimum output power (dBm)	Measurement bandwidth (MHz)
n257, n258, n260, n261	50	4	47.58
	100	4	95.16

	200	4	190.20
	400	4	380.28

Table 6.3A.1.0-2: Minimum output power for CA for power class 2, 3 and 4

Operating band	Channel bandwidth (MHz)	Minimum output power (dBm)	Measurement bandwidth (MHz)
n257, n258, n260, n261	50	-13	47.58
	100	-13	95.16
	200	-13	190.20
	400	-13	380.28

NOTE 1: n260 is not applied for power class 2.

Table 6.3A.1.0-3: Minimum output power for CA for power class 5 and 6

Operating band	Channel bandwidth (MHz)	Minimum output power (dBm)	Measurement bandwidth (MHz)
n257, n258, n260, n261	50	-6	47.58
	100	-6	95.16
	200	-6	190.20
	400	-6	380.28

NOTE 1: n261 is not applied for power class 5.

The normative reference for this requirement is TS 38.101-2 [3] clause 6.3A.1.

6.3A.1.1 Minimum output power for CA (2UL CA)

Editor's note: The following aspects are either missing or not yet determined:

- Relaxation, Measurement Uncertainties and Test Tolerances are FFS for power class other than 1, 3, 5, 6 and CA other than intra-band contiguous.
- Measurement Uncertainties and Test Tolerances for intra-band contiguous CA supporting aggregated BW > 800MHz is FFS as test system complexity might increase.

6.3A.1.1.1 Test purpose

To verify the UE's ability to transmit with a broadband output power below the value specified in the test requirement when the power on each component carrier is set to a minimum value.

6.3A.1.1.2 Test applicability

This test case applies to all types of NR UE release 15 and forward that support intra-band contiguous 2UL CA.

6.3A.1.1.3 Minimum conformance requirements

The minimum conformance requirements are defined in clause 6.3A.1.0.

6.3A.1.1.4 Test description

6.3A.1.1.4.1 Initial condition

Initial conditions are a set of test configurations the UE needs to be tested in and the steps for the SS to take with the UE to reach the correct measurement state.

The initial test configurations consist of environmental conditions, test frequencies, test channel bandwidths and sub-carrier spacing based on NR CA configuration specified in clause 5.5A. All of these configurations shall be tested with applicable test parameters for each CA configuration, and are shown in Table 6.3A.1.1.4.1-1. The details of the uplink reference measurement channels (RMCs) are specified in Annexes A.2. Configurations of PDSCH and PDCCH before measurement are specified in Annex C.2.

Table 6.3A.1.1.4.1-1: Test Configuration Table

Default Conditions						
Test Environment as specified in TS 38.508-1 [10] clause 4.1			Normal			
Test Frequencies as specified in TS 38.508-1 [10] clause 4.3.1.2.3 for different CA bandwidth classes.			Low and High range			
Test CC combination setting as specified TS 38.508-1 [10] clause 4.3.1.2.3 for the CA Configuration across bandwidth combination sets supported by the UE.			Lowest aggregated BW of the CA configuration Highest aggregated BW of the CA configuration			
Test SCS as specified in Table 5.3.5-1.			Highest			
Test Parameters						
Test ID	CC	ChBw(MHz)	Test frequency	DL RB allocation	UL Modulation	UL RB allocation
1	PCC	Default	Default	-	DFT-s-OFDM QPSK	Outer_Full
	SCC				DFT-s-OFDM QPSK	Outer_Full
NOTE 1: The specific configuration of each RB allocation is defined in Table 6.1-1 for PC2, PC3, PC4, PC5 and PC6 or Table 6.1-2 for PC1.						
NOTE 2: Number of DL CCs shall be configured the same as number of UL CCs. The requirements are applicable as per 5.3A.4: <i>"The requirements are applicable only when Uplink CCs are configured within the frequency range between lower edge of lowest downlink component carrier and upper edge of highest downlink component carrier"</i> .						

1. Connection between SS and UE is shown in TS 38.508-1 [10] Annex A, Figure A.3.3.1.1 for TE diagram and Figure A.3.4.1.1 for UE diagram.
2. The parameter settings for the cell are set up according to TS 38.508-1 [10] clause 4.4.3.
3. Downlink signals are initially set up according to Annex C, and uplink signals according to Annex G.
4. The UL Reference Measurement Channel is set according to Table 6.3A.1.1.4.1-1.
5. Propagation conditions are set according to Annex B.0.
6. Ensure the UE is in State RRC_CONNECTED with generic procedure parameters Connectivity NR, Connected without release On, Test Mode On and Test Loop Function On according to TS 38.508-1 [10] clause 4.5. Message contents are defined in clause 6.3A.1.1.4.3.

6.3A.1.1.4.2 Test procedure

1. Configure SCC according to Annex C.0, C.1, C.3.0 for all downlink physical channels.
2. The SS shall configure SCC as per TS 38.508-1 [10] clause 5.5.1. Message contents are defined in clause 6.3A.1.1.4.3
3. SS activates SCC by sending the activation MAC CE (Refer TS 38.321 [28], clauses 5.9, 6.1.3.10). Wait for at least 2 seconds (Refer TS 38.133[25], clause 9.2).
4. SS sends uplink scheduling information for each UL HARQ process via PDCCH DCI format 0_1 for C_RNTI to schedule the UL RMC according to Table 6.3A.1.1.4.1-1 on both PCC and SCC. Since the UE has no payload and no loopback data to send the UE sends uplink MAC padding bits on the UL RMC.
5. Set the UE in the Tx beam peak direction found with a 3D EIRP scan as performed in Annex K.1.1. Allow at least BEAM_SELECT_WAIT_TIME (NOTE 1) for the UE Tx beam selection to complete.
6. Send continuously uplink power control "down" commands in every uplink scheduling information to the UE; allow at least 200ms starting from the first TPC command in this step to ensure that the UE transmits at its minimum output power. If UE is disconnected, repeat the test case. Optionally, send continuously uplink power control "down" commands in every uplink scheduling information to the UE until the UE EIRP measured by the test system is at a level just before the UE was disconnected. Allow at least BEAM_SELECT_WAIT_TIME (NOTE 1) for the UE Tx beam selection to complete.

7. SS activates the UE Beamlock Function (UBF) by performing the procedure as specified in TS 38.508-1 [10] clause 4.9.2 using condition Tx only.
8. Measure UE EIRP of each component carrier in the Tx beam peak direction in the measurement bandwidth specified in Table 6.3A.1.1.5-1 for the specific channel bandwidth under test. EIRP test procedure is defined in Annex K. The measuring duration is at least one active uplink subframe. EIRP is calculated considering both polarizations, theta and phi. For TDD slots with transient periods are not under test.
9. SS deactivates the UE Beamlock Function (UBF) by performing the procedure as specified in TS 38.508-1 [10] clause 4.9.3.

NOTE 1: The BEAM_SELECT_WAIT_TIME default value is defined in Annex K.1.1.

6.3A.1.1.4.3 Message contents

Message contents are according to TS 38.508-1 [10] clause 4.6 with following exception.

Table 6.3A.1.1.4.3-1: PUSCH-Config

Derivation Path: TS 38.508-1 [10], Table 4.6.3-118 with condition TRANSFORM_PRECODER_ENABLED

6.3A.1.1.5 Test requirement

For each component carrier, the minimum EIRP shall not exceed the values specified in Table 6.3A.1.1.5-1 and 6.3A.1.1.5-2.

Table 6.3A.1.1.5-1: Minimum output power for 2UL CA for power class 1

Operating band	Channel bandwidth (MHz)	Minimum output power (dBm)	Measurement bandwidth (MHz)
n257, n258, n260, n261	50	4+TBD+TT	47.58
	100	4+TBD+TT	95.16
	200	4+TBD+TT	190.20
	400	4+TBD+TT	380.28

Table 6.3A.1.1.5-2: Minimum output power for 2UL CA for power class 3

Operating band	Channel bandwidth (MHz)	Minimum output power (dBm)	Measurement bandwidth (MHz)
n257, n258, n261	50	-13+TT	47.58
	100	-13+2.4+TT	95.16
	200	-13+5.4+TT	190.20
	400	-13+8.4+TT	380.28
n260	50	-13+4.5+TT	47.58
	100	-13+7.5+TT	95.16
	200	-13+10.5+TT	190.20
	400	-13+13.5+TT	380.28

NOTE 1: n260 is not applied for power class 2.

Table 6.3A.1.1.5-2a: Minimum output power for 2UL CA for power class 2 and 4

Operating band	Channel bandwidth (MHz)	Minimum output power (dBm)	Measurement bandwidth (MHz)
n257, n258, n260, n261	50	-13+TBD+TT	47.58
	100	-13+TBD+TT	95.16
	200	-13+TBD+TT	190.20
	400	-13+TBD+TT	380.28

NOTE 1: n260 is not applied for power class 2.

Table 6.3A.1.1.5-3: Test Tolerance for Minimum output power for 2UL CA for Power class 1

Test Metric	FR2a	FR2b
Max device size ≤ 30 cm	Same as in table 6.3.1.5-1a	Same as in table 6.3.1.5-1a

Table 6.3A.1.1.5-4: Test Tolerance for Minimum output power for 2UL CA for Power class 3

Test Metric	FR2a	FR2b
Max device size ≤ 30 cm	Same as in table 6.3.1.5-2	Same as in table 6.3.1.5-2

Table 6.3A.1.1.5-5: Minimum output power for power class 5

Operating band	Channel bandwidth (MHz)	Minimum output power (dBm)	Test Tolerance TT (dB)	Measurement bandwidth (MHz)
n257, n258	50	-6+TT	3.67 dB	47.58
	100	-6+TT	3.85 dB	95.16
	200	-6+TT	4.18 dB	190.20
	400	-6+1.4+TT ¹	3.38 dB	380.28
NOTE 1: Core requirement cannot be tested due to testability issue and test requirement includes relaxation to achieve impact from test system noise to measurement result = 1.0 dB (Minimum requirement + relaxation).				

Table 6.3A.1.1.5-6: Minimum output power for power class 6

Operating band	Channel bandwidth (MHz)	Minimum output power (dBm)	Test Tolerance TT (dB)	Measurement bandwidth (MHz)
n257, n258	50	-6+TT	3.66 dB	47.58
	100	-6+TT	3.84 dB	95.16
	200	-6+TT	4.17 dB	190.20
	400	-6+1.4+TT ¹	3.37 dB	380.28
NOTE 1: Core requirement cannot be tested due to testability issue and test requirement includes relaxation to achieve impact from test system noise to measurement result = 1.0 dB (Minimum requirement + relaxation).				

6.3A.1.2 Minimum output power for CA (3UL CA)

Editor's note: The following aspects are either missing or not yet determined:

- Relaxation, Measurement Uncertainties and Test Tolerances are FFS for power class other than 1, 3, 5, 6 and CA other than intra-band contiguous.
- Measurement Uncertainties and Test Tolerances for intra-band contiguous CA supporting aggregated BW > 800MHz is FFS as test system complexity might increase.

6.3A.1.2.1 Test purpose

To verify the UE's ability to transmit with a broadband output power below the value specified in the test requirement when the power on each component carrier is set to a minimum value.

6.3A.1.2.2 Test applicability

This test case applies to all types of NR UE release 15 and forward that supports FR2 3UL CA.

6.3A.1.2.3 Minimum conformance requirements

The minimum conformance requirements are defined in clause 6.3A.1.0.

6.3A.1.2.4 Test description

Same as in clause 6.3A.1.1.4 with following exceptions:

- Instead of Table 6.3A.1.1.4.1-1 → use Table 6.3A.1.2.4-1.
- Instead of Table 6.3A.1.1.5-1 and 6.3A.1.1.5-2 → use Table 6.3A.1.2.5-1 and 6.3A.1.2.5-2.

Table 6.3A.1.2.4-1: Test Configuration Table for 3UL CA

Default Conditions						
Test Environment as specified in TS 38.508-1 [10] clause 4.1				Normal		
Test Frequencies as specified in TS 38.508-1 [10] clause 4.3.1.2.3 for different CA bandwidth classes.				Low and High range		
Test CC combination setting as specified in TS 38.508-1 [10] clause 4.3.1.2.3 for the CA Configuration across bandwidth combination sets supported by the UE.				Lowest aggregated BW of the CA configuration Highest aggregated BW of the CA configuration		
Test SCS as specified in Table 5.3.5-1.				Highest		
Test Parameters						
Test ID	CC	ChBw(MHz)	Test frequency	DL RB allocation	UL Modulation	UL RB allocation
1	PCC	Default	Default	-	DFT-s-OFDM QPSK	Outer_Full
	SCC1				DFT-s-OFDM QPSK	Outer_Full
	SCC2				DFT-s-OFDM QPSK	Outer_Full
NOTE 1: The specific configuration of each RB allocation is defined in Table 6.1-1 for PC2, PC3, PC4, PC5 and PC6 or Table 6.1-2 for PC1.						
NOTE 2: Number of DL CCs shall be configured the same as number of UL CCs. The requirements are applicable as per 5.3A.4: "The requirements are applicable only when Uplink CCs are configured within the frequency range between lower edge of lowest downlink component carrier and upper edge of highest downlink component carrier".						

6.3A.1.2.5 Test requirement

For each component carrier, the minimum EIRP shall not exceed the values specified in Table 6.3A.1.2.5-1 and 6.3A.1.2.5-2.

Table 6.3A.1.2.5-1: Minimum output power for 3UL CA for power class 1

Operating band	Channel bandwidth (MHz)	Minimum output power (dBm)	Measurement bandwidth (MHz)
n257, n258, n260, n261	50	4+TBD+TT	47.58
	100	4+TBD+TT	95.16
	200	4+TBD+TT	190.20
	400	4+TBD+TT	380.28

Table 6.3A.1.2.5-2: Minimum output power for 3UL CA for power class 3

Operating band	Channel bandwidth (MHz)	Minimum output power (dBm)	Measurement bandwidth (MHz)
n257, n258, n261	50	-13+TT	47.58
	100	-13+2.4+TT	95.16
	200	-13+5.4+TT	190.20
	400	-13+8.4+TT	380.28
n260	50	-13+4.5+TT	47.58
	100	-13+7.5+TT	95.16
	200	-13+10.5+TT	190.20
	400	-13+13.5+TT	380.28
NOTE 1: n260 is not applied for power class 2.			

Table 6.3A.1.2.5-2a: Minimum output power for 3UL CA for power class 2 and 4

Operating band	Channel bandwidth (MHz)	Minimum output power (dBm)	Measurement bandwidth (MHz)
n257, n258, n260, n261	50	-13+TBD+TT	47.58
	100	-13+TBD+TT	95.16
	200	-13+TBD+TT	190.20
	400	-13+TBD+TT	380.28

NOTE 1: n260 is not applied for power class 2.

Table 6.3A.1.2.5-3: Test Tolerance for Minimum output power for 3UL CA for Power class 1

Test Metric	FR2a	FR2b
Max device size ≤ 30 cm	Same as in table 6.3.1.5-1a	Same as in table 6.3.1.5-1a

Table 6.3A.1.2.5-4: Test Tolerance for Minimum output power for 3UL CA for Power class 3

Test Metric	FR2a	FR2b
Max device size ≤ 30 cm	Same as in table 6.3.1.5-2	Same as in table 6.3.1.5-2

Table 6.3A.1.2.5-5: Minimum output power for power class 5

Operating band	Channel bandwidth (MHz)	Minimum output power (dBm)	Test Tolerance TT (dB)	Measurement bandwidth (MHz)
n257, n258	50	-6+TT	3.67 dB	47.58
	100	-6+TT	3.85 dB	95.16
	200	-6+TT	4.18 dB	190.20
	400	-6+1.4+TT ¹	3.38 dB	380.28

NOTE 1: Core requirement cannot be tested due to testability issue and test requirement includes relaxation to achieve impact from test system noise to measurement result = 1.0 dB (Minimum requirement + relaxation).

Table 6.3A.1.2.5-6: Minimum output power for power class 6

Operating band	Channel bandwidth (MHz)	Minimum output power (dBm)	Test Tolerance TT (dB)	Measurement bandwidth (MHz)
n257, n258	50	-6+TT	3.66 dB	47.58
	100	-6+TT	3.84 dB	95.16
	200	-6+TT	4.17 dB	190.20
	400	-6+1.4+TT ¹	3.37 dB	380.28

NOTE 1: Core requirement cannot be tested due to testability issue and test requirement includes relaxation to achieve impact from test system noise to measurement result = 1.0 dB (Minimum requirement + relaxation).

6.3A.1.3 Minimum output power for CA (4UL CA)

Editor's note: The following aspects are either missing or not yet determined:

- Relaxation, Measurement Uncertainties and Test Tolerances are FFS for power class other than 1, 3, 5 and CA other than intra-band contiguous.
- Measurement Uncertainties and Test Tolerances for intra-band contiguous CA supporting aggregated BW > 800MHz is FFS as test system complexity might increase.

6.3A.1.3.1 Test purpose

To verify the UE's ability to transmit with a broadband output power below the value specified in the test requirement when the power on each component carrier is set to a minimum value.

6.3A.1.3.2 Test applicability

This test case applies to all types of NR UE release 15 and forward that supports FR2 4UL CA.

6.3A.1.3.3 Minimum conformance requirements

The minimum conformance requirements are defined in clause 6.3A.1.0.

6.3A.1.3.4 Test description

Same as in clause 6.3A.1.1.4 with following exceptions:

- Instead of Table 6.3A.1.1.4.1-1 → use Table 6.3A.1.3.4-1.
- Instead of Table 6.3A.1.1.5-1 and 6.3A.1.1.5-2 → use Table 6.3A.1.3.5-1 and 6.3A.1.3.5-2.

Table 6.3A.1.3.4-1: Test Configuration Table for 4UL CA

Default Conditions						
Test Environment as specified in TS 38.508-1 [10] clause 4.1				Normal		
Test Frequencies as specified in TS 38.508-1 [10] clause 4.3.1.2.3 for different CA bandwidth classes.				Low and High range		
Test CC combination setting as specified in TS 38.508-1 [10] clause 4.3.1.2.3 for the CA Configuration across bandwidth combination sets supported by the UE.				Lowest aggregated BW of the CA configuration Highest aggregated BW of the CA configuration		
Test SCS as specified in Table 5.3.5-1.				Highest		
Test Parameters						
Test ID	CC	ChBw(MHz)	Test frequency	DL RB allocation	UL Modulation	UL RB allocation
1	PCC	Default	Default	-	DFT-s-OFDM QPSK	Outer_Full
	SCC1				DFT-s-OFDM QPSK	Outer_Full
	SCC2				DFT-s-OFDM QPSK	Outer_Full
	SCC3				DFT-s-OFDM QPSK	Outer_Full
NOTE 1: The specific configuration of each RB allocation is defined in Table 6.1-1 for PC2, PC3, PC4, PC5 and PC6 or Table 6.1-2 for PC1.						
NOTE 2: Number of DL CCs shall be configured the same as number of UL CCs. The requirements are applicable as per 5.3A.4: " <i>The requirements are applicable only when Uplink CCs are configured within the frequency range between lower edge of lowest downlink component carrier and upper edge of highest downlink component carrier</i> ".						

6.3A.1.3.5 Test requirement

For each component carrier, the minimum EIRP shall not exceed the values specified in Table 6.3A.1.3.5-1 and 6.3A.1.3.5-2.

Table 6.3A.1.3.5-1: Minimum output power for 4UL CA for power class 1

Operating band	Channel bandwidth (MHz)	Minimum output power (dBm)	Measurement bandwidth (MHz)
n257, n258, n260, n261	50	4+TBD+TT	47.58
	100	4+TBD+TT	95.16
	200	4+TBD+TT	190.20
	400	4+TBD+TT	380.28

Table 6.3A.1.3.5-2: Minimum output power for 4UL CA for power class 3

Operating band	Channel bandwidth (MHz)	Minimum output power (dBm)	Measurement bandwidth (MHz)
n257, n258, n261	50	-13+TT	47.58
	100	-13+2.4+TT	95.16
	200	-13+5.4+TT	190.20
	400	-13+8.4+TT	380.28
n260	50	-13+4.5+TT	47.58
	100	-13+7.5+TT	95.16
	200	-13+10.5+TT	190.20
	400	-13+13.5+TT	380.28

NOTE 1: n260 is not applied for power class 2.

Table 6.3A.1.3.5-2a: Minimum output power for 4UL CA for power class 2 and 4

Operating band	Channel bandwidth (MHz)	Minimum output power (dBm)	Measurement bandwidth (MHz)
n257, n258, n260, n261	50	-13+TBD+TT	47.58
	100	-13+TBD+TT	95.16
	200	-13+TBD+TT	190.20
	400	-13+TBD+TT	380.28

NOTE 1: n260 is not applied for power class 2.

Table 6.3A.1.3.5-3: Test Tolerance for Minimum output power for 4UL CA for Power class 1

Test Metric	FR2a	FR2b
Max device size ≤ 30 cm	Same as in table 6.3.1.5-1a	Same as in table 6.3.1.5-1a

Table 6.3A.1.3.5-4: Test Tolerance for Minimum output power for 4UL CA for Power class 3

Test Metric	FR2a	FR2b
Max device size ≤ 30 cm	Same as in table 6.3.1.5-2	Same as in table 6.3.1.5-2

Table 6.3A.1.3.5-5: Minimum output power for power class 5

Operating band	Channel bandwidth (MHz)	Minimum output power (dBm)	Test Tolerance TT (dB)	Measurement bandwidth (MHz)
n257, n258	50	-6+TT	3.67 dB	47.58
	100	-6+TT	3.85 dB	95.16
	200	-6+TT	4.18 dB	190.20
	400	-6+1.4+TT ¹	3.38 dB	380.28

NOTE 1: Core requirement cannot be tested due to testability issue and test requirement includes relaxation to achieve impact from test system noise to measurement result = 1.0 dB (Minimum requirement + relaxation).

Table 6.3A.1.3.5-6: Minimum output power for power class 6

Operating band	Channel bandwidth (MHz)	Minimum output power (dBm)	Test Tolerance TT (dB)	Measurement bandwidth (MHz)
n257, n258	50	-6+TT	3.66 dB	47.58
	100	-6+TT	3.84 dB	95.16
	200	-6+TT	4.17 dB	190.20
	400	-6+1.4+TT ¹	3.37 dB	380.28

NOTE 1: Core requirement cannot be tested due to testability issue and test requirement includes relaxation to achieve impact from test system noise to measurement result = 1.0 dB (Minimum requirement + relaxation).

6.3A.1.4 Minimum output power for CA (5UL CA)

Editor's note: The following aspects are either missing or not yet determined:

- Relaxation, Measurement Uncertainties and Test Tolerances are FFS for power class other than 1, 3, 5 and CA other than intra-band contiguous.
- Measurement Uncertainties and Test Tolerances for intra-band contiguous CA supporting aggregated BW > 800MHz is FFS as test system complexity might increase.

6.3A.1.4.1 Test purpose

To verify the UE's ability to transmit with a broadband output power below the value specified in the test requirement when the power on each component carrier is set to a minimum value.

6.3A.1.4.2 Test applicability

This test case applies to all types of NR UE release 15 and forward that supports FR2 5UL CA.

6.3A.1.4.3 Minimum conformance requirements

The minimum conformance requirements are defined in clause 6.3A.1.0.

6.3A.1.4.4 Test description

Same as in clause 6.3A.1.1.4 with following exceptions:

- Instead of Table 6.3A.1.1.4.1-1 → use Table 6.3A.1.4.4-1.
- Instead of Table 6.3A.1.1.5-1 and 6.3A.1.1.5-2 → use Table 6.3A.1.4.5-1 and 6.3A.1.4.5-2.

Table 6.3A.1.4.4-1: Test Configuration Table for 5UL CA

Default Conditions						
Test Environment as specified in TS 38.508-1 [10] clause 4.1				Normal		
Test Frequencies as specified in TS 38.508-1 [10] clause 4.3.1.2.3 for different CA bandwidth classes.				Low and High range		
Test CC combination setting as specified in TS 38.508-1 [10] clause 4.3.1.2.3 for the CA Configuration across bandwidth combination sets supported by the UE.				Lowest aggregated BW of the CA configuration Highest aggregated BW of the CA configuration		
Test SCS as specified in Table 5.3.5-1.				Highest		
Test Parameters						
Test ID	CC	ChBw(MHz)	Test frequency	DL RB allocation	UL Modulation	UL RB allocation
1	PCC	Default	Default	-	DFT-s-OFDM QPSK	Outer_Full
	SCC1				DFT-s-OFDM QPSK	Outer_Full
	SCC2				DFT-s-OFDM QPSK	Outer_Full
	SCC3				DFT-s-OFDM QPSK	Outer_Full
	SCC4				DFT-s-OFDM QPSK	Outer_Full

NOTE 1: The specific configuration of each RB allocation is defined in Table 6.1-1 for PC2, PC3, PC4,PC5 and PC6 or Table 6.1-2 for PC1.
 NOTE 2: Number of DL CCs shall be configured the same as number of UL CCs. The requirements are applicable as per 5.3A.4: "The requirements are applicable only when Uplink CCs are configured within the frequency range between lower edge of lowest downlink component carrier and upper edge of highest downlink component carrier".

6.3A.1.4.5 Test requirement

For each component carrier, the minimum EIRP shall not exceed the values specified in Table 6.3A.1.4.5-1 and 6.3A.1.4.5-2.

Table 6.3A.1.4.5-1: Minimum output power for 5UL CA for power class 1

Operating band	Channel bandwidth (MHz)	Minimum output power (dBm)	Measurement bandwidth (MHz)
n257, n258, n260, n261	50	4+TBD+TT	47.58
	100	4+TBD+TT	95.16
	200	4+TBD+TT	190.20
	400	4+TBD+TT	380.28

Table 6.3A.1.4.5-2: Minimum output power for 5UL CA for power class 3

Operating band	Channel bandwidth (MHz)	Minimum output power (dBm)	Measurement bandwidth (MHz)
n257, n258, n261	50	-13+TT	47.58
	100	-13+2.4+TT	95.16
	200	-13+5.4+TT	190.20
	400	-13+8.4+TT	380.28
n260	50	-13+4.5+TT	47.58
	100	-13+7.5+TT	95.16
	200	-13+10.5+TT	190.20
	400	-13+13.5+TT	380.28

NOTE 1: n260 is not applied for power class 2.

Table 6.3A.1.4.5-2a: Minimum output power for 5UL CA for power class 2 and 4

Operating band	Channel bandwidth (MHz)	Minimum output power (dBm)	Measurement bandwidth (MHz)
n257, n258, n260, n261	50	-13+TBD+TT	47.58
	100	-13+TBD+TT	95.16
	200	-13+TBD+TT	190.20
	400	-13+TBD+TT	380.28

NOTE 1: n260 is not applied for power class 2.

Table 6.3A.1.4.5-3: Test Tolerance for Minimum output power for 5UL CA for Power class 1

Test Metric	FR2a	FR2b
Max device size ≤ 30 cm	Same as in table 6.3.1.5-1a	Same as in table 6.3.1.5-1a

Table 6.3A.1.4.5-4: Test Tolerance for Minimum output power for 5UL CA for Power class 3

Test Metric	FR2a	FR2b
Max device size ≤ 30 cm	Same as in table 6.3.1.5-2	Same as in Table 6.3.1.5-2

Table 6.3A.1.4.5-5: Minimum output power for power class 5

Operating band	Channel bandwidth (MHz)	Minimum output power (dBm)	Test Tolerance TT (dB)	Measurement bandwidth (MHz)
n257, n258	50	-6+TT	3.67 dB	47.58
	100	-6+TT	3.85 dB	95.16
	200	-6+TT	4.18 dB	190.20
	400	-6+1.4+TT ¹	3.38 dB	380.28

NOTE 1: Core requirement cannot be tested due to testability issue and test requirement includes relaxation to achieve impact from test system noise to measurement result = 1.0 dB (Minimum requirement + relaxation).

Table 6.3A.1.4.5-6: Minimum output power for power class 6

Operating band	Channel bandwidth (MHz)	Minimum output power (dBm)	Test Tolerance TT (dB)	Measurement bandwidth (MHz)
n257, n258	50	-6+TT	3.66 dB	47.58
	100	-6+TT	3.84 dB	95.16
	200	-6+TT	4.17 dB	190.20
	400	-6+1.4+TT ¹	3.37 dB	380.28

NOTE 1: Core requirement cannot be tested due to testability issue and test requirement includes relaxation to achieve impact from test system noise to measurement result = 1.0 dB (Minimum requirement + relaxation).

6.3A.1.5 Minimum output power for CA (6UL CA)

Editor's note: The following aspects are either missing or not yet determined:

- Relaxation, Measurement Uncertainties and Test Tolerances are FFS for power class other than 1, 3, 5, 6 and CA other than intra-band contiguous.
- Measurement Uncertainties and Test Tolerances for intra-band contiguous CA supporting aggregated BW > 800MHz is FFS as test system complexity might increase.

6.3A.1.5.1 Test purpose

To verify the UE's ability to transmit with a broadband output power below the value specified in the test requirement when the power on each component carrier is set to a minimum value.

6.3A.1.5.2 Test applicability

This test case applies to all types of NR UE release 15 and forward that supports FR2 6UL CA.

6.3A.1.5.3 Minimum conformance requirements

The minimum conformance requirements are defined in clause 6.3A.1.0.

6.3A.1.5.4 Test description

Same as in clause 6.3A.1.1.4 with following exceptions:

- Instead of Table 6.3A.1.1.4.1-1 → use Table 6.3A.1.5.4-1.
- Instead of Table 6.3A.1.1.5-1 and 6.3A.1.1.5-2 → use Table 6.3A.1.5.5-1 and 6.3A.1.5.5-2.

Table 6.3A.1.5.4-1: Test Configuration Table for 6UL CA

Default Conditions	
Test Environment as specified in TS 38.508-1 [10] clause 4.1	Normal

Test Frequencies as specified in TS 38.508-1 [10] clause 4.3.1.2.3 for different CA bandwidth classes.			Low and High range			
Test CC combination setting as specified in TS 38.508-1 [10] clause 4.3.1.2.3 for the CA Configuration across bandwidth combination sets supported by the UE.			Lowest aggregated BW of the CA configuration Highest aggregated BW of the CA configuration			
Test SCS as specified in Table 5.3.5-1.			Highest			
Test Parameters						
Test ID	CC	ChBw(MHz)	Test frequency	DL RB allocation	UL Modulation	UL RB allocation
1	PCC	Default	Default	-	DFT-s-OFDM QPSK	Outer_Full
	SCC1				DFT-s-OFDM QPSK	Outer_Full
	SCC2				DFT-s-OFDM QPSK	Outer_Full
	SCC3				DFT-s-OFDM QPSK	Outer_Full
	SCC4				DFT-s-OFDM QPSK	Outer_Full
	SCC5				DFT-s-OFDM QPSK	Outer_Full
NOTE 1: The specific configuration of each RB allocation is defined in Table 6.1-1 for PC2, PC3, PC4,PC5 and PC6 or Table 6.1-2 for PC1. NOTE 2: Number of DL CCs shall be configured the same as number of UL CCs. The requirements are applicable as per 5.3A.4: "The requirements are applicable only when Uplink CCs are configured within the frequency range between lower edge of lowest downlink component carrier and upper edge of highest downlink component carrier".						

6.3A.1.5.5 Test requirement

For each component carrier, the minimum EIRP shall not exceed the values specified in Table 6.3A.1.5.5-1 and 6.3A.1.5.5-2.

Table 6.3A.1.5.5-1: Minimum output power for 6UL CA for power class 1

Operating band	Channel bandwidth (MHz)	Minimum output power (dBm)	Measurement bandwidth (MHz)
n257, n258, n260, n261	50	4+TBD+TT	47.58
	100	4+TBD+TT	95.16
	200	4+TBD+TT	190.20
	400	4+TBD+TT	380.28

Table 6.3A.1.5.5-2: Minimum output power for 6UL CA for power class 3

Operating band	Channel bandwidth (MHz)	Minimum output power (dBm)	Measurement bandwidth (MHz)
n257, n258, n261	50	-13+TT	47.58
	100	-13+2.4+TT	95.16
	200	-13+5.4+TT	190.20
	400	-13+8.4+TT	380.28
n260	50	-13+4.5+TT	47.58
	100	-13+7.5+TT	95.16
	200	-13+10.5+TT	190.20
	400	-13+13.5+TT	380.28

NOTE 1: n260 is not applied for power class 2.

Table 6.3A.1.5.5-2a: Minimum output power for 6UL CA for power class 2 and 4

Operating band	Channel bandwidth (MHz)	Minimum output power (dBm)	Measurement bandwidth (MHz)
n257, n258, n260, n261	50	-13+TBD+TT	47.58
	100	-13+TBD+TT	95.16

	200	-13+TBD+TT	190.20
	400	-13+TBD+TT	380.28

NOTE 1: n260 is not applied for power class 2.

Table 6.3A.1.5.5-3: Test Tolerance for Minimum output power for 6UL CA for Power class 1

Test Metric	FR2a	FR2b
Max device size ≤ 30 cm	Same as in table 6.3.1.5-1a	Same as in table 6.3.1.5-1a

Table 6.3A.1.5.5-4: Test Tolerance for Minimum output power for 6UL CA for Power class 3

Test Metric	FR2a	FR2b
Max device size ≤ 30 cm	Same as in table 6.3.1.5-2	Same as in table 6.3.1.5-2

Table 6.3A.1.5.5-5: Minimum output power for power class 5

Operating band	Channel bandwidth (MHz)	Minimum output power (dBm)	Test Tolerance TT (dB)	Measurement bandwidth (MHz)
n257, n258	50	-6+TT	3.67 dB	47.58
	100	-6+TT	3.85 dB	95.16
	200	-6+TT	4.18 dB	190.20
	400	-6+1.4+TT ¹	3.38 dB	380.28

NOTE 1: Core requirement cannot be tested due to testability issue and test requirement includes relaxation to achieve impact from test system noise to measurement result = 1.0 dB (Minimum requirement + relaxation).

Table 6.3A.1.5.5-6: Minimum output power for power class 6

Operating band	Channel bandwidth (MHz)	Minimum output power (dBm)	Test Tolerance TT (dB)	Measurement bandwidth (MHz)
n257, n258	50	-6+TT	3.66 dB	47.58
	100	-6+TT	3.84 dB	95.16
	200	-6+TT	4.17 dB	190.20
	400	-6+1.4+TT ¹	3.37 dB	380.28

NOTE 1: Core requirement cannot be tested due to testability issue and test requirement includes relaxation to achieve impact from test system noise to measurement result = 1.0 dB (Minimum requirement + relaxation).

6.3A.1.6 Minimum output power for CA (7UL CA)

Editor's note: The following aspects are either missing or not yet determined:

- Relaxation, Measurement Uncertainties and Test Tolerances are FFS for power class other than 1, 3, 5, 6 and CA other than intra-band contiguous.
- Measurement Uncertainties and Test Tolerances for intra-band contiguous CA supporting aggregated BW > 800MHz is FFS as test system complexity might increase.

6.3A.1.6.1 Test purpose

To verify the UE's ability to transmit with a broadband output power below the value specified in the test requirement when the power on each component carrier is set to a minimum value.

6.3A.1.6.2 Test applicability

This test case applies to all types of NR UE release 15 and forward that supports FR2 7UL CA.

6.3A.1.6.3 Minimum conformance requirements

The minimum conformance requirements are defined in clause 6.3A.1.0.

6.3A.1.6.4 Test description

Same as in clause 6.3A.1.1.4 with following exceptions:

- Instead of Table 6.3A.1.1.4.1-1 → use Table 6.3A.1.6.4-1.
- Instead of Table 6.3A.1.1.5-1 and 6.3A.1.1.5-2 → use Table 6.3A.1.6.5-1 and 6.3A.1.6.5-2.

Table 6.3A.1.6.4-1: Test Configuration Table for 7UL CA

Default Conditions						
Test Environment as specified in TS 38.508-1 [10] clause 4.1				Normal		
Test Frequencies as specified in TS 38.508-1 [10] clause 4.3.1.2.3 for different CA bandwidth classes.				Low and High range		
Test CC combination setting as specified in TS 38.508-1 [10] clause 4.3.1.2.3 for the CA Configuration across bandwidth combination sets supported by the UE.				Lowest aggregated BW of the CA configuration Highest aggregated BW of the CA configuration		
Test SCS as specified in Table 5.3.5-1.				Highest		
Test Parameters						
Test ID	CC	ChBw(MHz)	Test frequency	DL RB allocation	UL Modulation	UL RB allocation
1	PCC	Default	Default	-	DFT-s-OFDM QPSK	Outer_Full
	SCC1				DFT-s-OFDM QPSK	Outer_Full
	SCC2				DFT-s-OFDM QPSK	Outer_Full
	SCC3				DFT-s-OFDM QPSK	Outer_Full
	SCC4				DFT-s-OFDM QPSK	Outer_Full
	SCC5				DFT-s-OFDM QPSK	Outer_Full
	SCC6				DFT-s-OFDM QPSK	Outer_Full
NOTE 1: The specific configuration of each RB allocation is defined in Table 6.1-1 for PC2, PC3, PC4,PC5 and PC6 or Table 6.1-2 for PC1.						
NOTE 2: Number of DL CCs shall be configured the same as number of UL CCs. The requirements are applicable as per 5.3A.4: "The requirements are applicable only when Uplink CCs are configured within the frequency range between lower edge of lowest downlink component carrier and upper edge of highest downlink component carrier".						

6.3A.1.6.5 Test requirement

For each component carrier, the minimum EIRP shall not exceed the values specified in Table 6.3A.1.6.5-1 and 6.3A.1.6.5-2.

Table 6.3A.1.6.5-1: Minimum output power for 7UL CA for power class 1

Operating band	Channel bandwidth (MHz)	Minimum output power (dBm)	Measurement bandwidth (MHz)
n257, n258, n260, n261	50	4+TBD+TT	47.58
	100	4+TBD+TT	95.16
	200	4+TBD+TT	190.20
	400	4+TBD+TT	380.28

Table 6.3A.1.6.5-2: Minimum output power for 7UL CA for power class 3

Operating band	Channel bandwidth (MHz)	Minimum output power (dBm)	Measurement bandwidth (MHz)
n257, n258, n261	50	-13+TT	47.58
	100	-13+2.4+TT	95.16
	200	-13+5.4+TT	190.20
	400	-13+8.4+TT	380.28
n260	50	-13+4.5+TT	47.58
	100	-13+7.5+TT	95.16
	200	-13+10.5+TT	190.20
	400	-13+13.5+TT	380.28

NOTE 1: n260 is not applied for power class 2.

Table 6.3A.1.6.5-2a: Minimum output power for 7UL CA for power class 2 and 4

Operating band	Channel bandwidth (MHz)	Minimum output power (dBm)	Measurement bandwidth (MHz)
n257, n258, n260, n261	50	-13+TBD+TT	47.58
	100	-13+TBD+TT	95.16
	200	-13+TBD+TT	190.20
	400	-13+TBD+TT	380.28

NOTE 1: n260 is not applied for power class 2.

Table 6.3A.1.6.5-3: Test Tolerance for Minimum output power for 7UL CA for Power class 1

Test Metric	FR2a	FR2b
Max device size ≤ 30 cm	Same as in table 6.3.1.5-1a	Same as in table 6.3.1.5-1a

Table 6.3A.1.6.5-4: Test Tolerance for Minimum output power for 7UL CA for Power class 3

Test Metric	FR2a	FR2b
Max device size ≤ 30 cm	Same as in table 6.3.1.5-2	Same as in table 6.3.1.5-2

Table 6.3A.1.6.5-5: Minimum output power for power class 5

Operating band	Channel bandwidth (MHz)	Minimum output power (dBm)	Test Tolerance TT (dB)	Measurement bandwidth (MHz)
n257, n258	50	-6+TT	3.67 dB	47.58
	100	-6+TT	3.85 dB	95.16
	200	-6+TT	4.18 dB	190.20
	400	-6+1.4+TT ¹	3.38 dB	380.28

NOTE 1: Core requirement cannot be tested due to testability issue and test requirement includes relaxation to achieve impact from test system noise to measurement result = 1.0 dB (Minimum requirement + relaxation).

Table 6.3A.1.6.5-6: Minimum output power for power class 6

Operating band	Channel bandwidth (MHz)	Minimum output power (dBm)	Test Tolerance TT (dB)	Measurement bandwidth (MHz)
n257, n258	50	-6+TT	3.66 dB	47.58
	100	-6+TT	3.84 dB	95.16
	200	-6+TT	4.17 dB	190.20
	400	-6+1.4+TT ¹	3.37 dB	380.28

NOTE 1: Core requirement cannot be tested due to testability issue and test requirement includes relaxation to achieve impact from test system noise to measurement result = 1.0 dB (Minimum requirement + relaxation).

6.3A.1.7 Minimum output power for CA (8UL CA)

Editor's note: The following aspects are either missing or not yet determined:

- Relaxation, Measurement Uncertainties and Test Tolerances are FFS for power class other than 1, 3, 5, 6 and CA other than intra-band contiguous.
- Measurement Uncertainties and Test Tolerances for intra-band contiguous CA supporting aggregated BW > 800MHz is FFS as test system complexity might increase.

6.3A.1.7.1 Test purpose

To verify the UE's ability to transmit with a broadband output power below the value specified in the test requirement when the power on each component carrier is set to a minimum value.

6.3A.1.7.2 Test applicability

This test case applies to all types of NR UE release 15 and forward that supports FR2 8UL CA.

6.3A.1.7.3 Minimum conformance requirements

The minimum conformance requirements are defined in clause 6.3A.1.0.

6.3A.1.7.4 Test description

Same as in clause 6.3A.1.1.4 with following exceptions:

- Instead of Table 6.3A.1.1.4.1-1 → use Table 6.3A.1.7.4-1.
- Instead of Table 6.3A.1.1.5-1 and 6.3A.1.1.5-2 → use Table 6.3A.1.7.5-1 and 6.3A.1.7.5-2.

Table 6.3A.1.7.4-1: Test Configuration Table for 8UL CA

Default Conditions						
Test Environment as specified in TS 38.508-1 [10] clause 4.1				Normal		
Test Frequencies as specified in TS 38.508-1 [10] clause 4.3.1.2.3 for different CA bandwidth classes.				Low and High range		
Test CC combination setting as specified in TS 38.508-1 [10] clause 4.3.1.2.3 for the CA Configuration across bandwidth combination sets supported by the UE.				Lowest aggregated BW of the CA configuration Highest aggregated BW of the CA configuration		
Test SCS as specified in Table 5.3.5-1.				Highest		
Test Parameters						
Test ID	CC	ChBw(MHz)	Test frequency	DL RB allocation	UL Modulation	UL RB allocation
1	PCC	Default	Default	-	DFT-s-OFDM QPSK	Outer_Full
	SCC1				DFT-s-OFDM QPSK	Outer_Full
	SCC2				DFT-s-OFDM QPSK	Outer_Full
	SCC3				DFT-s-OFDM QPSK	Outer_Full
	SCC4				DFT-s-OFDM QPSK	Outer_Full
	SCC5				DFT-s-OFDM QPSK	Outer_Full
	SCC6				DFT-s-OFDM QPSK	Outer_Full

	SCC7				DFT-s-OFDM QPSK	Outer_Full
NOTE 1: The specific configuration of each RB allocation is defined in Table 6.1-1 for PC2, PC3, PC4 and PC5 or Table 6.1-2 for PC1. NOTE 2: Number of DL CCs shall be configured the same as number of UL CCs. The requirements are applicable as per 5.3A.4: " <i>The requirements are applicable only when Uplink CCs are configured within the frequency range between lower edge of lowest downlink component carrier and upper edge of highest downlink component carrier</i> ".						

6.3A.1.7.5 Test requirement

For each component carrier, the minimum EIRP shall not exceed the values specified in Table 6.3A.1.7.5-1 and 6.3A.1.7.5-2.

Table 6.3A.1.7.5-1: Minimum output power for 8UL CA for power class 1

Operating band	Channel bandwidth (MHz)	Minimum output power (dBm)	Measurement bandwidth (MHz)
n257, n258, n260, n261	50	4+TBD+TT	47.58
	100	4+TBD+TT	95.16
	200	4+TBD+TT	190.20
	400	4+TBD+TT	380.28

Table 6.3A.1.7.5-2: Minimum output power for 8UL CA for power class 3

Operating band	Channel bandwidth (MHz)	Minimum output power (dBm)	Measurement bandwidth (MHz)
n257, n258, n261	50	-13+TT	47.58
	100	-13+2.4+TT	95.16
	200	-13+5.4+TT	190.20
	400	-13+8.4+TT	380.28
n260	50	-13+4.5+TT	47.58
	100	-13+7.5+TT	95.16
	200	-13+10.5+TT	190.20
	400	-13+13.5+TT	380.28

NOTE 1: n260 is not applied for power class 2.

Table 6.3A.1.7.5-2a: Minimum output power for 8UL CA for power class 2 and 4

Operating band	Channel bandwidth (MHz)	Minimum output power (dBm)	Measurement bandwidth (MHz)
n257, n258, n260, n261	50	-13+TBD+TT	47.58
	100	-13+TBD+TT	95.16
	200	-13+TBD+TT	190.20
	400	-13+TBD+TT	380.28

NOTE 1: n260 is not applied for power class 2.

Table 6.3A.1.7.5-3: Test Tolerance for Minimum output power for 8UL CA for Power class 1

Test Metric	FR2a	FR2b
Max device size ≤ 30 cm	Same as in table 6.3.1.5-1a	Same as in table 6.3.1.5-1a

Table 6.3A.1.7.5-4: Test Tolerance for Minimum output power for 8UL CA for Power class 3

Test Metric	FR2a	FR2b
Max device size ≤ 30 cm	Same as in table 6.3.1.5-2	Same as in table 6.3.1.5-2

Table 6.3A.1.7.5-5: Minimum output power for power class 5

Operating band	Channel bandwidth (MHz)	Minimum output power (dBm)	Test Tolerance TT (dB)	Measurement bandwidth (MHz)
n257, n258	50	-6+TT	3.67 dB	47.58
	100	-6+TT	3.85 dB	95.16
	200	-6+TT	4.18 dB	190.20
	400	-6+1.4+TT ¹	3.38 dB	380.28
NOTE 1: Core requirement cannot be tested due to testability issue and test requirement includes relaxation to achieve impact from test system noise to measurement result = 1.0 dB (Minimum requirement + relaxation).				

Table 6.3A.1.7.5-6: Minimum output power for power class 6

Operating band	Channel bandwidth (MHz)	Minimum output power (dBm)	Test Tolerance TT (dB)	Measurement bandwidth (MHz)
n257, n258	50	-6+TT	3.66 dB	47.58
	100	-6+TT	3.84 dB	95.16
	200	-6+TT	4.17 dB	190.20
	400	-6+1.4+TT ¹	3.37 dB	380.28
NOTE 1: Core requirement cannot be tested due to testability issue and test requirement includes relaxation to achieve impact from test system noise to measurement result = 1.0 dB (Minimum requirement + relaxation).				

6.3A.2 Transmit OFF power for CA

6.3A.2.0 Minimum conformance requirements

For intra-band contiguous carrier aggregation, the transmit OFF power is defined as the TRP in the channel bandwidth per component carrier when the transmitter is OFF. The transmitter is considered OFF when the UE is not allowed to transmit or during periods when the UE is not transmitting a sub-frame. During DTX and measurements gaps, the transmitter is not considered OFF.

The transmit OFF power shall not exceed the values specified in Table 6.3A.2.0-1 for each operating band supported.

Table 6.3A.2.0-1: Transmit OFF power for CA

Operating band	Channel bandwidth / Transmit OFF power (dBm) / measurement bandwidth			
	50 MHz	100 MHz	200 MHz	400 MHz
n257, n258, n260, n261	-35	-35	-35	-35
	47.58 MHz	95.16 MHz	190.20 MHz	380.28 MHz

The normative reference for this requirement is TS 38.101-2 [3] clause 6.3A.2.

6.3A.2.1 Void

6.3A.2.2 Void

6.3A.2.3 Void

6.3A.3 Transmit ON/OFF time mask for CA

6.3A.3.0 Minimum conformance requirements

For intra-band contiguous carrier aggregation, the general output power ON/OFF time mask specified in clause 6.3.3.2 is applicable for each component carrier during the ON power period and the transient periods. The OFF period as specified in clause 6.3.3.2 shall only be applicable for each component carrier when all the component carriers are OFF.

The normative reference for this requirement is TS 38.101-2 [3] clause 6.3A.3.

6.3A.3.1 General ON/OFF time mask for CA

6.3A.3.1.1 General ON/OFF time mask for CA (2UL CA)

Editor's note: The following aspects are either missing or not yet determined:

- Measurement Uncertainties and Test Tolerances and Test limit analysis for intra-band contiguous CA supporting aggregated BW > 400MHz is TBD.
- Measurement Uncertainties and Test Tolerances and Test limit analysis are FFS for power class 1, 2, 4, 5, 6 and 7.

6.3A.3.1.1.1 Test purpose

To verify that the general ON/OFF time mask for CA meets the requirements given in 6.3A.3.1.1.5. Transmission of the wrong power increases interference to other channels, or increases transmission errors in the uplink channel.

6.3A.3.1.1.2 Test applicability

The requirements of this test apply to all types of NR UE release 15 and forward supporting 2UL CA.

6.3A.3.1.1.3 Minimum conformance requirements

The minimum conformance requirements are defined in clause 6.3A.3.0.

6.3A.3.1.1.4 Test description

6.3A.3.1.1.4.1 Initial conditions

Initial conditions are a set of test configurations the UE needs to be tested in and the steps for the SS to take with the UE to reach the correct measurement state.

The initial test configurations consist of environmental conditions, test frequencies, and CC combinations based on NR operating bands specified in clause 5.5A. All of these configurations shall be tested with applicable test parameters for each CA configuration and subcarrier spacing, are shown in Table 6.3A.3.1.1.4.1-1. The details of the uplink reference measurement channels (RMCs) are specified in Annexes A.2. Configurations of PDSCH and PDCCCH before measurement are specified in Annex C.2.

Table 6.3A.3.1.1.4.1-1: Intra-band Contiguous UL CA Test Configuration Table

Default Conditions	
Test Environment as specified in TS 38.508-1 [10] clause 4.1	Normal, TL, TH

Test Frequencies as specified in TS 38.508-1 [10] clause 4.3.1.2.3 for different CA bandwidth classes			Low and High range		
Test CC Combination setting (aggregated BW of the CA configuration) as specified in TS 38.508-1 [10] clause 4.3.1.2.3 for the CA Configuration across bandwidth combination sets supported by the UE			Lowest N_{RB_agg} , Highest N_{RB_agg} (≤ 400 MHz aggregated channel bandwidth)		
Test SCS as specified in Table 5.3.5-1			Highest		
Test Parameters					
CA Configuration / Aggregated BW			Downlink Configuration	Uplink Configuration	
Test ID	CC & Mapping (NOTE 3)	CBW (MHz)	RB allocation	Modulation	RB allocation (NOTE 1)
1	PCC/CC1	100	-	DFT-s-OFDM QPSK	Inner Full for PC2, PC3 and PC4 Inner_Full_Region1 for PC1
	SCC/CC2	100		-	-
2	PCC/CC1	200		DFT-s-OFDM QPSK	Inner Full for PC2, PC3 and PC4 Inner_Full_Region1 for PC1
	SCC/CC2	200		-	-
NOTE 1: The specific configuration of each RF allocation is defined in Table 6.1-1 for PC2, PC3 and PC4 or Table 6.1-2 for PC1.					
NOTE 2: CA Configuration Test cumulative aggregated BW settings are checked separately for each CA Configuration, which applicable aggregated channel bandwidths are specified in Table 5.5A.1-1.					
NOTE 3: PCC/CC _i and SCC/CC _j means PCC is on component carrier CC _i and SCC is on component carrier CC _j , with CC _i or CC _j frequencies defined in TS38.508-1 [10].					
NOTE 4: Number of DL CCs shall be configured the same as number of UL CCs. The requirements are applicable as per 5.3A.4: "The requirements are applicable only when Uplink CCs are configured within the frequency range between lower edge of lowest downlink component carrier and upper edge of highest downlink component carrier".					

1. Connection between SS and UE is shown in TS 38.508-1 [10] Annex A, Figure A.3.3.1.1 for TE diagram and Figure A.3.4.1.1 for UE diagram.
2. The parameter settings for the cell are set up according to TS 38.508-1 [10] clause 4.4.3.
3. Downlink signals are initially set up according to Annex C, and uplink signals according to Annex G.
4. The UL Reference Measurement channels are set according to Table 6.3A.3.1.1.4.1-1.
5. Propagation conditions are set according to Annex B.0
6. Ensure the UE is in state RRC_CONNECTED with generic procedure parameters Connectivity *NR*, Connected without release *On*, Test Mode *On* and Test Loop Function *On* according to TS 38.508-1 [10] clause 4.5. Message contents are defined in clause 6.3A.3.1.1.4.3.

6.3A.3.1.1.4.2 Test procedure

1. Configure SCC according to Annex C.0, C.1, C.2 and Annex C.3.0 for all downlink physical channels
2. The SS shall configure SCC as per TS 38.508-1 [10] clause 5.5.1 Procedure to configure SCC(s) for NR RF CA testing. Message contents are defined in clause 6.3A.3.1.1.4.3.
3. SS activates SCC by sending the activation MAC CE (Refer TS 38.321 [28], clauses 5.9, 6.1.3.10). Wait for at least 2 seconds (Refer TS 38.133[25], clause 9.3).
4. SS sends uplink scheduling information for each UL HARQ process via PDCCH DCI format 0_1 for C_RNTI to schedule the UL RMC according to Table 6.3A.3.1.1.4.1-1. Since the UL has no payload and no loopback data to send the UE sends uplink MAC padding bits on the UL RMC. The UL assignment is such that the UE transmits on slot 37 for 60kHz SCS and on slot 74 for 120kHz SCS.
5. Set the UE in the Tx beam peak direction found with a 3D EIRP scan as performed in Annex K.1.1. Allow at least BEAM_SELECT_WAIT_TIME (NOTE 1) for the UE Tx beam selection to complete.

6. Send continuously uplink power control "up" commands in every uplink scheduling information to the UE; allow at least 200 ms for the UE to reach maximum output power. Allow at least BEAM_SELECT_WAIT_TIME (NOTE 1) for the UE Tx beam selection to complete.
7. SS activates the UE Beamlock Function (UBF) by performing the procedure as specified in TS 38.508-1 [10] clause 4.9.2 using condition Tx only.
8. For UE transmission OFF power, measure UE EIRP in the Tx beam peak direction for the PCC in the channel bandwidth of the radio access mode according to the test configuration, which shall meet the requirements described in Table 6.3A.3.1.1.5-1. EIRP test procedure is defined in Annex K. The period of the measurement shall be the slot prior to the PUSCH transmission, excluding a transient period of 5 μ s in the end of the slot and any DL periods. EIRP is calculated considering both polarizations, theta and phi.
9. For UE transmission ON power, measure UE EIRP in the Tx beam peak direction for the PCC in the channel bandwidth of the radio access mode according to the test configuration, which shall meet the requirements described in Table 6.3A.3.1.1.5-2. EIRP test procedure is defined in Annex K. The period of the measurement shall be one slot with PUSCH transmission. EIRP is calculated considering both polarizations, theta and phi. For TDD slots with transient periods are not under test.
10. For UE transmission OFF power, measure UE EIRP in the Tx beam peak direction for the PCC in the channel bandwidth of the radio access mode according to the test configuration, which shall meet the requirements described in Table 6.3A.3.1.1.5-1. EIRP test procedure is defined in Annex K. The period of the measurement shall be the slot following the PUSCH transmission, excluding a transient period of 5 μ s at the beginning of the slot and any DL periods. EIRP is calculated considering both polarizations, theta and phi.
11. SS deactivates the UE Beamlock Function (UBF) by performing the procedure as specified in TS 38.508-1 [10] clause 4.9.3.

NOTE 1: The BEAM_SELECT_WAIT_TIME default value is defined in Annex K.

6.3A.3.1.1.4.3 Message contents

Message contents are according to TS 38.508-1 [10] clause 4.6 with TRANSFORM_PRECODER_ENABLED condition in Table 4.6.3-118 PUSCH-Config.

Table 6.3A.3.1.1.4.3-1: Void

Table 6.3A.3.1.1.4.3-2: Void

Table 6.3A.3.1.1.4.3-3: Void

Table 6.3A.3.1.1.4.3-4: Void

6.3A.3.1.1.5 Test requirements

The requirement for the power measured in steps 7, 8 and 9 of the test procedure shall not exceed the values specified in Table 6.3A.3.1.1.5-1 and Table 6.3A.3.1.1.5-2.

Table 6.3A.3.1.1.5-1: Test requirement of OFF power of General ON/OFF time mask for 2UL CA PC3

	Channel bandwidth / minimum output power / measurement bandwidth			
	50 MHz	100 MHz	200 MHz	400 MHz
Transmit OFF power	$\leq -30 + TT + R$ dBm			
Transmission OFF Measurement bandwidth	47.58 MHz	95.16 MHz	190.20 MHz	380.28 MHz

NOTE 1: Core requirement cannot be tested due to testability issue and test requirement includes relaxation to achieve impact from test system noise to measurement result = 1.0 dB (Minimum requirement + relaxation R).
 NOTE 2: Relaxation R is specified in Table 6.3.3.2.5-5.
 NOTE 3: TT = 0 dB.

Table 6.3A.3.1.1.5-2: Test requirement of ON power of General ON/OFF time mask for 2UL CA PC3

	Channel bandwidth / minimum output power / measurement bandwidth			
	50 MHz	100 MHz	200 MHz	400 MHz
Transmit ON power	For intra-band contiguous CA configurations, the test requirement of transmit on power of 2UL CA is the same as the EIRP requirements in Table 6.2A.1.1.1.5-3 with TT specified in Table 6.2A.1.1.1.5-3c:.			

Table 6.3A.3.1.1.5-3: Void

Table 6.3A.3.1.1.5-4: Void

6.3A.3.1.2 General ON/OFF time mask for CA (3UL CA)

Editor's note: The following aspects are either missing or not yet determined:

- *Measurement Uncertainties and Test Tolerances for intra-band contiguous CA supporting aggregated BW > 400MHz is TBD.*
- *Measurement Uncertainties and Test Tolerances are FFS for power class 1, 2, 4, 5, 6 and 7.*

6.3A.3.1.2.1 Test purpose

To verify that the general ON/OFF time mask for CA meets the requirements given in 6.3A.3.1.2.5. Transmission of the wrong power increases interference to other channels, or increases transmission errors in the uplink channel.

6.3A.3.1.2.2 Test applicability

The requirements of this test apply to all types of NR UE release 15 and forward supporting 3UL CA.

6.3A.3.1.2.3 Minimum conformance requirements

The minimum conformance requirements are defined in clause 6.3A.3.0.

6.3A.3.1.2.4 Test description

Same as in clause 6.3A.3.1.1.4 with following exceptions:

- Instead of Table 6.3A.3.1.1.4.1-1 → use Table 6.3A.3.1.2.4.1-1.

Table 6.3A.3.1.2.4.1-1: Intra-band Contiguous 3UL CA Test Configuration Table

Default Conditions	
Test Environment as specified in TS 38.508-1 [10] clause 4.1	Normal, TL, TH
Test Frequencies as specified in TS 38.508-1 [10] clause 4.3.1.2.3 for different CA bandwidth classes	Low and High range
Test CC Combination setting (aggregated BW of the CA configuration) as specified in TS 38.508-1 [10] clause 4.3.1.2.3 for the CA Configuration across bandwidth combination sets supported by the UE	Lowest N _{RB_agg} , Highest N _{RB_agg} (≤ 400 MHz aggregated channel bandwidth)
Test SCS as specified in Table 5.3.5-1	Highest
Test Parameters	

CA Configuration / Aggregated BW			Downlink Configuration	Uplink Configuration	
Test ID	CC & Mapping (NOTE 3)	CBW (MHz)	RB allocation	Modulation	RB allocation (NOTE 1)
1	PCC/CC1	100	-	DFT-s-OFDM QPSK	Inner Full for PC2, PC3 and PC4 Inner_Full_Region1 for PC1
	SCC/CC2	100		-	-
	SCC/CC3	100		-	-

NOTE 1: The specific configuration of each RF allocation is defined in Table 6.1-1 for PC2, PC3 and PC4 or Table 6.1-2 for PC1.

NOTE 2: CA Configuration Test cumulative aggregated BW settings are checked separately for each CA Configuration, which applicable aggregated channel bandwidths are specified in Table 5.5A.1-1.

NOTE 3: If the UE supports multiple CC Combinations in the CA Configuration with the same cumulative aggregated BW, only the combination with the lowest PCC ChBW is tested.

NOTE 4: PCC/CCi and SCC/CCj means PCC is on component carrier CCi and SCC is on component carrier CCj, with CCi or CCj frequencies defined in TS38.508-1 [10].

NOTE 5: Number of DL CCs shall be configured the same as number of UL CCs. The requirements are applicable as per 5.3A.4: "The requirements are applicable only when Uplink CCs are configured within the frequency range between lower edge of lowest downlink component carrier and upper edge of highest downlink component carrier".

6.3A.3.1.2.5 Test requirements

The requirement for the power measured in steps 7, 8 and 9 of the test procedure shall not exceed the values specified in Table 6.3A.3.1.2.5-1 and Table 6.3A.3.1.2.5-2.

Table 6.3A.3.1.2.5-1: Test requirement of OFF power of General ON/OFF time mask for 3UL CA

	Channel bandwidth / minimum output power / measurement bandwidth			
	50 MHz	100 MHz	200 MHz	400 MHz
Transmit OFF power	$\leq -30 + TT + R$ dBm			
Transmission OFF Measurement bandwidth	47.58 MHz	95.16 MHz	190.20 MHz	380.28 MHz

NOTE 1: Core requirement cannot be tested due to testability issue and test requirement includes relaxation to achieve impact from test system noise to measurement result = 1.0 dB (Minimum requirement + relaxation R).

NOTE 2: Relaxation R is specified in Table 6.3.3.2.5-5.

NOTE 3: TT = 0 dB.

Table 6.3A.3.1.2.5-2: Test requirement of ON power of General ON/OFF time mask for 3UL CA PC3

	Channel bandwidth / minimum output power / measurement bandwidth			
	50 MHz	100 MHz	200 MHz	400 MHz
Transmit ON power	For intra-band contiguous CA configurations, the test requirement of transmit on power of 3UL CA is the same as the EIRP requirements in Table 6.2A.1.1.2.5-1 with TT specified in Table 6.2A.1.1.2.5-1b.			

6.3A.3.1.3 General ON/OFF time mask for CA (4UL CA)

Editor's note: The following aspects are either missing or not yet determined:

- Measurement Uncertainties and Test Tolerances for intra-band contiguous CA supporting aggregated BW > 400MHz is TBD.
- Measurement Uncertainties and Test Tolerances are FFS for power class 1, 2, 4, 5, 6 and 7.

6.3A.3.1.3.1 Test purpose

To verify that the general ON/OFF time mask for CA meets the requirements given in 6.3A.3.1.3.5. Transmission of the wrong power increases interference to other channels, or increases transmission errors in the uplink channel.

6.3A.3.1.3.2 Test applicability

The requirements of this test apply to all types of NR UE release 15 and forward supporting 4UL CA.

6.3A.3.1.3.3 Minimum conformance requirements

The minimum conformance requirements are defined in clause 6.3A.3.0.

6.3A.3.1.3.4 Test description

Same as in clause 6.3A.3.1.1.4 with following exceptions:

- Instead of Table 6.3A.3.1.1.4.1-1 → use Table 6.3A.3.1.3.4.1-1.

Table 6.3A.3.1.3.4.1-1: Intra-band Contiguous 4UL CA Test Configuration Table

Default Conditions					
Test Environment as specified in TS 38.508-1 [10] clause 4.1			Normal, TL, TH		
Test Frequencies as specified in TS 38.508-1 [10] clause 4.3.1.2.3 for different CA bandwidth classes, and PCC and SCC are mapped onto physical frequencies according to Table 6.1-2			Low and High range		
Test CC Combination setting (cumulative aggregated BW of the CA configuration) as specified in TS 38.508-1 [10] clause 4.3.1.2.3 for the CA Configuration across bandwidth combination sets supported by the UE			Lowest N_{RB_agg} , Highest N_{RB_agg} (≤ 400 MHz aggregated channel bandwidth)		
Test SCS as specified in Table 5.3.5-1			Highest		
Test Parameters					
CA Configuration / Aggregated BW			Downlink Configuration	Uplink Configuration	
Test ID	CC & Mapping (NOTE 3)	ChBw	RB allocation	Modulation	RB allocation (NOTE 1)
1	PCC/CC1	100	-	DFT-s-OFDM QPSK	Inner Full for PC2, PC3 and PC4 Inner_Full_Region1 for PC1
	SCC/CC2	100		-	-
	SCC/CC3	100		-	-
	SCC/CC4	100		-	-
NOTE 1: The specific configuration of each RF allocation is defined in Table 6.1-1 for PC2, PC3 and PC4 or Table 6.1-2 for PC1.					
NOTE 2: CA Configuration Test cumulative aggregated BW settings are checked separately for each CA Configuration, which applicable aggregated channel bandwidths are specified in Table 5.5A.1-1.					
NOTE 3: If the UE supports multiple CC Combinations in the CA Configuration with the same cumulative aggregated BW, only the combination with the lowest PCC ChBW is tested.					
NOTE 4: PCC/CC _i and SCC/CC _j means PCC is on component carrier CC _i and SCC is on component carrier CC _j , with CC _i or CC _j frequencies defined in TS38.508-1 [10].					
NOTE 5: Number of DL CCs shall be configured the same as number of UL CCs. The requirements are applicable as per 5.3A.4: "The requirements are applicable only when Uplink CCs are configured within the frequency range between lower edge of lowest downlink component carrier and upper edge of highest downlink component carrier".					

6.3A.3.1.3.5 Test requirements

The requirement for the power measured in steps 7, 8 and 9 of the test procedure shall not exceed the values specified in Table 6.3A.3.1.3.5-1 and Table 6.3A.3.1.3.5-2.

Table 6.3A.3.1.3.5-1: Test requirement of OFF power of General ON/OFF time mask for 4UL CA PC3

	Channel bandwidth / minimum output power / measurement bandwidth			
	50 MHz	100 MHz	200 MHz	400 MHz
Transmit OFF power	$\leq -30+TT$ dBm			
Transmission OFF Measurement bandwidth	47.58 MHz	95.16 MHz	190.20 MHz	380.28 MHz
NOTE 1: Core requirement cannot be tested due to testability issue and test requirement includes relaxation to achieve impact from test system noise to measurement result = 1.0 dB (Minimum requirement + relaxation R).				
NOTE 2: Relaxation R is specified in Table 6.3.3.2.5-5.				
NOTE 3: TT = 0 dB.				

Table 6.3A.3.1.3.5-2: Test requirement of ON power of General ON/OFF time mask for 4UL CA PC3

	Channel bandwidth / minimum output power / measurement bandwidth			
	50 MHz	100 MHz	200 MHz	400 MHz
Transmit ON power	For intra-band contiguous CA configurations, the test requirement of transmit on power of 3UL CA is the same as the EIRP requirements in Table 6.2A.1.1.3.5-1 with TT specified in Table 6.2A.1.1.3.5-1b.			

6.3A.3.1.4 General ON/OFF time mask for CA (5UL CA)

FFS

6.3A.3.1.5 General ON/OFF time mask for CA (6UL CA)

FFS

6.3A.3.1.6 General ON/OFF time mask for CA (7UL CA)

FFS

6.3A.3.1.7 General ON/OFF time mask for CA (8UL CA)

FFS

6.3A.4 Power control for CA**6.3A.4.1 General**

The requirements in this section apply to a UE when it has at least one of UL or DL configured for CA operation. The requirements on power control accuracy in CA operation apply under normal conditions and are defined as a directional requirement. The requirements are verified in beam locked mode on beam peak direction. The requirements apply for one single PUCCH, PUSCH or SRS transmission of contiguous PRB allocation per configured UL CC with power setting in accordance with Clause 7.1 of TS 38.213 [22].

6.3A.4.2 Absolute power tolerance for CA**6.3A.4.2.0 Minimum conformance requirements**

The absolute power tolerance is the ability of the UE transmitter to set its initial output power to a specific value for the first sub-frame at the start of a contiguous transmission or non-contiguous transmission with a transmission gap on each active component carriers larger than 20 ms. For SRS switching, the absolute power tolerance is the ability of the UE transmitter to set its initial output power to a specific value for the first sub-frame at the start of a contiguous transmission or non-contiguous transmission with a transmission gap on component carriers (to which SRS switching

occurs) larger than 20 ms. The requirement can be tested by time aligning any transmission gaps on the component carriers. For intra-band contiguous CA, the absolute power control tolerance per configured UL CC is given in Tables 6.3.4.2.3-1 and 6.3.4.2.3-2.

6.3A.4.2.1 Absolute power tolerance for CA (2UL CA)

Editor's note: The following aspects are either missing or not yet determined:

- Measurement Uncertainty and Test Tolerances are FFS for power classes other than PC3.
- Measurement Uncertainty and Test Tolerances are FFS for n259.
- UE transmitted power for PC 1, 2 and 4 are FFS
- The UPLF test mode is applicable to UEs Release 16 and forward. This test case is incomplete for Release 15 until UE PHR method is used to prevent SCell drop.

6.3A.4.2.1.1 Test purpose

To verify the UE's ability to transmit with a broadband output power below the value specified in the test requirement when the power is set to a minimum value.

To verify the ability of the UE transmitter to set its initial output power to a specific value at the start of a contiguous transmission or non-contiguous transmission with a long transmission gap, i.e. transmission gap is larger than 20 ms.

6.3A.4.2.1.2 Test applicability

This test case applies to all types of NR UE release 16 and forward that supports FR2 2UL CA.

6.3A.4.2.1.3 Minimum conformance requirements

The minimum conformance requirements are defined in clause 6.3A.4.2.0.

6.3A.4.2.1.4 Test description

6.3A.4.2.1.4.1 Initial condition

Initial conditions are a set of test configurations the UE needs to be tested in and the steps for the SS to take with the UE to reach the correct measurement state.

The initial test configurations consist of environmental conditions, test frequencies, test channel bandwidth and subcarrier spacing based on NR CA configurations based on NR operating bands specified in clause 5.5A. All of these configurations shall be tested with applicable test parameters for each CA combination and subcarrier spacing, are shown in Table 6.3A.4.2.1.4.1-1. The details of the uplink reference measurement channels (RMCs) are specified in Annexes A.2. Configurations of PDSCH and PDCCH before measurement are specified in Annex C.2.

Table 6.3A.4.2.1.4.1-1: Test Configuration Table

Default Conditions						
Test Environment as specified in TS 38.508-1 [10] clause 4.1				Normal		
Test Frequencies as specified in TS 38.508-1 [10] clause 4.3.1.2.3 for different CA bandwidth classes.				Low and High range		
Test CC combination setting as specified in TS 38.508-1 [10] clause 4.3.1.2.3 for the CA Configuration across bandwidth combination sets supported by the UE.				Highest aggregated BW of the CA configuration		
Test SCS as specified in Table 5.3.5-1.				Highest		
Test Parameters						
Test ID	CC	ChBw(MHz)	Test frequency	DL RB allocation	UL Modulation	UL RB allocation (Note 1)
1	PCC	Default	Default	-	DFT-s-OFDM QPSK	Inner_Full

	SCC				DFT-s-OFDM QPSK	Inner_Full
NOTE 1: The specific configuration of each RB allocation is defined in Table 6.1-1 for PC2, PC3 and PC4 or Table 6.1-2 for PC1.						
NOTE 2: Number of DL CCs shall be configured the same as number of UL CCs. The requirements are applicable as per 5.3A.4: " <i>The requirements are applicable only when Uplink CCs are configured within the frequency range between lower edge of lowest downlink component carrier and upper edge of highest downlink component carrier</i> ".						

1. Connection between SS and UE is shown in TS 38.508-1 [10] Annex A, Figure A.3.3.1.1 for TE diagram and Figure A.3.4.1.1 for UE diagram.
2. The parameter settings for the cell are set up according to TS 38.508-1 [10] clause 4.4.3.
3. Downlink signals are initially set up according to Annex C, and uplink signals according to Annex G.
4. The UL Reference Measurement Channel is set according to Table 6.3A.4.2.1.4.1-1.
5. Propagation conditions are set according to Annex B.0.
6. Ensure the UE is in State RRC_CONNECTED with generic procedure parameters Connectivity NR, Connected without release *On*, Test Mode *On* and Test Loop Function *On* according to TS 38.508-1 [10] clause 4.5. Message contents are defined in clause 6.3A.4.2.1.4.3.

6.3A.4.2.1.4.2 Test procedure

1. Configure SCC according to Annex C.0, C.1, C.2, and C.3 for all downlink physical channels.
2. The SS shall configure SCC as per TS 38.508-1 [10] clause 5.5.1. Message contents are defined in clause 6.3A.4.2.1.4.3.
3. Apply the test step based on the 5G NR UE Release:
 - 3a. For Release 16 and forward 5G NR UEs: SS applies a backoff on the PCell power by activating the UE Power Limit Function (UPLF). The ACTIVATE POWER LIMIT REQUEST procedure is performed as specified in TS 38.508-1 [10] clause 4.9.32 using TOTAL NR AGGREGATED BANDWIDTH and PCELL NR bandwidth as per Test CC Combination setting. UE shall transmit ACTIVATE POWER LIMIT RESPONSE to SS. Go to step 4.
 - 3b. For Release 15 5G NR UEs: Test Procedure updates to keep SCell active are FFS. Skip remaining steps.
4. SS activates SCC by sending the activation MAC CE (Refer TS 38.321 [28], clauses 5.9, 6.1.3.10). Wait for at least 2 seconds (Refer TS 38.133[25], clause 9.2).
5. SS sends uplink scheduling information via PDCCH DCI format 0_1 with TPC command 0dB for C_RNTI to schedule the UL RMC according to Table 6.3A.4.2.1.4.1-1 on PCC and SCC(s). Since the UE has no payload and no loopback data to send the UE sends uplink MAC padding bits on the UL RMC.
6. Set the UE in the Tx beam peak direction found with a 3D EIRP scan as performed in Annex K.1.1. Allow at least BEAM_SELECT_WAIT_TIME (NOTE 1) for the UE Tx beam selection to complete.
7. Configure the UE transmitted output power to test point 1 in section 6.3A.4.2.1.4.3. Allow at least BEAM_SELECT_WAIT_TIME (NOTE 1) for the UE Tx beam selection to complete.
8. SS activates the UE Beamlock Function (UBF) by performing the procedure as specified in TS 38.508-1 [10] clause 4.9.2 using condition Tx only.
9. Measure UE EIRP of the first subframe of each component carrier in the Tx beam peak direction in the measurement bandwidth specified in Table 6.3.4.2.5-1 through Table 6.3.4.2.5-3 for the specific channel bandwidth under test. EIRP test procedure is defined in Annex K. The measuring duration is one active uplink subframe. EIRP is calculated considering both polarizations, theta and phi. For TDD slots with transient periods are not under test.
10. SS deactivates the UE Power Limit Function (UPLF) by performing the DEACTIVATE POWER LIMIT REQUEST procedure as specified in TS 38.508-1 [10] clause 4.9.33.

11. SS deactivates the UE Beamlock Function (UBF) by performing the procedure as specified in TS 38.508-1 [10] clause 4.9.3.

12. Repeat test steps 1~11 for measurement for test point 2~3. The timing of the execution between each test point shall be larger than 20ms.

NOTE 1: The BEAM_SELECT_WAIT_TIME default value is defined in Annex K.

6.3A.4.2.1.4.3 Message contents

Same message contents as in clause 6.3.4.2.4.1

Table 6.3A.4.2.1.4.3-1: Void

Table 6.3A.4.2.1.4.3-2: Void

Table 6.3A.4.2.1.4.3-3: Void

Table 6.3A.4.2.1.4.3-5: Void

Table 6.3A.4.2.1.4.3-6: Void

6.3A.4.2.1.5 Test requirement

The measured EIRP in step 8 and 10 shall not to exceed the values specified in Table 6.3.4.2.5-1 through 6.3.4.2.5-3.

Table 6.3A.4.2.1.5-1: Void

Table 6.3A.4.2.1.5-2: Void

Table 6.3A.4.2.1.5-3: Void

Table 6.3A.4.2.1.5-4: Void

Table 6.3A.4.2.1.5-5: Void

6.3A.4.2.2 Absolute power tolerance for CA (3UL CA)

Editor's note: The following aspects are either missing or not yet determined:

- Measurement Uncertainty and Test Tolerances are FFS for power classes other than PC3.
- Measurement Uncertainty and Test Tolerances are FFS for n259.
- UE transmitted power for PC 1, 2 and 4 are FFS
- The UPLF test mode is applicable to UEs Release 16 and forward. This test case is incomplete for Release 15 until UE PHR method is used to prevent SCell drop.

6.3A.4.2.2.1 Test purpose

To verify the UE's ability to transmit with a broadband output power below the value specified in the test requirement when the power is set to a minimum value.

To verify the ability of the UE transmitter to set its initial output power to a specific value at the start of a contiguous transmission or non-contiguous transmission with a long transmission gap, i.e. transmission gap is larger than 20 ms.

6.3A.4.2.2.2 Test applicability

This test case applies to all types of NR UE release 16 and forward that supports FR2 3UL CA.

6.3A.4.2.2.3 Minimum conformance requirements

The minimum conformance requirements are defined in clause 6.3A.4.2.0.

6.3A.4.2.2.4 Test description

Same as in clause 6.3A.4.2.1.4 with the following exceptions:

- Instead of Table 6.3A.4.2.1.4.1-1 → use Table 6.3A.4.2.2.4-1.

Table 6.3A.4.2.2.4-1: Test Configuration Table

Default Conditions						
Test Environment as specified in TS 38.508-1 [10] clause 4.1				Normal		
Test Frequencies as specified in TS 38.508-1 [10] clause 4.3.1.2.3 for different CA bandwidth classes.				Low and High range		
Test CC combination setting as specified in TS 38.508-1 [10] clause 4.3.1.2.3 for the CA Configuration across bandwidth combination sets supported by the UE.				Highest aggregated BW of the CA configuration		
Test SCS as specified in Table 5.3.5-1.				Highest		
Test Parameters						
Test ID	CC	ChBw(MHz)	Test frequency	DL RB allocation	UL Modulation	UL RB allocation (Note 1)
1	PCC	Default	Default	-	DFT-s-OFDM QPSK	Inner_Full
	SCC1				DFT-s-OFDM QPSK	Inner_Full
	SCC2				DFT-s-OFDM QPSK	Inner_Full
NOTE 1: The specific configuration of each RB allocation is defined in Table 6.1-1 for PC2, PC3 and PC4 or Table 6.1-2 for PC1.						
NOTE 2: Number of DL CCs shall be configured the same as number of UL CCs. The requirements are applicable as per 5.3A.4: " <i>The requirements are applicable only when Uplink CCs are configured within the frequency range between lower edge of lowest downlink component carrier and upper edge of highest downlink component carrier</i> ".						

6.3A.4.2.2.5 Test requirement

The measured EIRP in step 8 and 10 shall not to exceed the values specified in Table 6.3.4.2.5-1 through 6.3.4.2.5-3.

Table 6.3A.4.2.2.5-1: Void

Table 6.3A.4.2.2.5-2: Void

Table 6.3A.4.2.2.5-3: Void

Table 6.3A.4.2.2.5-4: Void

Table 6.3A.4.2.2.5-5: Void

6.3A.4.2.3 Absolute power tolerance for CA (4UL CA)

Editor's note: The following aspects are either missing or not yet determined:

- Measurement Uncertainty and Test Tolerances are FFS for power classes other than PC3.

- Measurement Uncertainty and Test Tolerances are FFS for n259.
- UE transmitted power for PC 1, 2 and 4 are FFS
- The UPLF test mode is applicable to UEs Release 16 and forward. This test case is incomplete for Release 15 until UE PHR method is used to prevent SCell drop.

6.3A.4.2.3.1 Test purpose

To verify the UE's ability to transmit with a broadband output power below the value specified in the test requirement when the power is set to a minimum value.

To verify the ability of the UE transmitter to set its initial output power to a specific value at the start of a contiguous transmission or non-contiguous transmission with a long transmission gap, i.e. transmission gap is larger than 20 ms.

6.3A.4.2.3.2 Test applicability

This test case applies to all types of NR UE release 16 and forward that supports FR2 4UL CA.

6.3A.4.2.3.3 Minimum conformance requirements

The minimum conformance requirements are defined in clause 6.3A.4.2.0.

6.3A.4.2.3.4 Test description

Same as in clause 6.3A.4.2.1.4 with the following exceptions:

- Instead of Table 6.3A.4.2.1.4.1-1 → use Table 6.3A.4.2.3.4-1.

Table 6.3A.4.2.3.4-1: Test Configuration Table

Default Conditions						
Test Environment as specified in TS 38.508-1 [10] clause 4.1				Normal		
Test Frequencies as specified in TS 38.508-1 [10] clause 4.3.1.2.3 for different CA bandwidth classes.				Low and High range		
Test CC combination setting as specified in TS 38.508-1 [10] clause 4.3.1.2.3 for the CA Configuration across bandwidth combination sets supported by the UE.				Highest aggregated BW of the CA configuration		
Test SCS as specified in Table 5.3.5-1.				Highest		
Test Parameters						
Test ID	CC	ChBw(MHz)	Test frequency	DL RB allocation	UL Modulation	UL RB allocation (Note 1)
1	PCC	Default	Default	-	DFT-s-OFDM QPSK	Inner_Full
	SCC1				DFT-s-OFDM QPSK	Inner_Full
	SCC2				DFT-s-OFDM QPSK	Inner_Full
	SCC3				DFT-s-OFDM QPSK	Inner_Full
NOTE 1: The specific configuration of each RB allocation is defined in Table 6.1-1 for PC2, PC3 and PC4 or Table 6.1-2 for PC1.						
NOTE 2: Number of DL CCs shall be configured the same as number of UL CCs. The requirements are applicable as per 5.3A.4: "The requirements are applicable only when Uplink CCs are configured within the frequency range between lower edge of lowest downlink component carrier and upper edge of highest downlink component carrier".						

6.3A.4.2.3.5 Test requirement

The measured EIRP in step 8 and 10 shall not to exceed the values specified in Table 6.3.4.2.5-1 through 6.3.4.2.5-3.

Table 6.3A.4.2.3.5-1: Void

Table 6.3A.4.2.3.5-2: Void

Table 6.3A.4.2.3.5-3: Void

Table 6.3A.4.2.3.5-4: Void

Table 6.3A.4.2.3.5-5: Void

6.3A.4.2.4 Absolute power tolerance for CA (5UL CA)

Editor's note: This clause is incomplete. The following aspects are either missing or not yet determined:

- Measurement Uncertainty and Test Tolerances are FFS.
- TP analysis is FFS.
- UE transmitted power for PC 1, 2 and 4 are FFS

6.3A.4.2.4.1 Test purpose

To verify the UE's ability to transmit with a broadband output power below the value specified in the test requirement when the power is set to a minimum value.

To verify the ability of the UE transmitter to set its initial output power to a specific value at the start of a contiguous transmission or non-contiguous transmission with a long transmission gap, i.e. transmission gap is larger than 20 ms.

6.3A.4.2.4.2 Test applicability

This test case applies to all types of NR UE release 16 and forward that supports FR2 5UL CA.

6.3A.4.2.4.3 Minimum conformance requirements

The minimum conformance requirements are defined in clause 6.3A.4.2.0.

6.3A.4.2.4.4 Test description

Same as in clause 6.3A.4.2.1.4 with the following exceptions:

- Instead of Table 6.3A.4.2.1.4.1-1 → use Table 6.3A.4.2.4.4-1.
- Instead of Table 6.3A.4.2.1.5-1 through 6.3A.4.2.1.5-3 → use Table 6.3A.4.2.4.5-1 and 6.3A.4.2.4.5-3.

Table 6.3A.4.2.4.4-1: Test Configuration Table

Default Conditions						
Test Environment as specified in TS 38.508-1 [10] clause 4.1				Normal		
Test Frequencies as specified in TS 38.508-1 [10] clause 4.3.1.2.3 for different CA bandwidth classes.				Low and High range		
Test CC combination setting as specified in TS 38.508-1 [10] clause 4.3.1.2.3 for the CA Configuration across bandwidth combination sets supported by the UE.				Highest aggregated BW of the CA configuration		
Test SCS as specified in Table 5.3.5-1.				Highest		
Test Parameters						
Test ID	CC	ChBw(MHz)	Test frequency	DL RB allocation	UL Modulation	UL RB allocation (Note 1)
1	PCC	Default	Default	-	DFT-s-OFDM QPSK	Outer_Full
	SCC1				DFT-s-OFDM QPSK	Outer_Full

	SCC2				DFT-s-OFDM QPSK	Outer_Full
	SCC3				DFT-s-OFDM QPSK	Outer_Full
	SCC4				DFT-s-OFDM QPSK	Outer_Full

NOTE 1: The specific configuration of each RB allocation is defined in Table 6.1-1 for PC2, PC3 and PC4 or Table 6.1-2 for PC1.
 NOTE 2: Number of DL CCs shall be configured the same as number of UL CCs. The requirements are applicable as per 5.3A.4: "The requirements are applicable only when Uplink CCs are configured within the frequency range between lower edge of lowest downlink component carrier and upper edge of highest downlink component carrier".

6.3A.4.2.4.5 Test requirement

Same as in clause 6.3A.4.2.1.5 with the following exceptions:

- Instead of Table 6.3A.4.2.1.5-1 → use Table 6.3A.4.2.4.5-1.
- Instead of Table 6.3A.4.2.1.5-2 → use Table 6.3A.4.2.4.5-2.
- Instead of Table 6.3A.4.2.1.5-3 → use Table 6.3A.4.2.4.5-3.
- Instead of Table 6.3A.4.2.1.5-4 → use Table 6.3A.4.2.4.5-4.
- Instead of Table 6.3A.4.2.1.5-5 → use Table 6.3A.4.2.4.5-5.

Table 6.3A.4.2.4.5-1: Test Requirements of Absolute power tolerance (Test point 1)

	SCS	Channel bandwidth / expected output power (dBm)			
		50 MHz	100 MHz	200 MHz	400 MHz
Expected Measured power	60kHz	8.1	7.1	8.1	N/A
	120kHz	8.1	7.1	8.1	7.1
Power tolerance		± (14+TT) dB			
Note 1: The lower power limit shall not exceed the minimum output power requirements defined in sub-clause 6.3A.1, and the higher power limit shall not exceed the Max EIRP defined in sub-clause 6.2A.1.					
Note 2: TT for each frequency and channel bandwidth is specified in Table 6.3A.4.2.4.5-4.					

Table 6.3A.4.2.4.5-2: Test Requirements of Absolute power tolerance (Test point 2)

	SCS	Channel bandwidth / expected output power (dBm)			
		50 MHz	100 MHz	200 MHz	400 MHz
Expected Measured power	60kHz	12.1	11.1	12.1	N/A
	120kHz	12.1	11.1	12.1	11.1
Power tolerance		± (12+TT) dB			
Note 1: The lower power limit shall not exceed the minimum output power requirements defined in sub-clause 6.3A.1, and the higher power limit shall not exceed the Max EIRP defined in sub-clause 6.2A.1.					
Note 2: TT for each frequency and channel bandwidth is specified in Table 6.3A.4.2.4.5-5.					

Table 6.3A.4.2.4.5-3: Test Requirements of Absolute power tolerance (Test point 3)

	SCS	Channel bandwidth / expected output power (dBm)			
		50 MHz	100 MHz	200 MHz	400 MHz
Expected Measured power	60kHz	22.1	21.1	22.1	N/A
	120kHz	22.1	21.1	22.1	21.1
Power tolerance		± (12+TT) dB			

Note 1: The lower power limit shall not exceed the minimum output power requirements defined in sub-clause 6.3A.1, and the higher power limit shall not exceed the Max EIRP defined in sub-clause 6.2A.1.

Note 2: TT for each frequency and channel bandwidth is specified in Table 6.3A.4.2.4.5-5.

Table 6.3A.4.2.4.5-4: Test Tolerance (Test point 1)

Test Metric	FR2a	FR2b
IFF (Max device size \leq 30 cm)	[FFS] dB	[FFS] dB

Table 6.3A.4.2.4.5-5: Test Tolerance (Test point 2 and Test point 3)

Test Metric	FR2a	FR2b
IFF (Max device size \leq 30 cm)	[FFS] dB	[FFS] dB

6.3A.4.2.5 Absolute power tolerance for CA (6UL CA)

Editor's note: This clause is incomplete. The following aspects are either missing or not yet determined:

- Measurement Uncertainty and Test Tolerances are FFS.
- TP analysis is FFS.
- UE transmitted power for PC 1, 2 and 4 are FFS

6.3A.4.2.5.1 Test purpose

To verify the UE's ability to transmit with a broadband output power below the value specified in the test requirement when the power is set to a minimum value.

To verify the ability of the UE transmitter to set its initial output power to a specific value at the start of a contiguous transmission or non-contiguous transmission with a long transmission gap, i.e. transmission gap is larger than 20 ms.

6.3A.4.2.5.2 Test applicability

This test case applies to all types of NR UE release 16 and forward that supports FR2 6UL CA.

6.3A.4.2.5.3 Minimum conformance requirements

The minimum conformance requirements are defined in clause 6.3A.4.2.0.

6.3A.4.2.5.4 Test description

Same as in clause 6.3A.4.2.1.4 with the following exceptions:

- Instead of Table 6.3A.4.2.1.4.1-1 \rightarrow use Table 6.3A.4.2.5.4-1.
- Instead of Table 6.3A.4.2.1.5-1 through 6.3A.4.2.1.5-3 \rightarrow use Table 6.3A.4.2.5.5-1 and 6.3A.4.2.5.5-3.

Table 6.3A.4.2.5.4-1: Test Configuration Table

Default Conditions	
Test Environment as specified in TS 38.508-1 [10] clause 4.1	Normal
Test Frequencies as specified in TS 38.508-1 [10] clause 4.3.1.2.3 for different CA bandwidth classes.	Low and High range

Test CC combination setting as specified in TS 38.508-1 [10] clause 4.3.1.2.3 for the CA Configuration across bandwidth combination sets supported by the UE.				Highest aggregated BW of the CA configuration		
Test SCS as specified in Table 5.3.5-1.				Highest		
Test Parameters						
Test ID	CC	ChBw(MHz)	Test frequency	DL RB allocation	UL Modulation	UL RB allocation (Note 1)
1	PCC	Default	Default	-	DFT-s-OFDM QPSK	Outer_Full
	SCC1				DFT-s-OFDM QPSK	Outer_Full
	SCC2				DFT-s-OFDM QPSK	Outer_Full
	SCC3				DFT-s-OFDM QPSK	Outer_Full
	SCC4				DFT-s-OFDM QPSK	Outer_Full
	SCC5				DFT-s-OFDM QPSK	Outer_Full
NOTE 1: The specific configuration of each RB allocation is defined in Table 6.1-1 for PC2, PC3 and PC4 or Table 6.1-2 for PC1.						
NOTE 2: Number of DL CCs shall be configured the same as number of UL CCs. The requirements are applicable as per 5.3A.4: "The requirements are applicable only when Uplink CCs are configured within the frequency range between lower edge of lowest downlink component carrier and upper edge of highest downlink component carrier".						

6.3A.4.2.5.5 Test requirement

Same as in clause 6.3A.4.2.1.5 with the following exceptions:

- Instead of Table 6.3A.4.2.1.5-1 → use Table 6.3A.4.2.5.5-1.
- Instead of Table 6.3A.4.2.1.5-2 → use Table 6.3A.4.2.5.5-2.
- Instead of Table 6.3A.4.2.1.5-3 → use Table 6.3A.4.2.5.5-3.
- Instead of Table 6.3A.4.2.1.5-4 → use Table 6.3A.4.2.5.5-4.
- Instead of Table 6.3A.4.2.1.5-5 → use Table 6.3A.4.2.5.5-5.

Table 6.3A.4.2.5.5-1: Test Requirements of Absolute power tolerance (Test point 1)

	SCS	Channel bandwidth / expected output power (dBm)			
		50 MHz	100 MHz	200 MHz	400 MHz
Expected Measured power	60kHz	8.1	7.1	8.1	N/A
	120kHz	8.1	7.1	8.1	7.1
Power tolerance		± (14+TT) dB			
Note 1: The lower power limit shall not exceed the minimum output power requirements defined in sub-clause 6.3A.1, and the higher power limit shall not exceed the Max EIRP defined in sub-clause 6.2A.1.					
Note 2: TT for each frequency and channel bandwidth is specified in Table 6.3A.4.2.5.5-4.					

Table 6.3A.4.2.5.5-2: Test Requirements of Absolute power tolerance (Test point 2)

	SCS	Channel bandwidth / expected output power (dBm)			
		50 MHz	100 MHz	200 MHz	400 MHz
Expected Measured power	60kHz	12.1	11.1	12.1	N/A
	120kHz	12.1	11.1	12.1	11.1
Power tolerance		± (12+TT) dB			
Note 1: The lower power limit shall not exceed the minimum output power requirements defined in sub-clause 6.3A.1, and the higher power limit shall not exceed the Max EIRP defined in sub-clause 6.2A.1.					
Note 2: TT for each frequency and channel bandwidth is specified in Table 6.3A.4.2.5.5-5.					

Table 6.3A.4.2.5.5-3: Test Requirements of Absolute power tolerance (Test point 3)

	SCS	Channel bandwidth / expected output power (dBm)			
		50 MHz	100 MHz	200 MHz	400 MHz
Expected Measured power	60kHz	22.1	21.1	22.1	N/A
	120kHz	22.1	21.1	22.1	21.1
Power tolerance		$\pm (12+TT)$ dB			
Note 1: The lower power limit shall not exceed the minimum output power requirements defined in sub-clause 6.3A.1, and the higher power limit shall not exceed the Max EIRP defined in sub-clause 6.2A.1.					
Note 2: TT for each frequency and channel bandwidth is specified in Table 6.3A.4.2.5.5-5.					

Table 6.3A.4.2.5.5-4: Test Tolerance (Test point 1 and Test point 2)

Test Metric	FR2a	FR2b
IFF (Max device size \leq 30 cm)	[FFS] dB	[FFS] dB

Table 6.3A.4.2.5.5-5: Test Tolerance (Test point 2 and Test point 3)

Test Metric	FR2a	FR2b
IFF (Max device size \leq 30 cm)	[FFS] dB	[FFS] dB

6.3A.4.2.6 Absolute power tolerance for CA (7UL CA)

Editor's note: This clause is incomplete. The following aspects are either missing or not yet determined:

- Measurement Uncertainty and Test Tolerances are FFS.
- TP analysis is FFS.
- UE transmitted power for PC 1, 2 and 4 are FFS

6.3A.4.2.6.1 Test purpose

To verify the UE's ability to transmit with a broadband output power below the value specified in the test requirement when the power is set to a minimum value.

To verify the ability of the UE transmitter to set its initial output power to a specific value at the start of a contiguous transmission or non-contiguous transmission with a long transmission gap, i.e. transmission gap is larger than 20 ms.

6.3A.4.2.6.2 Test applicability

This test case applies to all types of NR UE release 16 and forward that supports FR2 7UL CA.

6.3A.4.2.6.3 Minimum conformance requirements

The minimum conformance requirements are defined in clause 6.3A.4.2.0.

6.3A.4.2.6.4 Test description

Same as in clause 6.3A.4.2.1.4 with the following exceptions:

- Instead of Table 6.3A.4.2.1.4.1-1 \rightarrow use Table 6.3A.4.2.6.4-1.
- Instead of Table 6.3A.4.2.1.5-1 through 6.3A.4.2.1.5-3 \rightarrow use Table 6.3A.4.2.6.5-1 and 6.3A.4.2.6.5-3.

Table 6.3A.4.2.6.4-1: Test Configuration Table

Default Conditions						
Test Environment as specified in TS 38.508-1 [10] clause 4.1				Normal		
Test Frequencies as specified in TS 38.508-1 [10] clause 4.3.1.2.3 for different CA bandwidth classes.				Low and High range		
Test CC combination setting as specified in TS 38.508-1 [10] clause 4.3.1.2.3 for the CA Configuration across bandwidth combination sets supported by the UE.				Highest aggregated BW of the CA configuration		
Test SCS as specified in Table 5.3.5-1.				Highest		
Test Parameters						
Test ID	CC	ChBw(MHz)	Test frequency	DL RB allocation	UL Modulation	UL RB allocation (Note 1)
1	PCC	Default	Default	-	DFT-s-OFDM QPSK	Outer_Full
	SCC1				DFT-s-OFDM QPSK	Outer_Full
	SCC2				DFT-s-OFDM QPSK	Outer_Full
	SCC3				DFT-s-OFDM QPSK	Outer_Full
	SCC4				DFT-s-OFDM QPSK	Outer_Full
	SCC5				DFT-s-OFDM QPSK	Outer_Full
	SCC6				DFT-s-OFDM QPSK	Outer_Full
NOTE 1: The specific configuration of each RB allocation is defined in Table 6.1-1 for PC2, PC3 and PC4 or Table 6.1-2 for PC1.						
NOTE 2: Number of DL CCs shall be configured the same as number of UL CCs. The requirements are applicable as per 5.3A.4: "The requirements are applicable only when Uplink CCs are configured within the frequency range between lower edge of lowest downlink component carrier and upper edge of highest downlink component carrier".						

6.3A.4.2.6.5 Test requirement

Same as in clause 6.3A.4.2.1.5 with the following exceptions:

- Instead of Table 6.3A.4.2.1.5-1 → use Table 6.3A.4.2.6.5-1.
- Instead of Table 6.3A.4.2.1.5-2 → use Table 6.3A.4.2.6.5-2.
- Instead of Table 6.3A.4.2.1.5-3 → use Table 6.3A.4.2.6.5-3.
- Instead of Table 6.3A.4.2.1.5-4 → use Table 6.3A.4.2.6.5-4.
- Instead of Table 6.3A.4.2.1.5-5 → use Table 6.3A.4.2.6.5-5.

Table 6.3A.4.2.6.5-1: Test Requirements of Absolute power tolerance (Test point 1)

	SCS	Channel bandwidth / expected output power (dBm)			
		50 MHz	100 MHz	200 MHz	400 MHz
Expected Measured power	60kHz	7.1	8.1	7.1	N/A
	120kHz	7.1	8.1	7.1	8.1
Power tolerance		± (14+TT) dB			
Note 1: The lower power limit shall not exceed the minimum output power requirements defined in sub-clause 6.3A.1, and the higher power limit shall not exceed the Max EIRP defined in sub-clause 6.2A.1.					
Note 2: TT for each frequency and channel bandwidth is specified in Table 6.3A.4.2.6.5-4.					

Table 6.3A.4.2.6.5-2: Test Requirements of Absolute power tolerance (Test point 2)

	SCS	Channel bandwidth / expected output power (dBm)			
		50 MHz	100 MHz	200 MHz	400 MHz
Expected Measured power	60kHz	12.1	11.1	12.1	N/A
	120kHz	12.1	11.1	12.1	11.1
Power tolerance		$\pm (12+TT)$ dB			
Note 1: The lower power limit shall not exceed the minimum output power requirements defined in sub-clause 6.3A.1, and the higher power limit shall not exceed the Max EIRP defined in sub-clause 6.2A.1.					
Note 2: TT for each frequency and channel bandwidth is specified in Table 6.3A.4.2.6.5-5.					

Table 6.3A.4.2.6.5-3: Test Requirements of Absolute power tolerance (Test point 3)

	SCS	Channel bandwidth / expected output power (dBm)			
		50 MHz	100 MHz	200 MHz	400 MHz
Expected Measured power	60kHz	22.1	21.1	22.1	N/A
	120kHz	22.1	21.1	22.1	21.1
Power tolerance		$\pm (12+TT)$ dB			
Note 1: The lower power limit shall not exceed the minimum output power requirements defined in sub-clause 6.3A.1, and the higher power limit shall not exceed the Max EIRP defined in sub-clause 6.2A.1.					
Note 2: TT for each frequency and channel bandwidth is specified in Table 6.3A.4.2.6.5-5.					

Table 6.3A.4.2.6.5-4: Test Tolerance (Test point 1)

Test Metric	FR2a	FR2b
IFF (Max device size \leq 30 cm)	[FFS] dB	[FFS] dB

Table 6.3A.4.2.6.5-5: Test Tolerance (Test point 2 and Test point 3)

Test Metric	FR2a	FR2b
IFF (Max device size \leq 30 cm)	[FFS] dB	[FFS] dB

6.3A.4.2.7 Absolute power tolerance for CA (8UL CA)

Editor's note: This clause is incomplete. The following aspects are either missing or not yet determined:

- Measurement Uncertainty and Test Tolerances are FFS.
- TP analysis is FFS.
- UE transmitted power for PC 1, 2 and 4 are FFS

6.3A.4.2.7.1 Test purpose

To verify the UE's ability to transmit with a broadband output power below the value specified in the test requirement when the power is set to a minimum value.

To verify the ability of the UE transmitter to set its initial output power to a specific value at the start of a contiguous transmission or non-contiguous transmission with a long transmission gap, i.e. transmission gap is larger than 20 ms.

6.3A.4.2.7.2 Test applicability

This test case applies to all types of NR UE release 16 and forward that supports FR2 8UL CA.

6.3A.4.2.7.3 Minimum conformance requirements

The minimum conformance requirements are defined in clause 6.3A.4.2.0.

6.3A.4.2.7.4 Test description

Same as in clause 6.3A.4.2.1.4 with the following exceptions:

- Instead of Table 6.3A.4.2.1.4.1-1 → use Table 6.3A.4.2.7.4-1.
- Instead of Table 6.3A.4.2.1.5-1 through 6.3A.4.2.1.5-3 → use Table 6.3A.4.2.7.5-1 and 6.3A.4.2.7.5-3.

Table 6.3A.4.2.7.4-1: Test Configuration Table

Default Conditions						
Test Environment as specified in TS 38.508-1 [10] clause 4.1				Normal		
Test Frequencies as specified in TS 38.508-1 [10] clause 4.3.1.2.3 for different CA bandwidth classes.				Low and High range		
Test CC combination setting as specified in TS 38.508-1 [10] clause 4.3.1.2.3 for the CA Configuration across bandwidth combination sets supported by the UE.				Highest aggregated BW of the CA configuration		
Test SCS as specified in Table 5.3.5-1.				Highest		
Test Parameters						
Test ID	CC	ChBw(MHz)	Test frequency	DL RB allocation	UL Modulation	UL RB allocation (Note 1)
1	PCC	Default	Default	-	DFT-s-OFDM QPSK	Outer_Full
	SCC1				DFT-s-OFDM QPSK	Outer_Full
	SCC2				DFT-s-OFDM QPSK	Outer_Full
	SCC3				DFT-s-OFDM QPSK	Outer_Full
	SCC4				DFT-s-OFDM QPSK	Outer_Full
	SCC5				DFT-s-OFDM QPSK	Outer_Full
	SCC6				DFT-s-OFDM QPSK	Outer_Full
	SCC7				DFT-s-OFDM QPSK	Outer_Full
NOTE 1: The specific configuration of each RB allocation is defined in Table 6.1-1 for PC2, PC3 and PC4 or Table 6.1-2 for PC1.						
NOTE 2: Number of DL CCs shall be configured the same as number of UL CCs. The requirements are applicable as per 5.3A.4: "The requirements are applicable only when Uplink CCs are configured within the frequency range between lower edge of lowest downlink component carrier and upper edge of highest downlink component carrier".						

6.3A.4.2.7.5 Test requirement

Same as in clause 6.3A.4.2.1.5 with the following exceptions:

- Instead of Table 6.3A.4.2.1.5-1 → use Table 6.3A.4.2.7.5-1.
- Instead of Table 6.3A.4.2.1.5-2 → use Table 6.3A.4.2.7.5-2.
- Instead of Table 6.3A.4.2.1.5-3 → use Table 6.3A.4.2.7.5-3.
- Instead of Table 6.3A.4.2.1.5-4 → use Table 6.3A.4.2.7.5-4.
- Instead of Table 6.3A.4.2.1.5-5 → use Table 6.3A.4.2.7.5-5.

Table 6.3A.4.2.7.5-1: Test Requirements of Absolute power tolerance (Test point 1)

	SCS	Channel bandwidth / expected output power (dBm)			
		50 MHz	100 MHz	200 MHz	400 MHz
Expected Measured power	60kHz	8.1	7.1	8.1	N/A
	120kHz	8.1	7.1	8.1	7.1
Power tolerance		± (14+TT) dB			
Note 1: The lower power limit shall not exceed the minimum output power requirements defined in sub-clause 6.3A.1, and the higher power limit shall not exceed the Max EIRP defined in sub-clause 6.2A.1.					
Note 2: TT for each frequency and channel bandwidth is specified in Table 6.3A.4.2.7.5-4.					

Table 6.3A.4.2.7.5-2: Test Requirements of Absolute power tolerance (Test point 2)

	SCS	Channel bandwidth / expected output power (dBm)			
		50 MHz	100 MHz	200 MHz	400 MHz
Expected Measured power	60kHz	12.1	11.1	12.1	N/A
	120kHz	12.1	11.1	12.1	11.1
Power tolerance		± (12+TT) dB			
Note 1: The lower power limit shall not exceed the minimum output power requirements defined in sub-clause 6.3A.1, and the higher power limit shall not exceed the Max EIRP defined in sub-clause 6.2A.1.					
Note 2: TT for each frequency and channel bandwidth is specified in Table 6.3A.4.2.7.5-5.					

Table 6.3A.4.2.7.5-3: Test Requirements of Absolute power tolerance (Test point 3)

	SCS	Channel bandwidth / expected output power (dBm)			
		50 MHz	100 MHz	200 MHz	400 MHz
Expected Measured power	60kHz	22.1	21.1	22.1	N/A
	120kHz	22.1	21.1	22.1	21.1
Power tolerance		± (12+TT) dB			
Note 1: The lower power limit shall not exceed the minimum output power requirements defined in sub-clause 6.3A.1, and the higher power limit shall not exceed the Max EIRP defined in sub-clause 6.2A.1.					
Note 2: TT for each frequency and channel bandwidth is specified in Table 6.3A.4.2.7.5-5.					

Table 6.3A.4.2.7.5-4: Test Tolerance (Test point 1)

Test Metric	FR2a	FR2b
IFF (Max device size ≤ 30 cm)	[FFS] dB	[FFS] dB

Table 6.3A.4.2.7.5-5: Test Tolerance (Test point 2 and Test point 3)

Test Metric	FR2a	FR2b
IFF (Max device size ≤ 30 cm)	[FFS] dB	[FFS] dB

6.3A.4.3 Relative power tolerance for CA

6.3A.4.3.0 Minimum conformance requirements

FFS

6.3A.4.3.1 Relative power tolerance for CA (2UL CA)

FFS

6.3A.4.3.2 Relative power tolerance for CA (3UL CA)

FFS

6.3A.4.3.3 Relative power tolerance for CA (4UL CA)

FFS

6.3A.4.3.4 Relative power tolerance for CA (5UL CA)

FFS

6.3A.4.3.5 Relative power tolerance for CA (6UL CA)

FFS

6.3A.4.3.6 Relative power tolerance for CA (7UL CA)

FFS

6.3A.4.3.7 Relative power tolerance for CA (8UL CA)

FFS

6.3A.4.4 Aggregate power tolerance for CA

6.3A.4.4.0 Minimum conformance requirements

The aggregate power control tolerance is the ability of the UE transmitter to maintain its power during non-contiguous transmissions within 21 ms in response to 0 dB TPC commands with respect to the first UE transmission and all other power control parameters as specified in TS 38.213 [22] kept constant.

For intra-band contiguous CA, the aggregate power tolerance per CC is given in Tables 6.3.4.4.3-1 and 6.3.4.4.3-2, with simultaneous PUSCH configured. The average PSDs over each assigned CC shall be aligned before the start of the test. The requirement can be tested with the transmission gaps time aligned between component carriers.

6.3A.4.4.1 Aggregate power tolerance for CA (2UL CA)

Editor's note: The following aspects are either missing or not yet determined:

- Measurement Uncertainty and Test Tolerances are FFS for power classes other than PC3.
- UE transmitted power for PC 1, 2 and 4 are FFS.
- Power window is FFS for power classes other than PC3.
- The UPLF test mode is applicable to UEs Release 16 and forward. This test case is incomplete for Release 15 until UE PHR method is used to prevent SCell drop.

6.3A.4.4.1.1 Test purpose

To verify the ability of the UE transmitter to maintain its power during non-contiguous transmissions within 21ms in response to 0 dB commands with respect to the first UE transmission and all other power control parameters as specified in TS 38.213 [22] kept constant.

6.3A.4.4.1.2 Test applicability

This test case applies to all types of NR UE release 16 and forward that supports FR2 2UL CA.

6.3A.4.4.1.3 Minimum conformance requirements

The minimum conformance requirements are defined in clause 6.3A.4.4.0.

6.3A.4.4.1.4 Test description

6.3A.4.4.1.4.1 Initial condition

Initial conditions are a set of test configurations the UE needs to be tested in and the steps for the SS to take with the UE to reach the correct measurement state.

The initial test configurations consist of environmental conditions, test frequencies, test channel bandwidth and subcarrier spacing based on NR CA configurations based on NR operating bands specified in clause 5.5A. All of these configurations shall be tested with applicable test parameters for each CA combination and subcarrier spacing, are shown in Table 6.3A.4.4.1.4.1-1. The details of the uplink reference measurement channels (RMCs) are specified in Annexes A.2. Configurations of PDSCH and PDCCH before measurement are specified in Annex C.2.

Table 6.3A.4.4.1.4.1-1: Test Configuration Table: PUSCH

Default Conditions						
Test Environment as specified in TS 38.508-1 [10] clause 4.1				Normal		
Test Frequencies as specified in TS 38.508-1 [10] clause 4.3.1.2.3 for different CA bandwidth classes.				Mid range		
Test CC combination setting as specified in TS 38.508-1 [10] clause 4.3.1.2.3 for the CA Configuration across bandwidth combination sets supported by the UE.				Highest aggregated BW of the CA configuration		
Test SCS as specified in Table 5.3.5-1.				Highest		
Test Parameters						
Test ID	CC	ChBw(MHz)	Test frequency	DL RB allocation	UL Modulation	UL RB allocation (Note 1)
1	PCC	Default	Default	-	DFT-s-OFDM QPSK	Inner_Full
	SCC				DFT-s-OFDM QPSK	Inner_Full
NOTE 1: The specific configuration of each RB allocation is defined in Table 6.1-1 for PC2, PC3 and PC4 or Table 6.1-2 for PC1.						
NOTE 2: Number of DL CCs shall be configured the same as number of UL CCs. The requirements are applicable as per 5.3A.4: "The requirements are applicable only when Uplink CCs are configured within the frequency range between lower edge of lowest downlink component carrier and upper edge of highest downlink component carrier".						

1. Connection between SS and UE is shown in TS 38.508-1 [10] Annex A, Figure A.3.3.1.1 for TE diagram and Figure A.3.4.1.1 for UE diagram.
2. The parameter settings for the cell are set up according to TS 38.508-1 [10] clause 4.4.3.
3. Downlink signals are initially set up according to Annex C, and uplink signals according to Annex G.
4. The UL Reference Measurement Channel is set according to Table 6.3A.4.4.1.4.1-1.
5. Propagation conditions are set according to Annex B.0.
6. Ensure the UE is in State RRC_CONNECTED with generic procedure parameters Connectivity NR, Connected without release *On*, Test Mode *On* and Test Loop Function *On* according to TS 38.508-1 [10] clause 4.5. Message contents are defined in clause 6.3A.4.4.1.4.3.

6.3A.4.4.1.4.2 Test procedure

The procedure is only to verify PUSCH aggregate power control tolerance. The uplink transmission patterns are described in Figure 6.3.4.4.4.2-1.

1. Configure SCC according to Annex C.0, C.1, C.2, and C.3 for all downlink physical channels.
2. The SS shall configure SCC as per TS 38.508-1 [10] clause 5.5.1. Message contents are defined in clause 6.3A.4.4.1.4.3.
3. Apply the test step based on the 5G NR UE Release:
 - 3a. For Release 16 and forward 5G NR UEs: SS applies a backoff on the PCell power by activating the UE Power Limit Function (UPLF). The ACTIVATE POWER LIMIT REQUEST procedure is performed as specified in TS 38.508-1 [10] clause 4.9.32 using TOTAL NR AGGREGATED BANDWIDTH and PCELL NR bandwidth as per Test CC Combination setting. UE shall transmit ACTIVATE POWER LIMIT RESPONSE to SS. Go to step 4.
 - 3b. For Release 15 5G NR UEs: Test Procedure updates to keep SCell active are FFS. Skip remaining steps.
4. SS activates SCC by sending the activation MAC CE (Refer TS 38.321 [28], clause 5.9, 6.1.3.10). Wait for at least 2 seconds (Refer TS 38.133 [25], clause 9.2).
5. Set the UE in the Tx beam peak direction found with a 3D EIRP scan as performed in Annex K.1.1. Allow at least BEAM_SELECT_WAIT_TIME (NOTE 1) for the UE Tx beam selection to complete.
6. The SS sends uplink scheduling information via PDCCH DCI format 0_1 for C_RNTI to schedule the PUSCH on PCC and SCC according to Table 6.3A.4.4.1.4.1-1. Since the UE has no payload and no loopback data to send the UE sends uplink MAC padding bits on the UL RMC. Send uplink power control commands for PUSCH to the UE using 1dB power step size to ensure that the UE output power measured by the test system is within P_w of the target power level specified in Table 6.3.4.4.4.2-1 according to the power class with power ID = 1. P_w is the power window according to Table 6.3.4.4.4.2-2 for the carrier frequency f and the channel bandwidth BW. Allow at least BEAM_SELECT_WAIT_TIME (NOTE 1) for the UE Tx beam selection to complete.
7. SS activates the UE Beamlock Function (UBF) by performing the procedure as specified in TS 38.508-1 [10] clause 4.9.2 using condition Tx only.
8. Every 10 sub-frames (10ms) schedule the UE's PUSCH data transmission for 1 sub-frame (1ms) and transmit 0 dB TPC command for PUSCH via the PDCCH to make the UE transmit PUSCH. The uplink transmission patterns are described in Figure 6.3.4.4.4.2-1.
9. Measure the UE EIRP of 3 consecutive PUSCH transmissions on each component carrier in the Tx beam peak direction of in the measurement bandwidth specified in Table 6.3A.1.1.5-1 and Table 6.3A.1.1.5-2 to verify the UE transmitted PUSCH power is maintained within 21ms. EIRP test procedure is defined in Annex K. EIRP is calculated considering both polarizations, theta and phi. For TDD slots with transient periods are not under test.
10. SS deactivates the UE Power Limit Function (UPLF) by performing the DEACTIVATE POWER LIMIT REQUEST procedure as specified in TS 38.508-1 [10] clause 4.9.33.
11. SS deactivates the UE Beamlock Function (UBF) by performing the procedure as specified in TS 38.508-1 [10] clause 4.9.3.
12. Repeat test step 4 to 11 for measurement for power ID = 2 in Table 6.3.4.4.4.2-1.

NOTE 1: The BEAM_SELECT_WAIT_TIME default value is defined in Annex K.

6.3A.4.4.1.4.3 Message contents

Message contents are according to TS 38.508-1 [10] clause 4.6 with TRANSFORM_PRECODER_ENABLED condition in Table 4.6.3-118 PUSCH-Config.

6.3A.4.4.1.5 Test requirement

The requirement for the power measurements made in step 8 of the test procedure shall not exceed the values specified in Table 6.3A.4.4.1.5-1 and Table 6.3A.4.4.1.5-2. The power measurement period shall be 1 sub-frame (1ms).

Table 6.3A.4.4.1.5-1: Power control tolerance ($P_{int} \geq P \geq P_{min}$)

TPC command	UL channel	Test requirement measured power
0 dB	PUSCH	Given 3 power measurements in the pattern, the 2 nd , and later measurements shall be within $\pm(5.5\text{dB}+\text{TT})$ of the 1 st measurement.
Note 1: TT for each duplex, Sub-Carrier Spacing, frequency and channel bandwidth is specified in Table 6.3A.4.4.1.5-3.		

Table 6.3A.4.4.1.5-2: Power control tolerance ($P_{max} \geq P > P_{int}$)

TPC command	UL channel	Test requirement measured power
0 dB	PUSCH	Given 3 power measurements in the pattern, the 2 nd , and later measurements shall be within $\pm(3.5\text{dB}+\text{TT})$ of the 1 st measurement.
Note 1: TT for each duplex, Sub-Carrier Spacing, frequency and channel bandwidth is specified in Table 6.3A.4.4.1.5-4.		

Table 6.3A.4.4.1.5-3: Test Tolerance ($P_{int} \geq P \geq P_{min}$) for PC3

Test Metric	FR2a	FR2b
IFF (Quiet Zone size ≤ 30 cm)	0.26	0.26

Table 6.3A.4.4.1.5-4: Test Tolerance ($P_{max} \geq P > P_{int}$) for PC3

Test Metric	FR2a	FR2b
IFF (Quiet Zone size ≤ 30 cm)	0.26	0.26

6.3A.4.4.2 Aggregate power tolerance for CA (3UL CA)

Editor's note: The following aspects are either missing or not yet determined:

- Measurement Uncertainty and Test Tolerances are FFS for power classes other than PC3.
- UE transmitted power for PC 1, 2 and 4 are FFS.
- Power window is FFS for power classes other than PC3.

6.3A.4.4.2.1 Test purpose

To verify the ability of the UE transmitter to maintain its power during non-contiguous transmissions within 21 ms in response to 0 dB commands with respect to the first UE transmission and all other power control parameters as specified in TS 38.213 [22] kept constant.

6.3A.4.4.2.2 Test applicability

This test case applies to all types of NR UE release 16 and forward that supports FR2 3UL CA.

6.3A.4.4.2.3 Minimum conformance requirements

The minimum conformance requirements are defined in clause 6.3A.4.4.0.

6.3A.4.4.2.4 Test description

Same as in clause 6.3A.4.4.1.4 with the following exceptions:

- Instead of Table 6.3A.4.4.1.4.1-1 \rightarrow use Table 6.3A.4.4.2.4-1.

Table 6.3A.4.4.2.4-1: Test Configuration Table: PUSCH

Default Conditions						
Test Environment as specified in TS 38.508-1 [10] clause 4.1				Normal		
Test Frequencies as specified in TS 38.508-1 [10] clause 4.3.1.2.3 for different CA bandwidth classes.				Mid range		
Test CC combination setting as specified in TS 38.508-1 [10] clause 4.3.1.2.3 for the CA Configuration across bandwidth combination sets supported by the UE.				Highest aggregated BW of the CA configuration		
Test SCS as specified in Table 5.3.5-1.				Highest		
Test Parameters						
Test ID	CC	ChBw(MHz)	Test frequency	DL RB allocation	UL Modulation	UL RB allocation (Note 1)
1	PCC	Default	Default	-	DFT-s-OFDM QPSK	Inner_Full
	SCC1				DFT-s-OFDM QPSK	Inner_Full
	SCC2				DFT-s-OFDM QPSK	Inner_Full
NOTE 1: The specific configuration of each RB allocation is defined in Table 6.1-1 for PC2, PC3 and PC4 or Table 6.1-2 for PC1.						
NOTE 2: Number of DL CCs shall be configured the same as number of UL CCs. The requirements are applicable as per 5.3A.4: "The requirements are applicable only when Uplink CCs are configured within the frequency range between lower edge of lowest downlink component carrier and upper edge of highest downlink component carrier".						

6.3A.4.4.2.5 Test requirement

The requirement for the power measurements made in step 8 of the test procedure shall not exceed the values specified in Table 6.3A.4.4.2.5-1 and Table 6.3A.4.4.2.5-2. The power measurement period shall be 1 sub-frame (1ms).

Table 6.3A.4.4.2.5-1: Power control tolerance ($P_{int} \geq P \geq P_{min}$)

TPC command	UL channel	Test requirement measured power
0 dB	PUSCH	Given 3 power measurements in the pattern, the 2 nd , and later measurements shall be within $\pm(5.5\text{dB}+TT)$ of the 1 st measurement.
Note 1: TT for each duplex, Sub-Carrier Spacing, frequency and channel bandwidth is specified in Table 6.3A.4.4.2.5-3.		

Table 6.3A.4.4.2.5-2: Power control tolerance ($P_{max} \geq P > P_{int}$)

TPC command	UL channel	Test requirement measured power
0 dB	PUSCH	Given 3 power measurements in the pattern, the 2 nd , and later measurements shall be within $\pm(3.5\text{dB}+TT)$ of the 1 st measurement.
Note 1: TT for each duplex, Sub-Carrier Spacing, frequency and channel bandwidth is specified in Table 6.3A.4.4.2.5-4.		

Table 6.3A.4.4.2.5-3: Test Tolerance ($P_{int} \geq P \geq P_{min}$) for PC3

Test Metric	FR2a	FR2b
IFF (Quiet Zone size ≤ 30 cm)	0.26	0.26

Table 6.3A.4.4.2.5-4: Test Tolerance ($P_{max} \geq P > P_{int}$) for PC3

Test Metric	FR2a	FR2b
IFF (Quiet Zone size ≤ 30 cm)	0.26	0.26

6.3A.4.4.3 Aggregate power tolerance for CA (4UL CA)

Editor's note: The following aspects are either missing or not yet determined:

- Measurement Uncertainty and Test Tolerances are FFS for power classes other than PC3.
- UE transmitted power for PC 1, 2 and 4 are FFS.
- Power window is FFS for power classes other than PC3.

6.3A.4.4.3.1 Test purpose

To verify the ability of the UE transmitter to maintain its power during non-contiguous transmissions within 21 ms in response to 0 dB commands with respect to the first UE transmission and all other power control parameters as specified in TS 38.213 [22] kept constant.

6.3A.4.4.3.2 Test applicability

This test case applies to all types of NR UE release 16 and forward that supports FR2 4UL CA.

6.3A.4.4.3.3 Minimum conformance requirements

The minimum conformance requirements are defined in clause 6.3A.4.4.0.

6.3A.4.4.3.4 Test description

Same as in clause 6.3A.4.4.1.4 with the following exceptions:

- Instead of Table 6.3A.4.4.1.4.1-1 → use Table 6.3A.4.4.3.4-1.

Table 6.3A.4.4.3.4-1: Test Configuration Table: PUSCH

Default Conditions						
Test Environment as specified in TS 38.508-1 [10] clause 4.1				Normal		
Test Frequencies as specified in TS 38.508-1 [10] clause 4.3.1.2.3 for different CA bandwidth classes.				Mid range		
Test CC combination setting as specified in TS 38.508-1 [10] clause 4.3.1.2.3 for the CA Configuration across bandwidth combination sets supported by the UE.				Highest aggregated BW of the CA configuration		
Test SCS as specified in Table 5.3.5-1.				Highest		
Test Parameters						
Test ID	CC	ChBw(MHz)	Test frequency	DL RB allocation	UL Modulation	UL RB allocation (Note 1)
1	PCC	Default	Default	-	DFT-s-OFDM QPSK	Inner_Full
	SCC1				DFT-s-OFDM QPSK	Inner_Full
	SCC2				DFT-s-OFDM QPSK	Inner_Full
	SCC3				DFT-s-OFDM QPSK	Inner_Full
NOTE 1: The specific configuration of each RB allocation is defined in Table 6.1-1 for PC2, PC3 and PC4 or Table 6.1-2 for PC1.						
NOTE 2: Number of DL CCs shall be configured the same as number of UL CCs. The requirements are applicable as per 5.3A.4: "The requirements are applicable only when Uplink CCs are configured within the frequency range between lower edge of lowest downlink component carrier and upper edge of highest downlink component carrier".						

6.3A.4.4.3.5 Test requirement

The requirement for the power measurements made in step 8 of the test procedure shall not exceed the values specified in Table 6.3A.4.4.3.5-1 and Table 6.3A.4.4.3.5-2. The power measurement period shall be 1 sub-frame (1ms).

Table 6.3A.4.4.3.5-1: Power control tolerance ($P_{int} \geq P \geq P_{min}$)

TPC command	UL channel	Test requirement measured power
0 dB	PUSCH	Given 3 power measurements in the pattern, the 2 nd , and later measurements shall be within $\pm(5.5\text{dB}+\text{TT})$ of the 1 st measurement.
Note 1: TT for each duplex, Sub-Carrier Spacing, frequency and channel bandwidth is specified in Table 6.3A.4.4.3.5-3.		

Table 6.3A.4.4.3.5-2: Power control tolerance ($P_{max} \geq P > P_{int}$)

TPC command	UL channel	Test requirement measured power
0 dB	PUSCH	Given 3 power measurements in the pattern, the 2 nd , and later measurements shall be within $\pm(3.5\text{dB}+\text{TT})$ of the 1 st measurement.
Note 1: TT for each duplex, Sub-Carrier Spacing, frequency and channel bandwidth is specified in Table 6.3A.4.4.3.5-4.		

Table 6.3A.4.4.3.5-3: Test Tolerance ($P_{int} \geq P \geq P_{min}$) for PC3

Test Metric	FR2a	FR2b
IFF (Quiet Zone size ≤ 30 cm)	0.26	0.26

Table 6.3A.4.4.3.5-4: Test Tolerance ($P_{max} \geq P > P_{int}$) for PC3

Test Metric	FR2a	FR2b
IFF (Quiet Zone size ≤ 30 cm)	0.26	0.26

6.3A.4.4.4 Aggregate power tolerance for CA (5UL CA)

Editor's note: This clause is incomplete. The following aspects are either missing or not yet determined:

- Measurement Uncertainty and Test Tolerances are FFS.
- UE transmitted power for PC 1, 2 and 4 are FFS.
- Power window is FFS.
- How to ensure equal PSD between component carriers is FFS.

6.3A.4.4.4.1 Test purpose

To verify the ability of the UE transmitter to maintain its power during non-contiguous transmissions within 21ms in response to 0 dB commands with respect to the first UE transmission and all other power control parameters as specified in TS 38.213 [22] kept constant.

6.3A.4.4.4.2 Test applicability

This test case applies to all types of NR UE release 16 and forward that supports FR2 5UL CA.

6.3A.4.4.4.3 Minimum conformance requirements

The minimum conformance requirements are defined in clause 6.3A.4.4.0.

6.3A.4.4.4.4 Test description

Same as in clause 6.3A.4.4.1.4 with the following exceptions:

- Instead of Table 6.3A.4.4.1.4.1-1 \rightarrow use Table 6.3A.4.4.4.4-1.

Table 6.3A.4.4.4-1: Test Configuration Table: PUSCH

Default Conditions						
Test Environment as specified in TS 38.508-1 [10] clause 4.1				Normal		
Test Frequencies as specified in TS 38.508-1 [10] clause 4.3.1.2.3 for different CA bandwidth classes.				Mid range		
Test CC combination setting as specified in TS 38.508-1 [10] clause 4.3.1.2.3 for the CA Configuration across bandwidth combination sets supported by the UE.				Highest aggregated BW of the CA configuration		
Test SCS as specified in Table 5.3.5-1.				Highest		
Test Parameters						
Test ID	CC	ChBw(MHz)	Test frequency	DL RB allocation	UL Modulation	UL RB allocation (Note 1)
1	PCC	Default	Default	-	DFT-s-OFDM QPSK	Inner_Full
	SCC1				DFT-s-OFDM QPSK	Inner_Full
	SCC2				DFT-s-OFDM QPSK	Inner_Full
	SCC3				DFT-s-OFDM QPSK	Inner_Full
	SCC4				DFT-s-OFDM QPSK	Inner_Full
NOTE 1: The specific configuration of each RB allocation is defined in Table 6.1-1 for PC2, PC3 and PC4 or Table 6.1-2 for PC1.						
NOTE 2: Number of DL CCs shall be configured the same as number of UL CCs. The requirements are applicable as per 5.3A.4: "The requirements are applicable only when Uplink CCs are configured within the frequency range between lower edge of lowest downlink component carrier and upper edge of highest downlink component carrier".						

6.3A.4.4.4.5 Test requirement

The requirement for the power measurements made in step 8 of the test procedure shall not exceed the values specified in Table 6.3A.4.4.4.5-1 and Table 6.3A.4.4.4.5-2. The power measurement period shall be 1 sub-frame (1ms).

Table 6.3A.4.4.4.5-1: Power control tolerance ($P_{int} \geq P \geq P_{min}$)

TPC command	UL channel	Test requirement measured power
0 dB	PUSCH	Given 3 power measurements in the pattern, the 2 nd , and later measurements shall be within $\pm(5.5\text{dB}+TT)$ of the 1 st measurement.
Note 1: TT for each duplex, Sub-Carrier Spacing, frequency and channel bandwidth is specified in Table 6.3A.4.4.4.5-3.		

Table 6.3A.4.4.4.5-2: Power control tolerance ($P_{max} \geq P > P_{int}$)

TPC command	UL channel	Test requirement measured power
0 dB	PUSCH	Given 3 power measurements in the pattern, the 2 nd , and later measurements shall be within $\pm(3.5\text{dB}+TT)$ of the 1 st measurement.
Note 1: TT for each duplex, Sub-Carrier Spacing, frequency and channel bandwidth is specified in Table 6.3A.4.4.4.5-4.		

Table 6.3A.4.4.4.5-3: Test Tolerance ($P_{int} \geq P \geq P_{min}$)

Test Metric	FR2a	FR2b
IFF (Quiet Zone size ≤ 30 cm)	FFS	FFS

Table 6.3A.4.4.5-4: Test Tolerance ($P_{max} \geq P > P_{int}$)

Test Metric	FR2a	FR2b
IFF (Quiet Zone size \leq 30 cm)	FFS	FFS

6.3A.4.4.5 Aggregate power tolerance for CA (6UL CA)

Editor's note: This clause is incomplete. The following aspects are either missing or not yet determined:

- Measurement Uncertainty and Test Tolerances are FFS.
- UE transmitted power for PC 1, 2 and 4 are FFS.
- Power window is FFS.
- How to ensure equal PSD between component carriers is FFS.

6.3A.4.4.5.1 Test purpose

To verify the ability of the UE transmitter to maintain its power during non-contiguous transmissions within 21ms in response to 0 dB commands with respect to the first UE transmission and all other power control parameters as specified in TS 38.213 [22] kept constant.

6.3A.4.4.5.2 Test applicability

This test case applies to all types of NR UE release 16 and forward that supports FR2 6UL CA.

6.3A.4.4.5.3 Minimum conformance requirements

The minimum conformance requirements are defined in clause 6.3A.4.4.0.

6.3A.4.4.5.4 Test description

Same as in clause 6.3A.4.4.1.4 with the following exceptions:

- Instead of Table 6.3A.4.4.1.4.1-1 \rightarrow use Table 6.3A.4.4.5.4-1.

Table 6.3A.4.4.5.4-1: Test Configuration Table: PUSCH

Default Conditions						
Test Environment as specified in TS 38.508-1 [10] clause 4.1				Normal		
Test Frequencies as specified in TS 38.508-1 [10] clause 4.3.1.2.3 for different CA bandwidth classes.				Mid range		
Test CC combination setting as specified in TS 38.508-1 [10] clause 4.3.1.2.3 for the CA Configuration across bandwidth combination sets supported by the UE.				Highest aggregated BW of the CA configuration		
Test SCS as specified in Table 5.3.5-1.				Highest		
Test Parameters						
Test ID	CC	ChBw(MHz)	Test frequency	DL RB allocation	UL Modulation	UL RB allocation (Note 1)
1	PCC	Default	Default	-	DFT-s-OFDM QPSK	Inner_Full
	SCC1				DFT-s-OFDM QPSK	Inner_Full
	SCC2				DFT-s-OFDM QPSK	Inner_Full
	SCC3				DFT-s-OFDM QPSK	Inner_Full
	SCC4				DFT-s-OFDM QPSK	Inner_Full
	SCC5				DFT-s-OFDM QPSK	Inner_Full

NOTE 1: The specific configuration of each RB allocation is defined in Table 6.1-1 for PC2, PC3 and PC4 or Table 6.1-2 for PC1.

NOTE 2: Number of DL CCs shall be configured the same as number of UL CCs. The requirements are applicable as per 5.3A.4: "The requirements are applicable only when Uplink CCs are configured within the frequency range between lower edge of lowest downlink component carrier and upper edge of highest downlink component carrier".

6.3A.4.4.5.5 Test requirement

The requirement for the power measurements made in step 8 of the test procedure shall not exceed the values specified in Table 6.3A.4.4.5.5-1 and Table 6.3A.4.4.5.5-2. The power measurement period shall be 1 sub-frame (1ms).

Table 6.3A.4.4.5.5-1: Power control tolerance ($P_{int} \geq P \geq P_{min}$)

TPC command	UL channel	Test requirement measured power
0 dB	PUSCH	Given 3 power measurements in the pattern, the 2 nd , and later measurements shall be within $\pm(5.5\text{dB}+\text{TT})$ of the 1 st measurement.
Note 1: TT for each duplex, Sub-Carrier Spacing, frequency and channel bandwidth is specified in Table 6.3A.4.4.5.5-3.		

Table 6.3A.4.4.5.5-2: Power control tolerance ($P_{max} \geq P > P_{int}$)

TPC command	UL channel	Test requirement measured power
0 dB	PUSCH	Given 3 power measurements in the pattern, the 2 nd , and later measurements shall be within $\pm(3.5\text{dB}+\text{TT})$ of the 1 st measurement.
Note 1: TT for each duplex, Sub-Carrier Spacing, frequency and channel bandwidth is specified in Table 6.3A.4.4.5.5-4.		

Table 6.3A.4.4.5.5-3: Test Tolerance ($P_{int} \geq P \geq P_{min}$)

Test Metric	FR2a	FR2b
IFF (Quiet Zone size ≤ 30 cm)	FFS	FFS

Table 6.3A.4.4.5.5-4: Test Tolerance ($P_{max} \geq P > P_{int}$)

Test Metric	FR2a	FR2b
IFF (Quiet Zone size ≤ 30 cm)	FFS	FFS

6.3A.4.4.6 Aggregate power tolerance for CA (7UL CA)

Editor's note: This clause is incomplete. The following aspects are either missing or not yet determined:

- Measurement Uncertainty and Test Tolerances are FFS.
- UE transmitted power for PC 1, 2 and 4 are FFS.
- Power window is FFS.
- How to ensure equal PSD between component carriers is FFS.

6.3A.4.4.6.1 Test purpose

To verify the ability of the UE transmitter to maintain its power during non-contiguous transmissions within 21 ms in response to 0 dB commands with respect to the first UE transmission and all other power control parameters as specified in TS 38.213 [22] kept constant.

6.3A.4.4.6.2 Test applicability

This test case applies to all types of NR UE release 16 and forward that supports FR2 7UL CA.

6.3A.4.4.6.3 Minimum conformance requirements

The minimum conformance requirements are defined in clause 6.3A.4.4.0.

6.3A.4.4.6.4 Test description

Same as in clause 6.3A.4.4.1.4 with the following exceptions:

- Instead of Table 6.3A.4.4.1.4.1-1 → use Table 6.3A.4.4.6.4-1.

Table 6.3A.4.4.6.4-1: Test Configuration Table: PUSCH

Default Conditions						
Test Environment as specified in TS 38.508-1 [10] clause 4.1				Normal		
Test Frequencies as specified in TS 38.508-1 [10] clause 4.3.1.2.3 for different CA bandwidth classes.				Mid range		
Test CC combination setting as specified in TS 38.508-1 [10] clause 4.3.1.2.3 for the CA Configuration across bandwidth combination sets supported by the UE.				Highest aggregated BW of the CA configuration		
Test SCS as specified in Table 5.3.5-1.				Highest		
Test Parameters						
Test ID	CC	ChBw(MHz)	Test frequency	DL RB allocation	UL Modulation	UL RB allocation (Note 1)
1	PCC	Default	Default	-	DFT-s-OFDM QPSK	Inner_Full
	SCC1				DFT-s-OFDM QPSK	Inner_Full
	SCC2				DFT-s-OFDM QPSK	Inner_Full
	SCC3				DFT-s-OFDM QPSK	Inner_Full
	SCC4				DFT-s-OFDM QPSK	Inner_Full
	SCC5				DFT-s-OFDM QPSK	Inner_Full
	SCC6				DFT-s-OFDM QPSK	Inner_Full
NOTE 1: The specific configuration of each RB allocation is defined in Table 6.1-1 for PC2, PC3 and PC4 or Table 6.1-2 for PC1.						
NOTE 2: Number of DL CCs shall be configured the same as number of UL CCs. The requirements are applicable as per 5.3A.4: "The requirements are applicable only when Uplink CCs are configured within the frequency range between lower edge of lowest downlink component carrier and upper edge of highest downlink component carrier".						

6.3A.4.4.6.5 Test requirement

The requirement for the power measurements made in step 8 of the test procedure shall not exceed the values specified in Table 6.3A.4.4.6.5-1 and Table 6.3A.4.4.6.5-2. The power measurement period shall be 1 sub-frame (1ms).

Table 6.3A.4.4.6.5-1: Power control tolerance ($P_{int} \geq P \geq P_{min}$)

TPC command	UL channel	Test requirement measured power
0 dB	PUSCH	Given 3 power measurements in the pattern, the 2 nd , and later measurements shall be within $\pm(5.5dB+TT)$ of the 1 st measurement.
Note 1: TT for each duplex, Sub-Carrier Spacing, frequency and channel bandwidth is specified in Table 6.3A.4.4.6.5-3.		

Table 6.3A.4.4.6.5-2: Power control tolerance ($P_{\max} \geq P > P_{\text{int}}$)

TPC command	UL channel	Test requirement measured power
0 dB	PUSCH	Given 3 power measurements in the pattern, the 2 nd , and later measurements shall be within $\pm(3.5\text{dB}+\text{TT})$ of the 1 st measurement.
Note 1: TT for each duplex, Sub-Carrier Spacing, frequency and channel bandwidth is specified in Table 6.3A.4.4.6.5-4.		

Table 6.3A.4.4.6.5-3: Test Tolerance ($P_{\text{int}} \geq P \geq P_{\text{min}}$)

Test Metric	FR2a	FR2b
IFF (Quiet Zone size ≤ 30 cm)	FFS	FFS

Table 6.3A.4.4.6.5-4: Test Tolerance ($P_{\max} \geq P > P_{\text{int}}$)

Test Metric	FR2a	FR2b
IFF (Quiet Zone size ≤ 30 cm)	FFS	FFS

6.3A.4.4.7 Aggregate power tolerance for CA (8UL CA)

Editor's note: This clause is incomplete. The following aspects are either missing or not yet determined:

- Measurement Uncertainty and Test Tolerances are FFS.
- UE transmitted power for PC 1, 2 and 4 are FFS.
- Power window is FFS.
- How to ensure equal PSD between component carriers is FFS.

6.3A.4.4.7.1 Test purpose

To verify the ability of the UE transmitter to maintain its power during non-contiguous transmissions within 21ms in response to 0 dB commands with respect to the first UE transmission and all other power control parameters as specified in TS 38.213 [22] kept constant.

6.3A.4.4.7.2 Test applicability

This test case applies to all types of NR UE release 16 and forward that supports FR2 8UL CA.

6.3A.4.4.7.3 Minimum conformance requirements

The minimum conformance requirements are defined in clause 6.3A.4.4.0.

6.3A.4.4.7.4 Test description

Same as in clause 6.3A.4.4.1.4 with the following exceptions:

- Instead of Table 6.3A.4.4.1.4.1-1 \rightarrow use Table 6.3A.4.4.7.4-1.

Table 6.3A.4.4.7.4-1: Test Configuration Table: PUSCH

Default Conditions	
Test Environment as specified in TS 38.508-1 [10] clause 4.1	Normal
Test Frequencies as specified in TS 38.508-1 [10] clause 4.3.1.2.3 for different CA bandwidth classes.	Mid range
Test CC combination setting as specified in TS 38.508-1 [10] clause 4.3.1.2.3 for the CA Configuration across bandwidth combination sets supported by the UE.	Highest aggregated BW of the CA configuration

Test SCS as specified in Table 5.3.5-1.				Highest		
Test Parameters						
Test ID	CC	ChBw(MHz)	Test frequency	DL RB allocation	UL Modulation	UL RB allocation (Note 1)
1	PCC	Default	Default	-	DFT-s-OFDM QPSK	Inner_Full
	SCC1				DFT-s-OFDM QPSK	Inner_Full
	SCC2				DFT-s-OFDM QPSK	Inner_Full
	SCC3				DFT-s-OFDM QPSK	Inner_Full
	SCC4				DFT-s-OFDM QPSK	Inner_Full
	SCC5				DFT-s-OFDM QPSK	Inner_Full
	SCC6				DFT-s-OFDM QPSK	Inner_Full
	SCC7				DFT-s-OFDM QPSK	Inner_Full
NOTE 1: The specific configuration of each RB allocation is defined in Table 6.1-1 for PC2, PC3 and PC4 or Table 6.1-2 for PC1.						
NOTE 2: Number of DL CCs shall be configured the same as number of UL CCs. The requirements are applicable as per 5.3A.4: "The requirements are applicable only when Uplink CCs are configured within the frequency range between lower edge of lowest downlink component carrier and upper edge of highest downlink component carrier".						

6.3A.4.4.7.5 Test requirement

The requirement for the power measurements made in step 8 of the test procedure shall not exceed the values specified in Table 6.3A.4.4.7.5-1 and Table 6.3A.4.4.7.5-2. The power measurement period shall be 1 sub-frame (1ms).

Table 6.3A.4.4.7.5-1: Power control tolerance ($P_{int} \geq P \geq P_{min}$)

TPC command	UL channel	Test requirement measured power
0 dB	PUSCH	Given 3 power measurements in the pattern, the 2 nd , and later measurements shall be within $\pm(5.5dB+TT)$ of the 1 st measurement.
Note 1: TT for each duplex, Sub-Carrier Spacing, frequency and channel bandwidth is specified in Table 6.3A.4.4.7.5-3.		

Table 6.3A.4.4.7.5-2: Power control tolerance ($P_{max} \geq P > P_{int}$)

TPC command	UL channel	Test requirement measured power
0 dB	PUSCH	Given 3 power measurements in the pattern, the 2 nd , and later measurements shall be within $\pm(3.5dB+TT)$ of the 1 st measurement.
Note 1: TT for each duplex, Sub-Carrier Spacing, frequency and channel bandwidth is specified in Table 6.3A.4.4.7.5-4.		

Table 6.3A.4.4.7.5-3: Test Tolerance ($P_{int} \geq P \geq P_{min}$)

Test Metric	FR2a	FR2b
IFF (Quiet Zone size ≤ 30 cm)	FFS	FFS

Table 6.3A.4.4.7.5-4: Test Tolerance ($P_{max} \geq P > P_{int}$)

Test Metric	FR2a	FR2b
IFF (Quiet Zone size ≤ 30 cm)	FFS	FFS

6.3D Output power dynamics for UL MIMO

6.3D.0 General

The requirements in clause 6.3D shall be met with configurations specified in sub-clause 6.2D.1.1.3.x, where 'x' depends on power class. Unless otherwise specified, the requirements shall be verified in beam locked mode with the test metric of EIRP (Link=TX beam peak direction, Meas=Link angle).

6.3D.1 Minimum output power for UL MIMO

Editor's note: The following aspects are either missing or not yet determined:

- Measurement Uncertainty and Test Tolerances are FFS for power classes other than 1, 3 5, and 6.
- The test case is incomplete for band n259.

6.3D.1.1 Test purpose

To verify the UE's ability to transmit with a broadband output power below the value specified in the test requirement when the power is set to a minimum value.

6.3D.1.2 Test applicability

This test case applies to all types of NR UE release 15 and forward supporting UL MIMO.

6.3D.1.3 Minimum conformance requirements

The minimum output power is defined as the mean power in at least one subframe (1ms). The minimum controlled output power is defined as the EIRP, i.e. the sum of the power in the channel bandwidth for all transmit bandwidth configurations (resource blocks), when the UE power is set to a minimum value.

6.3D.1.3.1 Minimum output power for UL MIMO for power class 1

For UE supporting UL MIMO, the minimum output power shall not exceed the sum of the values specified in Table 6.3.1.3.1-1 and the quantity $10 \cdot \log_{10}(\text{Number of Layers})$.

6.3D.1.3.2 Minimum output power for UL MIMO for power class 2, 3 and 4

For UE supporting UL MIMO, the minimum output power shall not exceed the values specified in Table 6.3.1.3.2-1 and the quantity $10 \cdot \log_{10}(\text{Number of Layers})$.

6.3D.1.3.3 Minimum output power for UL MIMO for power class 5 and 6

For UE supporting UL MIMO, the minimum controlled output power is defined as the EIRP, i.e. the sum of the power in the channel bandwidth for all transmit bandwidth configurations (resource blocks), when the UE power is set to a minimum value. The minimum output power shall not exceed the values specified in Table 6.3.1.3.3-1. The minimum power is verified in beam locked mode with the test metric of EIRP (Link=TX beam peak direction, Meas=Link angle).

The normative reference for this requirement is TS 38.101-2 [3] clause 6.3D.1.

6.3D.1.4 Test description

6.3D.1.4.1 Initial condition

Initial conditions are a set of test configurations the UE needs to be tested in and the steps for the SS to take with the UE to reach the correct measurement state.

The initial test configurations consist of environmental conditions, test frequencies, test channel bandwidths and sub-carrier spacing based on NR operating bands specified in Table 5.2-1. All of these configurations shall be tested with applicable test parameters for each combination of test channel bandwidth and sub-carrier spacing, and are shown in

Table 6.3D.1.4.1-1. The details of the uplink reference measurement channels (RMCs) are specified in Annexes A.2. Configurations of PDSCH and PDCCH before measurement are specified in Annex C.2.

Table 6.3D.1.4.1-1: Test Configuration Table

Initial Conditions			
Test Environment as specified in TS 38.508-1 [10] clause 4.1		Normal	
Test Frequencies as specified in TS 38.508-1 [10] clause 4.3.1		Low range, Mid range, High range	
Test Channel Bandwidths as specified in TS 38.508-1 [10] clause 4.3.1		Lowest, Mid, Highest	
Test SCS as specified in Table 5.3.5-1.		Highest	
Test Parameters			
Test ID	Downlink Configuration	Uplink Configuration	
		Modulation	RB allocation (NOTE 1)
1	-	CP-OFDM QPSK	Outer_Full
NOTE 1: The specific configuration of each RB allocation is defined in Table 6.1-1 for PC2, PC3 and PC4 or Table 6.1-2 for PC1.			

1. Connection between SS and UE is shown in TS 38.508-1 [10] Annex A, Figure A.3.3.1.1 for TE diagram and Figure A.3.4.1.1 for UE diagram.
2. The parameter settings for the cell are set up according to TS 38.508-1 [10] clause 4.4.3.
3. Downlink signals are initially set up according to Annex C, and uplink signals according to Annex G.
4. The UL Reference Measurement Channel is set according to Table 6.3D.1.4.1-1.
5. Propagation conditions are set according to Annex B.0.
6. Ensure the UE is in State RRC_CONNECTED with generic procedure parameters Connectivity *NR*, Connected without release *On*, Test Mode *On* and Test Loop Function *On* according to TS 38.508-1 [10] clause 4.5. Message contents are defined in clause 6.3D.1.4.3.

6.3D.1.4.2 Test procedure

1. SS sends uplink scheduling information for each UL HARQ process via PDCCH DCI format 0_1 for C_RNTI to schedule the UL RMC according to Table 6.3D.1.4.1-1. Since the UE has no payload and no loopback data to send the UE sends uplink MAC padding bits on the UL RMC. The PDCCH DCI format 0_1 is specified with the condition 2TX_UL_MIMO in 38.508-1 [5] clause 4.3.6.1.1.2.
2. Set the UE in the Tx beam peak direction found with a 3D EIRP scan as performed in Annex K.1.1. Allow at least BEAM_SELECT_WAIT_TIME (NOTE 1) for the UE Tx beam selection to complete.
3. Send continuously uplink power control "down" commands in every uplink scheduling information to the UE; allow at least 200ms starting from the first TPC command in this step to ensure that the UE transmits at its minimum output power. If UE is disconnected, repeat the test case. Optionally, send continuously uplink power control "down" commands in every uplink scheduling information to the UE until the UE EIRP measured by the test system is at a level just before the UE was disconnected. Allow at least BEAM_SELECT_WAIT_TIME (NOTE 1) for the UE Tx beam selection to complete.
4. SS activates the UE Beamlock Function (UBF) by performing the procedure as specified in TS 38.508-1 [10] clause 4.9.2 using condition Tx only.
5. Measure UE EIRP in the Tx beam peak direction in the measurement bandwidth specified in Table 6.3D.1.5-1 and Table 6.3D.1.5-2 for the specific channel bandwidth under test. EIRP test procedure is defined in Annex K. The measuring duration is at least one active uplink subframe. EIRP is calculated considering both polarizations, theta and phi. For TDD slots with transient periods are not under test.
6. SS deactivates the UE Beamlock Function (UBF) by performing the procedure as specified in TS 38.508-1 [10] clause 4.9.3.

NOTE 1: The BEAM_SELECT_WAIT_TIME default value is defined in Annex K.

6.3D.1.4.3 Message contents

Message contents are according to TS 38.508-1 [5] clause 4.6 ensuring Table 4.6.3-182 with condition 2TX_UL_MIMO.

6.3D.1.5 Test requirement

The minimum EIRP, derived in step 5 shall not exceed the values specified in Table 6.3D.1.5-1 to Table 6.3D.1.5-3.

Table 6.3D.1.5-1: Minimum output power for power class 1

Operating band	Channel bandwidth (MHz)	Minimum output power (dBm)	Measurement bandwidth (MHz)
n257, n258, n260, n261	50	7+TT	47.58
	100	7+TT	95.16
	200	7+TT	190.20
	400	7+TT	380.28

Table 6.3.1.5-1a: Test Tolerance Minimum output power for power class 1

Test Metric	FR2a	FR2b
Max device size ≤ 30 cm	3.79 dB	4.09 dB

Table 6.3D.1.5-2: Minimum output power for power class 3

Operating band	Channel bandwidth (MHz)	Minimum output power (dBm)	Test Tolerance TT (dB)	Measurement bandwidth (MHz)
n257, n258, n261	50	-10+TT	3.80	47.58
	100	-10+TT	4.21	95.16
	200	-10+2.4+TT ¹	2.52	190.20
	400	-10+5.4+TT ¹	0.67	380.28
n260	50	-10+1.5+TT ¹	3.17	47.58
	100	-10+4.5+TT ¹	1.17	95.16
	200	-10+7.5+TT ¹	0	190.20
	400	-10+10.5+TT ¹	0	380.28
n259	50	-10+TBD+TT ¹	TBD	47.58
	100	-10+TBD+TT ¹	TBD	95.16
	200	-10+TBD+TT ¹	TBD	190.20
	400	-10+TBD+TT ¹	TBD	380.28

NOTE 1: Core requirement cannot be tested due to testability issue and test requirement includes relaxation to achieve impact from test system noise to measurement result = 1.0 dB (Minimum requirement + relaxation).

Table 6.3D.1.5-2a: Minimum output power for power class 2 and 4

FFS

Table 6.3D.1.5-3: Minimum output power for power class 5

Operating band	Channel bandwidth (MHz)	Minimum output power (dBm)	Test Tolerance TT (dB)	Measurement bandwidth (MHz)
n257, n258	50	-6+TT	3.67 dB	47.58
	100	-6+TT	3.85 dB	95.16
	200	-6+TT	4.18 dB	190.20
	400	-6+1.4+TT ¹	3.38 dB	380.28

NOTE 1: Core requirement cannot be tested due to testability issue and test requirement includes relaxation to achieve impact from test system noise to measurement result = 1.0 dB (Minimum requirement + relaxation).

Table 6.3D.1.5-4: Minimum output power for power class 6

Operating band	Channel bandwidth (MHz)	Minimum output power (dBm)	Test Tolerance TT (dB)	Measurement bandwidth (MHz)
n257, n258, n261	50	-6+TT	3.66 dB	47.58
	100	-6+TT	3.84 dB	95.16
	200	-6+TT	4.17 dB	190.20
	400	-6+1.4+TT ¹	3.37 dB	380.28

NOTE 1: Core requirement cannot be tested due to testability issue and test requirement includes relaxation to achieve impact from test system noise to measurement result = 1.0 dB (Minimum requirement + relaxation).

6.3D.2 Transmit OFF power for UL MIMO

Editor's note: The following aspects are either missing or not yet determined:

- Measurement Uncertainties and Test Tolerances are FFS for power class 1, 2, 4, 5 and 6.
- The testability of this test case is pending further analysis on relaxation of the requirement for other than Band n257.
- Measurement grid for PC2/4 in Annex M.4 is TBD.

6.3D.2.1 Test purpose

To verify that the UE transmit OFF power is lower than the value specified in the test requirement.

An excess transmit OFF power potentially increases the Rise Over Thermal (RoT) and therefore reduces the cell coverage area for other UEs.

6.3D.2.2 Test applicability

This test applies to all types of NR UE release 15 and forward supporting UL MIMO.

6.3D.2.3 Minimum conformance requirements

For UE supporting UL MIMO, the transmit OFF power is defined as the TRP in the channel bandwidth when the transmitter is OFF. The transmitter is considered OFF when the UE is not allowed to transmit on any of its ports. During DTX and measurements gaps, the transmitter is not considered OFF. The minimum output power shall not exceed the values specified in Table 6.3.2.3-1. The requirement is verified with the test metric of TRP (Link=TX beam peak direction, Meas=TRP grid).

The normative reference for this requirement is TS 38.101-2 [3] clause 6.3D.2.

6.3D.2.4 Test description

6.3D.2.4.1 Initial condition

Initial conditions are a set of test configurations the UE needs to be tested in and the steps for the SS to take with the UE to reach the correct measurement state.

The initial test configurations consist of environmental conditions, test frequencies, test channel bandwidths and sub-carrier spacing based on NR operating bands specified in Table 5.3.5-1. All of these configurations shall be tested with applicable test parameters for each combination of test channel bandwidth and sub-carrier spacing, and are shown in Table 6.3D.2.4.1-1. The details of the uplink reference measurement channels (RMCs) are specified in Annexes A.2. Configurations of PDSCH and PDCCH before measurement are specified in Annex C.2.

Table 6.3D.2.4.1-1: Test Configuration Table

Initial Conditions

Test Environment as specified in TS 38.508-1 [10] clause 4.1	Normal			
Test Frequencies as specified in TS 38.508-1 [10] clause 4.3.1	Low range, Mid range, High range			
Test Channel Bandwidths as specified in TS 38.508-1 [10] clause 4.3.1	Lowest			
Test SCS as specified in Table 5.3.5-1.	Highest			
Test Parameters				
Test ID	Downlink Configuration		Uplink Configuration	
	Modulation	RB allocation	Modulation	RB allocation
1	-	-	-	-

1. Connection between SS and UE is shown in TS 38.508-1 [10] Annex A Figure A.3.3.1.1 for TE diagram and Figure A.3.4.1.1 for UE diagram.
2. The parameter settings for the cell are set up according to TS 38.508-1 [10] clause 4.4.3.
3. Downlink signals are initially set up according to Annex C, and uplink signals according to Annex G.
4. The UL Reference Measurement Channels are set according to Table 6.3D.2.4.1-1.
5. Propagation conditions are set according to Annex B.0.
6. Ensure the UE is in State RRC_CONNECTED with generic procedure parameters Connectivity NR, Connected without release On, Test Mode On and Test Loop Function On according to TS 38.508-1 [10] clause 4.5. Message contents are defined in clause 6.3D.2.4.3.

6.3D.2.4.2 Test procedure

1. Set the UE in the Tx beam peak direction found with a 3D EIRP scan as performed in Annex K.1.1. Allow at least BEAM_SELECT_WAIT_TIME (NOTE) for the UE Tx beam selection to complete.
2. SS activates the UE Beamlock Function (UBF) by performing the procedure as specified in TS 38.508-1 [10] clause 4.9.2 using condition Tx only.
3. Measure UE TRP for the assigned NR channel with a rectangular measurement filter with bandwidths according to Table 6.3D.2.5-1. Total radiated power is measured according to TRP measurement procedure defined in Annex K. TRP is calculated considering both polarizations, theta and phi.

NOTE: The BEAM_SELECT_WAIT_TIME default value is defined in Annex K.

6.3D.2.4.3 Message contents

Message contents are according to TS 38.508-1 [10] clause 4.6 ensuring Table 4.6.3-182 with condition 2TX_UL_MIMO.

6.3D.2.5 Test requirement

The requirement for the transmit OFF power shall not exceed the values specified in Table 6.3D.2.5-1.

Table 6.3D.2.5-1: Transmit OFF power

Operating band	Channel bandwidth / Transmit OFF power (dBm) / measurement bandwidth			
	50 MHz	100 MHz	200 MHz	400 MHz
n257 ²	-35+21.4	-35+24.4	-35+27.4	-35+30.4
	47.58 MHz	95.16 MHz	190.20 MHz	380.28 MHz
n258, n261	-35+[21.4]	-35+[24.4]	-35+[27.4]	-35+[30.4]
	47.58 MHz	95.16 MHz	190.20 MHz	380.28 MHz
n260	-35+[24.1]	-35+[27.1]	-35+[30.1]	-35+[33.1]
	47.58 MHz	95.16 MHz	190.20 MHz	380.28 MHz

NOTE 1: Core requirement cannot be tested due to testability issue and test requirement includes relaxation to achieve impact from test system noise to measurement result = 1.0 dB (Minimum requirement + relaxation).

NOTE 2: Relaxed n257 test requirement is testable for PC3 and PC1.

6.3D.3 Transmit ON/OFF time mask for UL MIMO

6.3D.3.1 General ON/OFF time mask for UL MIMO

Editor's note: This clause is incomplete. The following aspects are either missing or not yet determined:

- Measurement Uncertainty and Test Tolerances are FFS.
- Test requirement of ON power is FFS.
- Testability of OFF power needs further study.
- OTA test procedure for UL-MIMO is still under investigation
- TP analysis is FFS.

6.3D.3.1.1 Test purpose

To verify that the general ON/OFF time mask meets the requirements given in 6.3D.3.1.5. Transmission of the wrong power increases interference to other channels, or increases transmission errors in the uplink channel.

6.3D.3.1.2 Test applicability

This test case applies to all types of NR UE release 15 and forward supporting UL MIMO.

6.3D.3.1.3 Minimum conformance requirements

For UE supporting UL MIMO, the ON/OFF time mask requirements in clause 6.3.3 apply.

The normative reference for this requirement is TS 38.101-2 [3] clause 6.3D.3.

6.3D.3.1.4 Test description

6.3D.3.1.4.1 Initial condition

Initial conditions are a set of test configurations the UE needs to be tested in and the steps for the SS to take with the UE to reach the correct measurement state.

The initial test configurations consist of environmental conditions, test frequencies, test channel bandwidths and sub-carrier spacing based on NR operating bands specified in Table 5.3.5-1. All of these configurations shall be tested with applicable test parameters for each combination of test channel bandwidth and sub-carrier spacing, and are shown in Table 6.3D.3.1.4.1-1. The details of the uplink reference measurement channels (RMCs) are specified in Annexes A.2. Configurations of PDSCH and PDCCH before measurement are specified in Annex C.2.

Table 6.3D.3.1.4.1-1: Test Configuration Table

Initial Conditions			
Test Environment as specified in TS 38.508-1 [10] clause 4.1	Normal, TL, TH		
Test Frequencies as specified in TS 38.508-1 [10] clause 4.3.1	Low range, Mid range, High range		
Test Channel Bandwidths as specified in TS 38.508-1 [10] clause 4.3.1	Lowest, Mid, Highest		
Test SCS as specified in Table 5.3.5-1.	Highest		
Test Parameters			
Test ID	Downlink Configuration		Uplink Configuration
	-		Modulation RB allocation (NOTE 1)

1		CP-OFDM QPSK	Outer_Full
NOTE 1: The specific configuration of each RB allocation is defined in Table 6.1-1 for PC2, PC3 and PC4 or Table 6.1-2 for PC1.			

1. Connection between SS and UE is shown in TS 38.508-1 [10] Annex A Figure A.3.3.1.1 for TE diagram and Figure A.3.4.1.1 for UE diagram.
2. The parameter settings for the cell are set up according to TS 38.508-1 [10] clause 4.4.3.
3. Downlink signals are initially set up according to Annex C, and uplink signals according to Annex G.
4. The UL Reference Measurement Channels are set according to Table 6.3D.3.1.4.1-1.
5. Propagation conditions are set according to Annex B.0.
6. Ensure the UE is in State RRC_CONNECTED with generic procedure parameters Connectivity *NR*, Connected without release *On*, Test Mode *On* and Test Loop Function *On* according to TS 38.508-1 [10] clause 4.5. Message contents are defined in clause 6.3D.3.1.4.3.

6.3D.3.1.4.2 Test procedure

1. SS sends uplink scheduling information for each UL HARQ process via PDCCH DCI format 0_1 for C_RNTI to schedule the UL RMC according to Table 6.3D.3.1.4.1-1. Since the UE has no payload and no loopback data to send the UE sends uplink MAC padding bits on the UL RMC. The PDCCH DCI format 0_1 is specified with the condition 2TX_UL_MIMO in 38.508-1 [5] clause 4.3.6.1.1.2.
2. Set the UE in the Inband Tx beam peak direction found with a 3D EIRP scan as performed in Annex K.1.1. Allow at least BEAM_SELECT_WAIT_TIME (NOTE) for the UE Tx beam selection to complete.
3. SS activates the UE Beamlock Function (UBF) by performing the procedure as specified in TS 38.508-1 [10] clause 4.9.2 using condition Tx only.
4. For UE transmission OFF power, measure UE EIRP in the Tx beam peak direction in the channel bandwidth of the radio access mode according to the test configuration, which shall meet the requirements described in Table 6.3D.3.1.5-1. EIRP test procedure is defined in Annex K. The period of the measurement shall be the slot prior to the PUSCH transmission, excluding a transient period of 5 μs in the end of the slot and any DL periods. EIRP is calculated considering both polarizations, theta and phi.
5. For UE transmission ON power, measure UE EIRP in the Tx beam peak direction in the channel bandwidth of the radio access mode according to the test configuration, which shall meet the requirements described in Table 6.3D.3.1.5-2. EIRP test procedure is defined in Annex K. The period of the measurement shall be one slot with PUSCH transmission. EIRP is calculated considering both polarizations, theta and phi. For TDD slots with transient periods are not under test.
6. For UE transmission OFF power, measure UE EIRP in the Tx beam peak direction in the channel bandwidth of the radio access mode according to the test configuration, which shall meet the requirements described in Table 6.3D.3.1.5-1. EIRP test procedure is defined in Annex K. The period of the measurement shall be the slot following the PUSCH transmission, excluding a transient period of 5 μs at the beginning of the slot and any DL periods. EIRP is calculated considering both polarizations, theta and phi.
7. SS deactivates the UE Beamlock Function (UBF) by performing the procedure as specified in TS 38.508-1 [10] clause 4.9.3.

NOTE: The BEAM_SELECT_WAIT_TIME default value is defined in Annex K.

6.3D.3.1.4.3 Message contents

Message contents are according to TS 38.508-1 [5] clause 4.6 ensuring Table 4.6.3-182 with condition 2TX_UL_MIMO.

Table 6.3D.3.1.4.3-1: PUSCH-ConfigCommon

Derivation Path: TS 38.508-1[10], Table 4.6.3-119			
Information Element	Value/remark	Comment	Condition

PUSCH-ConfigCommon ::= SEQUENCE {			
p0-NominalWithGrant	-102		50MHz
	-106		100MHz
	-108		200MHz
	-112		400MHz
}			

Table 6.3D.3.1.4.3-2: ServingCellConfigCommon

Derivation Path: 38.508-1[5], Table 4.6.3-168			
Information Element	Value/remark	Comment	Condition
ServingCellConfigCommon ::= SEQUENCE {			
ss-PBCH-BlockPower	4		SCS_120kHz
	7		SCS_240kHz
}			

Condition	Explanation
SCS_120kHz	SCS=120kHz for SS/PBCH block
SCS_240kHz	SCS=240kHz for SS/PBCH block

Table 6.3D.3.1.4.3-3: PUSCH-PowerControl

Derivation Path: TS 38.508-1 [10], Table 4.6.3-120			
Information Element	Value/remark	Comment	Condition
PUSCH-PowerControl ::= SEQUENCE {			
tpc-Accumulation	disabled		
p0-AlphaSets SEQUENCE (SIZE (1..maxNrofP0-PUSCH-AlphaSets)) OF SEQUENCE {	1 entry		
P0-PUSCH-AlphaSet[1] SEQUENCE {			
alpha	alpha1		
}			
}			
}			

6.3D.3.1.5 Test requirement

The requirement for the EIRP measured in steps 4, 5 and 6 of the test procedure shall not exceed the values specified in Table 6.3D.3.1.5-1 and 6.3D.3.1.5-2.

Table 6.3D.3.1.5-1: Test requirement of OFF power of General ON/OFF time mask for UL MIMO

	Channel bandwidth / minimum output power / measurement bandwidth			
	50 MHz	100 MHz	200 MHz	400 MHz
Transmit OFF power	≤ -30+TT dBm			
Transmission OFF Measurement bandwidth	47.58 MHz	95.16 MHz	190.20 MHz	380.28 MHz
Note 1:	Core requirements cannot be tested due to testability issue and test requirement includes relaxation to achieve impact from test system noise to measurement results = 1.0 dB (Minimum requirement + relaxation R).			
Note 2:	Relaxation R is specified in Table 6.3D.3.1.5-3.			

Table 6.3D.3.1.5-2: Test requirement of ON power of General ON/OFF time mask for UL MIMO

	SCS [kHz]	Channel bandwidth / measurement bandwidth			
		50 MHz	100 MHz	200 MHz	400 MHz
Expected Transmission ON power for DFT-s- OFDM	60	22.1	21.1	22.1	N/A
	120	22.1	21.1	22.1	21.1
Power tolerance		$\pm (14+TT)$ dB			
Note 1: The lower power limit shall not exceed the minimum output power requirements defined in sub-clause 6.3.2.3, and the higher power limit shall not exceed the Max EIRP defined in sub-clause 6.2.1.3.					

Table 6.3D.3.1.5-3: Relaxation required for OFF power for PC3 UEs

Operating band	50 MHz	100 MHz	200 MHz	400 MHz
n257, n258, n261	[19.4] dB	[22.4] dB	[25.4] dB	[28.4] dB
n260	[21.5] dB	[24.5] dB	[27.5] dB	[30.5] dB

Table 6.3D.3.1.5-4: Test Tolerance for ON power

FFS

6.3D.3.2 Void

6.3D.3.3 Void

6.3D.3.4 Void

6.4 Transmit signal quality

6.4.1 Frequency error

6.4.1.1 Test purpose

This test verifies the ability of both, the receiver and the transmitter, to process frequency correctly.

Receiver: to extract the correct frequency from the stimulus signal, offered by the System simulator, under ideal propagation conditions and low level.

Transmitter: to derive the correct modulated carrier frequency from the results, gained by the receiver.

6.4.1.2 Test applicability

This test case applies to all types of NR UE release 15 and forward.

6.4.1.3 Minimum conformance requirements

The UE basic measurement interval of modulated carrier frequency is 1 UL slot. The mean value of basic measurements of UE modulated carrier frequency shall be accurate to within ± 0.1 PPM observed over a period of 1 msec of cumulated measurement intervals compared to the carrier frequency received from the NR gNB.

The frequency error is defined as a directional requirement. The requirement is verified in beam locked mode with the test metric of Frequency (Link=TX beam peak direction, Meas=Link angle).

The normative reference for this requirement is TS 38.101-2 [3] clause 6.4.1

6.4.1.4 Test description

6.4.1.4.1 Initial condition

Initial conditions are a set of test configurations the UE needs to be tested in and the steps for the SS to take with the UE to reach the correct measurement state.

The initial test configurations consist of environmental conditions, test frequencies, test channel bandwidths and sub-carrier spacing based on NR operating bands specified in Table 5.3.5-1. All of these configurations shall be tested with applicable test parameters for each combination of channel bandwidth and sub-carrier spacing, are shown in Table 6.4.1.4.1-1. The details of the uplink and downlink reference measurement channels (RMCs) are specified in Annexes A.2 and A.3. Configurations of PDSCH and PDCCH before measurement are specified in Annex C.2.

Table 6.4.1.4.1-1: Test Configuration Table

Initial Conditions				
Test Environment as specified in TS 38.508-1 [10] clause 4.1			Normal, TL, TH	
Test Frequencies as specified in TS 38.508-1 [10] clause 4.3.1			Mid range	
Test Channel Bandwidths as specified in TS 38.508-1 [10] clause 4.3.1			Highest	
Test SCS as specified in Table 5.3.5-1.			Lowest	
Test Parameters				
Test ID	Downlink Configuration		Uplink Configuration	
	Modulation	RB allocation	Modulation	RB allocation
1	CP-OFDM QPSK	Full RB (NOTE 1)	DFT-s-OFDM QPSK	REFSENS (NOTE 2)
NOTE 1: Full RB allocation shall be used per each SCS and channel BW as specified in Table 7.3.2.4.1-2.				
NOTE 2: REFSENS refers to Table 7.3.2.4.1-3 which defines uplink RB configuration and start RB location for each SCS, channel BW and NR band.				

1. Connection between SS and UE is shown in TS 38.508-1 [10] Annex A, Figure A.3.3.1.1 for TE diagram and section A.3.4.1.1 for UE diagram.
2. The parameter settings for the cell are set up according to TS 38.508-1 [10] clause 4.4.3.
3. Downlink signals are initially set up according to Annex C, and uplink signals according to Annex G.
4. The DL and UL Reference Measurement channels are set according to Table 6.4.1.4.1-1.
5. Propagation conditions are set according to Annex B.0.
6. Ensure the UE is in state RRC_CONNECTED with generic procedure parameters Connectivity NR, Connected without release On, Test Mode On and Test Loop Function On according to TS 38.508-1 [10] clause 4.5. Message contents are defined in clause 6.4.1.4.3

6.4.1.4.2 Test procedure

1. Retrieve the LO position from the parameter txDirectCurrentLocation in UplinkTxDirectCurrent IE.
2. SS transmits PDSCH via PDCCH DCI format 1_1 for C_RNTI to transmit the DL RMC according to Table 6.4.1.4.1-1. The SS sends downlink MAC padding bits on the DL RMC.
3. SS sends uplink scheduling information for each UL HARQ process via PDCCH DCI format 0_1 for C_RNTI to schedule the UL RMC according to Table 6.4.1.4.1-1. Since the UL has no payload and no loopback data to send the UE sends uplink MAC padding bits on the UL RMC.
5. Set the UE in the Inband Tx beam peak direction and apply the associated polarization for the DL, both found with a 3D EIRP scan as performed in Annex K.1.1. Connect the SS (System Simulator) with the DUT through the measurement antenna with polarization reference PolLink to form the TX beam towards the TX beam peak direction and respective polarization. Allow at least BEAM_SELECT_WAIT_TIME (NOTE 1) for the UE Tx beam selection to complete.

4. Send continuously uplink power control "up" commands to the UE in every uplink scheduling information to the UE so that the UE transmits at P_{UMAX} level for the duration of the test. Allow at least 200ms starting from the first TPC Command for the UE to reach P_{UMAX} level. Allow at least BEAM_SELECT_WAIT_TIME (NOTE 1) for the UE Tx beam selection to complete.
6. SS activates the UE Beamlock Function (UBF) by performing the procedure as specified in TS 38.508-1 [10] clause 4.9.2 using condition TxRx.
7. Measure the Frequency Error using Global In-Channel Tx-Test (Annex E) for the θ - and ϕ -polarization of the UL. For TDD, only slots consisting of only UL symbols are under test.

NOTE 1: The BEAM_SELECT_WAIT_TIME default value is defined in Annex K.

6.4.1.4.3 Message contents

Message contents are according to TS 38.508-1 [10] clause 4.6 with DFT-s-OFDM condition in Table 4.6.3-118 PUSCH-Config.

6.4.1.5 Test requirement

The 10 frequency error Δf results for the θ -polarization or the 10 frequency error Δf results for the ϕ -polarization must fulfil the test requirement:

$$|\Delta f| \leq (0.1 \text{ PPM} + 0.005 \text{ PPM}),$$

6.4.2 Transmit modulation quality

Transmit modulation quality defines the modulation quality for expected in-channel RF transmissions from the UE. The transmit modulation quality is specified in terms of:

- Error Vector Magnitude (EVM) for the allocated resource blocks (RBs)
- EVM equalizer spectrum flatness derived from the equalizer coefficients generated by the EVM measurement process
- Carrier leakage
- In-band emissions for the non-allocated RB

All the parameters defined in clause 6.4.2 are defined using the measurement methodology specified in Annex E.

All the requirements in 6.4.2 are defined as directional requirement. The requirements are verified in beam locked mode on beam peak direction, with parameter *maxRank* (as defined in TS 38.331 [19]) set to 1. The requirements are applicable to UL transmission from each configurable antenna port (as defined in TS 38.331 [19]) of UE, enabled one at a time.

In case the parameter 3300 or 3301 is reported from UE via *txDirectCurrentLocation* IE (as defined in TS 38.331 [19]), carrier leakage measurement requirement in clause 6.4.2.2 and 6.4.2.3 shall be waived, and the RF correction with regard to the carrier leakage and IQ image shall be omitted during the calculation of transmit modulation quality.

6.4.2.1 Error vector magnitude

Editor's note This clause is complete for PUSCH and PUCCH with PC1 in FR2a, PC3 in FR2a and FR2b, PC5 in FR2a, PC6. The following aspects of the clause are for future consideration:

- Measurement Uncertainty and Test Tolerance are FFS except for PUSCH and PUCCH, PC1 in FR2a, PC3 in FR2a and FR2b, PC5 in FR2a, PC6.
- For a transition period until RAN#102 meeting (Dec 2023), the implementation of note 4 in Table 6.4.2.1.4.1-1 in test equipment is not applicable to avoid lack of test coverage until testcase 6.4.2.1_1 is available.
- For a transition period until RAN#108 (June 2025) previous test procedure in TS 38.521-2 V18.4.0 is allowed for TE implementation.

6.4.2.1.1 Test Purpose

The Error Vector Magnitude is a measure of the difference between the reference waveform and the measured waveform. This difference is called the error vector. Before calculating the EVM, the measured waveform is corrected by the sample timing offset and RF frequency offset. Then the carrier leakage shall be removed from the measured waveform before calculating the EVM.

The measured waveform is further equalised using the channel estimates subjected to the EVM equaliser spectrum flatness requirement specified in sub-clauses 6.4.2.4.3 and 6.4.2.5.3. For DFT-s-OFDM waveforms, the EVM result is defined after the front-end FFT and IDFT as the square root of the ratio of the mean error vector power to the mean reference power expressed as a %. For CP-OFDM waveforms, the EVM result is defined after the front-end FFT as the square root of the ratio of the mean error vector power to the mean reference power expressed as a %.

The basic EVM measurement interval in the time domain is one preamble sequence for the PRACH and the duration of PUCCH/PUSCH channel, or one hop, if frequency hopping is enabled for PUCCH and PUSCH in the time domain. The EVM measurement interval is reduced by any symbols that contain an allowable power transient as defined in clause 6.3.3.3.

6.4.2.1.2 Test applicability

This test case applies to all types of NR UE release 15 and forward.

6.4.2.1.3 Minimum conformance requirements

The RMS average of the basic EVM measurements for the average EVM case, and for the reference signal EVM case, for the different modulation schemes shall not exceed the values specified in Table 6.4.2.1.3-1 for the parameters defined in Table 6.4.2.1.3-2 to Table 6.4.2.1.3-4 depending on UE power class. For EVM evaluation purposes, all 13 PRACH preamble formats and all 5 PUCCH formats are considered to have the same EVM requirement as QPSK modulated.

The measurement interval for the EVM determination is 10 subframes. The requirement is verified with the test metric of EVM (Link=TX beam peak direction, Meas=Link angle).

Table 6.4.2.1.3-1: Minimum requirements for error vector magnitude

Parameter	Unit	Average EVM level	Reference signal EVM level
Pi/2 BPSK	%	30.0	30.0
QPSK	%	17.5	17.5
16 QAM	%	12.5	12.5
64 QAM	%	8.0	8.0

Table 6.4.2.1.3-2: Parameters for Error Vector Magnitude for power class 1

Parameter	Unit	Level
UE EIRP	dBm	≥ 4
UE EIRP for UL 16QAM	dBm	≥ 7
UE EIRP for UL 64QAM	dBm	≥ 11
Operating conditions		Normal conditions

Table 6.4.2.1.3-3: Parameters for Error Vector Magnitude for power class 2, 3, and 4

Parameter	Unit	Level
UE EIRP	dBm	≥ -13
UE EIRP for UL 16QAM	dBm	≥ -10
UE EIRP for UL 64QAM	dBm	≥ -6
Operating conditions		Normal conditions

Table 6.4.2.1.3-4: Parameters for Error Vector Magnitude for power class 5 and 6

Parameter	Unit	Level
UE EIRP	dBm	≥ -6
UE EIRP for UL 16 QAM	dBm	≥ -3
UE EIRP for UL 64 QAM	dBm	≥ 1
Operating conditions		Normal conditions

The normative reference for this requirement is TS 38.101-2 [3] clause 6.4.2.1.

6.4.2.1.4 Test description

6.4.2.1.4.1 Initial conditions

Initial conditions are a set of test configurations the UE needs to be tested in and the steps for the SS to take with the UE to reach the correct measurement state.

The initial test configurations consist of environmental conditions, test frequencies, test channel bandwidths and sub-carrier spacing based on NR operating bands specified in Table 5.3.5-1. All of these configurations shall be tested with applicable test parameters for each combination of channel bandwidth and sub-carrier spacing, are shown in Table 6.4.2.1.4.1-1. The details of the uplink reference measurement channels (RMCs) are specified in Annex A.2. Configurations of PDSCH and PDCCH before measurement are specified in Annex C.2.

Table 6.4.2.1.4.1-1: Test Configuration Table for PUSCH

Initial Conditions			
Test Environment as specified in TS 38.508-1 [10] clause 4.1		Normal	
Test Frequencies as specified in TS 38.508-1 [10] clause 4.3.1		Low range, Mid range, High range	
Test Channel Bandwidths as specified in TS 38.508-1 [10] clause 4.3.1		Lowest, Highest	
Test SCS as specified in Table 5.3.5-1		Lowest, Highest	
Test Parameters			
Test ID	Downlink Configuration	Uplink Configuration	
		Modulation	RB allocation (NOTE 1)
1	-	DFT-s-OFDM PI/2 BPSK	Inner_Full for PC2, PC3, PC4, PC5 and PC6 Inner_Full_Region1 for PC1
2		DFT-s-OFDM PI/2 BPSK	Outer_Full
3 (NOTE 4)		DFT-s-OFDM QPSK	Inner_Full for PC2, PC3, PC4, PC5 and PC6 Inner_Full_Region1 for PC1
4		DFT-s-OFDM QPSK	Outer_Full
5		DFT-s-OFDM 16 QAM	Inner_Full for PC2, PC3, PC4, PC5 and PC6 Inner_Full_Region1 for PC1
6		DFT-s-OFDM 16 QAM	Outer_Full
7		DFT-s-OFDM 64 QAM	Inner_Full for PC2, PC3, PC4, PC5 and PC6 Inner_Full_Region1 for PC1
8		DFT-s-OFDM 64 QAM	Outer_Full
9		CP-OFDM QPSK	Inner_Full for PC2, PC3, PC4, PC5 and PC6 Inner_Full_Region1 for PC1
10		CP-OFDM QPSK	Outer_Full
11		CP-OFDM 16 QAM	Inner_Full for PC2, PC3, PC4, PC5 and PC6 Inner_Full_Region1 for PC1
12		CP-OFDM 16 QAM	Outer_Full
13		CP-OFDM 64 QAM	Inner_Full for PC2, PC3, PC4, PC5 and PC6 Inner_Full_Region1 for PC1
14		CP-OFDM 64 QAM	Outer_Full

NOTE 1: The specific configuration of each RB allocation is defined in Table 6.1-1 for PC2, PC3, PC4, PC5, PC6 and PC7 or Table 6.1-2 for PC1.
 NOTE 2: Test Channel Bandwidths are checked separately for each NR band, which applicable channel bandwidths are specified in Table 5.3.5-1.
 NOTE 3: The following test points are not testable for PC3 devices:
 FR2a channel bandwidth 200MHz: test points 8, 13 and 14
 FR2a channel bandwidth 400MHz: test points 7, 8, 11, 12, 13 and 14
 FR2b channel bandwidth 50MHz: test points 13 and 14
 FR2b channel bandwidth 100MHz: test points 7, 8, 13 and 14
 FR2b channel bandwidth 200MHz: test points 7, 8, 13 and 14
 FR2b channel bandwidth 400MHz: test points 5, 6, 7, 8, 11, 12, 13 and 14
 NOTE 4: This test point shall be skipped if device supports mpr-PowerBoost-FR2-r16 UE capability.

Table 6.4.2.1.4.1-2: Test Configuration Table for PUCCH

Initial Conditions				
Test Environment as specified in TS 38.508-1 [10] clause 4.1		Normal		
Test Frequencies as specified in TS 38.508-1 [10] clause 4.3.1		See Table 6.4.2.1.4.1-1		
Test Channel Bandwidths as specified in TS 38.508-1 [10] clause 4.3.1		See Table 6.4.2.1.4.1-1		
Test SCS as specified in Table 5.3.5-1		See Table 6.4.2.1.4.1-1		
Test Parameters				
ID	Downlink Configuration		Uplink Configuration	
	Modulation	RB allocation	Waveform	PUCCH format
1	CP-OFDM QPSK	Full RB (Note 1)	CP-OFDM	PUCCH format = Format 1 Length in OFDM symbols = 14
2	CP-OFDM QPSK	Full RB (Note 1)	DFT-s-OFDM	PUCCH format = Format 3 Length in OFDM symbols = 14
NOTE 1: Full RB allocation shall be used per each SCS and channel BW as specified in Table 7.3.2.4.1-2.				
NOTE 2: Test Channel Bandwidths are checked separately for each NR band, which applicable channel bandwidths are specified in Table 5.3.5-1.				

Table 6.4.2.1.4.1-3: Test Configuration for PRACH

Initial Conditions	
Test Environment as specified in TS 38.508-1 [10] clause 4.1	Normal
Test Frequencies as specified in TS 38.508-1 [10] clause 4.3.1	See Table 6.4.2.1.4.1-1
Test Channel Bandwidths as specified in TS 38.508-1 [10] clause 4.3.1	See Table 6.4.2.1.4.1-1
Test SCS as specified in Table 5.3.5-1	See Table 6.4.2.1.4.1-1
PRACH preamble format	
PRACH Configuration Index	52
SS/PBCH SSS EPRE setting (dBm/120kHz)	-96

1. Connection between SS and UE is shown in TS 38.508-1 [10] Annex A, in Figure A.3.3.1.1 for TE diagram and section A.3.4.1.1 for UE diagram.
2. The parameter settings for the cell are set up according to TS 38.508-1 [10] clause 4.4.3.
3. Downlink signals are initially set up according to Annex C, and uplink signals according to Annex G.
4. The UL Reference Measurement channels are set according to Table 6.4.2.1.4.1-1.
5. Propagation conditions are set according to Annex B.0.
6. Ensure the UE is in state RRC_CONNECTED with generic procedure parameters Connectivity NR, Connected without release On, Test Mode On and Test Loop Function On according to TS 38.508-1 [10] clause 4.5. Message contents are defined in clause 6.4.2.1.4.3

6.4.2.1.4.2 Test procedure

Test procedure for PUSCH:

- 1.1 Retrieve the LO position from the parameter txDirectCurrentLocation in UplinkTxDirectCurrent IE.
- 1.2 SS sends uplink scheduling information for each UL HARQ process via PDCCH DCI format 0_1 for C_RNTI to schedule the UL RMC according to Table 6.4.2.1.4.1-1. Since the UE has no payload data to send, the UE transmits uplink MAC padding bits on the UL RMC.
- 1.3 Set the UE in the Inband Tx beam peak direction found with a 3D EIRP scan as performed in Annex K.1.1. Allow at least BEAM_SELECT_WAIT_TIME (NOTE 2) for the UE Tx beam selection to complete.
- 1.4 Send continuously uplink power control "up" commands in the uplink scheduling information to the UE until the UE transmits at P_{UMAX} level. Allow at least 200 ms starting from the first TPC command in this step for the UE to reach P_{UMAX} level. Allow at least BEAM_SELECT_WAIT_TIME (NOTE 2) for the UE Tx beam selection to complete.
- 1.5 SS activates the UE Beamlock Function (UBF) by performing the procedure as specified in TS 38.508-1 [10] clause 4.9.2 using condition TxRx.
- 1.6 If the UE transmits on only one polarization, measure the EVM_{θ} , EVM_{φ} , $\overline{EVM}_{DMRS,\theta}$ and $\overline{EVM}_{DMRS,\varphi}$ using Global In-Channel Tx-Test (Annex E) for the θ - and φ -polarizations, respectively. For TDD, only slots consisting of only UL symbols are under test. Calculate $\overline{EVM}_{DMRS} = \min(\overline{EVM}_{DMRS,\theta}, \overline{EVM}_{DMRS,\varphi})$ and $EVM = \min(EVM_{\theta}, EVM_{\varphi})$.
If the UE transmits on both polarizations, measure the EVM and \overline{EVM}_{DMRS} using Global In-Channel Tx-Test (Annex E with procedures in E.7.1 and E.7.3). For TDD, only slots consisting of only UL symbols are under test.
- 1.7 SS deactivates the UE Beamlock Function (UBF) by performing the procedure as specified in TS 38.508-1 [10] clause 4.9.3.

NOTE1: When switching to DFT-s-OFDM waveform, as specified in Table 6.4.2.1.4.1-1, send an NR RRCReconfiguration message according to TS 38.508-1 [10] clause 4.6.3 Table 4.6.3-118 PUSCH-Config with TRANSFORM_PRECODER_ENABLED condition.

NOTE 2: The BEAM_SELECT_WAIT_TIME default value is defined in Annex K.

Table 6.4.2.1.4.2-1: Void

Table 6.4.2.1.4.2-2: Void

Table 6.4.2.1.4.2-3: Void

Test procedure for PUCCH:

- 2.1 Retrieve the LO position from the parameter txDirectCurrentLocation in UplinkTxDirectCurrent IE.
- 2.2 PUCCH is set according to Table 6.4.2.1.4.1-2.
- 2.3 SS transmits PDSCH via PDCCH DCI format 1_1 for C_RNTI to transmit the DL RMC according to Table 6.4.2.1.4.1-2. The SS sends downlink MAC padding bits on the DL RMC. The transmission of PDSCH will make the UE send uplink ACK/NACK using PUCCH. There is no PUSCH transmission.
- 2.4 Set the UE in the Inband Tx beam peak direction found with a 3D EIRP scan as performed in Annex K.1.1. Allow at least BEAM_SELECT_WAIT_TIME (NOTE 2) for the UE Tx beam selection to complete.
- 2.5 SS send appropriate TPC commands for PUCCH to the UE until the UE transmit PUCCH at [P_{UMAX} level]. Allow at least 200 ms starting from the first TPC command in this step for the UE to reach [P_{UMAX} level]. Allow at least BEAM_SELECT_WAIT_TIME (NOTE 2) for the UE Tx beam selection to complete.

2.6 SS activates the UE Beamlock Function (UBF) by performing the procedure as specified in TS 38.508-1 [10] clause 4.9.2 using condition TxRx.

2.7 If the UE transmits on only one polarization, measure PUCCH EVM_θ and PUCCH EVM_φ using Global In-Channel Tx-Test (Annex E). Calculate $PUCCH\ EVM = \min(PUCCH\ EVM_{\theta}, PUCCH\ EVM_{\phi})$.

If the UE transmits on both polarizations, measure the PUCCH EVM using Global In-Channel Tx-Test (Annex E with procedures in E.7.1 and E.7.3).

2.8 SS deactivates the UE Beamlock Function (UBF) by performing the procedure as specified in TS 38.508-1 [10] clause 4.9.3.

NOTE1: When switching to DFT-s-OFDM waveform, as specified in Table 6.4.2.1.4.1-2, send an NR RRCReconfiguration message according to TS 38.508-1 [10] clause 4.6.3 Table 4.6.3-118 PUSCH-Config with TRANSFORM_PRECODER_ENABLED condition.

NOTE 2: The BEAM_SELECT_WAIT_TIME default value is defined in Annex K.

Test procedure for PRACH:

3.1 Retrieve the LO position from the parameter txDirectCurrentLocation in UplinkTxDirectCurrent IE.

3.2 Set the UE in the Inband Tx beam peak direction found with a 3D EIRP scan as performed in Annex K.1.1.

3.3 The SS shall set RS EPRE according to Table 6.4.2.1.4.1-3.

3.4 PRACH is set according to Table 6.4.2.1.4.1-3.

3.5 The SS shall signal a Random Access Preamble ID via a PDCCH order to the UE and initiate a Non-contention based Random Access procedure.

3.6 The UE shall send the signalled preamble to the SS.

3.7 In response to the preamble, the SS shall transmit a random access response not corresponding to the transmitted random access preamble, or send no response.

3.8 The UE shall consider the random access response reception not successful then re-transmit the preamble with the calculated PRACH transmission power.

3.9 Repeat step 3.5 and 3.6 until the SS collect enough PRACH preambles (10 preambles for format A2). Measure the EVM_θ and EVM_φ in PRACH channel using Global In-Channel Tx-Test (Annex E). Calculate $EVM = \min(EVM_{\theta}, EVM_{\phi})$.

6.4.2.1.4.3 Message contents

Message contents are according to TS 38.508-1 [10] clause 4.6 with the following exceptions for PRACH test.

Table 6.4.2.1.4.3-1: RACH-ConfigGeneric for PRACH test

Derivation Path: TS 38.508-1 [10], Table 4.6.3-130			
Information Element	Value/remark	Comment	Condition
RACH-ConfigGeneric ::= SEQUENCE {			
preambleReceivedTargetPower	-60		
powerRampingStep	dB0		
}			

Table 6.4.2.1.4.3-2: ServingCellConfigCommon

Derivation Path: TS 38.508-1 [10], Table 4.6.3-168			
Information Element	Value/remark	Comment	Condition
ServingCellConfigCommon ::= SEQUENCE {			
ss-PBCH-BlockPower	18		
}			

Table 6.4.2.1.4.3-3: ServingCellConfigCommonSIB

Derivation Path: TS 38.508-1 [10], Table 4.6.3-169			
Information Element	Value/remark	Comment	Condition
ServingCellConfigCommonSIB ::= SEQUENCE {			
ss-PBCH-BlockPower	18		
}			

6.4.2.1.5 Test requirement

The PUSCH EVM, derived in Annex E.4.2, shall not exceed the values in Table 6.4.2.1.5-1.

The PUSCH \overline{EVM}_{DMRS} , derived in Annex E.4.6.2, shall not exceed the values in Table 6.4.2.1.5-1 when embedded with data symbols of the respective modulation scheme.

The PUCCH EVM derived in Annex E.5.9.2 shall not exceed the values for QPSK in Table 6.4.2.1.5-1.

The PRACH EVM derived in Annex E.6.9.2 shall not exceed the values for QPSK in Table 6.4.2.1.5-1.

Table 6.4.2.1.5-1: Test requirements for Error Vector Magnitude

Parameter	Unit	Average EVM Level	Reference Signal EVM Level
Pi/2 BPSK	%	30+TT	30+TT
QPSK	%	17.5+TT	17.5+TT
16 QAM	%	12.5+TT	12.5+TT
64 QAM	%	8+TT	8+TT

Table 6.4.2.1.5-2: Test Tolerance (TT) for PUSCH, PC3, FR2a

Test ID	Modulation	RB alloc.	50MHz	100MHz	200MHz	400MHz
1	DFT-s-OFDM Pi/2 BPSK	Inner_Full	0.00%	0.00%	0.00%	0.00%
2	DFT-s-OFDM Pi/2 BPSK	Outer_Full	0.00%	0.00%	0.00%	0.00%
3	DFT-s-OFDM QPSK	Inner_Full	0.00%	0.00%	0.00%	1.61%
4	DFT-s-OFDM QPSK	Outer_Full	0.00%	0.00%	0.00%	2.18%
5	DFT-s-OFDM 16 QAM	Inner_Full	0.00%	0.00%	1.53%	4.29%
6	DFT-s-OFDM 16 QAM	Outer_Full	0.00%	0.00%	1.67%	4.29%
7	DFT-s-OFDM 64 QAM	Inner_Full	1.06%	1.97%	3.61%	NA
8	DFT-s-OFDM 64 QAM	Outer_Full	1.44%	2.68%	NA	NA
9	CP-OFDM QPSK	Inner_Full	0.00%	0.00%	0.00%	3.66%
10	CP-OFDM QPSK	Outer_Full	0.00%	0.00%	1.37%	3.66%
11	CP-OFDM 16 QAM	Inner_Full	0.00%	1.35%	2.57%	NA
12	CP-OFDM 16 QAM	Outer_Full	0.00%	1.35%	2.57%	NA
13	CP-OFDM 64 QAM	Inner_Full	2.19%	3.97%	NA	NA
14	CP-OFDM 64 QAM	Outer_Full	2.19%	3.97%	NA	NA

NOTE 1: Test combinations without TT defined must be skipped as not testable.

Table 6.4.2.1.5-3: Test Tolerance (TT) for PUSCH, PC3, FR2b

Test ID	Modulation	RB alloc.	50MHz	100MHz	200MHz	400MHz
1	DFT-s-OFDM Pi/2 BPSK	Inner_Full	0.00%	0.00%	0.00%	0.00%
2	DFT-s-OFDM Pi/2 BPSK	Outer_Full	0.00%	0.00%	0.00%	2.50%
3	DFT-s-OFDM QPSK	Inner_Full	0.00%	0.00%	1.31%	2.49%
4	DFT-s-OFDM QPSK	Outer_Full	0.00%	0.00%	1.79%	4.01%
5	DFT-s-OFDM 16 QAM	Inner_Full	0.00%	1.48%	2.85%	NA
6	DFT-s-OFDM 16 QAM	Outer_Full	1.00%	1.92%	3.60%	NA
7	DFT-s-OFDM 64 QAM	Inner_Full	2.49%	NA	NA	NA
8	DFT-s-OFDM 64 QAM	Outer_Full	3.35%	NA	NA	NA
9	CP-OFDM QPSK	Inner_Full	0.00%	1.42%	2.73%	8.42%
10	CP-OFDM QPSK	Outer_Full	0.00%	1.58%	3.04%	8.42%
11	CP-OFDM 16 QAM	Inner_Full	1.72%	3.25%	5.92%	NA
12	CP-OFDM 16 QAM	Outer_Full	1.72%	3.25%	5.92%	NA

13	CP-OFDM 64 QAM	Inner_Full	NA	NA	NA	NA
14	CP-OFDM 64 QAM	Outer_Full	NA	NA	NA	NA
NOTE 1: Test combinations without TT defined must be skipped as not testable.						

Table 6.4.2.1.5-4: Test Tolerance (TT) for PUSCH, PC1, FR2a

Test ID	Modulation	50MHz	100MHz	200MHz	400MHz
1-2	PI/2 BPSK	0.00%	0.00%	0.00%	0.00%
3-4, 9-10	QPSK	0.00%	0.00%	0.00%	1.35%
5-6, 11-12	16 QAM	0.00%	0.00%	0.94%	1.83%
7-8, 13,14	64 QAM	0.00%	0.73%	1.41%	2.63%
NOTE 1: Test combinations without TT defined must be skipped as not testable.					

Table 6.4.2.1.5-5: Test Tolerance (TT) for PUSCH, PC5, PC6, FR2a

Test ID	Modulation	RB alloc.	50MHz	100MHz	200MHz	400MHz
1	DFT-s-OFDM PI/2 BPSK	Inner_Full	0.00%	0.00%	0.00%	0.00%
2	DFT-s-OFDM PI/2 BPSK	Outer_Full	0.00%	0.00%	0.00%	0.00%
3	DFT-s-OFDM QPSK	Inner_Full	0.00%	0.00%	0.00%	1.35%
4	DFT-s-OFDM QPSK	Outer_Full	0.00%	0.00%	0.00%	1.46%
5	DFT-s-OFDM 16 QAM	Inner_Full	0.00%	0.00%	1.03%	2.25%
6	DFT-s-OFDM 16 QAM	Outer_Full	0.00%	0.00%	1.08%	2.25%
7	DFT-s-OFDM 64 QAM	Inner_Full	0.00%	0.93%	1.78%	3.82%
8	DFT-s-OFDM 64 QAM	Outer_Full	0.00%	1.03%	1.95%	3.82%
9	CP-OFDM QPSK	Inner_Full	0.00%	0.00%	0.00%	1.72%
10	CP-OFDM QPSK	Outer_Full	0.00%	0.00%	0.00%	1.72%
11	CP-OFDM 16 QAM	Inner_Full	0.00%	0.00%	1.21%	2.73%
12	CP-OFDM 16 QAM	Outer_Full	0.00%	0.00%	1.21%	2.73%
13	CP-OFDM 64 QAM	Inner_Full	0.63%	1.21%	2.28%	NA
14	CP-OFDM 64 QAM	Outer_Full	0.63%	1.21%	2.28%	NA
NOTE 1: Test combinations without TT defined must be skipped as not testable.						

Table 6.4.2.1.5-6: Test Tolerance (TT) for PUCCH

Power Class	Frequency	50MHz	100MHz	200MHz	400MHz
PC3	23.45GHz <= f <= 32.125GHz	0.00%	0.00%	0.00%	2.18%
	32.125GHz < f <= 40.8GHz	0.00%	0.00%	2.01%	4.01%
PC1	23.45GHz <= f <= 32.125GHz	0.00%	0.00%	0.00%	1.86%
PC5, PC6	23.45GHz <= f <= 32.125GHz	0.00%	0.00%	0.00%	1.47%
NOTE 1: Test combinations without TT defined must be skipped as not testable.					

6.4.2.1_1 Error vector magnitude with Power Boost

Editor's note: This clause is incomplete. The following aspects are either missing or not yet determined:

- Measurement Uncertainty and Test Tolerance are FFS except for PUSCH, PC3 in FR2a and FR2b.
- For a transition period until RAN#108 (June 2025) previous test procedure in TS 38.521-2 V18.4.0 is allowed for TE implementation.

6.4.2.1_1.1 Test Purpose

Same as clause 6.4.2.1.1.

6.4.2.1_1.2 Test applicability

This test case applies to all types of NR UE release 16 and forward supporting *mpr-PowerBoost-FR2-r16* UE capability.

6.4.2.1_1.3 Minimum conformance requirements

Same as clause 6.4.2.1.3.

6.4.2.1_1.4 Test description

6.4.2.1_1.4.1 Initial conditions

Initial conditions are a set of test configurations the UE needs to be tested in and the steps for the SS to take with the UE to reach the correct measurement state.

The initial test configurations consist of environmental conditions, test frequencies, test channel bandwidths and sub-carrier spacing based on NR operating bands specified in Table 5.3.5-1. All of these configurations shall be tested with applicable test parameters for each combination of channel bandwidth and sub-carrier spacing, are shown in Table 6.4.2.1.4.1-1. The details of the uplink reference measurement channels (RMCs) are specified in Annex A.2. Configurations of PDSCH and PDCCH before measurement are specified in Annex C.2.

Table 6.4.2.1_1.4.1-1: Test Configuration Table for PUSCH

Default Conditions					
Test Environment as specified in TS 38.508-1 [10] clause 4.1			Normal		
Test Frequencies as specified in TS 38.508-1 [10] clause 4.3.1			Low range, Mid Range, High range		
Test Channel Bandwidths as specified in TS 38.508-1 [10] clause 4.3.1			Lowest, 100 MHz, Highest		
Test SCS as specified in Table 5.3.5-1			120 kHz		
Test Parameters					
Test ID	ChBw	SCS	Downlink Configuration	Uplink Configuration	
		Default	-	Modulation	RB allocation (NOTE 1)
1	50			DFT-s-OFDM QPSK	Inner_Full for PC2, PC3 and PC4 Inner_Full_Region1 for PC1
2	100				
3	200				
4	400				
NOTE 1: The specific configuration of each RF allocation is defined in Table 6.1-1 for PC2, PC3 and PC4 or Table 6.1-2 for PC1.					

Table 6.4.2.1_1.4.1-2: Test Configuration Table for PUCCH

Initial Conditions				
Test Environment as specified in TS 38.508-1 [10] clause 4.1		Normal		
Test Frequencies as specified in TS 38.508-1 [10] clause 4.3.1		See Table 6.4.2.1_1.4.1-1		
Test Channel Bandwidths as specified in TS 38.508-1 [10] clause 4.3.1		See Table 6.4.2.1_1.4.1-1		
Test SCS as specified in Table 5.3.5-1		See Table 6.4.2.1_1.4.1-1		
Test Parameters				
ID	Downlink Configuration		Uplink Configuration	
	Modulation	RB allocation	Waveform	PUCCH format
1	CP-OFDM QPSK	Full RB (Note 1)	DFT-s-OFDM	PUCCH format = Format 3 Length in OFDM symbols = 14
NOTE 1: Full RB allocation shall be used per each SCS and channel BW as specified in Table 7.3.2.4.1-2.				
NOTE 2: Test Channel Bandwidths are checked separately for each NR band, which applicable channel bandwidths are specified in Table 5.3.5-1.				

1. Connection between SS and UE is shown in TS 38.508-1 [10] Annex A, in Figure A.3.3.1.1 for TE diagram and section A.3.4.1.1 for UE diagram.
2. The parameter settings for the cell are set up according to TS 38.508-1 [10] clause 4.4.3.
3. Downlink signals are initially set up according to Annex C, and uplink signals according to Annex G.

4. The UL Reference Measurement channels are set according to Table 6.4.2.1.4.1-1.
5. Propagation conditions are set according to Annex B.0.
6. Ensure the UE is in state RRC_CONNECTED with generic procedure parameters Connectivity *NR*, Connected without release *On*, Test Mode *On* and Test Loop Function *On* according to TS 38.508-1 [10] clause 4.5. Message contents are defined in clause 6.4.2.1.4.3

6.4.2.1_1.4.2 Test procedure

Same as clause 6.4.2.1.4.2 for PUSCH and PUCCH with following exceptions:

- Instead of Table 6.4.2.1.4.1-1 → use Table 6.4.2.1_1.4.1-1.
- Instead of Table 6.4.2.1.4.1-2 → use Table 6.4.2.1_1.4.1-2.

6.4.2.1_1.4.3 Message contents

Same as clause 6.2.4_1.4.3.

6.4.2.1_1.5 Test requirement

The PUSCH EVM, derived in Annex E.4.2, shall not exceed the values in Table 6.4.2.1_1.5-1.

The PUSCH \overline{EVM}_{DMRS} , derived in Annex E.4.6.2, shall not exceed the values in Table 6.4.2.1_1.5-1 when embedded with data symbols of the respective modulation scheme.

The PUCCH EVM derived in Annex E.5.9.2 shall not exceed the values for QPSK in Table 6.4.2.1_1.5-1.

The PRACH EVM derived in Annex E.6.9.2 shall not exceed the values for QPSK in Table 6.4.2.1_1.5-1.

Table 6.4.2.1_1.5-1: Test requirements for Error Vector Magnitude

Parameter	Unit	Average EVM Level	Reference Signal EVM Level
QPSK	%	17.5+TT	17.5+TT

Table 6.4.2.1_1.5-2: Test Tolerance (TT) for PUSCH, PC3, FR2a

Test ID	Modulation	RB alloc.	50MHz	100MHz	200MHz	400MHz
1, 2, 3, 4	DFT-s-OFDM QPSK	Inner_Full	0.00%	0.00%	0.00%	1.61%

Table 6.4.2.1_1.5-3: Test Tolerance (TT) for PUSCH, PC3, FR2b

Test ID	Modulation	RB alloc.	50MHz	100MHz	200MHz	400MHz
1, 2, 3, 4	DFT-s-OFDM QPSK	Inner_Full	0.00%	0.00%	1.31%	2.49%

6.4.2.2 Carrier leakage

Editor's note: The following aspects are either missing or not yet determined:

- Measurement Uncertainty and Test Tolerance are FFS for power class 1, 2, 4,5 and 6.
- The test case is incomplete for band n259.

6.4.2.2.1 Test purpose

Carrier leakage expresses itself as unmodulated sine wave with the carrier frequency. It is an interference of approximately constant amplitude and independent of the amplitude of the wanted signal. Carrier leakage interferes with the sub carriers at its position (if allocated), especially, when their amplitude is small.

The purpose of this test is to exercise the UE transmitter to verify its modulation quality in terms of carrier leakage.

6.4.2.2.2 Test applicability

This test case applies to all types of NR UE release 15 and forward.

6.4.2.2.3 Minimum conformance requirements

Carrier leakage is an additive sinusoid waveform. The carrier leakage requirement is defined for each component carrier. The measurement interval is one slot in the time domain. The relative carrier leakage power is a power ratio of the additive sinusoid waveform to the power in the modulated waveform.

The requirement is verified with the test metric of Carrier Leakage (Link=TX beam peak direction, Meas=Link angle).

When carrier leakage is contained inside the spectrum confined within the configured UL and DL CCs, the relative carrier leakage power shall not exceed the values specified in Table 6.4.2.2.3-1 for power class 1 UEs.

Table 6.4.2.2.3-1: Minimum requirements for relative carrier leakage power for power class 1

Parameters	Relative Limit (dBc)
EIRP > 17 dBm	-25
4 dBm ≤ EIRP ≤ 17 dBm	-20

When carrier leakage is contained inside the spectrum occupied by the configured UL CCs and DL CCs, the relative carrier leakage power shall not exceed the values specified in Table 6.4.2.2.3-2 for power class 2.

Table 6.4.2.2.3-2: Minimum requirements for relative carrier leakage power for power class 2

Parameters	Relative Limit (dBc)
EIRP > 6 dBm	-25
-13 dBm ≤ EIRP ≤ 6 dBm	-20

When carrier leakage is contained inside the spectrum occupied by the configured UL CCs and DL CCs, the relative carrier leakage power shall not exceed the values specified in Table 6.4.2.2.3-3 for power class 3 UEs.

Table 6.4.2.2.3-3: Minimum requirements for relative carrier leakage power for power class 3

Parameters	Relative Limit (dBc)
EIRP > 0 dBm	-25
-13 dBm ≤ EIRP ≤ 0 dBm	-20

When carrier leakage is contained inside the spectrum occupied by the configured UL CCs and DL CCs, the relative carrier leakage power shall not exceed the values specified in Table 6.4.2.2.3-4 for power class 4.

Table 6.4.2.2.3-4: Minimum requirements for relative carrier leakage power for power class 4

Parameters	Relative Limit (dBc)
EIRP > 11 dBm	-25
-13 dBm ≤ EIRP ≤ 11 dBm	-20

When carrier leakage is contained inside the spectrum occupied by the configured UL CCs and DL CCs, the relative carrier leakage power shall not exceed the values specified in Table 6.4.2.2.3-5 for power class 5.

Table 6.4.2.2.3-5: Minimum requirements for relative carrier leakage power for power class 5

Parameters	Relative Limit (dBc)
EIRP > 7 dBm	-25
-6 dBm ≤ EIRP ≤ 7 dBm	-20

The normative reference for this requirement is TS 38.101-2[3] clause 6.4.2.2.

When carrier leakage is contained inside the spectrum occupied by the configured UL CCs and DL CCs, the relative carrier leakage power shall not exceed the values specified in Table 6.4.2.2.3-6 for power class 6.

Table 6.4.2.2.3-6: Minimum requirements for relative carrier leakage power for power class 6

Parameters	Relative Limit (dBc)
EIRP > 7 dBm	-25
-6 dBm ≤ EIRP ≤ 7 dBm	-20

When carrier leakage is contained inside the spectrum occupied by the configured UL CCs and DL CCs, the relative carrier leakage power shall not exceed the values specified in Table 6.4.2.2.3-7 for power class 7.

Table 6.4.2.2.3-7: Minimum requirements for relative carrier leakage power for power class 7

Parameters	Relative Limit (dBc)
EIRP > 0 dBm	-25
-13 dBm ≤ EIRP ≤ 0 dBm	-20

6.4.2.2.4 Test description

6.4.2.2.4.1 Initial condition

Initial conditions are a set of test configurations the UE needs to be tested in and the steps for the SS to take with the UE to reach the correct measurement state.

The initial test configurations consist of environmental conditions, test frequencies, test channel bandwidths and sub-carrier spacing based on NR operating bands specified in Table 5.3.5-1. All of these configurations shall be tested with applicable test parameters for each combination of channel bandwidth and sub-carrier spacing, are shown in Table 6.4.2.2.4.1-1. The details of the uplink reference measurement channels (RMCs) are specified in Annexes A.2. Configurations of PDSCH and PDCCH before measurement are specified in Annex C.2.

Table 6.4.2.2.4.1-1: Test Configuration

Initial Conditions			
Test Environment as specified in TS 38.508-1 [10] clause 4.1		Normal	
Test Frequencies as specified in TS 38.508-1 [10] clause 4.3.1		Low range, Mid range, High range	
Test Channel Bandwidths as specified in TS 38.508-1 [10] clause 4.3.1		Mid	
Test SCS as specified in Table 5.3.5-1		Highest	
Test Parameters			
Test ID	Downlink Configuration	Uplink Configuration	
		Modulation	RB allocation (NOTE 1, 3)
1	-	DFT-s-OFDM QPSK	Inner_Partial_Left for PC2, PC3,, PC4, PC6 and PC7 Inner_Partial_Left_Region2 for PC1
NOTE 1: The specific configuration of each RB allocation is defined in Table 6.1-1 for PC2, PC3, PC4, PC6 and PC7 or Table 6.1-2 for PC1.			
NOTE 2: Test Channel Bandwidths are checked separately for each NR band, which applicable channel bandwidths are specified in Table 5.3.5-1.			
NOTE 3: When the signalled DC carrier position is at Inner_Partial_Left for PC2, PC3, PC4, PC6 and PC7, use Inner_Partial_Right for UL RB allocation. When the signalled DC carrier position is in Inner_Partial_Left_Region2 for PC1, use Inner_Partial_Right_Region2 for UL RB allocation.			

1. Connection between SS and UE is shown in TS 38.508-1 [10] Annex A, in Figure A.3.3.1.1 for TE diagram and section A.3.4.1.1 for UE diagram.
2. The parameter settings for the cell are set up according to TS 38.508-1 [10] clause 4.4.3.

3. Downlink signals are initially set up according to Annex C, and uplink signals according to Annex G.
4. The UL Reference Measurement channels are set according to Table 6.4.2.2.4.1-1.
5. Propagation conditions are set according to Annex B.0.
6. Ensure the UE is in state RRC_CONNECTED with generic procedure parameters Connectivity NR, Connected without release On, Test Mode On and Test Loop Function On according to TS 38.508-1 [10] clause 4.5. Message contents are defined in clause 6.4.2.2.4.3.
7. In case the parameter 3300 or 3301 is reported from the UE via *txDirectCurrentLocation* IE, do not proceed to test procedure and mark the test not applicable with reasoning in the test report.

6.4.2.2.4.2 Test procedure

1. Retrieve the LO position from the parameter *txDirectCurrentLocation* in UplinkTxDirectCurrent IE.
2. SS sends uplink scheduling information for each UL HARQ process via PDCCH DCI format 0_1 for C_RNTI to schedule the UL RMC according to Table 6.4.2.2.4.1-1. Since the UE has no payload and no loopback data to send the UE sends uplink MAC padding bits on the UL RMC.
3. Set the UE in the Inband Tx beam peak direction found with a 3D EIRP scan as performed in Annex K.1.1. Allow at least BEAM_SELECT_WAIT_TIME (NOTE 1) for the UE Tx beam selection to complete.
4. Send uplink power control commands to the UE using 1dB power step size to ensure that the UE $EIRP_{Total} = EIRP_{\theta} + EIRP_{\phi}$ measured by the test system is within the Uplink power control window, defined as +MU to +(MU + Uplink power control window size) dB of the target power level P_{req} , where:

- P_{req} is the power level specified in Table 6.4.2.2.4.2-1 according to the power class.
- MU is the test system uplink absolute power measurement uncertainty and is specified in Table F.1.2-1 under carrier leakage sub-clause for the carrier frequency f and the channel bandwidth BW.
- Uplink power control window size = 1dB (UE power step size) + 5 dB (UE power step tolerance) + (Test system uplink relative power measurement uncertainty), where, the UE power step tolerance is specified in TS 38.101-1 [2], Table 6.3.4.3-1 and is 5dB for 1dB power step size, and the Test system uplink relative power measurement uncertainty is specified in Table F.1.2-1.

Allow at least BEAM_SELECT_WAIT_TIME (NOTE 1) for the UE Tx beam selection to complete.

5. SS activates the UE Beamlock Function (UBF) by performing the procedure as specified in TS 38.508-1 [10] clause 4.9.2 using condition TxRx.
6. Measure carrier leakage using Global In-Channel Tx-Test (Annex E) for the θ - and ϕ -polarization at the LO position obtained in step 1. For TDD, only slots consisting of only UL symbols are under test. Calculate $CarrLeak = \min(CarrLeak_{\theta}, CarrLeak_{\phi})$.
7. SS deactivates the UE Beamlock Function (UBF) by performing the procedure as specified in TS 38.508-1 [10] clause 4.9.3.

NOTE 1: The BEAM_SELECT_WAIT_TIME default value is defined in Annex K.

NOTE 2: The purpose of the Uplink power control window is to ensure that the actual UE output power is no less than the target power level, and as close as possible to the target power level. The relationship between the Uplink power control window, the target power level and the corresponding possible actual UE Uplink power window is illustrated in Annex F.4.2.

Table 6.4.2.2.4.2-1: UE EIRP P_{req} (dBm) for carrier leakage

Power Class	P_{req} (dBm) for step 3
Power Class 1	17
Power Class 2	6
Power Class 3	0
Power Class 4	11
Power Class 5	FFS

Power Class 6	7
Power Class 7	0

Table 6.4.2.2.4-2: Void.

6.4.2.2.4.3 Message contents

Message contents are according to TS 38.508-1 [10] clause 4.6 with TRANSFORM_PRECODER_ENABLED condition in Table 4.6.3-118 PUSCH-Config.

6.4.2.2.5 Test requirement

The test requirement below shall only be considered if UE output power measured in the test procedure step 4 ends within the Uplink power control window.

For each of the n carrier leakage results derived in Annex E.3.1 for θ - and φ -polarization the minimum is calculated according to

$$\text{CarrLeak} = \min(\text{CarrLeak}_\theta, \text{CarrLeak}_\varphi), \text{ where}$$

$$n = \begin{cases} 30, & \text{for 60 kHz SCS} \\ 60, & \text{for 120 kHz SCS} \end{cases}$$

Each of the n carrier leakage results CarrLeak shall not exceed the values in Table 6.4.2.2.5-1 to Table 6.4.2.2.5-4. Allocated RBs are not under test.

Table 6.4.2.2.5-1a: Test requirements for relative carrier leakage power for power class 1

Parameter	Relative limit (dBc)
17 dBm + MU < EIRP ≤ 17 dBm + MU + Uplink power control window size	-25 + TT

Table 6.4.2.2.5-1b: Test Tolerance (carrier leakage for power class 1)

Test Metric	FR2a	FR2b
Max device size ≤ 30 cm	TBD	TBD

Table 6.4.2.2.5-2a: Test requirements for relative carrier leakage power for power class 2

Parameter	Relative limit (dBc)
6 dBm + MU < EIRP ≤ 6 dBm + MU + Uplink power control window size	-25 + TT

Table 6.4.2.2.5-2b: Test Tolerance (carrier leakage for power class 2)

Test Metric	FR2a	FR2b
Max device size ≤ 30 cm	TBD	TBD

Table 6.4.2.2.5-3a: Test requirements for relative carrier leakage power for power class 3

Parameter	Relative limit (dBc)
0 dBm + MU < EIRP ≤ 0 dBm + MU + Uplink power control window size	-25 + TT

Table 6.4.2.2.5-3b: Test Tolerance (carrier leakage for power class 3)

Test Metric	FR2a	FR2b
Max device size \leq 30 cm	3.54 dB	3.62 dB

Table 6.4.2.2.5-4a: Test requirements for relative carrier Leakage Power for power class 4

Parameter	Relative limit (dBc)
$11 \text{ dBm} + \text{MU} < \text{EIRP} \leq 11 \text{ dBm} + \text{MU} + \text{Uplink power}$ control window size	$-25 + \text{TT}$

Table 6.4.2.2.5-4b: Test Tolerance (carrier leakage for power class 4)

Test Metric	FR2a	FR2b
Max device size \leq 30 cm	TBD	TBD

Table 6.4.2.2.5-5a: Test requirements for relative carrier leakage power for power class 5 FFS**Table 6.4.2.2.5-5b: Test Tolerance (carrier leakage for power class 5) FFS****Table 6.4.2.2.5-6a: Test requirements for relative carrier Leakage Power for power class 6**

Parameter	Relative limit (dBc)
$7 \text{ dBm} + \text{MU} < \text{EIRP} \leq 7 \text{ dBm} + \text{MU} + \text{Uplink power}$ control window size	$-25 + \text{TT}$

Table 6.4.2.2.5-6b: Test Tolerance (carrier leakage for power class 6)

Test Metric	FR2a	FR2b
Max device size \leq 30 cm	TBD	TBD

Table 6.4.2.2.5-7a: Test requirements for relative carrier leakage power for power class 7

Parameter	Relative limit (dBc)
$0 \text{ dBm} + \text{MU} < \text{EIRP} \leq 0 \text{ dBm} + \text{MU} + \text{Uplink power}$ control window size	$-25 + \text{TT}$

Table 6.4.2.2.5-7b: Test Tolerance (carrier leakage for power class 7)

Test Metric	FR2a
Max device size \leq 30 cm	3.54 dB

6.4.2.3 In-band emissions

Editor's note: This clause is incomplete. The following aspects are either missing or not yet determined:

- Measurement Uncertainty and Test Tolerance are FFS.
- Testing of the general in-band emission requirement and if yes at which UE Tx power level and with which relaxation applied to the requirement is FFS.

6.4.2.3.1 Test purpose

The in-band emissions are a measure of the interference falling into the non-allocated resources blocks.

The purpose of this test is to exercise the UE transmitter to verify its modulation quality in terms of in-band emissions.

6.4.2.3.2 Test applicability

This test case applies to all types of NR UE release 15 and forward.

6.4.2.3.3 Minimum conformance requirements

The in-band emission is defined as the average across 12 sub-carriers and as a function of the RB offset from the edge of the allocated UL transmission bandwidth. The in-band emission is measured as the ratio of the UE output power in a non-allocated RB to the UE output power in an allocated RB. The IBE requirement does not apply if UE declares support for *mpr-PowerBoost-FR2-r16*, UL transmission is QPSK, $MPR_{f,c} = 0$ and when NS_200 applies, and the network configures the UE to operate with *mpr-PowerBoost-FR2-r16*.

The basic in-band emissions measurement interval is identical to that of the EVM test.

The requirement is verified with the test metric of In-band emission (Link=TX beam peak direction, Meas=Link angle).

The relative in-band emission shall not exceed the values specified in Table 6.4.2.3.3-1 for power class 1 UEs.

The average of the in-band emission measurement over 10 sub-frames shall not exceed the values specified in Table 6.4.2.3.3-1 for power class 1, Table 6.4.2.3.3-2 for power class 2, Table 6.4.2.3.3-3 for power class 3, Table 6.4.2.3.3-4 for power class 4 UEs and Table 6.4.2.3.3-5 for power class 5 UEs.

Table 6.4.2.3.3-1: Requirements for in-band emissions for power class 1

Parameter description	Unit	Limit (NOTE 1)		Applicable Frequencies
General	dB	$\max \left[\begin{array}{l} -25 - 10 \cdot \log_{10} \left(\frac{N_{RB}}{L_{CRB}} \right), \\ 20 \cdot \log_{10}(\text{EVM}) - 5 \cdot \frac{(\Delta_{RB} - 1)}{L_{CRB}}, \\ -55.1 \text{ dBm} - P_{RB} \end{array} \right]$		Any non-allocated (NOTE 2)
IQ Image	dB	-25	Output power > 27 dBm	Image frequencies (NOTES 2, 3)
		-20	Output power ≤ 27 dBm	
Carrier leakage	dBc	-25	Output power > 17 dBm	Carrier frequency (NOTES 4, 5)
		-20	4 dBm ≤ Output power ≤ 17 dBm	

- NOTE 1: An in-band emissions combined limit is evaluated in each non-allocated RB. For each such RB, the minimum requirement is calculated as the higher of ($P_{RB} - 25$ dB) and the power sum of all limit values (General, IQ Image or Carrier leakage) that apply. P_{RB} is defined in NOTE 10.
- NOTE 2: The measurement bandwidth is 1 RB and the limit is expressed as a ratio of measured power in one non-allocated RB to the measured average power per allocated RB, where the averaging is done across all allocated RBs. For pi/2 BPSK with Spectrum Shaping, the limit is expressed as a ratio of measured power in one non-allocated RB to the measured power in the allocated RB with highest PSD
- NOTE 3: The applicable frequencies for this limit are those that are enclosed in the reflection of the allocated bandwidth, based on symmetry with respect to the carrier frequency, but excluding any allocated RBs.
- NOTE 4: The measurement bandwidth is 1 RB and the limit is expressed as a ratio of measured power in one non-allocated RB to the measured total power in all allocated RBs.
- NOTE 5: The applicable frequencies for this limit depend on the parameter *txDirectCurrentLocation* in *UplinkTxDirectCurrent* IE, and are those that are enclosed in the RBs containing the DC frequency but excluding any allocated RB.
- NOTE 6: L_{CRB} is the Transmission Bandwidth (see Figure 5.3.1-1).
- NOTE 7: N_{RB} is the Transmission Bandwidth Configuration (see Section 5.3).
- NOTE 8: EVM s the limit for the modulation format used in the allocated RBs.
- NOTE 9: Δ_{RB} is the starting frequency offset between the allocated RB and the measured non-allocated RB (e.g. $\Delta_{RB} = 1$ or $\Delta_{RB} = -1$ for the first adjacent RB outside of the allocated bandwidth).
- NOTE 10: P_{RB} is the transmitted power per allocated RB, measured in dBm.
- NOTE 11: All powers are EIRP in beam peak direction.

The relative in-band emission shall not exceed the values specified in Table 6.4.2.3.3-2 for power class 2.

Table 6.4.2.3.3-2: Requirements for in-band emissions for power class 2

Parameter description	Unit	Limit (NOTE 1)		Applicable Frequencies
General	dB	$\max \left[\begin{array}{l} -25 - 10 \cdot \log_{10} \left(\frac{N_{RB}}{L_{CRB}} \right), \\ 20 \cdot \log_{10}(\text{EVM}) - 5 \cdot \frac{(\Delta_{RB} - 1)}{L_{CRB}}, \\ -55.1 \text{ dBm} - P_{RB} \end{array} \right]$		Any non-allocated (NOTE 2)
IQ Image	dB	-25	Output power > 16 dBm	Image frequencies (NOTES 2, 3)
		-20	Output power ≤ 16 dBm	
Carrier leakage	dBc	-25	Output power > 6 dBm	Carrier frequency (NOTES 4, 5)
		-20	-13 dBm ≤ Output power ≤ 6 dBm	
<p>NOTE 1: An in-band emissions combined limit is evaluated in each non-allocated RB. For each such RB, the minimum requirement is calculated as the higher of ($P_{RB} - 25$ dB) and the power sum of all limit values (General, IQ Image or Carrier leakage) that apply. P_{RB} is defined in NOTE 10.</p> <p>NOTE 2: The measurement bandwidth is 1 RB and the limit is expressed as a ratio of measured power in one non-allocated RB to the measured average power per allocated RB, where the averaging is done across all allocated RBs. For pi/2 BPSK with Spectrum Shaping, the limit is expressed as a ratio of measured power in one non-allocated RB to the measured power in the allocated RB with highest PSD</p> <p>NOTE 3: The applicable frequencies for this limit are those that are enclosed in the reflection of the allocated bandwidth, based on symmetry with respect to the carrier frequency, but excluding any allocated RBs.</p> <p>NOTE 4: The measurement bandwidth is 1 RB and the limit is expressed as a ratio of measured power in one non-allocated RB to the measured total power in all allocated RBs.</p> <p>NOTE 5: The applicable frequencies for this limit depend on the parameter <i>txDirectCurrentLocation</i> in <i>UplinkTxDirectCurrent</i> IE, and are those that are enclosed in the RBs containing the DC frequency but excluding any allocated RB.</p> <p>NOTE 6: L_{CRB} is the Transmission Bandwidth (see Figure 5.3.1-1).</p> <p>NOTE 7: N_{RB} is the Transmission Bandwidth Configuration (see Section 5.3).</p> <p>NOTE 8: EVM s the limit for the modulation format used in the allocated RBs.</p> <p>NOTE 9: Δ_{RB} is the starting frequency offset between the allocated RB and the measured non-allocated RB (e.g. $\Delta_{RB} = 1$ or $\Delta_{RB} = -1$ for the first adjacent RB outside of the allocated bandwidth).</p> <p>NOTE 10: P_{RB} is the transmitted power per allocated RB, measured in dBm.</p> <p>NOTE 11: All powers are EIRP in beam peak direction.</p>				

The relative in-band emission shall not exceed the values specified in Table 6.4.2.3.3-3 for power class 3 UEs.

Table 6.4.2.3.3-3: Requirements for in-band emissions for power class 3

Parameter description	Unit	Limit (NOTE 1)		Applicable Frequencies
General	dB	$\max \left[\begin{array}{l} -25 - 10 \cdot \log_{10} \left(\frac{N_{RB}}{L_{CRB}} \right), \\ 20 \cdot \log_{10}(\text{EVM}) - 5 \cdot \frac{(\Delta_{RB} - 1)}{L_{CRB}}, \\ -55.1 \text{ dBm} - P_{RB} \end{array} \right]$		Any non-allocated (NOTE 2)
IQ Image	dB	-25	Output power > 10 dBm	Image frequencies (NOTES 2, 3)
		-20	Output power ≤ 10 dBm	
Carrier leakage	dBc	-25	Output power > 0 dBm	Carrier frequency (NOTES 4, 5)
		-20	-13 dBm ≤ Output power ≤ 0 dBm	
<p>NOTE 1: An in-band emissions combined limit is evaluated in each non-allocated RB. For each such RB, the minimum requirement is calculated as the higher of ($P_{RB} - 25$ dB) and the power sum of all limit values (General, IQ Image or Carrier leakage) that apply. P_{RB} is defined in NOTE 10.</p> <p>NOTE 2: The measurement bandwidth is 1 RB and the limit is expressed as a ratio of measured power in one non-allocated RB to the measured average power per allocated RB, where the averaging is done across all allocated RBs. For pi/2 BPSK with Spectrum Shaping, the limit is expressed as a ratio of measured power in one non-allocated RB to the measured power in the allocated RB with highest PSD</p> <p>NOTE 3: The applicable frequencies for this limit are those that are enclosed in the reflection of the allocated bandwidth, based on symmetry with respect to the carrier frequency, but excluding any allocated RBs.</p> <p>NOTE 4: The measurement bandwidth is 1 RB and the limit is expressed as a ratio of measured power in one non-allocated RB to the measured total power in all allocated RBs.</p> <p>NOTE 5: The applicable frequencies for this limit depend on the parameter <i>txDirectCurrentLocation</i> in <i>UplinkTxDirectCurrent</i> IE, and are those that are enclosed in the RBs containing the DC frequency but excluding any allocated RB.</p> <p>NOTE 6: L_{CRB} is the Transmission Bandwidth (see Figure 5.3.1-1).</p> <p>NOTE 7: N_{RB} is the Transmission Bandwidth Configuration (see Section 5.3).</p> <p>NOTE 8: EVM is the limit for the modulation format used in the allocated RBs.</p> <p>NOTE 9: Δ_{RB} is the starting frequency offset between the allocated RB and the measured non-allocated RB (e.g. $\Delta_{RB} = 1$ or $\Delta_{RB} = -1$ for the first adjacent RB outside of the allocated bandwidth).</p> <p>NOTE 10: P_{RB} is the transmitted power per allocated RB, measured in dBm.</p> <p>NOTE 11: All powers are EIRP in beam peak direction.</p>				

The relative in-band emission shall not exceed the values specified in Table 6.4.2.3.3-4 for power class 4 UEs.

Table 6.4.2.3.3-4: Requirements for in-band emissions for power class 4

Parameter description	Unit	Limit (NOTE 1)		Applicable Frequencies
General	dB	$\max \left[\begin{array}{l} -25 - 10 \cdot \log_{10} \left(\frac{N_{RB}}{L_{CRB}} \right), \\ 20 \cdot \log_{10}(\text{EVM}) - 5 \cdot \frac{(\Delta_{RB} - 1)}{L_{CRB}}, \\ -55.1 \text{ dBm} - P_{RB} \end{array} \right]$		Any non-allocated (NOTE 2)
IQ Image	dB	-25	Output power > 21 dBm	Image frequencies (NOTES 2, 3)
		-20	Output power ≤ 21 dBm	
Carrier leakage	dBc	-25	Output power > 11 dBm	Carrier frequency (NOTES 4, 5)
		-20	-13 dBm ≤ Output power ≤ 11 dBm	

- NOTE 1: An in-band emissions combined limit is evaluated in each non-allocated RB. For each such RB, the minimum requirement is calculated as the higher of ($P_{RB} - 25$ dB) and the power sum of all limit values (General, IQ Image or Carrier leakage) that apply. P_{RB} is defined in NOTE 10.
- NOTE 2: The measurement bandwidth is 1 RB and the limit is expressed as a ratio of measured power in one non-allocated RB to the measured average power per allocated RB, where the averaging is done across all allocated RBs. For pi/2 BPSK with Spectrum Shaping, the limit is expressed as a ratio of measured power in one non-allocated RB to the measured power in the allocated RB with highest PSD
- NOTE 3: The applicable frequencies for this limit are those that are enclosed in the reflection of the allocated bandwidth, based on symmetry with respect to the carrier frequency, but excluding any allocated RBs.
- NOTE 4: The measurement bandwidth is 1 RB and the limit is expressed as a ratio of measured power in one non-allocated RB to the measured total power in all allocated RBs.
- NOTE 5: The applicable frequencies for this limit depend on the parameter *txDirectCurrentLocation* in *UplinkTxDirectCurrent* IE, and are those that are enclosed in the RBs containing the DC frequency but excluding any allocated RB.
- NOTE 6: L_{CRB} is the Transmission Bandwidth (see Figure 5.3.1-1).
- NOTE 7: N_{RB} is the Transmission Bandwidth Configuration (see Section 5.3).
- NOTE 8: EVM is the limit for the modulation format used in the allocated RBs.
- NOTE 9: Δ_{RB} is the starting frequency offset between the allocated RB and the measured non-allocated RB (e.g. $\Delta_{RB} = 1$ or $\Delta_{RB} = -1$ for the first adjacent RB outside of the allocated bandwidth).
- NOTE 10: P_{RB} is the transmitted power per allocated RB, measured in dBm.
- NOTE 11: All powers are EIRP in beam peak direction.

The normative reference for this requirement is TS 38.101-2 [3] clause 6.4.2.3.

The average of the in-band emission measurement over 10 sub-frames shall not exceed the values specified in Table 6.4.2.3.3-6 for power class 6 UEs.

Table 6.4A.2.3.6-1: Requirements for in-band emissions for power class 5

Parameter description	Unit	Limit (NOTE 1)		Applicable Frequencies
General	dB	$\max \left[\begin{array}{l} -25 - 10 \cdot \log_{10} \left(\frac{N_{RB}}{L_{CRB}} \right), \\ 20 \cdot \log_{10}(\text{EVM}) - 5 \cdot \frac{(\Delta_{RB} - 1)}{L_{CRB}}, \\ -55.1 \text{ dBm} - \overline{P_{RB}} \end{array} \right]$		Any non-allocated RB in allocated component carrier and not allocated component carriers (NOTE 2)
IQ Image	dB	-25	Output power > 17 dBm	Image frequencies (NOTES 2, 3)
		-20	Output power ≤ 17 dBm	
Carrier leakage	dBc	-25	Output power > 7 dBm	Carrier frequency (NOTES 4, 5)
		-20	-6 dBm ≤ Output power ≤ 7 dBm	

- NOTE 1: An in-band emissions combined limit is evaluated in each non-allocated RB. For each such RB, the minimum requirement is calculated as the higher of ($\overline{P_{RB}} - 25$ dB) and the power sum of all limit values (General, IQ Image or Carrier leakage) that apply. $\overline{P_{RB}}$ is defined in NOTE 9.
- NOTE 2: The measurement bandwidth is 1 RB and the limit is expressed as a ratio of measured power in one non-allocated RB to the measured average power per allocated RB, where the averaging is done across all allocated RBs. For pi/2 BPSK with Spectrum Shaping, the limit is expressed as a ratio of measured power in one non-allocated RB to the measured power in the allocated RB with highest PSD.
- NOTE 3: Image frequencies for UL CA are specified in relation to either UL or DL carrier frequency.
- NOTE 4: The measurement bandwidth is 1 RB and the limit is expressed as a ratio of measured power in one non-allocated RB to the measured total power in all allocated RBs.
- NOTE 5: The applicable frequencies for this limit are those that are enclosed in the RBs containing the DC frequency, or in the two RBs immediately adjacent to the DC frequency but excluding any allocated RB.
- NOTE 6: L_{CRB} is the Transmission Bandwidth (see Figure 5.3.1-1).
- NOTE 7: EVM is the limit for the modulation format used in the allocated RBs.
- NOTE 8: Δ_{RB} is the starting frequency offset between the allocated RB and the measured non-allocated RB (e.g. $\Delta_{RB} = 1$ or $\Delta_{RB} = -1$ for the first adjacent RB outside of the allocated bandwidth), and may take non-integer values when the carrier spacing between the CCs is not a multiple of RB.
- NOTE 9: $\overline{P_{RB}}$ is an average of the transmitted power over 10 sub-frames normalized by the number of allocated RBs, measured in dBm.
- NOTE 10: All powers are EIRP in beam peak direction.

The average of the in-band emission measurement over 10 sub-frames shall not exceed the values specified in Table 6.4A.2.3.6-1 for power class 6 UEs.

Table 6.4.2.3.3-6: Requirements for in-band emissions for power class 6

Parameter description	Unit	Limit (NOTE 1)		Applicable Frequencies
General	dB	$\max \left[\begin{array}{l} -25 - 10 \cdot \log_{10} \left(\frac{N_{RB}}{L_{CRB}} \right), \\ 20 \cdot \log_{10}(\text{EVM}) - 5 \cdot \frac{(\Delta_{RB} - 1)}{L_{CRB}}, \\ -55.1 \text{ dBm} - \overline{P_{RB}} \end{array} \right]$		Any non-allocated (NOTE 2)
IQ Image	dB	-25	Output power > 17 dBm	Image frequencies (NOTES 2, 3)
		-20	Output power ≤ 17 dBm	
Carrier leakage	dBc	-25	Output power > 7 dBm	Carrier frequency (NOTES 4, 5)
		-20	-6 dBm ≤ Output power ≤ 7 dBm	

- NOTE 1: An in-band emissions combined limit is evaluated in each non-allocated RB. For each such RB, the minimum requirement is calculated as the higher of ($\overline{P_{RB}} - 25$ dB) and the power sum of all limit values (General, IQ Image or Carrier leakage) that apply. $\overline{P_{RB}}$ is defined in NOTE 10.
- NOTE 2: The measurement bandwidth is 1 RB and the limit is expressed as a ratio of measured power in one non-allocated RB to the measured average power per allocated RB, where the averaging is done across all allocated RBs. For Pi/2 BPSK with Spectrum Shaping, the limit is expressed as a ratio of measured power in one non-allocated RB to the measured power in the allocated RB with highest PSD
- NOTE 3: The applicable frequencies for this limit are those that are enclosed in the reflection of the allocated bandwidth, based on symmetry with respect to the carrier frequency, but excluding any allocated RBs.
- NOTE 4: The measurement bandwidth is 1 RB and the limit is expressed as a ratio of measured power in one non-allocated RB to the measured total power in all allocated RBs.
- NOTE 5: The applicable frequencies for this limit depend on the parameter *txDirectCurrentLocation* in *UplinkTxDirectCurrent* IE, and are those that are enclosed in the RBs containing the DC frequency but excluding any allocated RB.
- NOTE 6: L_{CRB} is the Transmission Bandwidth (see Figure 5.3.1-1).
- NOTE 7: N_{RB} is the Transmission Bandwidth Configuration (see Clause 5.3).
- NOTE 8: EVM is the limit for the modulation format used in the allocated RBs.
- NOTE 9: Δ_{RB} is the starting frequency offset between the allocated RB and the measured non-allocated RB (e.g. $\Delta_{RB} = 1$ or $\Delta_{RB} = -1$ for the first adjacent RB outside of the allocated bandwidth).
- NOTE 10: $\overline{P_{RB}}$ is an average of the transmitted power over 10 sub-frames normalized by the number of allocated RBs, measured in dBm.
- NOTE 11: All powers are EIRP in beam peak direction.

The average of the in-band emission measurement over 10 sub-frames shall not exceed the values specified in Table 6.4.2.3.3-7 for power class 7 UEs.

Table 6.4.2.3.3-7: Requirements for in-band emissions for power class 7

Parameter description	Unit	Limit (NOTE 1)		Applicable Frequencies
General	dB	$\max \left[\begin{array}{l} -25 - 10 \cdot \log_{10} \left(\frac{N_{RB}}{L_{CRB}} \right), \\ 20 \cdot \log_{10}(\text{EVM}) - 5 \cdot \frac{(\Delta_{RB} - 1)}{L_{CRB}}, \\ -55.1 \text{ dBm} - P_{RB} \end{array} \right]$		Any non-allocated (NOTE 2)
IQ Image	dB	-25	Output power > 10 dBm	Image frequencies (NOTES 2, 3)
		-20	Output power ≤ 10 dBm	
Carrier leakage	dBc	-25	Output power > 0 dBm	Carrier frequency (NOTES 4, 5)
		-20	-13 dBm ≤ Output power ≤ 0 dBm	

- NOTE 1: An in-band emissions combined limit is evaluated in each non-allocated RB. For each such RB, the minimum requirement is calculated as the higher of ($P_{RB} - 25$ dB) and the power sum of all limit values (General, IQ Image or Carrier leakage) that apply. P_{RB} is defined in NOTE 10.
- NOTE 2: The measurement bandwidth is 1 RB and the limit is expressed as a ratio of measured power in one non-allocated RB to the measured average power per allocated RB, where the averaging is done across all allocated RBs. For pi/2 BPSK with Spectrum Shaping, the limit is expressed as a ratio of measured power in one non-allocated RB to the measured power in the allocated RB with highest PSD
- NOTE 3: The applicable frequencies for this limit are those that are enclosed in the reflection of the allocated bandwidth, based on symmetry with respect to the carrier frequency, but excluding any allocated RBs.
- NOTE 4: The measurement bandwidth is 1 RB and the limit is expressed as a ratio of measured power in one non-allocated RB to the measured total power in all allocated RBs.
- NOTE 5: The applicable frequencies for this limit depend on the parameter *txDirectCurrentLocation* in *UplinkTxDirectCurrent* IE, and are those that are enclosed in the RBs containing the DC frequency but excluding any allocated RB.
- NOTE 6: L_{CRB} is the Transmission Bandwidth (see Figure 5.3.1-1).
- NOTE 7: N_{RB} is the Transmission Bandwidth Configuration (see Section 5.3).
- NOTE 8: EVM is the limit for the modulation format used in the allocated RBs.
- NOTE 9: Δ_{RB} is the starting frequency offset between the allocated RB and the measured non-allocated RB (e.g. $\Delta_{RB} = 1$ or $\Delta_{RB} = -1$ for the first adjacent RB outside of the allocated bandwidth).
- NOTE 10: P_{RB} is the transmitted power per allocated RB, measured in dBm.
- NOTE 11: All powers are EIRP in beam peak direction.

The normative reference for this requirement is TS 38.101-2 [3] clause 6.4.2.3.

6.4.2.3.4 Test description

6.4.2.3.4.1 Initial condition

Initial conditions are a set of test configurations the UE needs to be tested in and the steps for the SS to take with the UE to reach the correct measurement state.

The initial test configurations consist of environmental conditions, test frequencies, test channel bandwidths and sub-carrier spacing based on NR operating bands specified in Table 5.3.5-1. All of these configurations shall be tested with applicable test parameters for each combination of channel bandwidth and sub-carrier spacing, are shown in Table 6.4.2.3.4.1-1. The details of the uplink reference measurement channels (RMCs) are specified in Annex A.2. Configurations of PDSCH and PDCCH before measurement are specified in Annex C.2.

Table 6.4.2.3.4.1-1: Test Configuration Table for PUSCH

Initial Conditions			
Test Environment as specified in TS 38.508-1 [10] clause 4.1		Normal	
Test Frequencies as specified in TS 38.508-1 [10] clause 4.3.1		Low range, Mid range, High range	
Test Channel Bandwidths as specified in TS 38.508-1 [10] clause 4.3.1		Lowest, Mid, Highest	
Test SCS as specified in Table 5.3.5-1		Lowest	
Test Parameters			
Test ID	Downlink Configuration	Uplink Configuration	
		Modulation	RB allocation (NOTE 1)
1	-	DFT-s-OFDM PI/2 BPSK	Inner_Partial_Left for PC2, PC3, PC4, PC6, PC7 Inner_Partial_Left_Region2 for PC1
2	-	DFT-s-OFDM PI/2 BPSK	Inner_Partial_Right for PC2, PC3, PC4, PC6, PC7 Inner_Partial_Right_Region2 for PC1
3	-	CP-OFDM QPSK	Inner_Partial_Left for PC2, PC3, PC4, PC6, PC7 Inner_Partial_Left_Region2 for PC1

4	CP-OFDM QPSK	Inner_Partial_Right for PC2, PC3, PC4, PC6, PC7 Inner_Partial_Right_Region2 for PC1
NOTE 1: The specific configuration of each RB allocation is defined in Table 6.1-1 for PC2, PC3, PC4, PC6 and PC7 or Table 6.1-2 for PC1.		
NOTE 2: Test Channel Bandwidths are checked separately for each NR band, which applicable channel bandwidths are specified in Table 5.3.5-1.		

Table 6.4.2.3.4.1-2: Test Configuration Table for PUCCH

Initial Conditions				
Test Environment as specified in TS 38.508-1 [10] clause 4.1		See Table 6.4.2.3.4.1-1		
Test Frequencies as specified in TS 38.508-1 [10] clause 4.3.1		See Table 6.4.2.3.4.1-1		
Test Channel Bandwidths as specified in TS 38.508-1 [10] clause 4.3.1		See Table 6.4.2.3.4.1-1		
Test SCS as specified in Table 5.3.5-1		See Table 6.4.2.3.4.1-1		
Test Parameters				
ID	Downlink Configuration		Uplink Configuration	
	Modulation	RB allocation	Waveform	PUCCH format
1	CP-OFDM QPSK	Full RB (Note 1)	CP-OFDM	PUCCH format = Format 1 Length in OFDM symbols = 14
2	CP-OFDM QPSK	Full RB (Note 1)	DFT-s-OFDM	PUCCH format = Format 3 Length in OFDM symbols = 14
NOTE 1: Full RB allocation shall be used per each SCS and channel BW as specified in Table 7.3.2.4.1-2.				
NOTE 2: Test Channel Bandwidths are checked separately for each NR band, which applicable channel bandwidths are specified in Table 5.3.5-1.				

1. Connection between SS and UE is shown in TS 38.508-1 [10] Annex A, in Figure A.3.3.1.1 for TE diagram and section A.3.4.1.1 for UE diagram.
2. The parameter settings for the cell are set up according to TS 38.508-1 [10] clause 4.4.3.
3. Downlink signals are initially set up according to Annex C, and uplink signals according to Annex G.
4. The UL Reference Measurement channels are set according to Table 6.4.2.3.4.1-1.
5. Propagation conditions are set according to Annex B.0.
6. Ensure the UE is in state RRC_CONNECTED with generic procedure parameters Connectivity NR, Connected without release On, Test Mode On and Test Loop Function On according to TS 38.508-1 [10] clause 4.5. Message contents are defined in clause 6.4.2.3.4.3

6.4.2.3.4.2 Test procedure

Test procedure for PUSCH:

- 1.1 Retrieve the LO position from the parameter txDirectCurrentLocation in UplinkTxDirectCurrent IE.
- 1.2 SS sends uplink scheduling information for each UL HARQ process via PDCCH DCI format 0_1 for C_RNTI to schedule the UL RMC according to Table 6.4.2.3.4.1-1. Since the UE has no payload and no loopback data to send the UE sends uplink MAC padding bits on the UL RMC.
- 1.3 Set the UE in the Inband Tx beam peak direction found with a 3D EIRP scan as performed in Annex K.1.1. Allow at least BEAM_SELECT_WAIT_TIME (NOTE 2) for the UE Tx beam selection to complete.
- 1.4 Send the appropriate TPC commands in the uplink scheduling information to the UE until UE output power is $P_{req} + P_W \pm P_W$, where P_{req} is the power level specified in Tables 6.4.2.3.4.2-1 according to the power class with power ID = 1. P_W is the power window according to Table 6.4.2.3.4.2-2 for the carrier frequency f and the channel bandwidth BW. Allow at least BEAM_SELECT_WAIT_TIME (NOTE 2) for the UE Tx beam selection to complete.

- 1.5 SS activates the UE Beamlock Function (UBF) by performing the procedure as specified in TS 38.508-1 [10] clause 4.9.2 using condition TxRx.
- 1.6 Measure In-band emission IE_{θ} , IE_{ϕ} using Global In-Channel Tx-Test (Annex E) for the θ - and ϕ -polarizations, respectively. For TDD, only slots consisting of only UL symbols are under test. Calculate $IE = IE_{\theta} + IE_{\phi}$, where the calculation is based on linear power ratios.
- 1.7 SS deactivates the UE Beamlock Function (UBF) by performing the procedure as specified in TS 38.508-1 [10] clause 4.9.3.
- 1.8 Repeat steps 1.3 through 1.6 until In-band emissions have been measured for all power IDs in Table 6.4.2.3.4.2-1.

NOTE 1: When switching to DFT-s-OFDM waveform, as specified in Table 6.4.2.3.4.1-1, send an NR RRCReconfiguration message according to TS 38.508-1 [10] clause 4.6.3 Table 4.6.3-118 PUSCH-Config with TRANSFORM_PRECODER_ENABLED condition.

NOTE 2: The BEAM_SELECT_WAIT_TIME default value is defined in Annex K.

Table 6.4.2.3.4.2-1: Parameters for In-band emissions FFS

Power ID	Unit	Level for power class 1	Level for power class 2	Level for power class 3	Level for power class 4	Level for power class 6	Level for power class 7
1	dBm	27	16	10	21	17	10
2	dBm	17	6	0	11	7	0

Table 6.4.2.3.4.2-2: Power Window (dB) for In-band emissions PUSCH and PUCCH

TBD

Test procedure for PUCCH:

- 2.1 Retrieve the LO position from the parameter txDirectCurrentLocation in UplinkTxDirectCurrent IE.
- 2.2 PUCCH is set according to Table 6.4.2.3.4.1-2. SS transmits PDSCH via PDCCH DCI format 1_1 for C_RNTI to transmit the DL RMC according to Table 6.4.2.3.4.1-2. The SS sends downlink MAC padding bits on the DL RMC. The transmission of PDSCH will make the UE send uplink ACK/NACK using PUCCH.
- 2.3 Set the UE in the Inband Tx beam peak direction found with a 3D EIRP scan as performed in Annex K.1.1. Allow at least BEAM_SELECT_WAIT_TIME (NOTE 1) for the UE Tx beam selection to complete.
- 2.4 Send the appropriate TPC commands in the uplink scheduling information for PUCCH to the UE until UE output power is $P_{req} + P_W \pm P_W$, where P_{req} is the power level specified in Tables 6.4.2.3.4.2-1 according to the power class with power ID = 1. P_W is the power window according to Table 6.4.2.3.4.2-2 for the carrier frequency f and the channel bandwidth BW . Allow at least BEAM_SELECT_WAIT_TIME (NOTE 1) for the UE Tx beam selection to complete.
- 2.5 SS activates the UE Beamlock Function (UBF) by performing the procedure as specified in TS 38.508-1 [10] clause 4.9.2 using condition TxRx.
- 2.6 Measure In-band emission IE_{θ} , IE_{ϕ} using Global In-Channel Tx-Test (Annex E) for the θ - and ϕ -polarizations, respectively. Calculate $IE = IE_{\theta} + IE_{\phi}$, where the calculation is based on linear power ratios.
- 2.7 SS deactivates the UE Beamlock Function (UBF) by performing the procedure as specified in TS 38.508-1 [10] clause 4.9.3.
- 2.8 Repeat steps 2.3 through 2.6 until In-band emissions have been measured for all power IDs in Table 6.4.2.3.4.2-1.

NOTE 1: The BEAM_SELECT_WAIT_TIME default value is defined in Annex K.

NOTE 2: When switching to DFT-s-OFDM waveform, as specified in Table 6.4.2.3.4.1-1, send an NR RRCReconfiguration message according to TS 38.508-1 [10] clause 4.6.3 Table 4.6.3-118 PUSCH-Config with TRANSFORM_PRECODER_ENABLED condition.

6.4.2.3.4.3 Message contents

Message contents are according to TS 38.508-1 [10] clause 4.6.

6.4.2.3.5 Test requirement

For power ID1 and ID2, the averaged in-band emissions result, derived in Annex E.4.3 shall not exceed the corresponding values for IQ Image and Carrier Leakage in Table 6.4.2.3.5-1 for power class 1 UEs.

Table 6.4.2.3.5-1: Test requirements for in-band emissions for power class 1

Parameter description	Unit	Limit (NOTE 1)		Applicable Frequencies
General (NOTE 12)	dB	$\max \left[\begin{array}{l} -25 - 10 \cdot \log_{10} \left(\frac{N_{RB}}{L_{CRB}} \right), \\ 20 \cdot \log_{10}(\text{EVM}) - 5 \cdot \frac{(\Delta_{RB} - 1)}{L_{CRB}}, \\ -55.1 \text{ dBm} - P_{RB} \end{array} \right] + TT$		Any non-allocated (NOTE 2)
IQ Image (NOTE 12)	dB	-25+TT	Output power > 27 dBm	Image frequencies (NOTES 2, 3)
		-20+TT	Output power ≤ 27 dBm	
Carrier leakage (NOTE 12)	dBc	-25+TT	Output power > 17 dBm	Carrier frequency (NOTES 4, 5)
		-20+TT	4 dBm ≤ Output power ≤ 17 dBm	
<p>NOTE 1: An in-band emissions combined limit is evaluated in each non-allocated RB. For each such RB, the minimum requirement is calculated as the higher of ($P_{RB} - 25$ dB) and the power sum of all limit values (General, IQ Image or Carrier leakage) that apply. P_{RB} is defined in NOTE 10.</p> <p>NOTE 2: The measurement bandwidth is 1 RB and the limit is expressed as a ratio of measured power in one non-allocated RB to the measured average power per allocated RB, where the averaging is done across all allocated RBs. For pi/2 BPSK with Spectrum Shaping, the limit is expressed as a ratio of measured power in one non-allocated RB to the measured power in the allocated RB with highest PSD</p> <p>NOTE 3: The applicable frequencies for this limit are those that are enclosed in the reflection of the allocated bandwidth, based on symmetry with respect to the carrier frequency, but excluding any allocated RBs.</p> <p>NOTE 4: The measurement bandwidth is 1 RB and the limit is expressed as a ratio of measured power in one non-allocated RB to the measured total power in all allocated RBs.</p> <p>NOTE 5: The applicable frequencies for this limit depend on the parameter <i>txDirectCurrentLocation</i> in <i>UplinkTxDirectCurrent</i> IE, and are those that are enclosed in the RBs containing the DC but excluding any allocated RB.</p> <p>NOTE 6: L_{CRB} is the Transmission Bandwidth (see Figure 5.3.1-1).</p> <p>NOTE 7: N_{RB} is the Transmission Bandwidth Configuration (see Section 5.3).</p> <p>NOTE 8: EVM is the limit for the modulation format used in the allocated RBs.</p> <p>NOTE 9: Δ_{RB} is the starting frequency offset between the allocated RB and the measured non-allocated RB (e.g. $\Delta_{RB} = 1$ or $\Delta_{RB} = -1$ for the first adjacent RB outside of the allocated bandwidth).</p> <p>NOTE 10: P_{RB} is the transmitted power per allocated RB, measured in dBm.</p> <p>NOTE 11: All powers are EIRP in beam peak direction.</p> <p>NOTE 12: In case the parameter 3300 or 3301 is reported from UE via <i>txDirectCurrentLocation</i> IE, IQ Image and Carrier leakage limit do not apply and General limit applies for all non-allocated frequencies.</p>				

For power ID1 and ID2, the averaged in-band emissions result, derived in Annex E.4.3 shall not exceed the corresponding values for IQ Image and Carrier Leakage in Table 6.4.2.3.5-2 for power class 2 UEs.

Table 6.4.2.3.5-2: Test requirements for in-band emissions for power class 2

Parameter description	Unit	Limit (NOTE 1)		Applicable Frequencies
General (NOTE 12)	dB	$\max \left[\begin{array}{l} -25 - 10 \cdot \log_{10} \left(\frac{N_{RB}}{L_{CRB}} \right), \\ 20 \cdot \log_{10}(\text{EVM}) - 5 \cdot \frac{(\Delta_{RB} - 1)}{L_{CRB}}, \\ -55.1 \text{ dBm} - P_{RB} \end{array} \right] + TT$		Any non-allocated (NOTE 2)
IQ Image	dB	-25 + TT	Output power > 16 dBm	Image frequencies

(NOTE 12)		-20 + TT	Output power ≤ 16 dBm	(NOTES 2, 3)
Carrier leakage (NOTE 12)	dBc	-25 + TT	Output power > 6 dBm	Carrier frequency (NOTES 4, 5)
		-20 + TT	-13 dBm ≤ Output power ≤ 6 dBm	
<p>NOTE 1: An in-band emissions combined limit is evaluated in each non-allocated RB. For each such RB, the minimum requirement is calculated as the higher of ($P_{RB} - 25$ dB) and the power sum of all limit values (General, IQ Image or Carrier leakage) that apply. P_{RB} is defined in NOTE 10.</p> <p>NOTE 2: The measurement bandwidth is 1 RB and the limit is expressed as a ratio of measured power in one non-allocated RB to the measured average power per allocated RB, where the averaging is done across all allocated RBs. For pi/2 BPSK with Spectrum Shaping, the limit is expressed as a ratio of measured power in one non-allocated RB to the measured power in the allocated RB with highest PSD</p> <p>NOTE 3: The applicable frequencies for this limit are those that are enclosed in the reflection of the allocated bandwidth, based on symmetry with respect to the carrier frequency, but excluding any allocated RBs.</p> <p>NOTE 4: The measurement bandwidth is 1 RB and the limit is expressed as a ratio of measured power in one non-allocated RB to the measured total power in all allocated RBs.</p> <p>NOTE 5: The applicable frequencies for this limit depend on the parameter <i>txDirectCurrentLocation</i> in <i>UplinkTxDirectCurrent</i> IE, and are those that are enclosed in the RBs containing the DC frequency if N_{RB} is odd, or in the two RBs immediately adjacent to the DC frequency if N_{RB} is even but excluding any allocated RB.</p> <p>NOTE 6: L_{CRB} is the Transmission Bandwidth (see Figure 5.3.1-1).</p> <p>NOTE 7: N_{RB} is the Transmission Bandwidth Configuration (see Section 5.3).</p> <p>NOTE 8: EVM is the limit for the modulation format used in the allocated RBs.</p> <p>NOTE 9: Δ_{RB} is the starting frequency offset between the allocated RB and the measured non-allocated RB (e.g. $\Delta_{RB} = 1$ or $\Delta_{RB} = -1$ for the first adjacent RB outside of the allocated bandwidth).</p> <p>NOTE 10: P_{RB} is the transmitted power per allocated RB, measured in dBm.</p> <p>NOTE 11: All powers are EIRP in beam peak direction.</p> <p>NOTE 12: In case the parameter 3300 or 3301 is reported from UE via <i>txDirectCurrentLocation</i> IE, IQ Image and Carrier leakage limit do not apply and General limit applies for all non-allocated frequencies.</p>				

For power ID1 and ID2, the averaged in-band emissions result, derived in Annex E.4.3 shall not exceed the corresponding values for IQ Image and Carrier Leakage in Table 6.4.2.3.5-3 for power class 3 UEs.

Table 6.4.2.3.5-3: Requirements for in-band emissions for power class 3

Parameter description	Unit	Limit (NOTE 1)		Applicable Frequencies
General (NOTE 12)	dB	$\max \left[\begin{array}{l} -25 - 10 \cdot \log_{10} \left(\frac{N_{RB}}{L_{CRB}} \right), \\ 20 \cdot \log_{10}(\text{EVM}) - 5 \cdot \frac{(\Delta_{RB} - 1)}{L_{CRB}}, \\ -55.1 \text{ dBm} - P_{RB} \end{array} \right] + \text{TT}$		Any non-allocated (NOTE 2)
IQ Image (NOTE 12)	dB	-25+TT	Output power > 10 dBm	Image frequencies (NOTES 2, 3)
		-20+TT	Output power ≤ 10 dBm	
Carrier leakage (NOTE 12)	dBc	-25+TT	Output power > 0 dBm	Carrier frequency (NOTES 4, 5)
		-20+TT	-13 dBm ≤ Output power ≤ 0 dBm	

- NOTE 1: An in-band emissions combined limit is evaluated in each non-allocated RB. For each such RB, the minimum requirement is calculated as the higher of ($P_{RB} - 25$ dB) and the power sum of all limit values (General, IQ Image or Carrier leakage) that apply. P_{RB} is defined in NOTE 10.
- NOTE 2: The measurement bandwidth is 1 RB and the limit is expressed as a ratio of measured power in one non-allocated RB to the measured average power per allocated RB, where the averaging is done across all allocated RBs. For pi/2 BPSK with Spectrum Shaping, the limit is expressed as a ratio of measured power in one non-allocated RB to the measured power in the allocated RB with highest PSD.
- NOTE 3: The applicable frequencies for this limit are those that are enclosed in the reflection of the allocated bandwidth, based on symmetry with respect to the carrier frequency, but excluding any allocated RBs.
- NOTE 4: The measurement bandwidth is 1 RB and the limit is expressed as a ratio of measured power in one non-allocated RB to the measured total power in all allocated RBs.
- NOTE 5: The applicable frequencies for this limit depend on the parameter *txDirectCurrentLocation* in *UplinkTxDirectCurrent* IE, and are those that are enclosed in the RBs containing the DC but excluding any allocated RB.
- NOTE 6: L_{CRB} is the Transmission Bandwidth (see Figure 5.3.1-1).
- NOTE 7: N_{RB} is the Transmission Bandwidth Configuration (see Section 5.3).
- NOTE 8: EVM is the limit for the modulation format used in the allocated RBs.
- NOTE 9: Δ_{RB} is the starting frequency offset between the allocated RB and the measured non-allocated RB (e.g. $\Delta_{RB} = 1$ or $\Delta_{RB} = -1$ for the first adjacent RB outside of the allocated bandwidth).
- NOTE 10: P_{RB} is the transmitted power per allocated RB, measured in dBm.
- NOTE 11: All powers are EIRP in beam peak direction.
- NOTE 12: In case the parameter 3300 or 3301 is reported from UE via *txDirectCurrentLocation* IE, IQ Image and Carrier leakage limit do not apply and General limit applies for all non-allocated frequencies.

For power ID1 and ID2, the averaged in-band emissions result, derived in Annex E.4.3 shall not exceed the corresponding values for IQ Image and Carrier Leakage in Table 6.4.2.3.5-4 for power class 4 UEs.

Table 6.4.2.3.5-4: Test requirements for in-band emissions for power class 4

Parameter description	Unit	Limit (NOTE 1)		Applicable Frequencies
General (NOTE 12)	dB	$\max \left[\begin{array}{l} -25 - 10 \cdot \log_{10} \left(\frac{N_{RB}}{L_{CRB}} \right), \\ 20 \cdot \log_{10}(\text{EVM}) - 5 \cdot \frac{(\Delta_{RB} - 1)}{L_{CRB}}, \\ -55.1 \text{ dBm} - P_{RB} \end{array} \right] + TT$		Any non-allocated (NOTE 2)
IQ Image (NOTE 12)	dB	-25 + TT	Output power > 21 dBm	Image frequencies (NOTES 2, 3)
		-20 + TT	Output power ≤ 21 dBm	
Carrier leakage (NOTE 12)	dBc	-25 + TT	Output power > 11 dBm	Carrier frequency (NOTES 4, 5)
		-20 + TT	-13 dBm ≤ Output power ≤ 11 dBm	

- NOTE 1: An in-band emissions combined limit is evaluated in each non-allocated RB. For each such RB, the minimum requirement is calculated as the higher of ($P_{RB} - 25$ dB) and the power sum of all limit values (General, IQ Image or Carrier leakage) that apply. P_{RB} is defined in NOTE 10.
- NOTE 2: The measurement bandwidth is 1 RB and the limit is expressed as a ratio of measured power in one non-allocated RB to the measured average power per allocated RB, where the averaging is done across all allocated RBs. For pi/2 BPSK with Spectrum Shaping, the limit is expressed as a ratio of measured power in one non-allocated RB to the measured power in the allocated RB with highest PSD
- NOTE 3: The applicable frequencies for this limit are those that are enclosed in the reflection of the allocated bandwidth, based on symmetry with respect to the carrier frequency, but excluding any allocated RBs.
- NOTE 4: The measurement bandwidth is 1 RB and the limit is expressed as a ratio of measured power in one non-allocated RB to the measured total power in all allocated RBs.
- NOTE 5: The applicable frequencies for this limit depend on the parameter *txDirectCurrentLocation* in *UplinkTxDirectCurrent* IE, and are those that are enclosed in the RBs containing the DC frequency but excluding any allocated RB.
- NOTE 6: L_{CRB} is the Transmission Bandwidth (see Figure 5.3.1-1).
- NOTE 7: N_{RB} is the Transmission Bandwidth Configuration (see Section 5.3).
- NOTE 8: EVM is the limit for the modulation format used in the allocated RBs.
- NOTE 9: Δ_{RB} is the starting frequency offset between the allocated RB and the measured non-allocated RB (e.g. $\Delta_{RB} = 1$ or $\Delta_{RB} = -1$ for the first adjacent RB outside of the allocated bandwidth).
- NOTE 10: P_{RB} is the transmitted power per allocated RB, measured in dBm.
- NOTE 11: All powers are EIRP in beam peak direction.
- NOTE 12: In case the parameter 3300 or 3301 is reported from UE via *txDirectCurrentLocation* IE, IQ Image and Carrier leakage limit do not apply and General limit applies for all non-allocated frequencies.

Table 6.4.2.3.5-5: Requirements for in-band emissions for power class 5

Parameter description	Unit	Limit (NOTE 1)		Applicable Frequencies
General	dB	$\max \left[\begin{array}{l} -25 - 10 \cdot \log_{10} \left(\frac{N_{RB}}{L_{CRB}} \right), \\ 20 \cdot \log_{10}(\text{EVM}) - 5 \cdot \frac{(\Delta_{RB} - 1)}{L_{CRB}}, \\ -55.1 \text{ dBm} - \overline{P_{RB}} \end{array} \right]$		Any non-allocated RB in allocated component carrier and not allocated component carriers (NOTE 2)
IQ Image	dB	-25 + TT	Output power > 17 dBm	Image frequencies (NOTES 2, 3)
		-20 + TT	Output power ≤ 17 dBm	
Carrier leakage	dBc	-25 + TT	Output power > 7 dBm	Carrier frequency (NOTES 4, 5)
		-20 + TT	-6 dBm ≤ Output power ≤ 7 dBm	
<p>NOTE 1: An in-band emissions combined limit is evaluated in each non-allocated RB. For each such RB, the minimum requirement is calculated as the higher of ($\overline{P_{RB}} - 25$ dB) and the power sum of all limit values (General, IQ Image or Carrier leakage) that apply. $\overline{P_{RB}}$ is defined in NOTE 9.</p> <p>NOTE 2: The measurement bandwidth is 1 RB and the limit is expressed as a ratio of measured power in one non-allocated RB to the measured average power per allocated RB, where the averaging is done across all allocated RBs. For pi/2 BPSK with Spectrum Shaping, the limit is expressed as a ratio of measured power in one non-allocated RB to the measured power in the allocated RB with highest PSD.</p> <p>NOTE 3: Image frequencies for UL CA are specified in relation to either UL or DL carrier frequency.</p> <p>NOTE 4: The measurement bandwidth is 1 RB and the limit is expressed as a ratio of measured power in one non-allocated RB to the measured total power in all allocated RBs.</p> <p>NOTE 5: The applicable frequencies for this limit are those that are enclosed in the RBs containing the DC frequency, or in the two RBs immediately adjacent to the DC frequency but excluding any allocated RB.</p> <p>NOTE 6: L_{CRB} is the Transmission Bandwidth (see Figure 5.3.1-1).</p> <p>NOTE 7: EVM is the limit for the modulation format used in the allocated RBs.</p> <p>NOTE 8: Δ_{RB} is the starting frequency offset between the allocated RB and the measured non-allocated RB (e.g. $\Delta_{RB} = 1$ or $\Delta_{RB} = -1$ for the first adjacent RB outside of the allocated bandwidth), and may take non-integer values when the carrier spacing between the CCs is not a multiple of RB.</p> <p>NOTE 9: $\overline{P_{RB}}$ is an average of the transmitted power over 10 sub-frames normalized by the number of allocated RBs, measured in dBm.</p> <p>NOTE 10: All powers are EIRP in beam peak direction.</p>				

Table 6.4.2.3.5-6: Test requirements for in-band emissions for power class 6

Parameter description	Unit	Limit (NOTE 1)		Applicable Frequencies
General	dB	$\max \left[\begin{array}{l} -25 - 10 \cdot \log_{10} \left(\frac{N_{RB}}{L_{CRB}} \right), \\ 20 \cdot \log_{10}(\text{EVM}) - 5 \cdot \frac{(\Delta_{RB} - 1)}{L_{CRB}}, \\ -55.1 \text{ dBm} - \overline{P_{RB}} \end{array} \right] + TT$		Any non-allocated (NOTE 2)
IQ Image	dB	-25+TT	Output power > 17 dBm	Image frequencies (NOTES 2, 3)
		-20+TT	Output power ≤ 17 dBm	
Carrier leakage	dBc	-25+TT	Output power > 7 dBm	Carrier frequency (NOTES 4, 5)
		-20+TT	-6 dBm ≤ Output power ≤ 7 dBm	
<p>NOTE 1: An in-band emissions combined limit is evaluated in each non-allocated RB. For each such RB, the minimum requirement is calculated as the higher of ($\overline{P_{RB}} - 25$ dB) and the power sum of all limit values (General, IQ Image or Carrier leakage) that apply. $\overline{P_{RB}}$ is defined in NOTE 10.</p> <p>NOTE 2: The measurement bandwidth is 1 RB and the limit is expressed as a ratio of measured power in one non-allocated RB to the measured average power per allocated RB, where the averaging is done across all allocated RBs. For Pi/2 BPSK with Spectrum Shaping, the limit is expressed as a ratio of measured power in one non-allocated RB to the measured power in the allocated RB with highest PSD</p> <p>NOTE 3: The applicable frequencies for this limit are those that are enclosed in the reflection of the allocated bandwidth, based on symmetry with respect to the carrier frequency, but excluding any allocated RBs.</p> <p>NOTE 4: The measurement bandwidth is 1 RB and the limit is expressed as a ratio of measured power in one non-allocated RB to the measured total power in all allocated RBs.</p> <p>NOTE 5: The applicable frequencies for this limit depend on the parameter <i>txDirectCurrentLocation</i> in <i>UplinkTxDirectCurrent</i> IE, and are those that are enclosed in the RBs containing the DC frequency but excluding any allocated RB.</p> <p>NOTE 6: L_{CRB} is the Transmission Bandwidth (see Clause 5.3).</p> <p>NOTE 7: N_{RB} is the Transmission Bandwidth Configuration (see Clause 5.3).</p> <p>NOTE 8: EVM is the limit for the modulation format used in the allocated RBs.</p> <p>NOTE 9: Δ_{RB} is the starting frequency offset between the allocated RB and the measured non-allocated RB (e.g. $\Delta_{RB} = 1$ or $\Delta_{RB} = -1$ for the first adjacent RB outside of the allocated bandwidth).</p> <p>NOTE 10: $\overline{P_{RB}}$ is an average of the transmitted power over 10 sub-frames normalized by the number of allocated RBs, measured in dBm.</p> <p>NOTE 11: All powers are EIRP in beam peak direction.</p>				

6.4.2.4 EVM equalizer spectrum flatness

Editor's note: This clause is incomplete. The following aspects are either missing or not yet determined:

- **Measurement Uncertainty and Test Tolerance are FFS.**

6.4.2.4.1 Test purpose

The zero-forcing equalizer correction applied in the EVM measurement process (as described in Annex E) must meet a spectral flatness requirement for the EVM measurement to be valid. The EVM equalizer spectrum flatness is defined in terms of the maximum peak-to-peak ripple of the equalizer coefficients (dB) across the allocated uplink block, at which the equalizer coefficients are generated by the EVM measurement process. The basic measurement interval is the same as for EVM.

The EVM equalizer spectrum flatness requirement does not limit the correction applied to the signal in the EVM measurement process but for the EVM result to be valid, the equalizer correction that was applied must meet the EVM equalizer spectrum flatness minimum requirements.

6.4.2.4.2 Test applicability

This test case applies to all types of NR UE release 15 and forward.

6.4.2.4.3 Minimum conformance requirements

For pi/2 BPSK modulation, the minimum requirements are defined in Clause 6.4.2.5.3.

The peak-to-peak variation of the EVM equalizer coefficients contained within the frequency range of the uplink allocation shall not exceed the maximum ripple specified in Table 6.4.2.4.3-1 for normal conditions. For uplink allocations contained within both Range 1 and Range 2, the coefficients evaluated within each of these frequency ranges shall meet the corresponding ripple requirement and the following additional requirements: the relative difference between the maximum coefficient in Range 1 and the minimum coefficient in Range 2 (Table 6.4.2.4.3-1) must not be larger than 7 dB, and the relative difference between the maximum coefficient in Range 2 and the minimum coefficient in Range 1 must not be larger than 8 dB (see Figure 6.4.2.4.3-1).

The requirement is verified with the test metric of EVM SF (Link=TX beam peak direction, Meas=Link angle).

Table 6.4.2.4.3-1: Minimum requirements for EVM equalizer spectrum flatness (normal conditions)

Frequency range	Maximum ripple (dB)
$ F_{UL_Meas} - F_{center} \leq X$ MHz (Range 1)	6 (p-p)
$ F_{UL_Meas} - F_{center} > X$ MHz (Range 2)	9 (p-p)

NOTE 1: F_{UL_Meas} refers to the sub-carrier frequency for which the equalizer coefficient is evaluated
 NOTE 2: F_{center} refers to the centre frequency of the CC
 NOTE 3: X, in MHz, is equal to 30% of the CC bandwidth

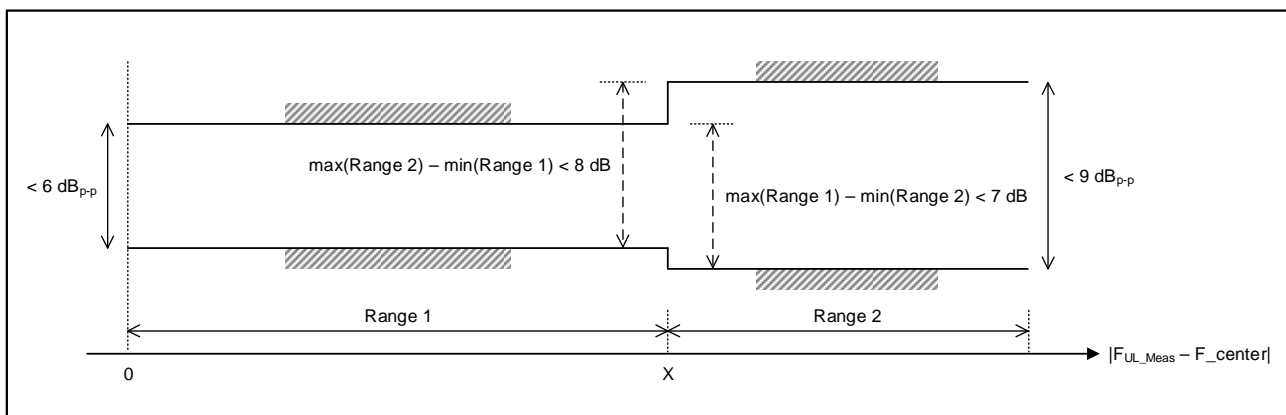

Figure 6.4.2.4.3-1: The limits for EVM equalizer spectral flatness with the maximum allowed variation of the coefficients indicated under normal conditions

The normative reference for this requirement is TS 38.101-2 [3] clause 6.4.2.4.

6.4.2.4.4 Test description

6.4.2.4.4.1 Initial condition

Initial conditions are a set of test configurations the UE needs to be tested in and the steps for the SS to take with the UE to reach the correct measurement state.

The initial test configurations consist of environmental conditions, test frequencies, test channel bandwidths and sub-carrier spacing based on NR operating bands specified in Table 5.3.5-1. All of these configurations shall be tested with applicable test parameters for each combination of channel bandwidth and sub-carrier spacing, are shown in Table

6.4.2.4.4.1-1. The details of the uplink reference measurement channels (RMCs) are specified in Annex A.2. Configurations of PDSCH and PDCCH before measurement are specified in Annex C.2.

Table 6.4.2.4.4.1-1: Test Configuration

Initial Conditions			
Test Environment as specified in TS 38.508-1 [10] clause 4.1		Normal	
Test Frequencies as specified in TS 38.508-1 [10] clause 4.3.1		Low range, Mid range, High range	
Test Channel Bandwidths as specified in TS 38.508-1 [10] clause 4.3.1		Lowest, Mid, Highest	
Test SCS as specified in Table 5.3.5-1		Lowest	
Test Parameters			
Test ID	Downlink Configuration	Uplink Configuration	
	-	Modulation	RB allocation (NOTE 1)
1		DFT-s-OFDM QPSK	Outer_Full
2		CP-OFDM QPSK	Outer_Full
NOTE 1: The specific configuration of each RB allocation is defined in Table 6.1-1 for PC2, PC3 and PC4 or Table 6.1-2 for PC1.			
NOTE 2: Test Channel Bandwidths are checked separately for each NR band, which applicable channel bandwidths are specified in Table 5.3.5-1.			

1. Connection between SS and UE is shown in TS 38.508-1 [10] Annex A, in Figure A.3.3.1.1 for TE diagram and section A.3.4.1.1 for UE diagram.
2. The parameter settings for the cell are set up according to TS 38.508-1 [10] clause 4.4.3.
3. Downlink signals are initially set up according to Annex C, and uplink signals according to Annex G.
4. The UL Reference Measurement channels are set according to Table 6.4.2.4.4.1-1.
5. Propagation conditions are set according to Annex B.0.
6. Ensure the UE is in state RRC_CONNECTED with generic procedure parameters Connectivity *NR*, Connected without release *On*, Test Mode *On* and Test Loop Function *On* according to TS 38.508-1 [10] clause 4.5. Message contents are defined in clause 6.4.2.4.4.3

6.4.2.4.4.2 Test procedure

1. Retrieve the LO position from the parameter txDirectCurrentLocation in UplinkTxDirectCurrent IE.
2. SS sends uplink scheduling information for each UL HARQ process via PDCCH DCI format 0_1 for C_RNTI to schedule the UL RMC according to Table 6.4.2.4.4.1-1. Since the UE has no payload and no loopback data to send the UE sends uplink MAC padding bits on the UL RMC
3. Set the UE in the Inband Tx beam peak direction found with a 3D EIRP scan as performed in Annex K.1.1. Allow at least BEAM_SELECT_WAIT_TIME (NOTE 2) for the UE Tx beam selection to complete.
4. Send continuously uplink power control "up" commands in the uplink scheduling information to the UE until the UE transmits at P_{UMAX} level. Allow at least 200 ms for the UE to reach P_{UMAX} level. Allow at least BEAM_SELECT_WAIT_TIME (NOTE 2) for the UE Tx beam selection to complete.
5. SS activates the UE Beamlock Function (UBF) by performing the procedure as specified in TS 38.508-1 [10] clause 4.9.2 using condition TxRx.
6. Measure spectrum flatness using Global In-Channel Tx-Test (Annex E) for the θ - and ϕ -polarizations, respectively. For TDD, only slots consisting of only UL symbols are under test.
7. SS deactivates the UE Beamlock Function (UBF) by performing the procedure as specified in TS 38.508-1 [10] clause 4.9.3.

NOTE1: When switching to DFT-s-OFDM waveform, as specified in Table 6.4.2.4.4.1-1, send an NR RRCReconfiguration message according to TS 38.508-1 [10] clause 4.6.3 Table 4.6.3-118 PUSCH-Config with TRANSFORM_PRECODER_ENABLED condition.

NOTE 2: The BEAM_SELECT_WAIT_TIME default value is defined in Annex K.

6.4.2.4.4.3 Message contents

Message contents are according to TS 38.508-1 [10] clause 4.6.

6.4.2.4.5 Test requirement

Each of the n spectrum flatness functions, shall derive four ripple results in Annex E.4.4. The derived results shall not exceed the values in Figure 6.4.2.4.5-1: The peak-to-peak variation of the EVM equalizer coefficients contained within the frequency range of the uplink allocation shall not exceed the maximum ripple specified in Table 6.4.2.4.5-1 for normal conditions. For uplink allocations contained within both Range 1 and Range 2, the coefficients evaluated within each of these frequency ranges shall meet the corresponding ripple requirement and the following additional requirements: the relative difference between the maximum coefficient in Range 1 and the minimum coefficient in Range 2 (Table 6.4.2.4.5-1) must not be larger than $7 \text{ dB} + \text{TT}$, and the relative difference between the maximum coefficient in Range 2 and the minimum coefficient in Range 1 must not be larger than $8 \text{ dB} + \text{TT}$ (see Figure 6.4.2.4.5-1).

The UE passes the test when the derived results for at least one polarization fulfil the test requirements.

Table 6.4.2.4.5-1: Test requirements for EVM equalizer spectrum flatness (normal conditions)

Frequency range	Maximum ripple (dB)
$ F_{UL_Meas} - F_{center} \leq X \text{ MHz}$ (Range 1)	$6 + \text{TT}$ (p-p)
$ F_{UL_Meas} - F_{center} > X \text{ MHz}$ (Range 2)	$9 + \text{TT}$ (p-p)

NOTE 1: F_{UL_Meas} refers to the sub-carrier frequency for which the equalizer coefficient is evaluated
 NOTE 2: F_{center} refers to the centre frequency of the CC
 NOTE 3: X , in MHz, is equal to 30% of the CC bandwidth

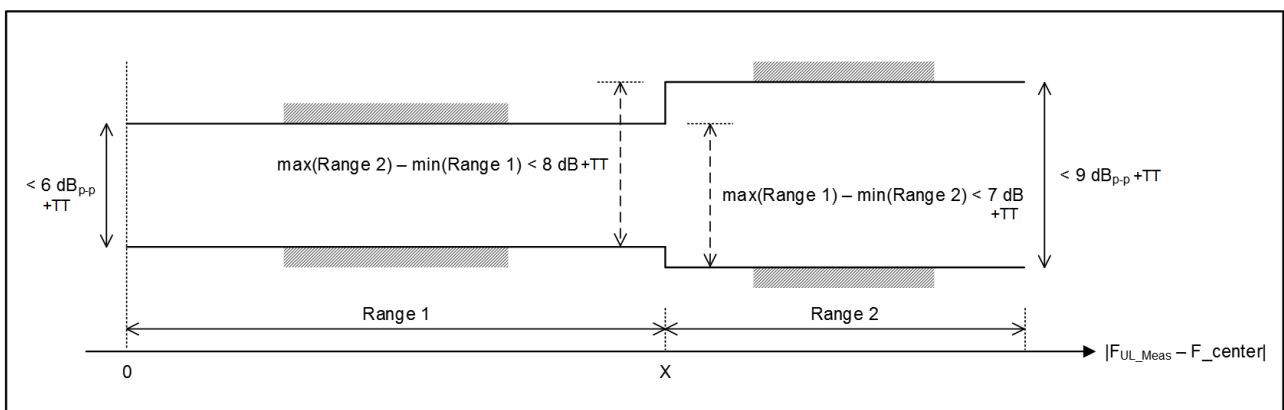

Figure 6.4.2.4.5-1: The limits for EVM equalizer spectral flatness with the maximum allowed variation of the coefficients indicated under normal conditions

6.4.2.5 EVM spectral flatness for pi/2 BPSK modulation

Editor's note: This clause is incomplete. The following aspects are either missing or not yet determined:

- Measurement Uncertainty and Test Tolerance are FFS.
- Whether and, if yes, how to test the requirement on shaping filter is FFS.

6.4.2.5.1 Test purpose

Same test purpose as in clause 6.4.2.4.1.

6.4.2.5.2 Test applicability

This test case applies to all types of NR FR2 UE release 15 and forward supporting pi/2 BPSK modulation.

6.4.2.5.3 Minimum conformance requirements

These requirements are defined for pi/2 BPSK modulation. The EVM equalizer coefficients across the allocated uplink block shall be modified to fit inside the mask specified in Table 6.4.2.5.3-1 for normal conditions, prior to the calculation of EVM. The limiting mask shall be placed to minimize the change in equalizer coefficients in a sum of squares sense.

Table 6.4.2.5.3-1: Mask for EVM equalizer coefficients for pi/2 BPSK (normal conditions)

Frequency range	Parameter	Maximum ripple (dB)
$ F_{UL_Meas} - F_{center} \leq X$ MHz (Range 1)	X1	6 (p-p)
$ F_{UL_Meas} - F_{center} > X$ MHz (Range 2)	X2	14 (p-p)

NOTE 1: F_{UL_Meas} refers to the sub-carrier frequency for which the equalizer coefficient is evaluated.
 NOTE 2: F_{center} refers to the centre frequency of an allocated block of PRBs.
 NOTE 3: X, in MHz, is equal to 25% of the bandwidth of the PRB allocation.
 NOTE 4: See Figure 6.4.2.5.3-1 for description of X1, X2 and X3.

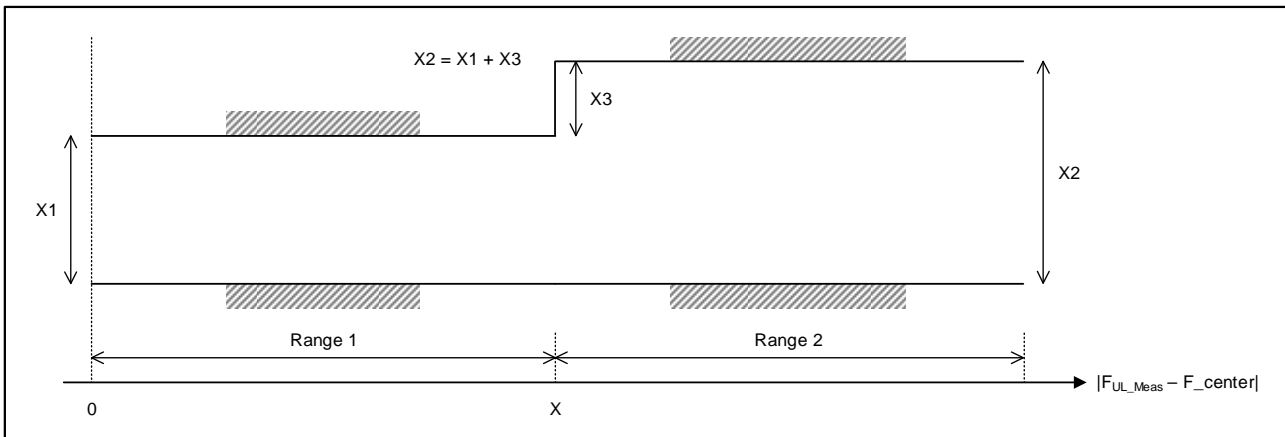

Figure 6.4.2.5.3-1: The limits for EVM equalizer spectral flatness with the maximum allowed variation. F_{center} denotes the centre frequency of the allocated block of PRBs. F_{alloc} denotes the bandwidth of the PRB allocation

This requirement does not apply to other modulation types. The UE shall be allowed to employ spectral shaping for pi/2 BPSK. The shaping filter shall be restricted so that the impulse response of the transmit chain shall meet

$$|\tilde{a}_t(t,0)| \geq |\tilde{a}_t(t,\tau)| \quad \forall \tau \neq 0$$

$$20\log_{10} |\tilde{a}_t(t,\tau)| < -15 \text{ dB} \quad 1 < \tau < M - 1,$$

Where:

$$|\tilde{a}_t(t,\tau)| = \text{IDFT} \{ |\tilde{a}_t(t,f)| e^{j\phi(t,f)} \},$$

f is the frequency of the M allocated subcarriers,

$\tilde{a}_t(t,f)$ and $\phi(t,f)$ are the amplitude and phase response, respectively of the transmit chain

0dB reference is defined as $20\log_{10} |\tilde{a}_t(t,0)|$

The normative reference for this requirement is TS 38.101-2 [3] clause 6.4.2.5.

6.4.2.5.4 Test description

6.4.2.5.4.1 Initial condition

Same initial conditions as in clause 6.4.2.4.4.1 with following exceptions:

- Instead of Table 6.4.2.4.4.1-1 → use Table 6.4.2.5.4.1-1

Table 6.4.2.5.4.1-1: Test Configuration

Initial Conditions			
Test Environment as specified in TS 38.508-1 [10] clause 4.1		Normal	
Test Frequencies as specified in TS 38.508-1 [10] clause 4.3.1		Low range, Mid range, High range	
Test Channel Bandwidths as specified in TS 38.508-1 [10] clause 4.3.1		Lowest, Mid, Highest	
Test SCS as specified in TS 38.508-1 [10] clause 5.3.5-1		Lowest	
Test Parameters			
Test ID	Downlink Configuration	Uplink Configuration	
	-	Modulation	RB allocation (NOTE 1)
1		DFT-s-OFDM pi/2-BPSK	Outer_Full
NOTE 1: The specific configuration of each RB allocation is defined in Table 6.1-1 for PC2, PC3 and PC4 or Table 6.1-2 for PC1.			
NOTE 2: Test Channel Bandwidths are checked separately for each NR band, which applicable channel bandwidths are specified in Table 5.3.5-1.			

6.4.2.5.4.2 Test procedure

1. Retrieve the LO position from the parameter txDirectCurrentLocation in UplinkTxDirectCurrent IE.
2. SS sends uplink scheduling information for each UL HARQ process via PDCCH DCI format 0_1 for C_RNTI to schedule the UL RMC according to Table 6.4.2.5.4.1-1. Since the UE has no payload and no loopback data to send the UE sends uplink MAC padding bits on the UL RMC
3. Set the UE in the Inband Tx beam peak direction found with a 3D EIRP scan as performed in Annex K.1.1. Allow at least BEAM_SELECT_WAIT_TIME (NOTE 1) for the UE Tx beam selection to complete.
4. Send continuously uplink power control "up" commands in the uplink scheduling information to the UE until the UE transmits at P_{UMAX} level. Allow at least 200 ms for the UE to reach P_{UMAX} level. Allow at least BEAM_SELECT_WAIT_TIME (NOTE 1) for the UE Tx beam selection to complete.
5. SS activates the UE Beamlock Function (UBF) by performing the procedure as specified in TS 38.508-1 [10] clause 4.9.2 using condition TxRx.
6. Measure spectrum flatness using Global In-Channel Tx-Test (Annex E) for the θ - and ϕ -polarizations, respectively. For TDD, only slots consisting of only UL symbols are under test.
7. SS deactivates the UE Beamlock Function (UBF) by performing the procedure as specified in TS 38.508-1 [10] clause 4.9.3.

NOTE 1: The BEAM_SELECT_WAIT_TIME default value is defined in Annex K.

6.4.2.5.4.3 Message contents

Message contents are according to TS 38.508-1 [10] clause 4.6 with TRANSFORM_PRECODER_ENABLED condition in Table 4.6.3-118 PUSCH-Config.

6.4.2.5.5 Test requirement

Each of the n spectrum flatness functions, shall derive four ripple results in Annex E.4.4. The derived results shall not exceed the values in Table 6.4.2.5.5-1 and Figure 6.4.2.5.5-1:

Table 6.4.2.5.5-1: Test requirement for EVM equalizer coefficients for pi/2 BPSK (normal conditions)

Frequency range	Parameter	Maximum ripple (dB)
$ F_{UL_Meas} - F_{center} \leq X$ MHz (Range 1)	X1	6 + TT (p-p)
$ F_{UL_Meas} - F_{center} > X$ MHz (Range 2)	X2	14 + TT (p-p)

NOTE 1: F_{UL_Meas} refers to the sub-carrier frequency for which the equalizer coefficient is evaluated.
 NOTE 2: F_{center} refers to the centre frequency of an allocated block of PRBs.
 NOTE 3: X, in MHz, is equal to 25% of the bandwidth of the PRB allocation.
 NOTE 4: See Figure 6.4.2.5.5-1 for description of X1, X2 and X3.

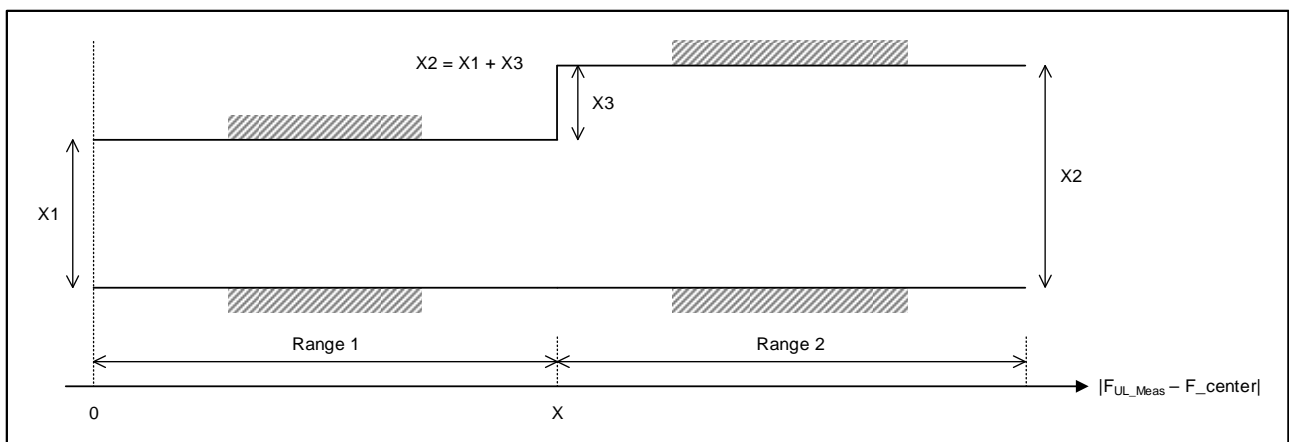

Figure 6.4.2.5.5-1: The limits for EVM equalizer spectral flatness with the maximum allowed variation. F_{center} denotes the centre frequency of the allocated block of PRBs

The UE passes the test when the derived results for at least one polarization fulfil the test requirements.

6.4.2.6 Phase continuity requirements for DMRS bundling

Editor's note: This clause is incomplete. The following aspects are either missing or not yet determined:

- MU/TT analysis is pending
- Message Contents requires to be finalized

6.4.2.6.1 Test purpose

The objective of this test is to determine the maximum allowable phase difference for UEs that support DMRS bundling.

6.4.2.6.2 Test applicability

This test case applies to all types of NR FR2 UEs which are release 17 and forward supporting TDD, *dmrs-BundlingPUCCH-Rep-r17* and either *dmrs-BundlingPUSCH-multiSlot-r17* or *dmrs-BundlingPUSCH-RepTypeA-r17* or *dmrs-BundlingPUSCH-RepTypeB-r17*.

6.4.2.6.3 Minimum conformance requirements

For bands that UE indicates the support of DMRS bundling, the maximum allowable difference between the measured phase value in any slot $p-1$ and slot p shall satisfy the requirements as listed in Table 6.4.2.6-1 for the measurement conditions defined in Table 6.4.2.6-2, within a measurement time window limited by the UE capability of maximum duration for DMRS bundling [maxDurationDMRS-Bundling-r17], and defined for each frequency band separately. The phase value for each slot is measured as shown in Annex F.8. These requirements apply to PUCCH and PUSCH transmissions with DFT-s-OFDM and CP-OFDM waveforms.

Table 6.4.2.6-1: Maximum allowable phase difference for DMRS bundling

UL channel	Modulation order	Phase difference between any slot $p-1$ and slot p (NOTE 2)
PUSCH	Pi/2 BPSK, QPSK	[25] degrees
PUCCH	Pi/2 BPSK, BPSK, QPSK	
NOTE 1: The UE capability of the length of maximum duration refers to the maximum time duration during which UE is able to meet the phase continuity requirements, assuming no phase consistency violating events defined in TS 38.214 in between.		
NOTE 2: This requirement applies for TDD bands, for supported DMRS bundling configurations ≤ 8 slots.		

The above requirements are applicable when all the following conditions are met within the measurement time window.

- RB allocation in terms of length and frequency position does not change, and intra-slot and inter-slot frequency hopping is not activated.
- Modulation order does not change.
- No network commanded TA takes effect.
- The TPMI precoder does not change.
- There is no change in UE EIRP level, and no change in the level of P-MPR applied by the UE.
- UE is not scheduled with uplink transmission of other physical channel/signal in-between the PUSCH or PUCCH transmissions.
- For TDD, no downlink slot(s) or downlink symbol(s) or flexible symbol(s) with/without DL monitoring occasion configured in-between the PUSCH or PUCCH transmissions.
- No uplink beam switching occurs.

Table 6.4.2.6-2: Measurement conditions for the maximum allowable phase difference

Parameter	Unit	Level
UE EIRP	dBm	$P_{UMAX,f,c}$ in clause 6.2.4, P-MPR = 0
UE downlink received power		Not change
Operating conditions		Normal conditions
Transmission bandwidth		Confined within $F_{UL,low} + [4]$ MHz and $F_{UL,high} - [4]$ MHz
DL signal frequency		Not change before and during the measurement window
DL signal timing		Maintained constant before and during the measurement window
UL slots for testing		Tested on consecutive UL slots
PUSCH waveform for testing		DFT-s-OFDM

NOTE: Phase continuity requirements for DMRS bundling is defined only within FR2-1 in this release of the specification.

6.4.2.6.4 Test description

6.4.2.6.4.1 Initial conditions

Initial conditions are a set of test configurations the UE needs to be tested in and the steps for the SS to take with the UE to reach the correct measurement state.

The initial test configurations consist of environmental conditions, test frequencies, test channel bandwidths and sub-carrier spacing based on NR operating bands specified in Table 5.3.5-1. All of these configurations shall be tested with applicable test parameters for each combination of channel bandwidth and sub-carrier spacing, are shown in Table 6.4.2.1.4.1-1. The details of the uplink reference measurement channels (RMCs) are specified in Annex A.2. Configurations of PDSCH and PDCCH before measurement are specified in Annex C.2.

Table 6.4.2.6.4.1-1: Test Configuration Table for PUSCH

Initial Conditions		
Test Environment as specified in TS 38.508-1 [10] clause 4.1	Normal	
Test Frequencies as specified in TS 38.508-1 [10] clause 4.3.1	Low range, Mid range, High range	
Test Channel Bandwidths as specified in TS 38.508-1 [10] clause 4.3.1	Lowest, Highest	
Test SCS as specified in Table 5.3.5-1	Lowest	
Test Parameters		
Test ID	Downlink Configuration	Uplink Configuration
	-	Modulation RB allocation (NOTE 1)
1		DFT-s-OFDM PI/2 BPSK Inner_Full for PC2, PC3, PC4 and PC6 Inner_Full_Region1 for PC1
2 (NOTE 4)		DFT-s-OFDM QPSK Inner_Full for PC2, PC3, PC4 and PC6 Inner_Full_Region1 for PC1
NOTE 1: The specific configuration of each RB allocation is defined in Table 6.1-1 for PC2, PC3, PC4, PC6 and PC7 or Table 6.1-2 for PC1.		
NOTE 2: Test Channel Bandwidths are checked separately for each NR band, which applicable channel bandwidths are specified in Table 5.3.5-1.		
NOTE 3: Void.		
NOTE 4: This test point shall be skipped if device supports mpr-PowerBoost-FR2-r16 UE capability.		

Table 6.4.2.6.4.1-2: Test Configuration Table for PUCCH

Initial Conditions		
Test Environment as specified in TS 38.508-1 [10] clause 4.1	Normal	
Test Frequencies as specified in TS 38.508-1 [10] clause 4.3.1	See Table 6.4.2.6.4.1-1	
Test Channel Bandwidths as specified in TS 38.508-1 [10] clause 4.3.1	See Table 6.4.2.6.4.1-1	
Test SCS as specified in Table 5.3.5-1	See Table 6.4.2.6.4.1-1	
Test Parameters		
ID	Downlink Configuration	Uplink Configuration
	Modulation RB allocation	Waveform PUCCH format
1	- -	DFT-s-OFDM PUCCH format = Format 3 Length in OFDM symbols = 14
NOTE 1: Test Channel Bandwidths are checked separately for each NR band, which applicable channel bandwidths are specified in Table 5.3.5-1.		

1. Connection between SS and UE is shown in TS 38.508-1 [10] Annex A, in Figure A.3.3.1.1 for TE diagram and section A.3.4.1.1 for UE diagram.
2. The parameter settings for the cell are set up according to TS 38.508-1 [10] clause 4.4.3.

3. Downlink signals are initially set up according to Annex C, and uplink signals according to Annex G.
4. The UL Reference Measurement channels are set according to Table 6.4.2.6.4.1-1
5. Propagation conditions are set according to Annex B.0.
6. Ensure the UE is in state RRC_CONNECTED with generic procedure parameters Connectivity NR, Connected without release On, Test Mode On and Test Loop Function On according to TS 38.508-1 [10] clause 4.5. Message contents are defined in clause 6.4.2.1.4.3

6.4.2.6.4.2 Test procedure

Test procedure for PUSCH:

- 1.1. SS sends uplink scheduling information for each UL HARQ process via PDCCH DCI format 0_1 for C_RNTI to schedule the UL RMC according to Table 6.4.2.1.4.1-1. Since the UE has no payload data to send, the UE transmits uplink MAC padding bits on the UL RMC.
- 1.2. Set the UE in the Inband Tx beam peak direction found with a 3D EIRP scan as performed in Annex K.1.1. Allow at least BEAM_SELECT_WAIT_TIME (NOTE 2) for the UE Tx beam selection to complete.
- 1.3. Send continuously uplink power control "up" commands in the uplink scheduling information to the UE until the UE transmits at PUMAX level. Allow at least 200 ms starting from the first TPC command in this step for the UE to reach PUMAX level. Allow at least BEAM_SELECT_WAIT_TIME (NOTE 2) for the UE Tx beam selection to complete.
- 1.4. SS activates the UE Beamlock Function (UBF) by performing the procedure as specified in TS 38.508-1 [10] clause 4.9.2 using condition TxRx.
- 1.5. Measure the phase offset using the test measurement described in Annex E.6.11. For TDD, only slots consisting of only UL symbols are under test.
- 1.6. SS deactivates the UE Beamlock Function (UBF) by performing the procedure as specified in TS 38.508-1 [10] clause 4.9.3.

NOTE1: When switching to DFT-s-OFDM waveform, as specified in Table 6.4.2.6.4.1-1, send an NR RRCReconfiguration message according to TS 38.508-1 [10] clause 4.6.3 Table 4.6.3-118 PUSCH-Config with TRANSFORM_PRECODER_ENABLED condition.

NOTE 2: The BEAM_SELECT_WAIT_TIME default value is defined in Annex K.1.1.

Test procedure for PUCCH:

- 2.1. PUCCH is set according to Table 6.4.2.6.4.1-2.
- 2.2 SS transmits PDSCH via PDCCH DCI format 1_1 for C_RNTI to transmit the DL RMC according to Table 6.4.2.6.4.1-2. The SS sends downlink MAC padding bits on the DL RMC. The transmission of PDSCH will make the UE send uplink ACK/NACK using PUCCH. There is no PUSCH transmission.
- 2.3. Set the UE in the Inband Tx beam peak direction found with a 3D EIRP scan as performed in Annex K.1.1. Allow at least BEAM_SELECT_WAIT_TIME (NOTE 2) for the UE Tx beam selection to complete.
- 2.4. Send continuously uplink power control "up" commands in the uplink scheduling information to the UE until the UE transmits PUCCH at PUMAX level. Allow at least 200 ms starting from the first TPC command in this step for the UE to reach PUMAX level. Allow at least BEAM_SELECT_WAIT_TIME (NOTE 2) for the UE Tx beam selection to complete.
- 2.5 SS activates the UE Beamlock Function (UBF) by performing the procedure as specified in TS 38.508-1 [10] clause 4.9.2 using condition TxRx.
- 2.6. Measure the phase offset using test measurement described in Annex E.6.11. For TDD, only slots consisting of only UL symbols are under test.
- 2.7. SS deactivates the UE Beamlock Function (UBF) by performing the procedure as specified in TS 38.508-1 [10] clause 4.9.3.

NOTE 2: The BEAM_SELECT_WAIT_TIME default value is defined in Annex K.1.1.

6.4.2.6.4.3 Message contents

Message contents are according to TS 38.508-1 [10] clause 4.6 with TRANSFORM_PRECODER_ENABLED condition in Table 4.6.3-118 PUSCH-Config. In addition, the following message contents shall be configured.

Table 6.4.2.6.4.3-1: DMRS-BundlingPUCCH-Config

Derivation Path: TS 38.331 [11], clause 6.3.2			
Information Element	Value/remark	Comment	Condition
DMRS-BundlingPUCCH-Config-r17::= CHOICE {			
Setup SEQUENCE {			
pucch-DMRS-Bundling-r17	ENABLED		
pucch-TimeDomainWindowLength-r17	2		
pucch-WindowRestart-r17	TBD		
pucch-FrequencyHoppingInterval-r17	s2		
}			

Table 6.4.2.6.4.3-2: DMRS-BundlingPUSCH-Config

Derivation Path: TS 38.331 [11], clause 6.3.2			
Information Element	Value/remark	Comment	Condition
DMRS-BundlingPUSCH-Config-r17::= CHOICE {			
Setup SEQUENCE {			
pusch-DMRS-Bundling-r17	ENABLED		
pusch-TimeDomainWindowLength-r17	2		
pusch-WindowRestart-r17	TBD		
pusch-FrequencyHoppingInterval-r17	s2		
}			

6.4.2.6.5 Test requirement

The maximum allowable phase difference for UEs supporting DMRS dbundling and as measured in Step [TBD] of test procedure should meet the following requirements.

Table 6.4.2.6.5-1: Test Requirements for Maximum allowable phase difference for DMRS bundling

UL channel	Modulation order	Phase difference between any slot $p-1$ and slot p (NOTE 2)
PUSCH	Pi/2 BPSK, QPSK	[25+TT] degrees
PUCCH	Pi/2 BPSK, BPSK, QPSK	
NOTE 1: The UE capability of the length of maximum duration refers to the maximum time duration during which UE is able to meet the phase continuity requirements, assuming no phase consistency violating events defined in TS 38.214 in between.		
NOTE 2: This requirement applies for TDD bands, for supported DMRS bundling configurations ≤ 8 slots.		

Table 6.4.2.6.5-2: Test Tolerance for Maximum allowable phase difference for DMRS bundling

UL channel	Modulation order	TT
PUSCH	Pi/2 BPSK, QPSK	FFS
PUCCH	Pi/2 BPSK, BPSK, QPSK	FFS

6.4A Transmit signal quality for CA

6.4A.1 Frequency error for CA

6.4A.1.0 Minimum conformance requirements

The requirements in this clause apply to UEs of all power classes.

For intra-band contiguous carrier aggregation, the UE basic measurement interval of modulated carrier frequency is 1 UL slot. The mean value of basic measurements of UE modulated carrier frequencies per band shall be accurate to within ± 0.1 PPM observed over a period of 1ms of cumulated measurement intervals compared to the carrier frequency of primary component carrier received from the gNB.

The frequency error is defined as a directional requirement. The requirement is verified in beam locked mode on beam peak direction.

6.4A.1.1 Frequency error for CA (2UL CA)

Editor's note: The following aspects are either missing or not yet determined:

- **Measurement Uncertainties and Test Tolerances for intra-band contiguous CA supporting aggregated BW > 400MHz is TBD.**

6.4A.1.1.1 Test purpose

This test verifies the ability of both, the receiver and the transmitter, to process frequency correctly.

Receiver: to extract the correct frequency from the stimulus signal, offered by the System simulator, under ideal propagation conditions and low level.

Transmitter: to derive the correct modulated carrier frequency from the results, gained by the receiver.

6.4A.1.1.2 Test applicability

This test case applies to all types of NR UE release 15 and forward that supports FR2 2UL CA.

6.4A.1.1.3 Minimum conformance requirements

The minimum conformance requirements are defined in clause 6.4A.1.0.

6.4A.1.1.4 Test description

6.4A.1.1.4.1 Initial condition

Initial conditions are a set of test configurations the UE needs to be tested in and the steps for the SS to take with the UE to reach the correct measurement state.

The initial test configurations consist of environmental conditions, test frequencies, and channel bandwidths based on NR operating bands specified in clause 5.5A. All of these configurations shall be tested with applicable test parameters for each channel bandwidth and subcarrier spacing, are shown in Table 6.4A.1.1.4.1-1. The details of the uplink reference measurement channels (RMCs) are specified in Annexes A.2. Configurations of PDSCH and PDCCH before measurement are specified in Annex C.2.

Table 6.4A.1.1.4.1-1: Test Configuration Table

Default Conditions	
Test Environment as specified in TS 38.508-1 [10] clause 4.1	Normal, TL, TH
Test Frequencies as specified in TS 38.508-1 [10] clause 4.3.1.2.3 for different CA bandwidth classes	Mid range

Test CC Combination setting (aggregated BW of the CA configuration) as specified in TS 38.508-1 [10] clause 4.3.1.2.3 for the CA Configuration across bandwidth combination sets supported by the UE				Highest aggregated BW of the CA configuration		
Test SCS as specified in Table 5.3.5-1				Lowest		
Test Parameters						
CA Configuration / Aggregated BW			Downlink Configuration		Uplink Configuration	
Test ID	CC & Mapping (NOTE 4)	CBW (MHz)	Modulation	RB allocation	Modulation	RB allocation (NOTE 1)
1	PCC/CC1	Default	CP-OFDM QPSK	Full RB (NOTE 1)	DFT-s-OFDM QPSK	REFSENS (NOTE 2)
	SCC/CC2		-	-	-	-
2	PCC/CC1	Default	CP-OFDM QPSK	Full RB (NOTE 1)	-	-
	SCC/CC2		-	-	DFT-s-OFDM QPSK	REFSENS (NOTE 2)
NOTE 1: Full RB allocation shall be used per each SCS and channel BW as specified in Table 7.3.2.4.1-2.						
NOTE 2: REFSSENS refers to Table 7.3.2.4.1-3 which defines uplink RB configuration and start RB location for each SCS, channel BW and NR band.						
NOTE 3: Number of DL CCs shall be configured the same as number of UL CCs. The requirements are applicable as per 5.3A.4: "The requirements are applicable only when Uplink CCs are configured within the frequency range between lower edge of lowest downlink component carrier and upper edge of highest downlink component carrier".						

1. Connection between SS and UE is shown in TS 38.508-1 [10] Annex A, Figure A.3.3.1.1 for TE diagram and Figure A.3.4.1.1 for UE diagram.
2. The parameter settings for the cell are set up according to TS 38.508-1 [10] clause 4.4.3.
3. Downlink signals are initially set up according to Annex C, and uplink signals according to Annex G.
4. The UL Reference Measurement channels are set according to Table 6.4A.1.1.4.1-1.
5. Propagation conditions are set according to Annex B.0
6. Ensure the UE is in state RRC_CONNECTED with generic procedure parameters Connectivity NR, Connected without release On, Test Mode On and Test Loop Function On according to TS 38.508-1 [10] clause 4.5. Message contents are defined in clause 6.4A.1.1.4.3

6.4A.1.1.4.2 Test procedure

1. Retrieve the LO position from the parameter txDirectCurrentLocation in UplinkTxDirectCurrent IE.
2. Configure SCC according to Annex C.0, C.1, C.2 for all downlink physical channels.
3. The SS shall configure SCC as per TS 38.508-1 [10] clause 5.5.1. Message contents are defined in clause 6.4A.1.1.4.3.
4. SS activates SCC by sending the activation MAC CE (Refer TS 38.321 [28], clauses 5.9, 6.1.3.10). Wait for at least 2 seconds (Refer TS 38.133[25], clause 9.3).
5. SS transmits PDSCH via PDCCH DCI format 1_1 for C_RNTI to transmit the DL RMC according to Table 6.4A.1.1.4.1-1. The SS sends downlink MAC padding bits on the DL RMC.
6. SS sends uplink scheduling information for each UL HARQ process via PDCCH DCI format 0_1 for C_RNTI to schedule the UL RMC according to Table 6.4A.1.1.4.1-1. Since the UL has no payload and no loopback data to send the UE sends uplink MAC padding bits on the UL RMC.
7. Set the UE in the Inband Tx beam peak direction found with a 3D EIRP scan as performed in Annex K.1.1. Allow at least BEAM_SELECT_WAIT_TIME (NOTE 1) for the UE Tx beam selection to complete.
8. Send continuously uplink power control "up" commands to the UE in every uplink scheduling information to the UE so that the UE transmits at P_{UMAX} level for the duration of the test. Allow at least 200ms starting from the first TPC Command for the UE to reach P_{UMAX} level. Allow at least BEAM_SELECT_WAIT_TIME (NOTE 1) for the UE Tx beam selection to complete.

9. SS activates the UE Beamlock Function (UBF) by performing the procedure as specified in TS 38.508-1 [10] clause 4.9.2 using condition Tx only.

10. For every UE modulated carrier frequency, measure the Frequency Error using Global In-Channel Tx-Test (Annex E) for the θ - and ϕ -polarization. For TDD, only slots consisting of only UL symbols are under test.

NOTE 1: The BEAM_SELECT_WAIT_TIME default value is defined in Annex K.

6.4A.1.1.4.3 Message contents

Message contents are according to TS 38.508-1 [10] clause 4.6 with TRANSFORM_PRECODER_ENABLED condition in Table 4.6.3-118 PUSCH-Config.

6.4A.1.1.5 Test Requirements

The 10 frequency error Δf results for the θ -polarization or the 10 frequency error Δf results for the ϕ -polarization must fulfil the test requirement:

$$|\Delta f| \leq (0.1 \text{ PPM} + 0.005 \text{ PPM}), \text{ (for Aggregated BW} \leq 400\text{MHz)}$$

6.4A.1.2 Frequency error for CA (3UL CA)

Editor's note: The following aspects are either missing or not yet determined:

- Measurement Uncertainties and Test Tolerances for intra-band contiguous CA supporting aggregated BW > 400MHz is TBD.

6.4A.1.2.1 Test purpose

This test verifies the ability of both, the receiver and the transmitter, to process frequency correctly.

Receiver: to extract the correct frequency from the stimulus signal, offered by the System simulator, under ideal propagation conditions and low level.

Transmitter: to derive the correct modulated carrier frequency from the results, gained by the receiver.

6.4A.1.2.2 Test applicability

This test case applies to all types of NR UE release 15 and forward that supports FR2 3UL CA.

6.4A.1.2.3 Minimum conformance requirements

The minimum conformance requirements are defined in clause 6.4A.1.0.

6.4A.1.2.4 Test description

Same as in clause 6.4A.1.1.4 with following exceptions:

- Instead of Table 6.4A.1.1.4.1-1 → use Table 6.4A.1.2.4-1.
- Instead of Table 6.4A.1.1.5-1 → use Table 6.4A.1.2.5-1.

Table 6.4A.1.2.4-1: Test Configuration Table

Default Conditions	
Test Environment as specified in TS 38.508-1 [10] clause 4.1	Normal, TL, TH
Test Frequencies as specified in TS 38.508-1 [10] clause 4.3.1.2.3 for different CA bandwidth classes	Mid range
Test CC Combination setting (aggregated BW of the CA configuration) as specified in TS 38.508-1 [10] clause 4.3.1.2.3 for the CA Configuration across bandwidth combination sets supported by the UE	Highest aggregated BW of the CA configuration
Test SCS as specified in Table 5.3.5-1	Lowest
Test Parameters	

CA Configuration / Aggregated BW			Downlink Configuration		Uplink Configuration	
Test ID	CC & Mapping (NOTE 4)	CBW (MHz)	Modulation	RB allocation	Modulation	RB allocation (NOTE 1)
1	PCC/CC1	default	CP-OFDM QPSK	Full RB (NOTE 1)	DFT-s-OFDM QPSK	REFSENS (NOTE 2)
	SCC/CC2		-	-	-	-
	SCC/CC3		-	-	-	-
2	PCC/CC1		CP-OFDM QPSK	Full RB (NOTE 1)	-	-
	SCC/CC2		-	-	DFT-s-OFDM QPSK	REFSENS (NOTE 2)
	SCC/CC3		-	-	-	-
3	PCC/CC1		CP-OFDM QPSK	Full RB (NOTE 1)	-	-
	SCC/CC2		-	-	-	-
	SCC/CC3		-	-	DFT-s-OFDM QPSK	REFSENS (NOTE 2)

NOTE 1: Full RB allocation shall be used per each SCS and channel BW as specified in Table 7.3.2.4.1-2.
NOTE 2: REFSSENS refers to Table 7.3.2.4.1-3 which defines uplink RB configuration and start RB location for each SCS, channel BW and NR band.
NOTE 3: Number of DL CCs shall be configured the same as number of UL CCs. The requirements are applicable as per 5.3A.4: "The requirements are applicable only when Uplink CCs are configured within the frequency range between lower edge of lowest downlink component carrier and upper edge of highest downlink component carrier".

6.4A.1.2.5 Test Requirements

The 10 frequency error Δf results for the θ -polarization or the 10 frequency error Δf results for the ϕ -polarization must fulfil the test requirement:

$$|\Delta f| \leq (0.1 \text{ PPM} + 0.005 \text{ PPM}), \text{ (for Aggregated BW} \leq 400\text{MHz)}$$

6.4A.1.3 Frequency error for CA (4UL CA)

Editor's note: The following aspects are either missing or not yet determined:

- **Measurement Uncertainties and Test Tolerances for intra-band contiguous CA supporting aggregated BW > 400MHz is TBD.**

6.4A.1.3.1 Test purpose

This test verifies the ability of both, the receiver and the transmitter, to process frequency correctly.

Receiver: to extract the correct frequency from the stimulus signal, offered by the System simulator, under ideal propagation conditions and low level.

Transmitter: to derive the correct modulated carrier frequency from the results, gained by the receiver.

6.4A.1.3.2 Test applicability

This test case applies to all types of NR UE release 15 and forward that supports FR2 4UL CA.

6.4A.1.3.3 Minimum conformance requirements

The minimum conformance requirements are defined in clause 6.4A.1.0.

6.4A.1.3.4 Test description

Same as in clause 6.4A.1.1.4 with following exceptions:

- Instead of Table 6.4A.1.1.4.1-1 → use Table 6.4A.1.3.4-1.

- Instead of Table 6.4A.1.1.5-1 → use Table 6.4A.1.3.5-1.

Table 6.4A.1.3.4-1: Test Configuration Table

Default Conditions						
Test Environment as specified in TS 38.508-1 [10] clause 4.1				Normal, TL, TH		
Test Frequencies as specified in TS 38.508-1 [10] clause 4.3.1.2.3 for different CA bandwidth classes				Mid range		
Test CC Combination setting (aggregated BW of the CA configuration) as specified in TS 38.508-1 [10] clause 4.3.1.2.3 for the CA Configuration across bandwidth combination sets supported by the UE				Highest aggregated BW of the CA configuration		
Test SCS as specified in Table 5.3.5-1				Lowest		
Test Parameters						
CA Configuration / Aggregated BW			Downlink Configuration		Uplink Configuration	
Test ID	CC & Mapping (NOTE 4)	CBW (MHz)	Modulation	RB allocation	Modulation	RB allocation (NOTE 1)
1	PCC/CC1	Default	CP-OFDM QPSK	Full RB (NOTE 1)	DFT-s-OFDM QPSK	REFSENS (NOTE 2)
	SCC/CC2		-	-	-	
	SCC/CC3		-	-	-	
	SCC/CC4		-	-	-	
2	PCC/CC1	Default	CP-OFDM QPSK	Full RB (NOTE 1)	-	-
	SCC/CC2		-	-	DFT-s-OFDM QPSK	REFSENS (NOTE 2)
	SCC/CC3		-	-	-	-
	SCC/CC4		-	-	-	-
3	PCC/CC1	Default	CP-OFDM QPSK	Full RB (NOTE 1)	-	-
	SCC/CC2		-	-	-	-
	SCC/CC3		-	-	DFT-s-OFDM QPSK	REFSENS (NOTE 2)
	SCC/CC4		-	-	-	-
4	PCC/CC1	Default	CP-OFDM QPSK	Full RB (NOTE 1)	-	-
	SCC/CC2		-	-	-	-
	SCC/CC3		-	-	-	-
	SCC/CC4		-	-	DFT-s-OFDM QPSK	REFSENS (NOTE 2)

NOTE 1: Full RB allocation shall be used per each SCS and channel BW as specified in Table 7.3.2.4.1-2.
 NOTE 2: REFSENS refers to Table 7.3.2.4.1-3 which defines uplink RB configuration and start RB location for each SCS, channel BW and NR band.
 NOTE 3: Number of DL CCs shall be configured the same as number of UL CCs. The requirements are applicable as per 5.3A.4: "The requirements are applicable only when Uplink CCs are configured within the frequency range between lower edge of lowest downlink component carrier and upper edge of highest downlink component carrier".

6.4A.1.3.5 Test Requirements

The 10 frequency error Δf results for the θ-polarization or the 10 frequency error Δf results for the φ-polarization must fulfil the test requirement:

$$|\Delta f| \leq (0.1 \text{ PPM} + 0.005 \text{ PPM}), \text{ (for Aggregated BW} \leq 400\text{MHz)}$$

6.4A.1.4 Frequency error for CA (5UL CA)

Editor's note: This clause is incomplete. The following aspects are either missing or not yet determined:

- Measurement Uncertainties and Test Tolerances are FFS.

6.4A.1.4.1 Test purpose

This test verifies the ability of both, the receiver and the transmitter, to process frequency correctly.

Receiver: to extract the correct frequency from the stimulus signal, offered by the System simulator, under ideal propagation conditions and low level.

Transmitter: to derive the correct modulated carrier frequency from the results, gained by the receiver.

6.4A.1.4.2 Test applicability

This test case applies to all types of NR UE release 15 and forward that supports FR2 5UL CA.

6.4A.1.4.3 Minimum conformance requirements

The minimum conformance requirements are defined in clause 6.4A.1.0.

6.4A.1.4.4 Test description

Same as in clause 6.4A.1.1.4 with following exceptions:

- Instead of Table 6.4A.1.1.4.1-1 → use Table 6.4A.1.4.4-1.

Table 6.4A.1.4.4-1: Test Configuration Table

Default Conditions						
Test Environment as specified in TS 38.508-1 [10] clause 4.1					Normal, TL, TH	
Test Frequencies as specified in TS 38.508-1 [10] clause 4.3.1.2.3 for different CA bandwidth classes					Mid range	
Test CC Combination setting (aggregated BW of the CA configuration) as specified in TS 38.508-1 [10] clause 4.3.1.2.3 for the CA Configuration across bandwidth combination sets supported by the UE					Highest aggregated BW of the CA configuration	
Test SCS as specified in Table 5.3.5-1					Lowest	
Test Parameters						
CA Configuration / Aggregated BW			Downlink Configuration		Uplink Configuration	
Test ID	CC & Mapping (NOTE 4)	CBW (MHz)	Modulation	RB allocation	Modulation	RB allocation (NOTE 1)
1	PCC/CC1	Default	CP-OFDM QPSK	Full RB (NOTE 1)	DFT-s-OFDM QPSK	REFSENS (NOTE 2)
	SCC/CC2		-	-	-	
	SCC/CC3		-	-	-	
	SCC/CC4		-	-	-	
	SCC/CC5		-	-	-	
2	PCC/CC1	Default	CP-OFDM QPSK	Full RB (NOTE 1)	-	-
	SCC/CC2		-	-	DFT-s-OFDM QPSK	REFSENS (NOTE 2)
	SCC/CC3		-	-	-	-
	SCC/CC4		-	-	-	-
	SCC/CC5		-	-	-	-
3	PCC/CC1	Default	CP-OFDM QPSK	Full RB (NOTE 1)	-	-
	SCC/CC2		-	-	-	-
	SCC/CC3		-	-	DFT-s-OFDM QPSK	REFSENS (NOTE 2)
	SCC/CC4		-	-	-	-
	SCC/CC5		-	-	-	-
4	PCC/CC1	Default	CP-OFDM QPSK	Full RB (NOTE 1)	-	-
	SCC/CC2		-	-	-	-
	SCC/CC3		-	-	-	-
	SCC/CC4		-	-	DFT-s-OFDM QPSK	REFSENS (NOTE 2)
	SCC/CC5		-	-	-	-
5	PCC/CC1	Default	CP-OFDM QPSK	Full RB (NOTE 1)	-	-
	SCC/CC2		-	-	-	-
	SCC/CC3		-	-	-	-

	SCC/CC4		-	-	-	-
	SCC/CC5		-	-	DFT-s-OFDM QPSK	REFSENS (NOTE 2)
<p>NOTE 1: Full RB allocation shall be used per each SCS and channel BW as specified in Table 7.3.2.4.1-2.</p> <p>NOTE 2: REFSENS refers to Table 7.3.2.4.1-3 which defines uplink RB configuration and start RB location for each SCS, channel BW and NR band.</p> <p>NOTE 3: Number of DL CCs shall be configured the same as number of UL CCs. The requirements are applicable as per 5.3A.4: "The requirements are applicable only when Uplink CCs are configured within the frequency range between lower edge of lowest downlink component carrier and upper edge of highest downlink component carrier".</p>						

6.4A.1.4.5 Test Requirements

The 10 frequency error Δf results for the θ-polarization or the 10 frequency error Δf results for the φ-polarization must fulfil the test requirement:

$$|\Delta f| \leq (0.1 \text{ PPM} + 0.005 \text{ PPM}), \text{ (for Aggregated BW} \leq 400\text{MHz)}$$

6.4A.1.5 Frequency error for CA (6UL CA)

Editor's note: This clause is incomplete. The following aspects are either missing or not yet determined:

- Measurement Uncertainties and Test Tolerances are FFS.

6.4A.1.5.1 Test purpose

This test verifies the ability of both, the receiver and the transmitter, to process frequency correctly.

Receiver: to extract the correct frequency from the stimulus signal, offered by the System simulator, under ideal propagation conditions and low level.

Transmitter: to derive the correct modulated carrier frequency from the results, gained by the receiver.

6.4A.1.5.2 Test applicability

This test case applies to all types of NR UE release 15 and forward that supports FR2 6UL CA.

6.4A.1.5.3 Minimum conformance requirements

The minimum conformance requirements are defined in clause 6.4A.1.0.

6.4A.1.5.4 Test description

Same as in clause 6.4A.1.1.4 with following exceptions:

- Instead of Table 6.4A.1.1.4.1-1 → use Table 6.4A.1.5.4-1.

Table 6.4A.1.5.4-1: Test Configuration Table

Default Conditions						
Test Environment as specified in TS 38.508-1 [10] clause 4.1				Normal, TL, TH		
Test Frequencies as specified in TS 38.508-1 [10] clause 4.3.1.2.3 for different CA bandwidth classes				Mid range		
Test CC Combination setting (aggregated BW of the CA configuration) as specified in TS 38.508-1 [10] clause 4.3.1.2.3 for the CA Configuration across bandwidth combination sets supported by the UE				Highest aggregated BW of the CA configuration		
Test SCS as specified in Table 5.3.5-1				Lowest		
Test Parameters						
CA Configuration / Aggregated BW			Downlink Configuration		Uplink Configuration	
Test ID	CC & Mapping (NOTE 4)	CBW (MHz)	Modulation	RB allocation	Modulation	RB allocation (NOTE 1)

1	PCC/CC1	Default	CP-OFDM QPSK	Full RB (NOTE 1)	DFT-s-OFDM QPSK	REFSENS (NOTE 2)
	SCC/CC2		-	-	-	-
	SCC/CC3		-	-	-	-
	SCC/CC4		-	-	-	-
	SCC/CC5		-	-	-	-
	SCC/CC6		-	-	-	-
2	PCC/CC1	Default	CP-OFDM QPSK	Full RB (NOTE 1)	-	-
	SCC/CC2		-	-	DFT-s-OFDM QPSK	REFSENS (NOTE 2)
	SCC/CC3		-	-	-	-
	SCC/CC4		-	-	-	-
	SCC/CC5		-	-	-	-
	SCC/CC6		-	-	-	-
3	PCC/CC1	Default	CP-OFDM QPSK	Full RB (NOTE 1)	-	-
	SCC/CC2		-	-	-	-
	SCC/CC3		-	-	DFT-s-OFDM QPSK	REFSENS (NOTE 2)
	SCC/CC4		-	-	-	-
	SCC/CC5		-	-	-	-
	SCC/CC6		-	-	-	-
4	PCC/CC1	Default	CP-OFDM QPSK	Full RB (NOTE 1)	-	-
	SCC/CC2		-	-	-	-
	SCC/CC3		-	-	-	-
	SCC/CC4		-	-	DFT-s-OFDM QPSK	REFSENS (NOTE 2)
	SCC/CC5		-	-	-	-
	SCC/CC6		-	-	-	-
5	PCC/CC1	Default	CP-OFDM QPSK	Full RB (NOTE 1)	-	-
	SCC/CC2		-	-	-	-
	SCC/CC3		-	-	-	-
	SCC/CC4		-	-	-	-
	SCC/CC5		-	-	DFT-s-OFDM QPSK	REFSENS (NOTE 2)
	SCC/CC6		-	-	-	-
6	PCC/CC1	Default	CP-OFDM QPSK	Full RB (NOTE 1)	-	-
	SCC/CC2		-	-	-	-
	SCC/CC3		-	-	-	-
	SCC/CC4		-	-	-	-
	SCC/CC5		-	-	-	-
	SCC/CC6		-	-	DFT-s-OFDM QPSK	REFSENS (NOTE 2)
<p>NOTE 1: Full RB allocation shall be used per each SCS and channel BW as specified in Table 7.3.2.4.1-2.</p> <p>NOTE 2: REFSENS refers to Table 7.3.2.4.1-3 which defines uplink RB configuration and start RB location for each SCS, channel BW and NR band.</p> <p>NOTE 3: Number of DL CCs shall be configured the same as number of UL CCs. The requirements are applicable as per 5.3A.4: "The requirements are applicable only when Uplink CCs are configured within the frequency range between lower edge of lowest downlink component carrier and upper edge of highest downlink component carrier".</p>						

6.4A.1.5.5 Test Requirements

The 10 frequency error Δf results for the θ -polarization or the 10 frequency error Δf results for the ϕ -polarization must fulfil the test requirement:

$$|\Delta f| \leq (0.1 \text{ PPM} + 0.005 \text{ PPM}), \text{ (for Aggregated BW} \leq 400\text{MHz)}$$

6.4A.1.6 Frequency error for CA (7UL CA)

Editor's note: This clause is incomplete. The following aspects are either missing or not yet determined:

- Measurement Uncertainties and Test Tolerances are FFS.

6.4A.1.6.1 Test purpose

This test verifies the ability of both, the receiver and the transmitter, to process frequency correctly.

Receiver: to extract the correct frequency from the stimulus signal, offered by the System simulator, under ideal propagation conditions and low level.

Transmitter: to derive the correct modulated carrier frequency from the results, gained by the receiver.

6.4A.1.6.2 Test applicability

This test case applies to all types of NR UE release 15 and forward that supports FR2 7UL CA.

6.4A.1.6.3 Minimum conformance requirements

The minimum conformance requirements are defined in clause 6.4A.1.0.

6.4A.1.6.4 Test description

Same as in clause 6.4A.1.1.4 with following exceptions:

- Instead of Table 6.4A.1.1.4.1-1 → use Table 6.4A.1.6.4-1.

Table 6.4A.1.6.4-1: Test Configuration Table

Default Conditions						
Test Environment as specified in TS 38.508-1 [10] clause 4.1				Normal, TL, TH		
Test Frequencies as specified in TS 38.508-1 [10] clause 4.3.1.2.3 for different CA bandwidth classes				Mid range		
Test CC Combination setting (aggregated BW of the CA configuration) as specified in TS 38.508-1 [10] clause 4.3.1.2.3 for the CA Configuration across bandwidth combination sets supported by the UE				Highest aggregated BW of the CA configuration		
Test SCS as specified in Table 5.3.5-1				Lowest		
Test Parameters						
CA Configuration / Aggregated BW			Downlink Configuration		Uplink Configuration	
Test ID	CC & Mapping (NOTE 4)	CBW (MHz)	Modulation	RB allocation	Modulation	RB allocation (NOTE 1)
1	PCC/CC1	Default	CP-OFDM QPSK	Full RB (NOTE 1)	DFT-s-OFDM QPSK	REFSENS (NOTE 2)
	SCC/CC2		-	-	-	
	SCC/CC3		-	-	-	
	SCC/CC4		-	-	-	
	SCC/CC5		-	-	-	
	SCC/CC6		-	-	-	
	SCC/CC7		-	-	-	
2	PCC/CC1	Default	CP-OFDM QPSK	Full RB (NOTE 1)	-	-
	SCC/CC2		-	-	DFT-s-OFDM QPSK	REFSENS (NOTE 2)
	SCC/CC3		-	-	-	-
	SCC/CC4		-	-	-	-
	SCC/CC5		-	-	-	-
	SCC/CC6		-	-	-	-
	SCC/CC7		-	-	-	-
3	PCC/CC1	Default	CP-OFDM QPSK	Full RB (NOTE 1)	-	-
	SCC/CC2		-	-	-	-

	SCC/CC3		-	-	DFT-s-OFDM QPSK	REFSENS (NOTE 2)
	SCC/CC4		-	-	-	-
	SCC/CC5		-	-	-	-
	SCC/CC6		-	-	-	-
	SCC/CC7		-	-	-	-
4	PCC/CC1	Default	CP-OFDM QPSK	Full RB (NOTE 1)	-	-
	SCC/CC2		-	-	-	-
	SCC/CC3		-	-	-	-
	SCC/CC4		-	-	DFT-s-OFDM QPSK	REFSENS (NOTE 2)
	SCC/CC5		-	-	-	-
	SCC/CC6		-	-	-	-
	SCC/CC7		-	-	-	-
5	PCC/CC1	Default	CP-OFDM QPSK	Full RB (NOTE 1)	-	-
	SCC/CC2		-	-	-	-
	SCC/CC3		-	-	-	-
	SCC/CC4		-	-	-	-
	SCC/CC5		-	-	DFT-s-OFDM QPSK	REFSENS (NOTE 2)
	SCC/CC6		-	-	-	-
	SCC/CC7		-	-	-	-
6	PCC/CC1	Default	CP-OFDM QPSK	Full RB (NOTE 1)	-	-
	SCC/CC2		-	-	-	-
	SCC/CC3		-	-	-	-
	SCC/CC4		-	-	-	-
	SCC/CC5		-	-	-	-
	SCC/CC6		-	-	DFT-s-OFDM QPSK	REFSENS (NOTE 2)
	SCC/CC7		-	-	-	-
7	PCC/CC1	Default	CP-OFDM QPSK	Full RB (NOTE 1)	-	-
	SCC/CC2		-	-	-	-
	SCC/CC3		-	-	-	-
	SCC/CC4		-	-	-	-
	SCC/CC5		-	-	-	-
	SCC/CC6		-	-	-	-
	SCC/CC7		-	-	DFT-s-OFDM QPSK	REFSENS (NOTE 2)
<p>NOTE 1: Full RB allocation shall be used per each SCS and channel BW as specified in Table 7.3.2.4.1-2.</p> <p>NOTE 2: REFSENS refers to Table 7.3.2.4.1-3 which defines uplink RB configuration and start RB location for each SCS, channel BW and NR band.</p> <p>NOTE 3: Number of DL CCs shall be configured the same as number of UL CCs. The requirements are applicable as per 5.3A.4: "The requirements are applicable only when Uplink CCs are configured within the frequency range between lower edge of lowest downlink component carrier and upper edge of highest downlink component carrier".</p>						

6.4A.1.6.5 Test Requirements

The 10 frequency error Δf results for the θ-polarization or the 10 frequency error Δf results for the φ-polarization must fulfil the test requirement:

$$|\Delta f| \leq (0.1 \text{ PPM} + 0.005 \text{ PPM}), \text{ (for Aggregated BW} \leq 400\text{MHz)}$$

6.4A.1.7 Frequency error for CA (8UL CA)

Editor's note: This clause is incomplete. The following aspects are either missing or not yet determined:

- Measurement Uncertainties and Test Tolerances are FFS.

6.4A.1.7.1 Test purpose

This test verifies the ability of both, the receiver and the transmitter, to process frequency correctly.

Receiver: to extract the correct frequency from the stimulus signal, offered by the System simulator, under ideal propagation conditions and low level.

Transmitter: to derive the correct modulated carrier frequency from the results, gained by the receiver.

6.4A.1.7.2 Test applicability

This test case applies to all types of NR UE release 15 and forward that supports FR2 8UL CA.

6.4A.1.7.3 Minimum conformance requirements

The minimum conformance requirements are defined in clause 6.4A.1.0.

6.4A.1.7.4 Test description

Same as in clause 6.4A.1.1.4 with following exceptions:

- Instead of Table 6.4A.1.1.4.1-1 → use Table 6.4A.1.7.4-1.

Table 6.4A.1.7.4-1: Test Configuration Table

Default Conditions						
Test Environment as specified in TS 38.508-1 [10] clause 4.1					Normal, TL, TH	
Test Frequencies as specified in TS 38.508-1 [10] clause 4.3.1.2.3 for different CA bandwidth classes					Mid range	
Test CC Combination setting (aggregated BW of the CA configuration) as specified in TS 38.508-1 [10] clause 4.3.1.2.3 for the CA Configuration across bandwidth combination sets supported by the UE					Highest aggregated BW of the CA configuration	
Test SCS as specified in Table 5.3.5-1					Lowest	
Test Parameters						
CA Configuration / Aggregated BW			Downlink Configuration		Uplink Configuration	
Test ID	CC & Mapping (NOTE 4)	CBW (MHz)	Modulation	RB allocation	Modulation	RB allocation (NOTE 1)
1	PCC/CC1	Default	CP-OFDM QPSK	Full RB (NOTE 1)	DFT-s-OFDM QPSK	REFSENS (NOTE 2)
	SCC/CC2		-	-	-	
	SCC/CC3		-	-	-	
	SCC/CC4		-	-	-	
	SCC/CC5		-	-	-	
	SCC/CC6		-	-	-	
	SCC/CC7		-	-	-	
	SCC/CC8		-	-	-	
2	PCC/CC1	Default	CP-OFDM QPSK	Full RB (NOTE 1)	-	-
	SCC/CC2		-	-	DFT-s-OFDM QPSK	REFSENS (NOTE 2)
	SCC/CC3		-	-	-	-
	SCC/CC4		-	-	-	-
	SCC/CC5		-	-	-	-
	SCC/CC6		-	-	-	-
	SCC/CC7		-	-	-	-
	SCC/CC8		-	-	-	-
3	PCC/CC1	Default	CP-OFDM QPSK	Full RB (NOTE 1)	-	-
	SCC/CC2		-	-	-	-
	SCC/CC3		-	-	DFT-s-OFDM QPSK	REFSENS (NOTE 2)
	SCC/CC4		-	-	-	-
	SCC/CC5		-	-	-	-
	SCC/CC6		-	-	-	-

4	SCC/CC7	Default	-	-	-	-
	SCC/CC8		-	-	-	-
	PCC/CC1		CP-OFDM QPSK	Full RB (NOTE 1)	-	-
	SCC/CC2		-	-	-	-
	SCC/CC3		-	-	-	-
	SCC/CC4		-	-	DFT-s-OFDM QPSK	REFSENS (NOTE 2)
	SCC/CC5		-	-	-	-
	SCC/CC6		-	-	-	-
	SCC/CC7		-	-	-	-
5	PCC/CC1	Default	CP-OFDM QPSK	Full RB (NOTE 1)	-	-
	SCC/CC2		-	-	-	-
	SCC/CC3		-	-	-	-
	SCC/CC4		-	-	-	-
	SCC/CC5		-	-	DFT-s-OFDM QPSK	REFSENS (NOTE 2)
	SCC/CC6		-	-	-	-
	SCC/CC7		-	-	-	-
	SCC/CC8		-	-	-	-
	6		PCC/CC1	Default	CP-OFDM QPSK	Full RB (NOTE 1)
SCC/CC2		-	-		-	-
SCC/CC3		-	-		-	-
SCC/CC4		-	-		-	-
SCC/CC5		-	-		-	-
SCC/CC6		-	-		DFT-s-OFDM QPSK	REFSENS (NOTE 2)
SCC/CC7		-	-		-	-
SCC/CC8		-	-		-	-
7		PCC/CC1	Default		CP-OFDM QPSK	Full RB (NOTE 1)
	SCC/CC2	-		-	-	-
	SCC/CC3	-		-	-	-
	SCC/CC4	-		-	-	-
	SCC/CC5	-		-	-	-
	SCC/CC6	-		-	-	-
	SCC/CC7	-		-	DFT-s-OFDM QPSK	REFSENS (NOTE 2)
	SCC/CC8	-		-	-	-
	8	PCC/CC1		Default	CP-OFDM QPSK	Full RB (NOTE 1)
SCC/CC2		-	-		-	-
SCC/CC3		-	-		-	-
SCC/CC4		-	-		-	-
SCC/CC5		-	-		-	-
SCC/CC6		-	-		-	-
SCC/CC7		-	-		-	-
SCC/CC8		-	-		DFT-s-OFDM QPSK	REFSENS (NOTE 2)

NOTE 1: Full RB allocation shall be used per each SCS and channel BW as specified in Table 7.3.2.4.1-2.
 NOTE 2: REFSENS refers to Table 7.3.2.4.1-3 which defines uplink RB configuration and start RB location for each SCS, channel BW and NR band.
 NOTE 3: Number of DL CCs shall be configured the same as number of UL CCs. The requirements are applicable as per 5.3A.4: "The requirements are applicable only when Uplink CCs are configured within the frequency range between lower edge of lowest downlink component carrier and upper edge of highest downlink component carrier".

6.4A.1.7.5 Test Requirements

The 10 frequency error Δf results for the θ -polarization or the 10 frequency error Δf results for the ϕ -polarization must fulfil the test requirement:

$$|\Delta f| \leq (0.1 \text{ PPM} + 0.005 \text{ PPM}), \text{ (for Aggregated BW} \leq 400\text{MHz)}$$

6.4A.2 Transmit modulation quality for CA

6.4A.2.0 General

For intra-band contiguous carrier aggregation, the requirements in subclauses 6.4A.2.1.0, 6.4A.2.2.0, and 6.4A.2.3.0.

All the parameters defined in clause 6.4A.2 are defined using the measurement methodology specified in Annex E.

All the requirements in 6.4A.2 are defined as directional requirement. The requirements are verified in beam locked mode on beam peak direction, with both UL polarizations active.

The carrier leakage frequency is optionally indicated with IE *UplinkTxDirectCurrentList*, *UplinkTxDirectCurrentTwoCarrierList-r16* for CA with two component carriers configured for uplink or IE *UplinkTxDirectCurrentMoreCarrierList-r17* for any CA configuration.

If the UE does not indicate DC location parameters, the carrier leakage measurement requirement in clauses 6.4A.2.2 and 6.4A.2.3 shall be waived and the UE's UL signal left uncorrected for carrier leakage. Any requirement relaxation to accommodate the IQ image shall be omitted.

If the UE indicates carrier leakage frequency as 3300 or 3301 with IE *UplinkTxDirectCurrentList* or *UplinkTxDirectCurrentTwoCarrierList-r16*, or if the carrier leakage frequency is outside the configured UL and DL carriers, the carrier leakage measurement requirement in clause 6.4A.2.2 and 6.4A.2.3 shall be waived and the UE's UL signal left uncorrected for carrier leakage. Any requirement relaxation to accommodate the IQ image shall be omitted.

The UE is defined to be configured for CA operation when it has at least one of UL or DL configured for CA.

For inter-band carrier aggregation with uplink assigned to two NR bands, and each UL band is configured with a single CC, the transmit modulation quality requirements are specified in clause 6.4.2 and are applicable for each CC with all CCs active with non-zero UL RB allocation.

6.4A.2.1 Error vector magnitude for CA

Editor's note: This test is incomplete due to lack of RRC framework for LO position retrieval.

6.4A.2.1.0 Minimum conformance requirements

The requirements in this clause apply to UEs of all power classes. For intra-band contiguous carrier aggregation, the Error Vector Magnitude requirement of section 6.4.2.1 is defined for each component carrier. Requirements only apply with PRB allocation in one of the component carriers. Similar transmitter impairment removal procedures are applied for CA waveform before EVM calculation as is specified for non-CA waveform.

6.4A.2.1.1 Error vector magnitude for CA (2UL CA)

Editor's note: This clause is incomplete. The following aspects are either missing or not yet determined:

- Measurement Uncertainty and Test Tolerance are FFS.
- For a transition period until RAN#108 (June 2025) previous test procedure in TS 38.521-2 V18.4.0 is allowed for TE implementation.

6.4A.2.1.1.1 Test Purpose

For 2UL carrier aggregation, the Error Vector Magnitude requirement should be defined for each component carrier. Requirement applies for the allocated component carrier, when all other component carriers are activated, but not allocated.

Similar transmitter impairment removal procedures are applied for CA waveform before EVM calculation as is specified for non-CA waveform in section 6.4.2.1.

6.4A.2.1.1.2 Test applicability

This test case applies to all types of NR UE release 15 and forward that supports FR2 2UL CA.

6.4A.2.1.1.3 Minimum conformance requirements

The minimum conformance requirements are defined in clause 6.4A.2.1.0

6.4A.2.1.1.4 Test description

6.4A.2.1.1.4.1 Initial conditions

Initial conditions are a set of test configurations the UE needs to be tested in and the steps for the SS to take with the UE to reach the correct measurement state.

The initial test configurations consist of environmental conditions, test frequencies, test channel bandwidths and sub-carrier spacing based on NR CA configuration specified in clause 5.5A. All of these configurations shall be tested with applicable test parameters for each CA configuration, are shown in Table 6.4A.2.1.1.4.1-1. The details of the uplink reference measurement channels (RMCs) are specified in Annex A.2. Configurations of PDSCH and PDCCH before measurement are specified in Annex C.2.

Table 6.4A.2.1.1.4.1-1: Test Configuration Table for 2UL CA

Default Conditions					
Test Environment as specified in TS 38.508-1 [10] clause 4.1			Normal		
Test Frequencies as specified in TS 38.508-1 [10] clause 4.3.1.2.3 for different CA bandwidth classes			Low and High range		
Test CC Combination setting (aggregated BW of the CA configuration) as specified in TS 38.508-1 [10] clause 4.3.1.2.3 for the CA Configuration across bandwidth combination sets supported by the UE			Lowest aggregated BW of the CA configuration Highest aggregated BW of the CA configuration		
Test SCS as specified in Table 5.3.5-1			Lowest, Highest		
Test Parameters					
CA Configuration / Aggregated BW			Downlink Configuration	Uplink Configuration	
Test ID	CC & Mapping (NOTE 3)	CBW (MHz)	RB allocation	Modulation	RB allocation (NOTE 1)
1	PCC/CC1	default	-	DFT-s-OFDM PI/2 BPSK	Inner_Full for PC2, PC3, PC4 Inner_Full_Region1 for PC1
	SCC/CC2			-	-
2	PCC/CC1			DFT-s-OFDM PI/2 BPSK	Outer_Full
	SCC/CC2			-	-
3	PCC/CC1			DFT-s-OFDM QPSK	Inner_Full for PC2, PC3, PC4 Inner_Full_Region1 for PC1
	SCC/CC2			-	-
4	PCC/CC1			DFT-s-OFDM QPSK	Outer_Full
	SCC/CC2			-	-
5	PCC/CC1			DFT-s-OFDM 16 QAM	Inner_Full for PC2, PC3, PC4 Inner_Full_Region1 for PC1
	SCC/CC2			-	-
6	PCC/CC1	DFT-s-OFDM 16 QAM	Outer_Full		
	SCC/CC2	-	-		
7	PCC/CC1	DFT-s-OFDM 64 QAM	Inner_Full for PC2, PC3, PC4 Inner_Full_Region1 for PC1		
	SCC/CC2	-	-		
8	PCC/CC1	DFT-s-OFDM 64 QAM	Outer_Full		
	SCC/CC2	-	-		
9	PCC/CC1	CP-OFDM QPSK	Inner_Full for PC2, PC3, PC4 Inner_Full_Region1 for PC1		
	SCC/CC2	-	-		
10	PCC/CC1	CP-OFDM QPSK	Outer_Full		
	SCC/CC2	-	-		

11	PCC/CC1			CP-OFDM 16 QAM	Inner_Full for PC2, PC3, PC4 Inner_Full_Region1 for PC1
	SCC/CC2			-	-
12	PCC/CC1			CP-OFDM 16 QAM	Outer_Full
	SCC/CC2			-	-
13	PCC/CC1			CP-OFDM 64 QAM	Inner_Full for PC2, PC3, PC4 Inner_Full_Region1 for PC1
	SCC/CC2			-	-
14	PCC/CC1			CP-OFDM 64 QAM	Outer_Full
	SCC/CC2			-	-
15 - 28	PCC/CC1			-	-
	SCC/CC2			NOTE 4	NOTE 4

NOTE 1: The specific configuration of each RB allocation is defined in Table 6.1-1 for PC2, PC3 and PC4 or Table 6.1-2 for PC1.

NOTE 2: CA Configuration Test cumulative aggregated BW settings are checked separately for each CA Configuration, which applicable aggregated channel bandwidths are specified in Table 5.5A.1-1.

NOTE 3: PCC/CC_i and SCC/CC_j means PCC is on component carrier CC_i and SCC is on component carrier CC_j, with CC_i or CC_j frequencies defined in TS38.508-1 [10].

NOTE 4: Same Modulation and RB allocation of Test ID 1 – 14 are applied to Test ID 15 – 28 in sequence.

NOTE 5: Number of DL CCs shall be configured the same as number of UL CCs. The requirements are applicable as per 5.3A.4: "The requirements are applicable only when Uplink CCs are configured within the frequency range between lower edge of lowest downlink component carrier and upper edge of highest downlink component carrier".

1. Connection between SS and UE is shown in TS 38.508-1 [10] Annex A, in Figure A.3.3.1.1 for TE diagram and section A.3.4.1.1 for UE diagram.
2. The parameter settings for the cell are set up according to TS 38.508-1 [10] clause 4.4.3.
3. Downlink signals for PCC are initially set up according to Annex C, and uplink signals according to Annex G.
4. The UL Reference Measurement channels are set according to Table 6.4A.2.1.1.4.1-1.
5. Propagation conditions are set according to Annex B.0.
6. Ensure the UE is in state RRC_CONNECTED with generic procedure parameters Connectivity NR, Connected without release On, Test Mode On and Test Loop Function On according to TS 38.508-1 [10] clause 4.5. Message contents are defined in clause 6.4A.2.1.1.4.3

6.4A.2.1.1.4.2 Test procedure

1. Retrieve the LO position from the parameter txDirectCurrentLocation in UplinkTxDirectCurrent IE.
2. Configure SCC according to Annex C.0, C.1, C.3 for all downlink physical channels.
3. The SS shall configure SCC as per TS 38.508-1 [10] clause 5.5.1. Message contents are defined in clause 6.4A.2.1.1.4.3.
4. SS activates SCC by sending the activation MAC CE (Refer TS 38.321 [28], clauses 5.9, 6.1.3.10). Wait for at least 2 seconds (Refer TS 38.133[25], clause9.2).
5. SS sends uplink scheduling information for each UL HARQ process via PDCCH DCI format 0_1 for C_RNTI to schedule the UL RMC according to Table 6.4A.2.1.1.4.1-1. Since the UE has no payload data to send, the UE transmits uplink MAC padding bits on the UL RMC.
6. Set the UE in the Inband Tx beam peak direction found with a 3D EIRP scan as performed in Annex K.1.1. Allow at least BEAM_SELECT_WAIT_TIME (NOTE 2) for the UE Tx beam selection to complete.
7. Send continuously uplink power control "up" commands in the uplink scheduling information to the UE until the UE transmits at P_{UMAX} level. Allow at least 200ms starting from the first TPC command in this step for the UE to reach P_{UMAX} level. Allow at least BEAM_SELECT_WAIT_TIME (NOTE 2) for the UE Tx beam selection to complete.
8. SS activates the UE Beamlock Function (UBF) by performing the procedure as specified in TS 38.508-1 [10] clause 4.9.2 using condition TxRx.

9. If the UE transmits on only one polarization, measure the EVM_{θ} , EVM_{ϕ} , $\overline{EVM}_{DMRS,\theta}$ and $\overline{EVM}_{DMRS,\phi}$ on PCC using Global In-Channel Tx-Test (Annex E) for the θ - and ϕ -polarizations, respectively. For TDD, only slots consisting of only UL symbols are under test. Calculate $\overline{EVM}_{DMRS} = \min(\overline{EVM}_{DMRS,\theta}, \overline{EVM}_{DMRS,\phi})$ and $EVM = \min(EVM_{\theta}, EVM_{\phi})$.

If the UE transmits on both polarizations, measure the EVM and \overline{EVM}_{DMRS} on PCC using Global In-Channel Tx-Test (Annex E with procedures in E.7.1 and E.7.3). For TDD, only slots consisting of only UL symbols are under test.

10. SS deactivates the UE Beamlock Function (UBF) by performing the procedure as specified in TS 38.508-1 [10] clause 4.9.3.

NOTE1: When switching to DFT-s-OFDM waveform, as specified in Table 6.4A.2.1.1.4.1-1, send an NR RRCReconfiguration message according to TS 38.508-1 [10] clause 4.6.3 Table 4.6.3-118 PUSCH-Config with TRANSFORM_PRECODER_ENABLED condition.

NOTE 2: The BEAM_SELECT_WAIT_TIME default value is defined in Annex K.

Table 6.4A.2.1.1.4.2-1: Void

Table 6.4A.2.1.1.4.2-2: Void

Table 6.4A.2.1.1.4.2-3: Power Window (dB) for EVM PUSCH

FFS

6.4A.2.1.1.4.3 Message contents

Message contents are according to TS 38.508-1 [10] clause 4.6.

6.4A.2.1.1.5 Test requirement

The PUSCH EVM, derived in Annex E.4.2, shall not exceed the values in Table 6.4A.2.1.1.5-1.

The PUSCH \overline{EVM}_{DMRS} , derived in Annex E.4.6.2, shall not exceed the values in Table 6.4A.2.1.1.5-1 when embedded with data symbols of the respective modulation scheme.

Table 6.4A.2.1.1.5-1: Test requirements for Error Vector Magnitude for CA

Parameter	Unit	Average EVM Level	Reference Signal EVM Level
Pi/2 BPSK	%	30+TT	30+TT
QPSK	%	17.5+TT	17.5+TT
16 QAM	%	12.5+TT	12.5+TT
64 QAM	%	8+TT	8+TT

Table 6.4A.2.1.1.5-2: Test Tolerance for Error Vector Magnitude for CA

Test Metric	FR2a	FR2b
Max device size \leq 30 cm	FFS	FFS

6.4A.2.1.2 Error vector magnitude for CA (3UL CA)

Editor's note: This clause is incomplete. The following aspects are either missing or not yet determined:

- Measurement Uncertainty and Test Tolerance are FFS.

- For a transition period until RAN#108 (June 2025) previous test procedure in TS 38.521-2 V18.4.0 is allowed for TE implementation.

6.4A.2.1.2.1 Test Purpose

For 3UL carrier aggregation, the Error Vector Magnitude requirement should be defined for each component carrier. Requirement applies for the allocated component carrier, when all other component carriers are activated, but not allocated.

Similar transmitter impairment removal procedures are applied for CA waveform before EVM calculation as is specified for non-CA waveform in clause 6.4.2.1.

6.4A.2.1.2.2 Test applicability

This test case applies to all types of NR UE release 15 and forward that supports FR2 3UL CA.

6.4A.2.1.2.3 Minimum conformance requirements

The minimum conformance requirements are defined in clause 6.4A.2.1.0

6.4A.2.1.2.4 Test description

Same as in clause 6.4A.2.1.1.4 with following exceptions:

- Instead of Table 6.4A.2.1.1.4.1-1 → use Table 6.4A.2.1.2.4-1.
- Instead of Table 6.4A.2.1.1.5-1 → use Table 6.4A.2.1.2.5-1.

Table 6.4A.2.1.2.4-1: Test Configuration Table for 3UL CA

Default Conditions					
Test Environment as specified in TS 38.508-1 [10] clause 4.1			Normal		
Test Frequencies as specified in TS 38.508-1 [10] clause 4.3.1.2.3 for different CA bandwidth classes			Low and High range		
Test CC Combination setting (aggregated BW of the CA configuration) as specified in TS 38.508-1 [10] clause 4.3.1.2.3 for the CA Configuration across bandwidth combination sets supported by the UE			Lowest aggregated BW of the CA configuration Highest aggregated BW of the CA configuration		
Test SCS as specified in Table 5.3.5-1			Lowest, Highest		
Test Parameters					
CA Configuration / Aggregated BW			Downlink Configuration	Uplink Configuration	
Test ID	CC & Mapping (NOTE 3)	CBW (MHz)	RB allocation	Modulation	RB allocation (NOTE 1)
1	PCC/CC1	default	-	DFT-s-OFDM PI/2 BPSK	Inner_Full for PC2, PC3, PC4 Inner_Full_Region1 for PC1
	SCC/CC2			-	
	SCC/CC3			-	
2	PCC/CC1	-	-	DFT-s-OFDM PI/2 BPSK	Outer_Full
	SCC/CC2			-	
	SCC/CC3			-	
3	PCC/CC1	-	-	DFT-s-OFDM QPSK	Inner_Full for PC2, PC3, PC4 Inner_Full_Region1 for PC1
	SCC/CC2			-	
	SCC/CC3			-	
4	PCC/CC1	-	-	DFT-s-OFDM QPSK	Outer_Full
	SCC/CC2			-	
	SCC/CC3			-	
5	PCC/CC1	-	-	DFT-s-OFDM 16 QAM	Inner_Full for PC2, PC3, PC4 Inner_Full_Region1 for PC1
	SCC/CC2			-	
	SCC/CC3			-	
6	PCC/CC1	-	-	DFT-s-OFDM 16 QAM	Outer_Full
	-			-	

7	SCC/CC2	-	-
	SCC/CC3	-	-
	PCC/CC1	DFT-s-OFDM 64 QAM	Inner_Full for PC2, PC3, PC4 Inner_Full_Region1 for PC1
8	SCC/CC2	-	-
	SCC/CC3	-	-
	PCC/CC1	DFT-s-OFDM 64 QAM	Outer_Full
9	SCC/CC2	-	-
	SCC/CC3	-	-
	PCC/CC1	CP-OFDM QPSK	Inner_Full for PC2, PC3, PC4 Inner_Full_Region1 for PC1
10	SCC/CC2	-	-
	SCC/CC3	-	-
	PCC/CC1	CP-OFDM QPSK	Outer_Full
11	SCC/CC2	-	-
	SCC/CC3	-	-
	PCC/CC1	CP-OFDM 16 QAM	Inner_Full for PC2, PC3, PC4 Inner_Full_Region1 for PC1
12	SCC/CC2	-	-
	SCC/CC3	-	-
	PCC/CC1	CP-OFDM 16 QAM	Outer_Full
13	SCC/CC2	-	-
	SCC/CC3	-	-
	PCC/CC1	CP-OFDM 64 QAM	Inner_Full for PC2, PC3, PC4 Inner_Full_Region1 for PC1
14	SCC/CC2	-	-
	SCC/CC3	-	-
	PCC/CC1	CP-OFDM 64 QAM	Outer_Full
15 - 28	SCC/CC2	-	-
	SCC/CC3	-	-
	PCC/CC1	-	-
		NOTE 4	NOTE 4

NOTE 1: The specific configuration of each RB allocation is defined in Table 6.1-1 for PC2, PC3 and PC4 or Table 6.1-2 for PC1.
 NOTE 2: CA Configuration Test cumulative aggregated BW settings are checked separately for each CA Configuration, which applicable aggregated channel bandwidths are specified in Table 5.5A.1-1.
 NOTE 3: PCC/CCi and SCC/CCj means PCC is on component carrier CCi and SCC is on component carrier CCj, with CCi or CCj frequencies defined in TS38.508-1 [10].
 NOTE 4: Same Modulation and RB allocation of Test ID 1 – 14 are applied to Test ID 15 – 28 in sequence.
 NOTE 5: Number of DL CCs shall be configured the same as number of UL CCs. The requirements are applicable as per 5.3A.4: "The requirements are applicable only when Uplink CCs are configured within the frequency range between lower edge of lowest downlink component carrier and upper edge of highest downlink component carrier".

6.4A.2.1.2.5 Test requirement

The PUSCH EVM, derived in Annex E.4.2, shall not exceed the values in Table 6.4A.2.1.2.5-1.

The PUSCH \overline{EVM}_{DMRS} , derived in Annex E.4.6.2, shall not exceed the values in Table 6.4A.2.1.2.5-1 when embedded with data symbols of the respective modulation scheme.

Table 6.4A.2.1.2.5-1: Test requirements for Error Vector Magnitude

Parameter	Unit	Average EVM Level	Reference Signal EVM Level
Pi/2 BPSK	%	30+TT	30+TT
QPSK	%	17.5+TT	17.5+TT
16 QAM	%	12.5+TT	12.5+TT
64 QAM	%	8+TT	8+TT

Table 6.4A.2.1.2.5-2: Test Tolerance for Error Vector Magnitude for CA

Test Metric	FR2a	FR2b
Max device size ≤ 30 cm	FFS	FFS

6.4A.2.1.3 Error vector magnitude for CA (4UL CA)

Editor's note: This clause is incomplete. The following aspects are either missing or not yet determined:

- Measurement Uncertainty and Test Tolerance are FFS.
- For a transition period until RAN#108 (June 2025) previous test procedure in TS 38.521-2 V18.4.0 is allowed for TE implementation.

6.4A.2.1.3.1 Test Purpose

For 4UL carrier aggregation, the Error Vector Magnitude requirement should be defined for each component carrier. Requirement applies for the allocated component carrier, when all other component carriers are activated, but not allocated.

Similar transmitter impairment removal procedures are applied for CA waveform before EVM calculation as is specified for non-CA waveform in clause 6.4.2.1.

6.4A.2.1.3.2 Test applicability

This test case applies to all types of NR UE release 15 and forward that supports FR2 4UL CA.

6.4A.2.1.3.3 Minimum conformance requirements

The minimum conformance requirements are defined in clause 6.4A.2.1.0

6.4A.2.1.3.4 Test description

Same as in clause 6.4A.2.1.1.4 with following exceptions:

- Instead of Table 6.4A.2.1.1.4.1-1 → use Table 6.4A.2.1.3.4-1.
- Instead of Table 6.4A.2.1.1.5-1 → use Table 6.4A.2.1.3.5-1.

Table 6.4A.2.1.3.4-1: Test Configuration Table for 4UL CA

Default Conditions					
Test Environment as specified in TS 38.508-1 [10] clause 4.1			Normal		
Test Frequencies as specified in TS 38.508-1 [10] clause 4.3.1.2.3 for different CA bandwidth classes			Low and High range		
Test CC Combination setting (aggregated BW of the CA configuration) as specified in TS 38.508-1 [10] clause 4.3.1.2.3 for the CA Configuration across bandwidth combination sets supported by the UE			Lowest aggregated BW of the CA configuration Highest aggregated BW of the CA configuration		
Test SCS as specified in Table 5.3.5-1			Lowest, Highest		
Test Parameters					
CA Configuration / Aggregated BW			Downlink Configuration	Uplink Configuration	
Test ID	CC & Mapping (NOTE 3)	CBW (MHz)	RB allocation	Modulation	RB allocation (NOTE 1)
1	PCC/CC1	default	-	DFT-s-OFDM PI/2 BPSK	Inner_Full for PC2, PC3, PC4 Inner_Full_Region1 for PC1
	SCC/CC2			-	-
	SCC/CC3			-	-
	SCC/CC4			-	-
2	PCC/CC1			DFT-s-OFDM PI/2 BPSK	Outer_Full

	SCC/CC2			-	-
	SCC/CC3			-	-
	SCC/CC4			-	-
3	PCC/CC1			DFT-s-OFDM QPSK	Inner_Full for PC2, PC3, PC4 Inner_Full_Region1 for PC1
	SCC/CC2			-	-
	SCC/CC3			-	-
	SCC/CC4			-	-
4	PCC/CC1			DFT-s-OFDM QPSK	Outer_Full
	SCC/CC2			-	-
	SCC/CC3			-	-
	SCC/CC4			-	-
5	PCC/CC1			DFT-s-OFDM 16 QAM	Inner_Full for PC2, PC3, PC4 Inner_Full_Region1 for PC1
	SCC/CC2			-	-
	SCC/CC3			-	-
	SCC/CC4			-	-
6	PCC/CC1			DFT-s-OFDM 16 QAM	Outer_Full
	SCC/CC2			-	-
	SCC/CC3			-	-
	SCC/CC4			-	-
7	PCC/CC1			DFT-s-OFDM 64 QAM	Inner_Full for PC2, PC3, PC4 Inner_Full_Region1 for PC1
	SCC/CC2			-	-
	SCC/CC3			-	-
	SCC/CC4			-	-
8	PCC/CC1			DFT-s-OFDM 64 QAM	Outer_Full
	SCC/CC2			-	-
	SCC/CC3			-	-
	SCC/CC4			-	-
9	PCC/CC1			CP-OFDM QPSK	Inner_Full for PC2, PC3, PC4 Inner_Full_Region1 for PC1
	SCC/CC2			-	-
	SCC/CC3			-	-
	SCC/CC4			-	-
10	PCC/CC1			CP-OFDM QPSK	Outer_Full
	SCC/CC2			-	-
	SCC/CC3			-	-
	SCC/CC4			-	-
11	PCC/CC1			CP-OFDM 16 QAM	Inner_Full for PC2, PC3, PC4 Inner_Full_Region1 for PC1
	SCC/CC2			-	-
	SCC/CC3			-	-
	SCC/CC4			-	-
12	PCC/CC1			CP-OFDM 16 QAM	Outer_Full
	SCC/CC2			-	-
	SCC/CC3			-	-
	SCC/CC4			-	-
13	PCC/CC1			CP-OFDM 64 QAM	Inner_Full for PC2, PC3, PC4 Inner_Full_Region1 for PC1
	SCC/CC2			-	-
	SCC/CC3			-	-
	SCC/CC4			-	-
14	PCC/CC1			CP-OFDM 64 QAM	Outer_Full
	SCC/CC2			-	-
	SCC/CC3			-	-
	SCC/CC4			-	-
15 - 28	PCC/CC1			-	-
	SCC/CC2			-	-
	SCC/CC3			-	-
	SCC/CC4			-	-
				NOTE 4	NOTE 4

NOTE 1: The specific configuration of each RB allocation is defined in Table 6.1-1 for PC2, PC3 and PC4 or Table 6.1-2 for PC1.
NOTE 2: CA Configuration Test cumulative aggregated BW settings are checked separately for each CA Configuration, which applicable aggregated channel bandwidths are specified in Table 5.5A.1-1.
NOTE 3: PCC/CCi and SCC/CCj means PCC is on component carrier CCi and SCC is on component carrier CCj, with CCi or CCj frequencies defined in TS38.508-1 [10].
NOTE 4: Same Modulation and RB allocation of Test ID 1 – 14 are applied to Test ID 15 – 28 in sequence.
NOTE 5: Number of DL CCs shall be configured the same as number of UL CCs. The requirements are applicable as per 5.3A.4: "The requirements are applicable only when Uplink CCs are configured within the frequency range between lower edge of lowest downlink component carrier and upper edge of highest downlink component carrier".

6.4A.2.1.3.5 Test requirement

The PUSCH EVM, derived in Annex E.4.2, shall not exceed the values in Table 6.4A.2.1.3.5-1.

The PUSCH \overline{EVM}_{DMRS} , derived in Annex E.4.6.2, shall not exceed the values in Table 6.4A.2.1.3.5-1 when embedded with data symbols of the respective modulation scheme.

Table 6.4A.2.1.3.5-1: Test requirements for Error Vector Magnitude

Parameter	Unit	Average EVM Level	Reference Signal EVM Level
Pi/2 BPSK	%	30+TT	30+TT
QPSK	%	17.5+TT	17.5+TT
16 QAM	%	12.5+TT	12.5+TT
64 QAM	%	8+TT	8+TT

Table 6.4A.2.1.3.5-2: Test Tolerance for Error Vector Magnitude for CA

Test Metric	FR2a	FR2b
Max device size ≤ 30 cm	FFS	FFS

6.4A.2.1.4 Error Vector magnitude for CA (5UL CA)

Editor's note: This clause is incomplete. The following aspects are either missing or not yet determined:

- Measurement Uncertainty and Test Tolerance are FFS.
- For a transition period until RAN#108 (June 2025) previous test procedure in TS 38.521-2 V18.4.0 is allowed for TE implementation.

6.4A.2.1.4.1 Test Purpose

For 5UL carrier aggregation, the Error Vector Magnitude requirement should be defined for each component carrier. Requirement applies for the allocated component carrier, when all other component carriers are activated, but not allocated.

Similar transmitter impairment removal procedures are applied for CA waveform before EVM calculation as is specified for non-CA waveform in clause 6.4.2.1.

6.4A.2.1.4.2 Test applicability

This test case applies to all types of NR UE release 15 and forward that supports FR2 5UL CA.

6.4A.2.1.4.3 Minimum conformance requirements

The minimum conformance requirements are defined in clause 6.4A.2.1.0

6.4A.2.1.4.4 Test description

Same as in clause 6.4A.2.1.1.4 with following exceptions:

- Instead of Table 6.4A.2.1.1.4.1-1 → use Table 6.4A.2.1.4.4-1.
- Instead of Table 6.4A.2.1.1.5-1 → use Table 6.4A.2.1.4.5-1.

Table 6.4A.2.1.4.4-1: Test Configuration Table for 5UL CA

Default Conditions					
Test Environment as specified in TS 38.508-1 [10] clause 4.1			Normal		
Test Frequencies as specified in TS 38.508-1 [10] clause 4.3.1.2.3 for different CA bandwidth classes			Low and High range		
Test CC Combination setting (aggregated BW of the CA configuration) as specified in TS 38.508-1 [10] clause 4.3.1.2.3 for the CA Configuration across bandwidth combination sets supported by the UE			Lowest aggregated BW of the CA configuration Highest aggregated BW of the CA configuration		
Test SCS as specified in Table 5.3.5-1			Lowest, Highest		
Test Parameters					
CA Configuration / Aggregated BW			Downlink Configuration	Uplink Configuration	
Test ID	CC & Mapping (NOTE 3)	CBW (MHz)	RB allocation	Modulation	RB allocation (NOTE 1)
1	PCC/CC1	default	-	DFT-s-OFDM PI/2 BPSK	Inner_Full for PC2, PC3, PC4 Inner_Full_Region1 for PC1
	SCC/CC2			-	-
	SCC/CC3			-	-
	SCC/CC4			-	-
	SCC/CC5			-	-
2	PCC/CC1			DFT-s-OFDM PI/2 BPSK	Outer_Full
	SCC/CC2			-	-
	SCC/CC3			-	-
	SCC/CC4			-	-
	SCC/CC5			-	-
3	PCC/CC1			DFT-s-OFDM QPSK	Inner_Full for PC2, PC3, PC4 Inner_Full_Region1 for PC1
	SCC/CC2			-	-
	SCC/CC3			-	-
	SCC/CC4			-	-
	SCC/CC5			-	-
4	PCC/CC1			DFT-s-OFDM QPSK	Outer_Full
	SCC/CC2			-	-
	SCC/CC3			-	-
	SCC/CC4			-	-
	SCC/CC5			-	-
5	PCC/CC1			DFT-s-OFDM 16 QAM	Inner_Full for PC2, PC3, PC4 Inner_Full_Region1 for PC1
	SCC/CC2			-	-
	SCC/CC3			-	-
	SCC/CC4			-	-
	SCC/CC5			-	-
6	PCC/CC1			DFT-s-OFDM 16 QAM	Outer_Full
	SCC/CC2			-	-
	SCC/CC3			-	-
	SCC/CC4			-	-
	SCC/CC5			-	-
7	PCC/CC1			DFT-s-OFDM 64 QAM	Inner_Full for PC2, PC3, PC4 Inner_Full_Region1 for PC1
	SCC/CC2			-	-
	SCC/CC3			-	-
	SCC/CC4			-	-
	SCC/CC5			-	-
8	PCC/CC1			DFT-s-OFDM 64 QAM	Outer_Full

	SCC/CC2			-	-
	SCC/CC3			-	-
	SCC/CC4			-	-
	SCC/CC5			-	-
9	PCC/CC1			CP-OFDM QPSK	Inner_Full for PC2, PC3, PC4 Inner_Full_Region1 for PC1
	SCC/CC2			-	-
	SCC/CC3			-	-
	SCC/CC4			-	-
	SCC/CC5			-	-
10	PCC/CC1			CP-OFDM QPSK	Outer_Full
	SCC/CC2			-	-
	SCC/CC3			-	-
	SCC/CC4			-	-
	SCC/CC5			-	-
11	PCC/CC1			CP-OFDM 16 QAM	Inner_Full for PC2, PC3, PC4 Inner_Full_Region1 for PC1
	SCC/CC2			-	-
	SCC/CC3			-	-
	SCC/CC4			-	-
	SCC/CC5			-	-
12	PCC/CC1			CP-OFDM 16 QAM	Outer_Full
	SCC/CC2			-	-
	SCC/CC3			-	-
	SCC/CC4			-	-
	SCC/CC5			-	-
13	PCC/CC1			CP-OFDM 64 QAM	Inner_Full for PC2, PC3, PC4 Inner_Full_Region1 for PC1
	SCC/CC2			-	-
	SCC/CC3			-	-
	SCC/CC4			-	-
	SCC/CC5			-	-
14	PCC/CC1			CP-OFDM 64 QAM	Outer_Full
	SCC/CC2			-	-
	SCC/CC3			-	-
	SCC/CC4			-	-
	SCC/CC5			-	-
15 - 28	PCC/CC1			-	-
	SCC/CC2			-	-
	SCC/CC3			-	-
	SCC/CC4			-	-
	SCC/CC5			-	-
				NOTE 4	NOTE 4
<p>NOTE 1: The specific configuration of each RB allocation is defined in Table 6.1-1 for PC2, PC3 and PC4 or Table 6.1-2 for PC1.</p> <p>NOTE 2: CA Configuration Test cumulative aggregated BW settings are checked separately for each CA Configuration, which applicable aggregated channel bandwidths are specified in Table 5.5A.1-1.</p> <p>NOTE 3: PCC/CCi and SCC/CCj means PCC is on component carrier CCi and SCC is on component carrier CCj, with CCi or CCj frequencies defined in TS38.508-1 [10].</p> <p>NOTE 4: Same Modulation and RB allocation of Test ID 1 – 14 are applied to Test ID 15 – 28 in sequence.</p> <p>NOTE 5: Number of DL CCs shall be configured the same as number of UL CCs. The requirements are applicable as per 5.3A.4: "The requirements are applicable only when Uplink CCs are configured within the frequency range between lower edge of lowest downlink component carrier and upper edge of highest downlink component carrier".</p>					

6.4A.2.1.4.5 Test requirement

The PUSCH EVM, derived in Annex E.4.2, shall not exceed the values in Table 6.4A.2.1.4.5-1.

The PUSCH \overline{EVM}_{DMRS} , derived in Annex E.4.6.2, shall not exceed the values in Table 6.4A.2.1.4.5-1 when embedded with data symbols of the respective modulation scheme.

Table 6.4A.2.1.4.5-1: Test requirements for Error Vector Magnitude for CA

Parameter	Unit	Average EVM Level	Reference Signal EVM Level
Pi/2 BPSK	%	30+TT	30+TT
QPSK	%	17.5+TT	17.5+TT
16 QAM	%	12.5+TT	12.5+TT
64 QAM	%	8+TT	8+TT

Table 6.4A.2.1.4.5-2: Test Tolerance for Error Vector Magnitude for CA

Test Metric	FR2a	FR2b
Max device size ≤ 30 cm	FFS	FFS

6.4A.2.1.5 Error Vector magnitude for CA (6UL CA)

Editor's note: This clause is incomplete. The following aspects are either missing or not yet determined:

- Measurement Uncertainty and Test Tolerance are FFS.
- For a transition period until RAN#108 (June 2025) previous test procedure in TS 38.521-2 V18.4.0 is allowed for TE implementation.

6.4A.2.1.5.1 Test Purpose

For 6UL carrier aggregation, the Error Vector Magnitude requirement should be defined for each component carrier. Requirement applies for the allocated component carrier, when all other component carriers are activated, but not allocated.

Similar transmitter impairment removal procedures are applied for CA waveform before EVM calculation as is specified for non-CA waveform in clause 6.4.2.1.

6.4A.2.1.5.2 Test applicability

This test case applies to all types of NR UE release 15 and forward that supports FR2 6UL CA.

6.4A.2.1.5.3 Minimum conformance requirements

The minimum conformance requirements are defined in clause 6.4A.2.1.0

6.4A.2.1.5.4 Test description

Same as in clause 6.4A.2.1.1.4 with following exceptions:

- Instead of Table 6.4A.2.1.1.4.1-1 → use Table 6.4A.2.1.5.4-1.
- Instead of Table 6.4A.2.1.1.5-1 → use Table 6.4A.2.1.5.5-1.

Table 6.4A.2.1.5.4-1: Test Configuration Table for 6UL CA

Default Conditions	
Test Environment as specified in TS 38.508-1 [10] clause 4.1	Normal
Test Frequencies as specified in TS 38.508-1 [10] clause 4.3.1.2.3 for different CA bandwidth classes	Low and High range
Test CC Combination setting (aggregated BW of the CA configuration) as specified in TS 38.508-1 [10] clause 4.3.1.2.3 for the CA Configuration across bandwidth combination sets supported by the UE	Lowest aggregated BW of the CA configuration Highest aggregated BW of the CA configuration
Test SCS as specified in Table 5.3.5-1	Lowest, Highest
Test Parameters	

CA Configuration / Aggregated BW			Downlink Configuration	Uplink Configuration	
Test ID	CC & Mapping (NOTE 3)	CBW (MHz)	RB allocation	Modulation	RB allocation (NOTE 1)
1	PCC/CC1	default	-	DFT-s-OFDM PI/2 BPSK	Inner_Full for PC2, PC3, PC4 Inner_Full_Region1 for PC1
	SCC/CC2			-	-
	SCC/CC3			-	-
	SCC/CC4			-	-
	SCC/CC5			-	-
	SCC/CC6			-	-
2	PCC/CC1			DFT-s-OFDM PI/2 BPSK	Outer_Full
	SCC/CC2			-	-
	SCC/CC3			-	-
	SCC/CC4			-	-
	SCC/CC5			-	-
	SCC/CC6			-	-
3	PCC/CC1			DFT-s-OFDM QPSK	Inner_Full for PC2, PC3, PC4 Inner_Full_Region1 for PC1
	SCC/CC2			-	-
	SCC/CC3			-	-
	SCC/CC4			-	-
	SCC/CC5			-	-
	SCC/CC6			-	-
4	PCC/CC1			DFT-s-OFDM QPSK	Outer_Full
	SCC/CC2			-	-
	SCC/CC3			-	-
	SCC/CC4			-	-
	SCC/CC5			-	-
	SCC/CC6			-	-
5	PCC/CC1			DFT-s-OFDM 16 QAM	Inner_Full for PC2, PC3, PC4 Inner_Full_Region1 for PC1
	SCC/CC2			-	-
	SCC/CC3			-	-
	SCC/CC4			-	-
	SCC/CC5			-	-
	SCC/CC6			-	-
6	PCC/CC1			DFT-s-OFDM 16 QAM	Outer_Full
	SCC/CC2			-	-
	SCC/CC3			-	-
	SCC/CC4			-	-
	SCC/CC5			-	-
	SCC/CC6			-	-
7	PCC/CC1			DFT-s-OFDM 64 QAM	Inner_Full for PC2, PC3, PC4 Inner_Full_Region1 for PC1
	SCC/CC2			-	-
	SCC/CC3			-	-
	SCC/CC4			-	-
	SCC/CC5			-	-
	SCC/CC6			-	-
8	PCC/CC1			DFT-s-OFDM 64 QAM	Outer_Full
	SCC/CC2			-	-
	SCC/CC3			-	-
	SCC/CC4			-	-
	SCC/CC5			-	-
	SCC/CC6			-	-
9	PCC/CC1			CP-OFDM QPSK	Inner_Full for PC2, PC3, PC4 Inner_Full_Region1 for PC1
	SCC/CC2			-	-
	SCC/CC3			-	-
	SCC/CC4			-	-
	SCC/CC5			-	-
	SCC/CC6			-	-
10	PCC/CC1			CP-OFDM QPSK	Outer_Full
	SCC/CC2			-	-

	SCC/CC3			-	-
	SCC/CC4			-	-
	SCC/CC5			-	-
	SCC/CC6			-	-
11	PCC/CC1			CP-OFDM 16 QAM	Inner_Full for PC2, PC3, PC4 Inner_Full_Region1 for PC1
	SCC/CC2			-	-
	SCC/CC3			-	-
	SCC/CC4			-	-
	SCC/CC5			-	-
	SCC/CC6			-	-
12	PCC/CC1			CP-OFDM 16 QAM	Outer_Full
	SCC/CC2			-	-
	SCC/CC3			-	-
	SCC/CC4			-	-
	SCC/CC5			-	-
	SCC/CC6			-	-
13	PCC/CC1			CP-OFDM 64 QAM	Inner_Full for PC2, PC3, PC4 Inner_Full_Region1 for PC1
	SCC/CC2			-	-
	SCC/CC3			-	-
	SCC/CC4			-	-
	SCC/CC5			-	-
	SCC/CC6			-	-
14	PCC/CC1			CP-OFDM 64 QAM	Outer_Full
	SCC/CC2			-	-
	SCC/CC3			-	-
	SCC/CC4			-	-
	SCC/CC5			-	-
	SCC/CC6			-	-
15 -28	PCC/CC1			-	-
	SCC/CC2			-	-
	SCC/CC3			-	-
	SCC/CC4			-	-
	SCC/CC5			-	-
	SCC/CC6			-	-
				NOTE 4	NOTE 4
<p>NOTE 1: The specific configuration of each RB allocation is defined in Table 6.1-1 for PC2, PC3 and PC4 or Table 6.1-2 for PC1.</p> <p>NOTE 2: CA Configuration Test cumulative aggregated BW settings are checked separately for each CA Configuration, which applicable aggregated channel bandwidths are specified in Table 5.5A.1-1.</p> <p>NOTE 3: PCC/CCi and SCC/CCj means PCC is on component carrier CCi and SCC is on component carrier CCj, with CCi or CCj frequencies defined in TS38.508-1 [10].</p> <p>NOTE 4: Same Modulation and RB allocation of Test ID 1 – 14 are applied to Test ID 15 – 28 in sequence.</p> <p>NOTE 5: Number of DL CCs shall be configured the same as number of UL CCs. The requirements are applicable as per 5.3A.4: "The requirements are applicable only when Uplink CCs are configured within the frequency range between lower edge of lowest downlink component carrier and upper edge of highest downlink component carrier".</p>					

6.4A.2.1.5.5 Test requirement

The PUSCH EVM, derived in Annex E.4.2, shall not exceed the values in Table 6.4A.2.1.5.5-1.

The PUSCH \overline{EVM}_{DMRS} , derived in Annex E.4.6.2, shall not exceed the values in Table 6.4A.2.1.5.5-1 when embedded with data symbols of the respective modulation scheme.

Table 6.4A.2.1.5.5-1: Test requirements for Error Vector Magnitude for CA

Parameter	Unit	Average EVM Level	Reference Signal EVM Level
Pi/2 BPSK	%	30+TT	30+TT
QPSK	%	17.5+TT	17.5+TT
16 QAM	%	12.5+TT	12.5+TT
64 QAM	%	8+TT	8+TT

Table 6.4A.2.1.5.5-2: Test Tolerance for Error Vector Magnitude for CA

Test Metric	FR2a	FR2b
Max device size ≤ 30 cm	FFS	FFS

6.4A.2.1.6 Error vector magnitude for CA (7UL CA)

Editor's note: This clause is incomplete. The following aspects are either missing or not yet determined:

- Measurement Uncertainty and Test Tolerance are FFS.
- For a transition period until RAN#108 (June 2025) previous test procedure in TS 38.521-2 V18.4.0 is allowed for TE implementation.

6.4A.2.1.6.1 Test Purpose

For 7UL carrier aggregation, the Error Vector Magnitude requirement should be defined for each component carrier. Requirement applies for the allocated component carrier, when all other component carriers are activated, but not allocated.

Similar transmitter impairment removal procedures are applied for CA waveform before EVM calculation as is specified for non-CA waveform in sub-section 6.4.2.1.

6.4A.2.1.6.2 Test applicability

This test case applies to all types of NR UE release 15 and forward that supports FR2 7UL CA.

6.4A.2.1.6.3 Minimum conformance requirements

The minimum conformance requirements are defined in clause 6.4A.2.1.0

6.4A.2.1.6.4 Test description

Same as in clause 6.4A.2.1.1.4 with following exceptions:

- Instead of Table 6.4A.2.1.1.4.1-1 → use Table 6.4A.2.1.6.4-1.
- Instead of Table 6.4A.2.1.1.5-1 → use Table 6.4A.2.1.6.5-1.

Table 6.4A.2.1.6.4-1: Test Configuration Table for 7UL CA

Default Conditions					
Test Environment as specified in TS 38.508-1 [10] clause 4.1			Normal		
Test Frequencies as specified in TS 38.508-1 [10] clause 4.3.1.2.3 for different CA bandwidth classes			Low and High range		
Test CC Combination setting (aggregated BW of the CA configuration) as specified in TS 38.508-1 [10] clause 4.3.1.2.3 for the CA Configuration across bandwidth combination sets supported by the UE			Lowest aggregated BW of the CA configuration Highest aggregated BW of the CA configuration		
Test SCS as specified in Table 5.3.5-1			Lowest, Highest		
Test Parameters					
CA Configuration / Aggregated BW			Downlink Configuration	Uplink Configuration	
Test ID	CC & Mapping (NOTE 3)	CBW (MHz)	RB allocation	Modulation	RB allocation (NOTE 1)
1	PCC/CC1	default	-	DFT-s-OFDM PI/2 BPSK	Inner_Full for PC2, PC3, PC4 Inner_Full_Region1 for PC1
	SCC/CC2			-	-
	SCC/CC3			-	-
	SCC/CC4			-	-

	SCC/CC5			-	-
	SCC/CC6			-	-
	SCC/CC7			-	-
2	PCC/CC1			DFT-s-OFDM PI/2 BPSK	Outer_Full
	SCC/CC2			-	-
	SCC/CC3			-	-
	SCC/CC4			-	-
	SCC/CC5			-	-
	SCC/CC6			-	-
	SCC/CC7			-	-
3	PCC/CC1			DFT-s-OFDM QPSK	Inner_Full for PC2, PC3, PC4 Inner_Full_Region1 for PC1
	SCC/CC2			-	-
	SCC/CC3			-	-
	SCC/CC4			-	-
	SCC/CC5			-	-
	SCC/CC6			-	-
	SCC/CC7			-	-
4	PCC/CC1			DFT-s-OFDM QPSK	Outer_Full
	SCC/CC2			-	-
	SCC/CC3			-	-
	SCC/CC4			-	-
	SCC/CC5			-	-
	SCC/CC6			-	-
	SCC/CC7			-	-
5	PCC/CC1			DFT-s-OFDM 16 QAM	Inner_Full for PC2, PC3, PC4 Inner_Full_Region1 for PC1
	SCC/CC2			-	-
	SCC/CC3			-	-
	SCC/CC4			-	-
	SCC/CC5			-	-
	SCC/CC6			-	-
	SCC/CC7			-	-
6	PCC/CC1			DFT-s-OFDM 16 QAM	Outer_Full
	SCC/CC2			-	-
	SCC/CC3			-	-
	SCC/CC4			-	-
	SCC/CC5			-	-
	SCC/CC6			-	-
	SCC/CC7			-	-
7	PCC/CC1			DFT-s-OFDM 64 QAM	Inner_Full for PC2, PC3, PC4 Inner_Full_Region1 for PC1
	SCC/CC2			-	-
	SCC/CC3			-	-
	SCC/CC4			-	-
	SCC/CC5			-	-
	SCC/CC6			-	-
	SCC/CC7			-	-
8	PCC/CC1			DFT-s-OFDM 64 QAM	Outer_Full
	SCC/CC2			-	-
	SCC/CC3			-	-
	SCC/CC4			-	-
	SCC/CC5			-	-
	SCC/CC6			-	-
	SCC/CC7			-	-
9	PCC/CC1			CP-OFDM QPSK	Inner_Full for PC2, PC3, PC4 Inner_Full_Region1 for PC1
	SCC/CC2			-	-
	SCC/CC3			-	-
	SCC/CC4			-	-
	SCC/CC5			-	-
	SCC/CC6			-	-
	SCC/CC7			-	-
10	PCC/CC1			CP-OFDM QPSK	Outer_Full
	SCC/CC2			-	-

	SCC/CC3			-	-
	SCC/CC4			-	-
	SCC/CC5			-	-
	SCC/CC6			-	-
	SCC/CC7			-	-
11	PCC/CC1			CP-OFDM 16 QAM	Inner_Full for PC2, PC3, PC4 Inner_Full_Region1 for PC1
	SCC/CC2			-	-
	SCC/CC3			-	-
	SCC/CC4			-	-
	SCC/CC5			-	-
	SCC/CC6			-	-
	SCC/CC7			-	-
12	PCC/CC1			CP-OFDM 16 QAM	Outer_Full
	SCC/CC2			-	-
	SCC/CC3			-	-
	SCC/CC4			-	-
	SCC/CC5			-	-
	SCC/CC6			-	-
	SCC/CC7			-	-
13	PCC/CC1			CP-OFDM 64 QAM	Inner_Full for PC2, PC3, PC4 Inner_Full_Region1 for PC1
	SCC/CC2			-	-
	SCC/CC3			-	-
	SCC/CC4			-	-
	SCC/CC5			-	-
	SCC/CC6			-	-
	SCC/CC7			-	-
14	PCC/CC1			CP-OFDM 64 QAM	Outer_Full
	SCC/CC2			-	-
	SCC/CC3			-	-
	SCC/CC4			-	-
	SCC/CC5			-	-
	SCC/CC6			-	-
	SCC/CC7			-	-
15 - 28	PCC/CC1			-	-
	SCC/CC2			-	-
	SCC/CC3			-	-
	SCC/CC4			-	-
	SCC/CC5			-	-
	SCC/CC6			-	-
	SCC/CC7			-	-
				NOTE 4	NOTE 4
<p>NOTE 1: The specific configuration of each RB allocation is defined in Table 6.1-1 for PC2, PC3 and PC4 or Table 6.1-2 for PC1.</p> <p>NOTE 2: CA Configuration Test cumulative aggregated BW settings are checked separately for each CA Configuration, which applicable aggregated channel bandwidths are specified in Table 5.5A.1-1.</p> <p>NOTE 3: PCC/CCi and SCC/CCj means PCC is on component carrier CCi and SCC is on component carrier CCj, with CCi or CCj frequencies defined in TS38.508-1 [10].</p> <p>NOTE 4: Same Modulation and RB allocation of Test ID 1 – 14 are applied to Test ID 15 – 28 in sequence.</p> <p>NOTE 5: Number of DL CCs shall be configured the same as number of UL CCs. The requirements are applicable as per 5.3A.4: "The requirements are applicable only when Uplink CCs are configured within the frequency range between lower edge of lowest downlink component carrier and upper edge of highest downlink component carrier".</p>					

6.4A.2.1.6.5 Test requirement

The PUSCH EVM, derived in Annex E.4.2, shall not exceed the values in Table 6.4A.2.1.6.5-1.

The PUSCH \overline{EVM}_{DMRS} , derived in Annex E.4.6.2, shall not exceed the values in Table 6.4A.2.1.6.5-1 when embedded with data symbols of the respective modulation scheme.

Table 6.4A.2.1.6.5-1: Test requirements for Error Vector Magnitude for CA

Parameter	Unit	Average EVM Level	Reference Signal EVM Level
Pi/2 BPSK	%	30+TT	30+TT
QPSK	%	17.5+TT	17.5+TT
16 QAM	%	12.5+TT	12.5+TT
64 QAM	%	8+TT	8+TT

Table 6.4A.2.1.6.5-2: Test Tolerance for Error Vector Magnitude for CA

Test Metric	FR2a	FR2b
Max device size ≤ 30 cm	FFS	FFS

6.4A.2.1.7 Error vector magnitude for CA (8UL CA)

Editor's note: This clause is incomplete. The following aspects are either missing or not yet determined:

- Measurement Uncertainty and Test Tolerance are FFS.
- For a transition period until RAN#108 (June 2025) previous test procedure in TS 38.521-2 V18.4.0 is allowed for TE implementation.

6.4A.2.1.7.1 Test Purpose

For 8UL carrier aggregation, the Error Vector Magnitude requirement should be defined for each component carrier. Requirement applies for the allocated component carrier, when all other component carriers are activated, but not allocated.

Similar transmitter impairment removal procedures are applied for CA waveform before EVM calculation as is specified for non-CA waveform in sub-section 6.4.2.1.

6.4A.2.1.7.2 Test applicability

This test case applies to all types of NR UE release 15 and forward that supports FR2 8UL CA.

6.4A.2.1.7.3 Minimum conformance requirements

The minimum conformance requirements are defined in clause 6.4A.2.1.0

6.4A.2.1.7.4 Test description

Same as in clause 6.4A.2.1.1.4 with following exceptions:

- Instead of Table 6.4A.2.1.1.4.1-1 → use Table 6.4A.2.1.7.4-1.
- Instead of Table 6.4A.2.1.1.5-1 → use Table 6.4A.2.1.7.5-1.

Table 6.4A.2.1.7.4-1: Test Configuration Table for 8UL CA

Default Conditions	
Test Environment as specified in TS 38.508-1 [10] clause 4.1	Normal
Test Frequencies as specified in TS 38.508-1 [10] clause 4.3.1.2.3 for different CA bandwidth classes	Low and High range
Test CC Combination setting (aggregated BW of the CA configuration) as specified in TS 38.508-1 [10] clause 4.3.1.2.3 for the CA Configuration across bandwidth combination sets supported by the UE	Lowest aggregated BW of the CA configuration Highest aggregated BW of the CA configuration
Test SCS as specified in Table 5.3.5-1	Lowest, Highest
Test Parameters	

CA Configuration / Aggregated BW			Downlink Configuration	Uplink Configuration	
Test ID	CC & Mapping (NOTE 3)	CBW (MHz)	RB allocation	Modulation	RB allocation (NOTE 1)
1	PCC/CC1	default	-	DFT-s-OFDM PI/2 BPSK	Inner_Full for PC2, PC3, PC4 Inner_Full_Region1 for PC1
	SCC/CC2			-	-
	SCC/CC3			-	-
	SCC/CC4			-	-
	SCC/CC5			-	-
	SCC/CC6			-	-
	SCC/CC7			-	-
	SCC/CC8			-	-
2	PCC/CC1			DFT-s-OFDM PI/2 BPSK	Outer_Full
	SCC/CC2			-	-
	SCC/CC3			-	-
	SCC/CC4			-	-
	SCC/CC5			-	-
	SCC/CC6			-	-
	SCC/CC7			-	-
	SCC/CC8			-	-
3	PCC/CC1			DFT-s-OFDM QPSK	Inner_Full for PC2, PC3, PC4 Inner_Full_Region1 for PC1
	SCC/CC2			-	-
	SCC/CC3			-	-
	SCC/CC4			-	-
	SCC/CC5			-	-
	SCC/CC6			-	-
	SCC/CC7			-	-
	SCC/CC8			-	-
4	PCC/CC1			DFT-s-OFDM QPSK	Outer_Full
	SCC/CC2			-	-
	SCC/CC3			-	-
	SCC/CC4			-	-
	SCC/CC5			-	-
	SCC/CC6			-	-
	SCC/CC7			-	-
	SCC/CC8			-	-
5	PCC/CC1			DFT-s-OFDM 16 QAM	Inner_Full for PC2, PC3, PC4 Inner_Full_Region1 for PC1
	SCC/CC2			-	-
	SCC/CC3			-	-
	SCC/CC4			-	-
	SCC/CC5			-	-
	SCC/CC6			-	-
	SCC/CC7			-	-
	SCC/CC8			-	-
6	PCC/CC1			DFT-s-OFDM 16 QAM	Outer_Full
	SCC/CC2			-	-
	SCC/CC3			-	-
	SCC/CC4			-	-
	SCC/CC5			-	-
	SCC/CC6			-	-
	SCC/CC7			-	-
	SCC/CC8			-	-
7	PCC/CC1			DFT-s-OFDM 64 QAM	Inner_Full for PC2, PC3, PC4 Inner_Full_Region1 for PC1
	SCC/CC2			-	-
	SCC/CC3			-	-
	SCC/CC4			-	-
	SCC/CC5			-	-
	SCC/CC6			-	-
	SCC/CC7			-	-
	SCC/CC8			-	-
8	PCC/CC1			DFT-s-OFDM 64 QAM	Outer_Full

	SCC/CC2			-	-
	SCC/CC3			-	-
	SCC/CC4			-	-
	SCC/CC5			-	-
	SCC/CC6			-	-
	SCC/CC7			-	-
	SCC/CC8			-	-
	9	PCC/CC1			CP-OFDM QPSK
SCC/CC2				-	-
SCC/CC3				-	-
SCC/CC4				-	-
SCC/CC5				-	-
SCC/CC6				-	-
SCC/CC7				-	-
SCC/CC8				-	-
10	PCC/CC1			CP-OFDM QPSK	Outer_Full
	SCC/CC2			-	-
	SCC/CC3			-	-
	SCC/CC4			-	-
	SCC/CC5			-	-
	SCC/CC6			-	-
	SCC/CC7			-	-
	SCC/CC8			-	-
11	PCC/CC1			CP-OFDM 16 QAM	Inner_Full for PC2, PC3, PC4 Inner_Full_Region1 for PC1
	SCC/CC2			-	-
	SCC/CC3			-	-
	SCC/CC4			-	-
	SCC/CC5			-	-
	SCC/CC6			-	-
	SCC/CC7			-	-
	SCC/CC8			-	-
12	PCC/CC1			CP-OFDM 16 QAM	Outer_Full
	SCC/CC2			-	-
	SCC/CC3			-	-
	SCC/CC4			-	-
	SCC/CC5			-	-
	SCC/CC6			-	-
	SCC/CC7			-	-
	SCC/CC8			-	-
13	PCC/CC1			CP-OFDM 64 QAM	Inner_Full for PC2, PC3, PC4 Inner_Full_Region1 for PC1
	SCC/CC2			-	-
	SCC/CC3			-	-
	SCC/CC4			-	-
	SCC/CC5			-	-
	SCC/CC6			-	-
	SCC/CC7			-	-
	SCC/CC8			-	-
14	PCC/CC1			CP-OFDM 64 QAM	Outer_Full
	SCC/CC2			-	-
	SCC/CC3			-	-
	SCC/CC4			-	-
	SCC/CC5			-	-
	SCC/CC6			-	-
	SCC/CC7			-	-
	SCC/CC8			-	-
15 -28	PCC/CC1			-	-
	SCC/CC2			-	-
	SCC/CC3			-	-
	SCC/CC4			-	-
	SCC/CC5			-	-
	SCC/CC6			-	-
	SCC/CC7			-	-

SCC/CC8	NOTE 4	NOTE 4
NOTE 1: The specific configuration of each RB allocation is defined in Table 6.1-1 for PC2, PC3 and PC4 or Table 6.1-2 for PC1.		
NOTE 2: CA Configuration Test cumulative aggregated BW settings are checked separately for each CA Configuration, which applicable aggregated channel bandwidths are specified in Table 5.5A.1-1.		
NOTE 3: PCC/CCi and SCC/CCj means PCC is on component carrier CCi and SCC is on component carrier CCj, with CCi or CCj frequencies defined in TS38.508-1 [10].		
NOTE 4: Same Modulation and RB allocation of Test ID 1 – 14 are applied to Test ID 15 – 28 in sequence.		
NOTE 5: Number of DL CCs shall be configured the same as number of UL CCs. The requirements are applicable as per 5.3A.4: "The requirements are applicable only when Uplink CCs are configured within the frequency range between lower edge of lowest downlink component carrier and upper edge of highest downlink component carrier".		

6.4A.2.1.7.5 Test requirement

The PUSCH EVM, derived in Annex E.4.2, shall not exceed the values in Table 6.4A.2.1.7.5-1.

The PUSCH \overline{EVM}_{DMRS} , derived in Annex E.4.6.2, shall not exceed the values in Table 6.4A.2.1.7.5-1 when embedded with data symbols of the respective modulation scheme.

Table 6.4A.2.1.7.5-1: Test requirements for Error Vector Magnitude for CA

Parameter	Unit	Average EVM Level	Reference Signal EVM Level
Pi/2 BPSK	%	30+TT	30+TT
QPSK	%	17.5+TT	17.5+TT
16 QAM	%	12.5+TT	12.5+TT
64 QAM	%	8+TT	8+TT

Table 6.4A.2.1.7.5-2: Test Tolerance for Error Vector Magnitude for CA

Test Metric	FR2a	FR2b
Max device size ≤ 30 cm	FFS	FFS

6.4A.2.2 Carrier leakage for CA

Editor's note: This test is incomplete due to lack of RRC framework for LO position retrieval.

6.4A.2.2.0 Minimum conformance requirements

6.4A.2.2.0.1 General

Carrier leakage is an additive sinusoid waveform. The carrier leakage requirement is defined for each component carrier and is measured on the component carrier with PRBs allocated. The measurement interval is one slot in the time domain.

Note: When UE has DL configured for non-contiguous CA, carrier leakage may land outside the spectrum occupied by all configured UL and DL CC.

The relative carrier leakage power is a power ratio of the additive sinusoid waveform and the modulated waveform. The requirement is verified with the test metric of Carrier Leakage (Link=TX beam peak direction, Meas=Link angle).

6.4A.2.2.0.2 Carrier leakage for power class 1

When carrier leakage is contained inside the spectrum occupied by all configured UL and DL CCs, the relative carrier leakage power shall not exceed the values specified in Table 6.4A.2.2.0.2-1 for power class 1 UEs.

Table 6.4A.2.2.0.2-1: Minimum requirements for relative carrier leakage for power class 1

Parameters	Relative Limit (dBc)
EIRP > 17 dBm	-25
4 dBm ≤ EIRP ≤ 17 dBm	-20

6.4A.2.2.0.3 Carrier leakage for power class 2

When carrier leakage is contained inside the spectrum occupied by all configured UL and DL CCs, the relative carrier leakage power shall not exceed the values specified in Table 6.4A.2.2.0.3-1 for power class 2.

Table 6.4A.2.2.0.3-1: Minimum requirements for relative carrier leakage power class 2

Parameters	Relative limit (dBc)
EIRP > 6 dBm	-25
-13 dBm ≤ EIRP ≤ 6 dBm	-20

6.4A.2.2.0.4 Carrier leakage for power class 3

When carrier leakage is contained inside the spectrum occupied by all configured UL and DL CCs, the relative carrier leakage power shall not exceed the values specified in Table 6.4A.2.2.0.4-1 for power class 3 UEs.

Table 6.4A.2.2.0.4-1: Minimum requirements for relative carrier leakage power class 3

Parameters	Relative limit (dBc)
Output power > 0 dBm	-25
-13 dBm ≤ Output power EIRP ≤ 0 dBm	-20

6.4A.2.2.0.5 Carrier leakage for power class 4

When carrier leakage is contained inside the spectrum occupied by all configured UL and DL CCs, the relative carrier leakage power shall not exceed the values specified in Table 6.4A.2.2.0.5-1 for power class 4 UEs.

Table 6.4A.2.2.0.5-1: Minimum requirements for relative carrier leakage power class 4

Parameters	Relative limit (dBc)
Output power > 11 dBm	-25
-13 dBm ≤ Output power EIRP ≤ 11 dBm	-20

6.4A.2.2.0.6 Carrier leakage for power class 5

When carrier leakage is contained inside the spectrum occupied by all configured UL and DL CCs, the relative carrier leakage power shall not exceed the values specified in Table 6.4A.2.2.6-1 for power class 5 UEs.

Table 6.4A.2.2.0.6-1: Minimum requirements for relative carrier leakage power class 5

Parameters	Relative limit (dBc)
Output power > 7 dBm	-25
-6 dBm ≤ Output power EIRP ≤ 7 dBm	-20

6.4A.2.2.0.7 Carrier leakage for power class 6

For intra-band contiguous and non-contiguous carrier aggregation, the carrier leakage requirement specified in clause 6.4A.2.2.6 for power class 5 applies.

6.4A.2.2.1 Carrier leakage for CA (2UL CA)

Editor's note: This clause is incomplete. The following aspects are either missing or not yet determined:

- This test is incomplete due to lack of RRC framework for LO position retrieval.
- Power window is TBD for power class 1, 2,4 and 5.
- Measurement Uncertainties and Test Tolerances for intra-band contiguous CA is TBD.

6.4A.2.2.1.1 Test purpose

Carrier leakage expresses itself as unmodulated sine wave with the carrier frequency. It is an interference of approximately constant amplitude and independent of the amplitude of the wanted signal. Carrier leakage interferes with the sub carriers at its position (if allocated), especially, when their amplitude is small.

The purpose of this test is to exercise the UE transmitter to verify its modulation quality in terms of carrier leakage.

6.4A.2.2.1.2 Test applicability

This test case applies to all types of NR UE release 15 and forward that supports FR2 2UL CA.

6.4A.2.2.1.3 Minimum conformance requirements

The minimum conformance requirements are defined in clause 6.4A.2.2.0.

6.4A.2.2.1.4 Test description

6.4A.2.2.1.4.1 Initial condition

Initial conditions are a set of test configurations the UE needs to be tested in and the steps for the SS to take with the UE to reach the correct measurement state.

The initial test configurations consist of environmental conditions, test frequencies, and CC combinations based on NR operating bands specified in clause 5.5A. All of these configurations shall be tested with applicable test parameters for each CA configuration and subcarrier spacing, are shown in Table 6.4A.2.2.1.4.1-1. The details of the uplink reference measurement channels (RMCs) are specified in Annexes A.2. Configurations of PDSCH and PDCCCH before measurement are specified in Annex C.2.

Table 6.4A.2.2.1.4.1-1: Intra-band Contiguous CA Test Configuration Table

Default Conditions					
Test Environment as specified in TS 38.508-1 [10] clause 4.1			Normal		
Test Frequencies as specified in TS 38.508-1 [10] clause 4.3.1.2.3 for different CA bandwidth classes			Low and High range		
Test CC Combination setting (aggregated BW of the CA configuration) as specified in TS 38.508-1 [10] clause 4.3.1.2.3 for the CA Configuration across bandwidth combination sets supported by the UE			Lowest aggregated BW of the CA configuration		
Test SCS as specified in Table 5.3.5-1			Highest		
Test Parameters					
CA Configuration / Aggregated BW			Downlink Configuration	Uplink Configuration	
Test ID	CC & Mapping (NOTE 5)	CBW (MHz)	RB allocation	Modulation	RB allocation (NOTE 1)
1	PCC/CC1	Default	-	DFT-s-OFDM QPSK	Inner_Partial_Left for PC2, PC3, PC4
	SCC/CC2				Inner_Partial_Left_Region2 for PC1

<p>NOTE 1: The specific configuration of each RF allocation is defined in Table 6.1-1 for PC2, PC3 and PC4 or Table 6.1-2 for PC1.</p> <p>NOTE 2: CA Configuration Test cumulative aggregated BW settings are checked separately for each CA Configuration, which applicable aggregated channel bandwidths are specified in Table 5.5A.1-1.</p> <p>NOTE 3: If the UE supports multiple CC Combinations in the CA Configuration with the same cumulative aggregated BW, only the combination with the lowest PCC ChBW is tested.</p> <p>NOTE 4: When the signalled DC carrier position is at Inner_Partial_Left for PC2, PC3, PC4, use Inner_Partial_Right for UL RB allocation. When the signalled DC carrier position is in Inner_Partial_Left_Region2 for PC1, use Inner_Partial_Right_Region2 for UL RB allocation.</p> <p>NOTE 5: PCC/CCi and SCC/CCj means PCC is on component carrier CCi and SCC is on component carrier CCj, with CCi or CCj frequencies defined in TS38.508-1 [10].</p> <p>NOTE 6: Number of DL CCs shall be configured the same as number of UL CCs. The requirements are applicable as per 5.3A.4: "<i>The requirements are applicable only when Uplink CCs are configured within the frequency range between lower edge of lowest downlink component carrier and upper edge of highest downlink component carrier</i>".</p>

1. Connection between SS and UE is shown in TS 38.508-1 [10] Annex A, Figure A.3.3.1.1 for TE diagram and Figure A.3.4.1.1 for UE diagram.
2. The parameter settings for the cell are set up according to TS 38.508-1 [10] clause 4.4.3.
3. Downlink signals are initially set up according to Annex C, and uplink signals according to Annex G.
4. The UL Reference Measurement channels are set according to Table 6.4A.2.2.1.4.1-1.
5. Propagation conditions are set according to Annex B.0
6. Ensure the UE is in state RRC_CONNECTED with generic procedure parameters Connectivity *NR*, Connected without release *On*, Test Mode *On* and Test Loop Function *On* according to TS 38.508-1 [10] clause 4.5. Message contents are defined in clause 6.4A.2.2.1.4.3

6.4A.2.2.1.4.2 Test procedure

1. Retrieve the LO position from the parameter txDirectCurrentLocation in UplinkTxDirectCurrent IE.
2. Configure PCC and SCC according to Annex C.0, C.1, C.2 and Annex C.3.0 for all downlink physical channels.
3. The SS shall configure SCC as per TS 38.508-1 [10] clause 5.5.1 Procedure to configure SCC(s) for NR RF CA testing. Message contents are defined in clause 6.4A.2.2.1.4.3.
4. SS activates SCC by sending the activation MAC CE (Refer TS 38.321 [28], clauses 5.9, 6.1.3.10). Wait for at least 2 seconds (Refer TS 38.133[25], clause 9.3).
5. SS sends uplink scheduling information for each UL HARQ process via PDCCH DCI format 0_1 for C_RNTI to schedule the UL RMC according to Table 6.4A.2.2.1.4.1-1. Since the UE has no payload and no loopback data to send the UE sends uplink MAC padding bits on the UL RMC.
6. Set the UE in the Inband Tx beam peak direction found with a 3D EIRP scan as performed in Annex K.1.1. Allow at least BEAM_SELECT_WAIT_TIME (NOTE 1) for the UE Tx beam selection to complete.
7. Send uplink power control commands to the UE using 1dB power step size to ensure that the UE $EIRP_{Total} = EIRP_{\theta} + EIRP_{\phi}$ measured by the test system is within the Uplink power control window, defined as $+MU$ to $+(MU + \text{Uplink power control window size})$ dB of the target power level P_{req} , where:
 - P_{req} is the power level specified in Table 6.4.2.2.4.2-1 according to the power class.
 - MU is the test system uplink absolute power measurement uncertainty and is specified in Table F.1.2-1 under carrier leakage sub-clause for the carrier frequency f and the channel bandwidth BW .
 - Uplink power control window size = 1dB (UE power step size) + 5 dB (UE power step tolerance) + (Test system uplink relative power measurement uncertainty), where, the UE power step tolerance is specified in TS 38.101-1 [2], Table 6.3.4.3-1 and is 5dB for 1dB power step size, and the Test system uplink relative power measurement uncertainty is specified in Table F.1.2-1.

Allow at least BEAM_SELECT_WAIT_TIME (NOTE 1) for the UE Tx beam selection to complete.

8. SS activates the UE Beamlock Function (UBF) by performing the procedure as specified in TS 38.508-1 [10] clause 4.9.2 using condition TxRx.
9. Measure carrier leakage on PCC using Global In-Channel Tx-Test (Annex E) for the θ - and ϕ -polarization at the LO position obtained in step 1. For TDD, only slots consisting of only UL symbols are under test. Calculate $\text{CarrLeak} = \min(\text{CarrLeak}_\theta, \text{CarrLeak}_\phi)$.
10. SS deactivates the UE Beamlock Function (UBF) by performing the procedure as specified in TS 38.508-1 [10] clause 4.9.3.

NOTE 1: The BEAM_SELECT_WAIT_TIME default value is defined in Annex K.

NOTE 2: The purpose of the Uplink power control window is to ensure that the actual UE output power is no less than the target power level, and as close as possible to the target power level. The relationship between the Uplink power control window, the target power level and the corresponding possible actual UE Uplink power window is illustrated in Annex F.4.2.

Table 6.4A.2.2.1.4.2-1: UE EIRP P_{req} (dBm) for carrier leakage

Power Class	P_{req} (dBm) for step 5
Power Class 1	17
Power Class 2	6
Power Class 3	0
Power Class 4	11
Power Class 5	FFS

Table 6.4A.2.2.1.4.2-2: Void.

6.4A.2.2.1.4.3 Message contents

Message contents are according to TS 38.508-1 [10] clause 4.6 with TRANSFORM_PRECODER_ENABLED condition in Table 4.6.3-118 PUSCH-Config.

6.4A.2.2.1.5 Test requirement

For each of the n carrier leakage results derived in Annex E.3.1 for θ - and ϕ -polarization the minimum is calculated according to

$$\text{CarrLeak} = \min(\text{CarrLeak}_\theta, \text{CarrLeak}_\phi), \text{ where}$$

$$n = \begin{cases} 30, & \text{for 60 kHz SCS} \\ 60, & \text{for 120 kHz SCS} \end{cases}$$

Each of the n carrier leakage results CarrLeak shall not exceed the values in Table 6.4.2.2.5-1 for power class 1 Table 6.4.2.2.5-2 for power class 2, Table 6.4.2.2.5-3 for power class 3, Table 6.4.2.2.5-4 for power class 4 and Table 6.4.2.2.5-5 for power class 5. Allocated RBs are not under test.

6.4A.2.2.2 Carrier leakage for CA (3UL CA)

Editor's note: This clause is incomplete. The following aspects are either missing or not yet determined:

- This test is incomplete due to lack of RRC framework for LO position retrieval.
- Power window is TBD for power class 1, 2 and 4.
- Measurement Uncertainties and Test Tolerances for intra-band contiguous CA is TBD.

6.4A.2.2.2.1 Test purpose

Carrier leakage expresses itself as unmodulated sine wave with the carrier frequency. It is an interference of approximately constant amplitude and independent of the amplitude of the wanted signal. Carrier leakage interferes with the sub carriers at its position (if allocated), especially, when their amplitude is small.

The purpose of this test is to exercise the UE transmitter to verify its modulation quality in terms of carrier leakage.

6.4A.2.2.2.2 Test applicability

This test case applies to all types of NR UE release 15 and forward that supports FR2 3UL CA.

6.4A.2.2.2.3 Minimum conformance requirements

The minimum conformance requirements are defined in clause 6.4A.2.2.0.

6.4A.2.2.2.4 Test description

Same as in clause 6.4A.2.2.1.4 with the following exceptions:

- Instead of Table 6.4A.2.2.1.4.1-1 → use Table 6.4A.2.2.2.4-1.

Table 6.4A.2.2.2.4-1: Intra-band Contiguous CA Test Configuration Table

Default Conditions					
Test Environment as specified in TS 38.508-1 [10] clause 4.1			Normal		
Test Frequencies as specified in TS 38.508-1 [10] clause 4.3.1.2.3 for different CA bandwidth classes			Low and High range		
Test CC Combination setting (aggregated BW of the CA configuration) as specified in TS 38.508-1 [10] clause 4.3.1.2.3 for the CA Configuration across bandwidth combination sets supported by the UE			Lowest aggregated BW of the CA configuration		
Test SCS as specified in Table 5.3.5-1			Highest		
Test Parameters					
CA Configuration / Aggregated BW			Downlink Configuration	Uplink Configuration	
Test ID	CC & Mapping (NOTE 5)	CBW (MHz)	RB allocation	Modulation	RB allocation (NOTE 1)
1	PCC/CC1	Default	-	DFT-s-OFDM QPSK	Inner_Partial_Left for PC2, PC3, PC4
					Inner_Partial_Left_Region2 for PC1
	SCC/CC2				
	SCC/CC3				
NOTE 1: The specific configuration of each RF allocation is defined in Table 6.1-1 for PC2, PC3 and PC4 or Table 6.1-2 for PC1.					
NOTE 2: CA Configuration Test cumulative aggregated BW settings are checked separately for each CA Configuration, which applicable aggregated channel bandwidths are specified in Table 5.5A.1-1.					
NOTE 3: If the UE supports multiple CC Combinations in the CA Configuration with the same cumulative aggregated BW, only the combination with the lowest PCC ChBW is tested.					
NOTE 4: When the signalled DC carrier position is at Inner_Partial_Left for PC2, PC3, PC4, use Inner_Partial_Right for UL RB allocation. When the signalled DC carrier position is in Inner_16RB_Left_Region2 for PC1, use Inner_16RB_Right_Region2 for UL RB allocation.					
NOTE 5: PCC/CCi and SCC/CCj means PCC is on component carrier CCi and SCC is on component carrier CCj, with CCi or CCj frequencies defined in TS38.508-1 [10].					
NOTE 6: Number of DL CCs shall be configured the same as number of UL CCs. The requirements are applicable as per 5.3A.4: "The requirements are applicable only when Uplink CCs are configured within the frequency range between lower edge of lowest downlink component carrier and upper edge of highest downlink component carrier".					

6.4A.2.2.2.5 Test requirement

For each of the n carrier leakage results derived in Annex E.3.1 for θ - and ϕ -polarization the minimum is calculated according to

$\text{CarrLeak} = \min(\text{CarrLeak}_\theta, \text{CarrLeak}_\phi)$, where

$$n = \begin{cases} 30, & \text{for 60 kHz SCS} \\ 60, & \text{for 120 kHz SCS} \end{cases}$$

Each of the n carrier leakage results CarrLeak shall not exceed the values in Table 6.4.2.2.5-1 for power class 1, Table 6.4.2.2.5-2 for power class 2, Table 6.4.2.2.5-3 for power class 3 and Table 6.4.2.2.5-4 for power class 4. Allocated RBs are not under test.

6.4A.2.2.3 Carrier leakage for CA (4UL CA)

Editor's note: This clause is incomplete. The following aspects are either missing or not yet determined:

- This test is incomplete due to lack of RRC framework for LO position retrieval.
- Power window is TBD for power class 1, 2 and 4.
- Measurement Uncertainties and Test Tolerances for intra-band contiguous CA is TBD.

6.4A.2.2.3.1 Test purpose

Carrier leakage expresses itself as unmodulated sine wave with the carrier frequency. It is an interference of approximately constant amplitude and independent of the amplitude of the wanted signal. Carrier leakage interferes with the sub carriers at its position (if allocated), especially, when their amplitude is small.

The purpose of this test is to exercise the UE transmitter to verify its modulation quality in terms of carrier leakage.

6.4A.2.2.3.2 Test applicability

This test case applies to all types of NR UE release 15 and forward that supports FR2 4UL CA.

6.4A.2.2.3.3 Minimum conformance requirements

The minimum conformance requirements are defined in clause 6.4A.2.2.0.

6.4A.2.2.3.4 Test description

Same as in clause 6.4A.2.2.1.4 with the following exceptions:

- Instead of Table 6.4A.2.2.1.4.1-1 → use Table 6.4A.2.2.3.4-1.

Table 6.4A.2.2.3.4-1: Intra-band Contiguous CA Test Configuration Table

Default Conditions					
Test Environment as specified in TS 38.508-1 [10] clause 4.1			Normal		
Test Frequencies as specified in TS 38.508-1 [10] clause 4.3.1.2.3 for different CA bandwidth classes			Low and High range		
Test CC Combination setting (aggregated BW of the CA configuration) as specified in TS 38.508-1 [10] clause 4.3.1.2.3 for the CA Configuration across bandwidth combination sets supported by the UE			Lowest aggregated BW		
Test SCS as specified in Table 5.3.5-1			Highest		
Test Parameters					
CA Configuration / Aggregated BW			Downlink Configuration	Uplink Configuration	
Test ID	CC & Mapping (NOTE 5)	CBW (MHz)	RB allocation	Modulation	RB allocation (NOTE 1)

1	PCC/CC1	50	-	DFT-s-OFDM QPSK	Inner_Partial_Left for PC2, PC3, PC4 Inner_Partial_Left_Region2 for PC1
	SCC/CC2	50		DFT-s-OFDM QPSK	
	SCC/CC3	50		DFT-s-OFDM QPSK	
	SCC/CC4	50		DFT-s-OFDM QPSK	
<p>NOTE 1: The specific configuration of each RF allocation is defined in Table 6.1-1 for PC2, PC3 and PC4 or Table 6.1-2 for PC1.</p> <p>NOTE 2: CA Configuration Test cumulative aggregated BW settings are checked separately for each CA Configuration, which applicable aggregated channel bandwidths are specified in Table 5.5A.1-1.</p> <p>NOTE 3: If the UE supports multiple CC Combinations in the CA Configuration with the same cumulative aggregated BW, only the combination with the lowest PCC ChBW is tested.</p> <p>NOTE 4: When the signalled DC carrier position is at Inner_Partial_Left for PC2, PC3, PC4, use Inner_Partial_Right for UL RB allocation. When the signalled DC carrier position is in Inner_Partial_Left_Region2 for PC1, use Inner_Partial_Right_Region2 for UL RB allocation.</p> <p>NOTE 5: PCC/CCi and SCC/CCj means PCC is on component carrier CCi and SCC is on component carrier CCj, with CCi or CCj frequencies defined in TS38.508-1 [10].</p> <p>NOTE 6: Number of DL CCs shall be configured the same as number of UL CCs. The requirements are applicable as per 5.3A.4: "The requirements are applicable only when Uplink CCs are configured within the frequency range between lower edge of lowest downlink component carrier and upper edge of highest downlink component carrier".</p>					

6.4A.2.2.3.5 Test requirement

For each of the n carrier leakage results derived in Annex E.3.1 for θ - and ϕ -polarization the minimum is calculated according to

$\text{CarrLeak} = \min(\text{CarrLeak}_\theta, \text{CarrLeak}_\phi)$, where

$$n = \begin{cases} 30, & \text{for 60 kHz SCS} \\ 60, & \text{for 120 kHz SCS} \end{cases}$$

Each of the n total carrier leakage results CarrLeak shall not exceed the values in Table 6.4.2.2.5-1 for power class 1, Table 6.4.2.2.5-2 for power class 2, Table 6.4.2.2.5-3 for power class 3 and Table 6.4.2.2.5-4 for power class 4. Allocated RBs are not under test.

6.4A.2.2.4 Carrier leakage for CA (5UL CA)

Editor's note: This clause is incomplete. The following aspects are either missing or not yet determined:

- This test is incomplete due to lack of RRC framework for LO position retrieval.
- Power window is TBD for power class 1, 2 and 4.
- Measurement Uncertainties and Test Tolerances for intra-band contiguous CA is TBD.

6.4A.2.2.4.1 Test purpose

Carrier leakage expresses itself as unmodulated sine wave with the carrier frequency. It is an interference of approximately constant amplitude and independent of the amplitude of the wanted signal. Carrier leakage interferes with the sub carriers at its position (if allocated), especially, when their amplitude is small.

The purpose of this test is to exercise the UE transmitter to verify its modulation quality in terms of carrier leakage.

6.4A.2.2.4.2 Test applicability

This test case applies to all types of NR UE release 15 and forward that supports FR2 5UL CA.

6.4A.2.2.4.3 Minimum conformance requirements

The minimum conformance requirements are defined in clause 6.4A.2.2.0.

6.4A.2.2.4.4 Test description

Same as in clause 6.4A.2.2.1.4 with the following exceptions:

- Instead of Table 6.4A.2.2.1.4.1-1 → use Table 6.4A.2.2.4.4-1.

Table 6.4A.2.2.4.4-1: Intra-band Contiguous CA Test Configuration Table

Default Conditions					
Test Environment as specified in TS 38.508-1 [10] clause 4.1			Normal		
Test Frequencies as specified in TS 38.508-1 [10] clause 4.3.1.2.3 for different CA bandwidth classes			Low and High range		
Test CC Combination setting (aggregated BW of the CA configuration) as specified in TS 38.508-1 [10] clause 4.3.1.2.3 for the CA Configuration across bandwidth combination sets supported by the UE			Lowest aggregated BW		
Test SCS as specified in Table 5.3.5-1			Highest		
Test Parameters					
CA Configuration / Aggregated BW			Downlink Configuration	Uplink Configuration	
Test ID	CC & Mapping (NOTE 5)	CBW (MHz)	RB allocation	Modulation	RB allocation (NOTE 1)
1	PCC/CC1	50	-	DFT-s-OFDM QPSK	Inner_Partial_Left for PC2, PC3, PC4 Inner_Partial_Left_Region2 for PC1
	SCC/CC2	50		-	-
	SCC/CC3	50		-	-
	SCC/CC4	50		-	-
	SCC/CC5	50		-	-
NOTE 1: The specific configuration of each RB allocation is defined in Table 6.1-1 for PC2, PC3 and PC4 or Table 6.1-2 for PC1.					
NOTE 2: CA Configuration Test cumulative aggregated BW settings are checked separately for each CA Configuration, which applicable aggregated channel bandwidths are specified in Table 5.5A.1-1.					
NOTE 3: If the UE supports multiple CC Combinations in the CA Configuration with the same cumulative aggregated BW, only the combination with the lowest PCC ChBW is tested.					
NOTE 4: When the signalled DC carrier position is at Inner_Partial_Left for PC2, PC3, PC4, use Inner_Partial_Right for UL RB allocation. When the signalled DC carrier position is in Inner_Partial_Left_Region2 for PC1, use Inner_Partial_Right_Region2 for UL RB allocation.					
NOTE 5: PCC/CC _i and SCC/CC _j means PCC is on component carrier CC _i and SCC is on component carrier CC _j , with CC _i or CC _j frequencies defined in TS 38.508-1 [10].					
NOTE 6: Number of DL CCs shall be configured the same as number of UL CCs. The requirements are applicable as per 5.3A.4: "The requirements are applicable only when Uplink CCs are configured within the frequency range between lower edge of lowest downlink component carrier and upper edge of highest downlink component carrier".					

6.4A.2.2.4.5 Test requirement

For each of the n carrier leakage results derived in Annex E.3.1 for θ - and φ -polarization the minimum is calculated according to

$$\text{CarrLeak} = \min(\text{CarrLeak}_\theta, \text{CarrLeak}_\varphi), \text{ where}$$

$$n = \begin{cases} 30, & \text{for 60 kHz SCS} \\ 60, & \text{for 120 kHz SCS} \end{cases}$$

Each of the n carrier leakage results CarrLeak shall not exceed the values in Table 6.4.2.2.5-1 for power class 1, Table 6.4.2.2.5-2 for power class 2, Table 6.4.2.2.5-3 for power class 3 and Table 6.4.2.2.5-4 for power class 4. Allocated RBs are not under test.

6.4A.2.2.5 Carrier leakage for CA (6UL CA)

Editor's note: This clause is incomplete. The following aspects are either missing or not yet determined:

- This test is incomplete due to lack of RRC framework for LO position retrieval.
- Power window is TBD for power class 1, 2 and 4.
- Measurement Uncertainties and Test Tolerances for intra-band contiguous CA is TBD.

6.4A.2.2.5.1 Test purpose

Carrier leakage expresses itself as unmodulated sine wave with the carrier frequency. It is an interference of approximately constant amplitude and independent of the amplitude of the wanted signal. Carrier leakage interferes with the sub carriers at its position (if allocated), especially, when their amplitude is small.

The purpose of this test is to exercise the UE transmitter to verify its modulation quality in terms of carrier leakage.

6.4A.2.2.5.2 Test applicability

This test case applies to all types of NR UE release 15 and forward that supports FR2 6UL CA.

6.4A.2.2.5.3 Minimum conformance requirements

The minimum conformance requirements are defined in clause 6.4A.2.2.0.

6.4A.2.2.5.4 Test description

Same as in clause 6.4A.2.2.1.4 with the following exceptions:

- Instead of Table 6.4A.2.2.1.4.1-1 → use Table 6.4A.2.2.5.4-1.

Table 6.4A.2.2.5.4-1: Intra-band Contiguous CA Test Configuration Table

Default Conditions					
Test Environment as specified in TS 38.508-1 [10] clause 4.1			Normal		
Test Frequencies as specified in TS 38.508-1 [10] clause 4.3.1.2.3 for different CA bandwidth classes			Low and High range		
Test CC Combination setting (aggregated BW of the CA configuration) as specified in TS 38.508-1 [10] clause 4.3.1.2.3 for the CA Configuration across bandwidth combination sets supported by the UE			Lowest aggregated BW		
Test SCS as specified in Table 5.3.5-1			Highest		
Test Parameters					
CA Configuration / Aggregated BW			Downlink Configuration	Uplink Configuration	
Test ID	CC & Mapping (NOTE 5)	CBW (MHz)	RB allocation	Modulation	RB allocation (NOTE 1)
1	PCC/CC1	50	-	DFT-s-OFDM QPSK	Inner_Partial_Left for PC2, PC3, PC4 Inner_Partial_Left_Region2 for PC1
	SCC/CC2	50	-	-	-
	SCC/CC3	50	-	-	-
	SCC/CC4	50	-	-	-
	SCC/CC5	50	-	-	-
	SCC/CC6	50	-	-	-

NOTE 1: The specific configuration of each RB allocation is defined in Table 6.1-1 for PC2, PC3 and PC4 or Table 6.1-2 for PC1.
NOTE 2: CA Configuration Test cumulative aggregated BW settings are checked separately for each CA Configuration, which applicable aggregated channel bandwidths are specified in Table 5.5A.1-1.
NOTE 3: If the UE supports multiple CC Combinations in the CA Configuration with the same cumulative aggregated BW, only the combination with the lowest PCC ChBW is tested.
NOTE 4: When the signalled DC carrier position is at Inner_Partial_Left for PC2, PC3, PC4, use Inner_Partial_Right for UL RB allocation. When the signalled DC carrier position is in Inner_Partial_Left_Region2 for PC1, use Inner_Partial_Right_Region2 for UL RB allocation.
NOTE 5: PCC/CCi and SCC/CCj means PCC is on component carrier CCi and SCC is on component carrier CCj, with CCi or CCj frequencies defined in TS 38.508-1 [10].
NOTE 6: Number of DL CCs shall be configured the same as number of UL CCs. The requirements are applicable as per 5.3A.4: "The requirements are applicable only when Uplink CCs are configured within the frequency range between lower edge of lowest downlink component carrier and upper edge of highest downlink component carrier".

6.4A.2.2.5.5 Test requirement

For each of the n carrier leakage results derived in Annex E.3.1 for θ - and φ -polarization the minimum is calculated according to

$$\text{CarrLeak} = \min(\text{CarrLeak}_{\theta}, \text{CarrLeak}_{\varphi}), \text{ where}$$

$$n = \begin{cases} 30, & \text{for 60 kHz SCS} \\ 60, & \text{for 120 kHz SCS} \end{cases}$$

Each of the n carrier leakage results CarrLeak shall not exceed the values in Table 6.4.2.2.5-1 for power class 1, Table 6.4.2.2.5-2 for power class 2, Table 6.4.2.2.5-3 for power class 3 and Table 6.4.2.2.5-4 for power class 4. Allocated RBs are not under test.

6.4A.2.2.6 Carrier leakage for CA (7UL CA)

Editor's note: This clause is incomplete. The following aspects are either missing or not yet determined:

- This test is incomplete due to lack of RRC framework for LO position retrieval.
- Power window is TBD for power class 1, 2 and 4.
- Measurement Uncertainties and Test Tolerances for intra-band contiguous CA is TBD.

6.4A.2.2.6.1 Test purpose

Carrier leakage expresses itself as unmodulated sine wave with the carrier frequency. It is an interference of approximately constant amplitude and independent of the amplitude of the wanted signal. Carrier leakage interferes with the sub carriers at its position (if allocated), especially, when their amplitude is small.

The purpose of this test is to exercise the UE transmitter to verify its modulation quality in terms of carrier leakage.

6.4A.2.2.6.2 Test applicability

This test case applies to all types of NR UE release 15 and forward that supports FR2 7UL CA.

6.4A.2.2.6.3 Minimum conformance requirements

The minimum conformance requirements are defined in clause 6.4A.2.2.0.

6.4A.2.2.6.4 Test description

Same as in clause 6.4A.2.2.1.4 with the following exceptions:

- Instead of Table 6.4A.2.2.1.4.1-1 → use Table 6.4A.2.2.6.4-1.

Table 6.4A.2.2.6.4-1: Intra-band Contiguous CA Test Configuration Table

Default Conditions					
Test Environment as specified in TS 38.508-1 [10] clause 4.1			Normal		
Test Frequencies as specified in TS 38.508-1 [10] clause 4.3.1.2.3 for different CA bandwidth classes			Low and High range		
Test CC Combination setting (aggregated BW of the CA configuration) as specified in TS 38.508-1 [10] clause 4.3.1.2.3 for the CA Configuration across bandwidth combination sets supported by the UE			Lowest aggregated BW		
Test SCS as specified in Table 5.3.5-1			Highest		
Test Parameters					
CA Configuration / Aggregated BW			Downlink Configuration	Uplink Configuration	
Test ID	CC & Mapping (NOTE 5)	CBW (MHz)	RB allocation	Modulation	RB allocation (NOTE 1)
1	PCC/CC1	50	-	DFT-s-OFDM QPSK	Inner_Partial_Left for PC2, PC3, PC4 Inner_Partial_Left_Region2 for PC1
	SCC/CC2	50		-	-
	SCC/CC3	50		-	-
	SCC/CC4	50		-	-
	SCC/CC5	50		-	-
	SCC/CC6	50		-	-
	SCC/CC7	50		-	-
NOTE 1: The specific configuration of each RB allocation is defined in Table 6.1-1 for PC2, PC3 and PC4 or Table 6.1-2 for PC1.					
NOTE 2: CA Configuration Test cumulative aggregated BW settings are checked separately for each CA Configuration, which applicable aggregated channel bandwidths are specified in Table 5.5A.1-1.					
NOTE 3: If the UE supports multiple CC Combinations in the CA Configuration with the same cumulative aggregated BW, only the combination with the lowest PCC ChBW is tested.					
NOTE 4: When the signalled DC carrier position is at Inner_Partial_Left for PC2, PC3, PC4, use Inner_Partial_Right for UL RB allocation. When the signalled DC carrier position is in Inner_Partial_Left_Region2 for PC1, use Inner_Partial_Right_Region2 for UL RB allocation.					
NOTE 5: PCC/CCi and SCC/CCj means PCC is on component carrier CCi and SCC is on component carrier CCj, with CCi or CCj frequencies defined in TS 38.508-1 [10].					
NOTE 6: Number of DL CCs shall be configured the same as number of UL CCs. The requirements are applicable as per 5.3A.4: "The requirements are applicable only when Uplink CCs are configured within the frequency range between lower edge of lowest downlink component carrier and upper edge of highest downlink component carrier".					

6.4A.2.2.6.5 Test requirement

For each of the n carrier leakage results derived in Annex E.3.1 for θ - and ϕ -polarization the minimum is calculated according to

$$\text{CarrLeak} = \min(\text{CarrLeak}_{\theta}, \text{CarrLeak}_{\phi}), \text{ where}$$

$$n = \begin{cases} 30, & \text{for 60 kHz SCS} \\ 60, & \text{for 120 kHz SCS} \end{cases}$$

Each of the n carrier leakage results CarrLeak shall not exceed the values in Table 6.4.2.2.5-1 for power class 1, Table 6.4.2.2.5-2 for power class 2, Table 6.4.2.2.5-3 for power class 3 and Table 6.4.2.2.5-4 for power class 4. Allocated RBs are not under test.

6.4A.2.2.7 Carrier leakage for CA (8UL CA)

Editor's note: This clause is incomplete. The following aspects are either missing or not yet determined:

- This test is incomplete due to lack of RRC framework for LO position retrieval.

- Power window is TBD for power class 1, 2 and 4.
- Measurement Uncertainties and Test Tolerances for intra-band contiguous CA is TBD.

6.4A.2.2.7.1 Test purpose

Carrier leakage expresses itself as unmodulated sine wave with the carrier frequency. It is an interference of approximately constant amplitude and independent of the amplitude of the wanted signal. Carrier leakage interferes with the sub carriers at its position (if allocated), especially, when their amplitude is small.

The purpose of this test is to exercise the UE transmitter to verify its modulation quality in terms of carrier leakage.

6.4A.2.2.7.2 Test applicability

This test case applies to all types of NR UE release 15 and forward that supports FR2 8UL CA.

6.4A.2.2.7.3 Minimum conformance requirements

The minimum conformance requirements are defined in clause 6.4A.2.2.0.

6.4A.2.2.7.4 Test description

Same as in clause 6.4A.2.2.1.4 with the following exceptions:

- Instead of Table 6.4A.2.2.1.4.1-1 → use Table 6.4A.2.2.7.4-1.

Table 6.4A.2.2.7.4-1: Intra-band Contiguous CA Test Configuration Table

Default Conditions					
Test Environment as specified in TS 38.508-1 [10] clause 4.1			Normal		
Test Frequencies as specified in TS 38.508-1 [10] clause 4.3.1.2.3 for different CA bandwidth classes			Low and High range		
Test CC Combination setting (aggregated BW of the CA configuration) as specified in TS 38.508-1 [10] clause 4.3.1.2.3 for the CA Configuration across bandwidth combination sets supported by the UE			Lowest aggregated BW		
Test SCS as specified in Table 5.3.5-1			Highest		
Test Parameters					
CA Configuration / Aggregated BW			Downlink Configuration	Uplink Configuration	
Test ID	CC & Mapping (NOTE 5)	CBW (MHz)	RB allocation	Modulation	RB allocation (NOTE 1)
1	PCC/CC1	50	-	DFT-s-OFDM QPSK	Inner_Partial_Left for PC2, PC3, PC4 Inner_Partial_Left_Region2 for PC1
	SCC/CC2	50	-	-	-
	SCC/CC3	50	-	-	-
	SCC/CC4	50	-	-	-
	SCC/CC5	50	-	-	-
	SCC/CC6	50	-	-	-
	SCC/CC7	50	-	-	-
	SCC/CC8	50	-	-	-

NOTE 1:	The specific configuration of each RB allocation is defined in Table 6.1-1 for PC2, PC3 and PC4 or Table 6.1-2 for PC1.
NOTE 2:	CA Configuration Test cumulative aggregated BW settings are checked separately for each CA Configuration, which applicable aggregated channel bandwidths are specified in Table 5.5A.1-1.
NOTE 3:	If the UE supports multiple CC Combinations in the CA Configuration with the same cumulative aggregated BW, only the combination with the lowest PCC ChBW is tested.
NOTE 4:	When the signalled DC carrier position is at Inner_Partial_Left for PC2, PC3, PC4, use Inner_Partial_Right for UL RB allocation. When the signalled DC carrier position is in Inner_Partial_Left_Region2 for PC1, use Inner_Partial_Right_Region2 for UL RB allocation.
NOTE 5:	PCC/CCi and SCC/CCj means PCC is on component carrier CCi and SCC is on component carrier CCj, with CCi or CCj frequencies defined in TS 38.508-1 [10].
NOTE 6:	Number of DL CCs shall be configured the same as number of UL CCs. The requirements are applicable as per 5.3A.4: "The requirements are applicable only when Uplink CCs are configured within the frequency range between lower edge of lowest downlink component carrier and upper edge of highest downlink component carrier".

6.4A.2.2.7.5 Test requirement

For each of the n carrier leakage results derived in Annex E.3.1 for θ - and ϕ -polarization the minimum is calculated according to

$$CarrLeak = \min(CarrLeak_{\theta}, CarrLeak_{\phi}), \text{ where}$$

$$n = \begin{cases} 30, & \text{for 60 kHz SCS} \\ 60, & \text{for 120 kHz SCS} \end{cases}$$

Each of the n carrier leakage results CarrLeak shall not exceed the values in Table 6.4.2.2.5-1 for power class 1, Table 6.4.2.2.5-2 for power class 2, Table 6.4.2.2.5-3 for power class 3 and Table 6.4.2.2.5-4 for power class 4. Allocated RBs are not under test.

6.4A.2.3 In-band emissions for CA

Editor's note: This test is incomplete due to lack of RRC framework for LO position retrieval

6.4A.2.3.0 Minimum conformance requirements

6.4A.2.3.0.1 General

Inband emission requirement is defined over the spectrum occupied by all configured UL and DL CCs. The measurement interval is as defined in section 6.4.2.4. The requirement is verified with the test metric of In-band emission (Link=TX beam peak direction, Meas=Link angle).

For intra-band contiguous carrier aggregation, the requirements in this clause apply with all component carriers active and with one single contiguous PRB allocation in one of uplink component carriers. The inband emission is defined as the interference falling into the non-allocated resource blocks for all component carriers.

6.4A.2.3.0.2 In-band emissions for power class 1

The relative in-band emission shall not exceed the values specified in Table 6.4A.2.3.0.2-1 for power class 1 UEs.

Table 6.4A.2.3.0.2-1: Requirements for in-band emissions for power class 1

Parameter description	Unit	Limit (NOTE 1)	Applicable Frequencies
General	dB	$\max \left[\begin{array}{l} -25 - 10 \cdot \log_{10} \left(\frac{N_{RB}}{L_{CRB}} \right), \\ 20 \cdot \log_{10}(\text{EVM}) - 5 \cdot \frac{(\Delta_{RB} - 1)}{L_{CRB}}, \\ -55.1 \text{ dBm} - P_{RB} \end{array} \right]$	Any non-allocated RB in allocated component carrier and not allocated component carriers (NOTE 2)
IQ Image	dB	-25	Output power > 27 dBm
			Image frequencies

		-20	Output power ≤ 27 dBm	(NOTES 2, 3)
Carrier leakage	dBc	-25	Output power > 17 dBm	Carrier frequency (NOTES 4, 5)
		-20	4 dBm \leq Output power ≤ 17 dBm	
NOTE 1: An in-band emissions combined limit is evaluated in each non-allocated RB. For each such RB, the minimum requirement is calculated as the higher of ($P_{RB} - 25$ dB) and the power sum of all limit values (General, IQ Image or Carrier leakage) that apply. P_{RB} is defined in NOTE 9.				
NOTE 2: The measurement bandwidth is 1 RB and the limit is expressed as a ratio of measured power in one non-allocated RB to the measured average power per allocated RB, where the averaging is done across all allocated RBs. For Pi/2 BPSK with Spectrum Shaping, the limit is expressed as a ratio of measured power in one non-allocated RB to the measured power in the allocated RB with highest PSD.				
NOTE 3: Image frequencies for UL CA are specified in relation to either UL or DL carrier frequency.				
NOTE 4: The measurement bandwidth is 1 RB and the limit is expressed as a ratio of measured power in one non-allocated RB to the measured total power in all allocated RBs.				
NOTE 5: The applicable frequencies for this limit are those that are enclosed in the RBs containing the DC frequency, or in the two RBs immediately adjacent to the DC frequency but excluding any allocated RB.				
NOTE 6: L_{CRB} is the Transmission Bandwidth for kth allocated component carrier (see Figure 5.3.1-1).				
NOTE 7: EVM s the limit for the modulation format used in the allocated RBs.				
NOTE 8: Δ_{RB} is the starting frequency offset between the allocated RB and the measured non-allocated RB (e.g. $\Delta_{RB} = 1$ or $\Delta_{RB} = -1$ for the first adjacent RB outside of the allocated bandwidth), and may take non-integer values when the carrier spacing between the CCs is not a multiple of RB.				
NOTE 9: P_{RB} is the transmitted power per allocated RB, measured in dBm.				
NOTE 10: All powers are EIRP in beam peak direction.				

6.4A.2.3.0.3 In-band emissions for power class 2

The relative in-band emission shall not exceed the values specified in Table 6.4A.2.3.0.3-1 for power class 2.

Table 6.4A.2.3.0.3-1: Requirements for in-band emissions for power class 2

Parameter description	Unit	Limit (NOTE 1)		Applicable Frequencies
General	dB	$\max \left[\begin{array}{l} -25 - 10 \cdot \log_{10} \left(\frac{N_{RB}}{L_{CRB}} \right), \\ 20 \cdot \log_{10}(\text{EVM}) - 5 \cdot \frac{(\Delta_{RB} - 1)}{L_{CRB}}, \\ -55.1 \text{ dBm} - P_{RB} \end{array} \right]$		Any non-allocated RB in allocated component carrier and not allocated component carriers (NOTE 2)
IQ Image	dB	-25	Output power > 16 dBm	Image frequencies (NOTES 2, 3)
		-20	Output power ≤ 16 dBm	
Carrier leakage	dBc	-25	Output power > 6 dBm	Carrier frequency (NOTES 4, 5)
		-20	-13 dBm \leq Output power ≤ 6 dBm	
NOTE 1: An in-band emissions combined limit is evaluated in each non-allocated RB. For each such RB, the minimum requirement is calculated as the higher of ($P_{RB} - 25$ dB) and the power sum of all limit values (General, IQ Image or Carrier leakage) that apply. P_{RB} is defined in NOTE 9.				
NOTE 2: The measurement bandwidth is 1 RB and the limit is expressed as a ratio of measured power in one non-allocated RB to the measured average power per allocated RB, where the averaging is done across all allocated RBs. For Pi/2 BPSK with Spectrum Shaping, the limit is expressed as a ratio of measured power in one non-allocated RB to the measured power in the allocated RB with highest PSD.				
NOTE 3: Image frequencies for UL CA are specified in relation to either UL or DL carrier frequency.				
NOTE 4: The measurement bandwidth is 1 RB and the limit is expressed as a ratio of measured power in one non-allocated RB to the measured total power in all allocated RBs.				
NOTE 5: The applicable frequencies for this limit are those that are enclosed in the RBs containing the DC frequency, or in the two RBs immediately adjacent to the DC frequency but excluding any allocated RB.				
NOTE 6: L_{CRB} is the Transmission Bandwidth for kth allocated component carrier (see Figure 5.3.1-1).				
NOTE 7: EVM s the limit for the modulation format used in the allocated RBs.				
NOTE 8: Δ_{RB} is the starting frequency offset between the allocated RB and the measured non-allocated RB (e.g. $\Delta_{RB} = 1$ or $\Delta_{RB} = -1$ for the first adjacent RB outside of the allocated bandwidth), and may take non-integer values when the carrier spacing between the CCs is not a multiple of RB.				
NOTE 9: P_{RB} is the transmitted power per allocated RB, measured in dBm.				
NOTE 10: All powers are EIRP in beam peak direction.				

6.4A.2.3.0.4 In-band emissions for power class 3

The relative in-band emission shall not exceed the values specified in Table 6.4A.2.3.0.4-1 for power class 3 UEs.

Table 6.4A.2.3.0.4-1: Requirements for in-band emissions for power class 3

Parameter description	Unit	Limit (NOTE 1)		Applicable Frequencies
General	dB	$\max \left[\begin{array}{l} -25 - 10 \cdot \log_{10} \left(\frac{N_{RB}}{L_{CRB}} \right), \\ 20 \cdot \log_{10}(\text{EVM}) - 5 \cdot \frac{(\Delta_{RB} - 1)}{L_{CRB}}, \\ -55.1 \text{ dBm} - P_{RB} \end{array} \right]$		Any non-allocated RB in allocated component carrier and not allocated component carriers (NOTE 2)
IQ Image	dB	-25	Output power > 10 dBm	Image frequencies (NOTES 2, 3)
		-20	Output power ≤ 10 dBm	
Carrier leakage	dBc	-25	Output power > 0 dBm	Carrier frequency (NOTES 4, 5)
		-20	-13 dBm ≤ Output power ≤ 0 dBm	
<p>NOTE 1: An in-band emissions combined limit is evaluated in each non-allocated RB. For each such RB, the minimum requirement is calculated as the higher of ($P_{RB} - 25$ dB) and the power sum of all limit values (General, IQ Image or Carrier leakage) that apply. P_{RB} is defined in NOTE 9.</p> <p>NOTE 2: The measurement bandwidth is 1 RB and the limit is expressed as a ratio of measured power in one non-allocated RB to the measured average power per allocated RB, where the averaging is done across all allocated RBs. For Pi/2 BPSK with Spectrum Shaping, the limit is expressed as a ratio of measured power in one non-allocated RB to the measured power in the allocated RB with highest PSD.</p> <p>NOTE 3: Image frequencies for UL CA are specified in relation to either UL or DL carrier frequency.</p> <p>NOTE 4: The measurement bandwidth is 1 RB and the limit is expressed as a ratio of measured power in one non-allocated RB to the measured total power in all allocated RBs.</p> <p>NOTE 5: The applicable frequencies for this limit are those that are enclosed in the RBs containing the DC frequency, or in the two RBs immediately adjacent to the DC frequency but excluding any allocated RB.</p> <p>NOTE 6: L_{CRB} is the Transmission Bandwidth for kth allocated component carrier (see Figure 5.3.1-1).</p> <p>NOTE 7: EVM is the limit for the modulation format used in the allocated RBs.</p> <p>NOTE 8: Δ_{RB} is the starting frequency offset between the allocated RB and the measured non-allocated RB (e.g. $\Delta_{RB} = 1$ or $\Delta_{RB} = -1$ for the first adjacent RB outside of the allocated bandwidth), and may take non-integer values when the carrier spacing between the CCs is not a multiple of RB.</p> <p>NOTE 9: P_{RB} is the transmitted power per allocated RB, measured in dBm.</p> <p>NOTE 10: All powers are EIRP in beam peak direction.</p>				

6.4A.2.3.0.5 In-band emissions for power class 4

The relative in-band emission shall not exceed the values specified in Table 6.4A.2.3.0.5-1 for power class 4 UEs.

Table 6.4A.2.3.0.5-1: Requirements for in-band emissions for power class 4

Parameter description	Unit	Limit (NOTE 1)		Applicable Frequencies
General	dB	$\max \left[\begin{array}{l} -25 - 10 \cdot \log_{10} \left(\frac{N_{RB}}{L_{CRB}} \right), \\ 20 \cdot \log_{10}(\text{EVM}) - 5 \cdot \frac{(\Delta_{RB} - 1)}{L_{CRB}}, \\ -55.1 \text{ dBm} - P_{RB} \end{array} \right]$		Any non-allocated RB in allocated component carrier and not allocated component carriers (NOTE 2)
IQ Image	dB	-25	Output power > 21 dBm	Image frequencies (NOTES 2, 3)
		-20	Output power ≤ 21 dBm	
Carrier leakage	dBc	-25	Output power > 11 dBm	Carrier frequency (NOTES 4, 5)
		-20	-13 dBm ≤ Output power ≤ 11 dBm	

- NOTE 1: An in-band emissions combined limit is evaluated in each non-allocated RB. For each such RB, the minimum requirement is calculated as the higher of ($P_{RB} - 25$ dB) and the power sum of all limit values (General, IQ Image or Carrier leakage) that apply. P_{RB} is defined in NOTE 9.
- NOTE 2: The measurement bandwidth is 1 RB and the limit is expressed as a ratio of measured power in one non-allocated RB to the measured average power per allocated RB, where the averaging is done across all allocated RBs. For pi/2 BPSK with Spectrum Shaping, the limit is expressed as a ratio of measured power in one non-allocated RB to the measured power in the allocated RB with highest PSD.
- NOTE 3: Image frequencies for UL CA are specified in relation to either UL or DL carrier frequency.
- NOTE 4: The measurement bandwidth is 1 RB and the limit is expressed as a ratio of measured power in one non-allocated RB to the measured total power in all allocated RBs.
- NOTE 5: The applicable frequencies for this limit are those that are enclosed in the RBs containing the DC frequency, or in the two RBs immediately adjacent to the DC frequency but excluding any allocated RB.
- NOTE 6: L_{CRB} is the Transmission Bandwidth for kth allocated component carrier (see Figure 5.3.1-1).
- NOTE 7: EVM is the limit for the modulation format used in the allocated RBs.
- NOTE 8: Δ_{RB} is the starting frequency offset between the allocated RB and the measured non-allocated RB (e.g. $\Delta_{RB} = 1$ or $\Delta_{RB} = -1$ for the first adjacent RB outside of the allocated bandwidth), and may take non-integer values when the carrier spacing between the CCs is not a multiple of RB.
- NOTE 9: P_{RB} is the transmitted power per allocated RB, measured in dBm.
- NOTE 10: All powers are EIRP in beam peak direction.

6.4A.2.3.0.6 Inband emissions for power class 5

For intra-band contiguous and non-contiguous carrier aggregation, the average of the in-band emission measurement over 10 sub-frames shall not exceed the values specified in Table 6.4A.2.3.6-1 for power class 6 UEs.

For inter-band carrier aggregation with uplink assigned to two NR bands, and each UL band is configured with a single CC, the in-band emissions requirements are specified in clause 6.4.2.3.6 and are applicable for each CC with all CCs active with non-zero UL RB allocation.

Table 6.4A.2.3.0.6-1: Requirements for in-band emissions for power class 5

Parameter description	Unit	Limit (NOTE 1)		Applicable Frequencies
General	dB	$\max \left[\begin{array}{l} -25 - 10 \cdot \log_{10} \left(\frac{N_{RB}}{L_{CRB}} \right), \\ 20 \cdot \log_{10}(\text{EVM}) - 5 \cdot \frac{(\Delta_{RB} - 1)}{L_{CRB}}, \\ -55.1 \text{ dBm} - \overline{P_{RB}} \end{array} \right]$		Any non-allocated RB in allocated component carrier and not allocated component carriers (NOTE 2)
IQ Image	dB	-25	Output power > 17 dBm	Image frequencies (NOTES 2, 3)
		-20	Output power ≤ 17 dBm	
Carrier leakage	dBc	-25	Output power > 7 dBm	Carrier frequency (NOTES 4, 5)
		-20	-6 dBm ≤ Output power ≤ 7 dBm	

NOTE 1:	An in-band emissions combined limit is evaluated in each non-allocated RB. For each such RB, the minimum requirement is calculated as the higher of ($\overline{P_{RB}} - 25$ dB) and the power sum of all limit values (General, IQ Image or Carrier leakage) that apply. $\overline{P_{RB}}$ is defined in NOTE 9.
NOTE 2:	The measurement bandwidth is 1 RB and the limit is expressed as a ratio of measured power in one non-allocated RB to the measured average power per allocated RB, where the averaging is done across all allocated RBs. For pi/2 BPSK with Spectrum Shaping, the limit is expressed as a ratio of measured power in one non-allocated RB to the measured power in the allocated RB with highest PSD.
NOTE 3:	Image frequencies for UL CA are specified in relation to either UL or DL carrier frequency.
NOTE 4:	The measurement bandwidth is 1 RB and the limit is expressed as a ratio of measured power in one non-allocated RB to the measured total power in all allocated RBs.
NOTE 5:	The applicable frequencies for this limit are those that are enclosed in the RBs containing the DC frequency, or in the two RBs immediately adjacent to the DC frequency but excluding any allocated RB.
NOTE 6:	L_{CRB} is the Transmission Bandwidth for kth allocated component carrier (see Figure 5.3.1-1).
NOTE 7:	EVM s the limit for the modulation format used in the allocated RBs.
NOTE 8:	Δ_{RB} is the starting frequency offset between the allocated RB and the measured non-allocated RB (e.g. $\Delta_{RB} = 1$ or $\Delta_{RB} = -1$ for the first adjacent RB outside of the allocated bandwidth), and may take non-integer values when the carrier spacing between the CCs is not a multiple of RB.
NOTE 9:	$\overline{P_{RB}}$ is an average of the transmitted power over 10 sub-frames normalized by the number of allocated RBs, measured in dBm.
NOTE 10:	All powers are EIRP in beam peak direction.

6.4A.2.3.0.7 In-band emissions for power class 6

For intra-band contiguous and non-contiguous carrier aggregation, the average of the in-band emission specified in clause 6.4A.2.3.0.6 applies

6.4A.2.3.1 In-band emissions for CA (2UL CA)

Editor's note: This clause is incomplete. The following aspects are either missing or not yet determined:

- The test procedure is incomplete due to that power window for CA is TBD
- Measurement Uncertainty and Test Tolerance are FFS.
- Testing of the general in-band emission requirement and if yes at which UE Tx power level and with which relaxation applied to the requirement is FFS.
- TP analysis is FFS

6.4A.2.3.1.1 Test purpose

The in-band emissions are a measure of the interference falling into the non-allocated resources blocks.

The purpose of this test is to exercise the UE transmitter to verify its modulation quality in terms of in-band emissions.

6.4A.2.3.1.2 Test applicability

This test case applies to all types of NR UE release 15 and forward that supports FR2 2UL CA.

6.4A.2.3.1.3 Minimum conformance requirements

The minimum conformance requirements are defined in clause 6.4A.2.3.0.

6.4A.2.3.1.4 Test description

6.4A.2.3.1.4.1 Initial condition

Initial conditions are a set of test configurations the UE needs to be tested in and the steps for the SS to take with the UE to reach the correct measurement state.

The initial test configurations consist of environmental conditions, test frequencies, and CC combinations based on NR operating bands specified in clause 5.5A. All of these configurations shall be tested with applicable test parameters for each channel bandwidth and subcarrier spacing, are shown in Table 6.4A.2.3.1.4.1-1. The details of the uplink reference measurement channels (RMCs) are specified in Annexes A.2. Configurations of PDSCH and PDCCH before measurement are specified in Annex C.2.

Table 6.4A.2.3.1.4.1-1: Test Configuration Table

Default Conditions					
Test Environment as specified in TS 38.508-1 [10] clause 4.1			Normal		
Test Frequencies as specified in TS 38.508-1 [10] clause 4.3.1.2.3 for different CA bandwidth classes.			Low and High range		
Test CC combination setting as specified in TS 38.508-1 [10] clause 4.3.1.2.3 for the CA Configuration across bandwidth combination sets supported by the UE.			Lowest aggregated BW of the CA configuration Highest aggregated BW of the CA configuration		
Test SCS as specified in Table 5.3.5-1.			Lowest		
Test Parameters					
CA Configuration / Aggregated BW			Downlink Configuration	Uplink Configuration	
Test ID	CC & Mapping	ChBw(MHz)	RB allocation	Modulation	RB allocation (NOTE 1)
1	PCC	Default	-	DFT-s-OFDM PI/2 BPSK	Inner_Partial_Left for PC2, PC3, PC4 Inner_Partial_Left_Region2 for PC1
	SCC1			-	-
2	PCC			DFT-s-OFDM PI/2 BPSK	Inner_Partial_Right for PC2, PC3, PC4 Inner_Partial_Right_Region2 for PC1
	SCC1			-	-
3	PCC			CP-OFDM QPSK	Inner_Partial_Left for PC2, PC3, PC4 Inner_Partial_Left_Region2 for PC1
	SCC1			-	-
4	PCC			CP-OFDM QPSK	Inner_Partial_Right for PC2, PC3, PC4 Inner_Partial_Right_Region2 for PC1
	SCC1			-	-
NOTE 1: The specific configuration of each RB allocation is defined in Table 6.1-1 for PC2, PC3 and PC4 or Table 6.1-2 for PC1.					
NOTE 2: CA Configuration Test cumulative aggregated BW settings are checked separately for each CA Configuration, which applicable aggregated channel bandwidths are specified in Table 5.5A.1-1.					
NOTE 3: Number of DL CCs shall be configured the same as number of UL CCs. The requirements are applicable as per 5.3A.4: "The requirements are applicable only when Uplink CCs are configured within the frequency range between lower edge of lowest downlink component carrier and upper edge of highest downlink component carrier".					

1. Connection between SS and UE is shown in TS 38.508-1 [10] Annex A, Figure A.3.3.1.1 for TE diagram and Figure A.3.4.1.1 for UE diagram.
2. The parameter settings for the cell are set up according to TS 38.508-1 [10] clause 4.4.3.
3. Downlink signals for PCC are initially set up according to Annex C, and uplink signals according to Annex G.
4. The UL Reference Measurement channels are set according to Table 6.4A.2.3.1.4.1-1.
5. Propagation conditions are set according to Annex B.0

6. Ensure the UE is in state RRC_CONNECTED with generic procedure parameters Connectivity *NR*, Connected without release *On*, Test Mode *On* and Test Loop Function *On* according to TS 38.508-1 [10] clause 4.5. Message contents are defined in clause 6.4A.2.3.1.4.3

6.4A.2.3.1.4.2 Test procedure

1. Retrieve the LO position from the parameter txDirectCurrentLocation in UplinkTxDirectCurrent IE.
2. Configure SCC according to Annex C.0, C.1 and C.3.0 for all downlink physical channels.
3. The SS shall configure SCC as per TS 38.508-1 [10] clause 5.5.1. Procedure to configure SCC(s) for NR RF CA testing. Message contents are defined in clause 6.4A.2.3.1.4.3.
4. SS activates SCC by sending the activation MAC CE (Refer TS 38.321 [28], clauses 5.9, 6.1.3.10). Wait for at least 2 seconds (Refer TS 38.133[25], clause 9.3).
5. SS sends uplink scheduling information for each UL HARQ process via PDCCH DCI format 0_1 for C_RNTI to schedule the UL RMC according to Table 6.4A.2.3.1.4.1-1. Since the UE has no payload and no loopback data to send the UE sends uplink MAC padding bits on the UL RMC.
6. Set the UE in the Inband Tx beam peak direction found with a 3D EIRP scan as performed in Annex K.1.1. Allow at least BEAM_SELECT_WAIT_TIME (NOTE 2) for the UE Tx beam selection to complete.
7. Send the appropriate TPC commands in the uplink scheduling information to the UE until UE output power is $P_{req} + P_W \pm P_W$, where P_{req} is the power level specified in Table 6.4A.2.3.1.4.2-1 according to the power class with power ID = 1. P_W is the power window according to Table 6.4A.2.3.1.4.2-2 for the carrier frequency f and the channel bandwidth BW . Allow at least BEAM_SELECT_WAIT_TIME (NOTE 2) for the UE Tx beam selection to complete.
8. SS activates the UE Beamlock Function (UBF) by performing the procedure as specified in TS 38.508-1 [10] clause 4.9.2 using condition TxRx.
9. Measure In-band emission IE_θ , IE_ϕ on PCC using Global In-Channel Tx-Test (Annex E) for the θ - and ϕ -polarizations, respectively. Measure power spectral density on the SCC. For TDD, only slots consisting of only UL symbols are under test. Calculate $IE = IE_\theta + IE_\phi$, where the calculation is based on linear power ratios.
10. SS deactivates the UE Beamlock Function (UBF) by performing the procedure as specified in TS 38.508-1 [10] clause 4.9.3.
11. Repeat steps 6 through 10 until In-band emissions have been measured for all power IDs in Table 6.4A.2.3.1.4.2-1.

NOTE 1: When switching to DFT-s-OFDM waveform, as specified in Table 6.4A.2.3.1.4.1-1, send an NR RRCReconfiguration message according to TS 38.508-1 [10] clause 4.6.3 Table 4.6.3-118 PUSCH-Config with TRANSFORM_PRECODER_ENABLED condition.

NOTE 2: The BEAM_SELECT_WAIT_TIME default value is defined in Annex K.

Table 6.4A.2.3.1.4.2-1: Parameters for In-band emissions FFS

Power ID	Unit	Level for power class 1	Level for power class 2	Level for power class 3	Level for power class 4
1	dBm	27	16	10	21
2	dBm	17	6	0	11

Table 6.4A.2.3.1.4.2-2: Power Window (dB) for In-band emissions

FFS

6.4A.2.3.1.4.3 Message contents

Message contents are according to TS 38.508-1 [10] clause 4.6.

6.4A.2.3.1.5 Test requirement

For power ID1 and ID2, the averaged in-band emissions result, derived in Annex E.4.3 shall not exceed the corresponding values for IQ Image and Carrier Leakage in Table 6.4A.2.3.1.5-1 for power class 1 UEs.

Table 6.4A.2.3.1.5-1: Test Requirements for in-band emissions for power class 1

Parameter description	Unit	Limit (NOTE 1)		Applicable Frequencies
General	dB	$\max \left[\begin{array}{l} -25 - 10 \cdot \log_{10} \left(\frac{N_{RB}}{L_{CRB}} \right), \\ 20 \cdot \log_{10}(\text{EVM}) - 5 \cdot \frac{(\Delta_{RB} - 1)}{L_{CRB}}, \\ -55.1 \text{ dBm} - P_{RB} \end{array} \right] + \text{TT}$		Any non-allocated RB in allocated component carrier and not allocated component carriers (NOTE 2)
IQ Image	dB	-25+TT	Output power > 27 dBm	Image frequencies (NOTES 2, 3)
		-20+TT	Output power ≤ 27 dBm	
Carrier leakage	dBc	-25+TT	Output power > 17 dBm	Carrier frequency (NOTES 4, 5)
		-20+TT	4 dBm ≤ Output power ≤ 17 dBm	
<p>NOTE 1: An in-band emissions combined limit is evaluated in each non-allocated RB. For each such RB, the minimum requirement is calculated as the higher of ($P_{RB} - 25$ dB) and the power sum of all limit values (General, IQ Image or Carrier leakage) that apply. P_{RB} is defined in NOTE 9.</p> <p>NOTE 2: The measurement bandwidth is 1 RB and the limit is expressed as a ratio of measured power in one non-allocated RB to the measured average power per allocated RB, where the averaging is done across all allocated RBs. For Pi/2 BPSK with Spectrum Shaping, the limit is expressed as a ratio of measured power in one non-allocated RB to the measured power in the allocated RB with highest PSD.</p> <p>NOTE 3: Image frequencies for UL CA are specified in relation to either UL or DL carrier frequency.</p> <p>NOTE 4: The measurement bandwidth is 1 RB and the limit is expressed as a ratio of measured power in one non-allocated RB to the measured total power in all allocated RBs.</p> <p>NOTE 5: The applicable frequencies for this limit are those that are enclosed in the RBs containing the DC frequency, or in the two RBs immediately adjacent to the DC frequency but excluding any allocated RB.</p> <p>NOTE 6: L_{CRB} is the Transmission Bandwidth for kth allocated component carrier (see Figure 5.3.1-1).</p> <p>NOTE 7: EVM is the limit for the modulation format used in the allocated RBs.</p> <p>NOTE 8: Δ_{RB} is the starting frequency offset between the allocated RB and the measured non-allocated RB (e.g. $\Delta_{RB} = 1$ or $\Delta_{RB} = -1$ for the first adjacent RB outside of the allocated bandwidth), and may take non-integer values when the carrier spacing between the CCs is not a multiple of RB.</p> <p>NOTE 9: P_{RB} is the transmitted power per allocated RB, measured in dBm.</p> <p>NOTE 10: All powers are EIRP in beam peak direction.</p>				

For power ID1 and ID2, the averaged in-band emissions result, derived in Annex E.4.3 shall not exceed the corresponding values for IQ Image and Carrier Leakage in Table 6.4A.2.3.1.5-2 for power class 2 UEs.

Table 6.4A.2.3.1.5-2: Test Requirements for in-band emissions for power class 2

Parameter description	Unit	Limit (NOTE 1)		Applicable Frequencies
General	dB	$\max \left[\begin{array}{l} -25 - 10 \cdot \log_{10} \left(\frac{N_{RB}}{L_{CRB}} \right), \\ 20 \cdot \log_{10}(\text{EVM}) - 5 \cdot \frac{(\Delta_{RB} - 1)}{L_{CRB}}, \\ -55.1 \text{ dBm} - P_{RB} \end{array} \right] + \text{TT}$		Any non-allocated RB in allocated component carrier and not allocated component carriers (NOTE 2)
IQ Image	dB	-25+TT	Output power > 16 dBm	Image frequencies (NOTES 2, 3)
		-20+TT	Output power ≤ 16 dBm	
Carrier leakage	dBc	-25+TT	Output power > 6 dBm	Carrier frequency (NOTES 4, 5)
		-20+TT	-13 dBm ≤ Output power ≤ 6 dBm	

NOTE 1: An in-band emissions combined limit is evaluated in each non-allocated RB. For each such RB, the minimum requirement is calculated as the higher of ($P_{RB} - 25$ dB) and the power sum of all limit values (General, IQ Image or Carrier leakage) that apply. P_{RB} is defined in NOTE 9.

NOTE 2: The measurement bandwidth is 1 RB and the limit is expressed as a ratio of measured power in one non-allocated RB to the measured average power per allocated RB, where the averaging is done across all allocated RBs. For Pi/2 BPSK with Spectrum Shaping, the limit is expressed as a ratio of measured power in one non-allocated RB to the measured power in the allocated RB with highest PSD.

NOTE 3: Image frequencies for UL CA are specified in relation to either UL or DL carrier frequency.

NOTE 4: The measurement bandwidth is 1 RB and the limit is expressed as a ratio of measured power in one non-allocated RB to the measured total power in all allocated RBs.

NOTE 5: The applicable frequencies for this limit are those that are enclosed in the RBs containing the DC frequency, or in the two RBs immediately adjacent to the DC frequency but excluding any allocated RB.

NOTE 6: L_{CRB} is the Transmission Bandwidth for kth allocated component carrier (see Figure 5.3.1-1).

NOTE 7: EVM s the limit for the modulation format used in the allocated RBs.

NOTE 8: Δ_{RB} is the starting frequency offset between the allocated RB and the measured non-allocated RB (e.g. $\Delta_{RB} = 1$ or $\Delta_{RB} = -1$ for the first adjacent RB outside of the allocated bandwidth), and may take non-integer values when the carrier spacing between the CCs is not a multiple of RB.

NOTE 9: P_{RB} is the transmitted power per allocated RB, measured in dBm.

NOTE 10: All powers are EIRP in beam peak direction.

For power ID1 and ID2, the averaged in-band emissions result, derived in Annex E.4.3 shall not exceed the corresponding values for IQ Image and Carrier Leakage in Table 6.4A.2.3.1.5-3 for power class 3 UEs.

Table 6.4A.2.3.1.5-3: Test Requirements for in-band emissions for power class 3

Parameter description	Unit	Limit (NOTE 1)		Applicable Frequencies
General	dB	$\max \left[\begin{array}{l} -25 - 10 \cdot \log_{10} \left(\frac{N_{RB}}{L_{CRB}} \right), \\ 20 \cdot \log_{10} (\text{EVM}) - 5 \cdot \frac{(\Delta_{RB} - 1)}{L_{CRB}}, \\ -55.1 \text{ dBm} - P_{RB} \end{array} \right] + \text{TT}$		Any non-allocated RB in allocated component carrier and not allocated component carriers (NOTE 2)
IQ Image	dB	-25+TT	Output power > 10 dBm	Image frequencies (NOTES 2, 3)
		-20+TT	Output power ≤ 10 dBm	
Carrier leakage	dBc	-25+TT	Output power > 0 dBm	Carrier frequency (NOTES 4, 5)
		-20+TT	-13 dBm ≤ Output power ≤ 0 dBm	
<p>NOTE 1: An in-band emissions combined limit is evaluated in each non-allocated RB. For each such RB, the minimum requirement is calculated as the higher of ($P_{RB} - 25$ dB) and the power sum of all limit values (General, IQ Image or Carrier leakage) that apply. P_{RB} is defined in NOTE 9.</p> <p>NOTE 2: The measurement bandwidth is 1 RB and the limit is expressed as a ratio of measured power in one non-allocated RB to the measured average power per allocated RB, where the averaging is done across all allocated RBs. For Pi/2 BPSK with Spectrum Shaping, the limit is expressed as a ratio of measured power in one non-allocated RB to the measured power in the allocated RB with highest PSD.</p> <p>NOTE 3: Image frequencies for UL CA are specified in relation to either UL or DL carrier frequency.</p> <p>NOTE 4: The measurement bandwidth is 1 RB and the limit is expressed as a ratio of measured power in one non-allocated RB to the measured total power in all allocated RBs.</p> <p>NOTE 5: The applicable frequencies for this limit are those that are enclosed in the RBs containing the DC frequency, or in the two RBs immediately adjacent to the DC frequency but excluding any allocated RB.</p> <p>NOTE 6: L_{CRB} is the Transmission Bandwidth for kth allocated component carrier (see Figure 5.3.1-1).</p> <p>NOTE 7: EVM s the limit for the modulation format used in the allocated RBs.</p> <p>NOTE 8: Δ_{RB} is the starting frequency offset between the allocated RB and the measured non-allocated RB (e.g. $\Delta_{RB} = 1$ or $\Delta_{RB} = -1$ for the first adjacent RB outside of the allocated bandwidth), and may take non-integer values when the carrier spacing between the CCs is not a multiple of RB.</p> <p>NOTE 9: P_{RB} is the transmitted power per allocated RB, measured in dBm.</p> <p>NOTE 10: All powers are EIRP in beam peak direction.</p>				

For power ID1 and ID2, the averaged in-band emissions result, derived in Annex E.4.3 shall not exceed the corresponding values for IQ Image and Carrier Leakage in Table 6.4A.2.3.1.5-4 for power class 4 UEs.

Table 6.4A.2.3.1.5-4: Test Requirements for in-band emissions for power class 4

Parameter description	Unit	Limit (NOTE 1)	Applicable Frequencies
-----------------------	------	----------------	------------------------

General	dB	$\max \left[\begin{array}{l} -25 - 10 \cdot \log_{10} \left(\frac{N_{RB}}{L_{CRB}} \right), \\ 20 \cdot \log_{10}(\text{EVM}) - 5 \cdot \frac{(\Delta_{RB} - 1)}{L_{CRB}}, \\ -55.1 \text{ dBm} - P_{RB} \end{array} \right] + \text{TT}$		Any non-allocated RB in allocated component carrier and not allocated component carriers (NOTE 2)
IQ Image	dB	-25+TT	Output power > 21 dBm	Image frequencies (NOTES 2, 3)
		-20+TT	Output power ≤ 21 dBm	
Carrier leakage	dBc	-25+TT	Output power > 11 dBm	Carrier frequency (NOTES 4, 5)
		-20+TT	-13 dBm ≤ Output power ≤ 11 dBm	
<p>NOTE 1: An in-band emissions combined limit is evaluated in each non-allocated RB. For each such RB, the minimum requirement is calculated as the higher of ($P_{RB} - 25$ dB) and the power sum of all limit values (General, IQ Image or Carrier leakage) that apply. P_{RB} is defined in NOTE 9.</p> <p>NOTE 2: The measurement bandwidth is 1 RB and the limit is expressed as a ratio of measured power in one non-allocated RB to the measured average power per allocated RB, where the averaging is done across all allocated RBs. For pi/2 BPSK with Spectrum Shaping, the limit is expressed as a ratio of measured power in one non-allocated RB to the measured power in the allocated RB with highest PSD.</p> <p>NOTE 3: Image frequencies for UL CA are specified in relation to either UL or DL carrier frequency.</p> <p>NOTE 4: The measurement bandwidth is 1 RB and the limit is expressed as a ratio of measured power in one non-allocated RB to the measured total power in all allocated RBs.</p> <p>NOTE 5: The applicable frequencies for this limit are those that are enclosed in the RBs containing the DC frequency, or in the two RBs immediately adjacent to the DC frequency but excluding any allocated RB.</p> <p>NOTE 6: L_{CRB} is the Transmission Bandwidth for kth allocated component carrier (see Figure 5.3.1-1).</p> <p>NOTE 7: EVM is the limit for the modulation format used in the allocated RBs.</p> <p>NOTE 8: Δ_{RB} is the starting frequency offset between the allocated RB and the measured non-allocated RB (e.g. $\Delta_{RB} = 1$ or $\Delta_{RB} = -1$ for the first adjacent RB outside of the allocated bandwidth), and may take non-integer values when the carrier spacing between the CCs is not a multiple of RB.</p> <p>NOTE 9: P_{RB} is the transmitted power per allocated RB, measured in dBm.</p> <p>NOTE 10: All powers are EIRP in beam peak direction.</p>				

For intra-band contiguous and non-contiguous carrier aggregation, the average of the in-band emission measurement over 10 sub-frames shall not exceed the values specified in Table 6.4A.2.3.6-1 for power class 6 UEs.

For inter-band carrier aggregation with uplink assigned to two NR bands, and each UL band is configured with a single CC, the in-band emissions requirements are specified in clause 6.4.2.3.6 and are applicable for each CC with all CCs active with non-zero UL RB allocation.

Table 6.4A.2.3.1.5-5: Requirements for in-band emissions for power class 5

Parameter description	Unit	Limit (NOTE 1)		Applicable Frequencies
General	dB	$\max \left[\begin{array}{l} -25 - 10 \cdot \log_{10} \left(\frac{N_{RB}}{L_{CRB}} \right), \\ 20 \cdot \log_{10}(\text{EVM}) - 5 \cdot \frac{(\Delta_{RB} - 1)}{L_{CRB}}, \\ -55.1 \text{ dBm} - \bar{P}_{RB} \end{array} \right]$		Any non-allocated RB in allocated component carrier and not allocated component carriers (NOTE 2)
IQ Image	dB	-25 +TT	Output power > 17 dBm	Image frequencies (NOTES 2, 3)
		-20 +TT	Output power ≤ 17 dBm	
Carrier leakage	dBc	-25 +TT	Output power > 7 dBm	Carrier frequency (NOTES 4, 5)
		-20 +TT	-6 dBm ≤ Output power ≤ 7 dBm	

NOTE 1: An in-band emissions combined limit is evaluated in each non-allocated RB. For each such RB, the minimum requirement is calculated as the higher of ($\overline{P_{RB}} - 25$ dB) and the power sum of all limit values (General, IQ Image or Carrier leakage) that apply. $\overline{P_{RB}}$ is defined in NOTE 9.
NOTE 2: The measurement bandwidth is 1 RB and the limit is expressed as a ratio of measured power in one non-allocated RB to the measured average power per allocated RB, where the averaging is done across all allocated RBs. For pi/2 BPSK with Spectrum Shaping, the limit is expressed as a ratio of measured power in one non-allocated RB to the measured power in the allocated RB with highest PSD.
NOTE 3: Image frequencies for UL CA are specified in relation to either UL or DL carrier frequency.
NOTE 4: The measurement bandwidth is 1 RB and the limit is expressed as a ratio of measured power in one non-allocated RB to the measured total power in all allocated RBs.
NOTE 5: The applicable frequencies for this limit are those that are enclosed in the RBs containing the DC frequency, or in the two RBs immediately adjacent to the DC frequency but excluding any allocated RB.
NOTE 6: L_{CRB} is the Transmission Bandwidth for kth allocated component carrier (see Figure 5.3.1-1).
NOTE 7: EVM s the limit for the modulation format used in the allocated RBs.
NOTE 8: Δ_{RB} is the starting frequency offset between the allocated RB and the measured non-allocated RB (e.g. $\Delta_{RB} = 1$ or $\Delta_{RB} = -1$ for the first adjacent RB outside of the allocated bandwidth), and may take non-integer values when the carrier spacing between the CCs is not a multiple of RB.
NOTE 9: $\overline{P_{RB}}$ is an average of the transmitted power over 10 sub-frames normalized by the number of allocated RBs, measured in dBm.
NOTE 10: All powers are EIRP in beam peak direction.

6.4A.2.3.2 In-band emissions for CA (3UL CA)

Editor's note: This clause is incomplete. The following aspects are either missing or not yet determined:

- The test procedure is incomplete due to that power window for CA is TBD
- Measurement Uncertainty and Test Tolerance are FFS.
- Testing of the general in-band emission requirement and if yes at which UE Tx power level and with which relaxation applied to the requirement is FFS.
- TP analysis is FFS

6.4A.2.3.2.1 Test purpose

The in-band emissions are a measure of the interference falling into the non-allocated resources blocks.

The purpose of this test is to exercise the UE transmitter to verify its modulation quality in terms of in-band emissions.

6.4A.2.3.2.2 Test applicability

This test case applies to all types of NR UE release 15 and forward that supports FR2 3UL CA.

6.4A.2.3.2.3 Minimum conformance requirements

The minimum conformance requirements are defined in clause 6.4A.2.3.0.

6.4A.2.3.2.4 Test description

Same as in clause 6.4A.2.3.1.4 with following exceptions:

- Instead of Table 6.4A.2.3.1.4.1-1 → use Table 6.4A.2.3.2.4-1.

Table 6.4A.2.3.2.4-1: Test Configuration Table for 3UL CA

Default Conditions	
Test Environment as specified in TS 38.508-1 [10] clause 4.1	Normal
Test Frequencies as specified in TS 38.508-1 [10] clause 4.3.1.2.3 for different CA bandwidth classes.	Low and High range

Test CC combination setting as specified in TS 38.508-1 [10] clause 4.3.1.2.3 for the CA Configuration across bandwidth combination sets supported by the UE.			Lowest aggregated BW of the CA configuration Highest aggregated BW of the CA configuration		
Test SCS as specified in Table 5.3.5-1.			Lowest		
Test Parameters					
CA Configuration / Aggregated BW			Downlink Configuration	Uplink Configuration	
Test ID	CC & Mapping	ChBw(MHz)	RB allocation	Modulation	RB allocation (NOTE 1)
1	PCC	Default	-	DFT-s-OFDM PI/2 BPSK	Inner_Partial_Left for PC2, PC3, PC4 Inner_Partial_Left_Region2 for PC1
	SCC1			-	-
	SCC2			-	-
2	PCC			DFT-s-OFDM PI/2 BPSK	Inner_Partial_Right for PC2, PC3, PC4 Inner_Partial_Right_Region2 for PC1
	SCC1			-	-
	SCC2			-	-
3	PCC			CP-OFDM QPSK	Inner_Partial_Left for PC2, PC3, PC4 Inner_Partial_Left_Region2 for PC1
	SCC1			-	-
	SCC2			-	-
4	PCC			CP-OFDM QPSK	Inner_Partial_Right for PC2, PC3, PC4 Inner_Partial_Right_Region2 for PC1
	SCC1			-	-
	SCC2			-	-
NOTE 1: The specific configuration of each RB allocation is defined in Table 6.1-1 for PC2, PC3 and PC4 or Table 6.1-2 for PC1.					
NOTE 2: CA Configuration Test cumulative aggregated BW settings are checked separately for each CA Configuration, which applicable aggregated channel bandwidths are specified in Table 5.5A.1-1.					
NOTE 3: Number of DL CCs shall be configured the same as number of UL CCs. The requirements are applicable as per 5.3A.4: "The requirements are applicable only when Uplink CCs are configured within the frequency range between lower edge of lowest downlink component carrier and upper edge of highest downlink component carrier".					

6.4A.2.3.2.5 Test requirement

For power ID1 and ID2, the averaged in-band emissions result, derived in Annex E.4.3 shall not exceed the corresponding values for IQ Image and Carrier Leakage in Table 6.4A.2.3.2.5-1 for power class 1 UEs.

Table 6.4A.2.3.2.5-1: Test Requirements for in-band emissions for power class 1

Parameter description	Unit	Limit (NOTE 1)		Applicable Frequencies
General	dB	$\max \left[\begin{array}{l} -25 - 10 \cdot \log_{10} \left(\frac{N_{RB}}{L_{CRB}} \right), \\ 20 \cdot \log_{10} (\text{EVM}) - 5 \cdot \frac{(\Delta_{RB} - 1)}{L_{CRB}}, \\ -55.1 \text{ dBm} - P_{RB} \end{array} \right] + \text{TT}$		Any non-allocated RB in allocated component carrier and not allocated component carriers (NOTE 2)
IQ Image	dB	-25+TT	Output power > 27 dBm	Image frequencies (NOTES 2, 3)
		-20+TT	Output power ≤ 27 dBm	
Carrier leakage	dBc	-25+TT	Output power > 17 dBm	Carrier frequency (NOTES 4, 5)
		-20+TT	4 dBm ≤ Output power ≤ 17 dBm	

NOTE 1: An in-band emissions combined limit is evaluated in each non-allocated RB. For each such RB, the minimum requirement is calculated as the higher of ($P_{RB} - 25$ dB) and the power sum of all limit values (General, IQ Image or Carrier leakage) that apply. P_{RB} is defined in NOTE 9.

NOTE 2: The measurement bandwidth is 1 RB and the limit is expressed as a ratio of measured power in one non-allocated RB to the measured average power per allocated RB, where the averaging is done across all allocated RBs. For Pi/2 BPSK with Spectrum Shaping, the limit is expressed as a ratio of measured power in one non-allocated RB to the measured power in the allocated RB with highest PSD.

NOTE 3: Image frequencies for UL CA are specified in relation to either UL or DL carrier frequency.

NOTE 4: The measurement bandwidth is 1 RB and the limit is expressed as a ratio of measured power in one non-allocated RB to the measured total power in all allocated RBs.

NOTE 5: The applicable frequencies for this limit are those that are enclosed in the RBs containing the DC frequency, or in the two RBs immediately adjacent to the DC frequency but excluding any allocated RB.

NOTE 6: L_{CRB} is the Transmission Bandwidth for kth allocated component carrier (see Figure 5.3.1-1).

NOTE 7: EVM is the limit for the modulation format used in the allocated RBs.

NOTE 8: Δ_{RB} is the starting frequency offset between the allocated RB and the measured non-allocated RB (e.g. $\Delta_{RB} = 1$ or $\Delta_{RB} = -1$ for the first adjacent RB outside of the allocated bandwidth), and may take non-integer values when the carrier spacing between the CCs is not a multiple of RB.

NOTE 9: P_{RB} is the transmitted power per allocated RB, measured in dBm.

NOTE 10: All powers are EIRP in beam peak direction.

For power ID1 and ID2, the averaged in-band emissions result, derived in Annex E.4.3 shall not exceed the corresponding values for IQ Image and Carrier Leakage in Table 6.4A.2.3.2.5-2 for power class 2 UEs.

Table 6.4A.2.3.2.5-2: Test Requirements for in-band emissions for power class 2

Parameter description	Unit	Limit (NOTE 1)		Applicable Frequencies
General	dB	$\max \left[\begin{array}{l} -25 - 10 \cdot \log_{10} \left(\frac{N_{RB}}{L_{CRB}} \right), \\ 20 \cdot \log_{10} (\text{EVM}) - 5 \cdot \frac{(\Delta_{RB} - 1)}{L_{CRB}}, \\ -55.1 \text{ dBm} - P_{RB} \end{array} \right] + \text{TT}$		Any non-allocated RB in allocated component carrier and not allocated component carriers (NOTE 2)
IQ Image	dB	-25+TT	Output power > 16 dBm	Image frequencies (NOTES 2, 3)
		-20+TT	Output power ≤ 16 dBm	
Carrier leakage	dBc	-25+TT	Output power > 6 dBm	Carrier frequency (NOTES 4, 5)
		-20+TT	-13 dBm ≤ Output power ≤ 6 dBm	
<p>NOTE 1: An in-band emissions combined limit is evaluated in each non-allocated RB. For each such RB, the minimum requirement is calculated as the higher of ($P_{RB} - 25$ dB) and the power sum of all limit values (General, IQ Image or Carrier leakage) that apply. P_{RB} is defined in NOTE 9.</p> <p>NOTE 2: The measurement bandwidth is 1 RB and the limit is expressed as a ratio of measured power in one non-allocated RB to the measured average power per allocated RB, where the averaging is done across all allocated RBs. For Pi/2 BPSK with Spectrum Shaping, the limit is expressed as a ratio of measured power in one non-allocated RB to the measured power in the allocated RB with highest PSD.</p> <p>NOTE 3: Image frequencies for UL CA are specified in relation to either UL or DL carrier frequency.</p> <p>NOTE 4: The measurement bandwidth is 1 RB and the limit is expressed as a ratio of measured power in one non-allocated RB to the measured total power in all allocated RBs.</p> <p>NOTE 5: The applicable frequencies for this limit are those that are enclosed in the RBs containing the DC frequency, or in the two RBs immediately adjacent to the DC frequency but excluding any allocated RB.</p> <p>NOTE 6: L_{CRB} is the Transmission Bandwidth for kth allocated component carrier (see Figure 5.3.1-1).</p> <p>NOTE 7: EVM is the limit for the modulation format used in the allocated RBs.</p> <p>NOTE 8: Δ_{RB} is the starting frequency offset between the allocated RB and the measured non-allocated RB (e.g. $\Delta_{RB} = 1$ or $\Delta_{RB} = -1$ for the first adjacent RB outside of the allocated bandwidth), and may take non-integer values when the carrier spacing between the CCs is not a multiple of RB.</p> <p>NOTE 9: P_{RB} is the transmitted power per allocated RB, measured in dBm.</p> <p>NOTE 10: All powers are EIRP in beam peak direction.</p>				

For power ID1 and ID2, the averaged in-band emissions result, derived in Annex E.4.3 shall not exceed the corresponding values for IQ Image and Carrier Leakage in Table 6.4A.2.3.2.5-3 for power class 3 UEs.

Table 6.4A.2.3.2.5-3: Test Requirements for in-band emissions for power class 3

Parameter description	Unit	Limit (NOTE 1)		Applicable Frequencies
General	dB	$\max \left[\begin{array}{l} -25 - 10 \cdot \log_{10} \left(\frac{N_{RB}}{L_{CRB}} \right), \\ 20 \cdot \log_{10} (\text{EVM}) - 5 \cdot \frac{(\Delta_{RB} - 1)}{L_{CRB}}, \\ -55.1 \text{ dBm} - P_{RB} \end{array} \right] + \text{TT}$		Any non-allocated RB in allocated component carrier and not allocated component carriers (NOTE 2)
IQ Image	dB	-25+TT	Output power > 10 dBm	Image frequencies (NOTES 2, 3)
		-20+TT	Output power ≤ 10 dBm	
Carrier leakage	dBc	-25+TT	Output power > 0 dBm	Carrier frequency (NOTES 4, 5)
		-20+TT	-13 dBm ≤ Output power ≤ 0 dBm	
<p>NOTE 1: An in-band emissions combined limit is evaluated in each non-allocated RB. For each such RB, the minimum requirement is calculated as the higher of ($P_{RB} - 25$ dB) and the power sum of all limit values (General, IQ Image or Carrier leakage) that apply. P_{RB} is defined in NOTE 9.</p> <p>NOTE 2: The measurement bandwidth is 1 RB and the limit is expressed as a ratio of measured power in one non-allocated RB to the measured average power per allocated RB, where the averaging is done across all allocated RBs. For Pi/2 BPSK with Spectrum Shaping, the limit is expressed as a ratio of measured power in one non-allocated RB to the measured power in the allocated RB with highest PSD.</p> <p>NOTE 3: Image frequencies for UL CA are specified in relation to either UL or DL carrier frequency.</p> <p>NOTE 4: The measurement bandwidth is 1 RB and the limit is expressed as a ratio of measured power in one non-allocated RB to the measured total power in all allocated RBs.</p> <p>NOTE 5: The applicable frequencies for this limit are those that are enclosed in the RBs containing the DC frequency, or in the two RBs immediately adjacent to the DC frequency but excluding any allocated RB.</p> <p>NOTE 6: L_{CRB} is the Transmission Bandwidth for kth allocated component carrier (see Figure 5.3.1-1).</p> <p>NOTE 7: EVM is the limit for the modulation format used in the allocated RBs.</p> <p>NOTE 8: Δ_{RB} is the starting frequency offset between the allocated RB and the measured non-allocated RB (e.g. $\Delta_{RB} = 1$ or $\Delta_{RB} = -1$ for the first adjacent RB outside of the allocated bandwidth), and may take non-integer values when the carrier spacing between the CCs is not a multiple of RB.</p> <p>NOTE 9: P_{RB} is the transmitted power per allocated RB, measured in dBm.</p> <p>NOTE 10: All powers are EIRP in beam peak direction.</p>				

For power ID1 and ID2, the averaged in-band emissions result, derived in Annex E.4.3 shall not exceed the corresponding values for IQ Image and Carrier Leakage in Table 6.4A.2.3.2.5-4 for power class 4 UEs.

Table 6.4A.2.3.2.5-4: Test Requirements for in-band emissions for power class 4

Parameter description	Unit	Limit (NOTE 1)		Applicable Frequencies
General	dB	$\max \left[\begin{array}{l} -25 - 10 \cdot \log_{10} \left(\frac{N_{RB}}{L_{CRB}} \right), \\ 20 \cdot \log_{10} (\text{EVM}) - 5 \cdot \frac{(\Delta_{RB} - 1)}{L_{CRB}}, \\ -55.1 \text{ dBm} - P_{RB} \end{array} \right] + \text{TT}$		Any non-allocated RB in allocated component carrier and not allocated component carriers (NOTE 2)
IQ Image	dB	-25+TT	Output power > 21 dBm	Image frequencies (NOTES 2, 3)
		-20+TT	Output power ≤ 21 dBm	
Carrier leakage	dBc	-25+TT	Output power > 11 dBm	Carrier frequency (NOTES 4, 5)
		-20+TT	-13 dBm ≤ Output power ≤ 11 dBm	

NOTE 1:	An in-band emissions combined limit is evaluated in each non-allocated RB. For each such RB, the minimum requirement is calculated as the higher of ($P_{RB} - 25$ dB) and the power sum of all limit values (General, IQ Image or Carrier leakage) that apply. P_{RB} is defined in NOTE 9.
NOTE 2:	The measurement bandwidth is 1 RB and the limit is expressed as a ratio of measured power in one non-allocated RB to the measured average power per allocated RB, where the averaging is done across all allocated RBs. For pi/2 BPSK with Spectrum Shaping, the limit is expressed as a ratio of measured power in one non-allocated RB to the measured power in the allocated RB with highest PSD.
NOTE 3:	Image frequencies for UL CA are specified in relation to either UL or DL carrier frequency.
NOTE 4:	The measurement bandwidth is 1 RB and the limit is expressed as a ratio of measured power in one non-allocated RB to the measured total power in all allocated RBs.
NOTE 5:	The applicable frequencies for this limit are those that are enclosed in the RBs containing the DC frequency, or in the two RBs immediately adjacent to the DC frequency but excluding any allocated RB.
NOTE 6:	L_{CRB} is the Transmission Bandwidth for kth allocated component carrier (see Figure 5.3.1-1).
NOTE 7:	EVM is the limit for the modulation format used in the allocated RBs.
NOTE 8:	Δ_{RB} is the starting frequency offset between the allocated RB and the measured non-allocated RB (e.g. $\Delta_{RB} = 1$ or $\Delta_{RB} = -1$ for the first adjacent RB outside of the allocated bandwidth), and may take non-integer values when the carrier spacing between the CCs is not a multiple of RB.
NOTE 9:	P_{RB} is the transmitted power per allocated RB, measured in dBm.
NOTE 10:	All powers are EIRP in beam peak direction.

6.4A.2.3.3 In-band emissions for CA (4UL CA)

Editor's note: This clause is incomplete. The following aspects are either missing or not yet determined:

- The test procedure is incomplete due to that power window for CA is TBD
- Measurement Uncertainty and Test Tolerance are FFS.
- Testing of the general in-band emission requirement and if yes at which UE Tx power level and with which relaxation applied to the requirement is FFS.
- TP analysis is FFS

6.4A.2.3.3.1 Test purpose

The in-band emissions are a measure of the interference falling into the non-allocated resources blocks.

The purpose of this test is to exercise the UE transmitter to verify its modulation quality in terms of in-band emissions.

6.4A.2.3.3.2 Test applicability

This test case applies to all types of NR UE release 15 and forward that supports FR2 4UL CA.

6.4A.2.3.3.3 Minimum conformance requirements

The minimum conformance requirements are defined in clause 6.4A.2.3.0.

6.4A.2.3.3.4 Test description

Same as in clause 6.4A.2.3.1.4 with following exceptions:

- Instead of Table 6.4A.2.3.1.4.1-1 → use Table 6.4A.2.3.3.4-1.

Table 6.4A.2.3.3.4-1: Test Configuration Table for 4UL CA

Default Conditions	
Test Environment as specified in TS 38.508-1 [10] clause 4.1	Normal
Test Frequencies as specified in TS 38.508-1 [10] clause 4.3.1.2.3 for different CA bandwidth classes.	Low and High range

Test CC combination setting as specified in TS 38.508-1 [10] clause 4.3.1.2.3 for the CA Configuration across bandwidth combination sets supported by the UE.			Lowest aggregated BW of the CA configuration Highest aggregated BW of the CA configuration		
Test SCS as specified in Table 5.3.5-1.			Lowest		
Test Parameters					
CA Configuration / Aggregated BW			Downlink Configuration	Uplink Configuration	
Test ID	CC & Mapping	ChBw(MHz)	RB allocation	Modulation	RB allocation (NOTE 1)
1	PCC	Default	-	DFT-s-OFDM PI/2 BPSK	Inner_Partial_Left for PC2, PC3, PC4 Inner_Partial_Left_Region2 for PC1
	SCC1			-	-
	SCC2			-	-
	SCC3			-	-
2	PCC			DFT-s-OFDM PI/2 BPSK	Inner_Partial_Right for PC2, PC3, PC4 Inner_Partial_Right_Region2 for PC1
	SCC1			-	-
	SCC2			-	-
	SCC3			-	-
3	PCC			CP-OFDM QPSK	Inner_Partial_Left for PC2, PC3, PC4 Inner_Partial_Left_Region2 for PC1
	SCC1			-	-
	SCC2			-	-
	SCC3			-	-
4	PCC			CP-OFDM QPSK	Inner_Partial_Right for PC2, PC3, PC4 Inner_Partial_Right_Region2 for PC1
	SCC1			-	-
	SCC2			-	-
	SCC3			-	-
NOTE 1: The specific configuration of each RB allocation is defined in Table 6.1-1 for PC2, PC3 and PC4 or Table 6.1-2 for PC1.					
NOTE 2: CA Configuration Test cumulative aggregated BW settings are checked separately for each CA Configuration, which applicable aggregated channel bandwidths are specified in Table 5.5A.1-1.					
NOTE 3: Number of DL CCs shall be configured the same as number of UL CCs. The requirements are applicable as per 5.3A.4: "The requirements are applicable only when Uplink CCs are configured within the frequency range between lower edge of lowest downlink component carrier and upper edge of highest downlink component carrier".					

6.4A.2.3.3.5 Test requirement

For power ID1 and ID2, the averaged in-band emissions result, derived in Annex E.4.3 shall not exceed the corresponding values for IQ Image and Carrier Leakage in Table 6.4A.2.3.3.5-1 for power class 1 UEs.

Table 6.4A.2.3.3.5-1: Test Requirements for in-band emissions for power class 1

Parameter description	Unit	Limit (NOTE 1)		Applicable Frequencies
General	dB	$\max \left[\begin{array}{l} -25 - 10 \cdot \log_{10} \left(\frac{N_{RB}}{L_{CRB}} \right), \\ 20 \cdot \log_{10}(\text{EVM}) - 5 \cdot \frac{(\Delta_{RB} - 1)}{L_{CRB}}, \\ -55.1 \text{ dBm} - P_{RB} \end{array} \right] + \text{TT}$		Any non-allocated RB in allocated component carrier and not allocated component carriers (NOTE 2)
IQ Image	dB	-25+TT	Output power > 27 dBm	Image frequencies

		-20+TT	Output power ≤ 27 dBm	(NOTES 2, 3)
Carrier leakage	dBc	-25+TT	Output power > 17 dBm	Carrier frequency (NOTES 4, 5)
		-20+TT	4 dBm ≤ Output power ≤ 17 dBm	
NOTE 1: An in-band emissions combined limit is evaluated in each non-allocated RB. For each such RB, the minimum requirement is calculated as the higher of ($P_{RB} - 25$ dB) and the power sum of all limit values (General, IQ Image or Carrier leakage) that apply. P_{RB} is defined in NOTE 9.				
NOTE 2: The measurement bandwidth is 1 RB and the limit is expressed as a ratio of measured power in one non-allocated RB to the measured average power per allocated RB, where the averaging is done across all allocated RBs. For Pi/2 BPSK with Spectrum Shaping, the limit is expressed as a ratio of measured power in one non-allocated RB to the measured power in the allocated RB with highest PSD.				
NOTE 3: Image frequencies for UL CA are specified in relation to either UL or DL carrier frequency.				
NOTE 4: The measurement bandwidth is 1 RB and the limit is expressed as a ratio of measured power in one non-allocated RB to the measured total power in all allocated RBs.				
NOTE 5: The applicable frequencies for this limit are those that are enclosed in the RBs containing the DC frequency, or in the two RBs immediately adjacent to the DC frequency but excluding any allocated RB.				
NOTE 6: L_{CRB} is the Transmission Bandwidth for kth allocated component carrier (see Figure 5.3.1-1).				
NOTE 7: EVM is the limit for the modulation format used in the allocated RBs.				
NOTE 8: Δ_{RB} is the starting frequency offset between the allocated RB and the measured non-allocated RB (e.g. $\Delta_{RB} = 1$ or $\Delta_{RB} = -1$ for the first adjacent RB outside of the allocated bandwidth), and may take non-integer values when the carrier spacing between the CCs is not a multiple of RB.				
NOTE 9: P_{RB} is the transmitted power per allocated RB, measured in dBm.				
NOTE 10: All powers are EIRP in beam peak direction.				

For power ID1 and ID2, the averaged in-band emissions result, derived in Annex E.4.3 shall not exceed the corresponding values for IQ Image and Carrier Leakage in Table 6.4A.2.3.3.5-2 for power class 2 UEs.

Table 6.4A.2.3.3.5-2: Test Requirements for in-band emissions for power class 2

Parameter description	Unit	Limit (NOTE 1)		Applicable Frequencies
General	dB	$\max \left[\begin{array}{l} -25 - 10 \cdot \log_{10} \left(\frac{N_{RB}}{L_{CRB}} \right), \\ 20 \cdot \log_{10} (\text{EVM}) - 5 \cdot \frac{(\Delta_{RB} - 1)}{L_{CRB}}, \\ -55.1 \text{ dBm} - P_{RB} \end{array} \right] + \text{TT}$		Any non-allocated RB in allocated component carrier and not allocated component carriers (NOTE 2)
IQ Image	dB	-25+TT	Output power > 16 dBm	Image frequencies (NOTES 2, 3)
		-20+TT	Output power ≤ 16 dBm	
Carrier leakage	dBc	-25+TT	Output power > 6 dBm	Carrier frequency (NOTES 4, 5)
		-20+TT	-13 dBm ≤ Output power ≤ 6 dBm	
NOTE 1: An in-band emissions combined limit is evaluated in each non-allocated RB. For each such RB, the minimum requirement is calculated as the higher of ($P_{RB} - 25$ dB) and the power sum of all limit values (General, IQ Image or Carrier leakage) that apply. P_{RB} is defined in NOTE 9.				
NOTE 2: The measurement bandwidth is 1 RB and the limit is expressed as a ratio of measured power in one non-allocated RB to the measured average power per allocated RB, where the averaging is done across all allocated RBs. For Pi/2 BPSK with Spectrum Shaping, the limit is expressed as a ratio of measured power in one non-allocated RB to the measured power in the allocated RB with highest PSD.				
NOTE 3: Image frequencies for UL CA are specified in relation to either UL or DL carrier frequency.				
NOTE 4: The measurement bandwidth is 1 RB and the limit is expressed as a ratio of measured power in one non-allocated RB to the measured total power in all allocated RBs.				
NOTE 5: The applicable frequencies for this limit are those that are enclosed in the RBs containing the DC frequency, or in the two RBs immediately adjacent to the DC frequency but excluding any allocated RB.				
NOTE 6: L_{CRB} is the Transmission Bandwidth for kth allocated component carrier (see Figure 5.3.1-1).				
NOTE 7: EVM is the limit for the modulation format used in the allocated RBs.				
NOTE 8: Δ_{RB} is the starting frequency offset between the allocated RB and the measured non-allocated RB (e.g. $\Delta_{RB} = 1$ or $\Delta_{RB} = -1$ for the first adjacent RB outside of the allocated bandwidth), and may take non-integer values when the carrier spacing between the CCs is not a multiple of RB.				
NOTE 9: P_{RB} is the transmitted power per allocated RB, measured in dBm.				
NOTE 10: All powers are EIRP in beam peak direction.				

For power ID1 and ID2, the averaged in-band emissions result, derived in Annex E.4.3 shall not exceed the corresponding values for IQ Image and Carrier Leakage in Table 6.4A.2.3.3.5-3 for power class 3 UEs.

Table 6.4A.2.3.3.5-3: Test Requirements for in-band emissions for power class 3

Parameter description	Unit	Limit (NOTE 1)	Applicable Frequencies
General	dB	$\max \left[\begin{array}{l} -25 - 10 \cdot \log_{10} \left(\frac{N_{RB}}{L_{CRB}} \right), \\ 20 \cdot \log_{10}(\text{EVM}) - 5 \cdot \frac{(\Delta_{RB} - 1)}{L_{CRB}}, \\ -55.1 \text{ dBm} - P_{RB} \end{array} \right] + \text{TT}$	Any non-allocated RB in allocated component carrier and not allocated component carriers (NOTE 2)
IQ Image	dB	-25+TT	Output power > 10 dBm
		-20+TT	Output power ≤ 10 dBm
Carrier leakage	dBc	-25+TT	Output power > 0 dBm
		-20+TT	-13 dBm ≤ Output power ≤ 0 dBm
<p>NOTE 1: An in-band emissions combined limit is evaluated in each non-allocated RB. For each such RB, the minimum requirement is calculated as the higher of ($P_{RB} - 25$ dB) and the power sum of all limit values (General, IQ Image or Carrier leakage) that apply. P_{RB} is defined in NOTE 9.</p> <p>NOTE 2: The measurement bandwidth is 1 RB and the limit is expressed as a ratio of measured power in one non-allocated RB to the measured average power per allocated RB, where the averaging is done across all allocated RBs. For Pi/2 BPSK with Spectrum Shaping, the limit is expressed as a ratio of measured power in one non-allocated RB to the measured power in the allocated RB with highest PSD.</p> <p>NOTE 3: Image frequencies for UL CA are specified in relation to either UL or DL carrier frequency.</p> <p>NOTE 4: The measurement bandwidth is 1 RB and the limit is expressed as a ratio of measured power in one non-allocated RB to the measured total power in all allocated RBs.</p> <p>NOTE 5: The applicable frequencies for this limit are those that are enclosed in the RBs containing the DC frequency, or in the two RBs immediately adjacent to the DC frequency but excluding any allocated RB.</p> <p>NOTE 6: L_{CRB} is the Transmission Bandwidth for kth allocated component carrier (see Figure 5.3.1-1).</p> <p>NOTE 7: EVM is the limit for the modulation format used in the allocated RBs.</p> <p>NOTE 8: Δ_{RB} is the starting frequency offset between the allocated RB and the measured non-allocated RB (e.g. $\Delta_{RB} = 1$ or $\Delta_{RB} = -1$ for the first adjacent RB outside of the allocated bandwidth), and may take non-integer values when the carrier spacing between the CCs is not a multiple of RB.</p> <p>NOTE 9: P_{RB} is the transmitted power per allocated RB, measured in dBm.</p> <p>NOTE 10: All powers are EIRP in beam peak direction.</p>			

For power ID1 and ID2, the averaged in-band emissions result, derived in Annex E.4.3 shall not exceed the corresponding values for IQ Image and Carrier Leakage in Table 6.4A.2.3.3.5-4 for power class 4 UEs.

Table 6.4A.2.3.3.5-4: Test Requirements for in-band emissions for power class 4

Parameter description	Unit	Limit (NOTE 1)	Applicable Frequencies
General	dB	$\max \left[\begin{array}{l} -25 - 10 \cdot \log_{10} \left(\frac{N_{RB}}{L_{CRB}} \right), \\ 20 \cdot \log_{10}(\text{EVM}) - 5 \cdot \frac{(\Delta_{RB} - 1)}{L_{CRB}}, \\ -55.1 \text{ dBm} - P_{RB} \end{array} \right] + \text{TT}$	Any non-allocated RB in allocated component carrier and not allocated component carriers (NOTE 2)
IQ Image	dB	-25+TT	Output power > 21 dBm
		-20+TT	Output power ≤ 21 dBm
Carrier leakage	dBc	-25+TT	Output power > 11 dBm
		-20+TT	-13 dBm ≤ Output power ≤ 11 dBm

NOTE 1:	An in-band emissions combined limit is evaluated in each non-allocated RB. For each such RB, the minimum requirement is calculated as the higher of ($P_{RB} - 25$ dB) and the power sum of all limit values (General, IQ Image or Carrier leakage) that apply. P_{RB} is defined in NOTE 9.
NOTE 2:	The measurement bandwidth is 1 RB and the limit is expressed as a ratio of measured power in one non-allocated RB to the measured average power per allocated RB, where the averaging is done across all allocated RBs. For pi/2 BPSK with Spectrum Shaping, the limit is expressed as a ratio of measured power in one non-allocated RB to the measured power in the allocated RB with highest PSD.
NOTE 3:	Image frequencies for UL CA are specified in relation to either UL or DL carrier frequency.
NOTE 4:	The measurement bandwidth is 1 RB and the limit is expressed as a ratio of measured power in one non-allocated RB to the measured total power in all allocated RBs.
NOTE 5:	The applicable frequencies for this limit are those that are enclosed in the RBs containing the DC frequency, or in the two RBs immediately adjacent to the DC frequency but excluding any allocated RB.
NOTE 6:	L_{CRB} is the Transmission Bandwidth for kth allocated component carrier (see Figure 5.3.1-1).
NOTE 7:	EVM is the limit for the modulation format used in the allocated RBs.
NOTE 8:	Δ_{RB} is the starting frequency offset between the allocated RB and the measured non-allocated RB (e.g. $\Delta_{RB} = 1$ or $\Delta_{RB} = -1$ for the first adjacent RB outside of the allocated bandwidth), and may take non-integer values when the carrier spacing between the CCs is not a multiple of RB.
NOTE 9:	P_{RB} is the transmitted power per allocated RB, measured in dBm.
NOTE 10:	All powers are EIRP in beam peak direction.

6.4A.2.3.4 In-band emissions for CA (5UL CA)

Editor's note: This clause is incomplete. The following aspects are either missing or not yet determined:

- The test procedure is incomplete due to that power window for CA is TBD
- Measurement Uncertainty and Test Tolerance are FFS.
- Testing of the general in-band emission requirement and if yes at which UE Tx power level and with which relaxation applied to the requirement is FFS.
- TP analysis is FFS

6.4A.2.3.4.1 Test purpose

The in-band emissions are a measure of the interference falling into the non-allocated resources blocks.

The purpose of this test is to exercise the UE transmitter to verify its modulation quality in terms of in-band emissions.

6.4A.2.3.4.2 Test applicability

This test case applies to all types of NR UE release 15 and forward that supports FR2 5UL CA.

6.4A.2.3.4.3 Minimum conformance requirements

The minimum conformance requirements are defined in clause 6.4A.2.3.0.

6.4A.2.3.4.4 Test description

Same as in clause 6.4A.2.3.1.4 with following exceptions:

- Instead of Table 6.4A.2.3.1.4.1-1 → use Table 6.4A.2.3.4.4-1.

Table 6.4A.2.3.4.4-1: Test Configuration Table for 5UL CA

Default Conditions	
Test Environment as specified in TS 38.508-1 [10] clause 4.1	Normal
Test Frequencies as specified in TS 38.508-1 [10] clause 4.3.1.2.3 for different CA bandwidth classes.	Low and High range

Test CC combination setting as specified in TS 38.508-1 [10] clause 4.3.1.2.3 for the CA Configuration across bandwidth combination sets supported by the UE.			Lowest aggregated BW of the CA configuration Highest aggregated BW of the CA configuration		
Test SCS as specified in Table 5.3.5-1.			Lowest		
Test Parameters					
CA Configuration / Aggregated BW			Downlink Configuration	Uplink Configuration	
Test ID	CC & Mapping	ChBw(MHz)	RB allocation	Modulation	RB allocation (NOTE 1)
1	PCC	Default	-	DFT-s-OFDM PI/2 BPSK	Inner_Partial_Left for PC2, PC3, PC4 Inner_Partial_Left_Region2 for PC1
	SCC1			-	-
	SCC2			-	-
	SCC3			-	-
	SCC4			-	-
2	PCC			DFT-s-OFDM PI/2 BPSK	Inner_Partial_Right for PC2, PC3, PC4 Inner_Partial_Right_Region2 for PC1
	SCC1			-	-
	SCC2			-	-
	SCC3			-	-
	SCC4			-	-
3	PCC			CP-OFDM QPSK	Inner_Partial_Left for PC2, PC3, PC4 Inner_Partial_Left_Region2 for PC1
	SCC1			-	-
	SCC2			-	-
	SCC3			-	-
	SCC4			-	-
4	PCC			CP-OFDM QPSK	Inner_Partial_Right for PC2, PC3, PC4 Inner_Partial_Right_Region2 for PC1
	SCC1			-	-
	SCC2			-	-
	SCC3			-	-
	SCC4			-	-
NOTE 1: The specific configuration of each RB allocation is defined in Table 6.1-1 for PC2, PC3 and PC4 or Table 6.1-2 for PC1.					
NOTE 2: CA Configuration Test cumulative aggregated BW settings are checked separately for each CA Configuration, which applicable aggregated channel bandwidths are specified in Table 5.5A.1-1.					
NOTE 3: Number of DL CCs shall be configured the same as number of UL CCs. The requirements are applicable as per 5.3A.4: "The requirements are applicable only when Uplink CCs are configured within the frequency range between lower edge of lowest downlink component carrier and upper edge of highest downlink component carrier".					

6.4A.2.3.4.5 Test requirement

For power ID1 and ID2, the averaged in-band emissions result, derived in Annex E.4.3 shall not exceed the corresponding values for IQ Image and Carrier Leakage in Table 6.4A.2.3.4.5-1 for power class 1 UEs.

Table 6.4A.2.3.4.5-1: Test Requirements for in-band emissions for power class 1

Parameter description	Unit	Limit (NOTE 1)	Applicable Frequencies
-----------------------	------	----------------	------------------------

General	dB	$\max \left[\begin{array}{l} -25 - 10 \cdot \log_{10} \left(\frac{N_{RB}}{L_{CRB}} \right), \\ 20 \cdot \log_{10} (\text{EVM}) - 5 \cdot \frac{(\Delta_{RB} - 1)}{L_{CRB}}, \\ -55.1 \text{ dBm} - P_{RB} \end{array} \right] + \text{TT}$		Any non-allocated RB in allocated component carrier and not allocated component carriers (NOTE 2)
IQ Image	dB	-25+TT	Output power > 27 dBm	Image frequencies (NOTES 2, 3)
		-20+TT	Output power ≤ 27 dBm	
Carrier leakage	dBc	-25+TT	Output power > 17 dBm	Carrier frequency (NOTES 4, 5)
		-20+TT	4 dBm ≤ Output power ≤ 17 dBm	
<p>NOTE 1: An in-band emissions combined limit is evaluated in each non-allocated RB. For each such RB, the minimum requirement is calculated as the higher of ($P_{RB} - 25$ dB) and the power sum of all limit values (General, IQ Image or Carrier leakage) that apply. P_{RB} is defined in NOTE 9.</p> <p>NOTE 2: The measurement bandwidth is 1 RB and the limit is expressed as a ratio of measured power in one non-allocated RB to the measured average power per allocated RB, where the averaging is done across all allocated RBs. For Pi/2 BPSK with Spectrum Shaping, the limit is expressed as a ratio of measured power in one non-allocated RB to the measured power in the allocated RB with highest PSD.</p> <p>NOTE 3: Image frequencies for UL CA are specified in relation to either UL or DL carrier frequency.</p> <p>NOTE 4: The measurement bandwidth is 1 RB and the limit is expressed as a ratio of measured power in one non-allocated RB to the measured total power in all allocated RBs.</p> <p>NOTE 5: The applicable frequencies for this limit are those that are enclosed in the RBs containing the DC frequency, or in the two RBs immediately adjacent to the DC frequency but excluding any allocated RB.</p> <p>NOTE 6: L_{CRB} is the Transmission Bandwidth for kth allocated component carrier (see Figure 5.3.1-1).</p> <p>NOTE 7: EVM is the limit for the modulation format used in the allocated RBs.</p> <p>NOTE 8: Δ_{RB} is the starting frequency offset between the allocated RB and the measured non-allocated RB (e.g. $\Delta_{RB} = 1$ or $\Delta_{RB} = -1$ for the first adjacent RB outside of the allocated bandwidth), and may take non-integer values when the carrier spacing between the CCs is not a multiple of RB.</p> <p>NOTE 9: P_{RB} is the transmitted power per allocated RB, measured in dBm.</p> <p>NOTE 10: All powers are EIRP in beam peak direction.</p>				

For power ID1 and ID2, the averaged in-band emissions result, derived in Annex E.4.3 shall not exceed the corresponding values for IQ Image and Carrier Leakage in Table 6.4A.2.3.4.5-2 for power class 2 UEs.

Table 6.4A.2.3.4.5-2: Test Requirements for in-band emissions for power class 2

Parameter description	Unit	Limit (NOTE 1)		Applicable Frequencies
General	dB	$\max \left[\begin{array}{l} -25 - 10 \cdot \log_{10} \left(\frac{N_{RB}}{L_{CRB}} \right), \\ 20 \cdot \log_{10} (\text{EVM}) - 5 \cdot \frac{(\Delta_{RB} - 1)}{L_{CRB}}, \\ -55.1 \text{ dBm} - P_{RB} \end{array} \right] + \text{TT}$		Any non-allocated RB in allocated component carrier and not allocated component carriers (NOTE 2)
IQ Image	dB	-25+TT	Output power > 16 dBm	Image frequencies (NOTES 2, 3)
		-20+TT	Output power ≤ 16 dBm	
Carrier leakage	dBc	-25+TT	Output power > 6 dBm	Carrier frequency (NOTES 4, 5)
		-20+TT	-13 dBm ≤ Output power ≤ 6 dBm	

NOTE 1: An in-band emissions combined limit is evaluated in each non-allocated RB. For each such RB, the minimum requirement is calculated as the higher of ($P_{RB} - 25$ dB) and the power sum of all limit values (General, IQ Image or Carrier leakage) that apply. P_{RB} is defined in NOTE 9.

NOTE 2: The measurement bandwidth is 1 RB and the limit is expressed as a ratio of measured power in one non-allocated RB to the measured average power per allocated RB, where the averaging is done across all allocated RBs. For Pi/2 BPSK with Spectrum Shaping, the limit is expressed as a ratio of measured power in one non-allocated RB to the measured power in the allocated RB with highest PSD.

NOTE 3: Image frequencies for UL CA are specified in relation to either UL or DL carrier frequency.

NOTE 4: The measurement bandwidth is 1 RB and the limit is expressed as a ratio of measured power in one non-allocated RB to the measured total power in all allocated RBs.

NOTE 5: The applicable frequencies for this limit are those that are enclosed in the RBs containing the DC frequency, or in the two RBs immediately adjacent to the DC frequency but excluding any allocated RB.

NOTE 6: L_{CRB} is the Transmission Bandwidth for kth allocated component carrier (see Figure 5.3.1-1).

NOTE 7: EVM is the limit for the modulation format used in the allocated RBs.

NOTE 8: Δ_{RB} is the starting frequency offset between the allocated RB and the measured non-allocated RB (e.g. $\Delta_{RB} = 1$ or $\Delta_{RB} = -1$ for the first adjacent RB outside of the allocated bandwidth), and may take non-integer values when the carrier spacing between the CCs is not a multiple of RB.

NOTE 9: P_{RB} is the transmitted power per allocated RB, measured in dBm.

NOTE 10: All powers are EIRP in beam peak direction.

For power ID1 and ID2, the averaged in-band emissions result, derived in Annex E.4.3 shall not exceed the corresponding values for IQ Image and Carrier Leakage in Table 6.4A.2.3.4.5-3 for power class 3 UEs.

Table 6.4A.2.3.4.5-3: Test Requirements for in-band emissions for power class 3

Parameter description	Unit	Limit (NOTE 1)		Applicable Frequencies
General	dB	$\max \left[\begin{array}{l} -25 - 10 \cdot \log_{10} \left(\frac{N_{RB}}{L_{CRB}} \right), \\ 20 \cdot \log_{10} (\text{EVM}) - 5 \cdot \frac{(\Delta_{RB} - 1)}{L_{CRB}}, \\ -55.1 \text{ dBm} - P_{RB} \end{array} \right] + \text{TT}$		Any non-allocated RB in allocated component carrier and not allocated component carriers (NOTE 2)
IQ Image	dB	-25+TT	Output power > 10 dBm	Image frequencies (NOTES 2, 3)
		-20+TT	Output power ≤ 10 dBm	
Carrier leakage	dBc	-25+TT	Output power > 0 dBm	Carrier frequency (NOTES 4, 5)
		-20+TT	-13 dBm ≤ Output power ≤ 0 dBm	
<p>NOTE 1: An in-band emissions combined limit is evaluated in each non-allocated RB. For each such RB, the minimum requirement is calculated as the higher of ($P_{RB} - 25$ dB) and the power sum of all limit values (General, IQ Image or Carrier leakage) that apply. P_{RB} is defined in NOTE 9.</p> <p>NOTE 2: The measurement bandwidth is 1 RB and the limit is expressed as a ratio of measured power in one non-allocated RB to the measured average power per allocated RB, where the averaging is done across all allocated RBs. For Pi/2 BPSK with Spectrum Shaping, the limit is expressed as a ratio of measured power in one non-allocated RB to the measured power in the allocated RB with highest PSD.</p> <p>NOTE 3: Image frequencies for UL CA are specified in relation to either UL or DL carrier frequency.</p> <p>NOTE 4: The measurement bandwidth is 1 RB and the limit is expressed as a ratio of measured power in one non-allocated RB to the measured total power in all allocated RBs.</p> <p>NOTE 5: The applicable frequencies for this limit are those that are enclosed in the RBs containing the DC frequency, or in the two RBs immediately adjacent to the DC frequency but excluding any allocated RB.</p> <p>NOTE 6: L_{CRB} is the Transmission Bandwidth for kth allocated component carrier (see Figure 5.3.1-1).</p> <p>NOTE 7: EVM is the limit for the modulation format used in the allocated RBs.</p> <p>NOTE 8: Δ_{RB} is the starting frequency offset between the allocated RB and the measured non-allocated RB (e.g. $\Delta_{RB} = 1$ or $\Delta_{RB} = -1$ for the first adjacent RB outside of the allocated bandwidth), and may take non-integer values when the carrier spacing between the CCs is not a multiple of RB.</p> <p>NOTE 9: P_{RB} is the transmitted power per allocated RB, measured in dBm.</p> <p>NOTE 10: All powers are EIRP in beam peak direction.</p>				

For power ID1 and ID2, the averaged in-band emissions result, derived in Annex E.4.3 shall not exceed the corresponding values for IQ Image and Carrier Leakage in Table 6.4A.2.3.4.5-4 for power class 4 UEs.

Table 6.4A.2.3.4.5-4: Test Requirements for in-band emissions for power class 4

Parameter description	Unit	Limit (NOTE 1)	Applicable Frequencies	
General	dB	$\max \left[\begin{array}{l} -25 - 10 \cdot \log_{10} \left(\frac{N_{RB}}{L_{CRB}} \right), \\ 20 \cdot \log_{10} (\text{EVM}) - 5 \cdot \frac{(\Delta_{RB} - 1)}{L_{CRB}}, \\ -55.1 \text{ dBm} - P_{RB} \end{array} \right] + \text{TT}$	Any non-allocated RB in allocated component carrier and not allocated component carriers (NOTE 2)	
IQ Image	dB	-25+TT	Output power > 21 dBm	Image frequencies (NOTES 2, 3)
		-20+TT	Output power ≤ 21 dBm	
Carrier leakage	dBc	-25+TT	Output power > 11 dBm	Carrier frequency (NOTES 4, 5)
		-20+TT	-13 dBm ≤ Output power ≤ 11 dBm	
<p>NOTE 1: An in-band emissions combined limit is evaluated in each non-allocated RB. For each such RB, the minimum requirement is calculated as the higher of ($P_{RB} - 25$ dB) and the power sum of all limit values (General, IQ Image or Carrier leakage) that apply. P_{RB} is defined in NOTE 9.</p> <p>NOTE 2: The measurement bandwidth is 1 RB and the limit is expressed as a ratio of measured power in one non-allocated RB to the measured average power per allocated RB, where the averaging is done across all allocated RBs. For pi/2 BPSK with Spectrum Shaping, the limit is expressed as a ratio of measured power in one non-allocated RB to the measured power in the allocated RB with highest PSD.</p> <p>NOTE 3: Image frequencies for UL CA are specified in relation to either UL or DL carrier frequency.</p> <p>NOTE 4: The measurement bandwidth is 1 RB and the limit is expressed as a ratio of measured power in one non-allocated RB to the measured total power in all allocated RBs.</p> <p>NOTE 5: The applicable frequencies for this limit are those that are enclosed in the RBs containing the DC frequency, or in the two RBs immediately adjacent to the DC frequency but excluding any allocated RB.</p> <p>NOTE 6: L_{CRB} is the Transmission Bandwidth for kth allocated component carrier (see Figure 5.3.1-1).</p> <p>NOTE 7: EVM is the limit for the modulation format used in the allocated RBs.</p> <p>NOTE 8: Δ_{RB} is the starting frequency offset between the allocated RB and the measured non-allocated RB (e.g. $\Delta_{RB} = 1$ or $\Delta_{RB} = -1$ for the first adjacent RB outside of the allocated bandwidth), and may take non-integer values when the carrier spacing between the CCs is not a multiple of RB.</p> <p>NOTE 9: P_{RB} is the transmitted power per allocated RB, measured in dBm.</p> <p>NOTE 10: All powers are EIRP in beam peak direction.</p>				

6.4A.2.3.5 In-band emissions for CA (6UL CA)

Editor's note: This clause is incomplete. The following aspects are either missing or not yet determined:

- *The test procedure is incomplete due to that power window for CA is TBD*
- *Measurement Uncertainty and Test Tolerance are FFS.*
- *Testing of the general in-band emission requirement and if yes at which UE Tx power level and with which relaxation applied to the requirement is FFS.*
- *TP analysis is FFS*

6.4A.2.3.5.1 Test purpose

The in-band emissions are a measure of the interference falling into the non-allocated resources blocks.

The purpose of this test is to exercise the UE transmitter to verify its modulation quality in terms of in-band emissions.

6.4A.2.3.5.2 Test applicability

This test case applies to all types of NR UE release 15 and forward that supports FR2 6UL CA.

6.4A.2.3.5.3 Minimum conformance requirements

The minimum conformance requirements are defined in clause 6.4A.2.3.0.

6.4A.2.3.5.4 Test description

Same as in clause 6.4A.2.3.1.4 with following exceptions:

- Instead of Table 6.4A.2.3.1.4.1-1 → use Table 6.4A.2.3.5.4-1.

Table 6.4A.2.3.5.4-1: Test Configuration Table for 6UL CA

Default Conditions					
Test Environment as specified in TS 38.508-1 [10] clause 4.1			Normal		
Test Frequencies as specified in TS 38.508-1 [10] clause 4.3.1.2.3 for different CA bandwidth classes.			Low and High range		
Test CC combination setting as specified in TS 38.508-1 [10] clause 4.3.1.2.3 for the CA Configuration across bandwidth combination sets supported by the UE.			Lowest aggregated BW of the CA configuration Highest aggregated BW of the CA configuration		
Test SCS as specified in Table 5.3.5-1.			Lowest		
Test Parameters					
CA Configuration / Aggregated BW			Downlink Configuration	Uplink Configuration	
Test ID	CC & Mapping	ChBw(MHz)	RB allocation	Modulation	RB allocation (NOTE 1)
1	PCC	Default	-	DFT-s-OFDM PI/2 BPSK	Inner_Partial_Left for PC2, PC3, PC4 Inner_Partial_Left_Region2 for PC1
	SCC1			-	-
	SCC2			-	-
	SCC3			-	-
	SCC4			-	-
	SCC5			-	-
2	PCC			DFT-s-OFDM PI/2 BPSK	Inner_Partial_Right for PC2, PC3, PC4 Inner_Partial_Right_Region2 for PC1
	SCC1			-	-
	SCC2			-	-
	SCC3			-	-
	SCC4			-	-
	SCC5			-	-
3	PCC			CP-OFDM QPSK	Inner_Partial_Left for PC2, PC3, PC4 Inner_Partial_Left_Region2 for PC1
	SCC1			-	-
	SCC2			-	-
	SCC3			-	-
	SCC4			-	-
	SCC5			-	-
4	PCC			CP-OFDM QPSK	Inner_Partial_Right for PC2, PC3, PC4 Inner_Partial_Right_Region2 for PC1
	SCC1			-	-
	SCC2			-	-
	SCC3			-	-
	SCC4			-	-
	SCC5			-	-

NOTE 1: The specific configuration of each RB allocation is defined in Table 6.1-1 for PC2, PC3 and PC4 or Table 6.1-2 for PC1.

NOTE 2: CA Configuration Test cumulative aggregated BW settings are checked separately for each CA Configuration, which applicable aggregated channel bandwidths are specified in Table 5.5A.1-1.

NOTE 3: Number of DL CCs shall be configured the same as number of UL CCs. The requirements are applicable as per 5.3A.4: "The requirements are applicable only when Uplink CCs are configured within the frequency range between lower edge of lowest downlink component carrier and upper edge of highest downlink component carrier".

6.4A.2.3.5.5 Test requirement

For power ID1 and ID2, the averaged in-band emissions result, derived in Annex E.4.3 shall not exceed the corresponding values for IQ Image and Carrier Leakage in Table 6.4A.2.3.5.5-1 for power class 1 UEs.

Table 6.4A.2.3.5.5-1: Test Requirements for in-band emissions for power class 1

Parameter description	Unit	Limit (NOTE 1)	Applicable Frequencies
General	dB	$\max \left[\begin{array}{l} -25 - 10 \cdot \log_{10} \left(\frac{N_{RB}}{L_{CRB}} \right), \\ 20 \cdot \log_{10} (\text{EVM}) - 5 \cdot \frac{(\Delta_{RB} - 1)}{L_{CRB}}, \\ -55.1 \text{ dBm} - P_{RB} \end{array} \right] + \text{TT}$	Any non-allocated RB in allocated component carrier and not allocated component carriers (NOTE 2)
IQ Image	dB	-25+TT	Image frequencies (NOTES 2, 3)
		-20+TT	
Carrier leakage	dBc	-25+TT	Carrier frequency (NOTES 4, 5)
		-20+TT	
<p>NOTE 1: An in-band emissions combined limit is evaluated in each non-allocated RB. For each such RB, the minimum requirement is calculated as the higher of ($P_{RB} - 25$ dB) and the power sum of all limit values (General, IQ Image or Carrier leakage) that apply. P_{RB} is defined in NOTE 9.</p> <p>NOTE 2: The measurement bandwidth is 1 RB and the limit is expressed as a ratio of measured power in one non-allocated RB to the measured average power per allocated RB, where the averaging is done across all allocated RBs. For Pi/2 BPSK with Spectrum Shaping, the limit is expressed as a ratio of measured power in one non-allocated RB to the measured power in the allocated RB with highest PSD.</p> <p>NOTE 3: Image frequencies for UL CA are specified in relation to either UL or DL carrier frequency.</p> <p>NOTE 4: The measurement bandwidth is 1 RB and the limit is expressed as a ratio of measured power in one non-allocated RB to the measured total power in all allocated RBs.</p> <p>NOTE 5: The applicable frequencies for this limit are those that are enclosed in the RBs containing the DC frequency, or in the two RBs immediately adjacent to the DC frequency but excluding any allocated RB.</p> <p>NOTE 6: L_{CRB} is the Transmission Bandwidth for kth allocated component carrier (see Figure 5.3.1-1).</p> <p>NOTE 7: EVM is the limit for the modulation format used in the allocated RBs.</p> <p>NOTE 8: Δ_{RB} is the starting frequency offset between the allocated RB and the measured non-allocated RB (e.g. $\Delta_{RB} = 1$ or $\Delta_{RB} = -1$ for the first adjacent RB outside of the allocated bandwidth), and may take non-integer values when the carrier spacing between the CCs is not a multiple of RB.</p> <p>NOTE 9: P_{RB} is the transmitted power per allocated RB, measured in dBm.</p> <p>NOTE 10: All powers are EIRP in beam peak direction.</p>			

For power ID1 and ID2, the averaged in-band emissions result, derived in Annex E.4.3 shall not exceed the corresponding values for IQ Image and Carrier Leakage in Table 6.4A.2.3.5.5-2 for power class 2 UEs.

Table 6.4A.2.3.5.5-2: Test Requirements for in-band emissions for power class 2

Parameter description	Unit	Limit (NOTE 1)	Applicable Frequencies
-----------------------	------	----------------	------------------------

General	dB	$\max \left[\begin{array}{l} -25 - 10 \cdot \log_{10} \left(\frac{N_{RB}}{L_{CRB}} \right), \\ 20 \cdot \log_{10} (\text{EVM}) - 5 \cdot \frac{(\Delta_{RB} - 1)}{L_{CRB}}, \\ -55.1 \text{ dBm} - P_{RB} \end{array} \right] + \text{TT}$		Any non-allocated RB in allocated component carrier and not allocated component carriers (NOTE 2)
IQ Image	dB	-25+TT	Output power > 16 dBm	Image frequencies (NOTES 2, 3)
		-20+TT	Output power ≤ 16 dBm	
Carrier leakage	dBc	-25+TT	Output power > 6 dBm	Carrier frequency (NOTES 4, 5)
		-20+TT	-13 dBm ≤ Output power ≤ 6 dBm	
<p>NOTE 1: An in-band emissions combined limit is evaluated in each non-allocated RB. For each such RB, the minimum requirement is calculated as the higher of ($P_{RB} - 25$ dB) and the power sum of all limit values (General, IQ Image or Carrier leakage) that apply. P_{RB} is defined in NOTE 9.</p> <p>NOTE 2: The measurement bandwidth is 1 RB and the limit is expressed as a ratio of measured power in one non-allocated RB to the measured average power per allocated RB, where the averaging is done across all allocated RBs. For Pi/2 BPSK with Spectrum Shaping, the limit is expressed as a ratio of measured power in one non-allocated RB to the measured power in the allocated RB with highest PSD.</p> <p>NOTE 3: Image frequencies for UL CA are specified in relation to either UL or DL carrier frequency.</p> <p>NOTE 4: The measurement bandwidth is 1 RB and the limit is expressed as a ratio of measured power in one non-allocated RB to the measured total power in all allocated RBs.</p> <p>NOTE 5: The applicable frequencies for this limit are those that are enclosed in the RBs containing the DC frequency, or in the two RBs immediately adjacent to the DC frequency but excluding any allocated RB.</p> <p>NOTE 6: L_{CRB} is the Transmission Bandwidth for kth allocated component carrier (see Figure 5.3.1-1).</p> <p>NOTE 7: EVM is the limit for the modulation format used in the allocated RBs.</p> <p>NOTE 8: Δ_{RB} is the starting frequency offset between the allocated RB and the measured non-allocated RB (e.g. $\Delta_{RB} = 1$ or $\Delta_{RB} = -1$ for the first adjacent RB outside of the allocated bandwidth), and may take non-integer values when the carrier spacing between the CCs is not a multiple of RB.</p> <p>NOTE 9: P_{RB} is the transmitted power per allocated RB, measured in dBm.</p> <p>NOTE 10: All powers are EIRP in beam peak direction.</p>				

For power ID1 and ID2, the averaged in-band emissions result, derived in Annex E.4.3 shall not exceed the corresponding values for IQ Image and Carrier Leakage in Table 6.4A.2.3.5.5-3 for power class 3 UEs.

Table 6.4A.2.3.5.5-3: Test Requirements for in-band emissions for power class 3

Parameter description	Unit	Limit (NOTE 1)		Applicable Frequencies
General	dB	$\max \left[\begin{array}{l} -25 - 10 \cdot \log_{10} \left(\frac{N_{RB}}{L_{CRB}} \right), \\ 20 \cdot \log_{10} (\text{EVM}) - 5 \cdot \frac{(\Delta_{RB} - 1)}{L_{CRB}}, \\ -55.1 \text{ dBm} - P_{RB} \end{array} \right] + \text{TT}$		Any non-allocated RB in allocated component carrier and not allocated component carriers (NOTE 2)
IQ Image	dB	-25+TT	Output power > 10 dBm	Image frequencies (NOTES 2, 3)
		-20+TT	Output power ≤ 10 dBm	
Carrier leakage	dBc	-25+TT	Output power > 0 dBm	Carrier frequency (NOTES 4, 5)
		-20+TT	-13 dBm ≤ Output power ≤ 0 dBm	

- NOTE 1: An in-band emissions combined limit is evaluated in each non-allocated RB. For each such RB, the minimum requirement is calculated as the higher of ($P_{RB} - 25$ dB) and the power sum of all limit values (General, IQ Image or Carrier leakage) that apply. P_{RB} is defined in NOTE 9.
- NOTE 2: The measurement bandwidth is 1 RB and the limit is expressed as a ratio of measured power in one non-allocated RB to the measured average power per allocated RB, where the averaging is done across all allocated RBs. For Pi/2 BPSK with Spectrum Shaping, the limit is expressed as a ratio of measured power in one non-allocated RB to the measured power in the allocated RB with highest PSD.
- NOTE 3: Image frequencies for UL CA are specified in relation to either UL or DL carrier frequency.
- NOTE 4: The measurement bandwidth is 1 RB and the limit is expressed as a ratio of measured power in one non-allocated RB to the measured total power in all allocated RBs.
- NOTE 5: The applicable frequencies for this limit are those that are enclosed in the RBs containing the DC frequency, or in the two RBs immediately adjacent to the DC frequency but excluding any allocated RB.
- NOTE 6: L_{CRB} is the Transmission Bandwidth for kth allocated component carrier (see Figure 5.3.1-1).
- NOTE 7: EVM is the limit for the modulation format used in the allocated RBs.
- NOTE 8: Δ_{RB} is the starting frequency offset between the allocated RB and the measured non-allocated RB (e.g. $\Delta_{RB} = 1$ or $\Delta_{RB} = -1$ for the first adjacent RB outside of the allocated bandwidth), and may take non-integer values when the carrier spacing between the CCs is not a multiple of RB.
- NOTE 9: P_{RB} is the transmitted power per allocated RB, measured in dBm.
- NOTE 10: All powers are EIRP in beam peak direction.

For power ID1 and ID2, the averaged in-band emissions result, derived in Annex E.4.3 shall not exceed the corresponding values for IQ Image and Carrier Leakage in Table 6.4A.2.3.5.5-4 for power class 4 UEs.

Table 6.4A.2.3.5.5-4: Test Requirements for in-band emissions for power class 4

Parameter description	Unit	Limit (NOTE 1)		Applicable Frequencies
General	dB	$\max \left[\begin{array}{l} -25 - 10 \cdot \log_{10} \left(\frac{N_{RB}}{L_{CRB}} \right), \\ 20 \cdot \log_{10} (\text{EVM}) - 5 \cdot \frac{(\Delta_{RB} - 1)}{L_{CRB}}, \\ -55.1 \text{ dBm} - P_{RB} \end{array} \right] + \text{TT}$		Any non-allocated RB in allocated component carrier and not allocated component carriers (NOTE 2)
IQ Image	dB	-25+TT	Output power > 21 dBm	Image frequencies (NOTES 2, 3)
		-20+TT	Output power ≤ 21 dBm	
Carrier leakage	dBc	-25+TT	Output power > 11 dBm	Carrier frequency (NOTES 4, 5)
		-20+TT	-13 dBm ≤ Output power ≤ 11 dBm	
<p>NOTE 1: An in-band emissions combined limit is evaluated in each non-allocated RB. For each such RB, the minimum requirement is calculated as the higher of ($P_{RB} - 25$ dB) and the power sum of all limit values (General, IQ Image or Carrier leakage) that apply. P_{RB} is defined in NOTE 9.</p> <p>NOTE 2: The measurement bandwidth is 1 RB and the limit is expressed as a ratio of measured power in one non-allocated RB to the measured average power per allocated RB, where the averaging is done across all allocated RBs. For pi/2 BPSK with Spectrum Shaping, the limit is expressed as a ratio of measured power in one non-allocated RB to the measured power in the allocated RB with highest PSD.</p> <p>NOTE 3: Image frequencies for UL CA are specified in relation to either UL or DL carrier frequency.</p> <p>NOTE 4: The measurement bandwidth is 1 RB and the limit is expressed as a ratio of measured power in one non-allocated RB to the measured total power in all allocated RBs.</p> <p>NOTE 5: The applicable frequencies for this limit are those that are enclosed in the RBs containing the DC frequency, or in the two RBs immediately adjacent to the DC frequency but excluding any allocated RB.</p> <p>NOTE 6: L_{CRB} is the Transmission Bandwidth for kth allocated component carrier (see Figure 5.3.1-1).</p> <p>NOTE 7: EVM is the limit for the modulation format used in the allocated RBs.</p> <p>NOTE 8: Δ_{RB} is the starting frequency offset between the allocated RB and the measured non-allocated RB (e.g. $\Delta_{RB} = 1$ or $\Delta_{RB} = -1$ for the first adjacent RB outside of the allocated bandwidth), and may take non-integer values when the carrier spacing between the CCs is not a multiple of RB.</p> <p>NOTE 9: P_{RB} is the transmitted power per allocated RB, measured in dBm.</p> <p>NOTE 10: All powers are EIRP in beam peak direction.</p>				

6.4A.2.3.6 In-band emissions for CA (7UL CA)

Editor's note: This clause is incomplete. The following aspects are either missing or not yet determined:

- The test procedure is incomplete due to that power window for CA is TBD
- Measurement Uncertainty and Test Tolerance are FFS.
- Testing of the general in-band emission requirement and if yes at which UE Tx power level and with which relaxation applied to the requirement is FFS.
- TP analysis is FFS

6.4A.2.3.6.1 Test purpose

The in-band emissions are a measure of the interference falling into the non-allocated resources blocks.

The purpose of this test is to exercise the UE transmitter to verify its modulation quality in terms of in-band emissions.

6.4A.2.3.6.2 Test applicability

This test case applies to all types of NR UE release 15 and forward that supports FR2 7UL CA.

6.4A.2.3.6.3 Minimum conformance requirements

The minimum conformance requirements are defined in clause 6.4A.2.3.0.

6.4A.2.3.6.4 Test description

Same as in clause 6.4A.2.3.1.4 with following exceptions:

- Instead of Table 6.4A.2.3.1.4.1-1 → use Table 6.4A.2.3.6.4-1.

Table 6.4A.2.3.6.4-1: Test Configuration Table for 7UL CA

Default Conditions					
Test Environment as specified in TS 38.508-1 [10] clause 4.1			Normal		
Test Frequencies as specified in TS 38.508-1 [10] clause 4.3.1.2.3 for different CA bandwidth classes.			Low and High range		
Test CC combination setting as specified in TS 38.508-1 [10] clause 4.3.1.2.3 for the CA Configuration across bandwidth combination sets supported by the UE.			Lowest aggregated BW of the CA configuration Highest aggregated BW of the CA configuration		
Test SCS as specified in Table 5.3.5-1.			Lowest		
Test Parameters					
CA Configuration / Aggregated BW			Downlink Configuration	Uplink Configuration	
Test ID	CC & Mapping	ChBw(MHz)	RB allocation	Modulation	RB allocation (NOTE 1)
1	PCC	Default	-	DFT-s-OFDM PI/2 BPSK	Inner_Partial_Left for PC2, PC3, PC4 Inner_Partial_Left_Region2 for PC1
	SCC1			-	-
	SCC2			-	-
	SCC3			-	-
	SCC4			-	-
	SCC5			-	-
2	PCC	Default	-	DFT-s-OFDM PI/2 BPSK	Inner_Partial_Right for PC2, PC3, PC4 Inner_Partial_Right_Region2 for PC1
	SCC1			-	-

	SCC2			-	-
	SCC3			-	-
	SCC4			-	-
	SCC5			-	-
	SCC6			-	-
	3	PCC			CP-OFDM QPSK
	SCC1			-	-
	SCC2			-	-
	SCC3			-	-
	SCC4			-	-
	SCC5			-	-
	SCC6			-	-
4	PCC			CP-OFDM QPSK	Inner_Partial_Right for PC2, PC3, PC4 Inner_Partial_Right_Region2 for PC1
	SCC1			-	-
	SCC2			-	-
	SCC3			-	-
	SCC4			-	-
	SCC5			-	-
	SCC6			-	-
<p>NOTE 1: The specific configuration of each RB allocation is defined in Table 6.1-1 for PC2, PC3 and PC4 or Table 6.1-2 for PC1.</p> <p>NOTE 2: CA Configuration Test cumulative aggregated BW settings are checked separately for each CA Configuration, which applicable aggregated channel bandwidths are specified in Table 5.5A.1-1.</p> <p>NOTE 3: Number of DL CCs shall be configured the same as number of UL CCs. The requirements are applicable as per 5.3A.4: "The requirements are applicable only when Uplink CCs are configured within the frequency range between lower edge of lowest downlink component carrier and upper edge of highest downlink component carrier".</p>					

6.4A.2.3.6.5 Test requirement

For power ID1 and ID2, the averaged in-band emissions result, derived in Annex E.4.3 shall not exceed the corresponding values for IQ Image and Carrier Leakage in Table 6.4A.2.3.6.5-1 for power class 1 UEs.

Table 6.4A.2.3.6.5-1: Test Requirements for in-band emissions for power class 1

Parameter description	Unit	Limit (NOTE 1)		Applicable Frequencies
General	dB	$\max \left[\begin{array}{l} -25 - 10 \cdot \log_{10} \left(\frac{N_{RB}}{L_{CRB}} \right), \\ 20 \cdot \log_{10}(\text{EVM}) - 5 \cdot \frac{(\Delta_{RB} - 1)}{L_{CRB}}, \\ -55.1 \text{ dBm} - P_{RB} \end{array} \right] + \text{TT}$		Any non-allocated RB in allocated component carrier and not allocated component carriers (NOTE 2)
IQ Image	dB	-25+TT	Output power > 27 dBm	Image frequencies (NOTES 2, 3)
		-20+TT	Output power ≤ 27 dBm	
Carrier leakage	dBc	-25+TT	Output power > 17 dBm	Carrier frequency (NOTES 4, 5)
		-20+TT	4 dBm ≤ Output power ≤ 17 dBm	

- NOTE 1: An in-band emissions combined limit is evaluated in each non-allocated RB. For each such RB, the minimum requirement is calculated as the higher of ($P_{RB} - 25$ dB) and the power sum of all limit values (General, IQ Image or Carrier leakage) that apply. P_{RB} is defined in NOTE 9.
- NOTE 2: The measurement bandwidth is 1 RB and the limit is expressed as a ratio of measured power in one non-allocated RB to the measured average power per allocated RB, where the averaging is done across all allocated RBs. For Pi/2 BPSK with Spectrum Shaping, the limit is expressed as a ratio of measured power in one non-allocated RB to the measured power in the allocated RB with highest PSD.
- NOTE 3: Image frequencies for UL CA are specified in relation to either UL or DL carrier frequency.
- NOTE 4: The measurement bandwidth is 1 RB and the limit is expressed as a ratio of measured power in one non-allocated RB to the measured total power in all allocated RBs.
- NOTE 5: The applicable frequencies for this limit are those that are enclosed in the RBs containing the DC frequency, or in the two RBs immediately adjacent to the DC frequency but excluding any allocated RB.
- NOTE 6: L_{CRB} is the Transmission Bandwidth for kth allocated component carrier (see Figure 5.3.1-1).
- NOTE 7: EVM is the limit for the modulation format used in the allocated RBs.
- NOTE 8: Δ_{RB} is the starting frequency offset between the allocated RB and the measured non-allocated RB (e.g. $\Delta_{RB} = 1$ or $\Delta_{RB} = -1$ for the first adjacent RB outside of the allocated bandwidth), and may take non-integer values when the carrier spacing between the CCs is not a multiple of RB.
- NOTE 9: P_{RB} is the transmitted power per allocated RB, measured in dBm.
- NOTE 10: All powers are EIRP in beam peak direction.

For power ID1 and ID2, the averaged in-band emissions result, derived in Annex E.4.3 shall not exceed the corresponding values for IQ Image and Carrier Leakage in Table 6.4A.2.3.6.5-2 for power class 2 UEs.

Table 6.4A.2.3.6.5-2: Test Requirements for in-band emissions for power class 2

Parameter description	Unit	Limit (NOTE 1)		Applicable Frequencies
General	dB	$\max \left[\begin{array}{l} -25 - 10 \cdot \log_{10} \left(\frac{N_{RB}}{L_{CRB}} \right), \\ 20 \cdot \log_{10} (\text{EVM}) - 5 \cdot \frac{(\Delta_{RB} - 1)}{L_{CRB}}, \\ -55.1 \text{ dBm} - P_{RB} \end{array} \right] + \text{TT}$		Any non-allocated RB in allocated component carrier and not allocated component carriers (NOTE 2)
IQ Image	dB	-25+TT	Output power > 16 dBm	Image frequencies (NOTES 2, 3)
		-20+TT	Output power ≤ 16 dBm	
Carrier leakage	dBc	-25+TT	Output power > 6 dBm	Carrier frequency (NOTES 4, 5)
		-20+TT	-13 dBm ≤ Output power ≤ 6 dBm	
<p>NOTE 1: An in-band emissions combined limit is evaluated in each non-allocated RB. For each such RB, the minimum requirement is calculated as the higher of ($P_{RB} - 25$ dB) and the power sum of all limit values (General, IQ Image or Carrier leakage) that apply. P_{RB} is defined in NOTE 9.</p> <p>NOTE 2: The measurement bandwidth is 1 RB and the limit is expressed as a ratio of measured power in one non-allocated RB to the measured average power per allocated RB, where the averaging is done across all allocated RBs. For Pi/2 BPSK with Spectrum Shaping, the limit is expressed as a ratio of measured power in one non-allocated RB to the measured power in the allocated RB with highest PSD.</p> <p>NOTE 3: Image frequencies for UL CA are specified in relation to either UL or DL carrier frequency.</p> <p>NOTE 4: The measurement bandwidth is 1 RB and the limit is expressed as a ratio of measured power in one non-allocated RB to the measured total power in all allocated RBs.</p> <p>NOTE 5: The applicable frequencies for this limit are those that are enclosed in the RBs containing the DC frequency, or in the two RBs immediately adjacent to the DC frequency but excluding any allocated RB.</p> <p>NOTE 6: L_{CRB} is the Transmission Bandwidth for kth allocated component carrier (see Figure 5.3.1-1).</p> <p>NOTE 7: EVM is the limit for the modulation format used in the allocated RBs.</p> <p>NOTE 8: Δ_{RB} is the starting frequency offset between the allocated RB and the measured non-allocated RB (e.g. $\Delta_{RB} = 1$ or $\Delta_{RB} = -1$ for the first adjacent RB outside of the allocated bandwidth), and may take non-integer values when the carrier spacing between the CCs is not a multiple of RB.</p> <p>NOTE 9: P_{RB} is the transmitted power per allocated RB, measured in dBm.</p> <p>NOTE 10: All powers are EIRP in beam peak direction.</p>				

For power ID1 and ID2, the averaged in-band emissions result, derived in Annex E.4.3 shall not exceed the corresponding values for IQ Image and Carrier Leakage in Table 6.4A.2.3.6.5-3 for power class 3 UEs.

Table 6.4A.2.3.6.5-3: Test Requirements for in-band emissions for power class 3

Parameter description	Unit	Limit (NOTE 1)		Applicable Frequencies
General	dB	$\max \left[\begin{array}{l} -25 - 10 \cdot \log_{10} \left(\frac{N_{RB}}{L_{CRB}} \right), \\ 20 \cdot \log_{10} (\text{EVM}) - 5 \cdot \frac{(\Delta_{RB} - 1)}{L_{CRB}}, \\ -55.1 \text{ dBm} - P_{RB} \end{array} \right] + \text{TT}$		Any non-allocated RB in allocated component carrier and not allocated component carriers (NOTE 2)
IQ Image	dB	-25+TT	Output power > 10 dBm	Image frequencies (NOTES 2, 3)
		-20+TT	Output power ≤ 10 dBm	
Carrier leakage	dBc	-25+TT	Output power > 0 dBm	Carrier frequency (NOTES 4, 5)
		-20+TT	-13 dBm ≤ Output power ≤ 0 dBm	
<p>NOTE 1: An in-band emissions combined limit is evaluated in each non-allocated RB. For each such RB, the minimum requirement is calculated as the higher of ($P_{RB} - 25$ dB) and the power sum of all limit values (General, IQ Image or Carrier leakage) that apply. P_{RB} is defined in NOTE 9.</p> <p>NOTE 2: The measurement bandwidth is 1 RB and the limit is expressed as a ratio of measured power in one non-allocated RB to the measured average power per allocated RB, where the averaging is done across all allocated RBs. For Pi/2 BPSK with Spectrum Shaping, the limit is expressed as a ratio of measured power in one non-allocated RB to the measured power in the allocated RB with highest PSD.</p> <p>NOTE 3: Image frequencies for UL CA are specified in relation to either UL or DL carrier frequency.</p> <p>NOTE 4: The measurement bandwidth is 1 RB and the limit is expressed as a ratio of measured power in one non-allocated RB to the measured total power in all allocated RBs.</p> <p>NOTE 5: The applicable frequencies for this limit are those that are enclosed in the RBs containing the DC frequency, or in the two RBs immediately adjacent to the DC frequency but excluding any allocated RB.</p> <p>NOTE 6: L_{CRB} is the Transmission Bandwidth for kth allocated component carrier (see Figure 5.3.1-1).</p> <p>NOTE 7: EVM is the limit for the modulation format used in the allocated RBs.</p> <p>NOTE 8: Δ_{RB} is the starting frequency offset between the allocated RB and the measured non-allocated RB (e.g. $\Delta_{RB} = 1$ or $\Delta_{RB} = -1$ for the first adjacent RB outside of the allocated bandwidth), and may take non-integer values when the carrier spacing between the CCs is not a multiple of RB.</p> <p>NOTE 9: P_{RB} is the transmitted power per allocated RB, measured in dBm.</p> <p>NOTE 10: All powers are EIRP in beam peak direction.</p>				

For power ID1 and ID2, the averaged in-band emissions result, derived in Annex E.4.3 shall not exceed the corresponding values for IQ Image and Carrier Leakage in Table 6.4A.2.3.6.5-4 for power class 4 UEs.

Table 6.4A.2.3.6.5-4: Test Requirements for in-band emissions for power class 4

Parameter description	Unit	Limit (NOTE 1)		Applicable Frequencies
General	dB	$\max \left[\begin{array}{l} -25 - 10 \cdot \log_{10} \left(\frac{N_{RB}}{L_{CRB}} \right), \\ 20 \cdot \log_{10} (\text{EVM}) - 5 \cdot \frac{(\Delta_{RB} - 1)}{L_{CRB}}, \\ -55.1 \text{ dBm} - P_{RB} \end{array} \right] + \text{TT}$		Any non-allocated RB in allocated component carrier and not allocated component carriers (NOTE 2)
IQ Image	dB	-25+TT	Output power > 21 dBm	Image frequencies (NOTES 2, 3)
		-20+TT	Output power ≤ 21 dBm	
Carrier leakage	dBc	-25+TT	Output power > 11 dBm	Carrier frequency (NOTES 4, 5)
		-20+TT	-13 dBm ≤ Output power ≤ 11 dBm	

NOTE 1:	An in-band emissions combined limit is evaluated in each non-allocated RB. For each such RB, the minimum requirement is calculated as the higher of ($P_{RB} - 25$ dB) and the power sum of all limit values (General, IQ Image or Carrier leakage) that apply. P_{RB} is defined in NOTE 9.
NOTE 2:	The measurement bandwidth is 1 RB and the limit is expressed as a ratio of measured power in one non-allocated RB to the measured average power per allocated RB, where the averaging is done across all allocated RBs. For pi/2 BPSK with Spectrum Shaping, the limit is expressed as a ratio of measured power in one non-allocated RB to the measured power in the allocated RB with highest PSD.
NOTE 3:	Image frequencies for UL CA are specified in relation to either UL or DL carrier frequency.
NOTE 4:	The measurement bandwidth is 1 RB and the limit is expressed as a ratio of measured power in one non-allocated RB to the measured total power in all allocated RBs.
NOTE 5:	The applicable frequencies for this limit are those that are enclosed in the RBs containing the DC frequency, or in the two RBs immediately adjacent to the DC frequency but excluding any allocated RB.
NOTE 6:	L_{CRB} is the Transmission Bandwidth for kth allocated component carrier (see Figure 5.3.1-1).
NOTE 7:	EVM is the limit for the modulation format used in the allocated RBs.
NOTE 8:	Δ_{RB} is the starting frequency offset between the allocated RB and the measured non-allocated RB (e.g. $\Delta_{RB} = 1$ or $\Delta_{RB} = -1$ for the first adjacent RB outside of the allocated bandwidth), and may take non-integer values when the carrier spacing between the CCs is not a multiple of RB.
NOTE 9:	P_{RB} is the transmitted power per allocated RB, measured in dBm.
NOTE 10:	All powers are EIRP in beam peak direction.

6.4A.2.3.7 In-band emissions for CA (8UL CA)

Editor's note: This clause is incomplete. The following aspects are either missing or not yet determined:

- The test procedure is incomplete due to that power window for CA is TBD
- Measurement Uncertainty and Test Tolerance are FFS.
- Testing of the general in-band emission requirement and if yes at which UE Tx power level and with which relaxation applied to the requirement is FFS.
- TP analysis is FFS

6.4A.2.3.7.1 Test purpose

The in-band emissions are a measure of the interference falling into the non-allocated resources blocks.

The purpose of this test is to exercise the UE transmitter to verify its modulation quality in terms of in-band emissions.

6.4A.2.3.7.2 Test applicability

This test case applies to all types of NR UE release 15 and forward that supports FR2 8UL CA.

6.4A.2.3.7.3 Minimum conformance requirements

The minimum conformance requirements are defined in clause 6.4A.2.3.0.

6.4A.2.3.7.4 Test description

Same as in clause 6.4A.2.3.1.4 with following exceptions:

- Instead of Table 6.4A.2.3.1.4.1-1 → use Table 6.4A.2.3.7.4-1.

Table 6.4A.2.3.7.4-1: Test Configuration Table for 8UL CA

Default Conditions	
Test Environment as specified in TS 38.508-1 [10] clause 4.1	Normal
Test Frequencies as specified in TS 38.508-1 [10] clause 4.3.1.2.3 for different CA bandwidth classes.	Low and High range

Test CC combination setting as specified in TS 38.508-1 [10] clause 4.3.1.2.3 for the CA Configuration across bandwidth combination sets supported by the UE.			Lowest aggregated BW of the CA configuration Highest aggregated BW of the CA configuration		
Test SCS as specified in Table 5.3.5-1.			Lowest		
Test Parameters					
CA Configuration / Aggregated BW			Downlink Configuration	Uplink Configuration	
Test ID	CC & Mapping	ChBw(MHz)	RB allocation	Modulation	RB allocation (NOTE 1)
1	PCC	Default	-	DFT-s-OFDM PI/2 BPSK	Inner_Partial_Left for PC2, PC3, PC4 Inner_Partial_Left_Region2 for PC1
	SCC1			-	-
	SCC2			-	-
	SCC3			-	-
	SCC4			-	-
	SCC5			-	-
	SCC6			-	-
	SCC7			-	-
2	PCC			DFT-s-OFDM PI/2 BPSK	Inner_Partial_Right for PC2, PC3, PC4 Inner_Partial_Right_Region2 for PC1
	SCC1			-	-
	SCC2			-	-
	SCC3			-	-
	SCC4			-	-
	SCC5			-	-
	SCC6			-	-
	SCC7			-	-
3	PCC			CP-OFDM QPSK	Inner_Partial_Left for PC2, PC3, PC4 Inner_Partial_Left_Region2 for PC1
	SCC1			-	-
	SCC2			-	-
	SCC3			-	-
	SCC4			-	-
	SCC5			-	-
	SCC6			-	-
	SCC7			-	-
4	PCC			CP-OFDM QPSK	Inner_Partial_Right for PC2, PC3, PC4 Inner_Partial_Right_Region2 for PC1
	SCC1			-	-
	SCC2			-	-
	SCC3			-	-
	SCC4			-	-
	SCC5			-	-
	SCC6			-	-
	SCC7			-	-
NOTE 1: The specific configuration of each RB allocation is defined in Table 6.1-1 for PC2, PC3 and PC4 or Table 6.1-2 for PC1.					
NOTE 2: CA Configuration Test cumulative aggregated BW settings are checked separately for each CA Configuration, which applicable aggregated channel bandwidths are specified in Table 5.5A.1-1.					
NOTE 3: Number of DL CCs shall be configured the same as number of UL CCs. The requirements are applicable as per 5.3A.4: "The requirements are applicable only when Uplink CCs are configured within the frequency range between lower edge of lowest downlink component carrier and upper edge of highest downlink component carrier".					

6.4A.2.3.7.5 Test requirement

For power ID1 and ID2, the averaged in-band emissions result, derived in Annex E.4.3 shall not exceed the corresponding values for IQ Image and Carrier Leakage in Table 6.4A.2.3.7.5-1 for power class 1 UEs.

Table 6.4A.2.3.7.5-1: Test Requirements for in-band emissions for power class 1

Parameter description	Unit	Limit (NOTE 1)		Applicable Frequencies
General	dB	$\max \left[\begin{array}{l} -25 - 10 \cdot \log_{10} \left(\frac{N_{RB}}{L_{CRB}} \right), \\ 20 \cdot \log_{10} (\text{EVM}) - 5 \cdot \frac{(\Delta_{RB} - 1)}{L_{CRB}}, \\ -55.1 \text{ dBm} - P_{RB} \end{array} \right] + \text{TT}$		Any non-allocated RB in allocated component carrier and not allocated component carriers (NOTE 2)
IQ Image	dB	-25+TT	Output power > 27 dBm	Image frequencies (NOTES 2, 3)
		-20+TT	Output power ≤ 27 dBm	
Carrier leakage	dBc	-25+TT	Output power > 17 dBm	Carrier frequency (NOTES 4, 5)
		-20+TT	4 dBm ≤ Output power ≤ 17 dBm	
<p>NOTE 1: An in-band emissions combined limit is evaluated in each non-allocated RB. For each such RB, the minimum requirement is calculated as the higher of ($P_{RB} - 25$ dB) and the power sum of all limit values (General, IQ Image or Carrier leakage) that apply. P_{RB} is defined in NOTE 9.</p> <p>NOTE 2: The measurement bandwidth is 1 RB and the limit is expressed as a ratio of measured power in one non-allocated RB to the measured average power per allocated RB, where the averaging is done across all allocated RBs. For Pi/2 BPSK with Spectrum Shaping, the limit is expressed as a ratio of measured power in one non-allocated RB to the measured power in the allocated RB with highest PSD.</p> <p>NOTE 3: Image frequencies for UL CA are specified in relation to either UL or DL carrier frequency.</p> <p>NOTE 4: The measurement bandwidth is 1 RB and the limit is expressed as a ratio of measured power in one non-allocated RB to the measured total power in all allocated RBs.</p> <p>NOTE 5: The applicable frequencies for this limit are those that are enclosed in the RBs containing the DC frequency, or in the two RBs immediately adjacent to the DC frequency but excluding any allocated RB.</p> <p>NOTE 6: L_{CRB} is the Transmission Bandwidth for kth allocated component carrier (see Figure 5.3.1-1).</p> <p>NOTE 7: EVM is the limit for the modulation format used in the allocated RBs.</p> <p>NOTE 8: Δ_{RB} is the starting frequency offset between the allocated RB and the measured non-allocated RB (e.g. $\Delta_{RB} = 1$ or $\Delta_{RB} = -1$ for the first adjacent RB outside of the allocated bandwidth), and may take non-integer values when the carrier spacing between the CCs is not a multiple of RB.</p> <p>NOTE 9: P_{RB} is the transmitted power per allocated RB, measured in dBm.</p> <p>NOTE 10: All powers are EIRP in beam peak direction.</p>				

For power ID1 and ID2, the averaged in-band emissions result, derived in Annex E.4.3 shall not exceed the corresponding values for IQ Image and Carrier Leakage in Table 6.4A.2.3.7.5-2 for power class 2 UEs.

Table 6.4A.2.3.7.5-2: Test Requirements for in-band emissions for power class 2

Parameter description	Unit	Limit (NOTE 1)		Applicable Frequencies
General	dB	$\max \left[\begin{array}{l} -25 - 10 \cdot \log_{10} \left(\frac{N_{RB}}{L_{CRB}} \right), \\ 20 \cdot \log_{10} (\text{EVM}) - 5 \cdot \frac{(\Delta_{RB} - 1)}{L_{CRB}}, \\ -55.1 \text{ dBm} - P_{RB} \end{array} \right] + \text{TT}$		Any non-allocated RB in allocated component carrier and not allocated component carriers (NOTE 2)
IQ Image	dB	-25+TT	Output power > 16 dBm	Image frequencies (NOTES 2, 3)
		-20+TT	Output power ≤ 16 dBm	
Carrier leakage	dBc	-25+TT	Output power > 6 dBm	Carrier frequency (NOTES 4, 5)
		-20+TT	-13 dBm ≤ Output power ≤ 6 dBm	

- NOTE 1: An in-band emissions combined limit is evaluated in each non-allocated RB. For each such RB, the minimum requirement is calculated as the higher of ($P_{RB} - 25$ dB) and the power sum of all limit values (General, IQ Image or Carrier leakage) that apply. P_{RB} is defined in NOTE 9.
- NOTE 2: The measurement bandwidth is 1 RB and the limit is expressed as a ratio of measured power in one non-allocated RB to the measured average power per allocated RB, where the averaging is done across all allocated RBs. For Pi/2 BPSK with Spectrum Shaping, the limit is expressed as a ratio of measured power in one non-allocated RB to the measured power in the allocated RB with highest PSD.
- NOTE 3: Image frequencies for UL CA are specified in relation to either UL or DL carrier frequency.
- NOTE 4: The measurement bandwidth is 1 RB and the limit is expressed as a ratio of measured power in one non-allocated RB to the measured total power in all allocated RBs.
- NOTE 5: The applicable frequencies for this limit are those that are enclosed in the RBs containing the DC frequency, or in the two RBs immediately adjacent to the DC frequency but excluding any allocated RB.
- NOTE 6: L_{CRB} is the Transmission Bandwidth for kth allocated component carrier (see Figure 5.3.1-1).
- NOTE 7: EVM is the limit for the modulation format used in the allocated RBs.
- NOTE 8: Δ_{RB} is the starting frequency offset between the allocated RB and the measured non-allocated RB (e.g. $\Delta_{RB} = 1$ or $\Delta_{RB} = -1$ for the first adjacent RB outside of the allocated bandwidth), and may take non-integer values when the carrier spacing between the CCs is not a multiple of RB.
- NOTE 9: P_{RB} is the transmitted power per allocated RB, measured in dBm.
- NOTE 10: All powers are EIRP in beam peak direction.

For power ID1 and ID2, the averaged in-band emissions result, derived in Annex E.4.3 shall not exceed the corresponding values for IQ Image and Carrier Leakage in Table 6.4A.2.3.7.5-3 for power class 3 UEs.

Table 6.4A.2.3.7.5-3: Test Requirements for in-band emissions for power class 3

Parameter description	Unit	Limit (NOTE 1)		Applicable Frequencies
General	dB	$\max \left[\begin{array}{l} -25 - 10 \cdot \log_{10} \left(\frac{N_{RB}}{L_{CRB}} \right), \\ 20 \cdot \log_{10} (\text{EVM}) - 5 \cdot \frac{(\Delta_{RB} - 1)}{L_{CRB}}, \\ -55.1 \text{ dBm} - P_{RB} \end{array} \right] + \text{TT}$		Any non-allocated RB in allocated component carrier and not allocated component carriers (NOTE 2)
IQ Image	dB	-25+TT	Output power > 10 dBm	Image frequencies (NOTES 2, 3)
		-20+TT	Output power ≤ 10 dBm	
Carrier leakage	dBc	-25+TT	Output power > 0 dBm	Carrier frequency (NOTES 4, 5)
		-20+TT	-13 dBm ≤ Output power ≤ 0 dBm	
<p>NOTE 1: An in-band emissions combined limit is evaluated in each non-allocated RB. For each such RB, the minimum requirement is calculated as the higher of ($P_{RB} - 25$ dB) and the power sum of all limit values (General, IQ Image or Carrier leakage) that apply. P_{RB} is defined in NOTE 9.</p> <p>NOTE 2: The measurement bandwidth is 1 RB and the limit is expressed as a ratio of measured power in one non-allocated RB to the measured average power per allocated RB, where the averaging is done across all allocated RBs. For Pi/2 BPSK with Spectrum Shaping, the limit is expressed as a ratio of measured power in one non-allocated RB to the measured power in the allocated RB with highest PSD.</p> <p>NOTE 3: Image frequencies for UL CA are specified in relation to either UL or DL carrier frequency.</p> <p>NOTE 4: The measurement bandwidth is 1 RB and the limit is expressed as a ratio of measured power in one non-allocated RB to the measured total power in all allocated RBs.</p> <p>NOTE 5: The applicable frequencies for this limit are those that are enclosed in the RBs containing the DC frequency, or in the two RBs immediately adjacent to the DC frequency but excluding any allocated RB.</p> <p>NOTE 6: L_{CRB} is the Transmission Bandwidth for kth allocated component carrier (see Figure 5.3.1-1).</p> <p>NOTE 7: EVM is the limit for the modulation format used in the allocated RBs.</p> <p>NOTE 8: Δ_{RB} is the starting frequency offset between the allocated RB and the measured non-allocated RB (e.g. $\Delta_{RB} = 1$ or $\Delta_{RB} = -1$ for the first adjacent RB outside of the allocated bandwidth), and may take non-integer values when the carrier spacing between the CCs is not a multiple of RB.</p> <p>NOTE 9: P_{RB} is the transmitted power per allocated RB, measured in dBm.</p> <p>NOTE 10: All powers are EIRP in beam peak direction.</p>				

For power ID1 and ID2, the averaged in-band emissions result, derived in Annex E.4.3 shall not exceed the corresponding values for IQ Image and Carrier Leakage Table 6.4A.2.3.7.5-4 for power class 4 UEs.

Table 6.4A.2.3.7.5-4: Test Requirements for in-band emissions for power class 4

Parameter description	Unit	Limit (NOTE 1)		Applicable Frequencies
General	dB	$\max \left[\begin{array}{l} -25 - 10 \cdot \log_{10} \left(\frac{N_{RB}}{L_{CRB}} \right), \\ 20 \cdot \log_{10} (\text{EVM}) - 5 \cdot \frac{(\Delta_{RB} - 1)}{L_{CRB}}, \\ -55.1 \text{ dBm} - P_{RB} \end{array} \right] + \text{TT}$		Any non-allocated RB in allocated component carrier and not allocated component carriers (NOTE 2)
IQ Image	dB	-25+TT	Output power > 21 dBm	Image frequencies (NOTES 2, 3)
		-20+TT	Output power ≤ 21 dBm	
Carrier leakage	dBc	-25+TT	Output power > 11 dBm	Carrier frequency (NOTES 4, 5)
		-20+TT	-13 dBm ≤ Output power ≤ 11 dBm	
<p>NOTE 1: An in-band emissions combined limit is evaluated in each non-allocated RB. For each such RB, the minimum requirement is calculated as the higher of ($P_{RB} - 25$ dB) and the power sum of all limit values (General, IQ Image or Carrier leakage) that apply. P_{RB} is defined in NOTE 9.</p> <p>NOTE 2: The measurement bandwidth is 1 RB and the limit is expressed as a ratio of measured power in one non-allocated RB to the measured average power per allocated RB, where the averaging is done across all allocated RBs. For pi/2 BPSK with Spectrum Shaping, the limit is expressed as a ratio of measured power in one non-allocated RB to the measured power in the allocated RB with highest PSD.</p> <p>NOTE 3: Image frequencies for UL CA are specified in relation to either UL or DL carrier frequency.</p> <p>NOTE 4: The measurement bandwidth is 1 RB and the limit is expressed as a ratio of measured power in one non-allocated RB to the measured total power in all allocated RBs.</p> <p>NOTE 5: The applicable frequencies for this limit are those that are enclosed in the RBs containing the DC frequency, or in the two RBs immediately adjacent to the DC frequency but excluding any allocated RB.</p> <p>NOTE 6: L_{CRB} is the Transmission Bandwidth for kth allocated component carrier (see Figure 5.3.1-1).</p> <p>NOTE 7: EVM is the limit for the modulation format used in the allocated RBs.</p> <p>NOTE 8: Δ_{RB} is the starting frequency offset between the allocated RB and the measured non-allocated RB (e.g. $\Delta_{RB} = 1$ or $\Delta_{RB} = -1$ for the first adjacent RB outside of the allocated bandwidth), and may take non-integer values when the carrier spacing between the CCs is not a multiple of RB.</p> <p>NOTE 9: P_{RB} is the transmitted power per allocated RB, measured in dBm.</p> <p>NOTE 10: All powers are EIRP in beam peak direction.</p>				

6.4A.2.4 EVM equalizer spectrum flatness for CA

Editor's note: This test is incomplete due to lack of RRC framework for LO position retrieval

6.4A.2.4.0 Minimum conformance requirements

For inter-band carrier aggregation with uplink assigned to two NR bands, and each UL band is configured with a single CC, the EVM equalizer spectrum flatness requirements are specified in clause 6.4.2.4 and are applicable for each CC with all CCs active with non-zero UL RB allocation.

6.4A.2.4.1 EVM equalizer spectrum flatness for CA (2UL CA)

Editor's note: This clause is incomplete. The following aspects are either missing or not yet determined:

- Measurement Uncertainty and Test Tolerance are FFS.

6.4A.2.4.1.1 Test Purpose

The zero-forcing equalizer correction applied in the EVM measurement process (as described in Annex E) must meet a spectral flatness requirement for the EVM measurement to be valid. The EVM equalizer spectrum flatness is defined in terms of the maximum peak-to-peak ripple of the equalizer coefficients (dB) across the allocated uplink block, at which the equalizer coefficients are generated by the EVM measurement process. The basic measurement interval is the same as for EVM.

The EVM equalizer spectrum flatness requirement does not limit the correction applied to the signal in the EVM measurement process but for the EVM result to be valid, the equalizer correction that was applied must meet the EVM equalizer spectrum flatness minimum requirements.

6.4A.2.4.1.2 Test applicability

This test case applies to all types of NR UE release 15 and forward that supports FR2 2UL CA.

6.4A.2.4.1.3 Minimum conformance requirements

The minimum conformance requirements are defined in clause 6.4A.2.4.0

6.4A.2.4.1.4 Test description

6.4A.2.4.1.4.1 Initial conditions

Initial conditions are a set of test configurations the UE needs to be tested in and the steps for the SS to take with the UE to reach the correct measurement state.

The initial test configurations consist of environmental conditions, test frequencies, test channel bandwidths and sub-carrier spacing based on NR operating bands specified in Table 5.5A. All of these configurations shall be tested with applicable test parameters for each combination of channel bandwidth and sub-carrier spacing, are shown in Table 6.4A.2.4.1.4.1-1. The details of the uplink reference measurement channels (RMCs) are specified in Annex A.2. Configurations of PDSCH and PDCCH before measurement are specified in Annex C.2.

Table 6.4A.2.4.1.4.1-1: Test Configuration

Default Conditions					
Test Environment as specified in TS 38.508-1 [10] clause 4.1			Normal		
Test Frequencies as specified in TS 38.508-1 [10] clause 4.3.1.2.3 for different CA bandwidth classes			Low and High range		
Test CC Combination setting (aggregated BW of the CA configuration) as specified in TS 38.508-1 [10] clause 4.3.1.2.3 for the CA Configuration across bandwidth combination sets supported by the UE			Lowest aggregated BW of the CA configuration Highest aggregated BW of the CA configuration		
Test SCS as specified in Table 5.3.5-1			Lowest, Highest		
Test Parameters					
CA Configuration / Aggregated BW			Downlink Configuration	Uplink Configuration	
Test ID	CC & Mapping (NOTE 3)	CBW (MHz)	RB allocation	Modulation	RB allocation (NOTE 1)
1	PCC/CC1	default	-	DFT-s-OFDM QPSK	Outer_Full
	SCC/CC2			-	-
2	PCC/CC1	-	-	CP-OFDM QPSK	Outer_Full
	SCC/CC2			-	-
NOTE 1: The specific configuration of each RB allocation is defined in Table 6.1-1 for PC2, PC3 and PC4 or Table 6.1-2 for PC1.					
NOTE 2: CA Configuration Test cumulative aggregated BW settings are checked separately for each CA Configuration, which applicable aggregated channel bandwidths are specified in Table 5.5A.1-1.					
NOTE 3: PCC/CCi and SCC/CCj means PCC is on component carrier CCi and SCC is on component carrier CCj, with CCi or CCj frequencies defined in TS38.508-1 [10].					
NOTE 4: Number of DL CCs shall be configured the same as number of UL CCs. The requirements are applicable as per 5.3A.4: "The requirements are applicable only when Uplink CCs are configured within the frequency range between lower edge of lowest downlink component carrier and upper edge of highest downlink component carrier".					

1. Connection between SS and UE is shown in TS 38.508-1 [10] Annex A, in Figure A.3.3.1.1 for TE diagram and section A.3.4.1.1 for UE diagram.
2. The parameter settings for the cell are set up according to TS 38.508-1 [10] clause 4.4.3.
3. Downlink signals for PCC are initially set up according to Annex C, and uplink signals according to Annex G.

4. The UL Reference Measurement channels are set according to Table 6.4A.2.4.1.4.1-1.
5. Propagation conditions are set according to Annex B.0.
6. Ensure the UE is in state RRC_CONNECTED with generic procedure parameters Connectivity *NR*, Connected without release *On*, Test Mode *On* and Test Loop Function *On* according to TS 38.508-1 [10] clause 4.5. Message contents are defined in clause 6.4.2.4.4.3

6.4A.2.4.1.4.2 Test procedure

1. Retrieve the LO position from the parameter txDirectCurrentLocation in UplinkTxDirectCurrent IE.
2. Configure SCC according to Annex C.0, C.1, C.3 for all downlink physical channels.
3. The SS shall configure SCC as per TS 38.508-1 [10] clause 5.5.1. Message contents are defined in clause 6.4A.2.4.1.4.3.
4. SS activates SCC by sending the activation MAC CE (Refer TS 38.321 [28], clauses 5.9, 6.1.3.10). Wait for at least 2 seconds (Refer TS 38.133[25], clause 9.2).
5. SS sends uplink scheduling information for each UL HARQ process via PDCCH DCI format 0_1 for C_RNTI to schedule the UL RMC according to Table 6.4A.2.4.1.4.1-1. Since the UE has no payload and no loopback data to send the UE sends uplink MAC padding bits on the UL RMC
6. Set the UE in the Inband Tx beam peak direction found with a 3D EIRP scan as performed in Annex K.1.1. Allow at least BEAM_SELECT_WAIT_TIME (NOTE 2) for the UE Tx beam selection to complete.
7. Send continuously uplink power control "up" commands in the uplink scheduling information to the UE until the UE transmits at P_{UMAX} level. Allow at least 200 ms for the UE to reach P_{UMAX} level. Allow at least BEAM_SELECT_WAIT_TIME (NOTE 2) for the UE Tx beam selection to complete.
8. SS activates the UE Beamlock Function (UBF) by performing the procedure as specified in TS 38.508-1 [10] clause 4.9.2 using condition TxRx.
9. Measure spectrum flatness using Global In-Channel Tx-Test (Annex E) for the θ - and ϕ -polarizations, respectively. For TDD, only slots consisting of only UL symbols are under test.
10. SS deactivates the UE Beamlock Function (UBF) by performing the procedure as specified in TS 38.508-1 [10] clause 4.9.3.

NOTE1: When switching to DFT-s-OFDM waveform, as specified in Table 6.4A.2.4.1.4.1-1, send an NR RRCReconfiguration message according to TS 38.508-1 [10] clause 4.6.3 Table 4.6.3-118 PUSCH-Config with TRANSFORM_PRECODER_ENABLED condition.

NOTE 2: The BEAM_SELECT_WAIT_TIME default value is defined in Annex K.

6.4A.2.4.1.4.3 Message contents

Message contents are according to TS 38.508-1 [10] clause 4.6.

6.4A.2.4.1.5 Test requirement

Each of the n spectrum flatness functions, shall derive four ripple results in Annex E.4.4. The derived results shall not exceed the values in Figure 6.4A.2.4.1.5-1: The peak-to-peak variation of the EVM equalizer coefficients contained within the frequency range of the uplink allocation shall not exceed the maximum ripple specified in Table 6.4A.2.4.1.5-1 for normal conditions. For uplink allocations contained within both Range 1 and Range 2, the coefficients evaluated within each of these frequency ranges shall meet the corresponding ripple requirement and the following additional requirements: the relative difference between the maximum coefficient in Range 1 and the minimum coefficient in Range 2 (Table 6.4A.2.4.1.5-1) must not be larger than 7 dB + TT, and the relative difference between the maximum coefficient in Range 2 and the minimum coefficient in Range 1 must not be larger than 8 dB + TT (see Figure 6.4A.2.4.1.5-1).

The UE passes the test when the derived results for at least one polarization fulfil the test requirements.

Table 6.4A.2.4.1.5-1: Test requirements for EVM equalizer spectrum flatness (normal conditions)

Frequency range	Maximum ripple (dB)
$ F_{UL_Meas} - F_{center} \leq X$ MHz (Range 1)	6 + TT (p-p)
$ F_{UL_Meas} - F_{center} > X$ MHz (Range 2)	9 + TT (p-p)

NOTE 1: F_{UL_Meas} refers to the sub-carrier frequency for which the equalizer coefficient is evaluated
 NOTE 2: F_{center} refers to the centre frequency of the CC
 NOTE 3: X, in MHz, is equal to 30% of the CC bandwidth

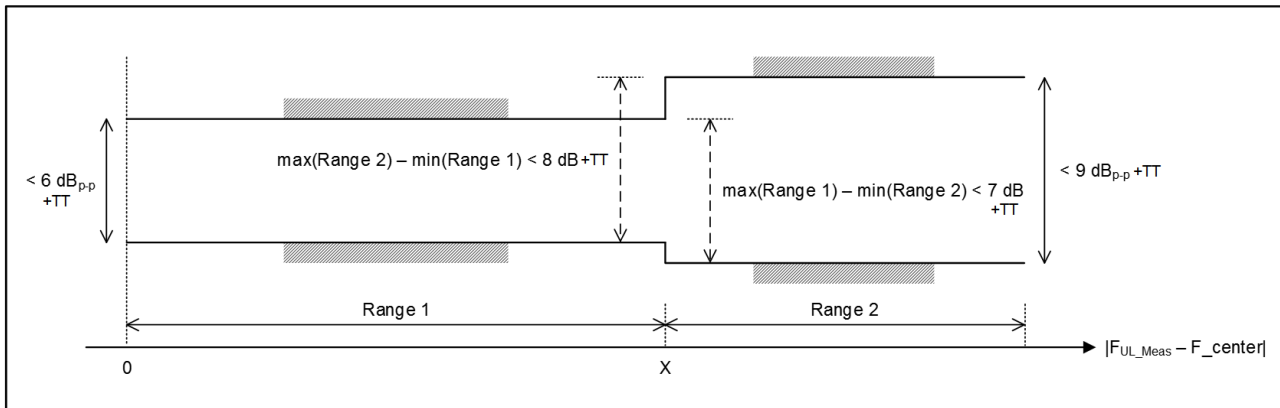

Figure 6.4A.2.4.1.5-1: The limits for EVM equalizer spectral flatness with the maximum allowed variation of the coefficients indicated under normal conditions

6.4A.2.4.2 EVM equalizer spectrum flatness for CA (3UL CA)

Editor's note: This clause is incomplete. The following aspects are either missing or not yet determined:

- Measurement Uncertainty and Test Tolerance are FFS.

6.4A.2.4.2.1 Test Purpose

The zero-forcing equalizer correction applied in the EVM measurement process (as described in Annex E) must meet a spectral flatness requirement for the EVM measurement to be valid. The EVM equalizer spectrum flatness is defined in terms of the maximum peak-to-peak ripple of the equalizer coefficients (dB) across the allocated uplink block, at which the equalizer coefficients are generated by the EVM measurement process. The basic measurement interval is the same as for EVM.

The EVM equalizer spectrum flatness requirement does not limit the correction applied to the signal in the EVM measurement process but for the EVM result to be valid, the equalizer correction that was applied must meet the EVM equalizer spectrum flatness minimum requirements.

6.4A.2.4.2.2 Test applicability

This test case applies to all types of NR UE Release 15 and forward that supports FR2 3UL CA.

6.4A.2.4.2.3 Minimum conformance requirements

The minimum conformance requirements are defined in clause 6.4A.2.4.0

6.4A.2.4.2.4 Test description

Same as in clause 6.4A.2.4.1.4 with following exceptions:

- Instead of Table 6.4A.2.4.1.4.1-1; use Table 6.4A.2.4.2.4.1-1.

Table 6.4A.2.4.2.4.1-1: Test Configuration

Default Conditions					
Test Environment as specified in TS 38.508-1 [10] clause 4.1			Normal		
Test Frequencies as specified in TS 38.508-1 [10] clause 4.3.1.2.3 for different CA bandwidth classes			Low and High range		
Test CC Combination setting (aggregated BW of the CA configuration) as specified in TS 38.508-1 [10] clause 4.3.1.2.3 for the CA Configuration across bandwidth combination sets supported by the UE			Lowest aggregated BW of the CA configuration Highest aggregated BW of the CA configuration		
Test SCS as specified in Table 5.3.5-1			Lowest		
Test Parameters					
CA Configuration / Aggregated BW			Downlink Configuration	Uplink Configuration	
Test ID	CC & Mapping (NOTE 3)	CBW (MHz)	RB allocation	Modulation	RB allocation (NOTE 1)
1	PCC/CC1	default	-	DFT-s-OFDM QPSK	Outer_Full
	SCC/CC2			-	-
	SCC/CC3			-	-
2	PCC/CC1	default	-	CP-OFDM QPSK	Outer_Full
	SCC/CC2			-	-
	SCC/CC3			-	-
NOTE 1: The specific configuration of each RB allocation is defined in Table 6.1-1 for PC2, PC3 and PC4 or Table 6.1-2 for PC1.					
NOTE 2: CA Configuration Test cumulative aggregated BW settings are checked separately for each CA Configuration, which applicable aggregated channel bandwidths are specified in Table 5.5A.1-1.					
NOTE 3: PCC/CC _i and SCC/CC _j means PCC is on component carrier CC _i and SCC is on component carrier CC _j , with CC _i or CC _j frequencies defined in TS38.508-1 [10].					
NOTE 4: Number of DL CCs shall be configured the same as number of UL CCs. The requirements are applicable as per 5.3A.4: "The requirements are applicable only when Uplink CCs are configured within the frequency range between lower edge of lowest downlink component carrier and upper edge of highest downlink component carrier".					

6.4A.2.4.2.5 Test requirement

Each of the n spectrum flatness functions, shall derive four ripple results in Annex E.4.4. The derived results shall not exceed the values in Figure 6.4A.2.4.2.5-1: The peak-to-peak variation of the EVM equalizer coefficients contained within the frequency range of the uplink allocation shall not exceed the maximum ripple specified in Table 6.4A.2.4.2.5-1 for normal conditions. For uplink allocations contained within both Range 1 and Range 2, the coefficients evaluated within each of these frequency ranges shall meet the corresponding ripple requirement and the following additional requirements: the relative difference between the maximum coefficient in Range 1 and the minimum coefficient in Range 2 (Table 6.4A.2.4.2.5-1) must not be larger than 7 dB + TT, and the relative difference between the maximum coefficient in Range 2 and the minimum coefficient in Range 1 must not be larger than 8 dB + TT (see Figure 6.4A.2.4.2.5-1).

The UE passes the test when the derived results for at least one polarization fulfil the test requirements.

Table 6.4A.2.4.2.5-1: Test requirements for EVM equalizer spectrum flatness (normal conditions)

Frequency range	Maximum ripple (dB)
$ F_{UL_Meas} - F_{center} \leq X$ MHz (Range 1)	6 + TT (p-p)
$ F_{UL_Meas} - F_{center} > X$ MHz (Range 2)	9 + TT (p-p)
NOTE 1: F_{UL_Meas} refers to the sub-carrier frequency for which the equalizer coefficient is evaluated	
NOTE 2: F_{center} refers to the centre frequency of the CC	
NOTE 3: X, in MHz, is equal to 30% of the CC bandwidth	

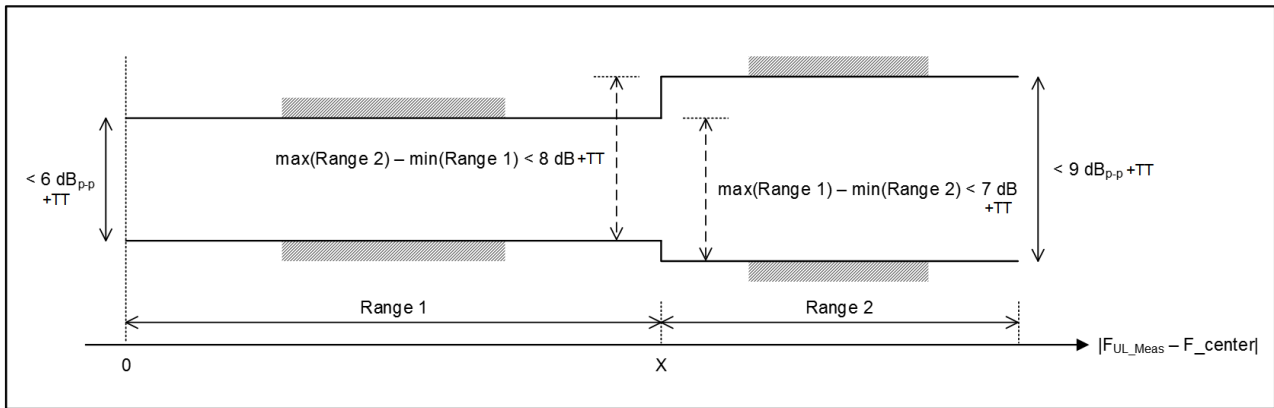

Figure 6.4A.2.4.2.5-1: The limits for EVM equalizer spectral flatness with the maximum allowed variation of the coefficients indicated under normal conditions

6.4A.2.4.3 EVM equalizer spectrum flatness for CA (4UL CA)

Editor's note: This clause is incomplete. The following aspects are either missing or not yet determined:

- Measurement Uncertainty and Test Tolerance are FFS.

6.4A.2.4.3.1 Test Purpose

The zero-forcing equalizer correction applied in the EVM measurement process (as described in Annex E) must meet a spectral flatness requirement for the EVM measurement to be valid. The EVM equalizer spectrum flatness is defined in terms of the maximum peak-to-peak ripple of the equalizer coefficients (dB) across the allocated uplink block, at which the equalizer coefficients are generated by the EVM measurement process. The basic measurement interval is the same as for EVM.

The EVM equalizer spectrum flatness requirement does not limit the correction applied to the signal in the EVM measurement process but for the EVM result to be valid, the equalizer correction that was applied must meet the EVM equalizer spectrum flatness minimum requirements.

6.4A.2.4.3.2 Test applicability

This test case applies to all types of NR UE release 15 and forward that supports FR2 4UL CA.

6.4A.2.4.3.3 Minimum conformance requirements

The minimum conformance requirements are defined in clause 6.4A.2.4.0

6.4A.2.4.3.4 Test description

Same as in clause 6.4A.2.4.1.4 with following exceptions:

- Instead of Table 6.4A.2.4.1.4.1-1: use Table 6.4A.2.4.3.4.1-1.

Table 6.4A.2.4.3.4.1-1: Test Configuration

Default Conditions	
Test Environment as specified in TS 38.508-1 [10] clause 4.1	Normal
Test Frequencies as specified in TS 38.508-1 [10] clause 4.3.1.2.3 for different CA bandwidth classes	Low and High range
Test CC Combination setting (aggregated BW of the CA configuration) as specified in TS 38.508-1 [10] clause 4.3.1.2.3 for the CA Configuration across bandwidth combination sets supported by the UE	Lowest aggregated BW of the CA configuration Highest aggregated BW of the CA configuration
Test SCS as specified in Table 5.3.5-1	Lowest
Test Parameters	

CA Configuration / Aggregated BW			Downlink Configuration	Uplink Configuration	
Test ID	CC & Mapping (NOTE 3)	CBW (MHz)	RB allocation	Modulation	RB allocation (NOTE 1)
1	PCC/CC1	default	-	DFT-s-OFDM QPSK	Outer_Full
	SCC/CC2			-	-
	SCC/CC3			-	-
	SCC/CC4			-	-
2	PCC/CC1			CP-OFDM QPSK	Outer_Full
	SCC/CC2			-	-
	SCC/CC3			-	-
	SCC/CC4			-	-

NOTE 1: The specific configuration of each RB allocation is defined in Table 6.1-1 for PC2, PC3 and PC4 or Table 6.1-2 for PC1.

NOTE 2: CA Configuration Test cumulative aggregated BW settings are checked separately for each CA Configuration, which applicable aggregated channel bandwidths are specified in Table 5.5A.1-1.

NOTE 3: PCC/CC_i and SCC/CC_j means PCC is on component carrier CC_i and SCC is on component carrier CC_j, with CC_i or CC_j frequencies defined in TS38.508-1 [10].

NOTE 4: Number of DL CCs shall be configured the same as number of UL CCs. The requirements are applicable as per 5.3A.4: "The requirements are applicable only when Uplink CCs are configured within the frequency range between lower edge of lowest downlink component carrier and upper edge of highest downlink component carrier".

6.4A.2.4.3.5 Test requirement

Each of the *n* spectrum flatness functions, shall derive four ripple results in Annex E.4.4. The derived results shall not exceed the values in Figure 6.4A.2.4.3.5-1: The peak-to-peak variation of the EVM equalizer coefficients contained within the frequency range of the uplink allocation shall not exceed the maximum ripple specified in Table 6.4A.2.4.3.5-1 for normal conditions. For uplink allocations contained within both Range 1 and Range 2, the coefficients evaluated within each of these frequency ranges shall meet the corresponding ripple requirement and the following additional requirements: the relative difference between the maximum coefficient in Range 1 and the minimum coefficient in Range 2 (Table 6.4A.2.4.3.5-1) must not be larger than 7 dB + TT, and the relative difference between the maximum coefficient in Range 2 and the minimum coefficient in Range 1 must not be larger than 8 dB + TT (see Figure 6.4A.2.4.3.5-1).

The UE passes the test when the derived results for at least one polarization fulfil the test requirements.

Table 6.4A.2.4.3.5-1: Test requirements for EVM equalizer spectrum flatness (normal conditions)

Frequency range	Maximum ripple (dB)
$ F_{UL_Meas} - F_{center} \leq X$ MHz (Range 1)	6 + TT (p-p)
$ F_{UL_Meas} - F_{center} > X$ MHz (Range 2)	9 + TT (p-p)

NOTE 1: F_{UL_Meas} refers to the sub-carrier frequency for which the equalizer coefficient is evaluated

NOTE 2: F_{center} refers to the centre frequency of the CC

NOTE 3: X, in MHz, is equal to 30% of the CC bandwidth

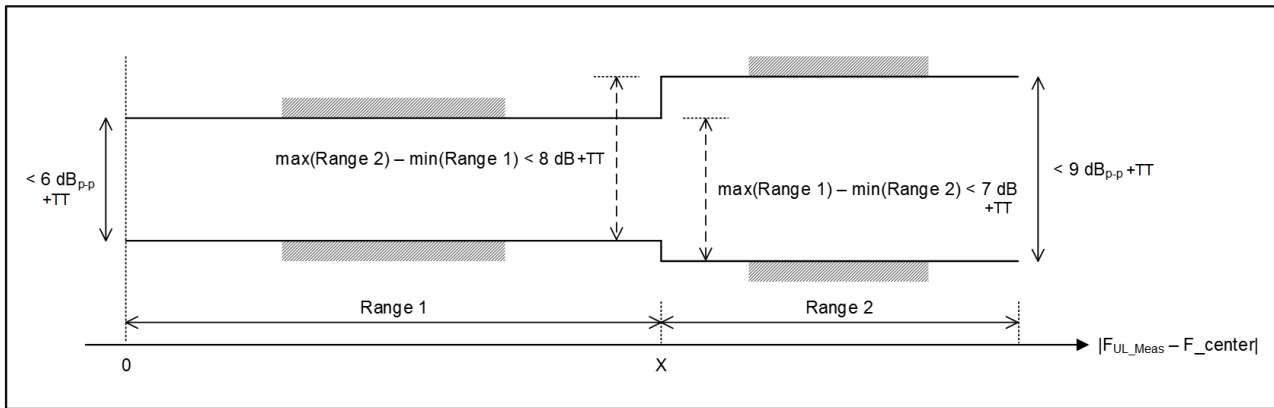

Figure 6.4A.2.4.3.5-1: The limits for EVM equalizer spectral flatness with the maximum allowed variation of the coefficients indicated under normal conditions

6.4A.2.4.4 EVM equalizer spectrum flatness for CA (5UL CA)

Editor's note: This clause is incomplete. The following aspects are either missing or not yet determined:

- Measurement Uncertainty and Test Tolerance are FFS.

6.4A.2.4.4.1 Test Purpose

The zero-forcing equalizer correction applied in the EVM measurement process (as described in Annex E) must meet a spectral flatness requirement for the EVM measurement to be valid. The EVM equalizer spectrum flatness is defined in terms of the maximum peak-to-peak ripple of the equalizer coefficients (dB) across the allocated uplink block, at which the equalizer coefficients are generated by the EVM measurement process. The basic measurement interval is the same as for EVM.

The EVM equalizer spectrum flatness requirement does not limit the correction applied to the signal in the EVM measurement process but for the EVM result to be valid, the equalizer correction that was applied must meet the EVM equalizer spectrum flatness minimum requirements.

6.4A.2.4.4.2 Test applicability

This test case applies to all types of NR UE release 15 and forward that supports FR2 5UL CA.

6.4A.2.4.4.3 Minimum conformance requirements

The minimum conformance requirements are defined in clause 6.4A.2.4.0

6.4A.2.4.4.4 Test description

Same as in clause 6.4A.2.4.1.4 with following exceptions:

- Instead of Table 6.4A.2.4.1.4.1-1: use Table 6.4A.2.4.4.1-1.

Table 6.4A.2.4.4.1-1: Test Configuration

Default Conditions	
Test Environment as specified in TS 38.508-1 [10] clause 4.1	Normal
Test Frequencies as specified in TS 38.508-1 [10] clause 4.3.1.2.3 for different CA bandwidth classes	Low and High range
Test CC Combination setting (aggregated BW of the CA configuration) as specified in TS 38.508-1 [10] clause 4.3.1.2.3 for the CA Configuration across bandwidth combination sets supported by the UE	Lowest aggregated BW of the CA configuration Highest aggregated BW of the CA configuration
Test SCS as specified in Table 5.3.5-1	Lowest
Test Parameters	

CA Configuration / Aggregated BW			Downlink Configuration	Uplink Configuration	
Test ID	CC & Mapping (NOTE 3)	CBW (MHz)	RB allocation	Modulation	RB allocation (NOTE 1)
1	PCC/CC1	default	-	DFT-s-OFDM QPSK	Outer_Full
	SCC/CC2			-	-
	SCC/CC3			-	-
	SCC/CC4			-	-
	SCC/CC5			-	-
2	PCC/CC1			CP-OFDM QPSK	Outer_Full
	SCC/CC2			-	-
	SCC/CC3			-	-
	SCC/CC4			-	-
	SCC/CC5			-	-

NOTE 1: The specific configuration of each RB allocation is defined in Table 6.1-1 for PC2, PC3 and PC4 or Table 6.1-2 for PC1.
 NOTE 2: CA Configuration Test cumulative aggregated BW settings are checked separately for each CA Configuration, which applicable aggregated channel bandwidths are specified in Table 5.5A.1-1.
 NOTE 3: PCC/CC_i and SCC/CC_j means PCC is on component carrier CC_i and SCC is on component carrier CC_j, with CC_i or CC_j frequencies defined in TS38.508-1 [10].
 NOTE 4: Number of DL CCs shall be configured the same as number of UL CCs. The requirements are applicable as per 5.3A.4: "The requirements are applicable only when Uplink CCs are configured within the frequency range between lower edge of lowest downlink component carrier and upper edge of highest downlink component carrier".

6.4A.2.4.4.5 Test requirement

Each of the *n* spectrum flatness functions, shall derive four ripple results in Annex E.4.4. The derived results shall not exceed the values in Figure 6.4A.2.4.4.5-1: The peak-to-peak variation of the EVM equalizer coefficients contained within the frequency range of the uplink allocation shall not exceed the maximum ripple specified in Table 6.4A.2.4.4.5-1 for normal conditions. For uplink allocations contained within both Range 1 and Range 2, the coefficients evaluated within each of these frequency ranges shall meet the corresponding ripple requirement and the following additional requirements: the relative difference between the maximum coefficient in Range 1 and the minimum coefficient in Range 2 (Table 6.4A.2.4.4.5-1) must not be larger than 7 dB + TT, and the relative difference between the maximum coefficient in Range 2 and the minimum coefficient in Range 1 must not be larger than 8 dB + TT (see Figure 6.4A.2.4.4.5-1).

The UE passes the test when the derived results for at least one polarization fulfil the test requirements.

Table 6.4A.2.4.4.5-1: Test requirements for EVM equalizer spectrum flatness (normal conditions)

Frequency range	Maximum ripple (dB)
$ F_{UL_Meas} - F_{center} \leq X$ MHz (Range 1)	6 + TT (p-p)
$ F_{UL_Meas} - F_{center} > X$ MHz (Range 2)	9 + TT (p-p)

NOTE 1: F_{UL_Meas} refers to the sub-carrier frequency for which the equalizer coefficient is evaluated
 NOTE 2: F_{center} refers to the centre frequency of the CC
 NOTE 3: X, in MHz, is equal to 30% of the CC bandwidth

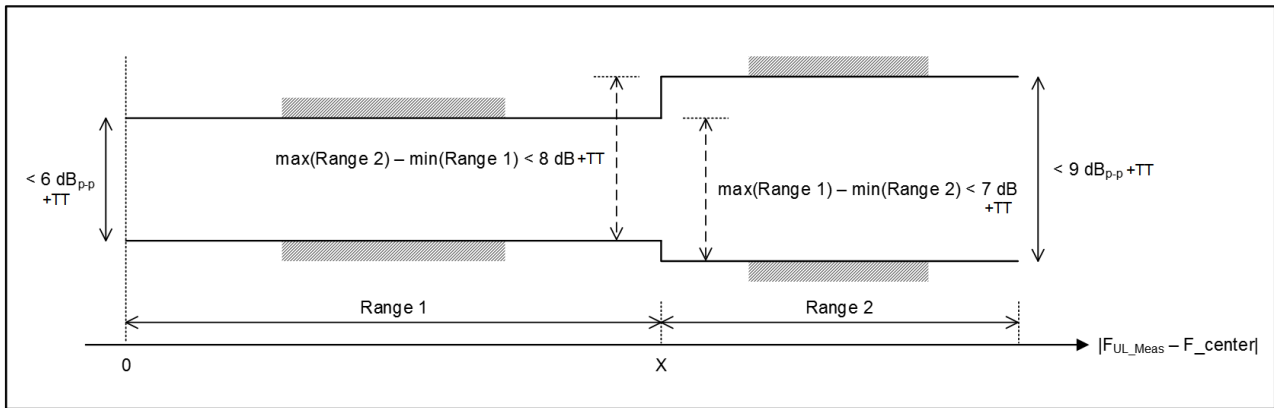

Figure 6.4A.2.4.4.5-1: The limits for EVM equalizer spectral flatness with the maximum allowed variation of the coefficients indicated under normal conditions

6.4A.2.4.5 EVM equalizer spectrum flatness for CA (6UL CA)

Editor's note: This clause is incomplete. The following aspects are either missing or not yet determined:

- Measurement Uncertainty and Test Tolerance are FFS.

6.4A.2.4.5.1 Test Purpose

The zero-forcing equalizer correction applied in the EVM measurement process (as described in Annex E) must meet a spectral flatness requirement for the EVM measurement to be valid. The EVM equalizer spectrum flatness is defined in terms of the maximum peak-to-peak ripple of the equalizer coefficients (dB) across the allocated uplink block, at which the equalizer coefficients are generated by the EVM measurement process. The basic measurement interval is the same as for EVM.

The EVM equalizer spectrum flatness requirement does not limit the correction applied to the signal in the EVM measurement process but for the EVM result to be valid, the equalizer correction that was applied must meet the EVM equalizer spectrum flatness minimum requirements.

6.4A.2.4.5.2 Test applicability

This test case applies to all types of NR UE release 15 and forward that supports FR2 6UL CA.

6.4A.2.4.5.3 Minimum conformance requirements

The minimum conformance requirements are defined in clause 6.4A.2.4.0

6.4A.2.4.5.4 Test description

Same as in clause 6.4A.2.4.1.4 with following exceptions:

- Instead of Table 6.4A.2.4.1.4.1-1: use Table 6.4A.2.4.5.4.1-1.

Table 6.4A.2.4.5.4.1-1: Test Configuration

Default Conditions	
Test Environment as specified in TS 38.508-1 [10] clause 4.1	Normal
Test Frequencies as specified in TS 38.508-1 [10] clause 4.3.1.2.3 for different CA bandwidth classes	Low and High range
Test CC Combination setting (aggregated BW of the CA configuration) as specified in TS 38.508-1 [10] clause 4.3.1.2.3 for the CA Configuration across bandwidth combination sets supported by the UE	Lowest aggregated BW of the CA configuration Highest aggregated BW of the CA configuration
Test SCS as specified in Table 5.3.5-1	Lowest
Test Parameters	

CA Configuration / Aggregated BW			Downlink Configuration	Uplink Configuration			
Test ID	CC & Mapping (NOTE 3)	CBW (MHz)	RB allocation	Modulation	RB allocation (NOTE 1)		
1	PCC/CC1	default	-	DFT-s-OFDM QPSK	Outer_Full		
	SCC/CC2			-	-		
	SCC/CC3			-	-		
	SCC/CC4			-	-		
	SCC/CC5			-	-		
	SCC/CC6			-	-		
2	PCC/CC1			default	-	CP-OFDM QPSK	Outer_Full
	SCC/CC2					-	-
	SCC/CC3					-	-
	SCC/CC4					-	-
	SCC/CC5					-	-
	SCC/CC6					-	-

NOTE 1: The specific configuration of each RB allocation is defined in Table 6.1-1 for PC2, PC3 and PC4 or Table 6.1-2 for PC1.

NOTE 2: CA Configuration Test cumulative aggregated BW settings are checked separately for each CA Configuration, which applicable aggregated channel bandwidths are specified in Table 5.5A.1-1.

NOTE 3: PCC/CC_i and SCC/CC_j means PCC is on component carrier CC_i and SCC is on component carrier CC_j, with CC_i or CC_j frequencies defined in TS38.508-1 [10].

NOTE 4: Number of DL CCs shall be configured the same as number of UL CCs. The requirements are applicable as per 5.3A.4: "The requirements are applicable only when Uplink CCs are configured within the frequency range between lower edge of lowest downlink component carrier and upper edge of highest downlink component carrier".

6.4A.2.4.5.5 Test requirement

Each of the *n* spectrum flatness functions, shall derive four ripple results in Annex E.4.4. The derived results shall not exceed the values in Figure 6.4A.2.4.5.5-1: The peak-to-peak variation of the EVM equalizer coefficients contained within the frequency range of the uplink allocation shall not exceed the maximum ripple specified in Table 6.4A.2.4.5.5-1 for normal conditions. For uplink allocations contained within both Range 1 and Range 2, the coefficients evaluated within each of these frequency ranges shall meet the corresponding ripple requirement and the following additional requirements: the relative difference between the maximum coefficient in Range 1 and the minimum coefficient in Range 2 (Table 6.4A.2.4.5.5-1) must not be larger than 7 dB + TT, and the relative difference between the maximum coefficient in Range 2 and the minimum coefficient in Range 1 must not be larger than 8 dB + TT (see Figure 6.4A.2.4.5.5-1).

The UE passes the test when the derived results for at least one polarization fulfil the test requirements.

Table 6.4A.2.4.5.5-1: Test requirements for EVM equalizer spectrum flatness (normal conditions)

Frequency range	Maximum ripple (dB)
$ F_{UL_Meas} - F_{center} \leq X$ MHz (Range 1)	6 + TT (p-p)
$ F_{UL_Meas} - F_{center} > X$ MHz (Range 2)	9 + TT (p-p)

NOTE 1: F_{UL_Meas} refers to the sub-carrier frequency for which the equalizer coefficient is evaluated

NOTE 2: F_{center} refers to the centre frequency of the CC

NOTE 3: X, in MHz, is equal to 30% of the CC bandwidth

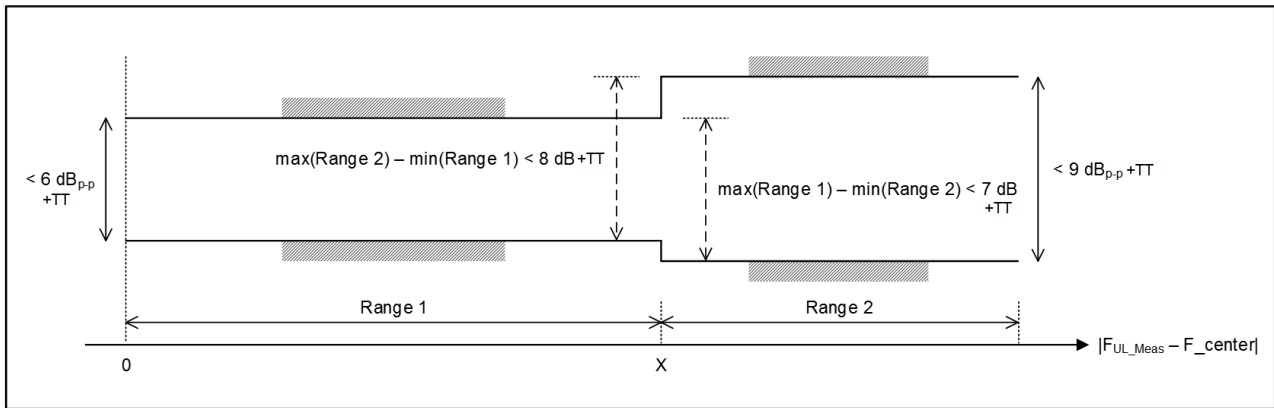

Figure 6.4A.2.4.5.5-1: The limits for EVM equalizer spectral flatness with the maximum allowed variation of the coefficients indicated under normal conditions

6.4A.2.4.6 EVM equalizer spectrum flatness for CA (7UL CA)

Editor's note: This clause is incomplete. The following aspects are either missing or not yet determined:

- Measurement Uncertainty and Test Tolerance are FFS.

6.4A.2.4.6.1 Test Purpose

The zero-forcing equalizer correction applied in the EVM measurement process (as described in Annex E) must meet a spectral flatness requirement for the EVM measurement to be valid. The EVM equalizer spectrum flatness is defined in terms of the maximum peak-to-peak ripple of the equalizer coefficients (dB) across the allocated uplink block, at which the equalizer coefficients are generated by the EVM measurement process. The basic measurement interval is the same as for EVM.

The EVM equalizer spectrum flatness requirement does not limit the correction applied to the signal in the EVM measurement process but for the EVM result to be valid, the equalizer correction that was applied must meet the EVM equalizer spectrum flatness minimum requirements.

6.4A.2.4.6.2 Test applicability

This test case applies to all types of NR UE release 15 and forward that supports FR2 7UL CA.

6.4A.2.4.6.3 Minimum conformance requirements

The minimum conformance requirements are defined in clause 6.4A.2.4.0

6.4A.2.4.6.4 Test description

Same as in clause 6.4A.2.4.1.4 with following exceptions:

- Instead of Table 6.4A.2.4.1.4.1-1: use Table 6.4A.2.4.6.4.1-1.

Table 6.4A.2.4.6.4.1-1: Test Configuration

Default Conditions	
Test Environment as specified in TS 38.508-1 [10] clause 4.1	Normal
Test Frequencies as specified in TS 38.508-1 [10] clause 4.3.1.2.3 for different CA bandwidth classes	Low and High range
Test CC Combination setting (aggregated BW of the CA configuration) as specified in TS 38.508-1 [10] clause 4.3.1.2.3 for the CA Configuration across bandwidth combination sets supported by the UE	Lowest aggregated BW of the CA configuration Highest aggregated BW of the CA configuration
Test SCS as specified in Table 5.3.5-1	Lowest
Test Parameters	

CA Configuration / Aggregated BW			Downlink Configuration	Uplink Configuration	
Test ID	CC & Mapping (NOTE 3)	CBW (MHz)	RB allocation	Modulation	RB allocation (NOTE 1)
1	PCC/CC1	default	-	DFT-s-OFDM QPSK	Outer_Full
	SCC/CC2			-	-
	SCC/CC3			-	-
	SCC/CC4			-	-
	SCC/CC5			-	-
	SCC/CC6			-	-
	SCC/CC7			-	-
2	PCC/CC1			CP-OFDM QPSK	Outer_Full
	SCC/CC2			-	-
	SCC/CC3			-	-
	SCC/CC4			-	-
	SCC/CC5			-	-
	SCC/CC6			-	-
	SCC/CC7			-	-

NOTE 1: The specific configuration of each RB allocation is defined in Table 6.1-1 for PC2, PC3 and PC4 or Table 6.1-2 for PC1.
 NOTE 2: CA Configuration Test cumulative aggregated BW settings are checked separately for each CA Configuration, which applicable aggregated channel bandwidths are specified in Table 5.5A.1-1.
 NOTE 3: PCC/CCi and SCC/CCj means PCC is on component carrier CCi and SCC is on component carrier CCj, with CCi or CCj frequencies defined in TS38.508-1 [10].
 NOTE 4: Number of DL CCs shall be configured the same as number of UL CCs. The requirements are applicable as per 5.3A.4: "The requirements are applicable only when Uplink CCs are configured within the frequency range between lower edge of lowest downlink component carrier and upper edge of highest downlink component carrier".

6.4A.2.4.6.5 Test requirement

Each of the *n* spectrum flatness functions, shall derive four ripple results in Annex E.4.4. The derived results shall not exceed the values in Figure 6.4A.2.4.6.5-1: The peak-to-peak variation of the EVM equalizer coefficients contained within the frequency range of the uplink allocation shall not exceed the maximum ripple specified in Table 6.4A.2.4.6.5-1 for normal conditions. For uplink allocations contained within both Range 1 and Range 2, the coefficients evaluated within each of these frequency ranges shall meet the corresponding ripple requirement and the following additional requirements: the relative difference between the maximum coefficient in Range 1 and the minimum coefficient in Range 2 (Table 6.4A.2.4.6.5-1) must not be larger than 7 dB + TT, and the relative difference between the maximum coefficient in Range 2 and the minimum coefficient in Range 1 must not be larger than 8 dB + TT (see Figure 6.4A.2.4.6.5-1).

The UE passes the test when the derived results for at least one polarization fulfil the test requirements.

Table 6.4A.2.4.6.5-1: Test requirements for EVM equalizer spectrum flatness (normal conditions)

Frequency range	Maximum ripple (dB)
$ F_{UL_Meas} - F_{center} \leq X$ MHz (Range 1)	6 + TT (p-p)
$ F_{UL_Meas} - F_{center} > X$ MHz (Range 2)	9 + TT (p-p)

NOTE 1: F_{UL_Meas} refers to the sub-carrier frequency for which the equalizer coefficient is evaluated
 NOTE 2: F_{center} refers to the centre frequency of the CC
 NOTE 3: X, in MHz, is equal to 30% of the CC bandwidth

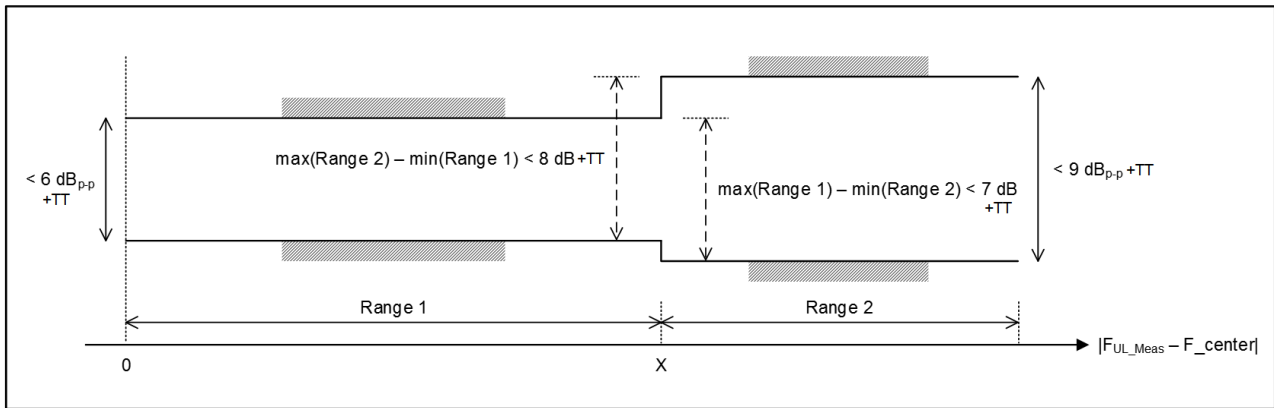

Figure 6.4A.2.4.6.5-1: The limits for EVM equalizer spectral flatness with the maximum allowed variation of the coefficients indicated under normal conditions

6.4A.2.4.7 EVM equalizer spectrum flatness for CA (8UL CA)

Editor's note: This clause is incomplete. The following aspects are either missing or not yet determined:

- Measurement Uncertainty and Test Tolerance are FFS.

6.4A.2.4.7.1 Test Purpose

The zero-forcing equalizer correction applied in the EVM measurement process (as described in Annex E) must meet a spectral flatness requirement for the EVM measurement to be valid. The EVM equalizer spectrum flatness is defined in terms of the maximum peak-to-peak ripple of the equalizer coefficients (dB) across the allocated uplink block, at which the equalizer coefficients are generated by the EVM measurement process. The basic measurement interval is the same as for EVM.

The EVM equalizer spectrum flatness requirement does not limit the correction applied to the signal in the EVM measurement process but for the EVM result to be valid, the equalizer correction that was applied must meet the EVM equalizer spectrum flatness minimum requirements.

6.4A.2.4.7.2 Test applicability

This test case applies to all types of NR UE release 15 and forward that supports FR2 8UL CA.

6.4A.2.4.7.3 Minimum conformance requirements

The minimum conformance requirements are defined in clause 6.4A.2.4.0

6.4A.2.4.7.4 Test description

Same as in clause 6.4A.2.4.1.4 with following exceptions:

- Instead of Table 6.4A.2.4.1.4.1-1: use Table 6.4A.2.4.7.4.1-1.

Table 6.4A.2.4.7.4.1-1: Test Configuration

Default Conditions	
Test Environment as specified in TS 38.508-1 [10] clause 4.1	Normal
Test Frequencies as specified in TS 38.508-1 [10] clause 4.3.1.2.3 for different CA bandwidth classes	Low and High range
Test CC Combination setting (aggregated BW of the CA configuration) as specified in TS 38.508-1 [10] clause 4.3.1.2.3 for the CA Configuration across bandwidth combination sets supported by the UE	Lowest aggregated BW of the CA configuration Highest aggregated BW of the CA configuration
Test SCS as specified in Table 5.3.5-1	Lowest
Test Parameters	

CA Configuration / Aggregated BW			Downlink Configuration	Uplink Configuration	
Test ID	CC & Mapping (NOTE 3)	CBW (MHz)	RB allocation	Modulation	RB allocation (NOTE 1)
1	PCC/CC1	default	-	DFT-s-OFDM QPSK	Outer_Full
	SCC/CC2			-	-
	SCC/CC3			-	-
	SCC/CC4			-	-
	SCC/CC5			-	-
	SCC/CC6			-	-
	SCC/CC7			-	-
	SCC/CC8			-	-
2	PCC/CC1			CP-OFDM QPSK	Outer_Full
	SCC/CC2			-	-
	SCC/CC3			-	-
	SCC/CC4			-	-
	SCC/CC5			-	-
	SCC/CC6			-	-
	SCC/CC7			-	-
	SCC/CC8			-	-

NOTE 1: The specific configuration of each RB allocation is defined in Table 6.1-1 for PC2, PC3 and PC4 or Table 6.1-2 for PC1.

NOTE 2: CA Configuration Test cumulative aggregated BW settings are checked separately for each CA Configuration, which applicable aggregated channel bandwidths are specified in Table 5.5A.1-1.

NOTE 3: PCC/CCi and SCC/CCj means PCC is on component carrier CCi and SCC is on component carrier CCj, with CCi or CCj frequencies defined in TS38.508-1 [10].

NOTE 4: Number of DL CCs shall be configured the same as number of UL CCs. The requirements are applicable as per 5.3A.4: "The requirements are applicable only when Uplink CCs are configured within the frequency range between lower edge of lowest downlink component carrier and upper edge of highest downlink component carrier".

6.4A.2.4.7.5 Test requirement

Each of the *n* spectrum flatness functions, shall derive four ripple results in Annex E.4.4. The derived results shall not exceed the values in Figure 6.4A.2.4.7.5-1: The peak-to-peak variation of the EVM equalizer coefficients contained within the frequency range of the uplink allocation shall not exceed the maximum ripple specified in Table 6.4A.2.4.7.5-1 for normal conditions. For uplink allocations contained within both Range 1 and Range 2, the coefficients evaluated within each of these frequency ranges shall meet the corresponding ripple requirement and the following additional requirements: the relative difference between the maximum coefficient in Range 1 and the minimum coefficient in Range 2 (Table 6.4A.2.4.7.5-1) must not be larger than 7 dB + TT, and the relative difference between the maximum coefficient in Range 2 and the minimum coefficient in Range 1 must not be larger than 8 dB + TT (see Figure 6.4A.2.4.7.5-1).

The UE passes the test when the derived results for at least one polarization fulfil the test requirements.

Table 6.4A.2.4.7.5-1: Test requirements for EVM equalizer spectrum flatness (normal conditions)

Frequency range	Maximum ripple (dB)
$ F_{UL_Meas} - F_{center} \leq X$ MHz (Range 1)	6 + TT (p-p)
$ F_{UL_Meas} - F_{center} > X$ MHz (Range 2)	9 + TT (p-p)
NOTE 1: F_{UL_Meas} refers to the sub-carrier frequency for which the equalizer coefficient is evaluated	
NOTE 2: F_{center} refers to the centre frequency of the CC	
NOTE 3: X, in MHz, is equal to 30% of the CC bandwidth	

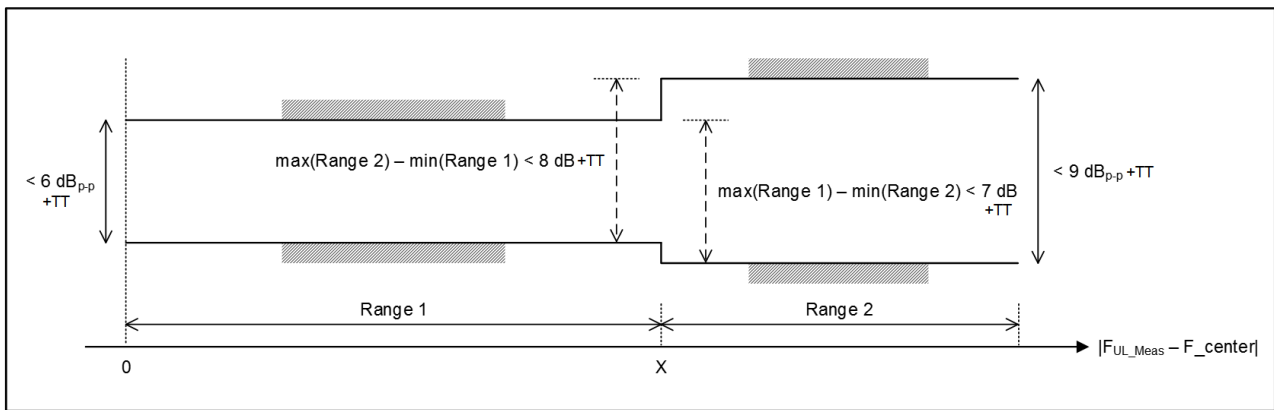

Figure 6.4A.2.4.7.5-1: The limits for EVM equalizer spectral flatness with the maximum allowed variation of the coefficients indicated under normal conditions

6.4A.2.5 Void

6.4D Transmit signal quality for UL MIMO

6.4D.0 General

For a UE supporting UL MIMO, the transmit modulation quality requirements in clause 6.4 apply but with all references to sub-clauses 6.3.1.3.x in clause 6.4 redirected to sub-clauses 6.3D.1.3.x, where 'x' depends on power class. The requirements apply when the UE is configured for 2-layer UL MIMO transmission as specified in Table 6.2D.1.0-1.

The requirement may alternatively be verified in each of the single layer UL MIMO configurations as specified in Table 6.4D.0-1. In this case, the transmit modulation quality requirements in clause 6.4 apply without modification.

Table 6.4D.0-1: Alternative UL MIMO configuration for transmit signal quality tests

Transmission scheme	DCI format	TPMI Index
Codebook based uplink	DCI format 0_1	0
Codebook based uplink	DCI format 0_1	1

6.4D.1 Frequency error for UL MIMO

6.4D.1.1 Test purpose

This test verifies the ability of both, the receiver and the transmitter, to process frequency correctly.

Receiver: to extract the correct frequency from the stimulus signal, offered by the System simulator, under ideal propagation conditions and low level.

Transmitter: to derive the correct modulated carrier frequency for each layer from the results, gained by the receiver.

6.4D.1.2 Test applicability

This test case applies to all types of NR UE release 15 and forward that support UL MIMO.

6.4D.1.3 Minimum conformance requirements

For a UE supporting UL MIMO, the UE basic measurement interval of modulated carrier frequency is 1 UL slot. The mean value of basic measurements of UE modulated carrier frequency at each layer shall be accurate to within ± 0.1

PPM observed over a period of 1 msec of cumulated measurement intervals compared to the carrier frequency received from the NR gNB.

The normative reference for this requirement is TS 38.101-2 [3] clause 6.4D.1

6.4D.1.4 Test description

6.4D.1.4.1 Initial condition

Initial conditions are a set of test configurations the UE needs to be tested in and the steps for the SS to take with the UE to reach the correct measurement state.

The initial test configurations consist of environmental conditions, test frequencies, test channel bandwidths and sub-carrier spacing based on NR operating bands specified in Table 5.3.5-1. All of these configurations shall be tested with applicable test parameters for each combination of channel bandwidth and sub-carrier spacing, are shown in Table 6.4D.1.4.1-1. The details of the uplink and downlink reference measurement channels (RMCs) are specified in Annexes A.2 and A.3. Configurations of PDSCH and PDCCH before measurement are specified in Annex C.2.

Table 6.4D.1.4.1-1: Test Configuration Table

Initial Conditions				
Test Environment as specified in TS 38.508-1 [10] clause 4.1			Normal, TL, TH	
Test Frequencies as specified in TS 38.508-1 [10] clause 4.3.1			Mid range	
Test Channel Bandwidths as specified in TS 38.508-1 [10] clause 4.3.1			Highest	
Test SCS as specified in Table 5.3.5-1.			Lowest	
Test Parameters				
Test ID	Downlink Configuration		Uplink Configuration	
	Modulation	RB allocation	Modulation	RB allocation
1	CP-OFDM QPSK	Full RB (NOTE 1)	CP-OFDM QPSK	REFSENS (NOTE 2)
NOTE 1: Full RB allocation shall be used per each SCS and channel BW as specified in Table 7.3.2.4.1-2.				
NOTE 2: REFSSENS refers to Table 7.3.2.4.1-3 which defines uplink RB configuration and start RB location for each SCS, channel BW and NR band.				

1. Connection between SS and UE is shown in TS 38.508-1 [10] Annex A, Figure A.3.3.1.1 for TE diagram and section A.3.4.1.1 for UE diagram.
2. The parameter settings for the cell are set up according to TS 38.508-1 [10] clause 4.4.3.
3. Downlink signals are initially set up according to Annex C, and uplink signals according to Annex G.
4. The DL and UL Reference Measurement channels are set according to Table 6.4D.1.4.1-1.
5. Propagation conditions are set according to Annex B.0.
6. Ensure the UE is in state RRC_CONNECTED with generic procedure parameters Connectivity *NR*, Connected without release *On*, Test Mode *On* and Test Loop Function *On* according to TS 38.508-1 [10] clause 4.5. Message contents are defined in clause 6.4D.1.4.3

6.4D.1.4.2 Test procedure

1. Retrieve the LO position from the parameter txDirectCurrentLocation in UplinkTxDirectCurrent IE.
2. SS transmits PDSCH via PDCCH DCI format 1_1 for C_RNTI to transmit the DL RMC according to Table 6.4D.1.4.1-1. The SS sends downlink MAC padding bits on the DL RMC.
3. SS sends uplink scheduling information for each UL HARQ process via PDCCH DCI format 0_1 for C_RNTI to schedule the UL RMC according to Table 6.4D.1.4.1-1. Since the UL has no payload and no loopback data to send the UE sends uplink MAC padding bits on the UL RMC. The PDCCH DCI format 0_1 is specified with the condition 2Tx_UL_MIMO in 38.508-1[10] clause 4.3.6.1.1.2.

5. Set the UE in the Inband Tx beam peak direction and apply the associated polarization for the DL, both found with a 3D EIRP scan as performed in Annex K.1.1. Connect the SS (System Simulator) with the DUT through the measurement antenna with polarization reference Pol_{Link} to form the TX beam towards the TX beam peak direction and respective polarization. Allow at least BEAM_SELECT_WAIT_TIME (NOTE 1) for the UE Tx beam selection to complete.
4. Send continuously uplink power control "up" commands to the UE in every uplink scheduling information to the UE so that the UE transmits at P_{UMAX} level for the duration of the test. Allow at least 200ms starting from the first TPC Command for the UE to reach P_{UMAX} level. Allow at least BEAM_SELECT_WAIT_TIME (NOTE 1) for the UE Tx beam selection to complete.
6. SS activates the UE Beamlock Function (UBF) by performing the procedure as specified in TS 38.508-1 [10] clause 4.9.2 using condition TxRx.
7. Measure the Frequency Error using Global In-Channel Tx-Test (Annex E) at each layer for the θ - and φ -polarization of the UL. For TDD, only slots consisting of only UL symbols are under test.

NOTE 1: The BEAM_SELECT_WAIT_TIME default value is defined in Annex K.

6.4D.1.4.3 Message contents

Message contents are according to TS 38.508-1 [10] clause 4.6 ensuring Table 4.6.3-182 with condition 2TX_UL_MIMO.

6.4D.1.5 Test requirement

The 10 frequency error Δf results for the θ -polarization or the 10 frequency error Δf results for the φ -polarization must fulfil the test requirement:

$$|\Delta f| \leq (0.1 \text{ PPM} + 0.005 \text{ PPM})$$

6.4D.2 Transmit signal quality for UL MIMO

Transmit modulation quality defines the modulation quality for expected in-channel RF transmissions from the UE. The transmit modulation quality is specified in terms of:

- Error Vector Magnitude (EVM) for the allocated resource blocks (RBs)
- EVM equalizer spectrum flatness derived from the equalizer coefficients generated by the EVM measurement process
- Carrier leakage
- In-band emissions for the non-allocated RB

6.4D.2.1 Error vector magnitude for UL MIMO

Editor's note: This clause is incomplete. The following aspects are either missing or not yet determined:

- OTA test procedure for UL MIMO is still under investigation.
- Test config table is FFS.
- TP analysis is FFS.
- Measurement Uncertainty and Test Tolerances are FFS.

6.4D.2.1.1 Test purpose

The Error Vector Magnitude is a measure of the difference between the reference waveform and the measured waveform. This difference is called the error vector.

6.4D.2.1.2 Test applicability

This test case applies to all types of NR UE release 15 and forward that support UL MIMO.

6.4D.2.1.3 Minimum conformance requirements

For UE supporting UL MIMO, the transmit modulation quality requirements are specified per layer in terms of:

Error Vector Magnitude (EVM) for the allocated resource blocks (RBs)

EVM equalizer spectrum flatness derived from the equalizer coefficients generated by the EVM measurement process

Carrier leakage (caused by IQ offset)

For UE supporting UL MIMO, the transmit modulation quality requirements are specified as the total component of EIRP in terms of:

In-band emissions for the non-allocated RB

The requirements are defined as directional requirements. The requirements are verified in beam locked mode in the TX beam peak direction (Link=TX beam peak direction, Meas=Link angle).

In case the parameter 3300 or 3301 is reported from UE via the parameter *txDirectCurrentLocation* in *UplinkTxDirectCurrentList* IE (as defined in TS 38.331 [13]), carrier leakage measurement requirement in clause 6.4D.2.2 and 6.4D.2.3 shall be waived, and the RF correction with regard to the carrier leakage and IQ image shall be omitted during the calculation of transmit modulation quality.

The normative reference for this requirement is TS 38.101-2 [3] clause 6.4D.2.

6.4D.2.1.4 Test description

6.4D.2.1.4.1 Initial condition

Initial conditions are a set of test configurations the UE needs to be tested in and the steps for the SS to take with the UE to reach the correct measurement state.

The initial test configurations consist of environmental conditions, test frequencies, test channel bandwidths and sub-carrier spacing based on NR operating bands specified in Table 5.3.5-1. All of these configurations shall be tested with applicable test parameters for each combination of channel bandwidth and sub-carrier spacing, are shown in Tables 6.4D.2.1.4.1-1. The details of the uplink reference measurement channels (RMCs) are specified in Annex A.2. Configurations of PDSCH and PDCCH before measurement are specified in Annex C.2.

Table 6.4D.2.1.4.1-1: Test Configuration Table for PUSCH

Initial Conditions			
Test Environment as specified in TS 38.508-1 [10] clause 4.1		FFS	
Test Frequencies as specified in TS 38.508-1 [10] clause 4.3.1		FFS	
Test Channel Bandwidths as specified in TS 38.508-1 [10] clause 4.3.1		FFS	
Test SCS as specified in Table 5.3.5-1		FFS	
Test Parameters			
Test ID	Downlink Configuration	Uplink Configuration	
	-	Modulation	RB allocation (NOTE 1)
1		FFS	FFS
2			
3			
4			
5			
6			
7			

8		
9		
10		
11		
12		
13		
14		
NOTE 1:		
NOTE 2:		

1. Connection between SS and UE is shown in TS 38.508-1 [10] Annex A, in Figure A.3.3.1.1 for TE diagram and section A.3.4.1.1 for UE diagram.
2. The parameter settings for the cell are set up according to TS 38.508-1 [10] clause 4.4.3.
3. Downlink signals are initially set up according to Annex C, and uplink signals according to Annex G.
4. The UL Reference Measurement channels are set according to Tables 6.4D.2.1.4.1-1, 6.4D.2.1.4.1-1 and 6.4D.2.1.4.1-3.
5. Propagation conditions are set according to Annex B.0.
6. Ensure the UE is in state RRC_CONNECTED with generic procedure parameters Connectivity NR, Connected without release On, Test Mode On and Test Loop Function On according to TS 38.508-1 [10] clause 4.5. Message contents are defined in clause 6.4D.2.1.4.3

6.4D.2.1.4.2 Test procedure

Test procedure for PUSCH:

- 1.1 Retrieve the LO position from the parameter txDirectCurrentLocation in UplinkTxDirectCurrent IE.
- 1.2 SS sends uplink scheduling information for each UL HARQ process via PDCCH DCI format 0_1 for C_RNTI to schedule the UL RMC according to Table 6.4D.2.1.4.1-1. Since the UE has no payload data to send, the UE transmits uplink MAC padding bits on the UL RMC.
- 1.3 Set the UE in the Inband Tx beam peak direction found with a 3D EIRP scan as performed in Annex K.1.1. Allow at least BEAM_SELECT_WAIT_TIME (NOTE 2) for the UE Tx beam selection to complete.
- 1.4 Send continuously uplink power control "up" commands in the uplink scheduling information to the UE until the UE transmits at P_{UMAX} level. Allow at least 200 ms starting from the first TPC command in this step for the UE to reach P_{UMAX} level. Allow at least BEAM_SELECT_WAIT_TIME (NOTE 2) for the UE Tx beam selection to complete.
- 1.5 SS activates the UE Beamlock Function (UBF) by performing the procedure as specified in TS 38.508-1 [10] clause 4.9.2 using condition TxRx.
- 1.6 Measure the EVM and \overline{EVM}_{DMRS} using Global In-Channel Tx-Test (Annex E with procedures in E.7.1 and E.7.2) for each layer. For TDD, only slots consisting of only UL symbols are under test.
- 1.7 SS deactivates the UE Beamlock Function (UBF) by performing the procedure as specified in TS 38.508-1 [10] clause 4.9.3.

NOTE1: When switching to DFT-s-OFDM waveform, as specified in Table 6.4D.2.1.4.1-1, send an NR RRCReconfiguration message according to TS 38.508-1 [10] clause 4.6.3 Table 4.6.3-118 PUSCH-Config with TRANSFORM_PRECODER_ENABLED condition.

NOTE 2: The BEAM_SELECT_WAIT_TIME default value is defined in Annex K.

6.4D.2.1.4.3 Message contents

Message contents are according to TS 38.508-1 [10] clause 4.6 ensuring Table 4.6.3-182 with condition 2TX_UL_MIMO.

Table 6.4D.2.1.4.3-1: Void

Table 6.4D.2.1.4.3-2: Void

Table 6.4D.2.1.4.3-3: Void

6.4D.2.1.5 Test requirement

The PUSCH EVM, derived in Annex E.4.2, shall not exceed the values in Table 6.4D.2.1.5-1.

The PUSCH \overline{EVM}_{DMRS} , derived in Annex E.4.6.2, shall not exceed the values in Table 6.4D.2.1.5-1 when embedded with data symbols of the respective modulation scheme.

Table 6.4D.2.1.5-1: Test requirements for Error Vector Magnitude

Parameter	Unit	Average EVM Level	Reference Signal EVM Level
Pi/2 BPSK	%	30+TT	30+TT
QPSK	%	17.5+TT	17.5+TT
16 QAM	%	12.5+TT	12.5+TT
64 QAM	%	8+TT	8+TT

6.4D.2.2 Carrier leakage for UL MIMO

Editor's note: This clause is incomplete. The following aspects are either missing or not yet determined:

- OTA test procedure for UL MIMO is still under investigation.
- Test config table is FFS.
- TP analysis is FFS.
- Measurement Uncertainty and Test Tolerances are FFS.

6.4D.2.2.1 Test purpose

The purpose of this test is to exercise the UE transmitter to verify its modulation quality in terms of carrier leakage.

6.4D.2.2.2 Test applicability

This test case applies to all types of NR UE release 15 and forward that support UL MIMO.

6.4D.2.2.3 Minimum conformance requirements

For a UE supporting UL MIMO, the Carrier leakage is an additive sinusoid waveform. The carrier leakage requirement is defined for each component carrier. The measurement interval is one slot in the time domain. The relative carrier leakage power is a power ratio of the additive sinusoid waveform to the power in the modulated waveform.

The requirement is verified with the test metric of Carrier Leakage (Link=TX beam peak direction, Meas=Link angle).

When carrier leakage is contained inside the spectrum confined within the configured UL and DL CCs, the relative carrier leakage power shall not exceed the values specified in Table 6.4D.2.2.3-1 for power class 1 UEs.

Table 6.4D.2.2.3-1: Minimum requirements for relative carrier leakage power for power class 1

Parameters	Relative Limit (dBc)
EIRP > 17 dBm	-25
4 dBm ≤ EIRP ≤ 17 dBm	-20

When carrier leakage is contained inside the spectrum occupied by the configured UL CCs and DL CCs, the relative carrier leakage power shall not exceed the values specified in Table 6.4D.2.2.3-2 for power class 2.

Table 6.4D.2.2.3-2: Minimum requirements for relative carrier leakage power for power class 2

Parameters	Relative Limit (dBc)
EIRP > 6 dBm	-25
-13 dBm ≤ EIRP ≤ 6 dBm	-20

When carrier leakage is contained inside the spectrum occupied by the configured UL CCs and DL CCs, the relative carrier leakage power shall not exceed the values specified in Table 6.4D.2.2.3-3 for power class 3 UEs.

Table 6.4D.2.2.3-3: Minimum requirements for relative carrier leakage power for power class 3

Parameters	Relative Limit (dBc)
EIRP > 0 dBm	-25
-13 dBm ≤ EIRP ≤ 0 dBm	-20

When carrier leakage is contained inside the spectrum occupied by the configured UL CCs and DL CCs, the relative carrier leakage power shall not exceed the values specified in Table 6.4D.2.2.3-4 for power class 4.

Table 6.4D.2.2.3-4: Minimum requirements for relative carrier leakage power for power class 4

Parameters	Relative Limit (dBc)
EIRP > 11 dBm	-25
-13 dBm ≤ EIRP ≤ 11 dBm	-20

The normative reference for this requirement is TS 38.101-2[3] clause 6.4D.2.

Table 6.4D.2.2.3-5:

FFS

When carrier leakage is contained inside the spectrum occupied by the configured UL CCs and DL CCs, the relative carrier leakage power shall not exceed the values specified in Table 6.4D.2.2.3-6 for power class 6.

Table 6.4D.2.2.3-6: Minimum requirements for relative carrier leakage power for power class 6

Parameters	Relative Limit (dBc)
EIRP > 7 dBm	-25
-6 dBm ≤ EIRP ≤ 7 dBm	-20

The normative reference for this requirement is TS 38.101-2[3] clause 6.4D.2.

6.4D.2.2.4 Test description

6.4D.2.2.4.1 Initial condition

Initial conditions are a set of test configurations the UE needs to be tested in and the steps for the SS to take with the UE to reach the correct measurement state.

The initial test configurations consist of environmental conditions, test frequencies, test channel bandwidths and sub-carrier spacing based on NR operating bands specified in Table 5.3.5-1. All of these configurations shall be tested with applicable test parameters for each combination of channel bandwidth and sub-carrier spacing, are shown in Table

6.4D.2.2.4.1-1. The details of the uplink reference measurement channels (RMCs) are specified in Annexes A.2. Configurations of PDSCH and PDCCH before measurement are specified in Annex C.2.

Table 6.4D.2.2.4.1-1: Test Configuration

Initial Conditions			
Test Environment as specified in TS 38.508-1 [10] clause 4.1		FFS	
Test Frequencies as specified in TS 38.508-1 [10] clause 4.3.1		FFS	
Test Channel Bandwidths as specified in TS 38.508-1 [10] clause 4.3.1		FFS	
Test SCS as specified in Table 5.3.5-1			
Test Parameters			
Test ID	Downlink Configuration	Uplink Configuration	
	-	Modulation	RB allocation (NOTE 1, 3)
1			
NOTE 1: NOTE 2: NOTE 3:			

1. Connection between SS and UE is shown in TS 38.508-1 [10] Annex A, in Figure A.3.3.1.1 for TE diagram and section A.3.4.1.1 for UE diagram.
2. The parameter settings for the cell are set up according to TS 38.508-1 [10] clause 4.4.3.
3. Downlink signals are initially set up according to Annex C, and uplink signals according to Annex G.
4. The UL Reference Measurement channels are set according to Table 6.4D.2.2.4.1-1.
5. Propagation conditions are set according to Annex B.0.
6. Ensure the UE is in state RRC_CONNECTED with generic procedure parameters Connectivity *NR*, Connected without release *On*, Test Mode *On* and Test Loop Function *On* according to TS 38.508-1 [10] clause 4.5. Message contents are defined in clause 6.4D.2.2.4.3.
7. In case the parameter 3300 or 3301 is reported from the UE via *txDirectCurrentLocation* IE, do not proceed to test procedure and mark the test not applicable with reasoning in the test report.

6.4D.2.2.4.2 Test procedure

1. Retrieve the LO position from the parameter *txDirectCurrentLocation* in UplinkTxDirectCurrent IE.
2. SS sends uplink scheduling information for each UL HARQ process via PDCCH DCI format 0_1 for C_RNTI to schedule the UL RMC according to Table 6.4D.2.2.4.1-1. Since the UE has no payload and no loopback data to send the UE sends uplink MAC padding bits on the UL RMC.
3. Set the UE in the Inband Tx beam peak direction found with a 3D EIRP scan as performed in Annex K.1.1. Allow at least BEAM_SELECT_WAIT_TIME (NOTE 1) for the UE Tx beam selection to complete.
4. Send uplink power control commands to the UE using 1dB power step size to ensure that the UE $EIRP_{Total} = EIRP_{\theta} + EIRP_{\phi}$ measured by the test system is within the Uplink power control window, defined as +MU to +(MU + Uplink power control window size) dB of the target power level P_{req} , where:
 - P_{req} is the power level specified in Table 6.4D.2.2.4.2-1 according to the power class.
 - MU is the test system uplink absolute power measurement uncertainty and is specified in Table F.1.2-1 under carrier leakage sub-clause for the carrier frequency f and the channel bandwidth BW.
 - Uplink power control window size = 1dB (UE power step size) + 5 dB (UE power step tolerance) + (Test system uplink relative power measurement uncertainty), where, the UE power step tolerance is specified in TS 38.101-1 [2], Table 6.3.4.3-1 and is 5dB for 1dB power step size, and the Test system uplink relative power measurement uncertainty is specified in Table F.1.2-1.

Allow at least BEAM_SELECT_WAIT_TIME (NOTE 1) for the UE Tx beam selection to complete.

5. SS activates the UE Beamlock Function (UBF) by performing the procedure as specified in TS 38.508-1 [10] clause 4.9.2 using condition TxRx.
6. Measure carrier leakage using Global In-Channel Tx-Test (Annex E) for the θ - and ϕ -polarization at the LO position obtained in step 1. For TDD, only slots consisting of only UL symbols are under test. Calculate $\text{CarrLeak} = \min(\text{CarrLeak}_\theta, \text{CarrLeak}_\phi)$.
7. SS deactivates the UE Beamlock Function (UBF) by performing the procedure as specified in TS 38.508-1 [10] clause 4.9.3.

NOTE 1: The BEAM_SELECT_WAIT_TIME default value is defined in Annex K.

NOTE 2: The purpose of the Uplink power control window is to ensure that the actual UE output power is no less than the target power level, and as close as possible to the target power level. The relationship between the Uplink power control window, the target power level and the corresponding possible actual UE Uplink power window is illustrated in Annex F.4.2.

Table 6.4.2.2.4.2-1: UE EIRP P_{req} (dBm) for carrier leakage

Power Class	P_{req} (dBm) for step 3
Power Class 1	17
Power Class 2	6
Power Class 3	0
Power Class 4	11
Power Class 6	7

Table 6.4.2.2.4.2-2: Void

6.4D.2.2.4.3 Message contents

Message contents are according to TS 38.508-1 [10] clause 4.6 ensuring Table 4.6.3-182 with condition 2TX_UL_MIMO and with TRANSFORM_PRECODER_ENABLED condition in Table 4.6.3-118 PUSCH-Config.

6.4D.2.2.5 Test requirement

For each of the n carrier leakage results derived in Annex E.3.1 for θ - and ϕ -polarization the minimum is calculated according to

$$\text{CarrLeak} = \min(\text{CarrLeak}_\theta, \text{CarrLeak}_\phi), \text{ where}$$

$$n = \begin{cases} 30, & \text{for 60 kHz SCS} \\ 60, & \text{for 120 kHz SCS} \end{cases}$$

Each of the n carrier leakage results CarrLeak shall not exceed the values in Table 6.4D.2.2.5-1 to Table 6.4D.2.2.5-4. Allocated RBs are not under test.

Table 6.4D.2.2.5-1a: Test requirements for relative carrier leakage power for power class 1

Parameter	Relative limit (dBc)
$17 \text{ dBm} + \text{MU} < \text{EIRP} \leq 17 \text{ dBm} + \text{MU} + \text{Uplink power control window size}$	-25 + TT

Table 6.4D.2.2.5-1b: Test Tolerance (carrier leakage for power class 1)

Test Metric	FR2a	FR2b
Max device size ≤ 30 cm	TBD	TBD

Table 6.4D.2.2.5-2a: Test requirements for relative carrier leakage power for power class 2

Parameter	Relative limit (dBc)
$6 \text{ dBm} + \text{MU} < \text{EIRP} \leq 6 \text{ dBm} + \text{MU} + \text{Uplink power}$ control window size	$-25 + \text{TT}$

Table 6.4D.2.2.5-2b: Test Tolerance (carrier leakage for power class 2)

Test Metric	FR2a	FR2b
Max device size ≤ 30 cm	TBD	TBD

Table 6.4D.2.2.5-3a: Test requirements for relative carrier leakage power for power class 3

Parameter	Relative limit (dBc)
$0 \text{ dBm} + \text{MU} < \text{EIRP} \leq 0 \text{ dBm} + \text{MU} + \text{Uplink power}$ control window size	$-25 + \text{TT}$

Table 6.4D.2.2.5-3b: Test Tolerance (carrier leakage for power class 3)

Test Metric	FR2a	FR2b
Max device size ≤ 30 cm	TBD	TBD

Table 6.4D.2.2.5-4a: Test requirements for relative carrier Leakage Power for power class 4

Parameter	Relative limit (dBc)
$11 \text{ dBm} + \text{MU} < \text{EIRP} \leq 11 \text{ dBm} + \text{MU} + \text{Uplink power}$ control window size	$-25 + \text{TT}$

Table 6.4D.2.2.5-4b: Test Tolerance (carrier leakage for power class 4)

Test Metric	FR2a	FR2b
Max device size ≤ 30 cm	TBD	TBD

Table 6.4D.2.2.5-5a

FFS

Table 6.4D.2.2.5-5b

FFS

Table 6.4D.2.2.5-6a: Test requirements for relative carrier Leakage Power for power class 6

Parameter	Relative limit (dBc)
$11 \text{ dBm} + \text{MU} < \text{EIRP} \leq 11 \text{ dBm} + \text{MU} + \text{Uplink power}$ control window size	$-25 + \text{TT}$

Table 6.4D.2.2.5-6b: Test Tolerance (carrier leakage for power class 6)

Test Metric	FR2a	FR2b
Max device size ≤ 30 cm	TBD	TBD

6.4D.2.3 In-band emissions for UL MIMO

Editor's note: This clause is incomplete. The following aspects are either missing or not yet determined:

- OTA test procedure for UL MIMO is still under investigation.
- Test config table is FFS.
- TP analysis is FFS.
- Measurement Uncertainty and Test Tolerances are FFS.

6.4D.2.3.1 Test purpose

The purpose of this test is to exercise the UE transmitter to verify its modulation quality in terms of in-band emissions.

6.4D.2.3.2 Test applicability

This test case applies to all types of NR UE release 15 and forward that support UL MIMO.

6.4D.2.3.3 Minimum conformance requirements

For a UE supporting UL MIMO, the in-band emission is defined as the average across 12 sub-carriers and as a function of the RB offset from the edge of the allocated UL transmission bandwidth. The in-band emission is measured as the ratio of the UE output power in a non-allocated RB to the UE output power in an allocated RB. The IBE requirement does not apply if UE declares support for *mpr-PowerBoost-FR2-r16*, UL transmission excluding Pi/2 BPSK is such that $MPR_{f,c} = 0$ and when NS_200 applies, and the network configures the UE to operate with *mpr-PowerBoost-FR2-r16*.

The basic in-band emissions measurement interval is identical to that of the EVM test.

The requirement is verified with the test metric of In-band emission (Link=TX beam peak direction, Meas=Link angle).

The relative in-band emission shall not exceed the values specified in Table 6.4D.2.3.3-1 for power class 1 UEs.

The average of the in-band emission measurement over 10 sub-frames shall not exceed the values specified in Table 6.4D.2.3.3-1 for power class 1, Table 6.4D.2.3.3-2 for power class 2, Table 6.4D.2.3.3-3 for power class 3 and Table 6.4D.2.3.3-4 for power class 4 UEs.

Table 6.4D.2.3.3-1: Requirements for in-band emissions for power class 1

Parameter description	Unit	Limit (NOTE 1)		Applicable Frequencies
General	dB	$\max \left[\begin{array}{l} -25 - 10 \cdot \log_{10} \left(\frac{N_{RB}}{L_{CRB}} \right), \\ 20 \cdot \log_{10}(\text{EVM}) - 5 \cdot \frac{(\Delta_{RB} - 1)}{L_{CRB}}, \\ -55.1 \text{ dBm} - P_{RB} \end{array} \right]$		Any non-allocated (NOTE 2)
IQ Image	dB	-25	Output power > 27 dBm	Image frequencies (NOTES 2, 3)
		-20	Output power ≤ 27 dBm	
Carrier leakage	dBc	-25	Output power > 17 dBm	Carrier frequency (NOTES 4, 5)
		-20	4 dBm ≤ Output power ≤ 17 dBm	

- NOTE 1: An in-band emissions combined limit is evaluated in each non-allocated RB. For each such RB, the minimum requirement is calculated as the higher of ($P_{RB} - 25$ dB) and the power sum of all limit values (General, IQ Image or Carrier leakage) that apply. P_{RB} is defined in NOTE 10.
- NOTE 2: The measurement bandwidth is 1 RB and the limit is expressed as a ratio of measured power in one non-allocated RB to the measured average power per allocated RB, where the averaging is done across all allocated RBs. For pi/2 BPSK with Spectrum Shaping, the limit is expressed as a ratio of measured power in one non-allocated RB to the measured power in the allocated RB with highest PSD
- NOTE 3: The applicable frequencies for this limit are those that are enclosed in the reflection of the allocated bandwidth, based on symmetry with respect to the carrier frequency, but excluding any allocated RBs.
- NOTE 4: The measurement bandwidth is 1 RB and the limit is expressed as a ratio of measured power in one non-allocated RB to the measured total power in all allocated RBs.
- NOTE 5: The applicable frequencies for this limit depend on the parameter *txDirectCurrentLocation* in *UplinkTxDirectCurrent* IE, and are those that are enclosed in the RBs containing the DC frequency but excluding any allocated RB.
- NOTE 6: L_{CRB} is the Transmission Bandwidth (see Section 5.3).
- NOTE 7: N_{RB} is the Transmission Bandwidth Configuration (see Section 5.3).
- NOTE 8: EVM s the limit for the modulation format used in the allocated RBs.
- NOTE 9: Δ_{RB} is the starting frequency offset between the allocated RB and the measured non-allocated RB (e.g. $\Delta_{RB} = 1$ or $\Delta_{RB} = -1$ for the first adjacent RB outside of the allocated bandwidth).
- NOTE 10: P_{RB} is the transmitted power per allocated RB, measured in dBm.
- NOTE 11: All powers are EIRP in beam peak direction.

The relative in-band emission shall not exceed the values specified in Table 6.4D.2.3.3-2 for power class 2.

Table 6.4D.2.3.3-2: Requirements for in-band emissions for power class 2

Parameter description	Unit	Limit (NOTE 1)		Applicable Frequencies
General	dB	$\max \left[\begin{array}{l} -25 - 10 \cdot \log_{10} \left(\frac{N_{RB}}{L_{CRB}} \right), \\ 20 \cdot \log_{10}(\text{EVM}) - 5 \cdot \frac{(\Delta_{RB} - 1)}{L_{CRB}}, \\ -55.1 \text{ dBm} - P_{RB} \end{array} \right]$		Any non-allocated (NOTE 2)
IQ Image	dB	-25	Output power > 16 dBm	Image frequencies (NOTES 2, 3)
		-20	Output power ≤ 16 dBm	
Carrier leakage	dBc	-25	Output power > 6 dBm	Carrier frequency (NOTES 4, 5)
		-20	-13 dBm ≤ Output power ≤ 6 dBm	
<p>NOTE 1: An in-band emissions combined limit is evaluated in each non-allocated RB. For each such RB, the minimum requirement is calculated as the higher of ($P_{RB} - 25$ dB) and the power sum of all limit values (General, IQ Image or Carrier leakage) that apply. P_{RB} is defined in NOTE 10.</p> <p>NOTE 2: The measurement bandwidth is 1 RB and the limit is expressed as a ratio of measured power in one non-allocated RB to the measured average power per allocated RB, where the averaging is done across all allocated RBs. For pi/2 BPSK with Spectrum Shaping, the limit is expressed as a ratio of measured power in one non-allocated RB to the measured power in the allocated RB with highest PSD</p> <p>NOTE 3: The applicable frequencies for this limit are those that are enclosed in the reflection of the allocated bandwidth, based on symmetry with respect to the carrier frequency, but excluding any allocated RBs.</p> <p>NOTE 4: The measurement bandwidth is 1 RB and the limit is expressed as a ratio of measured power in one non-allocated RB to the measured total power in all allocated RBs.</p> <p>NOTE 5: The applicable frequencies for this limit depend on the parameter <i>txDirectCurrentLocation</i> in <i>UplinkTxDirectCurrent</i> IE, and are those that are enclosed in the RBs containing the DC frequency but excluding any allocated RB.</p> <p>NOTE 6: L_{CRB} is the Transmission Bandwidth (see Section 5.3).</p> <p>NOTE 7: N_{RB} is the Transmission Bandwidth Configuration (see Section 5.3).</p> <p>NOTE 8: EVM s the limit for the modulation format used in the allocated RBs.</p> <p>NOTE 9: Δ_{RB} is the starting frequency offset between the allocated RB and the measured non-allocated RB (e.g. $\Delta_{RB} = 1$ or $\Delta_{RB} = -1$ for the first adjacent RB outside of the allocated bandwidth).</p> <p>NOTE 10: P_{RB} is the transmitted power per allocated RB, measured in dBm.</p> <p>NOTE 11: All powers are EIRP in beam peak direction.</p>				

The relative in-band emission shall not exceed the values specified in Table 6.4D.2.3.3-3 for power class 3 UEs.

Table 6.4D.2.3.3-3: Requirements for in-band emissions for power class 3

Parameter description	Unit	Limit (NOTE 1)		Applicable Frequencies
General	dB	$\max \left[\begin{array}{l} -25 - 10 \cdot \log_{10} \left(\frac{N_{RB}}{L_{CRB}} \right), \\ 20 \cdot \log_{10}(\text{EVM}) - 5 \cdot \frac{(\Delta_{RB} - 1)}{L_{CRB}}, \\ -55.1 \text{ dBm} - P_{RB} \end{array} \right]$		Any non-allocated (NOTE 2)
IQ Image	dB	-25	Output power > 10 dBm	Image frequencies (NOTES 2, 3)
		-20	Output power ≤ 10 dBm	
Carrier leakage	dBc	-25	Output power > 0 dBm	Carrier frequency (NOTES 4, 5)
		-20	-13 dBm ≤ Output power ≤ 0 dBm	
<p>NOTE 1: An in-band emissions combined limit is evaluated in each non-allocated RB. For each such RB, the minimum requirement is calculated as the higher of ($P_{RB} - 25$ dB) and the power sum of all limit values (General, IQ Image or Carrier leakage) that apply. P_{RB} is defined in NOTE 10.</p> <p>NOTE 2: The measurement bandwidth is 1 RB and the limit is expressed as a ratio of measured power in one non-allocated RB to the measured average power per allocated RB, where the averaging is done across all allocated RBs. For pi/2 BPSK with Spectrum Shaping, the limit is expressed as a ratio of measured power in one non-allocated RB to the measured power in the allocated RB with highest PSD</p> <p>NOTE 3: The applicable frequencies for this limit are those that are enclosed in the reflection of the allocated bandwidth, based on symmetry with respect to the carrier frequency, but excluding any allocated RBs.</p> <p>NOTE 4: The measurement bandwidth is 1 RB and the limit is expressed as a ratio of measured power in one non-allocated RB to the measured total power in all allocated RBs.</p> <p>NOTE 5: The applicable frequencies for this limit depend on the parameter <i>txDirectCurrentLocation</i> in <i>UplinkTxDirectCurrent</i> IE, and are those that are enclosed in the RBs containing the DC frequency but excluding any allocated RB.</p> <p>NOTE 6: L_{CRB} is the Transmission Bandwidth (see Section 5.3).</p> <p>NOTE 7: N_{RB} is the Transmission Bandwidth Configuration (see Section 5.3).</p> <p>NOTE 8: EVM is the limit for the modulation format used in the allocated RBs.</p> <p>NOTE 9: Δ_{RB} is the starting frequency offset between the allocated RB and the measured non-allocated RB (e.g. $\Delta_{RB} = 1$ or $\Delta_{RB} = -1$ for the first adjacent RB outside of the allocated bandwidth).</p> <p>NOTE 10: P_{RB} is the transmitted power per allocated RB, measured in dBm.</p> <p>NOTE 11: All powers are EIRP in beam peak direction.</p>				

The relative in-band emission shall not exceed the values specified in Table 6.4D.2.3.3-4 for power class 4 UEs.

Table 6.4D.2.3.3-4: Requirements for in-band emissions for power class 4

Parameter description	Unit	Limit (NOTE 1)		Applicable Frequencies
General	dB	$\max \left[\begin{array}{l} -25 - 10 \cdot \log_{10} \left(\frac{N_{RB}}{L_{CRB}} \right), \\ 20 \cdot \log_{10}(\text{EVM}) - 5 \cdot \frac{(\Delta_{RB} - 1)}{L_{CRB}}, \\ -55.1 \text{ dBm} - P_{RB} \end{array} \right]$		Any non-allocated (NOTE 2)
IQ Image	dB	-25	Output power > 21 dBm	Image frequencies (NOTES 2, 3)
		-20	Output power ≤ 21 dBm	
Carrier leakage	dBc	-25	Output power > 11 dBm	Carrier frequency (NOTES 4, 5)
		-20	-13 dBm ≤ Output power ≤ 11 dBm	

- NOTE 1: An in-band emissions combined limit is evaluated in each non-allocated RB. For each such RB, the minimum requirement is calculated as the higher of ($P_{RB} - 25$ dB) and the power sum of all limit values (General, IQ Image or Carrier leakage) that apply. P_{RB} is defined in NOTE 10.
- NOTE 2: The measurement bandwidth is 1 RB and the limit is expressed as a ratio of measured power in one non-allocated RB to the measured average power per allocated RB, where the averaging is done across all allocated RBs. For pi/2 BPSK with Spectrum Shaping, the limit is expressed as a ratio of measured power in one non-allocated RB to the measured power in the allocated RB with highest PSD
- NOTE 3: The applicable frequencies for this limit are those that are enclosed in the reflection of the allocated bandwidth, based on symmetry with respect to the carrier frequency, but excluding any allocated RBs.
- NOTE 4: The measurement bandwidth is 1 RB and the limit is expressed as a ratio of measured power in one non-allocated RB to the measured total power in all allocated RBs.
- NOTE 5: The applicable frequencies for this limit depend on the parameter *txDirectCurrentLocation* in *UplinkTxDirectCurrent* IE, and are those that are enclosed in the RBs containing the DC frequency but excluding any allocated RB.
- NOTE 6: L_{CRB} is the Transmission Bandwidth (see Section 5.3).
- NOTE 7: N_{RB} is the Transmission Bandwidth Configuration (see Section 5.3).
- NOTE 8: EVM is the limit for the modulation format used in the allocated RBs.
- NOTE 9: Δ_{RB} is the starting frequency offset between the allocated RB and the measured non-allocated RB (e.g. $\Delta_{RB} = 1$ or $\Delta_{RB} = -1$ for the first adjacent RB outside of the allocated bandwidth).
- NOTE 10: P_{RB} is the transmitted power per allocated RB, measured in dBm.
- NOTE 11: All powers are EIRP in beam peak direction.

The normative reference for this requirement is TS 38.101-2 [3] clause 6.4D.2.

Table 6.4D.2.3.3-5: FFS

FFS

The normative reference for this requirement is TS 38.101-2 [3] clause 6.4.2.3.

The average of the in-band emission measurement over 10 sub-frames shall not exceed the values specified in Table 6.4D.2.3.3-6 for power class 6 UEs.

6.4D.2.3.4 Test description

6.4D.2.3.4.1 Initial condition

Initial conditions are a set of test configurations the UE needs to be tested in and the steps for the SS to take with the UE to reach the correct measurement state.

The initial test configurations consist of environmental conditions, test frequencies, test channel bandwidths and sub-carrier spacing based on NR operating bands specified in Table 5.3.5-1. All of these configurations shall be tested with applicable test parameters for each combination of channel bandwidth and sub-carrier spacing, are shown in Table 6.4D.2.3.4.1-1. The details of the uplink reference measurement channels (RMCs) are specified in Annex A.2. Configurations of PDSCH and PDCCH before measurement are specified in Annex C.2.

Table 6.4D.2.3.4.1-1: Test Configuration Table for PUSCH

Initial Conditions			
Test Environment as specified in TS 38.508-1 [10] clause 4.1		FFS	
Test Frequencies as specified in TS 38.508-1 [10] clause 4.3.1			
Test Channel Bandwidths as specified in TS 38.508-1 [10] clause 4.3.1			
Test SCS as specified in Table 5.3.5-1			
Test Parameters			
Test ID	Downlink Configuration	Uplink Configuration	
		Modulation	RB allocation (NOTE 1)
1	-	FFS	

2		
3		
4		
NOTE 1: FFS		
NOTE 2: FFS		

Table 6.4D.2.3.4.1-2: Test Configuration Table for PUCCH

Initial Conditions				
Test Environment as specified in TS 38.508-1 [10] clause 4.1		FFS		
Test Frequencies as specified in TS 38.508-1 [10] clause 4.3.1				
Test Channel Bandwidths as specified in TS 38.508-1 [10] clause 4.3.1				
Test SCS as specified in Table 5.3.5-1				
Test Parameters				
ID	Downlink Configuration		Uplink Configuration	
	Modulation	RB allocation	Waveform	PUCCH format
1			FFS	
2				
NOTE 1: FFS				

1. Connection between SS and UE is shown in TS 38.508-1 [10] Annex A, in Figure A.3.3.1.1 for TE diagram and section A.3.4.1.1 for UE diagram.
2. The parameter settings for the cell are set up according to TS 38.508-1 [10] clause 4.4.3.
3. Downlink signals are initially set up according to Annex C, and uplink signals according to Annex G.
4. The UL Reference Measurement channels are set according to Table 6.4D.2.3.4.1-1.
5. Propagation conditions are set according to Annex B.0.
6. Ensure the UE is in state RRC_CONNECTED with generic procedure parameters Connectivity *NR*, Connected without release *On*, Test Mode *On* and Test Loop Function *On* according to TS 38.508-1 [10] clause 4.5. Message contents are defined in clause 6.4D.2.3.4.3

6.4D.2.3.4.2 Test procedure

Test procedure for PUSCH:

- 1.1 Retrieve the LO position from the parameter txDirectCurrentLocation in UplinkTxDirectCurrent IE.
- 1.2 SS sends uplink scheduling information for each UL HARQ process via PDCCH DCI format 0_1 for C_RNTI to schedule the UL RMC according to Table 6.4D.2.3.4.1-1. Since the UE has no payload and no loopback data to send the UE sends uplink MAC padding bits on the UL RMC.
- 1.3 Set the UE in the Inband Tx beam peak direction found with a 3D EIRP scan as performed in Annex K.1.1. Allow at least BEAM_SELECT_WAIT_TIME (NOTE 2) for the UE Tx beam selection to complete.
- 1.4 Send the appropriate TPC commands in the uplink scheduling information to the UE until UE output power is $P_{req} + P_W \pm P_W$, where P_{req} is the power level specified in Tables 6.4D.2.3.4.2-1 according to the power class with power ID = 1. P_W is the power window according to Table 6.4D.2.3.4.2-2 for the carrier frequency f and the channel bandwidth BW . Allow at least BEAM_SELECT_WAIT_TIME (NOTE 2) for the UE Tx beam selection to complete.
- 1.5 SS activates the UE Beamlock Function (UBF) by performing the procedure as specified in TS 38.508-1 [10] clause 4.9.2 using condition TxRx.
- 1.6 Measure In-band emission IE_θ , IE_ϕ using Global In-Channel Tx-Test (Annex E) for the θ - and ϕ -polarizations, respectively. For TDD, only slots consisting of only UL symbols are under test. Calculate $IE = IE_\theta + IE_\phi$, where the calculation is based on linear power ratios.

1.7 SS deactivates the UE Beamlock Function (UBF) by performing the procedure as specified in TS 38.508-1 [10] clause 4.9.3.

1.8 Repeat steps 1.3 through 1.6 until In-band emissions have been measured for all power IDs in Table 6.4D.2.3.4.2-1.

NOTE 1: When switching to DFT-s-OFDM waveform, as specified in Table 6.4D.2.3.4.1-1, send an NR RRCReconfiguration message according to TS 38.508-1 [10] clause 4.6.3 Table 4.6.3-118 PUSCH-Config with TRANSFORM_PRECODER_ENABLED condition.

NOTE 2: The BEAM_SELECT_WAIT_TIME default value is defined in Annex K.

Table 6.4D.2.3.4.2-1: Parameters for In-band emissions

Power ID	Unit	Level for power class 1	Level for power class 2	Level for power class 3	Level for power class 4	Level for power class 6
1	dBm	27	16	10	21	17
2	dBm	17	6	0	11	7

Table 6.4D.2.3.4.2-2: Power Window (dB) for In-band emissions PUSCH and PUCCH

TBD

Test procedure for PUCCH:

- 2.1 Retrieve the LO position from the parameter txDirectCurrentLocation in UplinkTxDirectCurrent IE.
- 2.2 PUCCH is set according to Table 6.4D.2.3.4.1-2. SS transmits PDSCH via PDCCH DCI format 1_1 for C_RNTI to transmit the DL RMC according to Table 6.4D.2.3.4.1-2. The SS sends downlink MAC padding bits on the DL RMC. The transmission of PDSCH will make the UE send uplink ACK/NACK using PUCCH.
- 2.3 Set the UE in the Inband Tx beam peak direction found with a 3D EIRP scan as performed in Annex K.1.1. Allow at least BEAM_SELECT_WAIT_TIME (NOTE 1) for the UE Tx beam selection to complete.
- 2.4 Send the appropriate TPC commands in the uplink scheduling information for PUCCH to the UE until UE output power is $P_{req} + P_W \pm P_W$, where P_{req} is the power level specified in Tables 6.4D.2.3.4.2-1 according to the power class with power ID = 1. P_W is the power window according to Table 6.4D.2.3.4.2-2 for the carrier frequency f and the channel bandwidth BW . Allow at least BEAM_SELECT_WAIT_TIME (NOTE 1) for the UE Tx beam selection to complete.
- 2.5 SS activates the UE Beamlock Function (UBF) by performing the procedure as specified in TS 38.508-1 [10] clause 4.9.2 using condition TxRx.
- 2.6 Measure In-band emission IE_θ , IE_ϕ using Global In-Channel Tx-Test (Annex E) for the θ - and ϕ -polarizations, respectively. Calculate $IE = IE_\theta + IE_\phi$, where the calculation is based on linear power ratios.
- 2.7 SS deactivates the UE Beamlock Function (UBF) by performing the procedure as specified in TS 38.508-1 [10] clause 4.9.3.
- 2.8 Repeat steps 2.3 through 2.6 until In-band emissions have been measured for all power IDs in Table 6.4D.2.3.4.2-1.

NOTE 1: The BEAM_SELECT_WAIT_TIME default value is defined in Annex K.

NOTE 2: When switching to DFT-s-OFDM waveform, as specified in Table 6.4D.2.3.4.1-1, send an NR RRCReconfiguration message according to TS 38.508-1 [10] clause 4.6.3 Table 4.6.3-118 PUSCH-Config with TRANSFORM_PRECODER_ENABLED condition.

6.4.2.3.4.3 Message contents

Message contents are according to TS 38.508-1 [10] clause 4.6 ensuring Table 4.6.3-182 with condition 2TX_UL_MIMO.

6.4.2.3.5 Test requirement

For power ID1 and ID2, the averaged in-band emissions result, derived in Annex E.4.3 shall not exceed the corresponding values for IQ Image and Carrier Leakage in Table 6.4D.2.3.5-1 for power class 1 UEs.

Table 6.4D.2.3.5-1: Test requirements for in-band emissions for power class 1

Parameter description	Unit	Limit (NOTE 1)		Applicable Frequencies
General (NOTE 12)	dB	$\max \left[\begin{array}{l} -25 - 10 \cdot \log_{10} \left(\frac{N_{RB}}{L_{CRB}} \right), \\ 20 \cdot \log_{10}(\text{EVM}) - 5 \cdot \frac{(\Delta_{RB} - 1)}{L_{CRB}}, \\ -55.1 \text{ dBm} - P_{RB} \end{array} \right] + TT$		Any non-allocated (NOTE 2)
IQ Image (NOTE 12)	dB	-25+TT	Output power > 27 dBm	Image frequencies (NOTES 2, 3)
		-20+TT	Output power ≤ 27 dBm	
Carrier leakage (NOTE 12)	dBc	-25+TT	Output power > 17 dBm	Carrier frequency (NOTES 4, 5)
		-20+TT	4 dBm ≤ Output power ≤ 17 dBm	
<p>NOTE 1: An in-band emissions combined limit is evaluated in each non-allocated RB. For each such RB, the minimum requirement is calculated as the higher of ($P_{RB} - 25$ dB) and the power sum of all limit values (General, IQ Image or Carrier leakage) that apply. P_{RB} is defined in NOTE 10.</p> <p>NOTE 2: The measurement bandwidth is 1 RB and the limit is expressed as a ratio of measured power in one non-allocated RB to the measured average power per allocated RB, where the averaging is done across all allocated RBs. For pi/2 BPSK with Spectrum Shaping, the limit is expressed as a ratio of measured power in one non-allocated RB to the measured power in the allocated RB with highest PSD</p> <p>NOTE 3: The applicable frequencies for this limit are those that are enclosed in the reflection of the allocated bandwidth, based on symmetry with respect to the carrier frequency, but excluding any allocated RBs.</p> <p>NOTE 4: The measurement bandwidth is 1 RB and the limit is expressed as a ratio of measured power in one non-allocated RB to the measured total power in all allocated RBs.</p> <p>NOTE 5: The applicable frequencies for this limit depend on the parameter <i>txDirectCurrentLocation</i> in <i>UplinkTxDirectCurrent</i> IE, and are those that are enclosed in the RBs containing the DC but excluding any allocated RB.</p> <p>NOTE 6: L_{CRB} is the Transmission Bandwidth (see Section 5.3).</p> <p>NOTE 7: N_{RB} is the Transmission Bandwidth Configuration (see Section 5.3).</p> <p>NOTE 8: EVM is the limit for the modulation format used in the allocated RBs.</p> <p>NOTE 9: Δ_{RB} is the starting frequency offset between the allocated RB and the measured non-allocated RB (e.g. $\Delta_{RB} = 1$ or $\Delta_{RB} = -1$ for the first adjacent RB outside of the allocated bandwidth).</p> <p>NOTE 10: P_{RB} is the transmitted power per allocated RB, measured in dBm.</p> <p>NOTE 11: All powers are EIRP in beam peak direction.</p> <p>NOTE 12: In case the parameter 3300 or 3301 is reported from UE via <i>txDirectCurrentLocation</i> IE, IQ Image and Carrier leakage limit do not apply and General limit applies for all non-allocated frequencies.</p>				

For power ID1 and ID2, the averaged in-band emissions result, derived in Annex E.4.3 shall not exceed the corresponding values for IQ Image and Carrier Leakage in Table 6.4D.2.3.5-2 for power class 2 UEs.

Table 6.4D.2.3.5-2: Test requirements for in-band emissions for power class 2

Parameter description	Unit	Limit (NOTE 1)		Applicable Frequencies
General (NOTE 12)	dB	$\max \left[\begin{array}{l} -25 - 10 \cdot \log_{10} \left(\frac{N_{RB}}{L_{CRB}} \right), \\ 20 \cdot \log_{10}(\text{EVM}) - 5 \cdot \frac{(\Delta_{RB} - 1)}{L_{CRB}}, \\ -55.1 \text{ dBm} - P_{RB} \end{array} \right] + TT$		Any non-allocated (NOTE 2)
IQ Image (NOTE 12)	dB	-25 + TT	Output power > 16 dBm	Image frequencies (NOTES 2, 3)
		-20 + TT	Output power ≤ 16 dBm	
Carrier leakage (NOTE 12)	dBc	-25 + TT	Output power > 6 dBm	Carrier frequency (NOTES 4, 5)
		-20 + TT	-13 dBm ≤ Output power ≤ 6 dBm	

- NOTE 1: An in-band emissions combined limit is evaluated in each non-allocated RB. For each such RB, the minimum requirement is calculated as the higher of ($P_{RB} - 25$ dB) and the power sum of all limit values (General, IQ Image or Carrier leakage) that apply. P_{RB} is defined in NOTE 10.
- NOTE 2: The measurement bandwidth is 1 RB and the limit is expressed as a ratio of measured power in one non-allocated RB to the measured average power per allocated RB, where the averaging is done across all allocated RBs. For pi/2 BPSK with Spectrum Shaping, the limit is expressed as a ratio of measured power in one non-allocated RB to the measured power in the allocated RB with highest PSD
- NOTE 3: The applicable frequencies for this limit are those that are enclosed in the reflection of the allocated bandwidth, based on symmetry with respect to the carrier frequency, but excluding any allocated RBs.
- NOTE 4: The measurement bandwidth is 1 RB and the limit is expressed as a ratio of measured power in one non-allocated RB to the measured total power in all allocated RBs.
- NOTE 5: The applicable frequencies for this limit depend on the parameter *txDirectCurrentLocation* in *UplinkTxDirectCurrent* IE, and are those that are enclosed in the RBs containing the DC frequency if N_{RB} is odd, or in the two RBs immediately adjacent to the DC frequency if N_{RB} is even but excluding any allocated RB.
- NOTE 6: L_{CRB} is the Transmission Bandwidth (see Section 5.3).
- NOTE 7: N_{RB} is the Transmission Bandwidth Configuration (see Section 5.3).
- NOTE 8: EVM is the limit for the modulation format used in the allocated RBs.
- NOTE 9: Δ_{RB} is the starting frequency offset between the allocated RB and the measured non-allocated RB (e.g. $\Delta_{RB} = 1$ or $\Delta_{RB} = -1$ for the first adjacent RB outside of the allocated bandwidth).
- NOTE 10: P_{RB} is the transmitted power per allocated RB, measured in dBm.
- NOTE 11: All powers are EIRP in beam peak direction.
- NOTE 12: In case the parameter 3300 or 3301 is reported from UE via *txDirectCurrentLocation* IE, IQ Image and Carrier leakage limit do not apply and General limit applies for all non-allocated frequencies.

For power ID1 and ID2, the averaged in-band emissions result, derived in Annex E.4.3 shall not exceed the corresponding values for IQ Image and Carrier Leakage in Table 6.4D.2.3.5-3 for power class 3 UEs.

Table 6.4D.2.3.5-3: Requirements for in-band emissions for power class 3

Parameter description	Unit	Limit (NOTE 1)		Applicable Frequencies
General (NOTE 12)	dB	$\max \left[\begin{array}{l} -25 - 10 \cdot \log_{10} \left(\frac{N_{RB}}{L_{CRB}} \right), \\ 20 \cdot \log_{10}(\text{EVM}) - 5 \cdot \frac{(\Delta_{RB} - 1)}{L_{CRB}}, \\ -55.1 \text{ dBm} - P_{RB} \end{array} \right] + \text{TT}$		Any non-allocated (NOTE 2)
IQ Image (NOTE 12)	dB	-25+TT	Output power > 10 dBm	Image frequencies (NOTES 2, 3)
		-20+TT	Output power ≤ 10 dBm	
Carrier leakage (NOTE 12)	dBc	-25+TT	Output power > 0 dBm	Carrier frequency (NOTES 4, 5)
		-20+TT	-13 dBm ≤ Output power ≤ 0 dBm	

- NOTE 1: An in-band emissions combined limit is evaluated in each non-allocated RB. For each such RB, the minimum requirement is calculated as the higher of ($P_{RB} - 25$ dB) and the power sum of all limit values (General, IQ Image or Carrier leakage) that apply. P_{RB} is defined in NOTE 10.
- NOTE 2: The measurement bandwidth is 1 RB and the limit is expressed as a ratio of measured power in one non-allocated RB to the measured average power per allocated RB, where the averaging is done across all allocated RBs. For pi/2 BPSK with Spectrum Shaping, the limit is expressed as a ratio of measured power in one non-allocated RB to the measured power in the allocated RB with highest PSD.
- NOTE 3: The applicable frequencies for this limit are those that are enclosed in the reflection of the allocated bandwidth, based on symmetry with respect to the carrier frequency, but excluding any allocated RBs.
- NOTE 4: The measurement bandwidth is 1 RB and the limit is expressed as a ratio of measured power in one non-allocated RB to the measured total power in all allocated RBs.
- NOTE 5: The applicable frequencies for this limit depend on the parameter *txDirectCurrentLocation* in *UplinkTxDirectCurrent* IE, and are those that are enclosed in the RBs containing the DC but excluding any allocated RB.
- NOTE 6: L_{CRB} is the Transmission Bandwidth (see Section 5.3).
- NOTE 7: N_{RB} is the Transmission Bandwidth Configuration (see Section 5.3).
- NOTE 8: EVM is the limit for the modulation format used in the allocated RBs.
- NOTE 9: Δ_{RB} is the starting frequency offset between the allocated RB and the measured non-allocated RB (e.g. $\Delta_{RB} = 1$ or $\Delta_{RB} = -1$ for the first adjacent RB outside of the allocated bandwidth).
- NOTE 10: P_{RB} is the transmitted power per allocated RB, measured in dBm.
- NOTE 11: All powers are EIRP in beam peak direction.
- NOTE 12: In case the parameter 3300 or 3301 is reported from UE via *txDirectCurrentLocation* IE, IQ Image and Carrier leakage limit do not apply and General limit applies for all non-allocated frequencies.

For power ID1 and ID2, the averaged in-band emissions result, derived in Annex E.4.3 shall not exceed the corresponding values for IQ Image and Carrier Leakage in Table 6.4D.2.3.5-4 for power class 4 UEs.

Table 6.4D.2.3.5-4: Test requirements for in-band emissions for power class 4

Parameter description	Unit	Limit (NOTE 1)		Applicable Frequencies
General (NOTE 12)	dB	$\max \left[\begin{array}{l} -25 - 10 \cdot \log_{10} \left(\frac{N_{RB}}{L_{CRB}} \right), \\ 20 \cdot \log_{10}(\text{EVM}) - 5 \cdot \frac{(\Delta_{RB} - 1)}{L_{CRB}}, \\ -55.1 \text{ dBm} - P_{RB} \end{array} \right] + TT$		Any non-allocated (NOTE 2)
IQ Image (NOTE 12)	dB	-25 + TT	Output power > 21 dBm	Image frequencies (NOTES 2, 3)
		-20 + TT	Output power ≤ 21 dBm	
Carrier leakage (NOTE 12)	dBc	-25 + TT	Output power > 11 dBm	Carrier frequency (NOTES 4, 5)
		-20 + TT	-13 dBm ≤ Output power ≤ 11 dBm	

- NOTE 1: An in-band emissions combined limit is evaluated in each non-allocated RB. For each such RB, the minimum requirement is calculated as the higher of ($P_{RB} - 25$ dB) and the power sum of all limit values (General, IQ Image or Carrier leakage) that apply. P_{RB} is defined in NOTE 10.
- NOTE 2: The measurement bandwidth is 1 RB and the limit is expressed as a ratio of measured power in one non-allocated RB to the measured average power per allocated RB, where the averaging is done across all allocated RBs. For pi/2 BPSK with Spectrum Shaping, the limit is expressed as a ratio of measured power in one non-allocated RB to the measured power in the allocated RB with highest PSD
- NOTE 3: The applicable frequencies for this limit are those that are enclosed in the reflection of the allocated bandwidth, based on symmetry with respect to the carrier frequency, but excluding any allocated RBs.
- NOTE 4: The measurement bandwidth is 1 RB and the limit is expressed as a ratio of measured power in one non-allocated RB to the measured total power in all allocated RBs.
- NOTE 5: The applicable frequencies for this limit depend on the parameter *txDirectCurrentLocation* in *UplinkTxDirectCurrent* IE, and are those that are enclosed in the RBs containing the DC frequency but excluding any allocated RB.
- NOTE 6: L_{CRB} is the Transmission Bandwidth (see Section 5.3).
- NOTE 7: N_{RB} is the Transmission Bandwidth Configuration (see Section 5.3).
- NOTE 8: EVM is the limit for the modulation format used in the allocated RBs.
- NOTE 9: Δ_{RB} is the starting frequency offset between the allocated RB and the measured non-allocated RB (e.g. $\Delta_{RB} = 1$ or $\Delta_{RB} = -1$ for the first adjacent RB outside of the allocated bandwidth).
- NOTE 10: P_{RB} is the transmitted power per allocated RB, measured in dBm.
- NOTE 11: All powers are EIRP in beam peak direction.
- NOTE 12: In case the parameter 3300 or 3301 is reported from UE via *txDirectCurrentLocation* IE, IQ Image and Carrier leakage limit do not apply and General limit applies for all non-allocated frequencies.

6.4D.2.4 EVM equalizer spectrum flatness for UL MIMO

Editor's note: **This clause is incomplete. The following aspects are either missing or not yet determined:**

- OTA test procedure for UL MIMO is still under investigation.
- Test config table is FFS.
- TP analysis is FFS.
- Measurement Uncertainty and Test Tolerances are FFS.

6.4D.2.4.1 Test purpose

The zero-forcing equalizer correction applied in the EVM measurement process (as described in Annex E) must meet a spectral flatness requirement for the EVM measurement to be valid.

6.4D.2.4.2 Test applicability

This test case applies to all types of NR UE release 15 and forward that support UL MIMO.

6.4D.2.4.3 Minimum conformance requirements

For pi/2 BPSK modulation, the minimum requirements are defined in Clause 6.4D.2.5.3.

For a UE supporting UL MIMO, the peak-to-peak variation of the EVM equalizer coefficients contained within the frequency range of the uplink allocation shall not exceed the maximum ripple specified in Table 6.4D.2.4.3-1 for normal conditions. For uplink allocations contained within both Range 1 and Range 2, the coefficients evaluated within each of these frequency ranges shall meet the corresponding ripple requirement and the following additional requirements: the relative difference between the maximum coefficient in Range 1 and the minimum coefficient in Range 2 (Table 6.4D.2.4.3-1) must not be larger than 7 dB, and the relative difference between the maximum coefficient in Range 2 and the minimum coefficient in Range 1 must not be larger than 8 dB (see Figure 6.4D.2.4.3-1).

The requirement is verified with the test metric of EVM SF (Link=TX beam peak direction, Meas=Link angle).

Table 6.4D.2.4.3-1: Minimum requirements for EVM equalizer spectrum flatness (normal conditions)

Frequency range	Maximum ripple (dB)
$ F_{UL_Meas} - F_{center} \leq X$ MHz (Range 1)	6 (p-p)
$ F_{UL_Meas} - F_{center} > X$ MHz (Range 2)	9 (p-p)

NOTE 1: F_{UL_Meas} refers to the sub-carrier frequency for which the equalizer coefficient is evaluated
 NOTE 2: F_{center} refers to the centre frequency of the CC
 NOTE 3: X, in MHz, is equal to 30% of the CC bandwidth

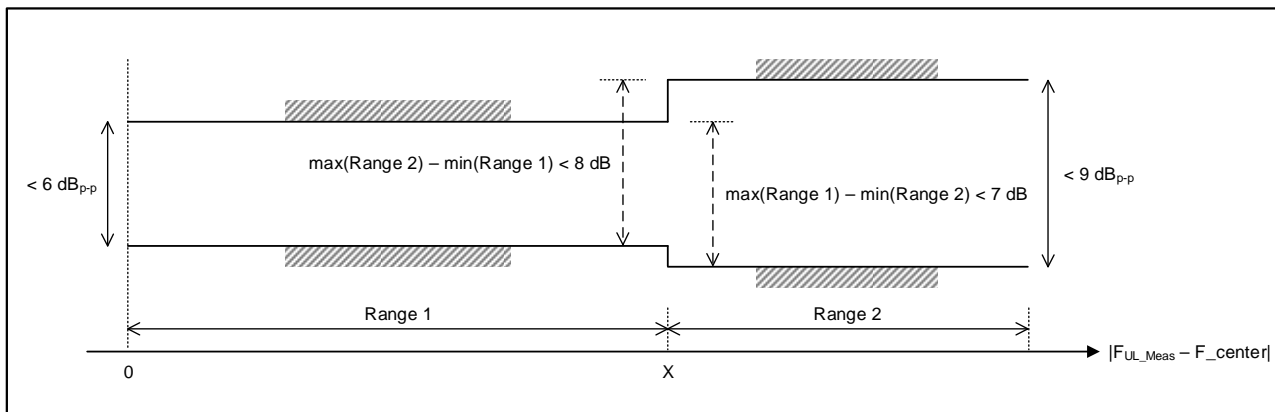

Figure 6.4D.2.4.3-1: The limits for EVM equalizer spectral flatness with the maximum allowed variation of the coefficients indicated under normal conditions

The normative reference for this requirement is TS 38.101-2 [3] clause 6.4D.2.

6.4D.2.4.4 Test description

6.4D.2.4.4.1 Initial condition

Initial conditions are a set of test configurations the UE needs to be tested in and the steps for the SS to take with the UE to reach the correct measurement state.

The initial test configurations consist of environmental conditions, test frequencies, test channel bandwidths and sub-carrier spacing based on NR operating bands specified in Table 5.3.5-1. All of these configurations shall be tested with applicable test parameters for each combination of channel bandwidth and sub-carrier spacing, are shown in Table 6.4D.2.4.4.1-1. The details of the uplink reference measurement channels (RMCs) are specified in Annex A.2. Configurations of PDSCH and PDCCH before measurement are specified in Annex C.2.

Table 6.4D.2.4.4.1-1: Test Configuration

Initial Conditions			
Test Environment as specified in TS 38.508-1 [10] clause 4.1		FFS	
Test Frequencies as specified in TS 38.508-1 [10] clause 4.3.1			
Test Channel Bandwidths as specified in TS 38.508-1 [10] clause 4.3.1			
Test SCS as specified in Table 5.3.5-1			
Test Parameters			
Test ID	Downlink Configuration	Uplink Configuration	
	-	Modulation	RB allocation (NOTE 1)
1		FFS	
2			

NOTE 1: XXX

1. Connection between SS and UE is shown in TS 38.508-1 [10] Annex A, in Figure A.3.3.1.1 for TE diagram and section A.3.4.1.1 for UE diagram.
2. The parameter settings for the cell are set up according to TS 38.508-1 [10] clause 4.4.3.
3. Downlink signals are initially set up according to Annex C, and uplink signals according to Annex G.
4. The UL Reference Measurement channels are set according to Table 6.4D.2.4.4.1-1.
5. Propagation conditions are set according to Annex B.0.
6. Ensure the UE is in state RRC_CONNECTED with generic procedure parameters Connectivity *NR*, Connected without release *On*, Test Mode *On* and Test Loop Function *On* according to TS 38.508-1 [10] clause 4.5. Message contents are defined in clause 6.4D.2.4.4.3

6.4D.2.4.4.2 Test procedure

1. Retrieve the LO position from the parameter txDirectCurrentLocation in UplinkTxDirectCurrent IE.
2. SS sends uplink scheduling information for each UL HARQ process via PDCCH DCI format 0_1 for C_RNTI to schedule the UL RMC according to Table 6.4D.2.4.4.1-1. Since the UE has no payload and no loopback data to send the UE sends uplink MAC padding bits on the UL RMC
3. Set the UE in the Inband Tx beam peak direction found with a 3D EIRP scan as performed in Annex K.1.1. Allow at least BEAM_SELECT_WAIT_TIME (NOTE 2) for the UE Tx beam selection to complete.
4. Send continuously uplink power control "up" commands in the uplink scheduling information to the UE until the UE transmits at P_{UMAX} level. Allow at least 200 ms for the UE to reach P_{UMAX} level. Allow at least BEAM_SELECT_WAIT_TIME (NOTE 2) for the UE Tx beam selection to complete.
5. SS activates the UE Beamlock Function (UBF) by performing the procedure as specified in TS 38.508-1 [10] clause 4.9.2 using condition TxRx.
6. Measure spectrum flatness using Global In-Channel Tx-Test (Annex E) for the θ - and ϕ -polarizations, respectively. For TDD, only slots consisting of only UL symbols are under test.
7. SS deactivates the UE Beamlock Function (UBF) by performing the procedure as specified in TS 38.508-1 [10] clause 4.9.3.

NOTE1: When switching to DFT-s-OFDM waveform, as specified in Table 6.4D.2.4.4.1-1, send an NR RRCReconfiguration message according to TS 38.508-1 [10] clause 4.6.3 Table 4.6.3-118 PUSCH-Config with TRANSFORM_PRECODER_ENABLED condition.

NOTE 2: The BEAM_SELECT_WAIT_TIME default value is defined in Annex K.

6.4D.2.4.4.3 Message contents

Message contents are according to TS 38.508-1 [10] clause 4.6 ensuring Table 4.6.3-182 with condition 2TX_UL_MIMO.

6.4D.2.4.5 Test requirement

Each of the n spectrum flatness functions, shall derive four ripple results in Annex E.4.4. The derived results shall not exceed the values in Figure 6.4D.2.4.5-1: The peak-to-peak variation of the EVM equalizer coefficients contained within the frequency range of the uplink allocation shall not exceed the maximum ripple specified in Table 6.4D.2.4.5-1 for normal conditions. For uplink allocations contained within both Range 1 and Range 2, the coefficients evaluated within each of these frequency ranges shall meet the corresponding ripple requirement and the following additional requirements: the relative difference between the maximum coefficient in Range 1 and the minimum coefficient in Range 2 (Table 6.4D.2.4.5-1) must not be larger than 7 dB + TT, and the relative difference between the maximum coefficient in Range 2 and the minimum coefficient in Range 1 must not be larger than 8 dB + TT (see Figure 6.4D.2.4.5-1).

The UE passes the test when the derived results for at least one polarization fulfil the test requirements.

Table 6.4D.2.4.5-1: Test requirements for EVM equalizer spectrum flatness (normal conditions)

Frequency range	Maximum ripple (dB)
$ F_{UL_Meas} - F_{center} \leq X$ MHz (Range 1)	6 + TT (p-p)
$ F_{UL_Meas} - F_{center} > X$ MHz (Range 2)	9 + TT (p-p)

NOTE 1: F_{UL_Meas} refers to the sub-carrier frequency for which the equalizer coefficient is evaluated
 NOTE 2: F_{center} refers to the centre frequency of the CC
 NOTE 3: X, in MHz, is equal to 30% of the CC bandwidth

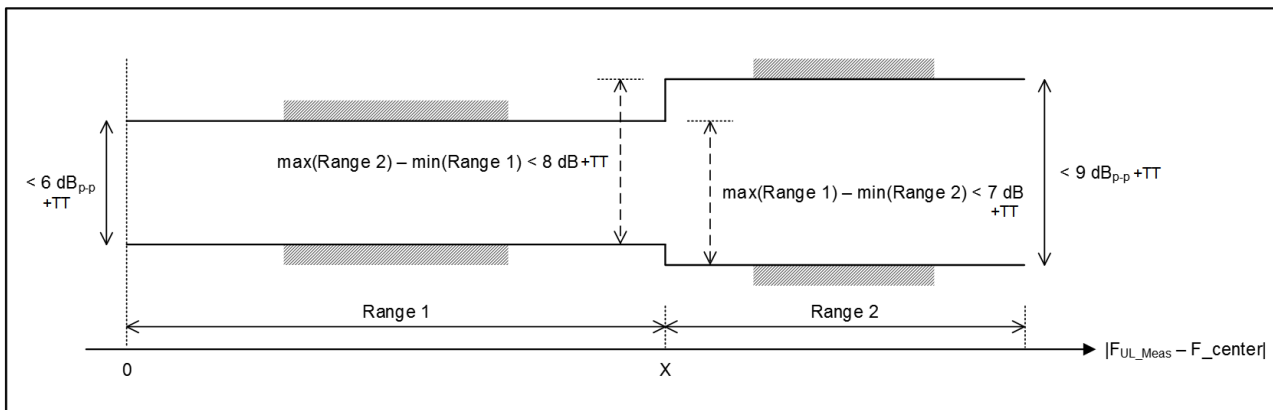

Figure 6.4D.2.4.5-1: The limits for EVM equalizer spectral flatness with the maximum allowed variation of the coefficients indicated under normal conditions

6.4D.2.5 EVM spectral flatness for pi/2 BPSK modulation

Editor's note: This clause is incomplete. The following aspects are either missing or not yet determined:

- Measurement Uncertainty and Test Tolerance are FFS.
- Whether and, if yes, how to test the requirement on shaping filter is FFS.
- Test config table is FFS.
- TP analysis is FFS.

6.4D.2.5.1 Test purpose

Same test purpose as in clause 6.4D.2.4.1.

6.4D.2.5.2 Test applicability

This test case applies to all types of NR FR2 UE release 15 and forward that support pi/2 BPSK modulation and UL MIMO.

6.4D.2.5.3 Minimum conformance requirements

For a UE supporting UL MIMO, these requirements are defined for pi/2 BPSK modulation. The EVM equalizer coefficients across the allocated uplink block shall be modified to fit inside the mask specified in Table 6.4D.2.5.3-1 for normal conditions, prior to the calculation of EVM. The limiting mask shall be placed to minimize the change in equalizer coefficients in a sum of squares sense.

Table 6.4D.2.5.3-1: Mask for EVM equalizer coefficients for pi/2 BPSK (normal conditions)

Frequency range	Parameter	Maximum ripple (dB)
-----------------	-----------	---------------------

$ F_{UL_Meas} - F_{center} \leq X$ MHz (Range 1)	X1	6 (p-p)
$ F_{UL_Meas} - F_{center} > X$ MHz (Range 2)	X2	14 (p-p)
NOTE 1: F_{UL_Meas} refers to the sub-carrier frequency for which the equalizer coefficient is evaluated. NOTE 2: F_{center} refers to the centre frequency of an allocated block of PRBs. NOTE 3: X, in MHz, is equal to 25% of the bandwidth of the PRB allocation. NOTE 4: See Figure 6.4D.2.5.3-1 for description of X1, X2 and X3.		

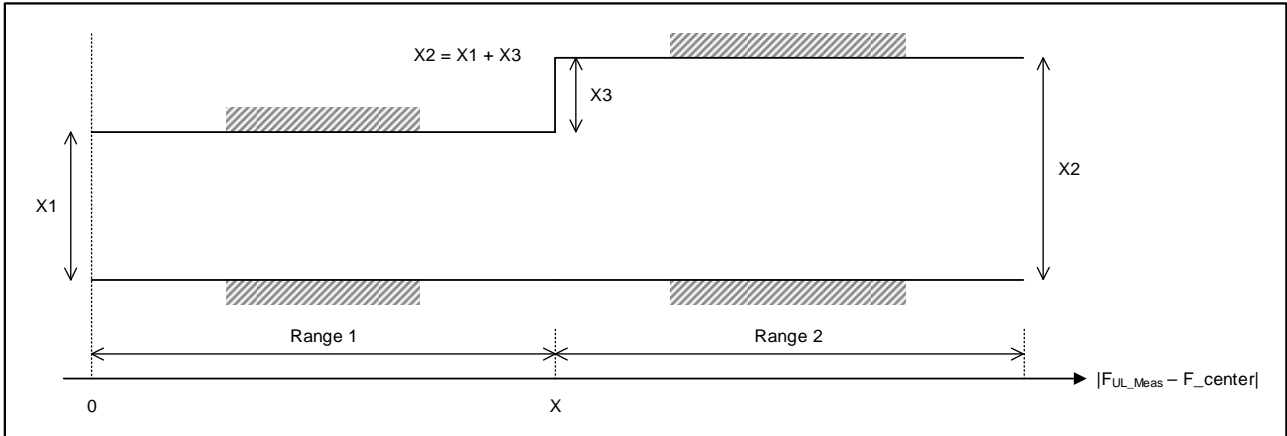

Figure 6.4D.2.5.3-1: The limits for EVM equalizer spectral flatness with the maximum allowed variation. F_{center} denotes the centre frequency of the allocated block of PRBs. F_{alloc} denotes the bandwidth of the PRB allocation

This requirement does not apply to other modulation types. The UE shall be allowed to employ spectral shaping for pi/2 BPSK. The shaping filter shall be restricted so that the impulse response of the transmit chain shall meet

$$|\tilde{a}_t(t,0)| \geq |\tilde{a}_t(t,\tau)| \quad \forall \tau \neq 0$$

$$20\log_{10} |\tilde{a}_t(t,\tau)| < -15 \text{ dB} \quad 1 < \tau < M - 1,$$

Where:

$$|\tilde{a}_t(t,\tau)| = \text{IDFT}\{ |\tilde{a}_t(t,f)| e^{j\varphi(t,f)} \},$$

f is the frequency of the M allocated subcarriers,

$\tilde{a}_t(t,f)$ and $\varphi(t,f)$ are the amplitude and phase response, respectively of the transmit chain

0dB reference is defined as $20\log_{10} |\tilde{a}_t(t,0)|$

The normative reference for this requirement is TS 38.101-2 [3] clause 6.4.2.5.

6.4D.2.5.4 Test description

6.4D.2.5.4.1 Initial condition

Same initial conditions as in clause 6.4D.2.4.4.1 with following exceptions:

- Instead of Table 6.4D.2.4.4.1-1 → use Table 6.4D.2.5.4.1-1

Table 6.4D.2.5.4.1-1: Test Configuration

Initial Conditions	
Test Environment as specified in TS 38.508-1 [10] clause 4.1	Normal

Test Frequencies as specified in TS 38.508-1 [10] clause 4.3.1	Low range, Mid range, High range	
Test Channel Bandwidths as specified in TS 38.508-1 [10] clause 4.3.1	Lowest, Mid, Highest	
Test SCS as specified in TS 38.508-1 [10] clause 5.3.5-1	Lowest	
Test Parameters		
Test ID	Downlink Configuration	Uplink Configuration
		Modulation
1	-	DFT-s-OFDM pi/2-BPSK Outer_Full
NOTE 1: The specific configuration of each RB allocation is defined in Table 6.1-1 for PC2, PC3 and PC4 or Table 6.1-2 for PC1.		
NOTE 2: Test Channel Bandwidths are checked separately for each NR band, which applicable channel bandwidths are specified in Table 5.3.5-1.		

6.4D.2.5.4.2 Test procedure

1. Retrieve the LO position from the parameter txDirectCurrentLocation in UplinkTxDirectCurrent IE.
2. SS sends uplink scheduling information for each UL HARQ process via PDCCH DCI format 0_1 for C_RNTI to schedule the UL RMC according to Table 6.4D.2.5.4.1-1. Since the UE has no payload and no loopback data to send the UE sends uplink MAC padding bits on the UL RMC.
3. Set the UE in the Inband Tx beam peak direction found with a 3D EIRP scan as performed in Annex K.1.1. Allow at least BEAM_SELECT_WAIT_TIME (NOTE 1) for the UE Tx beam selection to complete.
4. Send continuously uplink power control "up" commands in the uplink scheduling information to the UE until the UE transmits at P_{UMAX} level. Allow at least 200 ms for the UE to reach P_{UMAX} level. Allow at least BEAM_SELECT_WAIT_TIME (NOTE 1) for the UE Tx beam selection to complete.
5. SS activates the UE Beamlock Function (UBF) by performing the procedure as specified in TS 38.508-1 [10] clause 4.9.2 using condition TxRx.
6. Measure spectrum flatness using Global In-Channel Tx-Test (Annex E) for the θ- and φ-polarizations, respectively. For TDD, only slots consisting of only UL symbols are under test.
7. SS deactivates the UE Beamlock Function (UBF) by performing the procedure as specified in TS 38.508-1 [10] clause 4.9.3.

NOTE 1: The BEAM_SELECT_WAIT_TIME default value is defined in Annex K.

6.4D.2.5.4.3 Message contents

Message contents are according to TS 38.508-1 [10] clause 4.6 with TRANSFORM_PRECODER_ENABLED condition in Table 4.6.3-118 PUSCH-Config and ensuring Table 4.6.3-182 with condition 2TX_UL_MIMO.

6.4D.2.5.5 Test requirement

Each of the *n* spectrum flatness functions, shall derive four ripple results in Annex E.4.4. The derived results shall not exceed the values in Table 6.4D.2.5.5-1 and Figure 6.4D.2.5.5-1:

Table 6.4D.2.5.5-1: Test requirement for EVM equalizer coefficients for pi/2 BPSK (normal conditions)

Frequency range	Parameter	Maximum ripple (dB)
$ F_{UL_Meas} - F_{center} \leq X$ MHz (Range 1)	X1	6 + TT (p-p)
$ F_{UL_Meas} - F_{center} > X$ MHz (Range 2)	X2	14 + TT (p-p)
NOTE 1: F _{UL_Meas} refers to the sub-carrier frequency for which the equalizer coefficient is evaluated.		
NOTE 2: F _{center} refers to the centre frequency of an allocated block of PRBs.		
NOTE 3: X, in MHz, is equal to 25% of the bandwidth of the PRB allocation.		
NOTE 4: See Figure 6.4D.2.5.5-1 for description of X1, X2 and X3.		

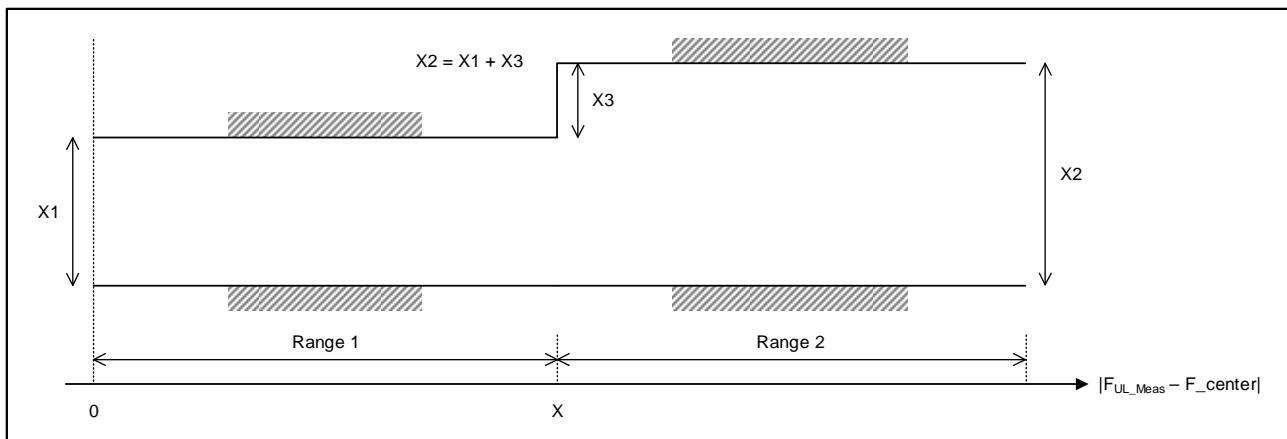

Figure 6.4D.2.5.5-1: The limits for EVM equalizer spectral flatness with the maximum allowed variation. F_{center} denotes the centre frequency of the allocated block of PRBs

The UE passes the test when the derived results for at least one polarization fulfil the test requirements.

6.4D.3 Time alignment error for UL MIMO

Editor's note: This clause is incomplete. The following aspects are either missing or not yet determined:

- OTA test procedure for UL MIMO is still under investigation.
- Test tolerance is FFS

6.4D.3.1 Test purpose

To verify that the error of time alignment in UL MIMO does not exceed the range prescribed by the specified UL MIMO Time Alignment Error (TAE) and tolerance.

An excess time alignment error has the possibility to interfere to other channels or other systems and decrease UL MIMO performance because of the timing unsynchronization.

6.4D.3.2 Test applicability

This test case applies to all types of NR UE release 15 and forward that support UL MIMO.

6.4D.3.3 Minimum conformance requirements

For UE(s) with multiple physical antenna ports supporting UL MIMO, this requirement applies to frame timing differences between transmissions on multiple physical antenna ports in the codebook transmission scheme.

The time alignment error (TAE) is defined as the average frame timing difference between any two transmissions on different physical antenna ports.

For UE(s) with multiple physical antenna ports, the Time Alignment Error (TAE) shall not exceed 130 ns.

The normative reference for this requirement is TS 38.101-2 [3] clause 6.4D.3.

6.4D.3.4 Test description

6.4D.3.4.1 Initial condition

Initial conditions are a set of test configurations the UE needs to be tested in and the steps for the SS to take with the UE to reach the correct measurement state.

The initial test configurations consist of environmental conditions, test frequencies, test channel bandwidths and sub-carrier spacing based on NR operating bands specified in Table 5.3.5-1. All of these configurations shall be tested with applicable test parameters for each combination of test channel bandwidth and sub-carrier spacing, are shown in Table 6.4D.3.4.1-1. The details of the uplink reference measurement channels (RMCs) are specified in Annexes A.2. Configurations of PDSCH and PDCCH before measurement are specified in Annex C.2.

Table 6.4D.3.4.1-1: Test Configuration Table

Initial Conditions			
Test Environment as specified in TS 38.508-1 [10] clause 4.1		Normal	
Test Frequencies as specified in TS 38.508-1 [10] clause 4.3.1		Mid range	
Test Channel Bandwidths as specified in TS 38.508-1 [10] clause 4.3.1		Lowest, Mid, Highest	
Test SCS as specified in Table 5.3.5-1.		Lowest, Highest	
Test Parameters			
Test ID	Downlink Configuration	Uplink Configuration	
		Modulation	RB allocation (NOTE 1)
1	-	CP-OFDM QPSK	Outer_Full
NOTE 1: The specific configuration of each RB allocation is defined in Table 6.1-1 for PC2, PC3 and PC4 or Table 6.1-2 for PC1.			

1. Connection between SS and UE is shown in TS 38.508-1 [10] Annex A Figure A.3.3.1.1 for TE diagram and Figure A.3.4.1.1 for UE diagram.
2. The parameter settings for the cell are set up according to TS 38.508-1 [10] clause 4.4.3.
3. Downlink signals are initially set up according to Annex C, and uplink signals according to Annex G.
4. The UL Reference Measurement Channels are set according to Table 6.4D.3.4.1-1.
5. Propagation conditions are set according to Annex B.0.
6. Ensure the UE is in state RRC_CONNECTED with generic procedure parameters Connectivity *NR*, Connected without release *On*, Test Mode *On* and Test Loop Function *On* according to TS 38.508-1 [10] clause 4.5. Message contents are defined in clause 6.4D.3.4.3.

6.4D.3.4.2 Test procedure

1. SS sends uplink scheduling information for each UL HARQ process via PDCCH DCI format 0_1 for C_RNTI to schedule the UL RMC according to Table 6.4D.3.4.1-1. Since the UE has no payload and no loopback data to send the UE sends uplink MAC padding bits on the UL RMC. The PDCCH DCI format 0_1 is specified with the condition 2TX_UL_MIMO in 38.508-1 [10] clause 4.3.6.1.1.2.
2. Set the UE in the Inband Tx beam peak direction found with a 3D EIRP scan as performed in Annex K.1.1. Allow at least BEAM_SELECT_WAIT_TIME (NOTE 1) for the UE Tx beam selection to complete.
3. Send continuously uplink power control "up" commands in every uplink scheduling information to the UE until the UE transmits at P_{UMAX} level. Allow at least 200ms starting from the first TPC Command for the UE to reach P_{UMAX} level. Allow at least BEAM_SELECT_WAIT_TIME (NOTE 1) for the UE Tx beam selection to complete.
4. SS activates the UE Beamlock Function (UBF) by performing the procedure as specified in TS 38.508-1 [10] clause 4.9.2 using condition TxRx.
5. Measure the timing of one sub-frame at each physical antenna port.

NOTE 1: The BEAM_SELECT_WAIT_TIME default value is defined in Annex K.

6.4D.3.4.3 Message contents

Message contents are according to TS 38.508-1 [10] clause 4.6 ensuring Table 4.6.3-182 with condition 2TX_UL_MIMO.

6.4D.3.5 Test requirement

For UE(s) with multiple physical antenna ports, the Time Alignment Error (TAE) shall not exceed $130 + TT$ ns.

Table 6.4D.3.5-1: Test Tolerance (Time alignment error for UL MIMO)

Test Tolerance
FFS

6.5 Output RF spectrum emissions

Unwanted emissions are divided into "Out-of-band emission" and "Spurious emissions" in 3GPP RF specifications. This notation is in line with ITU-R recommendations such as SM.329 [7] and the Radio Regulations [TBD].

ITU defines:

Out-of-band emission = Emission on a frequency or frequencies immediately outside the necessary bandwidth which results from the modulation process, but excluding spurious emissions.

Spurious emission = Emission on a frequency, or frequencies, which are outside the necessary bandwidth and the level of which may be reduced without affecting the corresponding transmission of information. Spurious emissions include harmonic emissions, parasitic emissions, intermodulation products and frequency conversion products but exclude out-of-band emissions.

Unwanted emissions = Consist of spurious emissions and out-of-band emissions.

The UE transmitter spectrum emission consists of the three components; the occupied bandwidth (channel bandwidth), the Out Of Band (OOB) emissions and the far out spurious emission domain.

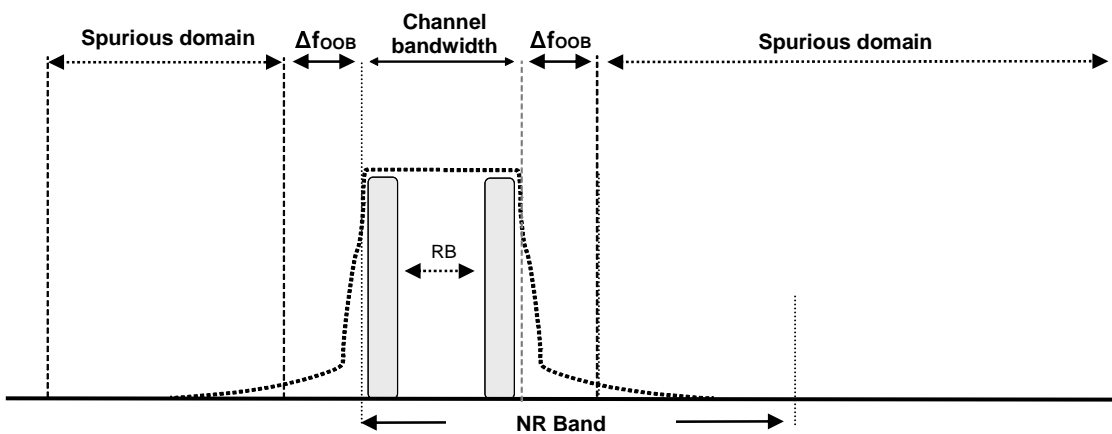

Figure 6.5-1: Transmitter RF spectrum

6.5.1 Occupied bandwidth

Editor's note: The following aspects are either missing or not yet determined:

- Measurement Uncertainties and Test Tolerances are FFS for power class other than PC1, PC3, PC5, PC6.
- Measurement Uncertainties and Test Tolerances for PC5 are FFS for bands other than n257 and n258.

6.5.1.1 Test purpose

To verify that the UE occupied bandwidth for all transmission bandwidth configurations supported by the UE are less than their specific limits

6.5.1.2 Test applicability

This test applies to all types of NR UE release 15 and forward.

6.5.1.3 Minimum conformance requirements

Occupied bandwidth is defined as the bandwidth containing 99 % of the total integrated mean power of the transmitted spectrum on the assigned channel. The occupied bandwidth for all transmission bandwidth configurations (Resources Blocks) shall be less than the channel bandwidth specified in Table 6.5.1.3-1.

The occupied bandwidth is defined as a directional requirement. The requirement is verified in beam locked mode with the test metric of OBW (Link=TX beam peak direction, Meas=Link angle).

Table 6.5.1.3-1: Occupied channel bandwidth

	Occupied channel bandwidth / Channel bandwidth			
	50 MHz	100 MHz	200 MHz	400 MHz
Channel bandwidth (MHz)	50	100	200	400

The normative reference for this requirement is TS 38.101-2 [3] clause 6.5.1.

6.5.1.4 Test description

6.5.1.4.1 Initial conditions

Initial conditions are a set of test configurations the UE needs to be tested in and the steps for the SS to take with the UE to reach the correct measurement state.

The initial test configurations consist of environmental conditions, test frequencies, and channel bandwidths based on NR operating bands specified in Table 5.3.5-1. All of these configurations shall be tested with applicable test parameters for each channel bandwidth and subcarrier spacing, are shown in Table 6.5.1.4.1-1. The details of the uplink reference measurement channels (RMCs) are specified in Annexes A.2. Configurations of PDSCH and PDCCH before measurement are specified in Annex C.2.

Table 6.5.1.4.1-1: Test Configuration Table

Initial Conditions			
Test Environment as specified in TS 38.508-1 [10] clause 4.1		Normal	
Test Frequencies as specified in TS 38.508-1 [10] clause 4.3.1		Low range, Mid range, High range	
Test Channel Bandwidths as specified in TS 38.508-1 [10] clause 4.3.1		All	
Test SCS as specified in Table 5.3.5-1		Lowest	
Test Parameters			
Test ID	Downlink Configuration	Uplink Configuration	
		Modulation	RB allocation (NOTE 1)
1	-	DFT-s-OFDM QPSK	Outer_full
NOTE 1: The specific configuration of each RB allocation is defined in Table 6.1-1 for PC2, PC3, PC4, PC5 and PC6 or Table 6.1-2 for PC1.			

1. Connection between SS and UE is shown in TS 38.508-1 [10] Annex A, Figure A.3.3.1.1 for TE diagram and clause A.3.4.1.1 for UE diagram.
2. The parameter settings for the cell are set up according to TS 38.508-1 [10] clause 4.4.3.
3. Downlink signals are initially set up according to Annex C, and uplink signals according to Annex G.
4. The UL Reference Measurement channels are set according to Table 6.5.1.4.1-1.
5. Propagation conditions are set according to Annex B.0
6. Ensure the UE is in state RRC_CONNECTED with generic procedure parameters Connectivity *NR*, Connected without release *On*, Test Mode *On* and Test Loop Function *On* according to TS 38.508-1 [10] clause 4.5. Message contents are defined in clause 6.5.1.4.3

6.5.1.4.2 Test procedure

1. SS sends uplink scheduling information for each UL HARQ process via PDCCH DCI format 0_1 for C_RNTI to schedule the UL RMC according to Table 6.5.1.4.1-1. Since the UL has no payload and no loopback data to send the UE sends uplink MAC padding bits on the UL RMC.
2. Set the UE in the Tx beam peak direction found with a 3D EIRP scan as performed in Annex K.1.1. Allow at least BEAM_SELECT_WAIT_TIME (Note 1) for the UE Tx beam selection to complete.
3. Send continuously uplink power control "up" commands in every uplink scheduling information to the UE; allow at least 200 ms for the UE to reach maximum output power. Allow at least BEAM_SELECT_WAIT_TIME (Note 1) for the UE Tx beam selection to complete.
4. SS activates the UE Beamlock Function (UBF) by performing the procedure as specified in TS 38.508-1 [10] clause 4.9.2 using condition Tx only.
5. Measure the EIRP spectrum distribution within N -times or more frequency range over the requirement for Occupied Bandwidth specification centring on the current carrier frequency. The characteristics of the filter shall be approximately Gaussian (typical spectrum analyser filter). The measuring duration is one active uplink subframe. EIRP is captured from both polarizations, theta and phi. The ratio of measured bandwidth to channel bandwidth N is specified in Table 6.5.1.4.2-1.

Table 6.5.1.4.2-1: Ratio of measured bandwidth to channel bandwidth

	Occupied channel bandwidth / Channel bandwidth			
	50 MHz	100 MHz	200 MHz	400 MHz
n257, n258, n261	1.5	1.5	1.5	1.5
n260	1.5	1.5	1.5	1.5
n259	1.5	1.5	1.5	1.3

6. Calculate the total EIRP from both polarizations, theta and phi, within the range of all frequencies measured in step 5 and save this value as "Total EIRP". EIRP measurement procedure is defined in Annex K.
7. Identify the measurement window whose centre is aligned on the centre of the channel for which the sum of the power measured in theta and phi polarization is 99% of the "Total EIRP".
8. The "Occupied Bandwidth" is the width of the measurement window obtained in step 7.

6.5.1.4.3 Message contents

Message contents are according to TS 38.508-1 [10] subclause 4.6 with TRANSFORM_PRECODER_ENABLED condition in Table 4.6.3-118 PUSCH-Config.

6.5.1.5 Test requirement

The measured Occupied Bandwidth shall not exceed values in Table 6.5.1.5-1.

Table 6.5.1.5-1: Occupied channel bandwidth

	Occupied channel bandwidth / Channel bandwidth			
	50 MHz	100 MHz	200 MHz	400 MHz
Channel bandwidth (MHz)	50 + R	100 + R	200 + R	400 + R
NOTE 1: R is relaxation : R for each frequency and channel bandwidth is specified in Table 6.5.1.5-2.				

Table 6.5.1.5-2: Relaxation due to testability limit (Occupied channel bandwidth)

	Occupied channel bandwidth / Channel bandwidth
--	--

	50 MHz	100 MHz	200 MHz	400 MHz
n257, n258, n261	0	0	0	0
n260	0	0	0	0
n259	0	0	0	0

6.5.2 Out of band emission

The Out of band emissions are unwanted emissions immediately outside the assigned channel bandwidth resulting from the modulation process and non-linearity in the transmitter but excluding spurious emissions. This out of band emission limit is specified in terms of a spectrum emission mask and an Adjacent Channel Leakage power Ratio. Additional requirements to protect specific bands are also considered.

The requirements in clause 6.5.2.1 only apply when both UL and DL of a UE are configured for single CC operation, and they are of the same bandwidth. For a UE that is configured for single CC operation with different channel bandwidths in UL and DL, the requirements in clause 6.5A.2.1 apply.

All out of band emissions for range 2 are TRP.

6.5.2.1 Spectrum Emission Mask

Editor's note: The following aspects are either missing or not yet determined:

- **Measurement Uncertainties and Test Tolerances are FFS for power class other than PC1 FR2a, PC3, PC5 and PC6.**

6.5.2.1.1 Test purpose

To verify that the power of any UE emission shall not exceed specified level for the specified channel bandwidth.

6.5.2.1.2 Test applicability

This test case applies to all types of NR UE release 15 and forward.

6.5.2.1.3 Minimum conformance requirements

The spectrum emission mask of the UE applies to frequencies (Δf_{OOB}) starting from the \pm edge of the assigned NR channel bandwidth. For frequencies offset greater than F_{OOB} as specified in Table 6.5.2.1.3-1 the spurious requirements in clause 6.5.3 are applicable.

The power of any UE emission shall not exceed the levels specified in Table 6.5.2.1.3-1 for the specified channel bandwidth. The requirement is verified in beam locked mode with the test metric of TRP (Link=TX beam peak direction, Meas=TRP grid).

Table 6.5.2.1.3-1: General NR spectrum emission mask for Range 2

Spectrum emission limit (dBm)/ Channel bandwidth					
Δf_{OOB} (MHz)	50 MHz	100 MHz	200 MHz	400 MHz	Measurement bandwidth
$\pm 0-5$	-5	-5	-5	-5	1 MHz
$\pm 5-10$	-13	-5	-5	-5	1 MHz
$\pm 10-20$	-13	-13	-5	-5	1 MHz
$\pm 20-40$	-13	-13	-13	-5	1 MHz
$\pm 40-100$	-13	-13	-13	-13	1 MHz
$\pm 100-200$		-13	-13	-13	1 MHz
$\pm 200-400$			-13	-13	1 MHz
$\pm 400-800$				-13	1 MHz

The normative reference for this requirement is TS 38.101-2 [3] clause 6.5.2.1.

6.5.2.1.4 Test description

6.5.2.1.4.1 Initial conditions

Initial conditions are a set of test configurations the UE needs to be tested in and the steps for the SS to take with the UE to reach the correct measurement state.

The initial test configurations consist of environmental conditions, test frequencies, and channel bandwidths based on NR operating bands specified in Table 5.3.5-1. All of these configurations shall be tested with applicable test parameters for each channel bandwidth and subcarrier spacing, are shown in Table 6.5.2.1.4.1-1. The details of the uplink reference measurement channels (RMCs) are specified in Annexes A.2. Configurations of PDSCH and PDCCH before measurement are specified in Annex C.2.

Table 6.5.2.1.4.1-1: Test Configuration Table

Initial Conditions			
Test Environment as specified in TS 38.508-1 [10] subclause 4.1		Normal	
Test Frequencies as specified in TS 38.508-1 [10] subclause 4.3.1		Mid range	
Test Channel Bandwidths as specified in TS 38.508-1 [10] subclause 4.3.1		Lowest, Highest	
Test SCS as specified in Table 5.3.5-1		Highest	
Test Parameters			
Test ID	Downlink Configuration	Uplink Configuration	
	-	Modulation	RB allocation (NOTE 1)
1		DFT-s-OFDM PI/2 BPSK	Outer_Full
2		DFT-s-OFDM QPSK	Outer_Full
3		DFT-s-OFDM 16 QAM	Outer_Full
4		DFT-s-OFDM 64 QAM	Outer_Full
5		CP-OFDM QPSK	Outer_Full
NOTE 1: The specific configuration of each RF allocation is defined in Table 6.1-1 for PC2, PC3 and PC4 or Table 6.1-2 for PC1.			
NOTE 2: All test points in this table must also exist in Table 6.2.2.4.1-1, Table 6.2.2.4.1-2, Table 6.2.2.4.1-3 (MPR) for PC1 or Table 6.2.2.4.1-7, Table 6.2.2.4.1-8, Table 6.2.2.4.1-9 (MPR) for PC2, PC3 and PC4.			

1. Connection between SS and UE is shown in TS 38.508-1 [10] Annex A, Figure A.3.3.1.1 for TE diagram and clause A.3.4.1.1 for UE diagram.
2. The parameter settings for the cell are set up according to TS 38.508-1 [10] subclause 4.4.3.
3. Downlink signals are initially set up according to Annex C, and uplink signals according to Annex G.
4. The UL Reference Measurement channels are set according to Table 6.5.2.1.4.1-1.
5. Propagation conditions are set according to Annex B.0
6. Ensure the UE is in state RRC_CONNECTED with generic procedure parameters Connectivity *NR*, Connected without release *On*, Test Mode *On* and Test Loop Function *On* according to TS 38.508-1 [10] clause 4.5. Message contents are defined in clause 6.5.2.1.4.3

6.5.2.1.4.2 Test procedure

1. SS sends uplink scheduling information for each UL HARQ process via PDCCH DCI format 0_1 for C_RNTI to schedule the UL RMC according to Table 6.5.2.1.4.1-1. Since the UL has no payload and no loopback data to send the UE sends uplink MAC padding bits on the UL RMC.
2. Set the UE in the Tx beam peak direction found with a 3D EIRP scan as performed in Annex K.1.1. Allow at least BEAM_SELECT_WAIT_TIME (NOTE 2) for the UE Tx beam selection to complete.

3. Send continuously uplink power control "up" commands in every uplink scheduling information to the UE; allow at least 200 ms for the UE to reach maximum output power. Allow at least BEAM_SELECT_WAIT_TIME (NOTE 2) for the UE Tx beam selection to complete.
4. SS activates the UE Beamlock Function (UBF) by performing the procedure as specified in TS 38.508-1 [10] clause 4.9.2 using condition Tx only.
5. Measure the TRP of the transmitted signal with a measurement filter of bandwidths according to Table 6.5.2.1.5-1 and using a rms detector. If the sweep count is higher than one, the trace mode shall be average. The centre frequency of the filter shall be stepped in continuous steps according to the same table. TRP shall be recorded for each step. The measurement period shall capture the active time slots. Total radiated power is measured according to TRP measurement procedure defined in Annex K. The measurement grid used for TRP measurement defined in Annex M. TRP is calculated considering both polarizations, theta and phi.

NOTE 1: When switching to DFT-s-OFDM waveform, as specified in Table 6.5.2.1.4.1-1, send an NR RRCReconfiguration message according to TS 38.508-1 [10] clause 4.6.3 Table 4.6.3-118 PUSCH-Config with TRANSFORM_PRECODER_ENABLED condition.

NOTE 2: The BEAM_SELECT_WAIT_TIME default value is defined in Annex K.

6.5.2.1.4.3 Message contents

Message contents are according to TS 38.508-1 [10] subclause 4.6.

6.5.2.1.5 Test requirement

The measured TRP of any UE emission derived in step 5, shall fulfil requirements in Table.6.5.2.1.5-1.

Table 6.5.2.1.5-1: General NR spectrum emission mask for Range 2

Spectrum emission limit (dBm)/ Channel bandwidth					
Δf_{OBS} (MHz)	50 MHz	100 MHz	200 MHz	400 MHz	Measurement bandwidth
± 0.5	-5 + TT	-5 + TT	-5 + TT	-5 + TT	1 MHz
$\pm 5-10$	-13 + TT	-5 + TT	-5 + TT	-5 + TT	1 MHz
$\pm 10-20$	-13 + TT	-13 + TT	-5 + TT	-5 + TT	1 MHz
$\pm 20-40$	-13 + TT	-13 + TT	-13 + TT	-5 + TT	1 MHz
$\pm 40-100$	-13 + TT	-13 + TT	-13 + TT	-13 + TT	1 MHz
$\pm 100-200$		-13 + TT	-13 + TT	-13 + TT	1 MHz
$\pm 200-400$			-13 + TT	-13 + TT	1 MHz
$\pm 400-800$				-13 + TT	1 MHz
NOTE 1: TT for each frequency and channel bandwidth is specified in Table 6.5.2.1.5-1a					
NOTE 2: At the boundary of spectrum emission limit, the first and last measurement position with a 1 MHz filter is the inside of +0.5MHz and -0.5MHz, respectively.					
NOTE 3: The measurements are to be performed above the upper edge of the channel and below the lower edge of the channel.					

Table 6.5.2.1.5-1a: Test Tolerance (Spectrum emission mask) for PC3

Test Metric	FR2a	FR2b	FR2c
IFF (Max device size \leq 30 cm)	3.33 dB	3.58 dB	4.46 dB

Table 6.5.2.1.5-1b: Test Tolerance (Spectrum emission mask) for PC1

Test Metric	FR2a	FR2b
IFF (Max device size ≤ 30 cm)	4.11 dB	FFS

Table 6.5.2.1.5-1c: Test Tolerance (Spectrum emission mask) for PC5 and PC6

Test Metric	FR2a
IFF (Max device size ≤ 30 cm)	3.33 dB

NOTE: As a general rule, the resolution bandwidth of the measuring equipment should be equal to the measurement bandwidth. However, to improve measurement accuracy, sensitivity and efficiency, the resolution bandwidth may be smaller than the measurement bandwidth. When the resolution bandwidth is smaller than the measurement bandwidth, the result should be integrated over the measurement bandwidth in order to obtain the equivalent noise bandwidth of the measurement bandwidth.

6.5.2.1_1 Spectrum Emission Mask with Power Boost

Editor's note: The following aspects are either missing or not yet determined:

- Measurement Uncertainties and Test Tolerances are FFS for power class 1, 2 and 4.

6.5.2.1_1.1 Test purpose

Same as clause 6.5.2.1.1.

6.5.2.1_1.2 Test applicability

This test case applies to all types of NR UE release 16 and forward supporting *mpr-PowerBoost-FR2-r16* UE capability.

6.5.2.1_1.3 Minimum conformance requirements

Same as clause 6.5.2.1.3.

6.5.2.1_1.4 Test description

6.5.2.1_1.4.1 Initial conditions

Initial conditions are a set of test configurations the UE needs to be tested in and the steps for the SS to take with the UE to reach the correct measurement state.

The initial test configurations consist of environmental conditions, test frequencies, and channel bandwidths based on NR operating bands specified in Table 5.3.5-1. All of these configurations shall be tested with applicable test parameters for each channel bandwidth and subcarrier spacing, are shown in Table 6.5.2.1_1.4.1-1. The details of the uplink reference measurement channels (RMCs) are specified in Annexes A.2. Configurations of PDSCH and PDCCH before measurement are specified in Annex C.2.

Table 6.5.2.1_1.4.1-1: Test Configuration Table

Default Conditions				
Test Environment as specified in TS 38.508-1 [10] subclause 4.1			Normal	
Test Frequencies as specified in TS 38.508-1 [10] subclause 4.3.1			Mid Range	
Test Channel Bandwidths as specified in TS 38.508-1 [10] subclause 4.3.1			Lowest, Highest	
Test SCS as specified in Table 5.3.5-1			Highest	
Test Parameters				
Test ID	ChBw	SCS	Downlink Configuration	Uplink Configuration

		Default	-	Modulation	RB allocation (NOTE 1)
1	50			DFT-s-OFDM QPSK	Inner_Full for PC2, PC3, PC4 and PC6 Inner_Full_Region1 for PC1
2	100				
3	200				
4	400				
NOTE 1: The specific configuration of each RF allocation is defined in Table 6.1-1 for PC2, PC3, PC4 and PC6 or Table 6.1-2 for PC1.					

1. Connection between SS and UE is shown in TS 38.508-1 [10] Annex A, Figure A.3.3.1.1 for TE diagram and clause A.3.4.1.1 for UE diagram.
2. The parameter settings for the cell are set up according to TS 38.508-1 [10] subclause 4.4.3.
3. Downlink signals are initially set up according to Annex C, and uplink signals according to Annex G.
4. The UL Reference Measurement channels are set according to Table 6.5.2.1_1.4.1-1.
5. Propagation conditions are set according to Annex B.0
6. Ensure the UE is in state RRC_CONNECTED with generic procedure parameters Connectivity *NR*, Connected without release *On*, Test Mode *On* and Test Loop Function *On* according to TS 38.508-1 [10] clause 4.5. Message contents are defined in clause 6.5.2.1_1.4.3

6.5.2.1_1.4.2 Test procedure

Same as clause 6.5.2.1.4.2 with following exceptions:

- Instead of Table 6.5.2.1.4.1-1 → use Table 6.2.1.1.4.1-1 in normal environmental conditions only.

6.5.2.1_1.4.3 Message contents

Same as clause 6.2.4_1.4.3.

6.5.2.1_1.5 Test requirement

Same as clause 6.5.2.1.5.

6.5.2.2 Void

6.5.2.3 Adjacent channel leakage ratio

Editor's note: The following aspects are either missing or not yet determined:

- Measurement Uncertainties and Test Tolerances are FFS for power class other than PC1, PC3, PC5 and PC6.
- Testability for power class 2 and 4 are FFS.

6.5.2.3.1 Test purpose

To verify that UE transmitter does not cause unacceptable interference to adjacent channels in terms of Adjacent Channel Leakage power Ratio (ACLR).

6.5.2.3.2 Test applicability

This test case applies to all types of NR UE release 15 and forward.

6.5.2.3.3 Minimum conformance requirements

Adjacent Channel Leakage power Ratio (ACLR) is the ratio of the filtered mean power centred on the assigned channel frequency to the filtered mean power centred on an adjacent channel frequency. ACLR requirement is specified for a scenario in which adjacent carrier is another NR channel.

NR Adjacent Channel Leakage power Ratio (NR_{ACLR}) is the ratio of the filtered mean power centred on the assigned channel frequency to the filtered mean power centred on an adjacent channel frequency at nominal channel spacing. The assigned NR channel power and adjacent NR channel power are measured with rectangular filters with measurement bandwidths specified in Table 6.5.2.3.3-1.

If the measured adjacent channel power is greater than -35 dBm then the NR_{ACLR} shall be higher than the value specified in Table 6.5.2.3.3-1. The requirement is verified in beam locked mode with the test metric of TRP (Link=TX beam peak direction, Meas=TRP grid).

Table 6.5.2.3.3-1: General requirements for NR_{ACLR}

	Channel bandwidth / NR_{ACLR} / Measurement bandwidth			
	50 MHz	100 MHz	200 MHz	400 MHz
NR_{ACLR} for band n257, n258, n261	17 dB	17 dB	17 dB	17 dB
NR_{ACLR} for band n259, n260	16 dB	16 dB	16 dB	16 dB
NR channel Measurement bandwidth (MHz)	47.58	95.16	190.20	380.28
Adjacent channel centre frequency offset [MHz]	+50 / -50	+100 / -100	+200 / -200	+400 / -400

The normative reference for this requirement is TS 38.101-2 [3] clause 6.5.2.3.

6.5.2.3.4 Test description

6.5.2.3.4.1 Initial conditions

Initial conditions are a set of test configurations the UE needs to be tested in and the steps for the SS to take with the UE to reach the correct measurement state.

The initial test configurations consist of environmental conditions, test frequencies, and channel bandwidths based on NR operating bands specified in Table 5.3.5-1. All of these configurations shall be tested with applicable test parameters for each channel bandwidth and subcarrier spacing, are shown in Table 6.5.2.3.4.1-1 and Table 6.5.2.3.4.1-2. The details of the uplink reference measurement channels (RMCs) are specified in Annexes A.2. Configurations of PDSCH and PDCCH before measurement are specified in Annex C.2.

Table 6.5.2.3.4.1-1: Test Configuration Table (Power Class 1)

Default Conditions							
Test Environment as specified in TS 38.508-1 [10] subclause 4.1			Normal, TL, TH				
Test Frequencies as specified in TS 38.508-1 [10] subclause 4.3.1			Low range, Mid range, High range				
Test Channel Bandwidths as specified in TS 38.508-1 [10] subclause 4.3.1			Lowest, Highest				
Test SCS as specified in Table 5.3.5-1			Lowest, Highest				
Test Parameters							
Test ID	Freq	ChBw	SCS	Downlink Configuration	Uplink Configuration		
		Default	Default	-	Modulation	RB allocation (NOTE 1)	
						SCS 60 kHz	SCS 120 kHz
1	Low				DFT-s-OFDM PI/2 BPSK	16@0	8@0
2	High				DFT-s-OFDM PI/2 BPSK	16@ $N_{RB}-16$	8@ $N_{RB}-8$
3	Mid				DFT-s-OFDM PI/2 BPSK	Outer_Full	Outer_Full
4	Low				DFT-s-OFDM QPSK	16@0	8@0
5	High				DFT-s-OFDM QPSK	16@ $N_{RB}-16$	8@ $N_{RB}-8$
6	Mid	DFT-s-OFDM QPSK	Outer_Full	Outer_Full			

7	Low			DFT-s-OFDM 16 QAM	16@0	8@0
8	High			DFT-s-OFDM 16 QAM	16@N _{RB} -16	8@N _{RB} -8
9	Mid			DFT-s-OFDM 16 QAM	Outer_Full	Outer_Full
10	Low			DFT-s-OFDM 64 QAM	16@0	8@0
11	High			DFT-s-OFDM 64 QAM	16@N _{RB} -16	8@N _{RB} -8
12	Mid			DFT-s-OFDM 64 QAM	Outer_Full	Outer_Full
13	Low			CP-OFDM QPSK	16@0	8@0
14	High			CP-OFDM QPSK	16@N _{RB} -16	8@N _{RB} -8
15	Mid			CP-OFDM QPSK	Outer_Full	Outer_Full

NOTE 1: The specific configuration of each RF allocation is defined in Table 6.1-2.
 NOTE 2: Following Test IDs shall be skipped for FR2b.
 - FFS
 NOTE 3: All test points in this table must also exist in Table 6.2.2.4.1-1, Table 6.2.2.4.1-2, Table 6.2.2.4.1-3 (MPR).

Table 6.5.2.3.4.1-2: Test Configuration Table (Power Class 2, 3, 4, 5 and 6)

Default Conditions						
Test Environment as specified in TS 38.508-1 [10] subclause 4.1				Normal, TL, TH		
Test Frequencies as specified in TS 38.508-1 [10] subclause 4.3.1				Low range, Mid range, High range		
Test Channel Bandwidths as specified in TS 38.508-1 [10] subclause 4.3.1				Lowest, Highest		
Test SCS as specified in Table 5.3.5-1				Lowest, Highest		
Test Parameters						
Test ID	Freq	ChBw	SCS	Downlink Configuration	Uplink Configuration	
		Default	Default	-	Modulation	RB allocation (NOTE 1)
1	Low				DFT-s-OFDM PI/2 BPSK	Outer_1RB_Left
2	High				DFT-s-OFDM PI/2 BPSK	Outer_1RB_Right
3	Mid				DFT-s-OFDM PI/2 BPSK	Outer_Full
4	Low				DFT-s-OFDM QPSK	Outer_1RB_Left
5	High				DFT-s-OFDM QPSK	Outer_1RB_Right
6	Mid				DFT-s-OFDM QPSK	Outer_Full
7	Low				DFT-s-OFDM 16 QAM	Outer_1RB_Left
8	High				DFT-s-OFDM 16 QAM	Outer_1RB_Right
9	Mid				DFT-s-OFDM 16 QAM	Outer_Full
10	Low				DFT-s-OFDM 64 QAM	Outer_1RB_Left
11	High				DFT-s-OFDM 64 QAM	Outer_1RB_Right
12	Mid				DFT-s-OFDM 64 QAM	Outer_Full
13	Low				CP-OFDM QPSK	Outer_1RB_Left
14	High				CP-OFDM QPSK	Outer_1RB_Right
15	Mid				CP-OFDM QPSK	Outer_Full

NOTE 1: The specific configuration of each RF allocation is defined in Table 6.1-1.
 NOTE 2: Following Test IDs shall be skipped for PC3.
 - All Test IDs for FR2b 400MHz Channel Bandwidth
 - Test ID 10-15 for FR2b 200MHz Channel Bandwidth
 - Test ID 10-12 for FR2b 100MHz Channel Bandwidth
 - All Test IDs for FR2c 400MHz Channel Bandwidth
 - Test ID 7-15 for FR2c 200MHz Channel Bandwidth
 - Test ID 10-12 for FR2c 100MHz Channel Bandwidth
 NOTE 3: All test points in this table must also exist in Table 6.2.2.4.1-7, Table 6.2.2.4.1-8, Table 6.2.2.4.1-9 (MPR).

1. Connection between SS and UE is shown in TS 38.508-1 [10] Annex A, Figure A.3.3.1.1 for TE diagram and section A.3.4.1.1 for UE diagram.
2. The parameter settings for the cell are set up according to TS 38.508-1 [10] subclause 4.4.3.
3. Downlink signals are initially set up according to Annex C, and uplink signals according to Annex G.
4. The UL Reference Measurement channels are set according to Table 6.5.2.3.4.1-1 and Table 6.5.2.3.4.1-2.
5. Propagation conditions are set according to Annex B.0.
6. Ensure the UE is in state RRC_CONNECTED with generic procedure parameters Connectivity *NR*, Connected without release *On*, Test Mode *On* and Test Loop Function *On* according to TS 38.508-1 [10] clause 4.5. Message contents are defined in clause 6.5.2.3.4.3

6.5.2.3.4.2 Test procedure

1. SS sends uplink scheduling information for each UL HARQ process via PDCCH DCI format 0_1 for C_RNTI to schedule the UL RMC according to Table 6.5.2.3.4.1-1 and Table 6.5.2.3.4.1-2. Since the UL has no payload and no loopback data to send the UE sends uplink MAC padding bits on the UL RMC.
2. Set the UE in the Tx beam peak direction found with a 3D EIRP scan as performed in Annex K.1.1. Allow at least BEAM_SELECT_WAIT_TIME (NOTE 2) for the UE Tx beam selection to complete.
3. Send continuously uplink power control "up" commands in every uplink scheduling information to the UE; allow at least 200 ms for the UE to reach maximum output power. Allow at least BEAM_SELECT_WAIT_TIME (NOTE 2) for the UE Tx beam selection to complete.
4. SS activates the UE Beamlock Function (UBF) by performing the procedure as specified in TS 38.508-1 [10] clause 4.9.2 using condition Tx only.
5. Measure EIRP of the transmitted signal in the Tx beam peak direction for the assigned NR channel with a rectangular measurement filter with bandwidths according to Table 6.5.2.3.5-1 and using a rms detector. If the sweep count is higher than one, the trace mode shall be average. EIRP measurement procedure defined in Annex K. EIRP is calculated considering both polarizations, theta and phi.
6. Measure EIRP of the first NR adjacent channel on both lower and upper side of the assigned NR channel, respectively using a rectangular measurement filter with bandwidths according to Table 6.5.2.3.5-1 and using a rms detector. If the sweep count is higher than one, the trace mode shall be average. EIRP measurement procedure defined in Annex K. EIRP is calculated considering both polarizations, theta and phi.
7. Calculate the ratios of the power between the values measured in step 5 over step 6 for lower and upper NR ACLR, respectively.

NOTE 1: When switching to DFT-s-OFDM waveform, as specified in the Table 6.5.2.3.4.1-1 and Table 6.5.2.3.4.1-2, send an NR RRCReconfiguration message according to TS 38.508-1 [10] clause 4.6.3 Table 4.6.3-118 PUSCH-Config with TRANSFORM_PRECODER_ENABLED condition.

NOTE 2: The BEAM_SELECT_WAIT_TIME default value is defined in Annex K.

6.5.2.3.4.3 Message contents

Message contents are according to TS 38.508-1 [10] subclause 4.6.

6.5.2.3.5 Test requirement

The measured NR ACLR, derived in step 7, shall be higher than the limits in Table 6.5.2.3.5-1.

Table 6.5.2.3.5-1: General requirements for NR_{ACLR}

	Channel bandwidth / NR _{ACLR} / Measurement bandwidth			
	50 MHz	100 MHz	200 MHz	400 MHz

NR_{ACLR} for band n257, n258, n261	17 - TT - R dB	17 - TT - R dB	17 - TT - R dB	17 - TT - R dB
NR_{ACLR} for band n260	16 - TT dB	16 - TT dB	16 - TT dB	16 - TT dB
NR_{ACLR} for band n259	16 - TT dB	16 - TT dB	16 - TT dB	16 - TT dB
NR channel Measurement bandwidth (MHz)	47.58	95.16	190.20	380.28
Adjacent channel centre frequency offset [MHz]	+50 / -50	+100 / -100	+200 / -200	+400 / -400
NOTE 1: TT for each frequency and channel bandwidth is specified in Table 6.5.2.3.5-1a NOTE 2: R for each frequency, channel bandwidth and test point is specified in Table 6.5.2.3.5-1b				

Table 6.5.2.3.5-1a: Test Tolerance (Adjacent channel leakage ratio) for PC3

	Test ID	Channel bandwidth / NR _{ACLR} / Measurement bandwidth			
		50 MHz	100 MHz	200 MHz	400 MHz
NR_{ACLR} for band n257, n258, n261	1-2, 4-5	4.10	4.49	4.66	5.06
	3, 6	4.08	4.45	4.59	5.06
	7-9	4.15	4.59	4.85	3.34
	10-12	4.36	4.98	4.06	1.46
	13-15	4.17	4.62	4.91	2.99
NR_{ACLR} for band n260	1-2, 4-5	4.48	4.65	4.97	-
	3, 6	4.45	4.58	4.84	-
	7-9	4.58	4.84	5.31	-
	10-12	4.97	-	-	-
	13-15	4.62	4.90	-	-
NR_{ACLR} for band n259	1-2, 4-5	5.61	5.91	6.44	-
	3, 6	5.55	5.79	6.23	-
	7-9	5.79	6.23	-	-
	10-12	6.44	-	-	-
	13-15	5.84	6.33	-	-

Table 6.5.2.3.5-1b: Relaxation due to testability limit (Adjacent channel leakage ratio) for PC3

	Test ID	Channel bandwidth / NR _{ACLR} / Measurement bandwidth			
		50 MHz	100 MHz	200 MHz	400 MHz
NR_{ACLR} for band n257, n258, n261	1-6	0	0	0	0
	7	0	0	0	2.5
	8	0	0	0	2.5
	9	0	0	0	2.5
	10	0	0	1.5	5.5
	11	0	0	1.5	5.5
	12	0	0	1.5	5.5
	13	0	0	0	3
	14	0	0	0	3
	15	0	0	0	3
NOTE 1: Relaxation value is derived by Table 6.5.2.3.5-1c for FR2a. NOTE 2: Relaxation value is 0 for FR2b.					

Table 6.5.2.3.5-1c: Relaxation value for FR2a ACLR for PC3

	CA bandwidth class
--	---------------------------

MPR	100 MHz	200 MHz	400 MHz
0	0	0	0
0.5	0	0	0
1	0	0	0
1.5	0	0	0
2	0	0	0
2.5	0	0	0
3	0	0	0
3.5	0	0	0.5
4	0	0	1
4.5	0	0	2.5
5	0	0	3
5.5	0	1.5	4.5
6	0	2	5
6.5	0	2.5	5.5
7	0	3	6
7.5	0.5	3.5	6.5
8	1	4	7
8.5	1.5	4.5	7.5
9	2	5	8

Table 6.5.2.3.5-1d: Test Tolerance (Adjacent channel leakage ratio) for PC1

Test Metric	FR2a	FR2b
Max device size \leq 30 cm	5.26 dB	5.26 dB

Table 6.5.2.3.5-1e: Relaxation due to testability limit (Adjacent channel leakage ratio) for PC1

Test Metric	FR2a	FR2b
Max device size \leq 30 cm	0 dB	0 dB

Table 6.5.2.3.5-1f: Test Tolerance (Adjacent channel leakage ratio) for PC5 and PC6

Test Metric	FR2a
Max device size \leq 30 cm	5.26 dB

Table 6.5.2.3.5-1g: Relaxation due to testability limit (Adjacent channel leakage ratio) for PC5 and PC6

Test Metric	FR2a
Max device size \leq 30 cm	0 dB

6.5.3 Spurious emissions

Spurious emissions are emissions which are caused by unwanted transmitter effects such as harmonics emission, parasitic emissions, intermodulation products and frequency conversion products, but exclude out of band emissions. The spurious emission limits are specified in terms of general requirements in line with SM.329 [7] and NR operating band requirement to address UE co-existence. Spurious emissions are measured as TRP.

To improve measurement accuracy, sensitivity and efficiency, the resolution bandwidth may be smaller than the measurement bandwidth. When the resolution bandwidth is smaller than the measurement bandwidth, the result should be integrated over the measurement bandwidth in order to obtain the equivalent noise bandwidth of the measurement bandwidth.

6.5.3.1 Transmitter Spurious emissions

Editor's note: This clause is complete for Band n257, n258, n259, n260 and n261 and for PC1, PC3, PC5, PC6. The following aspects of the clause are for future consideration:

- TRP Measurement uncertainty is TBD for above 87 GHz.
- Test procedure is FFS for laptop.

6.5.3.1.1 Test purpose

To verify that UE transmitter does not cause unacceptable interference to other channels or other systems in terms of transmitter spurious emissions.

6.5.3.1.2 Test applicability

This test case applies to all types of NR UE release 15 and forward.

6.5.3.1.3 Minimum conformance requirements

Unless otherwise stated, the spurious emission limits apply for the frequency ranges that are more than F_{OOB} (MHz) in Table 6.5.3.1.3-1 starting from the edge of the assigned NR channel bandwidth. The spurious emission limits in Table 6.5.3.1.3-2 apply for all transmitter band configurations (NRB) and channel bandwidths. The requirement is verified in beam locked mode with the test metric of TRP (Link=TX beam peak direction, Meas=TRP grid).

NOTE: For measurement conditions at the edge of each frequency range, the lowest frequency of the measurement position in each frequency range should be set at the lowest boundary of the frequency range plus MBW/2. The highest frequency of the measurement position in each frequency range should be set at the highest boundary of the frequency range minus MBW/2. MBW denotes the measurement bandwidth defined for the protected band.

Table 6.5.3.1.3-1: Boundary between NR out of band and spurious emission domain

Channel bandwidth	50 MHz	100 MHz	200 MHz	400 MHz
OOB boundary F_{OOB} (MHz)	100	200	400	800

The spurious emission limits in table 6.5.3.1.3-2 apply for all transmitter band configurations (RB) and channel bandwidths.

Table 6.5.3.1.3-2: Spurious emissions limits

Frequency Range	Maximum Level	Measurement bandwidth	NOTE
$30 \text{ MHz} \leq f < 1000 \text{ MHz}$	-36 dBm	100 kHz	
$1 \text{ GHz} \leq f < 12.75 \text{ GHz}$	-30 dBm	1 MHz	
$12.75 \text{ GHz} \leq f \leq 2^{\text{nd}}$ harmonic of the upper frequency edge of the UL operating band in GHz	-13 dBm	1 MHz	

The normative reference for this requirement is TS 38.101-2 subclause 6.5.3.

6.5.3.1.4 Test description

6.5.3.1.4.1 Initial conditions

Initial conditions are a set of test configurations the UE needs to be tested in and the steps for the SS to take with the UE to reach the correct measurement state.

The initial test configurations consist of environmental conditions, test frequencies, and channel bandwidths based on NR operating bands specified in Table 5.3.5-1. All of these configurations shall be tested with applicable test parameters for each channel bandwidth and subcarrier spacing, are shown in Table 6.5.3.1.4.1-1. The details of the

uplink reference measurement channels (RMCs) are specified in Annexes A.2. Configurations of PDSCH and PDCCH before measurement are specified in Annex C.2.

Table 6.5.3.1.4.1-1: Test Configuration Table

Initial Conditions			
Test Environment as specified in TS 38.508-1 [10] subclause 4.1		Normal	
Test Frequencies as specified in TS 38.508-1 [10] subclause 4.3.1		Low range, High range (NOTE 2)	
Test Channel Bandwidths as specified in TS 38.508-1 [10] subclause 4.3.1		Highest	
Test SCS as specified in Table 5.3.5-1		120kHz	
Test Parameters			
Test ID	Downlink Configuration	Uplink Configuration	
		Modulation	RB allocation (NOTE 1)
1 (NOTE 4)	-	DFT-s -OFDM QPSK	Inner_Full for PC2, PC3, PC4, PC5 and PC6 Inner_Full_Region1 for PC1
2	-	DFT-s -OFDM QPSK	Inner_1RB for PC2, PC3, PC4, PC5 and PC6 Inner_Partial for PC1 (NOTE 3)
NOTE 1: The specific configuration of each RB allocation is defined in Table 6.1-1 for PC2, PC3, PC4, PC5, PC6 and PC7 or Table 6.1-2 for PC1.			
NOTE 2: When testing Low range test only in Frequency Range lower than $(F_{UL_low} - \Delta f_{OOB})$ and when testing High range test only in Frequency Range higher than $(F_{UL_high} + \Delta f_{OOB})$.			
NOTE 3: When testing Low range configure uplink RB to Inner_1RB_Left for PC2, PC3, PC4, PC5 and PC6 or Inner_Partial_Left_Region1 for PC1 and when testing High range configure uplink RB to Inner_1RB_Right for PC2, PC3, PC4, PC5 and PC6 or Inner_Partial_Right_Region1 for PC1.			
NOTE 4: This test point shall be skipped if device supports <i>mpr-PowerBoost-FR2-r16</i> UE capability.			

1. Connection between SS and UE is shown in TS 38.508-1 [10] Annex A, Figure A.3.3.1.3 for TE diagram and Figure A.3.4.1.1 for UE diagram.
2. The parameter settings for the cell are set up according to TS 38.508-1 [10] subclause 4.4.3.
3. Downlink signals are initially set up according to Annex C, and uplink signals according to Annex G.
4. The UL Reference Measurement channels are set according to Table 6.5.3.1.4.1-1.
5. Propagation conditions are set according to Annex B.0.
6. Ensure the UE is in state RRC_CONNECTED with generic procedure parameters Connectivity *NR*, Connected without release *On*, Test Mode *On* and Test Loop Function *On* according to TS 38.508-1 [10] clause 4.5. Message contents are defined in clause 6.5.3.1.4.3.

6.5.3.1.4.2 Test procedure

1. Select any of the three Alignment Options (1, 2, or 3) from Tables N.2-1 through N.2-3 to mount the DUT inside the QZ.
2. If the re-positioning concept is applied, position the device in DUT Orientation 1 if the maximum beam peak direction is within zenith angular range $0^\circ \leq \theta \leq 90^\circ$ for the alignment option selected in step 1; position the device in DUT Orientation 2 (either Options 1 or 2) if the maximum beam peak direction is within zenith angular range $90^\circ < \theta \leq 180^\circ$ for DUT Orientation 1 for the alignment option selected in step 1. If the re-positioning concept is not applied, position the device in DUT Orientation 1.
3. SS sends uplink scheduling information for each UL HARQ process via PDCCH DCI format 0_1 for C_RNTI to schedule the UL RMC according to Table 6.5.3.1.4.1-1. Since the UL has no payload and no loopback data to send the UE sends uplink MAC padding bits on the UL RMC.

4. Set the UE in the Inband Tx beam peak direction found with a 3D EIRP scan as performed in Annex K.1.1. Allow at least BEAM_SELECT_WAIT_TIME (NOTE 3) for the UE Tx beam selection to complete.
5. Send continuously uplink power control "up" commands in every uplink scheduling information to the UE; allow at least 200msec for the UE to reach P_{UMAX}. Allow at least BEAM_SELECT_WAIT_TIME (NOTE 3) for the UE Tx beam selection to complete.
6. SS activates the UE Beamlock Function (UBF) by performing the procedure as specified in TS 38.508-1 [10] clause 4.9.2 using condition Tx only.
7. Measure the spurious emissions as per steps outlined below with an exception to the procedure in Annex K if the re-positioning concept is applied (NOTE 4). Step (a) is optional and applicable only if SNR (test requirement level in Table 6.5.3.1.5-1 minus offset value minus noise floor of the test system) ≥ 0 dB is guaranteed. During measurement the spectrum analyser shall be set to 'Detector' = RMS. If the sweep count is higher than one, the trace mode shall be average.
 - (a) Perform coarse TRP measurements to identify spurious emission frequencies and corresponding power level according to the procedures in Annex K, using coarse TRP measurement grid selection criteria as per Tables 6.5.3.1.4.2-1 through 6.5.3.1.4.2-3. The measurement is completed in both polarizations θ and ϕ over frequency range and measurement bandwidth according to Table 6.5.3.1.5-1. Optionally, a larger and non-constant measurement bandwidth than that of Table 6.5.3.1.5-1 may be applied. The measurement period shall capture the active time slots.

For each spurious emission frequency with coarse TRP identified to be less than the offsets listed in Tables 6.5.3.1.4.2-1 through 6.5.3.1.4.2-3 from the TRP limit according to Table 6.5.3.1.5-1, either continue with another coarse TRP procedure and corresponding offset according to step (a) or continue with fine TRP procedures according to step (b).

Different coarse TRP grids and corresponding offset values may be used for different frequencies. Multiple coarse TRP grids measurements with the corresponding offset values can be performed before the fine TRP measurement grid is applied. The coarse TRP grids and offset values used shall be recorded in the test report.

Table 6.5.3.1.4.2-1: Offset values for coarse TRP measurement step 7(a) for constant-step size grids with Clenshaw-Curtis quadrature

Power Class		PC1/ PC5	PC5/PC6	PC3	PC3
Antenna Assumptions		12x12	6x6 -alternate-	8x2	4x2 -alternate-
$\Delta\theta=\Delta\phi$ [°]	# of Grid Points				
45	26		10.8	7.5	4.4
30	62	12.1	6.4	3.7	2.5
15	266	5.4	2.0	1.5	
10	614	3.0			
7.5	1106	1.9			
Note: The alternate grids are based on optional vendor declaration, see Table A.4.3.9-10 in [11] for PC3 and Table A.4.3.9-10a in [11] for PC5.					

Table 6.5.3.1.4.2-2: Offset values for coarse TRP measurement step 7(a) for constant-step size grids with sin(θ) quadrature

Power Class		PC1/ PC5	PC5/PC6	PC3	PC3
Antenna Assumptions		12x12	6x6 -alternate-	8x2	4x2 -alternate-
$\Delta\theta=\Delta\phi$ [°]	# of Grid Points				
45	26		11.7	8.4	5.0

30	62	12.7	6.9	3.9	2.8
15	266	5.6	2.2	1.6	
10	614	3.1			
7.5	1106	1.9			
Note: The alternate grids are based on optional vendor declaration, see Table A.4.3.9-10 in [11] for PC3 and Table A.4.3.9-10a in [11] for PC5.					

Table 6.5.3.1.4.2-3: Offset values for coarse TRP measurement step 7(a) for constant density grids

Power Class	PC1/ PC5	PC5/PC6	PC3	PC3
Antenna Assumption	12x12	6x6 -alternate-	8x2	4x2 -alternate-
Number of Grid Pts				
20		13.6	9.9	5.4
50	11.7	6.5	4.2	2.4
200	4.3	2.0	1.8	
450	2.9			
850	1.6			
Note: The alternate grids are based on optional vendor declaration, see Table A.4.3.9-10 in [11] for PC3 and Table A.4.3.9-10a in [11] for PC5.				

(b) Measure fine TRP measurements according to procedures in Annex K, using fine TRP measurement grid selection criteria as per Table M.4.5-3 in Annex M, for each of the spurious emission frequency identified in step (a). Apply a measurement bandwidth according to Table 6.5.3.1.5-1.

8. SS deactivates the UE Beamlock Function (UBF) by performing the procedure as specified in TS 38.508-1 [10] clause 4.9.3.

NOTE 1: The frequency range defined in Table 6.5.3.1.5-1 may be split into ranges. For each range a different test system, e.g. antenna and/or chamber, may be used. To pass the test case all verdicts of the frequency ranges must pass.

NOTE 2: Void.

NOTE 3: The BEAM_SELECT_WAIT_TIME default value is defined in Annex K.

NOTE 4: If the (in-band) beam peak is within $0^\circ \leq \theta \leq 90^\circ$: perform first hemispherical TRP scan ($0^\circ \leq \theta \leq 90^\circ$) in DUT Orientation 1 and second hemispherical TRP scan ($90^\circ > \theta \geq 0^\circ$) in DUT Orientation 2. If the (in-band) beam peak is within $90^\circ < \theta \leq 180^\circ$: perform first hemispherical TRP scan ($0^\circ \leq \theta \leq 90^\circ$) in DUT Orientation 2 and second hemispherical TRP scan ($90^\circ > \theta \geq 0^\circ$) in DUT Orientation 1. The DUT with UBF activated needs to be re-positioned during the test.

NOTE 5: Void.

6.5.3.1.4.3 Message contents

Message contents are according to TS 38.508-1 [10] subclause 4.6 with TRANSFORM_PRECODER_ENABLED condition in Table 4.6.3-118 PUSCH-Config.

6.5.3.1.5 Test requirement

This clause specifies the requirements for the specified NR band for Transmitter Spurious emissions requirement with frequency range as indicated in Table 6.5.3.1.5-1.

The maximum TRP power of spurious emission, measured using RMS detector, shall not exceed the described value in Table 6.5.3.1.5-1.

Unless otherwise stated, the spurious emission limits apply for the frequency ranges that are more than F_{OOB} (MHz) in Table 6.5.3.1.3-1 starting from the edge of the assigned NR channel bandwidth. The spurious emission limits in Table 6.5.3.1.5-1 apply for all transmitter band configurations (NRB) and channel bandwidths.

NOTE: For measurement conditions at the edge of each frequency range, the lowest frequency of the measurement position in each frequency range should be set at the lowest boundary of the frequency range plus MBW/2. The highest frequency of the measurement position in each frequency range should be set at the highest boundary of the frequency range minus MBW/2. MBW denotes the measurement bandwidth defined for the protected band.

Table 6.5.3.1.5-1: Spurious emissions test requirements

Frequency Range	Maximum Level	Measurement bandwidth	NOTE
$6 \text{ GHz} \leq f < 12.75 \text{ GHz}$	-30 dBm	1 MHz	
$12.75 \text{ GHz} \leq f \leq 2^{\text{nd}}$ harmonic of the upper frequency edge of the UL operating band in GHz	-13 dBm	1 MHz	
NOTE 1: Applies for Band n257, n258, n259, n260, n261			

6.5.3.1_1 Transmitter Spurious emissions with Power Boost

Editor's note: This clause is complete for Band n257, n258, n259, n260 and n261 for PC1 and PC3. The following aspects of the clause are for future consideration:

- TRP Measurement uncertainty is TBD for above 87 GHz.
- Test procedure only includes the testing of smartphone and is FFS for laptop and FWA.
- For a transition period until RAN5#103 meeting (May 2024), previous fine/coarse TRP measurement grid and offset values for corresponding coarse TRP measurement in TS 38.521-2 V17.2.0 are allowed for TE implementation.

6.5.3.1_1.1 Test purpose

Same as clause 6.5.3.1.1.

6.5.3.1_1.2 Test applicability

This test case applies to all types of NR UE release 16 and forward supporting *mpr-PowerBoost-FR2-r16* UE capability.

6.5.3.1_1.3 Minimum conformance requirements

Same as clause 6.5.3.1.3.

6.5.3.1_1.4 Test description

6.5.3.1_1.4.1 Initial conditions

Initial conditions are a set of test configurations the UE needs to be tested in and the steps for the SS to take with the UE to reach the correct measurement state.

The initial test configurations consist of environmental conditions, test frequencies, and channel bandwidths based on NR operating bands specified in Table 5.3.5-1. All of these configurations shall be tested with applicable test parameters for each channel bandwidth and subcarrier spacing, are shown in Table 6.5.3.1_1.4.1-1. The details of the uplink reference measurement channels (RMCs) are specified in Annexes A.2. Configurations of PDSCH and PDCCH before measurement are specified in Annex C.2.

Table 6.5.3.1_1.4.1-1: Test Configuration Table

Default Conditions					
Test Environment as specified in TS 38.508-1 [10] subclause 4.1			Normal		
Test Frequencies as specified in TS 38.508-1 [10] subclause 4.3.1			Low Range, High Range		
Test Channel Bandwidths as specified in TS 38.508-1 [10] subclause 4.3.1			Highest		
Test SCS as specified in Table 5.3.5-1			120kHz		
Test Parameters					
Test ID	ChBw	SCS	Downlink Configuration	Uplink Configuration	
		Default	-	Modulation	RB allocation (NOTE 1)
1	50		DFT-s-OFDM QPSK	Inner_Full for PC2, PC3, PC4 and PC6 Inner_Full_Region1 for PC1	
2	100				
3	200				
4	400				
NOTE 1: The specific configuration of each RF allocation is defined in Table 6.1-1 for PC2, PC3, PC4 and PC6 or Table 6.1-2 for PC1.					
NOTE 2: When testing Low range test only in Frequency Range lower than $(F_{UL_low} - \Delta f_{OOB})$ and when testing High range test only in Frequency Range higher than $(F_{UL_high} + \Delta f_{OOB})$.					

1. Connection between SS and UE is shown in TS 38.508-1 [10] Annex A, Figure A.3.3.1.3 for TE diagram and Figure A.3.4.1.1 for UE diagram.
2. The parameter settings for the cell are set up according to TS 38.508-1 [10] subclause 4.4.3.
3. Downlink signals are initially set up according to Annex C, and uplink signals according to Annex G.
4. The UL Reference Measurement channels are set according to Table 6.5.3.1_1.4.1-1.
5. Propagation conditions are set according to Annex B.0.
6. Ensure the UE is in state RRC_CONNECTED with generic procedure parameters Connectivity NR, Connected without release On, Test Mode On and Test Loop Function On according to TS 38.508-1 [10] clause 4.5. Message contents are defined in clause 6.5.3.1_1.4.3.

6.5.3.1_1.4.2 Test procedure

Same as clause 6.5.3.1.4.2 with following exceptions:

- Instead of Table 6.5.3.1.4.1-1 → use Table 6.2.1.1.4.1-1 in normal environmental conditions only.

6.5.3.1_1.4.3 Message contents

Same as clause 6.2.4_1.4.3.

6.5.3.1_1.5 Test requirement

Same as clause 6.5.3.1.5.

6.5.3.2 Spurious emission band UE co-existence

Editor's note: This clause is complete for Band n257, n258, n259, n260 and n261 and for PC1, PC3, PC5, PC6. The following aspects of the clause are for future consideration:

- TRP Measurement uncertainty is TBD for PC2 and PC4.
- Test procedure is FFS for laptop.

- For a transition period until RAN#102 meeting (Dec 2023), the implementation of note 4 in Table 6.5.3.2.4.1-1 in test equipment is not applicable to avoid lack of test coverage until testcase 6.5.3.2_1 is available.
- For a transition period until RAN5#103 meeting (May 2024), previous fine/coarse TRP measurement grid and offset values for corresponding coarse TRP measurement in TS 38.521-2 V17.2.0 are allowed for TE implementation.

6.5.3.2.1 Test purpose

To verify that UE transmitter does not cause unacceptable interference when in co-existence with protected bands in terms of transmitter spurious emissions.

6.5.3.2.2 Test applicability

This test case applies to all types of NR UE release 15 and forward.

6.5.3.2.3 Minimum conformance requirements

This clause specifies the requirements for the specified NR band, for co-existence with protected bands. The requirement is verified in beam locked mode with the test metric of TRP (Link=TX beam peak direction, Meas=TRP grid).

NOTE: For measurement conditions at the edge of each frequency range, the lowest frequency of the measurement position in each frequency range should be set at the lowest boundary of the frequency range plus MBW/2. The highest frequency of the measurement position in each frequency range should be set at the highest boundary of the frequency range minus MBW/2. MBW denotes the measurement bandwidth defined for the protected band.

The spurious emission UE co-existence limits in Table 6.5.3.2.3-1 apply for all transmitter band configurations (RB) and channel bandwidths.

Table 6.5.3.2.3-1: Spurious emissions UE co-existence limits

NR Band	Spurious emission						
	Protected band/frequency range	Frequency range (MHz)			Maximum Level (dBm)	MBW (MHz)	NOTE
n257	NR Band n260	F _{DL_low}	-	F _{DL_high}	-2	100	
	Frequency range	57000	-	66000	2	100	
	Frequency range	23600	-	24000	1	200	3
n258	Frequency range	57000	-	66000	2	100	
n259	NR Band 257	F _{DL_low}	-	F _{DL_high}	-5	100	n259
	NR Band 261	F _{DL_low}	-	F _{DL_high}	-5	100	
	Frequency range	36000	-	37000	7	1000	
	Frequency range	57000	-	66000	2	100	
n260	NR Band 257	F _{DL_low}	-	F _{DL_high}	-5	100	
	NR Band 261	F _{DL_low}	-	F _{DL_high}	-5	100	
	Frequency range	57000	-	66000	2	100	
n261	NR Band 260	F _{DL_low}	-	F _{DL_high}	-2	100	
	Frequency range	57000	-	66000	2	100	

NOTE 1: F_{DL_low} and F_{DL_high} refer to each NR frequency band specified in Table 5.2-1.
 NOTE 2: Void.
 NOTE 3: The protection of frequency range 23600-24000 MHz is meant for protection of satellite passive services.

The normative reference for this requirement is TS 38.101-2 subclause 6.5.3.1.

6.5.3.2.4 Test description

6.5.3.2.4.1 Initial conditions

Initial conditions are a set of test configurations the UE needs to be tested in and the steps for the SS to take with the UE to reach the correct measurement state.

The initial test configurations consist of environmental conditions, test frequencies, and channel bandwidths based on NR operating bands specified in Table 5.3.5-1. All of these configurations shall be tested with applicable test parameters for each channel bandwidth and subcarrier spacing, are shown in Table 6.5.3.2.4.1-1. The details of the uplink reference measurement channels (RMCs) are specified in Annexes A.2. Configurations of PDSCH and PDCCH before measurement are specified in Annex C.2.

Table 6.5.3.2.4.1-1: Test Configuration Table

Initial Conditions			
Test Environment as specified in TS 38.508-1 [10] subclause 4.1		Normal	
Test Frequencies as specified in TS 38.508-1 [10] subclause 4.3.1		Low range, High range (NOTE 2)	
Test Channel Bandwidths as specified in TS 38.508-1 [10] subclause 4.3.1		Highest	
Test SCS as specified in Table 5.3.5-1		120kHz	
Test Parameters			
Test ID	Downlink Configuration	Uplink Configuration	
		Modulation	RB allocation (NOTE 1)
1 (NOTE 4)	-	DFT-s-OFDM QPSK	Inner_Full for PC2, PC3, PC4, PC5, PC6 and PC7 Inner_Full_Region1 for PC1
2		DFT-s-OFDM QPSK	Inner_1RB for PC2, PC3, PC4, PC5, PC6 and PC7 Inner_Partial for PC1 (NOTE 3)
NOTE 1: The specific configuration of each RB allocation is defined in Table 6.1-1 for PC2, PC3, PC4, PC5, PC6 and PC7 or Table 6.1-2 for PC1.			
NOTE 2: When testing Low range test only in Frequency Range lower than ($F_{UL_low} - \Delta f_{OOB}$) and when testing High range test only in Frequency Range higher than ($F_{UL_high} + \Delta f_{OOB}$).			
NOTE 3: When testing Low range configure uplink RB to Inner_1RB_Left for PC2, PC3, PC4, PC5 and PC6 or Inner_Partial_Left_Region1 for PC1 and when testing High range configure uplink RB to Inner_1RB_Right for PC2, PC3, PC4, PC5 and PC6 or Inner_Partial_Right_Region1 for PC1.			
NOTE 4: This test point shall be skipped if device supports <i>mpr-PowerBoost-FR2-r16</i> UE capability.			

1. Connection between SS and UE is shown in TS 38.508-1 [10] Annex A, Figure A.3.3.1.3 for TE diagram and Figure A.3.4.1.1 for UE diagram.
2. The parameter settings for the cell are set up according to TS 38.508-1 [10] subclause 4.4.3.
3. Downlink signals are initially set up according to Annex C, and uplink signals according to Annex G.
4. The UL Reference Measurement channels are set according to Table 6.5.3.2.4.1-1
5. Propagation conditions are set according to Annex B.0.
6. Ensure the UE is in state RRC_CONNECTED with generic procedure parameters Connectivity NR, Connected without release On, Test Mode On and Test Loop Function On according to TS 38.508-1 [10] clause 4.5. Message contents are defined in clause 6.5.3.2.4.3.

6.5.3.2.4.2 Test procedure

1. Select any of the three Alignment Options (1, 2, or 3) from Tables N.2-1 through N.2-3 to mount the DUT inside the QZ.

2. If the re-positioning concept is applied, position the device in DUT Orientation 1 if the maximum beam peak direction is within zenith angular range $0^\circ \leq \theta \leq 90^\circ$ for the alignment option selected in step 1; position the device in DUT Orientation 2 (either Options 1 or 2) if the maximum beam peak direction is within zenith angular range $90^\circ < \theta \leq 180^\circ$ for DUT Orientation 1 for the alignment option selected in step 1. If the re-positioning concept is not applied, position the device in DUT Orientation 1.
3. SS sends uplink scheduling information for each UL HARQ process via PDCCH DCI format 0_1 for C_RNTI to schedule the UL RMC according to Table 6.5.3.2.4.1-1. Since the UL has no payload and no loopback data to send the UE sends uplink MAC padding bits on the UL RMC.
4. Set the UE in the Inband Tx beam peak direction found with a 3D EIRP scan as performed in Annex K.1.1. Allow at least BEAM_SELECT_WAIT_TIME (NOTE 3) for the UE Tx beam selection to complete.
5. Send continuously uplink power control "up" commands in every uplink scheduling information to the UE; allow at least 200msec for the UE to reach P_{UMAX} . Allow at least BEAM_SELECT_WAIT_TIME (NOTE 3) for the UE Tx beam selection to complete.
6. SS activates the UE Beamlock Function (UBF) by performing the procedure as specified in TS 38.508-1 [10] clause 4.9.2 using condition Tx only.
7. Measure the spurious emissions as per steps outlined below with an exception to the procedure in Annex K if the re-positioning concept is applied (NOTE 4). During measurement the spectrum analyser shall be set to 'Detector' = RMS. If the sweep count is higher than one, the trace mode shall be average.
 - (a) Perform coarse TRP measurements to identify spurious emission frequencies and corresponding power level according to the procedures in Annex K, using coarse TRP measurement grid selection criteria as per Tables 6.5.3.1.4.2-1 through 6.5.3.1.4.2-3. The measurement is completed in both polarizations θ and ϕ over frequency range and measurement bandwidth according to Table 6.5.3.2.3-1. Optionally, a larger and non-constant measurement bandwidth than that of Table 6.5.3.2.3-1 may be applied as long as the SNR (ratio of test limit to floor noise of test equipment) ≥ 10 dB is guaranteed. The measurement period shall capture the active time slots. For each spurious emission frequency with coarse TRP identified to be less than the offsets listed in Tables 6.5.3.1.4.2-1 through 6.5.3.1.4.2-3 from the TRP limit according to Table 6.5.3.2.3-1, either continue with another coarse TRP procedure and corresponding offset according to step (a) or continue with fine TRP procedures according to step (b).

Different coarse TRP grids and corresponding offset values may be used for different frequencies. Multiple coarse TRP grids measurements with the corresponding offset values can be performed before the fine TRP measurement grid is applied. The coarse TRP grids and offset values used shall be recorded in the test report.
 - (b) Measure fine TRP measurements according to procedures in Annex K, using fine TRP measurement grid selection criteria as per Table M.4.5-3 in Annex M, for each of the spurious emission frequency identified in step (a). Apply a measurement bandwidth according to Table 6.5.3.2.3-1.
8. SS deactivates the UE Beamlock Function (UBF) by performing the procedure as specified in TS 38.508-1 [10] clause 4.9.3.

NOTE 1: The frequency range defined in Table 6.5.3.2.3-1 may be split into ranges. For each range a different test system, e.g. antenna and/or chamber, may be used. To pass the test case all verdicts of the frequency ranges must pass.

NOTE 2: Void.

NOTE 3: The BEAM_SELECT_WAIT_TIME default value is defined in Annex K.

NOTE 4: If the (in-band) beam peak is within $0^\circ \leq \theta \leq 90^\circ$: perform first hemispherical TRP scan ($0^\circ \leq \theta \leq 90^\circ$) in DUT Orientation 1 and second hemispherical TRP scan ($90^\circ > \theta \geq 0^\circ$) in DUT Orientation 2. If the (in-band) beam peak is within $90^\circ < \theta \leq 180^\circ$: perform first hemispherical TRP scan ($0^\circ \leq \theta \leq 90^\circ$) in DUT Orientation 2 and second hemispherical TRP scan ($90^\circ > \theta \geq 0^\circ$) in DUT Orientation 1. The DUT with UBF activated needs to be re-positioned during the test.

6.5.3.2.4.3 Message contents

Message contents are according to TS 38.508-1 [10] subclause 4.6 with TRANSFORM_PRECODER_ENABLED condition in Table 4.6.3-118 PUSCH-Config.

6.5.3.2.5 Test requirement

This clause specifies the requirements for the specified NR band for Transmitter Spurious emissions for UE co-existence requirement with frequency range as indicated in Table 6.5.3.2.5-1.

The maximum TRP power of spurious emission for UE co-existence, measured using RMS detector, shall not exceed the described value in Table 6.5.3.2.5-1.

The spurious emission UE co-existence limits in Table 6.5.3.2.5-1 apply for all transmitter band configurations (NRB) and channel bandwidths.

NOTE: For measurement conditions at the edge of each frequency range, the lowest frequency of the measurement position in each frequency range should be set at the lowest boundary of the frequency range plus MBW/2. The highest frequency of the measurement position in each frequency range should be set at the highest boundary of the frequency range minus MBW/2. MBW denotes the measurement bandwidth defined for the protected band.

Table 6.5.3.2.5-1: Spurious emissions UE co-existence test requirements

NR Band	Spurious emission					NOTE	
	Protected band/frequency range	Frequency range (MHz)		Maximum Level (dBm)	MBW (MHz)		
n257	NR Band n260	F _{DL_low}	-	F _{DL_high}	-2 + 5.0	100	NOTE 3
	Frequency range	57000	-	66000	2	100	
	Frequency range	23600	-	24000	1 + 0.3	200	NOTE 6
n258	Frequency range	57000	-	66000	2	100	
n259	NR Band 257	F _{DL_low}	-	F _{DL_high}	-5 + 3.3	100	n259, NOTE 4
	NR Band 261	F _{DL_low}	-	F _{DL_high}	-5 + 3.3	100	NOTE 4
	Frequency range	36000	-	37000	7 + 6.0	1000	NOTE 5
	Frequency range	57000	-	66000	2	100	
n260	NR Band 257	F _{DL_low}	-	F _{DL_high}	-5 + 3.3	100	NOTE 4
	NR Band 261	F _{DL_low}	-	F _{DL_high}	-5 + 3.3	100	NOTE 4
	Frequency range	57000	-	66000	2	100	
n261	NR Band 260	F _{DL_low}	-	F _{DL_high}	-2 + 5.0	100	NOTE 3
	Frequency range	57000	-	66000	2	100	

NOTE 1: F_{DL_low} and F_{DL_high} refer to each NR frequency band specified in Table 5.2-1.
 NOTE 2: Void.
 NOTE 3: 5.0 dB relaxation due to testability limit
 NOTE 4: 3.3 dB relaxation due to testability limit
 NOTE 5: 6.0 dB relaxation due to testability limit
 NOTE 6: 0.3 dB relaxation due to testability limit

6.5.3.2_1 Spurious emission band UE co-existence with Power Boost

Editor's note: This clause is complete for Band n257, n258, n259, n260 and n261 and for PC1 and PC3. The following aspects of the clause are for future consideration:

- TRP Measurement uncertainty is TBD for PC2 and PC4.
- Test procedure only includes the testing of smartphone and is FFS for laptop and FWA.
- For a transition period until RAN5#103 meeting (May 2024), previous fine/coarse TRP measurement grid and offset values for corresponding coarse TRP measurement in TS 38.521-2 V17.2.0 are allowed for TE implementation.

6.5.3.2_1.1 Test purpose

Same as clause 6.5.3.2.1.

6.5.3.2_1.2 Test applicability

This test case applies to all types of NR UE release 16 and forward supporting *mpr-PowerBoost-FR2-r16* UE capability.

6.5.3.2_1.3 Minimum conformance requirements

Same as clause 6.5.3.2.3.

6.5.3.2_1.4 Test description

6.5.3.2_1.4.1 Initial conditions

Initial conditions are a set of test configurations the UE needs to be tested in and the steps for the SS to take with the UE to reach the correct measurement state.

The initial test configurations consist of environmental conditions, test frequencies, and channel bandwidths based on NR operating bands specified in Table 5.3.5-1. All of these configurations shall be tested with applicable test parameters for each channel bandwidth and subcarrier spacing, are shown in Table 6.5.3.2.1_1.4.1-1. The details of the uplink reference measurement channels (RMCs) are specified in Annexes A.2. Configurations of PDSCH and PDCCH before measurement are specified in Annex C.2.

Table 6.5.3.2.1_1.4.1-1: Test Configuration Table

Default Conditions					
Test Environment as specified in TS 38.508-1 [10] subclause 4.1			Normal		
Test Frequencies as specified in TS 38.508-1 [10] subclause 4.3.1			Low Range, High Range		
Test Channel Bandwidths as specified in TS 38.508-1 [10] subclause 4.3.1			Highest		
Test SCS as specified in Table 5.3.5-1			120kHz		
Test Parameters					
Test ID	ChBw	SCS	Downlink Configuration	Uplink Configuration	
		Default	-	Modulation	RB allocation (NOTE 1)
1	50			DFT-s-OFDM QPSK	Inner_Full for PC2, PC3, PC4 and PC6
2	100				Inner_Full_Region1 for PC1
3	200				
4	400				
NOTE 1: The specific configuration of each RF allocation is defined in Table 6.1-1 for PC2, PC3, PC4 and PC6 or Table 6.1-2 for PC1.					
NOTE 2: When testing Low range test only in Frequency Range lower than $(F_{UL_low} - \Delta f_{OOB})$ and when testing High range test only in Frequency Range higher than $(F_{UL_high} + \Delta f_{OOB})$.					

1. Connection between SS and UE is shown in TS 38.508-1 [10] Annex A, Figure A.3.3.1.3 for TE diagram and Figure A.3.4.1.1 for UE diagram.
2. The parameter settings for the cell are set up according to TS 38.508-1 [10] subclause 4.4.3.
3. Downlink signals are initially set up according to Annex C, and uplink signals according to Annex G.
4. The UL Reference Measurement channels are set according to Table 6.5.3.2.1_1.4.1-1.
5. Propagation conditions are set according to Annex B.0.
6. Ensure the UE is in state RRC_CONNECTED with generic procedure parameters Connectivity NR, Connected without release On, Test Mode On and Test Loop Function On according to TS 38.508-1 [10] clause 4.5. Message contents are defined in clause 6.5.3.2.1_1.4.3.

6.5.3.2_1.4.2 Test procedure

Same as clause 6.5.3.2.4.2 with following exceptions:

- Instead of Table 6.5.3.2.4.1-1 → use Table 6.2.1.1.4.1-1 in normal environmental conditions only.

6.5.3.2_1.4.3 Message contents

Same as clause 6.2.4_1.4.3.

6.5.3.2_1.5 Test requirement

Same as clause 6.3.2.5.

6.5.3.3 Additional spurious emissions

Editor's note: This clause is complete for Band n257 and n258 and for PC1, PC3, PC5, PC6. The following aspects of the clause are for future consideration:

- Test procedure is FFS for laptop.

6.5.3.3.1 Test purpose

Additional spurious emission requirements are signalled by the network to indicate that the UE shall meet an additional requirement for a specific deployment scenario as part of the cell handover/broadcast message.

6.5.3.3.2 Test applicability

This test case applies to all types of NR UE release 15 and forward.

6.5.3.3.3 Minimum conformance requirements

The additional spurious emission limits in Table 6.5.3.3.3-2 through Table 6.5.3.3.3-3 apply for all transmitter band configurations (RB) and channel bandwidths. The requirement is verified in beam locked mode with the test metric of TRP (Link=TX beam peak direction, Meas=TRP grid).

NOTE: For measurement conditions at the edge of each frequency range, the lowest frequency of the measurement position in each frequency range should be set at the lowest boundary of the frequency range plus MBW/2. The highest frequency of the measurement position in each frequency range should be set at the highest boundary of the frequency range minus MBW/2. MBW denotes the measurement bandwidth defined for the protected band.

Table 6.5.3.3.3-1: Void

When "NS_202" is indicated in the cell, the power of any UE emission shall not exceed the levels specified in Table 6.5.3.3.3-2.

Table 6.5.3.3.3-2: Additional spurious emissions (NS_202) test limits

Frequency Range	Maximum Level	Measurement bandwidth
7.25 GHz ≤ f ≤ 2 nd harmonic of the upper frequency edge of the UL operating band	-10 dBm	100 MHz
23.6 GHz ≤ f ≤ 24.0 GHz	-5 dBm	200 MHz
NOTE 1: This requirement also applies for the frequency ranges that are less than F _{OOB} (MHz) in Table 6.5.3.1.3-1 from the edge of the channel bandwidth. The protection of frequency range 23600 - 24000 MHz is meant for protection of satellite passive services.		

When "NS_203" is indicated in the cell, the power of any UE emission shall not exceed the levels specified in Table 6.5.3.3.3-3. This requirement also applies for the frequency ranges that are less than F_{OOB} (MHz) in Table 6.5.3.1.3-1 from the edge of the channel bandwidth.

Table 6.5.3.3.3-3: Additional spurious emissions (NS_203) test limits

Frequency band (GHz)	Spectrum emission limit (dBm)	Measurement bandwidth
$23.6 \leq f \leq 24.0$	+1	200 MHz

When "NS_205" is indicated in the cell, the power of any UE emission shall not exceed the levels specified in Table 6.5.3.2.6-1. This requirement also applies for the frequency ranges that are less than F_{OOB} (MHz) in Table 6.5.3-1 from the edge of the channel bandwidth.

Table 6.5.3.3.3-4: Additional requirements (NS_205)

Frequency band (GHz)	Spectrum emission limit (dBm)	Measurement bandwidth
$23.6 \leq f \leq 24.0$	-5	200 MHz

The normative reference for this requirement is TS 38.101-2 subclause 6.5.3.2.

6.5.3.3.4 Test description

6.5.3.3.4.1 Initial conditions

Initial conditions are a set of test configurations the UE needs to be tested in and the steps for the SS to take with the UE to reach the correct measurement state.

The initial test configurations consist of environmental conditions, test frequencies, and channel bandwidths based on NR operating bands specified in Table 5.3.5-1. All of these configurations shall be tested with applicable test parameters for each channel bandwidth and subcarrier spacing, are shown in Table 6.5.3.3.4.1-1. The details of the uplink reference measurement channels (RMCs) are specified in Annexes A.2. Configurations of PDSCH and PDCCH before measurement are specified in Annex C.2.

Table 6.5.3.3.4.1-1: Test Configuration Table for NS_202

Initial Conditions			
Test Environment as specified in TS 38.508-1 [10] subclause 4.1		Normal	
Test Frequencies as specified in TS 38.508-1 [10] subclause 4.3.1		Low range, High range (NOTE 2)	
Test Channel Bandwidths as specified in TS 38.508-1 [10] subclause 4.3.1		Highest	
Test SCS as specified in Table 5.3.5-1		120kHz	
Test Parameters			
Test ID	Downlink Configuration	Uplink Configuration	
		Modulation	RB allocation (NOTE 1)
1 (NOTE 5, 6)	-	DFT-s-OFDM QPSK	Inner_Full
2		DFT-s-OFDM QPSK	Inner_1RB for PC2, PC3, PC4 PC5 and PC6 Inner_Partial for PC1 (NOTE 3)
3 (NOTE 4)		DFT-s-OFDM 64QAM	Outer_Full

NOTE 1: The specific configuration of each RB allocation is defined in Table 6.1-1 for PC2, PC3, PC4, PC5 and PC6 or Table 6.1-2 for PC1.
 NOTE 2: When testing Low range test only in Frequency Range lower than $(F_{UL_low} - \Delta f_{OoB})$ and when testing High range test only in Frequency Range higher than $(F_{UL_high} + \Delta f_{OoB})$.
 NOTE 3: When testing Low range configure uplink RB to Inner_1RB_Left for PC2, PC3, PC4, PC5 and PC6 or Inner_Partial_Left_Region1 for PC1 and when testing High range configure uplink RB to Inner_1RB_Right for PC2, PC3, PC4, PC5 and PC6 or Inner_Partial_Right_Region1 for PC1.
 NOTE 4: Test ID only applicable to PC1
 NOTE 5: Test ID not applicable to PC1.
 NOTE 6: This test point shall be skipped if device supports *mpr-PowerBoost-FR2-r16* UE capability.

Table 6.5.3.3.4.1-2: Test Configuration Table for NS_203

Initial Conditions					
Test Environment as specified in TS 38.508-1 [10] subclause 4.1				Normal	
Test Frequencies as specified in TS 38.508-1 [10] subclause 4.3.1				Low range	
Test Channel Bandwidths as specified in TS 38.508-1 [10] subclause 4.3.1				Highest	
Test SCS as specified in Table 5.3.5-1				120kHz	
Test Parameters					
Test ID	Frequency	Channel Bandwidth	Downlink Configuration	Uplink Configuration	
				Modulation	RB allocation (NOTE 1)
1	Default	Default	-	DFT-s-OFDM QPSK	Inner_Full
2	Default	Default		DFT-s-OFDM QPSK	Inner_1RB_Left for PC2, PC3, PC4, PC5 and PC6 Inner_Partial_Left_Region1 for PC1
3 (NOTE 2)	Low range + Channel Bandwidth (NOTE 3)	Default		DFT-s-OFDM QPSK	Inner_Partial_Left_Region1
NOTE 1: The specific configuration of each RB allocation is defined in Table 6.1-1 for PC2, PC3, PC4, PC5 and PC6 or Table 6.1-2 for PC1.					
NOTE 2: Test ID only applicable to PC1.					
NOTE 3: Test frequency for test ID 3 is specified in Table 6.2.3.4.1-4.					

Table 6.5.3.3.4.1-3: [Reserved]

Table 6.5.3.3.4.1-4: Test configuration table for NS_205

Initial Conditions					
Test Environment as specified in TS 38.508-1 [10] subclause 4.1				Normal	
Test Frequencies as specified in TS 38.508-1 [10] subclause 4.3.1				Low range	
Test Channel Bandwidths as specified in TS 38.508-1 [10] subclause 4.3.1				Highest	
Test SCS as specified in Table 5.3.5-1				120kHz	
Test Parameters					
Test ID	Frequency	Channel Bandwidth	Downlink Configuration	Uplink Configuration	
				Modulation	RB allocation (NOTE 1)
1 ²	Default	Default	-	DFT-s-OFDM QPSK	Outer_Full
2 ²	Default	Default		DFT-s-OFDM QPSK	Inner_Partial_Left_Region1

3 ^{2,4}	Mid	Default		DFT-s-OFDM QPSK	Outer_Full
4 ^{2,4}	Mid	Default		DFT-s-OFDM QPSK	Inner_Partial_Left_Region1
5 ³	Default	Default		DFT-s-OFDM QPSK	Inner_Full
6 ³	Default	Default		DFT-s-OFDM QPSK	Inner_1RB_Left
7 ^{3,4}	Mid	Default		DFT-s-OFDM QPSK	Inner_Full
8 ^{3,4}	Mid	Default		DFT-s-OFDM QPSK	Inner_1RB_Left
NOTE 1: The specific configuration of each RB allocation is defined in Table 6.1-1 for PC2, PC3, PC4, PC6 and PC7 or Table 6.1-2 for PC1.					
NOTE 2: The test ID applies to PC1.					
NOTE 3: The test ID applies to PC2, PC3, PC4, PC6 and PC7.					
NOTE 4: The test ID applies to band n258.					

1. Connection between SS and UE is shown in TS 38.508-1 [10] Annex A, Figure A.3.3.1.3 for TE diagram and Figure A.3.4.1.1 for UE diagram.
2. The parameter settings for the cell are set up according to TS 38.508-1 [10] subclause 4.4.3.
3. Downlink signals are initially set up according to Annex C, and uplink signals according to Annex G.
4. The UL Reference Measurement channels are set according to Table 6.5.3.3.4.1-1
5. Propagation conditions are set according to Annex B.0.
6. Ensure the UE is in state RRC_CONNECTED with generic procedure parameters Connectivity *NR*, Connected without release *On*, Test Mode *On* and Test Loop Function *On* according to TS 38.508-1 [10] clause 4.5. Message contents are defined in clause 6.5.3.3.4.3.

6.5.3.3.4.2 Test procedure

1. Select any of the three Alignment Options (1, 2, or 3) from Tables N.2-1 through N.2-3 to mount the DUT inside the QZ.
2. If the re-positioning concept is applied, position the device in DUT Orientation 1 if the maximum beam peak direction is within zenith angular range $0^\circ \leq \theta \leq 90^\circ$ for the alignment option selected in step 1; position the device in DUT Orientation 2 (either Options 1 or 2) if the maximum beam peak direction is within zenith angular range $90^\circ < \theta \leq 180^\circ$ for DUT Orientation 1 for the alignment option selected in step 1. If the re-positioning concept is not applied, position the device in DUT Orientation 1.
3. SS sends uplink scheduling information for each UL HARQ process via PDCCH DCI format 0_1 for C_RNTI to schedule the UL RMC according to Table 6.5.3.3.4.1-1. Since the UL has no payload and no loopback data to send the UE sends uplink MAC padding bits on the UL RMC.
4. Set the UE in the Inband Tx beam peak direction found with a 3D EIRP scan as performed in Annex K.1.1. Allow at least BEAM_SELECT_WAIT_TIME (NOTE 3) for the UE Tx beam selection to complete.
5. Send continuously uplink power control "up" commands in every uplink scheduling information to the UE; allow at least 200msec for the UE to reach P_{UMAX}. Allow at least BEAM_SELECT_WAIT_TIME (NOTE 3) for the UE Tx beam selection to complete.
6. SS activates the UE Beamlock Function (UBF) by performing the procedure as specified in TS 38.508-1 [10] clause 4.9.2 using condition Tx only.
7. Measure the spurious emissions as per steps outlined below with an exception to the procedure in Annex K if the re-positioning concept is applied (NOTE 4). Step (a) is optional and applicable only if SNR (test requirement level in Table 6.5.3.3.5-2 through Table 6.5.3.3.5-3, minus offset value minus noise floor of the test system) ≥ 0 dB is guaranteed. During measurement the spectrum analyser shall be set to 'Detector' = RMS. If the sweep count is higher than one, the trace mode shall be average.

- (a) Perform coarse TRP measurements to identify spurious emission frequencies and corresponding power level according to the procedures in Annex K, using coarse TRP measurement grid selection criteria as per Tables 6.5.3.1.4.2-1 through 6.5.3.1.4.2-3. The measurement is completed in both polarizations θ and ϕ over frequency range and measurement bandwidth according to Table 6.5.3.3.5-2 through Table 6.5.3.3.5-3. Optionally, a larger and non-constant measurement bandwidth than that of Table 6.5.3.3.5-2 through Table 6.5.3.3.5-3 may be applied. The measurement period shall capture the active time slots. For each spurious emission frequency with coarse TRP identified to be less than the offset listed in Tables 6.5.3.1.4.2-1 through 6.5.3.1.4.2-3 from the TRP limit according to Table 6.5.3.3.5-2 through Table 6.5.3.3.5-3, either continue with another coarse TRP procedure and corresponding offset according to step (a) or continue with fine TRP procedures according to step (b).

Different coarse TRP grids and corresponding offset values may be used for different frequencies. Multiple coarse TRP grids measurements with the corresponding offset values can be performed before the fine TRP measurement grid is applied. The coarse TRP grids and offset values used shall be recorded in the test report.

- (b) Measure fine TRP measurements according to procedures in Annex K, using fine TRP measurement grid selection criteria as per Table M.4.5-3 in Annex M, for each of the spurious emission frequency identified in step (a). Apply a measurement bandwidth according to Table 6.5.3.3.5-2 through Table 6.5.3.3.5-3.

8. SS deactivates the UE Beamlock Function (UBF) by performing the procedure as specified in TS 38.508-1 [10] clause 4.9.3.

NOTE 1: The frequency range defined in Table 6.5.3.3.5-2 through Table 6.5.3.3.5-3 may be split into ranges. For each range a different test system, e.g. antenna and/or chamber, may be used. To pass the test case all verdicts of the frequency ranges must pass.

NOTE 2: Void.

NOTE 3: The BEAM_SELECT_WAIT_TIME default value is defined in Annex K.

NOTE 4: If the (in-band) beam peak is within $0^\circ \leq \theta \leq 90^\circ$: perform first hemispherical TRP scan ($0^\circ \leq \theta \leq 90^\circ$) in DUT Orientation 1 and second hemispherical TRP scan ($90^\circ > \theta \geq 0^\circ$) in DUT Orientation 2. If the (in-band) beam peak is within $90^\circ < \theta \leq 180^\circ$: perform first hemispherical TRP scan ($0^\circ \leq \theta \leq 90^\circ$) in DUT Orientation 2 and second hemispherical TRP scan ($90^\circ > \theta \geq 0^\circ$) in DUT Orientation 1. The DUT with UBF activated needs to be re-positioned during the test.

6.5.3.3.4.3 Message contents

Message contents are according to TS 38.508-1 [10] subclause 4.6 with TRANSFORM_PRECODER_ENABLED condition in Table 4.6.3-118 PUSCH-Config and with the following exceptions:

Information element additionalSpectrumEmission is set to NS_202. This can be set in SIB1 as part of the cell broadcast message. This exception indicates that the UE shall meet the additional spurious emission requirement for a specific deployment scenario.

Table 6.5.3.3.4.3-1: AdditionalSpectrumEmission: Additional spurious emissions test requirement for "NS_202"

Derivation Path: TS 38.508-1 [10] clause 4.6.3, Table 4.6.3-1			
Information Element	Value/remark	Comment	Condition
additionalSpectrumEmission	2 (NS_202)		

Information element additionalSpectrumEmission is set to NS_203. This can be set in SIB1 as part of the cell broadcast message. This exception indicates that the UE shall meet the additional spurious emission requirement for a specific deployment scenario.

Table 6.5.3.3.4.3-2: AdditionalSpectrumEmission: Additional spurious emissions test requirement for "NS_203"

Derivation Path: TS 38.508-1 [10] clause 4.6.3, Table 4.6.3-1			
Information Element	Value/remark	Comment	Condition
additionalSpectrumEmission	3 (NS_203)		

Table 6.5.3.3.4.3-3: Additional Spectrum Emission: Additional spurious emissions test requirement for "NS_205"

Derivation Path: TS 38.508-1 [10] clause 4.6.3, Table 4.6.3-1			
Information Element	Value/remark	Comment	Condition
additionalSpectrumEmission	4 (NS_205)		

6.5.3.3.5 Test requirement

This clause specifies the requirements for the specified *NR* band for Transmitter Additional Spurious emissions requirement with frequency range as indicated in Table 6.5.3.3.5-2 and Table 6.5.3.3.5-3.

The maximum TRP power of spurious emission for Transmitter Additional Spurious emissions, measured using RMS detector, shall not exceed the described value in Table 6.5.3.3.5-2 and Table 6.5.3.3.5-3.

The Transmitter Additional Spurious emissions limits in Table 6.5.3.3.5-2 and Table 6.5.3.3.5-3 apply for all transmitter band configurations (NRB) and channel bandwidths.

NOTE: For measurement conditions at the edge of each frequency range, the lowest frequency of the measurement position in each frequency range should be set at the lowest boundary of the frequency range plus MBW/2. The highest frequency of the measurement position in each frequency range should be set at the highest boundary of the frequency range minus MBW/2. MBW denotes the measurement bandwidth defined for the protected band.

Table 6.5.3.3.5-1: Void**Table 6.5.3.3.5-2: Additional spurious emissions (NS_202) test requirements**

Frequency Range	Maximum Level (dBm)	Measurement bandwidth	NOTE
$7.25 \text{ GHz} \leq f \leq 12.75 \text{ GHz}$	-10	100 MHz	
$12.75 \text{ GHz} \leq f \leq 23.45 \text{ GHz}$	-10 + 13	100 MHz	NOTE 1
$23.45 \text{ GHz} \leq f \leq 40.8 \text{ GHz}$	-10 + 13	100 MHz	NOTE 1
$40.8 \text{ GHz} \leq f \leq 2\text{nd harmonic of the upper frequency edge of the UL operating band}$	-10 + 13	100 MHz	NOTE 1
$23.6 \text{ GHz} \leq f \leq 24.0 \text{ GHz}$	-5 + 6.3	200 MHz	NOTE 2
NOTE 1: 13 dB relaxation due to testability limit			
NOTE 2: 6.3 dB relaxation due to testability limit			

Table 6.5.3.3.5-3: Additional spurious emissions (NS_203) test requirements

Frequency band (GHz)	Spectrum emission limit (dBm)	Measurement bandwidth	NOTE
$23.6 \leq f \leq 24.0$	+1 + 0.3	200 MHz	NOTE 1
NOTE 1: 0.3 dB relaxation due to testability limit			

Table 6.5.3.3.5-4: Additional spurious emissions (NS_205) test requirements

Frequency band (GHz)	Spectrum emission limit (dBm)	Measurement bandwidth	NOTE
$23.6 \leq f \leq 24.0$	-5 + 6.3	200 MHz	NOTE 1
NOTE 1: 6.3 dB relaxation due to testability limit			

6.5.3.3_1 Additional spurious emissions with Power Boost

Editor's note: This clause is complete for Band n257, n258 and PC1, PC3, PC5, PC6. The following aspects of the clause are for future consideration:

- Test procedure only includes the testing of smartphone and is FFS for laptop.
- Measurement Uncertainties and Test Tolerances are FFS for power class other than 1, 3, 5, 6.

6.5.3.3_1.1 Test purpose

Same as clause 6.5.3.3.1.

6.5.3.3_1.2 Test applicability

This test case applies to all types of NR UE release 16 and forward supporting *mpr-PowerBoost-FR2-r16* UE capability.

6.5.3.3_1.3 Minimum conformance requirements

Same as clause 6.5.3.3.3.

6.5.3.3_1.4 Test description

6.5.3.3_1.4.1 Initial conditions

Initial conditions are a set of test configurations the UE needs to be tested in and the steps for the SS to take with the UE to reach the correct measurement state.

The initial test configurations consist of environmental conditions, test frequencies, and channel bandwidths based on NR operating bands specified in Table 5.3.5-1. All of these configurations shall be tested with applicable test parameters for each channel bandwidth and subcarrier spacing, are shown in Table 6.5.3.3_1.4.1-1. The details of the uplink reference measurement channels (RMCs) are specified in Annexes A.2. Configurations of PDSCH and PDCCH before measurement are specified in Annex C.2.

Table 6.5.3.3_1.4.1-1: Test Configuration Table

Default Conditions					
Test Environment as specified in TS 38.508-1 [10] subclause 4.1			Normal		
Test Frequencies as specified in TS 38.508-1 [10] subclause 4.3.1			Low Range, High Range		
Test Channel Bandwidths as specified in TS 38.508-1 [10] subclause 4.3.1			Highest		
Test SCS as specified in Table 5.3.5-1			120kHz		
Test Parameters					
Test ID	ChBw	SCS	Downlink Configuration	Uplink Configuration	
		Default	-	Modulation	RB allocation (NOTE 1)
1	50			DFT-s-OFDM	Inner_Full for PC2, PC3, PC4, PC5
2	100			QPSK	and PC6
3	200				Inner_Full_Region1 for
4	400				PC1
NOTE 1: The specific configuration of each RF allocation is defined in Table 6.1-1 for PC2, PC3, PC4, PC5 and PC6 or Table 6.1-2 for PC1.					
NOTE 2: When testing Low range test only in Frequency Range lower than $(F_{UL_low} - \Delta f_{OOB})$ and when testing High range test only in Frequency Range higher than $(F_{UL_high} + \Delta f_{OOB})$.					

1. Connection between SS and UE is shown in TS 38.508-1 [10] Annex A, Figure A.3.3.1.3 for TE diagram and Figure A.3.4.1.1 for UE diagram.
2. The parameter settings for the cell are set up according to TS 38.508-1 [10] subclause 4.4.3.

3. Downlink signals are initially set up according to Annex C, and uplink signals according to Annex G.
4. The UL Reference Measurement channels are set according to Table 6.5.3.3_1.4.1-1.
5. Propagation conditions are set according to Annex B.0.
6. Ensure the UE is in state RRC_CONNECTED with generic procedure parameters Connectivity NR, Connected without release On, Test Mode On and Test Loop Function On according to TS 38.508-1 [10] clause 4.5. Message contents are defined in clause 6.5.3.3_1.4.3.

6.5.3.3_1.4.2 Test procedure

Same as clause 6.5.3.3.4.2 with following exceptions:

- Instead of Table 6.5.3.3.4.1-1 → use Table 6.2.1.1.4.1-1 in normal environmental conditions only.

6.5.3.3_1.4.3 Message contents

Same as clause 6.2.4_1.4.3 and 6.5.3.3.4.3.

6.5.3.3_1.5 Test requirement

Same as clause 6.5.3.3.5.

6.5A Output RF spectrum emissions for CA

6.5A.1 Occupied bandwidth for CA

6.5A.1.0 Minimum conformance requirements

The normative reference for this requirement is TS 38.101-2 [3] clause 6.5A.1.

6.5A.1.0.0 General

The occupied bandwidth for UL CA is defined as a directional requirement. The requirement is verified in beam locked mode on beam peak direction. In case the CA configuration consists of a single UL CC, the occupied bandwidth requirement defined in subclause 6.5.1 applies.

6.5A.1.0.1 Occupied bandwidth for intra-band contiguous UL CA

For intra-band contiguous UL carrier aggregation, the occupied bandwidth is a measure of the bandwidth containing 99 % of the total integrated power of the transmitted spectrum. The occupied bandwidth for UL CA shall be less than the UL aggregated channel bandwidth defined in clause 5.3A.

6.5A.1.0.2 Occupied bandwidth for intra-band non-contiguous UL CA

TBD

6.5A.1.1 Occupied bandwidth for CA (2UL CA)

Editor's note: This clause is incomplete. The following aspects are either missing or not yet determined:

- Measurement Uncertainties and Test Tolerances for intra-band contiguous CA supporting aggregated BW > 400MHz and for intra-band non-contiguous CA are TBD
- Measurement Uncertainties and Test Tolerances are FFS
- TP analysis is FFS
- For a transition period of 2 meeting cycles after the test case is complete, the stability and repeatability of test procedure with PHR (variant b) for Rel-15 UEs is under evaluation.

6.5A.1.1.1 Test purpose

To verify that the UE occupied bandwidth for all transmission bandwidth configurations supported by the UE are less than their specific limits.

6.5A.1.1.2 Test applicability

This test case applies to all types of NR UE release 15 and forward that supports FR2 2UL CA.

6.5A.1.1.3 Minimum conformance requirements

The minimum conformance requirements are defined in clause 6.5A.1.0.

6.5A.1.1.4 Test description

6.5A.1.1.4.1 Initial condition

Initial conditions are a set of test configurations the UE needs to be tested in and the steps for the SS to take with the UE to reach the correct measurement state.

The initial test configurations consist of environmental conditions, test frequencies, test channel bandwidths and sub-carrier spacing based on NR CA configuration specified in clause 5.5A. All of these configurations shall be tested with applicable test parameters for each CA combination and subcarrier spacing, are shown in Table 6.5A.1.1.4.1-1. The details of the uplink reference measurement channels (RMCs) are specified in Annexes A.2. Configurations of PDSCH and PDCCH before measurement are specified in Annex C.2.

Table 6.5A.1.1.4.1-1: Test Configuration Table

Default Conditions						
Test Environment as specified in TS 38.508-1 [10] subclause 4.1				Normal		
Test Frequencies as specified in TS 38.508-1 [10] subclause 4.3.1.2.3 for different CA bandwidth classes.				Mid range		
Test CC combination setting as specified in TS 38.508-1 [10] subclause 4.3.1.2.3 for the CA Configuration across bandwidth combination sets supported by the UE.				Highest aggregated BW of the CA configuration		
Test SCS as specified in Table 5.3.5-1.				Lowest		
Test Parameters						
Test ID	CC	ChBw(MHz)	Test frequency	DL RB allocation	UL Modulation	UL RB allocation (Note 1)
1	PCC	Default	Default	-	CP-OFDM QPSK	Outer_Full
	SCC				CP-OFDM QPSK	Outer_Full
NOTE 1: The specific configuration of each RB allocation is defined in Table 6.1-1 for PC2, PC3 and PC4 or Table 6.1-2 for PC1.						
NOTE 2: Number of DL CCs shall be configured the same as number of UL CCs. The requirements are applicable as per 5.3A.4: " <i>The requirements are applicable only when Uplink CCs are configured within the frequency range between lower edge of lowest downlink component carrier and upper edge of highest downlink component carrier</i> ".						

1. Connection between SS and UE is shown in TS 38.508-1 [10] Annex A, Figure A.3.3.1.1 for TE diagram and Figure A.3.4.1.1 for UE diagram.
2. The parameter settings for the cell are set up according to TS 38.508-1 [10] clause 4.4.3.
3. Downlink signals are initially set up according to Annex C, and uplink signals according to Annex G.
4. The UL Reference Measurement Channel is set according to Table 6.5A.1.1.4.1-1.
5. Propagation conditions are set according to Annex B.0.

6. Ensure the UE is in State RRC_CONNECTED with generic procedure parameters Connectivity NR, Connected without release On, Test Mode On and Test Loop Function On according to TS 38.508-1 [10] clause 4.5. Message contents are defined in clause 6.5A.1.1.4.3.

6.5A.1.1.4.2 Test procedure

1. Configure SCC according to Annex C.0, C.1, C.2, and C.3.0 for all downlink physical channels.
2. The SS shall configure SCC as per TS 38.508-1 [10] clause 5.5.1. Message contents are defined in clause 6.5A.1.1.4.3.
3. Apply the test step based on the 5G NR UE Release:
 - 3a. For Release 16 and forward 5G NR UEs: SS applies a backoff on the PCell power by activating the UE Power Limit Function (UPLF). The ACTIVATE POWER LIMIT REQUEST procedure is performed as specified in TS 38.508-1 [10] clause 4.9.32 TOTAL NR AGGREGATED BANDWIDTH and PCELL NR bandwidth as per Test CC Combination setting. UE shall transmit ACTIVATE POWER LIMIT RESPONSE to SS. Go to step 4.
 - 3b. For Release 15 5G NR UEs: No action.
4. SS activates SCC by sending the activation MAC CE (Refer TS 38.321 [28], clauses 5.9, 6.1.3.10). Wait for at least 2 seconds (Refer TS 38.133[25], clause 9.2).
5. SS sends uplink scheduling information for each UL HARQ process via PDCCH DCI format 0_1 for C_RNTI to schedule the UL RMC according to Table 6.5A.1.1.4.1-1 on both PCC and SCC(s). Since the UE has no payload and no loopback data to send the UE sends uplink MAC padding bits on the UL RMC.
6. Set the UE in the Tx beam peak direction found with a 3D EIRP scan as performed in Annex K.1.1. Allow at least BEAM_SELECT_WAIT_TIME (NOTE 1) for the UE Tx beam selection to complete.
7. Apply the test step based on the 5G NR UE Release:
 - 7a. For Release 16 and forward 5G NR UEs: Send continuously uplink power control "up" commands in every uplink scheduling information to the UE; allow at least 200 ms for the UE to reach maximum output power. Allow at least BEAM_SELECT_WAIT_TIME (NOTE 1) for the UE Tx beam selection to complete.
 - 7b. For Release 15 5G NR UEs: Send uplink power control commands in uplink scheduling information to the UE per UL CC until the Power Headroom Report (PHR) from the UE for each UL CC is at the target value according to Table 6.2A.2.1.4.2-1. ; allow at least 200 ms for the UE to reach maximum output power. Allow at least BEAM_SELECT_WAIT_TIME (NOTE 1) for the UE Tx beam selection to complete.
8. Measure the EIRP spectrum distribution over all component carriers within 1.5 times or more frequency range over the requirement for Occupied Bandwidth for CA specification centring on the centre of aggregated channel bandwidth. The characteristics of the filter shall be approximately Gaussian (typical spectrum analyser filter). The measuring duration is one active uplink subframe. EIRP is captured from both polarizations, theta and phi.
9. Calculate the total EIRP from both polarizations, theta and phi, within the range of all frequencies measured in step 4 and save this value as "Total EIRP". EIRP measurement procedure is defined in Annex K.
10. Identify the measurement window whose centre is aligned on the centre of the channel for which the sum of the power measured in theta and phi polarization is 99% of the "Total EIRP".
11. The "Occupied Bandwidth" is the width of the measurement window obtained in step 9.
12. Apply the test step based on the 5G NR UE Release:
 - 12a. For Release 16 and forward 5G NR UEs: SS deactivates the UE Power Limit Function (UPLF) by performing the DEACTIVATE POWER LIMIT REQUEST procedure as specified in TS 38.508-1 [10] clause 4.9.33.
 - 12a. For Release 15 5G NR UEs: No action.

NOTE 1: The BEAM_SELECT_WAIT_TIME default value is defined in Annex K.

6.5A.1.1.4.3 Message contents

Message contents are according to TS 38.508-1 [10] subclause 4.6 with the following exceptions for Release 15 5G NR UE.

Table 6.5A.1.1.4.3-1: PUSCH-PowerControl

Derivation Path: TS 38.508-1 [10], Table 4.6.3-120			
Information Element	Value/remark	Comment	Condition
PUSCH-PowerControl ::= SEQUENCE {			
p0-AlphaSets SEQUENCE (SIZE (1..maxNrofP0-PUSCH-AlphaSets)) OF SEQUENCE {	1 entry		
P0-PUSCH-AlphaSet[1] SEQUENCE {			
alpha	alpha0		
}			
}			
}			

Table 6.5A.1.1.4.3-2: PUSCH-ConfigCommon

Derivation Path: TS 38.508-1[10], Table 4.6.3-119			
Information Element	Value/remark	Comment	Condition
PUSCH-ConfigCommon ::= SEQUENCE {			
p0-NominalWithGrant	-4		50 MHz
p0-NominalWithGrant	-8		100 MHz
p0-NominalWithGrant	-10		200 MHz
p0-NominalWithGrant	-14		400 MHz
}			

6.5A.1.1.5 Test requirement

The measured Occupied Bandwidth shall not exceed the aggregated channel bandwidth defined in subclause 5.3A .

6.5A.1.2 Occupied bandwidth for CA (3UL CA)

Editor's note: This clause is incomplete. The following aspects are either missing or not yet determined:

- Measurement Uncertainties and Test Tolerances for intra-band contiguous CA supporting aggregated BW > 400MHz and for intra-band non-contiguous CA are TBD
- Measurement Uncertainties and Test Tolerances are FFS
- TP analysis is FFS

6.5A.1.2.1 Test purpose

To verify that the UE occupied bandwidth for all transmission bandwidth configurations supported by the UE are less than their specific limits.

6.5A.1.2.2 Test applicability

This test case applies to all types of NR UE release 15 and forward that supports FR2 3UL CA.

6.5A.1.2.3 Minimum conformance requirements

The minimum conformance requirements are defined in clause 6.5A.1.0.

6.5A.1.2.4 Test description

Same as in clause 6.5A.1.1.4 with following exceptions:

- Instead of Table 6.5A.1.1.4.1-1 → use Table 6.5A.1.2.4-1.

Table 6.5A.1.2.4-1: Test Configuration Table

Default Conditions						
Test Environment as specified in TS 38.508-1 [10] subclause 4.1				Normal		
Test Frequencies as specified in TS 38.508-1 [10] subclause 4.3.1.2.3 for different CA bandwidth classes.				Mid range		
Test CC combination setting as specified in TS 38.508-1 [10] subclause 4.3.1.2.3 for the CA Configuration across bandwidth combination sets supported by the UE.				Highest aggregated BW of the CA configuration		
Test SCS as specified in Table 5.3.5-1.				Lowest		
Test Parameters						
Test ID	CC	ChBw(MHz)	Test frequency	DL RB allocation	UL Modulation	UL RB allocation (Note 1)
1	PCC	Default	Default	-	CP-OFDM QPSK	Outer_Full
	SCC1				CP-OFDM QPSK	Outer_Full
	SCC2				CP-OFDM QPSK	Outer_Full
NOTE 1: The specific configuration of each RB allocation is defined in Table 6.1-1 for PC2, PC3 and PC4 or Table 6.1-2 for PC1.						
NOTE 2: Number of DL CCs shall be configured the same as number of UL CCs. The requirements are applicable as per 5.3A.4: " <i>The requirements are applicable only when Uplink CCs are configured within the frequency range between lower edge of lowest downlink component carrier and upper edge of highest downlink component carrier</i> ".						

6.5A.1.2.5 Test requirement

The measured Occupied Bandwidth shall not exceed the aggregated channel bandwidth defined in subclause 5.3A .

6.5A.1.3 Occupied bandwidth for CA (4UL CA)

Editor's note: This clause is incomplete. The following aspects are either missing or not yet determined:

- **Measurement Uncertainties and Test Tolerances for intra-band contiguous CA supporting aggregated BW > 400MHz and for intra-band non-contiguous CA are TBD**
- **Measurement Uncertainties and Test Tolerances are FFS**
- **TP analysis is FFS**
- **This test case is incomplete until a suitable solution for preventing SCell drop is implemented in the test procedure.**

6.5A.1.3.1 Test purpose

To verify that the UE occupied bandwidth for all transmission bandwidth configurations supported by the UE are less than their specific limits.

6.5A.1.3.2 Test applicability

This test case applies to all types of NR UE release 15 and forward that supports FR2 4UL CA.

6.5A.1.3.3 Minimum conformance requirements

The minimum conformance requirements are defined in clause 6.5A.1.0.

6.5A.1.3.4 Test description

Same as in clause 6.5A.1.1.4 with following exceptions:

- Instead of Table 6.5A.1.1.4.1-1 → use Table 6.5A.1.3.4-1.

Table 6.5A.1.3.4-1: Test Configuration Table

Default Conditions						
Test Environment as specified in TS 38.508-1 [10] subclause 4.1				Normal		
Test Frequencies as specified in TS 38.508-1 [10] subclause 4.3.1.2.3 for different CA bandwidth classes.				Mid range		
Test CC combination setting as specified in TS 38.508-1 [10] subclause 4.3.1.2.3 for the CA Configuration across bandwidth combination sets supported by the UE.				Highest aggregated BW of the CA configuration		
Test SCS as specified in Table 5.3.5-1.				Lowest		
Test Parameters						
Test ID	CC	ChBw(MHz)	Test frequency	DL RB allocation	UL Modulation	UL RB allocation (Note 1)
1	PCC	Default	Default	-	CP-OFDM QPSK	Outer_Full
	SCC1				CP-OFDM QPSK	Outer_Full
	SCC2				CP-OFDM QPSK	Outer_Full
	SCC3				CP-OFDM QPSK	Outer_Full
NOTE 1: The specific configuration of each RB allocation is defined in Table 6.1-1 for PC2, PC3 and PC4 or Table 6.1-2 for PC1.						
NOTE 2: Number of DL CCs shall be configured the same as number of UL CCs. The requirements are applicable as per 5.3A.4: " <i>The requirements are applicable only when Uplink CCs are configured within the frequency range between lower edge of lowest downlink component carrier and upper edge of highest downlink component carrier</i> ".						

6.5A.1.3.5 Test requirement

The measured Occupied Bandwidth shall not exceed the aggregated channel bandwidth defined in subclause 5.3A .

6.5A.1.4 Occupied bandwidth for CA (5UL CA)

Editor's note: This clause is incomplete. The following aspects are either missing or not yet determined:

- Measurement Uncertainties and Test Tolerances for intra-band contiguous CA supporting aggregated BW > 400MHz and for intra-band non-contiguous CA are TBD
- Measurement Uncertainties and Test Tolerances are FFS
- TP analysis is FFS

6.5A.1.4.1 Test purpose

To verify that the UE occupied bandwidth for all transmission bandwidth configurations supported by the UE are less than their specific limits.

6.5A.1.4.2 Test applicability

This test case applies to all types of NR UE release 15 and forward that supports FR2 5UL CA.

6.5A.1.4.3 Minimum conformance requirements

The minimum conformance requirements are defined in clause 6.5A.1.0.

6.5A.1.4.4 Test description

Same as in clause 6.5A.1.1.4 with following exceptions:

- Instead of Table 6.5A.1.1.4.1-1 → use Table 6.5A.1.4.4-1.

Table 6.5A.1.4.4-1: Test Configuration Table

Default Conditions						
--------------------	--	--	--	--	--	--

Test Environment as specified in TS 38.508-1 [10] subclause 4.1		Normal				
Test Frequencies as specified in TS 38.508-1 [10] subclause 4.3.1.2.3 for different CA bandwidth classes.		Mid range				
Test CC combination setting as specified in TS 38.508-1 [10] subclause 4.3.1.2.3 for the CA Configuration across bandwidth combination sets supported by the UE.		Highest aggregated BW of the CA configuration				
Test SCS as specified in Table 5.3.5-1.		Lowest				
Test Parameters						
Test ID	CC	ChBw(MHz)	Test frequency	DL RB allocation	UL Modulation	UL RB allocation (Note 1)
1	PCC	Default	Default	-	CP-OFDM QPSK	Outer_Full
	SCC1				CP-OFDM QPSK	Outer_Full
	SCC2				CP-OFDM QPSK	Outer_Full
	SCC3				CP-OFDM QPSK	Outer_Full
	SCC4				CP-OFDM QPSK	Outer_Full
NOTE 1: The specific configuration of each RB allocation is defined in Table 6.1-1 for PC2, PC3 and PC4 or Table 6.1-2 for PC1.						
NOTE 2: Number of DL CCs shall be configured the same as number of UL CCs. The requirements are applicable as per 5.3A.4: " <i>The requirements are applicable only when Uplink CCs are configured within the frequency range between lower edge of lowest downlink component carrier and upper edge of highest downlink component carrier</i> ".						

6.5A.1.4.5 Test requirement

The measured Occupied Bandwidth shall not exceed the aggregated channel bandwidth defined in subclause 5.3A .

6.5A.1.5 Occupied bandwidth for CA (6UL CA)

Editor's note: This clause is incomplete. The following aspects are either missing or not yet determined:

- **Measurement Uncertainties and Test Tolerances for intra-band contiguous CA supporting aggregated BW > 400MHz and for intra-band non-contiguous CA are TBD**
- **Measurement Uncertainties and Test Tolerances are FFS**
- **TP analysis is FFS**
- **This test case is incomplete until a suitable solution for preventing SCell drop is implemented in the test procedure.**

6.5A.1.5.1 Test purpose

To verify that the UE occupied bandwidth for all transmission bandwidth configurations supported by the UE are less than their specific limits.

6.5A.1.5.2 Test applicability

This test case applies to all types of NR UE release 15 and forward that supports FR2 6UL CA.

6.5A.1.5.3 Minimum conformance requirements

The minimum conformance requirements are defined in clause 6.5A.1.0.

6.5A.1.5.4 Test description

Same as in clause 6.5A.1.1.4 with following exceptions:

- Instead of Table 6.5A.1.1.4.1-1 → use Table 6.5A.1.5.4-1.

Table 6.5A.1.5.4-1: Test Configuration Table

Default Conditions						
Test Environment as specified in TS 38.508-1 [10] subclause 4.1				Normal		
Test Frequencies as specified in TS 38.508-1 [10] subclause 4.3.1.2.3 for different CA bandwidth classes.				Mid range		
Test CC combination setting as specified in TS 38.508-1 [10] subclause 4.3.1.2.3 for the CA Configuration across bandwidth combination sets supported by the UE.				Highest aggregated BW of the CA configuration		
Test SCS as specified in Table 5.3.5-1.				Lowest		
Test Parameters						
Test ID	CC	ChBw(MHz)	Test frequency	DL RB allocation	UL Modulation	UL RB allocation (Note 1)
1	PCC	Default	Default	-	CP-OFDM QPSK	Outer_Full
	SCC1				CP-OFDM QPSK	Outer_Full
	SCC2				CP-OFDM QPSK	Outer_Full
	SCC3				CP-OFDM QPSK	Outer_Full
	SCC4				CP-OFDM QPSK	Outer_Full
	SCC5				CP-OFDM QPSK	Outer_Full
NOTE 1: The specific configuration of each RB allocation is defined in Table 6.1-1 for PC2, PC3 and PC4 or Table 6.1-2 for PC1.						
NOTE 2: Number of DL CCs shall be configured the same as number of UL CCs. The requirements are applicable as per 5.3A.4: " <i>The requirements are applicable only when Uplink CCs are configured within the frequency range between lower edge of lowest downlink component carrier and upper edge of highest downlink component carrier</i> ".						

6.5A.1.5.5 Test requirement

The measured Occupied Bandwidth shall not exceed the aggregated channel bandwidth defined in subclause 5.3A .

6.5A.1.6 Occupied bandwidth for CA (7UL CA)

Editor's note: This clause is incomplete. The following aspects are either missing or not yet determined:

- Measurement Uncertainties and Test Tolerances for intra-band contiguous CA supporting aggregated BW > 400MHz and for intra-band non-contiguous CA are TBD
- Measurement Uncertainties and Test Tolerances are FFS
- TP analysis is FFS

6.5A.1.6.1 Test purpose

To verify that the UE occupied bandwidth for all transmission bandwidth configurations supported by the UE are less than their specific limits.

6.5A.1.6.2 Test applicability

This test case applies to all types of NR UE release 15 and forward that supports FR2 7UL CA.

6.5A.1.6.3 Minimum conformance requirements

The minimum conformance requirements are defined in clause 6.5A.1.0.

6.5A.1.6.4 Test description

Same as in clause 6.5A.1.1.4 with following exceptions:

- Instead of Table 6.5A.1.1.4.1-1 → use Table 6.5A.1.6.4-1.

Table 6.5A.1.6.4-1: Test Configuration Table

Default Conditions						
Test Environment as specified in TS 38.508-1 [10] subclause 4.1				Normal		
Test Frequencies as specified in TS 38.508-1 [10] subclause 4.3.1.2.3 for different CA bandwidth classes.				Mid range		
Test CC combination setting as specified in TS 38.508-1 [10] subclause 4.3.1.2.3 for the CA Configuration across bandwidth combination sets supported by the UE.				Highest aggregated BW of the CA configuration		
Test SCS as specified in Table 5.3.5-1.				Lowest		
Test Parameters						
Test ID	CC	ChBw(MHz)	Test frequency	DL RB allocation	UL Modulation	UL RB allocation (Note 1)
1	PCC	Default	Default	-	CP-OFDM QPSK	Outer_Full
	SCC1				CP-OFDM QPSK	Outer_Full
	SCC2				CP-OFDM QPSK	Outer_Full
	SCC3				CP-OFDM QPSK	Outer_Full
	SCC4				CP-OFDM QPSK	Outer_Full
	SCC5				CP-OFDM QPSK	Outer_Full
	SCC6				CP-OFDM QPSK	Outer_Full
NOTE 1: The specific configuration of each RB allocation is defined in Table 6.1-1 for PC2, PC3 and PC4 or Table 6.1-2 for PC1. NOTE 2: Number of DL CCs shall be configured the same as number of UL CCs. The requirements are applicable as per 5.3A.4: " <i>The requirements are applicable only when Uplink CCs are configured within the frequency range between lower edge of lowest downlink component carrier and upper edge of highest downlink component carrier</i> ".						

6.5A.1.6.5 Test requirement

The measured Occupied Bandwidth shall not exceed the aggregated channel bandwidth defined in subclause 5.3A .

6.5A.1.7 Occupied bandwidth for CA (8UL CA)

Editor's note: This clause is incomplete. The following aspects are either missing or not yet determined:

- Measurement Uncertainties and Test Tolerances for intra-band contiguous CA supporting aggregated BW > 400MHz and for intra-band non-contiguous CA are TBD
- Measurement Uncertainties and Test Tolerances are FFS
- TP analysis is FFS
- This test case is incomplete until a suitable solution for preventing SCell drop is implemented in the test procedure.

6.5A.1.7.1 Test purpose

To verify that the UE occupied bandwidth for all transmission bandwidth configurations supported by the UE are less than their specific limits.

6.5A.1.7.2 Test applicability

This test case applies to all types of NR UE release 15 and forward that supports FR2 8UL CA.

6.5A.1.7.3 Minimum conformance requirements

The minimum conformance requirements are defined in clause 6.5A.1.0.

6.5A.1.7.4 Test description

Same as in clause 6.5A.1.1.4 with following exceptions:

- Instead of Table 6.5A.1.1.4.1-1 → use Table 6.5A.1.7.4-1.

Table 6.5A.1.7.4-1: Test Configuration Table

Default Conditions						
Test Environment as specified in TS 38.508-1 [10] subclause 4.1				Normal		
Test Frequencies as specified in TS 38.508-1 [10] subclause 4.3.1.2.3 for different CA bandwidth classes.				Mid range		
Test CC combination setting as specified in TS 38.508-1 [10] subclause 4.3.1.2.3 for the CA Configuration across bandwidth combination sets supported by the UE.				Highest aggregated BW of the CA configuration		
Test SCS as specified in Table 5.3.5-1.				Lowest		
Test Parameters						
Test ID	CC	ChBw(MHz)	Test frequency	DL RB allocation	UL Modulation	UL RB allocation (Note 1)
1	PCC	Default	Default	-	CP-OFDM QPSK	Outer_Full
	SCC1				CP-OFDM QPSK	Outer_Full
	SCC2				CP-OFDM QPSK	Outer_Full
	SCC3				CP-OFDM QPSK	Outer_Full
	SCC4				CP-OFDM QPSK	Outer_Full
	SCC5				CP-OFDM QPSK	Outer_Full
	SCC6				CP-OFDM QPSK	Outer_Full
	SCC7				CP-OFDM QPSK	Outer_Full
NOTE 1: The specific configuration of each RB allocation is defined in Table 6.1-1 for PC2, PC3 and PC4 or Table 6.1-2 for PC1.						
NOTE 2: Number of DL CCs shall be configured the same as number of UL CCs. The requirements are applicable as per 5.3A.4: " <i>The requirements are applicable only when Uplink CCs are configured within the frequency range between lower edge of lowest downlink component carrier and upper edge of highest downlink component carrier</i> ".						

6.5A.1.7.5 Test requirement

The measured Occupied Bandwidth shall not exceed the aggregated channel bandwidth defined in subclause 5.3A.

6.5A.2 Out of band emission for CA

6.5A.2.1 Spectrum Emission Mask for CA

6.5A.2.1.0 Minimum conformance requirements

The normative reference for this requirement is TS 38.101-2 [3] clause 6.5A.2.1.

6.5A.2.1.0.0 General

The requirements specified in this clause shall apply if the UE has at least one of UL or DL configured for CA or if the UE is configured for single CC operation with different channel bandwidths in UL and DL carriers. In case the CA configuration consists of a single UL CC, spectrum emission mask defined in subclause 6.5.2.1 applies. Spectral emission mask requirements do not apply at any frequency where IBE requirements of clause 6.4A.2.3 apply.

The requirement is verified in beam locked mode with the test metric of TRP (Link=TX beam peak direction).

6.5A.2.1.0.1 Spectrum emission mask for intra-band contiguous UL CA

For intra-band contiguous UL carrier aggregation, the spectrum emission mask of the UE applies to frequencies (Δf_{OoB}) starting from the \pm edge of the UL aggregated channel bandwidth (Table 5.3A.4-1). For any bandwidth class defined in Table 5.3A.4-1, the UE emission shall not exceed the levels specified in Table 6.5A.2.1.0.1-1.

Table 6.5A.2.1.0.1-1: General NR spectrum emission mask for intra-band contiguous CA in frequency range 2

Δf_{OOB} (MHz)	Any carrier aggregation bandwidth class	Measurement bandwidth
$\pm 0-0.1 \cdot BW_{\text{Channel_CA}}$	-5	1 MHz
$\pm 0.1 \cdot BW_{\text{Channel_CA}} - 2 \cdot BW_{\text{Channel_CA}}$	-13	1 MHz
NOTE 1: (void)		

6.5A.2.1.0.2 Spectrum emission mask for intra-band non-contiguous UL CA

TBD

6.5A.2.1.1 Spectrum Emission Mask for CA (2UL CA)

Editor's note: The following aspects are either missing or not yet determined:

- Measurement Uncertainties and Test Tolerances for intra-band contiguous CA supporting aggregated BW > 400MHz
- Measurement Uncertainties and Test Tolerances are FFS for power class other than 1, 3, 5.
- For a transition period until RAN#99, the stability and repeatability of test procedure with PHR (variant b) for Rel-15 UEs is under evaluation.
- Test for DL intra-band non-contiguous configurations with UL intra-band contiguous configuration is FFS.

6.5A.2.1.1.1 Test purpose

To verify that the power of any UE emission shall not exceed specified levels for the specified channel bandwidth for CA.

6.5A.2.1.1.2 Test applicability

This test case applies to all types of NR UE release 15 and forward that supports FR2 2UL CA.

6.5A.2.1.1.3 Minimum conformance requirements

The minimum conformance requirements are defined in clause 6.5A.2.1.0.

6.5A.2.1.1.4 Test description

6.5A.2.1.1.4.1 Initial condition

Initial conditions are a set of test configurations the UE needs to be tested in and the steps for the SS to take with the UE to reach the correct measurement state.

The initial test configurations consist of environmental conditions, test frequencies, test channel bandwidths and sub-carrier spacing based on NR CA configurations specified in clause 5.5A. All of these configurations shall be tested with applicable test parameters for each CA combination and subcarrier spacing, are shown in Table 6.5A.2.1.1.4.1-1. The details of the uplink reference measurement channels (RMCs) are specified in Annexes A.2. Configurations of PDSCH and PDCCH before measurement are specified in Annex C.2.

Table 6.5A.2.1.1.4.1-1: Test Configuration Table

Default Conditions	
Test Environment as specified in TS 38.508-1 [10] subclause 4.1	Normal
Test Frequencies as specified in TS 38.508-1 [10] subclause 4.3.1.2.3 and 4.3.1.2.4 for different CA bandwidth classes.	For intra-band contiguous CA: Mid range. For intra-band non-contiguous CA: FFS.

Test CC combination setting as specified in TS 38.508-1 [10] subclause 4.3.1.2.3 and 4.3.1.2.4 for the CA Configuration across bandwidth combination sets supported by the UE.				Highest aggregated BW of the CA configuration		
Test SCS as specified in Table 5.3.5-1.				Lowest, Highest		
Test Parameters						
Test ID	CC	ChBw(MHz)	Test frequency	DL RB allocation	UL Modulation	UL RB allocation (Note 1)
1	PCC	Default	Default	-	DFT-s-OFDM PI/2 BPSK	Outer_1RB_Left (Note 2) Outer_3RB_Left (Note 3)
	SCCs				DFT-s-OFDM PI/2 BPSK	Outer_1RB_Left (Note 2) Outer_3RB_Left (Note 3)
2	PCC				DFT-s-OFDM PI/2 BPSK	Outer_1RB_Right (Note 2) Outer_3RB_Right (Note 3)
	SCCs				DFT-s-OFDM PI/2 BPSK	Outer_1RB_Right (Note 2) Outer_3RB_Right (Note 3)
3	PCC				DFT-s-OFDM PI/2 BPSK	Outer_Full
	SCCs				DFT-s-OFDM PI/2 BPSK	Outer_Full
4	PCC				DFT-s-OFDM QPSK	Outer_1RB_Left (Note 2) Outer_2RB_Left (Note 3)
	SCCs				DFT-s-OFDM QPSK	Outer_1RB_Left (Note 2) Outer_2RB_Left (Note 3)
5	PCC				DFT-s-OFDM QPSK	Outer_1RB_Right (Note 2) Outer_2RB_Right (Note 3)
	SCCs				DFT-s-OFDM QPSK	Outer_1RB_Right (Note 2) Outer_2RB_Right (Note 3)
6	PCC				DFT-s-OFDM QPSK	Outer_Full
	SCCs	DFT-s-OFDM QPSK	Outer_Full			
7	PCC	DFT-s-OFDM 16QAM	Outer_1RB_Left			
	SCCs	DFT-s-OFDM 16QAM	Outer_1RB_Left			
8	PCC	DFT-s-OFDM 16QAM	Outer_1RB_Right			
	SCCs	DFT-s-OFDM 16QAM	Outer_1RB_Right			
9	PCC	DFT-s-OFDM 16QAM	Outer_Full			
	SCCs	DFT-s-OFDM 16QAM	Outer_Full			
10	PCC	DFT-s-OFDM 64QAM	Outer_1RB_Left			
	SCCs	DFT-s-OFDM 64QAM	Outer_1RB_Left			
11	PCC	DFT-s-OFDM 64QAM	Outer_1RB_Right			

	SCCs			DFT-s-OFDM 64QAM	Outer_1RB_Right
12	PCC			DFT-s-OFDM 64QAM	Outer_Full
	SCCs			DFT-s-OFDM 64QAM	Outer_Full
13	PCC			CP-OFDM QPSK	Outer_1RB_Left (Note 2) Outer_2RB_Left (Note 3)
	SCCs			CP-OFDM QPSK	Outer_1RB_Left (Note 3) Outer_2RB_Left (Note 4)
14	PCC			CP-OFDM QPSK	Outer_1RB_Right (Note 2) Outer_2RB_Right (Note 3)
	SCCs			CP-OFDM QPSK	Outer_1RB_Right (Note 2) Outer_2RB_Right (Note 3)
15	PCC			CP-OFDM QPSK	Outer_Full
	SCCs			CP-OFDM QPSK	Outer_Full
<p>NOTE 1: The specific configuration of each RB allocation is defined in Table 6.1-1 for PC2, PC3 and PC4 or Table 6.1-2 for PC1.</p> <p>NOTE 2: Applicable to Rel-16 and forward UEs.</p> <p>NOTE 3: Applicable to Rel-15 UEs.</p>					

1. Connection between SS and UE is shown in TS 38.508-1 [10] Annex A, Figure A.3.3.1.1 for TE diagram and Figure A.3.4.1.1 for UE diagram.
2. The parameter settings for the cell are set up according to TS 38.508-1 [10] subclause 4.4.3.
3. Downlink signals are initially set up according to Annex C, and uplink signals according to Annex G.
4. The UL Reference Measurement channels are set according to Table 6.5A.2.1.1.4.1-1.
5. Propagation conditions are set according to Annex B.0
6. Ensure the UE is in state RRC_CONNECTED with generic procedure parameters Connectivity NR, Connected without release On, Test Mode On and Test Loop Function On according to TS 38.508-1 [10] clause 4.5. Message contents are defined in clause 6.5A.2.1.1.4.3

6.5A.2.1.1.4.2 Test procedure

1. Configure SCC according to Annex C.0, C.1, C.2, and C.3 for all downlink physical channels.
2. The SS shall configure SCC as per TS 38.508-1 [10] clause 5.5.1. Message contents are defined in clause 6.5A.2.1.1.4.3.
3. Apply the test step based on the 5G NR UE Release:
 - 3a. For Release 16 and forward 5G NR UEs: SS applies a backoff on the PCell power by activating the UE Power Limit Function (UPLF). The ACTIVATE POWER LIMIT REQUEST procedure is performed as specified in TS 38.508-1 [10] clause 4.9.32 using TOTAL NR AGGREGATED BANDWIDTH and PCELL NR bandwidth as per Test CC Combination setting. UE shall transmit ACTIVATE POWER LIMIT RESPONSE to SS. Go to step 4.
 - 3b. For Release 15 5G NR UEs: No action.
4. SS activates SCC by sending the activation MAC CE (Refer TS 38.321 [28], clauses 5.9, 6.1.3.10). Wait for at least 2 seconds (Refer TS 38.133[25], clause 9.3).

5. SS sends uplink scheduling information for each UL HARQ process via PDCCH DCI format 0_1 for C_RNTI to schedule the UL RMC according to Table 6.5A.2.1.1.4.1-1 on both PCC and SCC(s). Since the UE has no payload and no loopback data to send the UE sends uplink MAC padding bits on the UL RMC.
6. Set the UE in the Tx beam peak direction found with a 3D EIRP scan as performed in Annex K.1.1. Allow at least BEAM_SELECT_WAIT_TIME (NOTE 2) for the UE Tx beam selection to complete.
7. Apply the test step based on the 5G NR UE Release:
 - 7a. For Release 16 and forward 5G NR UEs: Send continuously uplink power control "up" commands in every uplink scheduling information to the UE; allow at least 200 ms for the UE to reach maximum output power. Allow at least BEAM_SELECT_WAIT_TIME (NOTE 2) for the UE Tx beam selection to complete.
 - 7b. For Release 15 5G NR UEs: Send uplink power control commands in uplink scheduling information to the UE per UL CC until the Power Headroom Report (PHR) from the UE for each UL CC is at the target value according to Table 6.2A.2.1.4.2-1; allow at least 200 ms for the UE to reach maximum output power. Allow at least BEAM_SELECT_WAIT_TIME (NOTE 1) for the UE Tx beam selection to complete.
8. Measure the TRP of the transmitted signal with a measurement filter of bandwidths according to Table 6.5A.2.1.1.5-1 and using a rms detector. If the sweep count is higher than one, the trace mode shall be average. The centre frequency of the filter shall be stepped in continuous steps according to the same table. TRP shall be recorded for each step. The measurement period shall capture the active time slots. Total radiated power is measured according to TRP measurement procedure defined in Annex K. The measurement grid used for TRP measurement defined in Annex M. TRP is calculated considering both polarizations, theta and phi.
9. Apply the test step based on the 5G NR UE Release:
 - 9a. For Release 16 and forward 5G NR UEs SS deactivates the UE Power Limit Function (UPLF) by performing the DEACTIVATE POWER LIMIT REQUEST procedure as specified in TS 38.508-1 [10] clause 4.9.33.
 - 9b. For Release 15 5G NR UEs: No action.

NOTE 1: When switching to DFT-s-OFDM waveform, as specified in Table 6.5A.2.1.1.4.1-1, send an NR RRCReconfiguration message according to TS 38.508-1 [10] clause 4.6.3 Table 4.6.3-118 PUSCH-Config with TRANSFORM_PRECODER_ENABLED condition.

NOTE 2: The BEAM_SELECT_WAIT_TIME default value is defined in Annex K.

6.5A.2.1.1.4.3 Message contents

Message contents are according to TS 38.508-1 [10] subclause 4.6 with the following exceptions for Release 15 5G NR UE.

Table 6.5A.2.1.1.4.3-1: PUSCH-PowerControl

Derivation Path: TS 38.508-1 [10], Table 4.6.3-120			
Information Element	Value/remark	Comment	Condition
PUSCH-PowerControl ::= SEQUENCE {			
p0-AlphaSets SEQUENCE (SIZE (1..maxNrofP0-PUSCH-AlphaSets)) OF SEQUENCE {	1 entry		
P0-PUSCH-AlphaSet[1] SEQUENCE {			
alpha	alpha0		
}			
}			
}			

Table 6.5A.2.1.1.4.3-2: PUSCH-ConfigCommon

Derivation Path: TS 38.508-1[10], Table 4.6.3-119			
Information Element	Value/remark	Comment	Condition
PUSCH-ConfigCommon ::= SEQUENCE {			
p0-NominalWithGrant	-4		50 MHz
p0-NominalWithGrant	-8		100 MHz
p0-NominalWithGrant	-10		200 MHz

p0-NominalWithGrant	-14		400 MHz
}			

Table 6.5A.2.1.1.4.3-3: BSR-Config (Rel-15 UE only)

Derivation Path: TS 38.508-1 [10], Table 4.6.3-7			
Information Element	Value/remark	Comment	Condition
BSR-Config ::= SEQUENCE {			
periodicBSR-Timer	infinity		
retxBSR-Timer	sf80		
logicalChannelSR-DelayTimer	Not present		
}			

6.5A.2.1.1.5 Test Requirements

The measured TRP of any UE emission derived in step 7, shall fulfil requirements in Table.6.5A.2.1.1.5-1.

Table 6.5A.2.1.1.5-1: General NR spectrum emission mask for intra-band contiguous CA in frequency range 2

Δf_{oob} (MHz)	Any carrier aggregation bandwidth class	Measurement bandwidth
$\pm 0-0.1 \cdot BW_{Channel_CA}$	-5 + TT	1 MHz
$\pm 0.1 \cdot BW_{Channel_CA} - 2 \cdot BW_{Channel_CA}$	-13 + TT	1 MHz
NOTE 1: TT for each frequency and channel bandwidth is specified in Table 6.5A.2.1.1.5-1a NOTE 2: If carrier leakage or I/Q image lands inside the spectrum occupied by the configured UL and DL CCs, exception to the general spectrum emission mask limit applies. For carrier leakage the requirements specified in section 6.4A.2.2.0 shall apply. For I/Q image the requirements specified in section 6.4A.2.3.0 shall apply. NOTE 3: At the boundary of spectrum emission limit, the first and last measurement position with a 1 MHz filter is the inside of +0.5MHz and -0.5MHz, respectively. NOTE 4: The measurements are to be performed above the upper edge of the aggregated channel bandwidth and below the lower edge of the aggregated channel bandwidth.		

Table 6.5A.2.1.1.5-1a: Test Tolerance (Aggregated BW ≤ 400MHz)

Test Metric	FR2a	FR2b
IFF (Max device size ≤ 30 cm)	3.21 dB	3.46 dB

6.5A.2.1.2 Spectrum Emission Mask for CA (3UL CA)

Editor's note: The following aspects are either missing or not yet determined:

- Measurement Uncertainties and Test Tolerances for intra-band contiguous CA supporting aggregated BW > 400MHz and for intra-band non-contiguous CA are TBD.
- Measurement Uncertainties and Test Tolerances are FFS for power class other than 1, 3, 5.

6.5A.2.1.2.1 Test purpose

To verify that the power of any UE emission shall not exceed specified levels for the specified channel bandwidth for CA.

6.5A.2.1.2.2 Test applicability

This test case applies to all types of NR UE release 15 and forward that supports FR2 3UL CA.

6.5A.2.1.2.3 Minimum conformance requirements

The minimum conformance requirements are defined in clause 6.5A.2.1.0.

6.5A.2.1.2.4 Test description

Same as in clause 6.5A.2.1.1.4 with following exceptions:

- Instead of Table 6.5A.2.1.1.5-1 → use Table 6.5A.2.1.2.5-1.

6.5A.2.1.2.5 Test Requirements

The measured TRP of any UE emission derived in step 7, shall fulfil requirements in Table.6.5A.2.1.2.5-1.

Table 6.5A.2.1.2.5-1: General NR spectrum emission mask for intra-band contiguous CA in frequency range 2

Δf_{OoB} (MHz)	Any carrier aggregation bandwidth class	Measurement bandwidth
$\pm 0.1 \cdot BW_{\text{Channel_CA}}$	-5 + TT	1 MHz
$\pm 0.1 \cdot BW_{\text{Channel_CA}} - 2 \cdot BW_{\text{Channel_CA}}$	-13 + TT	1 MHz
NOTE 1: TT for each frequency and channel bandwidth is specified in Table 6.5A.2.1.2.5-1a NOTE 2: If carrier leakage or I/Q image lands inside the spectrum occupied by the configured UL and DL CCs, exception to the general spectrum emission mask limit applies. For carrier leakage the requirements specified in section 6.4A.2.2.0 shall apply. For I/Q image the requirements specified in section 6.4A.2.3.0 shall apply. NOTE 3: At the boundary of spectrum emission limit, the first and last measurement position with a 1 MHz filter is the inside of +0.5MHz and -0.5MHz, respectively. NOTE 4: The measurements are to be performed above the upper edge of the aggregated channel bandwidth and below the lower edge of the aggregated channel bandwidth		

Table 6.5A.2.1.2.5-1a: Test Tolerance (Aggregated BW ≤ 400MHz)

Test Metric	FR2a	FR2b
IFF (Max device size ≤ 30 cm)	3.21 dB	3.46 dB

6.5A.2.1.3 Spectrum Emission Mask for CA (4UL CA)

Editor's note: The following aspects are either missing or not yet determined:

- Measurement Uncertainties and Test Tolerances for intra-band contiguous CA supporting aggregated BW > 400MHz and for intra-band non-contiguous CA are TBD.
- Measurement Uncertainties and Test Tolerances are FFS for power class other than 1, 3, 5.

6.5A.2.1.3.1 Test purpose

To verify that the power of any UE emission shall not exceed specified levels for the specified channel bandwidth for CA.

6.5A.2.1.3.2 Test applicability

This test case applies to all types of NR UE release 15 and forward that supports FR2 4UL CA.

6.5A.2.1.3.3 Minimum conformance requirements

The minimum conformance requirements are defined in clause 6.5A.2.1.0.

6.5A.2.1.3.4 Test description

Same as in clause 6.5A.2.1.1.4 with following exceptions:

- Instead of Table 6.5A.2.1.1.5-1 → use Table 6.5A.2.1.3.5-1.

6.5A.2.1.3.5 Test Requirements

The measured TRP of any UE emission derived in step 7, shall fulfil requirements in Table.6.5A.2.1.3.5-1.

Table 6.5A.2.1.3.5-1: General NR spectrum emission mask for intra-band contiguous CA in frequency range 2

Δf_{OoB} (MHz)	Any carrier aggregation bandwidth class	Measurement bandwidth
$\pm 0-0.1 \cdot BW_{\text{Channel_CA}}$	-5 + TT	1 MHz
$\pm 0.1 \cdot BW_{\text{Channel_CA}} - 2 \cdot BW_{\text{Channel_CA}}$	-13 + TT	1 MHz
NOTE 1: TT for each frequency and channel bandwidth is specified in Table 6.5A.2.1.3.5-1a NOTE 2: If carrier leakage or I/Q image lands inside the spectrum occupied by the configured UL and DL CCs, exception to the general spectrum emission mask limit applies. For carrier leakage the requirements specified in section 6.4A.2.2.0 shall apply. For I/Q image the requirements specified in section 6.4A.2.3.0 shall apply. NOTE 3: At the boundary of spectrum emission limit, the first and last measurement position with a 1 MHz filter is the inside of +0.5MHz and -0.5MHz, respectively. NOTE 4: The measurements are to be performed above the upper edge of the aggregated channel bandwidth and below the lower edge of the aggregated channel bandwidth		

Table 6.5A.2.1.3.5-1a: Test Tolerance (Aggregated BW ≤ 400MHz)

Test Metric	FR2a	FR2b
IFF (Max device size ≤ 30 cm)	3.21 dB	3.46 dB

6.5A.2.1.4 Spectrum Emission Mask for CA (5UL CA)

Editor's note: This clause is incomplete. The following aspects are either missing or not yet determined:

- Measurement Uncertainties and Test Tolerances for intra-band contiguous CA supporting aggregated BW > 400MHz and for intra-band non-contiguous CA are TBD.
- Measurement Uncertainties and Test Tolerances are FFS for all power classes, since test frequencies require aggregated BW > 400 MHz.

6.5A.2.1.4.1 Test purpose

To verify that the power of any UE emission shall not exceed specified levels for the specified channel bandwidth for CA.

6.5A.2.1.4.2 Test applicability

This test case applies to all types of NR UE release 15 and forward that supports FR2 5UL CA.

6.5A.2.1.4.3 Minimum conformance requirements

The minimum conformance requirements are defined in clause 6.5A.2.1.0.

6.5A.2.1.4.4 Test description

Same as in clause 6.5A.2.1.1.4 with following exceptions:

- Instead of Table 6.5A.2.1.1.5-1 → use Table 6.5A.2.1.4.5-1.

6.5A.2.1.4.5 Test Requirements

The measured TRP of any UE emission derived in step 7, shall fulfil requirements in Table.6.5A.2.1.4.5-1.

Table 6.5A.2.1.4.5-1: General NR spectrum emission mask for intra-band contiguous CA in frequency range 2

Δf_{OOB} (MHz)	Any carrier aggregation bandwidth class	Measurement bandwidth
$\pm 0-0.1 \cdot BW_{Channel_CA}$	-5 + TT	1 MHz
$\pm 0.1 \cdot BW_{Channel_CA} - 2 \cdot BW_{Channel_CA}$	-13 + TT	1 MHz
NOTE 1: TT for each frequency and channel bandwidth is specified in Table 6.5A.2.1.4.5-1a NOTE 2: If carrier leakage or I/Q image lands inside the spectrum occupied by the configured UL and DL CCs, exception to the general spectrum emission mask limit applies. For carrier leakage the requirements specified in section 6.4A.2.2.0 shall apply. For I/Q image the requirements specified in section 6.4A.2.3.0 shall apply. NOTE 3: At the boundary of spectrum emission limit, the first and last measurement position with a 1 MHz filter is the inside of +0.5MHz and -0.5MHz, respectively. NOTE 4: The measurements are to be performed above the upper edge of the aggregated channel bandwidth and below the lower edge of the aggregated channel bandwidth		

Table 6.5A.2.1.4.5-1a: Test Tolerance (Aggregated BW ≤ 400MHz)

Test Metric	FR2a	FR2b
IFF (Max device size ≤ 30 cm)	3.21 dB	3.46 dB

6.5A.2.1.5 Spectrum Emission Mask for CA (6UL CA)

Editor's note: This clause is incomplete. The following aspects are either missing or not yet determined:

- Measurement Uncertainties and Test Tolerances for intra-band contiguous CA supporting aggregated BW > 400MHz and for intra-band non-contiguous CA TBD.
- Measurement Uncertainties and Test Tolerances are FFS for all power classes, since test frequencies require aggregated BW > 400 MHz.

6.5A.2.1.5.1 Test purpose

To verify that the power of any UE emission shall not exceed specified levels for the specified channel bandwidth for CA.

6.5A.2.1.5.2 Test applicability

This test case applies to all types of NR UE release 15 and forward that supports FR2 6UL CA.

6.5A.2.1.5.3 Minimum conformance requirements

The minimum conformance requirements are defined in clause 6.5A.2.1.0.

6.5A.2.1.5.4 Test description

Same as in clause 6.5A.2.1.1.4 with following exceptions:

- Instead of Table 6.5A.2.1.1.5-1 → use Table 6.5A.2.1.5.5-1.

6.5A.2.1.5.5 Test Requirements

The measured TRP of any UE emission derived in step 7, shall fulfil requirements in Table.6.5A.2.1.5.5-1.

Table 6.5A.2.1.5.5-1: General NR spectrum emission mask for intra-band contiguous CA in frequency range 2

Δf_{foob} (MHz)	Any carrier aggregation bandwidth class	Measurement bandwidth
$\pm 0.1 \cdot BW_{\text{Channel_CA}}$	-5 + TT	1 MHz
$\pm 0.1 \cdot BW_{\text{Channel_CA}} - 2 \cdot BW_{\text{Channel_CA}}$	-13 + TT	1 MHz
NOTE 1: TT for each frequency and channel bandwidth is specified in Table 6.5A.2.1.5.5-1a NOTE 2: If carrier leakage or I/Q image lands inside the spectrum occupied by the configured UL and DL CCs, exception to the general spectrum emission mask limit applies. For carrier leakage the requirements specified in section 6.4A.2.2.0 shall apply. For I/Q image the requirements specified in section 6.4A.2.3.0 shall apply. NOTE 3: At the boundary of spectrum emission limit, the first and last measurement position with a 1 MHz filter is the inside of +0.5MHz and -0.5MHz, respectively. NOTE 4: The measurements are to be performed above the upper edge of the aggregated channel bandwidth and below the lower edge of the aggregated channel bandwidth		

Table 6.5A.2.1.5.5-1a: Test Tolerance (Aggregated BW \leq 400MHz)

Test Metric	FR2a	FR2b
IFF (Max device size \leq 30 cm)	3.21 dB	3.46 dB

6.5A.2.1.6 Spectrum Emission Mask for CA (7UL CA)

Editor's note: This clause is incomplete. The following aspects are either missing or not yet determined:

- Measurement Uncertainties and Test Tolerances for intra-band contiguous CA supporting aggregated BW > 400MHz and for intra-band non-contiguous CA are TBD.
- Measurement Uncertainties and Test Tolerances are FFS for all power classes, since test frequencies require aggregated BW > 400 MHz.

6.5A.2.1.6.1 Test purpose

To verify that the power of any UE emission shall not exceed specified levels for the specified channel bandwidth for CA.

6.5A.2.1.6.2 Test applicability

This test case applies to all types of NR UE release 15 and forward that supports FR2 7UL CA.

6.5A.2.1.6.3 Minimum conformance requirements

The minimum conformance requirements are defined in clause 6.5A.2.1.0.

6.5A.2.1.6.4 Test description

Same as in clause 6.5A.2.1.1.4 with following exceptions:

- Instead of Table 6.5A.2.1.1.5-1 \rightarrow use Table 6.5A.2.1.6.5-1.

6.5A.2.1.6.5 Test Requirements

The measured TRP of any UE emission derived in step 7, shall fulfil requirements in Table.6.5A.2.1.6.5-1.

Table 6.5A.2.1.6.5-1: General NR spectrum emission mask for intra-band contiguous CA in frequency range 2

Δf_{OoB} (MHz)	Any carrier aggregation bandwidth class	Measurement bandwidth
$\pm 0.1 * BW_{\text{Channel_CA}}$	-5 + TT	1 MHz
$\pm 0.1 * BW_{\text{Channel_CA}} - 2 * BW_{\text{Channel_CA}}$	-13 + TT	1 MHz
NOTE 1: TT for each frequency and channel bandwidth is specified in Table 6.5A.2.1.6.5-1a NOTE 2: If carrier leakage or I/Q image lands inside the spectrum occupied by the configured UL and DL CCs, exception to the general spectrum emission mask limit applies. For carrier leakage the requirements specified in section 6.4A.2.2.0 shall apply. For I/Q image the requirements specified in section 6.4A.2.3.0 shall apply. NOTE 3: At the boundary of spectrum emission limit, the first and last measurement position with a 1 MHz filter is the inside of +0.5MHz and -0.5MHz, respectively. NOTE 4: The measurements are to be performed above the upper edge of the aggregated channel bandwidth and below the lower edge of the aggregated channel bandwidth		

Table 6.5A.2.1.6.5-1a: Test Tolerance (Aggregated BW \leq 400MHz)

Test Metric	FR2a	FR2b
IFF (Max device size \leq 30 cm)	3.21 dB	3.46 dB

6.5A.2.1.7 Spectrum Emission Mask for CA (8UL CA)

Editor's note: This clause is incomplete. The following aspects are either missing or not yet determined:

- Measurement Uncertainties and Test Tolerances for intra-band contiguous CA supporting aggregated BW > 400MHz and for intra-band non-contiguous CA are TBD.
- Measurement Uncertainties and Test Tolerances are FFS for all power classes, since test frequencies require aggregated BW > 400 MHz.

6.5A.2.1.7.1 Test purpose

To verify that the power of any UE emission shall not exceed specified levels for the specified channel bandwidth for CA.

6.5A.2.1.7.2 Test applicability

This test case applies to all types of NR UE release 15 and forward that supports FR2 8UL CA.

6.5A.2.1.7.3 Minimum conformance requirements

The minimum conformance requirements are defined in clause 6.5A.2.1.0.

6.5A.2.1.7.4 Test description

Same as in clause 6.5A.2.1.1.4 with following exceptions:

- Instead of Table 6.5A.2.1.1.5-1 \rightarrow use Table 6.5A.2.1.7.5-1.

6.5A.2.1.7.5 Test Requirements

The measured TRP of any UE emission derived in step 7, shall fulfil requirements in Table.6.5A.2.1.7.5-1.

Table 6.5A.2.1.7.5-1: General NR spectrum emission mask for intra-band contiguous CA in frequency range 2

Δf_{OOB} (MHz)	Any carrier aggregation bandwidth class	Measurement bandwidth
$\pm 0.1 * BW_{\text{Channel_CA}}$	-5 + TT	1 MHz
$\pm 0.1 * BW_{\text{Channel_CA}} - 2 * BW_{\text{Channel_CA}}$	-13 + TT	1 MHz
NOTE 1: TT for each frequency and channel bandwidth is specified in Table 6.5A.2.1.7.5-1a NOTE 2: If carrier leakage or I/Q image lands inside the spectrum occupied by the configured UL and DL CCs, exception to the general spectrum emission mask limit applies. For carrier leakage the requirements specified in section 6.4A.2.2.0 shall apply. For I/Q image the requirements specified in section 6.4A.2.3.0 shall apply. NOTE 3: At the boundary of spectrum emission limit, the first and last measurement position with a 1 MHz filter is the inside of +0.5MHz and -0.5MHz, respectively. NOTE 4: The measurements are to be performed above the upper edge of the aggregated channel bandwidth and below the lower edge of the aggregated channel bandwidth		

Table 6.5A.2.1.7.5-1a: Test Tolerance (Aggregated BW ≤ 400MHz)

Test Metric	FR2a	FR2b
IFF (Max device size ≤ 30 cm)	3.21 dB	3.46 dB

6.5A.2.2 Adjacent channel leakage ratio for CA

6.5A.2.2.0 Minimum conformance requirements

The normative reference for this requirement is TS 38.101-2 [3] clause 6.5A.2.3.

6.5A.2.2.0.1 Adjacent channel leakage ratio for intra-band contiguous UL CA

In case the CA configuration consists of a single UL CC, the adjacent channel leakage ratio defined in subclause 6.5.2.3 applies. For intra-band contiguous UL carrier aggregation, the carrier aggregation NR adjacent channel leakage power ratio (CA NR_{ACLR}) is the ratio of the filtered mean power centred on the UL aggregated channel bandwidth to the filtered mean power centred on an adjacent UL aggregated channel bandwidth at spacing equal to the UL aggregated channel bandwidth. The assigned UL aggregated channel bandwidth power and adjacent UL aggregated channel bandwidth power are measured with rectangular filters with measurement bandwidths specified in Table 6.5A.2.2.0.1-1. If the measured adjacent channel power is greater than -35 dBm then the CA NR_{ACLR} shall be higher than the value specified in Table 6.5A.2.2.0.1-1.

Table 6.5A.2.2.0.1-1: General requirements for contiguous UL CA NR_{ACLR}

	CA bandwidth class / CA NR _{ACLR} / Measurement bandwidth
	Any CA bandwidth class
CA NR _{ACLR} for band n257, n258, n261	17 dB
CA NR _{ACLR} for band n260	16 dB
NR channel measurement bandwidth ¹	$BW_{\text{Channel_CA}} - 2 * BW_{\text{GB}}$
Adjacent channel centre frequency offset (in MHz)	$+ BW_{\text{Channel_CA}}$ / $- BW_{\text{Channel_CA}}$
NOTE 1: BW _{GB} is defined in clause 5.3A.2.	

6.5A.2.2.0.2 Adjacent channel leakage ratio for intra-band non-contiguous UL CA

TBD

6.5A.2.2.1 Adjacent channel leakage ratio for CA (2UL CA)

Editor's note: The following aspects are either missing or not yet determined:

- Measurement Uncertainties and Test Tolerances and Test limit analysis for intra-band contiguous CA supporting aggregated BW > 400MHz is TBD.
- Measurement Uncertainties and Test Tolerances and Test limit analysis are FFS for power class other than 1, 3, 5.
- For a transition period until RAN#99, the stability and repeatability of test procedure with PHR (variant b) for Rel-15 UEs is under evaluation.
- Test for DL intra-band non-contiguous configurations with UL intra-band contiguous configuration is FFS.

6.5A.2.2.1.1 Test purpose

To verify that UE transmitter does not cause unacceptable interference to adjacent channels in terms of Adjacent Channel Leakage power Ratio (ACLR) for CA.

6.5A.2.2.1.2 Test applicability

This test case applies to all types of NR UE release 15 and forward that supports FR2 2UL CA.

6.5A.2.2.1.3 Minimum conformance requirements

The minimum conformance requirements are defined in clause 6.5A.2.2.0.

6.5A.2.2.1.4 Test description

6.5A.2.2.1.4.1 Initial condition

Initial conditions are a set of test configurations the UE needs to be tested in and the steps for the SS to take with the UE to reach the correct measurement state.

The initial test configurations consist of environmental conditions, test frequencies, test channel bandwidths and sub-carrier spacing based on NR CA configurations specified in clause 5.5A. All of these configurations shall be tested with applicable test parameters for each CA combination and subcarrier spacing, are shown in Table 6.5A.2.2.1.4.1-1. The details of the uplink reference measurement channels (RMCs) are specified in Annexes A.2. Configurations of PDSCH and PDCCH before measurement are specified in Annex C.2.

Table 6.5A.2.2.1.4.1-1: Test Configuration Table

Default Conditions						
Test Environment as specified in TS 38.508-1 [10] subclause 4.1				Normal		
Test Frequencies as specified in TS 38.508-1 [10] subclause 4.3.1.2.3 and 4.3.1.2.4 for different CA bandwidth classes.				For intra-band contiguous CA: Low and High range. For intra-band non-contiguous CA: FFS.		
Test CC combination setting as specified in TS 38.508-1 [10] subclause 4.3.1.2.3 and 4.3.1.2.4 for the CA Configuration across bandwidth combination sets supported by the UE.				Highest aggregated BW of the CA configuration		
Test SCS as specified in Table 5.3.5-1.				Lowest, Highest		
Test Parameters						
Test ID	CC	ChBw(MHz)	Test frequency	DL RB allocation	UL Modulation	UL RB allocation (Note 1)
1	PCC	Default	Low	-	DFT-s-OFDM PI/2 BPSK	Outer_1RB_Left (Note 3) Outer_3RB_Left (Note 4)
	SCCs		Low		DFT-s-OFDM PI/2 BPSK	Outer_1RB_Left (Note 3)

						Outer_3RB_Left (Note 4)
2	PCC		High		DFT-s-OFDM PI/2 BPSK	Outer_1RB_Right (Note 3) Outer_3RB_Right (Note 4)
	SCCs		High		DFT-s-OFDM PI/2 BPSK	Outer_1RB_Right (Note 3) Outer_3RB_Right (Note 4)
3	PCC		Default		DFT-s-OFDM PI/2 BPSK	Outer_Full
	SCCs		Default		DFT-s-OFDM PI/2 BPSK	Outer_Full
4	PCC		Low		DFT-s-OFDM QPSK	Outer_1RB_Left (Note 3) Outer_2RB_Left (Note 4)
	SCCs		Low		DFT-s-OFDM QPSK	Outer_1RB_Left (Note 3) Outer_2RB_Left (Note 4)
5	PCC		High		DFT-s-OFDM QPSK	Outer_1RB_Right (Note 3) Outer_2RB_Right (Note 4)
	SCCs		High		DFT-s-OFDM QPSK	Outer_1RB_Right (Note 3) Outer_2RB_Right (Note 4)
6	PCC		Default		DFT-s-OFDM QPSK	Outer_Full
	SCCs		Default		DFT-s-OFDM QPSK	Outer_Full
7	PCC		Low		DFT-s-OFDM 16QAM	Outer_1RB_Left
	SCCs		Low		DFT-s-OFDM 16QAM	Outer_1RB_Left
8	PCC		High		DFT-s-OFDM 16QAM	Outer_1RB_Right
	SCCs		High		DFT-s-OFDM 16QAM	Outer_1RB_Right
9	PCC		Default		DFT-s-OFDM 16QAM	Outer_Full
	SCCs		Default		DFT-s-OFDM 16QAM	Outer_Full
10	PCC		Default		DFT-s-OFDM 64QAM	Outer_Full
	SCCs		Default		DFT-s-OFDM 64QAM	Outer_Full
11	PCC		Low		CP-OFDM QPSK	Outer_1RB_Left (Note 3) Outer_2RB_Left (Note 4)
	SCCs		Low		CP-OFDM QPSK	Outer_1RB_Left (Note 3) Outer_2RB_Left (Note 4)
12	PCC		High		CP-OFDM QPSK	Outer_1RB_Right (Note 3) Outer_2RB_Right (Note 4)
	SCCs		High		CP-OFDM QPSK	Outer_1RB_Right (Note 3) Outer_2RB_Right (Note 4)
13	PCC		Default		CP-OFDM QPSK	Outer_Full

	SCCs		Default		CP-OFDM QPSK	Outer_Full
NOTE 1: The specific configuration of each RB allocation is defined in Table 6.1-1 for PC2, PC3 and PC4 or Table 6.1-2 for PC1.						
NOTE 2: Following Test IDs shall be skipped for FR2b						
- All Test IDs for $100 \text{ MHz} < \text{BW}_{\text{Channel_CA}} \leq 400 \text{ MHz}$						
- Test ID 1-2, 4-5, 7-12 for $50 \text{ MHz} < \text{BW}_{\text{Channel_CA}} \leq 100 \text{ MHz}$						
NOTE 3: Applicable to Rel-16 and forward UEs.						
NOTE 4: Applicable to Rel-15 UEs.						

1. Connection between SS and UE is shown in TS 38.508-1 [10] Annex A, Figure A.3.3.1.1 for TE diagram and Figure A.3.4.1.1 for UE diagram.
2. The parameter settings for the cell are set up according to TS 38.508-1 [10] subclause 4.4.3.
3. Downlink signals are initially set up according to Annex C, and uplink signals according to Annex G.
4. The UL Reference Measurement channels are set according to Table 6.5A.2.2.1.4.1-1.
5. Propagation conditions are set according to Annex B.0
6. Ensure the UE is in state RRC_CONNECTED with generic procedure parameters Connectivity *NR*, Connected without release *On*, Test Mode *On* and Test Loop Function *On* according to TS 38.508-1 [10] clause 4.5. Message contents are defined in clause 6.5A.2.2.1.4.3

6.5A.2.2.1.4.2 Test procedure

1. Configure SCC according to Annex C.0, C.1, C.2, and C.3 for all downlink physical channels.
2. The SS shall configure SCC as per TS 38.508-1 [10] clause 5.5.1. Message contents are defined in clause 6.5A.2.2.1.4.3.
3. Apply the test step based on the 5G NR UE Release:
 - 3a. For Release 16 and forward 5G NR UEs: SS applies a backoff on the PCell power by activating the UE Power Limit Function (UPLF). The ACTIVATE POWER LIMIT REQUEST procedure is performed as specified in TS 38.508-1 [10] clause 4.9.32 using TOTAL NR AGGREGATED BANDWIDTH and PCELL NR bandwidth as per Test CC Combination setting. UE shall transmit ACTIVATE POWER LIMIT RESPONSE to SS. Go to step 4.
 - 3b. For Release 15 5G NR UEs: No action.
4. SS activates SCC by sending the activation MAC CE (Refer TS 38.321 [28], clauses 5.9, 6.1.3.10). Wait for at least 2 seconds (Refer TS 38.133[25], clause 9.3).
5. SS sends uplink scheduling information for each UL HARQ process via PDCCH DCI format 0_1 for C_RNTI to schedule the UL RMC according to Table 6.5A.2.2.1.4.1-1 on both PCC and SCC(s). Since the UE has no payload and no loopback data to send the UE sends uplink MAC padding bits on the UL RMC.
6. Set the UE in the Tx beam peak direction found with a 3D EIRP scan as performed in Annex K.1.1. Allow at least BEAM_SELECT_WAIT_TIME (NOTE 2) for the UE Tx beam selection to complete.
7. Apply the test step based on the 5G NR UE Release:
 - 7a. For Release 16 and forward 5G NR UEs: Send continuously uplink power control "up" commands in every uplink scheduling information to the UE; allow at least 200 ms for the UE to reach maximum output power. Allow at least BEAM_SELECT_WAIT_TIME (NOTE 2) for the UE Tx beam selection to complete.
 - 7b. For Release 15 5G NR UEs: Send uplink power control commands in uplink scheduling information to the UE per UL CC until the Power Headroom Report (PHR) from the UE for each UL CC is at the target value according to Table 6.2A.2.1.4.2-1; allow at least 200 ms for the UE to reach maximum output power. Allow at least BEAM_SELECT_WAIT_TIME (NOTE 1) for the UE Tx beam selection to complete.
8. Measure EIRP of the transmitted signal for the assigned NR channel with a rectangular measurement filter with bandwidths according to Table 6.5A.2.2.1.5-1 and using a rms detector. If the sweep count is higher than one,

the trace mode shall be average. EIRP measurement procedure defined in Annex K. EIRP is calculated considering both polarizations, theta and phi.

9. Measure EIRP of the first NR adjacent channel on both lower and upper side of the assigned NR channel, respectively using a rectangular measurement filter with bandwidths according to Table 6.5A.2.2.1.5-1 and using a rms detector. If the sweep count is higher than one, the trace mode shall be average. EIRP measurement procedure defined in Annex K. EIRP is calculated considering both polarizations, theta and phi.
10. Calculate the ratios of the power between the values measured in step 7 over step 8 for lower and upper NR_{ACLR}, respectively.
11. Apply the test step based on the 5G NR UE Release:
 - 11a. For Release 16 and forward 5G NR UEs: SS deactivates the UE Power Limit Function (UPLF) by performing the DEACTIVATE POWER LIMIT REQUEST procedure as specified in TS 38.508-1 [10] clause 4.9.33.
 - 11b. For Release 15 5G NR UEs: No action.

NOTE 1: When switching to DFT-s-OFDM waveform, as specified in Table 6.5A.2.2.1.4.1-1, send an NR RRCReconfiguration message according to TS 38.508-1 [10] clause 4.6.3 Table 4.6.3-118 PUSCH-Config with TRANSFORM_PRECODER_ENABLED condition.

NOTE 2: The BEAM_SELECT_WAIT_TIME default value is defined in Annex K.

6.5A.2.2.1.4.3 Message contents

Message contents are according to TS 38.508-1 [10] subclause 4.6 with the following exceptions for Release 15 5G NR UE.

Table 6.5A.2.2.1.4.3-1: PUSCH-PowerControl

Derivation Path: TS 38.508-1 [10], Table 4.6.3-120			
Information Element	Value/remark	Comment	Condition
PUSCH-PowerControl ::= SEQUENCE {			
p0-AlphaSets SEQUENCE (SIZE (1..maxNrofP0-PUSCH-AlphaSets)) OF SEQUENCE {	1 entry		
P0-PUSCH-AlphaSet[1] SEQUENCE {			
alpha	alpha0		
}			
}			
}			

Table 6.5A.2.2.1.4.3-2: PUSCH-ConfigCommon

Derivation Path: TS 38.508-1[10], Table 4.6.3-119			
Information Element	Value/remark	Comment	Condition
PUSCH-ConfigCommon ::= SEQUENCE {			
p0-NominalWithGrant	-4		50 MHz
p0-NominalWithGrant	-8		100 MHz
p0-NominalWithGrant	-10		200 MHz
p0-NominalWithGrant	-14		400 MHz
}			

Table 6.5A.2.2.1.4.3-3: BSR-Config (Rel-15 UE only)

Derivation Path: TS 38.508-1 [10], Table 4.6.3-7			
Information Element	Value/remark	Comment	Condition
BSR-Config ::= SEQUENCE {			
periodicBSR-Timer	infinity		
retxBSR-Timer	sf80		
logicalChannelSR-DelayTimer	Not present		
}			

6.5A.2.2.1.5 Test Requirements

If the measured adjacent channel power, derived in step 8, is greater than -35 dBm then the measured NR_{ACLR}, derived in step 9, shall be higher than the limits in Table 6.5A.2.2.1.5-1.

Table 6.5A.2.2.1.5-1: General requirements for CA NR_{ACLR}

	CA bandwidth class / CA NR _{ACLR} / Measurement bandwidth
	Any CA bandwidth class
CA NR _{ACLR} for band n257, n258, n261	17 - TT - R dB
CA NR _{ACLR} for band n260	16 - TT dB
NR channel measurement bandwidth ¹	$BW_{Channel_CA} - 2 * BW_{GB}$
Adjacent channel centre frequency offset (in MHz)	$+ BW_{Channel_CA}$ / $- BW_{Channel_CA}$
NOTE 1: BW _{GB} is defined in clause 5.3A.2.	
NOTE 2: TT for each frequency and channel bandwidth is specified in Table 6.5A.2.2.1.5-1a	
NOTE 3: R for each frequency, channel bandwidth and test point is specified in Table 6.5A.2.2.1.5-1b	

Table 6.5A.2.2.1.5-1a: Test Tolerance (Aggregated BW ≤ 400MHz)

Test Metric	Any CA bandwidth class	23.45GHz ≤ f ≤ 30.3GHz	30.3GHz < f ≤ 40.8GHz
IFF (Max device size ≤ 30 cm)	$BW_{Channel_CA} \leq 100$ MHz	4.96 dB	4.96 dB
	$100 \text{ MHz} < BW_{Channel_CA} \leq 200$ MHz	4.96 dB	4.96 dB
	$200 \text{ MHz} < BW_{Channel_CA} \leq 400$ MHz	4.96 dB	4.96 dB

Table 6.5A.2.2.1.5-1b: Relaxation due to testability limit (Aggregated BW ≤ 400MHz)

	Test ID	Channel bandwidth / NR _{ACLR} / Measurement bandwidth		
		$BW_{Channel_CA} \leq 100$ MHz	$100 \text{ MHz} < BW_{Channel_CA} \leq 200$ MHz	$200 \text{ MHz} < BW_{Channel_CA} \leq 400$ MHz
NR _{ACLR} for band n257, n258, n261	1	0	3	6
	2	0	3	6
	3	0	0	3
	4	0	3	6
	5	0	3	6
	6	0	0	3
	7	0	3	6
	8	0	3	6
	9	0	2.5	5.5
	10	2	5	8
	11	0	3	6
	12	0	3	6
	13	0	0	3

NOTE 1: Relaxation value is 0 for FR2b.

6.5A.2.2.2 Adjacent channel leakage ratio for CA (3UL CA)

Editor's note: The following aspects are either missing or not yet determined:

- Measurement Uncertainties and Test Tolerances for intra-band contiguous CA supporting aggregated BW > 400MHz is TBD.

- Measurement Uncertainties and Test Tolerances are FFS for power class other than 1, 3, 5.

6.5A.2.2.2.1 Test purpose

To verify that UE transmitter does not cause unacceptable interference to adjacent channels in terms of Adjacent Channel Leakage power Ratio (ACLR) for CA.

6.5A.2.2.2.2 Test applicability

This test case applies to all types of NR UE release 15 and forward that supports FR2 3UL CA.

6.5A.2.2.2.3 Minimum conformance requirements

The minimum conformance requirements are defined in clause 6.5A.2.2.0.

6.5A.2.2.2.4 Test description

Same as in clause 6.5A.2.2.1.4 with following exceptions:

- Instead of Table 6.5A.2.2.1.5-1 → use Table 6.5A.2.2.2.5-1.

6.5A.2.2.2.5 Test Requirements

If the measured adjacent channel power, derived in step 8, is greater than -35 dBm then the measured NR ACLR, derived in step 9, shall be higher than the limits in Table 6.5A.2.2.2.5-1.

Table 6.5A.2.2.2.5-1: General requirements for CA NR_{ACLR}

	CA bandwidth class / CA NR _{ACLR} / Measurement bandwidth Any CA bandwidth class
CA NR _{ACLR} for band n257, n258, n261	17 - TT - R dB
CA NR _{ACLR} for band n260	16 - TT dB
NR channel measurement bandwidth ¹	BW _{Channel_CA} - 2*BW _{GB}
Adjacent channel centre frequency offset (in MHz)	+ BW _{Channel_CA} / - BW _{Channel_CA}
NOTE 1: BW _{GB} is defined in clause 5.3A.2. NOTE 2: TT for each frequency and channel bandwidth is specified in Table 6.5A.2.2.2.5-1a NOTE 3: R for each frequency, channel bandwidth and test point is specified in Table 6.5A.2.2.1.5-1b	

Table 6.5A.2.2.2.5-1a: Test Tolerance (Aggregated BW ≤ 400MHz)

Test Metric	Any CA bandwidth class	23.45GHz ≤ f ≤ 30.3GHz	30.3GHz < f ≤ 40.8GHz
IFF (Max device size ≤ 30 cm)	BW _{Channel_CA} ≤ 100 MHz	4.96 dB	4.96 dB
	100 MHz < BW _{Channel_CA} ≤ 200 MHz	4.96 dB	4.96 dB
	200 MHz < BW _{Channel_CA} ≤ 400 MHz	4.96 dB	4.96 dB

6.5A.2.2.3 Adjacent channel leakage ratio for CA (4UL CA)

Editor's note: The following aspects are either missing or not yet determined:

- Measurement Uncertainties and Test Tolerances for intra-band contiguous CA supporting aggregated BW > 400MHz is TBD.
- Measurement Uncertainties and Test Tolerances are FFS for power class other than 1, 3, 5.

6.5A.2.2.3.1 Test purpose

To verify that UE transmitter does not cause unacceptable interference to adjacent channels in terms of Adjacent Channel Leakage power Ratio (ACLR) for CA.

6.5A.2.2.3.2 Test applicability

This test case applies to all types of NR UE release 15 and forward that supports FR2 4UL CA.

6.5A.2.2.3.3 Minimum conformance requirements

The minimum conformance requirements are defined in clause 6.5A.2.2.0.

6.5A.2.2.3.4 Test description

Same as in clause 6.5A.2.2.1.4 with following exceptions:

- Instead of Table 6.5A.2.2.1.5-1 → use Table 6.5A.2.2.3.5-1.

6.5A.2.2.3.5 Test Requirements

If the measured adjacent channel power, derived in step 8, is greater than -35 dBm then the measured NR ACLR, derived in step 9, shall be higher than the limits in Table 6.5A.2.2.3.5-1.

Table 6.5A.2.2.3.5-1: General requirements for CA NR_{ACLR}

	CA bandwidth class / CA NR _{ACLR} / Measurement bandwidth
	Any CA bandwidth class
CA NR _{ACLR} for band n257, n258, n261	17 - TT - R dB
CA NR _{ACLR} for band n260	16 - TT dB
NR channel measurement bandwidth ¹	$BW_{Channel_CA} - 2 * BW_{GB}$
Adjacent channel centre frequency offset (in MHz)	$+ BW_{Channel_CA}$ / $- BW_{Channel_CA}$
NOTE 1: BW _{GB} is defined in clause 5.3A.2.	
NOTE 2: TT for each frequency and channel bandwidth is specified in Table 6.5A.2.2.3.5-1a	
NOTE 3: R for each frequency, channel bandwidth and test point is specified in Table 6.5A.2.2.1.5-1b	

Table 6.5A.2.2.3.5-1a: Test Tolerance (Aggregated BW ≤ 400MHz)

Test Metric	Any CA bandwidth class	23.45GHz ≤ f ≤ 30.3GHz	30.3GHz < f ≤ 40.8GHz
IFF (Max device size ≤ 30 cm)	$BW_{Channel_CA} \leq 100$ MHz	4.96 dB	4.96 dB
	$100 \text{ MHz} < BW_{Channel_CA} \leq 200$ MHz	4.96 dB	4.96 dB
	$200 \text{ MHz} < BW_{Channel_CA} \leq 400$ MHz	4.96 dB	4.96 dB

6.5A.2.2.4 Adjacent channel leakage ratio for CA (5UL CA)

Editor's note: This clause is incomplete. The following aspects are either missing or not yet determined:

- Measurement Uncertainties and Test Tolerances are for all power classes, since test frequencies require aggregated BW > 400 MHz.

6.5A.2.2.4.1 Test purpose

To verify that UE transmitter does not cause unacceptable interference to adjacent channels in terms of Adjacent Channel Leakage power Ratio (ACLR) for CA.

6.5A.2.2.4.2 Test applicability

This test case applies to all types of NR UE release 15 and forward that supports FR2 5UL CA.

6.5A.2.2.4.3 Minimum conformance requirements

The minimum conformance requirements are defined in clause 6.5A.2.2.0.

6.5A.2.2.4.4 Test description

Same as in clause 6.5A.2.2.1.4 with following exceptions:

- Instead of Table 6.5A.2.2.1.5-1 → use Table 6.5A.2.2.4.5-1.

6.5A.2.2.4.5 Test Requirements

If the measured adjacent channel power, derived in step 8, is greater than -35 dBm then the measured NR ACLR, derived in step 9, shall be higher than the limits in Table 6.5A.2.2.4.5-1.

Table 6.5A.2.2.4.5-1: General requirements for CA NR_{ACLR}

	CA bandwidth class / CA NR _{ACLR} / Measurement bandwidth
	Any CA bandwidth class
CA NR _{ACLR} for band n257, n258, n261	17 – TT dB
CA NR _{ACLR} for band n260	16 – TT dB
NR channel measurement bandwidth ¹	$BW_{Channel_CA} - 2 * BW_{GB}$
Adjacent channel centre frequency offset (in MHz)	+ $BW_{Channel_CA}$ / - $BW_{Channel_CA}$
NOTE 1: BW_{GB} is defined in clause 5.3A.2.	
NOTE 2: TT for each frequency and channel bandwidth is specified in Table 6.5A.2.2.4.5-1a	

Table 6.5A.2.2.4.5-1a: Test Tolerance (Aggregated BW ≤ 400MHz)

Test Metric	FR2a	FR2b
IFF (Max device size ≤ 30 cm)	[4.6] dB	[5.0] dB

6.5A.2.2.5 Adjacent channel leakage ratio for CA (6UL CA)

Editor's note: This clause is incomplete. The following aspects are either missing or not yet determined:

- **Measurement Uncertainties and Test Tolerances are for all power classes, since test frequencies require aggregated BW > 400 MHz.**

6.5A.2.2.5.1 Test purpose

To verify that UE transmitter does not cause unacceptable interference to adjacent channels in terms of Adjacent Channel Leakage power Ratio (ACLR) for CA.

6.5A.2.2.5.2 Test applicability

This test case applies to all types of NR UE release 15 and forward that supports FR2 6UL CA.

6.5A.2.2.5.3 Minimum conformance requirements

The minimum conformance requirements are defined in clause 6.5A.2.2.0.

6.5A.2.2.5.4 Test description

Same as in clause 6.5A.2.2.1.4 with following exceptions:

- Instead of Table 6.5A.2.2.1.5-1 → use Table 6.5A.2.2.5.5-1.

6.5A.2.2.5.5 Test Requirements

If the measured adjacent channel power, derived in step 8, is greater than -35 dBm then the measured NR ACLR, derived in step 9, shall be higher than the limits in Table 6.5A.2.2.5.5-1.

Table 6.5A.2.2.5.5-1: General requirements for CA NR_{ACLR}

	CA bandwidth class / CA NR _{ACLR} / Measurement bandwidth
	Any CA bandwidth class
CA NR _{ACLR} for band n257, n258, n261	17 – TT dB
CA NR _{ACLR} for band n260	16 – TT dB
NR channel measurement bandwidth ¹	$BW_{\text{Channel_CA}} - 2 \cdot BW_{\text{GB}}$
Adjacent channel centre frequency offset (in MHz)	+ $BW_{\text{Channel_CA}}$ / - $BW_{\text{Channel_CA}}$
NOTE 1: BW_{GB} is defined in clause 5.3A.2.	
NOTE 2: TT for each frequency and channel bandwidth is specified in Table 6.5A.2.2.5.5-1a	

Table 6.5A.2.2.5.5-1a: Test Tolerance (Aggregated BW ≤ 400MHz)

Test Metric	FR2a	FR2b
IFF (Max device size ≤ 30 cm)	[4.6] dB	[5.0] dB

6.5A.2.2.6 Adjacent channel leakage ratio for CA (7UL CA)

Editor's note: This clause is incomplete. The following aspects are either missing or not yet determined:

- **Measurement Uncertainties and Test Tolerances are for all power classes, since test frequencies require aggregated BW > 400 MHz.**

6.5A.2.2.6.1 Test purpose

To verify that UE transmitter does not cause unacceptable interference to adjacent channels in terms of Adjacent Channel Leakage power Ratio (ACLR) for CA.

6.5A.2.2.6.2 Test applicability

This test case applies to all types of NR UE release 15 and forward that supports FR2 7UL CA.

6.5A.2.2.6.3 Minimum conformance requirements

The minimum conformance requirements are defined in clause 6.5A.2.2.0.

6.5A.2.2.6.4 Test description

Same as in clause 6.5A.2.2.1.4 with following exceptions:

- Instead of Table 6.5A.2.2.1.5-1 → use Table 6.5A.2.2.6.5-1.

6.5A.2.2.6.5 Test Requirements

If the measured adjacent channel power, derived in step 8, is greater than -35 dBm then the measured NR ACLR, derived in step 9, shall be higher than the limits in Table 6.5A.2.2.6.5-1.

Table 6.5A.2.2.6.5-1: General requirements for CA NR_{ACLR}

	CA bandwidth class / CA NR _{ACLR} / Measurement bandwidth
	Any CA bandwidth class
CA NR _{ACLR} for band n257, n258, n261	17 – TT dB
CA NR _{ACLR} for band n260	16 – TT dB
NR channel measurement bandwidth ¹	$BW_{\text{Channel_CA}} - 2 \cdot BW_{\text{GB}}$
Adjacent channel centre frequency offset (in MHz)	+ $BW_{\text{Channel_CA}}$ / - $BW_{\text{Channel_CA}}$
NOTE 1: BW_{GB} is defined in clause 5.3A.2.	
NOTE 2: TT for each frequency and channel bandwidth is specified in Table 6.5A.2.2.6.5-1a	

Table 6.5A.2.2.6.5-1a: Test Tolerance (Aggregated BW ≤ 400MHz)

Test Metric	FR2a	FR2b
IFF (Max device size ≤ 30 cm)	[4.6] dB	[5.0] dB

6.5A.2.2.7 Adjacent channel leakage ratio for CA (8UL CA)

Editor's note: This clause is incomplete. The following aspects are either missing or not yet determined:

- Measurement Uncertainties and Test Tolerances are TBD.
- Measurement Uncertainties and Test Tolerances are FFS for power class 1, 2 and 4

6.5A.2.2.7.1 Test purpose

To verify that UE transmitter does not cause unacceptable interference to adjacent channels in terms of Adjacent Channel Leakage power Ratio (ACLR) for CA.

6.5A.2.2.7.2 Test applicability

This test case applies to all types of NR UE release 15 and forward that supports FR2 8UL CA.

6.5A.2.2.7.3 Minimum conformance requirements

The minimum conformance requirements are defined in clause 6.5A.2.2.0.

6.5A.2.2.7.4 Test description

Same as in clause 6.5A.2.2.1.4 with following exceptions:

- Instead of Table 6.5A.2.2.1.5-1 → use Table 6.5A.2.2.7.5-1.

6.5A.2.2.7.5 Test Requirements

If the measured adjacent channel power, derived in step 8, is greater than -35 dBm then the measured NR ACLR, derived in step 9, shall be higher than the limits in Table 6.5A.2.2.7.5-1.

Table 6.5A.2.2.7.5-1: General requirements for CA NR_{ACLR}

	CA bandwidth class / CA NR _{ACLR} / Measurement bandwidth
	Any CA bandwidth class
CA NR _{ACLR} for band n257, n258, n261	17 – TT dB
CA NR _{ACLR} for band n260	16 – TT dB
NR channel measurement bandwidth ¹	$BW_{\text{Channel_CA}} - 2 \cdot BW_{\text{GB}}$
Adjacent channel centre frequency offset (in MHz)	+ $BW_{\text{Channel_CA}}$ / -

	- $BW_{Channel_CA}$
NOTE 1: BW_{GB} is defined in clause 5.3A.2.	
NOTE 2: TT for each frequency and channel bandwidth is specified in Table 6.5A.2.2.7.5-1a	

Table 6.5A.2.2.7.5-1a: Test Tolerance (Aggregated BW \leq 400MHz)

Test Metric	FR2a	FR2b
IFF (Max device size \leq 30 cm)	[4.6] dB	[5.0] dB

6.5A.3 Spurious emissions for CA

6.5A.3.1 General spurious emissions for CA

6.5A.3.1.0 Minimum conformance requirements

The normative reference for this requirement is TS 38.101-2 [3] clause 6.5A.3.

6.5A.3.1.0.0 General

This clause specifies the spurious emission requirements for carrier aggregation. The requirement is verified in beam locked mode with the test metric of TRP (Link=TX beam peak direction, Meas=TRP grid). The TX beam peak direction used for CA testing is the [same as that found for single carrier scenario in clause 6.5.3].

In case the CA configuration consists of a single UL CC, spurious emissions requirements defined in subclause 6.5.3 apply. Spurious emissions requirements do not apply at any frequency where IBE requirements of clause 6.4A.2.3 apply.

NOTE: For measurement conditions at the edge of each frequency range, the lowest frequency of the measurement position in each frequency range should be set at the lowest boundary of the frequency range plus $MBW/2$. The highest frequency of the measurement position in each frequency range should be set at the highest boundary of the frequency range minus $MBW/2$. MBW denotes the measurement bandwidth defined for the protected band.

6.5A.3.1.0.1 Spurious emissions for intra-band contiguous UL CA

For intra-band contiguous UL carrier aggregation, the spurious emission limits apply for the frequency ranges that are more than F_{OOB} (MHz) from the edge of the UL aggregated channel bandwidth, where F_{OOB} is defined as the twice the UL aggregated channel bandwidth. For frequencies Δf_{OOB} greater than F_{OOB} , the spurious emission requirements in Table 6.5.3.1.3-2 are applicable.

6.5A.3.1.0.2 Spurious emissions for intra-band non-contiguous UL CA

TBD

6.5A.3.1.1 General spurious emissions for CA (2UL CA)

Editor's note: The following aspects are either missing or not yet determined:

- The testability of this test case is pending further analysis on relaxation of the requirement for band other than n257, n258, n260 and n261.
- Measurement Uncertainties and Test Tolerances are FFS for power class 1, 2, and 4.
- Test procedure only includes the testing of smartphone and is FFS for laptop and FWA.
- For a transition period until RAN#99, the stability and repeatability of test procedure with PHR (variant b) for Rel-15 UEs is under evaluation.

- For a transition period until RAN5#103 meeting (May 2024), previous fine/coarse TRP measurement grid and offset values for corresponding coarse TRP measurement in TS 38.521-2 V17.2.0 are allowed for TE implementation.

6.5A.3.1.1.1 Test purpose

To verify that UE transmitter does not cause unacceptable interference to other channels or other systems in terms of transmitter spurious emissions.

6.5A.3.1.1.2 Test applicability

This test case applies to all types of NR UE release 15 and forward that supports FR2 2UL CA.

6.5A.3.1.1.3 Minimum conformance requirements

The minimum conformance requirements are defined in clause 6.5A.3.1.0.

6.5A.3.1.1.4 Test description

6.5A.3.1.1.4.1 Initial condition

Initial conditions are a set of test configurations the UE needs to be tested in and the steps for the SS to take with the UE to reach the correct measurement state.

The initial test configurations consist of environmental conditions, test frequencies, and channel bandwidths based on NR operating bands specified in clause 5.5A. All of these configurations shall be tested with applicable test parameters for each channel bandwidth and subcarrier spacing, are shown in Table 6.5A.3.1.1.4.1-1. The details of the uplink reference measurement channels (RMCs) are specified in Annexes A.2. Configurations of PDSCH and PDCCH before measurement are specified in Annex C.2.

Table 6.5A.3.1.1.4.1-1: Test Configuration Table

Initial Conditions				
Test Environment as specified in TS 38.508-1 [10] subclause 4.1		Normal		
Test Frequencies as specified in TS 38.508-1 [10] subclause 4.3.1.2.3 for different CA bandwidth classes		Low range, High range (NOTE 2)		
Test CC combination setting as specified in TS 38.508-1 [10] subclause 4.3.1.2.3 for the CA Configuration across bandwidth combination sets supported by the UE.		Highest aggregated BW of the CA configuration		
Test SCS as specified in Table 5.3.5-1		120kHz		
Test Parameters				
Test ID	CC	Downlink Configuration	UL Modulation	UL RB allocation (NOTE 1)
1	PCC	-	DFT-s-OFDM QPSK	Outer_Full
	SCCs		DFT-s-OFDM QPSK	Outer_Full
2	PCC		DFT-s-OFDM QPSK	Inner_1RB for PC2, PC3 and PC4 (Note 5) Inner_2RB for PC2, PC3 and PC4 (Note 6) Inner_Partial for PC1 (NOTE 3)
	SCCs		DFT-s-OFDM QPSK	Inner_1RB for PC2, PC3 and PC4 (Note 5) Inner_2RB for PC2, PC3 and PC4 (Note 6) Inner_Partial for PC1 (NOTE 3)
NOTE 1: The specific configuration of each RB allocation is defined in Table 6.1-1 for PC2, PC3 and PC4 or Table 6.1-2 for PC1.				
NOTE 2: When testing Low range test only in Frequency Range lower than $(F_{UL_low} - \Delta f_{OoB})$ and when testing High range test only in Frequency Range higher than $(F_{UL_high} + \Delta f_{OoB})$.				

NOTE 3: When testing Low range configure uplink RB to Inner_1RB_Left for PC2, PC3 and PC4 or Inner_Partial_Left_Region1 for PC1 and when testing High range configure uplink RB to Inner_1RB_Right for PC2, PC3 and PC4 or Inner_Partial_Right_Region1 for PC1.

NOTE 4: The number of DL CCs shall be configured the same as the number of UL CCs. The requirements are applicable as per 5.3A.4 "The requirements are applicable only when Uplink CCs are configured within the frequency range between lower edge of lowest downlink component carrier and upper edge of highest downlink component carrier".

NOTE 5: Applicable to Rel-16 and forward UEs.

NOTE 6: Applicable to Rel-15 UEs.

1. Connection between SS and UE is shown in TS 38.508-1 [10] Annex A, Figure A.3.3.1.3 for TE diagram and Figure A.3.4.1.1 for UE diagram.
2. The parameter settings for the cell are set up according to TS 38.508-1 [10] subclause 4.4.3.
3. Downlink signals are initially set up according to Annex C, and uplink signals according to Annex G.
4. The UL Reference Measurement channels are set according to Table 6.5A.3.1.1.4.1-1.
5. Propagation conditions are set according to Annex B.0
6. Ensure the UE is in state RRC_CONNECTED with generic procedure parameters Connectivity *NR*, Connected without release *On*, Test Mode *On* and Test Loop Function *On* according to TS 38.508-1 [10] clause 4.5. Message contents are defined in clause 6.5A.3.1.1.4.3

6.5A.3.1.1.4.2 Test procedure

1. Select any of the three Alignment Options (1, 2, or 3) from Tables N.2-1 through N.2-3 to mount the DUT inside the QZ.
2. If the re-positioning concept is applied, position the device in DUT Orientation 1 if the maximum beam peak direction is within zenith angular range $0^\circ \leq \theta \leq 90^\circ$ for the alignment option selected in step 1; position the device in DUT Orientation 2 (either Options 1 or 2) if the maximum beam peak direction is within zenith angular range $90^\circ < \theta \leq 180^\circ$ for DUT Orientation 1 for the alignment option selected in step 1. If the re-positioning concept is not applied, position the device in DUT Orientation 1.
3. Configure SCC according to Annex C.0, C.1, C.2 for all downlink physical channels.
4. The SS shall configure SCC as per TS 38.508-1 [10] clause 5.5.1. Message contents are defined in clause 6.5A.3.1.1.4.3.
5. Apply the test step based on the 5G NR UE Release:
 - 5a. For Release 16 and forward 5G NR UEs: SS applies a backoff on the PCell power by activating the UE Power Limit Function (UPLF). The ACTIVATE POWER LIMIT REQUEST procedure is performed as specified in TS 38.508-1 [10] clause 4.9.32 using TOTAL NR AGGREGATED BANDWIDTH and PCELL NR bandwidth as per Test CC Combination setting. UE shall transmit ACTIVATE POWER LIMIT RESPONSE to SS. Go to step 6.
 - 5b. For Release 15 5G NR UEs: No action.
6. SS activates SCC by sending the activation MAC CE (Refer TS 38.321 [28], clauses 5.9, 6.1.3.10). Wait for at least 2 seconds (Refer TS 38.133[25], clause 9.3).
7. SS sends uplink scheduling information for each UL HARQ process via PDCCH DCI format 0_1 for C_RNTI to schedule the UL RMC according to Table 6.5A.3.1.1.4.1-1. Since the UL has no payload and no loopback data to send the UE sends uplink MAC padding bits on the UL RMC.
8. Set the UE in the Inband Tx beam peak direction [(same as that found for single carrier in clause 6.5.3)] found with a 3D EIRP scan as performed in Annex K.1.1. Allow at least BEAM_SELECT_WAIT_TIME (NOTE 3) for the UE Tx beam selection to complete.
9. Apply the test step based on the 5G NR UE Release:

- 9a. For Release 16 and forward 5G NR UEs: Send continuously uplink power control "up" commands in every uplink scheduling information to the UE; allow at least 200msec for the UE to reach P_{UMAX} . Allow at least BEAM_SELECT_WAIT_TIME (NOTE 3) for the UE Tx beam selection to complete.
- 9b. For Release 15 5G NR UEs: Send uplink power control commands in uplink scheduling information to the UE per UL CC until the Power Headroom Report (PHR) from the UE for each UL CC is at the target value according to Table 6.2A.2.1.4.2-1; allow at least 200 ms for the UE to reach maximum output power. Allow at least BEAM_SELECT_WAIT_TIME (NOTE 1) for the UE Tx beam selection to complete. 10. SS activates the UE Beamlock Function (UBF) by performing the procedure as specified in TS 38.508-1 [10] clause 4.9.2 using condition Tx only.
11. Measure the spurious emissions as per steps outlined below with an exception to the procedure in Annex K if the re-positioning concept is applied (NOTE 4). During measurement the spectrum analyser shall be set to 'Detector' = RMS. If the sweep count is higher than one, the trace mode shall be average.
- (a) Perform coarse TRP measurements to identify spurious emission frequencies and corresponding power level according to the procedures in Annex L, using coarse TRP measurement grid selection criteria as per Tables 6.5.3.1.4.2-1 through 6.5.3.1.4.2-3. The measurement is completed in both polarizations θ and ϕ over frequency range and measurement bandwidth according to Table 6.5A.3.1.1.5-1. Optionally, a larger and non-constant measurement bandwidth than that of Table 6.5A.3.1.1.5-1 may be applied as long as the SNR (ratio of test limit to floor noise of test equipment) ≥ 10 dB is guaranteed. The measurement period shall capture the [active time slots]. For each spurious emission frequency with coarse TRP identified to be less than the offsets listed in Tables 6.5.3.1.4.2-1 through 6.5.3.1.4.2-3 from the TRP limit according to Table 6.5A.3.1.1.5-1, either continue with another coarse TRP procedure and corresponding offset according to step (a) or continue with fine TRP procedures according to step (b).
- Different coarse TRP grids and corresponding offset values may be used for different frequencies. Multiple coarse TRP grids measurements with the corresponding offset values can be performed before the fine TRP measurement grid is applied. The coarse TRP grids and offset values used shall be recorded in the test report.
- (b) Measure fine TRP measurements according to procedures in Annex K, using fine TRP measurement grid selection criteria as per Table M.4.5-3 in Annex M, for each of the spurious emission frequency identified in step (a). Apply a measurement bandwidth according to Table 6.5A.3.1.1.5-1.

12. Apply the test step based on the 5G NR UE Release:

- 12a. For Release 16 and forward 5G NR UEs SS deactivates the UE Power Limit Function (UPLF) by performing the DEACTIVATE POWER LIMIT REQUEST procedure as specified in TS 38.508-1 [10] clause 4.9.33.
- 12b. For Release 15 5G NR UEs: No action.

13. SS deactivates the UE Beamlock Function (UBF) by performing the procedure as specified in TS 38.508-1 [10] clause 4.9.3.

NOTE 1: The frequency range defined in Table 6.5A.3.1.1.5-1 may be split into ranges. For each range a different test system, e.g. antenna and/or chamber, may be used. To pass the test case all verdicts of the frequency ranges must pass.

NOTE 2: Void.

NOTE 3: The BEAM_SELECT_WAIT_TIME default value is defined in Annex K.

NOTE 4: If the (in-band) beam peak is within $0^\circ \leq \theta \leq 90^\circ$: perform first hemispherical TRP scan ($0^\circ \leq \theta \leq 90^\circ$) in DUT Orientation 1 and second hemispherical TRP scan ($90^\circ > \theta \geq 0^\circ$) in DUT Orientation 2. If the (in-band) beam peak is within $90^\circ < \theta \leq 180^\circ$: perform first hemispherical TRP scan ($0^\circ \leq \theta \leq 90^\circ$) in DUT Orientation 2 and second hemispherical TRP scan ($90^\circ > \theta \geq 0^\circ$) in DUT Orientation 1. The DUT with UBF activated needs to be re-positioned during the test.

6.5A.3.1.1.4.3 Message contents

Message contents are according to TS 38.508-1 [10] subclause 4.6 with TRANSFORM_PRECODER_ENABLED condition in Table 4.6.3-118 PUSCH-Config with the following exceptions for Release 15 5G NR UE.

Table 6.5A.3.1.1.4.3-1: PUSCH-PowerControl

Derivation Path: TS 38.508-1 [10], Table 4.6.3-120			
Information Element	Value/remark	Comment	Condition
PUSCH-PowerControl ::= SEQUENCE {			
p0-AlphaSets SEQUENCE (SIZE (1..maxNrofP0-PUSCH-AlphaSets)) OF SEQUENCE {	1 entry		
P0-PUSCH-AlphaSet[1] SEQUENCE {			
alpha	alpha0		
}			
}			
}			

Table 6.5A.3.1.1.4.3-2: PUSCH-ConfigCommon

Derivation Path: TS 38.508-1[10], Table 4.6.3-119			
Information Element	Value/remark	Comment	Condition
PUSCH-ConfigCommon ::= SEQUENCE {			
p0-NominalWithGrant	-4		50 MHz
p0-NominalWithGrant	-8		100 MHz
p0-NominalWithGrant	-10		200 MHz
p0-NominalWithGrant	-14		400 MHz
}			

Table 6.5A.3.1.1.4.3-3: BSR-Config (Rel-15 UE only)

Derivation Path: TS 38.508-1 [10], Table 4.6.3-7			
Information Element	Value/remark	Comment	Condition
BSR-Config ::= SEQUENCE {			
periodicBSR-Timer	infinity		
retxBSR-Timer	sf80		
logicalChannelSR-DelayTimer	Not present		
}			

6.5A.3.1.1.5 Test Requirements

This clause specifies the requirements for the specified *NR* band for Transmitter Spurious emissions requirement with frequency range as indicated in Table 6.5A.3.1.1.5-1.

The maximum TRP power of spurious emission, measured using RMS detector, shall not exceed the described value in Table 6.5A.3.1.1.5-1.

Unless otherwise stated, the spurious emission limits apply for the frequency ranges that are more than F_{OoB} (MHz) in Table 6.5.3.1.3-1 starting from the edge of the assigned *NR* channel bandwidth. The spurious emission limits in Table 6.5A.3.1.1.5-1 apply for all transmitter band configurations (NRB) and channel bandwidths.

NOTE: For measurement conditions at the edge of each frequency range, the lowest frequency of the measurement position in each frequency range should be set at the lowest boundary of the frequency range plus MBW/2. The highest frequency of the measurement position in each frequency range should be set at the highest boundary of the frequency range minus MBW/2. MBW denotes the measurement bandwidth defined for the protected band.

Table 6.5A.3.1.1.5-1: Spurious emissions for CA test requirements

Frequency Range	Maximum Level	Measurement bandwidth	NOTE
6 GHz ≤ <i>f</i> < 12.75 GHz	-30 dBm	1 MHz	
12.75 GHz ≤ <i>f</i> ≤ 2 nd harmonic of the upper frequency edge of the UL operating band in GHz	-13 dBm	1 MHz	

NOTE 1: Applies for Band n257, n258, n260

6.5A.3.1.2 General spurious emissions for CA (3UL CA)

Editor's note: The following aspects are either missing or not yet determined:

- The testability of this test case is pending further analysis on relaxation of the requirement for band other than n257, n258, n260 and n261.
- Measurement Uncertainties and Test Tolerances are FFS for power class 1, 2, and 4.
- Test procedure only includes the testing of smartphone and is FFS for laptop and FWA.
- For a transition period until RAN5#103 meeting (May 2024), previous fine/coarse TRP measurement grid and offset values for corresponding coarse TRP measurement in TS 38.521-2 V17.2.0 are allowed for TE implementation.

6.5A.3.1.2.1 Test purpose

To verify that UE transmitter does not cause unacceptable interference to other channels or other systems in terms of transmitter spurious emissions.

6.5A.3.1.2.2 Test applicability

This test case applies to all types of NR UE release 15 and forward that supports FR2 3UL CA.

6.5A.3.1.2.3 Minimum conformance requirements

The minimum conformance requirements are defined in clause 6.5A.3.1.0.

6.5A.3.1.2.4 Test description

Same test description as in clause 6.5A.3.1.1.4.

6.5A.3.1.2.5 Test Requirements

The test requirement is the same as in clause 6.5A.3.1.1.5.

6.5A.3.1.3 General spurious emissions for CA (4UL CA)

Editor's note: The following aspects are either missing or not yet determined:

- The testability of this test case is pending further analysis on relaxation of the requirement for band other than n257, n258, n260 and n261.
- Measurement Uncertainties and Test Tolerances are FFS for power class 1, 2, and 4.
- Test procedure only includes the testing of smartphone and is FFS for laptop and FWA.
- For a transition period until RAN5#103 meeting (May 2024), previous fine/coarse TRP measurement grid and offset values for corresponding coarse TRP measurement in TS 38.521-2 V17.2.0 are allowed for TE implementation.

6.5A.3.1.3.1 Test purpose

To verify that UE transmitter does not cause unacceptable interference to other channels or other systems in terms of transmitter spurious emissions.

6.5A.3.1.3.2 Test applicability

This test case applies to all types of NR UE release 15 and forward that supports FR2 4UL CA.

6.5A.3.1.3.3 Minimum conformance requirements

The minimum conformance requirements are defined in clause 6.5A.3.1.0.

6.5A.3.1.3.4 Test description

Same test description as in clause 6.5A.3.1.1.4.

6.5A.3.1.3.5 Test Requirements

The test requirement is the same as in clause 6.5A.3.1.1.5.

6.5A.3.1.4 General spurious emissions for CA (5UL CA)

Editor's note: The following aspects are either missing or not yet determined:

- The testability of this test case is pending further analysis on relaxation of the requirement for band other than n257, n258, n260 and n261.
- Measurement Uncertainties and Test Tolerances are FFS for power class 1, 2, and 4.
- Test procedure only includes the testing of smartphone and is FFS for laptop and FWA.
- For a transition period until RAN5#103 meeting (May 2024), previous fine/coarse TRP measurement grid and offset values for corresponding coarse TRP measurement in TS 38.521-2 V17.2.0 are allowed for TE implementation.

6.5A.3.1.4.1 Test purpose

To verify that UE transmitter does not cause unacceptable interference to other channels or other systems in terms of transmitter spurious emissions.

6.5A.3.1.4.2 Test applicability

This test case applies to all types of NR UE release 15 and forward that supports FR2 5UL CA.

6.5A.3.1.4.3 Minimum conformance requirements

The minimum conformance requirements are defined in clause 6.5A.3.1.0.

6.5A.3.1.4.4 Test description

Same test description as in clause 6.5A.3.1.1.4.

6.5A.3.1.4.5 Test Requirements

The test requirement is the same as in clause 6.5A.3.1.1.5

6.5A.3.1.5 General spurious emissions for CA (6UL CA)

Editor's note: The following aspects are either missing or not yet determined:

- The testability of this test case is pending further analysis on relaxation of the requirement for band other than n257, n258, n260 and n261.
- Measurement Uncertainties and Test Tolerances are FFS for power class 1, 2, and 4.
- Test procedure only includes the testing of smartphone and is FFS for laptop and FWA.
- For a transition period until RAN5#103 meeting (May 2024), previous fine/coarse TRP measurement grid and offset values for corresponding coarse TRP measurement in TS 38.521-2 V17.2.0 are allowed for TE implementation.

6.5A.3.1.5.1 Test purpose

To verify that UE transmitter does not cause unacceptable interference to other channels or other systems in terms of transmitter spurious emissions.

6.5A.3.1.5.2 Test applicability

This test case applies to all types of NR UE release 15 and forward that supports FR2 6UL CA.

6.5A.3.1.5.3 Minimum conformance requirements

The minimum conformance requirements are defined in clause 6.5A.3.1.0.

6.5A.3.1.5.4 Test description

Same test description as in clause 6.5A.3.1.1.4.

6.5A.3.1.5.5 Test Requirements

The test requirement is the same as in clause 6.5A.3.1.1.5

6.5A.3.1.6 General spurious emissions for CA (7UL CA)

Editor's note: The following aspects are either missing or not yet determined:

- The testability of this test case is pending further analysis on relaxation of the requirement for band other than n257, n258, n260 and n261.
- Measurement Uncertainties and Test Tolerances are FFS for power class 1, 2, and 4.
- Test procedure only includes the testing of smartphone and is FFS for laptop and FWA.
- For a transition period until RAN5#103 meeting (May 2024), previous fine/coarse TRP measurement grid and offset values for corresponding coarse TRP measurement in TS 38.521-2 V17.2.0 are allowed for TE implementation.

6.5A.3.1.6.1 Test purpose

To verify that UE transmitter does not cause unacceptable interference to other channels or other systems in terms of transmitter spurious emissions.

6.5A.3.1.6.2 Test applicability

This test case applies to all types of NR UE release 15 and forward that supports FR2 7UL CA.

6.5A.3.1.6.3 Minimum conformance requirements

The minimum conformance requirements are defined in clause 6.5A.3.1.0.

6.5A.3.1.6.4 Test description

Same test description as in clause 6.5A.3.1.1.4.

6.5A.3.1.6.5 Test Requirements

The test requirement is the same as in clause 6.5A.3.1.1.5

6.5A.3.1.7 General spurious emissions for CA (8UL CA)

Editor's note: The following aspects are either missing or not yet determined:

- The testability of this test case is pending further analysis on relaxation of the requirement for band other than n257, n258, n260 and n261.
- Measurement Uncertainties and Test Tolerances are FFS for power class 1, 2, and 4.
- Test procedure only includes the testing of smartphone and is FFS for laptop and FWA.
- For a transition period until RAN5#103 meeting (May 2024), previous fine/coarse TRP measurement grid and offset values for corresponding coarse TRP measurement in TS 38.521-2 V17.2.0 are allowed for TE implementation.

6.5A.3.1.7.1 Test purpose

To verify that UE transmitter does not cause unacceptable interference to other channels or other systems in terms of transmitter spurious emissions.

6.5A.3.1.7.2 Test applicability

This test case applies to all types of NR UE release 15 and forward that supports FR2 8UL CA.

6.5A.3.1.7.3 Minimum conformance requirements

The minimum conformance requirements are defined in clause 6.5A.3.1.0.

6.5A.3.1.7.4 Test description

Same test description as in clause 6.5A.3.1.1.4.

6.5A.3.1.7.5 Test Requirements

The test requirement is the same as in clause 6.5A.3.1.1.5

6.5A.3.2 Spurious emission band UE co-existence for UL CA

This clause specifies the requirements for the specified carrier aggregation configurations for coexistence with protected bands. The requirement is verified in beam locked mode with the test metric of TRP (Link=TX beam peak direction, Meas=TRP grid). The TX beam peak direction used for CA testing is the [same as that found for single carrier scenario in clause 6.5.3].

NOTE: For measurement conditions at the edge of each frequency range, the lowest frequency of the measurement position in each frequency range should be set at the lowest boundary of the frequency range plus MBW/2. The highest frequency of the measurement position in each frequency range should be set at the highest boundary of the frequency range minus MBW/2. MBW denotes the measurement bandwidth defined for the protected band.

6.5A.3.2.0 Minimum conformance requirements

For intra-band contiguous carrier aggregation, the requirements in Table 6.5A.3.2.0-1 apply.

Table 6.5A.3.2.0-1: Spurious emissions UE co-existence CA limits

CA band	Spurious emission						
	Protected band / frequency range	Frequency range (MHz)			Maximum Level (dBm)	MBW (MHz)	NOTE
CA_n257	NR Band n260	F _{DL_low}	-	F _{DL_high}	-2	100	
	Frequency range	23600	-	24000	1	200	2
	Frequency range	57000	-	66000	2	100	
CA_n258							
	Frequency range	57000	-	66000	2	100	
CA_n259	NR Band 257	F _{DL_low}	-	F _{DL_high}	-5	100	
	NR Band 261	F _{DL_low}	-	F _{DL_high}	-5	100	

CA_n260	Frequency range	36000	-	37000	7	1000	
	Frequency range	57000	-	66000	2	100	
	NR Band 257	F _{DL_low}	-	F _{DL_high}	-5	100	
	NR Band 261	F _{DL_low}	-	F _{DL_high}	-5	100	
	Frequency range	57000	-	66000	2	100	
CA_n261	NR Band 260	F _{DL_low}	-	F _{DL_high}	-2	100	
	Frequency range	57000	-	66000	2	100	
	Frequency range	57000	-	66000	2	100	
NOTE 1: F _{DL_low} and F _{DL_high} refer to each NR frequency band specified in Table 5.2-1							
NOTE 2: The protection of frequency range 23600-24000MHz is meant for protection of satellite passive services.							

6.5A.3.2.1 Spurious emission band UE co-existence for CA (2UL CA)

Editor's note: The following aspects are either missing or not yet determined:

- The testability of this test case is pending further analysis on relaxation of the requirement for band other than n257, n258, n260 and n261.
- Measurement Uncertainties and Test Tolerances are FFS for power class 1, 2, and 4.
- Test procedure only includes the testing of smartphone and is FFS for laptop and FWA.
- For a transition period until RAN#99, the stability and repeatability of test procedure with PHR (variant b) for Rel-15 UEs is under evaluation.
- For a transition period until RAN5#103 meeting (May 2024), previous fine/coarse TRP measurement grid and offset values for corresponding coarse TRP measurement in TS 38.521-2 V17.2.0 are allowed for TE implementation.

6.5A.3.2.1.1 Test purpose

To verify that UE transmitter does not cause unacceptable interference when in co-existence with protected bands in terms of transmitter spurious emissions.

6.5A.3.2.1.2 Test applicability

This test case applies to all types of NR UE release 15 and forward that supports FR2 2UL CA.

6.5A.3.2.1.3 Minimum conformance requirements

Same minimum conformance requirements as in clause 6.5A.3.2.0.

6.5A.3.2.1.4 Test description

6.5A.3.2.1.4.1 Initial conditions

Initial conditions are a set of test configurations the UE needs to be tested in and the steps for the SS to take with the UE to reach the correct measurement state.

The initial test configurations consist of environmental conditions, test frequencies, and channel bandwidths based on NR operating bands specified in clause 5.5A. All of these configurations shall be tested with applicable test parameters for each channel bandwidth and subcarrier spacing, are shown in Table 6.5A.3.2.1.4.1-1. The details of the uplink reference measurement channels (RMCs) are specified in Annexes A.2. Configurations of PDSCH and PDCCH before measurement are specified in Annex C.2.

Table 6.5A.3.2.1.4.1-1: Test Configuration Table

Initial Conditions	
Test Environment as specified in TS 38.508-1 [10] subclause 4.1	Normal

Test Frequencies as specified in TS 38.508-1 [10] subclause 4.3.1.2.3 for different CA bandwidth classes		Low range, High range (NOTE 2)		
Test CC combination setting as specified in TS 38.508-1 [10] subclause 4.3.1.2.3 for the CA Configuration across bandwidth combination sets supported by the UE.		Maximum aggregated BW (contiguous CA)		
Test SCS as specified in Table 5.3.5-1		120kHz		
Test Parameters				
Test ID	CC	Downlink Configuration	UL Modulation	UL RB allocation (NOTE 1)
1	PCC	-	DFT-s-OFDM QPSK	Outer_Full
	SCCs		DFT-s-OFDM QPSK	Outer_Full
2	PCC		DFT-s-OFDM QPSK	Inner_1RB for PC2, PC3 and PC4 (Note 6) Inner_2RB for PC2, PC3 and PC4 (Note 7) Inner_Partial for PC1 (NOTE 3)
	SCCs		DFT-s-OFDM QPSK	Inner_1RB for PC2, PC3 and PC4 (Note 6) Inner_2RB for PC2, PC3 and PC4 (Note 7) Inner_Partial for PC1
NOTE 1: The specific configuration of each RB allocation is defined in Table 6.1-1 for PC2, PC3 and PC4 or Table 6.1-2 for PC1.				
NOTE 2: When testing Low range test only in Frequency Range lower than ($F_{UL_low} - \Delta f_{OOB}$) and when testing High range test only in Frequency Range higher than ($F_{UL_high} + \Delta f_{OOB}$).				
NOTE 3: When testing Low range configure uplink RB to Inner_1RB_Left for PC2, PC3 and PC4 or Inner_Partial_Left_Region1 for PC1 and when testing High range configure uplink RB to Inner_1RB_Right for PC2, PC3 and PC4 or Inner_Partial_Right_Region1 for PC1.				
NOTE 4: For a FR2 band under test, if the protected band frequency range in Table 6.5A.3.2.0-1 is only on lower or only higher frequency region with respect to the FR2 band under test then it is sufficient to test only Low range or High range frequencies, otherwise test at both Low range and High range.				
NOTE 5: Number of DL CCs shall be configured the same as number of UL CCs. The requirements are applicable as per 5.3A.4: " <i>The requirements are applicable only when Uplink CCs are configured within the frequency range between lower edge of lowest downlink component carrier and upper edge of highest downlink component carrier</i> ".				
NOTE 6: Applicable to Rel-16 and forward UEs.				
NOTE 7: Applicable to Rel-15 UEs.				

1. Connection between SS and UE is shown in TS 38.508-1 [10] Annex A, Figure A.3.3.1.3 for TE diagram and Figure A.3.4.1.1 for UE diagram.
2. The parameter settings for the cell are set up according to TS 38.508-1 [10] subclause 4.4.3.
3. Downlink signals are initially set up according to Annex C, and uplink signals according to Annex G.
4. The UL Reference Measurement channels are set according to Table 6.5A.3.2.1.4.1-1.
5. Propagation conditions are set according to Annex B.0.
6. Ensure the UE is in state RRC_CONNECTED with generic procedure parameters Connectivity *NR*, Connected without release *On*, Test Mode *On* and Test Loop Function *On* according to TS 38.508-1 [10] clause 4.5. Message contents are defined in clause 6.5A.3.2.1.4.3.

6.5A.3.2.1.4.2 Test procedure

1. Select any of the three Alignment Options (1, 2, or 3) from Tables N.2-1 through N.2-3 to mount the DUT inside the QZ.
2. If the re-positioning concept is applied, position the device in DUT Orientation 1 if the maximum beam peak direction is within zenith angular range $0^\circ \leq \theta \leq 90^\circ$ for the alignment option selected in step 1; position the device in DUT Orientation 2 (either Options 1 or 2) if the maximum beam peak direction is within zenith angular range

- 90° < θ ≤ 180° for DUT Orientation 1 for the alignment option selected in step 1. If the re-positioning concept is not applied, position the device in DUT Orientation 1.
3. Configure SCC according to Annex C.0, C.1, C.2 for all downlink physical channels.
 4. The SS shall configure SCC as per TS 38.508-1 [10] clause 5.5.1. Message contents are defined in clause 6.5A.3.2.1.4.3.
 5. Apply the test step based on the 5G NR UE Release:
 - 5a. For Release 16 and forward 5G NR UEs: SS applies a backoff on the PCell power by activating the UE Power Limit Function (UPLF). The ACTIVATE POWER LIMIT REQUEST procedure is performed as specified in TS 38.508-1 [10] clause 4.9.32 using TOTAL NR AGGREGATED BANDWIDTH and PCELL NR bandwidth as per Test CC Combination setting. UE shall transmit ACTIVATE POWER LIMIT RESPONSE to SS. Go to step 6.
 - 5b. For Release 15 5G NR UEs: No action.
 6. SS activates SCC by sending the activation MAC CE (Refer TS 38.321 [28], clauses 5.9, 6.1.3.10). Wait for at least 2 seconds (Refer TS 38.133[25], clause 9.3).
 7. SS sends uplink scheduling information for each UL HARQ process via PDCCH DCI format 0_1 for C_RNTI to schedule the UL RMC according to Table 6.5A.3.2.1.4.1-1. Since the UL has no payload and no loopback data to send the UE sends uplink MAC padding bits on the UL RMC.
 8. Set the UE in the Inband Tx beam peak direction [(same as that found for single carrier in clause 6.5.3)] found with a 3D EIRP scan as performed in Annex K.1.1. Allow at least BEAM_SELECT_WAIT_TIME (NOTE 3) for the UE Tx beam selection to complete.
 9. Apply the test step based on the 5G NR UE Release:
 - 9a. For Release 16 and forward 5G NR UEs: Send continuously uplink power control "up" commands in every uplink scheduling information to the UE; allow at least 200msec for the UE to reach P_{UMAX}. Allow at least BEAM_SELECT_WAIT_TIME (NOTE 3) for the UE Tx beam selection to complete.
 - 9b. For Release 15 5G NR UEs: Send uplink power control commands in uplink scheduling information to the UE per UL CC until the Power Headroom Report (PHR) from the UE for each UL CC is at the target value according to Table 6.2A.2.1.4.2-1; allow at least 200 ms for the UE to reach maximum output power. Allow at least BEAM_SELECT_WAIT_TIME (NOTE 1) for the UE Tx beam selection to complete.
 10. SS activates the UE Beamlock Function (UBF) by performing the procedure as specified in TS 38.508-1 [10] clause 4.9.2 using condition Tx only.
 11. Measure the spurious emissions as per steps outlined below with an exception to the procedure in Annex K if the re-positioning concept is applied (NOTE 4). During measurement the spectrum analyser shall be set to 'Detector' = RMS. If the sweep count is higher than one, the trace mode shall be average.
 - (a) Perform coarse TRP measurements to identify spurious emission frequencies and corresponding power level according to the procedures in Annex L, using coarse TRP measurement grid selection criteria as per Tables 6.5.3.1.4.2-1 through 6.5.3.1.4.2-3. The measurement is completed in both polarizations θ and ϕ over frequency range and measurement bandwidth according to Table 6.5A.3.2.1.5-1. Optionally, a larger and non-constant measurement bandwidth than that of Table 6.5A.3.2.1.5-1 may be applied as long as the SNR (ratio of test limit to floor noise of test equipment) ≥ 10dB is guaranteed. The measurement period shall capture the [active time slots]. For each spurious emission frequency with coarse TRP identified to be less than an offset dB (NOTE 2) from the TRP limit according to Table 6.5A.3.2.1.5-1, either continue with another coarse TRP procedure and corresponding offset according to step (a) or continue with fine TRP procedures according to step (b).

Different coarse TRP grids and corresponding offset values may be used for different frequencies. Multiple coarse TRP grids measurements with the corresponding offset values can be performed before the fine TRP measurement grid is applied. The coarse TRP grids and offset values used shall be recorded in the test report.
 - (b) Measure fine TRP measurements according to procedures in Annex K, using fine TRP measurement grid selection criteria as per Table M.4.5-3 in Annex M, for each of the spurious emission frequency identified in step (a). Apply a measurement bandwidth according to Table 6.5A.3.2.1.5-1.

12. Apply the test step based on the 5G NR UE Release:

12a. For Release 16 and forward 5G NR UEs: SS deactivates the UE Power Limit Function (UPLF) by performing the DEACTIVATE POWER LIMIT REQUEST procedure as specified in TS 38.508-1 [10] clause 4.9.33.

12b. For Release 15 5G NR UEs: No action.

13. SS deactivates the UE Beamlock Function (UBF) by performing the procedure as specified in TS 38.508-1 [10] clause 4.9.3.

NOTE 1: The frequency range defined in Table 6.5A.3.2.1.5-1 may be split into ranges. For each range a different test system, e.g. antenna and/or chamber, may be used. To pass the test case all verdicts of the frequency ranges must pass.

NOTE 2: Void.

NOTE 3: The BEAM_SELECT_WAIT_TIME default value is defined in Annex K.

NOTE 4: If the (in-band) beam peak is within $0^\circ \leq \theta < 90^\circ$: perform first hemispherical TRP scan ($0^\circ \leq \theta < 90^\circ$) in DUT Orientation 1 and second hemispherical TRP scan ($90^\circ > \theta \geq 0^\circ$) in DUT Orientation 2. If the (in-band) beam peak is within $90^\circ < \theta \leq 180^\circ$: perform first hemispherical TRP scan ($0^\circ \leq \theta < 90^\circ$) in DUT Orientation 2 and second hemispherical TRP scan ($90^\circ > \theta \geq 0^\circ$) in DUT Orientation 1. The DUT with UBF activated needs to be re-positioned during the test.

6.5A.3.2.1.4.3 Message contents

Message contents are according to TS 38.508-1 [10] subclause 4.6.1 with the following exceptions for Release 15 5G NR UE.

Table 6.5A.3.2.1.4.3-1: PUSCH-PowerControl

Derivation Path: TS 38.508-1 [10], Table 4.6.3-120			
Information Element	Value/remark	Comment	Condition
PUSCH-PowerControl ::= SEQUENCE {			
p0-AlphaSets SEQUENCE (SIZE (1..maxNrofP0-PUSCH-AlphaSets)) OF SEQUENCE {	1 entry		
P0-PUSCH-AlphaSet[1] SEQUENCE {			
alpha	alpha0		
}			
}			
}			

Table 6.5A.3.2.1.4.3-2: PUSCH-ConfigCommon

Derivation Path: TS 38.508-1[10], Table 4.6.3-119			
Information Element	Value/remark	Comment	Condition
PUSCH-ConfigCommon ::= SEQUENCE {			
p0-NominalWithGrant	-4		50 MHz
p0-NominalWithGrant	-8		100 MHz
p0-NominalWithGrant	-10		200 MHz
p0-NominalWithGrant	-14		400 MHz
}			

Table 6.5A.3.2.1.4.3-3: BSR-Config (Rel-15 UE only)

Derivation Path: TS 38.508-1 [10], Table 4.6.3-7			
Information Element	Value/remark	Comment	Condition
BSR-Config ::= SEQUENCE {			
periodicBSR-Timer	infinity		
retxBSR-Timer	sf80		
logicalChannelSR-DelayTimer	Not present		
}			

6.5A.3.2.1.5 Test requirement

This clause specifies the requirements for the specified NR band for Transmitter Spurious emissions for UE co-existence requirement with frequency range as indicated in Table 6.5A.3.2.1.5-1.

The maximum TRP power of spurious emission for UE co-existence, measured using RMS detector, shall not exceed the described value in Table 6.5A.3.2.1.5-1.

The spurious emission UE co-existence limits in Table 6.5A.3.2.1.5-1 apply for all transmitter band configurations (NRB) and channel bandwidths.

NOTE: For measurement conditions at the edge of each frequency range, the lowest frequency of the measurement position in each frequency range should be set at the lowest boundary of the frequency range plus MBW/2. The highest frequency of the measurement position in each frequency range should be set at the highest boundary of the frequency range minus MBW/2. MBW denotes the measurement bandwidth defined for the protected band.

Table 6.5A.3.2.1.5-1: Spurious emissions UE co-existence CA test requirements

UL CA for any CA bandwidth class	Spurious emission						
	Protected band / frequency range	Frequency range (MHz)			Maximum Level (dBm)	MBW (MHz)	NOTE
CA_n257	NR Band n260	F _{DL_low}	-	F _{DL_high}	-2 + 5.0	100	3
	Frequency range	23600	-	24000	1 + 0.3	200	2, 4
	Frequency range	57000	-	66000	2	100	
CA_n258	Frequency range	57000	-	66000	2	100	
CA_n259	NR Band 257	F _{DL_low}	-	F _{DL_high}	-5 + 3.3	100	5
	NR Band 261	F _{DL_low}	-	F _{DL_high}	-5 + 3.3	100	5
	Frequency range	36000	-	37000	7 + 6.0	1000	6
	Frequency range	57000	-	66000	2	100	
CA_n260	NR Band 257	F _{DL_low}	-	F _{DL_high}	-5 + 3.3	100	5
	NR Band 261	F _{DL_low}	-	F _{DL_high}	-5 + 3.3	100	5
	Frequency range	57000	-	66000	2	100	
CA_n261	NR Band 260	F _{DL_low}	-	F _{DL_high}	-2 + 5.0	100	3
	Frequency range	57000	-	66000	2	100	

NOTE 1: F_{DL_low} and F_{DL_high} refer to each NR frequency band specified in Table 5.2-1
NOTE 2: The protection of frequency range 23600-2400MHz is meant for protection of satellite passive services.
NOTE 3: 5.0 dB relaxation due to testability limit
NOTE 4: 0.3 dB relaxation due to testability limit
NOTE 5: 3.3 dB relaxation due to testability limit
NOTE 6: 6.0 dB relaxation due to testability limit

6.5A.3.2.2 Spurious emission band UE co-existence for CA (3UL CA)

Editor's note: The following aspects are either missing or not yet determined:

- The testability of this test case is pending further analysis on relaxation of the requirement for band other than n257, n258, n260 and n261.
- Measurement Uncertainties and Test Tolerances are FFS for power class 1, 2, and 4.
- Test procedure only includes the testing of smartphone and is FFS for laptop and FWA.
- For a transition period until RAN5#103 meeting (May 2024), previous fine/coarse TRP measurement grid and offset values for corresponding coarse TRP measurement in TS 38.521-2 V17.2.0 are allowed for TE implementation.

6.5A.3.2.2.1 Test purpose

To verify that UE transmitter does not cause unacceptable interference when in co-existence with protected bands in terms of transmitter spurious emissions.

6.5A.3.2.2.2 Test applicability

This test case applies to all types of NR UE release 15 and forward that supports FR2 3UL CA.

6.5A.3.2.2.3 Minimum conformance requirements

The minimum conformance requirements are defined in clause 6.5A.3.2.0.

6.5A.3.2.2.4 Test description

Same test description as in clause 6.5A.3.2.1.4.

6.5A.3.2.2.5 Test Requirements

The test requirement is the same as in clause 6.5A.3.2.1.5.

6.5A.3.2.3 Spurious emission band UE co-existence for CA (4UL CA)

Editor's note: The following aspects are either missing or not yet determined:

- The testability of this test case is pending further analysis on relaxation of the requirement for band other than n257, n258, n260 and n261.
- Measurement Uncertainties and Test Tolerances are FFS for power class 1, 2, and 4.
- Test procedure only includes the testing of smartphone and is FFS for laptop and FWA.
- For a transition period until RAN5#103 meeting (May 2024), previous fine/coarse TRP measurement grid and offset values for corresponding coarse TRP measurement in TS 38.521-2 V17.2.0 are allowed for TE implementation.

6.5A.3.2.3.1 Test purpose

To verify that UE transmitter does not cause unacceptable interference when in co-existence with protected bands in terms of transmitter spurious emissions.

6.5A.3.2.3.2 Test applicability

This test case applies to all types of NR UE release 15 and forward that supports FR2 4UL CA.

6.5A.3.2.3.3 Minimum conformance requirements

The minimum conformance requirements are defined in clause 6.5A.3.2.0.

6.5A.3.2.3.4 Test description

Same test description as in clause 6.5A.3.2.1.4.

6.5A.3.2.3.5 Test Requirements

The test requirement is the same as in clause 6.5A.3.2.1.5.

6.5A.3.2.4 Spurious emission band UE co-existence for CA (5UL CA)

Editor's note: The following aspects are either missing or not yet determined:

- The testability of this test case is pending further analysis on relaxation of the requirement for band other than n257, n258, n260 and n261.
- Measurement Uncertainties and Test Tolerances are FFS for power class 1, 2, and 4.
- Test procedure only includes the testing of smartphone and is FFS for laptop and FWA.
- For a transition period until RAN5#103 meeting (May 2024), previous fine/coarse TRP measurement grid and offset values for corresponding coarse TRP measurement in TS 38.521-2 V17.2.0 are allowed for TE implementation.

6.5A.3.2.4.1 Test purpose

To verify that UE transmitter does not cause unacceptable interference when in co-existence with protected bands in terms of transmitter spurious emissions.

6.5A.3.2.4.2 Test applicability

This test case applies to all types of NR UE release 15 and forward that supports FR2 5UL CA.

6.5A.3.2.4.3 Minimum conformance requirements

The minimum conformance requirements are defined in clause 6.5A.3.2.0.

6.5A.3.2.4.4 Test description

Same test description as in clause 6.5A.3.2.1.4.

6.5A.3.2.4.5 Test Requirements

The test requirement is the same as in clause 6.5A.3.2.1.5.

6.5A.3.2.5 Spurious emission band UE co-existence for CA (6UL CA)

Editor's note: The following aspects are either missing or not yet determined:

- The testability of this test case is pending further analysis on relaxation of the requirement for band other than n257, n258, n260 and n261.
- Measurement Uncertainties and Test Tolerances are FFS for power class 1, 2, and 4.
- Test procedure only includes the testing of smartphone and is FFS for laptop and FWA.
- For a transition period until RAN5#103 meeting (May 2024), previous fine/coarse TRP measurement grid and offset values for corresponding coarse TRP measurement in TS 38.521-2 V17.2.0 are allowed for TE implementation.

6.5A.3.2.5.1 Test purpose

To verify that UE transmitter does not cause unacceptable interference when in co-existence with protected bands in terms of transmitter spurious emissions.

6.5A.3.2.5.2 Test applicability

This test case applies to all types of NR UE release 15 and forward that supports FR2 6UL CA.

6.5A.3.2.5.3 Minimum conformance requirements

The minimum conformance requirements are defined in clause 6.5A.3.2.0.

6.5A.3.2.5.4 Test description

Same test description as in clause 6.5A.3.2.1.4.

6.5A.3.2.5.5 Test Requirements

The test requirement is the same as in clause 6.5A.3.2.1.5.

6.5A.3.2.6 Spurious emission band UE co-existence for CA (7UL CA)

Editor's note: The following aspects are either missing or not yet determined:

- The testability of this test case is pending further analysis on relaxation of the requirement for band other than n257, n258, n260 and n261.
- Measurement Uncertainties and Test Tolerances are FFS for power class 1, 2, and 4.
- Test procedure only includes the testing of smartphone and is FFS for laptop and FWA.
- For a transition period until RAN5#103 meeting (May 2024), previous fine/coarse TRP measurement grid and offset values for corresponding coarse TRP measurement in TS 38.521-2 V17.2.0 are allowed for TE implementation.

6.5A.3.2.6.1 Test purpose

To verify that UE transmitter does not cause unacceptable interference when in co-existence with protected bands in terms of transmitter spurious emissions.

6.5A.3.2.6.2 Test applicability

This test case applies to all types of NR UE release 15 and forward that supports FR2 7UL CA.

6.5A.3.2.6.3 Minimum conformance requirements

The minimum conformance requirements are defined in clause 6.5A.3.2.0.

6.5A.3.2.6.4 Test description

Same test description as in clause 6.5A.3.2.1.4.

6.5A.3.2.6.5 Test Requirements

The test requirement is the same as in clause 6.5A.3.2.1.5.

6.5A.3.2.7 Spurious emission band UE co-existence for CA (8UL CA)

Editor's note: The following aspects are either missing or not yet determined:

- The testability of this test case is pending further analysis on relaxation of the requirement for band other than n257, n258, n260 and n261.
- Measurement Uncertainties and Test Tolerances are FFS for power class 1, 2, and 4.
- Test procedure only includes the testing of smartphone and is FFS for laptop and FWA.
- For a transition period until RAN5#103 meeting (May 2024), previous fine/coarse TRP measurement grid and offset values for corresponding coarse TRP measurement in TS 38.521-2 V17.2.0 are allowed for TE implementation.

6.5A.3.2.7.1 Test purpose

To verify that UE transmitter does not cause unacceptable interference when in co-existence with protected bands in terms of transmitter spurious emissions.

6.5A.3.2.7.2 Test applicability

This test case applies to all types of NR UE release 15 and forward that supports FR2 8UL CA.

6.5A.3.2.7.3 Minimum conformance requirements

The minimum conformance requirements are defined in clause 6.5A.3.2.0.

6.5A.3.2.7.4 Test description

Same test description as in clause 6.5A.3.2.1.4.

6.5A.3.2.7.5 Test Requirements

The test requirement is the same as in clause 6.5A.3.2.1.5.

6.5A.3.3 Additional spurious emissions for CA

6.5A.3.3.0 Minimum conformance requirements

The additional spurious emission for CA limits in Table 6.5A.3.3.0-2 ,Table 6.5A.3.3.0-3 and Table 6.5A.3.3.0-4 apply for all transmitter band configurations (RB) and channel bandwidths. The requirement is verified in beam locked mode with the test metric of TRP (Link=TX beam peak direction, Meas=TRP grid).

NOTE: For measurement conditions at the edge of each frequency range, the lowest frequency of the measurement position in each frequency range should be set at the lowest boundary of the frequency range plus MBW/2. The highest frequency of the measurement position in each frequency range should be set at the highest boundary of the frequency range minus MBW/2. MBW denotes the measurement bandwidth defined for the protected band.

Table 6.5A.3.3.0-1: Void

When " CA_NS_202" is indicated in the cell, the power of any UE emission shall not exceed the levels specified in Table 6.5A.3.3.0-2.

Table 6.5A.3.3.0-2: Additional spurious emissions for (CA_NS_202) test limits

Frequency Range	Maximum Level	Measurement bandwidth	Note
7.25 GHz ≤ f ≤ 2 nd harmonic of the upper frequency edge of the UL operating band	-10 dBm	100 MHz	
23.6 GHz ≤ f ≤ 24.0 GHz	-5 dBm	200 MHz	1
NOTE 1: This requirement also applies for the frequency ranges that are less than F _{OOB} (MHz) in Table 6.5.3-1 from the edge of the channel bandwidth. The protection of frequency range 23600 - 24000 MHz is meant for protection of satellite passive services.			

When "CA_NS_203" is indicated in the cell, the power of any UE emission shall not exceed the levels specified in Table 6.5A.3.3.0-3. This requirement also applies for the frequency ranges that are less than F_{OOB} (MHz) in Table 6.5A.3.2.0-1 from the edge of the channel bandwidth.

Table 6.5A.3.3.0-3: Additional spurious emissions (CA_NS_203) test limits

Frequency band (GHz)	Spectrum emission limit (dBm)	Measurement bandwidth
23.6 ≤ f ≤ 24.0	+1	200 MHz

When "CA_NS_205" is indicated in the cell, the power of any UE emission shall not exceed the levels specified in Table 6.5A.3.3.0-4. This requirement also applies for the frequency ranges that are less than F_{OOB} (MHz) as defined in section 6.5A.3.2.0-1

Table 6.5A.3.3.0-4: Additional spurious emissions (CA_NS_205) test limits

Frequency band (GHz)	Spectrum emission limit (dBm)	Measurement bandwidth
$23.6 \leq f \leq 24.0$	-5	200 MHz

The normative reference for this requirement is TS 38.101-2 subclause 6.5A.3.2.

6.5A.3.3.1 Additional spurious emissions for CA (2UL CA)

Editor's note: The following aspects are either missing or not yet determined:

- This test case is incomplete for Power classes other than 1, 3, 5 and CA other than intra-band contiguous.
- Measurement Uncertainties and Test Tolerances are FFS for power class other than 1, 3, 5 and CA other than intra-band contiguous.
- The testability of this test case is pending further analysis on relaxation of the requirement for band other than n257, n258.
- Test procedure only includes the testing of smartphone and is FFS for laptop.
- For a transition period until RAN#99, the stability and repeatability of test procedure with PHR (variant b) for Rel-15 UEs is under evaluation.

6.5A.3.3.1.1 Test purpose

Additional spurious emission requirements are signalled by the network to indicate that the UE shall meet an additional requirement for a specific deployment scenario as part of the cell handover/broadcast message.

6.5A.3.3.1.2 Test applicability

This test case applies to all types of NR UE release 15 and forward that supports FR2 2UL CA.

6.5A.3.3.1.3 Minimum conformance requirements

Same minimum conformance requirements as in clause 6.5A.3.3.0.

6.5A.3.3.1.4 Test description

6.5A.3.3.1.4.1 Initial conditions

Initial conditions are a set of test configurations the UE needs to be tested in and the steps for the SS to take with the UE to reach the correct measurement state.

The initial test configurations consist of environmental conditions, test frequencies, and channel bandwidths based on NR operating bands specified in clause 5.5A. All of these configurations shall be tested with applicable test parameters for each channel bandwidth and subcarrier spacing, are shown in Table 6.5A.3.3.1.4.1-1, Table 6.5A.3.3.1.4.1-2 and Table 6.5A.3.3.1.4.1-2b. The details of the uplink reference measurement channels (RMCs) are specified in Annexes A.2. Configurations of PDSCH and PDCCH before measurement are specified in Annex C.2.

Table 6.5A.3.3.1.4.1-1: Test Configuration Table for CA_NS_202 (Power Class 1)

Initial Conditions	
Test Environment as specified in TS 38.508-1 [10] subclause 4.1	Normal

Test Frequencies as specified in TS 38.508-1 [10] subclause 4.3.1.2.3 for different CA bandwidth classes		Low range, High range (NOTE 2)		
Test CC combination setting as specified in TS 38.508-1 [10] subclause 4.3.1.2.3 for the CA Configuration across bandwidth combination sets supported by the UE.		Maximum aggregated BW (contiguous CA)		
Test SCS as specified in Table 5.3.5-1		120kHz		
Test Parameters				
Test ID	CC	Downlink Configuration	UL Modulation	UL RB allocation (NOTE 1)
1 (NOTE 4)	PCC	-	DFT-s-OFDM QPSK	Outer_Full
	SCCs		DFT-s-OFDM QPSK	Outer_Full
2 (NOTE 4)	PCC		DFT-s-OFDM 64QAM	Outer_Full
	SCCs		DFT-s-OFDM 64QAM	Outer_Full
NOTE 1: The specific configuration of each RB allocation is defined in Table 6.1-2 for PC1.				
NOTE 2: When testing Low range test only in Frequency Range lower than ($F_{UL_low} - \Delta f_{OOB}$) and when testing High range test only in Frequency Range higher than ($F_{UL_high} + \Delta f_{OOB}$).				
NOTE 3: Void				
NOTE 4: This Test ID applies only to PC1.				
NOTE 5: Number of DL CCs shall be configured the same as number of UL CCs. The requirements are applicable as per 5.3A.4: "The requirements are applicable only when Uplink CCs are configured within the frequency range between lower edge of lowest downlink component carrier and upper edge of highest downlink component carrier".				

Table 6.5A.3.3.1.4.1-1b: Test Configuration Table for CA_NS_202 (Power Class 2, 3, 4, 5)

Initial Conditions				
Test Environment as specified in TS 38.508-1 [10] subclause 4.1		Normal		
Test Frequencies as specified in TS 38.508-1 [10] subclause 4.3.1.2.3 for different CA bandwidth classes		Low range, High range		
Test CC combination setting as specified in TS 38.508-1 [10] subclause 4.3.1.2.3 for the CA Configuration across bandwidth combination sets supported by the UE.		Maximum aggregated BW (contiguous CA) with cumulative aggregated BW <= 400MHz		
Test SCS as specified in Table 5.3.5-1		120kHz		
Test Parameters				
Test ID	CC	Downlink Configuration	UL Modulation	UL RB allocation (NOTE 1)
1	PCC	-	DFT-s-OFDM QPSK	Inner_Full for PC2, PC3 PC4, PC5
	SCCs		-	
NOTE 1: The specific configuration of each RB allocation is defined in Table 6.1-1 for PC2, PC3, PC4, PC5.				
NOTE 2: Number of DL CCs shall be configured the same as number of UL CCs. The requirements are applicable as per 5.3A.4: "The requirements are applicable only when Uplink CCs are configured within the frequency range between lower edge of lowest downlink component carrier and upper edge of highest downlink component carrier".				

Table 6.5A.3.3.1.4.1-2: Test Configuration Table for CA_NS_203 (Power Class 1, 2, 3, 4, 5)

Initial Conditions	
Test Environment as specified in TS 38.508-1 [10] subclause 4.1	Normal
Test Frequencies as specified in TS 38.508-1 [10] subclause 4.3.1.2.3 for different CA bandwidth classes	Low range
Test CC combination setting as specified in TS 38.508-1 [10] subclause 4.3.1.2.3 for the CA Configuration across bandwidth combination sets supported by the UE.	Maximum aggregated BW (contiguous CA) with cumulative aggregated BW <= 400MHz

Test SCS as specified in Table 5.3.5-1		120kHz		
Test Parameters				
Test ID	CC	Downlink Configuration	UL Modulation	UL RB allocation (NOTE 1)
1	PCC	-	DFT-s-OFDM QPSK	Inner_Full for PC2, PC3 PC4, PC5 Inner_Full_Region1 for PC1
	SCCs		-	-
NOTE 1: The specific configuration of each RB allocation is defined in Table 6.1-1 for PC2, PC3, PC4, PC5 or Table 6.1-2 for PC1.				
NOTE 2: Number of DL CCs shall be configured the same as number of UL CCs. The requirements are applicable as per 5.3A.4: " <i>The requirements are applicable only when Uplink CCs are configured within the frequency range between lower edge of lowest downlink component carrier and upper edge of highest downlink component carrier</i> ".				

Table 6.5A.3.3.1.4.1-2b: Test Configuration Table for CA_NS_205 (Power Class 1)

Initial Conditions				
Test Environment as specified in TS 38.508-1 [10] subclause 4.1		Normal		
Test Frequencies as specified in TS 38.508-1 [10] subclause 4.3.1.2.3 for different CA bandwidth classes		Low range		
Test CC combination setting as specified in TS 38.508-1 [10] subclause 4.3.1.2.3 for the CA Configuration across bandwidth combination sets supported by the UE.		Maximum aggregated BW (contiguous CA) with cumulative aggregated BW <= 400MHz		
Test SCS as specified in Table 5.3.5-1		120kHz		
Test Parameters				
Test ID	CC	Downlink Configuration	UL Modulation	UL RB allocation (NOTE 1)
1	PCC	-	DFT-s-OFDM QPSK	Outer_Full
	SCCs		DFT-s-OFDM QPSK	Outer_Full
NOTE 1: The specific configuration of each RB allocation is defined in Table 6.1-1 for PC2, PC3, PC4, PC5 or Table 6.1-2 for PC1.				
NOTE 2: Number of DL CCs shall be configured the same as number of UL CCs. The requirements are applicable as per 5.3A.4: " <i>The requirements are applicable only when Uplink CCs are configured within the frequency range between lower edge of lowest downlink component carrier and upper edge of highest downlink component carrier</i> ".				

1. Connection between SS and UE is shown in TS 38.508-1 [10] Annex A, Figure A.3.3.1.3 for TE diagram and Figure A.3.4.1.1 for UE diagram.
2. The parameter settings for the cell are set up according to TS 38.508-1 [10] subclause 4.4.3.
3. Downlink signals are initially set up according to Annex C, and uplink signals according to Annex G.
4. The UL Reference Measurement channels are set according to Table 6.5A.3.3.1.4.1-1 and Table 6.5A.3.3.1.4.1-2.
5. Propagation conditions are set according to Annex B.0.
6. Ensure the UE is in state RRC_CONNECTED with generic procedure parameters Connectivity *NR*, Connected without release *On*, Test Mode *On* and Test Loop Function *On* according to TS 38.508-1 [10] clause 4.5. Message contents are defined in clause 6.5A.3.3.1.4.3.

6.5A.3.3.1.4.2 Test procedure

1. Select any of the three Alignment Options (1, 2, or 3) from Tables N.2-1 through N.2-3 to mount the DUT inside the QZ.

2. If the re-positioning concept is applied, position the device in DUT Orientation 1 if the maximum beam peak direction is within zenith angular range $0^\circ \leq \theta \leq 90^\circ$ for the alignment option selected in step 1; position the device in DUT Orientation 2 (either Options 1 or 2) if the maximum beam peak direction is within zenith angular range $90^\circ < \theta \leq 180^\circ$ for DUT Orientation 1 for the alignment option selected in step 1. If the re-positioning concept is not applied, position the device in DUT Orientation 1.
3. Configure SCC according to Annex C.0, C.1, C.2 for all downlink physical channels.
4. The SS shall configure SCC as per TS 38.508-1 [10] clause 5.5.1. Message contents are defined in clause 6.5A.3.3.1.4.3.
5. Apply the test step based on the 5G NR UE Release:
 - 5a. For Release 16 and forward 5G NR UEs: SS applies a backoff on the PCell power by activating the UE Power Limit Function (UPLF). The ACTIVATE POWER LIMIT REQUEST procedure is performed as specified in TS 38.508-1 [10] clause 4.9.32 using TOTAL NR AGGREGATED BANDWIDTH and PCELL NR bandwidth as per Test CC Combination setting. UE shall transmit ACTIVATE POWER LIMIT RESPONSE to SS. Go to step 6.
 - 5b. For Release 15 5G NR UEs: No action.
6. SS activates SCC by sending the activation MAC CE (Refer TS 38.321 [28], clauses 5.9, 6.1.3.10). Wait for at least 2 seconds (Refer TS 38.133[25], clause 9.3).
7. SS sends uplink scheduling information for each UL HARQ process via PDCCH DCI format 0_1 for C_RNTI to schedule the UL RMC according to Table 6.5A.3.3.1.4.1-1 or Table 6.5A.3.3.1.4.1-2. Since the UL has no payload and no loopback data to send the UE sends uplink MAC padding bits on the UL RMC.
8. Set the UE in the Inband Tx beam peak direction [(same as that found for single carrier in clause 6.5.3)] found with a 3D EIRP scan as performed in Annex K.1.1. Allow at least BEAM_SELECT_WAIT_TIME (NOTE 3) for the UE Tx beam selection to complete.
9. Apply the test step based on the 5G NR UE Release:
 - 9a. For Release 16 and forward 5G NR UEs: Send continuously uplink power control "up" commands in every uplink scheduling information to the UE; allow at least 200msec for the UE to reach P_{UMAX} . Allow at least BEAM_SELECT_WAIT_TIME (NOTE 3) for the UE Tx beam selection to complete.
 - 9b. For Release 15 5G NR UEs: Send uplink power control commands in uplink scheduling information to the UE per UL CC until the Power Headroom Report (PHR) from the UE for each UL CC is at the target value according to Table 6.2A.2.1.4.2-1; allow at least 200 ms for the UE to reach maximum output power. Allow at least BEAM_SELECT_WAIT_TIME (NOTE 1) for the UE Tx beam selection to complete.
10. SS activates the UE Beamlock Function (UBF) by performing the procedure as specified in TS 38.508-1 [10] clause 4.9.2 using condition Tx only.
11. Measure the spurious emissions as per steps outlined below with an exception to the procedure in Annex K if the re-positioning concept is applied (NOTE 4). During measurement the spectrum analyser shall be set to 'Detector' = RMS. If the sweep count is higher than one, the trace mode shall be average.
 - (a) Perform coarse TRP measurements to identify spurious emission frequencies and corresponding power level according to the procedures in Annex L, using coarse TRP measurement grid selection criteria as per Tables 6.5.3.1.4.2-1 through 6.5.3.1.4.2-3. The measurement is completed in both polarizations θ and ϕ over frequency range and measurement bandwidth according to Table 6.5A.3.3.1.5-2. Optionally, a larger and non-constant measurement bandwidth than that of Table 6.5A.3.3.1.5-2 may be applied as long as the SNR (ratio of test limit to floor noise of test equipment) ≥ 10 dB is guaranteed. The measurement period shall capture the [active time slots]. For each spurious emission frequency with coarse TRP identified to be less than the offset listed in Tables 6.5.3.1.4.2-1 through 6.5.3.1.4.2-3 from the TRP limit according to Table 6.5A.3.3.1.5-2, either continue with another coarse TRP procedure and corresponding offset according to step (a) or continue with fine TRP procedures according to step (b).

Different coarse TRP grids and corresponding offset values may be used for different frequencies. Multiple coarse TRP grids measurements with the corresponding offset values can be performed before the fine TRP measurement grid is applied. The coarse TRP grids and offset values used shall be recorded in the test report.

- (b) Measure fine TRP measurements according to procedures in Annex K, using fine TRP measurement grid selection criteria as per Table M.4.5-3 in Annex M, for each of the spurious emission frequency identified in step (a). Apply a measurement bandwidth according to Table 6.5A.3.3.1.5-2.

12. Apply the test step based on the 5G NR UE Release:

- 12a. For Release 16 and forward 5G NR UEs: SS deactivates the UE Power Limit Function (UPLF) by performing the DEACTIVATE POWER LIMIT REQUEST procedure as specified in TS 38.508-1 [10] clause 4.9.33.

- 12b. For Release 15 5G NR UEs: No action.

13. SS deactivates the UE Beamlock Function (UBF) by performing the procedure as specified in TS 38.508-1 [10] clause 4.9.3.

NOTE 1: The frequency range defined in Table 6.5A.3.3.1.5-2 may be split into ranges. For each range a different test system, e.g. antenna and/or chamber, may be used. To pass the test case all verdicts of the frequency ranges must pass.

NOTE 2: Void.

NOTE 3: The BEAM_SELECT_WAIT_TIME default value is defined in Annex K.

NOTE 4: If the (in-band) beam peak is within $0^\circ \leq \theta \leq 90^\circ$: perform first hemispherical TRP scan ($0^\circ \leq \theta \leq 90^\circ$) in DUT Orientation 1 and second hemispherical TRP scan ($90^\circ > \theta \geq 0^\circ$) in DUT Orientation 2. If the (in-band) beam peak is within $90^\circ < \theta \leq 180^\circ$: perform first hemispherical TRP scan ($0^\circ \leq \theta \leq 90^\circ$) in DUT Orientation 2 and second hemispherical TRP scan ($90^\circ > \theta \geq 0^\circ$) in DUT Orientation 1. The DUT with UBF activated needs to be re-positioned during the test.

6.5A.3.3.1.4.3 Message contents

Message contents are according to TS 38.508-1 [10] subclause 4.6.1 with the following exceptions for Release 15 5G NR UE.

Table 6.5A.3.3.1.4.3-1: PUSCH-PowerControl

Derivation Path: TS 38.508-1 [10], Table 4.6.3-120			
Information Element	Value/remark	Comment	Condition
PUSCH-PowerControl ::= SEQUENCE {			
p0-AlphaSets SEQUENCE (SIZE (1..maxNrofP0-PUSCH-AlphaSets)) OF SEQUENCE {	1 entry		
P0-PUSCH-AlphaSet[1] SEQUENCE {			
alpha	alpha0		
}			
}			
}			

Table 6.5A.3.3.1.4.3-2: PUSCH-ConfigCommon

Derivation Path: TS 38.508-1[10], Table 4.6.3-119			
Information Element	Value/remark	Comment	Condition
PUSCH-ConfigCommon ::= SEQUENCE {			
p0-NominalWithGrant	-4		50 MHz
p0-NominalWithGrant	-8		100 MHz
p0-NominalWithGrant	-10		200 MHz
p0-NominalWithGrant	-14		400 MHz
}			

6.5A.3.3.1.4.3.1 Message contents exceptions (network signalling value "CA_NS_202" on PCC and SCC)

Table 6.5A.3.3.1.4.3.1-1: AdditionalSpectrumEmission: Additional spurious emissions test requirement for "CA_NS_202"

Derivation Path: TS 38.508-1 [5] clause 4.6.3, Table 4.6.3-1 AdditionalSpectrumEmission			
Information Element	Value/remark	Comment	Condition
AdditionalSpectrumEmission	1 (CA_NS_202)		band n257
	2 (CA_NS_202)		band n258

6.5A.3.3.1.4.3.2 Message contents exceptions (network signalling value "CA_NS_203" on PCC and SCC)

Table 6.5A.3.3.1.4.3.2-1: AdditionalSpectrumEmission: Additional spurious emissions test requirement for "CA_NS_203"

Derivation Path: TS 38.508-1 [5] clause 4.6.3, Table 4.6.3-1 AdditionalSpectrumEmission			
Information Element	Value/remark	Comment	Condition
AdditionalSpectrumEmission	3 (CA_NS_203)		band n258

Table 6.5A.3.3.1.4.3.3-1: AdditionalSpectrumEmission: Additional spurious emissions test requirement for "CA_NS_205"

Derivation Path: TS 38.508-1 [5] clause 4.6.3, Table 4.6.3-1 AdditionalSpectrumEmission			
Information Element	Value/remark	Comment	Condition
AdditionalSpectrumEmission	4 (CA_NS_205)		band n257
	5 (CA_NS_205)		band n258

6.5A.3.3.1.5 Test requirement

This clause specifies the requirements for the specified NR band for Transmitter Spurious emissions for UE co-existence requirement with frequency range as indicated in Table 6.5A.3.3.1.5-2.

The maximum TRP power of spurious emission for UE co-existence, measured using RMS detector, shall not exceed the described value in the applicable table from Table 6.5A.3.3.1.5-2, Table 6.5A.3.3.1.5-3 and Table 6.5A.3.3.1.5-4.

The additional spurious emission for CA limits in Table 6.5A.3.3.1.5-2, Table 6.5A.3.3.1.5-3 and Table 6.5A.3.3.1.5-4 apply for all transmitter band configurations (NRB) and channel bandwidths.

NOTE: For measurement conditions at the edge of each frequency range, the lowest frequency of the measurement position in each frequency range should be set at the lowest boundary of the frequency range plus MBW/2. The highest frequency of the measurement position in each frequency range should be set at the highest boundary of the frequency range minus MBW/2. MBW denotes the measurement bandwidth defined for the protected band.

Table 6.5A.3.3.1.5-1: Void

Table 6.5A.3.3.1.5-2: Additional spurious emissions for CA (CA_NS_202) test requirements

Frequency Range	Maximum Level (dBm)	Measurement bandwidth	NOTE
$7.25 \text{ GHz} \leq f \leq 12.75 \text{ GHz}$	-10	100 MHz	
$12.75 \text{ GHz} \leq f \leq 23.45 \text{ GHz}$	-10 + 13	100 MHz	NOTE 1
$23.45 \text{ GHz} \leq f \leq 40.8 \text{ GHz}$	-10 + 13	100 MHz	NOTE 1
40.8 GHz $\leq f \leq$ 2nd harmonic of the upper frequency edge of the UL operating band	-10 + 13	100 MHz	NOTE 1
$23.6 \text{ GHz} \leq f \leq 24.0 \text{ GHz}$	-5+6.3	200 MHz	NOTE 2, NOTE 3

NOTE 1: 13 dB relaxation due to testability limit.
 NOTE 2: 6.3 dB relaxation due to testability limit.
 NOTE 3: The protection of frequency range 23600 - 24000 MHz is meant for protection of satellite passive services.

Table 6.5A.3.3.1.5-3: Additional spurious emissions for CA (CA_NS_203) test limits

Frequency band (GHz)	Spectrum emission limit (dBm)	Measurement bandwidth	NOTE
$23.6 \leq f \leq 24.0$	+1 + 0.3	200 MHz	NOTE 1
NOTE 1: 0.3 dB relaxation due to testability limit.			

Additional spurious emissions for CA (CA_NS_205) test limits

Frequency band (GHz)	Spectrum emission limit (dBm)	Measurement bandwidth	NOTE
$23.6 \leq f \leq 24.0$	-5 +6.3	200 MHz	NOTE 1 NOTE 2
NOTE 1: +6.3dB relaxation due to testability limit. NOTE 2: The protection of frequency range 23600 - 24000 MHz is meant for protection of satellite passive services.			

6.5A.3.3.2 Additional spurious emissions for CA (3UL CA)

Editor's note: The following aspects are either missing or not yet determined:

- This test case is incomplete for Power classes other than 1, 3, 5 and CA other than intra-band contiguous.
- Measurement Uncertainties and Test Tolerances are FFS for power class other than 1, 3, 5 and CA other than intra-band contiguous.
- The testability of this test case is pending further analysis on relaxation of the requirement for band other than n257, n258.
- For a transition period until RAN#99, the stability and repeatability of test procedure with PHR (variant b) for Rel-15 UEs is under evaluation.

6.5A.3.3.2.1 Test purpose

Additional spurious emission requirements are signalled by the network to indicate that the UE shall meet an additional requirement for a specific deployment scenario as part of the cell handover/broadcast message.

6.5A.3.3.2.2 Test applicability

This test case applies to all types of NR UE release 15 and forward that supports FR2 3UL CA.

6.5A.3.3.2.3 Minimum conformance requirements

Same minimum conformance requirements as in clause 6.5A.3.3.0.

6.5A.3.3.2.4 Test description

Same test description as in clause 6.5A.3.3.1.4.

6.5A.3.3.2.5 Test requirement

The test requirement is the same as in clause 6.5A.3.3.1.5

6.5A.3.3.3 Additional spurious emissions for CA (4UL CA)

Editor's note: The following aspects are either missing or not yet determined:

- This test case is incomplete for Power classes other than 1, 3, 5 and CA other than intra-band contiguous.
- Measurement Uncertainties and Test Tolerances are FFS for power class other than 1, 3, 5 and CA other than intra-band contiguous.
- The testability of this test case is pending further analysis on relaxation of the requirement for band other than n257, n258.
- Test procedure only includes the testing of smartphone and is FFS for laptop.
- For a transition period until RAN#99, the stability and repeatability of test procedure with PHR (variant b) for Rel-15 UEs is under evaluation.

6.5A.3.3.3.1 Test purpose

Additional spurious emission requirements are signalled by the network to indicate that the UE shall meet an additional requirement for a specific deployment scenario as part of the cell handover/broadcast message.

6.5A.3.3.3.2 Test applicability

This test case applies to all types of NR UE release 15 and forward that supports FR2 4UL CA.

6.5A.3.3.3.3 Minimum conformance requirements

Same minimum conformance requirements as in clause 6.5A.3.3.0.

6.5A.3.3.3.4 Test description

Same test description as in clause 6.5A.3.3.1.4.

6.5A.3.3.3.5 Test requirement

The test requirement is the same as in clause 6.5A.3.3.1.5.

6.5A.3.3.4 Additional spurious emissions for CA (5UL CA)

Editor's note: This clause is incomplete. The following aspects are either missing or not yet determined:

- The testability of this test case is pending further analysis on relaxation of the requirement for band other than n257, n258, n260 and n261.
- Measurement Uncertainties and Test Tolerances are FFS for power class 1, 2, and 4.
- TP analysis for CA is FFS (identify lowest MPR w/form, RB allocation for multiple carrier or PCC only, 1RB location if RB allocated for multiple carrier).
- Test procedure only includes the testing of smartphone and is FFS for laptop and FWA.
- For a transition period until RAN5#103 meeting (May 2024), previous fine/coarse TRP measurement grid and offset values for corresponding coarse TRP measurement in TS 38.521-2 V17.2.0 are allowed for TE implementation.

6.5A.3.3.4.1 Test purpose

Additional spurious emission requirements are signalled by the network to indicate that the UE shall meet an additional requirement for a specific deployment scenario as part of the cell handover/broadcast message.

6.5A.3.3.4.2 Test applicability

This test case applies to all types of NR UE release 15 and forward that supports FR2 5UL CA.

6.5A.3.3.4.3 Minimum conformance requirements

Same minimum conformance requirements as in clause 6.5A.3.3.0.

6.5A.3.3.4.4 Test description

Same test description as in clause 6.5A.3.3.1.4.

6.5A.3.3.4.5 Test requirement

The test requirement is the same as in clause 6.5A.3.3.1.5.

6.5A.3.3.5 Additional spurious emissions for CA (6UL CA)

Editor's note: This clause is incomplete. The following aspects are either missing or not yet determined:

- The testability of this test case is pending further analysis on relaxation of the requirement for band other than n257, n258, n260 and n261.
- Measurement Uncertainties and Test Tolerances are FFS for power class 1, 2, and 4.
- TP analysis for CA is FFS (identify lowest MPR w/form, RB allocation for multiple carrier or PCC only, IRB location if RB allocated for multiple carrier).
- Test procedure only includes the testing of smartphone and is FFS for laptop and FWA.
- For a transition period until RAN5#103 meeting (May 2024), previous fine/coarse TRP measurement grid and offset values for corresponding coarse TRP measurement in TS 38.521-2 V17.2.0 are allowed for TE implementation.

6.5A.3.3.5.1 Test purpose

Additional spurious emission requirements are signalled by the network to indicate that the UE shall meet an additional requirement for a specific deployment scenario as part of the cell handover/broadcast message.

6.5A.3.3.5.2 Test applicability

This test case applies to all types of NR UE release 15 and forward that supports FR2 6UL CA.

6.5A.3.3.5.3 Minimum conformance requirements

Same minimum conformance requirements as in clause 6.5A.3.3.0.

6.5A.3.3.5.4 Test description

Same test description as in clause 6.5A.3.3.1.4.

6.5A.3.3.5.5 Test requirement

The test requirement is the same as in clause 6.5A.3.3.1.5.

6.5A.3.3.6 Additional spurious emissions for CA (7UL CA)

Editor's note: This clause is incomplete. The following aspects are either missing or not yet determined:

- The testability of this test case is pending further analysis on relaxation of the requirement for band other than n257, n258, n260 and n261.

- Measurement Uncertainties and Test Tolerances are FFS for power class 1, 2, and 4.
- TP analysis for CA is FFS (identify lowest MPR w/form, RB allocation for multiple carrier or PCC only, IRB location if RB allocated for multiple carrier).
- Test procedure only includes the testing of smartphone and is FFS for laptop and FWA.
- For a transition period until RAN5#103 meeting (May 2024), previous fine/coarse TRP measurement grid and offset values for corresponding coarse TRP measurement in TS 38.521-2 V17.2.0 are allowed for TE implementation.

6.5A.3.3.6.1 Test purpose

Additional spurious emission requirements are signalled by the network to indicate that the UE shall meet an additional requirement for a specific deployment scenario as part of the cell handover/broadcast message.

6.5A.3.3.6.2 Test applicability

This test case applies to all types of NR UE release 15 and forward that supports FR2 7UL CA.

6.5A.3.3.6.3 Minimum conformance requirements

Same minimum conformance requirements as in clause 6.5A.3.3.0.

6.5A.3.3.6.4 Test description

Same test description as in clause 6.5A.3.3.1.4.

6.5A.3.3.6.5 Test requirement

The test requirement is the same as in clause 6.5A.3.3.1.5.

6.5A.3.3.7 Additional spurious emissions for CA (8UL CA)

Editor's note: This clause is incomplete. The following aspects are either missing or not yet determined:

- The testability of this test case is pending further analysis on relaxation of the requirement for band other than n257, n258, n260 and n261.
- Measurement Uncertainties and Test Tolerances are FFS for power class 1, 2, and 4.
- TP analysis for CA is FFS (identify lowest MPR w/form, RB allocation for multiple carrier or PCC only, IRB location if RB allocated for multiple carrier).
- Test procedure only includes the testing of smartphone and is FFS for laptop and FWA.
- For a transition period until RAN5#103 meeting (May 2024), previous fine/coarse TRP measurement grid and offset values for corresponding coarse TRP measurement in TS 38.521-2 V17.2.0 are allowed for TE implementation.

6.5A.3.3.7.1 Test purpose

Additional spurious emission requirements are signalled by the network to indicate that the UE shall meet an additional requirement for a specific deployment scenario as part of the cell handover/broadcast message.

6.5A.3.3.7.2 Test applicability

This test case applies to all types of NR UE release 15 and forward that supports FR2 8UL CA.

6.5A.3.3.7.3 Minimum conformance requirements

Same minimum conformance requirements as in clause 6.5A.3.3.0.

6.5A.3.3.7.4 Test description

Same test description as in clause 6.5A.3.3.1.4.

6.5A.3.3.7.5 Test requirement

The test requirement is the same as in clause 6.5A.3.3.1.5

6.5D Output RF spectrum emissions for UL MIMO

6.5D.1 Occupied bandwidth for UL MIMO

Editor's note: This clause is complete for Band n257, n258, n259, n260 and n261 for PC3. The following aspects are for future consideration:

- Measurement Uncertainty and testability is FFS for power classes other than PC3.

6.5D.1.1 Test purpose

To verify that the UE occupied bandwidth for all transmission bandwidth configurations supported by the UE supporting UL MIMO are less than their specific limits when UE is configured using UL MIMO transmission.

6.5D.1.2 Test applicability

This test applies to all types of NR UE release 15 and forward that supporting UL MIMO.

6.5D.1.3 Minimum conformance requirements

For UE configured with UL MIMO, the minimum conformance requirements are defined in clause 6.5.1.3. The requirements shall be met with the UL MIMO configurations specified in Table 6.5D.1.3-1.

Table 6.5D.1.3-1: UL MIMO configuration

Transmission scheme	DCI format	TPMI Index
Codebook based uplink	DCI format 0_1	0

The normative reference for this requirement is TS 38.101-2 [3] clause 6.5D.1.

6.5D.1.4 Test description

6.5D.1.4.1 Initial conditions

Initial conditions are a set of test configurations the UE needs to be tested in and the steps for the SS to take with the UE to reach the correct measurement state.

The initial test configurations consist of environmental conditions, test frequencies, test channel bandwidths and sub-carrier spacing based on NR operating bands specified in Table 5.3.5-1. All of these configurations shall be tested with applicable test parameters for each combination of channel bandwidth and subcarrier spacing, are shown in Table 6.5D.1.4.1-1. The details of the uplink reference measurement channels (RMCs) are specified in Annexes A.2. Configurations of PDSCH and PDCCH before measurement are specified in Annex C.2.

Table 6.5D.1.4.1-1: Test Configuration Table

Initial Conditions	
Test Environment as specified in TS 38.508-1 [10] clause 4.1	Normal
Test Frequencies as specified in TS 38.508-1 [10] clause 4.3.1	Low range, Mid range, High range

Test Channel Bandwidths as specified in TS 38.508-1 [10] clause 4.3.1		All	
Test SCS as specified in Table 5.3.5-1		Lowest	
Test Parameters			
Test ID	Downlink Configuration	Uplink Configuration	
		Modulation	RB allocation (NOTE 1)
1		CP-OFDM QPSK	Outer_full
NOTE 1: The specific configuration of each RB allocation is defined in Table 6.1-1 for PC2, PC3 and PC4 or Table 6.1-2 for PC1.			
NOTE 2: Void.			

1. Connection between SS and UE is shown in TS 38.508-1 [10] Annex A, Figure A.3.3.1.1 for TE diagram and clause A.3.4.1.1 for UE diagram.
2. The parameter settings for the cell are set up according to TS 38.508-1 [10] clause 4.4.3.
3. Downlink signals are initially set up according to Annex C, and uplink signals according to Annex G.
4. The UL Reference Measurement channels are set according to Table 6.5D.1.4.1-1.
5. Propagation conditions are set according to Annex B.0
6. Ensure the UE is in state RRC_CONNECTED with generic procedure parameters Connectivity NR, Connected without release On, Test Mode On and Test Loop Function On according to TS 38.508-1 [10] clause 4.5. Message contents are defined in clause 6.5D.1.4.3

6.5D.1.4.2 Test procedure

1. SS sends uplink scheduling information for each UL HARQ process via PDCCH DCI format 0_1 for C_RNTI to schedule the UL RMC according to Table 6.5D.1.4.1-1. Since the UL has no payload and no loopback data to send the UE sends uplink MAC padding bits on the UL RMC. The PDCCH DCI format 0_1 is specified with condition 2TX_UL_MIMO in 38.508-1 [10] subclause 4.3.6.1.1.2
2. Set the UE in the Tx beam peak direction found with a 3D EIRP scan as performed in Annex K.1.1. Allow at least BEAM_SELECT_WAIT_TIME (NOTE 1) for the UE Tx beam selection to complete.
3. Send continuously uplink power control "up" commands in every uplink scheduling information to the UE; allow at least 200 ms for the UE to reach maximum output power. Allow at least BEAM_SELECT_WAIT_TIME (NOTE 1) for the UE Tx beam selection to complete.
4. SS activates the UE Beamlock Function (UBF) by performing the procedure as specified in TS 38.508-1 [10] clause 4.9.2 using condition Tx only.
5. Measure the EIRP spectrum distribution within N-times or more frequency range over the requirement for Occupied Bandwidth specification centring on the current carrier frequency. The characteristics of the filter shall be approximately Gaussian (typical spectrum analyser filter). The measuring duration is one active uplink subframe. EIRP is captured from both polarizations, theta and phi. The ratio of measured bandwidth to channel bandwidth N is specified in Table 6.5D.1.4.2-1.

Table 6.5D.1.4.2-1: Ratio of measured bandwidth to channel bandwidth

	Occupied channel bandwidth / Channel bandwidth			
	50 MHz	100 MHz	200 MHz	400 MHz
n257, n258, n261	1.5	1.5	1.5	1.5
n260	1.5	1.5	1.5	1.3
n259	1.5	1.5	1.3	1.2

6. Calculate the total EIRP from both polarizations, theta and phi, within the range of all frequencies measured in step 5 and save this value as "Total EIRP". EIRP measurement procedure is defined in Annex K.

- 7. Identify the measurement window whose centre is aligned on the centre of the channel for which the sum of the power measured in theta and phi polarization is 99% of the "Total EIRP".
- 8. The "Occupied Bandwidth" is the width of the measurement window obtained in step 7.

NOTE 1: The BEAM_SELECT_WAIT_TIME default value is defined in Annex K.

6.5D.1.4.3 Message contents

Message contents are according to TS 38.508-1 [10] subclause 4.6 ensuring Table 4.6.3-182 with condition 2TX_UL_MIMO.

6.5D.1.5 Test requirement

The measured Occupied Bandwidth shall not exceed values in Table 6.5D.1.5-1.

Table 6D.5.1.5-1: Occupied channel bandwidth

	Occupied channel bandwidth / Channel bandwidth			
	50 MHz	100 MHz	200 MHz	400 MHz
Channel bandwidth (MHz)	50	100	200	400

6.5D.2 Out of band emission for UL MIMO

6.5D.2.1 Spectrum Emission Mask for UL MIMO

Editor's note: The following aspects are either missing or not yet determined:

- Measurement Uncertainties and Test Tolerances are FFS for power class 1 FR2b, 2, and 4.

6.5D.2.1.1 Test purpose

To verify that the power of any UE emission shall not exceed specified level for the specified channel bandwidth.

6.5D.2.1.2 Test applicability

This test case applies to all types of NR UE release 15 and forward supporting UL MIMO.

6.5D.2.1.3 Minimum conformance requirements

For UE(s) supporting UL MIMO, the Spectrum Emission Mask requirements in clause 6.5.2.1.3 apply. The requirements shall be met with the UL MIMO configurations specified in Table 6.2D.1.0-1.

The normative reference for this requirement is TS 38.101-2 [3] clause 6.5D.2.

6.5D.2.1.4 Test description

6.5D.2.1.4.1 Initial condition

Same initial condition in clause 6.5.2.1.4.1 with following exceptions:

- Instead of Table 6.5.2.1.4.1-1 → use Table 6.5D.2.1.4.1-1.
- Instead of Table 6.5.2.1.4.1-2 → use Table 6.5D.2.1.4.1-2

Table 6.5D.2.1.4.1-1: Test Configuration Table

Initial Conditions

Test Environment as specified in TS 38.508-1 [10] subclause 4.1	Normal		
Test Frequencies as specified in TS 38.508-1 [10] subclause 4.3.1	Mid range		
Test Channel Bandwidths as specified in TS 38.508-1 [10] subclause 4.3.1	Lowest, Highest		
Test SCS as specified in Table 5.3.5-1	Highest		
Test Parameters			
Test ID	Downlink Configuration	Uplink Configuration	
		Modulation	RB allocation (NOTE 1)
1	-	CP-OFDM QPSK	Outer_Full
2		CP-OFDM 16 QAM	Outer_Full
3		CP-OFDM 64 QAM	Outer_Full
NOTE 1: The specific configuration of each RF allocation is defined in Table 6.1-1 for PC2, PC3 and PC4 or Table 6.1-2 for PC1.			
NOTE 2: All test points in this table must also exist in Table 6.2D.2.4.1-1, Table 6.2D.2.4.1-2, Table 6.2D.2.4.1-3 (MPR) for PC1 or Table 6.2D.2.4.1-4, Table 6.2D.2.4.1-5, Table 6.2D.2.4.1-6 (MPR) for PC2, PC3 and PC4.			

Table 6.5D.2.1.4.1-2: Void**6.5D.2.1.4.2 Test procedure**

Same test procedure as in clause 6.5.2.1.4.2.

6.5D.2.1.4.3 Message contents

Message contents are according to TS 38.508-1 [10] subclause 4.6 ensuring Table 4.6.3-182 with condition 2TX_UL_MIMO.

6.5D.2.1.5 Test requirements

The test requirement is the same as in clause 6.5.2.1.5.

6.5D.2.2 Adjacent channel leakage ratio for UL MIMO

Editor's note: The following aspects are either missing or not yet determined:

- Measurement Uncertainties and Test Tolerances are FFS for power class 2, and 4.
- Testability for PC2 and 4 is FFS.

6.5D.2.2.1 Test purpose

To verify that the power of any UE emission shall not exceed specified lever for the specified channel bandwidth.

6.5.2.2.2 Test applicability

This test case applies to all types of NR UE release 15 and forward supporting UL MIMO.

6.5D.2.2.3 Minimum conformance requirements

For UE(s) supporting UL MIMO, the Adjacent channel leakage ratio requirements in clause 6.5.2.3.3 apply. The requirements shall be met with the UL MIMO configurations specified in Table 6.2D.1.0-1.

The normative reference for this requirement is TS 38.101-2 [3] clause 6.5D.2.

6.5D.2.2.4 Test description

6.5D.2.2.4.1 Initial condition

Same initial condition in clause 6.5.2.3.4.1 with following exceptions:

- Instead of Table 6.5.2.3.4.1-1 → use Table 6.5D.2.2.4.1-1.
- Instead of Table 6.5.2.3.4.1-2 → use Table 6.5D.2.2.4.1-2.

Table 6.5D.2.2.4.1-1: Test Configuration Table (Power Class 1)

Default Conditions							
Test Environment as specified in TS 38.508-1 [10] subclause 4.1				Normal, TL, TH			
Test Frequencies as specified in TS 38.508-1 [10] subclause 4.3.1				Low range, Mid range, High range			
Test Channel Bandwidths as specified in TS 38.508-1 [10] subclause 4.3.1				Lowest, Highest			
Test SCS as specified in Table 5.3.5-1				Lowest, Highest			
Test Parameters							
Test ID	Freq	ChBw	SCS	Downlink Configuration	Uplink Configuration		
		Default	Default	-	Modulation	RB allocation (NOTE 1)	
					SCS 60 kHz	SCS 120 kHz	
1	Low				CP-OFDM QPSK	16@0	8@0
2	High				CP-OFDM QPSK	16@N _{RB} -16	8@N _{RB} -8
3	Mid				CP-OFDM QPSK	Outer_Full	Outer_Full
4	Low				CP-OFDM 16 QAM	16@0	8@0
5	High				CP-OFDM 16 QAM	16@N _{RB} -16	8@N _{RB} -8
6	Mid				CP-OFDM 16 QAM	Outer_Full	Outer_Full
7	Low				CP-OFDM 64 QAM	16@0	8@0
8	High				CP-OFDM 64 QAM	16@N _{RB} -16	8@N _{RB} -8
9	Mid	CP-OFDM 64 QAM	Outer_Full	Outer_Full			

NOTE 1: The specific configuration of each RF allocation is defined in Table 6.1-2.
 NOTE 2: Applicability of test IDs for for CHBWs and frequency ranges is FFS.
 NOTE 3: All test points in this table must also exist in Table 6.2.2.4.1-1, Table 6.2.2.4.1-2, Table 6.2.2.4.1-3 (MPR).

Table 6.5D.2.2.4.1-2: Test Configuration Table (Power Class 2, 3 and 4)

Default Conditions						
Test Environment as specified in TS 38.508-1 [10] subclause 4.1				Normal, TL, TH		
Test Frequencies as specified in TS 38.508-1 [10] subclause 4.3.1				Low range, High range		
Test Channel Bandwidths as specified in TS 38.508-1 [10] subclause 4.3.1				Lowest, Highest		
Test SCS as specified in Table 5.3.5-1				Lowest, Highest		
Test Parameters						
Test ID	Freq	ChBw	SCS	Downlink Configuration	Uplink Configuration	
		Default	Default	-	Modulation	RB allocation (NOTE 1)
1	Low				CP-OFDM QPSK	Outer_1RB_Left
2	High				CP-OFDM QPSK	Outer_1RB_Right
3	Default				CP-OFDM QPSK	Outer Full
4	Low				CP-OFDM 16 QAM	Outer_1RB_Left
5	High				CP-OFDM 16 QAM	Outer_1RB_Right
6	Default				CP-OFDM 16 QAM	Outer Full
7	Low				CP-OFDM 64 QAM	Outer_1RB_Left
8	High				CP-OFDM 64 QAM	Outer_1RB_Right
9	Default				CP-OFDM 64 QAM	Outer Full

NOTE 1: The specific configuration of each RF allocation is defined in Table 6.1-1.

NOTE 2: Following Test IDs shall be skipped for FR2b

- All Test IDs for 400MHz Channel Bandwidth
- All Test IDs for 200MHz Channel Bandwidth
- Test ID 7-9 for 100MHz Channel Bandwidth

NOTE 3: All test points in this table must also exist in Table 6.2D.2.4.1-4, Table 6.2D.2.4.1-5, Table 6.2D.2.4.1-6 (MPR).

6.5D.2.2.4.2 Test procedure

Same test procedure as in clause 6.5.2.3.4.2.

6.5D.2.2.4.3 Message contents

Message contents are according to TS 38.508-1 [10] subclause 4.6 ensuring Table 4.6.3-182 with condition 2TX_UL_MIMO.

6.5D.2.2.5 Test requirements

The test requirement is the same as in clause 6.5.2.3.5 with the following exceptions:

- Instead of Table 6.5.2.3.5-1b → use Table 6.5D.2.2.5-1 for Power class 1.
- Instead of Table 6.5.2.3.5-1b → use Table 6.5D.2.2.5-2 for Power class 2.
- Instead of Table 6.5.2.3.5-1b → use Table 6.5D.2.2.5-3 for Power class 3.
- Instead of Table 6.5.2.3.5-1b → use Table 6.5D.2.2.5-4 for Power class 4.

Table 6.5D.2.2.5-1: Relaxation due to testability limit (Adjacent channel leakage ratio) for (Power Class 1)

FFS

Table 6.5D.2.2.5-2: Relaxation due to testability limit (Adjacent channel leakage ratio) for (Power Class 2)

FFS

Table 6.5D.2.2.5-3: Relaxation due to testability limit (Adjacent channel leakage ratio) for (Power Class 3)

	Test ID	Channel bandwidth / NR _{ACLR} / Measurement bandwidth			
		50 MHz	100 MHz	200 MHz	400 MHz
NR _{ACLR} for band n257, n258, n261	1	0	0	0	3
	2	0	0	0	3
	3	0	0	0	3
	4	0	0	0	5.5
	5	0	0	0	5.5
	6	0	0	0	5.5
	7	0	0.5	3.5	8
	8	0	0.5	3.5	8
	9	0	0.5	3.5	8

NOTE 1: Relaxation value is derived by Table 6.5.2.3.5-1c for FR2a.

Table 6.5D.2.2.5-4: Relaxation due to testability limit (Adjacent channel leakage ratio) for (Power Class 4)

FFS

6.5D.3 Spurious emissions for UL MIMO

6.5D.3.1 Transmitter Spurious emissions for UL MIMO

Editor's note: This clause is complete for Band n257, n258, n259, n260 and n261 and for PC1 and PC3. The following aspects of the clause are for future consideration:

- TRP Measurement uncertainty is TBD for above 87 GHz.
- Test procedure only includes the testing of smartphone and is FFS for laptop and FWA.
- For a transition period until RAN5#103 meeting (May 2024), previous fine/coarse TRP measurement grid and offset values for corresponding coarse TRP measurement in TS 38.521-2 V17.2.0 are allowed for TE implementation.

6.5D.3.1.1 Test purpose

To verify that UE transmitter does not cause unacceptable interference to other channels or other systems in terms of transmitter spurious emissions.

6.5D.3.1.2 Test applicability

This test case applies to all types of NR UE release 15 and forward supporting UL MIMO.

6.5D.3.1.3 Minimum conformance requirements

For UE configured with UL MIMO, the minimum conformance requirements are defined in clause 6.5.3.1.3. The requirements shall be met with the UL MIMO configurations specified in Table 6.5D.3.1.3-1.

Table 6.5D.3.1.3-1: UL MIMO configuration

Transmission scheme	DCI format	TPMI Index
Codebook based uplink	DCI format 0_1	0

The normative reference for this requirement is TS 38.101-2 [3] clause 6.5D.3.

6.5D.3.1.4 Test description

6.5D.3.1.4.1 Initial condition

Same initial condition in clause 6.5.3.1.4.1 with following exceptions:

- Instead of DFT-s -OFDM → use CP-OFDM.

6.5D.3.1.4.2 Test procedure

Same test procedure as in clause 6.5.3.1.4.2 with the following added to step 3 for UL MIMO configuration:

- 3.1 The PDCCH DCI format 0_1 is specified with the condition 2TX_UL_MIMO in 38.508-1 [10] subclause 4.3.6.1.1.2.

6.5D.3.1.4.3 Message contents

Message contents are according to TS 38.508-1 [10] subclause 4.6 ensuring Table 4.6.3-182 with condition 2TX_UL_MIMO.

6.5D.3.1.5 Test requirements

The test requirement is the same as in clause 6.5.3.1.5.

6.5D.3.2 Spurious emission band UE co-existence for UL MIMO

Editor's note: This clause is complete for Band n257, n258, n259, n260 and n261 and for PC1 and PC3. The following aspects of the clause are for future consideration:

- TRP Measurement uncertainty is TBD for above 87 GHz.
- Test procedure only includes the testing of smartphone and is FFS for laptop and FWA.
- For a transition period until RAN5#103 meeting (May 2024), previous fine/coarse TRP measurement grid and offset values for corresponding coarse TRP measurement in TS 38.521-2 V17.2.0 are allowed for TE implementation.

6.5D.3.2.1 Test purpose

To verify that UL MIMO configured UE's transmitter does not cause unacceptable interference when in co-existence with protected bands in terms of transmitter spurious emissions.

6.5D.3.2.2 Test applicability

This test case applies to all types of NR UE release 15 and forward supporting UL MIMO.

6.5D.3.2.3 Minimum conformance requirements

For UE configured with UL MIMO, the minimum conformance requirements are defined in clause 6.5.3.2.3. The requirements shall be met with the UL MIMO configurations specified in Table 6.5D.3.1.3-1.

The normative reference for this requirement is TS 38.101-2 [3] clause 6.5D.3.

6.5D.3.2.4 Test description

6.5D.3.2.4.1 Initial condition

Same initial condition in clause 6.5.3.2.4.1 with following exceptions:

- Instead of DFT-s -OFDM → use CP-OFDM.

6.5D.3.2.4.2 Test procedure

Same test procedure as in clause 6.5.3.2.4.2 with the following added to step 3 for UL MIMO configuration:

- 3.1 The PDCCH DCI format 0_1 is specified with the condition 2TX_UL_MIMO in 38.508-1 [10] subclause 4.3.6.1.1.2.

6.5D.3.2.4.3 Message contents

Message contents are according to TS 38.508-1 [10] subclause 4.6 ensuring Table 4.6.3-182 with condition 2TX_UL_MIMO.

6.5D.3.2.5 Test requirements

The test requirement is the same as in clause 6.5.3.2.5.

6.5D.3.3 Additional spurious emissions for UL MIMO

Editor's note: This clause is complete for Band n257 and n258 and PC3. The following aspects of the clause are for future consideration:

- Test procedure only includes the testing of smartphone and is FFS for laptop and FWA.
- For a transition period until RAN5#103 meeting (May 2024), previous fine/coarse TRP measurement grid and offset values for corresponding coarse TRP measurement in TS 38.521-2 V17.2.0 are allowed for TE implementation.

6.5D.3.3.1 Test purpose

Additional spurious emission requirements are signalled by the network to indicate that the UE shall meet an additional requirement for a specific deployment scenario as part of the cell handover/broadcast message.

6.5D.3.3.2 Test applicability

This test case applies to all types of NR UE release 15 and forward supporting UL MIMO.

6.5D.3.3.3 Minimum conformance requirements

For UE configured with UL MIMO, the minimum conformance requirements are defined in clause 6.5.3.3.3. The requirements shall be met with the UL MIMO configurations specified in Table 6.5D.3.1.3-1.

The normative reference for this requirement is TS 38.101-2 [3] clause 6.5D.3.

6.5D.3.3.4 Test description

6.5D.3.3.4.1 Initial condition

Same initial condition in clause 6.5.3.3.4.1 with following exceptions:

- Instead of DFT-s -OFDM → use CP-OFDM.

6.5D.3.3.4.2 Test procedure

Same test procedure as in clause 6.5.3.3.4.2 with the following added to step 3 for UL MIMO configuration:

- 3.1 The PDCCH DCI format 0_1 is specified with the condition 2TX_UL_MIMO in 38.508-1 [10] subclause 4.3.6.1.1.2.

6.5D.3.3.4.3 Message contents

Message contents are according to TS 38.508-1 [10] subclause 4.6 ensuring Table 4.6.3-182 with condition 2TX_UL_MIMO.

6.5D.3.3.5 Test requirements

The test requirement is the same as in clause 6.5.3.3.5.

6.6 Beam correspondence

6.6.0 General

Beam correspondence is the ability of the UE to select a suitable beam for UL transmission based on DL measurements with or without relying on UL beam sweeping. The beam correspondence requirement is satisfied assuming the presence of both SSB and CSI-RS signal and Type D QCL is maintained between SSB and CSI-RS.

Enhanced Beam correspondence is the ability of the UE to select a suitable beam for UL transmission based on DL measurements with or without relying on UL beam sweeping. The beam correspondence requirement is satisfied assuming the presence of either SSB and CSI-RS signal.

6.6.1 Beam correspondence - EIRP

Editor's note: The following aspects are either missing or not yet determined:

- The test case is incomplete for band n259.
- Measurement Uncertainties and Test Tolerances are FFS for power class other than PC3.

6.6.1.1 Test purpose

To verify the UE's ability to select a suitable beam for UL transmission based on DL measurements with or without relying on UL beam sweeping within the range prescribed by the specified nominal maximum output power and beam correspondence tolerance.

6.6.1.2 Test applicability

This test case is applicable only in in RRC_CONNECTED mode to all types of NR Power Class 3 UE release 15 that do not support beam correspondence without UL beam sweeping.

This test case is applicable only in in RRC_CONNECTED mode to all types of NR Power Class 3 UE release 16 and forward that do not support SSB-based or CSI-RS based enhanced beam correspondence and do not support beam correspondence without UL beam sweeping.

6.6.1.3 Minimum conformance requirements

6.6.1.3.1 (Void)

6.6.1.3.2 (Void)

6.6.1.3.3 Beam correspondence for PC3

6.6.1.3.3.1 General

The beam correspondence requirement for PC3 UEs in RRC_CONNECTED consists of three components: UE minimum peak EIRP (as defined in clause 6.2.1.1.3.3), UE spherical coverage (as defined in clause 6.2.1.1.3.3), and beam correspondence tolerance (as defined in clause 6.6.1.3.3.2). The beam correspondence requirement is fulfilled if the UE satisfies one of the following conditions, depending on the UE's beam correspondence capability IE *beamCorrespondenceWithoutUL-BeamSweeping*, as defined in TS 38.306 [26]:

- If *beamCorrespondenceWithoutUL-BeamSweeping* is supported, the UE shall meet the minimum peak EIRP requirement according to Table 6.2.1.1.3.3-1 and spherical coverage requirement according to Table 6.2.1.1.3.3-3 with its autonomously chosen UL beams and without uplink beam sweeping. Such a UE is considered to have met the beam correspondence tolerance requirement.
- If *beamCorrespondenceWithoutUL-BeamSweeping* is not present, the UE shall meet the minimum peak EIRP requirement according to Table 6.2.1.1.3.3-1 and spherical coverage requirement according to Table 6.2.1.1.3.3-3 with uplink beam sweeping. Such a UE shall meet the beam correspondence tolerance requirement defined in Clause 6.6.1.3.3.2 and shall support uplink beam management, as defined in TS 38.306 [26].

6.6.1.3.3.1.1 Side condition for SSB and CSI-RS

The beam correspondence requirements are only applied under the following conditions:

- The downlink reference signals including both SSB and CSI-RS are provided and Type D QCL shall be maintained between SSB and CSI-RS.
- The reference measurement channel for beam correspondence are fulfilled according to the CSI-RS configuration in Annex A.3.
- The beam correspondence conditions for L1-RSRP measurements are fulfilled according to Table 6.6.1.3.3.1.1-1 and Table 6.6.1.3.3.1.1-2.

Table 6.6.1.3.3.1.1-1: Conditions for SSB based L1-RSRP measurements for beam correspondence

Angle of arrival	NR operating bands	Minimum SSB_RP ^{Note 2}		SSB \hat{E}_s/lot dB
		dBm / SCS _{SSB}		
		SCS _{SSB} = 120 kHz		
All angles ^{Note 1}	n257	-96.2		≥6
	n258	-96.2		
	n259	-90.7		
	n260	-91.9		
	n261	-96.2		
NOTE 1: For UEs that support multiple FR2 bands, the Minimum SSB_RP values for all angles are increased by $\Delta\text{MB}_{S,n}$, the UE multi-band relaxation factor in dB specified in clause 6.2.1. NOTE 2: Values specified at the radiated requirements reference point to give minimum SSB \hat{E}_s/lot , with no applied noise.				

Table 6.6.1.3.3.1.1-2: Conditions for CSI-RS based L1-RSRP measurements for beam correspondence

Angle of arrival	NR operating bands	Minimum CSI-RS_RP ^{Note 2}		CSI-RS \hat{E}_s/lot dB
		dBm / SCS _{CSI-RS}		
		SCS _{CSI-RS} = 120 kHz		
All angles ^{Note 1}	n257	-96.2		≥6
	n258	-96.2		
	n259	-90.7		
	n260	-91.9		
	n261	-96.2		
NOTE 1: For UEs that support multiple FR2 bands, the Minimum CSI-RS_RP values are increased by $\Delta\text{MB}_{S,n}$, the UE multi-band relaxation factor in dB specified in clause 6.2.1. NOTE 2: Values specified at the radiated requirements reference point to give minimum CSI-RS \hat{E}_s/lot , with no applied noise.				

6.6.1.3.3.2 Beam correspondence tolerance for PC3

The beam correspondence tolerance requirement $\Delta\text{EIRP}_{\text{BC}}$ for power class 3 UEs is defined based on a percentile of the distribution of $\Delta\text{EIRP}_{\text{BC}}$, defined as $\Delta\text{EIRP}_{\text{BC}} = \text{EIRP}_2 - \text{EIRP}_1$ over the link angles spanning a subset of the spherical coverage grid points, such that

- EIRP_1 is the total EIRP in dBm calculated based on the beam the UE chooses autonomously (corresponding beam) to transmit in the direction of the incoming DL signal, which is based on beam correspondence without relying on UL beam sweeping.
- EIRP_2 is the best total EIRP (beam yielding highest EIRP in a given direction) in dBm which is based on beam correspondence with relying on UL beam sweeping.
- The link angles are the ones corresponding to the top N^{th} percentile of the EIRP_2 measurement over the whole sphere, where the value of N is according to the test point of EIRP spherical coverage requirement for power class 3, i.e. $N = 50$.

For power class 3 UEs, the requirement is fulfilled if the UE's corresponding UL beams satisfy the maximum limit in Table 6.6.1.3.3.2-1.

Table 6.6.1.3.3.2-1: UE beam correspondence tolerance for power class 3

Operating band	Max $\Delta\text{EIRP}_{\text{BC}}$ at 85 %-tile $\Delta\text{EIRP}_{\text{BC}}$ CDF (dB)
n257	3.0
n258	3.0
n260	3.2
n261	3.0

NOTE: The requirements in this table are verified only under normal temperature conditions as defined in TS 38.508-1 [10] subclause 4.1.1

6.6.1.3.3.3 Normative reference

The normative reference for this requirement is TS 38.101-2 [3] clause 6.6.4.

6.6.1.3.4 Beam correspondence for PC5

FFS

6.6.1.3.5 Beam correspondence for PC6

6.6.1.3.5.1 General

The beam correspondence requirement for power class 6 UEs in RRC_CONNECTED consists of two components: UE minimum peak EIRP (as defined in Clause 6.2.1.1.3.6), and UE spherical coverage (as defined in Clause 6.2.1.1.3.6). The beam correspondence requirement is fulfilled if the UE satisfies one of the following conditions, depending on the UE's beam correspondence capability IE *beamCorrespondenceWithoutUL-BeamSweeping*, as defined in TS 38.306 [26]:

- If *beamCorrespondenceWithoutUL-BeamSweeping* is supported, the UE shall meet the minimum peak EIRP requirement according to Table 6.2.1.1.3.6-1 and spherical coverage requirement according to Table 6.2.1.1.3.6-3 with its autonomously chosen UL beams and without uplink beam sweeping. Such a UE is considered to have met the beam correspondence tolerance requirement.

6.6.1.3.5.1.1 Side Condition for SSB based enhanced Beam Correspondence requirements

The beam correspondence requirements for beam correspondence based on SSB are only applied under the following side conditions:

- The downlink reference signal SSB is provided, and CSI-RS is not provided.
- For beam correspondence, conditions for L1-RSRP measurements are fulfilled according to Table 6.6.1.3.5.1.1-1.

Table 6.6.1.3.5.1.1-1: Conditions for SSB based L1-RSRP measurements for beam correspondence

Angle of arrival	NR operating bands	Minimum SSB_RP ^{Note 2}	
		dBm / SCS _{SSB}	
		SCS _{SSB} = 120 kHz	
All angles Note 1	n257	-101.4	
	n258	-101.6	
	n261	-101.4	
NOTE 1: For UEs that support multiple FR2 bands, the Minimum SSB_RP values for all angles are increased by $\Delta MB_{S,n}$, the UE multi-band relaxation factor in dB specified in clause 6.2.1.1.3.6.			
NOTE 2: Values specified at the radiated requirements reference point to give minimum SSB \dot{E}_s/lot , with no applied noise.			

6.6.1.3.5.1.2 Side Condition for CSI-RS based enhanced Beam Correspondence requirements

The beam correspondence requirements for beam correspondence based on CSI-RS are only applied under the following side conditions:

- The downlink reference signals including both SSB and CSI-RS are provided.

- The reference measurement channel for beam correspondence is fulfilled according to the CSI-RS configuration in Annex A.3.
- For beam correspondence, conditions for L1-RSRP measurements are fulfilled according to Table 6.6.1.3.5.1.2-2 and SSB signal is provided according to Table 6.6.1.3.5.1.2-1.

Table 6.6.1.3.5.1.2-1: SSB signal conditions for CSI-RS based beam correspondence requirements

Angle of arrival	NR operating bands	Minimum SSB_RP ^{Note 2}		SSB
		dBm / SCS _{SSB}		Ês/lot
		SCS _{SSB} = 120 kHz		dB
All angles ^{Note 1}	n257	-106.4		≥1
	n258	-106.6		
	n261	-106.4		
NOTE 1: For UEs that support multiple FR2 bands, the Minimum SSB_RP values for all angles are increased by ΔMB _{S,n} , the UE multi-band relaxation factor in dB specified in clause 6.2.1.1.3.6				
NOTE 2: Values specified at the radiated requirements reference point to give minimum SSB Ês/lot, with no applied noise.				

Table 6.6.1.3.5.1.2-2: Conditions for CSI-RS based L1-RSRP measurements for beam correspondence

Angle of arrival	NR operating bands	Minimum CSI-RS_RP ^{Note 2}		CSI-RS
		dBm / SCS _{CSI-RS}		Ês/lot
		SCS _{CSI-RS} = 120 kHz		dB
All angles ^{Note 1}	n257	-101.4		≥6
	n258	-101.6		
	n261	-101.4		
NOTE 1: For UEs that support multiple FR2 bands, the Minimum CSI-RS_RP values are increased by ΔMB _{S,n} , the UE multi-band relaxation factor in dB specified in clause 6.2.1.1.3.6				
NOTE 2: Values specified at the radiated requirements reference point to give minimum CSI-RS Ês/lot, with no applied noise.				

6.6.1.3.5.2 Normative reference

The normative reference for this requirement is TS 38.101-2 [3] clause 6.6.7.

6.6.1.3.6 Beam correspondence for PC7

6.6.1.3.6.1 General

The beam correspondence requirement for power class 7 UEs in RRC_CONNECTED consists of two components: UE minimum peak EIRP (as defined in Clause 6.2.1.1.3.7), and UE spherical coverage (as defined in Clause 6.2.1.1.3.7). The beam correspondence requirement is fulfilled if the UE satisfies one of the following conditions, depending on the UE's beam correspondence capability IE *beamCorrespondenceWithoutUL-BeamSweeping*, as defined in TS 38.306 [26]:

- If *beamCorrespondenceWithoutUL-BeamSweeping* is supported, the UE shall meet the minimum peak EIRP requirement according to Table 6.2.1.1.3.7-1 and spherical coverage requirement according to Table 6.2.1.1.3.7-3 with its autonomously chosen UL beams and without uplink beam sweeping. Such a UE is considered to have met the beam correspondence tolerance requirement.

6.6.1.3.6.1.1 Side Condition for beam correspondence based on SSB and CSI-RS

The beam correspondence requirements are only applied under the following side conditions:

- The downlink reference signals including both SSB and CSI-RS are provided and Type D QCL shall be maintained between SSB and CSI-RS.

- The reference measurement channel for beam correspondence is fulfilled according to the CSI-RS configuration in Annex A.3.
- For beam correspondence, conditions for L1-RSRP measurements are fulfilled according to Table 6.6.1.3.6.1.1-1 and Table 6.6.1.3.6.1.1-2.

Table 6.6.1.3.6.1.1-1: Conditions for SSB based L1-RSRP measurements for beam correspondence

Angle of arrival	NR operating bands	Minimum SSB_RP ^{Note 2}		SSB \hat{E}_s/lot dB
		dBm / SCS _{SSB}		
		SCS _{SSB} = 120 kHz		
All angles ^{Note 1}	n257	-93.2		≥6
	n258	-93.2		
	n261	-93.2		
NOTE 1: Void				
NOTE 2: Values specified at the radiated requirements reference point to give minimum SSB \hat{E}_s/lot , with no applied noise.				

Table 6.6.1.3.6.1.1-2: Conditions for CSI-RS based L1-RSRP measurements for beam correspondence

Angle of arrival	NR operating bands	Minimum CSI-RS_RP ^{Note 2}		CSI-RS \hat{E}_s/lot dB
		dBm / SCS _{CSI-RS}		
		SCS _{CSI-RS} = 120 kHz		
All angles ^{Note 1}	n257	-93.2		≥6
	n258	-93.2		
	n261	-93.2		
NOTE 1: For UEs that support multiple FR2 bands, the Minimum SSB_RP values for all angles are increased by $\Delta MB_{s,n}$, the UE multi-band relaxation factor in dB specified in clause 6.2.1.				
NOTE 2: Values specified at the radiated requirements reference point to give minimum CSI-RS \hat{E}_s/lot , with no applied noise.				

6.6.1.3.6.2 Normative reference

The normative reference for this requirement is TS 38.101-2 [3] clause 6.6.8.

6.6.1.4 Test description

6.6.1.4.1 Initial conditions

Initial conditions are a set of test configurations the UE needs to be tested in and the steps for the SS to take with the UE to reach the correct measurement state.

The initial test configurations consist of environmental conditions, test frequencies, and channel bandwidths based on NR operating bands specified in Table 5.3.5-1. All of these configurations shall be tested with applicable test parameters for each channel bandwidth and subcarrier spacing, are shown in Table 6.6.1.4.1-1. The details of the uplink reference measurement channels (RMCs) are specified in Annexes A.2. Configurations of PDSCH and PDCCH before measurement are specified in Annex C.2.

Table 6.6.1.4.1-1: Test Configuration Table for PC3

Default Conditions	
Test Environment as specified in TS 38.508-1 [10] subclause 4.1	Normal
Test Frequencies as specified in TS 38.508-1 [10] subclause 4.3.1	Low range, High range
Test Channel Bandwidths as specified in TS 38.508-1 [10] subclause 4.3.1	Lowest, Highest
Test SCS as specified in Table 5.3.5-1	120 kHz

Test Parameters					
Test ID	ChBw	SCS	Downlink Configuration	Uplink Configuration	
		Default	-	Modulation	
1	50			RB allocation (NOTE 1)	
2	100			DFT-s-OFDM QPSK	Inner_Full
3	200				
4	400				
NOTE 1: The specific configuration of each RF allocation is defined in Table 6.1-1.					

1. Connection between SS and UE is shown in TS 38.508-1 [10] Annex A, Figure A.3.3.1.1 for TE diagram and Figure A.3.4.1.1 for UE diagram.
2. The parameter settings for the cell are set up according to TS 38.508-1 [10] subclause 4.4.3.
3. Downlink signals are initially set up according to Annex C, and uplink signals according to Annex G.
4. The UL Reference Measurement channels are set according to Table 6.6.1.4.1-1.
5. Propagation conditions are set according to Annex B.0
6. Ensure the UE is in state RRC_CONNECTED with generic procedure parameters Connectivity *NR*, Connected without release *On*, Test Mode *On* and Test Loop Function *On* according to TS 38.508-1 [10] clause 4.5. Message contents are defined in clause 6.6.1.4.3.

6.6.1.4.2 Test procedure

Test procedure without uplink beam sweeping:

- 1.1 SS sends uplink scheduling information for each UL HARQ process via PDCCH DCI format 0_1 for C_RNTI to schedule the UL RMC according to Table 6.6.1.4.1-1. Since the UL has no payload and no loopback data to send the UE sends uplink MAC padding bits on the UL RMC. Messages to configure the appropriate uplink modulation in section 6.6.1.4.3.
- 1.1a. The side conditions for SSB-based and CSI-RS based L1-RSRP measurements are applied as per clause 6.6.1.3.3.1.3 for PC3.
- 1.2. Set the UE in the Tx beam peak direction found with a 3D EIRP scan as performed in Annex K.1.1 without uplink beam sweeping (i.e., not executing steps 5.1) to step 5.5) in Annex K.1.1). Allow at least BEAM_SELECT_WAIT_TIME (NOTE 1) for the UE Tx beam selection to complete.
- 1.3. Send continuously uplink power control "up" commands in every uplink scheduling information to the UE; allow at least 200 msec to ensure that the UE transmits at its maximum output power. Allow at least BEAM_SELECT_WAIT_TIME (NOTE 1) for the UE Tx beam selection to complete.
- 1.4. Measure UE EIRP₁ in the Tx beam peak direction in the channel bandwidth of the radio access mode according to the test configuration. Repeat EIRP₁ measurement for all directions in the sphere according to EIRP measurement procedure defined in Annex K.1.9 without beam sweeping for all the points in the grid. After a rotation, allow at least BEAM_SELECT_WAIT_TIME (NOTE 1) for UE to find the best beam to use. The measuring duration is one active uplink subframe. EIRP₁ is calculated considering both polarizations, theta and phi.
- 1.5 Record all the measured EIRP₁ values.

NOTE 1: The BEAM_SELECT_WAIT_TIME default value is defined in Annex K.

Test procedure with uplink beam sweeping:

- 2.1 SS sends uplink scheduling information for each UL HARQ process via PDCCH DCI format 0_1 for C_RNTI to schedule the UL RMC according to Table 6.6.1.4.1-1. Since the UL has no payload and no loopback data to send the UE sends uplink MAC padding bits on the UL RMC. Messages to configure the appropriate uplink modulation in section 6.6.1.4.3.
- 2.1a. The side conditions for SSB-based and CSI-RS based L1-RSRP measurements are applied as per clause 6.6.1.3.3.1.1 for PC3.

- 2.2. Set the UE in the Tx beam peak direction found with a 3D EIRP scan as performed in Annex K.1.1. Allow at least BEAM_SELECT_WAIT_TIME (NOTE 1) for the UE Tx beam selection to complete.
- 2.3. Send continuously uplink power control "up" commands in every uplink scheduling information to the UE; allow at least 200 msec to ensure that the UE transmits at its maximum output power. Allow at least BEAM_SELECT_WAIT_TIME (NOTE 1) for the UE Tx beam selection to complete.
- 2.4. Measure UE EIRP in the Tx beam peak direction in the channel bandwidth of the radio access mode according to the test configuration. Repeat EIRP measurements for all directions in the sphere according to EIRP measurement procedure defined in Annex K.1.9 with beam sweeping. After a rotation, allow at least BEAM_SELECT_WAIT_TIME (NOTE 1) for UE to find the best beam to use. The measuring duration is one active uplink subframe. EIRP is calculated considering both polarizations, theta and phi.
- 2.5. Record all the measured EIRP₂ values.

NOTE 1: The BEAM_SELECT_WAIT_TIME default value is defined in Annex K.

- 2.6. Calculate the $\Delta\text{EIRP}_{\text{BC}} = \text{EIRP}_2 - \text{EIRP}_1$.
- 2.7. Calculate a cumulative distribution function for the $\Delta\text{EIRP}_{\text{BC}}$ values.

NOTE 2: The $\Delta\text{EIRP}_{\text{target-CDF}}$ is then obtained from the Cumulative Distribution Function (CDF) computed using $\Delta\text{EIRP}_{\text{BC}}$ for each of all top Nth percentile of the EIRP₂ measurement points in the grid. When using constant step size measurement grids, a theta-dependent correction shall be applied, i.e., the PDF probability contribution for each measurement point is scaled by $\sin(\theta)$ or the normalized Clenshaw-Curtis weights $W(\theta)/W(90^\circ)$, introduced in Section M.4.2.1.

6.6.1.4.3 Message contents

Message contents are according to TS 38.508-1 [10] subclause 4.6 with TRANSFORM_PRECODER_ENABLED condition in Table 4.6.3-118 PUSCH-Config and with following exceptions:

Table 6.6.1.4.3-1: SRS-Config: SpatialRelationInfo test requirement for with beam sweeping

Derivation Path: TS 38.508-1 [10], clause 4.6.3, Table 4.6.3-182			
Information Element	Value/remark	Comment	Condition
spatialRelationInfo	Not present	The UE can consider the UL beam sweeping.	

Table 6.6.1.4.3-2: SRS-Config: SpatialRelationInfo test requirement for without beam sweeping

Derivation Path: TS 38.508-1 [10], clause 4.6.3, Table 4.6.3-182			
Information Element	Value/remark	Comment	Condition
spatialRelationInfo	SRS-SpatialRelationInfo	The UE consider autonomous beam selection	

Table 6.6.1.4.3-3: SRS-Config: ssb-Index test requirement for without beam sweeping

Derivation Path: TS 38.508-1 [10], clause 4.6.3, Table 4.6.3-182			
Information Element	Value/remark	Comment	Condition
ssb-Index	SSB-Index		

Table 6.6.1.4.3-4: SRS-Config: SRS resources test requirement for with beam sweeping

Derivation Path: TS 38.508-1 [10], clause 4.6.3, Table 4.6.3-182			
Information Element	Value/remark	Comment	Condition
srs-ResourceSetToReleaseList	Not present		
srs-ResourceSetToAddModList SEQUENCE (SIZE(1..maxNrofSRS-ResourceSets)) OF SEQUENCE {	3 entries	2 set with 4 SRS resources using	

		'beamManagement' plus 1 set with 1 semi-persistent SRS resource using 'codebook'	
SRS-ResourceSet[1] SEQUENCE{		For the 'beamManagement' resource set	
usage	beamManagement		
resourceType CHOICE {	aperiodic		
Aperiodic SEQUENCE {			
aperiodicSRS-ResourceTrigger	1		
slotOffset	3		
}			
SRS-ResourceSet[2] SEQUENCE{		For the 'beamManagement' resource set	
usage	beamManagement		
resourceType CHOICE {	aperiodic		
aperiodicSRS-ResourceTrigger	2		
slotOffset	3		
}			
SRS-ResourceSet[3] SEQUENCE{		For the semi-persistent SRS resource set	
usage	codebook		
resourceType CHOICE {	semi-persistent		
}			
srs-ResourceToReleaseList	Not present		
srs_ResourceToAddModList	9	The default beam correspondence SRS resource upper limit (M) = 8 in Rel-15 for the 'beamManagement' SRS Resource set plus 1 resource for the semi-persistent SRS 'codebook' resource set.	

Table 6.6.1.4.3-5: CSI-RS-ResourceMapping: CSI-RS test requirements

Derivation Path: TS 38.508-1 [10], clause 4.6.3, Table 4.6.3-45			
Information Element	Value/remark	Comment	Condition
CSI-RS-ResourceMapping ::= SEQUENCE {			
frequencyDomainAllocation CHOICE {			
row1	0001	k0 = 0, row1, 1Tx test cases	
}			
nrofPorts	p1	1Tx test cases	
firstOFDMsymbolInTimeDomain	6 for resource #0		
	7 for resource #1		
	8 for resource #2		
	9 for resource #3		
	10 for resource #4		
	11 for resource #5		
	12 for resource #6		
	13 for resource #7		
cdm-Type	noCDM		
density CHOICE {			
three	NULL		

}			
freqBand	CSI-FrequencyOccupation		
}			

Table 6.6.1.4.3-6: NZP-CSI-RS-Resource: CSI-RS test requirements

Derivation Path: TS 38.508-1 [10], clause 4.6.3, Table 4.6.3-85			
Information Element	Value/remark	Comment	Condition
NZP-CSI-RS-Resource ::= SEQUENCE {			
nzp-CSI-RS-ResourceId	NZP-CSI-RS-ResourceId		
resourceMapping	CSI-RS-ResourceMapping		
powerControlOffset	0		
powerControlOffsetSS	db0		
scramblingID	ScramblingId		
periodicityAndOffset	CSI-ResourcePeriodicityAndOffset		
qcl-InfoPeriodicCSI-RS	TCI-StateId		
}			

Table 6.6.1.4.3-7: NZP-CSI-RS-ResourceSet: CSI-RS test requirements

Derivation Path: TS 38.508-1 [10], clause 4.6.3, Table 4.6.3-87			
Information Element	Value/remark	Comment	Condition
NZP-CSI-RS-ResourceSet ::= SEQUENCE {			
nzp-CSI-ResourceSetId	NZP-CSI-RS-ResourceSetId		
nzp-CSI-RS-Resources SEQUENCE (SIZE (1..maxNrofNZP-CSI-RS-ResourcesPerSet)) OF {	[1 entry]		
NZP-CSI-RS-ResourceId[1]	NZP-CSI-RS-ResourceId		
}			
repetition	on		
aperiodicTriggeringOffset	0	Depending on UE capability	
trs-Info	Not present		
}			

Table 6.6.1.4.3-8: NZP-CSI-RS-ResourceId: CSI-RS test requirements

Derivation Path: TS 38.508-1 [10], clause 4.6.3, Table 4.6.3-86			
Information Element	Value/remark	Comment	Condition
NZP-CSI-RS-ResourceId	30 for resource #0		
	31 for resource #1		
	32 for resource #2		
	33 for resource #3		
	34 for resource #4		
	35 for resource #5		
	36 for resource #6		
	37 for resource #7		

Table 6.6.1.4.3-9: CSI-ResourceConfig: CSI-RS test requirements

Derivation Path: TS 38.508-1 [10], clause 4.6.3, Table 4.6.3-39			
Information Element	Value/remark	Comment	Condition
CSI-ResourceConfig ::= SEQUENCE {			
csi-ResourceConfigId	CSI-ResourceConfigId		
csi-RS-ResourceSetList CHOICE {			
nzp-CSI-RS-SSB SEQUENCE {			

nzp-CSI-RS-ResourceSetList SEQUENCE (SIZE (1..maxNrofNZP-CSI-RS-ResourceSetsPerConfig)) OF {	2 entries		
Nzp-CSI-RS-ResourceSetId[0]	0		
Nzp-CSI-RS-ResourceSetId[1]	1		
}			
csi-SSB-ResourceSetList	Not present		
}			
}			
bwp-Id	BWP-Id		
resourceType	aperiodic		
}			

Table 6.6.1.4.3-10: CSI-FrequencyOccupation: CSI-RS test requirements

Derivation Path: TS 38.508-1 [10], clause 4.6.3, Table 4.6.3-33			
Information Element	Value/remark	Comment	Condition
CSI-FrequencyOccupation ::= SEQUENCE {			
startingRB	0		
nrofRBs	48		FR2_≥100MHz
	32		FR2_50MHz
}			

Table 6.6.1.4.3-11: CSI-ReportConfigToAddModList: CSI-RS test requirements

Derivation Path: TS 38.508-1 [10], clause 4.6.3, Table 4.6.3-38			
Information Element	Value/remark	Comment	Condition
CSI-MeasConfig ::= SEQUENCE {			
csi-ReportConfigToAddModList SEQUENCE (SIZE (1..maxNrofCSI-ReportConfigurations)) OF CSI-ReportConfig {	1 entry		
CSI-ReportConfig[1] {	CSI-ReportConfig	entry 1	
ResourcesForChannelMeasurement	1		
reportConfigType	Aperiodic		
aperiodic SEQUENCE {			
reportSlotOffsetList {	2		
INTEGER[1]	8		
INTEGER[2]	8		
}			
}			
reportQuantity CHOISE	none		
}			
}			
reportTriggerSize	1		
aperiodicTriggerStateList CHOICE {			
setup	CSI-AperiodicTriggerStateList		
associatedReportConfigInfoList {			
CSI-AssociatedReportConfigInfo			
resourcesForChannel	nzp-CSI-RS		
nzp-CSI-RS {			
resourceSet	2		
qci-info	8		
TCI-StateID	0		
TCI-StateID	0		
TCI-StateID	0		
TCI-StateID	0		
TCI-StateID	0		
TCI-StateID	0		
TCI-StateID	0		
TCI-StateID	0		
TCI-StateID	0		
}			
}			

}			
}			

6.6.1.5 Test requirements

The defined %-tile EIRP in measurement distribution derived in step 2.6 shall exceed the values specified in Table 6.2.1.2.5-3 in clause 6.2.1.2.5. The defined %-tile $\Delta\text{EIRP}_{\text{BC}}$ in measurement distribution derived in step 2.7 shall not exceed the values specified in Table 6.6.1.5-1 and Table 6.6.1.5-2.

Table 6.6.1.5-1: UE beam correspondence tolerance for power class 3

Operating band	Max $\Delta\text{EIRP}_{\text{BC}}$ at 85 th %-tile $\Delta\text{EIRP}_{\text{BC}}$ CDF (dB)
n257	3.0 +TT
n258	3.0 +TT
n260	3.2 +TT
n261	3.0 +TT
NOTE: The requirements in this table are verified only under normal temperature conditions as defined in TS 38.508-1 [10] subclause 4.1.1	

Table 6.6.1.5-2: Test Tolerance (TT) for UE beam correspondence tolerance for power class 3

Operating band	Test Tolerance (dB)
n257, n258, n260, n261	1.26
n259	FFS

6.6.2 Enhanced Beam correspondence – EIRP

6.6.2.1 Test purpose

To verify the UE's ability to select a suitable beam for UL transmission based on DL measurements with or without relying on UL beam sweeping within the range prescribed by the specified nominal maximum output power and beam correspondence tolerance.

6.6.2.2 Test applicability

This test case applies to all types of NR Power Class 3 UE release 16 and forward that support CSI-RS or SSB based beam correspondence and do not support beam correspondence without UL beam sweeping.

6.6.2.3 Minimum conformance requirements

6.6.2.3.1 Enhanced Beam correspondence for PC3

6.6.2.3.1.1 General Test Coverage Rules

The beam correspondence requirement for PC3 UEs consists of three components: UE minimum peak EIRP (as defined in clause 6.2.1.1.3.3), UE spherical coverage (as defined in clause 6.2.1.1.3.3), and beam correspondence tolerance (as defined in clause 6.6.1.3.3.2). The beam correspondence requirement is fulfilled if the UE satisfies one of the following conditions, depending on the UE's beam correspondence capability IE *beamCorrespondenceWithoutUL-BeamSweeping*, as defined in TS 38.306 [26]:

If *beamCorrespondenceWithoutUL-BeamSweeping* and *beamCorrespondenceSSB-based-r16* are supported, the UE shall meet the minimum peak EIRP requirement according to Table 6.2.1.1.3.3-1 and spherical coverage requirement according to Table 6.2.1.1.3.3-3 using the side conditions for SSB based enhanced beam correspondence requirements as defined in Clause 6.6.2.3.1.3.1.

- If *beamCorrespondenceWithoutUL-BeamSweeping* and *beamCorrespondenceCSI-RS-based-r16* are supported, the UE shall meet the minimum peak EIRP requirement according to Table 6.2.1.1.3.3-1 and spherical coverage requirement according to Table 6.2.1.1.3.3-3 using the side conditions for CSI-RS based enhanced beam correspondence requirements as defined in Clause 6.6.2.3.1.3.2.

If *beamCorrespondenceWithoutUL-BeamSweeping* is not present and *beamCorrespondenceSSB-based-r16* is supported, the UE shall meet the minimum peak EIRP requirement according to Table 6.2.1.1.3.3-1 and spherical coverage requirement according to Table 6.2.1.1.3.3-3 with uplink beam sweeping using the side conditions for SSB based enhanced beam correspondence requirements as defined in Clause 6.6.2.3.1.3.1. Such a UE shall meet the beam correspondence tolerance requirement defined in Clause 6.6.1.3.3.2 and shall support uplink beam management, as defined in TS 38.306 [14].

- If *beamCorrespondenceWithoutUL-BeamSweeping* is not present and *beamCorrespondenceCSI-RS-based-r16* is supported, the UE shall meet the minimum peak EIRP requirement according to Table 6.2.1.1.3.3-1 and spherical coverage requirement according to Table 6.2.1.1.3.3-3 with uplink beam sweeping using the side conditions for CSI-RS based enhanced beam correspondence requirements as defined in Clause 6.6.2.3.1.3.2. Such a UE shall meet the beam correspondence tolerance requirement defined in Clause 6.6.1.3.3.2 and shall support uplink beam management, as defined in TS 38.306 [14].

6.6.2.3.1.2 Applicability rules based on support for type of enhanced beam correspondence

For UEs supporting more than one type of beam correspondence, the following applicability rules apply:

- If a UE meets enhanced beam correspondence requirements either based on SSB or based on CSI-RS, it is considered to have met the beam correspondence requirements based on SSB and CSI-RS.
- For a UE supporting either SSB based or CSI-RS based enhanced beam correspondence, UE shall meet the supported enhanced beam correspondence requirements.
- For a UE supporting both SSB based and CSI-RS based enhanced beam correspondence, the UE shall meet both SSB based and CSI-RS based enhanced beam correspondence requirements and the following applicability rules for verifying the requirements apply:
 - The enhanced beam correspondence requirements shall be verified with the SSB based enhanced beam correspondence side conditions in clause 6.6.2.3.1.3.1
 - If the UE meets the SSB based enhanced beam correspondence requirements using the side conditions in clause 6.6.2.3.2 and meets the minimum peak EIRP requirement as defined in clause 6.2.1.1 using the CSI-RS based side conditions in clause 6.6.2.3.1.3.2, where the link direction is determined in the SSB based enhanced beam correspondence test, the UE is considered to have met both the SSB based and CSI-RS based enhanced beam correspondence requirements.
- Otherwise, if UE does not meet the minimum peak EIRP requirement as defined in clause 6.2.1.3 using the CSI-RS based side conditions in clause 6.6.2.3.1.3.2, the enhanced beam correspondence requirements shall be further verified for the UE with the CSI-RS based enhanced beam correspondence side conditions in clause 6.6.2.3.1.3.2.

6.6.2.3.1.3 Side Condition

6.6.2.3.1.3.1 Side Condition for SSB based enhanced Beam Correspondence requirements

The beam correspondence requirements for beam correspondence based on SSB are only applied under the following side conditions:

- The downlink reference signal SSB is provided and CSI-RS is not provided.
- For beam correspondence, conditions for L1-RSRP measurements are fulfilled according to Table 6.6.1.3.3.1.1-1.

6.6.2.3.1.3.2 Side Condition for CSI-RS based enhanced Beam Correspondence requirements

The beam correspondence requirements for beam correspondence based on CSI-RS are only applied under the following side conditions:

- The downlink reference signals including both SSB and CSI-RS are provided.
- The reference measurement channel for beam correspondence are fulfilled according to the CSI-RS configuration in Annex A.3.
- For beam correspondence, conditions for L1-RSRP measurements are fulfilled according to Table 6.6.1.3.3.1.1-2 and SSB signal is provided according to Table 6.6.2.3.1.3.2-1.

Table 6.6.2.3.1.3.2-1: SSB signal conditions for CSI-RS based beam correspondence requirements

Angle of arrival	NR operating bands	Minimum SSB_RP ^{Note 2}		
		dBm / SCS _{SSB}		
		SCS _{SSB} = 120 kHz		
			SSB \hat{E}_s/lot dB	
All angles ^{Note 1}	n257	-101.2		≥1
	n258	-101.2		
	n259	-95.7		
	n260	-96.9		
	n261	-101.2		
NOTE 1: For UEs that support multiple FR2 bands, the Minimum SSB_RP values for all angles are increased by ΣMBs , the UE multi-band relaxation factor in dB specified in clause 6.2.1.				
NOTE 2: Values specified at the radiated requirements reference point to give minimum SSB \hat{E}_s/lot , with no applied noise.				

6.6.2.3.1 Normative reference

The normative reference for this requirement is TS 38.101-2 [3] clause 6.6.4

6.6.2.3.2 Enhanced Beam correspondence for PC5

FFS

6.6.2.3.3 Enhanced Beam correspondence for PC6

Editor's note: This test case is incomplete due to the following reason:

The TT/ MU analysis for PC6 is missing

6.6.2.3.3.1 General

The beam correspondence requirement for power class 6 UEs consists of two components: UE minimum peak EIRP (as defined in Clause 6.2.1.6), and UE spherical coverage (as defined in Clause 6.2.1.6).

Power class 6 UE shall mandatorily support *beamCorrespondenceWithoutUL-BeamSweeping* and *beamCorrespondenceSSB-based-r16*. The UE shall meet the minimum peak EIRP requirement according to Table 6.2.1.6-1 and spherical coverage requirement according to Table 6.2.1.6-3 using the side conditions for SSB based enhanced beam correspondence requirements as defined in Clause 6.6.7.3.2.

If the UE also support *beamCorrespondenceCSI-RS-based-r16*, the UE shall also meet the minimum peak EIRP requirement according to Table 6.2.1.6-1 and spherical coverage requirement according to Table 6.2.1.6-3 using the side conditions for CSI-RS based enhanced beam correspondence requirements as defined in Clause 6.6.7.3.3.

6.6.2.3.3.2 Side Conditions

6.6.2.3.3.2.1 Side Condition for SSB based enhanced Beam Correspondence requirements

The beam correspondence requirements for beam correspondence based on SSB are only applied under the following side conditions:

- The downlink reference signal SSB is provided, and CSI-RS is not provided.

- For beam correspondence, conditions for L1-RSRP measurements are fulfilled according to Table 6.6.2.3.3.2.1-1.

Table 6.6.2.3.3.2.1-1: Conditions for SSB based L1-RSRP measurements for beam correspondence

Angle of arrival	NR operating bands	Minimum SSB_RP ^{Note 2}		SSB \hat{E}_s/lot
		dBm / SCS _{SSB}		dB
		SCS _{SSB} = 120 kHz		
All angles ^{Note 1}	n257	-101.4		≥6
	n258	-101.6		
	n261	-101.4		
NOTE 1: For UEs that support multiple FR2 bands, the Minimum SSB_RP values for all angles are increased by $\Delta MB_{S,n}$, the UE multi-band relaxation factor in dB specified in clause 6.2.1.6.				
NOTE 2: Values specified at the radiated requirements reference point to give minimum SSB \hat{E}_s/lot , with no applied noise.				

6.6.2.3.3.2.2 Side Condition for CSI-RS based enhanced Beam Correspondence requirements

The beam correspondence requirements for beam correspondence based on CSI-RS are only applied under the following side conditions:

- The downlink reference signals including both SSB and CSI-RS are provided.
- The reference measurement channel for beam correspondence is fulfilled according to the CSI-RS configuration in Annex A.3.
- For beam correspondence, conditions for L1-RSRP measurements are fulfilled according to Table 6.6.2.3.3.2.2-2 and SSB signal is provided according to Table 6.6.2.3.3.2.2-1.

Table 6.6.2.3.3.2.2-1: SSB signal conditions for CSI-RS based beam correspondence requirements

Angle of arrival	NR operating bands	Minimum SSB_RP ^{Note 2}		SSB \hat{E}_s/lot
		dBm / SCS _{SSB}		dB
		SCS _{SSB} = 120 kHz		
All angles ^{Note 1}	n257	-106.4		≥1
	n258	-106.6		
	n261	-106.4		
NOTE 1: For UEs that support multiple FR2 bands, the Minimum SSB_RP values for all angles are increased by $\Delta MB_{S,n}$, the UE multi-band relaxation factor in dB specified in clause 6.2.1.6				
NOTE 2: Values specified at the radiated requirements reference point to give minimum SSB \hat{E}_s/lot , with no applied noise.				

Table 6.6.2.3.3.2.2-2: Conditions for CSI-RS based L1-RSRP measurements for beam correspondence

Angle of arrival	NR operating bands	Minimum CSI-RS_RP ^{Note 2}		CSI-RS \hat{E}_s/lot
		dBm / SCS _{CSI-RS}		dB
		SCS _{CSI-RS} = 120 kHz		
All angles ^{Note 1}	n257	-101.4		≥6
	n258	-101.6		
	n261	-101.4		
NOTE 1: For UEs that support multiple FR2 bands, the Minimum CSI-RS_RP values are increased by $\Delta MB_{S,n}$, the UE multi-band relaxation factor in dB specified in clause 6.2.1.6				
NOTE 2: Values specified at the radiated requirements reference point to give minimum CSI-RS \hat{E}_s/lot , with no applied noise.				

6.6.2.3.3.3 Applicability

For UEs supporting more than one type of beam correspondence, the following applicability rules apply:

- If a UE meets enhanced beam correspondence requirements either based on SSB or based on CSI-RS, it is considered to have met the beam correspondence requirements based on SSB and CSI-RS.
- For a UE supporting either SSB based or CSI-RS based enhanced beam correspondence, the UE shall meet the supported enhanced beam correspondence requirements.
- For a UE supporting both SSB based and CSI-RS based enhanced beam correspondence UE shall meet the both SSB based and CSI-RS based enhanced beam correspondence requirements and the following applicability rules for verifying the requirements apply:
 - The enhanced beam correspondence requirements shall be verified with the SSB based enhanced beam correspondence side conditions in clause 6.6.2.3.3.3. If the UE meets the SSB based enhanced beam correspondence requirements using the side conditions in clause 6.6.2.3.3.3 and meets the minimum peak EIRP requirement as defined in clause 6.2.1.6 using the CSI-RS based side conditions in clause 6.6.2.3.3.3.2, where the link direction is determined in the SSB based enhanced beam correspondence test, the UE is considered to have met both the SSB based and CSI-RS based enhanced beam correspondence requirements.
 - Otherwise, if UE does not meet the minimum peak EIRP requirement as defined in clause 6.2.1.6 using the CSI-RS based side conditions in clause 6.6.2.3.3.3.2, the enhanced beam correspondence requirements shall be further verified for the UE with the CSI-RS based enhanced beam correspondence side conditions in clause 6.6.2.3.3.3.2.

6.6.2.3.3.4 Normative reference

The normative reference for this requirement is TS 38.101-2 [3] clause 6.6.7.

6.6.2.3.4 Enhanced Beam correspondence for PC7

6.6.2.3.4.1 General Test Coverage Rules

The beam correspondence requirement for power class 7 UEs consists of two components: UE minimum peak EIRP (as defined in Clause 6.2.1.1.3.7), and UE spherical coverage (as defined in Clause 6.2.1.1.3.7). The beam correspondence requirement is fulfilled if the UE satisfies one of the following conditions, depending on the UE's beam correspondence capability IE *beamCorrespondenceWithoutUL-BeamSweeping*, as defined in TS 38.306 [26]:

- If *beamCorrespondenceWithoutUL-BeamSweeping* is supported, the UE shall meet the minimum peak EIRP requirement according to Table 6.2.1.1.3.7-1 and spherical coverage requirement according to Table 6.2.1.1.3.7-3 with its autonomously chosen UL beams and without uplink beam sweeping. Such a UE is considered to have met the beam correspondence tolerance requirement.
- If *beamCorrespondenceWithoutUL-BeamSweeping* and *beamCorrespondenceSSB-based-r16* are supported, the UE shall meet the minimum peak EIRP requirement according to Table 6.2.1.1.3.7-1 and spherical coverage requirement according to Table 6.2.1.1.3.7-3 using the side conditions for SSB based enhanced beam correspondence requirements as defined in Clause 6.6.2.3.4.3.1.
- If *beamCorrespondenceWithoutUL-BeamSweeping* and *beamCorrespondenceCSI-RS-based-r16* are supported, the UE shall meet the minimum peak EIRP requirement according to Table 6.2.1.7-1 and spherical coverage requirement according to Table 6.2.1.7-3 using the side conditions for CSI-RS based enhanced beam correspondence requirements as defined in Clause 6.6.2.3.4.3.2.

6.6.2.3.4.2 Applicability rules based on support for type of enhanced beam correspondence

For UEs supporting more than one type of beam correspondence, the following applicability rules apply:

- If a UE meets enhanced beam correspondence requirements either based on SSB or based on CSI-RS, it is considered to have met the beam correspondence requirements based on SSB and CSI-RS.

- For a UE supporting either SSB based or CSI-RS based enhanced beam correspondence, the UE shall meet the supported enhanced beam correspondence requirements.
- For a UE supporting both SSB based and CSI-RS based enhanced beam correspondence, the UE shall meet both SSB based and CSI-RS based enhanced beam correspondence requirements and the following applicability rules for verifying the requirements apply:
 - The enhanced beam correspondence requirements shall be verified with the SSB based enhanced beam correspondence side conditions in clause 6.6.2.3.4.3.1. If UE meets the SSB based enhanced beam correspondence requirements using the side conditions in clause 6.6.2.3.4.3.1 and meets the minimum peak EIRP requirement as defined in clause 6.2.1.1.3.7 using the CSI-RS based side conditions in clause 6.6.2.3.4.3.2, where the link direction is determined in the SSB based enhanced beam correspondence test, the UE is considered to have met both the SSB based and CSI-RS based enhanced beam correspondence requirements.
 - Otherwise, if UE does not meet the minimum peak EIRP requirement as defined in clause 6.2.1.1.3.7 using the CSI-RS based side conditions in clause 6.6.2.3.4.3.2, the enhanced beam correspondence requirements shall be further verified for the UE with the CSI-RS based enhanced beam correspondence side conditions in clause 6.6.2.3.4.3.2.

6.6.2.3.4.3 Side Conditions

6.6.2.3.4.3.1 Side Condition for SSB based enhanced Beam Correspondence requirements

The beam correspondence requirements for beam correspondence based on SSB are only applied under the following side conditions:

- The downlink reference signal SSB is provided, and CSI-RS is not provided.
- For beam correspondence, conditions for L1-RSRP measurements are fulfilled according to Table 6.6.1.3.6.1.1-1.

6.6.2.3.4.3.2 Side Condition for CSI-RS based enhanced Beam Correspondence requirements

The beam correspondence requirements for beam correspondence based on CSI-RS are only applied under the following side conditions:

- The downlink reference signals including both SSB and CSI-RS are provided.
- The reference measurement channel for beam correspondence is fulfilled according to the CSI-RS configuration in Annex A.3.
- For beam correspondence, conditions for L1-RSRP measurements are fulfilled according to Table 6.6.1.3.6.1.1-2 and SSB signal is provided according to Table 6.6.2.3.4.3.2-1.

Table 6.6.2.3.4.3.2-1: SSB signal conditions for CSI-RS based beam correspondence requirements

Angle of arrival	NR operating bands	Minimum SSB _{RP} ^{Note 2}	
		dBm / SCS _{SSB}	
		SCS _{SSB} = 120 kHz	
All angles ^{Note 1}	n257	-98.2	
	n258	-98.2	
	n261	-98.2	
NOTE 1: For UEs that support multiple FR2 bands, the Minimum SSB _{RP} values for all angles are increased by ΔMBs _n , the UE multi-band relaxation factor in dB specified in clause 6.2.1. NOTE 2: Values specified at the radiated requirements reference point to give minimum SSB \dot{E} s/lot, with no applied noise.			

6.6.2.3.4.4 Normative reference

The normative reference for this requirement is TS 38.101-2 [3] clause 6.6.8.6.6.2.4 Test description

6.6.2.4.1 Initial conditions

Same as 6.6.1.4.1.

6.6.2.4.2 Test procedure

The following cases are tested depending on UE capability:

1. Test procedure if *beamCorrespondenceWithoutUL-BeamSweeping* is NOT supported, uplink beam management and *beamCorrespondenceSSB-based-r16* are supported:
 - 1.1 Same as 6.6.1.4.2 with the exception that measurements shall be carried out using only side conditions defined in clause 6.6.2.3.1.3.1 for PC3.
 - 1.2 End test procedure.
2. Test procedure if *beamCorrespondenceWithoutUL-BeamSweeping* is NOT supported, uplink beam management and *beamCorrespondenceCSI-RS-based-r16* is supported
 - 2.1 Same as 6.6.1.4.2 with the exception that measurements shall be carried out using only side conditions defined in clause 6.6.2.3.1.3.2 for PC3.
 - 2.2 End test procedure.
3. Test procedure if *beamCorrespondenceWithoutUL-BeamSweeping* is NOT supported, uplink beam management, *beamCorrespondenceCSI-RS-based-r16* and *beamCorrespondenceSSB-based-r16* are supported
 - 3.1 Same as 6.6.1.4.2 with the exception that measurements shall be carried out using only side conditions defined in clause 6.6.2.3.1.3.1 for PC3.
 - 3.2 If measurement performed in 6.2.1.1_1.4.2 Step 3.2 was fail, repeat test same as 6.6.1.4.2 with the exception that measurements shall be carried out using only side conditions defined in clause 6.6.2.3.1.3.2.
 - 3.3 End test procedure.

6.6.2.4.3 Message contents

Same as the message contents in 6.6.1.4.3

6.6.2.5 Test requirements

The defined %-tile EIRP in measurement distribution derived within 6.6.2.4.2 (as per step 2.6 of clause 6.6.1.4.2) shall exceed the values specified in Table 6.2.1.2.5-3 in clause 6.2.1.2.5. The defined %-tile $\Delta\text{EIRP}_{\text{BC}}$ in measurement distribution derived in step 2.7 shall not exceed the values specified in Table 6.6.1.5-1.

Table 6.6.1.5-1: UE beam correspondence tolerance for power class 3

Operating band	Max $\Delta\text{EIRP}_{\text{BC}}$ at 85 th %-tile $\Delta\text{EIRP}_{\text{BC}}$ CDF (dB)
n257	3.0 +TT
n258	3.0 +TT
n260	3.2 +TT
n261	3.0 +TT
NOTE: The requirements in this table are verified only under normal temperature conditions as defined in TS 38.508-1 [10] subclause 4.1.1.	

6.6.3 Beam Correspondence in RRC_INACTIVE and initial access

Editor's note: This clause is incomplete. The following aspects are either missing or not yet determined:

- The test case is incomplete for Test procedure, Message Contents and Test Requirement.
- TP Analysis is pending
- Pending testability on which of the 2 approaches (without beamlock, with beamlock) to be used to verify the beam correspondence requirements

6.6.3.1 Test purpose

The purpose of this test is to verify the UE RACH MSG1 performance and uplink spatial coverage of the UE in expected directions is acceptable.

Transmission of the wrong power increases interference or transmission errors in the uplink channel.

6.6.3.2 Test applicability

This test case applies to all types of NR UEs release 18 and forward.

6.6.3.3 Minimum conformance requirements

The minimum conformance requirements for beam correspondence in RRC_INACTIVE and initial access are same as specified in section 6.2.1.1.3.3.

For the beam correspondence requirement for UEs in initial access and in RRC_INACTIVE, the following applicability rules apply:

- If a UE meets UE beam correspondence requirements in initial access, it is considered to have met the beam correspondence requirements in RRC_INACTIVE

The normative reference for this requirement is TS 38.101-2 [3] clause 6.6.3.

6.6.3.4 Test description

6.6.3.4.1 Initial conditions

Initial conditions are a set of test configurations the UE needs to be tested in and the steps for the SS to take with the UE to reach the correct measurement state.

The initial test configurations consist of environmental conditions, test frequencies, and channel bandwidths based on NR operating bands specified in Table 5.3.5-1. All of these configurations shall be tested with applicable test parameters for each channel bandwidth and subcarrier spacing, are shown in Table 6.6.3.4.1-1. The details of the uplink reference measurement channels (RMCs) are specified in Annexes A.2. Configurations of PDSCH and PDCCH before measurement are specified in Annex C.2.

Table 6.6.3.4.1-1: Test Configuration Table

Default Conditions	
Test Environment as specified in TS 38.508-1 [10] subclause 4.1	Normal
Test Frequencies as specified in TS 38.508-1 [10] subclause 4.3.1	Low range, Mid Range, High range
Test Channel Bandwidths as specified in TS 38.508-1 [10] subclause 4.3.1	100 MHz
Test SCS as specified in Table 5.3.5-1	120 kHz
PRACH preamble format	
PRACH Configuration Index	FFS

1. Connection between SS and UE is shown in TS 38.508-1 [10] Annex A, Figure A.3.3.1.1 for TE diagram and Figure A.3.4.1.1 for UE diagram.

2. The parameter settings for the cell are set up according to TS 38.508-1 [10] subclause 4.4.3.
3. Downlink signals are initially set up according to Annex C, and uplink signals according to Annex G.
4. Propagation conditions are set according to Annex B.0.
5. Ensure the UE is in State RRC_CONNECTED with generic procedure parameters Connectivity *NR*, Connected without release *On*, Test Mode *On* and Test Loop Function *On* according to TS 38.508-1 [10] clause 4.5. Message contents are defined in clause 6.6.3.4.3.

6.6.3.4.2 Test procedure

FFS

6.6.3.4.3 Message contents

FFS

6.6.3.5 Test requirement

FFS

6.6A Beam correspondence for CA

6.6A.1 Test purpose

Same test purpose as in clause 6.6

6.6A.2 Test applicability

The requirements in this test covered by section 6.6 dealing with non-CA Beam Correspondence.

No test case details are specified.

6.6A.3 Minimum Conformance Requirements

For intra-band CA in FR2, the same beam correspondence relationship for beam management is supported across CCs in Rel-15 and no requirement is specified. Beam correspondence performance for intra-band CA is fulfilled if the beam correspondence requirements defined in section 6.6 is met for non-CA case.

7 Receiver characteristics

7.1 General

Editor's note: Test configurations/environments that require new spherical scan shall be included in test procedure section and identifying such scenarios is currently FFS and owned by RAN5.

Unless otherwise stated, the receiver characteristics are specified over the air (OTA). The power levels for all DL signals and interferers are defined assuming a 0 dBi reference antenna located at the centre of the quiet zone.

For Rx test cases the identified beam peak direction can be stored and reused for a device under test in various configurations/environments for the full duration of device testing as long as beam peak direction is the same.

Unless otherwise stated, Channel Bandwidth shall be prioritized in the selecting of test points. Subcarrier spacing shall be selected after Test Channel Bandwidth is selected.

The UE under test shall be pre-configured with UL Tx diversity schemes disabled to account for single polarization System Simulator (SS) in the test environment. The UE under test may transmit with dual polarization.

7.1M General for LP-WUR/WUS

The criterion for verifying all receiver core RF requirements shall be MDR of the LP-WUS, which shall not exceed 1% with the LP-WUS parameters given in Annex [A.3M]. Beam peak direction refers to RX beam peak direction as determined for clause 7.3. The requirement applies to power classes 3 and 7 in this release.

A non-LP-WUS DL RB is defined as any RB in the DL transmission bandwidth configuration of the UE-specific channel that is not occupied by the LP-WUS carrier as defined in sub-clause 5.3M. Unless otherwise specified, the power in any non-LP-WUS DL RB is 0 mW.

7.2 Diversity characteristics

The minimum requirements on effective isotropic sensitivity (EIS) apply to two measurements, corresponding to DL signals in orthogonal polarizations.

7.2M Diversity characteristics for LP-WUR/WUS

Unless otherwise specified, the requirements apply to all polarizations of DL. The minimum requirements on sensitivity apply to two measurements, corresponding to DL signals in orthogonal polarizations.

7.3 Reference sensitivity

7.3.1 General

The reference sensitivity power level REFSENS is the EIS level (total component) at the centre of the quiet zone in the RX beam peak direction, at which the throughput shall meet or exceed the requirements for the specified reference measurement channel.

7.3.2 Reference sensitivity power level

Editor's note: The following aspects of the clause are for future consideration:

Measurement Uncertainties and Test Tolerances are FFS for power class other than 1, 3, 5, 6 and 7.

Editor's note: The following aspects of the clause are for future consideration:

The 3D EIS scan test time optimization in RAN 4/ RAN 5 is FFS (existing EIS based test time needs to be re-evaluated for 200/266 grid points).

Statistical model in Annex H.2 (currently based on LTE model) needs to be validated to confirm that it is also applicable for FR2

7.3.2.1 Test purpose

To verify the UE's ability to receive data with a given average throughput for a specified reference measurement channel, under conditions of low signal level, ideal propagation and no added noise.

A UE unable to meet the throughput requirement under these conditions will decrease the effective coverage area of an g-NodeB.

7.3.2.2 Test applicability

This test case applies to all types of NR UE release 15 and forward.

7.3.2.3 Minimum conformance requirements

The reference sensitivity power level REFSENS is defined as the EIS level at the centre of the quiet zone in the RX beam peak direction, at which the throughput shall meet or exceed the requirements for the specified reference measurement channel.

7.3.2.3.1 Reference sensitivity power level for power class 1

The throughput shall be $\geq 95\%$ of the maximum throughput of the reference measurement channels as specified in Annex A.2.3.2 and A.3.3.2 (with one sided dynamic OCNG Pattern OP.1 TDD for the DL-signal as described in Annex A.5.2.1) with peak reference sensitivity specified in Table 7.3.2.3.1-1. The requirement is verified with the test metric of EIS (Link=RX beam peak direction, Meas=Link Angle).

Table 7.3.2.3.1-1: Reference sensitivity for power class 1

Operating band	REFSENS (dBm) / Channel bandwidth						
	50 MHz	100 MHz	200 MHz	400 MHz	800 MHz	1600 MHz	2000 MHz
n257	-97.5	-94.5	-91.5	-88.5	N/A	N/A	N/A
n258	-97.5	-94.5	-91.5	-88.5	N/A	N/A	N/A
n260	-94.5	-91.5	-88.5	-85.5	N/A	N/A	N/A
n261	-97.5	-94.5	-91.5	-88.5	N/A	N/A	N/A

NOTE 1: The transmitter shall be set to P_{UMAX} as defined in subclause 6.2.4

The REFSENS requirement shall be met for an uplink transmission using QPSK DFT-s-OFDM waveforms and for uplink transmission bandwidth less than or equal to that specified in Table 7.3.2.3.1-2.

Table 7.3.2.3.1-2: Uplink configuration for reference sensitivity

Operating band	NR Band / Channel bandwidth / NRB / SCS / Duplex mode								
	50 MHz	100 MHz	200 MHz	400 MHz	800 MHz	1600 MHz	2000 MHz	SCS	Duplex Mode
n257	32	64	128	256	N/A	N/A	N/A	120 kHz	TDD
n258	32	64	128	256	N/A	N/A	N/A	120 kHz	TDD
n260	32	64	128	256	N/A	N/A	N/A	120 kHz	TDD
n261	32	64	128	256	N/A	N/A	N/A	120 kHz	TDD

Unless given by Table 7.3.2.3.1-3, the minimum requirements for reference sensitivity shall be verified with the network signalling value NS_200 (Table 6.2.3.3.1-1) configured.

Table 7.3.2.3.1-3: Reserved

Operating band	Network Signalling value

7.3.2.3.2 Reference sensitivity power level for power class 2

The throughput shall be $\geq 95\%$ of the maximum throughput of the reference measurement channels as specified in Annex A.2.3.2 and A.3.3.2 (with one sided dynamic OCNG Pattern OP.1 TDD for the DL-signal as described in Annex A.5.2.1) with peak reference sensitivity specified in Table 7.3.2.3.2-1. The requirement is verified with the test metric of EIS (Link=RX beam peak direction, Meas=Link Angle).

Table 7.3.2.3.2-1: Reference sensitivity for power class 2

Operating band	REFSENS (dBm) / Channel bandwidth						
	50 MHz	100 MHz	200 MHz	400 MHz	800 MHz	1600 MHz	2000 MHz
n257	-92	-89	-86	-83	N.A	N.A	N.A
n258	-92	-89	-86	-83	N.A	N.A	N.A
n261	-92	-89	-86	-83	N.A	N.A	N.A

NOTE 1: The transmitter shall be set to P_{UMAX} as defined in subclause 6.2.4

The REFSENS requirement shall be met for an uplink transmission using QPSK DFT-s-OFDM waveforms and for uplink transmission bandwidth less than or equal to that specified in Table 7.3.2.3.1-2.

Unless given by Table 7.3.2.3.1-3, the minimum requirements for reference sensitivity shall be verified with the network signalling value NS_200 (Table 6.2.3.3.1-1) configured.

7.3.2.3.3 Reference sensitivity power level for power class 3

The throughput shall be $\geq 95\%$ of the maximum throughput of the reference measurement channels as specified in Annex A.2.3.2 and A.3.3.2 (with one sided dynamic OCNG Pattern OP.1 TDD for the DL-signal as described in Annex A.5.2.1) with peak reference sensitivity specified in Table 7.3.2.3.3-1. The requirement is verified with the test metric of EIS (Link=RX beam peak direction, Meas=Link Angle).

For the power class 3 UEs that support multiple FR2 bands, the minimum requirement for Reference sensitivity in Table 7.3.2.3.3-1 shall be increased per band, respectively, by the reference sensitivity relaxation parameter $\sum MB_P$ and $\Delta MB_{P,n}$ as specified in Table 7.3.2.3.3-1a and 7.3.2.3.3-1b.

Table 7.3.2.3.3-1: Reference sensitivity for power class 3

Operating band	REFSENS (dBm) / Channel bandwidth						
	50 MHz	100 MHz	200 MHz	400 MHz	800 MHz	1600 MHz	2000 MHz
n257	-88.3	-85.3	-82.3	-79.3	N.A	N.A	N.A
n258	-88.3	-85.3	-82.3	-79.3	N.A	N.A	N.A
n259	-84.7	-81.7	-78.7	-75.7	N.A	N.A	N.A
n260	-85.7	-82.7	-79.7	-76.7	N.A	N.A	N.A
n261	-88.3	-85.3	-82.3	-79.3	N.A	N.A	N.A

NOTE 1: The transmitter shall be set to P_{UMAX} as defined in subclause 6.2.4

Table 7.3.2.3.3-1a: UE multi-band relaxation factors for power class 3 (Rel-15)

Supported bands	$\sum MB_P$ (dB)	$\sum MB_S$ (dB)
n257, n258	≤ 1.3	≤ 1.25
n257, n260	≤ 1.0	$\leq 0.75^3$
n258, n260	≤ 1.0	$\leq 0.75^3$
n258, n261	≤ 1.0	≤ 1.25
n260, n261	0.0	$\leq 0.75^2$
n257, n258, n260	≤ 1.7	$\leq 1.75^3$
n257, n258, n261	≤ 1.7	≤ 1.75
n257, n260, n261	≤ 0.5	$\leq 1.25^3$
n258, n260, n261	≤ 1.5	$\leq 1.25^3$
n257, n258, n260, n261	≤ 1.7	$\leq 1.75^3$

NOTE 1: The requirements in this table are applicable to UEs which support only the indicated bands
NOTE 2: For supported bands n260 + n261, $\Delta MB_{S,n}$ is not applied for band n260
NOTE 3: For n260, maximum applicable $\Delta MB_{S,n}$ is 0.4 dB and $\Delta MB_{P,n}$ is 0.75 dB
NOTE 4: For all bands except n260, the maximum applicable $\Delta MB_{P,n}$ and $\Delta MB_{S,n}$ is 0.75 dB

Table 7.3.2.3.3-1b: UE multi-band relaxation factors for power class 3 (Rel-16 and forward)

Band	$\Delta MB_{P,n}$ (dB)	$\Delta MB_{S,n}$ (dB)
n257	0.7 ³	0.7 ³
n258	0.6	0.7
n259	0.5	0.4
n260	0.5 ¹	0.4 ¹
n261	0.5 ^{2,4}	0.7 ⁴

NOTE 1: n260 peak and spherical relaxations are 0 dB for UE that exclusively supports n261+n260
NOTE 2: n261 peak relaxation is 0 dB for UE that exclusively supports n261+n260

NOTE 3: n257 peak and spherical relaxations are 0 dB for UE that exclusively supports n261+n257
 NOTE 4: n261 peak and spherical relaxations are 0 dB for UE that exclusively supports n261+n257

The REFSSENS requirement shall be met for an uplink transmission using QPSK DFT-s-OFDM waveforms and for uplink transmission bandwidth less than or equal to that specified in Table 7.3.2.3.1-2.

Unless given by Table 7.3.2.3.1-3, the minimum requirements for reference sensitivity shall be verified with the network signalling value NS_200 (Table 6.2.3.3.1-1) configured.

7.3.2.3.4 Reference sensitivity power level for power class 4

The throughput shall be $\geq 95\%$ of the maximum throughput of the reference measurement channels as specified in Annex A.2.3.2 and A.3.3.2 (with one sided dynamic OCNG Pattern OP.1 TDD for the DL-signal as described in Annex A.5.2.1) with peak reference sensitivity specified in Table 7.3.2.3.4-1. The requirement is verified with the test metric of EIS (Link=RX beam peak direction, Meas=Link Angle).

Table 7.3.2.3.4-1: Reference sensitivity for power class 4

Operating band	REFSENS (dBm) / Channel bandwidth			
	50 MHz	100 MHz	200 MHz	400 MHz
n257	-97.0	-94.0	-91.0	-88.0
n258	-97.0	-94.0	-91.0	-88.0
n260	-95.0	-92.0	-89.0	-86.0
n261	-97.0	-94.0	-91.0	-88.0

NOTE 1: The transmitter shall be set to P_{UMAX} as defined in subclause 6.2.4

The REFSSENS requirement shall be met for an uplink transmission using QPSK DFT-s-OFDM waveforms and for uplink transmission bandwidth less than or equal to that specified in Table 7.3.2.3.1-2.

Unless given by Table 7.3.2.3.1-3, the minimum requirements for reference sensitivity shall be verified with the network signalling value NS_200 (Table 6.2.3.3.1-1) configured.

The normative reference for this requirement is TS 38.101-2 [3] clause 7.3.2.

7.3.2.3.5 Reference sensitivity power level for power class 5

The throughput shall be $\geq 95\%$ of the maximum throughput of the reference measurement channels as specified in Annex A.2.3.2 and A.3.3.2 (with one sided dynamic OCNG Pattern OP.1 TDD for the DL-signal as described in Annex A.5.2.1) with peak reference sensitivity specified in Table 7.3.2.3.5-1. The requirement is verified with the test metric of EIS (Link=RX beam peak direction, Meas=Link Angle).

Table 7.3.2.3.5-1: Reference sensitivity for power class 5

Operating band	REFSENS (dBm) / Channel bandwidth			
	50 MHz	100 MHz	200 MHz	400 MHz
n257	-92.6	-89.6	-86.6	-83.6
n258	-92.8	-89.8	-86.8	-83.8

NOTE 1: The transmitter shall be set to P_{UMAX} as defined in subclause 6.2.4

The REFSSENS requirement shall be met for an uplink transmission using QPSK DFT-s-OFDM waveforms and for uplink transmission bandwidth less than or equal to that specified in Table 7.3.2.3.1-2.

Unless given by Table 7.3.2.3.1-3, the minimum requirements for reference sensitivity shall be verified with the network signalling value NS_200 (Table 6.2.3.3.1-1) configured.

The normative reference for this requirement is TS 38.101-2 [3] clause 7.3.2.

7.3.2.3.6 Reference sensitivity power level for power class 6

The throughput shall be $\geq 95\%$ of the maximum throughput of the reference measurement channels as specified in Annexes A.2.3.2 and A.3.3.2 (with one sided dynamic OCNG Pattern OP.1 TDD for the DL-signal as described in Annex A.5.2.1) with peak reference sensitivity specified in Table 7.3.2.3.6-1. The requirement is verified with the test metric of EIS (Link=RX beam peak direction, Meas=Link Angle).

Table 7.3.2.3.6-1: Reference sensitivity for power class 6

Operating band	REFSENS (dBm) / Channel bandwidth			
	50 MHz	100 MHz	200 MHz	400 MHz
n257	-92.6	-89.6	-86.6	-83.6
n258	-92.8	-89.8	-86.8	-83.8
n261	-92.6	-89.6	-86.6	-83.6

NOTE 1: The transmitter shall be set to P_{UMAX} as defined in clause 6.2.4

The REFSENS requirement shall be met for an uplink transmission using QPSK DFT-s-OFDM waveforms and for uplink transmission bandwidth less than or equal to that specified in Table 7.3.2.3.1-2.

Unless given by Table 7.3.2.3.1-3, the minimum requirements for reference sensitivity shall be verified with the network signalling value NS_200 (Table 6.2.3.3.1-1) configured.

The normative reference for this requirement is TS 38.101-2 [3] clause 7.3.2.

7.3.2.3.7 Reference sensitivity power level for power class 7

The throughput shall be $\geq 95\%$ of the maximum throughput of the reference measurement channels as specified in Annexes A.2.3.2 and A.3.3.2 (with one sided dynamic OCNG Pattern OP.1 TDD for the DL-signal as described in Annex A.5.2.1) with peak reference sensitivity specified in Table 7.3.2.3.7-1. The requirement is verified with the test metric of EIS (Link=RX beam peak direction, Meas=Link Angle).

Table 7.3.2.3.7-1: Reference sensitivity for power class 7

Operating band	REFSENS (dBm) / Channel bandwidth	
	50 MHz	100 MHz
n257	-85.3	-82.3
n258	-85.3	-82.3
n261	-85.3	-82.3

NOTE 1: The transmitter shall be set to P_{UMAX} as defined in clause 6.2.4

The REFSENS requirement shall be met for an uplink transmission using QPSK DFT-s-OFDM waveforms and for uplink transmission bandwidth less than or equal to that specified in Table 7.3.2.3.1-2.

Unless given by Table 7.3.2.3.1-3, the minimum requirements for reference sensitivity shall be verified with the network signalling value NS_200 (Table 6.2.3.3.1-1) configured.

The normative reference for this requirement is TS 38.101-2 [3] clause 7.3.2.

7.3.2.4 Test description

7.3.2.4.1 Initial conditions

Initial conditions are a set of test configurations the UE needs to be tested in and the steps for the SS to take with the UE to reach the correct measurement state.

The initial test configurations consist of environmental conditions, test frequencies, test channel bandwidths and sub-carrier spacing based on NR operating bands specified in Table 5.3.5-1. All of these configurations shall be tested with applicable test parameters for each combination of channel bandwidth and subcarrier spacing are shown in Table 7.3.2.4.1-1, Table 7.3.2.4.1-2, and Table 7.3.2.4.1-3. The details of the uplink and downlink reference measurement channels (RMCs) are specified in Annexes A.2 and A.3. The details of the OCNG patterns used are specified in Annex A.5. Configurations of PDSCH and PDCCH before measurement are specified in Annex C.2.

Table 7.3.2.4.1-1: Test Configuration Table

Initial Conditions				
Test Environment as specified in TS 38.508-1 [10] subclause 4.1		Normal, TL, TH		
Test Frequencies as specified in TS 38.508-1 [10] subclause 4.3.1		Low range, Mid range, High range		
Test Channel Bandwidths as specified in TS 38.508-1 [10] subclause 4.3.1		Lowest, 100MHz, Highest		
Test SCS as specified in Table 5.3.5-1		120kHz		
Test Parameters				
Test ID	Downlink Configuration		Uplink Configuration	
	Modulation	RB allocation	Modulation	RB allocation
1	CP-OFDM QPSK	Full RB (NOTE 1)	DFT-s-OFDM QPSK	REFSENS (NOTE 2)
NOTE 1: Full RB allocation shall be used per each SCS and channel BW as specified in Table 7.3.2.4.1-2. NOTE 2: REFSENS refers to Table 7.3.2.4.1-3 which defines uplink RB configuration and start RB location for each SCS, channel BW and NR band.				

Table 7.3.2.4.1-2: Downlink Configuration of each RB allocation

Channel Bandwidth	SCS kHz	LCRBmax	RB allocation (LCRB@RBstart)
50MHz	120	32	32@0
100MHz	120	66	66@0
200MHz	120	132	132@0
400MHz	120	264	264@0
NOTE 1: Test Channel Bandwidths are checked separately for each NR band, the applicable channel bandwidths are specified in Table 5.3.5-1. NOTE 2: The 200MHz and 400MHz bandwidths are not applicable to PC7 RedCap UEs			

Table 7.3.2.4.1-3: Uplink configuration for reference sensitivity, LCRB@RBstart format

Operating Band	SCS kHz	50 MHz	100 MHz	200 MHz	400 MHz	Duplex Mode
n257	120	32@0	64@0	128@0	256@0	TDD
n258	120	32@0	64@0	128@0	256@0	TDD
n259	120	32@0	64@0	128@0	256@0	TDD
n260	120	32@0	64@0	128@0	256@0	TDD
n261	120	32@0	64@0	128@0	256@0	TDD

1. Connection BETWEEN SS and UE is shown in TS 38.508-1 [10] Annex A, Figure A.3.3.1.1 for TE diagram and Figure A.3.4.1.1 for UE diagram.
2. The parameter settings for the cell are set up according to TS 38.508-1 [10] subclause 4.4.3.
3. Downlink signals are initially set up according to Annex C, and uplink signals according to Annex G.
4. The DL and UL Reference Measurement channels are set according to Table 7.3.2.4.1-1, Table 7.3.2.4.1-2, and Table 7.3.2.4.1-3.
5. Propagation conditions are set according to Annex B.0.
6. Ensure the UE is in State RRC_CONNECTED with generic procedure parameters Connectivity NR, Connected without release On, Test Mode On and Test Loop Function On according to TS 38.508-1 [10] clause 4.5. Message contents are defined in clause 7.3.2.4.3.

7.3.2.4.2 Test procedure

1. SS transmits PDSCH via PDCCH DCI format 1_1 for C_RNTI to transmit the DL RMC according to Table 7.3.2.4.1-1. The SS sends downlink MAC padding bits on the DL RMC.
2. SS sends uplink scheduling information for each UL HARQ process via PDCCH DCI format 0_1 for C_RNTI to schedule the UL RMC according to Tables 7.3.2.4.1-1. Since the UE has no payload data to send, the UE transmits uplink MAC padding bits on the UL RMC.
3. Send continuously uplink power control "up" commands in every uplink scheduling information to the UE; allow at least 200msec for the UE to reach P_{UMAX} .
4. Set the UE in the Rx beam peak direction found with a 3D EIS scan as performed in Annex K.1.2. Allow at least BEAM_SELECT_WAIT_TIME (NOTE 1) for the UE Rx beam selection to complete.
5. Perform EIS procedure as stated in Annex K.1.4 to calculate "averaged EIS". At each power level, by changing the power level of the wanted signal with a step size of 0.2dB (coarse and fine searches are not precluded as long as the fine search is using the 0.2dB step size near the sensitivity level). For each power step measure the average throughput for a duration sufficient to achieve statistical significance according to Annex H.2. The downlink power step size shall be no more than 0.2 dB when the RF power level is near the sensitivity level.
6. Compare the dB value of the "averaged EIS" value corresponding to the Rx beam peak direction identified in step 5 to the test requirement in Table 7.3.2.5-1 to Table 7.3.2.5-4. If the EIS value is lower or equal to the value in Table 7.3.2.5-1 to Table 7.3.2.5-4, pass the UE. Otherwise fail the UE.

NOTE 1: The BEAM_SELECT_WAIT_TIME default value is defined in Annex K.1.2.

7.3.2.4.3 Message contents

Message contents are according to TS 38.508-1 [10] subclause 4.6 with TRANSFORM_PRECODER_ENABLED condition in Table 4.6.3-118 PUSCH-Config.

7.3.2.5 Test requirement

The throughput shall be $\geq 95\%$ of the maximum throughput of the reference measurement channels as specified in A.2.3.2 and A.3.3.2 (with one sided dynamic OCNG Pattern OP.1 TDD for the DL-signal as described in Annex A.5.2.1) with peak reference sensitivity specified in Tables 7.3.2.5-1 to 7.3.2.5-4. The requirement is verified with the test metric of EIS (Link=RX beam peak direction, Meas=Link Angle).

Table 7.3.2.5-1: Reference sensitivity for power class 1

Operating band	REFSENS (dBm) / Channel bandwidth			
	50 MHz	100 MHz	200 MHz	400 MHz
n257	-97.5+TT	-94.5+TT	-91.5+TT	-88.5+TT
n258	-97.5+TT	-94.5+TT	-91.5+TT	-88.5+TT
n260	-94.5+TT	-91.5+TT	-88.5+TT	-85.5+TT
n261	-97.5+TT	-94.5+TT	-91.5+TT	-88.5+TT

Table 7.3.2.5-1a: Test Tolerance (Reference sensitivity for power class 1)

Test Metric	FR2a, FR2b
IFF (Max device size ≤ 30 cm)	2.51 dB , NTC 2.62 dB , ETC

Table 7.3.2.5-2: Reference sensitivity for power class 2

Operating band	REFSENS (dBm) / Channel bandwidth			
	50 MHz	100 MHz	200 MHz	400 MHz
n257	-92+TT	-89+TT	-86+TT	-83+TT
n258	-92+TT	-89+TT	-86+TT	-83+TT
n261	-92+TT	-89+TT	-86+TT	-83+TT

Table 7.3.2.5-3: Reference sensitivity for power class 3 for single band UE or multi-band UE declaring $MB_p = 0$ in all FR2 bands

Operating band	REFSENS (dBm) / Channel bandwidth			
	50 MHz	100 MHz	200 MHz	400 MHz
n257	-88.3+TT	-85.3+TT	-82.3+TT	-79.3+TT
n258	-88.3+TT	-85.3+TT	-82.3+TT	-79.3+TT
n259	-84.7+TT	-81.7+TT	-78.7+TT	-75.7+TT
n260	-85.7+TT	-82.7+TT	-79.7+TT	-76.7+TT
n261	-88.3+TT	-85.3+TT	-82.3+TT	-79.3+TT

Table 7.3.2.5-3a: Reference sensitivity for power class 3 for multi-band UE declaring $MB_p > 0$ in any FR2 band (Rel-15)

Operating band	REFSENS (dBm) / Channel bandwidth (NOTE 1)			
	50 MHz	100 MHz	200 MHz	400 MHz
n257	-88.3+TT+ MB_p	-85.3+TT+ MB_p	-82.3+TT+ MB_p	-79.3+TT+ MB_p
n258	-88.3+TT+ MB_p	-85.3+TT+ MB_p	-82.3+TT+ MB_p	-79.3+TT+ MB_p
n260	-85.7+TT+ MB_p	-82.7+TT+ MB_p	-79.7+TT+ MB_p	-76.7+TT+ MB_p
n261	-88.3+TT+ MB_p	-85.3+TT+ MB_p	-82.3+TT+ MB_p	-79.3+TT+ MB_p

NOTE 1: Refer Table 7.3.2.5-3b for details for MB_p allowance corresponding to supported FR2 bands set

NOTE 2: For a Rel-15 UE supporting FR2 bands set not defined in Table 7.3.2.3.3-1a, Table 7.3.2.5-3c applies.

Table 7.3.2.5-3b: Reference sensitivity multi-band relaxation factors for power class 3 (Rel-15)

ID	Supported FR2 bands set	Maximum sum of MB_p , $\sum MB_p$ (dB) (Note 3)	Comments
1	n257, n258	1.3	Maximum 0.75 dB relaxation allowed for each band
2	n257, n260	1.0	Maximum 0.75 dB relaxation allowed for each band
3	n258, n260	1.0	Maximum 0.75 dB relaxation allowed for each band
4	n258, n261	1.0	Maximum 0.75 dB relaxation allowed for each band
5	n260, n261	0.0	No relaxation factor allowed
6	n257, n258, n260	1.7	Maximum 0.75 dB relaxation allowed for each band
7	n257, n258, n261	1.7	Maximum 0.75 dB relaxation allowed for each band
8	n257, n260, n261	0.5	Maximum 0.75 dB relaxation allowed for each band
9	n258, n260, n261	1.5	Maximum 0.75 dB relaxation allowed for each band
10	n257, n258, n260, n261	1.7	Maximum 0.75 dB relaxation allowed for each band

NOTE 1: MB_p is the Multiband Relaxation factor declared by the UE for the tested band in table A.4.3.9-2 of TS38.508-2. This declaration shall fulfil the requirements in Table 7.3.2.3.3-1a.

NOTE 2: All UE supported bands needs to be tested to ensure the multiband relaxation declaration is compliant

NOTE 3: Max allowed sum of MB_p over all supported FR2 bands as defined in clause 7.3.2.3.3.

Table 7.3.2.5-3c: Reference sensitivity for power class 3 (Rel-16 and forward)

Operating band	REFSENS (dBm) / Channel bandwidth (NOTE 1)			
	50 MHz	100 MHz	200 MHz	400 MHz
n257	-88.3+TT+ $\Delta MB_{p,n}$	-85.3+TT+ $\Delta MB_{p,n}$	-82.3+TT+ $\Delta MB_{p,n}$	-79.3+TT+ $\Delta MB_{p,n}$
n258	-88.3+TT+ $\Delta MB_{p,n}$	-85.3+TT+ $\Delta MB_{p,n}$	-82.3+TT+ $\Delta MB_{p,n}$	-79.3+TT+ $\Delta MB_{p,n}$
n259	-84.7+TT+ $\Delta MB_{p,n}$	-81.7+TT+ $\Delta MB_{p,n}$	-78.7+TT+ $\Delta MB_{p,n}$	-75.7+TT+ $\Delta MB_{p,n}$
n260	-85.7+TT+ $\Delta MB_{p,n}$	-82.7+TT+ $\Delta MB_{p,n}$	-79.7+TT+ $\Delta MB_{p,n}$	-76.7+TT+ $\Delta MB_{p,n}$

n261	-88.3+TT+ Δ MB _{P,n}	-85.3+TT+ Δ MB _{P,n}	-82.3+TT+ Δ MB _{P,n}	-79.3+TT+ Δ MB _{P,n}
NOTE 1: Refer Table 7.3.2.5-3d for details for Δ MB _{P,n} allowance corresponding to supported FR2 bands set				

Table 7.3.2.5-3d: Reference sensitivity multi-band relaxation factors for power class 3 (Rel-16 and forward)

ID	FR2 bands/set	Δ MB _{P,n} (dB)	Comments
1	n257	0.7	
2	n258	0.6	
3	n259	0.5	
4	n260	0.5	
5	n261	0.5	
6	n257, n261	0	Δ MB _{P,n} relaxation is 0 dB
7	n260, n261	0	Δ MB _{P,n} relaxation is 0 dB

NOTE 1: Δ MB_{P,n} is the Multiband Relaxation factor for the tested band. This shall fulfil the requirements in Table 7.3.2.3.3-1b.

Table 7.3.2.5-3e: Test Tolerance (Reference sensitivity for power class 3)

Test Metric	FR2a, FR2b	FR2c
IFF (Max device size \leq 30 cm)	2.41 dB, NTC	2.85 dB, NTC
	2.52 dB, ETC	2.92 dB, ETC

Table 7.3.2.5-4: Reference sensitivity for power class 4

Operating band	REFSENS (dBm) / Channel bandwidth			
	50 MHz	100 MHz	200 MHz	400 MHz
n257	-97+TT	-94+TT	-91+TT	-88+TT
n258	-97+TT	-94+TT	-91+TT	-88+TT
n260	-95+TT	-92+TT	-89+TT	-86+TT
n261	-97+TT	-94+TT	-91+TT	-88+TT

Table 7.3.2.5-5: Reference sensitivity for power class 5

Operating band	REFSENS (dBm) / Channel bandwidth			
	50 MHz	100 MHz	200 MHz	400 MHz
n257	-92.6+TT	-89.6+TT	-86.6+TT	-83.6+TT
n258	-92.8+TT	-89.8+TT	-86.8+TT	-83.8+TT

Table 7.3.2.5-5a: Test Tolerance (Reference sensitivity for power class 5)

Test Metric	FR2a
IFF (Max device size \leq 30 cm)	2.51 dB, NTC
	2.62 dB, ETC

Table 7.3.2.5-6: Reference sensitivity for power class 6

Operating band	REFSENS (dBm) / Channel bandwidth			
	50 MHz	100 MHz	200 MHz	400 MHz
n257	-92.6+TT	-89.6+TT	-86.6+TT	-83.6+TT
n258	-92.8+TT	-89.8+TT	-86.8+TT	-83.8+TT
n261	-92.6+TT	-89.6+TT	-86.6+TT	-83.6+TT

Table 7.3.2.5-6a: Test Tolerance (Reference sensitivity for power class 6)

Test Metric	FR2a
IFF (Max device size \leq 30 cm)	2.50 dB, NTC 2.62 dB, ETC

Table 7.3.2.5-7: Reference sensitivity for power class 7

Operating band	REFSENS (dBm) / Channel bandwidth	
	50 MHz	100 MHz
n257	-85.3+TT	-82.3+TT
n258	-85.3+TT	-82.3+TT
n261	-85.3+TT	-82.3+TT

Table 7.3.2.5-7a: Test Tolerance (Reference sensitivity for power class 7)

Test Metric	FR2a
IFF (Max device size \leq 30 cm)	2.41 dB, NTC 2.52 dB, ETC

7.3.4 EIS spherical coverage

Editor's note: The following aspects are either missing or not yet determined:

- Measurement Uncertainties and Test Tolerances are FFS for power class other than 1, 3, 5, 6 and 7.

7.3.4.1 Test purpose

To verify that the EIS spherical coverage of the UE receiver is acceptable under conditions of low signal level, ideal propagation and no added noise.

7.3.4.2 Test applicability

This test case applies to all types of NR UE release 15 and forward.

7.3.4.3 Minimum conformance requirements

The reference sensitivity power level REFSENS at a single grid point of the spherical grid is the minimum mean power applied to each one of the UE antenna ports for all UE categories, at which the throughput shall meet or exceed the requirements for the specified reference measurement channel.

The reference measurement channels and throughput criterion shall be as specified in section 7.3.2.3.

For power class 1, the maximum EIS at the 85th percentile of the CCDF of EIS measured over the full sphere around the UE is defined as the spherical coverage requirement and is found in Table 7.3.4.3-1 below. The requirement is verified with the test metric of EIS (Link=Spherical coverage grid, Meas=Link angle).

Table 7.3.4.3-1: EIS spherical coverage for power class 1

Operating band	EIS at 85 th ile CCDF (dBm) / Channel bandwidth						
	50 MHz	100 MHz	200 MHz	400 MHz	800 MHz	1600 MHz	2000 MHz
n257	-89.5	-86.5	-83.5	-80.5	N/A	N/A	N/A
n258	-89.5	-86.5	-83.5	-80.5	N/A	N/A	N/A
n260	-86.5	-83.5	-80.5	-77.5	N/A	N/A	N/A
n261	-89.5	-86.5	-83.5	-80.5	N/A	N/A	N/A

NOTE 1: The transmitter shall be set to P_{UMAX} as defined in subclause 6.2.4.

NOTE 2: The EIS spherical coverage requirements are verified only under normal thermal conditions as defined in TS 38.508-1 [10] subclause 4.1.1.

For power class 2, the maximum EIS at the 60th percentile of the CCDF of EIS measured over the full sphere around the UE is defined as the spherical coverage requirement and is found in Table 7.3.4.3-2 below. The requirement is verified with the test metric of EIS (Link=Spherical coverage grid, Meas=Link angle).

Table 7.3.4.3-2: EIS spherical coverage for power class 2

Operating band	EIS at 60 th ile CCDF (dBm) / Channel bandwidth						
	50 MHz	100 MHz	200 MHz	400 MHz	800 MHz	1600 MHz	2000 MHz
n257	-81	-78	-75	-72	N.A	N.A	N.A
n258	-81	-78	-75	-72	N.A	N.A	N.A
n261	-81	-78	-75	-72	N.A	N.A	N.A

NOTE 1: The transmitter shall be set to P_{UMAX} as defined in subclause 6.2.4.
NOTE 2: The EIS spherical coverage requirements are verified only under normal thermal conditions as defined in TS 38.508-1 [10] subclause 4.1.1.

For power class 3, the maximum EIS at the 50th percentile of the CCDF of EIS measured over the full sphere around the UE is defined as the spherical coverage requirement and is found in Table 7.3.4.3-3 below. The requirement is verified with the test metric of EIS (Link=Spherical coverage grid, Meas=Link angle).

For power class 3, the UEs that support operation in multiple FR2 bands, the minimum requirement for EIS spherical coverage in Table 7.3.4.3-3 shall be increased per band, respectively, by the reference sensitivity relaxation parameter $\sum MB_S$ and $\Delta MB_{S,n}$ as specified in Table 7.3.2.3.3-1a and 7.3.2.3.3-1b..

Table 7.3.4.3-3: EIS spherical coverage for power class 3

Operating band	EIS at 50 th ile CCDF (dBm) / Channel bandwidth						
	50 MHz	100 MHz	200 MHz	400 MHz	800 MHz	1600 MHz	2000 MHz
n257	-77.4	-74.4	-71.4	-68.4	N.A	N.A	N.A
n258	-77.4	-74.4	-71.4	-68.4	N.A	N.A	N.A
n259	-71.9	-68.9	-65.9	-62.9	N.A	N.A	N.A
n260	-73.1	-70.1	-67.1	-64.1	N.A	N.A	N.A
n261	-77.4	-74.4	-71.4	-68.4	N.A	N.A	N.A

NOTE 1: The transmitter shall be set to P_{UMAX} as defined in subclause 6.2.4
NOTE 2: The EIS spherical coverage requirements are verified only under normal thermal conditions as defined in TS 38.508-1 [10] subclause 4.1.1.

For power class 4, the maximum EIS at the 20th percentile of the CCDF of EIS measured over the full sphere around the UE is defined as the spherical coverage requirement and is found in Table 7.3.4.3-4 below. The requirement is verified with the test metric of EIS (Link=Spherical coverage grid, Meas=Link angle).

Table 7.3.4.3-4: EIS spherical coverage for power class 4

Operating band	EIS at 20 th ile CCDF (dBm) / Channel bandwidth			
	50 MHz	100 MHz	200 MHz	400 MHz
n257	-88.0	-85.0	-82.0	-79.0
n258	-88.0	-85.0	-82.0	-79.0
n260	-83.0	-80.0	-77.0	-74.0
n261	-88.0	-85.0	-82.0	-79.0

NOTE 1: The transmitter shall be set to P_{UMAX} as defined in subclause 6.2.4
NOTE 2: The EIS spherical coverage requirements are verified only under normal thermal conditions as defined in TS 38.508-1 [10] subclause 4.1.1.

For power class 5, the maximum EIS at the 85th percentile of the CCDF of EIS measured over the full sphere around the UE is defined as the spherical coverage requirement and is found in Table 7.3.4.3-5 below. The requirement is verified with the test metric of EIS (Link=Spherical coverage grid, Meas=Link angle).

Table 7.3.4.3-5: EIS spherical coverage for power class 5

Operating band	EIS at 85 th ile CCDF (dBm) / Channel bandwidth			
	50 MHz	100 MHz	200 MHz	400 MHz
n257	-84.6	-81.6	-78.6	-75.6

n258	-84.8	-81.8	-78.8	-75.8
NOTE 1: The transmitter shall be set to P_{UMAX} as defined in subclause 6.2.4				
NOTE 2: The EIS spherical coverage requirements are verified only under normal thermal conditions as defined in TS 38.508-1 [10] subclause 4.1.1.				

For power class 6, the maximum EIS measured over the spherical coverage evaluation areas is defined as the spherical coverage requirement and is found in Table 7.3.4.3-6 below. UE spherical coverage evaluation areas are found in Table 7.3.4.3-6a below, by consisting of Area-1 and Area-2, in the reference coordinate system in Annex N.1. The requirement is verified with the test metric of EIS (Link=Spherical coverage grid, Meas=Link angle).

Table 7.3.4.3-6: EIS spherical coverage for power class 6

Operating band	Max EIS over UE spherical coverage evaluation areas (dBm) / Channel bandwidth			
	50 MHz	100 MHz	200 MHz	400 MHz
n257	-82.6	-79.6	-76.6	-73.6
n258	-82.8	-79.8	-76.8	-73.8
n261	-82.6	-79.6	-76.6	-73.6
NOTE 1: The transmitter shall be set to P_{UMAX} as defined in clause 6.2.4				
NOTE 2: The EIS spherical coverage requirements are verified only under normal thermal conditions as defined in TS 38.508-1 [10] subclause 4.1.1.				
NOTE 3: The requirements in this table are applicable to FR2 PC6 UE with the network signalling <i>highSpeedMeasFlagFR2-r17</i> configured as <i>set2</i> .				

Table 7.3.4.3-6a: UE spherical coverage evaluation areas for power class 6

	θ range (degree)	ϕ range (degree)
Area-1	90 to 60	- 37.5 to + 37.5
Area-2	90 to 60	142.5 to 217.5
NOTE 1: When testing power class 6 UEs, DUT orientation can be determined according to the UE spherical coverage evaluation areas, not necessarily following default alignment in Figure N.1-2 or positioning guidelines in clause N.3.		
NOTE 2: High speed train deployment is expected to be w.r.t. the reference coordination system: $\theta = 90$ (degree) corresponds to the ground plane the train is running on, and $\phi = 0$ or 180 with $\theta = 90$ are the train track directions.		

Table 7.3.4.3-7: EIS spherical coverage for power class 7

Operating band	EIS at 50 th %-tile CCDF (dBm) / Channel bandwidth	
	50 MHz	100 MHz
n257	-74.4	-71.4
n258	-74.4	-71.4
n261	-74.4	-71.4
NOTE 1: The transmitter shall be set to P_{UMAX} as defined in clause 6.2.4		
NOTE 2: The EIS spherical coverage requirements are verified only under normal thermal conditions as defined in TS 38.508-1 [10] subclause 4.1.1.		

The REFSSENS requirement shall be met for an uplink transmission using QPSK DFT-s-OFDM waveforms and for uplink transmission bandwidth less than or equal to that specified in Table 7.3.4.3-9.

Table 7.3.4.3-8: Uplink configuration for reference sensitivity

NR Band / Channel bandwidth / N_{RB} / SCS / Duplex mode						
NR Band	50 MHz	100 MHz	200 MHz	400 MHz	SCS	Duplex Mode
n257	32	64	128	256	120 kHz	TDD
n258	32	64	128	256	120 kHz	TDD
n260	32	64	128	256	120 kHz	TDD

n261	32	64	128	256	120 kHz	TDD
------	----	----	-----	-----	---------	-----

Unless given by Table 7.3.4.3-7, the minimum requirements specified in Table 7.3.4.3-1, Table 7.3.4.3-2, Table 7.3.4.3-3, Table 7.3.4.3-4, Table 7.3.4.3-5, Table 7.3.4.3-6 and Table 7.3.4.3-7 shall be verified with the network signalling value NS_200 configured.

Table 7.3.4.3-9: Network Signalling value for reference sensitivity

NR Band	Network Signalling value
n258	NS_201

For the UE which supports inter-band carrier aggregation, the minimum requirement for reference sensitivity in Table 7.3.4.3-1, Table 7.3.4.3-2, Table 7.3.4.3-3, Table 7.3.4.3-4, Table 7.3.4.3-5, Table 7.3.4.3-6 and Table 7.3.4.3-7 shall be increased by the amount given in $\Delta R_{IB,P,n}$ defined in subclause 7.3A.2.0.3 for the applicable operating bands.

The normative reference for this requirement is TS 38.101-2 [3] clause 7.3.4.

7.3.4.4 Test description

7.3.4.4.1 Initial conditions

Same initial conditions as in clause 7.3.2.4.1 except that only normal condition is tested.

7.3.4.4.2 Test procedure

1. SS transmits PDSCH via PDCCH DCI format 1_1 for C_RNTI to transmit the DL RMC according to Table 7.3.2.4.1-1. The SS sends downlink MAC padding bits on the DL RMC.
2. SS sends uplink scheduling information for each UL HARQ process via PDCCH DCI format 0_1 for C_RNTI to schedule the UL RMC according to Tables 7.3.2.4.1-1. Since the UE has no payload data to send, the UE transmits uplink MAC padding bits on the UL RMC.
3. Send continuously uplink power control "up" commands in every uplink scheduling information to the UE; allow at least 200msec for the UE to reach P_{UMAX} .

For power class UEs other than PC6, step 4a applies:

- 4a. Measure UE EIS value for each grid point according to EIS spherical coverage procedure defined in Annex K.1.6.0, and obtain a Complimentary Cumulative Distribution Function (CCDF) of all EIS dBm values. Alternatively, UE EIS measurement for each grid point could be done according to Rx Fast spherical coverage procedure defined in Annex K.1.6.1. After a rotation, allow at least BEAM_SELECT_WAIT_TIME (NOTE 1) for UE to find the best beam to use. EIS is calculated considering both polarizations, theta and phi.

For power class 6 UEs, step 4b applies:

- 4b. Measure UE EIS value for each grid point within the UE spherical coverage evaluation areas, Area-1 and Area-2, per Table 7.3.4.3-6a. After a rotation, allow at least BEAM_SELECT_WAIT_TIME (NOTE 1) for UE to find the best beam to use. EIS is calculated considering both polarizations, theta and phi.
5. Identify the EIS dBm value corresponding to %-tile (UE power class dependent) value in the applicable test requirement table in section 7.3.4.5.
 6. Compare the EIS dBm value identified in step 5, to the limit value in the applicable test requirement table in section 7.3.4.5. If the EIS dBm value is lower or equal to the limit value, pass the UE. Otherwise fail the UE.

NOTE 1: The BEAM_SELECT_WAIT_TIME default value is defined in Annex K.1.2.

7.3.4.4.3 Message contents

Message contents are according to TS 38.508-1 [10] subclause 4.6 with TRANSFORM_PRECODER_ENABLED condition in Table 4.6.3-118 PUSCH-Config.

7.3.4.5 Test requirement

The reference measurement channels and throughput criterion shall be as specified in section 7.3.2.5.

Table 7.3.4.5-1: EIS spherical coverage for power class 1

Operating band	EIS at 85 th ile CCDF (dBm) / Channel bandwidth			
	50 MHz	100 MHz	200 MHz	400 MHz
n257	-89.5 +TT	-86.5 +TT	-83.5 +TT	-80.5 +TT
n258	-89.5 +TT	-86.5 +TT	-83.5 +TT	-80.5 +TT
n260	-86.5 +TT	-83.5 +TT	-80.5 +TT	-77.5 +TT
n261	-89.5 +TT	-86.5 +TT	-83.5 +TT	-80.5 +TT

NOTE 1: The transmitter shall be set to P_{UMAX} as defined in subclause 6.2.4.
NOTE 2: The EIS spherical coverage requirements are verified only under normal thermal conditions as defined in TS 38.508-1 [10] subclause 4.1.1.

Table 7.3.4.5-1a: Test Tolerance (Reference sensitivity for power class 1)

Test Metric	$f \leq 40.8$ GHz
IFF (Max device size ≤ 30 cm)	2.28 dB

Table 7.3.4.5-2: EIS spherical coverage for power class 2

Operating band	EIS at 60 th ile CCDF (dBm) / Channel bandwidth			
	50 MHz	100 MHz	200 MHz	400 MHz
n257	-81 +TT	-78 +TT	-75 +TT	-72 +TT
n258	-81 +TT	-78 +TT	-75 +TT	-72 +TT
n261	-81 +TT	-78 +TT	-75 +TT	-72 +TT

NOTE 1: The transmitter shall be set to P_{UMAX} as defined in subclause 6.2.4.
NOTE 2: The EIS spherical coverage requirements are verified only under normal thermal conditions as defined in TS 38.508-1 [10] subclause 4.1.1.

Table 7.3.4.5-3: EIS spherical coverage for power class 3 for single band UE or multi-band UE declaring $MB_s = 0$ in all FR2 bands

Operating band	EIS at 50 th ile CCDF (dBm) / Channel bandwidth			
	50 MHz	100 MHz	200 MHz	400 MHz
n257	-77.4 +TT	-74.4 +TT	-71.4 +TT	-68.4 +TT
n259	-71.9 +TT	-68.9 +TT	-65.9 +TT	-62.9 +TT
n258	-77.4 +TT	-74.4 +TT	-71.4 +TT	-68.4 +TT
n260	-73.1 +TT	-70.1 +TT	-67.1 +TT	-64.1 +TT
n261	-77.4 +TT	-74.4 +TT	-71.4 +TT	-68.4 +TT

NOTE 1: The transmitter shall be set to P_{UMAX} as defined in subclause 6.2.4.
NOTE 2: The EIS spherical coverage requirements are verified only under normal thermal conditions as defined in TS 38.508-1 [10] subclause 4.1.1.

Table 7.3.4.5-3a: EIS spherical coverage for power class 3 for multi-band UE declaring $MB_s > 0$ in any FR2 band (Rel-15)

Operating band	EIS at 50 th ile CCDF (dBm) / Channel bandwidth (NOTE 3)			
	50 MHz	100 MHz	200 MHz	400 MHz
n257	-77.4 +TT+ MB_s	-74.4 +TT+ MB_s	-71.4 +TT+ MB_s	-68.4 +TT+ MB_s
n258	-77.4 +TT+ MB_s	-74.4 +TT+ MB_s	-71.4 +TT+ MB_s	-68.4 +TT+ MB_s
n260	-73.1 +TT+ MB_s	-70.1 +TT+ MB_s	-67.1 +TT+ MB_s	-64.1 +TT+ MB_s
n261	-77.4 +TT+ MB_s	-74.4 +TT+ MB_s	-71.4 +TT+ MB_s	-68.4 +TT+ MB_s

NOTE 1: The transmitter shall be set to P_{UMAX} as defined in subclause 6.2.4.
NOTE 2: The EIS spherical coverage requirements are verified only under normal thermal conditions as defined in TS 38.508-1 [10] subclause 4.1.1.
NOTE 3: Refer Table 7.3.4.5-3b for details for MB_s allowance corresponding to supported FR2 band set combination

NOTE 4: For a Rel-15 UE supporting FR2 bands set not defined in Table 7.3.2.3.3-1a, Table 7.3.4.5-3c applies.

Table 7.3.4.5-3b: EIS spherical coverage multiband relaxation factors for power class 3 (Rel-15)

ID	Supported FR2 bands set	Maximum sum of MB _s , $\sum MB_s$ (dB) (Note 3)	Comments
1	n257, n258	1.25	Maximum 0.75 dB relaxation allowed for each band
2	n257, n260	0.75	Maximum 0.4 dB relaxation allowed for n260 and 0.75 dB relaxation allowed for all other bands
3	n258, n260	0.75	Maximum 0.4 dB relaxation allowed for n260 and 0.75 dB relaxation allowed for all other bands
4	n258, n261	1.25	Maximum 0.75 dB relaxation allowed for each band
5	n260, n261	0.75	No relaxation allowed for n260 and 0.75 dB relaxation allowed for all other bands
6	n257, n258, n260	1.75	Maximum 0.4 dB relaxation allowed for n260 and 0.75 dB relaxation allowed for all other bands
7	n257, n258, n261	1.75	Maximum 0.75 dB relaxation allowed for each band
8	n257, n260, n261	1.25	Maximum 0.4 dB relaxation allowed for n260 and 0.75 dB relaxation allowed for all other bands
9	n258, n260, n261	1.25	Maximum 0.4 dB relaxation allowed for n260 and 0.75 dB relaxation allowed for all other bands
10	n257, n258, n260, n261	1.75	Maximum 0.4 dB relaxation allowed for n260 and 0.75 dB relaxation allowed for all other bands

NOTE 1: MB_s is the Multiband Relaxation factor declared by the UE for the tested band in Table A.4.3.9-3 of TS38.508-2 [11]. This declaration shall fulfil the requirements in Table 7.3.2.3.3-1a.
 NOTE 2: All UE supported bands needs to be tested to ensure the multiband relaxation declaration is compliant
 NOTE 3: Max allowed sum of MB_s over all supported FR2 bands as defined in clause 7.3.2.3.3.

Table 7.3.4.5-3c: EIS spherical coverage for power class 3 (Rel-16 and forward)

Operating band	EIS at 50 th ile CCDF (dBm) / Channel bandwidth (NOTE 3)			
	50 MHz	100 MHz	200 MHz	400 MHz
n257	-77.4 +TT+ΔMB _{s,n}	-74.4 +TT+ΔMB _{s,n}	-71.4 +TT+ΔMB _{s,n}	-68.4 +TT+ΔMB _{s,n}
n258	-77.4 +TT+ΔMB _{s,n}	-74.4 +TT+ΔMB _{s,n}	-71.4 +TT+ΔMB _{s,n}	-68.4 +TT+ΔMB _{s,n}
n259	-71.9 +TT+ΔMB _{s,n}	-68.9 +TT+ΔMB _{s,n}	-65.9 +TT+ΔMB _{s,n}	-62.9 +TT+ΔMB _{s,n}
n260	-73.1 +TT+ΔMB _{s,n}	-70.1 +TT+ΔMB _{s,n}	-67.1 +TT+ΔMB _{s,n}	-64.1 +TT+ΔMB _{s,n}
n261	-77.4 +TT+ΔMB _{s,n}	-74.4 +TT+ΔMB _{s,n}	-71.4 +TT+ΔMB _{s,n}	-68.4 +TT+ΔMB _{s,n}

NOTE 1: The transmitter shall be set to P_{UMAX} as defined in subclause 6.2.4.
 NOTE 2: The EIS spherical coverage requirements are verified only under normal thermal conditions as defined in TS 38.508-1 [10] subclause 4.1.1.
 NOTE 3: Refer Table 7.3.4.5-3d for details for MB_s allowance corresponding to supported FR2 band set combination

Table 7.3.4.5-3d: EIS spherical coverage multi-band relaxation factors for power class 3 (Rel-16 and forward)

ID	FR2 bands/set	Comments
1	n257	
2	n258	
3	n259	
4	n260	
5	n261	
6	n257, n261	ΔMB _{s,n} relaxation is 0 dB
7	n260, n261	ΔMB _{s,n} relaxation is 0 dB

NOTE 1: MB_{s,n} is the Multiband Relaxation factor for the tested band. This shall fulfil the requirements in Table 7.3.2.3.3-1b.

Table 7.3.4.5-3e: Test Tolerance (Reference sensitivity for power class 3)

Test Metric	FR2a, FR2b	FR2c
IFF (Max device size ≤ 30 cm)	2.28 dB	2.72 dB

Table 7.3.4.5-4: EIS spherical coverage for power class 4

Operating band	EIS at 20 th %ile CCDF (dBm) / Channel bandwidth			
	50 MHz	100 MHz	200 MHz	400 MHz
n257	-88.0 +TT	-85.0 +TT	-82.0 +TT	-79.0 +TT
n258	-88.0 +TT	-85.0 +TT	-82.0 +TT	-79.0 +TT
n260	-83.0 +TT	-80.0 +TT	-77.0 +TT	-74.0 +TT
n261	-88.0 +TT	-85.0 +TT	-82.0 +TT	-79.0 +TT

NOTE 1: The transmitter shall be set to P_{UMAX} as defined in subclause 6.2.4
NOTE 2: The EIS spherical coverage requirements are verified only under normal thermal conditions as defined in TS 38.508-1 [10] subclause 4.1.1.

Table 7.3.4.5-5: EIS spherical coverage for power class 5

Operating band	EIS at 85 th %ile CCDF (dBm) / Channel bandwidth			
	50 MHz	100 MHz	200 MHz	400 MHz
n257	-84.6 +TT	-81.6 +TT	-78.6 +TT	-75.6 +TT
n258	-84.8 +TT	-81.8 +TT	-78.8 +TT	-75.8 +TT

NOTE 1: The transmitter shall be set to P_{UMAX} as defined in subclause 6.2.4.
NOTE 2: The EIS spherical coverage requirements are verified only under normal thermal conditions as defined in TS 38.508-1 [10] subclause 4.1.1.

Table 7.3.4.5-5a: Test Tolerance (Reference sensitivity for power class 5)

Test Metric	FR2a
IFF (Max device size ≤ 30 cm)	2.28 dB

Table 7.3.4.5-6: EIS spherical coverage for power class 6

Operating band	Max EIS over UE spherical coverage evaluation areas (dBm) / Channel bandwidth			
	50 MHz	100 MHz	200 MHz	400 MHz
n257	-82.6+TT	-79.6+TT	-76.6+TT	-73.6+TT
n258	-82.8+TT	-79.8+TT	-76.8+TT	-73.8+TT
n261	-82.6+TT	-79.6+TT	-76.6+TT	-73.6+TT

NOTE 1: The transmitter shall be set to P_{UMAX} as defined in clause 6.2.4
NOTE 2: The EIS spherical coverage requirements are verified only under normal thermal conditions as defined in TS 38.508-1 [10] subclause 4.1.1.
NOTE 3: The requirements in this table are applicable to FR2 PC6 UE with the network signalling *highSpeedMeasFlagFR2-r17* configured as *set2*.

Table 7.3.4.5-6a: Test Tolerance (Reference sensitivity for power class 6)

Test Metric	FR2a
IFF (Max device size ≤ 30 cm)	2.50 dB

Table 7.3.4.5-7: EIS spherical coverage for power class 7

Operating band	EIS at 50 th %-tile CCDF (dBm) / Channel bandwidth	
	50 MHz	100 MHz

n257	-74.4+TT	-71.4+TT
n258	-74.4+TT	-71.4+TT
n261	-74.4+TT	-71.4+TT
NOTE 1: The transmitter shall be set to P_{UMAX} as defined in clause 6.2.4		
NOTE 2: The EIS spherical coverage requirements are verified only under normal thermal conditions as defined in TS 38.508-1 [10] subclause 4.1.1.		

Table 7.3.4.5-7a: Test Tolerance (Reference sensitivity for power class 7)

Test Metric	FR2a
IFF (Max device size \leq 30 cm)	2.28 dB

7.3A Reference sensitivity for CA

7.3A.1 General

The reference sensitivity power level REFSENS for both Intra-band non-contiguous CA and Intra-band contiguous CA is defined as the EIS level at the centre of the quiet zone in the RX beam peak direction [(same as that found for single carrier scenario in clause 7.3.2)], at which the throughput shall meet or exceed the requirements for the specified reference measurement channel.

7.3A.2 Reference sensitivity power level for CA

7.3A.2.0 Minimum Conformance Requirements

7.3A.2.0.1 Intra-band contiguous CA

For each component carrier in the intra-band contiguous carrier aggregation, the throughput in QPSK $R = 1/3$ shall be $\geq 95\%$ of the maximum throughput of the reference measurement channels as specified in Annex A (with one sided dynamic OCNG Pattern OP.1 TDD for the DL-signal) with peak reference sensitivity values determined from section 7.3.2.3, and relaxation applied to peak reference sensitivity requirement as specified in Table 7.3A.2.0.1-1.

Table 7.3A.2.0.1-1: ΔR_{IB} EIS Relaxation for CA operation by aggregated channel bandwidth

Aggregated Channel BW ' $BW_{Channel_CA}$ ' (MHz)	ΔR_{IB} (dB)
$BW_{Channel_CA} \leq 800$	0.0
$800 < BW_{Channel_CA} \leq 1200$	0.5
$1200 < BW_{Channel_CA} \leq 1600$	1.0
$1600 < BW_{Channel_CA} \leq 2000$	1.5

The normative reference for this requirement is TS 38.101-2 [3] clause 7.3A.2.1.

7.3A.2.0.2 Intra-band non-contiguous CA

For each component carrier in the intra-band non-contiguous carrier aggregation, the throughput in QPSK $R=1/3$ shall be $\geq 95\%$ of the maximum throughput of the reference measurement channels as specified in Annex A (with one sided dynamic OCNG Pattern OP.1 TDD for the DL-signal) with peak reference sensitivity values determined from section 7.3.2.3, and relaxation applied to peak reference sensitivity requirement as specified in Table 7.3A.2.0.2-1. The configured downlink spectrum is defined as the frequency band from the lowest edge of the lowest CC to the upper edge of the highest CC of all DL configured CCs.

Table 7.3A.2.0.2-1: ΔR_{IB} EIS Relaxation for CA operation by cumulative aggregated channel bandwidth

Cumulative Aggregated Channel BW (MHz)	ΔR_{IB} (dB)
--	----------------------

≤ 800	0.0
> 800 and ≤ 1400	0.5
> 1400 and ≤ 2400	1.5

The normative reference for this requirement is TS 38.101-2 [3] clause 7.3A.2.2.

7.3A.2.0.3 Inter-band CA

The inter-band requirement applies for all active component carriers. The throughput for each component carrier shall be ≥ 95 % of the maximum throughput of the reference measurement channels as specified in Annexes A.2.3.2 and A.3.3.2 (with one sided dynamic OCNG Pattern OP.1 TDD for the DL-signal as described in Annex A.5.2.1) with peak reference sensitivity for each carrier specified in section 7.3.2, and relaxation $\Delta R_{IB,P,n}$ applied to peak reference sensitivity requirement. $\Delta R_{IB,P,n}$ is specified in Table 7.3A.2.0.3-1. The requirement on each component carrier shall be met when the power in the component carrier in the other band is set to its EIS spherical coverage requirement for inter-band CA specified in sub-clause 7.3A.3.3.

For the combination of intra-band and inter-band carrier aggregation, the intra-band CA relaxation, ΔR_{IB} , is also applied according to the clause 7.3A.2.1 and 7.3A.2.2.

Table 7.3A.2.0.3-1: $\Delta R_{IB,P,n}$ reference sensitivity relaxation for inter-band CA

NR CA bands	NR band	$\Delta R_{IB,P,n}$ (dB)	
		PC1	PC3
CA_n260-n261	n260	2.5	3.5
	n261	2.5	3.5
NOTE: For each power class, band combinations without specified $\Delta R_{IB,P,n}$ are not enabled for inter-band downlink carrier aggregation up till current release.			

7.3A.2.1 Reference sensitivity power level for CA (2DL CA)

Editor's note: The following aspects are either missing or not yet determined:

- Measurement Uncertainties and Test Tolerances for intra-band contiguous CA supporting aggregated BW > 400MHz and for intra-band non-contiguous CA are TBD.
- Measurement Uncertainties and Test Tolerances are FFS for power class other than 1, 3, 5.
- In case of frequency separation larger than 800 MHz and in case the device manufacturer does not explicitly declare that the beam peak for a reference (frequency band, CBW) or (frequency band combination, CA BW class) is applicable for a group of other intra-band contiguous combinations and CA BW classes, according to Table A.4.3.9-6 in 38.508-2, following aspect of beam peak search procedures for CA is FFS: RB allocation, power level, channel bandwidth configuration, per CC approach or all CC combined approach, etc
- Some references are in square brackets for inter-band DL CA

7.3A.2.1.1 Test purpose

Same test purpose as in clause 7.3.2.1.

7.3A.2.1.2 Test applicability

This test case applies to all types of NR UE release 15 and forward that supports FR2 2DL CA.

7.3A.2.1.3 Minimum conformance requirements

Same minimum conformance requirements as in clause 7.3A.2.0.

7.3A.2.1.4 Test description

7.3A.2.1.4.1 Initial conditions

Initial conditions are a set of test configurations the UE needs to be tested in and the steps for the SS to take with the UE to reach the correct measurement state.

The initial test configurations consist of environmental conditions, test frequencies, test channel bandwidths and sub-carrier spacing based on NR CA configurations specified in clause 5.5A. All of these configurations shall be tested with applicable test parameters for each combination of channel bandwidth and subcarrier spacing are shown in Table 7.3A.2.1.4.1-1, Table 7.3A.2.1.4.1-2 and Table 7.3A.2.1.4.1-3. The details of the uplink and downlink reference measurement channels (RMCs) are specified in Annexes A.2 and A.3. The details of the OCNG patterns used are specified in Annex A.5. Configurations of PDSCH and PDCCH before measurement are specified in Annex C.2.

Table 7.3A.2.1.4.1-1: Test Configuration Table

Initial Conditions				
Test Environment as specified in TS 38.508-1 [10] subclause 4.1		Normal, TL, TH		
Test Frequencies as specified in TS 38.508-1 [10] subclause 4.3.1.2.3 and 4.3.1.2.4 for different CA bandwidth classes		Low range, High range		
Test CA Bandwidth combination as specified in TS 38.508-1 [10] subclause 4.3.1.2.3 and 4.3.1.2.4 for the CA Configuration across bandwidth combination sets supported by the UE		Maximum aggregated BW (contiguous CA) or Maximum cumulative aggregated BW (non-contiguous CA)		
Test SCS as specified in Table 5.3.5-1		120kHz		
Test Parameters				
Test ID	Downlink Configuration		Uplink Configuration	
	Modulation	RB allocation	Modulation	RB allocation
1	CP-OFDM QPSK	Full RB (NOTE 1)	DFT-s-OFDM QPSK	REFSENS (NOTE 2, NOTE 3)
NOTE 1: Full RB allocation shall be used per each SCS and component carrier as specified in Table 7.3A.2.1.4.1-2.				
NOTE 2: REFSENS refers to Table 7.3A.2.1.4.1-3 which defines uplink RB configuration and start RB location for each SCS, channel BW.				
NOTE 3: Use single carrier UL when testing reference sensitivity power level for CA. The PCC is located on the CC with the lowest carrier frequency.				

Table 7.3A.2.1.4.1-2: Downlink Configuration of each RB allocation

Component Carrier Bandwidth	SCS kHz	LCRBmax	RB allocation (LCRB@RBstart)
50MHz	120	32	32@0
100MHz	120	66	66@0
200MHz	120	132	132@0
400MHz	120	264	264@0
NOTE 1: CA Bandwidths are checked separately for each NR band, the applicable CA bandwidths are specified in Table 5.3A.4-1.			

Table 7.3A.2.1.4.1-3: Uplink configuration for reference sensitivity, LCRB@RBstart format

Operating Band	SCS kHz	50 MHz	100 MHz	200 MHz	400 MHz	Duplex Mode
n257	120	32@0	64@0	128@0	256@0	TDD
n258	120	32@0	64@0	128@0	256@0	TDD
n260	120	32@0	64@0	128@0	256@0	TDD
n261	120	32@0	64@0	128@0	256@0	TDD

1. Connection between SS and UE is shown in TS 38.508-1 [10] Annex A, Figure A.3.3.1.1 for TE diagram and Figure A.3.4.1.1 for UE diagram.
2. The parameter settings for the cell are set up according to TS 38.508-1 [10] subclause 4.4.3.
3. Downlink signals are initially set up according to Annex C, and uplink signals according to Annex G.
4. The UL Reference Measurement channels are set according to Table 7.3A.2.1.4.1-1, Table 7.3A.2.1.4.1-2 and Table 7.3A.2.1.4.1-3.
5. Propagation conditions are set according to Annex B.0.
6. Ensure the UE is in State RRC_CONNECTED with generic procedure parameters Connectivity *NR*, Connected without release *On*, Test Mode *On* and Test Loop Function *On* according to TS 38.508-1 [10] clause 4.5. Message contents are defined in clause 7.3A.2.1.4.3.

7.3A.2.1.4.2 Test Procedure

Test procedure for Intra-band:

1. Configure SCC according to Annex C.0, C.1, C.2 for all downlink physical channels.
2. The SS shall configure SCC as per TS 38.508-1 [10] clause 5.5.1. Message contents are defined in clause 7.3A.2.1.4.3.
3. SS activates SCC by sending the activation MAC CE (Refer TS 38.321[28], clauses 5.9, 6.1.3.10). Wait for at least 2 seconds (Refer TS 38.133[25], clause 9.2).
4. SS transmits PDSCH via PDCCH DCI format 1_1 for C_RNTI to transmit the DL RMC according to Table 7.3A.2.1.4.1-1. The SS sends downlink MAC padding bits on the DL RMC.
5. SS sends uplink scheduling information on PCC for each UL HARQ process via PDCCH DCI format 0_1 for C_RNTI to schedule the UL RMC according to Table 7.3A.2.1.4.1-1. Since the UE has no payload data to send, the UE transmits uplink MAC padding bits on the UL RMC.
6. Send continuously uplink power control "up" commands in every uplink scheduling information to the UE; allow at least 200msec for the UE to reach P_{UMAX} .
7. Set the UE in the Rx beam peak direction found with a 3D EIS scan as performed in Annex K.1.2. Allow at least BEAM_SELECT_WAIT_TIME (NOTE 1) for the UE Rx beam selection to complete.
8. For each component carrier, perform EIS procedure as stated in Annex K.1.4 to calculate "averaged EIS" by changing the power level of the wanted signal with a step size of 0.2dB, while increasing the power level of each component carrier other than the one being tested by a fixed offset of 5 dB compared to the current power level of the component carrier under test. Coarse and fine searches are not precluded as long as the fine search is using the 0.2dB step size near the sensitivity level. For each power step measure the average throughput for a duration sufficient to achieve statistical significance according to Annex H.2.
9. For each component carrier, compare the dB value of the "averaged EIS" value corresponding to the Rx beam peak direction (same as that found for single carrier in clause 7.3.2) identified in step 8 to the test requirement in Tables 7.3A.2.1.5-4 to Table 7.3A.2.1.5-7. If the EIS value is lower or equal to the value in Tables 7.3A.2.1.5-4 to Table 7.3A.2.1.5-7, pass the UE. Otherwise fail the UE.

NOTE 1: The BEAM_SELECT_WAIT_TIME default value is defined in Annex K.1.2.

Test procedure for Inter-band:

1. Configure SCC according to Annex C.0, C.1, C.2 for all downlink physical channels.
2. The SS shall configure SCC as per TS 38.508-1 [10] clause 5.5.1. Message contents are defined in clause 7.3A.2.1.4.3.
3. SS activates SCC by sending the activation MAC CE (Refer TS 38.321[28], clauses 5.9, 6.1.3.10). Wait for at least 2 seconds (Refer TS 38.133[25], clause 9.2).

4. SS transmits PDSCH via PDCCH DCI format 1_1 for C_RNTI to transmit the DL RMC according to Table 7.3A.2.1.4.1-1. The SS sends downlink MAC padding bits on the DL RMC.
5. SS sends uplink scheduling information on PCC for each UL HARQ process via PDCCH DCI format 0_1 for C_RNTI to schedule the UL RMC according to Table 7.3A.2.1.4.1-1. Since the UE has no payload data to send, the UE transmits uplink MAC padding bits on the UL RMC.
6. Send continuously uplink power control "up" commands in every uplink scheduling information to the UE; allow at least 200msec for the UE to reach PUMAX.
7. Set the UE in the Rx beam peak direction found for the primary component carrier with a 3D EIS scan as performed in Annex K.1.2. Allow at least BEAM_SELECT_WAIT_TIME (NOTE 1) for the UE Rx beam selection to complete.
8. Set downlink signal level for each component carrier equal to EIS spherical coverage values for each band in inter-band CA which are those in clause 7.3.4.5 corrected with $\Delta RIB_{S,n}$ defined in 7.3A.3.0.3-1.
9. For primary component carrier, perform EIS procedure as stated in Annex K.1.4 to calculate "averaged EIS" by changing the power level of the wanted signal with a step size of 0.2dB, while increasing the power level of each component carrier other than the one being tested by a fixed offset of 5 dB compared to the current power level of the component carrier under test. Coarse and fine searches are not precluded as long as the fine search is using the 0.2dB step size near the sensitivity level. For each power step measure the average throughput for a duration sufficient to achieve statistical significance according to Annex H.2.
10. Set the UE in the Rx beam peak direction found for the secondary component carrier with a 3D EIS scan as performed in Annex K.1.2. Allow at least BEAM_SELECT_WAIT_TIME (NOTE 1) for the UE Rx beam selection to complete.
11. Set downlink signal level for each component carrier equal to EIS spherical coverage values for each band in inter-band CA which are those in clause 7.3.4.5 corrected with $\Delta RIB_{S,n}$ defined in 7.3A.3.0.3-1.
12. For secondary component carrier, perform EIS procedure as stated in Annex K.1.4 to calculate "averaged EIS" by changing the power level of the wanted signal with a step size of 0.2dB, while increasing the power level of each component carrier other than the one being tested by a fixed offset of 5 dB compared to the current power level of the component carrier under test. Coarse and fine searches are not precluded as long as the fine search is using the 0.2dB step size near the sensitivity level. For each power step measure the average throughput for a duration sufficient to achieve statistical significance according to Annex H.2.
13. Compare the dB value of the "averaged EIS" values identified in steps 9 and 12 to the test requirement in Tables 7.3.2.5-1 to Table 7.3.2.5-4 for the corresponding frequency band and power class. If the EIS values are lower or equal to the values in Tables 7.3.2.5-1 to Table 7.3.2.5-4, pass the UE. Otherwise fail the UE.

NOTE 1: The BEAM_SELECT_WAIT_TIME default value is defined in Annex K.1.2.

7.3A.2.1.4.3 Message contents

Message contents are according to TS 38.508-1 [10] subclause 4.6 with TRANSFORM_PRECODER_ENABLED condition in Table 4.6.3-118 PUSCH-Config.

7.3A.2.1.5 Test requirement

For each component carrier, the throughput shall be $\geq 95\%$ of the maximum throughput of the reference measurement channels as specified in Annex A.2 and A.3 (with one sided dynamic OCNG Pattern OP.1 TDD for the DL-signal as described in Annex A.5) with peak reference sensitivity specified in Tables 7.3A.2.1.5-4 to 7.3A.2.1.5-7. The requirement is verified with the test metric of EIS (Link=RX beam peak direction, Meas=Link Angle).

Table 7.3A.2.1.5-1: ΔRIB EIS Relaxation per component carrier for intra-band contiguous CA

Aggregated Channel BW ' $BW_{Channel_CA}$ ' (MHz)	ΔRIB (dB) / CC
$BW_{Channel_CA} \leq 800$	0.0
$800 < BW_{Channel_CA} \leq 1200$	0.5

Table 7.3A.2.1.5-2: ΔR_{IB} EIS Relaxation per component carrier for intra-band non-contiguous CA

Cumulative Aggregated Channel BW (MHz)	ΔR_{IB} (dB) / CC
≤ 800	0.0
> 800 and ≤ 1400	0.5
> 1400 and ≤ 2400	1.5

Table 7.3A.2.1.5-3: ΔR_{IB} reference sensitivity relaxation for inter-band CA for power class 3

NR CA bands	NR band	$\Delta R_{IB,P,n}$ (dB)
CA_n260-n261	n260	3.5
	n261	3.5

Table 7.3A.2.1.5-3b: ΔR_{IB} reference sensitivity relaxation for inter-band CA for power class 1

NR CA bands	NR band	$\Delta R_{IB,P,n}$ (dB)
CA_n260-n261	n260	2.5
	n261	2.5

Table 7.3A.2.1.5-4: Reference sensitivity per component carrier for power class 1

Operating band	REFSENS (dBm) / CC			
	50 MHz	100 MHz	200 MHz	400 MHz
n257	$-97.5+TT+\Delta R_{IB}$	$-94.5+TT+\Delta R_{IB}$	$-91.5+TT+\Delta R_{IB}$	$-88.5+TT+\Delta R_{IB}$
n258	$-97.5+TT+\Delta R_{IB}$	$-94.5+TT+\Delta R_{IB}$	$-91.5+TT+\Delta R_{IB}$	$-88.5+TT+\Delta R_{IB}$
n260	$-94.5+TT+\Delta R_{IB}$	$-91.5+TT+\Delta R_{IB}$	$-88.5+TT+\Delta R_{IB}$	$-85.5+TT+\Delta R_{IB}$
n261	$-97.5+TT+\Delta R_{IB}$	$-94.5+TT+\Delta R_{IB}$	$-91.5+TT+\Delta R_{IB}$	$-88.5+TT+\Delta R_{IB}$

Table 7.3A.2.1.5-4a: Test Tolerance per component carrier (Reference sensitivity for power class 1)

Test Metric	FR2a, FR2b
IFF (Max device size ≤ 30 cm)	2.51 dB, NTC 2.62 dB, ETC

Table 7.3A.2.1.5-5: Reference sensitivity per component carrier for power class 2

Operating band	REFSENS (dBm) / CC			
	50 MHz	100 MHz	200 MHz	400 MHz
n257	$-94.5+TT+\Delta R_{IB}$	$-91.5+TT+\Delta R_{IB}$	$-88.5+TT+\Delta R_{IB}$	$-85.5+TT+\Delta R_{IB}$
n258	$-94.5+TT+\Delta R_{IB}$	$-91.5+TT+\Delta R_{IB}$	$-88.5+TT+\Delta R_{IB}$	$-85.5+TT+\Delta R_{IB}$
n260				
n261	$-94.5+TT+\Delta R_{IB}$	$-91.5+TT+\Delta R_{IB}$	$-88.5+TT+\Delta R_{IB}$	$-85.5+TT+\Delta R_{IB}$

Table 7.3A.2.1.5-6: Reference sensitivity per component carrier for power class 3

Operating band	REFSENS (dBm) / Channel bandwidth			
	50 MHz	100 MHz	200 MHz	400 MHz
n257	$-88.3+TT+\Delta R_{IB}$	$-85.3+TT+\Delta R_{IB}$	$-82.3+TT+\Delta R_{IB}$	$-79.3+TT+\Delta R_{IB}$
n258	$-88.3+TT+\Delta R_{IB}$	$-85.3+TT+\Delta R_{IB}$	$-82.3+TT+\Delta R_{IB}$	$-79.3+TT+\Delta R_{IB}$
n260	$-85.7+TT+\Delta R_{IB}$	$-82.7+TT+\Delta R_{IB}$	$-79.7+TT+\Delta R_{IB}$	$-76.7+TT+\Delta R_{IB}$
n261	$-88.3+TT+\Delta R_{IB}$	$-85.3+TT+\Delta R_{IB}$	$-82.3+TT+\Delta R_{IB}$	$-79.3+TT+\Delta R_{IB}$

Table 7.3A.2.1.5-6a: Test Tolerance per component carrier (Reference sensitivity for power class 3)

Test Metric	FR2a, FR2b
IFF (Max device size ≤ 30 cm)	2.41 dB, NTC 2.52 dB, ETC

Table 7.3A.2.1.5-7: Reference sensitivity per component carrier for power class 4

Operating band	REFSENS (dBm) / Channel bandwidth			
	50 MHz	100 MHz	200 MHz	400 MHz
n257	$-97+TT+\Delta R_{IB}$	$-94+TT+\Delta R_{IB}$	$-91+TT+\Delta R_{IB}$	$-88+TT+\Delta R_{IB}$
n258	$-97+TT+\Delta R_{IB}$	$-94+TT+\Delta R_{IB}$	$-91+TT+\Delta R_{IB}$	$-88+TT+\Delta R_{IB}$
n260	$-95+TT+\Delta R_{IB}$	$-92+TT+\Delta R_{IB}$	$-89+TT+\Delta R_{IB}$	$-86+TT+\Delta R_{IB}$
n261	$-97+TT+\Delta R_{IB}$	$-94+TT+\Delta R_{IB}$	$-91+TT+\Delta R_{IB}$	$-88+TT+\Delta R_{IB}$

7.3A.2.1.5-8: Reference sensitivity per component carrier for power class 5

Operating band	REFSENS (dBm) / Channel bandwidth			
	50 MHz	100 MHz	200 MHz	400 MHz
n257	$-92.6+TT+\Delta R_{IB}$	$-89.6+TT+\Delta R_{IB}$	$-86.6+TT+\Delta R_{IB}$	$-83.6+TT+\Delta R_{IB}$
n258	$-92.8+TT+\Delta R_{IB}$	$-89.8+TT+\Delta R_{IB}$	$-86.8+TT+\Delta R_{IB}$	$-83.8+TT+\Delta R_{IB}$

Table 7.3A.2.1.5-8a: Test Tolerance per component carrier (Reference sensitivity for power class 5)

Test Metric	FR2a
IFF (Max device size \leq 30 cm)	2.51 dB, NTC 2.62 dB, ETC

7.3A.2.2 Reference sensitivity power level for CA (3DL CA)

Editor's note: The following aspects are either missing or not yet determined:

- Measurement Uncertainties and Test Tolerances for intra-band contiguous CA supporting aggregated BW > 400MHz and for intra-band non-contiguous CA are TBD.
- Measurement Uncertainties and Test Tolerances are FFS for power class other than 1, 3, 5.
- In case of frequency separation larger than 800 MHz and in case the device manufacturer does not explicitly declare that the beam peak for a reference (frequency band, CBW) or (frequency band combination, CA BW class) is applicable for a group of other intra-band contiguous combinations and CA BW classes, according to Table A.4.3.9-6 in 38.508-2, following aspect of beam peak search procedures for CA is FFS: RB allocation, power level, channel bandwidth configuration, per CC approach or all CC combined approach, etc

7.3A.2.2.1 Test purpose

Same test purpose as in clause 7.3A.2.1.1.

7.3A.2.2.2 Test applicability

This test case applies to all types of NR UE release 15 and forward that supports FR2 3DL CA.

7.3A.2.2.3 Minimum conformance requirements

Same minimum conformance requirements as in clause 7.3A.2.0.

7.3A.2.2.4 Test description

Same test description as in clause 7.3A.2.1.4.

7.3A.2.2.5 Test requirement

For each component carrier, the test requirement is the same as in clause 7.3A.2.1.5.

7.3A.2.3 Reference sensitivity power level for CA (4DL CA)

Editor's note: The following aspects are either missing or not yet determined:

- Measurement Uncertainties and Test Tolerances for intra-band contiguous CA supporting aggregated BW > 400MHz and for intra-band non-contiguous CA are TBD.
- Measurement Uncertainties and Test Tolerances are FFS for power class other than 1, 3, 5.
- In case of frequency separation larger than 800 MHz and in case the device manufacturer does not explicitly declare that the beam peak for a reference (frequency band, CBW) or (frequency band combination, CA BW class) is applicable for a group of other intra-band contiguous combinations and CA BW classes, according to Table A.4.3.9-6 in 38.508-2, following aspect of beam peak search procedures for CA is FFS: RB allocation, power level, channel bandwidth configuration, per CC approach or all CC combined approach, etc

7.3A.2.3.1 Test purpose

Same test purpose as in clause 7.3A.2.1.1.

7.3A.2.3.2 Test applicability

This test case applies to all types of NR UE release 15 and forward that supports FR2 4DL CA.

7.3A.2.3.3 Minimum conformance requirements

Same minimum conformance requirements as in clause 7.3A.2.0.

7.3A.2.3.4 Test description

Same test description as in clause 7.3A.2.1.4.

7.3A.2.3.5 Test requirement

For each component carrier, the test requirement is the same as in clause 7.3A.2.1.5.

7.3A.2.4 Reference sensitivity power level for CA (5DL CA)

Editor's note: This clause is incomplete. The following aspects are either missing or not yet determined:

- Measurement Uncertainties and Test Tolerances for intra-band contiguous CA supporting aggregated BW > 400MHz and for intra-band non-contiguous CA are TBD.
- Measurement Uncertainties and Test Tolerances are FFS for power class other than 1, 3, 5.
- In case of frequency separation larger than 800 MHz and in case the device manufacturer does not explicitly declare that the beam peak for a reference (frequency band, CBW) or (frequency band combination, CA BW class) is applicable for a group of other intra-band contiguous combinations and CA BW classes, according to Table A.4.3.9-6 in 38.508-2, following aspect of beam peak search procedures for CA is FFS: RB allocation, power level, channel bandwidth configuration, per CC approach or all CC combined approach, etc

7.3A.2.4.1 Test purpose

Same test purpose as in clause 7.3A.2.1.1.

7.3A.2.4.2 Test applicability

This test case applies to all types of NR UE release 15 and forward that supports FR2 5DL CA.

7.3A.2.4.3 Minimum conformance requirements

Same minimum conformance requirements as in clause 7.3A.2.0.

7.3A.2.4.4 Test description

Same test description as in clause 7.3A.2.1.4.

7.3A.2.4.5 Test requirement

For each component carrier, the test requirement is the same as in clause 7.3A.2.1.5.

7.3A.2.5 Reference sensitivity power level for CA (6DL CA)

Editor's note: This clause is incomplete. The following aspects are either missing or not yet determined:

- Measurement Uncertainties and Test Tolerances for intra-band contiguous CA supporting aggregated BW > 400MHz and for intra-band non-contiguous CA are TBD.
- Measurement Uncertainties and Test Tolerances are FFS for power class other than 1, 3, 5.
- In case of frequency separation larger than 800 MHz and in case the device manufacturer does not explicitly declare that the beam peak for a reference (frequency band, CBW) or (frequency band combination, CA BW class) is applicable for a group of other intra-band contiguous combinations and CA BW classes, according to Table A.4.3.9-6 in 38.508-2, following aspect of beam peak search procedures for CA is FFS: RB allocation, power level, channel bandwidth configuration, per CC approach or all CC combined approach, etc

7.3A.2.5.1 Test purpose

Same test purpose as in clause 7.3A.2.1.1.

7.3A.2.5.2 Test applicability

This test case applies to all types of NR UE release 15 and forward that supports FR2 6DL CA.

7.3A.2.5.3 Minimum conformance requirements

Same minimum conformance requirements as in clause 7.3A.2.0.

7.3A.2.5.4 Test description

Same test description as in clause 7.3A.2.1.4.

7.3A.2.5.5 Test requirement

For each component carrier, the test requirement is the same as in clause 7.3A.2.1.5.

7.3A.2.6 Reference sensitivity power level for CA (7DL CA)

Editor's note: This clause is incomplete. The following aspects are either missing or not yet determined:

- Measurement Uncertainties and Test Tolerances for intra-band contiguous CA supporting aggregated BW > 400MHz and for intra-band non-contiguous CA are TBD.
- Measurement Uncertainties and Test Tolerances are FFS for power class other than 1, 3, 5.
- In case of frequency separation larger than 800 MHz and in case the device manufacturer does not explicitly declare that the beam peak for a reference (frequency band, CBW) or (frequency band combination, CA BW class) is applicable for a group of other intra-band contiguous combinations and CA BW classes, according to Table A.4.3.9-6 in 38.508-2, following aspect of beam peak search procedures for CA is FFS: RB allocation, power level, channel bandwidth configuration, per CC approach or all CC combined approach, etc.

7.3A.2.6.1 Test purpose

Same test purpose as in clause 7.3A.2.1.1.

7.3A.2.6.2 Test applicability

This test case applies to all types of NR UE release 15 and forward that supports FR2 7DL CA.

7.3A.2.6.3 Minimum conformance requirements

Same minimum conformance requirements as in clause 7.3A.2.0.

7.3A.2.6.4 Test description

Same test description as in clause 7.3A.2.1.4.

7.3A.2.6.5 Test requirement

For each component carrier, the test requirement is the same as in clause 7.3A.2.1.5.

7.3A.2.7 Reference sensitivity power level for CA (8DL CA)

Editor's note: This clause is incomplete. The following aspects are either missing or not yet determined:

- Measurement Uncertainties and Test Tolerances for intra-band contiguous CA supporting aggregated BW > 400MHz and for intra-band non-contiguous CA are TBD.
- Measurement Uncertainties and Test Tolerances are FFS for power class other than 1, 3, 5.
- In case of frequency separation larger than 800 MHz and in case the device manufacturer does not explicitly declare that the beam peak for a reference (frequency band, CBW) or (frequency band combination, CA BW class) is applicable for a group of other intra-band contiguous combinations and CA BW classes, according to Table A.4.3.9-6 in 38.508-2, following aspect of beam peak search procedures for CA is FFS: RB allocation, power level, channel bandwidth configuration, per CC approach or all CC combined approach, etc

7.3A.2.7.1 Test purpose

Same test purpose as in clause 7.3A.2.1.1.

7.3A.2.7.2 Test applicability

This test case applies to all types of NR UE release 15 and forward that supports FR2 3DL CA.

7.3A.2.7.3 Minimum conformance requirements

Same minimum conformance requirements as in clause 7.3A.2.0.

7.3A.2.7.4 Test description

Same test description as in clause 7.3A.2.1.4.

7.3A.2.7.5 Test requirement

For each component carrier, the test requirement is the same as in clause 7.3A.2.1.5.

7.3A.3 EIS spherical coverage for DL CA

7.3A.3.0 Minimum Conformance Requirements

7.3A.3.0.1 Void

7.3A.3.0.2 Void

7.3A.3.0.3 EIS spherical coverage for inter-band CA

The inter-band CA requirement applies per operating band, for all active component carriers with UL assigned to one band and one DL component carrier per band. The requirement on each component carrier shall be met when the power in the component carrier in the other band is set to its EIS spherical coverage requirement for inter-band CA specified in this sub-clause.

The inter-band CA spherical coverage requirement for each power class will be satisfied if the intersection set of spherical coverage areas exceeds the common coverage requirement. Intersection set of spherical coverage areas is defined as a fraction of area of full sphere measured around the UE where both bands meet their defined individual EIS spherical coverage requirements for inter-band CA operation. The common coverage requirement is determined as <100-percentile rank> %, where 'percentile rank' is the percentile value in the specification of spherical coverage for that power class from clause 7.3.4. The requirement is verified with the test metric of EIS (Link=Beam peak search grids, Meas=Link angle).

The reference measurement channels and throughput criterion shall be as specified in clause 7.3A.2.0.3. The requirement shall be met for an uplink transmission using QPSK DFT-s-OFDM waveforms and for uplink transmission bandwidth less than or equal to that specified in clause 7.3.2.

Unless otherwise specified, the minimum requirements for reference sensitivity shall be verified with the network signalling value NS_200 (Table 6.2.3.3.1-1) configured.

The required spherical coverage EIS for each band in inter-band CA operation is given in clause 7.3.4 and modified by $\Delta R_{IB,S,n}$. The value of $\Delta R_{IB,S,n}$ is defined in Table 7.3A.3.0.3-1.

Table 7.3A.3.0.3-1: $\Delta R_{IB,S,n}$ EIS spherical coverage requirement relaxation for inter-band CA for power class 3

NR CA band combination	NR band	$\Delta R_{IB,S,n}$ (dB)
CA_n260-n261	n260	3.5
	n261	3.5

7.3A.3.1 EIS Spherical Coverage for Inter-band CA (2DL CA)

Editor's note: This clause is incomplete. The following aspects are either missing or not yet determined:

- Measurement Uncertainties and Test Tolerances are FFS
- Test Config is FFS.
- In case of frequency separation larger than 800 MHz and in case the device manufacturer does not explicitly declare that the beam peak for a reference (frequency band, CBW) or (frequency band combination, CA BW class) is applicable for a group of other intra-band contiguous combinations and CA BW classes, according to Table A.4.3.9-6 in 38.508-2, following aspect of beam peak search procedures for CA is FFS: RB allocation, power level, channel bandwidth configuration, per CC approach or all CC combined approach, etc

7.3A.3.1.1 Test purpose

Same test purpose as in 7.3.4.1

7.3A.3.1.2 Test applicability

This test case applies to all types of NR UE release 15 and forward that supports FR2 2DL inter-band CA.

7.3A.3.1.3 Minimum conformance requirements

Same minimum conformance requirements as in clause 7.3A.3.0.

The normative reference for this requirement is TS 38.101-2 [3] clause 7.3A.3.

7.3A.3.1.4 Test description

7.3A.3.1.4.1 Initial conditions

Initial conditions are a set of test configurations the UE needs to be tested in and the steps for the SS to take with the UE to reach the correct measurement state.

The initial test configurations consist of environmental conditions, test frequencies, test channel bandwidths and sub-carrier spacing based on NR CA configurations specified in clause 5.5A. All of these configurations shall be tested with applicable test parameters for each combination of channel bandwidth and subcarrier spacing are shown in Table [TBD], Table [TBD] and Table [TBD]. The details of the uplink and downlink reference measurement channels (RMCs) are specified in Annexes A.2 and A.3. The details of the OCNG patterns used are specified in Annex A.5. Configurations of PDSCH and PDCCH before measurement are specified in Annex C.2.

Table 7.3A.3.1.4.1-1: Test Configuration Table

FFS

7.3A.3.1.4.2 Test procedure

1. Configure SCC according to Annex C.0, C.1, C.2 for all downlink physical channels.
2. The SS shall configure SCC as per TS 38.508-1 [10] clause 5.5.1. Message contents are defined in clause 7.3A.3.1.4.3.
3. SS activates SCC by sending the activation MAC CE (Refer TS 38.321[28], clauses 5.9, 6.1.3.10). Wait for at least 2 seconds (Refer TS 38.133[25], clause 9.2).
4. SS transmits PDSCH via PDCCH DCI format 1_1 for C_RNTI to transmit the DL RMC according to Table 7.3A.3.1.4.1-1. The SS sends downlink MAC padding bits on the DL RMC.
5. SS sends uplink scheduling information for each UL HARQ process via PDCCH DCI format 0_1 for C_RNTI to schedule the UL RMC according to Table 7.3A.3.1.4.1-1. Since the UE has no payload data to send, the UE transmits uplink MAC padding bits on the UL RMC.
6. Send continuously uplink power control "up" commands in every uplink scheduling information to the UE; allow at least 200msec for the UE to reach P_{UMAX} .
7. Set downlink signal level of each component carrier other than the one being tested equal to its EIS spherical coverage requirement for inter-band CA specified in 7.3A.3.0.3.
8. For each component carrier, measure UE EIS value for each grid point according to EIS spherical coverage procedure defined in Annex K.1.6.0, and obtain a Complimentary Cumulative Distribution Function (CCDF) of all EIS dBm values. Alternatively, UE EIS measurement for each grid point could be done according to Rx Fast spherical coverage procedure defined in Annex K.1.6.1. After a rotation, allow at least BEAM_SELECT_WAIT_TIME (NOTE 1) for UE to find the best beam to use. EIS is calculated considering both polarizations, theta and phi.
9. Identify the EIS dBm value corresponding to %-tile (UE power class dependent) value in the applicable test requirement tables in section 7.3A.3.1.5.
10. Compare the EIS dBm value identified in step 5, to the limit value in the applicable test requirement tables in section 7.3A.3.1.5. If the EIS dBm value is lower or equal to the limit value, pass the UE. Otherwise fail the UE.

NOTE 1: The BEAM_SELECT_WAIT_TIME default value is defined in Annex K.1.2.

7.3A.3.1.4.3 Message contents

Same as 7.3.4.4.3

7.3A.3.1.5 Test requirement

The reference measurement channels and throughput criterion shall be as specified in section 7.3.2.5.

Table 7.3A.3.1.5-1: $\Delta R_{IB,S,n}$ EIS spherical coverage requirement relaxation per component carrier for inter-band CA for power class 3

NR CA band combination	NR band	$\Delta R_{IB,S,n}$ (dB)
CA_n260-n261	n260	3.5
	n261	3.5

Table 7.3A.3.1.5-2: EIS spherical coverage per component carrier for power class 3 for single band UE or multi-band UE declaring $MB_s = 0$ in all FR2 bands

Operating band	EIS at 50 th ile CCDF (dBm) / Channel bandwidth			
	50 MHz	100 MHz	200 MHz	400 MHz
n257	-77.4 +TT+ $\Delta R_{IB,S,n}$	-74.4 +TT+ $\Delta R_{IB,S,n}$	-71.4 +TT+ $\Delta R_{IB,S,n}$	-68.4 +TT+ $\Delta R_{IB,S,n}$
n259	-71.9 +TT+ $\Delta R_{IB,S,n}$	-68.9 +TT+ $\Delta R_{IB,S,n}$	-65.9 +TT+ $\Delta R_{IB,S,n}$	-62.9 +TT+ $\Delta R_{IB,S,n}$
n258	-77.4 +TT+ $\Delta R_{IB,S,n}$	-74.4 +TT+ $\Delta R_{IB,S,n}$	-71.4 +TT+ $\Delta R_{IB,S,n}$	-68.4 +TT+ $\Delta R_{IB,S,n}$
n260	-73.1 +TT+ $\Delta R_{IB,S,n}$	-70.1 +TT+ $\Delta R_{IB,S,n}$	-67.1 +TT+ $\Delta R_{IB,S,n}$	-64.1 +TT+ $\Delta R_{IB,S,n}$
n261	-77.4 +TT+ $\Delta R_{IB,S,n}$	-74.4 +TT+ $\Delta R_{IB,S,n}$	-71.4 +TT+ $\Delta R_{IB,S,n}$	-68.4 +TT+ $\Delta R_{IB,S,n}$

NOTE 1: The transmitter shall be set to P_{UMAX} as defined in subclause 6.2.4.
 NOTE 2: The EIS spherical coverage requirements are verified only under normal thermal conditions as defined in TS 38.508-1 [10] subclause 4.1.1.

Table 7.3A.3.1.5-2a: EIS spherical coverage per component carrier for power class 3 for multi-band UE declaring $MB_s > 0$ in any FR2 band (Rel-15)

Operating band	EIS at 50 th ile CCDF (dBm) / Channel bandwidth (NOTE 3)			
	50 MHz	100 MHz	200 MHz	400 MHz
n257	-77.4 +TT+ MB_s + $\Delta R_{IB,S,n}$	-74.4 +TT+ MB_s + $\Delta R_{IB,S,n}$	-71.4 +TT+ MB_s + $\Delta R_{IB,S,n}$	-68.4 +TT+ MB_s + $\Delta R_{IB,S,n}$
n258	-77.4 +TT+ MB_s + $\Delta R_{IB,S,n}$	-74.4 +TT+ MB_s + $\Delta R_{IB,S,n}$	-71.4 +TT+ MB_s + $\Delta R_{IB,S,n}$	-68.4 +TT+ MB_s + $\Delta R_{IB,S,n}$
n260	-73.1 +TT+ MB_s + $\Delta R_{IB,S,n}$	-70.1 +TT+ MB_s + $\Delta R_{IB,S,n}$	-67.1 +TT+ MB_s + $\Delta R_{IB,S,n}$	-64.1 +TT+ MB_s + $\Delta R_{IB,S,n}$
n261	-77.4 +TT+ MB_s + $\Delta R_{IB,S,n}$	-74.4 +TT+ MB_s + $\Delta R_{IB,S,n}$	-71.4 +TT+ MB_s + $\Delta R_{IB,S,n}$	-68.4 +TT+ MB_s + $\Delta R_{IB,S,n}$

NOTE 1: The transmitter shall be set to P_{UMAX} as defined in subclause 6.2.4.
 NOTE 2: The EIS spherical coverage requirements are verified only under normal thermal conditions as defined in TS 38.508-1 [10] subclause 4.1.1.
 NOTE 3: Refer Table 7.3A.3.1.5-2b for details for MB_s allowance corresponding to supported FR2 band set combination
 NOTE 4: For a Rel-15 UE supporting FR2 bands set not defined in Table 7.3.2.3.3-1a, Table 7.3A.3.1.5-2c applies.

Table 7.3A.3.1.5-2b: EIS spherical coverage multiband relaxation factors per component carrier for power class 3 (Rel-15)

ID	Supported FR2 bands set	Maximum sum of MB_s , $\sum MB_s$ (dB) (Note 3)	Comments
----	-------------------------	---	----------

1	n257, n258	1.25	Maximum 0.75 dB relaxation allowed for each band
2	n257, n260	0.75	Maximum 0.4 dB relaxation allowed for n260 and 0.75 dB relaxation allowed for all other bands
3	n258, n260	0.75	Maximum 0.4 dB relaxation allowed for n260 and 0.75 dB relaxation allowed for all other bands
4	n258, n261	1.25	Maximum 0.75 dB relaxation allowed for each band
5	n260, n261	0.75	No relaxation allowed for n260 and 0.75 dB relaxation allowed for all other bands
6	n257, n258, n260	1.75	Maximum 0.4 dB relaxation allowed for n260 and 0.75 dB relaxation allowed for all other bands
7	n257, n258, n261	1.75	Maximum 0.75 dB relaxation allowed for each band
8	n257, n260, n261	1.25	Maximum 0.4 dB relaxation allowed for n260 and 0.75 dB relaxation allowed for all other bands
9	n258, n260, n261	1.25	Maximum 0.4 dB relaxation allowed for n260 and 0.75 dB relaxation allowed for all other bands
10	n257, n258, n260, n261	1.75	Maximum 0.4 dB relaxation allowed for n260 and 0.75 dB relaxation allowed for all other bands

NOTE 1: MB_s is the Multiband Relaxation factor declared by the UE for the tested band in Table A.4.3.9-3 of TS38.508-2 [11]. This declaration shall fulfil the requirements in Table 7.3.2.3.3-1a.
 NOTE 2: All UE supported bands needs to be tested to ensure the multiband relaxation declaration is compliant
 NOTE 3: Max allowed sum of MB_s over all supported FR2 bands as defined in clause 7.3.2.3.3.

Table 7.3A.3.1.5-2c: EIS spherical coverage per component carrier for power class 3 (Rel-16 and forward)

Operating band	EIS at 50 th ile CCDF (dBm) / Channel bandwidth (NOTE 3)			
	50 MHz	100 MHz	200 MHz	400 MHz
n257	$-77.4 + TT + \Delta MB_{s,n} + \Delta R_{IB,S,n}$	$-74.4 + TT + \Delta MB_{s,n} + \Delta R_{IB,S,n}$	$-71.4 + TT + \Delta MB_{s,n} + \Delta R_{IB,S,n}$	$-68.4 + TT + \Delta MB_{s,n} + \Delta R_{IB,S,n}$
n258	$-77.4 + TT + \Delta MB_{s,n} + \Delta R_{IB,S,n}$	$-74.4 + TT + \Delta MB_{s,n} + \Delta R_{IB,S,n}$	$-71.4 + TT + \Delta MB_{s,n} + \Delta R_{IB,S,n}$	$-68.4 + TT + \Delta MB_{s,n} + \Delta R_{IB,S,n}$
n259	$-71.9 + TT + \Delta MB_{s,n} + \Delta R_{IB,S,n}$	$-68.9 + TT + \Delta MB_{s,n} + \Delta R_{IB,S,n}$	$-65.9 + TT + \Delta MB_{s,n} + \Delta R_{IB,S,n}$	$-62.9 + TT + \Delta MB_{s,n} + \Delta R_{IB,S,n}$
n260	$-73.1 + TT + \Delta MB_{s,n} + \Delta R_{IB,S,n}$	$-70.1 + TT + \Delta MB_{s,n} + \Delta R_{IB,S,n}$	$-67.1 + TT + \Delta MB_{s,n} + \Delta R_{IB,S,n}$	$-64.1 + TT + \Delta MB_{s,n} + \Delta R_{IB,S,n}$
n261	$-77.4 + TT + \Delta MB_{s,n} + \Delta R_{IB,S,n}$	$-74.4 + TT + \Delta MB_{s,n} + \Delta R_{IB,S,n}$	$-71.4 + TT + \Delta MB_{s,n} + \Delta R_{IB,S,n}$	$-68.4 + TT + \Delta MB_{s,n} + \Delta R_{IB,S,n}$

NOTE 1: The transmitter shall be set to P_{UMAX} as defined in subclause 6.2.4.
 NOTE 2: The EIS spherical coverage requirements are verified only under normal thermal conditions as defined in TS 38.508-1 [10] subclause 4.1.1.
 NOTE 3: Refer Table 7.3A.3.1.5-2d for details for MB_s allowance corresponding to supported FR2 band set combination

Table 7.3A.3.1.5-2d: EIS spherical coverage multi-band relaxation factors per component carrier for power class 3 (Rel-16 and forward)

ID	FR2 bands/set	Comments
1	n257	
2	n258	
3	n259	
4	n260	
5	n261	
6	n257, n261	$\Delta MB_{s,n}$ relaxation is 0 dB
7	n260, n261	$\Delta MB_{s,n}$ relaxation is 0 dB

NOTE 1: $MB_{s,n}$ is the Multiband Relaxation factor for the tested band. This shall fulfil the requirements in Table 7.3.2.3.3-1b.

Table 7.3A.3.2.5-3: Test Tolerance per component carrier (EIS spherical coverage for power class 3)

Test Metric	f ≤ 40.8 GHz
IFF (Max device size ≤ 30 cm)	FFS

7.3A.3.2 EIS Spherical Coverage for Inter-band CA (3DL CA)

Editor's note: This clause is incomplete. The following aspects are either missing or not yet determined:

- Measurement Uncertainties and Test Tolerances are FFS
- Test Config is FFS.
- In case of frequency separation larger than 800 MHz and in case the device manufacturer does not explicitly declare that the beam peak for a reference (frequency band, CBW) or (frequency band combination, CA BW class) is applicable for a group of other intra-band contiguous combinations and CA BW classes, according to Table A.4.3.9-6 in 38.508-2, following aspect of beam peak search procedures for CA is FFS: RB allocation, power level, channel bandwidth configuration, per CC approach or all CC combined approach, etc

7.3A.3.2.1 Test purpose

Same test purpose as in 7.3.4.1

7.3A.3.2.2 Test applicability

This test case applies to all types of NR UE release 15 and forward that supports FR2 3DL inter-band CA.

7.3A.3.2.3 Minimum conformance requirements

Same minimum conformance requirements as in clause 7.3A.3.0.

The normative reference for this requirement is TS 38.101-2 [3] clause 7.3A.3.

7.3A.3.2.4 Test description

Same test description as in clause 7.3A.3.1.4 with test configurations details being FFS

7.3A.3.2.5 Test requirement

The reference measurement channels, and throughput criterion shall be as specified in section 7.3.2.5.

For each component carrier, the test requirement is the same as in clause 7.3A.3.1.5 with the listed relaxation applied per component carrier.

7.3A.3.3 EIS Spherical Coverage for Inter-band CA (4DL CA)

Editor's note: This clause is incomplete. The following aspects are either missing or not yet determined:

- Measurement Uncertainties and Test Tolerances are FFS
- Test Config is FFS.
- In case of frequency separation larger than 800 MHz and in case the device manufacturer does not explicitly declare that the beam peak for a reference (frequency band, CBW) or (frequency band combination, CA BW class) is applicable for a group of other intra-band contiguous combinations and CA BW classes, according to Table A.4.3.9-6 in 38.508-2, following aspect of beam peak search procedures for CA is FFS: RB allocation, power level, channel bandwidth configuration, per CC approach or all CC combined approach, etc

7.3A.3.3.1 Test purpose

Same test purpose as in 7.3.4.1

7.3A.3.3.2 Test applicability

This test case applies to all types of *NR* UE release 15 and forward that supports FR2 4DL inter-band CA.

7.3A.3.3.3 Minimum conformance requirements

Same minimum conformance requirements as in clause 7.3A.3.0.

The normative reference for this requirement is TS 38.101-2 [3] clause 7.3A.3.

7.3A.3.3.4 Test description

Same test description as in clause 7.3A.3.1.4 with test configurations details being FFS.

7.3A.3.3.5 Test requirement

The reference measurement channels, and throughput criterion shall be as specified in section 7.3.2.5.

For each component carrier, the test requirement is the same as in clause 7.3A.3.1.5 with the listed relaxation applied per component carrier..

7.3D Reference sensitivity for UL MIMO

The normative reference for this requirement is TS 38.101-2 [3] clause 7.3D.

No test case details are specified. Given UE's Rx performance would not be impacted by the Tx configuration on TDD bands, the requirements in this test case can be well covered in 7.3 and don't need to be tested again.

7.3K Spherical coverage requirement for simultaneous reception from multiple directions

7.3K.1 Spherical coverage with two Angle of Arrivals (AoAs) with simultaneous reception from multiple directions

7.3K.1.0 General

For this release, the requirement applies only to FR2-1 UEs that support the following set of capabilities:

1. `simultaneousReceptionDiffTypeD-r16`
2. At least one of:
 - a. `singleDCI-SDM-scheme-r16` or
 - b. `multiDCI-MultiTRP-r16` and either of:
 - i. `overlapPDSCHsFullyFreqTime-r16`.
 - ii. `overlapPDSCHsInTimePartiallyFreq-r16`

The requirement applies for simultaneous reception of rank 2 PDSCH, where each layer uses overlapping RBs in both time and frequency and is associated with a unique TCI state and AoA. The scheduled TCI states for the rank 2 PDSCH shall be configured with different QCL type-D reference signals respectively. The DL power at the centre of quiet zone from each AoA equals the EIS spherical coverage requirement from sub-clause 7.3.4.

For UEs supporting `singleDCI-SDM-scheme-r16`, the cumulative throughput in the DL associated with both TCI-states shall be ≥ 95 % of the maximum throughput of the reference measurement channels as specified A.3.3.2-5 and A.3.3.2-6 (with one sided dynamic OCNG Pattern OP.1 TDD for the DL-signal as described in Annex A.5.2.1).

For UEs supporting *multiDCI-MultiTRP-r16*, the throughput in the DL associated with each TCI-state shall be ≥ 95 % of the maximum throughput of the reference measurement channels as specified A.3.3.2-1 and A.3.3.2-2 (with one sided dynamic OCNG Pattern OP.1 TDD for the DL-signal as described in Annex A.5.2.1).

The requirement shall be met for an uplink transmission using QPSK DFT-s-OFDM waveforms and for uplink transmission bandwidth less than or equal to the downlink transmission bandwidth. The UL is assigned to any one of the two TCI-states scheduled for simultaneous DL, with reference measurement channel as specified in Annex A.2.3.2. The transmitter shall be set to PUMAX as defined in clause 6.2.4.

Unless otherwise specified, the minimum requirements shall be verified with the network signalling value NS_200 (Table 6.2.3.1-1) configured.

7.3K.1.1 UE spherical coverage for simultaneous reception from multiple directions (2 AoAs)

Editor's note: This clause is incomplete. The following aspects are either missing or not yet determined:

- Measurement Uncertainties and Test Tolerances are FFS for all power classes.
- DUT repositioning aspects needs further investigation.
- Test case to be updated to configure sDCI or mDCI as per UE capability. If UE supports both, then SS can configure via sDCI
- Test Methodology is FFS for Power Class 6

7.3K.1.1.1 Test purpose

To verify that the UE meets the spherical coverage requirements when receiving downlink from two directions or angle of arrivals.

7.3K.1.1.2 Test applicability

This test case applies to all types of release 18 and forward NR UEs that support *simultaneousReceptionDiffTypeD-r16* and at least one of At least one of:

- a. singleDCI-SDM-scheme-r16 or
- b. multiDCI-MultiTRP-r16 and either of:
 - i. overlapPDSCHsFullyFreqTime-r16.
 - ii. overlapPDSCHsInTimePartiallyFreq-r16

7.3K.1.1.3 Minimum conformance requirements

7.3K.1.1.3.1 2AoA spherical coverage for power class 3

The requirements apply to the UE when tested in a test system as described in Annex L. The requirement is verified with the test metric of throughput (Link= 2AoA spherical coverage grid, Meas=Link Angle).

The spherical coverage requirement for simultaneous reception from multiple directions is defined in terms of the probability to support simultaneous reception of rank 2 PDSCH defined in sub-clause 7.3K.0. The probability (see Annex L) is defined as the spatial average over the full sphere around the UE of the probability of any one direction to support 2 AoA reception. In the applicable test system (see Annex L), the probability of any one direction of the UE to support 2 AoA reception for any specific AoA separation is the ratio of the number of unique AoA pairs that include that direction and can support 2 AoA reception to the total number of verified unique AoA pairs that include that direction.

The requirement applies only for the UE's declared orientation in the positioner of the test system. The requirement for each AoA separation condition applies only for the UE's declared orientation in the positioner of the test system for that AoA separation. The minimum required overall probability to support 2 AoA reception for power class 3 UEs for any

channel bandwidth is specified by AoA separation in table 7.3K.3-1. The UE is only required to fulfil the requirement at any one of AoA separations declared from Table 7.3K.3-1.

Table 7.3K.3-1: Requirement for power class 3

AoA separation (degrees)	Probability (%)
30	18.5
60	13.5
90	12.5
120	20.5
150	28.5

7.3K.1.1.3.2 2AoA spherical coverage for power class 6

The requirements for a power class 6 UE are applicable with network signalling *highSpeedDeploymentTypeFR2-r17* configured as *bidirectional*. UE spherical coverage evaluation areas are found in Table 6.2.1.6-3a in clause 6.2.1.6, by consisting of Area-1 and Area-2, in the reference coordinate system in Annex L.1. If one AoA is within Area-1 and another AoA is within Area-2, the 2AoA spherical coverage requirements apply with DL power specified in Table 7.3K.6-1 for the PDSCH of each AoA. For any AoA pair selected from Area-1 and Area-2, respectively, the throughput shall be ≥ 95 % of the maximum throughput of the reference measurement channels. The requirement is verified with a 150° angular separation between 2AoAs. The requirement is verified with the test metric of Throughput (Link=2AoA Spherical coverage grid, Meas=Link angle).

Table 7.3K.1.1.3.2-1: DL power for 2AoA spherical coverage requirement for power class 6

Operating band	PDSCH DL power over UE spherical coverage evaluation areas (dBm) / Channel bandwidth			
	50 MHz	100 MHz	200 MHz	400 MHz
n257	-82.6	-79.6	-76.6	-73.6
n258	-82.8	-79.8	-76.8	-73.8
n261	-82.6	-79.6	-76.6	-73.6
NOTE 1: The transmitter shall be set to P_{UMAX} as defined in clause 6.2.4				
NOTE 2: The 2AoA spherical coverage requirements are verified only under normal thermal conditions as defined in TS 38.508-1 [10] subclause 4.1.1.				
NOTE 3: The requirements in this table are applicable with the network signalling <i>highSpeedMeasFlagFR2-r17</i> configured as <i>set2</i> .				

The requirement shall be met for an uplink transmission using QPSK DFT-s-OFDM waveforms and for uplink transmission bandwidth less than or equal to that specified in Table 7.3.2.1-2.

Unless given by Table 7.3.2.1-3, the minimum requirements for 2AoA spherical coverage shall be verified with the network signalling value NS_200 (Table 6.2.3.1-1) configured.

The normative reference for this requirement is TS 38.101-2 [3] clause 7.3K.6.

7.3K.1.1.4 Test description

7.3K.1.1.4.1 Initial conditions

Initial conditions are a set of test configurations the UE needs to be tested in and the steps for the SS to take with the UE to reach the correct measurement state.

The initial test configurations consist of environmental conditions, test frequencies, and channel bandwidths based on NR operating bands specified in Table 5.3.5-1. All of these configurations shall be tested with applicable test parameters for each channel bandwidth and subcarrier spacing, are shown in Table 7.3.2.4.1-1. The details of the downlink reference measurement channels (RMCs) are specified in Annexes A.3.3.2-5 and A.3.3.2-6 (with one sided dynamic OCNG Pattern OP.1 TDD for the DL-signal as described in Annex A.5.2.1, for UEs supporting *singleDCI-SDM-scheme-r16* and in A.3.3.2-1 and A.3.3.2-2 (with one sided dynamic OCNG Pattern OP.1 TDD for the DL-signal as described in Annex A.5.2.1) for UEs supporting *multiDCI-MultiTRP-r16*. Configurations of PDSCH and PDCCH before measurement are specified in Annex C.2.

The test configuration table is same as Table 7.3.2.4.1-1

1. Connection between SS and UE is shown in TS 38.508-1 [10] Annex A, Figure [A.3.3.1.X] for TE diagram and Figure A.3.4.1.X for UE diagram.
2. The parameter settings for the cell are set up according to TS 38.508-1 [10] subclause 4.4.3.
3. Downlink signals are initially set up according to Annex C, and uplink signals according to Annex G.
4. The UL Reference Measurement channels are set according to Table 7.3.2.4.1-1, Table 7.3.2.4.1-2, and Table 7.3.2.4.1-3.
5. Propagation conditions are set according to Annex B.0
6. Ensure the UE is in state RRC_CONNECTED with generic procedure parameters Connectivity *NR*, Connected without release *On*, Test Mode *On* and Test Loop Function *On* according to TS 38.508-1 [10] clause 4.5. Message contents are defined in clause 6.2.1.1.4.3

7.3K.1.1.4.2 Test procedure

Follow the below test procedure for power class 3 UEs:

1. SS transmits PDSCH via PDCCH DCI format 1_1 for C_RNTI to transmit the DL RMC according to Table 7.3.2.4.1-1. The SS sends downlink MAC padding bits on the DL RMC.
2. SS sends uplink scheduling information for each UL HARQ process via PDCCH DCI format 0_1 for C_RNTI to schedule the UL RMC according to Tables 7.3.2.4.1-1. Since the UE has no payload data to send, the UE transmits uplink MAC padding bits on the UL RMC.
3. Send continuously uplink power control "up" commands in every uplink scheduling information to the UE; allow at least 200msec for the UE to reach P_{UMAX} .
4. Measure the spatial average probability for the UE declared AoA separation according to spherical coverage procedure for simultaneous multi-Rx reception defined in Annex R.3. After a rotation, allow at least BEAM_SELECT_WAIT_TIME (NOTE 1) for UE to find the best beam to use. Throughput measurements are performed considering both polarizations, theta and phi, as per the detailed procedure in Annex R.3.
5. The UE shall be considered PASS if the final spatial-average probability is greater than or equal to the requirement specified in Table 7.3K.1.1.5-1 for the declared AoA separation Δ .

NOTE 1: The BEAM_SELECT_WAIT_TIME default value is defined in Annex K.1.2

7.3K.1.1.4.3 Message contents

Message contents are according to TS 38.508-1 [10] subclause 4.6 with TRANSFORM_PRECODER_ENABLED condition in Table 4.6.3-118 PUSCH-Config.

7.3K.1.1.5 Test requirement

For power class 3 UEs, the spherical coverage requirement for simultaneous reception from multiple directions is defined in terms of the probability to support simultaneous reception of rank 2 PDSCH defined in sub-clause 7.3K.0. The probability (see Annex L) is defined as the spatial average over the full sphere around the UE of the probability of any one direction to support 2 AoA reception. In the applicable test system (see Annex L), the probability of any one direction of the UE to support 2 AoA reception for any specific AoA separation is the ratio of the number of unique AoA pairs that include that direction and can support 2 AoA reception to the total number of verified unique AoA pairs that include that direction.

The requirement applies only for the UE's declared orientation in the positioner of the test system. The requirement for each AoA separation condition applies only for the UE's declared orientation in the positioner of the test system for that AoA separation. The minimum required overall probability to support 2 AoA reception for power class 3 UEs for any channel bandwidth is specified by AoA separation in table 7.3K.1.1.5-1. The UE is only required to fulfil the requirement at any one of AoA separations declared from Table 7.3K.1.1.5-1.

Table 7.3K.1.1.5-1: Test requirement for power class 3

AoA separation (degrees)	Probability (%)
30	18.5-TT
60	13.5-TT
90	12.5-TT
120	20.5-TT
150	28.5-TT
NOTE 1: The UE shall declare one AoA separation Δ . The UE shall only be required to meet the requirement for the declared AoA separation.	

Table 7.3K.1.1.5-2: Test Tolerance (Probability metric for power class 3)

Test Metric	FR2a, FR2b
Probability (Spatial average over the full sphere around the UE of the probability of any one direction to support 2 AoA reception)	FFS

For power class 6 UEs, UE spherical coverage evaluation areas are found in Table 6.2.1.6-3a in clause 6.2.1.6, by consisting of Area-1 and Area-2, in the reference coordinate system in Annex L.1. If one AoA is within Area-1 and another AoA is within Area-2, the 2AoA spherical coverage requirements apply with DL power specified in Table 7.3K.6-1 for the PDSCH of each AoA. For any AoA pair selected from Area-1 and Area-2, respectively, the throughput shall be $\geq 95\%$ of the maximum throughput of the reference measurement channels. The requirement is verified with a 150° angular separation between 2AoAs. The requirement is verified with the test metric of Throughput (Link=2AoA Spherical coverage grid, Meas=Link angle).

Table 7.3K.1.1.5-3: DL power for 2AoA spherical coverage test requirement for power class 6

Operating band	PDSCH DL power over UE spherical coverage evaluation areas (dBm) / Channel bandwidth			
	50 MHz	100 MHz	200 MHz	400 MHz
n257	-82.6+TT	-79.6+TT	-76.6+TT	-73.6+TT
n258	-82.8+TT	-79.8+TT	-76.8+TT	-73.8+TT
n261	-82.6+TT	-79.6+TT	-76.6+TT	-73.6+TT
NOTE 1: The transmitter shall be set to P_{UMAX} as defined in clause 6.2.4				
NOTE 2: The 2AoA spherical coverage requirements are verified only under normal thermal conditions as defined in TS 38.508-1 [10] subclause 4.1.1.				
NOTE 3: The requirements in this table are applicable with the network signalling <i>highSpeedMeasFlagFR2-r17</i> configured as <i>set2</i> .				
NOTE 4: The test tolerance values in Table 7.3K.1.1.5-3 shall be applied to calculate the test requirements.				

Table 7.3K.1.1.5-4: Test Tolerance (Spherical Cov Requirement for power class 6)

Test Metric	FR2a, FR2b
Spherical Coverage (Test method FFS)	FFS

7.3M Reference sensitivity for LP-WUR/WUS

7.3M.1 General

The sensitivity power level is defined as the lowest LP-WUS power level at the centre of the quiet zone in the direction of measurement at which the MDR criterion in clause 7.1M is met by the UE with the side conditions in clause 7.1M.

7.3M.2 Reference sensitivity power level for LP-WUS/WUR

Editor's note: This clause is incomplete. The following aspects are either missing or not yet determined:

- Test Description is FFS
- Test Requirements as well as Measurement Uncertainties and Test Tolerances are FFS

7.3M.2.1 Test purpose

To verify a LP-WUR/WUS capable UE's sensitivity power level as defined in clause 7.3M.1 under the side conditions in clause 7.1M.

7.3M.2.2 Test applicability

This test case applies to all types of release 19 and forward NR UEs that support LP-WUS/WUR.

7.3M.2.3 Minimum conformance requirements

The reference sensitivity power level is defined as the sensitivity in the RX beam peak direction. The requirement on max. reference sensitivity for LP-WUS detection is given by:

$$P_{REFSENS,LPWUS} = P_{REFSENS} + 0.5 + 10 \log_{10} \left(\frac{N_{RB}}{N_{RB,LPWUS}} \right) + X \text{ dB}$$

Where $P_{REFSENS}$ is the reference sensitivity (dBm) specified in clause 7.3 for the respective power classes and channel bandwidths and X is specified in table 7.3M.2-1.

Table 7.3M.2.3-1: REFSENS parameter by power class

UE power class	'X' (dB)
3	6.0
7	3.0

The normative reference for this requirement is TS 38.101-2 [3] clause 7.3M.2.

7.3M.2.4 Test description

FFS

7.3M.2.5 Test requirement

FFS

7.3M.3 Void

7.3M.4 LP-WUR/WUS [sensitivity] spherical coverage

Editor's note: This clause is incomplete. The following aspects are either missing or not yet determined:

- Test Description is FFS
- Test Requirements as well as Measurement Uncertainties and Test Tolerances are FFS

7.3M.4.1 Test purpose

To verify that the EIS spherical coverage of a LP-WUR/WUS capable UE as defined in clause 7.3M.1 is acceptable under conditions of low signal level, ideal propagation and no added noise and the side conditions in clause 7.1M

7.3M.4.2 Test applicability

This test case applies to all types of release 19 and forward NR UEs that support LP-WUS/WUR.

7.3M.4.3 Minimum conformance requirements

The requirement on spherical coverage of the UE's detection sensitivity to LP-WUS consists of two parts. The first part is an LP-WUS sensitivity criterion, and the second part is a spherical coverage requirement.

The requirement on spherical coverage LP-WUS sensitivity ' $P_{SENS,LPWUS}$ ' (sensitivity criterion) is given by:

$$P_{SENS,LPWUS} = P_{SENS} + 0.5 + 10 \log_{10} \left(\frac{N_{RB}}{N_{RB,LPWUS}} \right) + X \text{ dB}$$

Where P_{SENS} is the EIS spherical coverage value (dBm) specified in clause 7.3.4 for the respective power classes and channel bandwidths and X is specified in table 7.3M.2-1.

The associated spherical coverage requirement (unless otherwise specified) is the covered fraction of the sphere over which the UE's sensitivity to LP-WUS is level less than or equal to the LP-WUS sensitivity criterion above and is specified in table 7.3M.4-1. (Link=Spherical coverage grid, Meas=Link angle).

Table 7.3M.4.3-1: Spherical coverage requirement

UE power class	Spherical coverage (min.)
3	50 %
7	50%

The normative reference for this requirement is TS 38.101-2 [3] clause 7.3M.4.

7.3M.4.4 Test description

FFS

7.3M.4.5 Test requirement

FFS

7.4 Maximum input level

Editor's note: This clause is incomplete. The following aspects are either missing or not yet determined:

- Measurement uncertainty is FFS.
- UL power level configuration is TBD.
- Relaxation of DL power for 256 QAM is FFS

7.4.1 Test purpose

Maximum input level tests the UE's ability to receive data with a given average throughput for a specified reference measurement channel, under conditions of high signal level, ideal propagation and no added noise.

A UE unable to meet the throughput requirement under these conditions will decrease the coverage area near to a g-NodeB.

7.4.2 Test applicability

The minimum conformance requirements in this test case are not testable due to maximum input level unachievable in IFF OTA test setup. Other test setups have not been analysed. Thus the test case will not be tested as part of UE conformance testing.

NOTE: This does not preclude the test from being used for R&D or other purposes if deemed useful to all types of NR UEs release 15 and forward.

7.4.3 Minimum conformance requirements

The maximum input level is defined as the maximum mean power, for which the throughput shall meet or exceed the minimum requirements for the specified reference measurement channel.

The maximum input level is defined as a directional requirement. The requirement is verified in beam locked mode in the direction where peak gain is achieved.

The throughput shall be $\geq 95\%$ of the maximum throughput of the reference measurement channels as specified in Annex A (with one sided dynamic OCNG Pattern OP.1 TDD for the DL-signal as described in Annex A.5.2.1) with parameters specified in Table 7.4.3-1. The requirement is verified with the test metric of EIS (Link=RX beam peak direction, Meas=Link angle).

Table 7.4.3-1: Maximum input level

Rx Parameter	Units	Channel bandwidth			
		50 MHz	100 MHz	200 MHz	400 MHz
Power in transmission bandwidth configuration	dBm	-25 (NOTE 2) -27 (NOTE 3)			
NOTE 1: The transmitter shall be set to 4 dB below the $P_{UMAX,f,c}$ as defined in subclause 6.2.4, with uplink configuration specified in Table 7.3.2.3.1-2.					
NOTE 2: Reference measurement channel is specified in Annex A.3.3.2: QPSK, R=1/3 variant with one sided dynamic OCNG Pattern as described in Annex A.					
NOTE 3: Reference measurement channel is specified in Annex A.3.3.5: 256QAM, R=4/5 variant with one sided dynamic OCNG Pattern as described in Annex A.					

The normative reference for this requirement is TS 38.101-2 [3] clause 7.4.

7.4.4 Test description

7.4.4.1 Initial conditions

Initial conditions are a set of test configurations the UE needs to be tested in and the steps for the SS to take with the UE to reach the correct measurement state.

The initial test configurations consist of environmental conditions, test frequencies, test channel bandwidths and sub-carrier spacing based on NR operating bands specified in Table 5.3.5-1. All of these configurations shall be tested with applicable test parameters for each combination of channel bandwidth and sub-carrier spacing, are shown in Table 7.4.4.1-1. The details of the uplink and downlink reference measurement channels (RMC) are specified in Annexes A.2 and A.3. The details of the OCNG patterns used are specified in Annex A.5. Configurations of PDSCH and PDCCH before measurement are specified in Annex C.2.

Table 7.4.4.1-1: Test Configuration Table

Initial Conditions		
Test Environment as specified in TS 38.508-1 [10] subclause 4.1	Normal	
Test Frequencies as specified in TS 38.508-1 [10] subclause 4.3.1	Mid range	
Test Channel Bandwidths as specified in TS 38.508-1 [10] subclause 4.3.1	Lowest, Mid, Highest	
Test SCS as specified in Table 5.3.5-1	120kHz	
Test Parameters for Channel Bandwidths		
Test ID	Downlink Configuration	Uplink Configuration

	Modulation	RB allocation	Modulation	RB allocation
1	CP-OFDM QPSK	NOTE1	DFT-s-OFDM QPSK	NOTE2
2	CP-OFDM 256QAM	NOTE1	DFT-s-OFDM QPSK	NOTE2
NOTE 1: The specific configuration of downlink RB allocation is defined in Table 7.3.2.4.1-2. NOTE 2: The specific configuration of uplink RB allocation is defined in Table 7.3.2.4.1-3. NOTE 3: For PC7 RedCap UEs only 50MHz and 100MHz Test Channel Bandwidths are applicable				

1. Connection between SS and UE is shown in TS 38.508-1 [10] Annex A, Figure A.3.3.1.1 for TE diagram and Figure A.3.4.1.1 for UE diagram.
2. The parameter settings for the cell are set up according to TS 38.508-1 [10] subclause 4.4.3.
3. Downlink signals are initially set up according to Annex C, and uplink signals according to Annex G.
4. The DL and UL Reference Measurement channels are set according to Table 7.4.4.1-1.
5. Propagation conditions are set according to Annex B.0.
6. Ensure the UE is in state RRC_CONNECTED with generic procedure parameters Connectivity *NR*, Connected without release *On*, Test Mode *On* and Test Loop Function *On* according to TS 38.508-1 [10] clause 4.5. Message contents are defined in clause 7.4.4.3.

7.4.4.2 Test procedure

1. SS transmits PDSCH via PDCCH DCI format 1_1 for C_RNTI to transmit the DL RMC according to Table 7.4.4.1-1. The SS sends downlink MAC padding bits on the DL RMC.
2. SS sends uplink scheduling information for each UL HARQ process via PDCCH DCI format 0_1 for C_RNTI to schedule the UL RMC according to Table 7.4.4.1-1. Since the UL has no payload data to send, the UE transmits uplink MAC padding bits on the UL RMC.
3. Set the Downlink signal level for θ -polarization to the value as defined in Table 7.4.5-1.
4. Set the UE in the Rx beam peak direction found with a 3D EIS scan as performed in Annex K.1.2. Allow at least BEAM_SELECT_WAIT_TIME (NOTE) for the UE Rx beam selection to complete.
5. Send Uplink power control commands to the UE (less or equal to 1dB step size should be used), to ensure that the UE output power is within [TBD] dB of the target power level in Table 7.4.5-1, for at least the duration of the throughput measurement.
6. SS activates the UE Beamlock Function (UBF) by performing the procedure as specified in TS 38.508-1 [10] clause 4.9.2 using condition Rx Only.
7. Measure the average throughput for a duration sufficient to achieve statistical significance according to Annex H.2.
8. SS deactivates the UE Beamlock Function (UBF) by performing the procedure as specified in TS 38.508-1 [10] clause 4.9.3.
9. Repeat steps from 3 to 8, for the downlink signal from ϕ -polarization.
10. Compare the results for both the θ -polarization and ϕ -polarization against the requirement. If either result meets the requirements, pass the UE.

NOTE: The BEAM_SELECT_WAIT_TIME default value is defined in Annex K.1.2.

7.4.4.3 Message contents

Message contents are according to TS 38.508-1 [10] subclause 4.6 with TRANSFORM_PRECODER_ENABLED condition in Table 4.6.3-118 PUSCH-Config.

7.4.5 Test requirement

The throughput measurement derived in test procedure shall be $\geq 95\%$ of the maximum throughput of the reference measurement channels as specified in Annex A with parameters specified in Tables 7.4.5-1.

Table 7.4.5-1: Maximum input level

Rx Parameter	Units	Channel bandwidth			
		50 MHz	100 MHz	200 MHz	400 MHz
Power in Transmission Bandwidth Configuration	dBm	-51 (NOTE 2,3) for band n257, n258 and n261 -59 (NOTE 2,3) for band n260 -53 (NOTE 3,4) for band n257, n258 and n261 -61 (NOTE 3,4) for band n260			
NOTE 1: The transmitter shall be set to 4 dB below the $P_{UMAX,f,c}$ as defined in subclause 6.2.4, with uplink configuration specified in Table 7.3.2.3.1-2.					
NOTE 2: Reference measurement channel is specified in Annex A.3.3.2: QPSK, R=1/3 variant with one sided dynamic OCNG Pattern as described in Annex A.					
NOTE 3: The test requirements deviate from minimum requirements by 26dB relaxation for 24.25 ~ 29.5 GHz and 34 dB relaxation for 37 ~ 40 GHz.					
NOTE 4: Reference measurement channel is specified in Annex A.3.3.5: 256QAM, R=4/5 variant with one sided dynamic OCNG Pattern as described in Annex A.					

7.4A Maximum input level for CA

7.4A.0 Minimum Conformance Requirements

7.4A.0.1 Maximum input level for Intra-band contiguous CA

For intra-band contiguous carrier aggregation the input level is defined as the cumulative received power, summed over the transmission bandwidth configurations of each active DL CC. All DL CCs shall be active throughout the test. The input power shall be distributed among the active DL CCs so their PSDs are aligned with each other. At the maximum input level, the specified relative throughput shall meet or exceed the minimum requirements for the specified reference measurement channel over each component carrier. The minimum requirement is specified in Table 7.4A.0.1-1.

The maximum input level is defined as a directional requirement. The requirement is verified in beam locked mode in the direction where peak gain is achieved. The requirement is verified with the test metric of EIS (Link=RX beam peak direction, Meas=Link angle).

Table 7.4A.0.1-1: Maximum input level for Intra-band contiguous CA

Rx Parameter	Units	Level
Power summed over transmission bandwidth configurations of all active DL CCs	dBm	-25 (NOTE 2) -27 (NOTE 3)
NOTE 1: The transmitter shall be set to 4 dB below the $P_{UMAX,f,c}$ as defined in clause 6.2.4, with uplink configuration specified in Table 7.3.2.3.1-2.		
NOTE 2: Reference measurement channel in each CC is specified in Annex A.3.3.2: QPSK, R=1/3 variant with one sided dynamic OCNG Pattern as described in Annex A.		
NOTE 3: Reference measurement channel is specified in Annex A.3.3.5: 256QAM, R=4/5 variant with one sided dynamic OCNG Pattern as described in Annex A.		

7.4A.0.2 Maximum input level for Intra-band non-contiguous CA

For intra-band non-contiguous carrier aggregation the requirement of clause 7.4A.0.1 applies.

7.4A.0.3 Maximum input level for inter-band CA

For inter-band carrier aggregation with one component carrier per operating band and the uplink assigned to one NR band, the maximum input level is defined with the uplink active on the band other than the band whose downlink is

being tested. The UE shall meet the requirements specified in clause 7.4 for each component carrier while all downlink carriers are active.

For the combination of intra-band and inter-band carrier aggregation and uplink carrier(s) assigned to one NR band, the requirement is defined with the uplink active on the band other than the band whose downlink is being tested. The UE shall meet the requirements specified in clause 7.4A.1 and 7.4A.2 for each band while all downlink carriers are active.

7.4A.1 Maximum input level for CA (2DL CA)

Editor's note: This clause is incomplete. The following aspects are either missing or not yet determined:

- Measurement uncertainty and test requirement are FFS.
- UL power level configuration is TBD.
- Relaxation of DL power for 256 QAM is FFS.
- Test for DL intra-band non-contiguous configurations with UL intra-band contiguous configuration is FFS.

7.4A.1.1 Test purpose

Same test purpose as in clause 7.4.1.

7.4A.1.2 Test applicability

This test case applies to all types of NR UEs release 15 and forward that support FR2 2DL CA.

The minimum conformance requirements in this test case are not testable due to maximum input level unachievable in IFF OTA test setup. Other test setups have not been analysed. Thus the test case will not be tested as part of UE conformance testing.

NOTE: This does not preclude the test from being used for R&D or other purposes if deemed useful to all types of NR UEs release 15 and forward that support FR2 2DL CA.

7.4A.1.3 Minimum conformance requirements

Same minimum conformance requirements as in clause 7.4A.0.

7.4A.1.4 Test description

7.4A.1.4.1 Initial conditions

Initial conditions are a set of test configurations the UE needs to be tested in and the steps for the SS to take with the UE to reach the correct measurement state.

The initial test configurations consist of environmental conditions, test frequencies, and channel bandwidths and sub-carrier spacing based on NR CA configurations specified in clause 5.5A. All of these configurations shall be tested with applicable test parameters for each combination of channel bandwidth and sub-carrier spacing, are shown in Table 7.4A.1.4.1-1. The details of the uplink and downlink reference measurement channels (RMC) are specified in Annexes A.2 and A.3. The details of the OCNG patterns used are specified in Annex A.5. Configurations of PDSCH and PDCCH before measurement are specified in Annex C.2.

Table 7.4A.1.4.1-1: Test Configuration Table

Initial Conditions	
Test Environment as specified in TS 38.508-1 [10] subclause 4.1	Normal
Test Frequencies as specified in TS 38.508-1 [10] subclause 4.3.1.2.2, 4.3.1.2.3 and 4.3.1.2.4 for different CA bandwidth classes	For intra-band contiguous CA: Mid range For intra-band non-contiguous CA: Max Wgap For inter-band CA: Mid range
Test CA Bandwidth combination as specified in TS 38.508-1 [10] subclause 4.3.1.2.2, 4.3.1.2.3 and	Maximum aggregated BW (contiguous CA) or Maximum cumulative aggregated BW (non-contiguous CA)

4.3.1.2.4 for the CA Configuration across bandwidth combination sets supported by the UE				
Test SCS as specified in Table 5.3.5-1		120kHz		
Test Parameters				
Test ID	Downlink Configuration		Uplink Configuration	
	Modulation	RB allocation	Modulation	RB allocation
1	CP-OFDM QPSK	Full RB (NOTE 1)	DFT-s-OFDM QPSK	REFSENS (NOTE 2, NOTE 3)
2	CP-OFDM 256QAM	Full RB (NOTE 1)	DFT-s-OFDM QPSK	REFSENS (NOTE 2, NOTE 3)
NOTE 1: Full RB allocation shall be used per each SCS and component carrier as specified in Table 7.3A.2.1.4.1-2.				
NOTE 2: REFSENS refers to Table 7.3A.2.1.4.1-3 which defines uplink RB configuration and start RB location for each SCS, channel BW.				
NOTE 3: Use single carrier UL when testing Maximum input level for CA. The PCC is located on the CC with the lowest carrier frequency.				
NOTE 4: For inter-band DL CA, the frequencies of PCC and SCC shall be switched and tested in each configuration, according to the UE declared capability for UL support (within CA operation) in the individual bands.				

1. Connection between SS and UE is shown in TS 38.508-1 [10] Annex A, Figure A.3.3.1.1 for TE diagram and Figure A.3.4.1.1 for UE diagram.
2. The parameter settings for the cell are set up according to TS 38.508-1 [10] subclause 4.4.3.
3. Downlink signals are initially set up according to Annex C, and uplink signals according to Annex G.
4. The DL and UL Reference Measurement channels are set according to Table 7.4A.1.4.1-1.
5. Propagation conditions are set according to Annex B.0.
6. Ensure the UE is in State RRC_CONNECTED with generic procedure parameters Connectivity *NR*, Connected without release *On*, Test Mode *On* and Test Loop Function *On* according to TS 38.508-1 [10] clause 4.5. Message contents are defined in clause 7.4A.1.4.3.

7.4A.1.4.2 Test Procedure

Test procedure for Intra-band:

1. Configure SCC according to Annex C.0, C.1, C.2 for all downlink physical channels.
2. The SS shall configure SCC as per TS 38.508-1 [10] clause 5.5.1. Message contents are defined in clause 7.4A.1.4.3.
3. SS activates SCC by sending the activation MAC CE (Refer TS 38.321[28], clauses 5.9, 6.1.3.10). Wait for at least 2 seconds (Refer TS 38.133[25], clause 9.2).
4. SS transmits PDSCH via PDCCH DCI format 1_1 for C_RNTI to transmit the DL RMC according to Table 7.4A.1.4.1-1. The SS sends downlink MAC padding bits on the DL RMC.
5. SS sends uplink scheduling information for each UL HARQ process via PDCCH DCI format 0_1 for C_RNTI to schedule the UL RMC according to Table 7.4A.1.4.1-1. Since the UE has no payload data to send, the UE transmits uplink MAC padding bits on the UL RMC.
6. Set the Downlink signal level for θ -polarization to the value as defined in Table 7.4A.1.5-1.
7. Set the UE in the Rx beam peak direction found with a 3D EIS scan as performed in Annex K.1.2. Allow at least BEAM_SELECT_WAIT_TIME (NOTE) for the UE Rx beam selection to complete.
8. Send Uplink power control commands to the UE (less or equal to 1dB step size should be used), to ensure that the UE output power is within [TBD] dB of the target power level in Table 7.4A.1.5-1, for at least the duration of the throughput measurement.
9. SS activates the UE Beamlock Function (UBF) by performing the procedure as specified in TS 38.508-1 [10] clause 4.9.2 using condition Rx Only.

10. For each component carrier, ensure the average throughput for a duration sufficient to achieve statistical significance according to Annex H.2.
11. SS deactivates the UE Beamlock Function (UBF) by performing the procedure as specified in TS 38.508-1 [10] clause 4.9.3.
12. Repeat steps from 3 to 8, for the downlink signal from ϕ -polarization.
13. Compare the results for both the θ -polarization and ϕ -polarization against the requirement. If either result meets the requirements, pass the UE.

NOTE: The BEAM_SELECT_WAIT_TIME default value is defined in Annex K.1.2.

Test procedure for Inter-band:

1. Configure SCC according to Annex C.0, C.1, C.2 for all downlink physical channels.
2. The SS shall configure SCC as per TS 38.508-1 [10] clause 5.5.1. Message contents are defined in clause 7.4A.1.4.3.
3. SS activates SCC by sending the activation MAC CE (Refer TS 38.321[28], clauses 5.9, 6.1.3.10). Wait for at least 2 seconds (Refer TS 38.133[25], clause 9.2).
4. SS transmits PDSCH via PDCCH DCI format 1_1 for C_RNTI to transmit the DL RMC according to Table 7.4A.1.4.1-1. The SS sends downlink MAC padding bits on the DL RMC.
5. SS sends uplink scheduling information on PCC for each UL HARQ process via PDCCH DCI format 0_1 for C_RNTI to schedule the UL RMC according to Table 7.4A.1.4.1-1. Since the UE has no payload data to send, the UE transmits uplink MAC padding bits on the UL RMC.
6. Set SS with the downlink signal applied to the θ -polarization of the measurement antenna.
7. Set the UE in the SCC Rx beam peak direction found for the primary component carrier with a 3D EIS scan as performed in Annex K.1.2. Allow at least BEAM_SELECT_WAIT_TIME (NOTE 1) for the UE Rx beam selection to complete.
8. Set downlink signal level for θ -polarization values described in 7.4.5-1 for SCC.
9. Send Uplink power control commands to the UE (less or equal to 1dB step size should be used), to ensure that the UE output power is within [TBD] dB of the target power level in Table 7.4A.1.5-1, for at least the duration of the throughput measurement.
10. SS activates the UE Beamlock Function (UBF) by performing the procedure as specified in TS 38.508-1 [10] clause 4.9.2 using condition Rx Only.
11. For SCC, measure the average throughput for a duration sufficient to achieve statistical significance according to Annex H.2.
12. SS deactivates the UE Beamlock Function (UBF) by performing the procedure as specified in TS 38.508-1 [10] clause 4.9.3.
13. Repeat steps from 3 to 12, for the downlink signal from ϕ -polarization.
14. Repeat steps 3 to 13 switching PCC and SCC test frequencies.
15. Compare the throughput results for both the θ -polarization and ϕ -polarization for each component carrier against the requirement. If either result, θ -polarization and ϕ -polarization, for each component carrier meet the requirements, pass the UE.

NOTE 1: The BEAM_SELECT_WAIT_TIME default value is defined in Annex K.1.2

7.4A.1.4.3 Message contents

Message contents are according to TS 38.508-1 [10] subclause 4.6 with TRANSFORM_PRECODER_ENABLED condition in Table 4.6.3-118 PUSCH-Config.

7.4A.1.5 Test requirement

The throughput measurement derived in test procedure shall be $\geq 95\%$ of the maximum throughput of the reference measurement channels as specified in Annex A with parameters specified in Tables 7.4A.1.5-1.

The UE shall meet the requirements specified for each band while all downlink carriers are active.

Table 7.4A.1.5-1: Maximum input level for Intra-band contiguous, Intra-band non-contiguous CA

Rx Parameter	Units	Level
Power summed over transmission bandwidth configurations of all active DL CCs	dBm	[-51 (NOTE 2,3) for band n257, n258 and n261 -59 (NOTE 2,3) for band n260] [-53 (NOTE 3,4) for band n257, n258 and n261 -61 (NOTE 3,4) for band n260]
NOTE 1: The transmitter shall be set to 4 dB below the $P_{UMAX,f,c}$ as defined in subclause 6.2.4, with uplink configuration specified in Table 7.3.2.3.1-2.		
NOTE 2: Reference measurement channel in each CC is specified in Annex A.3.3.2: QPSK, R=1/3 variant with one sided dynamic OCNG Pattern as described in Annex A.		
[NOTE 3: The test requirements deviate from minimum requirements by 26dB relaxation for 24.25 ~ 29.5 GHz and 34 dB relaxation for 37 ~ 40 GHz.]		
NOTE 4: Reference measurement channel is specified in Annex A.3.3.5: 256QAM, R=4/5 variant with one sided dynamic OCNG Pattern as described in Annex A.		

7.4A.2 Maximum input level for CA (3DL CA)

Editor's note: This clause is incomplete. The following aspects are either missing or not yet determined:

- Measurement uncertainty and test requirement are FFS.
- UL power level configuration is TBD.

7.4A.2.1 Test purpose

Same test purpose as in clause 7.4A.1.1.

7.4A.2.2 Test applicability

This test case applies to all types of NR UEs release 15 and forward that support FR2 3DL CA.

The minimum conformance requirements in this test case are not testable due to maximum input level unachievable in IFF OTA test setup. Other test setups have not been analysed. Thus the test case will not be tested as part of UE conformance testing.

NOTE: This does not preclude the test from being used for R&D or other purposes if deemed useful to all types of NR UEs release 15 and forward that support FR2 3DL CA.

7.4A.2.3 Minimum conformance requirements

Same minimum conformance requirements as in clause 7.4A.0.

7.4A.2.4 Test description

Same test description as in clause 7.4A.1.4.

7.4A.2.5 Test requirement

The test requirement is the same as in clause 7.4A.1.5.

7.4A.3 Maximum input level for CA (4DL CA)

Editor's note: This clause is incomplete. The following aspects are either missing or not yet determined:

- Measurement uncertainty and test requirement are FFS.
- UL power level configuration is TBD.

7.4A.3.1 Test purpose

Same test purpose as in clause 7.4A.1.1.

7.4A.3.2 Test applicability

This test case applies to all types of NR UEs release 15 and forward that support FR2 4DL CA.

The minimum conformance requirements in this test case are not testable due to maximum input level unachievable in IFF OTA test setup. Other test setups have not been analysed. Thus the test case will not be tested as part of UE conformance testing.

NOTE: This does not preclude the test from being used for R&D or other purposes if deemed useful to all types of NR UEs release 15 and forward that support FR2 4DL CA.

7.4A.3.3 Minimum conformance requirements

Same minimum conformance requirements as in clause 7.4A.0.

7.4A.3.4 Test description

Same test description as in clause 7.4A.1.4.

7.4A.3.5 Test requirement

The test requirement is the same as in clause 7.4A.1.5.

7.4A.4 Maximum input level for CA (5DL CA)

Editor's note: This clause is incomplete. The following aspects are either missing or not yet determined:

- Measurement uncertainty and test requirement are FFS.
- UL power level configuration is TBD.

7.4A.4.1 Test purpose

Same test purpose as in clause 7.4A.1.1.

7.4A.4.2 Test applicability

This test case applies to all types of NR UEs release 15 and forward that support FR2 5DL CA.

The minimum conformance requirements in this test case are not testable due to maximum input level unachievable in IFF OTA test setup. Other test setups have not been analysed. Thus the test case will not be tested as part of UE conformance testing.

NOTE: This does not preclude the test from being used for R&D or other purposes if deemed useful to all types of NR UEs release 15 and forward that support FR2 5DL CA.

7.4A.4.3 Minimum conformance requirements

Same minimum conformance requirements as in clause 7.4A.0.

7.4A.4.4 Test description

Same test description as in clause 7.4A.1.4.

7.4A.4.5 Test requirement

The test requirement is the same as in clause 7.4A.1.5.

7.4A.5 Maximum input level for CA (6DL CA)

Editor's note: This clause is incomplete. The following aspects are either missing or not yet determined:

- Measurement uncertainty and test requirement are FFS.
- UL power level configuration is TBD.

7.4A.5.1 Test purpose

Same test purpose as in clause 7.4A.1.1.

7.4A.5.2 Test applicability

This test case applies to all types of NR UEs release 15 and forward that support FR2 6DL CA.

The minimum conformance requirements in this test case are not testable due to maximum input level unachievable in IFF OTA test setup. Other test setups have not been analysed. Thus the test case will not be tested as part of UE conformance testing.

NOTE: This does not preclude the test from being used for R&D or other purposes if deemed useful to all types of NR UEs release 15 and forward that support FR2 6DL CA.

7.4A.5.3 Minimum conformance requirements

Same minimum conformance requirements as in clause 7.4A.0.

7.4A.5.4 Test description

Same test description as in clause 7.4A.1.4.

7.4A.5.5 Test requirement

The test requirement is the same as in clause 7.4A.1.5.

7.4A.6 Maximum input level for CA (7DL CA)

Editor's note: This clause is incomplete. The following aspects are either missing or not yet determined:

- Measurement uncertainty and test requirement are FFS.
- UL power level configuration is TBD.

7.4A.6.1 Test purpose

Same test purpose as in clause 7.4A.1.1.

7.4A.6.2 Test applicability

This test case applies to all types of NR UEs release 15 and forward that support FR2 7DL CA.

The minimum conformance requirements in this test case are not testable due to maximum input level unachievable in IFF OTA test setup. Other test setups have not been analysed. Thus the test case will not be tested as part of UE conformance testing.

NOTE: This does not preclude the test from being used for R&D or other purposes if deemed useful to all types of NR UEs release 15 and forward that support FR2 7DL CA.

7.4A.6.3 Minimum conformance requirements

Same minimum conformance requirements as in clause 7.4A.0.

7.4A.6.4 Test description

Same test description as in clause 7.4A.1.4.

7.4A.6.5 Test requirement

The test requirement is the same as in clause 7.4A.1.5.

7.4A.7 Maximum input level for CA (8DL CA)

Editor's note: This clause is incomplete. The following aspects are either missing or not yet determined:

- Measurement uncertainty and test requirement are FFS.
- UL power level configuration is TBD.

7.4A.7.1 Test purpose

Same test purpose as in clause 7.4A.1.1.

7.4A.7.2 Test applicability

This test case applies to all types of NR UEs release 15 and forward that support FR2 8DL CA.

The minimum conformance requirements in this test case are not testable due to maximum input level unachievable in IFF OTA test setup. Other test setups have not been analysed. Thus the test case will not be tested as part of UE conformance testing.

NOTE: This does not preclude the test from being used for R&D or other purposes if deemed useful as per the applicability listed in this sub-clause that support FR2 8DL CA.

7.4A.7.3 Minimum conformance requirements

Same minimum conformance requirements as in clause 7.4A.0.

7.4A.7.4 Test description

Same test description as in clause 7.4A.1.4.

7.4A.7.5 Test requirement

The test requirement is the same as in clause 7.4A.1.5.

7.4D Maximum input level for UL MIMO

The normative reference for this requirement is TS 38.101-2 [3] clause 7.4D.

No test case details are specified. Given UE's Rx performance would not be impacted by the Tx configuration on TDD bands, the requirements in this test case can be well covered in clause 7.4 and don't need to be tested again.

7.5 Adjacent channel selectivity

Editor's note: The following aspects are either missing or not yet determined:

- Measurement Uncertainty is FFS for power classes other than 1, 3, 5, 6 and 7.
- The minimum conformance requirements for Case 2 in this test case are not testable due to maximum input level unachievable in IFF OTA test setup. Other test setups have not been analysed.
- For power class 1, if testing were extended beyond 100MHz, potential relaxation required is FFS.

7.5.1 Test purpose

Adjacent channel selectivity tests the UE's ability to receive data with a given average throughput for a specified reference measurement channel, in the presence of an adjacent channel signal at a given frequency offset from the centre frequency of the assigned channel, under conditions of ideal propagation and no added noise.

7.5.2 Test applicability

This test applies to all types of NR UE release 15 and forward.

7.5.3 Minimum conformance requirements

Adjacent Channel Selectivity (ACS) is a measure of a receiver's ability to receive a NR signal at its assigned channel frequency in the presence of an adjacent channel signal at a given frequency offset from the centre frequency of the assigned channel. ACS is the ratio of the receive filter attenuation on the assigned channel frequency to the receive filter attenuation on the adjacent channel(s).

The requirement applies at the Radiated Interface Boundary (RIB) when the AoA of the incident wave of the wanted signal and the interfering signal are both from the direction where peak gain is achieved.

The wanted and interfering signals apply to all supported polarizations, under the assumption of polarization match.

The UE shall fulfil the minimum requirement specified in Table 7.5.3-1 for all values of an adjacent channel interferer up to -25 dBm. However, it is not possible to directly measure the ACS, instead the lower and upper range of test parameters are chosen in Table 7.5.3-2 and Table 7.5.3-3 where the throughput shall be ≥ 95% of the maximum throughput of the reference measurement channels as specified in Annexes A.2.3.2 and A.3.3.2, with one sided dynamic OCNG Pattern OP.1 TDD for the DL-signal as described in Annex A.5.2.1. The requirement is verified with the test metric of EIS (Link=RX beam peak direction, Meas=Link angle).

Table 7.5.3-1: Adjacent channel selectivity

Operating band	Units	Adjacent channel selectivity / Channel bandwidth						
		50 MHz	100 MHz	200 MHz	400 MHz	800 MHz	1600 MHz	2000 MHz
n257, n258, n261	dB	23	23	23	23	N/A	N/A	N/A
n259, n260	dB	22	22	22	22	N/A	N/A	N/A

Table 7.5.3-2: Test parameters for adjacent channel selectivity, Case 1

Rx Parameter	Units	Channel bandwidth			
		50 MHz	100 MHz	200 MHz	400 MHz
Power in Transmission Bandwidth Configuration	dBm	REFSENS + 14 dB			
P _{Interferer} for band n257, n258, n261	dBm	REFSENS + 35.5 dB	REFSENS +35.5dB	REFSENS +35.5dB	REFSENS +35.5dB
P _{Interferer} for band n259, n260	dBm	REFSENS + 34.5 dB	REFSENS +34.5dB	REFSENS +34.5dB	REFSENS +34.5dB
BW _{Interferer}	MHz	50	100	200	400

$F_{\text{Interferer}}$ (offset)	MHz	50 / -50 NOTE 3	100 / -100 NOTE 3	200 / -200 NOTE 3	400 / -400 NOTE 3
<p>NOTE 1: The interferer consists of the Reference measurement channel specified in Annex A.3.3.2 with one sided dynamic OCNG Pattern OP.1 TDD as described in Annex A.5.2.1 and set-up according to Annex C.</p> <p>NOTE 2: The REFSENS power level is specified in subclause 7.3.2.3, which are applicable to different UE power classes.</p> <p>NOTE 3: The absolute value of the interferer offset $F_{\text{Interferer}}$ (offset) shall be further adjusted to $(\text{CEIL}(F_{\text{Interferer}}(\text{offset}) /\text{SCS}) + 0.5) * \text{SCS}$ MHz with SCS the sub-carrier spacing of the wanted signal in MHz. Wanted and interferer signal have same SCS.</p> <p>NOTE 4: The transmitter shall be set to 4 dB below the $P_{\text{UMAX},f,c}$ as defined in clause 6.2.4, with uplink configuration specified in Table 7.3.2.3.1-2.</p> <p>NOTE 5: For PC7 RedCap UEs only 50MHz and 100MHz Test Channel Bandwidths are applicable</p>					

Table 7.5.3-3: Test parameters for adjacent channel selectivity, Case 2

Rx Parameter	Units	Channel bandwidth						
		50 MHz	100 MHz	200 MHz	400 MHz	800 MHz	1600 MHz	2000 MHz
Power in Transmission Bandwidth Configuration for band n257, n258, n261	dBm	-46.5	-46.5	-46.5	-46.5	N/A	N/A	N/A
Power in Transmission Bandwidth Configuration for band n259, n260	dBm	-45.5	-45.5	-45.5	-45.5	N/A	N/A	N/A
$P_{\text{Interferer}}$	dBm	-25						
$BW_{\text{Interferer}}$	MHz	50	100	200	400	800	1600	2000
$F_{\text{Interferer}}$ (offset)	MHz	50 / -50 NOTE 2	100 / -100 NOTE 2	200 / -200 NOTE 2	400 / -400 NOTE 2	800 / -800 NOTE 2	1600 / -1600 NOTE 2	2000 / -2000 NOTE 2
<p>NOTE 1: The interferer consists of the Reference measurement channel specified in Annex 3.2 with one sided dynamic OCNG Pattern TDD as described in Annex A and set-up according to Annex C.</p> <p>NOTE 2: The absolute value of the interferer offset $F_{\text{Interferer}}$ (offset) shall be further adjusted to $(\text{CEIL}(F_{\text{Interferer}}(\text{offset}) /\text{SCS}) + 0.5) * \text{SCS}$ MHz with SCS the sub-carrier spacing of the wanted signal in MHz. Wanted and interferer signal have same SCS.</p> <p>NOTE 3: The transmitter shall be set to 4 dB below the $P_{\text{UMAX},f,c}$ as defined in clause 6.2.4, with uplink configuration specified in Table 7.3.2.1-2.</p>								

The normative reference for this requirement is TS 38.101-2 [3] clause 7.5.

7.5.4 Test description

7.5.4.1 Initial conditions

Initial conditions are a set of test configurations the UE needs to be tested in and the steps for the SS to take with the UE to reach the correct measurement state.

The initial test configurations consist of environmental conditions, test frequencies, and test channel bandwidths and sub-carrier spacing based on NR operating bands specified in Table 5.3.5-1. All of these configurations shall be tested with applicable test parameters for each combination of channel bandwidth and subcarrier spacing, are shown in Table 7.5.4.1-1. The details of the uplink and downlink reference measurement channels (RMCs) are specified in Annexes A.2 and A.3. The details of the OCNG patterns used are specified in Annex A.5. Configurations of PDSCH and PDCCH before measurement are specified in Annex C.2.

Table 7.5.4.1-1: Test Configuration

Initial Conditions				
Test Environment as specified in TS 38.508-1 [10] subclause 4.1		Normal		
Test Frequencies as specified in TS 38.508-1 [10] subclause 4.3.1		Mid range		
Test Channel Bandwidths as specified in TS 38.508-1 [10] subclause 4.3.1		50 MHz, 100 MHz		
Test SCS as specified in Table 5.3.5-1		120 kHz		
Test Parameters				
Test ID	Downlink Configuration		Uplink Configuration	
	Modulation	RB allocation	Modulation	RB allocation
1	CP-OFDM QPSK	NOTE 1	DFT-s-OFDM QPSK	NOTE 1
NOTE 1: The specific configuration of each RB allocation is defined in Table 7.3.2.4.1-1.				
NOTE 2: For PC7 RedCap UEs only 50MHz and 100MHz Test Channel Bandwidths are applicable				

1. Connection between SS and UE is shown in TS 38.508-1 [10] Annex A, Figure A.3.3.1.2 for TE diagram and Figure A.3.4.1.1 for UE diagram.
2. The parameter settings for the cell are set up according to TS 38.508-1 [10] subclause 4.4.3.
3. Downlink signals are initially set up according to Annex C, and uplink signals according to Annex G.
4. The DL and UL Reference Measurement channels are set according to Table 7.5.4.1-1.
5. Propagation conditions are set according to Annex B.0.
6. Ensure the UE is in state RRC_CONNECTED with generic procedure parameters Connectivity *NR*, Connected without release *On*, Test Mode *On* and Test Loop Function *On* according to TS 38.508-1 [10] clause 4.5. Message contents are defined in clause 7.5.4.3.

7.5.4.2 Test procedure

1. Set the UE in the Rx beam peak direction found with a 3D EIRP scan as performed in Annex K.1.2. Allow at least BEAM_SELECT_WAIT_TIME (NOTE 1) for the UE Rx beam selection to complete.
2. SS transmits PDSCH via PDCCH DCI format 1_1 for C_RNTI to transmit the DL RMC according to Table 7.5.4.1-1. The SS sends downlink MAC padding bits on the DL RMC.
3. SS sends uplink scheduling information for each UL HARQ process via PDCCH DCI format 0_1 for C_RNTI to schedule the UL RMC according to Table 7.5.4.1-1. Since the UL has no payload data to send, the UE transmits uplink MAC padding bits on the UL RMC.
4. Send Uplink power control commands to the UE (less or equal to 1dB step size should be used), to ensure that the UE output power measured by the test system is within the Uplink power control window, defined as $-(\text{MU} + \text{Uplink power control window size})$ dB of the target power level in Table 7.5.5-2 (Case 1, PC3) or Table 7.5.5-2a (Case 1, PC1) or Table 7.5.5-3 (Case 2), for at least the duration of the throughput measurement, where:
 - MU is the test system uplink power measurement uncertainty and is specified in Table F.1.3-1 for the carrier frequency f and the channel bandwidth BW.
 - Uplink power control window size = 1dB (UE power step size) + 1dB (UE power step tolerance) + (Test system relative power measurement uncertainty), where, the UE power step tolerance is specified in TS 38.101-2 [3], Table 6.3.4.3-2 and is 1dB for 1dB power step size, and the Test system relative power measurement uncertainty is specified in Table F.1.3-1.
5. Perform Blocking measurement procedure as stated in Annex K.1.8 using Downlink signal level and Interferer signal level as defined in Table 7.5.5-2 (Case 1, PC3) or Table 7.5.5-2a (Case 1, PC1). Modulated interferer signal characteristics as defined in Annex D with frequency below the wanted signal. Measure throughput for a duration sufficient to achieve statistical significance according to Annex H.2.
6. Repeat step 5 using an interfering signal frequency above the wanted signal in Case 1.

7. Repeat for applicable channel bandwidths and operating band combinations in Case 1.

NOTE 1: The BEAM_SELECT_WAIT_TIME default value is defined in Annex K.1.2.

7.5.4.3 Message contents

Message contents are according to TS 38.508-1 [10] subclause 4.6 with TRANSFORM_PRECODER_ENABLED condition in Table 4.6.3-118 PUSCH-Config.

7.5.5 Test requirements

The requirement below shall only be considered if UE output power measured in the test procedure step 4 ends within the Uplink power control window.

The throughput measurement derived in test procedure shall be $\geq 95\%$ of the maximum throughput of the reference measurement channels as specified in Annex A, under the conditions specified in 7.5.5-2, Table 7.5.5-2a, Table 7.5.5-2b and Table 7.5.5-2c.

Table 7.5.5-1: Adjacent channel selectivity

Rx Parameter	Units	Channel bandwidth			
		50 MHz	100 MHz	200 MHz	400 MHz
ACS for band n257, n258, n261	dB	23	23	23	23
ACS for band n259, n260	dB	22	22	22	22

Table 7.5.5-2: Test parameters for adjacent channel selectivity, Case 1, PC3

Rx Parameter	Units	Channel bandwidth			
		50 MHz	100 MHz	200 MHz	400 MHz
Power in Transmission Bandwidth Configuration for band n257, n258, n261	dBm	REFSENS + 14 dB			
Power in Transmission Bandwidth Configuration for band n260	dBm	REFSENS + 14 - 1.8 dB NOTE 4	REFSENS + 14 - 4.8 dB NOTE 4	REFSENS + 14 dB	REFSENS + 14 dB
Power in Transmission Bandwidth Configuration for band n259	dBm	REFSENS + 14 - 3.8 dB NOTE 4	REFSENS + 14 - 6.8 dB NOTE 4	REFSENS + 14 dB	REFSENS + 14 dB
Power in Transmission Bandwidth Configuration for band n262	dBm	REFSENS + 14 - TBD dB NOTE 4	REFSENS + 14 - TBD dB NOTE 4	REFSENS + 14 dB	REFSENS + 14 dB
$P_{\text{Interferer}}$ for band n257, n258, n261	dBm	REFSENS + 35.5 dB	REFSENS +35.5dB	REFSENS +35.5dB NOTE 5	REFSENS +35.5dB NOTE 5
$P_{\text{Interferer}}$ for band n260	dBm	REFSENS + 34.5 - 1.8 dB NOTE 4	REFSENS +34.5 - 4.8 dB NOTE 4	REFSENS +34.5dB NOTE 5	REFSENS +34.5dB NOTE 5
$P_{\text{Interferer}}$ for band n259	dBm	REFSENS + 34.5 - 3.8 dB NOTE 4	REFSENS +34.5 - 6.8 dB NOTE 4	REFSENS +34.5 dB NOTE 5	REFSENS +34.5 dB NOTE 5
$BW_{\text{Interferer}}$	MHz	50	100	200	400
$F_{\text{Interferer}}$ (offset)	MHz	50	100	200	400

	/	/	/	/
	-50	-100	-200	-400
	NOTE 3	NOTE 3	NOTE 3	NOTE 3
NOTE 1:	The interferer consists of the Reference measurement channel specified in Annex A.3.3.2 with one sided dynamic OCNG Pattern OP.1 as described in Annex A.5.2.1 and set-up according to Annex C.			
NOTE 2:	The REFSSENS power level is specified in subclause 7.3.2.5.			
NOTE 3:	The absolute value of the interferer offset $F_{\text{Interferer}}$ (offset) shall be further adjusted to $(\text{CEIL}(F_{\text{Interferer}}(\text{offset}) /\text{SCS}) + 0.5) * \text{SCS}$ MHz with SCS the sub-carrier spacing of the wanted signal in MHz. Wanted and interferer signal have same SCS.			
NOTE 4:	Core requirement cannot be tested due to testability issue and test requirement for wanted signal and interferer includes relaxation to achieve feasible interferer power level.			
NOTE 5:	Core requirement cannot be tested due to testability issue.			
NOTE 6:	The transmitter shall be set to 4 dB below the $P_{\text{UMAX},f,c}$ as defined in clause 6.2.4, with uplink configuration specified in Table 7.3.2.3.1-2.			
NOTE 7:	Void			

Table 7.5.5-2a: Test parameters for adjacent channel selectivity, Case 1, PC1

Rx Parameter	Units	Channel bandwidth			
		50 MHz	100 MHz	200 MHz	400 MHz
Power in Transmission Bandwidth Configuration for band n257, n258, n260, n261	dBm	REFSENS + 14 dB			
$P_{\text{Interferer}}$ for band n257, n258, n261	dBm	REFSENS + 35.5 dB	REFSENS +35.5dB	REFSENS +35.5dB - TBD dB	REFSENS +35.5dB - TBD dB
$P_{\text{Interferer}}$ for band n260	dBm	REFSENS +34.5dB	REFSENS +34.5dB	REFSENS +34.5dB - TBD dB	REFSENS +34.5dB - TBD dB
$BW_{\text{Interferer}}$	MHz	50	100	200	400
$F_{\text{Interferer}}$ (offset)	MHz	50 / -50 NOTE 3	100 / -100 NOTE 3	200 / -200 NOTE 3	400 / -400 NOTE 3
NOTE 1:	The interferer consists of the Reference measurement channel specified in Annex A.3.3.2 with one sided dynamic OCNG Pattern OP.1 as described in Annex A.5.2.1 and set-up according to Annex C.				
NOTE 2:	The REFSSENS power level is specified in subclause 7.3.2.5.				
NOTE 3:	The absolute value of the interferer offset $F_{\text{Interferer}}$ (offset) shall be further adjusted to $(\text{CEIL}(F_{\text{Interferer}}(\text{offset}) /\text{SCS}) + 0.5) * \text{SCS}$ MHz with SCS the sub-carrier spacing of the wanted signal in MHz. Wanted and interferer signal have same SCS.				
NOTE 4:	The transmitter shall be set to 4 dB below the $P_{\text{UMAX},f,c}$ as defined in clause 6.2.4, with uplink configuration specified in Table 7.3.2.3.1-2.				
NOTE 5:	Void				

Table 7.5.5-2b: Test parameters for adjacent channel selectivity, Case 1, PC5 (n257, n258) and PC6

Rx Parameter	Units	Channel bandwidth			
		50 MHz	100 MHz	200 MHz	400 MHz
Power in Transmission Bandwidth Configuration for band n257, n258, n261	dBm	REFSENS + 14 dB			
$P_{\text{Interferer}}$ for band n257, n258, n261	dBm	REFSENS + 35.5 dB	REFSENS +35.5dB	REFSENS +35.5dB	REFSENS +35.5dB
$BW_{\text{Interferer}}$	MHz	50	100	200	400
$F_{\text{Interferer}}$ (offset)	MHz	50 / -50 NOTE 3	100 / -100 NOTE 3	200 / -200 NOTE 3	400 / -400 NOTE 3

NOTE 1:	The interferer consists of the Reference measurement channel specified in Annex A.3.3.2 with one sided dynamic OCNG Pattern OP.1 as described in Annex A.5.2.1 and set-up according to Annex C.
NOTE 2:	The REFSSENS power level is specified in subclause 7.3.2.5.
NOTE 3:	The absolute value of the interferer offset $F_{\text{Interferer}}(\text{offset})$ shall be further adjusted to $(\text{CEIL}(F_{\text{Interferer}}(\text{offset}) /\text{SCS}) + 0.5) * \text{SCS}$ MHz with SCS the sub-carrier spacing of the wanted signal in MHz. Wanted and interferer signal have same SCS.
NOTE 4:	The transmitter shall be set to 4 dB below the $P_{\text{UMAX},f,c}$ as defined in clause 6.2.4, with uplink configuration specified in Table 7.3.2.3.1-2.
NOTE 5:	Void

Table 7.5.5-2c: Test parameters for adjacent channel selectivity, Case 1, PC7

Rx Parameter	Units	Channel bandwidth	
		50 MHz	100 MHz
Power in Transmission Bandwidth Configuration for band n257, n258, n261	dBm	REFSENS + 14 dB	REFSENS + 14 - 3 dB NOTE 4
$P_{\text{Interferer}}$ for band n257, n258, n261	dBm	REFSENS + 35.5 dB	REFSENS + 35.5 - 3 dB NOTE 5
$BW_{\text{Interferer}}$	MHz	50	100
$F_{\text{Interferer}}(\text{offset})$	MHz	50 / -50 NOTE 3	100 / -100 NOTE 3
<p>NOTE 1: The interferer consists of the Reference measurement channel specified in Annex A.3.3.2 with one sided dynamic OCNG Pattern OP.1 as described in Annex A.5.2.1 and set-up according to Annex C.</p> <p>NOTE 2: The REFSSENS power level is specified in subclause 7.3.2.5.</p> <p>NOTE 3: The absolute value of the interferer offset $F_{\text{Interferer}}(\text{offset})$ shall be further adjusted to $(\text{CEIL}(F_{\text{Interferer}}(\text{offset}) /\text{SCS}) + 0.5) * \text{SCS}$ MHz with SCS the sub-carrier spacing of the wanted signal in MHz. Wanted and interferer signal have same SCS.</p> <p>NOTE 4: Core requirement cannot be tested due to testability issue and test requirement for wanted signal and interferer includes relaxation to achieve feasible interferer power level.</p> <p>NOTE 5: Core requirement cannot be tested due to testability issue.</p> <p>NOTE 6: The transmitter shall be set to 4 dB below the $P_{\text{UMAX},f,c}$ as defined in clause 6.2.4, with uplink configuration specified in Table 7.3.2.3.1-2.</p>			

Table 7.5.5-3: Void

7.5A Adjacent channel selectivity for CA

7.5A.0 Minimum Conformance Requirements

7.5A.0.1 Adjacent channel selectivity for Intra-band contiguous CA

For intra-band contiguous carrier aggregation, the SCC(s) shall be configured at nominal channel spacing to the PCC. The input power shall be distributed among the active DL CCs so their PSDs are aligned with each other. The UE shall fulfil the minimum requirement specified in Table 7.5A.0.1-1 for an adjacent channel interferer on either side of the aggregated downlink signal at a specified frequency offset and for an interferer power up to -25 dBm.

The throughput of each carrier shall be $\geq 95\%$ of the maximum throughput of the reference measurement channels as specified in Annexes A.2.3.2 and A.3.3.2 (with one sided dynamic OCNG Pattern OP.1 TDD for the DL-signal as described in Annex A.5.2.1). The requirement is verified with the test metric of EIS (Link=RX beam peak direction, Meas=Link angle).

Table 7.5A.0.1-1: Adjacent channel selectivity for intra-band contiguous CA

Operating band	Units	Adjacent channel selectivity / CA bandwidth class
		All CA bandwidth class
n257, n258, n261	dB	23
n259, n260	dB	22

Table 7.5A.0.1-2: Adjacent channel selectivity test parameters for intra-band contiguous CA, Case 1

Rx Parameter	Units	All CA bandwidth Classes
P _w in Transmission Bandwidth Configuration, per CC		REFSENS + 14 dB
P _{Interferer} for band n257, n258, n261	dBm	Aggregated power + 21.5
P _{Interferer} for band n259, n260	dBm	Aggregated power + 20.5
BW _{Interferer}	MHz	BW _{Channel_CA}
F _{Interferer} (offset)	MHz	+ BW _{channel CA} / - BW _{channel CA} NOTE 3
<p>NOTE 1: The interferer consists of the Reference measurement channel specified in Annex 3.3.2 with one sided dynamic OCNG Pattern OP.1 TDD as described in Annex A.5.2.1 and set-up according to Annex C.</p> <p>NOTE 2: The F_{interferer} (offset) is the frequency separation between the centre of the aggregated CA bandwidth and the centre frequency of the Interferer signal</p> <p>NOTE 3: The absolute value of the interferer offset F_{interferer} (offset) shall be further adjusted to (CEIL(F_{interferer}(offset) /SCS) + 0.5)*SCS MHz with SCS the sub-carrier spacing of the carrier closest to the interferer in MHz. The interfering signal has the same SCS as that of the closest carrier.</p> <p>NOTE 4: The transmitter shall be set to 4 dB below the P_{UMAX,f,c} as defined in clause 6.2.4, with uplink configuration specified in Table 7.3.2.3.1-2.</p>		

Table 7.5A.0.1-3: Adjacent channel selectivity test parameters for intra-band contiguous CA, Case 2

Rx Parameter	Units	All CA bandwidth classes
P _w in Transmission Bandwidth Configuration, aggregated power for band n257, n258, n261	dBm	- 46.5
P _w in Transmission Bandwidth Configuration, aggregated power for band n259, n260	dBm	- 45.5
P _{Interferer}	dBm	- 25
BW _{Interferer}	MHz	BW _{Channel_CA}
F _{Interferer} (offset)	MHz	+ BW _{channel CA} / - BW _{channel CA} NOTE 3
<p>NOTE 1: The interferer consists of the Reference measurement channel specified in Annex A.3.3.2 with one sided dynamic OCNG Pattern OP.1 TDD as described in Annex A.5.2.1 and set-up according to Annex C.</p> <p>NOTE 2: The F_{interferer} (offset) is the frequency separation between the centre of the aggregated CA bandwidth and the centre frequency of the Interferer signal</p> <p>NOTE 3: The absolute value of the interferer offset F_{interferer} (offset) shall be further adjusted to (CEIL(F_{interferer}(offset) /SCS) + 0.5)*SCS MHz with SCS the sub-carrier spacing of the carrier closest to the interferer in MHz. The interfering signal has the same SCS as that of the closest carrier.</p> <p>NOTE 4: The transmitter shall be set to 4 dB below the P_{UMAX,f,c} as defined in clause 6.2.4, with uplink configuration specified in Table 7.3.2.3.1-2.</p>		

7.5A.0.2 Adjacent channel selectivity for Intra-band non-contiguous CA

For intra-band non-contiguous carrier aggregation with two component carriers, two different requirements apply for out-of-gap and in-gap. For out-of-gap, the UE shall meet the requirements for each component carrier as specified in clauses 7.5. For in-gap, the requirement applies if the following minimum gap condition is met:

$$\Delta f_{ACS} \geq BW_1/2 + BW_2/2 + \max(BW_1, BW_2),$$

where Δf_{ACS} is the frequency separation between the centre frequencies of the component carriers and BW_k are the channel bandwidths of carrier k , $k = 1, 2$.

If the minimum gap condition is met, the UE shall meet the requirements specified in clauses 7.5 for each component carrier considered. The respective channel bandwidth of the component carrier under test will be used in the parameter calculations of the requirement. In case of more than two component carriers, the minimum gap condition is computed for any pair of adjacent component carriers following the same approach as the two component carriers. The in-gap requirement for the corresponding pairs shall apply if the minimum gap condition is met.

For every component carrier to which the requirements apply, the UE shall meet the requirement with one active interferer signal (in-gap or out-of-gap) while all downlink carriers are active and the input power shall be distributed among the active DL CCs so their PSDs are aligned with each other.

7.5A.0.3 Adjacent channel selectivity for Inter-band CA

For inter-band carrier aggregation with one component carrier per operating band and the uplink assigned to one NR band, the adjacent channel requirements are defined with the uplink active on the band other than the band whose downlink is being tested. The UE shall meet the requirements specified in clause 7.5 for each component carrier while all downlink carriers are active.

For the combination of intra-band and inter-band carrier aggregation and uplink carrier(s) assigned to one NR band, the requirement is defined with the uplink active on the band other than the band whose downlink is being tested. The UE shall meet the requirements specified in clauses 7.5A.1 and 7.5A.2 for each band while all downlink carriers are active.

7.5A.1 Adjacent channel selectivity for CA (2DL CA)

FFS

7.5A.2 Adjacent channel selectivity for CA (3DL CA)

FFS

7.5A.3 Adjacent channel selectivity for CA (4DL CA)

FFS

7.5A.4 Adjacent channel selectivity for CA (5DL CA)

FFS

7.5A.5 Adjacent channel selectivity for CA (6DL CA)

FFS

7.5A.6 Adjacent channel selectivity for CA (7DL CA)

FFS

7.5A.7 Adjacent channel selectivity for CA (8DL CA)

FFS

7.5D Adjacent channel selectivity for UL MIMO

The normative reference for this requirement is TS 38.101-2 [3] clause 7.5D.

No test case details are specified. Given UE's Rx performance would not be impacted by the Tx configuration on TDD bands, the requirements in this test case can be well covered in 7.5 and don't need to be tested again.

7.5M Adjacent channel and subcarrier selectivity for LP-WUS/WUR

7.5M.1 General

This clause specifies the requirements for Adjacent channel selectivity (ACS) and Adjacent subcarrier selectivity (ASCS) for LP-WUS/WUR.

7.5M.2 Adjacent channel selectivity for LP-WUS/WUR

Editor's note: This clause is incomplete. The following aspects are either missing or not yet determined:

- **Test Description is FFS**
- **Test Requirements as well as Measurement Uncertainties and Test Tolerances are FFS**

7.5M.2.1 Test purpose

Adjacent channel selectivity test for LP-WUS/WUR is defined as a LP-WUS/WUR supporting UE's ability to receive data with a given average throughput for a specified reference measurement channel, in the presence of an adjacent channel signal at a given frequency offset from the centre frequency of the assigned channel, under conditions of ideal propagation and no added noise.

7.5M.2.2 Test applicability

This test case applies to all types of release 19 and forward NR UEs that support LP-WUS/WUR.

7.5M.2.3 Minimum conformance requirements

The adjacent channel selectivity (ACS) is a measure of a UE's ability to detect the LP-WUS signal at its configured RBs inside the configured channel, in the presence of an adjacent channel signal at a given frequency offset from the centre frequency of the configured channel. ACS is the ratio of the receive filter attenuation on the LP-WUS frequency to the receive filter attenuation on the adjacent channel(s).

The requirement applies at the RIB when the AoA of the incident wave of the wanted signal and the interfering signal are both along the Rx beam peak direction. The requirement applies with the wanted and interfering signals in the same polarization. The requirement applies to all polarizations.

These requirements apply for any SCS specified in table 5.3M.2-1. The ACS requirement in table 7.5M.2-1 shall be verified for each set of test parameters in Table 7.5M.2-2 and Table 7.5M.2-3, respectively. For these parameters, the MDR criterion in clause 7.1M shall be met with the side conditions in clause 7.1M. The requirement applies for all channel BW included in sub-clause 5.3M.

Table 7.5M.2.3-1: Adjacent channel selectivity for LP-WUS

Operating band	Units	ACS (dB) (min.)
n257, n258, n261	dB	21.0 - X + Z
n259, n260, n262	dB	20.0 - X + Z
NOTE 1: ACS value is rounded to the next higher 0.5dB value		
NOTE 2: $Z = 10\log_{10}(N_{RB}/N_{RB,LP-WUS})$		
NOTE 3: X is specified in Table 7.3M.2-1		

Table 7.5M.2.3-2: Adjacent channel selectivity test parameters, Case 1

Rx Parameter	Units	Value
Power in LP-WUS transmission BW config	dBm	REFSENS _{LP-WUS} + 14.0 dB
P _{Interferer} (min.)	dBm	REFSENS _{LP-WUS} ² + ACS ⁴ + 16.0 dB
BW _{Interferer}	MHz	BW _{Channel}
F _{Interferer} (offset)	MHz	BW _{Channel} / -BW _{Channel}
NOTE 1: The interferer consists of the Reference measurement channel specified in Annex A.3.3.2 with one sided dynamic OCNG Pattern OP.1 TDD as described in Annex A.5.2.1 and set-up according to Annex C.		
NOTE 2: REFSENS _{LP-WUS} is specified in clause 7.3M.2		
NOTE 3: The absolute value of the interferer offset F _{Interferer} (offset) shall be further adjusted to (CEIL(F _{Interferer} (offset) /SCS) + 0.5)*SCS MHz with SCS the sub-carrier spacing of the wanted signal in MHz. Wanted and interferer signal have same SCS.		
NOTE 4: Defined in table 7.5M.2-1		

Table 7.5M.2.3-3: Adjacent channel selectivity test parameters, Case 2

Rx Parameter	Units	Value
P _{Interferer}	dBm	-25.0
Max. Power in LP-WUS transmission BW config	dBm	P _{interferer} – ACS ⁴ - 2.0 dB
BW _{Interferer}	MHz	BW _{Channel}
F _{Interferer} (offset)	MHz	BW _{Channel} / -BW _{Channel}
NOTE 1: The interferer consists of the Reference measurement channel specified in Annex A.3.3.2 with one sided dynamic OCNG Pattern OP.1 TDD as described in Annex A.5.2.1 and set-up according to Annex C.		
NOTE 2: The absolute value of the interferer offset F _{Interferer} (offset) shall be further adjusted to (CEIL(F _{Interferer} (offset) /SCS) + 0.5)*SCS MHz with SCS the sub-carrier spacing of the wanted signal in MHz. Wanted and interferer signal have same SCS.		
NOTE 3: 10log ₁₀ (x) is rounded to the next higher 0.5 dB value.		
NOTE 4: Defined in table 7.5M.2-1		

The normative reference for this requirement is TS 38.101-2 [3] clause 7.5M.2.

7.5M.2.4 Test description

FFS

7.5M.2.5 Test requirement

FFS

7.5M.3 Adjacent subcarrier selectivity for LP-WUS/WUR

Editor's note: This clause is incomplete. The following aspects are either missing or not yet determined:

- Test Description is FFS
- Test Requirements as well as Measurement Uncertainties and Test Tolerances are FFS

7.5M.3.1 Test purpose

To verify that a LP-WUS/WUR UE can successfully detect an LP-WUS at its configured RBs in the presence of fully populated non-LPWUS DL RBs.

7.5M.3.2 Test applicability

This test case applies to all types of release 19 and forward NR UEs that support LP-WUS/WUR.

7.5M.3.3 Minimum conformance requirements

Adjacent subcarrier selectivity (ASCS) is a measure of a UE's ability to detect an LP-WUS at its configured RBs, in the presence of fully populated non-LPWUS DL RBs.

The MDR criterion in clause 7.1M shall be met with the side conditions in 7.1M and the parameter set specified in Tables 7.11M-1. The requirement applies for all channel BW included in sub-clause 5.3M. The requirement applies at the RIB when the AoA of the incident wave of the wanted signal is along the Rx beam peak direction.

Table 7.5M.3.3-1: ASCS test parameters

RX parameter	Units	Value
Power in LP-WUS	dBm	REFSENS _{LP-WUS} ¹
LP-WUS power boosting ²	dB	0
NOTE 1: REFSENS _{LP-WUS} is the value specified in clause 7.3M.2 NOTE 2: 0dB power boost means equal PSD between NR RBs and LP-WUS RBs. NOTE 3: The interfering NR RBs consists of CP-OFDM QPSK with the same SCS as LP-WUS, in all PRB in the DL transmission BW configuration not occupied by either LP-WUS or Guard RB.		

The normative reference for this requirement is TS 38.101-2 [3] clause 7.5M.3.

7.3M.2.4 Test description

FFS

7.3M.2.5 Test requirement

FFS

7.6 Blocking characteristics

7.6.1 General

The blocking characteristic is a measure of the receiver's ability to receive a wanted signal at its assigned channel frequency in the presence of an unwanted interferer on frequencies other than those of the spurious response or the adjacent channels, without this unwanted input signal causing a degradation of the performance of the receiver beyond a specified limit. The blocking performance shall apply at all frequencies except those at which a spurious response occurs.

The requirement applies at the RIB when the AoA of the incident wave of the wanted signal and the interfering signal are both from the direction where peak gain is achieved.

The wanted and interfering signals apply to all supported polarizations, under the assumption of polarization match.

7.6.2 In-band blocking

Editor's note: The following aspects are either missing or not yet determined:

- Measurement uncertainty is FFS for power classes other than 1, 3, 5, 6 and 7.
- For power class 1, if testing were extended beyond 100MHz, potential relaxation required is FFS.

7.6.2.0 General

In-band blocking is a measure of a receiver's ability to receive a NR signal at its assigned channel frequency in the presence of an interferer at a given frequency offset from the centre frequency of the assigned channel.

7.6.2.1 Test purpose

In-band blocking is defined for an unwanted interfering signal falling into the UE receive band or into the spectrum equivalent to twice the channel bandwidth below or above the UE receive band at which the relative throughput shall meet or exceed the minimum requirement for the specified measurement channels.

7.6.2.2 Test applicability

This test applies to all types of NR UE release 15 and forward.

7.6.2.3 Minimum conformance requirements

The throughput shall be $\geq 95\%$ of the maximum throughput of the reference measurement channels as specified in Annexes A.2.3.2 and A.3.3.2 (with one sided dynamic OCNG Pattern OP.1 TDD for the DL-signal as described in Annex A.5.2.1). The requirement is verified with the test metric of EIS (Link=RX beam peak direction, Meas=Link angle).

Table 7.6.2.3-1: In-band blocking requirements

Rx parameter	Units	Channel bandwidth						
		50 MHz	100 MHz	200 MHz	400 MHz	800 MHz	1600 MHz	2000 MHz
Power in Transmission Bandwidth Configuration	dBm	REFSENS + 14dB						
$BW_{\text{Interferer}}$	MHz	50	100	200	400	800	1600	2000
$P_{\text{Interferer}}$ for bands n257, n258, n261	dBm	REFSENS + 35.5 dB	REFSENS + 35.5 dB	REFSENS + 35.5 dB	REFSENS + 35.5 dB	N/A	N/A	N/A
$P_{\text{Interferer}}$ for band n259, n260	dBm	REFSENS + 34.5 dB	REFSENS + 34.5 dB	REFSENS + 34.5 dB	REFSENS + 34.5 dB	N/A	N/A	N/A
$F_{\text{Interferer}}(\text{offset})$	MHz	≤ -100 & ≥ 100 NOTE 5	≤ -200 & ≥ 200 NOTE 5	≤ -400 & ≥ 400 NOTE 5	≤ -800 & ≥ 800 NOTE 5	≤ -1600 & ≥ 1600 NOTE 5	≤ -3200 & ≥ 3200	≤ -4000 & ≥ 4000
$F_{\text{Interferer}}$	MHz	$F_{\text{DL_low}} + 25$ to $F_{\text{DL_high}} - 25$	$F_{\text{DL_low}} + 50$ to $F_{\text{DL_high}} - 50$	$F_{\text{DL_low}} + 100$ to $F_{\text{DL_high}} - 100$	$F_{\text{DL_low}} + 200$ to $F_{\text{DL_high}} - 200$	$F_{\text{DL_low}} + 400$ to $F_{\text{DL_high}} - 400$	$F_{\text{DL_low}} + 800$ to $F_{\text{DL_high}} - 800$	$F_{\text{DL_low}} + 1600$ to $F_{\text{DL_high}} - 1600$
<p>NOTE 1: The interferer consists of the Reference measurement channel specified in Annexes A.2.3.2 and A.3.3.2 (with one sided dynamic OCNG Pattern OP.1 TDD for the DL-signal as described in Annex A.5.2.1) and set-up according to Annex C.</p> <p>NOTE2: The REFSENS power level is specified in Section 7.3.2.3, which are applicable according to different UE power classes.</p> <p>NOTE 3: The wanted signal consists of the reference measurement channel specified in Annexes A.2.3.2 and A.3.3.2 (with one sided dynamic OCNG Pattern OP.1 TDD for the DL-signal as described in Annex A.5.2.1) and set-up according to Annex C.</p> <p>NOTE 4: Void.</p> <p>NOTE 5: The absolute value of the interferer offset $F_{\text{Interferer}}(\text{offset})$ shall be further adjusted $(\text{CEIL}(F_{\text{Interferer}}(\text{offset}) /\text{SCS}) + 0.5) * \text{SCS}$ MHz with SCS the sub-carrier spacing of the wanted signal in MHz. Wanted and interferer signal have same SCS.</p> <p>NOTE 6: $F_{\text{Interferer}}$ range values for unwanted modulated interfering signals are interferer centre frequencies.</p> <p>NOTE 7: The transmitter shall be set to 4 dB below the $P_{\text{UMAX},f,c}$ as defined in clause 6.2.4, with uplink configuration specified in Table 7.3.2.3.1-2.</p>								

The normative reference for this requirement is TS 38.101-2 [10] clause 7.6.2.

7.6.2.4 Test description

7.6.2.4.1 Initial conditions

Initial conditions are a set of test configurations the UE needs to be tested in and the steps for the SS to take with the UE to reach the correct measurement state.

The initial test configurations consist of environmental conditions, test frequencies, test channel bandwidths and sub-carrier spacing based on NR operating bands specified in Table 5.3.5-1. All of these configurations shall be tested with applicable test parameters for each combination of channel bandwidth and sub-carrier spacing, are shown in Table 7.6.2.4.1-1. The details of the uplink and downlink reference measurement channels (RMC) are specified in Annexes

A.2 and A.3. Configuration of PDSCH and PDCCH before measurement are specified in Annex C.2. The details of the OCNG patterns used are specified in Annex A.5.

Table 7.6.2.4.1-1: Test Configuration Table

Initial Conditions				
Test Environment as specified in TS 38.508-1 [10] subclause 4.1		Normal		
Test Frequencies as specified in TS 38.508-1 [10] subclause 4.3.1		Mid range		
Test Channel Bandwidths as specified in TS 38.508-1 [10] subclause 4.3.1		50 MHz, 100 MHz		
Test SCS as specified in Table 5.3.5-1		120 kHz		
Test Parameters				
Test ID	Downlink Configuration		Uplink Configuration	
	Modulation	RB allocation	Modulation	RB allocation
1	CP-OFDM QPSK	NOTE 1	DFT-s-OFDM QPSK	NOTE 1
NOTE 1: The specific configuration of each RB allocation is defined in Table 7.3.2.4.1-1.				
NOTE 2: For PC7 RedCap UEs only 50MHz and 100MHz Test Channel Bandwidths are applicable				

1. Connection between SS and UE is shown in TS 38.508-1 [10] Annex A, Figure A.3.3.1.2 for TE diagram and Figure A.3.4.1.1 for UE diagram.
2. The parameter settings for the cell are set up according to TS 38.508-1 [10] subclause 4.4.3.
3. Downlink signals are initially set up according to Annex C, and uplink signals according to Annex G.
4. The DL and UL Reference Measurement channels are set according to Table 7.6.2.4.1-1.
5. Propagation conditions are set according to Annex B.0.
6. Ensure the UE is in state RRC_CONNECTED with generic procedure parameters Connectivity *NR*, Connected without release *On*, Test Mode *On* and Test Loop Function *On* according to TS 38-508-1 [10] clause 4.5. Message content are defined in clause 7.6.2.4.3.

7.6.2.4.2 Test procedure

1. Set the UE in the Rx beam peak direction found with a 3D EIRP scan as performed in Annex K.1.2. Allow at least BEAM_SELECT_WAIT_TIME (NOTE 1) for the UE Rx beam selection to complete.
2. SS transmits PDSCH via PDCCH DCI format 1_1 for C_RNTI to transmit the DL RMC according to Table 7.6.2.4.1-1. The SS sends downlink MAC padding bits on the DL RMC.
3. SS sends uplink scheduling information for each UL HARQ process via PDCCH DCI format 0_1 for C_RNTI to schedule the UL RMC according to Table 7.6.2.4.1-1. Since the UL has no payload and no loopback data to send the UE sends uplink MAC padding bits on the UL RMC.
4. Send Uplink power control commands to the UE (less or equal to 1dB step size should be used), to ensure that the UE output power measured by the test system is within the Uplink power control window, defined as $-(\text{MU} + \text{Uplink power control window size})$ dB of the target power level in Table 7.6.2.5-1, for at least the duration of the throughput measurement, where:
 - MU is the test system uplink power measurement uncertainty and is specified in Table F.1.3-1 for the carrier frequency f and the channel bandwidth BW.
 - Uplink power control window size = $1\text{dB (UE power step size)} + 1\text{dB (UE power step tolerance)} + (\text{Test system relative power measurement uncertainty})$, where, the UE power step tolerance is specified in TS 38.101-2 [3], Table 6.3.4.3-2 and is 1dB for 1dB power step size, and the Test system relative power measurement uncertainty is specified in Table F.1.3-1.
5. Perform Blocking measurement procedure as stated in Annex K.1.8 using Downlink signal level and Interferer signal level as defined in Table 7.6.2.5-1. Modulated interferer signal characteristics as defined in Annex D. Measure throughput for a duration sufficient to achieve statistical significance according to Annex H.2.

6. Repeat step 5 using interfering signals specified in 7.6.2.5-1. The ranges are covered in steps equal to the interferer bandwidth. Interferer frequencies should be chosen starting with an offset nearest to the centre frequency and sweep outwards towards the band edges. In order to ensure that full range is tested for interferer frequency, run last test steps at frequency equal to $F_{\text{Interferer}}$ range limit defined at the corresponding band edge.

NOTE 1: The BEAM_SELECT_WAIT_TIME default value is defined in Annex K.1.2.

Table 7.6.2.4.2-1: Example for interferer frequencies

	Lower frequency	Upper frequency
Band n257	26500.00 MHz	29500.00 MHz
Band n257 Midrange	27999.96 MHz	
SCS	120 kHz	
CHBW	100 MHz	
Interferer (1 st :most inner)	FFS	FFS
Interferer (2 nd)	FFS	FFS
:	:	:
Interferer (13 th)	FFS	FFS
Interferer (last step) ^{NOTE 1}	FFS	FFS
Outer limit for in band blocking	FFS	FFS
Number of test frequencies	14	14
NOTE 1: Adjusted interferer frequency in the last step will be out of outer limit but should be tested.		

7.6.2.4.3 Message contents

Message contents are according to TS 38.508-1 [10] subclause 4.6 with TRANSFORM_PRECODER_ENABLED condition in Table 4.6.3-118 PUSCH-Config.

7.6.2.5 Test requirement

The requirement below shall only be considered if UE output power measured in the test procedure step 4 ends within the Uplink power control window.

The throughput measurement derived in test procedure shall be $\geq 95\%$ of the maximum throughput of the reference measurement channels as specified in Annex A with parameters specified in Table 7.6.2.5-1, Table 7.6.2.5-1a, Table 7.6.2.5-1b and Table 7.6.2.5-1c.

Table 7.6.2.5-1: In-band blocking test requirement for PC3

Rx parameter	Units	Channel bandwidth			
		50 MHz	100 MHz	200 MHz	400 MHz
Power in Transmission Bandwidth Configuration for bands n257, n258, n261	dBm	REFSENS + 14dB			
Power in Transmission Bandwidth Configuration for band n260	dBm	REFSENS + 14 - 1.8 dB NOTE 7	REFSENS + 14 - 4.8 dB NOTE 7	REFSENS + 14 dB	REFSENS + 14 dB
Power in Transmission Bandwidth Configuration for band n259	dBm	REFSENS + 14 - 3.8 dB NOTE 7	REFSENS + 14 - 6.8 dB NOTE 7	REFSENS + 14 dB	REFSENS + 14 dB
$BW_{\text{Interferer}}$	MHz	50	100	200	400
$P_{\text{Interferer}}$ for bands n257, n258, n261	dBm	REFSENS + 35.5 dB	REFSENS + 35.5 dB	REFSENS + 35.5 dB NOTE 8	REFSENS + 35.5 dB NOTE 8
$P_{\text{Interferer}}$ for band n260	dBm	REFSENS + 34.5 - 1.8 dB	REFSENS + 34.5 - 4.8 dB	REFSENS + 34.5 dB	REFSENS + 34.5 dB NOTE 8

		NOTE 7	NOTE 7	NOTE 8	
$P_{\text{Interferer}}$ for band n259	dBm	REFSENS + 34.5 - 3.8 dB NOTE 7	REFSENS + 34.5 - 6.8 dB NOTE 7	REFSENS + 34.5 dB NOTE 8	REFSENS + 34.5 dB NOTE 8
$F_{\text{Interferer}}(\text{offset})$	MHz	≤ -100 & ≥ 100 NOTE 5	≤ -200 & ≥ 200 NOTE 5	≤ -400 & ≥ 400 NOTE 5	≤ -800 & ≥ 800 NOTE 5
$F_{\text{Interferer}}$	MHz	$F_{\text{DL_low}} + 25$ to $F_{\text{DL_high}} - 25$	$F_{\text{DL_low}} + 50$ to $F_{\text{DL_high}} - 50$	$F_{\text{DL_low}} + 100$ to $F_{\text{DL_high}} - 100$	$F_{\text{DL_low}} + 200$ to $F_{\text{DL_high}} - 200$
<p>NOTE 1: The interferer consists of the Reference measurement channel specified in Annex A.3.3.2 with one sided dynamic OCNG Pattern OP.1.TDD as described in Annex A.5.2.1 and set-up according to Annex C.</p> <p>NOTE 2: The REFSENS power level is specified in Section 7.3.2.5, which are applicable according to different UE power classes.</p> <p>NOTE 3: The wanted signal consists of the reference measurement channel specified in Annex A.3.3.2 with one sided dynamic OCNG pattern OP.1.TDD as described in Annex A.5.2.1 and set-up according to Annex C.</p> <p>NOTE 4: Void.</p> <p>NOTE 5: The absolute value of the interferer offset $F_{\text{Interferer}}(\text{offset})$ shall be further adjusted $(\text{CEIL}(F_{\text{Interferer}}(\text{offset}) /\text{SCS}) + 0.5) * \text{SCS}$ MHz with SCS the sub-carrier spacing of the wanted signal in MHz. Wanted and interferer signal have same SCS.</p> <p>NOTE 6: $F_{\text{Interferer}}$ range values for unwanted modulated interfering signals are interferer centre frequencies.</p> <p>NOTE 7: Core requirement cannot be tested due to testability issue and test requirement for wanted signal and interferer includes relaxation to achieve feasible interferer power level.</p> <p>NOTE 8: Core requirement cannot be tested due to testability issue.</p> <p>NOTE 9: The transmitter shall be set to 4 dB below the $P_{\text{UMAX},f,c}$ as defined in clause 6.2.4, with uplink configuration specified in Table 7.3.2.3.1-2.</p>					

Table 7.6.2.5-1a: In-band blocking test requirement for PC1

Rx parameter	Units	Channel bandwidth			
		50 MHz	100 MHz	200 MHz	400 MHz
Power in Transmission Bandwidth Configuration for bands n257, n258, n260, n261	dBm	REFSENS + 14dB			
$BW_{\text{Interferer}}$	MHz	50	100	200	400
$P_{\text{Interferer}}$ for bands n257, n258, n261	dBm	REFSENS + 35.5 dB	REFSENS + 35.5 dB	REFSENS + 35.5 dB	REFSENS + 35.5 dB
$P_{\text{Interferer}}$ for band n260	dBm	REFSENS +34.5dB	REFSENS +34.5dB	REFSENS +34.5dB	REFSENS +34.5dB
$F_{\text{Interferer}}(\text{offset})$	MHz	≤ -100 & ≥ 100 NOTE 5	≤ -200 & ≥ 200 NOTE 5	≤ -400 & ≥ 400 NOTE 5	≤ -800 & ≥ 800 NOTE 5
$F_{\text{Interferer}}$	MHz	$F_{\text{DL_low}} + 25$ to $F_{\text{DL_high}} - 25$	$F_{\text{DL_low}} + 50$ to $F_{\text{DL_high}} - 50$	$F_{\text{DL_low}} + 100$ to $F_{\text{DL_high}} - 100$	$F_{\text{DL_low}} + 200$ to $F_{\text{DL_high}} - 200$
<p>NOTE 1: The interferer consists of the Reference measurement channel specified in Annex A.3.3.2 with one sided dynamic OCNG Pattern OP.1.TDD as described in Annex A.5.2.1 and set-up according to Annex C.</p> <p>NOTE 2: The REFSENS power level is specified in Section 7.3.2.5, which are applicable according to different UE power classes.</p> <p>NOTE 3: The wanted signal consists of the reference measurement channel specified in Annex A.3.3.2 with one sided dynamic OCNG pattern OP.1.TDD as described in Annex A.5.2.1 and set-up according to Annex C.</p> <p>NOTE 4: Void.</p> <p>NOTE 5: The absolute value of the interferer offset $F_{\text{Interferer}}(\text{offset})$ shall be further adjusted $(\text{CEIL}(F_{\text{Interferer}}(\text{offset}) /\text{SCS}) + 0.5) * \text{SCS}$ MHz with SCS the sub-carrier spacing of the wanted signal in MHz. Wanted and interferer signal have same SCS.</p> <p>NOTE 6: $F_{\text{Interferer}}$ range values for unwanted modulated interfering signals are interferer centre frequencies.</p> <p>NOTE 7: The transmitter shall be set to 4 dB below the $P_{\text{UMAX},f,c}$ as defined in clause 6.2.4, with uplink configuration specified in Table 7.3.2.3.1-2.</p>					

Table 7.6.2.5-1b: In-band blocking test requirement for PC5 (n257, n258) and PC6

Rx parameter	Units	Channel bandwidth			
		50 MHz	100 MHz	200 MHz	400 MHz
Power in Transmission Bandwidth Configuration for bands n257, n258, n261	dBm	REFSENS + 14dB			
BW _{Interferer}	MHz	50	100	200	400
P _{Interferer} for bands n257, n258, n261	dBm	REFSENS + 35.5 dB	REFSENS + 35.5 dB	REFSENS + 35.5 dB	REFSENS + 35.5 dB
F _{Interferer} (offset)	MHz	≤ -100 & ≥ 100 NOTE 5	≤ -200 & ≥ 200 NOTE 5	≤ -400 & ≥ 400 NOTE 5	≤ -800 & ≥ 800 NOTE 5
F _{Interferer}	MHz	F _{DL_low} + 25 to F _{DL_high} - 25	F _{DL_low} + 50 to F _{DL_high} - 50	F _{DL_low} + 100 to F _{DL_high} - 100	F _{DL_low} + 200 to F _{DL_high} - 200
<p>NOTE 1: The interferer consists of the Reference measurement channel specified in Annex A.3.3.2 with one sided dynamic OCNG Pattern OP.1.TDD as described in Annex A.5.2.1 and set-up according to Annex C.</p> <p>NOTE 2: The REFSENS power level is specified in Section 7.3.2.5, which are applicable according to different UE power classes.</p> <p>NOTE 3: The wanted signal consists of the reference measurement channel specified in Annex A.3.3.2 with one sided dynamic OCNG pattern OP.1.TDD as described in Annex A.5.2.1 and set-up according to Annex C.</p> <p>NOTE 4: Void.</p> <p>NOTE 5: The absolute value of the interferer offset F_{Interferer}(offset) shall be further adjusted (CEIL(F_{Interferer}(offset) /SCS) + 0.5)*SCS MHz with SCS the sub-carrier spacing of the wanted signal in MHz. Wanted and interferer signal have same SCS.</p> <p>NOTE 6: F_{Interferer} range values for unwanted modulated interfering signals are interferer centre frequencies.</p> <p>NOTE 7: The transmitter shall be set to 4 dB below the P_{UMAX,f,c} as defined in clause 6.2.4, with uplink configuration specified in Table 7.3.2.3.1-2.</p>					

Table 7.6.2.5-1c: Test parameters for adjacent channel selectivity, Case 1, PC7

Rx Parameter	Units	Channel bandwidth	
		50 MHz	100 MHz
Power in Transmission Bandwidth Configuration for band n257, n258, n261	dBm	REFSENS + 14 dB	REFSENS + 14 - 3 dB NOTE 4
P _{Interferer} for band n257, n258, n261	dBm	REFSENS + 35.5 dB	REFSENS + 35.5 - 3 dB NOTE 5
BW _{Interferer}	MHz	50	100
F _{Interferer} (offset)	MHz	50 / -50 NOTE 3	100 / -100 NOTE 3
<p>NOTE 1: The interferer consists of the Reference measurement channel specified in Annex A.3.3.2 with one sided dynamic OCNG Pattern OP.1 as described in Annex A.5.2.1 and set-up according to Annex C.</p> <p>NOTE 2: The REFSENS power level is specified in subclause 7.3.2.5.</p> <p>NOTE 3: The absolute value of the interferer offset F_{Interferer} (offset) shall be further adjusted to (CEIL(F_{Interferer}(offset) /SCS) + 0.5)*SCS MHz with SCS the sub-carrier spacing of the wanted signal in MHz. Wanted and interferer signal have same SCS.</p> <p>NOTE 4: Core requirement cannot be tested due to testability issue and test requirement for wanted signal and interferer includes relaxation to achieve feasible interferer power level.</p> <p>NOTE 5: Core requirement cannot be tested due to testability issue.</p> <p>NOTE 6: The transmitter shall be set to 4 dB below the P_{UMAX,f,c} as defined in clause 6.2.4, with uplink configuration specified in Table 7.3.2.3.1-2.</p>			

7.6.3 Void

7.6A Blocking characteristics for CA

7.6A.1 General

FFS

7.6A.2 In-band blocking for CA

7.6A.2.0 Minimum Conformance Requirements

7.6A.2.0.1 In-band blocking for Intra-band contiguous CA

For intra-band contiguous carrier aggregation, the SCC(s) shall be configured at nominal channel spacing to the PCC. The input power shall be distributed among the active DL CCs so their PSDs are aligned with each other. The UE shall fulfil the minimum requirement specified in Table 7.6A.2.0.1-1 for in the presence of an interferer at a given frequency offset from the centre frequency of the assigned channel and an interferer power shall not exceed -25 dBm. The throughput of each carrier shall be $\geq 95\%$ of the maximum throughput of the reference measurement channels as specified in Annexes A.2.3.2 and A.3.3.2 (with one sided dynamic OCNG Pattern OP.1 TDD for the DL-signal as described in Annex A.5.2.1). The requirement is verified with the test metric of EIS (Link=RX beam peak direction, Meas=Link angle).

Table 7.6A.2.0.1-1: In band blocking minimum requirements for intra-band contiguous CA

Rx Parameter	Units	All CA bandwidth classes
Power in Transmission Bandwidth Configuration, per CC	dBm	REFSENS + 14 dB
Pinterferer for band n257, n258, n261	dBm	Aggregated power + 21.5 dB
Pinterferer for band n259, n260	dBm	Aggregated power + 20.5 dB
$BW_{\text{Interferer}}$	MHz	$BW_{\text{Channel_CA}}$
$F_{\text{Interferer}}(\text{offset})$	MHz	$+2 \cdot BW_{\text{Channel_CA}} / -2 \cdot BW_{\text{Channel_CA}}$ NOTE 5
$F_{\text{Interferer}}$	MHz	$F_{\text{DL_low}} + 0.5 \cdot BW_{\text{Channel_CA}}$ To $F_{\text{DL_high}} - 0.5 \cdot BW_{\text{Channel_CA}}$
<p>NOTE 1: The interferer consists of the Reference measurement channel specified in Annex A.3.3.2 with one sided dynamic OCNG Pattern OP.1 TDD as described in Annex A.5.2.1. and set-up according to Annex C.</p> <p>NOTE 2: The REFSENS power level is specified in clause 7.3.2.</p> <p>NOTE 3: The wanted signal consists of the reference measurement channel specified in Annex A.3.3.2 QPSK, R=1/3 with one sided dynamic OCNG pattern OP.1 TDD as described in Annex A.5.2.1 and set-up according to Annex C.</p> <p>NOTE 4: The $F_{\text{Interferer}}(\text{offset})$ is the frequency separation between the centre of the aggregated CA bandwidth and the centre frequency of the Interferer signal.</p> <p>NOTE 5: The absolute value of the interferer offset $F_{\text{Interferer}}(\text{offset})$ shall be further adjusted to $(\text{CEIL}(F_{\text{Interferer}}(\text{offset}) /\text{SCS}) + 0.5) \cdot \text{SCS}$ MHz with SCS the sub-carrier spacing of the carrier closest to the interferer in MHz. The interfering signal has the same SCS as that of the closest carrier.</p>		

NOTE 6: $F_{\text{Interferer}}$ range values for unwanted modulated interfering signals are interferer centre frequencies.

NOTE 7: The transmitter shall be set to 4 dB below the $P_{\text{UMAX},f,c}$ as defined in clause 6.2.4, with uplink configuration specified in Table 7.3.2.3.1-2.

7.6A.2.0.2 In-band blocking for Intra-band non-contiguous CA

For intra-band non-contiguous carrier aggregation with two component carriers, the requirement applies to out-of-gap and in-gap. For out-of-gap, the UE shall meet the requirements for each component carrier with parameters as specified in Table 7.6.2.3-1. The requirement associated to the maximum channel between across the component carriers is selected. For in-gap, the requirement shall apply if the following minimum gap condition is met:

$$\Delta f_{IBB} \geq 0.5(BW_1 + BW_2) + 2 \max(BW_1, BW_2),$$

where Δf_{IBB} is the frequency separation between the centre frequencies of the component carriers and BW_k are the channel bandwidths of carrier k , $k = 1, 2$.

If the minimum gap condition is met, the UE shall meet the requirement specified in Table 7.6.2.3-1 for each component carrier. The respective channel bandwidth of the component carrier under test will be used in the parameter calculations of the requirement. In case of more than two component carriers, the minimum gap condition is computed for any pair of adjacent component carriers following the same approach as the two component carriers. The in-gap requirement for the corresponding pairs shall apply if the minimum gap condition is met. For every component carrier to which the requirements apply, the UE shall meet the requirement with one active interferer signal (in-gap or out-of-gap) while all downlink carriers are active and the input power shall be distributed among the active DL CCs so their PSDs are aligned with each other.

7.6A.2.0.3 In-band blocking for Inter-band CA

For inter-band carrier aggregation with one component carrier per operating band and the uplink assigned to one NR band, the in-band blocking requirements are defined with the uplink active on the band other than the band whose downlink is being tested. The UE shall meet the requirements specified in clause 7.6.2 for each component carrier while all downlink carriers are active.

For the combination of intra-band and inter-band carrier aggregation and uplink carrier(s) assigned to one NR band, the requirement is defined with the uplink active on the band other than the band whose downlink is being tested. The UE shall meet the requirements specified in clauses 7.6A.2.1 and 7.6A.2.2 for each band while all downlink carriers are active.

7.6A.2.1 In-band blocking for CA (2DL CA)

Editor's note: The following aspects are either missing or not yet determined:

- Measurement Uncertainties and Test Tolerances for intra-band contiguous CA supporting aggregated BW > 400MHz and for intra-band non-contiguous CA are TBD.
- Measurement Uncertainties and Test Tolerances are FFS for power class 1, 2 and 4.
- In case of frequency separation larger than 800 MHz and in case the device manufacturer does not explicitly declare that the beam peak for a reference (frequency band, CBW) or (frequency band combination, CA BW class) is applicable for a group of other intra-band contiguous combinations and CA BW classes, according to Table A.4.3.9-6 in 38.508-2, following aspect of beam peak search procedures for CA is FFS: RB allocation, power level, channel bandwidth configuration, per CC approach or all CC combined approach, etc
- Some references are in square brackets for inter-band DL CA
- Test Point Analysis is FFS

7.6A.2.1.1 Test purpose

Same test purpose as in clause 7.6.2.1.

7.6A.2.1.2 Test applicability

This test case applies to all types of NR UE release 15 and forward that supports FR2 inter-band 2DL CA.

7.6A.2.1.3 Minimum conformance requirements

Same minimum conformance requirements as in clause 7.6A.2.0.

7.6A.2.1.4 Test description

7.6A.2.1.4.1 Initial conditions

Initial conditions are a set of test configurations the UE needs to be tested in and the steps for the SS to take with the UE to reach the correct measurement state.

The initial test configurations consist of environmental conditions, test frequencies, test channel bandwidths and sub-carrier spacing based on NR operating bands specified in Table 5.3.5-1. All of these configurations shall be tested with applicable test parameters for each combination of channel bandwidth and sub-carrier spacing, are shown in Table 7.6A.2.1.4.1-1. The details of the uplink and downlink reference measurement channels (RMC) are specified in Annexes A.2 and A.3. Configuration of PDSCH and PDCCH before measurement are specified in Annex C.2. The details of the OCNG patterns used are specified in Annex A.5.

Table 7.6A.2.1.4.1-1: Test Configuration Table

FFS

1. Connection between SS and UE is shown in TS 38.508-1 [10] Annex A, Figure A.3.3.1.2 for TE diagram and Figure A.3.4.1.1 for UE diagram.
2. The parameter settings for the cell are set up according to TS 38.508-1 [10] subclause 4.4.3.
3. Downlink signals are initially set up according to Annex C, and uplink signals according to Annex G.
4. The DL and UL Reference Measurement channels are set according to Table 7.6A.2.1.4.1-1.
5. Propagation conditions are set according to Annex B.0.
6. Ensure the UE is in state RRC_CONNECTED with generic procedure parameters Connectivity *NR*, Connected without release *On*, Test Mode *On* and Test Loop Function *On* according to TS 38-508-1 [10] clause 4.5. Message content are defined in clause 7.6A.2.1.4.3.

7.6A.2.1.4.2 Test Procedure

Test procedure for Inter-band:

1. Configure SCC according to Annex C.0, C.1, C.2 for all downlink physical channels.
2. The SS shall configure SCC as per TS 38.508-1 [10] clause 5.5.1. Message contents are defined in clause 7.4A.1.4.3.
3. SS activates SCC by sending the activation MAC CE (Refer TS 38.321[28], clauses 5.9, 6.1.3.10). Wait for at least 2 seconds (Refer TS 38.133[25], clause 9.2).
4. SS transmits PDSCH via PDCCH DCI format 1_1 for C_RNTI to transmit the DL RMC according to Table 7.6A.2.1.4.1-1. The SS sends downlink MAC padding bits on the DL RMC.
5. SS sends uplink scheduling information on PCC for each UL HARQ process via PDCCH DCI format 0_1 for C_RNTI to schedule the UL RMC according to Table 7.6A.2.1.4.1-1. Since the UE has no payload data to send, the UE transmits uplink MAC padding bits on the UL RMC.
6. Set SS with the downlink signal applied to the θ -polarization of the measurement antenna.
7. Set the UE in the SCC Rx beam peak direction found for the primary component carrier with a 3D EIS scan as performed in Annex K.1.2. Allow at least BEAM_SELECT_WAIT_TIME (NOTE 1) for the UE Rx beam selection to complete.

8. Set downlink signal level for θ -polarization 3dB below values described in 7.6.2.5-1 for SCC.
9. Send Uplink power control commands to the UE (less or equal to 1dB step size should be used), to ensure that the UE output power is within [TBD] dB of the target power level in Table 7.6A.2.1.4.1-1, for at least the duration of the throughput measurement.
10. Apply the blocking signal with the same polarization and coming from the same direction as the downlink signal. Set the power level of the blocking signal 3dB below the level stated in the requirement in 7.6.2.5-1.
11. For SCC, measure the average throughput for a duration sufficient to achieve statistical significance according to Annex H.2.
12. Repeat steps from 3 to 11, for the downlink signal from ϕ -polarization.
13. Repeat steps 3 to 12 switching PCC and SCC test frequencies.
14. Compare the results for both the θ -polarization and ϕ -polarization against the requirement for each component carrier. If all results meet the requirements, pass the UE.

NOTE 1: The BEAM_SELECT_WAIT_TIME default value is defined in Annex K.1.2

7.6A.2.1.4.3 Message contents

Message contents are according to TS 38.508-1 [10] subclause 4.6 with TRANSFORM_PRECODER_ENABLED condition in Table 4.6.3-118 PUSCH-Config.

7.6A.2.1.5 Test requirement

For each component carrier, the throughput measurement derived in test procedure shall be $\geq 95\%$ of the maximum throughput of the reference measurement channels as specified in Annex A with parameters specified in Table 7.6A.2.1.5-1.

Table 7.6A.2.1.5-1: In-band blocking test requirement

Rx parameter	Units	Channel bandwidth			
		50 MHz	100 MHz	200 MHz	400 MHz
Power in Transmission Bandwidth Configuration for bands n257, n258, n261	dBm	REFSENS + 14dB			
Power in Transmission Bandwidth Configuration for band n260	dBm	REFSENS + 14 - 1.8 dB NOTE 7	REFSENS + 14 - 4.8 dB NOTE 7	REFSENS + 14 dB	REFSENS + 14 dB
BW _{Interferer}	MHz	50	100	200	400
P _{Interferer} for bands n257, n258, n261	dBm	REFSENS + 35.5 dB	REFSENS + 35.5 dB	REFSENS + 35.5 dB NOTE 8	REFSENS + 35.5 dB NOTE 8
P _{Interferer} for band n260	dBm	REFSENS + 34.5 - 1.8 dB NOTE 7	REFSENS + 34.5 - 4.8 dB NOTE 7	REFSENS + 34.5 dB NOTE 8	REFSENS + 34.5 dB NOTE 8
F _{Interferer} (offset)	MHz	≤ -100 & ≥ 100 NOTE 5	≤ -200 & ≥ 200 NOTE 5	≤ -400 & ≥ 400 NOTE 5	≤ -800 & ≥ 800 NOTE 5
F _{Interferer}	MHz	F _{DL_low} + 25 to F _{DL_high} - 25	F _{DL_low} + 50 to F _{DL_high} - 50	F _{DL_low} + 100 to F _{DL_high} - 100	F _{DL_low} + 200 to F _{DL_high} - 200
NOTE 1: The interferer consists of the Reference measurement channel specified in Annex A.3.3.2 with one sided dynamic OCN Pattern OP.1.TDD as described in Annex A.5.2.1 and set-up according to Annex C.					
NOTE 2: The REFSENS power level is specified in Section 7.3.2.5, which are applicable according to different UE power classes.					

- NOTE 3: The wanted signal consists of the reference measurement channel specified in Annex A.3.3.2 with one sided dynamic OCN pattern OP.1.TDD as described in Annex A.5.2.1 and set-up according to Annex C.
- NOTE 4: The $F_{\text{Interferer}}$ (offset) is the frequency separation between the centre of the aggregated CA bandwidth and the centre frequency of the Interferer signal.
- NOTE 5: The absolute value of the interferer offset $F_{\text{Interferer}}$ (offset) shall be further adjusted $(\text{CEIL}(|F_{\text{Interferer}}(\text{offset})|/\text{SCS}) + 0.5) * \text{SCS}$ MHz with SCS the sub-carrier spacing of the wanted signal in MHz. Wanted and interferer signal have same SCS.
- NOTE 6: $F_{\text{Interferer}}$ range values for unwanted modulated interfering signals are interferer centre frequencies.
- NOTE 7: Core requirement cannot be tested due to testability issue and test requirement for wanted signal and interferer includes relaxation to achieve feasible interferer power level.
- NOTE 8: Core requirement cannot be tested due to testability issue.
- NOTE 9: The transmitter shall be set to 4 dB below the $P_{\text{UMAX},f,c}$ as defined in clause 6.2.4, with uplink configuration specified in Table 7.3.2.3.1-2.

7.6A.2.2 Void

7.6A.2.3 Void

7.6A.2.4 Void

7.6A.2.5 Void

7.6A.2.6 Void

7.6A.2.7 Void

7.6D Blocking characteristics for UL MIMO

The normative reference for this requirement is TS 38.101-2 [3] clause 7.6D.

No test case details are specified. Given UE's Rx performance would not be impacted by the Tx configuration on TDD bands, the requirements in this test case can be well covered in 7.6 and don't need to be tested again.

7.7 Void

7.8 Void

7.9 Spurious emissions

Editor's note: Following aspects are either missing or not yet determined:

- The testability of this test case is pending further analysis on relaxation of the requirement for band other than n257, n258, n259, n260 and n261.
- TRP Measurement uncertainty is TBD for above 87 GHz.
- Measurement Uncertainties and Test Tolerances are FFS for power class other than PC1, PC3, PC5, PC6.
- Connection diagram between SS and UE in TS 38.508-1 [10] Annex A is FFS.
- Test procedure is FFS for laptop.

7.9.1 Test purpose

Test verifies the UE's spurious emissions meet the requirements described in clause 7.9.3.

Excess spurious emissions increase the interference to other systems.

7.9.2 Test applicability

This test case applies to all types of NR UE release 15 and forward.

7.9.3 Minimum conformance requirements

The spurious emissions power is the power of emissions generated or amplified in a receiver. The spurious emissions power level is measured as TRP.

The power of any narrow band CW spurious emission shall not exceed the maximum level specified in Table 7.9.3-1. The requirement is verified in beam locked mode with the test metric of TRP (Link=TX beam peak direction, Meas=TRP grid).

Table 7.9.3-1: General receiver spurious emission requirements

Frequency range	Measurement bandwidth	Maximum level	NOTE
$30\text{MHz} \leq f < 1\text{GHz}$	100 kHz	-57 dBm	1
$1\text{GHz} \leq f \leq 2^{\text{nd}}$ harmonic of the upper frequency edge of the DL operating band in GHz	1 MHz	-47 dBm	
NOTE 1: Unused PDCCH resources are padded with resource element groups with power level given by PDCCH as defined in Annex C.3.1.			

The normative reference for this requirement is TS 38.101-2 [3] clause 7.9.

7.9.4 Test description

7.9.4.1 Initial conditions

Initial conditions are a set of test configurations the UE needs to be tested in and the steps for the SS to take with the UE to reach the correct measurement state.

The initial test configurations consist of environmental conditions, test frequencies, test channel bandwidths and sub-carrier spacing based on NR operating bands specified in Table 5.3.5-1. All of these configurations shall be tested with applicable test parameters for each combination of channel bandwidth and sub-carrier spacing, are shown in table 7.9.4.1-1. The details of the uplink and downlink reference measurement channels (RMC) are specified in Annexes A.2 and A.3. Configurations of PDSCH and PDCCH before measurement are specified in Annex C.2.

Table 7.9.4.1-1: Test Configuration Table

Default Conditions				
Test Environment as specified in TS 38.508-1 [10] subclause 4.1		Normal		
Test Frequencies as specified in TS 38.508-1 [10] subclause 4.3.1		Low range, Mid range, High range		
Test Channel Bandwidths as specified in TS 38.508-1 [10] subclause 4.3.1		Highest		
Test SCS as specified in Table 5.3.5-1		Highest		
Test Parameters				
Test ID	Downlink Configuration		Uplink Configuration	
	Mod'n	RB allocation	Mod'n	RB allocation
1	-	-	-	-
NOTE 1: The specific configuration of uplink and downlink are defined in Table 7.3.2.4.1-1.				
NOTE 2: For PC7 RedCap UEs only 50MHz and 100MHz Test Channel Bandwidths are applicable				

1. Connection between SS and UE is shown in TS 38.508-1 [10] Annex A, [Figure TBD] for TE diagram and [Figure TBD] for UE diagram.

2. The parameter settings for the cell are set up according to TS 38.508-1 [10] subclause 4.4.3.
3. Downlink signals are initially set up according to Annex C, and uplink signals according to Annex G.
4. The DL and UL Reference Measurement channels are set according to Table 7.9.4.1-1.
5. Propagation conditions are set according to Annex B.0.
6. Ensure the UE is in state RRC_CONNECTED with generic procedure parameters Connectivity NR, Connected without release *On*, Test Mode *On* and Test Loop Function *On* according to TS 38.508-1 [10] clause 4.5. Message content are defined in clause 7.9.4.3.

7.9.4.2 Test procedure

1. Select any of the three Alignment Options (1, 2, or 3) from Tables N.2-1 through N.2-3 to mount the DUT inside the QZ.
2. If the re-positioning concept is applied, position the device in DUT Orientation 1 if the maximum beam peak direction is within zenith angular range $0^\circ < \theta < 90^\circ$ for the alignment option selected in step 1; position the device in DUT Orientation 2 (either Options 1 or 2) if the maximum beam peak direction is within zenith angular range $90^\circ < \theta < 180^\circ$ for DUT Orientation 1 for the alignment option selected in step 1. If the re-positioning concept is not applied, position the device in DUT Orientation 1.
3. Set the UE in the Inband Tx beam peak direction found with a 3D EIRP scan as performed in Annex K.1.1 using the uplink configuration in section 6.2.1.1. Allow at least BEAM_SELECT_WAIT_TIME (NOTE 3) for the UE Tx beam selection to complete.
4. SS activates the UE Beamlock Function (UBF) by performing the procedure as specified in TS 38.508-1 [10] clause 4.9.2 using condition Tx only.
5. Measure the spurious emissions as per steps outlined below with an exception to the procedure in Annex K if the re-positioning concept is applied (NOTE 4). Step (a) is optional and applicable only if SNR (test requirement level in Table 7.9.5-1 minus offset value minus noise floor of the test system) ≥ 0 dB is guaranteed. During measurement the spectrum analyser shall be set to 'Detector' = RMS.
 - (a) Perform coarse TRP measurements to identify spurious emission frequencies and corresponding power level according to the procedures in Annex K, using coarse TRP measurement grid selection criteria as per Tables 6.5.3.1.4.2-1 through 6.5.3.1.4.2-3. The measurement is completed in both polarizations θ and ϕ over frequency range and measurement bandwidth according to Table 7.9.5-1. Optionally, a larger and non-constant measurement bandwidth than that of Table 7.9.5-1 may be applied. The measurement period shall capture the active time slots. For each spurious emission frequency with coarse TRP identified to be less than the offsets listed in Tables 6.5.3.1.4.2-1 through 6.5.3.1.4.2-3 from the TRP limit according to Table 7.9.5-1, either continue with another coarse TRP procedure and corresponding offset according to step (a) or continue with fine TRP procedures according to step (b).

Different coarse TRP grids and corresponding offset values may be used for different frequencies. Multiple coarse TRP grids measurements with the corresponding offset values can be performed before the fine TRP measurement grid is applied. The coarse TRP grids and offset values used shall be recorded in the test report.
 - (b) Measure fine TRP measurements according to procedures in Annex K, using fine TRP measurement grid selection criteria as per Table M.4.5-3 in Annex M, for each of the spurious emission frequency identified in step (a). Apply a measurement bandwidth according to Table 7.9.5-1.
6. SS deactivates the UE Beamlock Function (UBF) by performing the procedure as specified in TS 38.508-1 [10] clause 4.9.3.

NOTE 1: The frequency range defined in Table 7.9.5-1 may be split into ranges. For each range a different test system, e.g. antenna and/or chamber, may be used. To pass the test case all verdicts of the frequency ranges must pass.

NOTE 2: Void.

NOTE 3: The BEAM_SELECT_WAIT_TIME default value is defined in Annex K.

NOTE 4: If the (in-band) beam peak is within $0^\circ \leq \theta \leq 90^\circ$: perform first hemispherical TRP scan ($0^\circ \leq \theta \leq 90^\circ$) in DUT Orientation 1 and second hemispherical TRP scan ($90^\circ > \theta \geq 0^\circ$) in DUT Orientation 2. If the (in-band) beam peak is within $90^\circ < \theta \leq 180^\circ$: perform first hemispherical TRP scan ($0^\circ \leq \theta \leq 90^\circ$) in DUT Orientation 2 and second hemispherical TRP scan ($90^\circ > \theta \geq 0^\circ$) in DUT Orientation 1. The DUT with UBF activated needs to be re-positioned during the test.

NOTE 5: Void.

7.9.4.3 Message contents

Message contents are according to TS 38.508-1 [10] subclause 4.6.

7.9.5 Test requirement

The measured spurious emissions derived in step 5, shall not exceed the maximum level specified in Table 7.9.5-1.

Table 7.9.5-1: General receiver spurious emission requirements (Band n257, n258, n259, n260, n261)

Frequency range	Measurement bandwidth	Maximum level	NOTE
$6\text{GHz} \leq f < 20\text{GHz}$	1 MHz	$-47 + 10.2$ dBm	1
$20\text{GHz} \leq f < 40\text{GHz}$	1 MHz	$-47 + 17.2$ dBm	1
$40\text{GHz} \leq f \leq 2^{\text{nd}}$ harmonic of the upper frequency edge of the DL operating band in GHz	1 MHz	$-47 + 33.1$ dBm	1
NOTE 1: Unused PDCCH resources are padded with resource element groups with power level given by PDCCH as defined in Annex C.3.1.			

Table 7.9.5-2: Void

7.10 Void

Annex A (normative): Measurement channels

A.1 General

TBD

A.2 UL reference measurement channels

A.2.1 General

TBD

A.2.2 Void

A.2.3 Reference measurement channels for TDD

For UL RMCs defined below, TDD slot pattern defined in Table A.2.3-1 will be used for the requirements requiring at least one sub frame (1 ms) for the measurement period. For other requirements, TDD slot patterns defined for reference sensitivity tests in Table A.3.3.1-1 will be used.

Table A.2.3-1: Additional reference channels parameters for TDDParameter

		Value			
		SCS 60 kHz ($\mu=2$)	SCS 120 kHz ($\mu=3$)	SCS 480 kHz ($\mu=5$)	SCS 960 kHz ($\mu=6$)
TDD Slot Configuration pattern (Note 1)		DDDSUUUU	7DS8U	31DS32U	63DS64U
Special Slot Configuration (Note 2)		S=4D+6G+4U	S=12D+2G	S=2D+12G	S=2D+12G
referenceSubcarrierSpacing		60 kHz	120 kHz	480 kHz	960 kHz
UL-DL configuration	<i>dl-UL-TransmissionPeriodicity</i>	2 ms	2 ms	2 ms	2ms
	<i>nrofDownlinkSlots</i>	3	7	31	63
	<i>nrofDownlinkSymbols</i>	4	12	2	2
	<i>nrofUplinkSlot</i>	4	8	32	64
	<i>nrofUplinkSymbols</i>	4	0	0	0
Indexes of active UL slots		$\text{mod}(\text{slot index}, 40) = \{36, \dots, 39\}$	$\text{mod}(\text{slot index}, 80) = \{72, \dots, 79\}$	$\text{mod}(\text{slot index}, 320) = \{288, \dots, 319\}$	$\text{mod}(\text{slot index}, 640) = \{576, \dots, 639\}$
Indexes of active UL slots for UL Gap test		$\text{mod}(\text{slot index}, 40) = \{12, \dots, 15, 36, \dots, 39\}$	$\text{mod}(\text{slot index}, 80) = \{24, \dots, 31, 72, \dots, 79\}$		
Indexes of the UL slots for UL Gap when UL gap pattern configuration 3 (IE <i>UL-GapFR2-Config-r17</i>) is configured		$\text{mod}(\text{slot index}, 40) = \{7, 28\}$	$\text{mod}(\text{slot index}, 80) = \{15, 56\}$		
Indexes of the UL slots for UL Gap when UL gap pattern configuration 1 (IE <i>UL-GapFR2-Config-r17</i>) is configured		$\text{mod}(\text{slot index}, 160) = \{20, 21, 22, 23, 28, 29, 30, 31\}$	$\text{mod}(\text{slot index}, 320) = \{8, \dots, 15\}$		
NOTE 1: D denotes a slot with all DL symbols; S denotes a slot with a mix of DL, UL and guard symbols; U denotes a slot with all UL symbols. The field is for information.					
NOTE 2: D, G, U denote DL, guard and UL symbols, respectively. The field is for information.					

A.2.3.1 DFT-s-OFDM Pi/2-BPSK

Table A.2.3.1-1: Reference Channels for DFT-s-OFDM pi/2-BPSK

Parameter	Allocated resource blocks (L _{CRB})	DFT-s-OFDM Symbols per slot (Note 1)	Modulation	MCS Index (Note 2)	Payload size	Transport block CRC	LDPC Base Graph	Number of code blocks per slot (Note 3)	Total number of bits per slot	Total modulated symbols per slot
Unit					Bits	Bits			Bits	
	1	11	pi/2 BPSK	0	24	16	2	1	132	132
	16	11	pi/2 BPSK	0	504	16	2	1	2112	2112
	32	11	pi/2 BPSK	0	1032	16	2	1	4224	4224
	64	11	pi/2 BPSK	0	2024	16	2	1	8448	8448
	128	11	pi/2 BPSK	0	3976	24	2	2	16896	16896
	256	11	pi/2 BPSK	0	7944	24	2	3	33792	33792
NOTE 1: PUSCH mapping Type-A and single-symbol DM-RS configuration Type-1 with 2 additional DM-RS symbols, such that the DM-RS positions are set to symbols 2, 7, 11. DMRS is [TDM'ed] with PUSCH data. DM-RS symbols are not counted.										
NOTE 2: MCS Index is based on MCS table 6.1.4.1-1 defined in 38.214.										
NOTE 3: If more than one Code Block is present, an additional CRC sequence of L = 24 Bits is attached to each Code Block (otherwise L = 0 Bit)										
NOTE 4: Indexes of active UL slots are given by Table A.2.3-1 with TDD UL-DL configuration specified in A2.3 for the requirements requiring at least one sub frame (1ms) for the measurement period. For other requirements, indexes of active UL slots are given by the slots satisfying mod(slot index+1, 5) = 0 with TDD UL-DL configuration specified in A.3.3.1.										
NOTE 5: The RMCs apply to all channel bandwidth where L _{CRB} ≤ N _{RB} .										

Table A.2.3.1-2: Void

A.2.3.2 DFT-s-OFDM QPSK

Table A.2.3.2-1: Reference Channels for DFT-s-OFDM QPSK

Parameter	Allocated resource blocks (L _{CRB})	DFT-s-OFDM Symbols per slot (Note 1)	Modulation	MCS Index (Note 2)	Payload size	Transport block CRC	LDPC Base Graph	Number of code blocks per slot (Note 3)	Total number of bits per slot	Total modulated symbols per slot
Unit					Bits	Bits			Bits	
	1	11	QPSK	2	48	16	2	1	264	132
	16	11	QPSK	2	808	16	2	1	4224	2112

	20	11	QPSK	2	1032	16	2	1	5280	2640
	32	11	QPSK	2	1608	16	2	1	8448	4224
	64	11	QPSK	2	3240	16	2	1	16896	8448
	128	11	QPSK	2	6408	24	2	2	33792	16896
	256	11	QPSK	2	12808	24	2	4	67584	33792

NOTE 1: PUSCH mapping Type-A and single-symbol DM-RS configuration Type-1 with 2 additional DM-RS symbols, such that the DM-RS positions are set to symbols 2, 7, 11. DMRS is [TDM'ed] with PUSCH data. DM-RS symbols are not counted.

NOTE 2: MCS Index is based on MCS table 6.1.4.1-1 defined in 38.214.

NOTE 3: If more than one Code Block is present, an additional CRC sequence of L = 24 Bits is attached to each Code Block (otherwise L = 0 Bit)

NOTE 4: Indexes of active UL slots are given by Table A.2.3-1 with TDD UL-DL configuration specified in A2.3 for the requirements requiring at least one sub frame (1ms) for the measurement period. For other requirements, indexes of active UL slots are given by the slots satisfying $\text{mod}(\text{slot index}+1, 5) = 0$ with TDD UL-DL configuration specified in A.3.3.1.

NOTE 5: The RMCs apply to all channel bandwidth where $L_{\text{CRB}} \leq N_{\text{RB}}$.

Table A.2.3.2-2: Void

A.2.3.3 DFT-s-OFDM 16QAM

Table A.2.3.3-1: Reference Channels for DFT-s-OFDM 16QAM

Parameter	Allocated resource blocks (L_{CRB})	DFT-s-OFDM Symbols per slot (Note 1)	Modulation	MCS Index (Note 2)	Payload size	Transport block CRC	LDPC Base Graph	Number of code blocks per slot (Note 3)	Total number of bits per slot	Total modulated symbols per slot
Unit					Bits	Bits			Bits	
	1	11	16QAM	10	176	16	2	1	528	132
	16	11	16QAM	10	2792	16	2	1	8448	2112
	32	11	16QAM	10	5632	24	1	1	16896	4224
	64	11	16QAM	10	11272	24	1	2	33792	8448
	128	11	16QAM	10	22536	24	1	3	67584	16896
	256	11	16QAM	10	45096	24	1	6	135168	33792

NOTE 1:	PUSCH mapping Type-A and single-symbol DM-RS configuration Type-1 with 2 additional DM-RS symbols, such that the DM-RS positions are set to symbols 2, 7, 11. DMRS is [TDM'ed] with PUSCH data. DM-RS symbols are not counted.
NOTE 2:	MCS Index is based on MCS table 6.1.4.1-1 defined in 38.214.
NOTE 3:	If more than one Code Block is present, an additional CRC sequence of L = 24 Bits is attached to each Code Block (otherwise L = 0 Bit)
NOTE 4:	Indexes of active UL slots are given by Table A.2.3-1 with TDD UL-DL configuration specified in A2.3 for the requirements requiring at least one sub frame (1ms) for the measurement period. For other requirements, indexes of active UL slots are given by the slots satisfying $\text{mod}(\text{slot index}+1, 5) = 0$ with TDD UL-DL configuration specified in A.3.3.1.
NOTE 5:	The RMCs apply to all channel bandwidth where $L_{\text{CRB}} \leq N_{\text{RB}}$.

Table A.2.3.3-2: Void

A.2.3.4 DFT-s-OFDM 64QAM

Table A.2.3.4-1: Reference Channels for DFT-s-OFDM 64QAM

Parameter	Allocated resource blocks (L_{CRB})	DFT-s-OFDM Symbols per slot (Note 1)	Modulation	MCS Index (Note 2)	Payload size	Transport block CRC	LDPC Base Graph	Number of code blocks per slot (Note 3)	Total number of bits per slot	Total modulated symbols per slot
Unit					Bits	Bits			Bits	
	1	11	64QAM	18	408	16	2	1	792	132
	16	11	64QAM	18	6400	24	1	1	12672	2112
	32	11	64QAM	18	12808	24	1	2	25344	4224
	64	11	64QAM	18	25608	24	1	4	50688	8448
	128	11	64QAM	18	51216	24	1	7	101376	16896
	256	11	64QAM	18	102416	24	1	13	202752	33792

NOTE 1: PUSCH mapping Type-A and single-symbol DM-RS configuration Type-1 with 2 additional DM-RS symbols, such that the DM-RS positions are set to symbols 2, 7, 11. DMRS is [TDM'ed] with PUSCH data. DM-RS symbols are not counted.

NOTE 2: MCS Index is based on MCS table 6.1.4.1-1 defined in 38.214.

NOTE 3: If more than one Code Block is present, an additional CRC sequence of L = 24 Bits is attached to each Code Block (otherwise L = 0 Bit)

NOTE 4: Indexes of active UL slots are given by Table A.2.3-1 with TDD UL-DL configuration specified in A2.3 for the requirements requiring at least one sub frame (1ms) for the measurement period. For other requirements, indexes of active UL slots are given by the slots satisfying $\text{mod}(\text{slot index}+1, 5) = 0$ with TDD UL-DL configuration specified in A.3.3.1.

NOTE 5: The RMCs apply to all channel bandwidth where $L_{\text{CRB}} \leq N_{\text{RB}}$.

Table A.2.3.4-2: Void

A.2.3.5 CP-OFDM QPSK

Table A.2.3.5-1: Reference Channels for CP-OFDM QPSK

Parameter	Allocated resource blocks (L_{CRB})	DFT-s-OFDM Symbols per slot (Note 1)	Modulation	MCS Index (Note 2)	Payload size	Transport block CRC	LDPC Base Graph	Number of code blocks per slot (Note 3)	Total number of bits per slot	Total modulated symbols per slot
Unit					Bits	Bits			Bits	
	1	11	QPSK	2	48	16	2	1	264	132
	16	11	QPSK	2	808	16	2	1	4224	2112
	32	11	QPSK	2	1608	16	2	1	8448	4224
	33	11	QPSK	2	1672	16	2	1	8712	4356
	66	11	QPSK	2	3368	16	2	1	17424	8712
	132	11	QPSK	2	6536	24	2	2	34848	17424
	264	11	QPSK	2	13064	24	2	4	69696	34848

NOTE 1: PUSCH mapping Type-A and single-symbol DM-RS configuration Type-1 with 2 additional DM-RS symbols, such that the DM-RS positions are set to symbols 2, 7, 11. DMRS is [TDM'ed] with PUSCH data. DM-RS symbols are not counted.

NOTE 2: MCS Index is based on MCS table 5.1.3.1-1 defined in 38.214.

NOTE 3: If more than one Code Block is present, an additional CRC sequence of $L = 24$ Bits is attached to each Code Block (otherwise $L = 0$ Bit)

NOTE 4: Indexes of active UL slots are given by Table A.2.3-1 with TDD UL-DL configuration specified in A2.3 for the requirements requiring at least one sub frame (1ms) for the measurement period. For other requirements, indexes of active UL slots are given by the slots satisfying $\text{mod}(\text{slot index}+1, 5) = 0$ with TDD UL-DL configuration specified in A.3.3.1.

NOTE 5: The RMCs apply to all channel bandwidth where $L_{CRB} \leq N_{RB}$.

Table A.2.3.5-2: Void

A.2.3.6 CP-OFDM 16QAM

Table A.2.3.6-1: Reference Channels for CP-OFDM 16QAM

Parameter	Allocated resource blocks (L_{CRB})	DFT-s-OFDM Symbols per slot (Note 1)	Modulation	MCS Index (Note 2)	Payload size	Transport block CRC	LDPC Base Graph	Number of code blocks per slot (Note 3)	Total number of bits per slot	Total modulated symbols per slot
Unit					Bits	Bits			Bits	
	1	11	16QAM	10	176	16	2	1	528	132

	16	11	16QAM	10	2792	16	2	1	8448	2112
	32	11	16QAM	10	5632	24	1	1	16896	4224
	33	11	16QAM	10	5760	24	1	1	17424	4356
	66	11	16QAM	10	11528	24	1	2	34848	8712
	132	11	16QAM	10	23040	24	1	3	69696	17424
	264	11	16QAM	10	46104	24	1	6	139392	34848

NOTE 1: PUSCH mapping Type-A and single-symbol DM-RS configuration Type-1 with 2 additional DM-RS symbols, such that the DM-RS positions are set to symbols 2, 7, 11. DMRS is [TDM'ed] with PUSCH data. DM-RS symbols are not counted.

NOTE 2: MCS Index is based on MCS table 5.1.3.1-1 defined in 38.214.

NOTE 3: If more than one Code Block is present, an additional CRC sequence of L = 24 Bits is attached to each Code Block (otherwise L = 0 Bit)

NOTE 4: Indexes of active UL slots are given by Table A.2.3-1 with TDD UL-DL configuration specified in A2.3 for the requirements requiring at least one sub frame (1ms) for the measurement period. For other requirements, indexes of active UL slots are given by the slots satisfying $\text{mod}(\text{slot index}+1, 5) = 0$ with TDD UL-DL configuration specified in A.3.3.1.

NOTE 5: The RMCs apply to all channel bandwidth where $L_{\text{CRB}} \leq N_{\text{RB}}$.

Table A.2.3.6-2: Void

A.2.3.7 CP-OFDM 64QAM

Table A.2.3.7-1: Reference Channels for CP-OFDM 64QAM

Parameter	Allocated resource blocks (L_{CRB})	DFT-s-OFDM Symbols per slot (Note 1)	Modulation	MCS Index (Note 2)	Payload size	Transport block CRC	LDPC Base Graph	Number of code blocks per slot (Note 3)	Total number of bits per slot	Total modulated symbols per slot
Unit					Bits	Bits			Bits	
	1	11	64QAM	19	408	16	2	1	792	132
	16	11	64QAM	19	6400	24	1	1	12672	2112
	32	11	64QAM	19	12808	24	1	2	25344	4224
	33	11	64QAM	19	13064	24	1	2	26136	4356
	66	11	64QAM	19	26120	24	1	4	52272	8712
	132	11	64QAM	19	53288	24	1	7	104544	17424
	264	11	64QAM	19	106576	24	1	13	209088	34848

- NOTE 1: PUSCH mapping Type-A and single-symbol DM-RS configuration Type-1 with 2 additional DM-RS symbols, such that the DM-RS positions are set to symbols 2, 7, 11. DMRS is [TDM'ed] with PUSCH data. DM-RS symbols are not counted.
- NOTE 2: MCS Index is based on MCS table 5.1.3.1-1 defined in 38.214.
- NOTE 3: If more than one Code Block is present, an additional CRC sequence of $L = 24$ Bits is attached to each Code Block (otherwise $L = 0$ Bit)
- NOTE 4: Indexes of active UL slots are given by Table A.2.3-1 with TDD UL-DL configuration specified in A2.3 for the requirements requiring at least one sub frame (1ms) for the measurement period. For other requirements, indexes of active UL slots are given by the slots satisfying $\text{mod}(\text{slot index}+1, 5) = 0$ with TDD UL-DL configuration specified in A.3.3.1.
- NOTE 5: The RMCs apply to all channel bandwidth where $L_{\text{CRB}} \leq N_{\text{RB}}$.

Table A.2.3.7-2: Void

A.3 DL reference measurement channels

A.3.1 General

Unless otherwise stated, Tables A.3.3.2-1 and A.3.3.2-2 are applicable for measurements of the Receiver Characteristics (clause 7).

Unless otherwise stated, Tables A.3.3.2-1 and A.3.3.2-2 also apply for the modulated interferer used in Clauses 7.5 and 7.6 with test specific bandwidths.

CSI-RS configuration parameter defined in A.3.1-2 is used for verifying the beam correspondence requirement, 2 slots of CSI-RS shall be provided at each test grid point. The DL channel shall be configured for zero power on all tones except those used by CSI-RS in slots containing CSI-RS for beam refinement, and the DL and UL channel sizes shall be the same during verification.

Table A.3.1-1: Test parameters

Parameter		Unit	Value
CORESET frequency domain allocation			Full BW
CORESET time domain allocation			2 OFDM symbols at the begin of each slot
PDSCH mapping type			Type A
PDSCH start symbol index (S)			2
Number of consecutive PDSCH symbols (L)			12
PDSCH PRB bundling		PRBs	2
Dynamic PRB bundling			false
MCS table for TBS determination			64QAM
Overhead value for TBS determination			0
First DMRS position for Type A PDSCH mapping			2
DMRS type			Type 1
Number of additional DMRS			2
FDM between DMRS and PDSCH			Disable
CSI-RS for tracking	First subcarrier index in the PRB used for CSI-RS (k_0)		0 for CSI-RS resource 1,2
	OFDM symbols in the PRB used for CSI-RS		10 = 8 for CSI-RS resource 1 10 = 12 for CSI-RS resource 2
	Number of CSI-RS ports		1 for CSI-RS resource 1,2
	CDM Type		'No CDM' for CSI-RS resource 1,2
	Density (ρ)		3 for CSI-RS resource 1,2
	CSI-RS periodicity	Slots	60 kHz SCS: 80 for CSI-RS resources 1 and 2 120 kHz SCS: 160 for CSI-RS resources 1 and 2
	CSI-RS offset	Slots	60 kHz SCS: 40 for CSI-RS resources 1 and 2 120kHz SCS: 80 for CSI-RS resources 1 and 2
	Frequency Occupation		Start PRB 0 Number of PRB = BWP size
	QCL info		TCI state #0
PTRS configuration			PTRS is not configured

Table A.3.1-2: CSI-RS parameters

Resource Type	aperiodic
Resource Set Config	
repetition	on
aperiodicTriggeringOffset	Depending on UE capability
Resource Config	
nzp-CSI-RS-ResourceId	30 for resource #0
	31 for resource #1
	32 for resource #2
	33 for resource #3
	34 for resource #4
	35 for resource #5
	36 for resource #6

	37 for resource #7
powerControlOffset	0
powerControlOffsetSS	db0
nrofPorts	1
firstOFDMSymbolInTimeDomain	6 for resource #0
	7 for resource #1
	8 for resource #2
	9 for resource #3
	10 for resource #4
	11 for resource #5
	12 for resource #6
	13 for resource #7
cdm-Type	noCDM
density	3
nrofRBs	48 for channel bandwidth≥100MHz 32 for channel bandwidth=50MHz
qcl-info	Type D to SSB

The CSI-RS configuration parameter defined in Table A.3.1-3 is used for verifying the beam correspondence requirement. CSI-RS shall be provided once every 10msec.

Table A.3.1-3: CSI-RS parameters for CSI-RS based beam correspondence

Resource Type	aperiodic
Resource Set Config	
repetition	on
aperiodicTriggeringOffset	Depending on UE capability
Resource Config	
nzp-CSI-RS-ResourceId	30 for resource #0
	31 for resource #1
	32 for resource #2
	33 for resource #3
	...
	...
	...
	29+N for resource #(N-1), where N is <i>maxNumberRxBeam</i> in UE capability IE of <i>MIMO-ParametersPerBand</i>
powerControlOffset	0
powerControlOffsetSS	db0
nrofPorts	1
firstOFDMSymbolInTimeDomain	6 for resource #0
	7 for resource #1
	8 for resource #2
	9 for resource #3
	...
	...
	...
	5+N for resource #(N-1), where N= <i>maxNumberRxBeam</i> -1 in UE capability IE of <i>MIMO-ParametersPerBand</i>
cdm-Type	noCDM
density	3
nrofRBs	48 for channel bandwidth≥100MHz
	32 for channel bandwidth=50MHz
qcl-info	Type D to SSB

A.3.2 Void

A.3.3 DL reference measurement channels for TDD

A.3.3.1 General

Table A.3.3.1-1: Additional test parameters for TDD

Parameter		Value	
		SCS 60 kHz ($\mu=2$)	SCS 120 kHz ($\mu=3$)
UL-DL configuration	<i>referenceSubcarrierSpacing</i>	60 kHz	120 kHz
	<i>dl-UL-TransmissionPeriodicity</i>	1.25 ms	0.625 ms
	<i>nrofDownlinkSlots</i>	3	3
	<i>nrofDownlinkSymbols</i>	4	10
	<i>nrofUplinkSlot</i>	1	1
	<i>nrofUplinkSymbols</i>	4	2
Number of HARQ Processes		8	8
K1 value		K1 = 4 if $\text{mod}(i,5) = 0$ K1 =3 if $\text{mod}(i,5) = 1$ K1 =7 if $\text{mod}(i,5) = 2$ where i is slot index per frame; i = {0,...,39}	K1 = 4 if $\text{mod}(i,5) = 0$ K1 =3 if $\text{mod}(i,5) = 1$ K1 =7 if $\text{mod}(i,5) = 2$ where i is slot index per frame; i = {0,...,79}

A.3.3.2 FRC for receiver requirements for QPSK

Table A.3.3.2-1: Fixed Reference Channel for Receiver Requirements (SCS 60 kHz, TDD)

Parameter	Unit	Value		
Channel bandwidth	MHz	50	100	200
Subcarrier spacing configuration μ		2	2	2
Allocated resource blocks		66	132	264
Subcarriers per resource block		12	12	12
Allocated slots per Frame (NOTE 7)		23 / 24	23 / 24	23 / 24
MCS index		4	4	4
Modulation		QPSK	QPSK	QPSK
Target Coding Rate		1/3	1/3	1/3
Maximum number of HARQ transmissions		1	1	1
Information Bit Payload per Slot				
For Slots 0 and Slot i, if $\text{mod}(i, 5) = \{3,4\}$ for i from {0,...,79} (NOTE 5)	Bits	N/A	N/A	N/A
For Slot i, if $\text{mod}(i, 5) = \{0,1,2\}$ for i from {1,...,79} (NOTE 6)	Bits	4224	8456	16896
Transport block CRC	Bits	24	24	24
LDPC base graph		1	1	1
Number of Code Blocks per Slot				
For Slots 0 and Slot i, if $\text{mod}(i, 5) = \{3,4\}$ for i from {0,...,79} (NOTE 5)	CBs	N/A	N/A	N/A
For Slot i, if $\text{mod}(i, 5) = \{0,1,2\}$ for i from {1,...,79} (NOTE 6)	CBs	1	2	2
Binary Channel Bits Per Slot				
For Slots 0 and Slot i, if $\text{mod}(i, 5) = \{3,4\}$ for i from {0,...,79} (NOTE 5)	Bits	N/A	N/A	N/A
For Slot i, if $\text{mod}(i, 5) = \{0,1,2\}$ for i from {1,...,79} (NOTE 6)	Bits	14256	28512	57024
Max. Throughput averaged over 1 frame (NOTE 8)	Mbps	10.138	20.294	40.550

Note 1:	Additional parameters are specified in Table A.3.1-1 and Table A.3.3.1-1.
Note 2:	If more than one Code Block is present, an additional CRC sequence of L = 24 Bits is attached to each Code Block (otherwise L = 0 Bit).
Note 3:	SS/PBCH block is transmitted in slot 0 with periodicity 20 ms
Note 4:	Slot i is slot index per 2 frames
Note 5:	When this DL RMC used together with the UL RMC for the transmitter requirements requiring at least one sub frame (1ms) for the measurement period, Slot i, if $\text{mod}(i, 8) = \{3,4,5,6,7\}$ for i from $\{0, \dots, 79\}$ together with the TDD UL-DL configuration specified in A2.3.
Note 6:	When this DL RMC used together with the UL RMC for the transmitter requirements requiring at least one sub frame (1ms) for the measurement period, Slot i, if $\text{mod}(i, 8) = \{0,1,2\}$ for i from $\{0, \dots, 79\}$ together with the TDD UL-DL configuration specified in A2.3.
NOTE 7:	First number corresponds to the number slots allocated in the first frame of the RMC; second number corresponds to the number slots allocated in the second frame of the RMC.
NOTE 8:	Throughput is averaged over 2nd frame of RMC.

Table A.3.3.2-2: Fixed Reference Channel for Receiver Requirements (SCS 120 kHz, TDD)

Parameter	Unit	Value			
		50	100	200	400
Channel bandwidth	MHz	50	100	200	400
Subcarrier spacing configuration μ		3	3	3	3
Allocated resource blocks		32	66	132	264
Subcarriers per resource block		12	12	12	12
Allocated slots per Frame (NOTE 7)		47 / 48	47 / 48	47 / 48	47 / 48
MCS index		4	4	4	4
Modulation		QPSK	QPSK	QPSK	QPSK
Target Coding Rate		1/3	1/3	1/3	1/3
Maximum number of HARQ transmissions		1	1	1	1
Information Bit Payload per Slot					
For Slots 0 and Slot i, if $\text{mod}(i, 5) = \{3,4\}$ for i from $\{0, \dots, 159\}$ (NOTE 5)	Bits	N/A	N/A	N/A	N/A
For Slot i, if $\text{mod}(i, 5) = \{0,1,2\}$ for i from $\{1, \dots, 159\}$ (NOTE 6)	Bits	2088	4224	8456	16896
Transport block CRC	Bits	16	24	24	24
LDPC base graph		2	1	1	1
Number of Code Blocks per Slot					
For Slots 0 and Slot i, if $\text{mod}(i, 5) = \{3,4\}$ for i from $\{0, \dots, 159\}$ (NOTE 5)	CBs	N/A	N/A	N/A	N/A
For Slot i, if $\text{mod}(i, 5) = \{0,1,2\}$ for i from $\{1, \dots, 159\}$ (NOTE 6)	CBs	1	1	2	2
Binary Channel Bits Per Slot					
For Slots 0 and Slot i, if $\text{mod}(i, 5) = \{3,4\}$ for i from $\{0, \dots, 159\}$ (NOTE 5)	Bits	N/A	N/A	N/A	N/A
For Slot i, if $\text{mod}(i, 5) = \{0,1,2\}$ for i from $\{1, \dots, 159\}$ (NOTE 6)	Bits	6912	14256	28512	57024
Max. Throughput averaged over 1 frame (NOTE 8)	Mbps	10.022	20.275	40.589	81.101
Note 1:	Additional parameters are specified in Table A.3.1-1 and Table A.3.3.1-1.				
Note 2:	If more than one Code Block is present, an additional CRC sequence of L = 24 Bits is attached to each Code Block (otherwise L = 0 Bit).				
Note 3:	SS/PBCH block is transmitted in slot 0 with periodicity 20 ms				
Note 4:	Slot i is slot index per 2 frames				
Note 5:	When this DL RMC used together with the UL RMC for the transmitter requirements requiring at least one sub frame (1ms) for the measurement period, Slot i, if $\text{mod}(i, 16) = \{7, \dots, 15\}$ for i from $\{0, \dots, 159\}$ together with the TDD UL-DL configuration specified in A2.3.				
Note 6:	When this DL RMC used together with the UL RMC for the transmitter requirements requiring at least one sub frame (1ms) for the measurement period, Slot i, if $\text{mod}(i, 16) = \{0, \dots, 6\}$ for i from $\{0, \dots, 159\}$ together with the TDD UL-DL configuration specified in A2.3.				
NOTE 7:	First number corresponds to the number slots allocated in the first frame of the RMC; second number corresponds to the number slots allocated in the second frame of the RMC.				
NOTE 8:	Throughput is averaged over 2nd frame of RMC.				

Table A.3.3.2-3: FFS

Table A.3.3.2-4: FFS

Table A.3.3.2-5: Fixed Reference Channel for Receiver Requirements (SCS 60 kHz, TDD)

Parameter	Unit	Value		
Channel bandwidth	MHz	50	100	200
Subcarrier spacing configuration μ		2	2	2
Allocated resource blocks		66	132	264
Subcarriers per resource block		12	12	12
Allocated slots per Frame		23	23	23
MCS index		4	4	4
Modulation		QPSK	QPSK	QPSK
Target Coding Rate		1/3	1/3	1/3
Maximum number of HARQ transmissions		1	1	1
Information Bit Payload per Slot				
For Slots 0 and Slot i, if $\text{mod}(i, 5) = \{3,4\}$ for i from $\{0, \dots, 79\}$ (NOTE 5)	Bits	N/A	N/A	N/A
For Slot i, if $\text{mod}(i, 5) = \{0,1,2\}$ for i from $\{1, \dots, 79\}$ (NOTE 6)	Bits	8456	16896	33816
Transport block CRC	Bits	24	24	24
LDPC base graph		1	1	1
Number of Code Blocks per Slot				
For Slots 0 and Slot i, if $\text{mod}(i, 5) = \{3,4\}$ for i from $\{0, \dots, 79\}$ (NOTE 5)	CBs	N/A	N/A	N/A
For Slot i, if $\text{mod}(i, 5) = \{0,1,2\}$ for i from $\{1, \dots, 79\}$ (NOTE 6)	CBs	1	2	2
Binary Channel Bits Per Slot				
For Slots 0 and Slot i, if $\text{mod}(i, 5) = \{3,4\}$ for i from $\{0, \dots, 79\}$ (NOTE 5)	Bits	N/A	N/A	N/A
For Slot i, if $\text{mod}(i, 5) = \{0,1,2\}$ for i from $\{1, \dots, 79\}$ (NOTE 6)	Bits	28512	57024	114048
Max. Throughput averaged over 1 frame	Mbps	19.449	38.861	77.777
NOTE 1: Additional parameters are specified in Table A.3.1-1 and Table A.3.3.1-1.				
NOTE 2: If more than one Code Block is present, an additional CRC sequence of L = 24 Bits is attached to each Code Block (otherwise L = 0 Bit).				
NOTE 3: SS/PBCH block is transmitted in slot 0 with periodicity 20 ms				
NOTE 4: Slot i is slot index per 2 frames				
NOTE 5: When this DL RMC used together with the UL RMC for the transmitter requirements requiring at least one sub frame (1ms) for the measurement period, Slot i, if $\text{mod}(i, 8) = \{3,4,5,6,7\}$ for i from $\{0, \dots, 79\}$ together with the TDD UL-DL configuration specified in A2.3.				
NOTE 6: When this DL RMC used together with the UL RMC for the transmitter requirements requiring at least one sub frame (1ms) for the measurement period, Slot i, if $\text{mod}(i, 8) = \{0,1,2\}$ for i from $\{0, \dots, 79\}$ together with the TDD UL-DL configuration specified in A2.3.				

Table A.3.3.2-6: Fixed Reference Channel for Receiver Requirements (SCS 120 kHz, TDD)

Parameter	Unit	Value			
Channel bandwidth	MHz	50	100	200	400
Subcarrier spacing configuration μ		3	3	3	3
Allocated resource blocks		32	66	132	264
Subcarriers per resource block		12	12	12	12
Allocated slots per Frame		47	47	47	47
MCS index		4	4	4	4
Modulation		QPSK	QPSK	QPSK	QPSK
Target Coding Rate		1/3	1/3	1/3	1/3
Maximum number of HARQ transmissions		1	1	1	1
Information Bit Payload per Slot					
For Slots 0 and Slot i, if $\text{mod}(i, 5) = \{3,4\}$ for i from $\{0, \dots, 159\}$ (NOTE 5)	Bits	N/A	N/A	N/A	N/A

Parameter	Unit	Value			
For Slot i , if $\text{mod}(i, 5) = \{0,1,2\}$ for i from $\{1, \dots, 159\}$ (NOTE 6)	Bits	4096	8456	16896	33816
Transport block CRC	Bits	16	24	24	24
LDPC base graph		2	1	1	1
Number of Code Blocks per Slot					
For Slots 0 and Slot i , if $\text{mod}(i, 5) = \{3,4\}$ for i from $\{0, \dots, 159\}$ (NOTE 5)	CBs	N/A	N/A	N/A	N/A
For Slot i , if $\text{mod}(i, 5) = \{0,1,2\}$ for i from $\{1, \dots, 159\}$ (NOTE 6)	CBs	1	1	2	2
Binary Channel Bits Per Slot					
For Slots 0 and Slot i , if $\text{mod}(i, 5) = \{3,4\}$ for i from $\{0, \dots, 159\}$ (NOTE 5)	Bits	N/A	N/A	N/A	N/A
For Slot i , if $\text{mod}(i, 5) = \{0,1,2\}$ for i from $\{1, \dots, 159\}$ (NOTE 6)	Bits	13824	28512	57024	114048
Max. Throughput averaged over 1 frame	Mbps	19.660	40.589	81.101	162.317
NOTE 1: Additional parameters are specified in Table A.3.1-1 and Table A.3.3.1-1.					
NOTE 2: If more than one Code Block is present, an additional CRC sequence of $L = 24$ Bits is attached to each Code Block (otherwise $L = 0$ Bit).					
NOTE 3: SS/PBCH block is transmitted in slot 0 with periodicity 20 ms					
NOTE 4: Slot i is slot index per 2 frames					
NOTE 5: When this DL RMC used together with the UL RMC for the transmitter requirements requiring at least one sub frame (1 ms) for the measurement period, Slot i , if $\text{mod}(i, 16) = \{7, \dots, 15\}$ for i from $\{0, \dots, 159\}$ together with the TDD UL-DL configuration specified in A2.3.					
NOTE 6: When this DL RMC used together with the UL RMC for the transmitter requirements requiring at least one sub frame (1 ms) for the measurement period, Slot i , if $\text{mod}(i, 16) = \{0, \dots, 6\}$ for i from $\{0, \dots, 159\}$ together with the TDD UL-DL configuration specified in A2.3.					

A.3.3.3 FRC for receiver requirements for 16QAM

TBD

A.3.3.4 FRC for receiver requirements for 64QAM

Table A.3.3.4-1: Fixed Reference Channel for Receiver Requirements (SCS 60 kHz, TDD)

Parameter	Unit	Value		
Channel bandwidth	MHz	50	100	200
Subcarrier spacing configuration μ		2	2	2
Allocated resource blocks		66	132	264
Subcarriers per resource block		12	12	12
Allocated slots per Frame (NOTE 6)		23 / 24	23 / 24	23 / 24
MCS index		19	19	19
Modulation		64QAM	64QAM	64QAM
Target Coding Rate		1/2	1/2	1/2
Maximum number of HARQ transmissions		1	1	1
Information Bit Payload per Slot				
For Slots 0 and Slot i , if $\text{mod}(i, 5) = \{3,4\}$ for i from $\{0, \dots, 79\}$	Bits	N/A	N/A	N/A
For Slot i , if $\text{mod}(i, 10) = \{0,1,2\}$ for i from $\{1, \dots, 79\}$	Bits	20496	40976	81976
Transport block CRC	Bits	24	24	24
LDPC base graph		1	1	1
Number of Code Blocks per Slot				
For Slots 0 and Slot i , if $\text{mod}(i, 5) = \{3,4\}$ for i from $\{0, \dots, 79\}$	CBs	N/A	N/A	N/A
For Slot i , if $\text{mod}(i, 10) = \{0,1,2\}$ for i from $\{1, \dots, 79\}$	CBs	3	5	10
Binary Channel Bits Per Slot				
For Slots 0 and Slot i , if $\text{mod}(i, 5) = \{3,4\}$ for i from $\{0, \dots, 79\}$	Bits	N/A	N/A	N/A
For Slot i , if $\text{mod}(i, 5) = \{0,1,2\}$ for i from $\{1, \dots, 79\}$	Bits	40392	80784	161568

Max. Throughput averaged over 1 frame (NOTE 7)	Mbps	49.190	98.343	196.742
Note 1: Additional parameters are specified in Table A.3.1-1 and Table A.3.3.1-1. Note 2: If more than one Code Block is present, an additional CRC sequence of L = 24 Bits is attached to each Code Block (otherwise L = 0 Bit). Note 3: SS/PBCH block is transmitted in slot 0 with periodicity 20 ms Note 4: Slot i is slot index per 2 frames Note 5: PTRS is configured on symbols containing PDSCH with 1 port, per 2PRB in frequency domain, per symbol in time domain. Overhead for TBS calculation is assumed to be 6. NOTE 6: First number corresponds to the number slots allocated in the first frame of the RMC; second number corresponds to the number slots allocated in the second frame of the RMC. NOTE 7: Throughput is averaged over 2nd frame of RMC.				

Table A.3.3.4-2: Fixed Reference Channel for Receiver Requirements (SCS 120 kHz, TDD)

Parameter	Unit	Value			
		50	100	200	400
Channel bandwidth	MHz	50	100	200	400
Subcarrier spacing configuration μ		3	3	3	3
Allocated resource blocks		32	66	132	264
Subcarriers per resource block		12	12	12	12
Allocated slots per Frame (NOTE 6)		47 / 48	47 / 48	47 / 48	47 / 48
MCS index		19	19	19	19
Modulation		64QAM	64QAM	64QAM	64QAM
Target Coding Rate		1/2	1/2	1/2	1/2
Maximum number of HARQ transmissions		1	1	1	1
Information Bit Payload per Slot					
For Slots 0 and Slot i, if mod(i, 5) = {3,4} for i from {0,...,159}	Bits	N/A	N/A	N/A	N/A
For Slot i, if mod(i, 5) = {0,1,2} for i from {1,...,159}	Bits	9992	20496	40976	81976
Transport block CRC	Bits	24	24	24	24
LDPC base graph		1	1	1	1
Number of Code Blocks per Slot					
For Slots 0 and Slot i, if mod(i, 5) = {3,4} for i from {0,...,159}	CBs	N/A	N/A	N/A	N/A
For Slot i, if mod(i, 5) = {0,1,2} for i from {1,...,159}	CBs	2	3	5	10
Binary Channel Bits Per Slot					
For Slots 0 and Slot i, if mod(i, 5) = {3,4} for i from {0,...,159}	Bits	N/A	N/A	N/A	N/A
For Slot i, if mod(i, 5) = {0,1,2} for i from {1,...,159}	Bits	19584	40392	80784	161568
Max. Throughput averaged over 1 frame (NOTE 7)	Mbps	47.962	98.381	196.685	393.485
Note 1: Additional parameters are specified in Table A.3.1-1 and Table A.3.3.1-1. Note 2: If more than one Code Block is present, an additional CRC sequence of L = 24 Bits is attached to each Code Block (otherwise L = 0 Bit). Note 3: SS/PBCH block is transmitted in slot with periodicity 20 ms Note 4: Slot i is slot index per 2 frames Note 5: PTRS is configured on symbols containing PDSCH with 1 port, per 2PRB in frequency domain, per symbol in time domain. Overhead for TBS calculation is assumed to be 6. NOTE 6: First number corresponds to the number slots allocated in the first frame of the RMC; second number corresponds to the number slots allocated in the second frame of the RMC. NOTE 7: Throughput is averaged over 2nd frame of RMC.					

A.3.3.5 FRC for receiver requirements for 256QAM

Table A.3.3.5-1 Fixed Reference Channel for Receiver Requirements (SCS 60 kHz, TDD)

Parameter	Unit	Value		
		50	100	200
Channel bandwidth	MHz	50	100	200

Subcarrier spacing configuration μ		2	2	2
Allocated resource blocks		66	132	264
Subcarriers per resource block		12	12	12
Allocated slots per Frame (NOTE 6)		23 / 24	23 / 24	23 / 24
MCS index		24	24	24
Modulation		256QAM	256QAM	256QAM
Target Coding Rate		4/5	4/5	4/5
Maximum number of HARQ transmissions		1	1	1
Information Bit Payload per Slot				
For Slots 0 and Slot i, if mod(i, 5) = {3,4} for i from {0,...,79}	Bits	N/A	N/A	N/A
For Slot i, if mod(i, 5) = {0,1,2} for i from {1,...,79}	Bits	44040	88064	176208
Transport block CRC	Bits	24	24	24
LDPC base graph		1	1	1
Number of Code Blocks per Slot				
For Slots 0 and Slot i, if mod(i, 5) = {3,4} for i from {0,...,79}	CBs	N/A	N/A	N/A
For Slot i, if mod(i, 5) = {0,1,2} for i from {1,...,79}	CBs	6	11	21
Binary Channel Bits Per Slot				
For Slots 0 and Slot i, if mod(i, 5) = {3,4} for i from {0,...,79}	Bits	N/A	N/A	N/A
For Slot i, if mod(i, 5) = {0,1,2} for i from {1,...,79}	Bits	53856	107712	215424
Max. Throughput averaged over 1 frame (NOTE 7)	Mbps	105.696	211.354	422.899
<p>NOTE 1: Additional parameters are specified in Table A.3.1-1 and Table A.3.3.1-1.</p> <p>NOTE 2: If more than one Code Block is present, an additional CRC sequence of L = 24 Bits is attached to each Code Block (otherwise L = 0 Bit).</p> <p>NOTE 3: SS/PBCH block is transmitted in slot 0 of each frame</p> <p>NOTE 4: Slot i is slot index per 2 frames</p> <p>NOTE 5: PTRS is configured on symbols containing PDSCH with 1 port, per 2PRB in frequency domain, per symbol in time domain. Overhead for TBS calculation is assumed to be 6.</p> <p>NOTE 6: First number corresponds to the number slots allocated in the first frame of the RMC; second number corresponds to the number slots allocated in the second frame of the RMC.</p> <p>NOTE 7: Throughput is averaged over 2nd frame of RMC.</p>				

Table A.3.3.5-2 Fixed Reference Channel for Receiver Requirements (SCS 120 kHz, TDD)

Parameter	Unit	Value			
		50	100	200	400
Channel bandwidth	MHz	50	100	200	400
Subcarrier spacing configuration μ		3	3	3	3
Allocated resource blocks		32	66	132	264
Subcarriers per resource block		12	12	12	12
Allocated slots per Frame (NOTE 6)		47 / 48	47 / 48	47 / 48	47 / 48
MCS index		24	24	24	24
Modulation		256QAM	256QAM	256QAM	256QAM
Target Coding Rate		4/5	4/5	4/5	4/5
Maximum number of HARQ transmissions		1	1	1	1
Information Bit Payload per Slot					
For Slots 0 and Slot i, if mod(i, 5) = {3,4} for i from {0,...,159}	Bits	N/A	N/A	N/A	N/A
For Slot i, if mod(i, 5) = {0,1,2} for i from {1,...,159}	Bits	21504	44040	88064	176208
Transport block CRC	Bits	24	24	24	24
LDPC base graph		1	1	1	1
Number of Code Blocks per Slot					
For Slots 0 and Slot i, if mod(i, 5) = {3,4} for i from {0,...,159}	CBs	N/A	N/A	N/A	N/A
For Slot i, if mod(i, 5) = {0,1,2} for i from {1,...,159}	CBs	3	6	11	21

Binary Channel Bits Per Slot					
For Slots 0 and Slot i, if $\text{mod}(i, 5) = \{3,4\}$ for i from $\{0, \dots, 159\}$	Bits	N/A	N/A	N/A	N/A
For Slot i, if $\text{mod}(i, 5) = \{0,1,2\}$ for i from $\{1, \dots, 159\}$	Bits	26112	53856	107712	215424
Max. Throughput averaged over 1 frame (NOTE 7)	Mbps	103.219	211.392	422.707	845.798
NOTE 1: Additional parameters are specified in Table A.3.1-1 and Table A.3.3.1-1.					
NOTE 2: If more than one Code Block is present, an additional CRC sequence of L = 24 Bits is attached to each Code Block (otherwise L = 0 Bit).					
NOTE 3: SS/PBCH block is transmitted in slot 0 of each frame					
NOTE 4: Slot i is slot index per 2 frames					
NOTE 5: PTRS is configured on symbols containing PDSCH with 1 port, per 2PRB in frequency domain, per symbol in time domain. Overhead for TBS calculation is assumed to be 6.					
NOTE 6: First number corresponds to the number slots allocated in the first frame of the RMC; second number corresponds to the number slots allocated in the second frame of the RMC.					
NOTE 7: Throughput is averaged over 2nd frame of RMC.					

A.4 Void

A.5 OFDMA Channel Noise Generator (OCNG)

A.5.1 OCNG Patterns for FDD

TBD

A.5.2 OCNG Patterns for TDD

A.5.2.1 OCNG TDD pattern 1: Generic OCNG TDD Pattern for all unused REs

Table A.5.2.1-1: OP.1 TDD: Generic OCNG TDD Pattern for all unused REs

OCNG Distribution	Control Region (Core Set)	Data Region
OCNG Parameters		
Resources allocated	All unused REs (Note 1)	All unused REs (Note 2)
Structure	PDCCH	PDSCH
Content	Uncorrelated pseudo random QPSK modulated data	Uncorrelated pseudo random QPSK modulated data
Transmission scheme for multiple antennas ports transmission	Single Tx port transmission	Spatial multiplexing using any precoding matrix with dimensions same as the precoding matrix for PDSCH
Subcarrier Spacing	Same as for RMC PDCCH in the active BWP	Same as for RMC PDSCH in the active BWP
Power Level	Same as for RMC PDCCH	Same as for RMC PDSCH
Note 1: All unused REs in the active CORESETS appointed by the search spaces in use.		
Note 2: Unused available REs refer to REs in PRBs not allocated for any physical channels, CORESETs, synchronization signals or reference signals in channel bandwidth.		

A.6 FR2 RF tests with testability issues

Editor's note: Please note that the list of FR2 RF testability issues related to MU are maintained in in TR 38.903 Annex B.26.

A.6.1 FR2 RF tests with testability issues not related to Measurement Uncertainty (MU)

Editor's note: The list of FR2 RF testability issues not related to MU and listed in the table below is incomplete and ongoing updates.

Table A.6-1: FR2 RF test cases and testability issues not related to MU

Clause	Requirement	FR2 RF Testability issue not related to MU
6.2.2	UE maximum output power reduction	How to deal with power classes reusing PC3 MPR requirements, especially those defined from Release 17 and forward, and then the relationship with 6.2.2_1 test is FFS.
6.2D.1.1	UE maximum output power - EIRP and TRP for UL MIMO	No test points are defined for 2-layer UL MIMO since there is no configuration satisfying MPR=0dB requirements in RAN4.
6.3.2	Transmit OFF Power	Test Procedure aspects for UE indicating <i>ul-GapFR2-r17</i> is FFS
6.3.3.1	PRACH Time Mask	Further investigation is essential that how does beamforming affect the initial access procedure
6.3D.3.1	General ON/OFF time mask for UL MIMO	Testability of OFF power needs further study OTA test procedure for UL-MIMO is still under investigation
6.4.2.3	In-band emissions	Testing of the general in-band emission requirement and if yes at which UE Tx power level and with which relaxation applied to the requirement is FFS.
6.4A.2.2.1	Carrier leakage for CA (2UL CA)	This test is incomplete due to lack of RRC framework for LO position retrieval
6.4A.2.2.1	Carrier leakage for CA (2UL CA)	
6.4A.2.2.2	Carrier leakage for CA (3UL CA)	
6.4A.2.2.3	Carrier leakage for CA (4UL CA)	
6.4A.2.2.4	Carrier leakage for CA (5UL CA)	
6.4A.2.2.5	Carrier leakage for CA (6UL CA)	
6.4A.2.2.6	Carrier leakage for CA (7UL CA)	
6.4A.2.2.7	Carrier leakage for CA (8UL CA)	
6.4A.2.3.1	In-band emissions for CA (2UL CA)	Testing of the general in-band emission requirement and if yes at which UE Tx power level and with which relaxation applied to the requirement is FFS.
6.4A.2.3.2	In-band emissions for CA (3UL CA)	Testing of the general in-band emission requirement and if yes at which UE Tx power level and with which relaxation applied to the requirement is FFS.
6.4A.2.3.3	In-band emissions for CA (4UL CA)	Testing of the general in-band emission requirement and if yes at which UE Tx power level and with which relaxation applied to the requirement is FFS.
6.4A.2.3.4	In-band emissions for CA (5UL CA)	Testing of the general in-band emission requirement and if yes at which UE Tx power level and with which relaxation applied to the requirement is FFS.
6.4A.2.3.5	In-band emissions for CA (6UL CA)	Testing of the general in-band emission requirement and if yes at which UE Tx power level and with which relaxation applied to the requirement is FFS.
6.4A.2.3.6	In-band emissions for CA (7UL CA)	Testing of the general in-band emission requirement and if yes at which UE Tx power level and with which relaxation applied to the requirement is FFS.
6.4A.2.3.7	In-band emissions for CA (8UL CA)	Testing of the general in-band emission requirement and if yes at which UE Tx power level and with which relaxation applied to the requirement is FFS.
6.4.2.5	EVM spectral flatness for pi/2 BPSK modulation	Whether and, if yes, how to test the requirement on shaping filter is FFS.
6.6.3	Beam Correspondence in RRC_INACTIVE and initial access	Testability on which of the 2 approaches (without beamlock, with beamlock) to be used to verify the beam correspondence requirements needs further study.
7.9	Spurious Emissions	Connection diagram between SS and UE in TS 38.508-1 [10] Annex A is FFS.

Annex B (normative): Propagation conditions

B.0 No interference

The downlink connection between the System Simulator and the UE is without Additive White Gaussian Noise, and has no fading or multipath effects.

Annex C (normative): Downlink Physical Channels

C.0 Downlink signal levels

Editor's note: Consideration to minimize the required number of additional FR2 link is under discussion

The downlink power settings in Table C.0-1 is used unless otherwise specified in a test case.

Table C.0-1: Default Downlink power levels for NR

SCS (kHz)		Unit	Channel Bandwidth			
			50 MHz	100 MHz	200 MHz	400 MHz
60	Number of RBs		66	132	264	N/A
	Channel BW power	dBm	-70	-67	-64	N/A
120	Number of RBs		32	66	132	264
	Channel BW power	dBm	-70	-67	-64	-61
	SS/PBCH SSS EPRE	dBm/SCS	-99 for DL SCS = 60 kHz -96 for DL SCS = 120 kHz	-99 for DL SCS = 60 kHz -96 for DL SCS = 120 kHz	-99 for DL SCS = 60 kHz -96 for DL SCS = 120 kHz	-99 for DL SCS = 60 kHz -96 for DL SCS = 120 kHz
<p>Note 1: The channel bandwidth powers are informative, based on [-99]dBm/60kHz SS/PBCH SSS EPRE, then scaled according to the number of RBs and rounded to the nearest integer dBm value. Full RE allocation with no boost or deboost is assumed.</p> <p>Note 2: The power level is specified at the centre of quiet zone.</p> <p>Note 3: DL level is applied for any of the Subcarrier Spacing configuration (μ) with the same power spectrum density of [-99]dBm/60kHz.</p>						

The default downlink signal level uncertainty is +/- TBD dB, for any level specified. If the uncertainty value is critical for the test purpose, a tighter uncertainty is specified for the related test case in Annex F.

For TRP measurement, DL signal may be supplied from RSRP based pathloss compensation link. Downlink signal level using RSRP based pathloss compensation link is specified in Table C.0-2 or Table C.0-3.

Table C.0-2: Downlink power levels for RSRP based pathloss compensation link for TRP measurement for n257, n258 and n260

SCS (kHz)		Unit	Channel Bandwidth			
			50 MHz	100 MHz	200 MHz	400 MHz
60	Number of RBs		66	132	264	N/A
	Channel BW power	dBm	≥ -87	≥ -84	≥ -80	N/A
120	Number of RBs		32	66	132	264
	Channel BW power	dBm	≥ -87	≥ -84	≥ -80	≥ -77
	SS/PBCH SSS EPRE	dBm/SCS	≥ -115.5 for DL SCS = 60 kHz ≥ -112.5 for DL SCS = 120 kHz	≥ -115.5 for DL SCS = 60 kHz ≥ -112.5 for DL SCS = 120 kHz	≥ -115.5 for DL SCS = 60 kHz ≥ -112.5 for DL SCS = 120 kHz	≥ -115.5 for DL SCS = 60 kHz ≥ -112.5 for DL SCS = 120 kHz
<p>Note 1: The channel bandwidth powers are informative, based on -115.5dBm/60kHz SS/PBCH SSS EPRE, then scaled according to the number of RBs and rounded to the nearest integer dBm value. Full RE allocation with no boost or deboost is assumed.</p> <p>Note 2: The power level is specified at the RSRP reference point as defined in TS 38.215 [24].</p> <p>Note 3: DL level is applied for any of the Subcarrier Spacing configuration (μ) with the same power spectrum density of ≥ -115.5 dBm/60kHz.</p>						

Table C.0-3: Downlink power levels for RSRP based pathloss compensation link for TRP measurement for n261

SCS (kHz)		Unit	Channel Bandwidth			
			50 MHz	100 MHz	200 MHz	400 MHz
60	Number of RBs		66	132	264	N/A
	Channel BW power	dBm	≥ -84	≥ -81	≥ -78	N/A
120	Number of RBs		32	66	132	264
	Channel BW power	dBm	≥ -84	≥ -81	≥ -78	≥ -75
	SS/PBCH SSS EPRE	dBm/SCS	≥ -113 for DL SCS = 60 kHz ≥ -110 for DL SCS = 120 kHz	≥ -113 for DL SCS = 60 kHz ≥ -110 for DL SCS = 120 kHz	≥ -113 for DL SCS = 60 kHz ≥ -110 for DL SCS = 120 kHz	≥ -113 for DL SCS = 60 kHz ≥ -110 for DL SCS = 120 kHz

Note 1: The channel bandwidth powers are informative, based on -113dBm/60kHz SS/PBCH SSS EPRE, then scaled according to the number of RBs and rounded to the nearest integer dBm value. Full RE allocation with no boost or deboost is assumed.

Note 2: The power level is specified at the RSRP reference point as defined in TS 38.215 [24].

Note 3: DL level is applied for any of the Subcarrier Spacing configuration (μ) with the same power spectrum density of ≥ -113 dBm/60kHz.

C.1 General

The following clauses describes the downlink Physical Channels that are transmitted during a connection i.e., when measurements are done.

C.2 Setup

Table C.2-1 describes the downlink Physical Channels that are required for connection set up.

Table C.2-1: Downlink Physical Channels required for connection set-up

Physical Channel
PBCH
SSS
PSS
PDCCH
PDSCH
PBCH DMRS
PDCCH DMRS
PDSCH DMRS
CSI-RS
PTRS

As common PDSCH and PDCCH configuration parameters the parameters in Table A.3.1-1, C.2-2, C.2-3, and C.2-4 shall be used to bring up the connection setup for FR1 NR cell.

Table C.2-2: PDSCH and PDCCH configuration

Parameter	Unit	Value
Number of HARQ processes		8 (TDD)
Aggregation level	CCE	4

Table C.2-3: Additional test parameters for TDD for SCS 60 KHz

Parameter	Unit	UL-DL pattern
-----------	------	---------------

TDD Slot Configuration pattern (Note 1)			DDSU
Special Slot Configuration (Note 2)			11D+3G+0U
UL-DL configuration (<i>tdd-UL-DL-ConfigurationCommon</i>)	<i>referenceSubcarrierSpacing</i>	kHz	60
	<i>dl-UL-TransmissionPeriodicity</i>	ms	1
	<i>nrofDownlinkSlots</i>		2
	<i>nrofDownlinkSymbols</i>		11
	<i>nrofUplinkSlot</i>		1
			0
K1 value (PDSCH-to-HARQ-timing-indicator)			K1 = 3 if $\text{mod}(i,4) = 0$ K1 = 2 if $\text{mod}(i,4) = 1$ K1 = 5 if $\text{mod}(i,4) = 2$
Note 1: D denotes a slot with all DL symbols; S denotes a slot with a mix of DL, UL and guard symbols; U denotes a slot with all UL symbols. The field is for information.			
Note 2: D, G, U denote DL, guard and UL symbols, respectively. The field is for information.			
Note 3: i is the slot index per frame; $i = \{0, \dots, 39\}$			

Table C.2-4: Additional test parameters for TDD for SCS 120 KHz

Parameter	Unit	UL-DL pattern	
TDD Slot Configuration pattern (Note 1)		DDDSU	
Special Slot Configuration (Note 2)		10D+2G+2U	
UL-DL configuration (<i>tdd-UL-DL-ConfigurationCommon</i>)	<i>referenceSubcarrierSpacing</i>	kHz	120
	<i>dl-UL-TransmissionPeriodicity</i>	ms	0.625
	<i>nrofDownlinkSlots</i>		3
	<i>nrofDownlinkSymbols</i>		10
	<i>nrofUplinkSlot</i>		1
			2
K1 value (PDSCH-to-HARQ-timing-indicator)			K1 = [4] if $\text{mod}(i,5) = 0$ K1 = [3] if $\text{mod}(i,5) = 1$ K1 = [2] if $\text{mod}(i,5) = 2$ K1 = [6] if $\text{mod}(i,5) = 3$
Note 1: D denotes a slot with all DL symbols; S denotes a slot with a mix of DL, UL and guard symbols; U denotes a slot with all UL symbols. The field is for information.			
Note 2: D, G, U denote DL, guard and UL symbols, respectively. The field is for information.			
Note 3: i is the slot index per frame; $i = \{0, \dots, 79\}$			

C.3 Connection

C.3.0 Measurement of Transmitter Characteristics

Unless otherwise stated, Table C.3.0-1 is applicable for measurements on the Transmitter Characteristics (clause 6).

Table C.3.0-1: Downlink Physical Channels transmitted during a connection (TDD)

Parameter	Unit	Value
SSS transmit power	W	Test specific
EPRE ratio of PSS to SSS	dB	0
EPRE ratio of PBCH to SSS	dB	0
EPRE ratio of PBCH to PBCH DMRS	dB	0
EPRE ratio of PDCCH to SSS	dB	0
EPRE ratio of PDCCH to PDCCH DMRS	dB	0
EPRE ratio of PDSCH to SSS	dB	0
EPRE ratio of PDSCH to PDSCH DMRS (Note 1)	dB	-3
EPRE ratio of CSI-RS to SSS	dB	0
EPRE ratio of PTRS to PDSCH	dB	Test specific
EPRE ratio of OCNG DMRS to SSS	dB	0
EPRE ratio of OCNG to OCNG DMRS (Note 1)	dB	0
Note 1: No boosting is applied to any of the channels except PDSCH DMRS. For PDSCH DMRS, 3 dB power boosting is applied assuming DMRS Type 1 configuration when DMRS and PDSCH are TDM'ed and only half of the DMRS REs are occupied.		

Note 2: Number of DMRS CDM groups without data for PDSCH DMRS configuration for OCNG is set to 1.

C.3.1 Measurement of Receiver Characteristics

Unless otherwise stated, Table C.3.1-1 is applicable for measurements on the Receiver Characteristics (clause 7). For Adjacent channel selectivity testing, Table C.3.1-2 is applied.

Table C.3.1-1: Downlink Physical Channels transmitted during a connection (TDD)

Parameter	Unit	Value
SSS transmit power	W	Test specific
EPRE ratio of PSS to SSS	dB	0
EPRE ratio of PBCH to SSS	dB	0
EPRE ratio of PBCH to PBCH DMRS	dB	0
EPRE ratio of PDCCH to SSS	dB	0
EPRE ratio of PDCCH to PDCCH DMRS	dB	0
EPRE ratio of PDSCH to SSS	dB	0
EPRE ratio of PDSCH to PDSCH DMRS (Note 1)	dB	-3
EPRE ratio of CSI-RS to SSS	dB	0
EPRE ratio of PTRS to PDSCH	dB	Test specific
EPRE ratio of OCNG DMRS to SSS	dB	0
EPRE ratio of OCNG to OCNG DMRS (Note 1)	dB	0
Note 1: No boosting is applied to any of the channels except PDSCH DMRS. For PDSCH DMRS, 3 dB power boosting is applied assuming DMRS Type 1 configuration when DMRS and PDSCH are TDM'ed and only half of the DMRS REs are occupied.		
Note 2: Number of DMRS CDM groups without data for PDSCH DMRS configuration for OCNG is set to 1.		

Table C.3.1-2: PDCCH Aggregation Level for ACS testing

Parameter	Unit	Value	Comment
Aggregation level	CCE	4	CBW=50MHz when SCS=120kHz
		8	CBW=50MHz when SCS=60kHz CBW=100MHz when SCS=120kHz
		16	CBW>100 MHz when SCS=60kHz CBW>100 MHz when SCS=120kHz

Annex D (normative): Characteristics of the interfering signal

D.1 General

Unless otherwise stated, a modulated full bandwidth NR downlink signal, which equals to channel bandwidth of the wanted signal for Single Carrier case is used as interfering signals when RF performance requirements for NR UE receiver are defined. For intra-band contiguous CA case, a modulated NR downlink signal which equals to the aggregated channel bandwidth of the wanted signal is used.

D.2 Interference signals

Table D.2-1 describes the modulated interferer for different channel bandwidth options.

Table D.2-1: Description of modulated NR interferer

	Channel bandwidth for Single Carrier				Intra band contiguous CA
	50 MHz	100 MHz	200 MHz	400 MHz	
BW _{interferer}	50 MHz	100 MHz	200 MHz	400MHz	BW _{Channel_CA}
RB	NOTE1				
NOTE 1: The RB configured for interfering signal is the same as maximum RB number defined in Table 5.3.2-1 for each sub-carrier spacing.					

Annex E (normative): Global In-Channel TX-Test

NOTE: Clauses E.2.2 to E.5.9.3 are descriptions, which assume no power ramping adjacent to the measurement period.

E.1 General

The global in-channel TX test enables the measurement of all relevant parameters that describe the in-channel quality of the output signal of the TX under test in a single measurement process.

The parameters describing the in-channel quality of a transmitter, however, are not necessarily independent. The algorithm chosen for description inside this annex places particular emphasis on the exclusion of all interdependencies among the parameters.

E.2 Signals and results

E.2.1 Basic principle

The process is based on the comparison of the actual **output signal of the TX under test**, received by an ideal receiver, with a **reference signal**, that is generated by the measuring equipment and represents an ideal error free received signal. All signals are represented as equivalent (generally complex) baseband signals.

The description below uses numbers as examples. These numbers are taken from TDD with normal CP length and 100 MHz bandwidth with 60 kHz SCS. The application of the text below, however, is not restricted to this frame structure and bandwidth.

E.2.2 Output signal of the TX under test

The output signal of the TX under test is acquired by the measuring equipment and stored for further processing. It is sampled at a sampling rate of 122.88 Mbps. In the time domain it comprises at least 10 uplink subframes. The measurement period is derived by concatenating the correct number of individual uplink slots until the correct measurement period is reached. The output signal is named $z(v)$. Each slot is modelled as a signal with the following parameters: demodulated data content, carrier frequency, amplitude and phase for each subcarrier, timing, carrier leakage.

NOTE 1: TDD

Since the uplink subframes are not continuous, the n slots should be extracted from more than 1 continuous radio frame where

$$n = \begin{cases} 40, & \text{for 60 kHz SCS} \\ 80, & \text{for 120 kHz SCS} \end{cases}$$

E.2.3 Reference signal

Two types of reference signal are defined:

The reference signal $i_1(v)$ is constructed by the measuring equipment according to the relevant TX specifications, using the following parameters: demodulated data content, nominal carrier frequency, nominal amplitude and phase for each subcarrier, nominal timing, no carrier leakage. It is represented as a sequence of samples at a sampling rate of 122.88 Mbps in the time domain.

The reference signal $i_2(v)$ is constructed by the measuring equipment according to the relevant TX specifications, using the following parameters: restricted data content: nominal reference symbols, (all modulation symbols for user data symbols are set to 0V), nominal carrier frequency, nominal amplitude and phase for each applicable subcarrier, nominal timing, no carrier leakage. It is represented as a sequence of samples at a sampling rate of 122.88 Mbps in the time domain.

NOTE: The PUCCH is off during the time under test.

E.2.4 Measurement results

The measurement results, achieved by the global in channel TX test are the following:

- Carrier Frequency error
- EVM (Error Vector Magnitude)
- Carrier leakage
- Unwanted emissions, falling into non allocated resource blocks.
- EVM equalizer spectrum flatness

E.2.5 Measurement points

The unwanted emission falling into non-allocated RB(s) is calculated directly after the FFT as described below. In contrast to this, the EVM for the allocated RB(s) is calculated after the IDFT for DFT-s-OFDM or after the Tx-Rx chain equalizer for CP-OFDM. The samples after the TX-RX chain equalizer are used to calculate EVM equalizer spectrum flatness. Carrier frequency error and carrier leakage is calculated in the block "RF correction".

In case the parameter 3300 or 3301 is reported from UE via *txDirectCurrentLocation* IE (as defined in TS 38.331 [6]), carrier leakage measurement in the RF correction block shall be omitted. All statements from Annex E.3 onwards shall be read assuming that no carrier leakage has been measured.

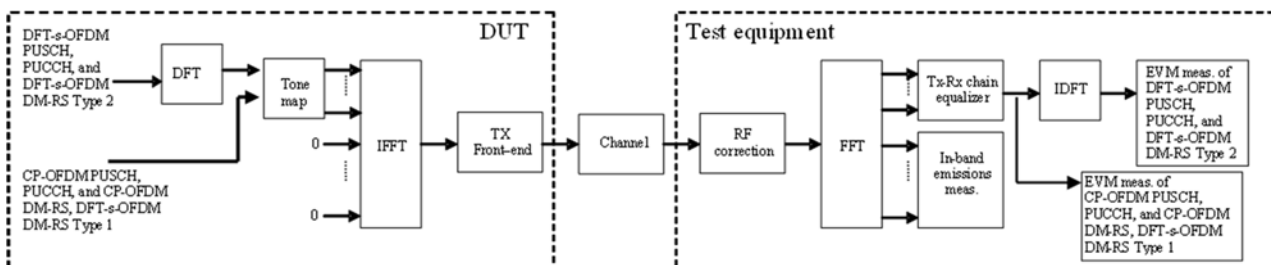

Figure E.2.5-1: EVM measurement points

E.3 Signal processing

E.3.1 Pre FFT minimization process

Before applying the pre-FFT minimization process, $z(v)$ and $i(v)$ are portioned into n pieces, comprising one slot each, where n is as defined in Annex E.2.2.

Each slot is processed separately. Sample timing, Carrier frequency and carrier leakage in $z(v)$ are jointly varied in order to minimise the difference between $z(v)$ and $i(v)$. Best fit (minimum difference) is achieved when the RMS difference value between $z(v)$ and $i(v)$ is an absolute minimum.

The carrier frequency variation and the IQ variation are the measurement results: Carrier Frequency Error and Carrier leakage.

From the acquired samples 10 carrier frequencies can be derived by averaging frequency errors for every 4 or 8 slots for 60 and 120 kHz SCS.

From the acquired samples n carrier frequencies and n carrier leakages can be derived.

NOTE 1: The minimisation process, to derive carrier leakage and RF error can be supported by Post FFT operations. However the minimisation process defined in the pre FFT domain comprises all acquired samples (i.e. it does not exclude the samples in between the FFT widths and it does not exclude the bandwidth outside the transmission bandwidth configuration)

NOTE 2: The algorithm would allow deriving Carrier Frequency error and Sample Frequency error of the TX under test separately. However there are no requirements for Sample Frequency error. Hence the algorithm models the RF and the sample frequency commonly (not independently). It returns one error and does not distinguish between both.

After this process the samples $z(v)$ are called $z^0(v)$.

E.3.2 Timing of the FFT window

The FFT window length is 2048 samples per OFDM symbol. 14 FFTs (28672 samples) cover less than the acquired number of samples (30720 samples). The position in time for FFT must be determined.

In an ideal signal, the FFT may start at any instant within the cyclic prefix without causing an error. The TX filter, however, reduces the window. The EVM requirements shall be met within a window $W < CP$. There are three different instants for FFT:

Centre of the reduced window, called $\Delta\tilde{c}$, $\Delta\tilde{c} - W/2$ and $\Delta\tilde{c} + W/2$.

The timing of the measured signal is determined in the pre FFT domain as follows, using $z^0(v)$ and $i_2(v)$:

1. The measured signal is delay spread by the TX filter. Hence the distinct borders between the OFDM symbols and between Data and CP are also spread and the timing is not obvious.
2. In the Reference Signal $i_2(v)$ the timing is known.
3. Correlation between (1.) and (2.) will result in a correlation peak. The meaning of the correlation peak is approx. the "impulse response" of the TX filter. The meaning of "impulse response" assumes that the autocorrelation of the reference signal $i_2(v)$ is a Dirac peak and that the correlation between the reference signal $i_2(v)$ and the data in the measured signal is 0. The correlation peak, (the highest, or in case of more than one, the earliest) indicates the timing in the measured signal.

From the acquired samples, n timings can be derived.

For all calculations, except EVM, the number of samples in $z^0(v)$ is reduced to 14 blocks of samples, comprising 2048 samples (FFT width) and starting with $\Delta\tilde{c}$ in each OFDM symbol including the demodulation reference signal.

For the EVM calculation the output signal under test is reduced to 28 blocks of samples, comprising 2048 samples (FFT width) and starting with $\Delta\tilde{c} - W/2$ and $\Delta\tilde{c} + W/2$ in each OFDM symbol including the demodulation reference signal.

The number of samples, used for FFT is reduced compared to $z^0(v)$. This subset of samples is called $z'(v)$.

The timing of the centre $\Delta\tilde{c}$ with respect to the different CP length in a slot is as follows: (TDD, normal CP length)

$\Delta\tilde{c}$ is on $T_f=72$ ($=CP/2$) within the CP of length 144 FFT samples (in OFDM symbols except 0 and 28 ($=7 \cdot 2^\mu$), where symbol 0 is the first symbol of each subframe) for channel bandwidth of 100 MHz and SCS = 60 kHz.

$\Delta\tilde{c}$ is on $T_f=136$ ($=208-72$) within the CP of length 208 FFT samples (in OFDM symbol 0 and 28 ($=7 \cdot 2^4$), where symbol 0 is the first symbol of each subframe) for channel bandwidth of 100 MHz and SCS = 60 kHz.

E.3.3 Post FFT equalisation

Perform 14 FFTs on $z'(v)$, one for each OFDM symbol in a slot using the timing $\Delta\tilde{c}$, including the demodulation reference symbol. The result is an array of samples, 14 in the time axis t times 2048 in the frequency axis f . The samples represent the data symbols (in OFDM-symbol 0,1,3,4,5,6,8,9,10,12,13 in each slot) and demodulation reference symbols (OFDM symbol 2, 7, 11 in each slot) in the allocated RBs and inband emissions in the non allocated RBs within the transmission BW.

Only the allocated resource blocks in the frequency domain are used for equalisation.

The nominal demodulation reference symbols and nominal data symbols are used to equalize the measured data symbols. (Location for equalization see Figure E.2.5-1)

NOTE: The nomenclature inside this note is local and not valid outside.

The nominal data symbols are created by a demodulation process. The location to gain the demodulated data symbols is "EVM" in Figure E.2.5-1. For CP-OFDM, the process described in Annex E.5 can be applied. A demodulation process as follows is recommended for DFT-s-OFDM:

1. Equalize the measured data symbols using the reference symbols for equalisation. Result: Equalized data symbols
2. Only for DFT-s-OFDM, iDFT transform the equalized data symbols: Result: Equalized data symbols
3. Decide for the nearest constellation point: Result: Nominal data symbols
4. Only for DFT-s-OFDM, DFT transform the nominal data symbols: Result: Nominal data symbols

At this stage we have an array of Measured data-Symbols and reference-Symbols ($MS(f,t)$)

versus an array of Nominal data-Symbols and reference Symbols ($NS(f,t)$)

(complex, the arrays comprise 11 data symbols and 3 demodulation reference symbol in the time axis and the number of allocated subcarriers in the frequency axis.)

$MS(f,t)$ and $NS(f,t)$ are processed with a least square (LS) estimator, to derive one equalizer coefficient per time slot and per allocated subcarrier. $EC(f)$ is defined as

$$EC(f) = \frac{\sum_{t=0}^{13} NS(f,t) * NS(f,t)}{\sum_{t=0}^{13} NS(f,t) * MS(f,t)}$$

With $*$ denoting complex conjugation.

$EC(f)$ are used to equalize the DFT-coded data symbols. The measured DFT-coded data and the references symbols are equalized by:

$$Z'(f,t) = MS(f,t) \cdot EC(f)$$

With \cdot denoting multiplication.

$Z'(f,t)$, restricted to the data symbol (excluding $t=2,7,11$) is used to calculate EVM, as described in E.4.1.

$EC(f)$ is used in E.4.4 to calculate EVM equalizer spectral flatness.

NOTE: The post FFT minimisation process is done over 14 symbols (11 DFT-coded data symbols and 3 reference symbols).

The samples of the non allocated resource blocks within the transmission bandwidth configuration in the post FFT domain are called $Y(f,t)$ (f covering the non allocated subcarriers within the transmission bandwidth configuration, t covering the OFDM symbols during 1 slot).

E.4 Derivation of the results

E.4.1 EVM

For EVM create two sets of $Z'(f,t)$, according to the timing " $\Delta\tilde{C} -W/2$ and $\Delta\tilde{C} +W/2$ " using the equalizer coefficients from E.3.3.

Perform the iDFTs on $Z'(f,t)$ in the case of DFT-s-OFDM waveform. The IDFT-decoding preserves the meaning of t but transforms the variable f (representing the allocated sub carriers) into another variable g , covering the same count and representing the demodulated symbols. The samples in the post IDFT domain are called $iZ'(g, t)$. The equivalent ideal samples are called $iI(g,t)$. Those samples of $Z'(f,t)$, carrying the reference symbols (=symbol 2,7,11) are not iDFT processed.

The EVM is the difference between the ideal waveform and the measured and equalized waveform for the allocated RB(s)

$$EVM = \sqrt{\frac{\sum_{t \in T} \sum_{g \in G} |iZ'(g, t) - iI(g, t)|^2}{|G| \cdot |T| \cdot P_0}},$$

where

t covers the count of demodulated symbols with the considered modulation scheme being active within the measurement period, (i.e. symbol 0,1,3,4,5,6,8,9,10,12,13 in each slot, $\rightarrow |T|=11$)

g covers the count of demodulated symbols with the considered modulation scheme being active within the allocated bandwidth. ($|G|=12 \cdot L_{CRBs}$ (with L_{CRBs} : number of allocated resource blocks)).

$iZ'(g, t)$ are the samples of the signal evaluated for the EVM.

$iI(g, t)$ is the ideal signal reconstructed by the measurement equipment, and

P_0 is the average power of the ideal signal. For normalized modulation symbols P_0 is equal to 1.

From the acquired samples $2n$ EVM values can be derived, n values for the timing $\Delta\tilde{C} -W/2$ and n values for the timing $\Delta\tilde{C} +W/2$

E.4.2 Averaged EVM

EVM is averaged over all basic EVM measurements.

The averaging comprises n UL slots

$$\overline{EVM} = \sqrt{\frac{1}{n} \sum_{i=1}^n EVM_i^2}$$

where

$$n = \begin{cases} 30, & \text{for 60 kHz SCS} \\ 60, & \text{for 120 kHz SCS} \end{cases}$$

for PUCCH, PUSCH.

The averaging is done separately for timing! $\Delta\tilde{c} -W/2$ and $\Delta\tilde{c} +W/2$ leading to \overline{EVM}_l and \overline{EVM}_h

$EVM_{final} = \max(\overline{EVM}_l, \overline{EVM}_h)$ is compared against the test requirements.

E.4.3 In-band emissions measurement

The in-band emissions are a measure of the interference falling into the non-allocated resources blocks.

Explanatory Note:

The inband emission measurement is only meaningful with allocated RB(s) next to non-allocated RB. The allocated RB(s) are necessary but not under test. The non allocated RBs are under test. The RB allocation for this test is as follows: The allocated RB(s) are at one end of the channel BW, leaving the other end unallocated. The number of allocated RB(s) is smaller than half of the number of RBs, available in the channel BW. This means that the vicinity of the carrier in the centre is unallocated.

There are 3 types of inband emissions:

1. General
2. IQ image
3. Carrier leakage

Carrier leakage are inband emissions next to the carrier.

IQ image are inband emissions symmetrically (with respect to the carrier) on the other side of the allocated RBs.

General are applied to all unallocated RBs.

For each evaluated RB, the minimum requirement is calculated as the higher of $P_{RB} - 30$ dB and the power sum of all limit values (General, IQ Image or Carrier leakage) that apply.

In specific the following combinations:

- Power (General)
- Power (General + Carrier leakage)
- Power (General + IQ Image)

1 and 2 is expressed in terms of power in one non allocated RB under test, normalized to the average power of an allocated RB (unit dB).

3 is expressed in terms of power in one non allocated RB, normalized to the power of all allocated RBs. (unit dBc).

This is the reason for two formulas *Emissions relative*.

Create one set of $Y(t,f)$ per slot according to the timing " $\Delta\tilde{c}$ "

For the non-allocated RBs below the in-band emissions are calculated as follows

$$Emissions_{absolute}(\Delta_{RB}) = \begin{cases} \frac{1}{|T_s|} \sum_{t \in T_s} \sum_{\substack{c_l + (12 \cdot \Delta_{RB} + 11) \cdot \Delta f \\ \max(f_{min}, (c_l + 12 \cdot \Delta_{RB} \cdot \Delta f))}} |Y(t, f)|^2, \Delta_{RB} < 0 \\ \frac{1}{|T_s|} \sum_{t \in T_s} \sum_{\substack{\min(f_{max}, (c_h + 12 \cdot \Delta_{RB} \cdot \Delta f)) \\ c_h + (12 \cdot \Delta_{RB} - 11) \cdot \Delta f}} |Y(t, f)|^2, \Delta_{RB} > 0 \end{cases},$$

where

the upper formula represents the in band emissions below the allocated frequency block and the lower one the in band emissions above the allocated frequency block.

T_s is a set of $|T_s|$ DFT-s-OFDM symbols with the considered modulation scheme being active within the measurement period,

Δ_{RB} is the starting frequency offset between the allocated RB and the measured non-allocated RB (e.g.

$\Delta_{RB}=1$ for the first upper or $\Delta_{RB}=-1$ for the first lower adjacent RB),

f_{\min} and f_{\max} are the lower and upper edge of the UL transmission BW configuration,

c_l and c_h are the lower and upper edge of the allocated BW,

Δf is the SCS, and

$Y(t, f)$ is the frequency domain signal evaluated for in-band emissions as defined in clause E.3.3

The allocated RB power per RB and the total allocated RB power are given by:

$$P_{RB} = \frac{1}{|T_s| \cdot L_{CRBS}} \sum_{t \in T_s} \sum_{c_1}^{c_1 + (12 \cdot L_{CRBS} - 1) \cdot \Delta f} |MS(t, f)|^2 [\text{dBm}/(12\Delta f)]$$

$$P_{All-RBs} = \frac{1}{|T_s|} \sum_{t \in T_s} \sum_{c_1}^{c_1 + (12 \cdot L_{CRBS} - 1) \cdot \Delta f} |MS(t, f)|^2 [\text{dBm}]$$

The relative in-band emissions, applicable for General and IQ image, are given by:

$$\begin{aligned} Emissions_{relative}(\Delta_{RB}) &= 10 \cdot \log_{10} \left(\frac{Emissions_{absolute}(\Delta_{RB})}{\frac{1}{|T_s| \cdot L_{CRBS}} \sum_{t \in T_s} \sum_{c_l}^{c_l + (12 \cdot L_{CRBS} - 1) \cdot \Delta f} |MS(t, f)|^2} \right) [\text{dB}] = \\ &= Emissions_{absolute}(\Delta_{RB}) [\text{dBm}/12\Delta f] - P_{RB} [\text{dBm}/12\Delta f] \end{aligned}$$

where

L_{CRBS} is the number of allocated resource blocks,

and

$MS(t, f)$ is the frequency domain samples for the allocated bandwidth, as defined in clause E.3.3.

The relative in-band emissions, applicable for carrier leakage, is given by:

$$\begin{aligned} Emissions_{relative} &= 10 \cdot \log_{10} \left(\frac{Emissions_{absolute}(RB_{nextDC})}{\frac{1}{|T_s|} \sum_{t \in T_s} \sum_{c_l}^{c_l + (12 \cdot L_{CRBS} - 1) \cdot \Delta f} |MS(t, f)|^2} \right) [\text{dBc}] \\ &= Emissions_{absolute}(RB_{nextDC}) [\text{dBm}/12\Delta f] - P_{All-RBs} [\text{dBm}] \end{aligned}$$

where RBnextDC means: Resource Block next to the carrier.

This can be one RB or one pair of RBs, depending whether the DC carrier is inside an RB or in-between two RBs.

Although an exclusion period may be applicable in the time domain, when evaluating EVM, the inband emissions measurement interval is defined over one complete slot in the time domain.

From the acquired samples n functions for general in band emissions and IQ image inband emissions can be derived. n values or n pairs of carrier leakage inband emissions can be derived. They are compared against different limits.

The in-band emissions are averaged over the n samples (equivalent to 10 UL subframes):

$$\overline{Emissions}_{absolute}(\Delta_{RB}) = \frac{1}{n} \sum_{i=1}^n Emissions_{absolute,i}(\Delta_{RB})$$

$$\overline{Emissions}_{relative}(\Delta_{RB}) = 10 * \log_{10} \left(\frac{1}{n} \sum_{i=1}^n 10^{Emissions_{relative,i}(\Delta_{RB})/10} \right) \quad [dB]$$

$$\overline{Emissions}_{relative} = 10 * \log_{10} \left(\frac{1}{n} \sum_{i=1}^n 10^{Emissions_{relative,i}/10} \right) \quad [dBc]$$

E.4.4 EVM equalizer spectrum flatness

For EVM equalizer spectrum flatness use EC(f) as defined in E.3.3.

NOTE: EC(f) represents equalizer coefficient $f \in F$, f is the allocated subcarriers within the transmission bandwidth ($(|F|=12 * L_{CRBs})$)

From the acquired samples n functions EC(f) can be derived.

EC(f) is broken down to 2 functions:

$$EC_1(f), f \in Range 1$$

$$EC_2(f), f \in Range 2$$

Where Range 1 and Range 2 are as defined in Table 6.5.2.4.5-1 for normal condition and Table 6.5.2.4.5-2 for extreme condition

The following peak to peak ripple is calculated:

$$RP_1 = 20 * \log(\max(|EC_1(f)|) / \min(|EC_1(f)|)) , \text{which denote the maximum ripple in Range 1}$$

$$RP_2 = 20 * \log(\max(|EC_2(f)|) / \min(|EC_2(f)|)) , \text{which denote the maximum ripple in Range 2}$$

$$RP_{12} = 20 * \log(\max(|EC_1(f)|) / \min(|EC_2(f)|)) , \text{which denote the maximum ripple between the upper side of Range 1 and lower side of Range 2}$$

$$RP_{21} = 20 * \log(\max(|EC_2(f)|) / \min(|EC_1(f)|)) , \text{which denote the maximum ripple between the upper side of Range 2 and lower side of Range 1}$$

E.4.5 Frequency error and Carrier leakage

See E.3.1.

E.4.6 EVM of Demodulation reference symbols (EVM_{DMRS})

For the purpose of EVM_{DMRS}, the steps E.2.2 to E.4.2 are repeated 6 times, constituting 6 EVM_{DMRS} sub-periods. The only purpose of the repetition is to cover the longer gross measurement period of EVM_{DMRS} (6 · n time slots) and to derive the FFT window timing per sub-period.

The bigger of the EVM results in one n TS period corresponding to the timing! Δc̃_{-W/2} or Δc̃_{+W/2} is compared against the limit. (Clause E.4.2) This timing is re-used for EVM_{DMRS} in the equivalent EVM_{DMRS} sub-period.

For EVM the demodulation reference symbols are excluded, while the data symbols are used. For EVM_{DMRS} the data symbols are excluded, while the demodulation references symbols are used. This is illustrated in figure E.4.6-1

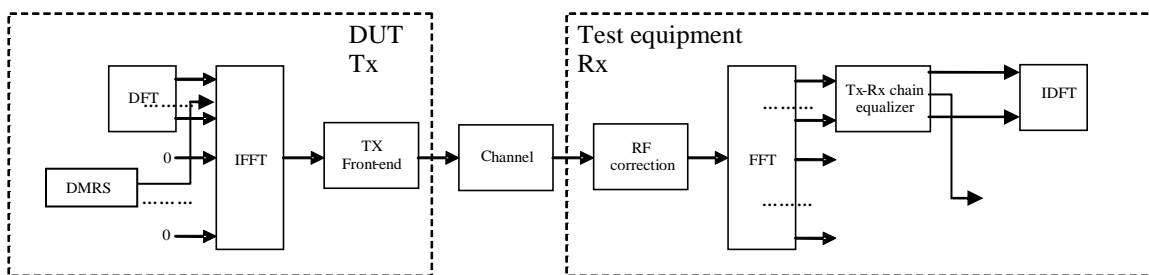

Figure E.4.6-1: EVM_{DMRS} measurement points

Re-use the following formula from E.3.3:

$$Z'(f,t) = MS(f,t) \cdot EC(f)$$

To calculate EVM_{DMRS}, the data symbol (t=0,1,3,4,5,6,8,9,10,12,13) in Z'(f,t) are excluded and only the reference symbols (t=2,7,11) is used.

The EVM_{DMRS} is the difference between the ideal waveform and the measured and equalized waveform for the allocated RB(s)

$$EVM_{DMRS} = \sqrt{\frac{\sum_{t \in T} \sum_{f \in F} |Z'(f,t) - I(f,t)|^2}{|T| \cdot P_0 \cdot |F|}},$$

where

t covers the count of demodulation reference symbols (i.e. symbols 2,7,11 in each slot, so count=3)

f covers the count of demodulation reference symbols within the allocated bandwidth. (|F|=12* L_{CRBs} (with L_{CRBs} : number of allocated resource blocks)).

Z'(f,t) are the samples of the signal evaluated for the EVM_{DMRS}

I(f,t) is the ideal signal reconstructed by the measurement equipment, and

P₀ is the average power of the ideal signal. For normalized modulation symbols P₀ is equal to 1.

n such results are generated per measurement sub-period.

E.4.6.1 1st average for EVM_{DMRS}

EVM_{DMRS} is averaged over all basic EVM_{DMRS} measurements in one sub-period

The averaging comprises n UL slots

$$1stEVM_{DMRS} = \sqrt{\frac{1}{n} \sum_{i=1}^n (EVM_{DMRS,i})^2}$$

The timing is taken from the EVM for the data. 6 of those results are achieved from the samples. In general the timing is not the same for each result.

E.4.6.2 Final average for EVM_{DMRS}

$$finalEVM_{DMRS} = \sqrt{\frac{1}{6} \sum_{i=1}^6 (1stEVM_{DMRS,i})^2}$$

E.5 EVM and inband emissions for PUCCH

For the purpose of worst case testing, the PUCCH shall be located on the edges of the Transmission Bandwidth Configuration (6,15,25,50,75,100 RBs).

The EVM for PUCCH (EVM_{PUCCH}) is averaged over n slots, where

$$n = \begin{cases} 30, & \text{for 60 kHz SCS} \\ 60, & \text{for 120 kHz SCS} \end{cases}$$

At least n TSs shall be transmitted by the UE without power change. SRS multiplexing shall be avoided during this period. The following transition periods are applicable: One OFDM symbol on each side of the slot border (instant of band edge alternation).

The description below is generic in the sense that all 5 PUCCH formats are covered. Although the number of OFDM symbols in one slot can be different from 7 (depending on the format, configuration and cyclic prefix length), the text below uses 7 without excluding the others.

E.5.1 Basic principle

The basic principle is the same as described in E.2.1

E.5.2 Output signal of the TX under test

The output signal of the TX under test is processed same as described in E.2.2

E.5.3 Reference signal

The reference signal is defined same as in E.2.3. Same as in E.2.3, $i_1(v)$ is the ideal reference for EVM_{PUCCH} and $i_2(v)$ is used to estimate the FFT window timing.

Note PUSCH is off during the PUCCH measurement period.

E.5.4 Measurement results

The measurement results are:

- EVM_{PUCCH}
- Inband emissions with the sub-results: General in-band emission, IQ image (according to: 38.101. Annex F.4, clause starting with: "At this stage the")

E.5.5 Measurement points

The measurement points are illustrated in the Figure E.2.5-1.

E.5.6 Pre FFT minimization process

The pre FFT minimisation process is the same as describes in clause E.3.1.

NOTE: although an exclusion period for EVM_{PUCCH} is applicable in E.5.9.1, the pre FFT minimisation process is done over the complete slot.

RF error, and carrier leakage are necessary for best fit of the measured signal towards the ideal signal in the pre FFT domain. However they are not used to compare them against the limits.

E.5.7 Timing of the FFT window

Timing of the FFT window is estimated with the same method as described in E.3.2.

E.5.8 Post FFT equalisation

The post FFT equalisation is described separately without reference to E.3.3:

Perform 14 FFTs on $z'(v)$, one for each OFDM symbol in a slot using the timing $\Delta\tilde{C}$, including the demodulation reference symbol. The result is an array of samples, 14 in the time axis t times 2048 in the frequency axis f . The samples represent the OFDM symbols (data and reference symbols) in the allocated RBs and inband emissions in the non allocated RBs within the transmission BW.

Only the allocated resource blocks in the frequency domain are used for equalisation.

The nominal reference symbols and **nominal** OFDM data symbols are used to equalize the measured data symbols.

Note: (The nomenclature inside this note is local and not valid outside)

The nominal OFDM data symbols are created by a demodulation process. A demodulation process as follows is recommended:

1. Equalize the measured OFDM data symbols using the reference symbols for equalisation. Result: Equalized OFDM data symbols
2. Decide for the nearest constellation point, however not independent for each subcarrier in the RB. 12 constellation points are decided dependent, using the applicable CAZAC sequence. Result: Nominal OFDM data symbols

At this stage we have an array of Masured data-Symbols and reference-Symbols ($MS(f,t)$)

versus an array of Nominal data-Symbols and reference Symbols ($NS(f,t)$)

The arrays comprise in sum 7 data and reference symbols, depending on the PUCCH format, in the time axis and the number of allocated sub-carriers in the frequency axis.

$MS(f,t)$ and $NS(f,t)$ are processed with a least square (LS) estimator, to derive one equalizer coefficient per time slot and per allocated subcarrier. $EC(f)$

$$EC(f) = \frac{\sum_{t=0}^6 NS(f,t)^* NS(f,t)}{\sum_{t=0}^6 MS(f,t)^* NS(f,t)}$$

With * denoting complex conjugation.

EC(f) are used to equalize the OFDM data together with the demodulation reference symbols by:

$$Z'(f,t) = MS(f,t) \cdot EC(f)$$

With · denoting multiplication.

Z'(f,t) is used to calculate EVM_{PUCCH}, as described in E.5.9.1

NOTE: although an exclusion period for EVM_{PUCCH} is applicable in E.5.9.1, the post FFT minimisation process is done over 7 OFDM symbols.

The samples of the non allocated resource blocks within the transmission bandwidth configuration in the post FFT domain are called Y(f,t) (f covering the non allocated subcarriers within the transmission bandwidth configuration, t covering the OFDM symbols during 1 slot).

E.5.9 Derivation of the results

E.5.9.1 EVM_{PUCCH}

For EVM_{PUCCH} create two sets of Z'(f,t), according to the timing " $\Delta\tilde{c} - W/2$ and " $\Delta\tilde{c} + W/2$ " using the equalizer coefficients from E.5.8

The EVM_{PUCCH} is the difference between the ideal waveform and the measured and equalized waveform for the allocated RB(s)

$$EVM_{PUCCH} = \sqrt{\frac{\sum_{t \in T} \sum_{f \in F} |Z'(f,t) - I(f,t)|^2}{|T| \cdot P_0 \cdot |F|}},$$

where

the OFDM symbols next to transition boards (instant of PUCCH frequency hopping) are excluded:

t covers less than the count of demodulated symbols in the slot (|T|=5)

f covers the count of subcarriers within the allocated bandwidth. (|F|=12)

Z'(f,t) are the samples of the signal evaluated for the EVM_{PUCCH}

I(f,t) is the ideal signal reconstructed by the measurement equipment, and

P₀ is the average power of the ideal signal. For normalized modulation symbols P₀ is equal to 1.

From the acquired samples 2n EVM_{PUCCH} value can be derived, n values for the timing " $\Delta\tilde{c} - W/2$ and n values for the timing " $\Delta\tilde{c} + W/2$ "

E.5.9.2 Averaged EVM_{PUCCH}

EVM_{PUCCH} is averaged over all basic EVM_{PUCCH} measurements

The averaging comprises n UL slots

$$\overline{EVM}_{PUCCH} = \sqrt{\frac{1}{n} \sum_{i=1}^n (EVM_{PUCCH,i})^2}$$

The averaging is done separately for timing! $\Delta\tilde{c} - W/2$ and $\Delta\tilde{c} + W/2$ leading to $\overline{EVM}_{PUCCH,low}$ and $\overline{EVM}_{PUCCH,high}$

$EVM_{PUCCH,final} = \max(\overline{EVM}_{PUCCH,low}, \overline{EVM}_{PUCCH,high})$ is compared against the test requirements.

E.5.9.3 In-band emissions measurement

The in-band emissions are a measure of the interference falling into the non-allocated resources blocks

Create one set of $Y(t,f)$ per slot according to the timing " $\Delta\tilde{c}$ "

For the non-allocated RBs the in-band emissions are calculated as follows

$$Emissions_{absolute}(\Delta_{RB}) = \begin{cases} \frac{1}{|T_s|} \sum_{t \in T_s} \sum_{c_l + (12 \cdot \Delta_{RB} + 1) \cdot \Delta f}^{c_l + (12 \cdot \Delta_{RB} + 11) \cdot \Delta f} |Y(t, f)|^2, \Delta_{RB} < 0 \\ \frac{1}{|T_s|} \sum_{t \in T_s} \sum_{c_h + (12 \cdot \Delta_{RB} - 11) \cdot \Delta f}^{\min(f_{max}, (c_h + 12 \cdot \Delta_{RB}) \cdot \Delta f)} |Y(t, f)|^2, \Delta_{RB} > 0 \end{cases},$$

where

the upper formula represents the inband emissions below the allocated frequency block and the lower one the inband emissions above the allocated frequency block.

T_s is a set of $|T_s|$ OFDM symbols in the measurement period,

Δ_{RB} is the starting frequency offset between the allocated RB and the measured non-allocated RB (e.g.

$\Delta_{RB} = 1$ for the first upper or $\Delta_{RB} = -1$ for the first lower adjacent RB),

f_{min} and f_{max} are the lower and upper edge of the UL system BW,

c_l and c_h are the lower and upper edge of the allocated BW,

Δf is the SCS, and

$Y(t, f)$ is the frequency domain signal evaluated for in-band emissions as defined in the subsection E.5.8

The relative in-band emissions are, given by

$$Emissions_{relative}(\Delta_{RB}) = 10 * \log_{10} \frac{Emissions_{absolute}(\Delta_{RB})}{\frac{1}{|T_s|} \cdot L_{CRBs} \sum_{t \in T_s} \sum_{c_1}^{c_1 + (12 \cdot L_{CRBs} - 1) \cdot \Delta f} |MS(t, f)|^2} [dB]$$

where

L_{CRBs} is the number of allocated RBs,

and $MS(t, f)$ is the frequency domain samples for the allocated bandwidth, as defined in the subsection E.5.8

Although an exclusion period for EVM is applicable in E.5.9.1, the inband emissions measurement interval is defined over one complete slot in the time domain.

From the acquired samples n functions for inband emissions can be derived.

The in-band emissions are averaged over the n samples (equivalent to 10 UL subframes) with the same PUCCH position to prevent averaging of allocated and non-allocated RBs due to PUCCH frequency hopping:

$$\overline{Emissions}_{absolute}(\Delta_{RB}) = \frac{1}{n} \sum_{i=1}^n Emissions_{absolute,i}(\Delta_{RB})$$

$$\overline{Emissions}_{relative}(\Delta_{RB}) = 10 * \log_{10} \left(\frac{1}{n} \sum_{i=1}^n 10^{Emissions_{relative,i}(\Delta_{RB})/10} \right) [dB]$$

Since the PUCCH allocation is always on the upper or lower band-edge, the opposite of the allocated one represents the IQ image, and the remaining inner RBs represent the general inband emissions. They are compared against different limits.

E.5.10 Modified signal under test

Implicit in the definition of EVM is an assumption that the receiver is able to compensate a number of transmitter impairments.

The DFT-s-OFDM modulated signals or PRACH signal under test is modified and, in the case of DFT-s-OFDM modulated signals, decoded according to:

$$Z'(t, f) = IDFT \left\{ \frac{FFT \left\{ z(v - \Delta\tilde{t}) \cdot e^{-j2\pi\Delta\tilde{f}v} \right\} e^{j2\pi f \Delta\tilde{t}}}{\tilde{a}(t, f) \cdot e^{j\tilde{\varphi}(t, f)}} \right\}$$

where

$z(v)$ is the time domain samples of the signal under test.

The CP-OFDM modulated signals or PUSCH demodulation reference signal or CP-OFDM modulated signals under test is equalised and, in the case of PUCCH data signal decoded according to:

$$Z'(t, f) = \frac{FFT \left\{ z(v - \Delta\tilde{t}) \cdot e^{-j2\pi\Delta\tilde{f}v} \right\} e^{j2\pi f \Delta\tilde{t}}}{\tilde{a}(t, f) \cdot e^{j\tilde{\varphi}(t, f)}}$$

where

$z(v)$ is the time domain samples of the signal under test.

To minimize the error, the signal under test should be modified with respect to a set of parameters following the procedure explained below.

Notation:

$\Delta\tilde{t}$ is the sample timing difference between the FFT processing window in relation to nominal timing of the ideal signal.

$\Delta\tilde{f}$ is the RF frequency offset.

$\tilde{\varphi}(t, f)$ is the phase response of the TX chain.

$\tilde{a}(t, f)$ is the amplitude response of the TX chain.

In the following $\Delta\tilde{c}$ represents the middle sample of the EVM window of length W (defined in the next clauses) or the last sample of the first window half if W is even.

The EVM analyser shall

- detect the start of each slot and estimate $\Delta\tilde{t}$ and $\Delta\tilde{f}$,
- determine $\Delta\tilde{c}$ so that the EVM window of length W is centred
 - on the time interval determined by the measured cyclic prefix minus 16κ samples of the considered OFDM symbol for symbol l for subcarrier spacing configuration μ in a subframe, with $l = 0$ or $l = 7 \cdot 2^\mu$ for normal CP, i.e. the first 16κ samples of the CP should not be taken into account for this step. In the determination of the number of excluded samples, a sampling rate of $1/T_c$ is assumed. If a different sampling rate is used, the number of excluded samples is scaled linearly.
 - on the measured cyclic prefix of the considered OFDM symbol for all other symbols for normal CP and for symbol 0 to 11 for extended CP.
 - on the measured preamble cyclic prefix for the PRACH

To determine the other parameters a sample timing offset equal to $\Delta\tilde{c}$ is corrected from the signal under test. The EVM analyser shall then

- correct the RF frequency offset $\Delta\tilde{f}$ for each time slot, and
- apply an FFT of appropriate size. The chosen FFT size shall ensure that in the case of an ideal signal under test, there is no measured inter-subcarrier interference.

The carrier leakage shall be removed from the evaluated signal before calculating the EVM and the in-band emissions; however, the removed relative carrier leakage power also has to satisfy the applicable requirement.

At this stage the allocated RBs shall be separated from the non-allocated RBs. In the case of PUCCH and PUSCH EVM, the signal on the non-allocated RB(s), $Y(t, f)$, is used to evaluate the in-band emissions.

Moreover, the following procedure applies only to the signal on the allocated RB(s).

- In the case of PUCCH and PUSCH, the UL EVM analyzer shall estimate the TX chain equalizer coefficients $\tilde{a}(t, f)$ and $\tilde{\varphi}(t, f)$ used by the ZF equalizer for all subcarriers by time averaging at each signal subcarrier of the amplitude and phase of the reference and data symbols. The time-averaging length is 1 slot. This process creates an average amplitude and phase for each signal subcarrier used by the ZF equalizer. The knowledge of data modulation symbols may be required in this step because the determination of symbols by demodulation is not reliable before signal equalization.
- In the case of PRACH, the UL EVM analyzer shall estimate the TX chain coefficients $\tilde{a}(t)$ and $\tilde{\varphi}(t)$ used for phase and amplitude correction and are selected so as to minimize the resulting EVM. The TX chain coefficients are not dependent on frequency, i.e. $\tilde{a}(t, f) = \tilde{a}(t)$ and $\tilde{\varphi}(t, f) = \tilde{\varphi}(t)$. The TX chain coefficients are chosen independently for each preamble transmission and for each $\Delta\tilde{t}$.

At this stage estimates of $\Delta\tilde{f}$, $\tilde{a}(t, f)$, $\tilde{\varphi}(t, f)$ and $\Delta\tilde{c}$ are available. $\Delta\tilde{t}$ is one of the extremities of the window W , i.e. $\Delta\tilde{t}$ can be $\Delta\tilde{c} + \alpha - \left\lfloor \frac{W}{2} \right\rfloor$ or $\Delta\tilde{c} + \left\lfloor \frac{W}{2} \right\rfloor$, where $\alpha = 0$ if W is odd and $\alpha = 1$ if W is even.

The EVM analyser shall then

- calculate EVM_l with $\Delta\tilde{f}$ set to $\Delta\tilde{c} + \alpha - \left\lfloor \frac{W}{2} \right\rfloor$,
- calculate EVM_h with $\Delta\tilde{f}$ set to $\Delta\tilde{c} + \left\lfloor \frac{W}{2} \right\rfloor$.

E.6 EVM for PRACH

The description below is generic in the sense that all PRACH formats are covered. The numbers, used in the text below are taken from PRACH format B4 without excluding the other formats. The sampling rate for the PUSCH, 122.88 Mbps in the time domain, is re-used for the PRACH. The carrier spacing of the PUSCH is up to 48 times higher than that of PRACH depending on the PRACH format and SCS. This results in an oversampling factor *ovf* of up to 48, when acquiring the time samples for the PRACH. The pre-FFT algorithms (clauses E.6.6 and E.6.7) use all time samples, although oversampled. For the FFT the time samples are decimated by the *ovf*, resulting in the same FFT size as for the other transmit modulation tests. Decimation requires a decision, which samples are used and which ones are rejected. The algorithm in E.6.6, Timing of the FFT window, can also be used to decide about the used samples.

E.6.1 Basic principle

The basic principle is the same as described in E.2.1

E.6.2 Output signal of the TX under test

The output signal of the TX under test is processed same as described in E.2.2

The measurement period is different since 2 PRACH preambles are recorded for long preamble formats as defined in Table 6.3.3.1-1 in [9] and 10 preambles are recorded for short preamble formats as defined in Table 6.3.3.1-2 in [9].

E.6.3 Reference signal

The test description in 6.4.2.1.4.1 is based on non-contention based access:

- PRACH configuration index (responsible for Preamble format, System frame number and subframe number)
- Preamble ID
- Preamble power

signalled to the UE, defines the reference signal unambiguously, such that no demodulation process is necessary to gain the reference signal.

The reference signal $i(v)$ is constructed by the measuring equipment according to the relevant TX specifications, using the following parameters: the applicable Zadoff Chu sequence, nominal carrier frequency, nominal amplitude and phase for each subcarrier, nominal timing, no carrier leakage. It is represented as a sequence of samples at a sampling rate of 122.88 Mbps in the time domain.

E.6.4 Measurement results

The measurement result is:

- $\text{EVM}_{\text{PRACH}}$

E.6.5 Measurement points

The measurement points are illustrated in the figure below:

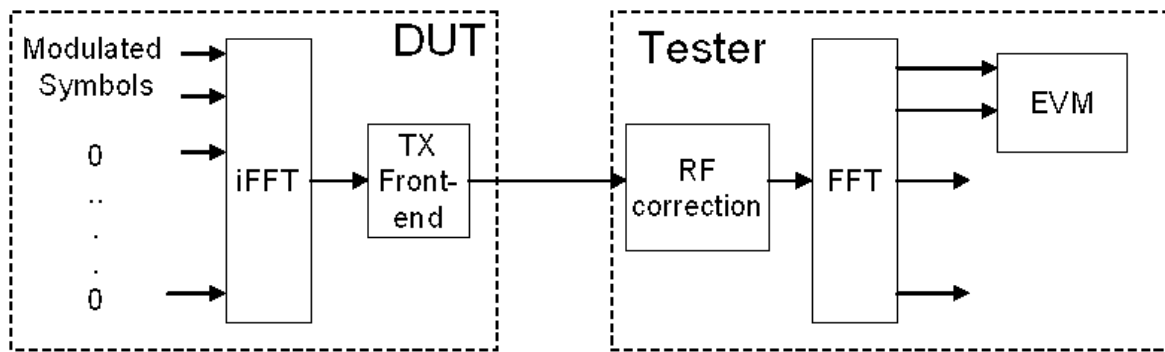

Figure E.6.5-1: Measurement points

E.6.6 Pre FFT minimization process

The pre-FFT minimization process is applied to each PRACH preamble separately. The time period for the pre-FFT minimisation process includes the complete CP and Zadoff-Chu sequence (in other words, the power transition period is per definition outside of this time period) Sample timing, Carrier frequency and carrier leakage in $z(v)$ are jointly varied in order to minimise the difference between $z(v)$ and $i(v)$. Best fit (minimum difference) is achieved when the RMS difference value between $z(v)$ and $i(v)$ is an absolute minimum.

After this process the samples $z(v)$ are called $z^0(v)$.

RF error, and carrier leakage are necessary for best fit of the measured signal towards the ideal signal in the pre FFT domain. However they are not used to compare them against the limits.

E.6.7 Timing of the FFT window

The FFT window length is $8192 \cdot 2^{-\mu}$ samples for preamble format B4, however in the measurement period at least $11936 \cdot 2^{-\mu}$ samples are taken where $\mu \in \{2,3\}$. The position in time for FFT must be determined.

In an ideal signal, the FFT may start at any instant within the cyclic prefix without causing an error. The TX filter, however, reduces the window. The EVM requirements shall be met within a window $W < CP$.

The reference instant for the FFT start is the centre of the reduced window, called $\Delta\tilde{c}$,

EVM is measured at the following two instants: $\Delta\tilde{c} - W/2$ and $\Delta\tilde{c} + W/2$.

The timing of the measured signal $z^0(v)$ with respect to the ideal signal $i(v)$ is determined in the pre FFT domain as follows:

Correlation between $z^0(v)$ and $i(v)$ will result in a correlation peak. The meaning of the correlation peak is approx. the "impulse response" of the TX filter. The correlation peak, (the highest, or in case of more than one, the earliest) indicates the timing in the measured signal with respect to the ideal signal.

W is different for different preamble formats and shown in Table E.6.7-1 for $L_{RA} = 139$ and $\Delta f^{RA} = 15 \cdot 2^{\mu}$ kHz where $\mu \in \{2,3\}$.

Table E.6.7-1 EVM window length for PRACH formats for $L_{RA} = 139$

Preamble format	Cyclic prefix length N_{cp}	Nominal FFT size ¹	EVM window length W in FFT samples	Ratio of W to CP*
A1	1152	8192	576	50.0%
A2	2304	8192	1728	75.0%
A3	3456	8192	2880	83.3%
B1	864	8192	288	33.3%
B2	1440	8192	864	60.0%
B3	2016	8192	1440	71.4%
B4	3744	8192	3168	84.6%
C0	4960	8192	4384	88.4%
C2	8192	8192	7616	93.0%

NOTE 1: The use of other FFT sizes is possible as long as appropriate scaling of the window length is applied.
NOTE 2: These percentages are informative.

The number of samples, used for FFT is reduced compared to $z^0(v)$. This subset of samples is called $z'(v)$.

The sample frequency 122.88 MHz is oversampled with respect to the PRACH-subcarrier spacing of $\Delta f^{RA} = 15 \cdot 2^\mu$ kHz. EVM is based on 8192 samples per PRACH preamble and requires decimation of the time samples by the factor of $12 \cdot 2^\mu$. The final number of samples per PRACH preamble, used for FFT is reduced compared to $z'(v)$ by the same factor. This subset of samples is called $z''(v)$.

E.6.8 Post FFT equalisation

Equalisation is not applicable for the PRACH.

E.6.9 Derivation of the results

E.6.9.1 EVM_{PRACH}

Perform FFT on $z'(v)$ and $i(v)$ using the FFT timing $\Delta\tilde{c} - W/2$ and $\Delta\tilde{c} + W/2$.

For format B4 the first and the repeated preamble sequence are FFT-converted separately using the standard FFT length of 8192.

The EVM_{PRACH} is the difference between the ideal waveform and the measured and equalized waveform for the allocated RB(s).

$$EVM_{PRACH} = \sqrt{\frac{\sum_{t \in T} \sum_{f \in F} |Z'(f, t) - I(f, t)|^2}{|T| \cdot P_0 \cdot |F|}}$$

where

t covers the count of demodulated symbols in the slot.

f covers the count of demodulated symbols within the allocated bandwidth.

$Z'(f, t)$ are the samples of the signal evaluated for the EVM_{PRACH}

$I(f, t)$ is the ideal signal reconstructed by the measurement equipment, and

P_0 is the average power of the ideal signal. For normalized modulation symbols P_0 is equal to 1.

From the acquired samples $2m$ EVM_{PRACH} values can be derived, m values for the timing $\Delta\tilde{c} -W/2$ and m values for the timing $\Delta\tilde{c} +W/2$.

E.6.9.2 Averaged EVM_{PRACH}

The PRACH EVM, EVM_{PRACH} , is averaged over m preamble sequence measurements.

$$\overline{EVM}_{PRACH} = \sqrt{\frac{1}{m} \sum_{i=1}^m (EVM_{PRACH,i})^2}$$

where m is the number of recorded preambles as defined in Annex E.6.2.

The averaging is done separately for timing $\Delta\tilde{c} -W/2$ and $\Delta\tilde{c} +W/2$ leading to $\overline{EVM}_{PRACH,low}$ and $\overline{EVM}_{PRACH,high}$

$EVM_{PRACH,final} = \max(\overline{EVM}_{PRACH,low}, \overline{EVM}_{PRACH,high})$ is compared against the test requirements.

E.6.10 Modified signal under test

Same as Annex E.5.10 and applies to EVM measurements on PRACH.

E.6.11 Phase offset measurement for DMRS bundling

E.6.11.1 Measurement point

The measurement point for phase offset measurement is defined in Figure F.8.1-1.

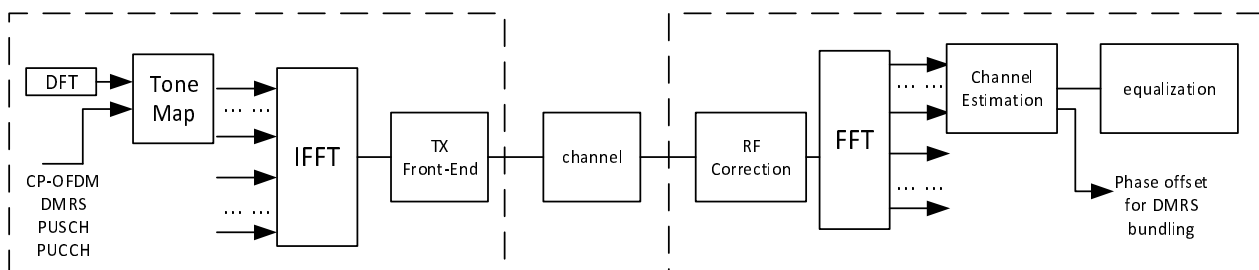

Figure F.8.1-1: Measurement point for phase offset for DMRS bundling

E.6.11.2 Symbols used

Phase offset is determined based on DMRS REs (3 DMRS symbols per slot) with the option to use data symbols.

E.6.11.3 Modified test signal

Same as described in Annex E.5.10 and Annex E.6.10.

E.6.11.4 Phase offset measurement

The phase offset measurement is based on the phase response of the Tx chain $\tilde{\varphi}(t, f)$ as derived based on Annex F.4.

The subcarrier at the carrier leakage frequency of the transmitted signal shall be excluded from the measured subcarriers.

The phase difference $\Delta\tilde{\varphi}(f)$ for each measured subcarrier between a reference timeslot t_{ref} and the measurement timeslot t_m is then calculated as defined below:

$$\Delta\tilde{\varphi}(f) = \tilde{\varphi}(t_m, f) - \tilde{\varphi}(t_{ref}, f)$$

The phase offset between the reference and measurement timeslots are then calculated as the maximum over the results for all measured subcarriers as shown below:

$$PhaseOffset = \max_f(|\Delta\tilde{\varphi}(f)|)$$

E.6.12 Void

E.7 EVM for dual transmit polarizations

E.7.1 General

A zero-forcing (ZF) MIMO receiver architecture is used so that transmissions by the UE, which are received by the test equipment on two polarizations, can be demodulated by the test equipment receiver.

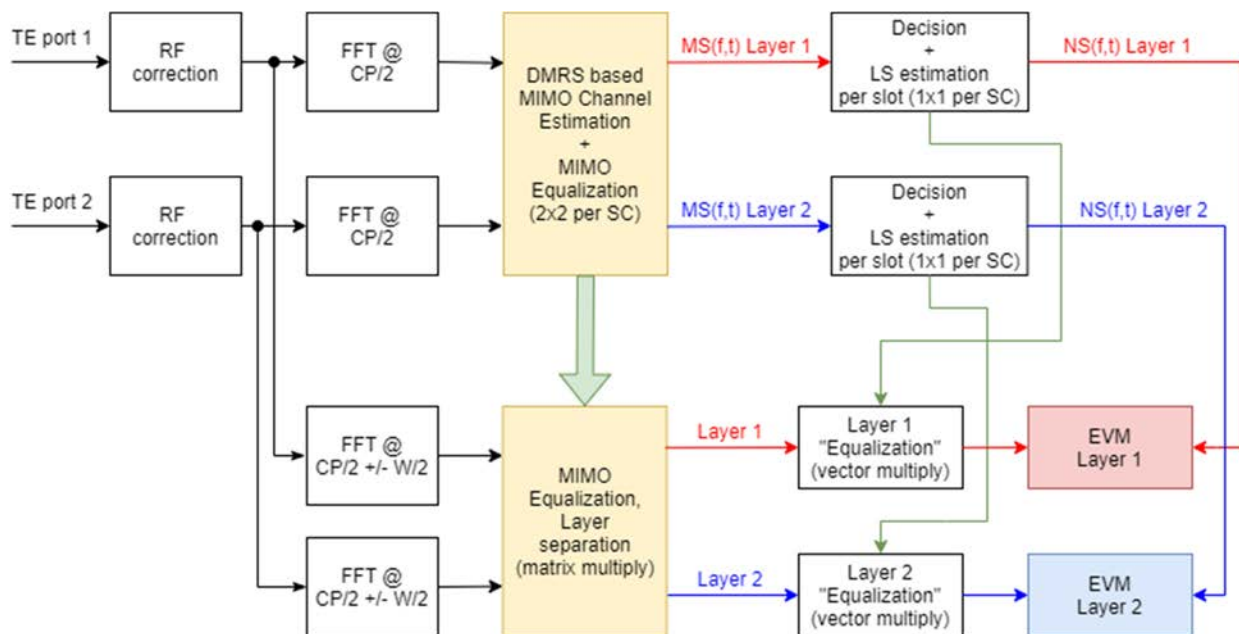

Figure E.7.1-1: EVM calculation block diagram for 2-Layer UL MIMO

The TE receives signals from 2 different ports on two antenna polarizations in the test system.

For UL MIMO measurements a MIMO equalization step as described in section E.7.2 is performed to separate the layers.

For single layer transmissions received on two polarizations the MIMO equalization step as described in section E.7.2 is replaced by a maximum ratio combining step as described in section E.7.3.

Each layer is then processed as described in section E.7.4 to receive the measurement results for each individual layer.

E.7.2 MIMO Equalization (UL MIMO transmission)

The MIMO equalization is based only on reference signals (DMRS) without using any data symbols. For the equalization process all available DMRS symbols shall be used.

The effective 2x2 channel matrix is estimated using reference signals of different subcarriers, e.g. in case of DMRS antenna ports 0 and 2. In case that same subcarriers are used, e.g. DMRS antenna ports 0 and 1, a channel

decomposition is necessary taking advantage of the orthogonal codes w_f and w_t and assuming identical channel coefficients for adjacent subcarriers of same CDM group.

Effective channel including the precoding matrix P is:

$$\tilde{H} = HP = \begin{bmatrix} \tilde{h}_{0,0} & \tilde{h}_{0,1} \\ \tilde{h}_{1,0} & \tilde{h}_{1,1} \end{bmatrix}$$

with

$$\tilde{h}_{n,v} = \frac{y_n r_v^*}{|r_v|^2}$$

where y denotes the received symbol on port index n and r the reference signal for layer index v .

Since reference signals of a specific layer are transmitted only on subcarriers of one CDM group channel, interpolation is needed in order to obtain channel coefficients for all subcarriers. Channel interpolation is done using the channel coefficients of active CDM group in all other CDM groups.

The channel coefficients used to calculate the equalizer coefficients are obtained after channel smoothing in frequency domain by computing the moving average of interpolated channel coefficients. The moving average window size is 7. For subcarriers at or near the edge of allocation the window size is reduced accordingly.

The ZF equalizer coefficients are calculated as the inverse of the effective channel matrix, in general:

$$G_{ZF} = \tilde{H}^{-1}$$

E.7.3 Maximum Ratio combining (Tx diversity transmission)

The maximum ratio combining is based only on reference signals (DMRS) without using any data symbols. For the equalization process all available DMRS symbols shall be used.

The effective 2x1 channel matrix is estimated using reference signals of different subcarriers. In case of transmit diversity, the effective channel includes the precoding matrix P :

$$\tilde{H} = HP = \begin{bmatrix} \tilde{h}_0 \\ \tilde{h}_1 \end{bmatrix}$$

with

$$\tilde{h}_n = \frac{y_n r^*}{|r|^2}$$

where y denotes the received symbol on port index n and r the reference signal.

Since reference signals are transmitted only on subcarriers of one CDM group, channel interpolation is needed in order to obtain channel coefficients for all subcarriers. Channel interpolation is done using the channel coefficients of active CDM group in all other CDM groups.

The channel coefficients used to calculate the equalizer coefficients are obtained after channel smoothing in frequency domain by computing the moving average of interpolated channel coefficients. The moving average window size is 7. For subcarriers at or near the edge of allocation the window size is reduced accordingly.

The ZF equalizer coefficients for maximum ratio combining are calculated as pseudo inverse of effective channel, in general:

$$G_{ZF} = \tilde{H}^+ = (\tilde{H}^H \tilde{H})^{-1} \tilde{H}^H$$

E.7.4 Layer processing

After performing either the MIMO equalization or maximum ratio combining as described in section E.7.2 or E.7.3 respectively, each layer is processed using the existing procedure as defined in Annex E.

Since the channel estimation is calculated only on the DMRS symbols, an averaging including all 14 symbols of one slot, i.e. data and reference signals, is needed in order to minimize EVM. The averaging is achieved by the least square (LS) equalization method described for single layer in Annex E.3.

$MS(f,t)$ and $NS(f,t)$ are processed with a LS estimator, to derive one equalizer coefficient per time slot and per allocated subcarrier. $EC(f)$ is defined for each layer as:

$$EC_v(f) = \frac{\sum_{t=0}^{13} NS_v(f,t) * NS_v(f,t)}{\sum_{t=0}^{13} MS_v(f,t) * NS_v(f,t)}$$

With * denoting complex conjugation. $EC(f)$ are used to equalize layer data symbols.

EVM equalizer spectral flatness is derived from equalizer coefficients for each layer as follows:

$$c_v = |EC_v(f)| \sqrt{|g_{v,0}|^2 + |g_{v,1}|^2}$$

Annex F (normative): Measurement uncertainties and Test Tolerances

F.1 Acceptable uncertainty of Test System (normative)

F.1.0 General

The maximum acceptable uncertainty of the Test System is specified below for each test, where appropriate. The Test System shall enable the stimulus signals in the test case to be adjusted to within the specified range, and the equipment under test to be measured with an uncertainty not exceeding the specified values. Care should be taken to ensure that each conformance test implementation including the OTA chamber aspects meets the specified measurement uncertainty for each test case by requiring the test laboratory to maintain a detailed measurement uncertainty test report showing compliance to all the measurement uncertainty requirements. The detailed measurement uncertainty report would contain the justification for each measurement uncertainty component and its value and distribution. The derivation of these values is based on the minimum conformance requirements plus relaxation, i.e., test tolerance is not to be considered. All ranges and uncertainties are absolute values, and are valid for a confidence level of 95 %, unless otherwise stated.

A confidence level of 95 % is the measurement uncertainty tolerance interval for a specific measurement that contains 95 % of the performance of a population of test equipment.

The downlink signal uncertainties apply at the defined quiet zone with the UE properly positioned in the quiet zone. The uplink signal uncertainties apply at the measurement equipment with the UE positioned properly in the quiet zone.

F.1.1 Measurement of test environments

Editor's note: Various measurement accuracies for UE test environments, e.g., pressure, relative humidity, DC&AC voltage, vibration, and vibration frequency, are FFS:

The measurement accuracy of the UE test environments defined in TS 38.508-1 [5] clause 4.1, Test environments shall be

- Temperature ± 4 degrees.

The above values shall apply unless the test environment is otherwise controlled and the specification for the control of the test environment specifies the uncertainty for the parameter.

F.1.2 Measurement of transmitter

Table F.1.2-1: Maximum Test System Uncertainty (MTSU) for transmitter tests

Sub clause	Maximum Test System Uncertainty	Derivation of MTSU
------------	---------------------------------	--------------------

<p>6.2.1.1 UE maximum output power (EIRP)</p>	<p><u>PC3</u> Minimum peak EIRP, Max EIRP Max Device size \leq 30 cm \pm5.08 dB (FR2a, NTC testing) \pm5.28 dB (FR2b, NTC testing) \pm6.64 dB (FR2c, NTC testing) \pm5.35 dB (FR2a, ETC testing) \pm5.55 dB (FR2b, ETC testing) \pm6.78 dB (FR2c, ETC testing)</p> <p><u>PC1</u> Minimum peak EIRP, Max EIRP Max Device size \leq 30 cm \pm5.33 dB (FR2a, NTC testing) \pm5.40 dB (FR2b, NTC testing) \pm5.60 dB (FR2a, ETC testing) \pm5.67 dB (FR2b, ETC testing)</p> <p><u>PC5</u> Minimum peak EIRP, Max EIRP Max Device size \leq 30 cm \pm5.33 dB (FR2a, NTC testing) \pm5.60 dB (FR2a, ETC testing)</p> <p><u>PC6</u> Minimum peak EIRP, Max EIRP Max Device size \leq 30 cm \pm5.31 dB (FR2a, NTC testing) \pm5.58 dB (FR2a, ETC testing)</p> <p><u>PC7</u> Minimum peak EIRP, Max EIRP Max Device size \leq 30 cm \pm5.08 dB (FR2a, NTC testing) \pm5.35 dB (FR2a, ETC testing)</p>	<p>MTSU = 1.00 x MU (from Table B.3-1 in TR 38.903)</p>
---	---	---

6.2.1.1 UE maximum output power (TRP)	<p><u>PC3</u> Max TRP Max Device size \leq 30 cm ± 4.61 dB (FR2a, NTC testing) ± 4.81 dB (FR2b, NTC testing) ± 6.16 dB (FR2c, NTC testing) ± 4.85 dB (FR2a, ETC testing) ± 5.07 dB (FR2b, ETC testing) ± 6.30 dB (FR2c, ETC testing)</p> <p><u>PC1</u> Max TRP Max Device size \leq 30 cm ± 4.64 dB (FR2a, NTC testing) ± 4.78 dB (FR2b, NTC testing) ± 4.90 dB (FR2a, ETC testing) ± 5.04 dB (FR2b, ETC testing)</p> <p><u>PC5</u> Max TRP Max Device size \leq 30 cm ± 4.64 dB (FR2a, NTC testing) ± 4.90 dB (FR2a, ETC testing)</p> <p><u>PC6</u> Max TRP Max Device size \leq 30 cm ± 4.64 dB (FR2a, NTC testing) ± 4.90 dB (FR2a, ETC testing)</p> <p><u>PC7</u> Max TRP Max Device size \leq 30 cm ± 4.61 dB (FR2a, NTC testing) ± 4.85 dB (FR2a, ETC testing)</p>	MTSU = 1.00 x MU (from Table B.3-2 in TR 38.903)
6.2.1.1_1 UE maximum output power – EIRP (Rel-16 and forward)	<u>Same as 6.2.1.1</u>	
6.2.1.2 UE maximum output power (Spherical coverage)	<p><u>PC3</u> Max Device size \leq 30 cm ± 4.78 dB (FR2a) ± 5.38 dB (FR2b) ± 6.84 dB (FR2c)</p> <p><u>PC1</u> Max Device size \leq 30 cm ± 4.69 dB (FR2a) ± 4.84 dB (FR2b)</p> <p><u>PC5</u> Max Device size \leq 30 cm ± 4.69 dB (FR2a)</p> <p><u>PC6</u> Max Device size \leq 30 cm ± 5.38 dB (FR2a)</p> <p><u>PC7</u> Max Device size \leq 30 cm ± 4.78 dB (FR2a)</p>	MTSU = 1.00 x MU (from Table B.3-3 in TR 38.903)
6.2.1.2_1 UE maximum output power – Spherical coverage (Rel16 and forward)	<u>Same as 6.2.1.2</u>	

6.2.2 UE maximum output power reduction	<p><u>PC3</u> Max Device size \leq 30 cm ± 5.11 dB (FR2a, NTC testing) ± 5.29 dB (FR2b, NTC testing) ± 6.89 dB (FR2c, NTC testing) ± 5.38 dB (FR2a, ETC testing) ± 5.56 dB (FR2b, ETC testing) ± 7.03 dB (FR2c, ETC testing)</p> <p><u>PC1</u> Max Device size \leq 30 cm ± 5.33 dB (FR2a, NTC testing) ± 5.50 dB (FR2b, NTC testing) ± 5.60 dB (FR2a, ETC testing) ± 5.77 dB (FR2b, ETC testing)</p> <p><u>PC5</u> Max Device size \leq 30 cm ± 5.33 dB (FR2a, NTC testing) ± 5.60 dB (FR2a, ETC testing)</p> <p><u>PC6</u> Max Device size \leq 30 cm ± 5.31 dB (FR2a, NTC testing) ± 5.58 dB (FR2a, ETC testing)</p> <p><u>PC7</u> Max Device size \leq 30 cm ± 5.11 dB (FR2a, NTC testing) ± 5.38 dB (FR2a, ETC testing)</p>	MTSU = 1.00 x MU (from Table B.4-1 in TR 38.903)
6.2.2_1 UE maximum output power reduction enhancements	Same as 6.2.2 for FR2a, FR2b, FR2c <u>PC3</u> Max Device size \leq 30 cm	MTSU = 1.00 x MU (from Table B.4-1 in TR 38.903)
6.2.3 UE maximum output power with additional requirements	Same as 6.2.2	
6.2.4 Configured transmitted power	TBD	
6.2.4_1 Configured transmitted power with Power Boost	Same as 6.2.1.1	
6.2.5 UE Maximum Output Power – EIRP with UL Gaps	<p><u>PC3</u> Max Device size \leq 30 cm $P_{UMAX,f,c_GAP_ON} - P_{UMAX,f,c_GAP_OFF}$: ± 1.7 dB (FR2a & FR2b, NTC testing) [± 1.7 dB] (FR2a & FR2b, ETC testing) $EIRP_{meas_peak}$: ± 5.11 dB (FR2a, NTC testing) ± 5.29 dB (FR2b, NTC testing) ± 5.38 dB (FR2a, ETC testing) ± 5.56 dB (FR2b, ETC testing)</p> <p><u>PC1</u> Max Device size \leq 30 cm $P_{UMAX,f,c_GAP_ON} - P_{UMAX,f,c_GAP_OFF}$: TBD (FR2a & FR2b, NTC testing) TBD (FR2a & FR2b, ETC testing) $EIRP_{meas_peak}$: ± 5.33 dB (FR2a, NTC testing) ± 5.50 dB (FR2b, NTC testing) ± 5.60 dB (FR2a, ETC testing) ± 5.77 dB (FR2b, ETC testing)</p>	MTSU = 1.00 x MU in TR 38.903

6.2A.1.1.1 UE maximum output power - EIRP and TRP for CA (2UL CA)	<p><u>Intra-band contiguous CA</u> Maximum aggregated BW \leq 400MHz Same as 6.2.1</p> <p>Maximum aggregated BW > 400MHz TBD</p> <p><u>Intra-band non-contiguous, Inter-band CA</u> TBD</p>	
6.2A.1.1.2 UE maximum output power - EIRP and TRP for CA (3UL CA)	<p><u>Intra-band contiguous CA</u> Maximum aggregated BW \leq 400MHz Same as 6.2.1</p> <p>Maximum aggregated BW > 400MHz TBD</p> <p><u>Intra-band non-contiguous, Inter-band CA</u> TBD</p>	
6.2A.1.1.3 UE maximum output power - EIRP and TRP for CA (4UL CA)	<p><u>Intra-band contiguous CA</u> Maximum aggregated BW \leq 400MHz Same as 6.2.1</p> <p>Maximum aggregated BW > 400MHz TBD</p> <p><u>Intra-band non-contiguous, Inter-band CA</u> TBD</p>	
6.2A.1.1.4 UE maximum output power - EIRP and TRP for CA (5UL CA)	<p><u>Intra-band contiguous CA</u> TBD</p>	
6.2A.1.1.5 UE maximum output power - EIRP and TRP for CA (6UL CA)	<p><u>Intra-band contiguous CA</u> TBD</p>	
6.2A.1.1.6 UE maximum output power - EIRP and TRP for CA (7UL CA)	<p><u>Intra-band contiguous CA</u> TBD</p>	
6.2A.1.1.7 UE maximum output power - EIRP and TRP for CA (8UL CA)	<p><u>Intra-band contiguous CA</u> TBD</p>	
6.2A.1.2.1 Spherical coverage for CA (2UL CA)	<p><u>Intra-band contiguous CA</u> Maximum aggregated BW \leq 400MHz <u>Same as 6.2.1.2</u></p> <p>Maximum aggregated BW > 400MHz TBD</p> <p><u>Intra-band non-contiguous, Inter-band CA</u> TBD</p>	
6.2A.1.2.2 Spherical coverage for CA (3UL CA)	<p><u>Intra-band contiguous CA</u> Maximum aggregated BW \leq 400MHz <u>Same as 6.2.1.2</u></p> <p>Maximum aggregated BW > 400MHz TBD</p> <p><u>Intra-band non-contiguous, Inter-band CA</u> TBD</p>	
6.2A.1.2.3 Spherical coverage for CA (4UL CA)	<p><u>Intra-band contiguous CA</u> Maximum aggregated BW \leq 400MHz <u>Same as 6.2.1.2</u></p> <p>Maximum aggregated BW > 400MHz TBD</p> <p><u>Intra-band non-contiguous, Inter-band CA</u> TBD</p>	
6.2A.1.2.4 Spherical coverage for CA (5UL CA)	<p><u>Intra-band contiguous CA</u> TBD</p>	

6.2A.1.2.5 Spherical coverage for CA (6UL CA)	<u>Intra-band contiguous CA</u> <u>TBD</u>	
6.2A.1.2.6 Spherical coverage for CA (7UL CA)	<u>Intra-band contiguous CA</u> <u>TBD</u>	
6.2A.1.2.7 Spherical coverage for CA (8UL CA)	<u>Intra-band contiguous CA</u> <u>TBD</u>	
6.2A.2.1 UE maximum output power reduction for CA (2UL CA)	<u>Intra-band contiguous CA</u> <u>Maximum aggregated BW \leq 400MHz</u> <u>Same as 6.2.2</u> <u>Maximum aggregated BW > 400MHz</u> <u>TBD</u> <u>Intra-band non-contiguous, Inter-band CA</u> <u>TBD</u>	MTSU = 1.00 x MU (from Table B.4-1 in TR 38.903)
6.2A.2.2 UE maximum output power reduction for CA (3UL CA)	<u>Intra-band contiguous CA</u> <u>Maximum aggregated BW \leq 400MHz</u> <u>Same as 6.2.2</u> <u>Maximum aggregated BW > 400MHz</u> <u>TBD</u> <u>Intra-band non-contiguous, Inter-band CA</u> <u>TBD</u>	
6.2A.2.3 UE maximum output power reduction for CA (4UL CA)	<u>Intra-band contiguous CA</u> <u>Maximum aggregated BW \leq 400MHz</u> <u>Same as 6.2.2</u> <u>Maximum aggregated BW > 400MHz</u> <u>TBD</u> <u>Intra-band non-contiguous, Inter-band CA</u> <u>TBD</u>	
6.2A.2.4 UE maximum output power reduction for CA (5UL CA)	<u>Intra-band contiguous CA</u> <u>TBD</u>	
6.2A.2.5 UE maximum output power reduction for CA (6UL CA)	<u>Intra-band contiguous CA</u> <u>TBD</u>	
6.2A.2.6 UE maximum output power reduction for CA (7UL CA)	<u>Intra-band contiguous CA</u> <u>TBD</u>	
6.2A.2.7 UE maximum output power reduction for CA (8UL CA)	<u>Intra-band contiguous CA</u> <u>TBD</u>	
6.2A.3.1 UE maximum output power with additional requirements for CA (2UL CA)	<u>Intra-band contiguous CA</u> <u>Maximum aggregated BW \leq 400MHz</u> <u>Same as 6.2.3</u> <u>Maximum aggregated BW > 400MHz</u> <u>TBD</u> <u>Intra-band non-contiguous, Inter-band CA</u> <u>TBD</u>	
6.2A.3.2 UE maximum output power with additional requirements for CA (3UL CA)	<u>Intra-band contiguous CA</u> <u>Maximum aggregated BW \leq 400MHz</u> <u>Same as 6.2.3</u> <u>Maximum aggregated BW > 400MHz</u> <u>TBD</u> <u>Intra-band non-contiguous, Inter-band CA</u> <u>TBD</u>	

6.2A.3.3 UE maximum output power with additional requirements for CA (4UL CA)	<u>Intra-band contiguous CA</u> <u>Maximum aggregated BW ≤ 400MHz</u> <u>Same as 6.2.3</u> <u>Maximum aggregated BW > 400MHz</u> <u>TBD</u> <u>Intra-band non-contiguous, Inter-band CA</u> <u>TBD</u>	
6.2D.1.1 UE maximum output power (EIRP) for UL MIMO	Same as 6.2.1.1 (EIRP)	
6.2D.1.1 UE maximum output power (TRP) for UL MIMO	Same as 6.2.1.1 (TRP)	
6.2D.1.2 UE maximum output power (Spherical coverage) for UL MIMO	Same as 6.2.1.2	
6.2D.2 UE maximum output power reduction for UL MIMO	Same as 6.2.2	
6.2D.3 UE maximum output power with additional requirements for UL MIMO	Same as 6.2.3	
6.2K.1 UE maximum output power for simultaneous transmission to multiple directions	FFS	FFS
6.3.1 Minimum output power	<u>PC1</u> Minimum peak EIRP, Max EIRP Max Device size ≤ 30 cm ±5.66 dB (FR2a, NTC testing) ±5.96 dB (FR2b, NTC testing) ±5.92 dB (FR2a, ETC testing) ±6.22 dB (FR2b, ETC testing) <u>PC3</u> Minimum peak EIRP, Max EIRP Max Device size ≤ 30 cm ±6.15 dB (FR2a & FR2b, NTC testing) ±7.34 dB (FR2c, NTC testing) ±6.41 dB (FR2a & FR2b, ETC testing) ±7.48 dB (FR2c, ETC testing) <u>PC5</u> Minimum peak EIRP, Max EIRP Max Device size ≤ 30 cm ±6.36 dB (FR2a, NTC testing) ±6.62 dB (FR2a, ETC testing) <u>PC6</u> Minimum peak EIRP, Max EIRP Max Device size ≤ 30 cm ±6.35 dB (FR2a, NTC testing) ±6.61 dB (FR2a, ETC testing) <u>PC7</u> Minimum peak EIRP, Max EIRP Max Device size ≤ 30 cm ±6.15 dB (FR2a, NTC testing) ±6.41 dB (FR2a, ETC testing)	MTSU = 1.00 x MU (from Table B.7-1 in TR 38.903)

6.3.2 Transmit OFF power	<p><u>PC3:</u> Max Device size \leq 30 cm ± 5.67 dB (FR2a) ± 5.67 dB (FR2b) ± 6.86 dB (FR2c)</p> <p><u>PC1:</u> Max Device size \leq 30 cm ± 5.67 dB (FR2a) ± 5.67 dB (FR2b)</p> <p><u>PC5, PC6:</u> Max Device size \leq 30 cm ± 5.67 dB (FR2a)</p>	MTSU = 1.00 x MU (from Table B.8-1 in TR 38.903)
6.3.3.2 General ON/OFF time mask	<p>ON power: Same as 6.2.1.1 (EIRP) for the respective power class</p> <p>OFF power: Same as 6.3.1 for the respective power class</p>	
6.3.3.4 PRACH time mask	<p><u>PC3:</u> PRACH power: TBD</p> <p>OFF power: Max Device size \leq 30 cm ± 6.15 dB (FR2a & FR2b, NTC testing) ± 6.41 dB (FR2a & FR2b, ETC testing)</p>	
6.3.3.6 SRS time mask	TBD	
6.3.4.2 Absolute power tolerance	<p><u>PC3</u> Max Device size \leq 30 cm ± 8.16 dB (FR2a & FR2b, NTC testing) ± 8.52 dB (FR2a & FR2b, ETC testing)</p>	<p>MTSU = SQRT (UL Meas Uncer² + DL Meas Uncer²) UL Meas Uncer: Same as 6.3.1 DL Meas Uncer: Same as 7.3.2</p>
6.3.4.3 Relative power tolerance	<p><u>PC3</u> Max Device size \leq 30 cm [± 1.7 dB] (FR2a) [± 1.7 dB] (FR2b)</p>	MTSU = 1.00 x MU (from Table B.9a.2.2-2 in TR 38.903)
6.3.4.4 Aggregate power tolerance	<p><u>PC3</u> Max Device size \leq 30 cm ± 1.4 dB (FR2a) ± 1.4 dB (FR2b)</p>	MTSU = 1.00 x MU (from Table B.9a.3.2-2 in TR 38.903)
6.3A.1.1 Minimum output power for CA (2UL CA)	<p>For UL CA aggregated BW \leq 800 MHz: Same as 6.3.1 for each CC</p> <p>For UL CA aggregated BW > 800 MHz: TBD</p>	
6.3A.1.2 Minimum output power for CA (3UL CA)	<p>For UL CA aggregated BW \leq 800 MHz: Same as 6.3.1 for each CC</p> <p>For UL CA aggregated BW > 800 MHz: TBD</p>	
6.3A.1.3 Minimum output power for CA (4UL CA)	<p>For UL CA aggregated BW \leq 800 MHz: Same as 6.3.1 for each CC</p> <p>For UL CA aggregated BW > 800 MHz: TBD</p>	
6.3A.1.4 Minimum output power for CA (5UL CA)	<p>For UL CA aggregated BW \leq 800 MHz: Same as 6.3.1 for each CC</p> <p>For UL CA aggregated BW > 800 MHz: TBD</p>	
6.3A.1.5 Minimum output power for CA (6UL CA)	<p>For UL CA aggregated BW \leq 800 MHz: Same as 6.3.1 for each CC</p> <p>For UL CA aggregated BW > 800 MHz: TBD</p>	
6.3A.1.6 Minimum output power for CA (7UL CA)	<p>For UL CA aggregated BW \leq 800 MHz: Same as 6.3.1 for each CC</p> <p>For UL CA aggregated BW > 800 MHz: TBD</p>	
6.3A.1.7 Minimum output power for CA (8UL CA)	<p>For UL CA aggregated BW \leq 800 MHz: Same as 6.3.1 for each CC</p> <p>For UL CA aggregated BW > 800 MHz: TBD</p>	

6.3A.3.1.1 General ON/OFF time mask for CA (2UL CA)	<p><u>Intra-band contiguous CA</u> Maximum aggregated BW \leq 400MHz Same as 6.3.3.2</p> <p>Maximum aggregated BW > 400MHz TBD</p> <p><u>Intra-band non-contiguous, Inter-band CA</u> TBD</p>	
6.3A.3.1.2 General ON/OFF time mask for CA (3UL CA)	<p><u>Intra-band contiguous CA</u> Maximum aggregated BW \leq 400MHz Same as 6.3.3.2</p> <p>Maximum aggregated BW > 400MHz TBD</p> <p><u>Intra-band non-contiguous, Inter-band CA</u> TBD</p>	
6.3A.3.1.3 General ON/OFF time mask for CA (4UL CA)	<p><u>Intra-band contiguous CA</u> Maximum aggregated BW \leq 400MHz Same as 6.3.3.2</p> <p>Maximum aggregated BW > 400MHz TBD</p> <p><u>Intra-band non-contiguous, Inter-band CA</u> TBD</p>	
6.3A.3.1.4 General ON/OFF time mask for CA (5UL CA)	<p><u>Intra-band contiguous CA</u> TBD</p>	
6.3A.3.1.5 General ON/OFF time mask for CA (6UL CA)	<p><u>Intra-band contiguous CA</u> TBD</p>	
6.3A.3.1.6 General ON/OFF time mask for CA (7UL CA)	<p><u>Intra-band contiguous CA</u> TBD</p>	
6.3A.3.1.7 General ON/OFF time mask for CA (8UL CA)	<p><u>Intra-band contiguous CA</u> TBD</p>	
6.3A.4.2.1 Absolute power tolerance for CA (2UL CA)	<p><u>Intra-band contiguous CA</u> Maximum aggregated BW \leq 400MHz Same as 6.3.4.2 for each CC.</p> <p>Maximum aggregated BW > 400MHz TBD</p> <p><u>Intra-band non-contiguous, Inter-band CA</u> TBD</p>	
6.3A.4.2.2 Absolute power tolerance for CA (3UL CA)	<p><u>Intra-band contiguous CA</u> Maximum aggregated BW \leq 400MHz Same as 6.3.4.2 for each CC.</p> <p>Maximum aggregated BW > 400MHz TBD</p> <p><u>Intra-band non-contiguous, Inter-band CA</u> TBD</p>	
6.3A.4.2.3 Absolute power tolerance for CA (4UL CA)	<p><u>Intra-band contiguous CA</u> Maximum aggregated BW \leq 400MHz Same as 6.3.4.2 for each CC.</p> <p>Maximum aggregated BW > 400MHz TBD</p> <p><u>Intra-band non-contiguous, Inter-band CA</u> TBD</p>	

6.3A.4.2.4 Absolute power tolerance for CA (5UL CA)	<p><u>Intra-band contiguous CA</u> Maximum aggregated BW \leq 400MHz Same as 6.3.4.2 for each CC.</p> <p>Maximum aggregated BW > 400MHz TBD</p> <p><u>Intra-band non-contiguous, Inter-band CA</u> TBD</p>	
6.3A.4.2.5 Absolute power tolerance for CA (6UL CA)	<p><u>Intra-band contiguous CA</u> Maximum aggregated BW \leq 400MHz Same as 6.3.4.2 for each CC.</p> <p>Maximum aggregated BW > 400MHz TBD</p> <p><u>Intra-band non-contiguous, Inter-band CA</u> TBD</p>	
6.3A.4.2.6 Absolute power tolerance for CA (7UL CA)	<p><u>Intra-band contiguous CA</u> Maximum aggregated BW \leq 400MHz Same as 6.3.4.2 for each CC.</p> <p>Maximum aggregated BW > 400MHz TBD</p> <p><u>Intra-band non-contiguous, Inter-band CA</u> TBD</p>	
6.3A.4.2.7 Absolute power tolerance for CA (8UL CA)	<p><u>Intra-band contiguous CA</u> Maximum aggregated BW \leq 400MHz Same as 6.3.4.2 for each CC.</p> <p>Maximum aggregated BW > 400MHz TBD</p> <p><u>Intra-band non-contiguous, Inter-band CA</u> TBD</p>	
6.3A.4.3.1 Relative power tolerance for CA (2UL CA)	<p><u>Intra-band contiguous CA</u> Maximum aggregated BW \leq 400MHz TBD</p> <p>Maximum aggregated BW > 400MHz TBD</p> <p><u>Intra-band non-contiguous, Inter-band CA</u> TBD</p>	
6.3A.4.3.2 Relative power tolerance for CA (3UL CA)	<p><u>Intra-band contiguous CA</u> Maximum aggregated BW \leq 400MHz TBD</p> <p>Maximum aggregated BW > 400MHz TBD</p> <p><u>Intra-band non-contiguous, Inter-band CA</u> TBD</p>	
6.3A.4.3.3 Relative power tolerance for CA (4UL CA)	<p><u>Intra-band contiguous CA</u> Maximum aggregated BW \leq 400MHz TBD</p> <p>Maximum aggregated BW > 400MHz TBD</p> <p><u>Intra-band non-contiguous, Inter-band CA</u> TBD</p>	

6.3A.4.3.4 Relative power tolerance for CA (5UL CA)	<u>Intra-band contiguous CA</u> TBD	
6.3A.4.3.5 Relative power tolerance for CA (6UL CA)	<u>Intra-band contiguous CA</u> TBD	
6.3A.4.3.6 Relative power tolerance for CA (7UL CA)	<u>Intra-band contiguous CA</u> TBD	
6.3A.4.3.7 Relative power tolerance for CA (8UL CA)	<u>Intra-band contiguous CA</u> TBD	
6.3A.4.4.1 Aggregate power tolerance for CA (2UL CA)	<u>Intra-band contiguous CA</u> Maximum aggregated BW \leq 400MHz Same as 6.3.4.4 for each CC. Maximum aggregated BW > 400MHz TBD <u>Intra-band non-contiguous, Inter-band CA</u> TBD	
6.3A.4.4.2 Aggregate power tolerance for CA (3UL CA)	<u>Intra-band contiguous CA</u> Maximum aggregated BW \leq 400MHz Same as 6.3.4.4 for each CC. Maximum aggregated BW > 400MHz TBD <u>Intra-band non-contiguous, Inter-band CA</u> TBD	
6.3A.4.4.3 Aggregate power tolerance for CA (4UL CA)	<u>Intra-band contiguous CA</u> Maximum aggregated BW \leq 400MHz Same as 6.3.4.4 for each CC. Maximum aggregated BW > 400MHz TBD <u>Intra-band non-contiguous, Inter-band CA</u> TBD	
6.3A.4.4.4 Aggregate power tolerance for CA (5UL CA)	<u>Intra-band contiguous CA</u> TBD	
6.3A.4.4.5 Aggregate power tolerance for CA (6UL CA)	<u>Intra-band contiguous CA</u> TBD	
6.3A.4.4.6 Aggregate power tolerance for CA (7UL CA)	<u>Intra-band contiguous CA</u> TBD	
6.3A.4.4.7 Aggregate power tolerance for CA (8UL CA)	<u>Intra-band contiguous CA</u> TBD	
6.3D.1 Minimum output power for UL MIMO	<u>PC1</u> Minimum peak EIRP, Max EIRP Max Device size \leq 30 cm ± 5.51 dB (FR2a, NTC testing) ± 5.66 dB (FR2b, NTC testing) <u>PC3:</u> Same as 6.3.1 for PC3 in NTC <u>PC5:</u> Same as 6.3.1 for PC5 in NTC <u>PC6:</u> Same as 6.3.1 for PC6 in NTC other PCs: TBD	MTSU = 1.00 x MU (from Table B.7-1 in TR 38.903)
6.3D.2 Transmit OFF power for UL MIMO	<u>Same as 6.3.2</u>	<u>Same as 6.3.2</u>

6.3D.3.1 General ON/OFF time mask for UL MIMO	<p>PC3: <u>OFF Power</u> Max Device size $\leq 30\text{cm}$ $\pm 6.15\text{ dB}$ (FR2a) $\pm 6.15\text{ dB}$ (FR2b)</p> <p><u>ON Power</u> Quiet Zone size $\leq 30\text{cm}$ TBD (FR2a) TBD (FR2b)</p>	<p><u>OFF Power</u> MTSU = $1.00 \times \text{MU}$ (from Table B.8-2-4 in TR 38.903)</p> <p><u>ON Power</u> TBD</p>
6.3D.3.4 SRS time mask for UL MIMO	<p>PC3: <u>OFF Power</u> Max Device size $\leq 30\text{cm}$ $\pm 6.15\text{ dB}$ (FR2a) $\pm 6.15\text{ dB}$ (FR2b)</p> <p><u>ON Power</u> Quiet Zone size $\leq 30\text{cm}$ TBD (FR2a) TBD (FR2b)</p>	<p><u>OFF Power</u> MTSU = $1.00 \times \text{MU}$ (from Table B.8-2-4 in TR 38.903)</p> <p><u>ON Power</u> TBD</p>
6.4.1 Frequency error	$\pm 0.01\text{ ppm}$ (NTC & ETC testing)	MTSU = $1.00 \times \text{MU}$ (from B.10.1 and B.10.2 in TR 38.903)
6.4.2.1 Error vector magnitude	<p>PUSCH, PC3, FR2a: As defined in Table F.1.2-2.</p> <p>PUSCH, PC3, FR2b: As defined in Table F.1.2-3.</p> <p>PUSCH, PC1, FR2a: 2.48% (BW 50MHz) 3.50% (BW 100MHz) 4.95% (BW 200MHz) 7.00% (BW 400MHz)</p> <p>PUSCH, PC5, PC6, FR2a: As defined in Table F.1.2-4.</p> <p>PUCCH, PC3, FR2a: 3.23% (BW 50MHz) 4.36% (BW 100MHz) 6.17% (BW 200MHz) 9.00% (BW 400MHz)</p> <p>PUCCH, PC3, FR2b: 4.39% (BW 50MHz) 6.05% (BW 100MHz) 8.62% (BW 200MHz) 12.51% (BW 400MHz)</p> <p>PUCCH, PC1, FR2a: 2.96% (BW 50MHz) 4.18% (BW 100MHz) 5.91% (BW 200MHz) 8.29% (BW 400MHz)</p> <p>PUCCH, PC5, PC6, FR2a: 2.56% (BW 50MHz) 3.63% (BW 100MHz) 5.14% (BW 200MHz) 7.31% (BW 400MHz)</p> <p>PRACH: TBD</p>	
6.4.2.1_1 Error vector magnitude with Power Boost	Same as 6.4.2.1 for PUSCH and PUCCH.	

6.4.2.2 Carrier leakage	<p><u>PC3</u> Max Device size \leq 30 cm</p> <p>± 5.44 dB (FR2a) ± 5.57 dB (FR2b)</p> <p><u>PC7</u> Max Device size \leq 30 cm</p> <p>± 5.44 dB (FR2a)</p> <p>uplink absolute power measurement uncertainty: 6.15 dB (FR2a & FR2b, NTC testing) uplink relative power measurement uncertainty: 1.4 dB (FR2a & FR2b, NTC testing)</p>	MTSU = 1.00 x MU (from Table B.11-1 in TR 38.903)
6.4.2.3 In-band emissions	TBD	
6.4.2.4 EVM equalizer spectrum flatness	TBD	
6.4.2.5 EVM equalizer spectrum flatness for BPSK modulation	TBD	
6.4A.1.1 Frequency error for CA (2UL CA)	<p><u>Intra-band contiguous CA</u> Maximum aggregated BW \leq 400MHz Same as 6.4.1</p> <p>Maximum aggregated BW > 400MHz TBD</p> <p><u>Intra-band non-contiguous, Inter-band CA</u> TBD</p>	
6.4A.1.2 Frequency error for CA (3UL CA)	<p><u>Intra-band contiguous CA</u> Maximum aggregated BW \leq 400MHz Same as 6.4.1</p> <p>Maximum aggregated BW > 400MHz TBD</p> <p><u>Intra-band non-contiguous, Inter-band CA</u> TBD</p>	
6.4A.1.3 Frequency error for CA (4UL CA)	<p><u>Intra-band contiguous CA</u> Maximum aggregated BW \leq 400MHz Same as 6.4.1</p> <p>Maximum aggregated BW > 400MHz TBD</p> <p><u>Intra-band non-contiguous, Inter-band CA</u> TBD</p>	
6.4A.1.4 Frequency error for CA (5UL CA)	<p><u>Intra-band contiguous CA</u> TBD</p>	
6.4A.1.5 Frequency error for CA (6UL CA)	<p><u>Intra-band contiguous CA</u> TBD</p>	
6.4A.1.6 Frequency error for CA (7UL CA)	<p><u>Intra-band contiguous CA</u> TBD</p>	
6.4A.1.7 Frequency error for CA (8UL CA)	<p><u>Intra-band contiguous CA</u> TBD</p>	
6.4A.2.1.1 Error Vector magnitude for CA (2UL CA)	TBD	
6.4A.2.1.2 Error Vector magnitude for CA (3UL CA)	TBD	
6.4A.2.1.3 Error Vector magnitude for CA (4UL CA)	TBD	
6.4A.2.1.4 Error Vector magnitude for CA (5UL CA)	TBD	
6.4A.2.1.5 Error Vector magnitude for CA (6UL CA)	TBD	

6.4A.2.1.6 Error Vector magnitude for CA (7UL CA)	TBD	
6.4A.2.1.7 Error Vector magnitude for CA (8UL CA)	TBD	
6.4A.2.2.1 Carrier leakage for CA (2UL CA)	<u>TBD</u>	
6.4A.2.2.2 Carrier leakage for CA (3UL CA)	<u>TBD</u>	
6.4A.2.2.3 Carrier leakage for CA (4UL CA)	<u>TBD</u>	
6.4A.2.2.4 Carrier leakage for CA (5UL CA)	<u>TBD</u>	
6.4A.2.2.5 Carrier leakage for CA (6UL CA)	<u>TBD</u>	
6.4A.2.2.6 Carrier leakage for CA (7UL CA)	<u>TBD</u>	
6.4A.2.2.7 Carrier leakage for CA (8UL CA)	<u>TBD</u>	
6.4A.2.3.1 In-band emissions for CA (2UL CA)	<u>TBD</u>	
6.4A.2.3.2 In-band emissions for CA (3UL CA)	<u>TBD</u>	
6.4A.2.3.3 In-band emissions for CA (4UL CA)	<u>TBD</u>	
6.4A.2.3.4 In-band emissions for CA (5UL CA)	<u>TBD</u>	
6.4A.2.3.5 In-band emissions for CA (6UL CA)	<u>TBD</u>	
6.4A.2.3.6 In-band emissions for CA (7UL CA)	<u>TBD</u>	
6.4A.2.3.7 In-band emissions for CA (8UL CA)	<u>TBD</u>	
6.4D.1 Frequency error for UL MIMO	Same as 6.4.1	Same as 6.4.1
6.5.1 Occupied bandwidth	<p>Max Device size \leq 30cm</p> <p><u>PC3 and PC1:</u> FR2a: ± 0.4 [%CBW] (BW 50MHz) ± 0.4 [%CBW] (BW 100MHz) ± 1.2 [%CBW] (BW 200MHz) ± 1.2 [%CBW] (BW 400MHz)</p> <p>FR2b: ± 0.4 [%CBW] (BW 50MHz) ± 0.4 [%CBW] (BW 100MHz) ± 1.3 [%CBW] (BW 200MHz) ± 1.3 [%CBW] (BW 400MHz)</p> <p><u>PC3:</u> FR2c: ± 0.65 [%CBW] (BW 50MHz) ± 0.65 [%CBW] (BW 100MHz) ± 1.3 [%CBW] (BW 200MHz) ± 1.5 [%CBW] (BW 400MHz)</p> <p><u>PC5, PC6:</u> FR2a: ± 0.4 [%CBW] (BW 50MHz) ± 0.4 [%CBW] (BW 100MHz) ± 1.2 [%CBW] (BW 200MHz) ± 1.2 [%CBW] (BW 400MHz)</p>	

6.5.2.1 Spectrum Emission Mask	<p>PC3 Max Device size \leq 30 cm ± 5.13 dB (FR2a) ± 5.51 dB (FR2b) ± 6.86 dB (FR2c)</p> <p>PC1 Max Device size \leq 30 cm ± 6.32 dB (FR2a) \pmFFS (FR2b)</p> <p>PC5, PC6 Max Device size \leq 30 cm ± 5.13 dB (FR2a)</p>	MTSU = 1.00 x MU (from Table B.16-1 in TR 38.903)
6.5.2.1_1 Spectrum Emission Mask with Power Boost	Same as 6.5.2.1	
6.5.2.3 Adjacent Channel Leakage Ratio	<p>PC3 Max Device size \leq 30cm</p> <p>FR2a, NTC & ETC testing: ± 5.63 dB (BW \leq 50MHz) ± 6.09 dB (50MHz < BW \leq 100MHz) ± 6.09 dB (100MHz < BW \leq 200MHz) ± 6.09 dB (200MHz < BW \leq 400MHz)</p> <p>FR2b, NTC & ETC testing: ± 6.09 dB (BW \leq 50MHz) ± 6.09 dB (50MHz < BW \leq 100MHz) ± 6.09 dB (100MHz < BW \leq 200MHz) ± 6.09 dB (200MHz < BW \leq 400MHz)</p> <p>FR2c, NTC & ETC testing: ± 7.75 dB (BW \leq 50MHz) ± 7.75 dB (50MHz < BW \leq 100MHz) ± 7.75 dB (100MHz < BW \leq 200MHz) ± 7.75 dB (200MHz < BW \leq 400MHz)</p> <p>PC1 Max Device size \leq 30cm</p> <p>FR2a, NTC & ETC testing: ± 6.04 dB (BW \leq 400MHz)</p> <p>FR2b, NTC & ETC testing: ± 6.04 dB (BW \leq 400MHz)</p> <p>PC5, PC6 Max Device size \leq 30cm</p> <p>FR2a, NTC & ETC testing: ± 6.04 dB (BW \leq 400MHz)</p>	MTSU = 1.00 x MU (from Table B.17-1B in TR 38.903)

6.5.3.1 Transmitter Spurious emissions	<p>Max Device size ≤ 30 cm Maximum in-band BW ≤ 400MHz</p> <p>PC3: ± 5.29 dB ($6\text{GHz} \leq f < 12.75\text{GHz}$) ± 5.25 dB ($12.75\text{GHz} \leq f < 23.45\text{GHz}$) ± 5.41 dB ($23.45\text{GHz} \leq f < 40.8\text{GHz}$) ± 7.42 dB ($40.8\text{GHz} \leq f < 66\text{GHz}$) ± 7.72 dB ($66\text{GHz} \leq f \leq 80\text{GHz}$) ± 8.14 dB ($80\text{GHz} < f \leq 87\text{GHz}$)</p> <p>PC1: ± 5.28 dB ($6\text{GHz} \leq f < 12.75\text{GHz}$) ± 5.91 dB ($12.75\text{GHz} \leq f < 23.45\text{GHz}$) ± 6.07 dB ($23.45\text{GHz} \leq f < 40.8\text{GHz}$) ± 8.09 dB ($40.8\text{GHz} \leq f < 66\text{GHz}$) ± 7.71 dB ($66\text{GHz} \leq f \leq 80\text{GHz}$)</p> <p>PC5, PC6: ± 5.28 dB ($6\text{GHz} \leq f < 12.75\text{GHz}$) ± 5.24 dB ($12.75\text{GHz} \leq f < 23.45\text{GHz}$) ± 5.40 dB ($23.45\text{GHz} \leq f < 40.8\text{GHz}$) ± 7.42 dB ($40.8\text{GHz} \leq f < 66\text{GHz}$) ± 7.71 dB ($66\text{GHz} \leq f \leq 80\text{GHz}$) (PC5 only) ± 8.13 dB ($80\text{GHz} < f \leq 87\text{GHz}$) (PC5 only)</p>	MTSU = 1.00 x MU (from Table B.18-1 in TR 38.903)
6.5.3.1_1 Transmitter Spurious emissions with Power Boost	Same as 6.5.3.1	
6.5.3.2 Spurious emission band UE co-existence	<p>Max Device size ≤ 30 cm Maximum in-band BW ≤ 400MHz</p> <p>PC3: Protected band n260, n261, n257: ± 6.00 dB</p> <p>Protected frequency $23.6\text{ GHz} \leq f \leq 24.0\text{ GHz}$: ± 6.00 dB</p> <p>Protected frequency $57\text{ GHz} \leq f \leq 66\text{GHz}$: ± 8.01 dB</p> <p>Protected frequency $36\text{ GHz} \leq f \leq 37\text{GHz}$: ± 6.00 dB</p> <p>PC1: Protected band n257, n260, n261: ± 7.32 dB Protected frequency $23.6\text{ GHz} \leq f \leq 24.0\text{ GHz}$: ± 7.32 dB Protected frequency $57\text{ GHz} \leq f \leq 66\text{ GHz}$: ± 8.00 dB</p> <p>PC5, PC6: Protected band n260: ± 5.98 dB Protected frequency $23.6\text{ GHz} \leq f \leq 24.0\text{ GHz}$: ± 5.98 dB Protected frequency $57\text{ GHz} \leq f \leq 66\text{ GHz}$: ± 8.00 dB</p>	MTSU = 1.00 x MU (from Table B.18-1a in TR 38.903)
6.5.3.2_1 Spurious emission band UE co-existence with Power Boost	Same as 6.5.3.2	

6.5.3.3 Additional Spurious emission	<p>Max Device size ≤ 30 cm Maximum in-band BW ≤ 400MHz PC3: ± 5.29 dB ($6\text{GHz} \leq f \leq 12.75\text{GHz}$), NS_202 ± 5.84 dB ($12.75\text{GHz} < f \leq 23.45\text{GHz}$), NS_202 ± 6.00 dB ($23.45\text{GHz} < f < 40.8\text{GHz}$), NS_202, NS_203 ± 8.01 dB ($40.8\text{GHz} \leq f \leq 2\text{nd harmonic of the upper frequency edge of the UL operating band}$), NS_202</p> <p>PC1: ± 5.28 dB ($6\text{GHz} \leq f \leq 12.75\text{GHz}$), NS_202 ± 7.16 dB ($12.75\text{GHz} < f \leq 23.45\text{GHz}$), NS_202 ± 7.32 dB ($23.45\text{GHz} < f < 40.8\text{GHz}$), NS_202, NS_203 ± 9.34 dB ($40.8\text{GHz} \leq f \leq 2\text{nd harmonic of the upper frequency edge of the UL operating band}$), NS_202</p> <p>PC5, PC6: ± 5.28 dB ($6\text{GHz} \leq f \leq 12.75\text{GHz}$), NS_202 ± 5.82 dB ($12.75\text{GHz} < f \leq 23.45\text{GHz}$), NS_202 ± 5.98 dB ($23.45\text{GHz} < f < 40.8\text{GHz}$), NS_202, NS_203 ± 8.00 dB ($40.8\text{GHz} \leq f \leq 2\text{nd harmonic of the upper frequency edge of the UL operating band}$), NS_202</p>	MTSU = 1.00 x MU (from Table B.18-1b in TR 38.903)
6.5.3.3_1 Additional spurious emissions with Power Boost	Same as 6.5.3.3	
6.5A.1.1 Occupied bandwidth for CA (2UL CA)	<p><u>Intra-band contiguous CA</u> Maximum aggregated BW ≤ 400MHz Max Device size ≤ 30cm</p> <p>PC3: FR2a: TBD</p> <p>FR2b: TBD</p> <p>FR2c: TBD</p> <p>Maximum aggregated BW > 400MHz TBD</p> <p><u>Intra-band non-contiguous, Inter-band CA</u> TBD</p>	
6.5A.1.2 Occupied bandwidth for CA (3UL CA)	<p><u>Intra-band contiguous CA</u> Maximum aggregated BW ≤ 400MHz Same as 6.5A.1.1</p> <p>Maximum aggregated BW > 400MHz TBD</p> <p><u>Intra-band non-contiguous, Inter-band CA</u> TBD</p>	

6.5A.1.3 Occupied bandwidth for CA (4UL CA)	<p><u>Intra-band contiguous CA</u> Maximum aggregated BW \leq 400MHz Same as 6.5A.1.1</p> <p>Maximum aggregated BW > 400MHz TBD</p> <p><u>Intra-band non-contiguous, Inter-band CA</u> TBD</p>	
6.5A.1.4 Occupied bandwidth for CA (5UL CA)	<p><u>Intra-band contiguous CA</u> Maximum aggregated BW \leq 400MHz Same as 6.5A.1.1</p> <p>Maximum aggregated BW > 400MHz TBD</p> <p><u>Intra-band non-contiguous, Inter-band CA</u> TBD</p>	
6.5A.1.5 Occupied bandwidth for CA (6UL CA)	<p><u>Intra-band contiguous CA</u> Maximum aggregated BW \leq 400MHz Same as 6.5A.1.1</p> <p>Maximum aggregated BW > 400MHz TBD</p> <p><u>Intra-band non-contiguous, Inter-band CA</u> TBD</p>	
6.5A.1.6 Occupied bandwidth for CA (7UL CA)	<p><u>Intra-band contiguous CA</u> Maximum aggregated BW \leq 400MHz Same as 6.5A.1.1</p> <p>Maximum aggregated BW > 400MHz TBD</p> <p><u>Intra-band non-contiguous, Inter-band CA</u> TBD</p>	
6.5A.1.7 Occupied bandwidth for CA (8UL CA)	<p><u>Intra-band contiguous CA</u> Maximum aggregated BW \leq 400MHz Same as 6.5A.1.1</p> <p>Maximum aggregated BW > 400MHz TBD</p> <p><u>Intra-band non-contiguous, Inter-band CA</u> TBD</p>	
6.5A.2.1.1 Spectrum Emission Mask for CA (2UL CA)	<p><u>Intra-band contiguous CA</u> Maximum aggregated BW \leq 400MHz Same as 6.5.2.1</p> <p>Maximum aggregated BW > 400MHz TBD</p> <p><u>Intra-band non-contiguous, Inter-band CA</u> TBD</p>	
6.5A.2.1.2 Spectrum Emission Mask for CA (3UL CA)	<p><u>Intra-band contiguous CA</u> Maximum aggregated BW \leq 400MHz Same as 6.5.2.1</p> <p>Maximum aggregated BW > 400MHz TBD</p> <p><u>Intra-band non-contiguous, Inter-band CA</u> TBD</p>	

6.5A.2.1.3 Spectrum Emission Mask for CA (4UL CA)	<p><u>Intra-band contiguous CA</u> Maximum aggregated BW \leq 400MHz Same as 6.5.2.1</p> <p>Maximum aggregated BW > 400MHz TBD</p> <p><u>Intra-band non-contiguous, Inter-band CA</u> TBD</p>	
6.5A.2.1.4 Spectrum Emission Mask for CA (5UL CA)	TBD	
6.5A.2.1.5 Spectrum Emission Mask for CA (6UL CA)	TBD	
6.5A.2.1.6 Spectrum Emission Mask for CA (7UL CA)	TBD	
6.5A.2.1.7 Spectrum Emission Mask for CA (8UL CA)	TBD	
6.5A.2.2.1 Adjacent channel leakage ratio for CA (2UL CA)	<p><u>Intra-band contiguous CA</u> Maximum aggregated BW \leq 400MHz Same as 6.5.2.3</p> <p>Maximum aggregated BW > 400MHz TBD</p> <p><u>Intra-band non-contiguous, Inter-band CA</u> TBD</p>	MTSU = 1.00 x MU (from Table B.17-1B in TR 38.309)
6.5A.2.2.2 Adjacent channel leakage ratio for CA (3UL CA)	<p><u>Intra-band contiguous CA</u> Maximum aggregated BW \leq 400MHz Same as 6.5.2.3</p> <p>Maximum aggregated BW > 400MHz TBD</p> <p><u>Intra-band non-contiguous, Inter-band CA</u> TBD</p>	
6.5A.2.2.3 Adjacent channel leakage ratio for CA (4UL CA)	<p><u>Intra-band contiguous CA</u> Maximum aggregated BW \leq 400MHz Same as 6.5.2.3</p> <p>Maximum aggregated BW > 400MHz TBD</p> <p><u>Intra-band non-contiguous, Inter-band CA</u> TBD</p>	
6.5A.2.2.4 Adjacent channel leakage ratio for CA (5UL CA)	<p>Intra-band contiguous CA 400 MHz < aggregated BW \leq TBD MHz</p> <p>Intra-band non-contiguous CA TBD</p>	
6.5A.2.2.5 Adjacent channel leakage ratio for CA (6UL CA)	<p>Intra-band contiguous CA 400 MHz < aggregated BW \leq TBD MHz</p> <p>Intra-band non-contiguous CA TBD</p>	
6.5A.2.2.6 Adjacent channel leakage ratio for CA (7UL CA)	<p>Intra-band contiguous CA 400 MHz < aggregated BW \leq TBD MHz</p> <p>Intra-band non-contiguous CA TBD</p>	
6.5A.2.2.7 Adjacent channel leakage ratio for CA (8UL CA)	<p>Intra-band contiguous CA 400 MHz < aggregated BW \leq TBD MHz</p> <p>Intra-band non-contiguous CA TBD</p>	

6.5A.3.1.1 Transmitter Spurious emissions for CA (2UL CA)	<p><u>Intra-band contiguous CA</u> Maximum aggregated BW \leq 400MHz Same as 6.5.3.1</p> <p>Maximum aggregated BW > 400MHz TBD</p> <p><u>Intra-band non-contiguous, Inter-band CA</u> TBD</p>	
6.5A.3.1.2 Transmitter Spurious emissions for CA (3UL CA)	<p><u>Intra-band contiguous CA</u> Maximum aggregated BW \leq 400MHz Same as 6.5.3.1</p> <p>Maximum aggregated BW > 400MHz TBD</p> <p><u>Intra-band non-contiguous, Inter-band CA</u> TBD</p>	
6.5A.3.1.3 Transmitter Spurious emissions for CA (4UL CA)	<p><u>Intra-band contiguous CA</u> Maximum aggregated BW \leq 400MHz Same as 6.5.3.1</p> <p>Maximum aggregated BW > 400MHz TBD</p> <p><u>Intra-band non-contiguous, Inter-band CA</u> TBD</p>	
6.5A.3.1.4 Transmitter Spurious emissions for CA (5UL CA)	<p><u>Intra-band contiguous CA</u> 400 MHz < aggregated BW \leq TBD MHz</p> <p><u>Intra-band non-contiguous CA</u> TBD</p>	
6.5A.3.1.5 Transmitter Spurious emissions for CA (6UL CA)	<p><u>Intra-band contiguous CA</u> 400 MHz < aggregated BW \leq TBD MHz</p> <p><u>Intra-band non-contiguous CA</u> TBD</p>	
6.5A.3.1.6 Transmitter Spurious emissions for CA (7UL CA)	<p><u>Intra-band contiguous CA</u> 400 MHz < aggregated BW \leq TBD MHz</p> <p><u>Intra-band non-contiguous CA</u> TBD</p>	
6.5A.3.1.7 Transmitter Spurious emissions for CA (8UL CA)	<p><u>Intra-band contiguous CA</u> 400 MHz < aggregated BW \leq TBD MHz</p> <p><u>Intra-band non-contiguous CA</u> TBD</p>	
6.5A.3.2.1 Spurious emission band UE co-existence for CA (2UL CA)	<p><u>Intra-band contiguous CA</u> Maximum aggregated BW \leq 400MHz Same as 6.5.3.2</p> <p>Maximum aggregated BW > 400MHz TBD</p> <p><u>Intra-band non-contiguous, Inter-band CA</u> TBD</p>	
6.5A.3.2.2 Spurious emission band UE co-existence for CA (3UL CA)	<p><u>Intra-band contiguous CA</u> Maximum aggregated BW \leq 400MHz Same as 6.5.3.2</p> <p>Maximum aggregated BW > 400MHz TBD</p> <p><u>Intra-band non-contiguous, Inter-band CA</u> TBD</p>	

6.5A.3.2.3 Spurious emission band UE co-existence for CA (4UL CA)	<p><u>Intra-band contiguous CA</u> Maximum aggregated BW \leq 400MHz Same as 6.5.3.2</p> <p>Maximum aggregated BW > 400MHz TBD</p> <p><u>Intra-band non-contiguous, Inter-band CA</u> TBD</p>	
6.5A.3.2.4 Spurious emission band UE co-existence for CA (5UL CA)	TBD	
6.5A.3.2.5 Spurious emission band UE co-existence for CA (6UL CA)	TBD	
6.5A.3.2.6 Spurious emission band UE co-existence for CA (7UL CA)	TBD	
6.5A.3.2.7 Spurious emission band UE co-existence for CA (8UL CA)	TBD	
6.5A.3.3.1 Additional spurious emissions for CA (2UL CA)	<p><u>Intra-band contiguous CA</u> Maximum aggregated BW \leq 400MHz Same as 6.5.3.3</p> <p>Maximum aggregated BW > 400MHz TBD</p> <p><u>Intra-band non-contiguous, Inter-band CA</u> TBD</p>	
6.5A.3.3.2 Additional spurious emissions for CA (3UL CA)	<p><u>Intra-band contiguous CA</u> Maximum aggregated BW \leq 400MHz Same as 6.5.3.3</p> <p>Maximum aggregated BW > 400MHz TBD</p> <p><u>Intra-band non-contiguous, Inter-band CA</u> TBD</p>	
6.5A.3.3.3 Additional spurious emissions for CA (4UL CA)	<p><u>Intra-band contiguous CA</u> Maximum aggregated BW \leq 400MHz Same as 6.5.3.3</p> <p>Maximum aggregated BW > 400MHz TBD</p> <p><u>Intra-band non-contiguous, Inter-band CA</u> TBD</p>	
6.5A.3.3.4 Additional spurious emissions for CA (5UL CA)	TBD	
6.5A.3.3.5 Additional spurious emissions for CA (6UL CA)	TBD	
6.5A.3.3.6 Additional spurious emissions for CA (7UL CA)	TBD	
6.5A.3.3.7 Additional spurious emissions for CA (8UL CA)	TBD	

6.5D.1 Occupied bandwidth for UL MIMO	<p>Max Device size \leq 30cm</p> <p><u>PC3:</u> FR2a: ± 0.4 [%CBW] (BW 50MHz) ± 0.4 [%CBW] (BW 100MHz) ± 1.2 [%CBW] (BW 200MHz) ± 1.3 [%CBW] (BW 400MHz)</p> <p>FR2b: ± 0.4 [%CBW] (BW 50MHz) ± 0.4 [%CBW] (BW 100MHz) ± 1.3 [%CBW] (BW 200MHz) ± 1.7 [%CBW] (BW 400MHz)</p> <p>FR2c: ± 0.65 [%CBW] (BW 50MHz) ± 0.65 [%CBW] (BW 100MHz) ± 1.2 [%CBW] (BW 200MHz) ± 2.0 [%CBW] (BW 400MHz)</p>	
6.5D.2.1 Spectrum Emission Mask for UL MIMO	Same as 6.5.2.1	
6.5D.2.2 Adjacent channel leakage ratio for UL MIMO	Same as 6.5.2.3	
6.5D.3.1 Transmitter Spurious emissions for UL MIMO	Same ad 6.5.3.1	
6.5D.3.2 Spurious emission band UE co-existence for UL MIMO	Same ad 6.5.3.2	
6.5D.3.3 Additional spurious emissions for UL MIMO	Same ad 6.5.3.3	
6.6.1 Beam correspondence – EIRP	<p><u>PC3</u> Max Device size \leq 30 cm 2.67 dB (FR2a, NTC testing) 3.80 dB (FR2b, NTC testing)</p>	MTSU = 1.00 x MU (from Table B.18a.2-2 in TR 38.309)
6.6.2 Enhanced Beam correspondence - EIRP	Same as 6.6.1	
NOTE 1: FR2a, FR2b and FR2c are specified in Table 5.1-2.		

Table F.1.2-2: EVM Measurement Uncertainty (MU) for PUSCH, PC3, FR2a (23.45GHz \leq f \leq 32.125GHz)

Test ID	Modulation	RB alloc.	50MHz	100MHz	200MHz	400MHz
1	DFT-s-OFDM PI/2 BPSK	Inner_Full	2.78%	3.85%	5.44%	7.69%
2	DFT-s-OFDM PI/2 BPSK	Outer_Full	3.10%	4.16%	5.88%	8.99%
3	DFT-s-OFDM QPSK	Inner_Full	2.78%	3.85%	5.44%	7.69%
4	DFT-s-OFDM QPSK	Outer_Full	3.10%	4.16%	5.88%	8.99%
5	DFT-s-OFDM 16 QAM	Inner_Full	3.31%	4.50%	6.36%	11.21%
6	DFT-s-OFDM 16 QAM	Outer_Full	3.60%	4.73%	6.68%	11.21%
7	DFT-s-OFDM 64 QAM	Inner_Full	4.26%	5.96%	8.41%	15.84%
8	DFT-s-OFDM 64 QAM	Outer_Full	5.01%	7.08%	9.99%	15.84%
9	CP-OFDM QPSK	Inner_Full	3.60%	4.73%	6.68%	11.89%
10	CP-OFDM QPSK	Outer_Full	3.71%	4.99%	7.07%	11.89%
11	CP-OFDM 16 QAM	Inner_Full	4.26%	5.96%	8.41%	15.84%
12	CP-OFDM 16 QAM	Outer_Full	4.26%	5.96%	8.41%	15.84%
13	CP-OFDM 64 QAM	Inner_Full	6.31%	8.91%	12.59%	21.13%
14	CP-OFDM 64 QAM	Outer_Full	6.31%	8.91%	12.59%	21.13%

Table F.1.2-3: EVM Measurement Uncertainty (MU) for PUSCH, PC3, FR2b (32.125GHz < f \leq 40.8GHz)

Test ID	Modulation	RB alloc.	50MHz	100MHz	200MHz	400MHz
1	DFT-s-OFDM PI/2 BPSK	Inner_Full	3.56%	4.83%	6.91%	9.65%
2	DFT-s-OFDM PI/2 BPSK	Outer_Full	4.15%	5.69%	8.11%	12.50%
3	DFT-s-OFDM QPSK	Inner_Full	3.56%	4.83%	6.91%	9.65%
4	DFT-s-OFDM QPSK	Outer_Full	4.15%	5.69%	8.11%	12.50%

5	DFT-s-OFDM 16 QAM	Inner_Full	4.54%	6.26%	8.91%	18.06%
6	DFT-s-OFDM 16 QAM	Outer_Full	5.09%	7.19%	10.15%	18.06%
7	DFT-s-OFDM 64 QAM	Inner_Full	6.78%	9.58%	13.54%	25.50%
8	DFT-s-OFDM 64 QAM	Outer_Full	8.06%	11.38%	16.09%	25.50%
9	CP-OFDM QPSK	Inner_Full	5.09%	7.19%	10.15%	19.13%
10	CP-OFDM QPSK	Outer_Full	5.39%	7.61%	10.75%	19.13%
11	CP-OFDM 16 QAM	Inner_Full	6.78%	9.58%	13.54%	25.50%
12	CP-OFDM 16 QAM	Outer_Full	6.78%	9.58%	13.54%	25.50%
13	CP-OFDM 64 QAM	Inner_Full	10.14%	14.33%	20.25%	34.01%
14	CP-OFDM 64 QAM	Outer_Full	10.14%	14.33%	20.25%	34.01%

Table F.1.2-4: EVM Measurement Uncertainty (MU) for PUSCH, PC5, PC6, FR2a (23.45GHz <= f <= 32.125GHz)

Test ID	Modulation	RB alloc.	50MHz	100MHz	200MHz	400MHz
1	DFT-s-OFDM PI/2 BPSK	Inner_Full	2.47%	3.50%	4.95%	7.00%
2	DFT-s-OFDM PI/2 BPSK	Outer_Full	2.54%	3.59%	5.08%	7.31%
3	DFT-s-OFDM QPSK	Inner_Full	2.47%	3.50%	4.95%	7.00%
4	DFT-s-OFDM QPSK	Outer_Full	2.54%	3.59%	5.08%	7.31%
5	DFT-s-OFDM 16 QAM	Inner_Full	2.58%	3.65%	5.17%	7.84%
6	DFT-s-OFDM 16 QAM	Outer_Full	2.65%	3.74%	5.30%	7.84%
7	DFT-s-OFDM 64 QAM	Inner_Full	2.81%	3.97%	5.62%	8.71%
8	DFT-s-OFDM 64 QAM	Outer_Full	2.96%	4.18%	5.91%	8.71%
9	CP-OFDM QPSK	Inner_Full	2.65%	3.74%	5.30%	7.95%
10	CP-OFDM QPSK	Outer_Full	2.67%	3.78%	5.35%	7.95%
11	CP-OFDM 16 QAM	Inner_Full	2.81%	3.97%	5.62%	8.71%
12	CP-OFDM 16 QAM	Outer_Full	2.81%	3.97%	5.62%	8.71%
13	CP-OFDM 64 QAM	Inner_Full	3.23%	4.56%	6.45%	9.91%
14	CP-OFDM 64 QAM	Outer_Full	3.23%	4.56%	6.45%	9.91%

F.1.3 Measurement of receiver

Table F.1.3-1: Maximum Test System Uncertainty (MTSU) for receiver tests

Sub clause	Maximum Test System Uncertainty	Derivation of MTSU
7.3.2 Reference sensitivity power level	<p><u>PC3</u> Max Device size ≤ 30 cm ±5.36 dB (FR2a, FR2b, NTC testing) ±6.34 dB (FR2c NTC testing) ±5.61 dB (FR2a, FR2b, ETC testing) ±6.48 dB (FR2c ETC testing)</p> <p><u>PC1</u> Max Device size ≤ 30 cm ±5.58 dB (FR2a, FR2b, NTC testing) ±5.83 dB (FR2a, FR2b, ETC testing)</p> <p><u>PC5</u> Max Device size ≤ 30 cm ±5.58 dB (FR2a, NTC testing) ±5.83 dB (FR2a, ETC testing)</p> <p><u>PC6</u> Max Device size ≤ 30 cm ±5.56 dB (FR2a, NTC testing) ±5.81 dB (FR2a, ETC testing)</p> <p><u>PC7</u> Max Device size ≤ 30 cm ±5.36 dB (FR2a, NTC testing) ±5.61 dB (FR2a, ETC testing)</p>	MTSU = 1.00 x MU (from Table B.19-1 in TR 38.903)

<p>7.3.4 EIS spherical coverage</p>	<p><u>PC3</u> ±5.07 dB (Max Device size ≤ 30 cm, FR2a, FR2b) ±6.04 dB (Max Device size ≤ 30 cm, FR2c)</p> <p><u>PC1</u> ±5.07 dB (Max Device size ≤ 30 cm, FR2a, FR2b)</p> <p><u>PC5</u> ±5.07 dB (Max Device size ≤ 30 cm, FR2a)</p> <p><u>PC6</u> ±5.56 dB (Max Device size ≤ 30 cm, FR2a)</p> <p><u>PC7</u> Max Device size ≤ 30 cm ±5.07 dB (Max Device size ≤ 30 cm, FR2a)</p>	<p>MTSU = 1.00 x MU (from Table B.19-2 in TR 38.903)</p>
<p>7.3A.2.1 Reference sensitivity power level for CA (2DL CA)</p>	<p><u>Intra-band contiguous CA</u> Maximum aggregated BW ≤ 400MHz Same as 7.3.2 for each component carrier</p> <p>Maximum aggregated BW > 400MHz TBD</p> <p><u>Intra-band non-contiguous, Inter-band CA</u> TBD</p>	
<p>7.3A.2.2 Reference sensitivity power level for CA (3DL CA)</p>	<p><u>Intra-band contiguous CA</u> Maximum aggregated BW ≤ 400MHz Same as 7.3.2 for each component carrier</p> <p>Maximum aggregated BW > 400MHz TBD</p> <p><u>Intra-band non-contiguous, Inter-band CA</u> TBD</p>	
<p>7.3A.2.3 Reference sensitivity power level for CA (4DL CA)</p>	<p><u>Intra-band contiguous CA</u> Maximum aggregated BW ≤ 400MHz Same as 7.3.2 for each component carrier</p> <p>Maximum aggregated BW > 400MHz TBD</p> <p><u>Intra-band non-contiguous, Inter-band CA</u> TBD</p>	
<p>7.3A.2.4 Reference sensitivity power level for CA (5DL CA)</p>	<p><u>Intra-band contiguous CA</u> Maximum aggregated BW ≤ 400MHz Same as 7.3.2 for each component carrier</p> <p>Maximum aggregated BW > 400MHz TBD</p> <p><u>Intra-band non-contiguous, Inter-band CA</u> TBD</p>	
<p>7.3A.2.5 Reference sensitivity power level for CA (6DL CA)</p>	<p><u>Intra-band contiguous CA</u> Maximum aggregated BW ≤ 400MHz Same as 7.3.2 for each component carrier</p> <p>Maximum aggregated BW > 400MHz TBD</p> <p><u>Intra-band non-contiguous, Inter-band CA</u> TBD</p>	

7.3A.2.6 Reference sensitivity power level for CA (7DL CA)	Intra-band contiguous CA Maximum aggregated BW \leq 400MHz Same as 7.3.2 for each component carrier Maximum aggregated BW > 400MHz TBD Intra-band non-contiguous, Inter-band CA TBD	
7.3A.2.7 Reference sensitivity power level for CA (8DL CA)	Intra-band contiguous CA Maximum aggregated BW \leq 400MHz Same as 7.3.2 for each component carrier Maximum aggregated BW > 400MHz TBD Intra-band non-contiguous, Inter-band CA TBD	
7.3A.3.1 EIS spherical coverage for CA (2DL CA)	<u>TBD</u>	
7.3A.3.2 EIS spherical coverage for CA (3DL CA)	<u>TBD</u>	
7.3A.3.3 EIS spherical coverage for CA (4DL CA)	<u>TBD</u>	
7.3A.3.4 EIS spherical coverage for CA (5DL CA)	<u>TBD</u>	
7.3A.3.5 EIS spherical coverage for CA (6DL CA)	<u>TBD</u>	
7.3A.3.6 EIS spherical coverage for CA (7DL CA)	<u>TBD</u>	
7.3A.3.7 EIS spherical coverage for CA (8DL CA)	<u>TBD</u>	
7.4 Maximum input level	TBD	
7.4A.1 Maximum input level for CA (2DL CA)	TBD	
7.4A.2 Maximum input level for CA (3DL CA)	TBD	
7.4A.3 Maximum input level for CA (4DL CA)	TBD	
7.4A.4 Maximum input level for CA (5DL CA)	TBD	
7.4A.5 Maximum input level for CA (6DL CA)	TBD	
7.4A.6 Maximum input level for CA (7DL CA)	TBD	
7.4A.7 Maximum input level for CA ((DL CA)	TBD	
7.5 Adjacent channel selectivity	<u>PC3</u> ± 8.08 dB (Max Device size \leq 30 cm, FR2a, FR2b) ± 9.46 dB (Max Device size \leq 30 cm, FR2c) <u>PC1</u> ± 8.31 dB (Max Device size \leq 30 cm, FR2a, FR2b) <u>PC5</u> ± 8.31 dB (Max Device size \leq 30 cm, FR2a) <u>PC6</u> ± 8.28 dB (Max Device size \leq 30 cm, FR2a) <u>PC7</u> ± 8.08 dB (Max Device size \leq 30 cm, FR2a)	MTSU = 1.00 x MU (from Table B.21-1 in TR 38.903)
7.5A.1 Adjacent channel selectivity for CA (2UL CA)	<u>TBD</u>	
7.5A.2 Adjacent channel selectivity for CA (3UL CA)	<u>TBD</u>	

7.5A.3 Adjacent channel selectivity for CA (4UL CA)	TBD	
7.5A.4 Adjacent channel selectivity for CA (5UL CA)	TBD	
7.5A.5 Adjacent channel selectivity for CA (6UL CA)	TBD	
7.5A.6 Adjacent channel selectivity for CA (7UL CA)	TBD	
7.5A.7 Adjacent channel selectivity for CA (8UL CA)	TBD	
7.6.2 In-band blocking	Same as 7.5	
7.6A.2.1 In-band blocking for CA (2UL CA)	TBD	
7.6A.2.2 In-band blocking for CA (3UL CA)	TBD	
7.6A.2.3 In-band blocking for CA (4UL CA)	TBD	
7.6A.2.4 In-band blocking for CA (5UL CA)	TBD	
7.6A.2.5 In-band blocking for CA (6UL CA)	TBD	
7.6A.2.6 In-band blocking for CA (7UL CA)	TBD	
7.6A.2.7 In-band blocking for CA (8UL CA)	TBD	
7.9 Spurious emissions	<p>Max Device size ≤ 30 cm Maximum in-band BW ≤ 400MHz</p> <p>PC3: For Band n257, n258, n259, n260, n261: ± 5.64dB ($6\text{GHz} \leq f < 12.75\text{GHz}$) ± 5.60dB ($12.75\text{GHz} \leq f < 23.45\text{GHz}$) ± 6.11dB ($23.45\text{GHz} \leq f < 40.8\text{GHz}$) ± 7.65dB ($40.8\text{GHz} \leq f < 66\text{GHz}$) ± 7.95 dB ($66\text{GHz} \leq f \leq 80\text{GHz}$) ± 8.31 dB ($80\text{GHz} < f \leq 87\text{GHz}$)</p> <p>PC1: For Band n257, n258, n260, n261: ± 5.63dB ($6\text{GHz} \leq f < 12.75\text{GHz}$) ± 5.59dB ($12.75\text{GHz} \leq f < 23.45\text{GHz}$) ± 6.10dB ($23.45\text{GHz} \leq f < 40.8\text{GHz}$) ± 7.64dB ($40.8\text{GHz} \leq f < 66\text{GHz}$) ± 7.95 dB ($66\text{GHz} \leq f \leq 80\text{GHz}$)</p> <p>PC5, PC6: For Band n257, n258: ± 5.63dB ($6\text{GHz} \leq f < 12.75\text{GHz}$) ± 5.59dB ($12.75\text{GHz} \leq f < 23.45\text{GHz}$) ± 6.10dB ($23.45\text{GHz} \leq f < 40.8\text{GHz}$) ± 7.64dB ($40.8\text{GHz} \leq f < 66\text{GHz}$) ± 7.95 dB ($66\text{GHz} \leq f \leq 80\text{GHz}$) (PC5 only) ± 8.31 dB ($80\text{GHz} < f \leq 87\text{GHz}$) (PC5 only)</p>	MTSU = 1.00 x MU (from Table B.25-1 in TR 38.903)
NOTE 1: FR2a, FR2b and FR2c are specified in Table 5.1-2.		

F.2 Interpretation of measurement results (normative)

The actual measurement uncertainty of the Test System for the measurement of each parameter shall be included in the test report.

The recorded value for the Test System uncertainty shall be, for each measurement, equal to or lower than the appropriate figure in clause F.1 of the present document.

If the Test System using one of the permitted test methods defined in TR38.903 [20] for a test is known to have a measurement uncertainty greater than that specified in clause F.1, it is still permitted to use this apparatus provided that an adjustment is made value as follows:

Any additional uncertainty in the Test System over and above that specified in clause F.1 shall be used to tighten the Test Requirement, making the test harder to pass. For some tests, for example receiver tests, this may require modification of stimulus signals. This procedure will ensure that a Test System not compliant with clause F.1 does not increase the chance of passing a device under test where that device would otherwise have failed the test if a Test System compliant with clause F.1 had been used.

F.3 Test Tolerance and Derivation of Test Requirements (informative)

F.3.1 Measurement of test environments

TBD

F.3.2 Measurement of transmitter

Editor's note: This clause is incomplete. The following aspects are either missing or not yet determined:

- Influence of noise is subtracted from MTSU before calculating the TT for lower limit Tx test cases.

Table F.3.2-1: Derivation of Test Requirements (Transmitter tests)

Sub clause	Test Tolerance (TT)	Formula for test requirement
6.2.1.1 UE maximum output power (EIRP)	PC3 Minimum peak EIRP IFF (Max Device size ≤ 30 cm) 2.99 dB (FR2a, NTC) 2.99 dB (FR2b, NTC) 3.80 dB (FR2c, NTC) 3.15 dB (FR2a, ETC) 3.15 dB (FR2b, ETC) 3.89 (FR2c, ETC)	PC3 Minimum peak EIRP $TT = 0.60 \times (MTSU_{IFF} - 0.1)$ (FR2a) $TT = 0.60 \times (MTSU_{IFF} - 0.3)$ (FR2b) $TT = 0.60 \times (MTSU_{IFF} - 0.3)$ (FR2c)
	PC1 Minimum peak EIRP IFF (Max Device size ≤ 30 cm) 3.12 dB (FR2a, NTC) 3.12 dB (FR2b, NTC) 3.28 dB (FR2a, ETC) 3.28 dB (FR2b, ETC)	PC1 Minimum peak EIRP $TT = 0.60 \times (MTSU_{IFF} - 0.13)$ (FR2a) $TT = 0.60 \times (MTSU_{IFF} - 0.20)$ (FR2b)
	PC5 Minimum peak EIRP IFF (Max Device size ≤ 30 cm) 3.12 dB (FR2a, NTC) 3.28 dB (FR2a, ETC) Max EIRP 0 dB	PC5, PC6 Minimum peak EIRP $TT = 0.60 \times (MTSU_{IFF} - 0.13)$ (FR2a)
	PC6 Minimum peak EIRP IFF (Max Device size ≤ 30 cm) 3.11 dB (FR2a, NTC) 3.27 dB (FR2a, ETC) Max EIRP 0 dB	PC7 Minimum peak EIRP $TT = 0.60 \times (MTSU_{IFF} - 0.1)$ (FR2a)
	PC7	

	<p>Minimum peak EIRP IFF (Max Device size ≤ 30 cm) 2.99 dB (FR2a, NTC) 3.15 dB (FR2a, ETC)</p>	
6.2.1.1 UE maximum output power (TRP)	<p><u>PC3</u> Max TRP IFF (Max Device size ≤ 30 cm) 2.77 dB (FR2a, NTC) 2.89 dB (FR2b, NTC) 3.70 dB (FR2c, NTC) 2.91 dB (FR2a, ETC) 3.04 dB (FR2b, ETC) 3.78 (FR2c, ETC)</p> <p><u>PC1</u> Max TRP IFF (Max Device size ≤ 30 cm) 2.78 dB (FR2a, NTC) 2.87 dB (FR2b, NTC) 2.94 dB (FR2a, ETC) 3.03 dB (FR2b, ETC)</p> <p><u>PC5</u> Max TRP IFF (Max Device size ≤ 30 cm) 2.78 dB (FR2a, NTC) 2.94 dB (FR2a, ETC)</p> <p><u>PC6</u> Max TRP IFF (Max Device size ≤ 30 cm) 2.78 dB (FR2a, NTC) 2.94 dB (FR2a, ETC)</p> <p><u>PC7</u> Max TRP IFF (Max Device size ≤ 30 cm) 2.77 dB (FR2a, NTC) 2.91 dB (FR2a, ETC)</p>	<p>Max TRP TT = 0.60 x MTSU_{IFF}</p>
6.2.1.1_1 UE maximum output power – EIRP (Rel-16 and forward)	<p><u>Same as 6.2.1.1</u></p>	
6.2.1.2 UE maximum output power (Spherical coverage)	<p><u>PC1</u> IFF (Max Device size ≤ 30 cm) 2.69 dB (FR2a) 2.69 dB (FR2b)</p> <p><u>PC2</u> TBD</p> <p><u>PC3</u> IFF (Max Device size ≤ 30 cm) 2.69 dB (FR2a) 2.69 dB (FR2b) 3.50 dB (FR2c)</p> <p><u>PC4</u> TBD</p> <p><u>PC5</u> IFF (Max Device size ≤ 30 cm) 2.69 dB (FR2a)</p> <p><u>PC6</u> IFF (Max Device size ≤ 30 cm) 3.11 dB (FR2a)</p> <p><u>PC7</u></p>	<p><u>PC3</u> TT = 0.60 x (MTSU_{IFF} - 0.3) (FR2a) TT = 0.60 x (MTSU_{IFF} - 0.9) (FR2b) TT = 0.60 x (MTSU_{IFF} - 1.0) (FR2c)</p> <p><u>PC1</u> TT = 0.60 x (MTSU_{IFF} - 0.20) (FR2a) TT = 0.60 x (MTSU_{IFF} - 0.35) (FR2b)</p> <p><u>PC5, PC6</u> TT = 0.60 x (MTSU_{IFF} - 0.20) (FR2a)</p> <p><u>PC7</u> TT = 0.60 x (MTSU_{IFF} - 0.3) (FR2a)</p>

	IFF (Max Device size \leq 30 cm) 2.69 dB (FR2a)	
6.2.1.2_1 UE maximum output power – Spherical coverage (Rel16 and forward)	<u>Same as 6.2.1.2</u>	
6.2.2 UE maximum output power reduction	<p><u>PC3</u> Minimum peak EIRP IFF (Max Device size \leq 30 cm) 3.24 dB (FR2a, NTC) 3.24 dB (FR2b, NTC) 4.12 dB (FR2c, NTC) 3.41 dB (FR2a, ETC) 3.41 dB (FR2b, ETC) 4.21 dB (FR2c, ETC)</p> <p><u>PC1</u> Minimum peak EIRP IFF (Max Device size \leq 30 cm) 3.38 dB (FR2a, NTC) 3.38 dB (FR2b, NTC) 3.56 dB (FR2a, ETC) 3.56 dB (FR2b, ETC)</p> <p><u>PC5</u> Minimum peak EIRP IFF (Max Device size \leq 30 cm) 3.38 dB (FR2a, NTC) 3.56 dB (FR2a, ETC)</p> <p><u>PC6</u> Minimum peak EIRP IFF (Max Device size \leq 30 cm) 3.37 dB (FR2a, NTC) 3.54 dB (FR2a, ETC)</p> <p><u>PC7</u> Minimum peak EIRP IFF (Max Device size \leq 30 cm) 3.24 dB (FR2a, NTC) 3.41 dB (FR2a, ETC)</p>	<p>Minimum peak EIRP</p> <p><u>PC3</u> TT = 0.65 x (MTSU_{IFF} - 0.13) (FR2a) TT = 0.65 x (MTSU_{IFF} - 0.31) (FR2b) TT = 0.65 x (MTSU_{IFF} - 0.55) (FR2c)</p> <p><u>PC1</u> TT = 0.65 x (MTSU_{IFF} - 0.13) (FR2a) TT = 0.65 x (MTSU_{IFF} - 0.3) (FR2b)</p> <p><u>PC5, PC6</u> TT = 0.65 x (MTSU_{IFF} - 0.13) (FR2a)</p> <p><u>PC7</u> TT = 0.65 x (MTSU_{IFF} - 0.13) (FR2a)</p>
6.2.2_1 UE maximum output power reduction enhancements	<u>Same as 6.2.2 for FR2a, FR2b</u> <u>PC3</u> <u>Minimum peak EIRP</u> <u>IFF (Max Device size \leq 30 cm)</u> <u>TBD (FR2c, NTC)</u> <u>TBD (FR2c, ETC)</u>	
6.2.3 UE maximum output power with additional requirements	Same as 6.2.2	
6.2.4 Configured transmitted power	TBD	
6.2.4_1 Configured transmitted power with Power Boost	<u>Same as 6.2.1.1</u>	
6.2.5 UE Maximum Output Power – EIRP with UL Gaps	<p><u>PC3</u> IFF (Max Device size \leq 30 cm) P_{UMAX,f,c_GAP_ON} - P_{UMAX,f,c_GAP_OFF}: 0.46 dB (FR2a & FR2b, NTC testing) [0.46 dB] (FR2a & FR2b, ETC testing) EIRP_{meas_peak}: 2.99 dB (FR2a & FR2b, NTC) 3.15 dB (FR2a, & FR2b, ETC) [3.37]dB (FR2c, NTC) TBD (FR2c, ETC)</p> <p><u>PC1</u> IFF (Max Device size \leq 30 cm) P_{UMAX,f,c_GAP_ON} - P_{UMAX,f,c_GAP_OFF}:</p>	<p><u>PC3</u> IFF (Max Device size \leq 30 cm) P_{UMAX,f,c_GAP_ON} - P_{UMAX,f,c_GAP_OFF}: TT = 0.65 x (MTSU_{IFF}-1) (FR2a, FR2b)</p> <p>EIRP_{meas_peak}: TT = 0.60 x (MTSU_{IFF} - 0.1) (FR2a) TT = 0.60 x (MTSU_{IFF} - 0.3) (FR2b) TT = 0.60 x (MTSU_{IFF} - 0.3) (FR2c)</p>

	<p>TBD (FR2a & FR2b, NTC testing) TBD dBJ (FR2a & FR2b, ETC testing) EIRP_{meas_peak}: 3.12 dB (FR2a, & FR2b, NTC) 3.28 dB (FR2a & FR2b, ETC)</p>	<p>PC1 $P_{UMAX,f,c_GAP_ON} - P_{UMAX,f,c_GAP_OFF}$: $TT = 0.65 \times (MTSU_{IFF} - \text{influence of noise})$ (FR2a, FR2b) EIRP_{meas_peak}: $TT = 0.60 \times (MTSU_{IFF} - 0.13)$ (FR2a) $TT = 0.60 \times (MTSU_{IFF} - 0.20)$ (FR2b)</p>
6.2A.1.1.1 UE maximum output power - EIRP and TRP for CA (2UL CA)	<p><u>Intra-band contiguous CA</u> Maximum aggregated BW \leq 400MHz Same as 6.2.1</p> <p>Maximum aggregated BW > 400MHz TBD</p> <p><u>Intra-band non-contiguous</u> TBD</p>	
6.2A.1.1.2 UE maximum output power - EIRP and TRP for CA (3UL CA)	<p><u>Intra-band contiguous CA</u> Maximum aggregated BW \leq 400MHz Same as 6.2.1</p> <p>Maximum aggregated BW > 400MHz TBD</p> <p><u>Intra-band non-contiguous</u> TBD</p>	
6.2A.1.1.3 UE maximum output power - EIRP and TRP for CA (4UL CA)	<p><u>Intra-band contiguous CA</u> Maximum aggregated BW \leq 400MHz Same as 6.2.1</p> <p>Maximum aggregated BW > 400MHz TBD</p> <p><u>Intra-band non-contiguous</u> TBD</p>	
6.2A.1.1.4 UE maximum output power - EIRP and TRP for CA (5UL CA)	<p><u>Intra-band contiguous CA, Intra-band non-contiguous CA</u> TBD</p>	
6.2A.1.1.5 UE maximum output power - EIRP and TRP for CA (6UL CA)	<p><u>Intra-band contiguous CA, Intra-band non-contiguous CA</u> TBD</p>	
6.2A.1.1.6 UE maximum output power - EIRP and TRP for CA (7UL CA)	<p><u>Intra-band contiguous CA, Intra-band non-contiguous CA</u> TBD</p>	
6.2A.1.1.7 UE maximum output power - EIRP and TRP for CA (8UL CA)	<p><u>Intra-band contiguous CA</u> TBD</p>	
6.2A.1.2.1 Spherical coverage for CA (2UL CA)	<p><u>Intra-band contiguous CA</u> Maximum aggregated BW \leq 400MHz Same as 6.2.1.2</p> <p>Maximum aggregated BW > 400MHz TBD</p> <p><u>Intra-band non-contiguous, Inter-band CA</u> TBD</p>	
6.2A.1.2.2 Spherical coverage for CA (3UL CA)	<p>Maximum aggregated BW \leq 400MHz Same as 6.2.1.2</p> <p>Maximum aggregated BW > 400MHz TBD</p> <p><u>Intra-band non-contiguous, Inter-band CA</u> TBD</p>	
6.2A.1.2.3 Spherical coverage for CA (4UL CA)	<p><u>Intra-band contiguous CA</u> Maximum aggregated BW \leq 400MHz Same as 6.2.1.2</p>	

	<p>Maximum aggregated BW > 400MHz TBD</p> <p><u>Intra-band non-contiguous, Inter-band CA</u> TBD</p>	
6.2A.1.2.4 Spherical coverage for CA (5UL CA)	<u>Intra-band contiguous CA</u> TBD	
6.2A.1.2.5 Spherical coverage for CA (6UL CA)	<u>Intra-band contiguous CA</u> TBD	
6.2A.1.2.6 Spherical coverage for CA (7UL CA)	<u>Intra-band contiguous CA</u> TBD	
6.2A.1.2.7 Spherical coverage for CA (8UL CA)	<u>Intra-band contiguous CA</u> TBD	
6.2A.2.1 UE maximum output power reduction for CA (2UL CA)	<p><u>Intra-band contiguous CA</u> <u>Maximum aggregated BW \leq 400MHz</u> <u>Same as 6.2.2</u></p> <p><u>Maximum aggregated BW > 400MHz</u> TBD</p> <p><u>Intra-band non-contiguous, Inter-band CA</u> TBD</p>	
6.2A.2.2 UE maximum output power reduction for CA (3UL CA)	<p><u>Intra-band contiguous CA</u> <u>Maximum aggregated BW \leq 400MHz</u> <u>Same as 6.2.2</u></p> <p><u>Maximum aggregated BW > 400MHz</u> TBD</p> <p><u>Intra-band non-contiguous, Inter-band CA</u> TBD</p>	
6.2A.2.3 UE maximum output power reduction for CA (4UL CA)	<p><u>Intra-band contiguous CA</u> <u>Maximum aggregated BW \leq 400MHz</u> <u>Same as 6.2.2</u></p> <p><u>Maximum aggregated BW > 400MHz</u> TBD</p> <p><u>Intra-band non-contiguous, Inter-band CA</u> TBD</p>	
6.2A.2.4 UE maximum output power reduction for CA (5UL CA)	<u>Intra-band contiguous CA</u> TBD	
6.2A.2.5 UE maximum output power reduction for CA (6UL CA)	<u>Intra-band contiguous CA</u> TBD	
6.2A.2.6 UE maximum output power reduction for CA (7UL CA)	<u>Intra-band contiguous CA</u> TBD	
6.2A.2.7 UE maximum output power reduction for CA (8UL CA)	<u>Intra-band contiguous CA</u> TBD	
6.2A.3.1 UE maximum output power with additional requirements for CA (2UL CA)	<p><u>Intra-band contiguous CA</u> <u>Maximum aggregated BW \leq 400MHz</u> <u>Same as 6.2.3</u></p> <p><u>Maximum aggregated BW > 400MHz</u> TBD</p> <p><u>Intra-band non-contiguous, Inter-band CA</u> TBD</p>	
6.2A.3.2 UE maximum output power with additional requirements for CA (3UL CA)	<p><u>Intra-band contiguous CA</u> <u>Maximum aggregated BW \leq 400MHz</u> <u>Same as 6.2.3</u></p> <p><u>Maximum aggregated BW > 400MHz</u> TBD</p>	

	<u>Intra-band non-contiguous, Inter-band CA</u> <u>TBD</u>	
6.2A.3.3 UE maximum output power with additional requirements for CA (4UL CA)	<u>Intra-band contiguous CA</u> <u>Maximum aggregated BW ≤ 400MHz</u> <u>Same as 6.2.3</u> <u>Maximum aggregated BW > 400MHz</u> <u>TBD</u> <u>Intra-band non-contiguous, Inter-band CA</u> <u>TBD</u>	
6.2D.1.1 UE maximum output power (EIRP) for UL MIMO	Same as 6.2.1.1 (EIRP)	
6.2D.1.1 UE maximum output power (TRP) for UL MIMO	Same as 6.2.1.1 (TRP)	
6.2D.1.2 UE maximum output power (Spherical coverage) for UL MIMO	Same as 6.2.1.2	
6.2D.2 UE maximum output power reduction for UL MIMO	Same as 6.2.2	
6.2D.3 UE maximum output power with additional requirements for UL MIMO	Same as 6.2.3	
6.2K.1 UE maximum output power for simultaneous transmission to multiple directions	FFS	FFS
6.3.1 Minimum output power	<u>PC3</u> Minimum EIRP IFF (Max Device size ≤ 30 cm) NTC 4.21 dB (FR2a 50 MHz) 2.52 dB (FR2a 100 MHz) 0.66 dB (FR2a 200 MHz) 0 dB (FR2a 400 MHz) 1.17 dB (FR2b 50 MHz) 0 dB (FR2b 100 MHz) 0 dB (FR2b 200 MHz) 0 dB (FR2b 400 MHz) 1.39 dB (FR2c 50 MHz) 0.06 dB (FR2c 100 MHz) 0 dB (FR2c 200 MHz) 0 dB (FR2c 400 MHz) ETC 4.37 dB (FR2a 50 MHz) 2.68 dB (FR2a 100 MHz) 0.82 dB (FR2a 200 MHz) 0 dB (FR2a 400 MHz) 1.33 dB (FR2b 50 MHz) 0 dB (FR2b 100 MHz) 0 dB (FR2b 200 MHz) 0 dB (FR2b 400 MHz) 1.48 dB (FR2c 50 MHz) 0.15 dB (FR2c 100 MHz) 0 dB (FR2c 200 MHz) 0 dB (FR2c 400 MHz) <u>PC1</u> Minimum EIRP IFF (Max Device size ≤ 30 cm) NTC 3.79 dB (FR2a ≤400 MHz)	Minimum EIRP PC3, PC5, PC6, PC7 $TT = \max(R, \Delta SNR_{mr} + 0.65 \times (MTSU_{IFF} - 1.0)) - R$ PC1 $TT = \Delta SNR_{mr} + 0.65 \times (MTSU_{IFF} - \Delta SNR_{mr})$ R: Relaxation needed to limit influence of TE noise to 1 dB (specified in clause 6.3.1.5) ΔSNR_{mr} : Systematic offset due to noise when measuring at minimum requirement level (-13 dBm for PC3, 4dBm for PC1, -6dBm for PC5) ΔSNR_{mr} for PC3: FR2a 50 MHz: $\Delta SNR_{mr} = 0.86$ dB FR2a 100 MHz: $\Delta SNR_{mr} = 1.57$ dB FR2a 200 MHz: $\Delta SNR_{mr} = 2.71$ dB FR2a 400 MHz: $\Delta SNR_{mr} = 4.35$ dB FR2b 50 MHz: $\Delta SNR_{mr} = 2.32$ dB FR2b 100 MHz: $\Delta SNR_{mr} = 3.82$ dB FR2b 200 MHz: $\Delta SNR_{mr} = 5.82$ dB FR2b 400 MHz: $\Delta SNR_{mr} = 8.21$ dB FR2c 50 MHz: $\Delta SNR_{mr} = 2.77$ dB FR2c 100 MHz: $\Delta SNR_{mr} = 4.44$ dB FR2c 200 MHz: $\Delta SNR_{mr} = 6.58$ dB FR2c 400 MHz: $\Delta SNR_{mr} = 9.07$ dB ΔSNR_{mr} for PC1: FR2a: $\Delta SNR_{mr} = 0.3$ dB FR2b: $\Delta SNR_{mr} = 0.6$ dB ΔSNR_{mr} for PC5, PC6: FR2a 50 MHz: $\Delta SNR_{mr} = 0.19$ dB

	<p>4.09 dB (FR2b <=400 MHz)</p> <p>ETC</p> <p>3.95 dB (FR2a <=400 MHz)</p> <p>4.25 dB (FR2b <=400 MHz)</p> <p><u>PC5</u></p> <p>Minimum EIRP</p> <p>IFF (Max Device size ≤ 30 cm)</p> <p>NTC</p> <p>3.67 dB (FR2a 50 MHz)</p> <p>3.85 dB (FR2a 100 MHz)</p> <p>4.18 dB (FR2a 200 MHz)</p> <p>3.38 dB (FR2a 400 MHz)</p> <p>ETC</p> <p>3.84 dB (FR2a 50 MHz)</p> <p>4.02 dB (FR2a 100 MHz)</p> <p>4.35 dB (FR2a 200 MHz)</p> <p>3.55 dB (FR2a 400 MHz)</p> <p><u>PC6</u></p> <p>Minimum EIRP</p> <p>IFF (Max Device size ≤ 30 cm)</p> <p>NTC</p> <p>3.66 dB (FR2a 50 MHz)</p> <p>3.84 dB (FR2a 100 MHz)</p> <p>4.17 dB (FR2a 200 MHz)</p> <p>3.37 dB (FR2a 400 MHz)</p> <p>ETC</p> <p>3.83 dB (FR2a 50 MHz)</p> <p>4.01 dB (FR2a 100 MHz)</p> <p>4.34 dB (FR2a 200 MHz)</p> <p>3.54 dB (FR2a 400 MHz)</p> <p><u>PC7</u></p> <p>Minimum EIRP</p> <p>IFF (Max Device size ≤ 30 cm)</p> <p>NTC</p> <p>4.21 dB (FR2a 50 MHz)</p> <p>2.52 dB (FR2a 100 MHz)</p> <p>ETC</p> <p>4.37 dB (FR2a 50 MHz)</p> <p>2.68 dB (FR2a 100 MHz)</p>	<p>FR2a 100 MHz: ΔSNR_{mr} = 0.36 dB</p> <p>FR2a 200 MHz: ΔSNR_{mr} = 0.70 dB</p> <p>FR2a 400 MHz: ΔSNR_{mr} = 1.29 dB</p>
6.3.2 Transmit OFF power	0 dB	
6.3.3.2 General ON/OFF time mask	<p><u>PC3</u>:</p> <p><u>ON Power</u></p> <p>Same as 6.2.1.1 (EIRP)</p> <p><u>OFF Power</u></p> <p>0 dB</p>	<p><u>ON Power</u>:</p> <p>Same as 6.2.1.1 (EIRP)</p> <p><u>OFF Power</u>:</p> <p>Same as 6.3.1</p>
6.3.3.4 PRACH time mask	<p><u>PC3</u>:</p> <p><u>OFF Power</u></p> <p>Max Device size ≤ 30cm</p> <p>0 dB</p> <p><u>ON Power</u></p> <p>Max Device size ≤ 30cm</p> <p>TBD (FR2a)</p> <p>TBD (FR2b)TBD</p>	<p><u>ON Power</u></p> <p>TBD</p>
6.3.4.2 Absolute power tolerance	<p><u>PC3</u></p> <p>Max Device size ≤ 30 cm</p> <p>±8.16 dB (FR2a & FR2b, NTC testing)</p> <p>±8.52 dB (FR2a & FR2b, ETC testing)</p>	TT = MTSU
6.3.4.3 Relative power tolerance	<p><u>PC3</u></p> <p>IFF (Max Device size ≤ 30 cm)</p> <p>[0.46 dB] (FR2a)</p>	<p>PC3</p> <p>TT = 0.65 x (MTSU_{IFF} - 1.0) (FR2a)</p> <p>TT = 0.65 x (MTSU_{IFF} - 1.0) (FR2b)</p>

	[0.46 dB] (FR2b)	(assuming a power step $\Delta P = 1$ dB)
6.3.4.4 Aggregate power tolerance	PC3 IFF (Max Device size ≤ 30 cm) 0.26 dB (FR2a) 0.26 dB (FR2b)	PC3 TT = 0.65 x (MTSU _{IFF} - 1.0) (FR2a) TT = 0.65 x (MTSU _{IFF} - 1.0) (FR2b) (assuming a power step $\Delta P = 1$ dB)
6.3A.1.1 Minimum output power for CA (2UL CA)	For UL CA aggregated BW ≤ 800 MHz: Same as 6.3.1 For UL CA aggregated BW > 800 MHz: TBD	
6.3A.1.2 Minimum output power for CA (3UL CA)	For UL CA aggregated BW ≤ 800 MHz: Same as 6.3.1 For UL CA aggregated BW > 800 MHz: TBD	
6.3A.1.3 Minimum output power for CA (4UL CA)	For UL CA aggregated BW ≤ 800 MHz: Same as 6.3.1 For UL CA aggregated BW > 800 MHz: TBD	
6.3A.1.4 Minimum output power for CA (5UL CA)	For UL CA aggregated BW ≤ 800 MHz: Same as 6.3.1 For UL CA aggregated BW > 800 MHz: TBD	
6.3A.1.5 Minimum output power for CA (6UL CA)	For UL CA aggregated BW ≤ 800 MHz: Same as 6.3.1 For UL CA aggregated BW > 800 MHz: TBD	
6.3A.1.6 Minimum output power for CA (7UL CA)	For UL CA aggregated BW ≤ 800 MHz: Same as 6.3.1 For UL CA aggregated BW > 800 MHz: TBD	
6.3A.1.7 Minimum output power for CA (8UL CA)	For UL CA aggregated BW ≤ 800 MHz: Same as 6.3.1 For UL CA aggregated BW > 800 MHz: TBD	
6.3A.3.1.1 General ON/OFF time mask for CA (2UL CA)	<u>Intra-band contiguous CA</u> Maximum aggregated BW ≤ 400 MHz Same as 6.3.3.2 Maximum aggregated BW > 400 MHz TBD <u>Intra-band non-contiguous, Inter-band CA</u> TBD	
6.3A.3.1.2 General ON/OFF time mask for CA (3UL CA)	<u>Intra-band contiguous CA</u> Maximum aggregated BW ≤ 400 MHz Same as 6.3.3.2 Maximum aggregated BW > 400 MHz TBD <u>Intra-band non-contiguous, Inter-band CA</u> TBD	
6.3A.3.1.3 General ON/OFF time mask for CA (4UL CA)	<u>Intra-band contiguous CA</u> Maximum aggregated BW ≤ 400 MHz Same as 6.3.3.2 Maximum aggregated BW > 400 MHz TBD <u>Intra-band non-contiguous, Inter-band CA</u> TBD	
6.3A.3.1.4 General ON/OFF time mask for CA (5UL CA)	<u>Intra-band contiguous CA</u> TBD	
6.3A.3.1.5 General ON/OFF time mask for CA (6UL CA)	<u>Intra-band contiguous CA</u> TBD	
6.3A.3.1.6 General ON/OFF time mask for CA (7UL CA)	<u>Intra-band contiguous CA</u> TBD	
6.3A.3.1.7 General ON/OFF time mask for CA (8UL CA)	<u>Intra-band contiguous CA</u> TBD	

6.3A.4.2.1 Absolute power tolerance for CA (2UL CA)	<p><u>Intra-band contiguous CA</u> Maximum aggregated BW \leq 400MHz Same as 6.3.4.2 for each CC. Maximum aggregated BW > 400MHz TBD</p> <p><u>Intra-band non-contiguous, Inter-band CA</u> TBD</p>	
6.3A.4.2.2 Absolute power tolerance for CA (3UL CA)	<p><u>Intra-band contiguous CA</u> Maximum aggregated BW \leq 400MHz Same as 6.3.4.2 for each CC. Maximum aggregated BW > 400MHz TBD</p> <p><u>Intra-band non-contiguous, Inter-band CA</u> TBD</p>	
6.3A.4.2.3 Absolute power tolerance for CA (4UL CA)	<p><u>Intra-band contiguous CA</u> Maximum aggregated BW \leq 400MHz Same as 6.3.4.2 for each CC. Maximum aggregated BW > 400MHz TBD</p> <p><u>Intra-band non-contiguous, Inter-band CA</u> TBD</p>	
6.3A.4.2.4 Absolute power tolerance for CA (5UL CA)	<p><u>Intra-band contiguous CA</u> Maximum aggregated BW \leq 400MHz Same as 6.3.4.2 for each CC. Maximum aggregated BW > 400MHz TBD</p> <p><u>Intra-band non-contiguous, Inter-band CA</u> TBD</p>	
6.3A.4.2.5 Absolute power tolerance for CA (6UL CA)	<p><u>Intra-band contiguous CA</u> Maximum aggregated BW \leq 400MHz Same as 6.3.4.2 for each CC. Maximum aggregated BW > 400MHz TBD</p> <p><u>Intra-band non-contiguous, Inter-band CA</u> TBD</p>	
6.3A.4.2.6 Absolute power tolerance for CA (7UL CA)	<p><u>Intra-band contiguous CA</u> Maximum aggregated BW \leq 400MHz Same as 6.3.4.2 for each CC. Maximum aggregated BW > 400MHz TBD</p> <p><u>Intra-band non-contiguous, Inter-band CA</u> TBD</p>	
6.3A.4.2.7 Absolute power tolerance for CA (8UL CA)	<p><u>Intra-band contiguous CA</u> Maximum aggregated BW \leq 400MHz Same as 6.3.4.2 for each CC. Maximum aggregated BW > 400MHz TBD</p> <p><u>Intra-band non-contiguous, Inter-band CA</u> TBD</p>	
6.3A.4.3.1 Relative power tolerance for CA (2UL CA)	<p><u>Intra-band contiguous CA</u> Maximum aggregated BW \leq 400MHz TBD</p> <p>Maximum aggregated BW > 400MHz TBD</p> <p><u>Intra-band non-contiguous, Inter-band CA</u> TBD</p>	
6.3A.4.3.2 Relative power tolerance for CA (3UL CA)	<p><u>Intra-band contiguous CA</u> Maximum aggregated BW \leq 400MHz TBD</p>	

	<p>Maximum aggregated BW > 400MHz TBD</p> <p><u>Intra-band non-contiguous, Inter-band CA</u> TBD</p>	
6.3A.4.3.3 Relative power tolerance for CA (4UL CA)	<p><u>Intra-band contiguous CA</u> Maximum aggregated BW ≤ 400MHz TBD</p> <p>Maximum aggregated BW > 400MHz TBD</p> <p><u>Intra-band non-contiguous, Inter-band CA</u> TBD</p>	
6.3A.4.3.4 Relative power tolerance for CA (5UL CA)	<u>Intra-band contiguous CA</u> TBD	
6.3A.4.3.5 Relative power tolerance for CA (6UL CA)	<u>Intra-band contiguous CA</u> TBD	
6.3A.4.3.6 Relative power tolerance for CA (7UL CA)	<u>Intra-band contiguous CA</u> TBD	
6.3A.4.3.7 Relative power tolerance for CA (8UL CA)	<u>Intra-band contiguous CA</u> TBD	
6.3A.4.4.1 Aggregate power tolerance for CA (2UL CA)	<p><u>Intra-band contiguous CA</u> Maximum aggregated BW ≤ 400MHz Same as 6.3.4.4 for each CC.</p> <p>Maximum aggregated BW > 400MHz TBD</p> <p><u>Intra-band non-contiguous, Inter-band CA</u> TBD</p>	
6.3A.4.4.2 Aggregate power tolerance for CA (3UL CA)	<p><u>Intra-band contiguous CA</u> Maximum aggregated BW ≤ 400MHz Same as 6.3.4.4 for each CC.</p> <p>Maximum aggregated BW > 400MHz TBD</p> <p><u>Intra-band non-contiguous, Inter-band CA</u> TBD</p>	
6.3A.4.4.3 Aggregate power tolerance for CA (4UL CA)	<p><u>Intra-band contiguous CA</u> Maximum aggregated BW ≤ 400MHz Same as 6.3.4.4 for each CC.</p> <p>Maximum aggregated BW > 400MHz TBD</p> <p><u>Intra-band non-contiguous, Inter-band CA</u> TBD</p>	
6.3A.4.4.4 Aggregate power tolerance for CA (5UL CA)	<u>Intra-band contiguous CA</u> TBD	
6.3A.4.4.5 Aggregate power tolerance for CA (6UL CA)	<u>Intra-band contiguous CA</u> TBD	
6.3A.4.4.6 Aggregate power tolerance for CA (7UL CA)	<u>Intra-band contiguous CA</u> TBD	
6.3A.4.4.7 Aggregate power tolerance for CA (8UL CA)	<u>Intra-band contiguous CA</u> TBD	
6.3D.1 Minimum output power for UL MIMO	<p>PC3: Minimum EIRP IFF (Max Device size ≤ 30 cm) NTC 3.80 dB (FR2a 50 MHz) 4.21 dB (FR2a 100 MHz) 2.52 dB (FR2a 200 MHz)</p>	<p>Minimum EIRP PC3 TT = max(R, ΔSNR_{mr} + 0.65 x (MTSU_{IFF} - 1.0)) -R</p>

	<p>0.67 dB (FR2a 400 MHz)</p> <p>3.17 dB (FR2b 50 MHz) 1.17 dB (FR2b 100 MHz) 0 dB (FR2b 200 MHz) 0 dB (FR2b 400 MHz)</p> <p>TBD (FR2c)</p> <p><u>PC1</u> Minimum EIRP IFF (Max Device size ≤ 30 cm) NTC 3.79 dB (FR2a ≤400 MHz) 4.09 dB (FR2b ≤400 MHz)</p> <p>PC5: Same as 6.3.1 for PC5 in NTC</p> <p>PC6: Same as 6.3.1 for PC6 in NTC</p> <p>Other PCs: FFS</p>	<p>R: Relaxation needed to limit influence of TE noise to 1 dB (specified in clause 6.3D.1.5)</p> <p>$\Delta\text{SNR}_{\text{mr}}$: Systematic offset due to noise when measuring at minimum requirement level (-10 dBm for PC3)</p> <p>$\Delta\text{SNR}_{\text{mr}}$ for PC3: FR2a 50 MHz: $\Delta\text{SNR}_{\text{mr}} = 0.45$ dB FR2a 100 MHz: $\Delta\text{SNR}_{\text{mr}} = 0.86$ dB FR2a 200 MHz: $\Delta\text{SNR}_{\text{mr}} = 1.57$ dB FR2a 400 MHz: $\Delta\text{SNR}_{\text{mr}} = 2.72$ dB</p> <p>FR2b 50 MHz: $\Delta\text{SNR}_{\text{mr}} = 1.32$ dB FR2b 100 MHz: $\Delta\text{SNR}_{\text{mr}} = 2.32$ dB FR2b 200 MHz: $\Delta\text{SNR}_{\text{mr}} = 3.82$ dB FR2b 400 MHz: $\Delta\text{SNR}_{\text{mr}} = 5.82$ dB</p> <p>PC1 $\text{TT} = \Delta\text{SNR}_{\text{mr}} + 0.65 \times (\text{MTSU}_{\text{IFF}} - \Delta\text{SNR}_{\text{mr}})$</p> <p>$\Delta\text{SNR}_{\text{mr}}$ for PC1: FR2a: $\Delta\text{SNR}_{\text{mr}} = 0.15$ dB FR2b: $\Delta\text{SNR}_{\text{mr}} = 0.30$ dB</p>
<p>6.3D.2 Transmit OFF power for UL MIMO</p>	<p>Same as 6.3.2</p>	
<p>6.3D.3.1 General ON/OFF time mask for UL MIMO</p>	<p>PC3: <u>OFF Power</u> Max Device size ≤ 30cm 0 dB</p> <p><u>ON Power</u> Max Device size ≤ 30cm TBD (FR2a) TBD (FR2b)</p>	<p><u>ON Power</u> TBD</p>
<p>6.3D.3.4 SRS time mask for UL MIMO</p>	<p>PC3: <u>OFF Power</u> Max Device size ≤ 30cm 0 dB</p> <p><u>ON Power</u> Max Device size ≤ 30cm TBD (FR2a) TBD (FR2b)</p>	<p><u>ON Power</u> TBD</p>
<p>6.4.1 Frequency error</p>	<p>0.005 ppm (NTC & ETC testing)</p>	<p>$\text{TT} = 0.5 \times \text{MTSU}$</p>
<p>6.4.2.1 Error vector magnitude</p>	<p>PUSCH, PC3, FR2a: As defined in Table 6.4.2.1.5-2.</p> <p>PUSCH, PC3, FR2b: As defined in Table 6.4.2.1.5-3.</p> <p>PUSCH, PC1, FR2a: As defined in Table 6.4.2.1.5-4.</p> <p>PUSCH, PC1, FR2b: TBD</p> <p>PUSCH, PC5, PC6, FR2a: As defined in Table 6.4.2.1.5-5.</p> <p><u>PUCCH</u>:</p>	<p>Minimum requirement + TT</p> <p>$\text{EVM}_{\text{meas_Increase}} = \sqrt{(\text{Minimum requirement}^2 + \text{MTSU}^2) - \text{Minimum requirement}}$; it is the increase of measured EVM due to test equipment uncertainty.</p> <p>$\text{EVM}_{\text{meas_Increase_Relative}} = \text{EVM}_{\text{meas_Increase}} / \text{Minimum requirement}$ [%]</p> <p>If ($\text{EVM}_{\text{meas_Increase_Relative}} < 7.5\%$) TT = 0%</p>

	As defined in Table 6.4.2.1.5-6. <u>PRACH:</u> <u>TBD</u>	Else if ($7.5\% \leq \text{EVM_meas_Increase_Relative} \leq 50\%$) TT = EVM_meas_Increase Else Skip the test as not testable.
6.4.2.1_1 Error vector magnitude with Power Boost	Same as 6.4.2.1 for PUSCH and PUCCH.	
6.4.2.2 Carrier leakage	PC3 IFF (Max Device size ≤ 30 cm) FR2a: ± 3.54 dB (BW ≤ 400 MHz) FR2b: ± 3.62 dB (BW ≤ 400 MHz) PC7 IFF (Max Device size ≤ 30 cm) FR2a: ± 3.54 dB (BW ≤ 100 MHz)	TT = $0.65 \times \text{MTSU}_{\text{IFF}}$
6.4.2.3 In-band emissions	TBD	
6.4.2.4 EVM equalizer spectrum flatness	TBD	
6.4.2.5 EVM equalizer spectrum flatness for BPSK modulation	TBD	
6.4A.1.1 Frequency error for CA (2UL CA)	<u>Intra-band contiguous CA</u> Maximum aggregated BW ≤ 400 MHz Same as 6.4.1 Maximum aggregated BW > 400 MHz TBD <u>Intra-band non-contiguous, Inter-band CA</u> TBD	
6.4A.1.2 Frequency error for CA (3UL CA)	<u>Intra-band contiguous CA</u> Maximum aggregated BW ≤ 400 MHz Same as 6.4.1 Maximum aggregated BW > 400 MHz TBD <u>Intra-band non-contiguous, Inter-band CA</u> TBD	
6.4A.1.3 Frequency error for CA (4UL CA)	<u>Intra-band contiguous CA</u> Maximum aggregated BW ≤ 400 MHz Same as 6.4.1 Maximum aggregated BW > 400 MHz TBD <u>Intra-band non-contiguous, Inter-band CA</u> TBD	
6.4A.1.4 Frequency error for CA (5UL CA)	<u>Intra-band contiguous CA</u> TBD	
6.4A.1.5 Frequency error for CA (6UL CA)	<u>Intra-band contiguous CA</u> TBD	
6.4A.1.6 Frequency error for CA (7UL CA)	<u>Intra-band contiguous CA</u> TBD	
6.4A.1.7 Frequency error for CA (8UL CA)	<u>Intra-band contiguous CA</u> TBD	
6.4A.2.1.1 Error Vector magnitude for CA (2UL CA)	<u>TBD</u>	
6.4A.2.1.2 Error Vector magnitude for CA (3UL CA)	<u>TBD</u>	
6.4A.2.1.3 Error Vector magnitude for CA (4UL CA)	<u>TBD</u>	

6.4A.2.1.4 Error Vector magnitude for CA (5UL CA)	<u>TBD</u>	
6.4A.2.1.5 Error Vector magnitude for CA (6UL CA)	<u>TBD</u>	
6.4A.2.1.6 Error Vector magnitude for CA (7UL CA)	<u>TBD</u>	
6.4A.2.1.7 Error Vector magnitude for CA (8UL CA)	<u>TBD</u>	
6.4A.2.2.1 Carrier leakage for CA (2UL CA)	<u>TBD</u>	
6.4A.2.2.2 Carrier leakage for CA (3UL CA)	<u>TBD</u>	
6.4A.2.2.3 Carrier leakage for CA (4UL CA)	<u>TBD</u>	
6.4A.2.2.4 Carrier leakage for CA (5UL CA)	<u>TBD</u>	
6.4A.2.2.5 Carrier leakage for CA (6UL CA)	<u>TBD</u>	
6.4A.2.2.6 Carrier leakage for CA (7UL CA)	<u>TBD</u>	
6.4A.2.2.7 Carrier leakage for CA (8UL CA)	<u>TBD</u>	
6.4A.2.3.1 In-band emissions for CA (2UL CA)	<u>TBD</u>	
6.4A.2.3.2 In-band emissions for CA (3UL CA)	<u>TBD</u>	
6.4A.2.3.3 In-band emissions for CA (4UL CA)	<u>TBD</u>	
6.4A.2.3.4 In-band emissions for CA (5UL CA)	<u>TBD</u>	
6.4A.2.3.5 In-band emissions for CA (6UL CA)	<u>TBD</u>	
6.4A.2.3.6 In-band emissions for CA (7UL CA)	<u>TBD</u>	
6.4A.2.3.7 In-band emissions for CA (8UL CA)	<u>TBD</u>	
6.4D.1 Frequency error for UL MIMO	Same as 6.4.1	Same as 6.4.1
6.5.1 Occupied bandwidth	0 kHz	Minimum requirement + TT
6.5.2.1 Spectrum Emission Mask	<p>PC3 IFF (Max Device size \leq 30 cm) 3.33 dB (FR2a) 3.58 dB (FR2b) 4.46 dB (FR2c)</p> <p>PC1 IFF (Max Device size \leq 30 cm) 4.11 dB (FR2a) FFS dB (FR2b)</p> <p>PC5, PC6 IFF (Max Device size \leq 30 cm) 3.33 dB (FR2a)</p>	TT = 0.65 x MTSU _{IFF}
6.5.2.1_1 Spectrum Emission Mask with Power Boost	Same as 6.5.2.1	
6.5.2.3 Adjacent Channel Leakage Ratio	<p><u>Absolute requirement</u> 0 dB</p> <p><u>Relative requirement</u> PC3 IFF (Max Device size \leq 30 cm) FR2a: BW \leq 50MHz: 4.10 dB (Test ID 1-2, 4-5) 4.08 dB (Test ID 3, 6) 4.15 dB (Test ID 7-9) 4.36 dB (Test ID 10-12)</p>	<p>PC3 TT = max(R, ΔSNR_{mr}+0.65 x (MTSU_{IFF}-1.0)) -R + TT due to metric change</p> <p>TT due to metric change : 1.0 dB R: Relaxation needed to limit influence of TE noise to 1 dB (specified in clause 6.5.2.3.5) ΔSNR_{mr}: Systematic offset due to noise when measuring ACP at minimum requirement level</p>

	<p>4.17 dB (Test ID 13-15) 50MHz < BW ≤ 100MHz: 4.49 dB (Test ID 1-2, 4-5) 4.45 dB (Test ID 3, 6) 4.59 dB (Test ID 7-9) 4.98 dB (Test ID 10-12) 4.62 dB (Test ID 13-15) 100MHz < BW ≤ 200MHz: 4.66 dB (Test ID 1-2, 4-5) 4.59 dB (Test ID 3, 6) 4.85 dB (Test ID 7-9) 4.06 dB (Test ID 10-12) 4.91 dB (Test ID 13-15) 200MHz < BW ≤ 400MHz: 5.06 dB (Test ID 1-6) 3.34 dB (Test ID 7-9) 1.46 dB (Test ID 10-12) 2.99 dB (Test ID 13-15)</p> <p>FR2b: BW ≤ 50MHz: 4.48 dB (Test ID 1-2, 4-5) 4.45 dB (Test ID 3, 6) 4.58 dB (Test ID 7-9) 4.97 dB (Test ID 10-12) 4.62 dB (Test ID 13-15) 50MHz < BW ≤ 100MHz: 4.65 dB (Test ID 1-2, 4-5) 4.58 dB (Test ID 3, 6) 4.84 dB (Test ID 7-9) 4.90 dB (Test ID 13-15) 100MHz < BW ≤ 200MHz: 4.97 dB (Test ID 1-2, 4-5) 4.84 dB (Test ID 3, 6) 5.31 dB (Test ID 7-9)</p> <p>FR2c: BW ≤ 50MHz: 5.61 dB (Test ID 1-2, 4-5) 5.55 dB (Test ID 3, 6) 5.79 dB (Test ID 7-9) 6.44 dB (Test ID 10-12) 5.84 dB (Test ID 13-15) 50MHz < BW ≤ 100MHz: 5.91 dB (Test ID 1-2, 4-5) 5.79 dB (Test ID 3, 6) 6.23 dB (Test ID 7-9) 6.33 dB (Test ID 13-15) 100MHz < BW ≤ 200MHz: 6.44 dB (Test ID 1-2, 4-5) 6.23 dB (Test ID 3, 6)</p> <p>PC1 IFF (Max Device size ≤ 30 cm) FR2a: ±5.26 dB (BW ≤ 400MHz)</p> <p>FR2b: ±5.26 dB (BW ≤ 400MHz)</p> <p>PC5, PC6 IFF (Max Device size ≤ 30 cm) FR2a: ±5.26 dB (BW ≤ 400MHz)</p>	<p>PC1, PC5, PC6 TT = max(R, ΔSNR_{mr}+0.65 x (MTSU_{IFF}-0.95)) -R + TT due to metric change</p>
<p>6.5.3.1 Transmitter Spurious emissions</p>	<p>0 dB</p>	<p>Minimum requirement + TT</p>

6.5.3.1_1 Transmitter Spurious emissions with Power Boost	Same as 6.5.3.1	
6.5.3.2 Spurious emission band UE co-existence	0 dB	Minimum requirement + TT
6.5.3.2_1 Spurious emission band UE co-existence with Power Boost	Same as 6.5.3.2	
6.5.3.3 Additional spurious emission	0 dB	Minimum requirement + TT
6.5.3.3_1 Additional spurious emissions with Power Boost	Same as 6.5.3.3	
6.5A.1.1 Occupied bandwidth for CA (2UL CA)	<u>Intra-band contiguous CA</u> Maximum aggregated BW \leq 400MHz Same as 6.5.1 Maximum aggregated BW > 400MHz TBD <u>Intra-band non-contiguous, Inter-band CA</u> TBD	
6.5A.1.2 Occupied bandwidth for CA (3UL CA)	<u>Intra-band contiguous CA</u> Maximum aggregated BW \leq 400MHz Same as 6.5.1 Maximum aggregated BW > 400MHz TBD <u>Intra-band non-contiguous, Inter-band CA</u> TBD	
6.5A.1.3 Occupied bandwidth for CA (4UL CA)	<u>Intra-band contiguous CA</u> Maximum aggregated BW \leq 400MHz Same as 6.5.1 Maximum aggregated BW > 400MHz TBD <u>Intra-band non-contiguous, Inter-band CA</u> TBD	
6.5A.1.4 Occupied bandwidth for CA (5UL CA)	TBD	
6.5A.1.5 Occupied bandwidth for CA (6UL CA)	TBD	
6.5A.1.6 Occupied bandwidth for CA (7UL CA)	TBD	
6.5A.1.7 Occupied bandwidth for CA (8UL CA)	TBD	
6.5A.2.1.1 Spectrum Emission Mask for CA (2UL CA)	<u>Intra-band contiguous CA</u> Maximum aggregated BW \leq 400MHz Same as 6.5.2.1 Maximum aggregated BW > 400MHz TBD <u>Intra-band non-contiguous, Inter-band CA</u> TBD	
6.5A.2.1.2 Spectrum Emission Mask for CA (3UL CA)	<u>Intra-band contiguous CA</u> Maximum aggregated BW \leq 400MHz Same as 6.5.2.1 Maximum aggregated BW > 400MHz TBD <u>Intra-band non-contiguous, Inter-band CA</u> TBD	
6.5A.2.1.3 Spectrum Emission Mask for CA (4UL CA)	<u>Intra-band contiguous CA</u> Maximum aggregated BW \leq 400MHz Same as 6.5.2.1	

	<p>Maximum aggregated BW > 400MHz TBD</p> <p><u>Intra-band non-contiguous, Inter-band CA</u> TBD</p>	
6.5A.2.1.4 Spectrum Emission Mask for CA (5UL CA)	TBD	
6.5A.2.1.5 Spectrum Emission Mask for CA (6UL CA)	TBD	
6.5A.2.1.6 Spectrum Emission Mask for CA (7UL CA)	TBD	
6.5A.2.1.7 Spectrum Emission Mask for CA (8UL CA)	TBD	
6.5A.2.2.1 Adjacent channel leakage ratio for CA (2UL CA)	<p><u>Intra-band contiguous CA</u> Maximum aggregated BW \leq 400MHz Same as 6.5.2.3</p> <p>Maximum aggregated BW > 400MHz TBD</p> <p><u>Intra-band non-contiguous, Inter-band CA</u> TBD</p>	<p>TT = 0.65 x MTSU_{IFF} + TT due to metric change</p> <p>TT due to metric change : 1.0 dB</p>
6.5A.2.2.2 Adjacent channel leakage ratio for CA (3UL CA)	<p><u>Intra-band contiguous CA</u> Maximum aggregated BW \leq 400MHz Same as 6.5.2.3</p> <p>Maximum aggregated BW > 400MHz TBD</p> <p><u>Intra-band non-contiguous, Inter-band CA</u> TBD</p>	<p>TT = 0.65 x MTSU_{IFF} + TT due to metric change</p> <p>TT due to metric change : 1.0 dB</p>
6.5A.2.2.3 Adjacent channel leakage ratio for CA (4UL CA)	<p><u>Intra-band contiguous CA</u> Maximum aggregated BW \leq 400MHz Same as 6.5.2.3</p> <p>Maximum aggregated BW > 400MHz TBD</p> <p><u>Intra-band non-contiguous, Inter-band CA</u> TBD</p>	<p>TT = 0.65 x MTSU_{IFF} + TT due to metric change</p> <p>TT due to metric change : 1.0 dB</p>
6.5A.2.2.4 Adjacent channel leakage ratio for CA (5UL CA)	<p>Intra-band contiguous CA 400 MHz < aggregated BW \leq TBD MHz</p> <p>Intra-band non-contiguous CA TBD</p>	TBD
6.5A.2.2.5 Adjacent channel leakage ratio for CA (6UL CA)	<p>Intra-band contiguous CA 400 MHz < aggregated BW \leq TBD MHz</p> <p>Intra-band non-contiguous CA TBD</p>	TBD
6.5A.2.2.6 Adjacent channel leakage ratio for CA (7UL CA)	<p>Intra-band contiguous CA 400 MHz < aggregated BW \leq TBD MHz</p> <p>Intra-band non-contiguous CA TBD</p>	TBD
6.5A.2.2.7 Adjacent channel leakage ratio for CA (8UL CA)	<p>Intra-band contiguous CA 400 MHz < aggregated BW \leq TBD MHz</p> <p>Intra-band non-contiguous CA TBD</p>	TBD
6.5A.3.1.1 Transmitter Spurious emissions for CA (2UL CA)	<p><u>Intra-band contiguous CA</u> Maximum aggregated BW \leq 400MHz Same as 6.5.3.1</p> <p>Maximum aggregated BW > 400MHz TBD</p>	

	<u>Intra-band non-contiguous, Inter-band CA</u> TBD	
6.5A.3.1.2 Transmitter Spurious emissions for CA (3UL CA)	<u>Intra-band contiguous CA</u> Maximum aggregated BW \leq 400MHz Same as 6.5.3.1 Maximum aggregated BW > 400MHz TBD <u>Intra-band non-contiguous, Inter-band CA</u> TBD	
6.5A.3.1.3 Transmitter Spurious emissions for CA (4UL CA)	<u>Intra-band contiguous CA</u> Maximum aggregated BW \leq 400MHz Same as 6.5.3.1 Maximum aggregated BW > 400MHz TBD <u>Intra-band non-contiguous, Inter-band CA</u> TBD	
6.5A.3.1.4 Transmitter Spurious emissions for CA (5UL CA)	<u>Intra-band contiguous CA</u> 400 MHz < aggregated BW \leq TBD MHz Intra-band non-contiguous CA TBD	TBD
6.5A.3.1.5 Transmitter Spurious emissions for CA (6UL CA)	<u>Intra-band contiguous CA</u> 400 MHz < aggregated BW \leq TBD MHz Intra-band non-contiguous CA TBD	TBD
6.5A.3.1.6 Transmitter Spurious emissions for CA (7UL CA)	<u>Intra-band contiguous CA</u> 400 MHz < aggregated BW \leq TBD MHz Intra-band non-contiguous CA TBD	TBD
6.5A.3.1.7 Transmitter Spurious emissions for CA (8UL CA)	<u>Intra-band contiguous CA</u> 400 MHz < aggregated BW \leq TBD MHz Intra-band non-contiguous CA TBD	TBD
6.5A.3.2.1 Spurious emission band UE co-existence for CA (2UL CA)	<u>Intra-band contiguous CA</u> Maximum aggregated BW \leq 400MHz Same as 6.5.3.2 Maximum aggregated BW > 400MHz TBD <u>Intra-band non-contiguous, Inter-band CA</u> TBD	
6.5A.3.2.2 Spurious emission band UE co-existence for CA (3UL CA)	<u>Intra-band contiguous CA</u> Maximum aggregated BW \leq 400MHz Same as 6.5.3.2 Maximum aggregated BW > 400MHz TBD <u>Intra-band non-contiguous, Inter-band CA</u> TBD	
6.5A.3.2.3 Spurious emission band UE co-existence for CA (4UL CA)	<u>Intra-band contiguous CA</u> Maximum aggregated BW \leq 400MHz Same as 6.5.3.2 Maximum aggregated BW > 400MHz TBD <u>Intra-band non-contiguous, Inter-band CA</u> TBD	
6.5A.3.2.4 Spurious emission band UE co-existence for CA (5UL CA)	<u>Intra-band contiguous CA</u> 400 MHz < aggregated BW \leq TBD MHz Intra-band non-contiguous CA TBD	TBD

6.5A.3.2.5 Spurious emission band UE co-existence for CA (6UL CA)	<u>Intra-band contiguous CA</u> 400 MHz < aggregated BW ≤ TBD MHz Intra-band non-contiguous CA TBD	TBD
6.5A.3.2.6 Spurious emission band UE co-existence for CA (7UL CA)	<u>Intra-band contiguous CA</u> 400 MHz < aggregated BW ≤ TBD MHz Intra-band non-contiguous CA TBD	TBD
6.5A.3.2.7 Spurious emission band UE co-existence for CA (8UL CA)	<u>Intra-band contiguous CA</u> 400 MHz < aggregated BW ≤ TBD MHz Intra-band non-contiguous CA TBD	TBD
6.5A.3.3.1 Additional spurious emissions for CA (2UL CA)	<u>Intra-band contiguous CA</u> Maximum aggregated BW ≤ 400MHz Same as 6.5.3.3 Maximum aggregated BW > 400MHz TBD <u>Intra-band non-contiguous, Inter-band CA</u> TBD	
6.5A.3.3.2 Additional spurious emissions for CA (3UL CA)	<u>Intra-band contiguous CA</u> Maximum aggregated BW ≤ 400MHz Same as 6.5.3.3 Maximum aggregated BW > 400MHz TBD <u>Intra-band non-contiguous, Inter-band CA</u> TBD	
6.5A.3.3.3 Additional spurious emissions for CA (4UL CA)	<u>Intra-band contiguous CA</u> Maximum aggregated BW ≤ 400MHz Same as 6.5.3.3 Maximum aggregated BW > 400MHz TBD <u>Intra-band non-contiguous, Inter-band CA</u> TBD	
6.5A.3.3.4 Additional spurious emissions for CA (5UL CA)	<u>Intra-band contiguous CA</u> 400 MHz < aggregated BW ≤ TBD MHz Intra-band non-contiguous CA TBD	TBD
6.5A.3.3.5 Additional spurious emissions for CA (6UL CA)	<u>Intra-band contiguous CA</u> 400 MHz < aggregated BW ≤ TBD MHz Intra-band non-contiguous CA TBD	TBD
6.5A.3.3.6 Additional spurious emissions for CA (7UL CA)	<u>Intra-band contiguous CA</u> 400 MHz < aggregated BW ≤ TBD MHz Intra-band non-contiguous CA TBD	TBD
6.5A.3.3.7 Additional spurious emissions for CA (8UL CA)	<u>Intra-band contiguous CA</u> 400 MHz < aggregated BW ≤ TBD MHz Intra-band non-contiguous CA TBD	TBD
6.5D.1 Occupied bandwidth for UL MIMO	0 kHz	Minimum requirement + TT
6.5D.2.1 Spectrum Emission Mask for UL MIMO	<u>Same as 6.5.2.1</u>	
6.5D.2.2 Adjacent channel leakage ratio for UL MIMO	<u>Same as 6.5.2.3</u>	
6.5D.3.1 Transmitter Spurious emissions for UL MIMO	Same ad 6.5.3.1	
6.5D.3.2 Spurious emission band UE co-existence for UL MIMO	Same ad 6.5.3.2	

6.5D.3.3 Additional spurious emissions for UL MIMO	Same as 6.5.3.3	
6.6.1 Beam correspondence - EIRP	PC3 1.26 dB (FR2a, FR2b)	PC3 $TT = 0.60 \times (MTSU_{IFF} - \Delta SNR_{mr})$ ΔSNR_{mr} : Systematic offset due to noise when measuring at minimum requirement level
6.6.2 Enhanced Beam correspondence - EIRP	Same as 6.6.1	
NOTE 1: FR2a, FR2b and FR2c are specified in Table 5.1-2.		

F.3.3 Measurement of receiver

Table F.3.3-1: Derivation of Test Requirements (Receiver tests)

Sub clause	Test Tolerance (TT)	Formula for test requirement
7.3.2 Reference sensitivity power level	<p><u>PC3</u> IFF (Max Device size \leq 30 cm) 2.41 dB (FR2a, FR2b, NTC) 2.52 dB (FR2a, FR2b, ETC) 2.85 dB (FR2c, NTC) 2.92 dB (FR2c, ETC)</p> <p><u>PC1</u> IFF (Max Device size \leq 30 cm) 2.51 dB (FR2a, FR2b, NTC) 2.62 dB (FR2a, FR2b, ETC)</p> <p><u>PC5</u> IFF (Max Device size \leq 30 cm) 2.51 dB (FR2a, NTC) 2.62 dB (FR2a, ETC)</p> <p><u>PC6</u> IFF (Max Device size \leq 30 cm) 2.50 dB (FR2a, NTC) 2.62 dB (FR2a, ETC)</p> <p><u>PC7</u> IFF (Max Device size \leq 30 cm) 2.41 dB (FR2a, NTC) 2.52 dB (FR2a, ETC)</p>	$TT = 0.45 \times MTSU_{IFF}$
7.3.4 EIS spherical coverage	<p><u>PC3</u> IFF (Max Device size \leq 30 cm, FR2a, FR2b) 2.28 dB IFF (Max Device size \leq 30 cm, FR2c) 2.72 dB</p> <p><u>PC1</u> IFF (Max Device size \leq 30 cm, FR2a, FR2b) 2.28 dB</p> <p><u>PC5</u> IFF (Max Device size \leq 30 cm, FR2a) 2.28 dB</p> <p><u>PC6</u> IFF (Max Device size \leq 30 cm) 2.50 dB (FR2a)</p> <p><u>PC7</u> IFF (Max Device size \leq 30 cm, FR2a)</p>	$TT = 0.45 \times MTSU_{IFF}$

	2.28 dB	
7.3A.2.1 Reference sensitivity power level for CA (2DL CA)	<u>Intra-band contiguous CA</u> Maximum aggregated BW \leq 400MHz Same as 7.3.2 for each component carrier Maximum aggregated BW > 400MHz TBD <u>Intra-band non-contiguous, Inter-band CA</u> TBD	
7.3A.2.2 Reference sensitivity power level for CA (3DL CA)	<u>Intra-band contiguous CA</u> Maximum aggregated BW \leq 400MHz Same as 7.3.2 for each component carrier Maximum aggregated BW > 400MHz TBD <u>Intra-band non-contiguous, Inter-band CA</u> TBD	
7.3A.2.3 Reference sensitivity power level for CA (4DL CA)	<u>Intra-band contiguous CA</u> Maximum aggregated BW \leq 400MHz Same as 7.3.2 for each component carrier Maximum aggregated BW > 400MHz TBD <u>Intra-band non-contiguous, Inter-band CA</u> TBD	
7.3A.2.4 Reference sensitivity power level for CA (5DL CA)	<u>Intra-band contiguous CA</u> Maximum aggregated BW \leq 400MHz Same as 7.3.2 for each component carrier Maximum aggregated BW > 400MHz TBD <u>Intra-band non-contiguous, Inter-band CA</u> TBD	
7.3A.2.5 Reference sensitivity power level for CA (6DL CA)	<u>Intra-band contiguous CA</u> Maximum aggregated BW \leq 400MHz Same as 7.3.2 for each component carrier Maximum aggregated BW > 400MHz TBD <u>Intra-band non-contiguous, Inter-band CA</u> TBD	
7.3A.2.6 Reference sensitivity power level for CA (7DL CA)	<u>Intra-band contiguous CA</u> Maximum aggregated BW \leq 400MHz Same as 7.3.2 for each component carrier Maximum aggregated BW > 400MHz TBD <u>Intra-band non-contiguous, Inter-band CA</u> TBD	
7.3A.2.7 Reference sensitivity power level for CA (8DL CA)	<u>Intra-band contiguous CA</u> Maximum aggregated BW \leq 400MHz Same as 7.3.2 for each component carrier Maximum aggregated BW > 400MHz TBD <u>Intra-band non-contiguous, Inter-band CA</u> TBD	
7.3A.3.1 EIS spherical coverage for CA (2DL CA)	TBD	
7.3A.3.2 EIS spherical coverage for CA (3DL CA)	TBD	

7.3A.3.3 EIS spherical coverage for CA (4DL CA)	<u>TBD</u>	
7.3A.3.4 EIS spherical coverage for CA (5DL CA)	<u>TBD</u>	
7.3A.3.5 EIS spherical coverage for CA (6DL CA)	<u>TBD</u>	
7.3A.3.6 EIS spherical coverage for CA (7DL CA)	<u>TBD</u>	
7.3A.3.7 EIS spherical coverage for CA (8DL CA)	<u>TBD</u>	
7.4 Maximum input level	<u>TBD</u>	
7.4A.1 Maximum input level for CA (2DL CA)	<u>TBD</u>	
7.4A.2 Maximum input level for CA (3DL CA)	<u>TBD</u>	
7.4A.3 Maximum input level for CA (4DL CA)	<u>TBD</u>	
7.4A.4 Maximum input level for CA (5DL CA)	<u>TBD</u>	
7.4A.5 Maximum input level for CA (6DL CA)	<u>TBD</u>	
7.4A.6 Maximum input level for CA (7DL CA)	<u>TBD</u>	
7.4A.7 Maximum input level for CA ((DL CA)	<u>TBD</u>	
7.5 Adjacent channel selectivity	<u>0 dB</u>	Wanted signal power + TT T-put limit unchanged
7.5A.1 Adjacent channel selectivity for CA (2UL CA)	<u>TBD</u>	
7.5A.2 Adjacent channel selectivity for CA (3UL CA)	<u>TBD</u>	
7.5A.3 Adjacent channel selectivity for CA (4UL CA)	<u>TBD</u>	
7.5A.4 Adjacent channel selectivity for CA (5UL CA)	<u>TBD</u>	
7.5A.5 Adjacent channel selectivity for CA (6UL CA)	<u>TBD</u>	
7.5A.6 Adjacent channel selectivity for CA (7UL CA)	<u>TBD</u>	
7.5A.7 Adjacent channel selectivity for CA (8UL CA)	<u>TBD</u>	
7.6.2 In-band blocking	<u>0 dB</u>	Wanted signal power + TT T-put limit unchanged
7.6A.2.1 In-band blocking for CA (2UL CA)	<u>TBD</u>	
7.6A.2.2 In-band blocking for CA (3UL CA)	<u>TBD</u>	
7.6A.2.3 In-band blocking for CA (4UL CA)	<u>TBD</u>	
7.6A.2.4 In-band blocking for CA (5UL CA)	<u>TBD</u>	
7.6A.2.5 In-band blocking for CA (6UL CA)	<u>TBD</u>	
7.6A.2.6 In-band blocking for CA (7UL CA)	<u>TBD</u>	
7.6A.2.7 In-band blocking for CA (8UL CA)	<u>TBD</u>	
7.9 Spurious emissions	<u>0 dB</u>	Minimum requirement + TT T-put limit unchanged
NOTE 1: FR2a, FR2b and FR2c are specified in Table 5.1-2.		

F.4 Uplink power window

F.4.1 Introduction

A number of Tx and Rx Test cases set the UE uplink power to be within a defined window to ensure the test is carried out in the intended conditions. This clause gives the method for calculating the uplink power window used in Tx test cases and Rx Test cases.

F.4.2 Setting the power window above a requirement

The method used to derive the uplink power window for NR FR2 is defined in TS 38.521-3 [14] clause F.4.2.2.

F.4.3 Setting the power window below a requirement

The method used to derive the uplink power window for NR FR2 is defined in TS 38.521-3 [14] clause F.4.3.2.

F.4.4 Setting the power window centred on a target value

The method used to derive the uplink power window for NR FR2 is defined in TS 38.521-3 [14] clause F.4.4.2.

F.8 FFS

F.9 FFS

F.10 FFS

Annex G (normative): Uplink Physical Channels

G.0 Uplink Signal Levels

Please refer to Annex G.0 in TS 38.521-1 [13].

G.1 General

Please refer to Annex G.1 in TS 38.521-1 [13].

G.2 Set-up

Please refer to Annex G.2 in TS 38.521-1 [13].

G.3 Connection

Please refer to Annex G.3 in TS 38.521-1 [13].

G.3.0 Measurement of Transmitter Characteristics

Please refer to Annex G.3.0 in TS 38.521-1 [13].

G.3.1 Measurement of Receiver Characteristics

Please refer to Annex G.3.1 in TS 38.521-1 [13].

Annex H (normative): Statistical Testing

H.1 General

This annex specifies mapping throughput to error ratio, pass fail limits and pass fail decision rules that are needed for measuring average throughput for a duration sufficient to achieve statistical significance for testing receiver characteristics.

H.2 Statistical testing of receiver characteristics

H.2.1 General

The test of receiver characteristics is twofold.

1. A signal or a combination of signals is offered to the RX port(s) of the receiver.
2. The ability of the receiver to demodulate /decode this signal is verified by measuring the throughput.

In (2) is the statistical aspect of the test and is treated here.

The minimum requirement for all receiver tests is >95% of the maximum throughput.

All receiver tests are performed in static propagation conditions. No fading conditions are applied.

H.2.2 Mapping throughput to error ratio

- a) The measured information bit throughput R is defined as the sum (in kilobits) of the information bit payloads successfully received during the test interval, divided by the duration of the test interval (in seconds).
- b) In measurement practice the UE indicates successfully received information bit payload by signalling an ACK to the SS.
If payload is received, but damaged and cannot be decoded, the UE signals a NACK.
- c) Only the ACK and NACK signals, not the data bits received, are accessible to the SS.
The number of bits is known in the SS from knowledge of what payload was sent.
- d) For the reference measurement channel, applied for testing, the number of bits is different in different slots, however in a radio frame it is fixed during one test.
- e) The time in the measurement interval is composed of successfully received slots (ACK), unsuccessfully received slots (NACK) and no reception at all (DTX-slots).
- f) DTX-slots may occur regularly according the applicable reference measurement channel (regDTX).
In real live networks this is the time when other UEs are served. In TDD these are the UL and special slots.
regDTX vary from test to test but are fixed within the test.
- g) Additional DTX-slots occur statistically when the UE is not responding ACK or NACK where it should.
(statDTX)
This may happen when the UE was not expecting data or decided that the data were not intended for it.

The pass / fail decision is done by observing the:

- number of NACKs
- number of ACKs and
- number of statDTXs (regDTX is implicitly known to the SS)

The ratio $(NACK + statDTX)/(NACK + statDTX + ACK)$ is the Error Ratio (ER). Taking into account the time consumed by the ACK, NACK, and DTX-TTIs (regular and statistical), ER can be mapped unambiguously to throughput for any single reference measurement channel test.

H.2.3 Design of the test

The test is defined by the following design principles (see clause H. 2.6, Theory....):

1. The early decision concept is applied.
2. A second limit is introduced: Bad DUT factor $M > 1$
3. To decide the test pass:

Supplier risk is applied based on the Bad DUT quality

To decide the test fail

Customer Risk is applied based on the specified DUT quality

The test is defined by the following parameters:

1. Limit ER = 0.05 (Throughput limit = 95%)
2. Bad DUT factor $M = 1.5$ (selectivity)
3. Confidence level CL = 95% (for specified DUT and Bad DUT-quality)

H.2.4 Numerical definition of the pass fail limits

Table H.2.4-1: pass fail limits

ne	ns _p	ns _f	ne	ns _p	ns _f	ne	ns _p	ns _f	ne	ns _p	ns _f
0	67	NA	37	715	477	74	1290	1093	111	1847	1739
1	67	NA	38	731	493	75	1306	1110	112	1862	1756
2	95	NA	39	747	509	76	1321	1128	113	1877	1774
3	119	NA	40	763	525	77	1336	1145	114	1891	1792
4	141	NA	41	779	541	78	1351	1162	115	1906	1809
5	162	NA	42	795	557	79	1366	1179	116	1921	1827
6	183	NA	43	810	573	80	1382	1197	117	1936	1845
7	203	NA	44	826	590	81	1397	1214	118	1951	1863
8	222	NA	45	842	606	82	1412	1231	119	1966	1880
9	241	67	46	858	622	83	1427	1248	120	1981	1898
10	259	80	47	873	639	84	1442	1266	121	1995	1916
11	278	92	48	889	655	85	1457	1283	122	2010	1934
12	296	105	49	905	672	86	1472	1300	123	2025	1951
13	314	118	50	920	688	87	1487	1318	124	2040	1969
14	332	131	51	936	705	88	1503	1335	125	2055	1987
15	349	145	52	952	721	89	1518	1353	126	2069	2005
16	367	159	53	967	738	90	1533	1370	127	2084	2023
17	384	173	54	983	755	91	1548	1387	128	2099	2041
18	401	187	55	998	771	92	1563	1405	129	2114	2058
19	419	201	56	1014	788	93	1578	1422	130	2128	2076
20	436	216	57	1029	805	94	1593	1440	131	2143	2094
21	453	230	58	1045	822	95	1608	1457	132	2158	2112
22	469	245	59	1060	838	96	1623	1475	133	2173	2130
23	486	260	60	1076	855	97	1638	1492	134	2187	2148
24	503	275	61	1091	872	98	1653	1510	135	2202	2166
25	520	290	62	1107	889	99	1668	1527	136	2217	2183
26	536	305	63	1122	906	100	1683	1545	137	2232	2201
27	553	320	64	1137	923	101	1698	1562	138	2246	2219
28	569	335	65	1153	940	102	1713	1580	139	2261	2237
29	585	351	66	1168	957	103	1728	1598	140	2276	2255
30	602	366	67	1184	974	104	1742	1615	141	2291	2273

31	618	382	68	1199	991	105	1757	1633	142	2305	2291
32	634	398	69	1214	1008	106	1772	1650	143	2320	2309
33	651	413	70	1229	1025	107	1787	1668	144	2335	2327
34	667	429	71	1245	1042	108	1802	1686	145	2349	2345
35	683	445	72	1260	1059	109	1817	1703	146	2364	2363
36	699	461	73	1275	1076	110	1832	1721	*) note 2 in H.2.5		

NOTE 1: The first column is the number of errors (ne = number of NACK + statDTX)

NOTE 2: The second column is the number of samples for the pass limit (ns_p, ns=Number of Samples= number of NACK + statDTX + ACK)

NOTE 3: The third column is the number of samples for the fail limit (ns_f)

NOTE 4: The UE could be decided as early pass/fail when at least 67 samples are received. The ns_f is set to NA for ne less than 9.

H.2.5 Pass fail decision rules

The pass fail decision rules apply for a single test, comprising one component in the test vector. The overall Pass /Fail conditions are defined in clause H.2.6 and H.2.A.6

Having observed 0 errors, pass the test at 67+ samples, otherwise continue
 Having observed 1 error, pass the test at 67+ samples, otherwise continue
 Having observed 2 errors, pass the test at 95+ samples, otherwise continue

Etc. etc.

Having observed 145 errors, pass the test at 2349+ samples, fail the test at 2345- samples, otherwise continue

Having observed 146 errors, pass the test at 2364+ samples, fail the test at 2363- samples.

Where x+ means: x or more, x- means x or less

NOTE 1: an ideal DUT passes after 67 samples. The maximum test time is 2364 samples.

NOTE 2: It is allowed to deviate from the early decision concept by postponing the decision (pass/fail or continue). Postponing the decision to or beyond the end of Table H.2.4-1 requires a pass fail decision against the test limit: pass the DUT for ER<0.0618, otherwise fail.

H.2.6 Theory to derive the pass fail limits (Informative)

Editor's note: This clause of the Annex H is for information only and it describes the background theory and information for statistical testing.

H.2.6.1 Numerical definition of the pass-fail limits

A statistical test is characterized by test time, selectivity and confidence level. The outcome of the statistical test is a decision. This decision may be correct, i.e., DUTs whose throughput is less than 95% maximum throughput being declared to fail, and DUTs whose throughput is higher or equal to 95% being declared to pass, or in-correct with opposite decision. The Confidence Level (CL) describes the probability that the decision is a correct one. The complement is the wrong decision probability (risk) $D = 1 - CL$.

As described in H.2.2, the measurement of throughput could be mapped to ER (Error Ratio). When testing ER, transport blocks or "samples" are observed and the number of correctly and erroneously received blocks are recorded. For a "standard" test, a pre-defined number of samples are observed, and a pass/fail decision is made based on the number of observed errors being above/below a threshold. This threshold is based on the targeted throughput or BLER and the design target CL. There is always some risk of a statistical variation leading to an incorrect pass/fail decision. The greater the number of samples that are recorded, the lower is the risk of such an error. The number of samples that are

observed in a standard test is dimensioned to achieve an acceptable low risk of error (i.e., an acceptable high confidence level) for DUTs that just meet the specified limit.

The standard test works well where the target ER level is relatively high and confidence level relatively low (both are chosen to be on a comparable order of magnitude). However, for relatively low ER testing the length of time required for observing sufficient samples to achieve a 95% confidence level is excessive. In many cases, the DUTs will in fact have a much lower true ER level than the target ER level, (in which case, the number of samples needed to achieve high confidence that the true ER level is lower than the limit is much smaller). On the other hand, a bad DUT which is expected to fail the requirement might have a much higher true ER level (in which case, errors occur more frequently and it can be demonstrated that the DUT is above the target ER limit with fewer samples).

To avoid long test time, an alternative test method called early pass/fail is adopted. With the early pass/fail, each time a block error is encountered, a decision is made on whether the DUT can be passed/failed with 95% CL or the test needs to continue until another error is encountered. In the case of very good DUTs, the test can also be passed, when the number of samples permissible for one error event is reached and no error event is recorded. Pass/Fail is decided based on the total number of observed samples and errors, and a statistical calculation based on an inverse binomial cumulative distribution. The calculation involves one parameter, one variable and the result:

- Parameter: d (per step decision probability).
- Variable: ne (number of observed errors).
- Result: ns (number of expected samples for pass/fail, depending on which one is calculated).

The per step decision probability risk, d, expresses the probability of making an incorrect pass/fail decision in the current step (i.e., for the current decision coordinate). d is determined by simulation such that the overall risk of making a wrong decision over all steps of each test of a large number of tests on a large number of DUTs that exactly meet the target ER limit is D=5% (and hence the CL 95%).

It should be noted that d is determined separately considering early pass and early fail testing.

For a marginal DUT (i.e., a DUT almost exactly meeting the target ER level), the unmodified early pass/early fail approach is unable to distinguish whether the DUT has just passed or just failed the BLER ($\epsilon \rightarrow 0$), and can thus terminate with an "undecided" result. To avoid this undecided result and provide selectivity, a so-called "bad device factor" (M) is introduced into the early pass calculation. This factor biases the decision towards avoiding failing good DUT.

H.2.6.2 Simulation to derive the pass-fail limits for testing 95% throughput

As per the description in H.2.2, the 95% throughput measurement is mapped to $ER=0.05$, where ER is $(NACK + statDTX)/(NACK + statDTX + ACK)$.

The binomial distribution and its inverse are used to design the pass and fail limits. Note that this method is not unique and that other methods exist.

$$\text{fail}(ne, d_f) := \frac{ne}{ns_f} = \frac{ne}{(ne + qnbinom(d_f, ne, ER))}$$

$$\text{pass}(ne, cl_p, M) := \frac{ne}{ns_p} = \frac{ne}{(ne + qnbinom(cl_p, ne, ER \cdot M))}$$

Where

- fail(..) is the error ratio for the fail limit.
- pass(..) is the error ratio for the pass limit.
- ER is the specified error ratio 5%.
- ne is the number of bad results. This is the variable in both equations.

- M is the Bad DUT factor $M=1.5$.
- d_f is the wrong decision probability of a single (ne, ns) co-ordinate for the fail limit. It is found by simulation to be $d_f = 0.006$.
- cl_p is the confidence level of a single (ne, ns) co-ordinate for the pass limit. It is found by simulation to be $cl_p = 0.9945$.
- $qnbinom(\cdot)$: The inverse cumulative function of the negative binomial distribution.

The simulation works as follows:

- A large population of limit DUTs with true $ER = 0.05$ is decided against the pass and fail limits.
- cl_p and d_f are tuned such that CL (95 %) of the population passes and D (5 %) of the population fails.
- A population of Bad DUTs with true $ER = M*0.05$ is decided against the same pass and fail limits.
- cl_p and d_f are tuned such that CL (95 %) of the population fails and D (5 %) of the population passes.
- The number of DUTs decrease during the simulation, as the decided DUTs leave the population. That number decreases with an approximately exponential characteristics. After 146 bad results all DUTs of the population are decided.

NOTE: The exponential decrease of the population is an optimal design goal for the decision co-ordinates (ne, ns), which can be achieved with other formulas or methods as well.

Annex I: Void

Annex J (normative): Test applicability per permitted test method

This annex describes, per test requirement, the permitted test methodologies as a function of DUT antenna configuration.

Table J-1: Test metric applicability per permitted test method

Test Metric	No DUT antenna configuration declaration	DUT antenna configuration declaration		
		Configuration 1 (one antenna panel with $D \leq 5$ cm active at any one time)	Configuration 2 (More than one antenna panel $D \leq 5$ cm without phase coherency between panels active at any one time)	Configuration 3 (Any phase coherent antenna panel of any size)
EIRP, TRP	IFF, Enhanced IFF, DFF+IFF (Note 1)	DFF, DFF simplification, IFF, Enhanced IFF, DFF+IFF (Note 2), NFTF	DFF, DFF simplification, IFF, Enhanced IFF, DFF+IFF (Note 2), NFTF	IFF, Enhanced IFF, DFF+IFF (Note 1)
EIS, Frequency Error, EVM, Carrier Leakage, In-Band Emission, EVM SF, OBW	IFF, Enhanced IFF, DFF+IFF (Note 1)	DFF, DFF simplification, IFF, Enhanced IFF, DFF+IFF (Note 2)	DFF, DFF simplification, IFF, Enhanced IFF, DFF+IFF (Note 2)	IFF, Enhanced IFF, DFF+IFF (Note 1)
NOTE: D = DUT radiating aperture declared by UE vendor. Note 1: Only the IFF probe(s) are applicable Note 2: Either DFF or IFF probe(s) are applicable				

Annex K (normative): EIRP, TRP, and EIS measurement procedures

Annex K defines the EIRP, TRP, and EIS measurement procedures which includes Tx and Rx beam peak direction search, spherical coverage procedures and TRP procedures for the permitted testing methodologies defined in [5].

The default value for BEAM_SELECT_WAIT_TIME = 3 sec for all applicable Tx and Rx test cases. The BEAM_SELECT_WAIT_TIME represents a default minimum wait time period required to complete beam selection process at a single position before start of measurement. For a particular EUT, if it is known/determined that a lower wait time than default value is enough to complete beam selection process, then such a lower value may be used by the Test system to achieve test time optimization.

K.1 Direct far field (DFF)

K.1.1 TX beam peak direction search

This Tx beam peak search procedure applies to DUTs with and without support of *beamCorrespondenceWithoutUL-BeamSweeping*. The TX beam peak direction is found with a 3D EIRP scan (separately for each orthogonal downlink polarization). The TX beam peak direction search grid points for this single grid approach are defined in Annex M.2.1. Alternatively, a coarse and fine grid approach could be used according to the definition in Annex M.2.2.

The beam peak searches shall be performed for every test frequency range by default unless the device manufacturer explicitly declares that the beam peak at the mid test frequency range is applicable for the remaining (low, high) test frequency ranges. Beam peak search results cannot be re-used across different bands that do not overlap. Beam peak search results can be re-used from bands that completely contain the target bands if explicitly declared with a declaration.

A beam peak search shall be performed for every intra-band contiguous combination and CA BW class by default unless the device manufacturer explicitly declares that the beam peak for a reference (frequency band, CBW) or (frequency band combination, CA BW class) is applicable for a group of other intra-band contiguous combinations and CA BW classes.

The beam peak searches shall be performed for every modulation by default unless the device manufacturer explicitly declares that the beam peak at the QPSK modulation is applicable for the remaining 16QAM and 64QAM modulations.

The beam peak searches shall be performed for every waveform by default unless the device manufacturer explicitly declares that the beam peak from one waveform is applicable for the other waveform.

The beam peak searches shall be performed separately for NTC (Normal), ETC (TL), and ETC (TH).

The beam peak search results from single carrier can be re-used for UL MIMO testing.

The measurement procedure includes the following steps:

- 1) Select any of the three Alignment Options (1, 2, or 3) from Tables N.2-1 through N.2-7 [3] to mount the DUT inside the QZ.
- 2) Position the DUT in DUT Orientation 1 from Tables N.2-1 through N.2-7 [3].
- 3) Connect the SS (System Simulator) with the DUT through the measurement antenna with $\text{Pol}_{\text{Link}}=\theta$ polarization to form the TX beam towards the measurement antenna. Allow at least BEAM_SELECT_WAIT_TIME for the UE TX beam selection to complete.
- 4) Send continuously uplink power control "up" commands in every uplink scheduling information to the UE; allow at least 200 msec starting from the first TPC Command in this step for the UE to reach P_{UMAX} level. Allow at least BEAM_SELECT_WAIT_TIME for the UE Tx beam selection to complete.
- 5) Through its beam correspondence procedure, DUT refines its TX beam toward that direction depending on DUT's beam correspondence capability which shall match OEM declaration:

- If the DUT's beam correspondence capability *beamCorrespondenceWithoutUL-BeamSweeping* is supported, then DUT autonomously chooses the corresponding TX beam for PUSCH transmission using downlink reference signals to transmit in the direction of the incoming DL signal, which is based on beam correspondence without relying on UL beam sweeping;
 - If the DUT's beam correspondence capability *beamCorrespondenceWithoutUL-BeamSweeping* is not present, then DUT chooses the TX beam for PUSCH transmission which is based on beam correspondence with relying on both DL measurements on downlink reference signals and network-assisted uplink beam sweeping (NOTE 3).
- 6) SS activates the UE Beamlock Function (UBF) by performing the procedure as specified in TS 38.508-1 [10] clause 4.9.2 using condition Tx only.
 - 7) Measure the mean power $P_{\text{meas}}(\text{Pol}_{\text{Meas}}=\theta, \text{Pol}_{\text{Link}}=\theta)$ of the modulated signal arriving at the power measurement equipment (such as a spectrum analyser, power meter, or gNB emulator).
 - 8) Calculate EIRP ($\text{Pol}_{\text{Meas}}=\theta, \text{Pol}_{\text{Link}}=\theta$) by adding the composite loss of the entire transmission path for utilized signal path, $L_{\text{EIRP},\theta}$, and frequency to the measured power $P_{\text{meas}}(\text{Pol}_{\text{Meas}}=\theta, \text{Pol}_{\text{Link}}=\theta)$.
 - 9) Measure the mean power $P_{\text{meas}}(\text{Pol}_{\text{Meas}}=\phi, \text{Pol}_{\text{Link}}=\theta)$ of the modulated signal arriving at the power measurement equipment.
 - 10) Calculate EIRP ($\text{Pol}_{\text{Meas}}=\phi, \text{Pol}_{\text{Link}}=\theta$) by adding the composite losses of the entire transmission path for utilized signal path, $L_{\text{EIRP},\phi}$, and frequency to the measured power $P_{\text{meas}}(\text{Pol}_{\text{Meas}}=\phi, \text{Pol}_{\text{Link}}=\theta)$.
 - 11) Calculate total EIRP($\text{Pol}_{\text{Link}}=\theta$) = $\text{EIRP}(\text{Pol}_{\text{Meas}}=\theta, \text{Pol}_{\text{Link}}=\theta) + \text{EIRP}(\text{Pol}_{\text{Meas}}=\phi, \text{Pol}_{\text{Link}}=\theta)$.
 - 12) SS deactivates the UE Beamlock Function (UBF) by performing the procedure as specified in TS 38.508-1 [10] clause 4.9.3.
 - 13) Connect the SS (System Simulator) with the DUT through the measurement antenna with $\text{Pol}_{\text{Link}}=\phi$ polarization to form the TX beam towards the measurement antenna. Allow at least BEAM_SELECT_WAIT_TIME for the UE TX beam selection to complete.
 - 14) Repeat steps 4 through 12 and get the result of total EIRP($\text{Pol}_{\text{Link}}=\phi$) = $\text{EIRP}(\text{Pol}_{\text{Meas}}=\theta, \text{Pol}_{\text{Link}}=\phi) + \text{EIRP}(\text{Pol}_{\text{Meas}}=\phi, \text{Pol}_{\text{Link}}=\phi)$
 - 15) Advance to the next grid point and repeat steps 3 through 14 until measurements within zenith range $0^\circ \leq \theta \leq 90^\circ$ have been completed
 - 16) After the measurements within zenith range $0^\circ \leq \theta \leq 90^\circ$ have been completed and
 - a) if the re-positioning concept is applied to the TX test cases, position the device in DUT Orientation 2 (either Options 1 or 2) from Tables N.2-1 through N.2-7 [3] for the Alignment Option selected in Step 1. For the TX beam peak search in the second hemisphere, perform steps 3 through 15 for the range of zenith angles $90^\circ > \theta \geq 0^\circ$.
 - b) if the re-positioning concept is not applied to the TX test cases, continue steps 3 through 15 for the range of zenith angles $90^\circ < \theta \leq 180^\circ$

If the beam correspondence capability *beamCorrespondenceWithoutUL-BeamSweeping* is not present, the above step 5) can be further clarified as following sub-steps:

- 5.1) DUT uses downlink reference signals to select proper RX beam and uses autonomous beam correspondence to select the TX beam.
- 5.2) SS configures $M=8$ SRS resources to DUT, with the field *spatialRelationInfo* omitted and the field *usage* set as 'beamManagement'. In case DUT supports less than 8 SRS resources, SS configures the number of SRS resources according to the maximum number of SRS resources indicated by UE capability signalling. Additionally, for codebook based PUSCH transmission, SS configures a semi-persistent SRS resource set with the field *usage* as 'codebook'.
- 5.3) Based on the TX beam autonomously selected by DUT, DUT chooses TX beams to transmit SRS-resources configured by SS.

5.4) Based on measurement of the received *beamManagement* SRS, SS chooses the best SRS beam and, if needed, updates the spatial relation information between the semi-persistent *codebook* SRS resources and the SS selected *beamManagement* SRS resource in the activation MAC CE of the semi-persistent SRS resource. The SS indicates in the SRS Resource Indicator (SRI) field in the scheduling grant for PUSCH, if present, the SRS resource within the semi-persistent SRS resource set whose spatial relation is linked to the best detected SRS beam.

5.5) DUT transmits PUSCH corresponding to the SRS resource indicated by the SRI.

The TX beam peak direction is where the maximum total component of $EIRP(Pol_{Link}=\theta)$ or $EIRP(Pol_{Link}=\phi)$ is found. Whenever this TX beam peak direction is used, if the UE does not support *beamCorrespondenceWithoutUL-BeamSweeping*, the side conditions for SSB-based and CSI-RS based L1-RSRP measurements are applied as per Table 6.6.1.3.3.1.1-1 and Table 6.6.1.3.3.1.1-2 respectively just before setting TX beam peak direction.

NOTE 1: Void.

NOTE 2: Void.

NOTE 3: Void.

In order to allow the UE to carry out its Rel 15 beam correspondence procedure, the side conditions for SSB based and CSI-RS based L1-RSRP measurements are configured as per Table 6.6.1.3.3.1.1-1 and Table 6.6.1.3.3.1.1-2 respectively.

For Release 16 and forward UEs: unless otherwise stated within the test case, the following side conditions are applied for the enhanced beam correspondence procedure, depending on the UE capability

- a) If *beamCorrespondenceWithoutUL-BeamSweeping* is NOT supported and *beamCorrespondenceSSB-based-r16* is supported: use side conditions defined in Table 6.6.1.3.3.1.1-1
- b) If *beamCorrespondenceWithoutUL-BeamSweeping* is NOT supported, and *beamCorrespondenceCSI-RS-based-r16* is supported: use side conditions defined in Table 6.6.2.3.3-1
- c) If *beamCorrespondenceWithoutUL-BeamSweeping* is NOT supported and *beamCorrespondenceSSB-based-r16* and *beamCorrespondenceCSI-RS-based-r16* are supported: use side conditions defined in Table 6.6.1.3.3.1.1-1.
- d) If *beamCorrespondenceWithoutUL-BeamSweeping* is NOT supported and *beamCorrespondenceSSB-based-r16* and *beamCorrespondenceCSI-RS-based-r16* are NOT supported: use side conditions defined in Table 6.6.1.3.3.1.1-1 and Table 6.6.1.3.3.1.1-2.
- e) If *beamCorrespondenceWithoutUL-BeamSweeping* is supported and *beamCorrespondenceSSB-based-r16* is supported: use side conditions defined in Table 6.6.1.3.3.1.1-1
- f) If *beamCorrespondenceWithoutUL-BeamSweeping* is supported, and *beamCorrespondenceCSI-RS-based-r16* is supported: use side conditions defined in Table 6.6.2.3.3-1
- g) If *beamCorrespondenceWithoutUL-BeamSweeping* is supported and *beamCorrespondenceSSB-based-r16* and *beamCorrespondenceCSI-RS-based-r16* are supported: use side conditions defined in Table 6.6.1.3.3.1.1-1.
- h) If *beamCorrespondenceWithoutUL-BeamSweeping* is supported and *beamCorrespondenceSSB-based-r16* and *beamCorrespondenceCSI-RS-based-r16* are NOT supported: use side conditions defined in Table 6.6.1.3.3.1.1-1 and Table 6.6.1.3.3.1.1-2.

K.1.2 RX beam peak direction search

Editor's note: The following aspects are either missing or not yet determined:

- The Rx beam peak direction search for intra-band DL CA configurations with frequency separations larger than 800 MHz is currently FFS.

The RX beam peak direction is found with a 3D EIS scan (separately for each orthogonal downlink polarization). The RX beam peak direction search grid points for this single grid approach are defined in Annex M.2.1. Alternatively, a coarse and fine grid approach could be used according to the definition in Annex M.2.4.

The beam peak searches shall be performed for every test frequency range by default unless the device manufacturer explicitly declares that the beam peak at the mid test frequency range is applicable for the remaining (low, high) test frequency ranges. Beam peak search results cannot be re-used across different bands that do not overlap. Beam peak search results can be re-used from bands that completely contain the target bands if explicitly declared with a declaration.

A beam peak search shall be performed for every intra-band contiguous combination and CA BW class by default unless the device manufacturer explicitly declares that the beam peak for a reference (frequency band, CBW) or (frequency band combination, CA BW class) is applicable for a group of other intra-band contiguous combinations and CA BW classes.

The beam peak searches shall be performed for every modulation by default unless the device manufacturer explicitly declares that the beam peak at the QPSK modulation is applicable for the remaining 16QAM and 64QAM modulations.

The beam peak searches shall be performed separately for NTC (Normal), ETC (TL), and ETC (TH).

The single carrier measurement procedure includes the following steps:

- 1) Select any of the three Alignment Options (1, 2, or 3) from Tables N.2-1 through N.2-7 [3] to mount the DUT inside the QZ.
- 2) Position the DUT in DUT Orientation 1 from Tables N.2-1 through N.2-7 [3].
- 3) Connect the SS (System Simulator) with the DUT through the measurement antenna with $\text{Pol}_{\text{Link}}=\theta$ polarization to form the RX beam towards the DUT. Allow at least `BEAM_SELECT_WAIT_TIME` for the UE RX beam selection to complete.
- 4) Determine $\text{EIS}(\text{Pol}_{\text{Meas}}=\theta, \text{Pol}_{\text{Link}}=\theta)$ for θ -polarization, i.e., by sweeping the power level for the θ -polarization, at which the throughput exceeds the requirements for the specified reference measurement channel. The downlink power step size shall be no more than 0.2 dB when the RF power level is near the sensitivity level (coarse and fine searches are not precluded as long as the fine search is using the 0.2dB step size near the sensitivity level).
- 5) Connect the SS (System Simulator) with the DUT through the measurement antenna with $\text{Pol}_{\text{Link}}=\phi$ polarization to form the RX beam towards the DUT. Allow at least `BEAM_SELECT_WAIT_TIME` for the UE RX beam selection to complete.
- 6) Determine $\text{EIS}(\text{Pol}_{\text{Meas}}=\phi, \text{Pol}_{\text{Link}}=\phi)$ for ϕ -polarization, i.e., by sweeping the power level for the ϕ -polarization, at which the throughput exceeds the requirements for the specified reference measurement channel. The downlink power step size shall be no more than 0.2 dB when the RF power level is near the sensitivity level (coarse and fine searches are not precluded as long as the fine search is using the 0.2dB step size near the sensitivity level).
- 7) Advance to the next grid point and repeat steps 3 through 6 until measurements within zenith range $0^\circ \leq \theta \leq 90^\circ$ have been completed
- 8) After the measurements within zenith range $0^\circ \leq \theta \leq 90^\circ$ have been completed and
 - a) if the re-positioning concept is applied to the RX test cases, position the device in DUT Orientation 2 (either Options 1 or 2) from Tables N.2-1 through N.2-7 [3] for the Alignment Option selected in Step 1. For the RX beam peak search in the second hemisphere, perform steps 3 through 6 for the range of zenith angles $90^\circ > \theta \geq 0^\circ$.
 - b) If the re-positioning concept is not applied to the RX test cases, continue steps 3 through 6 for the range of zenith angles $90^\circ < \theta \leq 180^\circ$
- 9) Calculate the resulting "averaged EIS" as:

$$\text{averaged EIS} = 2 * [1/\text{EIS}(\text{Pol}_{\text{Meas}}=\theta, \text{Pol}_{\text{Link}}=\theta) + 1/\text{EIS}(\text{Pol}_{\text{Meas}}=\phi, \text{Pol}_{\text{Link}}=\phi)]^{-1}$$

The RX beam peak direction is where the minimum "averaged EIS" is found.

Alternatively, the RX beam peak direction for single carrier could be determined following the procedure described in Annex K.1.11.

For intra-band DL CA configurations with a frequency separation up to 800 MHz, if for single carrier test the Rx beam peak direction has been found for any frequency within the CA bandwidth, such direction shall be used. Otherwise, the single carrier measurement procedure is performed only on the PCC and the RX beam peak direction for the DL CA configuration is the direction of the PCC Rx beam peak direction.

For intra-band DL CA configurations with a frequency separation up to 800 MHz, if UE vendor provides a Beam Peak Search Declaration with respect to test frequency range for single CC for a given band, see 38.508-2 [4] table A.4.3.9-5, such declaration will also apply to PCC in DL CA configurations for that band.

For intra-band DL CA configurations with a frequency separation larger than 800 MHz the beam peak direction search procedure is FFS.

K.1.3 Peak EIRP measurement procedure

This section describes EIRP measurement procedure for a chosen Pol_{Link} of θ or ϕ

The TX beam peak direction is where the maximum total component of EIRP is found, including the respective polarization of the measurement antenna used to form the TX beam, according to K.1.1.

The measurement procedure includes the following steps:

- 1) Select any of the three Alignment Options (1, 2, or 3) from Tables N.2-1 through N.2-7 [3] to mount the DUT inside the QZ.
- 2) If the re-positioning concept is not applied to the TX test cases, position the device in DUT Orientation 1. If the re-positioning concept is applied to the TX test cases,
 - a) position the device in DUT Orientation 1 from Tables N.2-1 through N.2-7 [3] if the maximum beam peak direction is within zenith angular range $0^\circ \leq \theta \leq 90^\circ$ for the alignment option selected in step 1
 - b) position the device in DUT Orientation 2 (either Options 1 or 2) from Tables N.2-1 through N.2-7 [3] if the maximum beam peak direction is within zenith angular range $90^\circ < \theta \leq 180^\circ$ for DUT Orientation 1 for the alignment option selected in step 1.
- 3) Connect the SS (System Simulator) with the DUT through the measurement antenna with polarization reference Pol_{Link} to form the TX beam towards the TX beam peak direction and respective polarization. Allow at least BEAM_SELECT_WAIT_TIME for the UE TX beam selection to complete.
- 4) SS activates the UE Beamlock Function (UBF) by performing the procedure as specified in TS 38.508-1 [10] clause 4.9.2 using condition Tx only.
- 5) Measure the mean power $P_{\text{meas}}(\text{Pol}_{\text{Meas}}=\theta, \text{Pol}_{\text{Link}})$ of the modulated signal arriving at the power measurement equipment (such as a spectrum analyser, power meter, or gNB emulator).
- 6) Calculate $\text{EIRP}(\text{Pol}_{\text{Meas}}=\theta, \text{Pol}_{\text{Link}})$ by adding the composite loss of the entire transmission path for utilized signal path, $L_{\text{EIRP},\theta}$, and frequency to the measured power $P_{\text{meas}}(\text{Pol}_{\text{Meas}}=\theta, \text{Pol}_{\text{Link}})$.
- 7) Measure the mean power $P_{\text{meas}}(\text{Pol}_{\text{Meas}}=\phi, \text{Pol}_{\text{Link}})$ of the modulated signal arriving at the power measurement equipment.
- 8) Calculate $\text{EIRP}(\text{Pol}_{\text{Meas}}=\phi, \text{Pol}_{\text{Link}})$ by adding the composite losses of the entire transmission path for utilized signal path, $L_{\text{EIRP},\phi}$ and frequency to the measured power $P_{\text{meas}}(\text{Pol}_{\text{Meas}}=\phi, \text{Pol}_{\text{Link}})$
- 9) Calculate the resulting "total EIRP(Pol_{Link})", for the chosen Pol_{Link} of θ or ϕ as follows:

$$\text{total EIRP}(\text{Pol}_{\text{Link}}) = \text{EIRP}(\text{Pol}_{\text{Meas}}=\theta, \text{Pol}_{\text{Link}}) + \text{EIRP}(\text{Pol}_{\text{Meas}}=\phi, \text{Pol}_{\text{Link}})$$

- 10) SS deactivates the UE Beamlock Function (UBF) by performing the procedure as specified in TS 38.508-1 [10] clause 4.9.3.

K.1.4 Peak EIS measurement procedure

This section describes EIS measurement procedure. The RX beam peak direction is where the minimum EIS is found according to K.1.2.

The measurement procedure includes the following steps:

- 1) Select any of the three Alignment Options (1, 2, or 3) from Tables N.2-1 through N.2-7 [3] to mount the DUT inside the QZ.
- 2) If the re-positioning concept is not applied to the RX test cases, position the device in DUT Orientation 1. If the re-positioning concept is applied to the RX test cases
 - a) position the device in DUT Orientation 1 from Tables N.2-1 through N.2-7 [3] if the maximum beam peak direction is within zenith angular range $0^\circ \leq \theta \leq 90^\circ$ for the alignment option selected in step 1
 - b) position the device in DUT Orientation 2 (either Options 1 or 2) from Tables N.2-1 through N.2-7 [3] if the maximum beam peak direction is within zenith angular range $90^\circ < \theta \leq 180^\circ$ for DUT Orientation 1 for the alignment option selected in step 1.
- 3) Connect the SS (System Simulator) with the DUT through the measurement antenna with $\text{Pol}_{\text{Link}}=\theta$ polarization to form the RX beam towards the RX beam peak direction. Allow at least BEAM_SELECT_WAIT_TIME for the UE RX beam selection to complete.
- 4) Determine $\text{EIS}(\text{Pol}_{\text{Meas}}=\theta, \text{Pol}_{\text{Link}}=\theta)$ for θ -polarization, i.e., the power level for the θ -polarization at which the throughput exceeds the requirements for the specified reference measurement channel. The downlink power step size shall be no more than 0.2 dB when the RF power level is near the sensitivity level.
- 5) Connect the SS (System Simulator) with the DUT through the measurement antenna with $\text{Pol}_{\text{Link}}=\phi$ polarization to form the RX beam towards the RX beam peak direction. Allow at least BEAM_SELECT_WAIT_TIME for the UE RX beam selection to complete.
- 6) Determine $\text{EIS}(\text{Pol}_{\text{Meas}}=\phi, \text{Pol}_{\text{Link}}=\phi)$ for ϕ -polarization, i.e., the power level for the ϕ -polarization at which the throughput exceeds the requirements for the specified reference measurement channel. The downlink power step size shall be no more than 0.2 dB when the RF power level is near the sensitivity level.
- 7) Calculate the resulting averaged EIS as:

$$\text{EIS} = 2 * [1/\text{EIS}(\text{Pol}_{\text{Meas}}=\theta, \text{Pol}_{\text{Link}}=\theta) + 1/\text{EIS}(\text{Pol}_{\text{Meas}}=\phi, \text{Pol}_{\text{Link}}=\phi)]^{-1}$$

K.1.5 EIRP spherical coverage

The EIRP results from the TX beam peak search procedures of K.1.1, using the minimum number of grid points as described in Annex M.2.1 can be re-used for EIRP spherical coverage.

In case a coarse beam peak grid is used for TX beam peak search, using the minimum number of grid points defined in Annex M.3.1.1, the EIRP results can be re-used for EIRP spherical coverage.

K.1.5.0 Tx Spherical Coverage Method

In case a separate test is performed for EIRP spherical coverage, the procedure as per K.1.1 should be followed using the minimum number of grid points defined in Annex M.3.1.1 for spherical coverage.

The $\text{EIRP}_{\text{target-CDF}}$ is then obtained from the Cumulative Distribution Function (CDF) computed using $\text{maximum}(\text{EIRP}(\text{Pol}_{\text{Link}}=\theta), \text{EIRP}(\text{Pol}_{\text{Link}}=\phi))$ for all grid points. When using constant step size measurement grids, a theta-dependent correction shall be applied, i.e., the PDF probability contribution for each measurement point is scaled by $\sin(\theta)$ or the normalized Clenshaw-Curtis weights $W(\theta)/W(90^\circ)$, introduced in Section M.4.2.1, to account for the denser grid point distribution near the poles. In case of Clenshaw-Curtis weights, when just a single measurement at the poles is performed, the PDF probability contributions need to be scaled by $M * W(\theta)/W(\theta=90^\circ)$ to account for the M longitudes at those two grid points. When using constant density grids, these corrections are not needed.

K.1.5.1 Tx Fast Spherical Coverage Method

K.1.5.1.1 Introduction

The Fast Spherical Coverage Method is a test method providing an optimized test time for Tx spherical coverage measurements. This method is applicable to constant density and constant step size grid type. Instead of measuring all grid points as per Annex M, as required by the test procedure defined in Annex K.1.5, this method requires only a reduced number of grid points to be measured.

K.1.5.1.2 Description

To use this method, apply the following steps

- 1) During the EIRP Spherical coverage measurements, calculate the EIRP result for the grid point as $EIRP_{spherical} = \text{Max}(EIRP(\text{Pol}_{Link} = \theta), EIRP(\text{Pol}_{Link} = \phi))$ starting with $N_{grid, meas, PASS} = 0$. If the $EIRP_{spherical}$ value is above the Min EIRP spherical coverage limit increase $N_{grid, meas, PASS}$ by 1.
- 2) Calculate the percentage of total grid points measured thus far above the EIRP spherical coverage requirement limit $N_{grid, meas, PASS}$ compared to the total number of grid points on the measurement grid $N_{grid, total}$.
- 3) If the percentage calculated in step 2) is equal to or higher than $(100 - n^{th} \text{ percentile for EIRP spherical coverage})\%$, pass the device, otherwise continue to step 4. If all grid points have been measured, calculate the CDF for all grid points and pass the UE if the derived %-tile EIRP in measurement distribution exceeds the requirement. Otherwise fail the UE.
- 4) Advance to the next grid point and repeat the steps until measurements within zenith range $0^\circ \leq \theta \leq 90^\circ$ have been completed

NOTE 1: For test systems where the device repositioning approach outlined in Annex N is applied, the grid points of up to a zenith of 90° are allowed to be measured in the first hemisphere before the device needs to be placed in the second orientation.

K.1.5.1.3 Measurement uncertainties

Same as when test procedure described in clause K.1.5.0 is used.

K.1.6 EIS spherical coverage

The EIS results from the RX beam peak search procedures of K.1.2, using the minimum number of grid points as described in Annex M.2.2 can be re-used for EIS spherical coverage.

In case a coarse beam peak grid is used for RX beam peak search with an EIS metric, using the minimum number of grid points defined in Annex M.3.2.1, the EIS results can be re-used for EIS spherical coverage.

K.1.6.0 Rx Spherical Coverage Method

In case a separate test is performed for spherical coverage, the procedure K.1.2 should be followed using the minimum number of grid points defined in Annex M.3.2.1 for spherical coverage.

The $EIS_{target-CDF}$ is then obtained from the Cumulative Distribution Function (CDF) computed using averaged EIS for all grid points. When using constant step size measurement grids, a theta-dependent correction shall be applied, i.e., the PDF probability contribution for each measurement point is scaled by $\sin(\theta)$ or the normalized Clenshaw-Curtis weights $W(\theta)/W(90^\circ)$, introduced in Section M.4.2.1, to account for the denser grid point distribution near the poles. In case of Clenshaw-Curtis weights, when just a single measurement at the poles is performed, the PDF probability contributions need to be scaled by $M \cdot W(\theta)/W(\theta=90^\circ)$ to account for the M longitudes at those two grid points. When using constant density grids, these corrections are not needed.

K.1.6.1 Rx Fast Spherical Coverage Method

K.1.6.1.1 Introduction

Same as Annex K.1.5.1.2 except that this sub-clause is applicable to Rx measurements in Annex K.1.6.

K.1.6.1.2 Description

To use this method, apply the following steps

- 1) During the EIS Spherical coverage measurements, calculate the averaged EIS as: $EIS = 2 * [1/EIS(Pol_{Meas} = \theta, Pol_{Link} = \theta) + 1/EIS(Pol_{Meas} = \phi, Pol_{Link} = \phi)]^{-1}$ at each grid point starting with $N_{grid, meas, PASS} = 0$. If the EIS value is below the EIS spherical coverage limit increase $N_{grid, meas, PASS}$ by 1.
- 2) Calculate the percentage of total grid points measured thus far above the EIS spherical coverage requirement limit $N_{grid, meas, PASS}$ compared to the total number of grid points on the measurement grid $N_{grid, total}$.
- 3) If the percentage calculated in step 2) is equal to or higher than (100 - nth percentile for EIS spherical coverage)%, pass the device, otherwise continue to step 4. If all grid points have been measured, calculate the CCDF for all grid points and pass the UE if the derived %-tile EIS in measurement distribution exceeds the requirement. Otherwise fail the UE.
- 4) Advance to the next grid point and repeat the steps until measurements within zenith range $0^\circ \leq \theta \leq 90^\circ$ have been completed.

NOTE 1: Same as NOTE 1 in Annex K.1.5.1.2.

K.1.6.1.3 Measurement uncertainties

Same as when test procedure described in clause K.1.6.0 is used.

K.1.7 TRP measurement procedure

The minimum number of measurement points for TRP measurement grid is outlined in Annex M.4.

The measurement procedure includes the following steps:

- 1) Select any of the three Alignment Options (1, 2, or 3) from Tables N.2-1 through N.2-7 [3] to mount the DUT inside the QZ.
- 2) If the re-positioning concept is not applied to the TX test cases, position the device in DUT Orientation 1. If the re-positioning concept is applied to the TX test cases
 - a) position the device in DUT Orientation 1 from Tables N.2-1 through N.2-7 [3] if the maximum beam peak direction is within zenith angular range $0^\circ \leq \theta \leq 90^\circ$ for the alignment option selected in step 1
 - b) Position de device in DUT Orientation 2 (either Options 1 or 2) from Tables N.2-1 through N.2-7 [3] if the maximum beam peak direction is within zenith angular range $90^\circ < \theta \leq 180^\circ$ for DUT Orientation 1 for the alignment option selected in step 1.
- 3) Connect the SS with the DUT through the measurement antenna with desired polarization reference Pol_{Link} to form the TX beam towards the desired TX beam direction and respective polarization. Allow at least BEAM_SELECT_WAIT_TIME for the UE TX beam selection to complete.
- 4) SS activates the UE Beamlock Function (UBF) by performing the procedure as specified in TS 38.508-1 [10] clause 4.9.2 using condition Tx only.
- 5) For each measurement grid point, measure $P_{meas}(Pol_{Meas} = \theta, Pol_{Link})$ and $P_{meas}(Pol_{Meas} = \phi, Pol_{Link})$. The angle between the measurement antenna and the DUT ($\theta_{Meas}, \phi_{Meas}$) is achieved by rotating the measurement antenna and the DUT (based on system architecture).

- 6) Calculate $EIRP(Pol_{Meas}=\theta, Pol_{Link})$ and $EIRP(Pol_{Meas}=\phi, Pol_{Link})$ by adding the composite loss of the entire transmission path for utilized signal paths, $L_{EIRP,\theta}$, $L_{EIRP,\phi}$ and frequency to the respective measured powers P_{meas} .
- 7) The TRP value for the uniform measurement grid is calculated using the TRP integration approaches outlined in Annex M.4.2. The TRP value for the constant density grid is calculated using the TRP integration formula in Annex M.4.3.
- 8) SS deactivates the UE Beamlock Function (UBF) by performing the procedure as specified in TS 38.508-1 [10] clause 4.9.3.

K.1.8 Blocking measurement procedure

The RX beam peak direction is where the minimum EIS is found according to K.1.2.

The measurement procedure includes the following steps:

- 1) Select any of the three Alignment Options (1, 2, or 3) from Tables N.2-1 through N.2-7 to mount the DUT inside the QZ.
- 2) If the re-positioning concept is not applied to the RX test cases, position the device in DUT Orientation 1. If the re-positioning concept is applied to the RX test cases
 - a) position the device in DUT Orientation 1 from Tables N.2-1 through N.2-7 [3] if the maximum beam peak direction is within zenith angular range $0^\circ \leq \theta \leq 90^\circ$ for the alignment option selected in step 1
 - b) position the device in DUT Orientation 2 (either Options 1 or 2) from Tables N.2-1 through N.2-7 [3] if the maximum beam peak direction is within zenith angular range $90^\circ < \theta \leq 180^\circ$ for DUT Orientation 1 for the alignment option selected in step 1.
- 3) Establish a connection between the DUT and the SS with the downlink signal applied to the θ -polarization of the measurement antenna
- 4) Position the UE so that the beam is formed towards the measurement antenna in the RX beam peak direction.
- 5) Apply a signal with the specified reference measurement channel on the θ -polarization, setting the power level of the signal 3dB below the level stated in the requirement.
- 6) Apply the blocking signal with the same polarization and coming from the same direction as the downlink signal. Set the power level of the blocking signal 3dB below the level stated in the requirement.
- 7) Measure the throughput of the downlink signal on the θ -polarization.
- 8) Switch the downlink and blocking signal to the ϕ -polarization of the measurement antenna.
- 9) Repeat steps 3 to 7 on the ϕ -polarization.
- 10) Compare the results for both the θ -polarization and ϕ -polarization against the requirement. If both results meet the requirements, pass the UE.

K.1.9 Beam Correspondence tolerance procedure

This beam correspondence tolerance procedure applies to the DUT with beam correspondence capability *beamCorrespondenceWithoutUL-BeamSweeping* not present (which shall match OEM declaration), such that DUT relies on uplink beam sweeping to fulfil the minimum peak EIRP and spherical coverage requirements.

The measurement procedure includes the following steps for each of the points in the grid:

- 1) Follow the test procedures specified in clause K.1.5 with uplink beam sweeping disabled, obtain total $EIRP_1(Pol_{Link}=\theta)$ and total $EIRP_1(Pol_{Link}=\phi)$. $EIRP_1$ is calculated by $EIRP_1 = \text{maximum}(EIRP_1(Pol_{Link}=\theta), EIRP_1(Pol_{Link}=\phi))$.

- 2) Follow the test procedures specified in clause K.1.5, with uplink beam sweeping enabled (SS does not configure the *spatialRelationInfo* to DUT) during DUT TX beam refinement, obtain total $EIRP_2(Pol_{Link}=\theta)$ and total $EIRP_2(Pol_{Link}=\phi)$. $EIRP_2$ is calculated by $EIRP_2 = \text{maximum}(EIRP_2(Pol_{Link}=\theta), EIRP_2(Pol_{Link}=\phi))$.
- 3) Calculate the $\Delta EIRP_{BC} = EIRP_2 - EIRP_1$.

The $\Delta EIRP_{\text{target-CDF}}$ is then obtained from the Cumulative Distribution Function (CDF) computed using $\Delta EIRP_{BC}$ for each of all top N^{th} percentile of the $EIRP_2$ measurement points in the grid. When using constant step size measurement grids, a theta-dependent correction shall be applied, i.e., the PDF probability contribution for each measurement point is scaled by $\sin(\theta)$ or the normalized Clenshaw-Curtis weights $W(\theta)/W(90^\circ)$, introduced in Section M.4.2.1.

NOTE: $\Delta EIRP_{BC}$ is introduced for beam correspondence tolerance based on two EIRP measurements ($EIRP_1$ and $EIRP_2$). $EIRP_1$ is the measured total EIRP based on the beam which DUT chooses autonomously (corresponding beam) to transmit in the direction of the incoming DL signal, which is based on beam correspondence without relying on UL beam sweeping. $EIRP_2$ is the measured total EIRP based on the beam yielding highest EIRP in a given direction, which is based on beam correspondence with relying on UL beam sweeping. $\Delta EIRP_{BC}$ shall be calculated over the link angles spanning a subset of the spherical coverage grid points which are corresponding to the top N^{th} percentile of the $EIRP_2$ measurement points in the grid, where the value of N is according to EIRP spherical coverage requirement of DUT's power class defined in TS 38.101-2 [3] clause 6.2.1, e.g., $N=50$ for power class 3 DUT.

K.1.11 RSRP(B) based RX beam peak search

Editor's note: This clause is incomplete. The following aspects are not determined.

- Feasibility and Applicability of this RSRP-B based Rx beam peak search is FFS
- Additional analysis of side conditions to be applied is FFS
- Analysis of MU impact is FFS
- Additional optimization of the method for use in scenarios such as Carrier Aggregation and EN-DC is still FFS

RSRP(B)-based RX beam peak search approach is applicable to find the beam peak, the beam peak search time can be reduced significantly.

K.1.11.1 Test procedure

The RX beam peak direction is found with a 3D RSRP(B) scan (separately for each orthogonal downlink polarization). The RX beam peak direction is where the maximum total component of RSRP is found. The RX beam peak direction search grid points for this single grid approach are defined in Annex M,2.

The measurement procedure includes the following steps:

- 1) Select any of the three Alignment Options (1, 2, or 3) from Tables N.2-1 through N.2-3 [3] to mount the DUT inside the QZ.
- 2) Position the DUT in DUT Orientation 1 or 2 from Tables N.2-1 through N.2-3 [3].
- 3) Connect the SS (System Simulator) with the DUT through the measurement antenna with $Pol_{Link}=\theta$ polarization to form the RX beam towards the measurement antenna.
- 4) Adjust the DL power of the SS to obtain the NR DL signal level as per Table C.0-1 at the centre of QZ. Determine RSRP or RSRPBs (one per receiver branch) at $Pol_{Meas}=Pol_{Link}=\theta$ condition reported by UE.
- 5) Connect the SS (System Simulator) with the DUT through the measurement antenna with $Pol_{Link}=\phi$ polarization to form the RX beam towards the measurement antenna.
- 6) Set the same DL power as the one in step 4. Determine RSRP or RSRPBs (one per receiver branch) at $Pol_{Meas}=Pol_{Link}=\phi$ condition reported by UE.
- 7) Advance to the next grid point and repeat steps 3 through 6 until measurements within the full 3D scan have been completed.

8) Data processing the linear sum of four reported RSRPBs. How to calculate the reported RSRPs is FFS.

To guarantee RSRP(B) accuracy, SNR side condition configuration can refer to the minimum SSB_RP specified for beam correspondence defined in Table K.1.11-1 (from TS 38.101-2 [3] Table 6.6.4.3.1-1):

Table K.1.11.1-1: Conditions for SSB based L1-RSRP measurements for beam correspondence

Angle of arrival	NR operating bands	Minimum SSB_RP ^{Note 2}		SSB \hat{E}_s/lot dB
		dBm / SCS _{SSB}		
		SCS _{SSB} = 120 kHz		
All angles ^{Note 1}	n257	-96.2		≥6
	n258	-96.2		
	n259	-90.7		
	n260	-91.9		
	n261	-96.2		
	n262	-88.5		
NOTE 1: For UEs that support multiple FR2 bands, the Minimum SSB_RP values for all angles are increased by $\Delta\text{MB}_{S,n}$, the UE multi-band relaxation factor in dB specified in clause 6.2.1.				
NOTE 2: Values specified at the radiated requirements reference point to give minimum SSB \hat{E}_s/lot , with no applied noise.				

K.1.12 Enhanced test method for EIRP measurements

Editor's note: This clause is incomplete. The following aspects are not determined.

- Applicability of this enhanced method is FFS
- Additional analysis of how this method can be used within existing tests is FFS
- Additional optimization of the method for use in scenarios such as Carrier Aggregation and EN-DC is still FFS

Transmitted Matrix Precoding Indicator (TPMI) is the basis of codebook based transmission enabling multi-port antenna transmission. TPMI method is identified as applicable method to enhance EIRP measurement, which is able to activate dual polarization transmission in EIRP measurement. The applicability of this method is defined in clause K.1.12.1.

For FR2 UEs support the TPMI method, the precoding matrix W is given by Table K.1.12-1 (same as Table 6.3.1.5-1 in TS 38.211 [9]). 2Tx TPMI index 2-5 can force UE single-layer transmission using two antenna ports. Among them, only TPMI index 2 is selected for EIRP measurement.

Table K.1.12-1-1: Precoding matrix W for single-layer transmission using two antenna ports

TPMI index	W (ordered from left to right in increasing order of TPMI index)							-	-
	$\frac{1}{\sqrt{2}} \begin{bmatrix} 1 \\ 0 \end{bmatrix}$	$\frac{1}{\sqrt{2}} \begin{bmatrix} 0 \\ 1 \end{bmatrix}$	$\frac{1}{\sqrt{2}} \begin{bmatrix} 1 \\ 1 \end{bmatrix}$	$\frac{1}{\sqrt{2}} \begin{bmatrix} 1 \\ -1 \end{bmatrix}$	$\frac{1}{\sqrt{2}} \begin{bmatrix} 1 \\ j \end{bmatrix}$	$\frac{1}{\sqrt{2}} \begin{bmatrix} 1 \\ -j \end{bmatrix}$			
0 – 5									

The permitted test methods (i.e. DFF, IFF and NFTF) in [5] are all applicable for TPMI method with the additional procedure that the UE should be configured with TPMI index and working at single-layer transmission using two antenna ports, before performing EIRP-based test procedures in clause 5.2.1.3 in TR38.810 [5].:

- Peak EIRP Measurement Procedure
- TRP Measurement Procedure
- TX Beam Peak direction search and EIRP Spherical Coverage

K.1.12.1 Applicability of TPMI side condition method

TPMI is applicable for one layer transmission with multi-port antenna. In FR2, dual polarization can be regarded as dual antenna ports, so it is natural to activate dual polarization transmission with TPMI side condition in EIRP measurement procedure. However, for TPMI supporting dual antenna ports, the number of SRS ports (*nrofSRS-Ports*) is configured as 2 for both one layer transmission with 'full power transmission' and two layers transmission with regular UL MIMO, as specified in clause 6.1 of TS 38.101-2 [3]:

For a UE that supports 'UL full power transmission' and is configured to transmit a single layer with *nrofSRS-Ports* = 2, the requirements for UL MIMO operation apply only when it is configured for any of its declared full power modes in IE *FullPowerTransmission-r16* (as defined in TS 38.331[19]).

For a UE configured to transmit 2 layers, transmitter requirements for UL MIMO operation apply when the UE transmits on 2 ports on the same CDM group. The UE may use higher MPR values outside this limitation.

Thus, TPMI method is applicable for the following FR2 UEs:

- Rel-15 Coherent UE (UE capability *pusch-TransCoherence* = *fullCoherent* with network configuration *codebookSubset*= *FullyAndPartialAndNonCoherent*).
- Rel-16 and onwards Coherent UE (UE capability *pusch-TransCoherence* = *fullCoherent* with network configuration *codebookSubset*= *FullyAndPartialAndNonCoherent*).
- Rel-16 and onwards UE supporting UL full power transmission mode1 (UE capability *ul-FullPwrMode1-r16*= *supported* with network configuration *ul-FullPowerTransmission* = *fullpowerMode1*).

Other UEs are not applicable for TPMI based test method.

K.1.12.2 TPMI side condition method Measurement uncertainties impact

TPMI side condition method has no impact on measurement uncertainties.

K.2 Direct far field (DFF) simplification

K.2.1 TX beam peak direction search

Same measurement procedure as in clause K.1.1.

K.2.2 RX beam peak direction search

Same measurement procedure as in clause K.1.2.

K.2.3 Peak EIRP measurement procedure

Same measurement procedure as in clause K.1.3.

K.2.4 Peak EIS measurement procedure

Same measurement procedure as in clause K.1.4.

K.2.5 EIRP spherical coverage

Same measurement procedure as in clause K.1.5.

K.2.6 EIS spherical coverage

Same measurement procedure as in clause K.1.6.

K.2.7 TRP measurement procedure

Same measurement procedure as in clause K.1.7.

K.2.8 Blocking measurement procedure

Same measurement procedure as in clause K.1.8.

K.3 Indirect far field (IFF)

K.3.1 TX beam peak direction search

Same measurement procedure as in clause K.1.1.

K.3.2 RX beam peak direction search

Same measurement procedure as in clause K.1.2.

K.3.3 Peak EIRP measurement procedure

Same measurement procedure as in clause K.1.3.

K.3.4 Peak EIS measurement procedure

Same measurement procedure as in clause K.1.4.

K.3.5 EIRP spherical coverage

Same measurement procedure as in clause K.1.5.

K.3.6 EIS spherical coverage

Same measurement procedure as in clause K.1.6.

K.3.7 TRP measurement procedure

Same measurement procedure as in clause K.1.7.

K.3.8 Blocking measurement procedure

Same measurement procedure as in clause K.1.8.

K.4 Near field to far field transform (NFTF)

K.4.1 TX beam peak direction search

The TX beam peak direction is found with a 3D EIRP scan (separately for each orthogonal polarization) with a grid that is TBD. The TX beam peak direction is where the maximum total component of EIRP is found.

FFS.

K.4.2 RX beam peak direction search

Not applicable for NFTF method.

K.4.3 Peak EIRP measurement procedure

- 1) Connect the SS (System Simulator) to the DUT through the measurement antenna with polarization reference Pol_{Meas} to form the TX beam towards the previously determined TX beam peak direction and respective polarization.
- 2) Lock the beam toward that direction for the entire duration of the test.
- 3) Perform a 3D pattern measurement (amplitude and phase) with the DUT sending a modulated signal.
- 4) Determine the EIRP for both polarization towards the TX beam peak direction by using a Near Field to Far Field transform.
- 5) Calculate total EIRP = $EIRP_{\theta} + EIRP_{\phi}$

K.4.4 Peak EIS measurement procedure

Not applicable for NFTF method.

K.4.5 EIRP spherical coverage

Same measurement procedure as in clause K.1.5.

K.4.6 EIS spherical coverage

Not applicable for NFTF method.

K.4.7 TRP measurement procedure

The minimum number of measurement points for TRP measurement grid is outlined in Annex M.4.

The measurement procedure includes the following steps:

- 1) Connect the SS to the DUT through the measurement antenna with polarization reference Pol_{Meas} to form the TX beam towards the previously determined TX beam peak direction and respective polarization.
- 2) Lock the beam toward that direction for the entire duration of the test.
- 3) Perform a 3D pattern measurement (amplitude and phase) with the DUT sending a modulated signal.
- 4) For each measurement point on the grid, determine the EIRP for both polarization by using a Near Field to Far Field transform.

5) The TRP value for the constant step size measurement grids are calculated using the TRP integration approaches outlined in Annex M.4.2. The TRP value for the constant density grid is calculated using the TRP integration formula in Annex M.4.3.

K.4.8 Blocking measurement procedure

Not applicable for NFTF method.

Annex L (normative):
Void

Annex M:(normative) Measurement grids

This appendix describes the assumptions and definition of the minimum number of measurement grid points for various grid types. Further details can be found in [5].

A total of three measurement grids are considered:

- Beam Peak Search Grid: using this grid, the TX and RX beam peak direction will be determined. 3D EIRP scans are used to determine the TX beam peak direction and 3D Throughput/RSRP/EIS scans for RX beam peak directions.
- Spherical Coverage Grid: using this grid, the CDF of the EIRP/EIS distribution in 3D is calculated to determine the spherical coverage performance.
- TRP Measurement Grid: using this grid, the total power radiated by the DUT in the TX beam peak direction is determined by integrating the EIRP measurements taken on the sampling grid.

M.1 Grid Types

Two different measurement grid types are considered:

- The constant step size grid type has the azimuth and elevation angles uniformly distributed as in the examples illustrated in Figures M.1-1 in 2D and M.1-2 in 3D.

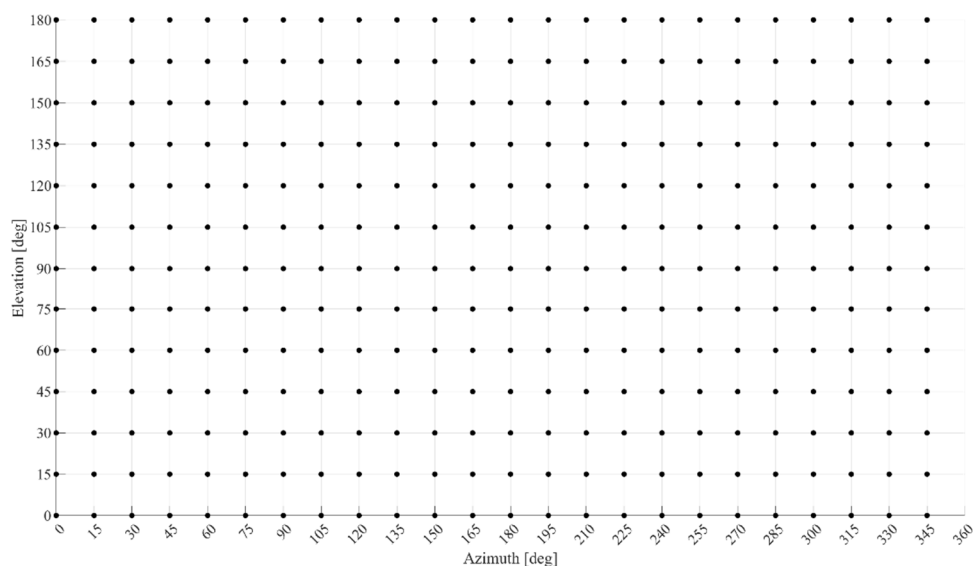

Figure M.1-1: Distribution of measurement grid points in 2D for a constant step size grid with $\Delta\theta=\Delta\phi=15^\circ$ (266 unique measurement points)

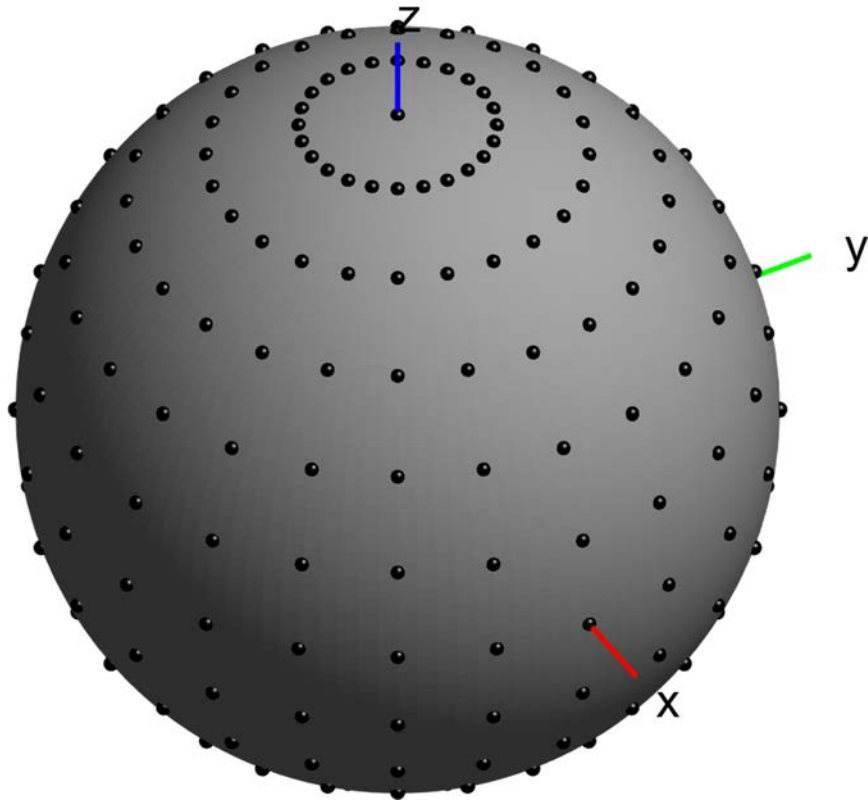

Figure M.1-2: Distribution of measurement grid points in 3D for a constant step size grid with $\Delta\theta=\Delta\phi=15^\circ$ (266 unique measurement points)

- Constant density grid types have measurement points that are evenly distributed on the surface of the sphere with a constant density as in the example illustrated in Figures M.1-3 in 2D and M.1-4 in 3D.

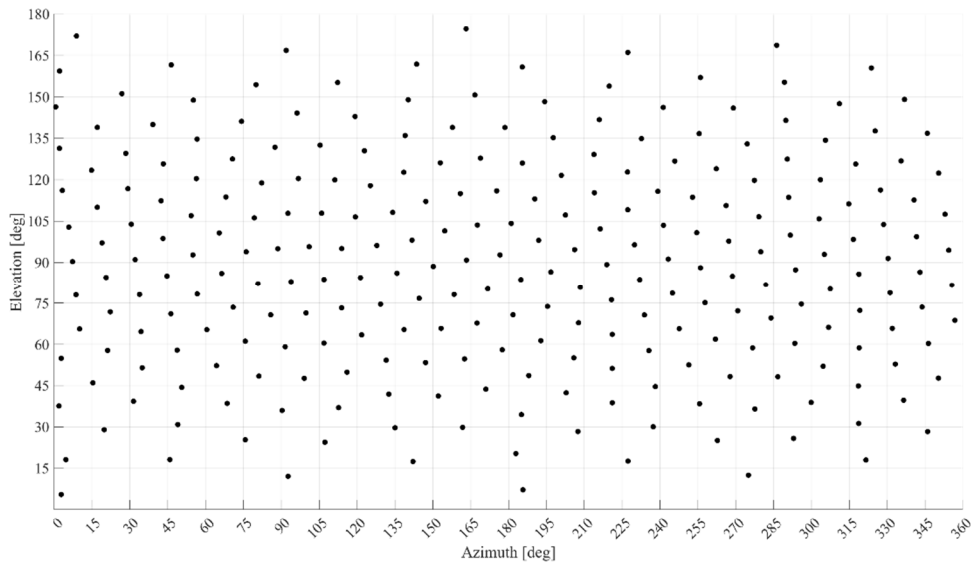

Figure M.1-3: Distribution of measurement grid points in 2D for a constant density grid with 266 unique measurement points

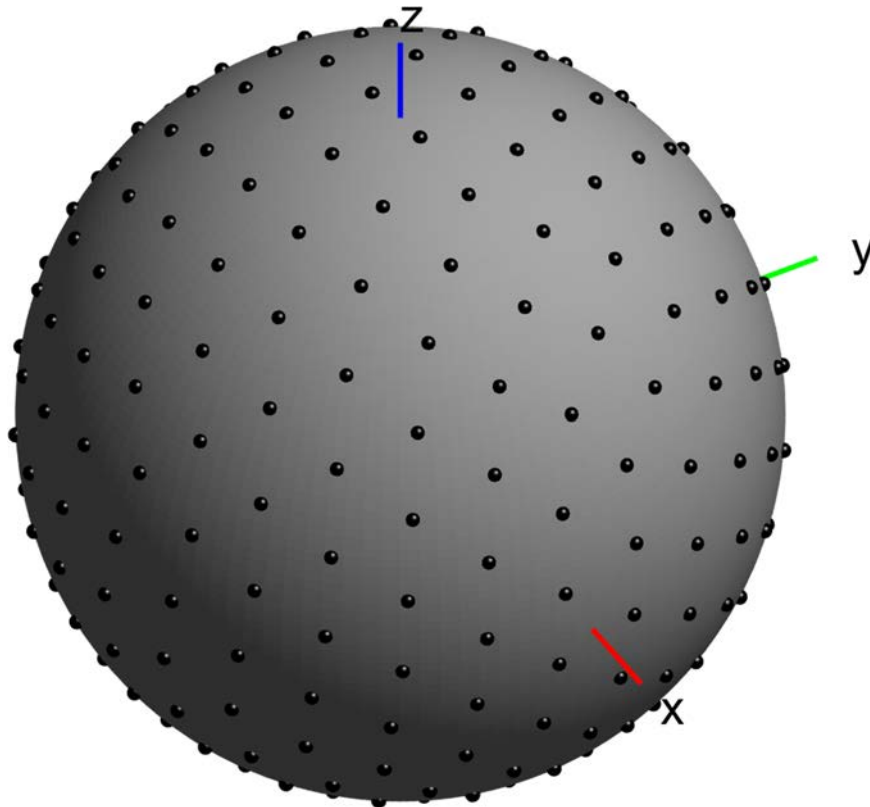

Figure M.1-4: Distribution of measurement grid points in 3D for a constant density grid type with 266 unique measurement points

M.2 Beam Peak Search Grid

Editor's note: Other implementations are not precluded as far as the respective analysis are presented and included in this TS

M.2.1 UE Power classes

M.2.1.1 Power class 1 devices

The antenna array assumptions for the MU simulations are outlined in Table M.2.1.1-0 and M.2.1.1-0a for PC1.

Table M.2.1.1-0: Single Antenna Element Radiation Pattern for PC1 and PC5

Antenna element horizontal radiation pattern	$A_{E,H}(\phi) = -\min \left[12 \left(\frac{\phi}{\phi_{3dB}} \right)^2, A_m \right] dB$ $A_m = 25 \text{ dB}$
Horizontal half-power beamwidth of single element	$\phi_{3dB} = 90^\circ$
Antenna element vertical radiation pattern	$A_{E,V}(\theta) = -\min \left[12 \left(\frac{\theta - 90}{\theta_{3dB}} \right)^2, SLA_v \right]$ $SLA_v = 25 \text{ dB}$
Vertical half-power beamwidth of single array element	$\theta_{3dB} = 90^\circ$
Array element radiation pattern	$A_E(\varphi, \theta) = G_{E,max} - \min \left\{ -[A_{E,H}(\varphi) + A_{E,V}(\theta)], A_m \right\}$
Element gain without antenna losses	$G_{E,max} = 5 \text{ dBi}$

Table M.2.1.1-0a: Composite Antenna Array Radiation Pattern for PC1 and PC5

Composite array radiation pattern in dB $A_A(\theta, \varphi)$	$A_{A,Beami}(\theta, \varphi) = A_E(\theta, \varphi) + 10 \log_{10} \left(\left \sum_{m=1}^{N_H} \sum_{n=1}^{N_V} w_{i,n,m} \cdot v_{n,m} \right ^2 \right)$ <p>the super position vector is given by:</p> $v_{n,m} = \exp \left(i \cdot 2\pi \left((n-1) \cdot \frac{d_V}{\lambda} \cdot \cos(\theta) + (m-1) \cdot \frac{d_H}{\lambda} \cdot \sin(\theta) \cdot \sin(\varphi) \right) \right),$ <p>$n = 1, 2, \dots, N_V; m = 1, 2, \dots, N_H;$</p> <p>the weighting is given by:</p> $w_{i,n,m} = \frac{1}{\sqrt{N_H N_V}} \exp \left(i \cdot 2\pi \left((n-1) \cdot \frac{d_V}{\lambda} \cdot \sin(\theta_{i,elit}) - (m-1) \cdot \frac{d_H}{\lambda} \cdot \cos(\theta_{i,elit}) \cdot \sin(\varphi_{i,escan}) \right) \right)$
Antenna array configuration (RowxColumn)	12 x 12 (default), 6 x 6 (optional for PC5)
Horizontal radiating element spacing	$d_h/\lambda = 0.5$
Vertical radiating element spacing	$d_v/\lambda = 0.5$

In order to make a reasonable trade-off with measurement uncertainties, it is recommended to use for beam peak search the following measurement grids leading to a systematic error of "Beam Peak Search" of 0.7 dB:

- Constant density grid (using the charged particle implementation) with at least 3000 grid points.
- Constant step size grid with at least 4902 grid points, corresponding to an angular step size of 3.6°.

For better measurement uncertainties, finer measurement grids as shown in Table M.2.1.1-1 may be used. Choice of grids among these 2 types of grids is up to test system implementation.

Table M.2.1.1-1: Minimum number of unique grid points for sample systematic errors

Systematic Error of 'Beam Peak Search': Offset from Beam Peak at which CDF is 5%	Minimum Number of Unique Grid Points for Constant Step Size Grid	Minimum Number of Unique Grid Points for Constant Density Grid
0.3dB	10226 (2.5° step size)	7000
0.4dB	N/A	5000
0.5dB	7082 (3° step size)	4500
0.6dB	N/A	3500
0.7dB	4902 (3.6° step size)	3000

M.2.1.2 Power class 2 devices

TBD

M.2.1.3 Power class 3 devices

The antenna array assumptions for the MU simulations are outlined in Table M.2.1.3-0 and M.2.1.3-0a for PC3.

Table M.2.1.3-0: Single Antenna Element Radiation Pattern for PC3

Antenna element horizontal radiation pattern	$A_{E,H}(\varphi) = -\min \left[12 \left(\frac{\varphi}{\varphi_{3dB}} \right)^2, A_m \right] \text{ dB}$ <p>, $A_m = 30 \text{ dB}$</p>
Horizontal half-power beamwidth of single element	260° for 8 x 2 antenna array configuration, 90° for other optional configurations
Antenna element vertical radiation pattern	$A_{E,V}(\theta) = -\min \left[12 \left(\frac{\theta - 90}{\theta_{3dB}} \right)^2, SLA_v \right]$ <p>, $SLA_v = 30 \text{ dB}$</p>

Vertical half-power beamwidth of single array element	130° for 8 x 2 antenna array configuration, 90° for other optional configurations
Array element radiation pattern	$A_E(\varphi, \theta) = G_{E,max} - \min\{-[A_{E,H}(\varphi) + A_{E,V}(\theta)], A_m\}$
Element gain without antenna losses	$G_{E,max} = 1.5$ dBi

Table M.2.1.3-0a: Composite Antenna Array Radiation Pattern for PC3

Composite array radiation pattern in dB $A_A(\theta, \varphi)$	$A_{A,Beami}(\theta, \varphi) = A_E(\theta, \varphi) + 10 \log_{10} \left(\left \sum_{m=1}^{N_H} \sum_{n=1}^{N_V} w_{i,n,m} \cdot v_{n,m} \right ^2 \right)$ <p>the super position vector is given by:</p> $v_{n,m} = \exp \left(i \cdot 2\pi \left((n-1) \cdot \frac{d_V}{\lambda} \cdot \cos(\theta) + (m-1) \cdot \frac{d_H}{\lambda} \cdot \sin(\theta) \cdot \sin(\varphi) \right) \right),$ <p>$n = 1, 2, \dots, N_V; m = 1, 2, \dots, N_H;$</p> <p>the weighting is given by:</p> $w_{i,n,m} = \frac{1}{\sqrt{N_H N_V}} \exp \left(i \cdot 2\pi \left((n-1) \cdot \frac{d_V}{\lambda} \cdot \sin(\theta_{i,etilt}) - (m-1) \cdot \frac{d_H}{\lambda} \cdot \cos(\theta_{i,etilt}) \cdot \sin(\varphi_{i,escan}) \right) \right)$
Antenna array configuration (RowxColumn)	8 x 2 (default), 4 x 2 (optional), 6 x 2 (optional)
Horizontal radiating element spacing d_h/λ	0.5
Vertical radiating element spacing d_v/λ	0.5

In order to make a reasonable trade-off between measurement uncertainties, at least 800 (constant density grid with charged particle implementation) or 1106 (constant step size grid) measurement grid points shall be used for beam peak search procedures. For better measurement uncertainties, finer measurement grids as shown below may be used. Choice of grids among these 2 types of grids is up to test system implementation.

Table M.2.1.3-1: Minimum number of unique grid points for sample systematic errors (non-sparse antenna arrays)

Systematic Error of 'Beam Peak Search': Offset from Beam Peak at which CDF is 5%	Minimum Number of Unique Grid Points for Constant Step Size Grid	Minimum Number of Unique Grid Points for Constant Density Grid (charged particle implementation)
0.2dB	2522 (5° step size)	2000
0.3dB	1742 (6° step size)	1500
0.4dB	N/A	1000
0.5dB	1106 (7.5°step size)	800

Based on an optional vendor declaration with respect to the antenna array configuration, see Table A.4.3.9-10 of [11], devices with an $M \times N$ ($M \geq N$) configuration with $M \leq 4$ and $N \leq 2$ can utilize either of the following minimum number of grid points with the same systematic error of 'Beam Peak Search' of 0.5dB for beam peak search procedures:

- 310 (constant density grid with charged particle implementation) measurement grid points.
- 422 (constant step size grid with $\Delta\theta=\Delta\phi=12.0^\circ$) measurement grid points.

Based on an optional vendor declaration with respect to the antenna array configuration, see Table A.4.3.9-10 of [11], devices with an $M \times N$ ($M \geq N$) configuration with $4 < M \leq 6$ and $N \leq 2$ can utilize either of the following minimum number of grid points with the same systematic error of 'Beam Peak Search' of 0.5dB for beam peak search procedures:

- 575 (constant density grid with charged particle implementation) measurement grid points.
- 762 (constant step size grid with $\Delta\theta=\Delta\phi=9.0^\circ$) measurement grid points.

M.2.1.4 Power class 4 devices

TBD

M.2.1.5 Power class 5 devices

The same antenna array assumptions and measurement grids as in clause M.2.1.1 apply.

Based on an optional vendor declaration with respect to the antenna array configuration, see Table A.4.3.9-10a of [11], devices with an $M \times N$ ($M \geq N$) configuration with $M \leq 6$ and $N \leq 6$ can utilize either of the following minimum number of grid points with the same systematic error of 'Beam Peak Search' of 0.7dB for beam peak search procedures:

- Constant density grid (using the charged particle implementation) with at least 750 grid points.
- Constant step size grid with at least 1106 grid points, corresponding to an angular step size of 7.5°.

M.2.1.6 Power class 6 devices

The same antenna array assumptions and measurement grids as in clause M.2.1.1 with a default antenna array configuration of 6 x 6 apply.

In order to make a reasonable trade-off with measurement uncertainties, it is recommended to use for beam peak search the following measurement grids leading to a systematic error of "Beam Peak Search" of 0.7 dB:

- Constant density grid (using the charged particle implementation) with at least 750 grid points.
- Constant step size grid with at least 1106 grid points, corresponding to an angular step size of 7.5°.

M.2.2 Coarse and fine measurement grids

The baseline beam peak search is based on a single and fine beam peak search grid to determine the TX/RX beam peak of the DUT in any given direction. This means that even in sectors where poor EIRP/EIS performance is observed, a very fine grid is used to search for the TX/RX beam peak.

An optimized approach, based on an initial coarse search followed by a subsequent fine search could reduce the number of beam peak search grid points significantly. The basis for this approach is to use a coarse grid with fewer number of points than the ones described in section M.2.1 in the first stage to identify candidate regions that contain the global beam peak and search for the global beam peak with the fine grid in the second stage with a minimum number of points described in section M.2.1.

As an example, Figure M.2.2-1 illustrates the coarse and fine measurement grid approach applied to TX beam search; while this illustration is for EIRP, it can easily be extended to RX beam peak search using EIS. For simplification purposes, 2D coarse and fine searches are illustrated but the concept can be extended to 3D easily. The UE is assumed to form a total of six beams in the 2D plane as illustrated on the left of Figure M.2.2-1. In the centre of Figure M.2.2-1, the 36 coarse beam peak search grid points in the 2D plane are illustrated. On the right, the grey dots on the respective antenna patterns illustrate the measured EIRP values towards each coarse grid point direction based on the respective beam steering directions. This illustration shows that the EIRP beam peak of the coarse search, $EIRP_{CSBP}$, is found to be the peak of the orange beam while the global TX beam peak (red beam) was not identified due to the coarse sampling of the grid points.

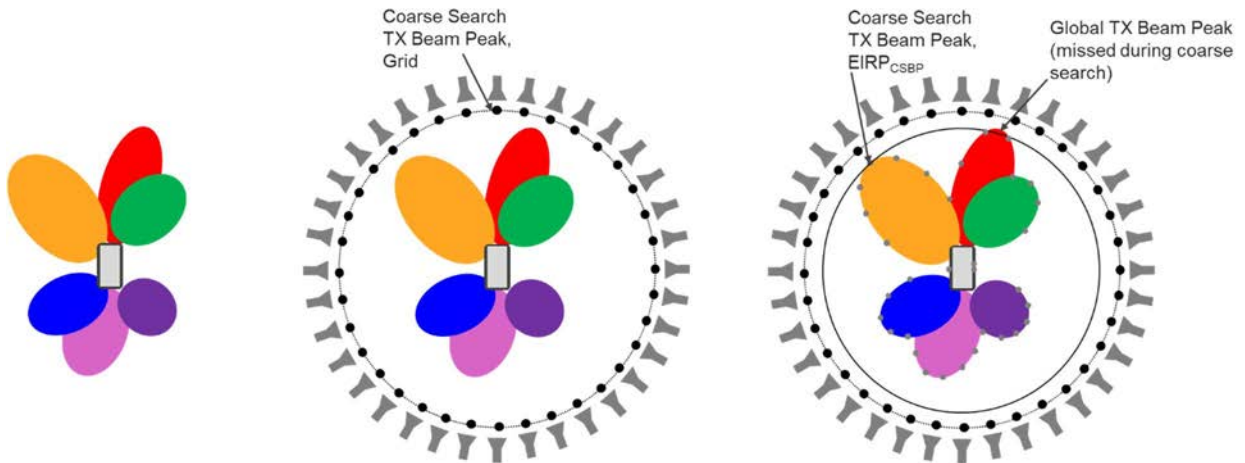

Figure M.2.2-1: Illustration of the Coarse Search Approach for TX Beam Peak Search. Left: Antenna Pattern assumptions in 2D, Centre: Coarse beam peak search grid points/discrete antenna measurement positions, Right: TX beam EIRP measurements per grid point

The proposed fine search approach is illustrated further in Figure M.2.2-2. A fine search region starting from the beam peak identified in the coarse search, $EIRP_{CSBP}$, over a range of Δ_{FS} is used to identify the regions that need to be investigated more closely with the fine search algorithm. The fine search range Δ_{FS} is a function of the angular spacing of the coarse beam peak search grid as well as the beam width of the reference antenna pattern considered for smartphone UEs.

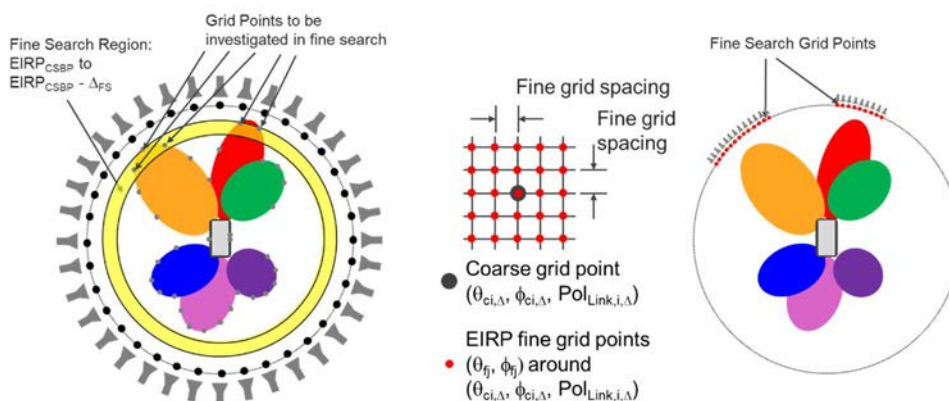

Figure M.2.2-2: Illustration of the fine beam peak search grid. Left: identify the measurement grid points that yielded EIRP values within the fine search region, right: placement of fine beam peak search grid points

In order to maintain the same MU as the fine beam peak search measurement grids in clause M.2.1.3, i.e., 0.5 dB for PC3 UEs, the minimum Δ_{FS} from Table M.2.2-1 for constant step-size grids and from Table M.2.2-2 for constant density grids shall be applied to the coarse&fine search for PC3 UEs. The results presented in these tables utilize coarse measurement grids that match the spherical coverage grids from clause M.3.

Table M.2.2-1: Measurement grid parameters for the constant step-size coarse&fine beam peak search measurement grids for PC3 UEs with a coarse grid of $\Delta\theta=\Delta\phi=15^\circ$ (spherical coverage grid).

Antenna Configuration	8x2	6x2	4x2
Grid Parameters			
Δ_{FS} [dB] with fine grid $\Delta\theta=\Delta\phi=7.5^\circ$ (Note 1)	2.5	1.5	0.5
Δ_{FS} [dB] with fine grid $\Delta\theta=\Delta\phi=9^\circ$ (Note 2)		1.5	
Δ_{FS} [dB] with fine grid $\Delta\theta=\Delta\phi=12^\circ$ (Note 2)			0.5

Coarse grid with $\Delta\theta=\Delta\phi$ [°]	15	15	15
Note 1: Local searches in the "fine search region" are performed on the 8 fine grid points surrounding each coarse grid point within the Δ_{FS} region (Figure M.2.2-3). Note 2: Local searches in the "fine search region" are performed on the fine grid points surrounding each coarse grid point within the Δ_{FS} region that are within a conical region (half angle) of $1.5 \times$ step size of the fine grid, as illustrated in Figure M.2.2-4.			

Table M.2.2-2: Measurement grid parameters for the constant-density coarse&fine beam peak search measurement grids with a coarse grid using 200 unique grid points (spherical coverage grid)

Antenna Configuration Grid Parameters	8x2	6x2	4x2
Δ_{FS} [dB]	3	1.5	0.5
Number of Unique Grid Points (fine grid)	800	575	310
Number of Unique Grid Points (coarse grid)	200	200	200
Min. Conical Region (Half Angle) Surrounding Coarse Grid Point to Identify Fine Grid Points [°] (Note 1)	11.25	13.7	19.3
Note 1: Local searches in the "fine search region" are performed on the fine grid points surrounding each coarse grid point within the Δ_{FS} region that are within tabulated conical region (half angle), as illustrated in Figure M.2.2-5.			

When the coarse&fine searches with constant-step size grids are utilizing step sizes of $\Delta_{coarse}=\Delta\theta_{coarse}=\Delta\phi_{coarse}$ with $\Delta_{coarse}=2\Delta_{fine}$, 8 fine grid points are selected for each coarse grid point within Δ_{FS} as outlined highlighted in Figure M.2.2-3.

For the 6x2 and 4x2 configurations utilizing the spherical coverage grid with constant step size grids, outlined in clause M.3, as coarse measurement grid, the coarse and fine grid step sizes are no longer an integer multiple of each other. The above approach to select the 8 closest neighbours of the coarse grid point, Figure M.2.2-3, is no longer applicable. Instead, a different approach shall be applied to those constant-step size grids as well as all constant-density grids. Here, the fine grid points surrounding a coarse grid point identified to be within Δ_{FS} shall be contained within a conical region around that coarse grid point. This approach is further visualized in Figure M.2.2-4 for the constant step size grids and in Figure M.2.2-5 for the constant density grids. The half-angle of the cone shall match the values in Table M.2.2-1 and Table M.2.2-2, respectively, which correspond to $1.5\Delta_{fine}$ for the constant step size grids and $1.5 \times$ maximum separation between a fine grid point and its 6 closest neighbours.

In these figures, red grid points correspond to fine grid points and the blue points correspond to the coarse grid points. The conical region around a sample coarse grid point is visualized in yellow, while the fine grid points within those regions are highlighted in green.

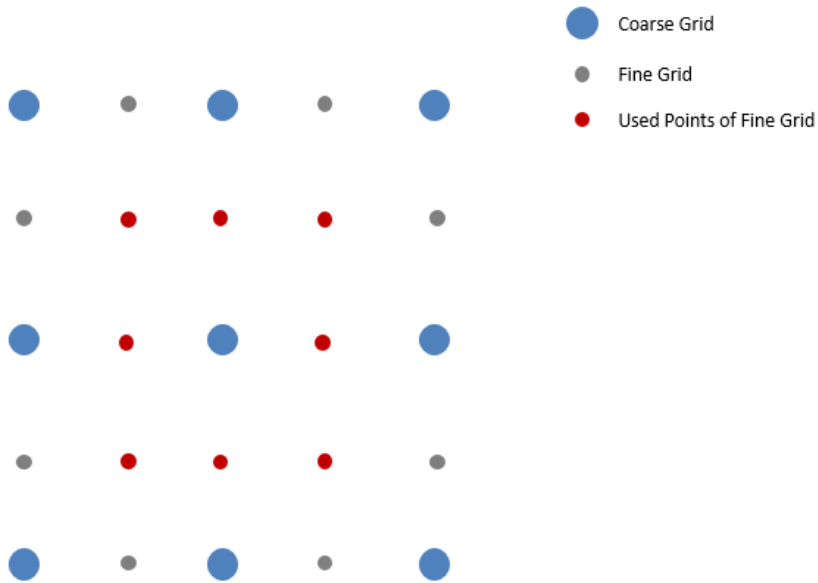

Figure M.2.2-3: Illustration: Coarse & Fine Constant Step Size Grids with $\Delta_{\text{coarse}}=2\Delta_{\text{fine}}$ (with $\Delta=\Delta\theta=\Delta\phi$)

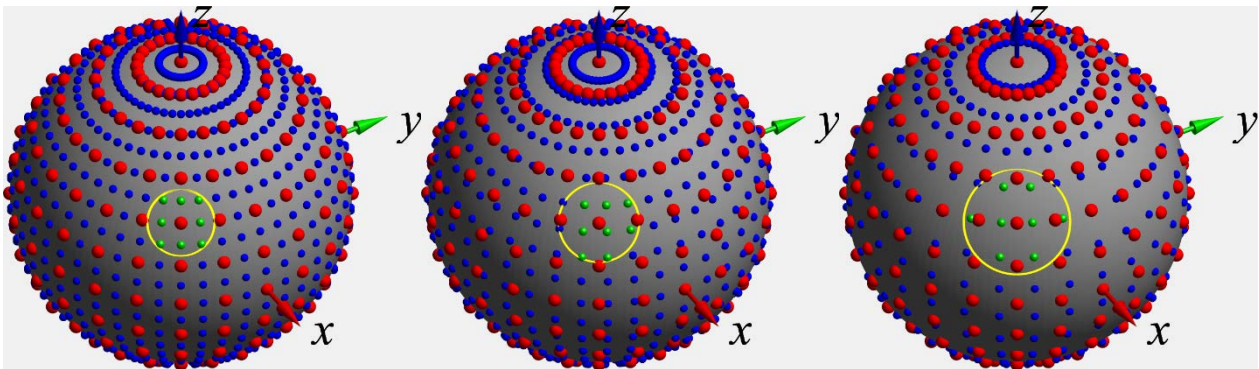

Figure M.2.2-4: Coarse & Fine Constant Step Size Grids for sample PC3 grids, left: 8x2, centre: 6x2, right: 4x2.

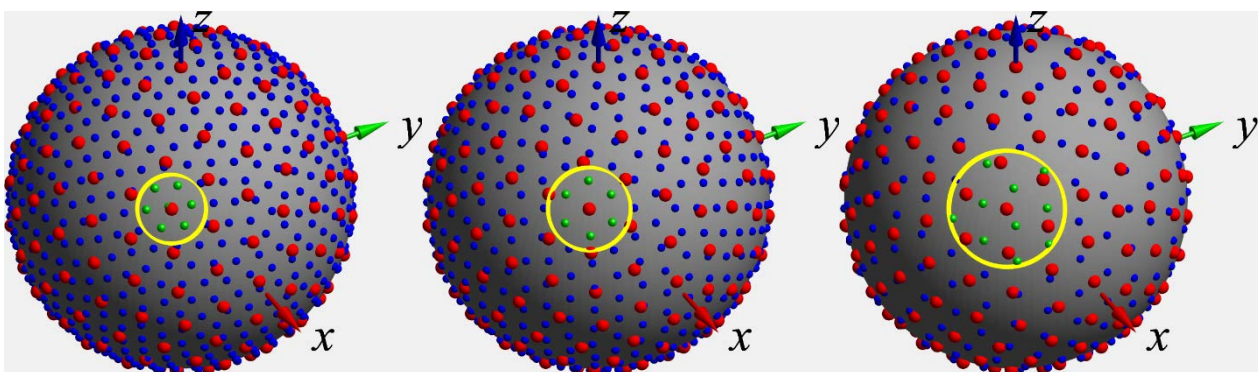

Figure M.2.2-5: Coarse & Fine Constant Density Grids for sample PC3 grids, left: 8x2, centre: 6x2, right: 4x2.

The metric using a coarse & fine grid approach for the TX beam peak search is EIRP for both grids. For RX beam peak search, the metric is EIS for coarse grids and for fine grids.

M.3 Spherical Coverage Grid

Editor's note: Other implementations are not precluded as far as the respective analysis are presented and included in this TS

M.3.1 EIRP spherical coverage

M.3.1.1 UE Power classes

M.3.1.1.1 Power class 1 devices

The same antenna array assumptions as in clause M.2.1.1 apply. Additionally, the following assumptions apply:

- a single antenna array is integrated inside DUT
- beam steering assumptions as follows:
 - In the xz plane, 4° beam steering granularity (from 30° to 150°)
 - In the xy plane, 4° beam steering granularity (from -60° to 60°)

In order to make a reasonable trade-off with measurement uncertainties, it is recommended to use the following recommendation in terms of min. number of grid points, standard deviation, and mean error for spherical coverage grids:

- constant density grid (using the charged particle implementation) with at least 200 grid points: standard deviation (MU element 'Influence of spherical coverage grid') of 0.13dB and 0.04dB Mean Error
- constant step size grid with at least 266 grid points: standard deviation (MU element 'Influence of spherical coverage grid') of 0.12dB and 0.06dB Mean Error

For better measurement uncertainties, finer measurement grids as shown in Tables M.3.1.1.1-1 and M.3.1.1.1-2 may be used. Choice of grids among these 2 types of grids is up to test system implementation.

There is no need to have the Tx beam peak placed on a measurement grid point.

For constant step size measurement grids, the CDF analyses require the PDFs to be scaled by $\sin(\theta)$ or the normalized Clenshaw-Curtis weights $W(\theta)/W(90^\circ)$, introduced in Section M.4.2.1.

Table M.3.1.1.1-1: Statistical results of $\text{EIRP}_{85\% \text{CDF}}$ for the 12x12 antenna array for constant step size measurement grids and the beam peak oriented in completely random orientations.

Step Size [°]	Number of unique grid points	Std. Dev [dB]	Mean Error [dB]
12	422	0.10	0.03
15	266	0.12	0.06
20	146	0.23	0.05

Table M.3.1.1.1-2: Statistical results of $\text{EIRP}_{85\% \text{CDF}}$ for the 12x12 antenna array for constant density measurement grids and the beam peak oriented in completely random orientations.

Number of unique grid points	Std. Dev [dB]	Mean Error [dB]
150	0.15	0.06
175	0.13	0.04

200	0.13	0.04
-----	------	------

M.3.1.1.2 Power class 2 devices

TBD.

M.3.1.1.3 Power class 3 devices

The same antenna array assumptions as in clause M.2.1.3 apply. Additionally, the following assumptions apply:

- two antenna arrays integrated inside DUT, one in the front and one in the back
- the implementation loss for the antenna near the front is 5dB less than that for the antenna near the back
- beam steering assumptions as follows:
 - In the xz plane, 45° beam steering granularity (from 45° to 135°)
 - In the xy plane, 25° beam steering granularity (from -90° to 90°)

In order to make a reasonable trade-off between measurement uncertainties, at least 200 (constant density grid with charged particle implementation) or 266 (constant step size grid) measurement grid points shall be used for EIRP spherical coverage procedure. For better measurement uncertainties, finer measurement grids as shown below may be used. Choice of grids among these 2 types of grids is up to test system implementation.

There is no need to have the Tx beam peak placed on a measurement grid point.

For constant step size measurement grids, the CDF analyses require the PDFs to be scaled by $\sin(\theta)$ or the normalized Clenshaw-Curtis weights $W(\theta)/W(90^\circ)$, introduced in Section M.4.2.1.

Table M.3.1.1.3-1: Statistical results of EIRP50%CDF for the 8x2 antenna array for constant density measurement grids (with charged particle implementation) and the beam peak oriented in completely random orientations errors (non-sparse antenna arrays)

Number of unique grid points	STD [dB]	Mean Error [dB]
200	0.11	0.02
300	0.08	0.01
400	0.07	0.01
500	0.06	0.01

Table M.3.1.1.3-2: Statistical results of EIRP50%CDF for the 8x2 antenna array for constant step size measurement grids and the beam peak oriented in completely random orientations errors (non-sparse antenna arrays)

Step Size [°]	Number of unique grid points	STD [dB]	Mean Error [dB]
9	762	0.05	0.00
10	614	0.06	0.00
12	422	0.07	0.01
15	266	0.12	0.01

Based on an optional vendor declaration with respect to the antenna array configuration, see Table A.4.3.9-10 of [11], devices with an $M \times N$ ($M \geq N$) configuration with $M \leq 4$ and $N \leq 2$ can utilize either of the following minimum number of grid points for spherical coverage procedures:

- 180 (constant density grid with charged particle implementation) measurement grid points with std. deviation of 0.12dB.

- 266 (constant step size grid with $\Delta\theta=\Delta\phi=15.0^\circ$) measurement grid points with std. deviation of 0.11dB.

Based on an optional vendor declaration with respect to the antenna array configuration, see Table A.4.3.9-10 of [11], devices with an $M \times N$ ($M \geq N$) configuration with $4 < M \leq 6$ and $N \leq 2$ can utilize either of the following minimum number of grid points for spherical coverage procedures:

- 200 (constant density grid with charged particle implementation) measurement grid points with std. deviation of 0.14dB.
- 266 (constant step size grid with $\Delta\theta=\Delta\phi=15.0^\circ$) measurement grid points with std. deviation of 0.15dB.

M.3.1.1.4 Power class 4 devices

TBD.

M.3.1.1.5 Power class 5 devices

The same antenna array, integration and beam steering assumptions and measurement grids as in clause M.3.1.1.1 apply.

Based on an optional vendor declaration with respect to the antenna array configuration, see Table A.4.3.9-10a of [11], devices with an $M \times N$ ($M \geq N$) configuration with $M \leq 6$ and $N \leq 6$ can utilize either of the following minimum number of grid points for spherical coverage procedures:

- constant density grid (using the charged particle implementation) with at least 200 grid points: standard deviation (MU element 'Influence of spherical coverage grid') of 0.13dB.
- constant step size grid with at least 266 grid points: standard deviation (MU element 'Influence of spherical coverage grid') of 0.12dB.

M.3.1.1.6 Power class 6 devices

Given the lack of CDF evaluation for spherical coverage for PC6 UEs, spherical coverage measurement grid analyses applied for all the other power class UEs are not applicable here. Instead, the same measurement grid requirements for spherical coverage as for the beam peak search apply for PC6 UEs, i.e. the measurement grids defined in clause M.2.1.6 apply.

clause M.3.2 EIS spherical coverage

M.3.2.1 UE Power classes

M.3.2.1.1 Power class 1 devices

The same antenna array and integration assumptions as in clause M.2.1.1 apply. Additionally, the same beam steering assumptions as in clause M.3.1.1.1 apply.

In order to make a reasonable trade-off with measurement uncertainties, it is recommended to use the following recommendation in terms of min. number of grid points, standard deviation, and mean error for spherical coverage grids:

- constant density grid (using the charged particle implementation) with at least 200 grid points: standard deviation (MU element 'Influence of spherical coverage grid') of 0.13dB and 0.04dB Mean Error
- constant step size grid with at least 266 grid points: standard deviation (MU element 'Influence of spherical coverage grid') of 0.12dB and 0.06dB Mean Error
- the MU element 'Systematic error related to EIS spherical coverage' is the DL step size, i.e., 0.2dB.

Choice of grids among these 2 types of grids is up to test system implementation.

There is no need to have the Rx beam peak placed on a measurement grid point.

For constant step size measurement grids, the CCDF analyses require the PDFs to be scaled by $\sin(\theta)$ or the normalized Clenshaw-Curtis weights $W(\theta)/W(90^\circ)$, introduced in Section M.4.2.1.

M.3.2.1.2 Power class 2 devices

TBD.

M.3.2.1.3 Power class 3 devices

The same antenna array and integration assumptions as in clause M.2.1.3 apply. Additionally, the same beam steering assumptions as in clause M.3.1.1.3 apply.

In order to make a reasonable trade-off between measurement uncertainties, at least 200 (constant density grid with charged particle implementation) or 266 (constant step size grid) measurement grid points shall be used for EIS spherical coverage procedure. For better measurement uncertainties, finer measurement grids as shown below may be used. Choice of grid(s) among these 2 types of grids is up to test system implementation.

There is no need to have the Rx beam peak placed on a measurement grid point.

For constant step size measurement grids, the CCDF analyses require the PDFs to be scaled by $\sin(\theta)$ or the normalized Clenshaw-Curtis weights $W(\theta)/W(90^\circ)$, introduced in Section M.4.2.1.

Table M.3.2.1.3-1: Statistical results of EIS50%CDF for the 8x2 antenna array for constant step size measurement grids and the beam peak oriented in completely random orientations errors (non-sparse antenna arrays)

		DL Power Step Size: infinitesimal		DL Power Step Size: 0.1dB		DL Power Step Size: 0.5dB		DL Power Step Size: 1dB	
Step Size [°]	Number of unique grid points	STD [dB]	Mean Error [dB]	STD [dB]	Mean Error [dB]	STD [dB]	Mean Error [dB]	STD [dB]	Mean Error [dB]
6.0	1742	0.03	0.00	0.03	0.10	0.03	0.50	0.02	1.02
9.0	762	0.05	0.00	0.05	0.10	0.05	0.50	0.04	1.02
10.0	614	0.06	0.00	0.06	0.10	0.06	0.50	0.05	1.02
12.0	422	0.08	0.01	0.07	0.10	0.07	0.50	0.07	1.02
15.0	266	0.12	0.02	0.12	0.10	0.11	0.50	0.10	1.02

Table M.3.2.1.3-2: Statistical results of EIS50%CDF for the 8x2 antenna array for constant density measurement grids (with charged particle implementation) and the beam peak oriented in completely random orientations errors (non-sparse antenna arrays)

	DL Power Step Size: infinitesimal		DL Power Step Size: 0.1dB		DL Power Step Size: 0.5dB		DL Power Step Size: 1dB	
Number of unique grid points	STD [dB]	Mean Error [dB]	STD [dB]	Mean Error [dB]	STD [dB]	Mean Error [dB]	STD [dB]	Mean Error [dB]
200	0.10	0.02	0.10	0.10	0.10	0.50	0.09	1.01
300	0.08	0.01	0.08	0.10	0.08	0.50	0.07	1.01
400	0.06	0.01	0.06	0.10	0.06	0.50	0.05	1.01
500	0.06	0.01	0.06	0.10	0.06	0.50	0.05	1.01

Based on an optional vendor declaration with respect to the antenna array configuration, see Table A.4.3.9-10 of [11], devices with an $M \times N$ ($M \geq N$) configuration with $M \leq 4$ and $N \leq 2$ can utilize either of the following minimum number of grid points for spherical coverage procedures:

- 180 (constant density grid with charged particle implementation) measurement grid points with std. deviation of 0.12dB.
- 266 (constant step size grid with $\Delta\theta=\Delta\phi=15.0^\circ$) measurement grid points with std. deviation of 0.11dB.

Based on an optional vendor declaration with respect to the antenna array configuration, see Table A.4.3.9-10 of [11], devices with an $M \times N$ ($M \geq N$) configuration with $4 < M \leq 6$ and $N \leq 2$ can utilize either of the following minimum number of grid points for spherical coverage procedures:

- 200 (constant density grid with charged particle implementation) measurement grid points with std. deviation of 0.14dB.
- 266 (constant step size grid with $\Delta\theta=\Delta\phi=15.0^\circ$) measurement grid points with std. deviation of 0.15dB.

M.3.2.1.4 Power class 4 devices

TBD.

M.3.2.1.5 Power class 5 devices

The same antenna array and integration assumptions and measurement grids as in clause M.3.2.1.1 apply. Additionally, the same beam steering assumptions as in clause M.3.1.1.5 apply.

Based on an optional vendor declaration with respect to the antenna array configuration, see Table A.4.3.9-10a of [11], devices with an $M \times N$ ($M \geq N$) configuration with $M \leq 6$ and $N \leq 6$ can utilize either of the following minimum number of grid points for spherical coverage procedures:

- constant density grid (using the charged particle implementation) with at least 200 grid points: standard deviation (MU element 'Influence of spherical coverage grid') of 0.13dB
- constant step size grid with at least 266 grid points: standard deviation (MU element 'Influence of spherical coverage grid') of 0.12dB.
- the MU element 'Systematic error related to EIS spherical coverage' is the DL step size, i.e., 0.2dB

M.3.2.1.6 Power class 6 devices

Given the lack of CCDF evaluation for spherical coverage for PC6 UEs, spherical coverage measurement grid analyses applied for all the other power class UEs are not applicable here. Instead, the same measurement grid requirements for spherical coverage as for the beam peak search apply for PC6 UEs, i.e. the measurement grids defined in clause M.2.1.6 apply.

clause M.4 TRP Measurement Grid

Editor's note: Other implementations are not precluded as far as the respective analysis are presented and included in this TS.

M.4.1 UE Power Classes

M.4.1.1 Power class 1 devices

The same antenna array assumptions as in clause M.2.1.1 apply.

In order to make a reasonable trade-off between measurement uncertainties, at least the following number of points shall be included in the measurement grid for TRP measurements PC1 UEs based on the assumption that the standard deviation does not exceed 0.25dB. If the re-positioning concept is not applied to TRP test cases:

- 500 measurement grid points for constant density grid – Charged Particle implementation, with standard deviation of 0.25 dB
- 25 latitudes and 48 longitudes (1106 unique grid points) for constant step size grid – sin (theta) weights integration approach, with standard deviation of 0.10dB with the allowance to skip and interpolate measurements at the pole at $\theta=180^\circ$, see Annex M.4.4
- 25 latitudes and 48 longitudes (1106 unique grid points) for constant step size grid – Clenshaw Curtis weights integration approach, with standard deviation of 0.07dB with the allowance to skip and interpolate measurements at the pole at $\theta=180^\circ$, see Annex M.4.4

If the re-positioning concept is applied to TRP test cases:

- 500 measurement grid points for constant density grid – Charged Particle implementation, with standard deviation of 0.25 dB with the allowance to skip and interpolate measurements for $\theta \geq 150^\circ$, see Annex M.4.4
- 25 latitudes and 48 longitudes (1106 unique grid points) for constant step size grid – sin (theta) weights integration approach, with standard deviation of 0.09dB with the allowance to skip and interpolate measurements for $\theta \geq 157.5^\circ$, see Annex M.4.4
- 25 latitudes and 48 longitudes (1106 unique grid points) for constant step size grid – Clenshaw-Curtis weights integration approach, with standard deviation of 0.03dB with the allowance to skip and interpolate measurements for $\theta \geq 157.5^\circ$, see Annex M.4.4
- 21 latitudes and 40 longitudes (762 unique grid points) for constant step size grid – Clenshaw Curtis weights integration approach, with standard deviation of 0.24 dB with the allowance to skip and interpolate measurements for $\theta \geq 153^\circ$, see Annex M.4.4

M.4.1.2 Power class 2 devices

TBD

M.4.1.3 Power class 3 devices

The same antenna array assumptions as in clause M.2.1.3 apply.

In order to make a reasonable trade-off between measurement uncertainties, at least the following number of points should be included in the measurement grid for TRP measurements for non-sparse antenna arrays case. If the re-positioning concept is not applied to TRP test cases:

- 135 measurement grid points for constant density grid – Charged Particle implementation, with standard deviation of 0.23 dB
- 12 latitudes and 19 longitudes for constant step size grid – sin (theta) weights integration approach, with standard deviation of 0.25dB with the allowance to skip and interpolate measurements at the pole at $\theta=180^\circ$.
- 12 latitudes and 19 longitudes for constant step size grid – Clenshaw Curtis weights integration approach, with standard deviation of 0.20 dB with the allowance to skip and interpolate measurements at the pole at $\theta=180^\circ$.

If the re-positioning concept is applied to TRP test cases:

- 135 measurement grid points for constant density grid – Charged Particle implementation, with standard deviation of 0.23 dB with the allowance to skip and interpolate measurements for $\theta \geq 165^\circ$, see Annex M.4.4
- 150 measurement grid points for constant density grid – Charged Particle implementation, with standard deviation of 0.25 dB with the allowance to skip and interpolate measurements for $\theta \geq 150^\circ$, see Annex M.4.4

- 12 latitudes and 19 longitudes for constant step size grid – sin (theta) weights integration approach, with standard deviation of 0.25dB with the allowance to skip and interpolate measurements the at pole at $\theta=180^\circ$, see Annex M.4.4
- 12 latitudes and 19 longitudes for constant step size grid – Clenshaw Curtis weights integration approach, with standard deviation of 0.20 dB with the allowance to skip and interpolate measurements the at pole at $\theta=180^\circ$, see Annex M.4.4
- 13 latitudes and 24 longitudes for constant step size grid – sin (theta) weights integration approach, with standard deviation of 0.21dB with the allowance to skip and interpolate measurements for $\theta \geq 165^\circ$, see Annex M.4.4
- 13 latitudes and 24 longitudes for constant step size grid – Clenshaw Curtis weights integration approach, with standard deviation of 0.15 dB with the allowance to skip and interpolate measurements for $\theta \geq 165^\circ$, see Annex M.4.4.

Choice of grid(s) among above 3 types of grids is up to test system implementation.

Based on an optional vendor declaration with respect to the antenna array configuration, see Table A.4.3.9-10 of [11], devices with an $M \times N$ ($M \geq N$) configuration with $M \leq 4$ and $N \leq 2$ can utilize either of the following minimum number of grid points for TRP procedures without the repositioning approach:

- 50 measurement grid points for constant density grid – Charged Particle implementation, with standard deviation of 0.14 dB.
- 80 measurement grid points for constant density grid – Charged Particle implementation, with standard deviation of 0.23 dB with the allowance to skip and interpolate measurements for $\theta \geq 165^\circ$, see Annex M.4.4.
- 8 latitudes and 14 longitudes (84 unique number of grid points) for constant step size grid – sin (theta) weights integration approach, with standard deviation of 0.25dB with the allowance to skip and interpolate measurements at the pole at $\theta=180^\circ$.
- 8 latitudes and 14 longitudes (84 unique number of grid points) for constant step size grid – Clenshaw Curtis weights integration approach, with standard deviation of 0.20 dB with the allowance to skip and interpolate measurements at the pole at $\theta=180^\circ$.

Either of the following minimum number of grid points for TRP procedures apply if the re-positioning is applied:

- 50 measurement grid points for constant density grid – Charged Particle implementation, with standard deviation of 0.14 dB with the allowance to skip and interpolate measurements for $\theta \geq 150^\circ$, see Annex M.4.4.
- 7 latitudes and 12 longitudes (62 unique number of grid points) for constant step size grid – Clenshaw Curtis weights integration approach, with standard deviation of 0.20 dB with the allowance to skip and interpolate measurements the at pole at $\theta=180^\circ$, see Annex M.4.4.
- 8 latitudes and 14 longitudes (86 unique number of grid points) for constant step size grid – sin (theta) weights integration approach, with standard deviation of 0.25dB with the allowance to skip and interpolate measurements for $\theta \geq 154.29^\circ$, see Annex M.4.4.
- 8 latitudes and 14 longitudes (86 unique number of grid points) for constant step size grid – Clenshaw Curtis weights integration approach, with standard deviation of 0.09 dB with the allowance to skip and interpolate measurements for $\theta \geq 128.58^\circ$, see Annex M.4.4.

Based on an optional vendor declaration with respect to the antenna array configuration, see Table A.4.3.9-10 of [11], devices with an $M \times N$ ($M \geq N$) configuration with $4 < M \leq 6$ and $N \leq 2$ can utilize either of the following minimum number of grid points for TRP procedures without the repositioning approach:

- 100 measurement grid points for constant density grid – Charged Particle implementation, with standard deviation of 0.13 dB.
- 10 latitudes and 18 longitudes ($\Delta\theta=\Delta\phi=20^\circ$, 146 unique grid points) for constant step size grid – sin (theta) weights integration approach, with standard deviation of 0.23dB with the allowance to skip and interpolate measurements at the pole at $\theta=180^\circ$, see Annex M.4.4.

- 10 latitudes and 16 longitudes ($\Delta\theta=20^\circ$, $\Delta\phi=22.5^\circ$, 130 unique grid points) for constant step size grid – Clenshaw Curtis weights integration approach, with standard deviation of 0.23dB with the allowance to skip and interpolate measurements at the pole at $\theta=180^\circ$, see Annex M.4.4.

Either of the following minimum number of grid points for TRP procedures apply if the re-positioning is applied:

- 90 measurement grid points for constant density grid – Charged Particle implementation, with standard deviation of 0.21 dB with the allowance to skip and interpolate measurements for $\theta\geq 150^\circ$, see Annex M.4.4
- 10 latitudes and 18 longitudes ($\Delta\theta=\Delta\phi=20^\circ$, 146 unique grid points) for constant step size grid – sin (theta) weights integration approach, with standard deviation of 0.23dB with the allowance to skip and interpolate measurements $\theta\geq 140^\circ$, see Annex M.4.4
- 10 latitudes and 16 longitudes ($\Delta\theta=20^\circ$, $\Delta\phi=22.5^\circ$, 122 unique grid points) for constant step size grid – Clenshaw-Curtis weights integration approach, with standard deviation of 0.18dB with the allowance to skip and interpolate measurements for $\theta\geq 140^\circ$, see Annex M.4.4.

Choice of grid(s) among above 3 types of grids is up to test system implementation.

M.4.1.4 Power class 4 devices

TBD.

M.4.1.5 Power class 5 devices

The same antenna array assumptions and measurement grids as in clause M.4.1.1 apply.

Based on an optional vendor declaration with respect to the antenna array configuration, see Table A.4.3.9-10a of [11], devices with an $M \times N$ ($M \geq N$) configuration with $M \leq 6$ and $N \leq 6$ can utilize either of the following minimum number of grid points for TRP procedures without the repositioning approach:

- 150 measurement grid points for constant density grid – Charged Particle implementation, with standard deviation of 0.13 dB
- 13 latitudes and 24 longitudes (266 unique grid points) for constant step size grid – sin (theta) weights integration approach, with standard deviation of 0.20dB with the allowance to skip and interpolate measurements at the pole at $\theta=180^\circ$, see Annex M.4.4.
- 13 latitudes and 24 longitudes (266 unique grid points) for constant step size grid – Clenshaw Curtis weights integration approach, with standard deviation of 0.15dB with the allowance to skip and interpolate measurements at the pole at $\theta=180^\circ$, see Annex M.4.4.

Either of the following minimum number of grid points for TRP procedures apply if the re-positioning is applied:

- 150 measurement grid points for constant density grid – Charged Particle implementation, with standard deviation of 0.13 dB with the allowance to skip and interpolate measurements for $\theta\geq 150^\circ$, see Annex M.4.4
- 13 latitudes and 24 longitudes (266 unique grid points) for constant step size grid – sin (theta) weights integration approach, with standard deviation of 0.19dB with the allowance to skip and interpolate measurements for $\theta\geq 150^\circ$, see Annex M.4.4
- 13 latitudes and 24 longitudes (266 unique grid points) for constant step size grid – Clenshaw-Curtis weights integration approach, with standard deviation of 0.04dB with the allowance to skip and interpolate measurements for $\theta\geq 150^\circ$, see Annex M.4.4.

M.4.1.6 Power class 6 devices

The same antenna array assumptions and measurement grids as in clause M.4.1.1 with an antenna array configuration of 6×6 apply.

In order to make a reasonable trade-off between measurement uncertainties, at least the following number of points shall be included in the measurement grid for TRP measurements PC1 UEs based on the assumption that the standard deviation does not exceed 0.25dB. If the re-positioning concept is not applied to TRP test cases:

- 150 measurement grid points for constant density grid – Charged Particle implementation, with standard deviation of 0.13 dB
- 13 latitudes and 24 longitudes (266 unique grid points) for constant step size grid – sin (theta) weights integration approach, with standard deviation of 0.20dB with the allowance to skip and interpolate measurements at the pole at $\theta=180^\circ$, see Annex M.4.4.
- 13 latitudes and 24 longitudes (266 unique grid points) for constant step size grid – Clenshaw Curtis weights integration approach, with standard deviation of 0.15dB with the allowance to skip and interpolate measurements at the pole at $\theta=180^\circ$, see Annex M.4.4.

Either of the following minimum number of grid points for TRP procedures apply if the re-positioning is applied:

- 150 measurement grid points for constant density grid – Charged Particle implementation, with standard deviation of 0.13 dB with the allowance to skip and interpolate measurements for $\theta \geq 150^\circ$, see Annex M.4.4
- 13 latitudes and 24 longitudes (266 unique grid points) for constant step size grid – sin (theta) weights integration approach, with standard deviation of 0.19dB with the allowance to skip and interpolate measurements for $\theta \geq 150^\circ$, see Annex M.4.4
- 13 latitudes and 24 longitudes (266 unique grid points) for constant step size grid – Clenshaw-Curtis weights integration approach, with standard deviation of 0.04dB with the allowance to skip and interpolate measurements for $\theta \geq 150^\circ$, see Annex M.4.4.

M.4.2 TRP Integration for Constant Step Size Grid Type

Different approaches to perform the TRP integration from the respective EIRP measurements are outlined in the next sub clauses for the constant step size grid type.

M.4.2.1 TRP Integration using Weights

In many engineering disciplines, the integral of a function needs to be solved using numerical integration techniques, commonly referred to as "quadrature". Here, the approximation of the integral of a function is usually stated as a weighted sum of function values at specified points within the domain of integration. The derivation from the closed surface TRP integral

$$TRP = \iint_S \frac{EIRP(\theta, \phi)}{4\pi} \cdot \sin \theta \cdot d\theta d\phi$$

to the classical discretized summation equation used for OTA

$$TRP \approx \frac{\pi}{2NM} \sum_{i=1}^{N-1} \sum_{j=0}^{M-1} [EIRP_\theta(\theta_i, \phi_j) + EIRP_\phi(\theta_i, \phi_j)] \sin(\theta_i)$$

The weights for this integral are based on the $\sin\theta \cdot \Delta\theta$ weights. More accurate implementations are based on the Clenshaw-Curtis quadrature integral approximation based on an expansion of the integrand in terms of Chebyshev polynomials. This implementation does not ignore the measurement points at the poles ($\theta=0^\circ$ and 180°) where $\sin\theta = 0$. The discretized TRP can be expressed as

$$TRP \approx \frac{1}{2M} \sum_{i=0}^N \sum_{j=0}^{M-1} [EIRP_\theta(\theta_i, \phi_j) + EIRP_\phi(\theta_i, \phi_j)] W(\theta_i)$$

which the $\sin\theta \cdot \Delta\theta$ weights replaced by a weight function $W(\theta)$ and extends the sum over i to include the poles. There is no simple closed-form expression for the Clenshaw-Curtis weights; however, a numerical straightforward approach is available, i.e.,

$$W(\theta_i) = \frac{c_i}{N} \left[1 - \sum_{j=1}^{\text{int}(\frac{N}{2})} \frac{b_j}{4j^2 - 1} \cos(2j\theta_i) \right]$$

with

$$b_j = \begin{cases} 1, & 2j = N \\ 2, & \text{otherwise} \end{cases}$$

and

$$c_i = \begin{cases} 1, & i = 0 \text{ or } N \\ 2, & \text{otherwise} \end{cases}$$

The Clenshaw-Curtis weights are compared to the classical $\sin \theta \cdot \Delta\theta$ weights in Tables M.4.2.1-1 and M.4.2.1-2 for two different numbers of latitudes. The TRP measurement grid consists of N+1 latitudes and M longitudes with

$$\theta_i = i\Delta\theta \text{ where } \Delta\theta = \frac{\pi}{N}$$

and

$$\phi_j = j\Delta\phi \text{ where } \Delta\phi = \frac{2\pi}{M}$$

Table M.4.2.1-1: Samples and weights for the classical $\sin \theta \cdot \Delta\theta$ weighting and Clenshaw-Curtis quadratures with 12 latitudes ($\Delta\theta=16.4^\circ$)

Classical $\sin\theta \cdot \Delta\theta$		Clenshaw-Curtis	
θ [deg]	Weights	θ [deg]	Weights
0	0	0	0.008
16.4	0.08	16.4	0.079
32.7	0.154	32.7	0.155
49.1	0.216	49.1	0.216
65.5	0.26	65.5	0.26
81.8	0.283	81.8	0.283
98.2	0.283	98.2	0.283
114.6	0.26	114.6	0.26
130.9	0.216	130.9	0.216
147.3	0.154	147.3	0.155
163.6	0.08	163.6	0.079
180	0	180	0.008

Table M.4.2.1-2: Samples and weights for the classical $\sin \theta \cdot \Delta\theta$ weighting and Clenshaw-Curtis quadratures with 13 latitudes ($\Delta\theta=15^\circ$)

Classical $\sin\theta \cdot \Delta\theta$		Clenshaw-Curtis	
θ [deg]	Weights	θ [deg]	Weights
0	0	0	0.007
15	0.0678	15	0.0661
30	0.1309	30	0.1315
45	0.1851	45	0.1848
60	0.2267	60	0.227

75	0.2529	75	0.2527
90	0.2618	90	0.262
105	0.2529	105	0.2527
120	0.2267	120	0.227
135	0.1851	135	0.1848
150	0.1309	150	0.1315
165	0.0678	165	0.0661
180	0	180	0.007

M.4.3 TRP Integration for Constant Density Grid Types

For constant density grid types, the TRP integration should ideally take into account the area of the Voronoi region surrounding each grid point. Assuming an ideal constant density configuration of the grid points, the TRP can be approximated using

$$TRP \approx \frac{1}{N} \sum_{i=0}^{N-1} [EIRP_{\theta}(\theta_i, \phi_i) + EIRP_{\phi}(\theta_i, \phi_i)]$$

where N is the number of grid points of the constant density grid type.

M.4.4 Interpolation at or near the Pole

As illustrated in Figure M.4.4-1, for systems that either do not allow measurements at the pole ($\theta=180^\circ$), e.g., using distributed-axes positioners, or systems that have the positioners/support structures block the radiation towards the pole ($\theta=180^\circ$), e.g., combined-axes positioners, measurements beyond 150° in θ can be skipped and interpolated instead for measurement grids defined in Annex M.4.1.

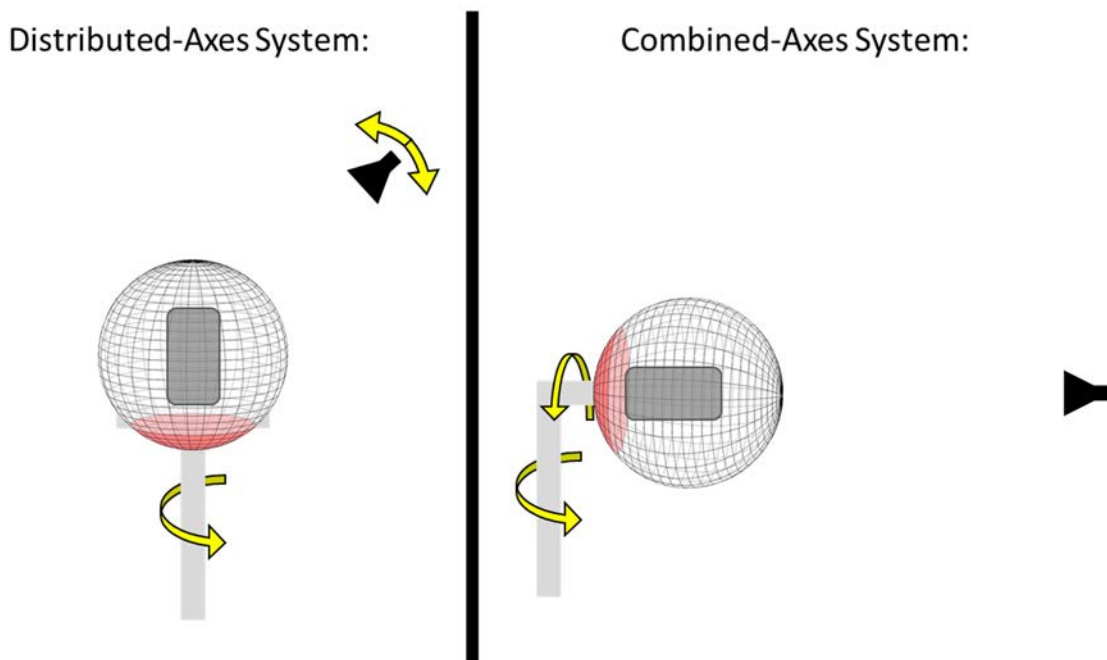

Figure M.4.4-1: Illustration of areas around the pole that either cannot be reached by the measurement antenna or are blocked by the positioner

M.4.5 TRP Grids for Spurious Emissions

The worst antenna array assumptions for the MU simulations are outlined in Tables M.4.5-1 and M.4.5-2 for PC1, PC3, PC5 and PC6 with the antenna configurations per power class listed in Table M.4.5-2c.

Table M.4.5-1: Single Antenna Element Radiation Pattern for spurious emission measurements for PC1, PC3, and PC5

Antenna element horizontal radiation pattern	$A_{E,H}(\varphi) = -\min \left[12 \left(\frac{\varphi}{\varphi_{3dB}} \right)^2, A_m \right] \text{ dB}$, $A_m = 25 \text{ dB}$
Horizontal half-power beam width of single element	90°
Antenna element vertical radiation pattern	$A_{E,V}(\theta) = -\min \left[12 \left(\frac{\theta - 90}{\theta_{3dB}} \right)^2, SLA \right]$, $SLA_v = 25 \text{ dB}$
Vertical half-power beam width of single array element	90°
Array element radiation pattern	$A_E(\varphi, \theta) = G_{E,max} - \min \left\{ - \left[A_{E,H}(\varphi) + A_{E,V}(\theta) \right], A_m \right\}$
Element gain without antenna losses	$G_{E,max} = 5 \text{ dBi}$

Table M.4.5-1a: Void

Table M.4.5-2: Composite Antenna Array Radiation Pattern for spurious emission measurements for PC1, PC3, PC5 and PC6

Composite array radiation pattern in dB $A_A(\theta, \varphi)$	$A_{A,Beam1}(\theta, \varphi) = A_E(\theta, \varphi) + 10 \log_{10} \left(\left \sum_{m=1}^{N_H} \sum_{n=1}^{N_V} w_{i,n,m} \cdot v_{n,m} \right ^2 \right)$ <p>the super position vector is given by:</p> $v_{n,m} = \exp \left(i \cdot 2\pi \left((n-1) \cdot \frac{d_v}{\lambda} \cdot \cos(\theta) + (m-1) \cdot \frac{d_H}{\lambda} \cdot \sin(\theta) \cdot \sin(\varphi) \right) \right),$ <p>$n = 1, 2, \dots, N_V; m = 1, 2, \dots, N_H;$</p> <p>the weighting is given by:</p> $w_{i,n,m} = \frac{1}{\sqrt{N_H N_V}} \exp \left(i \cdot 2\pi \left((n-1) \cdot \frac{d_v}{\lambda} \cdot \sin(\theta_{i,elit}) - (m-1) \cdot \frac{d_H}{\lambda} \cdot \cos(\theta_{i,elit}) \cdot \sin(\varphi_{i,escan}) \right) \right)$
Antenna array configuration (RowxColumn)	M x N
Horizontal radiating element spacing, d_h/λ	1
Vertical radiating element spacing, d_v/λ	1

Table M.4.5-2a: Void

Table M.4.5-2c: Antenna Configuration Assumptions for Different Power Classes

Power Class	M	N
PC1	12	12
PC3	8	2
PC3 (Alternate)	4	2
PC5	12	12

PC5 (Alternate) 6 6
 PC6 6 6
 Note: The alternate grids are based on an optional vendor declaration, see Table A.4.3.9-10 in [11] for PC3 and Table A.4.3.9-10a in [11] for PC5.

The fine TRP measurement grid selection for spurious emissions is up to test system implementation but shall meet the criteria shown in Table M.4.5-3 for PC1, PC3, and PC5.

Table M.4.5-3: Fine TRP measurement grid requirement for spurious emission measurements

Power Class	Antenna Assumption	Grid Type	Standard Deviation of MU Element 'Influence of TRP Measurement'	Systematic error due to TRP calculation/quadrature	Number of unique grid points
PC1	12x12	Constant Density	0.23	0dB	1600
		Constant-Step Size – sin(θ)	0.21	0dB	2522 (Δθ=Δφ=5°)
		Constant-Step Size – CC	0.21	0dB	2522 (Δθ=Δφ=5°)
PC3	8x2	Constant Density	0.29	0dB	450
		Constant-Step Size – sin(θ)	0.29	0dB	614 (Δθ=Δφ=10°)
		Constant-Step Size – CC	0.28	0dB	614 (Δθ=Δφ=10°)
	4x2 (alternate)	Constant Density	0.30	0dB	125
		Constant-Step Size – sin(θ)	0.31	0dB	182 (Δθ=Δφ=18°)
		Constant-Step Size – CC	0.28	0dB	182 (Δθ=Δφ=18°)
PC5	12x12	Constant Density	0.23	0dB	1600
		Constant-Step Size – sin(θ)	0.21	0dB	2522 (Δθ=Δφ=5°)
		Constant-Step Size – CC	0.21	0dB	2522 (Δθ=Δφ=5°)
	6x6 (alternate)	Constant Density	0.25	0dB	400
		Constant-Step Size – sin(θ)	0.25	0dB	614 (Δθ=Δφ=10°)
		Constant-Step Size – CC	0.23	0dB	614 (Δθ=Δφ=10°)
PC6	6x6	Constant Density	0.25	0dB	400
		Constant-Step Size – sin(θ)	0.25	0dB	614 (Δθ=Δφ=10°)
		Constant-Step Size – CC	0.23	0dB	614 (Δθ=Δφ=10°)
Note:	The alternate grids are based on an optional vendor declaration, see Table A.4.3.9-10 in [11] for PC3 and Table A.4.3.9-10a in [11] for PC5.				

Table M.4.5-3a: Void

For spurious emissions, TRP measurements with measurement antennas displaced up to 10° from the focal point (based on electrical switching) in an IFF (based on CATR) test system, alternate TRP approaches for constant-step size grids are allowed for the coarse and fine grids:

- interpolation to the non-offset system coordinate system that allows the use of Clenshaw-Curtis or classical $\sin(\theta)$ quadratures
- use of the advanced Jacobian matrix quadrature approach that uses triangulations of the sphere

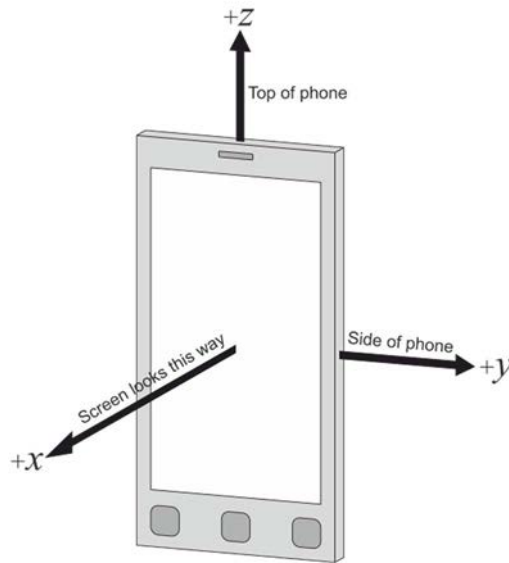

Figure N.1-2: DUT default alignment of example smartphone UE to coordinate system

The following aspects are necessary:

- A basic understanding of the top and bottom of the device is needed in order to define unambiguous DUT positioning requirements for the test, e.g., in the drawings used in this annex, the three buttons are on the bottom of the device (front) and the camera is on the top of the device (back).
- An understanding of the origin and alignment the coordinate system inside the test system i.e. the directions in which the x, y, z -axes points inside the test chamber is needed in order to define unambiguous DUT orientation, DUT beam, signal, interference, and measurement angles

N.2 Test conditions and angle definitions

Tables N.2-1 through N.2-3 below provides the test conditions and angle definitions for three permitted device alignment for smartphones and tablets for the default test condition, DUT orientation 1, and two different options for each permitted device alignment to re-position the device for DUT Orientation 2 by figures in Tables N.2-1 through N.2-3.

Table N.2-1: Test conditions and angle definitions for smartphones and tablets for Alignment Option 1

Test condition	DUT orientation	Link angle	Measurement angle	Diagram
Free space DUT Orientation 1 (default)	$\alpha = 0^\circ$; $\beta = 0^\circ$; $\gamma = 0^\circ$	θ_{Link} ; ϕ_{Link} with polarization reference $Pol_{Link} = \theta$ or ϕ	θ_{Meas} ; ϕ_{Meas} with polarization reference $Pol_{Meas} = \theta$ or ϕ	<p>A diagram of a smartphone oriented vertically. Three coordinate axes are shown: a vertical arrow pointing upwards labeled '+Z', a horizontal arrow pointing to the right labeled '+y', and a diagonal arrow pointing towards the bottom-left labeled '+x'. Three rotation matrices are indicated with red circular arrows: 'Rotation Matrix $R_z(\gamma)$' around the +Z axis, 'Rotation Matrix $R_x(\alpha)$' around the +x axis, and 'Rotation Matrix $R_y(\beta)$' around the +y axis.</p>

<p>Free space DUT Orientation 2 – Option 1 (based on re-positioning approach)</p>	<p>$\alpha = 180^\circ$; $\beta = 0^\circ$; $\gamma = 0^\circ$</p>	<p>θ_{Link}; ϕ_{Link} with polarization reference $Pol_{Link} = \theta$ or ϕ</p>	<p>θ_{Meas}; ϕ_{Meas} with polarization reference $Pol_{Meas} = \theta$ or ϕ</p>	
<p>Free space DUT Orientation 2 – Option 2 (based on re-positioning approach)</p>	<p>$\alpha = 0^\circ$; $\beta = 180^\circ$; $\gamma = 0^\circ$</p>	<p>θ_{Link}; ϕ_{Link} with polarization reference $Pol_{Link} = \theta$ or ϕ</p>	<p>θ_{Meas}; ϕ_{Meas} with polarization reference $Pol_{Meas} = \theta$ or ϕ</p>	
<p>NOTE 1: A polarization reference, as defined in relation to the reference coordinate system in N.1-1, is maintained for each signal angle, link or interferer angle, and measurement angle. NOTE 2: The combination of rotations is captured by matrix $M=R_z(\gamma) \cdot R_y(\beta) \cdot R_x(\alpha)$</p>				

Table N.2-2: Test conditions and angle definitions for smartphones and tablets for Alignment Option 2

Test condition	DUT orientation	Link angle	Measurement angle	Diagram
<p>Free space DUT Orientation 1 (default)</p>	<p>$\alpha = 0^\circ$; $\beta = -90^\circ$; $\gamma = 0^\circ$</p>	<p>θ_{Link}; ϕ_{Link} with polarization reference $Pol_{Link} = \theta$ or ϕ</p>	<p>θ_{Meas}; ϕ_{Meas} with polarization reference $Pol_{Meas} = \theta$ or ϕ</p>	
<p>Free space DUT Orientation 2 – Option 1 (based on re-positioning approach)</p>	<p>$\alpha = 180^\circ$; $\beta = 90^\circ$; $\gamma = 0^\circ$</p>	<p>θ_{Link}; ϕ_{Link} with polarization reference $Pol_{Link} = \theta$ or ϕ</p>	<p>θ_{Meas}; ϕ_{Meas} with polarization reference $Pol_{Meas} = \theta$ or ϕ</p>	

Free space DUT Orientation 2 – Option 2 (based on re-positioning approach)	$\alpha = 0^\circ;$ $\beta = 90^\circ;$ $\gamma = 0^\circ$	$\theta_{\text{Link}};$ ϕ_{Link} with polarization reference $\text{Pol}_{\text{Link}} = \theta$ or ϕ	$\theta_{\text{Meas}};$ ϕ_{Meas} with polarization reference $\text{Pol}_{\text{Meas}} = \theta$ or ϕ	
NOTE 1: A polarization reference, as defined in relation to the reference coordinate system in N.1-1, is maintained for each signal angle, link or interferer angle, and measurement angle. NOTE 2: The combination of rotations is captured by matrix $M=R_z(\gamma)\cdot R_y(\beta)\cdot R_x(\alpha)$				

Table N.2-3: Test conditions and angle definitions for smartphones and tablets for Alignment Option 3

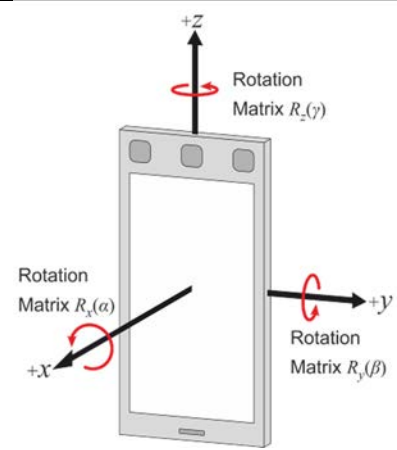
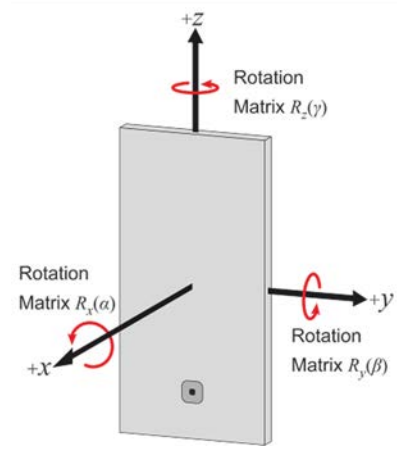
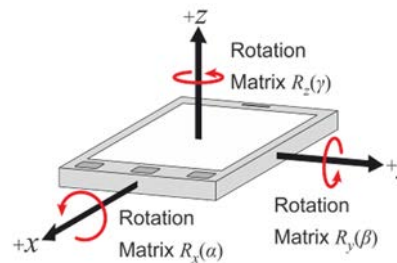
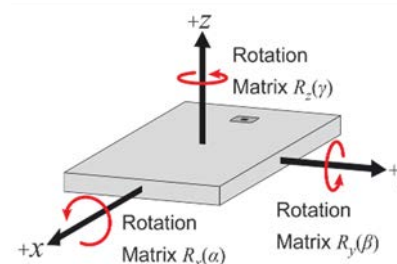
Test condition	DUT orientation	Link angle	Measurement angle	Diagram
Free space DUT Orientation 1 (default)	$\alpha = 90^\circ;$ $\beta = 0^\circ;$ $\gamma = 0^\circ$	$\theta_{\text{Link}};$ ϕ_{Link} with polarization reference $\text{Pol}_{\text{Link}} = \theta$ or ϕ	$\theta_{\text{Meas}};$ ϕ_{Meas} with polarization reference $\text{Pol}_{\text{Meas}} = \theta$ or ϕ	
Free space DUT Orientation 2 – Option 1 (based on re-positioning approach)	$\alpha = -90^\circ;$ $\beta = 0^\circ;$ $\gamma = 0^\circ$	$\theta_{\text{Link}};$ ϕ_{Link} with polarization reference $\text{Pol}_{\text{Link}} = \theta$ or ϕ	$\theta_{\text{Meas}};$ ϕ_{Meas} with polarization reference $\text{Pol}_{\text{Meas}} = \theta$ or ϕ	
Free space DUT Orientation 2 – Option 2 (based on re-positioning approach)	$\alpha = 90^\circ;$ $\beta = 180^\circ;$ $\gamma = 0^\circ$	$\theta_{\text{Link}};$ ϕ_{Link} with polarization reference $\text{Pol}_{\text{Link}} = \theta$ or ϕ	$\theta_{\text{Meas}};$ ϕ_{Meas} with polarization reference $\text{Pol}_{\text{Meas}} = \theta$ or ϕ	
NOTE 1: A polarization reference, as defined in relation to the reference coordinate system in N.1-1, is maintained for each signal angle, link or interferer angle, and measurement angle. NOTE 2: The combination of rotations is captured by matrix $M=R_z(\gamma)\cdot R_y(\beta)\cdot R_x(\alpha)$				

Table N.2-4 below provides the test conditions and angle definitions for the permitted device alignment for laptops for the default test condition, DUT orientation 1, and two different options for each permitted device alignment to re-position the device for DUT Orientation 2 as outlined in Figures N.3-1 and N.3-2. The display is open at a lid angle of $110^\circ \pm 5^\circ$, where lid angle is defined as the angle between the front of the display to the levelled base, and the full projected volume is centred inside the test volume.

Table N.2-4: Test conditions and angle definitions for laptops

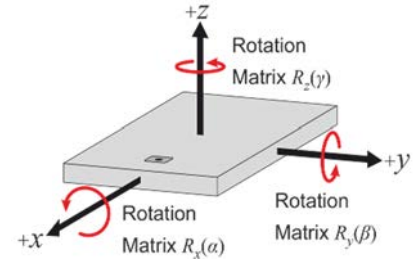
Test condition	DUT orientation	Link angle	Measurement angle	Diagram
Free space DUT Orientation (default)	$\alpha = 0^\circ$; $\beta = 0^\circ$; $\gamma = 0^\circ$	θ_{Link} ; ϕ_{Link} with polarization reference $Pol_{Link} = \theta$ or ϕ	θ_{Meas} ; ϕ_{Meas} with polarization reference $Pol_{Meas} = \theta$ or ϕ	
Free space DUT Orientation 2 – Option 1 (based on re-positioning approach)	$\alpha = 180^\circ$; $\beta = 0^\circ$; $\gamma = 0^\circ$	θ_{Link} ; ϕ_{Link} with polarization reference $Pol_{Link} = \theta$ or ϕ	θ_{Meas} ; ϕ_{Meas} with polarization reference $Pol_{Meas} = \theta$ or ϕ	
Free space DUT Orientation 2 – Option 2 (based on re-positioning approach)	$\alpha = 0^\circ$; $\beta = 180^\circ$; $\gamma = 0^\circ$	θ_{Link} ; ϕ_{Link} with polarization reference $Pol_{Link} = \theta$ or ϕ	θ_{Meas} ; ϕ_{Meas} with polarization reference $Pol_{Meas} = \theta$ or ϕ	
NOTE 1: A polarization reference, as defined in relation to the reference coordinate system in N.1-1, is maintained for each signal angle, link or interferer angle, and measurement angle. NOTE 2: The combination of rotations is captured by matrix $M=R_x(\gamma)\bullet R_y(\beta)\bullet R_x(\alpha)$				

Tables N.2-5 through N.2-7 below provides the test conditions and angle definitions for the three permitted device alignment options for Fixed Wireless Access (FWA) for the default test condition, DUT orientation 1, and two different options for each permitted device alignment to re-position the device for DUT Orientation 2 as outlined in Figures N.3-1 and N.3-2. Due to changes in DUT orientations α , β , and γ for the alignment options for FWA proposed in Tables N.2-6 through N.2-7 when compared to those in Tables N.2-2 through N.2-3, new alignment options, i.e., Options 4 and 5, were introduced.

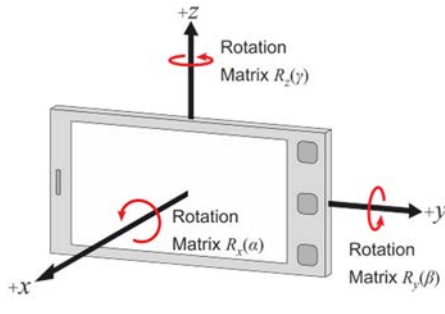
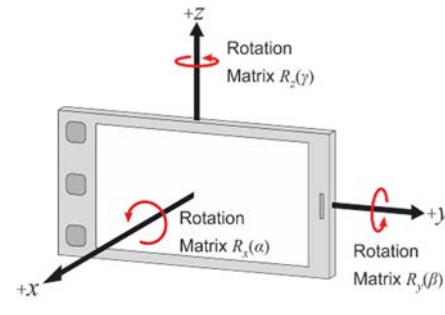
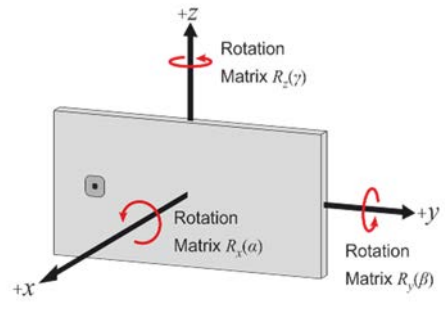
Table N.2-5: Test conditions and angle definitions for FWA for Alignment Option 1

Test condition	DUT orientation	Link angle	Measurement angle	Diagram
----------------	-----------------	------------	-------------------	---------

<p>Free space DUT Orientation 1 (default)</p>	<p>$\alpha = 0^\circ;$ $\beta = 0^\circ;$ $\gamma = 0^\circ$</p>	<p>$\theta_{Link};$ ϕ_{Link} with polarization reference $Pol_{Link} = \theta$ or ϕ</p>	<p>$\theta_{Meas};$ ϕ_{Meas} with polarization reference $Pol_{Meas} = \theta$ or ϕ</p>	
<p>Free space DUT Orientation 2 – Option 1 (based on re-positioning approach)</p>	<p>$\alpha = 180^\circ;$ $\beta = 0^\circ;$ $\gamma = 0^\circ$</p>	<p>$\theta_{Link};$ ϕ_{Link} with polarization reference $Pol_{Link} = \theta$ or ϕ</p>	<p>$\theta_{Meas};$ ϕ_{Meas} with polarization reference $Pol_{Meas} = \theta$ or ϕ</p>	
<p>Free space DUT Orientation 2 – Option 2 (based on re-positioning approach)</p>	<p>$\alpha = 0^\circ;$ $\beta = 180^\circ;$ $\gamma = 0^\circ$</p>	<p>$\theta_{Link};$ ϕ_{Link} with polarization reference $Pol_{Link} = \theta$ or ϕ</p>	<p>$\theta_{Meas};$ ϕ_{Meas} with polarization reference $Pol_{Meas} = \theta$ or ϕ</p>	
<p>NOTE 1: A polarization reference, as defined in relation to the reference coordinate system in N.1-1, is maintained for each signal angle, link or interferer angle, and measurement angle. NOTE 2: The combination of rotations is captured by matrix $M=R_z(\gamma) \cdot R_y(\beta) \cdot R_x(\alpha)$</p>				

Table N.2-6: Test conditions and angle definitions for FWA for Alignment Option 4

Test condition	DUT orientation	Link angle	Measurement angle	Diagram
Free space DUT Orientation 1 (default)	$\alpha = 90^\circ$; $\beta = 0^\circ$; $\gamma = 90^\circ$	θ_{Link} ; ϕ_{Link} with polarization reference $Pol_{Link} = \theta$ or ϕ	θ_{Meas} ; ϕ_{Meas} with polarization reference $Pol_{Meas} = \theta$ or ϕ	
Free space DUT Orientation 2 – Option 1 (based on re-positioning approach)	$\alpha = -90^\circ$; $\beta = 0^\circ$; $\gamma = -90^\circ$	θ_{Link} ; ϕ_{Link} with polarization reference $Pol_{Link} = \theta$ or ϕ	θ_{Meas} ; ϕ_{Meas} with polarization reference $Pol_{Meas} = \theta$ or ϕ	
Free space DUT Orientation 2 – Option 2 (based on re-positioning approach)	$\alpha = -90^\circ$; $\beta = 0^\circ$; $\gamma = 90^\circ$	θ_{Link} ; ϕ_{Link} with polarization reference $Pol_{Link} = \theta$ or ϕ	θ_{Meas} ; ϕ_{Meas} with polarization reference $Pol_{Meas} = \theta$ or ϕ	

NOTE 1: A polarization reference, as defined in relation to the reference coordinate system in N.1-1, is maintained for each signal angle, link or interferer angle, and measurement angle.

NOTE 2: The combination of rotations is captured by matrix $M=R_z(\gamma) \cdot R_y(\beta) \cdot R_x(\alpha)$

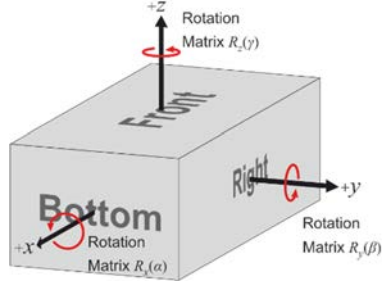
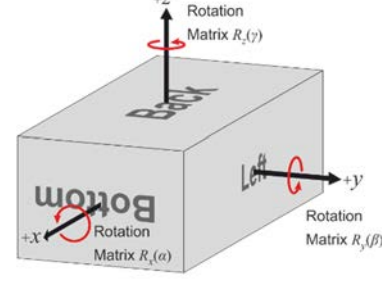
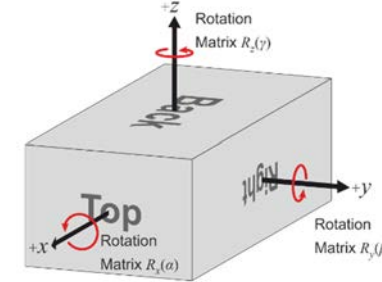
Table N.2-7: Test conditions and angle definitions for FWA for Alignment Option 5

Test condition	DUT orientation	Link angle	Measurement angle	Diagram
Free space DUT Orientation 1 (default)	$\alpha = 0^\circ$; $\beta = 90^\circ$; $\gamma = 0^\circ$	θ_{Link} ; ϕ_{Link} with polarization reference $Pol_{Link} = \theta$ or ϕ	θ_{Meas} ; ϕ_{Meas} with polarization reference $Pol_{Meas} = \theta$ or ϕ	
Free space DUT Orientation 2 – Option 1 (based on re-positioning approach)	$\alpha = 180^\circ$; $\beta = -90^\circ$; $\gamma = 0^\circ$	θ_{Link} ; ϕ_{Link} with polarization reference $Pol_{Link} = \theta$ or ϕ	θ_{Meas} ; ϕ_{Meas} with polarization reference $Pol_{Meas} = \theta$ or ϕ	
Free space DUT Orientation 2 – Option 2 (based on re-positioning approach)	$\alpha = 0^\circ$; $\beta = -90^\circ$; $\gamma = 0^\circ$	θ_{Link} ; ϕ_{Link} with polarization reference $Pol_{Link} = \theta$ or ϕ	θ_{Meas} ; ϕ_{Meas} with polarization reference $Pol_{Meas} = \theta$ or ϕ	

NOTE 1: A polarization reference, as defined in relation to the reference coordinate system in N.1-1, is maintained for each signal angle, link or interferer angle, and measurement angle.
NOTE 2: The combination of rotations is captured by matrix $M=R_z(\gamma) \cdot R_y(\beta) \cdot R_x(\alpha)$

Table N.2-8 through N.2-10 provides the test conditions and angle definitions for twelve permitted device orientations for the initial test condition for simultaneous reception from multiple directions. The DUT orientation to be tested is chosen from Table N.2-8, Table N.2-9 and Table N.2-10 by UE vendor declaration.

Table N.2-8: Test conditions and angle definitions for Alignment Option 1

Test condition	DUT orientation	Diagram
----------------	-----------------	---------

<p>Orientation 1 (Option 1)</p>	<p>$\alpha = 0^\circ$; $\beta = 0^\circ$; $\gamma = 0^\circ$</p>	
<p>Orientation 1 (Option 2)</p>	<p>$\alpha = 0^\circ$; $\beta = 0^\circ$; $\gamma = 180^\circ$</p>	
<p>Orientation 2 (Option 1)</p>	<p>$\alpha = 180^\circ$; $\beta = 0^\circ$; $\gamma = 0^\circ$</p>	
<p>Orientation 2 (Option 2)</p>	<p>$\alpha = 0^\circ$; $\beta = 180^\circ$; $\gamma = 0^\circ$</p>	
<p>NOTE 1: The combination of rotations is captured by matrix $M=R_z(\gamma)\bullet R_y(\beta)\bullet R_x(\alpha)$</p>		

Table N.2-9: Test conditions and angle definitions for Alignment Option 2

Test condition	DUT orientation	Diagram
Orientation 1 (Option 1)	$\alpha = 0^\circ$; $\beta = -90^\circ$; $\gamma = 0^\circ$	
Orientation 1 (Option 2)	$\alpha = 0^\circ$; $\beta = -90^\circ$; $\gamma = 180^\circ$	
Orientation 2 (Option 1)	$\alpha = 180^\circ$; $\beta = 90^\circ$; $\gamma = 0^\circ$	
Orientation 2 (Option 2)	$\alpha = 0^\circ$; $\beta = 90^\circ$; $\gamma = 0^\circ$	

NOTE 1: The combination of rotations is captured by matrix $M=R_z(\gamma)\cdot R_y(\beta)\cdot R_x(\alpha)$

Table N.2-10: Test conditions and angle definitions for Alignment Option 3

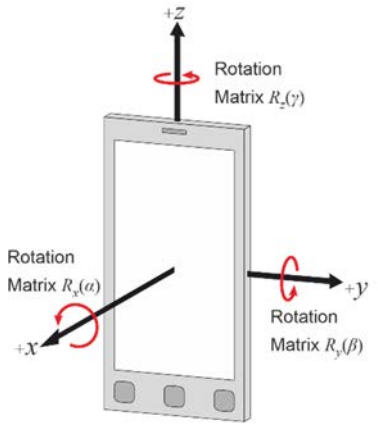
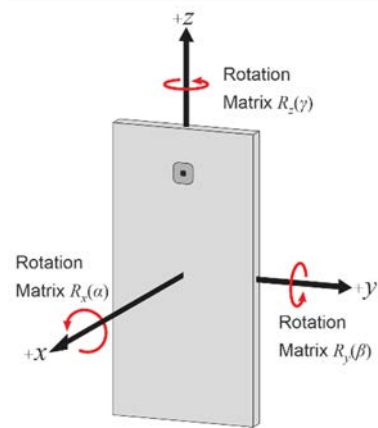
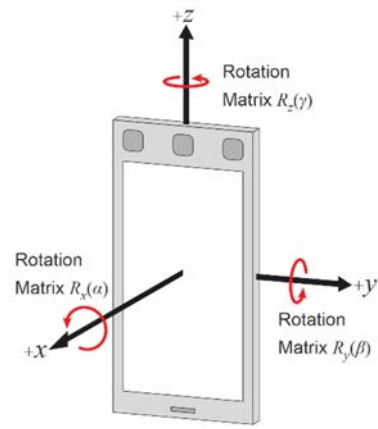
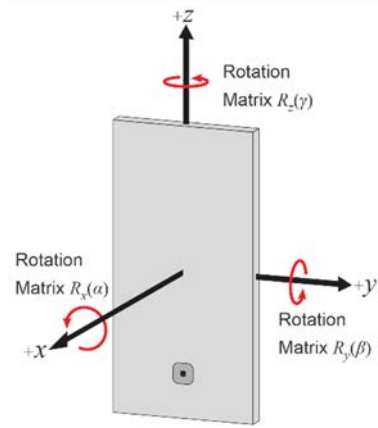
Test condition	DUT orientation	Diagram
Orientation 1 (Option 1)	$\alpha = 90^\circ$; $\beta = 0^\circ$; $\gamma = 0^\circ$	

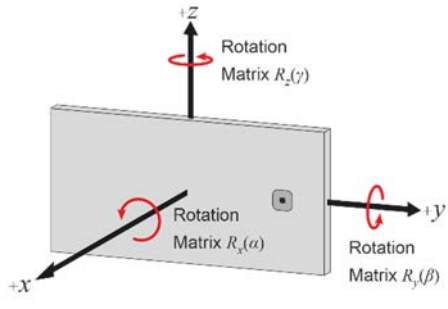
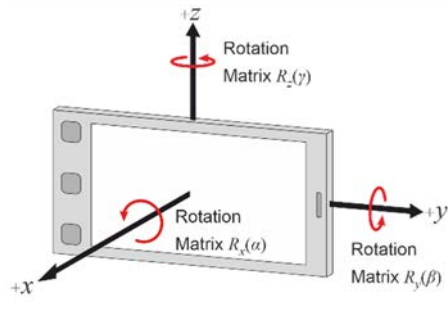
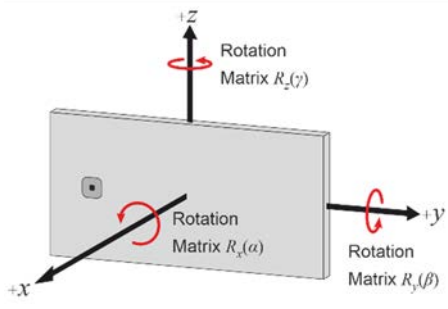
<p>Orientation 1 (Option 2)</p>	<p>$\alpha = 90^\circ;$ $\beta = 0^\circ;$ $\gamma = 180^\circ$</p>	
<p>Orientation 2 (Option 1)</p>	<p>$\alpha = -90^\circ;$ $\beta = 0^\circ;$ $\gamma = 0^\circ$</p>	
<p>Orientation 2 (Option 2)</p>	<p>$\alpha = 90^\circ;$ $\beta = 180^\circ;$ $\gamma = 0^\circ$</p>	

NOTE 1: The combination of rotations is captured by matrix $M=R_z(\gamma)\cdot R_y(\beta)\cdot R_x(\alpha)$

For each UE requirement and test case, each of the parameters in Table J.2-1 through J.2-10 need to be recorded, such that DUT positioning, DUT beam direction, and angles of the signal, link/interferer, and measurement are specified in terms of the fixed coordinate system.

Due to the non-commutative nature of rotations, the order of rotations is important and needs to be defined when multiple DUT orientations are tested.

The rotations around the x, y, and z axes can be defined with the following rotation matrices

$$R_x(\alpha) = \begin{bmatrix} 1 & 0 & 0 & 0 \\ 0 & \cos \alpha & -\sin \alpha & 0 \\ 0 & \sin \alpha & \cos \alpha & 0 \\ 0 & 0 & 0 & 1 \end{bmatrix}$$

$$R_y(\beta) = \begin{bmatrix} \cos \beta & 0 & \sin \beta & 0 \\ 0 & 1 & 0 & 0 \\ -\sin \beta & 0 & \cos \beta & 0 \\ 0 & 0 & 0 & 1 \end{bmatrix}$$

and

$$R_z(\gamma) = \begin{bmatrix} \cos \gamma & -\sin \gamma & 0 & 0 \\ \sin \gamma & \cos \gamma & 0 & 0 \\ 0 & 0 & 1 & 0 \\ 0 & 0 & 0 & 1 \end{bmatrix}$$

with the respective angles of rotation, α , β , γ , and

$$\begin{bmatrix} x' \\ y' \\ z' \\ 1 \end{bmatrix} = R \begin{bmatrix} x \\ y \\ z \\ 1 \end{bmatrix}$$

Additionally, any translation of the DUT can be defined with the translation matrix

$$T(t_x, t_y, t_z) = \begin{bmatrix} 1 & 0 & 0 & t_x \\ 0 & 1 & 0 & t_y \\ 0 & 0 & 1 & t_z \\ 0 & 0 & 0 & 1 \end{bmatrix}$$

with offsets t_x , t_y , t_z in x, y, and z, respectively and with

$$\begin{bmatrix} x' \\ y' \\ z' \\ 1 \end{bmatrix} = T \begin{bmatrix} x \\ y \\ z \\ 1 \end{bmatrix}$$

The combination of rotations and translation is captured by the multiplication of rotation and translation matrices.

For instance, the matrix M

$$M = T(t_x, t_y, t_z) \cdot R_z(\gamma) \cdot R_y(\beta) \cdot R_x(\alpha)$$

describes an initial rotation of the DUT around the x axis with angle α , a subsequent rotation around the y axis with angle β , and a final rotation around the z axis with angle γ . After those rotations, the DUT is translated by t_x , t_y , t_z in x, y, and z, respectively.

N.3 DUT positioning guidelines

Near-field coupling effects between the antenna and the pedestals/positioners/fixtures generally cause increased signal ripples. Re-positioning the DUT by directing the beam peak away from those areas can reduce the effect of signal ripple on EIRP/EIS measurements. Figure N.3-1 and N.3-2 illustrate how to reposition the DUT in distributed axes and combined axes system, when the beam peak is directed to the DUTs upper hemisphere (DUT orientation 1) or the DUTs lower hemisphere (DUT orientation 2). While these figures are examples of different positioning systems and other implementations are not precluded, the relative orientation of the coordinate system with respect to the antennas/reflectors and the axes of rotation shall apply to any measurement setup.

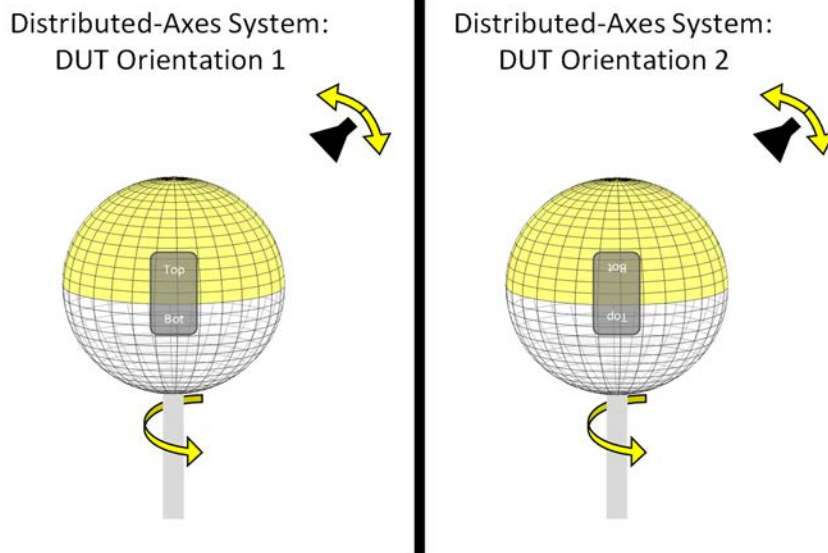

Figure N.3-1: DUT re-positioning for an example of distributed-axes system

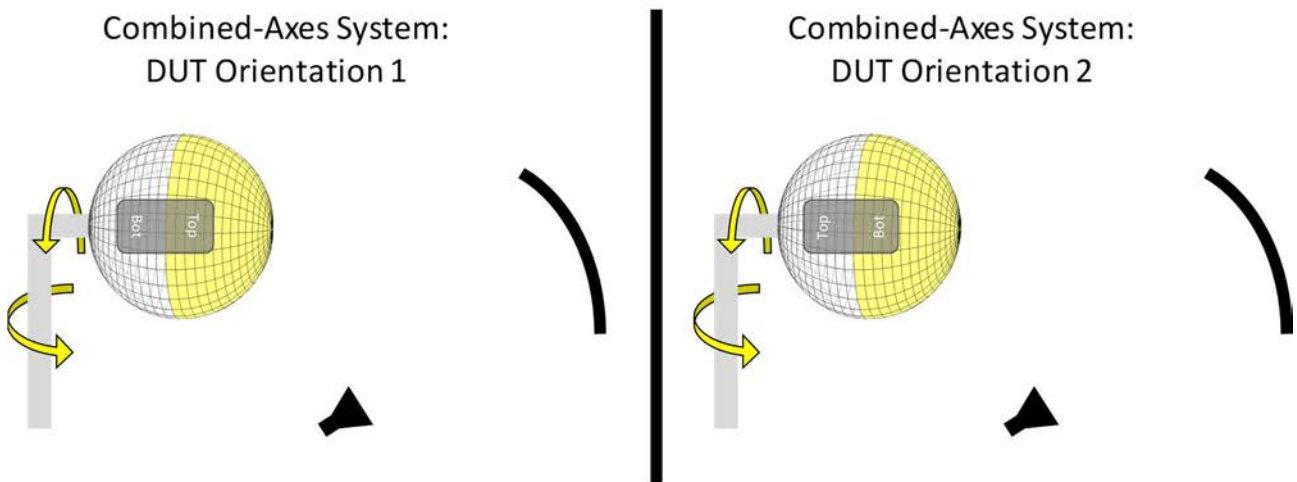

Figure N.3-2: DUT re-positioning for an example of combined-axes system

For EIRP/EIS measurements, re-positioning the DUT makes sure the pedestal is not obstructing the beam path and that the pedestal is not in closer proximity to the measurement antenna/reflector than the DUT. For TRP measurements, re-positioning the DUT makes sure that the beam peak direction is not obstructed by the pedestal and the pedestal is in the measurement path only when measuring the back-hemisphere. No re-positioning during the TRP measurement is required.

The radiating portions of the device have to be fully enclosed within the quiet zone, but the non-radiating portions of the device can be located/placed outside the quiet zone if a vendor declaration with positioning reference points and the minimum QZ required to contain all active antennas within the quiet zone (per band) is provided. This grey-box testing approach where the declared reference point is aligned with the centre of the QZ is further illustrated in Figure N.3-3.

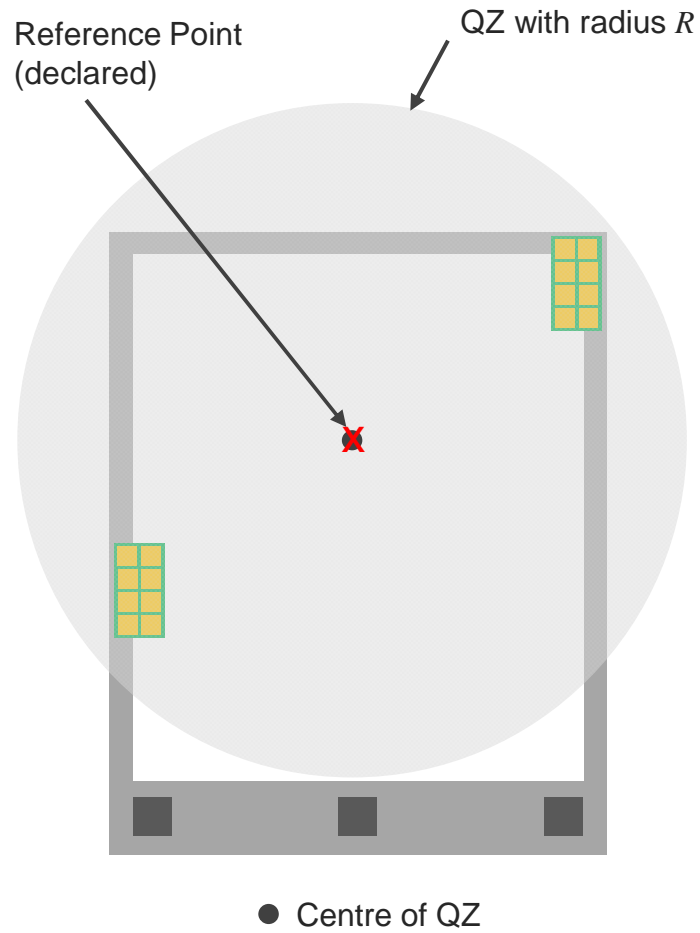

Figure N.3-3: Grey-box test approach

In the absence of a vendor declaration, the geometric centre of the DUT shall be aligned with the centre of the QZ and the DUT shall be fully contained within the QZ. This black-box testing approach is further illustrated in Figure N.3-4.

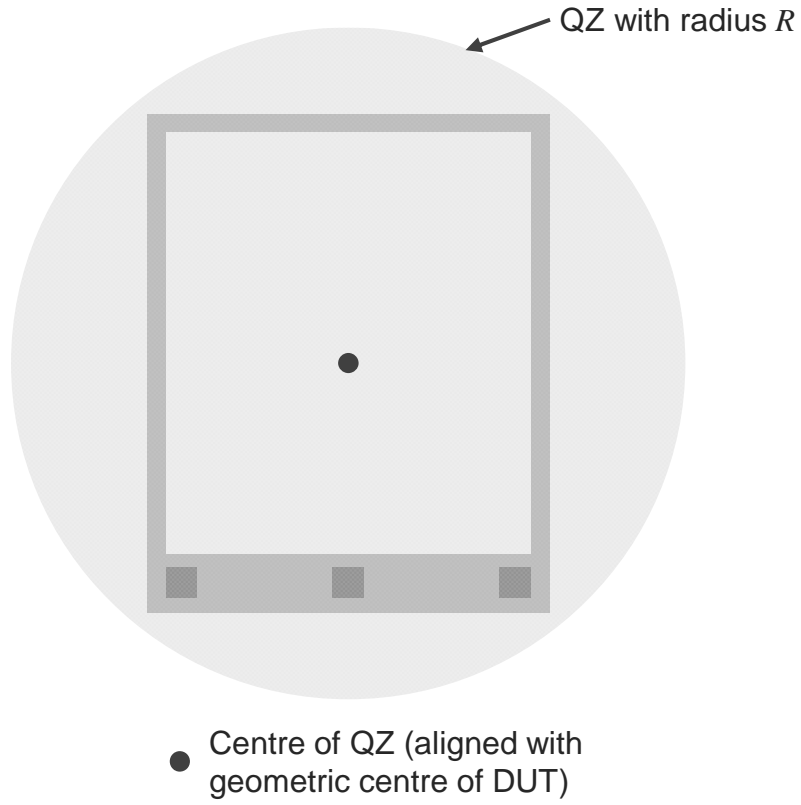

Figure N.3-4: Black-box test approach

Annex O: Quality of the quiet zone validation

O.1 General

This annex describes the procedures for validating the quality of the quiet zone for the permitted far-field methods outlined in Annex B.2.2 (DFF), B.2.3 (simplified DFF), and in B.2.4 (IFF based on CATR) in [10]. Annex O.2 focuses on the procedure for in-band and OOB test cases while Annex O.3 focuses on the procedure for spurious emissions test cases. These procedures are applicable to PC1 and PC3 UEs.

The quality of quiet zone validation shall be repeated when the RF/propagation conditions inside the chamber have changed, e.g., the chamber has been disassembled and reassembled, portions of the absorber been replaced, measurement antennas/probes been replaced, positioning system been replaced, etc.

O.2 Procedure to characterize the quality of the quiet zone for in-band/OOB for the permitted far field methods

This procedure is mandatory before the test system is commissioned for certification tests and characterizes the quiet zone performance of the anechoic chamber, specifically the effect of reflections within the anechoic chamber including any positioners and support structures. Additionally, it includes the effect of offsetting the directive antenna array inside a DUT from the centre of the quiet zone, i.e., the centre of rotation of the DUT and measurement antenna positioning systems as well as the directivity MU, i.e., the variation of antenna gains in the different direct line-of-sight links.

The quiet zone is illustrated in Figure O.2-1 which includes the definitions of centre of quiet zone range, i.e., the geometric centre of the positioning systems, and the range length, i.e., the distance between the centre of the quiet zone and the aperture of the measurement antenna.

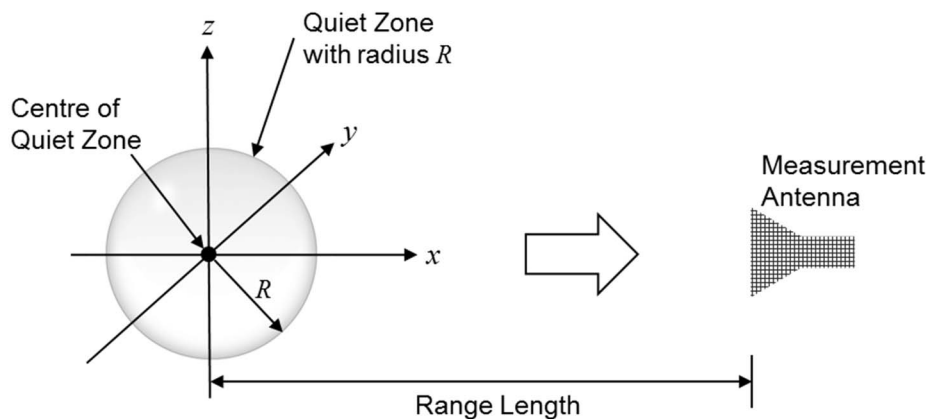

Figure O.2-1: Quiet Zone Illustration

The outcome of the procedures can be used to predict the

- variation of the TRP measurements, spherical surface integrals of EIRP/EIS, when the DUT is placed anywhere within the quiet zone and with the beam formed in any arbitrary direction inside the chamber
- variation of the EIRP/EIS measurements when the DUT is placed anywhere within the quiet zone and with the beam formed in any arbitrary direction inside the chamber

The reference coordinate system defined in Annex N applies to this procedure.

O.2.1 Equipment used

The reference antenna under test (AUT) that is placed at various locations within the quiet zone shall be a directive antenna with similar properties of typical antenna arrays integrated in DUTs. The characteristics in terms of Directivity and Half Power Beamwidth (HPBW) of the reference AUT are shown in Figure O.2.1-1, O.2.1-2, and O.2.1-3.

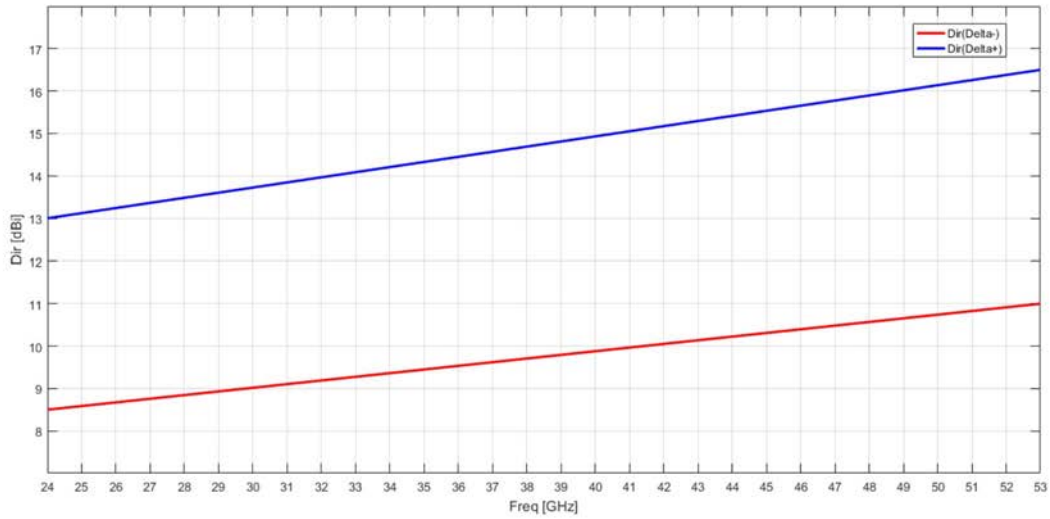

Figure O.2.1-1: Directivity mask

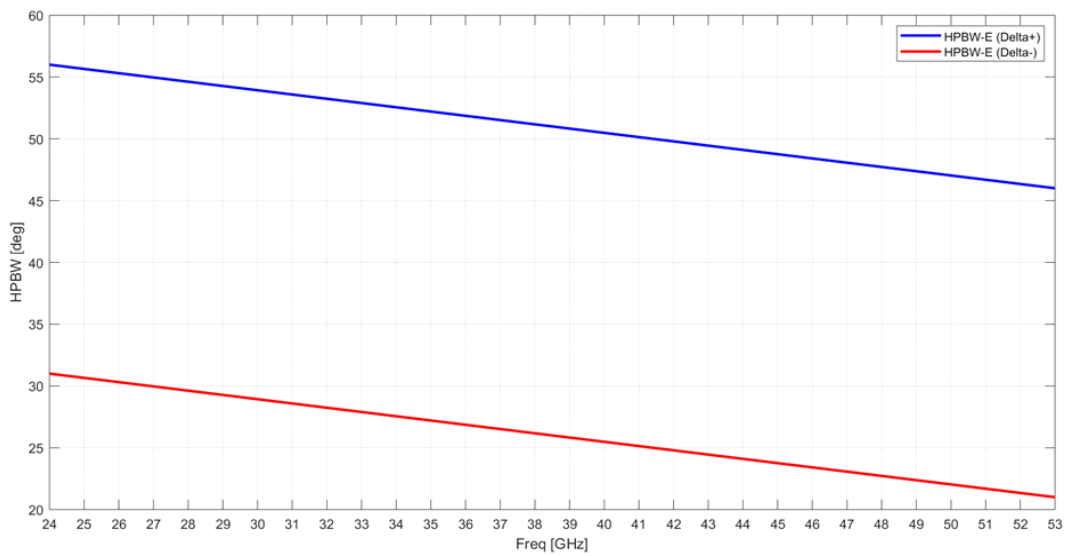

Figure O.2.1-2: 2xHPBW-E mask

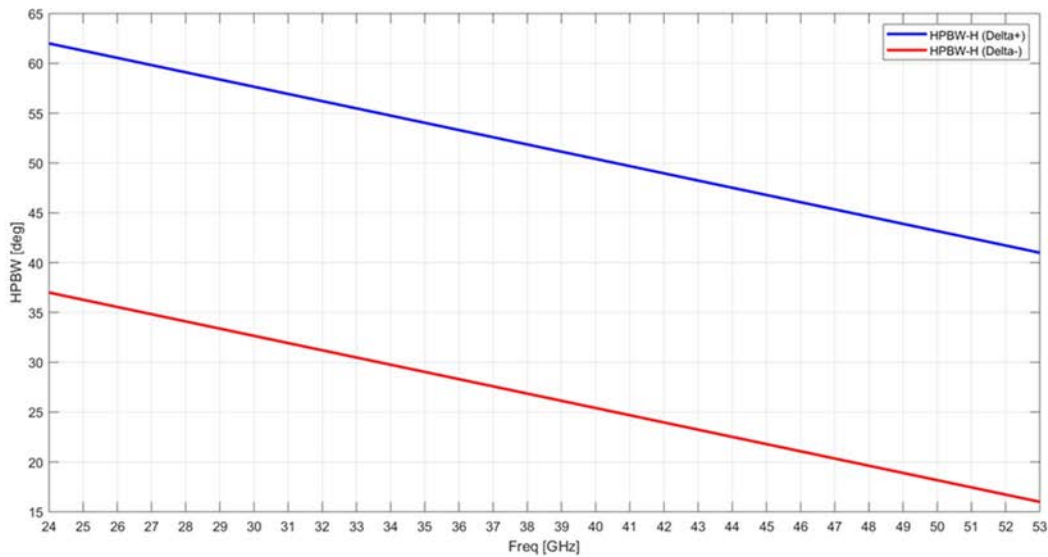

Figure O.2.1-3: 2xHPBW-H mask

AUT shall be symmetric on E and H planes.

The above masks for the reference antenna are met based on antenna vendors' calibration report.

For the measurement, a combination of signal generator and spectrum analyser or a network analyser can be used. The multi-port (with three ports) network analyser is most suitable to reduce test time as both polarizations of the measurement antenna can be measured simultaneously, and multiple frequencies can be measured in a sweep.

O.2.2 Test frequencies

The frequencies to be used to characterize the quality of the quiet zone are 23.45 GHz, 32.125 GHz, 40.8 GHz, 44.3 GHz, and 49 GHz. The quiet zone validation analysis is performed for each frequency individually.

O.2.3 Reference measurements

The quality of the quiet measurements for integrated RF parameters such as TRP shall use 3D pattern measurements of the reference antenna patterns as they most closely resemble the 3D/spherical surface measurements/integrals of EIRP or EIS. Therefore, the quality of the quiet zone measurements for TRP metrics shall be based on efficiency measurements. On the other hand, the quality of the quiet zone measurements for single-directional EIRP and EIS metrics shall be based on gain measurements of the direct line-of-sight link between the reference AUT and the measurement antenna.

The grid types for the TRP measurements shall match those outlined in M.1. Considering the reference AUT is assumed to have similar properties of typical antenna arrays integrated in DUTs, see clause O.2.1, the TRP measurement grids used for the QoQZ validation shall meet the minimum number of grids points as defined for Power Class 3 devices in clause M.4.1.3 with the default TRP measurement grids, i.e., not those based on the optional vendor declaration.

O.2.4 Size of the quiet zone

The size of the quiet zone within which the variations of measurements are evaluated depends on the size of the DUT. For smartphones, the quiet zone shall be considered a sphere with radius of $R=10\text{cm}$. For larger smartphones and tablet type devices, the quiet zone shall be considered a sphere with radius of $R=15\text{cm}$. For even larger device, e.g., larger tablets and laptops, quiet zones of radius $R=20\text{cm}$ and $R=27.5\text{cm}$ shall be considered. Alternate quiet zone sizes can be defined for even larger DUTs.

The quality of quiet zone procedure for systems supporting multiple quiet zone sizes can be performed for the largest quiet zone radius only and the results can be applied to the smaller quiet zone radii if the same chamber components

affecting QoQZ, i.e., reflector, feed probes, etc, are used. Performing separate sets of quality of quiet zone measurements for different radii is not precluded.

O.2.5 Reference AUT positions

The reference AUT shall be positioned in a total of 7 different reference positions, shown in Figure O.2.5.1-1 and O.2.5.2-1

While position 1, P1, is the centre of the quiet zone, the remaining positions, 2 through 7, are off-centre positions each displaced by the radius of the quiet zone, R . The coordinates of the respective test points are shown in Table O.2.5-1.

Table O.2.5-1: Reference AUT Measurement Coordinates

Position	x	y	z
P1	0	0	0
P2	R	0	0
P3	$-R$	0	0
P4	0	R	0
P5	0	$-R$	0
P6	0	0	R
P7	0	0	$-R$

For quiet zones exceeding 30cm in diameter, i.e., $R=20\text{cm}$ and $R=27.5\text{cm}$, an alternate set of reference points can be selected for the quality of quiet zone evaluation, summarized in Table O.2.5-2

Table O.2.5-2: Alternate Reference AUT Measurement Coordinates for $R=20\text{cm}$ and $R=27.5\text{cm}$ Quiet Zones

Position	x	y	z
P1	0	0	0
P2	R	0	0
P3	$-R$	0	0
P4	0	R	0
P5	0	$-R$	0
P6	0	0	z_6
P7	0	0	$-z_7$

Note: z_6 and z_7 are the maximum declared DUT heights in $\pm z$ defined in the chamber specification and are bound to a minimum of 15cm. The DUT antennas (grey-box approach)/the DUT (black box approach) cannot extend past these heights within the QZ (in z) when installed in the system.

O.2.5.1 Distributed-axes system

The reference AUT shall be positioned in a total of 7 different reference positions, shown in Figure O.2.5.1-1.

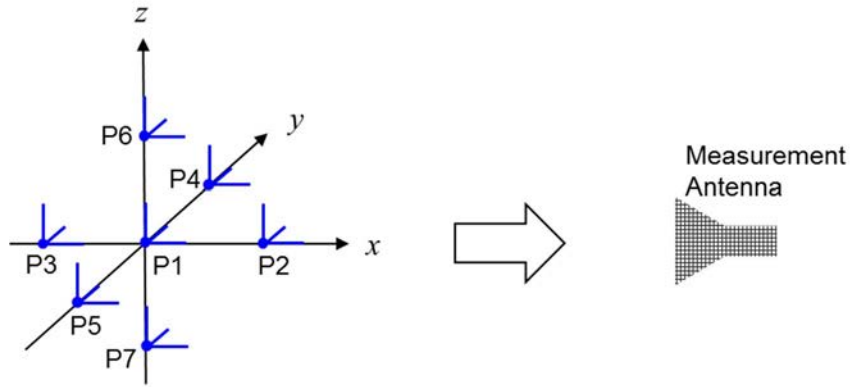

Figure O.2.5.1-1: Reference AUT Measurement Positions for distributed-axes system

The reference AUT positions inside a typical distributed-axes system are shown in Figure O.2.5.1-2.

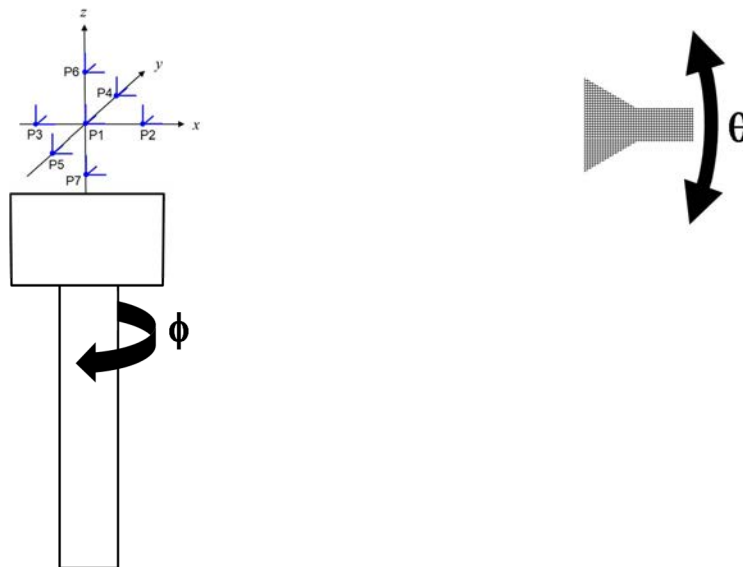

Figure O.2.5.1-2: Reference AUT Measurement Positions for distributed-axes system

O.2.5.2 Combined-axes system

The reference AUT shall be positioned in a total of 7 different reference positions, shown in Figure O.2.5.2-1.

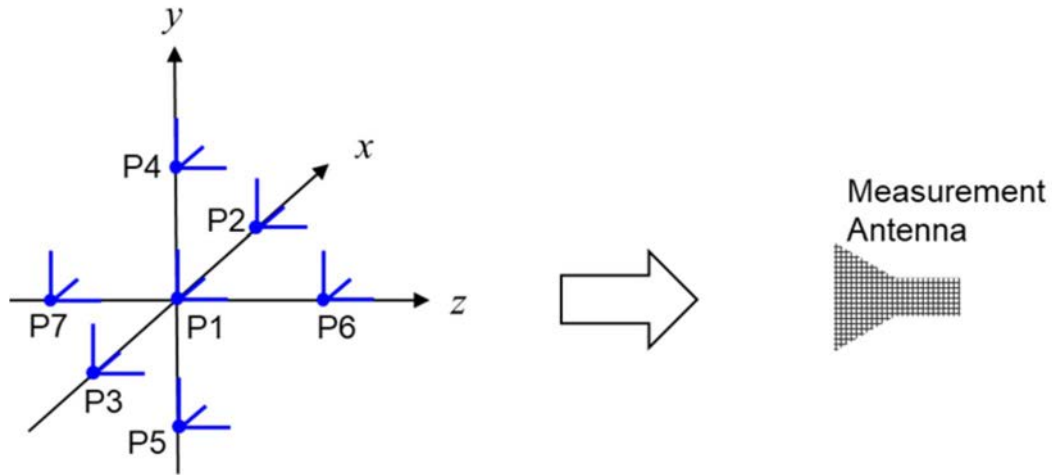

Figure O.2.5.2-1: Reference AUT Measurement Positions for combined-axes system

The reference AUT positions inside a typical combined-axes system are shown in Figure O.2.5.2-2.

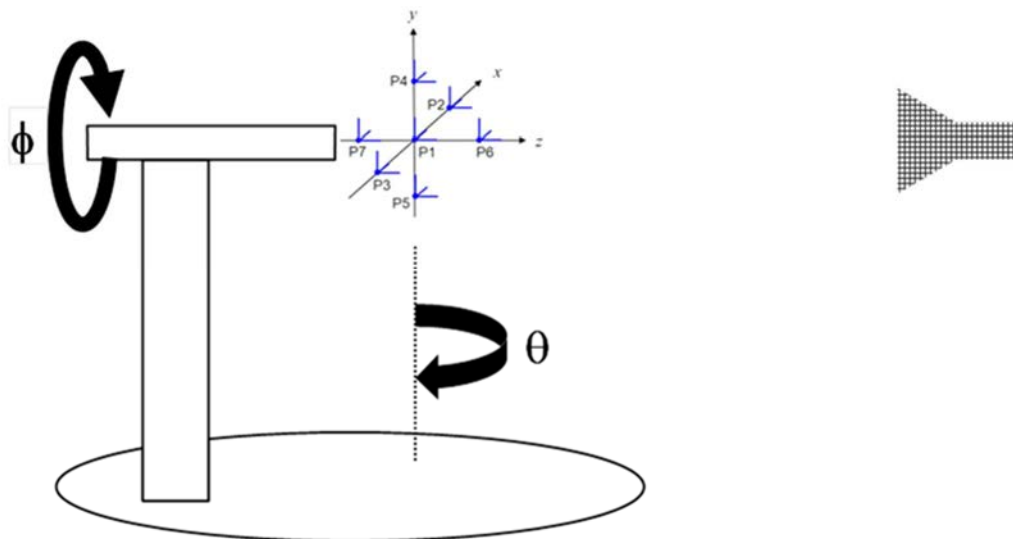

Figure O.2.5.2-2: Reference AUT Measurement Positions for combined-axes system

O.2.6 Reference AUT orientations

As different areas within the chamber could yield variations in the field uniformity inside the quiet zone caused by reflections, it is important to characterize the electromagnetic fields with the reference antennas uniformly illuminating the anechoic chamber.

O.2.6.1 Distributed-axes system

In order to keep the quality of the quiet zone characterization manageable in terms of test times, it is suggested to perform the reference measurements for the reference AUT placed at the 7 antenna positions with the antenna rotated around the y axis with 5 different angles β , i.e., $\beta = 0^\circ, 45^\circ, 90^\circ, 135^\circ,$ and 180° , and rotated around the z axis with 8 different $\gamma = 0^\circ, 45^\circ, 90^\circ, 135^\circ, 180^\circ, 225^\circ, 270^\circ,$ and 315° . A graphical illustration of the some sample reference AUT orientations is shown in Figure O.2.6.1-1 with a reference AUT placed at position 6, P6, for reference antenna polarization $\gamma_{pol} = 0^\circ$; Figure O.2.6.1-2 illustrates the reference AUT orientations for the reference polarization $\gamma_{pol} = 90^\circ$.

The matrix operation for the rotations and translation is defined as

$$M = T(t_x, t_y, t_z) \cdot R_z(\gamma) \cdot R_y(\beta) \cdot R_{z,pol}(\gamma_{pol})$$

for the distributed-axes system.

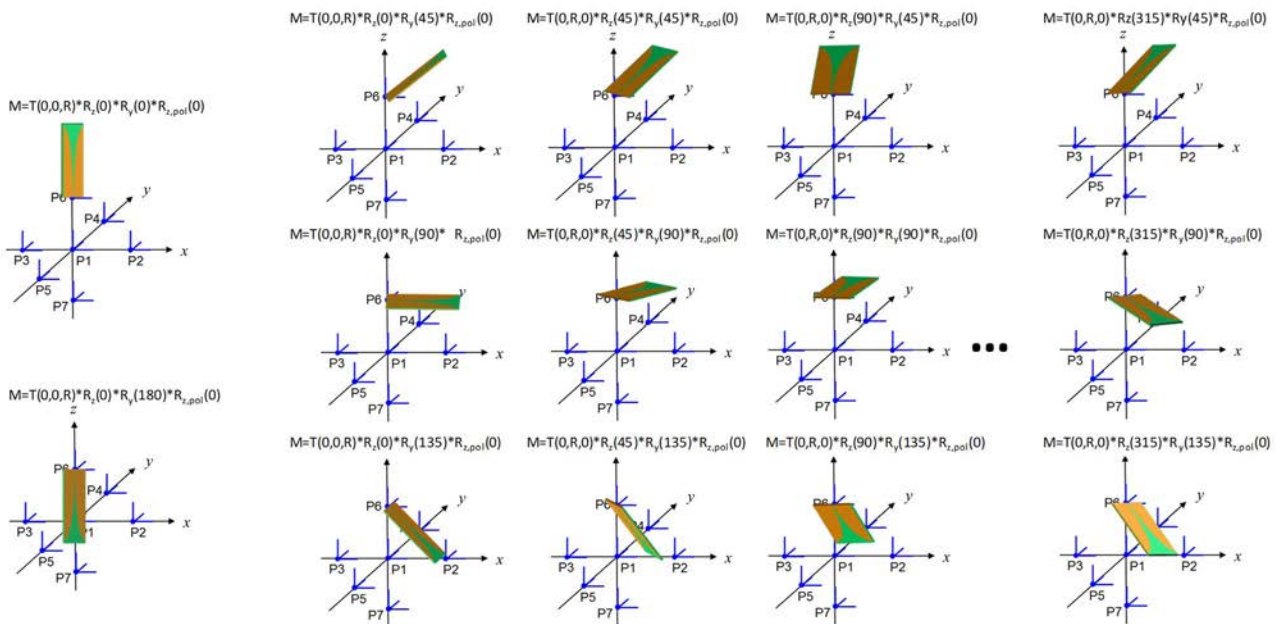

Figure O.2.6.1-1: Sample reference AUT orientations for position 6, P6 for reference antenna polarization $\gamma_{pol} = 0^\circ$

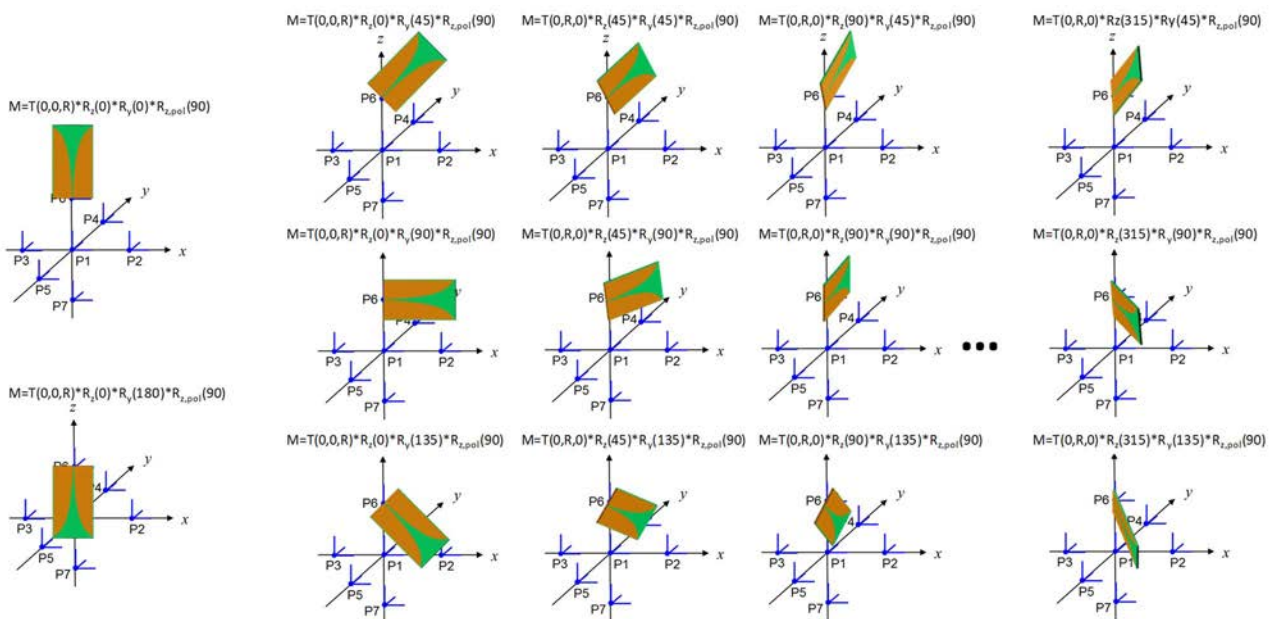

Figure O.2.6.1-2: Sample reference AUT orientations for position 6, P6, for reference antenna polarization $\gamma_{pol} = 90^\circ$

When facing the z-axis, $\beta = 0^\circ$ and $\beta = 180^\circ$, the antenna does not need to be evaluated for the 8 different rotations around the z axis. A single orientation is sufficient since those orientations are unique. Due to the pedestal, distributed-axes systems are not able to measure towards the $\beta = 180^\circ$ direction; for those systems, the reference measurements at this reference AUT orientation can be skipped.

If the device re-positioning approach outlined in Annex N is adopted for the EIRP/EIS/TRP based conformance test cases, the quality of quiet zone analysis is sufficient only for $\beta = 0^\circ, 45^\circ, 90^\circ$.

The positioner relative coordinates/orientations with respect to the measurement antenna/reflector in the initial position shall remain the same for each reference antenna orientation, e.g., in the sample distributed-axes system shown in Figure O.2.5.1-2 the reference antenna shall be pointed towards the positioner for $\beta = 135^\circ$ for the initial position of (θ, ϕ) of $(0, 0)$.

O.2.6.2 Combined-axes system

In order to keep the quality of the quiet zone characterization manageable in terms of test times, it is suggested to perform the reference measurements for the reference AUT placed at the 7 antenna positions with the antenna rotated around the x axis with 5 different angles α , i.e., $\alpha = -90^\circ, -45^\circ, 0^\circ, 45^\circ$, and 90° and rotated around the y axis with 8 different angles $\beta = 0^\circ, 45^\circ, 90^\circ, 135^\circ, 180^\circ, 225^\circ, 270^\circ$, and 315° . A graphical illustration of some sample reference AUT orientations is shown in Figure O.2.6.2-1 with a reference AUT placed at position 4, P4, for reference antenna polarization $\gamma_{pol} = 0^\circ$; Figure O.2.6.2-2 illustrates the reference AUT orientations for the reference polarization $\gamma_{pol} = 90^\circ$.

The matrix operation for the rotations and translation is defined as

$$M = T(t_x, t_y, t_z) \cdot R_y(\beta) \cdot R_x(\alpha) \cdot R_{z,pol}(\gamma_{pol})$$

for the combined-axes system.

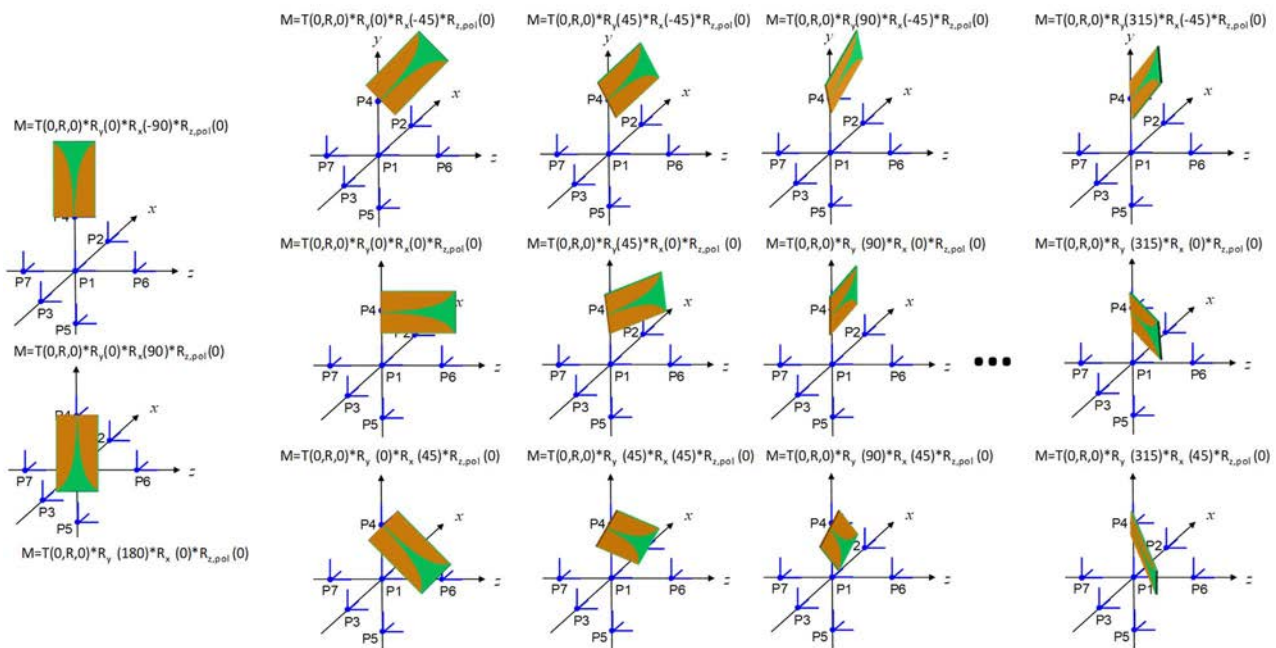

Figure O.2.6.2-1: Sample reference AUT orientations for position 4, P4, for reference antenna polarization $\gamma_{pol} = 0^\circ$

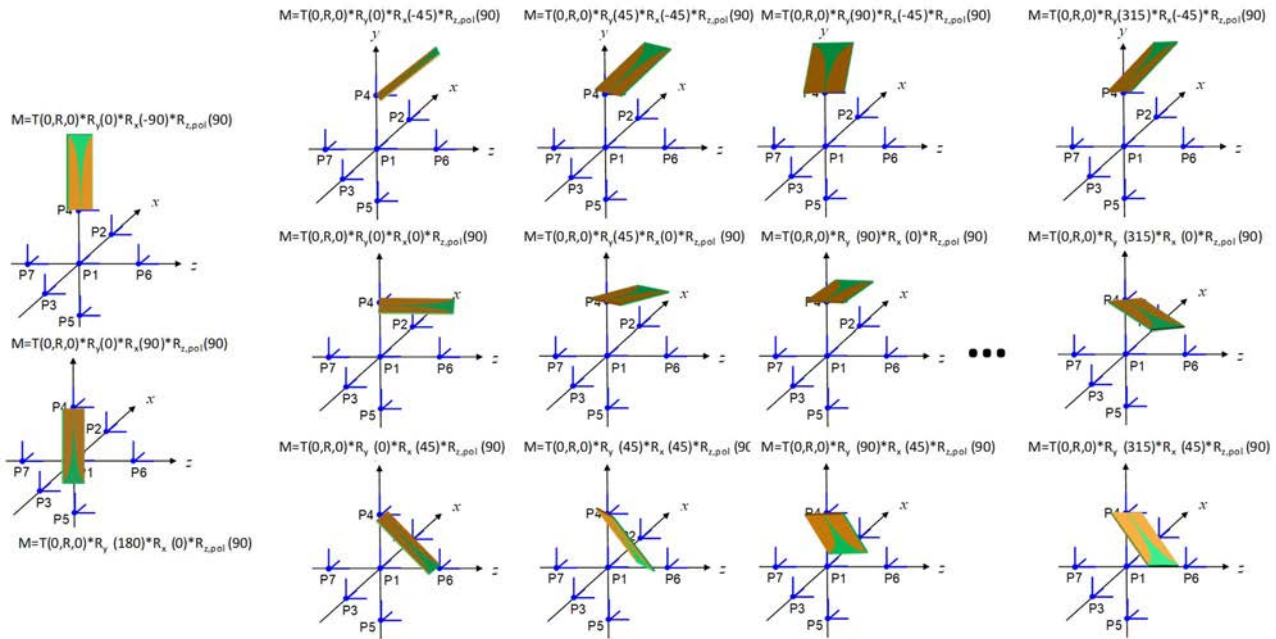

Figure O.2.6.2-2: Sample reference AUT orientations for position 4, P4, for reference antenna polarization $\gamma_{pol} = 90^\circ$

When facing the y axis, $\alpha = 90^\circ$ and $\alpha = -90^\circ$, the antenna does not need to be evaluated for the 8 different rotations around the y axis. A single rotation is sufficient since those orientations are unique. Due to the pedestal of the 2-axis positioner, combined-axes systems are not able to measure towards the $\beta = 180^\circ$ direction; for those systems, the reference measurements at this reference AUT orientation can be skipped.

If the device re-positioning approach outlined in Annex N is adopted for all EIRP/EIS/TRP based conformance test cases, the quality of quiet zone analysis is sufficient only for $\beta = 0^\circ, 45^\circ, 90^\circ, 270^\circ$, and 315° .

The positioner relative coordinates/orientations with respect to the measurement antenna/reflector shall remain the same for each reference antenna orientation, e.g., in the sample combined-axes system shown in O.2.5.2-2 the reference antenna shall be pointed towards the positioner for $\beta = 135^\circ$ and 225° for the initial position of (θ, ϕ) of $(0, 0)$.

O.2.7 Quality of quiet zone measurement uncertainty calculations for TRP

The combined MU element related to the quality of the quiet zone for TRP and offset between UE antenna array and centre of quiet zone is the standard deviation of the various efficiency measurement results that are based on the 7 different reference AUT positions, the respective reference AUT orientations, and the two reference AUT polarization orientations.

O.2.8 Quality of quiet zone measurement uncertainty for EIRP/EIS

The MU for the quality of the quiet zone for EIRP/EIS includes the additional MU element of the directivity of the DUT and measurement antennas as shown in Figure O.2.9-1. The EIRP/EIS measurements are taking the peak gains of the respective antennas into account with the reference AUT placed in the centre of the quiet zone. Once the antenna is displaced in directions other than the measurement antenna, the direct line-of-sight link is taking reduced antenna gains into account. The type of reference AUT should therefore have similar pattern properties as typical UE antennas. For systems with very large range lengths, the directivity MU will be insignificant.

The combined MU element related to the quality of the quiet zone for EIRP/EIS, offset between UE antenna array and centre of quiet zone, and directivity is the standard deviation of the single-point gain measurement results that are based on the 7 different reference AUT positions, the respective reference AUT orientations, and the two reference AUT polarization orientations.

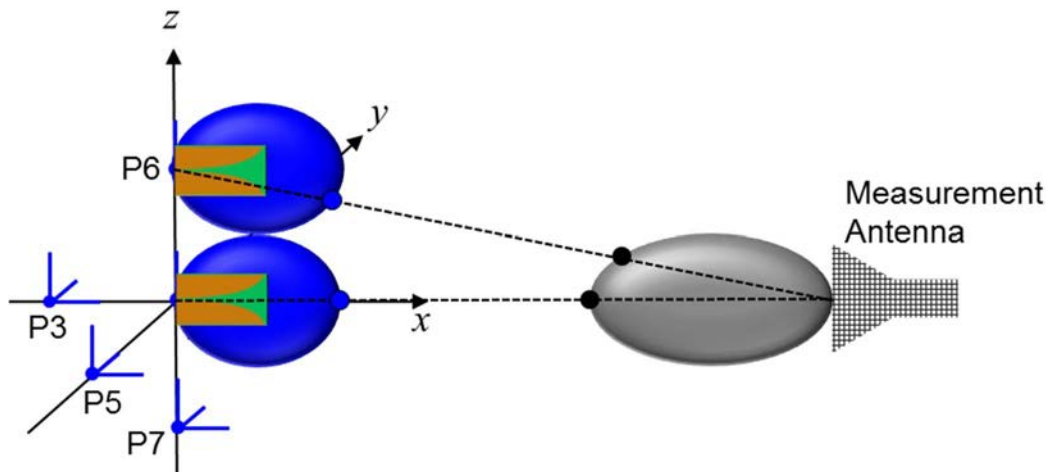

Figure O.2.9-1: Illustration of the Directivity MU Element

O.3 Procedure to characterize the spurious emissions quality of the quiet zone for the permitted far field methods

This procedure is mandatory before the spurious emissions test system is commissioned for certification tests and characterizes the quiet zone performance of the anechoic chamber, specifically the effect of reflections within the anechoic chamber including any positioners and support structures. Additionally, it includes the effect of offsetting the directive antenna array inside a DUT from the centre of the quiet zone, i.e., the centre of rotation of the DUT and measurement antenna positioning systems.

The quiet zone is illustrated in Figure O.2-1 which includes the definitions of centre of quiet zone range, i.e., the geometric centre of the positioning systems, and the range length, i.e., the distance between the centre of the quiet zone and the aperture of the measurement antenna.

The outcome of the procedures can be used to predict the variation of the TRP measurements, spherical surface integrals of EIRP, when the DUT is placed anywhere within the quiet zone and with the beam formed in any arbitrary direction inside the chamber

The reference coordinate system defined in Annex N applies to this procedure.

O.3.1 Equipment used

The reference antenna under test (AUT) that is placed at various locations within the quiet zone shall be a directive antenna with a half-power beam width (HPBW) of $\geq 20^\circ$ in E-Plane and H-Plane. The HPBWs met based on antenna vendors' calibration report or datasheet.

For the measurement, a combination of signal generator and spectrum analyser or a network analyser can be used. The multi-port (with three ports) network analyser is most suitable to reduce test time as both polarizations of the measurement antenna can be measured simultaneously, and multiple frequencies can be measured in a sweep.

O.3.2 Test frequencies

Editor note: Another test frequency of [TBD] GHz will be added as soon as FR2 bands >49 GHz are introduced.

The frequencies to characterize the quality of the quiet zone shall be 6, 12.75, 23.45, 40.8, 49.0, 66, 80, and 87 GHz. The quiet zone validation analysis is performed for each frequency individually.

The measurements from the 23.45, 40.8, and 49.0 GHz in-band QoQZ validation can be re-used provided that the reference antenna position and orientation as well as the measurement frequency and measurement antenna are identical in both cases.

O.3.3 Reference measurements

The spurious emissions quality of the quiet zone measurements shall use 3D pattern measurements of the reference antenna patterns as they most closely resemble the 3D/spherical surface measurements/integrals of EIRP. Therefore, the quality of the quiet zone measurements for TRP metrics shall be based on efficiency measurements.

The grid types for the TRP measurements shall meet the 0.25 dB maximum standard uncertainty. The min number of grid points for the two grid types are:

- 192 grid points for the constant step-size measurement grids
- 100 grid points for the constant density measurement grids (charged particle implementation)

O.3.4 Size of the quiet zone

The size of the quiet zone within which the variations of measurements are evaluated depends on the size of the DUT. For smartphones, the quiet zone shall be considered a sphere with radius of $R=10\text{cm}$. For larger smartphones and tablet type devices, the quiet zone shall be considered a sphere with radius of $R=15\text{cm}$. Alternate quiet zone sizes can be defined for even larger DUTs.

The quality of quiet zone procedure for systems supporting larger quiet zone sizes can be performed for the largest quiet zone radius only and the results can be applied to the smaller quiet zone radius. Performing separate sets of quality of quiet zone measurements for different radii is not precluded.

O.3.5 Reference AUT positions

The reference AUT shall be positioned in a total of 7 different reference positions, shown in Figure O.2.5.1-1 and O.2.5.2-1

While position 1, P1, is the centre of the quiet zone, the remaining positions, 2 through 7, are off-centre positions each displaced by the radius of the quiet zone, R . The coordinates of the respective test points are shown in Table O.2.5-1.

O.3.5.1 Distributed-axes system

The reference AUT shall be positioned in a total of 7 different reference positions, shown in Figure O.2.5.1-1 for distributed-axes systems.

The reference AUT positions inside a typical distributed-axes system are shown in Figure O.2.5.1-2.

O.3.5.2 Combined-axes system

The reference AUT shall be positioned in a total of 7 different reference positions, shown in Figure O.2.5.2-1 for combined-axes systems.

The reference AUT positions inside a typical combined-axes system are shown in Figure O.2.5.2-2.

O.3.6 Reference AUT orientations

As different areas within the chamber could yield variations in the field uniformity inside the quiet zone caused by reflections, it is important to characterize the electromagnetic fields with the reference antennas uniformly illuminating the anechoic chamber. However, in order to keep the spurious emissions quality of the quiet zone characterization manageable in terms of test time, the number of orientations for the spurious emissions quality of quiet zone validation is limited when compared to the number of orientations for the in-band quality of quiet zone validation.

O.3.6.1 Distributed-axes system

The reference measurements for the reference AUT placed at the 7 antenna positions shall be rotated around the y axis with 2 different angles β , i.e., $\beta = 0^\circ$ and 180° and fixed $\gamma = 0^\circ$. A graphical illustration of the reference AUT orientations is shown in Figure O.3.6.1-1 with a reference AUT placed at position 6, P6, for reference antenna

polarization $\gamma_{pol} = 0^\circ$; Figure O.3.6.1-2 illustrates the reference AUT orientations for the reference polarization $\gamma_{pol} = 90^\circ$.

The matrix operation for the rotations and translation is defined as

$$M = T(t_x, t_y, t_z) \cdot R_z(\gamma) \cdot R_y(\beta) \cdot R_{z,pol}(\gamma_{pol})$$

for the distributed-axes system. The matrices are defined in Annex J.2 of TS 38.101-2.

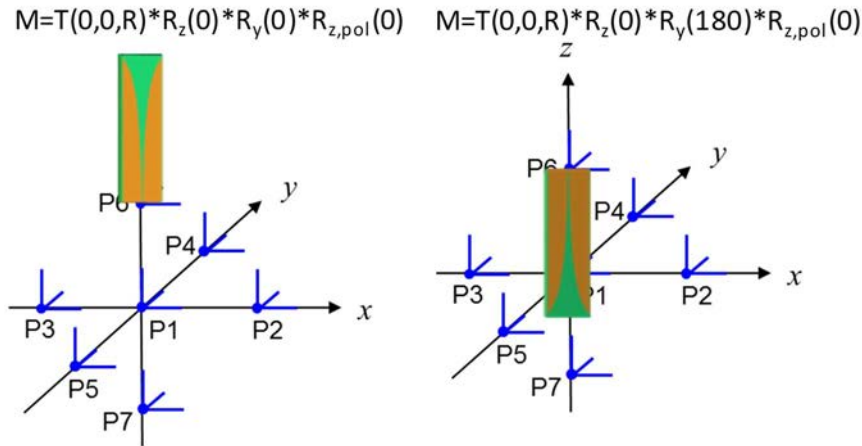

Figure O.3.6.1-1: Reference AUT orientations for position 6, P6 for reference antenna polarization $\gamma_{pol} = 0^\circ$

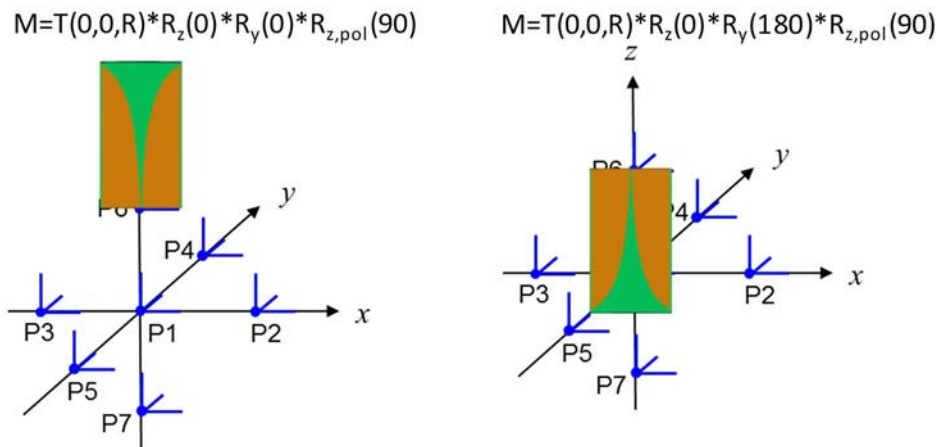

Figure O.3.6.1-2: Reference AUT orientations for position 6, P6, for reference antenna polarization $\gamma_{pol} = 90^\circ$

If the device re-positioning approach is adopted for the spurious emissions test cases, i.e., two hemispheres are measured separately which involves the DUT, while connected to the gNB emulator, to be rotated by 180° around its axis halfway through the test, the quality of quiet zone analysis is sufficient only for $\beta = 0^\circ$.

The positioner relative coordinates/orientations with respect to the measurement antenna/reflector in the initial position shall remain the same for each reference antenna orientation, e.g., in the sample distributed-axes system shown in Figure O.2.5.1-2 the reference antenna shall be pointed at the positioner for $\beta = 180^\circ$ for the initial position of (θ, ϕ) of $(0, 0)$.

O.3.6.2 Combined-axes system

The reference measurements for the reference AUT placed at the 7 antenna positions shall be rotated around the x axis with 2 different angles β , i.e., $\beta = 0^\circ$ and 180° and fixed $\alpha = 0^\circ$. A graphical illustration of the sample reference AUT orientations is shown in Figure O.3.6.2-1 with a reference AUT placed at position 4, P4, for reference antenna polarization $\gamma_{pol} = 0^\circ$; Figure O.3.6.2-2 illustrates the reference AUT orientations for the reference polarization $\gamma_{pol} = 90^\circ$.

The matrix operation for the rotations and translation is defined as

$$M = T(t_x, t_y, t_z) \cdot R_y(\beta) \cdot R_x(\alpha) \cdot R_{z,pol}(\gamma_{pol})$$

for the combined-axes system. The matrices are defined in Annex J.2 of TS 38.101-2.

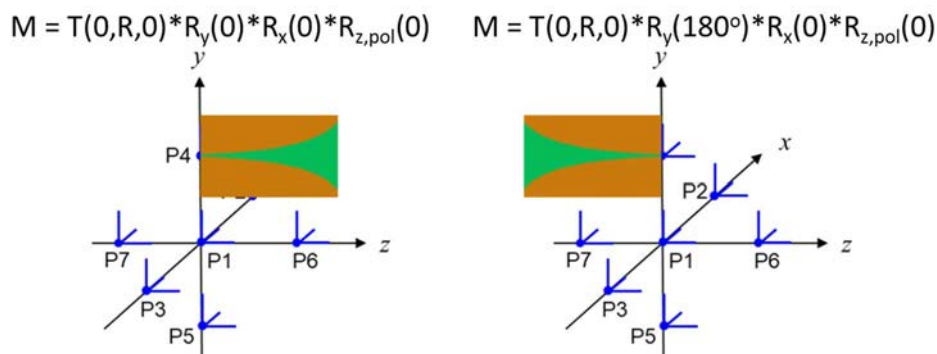

Figure O.3.6.2-1: Reference AUT orientations for position 4, P4, for reference antenna polarization $\gamma_{pol} = 0^\circ$.

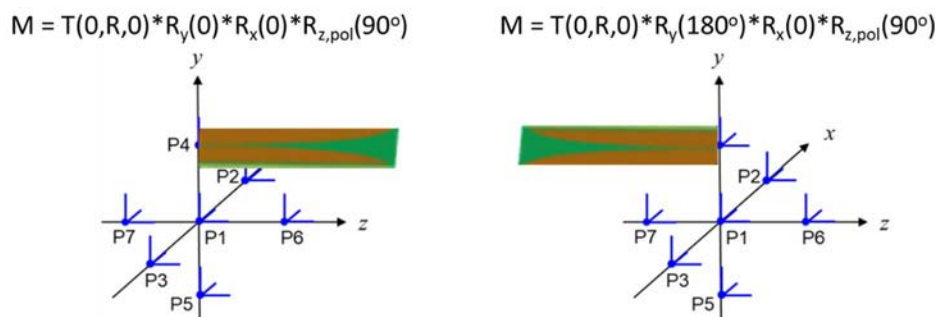

Figure O.3.6.2-2: Reference AUT orientations for position 4, P4, for reference antenna polarization $\gamma_{pol} = 90^\circ$.

If the device re-positioning approach is adopted for the spurious emissions test cases, i.e., two hemispheres are measured separately which involves the DUT, while connected to the gNB emulator, to be rotated by 180° around its axis halfway through the test, the quality of quiet zone analysis is sufficient only for $\beta = 0^\circ$.

The positioner relative coordinates/orientations with respect to the measurement antenna/reflector shall remain the same for each reference antenna orientation, e.g., in the sample combined-axes system shown in O.2.5.2-2 the reference antenna shall be pointed at the positioner for $\beta = 180^\circ$ for the initial position of (θ, ϕ) of $(0, 0)$.

O.3.7 Quality of quiet zone measurement uncertainty calculations for TRP

The combined MU element related to the spurious emissions quality of the quiet zone for TRP and offset between UE antenna array and centre of quiet zone is the standard deviation of the various efficiency measurement results that are based on the 7 different reference AUT positions, the respective reference AUT orientations, and the two reference AUT polarization orientations.

Annex P (normative): Modified MPR behaviour

P.1 Indication of modified MPR behaviour

This annex contains the definitions of the bits in the field *modifiedMPR-Behavior* indicated per supported NR band in the IE *RF-Parameters* [19] by a UE supporting an MPR or A-MPR modified in a given version of this specification. A modified MPR or A-MPR behaviour can apply to a supported NR band in stand-alone operation (including CA and NN-DC operation) or in non-standalone operation with the said NR band as part of an EN-DC or NE-DC band combination. Moreover, the bits in the field can explicitly indicate NS value(s) supported by a UE.

NOTE 1: In the present release, the *modifiedMPR-Behavior* is indicated [19] by an 8-bit bitmap per supported NR band.

Table P.1-1: Definitions of the bits in the field *modifiedMPRbehavior* (Release 15)

NR Band	Index of field (bit number)	Definition (description of the supported functionality if indicator set to one)	Notes
n257	0 (leftmost bit)	- FR2 power class 3 MPR as defined in clause 6.2.2.3 of 38.101-2 v16.2.0	- This bit may be set to 1 by a UE supporting n257
	1	- NS_202 as defined in clause 6.2.3.3 or both NS_202 and CA_NS_202 as defined in clause 6.2A.3.3 of 38.101-2 v15.27.0	- This bit shall be set to 1 by a UE supporting n257 or both n257 and CA_n257
	2	- NS_205 as defined in clause 6.2.3.6 or both NS_205 and CA_NS_205 as defined in clause 6.2A.3.6 of 38.101-2 v15.27.0	- This bit shall be set to 1 by a UE supporting n257 or both n257 and CA_n257
n258	0 (leftmost bit)	- FR2 power class 3 MPR as defined in clause 6.2.2.3 of 38.101-2 v16.2.0	- This bit may be set to 1 by a UE supporting n258
	1	Void	
	2	- NS_203 as defined in clause 6.5.3.2.4 or both NS_203 and CA_NS_203 as defined in clause 6.5A.3.2.4 of 38.101-2 v15.12.0	- This bit shall be set to 1 by a UE supporting n258 or both n258 and CA_n258
	3	- NS_202 as defined in clause 6.2.3.3 or both NS_202 and CA_NS_202 as defined in clause 6.2A.3.3 of 38.101-2 v15.27.0	- This bit shall be set to 1 by a UE supporting n258 or both n258 and CA_n258
	4	- NS_205 as defined in clause 6.2.3.6 or both NS_205 and CA_NS_205 as defined in clause 6.2A.3.6 of 38.101-2 v15.27.0	- This bit shall be set to 1 by a UE supporting n258 or both n258 and CA_n258
n260	0 (leftmost bit)	- FR2 power class 3 MPR as defined in clause 6.2.2.3 of 38.101-2 v16.2.0	- This bit may be set to 1 by a UE supporting n260
n261	0 (leftmost bit)	- FR2 power class 3 MPR as defined in clause 6.2.2.3 of 38.101-2 v16.2.0	- This bit may be set to 1 by a UE supporting n261

Table P.1-1b: Definitions of the bits in the field *modifiedMPRbehavior* (Release 16)

NR Band	Index of field (bit number)	Definition (description of the supported functionality if indicator set to one)	Notes
n257	0 (leftmost bit)	- FR2 power class 3 MPR as defined in clause 6.2.2.3 of 38.101-2 v16.2.0 onwards	- This bit may be set to 1 by a UE supporting n257
	1	- NS_202 as defined in clause 6.2.3.3 or both NS_202 and CA_NS_202 as defined in clause 6.2A.3.3 of 38.101-2 v16.22.0	- This bit shall be set to 1 by a UE supporting n257 or both n257 and CA_n257
	2	- NS_205 as defined in clause 6.2.3.6 or both NS_205 and CA_NS_205 as defined in clause 6.2A.3.6 of 38.101-2 v16.22.0	- This bit shall be set to 1 by a UE supporting n257 or both n257 and CA_n257
n258	0 (leftmost bit)	- FR2 power class 3 MPR as defined in clause 6.2.2.3 of 38.101-2 v16.2.0 onwards	- This bit may be set to 1 by a UE supporting n258
	1	Void	

	2	- NS_203 as defined in clause 6.5.3.2.4 or both NS_203 and CA_NS_203 as defined in clause 6.5A.3.2.4 of 38.101-2 v15.12.0	- This bit shall be set to 1 by a UE supporting n258 or both n258 and CA_n258
	3	- NS_202 as defined in clause 6.2.3.3 or both NS_202 and CA_NS_202 as defined in clause 6.2A.3.3 of 38.101-2 v16.22.0	- This bit shall be set to 1 by a UE supporting n258 or both n258 and CA_n258
	4	- NS_205 as defined in clause 6.2.3.6 or both NS_205 and CA_NS_205 as defined in clause 6.2A.3.6 of 38.101-2 v16.22.0	- This bit shall be set to 1 by a UE supporting n258 or both n258 and CA_n258
n260	0 (leftmost bit)	- FR2 power class 3 MPR as defined in clause 6.2.2.3 of 38.101-2 v16.2.0 onwards	- This bit may be set to 1 by a UE supporting n260
n261	0 (leftmost bit)	- FR2 power class 3 MPR as defined in clause 6.2.2.3 of 38.101-2 v16.2.0 onwards	- This bit may be set to 1 by a UE supporting n261

Table P.1-1c: Definitions of the bits in the field *modifiedMPRbehavior* (Release 17 and forward)

NR Band	Index of field (bit number)	Definition (description of the supported functionality if indicator set to one)	Notes
n257	0 (leftmost bit)	- FR2 power class 3 MPR as defined in clause 6.2.2.3 of 38.101-2	- This bit shall be set to 1 by a UE supporting n257
	1	- NS_202 as defined in clause 6.2.3.3 or both NS_202 and CA_NS_202 as defined in clause 6.2A.3.3 of 38.101-2 v17.18.0	- This bit shall be set to 1 by a UE supporting n257 or both n257 and CA_n257
	2	- NS_205 as defined in clause 6.2.3.6 or both NS_205 and CA_NS_205 as defined in clause 6.2A.3.6 of 38.101-2 v17.18.0	- This bit shall be set to 1 by a UE supporting n257 or both n257 and CA_n257
n258	0 (leftmost bit)	- FR2 power class 3 MPR as defined in clause 6.2.2.3 of 38.101-2	- This bit shall be set to 1 by a UE supporting n258
	1	Void	
	2	- NS_203 as defined in clause 6.5.3.2.4 or both NS_203 and CA_NS_203 as defined in clause 6.5A.3.2.4 of 38.101-2 v15.12.0	- This bit shall be set to 1 by a UE supporting n258 or both n258 and CA_n258
	3	- NS_202 as defined in clause 6.2.3.3 or both NS_202 and CA_NS_202 as defined in clause 6.2A.3.3 of 38.101-2 v17.18.0	- This bit shall be set to 1 by a UE supporting n258 or both n258 and CA_n258
	4	- NS_205 as defined in clause 6.2.3.6 or both NS_205 and CA_NS_205 as defined in clause 6.2A.3.6 of 38.101-2 v17.18.0	- This bit shall be set to 1 by a UE supporting n258 or both n258 and CA_n258
n260	0 (leftmost bit)	- FR2 power class 3 MPR as defined in clause 6.2.2.3 of 38.101-2	- This bit shall be set to 1 by a UE supporting n260
n261	0 (leftmost bit)	- FR2 power class 3 MPR as defined in clause 6.2.2.3 of 38.101-2	- This bit shall be set to 1 by a UE supporting n261

Annex Q (normative): Difference of relative phase and power errors

Q.0 General

This annex gives further information needed for understanding and implementing 6.4D.4. The following terms should be understood as follows:

- Relative phase error: refers to the phase difference between signals at different antenna ports, which should be ideally 0. It should be understood as for a slot i.e. (slot) relative phase. It is calculated based on DMRS symbols of that slot or on SRS symbols.
- Difference of relative phase error: refers to the difference between the relative phase error determined per slot and the relative phase error determined based on the SRS transmitted.

Q.1 Measurement Point

Figure Q.1-1 shows the measurement point for the difference of relative phase and power errors. To separate signals from the two transmitters, it is necessary for the test equipment to perform joint demodulation by inverting the 2x2 composite channel ('HGW') resulting from DUT precoding 'W' and antenna virtualization 'G' and OTA channel between DUT and test equipment 'H'. Post processing refers to the calculation of the phase/power errors, the averaging of phase and power errors per RB per slot per channel port and the calculation of difference between relative phases.

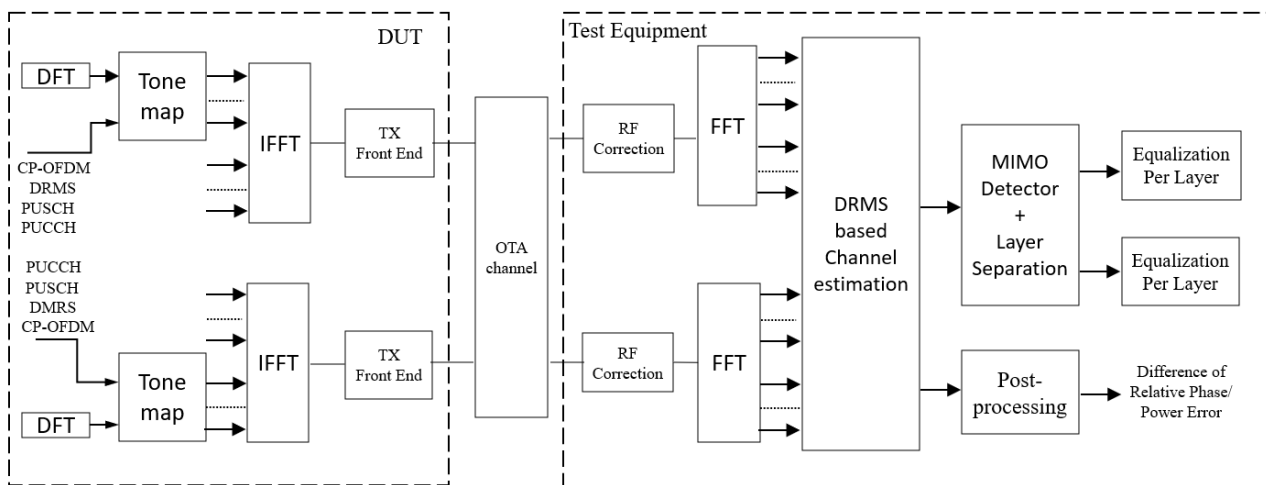

Figure Q.1-1 - Measurement point for difference of relative phase/power error for UL coherent MIMO

Q.2 Relative Phase Error Measurement

Here are listed the different aspects that may lead to different interpretations.

Q.2.1 Symbols used

Phase error is determined based on DMRS REs (DMRS mapping type A with 3 DMRS symbols per slot, the REs corresponding to the odd subcarriers and DMRS symbols are non-allocated for data or DMRS) and SRS REs (with 4 SRS symbols in the SRS slot, same SRS resource mapping is used for non-codebook-based and codebook-based precoding).

For the DMRS and SRS to occupy identical SCs and maximize their frequency density, DMRS configuration type 1 and SRS comb2 configuration are used.

UL RMC described in Annex A.2 is used.

Q.2.2 CFO (carrier frequency offset) correction

The TE performs a CFO correction on a slot-by-slot basis using a common frequency correction at the two uplink layers.

Q.2.3 Steps of the measurement method

Below are detailed the steps necessary to obtain the maximum difference of relative phase error during the 20ms time window.

1. Determination for each subcarrier and at each antenna port, the SRS relative phase error based on the last SRS transmitted on Ant1 and Ant2, that relative phase error serves as a reference for the calculation of the difference of relative phase error for each slot inside the 20 ms time window.
 - The output is the "SRS relative phase error" vector for the last SRS transmitted: $[1 \times \text{number_of_subcarriers}]$.
2. Calculation for the last SRS transmitted, for each RB of the SRS relative phase errors based on the arithmetic mean of the subcarrier SRS relative phase errors determined in previous step.
 - The output is the "SRS relative phase error" vector for the last SRS transmitted: $[1 \times \text{number_of_RBs}]$.
3. CFO correction on slot-by-slot basis using a common frequency correction for both antenna ports.
4. Determination for each subcarrier and at each antenna, the phase over the slot being analyzed. The phase is extracted from the channel estimate derived from the 3 DMRS symbols of the slot using the LSE technique.
 - The output is one vector of dimension $[1 \times \text{number_of_subcarriers}]$ for each antenna port.
5. Calculation for a slot for each subcarrier of the relative phase error (difference between the vectors determined in the previous step).
 - The output is subcarrier relative phase errors of a slot: $[1 \times \text{number_of_subcarriers}]$.
6. Calculation for a slot, for each RB of the relative phase errors based on the arithmetic mean of the subcarrier relative phase errors determined in previous step.
 - The output is a "slot relative phase error" vector for a slot: $[1 \times \text{number_of_RBs}]$.
7. Calculation for a slot of the difference of relative phase errors based on the "SRS relative phase error" (reference) determined in step 2 and the "slot relative phase error" determined in previous step.
 - The output is a "difference of relative phase error" vector for a slot: $[1 \times \text{number_of_RBs}]$.
8. Calculation for a slot of the arithmetic mean value of the "difference of relative phase error" vector determined in previous step, this value corresponds to an RB.
 - The output is a "difference of relative phase error" value for a slot: $[1 \times 1]$.
9. Perform for each slot of the 20ms time window, steps 3 to 8.
 - The output is a "difference of relative phase error" vector: $[1 \times \text{number_of_slots}]$.
10. Calculation of the maximum value of the "difference of relative phase error".
 - The output is the "difference of relative phase error" that should be verified as complying with the 40° maximum allowable difference of relative phase error requirement: $[1 \times 1]$.

Annex R (normative):

Requirement metric for simultaneous reception from multiple directions

R.1 Spherical coverage grid for simultaneous reception or transmission in multiple directions

The reference coordinate system grid is defined as follows: The grid is the set of locations described by a source/probe from the UE's perspective when the TE completes a 3D spherical scan with a constant step size for each rotational axis of its positioner. The grid comprises intersection points of circles of fixed polar angle (geographic analogue: 'latitude') and meridians of fixed azimuthal angle (geographic analogue: 'longitude') and completely covers the sphere around the UE. A valid set of locations for the source/probes are those that describes the same constant step size grid from the UE's perspective over a complete spherical scan. This condition is satisfied when the active probes/sources are always contained in a plane of constant azimuthal angle 'φ' in this reference system. The reference coordinate system with example UE orientations is shown in figures in Tables N.2-8, N.2-9 and N.2-10.

R.2 Probability to support 2AoA reception

For UEs required to fulfil a requirement on the probability for 2AoA reception, the metric for a given AoA separation is the spatial average:

$$P_{spatial_av} = \sum_{\theta_1} \sum_{\phi_1} \{P_{directional}(\theta_1, \phi_1) \cdot AW(\theta_1)\}$$

Where:

(θ_1, ϕ_1) are coordinates of any grid point in the UE-centred reference system described above.

$AW(\theta_1)$ is the area weight associated with each grid point with polar angle 'θ₁', and:

$$\sum_{\theta_1} \sum_{\phi_1} \{AW(\theta_1)\} = 1$$

$P_{directional}(\theta_1, \phi_1)$ is the probability that the direction given by coordinates (θ_1, ϕ_1) can support 2 AoA reception under the agreed UERF test conditions. $P_{directional}(\theta_1, \phi_1)$ is given by:

$$P_{directional}(\theta_1, \phi_1) = \left\{ \frac{PF(AoA_{pair\#1}) + PF(AoA_{pair\#2}) + \dots + PF(AoA_{pair\#n})}{n} \right\}$$

Where:

AoA_{pair}#x represents an AoA_{pair} with the chosen AoA separation of test that has one source at coordinates (θ_1, ϕ_1) .

'n' is the maximum number of unique AoA_{pairs} that the TE can generate with one source at coordinates (θ_1, ϕ_1)

$PF(AoA_{pair\#x})$ is the pass/fail outcome (1/0 respectively) of the throughput verification test

R.3 Spherical coverage procedure for simultaneous multi-Rx reception

This procedure described in this section is a practical implementation of the requirements specified in sections R.1, R.2, as well as section 7.3K.

The SS shall conduct the following steps:

- 1) Select any of the three Alignment Options (1, 2, or 3) from Tables N.2-8 through N.2-10 to mount the DUT inside the QZ.
- 2) Position the DUT in the Orientation declared by UE vendor for simultaneous reception from multiple directions from Tables N.2-8 through N.2-10.
- 3) Rotate the DUT to the grid point $AoA1 = (\theta_1, \varphi_1)$, where the grid points are defined in Annex R.1.
- 4.1) Select AoA2 grid point as $AoA2 = (\theta_2, \varphi_2) = (\theta_1 - \Delta, \varphi_1)$, such that:

$$AoA_{pair_1} = \{AoA1, AoA2\} = \{(\theta_1, \varphi_1), (\theta_1 - \Delta, \varphi_1)\}$$

Where Δ is the angular separation declared by the UE vendor for simultaneous reception from multiple directions, from those defined in Table 7.3K.3-1 for power class 3.

- 4.2) Connect the SS (System Simulator) with the DUT to form RX beams towards the DUT. The DL power at the center of quiet zone from each AoA equals the EIS spherical coverage requirement from sub-clause 7.3.4. Allow at least BEAM_SELECT_WAIT_TIME for the UE RX beam selection to complete.
- 4.3) The SS shall schedule each AoA simultaneously meeting the statistical significance criteria as defined in section H.2 with the following reference measurement channels:
 - A.3.3.2-5 and A.3.3.2-6 (with one sided dynamic OCNG Pattern OP.1 TDD for the DL-signal as described in Annex A.5.2.1) for testing *singleDCI-SDM-scheme-r16* case; or
 - A.3.3.2-1 and A.3.3.2-2 (with one sided dynamic OCNG Pattern OP.1 TDD for the DL-signal as described in Annex A.5.2.1) for testing *multiDCI-MultiTRP-r16* case
- 4.4) For each AoA, simultaneously, determine whether the UE satisfies the minimum throughput requirement for θ -polarization in the RF conditions described in step 4.2. Similarly, determine whether the UE satisfies the minimum throughput requirement for φ -polarization in the RF conditions described in step 4.2. Allow at least BEAM_SELECT_WAIT_TIME for the UE RX beam selection to complete, when switching between polarizations.
- 4.5) Evaluate throughput per polarization as:

$$Throughput_{i,j} \geq 95\%, \text{ where } i = \{\theta, \varphi\}, j = \{1,2\}$$

Where $Throughput_{i,j}$ is the throughput measured in polarization i for AoA j . 4.6) Evaluate whether the throughput exceeds the requirements, ($\geq 95\%$ maximum throughput) for the AoA pair being tested. Determine, the AoA pair pass/fail criteria as follows:

$$PF(AoA_{pair_1}) = \begin{cases} 1 & \text{Where } Throughput_{i,j} \text{ is the throughput measured in polarization } i \text{ for AoA } j. \\ 0 & \text{otherwise} \end{cases}$$

- 5) Repeat steps 4.1 to 4.6 for each AoA pair that can be generated from the grid point (θ_1, φ_1) :

$$AoA_{pair_1} = \{AoA1, AoA2\} = \{(\theta_1, \varphi_1), (\theta_1 - \Delta, \varphi_1)\}$$

$$AoA_{pair_2} = \{AoA1, AoA2\} = \{(\theta_1, \varphi_1), (\theta_1 + \Delta, \varphi_1)\}$$

$$AoA_{pair_3} = \{AoA1, AoA2\} = \{(\theta_1, \varphi_1), (\theta_1, \varphi_1 - \Delta)\}$$

$$AoA_{pair_4} = \{AoA1, AoA2\} = \{(\theta_1, \varphi_1), (\theta_1, \varphi_1 + \Delta)\}$$

For each AoA_{pair_i} , the SS shall determine its corresponding $PF(AoA_{pair_i})$.

- 6) The SS shall calculate the directional probability (that is, the probability that the direction can support 2 AoA reception under the agreed UE RF test conditions) for the grid point (θ_1, φ_1) as follows:

$$P_{directional}(\theta_1, \varphi_1) = \frac{PF(AoA_{pair_1}) + PF(AoA_{pair_2}) + \dots + PF(AoA_{pair_n})}{n}$$

- 7) Advance to the next grid point and repeat steps 3 through 6.
- 8) The SS shall calculate the spatial average probability as follows:

$$P_{spatial_av} = \sum_{\theta_1} \sum_{\varphi_1} \{P_{directional}(\theta_1, \varphi_1) \cdot AW(\theta_1)\}$$

Where:

(θ_1, φ_1) are the coordinates of the grid points defined in Annex R.1.

$AW(\theta_1)$ is the normalized area weight based on sin(theta) or Clenshaw Curtis weighting associated with each grid point with polar angle ' θ_1 ', and:

$$\sum_{\theta_1} \sum_{\varphi_1} \{AW(\theta_1)\} = 1$$

Annex S (informative): Change history

Change history							
Date	Meeting	TDoc	CR	R ev	Cat	Subject/Comment	New version
2017-08	RAN5 #76	R5-174709	-	-	-	Draft skeleton	0.0.1
2018-01	RAN5#1-5G-NR Adhoc	R5-180002	-	-	-	Add references	0.1.0
2018-01	RAN5#1-5G-NR Adhoc	R5-180103	-	-	-	Add definitions, symbols and abbreviations	0.1.0
2018-01	RAN5#1-5G-NR Adhoc	R5-180104	-	-	-	Introduction of Operating bands and Channel arrangement	0.1.0
2018-01	RAN5#1-5G-NR Adhoc	R5-180094	-	-	-	Introduction of new test case 6.3.2 Transmit OFF power	0.1.0
2018-01	RAN5#1-5G-NR Adhoc	R5-180095	-	-	-	TP to add skeleton of 6.5.1 Occupied bandwidth to 38.521-2	0.1.0
2018-01	RAN5#1-5G-NR Adhoc	R5-180096	-	-	-	TP to add skeleton of 6.5.2.1 SEM to 38.521-2	0.1.0
2018-01	RAN5#1-5G-NR Adhoc	R5-180097	-	-	-	TP to add skeleton of 6.5.2.3 ACLR to 38.521-2	0.1.0
2018-03	RAN5 #78	R5-181508	-	-	-	Updated 38.521-2 to extend Annex with additional testing information	0.2.0
2018-03	RAN5 #78	R5-181680	-	-	-	TP to skeleton of 7.6.1 Inband blocking to 38.521-2	0.2.0
2018-03	RAN5 #78	R5-181681	-	-	-	5G-NR: Text Proposal to add spurious emissions test case to 38.521-2	0.2.0
2018-04	RAN5#2-5G-NR Adhoc	R5-181978	-	-	-	Update TS 38.521-2 further to align with the latest TS 38.101-2 spec structure.	0.3.1
2018-04	RAN5#2-5G-NR Adhoc	R5-182027	-	-	-	5G-NR Text Proposal to update spurious emissions test case to 38.521-2	0.4.0
2018-04	RAN5#2-5G-NR Adhoc	R5-182041	-	-	-	5G-NR Text Proposal to add REFSSENS test case to 38.521-2	0.4.0
2018-04	RAN5#2-5G-NR Adhoc	R5-182009	-	-	-	General section updated to 38.521-2	0.4.0
2018-04	RAN5#2-5G-NR Adhoc	R5-182048	-	-	-	Addition of FR2 test case 6.3.1 Minimum Output Power	0.4.0
2018-04	RAN5#2-5G-NR Adhoc	R5-182049	-	-	-	Addition of FR2 test case 6.3.3.2 General ON/OFF time mask	0.4.0
2018-04	RAN5#2-5G-NR Adhoc	R5-181839	-	-	-	Definitions and abbreviations updated to 38.521-2	0.4.0
2018-04	RAN5#2-5G-NR Adhoc	R5-181840	-	-	-	Operating bands and Channel arrangement updated to 38.521-2	0.4.0
2018-04	RAN5#2-5G-NR Adhoc	R5-182008	-	-	-	Introduction of new test case 7.4 Maximum input level	0.4.0
2018-04	RAN5#2-5G-NR Adhoc	R5-182010	-	-	-	Common uplink configuration table for Tx test cases for TS 38.521-2 non-CA	0.4.0
2018-04	RAN5#2-5G-NR Adhoc	R5-182011	-	-	-	TP for 6.5.1 Occupied Bandwidth in TS 38.521-2	0.4.0
2018-04	RAN5#2-5G-NR Adhoc	R5-182029	-	-	-	TP for 6.5.2.1 Spectrum Emission Mask in TS 38.521-2	0.4.0
2018-04	RAN5#2-5G-NR Adhoc	R5-182031	-	-	-	TP for 6.5.2.3 Adjacent Channel Leakage Ratio in TS 38.521-2	0.4.0

2018-04	RAN5#2-5G-NR Adhoc	R5-182043	-	-	-	TP for 7.6.2 InBand Blocking in TS 38.521-2	0.4.0
2018-04	RAN5#2-5G-NR Adhoc	R5-182046	-	-	-	TP for 7.5 Adjacent channel selectivity in TS 38.521-2	0.4.0
2018-04	RAN5#2-5G-NR Adhoc	R5-181844	-	-	-	Add Annex G (normative): Measurement uncertainties and Test Tolerances	0.4.0
2018-04	RAN5#2-5G-NR Adhoc	R5-181844	-	-	-	Add clause 4.4 Test point analysis	0.4.0
2018-05	RAN5 #79	R5-183908	-	-	-	Introduction of New FR2 test case 6.3.3.4 PRACH time mask	0.5.0
2018-05	RAN5 #79	R5-182769	-	-	-	General section updated to 38.521-2	0.5.0
2018-05	RAN5 #79	R5-183914	-	-	-	TP for FR2 spurious test procedure (38.521-2)	0.5.0
2018-05	RAN5 #79	R5-183925	-	-	-	Update of Refsens test procedure for FR2	0.5.0
2018-05	RAN5 #79	R5-182883	-	-	-	Definitions, symbols and abbreviations updated to 38.521-2	0.5.0
2018-05	RAN5 #79	R5-182884	-	-	-	Operating bands and Channel arrangement updated to 38.521-2	0.5.0
2018-05	RAN5 #79	R5-182890	-	-	-	Update minimum conformance requirements and test requirement for 6.3.2 Transmit OFF power	0.5.0
2018-05	RAN5 #79	R5-183926	-	-	-	Annex for test case applicability per permitted test method	0.5.0
2018-05	RAN5 #79	R5-183712	-	-	-	Corrections annexes for EIRP and TRP metric definition	0.5.0
2018-05	RAN5 #79	R5-183927	-	-	-	Clean up TBD from Occupied Bandwidth, SEM and ACLR test cases	0.5.0
2018-05	RAN5 #79	R5-183928	-	-	-	Clean up TBD from ACS and Inband Blocking test cases	0.5.0
2018-05	RAN5 #79	R5-183948	-	-	-	Statistical Testing Annex for 38.521-2	0.5.0
2018-08	RAN5 #80	R5-185348	-	-	-	Correction to FR2 Spurious TC and introduction of TRP measurement grid requirement	1.0.0
2018-08	RAN5 #80	R5-185350	-	-	-	Addition of Frequency Error test case to TS 38.521-2	1.0.0
2018-08	RAN5 #80	R5-185490	-	-	-	FR2_TxSpurious_TestConfig_38.521-2	1.0.0
2018-08	RAN5 #80	R5-185562	-	-	-	FR2_StoreTxRxBeamPeakCoordinates_38.521-2	1.0.0
2018-08	RAN5 #80	R5-184742	-	-	-	Update of FR2 test case 6.3.1	1.0.0
2018-08	RAN5 #80	R5-184743	-	-	-	Update of FR2 test case 6.3.3.2	1.0.0
2018-08	RAN5 #80	R5-184856	-	-	-	General sections updated to 38.521-2	1.0.0
2018-08	RAN5 #80	R5-185519	-	-	-	Updates of FR2 TRx MU and TT in Annex	1.0.0
2018-08	RAN5 #80	R5-185555	-	-	-	FR2_UE_BeamlockInvoke_38.521-2	1.0.0
2018-08	RAN5 #80	R5-185191	-	-	-	Update to Occupied Bandwidth, SEM and ACLR test cases in TS 38.521-2	1.0.0
2018-08	RAN5 #80	R5-185192	-	-	-	Update to ACS and inband blocking test cases in TS 38.521-2	1.0.0
2018-08	RAN5 #80	R5-185187	-	-	-	FR2_RefSens_TestConfig_38.521-2	1.0.0
2018-08	RAN5 #80	R5-185188	-	-	-	DL and UL RMC updated for FR2 tests	1.0.0
2018-08	RAN5 #80	R5-185189	-	-	-	Downlink physical channel updated for FR2 tests	1.0.0
2018-08	RAN5 #80	R5-185190	-	-	-	OCNG Patterns updated for FR2 tests	1.0.0
2018-08	RAN5 #80	R5-185194	-	-	-	Update to Test frequencies for SEM in TS 38.521-2	1.0.0
2018-08	RAN5 #80	R5-185196	-	-	-	Addition of Carrier Leakage test case to TS 38.521-2	1.0.0
2018-08	RAN5 #80	R5-185193	-	-	-	Addition of Annex Global In-Channel TX-Test to 38.521-2	1.0.0
2018-08	RAN5 #80	R5-185197	-	-	-	Introduction of maximum output power test cases	1.0.0
2018-08	RAN5 #80	R5-185195	-	-	-	Addition of EVM test case to TS 38.521-2	1.0.0
2018-09	RAN #81	-	-	-	-	raised to v15.0.0 with editorial changes only	15.0.0
2018-12	RAN #82	R5-186504	0021	-	F	FR2 RefSens test case updates	15.1.0
2018-12	RAN #82	R5-186505	0022	-	F	Update Text on Store Beam Peak Coordinate	15.1.0
2018-12	RAN #82	R5-186510	0023	-	F	Structure updates to Annex C and G	15.1.0
2018-12	RAN #82	R5-186675	0026	-	F	Updating test case 6.2.3 maximum output power with additional requirements	15.1.0
2018-12	RAN #82	R5-187151	0034	-	F	Updated to Annexes for FR2 tests	15.1.0
2018-12	RAN #82	R5-187152	0035	-	F	General Information updated for TS38.521-2	15.1.0
2018-12	RAN #82	R5-187561	0042	-	F	Update to Table 5.3.5-1 in TS 38.521-2	15.1.0
2018-12	RAN #82	R5-187619	0050	-	F	Update of Section 6.3.3.1 General	15.1.0
2018-12	RAN #82	R5-187838	0045	1	F	Update of transmit signal quality test cases in 38.521-2	15.1.0
2018-12	RAN #82	R5-187839	0046	1	F	Addition of In-band Emissions test case to TS 38.521-2	15.1.0
2018-12	RAN #82	R5-187840	0047	1	F	Addition of EVM equalizer spectral flatness test cases 6.4.2.4 and 6.4.2.5 to TS 38.521-2	15.1.0
2018-12	RAN #82	R5-187841	0048	1	F	Update of Common Uplink Configuration for FR2	15.1.0
2018-12	RAN #82	R5-187842	0029	1	F	General sections updated to 38.521-2	15.1.0
2018-12	RAN #82	R5-187843	0044	1	F	Update of Global In-channel Tx Test Annex in 38.521-2	15.1.0
2018-12	RAN #82	R5-187886	0020	1	F	FR2 Spurious Emission test case updates	15.1.0
2018-12	RAN #82	R5-187912	0038	1	F	Addition of notes to clarify test point selection into general section of TS 38.521-2	15.1.0
2018-12	RAN #82	R5-188037	0032	1	F	Removing the Editor's notes of SA messages and procedures for all FR2 test cases	15.1.0
2018-12	RAN #82	R5-188038	0036	1	F	FR2 downlink signal level(38.521-2)	15.1.0
2018-12	RAN #82	R5-188063	0027	1	F	Update of FR2 6.3.2 Transmit OFF power	15.1.0
2018-12	RAN #82	R5-188212	0040	2	F	Updates to maximum output power test cases	15.1.0

2018-12	RAN #82	R5-188213	0028	1	F	Update of FR2 test case 7.4	15.1.0
2018-12	RAN #82	R5-188214	0025	1	F	Updates of TT in TS 38.521-2 Annex F during RAN5#81	15.1.0
2018-12	RAN #82	R5-188215	0031	1	F	TDD configuration for UE Tx test in FR2	15.1.0
2018-12	RAN #82	R5-188216	0039	1	F	Core alignment CR to capture TS 38.101-2 updates during RAN4#89	15.1.0
2018-12	RAN #82	R5-188217	0041	2	F	On measurement grids	15.1.0
2018-12	RAN #82	R5-188218	0043	1	F	Update to Annex K	15.1.0
2018-12	RAN #82	RP-182736	0024	2	F	Updates of MU Annex F	15.1.0
2019-03	RAN #83	R5-191091	0083	-	F	Updates of TT in TS38.521-2 Annex F during RAN5#NR4	15.2.0
2019-03	RAN #83	R5-191092	0084	-	F	Editorial correction of core alignment in TS 38.521-2	15.2.0
2019-03	RAN #83	R5-191093	0085	-	F	Editorial cleaning up of test configuration tables in TS 38.521-2	15.2.0
2019-03	RAN #83	R5-191246	0086	-	F	Update TRP measurement procedure Annex in TS38.521-2	15.2.0
2019-03	RAN #83	R5-191247	0087	-	F	Update Annex K and Annex M in TS38.521-2	15.2.0
2019-03	RAN #83	R5-191259	0088	-	F	Update to FR2 test case 6.3.3.4 PRACH time mask	15.2.0
2019-03	RAN #83	R5-191507	0090	-	F	Shared Risk clarification in TS 38.521-2	15.2.0
2019-03	RAN #83	R5-191609	0093	-	F	CR to TS 38.521-2 to add text proposal for Annex F.1	15.2.0
2019-03	RAN #83	R5-191676	0094	-	F	Addition of FR2 6.2.4 Configured transmitted power	15.2.0
2019-03	RAN #83	R5-191677	0095	-	F	Update of FR2 6.3.1 Minimum Output Power	15.2.0
2019-03	RAN #83	R5-191679	0096	-	F	Addition of FR2 6.3.4.2 Absolute power tolerance	15.2.0
2019-03	RAN #83	R5-191680	0097	-	F	Update of FR2 6.3.3.2 General ON/OFF time mask	15.2.0
2019-03	RAN #83	R5-191793	0098	-	F	Introduction of Minimum output power for 2UL CA	15.2.0
2019-03	RAN #83	R5-191809	0099	-	F	OBW test procedure update for 38.521-2	15.2.0
2019-03	RAN #83	R5-191812	0100	-	F	FR2 Spurious Emission test case updates	15.2.0
2019-03	RAN #83	R5-191824	0102	-	F	Update to Annex K and Annex L	15.2.0
2019-03	RAN #83	R5-191986	0107	-	F	Introduction of Annex on Characteristics of the Interfering Signal FR2	15.2.0
2019-03	RAN #83	R5-192092	0110	-	F	Test mode and test loop function activation in SA Tx RF test cases in TS 38.521-2	15.2.0
2019-03	RAN #83	R5-192095	0111	-	F	Test mode and test loop function activation in SA Rx RF test cases in TS 38.521-2	15.2.0
2019-03	RAN #83	R5-192122	0112	-	F	Update of Global In-channel Tx Test Annex for FR2	15.2.0
2019-03	RAN #83	R5-192450	0089	1	F	Update of test case 6.3.4.3, Relative power tolerance in 38.521-2	15.2.0
2019-03	RAN #83	R5-192451	0082	1	F	Updates of test environment for frequency error	15.2.0
2019-03	RAN #83	R5-192452	0105	1	F	FR2 SA Spurious Emission Coexistence test case	15.2.0
2019-03	RAN #83	R5-192648	0106	1	F	Introduction of Aggregate power tolerance in NR SA FR2	15.2.0
2019-03	RAN #83	R5-192649	0117	1	F	CR to add UL RMC for 60kHz SCS in Annex A.2.3	15.2.0
2019-03	RAN #83	R5-192650	0113	1	F	Update of transmit signal quality test cases for FR2	15.2.0
2019-03	RAN #83	R5-192651	0114	1	F	Update OBW test case in TS 38.521-2	15.2.0
2019-03	RAN #83	R5-192652	0115	1	F	Update SEM test case in TS 38.521-2	15.2.0
2019-03	RAN #83	R5-192653	0116	1	F	Update ACLR test case in TS 38.521-2	15.2.0
2019-03	RAN #83	R5-192654	0101	1	F	FR2 Reference Sensitivity test case updates	15.2.0
2019-03	RAN #83	R5-192655	0104	1	F	FR2 Reference Sensitivity EIS spherical coverage	15.2.0
2019-03	RAN #83	R5-192667	0108	1	F	Update of Annex F.2	15.2.0
2019-03	RAN #83	R5-192849	0080	2	F	Updates of MU in TS38.521-2 Annex F during RAN5#82	15.2.0
2019-03	RAN #83	R5-192843	0081	2	F	Updates of TT in TS38.521-2 Annex F during RAN5#82	15.2.0
2019-03	RAN #83	R5-192680	0103	1	F	38.521-2 Editor's Note Updates	15.2.0
2019-03	RAN #83	RP-190746	0118	4	F	Updates to maximum output power test cases	15.2.0
2019-03	RAN#83	-	-	-	-	Editorial correction of references to TS 38.508-1 clause 4.6 tables	15.2.0
2019-06	RAN#84	R5-193541	0137	-	F	Alignment of scheduling of DL RMC with scheduling of UL RMC	15.3.0
2019-06	RAN#84	R5-193552	0138	-	F	Core alignment of RAN4 pending issues in TS 38.521-2	15.3.0
2019-06	RAN#84	R5-193575	0143	-	F	Correction of 38.521-2 7.4	15.3.0
2019-06	RAN#84	R5-193749	0151	-	F	Updates of ACLR test procedure	15.3.0
2019-06	RAN#84	R5-193820	0152	-	F	Correction of 38.521-2 clause 2 to 5	15.3.0
2019-06	RAN#84	R5-194009	0153	-	F	FR2 Reference Sensitivity test case updates	15.3.0
2019-06	RAN#84	R5-194243	0161	-	F	Addition FR2 blocking measurement procedure in Annex K	15.3.0
2019-06	RAN#84	R5-194264	0163	-	F	Correction to FR2 EIRP test configurations	15.3.0
2019-06	RAN#84	R5-194265	0164	-	F	Correction to FR2 EIS test configurations	15.3.0
2019-06	RAN#84	R5-194269	0165	-	F	Update FR2 ACS and Inband blocking test cases	15.3.0
2019-06	RAN#84	R5-194461	0170	-	F	Update to 6.2.3 A-MPR FR2	15.3.0
2019-06	RAN#84	R5-194618	0171	-	F	Update of Global In-channel Tx Test Annex for FR2	15.3.0
2019-06	RAN#84	R5-194958	0139	1	F	Updates of MU and TT in TS 38.521-2 Annex F during RAN5#NR5	15.3.0
2019-06	RAN#84	R5-194968	0167	1	F	Update of TC 6.3A.1.1 Minimum output power for 2UL CA	15.3.0
2019-06	RAN#84	R5-194969	0166	1	F	Clean up FR2 SA test cases	15.3.0
2019-06	RAN#84	R5-194970	0160	1	F	Introduction of beam correspondence	15.3.0
2019-06	RAN#84	R5-194971	0162	1	F	Introduction of beam correspondence for CA	15.3.0
2019-06	RAN#84	R5-194976	0173	1	F	Update of Frequency Error Test Case for FR2	15.3.0
2019-06	RAN#84	R5-194977	0175	1	F	Editorial corrections for 6.2.1 UE maximum output power	15.3.0
2019-06	RAN#84	R5-195080	0176	-	F	Update of FR2 ON_ON time mask test cases	15.3.0
2019-06	RAN#84	R5-195147	0141	1	F	Addition of new SA FR2 RF test case 6.2.2	15.3.0
2019-06	RAN#84	R5-195149	0142	1	F	Correction of 38.521-2 6.3.2	15.3.0
2019-06	RAN#84	R5-195151	0144	1	F	Introduction of MOP (SA UL CA)	15.3.0

2019-06	RAN#84	R5-195152	0145	1	F	Introduction of OFF power (SA UL CA)	15.3.0
2019-06	RAN#84	R5-195153	0146	1	F	Introduction of Frequency error (SA UL CA)	15.3.0
2019-06	RAN#84	R5-195154	0148	1	F	Introduction of SEM (SA UL CA)	15.3.0
2019-06	RAN#84	R5-195155	0149	1	F	Introduction of ACLR (SA UL CA)	15.3.0
2019-06	RAN#84	R5-195156	0150	1	F	Introduction of General Spurious (SA UL CA)	15.3.0
2019-06	RAN#84	R5-195157	0157	1	F	Introduction of New test case 6.5A.1.1 Occupied bandwidth for CA (2UL CA)	15.3.0
2019-06	RAN#84	R5-195158	0156	1	F	Update Out of band emission test cases in TS 38.521-2	15.3.0
2019-06	RAN#84	R5-195160	0159	1	F	Introduction of SRS time mask for UL-MIMO	15.3.0
2019-06	RAN#84	R5-195404	0172	1	F	Update of transmit signal quality test cases for FR2	15.3.0
2019-06	RAN#84	R5-195417	0154	1	F	38.521-2 implementation of FR2 UL demod OTA tests using single pol Rx TE	15.3.0
2019-06	RAN#84	R5-195432	0168	2	F	Update to 6.2.1.1 UE maximum output power - EIRP and TRP	15.3.0
2019-06	RAN#84	R5-195433	0169	2	F	Update to 6.2.1.2 UE maximum output power - Spherical coverage	15.3.0
2019-06	RAN#84	R5-195434	0140	1	F	Updates of MU and TT in TS 38.521-2	15.3.0
2019-06	RAN#84	R5-195435	0155	1	F	Core alignment with TS 38.101-2	15.3.0
2019-06	RAN#84	-	-	-	-	Administrative release upgrade to match the release of 3GPP TS 38.508-1 and TS 38.521-1 which were upgraded at RAN#84 to Rel-16 due to Rel-16 relevant CR(s)	16.0.0
2019-09	RAN#85	R5-195695	0178	-	F	Change of TS 38.521-2 UL CA MOP Minimum conformance requirements	16.1.0
2019-09	RAN#85	R5-196069	0194	-	F	Introduction of absolute power tolerance for CA test cases	16.1.0
2019-09	RAN#85	R5-196165	0198	-	F	Correction of wrong spec reference numbers for TS 38.508-1	16.1.0
2019-09	RAN#85	R5-196236	0202	-	F	Correction to test procedure of TC 6.4.2.2 Carrier Leakage	16.1.0
2019-09	RAN#85	R5-196240	0206	-	F	Clarification on EVM test requirement for PUCCH and PRACH	16.1.0
2019-09	RAN#85	R5-196427	0208	-	F	Update of FR2 6.2.4 Configured transmitted power	16.1.0
2019-09	RAN#85	R5-196428	0209	-	F	Update of FR2 6.3.3.2 General ON_OFF time mask	16.1.0
2019-09	RAN#85	R5-196431	0211	-	F	Addition of FR2 6.2A.4 Configured transmitted power for 2UL CA	16.1.0
2019-09	RAN#85	R5-196433	0213	-	F	Addition of FR2 6.2D.4 Configured transmitted power for UL MIMO	16.1.0
2019-09	RAN#85	R5-196434	0214	-	F	Addition of FR2 6.3D.1 Minimum output power for UL MIMO	16.1.0
2019-09	RAN#85	R5-196594	0220	-	F	Addition of new test case 6.4A.2.1.2 Error vector magnitude for 3UL CA in FR2	16.1.0
2019-09	RAN#85	R5-196595	0221	-	F	Addition of new test case 6.4A.2.1.3 Error vector magnitude for 4UL CA in FR2	16.1.0
2019-09	RAN#85	R5-196650	0225	-	F	Update of Minimum conformance requirements and test configurations in TC 6.2.2	16.1.0
2019-09	RAN#85	R5-196810	0229	-	F	Update to TRP measurement grid section in TS 38.521-2	16.1.0
2019-09	RAN#85	R5-196950	0239	-	F	Corrections on clause 2 and 3 in 38.521-2	16.1.0
2019-09	RAN#85	R5-197384	0197	1	F	Update UL-MIMO to UL MIMO to align with RAN4 terminology in FR2	16.1.0
2019-09	RAN#85	R5-197385	0238	1	F	Update OBW FR2 test case	16.1.0
2019-09	RAN#85	R5-197386	0200	1	F	Alignment of clause 2 to 5 with the core spec	16.1.0
2019-09	RAN#85	R5-197387	0242	-	F	Integrating the QoQZ Procedures into 38.521-2	16.1.0
2019-09	RAN#85	R5-197388	0219	1	F	Addition of new test case 6.4A.2.1.1 Error vector magnitude for 2UL CA in FR2	16.1.0
2019-09	RAN#85	R5-197389	0222	1	F	Update of TC 6.3A.1.1 Minimum output power for 2UL CA	16.1.0
2019-09	RAN#85	R5-197390	0223	1	F	Addition of new test case 6.3A.1.2 Minimum output power for 3UL CA in FR2	16.1.0
2019-09	RAN#85	R5-197391	0224	1	F	Addition of new test case 6.3A.1.3 Minimum output power for 4UL CA in FR2	16.1.0
2019-09	RAN#85	R5-197392	0227	1	F	Update of Common Uplink Configuration table for PC3	16.1.0
2019-09	RAN#85	R5-197393	0212	1	F	Addition of FR2 6.3A.3 ON_OFF time mask for 2 UL CA	16.1.0
2019-09	RAN#85	R5-197394	0215	1	F	Addition of FR2 6.3D.3 General ON_OFF power for UL MIMO	16.1.0
2019-09	RAN#85	R5-197395	0199	1	F	Addition of new Annex N (normative): UE coordinate system	16.1.0
2019-09	RAN#85	R5-197500	0231	1	F	Update of Spurious Emissions TRP test procedure	16.1.0
2019-09	RAN#85	R5-197501	0233	1	F	Update of FR2 MUs in TS 38.521-2	16.1.0
2019-09	RAN#85	R5-197503	0230	1	F	Update of TRP measurement grids for spurious emissions	16.1.0
2019-09	RAN#85	R5-197529	0180	1	F	New Introduction of TC 6.2A.1.2.1 UE Maximum output power Spherical coverage 2UL CA	16.1.0
2019-09	RAN#85	R5-197530	0181	1	F	New Introduction of TC 6.2A.1.2.2 UE Maximum output power Spherical coverage 3UL CA	16.1.0
2019-09	RAN#85	R5-197531	0182	1	F	New Introduction of TC 6.2A.1.2.3 UE Maximum output power Spherical coverage 4UL CA	16.1.0
2019-09	RAN#85	R5-197532	0183	1	F	New Introduction of TC 6.4A.2.2.1 Carrier leakage 2UL CA	16.1.0
2019-09	RAN#85	R5-197533	0184	1	F	New Introduction of TC 6.4A.2.2.2 Carrier leakage 3UL CA	16.1.0
2019-09	RAN#85	R5-197534	0185	1	F	New Introduction of TC 6.4A.2.2.3 Carrier leakage 4UL CA	16.1.0
2019-09	RAN#85	R5-197535	0189	1	F	Rel-16_NR_38.521-2_Addition of new TC 6.2A.1.1.1	16.1.0
2019-09	RAN#85	R5-197536	0193	1	F	Additions to the SRS time mask for UL-MIMO test case	16.1.0
2019-09	RAN#85	R5-197537	0195	1	F	Additions to the beam correspondence test case	16.1.0
2019-09	RAN#85	R5-197538	0203	1	F	Correction to RB allocation in 6.2.2 UE maximum output power reduction	16.1.0
2019-09	RAN#85	R5-197539	0204	1	F	Correction to number of measurements of 6.4.2.3 In-band emissions	16.1.0

2019-09	RAN#85	R5-197540	0205	1	F	Correction to UBF in transmit modulation quality test cases	16.1.0
2019-09	RAN#85	R5-197541	0226	1	F	Update of FR2 A-MPR test case	16.1.0
2019-09	RAN#85	R5-197543	0190	1	F	Refsens test case updates	16.1.0
2019-09	RAN#85	R5-197544	0196	1	F	Introduction of beam correspondence to direct far field (DFF)	16.1.0
2019-09	RAN#85	R5-197545	0216	1	F	Updated to Annex A for RF FR2 tests	16.1.0
2019-09	RAN#85	R5-197546	0232	1	F	Integrating the Re-Positioning Concept into Annex K	16.1.0
2019-09	RAN#85	R5-197614	0191	1	F	Spurious test case updates	16.1.0
2019-09	RAN#85	R5-197642	0201	1	F	Correction to 6.5.2.1 SEM and 6.5.2.3 ACLR to consider MPR values	16.1.0
2019-09	RAN#85	R5-197643	0210	2	F	Addition of FR2 6.2A.2 MPR for 2 UL CA	16.1.0
2019-09	RAN#85	R5-197644	0177	2	F	Updates of MU and TT in TS 38.521-2	16.1.0
2019-09	RAN#85	R5-197645	0234	2	F	Addition of the connection setup in TS 38.521-2	16.1.0
2019-12	RAN#86	R5-198072	0247	-	F	Introduction of 4 New test cases 6.5A.1 Occupied bandwidth for CA	16.2.0
2019-12	RAN#86	R5-198073	0248	-	F	Introduction of 4 New test cases 6.5A.2.1 Spectrum Emission Mask for CA	16.2.0
2019-12	RAN#86	R5-198075	0249	-	F	Introduction of 4 New test cases 6.5A.2.2 Adjacent channel leakage ratio for CA	16.2.0
2019-12	RAN#86	R5-198078	0250	-	F	New Introduction of TC 6.2A.1.2.4 UE maximum output power - Spherical coverage 5UL CA	16.2.0
2019-12	RAN#86	R5-198079	0251	-	F	New Introduction of TC 6.2A.1.2.5 UE maximum output power - Spherical coverage 6UL CA	16.2.0
2019-12	RAN#86	R5-198080	0252	-	F	New Introduction of TC 6.2A.1.2.6 UE maximum output power - Spherical coverage 7UL CA	16.2.0
2019-12	RAN#86	R5-198081	0253	-	F	New Introduction of TC 6.2A.1.2.7 UE maximum output power - Spherical coverage 8UL CA	16.2.0
2019-12	RAN#86	R5-198210	0260	-	F	Addition of Common Uplink Configuration for PC1 in SA FR2 6.1	16.2.0
2019-12	RAN#86	R5-198381	0267	-	F	Introduction of beam correspondence side conditions	16.2.0
2019-12	RAN#86	R5-198385	0269	-	F	Update of minimum conformance requirements for SA FR2 7.4	16.2.0
2019-12	RAN#86	R5-198636	0276	-	F	General clause updated for FR2 spec	16.2.0
2019-12	RAN#86	R5-198730	0278	-	F	Correction of test requirements	16.2.0
2019-12	RAN#86	R5-199086	0262	1	F	CR to 38.521-2 on Measurement Grids for PC1 UEs	16.2.0
2019-12	RAN#86	R5-199087	0243	2	F	Updates of MU and TT in TS 38.521-2	16.2.0
2019-12	RAN#86	R5-199356	0245	1	F	Update of FR2 6.3.3.2 ON-OFF time mask	16.2.0
2019-12	RAN#86	R5-199357	0244	1	F	Update of FR2 6.3.1 minimum output power	16.2.0
2019-12	RAN#86	R5-199358	0263	1	F	CR to 38.521-2 on optimized search procedure for REFSENS	16.2.0
2019-12	RAN#86	R5-199359	0264	1	F	CR to 38.521-2 on optimized search procedure for RX Beam Peak Search	16.2.0
2019-12	RAN#86	R5-199360	0254	1	F	Updating incorrect note in test procedure	16.2.0
2019-12	RAN#86	R5-199361	0256	1	F	Spurious UL MIMO test case updates	16.2.0
2019-12	RAN#86	R5-199373	0265	1	F	Introduction of New TC 6.4A.2.3.1 In-band emissions for 2UL CA	16.2.0
2019-12	RAN#86	R5-199374	0266	1	F	Update to test case 6.3.3.4 PRACH time mask in FR2	16.2.0
2019-12	RAN#86	R5-199375	0257	1	F	Ref Sens UL MIMO test case updates	16.2.0
2019-12	RAN#86	R5-199376	0258	1	F	Alignment of clause 3 to 5 with the core spec	16.2.0
2019-12	RAN#86	R5-199461	0271	2	F	Further updates to the SRS time mask for UL-MIMO test case	16.2.0
2019-12	RAN#86	R5-199473	0282	-	F	Update to UE maximum output power - Spherical coverage	16.2.0
2019-12	RAN#86	R5-199483	0277	1	F	Update of applicability for Spherical coverage and Beam Correspondence test cases	16.2.0
2019-12	RAN#86	R5-199494	0281	1	F	Add section 4.5 Applicability and test coverage rules	16.2.0
2019-12	RAN#86	R5-199495	0246	1	F	Update of FR2 6.3.4.2 absolute power tolerance	16.2.0
2019-12	RAN#86	R5-199496	0270	1	F	Further updates to the absolute power tolerance for CA test cases	16.2.0
2019-12	RAN#86	R5-199504	0259	1	F	Addition of test requirements and update of minimum conformance requirements and test configurations for SA FR2 6.2.2	16.2.0
2019-12	RAN#86	R5-199548	0268	1	F	Updates to the beam correspondence TC	16.2.0
2019-12	RAN#86	R5-199579	0279	1	F	Update of quality of quiet zone validation procedure	16.2.0
2019-12	RAN#86	R5-199586	0275	1	F	Update on FR2 Spurious Test in 38.521-2	16.2.0
2020-03	RAN#87	R5-200319	0288		F	CR to 38.521-2 on CDF/PDF Scaling Factor	16.3.0
2020-03	RAN#87	R5-200320	0289		F	CR to 38.521-2: Correction to TRP grid	16.3.0
2020-03	RAN#87	R5-200368	0292		F	Addition of new test case 6.3A.1.4 Minimum output power for 5UL CA in FR2	16.3.0
2020-03	RAN#87	R5-200369	0293		F	Addition of new test case 6.3A.1.5 Minimum output power for 6UL CA in FR2	16.3.0
2020-03	RAN#87	R5-200372	0294		F	Addition of new test case 6.3A.1.6 Minimum output power for 7UL CA in FR2	16.3.0
2020-03	RAN#87	R5-200374	0295		F	Addition of new test case 6.3A.1.7 Minimum output power for 8UL CA in FR2	16.3.0
2020-03	RAN#87	R5-200375	0296		F	Addition of new test case 6.4A.2.1.4 Error vector magnitude for 5UL CA in FR2	16.3.0
2020-03	RAN#87	R5-200376	0297		F	Addition of new test case 6.4A.2.1.5 Error vector magnitude for 6UL CA in FR2	16.3.0
2020-03	RAN#87	R5-200377	0298		F	Addition of new test case 6.4A.2.1.6 Error vector magnitude for 7UL CA in FR2	16.3.0
2020-03	RAN#87	R5-200382	0300		F	Addition of new test case 6.4A.2.1.7 Error vector magnitude for 8UL CA in FR2	16.3.0

2020-03	RAN#87	R5-200383	0301		F	Update of test cases for Error vector magnitude for CA in FR2	16.3.0
2020-03	RAN#87	R5-200418	0302		F	Update of Operating bands and Channel arrangement of SA FR2 R15	16.3.0
2020-03	RAN#87	R5-200444	0303		F	Clarification of measurement interval of frequency error in FR2	16.3.0
2020-03	RAN#87	R5-200557	0309		F	Clarify absolute power tolerance for CA TP3	16.3.0
2020-03	RAN#87	R5-200602	0312		F	Updates to reference sensitivity test case	16.3.0
2020-03	RAN#87	R5-200656	0317		F	Correction of Editor's note of 6.2.2 and 6.3.2 of SA FR2 R15	16.3.0
2020-03	RAN#87	R5-201248	0318	1	F	Alignment of Table A.3.1-1 in 38.521-2 to core spec 38.101-2	16.3.0
2020-03	RAN#87	R5-200800	0319		F	Update of Standalone FR2 A-MPR test case	16.3.0
2020-03	RAN#87	R5-200894	0286	1	F	Correction to TC 6.3.4.4 Aggregate power tolerance	16.3.0
2020-03	RAN#87	R5-200910	0310	1	F	Beam correspondence TC message contents clarifications	16.3.0
2020-03	RAN#87	R5-200911	0285	1	F	Update of clause 4 in TS 38.521-2	16.3.0
2020-03	RAN#87	R5-200980	0284	1	F	Correction of reference numbers in TS 38.521-2	16.3.0
2020-03	RAN#87	R5-200992	0291	1	F	Updates of MU and TT in TS 38.521-2 for Rel-16	16.3.0
2020-03	RAN#87	R5-201059	0305	1	F	Update of rx beampeak search	16.3.0
2020-03	RAN#87	R5-201060	0307	1	F	Update of absolute power tolerance for test point 3	16.3.0
2020-03	RAN#87	R5-201161	0313	1	F	Updates to test case relative power tolerance 6.3.4.3	16.3.0
2020-03	RAN#87	R5-201192	0283	1	F	Updates of MU and TT in TS 38.521-2	16.3.0
2020-03	RAN#87	R5-201244	0311	3	F	Correction of the FR2 RMC slot patterns for MOP test cases	16.3.0
2020-06	RAN#88	R5-201328	0321	-	F	Add n261 to FR2 ACLR requirements	16.4.0
2020-06	RAN#88	R5-201330	0323	-	F	Update to UBF command implementation for Relative power sub tests	16.4.0
2020-06	RAN#88	R5-201795	0325	-	F	Introduction of New TC 6.4A.2.2.4 Carrier leakage for 5UL CA	16.4.0
2020-06	RAN#88	R5-201796	0326	-	F	Introduction of New TC 6.4A.2.2.5 Carrier leakage for 6UL CA	16.4.0
2020-06	RAN#88	R5-201797	0327	-	F	Introduction of New TC 6.4A.2.2.6 Carrier leakage for 7UL CA	16.4.0
2020-06	RAN#88	R5-201811	0328	-	F	Introduction of New TC 6.4A.2.2.7 Carrier leakage for 8UL CA	16.4.0
2020-06	RAN#88	R5-201812	0329	-	F	Introduction of New TC 6.4A.2.3.2 In-band emissions for 3UL CA	16.4.0
2020-06	RAN#88	R5-201813	0330	-	F	Introduction of New TC 6.4A.2.3.3 In-band emissions for 4UL CA	16.4.0
2020-06	RAN#88	R5-201814	0331	-	F	Introduction of New TC 6.4A.2.3.4 In-band emissions for 5UL CA	16.4.0
2020-06	RAN#88	R5-201815	0332	-	F	Introduction of New TC 6.4A.2.3.5 In-band emissions for 6UL CA	16.4.0
2020-06	RAN#88	R5-201835	0333	-	F	Correction of FR2 PUCCH EVM definition	16.4.0
2020-06	RAN#88	R5-201849	0334	-	F	Updating common uplink allocation for PC1	16.4.0
2020-06	RAN#88	R5-201850	0335	-	F	Cleaning up references to common uplink configuration	16.4.0
2020-06	RAN#88	R5-201851	0336	-	F	Updating test requirements of 6.2.3 AMPR for NS_201	16.4.0
2020-06	RAN#88	R5-202045	0342	-	F	Correction of test metric in minimum conformance requirements and some test style in 6.3.2 of SA FR2 R15	16.4.0
2020-06	RAN#88	R5-202046	0343	-	F	Correction of uplink configuration table number in minimum conformance requirements and test requirement table of 7.4 of SA FR2 R15	16.4.0
2020-06	RAN#88	R5-202120	0346	-	F	CR to 38.521-2 to correct Clenshaw-Curtis Weight Equations	16.4.0
2020-06	RAN#88	R5-202122	0348	-	F	CR to 38.521-2 to clarify the applicability of QoQZ validation	16.4.0
2020-06	RAN#88	R5-202135	0354	-	F	Update to 6 test cases 6.5A.2.1.x Spectrum Emission Mask for 3 to 8 UL CA	16.4.0
2020-06	RAN#88	R5-202137	0356	-	F	Update to 6 test cases 6.5A.2.2.x Adjacent channel leakage ratio for 3 to 8 UL CA	16.4.0
2020-06	RAN#88	R5-202447	0367	-	F	Editorial correction to the test requirement of in-band blocking	16.4.0
2020-06	RAN#88	R5-202450	0368	-	F	Correction of Spectrum Emission Mask CA test cases	16.4.0
2020-06	RAN#88	R5-202504	0372	-	F	CR on EVM Window Centre Timing Definition in FR2	16.4.0
2020-06	RAN#88	R5-202720	0345	1	F	CR to 38.521-2 to correct Clenshaw-Curtis Weights at the Poles for CDF/CCDF	16.4.0
2020-06	RAN#88	R5-202722	0364	1	F	Additions to Initial Conditions and Messages for SRS time mask with UL MIMO	16.4.0
2020-06	RAN#88	R5-202723	0337	1	F	Aligning test procedure for Rx beam peak direction	16.4.0
2020-06	RAN#88	R5-202724	0341	1	F	Alignment of section 3 and 5 with core spec of SA FR2 R15	16.4.0
2020-06	RAN#88	R5-202808	0365	1	F	Receiver characteristics testing update to 38.521-2	16.4.0
2020-06	RAN#88	R5-202824	0351	1	F	Update to test case 6.5A.1.1 Occupied bandwidth for 2UL CA	16.4.0
2020-06	RAN#88	R5-202825	0353	1	F	Update to test case 6.5A.2.1.1 Spectrum Emission Mask for 2UL CA	16.4.0
2020-06	RAN#88	R5-202826	0355	1	F	Update to test case 6.5A.2.2.1 Adjacent channel leakage ratio for 2UL CA	16.4.0
2020-06	RAN#88	R5-202827	0371	1	F	Update to 6 test cases 6.5A.1.x Occupied bandwidth for 3 to 8 UL CA	16.4.0
2020-06	RAN#88	R5-202828	0338	1	F	Updating SRS config table in test case 6.3D.3.4	16.4.0
2020-06	RAN#88	R5-202885	0322	1	F	Add NS 202 requirements to FR2 additional spurious emission test case	16.4.0
2020-06	RAN#88	R5-202893	0349	1	F	Editorial correction of test case 6.5.1 Occupied bandwidth to align with core spec	16.4.0
2020-06	RAN#88	R5-202894	0350	1	F	Editorial correction of Tx test cases for Out of band emission to align with core spec	16.4.0
2020-06	RAN#88	R5-202895	0357	1	F	Clarification of disabling Tx diversity for FR2 UE for SA FR2 testing	16.4.0
2020-06	RAN#88	R5-202896	0358	1	F	Updates of Test Points of Tx CA test cases	16.4.0
2020-06	RAN#88	R5-202897	0360	1	F	Correction on txDirectCurrentLocation in FR2 SA tests	16.4.0
2020-06	RAN#88	R5-202898	0370	1	F	Update on transmit modulation quality test cases	16.4.0

2020-06	RAN#88	R5-202899	0361	1	F	Update to SA FR2 Receiver Spurious Emission Test Case	16.4.0
2020-06	RAN#88	R5-202943	0363	1	F	CR to 38.521-2: On the order of test steps for output power dynamics test cases	16.4.0
2020-06	RAN#88	R5-202968	0359	1	F	Core spec alignment of k1 value for RF test cases	16.4.0
2020-06	RAN#88	R5-202990	0362	2	F	Updates of FR2 MU and TT in TS 38.521-2	16.4.0
2020-06	RAN#88	R5-203117	0347	2	F	CR to 38.521-2 to properly define Link and Meas Angles	16.4.0
2020-09	RAN#89	R5-203292	0373	-	F	Clarification of Interferer frequency selection in FR2 IBB test case 7.6.2	16.5.0
2020-09	RAN#89	R5-203875	0392	-	F	Alignment of general sections with core spec of SA FR2 R15	16.5.0
2020-09	RAN#89	R5-203969	0394	-	F	Updating beam correspondence capability	16.5.0
2020-09	RAN#89	R5-204264	0412	-	F	Editorial correction of ACLR CA test cases	16.5.0
2020-09	RAN#89	R5-204265	0413	-	F	Editorial correction of Annex C.3 Connection	16.5.0
2020-09	RAN#89	R5-204266	0414	-	F	Update of FR2 OBW test case	16.5.0
2020-09	RAN#89	R5-204713	0382	1	F	Correction to test configuration for Carrier leakage for CA	16.5.0
2020-09	RAN#89	R5-204714	0383	1	F	Correction to TC 6.4A.2.3.1 In-band emissions for 2UL CA	16.5.0
2020-09	RAN#89	R5-204715	0384	1	F	Correction to test cases 6.4A.2.3.x In-band emissions for 3 to 6 UL CA	16.5.0
2020-09	RAN#89	R5-204716	0385	1	F	Introduction of New TC 6.4A.2.3.6 In-band emissions for 7UL CA	16.5.0
2020-09	RAN#89	R5-204717	0386	1	F	Introduction of New TC 6.4A.2.3.7 In-band emissions for 8UL CA	16.5.0
2020-09	RAN#89	R5-204763	0393	1	F	Miscellaneous corrections due to core spec alignment	16.5.0
2020-09	RAN#89	R5-204764	0415	1	F	Update of Tx signal quality test cases	16.5.0
2020-09	RAN#89	R5-204765	0395	1	F	Addition of UL power setting for Rx test cases	16.5.0
2020-09	RAN#89	R5-204856	0403	1	F	CR to update MU and TT in 38.521-2	16.5.0
2020-09	RAN#89	R5-204857	0380	1	F	Beam correspondence - SRS configuration corrections in section 6.6.1	16.5.0
2020-09	RAN#89	R5-204858	0397	1	F	CR to 38.521-2 to update Absolute Power Tolerance for CA on the order of test steps	16.5.0
2020-09	RAN#89	R5-204859	0401	1	F	CR to TS 38.521-2: Correction to MB relaxation minimum requirements	16.5.0
2020-09	RAN#89	R5-204860	0406	1	F	CR to 38.521-2 to adjust the test step sequences	16.5.0
2020-09	RAN#89	R5-204861	0407	1	F	CR to 38.521-2 to allow vendor declarations related to beam peak searches	16.5.0
2020-09	RAN#89	R5-204862	0408	1	F	CR to 38.521-2 on QoQZ Verification Clarification	16.5.0
2020-09	RAN#89	R5-204863	0411	1	F	FR2 Minimum output power MU updates	16.5.0
2020-09	RAN#89	R5-204864	0417	1	F	FR2 EIRP OFF power MU updates	16.5.0
2020-09	RAN#89	R5-204865	0379	1	F	Beam correspondence - SRS configuration corrections in annex K.1.1	16.5.0
2020-09	RAN#89	R5-204914	0388	1	F	Updates to test case 6.3.4.3, relative power tolerance	16.5.0
2020-09	RAN#89	R5-204915	0398	1	F	CR to 38.521-2 to update Transmit OFF Power	16.5.0
2020-09	RAN#89	R5-204916	0399	1	F	CR to TS 38.521-2: Correction to time mask requirements	16.5.0
2020-09	RAN#89	R5-204917	0402	1	F	Clean up complete status for FR2 SA test cases	16.5.0
2020-09	RAN#89	R5-204918	0404	1	F	Update to UE maximum output power for CA	16.5.0
2020-09	RAN#89	R5-204919	0410	1	F	FR2 Minimum output power measurement period definition	16.5.0
2020-09	RAN#89	R5-204920	0389	1	F	FR2 RefSens and EIS spherical PC3 MBR table update	16.5.0
2020-09	RAN#89	R5-204921	0396	1	F	Addition of modified MPR behaviour	16.5.0
2020-09	RAN#89	R5-204922	0400	1	F	CR to TS 38.521-2: Annex F EIRP OFF Power	16.5.0
2020-09	RAN#89	R5-204923	0409	1	F	CR to TS 38.521-2 on DUT alignment options	16.5.0
2020-09	RAN#89	RP-201671	0418	-	F	Adding FR2 PDCCH Aggregation Level in Annex C.3	16.5.0
2020-12	RAN#90	R5-205259	0420	-	F	Addition of new test case 6.4D.3 Time alignment error for UL MIMO in FR2	16.6.0
2020-12	RAN#90	R5-205260	0421	-	F	Addition of new test case 6.5D.1 Occupied bandwidth for UL MIMO in FR2	16.6.0
2020-12	RAN#90	R5-205496	0422	-	F	Alignment of general sections with core spec	16.6.0
2020-12	RAN#90	R5-205497	0423	-	F	Correction of minimum conformance requirements for 6.2.2 MPR	16.6.0
2020-12	RAN#90	R5-205536	0427	-	F	Aligning tested subframe numbers with defined RMC in test case 6.3.4.3	16.6.0
2020-12	RAN#90	R5-205573	0428	-	F	Adding a new note in test configuration table for ACLR and SEM test case	16.6.0
2020-12	RAN#90	R5-205711	0431	-	F	FR2 EIS editor's note clean up	16.6.0
2020-12	RAN#90	R5-205811	0433	-	F	Correction to Carrier leakage for CA	16.6.0
2020-12	RAN#90	R5-205812	0434	-	F	Correction to In-band emissions for CA	16.6.0
2020-12	RAN#90	R5-205854	0438	-	F	Correction of transmission gap for relative power tolerance TC 6.3.4.3	16.6.0
2020-12	RAN#90	R5-206009	0439	-	F	Update of in-band emission and carrier leakage test cases	16.6.0
2020-12	RAN#90	R5-206206	0448	-	F	Update of occupied bandwidth test case	16.6.0
2020-12	RAN#90	R5-206210	0449	-	F	Correction of Annex F for absolute power tolerance for CA	16.6.0
2020-12	RAN#90	R5-206644	0437	1	F	Correction of MBW for output power dynamics TCs 6.3.x and ACLR TC 6.5.2.3	16.6.0
2020-12	RAN#90	R5-206645	0440	1	F	Correction of 6.2.3.3.1 for UE additional maximum power reduction	16.6.0
2020-12	RAN#90	R5-206646	0419	1	F	Forgotten change extending Table range to N.2-7	16.6.0
2020-12	RAN#90	R5-206647	0430	1	F	CR to update DMRS position in UL RMC for FR2	16.6.0
2020-12	RAN#90	R5-206821	0442	1	F	CR to 38.521-2 on ETC Testing	16.6.0

2020-12	RAN#90	R5-206822	0445	1	F	Minimum output power updates	16.6.0
2020-12	RAN#90	R5-206823	0446	1	F	FR2 time masks updates	16.6.0
2020-12	RAN#90	R5-206824	0443	1	F	Update FR2 TRx MU and TT in 38.521-2	16.6.0
2020-12	RAN#90	R5-206825	0444	1	F	Minimum output power measurement uncertainties and test tolerances	16.6.0
2020-12	RAN#90	R5-206826	0447	1	F	FR2 Time masks updates	16.6.0
2020-12	RAN#90	R5-206865	0429	1	F	Update on Test points of FR2 Transmit OFF power for CA	16.6.0
2020-12	RAN#90	R5-206866	0432	1	F	Adding NS202 and NS203 to MOP and Spurious	16.6.0
2020-12	RAN#90	R5-206867	0435	1	F	Addition of 6.5D.2.1 Spectrum Emission Mask for UL MIMO in FR2	16.6.0
2020-12	RAN#90	R5-206868	0436	1	F	Addition of 6.5D.2.2 Adjacent channel leakage ratio for UL MIMO in FR2	16.6.0
2021-03	RAN#91	R5-210489	0457	-	F	Correction of test purpose for 6.3.2 Transmit OFF power	16.7.0
2021-03	RAN#91	R5-210490	0458	-	F	Addition of new test case 6.3D.2 Transmit OFF power for UL MIMO	16.7.0
2021-03	RAN#91	R5-210491	0459	-	F	Correction of test applicability and test description for 7.4 Maximum input level	16.7.0
2021-03	RAN#91	R5-210492	0460	-	F	Addition of new test cases for 7.4A Maximum input level for CA	16.7.0
2021-03	RAN#91	R5-210494	0462	-	F	Removal of brackets for MU of EIS spherical coverage	16.7.0
2021-03	RAN#91	R5-210495	0463	-	F	Correction of Annex P for Modified MPR behaviour	16.7.0
2021-03	RAN#91	R5-210496	0464	-	F	Correction of definition for EIS	16.7.0
2021-03	RAN#91	R5-210565	0467	-	F	Update of waveform to be used during Rx beam search in Annex K.1.2	16.7.0
2021-03	RAN#91	R5-210724	0468	-	F	Omitting of FR2 Rx cases with UL-MIMO on TDD bands	16.7.0
2021-03	RAN#91	R5-210729	0471	-	F	Removing test condition of extreme voltage	16.7.0
2021-03	RAN#91	R5-210731	0473	-	F	Adding definition of FR2a, FR2b and FR2c in general section	16.7.0
2021-03	RAN#91	R5-210732	0474	-	F	Cleaning up of Annex K	16.7.0
2021-03	RAN#91	R5-211094	0481	-	F	Correction to assumption of aggregated channel bandwidth in TC 6.5A.2.2	16.7.0
2021-03	RAN#91	R5-211097	0484	-	F	Definition of relaxation value of spurious emissions UE co-existence in TC 6.5.3.2	16.7.0
2021-03	RAN#91	R5-211110	0486	-	F	Corrections to subclauses in 38.521-2 with appropriate clause level and heading styles	16.7.0
2021-03	RAN#91	R5-211126	0488	-	F	Update of 5.5A.2 for corrections to configurations for intra-band non-contiguous CA	16.7.0
2021-03	RAN#91	R5-211683	0456	1	F	Editorial corrections in Occupied bandwidth test procedure	16.7.0
2021-03	RAN#91	R5-211684	0465	1	F	FR2 UL CA Frequency error test cases update	16.7.0
2021-03	RAN#91	R5-211685	0469	1	F	Addition of Inner_partial allocation in general section and a few test cases	16.7.0
2021-03	RAN#91	R5-211686	0470	1	F	Correction of parameter configuration for open loop power control	16.7.0
2021-03	RAN#91	R5-211688	0476	1	F	Addition of new test case 6.2A.1.1.4 UE maximum output power - EIRP and TRP for 5UL CA	16.7.0
2021-03	RAN#91	R5-211689	0477	1	F	Addition of new test case 6.2A.1.1.5 UE maximum output power - EIRP and TRP for 6UL CA	16.7.0
2021-03	RAN#91	R5-211690	0478	1	F	Addition of new test case 6.2A.1.1.6 UE maximum output power - EIRP and TRP for 7UL CA	16.7.0
2021-03	RAN#91	R5-211691	0479	1	F	Addition of new test case 6.2A.1.1.7 UE maximum output power - EIRP and TRP for 8UL CA	16.7.0
2021-03	RAN#91	R5-211692	0487	1	F	Corrections to reference figures for transmission bandwidth configuration in FR2	16.7.0
2021-03	RAN#91	R5-211693	0493	1	F	Update of Annex F for test case 7.3.4	16.7.0
2021-03	RAN#91	R5-211863	0466	1	F	FR2 MPR, ACLR and SEM test cases update as per TP analysis update	16.7.0
2021-03	RAN#91	R5-211864	0472	1	F	Cleaning up of FR2 test specification	16.7.0
2021-03	RAN#91	R5-211865	0475	1	F	Update of TX Test Cases for UL MIMO in FR2	16.7.0
2021-03	RAN#91	R5-211866	0482	1	F	Correction to definition of power control window size in FR2 relative power tolerance in TC 6.3.4.3	16.7.0
2021-03	RAN#91	R5-211867	0491	1	F	FR2 Tx additional spurious emission test case updates	16.7.0
2021-03	RAN#91	R5-211868	0453	1	F	ACS FR2 test case update	16.7.0
2021-03	RAN#91	R5-211869	0454	1	F	IBB FR2 test case update	16.7.0
2021-03	RAN#91	R5-211919	0451	1	F	Introduction of FR2 DL 256QAM	16.7.0
2021-03	RAN#91	R5-211921	0480	1	F	Correction to ACLR relaxation value in TC 6.5.2.3	16.7.0
2021-03	RAN#91	R5-211922	0455	1	F	MU and TT definition for REFSSENS FR2 CA test cases	16.7.0
2021-03	RAN#91	R5-211923	0485	1	F	Update FR2 MU and TT in 38.521-2	16.7.0
2021-03	RAN#91	R5-211924	0490	1	F	CR to 38.521-2 on PC1 Measurement Grid MUs	16.7.0
2021-03	RAN#91	R5-211925	0492	1	F	Update of ETC MTSU	16.7.0
2021-06	RAN#92	R5-212225	0496	-	F	Configured transmitter power for UL power boosting	16.8.0
2021-06	RAN#92	R5-212226	0497	-	F	In-band emissions for UL power boosting	16.8.0
2021-06	RAN#92	R5-212227	0498	-	F	Output power dynamics for CA	16.8.0
2021-06	RAN#92	R5-212229	0500	-	F	Occupied bandwidth for CA	16.8.0
2021-06	RAN#92	R5-212230	0501	-	F	Spectrum emission mask for CA	16.8.0
2021-06	RAN#92	R5-212231	0502	-	F	Adjacent channel leakage ratio for CA	16.8.0
2021-06	RAN#92	R5-212233	0504	-	F	Spurious emission band UE co-existence for CA	16.8.0
2021-06	RAN#92	R5-212341	0505	-	F	FR2 MPR - Test configuration correction	16.8.0

2021-06	RAN#92	R5-212342	0506	-	F	Removal of requirement for EIRP measurement in the transmitter spurious emission test cases	16.8.0
2021-06	RAN#92	R5-212343	0507	-	F	Test limits update for MOP spherical coverage test case 6.2.1.2	16.8.0
2021-06	RAN#92	R5-212351	0508	-	F	ACS and IBB - FR2 MU definition in 38.521-2	16.8.0
2021-06	RAN#92	R5-212523	0510	-	F	Update of the test configuration for 6.5D.1 Occupied Bandwidth for UL MIMO test case	16.8.0
2021-06	RAN#92	R5-212814	0515	-	F	Updated CA NS 201 202 203 for additional spurious emission	16.8.0
2021-06	RAN#92	R5-212815	0516	-	F	Align CA spurious emission UE coex requirements with core spec	16.8.0
2021-06	RAN#92	R5-212829	0519	-	F	Correction of 7.6 for test of blocking characteristics	16.8.0
2021-06	RAN#92	R5-212858	0521	-	F	Removal of brackets for the Configured transmitted power requirements	16.8.0
2021-06	RAN#92	R5-212859	0522	-	F	Removal of test cases in 6.3A.2	16.8.0
2021-06	RAN#92	R5-212861	0524	-	F	Correction of definition for bit 1 of modifiedMPRbehavior field of n28	16.8.0
2021-06	RAN#92	R5-212975	0531	-	F	Updating H.2.2 for NR SA FR2 testing	16.8.0
2021-06	RAN#92	R5-213309	0545	-	F	Update of output power dynamic test cases	16.8.0
2021-06	RAN#92	R5-213319	0546	-	F	Update of Spectrum Emission Mask for UL MIMO test case	16.8.0
2021-06	RAN#92	R5-213325	0549	-	F	Editorial Correction to FR2 frequency sub-group definitions	16.8.0
2021-06	RAN#92	R5-213329	0552	-	F	EIS Requirements update for Rel.16 Inter-band CA	16.8.0
2021-06	RAN#92	R5-213333	0555	-	F	Align MBR requirements table with current core spec	16.8.0
2021-06	RAN#92	R5-213836	0511	1	F	Correction of power control in 38.521-2	16.8.0
2021-06	RAN#92	R5-213837	0540	1	F	FR2 Carrier Aggregation Minimum Output power updates	16.8.0
2021-06	RAN#92	R5-213838	0548	1	F	Implementation of PCC Prio test procedure updates in UL-CA tests	16.8.0
2021-06	RAN#92	R5-213839	0535	1	F	CR to 38.521-2 on Optional 4x2 PC3 Antenna Array Configuration	16.8.0
2021-06	RAN#92	R5-213840	0536	1	F	CR to 38.521-2 on larger quiet zone with grey-box approach	16.8.0
2021-06	RAN#92	R5-213841	0537	1	F	CR to 38.521-2 to clarify BP Searches for NTC and ETC	16.8.0
2021-06	RAN#92	R5-213842	0539	1	F	Measurement uncertainties and test tolerances for FR2 Relative and aggregate power tolerance	16.8.0
2021-06	RAN#92	R5-213895	0509	1	F	Update of the test configuration for 6.4A.2.1 EVM CA test cases	16.8.0
2021-06	RAN#92	R5-213896	0514	1	F	Update to FR2 test case title in clause 6	16.8.0
2021-06	RAN#92	R5-213897	0518	1	F	Correction of 6.2.3 for mapping of network signalling label	16.8.0
2021-06	RAN#92	R5-213898	0523	1	F	Correction of Test applicability of 6.4.2.5	16.8.0
2021-06	RAN#92	R5-213899	0526	1	F	Correction of clause titles with appropriate styles	16.8.0
2021-06	RAN#92	R5-213900	0529	1	F	Editorial correction of AMPR and Additional spurious emission	16.8.0
2021-06	RAN#92	R5-213901	0530	1	F	Clean up of CA sub-titles	16.8.0
2021-06	RAN#92	R5-213902	0541	1	F	Clarifications on UE beamlock function applicability	16.8.0
2021-06	RAN#92	R5-213903	0538	1	F	CR to 38.521-2 on Temperature Tolerance for FR2 Testing	16.8.0
2021-06	RAN#92	R5-213904	0542	1	F	Annex C: Clarifications to downlink signal levels	16.8.0
2021-06	RAN#92	R5-213984	0550	1	F	Add n259 definition in common section	16.8.0
2021-06	RAN#92	R5-214011	0495	1	F	Introduction of FR2 DL 256QAM to Maximum input level for CA	16.8.0
2021-06	RAN#92	R5-214028	0503	1	F	Spurious emissions for CA	16.8.0
2021-06	RAN#92	R5-214029	0551	1	F	Update with Rel16 Beam Correspondence requirements	16.8.0
2021-06	RAN#92	R5-214048	0512	1	F	Correction of ON OFF time mask in 38.521-2	16.8.0
2021-06	RAN#92	R5-214049	0525	1	F	Removal of for further study notes about ETC testing	16.8.0
2021-06	RAN#92	R5-214050	0554	1	F	Addition of missing clauses for SA FR2 UL-CA scenarios	16.8.0
2021-06	RAN#92	R5-214051	0534	1	F	Measurement Uncertainties updates for FR2 Extreme Testing Conditions	16.8.0
2021-06	RAN#92	R5-214078	0517	1	F	Updated spurious emission CA test configuration table	16.8.0
2021-06	RAN#92	R5-214104	0499	1	F	Transmit signal quality for CA	16.8.0
2021-09	RAN#93	R5-214605	0572	-	F	Removal of empty cells in the test configuration table	16.9.0
2021-09	RAN#93					Removal of brackets from the Minimum Conformance Requirements of Reference sensitivity power level for Intra-band non-contiguous CA	16.9.0
2021-09	RAN#93	R5-214606	0573	-	F		
2021-09	RAN#93	R5-214608	0575	-	F	Move the definition of cumulative aggregated channel bandwidth to the Definitions section	16.9.0
2021-09	RAN#93	R5-214910	0582	-	F	Editorial correction to Reference sensitivity power level for Inter-band CA	16.9.0
2021-09	RAN#93					Transmit ON/OFF time mask test configuration for non-contiguous CA	16.9.0
2021-09	RAN#93	R5-214914	0586	-	F		
2021-09	RAN#93	R5-214915	0587	-	F	Frequency error for non-contiguous CA	16.9.0
2021-09	RAN#93	R5-215056	0590	-	F	Update to time mask for FR2 UL-MIMO	16.9.0
2021-09	RAN#93					Correction to MU and TT for spurious emission band UE co-existence	16.9.0
2021-09	RAN#93	R5-215329	0598	-	F		
2021-09	RAN#93	R5-215473	0605	-	F	Clarification of PCC for FR2 DL CA	16.9.0
2021-09	RAN#93	R5-215474	0606	-	F	Correction of common UL configuration	16.9.0
2021-09	RAN#93					Minor correction on UL additional reference channels parameters for TDD 60kHz SCS	16.9.0
2021-09	RAN#93	R5-215517	0609	-	F		
2021-09	RAN#93	R5-215583	0618	-	F	MTSU and TT mapping related to Max Device Size	16.9.0
2021-09	RAN#93	R5-215584	0619	-	F	MTSU and TT mapping related to Max Device Size	16.9.0
2021-09	RAN#93	R5-215585	0620	-	F	MTSU and TT mapping related to Max Device Size	16.9.0
2021-09	RAN#93	R5-215618	0622	-	F	EIS spherical coverage for inter-band CA	16.9.0
2021-09	RAN#93					Updates to CSI-RS based beam correspondence minimum requirements	16.9.0
2021-09	RAN#93	R5-215636	0628	-	F		

2021-09	RAN#93	R5-215637	0629	-	F	Updates to SSB based beam correspondence minimum requirements	16.9.0
2021-09	RAN#93	R5-215641	0630	-	F	Text correction to section clarifying leverage from NSA test coverage	16.9.0
2021-09	RAN#93	R5-215830	0612	1	F	FR2 SA UL MIMO measurement uncertainties and test tolerances updates	16.9.0
2021-09	RAN#93	R5-215831	0614	1	F	Editorial correction for Receiver Spurious Emissions Measurement Uncertainty	16.9.0
2021-09	RAN#93	R5-215848	0558	1	F	Introduction of new clause 6.3A.4.4 and Minimum conformance requirements	16.9.0
2021-09	RAN#93	R5-215849	0565	1	F	Introduction of new TC 6.3A.4.4.1 Aggregate power tolerance for CA (2UL CA)	16.9.0
2021-09	RAN#93	R5-215850	0566	1	F	Introduction of new TC 6.3A.4.4.2 Aggregate power tolerance for CA (3UL CA)	16.9.0
2021-09	RAN#93	R5-215851	0567	1	F	Introduction of new TC 6.3A.4.4.3 Aggregate power tolerance for CA (4UL CA)	16.9.0
2021-09	RAN#93	R5-215852	0568	1	F	Introduction of new TC 6.3A.4.4.4 Aggregate power tolerance for CA (5UL CA)	16.9.0
2021-09	RAN#93	R5-215853	0569	1	F	Introduction of new TC 6.3A.4.4.5 Aggregate power tolerance for CA (6UL CA)	16.9.0
2021-09	RAN#93	R5-215854	0570	1	F	Introduction of new TC 6.3A.4.4.6 Aggregate power tolerance for CA (7UL CA)	16.9.0
2021-09	RAN#93	R5-215855	0571	1	F	Introduction of new TC 6.3A.4.4.7 Aggregate power tolerance for CA (8UL CA)	16.9.0
2021-09	RAN#93	R5-215856	0580	1	F	Addition of new test case 6.4D.1 Frequency error for UL MIMO in FR2	16.9.0
2021-09	RAN#93	R5-215857	0581	1	F	Update of test case 6.4D.3 Time alignment error for UL MIMO in FR2	16.9.0
2021-09	RAN#93	R5-215858	0591	1	F	Cleaning up the specification skeleton	16.9.0
2021-09	RAN#93	R5-215859	0593	1	F	Editorial corrections for various test cases	16.9.0
2021-09	RAN#93	R5-215860	0595	1	F	Correction of FR2 Carrier Leakage Test Case	16.9.0
2021-09	RAN#93	R5-215861	0599	1	F	Editors note correction to reference sensitivity for CA	16.9.0
2021-09	RAN#93	R5-215862	0589	1	F	Update of FR2 UL RMCs	16.9.0
2021-09	RAN#93	R5-215925	0603	1	F	Correct the abbreviations for network signalling value in 38.521-2	16.9.0
2021-09	RAN#93	R5-215975	0588	1	F	Transmit modulation quality for non-contiguous CA	16.9.0
2021-09	RAN#93	R5-215976	0576	1	F	Update Minimum conformance requirement clause 7.4A.0 for Rel-16 Enhancement	16.9.0
2021-09	RAN#93	R5-215977	0577	1	F	Addition of clause 7.5A.0 minimum conformance requirement for Rel-16 Enhancement WP	16.9.0
2021-09	RAN#93	R5-215978	0578	1	F	Addition of clause 7.6A.2.0 minimum conformance requirement for Rel-16 Enhancement WP	16.9.0
2021-09	RAN#93	R5-215979	0623	1	F	DL CA BW Enhancement and CA REFSENS	16.9.0
2021-09	RAN#93	R5-215980	0627	1	F	Common clause updates to cover Rel.16 FR2 changes	16.9.0
2021-09	RAN#93	R5-216036	0611	1	F	FR2 SA UL MIMO Out-of-band emissions initial conditions updates	16.9.0
2021-09	RAN#93	R5-216037	0613	1	F	FR2 SA UL MIMO Maximum Power Reduction update	16.9.0
2021-09	RAN#93	R5-216063	0602	1	F	Update of 5.5A.1 for intra-band contiguous CA configuration table	16.9.0
2021-09	RAN#93	R5-216081	0626	1	F	Updates to Rel.16 enhanced Beam Correspondence test	16.9.0
2021-09	RAN#93	R5-216087	0556	1	F	Update to FR2 minimum output power test case	16.9.0
2021-09	RAN#93	R5-216088	0557	1	F	Update to FR2 ACLR test case	16.9.0
2021-09	RAN#93	R5-216089	0592	1	F	Add missing LO retrieval step in ULCA carrier leakage test procedure	16.9.0
2021-09	RAN#93	R5-216090	0594	1	F	FR2 Spur emissions test config table updates and editor notes clean up	16.9.0
2021-09	RAN#93	R5-216091	0596	1	F	Correction of power control in 38.521-2	16.9.0
2021-09	RAN#93	R5-216092	0625	1	F	38.521-2 CR FR2 ETC MU & TT updates	16.9.0
2021-09	RAN#93	R5-216111	0621	1	F	UE maximum output power for UL-MIMO	16.9.0
2021-12	RAN#94	R5-216546	0631	-	F	Addition of test configuration for FR2 DL 256QAM to Maximum input level	16.10.0
2021-12	RAN#94	R5-217092	0636	-	F	Update Rx beam peak direction search	16.10.0
2021-12	RAN#94	R5-217093	0637	-	F	Update of Reference Sensitivity Test Cases for CA	16.10.0
2021-12	RAN#94	R5-217113	0638	-	F	FR2 Refsens correction for power class 2	16.10.0
2021-12	RAN#94	R5-217114	0639	-	F	FR2 EIS spherical coverage correction for power class 2	16.10.0
2021-12	RAN#94	R5-217248	0645	-	F	Correction of note for BEAM_SELECT_WAIT_TIME	16.10.0
2021-12	RAN#94	R5-217249	0646	-	F	Correction of clause style, number and position	16.10.0
2021-12	RAN#94	R5-217250	0647	-	F	Correction of Table 6.2.2.4.1-9 for Test Frequency	16.10.0
2021-12	RAN#94	R5-217331	0651	-	F	Correction to test requirements of 6.2D.2 MPR for UL-MIMO	16.10.0
2021-12	RAN#94	R5-217333	0653	-	F	Removing 6.3D.3.4.5 SRS time mask for MIMO	16.10.0
2021-12	RAN#94	R5-217341	0654	-	F	Correction of 3.2 and 3.3 for symbols and abbreviations	16.10.0
2021-12	RAN#94	R5-217419	0658	-	F	Correction of test configuration table in 6.3.4.2	16.10.0
2021-12	RAN#94	R5-217420	0659	-	F	Correction of aggregate power tolerance	16.10.0
2021-12	RAN#94	R5-217421	0660	-	F	Correction of core requirement of aggregate power tolerance	16.10.0
2021-12	RAN#94	R5-217614	0665	-	F	Update to FR2 Tx test cases for n260	16.10.0
2021-12	RAN#94	R5-217708	0671	-	F	FR2 Extreme Temperature Conditions applicability for ACLR	16.10.0
2021-12	RAN#94	R5-217709	0672	-	F	Minimum Output Power Editor notes review	16.10.0

2021-12	RAN#94	R5-217710	0673	-	F	38.521-2 FR2 Extreme Temperature Conditions applicability for UL-MIMO	16.10.0
2021-12	RAN#94	R5-218234	0644	1	F	Correction of exception of message contents for DFT-s-OFDM modulation	16.10.0
2021-12	RAN#94	R5-218235	0650	1	F	Global correction of test cases except those having impact on ETSI EN 301 908 25	16.10.0
2021-12	RAN#94	R5-218236	0652	1	F	Correction to testability statement of 6.5.2.3 ACLR	16.10.0
2021-12	RAN#94	R5-218237	0656	1	F	Correction of 6.2.4 for configured transmitted power	16.10.0
2021-12	RAN#94	R5-218238	0664	1	F	Correction to FR2 Rx test cases	16.10.0
2021-12	RAN#94	R5-218239	0669	1	F	Clarification on reference sensitivity power level	16.10.0
2021-12	RAN#94	R5-218240	0635	1	F	Handling of fallbacks for FR2 CA	16.10.0
2021-12	RAN#94	R5-218241	0655	1	F	Correction of 4.1 and 4.2 for minimum requirements and test requirements	16.10.0
2021-12	RAN#94	R5-218366	0678	1	F	Updates to CSI-RS based beam correspondence minimum requirements	16.10.0
2021-12	RAN#94	R5-218367	0679	1	F	Updates to SSB based beam correspondence minimum requirements	16.10.0
2021-12	RAN#94	R5-218368	0633	1	F	MTSUs for Rel-16 RF Enhancement for FR2	16.10.0
2021-12	RAN#94	R5-218369	0634	1	F	TTs for Rel-16 RF Enhancement for FR2	16.10.0
2021-12	RAN#94	R5-218401	0662	1	F	Update of transmit modulation quality test cases	16.10.0
2021-12	RAN#94	R5-218407	0670	1	F	38.521-2 Beam correspondence Measurement Uncertainties	16.10.0
2021-12	RAN#94	R5-218425	0640	1	F	Spur emissions coex test config update and editor notes clean up	16.10.0
2021-12	RAN#94	R5-218426	0641	1	F	Clarify DL CC config for UL CA test	16.10.0
2021-12	RAN#94	R5-218427	0642	1	F	Update Minimum Output Power requirement	16.10.0
2021-12	RAN#94	R5-218428	0643	1	F	Alignment of the description for initial set up of downlink and uplink signals	16.10.0
2021-12	RAN#94	R5-218429	0648	1	F	Correction of test cases having impact on ETSI EN 301 908 25	16.10.0
2021-12	RAN#94	R5-218430	0649	1	F	Correction of test configuration for CA test cases	16.10.0
2021-12	RAN#94	R5-218431	0667	1	F	Update of test case 6.2.3 A-MPR	16.10.0
2021-12	RAN#94	R5-218432	0668	1	F	Update of test case 6.5.3.3 A-Spurious	16.10.0
2021-12	RAN#94	R5-218474	0676	1	F	Enhanced Beam Correspondence test updates	16.10.0
2021-12	RAN#94	R5-218475	0677	1	F	Common clause updates to cover Rel.16 FR2 changes	16.10.0
2021-12	RAN#94	R5-218484	0675	1	F	Rel.15 Beam Correspondence Updates and clarifications	16.10.0
2022-03	RAN#95	R5-220256	0684	-	F	FR2 Frequency error tests - unify requirements per polarization	16.11.0
2022-03	RAN#95	R5-220257	0685	-	F	Test limit correction in FR2 MPR test case	16.11.0
2022-03	RAN#95	R5-220258	0686	-	F	RX beam peak direction search procedure update in case of intra-band DL CA	16.11.0
2022-03	RAN#95	R5-220259	0687	-	F	Updated reference to FR2 connection diagram in tests using modulated interferer	16.11.0
2022-03	RAN#95	R5-220274	0688	-	F	Clarifications on 5G NR connectivity options for RF FR2	16.11.0
2022-03	RAN#95	R5-220791	0693	-	F	Update to 6.2D.1 for ULFP Tx	16.11.0
2022-03	RAN#95	R5-220792	0694	-	F	Update to 6.2D.2 for ULFP Tx	16.11.0
2022-03	RAN#95	R5-220793	0695	-	F	Update to 6.2D.4 for ULFP Tx	16.11.0
2022-03	RAN#95	R5-220908	0698	-	F	Correction to test procedure of 6.4A.1.1	16.11.0
2022-03	RAN#95	R5-221060	0699	-	F	Update of 6.2A.1 for UE maximum output power	16.11.0
2022-03	RAN#95	R5-221061	0700	-	F	Update of 6.2.3 for UE maximum output power with additional requirements	16.11.0
2022-03	RAN#95	R5-221063	0702	-	F	Update of 6.2A.4 for configured transmitted power for CA	16.11.0
2022-03	RAN#95	R5-221111	0704	-	F	Editorial correction to titles of FR2 test cases	16.11.0
2022-03	RAN#95	R5-221112	0705	-	F	Update to test applicability to FR2 test cases	16.11.0
2022-03	RAN#95	R5-221269	0706	-	F	Correction of ON OFF time mask test cases for FR2	16.11.0
2022-03	RAN#95	R5-221334	0709	-	F	Removing TP analysis editor note for FR2 Tx spur emission UL MIMO test case	16.11.0
2022-03	RAN#95	R5-221338	0710	-	F	Update to clause 7.6 Blocking Characteristics	16.11.0
2022-03	RAN#95	R5-221341	0712	-	F	Update to Intra-band non-contiguous CA	16.11.0
2022-03	RAN#95	R5-221354	0716	-	F	Update reference to intra-band non-contiguous UL-CA FR2 RF tests in Annex	16.11.0
2022-03	RAN#95	R5-221355	0717	-	F	Editorial correction in intra-band non-contiguous configurations table	16.11.0
2022-03	RAN#95	R5-221356	0718	-	F	Add correct test case structure to Beam Correspondence CA test case	16.11.0
2022-03	RAN#95	R5-221357	0719	-	F	Introduce EIS test cases to incorporate Rel.16 inter-band CA	16.11.0
2022-03	RAN#95	R5-221657	0707	2	F	38.521-2 Beam correspondence Measurement Uncertainties and test tolerances	16.11.0
2022-03	RAN#95	R5-221685	0683	1	F	Correction of test config tables of non-CA test cases for consistency with CA test cases on without RB allocation case	16.11.0
2022-03	RAN#95	R5-221686	0689	1	F	FR2 SA EVM test case update based on MU and TT analysis	16.11.0
2022-03	RAN#95	R5-221687	0696	1	F	Correction of general ON OFF time mask	16.11.0
2022-03	RAN#95	R5-221688	0697	1	F	Correction to FR2 absolute power tolerance MU and TT	16.11.0
2022-03	RAN#95	R5-221689	0681	1	F	Removal of empty lines in Table 7.3.2.3.2-1 and Table 7.3.2.5-2	16.11.0
2022-03	RAN#95	R5-221690	0703	1	F	Correction to PDCCH DCI format for FR2 test cases	16.11.0
2022-03	RAN#95	R5-221691	0711	1	F	Update to clause 7.5 Adjacent channel selectivity	16.11.0
2022-03	RAN#95	R5-221692	0682	1	F	Correction of the table title style of Table 5.5A.3-1	16.11.0

2022-03	RAN#95	R5-221766	0701	1	F	Update of 6.2A.2 for UE maximum output power reduction for CA	16.11.0
2022-03	RAN#95	R5-221792	0708	1	F	ETC for FR2 RF CA	16.11.0
2022-03	RAN#95	R5-221889	0714	1	F	FR2 Enhanced Beam Correspondence test updates	16.11.0
2022-03	RAN#95	R5-221890	0715	1	F	Minimum Conformance Requirements updates to enhanced beam correspondence	16.11.0
2022-06	RAN#96	R5-222198	0720	-	F	Correction of table numbers in 6.2D.2.5	16.12.0
2022-06	RAN#96	R5-222199	0721	-	F	Correction of Test Environment for UL MIMO MPR test case	16.12.0
2022-06	RAN#96	R5-222342	0723	-	F	Beam peak search - re-positioning formula correction	16.12.0
2022-06	RAN#96	R5-222488	0731	-	F	Editorial correction for Tx test cases	16.12.0
2022-06	RAN#96	R5-222544	0733	-	F	Update of A-MPR and A-SE test cases	16.12.0
2022-06	RAN#96	R5-222879	0736	-	F	Update to FR2 6.2.3 A-MPR	16.12.0
2022-06	RAN#96	R5-223122	0749	-	F	Addition of FR2 6.2D.3 for ULFPTx	16.12.0
2022-06	RAN#96	R5-223258	0752	-	F	Correction of FR2 MOP and beam correspondence test cases	16.12.0
2022-06	RAN#96	R5-223617	0728	1	F	Update FR2 TRx MU in 38.521-2	16.12.0
2022-06	RAN#96	R5-223749	0726	1	F	Common Uplink Configuration updates for NR RF requirement enhancements for FR2	16.12.0
2022-06	RAN#96	R5-223750	0740	1	F	FR2 Enhanced Beam Correspondence test updates	16.12.0
2022-06	RAN#96	R5-223751	0742	1	F	Updates across Spherical Coverage test cases to incorporate Rel.16 requirements	16.12.0
2022-06	RAN#96	R5-223752	0748	1	F	Test case updates in Max Input Level FR2 CA tests	16.12.0
2022-06	RAN#96	R5-223814	0724	1	F	Rel-15 MPR updates	16.12.0
2022-06	RAN#96	R5-223815	0725	1	F	Common Uplink Configuration updates for Rel-15 FR2	16.12.0
2022-06	RAN#96	R5-223816	0732	1	F	Correction to DCI format in signal quality TCs	16.12.0
2022-06	RAN#96	R5-223817	0739	1	F	Implement test function approach to limit Pcell Power in FR2 UL-CA tests	16.12.0
2022-06	RAN#96	R5-223818	0750	1	F	Correction to 6.2.1.1 for multi-band relaxation factors for PC3 UE	16.12.0
2022-06	RAN#96	R5-223819	0755	1	F	Clarification on Configured transmitted power	16.12.0
2022-06	RAN#96	R5-223820	0757	1	F	Implementation of FR2 single carrier Tx beam peak applicability for UL MIMO Tx tests	16.12.0
2022-06	RAN#96	R5-223821	0761	1	F	Editorial correction to test requirement of FR2 test cases	16.12.0
2022-06	RAN#96	R5-223822	0754	1	F	Clarification on Adjacent channel selectivity	16.12.0
2022-06	RAN#96	R5-223823	0758	1	F	Clarification on In-band blocking	16.12.0
2022-06	RAN#96	R5-223824	0730	1	F	Editorial correction in Annex	16.12.0
2022-06	RAN#96	R5-223825	0734	1	F	Correction of TRP Measurement Grids	16.12.0
2022-06	RAN#96	R5-223826	0735	1	F	CR on applicability per permitted test method	16.12.0
2022-06	RAN#96	R5-223827	0743	1	F	Correction to FR2 DL RMCs	16.12.0
2022-06	RAN#96	R5-223828	0744	1	F	Initial introduction of fast spherical coverage test method	16.12.0
2022-06	RAN#96	R5-223829	0745	1	F	Initial introduction of RSRP-B based Rx Peak Beam Search	16.12.0
2022-06	RAN#96	R5-223830	0746	1	F	Initial introduction of Enhanced EIRP measurement method	16.12.0
2022-06	RAN#96	R5-223831	0751	1	F	Correction to A.2.3 and A.3.3 for UL and DL RMCs	16.12.0
2022-06	RAN#96	R5-223832	0760	1	F	Clarification on UE Channel bandwidth per operating band for CA	16.12.0
2022-09	RAN#97	R5-224247	0772	-	F	Correction of the SCS value in Table 5.3.5-1 for n259	16.13.0
2022-09	RAN#97	R5-224247	0772	-	F	Correction of the SCS value in Table 5.3.5-1 for n259	16.13.0
2022-09	RAN#97	R5-224248	0773	-	F	Correction of the clause numbers and table numbers in 7.3A.3	16.13.0
2022-09	RAN#97	R5-224303	0775	-	F	PUCCH format correction to test DFT-s-OFDM in FR2	16.13.0
2022-09	RAN#97	R5-224305	0777	-	F	FR2 SA EVM test case update based on TT analysis	16.13.0
2022-09	RAN#97	R5-224907	0787	-	F	Reference sensitivity power level for CA, editor notes update on ETC	16.13.0
2022-09	RAN#97	R5-225107	0794	-	F	Update of spurious emissions test cases	16.13.0
2022-09	RAN#97	R5-225205	0797	-	F	CR to update validation test frequencies and sub-ranges	16.13.0
2022-09	RAN#97	R5-225607	0798	1	F	Addition of new test case 6.2.2_1 for FR2 MPR enhancements	16.13.0
2022-09	RAN#97	R5-225658	0762	1	F	New test case addition: 6.2.4_1 Configured transmitted power with Power Boost	16.13.0
2022-09	RAN#97	R5-225659	0765	1	F	Enhanced Beam correspondence Measurement Uncertainties and test tolerances	16.13.0
2022-09	RAN#97	R5-225660	0764	1	F	Measurement uncertainties and test tolerances for test case 6.2.4_1 Configured transmitted power with Power Boost	16.13.0
2022-09	RAN#97	R5-225664	0776	1	F	PC1 - MU and TT definition for MOP in 38.521-2	16.13.0
2022-09	RAN#97	R5-225665	0778	1	F	PC1 - MU and TT definition for REFSSENS in 38.521-2	16.13.0
2022-09	RAN#97	R5-225666	0767	1	F	Updates to Spherical Coverage annexes	16.13.0
2022-09	RAN#97	R5-225667	0780	1	F	Definition of PC1 MU and relaxation	16.13.0
2022-09	RAN#97	R5-225679	0779	1	F	Update of FR2 5 to 8UL CA Test Cases	16.13.0
2022-09	RAN#97	R5-225680	0766	1	F	Updates related to TPMI test methods	16.13.0
2022-09	RAN#97	R5-225719	0774	1	F	Applicable NR-ARFCN correction for n259	16.13.0
2022-09	RAN#97	R5-225743	0763	1	F	In-band emissions minimum conformance requirements update	16.13.0
2022-09	RAN#97	R5-225744	0786	1	F	Reference sensitivity power level for CA, update on intra-band non-continuous CA	16.13.0
2022-09	RAN#97	R5-225792	0768	1	F	Tx Fast Spherical Coverage test cases integration	16.13.0
2022-09	RAN#97	R5-225793	0771	1	F	FR2 Tx Signal Quality UL MIMO Test Case Updates	16.13.0
2022-09	RAN#97	R5-225794	0795	1	F	Correction of spurious emissions test case	16.13.0
2022-09	RAN#97	R5-225795	0800	1	F	Updated Test points in FR2 CA MPR test case	16.13.0
2022-09	RAN#97	R5-225796	0769	1	F	Rx Fast Spherical Coverage test cases integration	16.13.0
2022-09	RAN#97	R5-225797	0785	1	F	Correction to interfere offset in 7.6.2	16.13.0

2022-09	RAN#97	R5-225798	0770	1	F	Annex updates related to RSRP-B Rx Beam peak search	16.13.0
2022-09	RAN#97	R5-225843	0796	1	F	Update to FR2 CA MPR test case 6.2A.2.1 to prevent SCell drop by using UE PHR	16.13.0
2022-09	RAN#97	R5-225844	0799	1	F	Extension of test function approach to limit Pcell Power in some FR2 UL CA tests	16.13.0
2022-09	RAN#97	R5-225845	0784	1	F	Correction to test procedure of minimum output power	16.13.0
2022-09	RAN#97	R5-225870	0782	1	F	Correction to EVM measurement point for DFTs-OFDM DM-RS Type 2	16.13.0
2022-09	RAN#97	R5-225771	0788	1	F	HST FR2 6.2.3 UE maximum output power with additional requirements	17.0.0
2022-09	RAN#97	R5-225772	0789	1	F	HST FR2 6.2D.1.1 adding Release-17 FR2 PC6 UE maximum output power for UL MIMO	17.0.0
2022-09	RAN#97	R5-225773	0790	1	F	HST FR2 6.3.1 adding Release-17 FR2 PC6 Minimum output power	17.0.0
2022-09	RAN#97	R5-225774	0791	1	F	HST FR2 6.4.2.2 adding Release-17 FR2 PC6 Carrier leakage	17.0.0
2022-09	RAN#97	R5-225775	0792	1	F	HST FR2 6.4.2.3 adding Release-17 FR2 PC6 In-band emissions	17.0.0
2022-10	RAN#97	-	-	-	-	history table correction concerning the Rel-17 CRs	17.0.1
2022-12	RAN#98	R5-225966	0804		F	Definitions and symbols for further FR2 enhancements	17.1.0
2022-12	RAN#98	R5-226838	0830		F	Clarification on Maximum input and ACS and IBB for FR2 DL intra and inter combinations	17.1.0
2022-12	RAN#98	R5-227375	0859		F	Editorial clean-up of Pending R15 FR2 CA configs from cl 7 of SA FR2 RF test specification	17.1.0
2022-12	RAN#98	R5-227762	0841	1	F	TRP measurement addition in test 6.2.1.1_1	17.1.0
2022-12	RAN#98	R5-227763	0821	1	F	Editorial correction of clause styles and clause numbers in 6.2.2_1 and 6.2.4_1	17.1.0
2022-12	RAN#98	R5-227764	0802	1	F	Editorial correction to EIS spherical coverage	17.1.0
2022-12	RAN#98	R5-227765	0822	1	F	Editorial correction for 6.4D.2.1.4	17.1.0
2022-12	RAN#98	R5-227766	0857	1	F	Editorial clean-up of Pending R15 FR2 CA configs from cl 5 of SA FR2 RF test specification	17.1.0
2022-12	RAN#98	R5-227767	0861	1	F	Editorial clean-up of Pending R16 FR2 CA configs from cl 6 of SA FR2 RF test specification	17.1.0
2022-12	RAN#98	R5-227769	0860	1	F	Editorial clean-up of Pending R16 FR2 CA configs from cl 5 of SA FR2 RF test specification	17.1.0
2022-12	RAN#98	R5-227770	0858	1	F	Editorial clean-up of Pending R15 FR2 CA configs from cl 6 of SA FR2 RF test specification	17.1.0
2022-12	RAN#98	R5-227771	0811	1	F	CBW requirement correction for Carrier Leakage FR2 UL CA test cases	17.1.0
2022-12	RAN#98	R5-227772	0866	1	F	Pending updates to clause 7 of SA FR2 spec related to FR2 RF enhancements in Rel16	17.1.0
2022-12	RAN#98	R5-227773	0856	1	F	Introduce FR2 RF test case for UE phase continuity requirements when UE supports DMRS bundling	17.1.0
2022-12	RAN#98	R5-227774	0855	1	F	Introduce framework for UL-Gaps related Tx Power tests	17.1.0
2022-12	RAN#98	R5-227775	0838	1	F	Updates to test 6.2.2_1 UE maximum output power reduction enhancements	17.1.0
2022-12	RAN#98	R5-227776	0845	1	F	Updates to PHR configuration	17.1.0
2022-12	RAN#98	R5-227777	0824	1	F	FR2 Redcap UL configuration and UE type definition	17.1.0
2022-12	RAN#98	R5-227782	0803	1	F	Update of Maximum input level for CA	17.1.0
2022-12	RAN#98	R5-227785	0823	1	F	Addition of clause 7.6.2.0	17.1.0
2022-12	RAN#98	R5-227819	0836	1	F	Measurement uncertainties and test tolerances for mpr-PowerBoost tests 6.4.2.1_1, 6.5.2.1_1, 6.5.3.1_1, 6.5.3.2_1 and 6.5.3.3_1	17.1.0
2022-12	RAN#98	R5-227910	0832	1	F	New test case addition: 6.5.2.1_1 Spectrum Emission Mask with Power Boost	17.1.0
2022-12	RAN#98	R5-227911	0831	1	F	New test case addition: 6.4.2.1_1 Error vector magnitude with Power Boost	17.1.0
2022-12	RAN#98	R5-227941	0854	1	F	Test procedure update for Reference sensitivity power level for CA (2DL CA) for inter-band DL CA	17.1.0
2022-12	RAN#98	R5-227944	0839	1	F	SSB-based and CSI-RS based L1-RSRP measurements side conditions clarifications in test 6.2.1.1	17.1.0
2022-12	RAN#98	R5-227945	0840	1	F	SSB-based and CSI-RS based L1-RSRP measurements side conditions clarifications in test 6.6.1	17.1.0
2022-12	RAN#98	R5-227960	0812	1	F	PC1 - ACLR test case update in 38.521-2	17.1.0
2022-12	RAN#98	R5-227961	0815	1	F	PC1 - MOP test case update in 38.521-2	17.1.0
2022-12	RAN#98	R5-227962	0818	1	F	PC1 - OFF power test case update in 38.521-2	17.1.0
2022-12	RAN#98	R5-227963	0820	1	F	PC1 - SEM test case update in 38.521-2	17.1.0
2022-12	RAN#98	R5-227964	0813	1	F	PC1 - ACS and IBB test case update in 38.521-2	17.1.0
2022-12	RAN#98	R5-227965	0819	1	F	PC1 - REFSENS test case update in 38.521-2	17.1.0
2022-12	RAN#98	R5-227985	0842	1	F	Definition of PC1 MU and TT	17.1.0
2022-12	RAN#98	R5-227641	0843	2	F	Definition of TRP grids for spurious emissions for PC1	17.1.0
2022-12	RAN#98	R5-228031	0844	1	F	Addition of new Annex Q for Difference of relative phase and power errors	17.1.0
2022-12	RAN#98	R5-228037	0833	1	F	New test case addition: 6.5.3.1_1 Transmitter Spurious emissions with Power Boost	17.1.0
2022-12	RAN#98	R5-228038	0834	1	F	New test case addition: 6.5.3.2_1 Spurious emission band UE co-existence with Power Boost	17.1.0

2022-12	RAN#98	R5-228039	0835	1	F	New test case addition: 6.5.3.3_1 Additional spurious emissions with Power Boost	17.1.0
2022-12	RAN#98	R5-228041	0850	1	F	Updates on EIS spherical coverage for Power Classes 1, 2,3 and 4	17.1.0
2022-12	RAN#98	R5-228042	0852	1	F	Updates on Reference sensitivity for power class 1, 2 and 3	17.1.0
2022-12	RAN#98	R5-228043	0853	1	F	Updates on In-band blocking requirements	17.1.0
2023-03	RAN#99	R5-230214	0879	-	F	Correction of RB allocation in MPR and ACLR for PC1	17.2.0
2023-03	RAN#99	R5-230563	0882	-	F	Editorial correction for style of clause title in 6.2.4 and 6.2.5	17.2.0
2023-03	RAN#99	R5-230566	0885	-	F	Addition of clause F.1.0	17.2.0
2023-03	RAN#99	R5-230839	0894	-	F	Updates on aggregate channel bandwidth EIS relaxation	17.2.0
2023-03	RAN#99	R5-230840	0895	-	F	Updates on Adjacent Channel Selectivity (ACS)	17.2.0
2023-03	RAN#99	R5-230841	0896	-	F	Updates on diversity characteristics	17.2.0
2023-03	RAN#99	R5-230976	0902	-	F	Correction to beam correspondence	17.2.0
2023-03	RAN#99	R5-231244	0903	-	F	Minor updates to UPLF activation in applicable UL CA test procedures	17.2.0
2023-03	RAN#99	R5-231285	0905	-	F	Additions to the definition of RedCap UE	17.2.0
2023-03	RAN#99	R5-231303	0907	-	F	Update of MOP with additional requirements	17.2.0
2023-03	RAN#99	R5-231371	0911	-	F	Update to FR2 RF phase continuity test	17.2.0
2023-03	RAN#99	R5-231373	0912	-	F	Updates to FR2 RF test case 6.2.5 for EIRP with UL-Gaps	17.2.0
2023-03	RAN#99	R5-231660	0867	1	F	Update of Maximum input level for CA	17.2.0
2023-03	RAN#99	R5-231661	0887	1	F	Correcting reference to BEAM SELECT WAIT TIME definition	17.2.0
2023-03	RAN#99	R5-231662	0888	1	F	Correcting reference to BEAM SELECT WAIT TIME definition	17.2.0
2023-03	RAN#99	R5-231663	0886	1	F	Correction of Typos in Annex	17.2.0
2023-03	RAN#99	R5-231664	0889	1	F	Correction of BPS references in SphCov Annex procedures	17.2.0
2023-03	RAN#99	R5-231665	0897	1	F	add test case configuration and requirements for 38.521-2 Tx 6.2.3	17.2.0
2023-03	RAN#99	R5-231666	0898	1	F	add test case configuration and requirements for 38.521-2 Tx 6.2D.1.1	17.2.0
2023-03	RAN#99	R5-231667	0899	1	F	add test case configuration and requirements for 38.521-2 Tx 6.3.1	17.2.0
2023-03	RAN#99	R5-231668	0900	1	F	add test case configuration and requirements for 38.521-2 Tx 6.4.2.2	17.2.0
2023-03	RAN#99	R5-231669	0901	1	F	add test case configuration and requirements for 38.521-2 Tx 6.4.2.3	17.2.0
2023-03	RAN#99	R5-231775	0876	1	F	PC5 - REFSSENS test cases update in 38.521-2	17.2.0
2023-03	RAN#99	R5-231776	0877	1	F	CR on PC5 Measurement Grids	17.2.0
2023-03	RAN#99	R5-231779	0868	1	F	PC1 - ACLR test case update in 38.521-2	17.2.0
2023-03	RAN#99	R5-231780	0870	1	F	PC1 - MOP test case update in 38.521-2	17.2.0
2023-03	RAN#99	R5-231781	0881	1	F	Update of PC1 MU and TT	17.2.0
2023-03	RAN#99	R5-231782	0873	1	F	PC1 - REFSSENS test cases update in 38.521-2	17.2.0
2023-03	RAN#99	R5-231791	0878	1	F	Definition of PC1 MU and TT	17.2.0
2023-03	RAN#99	R5-231837	0906	1	F	Corrections on CA MPR definition in FR2	17.2.0
2023-03	RAN#99	R5-231845	0871	1	F	PC1 - MPR test case update in 38.521-2	17.2.0
2023-03	RAN#99	R5-231846	0875	1	F	PC1 - TX spurious test cases update in 38.521-2	17.2.0
2023-03	RAN#99	R5-231852	0910	1	F	Inter-band DL CA updates	17.2.0
2023-03	RAN#99	R5-231866	0869	1	F	PC1 - Min power test case update in 38.521-2	17.2.0
2023-03	RAN#99	R5-231870	0908	1	F	Update to in-band blocking for CA	17.2.0
2023-03	RAN#99	R5-231873	0893	1	F	Adding FR2 Redcap UE MoP EIRP and TRP test cases	17.2.0
2023-03	RAN#99	R5-231881	0891	1	F	Removal of Tx beam peak direction reference in TX spherical coverage test procedure	17.2.0
2023-03	RAN#99	R5-231882	0890	1	F	Removal of Rx beam peak direction reference in RX spherical coverage test procedure	17.2.0
2023-03	RAN#99	R5-231886	0909	1	F	Updates to PHR method to avoid Scell drop	17.2.0
2023-03	RAN#99	R5-231890	0892	1	F	Update to test applicability of MPR	17.2.0
2023-03	RAN#99	R5-231967	0880	1	F	Update of the spurious emissions test cases	17.2.0
2023-06	RAN#100	R5-232170	0918	-	F	FR2 PC3 - Network Analyzer MU and TT update in 38.521-2	17.3.0
2023-06	RAN#100	R5-232356	0919	-	F	FR2 OBW CA - Test requirements misaligned with minimum requirements	17.3.0
2023-06	RAN#100	R5-232357	0920	-	F	1RB allocation increased to accommodate PHR in 2UL CA tests	17.3.0
2023-06	RAN#100	R5-232515	0921	-	F	HST FR2 6.2D.1.2 UE maximum output power - Spherical coverage for UL MIMO	17.3.0
2023-06	RAN#100	R5-232516	0922	-	F	HST FR2 6.3D.1 Minimum output power for UL MIMO	17.3.0
2023-06	RAN#100	R5-232617	0924	-	F	Adding FR2 Redcap Rx RefSens test case	17.3.0
2023-06	RAN#100	R5-232618	0925	-	F	Adding FR2 Redcap PC7 to Rx Test Config Tables	17.3.0
2023-06	RAN#100	R5-232632	0930	-	F	Clarification of QoQZ TRP Grids	17.3.0
2023-06	RAN#100	R5-232634	0931	-	F	Clarification of Example DUT Coordinate System	17.3.0
2023-06	RAN#100	R5-233024	0936	-	F	Adding noise impact of PC1 minimum output power in Annex F	17.3.0
2023-06	RAN#100	R5-233206	0944	-	F	Addition to the abbreviations on RedCap for FR2 UE	17.3.0
2023-06	RAN#100	R5-233219	0947	-	F	Corrections on the minimum guardband calculation for FR2	17.3.0
2023-06	RAN#100	R5-233225	0949	-	F	FR2 Spectrum Emission Mask test procedure update	17.3.0
2023-06	RAN#100	R5-233527	0940	1	F	Update of Additional Spurious Emissions CA test cases	17.3.0
2023-06	RAN#100	R5-233544	0937	1	F	Clarification of spurious emission testing configuration - Part 2	17.3.0
2023-06	RAN#100	R5-233551	0950	1	F	Update to FR2 RF phase continuity test	17.3.0
2023-06	RAN#100	R5-233552	0913	1	F	Adding RedCap UE FR2 PC7 Carrier leakage requirement	17.3.0
2023-06	RAN#100	R5-233553	0914	1	F	Adding RedCap UE FR2 PC7 In-band emissions requirement	17.3.0
2023-06	RAN#100	R5-233554	0939	1	F	Adding side condition of beam correspondence for PC7	17.3.0
2023-06	RAN#100	R5-233559	0953	1	F	Updates to FR2 CA EIS Sph Cov tests	17.3.0

2023-06	RAN#100	R5-233560	0952	1	F	Updates to FR2 CA Refsens tests	17.3.0
2023-06	RAN#100	R5-233561	0954	1	F	Updates to FR2 CA Max Input Level tests	17.3.0
2023-06	RAN#100	R5-233562	0941	1	F	Update of Additional MPR CA test cases	17.3.0
2023-06	RAN#100	R5-233578	0945	1	F	Corrections on test parameters for adjacent channel selectivity for FR2	17.3.0
2023-06	RAN#100	R5-233579	0946	1	F	Corrections on test parameters for blocking characteristics for FR2	17.3.0
2023-06	RAN#100	R5-233631	0915	1	F	PC5 - MOP test cases update in 38.521-2	17.3.0
2023-06	RAN#100	R5-233635	0932	1	F	Definition of MU and requirements for FR2c	17.3.0
2023-06	RAN#100	R5-233636	0917	1	F	PC1 - ACS Case 1 and IBB test cases update in 38.521-2	17.3.0
2023-06	RAN#100	R5-233637	0928	1	F	Update of SE TRP Offsets	17.3.0
2023-06	RAN#100	R5-233641	0929	1	F	Update of Fine SE TRP Grids	17.3.0
2023-06	RAN#100	R5-233702	0927	1	F	Update of SE TRP Offsets	17.3.0
2023-06	RAN#100	R5-233716	0951	1	F	Updates to FR2 RF test case 6.2.5 for EIRP with UL-Gaps	17.3.0
2023-06	RAN#100	R5-233717	0938	1	F	Update to test applicability and side condition of beam correspondence	17.3.0
2023-06	RAN#100	R5-233718	0926	2	F	Adding FR2 Redcap PC7 to Tx Test Config Tables	17.3.0
2023-06	RAN#100	R5-233719	0923	2	F	Adding FR2 Redcap Rx EIS test case	17.3.0
2023-06	RAN#100	R5-233723	0935	1	F	Addition of Annex Q.2 for Relative Phase Error Measurement	17.3.0
2023-09	RAN#101	R5-233981	0961	-	F	FR2 MU - Absolute power tolerance test update to new Network Analyzer MU value	17.4.0
2023-09	RAN#101	R5-234228	0962	-	F	HST FR2 7.3.2 Reference sensitivity power level	17.4.0
2023-09	RAN#101	R5-234896	0974	-	F	Correction to ACLR TT values for PC3	17.4.0
2023-09	RAN#101	R5-235042	0975	-	F	Updating FR2 MPR for 2UL CA test case for PC3	17.4.0
2023-09	RAN#101	R5-235097	0979	-	F	Introduction of CA configurations for n258	17.4.0
2023-09	RAN#101	R5-235144	0980	-	F	Correction of spurious emission UE co-existence for UL CA	17.4.0
2023-09	RAN#101	R5-235150	0981	-	F	Editorial correction of EVM test case	17.4.0
2023-09	RAN#101	R5-235228	0985	-	F	Clarification of DC location wording in FR2 Transmit Mod Quality tests	17.4.0
2023-09	RAN#101	R5-235229	0986	-	F	Update of FR2 UL MIMO EVM measurement description	17.4.0
2023-09	RAN#101	R5-235230	0987	-	F	Editorial and core spec alignment updates to FR2 Beam Correspondence tests	17.4.0
2023-09	RAN#101	R5-235667	0963	1	F	HST FR2 7.3.4 EIS spherical coverage	17.4.0
2023-09	RAN#101	R5-235668	0984	1	F	Updates to FR2 RF test case 6.2.5 for EIRP with UL-Gaps	17.4.0
2023-09	RAN#101	R5-235669	0971	1	F	Clarification of unwanted emission testing configuration - Part 2	17.4.0
2023-09	RAN#101	R5-235670	0973	1	F	Update for transition period of spurious TRP measurement grid	17.4.0
2023-09	RAN#101	R5-235671	0982	1	F	Update of spurious emissions test cases	17.4.0
2023-09	RAN#101	R5-235746	0959	1	F	PC5 MU - Tx test cases update in 38.521-2	17.4.0
2023-09	RAN#101	R5-235747	0957	1	F	FR2c MU - Tx test cases update in 38.521-2	17.4.0
2023-09	RAN#101	R5-235748	0972	1	F	Update for FR2c MU	17.4.0
2023-09	RAN#101	R5-235749	0958	1	F	FR2c MU - Rx test cases update in 38.521-2	17.4.0
2023-09	RAN#101	R5-235819	0956	1	F	Addition of test requirement for relative power tolerance inside some TRX test cases	17.4.0
2023-09	RAN#101	R5-235831	0964	1	F	Updates on PUMAX,f,c tolerance	17.4.0
2023-09	RAN#101	R5-235832	0966	1	F	Updates on PUMAX,f,c tolerance	17.4.0
2023-09	RAN#101	R5-235833	0976	1	F	Adding new test case UE maximum output power reduction for CA (3UL CA) for PC3	17.4.0
2023-09	RAN#101	R5-235834	0977	1	F	Adding new test case UE maximum output power reduction for CA (4UL CA) for PC3	17.4.0
2023-09	RAN#101	R5-235835	0965	1	F	Updates on EIS Relaxation for CA operation by aggregate channel bandwidth	17.4.0
2023-09	RAN#101	R5-235836	0967	1	F	Updates on In band blocking minimum requirements for intra-band contiguous CA	17.4.0
2023-09	RAN#101	R5-235837	0968	1	F	Updates on Adjacent channel selectivity	17.4.0
2023-09	RAN#101	R5-235838	0969	1	F	Updates on test parameters for adjacent channel selectivity	17.4.0
2023-09	RAN#101	R5-235457	0978	2	F	Updating FR2 MOP for CA test cases	17.4.0
2023-09	RAN#101	R5-235936	0983	1	F	Updates to FR2 RF phase continuity test	17.4.0
2023-09	RAN#101	-	-	-	-	Administrative release upgrade to match the release of 3GPP TS 38.521-3 and TS 38.522 which were upgraded at RAN#101 to Rel-18 due to Rel-18 relevant CR(s)	18.0.0
2023-12	RAN#102	R5-236061	0988		F	PC5 MU - ACS Case 1 and IBB update in 38.521-2	18.1.0
2023-12	RAN#102	R5-236245	0992		F	Removal of technical content in TS 38.521-2 v17.4.0 and substitution with pointer to the next Release	18.1.0
2023-12	RAN#102	R5-236633	0993		F	Update to FR2 additional spurious emission for CA test cases	18.1.0
2023-12	RAN#102	R5-236944	1001		F	Core spec alignment to 6.2A.3 for FR2 A-MPR for CA	18.1.0
2023-12	RAN#102	R5-236945	1002		F	Corrections to 6.2.3 on UE maximum output power with additional requirements for PC3	18.1.0

2023-12	RAN#102	R5-237133	1007		F	CR to implement 6x2 Grids	18.1.0
2023-12	RAN#102	R5-237234	1008		F	Tx OFF Power test with UL-Gaps	18.1.0
2023-12	RAN#102	R5-237235	1009		F	Updates to EIRP test with UL-Gaps	18.1.0
2023-12	RAN#102	R5-237656	1003	1	F	Updating wording of test applicability in FR2 MOP for CA test cases	18.1.0
2023-12	RAN#102	R5-237657	0996	1	F	Adding TT for FR2 RF test case 6.2.5 EIRP with UL-Gaps	18.1.0
2023-12	RAN#102	R5-237658	1013	1	F	Update of FR2 DMRS bundling measurements	18.1.0
2023-12	RAN#102	R5-237659	1012	1	F	Editorial correction for UE orientation illustrations	18.1.0
2023-12	RAN#102	R5-237660	0997	1	F	Adding FR2 Redcap UE MPR test case to 6.2.3 for NS_202 and NS_203	18.1.0
2023-12	RAN#102	R5-237661	0998	1	F	Adding test case to 6.3.1 for FR2 PC7 minimum output power	18.1.0
2023-12	RAN#102	R5-237662	0999	1	F	Adding test cases to 6.2.2 for FR2 Redcap UE MPR	18.1.0
2023-12	RAN#102	R5-237727	0989	1	F	FR2c MU - Tx test cases update in 38.521-2	18.1.0
2023-12	RAN#102	R5-237728	0991	1	F	Defined MU and TT for 6.2D.1.1 and 6.2D.1.2 MOP FR2 UL MIMO tests	18.1.0
2023-12	RAN#102	R5-237729	0994	1	F	Update for FR2c MU	18.1.0
2023-12	RAN#102	R5-237730	1014	1	F	Update of MU and TT in FR2 UL MIMO test cases	18.1.0
2023-12	RAN#102	R5-237731	0990	1	F	FR2c MU - Rx test cases update in 38.521-2	18.1.0
2023-12	RAN#102	R5-237898	1004	1	F	Addition of FR2 AMPR for 2UL CA	18.1.0
2023-12	RAN#102	R5-237899	1005	1	F	Addition of FR2 AMPR for 3UL CA	18.1.0
2023-12	RAN#102	R5-237900	1006	1	F	Addition of FR2 AMPR for 4UL CA	18.1.0
2023-12	RAN#102	R5-237944	1010	1	F	Updates to FR2 RF phase continuity test	18.1.0
2023-12	RAN#102	R5-237945	1011	1	F	Updates to Annex for FR2 RF Phase continuity test	18.1.0
2024-03	RAN#103	R5-240407	1017	-	F	FR2 MU - PC1 UL MIMO - Minimum output power test - 38.521-2	18.2.0
2024-03	RAN#103	R5-240409	1018	-	F	Blocking measurement procedure updates in section K.1.8	18.2.0
2024-03	RAN#103	R5-240604	1019	-	F	CR on Coarse&Fine Beam Peak Search Grids	18.2.0
2024-03	RAN#103	R5-240626	1020	-	F	FR2 DL RMCs - Missing notes update	18.2.0
2024-03	RAN#103	R5-240838	1022	-	F	Corrections on 6.3.1 for FR2 Redcap UE minimum output power	18.2.0
2024-03	RAN#103	R5-240962	1024	-	F	Update to FR2 ACS TC	18.2.0
2024-03	RAN#103	R5-241005	1027	-	F	Update to MU and TT for AMPR for CA test case	18.2.0
2024-03	RAN#103	R5-241107	1029	-	F	Clarification of test procedure of EIS spherical coverage for inter-band CA	18.2.0
2024-03	RAN#103	R5-241174	1030	-	F	Correction to CA A-MPR requirements	18.2.0
2024-03	RAN#103	R5-241343	1031	-	F	Correction of MPR CA test cases	18.2.0
2024-03	RAN#103	R5-241353	1032	-	F	Editorial correction of TT for Minimum Output Power for UL MIMO	18.2.0
2024-03	RAN#103	R5-241430	1036	-	F	Update to FR2 Tx OFF Power test specific to UL-Gaps	18.2.0
2024-03	RAN#103	R5-241780	1037	1	F	Updates to FR2 ACS test	18.2.0
2024-03	RAN#103	R5-241781	1021	1	F	Corrections on 6.2.3 for FR2 Redcap UE MPR test case for NS_202 and NS_203	18.2.0
2024-03	RAN#103	R5-241782	1040	1	F	Addition of CA test for EIRP test with ULGaps	18.2.0

2024-03	RAN#103	R5-241783	1025	1	F	Clarification of trace mode in emission testing_FR2	18.2.0
2024-03	RAN#103	R5-241859	1028	1	F	Update for FR2c MU	18.2.0
2024-03	RAN#103	R5-241949	1038	1	F	Updates to FR2 RF phase continuity test	18.2.0
2024-03	RAN#103	R5-241950	1039	1	F	Updates to Annex E content and structure	18.2.0
2024-03	RAN#103	R5-241966	1035	1	F	Update to FR2 Tx Power test with UL-Gaps	18.2.0
2024-03	RAN#103	R5-241990	1026	1	F	Adding FR2 test case of SRS time mask	18.2.0
2024-03	RAN#103	R5-242025	1034	1	F	Updates to UE Maximum Output Power - EIRP with UL Gaps test case	18.2.0
2024-03	RAN#103	R5-242026	1033	1	F	Updates to Annex F for UE Maximum Output Power - EIRP with UL Gaps test case	18.2.0
2024-06	RAN#104	R5-242260	1041	-	F	Pending UL MIMO update in 38.521-2	18.3.0
2024-06	RAN#104	R5-242267	1044	-	F	PC5 FR2 MU - Rx test cases update in 38.521-2	18.3.0
2024-06	RAN#104	R5-243309	1055	-	F	Clarification of QoQZ Validation Procedure	18.3.0
2024-06	RAN#104	R5-243652	1046	1	F	Additional test case for Enhanced Beam correspondence for PC6	18.3.0
2024-06	RAN#104	R5-243660	1053	1	F	Corrections on 6.2.2 and 6.2A.2.0.2 for UE MPR requirements	18.3.0
2024-06	RAN#104	R5-243661	1057	1	F	Updates to FR2 RF phase continuity test	18.3.0
2024-06	RAN#104	R5-243662	1054	1	F	Corrections on 7.1 for general description to receiver characteristics	18.3.0
2024-06	RAN#104	R5-243663	1049	1	F	Clarification of antenna array assumptions for in-band measurement	18.3.0
2024-06	RAN#104	R5-243664	1050	1	F	Correction to Rx fast spherical coverage method	18.3.0
2024-06	RAN#104	R5-243721	1043	1	F	PC5 FR2 MU - Tx test cases update in 38.521-2	18.3.0
2024-06	RAN#104	R5-243722	1045	1	F	PC5 FR2 MU - Annex F update in 38.521-2	18.3.0
2024-06	RAN#104	R5-243726	1042	1	F	FR2c MU - Tx test cases update in 38.521-2	18.3.0
2024-06	RAN#104	R5-243727	1051	1	F	Update of MU for n259	18.3.0
2024-06	RAN#104	R5-243830	1052	1	F	Update of MU and TT for CA and UL MIMO	18.3.0
2024-06	RAN#104	R5-243831	1048	1	F	Update for FR2c MU	18.3.0
2024-06	RAN#104	R5-243841	1047	1	F	Introducing framework for Beam Correspondence during Initial Access in IDLE related Tx Power tests	18.3.0
2024-09	RAN#105	R5-244165	1059	-	F	PC5 FR2 MU - Rx test cases update in 38.521-2	18.4.0
2024-09	RAN#105	R5-244169	1061	-	F	FR2c MU - MOP-TRP update in 38.521-2	18.4.0
2024-09	RAN#105	R5-244175	1064	-	F	PC6 FR2 MU - Rx test cases update in 38.521-2	18.4.0
2024-09	RAN#105	R5-244176	1065	-	F	PC6 FR2 MU - Annex F and M update in 38.521-2	18.4.0
2024-09	RAN#105	R5-244381	1067	-	F	FR2 UL MIMO - MOP test procedure update	18.4.0
2024-09	RAN#105	R5-244442	1068	-	F	Correction of SE QoQZ Validation Frequencies	18.4.0
2024-09	RAN#105	R5-244449	1069	-	F	Clarification of spherical coverage assumptions	18.4.0
2024-09	RAN#105	R5-244686	1075	-	F	Update of 256QAM minimum conformance requirements in TC6.2.2	18.4.0
2024-09	RAN#105	R5-244856	1078	-	F	Update to 38.521-2 Annex H	18.4.0
2024-09	RAN#105	R5-245730	1087	1	F	Correction for adding missing information for PC6 in RF Tx part	18.4.0
2024-09	RAN#105	R5-245840	1092	1	F	introduction of 2AoA spherical coverage requirement for PC6 UE	18.4.0
2024-09	RAN#105	R5-245841	1070	1	F	Update of test case 6.4A.1.4 Frequency Error for NR CA for 5CCs	18.4.0

2024-09	RAN#105	R5-245842	1071	1	F	Update of test case 6.4A.1.5 Frequency Error for NR CA for 6CCs	18.4.0
2024-09	RAN#105	R5-245843	1072	1	F	Update of test case 6.4A.1.6 Frequency Error for NR CA for 7CCs	18.4.0
2024-09	RAN#105	R5-245844	1073	1	F	Update of test case 6.4A.1.7 Frequency Error for NR CA for 8CCs	18.4.0
2024-09	RAN#105	R5-245845	1088	1	F	Updates to message contents of FR2 RF phase continuity test	18.4.0
2024-09	RAN#105	R5-245849	1083	1	F	Core spec alignment CR to clarify RedCap applicability	18.4.0
2024-09	RAN#105	R5-245926	1058	1	F	PC5 FR2 MU - Tx test cases update in 38.521-2	18.4.0
2024-09	RAN#105	R5-245927	1060	1	F	PC5 FR2 MU - Annex F update in 38.521-2	18.4.0
2024-09	RAN#105	R5-245929	1063	1	F	PC6 FR2 MU - Tx test cases update in 38.521-2	18.4.0
2024-09	RAN#105	R5-245946	1076	1	F	Update of FR2c MU	18.4.0
2024-09	RAN#105	R5-245947	1077	1	F	Update of Transmit OFF power for FR2b	18.4.0
2024-09	RAN#105	R5-245948	1079	1	F	Update of MU and TT for UL MIMO	18.4.0
2024-09	RAN#105	R5-245984	1080	1	F	Update of FR2 frequency error for UL MIMO test case	18.4.0
2024-09	RAN#105	R5-245989	1066	1	F	Modified MPR behaviour correction in 38.521-2	18.4.0
2024-09	RAN#105	R5-245998	1082	1	F	Updates to the Beam Correspondence in RRC_Inactive and Initial Access test	18.4.0
2024-09	RAN#105	R5-246026	1085	1	F	Correction of 6.2D2 for adding PC6	18.4.0
2024-09	RAN#105	R5-246030	1084	1	F	Correction to 6.3.4 to adding power class 6	18.4.0
2024-09	RAN#105	R5-246031	1086	1	F	Correction for the General and UE maximum output power for PC6	18.4.0
2024-12	RAN#106	R5-246233	1094	-	F	PC7 FR2 MU - Rx test cases update in 38.521-2	18.5.0
2024-12	RAN#106	R5-246236	1096	-	F	PC6 FR2 MU - Tx test cases update in 38.521-2	18.5.0
2024-12	RAN#106	R5-246237	1097	-	F	PC6 FR2 MU - Rx test cases update in 38.521-2	18.5.0
2024-12	RAN#106	R5-246238	1098	-	F	PC6 FR2 MU - Annex F update in 38.521-2	18.5.0
2024-12	RAN#106	R5-246239	1099	-	F	PC5 FR2 - Tx 2UL CA test cases update in 38.521-2	18.5.0
2024-12	RAN#106	R5-246241	1101	-	F	PC5 FR2 MU - Annex F update in 38.521-2	18.5.0
2024-12	RAN#106	R5-246244	1103	-	F	FR2c MU - Annex F update in 38.521-2	18.5.0
2024-12	RAN#106	R5-247500	1121	-	F	Updates to 2AoA spherical coverage requirement for PC6 UE	18.5.0
2024-12	RAN#106	R5-247503	1122	-	F	introduction of 2AoA spherical coverage requirement for PC3 UEs	18.5.0
2024-12	RAN#106	R5-247504	1123	-	F	Update to Annexes relevant to 2AoA tests	18.5.0
2024-12	RAN#106	R5-247773	1116	1	F	Update to editors note and clause content for multiple Tx test cases	18.5.0
2024-12	RAN#106	R5-247774	1112	1	F	Update of EVM test cases	18.5.0
2024-12	RAN#106	R5-247775	1113	1	F	Corrections on applicable maximum BW for Redcap UE	18.5.0
2024-12	RAN#106	R5-247776	1117	1	F	Editorial Correction to 6.2D.2	18.5.0
2024-12	RAN#106	R5-247777	1119	1	F	Cleanup of n262 related content in clause 6 FR2 transmitter tests	18.5.0
2024-12	RAN#106	R5-247778	1118	1	F	Correction of FR2 ACS test case	18.5.0
2024-12	RAN#106	R5-247779	1120	1	F	Cleanup of n262 related content in clause 7 FR2 receiver tests	18.5.0
2024-12	RAN#106	R5-247782	1108	1	F	Correction of the RB allocation condition	18.5.0
2024-12	RAN#106	R5-247849	1105	1	F	Update to UL-256QAM requirements in 6.2A.2.0.2	18.5.0
2024-12	RAN#106	R5-247852	1100	1	F	PC5 FR2 - Tx UL MIMO test cases update in 38.521-2	18.5.0

2024-12	RAN#106	R5-247853	1093	1	F	PC7 FR2 MU - Tx test cases update in 38.521-2	18.5.0
2024-12	RAN#106	R5-247854	1102	1	F	FR2c MU - Tx test cases update in 38.521-2	18.5.0
2024-12	RAN#106	R5-247855	1111	1	F	Update of MU and TT for SISO and UL MIMO	18.5.0
2024-12	RAN#106	R5-247856	1095	1	F	PC7 FR2 MU - Annex F update in 38.521-2	18.5.0
2024-12	RAN#106	R5-247935	1115	1	F	Updates to the Beam Correspondence in RRC_Inactive and Initial Access test	18.5.0
2024-12	RAN#106	R5-247944	1104	1	F	Correction to PC5,6 FR2 MBW for Minimum output power	18.5.0
2024-12	RAN#106	R5-247971	1106	1	F	Update of General ONOFF time mask for CA (2UL CA)	18.5.0
2024-12	RAN#106	R5-247972	1107	1	F	Addition of General ONOFF time mask for CA (3UL CA) & (4UL CA)	18.5.0
2025-01	RAN#106	-	-	-	-	fixed wrong entries in Table F.3.2-1 for 6.2.1.1 UE maximum output power (TRP)	18.5.1
2025-01	RAN#106	R5-247856	1095	1	F	fixed a wrong implementation of R5-247856 in Table F.3.2-1 for 6.2.1.1 UE maximum output power (TRP)	18.5.2
2025-03	RAN#107	R5-250203	1126	-	F	FR2 MU - Tx test cases update for PC6 in 38.521-2	18.6.0
2025-03	RAN#107	R5-250204	1127	-	F	FR2 MU - Rx test cases update for PC6 in 38.521-2	18.6.0
2025-03	RAN#107	R5-250205	1128	-	F	FR2 MU - Annex updates for PC6 in 38.521-2	18.6.0
2025-03	RAN#107	R5-250207	1129	-	F	FR2 MU - Refsens CA test cases definition update for PC1 and PC5	18.6.0
2025-03	RAN#107	R5-250209	1131	-	F	FR2 MU - MPR CA test cases definition update for PC1 and PC5	18.6.0
2025-03	RAN#107	R5-250302	1134	-	F	Editorial corrections in test configuration table in FR2 phase continuity test	18.6.0
2025-03	RAN#107	R5-250938	1136	-	F	Update of EVM test case for PUCCH	18.6.0
2025-03	RAN#107	R5-250946	1137	-	F	Correction of statistical testing of receiver characteristics for NR SA FR2	18.6.0
2025-03	RAN#107	R5-250954	1138	-	F	Removal of unnecessary applicability note from TC 6.3.2	18.6.0
2025-03	RAN#107	R5-251142	1141	-	F	Correction of ON OFF time mask CA test cases	18.6.0
2025-03	RAN#107	R5-251518	1143	1	F	Updates to 2AoA spherical coverage test	18.6.0
2025-03	RAN#107	R5-251523	1133	1	F	FR2 - Updates for CA NS 202 and NS 203 in 38.521-2	18.6.0
2025-03	RAN#107	R5-251553	1139	1	F	Corrections on Ch6 for high speed MeasFlag UE capability for FR2	18.6.0
2025-03	RAN#107	R5-251554	1140	1	F	Corrections on Ch7 for high speed MeasFlag UE capability for FR2	18.6.0
2025-03	RAN#107	R5-251574	1130	1	F	FR2 MU - MOP CA test cases definition update for PC1 and PC5	18.6.0
2025-03	RAN#107	R5-251575	1132	1	F	FR2 MU - Min power CA test cases definition update for PC1 and PC5	18.6.0
2025-03	RAN#107	R5-251678	1142	1	F	Addition of FR2 RF testability issue list to specification	18.6.0
2025-03	RAN#107	R5-251707	1124	1	F	Correction to Editor Notes of FR2 TCs	18.6.0
2025-06	RAN#108	R5-251889	1144	-	F	FR2 MU - Measurement grids updates for PC6 in Annex M	18.7.0
2025-06	RAN#108	R5-251892	1145	-	F	FR2 MU - PC7 update for ACS and IBB tests in 38.521-2	18.7.0
2025-06	RAN#108	R5-251893	1146	-	F	FR2 MU - PC7 MU and TT update for ACS and IBB tests in 38.521-2 Annex F	18.7.0
2025-06	RAN#108	R5-251992	1149	-	F	Addition of EVM equalizer spectrum flatness for CA (2UL CA)	18.7.0
2025-06	RAN#108	R5-252313	1151	-	F	Update to 256QAM requirements in 6.2A.2.0.3 MPR PC2	18.7.0
2025-06	RAN#108	R5-252344	1156	-	F	Updating Carrier leakage for CA (2UL CA) with PC5	18.7.0

2025-06	RAN#108	R5-253456	1153	1	F	Updating Carrier leakage with PC5	18.7.0
2025-06	RAN#108	R5-253457	1154	1	F	Updating In-band emissions with PC5	18.7.0
2025-06	RAN#108	R5-253458	1155	1	F	Updating Carrier leakage for CA minimum conformance requirements for PC5	18.7.0
2025-06	RAN#108	R5-253459	1157	1	F	Updating In-band emissions for CA Minimum conformance requirements with PC5	18.7.0
2025-06	RAN#108	R5-253460	1158	1	F	Updating In-band emissions for CA (2UL CA) with PC5	18.7.0
2025-06	RAN#108	R5-253462	1163	1	F	Updates to 2AoA spherical coverage test	18.7.0
2025-06	RAN#108	R5-253463	1165	1	F	Updates to FR2 RF test spec clause 6	18.7.0
2025-06	RAN#108	R5-253464	1166	1	F	Updates to FR2 RF test spec clause 7	18.7.0
2025-06	RAN#108	R5-253465	1162	1	F	Addition of FR2 RF testability issue list to specification	18.7.0
2025-06	RAN#108	R5-253531	1147	1	F	FR2 MU - PC3 update for OBW UL MIMO test in 38.521-2	18.7.0
2025-06	RAN#108	R5-253532	1148	1	F	FR2 MU - PC3 MU update for OBW UL MIMO test in 38.521-2 Annex F	18.7.0
2025-06	RAN#108	R5-253605	1152	1	F	Update to 256QAM requirements in 6.2A.2.0.6 MPR PC5	18.7.0
2025-09	RAN#109	R5-253800	1172	-	F	FR2 MU - PC6 spherical Tx test update in 38.521-2	18.8.0
2025-09	RAN#109	R5-253801	1173	-	F	FR2 MU - PC6 spherical Rx test update in 38.521-2	18.8.0
2025-09	RAN#109	R5-253802	1174	-	F	FR2 MU - PC6 annexes update in 38.521-2	18.8.0
2025-09	RAN#109	R5-254047	1179	-	F	Correction of Antenna Assumptions in Annex M	18.8.0
2025-09	RAN#109	R5-254329	1181	-	F	Corrections on suspended reference for ITU-R recommendation in 38.521-2	18.8.0
2025-09	RAN#109	R5-254348	1182	-	F	Corrections on symbols for NR carrier aggregation in 38.521-2	18.8.0
2025-09	RAN#109	R5-254865	1189	-	F	Updates to Annexes for 2AoA spherical coverage test	18.8.0
2025-09	RAN#109	R5-255273	1188	1	F	Updates to 2AoA spherical coverage test	18.8.0
2025-09	RAN#109	R5-255274	1180	1	F	Update of Beam correspondence for PC6 in clause 6.6.1.3.5	18.8.0
2025-09	RAN#109	R5-255275	1186	1	F	Add missing in-band blocking requirement for n259 intra-band contiguous CA	18.8.0
2025-09	RAN#109	R5-255276	1183	1	F	Correction to clause 6.2A.3	18.8.0
2025-09	RAN#109	R5-255296	1175	1	F	FR2 MU - PC3 update for OBW UL MIMO test in 38.521-2	18.8.0
2025-09	RAN#109	R5-255297	1176	1	F	FR2 MU - PC3 MU update for OBW UL MIMO test in 38.521-2 Annex F	18.8.0
2025-09	RAN#109	R5-255300	1177	1	F	Addition of EVM equalizer spectrum flatness for CA (3UL & 4UL CA)	18.8.0
2025-09	RAN#109	R5-255353	1178	1	F	Addition of EVM equalizer spectrum flatness for CA (5UL to 8UL CA)	18.8.0
2025-09	RAN#109	R5-255394	1187	1	F	Addition of FR2 RF testability issue list to specification	18.8.0
2025-09	RAN#109	R5-254866	1190	-	F	Introduction of minimum conformance requirements for additional spurious emissions tests	19.0.0
2025-09	RAN#109	R5-255231	1184	1	F	Additional of A-MPR test case for NS 205 in TS 38.521-2	19.0.0
2025-12	RAN#110	R5-255562	1192	-	F	FR2 MU - relaxation update for NS_202 additional spurious	19.1.0
2025-12	RAN#110	R5-256102	1207	-	F	Addition of PC6 in clause 6.2.1.2_1 of TS38.521-2	19.1.0
2025-12	RAN#110	R5-256226	1209	-	F	CR to amend missing info of 6.2D.2 for R17 HST	19.1.0
2025-12	RAN#110	R5-256227	1210	-	F	CR to amend missing info of 6.2D.3 for R17 HST	19.1.0

2025-12	RAN#110	R5-256229	1212	-	F	CR to amend missing item in 6.4.2.3 for R17 HST	19.1.0
2025-12	RAN#110	R5-256231	1213	-	F	CR to amend TT in 6.2D.1.1 for R17 HST	19.1.0
2025-12	RAN#110	R5-256232	1214	-	F	CR to amend TT in 6.2D.1.2 for R17 HST	19.1.0
2025-12	RAN#110	R5-256233	1215	-	F	Minor corrections in 6.2.3.5 for R17 HST	19.1.0
2025-12	RAN#110	R5-256268	1217	-	F	Clarification of LCRB in Figure 5.3.1-1 and reference correction	19.1.0
2025-12	RAN#110	R5-256833	1218	1	F	Adding description for simultaneous transmission to multiple directions	19.1.0
2025-12	RAN#110	R5-256834	1224	1	F	Addition of FR2 max output power test for simultaneous transmission to multiple directions	19.1.0
2025-12	RAN#110	R5-256835	1225	1	F	Addition of FR2 MPR test for simultaneous transmission to multiple directions	19.1.0
2025-12	RAN#110	R5-256836	1220	1	F	Addition of a new test case for transmitter power for simultaneous transmission to multiple directions	19.1.0
2025-12	RAN#110	R5-256837	1193	1	F	Update A-MPR test case for NS 202	19.1.0
2025-12	RAN#110	R5-256838	1194	1	F	Update A-MPR test case for CA NS 202	19.1.0
2025-12	RAN#110	R5-256890	1191	1	F	FR2 MU - PC3 update for OBW UL MIMO test in 38.521-2	19.1.0
2025-12	RAN#110	R5-256893	1211	1	F	CR to amend missing info of 6.3D.1 for R17 HST	19.1.0
2025-12	RAN#110	R5-256894	1196	1	F	Update additional spurious emission for CA NS 202	19.1.0
2025-12	RAN#110	R5-256915	1197	1	F	Update additional spurious emission for new CA NS 205	19.1.0
2025-12	RAN#110	R5-256916	1219	1	F	Addition of a new test case for transmitter power for simultaneous transmission to multiple directions	19.1.0
2025-12	RAN#110	R5-256970	1204	1	F	Additional of A-MPR test case for CA_NS_205	19.1.0
2025-12	RAN#110	R5-256971	1205	1	F	Update Annex P for NS_202 and NS_205	19.1.0
2025-12	RAN#110	R5-256980	1223	1	F	Update additional spurious emission for new NS_205	19.1.0
2026-03	RAN#111	R5-260190	1229	-	F	CR to introduce Carrier leakage for power class 6 R18 HST	19.2.0
2026-03	RAN#111	R5-260393	1234	-	F	General updates for NS_205	19.2.0
2026-03	RAN#111	R5-260617	1236	-	F	Corrections on the symbols for BWintraCA and A-MPR NS_202	19.2.0
2026-03	RAN#111	R5-260628	1237	-	F	Corrections on the figure reference for SRS time mask	19.2.0
2026-03	RAN#111	R5-260669	1238	-	F	Correction to tables 6.2.3.4.1-2, 6.2D.3.4.1-1, 6.2D.3.4.1-3, and 6.5.3.3.4.1-1	19.2.0
2026-03	RAN#111	R5-260791	1241	-	F	Addition of UL CA MPR test case for PC6 in R18 HST	19.2.0
2026-03	RAN#111	R5-260792	1242	-	F	Addition of new symbols for StxMP related requirements	19.2.0
2026-03	RAN#111	R5-260865	1243	-	F	Removal of brackets for DCI format in Rx test cases	19.2.0
2026-03	RAN#111	R5-261081	1248	-	F	Update of FR2 RF common sections relevant to LPWUS	19.2.0
2026-03	RAN#111	R5-261251	1249	2	F	Introduction of Reference sensitivity power level test for LP-WUS/WUR	19.2.0
2026-03	RAN#111	R5-261442	1228	1	F	CR to Introduce MOP requirements for CA for PC 6 R18 HST	19.2.0
2026-03	RAN#111	R5-261444	1230	1	F	CR to Introduce In-band emissions for power class 6 R18 HST	19.2.0
2026-03	RAN#111	R5-261445	1226	1	F	Addition of a new test case for transmitter power for simultaneous transmission to multiple directions	19.2.0
2026-03	RAN#111	R5-261446	1227	1	F	Addition of a new test case configured transmitted power for simultaneous transmission to multiple directions	19.2.0

2026-03	RAN#111	R5-261447	1253	1	F	Core alignment on QPSK FRC for multi-Rx	19.2.0
2026-03	RAN#111	R5-261448	1240	1	F	Addition of UL CA A-MPR test case for PC6 in R18 HST	19.2.0
2026-03	RAN#111	R5-261619	1239	1	F	Correction to tables in clause 6.2.3.5	19.2.0
2026-03	RAN#111	R5-261621	1250	1	F	Introduction of LP-WUR WUS spherical coverage test	19.2.0
2026-03	RAN#111	R5-261622	1251	1	F	Introduction of LP-WUR WUS Adjacent channel selectivity	19.2.0
2026-03	RAN#111	R5-261644	1235	1	F	Updates to TC 6.6.3 Beam correspondence for initial access	19.2.0
2026-03	RAN#111	R5-261657	1245	1	F	Updates to 2AoA spherical coverage test	19.2.0
2026-03	RAN#111	R5-261658	1252	1	F	Addition of spherical coverage procedure for simultaneous multi-Rx reception	19.2.0

History

Version	Date	Status
V19.0.0	October 2025	Publication
V19.1.0	March 2026	Publication
V19.2.0	April 2026	Publication