

ETSI TS 129 509 V19.5.0 (2026-02)



TECHNICAL SPECIFICATION

**5G;
5G System;
Authentication Server Services;
Stage 3
(3GPP TS 29.509 version 19.5.0 Release 19)**



Reference

RTS/TSGC-0429509vj50

Keywords

5G

ETSI

650 Route des Lucioles
F-06921 Sophia Antipolis Cedex - FRANCE

Tel.: +33 4 92 94 42 00 Fax: +33 4 93 65 47 16

Siret N° 348 623 562 00017 - APE 7112B
Association à but non lucratif enregistrée à la
Sous-Préfecture de Grasse (06) N° w061004871

Important notice

The present document can be downloaded from the
[ETSI Search & Browse Standards](#) application.

The present document may be made available in electronic versions and/or in print. The content of any electronic and/or print versions of the present document shall not be modified without the prior written authorization of ETSI. In case of any existing or perceived difference in contents between such versions and/or in print, the prevailing version of an ETSI deliverable is the one made publicly available in PDF format on [ETSI deliver](#) repository.

Users should be aware that the present document may be revised or have its status changed,
this information is available in the [Milestones listing](#).

If you find errors in the present document, please send your comments to
the relevant service listed under [Committee Support Staff](#).

If you find a security vulnerability in the present document, please report it through our
[Coordinated Vulnerability Disclosure \(CVD\)](#) program.

Notice of disclaimer & limitation of liability

The information provided in the present deliverable is directed solely to professionals who have the appropriate degree of experience to understand and interpret its content in accordance with generally accepted engineering or other professional standard and applicable regulations.

No recommendation as to products and services or vendors is made or should be implied.

No representation or warranty is made that this deliverable is technically accurate or sufficient or conforms to any law and/or governmental rule and/or regulation and further, no representation or warranty is made of merchantability or fitness for any particular purpose or against infringement of intellectual property rights.

In no event shall ETSI be held liable for loss of profits or any other incidental or consequential damages.

Any software contained in this deliverable is provided "AS IS" with no warranties, express or implied, including but not limited to, the warranties of merchantability, fitness for a particular purpose and non-infringement of intellectual property rights and ETSI shall not be held liable in any event for any damages whatsoever (including, without limitation, damages for loss of profits, business interruption, loss of information, or any other pecuniary loss) arising out of or related to the use of or inability to use the software.

Copyright Notification

No part may be reproduced or utilized in any form or by any means, electronic or mechanical, including photocopying and microfilm except as authorized by written permission of ETSI.

The content of the PDF version shall not be modified without the written authorization of ETSI.

The copyright and the foregoing restriction extend to reproduction in all media.

© ETSI 2026.
All rights reserved.

Intellectual Property Rights

Essential patents

IPRs essential or potentially essential to normative deliverables may have been declared to ETSI. The declarations pertaining to these essential IPRs, if any, are publicly available for **ETSI members and non-members**, and can be found in ETSI SR 000 314: "*Intellectual Property Rights (IPRs); Essential, or potentially Essential, IPRs notified to ETSI in respect of ETSI standards*", which is available from the ETSI Secretariat. Latest updates are available on the [ETSI IPR online database](#).

Pursuant to the ETSI Directives including the ETSI IPR Policy, no investigation regarding the essentiality of IPRs, including IPR searches, has been carried out by ETSI. No guarantee can be given as to the existence of other IPRs not referenced in ETSI SR 000 314 (or the updates on the ETSI Web server) which are, or may be, or may become, essential to the present document.

Trademarks

The present document may include trademarks and/or tradenames which are asserted and/or registered by their owners. ETSI claims no ownership of these except for any which are indicated as being the property of ETSI, and conveys no right to use or reproduce any trademark and/or tradename. Mention of those trademarks in the present document does not constitute an endorsement by ETSI of products, services or organizations associated with those trademarks.

DECT™, **PLUGTESTS™**, **UMTS™** and the ETSI logo are trademarks of ETSI registered for the benefit of its Members. **3GPP™**, **LTE™** and **5G™** logo are trademarks of ETSI registered for the benefit of its Members and of the 3GPP Organizational Partners. **oneM2M™** logo is a trademark of ETSI registered for the benefit of its Members and of the oneM2M Partners. **GSM®** and the GSM logo are trademarks registered and owned by the GSM Association.

Legal Notice

This Technical Specification (TS) has been produced by ETSI 3rd Generation Partnership Project (3GPP).

The present document may refer to technical specifications or reports using their 3GPP identities. These shall be interpreted as being references to the corresponding ETSI deliverables.

The cross reference between 3GPP and ETSI identities can be found at [3GPP to ETSI numbering cross-referencing](#).

Modal verbs terminology

In the present document "**shall**", "**shall not**", "**should**", "**should not**", "**may**", "**need not**", "**will**", "**will not**", "**can**" and "**cannot**" are to be interpreted as described in clause 3.2 of the [ETSI Drafting Rules](#) (Verbal forms for the expression of provisions).

"**must**" and "**must not**" are **NOT** allowed in ETSI deliverables except when used in direct citation.

Contents

Intellectual Property Rights	2
Legal Notice	2
Modal verbs terminology.....	2
Foreword.....	7
1 Scope	9
2 References	9
3 Definitions and abbreviations.....	10
3.1 Definitions	10
3.2 Abbreviations	10
4 Overview	10
4.1 Introduction	10
5 Services offered by the AUSF.....	11
5.1 Introduction	11
5.2 Nausf_UEAuthentication Service	12
5.2.1 Service Description.....	12
5.2.2 Service Operations.....	12
5.2.2.1 Introduction.....	12
5.2.2.2 Authenticate	13
5.2.2.2.1 General	13
5.2.2.2.2 5G AKA	13
5.2.2.2.3 EAP-based authentication method.....	15
5.2.2.2.4 Authentication for FN-RG.....	16
5.2.2.2.5 Authentication Result Removal with 5G AKA method	17
5.2.2.2.6 Authentication Result Removal with EAP-AKA' method.....	18
5.2.2.3 Deregister	18
5.2.2.3.1 General	18
5.2.2.4 ProseAuthenticate	19
5.2.2.4.1 General	19
5.2.2.4.2 ProSe Authentication Result Removal with EAP-AKA' method	21
5.3 Nausf_SoRProtection Service	21
5.3.1 Service Description.....	21
5.3.2 Service Operations.....	22
5.3.2.1 Introduction.....	22
5.3.2.2 Protect	22
5.3.2.2.1 General	22
5.4 Nausf_UPUProtection Service	23
5.4.1 Service Description.....	23
5.4.2 Service Operations.....	23
5.4.2.1 Introduction.....	23
5.4.2.2 Protect	23
5.4.2.2.1 General	23
6 API Definitions	24
6.1 Nausf_UEAuthentication Service API	24
6.1.1 API URI.....	24
6.1.2 Usage of HTTP.....	25
6.1.2.1 General	25
6.1.2.2 HTTP standard headers	25
6.1.2.2.1 General	25
6.1.2.2.2 Content type	25
6.1.2.3 HTTP custom headers	25
6.1.2.3.1 General	25
6.1.3 Resources.....	25

6.1.3.1	Overview	25
6.1.3.2	Resource: ue-authentications (Collection)	27
6.1.3.2.1	Description	27
6.1.3.2.2	Resource Definition	27
6.1.3.2.3	Resource Standard Methods	28
6.1.3.2.4	Resource Custom Operations	30
6.1.3.3	Resource: 5g-aka-confirmation (Document)	31
6.1.3.3.1	Description	31
6.1.3.3.2	Resource Definition	31
6.1.3.3.3	Resource Standard Methods	32
6.1.3.4	Resource: eap-session (Document)	34
6.1.3.4.1	Description	34
6.1.3.4.2	Resource Definition	34
6.1.3.4.3	Resource Standard Methods	34
6.1.3.5	Resource: rg-authentications (Collection)	36
6.1.3.5.1	Description	36
6.1.3.5.2	Resource Definition	36
6.1.3.5.3	Resource Standard Methods	37
6.1.3.6	Resource: prose-authentications (Collection)	38
6.1.3.6.1	Description	38
6.1.3.6.2	Resource Definition	38
6.1.3.6.3	Resource Standard Methods	38
6.1.3.7	Resource: prose-auth (Document)	40
6.1.3.7.1	Description	40
6.1.3.7.2	Resource Definition	40
6.1.3.7.3	Resource Standard Methods	40
6.1.4	Custom Operations without associated resources	42
6.1.4.1	Overview	42
6.1.5	Notifications	43
6.1.5.1	General	43
6.1.6	Data Model	43
6.1.6.1	General	43
6.1.6.2	Structured data types	44
6.1.6.2.1	Introduction	44
6.1.6.2.2	Type: AuthenticationInfo	45
6.1.6.2.3	Type: UEAuthenticationCtx	46
6.1.6.2.4	Type: 5gAuthData	46
6.1.6.2.5	Type: Av5gAka	46
6.1.6.2.6	Type: ConfirmationData	46
6.1.6.2.7	Type: EapSession	47
6.1.6.2.8	Type: ConfirmationDataResponse	47
6.1.6.2.9	Type: RgAuthenticationInfo	47
6.1.6.2.10	Type: RgAuthCtx	48
6.1.6.2.11	Type: DeregistrationInfo	48
6.1.6.2.12	Type: ProSeAuthenticationInfo	48
6.1.6.2.13	Type: ProSeAuthenticationCtx	49
6.1.6.2.14	Type: ProSeEapSession	49
6.1.6.2.15	Type: ProSeAuthData	49
6.1.6.2.16	Type: ProSeAuthenticationResult	50
6.1.6.3	Simple data types and enumerations	50
6.1.6.3.1	Introduction	50
6.1.6.3.2	Simple data types	50
6.1.6.3.3	Enumeration: AuthType	51
6.1.6.3.4	Enumeration: AuthResult	51
6.1.6.3.5	Relation Types	51
6.1.6.4	Binary data	51
6.1.6.4.1	Introduction	51
6.1.7	Error Handling	52
6.1.7.1	General	52
6.1.7.2	Protocol Errors	52
6.1.7.3	Application Errors	52
6.1.8	Security	52

6.1.9	Feature Negotiation.....	53
6.1.10	HTTP redirection	53
6.2	Nausf_SoRProtection Service API.....	54
6.2.1	API URI.....	54
6.2.2	Usage of HTTP.....	54
6.2.2.1	General.....	54
6.2.2.2	HTTP standard headers	54
6.2.2.2.1	General	54
6.2.2.2.2	Content type	54
6.2.2.3	HTTP custom headers	54
6.2.2.3.1	General	54
6.2.3	Resources.....	55
6.2.3.1	Overview.....	55
6.2.3.2	Resource: supi (Custom operation).....	55
6.2.3.2.1	Description	55
6.2.3.2.2	Resource Definition.....	55
6.2.3.2.3	Resource Standard Methods	56
6.2.3.2.4	Resource Custom Operations	56
6.2.4	Custom Operations without associated resources	57
6.2.4.1	Overview.....	57
6.2.5	Notifications	57
6.2.5.1	General.....	57
6.2.6	Data Model	58
6.2.6.1	General.....	58
6.2.6.2	Structured data types	58
6.2.6.2.1	Introduction	58
6.2.6.2.2	Type: SorInfo	59
6.2.6.2.3	Type: SorSecurityInfo	59
6.2.6.2.4	Type: SteeringInfo.....	59
6.2.6.2.5	Type: SteeringContainer.....	60
6.2.6.3	Simple data types and enumerations	60
6.2.6.3.1	Introduction	60
6.2.6.3.2	Simple data types.....	60
6.2.6.3.3	Enumeration: AccessTech	60
6.2.7	Error Handling.....	61
6.2.7.1	General.....	61
6.2.7.2	Protocol Errors	61
6.2.7.3	Application Errors.....	61
6.2.8	Security	61
6.2.9	Feature Negotiation.....	61
6.2.10	HTTP redirection	62
6.3	Nausf_UPUProtection Service API.....	62
6.3.1	API URI.....	62
6.3.2	Usage of HTTP	62
6.3.2.1	General.....	62
6.3.2.2	HTTP standard headers	63
6.3.2.2.1	General	63
6.3.2.2.2	Content type	63
6.3.2.3	HTTP custom headers	63
6.3.2.3.1	General	63
6.3.3	Resources.....	63
6.3.3.1	Overview.....	63
6.3.3.2	Resource: supi (Custom operation).....	64
6.3.3.2.1	Description	64
6.3.3.2.2	Resource Definition.....	64
6.3.3.2.3	Resource Standard Methods	64
6.3.3.2.4	Resource Custom Operations	64
6.3.4	Custom Operations without associated resources	65
6.3.4.1	Overview.....	65
6.3.5	Notifications	66
6.3.5.1	General.....	66
6.3.6	Data Model	66

6.3.6.1	General	66
6.3.6.2	Structured data types	66
6.3.6.2.1	Introduction	66
6.3.6.2.2	Type: UpuInfo	67
6.3.6.2.3	Type: UpuSecurityInfo	67
6.3.6.2.4	Type: UpuData	68
6.3.6.3	Simple data types and enumerations	68
6.3.6.3.1	Introduction	68
6.3.6.3.2	Simple data types.....	69
6.3.6.3.3	Void.....	69
6.3.7	Error Handling	69
6.3.7.1	General	69
6.3.7.2	Protocol Errors	69
6.3.7.3	Application Errors.....	69
6.3.8	Security	69
6.3.9	Feature Negotiation.....	70
6.3.10	HTTP redirection.....	70
Annex A (normative): OpenAPI specification.....		71
A.1	General	71
A.2	Nausf_UEAuthentication API.....	71
A.3	Nausf_SoRProtection API.....	84
A.4	Nausf_UPUProtection API.....	86
Annex B (Informative): Use of EAP-TLS.....		90
B.1	General	90
B.2	EAP method: EAP-TLS	90
Annex C (informative): Withdrawn API versions.....		92
C.1	General	92
C.2	Nausf_SoRProtection API.....	92
Annex D (informative): Change history		93
History		97

Foreword

This Technical Specification has been produced by the 3rd Generation Partnership Project (3GPP).

The contents of the present document are subject to continuing work within the TSG and may change following formal TSG approval. Should the TSG modify the contents of the present document, it will be re-released by the TSG with an identifying change of release date and an increase in version number as follows:

Version x.y.z

where:

- x the first digit:
 - 1 presented to TSG for information;
 - 2 presented to TSG for approval;
 - 3 or greater indicates TSG approved document under change control.
- y the second digit is incremented for all changes of substance, i.e. technical enhancements, corrections, updates, etc.
- z the third digit is incremented when editorial only changes have been incorporated in the document.

In the present document, modal verbs have the following meanings:

- shall** indicates a mandatory requirement to do something
- shall not** indicates an interdiction (prohibition) to do something

The constructions "shall" and "shall not" are confined to the context of normative provisions, and do not appear in Technical Reports.

The constructions "must" and "must not" are not used as substitutes for "shall" and "shall not". Their use is avoided insofar as possible, and they are not used in a normative context except in a direct citation from an external, referenced, non-3GPP document, or so as to maintain continuity of style when extending or modifying the provisions of such a referenced document.

- should** indicates a recommendation to do something
- should not** indicates a recommendation not to do something
- may** indicates permission to do something
- need not** indicates permission not to do something

The construction "may not" is ambiguous and is not used in normative elements. The unambiguous constructions "might not" or "shall not" are used instead, depending upon the meaning intended.

- can** indicates that something is possible
- cannot** indicates that something is impossible

The constructions "can" and "cannot" are not substitutes for "may" and "need not".

- will** indicates that something is certain or expected to happen as a result of action taken by an agency the behaviour of which is outside the scope of the present document
- will not** indicates that something is certain or expected not to happen as a result of action taken by an agency the behaviour of which is outside the scope of the present document
- might** indicates a likelihood that something will happen as a result of action taken by some agency the behaviour of which is outside the scope of the present document

might not indicates a likelihood that something will not happen as a result of action taken by some agency the behaviour of which is outside the scope of the present document

In addition:

is (or any other verb in the indicative mood) indicates a statement of fact

is not (or any other negative verb in the indicative mood) indicates a statement of fact

The constructions "is" and "is not" do not indicate requirements.

1 Scope

The present document specifies the stage 3 protocol and data model for the Nausf Service Based Interface. It provides stage 3 protocol definitions and message flows, and specifies the API for each service offered by the AUSF.

The 5G System stage 2 architecture and procedures are specified in 3GPP TS 23.501 [2], 3GPP TS 23.502 [3] and 3GPP TS 33.501 [8].

The Technical Realization of the Service Based Architecture and the Principles and Guidelines for Services Definition are specified in 3GPP TS 29.500 [4] and 3GPP TS 29.501 [5].

2 References

The following documents contain provisions which, through reference in this text, constitute provisions of the present document.

- References are either specific (identified by date of publication, edition number, version number, etc.) or non-specific.
- For a specific reference, subsequent revisions do not apply.
- For a non-specific reference, the latest version applies. In the case of a reference to a 3GPP document (including a GSM document), a non-specific reference implicitly refers to the latest version of that document *in the same Release as the present document*.

- [1] 3GPP TR 21.905: "Vocabulary for 3GPP Specifications".
- [2] 3GPP TS 23.501: "System Architecture for the 5G System; Stage 2".
- [3] 3GPP TS 23.502: "Procedures for the 5G System; Stage 2".
- [4] 3GPP TS 29.500: "5G System; Technical Realization of Service Based Architecture; Stage 3".
- [5] 3GPP TS 29.501: "5G System; Principles and Guidelines for Services Definition; Stage 3".
- [6] IETF RFC 9113: "HTTP/2".
- [7] IETF RFC 8259: "The JavaScript Object Notation (JSON) Data Interchange Format".
- [8] 3GPP TS 33.501: "Security Architecture and Procedures for 5G System".
- [9] Void
- [10] 3GPP TS 29.571: "5G System; Common Data Types for Service Based Interfaces; Stage 3".
- [11] IETF RFC 9457: "Problem Details for HTTP APIs".
- [12] 3GPP TS 29.503: "5G System; Unified Data Management Services; Stage 3".
- [13] IETF RFC 6749: "The OAuth 2.0 Authorization Framework".
- [14] 3GPP TS 29.510: "Network Function Repository Services; Stage 3".
- [15] 3GPP TS 31.102: "Characteristics of the Universal Subscriber Identity Module (USIM) application".
- [16] IETF RFC 5216: "The EAP-TLS Authentication Protocol".
- [17] IETF RFC 9048: "Improved Extensible Authentication Protocol Method for 3rd Generation Authentication and Key Agreement (EAP-AKA)".
- [18] IETF RFC 3748: "Extensible Authentication Protocol (EAP)".
- [19] IETF RFC 4648: "The Base16, Base32 and Base64 Data Encodings".

- [20] 3GPP TS 24.501: "Non-Access-Stratum (NAS) protocol for 5G System (5GS); Stage 3".
- [21] 3GPP TR 21.900: "Technical Specification Group working methods".
- [22] 3GPP TS 29.544: "5G System; SP-AF Services; Stage 3".
- [23] 3GPP TS 23.316: " Wireless and wireline convergence access support for the 5G System (5GS); Release 16".
- [24] 3GPP TS 29.524: "5G System; Cause codes mapping between 5GC interfaces; Stage 3".
- [25] OpenAPI Initiative, "OpenAPI Specification Version 3.0.0", <https://spec.openapis.org/oas/v3.0.0>
- [26] 3GPP TS 33.503: " Security Aspects of Proximity based Services (ProSe) in the 5G System (5GS)".

3 Definitions and abbreviations

3.1 Definitions

For the purposes of the present document, the terms and definitions given in 3GPP TR 21.905 [1] and the following apply. A term defined in the present document takes precedence over the definition of the same term, if any, in 3GPP TR 21.905 [1].

3.2 Abbreviations

For the purposes of the present document, the abbreviations given in 3GPP TR 21.905 [1] and the following apply. An abbreviation defined in the present document takes precedence over the definition of the same abbreviation, if any, in 3GPP TR 21.905 [1].

5G Prose	5G Proximity-based Services
AMF	Access and Mobility Management Function
API	Application Programming Interface
AUSF	Authentication Server Function
CH	Credentials Holder
DCS	Default Credentials Server
FN-RG	Fixed Network RG
MAC	Message Authentication Code
N5GC	Non-5G-Capable
NF	Network Function
RG	Residential Gateway
SEAF	SEcurity Anchor Function
SNPN	Stand-alone Non-Public Network
SoR	Steering of Roaming
URI	Uniform Resource Identifier
UPU	UE Parameters Update
W-AGF	Wireline Access Gateway Function

4 Overview

4.1 Introduction

The Network Function (NF) Authentication Server Function (AUSF) is the network entity in the 5G Core Network (5GC) supporting the following functionalities:

- Authenticate the UE for the requester NF,
- Provide keying material to the requester NF,
- Protect the Steering Information List for the requester NF.
- Protect the UE Parameter Update Data for the requester NF.

Figure 4-1 shows the reference architecture for the AUSF:

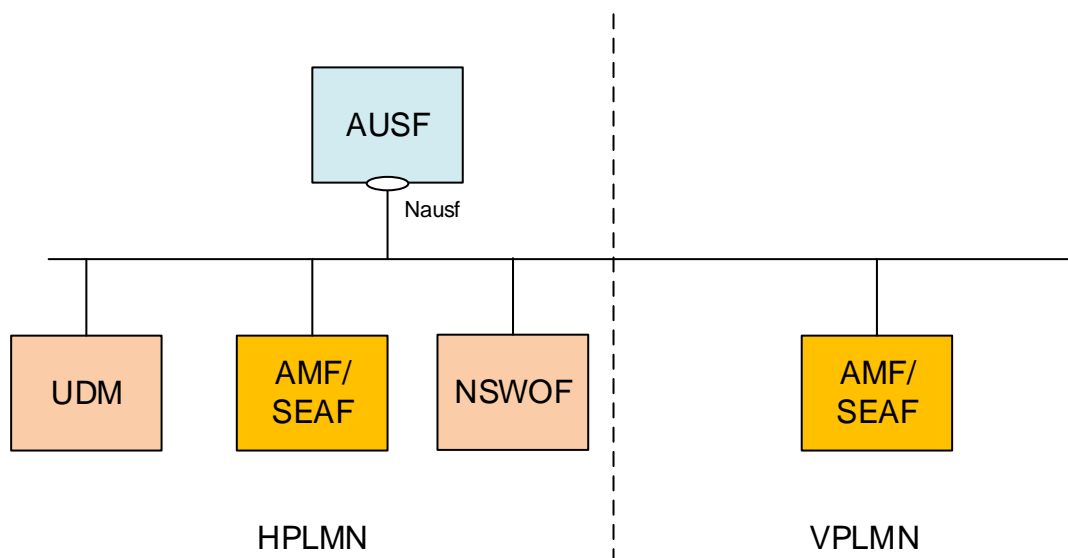

Figure 4-1: AUSF in 5G System architecture

This figure represents the AUSF architecture in the Service-based Architecture model. In the reference point model, the interface between the AMF and the AUSF is named N12, the interface between the NSWOF and the AUSF is named N60, the interface between the UDM and the AUSF is named N13. In this release, the SEAF function is collocated with the AMF.

Figure 4-1 illustrates PLMN level scenarios, but this architecture is also applicable to the SNPN scenarios, as explained below.

In the case of SNPN, the AUSF provides services e.g. in the following scenarios:

- For an SNPN for which roaming is not supported (see 3GPP TS 23.501 [2], clause 5.30.2.0)
- For the case of UE access to SNPN using credentials from Credentials Holder (see 3GPP TS 23.501 [2], clause 5.30.2.9)
- For the case of Onboarding of UEs for SNPNs (see 3GPP TS 23.501 [2], clause 5.30.2.10)
- For the case of supporting the authentication of a 5G ProSe Remote UE or a 5G ProSe End UE (see 3GPP TS 33.503 [26], clause 7.3)

5 Services offered by the AUSF

5.1 Introduction

The AUSF offers to NF Service Consumers (e.g. AMF) the following services:

- Nausf_UEAuthentication
- Nausf_SoRProtection
- Nausf_UPUProtection

Table 5.1-1 summarizes the corresponding APIs defined for this specification.

Table 5.1-1: API Descriptions

Service Name	Clause	Description	OpenAPI Specification File	apiName	Annex
Nausf_UEAuthentication	6.1	AUSF UE Authentication Service	TS29509_Nausf_UEAuthentication.yaml	nausf-auth	A.2
Nausf_SoRProtection	6.2	AUSF SoR Protection Service	TS29509_Nausf_SoRProtection.yaml	nausf-sorprotection	A.3
Nausf_UPUProtection	6.3	AUSF UPU Protection Service	TS29509_Nausf_UPUProtection.yaml	nausf-upuprotection	A.4

AUSF provides services to the following SNPN scenarios (see clauses 5.30.2 in 3GPP TS 23.501 [2]):

- In a SNPN where roaming is not supported;
- In the case of UE access to SNPN using credentials from Credentials Holder with AAA-S;
- In the case of UE access to SNPN using credentials from Credentials Holder with AUSF and UDM;
- In the case of Onboarding of UEs for SNPNs without using Default Credentials Server;
- In the case of Onboarding of UEs for SNPNs using Default Credentials Server with AAA-S;
- In the case of Onboarding of UEs for SNPNs using Default Credentials Server with AUSF and UDM.

5.2 Nausf_UEAuthentication Service

5.2.1 Service Description

The AUSF is acting as NF Service Producer. It provides UE authentication service to the requester NF. The NF Service Consumer is the AMF.

For this service, the following service operations are defined:

- Authenticate

This service permits to authenticate the UE and to provide one or more master keys which are used by the AMF to derive subsequent keys.

5.2.2 Service Operations

5.2.2.1 Introduction

The service operation defined for the Nausf_UEAuthentication is as follows:

- Authenticate: It allows the AMF to authenticate the UE and allows the AMF to inform AUSF to remove the UE authentication result in the UDM.
- Deregister: It allows UDM to request the AUSF to clear the Security Context.

- ProseAuthenticate: It allows the AUSF of the 5G ProSe Remote UE to support the authentication of a 5G ProSe Remote UE via the AMF of the 5G ProSe UE-to-Network Relay or allows the AUSF of the 5G ProSe End UE to support the authentication of a 5G ProSe End UE via the AMF of the 5G ProSe UE-to-UE Relay.

5.2.2.2 Authenticate

5.2.2.2.1 General

The service operation "Authenticate" permits the requester NF to initiate the Authentication of the UE by providing the following information to the AUSF:

- UE id (i.e. SUPI or SUCI)
- Serving Network Name

In the case of Indirect Network Sharing (see clause 5.18 of 3GPP TS 23.501 [2]), the serving AMF in the hosting operator's network shall set the PLMN ID in the Serving Network Name to the PLMN ID selected by the UE.

The AUSF retrieves the UE's subscribed authentication method from the UDM and depending on the information provided by the UDM, the AUSF enters in one of the following procedures:

- 5G-AKA
- EAP-based authentication'

For those two different procedures a new resource is generated by the AUSF. The content of the resource will depend on the procedure and will be returned to the AMF.

This service operation "Authenticate" also permits the requester NF to initiate the Authentication of the FN-RG registration via W-AGF by providing the following information to the AUSF:

- UE id (i.e. SUCI)
- Indication that the W-AGF has authenticated the FN-RG

The AUSF retrieves the UE's SUPI, indication that authentication is not required for the FN-RG from the UDM, and AUSF shall not perform the authentication.

The service operation "Authenticate" also permits the requester NF to inform the AUSF to remove the UE authentication result in the UDM.

5.2.2.2.2 5G AKA

In this procedure, the NF Service Consumer (AMF) requests the authentication of the UE by providing UE related information and the Serving Network Name to the NF Service Producer (AUSF), which retrieves UE related data and authentication method from the UDM. In this case the retrieved authentication method is 5G AKA. The NF Service Consumer (AMF) shall then return to the AUSF the result received from the UE:

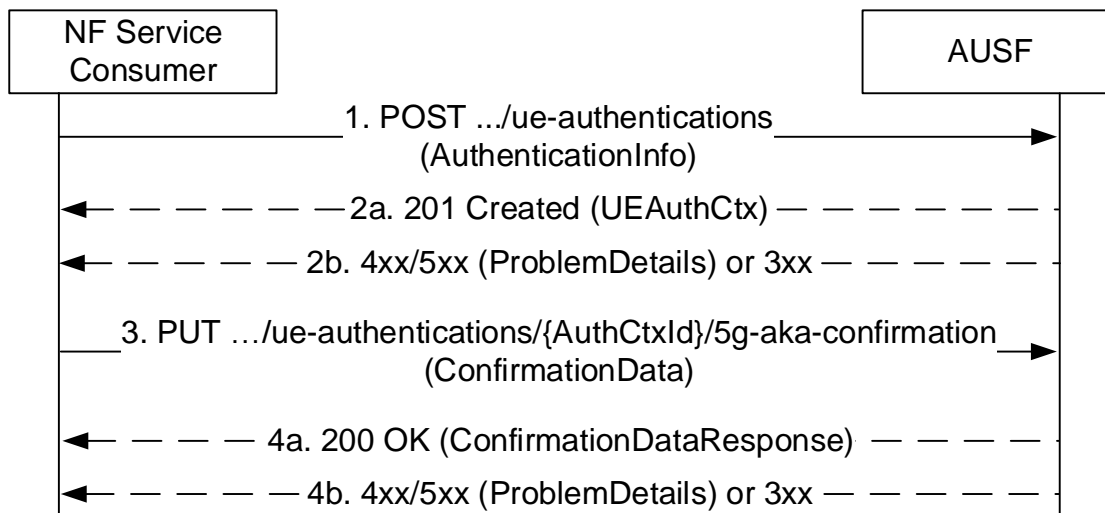

Figure 5.2.2.2-1: 5G AKA

1. The NF Service Consumer (AMF) shall send a POST request to the AUSF. The content shall contain at least the UE Id and the Serving Network Name.
- 2a. On success, "201 Created" shall be returned. The content shall contain the representation of the resource created and the "Location" header shall contain the URI of the created resource (e.g. .../ue_authentications/{authCtxId}). The AUSF generates a sub-resource "5g-aka-confirmation". There shall be only one sub-resource "5g-aka-confirmation" per UE per Serving Network identified by the supiOrSuci and servingNetworkName in AuthenticationInfo. The AUSF shall provide a hypermedia link towards this sub-resource in the content to indicate to the AMF where it shall send a PUT for the confirmation.
- 2b. On failure or redirection, one of the HTTP status codes listed in table 6.1.3.2.3.1-3 shall be returned. For a 4xx/5xx response, the message body may contain a ProblemDetails structure with the "cause" attribute set to one of the application errors listed in Table 6.1.3.2.3.1-3. If the serving network is not authorized, the AUSF shall use the SERVING_NETWORK_NOT_AUTHORIZED "cause".
3. Based on the relation type, the NF Service Consumer (AMF) deduces that it shall send a PUT containing the "RES*" provided by the UE to the URI provided by the AUSF or derived by itself. The NF Service Consumer (AMF) shall also send a PUT containing null value in the RES* to indicate the failure to the AUSF for the following cases:
 - if the UE is not reached, and the RES* is never received by the NF Service Consumer (AMF);
 - the comparison of the HRES* and HXRES* is unsuccessful in the NF Service Consumer (AMF);
 - the authentication failure is received from the UE, e.g. synchronization failure or MAC failure;
- 4a. On success, "200 OK" shall be returned. If the UE is not authenticated, e.g. the verification of the RES* was not successful in the AUSF, the AUSF shall set the value of AuthResult to AUTHENTICATION_FAILURE.

In SNPN onboarding scenarios, if the UE is authenticated successfully, the AUSF may include in the response the FQDN(s) and/or IP address(es) of an onboarding Provisioning Server (PVS) to the NF Service Consumer (AMF); see 3GPP TS 23.501 [2], clause 5.30.2.10.

4b. On failure or redirection, one of the HTTP status codes listed in table 6.1.3.3.3.1-3 shall be returned. For a 4xx/5xx response, the message body may contain a ProblemDetails structure with the "cause" attribute set to one of the application errors listed in Table 6.1.3.3.3.1-3.

5.2.2.2.3 EAP-based authentication method

5.2.2.2.3.1 General

In this procedure, the NF Service Consumer requests the authentication of the UE by providing UE related information and the serving network and the EAP-based authentication is selected (see IETF RFC 3748 [18]). EAP messages are exchanged between a UE acting as EAP peer, an NF Service Consumer (AMF/SEAF, NSWOF) acting as a pass-through authenticator and the AUSF acting as the EAP server.

5.2.2.2.3.2 EAP method: EAP-AKA'

EAP-AKA' is the EAP method used in this procedure

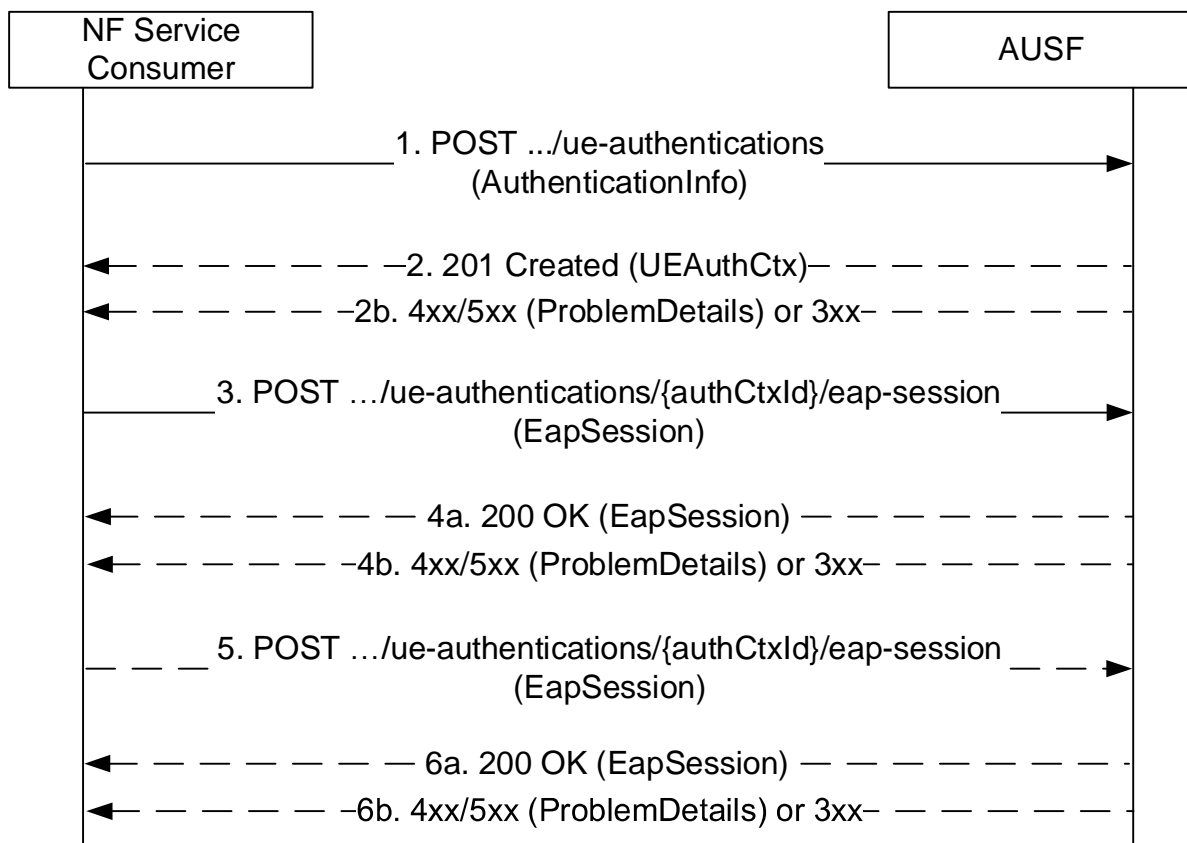

Figure 5.2.2.2.3-1: EAP-based authentication with EAP-AKA' method

1. The NF Service Consumer (AMF, NSWOF) shall send a POST request to the AUSF. The content shall contain at least the UE Id, Serving Network Name. If the consumer is an NSWOF the NSWOF Indicator shall be present in the content.
- 2a. On success, "201 Created" shall be returned. The content shall contain the representation of the resource generated and the "Location" header shall contain the URI of the generated resource (e.g. .../ue_authentications/{authCtxId}). The AUSF generates a sub-resource "eap-session". There shall be only one sub-resource "eap-session" per UE per Serving Network identified by the supiOrSuci and servingNetworkName in AuthenticationInfo. The AUSF shall provide a hypermedia link towards this sub-resource in the payload to

indicate to the AMF or NSWOF where it shall send a POST containing the EAP packet response. The content shall also contain the EAP packet EAP-Request/AKA'-Challenge.

- 2b. On failure or redirection, one of the HTTP status codes listed in table 6.1.3.2.3.1-3 shall be returned. For a 4xx/5xx response, the message body may contain a ProblemDetails structure with the "cause" attribute set to one of the application errors listed in Table 6.1.3.2.3.1-3. In particular, if the serving network is not authorized, the AUSF shall use the "Cause" SERVING_NETWORK_NOT_AUTHORIZED.
3. Based on the relation type, the NF Service Consumer (AMF, NSWOF) shall send a POST request including the EAP-Response/AKA' Challenge received from the UE. The POST request is sent to the URI provided by the AUSF or derived by the NF Service Consumer (AMF, NSWOF).
- 4a. On success, and if the AUSF and the UE have indicated the use of protected successful result indications as in IETF RFC 9048 [17], the AUSF shall reply with a "200 OK" HTTP message containing the EAP Request/AKA' Notification and a hypermedia link towards the sub-resource "eap-session".
- 4b. On failure or redirection, one of the HTTP status codes listed in table 6.1.3.4.3.1-3 shall be returned. For a 4xx/5xx response, the message body may contain a ProblemDetails structure with the "cause" attribute set to one of the application errors listed in Table 6.1.3.4.3.1-3.

NOTE: Steps 4 to 5 are optional.

5. The NF Service Consumer (AMF, NSWOF) shall send a POST request including the EAP Response/AKA' Notification received from the UE. The POST request is sent to the URI provided by the AUSF or derived by the NF Service Consumer (AMF, NSWOF).
- 6a. If the EAP authentication exchange is successfully completed (with or without the optional Notification Request/Response messages exchange), "200 OK" shall be returned to the NF Service Consumer (AMF, NSWOF). The content shall contain the result of the authentication, an EAP success/failure and if the authentication is successful the Kseaf if the consumer is an AMF or the MSK if the consumer is a NSWOF (as indicated by the NSWO indicator received in step 1). If the UE is not authenticated, the AUSF shall set the authResult to AUTHENTICATION_FAILURE.

In SNPN onboarding scenarios, if the UE is authenticated successfully, the AUSF may include in the response the FQDN(s) and/or IP address(es) of an onboarding Provisioning Server (PVS) to the NF Service Consumer (AMF) ; see 3GPP TS 23.501 [2], clause 5.30.2.10.

- 6b. On failure or redirection, one of the HTTP status codes listed in table 6.1.3.4.3.1-3 shall be returned. For a 4xx/5xx response, the message body may contain a ProblemDetails structure with the "cause" attribute set to one of the application errors listed in Table 6.1.3.4.3.1-3.

5.2.2.2.3.3 EAP method: EAP-TLS

The EAP-TLS method can be used in private networks as an EAP method (see 3GPP TS 33.501 [8] Annex B.1). The corresponding stage 3 implementation is described in Annex B.

The EAP-TLS method is applicable for N5GC devices behind Cable RGs in private networks or in deployment scenarios with wireline access; see 3GPP TS 33.501 [8] Annex O.

5.2.2.2.3.4 EAP method: EAP-TTLS

The EAP-TTLS method can be used as an EAP method (see 3GPP TS 33.501 [8] Annex U) in case of UE access to SNPN using credentials from Credential Holder with AAA Server.

5.2.2.2.4 Authentication for FN-RG

In this procedure, the NF Service Consumer (AMF) requests the authentication of the FN-RG registration via W-AGF by providing the SUCI of the FN-RG and the authenticated indication.

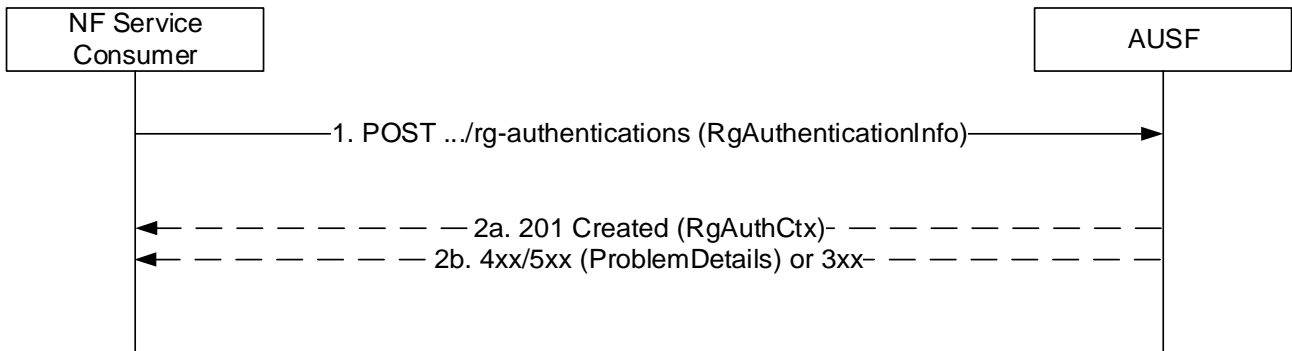

Figure 5.2.2.2.4-1: Authentication for FN-RG

1. The NF Service Consumer (AMF) shall send a POST request to the AUSF. The content shall contain at least the UE Id and the authenticated indication.
- 2a. On success, "201 Created" shall be returned. The content shall contain the representation of the resource created and the "Location" header shall contain the URI of the created resource (e.g. .../rg-authentications/{authCtxId}).
- 2b. On failure or redirection, one of the HTTP status code listed in table 6.1.3.4.3.1-3 shall be returned. For a 4xx/5xx response, the message body may contain a ProblemDetails structure with the "cause" attribute set to one of the application error listed in Table 6.1.3.4.3.1-3.

5.2.2.2.5 Authentication Result Removal with 5G AKA method

In the case that the Purge of subscriber data in AMF after the UE deregisters from the network or the NAS SMC fails following the successful authentication in the registration procedure, the NF Service Consumer (AMF) requests the AUSF to inform the UDM to remove the authentication result:

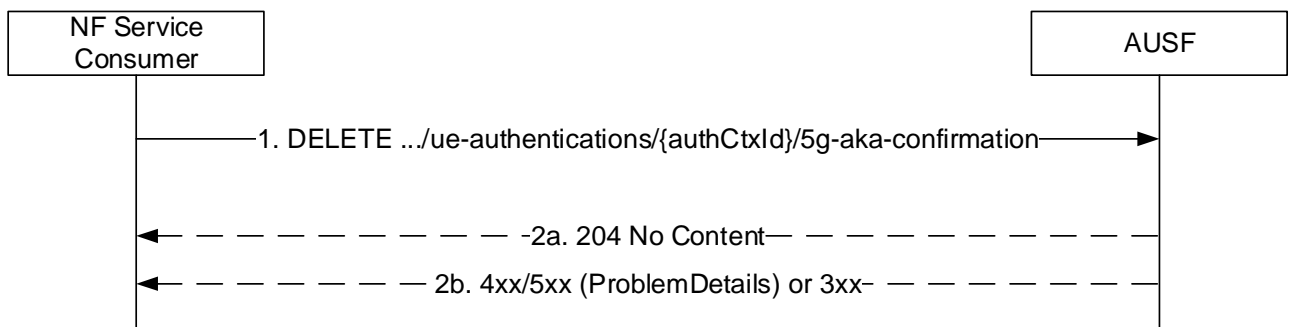

Figure 5.2.2.2.5-1: Authentication Result Removal with 5G AKA method

1. The NF Service Consumer (AMF) shall send a DELETE request to the resource URI representing the sub-resource "5g-aka-confirmation". The request body shall be empty.
- 2a. On success, "204 No Content" shall be returned. The AUSF shall send a DELETE request to the UDM for removing the authentication result of the UE after receiving the above DELETE request message.
- 2b. On failure or redirection, one of the HTTP status code listed in table 6.1.3.3.3.2-3 shall be returned. For a 4xx/5xx response, the message body may contain a ProblemDetails structure with the "cause" attribute set to one of the application error listed in Table 6.1.3.3.3.2-3..

5.2.2.2.6 Authentication Result Removal with EAP-AKA' method

In the case that the Purge of subscriber data in AMF after the UE deregisters from the network or the NAS SMC fails following the successful authentication the registration procedure, the NF Service Consumer (AMF) requests the AUSF to inform the UDM to remove the authentication result:

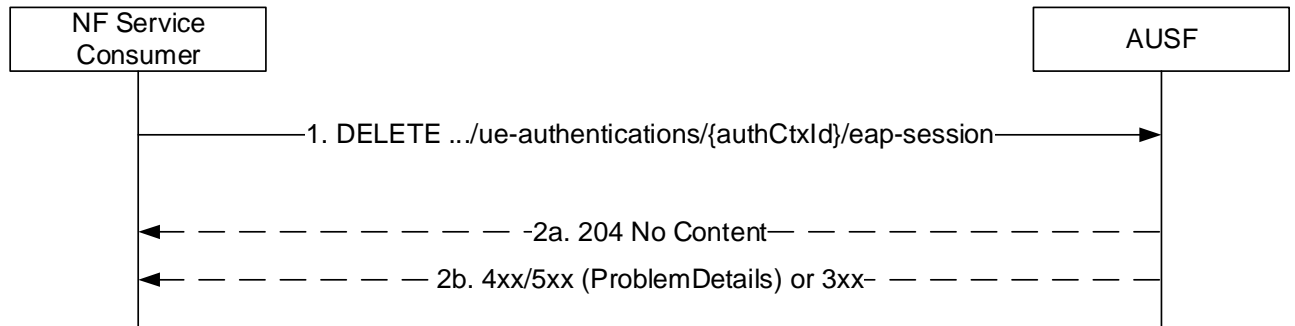

Figure 5.2.2.2.6-1: Authentication Result Removal with EAP-AKA' method

1. The NF Service Consumer (AMF) shall send a DELETE request to the resource URI representing the sub-resource "eap-session". The request body shall be empty.
- 2a. On success, "204 No Content" shall be returned. The AUSF shall send a DELETE request to the UDM for removing the authentication result of the UE after receiving the above DELETE request message.
- 2b. On failure or redirection, one of the HTTP status code listed in table 6.1.3.4.3.2-3 shall be returned. For a 4xx/5xx response, the message body may contain a ProblemDetails structure with the "cause" attribute set to one of the application error listed in Table 6.1.3.4.3.2-3.

5.2.2.3 Deregister

5.2.2.3.1 General

The Deregister service operation is used in the following scenario:

- Deletion of security context in AUSF

The NF Service Consumer (e.g. UDM) uses this service operation to request the AUSF to clear the stale security context, after the UE has been successfully (re)authenticated in same or different Serving Network via another AUSF Instance, e.g. due to registration via another access-type; so as to ensure only latest Kausf is maintained in the network. The service may also be used by UDM when the UE is no longer registered via any access-type or serving-network. It is responsibility of NF Service Consumers to ensure that security context being deleted does not hold the latest Kausf if UE is also connected via another Serving-Network.

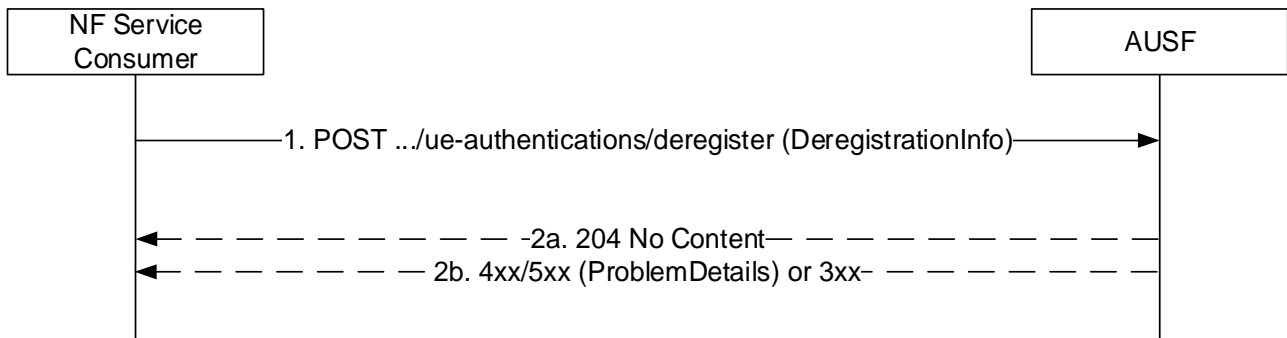

Figure 5.2.2.3.1-1: UE Context Clean-up in AUSF

1. The NF Service Consumer (e.g. UDM) shall send a POST request to the AUSF that was used to authenticate the UE. The content shall contain the UE id (e.g. SUPI).
- 2a. On success, "204 No Content" shall be returned.
- 2b. On failure or redirection, one of the HTTP status code listed in table 6.1.3.2.4.2.2-2 shall be returned. For a 4xx/5xx response, the message body may contain a ProblemDetails structure with the "cause" attribute set to one of the application error listed in Table 6.1.3.2.4.2.2-2.

5.2.2.4 ProseAuthenticate

5.2.2.4.1 General

The ProseAuthenticate service operation is used in the following scenario:

- Authenticate the 5G ProSe Remote UE in AUSF or 5G ProSe End UE

The NF Service Consumer (AMF) requests the authentication of the 5G ProSe Remote UE or the 5G ProSe End UE by providing 5G ProSe Remote UE or the 5G ProSe End UE related information (SUCI or CP-PRUK ID), the Relay Service Code and Nonce_1 to the NF Service Producer (AUSF) in the initial authentication request. When CP-PRUK ID is provided, the AUSF shall retrieve the CP-PRUK from PANf; when SUCI is provided, the AUSF retrieves 5G ProSe Remote UE or the 5G ProSe End UE related data and authentication method from the UDM. In this case the retrieved authentication method is EAP-AKA. The NF Service Consumer (AMF) shall then return to the AUSF the result received from the 5G ProSe Remote UE or the 5G ProSe End UE to continue the authentication:

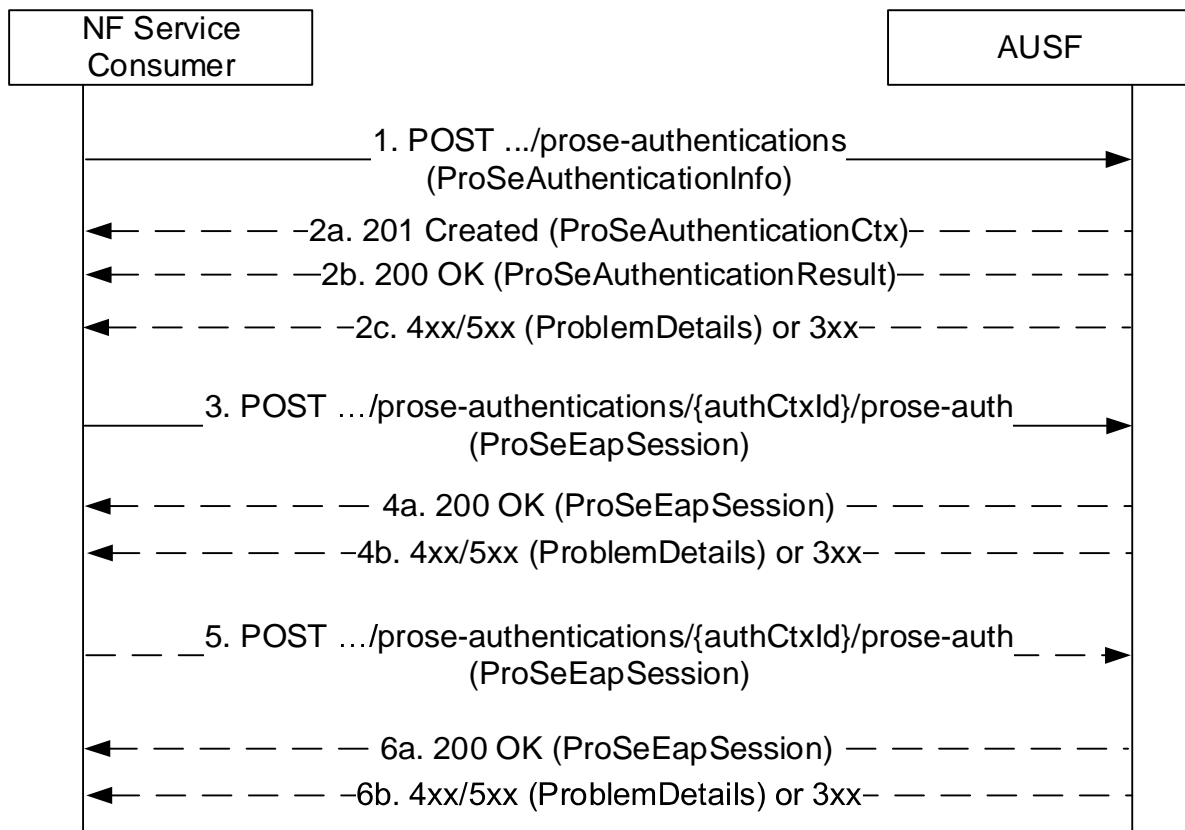

Figure 5.2.2.4.1-1: ProSe Authentication

1. The NF Service Consumer (AMF) shall send a POST request to the AUSF. The content shall contain the UE Id (SUCI) or CP-PRUK ID, Relay Service Code and Nonce_1.
- 2a. On success, "201 Created" shall be returned if UE Id (SUCI) is received. The content shall contain the representation of the resource generated and the "Location" header shall contain the URI of the generated resource (e.g. .../prose_authentications/{authCtxId}). The AUSF generates a sub-resource "prose-auth". There shall be only one sub-resource "prose-auth" per UE identified by the supiOrSuci in ProSeAuthenticationInfo. The AUSF shall provide a hypermedia link towards this sub-resource in the content to indicate to the AMF where it shall send a POST containing the EAP packet response. The content shall also contain the EAP packet EAP-Request/AKA'-Challenge.
- 2b. On success, "200 OK" shall be returned if CP-PRUK ID is received. The content shall contain the K_{NR_ProSe} and Nonce_2. Step 3 to 6 are skipped.
- 2c. On failure or redirection, one of the HTTP status code listed in table 6.1.3.2.3.1-3 shall be returned. For a 4xx/5xx response, the message body may contain a ProblemDetails structure with the "cause" attribute set to one of the application error listed in Table 6.1.3.2.3.1-3.
3. Based on the relation type, the NF Service Consumer (AMF) shall send a POST request including the EAP-Response/AKA' Challenge received from the 5G ProSe Remote UE or the 5G ProSe End UE. The POST request is sent to the URI provided by the AUSF or derived by the NF Service Consumer (AMF).
- 4a. On success, and if the AUSF and the UE have indicated the use of protected successful result indications as in IETF RFC 9048 [17], the AUSF shall reply with a "200 OK" HTTP message containing the EAP Request/AKA' Notification and an hypermedia link towards the sub-resource "prose-auth".

4b. On failure or redirection, one of the HTTP status code listed in table 6.1.3.4.3.1-3 shall be returned. For a 4xx/5xx response, the message body may contain a ProblemDetails structure with the "cause" attribute set to one of the application error listed in Table 6.1.3.4.3.1-3.

NOTE: Steps 4 to 5 are optional.

5. The NF Service Consumer (AMF) shall send a POST request including the EAP Response/AKA' Notification received from the UE. The POST request is sent to the URI provided by the AUSF or derived by the NF Service Consumer (AMF).

6a. If the ProSe authentication exchange is successfully completed (with or without the optional Notification Request/Response messages exchange), "200 OK" shall be returned to the NF Service Consumer (AMF). The content shall contain the result of the authentication, an EAP success/failure. The content shall also contain the K_{NR_ProSe} , Nonce_2 and CP-PRUK ID if the authentication is successful. If the 5G ProSe Remote UE or the 5G ProSe End UE is not authenticated, the AUSF shall set the authResult to AUTHENTICATION_FAILURE.

6b. On failure or redirection, one of the HTTP status code listed in table 6.1.3.4.3.1-3 shall be returned. For a 4xx/5xx response, the message body may contain a ProblemDetails structure with the "cause" attribute set to one of the application error listed in Table 6.1.3.4.3.1-3.

5.2.2.4.2 ProSe Authentication Result Removal with EAP-AKA' method

In the case that the authentication of a 5G ProSe Remote UE or the 5G ProSe End UE fails, the NF Service Consumer (AMF) requests the AUSF to inform the UDM to remove the authentication result:

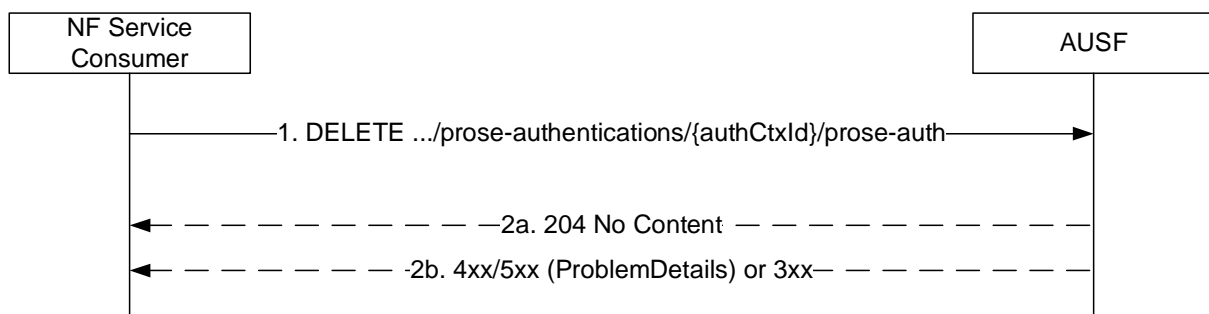

Figure 5.2.2.4.2-1: ProSe Authentication Result Removal with EAP-AKA' method

1. The NF Service Consumer (AMF) shall send a DELETE request to the resource URI representing the sub-resource "prose-auth". The request body shall be empty.
- 2a. On success, "204 No Content" shall be returned. The AUSF shall send a DELETE request to the UDM for removing the authentication result of the UE after receiving the above DELETE request message.
- 2b. On failure or redirection, one of the HTTP status code listed in table 6.1.3.4.3.2-3 shall be returned. For a 4xx/5xx response, the message body may contain a ProblemDetails structure with the "cause" attribute set to one of the application error listed in Table 6.1.3.4.3.2-3.

5.3 Nausf_SoRProtection Service

5.3.1 Service Description

The AUSF is acting as NF Service Producer. It provides SoRProtection service to the NF Service Consumer.

This service permits to provide the NF Service Consumer (e.g. UDM) with the SoR-MAC-IAUSF and CounterSoR to protect the Steering Information from being tampered with or removed by the VPLMN.

NOTE: If the Steering Information is not available or HPLMN determines that no steering of the UE is required, a SOR transparent container information element with an HPLMN indication that 'no change of the "Operator Controlled PLMN Selector with Access Technology" list stored in the UE protected by SoR-MAC-IAUSF and CounterSoR is still sent to the UE during registration. The Steering Information in such a case, the NF Service Consumer shall send an empty list to the AUSF when consuming the Nausf_SoRProtection Service.

In option this service also allows to provide the NF Service Consumer (e.g. UDM) with the SoR-XMAC-IUE that allows the NF Service Consumer (e.g. UDM) to verify that the UE received the Steering Information List.

5.3.2 Service Operations

5.3.2.1 Introduction

The service operation defined for the Nausf_SoRProtection is as follows:

- Protect

5.3.2.2 Protect

5.3.2.2.1 General

The Protect service operation is used in the following procedures:

- Procedure for steering of UE in VPLMN during registration (see clause 6.14.2.1 of 3GPP TS 33.501 [8]);
- Procedure for steering of UE in VPLMN after registration (see clause 6.14.2.2 of 3GPP TS 33.501 [8]).

The NF Service Consumer (e.g. UDM) uses this service operation to request the AUSF to compute the SoR-MAC-IAUSF and the CounterSoR by providing Steering Information. The NF Service Consumer (e.g. UDM) may also request the AUSF to compute the SoR-XMAC-IUE by providing the indication that an acknowledgement is requested from the UE.

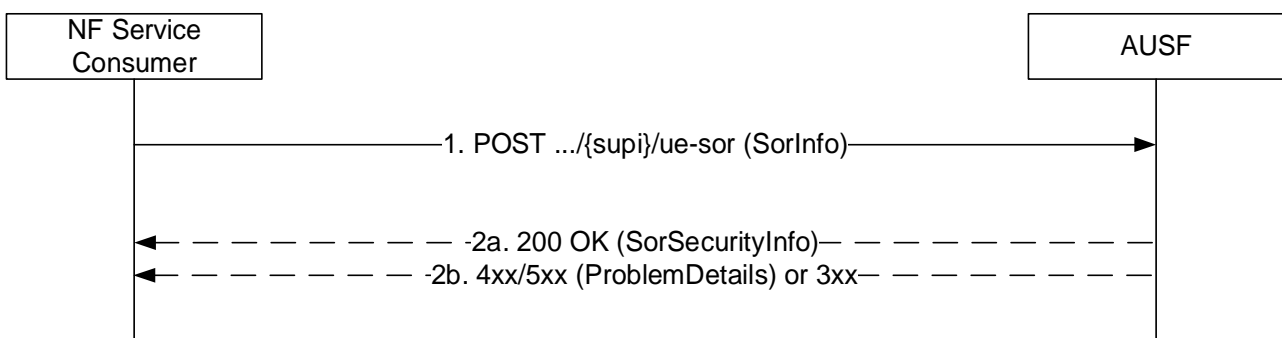

Figure 5.3.2.2.1-1: Steering of UE in VPLMN

1. The NF Service Consumer (e.g. UDM) shall send a POST request to the AUSF that was used to authenticate the UE. The content shall contain the Steering Information and the acknowledge indication.
- 2a. On success, "200 OK" shall be returned. The content shall contain the requested security material (e.g. SoR-MAC-IAUSF, CounterSoR, SoR-XMAC-IUE) necessary to protect the Steering of Roaming procedure.

SoR Header shall be used to form the input as one of multiple parameters to calculate the SoR-MAC-I_{AUSF}. If SoRHeader attribute is not provided by NF Service Consumer (e.g. UDM) as part of SorInfo, SoR Header shall be constructed by AUSF based on the information received in the request and encoded as specified in clause 9.11.3.51 of 3GPP TS 24.501[20].

- 2b. On failure or redirection, one of the HTTP status code listed in table 6.2.3.2.4.2.2-2 shall be returned. For a 4xx/5xx response, the message body may contain a ProblemDetails structure with the "cause" attribute set to one of the application error listed in Table 6.2.3.2.4.2.2-21. If the Counter_{SoR} associated with the K_{AUSF} of the UE, is about to wrap around, the AUSF shall use the "COUNTER-WRAP" cause.

5.4 Nausf_UPUProtection Service

5.4.1 Service Description

The AUSF is acting as NF Service Producer. It provides UPUProtection service to the NF Service Consumer.

This service permits to provide the NF Service Consumer (e.g. UDM) with the UPU-MAC-I_{AUSF} and Counter_{UPU} to protect the UE Parameters Update Data from being tampered with or removed.

In option this service also allows to provide the NF Service Consumer (e.g. UDM) with the UPU-XMAC-I_{UE} that allows the NF Service Consumer (e.g. UDM) to verify that the UE received UE Parameters Update Data correctly.

5.4.2 Service Operations

5.4.2.1 Introduction

The service operation defined for the Nausf_UPUProtection is as follows:

- Protect

5.4.2.2 Protect

5.4.2.2.1 General

The Protect service operation is used in the following procedures:

- Procedure for UE Parameters Update (see clause 6.15.2.1 of 3GPP TS 33.501 [8]).

The NF Service Consumer (e.g. UDM) uses this service operation to request the AUSF to compute the UPU-MAC-I_{AUSF} and Counter_{UPU} by providing the UE Parameters Update Data (UPU Data). The NF Service Consumer (e.g. UDM) may also request the AUSF to compute the UPU-XMAC-I_{UE} by providing the indication that an acknowledgement is requested from the UE.

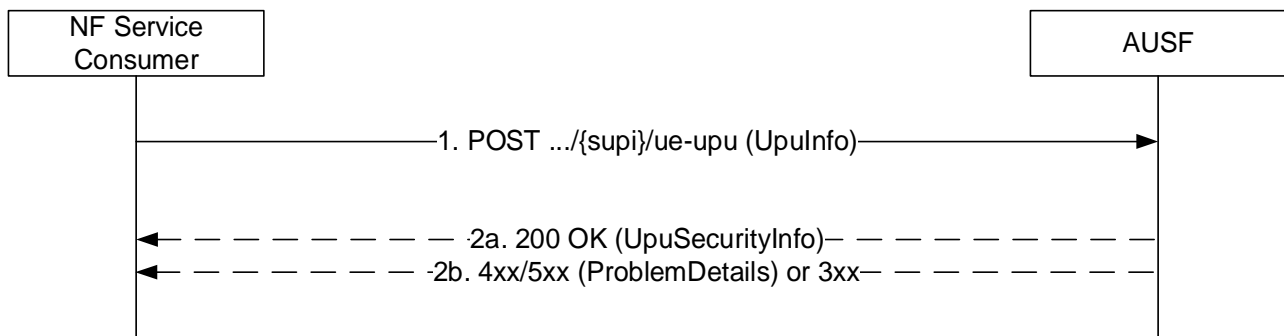

Figure 5.4.2.2-1: UE Parameters Update in VPLMN

1. The NF Service Consumer (e.g. UDM) shall send a POST request to the AUSF that was used to authenticate the UE and stores the latest K_{AUSF} for the UE. The content shall contain the UE Parameters Update Data (UPU Data), the UPU Header and the acknowledge indication.
- 2a. On success, "200 OK" shall be returned. The content shall contain the requested security material necessary to protect the UE Parameters Update procedure.
- 2b. On failure or redirection, one of the HTTP status code listed in table 6.3.3.2.4.2.2-2 shall be returned. For a 4xx/5xx response, the message body may contain a ProblemDetails structure with the "cause" attribute set to one of the application error listed in Table 6.3.3.2.4.2.2-2. If the Counter_{UPU} associated with the K_{AUSF} of the UE, is about to wrap around, the AUSF shall use the "COUNTER-WRAP" cause.

6 API Definitions

6.1 Nausf_UEAuthentication Service API

6.1.1 API URI

URIs of this API shall have the following root:

{apiRoot}/<apiName>/<apiVersion>

The request URIs used in HTTP requests from the NF service consumer towards the NF service producer shall have the Resource URI structure defined in clause 4.4.1 of 3GPP TS 29.501 [5], i.e.:

{apiRoot}/<apiName>/<apiVersion>/<apiSpecificResourceUriPart>

with the following components:

- The {apiRoot} shall be set as described in 3GPP TS 29.501 [6].
- The <apiName> shall be "nausf-auth".
- The <apiVersion> shall be "v1".
- The <apiSpecificResourceUriPart> shall be set as described in clause 6.1.3.

6.1.2 Usage of HTTP

6.1.2.1 General

HTTP/2, as defined in IETF RFC 9113 [6], shall be used as specified in clause 5 of 3GPP TS 29.500 [4].

6.1.2.2 HTTP standard headers

6.1.2.2.1 General

The usage of HTTP standard headers is specified in clause 5.2.2 of 3GPP TS 29.500 [4].

6.1.2.2.2 Content type

The following content types shall be supported:

- JSON, as defined in IETF RFC 8259 [7], shall be used as content type of the HTTP bodies specified in the present specification as indicated in clause 5.4 of 3GPP TS 29.500 [4].
- The Problem Details JSON Object (IETF RFC 9457 [11]). The use of the Problem Details JSON object in a HTTP response body shall be signalled by the content type "application/problem+json"
- The 3GPP hypermedia format as defined in 3GPP TS 29.501 [5]. The use of the 3GPP hypermedia format in a HTTP response body shall be signalled by the content type "application/3gppHal+json"

6.1.2.3 HTTP custom headers

6.1.2.3.1 General

The usage of HTTP custom headers shall be supported as specified in clause 5.2.3 of 3GPP TS 29.500 [4].

6.1.3 Resources

6.1.3.1 Overview

The structure of the Resource URIs of the Nausf_UEAuthentication service is shown in Figure 6.1.3.1-1

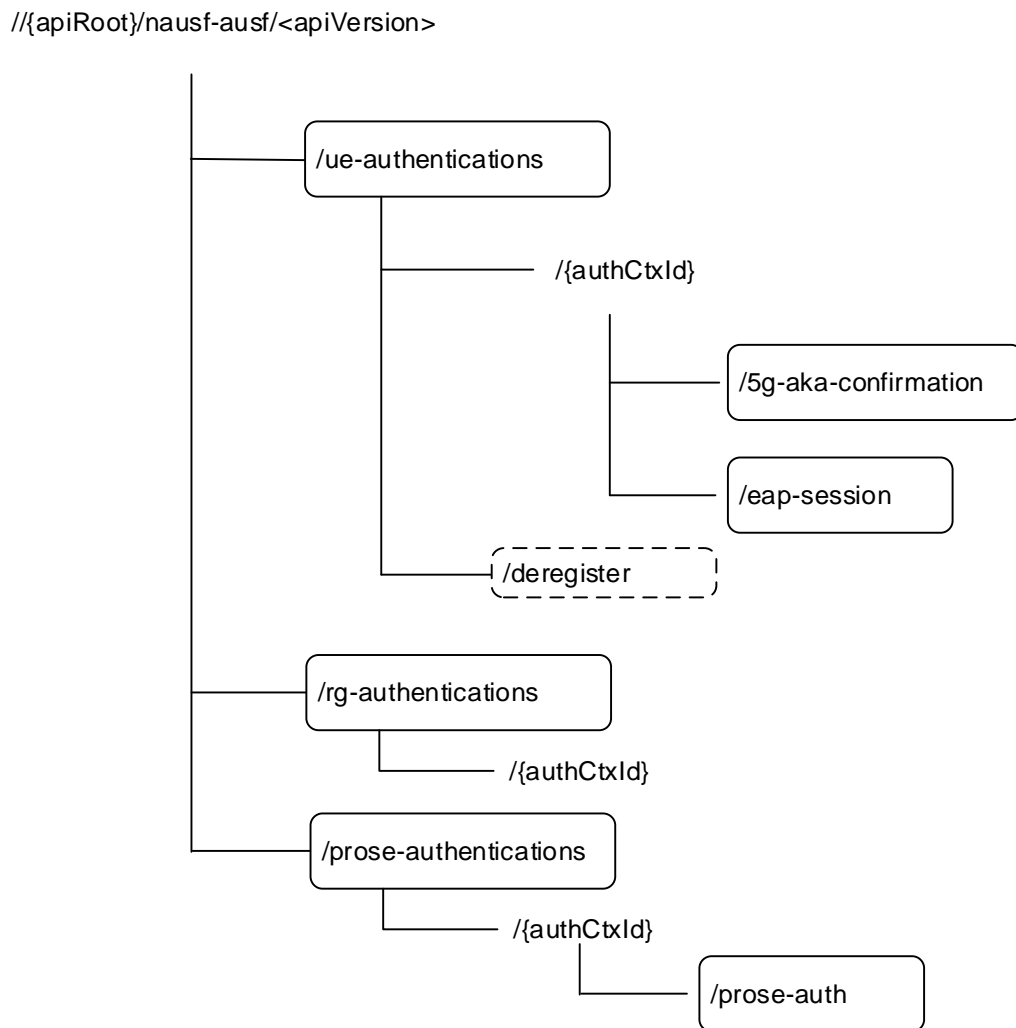

Figure 6.1.3.1-1: Resource URI structure of the AUSF API

Table 6.1.3.1-1 provides an overview of the resources and applicable HTTP methods.

Table 6.1.3.1-1: Resources and methods overview

Resource name	Resource URI	HTTP method or custom operation	Description
ue-authentications (Collection)	/ue-authentications	POST	Initiate the authentication process by providing inputs related to the UE
	/ue-authentications/deregister	deregister (POST)	Clear the security context of the UE
Individual UE authentication (Document)	/ue-authentications/{authCtxId}		See NOTE 1
5g-aka-confirmation (Document)	/ue-authentications/{authCtxId}/5g-aka-confirmation	PUT	Put the UE response from the 5G-AKA process.
		DELETE	DELETE the authentication result.
eap-session (Document)	/ue-authentications/{authCtxId}/eap-session	POST	Post the EAP response from the UE. See NOTE.
		DELETE	DELETE the authentication result.
rg-authentications (Collection)	/rg-authentications	POST	Initiate the authentication process by providing inputs related to the FN-RG
Individual RG authentication (Document)	/rg-authentications/{authCtxId}		See NOTE 3
prose-authentications (Collection)	/prose-authentications	POST	Initiate the authentication process by providing inputs related to the 5G ProSe Remote UE or the 5G ProSe End UE.
prose-auth (Document)	/prose-authentications/{authCtxId}/prose-auth	POST	Post the EAP response from the 5G ProSe Remote UE or the 5G ProSe End UE. See NOTE.
		DELETE	DELETE the authentication result.
<p>NOTE 1: This resource represents the created individual UE authentication, the URI of the created resource is contained in the "Location" header of the "201 Created" response (See step 2a of Figure 5.2.2.2.3.2-1 and Figure 5.2.2.2.3.2-1). There are no service operations defined on this resource.</p> <p>NOTE 2: This POST is used to provide EAP response to the AUSF in a sub-resource (Document) generated by the first POST operation. As this operation is not idempotent (it triggers subsequent EAP operations), a PUT was not adequate.</p> <p>NOTE 3: This resource represents the created individual RG authentication, the URI of the created resource is contained in the "Location" header of the "201 Created" response (See step 2a of Figure 5.2.2.2.4-1). There are no service operations defined on this resource.</p>			

6.1.3.2 Resource: ue-authentications (Collection)

6.1.3.2.1 Description

This resource represents a collection of the ue-authentication resources generated by the AUSF.

6.1.3.2.2 Resource Definition

Resource URI: **{apiRoot}/nausf-auth/<apiVersion>/ue-authentications**

This resource shall support the resource URI variables defined in table 6.1.3.3.2-1.

Table 6.1.3.2.2-1: Resource URI variables for this resource

Name	Data type	Definition
apiRoot	string	See clause 6.1.1

6.1.3.2.3 Resource Standard Methods

6.1.3.2.3.1 POST

This method shall support the URI query parameters specified in table 6.1.3.2.3.1-1.

Table 6.1.3.2.3.1-1: URI query parameters supported by the POST method on this resource

Name	Data type	P	Cardinality	Description
n/a				

This method shall support the request data structures specified in table 6.1.3.2.3.1-2 and the response data structures and response codes specified in table 6.1.3.2.3.1-3.

Table 6.1.3.2.3.1-2: Data structures supported by the POST Request Body on this resource

Data type	P	Cardinality	Description
AuthenticationInfo	M	1	Contains the UE id (i.e. SUCI or SUPI as specified in 3GPP TS 33.501 [8]) and the serving network name. It may also contain Trace Data as specified in 3GPP TS 23.501 [2].

Table 6.1.3.2.3.1-3: Data structures supported by the POST Response Body on this resource

Data type	P	Cardinality	Response Codes	Description
UEAuthentication Ctx	M	1	201 Created	Upon success, if 5G AKA is selected, the response body will contain one AV and "link" for the AMF to PUT the confirmation. If an EAP-based method is selected, the response body will contain the EAP method selected, the corresponding EAP packet request and a "link" for the AMF to POST the EAP response. The HTTP response shall include a "Location" header that contains the resource URI of the created resource.
RedirectResponse	O	0..1	307 Temporary Redirect	Temporary redirection. (NOTE 2)
RedirectResponse	O	0..1	308 Permanent Redirect	Permanent redirection. (NOTE 2)
ProblemDetails	O	0..1	400 Bad Request	This case represents the failure to start authentication service because of input parameter error.
ProblemDetails	O	0..1	403 Forbidden	This case represents when the UE is not allowed to be authenticated. The "cause" attribute may be used to indicate one of the following application errors: - AUTHENTICATION_REJECTED - SERVING_NETWORK_NOT_AUTHORIZED - INVALID_HN_PUBLIC_KEY_IDENTIFIER - INVALID_SCHEME_OUTPUT
ProblemDetails	O	0..1	404 Not Found	The "cause" attribute may be used to indicate one of the following application errors: - USER_NOT_FOUND
ProblemDetails	O	0..1	500 Internal Server Error	This case represents the failure in starting the authentication service because of a server internal error. If the error is due to a problem with UDM not able to generate the requested AV, the AUSF shall indicate the following application error: "AV_GENERATION_PROBLEM"
ProblemDetails	O	0..1	501 Not Implemented	The "cause" attribute may be used to indicate one of the following application errors: - UNSUPPORTED_PROTECTION_SCHEME This response shall not be cached.
NOTE 1: The mandatory HTTP error status codes for the POST method listed in Table 5.2.7.1-1 of 3GPP TS 29.500 [4] other than those specified in the table above also apply, with a ProblemDetails data type (see clause 5.2.7 of 3GPP TS 29.500 [4]).				
NOTE 2: RedirectResponse may be inserted by an SCP, see clause 6.10.9.1 of 3GPP TS 29.500 [4].				

Table 6.1.3.2.3.1-4: Headers supported by the 201 Response Code on this resource

Name	Data type	P	Cardinality	Description
Location	string	M	1	Contains the URI of the newly created resource according to the structure: {apiRoot}/nausf-auth/<apiVersion>/ue-authentications/{authCtxId}

Table 6.1.3.2.3.1-5: Headers supported by the 307 Response Code on this resource

Name	Data type	P	Cardinality	Description
Location	string	M	1	An alternative URI of the resource located on an alternative service instance within the same AUSF or AUSF (service) set. For the case, when a request is redirected to the same target resource via a different SCP, see clause 6.10.9.1 in 3GPP TS 29.500 [4].
3gpp-Sbi-Target-Nf-Id	string	O	0..1	Identifier of the target NF (service) instance ID towards which the request is redirected

Table 6.1.3.2.3.1-6: Headers supported by the 308 Response Code on this resource

Name	Data type	P	Cardinality	Description
Location	string	M	1	An alternative URI of the resource located on an alternative service instance within the same AUSF or AUSF (service) set. For the case, when a request is redirected to the same target resource via a different SCP, see clause 6.10.9.1 in 3GPP TS 29.500 [4].
3gpp-Sbi-Target-Nf-Id	string	O	0..1	Identifier of the target NF (service) instance ID towards which the request is redirected

6.1.3.2.4 Resource Custom Operations

6.1.3.2.4.1 Overview

Table 6.1.3.2.4.1-1: Custom operations

Custom operation URI	Mapped HTTP method	Description
{apiRoot}/nausf-auth/<apiVersion>/ue-authentications/deregister	POST	Clear the Security Context of the UE

6.1.3.2.4.2 Operation: deregister (POST)

6.1.3.2.4.2.1 Description

This custom operation is used by the NF service consumer (e.g. UDM) to request the AUSF to clear the Security Context, after the UE has been successfully re-authenticated in same Serving Network, or has been successfully authenticated in another Serving Network, e.g. due to registration via another access-type.

6.1.3.2.4.2.2 Operation Definition

This operation shall support the request data structures specified in table 6.1.3.2.4.2.2-1 and the response data structure and response codes specified in table 6.1.3.2.4.2.2-2.

Table 6.1.3.2.4.2.2-1: Data structures supported by the POST Request Body on this resource

Data type	P	Cardinality	Description
DeregistrationInfo	M	1	See 6.1.6.2.11.

Table 6.1.3.2.4.2-2: Data structures supported by the POST Response Body on this resource

Data type	P	Cardinality	Response codes	Description
n/a			204 No Content	This case represents the handover is cancelled successfully.
RedirectResponse	O	0..1	307 Temporary Redirect	Temporary redirection. (NOTE 2)
RedirectResponse	O	0..1	308 Permanent Redirect	Permanent redirection. (NOTE 2)
ProblemDetails	O	1	404 Not Found	The "cause" attribute may be used to indicate one of the following application errors: - CONTEXT_NOT_FOUND See table 6.1.7.3-1 for the description of this error.
NOTE 1: The mandatory HTTP error status codes for the POST method listed in Table 5.2.7.1-1 of 3GPP TS 29.500 [4] other than those specified in the table above also apply, with a ProblemDetails data type (see clause 5.2.7 of 3GPP TS 29.500 [4]).				
NOTE 2: RedirectResponse may be inserted by an SCP, see clause 6.10.9.1 of 3GPP TS 29.500 [4].				

Table 6.1.3.2.4.4-3: Headers supported by the 307 Response Code on this resource

Name	Data type	P	Cardinality	Description
Location	string	M	1	An alternative URI of the resource located on an alternative service instance within the same AUSF or AUSF (service) set. For the case, when a request is redirected to the same target resource via a different SCP, see clause 6.10.9.1 in 3GPP TS 29.500 [4].
3gpp-Sbi-Target-Nf-Id	string	O	0..1	Identifier of the target NF (service) instance ID towards which the request is redirected

Table 6.1.3.2.4.4-4: Headers supported by the 308 Response Code on this resource

Name	Data type	P	Cardinality	Description
Location	string	M	1	An alternative URI of the resource located on an alternative service instance within the same AUSF or AUSF (service) set. For the case, when a request is redirected to the same target resource via a different SCP, see clause 6.10.9.1 in 3GPP TS 29.500 [4].
3gpp-Sbi-Target-Nf-Id	string	O	0..1	Identifier of the target NF (service) instance ID towards which the request is redirected

6.1.3.3 Resource: 5g-aka-confirmation (Document)

6.1.3.3.1 Description

The subresource "5g-aka-confirmation" is generated by the AUSF. This subresource should not persist after the AUSF has read its content.

6.1.3.3.2 Resource Definition

Resource URI: {apiRoot}/nausf-auth/<apiVersion>/ue-authentications/{authCtxId}/5g-aka-confirmation

This resource shall support the resource URI variables defined in table 6.1.3.3.2-1.

Table 6.1.3.3.2-1: Resource URI variables for this resource

Name	Data Type	Definition
apiRoot	string	See clause 6.1.1
authCtxId	string	Represents a specific ue-authentication per UE per serving network

6.1.3.3.3 Resource Standard Methods

6.1.3.3.3.1 PUT

This method shall support the URI query parameters specified in table 6.1.3.3.3.1-1.

Table 6.1.3.3.3.1-1: URI query parameters supported by the PUT method on this resource

Name	Data type	P	Cardinality	Description
n/a				

This method shall support the request data structures specified in table 6.1.3.3.3.1-2 and the response data structures and response codes specified in table 6.1.3.3.3.1-3.

Table 6.1.3.3.3.1-2: Data structures supported by the PUT Request Body on this resource

Data type	P	Cardinality	Description
ConfirmationData	M	1	Contains the "RES*" generated by the UE and provided to the AMF.

Table 6.1.3.3.3.1-3: Data structures supported by the PUT Response Body on this resource

Data type	P	Cardinality	Response Codes	Description
ConfirmationData Response	M	1	200 OK	This case indicates that the AUSF has performed the verification of the 5G AKA confirmation. The response body shall contain the result of the authentication and the Kseaf if the authentication is successful.
RedirectResponse	O	0..1	307 Temporary Redirect	Temporary redirection. (NOTE 2)
RedirectResponse	O	0..1	308 Permanent Redirect	Permanent redirection. (NOTE 2)
ProblemDetails	O	0..1	400 Bad Request	This case represents a 5G AKA confirmation failure because of input parameter error. This indicates that the AUSF was not able to confirm the authentication.
ProblemDetails	O	0..1	500 Internal Server Error	This case represents a 5G AKA confirmation failure because of a server internal error.
NOTE 1: The mandatory HTTP error status codes for the PUT method listed in Table 5.2.7.1-1 of 3GPP TS 29.500 [4] other than those specified in the table above also apply, with a ProblemDetails data type (see clause 5.2.7 of 3GPP TS 29.500 [4]).				
NOTE 2: RedirectResponse may be inserted by an SCP, see clause 6.10.9.1 of 3GPP TS 29.500 [4].				

Table 6.1.3.3.3.1-4: Headers supported by the 307 Response Code on this resource

Name	Data type	P	Cardinality	Description
Location	string	M	1	An alternative URI of the resource located on an alternative service instance within the same AUSF or AUSF (service) set. For the case, when a request is redirected to the same target resource via a different SCP, see clause 6.10.9.1 in 3GPP TS 29.500 [4].
3gpp-Sbi-Target-Nf-Id	string	O	0..1	Identifier of the target NF (service) instance ID towards which the request is redirected

Table 6.1.3.3.3.1-5: Headers supported by the 308 Response Code on this resource

Name	Data type	P	Cardinality	Description
Location	string	M	1	An alternative URI of the resource located on an alternative service instance within the same AUSF or AUSF (service) set. For the case, when a request is redirected to the same target resource via a different SCP, see clause 6.10.9.1 in 3GPP TS 29.500 [4].
3gpp-Sbi-Target-Nf-Id	string	O	0..1	Identifier of the target NF (service) instance ID towards which the request is redirected

6.1.3.3.3.2 DELETE

This method shall support the URI query parameters specified in table 6.1.3.3.3.2-1.

Table 6.1.3.3.3.2-1: URI query parameters supported by the DELETE method on this resource

Name	Data type	P	Cardinality	Description
n/a				

This method shall support the request data structures specified in table 6.1.3.3.3.2-2 and the response data structures and response codes specified in table 6.1.3.3.3.2-3.

Table 6.1.3.3.3.2-2: Data structures supported by the DELETE Request Body on this resource

Data type	P	Cardinality	Description
n/a			

Table 6.1.3.3.3.2-3: Data structures supported by the DELETE Response Body on this resource

Data type	P	Cardinality	Response Codes	Description
n/a			204 No Content	
RedirectResponse	O	0..1	307 Temporary Redirect	Temporary redirection. (NOTE 2)
RedirectResponse	O	0..1	308 Permanent Redirect	Permanent redirection. (NOTE 2)
NOTE 1: The mandatory HTTP error status codes for the DELETE method listed in Table 5.2.7.1-1 of 3GPP TS 29.500 [4] other than those specified in the table above also apply, with a ProblemDetails data type (see clause 5.2.7 of 3GPP TS 29.500 [4]).				
NOTE 2: RedirectResponse may be inserted by an SCP, see clause 6.10.9.1 of 3GPP TS 29.500 [4].				

Table 6.1.3.3.3.2-4: Headers supported by the 307 Response Code on this resource

Name	Data type	P	Cardinality	Description
Location	string	M	1	An alternative URI of the resource located on an alternative service instance within the same AUSF or AUSF (service) set. For the case, when a request is redirected to the same target resource via a different SCP, see clause 6.10.9.1 in 3GPP TS 29.500 [4].
3gpp-Sbi-Target-Nf-Id	string	O	0..1	Identifier of the target NF (service) instance ID towards which the request is redirected

Table 6.1.3.3.2-5: Headers supported by the 308 Response Code on this resource

Name	Data type	P	Cardinality	Description
Location	string	M	1	An alternative URI of the resource located on an alternative service instance within the same AUSF or AUSF (service) set. For the case, when a request is redirected to the same target resource via a different SCP, see clause 6.10.9.1 in 3GPP TS 29.500 [4].
3gpp-Sbi-Target-Nf-Id	string	O	0..1	Identifier of the target NF (service) instance ID towards which the request is redirected

6.1.3.4 Resource: eap-session (Document)

6.1.3.4.1 Description

The "eap-session" is generated by the AUSF if an EAP-based authentication method is selected. This resource is used to handle the EAP session. This subresource should not persist after the EAP exchanges.

6.1.3.4.2 Resource Definition

Resource URI: {apiRoot}/nausf-auth/<apiVersion>/ue-authentications/{authCtxId}/eap-session

This resource shall support the resource URI variables defined in table 6.1.3.4.2-1.

Table 6.1.3.4.2-1: Resource URI variables for this resource

Name	Data type	Definition
apiRoot	string	See clause 6.1.1
authCtxId	string	Represents a specific ue-authentication per UE per serving network

6.1.3.4.3 Resource Standard Methods

6.1.3.4.3.1 POST

This method shall support the URI query parameters specified in table 6.1.3.4.3.1-1.

Table 6.1.3.4.3.1-1: URI query parameters supported by the POST method on this resource

Name	Data type	P	Cardinality	Description
n/a				

This method shall support the request data structures specified in table 6.1.3.4.3.1-2 and the response data structures and response codes specified in table 6.1.3.4.3.1-3.

Table 6.1.3.4.3.1-2: Data structures supported by the POST Request Body on this resource

Data type	P	Cardinality	Description
EapSession	M	1	Contains the EAP packet response (see IETF RFC 3748 [18]) from the UE and transferred by the AMF

Table 6.1.3.4.3.1-3: Data structures supported by the POST Response Body on this resource

Data type	P	Cardinality	Response Codes	Description
EapSession	M	1	200 OK	During an EAP session, the body response shall contain the EAP packet Response and a hypermedia link. At the end of the EAP session, the body response shall contain the EAP packet Success or Failure (see IETF RFC 3748 [18]) and the Kseaf if the authentication is successful
RedirectResponse	O	0..1	307 Temporary Redirect	Temporary redirection. (NOTE 2)
RedirectResponse	O	0..1	308 Permanent Redirect	Permanent redirection. (NOTE 2)
ProblemDetails	O	0..1	400 Bad Request	This case represents an EAP session failure because of input parameter error. This indicates that the AUSF was not able to continue the EAP session.
ProblemDetails	O	0..1	500 Internal Server Error	This case represents an EAP session failure because of a server internal error.
NOTE: The mandatory HTTP error status codes for the POST method listed in Table 5.2.7.1-1 of 3GPP TS 29.500 [4] other than those specified in the table above also apply, with a ProblemDetails data type (see clause 5.2.7 of 3GPP TS 29.500 [4].				
NOTE 2: RedirectResponse may be inserted by an SCP, see clause 6.10.9.1 of 3GPP TS 29.500 [4]				

Table 6.1.3.4.3.1-4: Headers supported by the 307 Response Code on this resource

Name	Data type	P	Cardinality	Description
Location	string	M	1	An alternative URI of the resource located on an alternative service instance within the same AUSF or AUSF (service) set. For the case, when a request is redirected to the same target resource via a different SCP, see clause 6.10.9.1 in 3GPP TS 29.500 [4].
3gpp-Sbi-Target-Nf-Id	string	O	0..1	Identifier of the target NF (service) instance ID towards which the request is redirected

Table 6.1.3.4.3.1-5: Headers supported by the 308 Response Code on this resource

Name	Data type	P	Cardinality	Description
Location	string	M	1	An alternative URI of the resource located on an alternative service instance within the same AUSF or AUSF (service) set. For the case, when a request is redirected to the same target resource via a different SCP, see clause 6.10.9.1 in 3GPP TS 29.500 [4].
3gpp-Sbi-Target-Nf-Id	string	O	0..1	Identifier of the target NF (service) instance ID towards which the request is redirected

6.1.3.4.3.2 DELETE

This method shall support the URI query parameters specified in table 6.1.3.4.3.2-1.

Table 6.1.3.4.3.2-1: URI query parameters supported by the DELETE method on this resource

Name	Data type	P	Cardinality	Description
n/a				

This method shall support the request data structures specified in table 6.1.3.4.3.2-2 and the response data structures and response codes specified in table 6.1.3.4.3.2-3.

Table 6.1.3.4.3.2-2: Data structures supported by the DELETE Request Body on this resource

Data type	P	Cardinality	Description
n/a			

Table 6.1.3.4.3.2-3: Data structures supported by the DELETE Response Body on this resource

Data type	P	Cardinality	Response Codes	Description
n/a			204 No Content	
RedirectResponse	O	0..1	307 Temporary Redirect	Temporary redirection. (NOTE 2)
RedirectResponse	O	0..1	308 Permanent Redirect	Permanent redirection. (NOTE 2)
NOTE 1: The mandatory HTTP error status codes for the DELETE method listed in Table 5.2.7.1-1 of 3GPP TS 29.500 [4] other than those specified in the table above also apply, with a ProblemDetails data type (see clause 5.2.7 of 3GPP TS 29.500 [4]).				
NOTE 2: RedirectResponse may be inserted by an SCP, see clause 6.10.9.1 of 3GPP TS 29.500 [4].				

Table 6.1.3.4.3.2-4: Headers supported by the 307 Response Code on this resource

Name	Data type	P	Cardinality	Description
Location	string	M	1	An alternative URI of the resource located on an alternative service instance within the same AUSF or AUSF (service) set. For the case, when a request is redirected to the same target resource via a different SCP, see clause 6.10.9.1 in 3GPP TS 29.500 [4].
3gpp-Sbi-Target-Nf-Id	string	O	0..1	Identifier of the target NF (service) instance ID towards which the request is redirected

Table 6.1.3.4.3.2-5: Headers supported by the 308 Response Code on this resource

Name	Data type	P	Cardinality	Description
Location	string	M	1	An alternative URI of the resource located on an alternative service instance within the same AUSF or AUSF (service) set. For the case, when a request is redirected to the same target resource via a different SCP, see clause 6.10.9.1 in 3GPP TS 29.500 [4].
3gpp-Sbi-Target-Nf-Id	string	O	0..1	Identifier of the target NF (service) instance ID towards which the request is redirected

6.1.3.5 Resource: rg-authentications (Collection)

6.1.3.5.1 Description

This resource represents a collection of the rg-authentication resources generated by the AUSF.

6.1.3.5.2 Resource Definition

Resource URI: **{apiRoot}/nausf-auth/<apiVersion>/rg-authentications**

This resource shall support the resource URI variables defined in table 6.1.3.5.2-1.

Table 6.1.3.5.2-1: Resource URI variables for this resource

Name	Data type	Definition
apiRoot	string	See clause 6.1.1

6.1.3.5.3 Resource Standard Methods

6.1.3.5.3.1 POST

This method shall support the URI query parameters specified in table 6.1.3.5.3.1-1.

Table 6.1.3.5.3.1-1: URI query parameters supported by the POST method on this resource

Name	Data type	P	Cardinality	Description
n/a				

This method shall support the request data structures specified in table 6.1.3.5.3.1-2 and the response data structures and response codes specified in table 6.1.3.5.3.1-3.

Table 6.1.3.5.3.1-2: Data structures supported by the POST Request Body on this resource

Data type	P	Cardinality	Description
RgAuthenticationInfo	M	1	Contains the UE id (i.e. SUCI as specified in 3GPP TS 23.316 [23] or 3GPP TS 33.501 [8]) and the authenticated indication.

Table 6.1.3.5.3.1-3: Data structures supported by the POST Response Body on this resource

Data type	P	Cardinality	Response codes	Description
RgAuthCtx	M	1	201 Created	Upon success, the response body will contain the SUPI of the UE and the authentication indication. The HTTP response shall include a "Location" header that contains the resource URI of the created resource.
RedirectResponse	O	0..1	307 Temporary Redirect	Temporary redirection. (NOTE 2)
RedirectResponse	O	0..1	308 Permanent Redirect	Permanent redirection. (NOTE 2)
ProblemDetails	O	0..1	400 Bad Request	This case represents the failure to start authentication service because of input parameter error.
ProblemDetails	O	0..1	403 Forbidden	This case represents when the UE is not allowed to be authenticated. The "cause" attribute may be used to indicate one of the following application errors: - AUTHENTICATION_REJECTED - INVALID_SCHEME_OUTPUT
ProblemDetails	O	0..1	404 Not Found	The "cause" attribute may be used to indicate the following application error: - USER_NOT_FOUND
NOTE 1: The mandatory HTTP error status codes for the POST method listed in Table 5.2.7.1-1 of 3GPP TS 29.500 [4] other than those specified in the table above also apply, with a ProblemDetails data type (see clause 5.2.7 of 3GPP TS 29.500 [4]).				
NOTE 2: RedirectResponse may be inserted by an SCP, see clause 6.10.9.1 of 3GPP TS 29.500 [4].				

Table 6.1.3.5.3.1-4: Headers supported by the 307 Response Code on this resource

Name	Data type	P	Cardinality	Description
Location	string	M	1	An alternative URI of the resource located on an alternative service instance within the same AUSF or AUSF (service) set. For the case, when a request is redirected to the same target resource via a different SCP, see clause 6.10.9.1 in 3GPP TS 29.500 [4].
3gpp-Sbi-Target-Nf-Id	string	O	0..1	Identifier of the target NF (service) instance ID towards which the request is redirected

Table 6.1.3.5.3.1-5: Headers supported by the 308 Response Code on this resource

Name	Data type	P	Cardinality	Description
Location	string	M	1	An alternative URI of the resource located on an alternative service instance within the same AUSF or AUSF (service) set. For the case, when a request is redirected to the same target resource via a different SCP, see clause 6.10.9.1 in 3GPP TS 29.500 [4].
3gpp-Sbi-Target-Nf-Id	string	O	0..1	Identifier of the target NF (service) instance ID towards which the request is redirected

6.1.3.6 Resource: prose-authentications (Collection)

6.1.3.6.1 Description

This resource represents a collection of the prose-authentication resources generated by the AUSF.

6.1.3.6.2 Resource Definition

Resource URI: **{apiRoot}/nausf-auth/<apiVersion>/prose-authentications**

This resource shall support the resource URI variables defined in table 6.1.3.6x.2-1.

Table 6.1.3.6x.2-1: Resource URI variables for this resource

Name	Data type	Definition
apiRoot	string	See clause 6.1.1

6.1.3.6.3 Resource Standard Methods

6.1.3.6.3.1 POST

This method shall support the URI query parameters specified in table 6.1.3.6.3.1-1.

Table 6.1.3.6.3.1-1: URI query parameters supported by the POST method on this resource

Name	Data type	P	Cardinality	Description
n/a				

This method shall support the request data structures specified in table 6.1.3.6.3.1-2 and the response data structures and response codes specified in table 6.1.3.6x.3.1-3.

Table 6.1.3.6.3.1-2: Data structures supported by the POST Request Body on this resource

Data type	P	Cardinality	Description
ProSeAuthenticationInfo	M	1	Contains the UE Id (i.e. SUCI as specified in 3GPP TS 33.503 [26]) or the CP-PRUK ID, the Relay Service Code and Nonce_1.

Table 6.1.3.6.3.1-3: Data structures supported by the POST Response Body on this resource

Data type	P	Cardinality	Response Codes	Description
ProSeAuthenticationCtx	M	1	201 Created	Upon success, when UE Id (i.e. SUCI) was received in the request, the response body will contain the EAP method selected, the corresponding EAP packet request and a "link" for the AMF to POST the EAP response. The HTTP response shall include a "Location" header that contains the resource URI of the created resource.
ProSeAuthenticationResult	M	1	200 OK	Upon success, when CP-PRUK ID was received in the request, the response body will contain the K _{NR_ProSe} and Nonce ₂ .
RedirectResponse	O	0..1	307 Temporary Redirect	Temporary redirection. (NOTE 2)
RedirectResponse	O	0..1	308 Permanent Redirect	Permanent redirection. (NOTE 2)
ProblemDetails	O	0..1	400 Bad Request	This case represents the failure to start authentication service because of input parameter error.
ProblemDetails	O	0..1	403 Forbidden	This case represents when the 5G ProSe Remote UE or the 5G ProSe End UE is not allowed to be authenticated. The "cause" attribute may be used to indicate one of the following application errors: - AUTHENTICATION_REJECTED - INVALID_HN_PUBLIC_KEY_IDENTIFIER - INVALID_SCHEME_OUTPUT
ProblemDetails	O	0..1	404 Not Found	The "cause" attribute may be used to indicate one of the following application errors: - USER_NOT_FOUND
ProblemDetails	O	0..1	500 Internal Server Error	This case represents the failure in starting the authentication service because of a server internal error. If the error is due to a problem with UDM not able to generate the requested AV, the AUSF shall indicate the following application error: "AV_GENERATION_PROBLEM"
NOTE 1: The mandatory HTTP error status codes for the POST method listed in Table 5.2.7.1-1 of 3GPP TS 29.500 [4] other than those specified in the table above also apply, with a ProblemDetails data type (see clause 5.2.7 of 3GPP TS 29.500 [4]).				
NOTE 2: RedirectResponse may be inserted by an SCP, see clause 6.10.9.1 of 3GPP TS 29.500 [4].				

Table 6.1.3.6.3.1-4: Headers supported by the 201 Response Code on this resource

Name	Data type	P	Cardinality	Description
Location	string	M	1	Contains the URI of the newly created resource according to the structure: {apiRoot}/nausf-auth/<apiVersion>/prose-authentications/{authCtxId}

Table 6.1.3.6.3.1-5: Headers supported by the 307 Response Code on this resource

Name	Data type	P	Cardinality	Description
Location	string	M	1	An alternative URI of the resource located on an alternative service instance within the same AUSF or AUSF (service) set. For the case, when a request is redirected to the same target resource via a different SCP, see clause 6.10.9.1 in 3GPP TS 29.500 [4].
3gpp-Sbi-Target-Nf-Id	string	O	0..1	Identifier of the target NF (service) instance ID towards which the request is redirected

Table 6.1.3.6.3.1-6: Headers supported by the 308 Response Code on this resource

Name	Data type	P	Cardinality	Description
Location	string	M	1	An alternative URI of the resource located on an alternative service instance within the same AUSF or AUSF (service) set. For the case, when a request is redirected to the same target resource via a different SCP, see clause 6.10.9.1 in 3GPP TS 29.500 [4].
3gpp-Sbi-Target-Nf-Id	string	O	0..1	Identifier of the target NF (service) instance ID towards which the request is redirected

6.1.3.7 Resource: prose-auth (Document)

6.1.3.7.1 Description

The "prose-auth" is generated by the AUSF if an EAP-based authentication method is selected. This resource is used to handle the EAP session. This subresource should not persist after the EAP exchanges.

6.1.3.7.2 Resource Definition

Resource URI: **{apiRoot}/nausf-auth/<apiVersion>/prose-authentications/{authCtxId}/prose-auth**

This resource shall support the resource URI variables defined in table 6.1.3.7.2-1.

Table 6.1.3.7.2-1: Resource URI variables for this resource

Name	Data type	Definition
apiRoot	string	See clause 6.1.1
authCtxId	string	Represents a specific prose-authentication per UE

6.1.3.7.3 Resource Standard Methods

6.1.3.7.3.1 POST

This method shall support the URI query parameters specified in table 6.1.3.7.3.1-1.

Table 6.1.3.7.3.1-1: URI query parameters supported by the POST method on this resource

Name	Data type	P	Cardinality	Description
n/a				

This method shall support the request data structures specified in table 6.1.3.7.3.1-2 and the response data structures and response codes specified in table 6.1.3.7.3.1-3.

Table 6.1.3.7.3.1-2: Data structures supported by the POST Request Body on this resource

Data type	P	Cardinality	Description
ProSeEapSession	M	1	Contains the EAP packet response (see IETF RFC 3748 [18]) from the 5G ProSe Remote UE or the 5G ProSe End UE and transferred by the AMF

Table 6.1.3.7.3.1-3: Data structures supported by the POST Response Body on this resource

Data type	P	Cardinality	Response Codes	Description
ProSeEapSession	M	1	200 OK	During an EAP session, the body response shall contain the EAP packet Response and an hypermedia link. At the end of the EAP session, the body response shall contain the EAP packet Success or Failure (see IETF RFC 3748 [18]) and the K_{NR_ProSe} if the authentication is successful
RedirectResponse	O	0..1	307 Temporary Redirect	Temporary redirection. (NOTE 2)
RedirectResponse	O	0..1	308 Permanent Redirect	Permanent redirection. (NOTE 2)
ProblemDetails	O	0..1	400 Bad Request	This case represents an EAP session failure because of input parameter error. This indicates that the AUSF was not able to continue the EAP session.
ProblemDetails	O	0..1	500 Internal Server Error	This case represents an EAP session failure because of a server internal error.
NOTE: The mandatory HTTP error status codes for the POST method listed in Table 5.2.7.1-1 of 3GPP TS 29.500 [4] other than those specified in the table above also apply, with a ProblemDetails data type (see clause 5.2.7 of 3GPP TS 29.500 [4].				
NOTE 2: RedirectResponse may be inserted by an SCP, see clause 6.10.9.1 of 3GPP TS 29.500 [4]				

Table 6.1.3.7.3.1-4: Headers supported by the 307 Response Code on this resource

Name	Data type	P	Cardinality	Description
Location	String	M	1	An alternative URI of the resource located on an alternative service instance within the same AUSF or AUSF (service) set. For the case, when a request is redirected to the same target resource via a different SCP, see clause 6.10.9.1 in 3GPP TS 29.500 [4].
3gpp-Sbi-Target-Nf-Id	String	O	0..1	Identifier of the target NF (service) instance ID towards which the request is redirected

Table 6.1.3.7.3.1-5: Headers supported by the 308 Response Code on this resource

Name	Data type	P	Cardinality	Description
Location	string	M	1	An alternative URI of the resource located on an alternative service instance within the same AUSF or AUSF (service) set. For the case, when a request is redirected to the same target resource via a different SCP, see clause 6.10.9.1 in 3GPP TS 29.500 [4].
3gpp-Sbi-Target-Nf-Id	string	O	0..1	Identifier of the target NF (service) instance ID towards which the request is redirected

6.1.3.7.3.2 DELETE

This method shall support the URI query parameters specified in table 6.1.3.7y.3.2-1.

Table 6.1.3.7.3.2-1: URI query parameters supported by the DELETE method on this resource

Name	Data type	P	Cardinality	Description
n/a				

This method shall support the request data structures specified in table 6.1.3.7.3.2-2 and the response data structures and response codes specified in table 6.1.3.7.3.2-3.

Table 6.1.3.7.3.2-2: Data structures supported by the DELETE Request Body on this resource

Data type	P	Cardinality	Description
n/a			

Table 6.1.3.7.3.2-3: Data structures supported by the DELETE Response Body on this resource

Data type	P	Cardinality	Response Codes	Description
n/a			204 No Content	
RedirectResponse	O	0..1	307 Temporary Redirect	Temporary redirection. (NOTE 2)
RedirectResponse	O	0..1	308 Permanent Redirect	Permanent redirection. (NOTE 2)
NOTE 1: The mandatory HTTP error status codes for the DELETE method listed in Table 5.2.7.1-1 of 3GPP TS 29.500 [4] other than those specified in the table above also apply, with a ProblemDetails data type (see clause 5.2.7 of 3GPP TS 29.500 [4]).				
NOTE 2: RedirectResponse may be inserted by an SCP, see clause 6.10.9.1 of 3GPP TS 29.500 [4].				

Table 6.1.3.7.3.2-4: Headers supported by the 307 Response Code on this resource

Name	Data type	P	Cardinality	Description
Location	string	M	1	An alternative URI of the resource located on an alternative service instance within the same AUSF or AUSF (service) set. For the case, when a request is redirected to the same target resource via a different SCP, see clause 6.10.9.1 in 3GPP TS 29.500 [4].
3gpp-Sbi-Target-Nf-Id	string	O	0..1	Identifier of the target NF (service) instance ID towards which the request is redirected

Table 6.1.3.7.3.2-5: Headers supported by the 308 Response Code on this resource

Name	Data type	P	Cardinality	Description
Location	string	M	1	An alternative URI of the resource located on an alternative service instance within the same AUSF or AUSF (service) set. For the case, when a request is redirected to the same target resource via a different SCP, see clause 6.10.9.1 in 3GPP TS 29.500 [4].
3gpp-Sbi-Target-Nf-Id	string	O	0..1	Identifier of the target NF (service) instance ID towards which the request is redirected

6.1.4 Custom Operations without associated resources

6.1.4.1 Overview

There is no Custom Operation in the current version of this API.

6.1.5 Notifications

6.1.5.1 General

There is no use of notification in the current version of this API.

6.1.6 Data Model

6.1.6.1 General

This clause specifies the application data model supported by the API.

Table 6.1.6.1-1 specifies the data types defined for the Nausf_UEAuthentication service based interface protocol.

Table 6.1.6.1-1: Nausf_UEAuthentication specific Data Types

Data type	Clause defined	Description
AuthenticationInfo	6.1.6.2.2	Contains the UE id (i.e. SUCI or SUPI) and the Serving Network Name.
UEAuthenticationCtx	6.1.6.2.3	Contains the information related to the resource generated to handle the UE authentication. It contains at least the UE id, Serving Network, the Authentication Method and related EAP information or related 5G-AKA information.
5gAuthData	6.1.6.2.4	Contains 5G authentication related information.
Av5gAka	6.1.6.2.5	Contains Authentication Vector for method 5G AKA.
ConfirmationData	6.1.6.2.6	Contains the "RES*" generated by the UE.
EapSession	6.1.6.2.7	Contains information related to the EAP session.
ConfirmationDataResponse	6.1.6.2.8	Contains the result of the authentication.
RgAuthenticationInfo	6.1.6.2.9	Contains the UE id (i.e. SUCI) and the authenticated indication.
RgAuthCtx	6.1.6.2.10	Contains the UE id (i.e. SUPI) and the authentication indication.
DeregistrationInfo	6.1.6.2.11	Contains the UE id (i.e. SUPI).
ProSeAuthenticationInfo	6.1.6.2.12	Contains the information related to the ProSe authentication received from the 5G ProSe Remote UE or the 5G ProSe End UE.
ProSeAuthenticationCtx	6.1.6.2.13	Contains the information related to the resource generated to handle the ProSe authentication.
ProSeEapSession	6.1.6.2.14	Contains information related to the EAP session for the 5G ProSe Remote UE or the 5G ProSe End UE.
ProSeAuthData	6.1.6.2.15	Contains ProSe authentication related information.
ProSeAuthenticationResult	6.1.6.2.16	ProSe Authentication Result
EapPayload	6.1.6.3.2	Contains the EAP packets.
ResStar	6.1.6.3.2	Contains the RES*.
Kseaf	6.1.6.3.2	Contains the Kseaf.
HxresStar	6.1.6.3.2	Contains the HXRES*.
Suci	6.1.6.3.2	Contains the SUCI.
KnrProSe	6.1.6.3.2	Contains the K_{NR_ProSe} .
Nonce1	6.1.6.3.2	Contains the Nonce1.
Nonce2	6.1.6.3.2	Contains the Nonce2.
Msk	6.1.6.3.2	Contains the Master Session Key.
AuthType	6.1.6.3.3	Indicates the authentication method used.
AuthResult	6.1.6.3.4	Indicates the result of the authentication.

Table 6.1.6.1-2 specifies data types re-used by the Nausf_UEAuthentication service based interface protocol from other specifications, including a reference to their respective specifications and when needed, a short description of their use within the Nausf_UEAuthentication service based interface.

Table 6.1.6.1-2: Nausf_UEAuthentication re-used Data Types

Data type	Reference	Comments
ResynchronizationInfo	3GPP TS 29.503 [12]	
ServingNetworkName	3GPP TS 29.503 [12]	
Autn	3GPP TS 29.503 [12]	
Rand	3GPP TS 29.503 [12]	
LinksValueSchema	3GPP TS 29.571 [10]	3GPP Hypermedia link
ProblemDetails	3GPP TS 29.571 [10]	Common Data Type used in response bodies
Supi	3GPP TS 29.571 [10]	
Uri	3GPP TS 29.571 [10]	
SupiOrSuci	3GPP TS 29.571 [10]	
Pei	3GPP TS 29.571 [10]	
TraceData	3GPP TS 29.571 [10]	
NfGroupId	3GPP TS 29.571 [10]	
CaId	3GPP TS 29.571 [10]	
SupportedFeatures	3GPP TS 29.571 [10]	Supported Features
ServerAddressingInfo	3GPP TS 29.571 [10]	
RelayServiceCode	3GPP TS 29.571 [10]	
5GPrkId	3GPP TS 29.571 [10]	

6.1.6.2 Structured data types

6.1.6.2.1 Introduction

The following clause defines the structures to be used in resource representations.

6.1.6.2.2 Type: AuthenticationInfo

Table 6.1.6.2.2-1: Definition of type AuthenticationInfo

Attribute name	Data type	P	Cardinality	Description
supiOrSuci	SupiOrSuci	M	1	Contains the SUPI or SUCI of the UE.
servingNetworkName	ServingNetworkName	M	1	Contains the Serving Network Name.
resynchronizationInfo	ResynchronizationInfo	O	0..1	Contains RAND and AUTS; see 3GPP 33.501 [8] clause 9.4.
pei	Pei	O	0..1	Permanent Equipment Identifier
traceData	TraceData	O	0..1	Contains TraceData provided by the UDM to the AMF
udmGroupld	NfGroupld	O	0..1	Identity of the UDM group serving the SUPI
routingIndicator	String	O	0..1	When present, it shall indicate the Routing Indicator of the UE. Pattern: '[0-9]{1,4}\$'
cellCagInfo	array(Cagld)	O	1..N	CAGList of the CAG cell.
n5gcInd	boolean	O	0..1	N5GC device indicator (see 3GPP TS 33.501 [8]) When present, this IE shall be set as follows: - true: authentication is for a N5GC device; - false (default): authentication is not for a N5GC device. See NOTE
supportedFeatures	SupportedFeatures	C	0..1	This IE shall be present if at least one feature defined in clause 6.1.9 is supported.
nswolnd	boolean	O	0..1	NSWO Indicator (see 3GPP TS 33.501 [8]) When present, this IE shall be set as follows: - true: Non-Seamless WLAN Offload is applied; - false (default): Non-Seamless WLAN Offload is not applied.
disasterRoamingInd	boolean	O	0..1	Disaster Roaming Indicator (see 3GPP TS 23.502 [3]). When present, this IE shall be set as follows: - true: Disaster Roaming service is applied; - false (default): Disaster Roaming service is not applied.
onboardingInd	boolean	O	0..1	UE Onboarding Indicator for the authentication When present, this IE shall be set as follows: - true: authentication is for UE onboarding; - false (default): authentication is not for UE onboarding.
aun3Ind	boolean	O	0..1	AUN3 Indicator (see 3GPP TS 33.501 [8]) When present, this IE shall be set as follows: - true: authentication is for an AUN3 device behind RG; - false (default): authentication is not for an AUN3 device behind RG.
NOTE: The attribute n5gcInd is used for EAP-TLS, which is described in the informative annex O of 3GPP TS 33.501 [8] and is not mandatory to support.				

6.1.6.2.3 Type: UEAuthenticationCtx

Table 6.1.6.2.3-1: Definition of type UEAuthenticationCtx

Attribute name	Data type	P	Cardinality	Description
authType	AuthType	M	1	Indicates the authentication method used for this UE i.e. "5G-AKA-Confirmation", "EAP-AKA"; "EAP-TLS" or "EAP-TTLS". See clause 6.1.6.3.3
_links	map(LinksValueSchema)	M	1..N	If 5G-AKA has been selected, this IE shall contain a member whose name is set to "5g-aka" and the URI to perform the confirmation. If an EAP-based method has been selected, this IE shall contain a member whose name is set to "eap-session" and the URI to perform the EAP session. See NOTE
5gAuthData	5gAuthData	M	1	Contains either 5G-AKA or EAP related information.
servingNetworkName	ServingNetworkName	O	0..1	Contains the Serving Network Name.

NOTE: In the current version of this API, only one hypermedia link is provided

6.1.6.2.4 Type: 5gAuthData

Table 6.1.6.2.4-1: Definition of type 5gAuthData as a list of mutually exclusive alternatives

Data type	Cardinality	Description
Av5gAka	1	Contains the 5G AV if 5G-AKA has been selected.
EapPayload	1	Contains the EAP packet request.

6.1.6.2.5 Type: Av5gAka

Table 6.1.6.2.5-1: Definition of type Av5gAka

Attribute name	Data type	P	Cardinality	Description
rand	Rand	M	1	
autn	Autn	M	1	
hxresStar	HxresStar	M	1	

6.1.6.2.6 Type: ConfirmationData

Table 6.1.6.2.6-1: Definition of type ConfirmationData

Attribute name	Data type	P	Cardinality	Description
resStar	ResStar	M	1	Contains the "RES*" provided by the UE to the AMF. If no RES* has been provided by the UE the null value is conveyed to the AUSF.
supportedFeatures	SupportedFeatures	C	0..1	This IE shall be present if at least one feature defined in clause 6.1.9 is supported.

6.1.6.2.7 Type: EapSession

Table 6.1.6.2.7-1: Definition of type EapSession

Attribute name	Data type	P	Cardinality	Description
eapPayload	EapPayload	M	1	Contains the EAP packet (see IETF RFC 3748 [18]). If no EAP packet has been provided by the UE the null value is conveyed to the AUSF.
kSeaf	Kseaf	C	0..1	Shall be absent for N5GC device authentication; otherwise: If the authentication is successful and the consumer is an AMF, the Kseaf shall be included
_links	map(LinksValueSchema)	C	1..N	If the EAP session requires another exchange e.g. for EAP-AKA' notification, this IE shall contain a member whose name is "eap-session" and the URI to continue the EAP session. See NOTE.
authResult	AuthResult	C	0..1	Indicates the result of the authentication.
supi	Supi	C	0..1	If the authentication is successful and if the AMF had provided a SUCI, this IE shall contain the SUPI of the UE.
supportedFeatures	SupportedFeatures	C	0..1	This IE shall be present if at least one feature defined in clause 6.1.9 is supported.
pvsInfo	array(ServerAddressingInfo)	O	1..N	FQDN(s) and/or IP address(es) of the SNPN UE onboarding Provisioning Servers (PVS).
msk	Msk	C	0..1	If the authentication is successful and the consumer is an NSWOF as indicated by the NSWOF indicator received within the AuthenticationInfo, the MSK shall be included (see 3GPP TS 33.501 [8] annex S) If the authentication is successful and the MSK indicator is received from UDM, the MSK shall be included. (see clause 7B.7 of 3GPP TS 33.501 [8])

NOTE: In the current version of this API, only 0 or 1 hypermedia link is provided.

6.1.6.2.8 Type: ConfirmationDataResponse

Table 6.1.6.2.8-1: Definition of type ConfirmationDataResponse

Attribute name	Data type	P	Cardinality	Description
authResult	AuthResult	M	1	Indicates the result of the authentication
supi	Supi	C	0..1	If the authentication is successful and if the AMF had provided a SUCI, this IE shall contain the SUPI of the UE
kseaf	Kseaf	C	0..1	Contains the Kseaf if authentication is successful.
pvsInfo	array(ServerAddressingInfo)	O	1..N	FQDN(s) and/or IP address(es) of the SNPN UE onboarding Provisioning Servers (PVS).

6.1.6.2.9 Type: RgAuthenticationInfo

Table 6.1.6.2.9-1: Definition of type RgAuthenticationInfo

Attribute name	Data type	P	Cardinality	Description
suci	Suci	M	1	Contains the SUCI of the FN-RG.
authenticatedInd	boolean	M	1	This IE shall be set as follows: - true: authenticated by the W-AGF; - false (default): unauthenticated by the W-AGF.
supportedFeatures	SupportedFeatures	C	0..1	This IE shall be present if at least one feature defined in clause 6.1.9 is supported.

6.1.6.2.10 Type: RgAuthCtx

Table 6.1.6.2.10-1: Definition of type RgAuthCtx

Attribute name	Data type	P	Cardinality	Description
authResult	AuthResult	M	1	Indicates the result of the authentication
supi	Supi	C	0..1	If the authentication is successful and if the AMF had provided a SUCI, this IE shall contain the SUPI of the UE.
authInd	boolean	C	0..1	When present, this IE shall be set as follows: <ul style="list-style-type: none"> - true: authentication is not required; - false (default): authentication is required.

6.1.6.2.11 Type: DeregistrationInfo

Table 6.1.6.2.11-1: Definition of type DeregistrationInfo

Attribute name	Data type	P	Cardinality	Description
supi	Supi	M	1	Contains the SUPI of the UE.
supportedFeatures	SupportedFeatures	C	0..1	This IE shall be present if at least one feature defined in clause 6.1.9 is supported.

6.1.6.2.12 Type: ProSeAuthenticationInfo

Table 6.1.6.2.12-1: Definition of type ProSeAuthenticationInfo

Attribute name	Data type	P	Cardinality	Description
supiOrSuci	SupiOrSuci	C	0..1	This IE shall be present if received from 5G ProSe Remote UE or the 5G ProSe End UE. When received, this IE shall contain the SUCI of the 5G ProSe Remote UE or the 5G ProSe End UE.
5gPrukId	5GPrukId	C	0..1	This IE shall be present if the CP-PRUK is received from 5G ProSe Remote UE or the 5G ProSe End UE. When present, this IE shall indicate the CP-PRUK ID received from the 5G ProSe Remote UE or the 5G ProSe End UE.
relayServiceCode	RelayServiceCode	M	1	Indicates Relay Service Code. See 3GPP TS 29.571 [7] clause 5.4.2
nonce1	Nonce1	M	1	Indicates Nonce_1.
servingNetworkName	ServingNetworkName	M	1	Serving network name of the UE-to-Network relay or the UE-to-UE relay
supportedFeatures	SupportedFeatures	C	0..1	This IE shall be present if at least one feature defined in clause 6.1.9 is supported.

6.1.6.2.13 Type: ProSeAuthenticationCtx

Table 6.1.6.2.13-1: Definition of type ProSeAuthenticationCtx

Attribute name	Data type	P	Cardinality	Description
authType	AuthType	M	1	Indicates the authentication method used for this UE i.e. "EAP-AKA".
_links	map(LinksValueSchema)	M	1..N	This IE shall contain a member whose name is set to "prose-auth" and the URI to perform the EAP session. See NOTE
proSeAuthData	ProSeAuthData	M	1	Contains ProSe Authentication related information
supportedFeatures	SupportedFeatures	C	0..1	This IE shall be present if at least one feature defined in clause 6.1.9 is supported.

NOTE: In the current version of this API, only one hypermedia link is provided

6.1.6.2.14 Type: ProSeEapSession

Table 6.1.6.2.14-1: Definition of type ProSeEapSession

Attribute name	Data type	P	Cardinality	Description
eapPayload	EapPayload	M	1	Contains the EAP packet (see IETF RFC 3748 [18]). If no EAP packet has been provided by the 5G ProSe Remote UE or the 5G ProSe End UE the null value is conveyed to the AUSF.
knrProSe	KnrProSe	C	0..1	If the authentication is successful and no EAP packet has been provided by the 5G ProSe Remote UE or the 5G ProSe End UE, the K _{NR_ProSe} shall be included
_links	map(LinksValueSchema)	C	1..N	If the EAP session requires another exchange e.g. for EAP-AKA' notification, this IE shall contain a member whose name is "prose-auth" and the URI to continue the EAP session. See NOTE.
authResult	AuthResult	C	0..1	This IE shall be present if no EAP packet has been provided by the 5G ProSe Remote UE or the 5G ProSe End UE. When present, this IE shall indicate the result of the authentication.
nonce2	Nonce2	C	0..1	If the authentication is successful and no EAP packet has been provided by the 5G ProSe Remote UE or the 5G ProSe End UE, the Nonce_2 shall be included.
5gPrukId	5GPrukId	C	0..1	This IE shall be present if authentication is successful and no EAP packet has been provided by the 5G ProSe Remote UE or the 5G ProSe End UE. When present, this IE shall contain the CP-PRUK ID to the 5G ProSe Remote UE or the 5G ProSe End UE.
supportedFeatures	SupportedFeatures	C	0..1	This IE shall be present if at least one feature defined in clause 6.1.9 is supported.

NOTE: In the current version of this API, only 0 or 1 hypermedia link is provided.

6.1.6.2.15 Type: ProSeAuthData

Table 6.1.6.2.15-1: Definition of type ProSeAuthData

Data type	Cardinality	Description
EapPayload	1	Contains the EAP packet request.

6.1.6.2.16 Type: ProSeAuthenticationResult

Table 6.1.6.2.16-1: Definition of type ProSeAuthenticationResult

Attribute name	Data type	P	Cardinality	Description
knrProSe	KnrProSe	C	0..1	If the authentication is successful, the K _{NR_ProSe} shall be included
nonce2	Nonce2	C	0..1	If the authentication is successful, the Nonce_2 shall be included.
supportedFeatures	SupportedFeatures	C	0..1	This IE shall be present if at least one feature defined in clause 6.1.9 is supported.

6.1.6.3 Simple data types and enumerations

6.1.6.3.1 Introduction

This clause defines simple data types and enumerations that can be referenced from data structures defined in the previous clauses.

6.1.6.3.2 Simple data types

Table 6.1.6.3.2-1: Simple data types

Type Name	Type Definition	Description
EapPayload	string	The EAP packet is encoded using base64 (see IETF RFC 4648 [19]) and represented as a String. Format: byte
ResStar	string	pattern: "[A-Fa-f0-9]{32}\$"; nullable
Kseaf	string	pattern: "[A-Fa-f0-9]{64}\$"
HxresStar	string	pattern: "[A-Fa-f0-9]{32}\$"
Suci	string	String containing a SUCI. Pattern: "(suci-(0-[0-9]{3}-[0-9]{2,3})[1-7]-.)-[0-9]{1,4}-(0-0-.[a-fA-F1-9]-([1-9][1-9][0-9]1[0-9]{2})2[0-4][0-9]25[0-5])-[a-fA-F0-9]+).+)\$"
KnrProSe	string	String contain the K _{NR_ProSe} pattern: "[A-Fa-f0-9]{64}\$"
Nonce1	string	The Nonce1 is encoded using base64 (see IETF RFC 4648 [19]) and represented as a String. Format: byte
Nonce2	string	The Nonce2 is encoded using base64 (see IETF RFC 4648 [19]) and represented as a String. Format: byte
Msk	string	pattern: "[A-Fa-f0-9]{128}\$"

6.1.6.3.3 Enumeration: AuthType

Table 6.1.6.3.3-1: Enumeration AuthType

Enumeration value	Description
5G_AKA	5G AKA
EAP_AKA_PRIME	EAP-AKA'
EAP_TLS	EAP-TLS is only used in the case where the Annex B is supported.
EAP_TTLS	EAP-TTLS is used in the case where the Annex U of 3GPP TS 33.501 [8] is supported.

6.1.6.3.4 Enumeration: AuthResult

Table 6.1.6.3.4-1: Enumeration AuthResult

Enumeration value	Description
AUTHENTICATION_SUCCESS	This value is used to indicate that the AUSF successfully authenticate the UE
AUTHENTICATION_FAILURE	This value is used to indicate that the AUSF fails to authenticate the UE.
AUTHENTICATION_ONGOING	This value is used during an EAP Session to indicate that the EAP session is still ongoing.

6.1.6.3.5 Relation Types

6.1.6.3.5.1 General

This clause describes the possible relation types defined within AUSF API.

Table 6.1.6.3.5-1: supported registered relation types

Relation Name
5g-aka
eap-session

6.1.6.3.5.2 The "5g-aka" Link relation

The value "5g-aka" specifies that the value of the href attribute is the URI where NF Service Consumer shall send a PUT containing the result "RES*" received from the UE.

6.1.6.3.5.3 The "eap-session" Link relation

The value "eap-session" specifies that the value of the href attribute is the URI that will be used by the NF Service Consumer to provide EAP packet response during an EAP exchange. The NF Service Consumer shall use a POST to provide the EAP Packet Response to the AUSF to the corresponding URI.

6.1.6.4 Binary data

6.1.6.4.1 Introduction

There is no binary data in the current version of this API.

6.1.7 Error Handling

6.1.7.1 General

HTTP error handling shall be supported as specified in clause 5.2.4 of 3GPP TS 29.500 [4].

The Cause codes mapping performed by AMF between the following HTTP responses returned by the AUSF services to the AMF and the 5GMM related values is specified in clause 4.2.2 of 3GPP TS 29.524 [24].

6.1.7.2 Protocol Errors

Protocol errors shall be supported as specified in clause 5.2.7 of 3GPP TS 29.500 [4].

6.1.7.3 Application Errors

The common application errors defined in the Table 5.2.7.2-1 in 3GPP TS 29.500 [4] may also be used for the Nausf_UEAuthentication service. The following application errors listed in Table 6.1.7.3-1 are specific for the Nausf_UEAuthentication service.

Table 6.1.7.3-1: Application errors

Application Error	HTTP status code	Description
SERVING_NETWORK_NOT_AUTHORIZED	403 Forbidden	The serving network is not authorized, e.g. serving PLMN.
AUTHENTICATION_REJECTED	403 Forbidden	The user cannot be authenticated with this authentication method e.g. only SIM data available
INVALID_HN_PUBLIC_KEY_IDENTIFIER	403 Forbidden	Invalid HN public key identifier received
INVALID_SCHEME_OUTPUT	403 Forbidden	SUCI cannot be decrypted with received data
CONTEXT_NOT_FOUND	404 Not Found	The AUSF cannot find the resource corresponding to the URI provided by the NF Service Consumer.
USER_NOT_FOUND	404 Not Found	The user does not exist in the HPLMN
UPSTREAM_SERVER_ERROR	504 Gateway Timeout	No response is received from a remote peer, e.g. from the UDM
NETWORK_FAILURE	504 Gateway Timeout	The request is rejected due to a network problem.
AV_GENERATION_PROBLEM	500 Internal Server Error	The UDM has indicated that it was not able to generate AV.
UNSUPPORTED_PROTECTION_SCHEME	501 Not implemented	The received protection scheme is not supported by HPLMN

6.1.8 Security

As indicated in 3GPP TS 33.501 [8], the access to the Nausf_UEAuthentication Service API may be authorized by means of the OAuth2 protocol (see IETF RFC 6749 [13]), using the "Client Credentials" authorization grant, where the NRF (see 3GPP TS 29.510 [14]) plays the role of the authorization server.

If OAuth2 is used, an NF Service Consumer, prior to consuming service offered by the Nausf_UEAuthentication Service API, shall obtain a "token" from the authorization server, by invoking the Access Token Request service, as described in 3GPP TS 29.510 [14], clause 5.4.2.2.

NOTE: When multiple NRFs are deployed in a network, the NRF used as authorization server is the same NRF that the NF Service Consumer used for discovering the Nausf_UEAuthentication service.

The Nausf_UEAuthentication Service API defines the following scopes.

Table 6.1.8-1: OAuth2 scopes defined in Nausf_UEAuthentication API

Scope	Description
"nausf-auth"	Access to the Nausf_UEAuthentication API.
"nausf-auth:ue-authentications"	Access to service operations applying to the collection of the ue-authentication resources and the subresources, i.e. 5g-aka-confirmation and eap-session.
"nausf-auth:rg-authentications"	Access to service operations applying to the collection of the rg-authentication resources.
"nausf-auth:prose-authentications"	Access to service operations applying to the collection of the prose-authentication resources and the subresources, i.e. prose-auth.

6.1.9 Feature Negotiation

The features in table 6.1.9-1 are defined for the Nausf_UEAuthentication API. They shall be negotiated using the extensibility mechanism defined in clause 6.6 of 3GPP TS 29.500 [4].

Table 6.1.9-1: Supported Features

Feature number	Feature Name	M/O	Description
1	ES3XX	M	<p>Extended Support of HTTP 307/308 redirection</p> <p>An NF Service Consumer (e.g. AMF) that supports this feature shall support handling of HTTP 307/308 redirection for any service operation of the UEAuthentication service. An NF Service Consumer that does not support this feature does only support HTTP redirection as specified for 3GPP Release 15.</p>

6.1.10 HTTP redirection

An HTTP request may be redirected to a different AUSF service instance, within the same AUSF or a different AUSF of an AUSF set, e.g. when an AUSF service instance is part of an AUSF (service) set or when using indirect communications (see 3GPP TS 29.500 [4]). See also the ES3XX feature in clause 6.1.10.

An SCP that reselects a different AUSF producer instance will return the NF Instance ID of the new AUSF producer instance in the 3gpp-Sbi-Producer-Id header, as specified in clause 6.10.3.4 of 3GPP TS 29.500 [4].

If an AUSF within an AUSF set redirects a service request to a different AUSF of the set using an 307 Temporary Redirect or 308 Permanent Redirect status code, the identity of the new AUSF towards which the service request is redirected shall be indicated in the 3gpp-Sbi-Target-Nf-Id header of the 307 Temporary Redirect or 308 Permanent Redirect response as specified in clause 6.10.9.1 of 3GPP TS 29.500 [4].

6.2 Nausf_SoRProtection Service API

6.2.1 API URI

URIs of this API shall have the following root:

{apiRoot}/<apiName>/<apiVersion>

The request URIs used in HTTP requests from the NF service consumer towards the NF service producer shall have the Resource URI structure defined in clause 4.4.1 of 3GPP TS 29.501 [5], i.e.:

{apiRoot}/<apiName>/<apiVersion>/<apiSpecificResourceUriPart>

with the following components:

- The {apiRoot} shall be set as described in 3GPP TS 29.501 [6].
- The <apiName> shall be "nausf-sorprotection".
- The <apiVersion> shall be "v1".
- The <apiSpecificResourceUriPart> shall be set as described in clause 6.2.3.

6.2.2 Usage of HTTP

6.2.2.1 General

HTTP/2, as defined in IETF RFC 9113 [6], shall be used as specified in clause 5 of 3GPP TS 29.500 [4].

6.2.2.2 HTTP standard headers

6.2.2.2.1 General

The usage of HTTP standard headers is specified in clause 5.2.2 of 3GPP TS 29.500 [4].

6.2.2.2.2 Content type

The following content types shall be supported:

- JSON, as defined in IETF RFC 8259 [7], shall be used as content type of the HTTP bodies specified in the present specification as indicated in clause 5.4 of 3GPP TS 29.500 [4].
- The Problem Details JSON Object (IETF RFC 9475 [11]). The use of the Problem Details JSON object in a HTTP response body shall be signalled by the content type "application/problem+json"

6.2.2.3 HTTP custom headers

6.2.2.3.1 General

In this version of the API, no specific custom headers are defined for the "Nausf_SoRProtection" service.

For 3GPP specific HTTP custom headers used across all service based interfaces, see clause 5.2.3 of 3GPP TS 29.500 [4].

6.2.3 Resources

6.2.3.1 Overview

The structure of the Resource URIs of the Nausf_SoRProtection service is shown in Figure 6.2.3.1-1

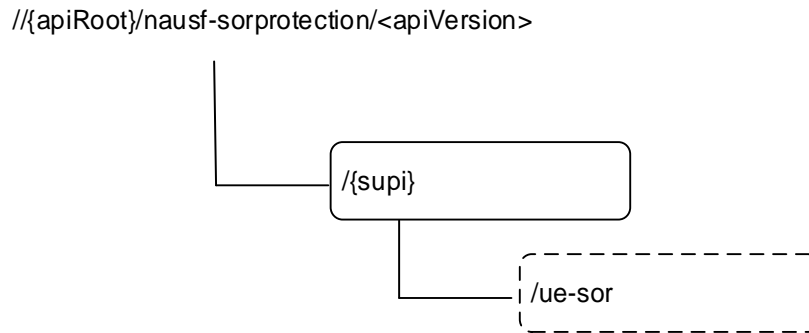

Figure 6.2.3.1-1: Resource URI structure of the SoRProtection API

Table 6.2.3.1-1 provides an overview of the resources and applicable HTTP methods.

Table 6.2.3.1-1: Resources and methods overview

Resource name	Resource URI	HTTP method or custom operation	Description
supi (Custom operation)	<code>/{supi}/ue-sor/</code>	ue-sor(POST)	Resource for SoR security material computation

6.2.3.2 Resource: supi (Custom operation)

6.2.3.2.1 Description

It is the resource to which the custom operation used to generate the SoR security material is associated with.

6.2.3.2.2 Resource Definition

Resource URI: `{apiRoot}/nausf-sorprotection/<apiVersion>/{supi}/`

This resource shall support the resource URI variables defined in table 6.2.3.2.2-1.

Table 6.2.3.2.2-1: Resource URI variables for this resource

Name	Data type	Definition
apiRoot	string	See clause 6.2.1
supi	Supi	Represents the Subscription Permanent Identifier (see 3GPP TS 23.501 [2] clause 5.9.2) pattern: See pattern of type Supi in 3GPP TS 29.571 [10]

6.2.3.2.3 Resource Standard Methods

No Standard Methods are supported for this resource.

6.2.3.2.4 Resource Custom Operations

6.2.3.2.4.1 Overview

Table 6.2.3.2.4.1-1: Custom operations

Operation Name	Custom operation URI	Mapped HTTP method	Description
ue-sor	/ue-sor	POST	The AUSF calculates the SoR-MAC-IAUSF and the CounterSoR to protect the Steering Information List provided. It may also calculate the SoR-XMAC-IUE to verify that the UE received the Steering Information List if the indication that an acknowledgement is requested from the UE.

6.2.3.2.4.2 Operation: ue-sor

6.2.3.2.4.2.1 Description

This custom operation is used by the NF service consumer (e.g. UDM) to request the AUSF to compute the security material (SoR-MAC-IAUSF, CounterSoR and SoR-XMAC-IUE) needed to ensure the protection of the SoR procedure (see 3GPP TS 33.501 [8]).

6.2.3.2.4.2.2 Operation Definition

This method shall support the request data structures specified in table 6.2.3.2.4.2.2-1 and the response data structures and response codes specified in table 6.2.3.2.4.2.2-2.

Table 6.2.3.2.4.2.2-1: Data structures supported by the POST Request Body on this resource

Data type	P	Cardinality	Description
SorInfo	M	1	Contains the Steering Information List and shall contain the indication of whether an acknowledgement is requested from the UE or not (as specified in 3GPP TS 33.501 [8]).

Table 6.2.3.2.4.2.2-2: Data structures supported by the POST Response Body on this resource

Data type	P	Cardinality	Response codes	Description
SorSecurityInfo	M	1	200 OK	Upon success, the response body will contain SoR-MAC-IAUSF and CounterSoR and may contain the SoR-XMAC-IUE.
RedirectResponse	O	0..1	307 Temporary Redirect	Temporary redirection. (NOTE 2)
RedirectResponse	O	0..1	308 Permanent Redirect	Permanent redirection. (NOTE 2)
ProblemDetails	O	0..1	503 Service Unavailable	The "cause" attribute may be used to indicate one of the following application errors: - COUNTER_WRAP See table 6.2.7.3-1 for the description of these errors.
NOTE 1: The mandatory HTTP error status codes for the POST method listed in Table 5.2.7.1-1 of 3GPP TS 29.500 [4] other than those specified in the table above also apply, with a ProblemDetails data type (see clause 5.2.7 of 3GPP TS 29.500 [4]).				
NOTE 2: RedirectResponse may be inserted by an SCP, see clause 6.10.9.1 of 3GPP TS 29.500 [4].				

Table 6.2.3.2.4.2.2-3: Headers supported by the 307 Response Code on this resource

Name	Data type	P	Cardinality	Description
Location	string	M	1	An alternative URI of the resource located on an alternative service instance within the same AUSF or AUSF (service) set. For the case, when a request is redirected to the same target resource via a different SCP, see clause 6.10.9.1 in 3GPP TS 29.500 [4].
3gpp-Sbi-Target-Nf-Id	string	O	0..1	Identifier of the target NF (service) instance ID towards which the request is redirected

Table 6.2.3.2.4.2.2-4: Headers supported by the 308 Response Code on this resource

Name	Data type	P	Cardinality	Description
Location	string	M	1	An alternative URI of the resource located on an alternative service instance within the same AUSF or AUSF (service) set. For the case, when a request is redirected to the same target resource via a different SCP, see clause 6.10.9.1 in 3GPP TS 29.500 [4].
3gpp-Sbi-Target-Nf-Id	string	O	0..1	Identifier of the target NF (service) instance ID towards which the request is redirected

6.2.4 Custom Operations without associated resources

6.2.4.1 Overview

There is no Custom Operation in the current version of this API.

6.2.5 Notifications

6.2.5.1 General

There is no use of notification in the current version of this API.

6.2.6 Data Model

6.2.6.1 General

This clause specifies the application data model supported by the API.

Table 6.2.6.1-1 specifies the data types defined for the Nausf_SORProtection service based interface protocol.

Table 6.2.6.1-1: Nausf_SORProtection specific Data Types

Data type	Clause defined	Description
SorInfo	6.2.6.2.2	Contains the Steering Information
SorSecurityInfo	6.2.6.2.3	Contains the material generated for securing of SoR. It contains at least the SoR-MAC-IAUSF and CounterSoR.
SteeringInfo	6.2.6.2.4	Contains a combination of one PLMN identity and zero or more access technologies.
SteeringContainer	6.2.6.2.5	Contains the information sent to UE.
SorMac	6.2.6.3.2	MAC value for protecting SOR procedure (SoR-MAC-IAUSF and SoR-XMAC-IUE)
CounterSor	6.2.6.3.2	CounterSoR
AckInd	6.2.6.3.2	Contains indication whether the acknowledgement from UE is needed
SecuredPacket	6.2.6.3.2	Contains a secure packet.
AccessTech	6.2.6.3.3	Access Technology
SorHeader	6.2.6.3.2	Contains the SoR Header.
SorTransparentInfo	6.2.6.3.2	Contains steering information encoded as transparent containers.

Table 6.2.6.1-2 specifies data types re-used by the Nausf_SORProtection service based interface protocol from other specifications, including a reference to their respective specifications and when needed, a short description of their use within the Nausf_SORProtection service based interface.

Table 6.2.6.1-2: Nausf_SORProtection re-used Data Types

Data type	Reference	Comments
PlmnId	3GPP TS 29.571 [10]	PLMN ID
SupportedFeatures	3GPP TS 29.571 [10]	Supported Features

6.2.6.2 Structured data types

6.2.6.2.1 Introduction

The following clauses define the structures to be used in resource representations.

6.2.6.2.2 Type: SorInfo

Table 6.2.6.2.2-1: Definition of type SorInfo

Attribute name	Data type	P	Cardinality	Description
ackInd	AckInd	M	1	Contains the indication whether the acknowledgement from UE is needed.
steeringContainer	SteeringContainer	C	0..1	When present, this information contains the information needed to update the "Operator Controlled PLMN Selector with Access Technology" list stored in the USIM. It may contain an array of preferred PLMN/AccessTechnologies combinations in priority order. The first entry in the array indicates the highest priority and the last entry indicates the lowest. Or it may contain a secured packet. If no change of the "Operator Controlled PLMN Selector with Access Technology" list stored in the USIM is needed then this attribute shall be absent.
sorHeader	SorHeader	O	0..1	This attribute contains SoR Header encoded as defined in clause 6.2.6.3.2 and shall be present if AUSF supports receiving SoR Information encoded as transparent containers.
sorTransparentInfo	SorTransparentInfo	O	0..1	This attribute contains steering information encoded as defined in clause 6.2.6.3.2, and may be present if AUSF supports receiving SoR Information encoded as transparent containers. It may be absent if no change of the "Operator Controlled PLMN Selector with Access Technology" list stored in the USIM is needed.
supportedFeatures	SupportedFeatures	C	0..1	This IE shall be present if at least one feature defined in clause 6.2.9 is supported.

6.2.6.2.3 Type: SorSecurityInfo

Table 6.2.6.2.3-1: Definition of type SorSecurityInfo

Attribute name	Data type	P	Cardinality	Description
sorMaclausf	SorMac	M	1	Contains the SoR-MAC-IAUSF.
counterSor	CounterSor	M	1	Contains the Counter _{SoR} .
sorXmaclue	SorMac	O	0..1	When present, contains the SoR-XMAC-IUE. It shall be included, if the UDM requests the acknowledgement from the UE.

6.2.6.2.4 Type: SteeringInfo

Table 6.2.6.2.4-1: Definition of type SteeringInfo

Attribute name	Data type	P	Cardinality	Description
plmnId	PlmnId	M	1	Contains a preferred PLMN identity.
accessTechList	array(AccessTech)	C	1..N	When present it contains the preferred access technologies as listed in clause 4.2.5 of 3GPP TS 31.102 [15]. If absent it means that all access technologies are equivalently preferred in this PLMN.

6.2.6.2.5 Type: SteeringContainer

Table 6.2.6.2.5-1: Definition of type SteeringContainer as a list of mutually exclusive alternatives

Data type	Cardinality	Description
array(SteeringInfo)	1..N	List of PLMN/AccessTechnologies combinations.
SecuredPacket	1	A secured packet containing one or more APDUs commands dedicated to Remote File Management.

6.2.6.3 Simple data types and enumerations

6.2.6.3.1 Introduction

This clause defines simple data types and enumerations that can be referenced from data structures defined in the previous clauses.

6.2.6.3.2 Simple data types

Table 6.2.6.3.2-1: Simple data types

Type Name	Type Definition	Description
SorMac	string	pattern: "[A-Fa-f0-9]{32}\$"
CounterSor	string	pattern: "[A-Fa-f0-9]{4}\$"
AckInd	boolean	true indicates that the SoR-XMAC-IUE shall be computed and returned in the response
SecuredPacket	string	Contains a secure packet as specified in 3GPP TS 24.501 [20]. It is encoded using base64 and represented as a String. Format: byte
SorHeader	Bytes	String with format "byte" as defined in OpenAPI Specification [25], i.e. base64-encoded characters, encoding the "SOR Header" IE as specified in clause 9.11.3.51 of 3GPP TS 24.501 [20] (octet 4).
SorTransparentInfo	Bytes	String with format "byte" as defined in OpenAPI Specification [25], i.e. base64-encoded characters, encoding the "SOR transparent container" IE as specified in clause 9.11.3.51 of 3GPP TS 24.501 [20] (starting from octet 23).

6.2.6.3.3 Enumeration: AccessTech

Table 6.2.6.3.3-1: Enumeration AccessTech

Enumeration value	Description
"NR"	
"EUTRAN_IN_WBS1_MODE_AND_NBS1_MODE"	
"EUTRAN_IN_NBS1_MODE_ONLY"	
"EUTRAN_IN_WBS1_MODE_ONLY"	
"UTRAN"	
"GSM_AND_ECGSM_IoT"	
"GSM_WITHOUT_ECGSM_IoT"	
"ECGSM_IoT_ONLY"	
"CDMA_1xRTT"	
"CDMA_HRPD"	
"GSM_COMPACT"	
"SATELLITE_NG_RAN"	
"SATELLITE_EUTRAN_IN_NBS1_MODE"	
"SATELLITE_EUTRAN_IN_WBS1_MODE"	

NOTE: Some of the values in the enumeration deviate from the naming conventions indicated in 3GPP TS 29.501 [5] Clause 5.1.4 (i.e., to use UPPER_WITH_UNDERSCORE); however, it is kept as currently defined in this specification to maintain backwards compatibility.

6.2.7 Error Handling

6.2.7.1 General

HTTP error handling shall be supported as specified in clause 5.2.4 of 3GPP TS 29.500 [4].

6.2.7.2 Protocol Errors

Protocol Error Handling shall be supported as specified in clause 5.2.7.2 of 3GPP TS 29.500 [4].

6.2.7.3 Application Errors

The common application errors defined in the Table 5.2.7.2-1 in 3GPP TS 29.500 [4] may also be used for the Nausf_SoRProtection service. The following application errors listed in Table 6.2.7.3-1 are specific for the Nausf_SoRProtection service.

Table 6.2.7.3-1: Application errors

Application Error	HTTP status code	Description
COUNTER_WRAP	503 Service Unavailable	The Counter _{SoR} associated with the KAUSF of the UE is about to wrap around. The AUSF suspends the SoR protection service for the UE until a new KAUSF is generated.

6.2.8 Security

As indicated in 3GPP TS 33.501 [8], the access to the Nausf_SoRProtection API may be authorized by means of the OAuth2 protocol (see IETF RFC 6749 [13]), using the "Client Credentials" authorization grant, where the NRF (see 3GPP TS 29.510 [14]) plays the role of the authorization server.

If OAuth2 is used, an NF Service Consumer, prior to consuming services offered by the Nausf_SoRProtection API, shall obtain a "token" from the authorization server, by invoking the Access Token Request service, as described in 3GPP TS 29.510 [14], clause 5.4.2.2.

NOTE: When multiple NRFs are deployed in a network, the NRF used as authorization server is the same NRF that the NF Service Consumer used for discovering the Nausf_SoRProtection service.

The Nausf_SoRProtection Service API defines a single scope `nausf-sorprotection` (as specified in 3GPP TS 33.501 [8]), and it does not define any additional scopes at resource or operation level.

6.2.9 Feature Negotiation

The features in table 6.2.9-1 are defined for the Nausf_SoRProtection API. They shall be negotiated using the extensibility mechanism defined in clause 6.6 of 3GPP TS 29.500 [4].

Table 6.2.9-1: Supported Features

Feature number	Feature Name	M/O	Description
1	ES3XX	M	Extended Support of HTTP 307/308 redirection An NF Service Consumer (e.g. UDM) that supports this feature shall support handling of HTTP 307/308 redirection for any service operation of the SoRProtection service. An NF Service Consumer that does not support this feature does only support HTTP redirection as specified for 3GPP Release 15.
2	soTransparentSupport	O	This flag is used by AUSF to register (in NRF) its support of receiving SoR Transparent Information instead of individual IEs from UDM.

6.2.10 HTTP redirection

An HTTP request may be redirected to a different AUSF service instance, within the same AUSF or a different AUSF of an AUSF set, e.g. when an AUSF service instance is part of an AUSF (service) set or when using indirect communications (see 3GPP TS 29.500 [4]). See also the ES3XX feature in clause 6.2.9.

An SCP that reselects a different AUSF producer instance will return the NF Instance ID of the new AUSF producer instance in the 3gpp-Sbi-Producer-Id header, as specified in clause 6.10.3.4 of 3GPP TS 29.500 [4].

If an AUSF within an AUSF set redirects a service request to a different AUSF of the set using an 307 Temporary Redirect or 308 Permanent Redirect status code, the identity of the new AUSF towards which the service request is redirected shall be indicated in the 3gpp-Sbi-Target-Nf-Id header of the 307 Temporary Redirect or 308 Permanent Redirect response as specified in clause 6.10.9.1 of 3GPP TS 29.500 [4].

6.3 Nausf_UPUProtection Service API

6.3.1 API URI

URIs of this API shall have the following root:

{apiRoot}/{apiName}/<apiVersion>

The request URIs used in HTTP requests from the NF service consumer towards the NF service producer shall have the Resource URI structure defined in clause 4.4.1 of 3GPP TS 29.501 [5], i.e.:

{apiRoot}/<apiName>/<apiVersion>/<apiSpecificResourceUriPart>

with the following components:

- The {apiRoot} shall be set as described in 3GPP TS 29.501 [6].
- The <apiName> shall be "nausf-upuprotection".
- The <apiVersion> shall be "v1".
- The <apiSpecificResourceUriPart> shall be set as described in clause 6.3.3.

6.3.2 Usage of HTTP

6.3.2.1 General

HTTP/2, as defined in IETF RFC 7540 [6], shall be used as specified in clause 5 of 3GPP TS 29.500 [4].

6.3.2.2 HTTP standard headers

6.3.2.2.1 General

The usage of HTTP standard headers is specified in clause 5.2.2 of 3GPP TS 29.500 [4].

6.3.2.2.2 Content type

The following content types shall be supported:

- JSON, as defined in IETF RFC 8259 [7], shall be used as content type of the HTTP bodies specified in the present specification as indicated in clause 5.4 of 3GPP TS 29.500 [4].
- The Problem Details JSON Object (IETF RFC 9457 [11]). The use of the Problem Details JSON object in a HTTP response body shall be signalled by the content type "application/problem+json"

6.3.2.3 HTTP custom headers

6.3.2.3.1 General

In this version of the API, no specific custom headers are defined for the "Nausf_UPUProtection" service.

For 3GPP specific HTTP custom headers used across all service based interfaces, see clause 5.2.3 of 3GPP TS 29.500 [4].

6.3.3 Resources

6.3.3.1 Overview

The structure of the Resource URIs of the Nausf_UPUProtection service is shown in Figure 6.3.3.1-1

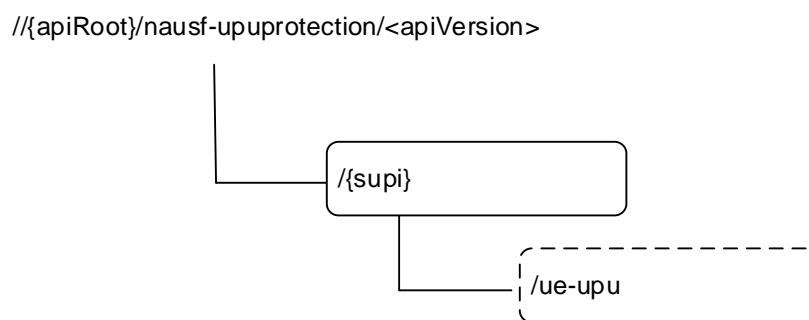

Figure 6.3.3.1-1: Resource URI structure of the UPUProtection API

Table 6.3.3.1-1 provides an overview of the resources and applicable HTTP methods.

Table 6.3.3.1-1: Resources and methods overview

Resource name	Resource URI	HTTP method or custom operation	Description
supi (Custom operation)	//{supi}/ue-upu/	ue-upu (POST)	Resource for UPU security material computation

6.3.3.2 Resource: supi (Custom operation)

6.3.3.2.1 Description

It is the resource to which the custom operation used to generate the UPU security material is associated with.

6.3.3.2.2 Resource Definition

Resource URI: {apiRoot}/nausf-upuprotection/<apiVersion>/{supi}/

This resource shall support the resource URI variables defined in table 6.3.3.2.2-1.

Table 6.3.3.2.2-1: Resource URI variables for this resource

Name	Data type	Definition
apiRoot	string	See clause 6.3.1
supi	Supi	Represents the Subscription Permanent Identifier (see 3GPP TS 23.501 [2] clause 5.9.2) pattern: See pattern of type Supi in 3GPP TS 29.571 [10]

6.3.3.2.3 Resource Standard Methods

No Standard Methods are supported for this resource.

6.3.3.2.4 Resource Custom Operations

6.3.3.2.4.1 Overview

Table 6.3.3.2.4.1-1: Custom operations

Operation Name	Custom operation URI	Mapped HTTP method	Description
ue-upu	/ue-upu	POST	The AUSF calculates the UPU-MAC-I _{AUSF} and the Counter _{UPU} to protect the UE Parameters Update Data provided. It may also calculate the UPU-XMAC-I _{UE} to verify that the UE received the UE Parameters Update Data if the indication that an acknowledgement is requested from the UE is provided.

6.3.3.2.4.2 Operation: ue-upu

6.3.3.2.4.2.1 Description

This custom operation is used by the NF service consumer (e.g. UDM) to request the AUSF to compute the security material (UPU-MAC-I_{AUSF}, Counter_{UPU} and UPU-XMAC-I_{UE}) needed to ensure the protection of the UPU procedure (see 3GPP TS 33.501 [8]).

6.3.3.2.4.2.2 Operation Definition

This method shall support the request data structures specified in table 6.3.3.2.4.2.2-1 and the response data structures and response codes specified in table 6.3.3.2.4.2.2-2.

Table 6.3.3.2.4.2.2-1: Data structures supported by the POST Request Body on this resource

Data type	P	Cardinality	Description
UpuInfo	M	1	Contains the UE Parameters Update Data and shall contain the indication of whether an acknowledgement is requested from the UE or not (as specified in 3GPP TS 33.501 [8]).

Table 6.3.3.2.4.2.2-2: Data structures supported by the POST Response Body on this resource

Data type	P	Cardinality	Response codes	Description
UpuSecurityInfo	M	1	200 OK	Upon success, the response body will contain UPU-MAC-I _{AUSF} and Counter _{UPU} and may contain the UPU-XMAC-I _{UE} .
RedirectResponse	O	0..1	307 Temporary Redirect	Temporary redirection. (NOTE 2)
RedirectResponse	O	0..1	308 Permanent Redirect	Permanent redirection. (NOTE 2)
ProblemDetails	O	0..1	503 Service Unavailable	The "cause" attribute may be used to indicate one of the following application errors: - COUNTER_WRAP See table 6.3.7.3-1 for the description of these errors.
NOTE 1: The mandatory HTTP error status codes for the POST method listed in Table 5.2.7.1-1 of 3GPP TS 29.500 [4] other than those specified in the table above also apply, with a ProblemDetails data type (see clause 5.2.7 of 3GPP TS 29.500 [4]).				
NOTE 2: RedirectResponse may be inserted by an SCP, see clause 6.10.9.1 of 3GPP TS 29.500 [4].				

Table 6.3.3.2.4.2.2-3: Headers supported by the 307 Response Code on this resource

Name	Data type	P	Cardinality	Description
Location	string	M	1	An alternative URI of the resource located on an alternative service instance within the same AUSF or AUSF (service) set. For the case, when a request is redirected to the same target resource via a different SCP, see clause 6.10.9.1 in 3GPP TS 29.500 [4].
3gpp-Sbi-Target-Nf-Id	string	O	0..1	Identifier of the target NF (service) instance ID towards which the request is redirected

Table 6.3.3.2.4.2.2-4: Headers supported by the 308 Response Code on this resource

Name	Data type	P	Cardinality	Description
Location	string	M	1	An alternative URI of the resource located on an alternative service instance within the same AUSF or AUSF (service) set. For the case, when a request is redirected to the same target resource via a different SCP, see clause 6.10.9.1 in 3GPP TS 29.500 [4].
3gpp-Sbi-Target-Nf-Id	string	O	0..1	Identifier of the target NF (service) instance ID towards which the request is redirected

6.3.4 Custom Operations without associated resources

6.3.4.1 Overview

There is no Custom Operation in the current version of this API.

6.3.5 Notifications

6.3.5.1 General

There is no use of notification in the current version of this API.

6.3.6 Data Model

6.3.6.1 General

This clause specifies the application data model supported by the API.

Table 6.3.6.1-1 specifies the data types defined for the Nausf_UPUProtection service based interface protocol.

Table 6.3.6.1-1: Nausf_UPUProtection specific Data Types

Data type	Clause defined	Description
UpuInfo	6.3.6.2.2	Contains the UE parameters update Information
UpuSecurityInfo	6.3.6.2.3	Contains the material generated for securing of UPU. It contains at least the UPU-MAC-I _{AUSF} and Counter _{UPU} .
UpuData	6.3.6.2.4	Contains UE parameters update data set (e.g., the updated Routing ID Data or the Default configured NSSAI).
UpuMac	6.3.6.3.2	MAC value for protecting UPU procedure (UPU-MAC-I _{AUSF} and UPU-MAC-I _{UE})
CounterUpu	6.3.6.3.2	Counter _{UPU}
UpuAckInd	6.3.6.3.2	Contains the indication of whether the acknowledgement from UE is needed
UpuHeader	6.3.6.3.2	Contains the "UPU Header" IE as specified in clause 9.11.3.53A of 3GPP TS 24.501 [20] (octet 4),
UpuTransparentInfo	6.3.6.3.2	Contains UPU information encoded as transparent container.

Table 6.3.6.1-2 specifies data types re-used by the Nausf_UPUProtection service based interface protocol from other specifications and from other service APIs in current specification, including a reference to the respective specifications and when needed, a short description of their use within the Nausf_UPUProtection service based interface.

Table 6.3.6.1-2: Nausf_UPUProtection re-used Data Types

Data type	Reference	Comments
Snssai	3GPP TS 29.571 [10]	Default configured NSSAI
SecuredPacket	6.2.6.3.2	Defined in Nausf_SORProtection API. Secured Packet
RoutingId	3GPP TS 29.544 [22]	Routing ID
SupportedFeatures	3GPP TS 29.571 [10]	Supported Features

6.3.6.2 Structured data types

6.3.6.2.1 Introduction

The following clauses define the structures to be used in resource representations.

6.3.6.2.2 Type: UpuInfo

Table 6.3.6.2.2-1: Definition of type UpuInfo

Attribute name	Data type	P	Cardinality	Description	Applicability
upuDataList	array(Upu Data)	M	1..N	This information defines the UE Parameters Update (UPU). A secured packed with the Routing indicator update data and/or the Default configured NSSAI update data are included. See clause 6.3.6.2.4. This attribute shall be ignored by AUSF when upuTransparentInfo is present.	
upuHeader	UpuHeader	O	0..1	This attribute contains UPU Header encoded as defined in clause 6.3.6.3.2.	
upuAckInd	UpuAckInd	M	1	Contains the indication of whether the acknowledgement from UE is needed.	
supportedFeatures	Supported Features	C	0..1	This IE shall be present if at least one feature defined in clause 6.3.9 is supported.	
upuTransparentInfo	UpuTransparentInfo	O	0..1	This attribute contains UPU information encoded as defined in clause 6.3.6.3.2, and may be present if AUSF supports receiving UPU Information encoded as transparent container.	upuTransparentSupport

6.3.6.2.3 Type: UpuSecurityInfo

Table 6.3.6.2.3-1: Definition of type UpuSecurityInfo

Attribute name	Data type	P	Cardinality	Description
upuMacIausf	UpuMac	M	1	Contains the UPU-MAC-I _{AUSF} .
counterUpu	CounterUpu	M	1	Contains the Counter _{UPU} .
upuXmaclue	UpuMac	O	0..1	When present, contains the UPU-XMAC-I _{UE} . It shall be included, if the UDM requests the acknowledgement from the UE.

6.3.6.2.4 Type: UpuData

Table 6.3.6.2.4-1: Definition of type UpuData

Attribute name	Data type	P	Cardinality	Description
secPacket	SecuredPacket	C	0..1	Shall be present if the Routing indicator update data is required to be updated, and contains a secured packet with the Routing indicator to be updated.
defaultConfNssai	array(Snssai)	C	1..N	Shall be present if the Default configured NSSAI is required to be updated, and contains the Default configured NSSAI to be updated. The S-NSSAIs of the default configured NSSAIs shall be a subset of the union of singleNssais and defaultSingleNssais, and should be a subset of the defaultSingleNssais. The defaultSingleNssais and singleNssais are specified in 3GPP TS 29.503 [12] clause 6.1.6.2.2.
routingId	RoutingId	C	0..1	May be present when sent from UDR to UDM. The UDM shall make use of Nspaf services (see 3GPP TS 29.544 [22]) to encapsulate the routing id in a secured packet which is then conveyed to the AUSF and AMF.
drei	boolean	O	0..1	Disaster Roaming Enabled Indication (DREI). May be present when sent from UDR to UDM. - false: Disaster roaming is disabled in the UE in 5GS - true: Disaster roaming is enabled in the UE in 5GS
dreiEps	boolean	O	0..1	Disaster Roaming in EPS Enabled Indication. This attribute indicates whether disaster roaming in EPS is enabled in the UE. May be present when sent from UDR to UDM. - false: Disaster roaming in EPS is disabled in the UE - true: Disaster roaming in EPS is enabled in the UE
aol	boolean	C	0..1	Indication of 'applicability of "lists of PLMN(s) to be used in disaster condition" provided by a VPLMN'. May be present when sent from UDR to UDM. - false: the list of PLMNs provided by the VPLMN is not applicable - true: the list of PLMNs provided by the VPLMN is applicable
disasterCondPlmnIds	array(PlmnId)	C	1..N	List of PLMN Ids identifying PLMNs allowed to be used in Disaster Conditions. May be present when sent from UDR to UDM.

6.3.6.3 Simple data types and enumerations

6.3.6.3.1 Introduction

This clause defines simple data types and enumerations that can be referenced from data structures defined in the previous clauses.

6.3.6.3.2 Simple data types

Table 6.3.6.3.2-1: Simple data types

Type Name	Type Definition	Description
UpuMac	string	pattern: "[A-Fa-f0-9]{32}\$"
CounterUpu	string	pattern: "[A-Fa-f0-9]{4}\$"
UpuAckInd	boolean	true indicates that the UPU-XMAC-I _{UE} shall be computed and returned in the response
UpuHeader	string	It contains the "UPU Header" IE as specified in clause 9.11.3.53A of 3GPP TS 24.501 [20] (octet 4), encoded as 2 hexadecimal characters. Pattern: "[A-Fa-f0-9]{2}\$"
UpuTransparentInfo	Bytes	String with format "byte" as defined in OpenAPI Specification [25], i.e. base64-encoded characters, encoding the "UPU transparent container" IE as specified in clause 9.11.3.53A of 3GPP TS 24.501 [20] (starting from octet 23).

6.3.6.3.3 Void

6.3.7 Error Handling

6.3.7.1 General

HTTP error handling shall be supported as specified in clause 5.2.4 of 3GPP TS 29.500 [4].

6.3.7.2 Protocol Errors

Protocol Error Handling shall be supported as specified in clause 5.2.7.2 of 3GPP TS 29.500 [4].

6.3.7.3 Application Errors

The common application errors defined in the Table 5.2.7.2-1 in 3GPP TS 29.500 [4] may also be used for the Nausf_UPUProtection service. The following application errors listed in Table 6.3.7.3-1 are specific for the Nausf_UPUProtection service.

Table 6.3.7.3-1: Application errors

Application Error	HTTP status code	Description
COUNTER_WRAP	503 Service Unavailable	The Counter _{UPU} associated with the K _{AUSF} of the UE is about to wrap around. The AUSF suspends the UPU protection service for the UE until a new K _{AUSF} is generated.

6.3.8 Security

As indicated in 3GPP TS 33.501 [8], the access to the Nausf_UPUProtection API may be authorized by means of the Oauth2 protocol (see IETF RFC 6749 [13]), using the "Client Credentials" authorization grant, where the NRF (see 3GPP TS 29.510 [14]) plays the role of the authorization server.

If Oauth2 is used, an NF Service Consumer, prior to consuming services offered by the Nausf_UPUProtection API, shall obtain a "token" from the authorization server, by invoking the Access Token Request service, as described in 3GPP TS 29.510 [14], clause 5.4.2.2.

NOTE: When multiple NRFs are deployed in a network, the NRF used as authorization server is the same NRF that the NF Service Consumer used for discovering the Nausf_UPUProtection service.

The Nausf_UPUProtection Service API does not define any scopes for OAuth2 authorization as specified in 3GPP TS 33.501 [8]; it defines a single scope consisting on the name of the service (i.e., "nausf-upuprotection"), and it does not define any additional scopes at resource or operation level.

6.3.9 Feature Negotiation

The features in table 6.3.9-1 are defined for the Nausf_UPUProtection API. They shall be negotiated using the extensibility mechanism defined in clause 6.6 of 3GPP TS 29.500 [4].

Table 6.3.9-1: Supported Features

Feature number	Feature Name	M/O	Description
1	ES3XX	M	Extended Support of HTTP 307/308 redirection An NF Service Consumer (e.g. UDM) that supports this feature shall support handling of HTTP 307/308 redirection for any service operation of the UPUProtection service. An NF Service Consumer that does not support this feature does only support HTTP redirection as specified for 3GPP Release 15.
2	upuTransparentSupport	O	This flag is used by AUSF to register (in NRF) its support of receiving UPU Transparent Information instead of individual les from UDM

6.3.10 HTTP redirection

An HTTP request may be redirected to a different AUSF service instance, within the same AUSF or a different AUSF of an AUSF set, e.g. when an AUSF service instance is part of an AUSF (service) set or when using indirect communications (see 3GPP TS 29.500 [4]). See also the ES3XX feature in clause 6.3.9.

An SCP that reselects a different AUSF producer instance will return the NF Instance ID of the new AUSF producer instance in the 3gpp-Sbi-Producer-Id header, as specified in clause 6.10.3.4 of 3GPP TS 29.500 [4].

If an AUSF within an AUSF set redirects a service request to a different AUSF of the set using an 307 Temporary Redirect or 308 Permanent Redirect status code, the identity of the new AUSF towards which the service request is redirected shall be indicated in the 3gpp-Sbi-Target-Nf-Id header of the 307 Temporary Redirect or 308 Permanent Redirect response as specified in clause 6.10.9.1 of 3GPP TS 29.500 [4].

Annex A (normative): OpenAPI specification

A.1 General

This Annex specifies the formal definition of the Nausf Service API(s). It consists of OpenAPI 3.0.0 specifications in YAML format.

NOTE 1: OpenAPI 3.0 does not support description of API using HATEOAS. Indeed, only relative paths can be used and as a consequence the URI provided in the "href" cannot be reused as it is.

This Annex takes precedence when being discrepant to other parts of the specification with respect to the encoding of information elements and methods within the API(s).

NOTE 2: The semantics and procedures, as well as conditions, e.g. for the applicability and allowed combinations of attributes or values, not expressed in the OpenAPI definitions but defined in other parts of the specification also apply.

Informative copies of the OpenAPI specification files contained in this 3GPP Technical Specification are available on a Git-based repository that uses the GitLab software version control system (see 3GPP TS 29.501 [5] clause 5.3.1 and 3GPP TR 21.900 [21] clause 5B).

A.2 Nausf_UEAuthentication API

```

openapi: 3.0.0
info:
  version: 1.4.0
  title: AUSF API
  description: |
    AUSF UE Authentication Service.
    © 2025, 3GPP Organizational Partners (ARIB, ATIS, CCSA, ETSI, TSDSI, TTA, TTC).
    All rights reserved.

externalDocs:
  description: 3GPP TS 29.509 V19.5.0; 5G System; 3GPP TS Authentication Server services.
  url: 'https://www.3gpp.org/ftp/Specs/archive/29_series/29.509'

servers:
- url: '{apiRoot}/nausf-auth/v1'
  variables:
    apiRoot:
      default: https://example.com
      description: apiRoot as defined in clause 4.4 of 3GPP TS 29.501.

security:
- {}
- oAuth2ClientCredentials:
  - nausf-auth

paths:
  /ue-authentications:
    post:
      security:
        - {}
        - oAuth2ClientCredentials:
          - nausf-auth
        - oAuth2ClientCredentials:
          - nausf-auth
        - nausf-auth:ue-authentications
      requestBody:
        content:
          application/json:
            schema:
              $ref: '#/components/schemas/AuthenticationInfo'
            required: true
      responses:

```

```

'201':
  description: UEAuthenticationCtx
  content:
    application/3gppHal+json:
      schema:
        $ref: '#/components/schemas/UEAuthenticationCtx'
  headers:
    Location:
      description: >
        'Contains the URI of the newly created resource according to the structure:
        {apiRoot}/nausf-auth/<apiVersion>/ue-authentications/{authCtxId}'
      required: true
      schema:
        type: string
'307':
  $ref: 'TS29571_CommonData.yaml#/components/responses/307'
'308':
  $ref: 'TS29571_CommonData.yaml#/components/responses/308'
'400':
  description: Bad Request from the AMF
  content:
    application/problem+json:
      schema:
        $ref: 'TS29571_CommonData.yaml#/components/schemas/ProblemDetails'
'401':
  $ref: 'TS29571_CommonData.yaml#/components/responses/401'
'403':
  description: Forbidden due to serving network not authorized
  content:
    application/problem+json:
      schema:
        $ref: 'TS29571_CommonData.yaml#/components/schemas/ProblemDetails'
'404':
  description: User does not exist in the HPLMN
  content:
    application/problem+json:
      schema:
        $ref: 'TS29571_CommonData.yaml#/components/schemas/ProblemDetails'
'411':
  $ref: 'TS29571_CommonData.yaml#/components/responses/411'
'413':
  $ref: 'TS29571_CommonData.yaml#/components/responses/413'
'415':
  $ref: 'TS29571_CommonData.yaml#/components/responses/415'
'429':
  $ref: 'TS29571_CommonData.yaml#/components/responses/429'
'500':
  description: Internal Server Error
  content:
    application/problem+json:
      schema:
        $ref: 'TS29571_CommonData.yaml#/components/schemas/ProblemDetails'
'501':
  description: Received protection scheme is not supported by HPLMN
  content:
    application/problem+json:
      schema:
        $ref: 'TS29571_CommonData.yaml#/components/schemas/ProblemDetails'
'502':
  $ref: 'TS29571_CommonData.yaml#/components/responses/502'
'503':
  $ref: 'TS29571_CommonData.yaml#/components/responses/503'

/ue-authentications/deregister:
  post:
    security:
      - {}
      - oAuth2ClientCredentials:
          - nausf-auth
      - oAuth2ClientCredentials:
          - nausf-auth
          - nausf-auth:ue-authentications
    requestBody:
      content:
        application/json:
          schema:
            $ref: '#/components/schemas/DeregistrationInfo'
      required: true

```

```

responses:
  '204':
    description: Expected response to a successful removal of security context
  '307':
    $ref: 'TS29571_CommonData.yaml#/components/responses/307'
  '308':
    $ref: 'TS29571_CommonData.yaml#/components/responses/308'
  '400':
    $ref: 'TS29571_CommonData.yaml#/components/responses/400'
  '401':
    $ref: 'TS29571_CommonData.yaml#/components/responses/401'
  '403':
    $ref: 'TS29571_CommonData.yaml#/components/responses/403'
  '404':
    $ref: 'TS29571_CommonData.yaml#/components/responses/404'
  '411':
    $ref: 'TS29571_CommonData.yaml#/components/responses/411'
  '413':
    $ref: 'TS29571_CommonData.yaml#/components/responses/413'
  '415':
    $ref: 'TS29571_CommonData.yaml#/components/responses/415'
  '429':
    $ref: 'TS29571_CommonData.yaml#/components/responses/429'
  '500':
    $ref: 'TS29571_CommonData.yaml#/components/responses/500'
  '502':
    $ref: 'TS29571_CommonData.yaml#/components/responses/502'
  '503':
    $ref: 'TS29571_CommonData.yaml#/components/responses/503'

/ue-authentications/{authCtxId}/5g-aka-confirmation:
  put:
    security:
      - {}
      - OAuth2ClientCredentials:
          - nausf-auth
      - OAuth2ClientCredentials:
          - nausf-auth
          - nausf-auth:ue-authentications
    parameters:
      - name: authCtxId
        in: path
        required: true
        schema:
          type: string
    requestBody:
      content:
        application/json:
          schema:
            $ref: '#/components/schemas/ConfirmationData'
    responses:
      '200':
        description: Request processed (EAP success or Failure)
        content:
          application/json:
            schema:
              $ref: '#/components/schemas/ConfirmationDataResponse'
      '307':
        $ref: 'TS29571_CommonData.yaml#/components/responses/307'
      '308':
        $ref: 'TS29571_CommonData.yaml#/components/responses/308'
      '400':
        description: Bad Request
        content:
          application/problem+json:
            schema:
              $ref: 'TS29571_CommonData.yaml#/components/schemas/ProblemDetails'
      '401':
        $ref: 'TS29571_CommonData.yaml#/components/responses/401'
      '403':
        $ref: 'TS29571_CommonData.yaml#/components/responses/403'
      '404':
        $ref: 'TS29571_CommonData.yaml#/components/responses/404'
      '411':
        $ref: 'TS29571_CommonData.yaml#/components/responses/411'
      '413':
        $ref: 'TS29571_CommonData.yaml#/components/responses/413'
      '415':

```

```

    $ref: 'TS29571_CommonData.yaml#/components/responses/415'
  '429':
    $ref: 'TS29571_CommonData.yaml#/components/responses/429'
  '500':
    description: Internal Server Error
    content:
      application/problem+json:
        schema:
          $ref: 'TS29571_CommonData.yaml#/components/schemas/ProblemDetails'
  '502':
    $ref: 'TS29571_CommonData.yaml#/components/responses/502'
  '503':
    $ref: 'TS29571_CommonData.yaml#/components/responses/503'

delete:
  summary: Deletes the authentication result in the UDM
  operationId: Delete5gAkaAuthenticationResult
  tags:
    - Authentication Result Deletion
  security:
    - {}
    - oAuth2ClientCredentials:
      - nausf-auth
    - oAuth2ClientCredentials:
      - nausf-auth
      - nausf-auth:ue-authentications
  parameters:
    - name: authCtxId
      in: path
      required: true
      schema:
        type: string
  responses:
    '204':
      description: Expected response to a successful authentication result removal
    '307':
      $ref: 'TS29571_CommonData.yaml#/components/responses/307'
    '308':
      $ref: 'TS29571_CommonData.yaml#/components/responses/308'
    '400':
      $ref: 'TS29571_CommonData.yaml#/components/responses/400'
    '401':
      $ref: 'TS29571_CommonData.yaml#/components/responses/401'
    '403':
      $ref: 'TS29571_CommonData.yaml#/components/responses/403'
    '404':
      $ref: 'TS29571_CommonData.yaml#/components/responses/404'
    '429':
      $ref: 'TS29571_CommonData.yaml#/components/responses/429'
    '500':
      $ref: 'TS29571_CommonData.yaml#/components/responses/500'
    '502':
      $ref: 'TS29571_CommonData.yaml#/components/responses/502'
    '503':
      $ref: 'TS29571_CommonData.yaml#/components/responses/503'
    default:
      $ref: 'TS29571_CommonData.yaml#/components/responses/default'

/ue-authentications/{authCtxId}/eap-session:
  post:
    operationId: EapAuthMethod
    security:
      - {}
      - oAuth2ClientCredentials:
        - nausf-auth
      - oAuth2ClientCredentials:
        - nausf-auth
        - nausf-auth:ue-authentications
    parameters:
      - name: authCtxId
        in: path
        required: true
        schema:
          type: string
    requestBody:
      content:
        application/json:
          schema:

```

```

    $ref: '#/components/schemas/EapSession'
responses:
  '200':
    description: Use to handle or close the EAP session
    content:
      application/json:
        schema:
          $ref: '#/components/schemas/EapSession'

      application/3gppHal+json:
        schema:
          type: object
          properties:
            eapPayload:
              $ref: '#/components/schemas/EapPayload'
            _links:
              type: object
              description: >
                A map (list of key-value pairs) where the key is set to "eap-session"
              additionalProperties:
                $ref: 'TS29571_CommonData.yaml#/components/schemas/LinksValueSchema'
              minProperties: 1
          required:
            - eapPayload
            - _links
  '307':
    $ref: 'TS29571_CommonData.yaml#/components/responses/307'
  '308':
    $ref: 'TS29571_CommonData.yaml#/components/responses/308'
  '400':
    description: Bad Request
    content:
      application/problem+json:
        schema:
          $ref: 'TS29571_CommonData.yaml#/components/schemas/ProblemDetails'
  '401':
    $ref: 'TS29571_CommonData.yaml#/components/responses/401'
  '403':
    $ref: 'TS29571_CommonData.yaml#/components/responses/403'
  '404':
    $ref: 'TS29571_CommonData.yaml#/components/responses/404'
  '411':
    $ref: 'TS29571_CommonData.yaml#/components/responses/411'
  '413':
    $ref: 'TS29571_CommonData.yaml#/components/responses/413'
  '415':
    $ref: 'TS29571_CommonData.yaml#/components/responses/415'
  '429':
    $ref: 'TS29571_CommonData.yaml#/components/responses/429'
  '500':
    description: Internal Server Error
    content:
      application/problem+json:
        schema:
          $ref: 'TS29571_CommonData.yaml#/components/schemas/ProblemDetails'
  '502':
    $ref: 'TS29571_CommonData.yaml#/components/responses/502'
  '503':
    $ref: 'TS29571_CommonData.yaml#/components/responses/503'

delete:
  summary: Deletes the authentication result in the UDM
  operationId: DeleteEapAuthenticationResult
  tags:
    - Authentication Result Deletion
  security:
    - {}
    - oAuth2ClientCredentials:
      - nausf-auth
    - oAuth2ClientCredentials:
      - nausf-auth
      - nausf-auth:ue-authentications
  parameters:
    - name: authCtxId
      in: path
      required: true
      schema:
        type: string

```

```

responses:
  '204':
    description: Expected response to a successful authentication result removal
  '307':
    $ref: 'TS29571_CommonData.yaml#/components/responses/307'
  '308':
    $ref: 'TS29571_CommonData.yaml#/components/responses/308'
  '400':
    $ref: 'TS29571_CommonData.yaml#/components/responses/400'
  '401':
    $ref: 'TS29571_CommonData.yaml#/components/responses/401'
  '403':
    $ref: 'TS29571_CommonData.yaml#/components/responses/403'
  '404':
    $ref: 'TS29571_CommonData.yaml#/components/responses/404'
  '429':
    $ref: 'TS29571_CommonData.yaml#/components/responses/429'
  '500':
    $ref: 'TS29571_CommonData.yaml#/components/responses/500'
  '502':
    $ref: 'TS29571_CommonData.yaml#/components/responses/502'
  '503':
    $ref: 'TS29571_CommonData.yaml#/components/responses/503'
  default:
    $ref: 'TS29571_CommonData.yaml#/components/responses/default'

/rg-authentications:
  post:
    security:
      - {}
      - oAuth2ClientCredentials:
          - nausf-auth
      - oAuth2ClientCredentials:
          - nausf-auth
          - nausf-auth:rg-authentications
    requestBody:
      content:
        application/json:
          schema:
            $ref: '#/components/schemas/RgAuthenticationInfo'
      required: true
    responses:
      '201':
        description: RgAuthCtx
        content:
          application/json:
            schema:
              $ref: '#/components/schemas/RgAuthCtx'
        headers:
          Location:
            description: >
              'Contains the URI of the newly created resource according to the structure:
              {apiRoot}/nausf-auth/<apiVersion>/rg-authentications/{authCtxId}'
            required: true
            schema:
              type: string
      '307':
        $ref: 'TS29571_CommonData.yaml#/components/responses/307'
      '308':
        $ref: 'TS29571_CommonData.yaml#/components/responses/308'
      '400':
        description: Bad Request from the AMF
        content:
          application/problem+json:
            schema:
              $ref: 'TS29571_CommonData.yaml#/components/schemas/ProblemDetails'
      '401':
        $ref: 'TS29571_CommonData.yaml#/components/responses/401'
      '403':
        description: The UE is not allowed to be authenticated
        content:
          application/problem+json:
            schema:
              $ref: 'TS29571_CommonData.yaml#/components/schemas/ProblemDetails'
      '404':
        description: User does not exist in the HPLMN
        content:
          application/problem+json:

```

```

    schema:
      $ref: 'TS29571_CommonData.yaml#/components/schemas/ProblemDetails'
  '411':
    $ref: 'TS29571_CommonData.yaml#/components/responses/411'
  '413':
    $ref: 'TS29571_CommonData.yaml#/components/responses/413'
  '415':
    $ref: 'TS29571_CommonData.yaml#/components/responses/415'
  '429':
    $ref: 'TS29571_CommonData.yaml#/components/responses/429'
  '500':
    $ref: 'TS29571_CommonData.yaml#/components/responses/500'
  '502':
    $ref: 'TS29571_CommonData.yaml#/components/responses/502'
  '503':
    $ref: 'TS29571_CommonData.yaml#/components/responses/503'

/prose-authentications:
  post:
    security:
      - {}
      - oAuth2ClientCredentials:
          - nausf-auth
      - oAuth2ClientCredentials:
          - nausf-auth
          - nausf-auth:prose-authentications
    requestBody:
      content:
        application/json:
          schema:
            $ref: '#/components/schemas/ProSeAuthenticationInfo'
      required: true
    responses:
      '200':
        description: Successful authentication with CP-PRUK ID
        content:
          application/json:
            schema:
              $ref: '#/components/schemas/ProSeAuthenticationResult'
      '201':
        description: ProSeAuthenticationCtx
        content:
          application/3gppHal+json:
            schema:
              $ref: '#/components/schemas/ProSeAuthenticationCtx'
        headers:
          Location:
            description: >
              'Contains the URI of the newly created resource according to the structure:
              {apiRoot}/nausf-auth/<apiVersion>/prose-authentications/{authCtxId}'
            required: true
            schema:
              type: string
      '307':
        $ref: 'TS29571_CommonData.yaml#/components/responses/307'
      '308':
        $ref: 'TS29571_CommonData.yaml#/components/responses/308'
      '400':
        $ref: 'TS29571_CommonData.yaml#/components/responses/400'
      '401':
        $ref: 'TS29571_CommonData.yaml#/components/responses/401'
      '403':
        $ref: 'TS29571_CommonData.yaml#/components/responses/403'
      '404':
        $ref: 'TS29571_CommonData.yaml#/components/responses/404'
      '411':
        $ref: 'TS29571_CommonData.yaml#/components/responses/411'
      '413':
        $ref: 'TS29571_CommonData.yaml#/components/responses/413'
      '415':
        $ref: 'TS29571_CommonData.yaml#/components/responses/415'
      '429':
        $ref: 'TS29571_CommonData.yaml#/components/responses/429'
      '500':
        $ref: 'TS29571_CommonData.yaml#/components/responses/500'
      '502':
        $ref: 'TS29571_CommonData.yaml#/components/responses/502'

```

```

'503':
  $ref: 'TS29571_CommonData.yaml#/components/responses/503'
/prose-authentications/{authCtxId}/prose-auth:
  post:
    operationId: proseAuth
    security:
      - {}
      - oAuth2ClientCredentials:
          - nausf-auth
      - oAuth2ClientCredentials:
          - nausf-auth
          - nausf-auth:prose-authentications
    parameters:
      - name: authCtxId
        in: path
        required: true
        schema:
          type: string
    requestBody:
      content:
        application/json:
          schema:
            $ref: '#/components/schemas/ProSeEapSession'
    responses:
      '200':
        description: >
          Use to handle or close the EAP session for 5G ProSe Remote UE or a 5G ProSe End UE
        content:
          application/json:
            schema:
              $ref: '#/components/schemas/ProSeEapSession'
          application/3gppHal+json:
            schema:
              type: object
              properties:
                eapPayload:
                  $ref: '#/components/schemas/EapPayload'
                _links:
                  type: object
                  description: >
                    A map (list of key-value pairs) where the key is set to
                    "prose-auth"
                  additionalProperties:
                    $ref: 'TS29571_CommonData.yaml#/components/schemas/LinksValueSchema'
                  minProperties: 1
              required:
                - eapPayload
                - _links
      '307':
        $ref: 'TS29571_CommonData.yaml#/components/responses/307'
      '308':
        $ref: 'TS29571_CommonData.yaml#/components/responses/308'
      '400':
        $ref: 'TS29571_CommonData.yaml#/components/responses/400'
      '401':
        $ref: 'TS29571_CommonData.yaml#/components/responses/401'
      '403':
        $ref: 'TS29571_CommonData.yaml#/components/responses/403'
      '404':
        $ref: 'TS29571_CommonData.yaml#/components/responses/404'
      '411':
        $ref: 'TS29571_CommonData.yaml#/components/responses/411'
      '413':
        $ref: 'TS29571_CommonData.yaml#/components/responses/413'
      '415':
        $ref: 'TS29571_CommonData.yaml#/components/responses/415'
      '429':
        $ref: 'TS29571_CommonData.yaml#/components/responses/429'
      '500':
        $ref: 'TS29571_CommonData.yaml#/components/responses/500'
      '502':
        $ref: 'TS29571_CommonData.yaml#/components/responses/502'
      '503':
        $ref: 'TS29571_CommonData.yaml#/components/responses/503'
  delete:
    summary: Deletes the authentication result in the UDM

```

```

operationId: DeleteProSeAuthenticationResult
tags:
  - Authentication Result Deletion
security:
  - {}
  - oAuth2ClientCredentials:
    - nausf-auth
  - oAuth2ClientCredentials:
    - nausf-auth
    - nausf-auth:prose-authentications
parameters:
  - name: authCtxId
    in: path
    required: true
    schema:
      type: string
responses:
  '204':
    description: Expected response to a successful authentication result removal
  '307':
    $ref: 'TS29571_CommonData.yaml#/components/responses/307'
  '308':
    $ref: 'TS29571_CommonData.yaml#/components/responses/308'
  '400':
    $ref: 'TS29571_CommonData.yaml#/components/responses/400'
  '401':
    $ref: 'TS29571_CommonData.yaml#/components/responses/401'
  '403':
    $ref: 'TS29571_CommonData.yaml#/components/responses/403'
  '404':
    $ref: 'TS29571_CommonData.yaml#/components/responses/404'
  '429':
    $ref: 'TS29571_CommonData.yaml#/components/responses/429'
  '500':
    $ref: 'TS29571_CommonData.yaml#/components/responses/500'
  '502':
    $ref: 'TS29571_CommonData.yaml#/components/responses/502'
  '503':
    $ref: 'TS29571_CommonData.yaml#/components/responses/503'
default:
  $ref: 'TS29571_CommonData.yaml#/components/responses/default'

```

```

components:
  securitySchemes:
    oAuth2ClientCredentials:
      type: oauth2
      flows:
        clientCredentials:
          tokenUrl: '{nrfApiRoot}/oauth2/token'
          scopes:
            nausf-auth: Access to Nausf_UEAuthentication API
            nausf-auth:ue-authentications: >
              Access to service operations applying to the collection of the ue-authentication
              resources and the subresources, i.e. 5g-aka-confirmation and eap-session
            nausf-auth:rg-authentications: >
              Access to service operations applying to the collection of the rg-authentication
              resources
            nausf-auth:prose-authentications: >
              Access to service operations applying to the collection of the prose-authentication
              resources and the subresources, i.e. prose-auth.

```

```

schemas:
  AuthenticationInfo:
    description: Contains the UE id (i.e. SUCI or SUPI) and the Serving Network Name.
    type: object
    properties:
      supiOrSuci:
        $ref: 'TS29571_CommonData.yaml#/components/schemas/SupiOrSuci'
      servingNetworkName:
        $ref: 'TS29503_Nudm_UEAU.yaml#/components/schemas/ServingNetworkName'
      resynchronizationInfo:
        $ref: 'TS29503_Nudm_UEAU.yaml#/components/schemas/ResynchronizationInfo'
      pei:
        $ref: 'TS29571_CommonData.yaml#/components/schemas/Pei'
      traceData:
        $ref: 'TS29571_CommonData.yaml#/components/schemas/TraceData'
      udmGroupId:

```

```

    $ref: 'TS29571_CommonData.yaml#/components/schemas/NfGroupId'
  routingIndicator:
    type: string
    pattern: '^[0-9]{1,4}$'
  cellCagInfo:
    type: array
    items:
      $ref: 'TS29571_CommonData.yaml#/components/schemas/CagId'
    minItems: 1
  n5gcInd:
    type: boolean
    default: false
  supportedFeatures:
    $ref: 'TS29571_CommonData.yaml#/components/schemas/SupportedFeatures'
  nswInd:
    type: boolean
    default: false
  disasterRoamingInd:
    type: boolean
    default: false
  onboardingInd:
    type: boolean
    default: false
  aun3Ind:
    type: boolean
    default: false
  required:
    - supiOrSuci
    - servingNetworkName

UEAuthenticationCtx:
  description: >
    Contains the information related to the resource generated to handle
    the UE authentication. It contains at least the UE id, Serving Network,
    the Authentication Method and related EAP information or related 5G-AKA information.
  type: object
  properties:
    authType:
      $ref: '#/components/schemas/AuthType'
    5gAuthData:
      oneOf:
        - $ref: '#/components/schemas/Av5gAka'
        - $ref: '#/components/schemas/EapPayload'
    _links:
      type: object
      description: >
        A map(list of key-value pairs) where the key is set to "eap-session" or "5g-aka"
      additionalProperties:
        $ref: 'TS29571_CommonData.yaml#/components/schemas/LinksValueSchema'
    servingNetworkName:
      $ref: 'TS29503_Nudm_UEAU.yaml#/components/schemas/ServingNetworkName'
  required:
    - authType
    - 5gAuthData
    - _links

Av5gAka:
  description: Contains Authentication Vector for method 5G AKA.
  type: object
  required:
    - rand
    - hxresStar
    - autn
  properties:
    rand:
      $ref: 'TS29503_Nudm_UEAU.yaml#/components/schemas/Rand'
    hxresStar:
      $ref: '#/components/schemas/HxresStar'
    autn:
      $ref: 'TS29503_Nudm_UEAU.yaml#/components/schemas/Autn'

ConfirmationData:
  description: Contains the result of the authentication.
  type: object
  required:
    - resStar
  properties:
    resStar:

```

```

    $ref: '#/components/schemas/ResStar'
  supportedFeatures:
    $ref: 'TS29571_CommonData.yaml#/components/schemas/SupportedFeatures'

ConfirmationDataResponse:
  description: Contains the result of the authentication
  type: object
  properties:
    authResult:
      $ref: '#/components/schemas/AuthResult'
    supi:
      $ref: 'TS29571_CommonData.yaml#/components/schemas/Supi'
    kseaf:
      $ref: '#/components/schemas/Kseaf'
    pvsInfo:
      type: array
      items:
        $ref: 'TS29571_CommonData.yaml#/components/schemas/ServerAddressingInfo'
      minItems: 1
  required:
    - authResult

EapSession:
  description: Contains information related to the EAP session.
  type: object
  properties:
    eapPayload:
      $ref: '#/components/schemas/EapPayload'
    kSeaf:
      $ref: '#/components/schemas/Kseaf'
    _links:
      type: object
      description: A map(list of key-value pairs) where the key is set to "eap-session"
      additionalProperties:
        $ref: 'TS29571_CommonData.yaml#/components/schemas/LinksValueSchema'
    authResult:
      $ref: '#/components/schemas/AuthResult'
    supi:
      $ref: 'TS29571_CommonData.yaml#/components/schemas/Supi'
    supportedFeatures:
      $ref: 'TS29571_CommonData.yaml#/components/schemas/SupportedFeatures'
    pvsInfo:
      type: array
      items:
        $ref: 'TS29571_CommonData.yaml#/components/schemas/ServerAddressingInfo'
      minItems: 1
    msk:
      $ref: '#/components/schemas/Msk'
  required:
    - eapPayload

DeregistrationInfo:
  description: Contains the UE id (i.e. SUPI).
  type: object
  properties:
    supi:
      $ref: 'TS29571_CommonData.yaml#/components/schemas/Supi'
    supportedFeatures:
      $ref: 'TS29571_CommonData.yaml#/components/schemas/SupportedFeatures'
  required:
    - supi

RgAuthenticationInfo:
  description: Contains the UE id (i.e. SUCI) and the authenticated indication.
  type: object
  properties:
    suci:
      $ref: '#/components/schemas/Suci'
    authenticatedInd:
      type: boolean
      default: false
    supportedFeatures:
      $ref: 'TS29571_CommonData.yaml#/components/schemas/SupportedFeatures'
  required:
    - suci
    - authenticatedInd

RgAuthCtx:

```

```

description: Contains the UE id (i.e. SUPI) and the authentication indication.
type: object
properties:
  authResult:
    $ref: '#/components/schemas/AuthResult'
  supi:
    $ref: 'TS29571_CommonData.yaml#/components/schemas/Supi'
  authInd:
    type: boolean
    default: false
required:
  - authResult

AuthResult:
description: Indicates the result of the authentication.
type: string
enum:
  - AUTHENTICATION_SUCCESS
  - AUTHENTICATION_FAILURE
  - AUTHENTICATION_ONGOING

EapPayload:
type: string
format: byte
description: contains an EAP packet
nullable: true

Kseaf:
description: Contains the Kseaf.
type: string
pattern: '[A-Fa-f0-9]{64}'

Msk:
description: Contains the Master Session Key.
type: string
pattern: '[A-Fa-f0-9]{128}'

ResStar:
description: Contains the RES*.
type: string
pattern: '[A-Fa-f0-9]{32}'
nullable: true

HxresStar:
description: Contains the HXRES*.
type: string
pattern: "[A-Fa-f0-9]{32}"

Suci:
description: Contains the SUCI.
type: string
pattern: '^((suci-(0-[0-9]{3}-[0-9]{2,3}|[1-7]-.+)-[0-9]{1,4}-(0-0-.+|[a-fA-F1-9]-([1-9]|1-9|[0-9]|1[0-9]{2}|2[0-4][0-9]|25[0-5]))-[a-fA-F0-9]+)|.+)$'

AuthType:
description: Indicates the authentication method used.
anyOf:
  - type: string
  - enum:
    - 5G_AKA
    - EAP_AKA_PRIME
    - EAP_TLS
    - EAP_TTLS
  - type: string

ProSeAuthenticationInfo:
description: >
  Contains the UE id (i.e. SUCI) or CP-PRUK ID, Relay Service Code and Nonce_1.
type: object
properties:
  supiOrSuci:
    $ref: 'TS29571_CommonData.yaml#/components/schemas/SupiOrSuci'
  5gPrukId:
    $ref: 'TS29571_CommonData.yaml#/components/schemas/5GPrukId'
  relayServiceCode:
    $ref: 'TS29571_CommonData.yaml#/components/schemas/RelayServiceCode'
  noncel:
    $ref: '#/components/schemas/Noncel'

```

```

    servingNetworkName:
      $ref: 'TS29503_Nudm_UEAU.yaml#/components/schemas/ServingNetworkName'
    supportedFeatures:
      $ref: 'TS29571_CommonData.yaml#/components/schemas/SupportedFeatures'
  required:
    - relayServiceCode
    - noncel
    - servingNetworkName

ProSeAuthenticationCtx:
  description: >
    Contains the information related to the resource generated to handle
    the ProSe authentication.
  type: object
  properties:
    authType:
      $ref: '#/components/schemas/AuthType'
    _links:
      type: object
      description: A map(list of key-value pairs) where the key is set to "prose-auth"
      additionalProperties:
        $ref: 'TS29571_CommonData.yaml#/components/schemas/LinksValueSchema'
    proSeAuthData:
      $ref: '#/components/schemas/ProSeAuthData'
    supportedFeatures:
      $ref: 'TS29571_CommonData.yaml#/components/schemas/SupportedFeatures'
  required:
    - authType
    - _links
    - proSeAuthData

ProSeEapSession:
  description: >
    Contains information related to the EAP session. If present the 5gPrukId IE shall
    carry the CP-PRUK ID.
  type: object
  properties:
    eapPayload:
      $ref: '#/components/schemas/EapPayload'
    knrProSe:
      $ref: '#/components/schemas/KnrProSe'
    _links:
      type: object
      description: A map(list of key-value pairs) where the key is set to "prose-auth"
      additionalProperties:
        $ref: 'TS29571_CommonData.yaml#/components/schemas/LinksValueSchema'
    authResult:
      $ref: '#/components/schemas/AuthResult'
    supportedFeatures:
      $ref: 'TS29571_CommonData.yaml#/components/schemas/SupportedFeatures'
    nonce2:
      $ref: '#/components/schemas/Nonce2'
    5gPrukId:
      $ref: 'TS29571_CommonData.yaml#/components/schemas/5GPrukId'
  required:
    - eapPayload

ProSeAuthData:
  $ref: '#/components/schemas/EapPayload'

ProSeAuthenticationResult:
  description: Successful authentication for CP-PRUK ID.
  type: object
  properties:
    knrProSe:
      $ref: '#/components/schemas/KnrProSe'
    nonce2:
      $ref: '#/components/schemas/Nonce2'
    supportedFeatures:
      $ref: 'TS29571_CommonData.yaml#/components/schemas/SupportedFeatures'

KnrProSe:
  description: Contains the KNR_ProSe.
  type: string
  pattern: '[A-Fa-f0-9]{64}'
Noncel:
  type: string
  format: byte

```

```

description: contains an Noncel
nullable: true

```

```

Nonce2:
  type: string
  format: byte
  description: contains an Nonce2
  nullable: true

```

A.3 Nausf_SoRProtection API

```
openapi: 3.0.0
```

```

info:
  version: 1.4.0
  title: Nausf_SoRProtection Service
  description: |
    AUSF SoR Protection Service.
    © 2025, 3GPP Organizational Partners (ARIB, ATIS, CCSA, ETSI, TSDSI, TTA, TTC).
    All rights reserved.

```

```

externalDocs:
  description: 3GPP TS 29.509 V19.5.0; 5G System; Authentication Server Services
  url: 'https://www.3gpp.org/ftp/Specs/archive/29_series/29.509'

```

```

servers:
- url: '{apiRoot}/nausf-sorprotection/v1'
  variables:
    apiRoot:
      default: https://example.com
      description: apiRoot as defined in clause 4.4 of 3GPP TS 29.501.

```

```

security:
- {}
- oAuth2ClientCredentials:
  - nausf-sorprotection

```

```

paths:
  /{supi}/ue-sor:
    post:
      parameters:
        - name: supi
          in: path
          description: Identifier of the UE
          required: true
          schema:
            $ref: 'TS29571_CommonData.yaml#/components/schemas/Supi'
      requestBody:
        content:
          application/json:
            schema:
              $ref: '#/components/schemas/SorInfo'
            required: true
      responses:
        '200':
          description: SorSecurityInfo
          content:
            application/json:
              schema:
                $ref: '#/components/schemas/SorSecurityInfo'
        '307':
          $ref: 'TS29571_CommonData.yaml#/components/responses/307'
        '308':
          $ref: 'TS29571_CommonData.yaml#/components/responses/308'
        '400':
          $ref: 'TS29571_CommonData.yaml#/components/responses/400'
        '401':
          $ref: 'TS29571_CommonData.yaml#/components/responses/401'
        '403':
          $ref: 'TS29571_CommonData.yaml#/components/responses/403'
        '404':
          $ref: 'TS29571_CommonData.yaml#/components/responses/404'
        '411':

```

```

    $ref: 'TS29571_CommonData.yaml#/components/responses/411'
  '413':
    $ref: 'TS29571_CommonData.yaml#/components/responses/413'
  '415':
    $ref: 'TS29571_CommonData.yaml#/components/responses/415'
  '429':
    $ref: 'TS29571_CommonData.yaml#/components/responses/429'
  '500':
    $ref: 'TS29571_CommonData.yaml#/components/responses/500'
  '502':
    $ref: 'TS29571_CommonData.yaml#/components/responses/502'
  '503':
    description: Service Unavailable
    content:
      application/problem+json:
        schema:
          $ref: 'TS29571_CommonData.yaml#/components/schemas/ProblemDetails'

```

```

components:
  securitySchemes:
    oAuth2ClientCredentials:
      type: oauth2
      flows:
        clientCredentials:
          tokenUrl: '{nrfApiRoot}/oauth2/token'
          scopes:
            nausf-sorprotection: Access to the Nausf_SoRProtection API
  schemas:

```

```

#
# COMPLEX TYPES:
#

```

```

SorInfo:
  description: Contains the Steering Information.
  type: object
  properties:
    steeringContainer:
      $ref: '#/components/schemas/SteeringContainer'
    ackInd:
      $ref: '#/components/schemas/AckInd'
    sorHeader:
      $ref: '#/components/schemas/SorHeader'
    sorTransparentInfo:
      $ref: '#/components/schemas/SorTransparentInfo'
    supportedFeatures:
      $ref: 'TS29571_CommonData.yaml#/components/schemas/SupportedFeatures'
  required:
    - ackInd

```

```

SorSecurityInfo:
  description: >
    Contains the material generated for securing of SoR. It contains at least the
    SoR-MAC-IAUSF and CounterSoR.
  type: object
  properties:
    sorMacIausf:
      $ref: '#/components/schemas/SorMac'
    counterSor:
      $ref: '#/components/schemas/CounterSor'
    sorXmacIue:
      $ref: '#/components/schemas/SorMac'
  required:
    - sorMacIausf
    - counterSor

```

```

SteeringContainer:
  description: Contains the information sent to UE.
  oneOf:
    - type: array
      items:
        $ref: '#/components/schemas/SteeringInfo'
      minItems: 1
    - $ref: '#/components/schemas/SecuredPacket'

```

```

SteeringInfo:
  description: Contains a combination of one PLMN identity and zero or more access technologies.
  type: object

```

```

properties:
  plmnId:
    $ref: 'TS29571_CommonData.yaml#/components/schemas/PlmnId'
  accessTechList:
    type: array
    items:
      $ref: '#/components/schemas/AccessTech'
    minItems: 1
  required:
    - plmnId

#
# SIMPLE TYPES:
#

SorMac:
  description: MAC value for protecting SOR procedure (SoR-MAC-IAUSF and SoR-XMAC-IUE).
  type: string
  pattern: '^[A-Fa-f0-9]{32}$'

CounterSor:
  description: CounterSor.
  type: string
  pattern: '^[A-Fa-f0-9]{4}$'

AckInd:
  description: Contains indication whether the acknowledgement from UE is needed.
  type: boolean

SecuredPacket:
  description: Contains a secure packet.
  type: string
  format: byte

SorHeader:
  $ref: 'TS29571_CommonData.yaml#/components/schemas/Bytes'

SorTransparentInfo:
  $ref: 'TS29571_CommonData.yaml#/components/schemas/Bytes'

#
# ENUMS:

AccessTech:
  description: Represents the access technology
  anyOf:
    - type: string
      enum:
        - NR
        - EUTRAN_IN_WBS1_MODE_AND_NBS1_MODE
        - EUTRAN_IN_NBS1_MODE_ONLY
        - EUTRAN_IN_WBS1_MODE_ONLY
        - UTRAN
        - GSM_AND_ECGSM_IoT
        - GSM_WITHOUT_ECGSM_IoT
        - ECGSM_IoT_ONLY
        - CDMA_1xRTT
        - CDMA_HRPD
        - GSM_COMPACT
        - SATELLITE_NG_RAN
        - SATELLITE_EUTRAN_IN_NBS1_MODE
        - SATELLITE_EUTRAN_IN_WBS1_MODE
    - type: string

```

A.4 Nausf_UPUProtection API

```

openapi: 3.0.0
info:
  version: 1.4.0
  title: Nausf_UPUProtection Service
  description: |
    AUSF UPU Protection Service.
    © 2025, 3GPP Organizational Partners (ARIB, ATIS, CCSA, ETSI, TSDSI, TTA, TTC).

```

All rights reserved.

```
externalDocs:
  description: 3GPP TS 29.509 V19.5.0; 5G System; Authentication Server Services
  url: 'https://www.3gpp.org/ftp/Specs/archive/29_series/29.509'

servers:
- url: '{apiRoot}/nausf-upuprotection/v1'
  variables:
    apiRoot:
      default: https://example.com
      description: apiRoot as defined in clause 4.4 of 3GPP TS 29.501.

security:
- {}
- oAuth2ClientCredentials:
  - nausf-upuprotection

paths:
  /{supi}/ue-upu:
    post:
      parameters:
        - name: supi
          in: path
          description: Identifier of the UE
          required: true
          schema:
            $ref: 'TS29571_CommonData.yaml#/components/schemas/Supi'
      requestBody:
        content:
          application/json:
            schema:
              $ref: '#/components/schemas/UpuInfo'
          required: true
      responses:
        '200':
          description: UpuSecurityInfo
          content:
            application/json:
              schema:
                $ref: '#/components/schemas/UpuSecurityInfo'
        '307':
          $ref: 'TS29571_CommonData.yaml#/components/responses/307'
        '308':
          $ref: 'TS29571_CommonData.yaml#/components/responses/308'
        '400':
          $ref: 'TS29571_CommonData.yaml#/components/responses/400'
        '401':
          $ref: 'TS29571_CommonData.yaml#/components/responses/401'
        '403':
          $ref: 'TS29571_CommonData.yaml#/components/responses/403'
        '404':
          $ref: 'TS29571_CommonData.yaml#/components/responses/404'
        '411':
          $ref: 'TS29571_CommonData.yaml#/components/responses/411'
        '413':
          $ref: 'TS29571_CommonData.yaml#/components/responses/413'
        '415':
          $ref: 'TS29571_CommonData.yaml#/components/responses/415'
        '429':
          $ref: 'TS29571_CommonData.yaml#/components/responses/429'
        '500':
          $ref: 'TS29571_CommonData.yaml#/components/responses/500'
        '502':
          $ref: 'TS29571_CommonData.yaml#/components/responses/502'
        '503':
          description: Service Unavailable
          content:
            application/problem+json:
              schema:
                $ref: 'TS29571_CommonData.yaml#/components/schemas/ProblemDetails'

components:
  securitySchemes:
    oAuth2ClientCredentials:
      type: oauth2
      flows:
        clientCredentials:
```

```

    tokenUrl: '{nrfApiRoot}/oauth2/token'
    scopes:
      nausf-upuprotection: Access to the Nausf_UPUProtection API

schemas:

#
# COMPLEX TYPES:
#

UpuInfo:
  description: Contains the UE parameters update Information.
  type: object
  properties:
    upuDataList:
      type: array
      items:
        $ref: '#/components/schemas/UpuData'
      minItems: 1
    upuHeader:
      $ref: '#/components/schemas/UpuHeader'
    upuAckInd:
      $ref: '#/components/schemas/UpuAckInd'
    supportedFeatures:
      $ref: 'TS29571_CommonData.yaml#/components/schemas/SupportedFeatures'
    upuTransparentInfo:
      $ref: '#/components/schemas/UpuTransparentInfo'
  required:
    - upuDataList
    - upuAckInd

UpuSecurityInfo:
  description: >
    Contains the material generated for securing of UPU. It contains at least
    the UPU-MAC-IAUSF and CounterUPU.
  type: object
  properties:
    upuMacIausf:
      $ref: '#/components/schemas/UpuMac'
    counterUpu:
      $ref: '#/components/schemas/CounterUpu'
    upuXmacIue:
      $ref: '#/components/schemas/UpuMac'
  required:
    - upuMacIausf
    - counterUpu

UpuData:
  description: >
    Contains UE parameters update data set (e.g., the updated Routing ID Data
    or the Default configured NSSAI or the disaster roaming parameters).
  type: object
  properties:
    secPacket:
      $ref: 'TS29509_Nausf_SoRProtection.yaml#/components/schemas/SecuredPacket'
    defaultConfNssai:
      type: array
      items:
        $ref: 'TS29571_CommonData.yaml#/components/schemas/Snssai'
      minItems: 1
    routingId:
      $ref: 'TS29544_Nspaf_SecuredPacket.yaml#/components/schemas/RoutingId'
    drei:
      type: boolean
    dreiEps:
      type: boolean
    aol:
      type: boolean
    disasterCondPlmnIds:
      type: array
      items:
        $ref: 'TS29571_CommonData.yaml#/components/schemas/PlmnId'
      minItems: 1

#
# SIMPLE TYPES:
#

```

UpuMac:
description: MAC value for protecting UPU procedure (UPU-MAC-IAUSF and UPU-MAC-IUE).
type: string
pattern: '^[A-Fa-f0-9]{32}\$'

CounterUpu:
description: CounterUPU.
type: string
pattern: '^[A-Fa-f0-9]{4}\$'

UpuAckInd:
description: Contains the indication of whether the acknowledgement from UE is needed.
type: boolean

UpuHeader:
description: >
Contains the "UPU Header" IE as specified in clause 9.11.3.53A of
3GPP TS 24.501 (octet 4), encoded as 2 hexadecimal characters.
type: string
pattern: '^[A-Fa-f0-9]{2}\$'

UpuTransparentInfo:
\$ref: 'TS29571_CommonData.yaml#/components/schemas/Bytes'

Annex B (Informative): Use of EAP-TLS

B.1 General

The Annex B of 3GPP TS 33.501 [8] describes the use of EAP-TLS as an alternative authentication method in the case of private network. This annex describes corresponding stage 3.

B.2 EAP method: EAP-TLS

EAP-TLS as defined in IETF RFC 5216 [16] is the EAP method used in this procedure. This procedure is described in Annex B.2.1 of 3GPP TS 33.501 [8].

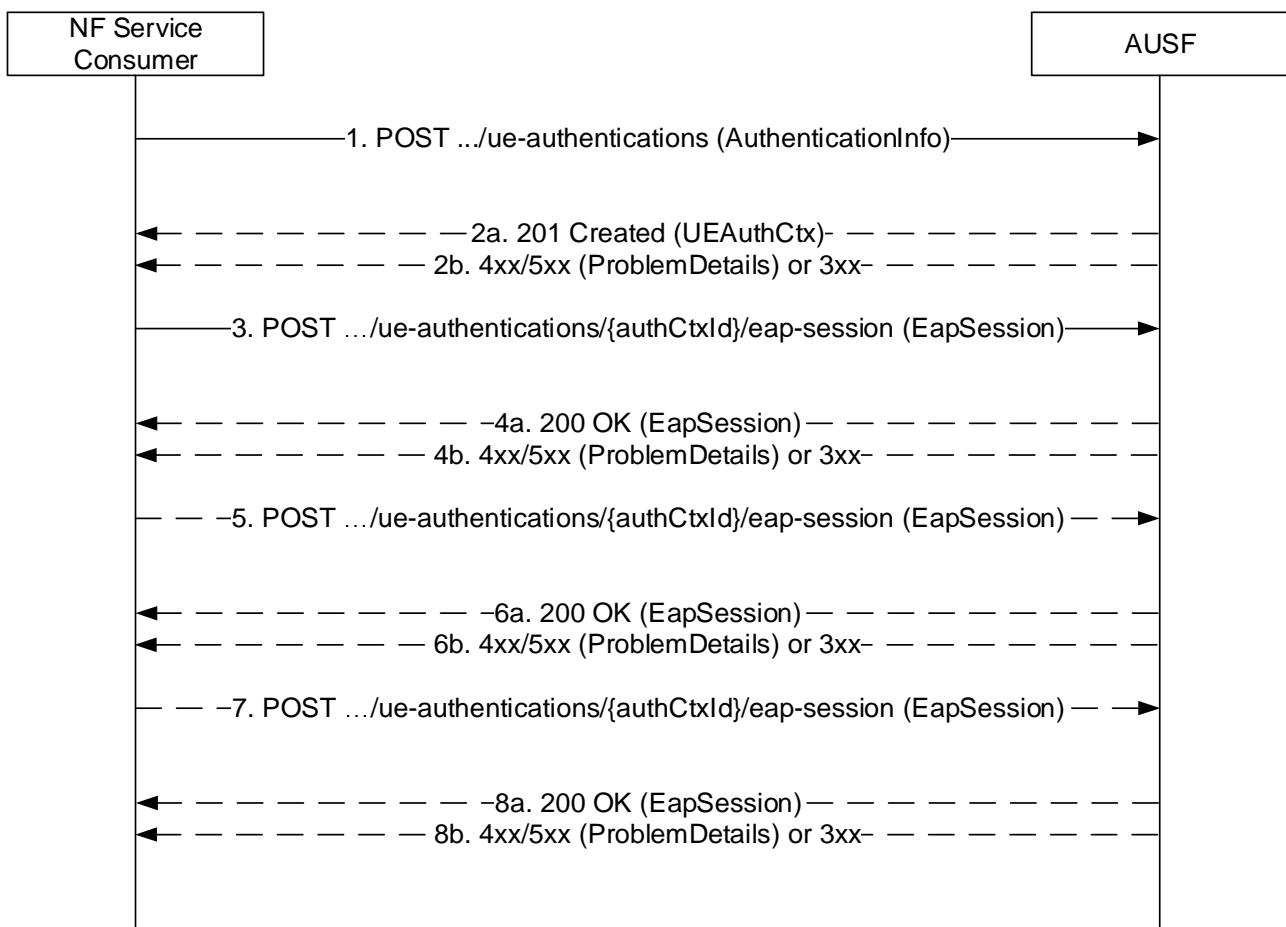

Figure B.2-1: EAP method

1. The NF Service Consumer (AMF) shall send a POST request to the AUSF. The content shall contain at least the UE Id and Serving Network Name.
- 2a. On success, "201 Created" shall be returned. The content shall contain the representation of the resource generated and the "Location" header shall contain the URI of the generated resource (e.g. `.../ue_authentications/{authCtxId}/eap-session`). The AUSF generates a sub-resource "eap-session". The AUSF shall provide a hypermedia link towards this sub-resource in the content to indicate to the AMF where it shall send a POST containing the EAP packet response. The content shall also contain the EAP packet EAP-Request/EAP-Type=EAP-TLS (TLS Start)

- 2b. On failure or redirection, one of the HTTP status code listed in table 6.1.7.3-1 shall be returned with the message body containing a ProblemDetails structure with the "cause" attribute set to one of the application error listed in Table 6.1.7.3-1. In particular, if the serving network is not authorized, the AUSF shall use the "Cause" SERVING_NETWORK_NOT_AUTHORIZED.
3. Based on the relation type, the NF Service Consumer (AMF) shall send a POST request including the EAP-Response/EAP-Type=EAP-TLS (TLS client_hello) received from the UE. The POST request is sent to the URI provided by the AUSF or derived by the NF Service Consumer (AMF).
- 4a. On success, the AUSF shall reply with a "200 OK" HTTP message containing the EAP Request as described in Annex B.2.1 of 3GPP TS 33.501 [8] and a hypermedia link towards the sub-resource "eap-session".
- 4b. On failure or redirection, one of the HTTP status code listed in table 6.1.7.3-1 shall be returned with the message body containing a ProblemDetails structure with the "cause" attribute set to one of the application error listed in Table 6.1.7.3-1.
5. The NF Service Consumer (AMF) shall send a POST request including the EAP Response received from the UE. The POST request is sent to the URI provided by the AUSF or derived by the NF Service Consumer (AMF).
- 6a. On success, the AUSF shall reply with a "200 OK" HTTP message containing the EAP Request as described in Annex B.2.1 of 3GPP TS 33.501 [8] and a hypermedia link towards the sub-resource "eap-session".
- 6b. On failure or redirection, one of the HTTP status code listed in table 6.1.7.3-1 shall be returned with the message body containing a ProblemDetails structure with the "cause" attribute set to one of the application error listed in Table 6.1.7.3-1.
7. The NF Service Consumer (AMF) shall send a POST request including the EAP Response received from the UE. The POST request is sent to the URI provided by the AUSF or derived by the NF Service Consumer (AMF).
- 8a. If the EAP authentication exchange is successfully completed (with or without the optional Notification Request/Response messages exchange), "200 OK" shall be returned to the NF Service Consumer (AMF). The content shall contain the result of the authentication, an EAP success/failure and the Kseaf if the authentication is successful.
- 8b. On failure or redirection, one of the HTTP status code listed in table 6.1.7.3-1 shall be returned with the message body containing a ProblemDetails structure with the "cause" attribute set to one of the application error listed in Table 6.1.7.3-1.

Annex C (informative): Withdrawn API versions

C.1 General

This Annex lists withdrawn API versions of the APIs defined in the present specification. 3GPP TS 29.501 [5] clause 4.3.1.6 describes the withdrawal of API versions.

C.2 Nausf_SoRProtection API

The API versions listed in table C.2-1 are withdrawn for the Nausf_SoRProtection API.

Table C.2-1: Withdrawn API versions of the Nausf_SoRProtection service

API version number	Reason for withdrawal
1.0.0	The version 1.0.0 indicates that a 201 "Created" must be sent in response to the POST Custom Operations while it should be a "200 OK" as indicated in clause 6.2.3.2.4.2.2. The version 1.0.1 corrects this mistake. As a consequence, the version 1.0.0 is withdrawn in order to avoid interoperability problems with further version of the Nausf_SoRProtection service.

Annex D (informative): Change history

Change history							
Date	Meeting	Tdoc	CR	Rev	Cat	Subject/Comment	New version
2017-10	CT4#80	C4-175268				Initial Draft.(Agreed Skeleton)	0.1.0
2017-10	CT4#80	C4-175394				Inclusion of pCR agrees during CT4#80: C4-175269 and C4-175270	0.2.0
2017-12	CT4#81	C4-176437				Inclusion of pCR agrees during CT4#81: C4-176267, C4-176269, C4-176426, C4-17427	0.3.0
2018-01	CT4#82	C4-181391				Inclusion of pCR agrees during CT4#82: C4-181341, C4-181342, C4-181343, C4-181344, C4-181345, C4-181346, C4-181347, C4-181155	0.4.0
2018-03	CT4#83	C4-182434				Inclusion of pCRs agrees during CT4#83: C4-182283 and C4-182279	0.5.0
2018-03	CT#79	CP-180031				Presented for information	1.0.0
2018-04	CT4#84	C4-183516				Inclusion of pCRs agreed during CT4#84: C4-183309, C4-183313, C4-183346, C4-183347 and C4-183448	1.1.0
2018-05	CT4#85	C4-184623				Inclusion of PCR agrees during CT4#83: C4-184219, C4-184220, C4-184224, C4-184227, C4-184227, C4-184362, C4-184363, C4-184367, C4-184368, C4-184370, C4-184376, C4-184380, C4-184584, C4-184624	1.2.0
2018-06	CT#80	CP-181104				Presented for approval	2.0.0
2018-06	CT#80					Approved in CT#80.	15.0.0
2018-09	CT#81	CP-182059	0002	2	F	Requester ID in Authentication Info	15.1.0
2018-09	CT#81	CP-182059	0003	1	F	HTTP method in figure 5.2.2.2-1 (Note: clause 6.1.3.1 is not included, already covered)	15.1.0
2018-09	CT#81	CP-182059	0004	4	F	SoRProtection service operation	15.1.0
2018-09	CT#81	CP-182059	0010	1	F	Adding TS 33.501 reference	15.1.0
2018-09	CT#81	CP-182059	0011	-	F	HTTP Custom Header	15.1.0
2018-09	CT#81	CP-182059	0013	1	F	SUPI sends to AMF	15.1.0
2018-09	CT#81	CP-182068	0014	2	B	5G Trace for AUSF	15.1.0
2018-09	CT#81	CP-182013	0015	2	F	Making Oauth 2.0 optional in OAS description	15.1.0
2018-09	CT#81	CP-182059	0016	1	F	Editorial Corrections	15.1.0
2018-09	CT#81	CP-182059	0017	1	F	Error code correction	15.1.0
2018-09	CT#81	CP-182059	0018	1	F	Add support to EAP-TLS (Optional)	15.1.0
2018-09	CT#81	CP-182059	0019	-	F	Correcting Presentation of resources for AUSF API	15.1.0
2018-09	CT#81	CP-182059	0020	1	F	Correcting confirmation message	15.1.0
2018-09	CT#81	CP-182059	0021	-	F	API version number update	15.1.0
2018-12	CT#82	CP-183017	0026	-	F	Remove the "supiOrSuci" in Confirmation Data	15.2.0
2018-12	CT#82	CP-183017	0027	-	F	Correcting Resource URI structure of the SoRProtection Service	15.2.0
2018-12	CT#82	CP-183017	0030	-	F	Cardinality	15.2.0
2018-12	CT#82	CP-183017	0031	-	F	Add supi and authResult to EapSession in OpenAPI definitions	15.2.0
2018-12	CT#82	CP-183017	0022	-	F	Requester ID not needed in initial request from AMF	15.2.0
2018-12	CT#82	CP-183017	0023	-	F	Delaying transmission of Kseaf	15.2.0
2018-12	CT#82	CP-183017	0024	1	F	Correcting the reference to EAP-AKA'	15.2.0
2018-12	CT#82	CP-183017	0025	1	F	Adding a reference to the Annex in the Specification	15.2.0
2018-12	CT#82	CP-183017	0028	1	F	Error handling in AUSF	15.2.0
2018-12	CT#82	CP-183017	0029	1	F	Add a reference to the IETF RFC 3748 on EAP Framework	15.2.0
2018-12	CT#82	CP-183017	0032	-	F	Base64 reference	15.2.0
2018-12	CT#82	CP-183017	0033	-	F	APIRoot Clarification	15.2.0
2018-12	CT#82	CP-183017	0034	-	F	Reference correction	15.2.0
2018-12	CT#82	CP-183017	0036	-	F	OpenAPI version number for Nausf_UEAuthentication service	15.2.0
2018-12	CT#82	CP-183017	0037	1	F	OpenAPI version number for Nausf_SoRProtection	15.2.0
2018-12	CT#82	CP-183017	0038	1	F	Correct "externalDocs" for Nausf_UEAuthentication OAS	15.2.0
2018-12	CT#82	CP-183017	0039	1	F	Clarification on the 200 OK returned by AUSF in case of authentication failure	15.2.0
2018-12	CT#82	CP-183017	0040	-	F	Secured packet in SorInfo	15.2.0
2018-12	CT#82	CP-183170	0035	2	F	Location Header in OpenAPI	15.2.0
2018-12	CT#82	CP-183172	0041	-	F	Alignment for Oauth scopes - Nausf_UEAuthentication	15.2.0
2018-12	CT#82	CP-183173	0042	-	F	Alignment for Oauth scopes - Nausf_SoRProtection	15.2.0
2018-12	CT#82	CP-183203	0043	-	F	externalDocs for Nausf_SoRProtection OpenAPI Annex	15.2.0
2019-03	CT#83	CP-190022	0047	1	F	Mandatory HTTP status codes	15.3.0
2019-03	CT#83	CP-190022	0049	1	F	SoR Protection response code alignment	15.3.0
2019-03	CT#83	CP-190022	0044	3	F	Authentication Failure scenarios	15.3.0
2019-03	CT#83	CP-190153	0046	7	F	UE parameters update support (indicated as C4-190618 + C4-190618_rev71)	15.3.0
2019-03	CT#83	CP-19205	0050	1	F	3GPP TS 29.509 API version update	15.3.0
2019-06	CT#84	CP-191033	0051	-	F	Correct the expression of URI variables in 5g-aka-confirmation resource	15.4.0
2019-06	CT#84	CP-191033	0053	2	F	Storage of OpenAPI specification files	15.4.0
2019-06	CT#84	CP-191033	0056	-	F	AUSF Tracing Targeting a PEI	15.4.0
2019-06	CT#84	CP-191033	0055	1	F	Determination of the Authentication Method	15.4.0
2019-06	CT#84	CP-191218	0059	4	F	Add withdrawn API version Annex	15.4.0

2019-06	CT#84	CP-191033	0058	1	F	Essential correction to add Copyright on OpenAPI specifications	15.4.0
2019-06	CT#84	CP-191057	0054	1	F	Non cacheable 501 response	16.0.0
2019-06	CT#84	CP-191057	0057	1	B	UDM service discovery based on GroupID and/or RoutingID	16.0.0
2019-06	CT#84	CP-191223	0060	2	F	3GPP TS 29.509 API version update	16.0.0
2019-09	CT#85	CP-192106	0063	1	F	Missing status codes	16.1.0
2019-09	CT#85	CP-192120	0066	-	F	API version and ExternalDocs update	16.1.0
2019-10						Corrupted references fixed	16.1.1
2019-12	CT#86	CP-193063	0072	-	F	Add UPU protection in AUSF functionality	16.2.0
2019-12	CT#86	CP-193058	0067	1	B	RoutingId	16.2.0
2019-12	CT#86	CP-193134	0069	2	B	Authentication Indication from W-AGF (tmp)	16.2.0
2019-12	CT#86	CP-193241	0071	2	F	Move ExternalDocs in OpenAPI specifications	16.2.0
2019-12	CT#86	CP-193036	0068	1	F	EAP Payload	16.2.0
2019-12	CT#86	CP-193036	0070	1	F	Add reference to TS 29.524	16.2.0
2019-12	CT#86	CP-193044	0074	-	F	3GPP TS 29.509 API version update	16.2.0
2020-03	CT#87-e	CP-200020	0076	1	F	Reference to Data Type SteeringInfo	16.3.0
2020-03	CT#87-e	CP-200242	0082	-	F	Initial Registration procedure on a CAG Cell	16.3.0
2020-03	CT#87-e	CP-200039	0075	1	F	Add Corresponding API descriptions in clause 5.1	16.3.0
2020-03	CT#87-e	CP-200039	0077	2	F	Correction - formatting consistency	16.3.0
2020-03	CT#87-e	CP-200035	0078	2	F	Editorial corrections	16.3.0
2020-03	CT#87-e	CP-200035	0081	1	F	SUPI pattern	16.3.0
2020-03	CT#87-e	CP-200242	0083	1	F	AUSF service update for the authentication result removal	16.3.0
2020-03	CT#87-e	CP-200020	079	2	F	Optionality of ProblemDetails	16.3.0
2020-03	CT#87-e	CP-200052	0084	-	F	3GPP TS 29.509 Rel16 API version and External doc update	16.3.0
2020-03	CT#87-e	CP-200252	0085	-	F	OTAF NF name change to SP-AF	16.3.0
2020-06	CT#88-e	CP-201034	0093	-	D	Editorial Clarifications	16.4.0
2020-06	CT#88-e	CP-201034	0095	-	B	Maintain only latest Kausf in network	16.4.0
2020-06	CT#88-e	CP-201034	0096	-	F	AUSF service update for the authentication result removal	16.4.0
2020-06	CT#88-e	CP-201034	0097	-	F	Miscellaneous Corrections	16.4.0
2020-06	CT#88-e	CP-201048	0094	1	B	N5GC device Authentication	16.4.0
2020-06	CT#88-e	CP-201063	0086	1	F	Supported Headers Tables for Response code 201	16.4.0
2020-06	CT#88-e	CP-201063	0091	1	F	Datatype column in Resource URI variables Table	16.4.0
2020-06	CT#88-e	CP-201063	0092	1	F	Add custom operation Name	16.4.0
2020-06	CT#88-e	CP-201063	0088	2	F	Editorial Error Corrections	16.4.0
2020-06	CT#88-e	CP-201073	0098	-	F	29.509 Rel16 API version and External doc update	16.4.0
2020-09	CT#89-e	CP-202088	0100	-	F	Custom Operation Correction	16.5.0
2020-09	CT#89-e	CP-202043	0103	-	F	SoR Header	16.5.0
2020-09	CT#89-e	CP-202115	0104	-	F	Corrections on SoRProtection service	16.5.0
2020-09	CT#89-e	CP-202110	0105	-	F	Corrections on UPUProtection service	16.5.0
2020-09	CT#89-e	CP-202089	0101	1	F	Storage of YAML files in 3GPP Forge	16.5.0
2020-12	CT#90-e	CP-203042	0110	2	F	Initial Registration procedure on a CAG Cell	16.6.0
2020-12	CT#90-e	CP-203036	0111	-	F	API Version and External Doc Update (R16)	16.6.0
2020-12	CT#90-e	CP-203063	0108	1	C	Evolution of SoR delivery mechanism – AUSF API Changes	17.0.0
2020-12	CT#90-e	CP-203055	0112	-	F	API Version and External Doc Update (R17)	17.0.0
2021-02						Clauses 5.2.2.X/5.2.2.X.1 numbered correctly	17.0.1
2021-03	CT#91-e	CP-210021	0114	-	D	Miscellaneous Corrections	17.1.0
2021-03	CT#91-e	CP-210029	0121	-	F	29.509 Rel-17 API version and External Doc update	17.1.0
2021-03	CT#91-e	CP-210034	0120	1	F	OpenAPI Reference and description field for map data types	17.1.0
2021-03	CT#91-e	CP210037	0119	1	F	HTTP 3xx redirection	17.1.0
2021-06	CT#92-e	CP-211028	0123	-	F	Data Types Descriptions	17.2.0
2021-06	CT#92-e	CP-211028	0125	1	F	Resource for Individual Authentication	17.2.0
2021-06	CT#92-e	CP-211046	0124	-	F	Data Type Correction	17.2.0
2021-06	CT#92-e	CP-211050	0126	-	F	29.509 Rel-17 API version and External doc update	17.2.0
2021-09	CT#93-e	CP-212082	0130	1	A	UPU Header within UPU Data Protection	17.3.0
2021-09	CT#93-e	CP-212026	0131	-	F	Base64 Encoding of binary attributes in JSON objects	17.3.0
2021-09	CT#93-e	CP-212059	0132	-	F	29.509 Rel-17 API version and External doc update	17.3.0
2021-12	CT#94-e	CP-213085	0135	-	F	Feature numbering	17.4.0
2021-12	CT#94-e	CP-213085	0136	-	F	Corrections to the API URI	17.4.0
2021-12	CT#94-e	CP-213087	0138	-	F	Corrections related to the description fields in the OpenAPI descriptions	17.4.0
2022-03	CT#95-e	CP-220026	0149	-	F	Routing Indicator	17.5.0
2022-03	CT#95-e	CP-220047	0141	-	F	SNPN onboarding impacts on AUSF services – R17	17.5.0
2022-03	CT#95-e	CP-220047	0152	-	B	EAP-TTLS support in SNPN (TS 29.509)	17.5.0
2022-03	CT#95-e	CP-220047	0144	3	B	PVS Info	17.5.0
2022-03	CT#95-e	CP-220053	0143	1	B	NSWO authentication	17.5.0
2022-03	CT#95-e	CP-220069	0151	-	A	307/308 redirection	17.5.0
2022-03	CT#95-e	CP-220066	0155	-	F	29.509 Rel-17 API version and External doc update	17.5.0
2022-06	CT#96	CP-221039	0162	1	B	UPU Transparent Container	17.6.0
2022-06	CT#96	CP-221027	0157	-	F	Correction of typos in description fields	17.6.0
2022-06	CT#96	CP-221039	0158	-	B	Disaster Roaming Indicator	17.6.0
2022-06	CT#96	CP-221043	0161	-	B	Overview of New ProseAuthenticate service operation	17.6.0

2022-06	CT#96	CP-221043	0160	1	B	New ProseAuthenticate service operation	17.6.0
2022-06	CT#96	CP-221053	0159	-	F	Reused data types	17.6.0
2022-06	CT#96	CP-221053	0164	-	F	Editorial corrections	17.6.0
2022-06	CT#96	CP-221056	0163	1	A	IETF has published RFC 9048	17.6.0
2022-06	CT#96	CP-221338	0168	1	F	29.509 Rel-17 API version and External doc update	17.6.0
2022-09	CT#97	CP-222026	0170	-	F	Description alignment with yaml	17.7.0
2022-09	CT#97	CP-222034	0171	1	F	MSK in EapSession	17.7.0
2022-09	CT#97	CP-222035	0172	-	F	5G ProSe Authentication Service Description Alignment	17.7.0
2022-09	CT#97	CP-222035	0173	1	F	5G ProSe Authentication API Update	17.7.0
2022-09	CT#97	CP-222035	0174	1	F	Resolve EN For 5G_AKA support	17.7.0
2022-09	CT#97	CP-222037	0169	-	F	PVS related alignment	17.7.0
2022-09	CT#97	CP-222058	0176	-	F	29.509 Rel-17 API version and External doc update	17.7.0
2022-12	CT#98	CP-223049	0180	-	F	UE onboarding in authentication request	17.8.0
2022-12	CT#98	CP-223054	0185	1	F	Update on Nausf_UEAuthentication_Authenticate service operation	17.8.0
2022-12	CT#98	CP-223054	0179	1	F	5GPRUK Name Alignment	17.8.0
2022-12	CT#98	CP-223027	0178	1	F	Missing Mandatory Status Codes in OpenAPI	18.0.0
2022-12	CT#98	CP-223033	0186	-	F	29.509 Rel-18 API version and External doc update	18.0.0
2022-12	CT#98	CP-223063	0181	1	F	boolean type IEs definition correction	18.0.0
2022-12	CT#98	CP-223063	0182	1	D	Editorial corrections	18.0.0
2023-06	CT#100	CP-231346	0191	1	B	OAuth2 scopes in the Nausf_UEAuthentication API	18.1.0
2023-06	CT#100	CP-231026	0189	3	F	Location header description	18.1.0
2023-06	CT#100	CP-231041	0195	1	B	Update the reference model	18.1.0
2023-06	CT#100	CP-231078	0194	-	A	Add serving network name in ProSeAuthenticationInfo	18.1.0
2023-06	CT#100	CP-231345	0198	-	F	29.509 Rel-18 API version and External doc update	18.1.0
2023-09	CT#101	CP-232033	0202	-	F	Adding the missing description fields	18.2.0
2023-09	CT#101	CP-232056	0199	-	B	Authentication of AUN3 devices behind RG	18.2.0
2023-09	CT#101	CP-232056	0200	1	B	Update the description of MSK to support authentication for AUN3 devices behind 5G-RG	18.2.0
2023-09	CT#101	CP-232060	0203	-	F	29.509 Rel-18 API version and External doc update	18.2.0
2023-12	CT#102	CP-233027	0204		F	HTTP RFC obsoleted by IETF RFC 9113	18.3.0
2023-12	CT#102	CP-233030	0207		F	ProblemDetails RFC 7807 obsoleted by 9457	18.3.0
2023-12	CT#102	CP-233055	0206	1	B	Enhancement to support UE-to-UE relay	18.3.0
2023-12	CT#102	CP-233060	0208		F	29.509 Rel-18 API version and External doc update	18.3.0
2024-03	CT#103	CP-240067	0210		F	Disaster Roaming Indication	18.4.0
2024-03	CT#103	CP-240056	0211	-	F	29.509 Rel-18 API version and External doc update	18.4.0
2024-06	CT#104	CP-241028	0217	1	F	Clarification on deviation of naming-convention for enum values in Nausf specific Data Type	18.5.0
2024-06	CT#104	CP-241050	0216	1	F	Definition of ProseAuthData	18.5.0
2024-06	CT#104	CP-241060	0214	2	A	Disaster Condition PLMN List	18.5.0
2024-06	CT#104	CP-241050	0215	3	F	Style Corrections of Nausf APIs	18.5.0
2024-06	CT#104	CP-241050	0220	-	F	Feature negotiation correction	18.5.0
2024-06	CT#104	CP-241050	0221	-	F	Update on incorrect attribute name	18.5.0
2024-06	CT#104	CP-241050	0219	1	F	Clarifying the self-references and editorial corrections	18.5.0
2024-06	CT#104	CP-241052	0222	-	F	29.509 Rel-18 API version and External doc update	18.5.0
2024-09	CT#105	CP-242033	0226	1	F	Replacing the RFC reference with the updated one	19.0.0
2024-09	CT#105	CP-242030	0218	3	F	Default Configured S-NSSAIs	19.0.0
2024-09	CT#105	CP-242030	0227	1	F	The term Payload is replaced with Content due to RFC 9113	19.0.0
2024-09	CT#105	CP-242030	0224	-	D	Tdoc numbers in Annex D are wrong	19.0.0
2024-12	CT#106	CP-243037	0229	1	B	Clarification on Serving Network Name for Indirect Network Sharing	19.1.0
2024-12	CT#106	CP-243069	0232	-	F	29.509 Rel-19 API version and External doc update	19.1.0
2025-03	CT#107	CP-250046	0233	1	F	Correction on attribute definitions of pvsInfo and routingId	19.2.0
2025-06	CT#108	CP-251079	0234	-	F	29.509 Rel-19 API version and External doc update	19.3.0
2025-09	CT#109	CP-252049	0235	1	D	General text corrections	19.4.0
2025-09	CT#109	CP-252176	0236	-	F	29.509 Rel-19 API version and External doc update	19.4.0
2025-12	CT#110	CP-253133	0240	-	A	Access Tech	19.5.0
2025-12	CT#110	CP-253161	0242	1	B	Support of MINT-EPS	19.5.0
2025-12	CT#110	CP-253167	0247	-	F	29.509 Rel-19 OpenAPI version and ExternalDocs Update CRs	19.5.0

History

Version	Date	Status
V19.4.0	January 2026	Publication
V19.5.0	February 2026	Publication