

ETSI TS 125 102 V7.1.0 (2005-12)

Technical Specification

**Universal Mobile Telecommunications System (UMTS);
User Equipment (UE) radio transmission and reception (TDD)
(3GPP TS 25.102 version 7.1.0 Release 7)**



ReferenceRTS/TSGR-0425102v710

KeywordsUMTS

ETSI

650 Route des Lucioles
F-06921 Sophia Antipolis Cedex - FRANCE

Tel.: +33 4 92 94 42 00 Fax: +33 4 93 65 47 16

Siret N° 348 623 562 00017 - NAF 742 C
Association à but non lucratif enregistrée à la
Sous-Préfecture de Grasse (06) N° 7803/88

Important notice

Individual copies of the present document can be downloaded from:

<http://www.etsi.org>

The present document may be made available in more than one electronic version or in print. In any case of existing or perceived difference in contents between such versions, the reference version is the Portable Document Format (PDF). In case of dispute, the reference shall be the printing on ETSI printers of the PDF version kept on a specific network drive within ETSI Secretariat.

Users of the present document should be aware that the document may be subject to revision or change of status. Information on the current status of this and other ETSI documents is available at

<http://portal.etsi.org/tb/status/status.asp>

If you find errors in the present document, please send your comment to one of the following services:

http://portal.etsi.org/chaicor/ETSI_support.asp

Copyright Notification

No part may be reproduced except as authorized by written permission.
The copyright and the foregoing restriction extend to reproduction in all media.

© European Telecommunications Standards Institute 2005.
All rights reserved.

DECTTM, **PLUGTESTS**TM and **UMTS**TM are Trade Marks of ETSI registered for the benefit of its Members.
TIPHONTM and the **TIPHON logo** are Trade Marks currently being registered by ETSI for the benefit of its Members.
3GPPTM is a Trade Mark of ETSI registered for the benefit of its Members and of the 3GPP Organizational Partners.

Intellectual Property Rights

IPRs essential or potentially essential to the present document may have been declared to ETSI. The information pertaining to these essential IPRs, if any, is publicly available for **ETSI members and non-members**, and can be found in ETSI SR 000 314: "*Intellectual Property Rights (IPRs); Essential, or potentially Essential, IPRs notified to ETSI in respect of ETSI standards*", which is available from the ETSI Secretariat. Latest updates are available on the ETSI Web server (<http://webapp.etsi.org/IPR/home.asp>).

Pursuant to the ETSI IPR Policy, no investigation, including IPR searches, has been carried out by ETSI. No guarantee can be given as to the existence of other IPRs not referenced in ETSI SR 000 314 (or the updates on the ETSI Web server) which are, or may be, or may become, essential to the present document.

Foreword

This Technical Specification (TS) has been produced by ETSI 3rd Generation Partnership Project (3GPP).

The present document may refer to technical specifications or reports using their 3GPP identities, UMTS identities or GSM identities. These should be interpreted as being references to the corresponding ETSI deliverables.

The cross reference between GSM, UMTS, 3GPP and ETSI identities can be found under <http://webapp.etsi.org/key/queryform.asp>.

Contents

| | |
|---|----|
| Intellectual Property Rights | 2 |
| Foreword..... | 2 |
| Foreword..... | 7 |
| 1 Scope | 8 |
| 2 References | 8 |
| 3 Definitions, symbols and abbreviations | 8 |
| 3.1 Definitions | 8 |
| 3.2 Symbols..... | 9 |
| 3.3 Abbreviations | 9 |
| 4 General | 10 |
| 4.1 Relationship between Minimum Requirements and Test Requirements | 10 |
| 4.2 Power Classes..... | 10 |
| 4.3 Control and monitoring functions | 10 |
| 4.3.1 Minimum requirement | 10 |
| 5 Frequency bands and channel arrangement..... | 10 |
| 5.1 General | 10 |
| 5.2 Frequency bands..... | 11 |
| 5.3 TX–RX frequency separation..... | 11 |
| 5.3.1 3.84 Mcps TDD Option | 11 |
| 5.3.2 1.28 Mcps TDD Option | 11 |
| 5.4 Channel arrangement..... | 11 |
| 5.4.1 Channel spacing..... | 11 |
| 5.4.1.1 3.84 Mcps TDD Option..... | 11 |
| 5.4.1.2 1.28 Mcps TDD Option..... | 11 |
| 5.4.2 Channel raster | 11 |
| 5.4.2.1 3.84 Mcps TDD Option..... | 11 |
| 5.4.3 Channel number..... | 12 |
| 5.4.4 UARFCN | 12 |
| 5.4.4.1 3.84 Mcps TDD Option..... | 12 |
| 5.4.4.2 1.28 Mcps TDD Option..... | 12 |
| 6 Transmitter characteristics | 13 |
| 6.1 General | 13 |
| 6.2 Transmit power | 13 |
| 6.2.1 User Equipment maximum output power | 13 |
| 6.3 UE frequency stability..... | 13 |
| 6.4 Output power dynamics..... | 13 |
| 6.4.1 Power control..... | 14 |
| 6.4.1.1 3.84 Mcps option..... | 14 |
| 6.4.1.1.1 Initial Accuracy | 14 |
| 6.4.1.1.2 Differential accuracy, controlled input | 14 |
| 6.4.1.1.3 Differential accuracy, measured input | 14 |
| 6.4.1.2 1.28 Mcps TDD Option..... | 14 |
| 6.4.1.2.1 Open loop power control | 14 |
| 6.4.1.2.2 Closed loop power control..... | 15 |
| 6.4.2 Minimum output power | 15 |
| 6.4.2.1 Minimum requirement | 15 |
| 6.4.2.1.1 3.84 Mcps TDD Option..... | 15 |
| 6.4.2.1.2 1.28 Mcps TDD Option..... | 16 |
| 6.4.3 Out-of-synchronisation handling of output power | 16 |
| 6.4.3.1 Requirement for continuous transmission | 16 |
| 6.4.3.1.1 3.84 Mcps TDD Option..... | 16 |
| 6.4.3.1.2 1.28 Mcps TDD Option..... | 17 |

| | | |
|-----------|---|----|
| 6.4.3.2 | Requirement for discontinuous transmission | 19 |
| 6.4.3.2.1 | 3.84 Mcps TDD Option | 19 |
| 6.4.3.2.2 | 1.28 Mcps TDD Option | 21 |
| 6.5 | Transmit ON/OFF power | 22 |
| 6.5.1 | Transmit OFF power | 22 |
| 6.5.1.1 | Minimum Requirement | 22 |
| 6.5.2 | Transmit ON/OFF Time mask | 23 |
| 6.5.2.1 | Minimum Requirement | 23 |
| 6.5.2.1.1 | 3.84 Mcps TDD Option | 23 |
| 6.5.2.1.2 | 1.28 Mcps TDD Option | 23 |
| 6.6 | Output RF spectrum emissions | 24 |
| 6.6.1 | Occupied bandwidth | 24 |
| 6.6.1.1 | 3.84 Mcps TDD Option | 24 |
| 6.6.1.2 | 1.28 Mcps TDD Option | 24 |
| 6.6.2 | Out of band emission | 24 |
| 6.6.2.1 | Spectrum emission mask | 24 |
| 6.6.2.1.1 | 3.84 Mcps TDD Option | 24 |
| 6.6.2.1.2 | 1.28 Mcps TDD Option | 25 |
| 6.6.2.2 | Adjacent Channel Leakage power Ratio (ACLR) | 25 |
| 6.6.2.2.1 | Minimum requirement | 25 |
| 6.6.3 | Spurious emissions | 26 |
| 6.6.3.1 | Minimum Requirement | 26 |
| 6.6.3.1.1 | 3.84 Mcps TDD Option | 26 |
| 6.6.3.1.2 | 1.28 Mcps TDD Option | 27 |
| 6.7 | Transmit intermodulation | 27 |
| 6.7.1 | Minimum requirement | 27 |
| 6.7.1.1 | 3.84 Mcps TDD Option | 27 |
| 6.7.1.2 | 1.28 Mcps TDD Option | 27 |
| 6.8 | Transmit Modulation | 28 |
| 6.8.1 | Transmit pulse shape filter | 28 |
| 6.8.2 | Error Vector Magnitude | 28 |
| 6.8.2.1 | Minimum Requirement | 28 |
| 6.8.3 | Peak Code Domain Error | 28 |
| 6.8.3.1 | Minimum Requirement | 28 |
| 7 | Receiver characteristics | 29 |
| 7.1 | General | 29 |
| 7.2 | Diversity characteristics | 29 |
| 7.3 | Reference sensitivity level | 29 |
| 7.3.1 | Minimum Requirements | 29 |
| 7.3.1.1 | 3.84 Mcps TDD Option | 29 |
| 7.3.1.2 | 1.28 Mcps TDD Option | 30 |
| 7.4 | Maximum input level | 30 |
| 7.4.1 | Minimum Requirements | 30 |
| 7.4.1.1 | 3.84 Mcps TDD Option | 30 |
| 7.4.1.2 | 1.28 Mcps TDD Option | 30 |
| 7.5 | Adjacent Channel Selectivity (ACS) | 30 |
| 7.5.1 | Minimum Requirement | 31 |
| 7.5.1.1 | 3.84 Mcps TDD Option | 31 |
| 7.5.1.2 | 1.28 Mcps TDD Option | 31 |
| 7.6 | Blocking characteristics | 31 |
| 7.6.1 | Minimum Requirement | 32 |
| 7.6.1.1 | 3.84 Mcps TDD Option | 32 |
| 7.6.1.2 | 1.28 Mcps TDD Option | 32 |
| 7.7 | Spurious response | 33 |
| 7.7.1 | Minimum Requirement | 33 |
| 7.7.1.1 | 3.84 Mcps TDD Option | 33 |
| 7.7.1.2 | 1.28 Mcps TDD Option | 34 |
| 7.8 | Intermodulation characteristics | 34 |
| 7.8.1 | Minimum Requirements | 34 |
| 7.8.1.1 | 3.84 Mcps TDD Option | 34 |
| 7.8.1.2 | 1.28 Mcps TDD Option | 35 |

| | | |
|-----------------------------|---|-----------|
| 7.9 | Spurious emissions | 35 |
| 7.9.1 | Minimum Requirement | 35 |
| 7.9.1.1 | 3.84 Mcps TDD Option..... | 35 |
| 7.9.1.2 | 1.28 Mcps TDD Option..... | 36 |
| 8 | Performance requirement | 36 |
| 8.1 | General | 36 |
| 8.2 | Demodulation in static propagation conditions | 36 |
| 8.2.1 | Demodulation of DCH..... | 36 |
| 8.2.1.1 | Minimum requirement | 37 |
| 8.2.1.1.1 | 3.84 Mcps TDD Option..... | 37 |
| 8.2.1.1.2 | 1.28 Mcps TDD Option..... | 37 |
| 8.3 | Demodulation of DCH in multipath fading conditions | 38 |
| 8.3.1 | Multipath fading Case 1..... | 38 |
| 8.3.1.1 | Minimum requirement | 38 |
| 8.3.1.1.1 | 3.84 Mcps TDD Option..... | 38 |
| 8.3.1.1.2 | 1.28 Mcps TDD Option..... | 39 |
| 8.3.2 | Multipath fading Case 2..... | 39 |
| 8.3.2.1 | Minimum requirement | 39 |
| 8.3.2.1.1 | 3.84 Mcps TDD Option..... | 39 |
| 8.3.2.1.2 | 1.28 Mcps TDD Option..... | 40 |
| 8.3.3 | Multipath fading Case 3..... | 41 |
| 8.3.3.1 | Minimum requirement | 41 |
| 8.3.3.1.1 | 3.84 Mcps TDD Option..... | 41 |
| 8.3.3.1.2 | 1.28 Mcps TDD Option..... | 42 |
| 8.4 | Base station transmit diversity mode for 3.84 Mcps TDD Option | 42 |
| 8.4.1 | Demodulation of BCH in SCTD mode | 42 |
| 8.4.1.1 | Minimum requirement | 42 |
| 8.5 | Power control in downlink | 43 |
| 8.5.1 | Power control in downlink, constant BLER target | 43 |
| 8.5.1.1 | Minimum requirements 3.84 Mcps TDD option..... | 43 |
| 8.5.1.2 | Minimum requirements 1.28 Mcps TDD option..... | 44 |
| 8.6 | Uplink Power Control for 3.84 Mcps TDD Option..... | 44 |
| 8.6.1 | Test Conditions | 44 |
| 8.6.2 | Performance..... | 45 |
| 9 | Performance requirements (HSDPA) | 46 |
| 9.1 | Performance requirement for 3.84 Mcps TDD option..... | 46 |
| 9.1.1 | HS-DSCH throughput for fixed reference channels | 46 |
| 9.1.1.1 | Minimum requirement QPSK, Fixed Reference Channel, 7,3 Mbps – Category 8 - UE..... | 46 |
| 9.1.1.2 | Minimum requirement 16QAM, Fixed Reference Channel, 7,3 Mbps – Category 8 - UE..... | 47 |
| 9.1.2 | HS-DSCH throughput for Variable Reference Channels..... | 48 |
| 9.1.2.1 | Minimum requirement Variable Reference Channel, 7,3 Mbps – Category 8 - UE | 48 |
| 9.1.3 | Reporting of Channel Quality Indicator..... | 48 |
| 9.1.3.1 | Minimum requirement Channel Quality Indicator, 7,3 Mbps – Category 8 - UE..... | 49 |
| 9.2 | Performance requirements for 1.28 Mcps TDD option | 49 |
| 9.2.1 | HS-DSCH throughput for fixed reference channels | 49 |
| 9.2.1.1 | Minimum requirement QPSK, Fixed Reference Channel, 1.4 Mbps UE class | 50 |
| 9.2.1.2 | Minimum requirement 16QAM, Fixed Reference Channel, 1.4 Mbps UE class | 50 |
| 9.2.2 | HS-DSCH throughput for Variable Reference Channels..... | 51 |
| 9.2.2.1 | Minimum requirement, Variable Reference Channel - 1.4 Mbps UE class | 51 |
| 9.2.3 | Reporting of Channel Quality Indicator | 52 |
| 9.2.3.1 | Minimum Requirement, Channel Quality Indicator – 1.4Mbps UE class..... | 52 |
| 9.2.4 | HS-SCCH Detection Performance | 53 |
| 9.2.4.1 | Minimum Requirements for HS-SCCH Detection | 53 |
| Annex A (normative): | Measurement channels..... | 55 |
| A.1 | General | 55 |
| A.2 | Reference measurement channel | 55 |
| A.2.1 | UL reference measurement channel (12.2 kbps) | 55 |
| A.2.1.1 | 3.84 Mcps TDD Option | 55 |

| | | |
|--|--|-----------|
| A.2.1.2 | 1.28 Mcps TDD Option | 56 |
| A.2.2 | DL reference measurement channel (12.2 kbps) | 57 |
| A.2.2.1 | 3.84 Mcps TDD Option | 57 |
| A.2.2.2 | 1.28 Mcps TDD Option | 58 |
| A.2.3 | DL reference measurement channel (64 kbps) | 59 |
| A.2.3.1 | 3.84 Mcps TDD Option | 59 |
| A.2.3.2 | 1.28 Mcps TDD Option | 60 |
| A.2.4 | DL reference measurement channel (144 kbps) | 61 |
| A.2.4.1 | 3.84 Mcps TDD Option | 61 |
| A.2.4.2 | 1.28 Mcps TDD Option | 63 |
| A.2.5 | DL reference measurement channel (384 kbps) | 64 |
| A.2.5.1 | 3.84 Mcps TDD Option | 64 |
| A.2.5.2 | 1.28 Mcps TDD Option | 66 |
| A.2.6 | BCH reference measurement channel | 67 |
| A.2.6.1 | 3.84 Mcps TDD Option | 67 |
| A.2.6.2 | 1.28 Mcps TDD Option | 67 |
| A.2.7 | UL multi code reference measurement channel (12.2 kbps) | 68 |
| A.2.7.1 | 3.84 Mcps TDD Option | 68 |
| A.2.7.2 | 1.28 Mcps TDD Option | 69 |
| A.2.8 | DL reference measurement channel (2 Mbps)..... | 70 |
| A.2.8.1 | 3.84 Mcps TDD Option | 70 |
| A.2.8.2 | 1.28 Mcps TDD Option | 72 |
| A.3 | HSDPA reference measurement channels | 73 |
| A.3.1 | HSDPA reference measurement channels for 3,84 Mcps TDD option | 73 |
| A.3.1.1 | Reference measurement channels for 7,3 Mbps – Category 8 - UE | 73 |
| A.3.1.1.1 | QPSK modulation scheme for test 1, 2, 3 | 73 |
| A.3.1.1.2 | QPSK modulation scheme for test 4 | 74 |
| A.3.1.1.3 | 16QAM modulation scheme for test 1, 2, 3 | 75 |
| A.3.1.1.4 | 16QAM modulation scheme for test 4 | 76 |
| A.3.2 | HSDPA reference measurement channels for 1.28 Mcps TDD option | 77 |
| A.3.2.1 | Reference measurement channels for 1.4 Mbps UE class | 77 |
| A.3.2.1.1 | QPSK modulation scheme | 77 |
| A.3.2.1.2 | 16QAM modulation scheme | 79 |
| A.3.3 | Variable Reference Channel definition for 3,84 Mcps and 1,28 Mcps TDD options..... | 81 |
| Annex B (normative): Propagation conditions..... | | 82 |
| B.1 | Static propagation condition..... | 82 |
| B.2 | Multi-path fading propagation conditions | 82 |
| B.2.1 | 3.84 Mcps TDD Option..... | 82 |
| B.2.2 | 1.28 Mcps TDD Option..... | 83 |
| Annex C (normative): Environmental conditions | | 85 |
| C.1 | General | 85 |
| C.2 | Environmental requirements for the UE | 85 |
| C.2.1 | Temperature | 85 |
| C.2.2 | Voltage | 85 |
| C.2.3 | Vibration..... | 86 |
| Annex D (informative): Terminal capabilities (TDD)..... | | 87 |
| Annex E (informative): Change request history..... | | 88 |
| History | | 93 |

Foreword

This Technical Specification has been produced by the 3GPP.

The contents of the present document are subject to continuing work within the TSG and may change following formal TSG approval. Should the TSG modify the contents of this TS, it will be re-released by the TSG with an identifying change of release date and an increase in version number as follows:

Version 3.y.z

where:

- x the first digit:
 - 1 presented to TSG for information;
 - 2 presented to TSG for approval;
 - 3 Indicates TSG approved document under change control.
- y the second digit is incremented for all changes of substance, i.e. technical enhancements, corrections, updates, etc.
- z the third digit is incremented when editorial only changes have been incorporated in the specification;

1 Scope

This document establishes the minimum RF characteristics of both options of the TDD mode of UTRA. The two options are the 3.84 Mcps and 1.28 Mcps options respectively. The requirements are listed in different subsections only if the parameters deviate.

2 References

The following documents contain provisions, which, through reference in this text, constitute provisions of the present document.

- References are either specific (identified by date of publication, edition number, version number, etc.) or non-specific.
- For a specific reference, subsequent revisions do not apply.
- For a non-specific reference, the latest version applies. In the case of a reference to a 3GPP document (including a GSM document), a non-specific reference implicitly refers to the latest version of that document *in the same Release as the present document*.

- [1] ETSI ETR 273-1-2: "Electromagnetic compatibility and Radio spectrum Matters (ERM); Improvement of radiated methods of measurement (using test sites) and evaluation of the corresponding measurement uncertainties; Part 1: Uncertainties in the measurement of mobile radio equipment characteristics; Sub-part 2: Examples and annexes"
- [2] 3GPP TS 25.306: "UE Radio Access capabilities definition".
- [3] ITU-R Recommendation SM.329: "Unwanted emissions in the spurious domain".

3 Definitions, symbols and abbreviations

3.1 Definitions

For the purposes of the present document, the following definitions apply:

Power Spectral Density: The units of Power Spectral Density (PSD) are extensively used in this document. PSD is a function of power versus frequency and when integrated across a given bandwidth, the function represents the mean power in such a bandwidth. When the mean power is normalised to (divided by) the chip-rate it represents the mean energy per chip. Some signals are directly defined in terms of energy per chip, (DPCH_Ec, Ec, and P-CCPCH_Ec) and others defined in terms of PSD (Io, Ioc, Ior and \hat{I} or). There also exist quantities that are a ratio of energy per chip to PSD (DPCH_Ec/Ior, Ec/Ior etc.). This is the common practice of relating energy magnitudes in communication systems.

It can be seen that if both energy magnitudes in the ratio are divided by time, the ratio is converted from an energy ratio to a power ratio, which is more useful from a measurement point of view. It follows that an energy per chip of X dBm/3.84 MHz (3.84 Mcps TDD option) or X dBm/1.28 MHz (1.28 Mcps TDD option) can be expressed as a mean power per chip of X dBm. Similarly, a signal PSD of Y dBm/3.84 MHz (3.84 Mcps TDD option) or Y dBm/1.28 MHz (1.28 Mcps TDD option) can be expressed as a signal power of Y dBm.

Maximum Output Power: This is a measure of the maximum power the UE can transmit (i.e. the actual power as would be measured assuming no measurement error) in a bandwidth of at least $(1 + \alpha)$ times the chip rate of the radio access mode. The period of measurement shall be a transmit timeslot excluding the guard period.

Mean Power: When applied to a CDMA modulated signal this is the power (transmitted or received) in a bandwidth of at least $(1 + \alpha)$ times the chip rate of the radio access mode. The period of measurement shall be a transmit timeslot excluding the guard period unless otherwise stated.

RRC Filtered Mean Power: The mean power as measured through a root raised cosine filter with roll-off factor α and a bandwidth equal to the chip rate of the radio access mode.

Nominal Maximum Output Power: This is the nominal power defined by the UE power class. The period of measurement shall be a transmit timeslot excluding the guard period.

Received Signal Code Power (RSCP): Given only signal power is received, the RRC filtered mean power of the received signal after despreading and combining.

Interference Signal Code Power (ISCP): Given only interference power is received, the RRC filtered mean power of the received signal after despreading to the code and combining. Equivalent to the RSCP value but now only interference is received instead of signal

NOTE 1: The RRC filtered mean power of a perfectly modulated CDMA signal is 0.246 dB lower than the mean power of the same signal.

NOTE 2: The roll-off factor α is defined in section 6.8.1.

3.2 Symbols

(void)

3.3 Abbreviations

For the purposes of the present document, the following abbreviations apply:

| | |
|----------------------------------|--|
| ACIR | Adjacent Channel Interference Ratio |
| ACLR | Adjacent Channel Leakage power Ratio |
| ACS | Adjacent Channel Selectivity |
| BS | Base Station |
| CW | Continuous wave (unmodulated signal) |
| DL | Down link (forward link) |
| DPCH | Dedicated physical channel |
| DPCH_Ec | Average energy per PN chip for DPCH |
| $\frac{DPCH_Ec}{I_{or}}$ | The ratio of the average energy per PN chip of the DPCH to the total transmit power spectral density of the downlink at the BS antenna connector |
| $\frac{\Sigma DPCH_Ec}{I_{or}}$ | The ratio of the sum of DPCH_Ec for one service in case of multicode to the total transmit power spectral density of the downlink at the BS antenna connector |
| EIRP | Effective Isotropic Radiated Power |
| FDD | Frequency Division Duplexing |
| FER | Frame Error Ratio |
| Fuw | Frequency of unwanted signal. This is specified in bracket in terms of an absolute frequency(s) or frequency offset from the assigned channel frequency. |
| Hybrid ARQ | Hybrid Automatic Repeat reQuest |
| HSDPA | High Speed Downlink Packet Access |
| HS-DSCH | High Speed Downlink Shared Channel |
| HS-PDSCH | High Speed Physical Downlink Shared Channel |
| I _{oc} | The power spectral density (integrated in a noise bandwidth equal to the chip rate and normalized to the chip rate) of a band limited white noise source (simulating interference from other cells) as measured at the UE antenna connector. |
| I _{or} | The total transmit power spectral density (integrated in a bandwidth of $(1 + \alpha)$ times the chip rate and normalized to the chip rate) of the downlink signal at the BS antenna connector |

| | |
|----------------|--|
| \hat{I}_{or} | The received power spectral density (integrated in a bandwidth of $(1+\alpha)$ times the chip rate and normalized to the chip rate) of the downlink signal as measured at the UE antenna connector |
| PPM | Parts Per Million |
| RSSI | Received Signal Strength Indicator |
| R | Number of information bits per second excluding CRC bits successfully received on HS-DSCH by a HSDPA capable UE. |
| RU | Resource Unit |
| SCTD | Space Code Transmit Diversity |
| SIR | Signal to Interference ratio |
| TDD | Time Division Duplexing |
| TPC | Transmit Power Control |
| UE | User Equipment |
| UL | Up link (reverse link) |
| UTRA | UMTS Terrestrial Radio Access |

4 General

4.1 Relationship between Minimum Requirements and Test Requirements

The Minimum Requirements given in this specification make no allowance for measurement uncertainty. The test specification 34.122 Annex F defines Test Tolerances. These Test Tolerances are individually calculated for each test. The Test Tolerances are used to relax the Minimum Requirements in this specification to create Test Requirements. The measurement results returned by the test system are compared – without any modifications - against the Test Requirements as defined by the shared risk principle.

The Shared Risk principle is defined in ETR 273 Part 1 sub-part 2 section 6.5.

4.2 Power Classes

For UE power classes 1 and 4, a number of RF parameter are not specified. It is intended that these are part of a later release.

4.3 Control and monitoring functions

This requirement verifies that the control and monitoring functions of the UE prevent it from transmitting if no acceptable cell can be found by the UE.

4.3.1 Minimum requirement

The power of the UE, as measured with a thermal detector, shall not exceed -30dBm if no acceptable cell can be found by the UE.

5 Frequency bands and channel arrangement

5.1 General

The information presented in this section is based on the chip rates of 3.84 Mcps Option and 1.28 Mcps Option..

NOTE: Other chip rates may be considered in future releases.

5.2 Frequency bands

UTRA/TDD is designed to operate in the following bands;

- a) 1900 – 1920 MHz: Uplink and downlink transmission
2010 – 2025 MHz: Uplink and downlink transmission
- b)* 1850 – 1910 MHz: Uplink and downlink transmission
1930 – 1990 MHz: Uplink and downlink transmission
- c)* 1910 – 1930 MHz: Uplink and downlink transmission
- d)** 2570 – 2620 MHz: Uplink and downlink transmission

* Used in ITU Region 2

**Used in ITU Region 1

Additional allocations in ITU region 2 are FFS.

Deployment in existing or other frequency bands is not precluded.

5.3 TX–RX frequency separation

5.3.1 3.84 Mcps TDD Option

No TX-RX frequency separation is required as Time Division Duplex (TDD) is employed. Each TDMA frame consists of 15 timeslots where each timeslot can be allocated to either transmit or receive.

5.3.2 1.28 Mcps TDD Option

No TX-RX frequency separation is required as Time Division Duplex (TDD) is employed. Each subframe consists of 7 main timeslots where all main timeslots (at least the first one) before the single switching point are allocated DL and all main timeslots (at least the last one) after the single switching point are allocated UL.

5.4 Channel arrangement

5.4.1 Channel spacing

5.4.1.1 3.84 Mcps TDD Option

The nominal channel spacing is 5 MHz, but this can be adjusted to optimise performance in a particular deployment scenario.

5.4.1.2 1.28 Mcps TDD Option

The nominal channel spacing is 1.6 MHz, but this can be adjusted to optimise performance in a particular deployment scenario.

5.4.2 Channel raster

The channel raster is 200 kHz for all bands, which means that the carrier frequency must be a multiple of 200 kHz.

5.4.2.1 3.84 Mcps TDD Option

In addition a number of additional centre frequencies are specified according to table 5.1, which means that the centre frequencies for these channels are shifted 100 kHz relative to the general raster.

5.4.3 Channel number

The carrier frequency is designated by the UTRA absolute radio frequency channel number (UARFCN). The value of the UARFCN in the IMT2000 band is defined in the general case as follows:

$$N_i = 5 * F \quad 0.0 \text{ MHz} \leq F \leq 3276.6 \text{ MHz}$$

where F is the carrier frequency in MHz

Additional channels applicable to operation in the frequency band defined in sub-clause 5.2(d) are defined via the following UARFCN definition:

$$N_i = 5 * (F - 2150.1 \text{ MHz}) \quad 2572.5 \text{ MHz} \leq F \leq 2617.5 \text{ MHz}$$

5.4.4 UARFCN

5.4.4.1 3.84 Mcps TDD Option

The following UARFCN range shall be supported for each band:

Table 5.1: UTRA Absolute Radio Frequency Channel Number 3.84 Mcps TDD Option

| Frequency Band | Frequency Range | UARFCN Uplink and Downlink transmission | Additional UARFCN Uplink and Downlink transmission |
|---|--------------------------------|---|--|
| For operation in frequency band as defined in subclause 5.2 (a) | 1900-1920 MHz 2010-2025 MHz | 9512 to 9588 10062 to 10113 | - |
| For operation in frequency band as defined in subclause 5.2 (b) | 1850-1910 MHz 1930-1990 MHz | 9262 to 9538 9662 to 9938 | - |
| For operation in frequency band as defined in subclause 5.2 (c) | 1910-1930 MHz | 9562 to 9638 | - |
| For operation in frequency band as defined in subclause 5.2 (d) | 2570-2620 MHz | 12862 to 13088 | 2112, 2137, 2162, 2187, 2212, 2237, 2262, 2287, 2312, 2337 |

5.4.4.2 1.28 Mcps TDD Option

The following UARFCN range shall be supported for each band:

Table 5.2: UTRA Absolute Radio Frequency Channel Number 1.28 Mcps TDD Option

| Frequency Band | Frequency Range | UARFCN Uplink and Downlink transmission |
|---|--------------------------------|---|
| For operation in frequency band as defined in subclause 5.2 (a) | 1900-1920 MHz 2010-2025 MHz | 9504 to 9596 10054 to 10121 |
| For operation in frequency band as defined in subclause 5.2 (b) | 1850-1910 MHz 1930-1990 MHz | 9254 to 9546 9654 to 9946 |
| For operation in frequency band as defined in subclause 5.2 (c) | 1910-1930 MHz | 9554 to 9646 |
| For operation in frequency band as defined in subclause 5.2 (d) | 2570-2620 MHz | 12854 to 13096 |

6 Transmitter characteristics

6.1 General

Unless detailed the transmitter characteristic are specified at the antenna connector of the UE. For UE with integral antenna only, a reference antenna with a gain of 0 dBi is assumed. Transmitter characteristics for UE(s) with multiple antennas/antenna connectors are FFS.

The UE antenna performance has a significant impact on system performance and minimum requirements on the antenna efficiency are therefore intended to be included in future versions of this specification. It is recognised that different requirements and test methods are likely to be required for the different types of UE.

All the parameters in section 6 are defined using the UL reference measurement channel (12.2 kbps) specified in Annex A.2.1.

6.2 Transmit power

6.2.1 User Equipment maximum output power

The following Power Classes define the nominal maximum output power. The nominal power defined is the broadband transmit power of the UE, i.e. the power in a bandwidth of at least $(1+\alpha)$ times the chip rate of the radio access mode. The period of measurement shall be a transmit timeslot excluding the guard period.

Table 6.1: UE power classes

| Power Class | Nominal maximum output power | Tolerance |
|-------------|------------------------------|---------------|
| 1 | +30 dBm | +1 dB / -3 dB |
| 2 | +24 dBm | +1 dB / -3 dB |
| 3 | +21 dBm | +2 dB / -2 dB |
| 4 | +10 dBm | +4 dB / -4 dB |

NOTE:

- 1) For multi-code operation the nominal maximum output power will be reduced by the difference of peak to average ratio between single and multi-code transmission.
- 2) The tolerance allowed for the nominal maximum power applies even at the multi code transmission mode.
- 3) For UE using directive antennas for transmission, a class dependent limit will be placed on the maximum EIRP (Equivalent Isotropic Radiated Power).

6.3 UE frequency stability

The UE modulated carrier frequency shall be accurate to within ± 0.1 PPM observed over a period of one timeslot compared to carrier frequency received from the BS. These signals will have an apparent error due to BS frequency error and Doppler shift. In the later case, signals from the BS must be averaged over sufficient time that errors due to noise or interference are allowed for within the above ± 0.1 PPM figure. The UE shall use the same frequency source for both RF frequency generation and the chip clock.

6.4 Output power dynamics

Power control is used to limit the interference level.

6.4.1 Power control

6.4.1.1 3.84 Mcps option

Uplink power control is the ability of the UE transmitter to sets its output power in accordance with measured downlink path loss, values determined by higher layer signalling and path loss weighting parameter α as defined in TS 25.331. The output power is defined as the RRC filtered mean power of the transmit timeslot.

6.4.1.1.1 Initial Accuracy

The UE power control initial accuracy error shall be less than +/-9dB under normal conditions and +/- 12dB under extreme conditions.

6.4.1.1.2 Differential accuracy, controlled input

The power control differential accuracy, controlled input, is defined as the error in the UE transmitter power step as a result of a step in SIR_{TARGET} when the path loss weighting parameter $\alpha=0$. The step in SIR_{TARGET} shall be rounded to the closest integer dB value. The power control error resulting from a change in I_{BTS} or DPCH Constant Value shall not exceed the values defined in Table 6.3.

Table 6.3: Transmitter power step tolerance as a result of control power step

| ΔSIR_{TARGET} [dB] | Transmitter power step tolerance [dB] |
|--|---------------------------------------|
| $\Delta SIR_{TARGET} \leq 1$ | ± 0.5 |
| $1 < \Delta SIR_{TARGET} \leq 2$ | ± 1 |
| $2 < \Delta SIR_{TARGET} \leq 3$ | ± 1.5 |
| $3 < \Delta SIR_{TARGET} \leq 10$ | ± 2 |
| $10 < \Delta SIR_{TARGET} \leq 20$ | ± 4 |
| $20 < \Delta SIR_{TARGET} \leq 30$ | ± 6 |
| $30 < \Delta SIR_{TARGET}$ | $\pm 9^{(1)}$ |
| Note 1: Value is given for normal conditions. For extreme conditions value is ± 12 | |

6.4.1.1.3 Differential accuracy, measured input

The power control differential accuracy, measured input, is defined as the error in UE transmitter power step change as a result of a step change in path loss L_{PCCPCH} .

The error shall not exceed the sum of the following two errors:

- The power control error, resulting from a change in the path loss (ΔL_{PCCPCH}), the same tolerances as defined in table 6.3 shall apply,
- and the errors in the PCCPCH RSCP measurement as defined in TS 25.123.

6.4.1.2 1.28 Mcps TDD Option

6.4.1.2.1 Open loop power control

Open loop power control is the ability of the UE transmitter to sets its output power to a specific value. The open loop power control tolerance is given in Table 6.3A

6.4.1.2.1.1 Minimum requirement

The UE open loop power is defined as the RRC filtered mean power in a timeslot or ON power duration, whichever is available.

Table 6.3A: Open loop power control tolerance

| | |
|--------------------|-------------|
| Normal conditions | ± 9 dB |
| Extreme conditions | ± 12 dB |

6.4.1.2.2 Closed loop power control

Closed loop power control in the Uplink is the ability of the UE transmitter to adjust its output power in accordance with one or more TPC commands received in the downlink.

6.4.1.2.2.1 Power control steps

The power control step is the change in the UE transmitter output power in response to a single TPC command, TPC_cmd, arrived at the UE.

6.4.1.2.2.1.1 Minimum requirement

The UE transmitter shall have the capability of changing the output power with a step size of 1, 2 and 3 dB according to the value of Δ_{TPC} or $\Delta_{\text{RP-TPC}}$, in the slot immediately after the TPC_cmd can be arrived.

- The transmitter output power step due to closed loop power control shall be within the range shown in Table 6.3B.
- The transmitter average output power step due to closed loop power control shall be within the range shown in Table 6.3C. Here a TPC_cmd group is a set of TPC_cmd values derived from a corresponding sequence of TPC commands of the same duration.

The closed loop power is defined as the relative power differences between RRC filtered mean power of original (reference) timeslot and RRC filtered mean power of the target timeslot without transient duration.

Table 6.3B: Transmitter power control range

| TPC_cmd | Transmitter power control range | | | | | |
|---------|---------------------------------|---------|----------------|-------|----------------|---------|
| | 1 dB step size | | 2 dB step size | | 3 dB step size | |
| | Lower | Upper | Lower | Upper | Lower | Upper |
| Up | +0.5 dB | +1.5 dB | +1 dB | +3 dB | +1.5 dB | +4.5 dB |
| Down | -0.5 dB | -1.5 dB | -1 dB | -3 dB | -1.5 dB | -4.5 dB |

Table 6.3C: Transmitter average power control range

| TPC_cmd group | Transmitter power control range after 10 equal TPC_cmd groups | | | | | |
|---------------|---|--------|----------------|--------|----------------|--------|
| | 1 dB step size | | 2 dB step size | | 3 dB step size | |
| | Lower | Upper | Lower | Upper | Lower | Upper |
| Up | +8 dB | +12 dB | +16 dB | +24 dB | +24 dB | +36 dB |
| Down | -8 dB | -12 dB | -16 dB | -24 dB | -24 dB | -36 dB |

6.4.2 Minimum output power

The minimum controlled output power of the UE is when the power is set to a minimum value.

6.4.2.1 Minimum requirement

6.4.2.1.1 3.84 Mcps TDD Option

The minimum output power is defined as the mean power in one time slot excluding the guard period. The minimum output power shall be less than -44 dBm.

6.4.2.1.2 1.28 Mcps TDD Option

The minimum output power is defined as the mean power in one time slot excluding the guard period. The minimum output power shall be less than -49 dBm.

6.4.3 Out-of-synchronisation handling of output power

The UE shall monitor the DPCH quality in order to detect a loss of the signal on Layer 1, as specified in TS 25.224. The thresholds Q_{out} , Q_{in} , Q_{sout} and Q_{sbin} specify at what DPCH quality levels the UE shall shut its power off and when it shall turn its power on, respectively. The thresholds are not defined explicitly, but are defined by the conditions under which the UE shall shut its transmitter off and turn it on, as stated in this clause.

6.4.3.1 Requirement for continuous transmission

6.4.3.1.1 3.84 Mcps TDD Option

6.4.3.1.1.1 Minimum requirement

When the UE estimates the DPCH quality over the last 160 ms period to be worse than a threshold Q_{out} , the UE shall shut its transmitter off within 40 ms. The UE shall not turn its transmitter on again until the DPCH quality exceeds an acceptable level Q_{in} . When the UE estimates the DPCH quality over the last 160 ms period to be better than a threshold Q_{in} , the UE shall again turn its transmitter on within 40 ms.

The UE transmitter shall be considered "off" if the transmitted power is below the level defined in subclause 6.5.1 (Transmit off power). Otherwise the transmitter shall be considered as "on".

6.4.3.1.1.2 Test case

This subclause specifies a test case, which provides additional information for how the minimum requirement should be interpreted for the purpose of conformance testing in case of continuous transmission.

The conditions for the continuous test case are as follows:

The handover triggering level shall be set very high to ensure that the beacon channel power never exceeds the value of 10dB above it. Therefore the averaging time for signal quality will always be 160 milliseconds.

The quality levels at the thresholds Q_{out} and Q_{in} correspond to different signal levels depending on the downlink conditions DCH parameters. For the conditions in Table 6.4, a signal with the quality at the level Q_{out} can be generated by a $\Sigma DPCH_Ec/I_{or}$ ratio of -13 dB, and a signal with Q_{in} by a $\Sigma DPCH_Ec/I_{or}$ ratio of -9 dB. In this test, the DL reference measurement channel (12.2) kbps specified in subclauseA.2.2, where the CRC bits are replaced by data bits, and with static propagation conditions is used.

Table 6.4: DCH parameters for the of Out-of-synch handling test case – 3.84 Mcps TDD option – continuous transmission

| Parameter | Unit | Value |
|----------------------------------|--------------|----------------|
| \hat{I}_{or}/I_{oc} | dB | 1.1 |
| I_{oc} | dBm/3.84 MHz | -60 |
| $\frac{\Sigma DPCH_Ec}{I_{or}}$ | dB | See figure 6.1 |
| Information Data Rate | kbps | 13 |
| TFCI | - | On |

Figure 6.1 shows an example scenario where the $\Sigma DPCH_Ec/I_{or}$ ratio varies from a level where the DPCH is demodulated under normal conditions, down to a level below Q_{out} where the UE shall shut its power off and then back up to a level above Q_{in} where the UE shall turn the power back on.

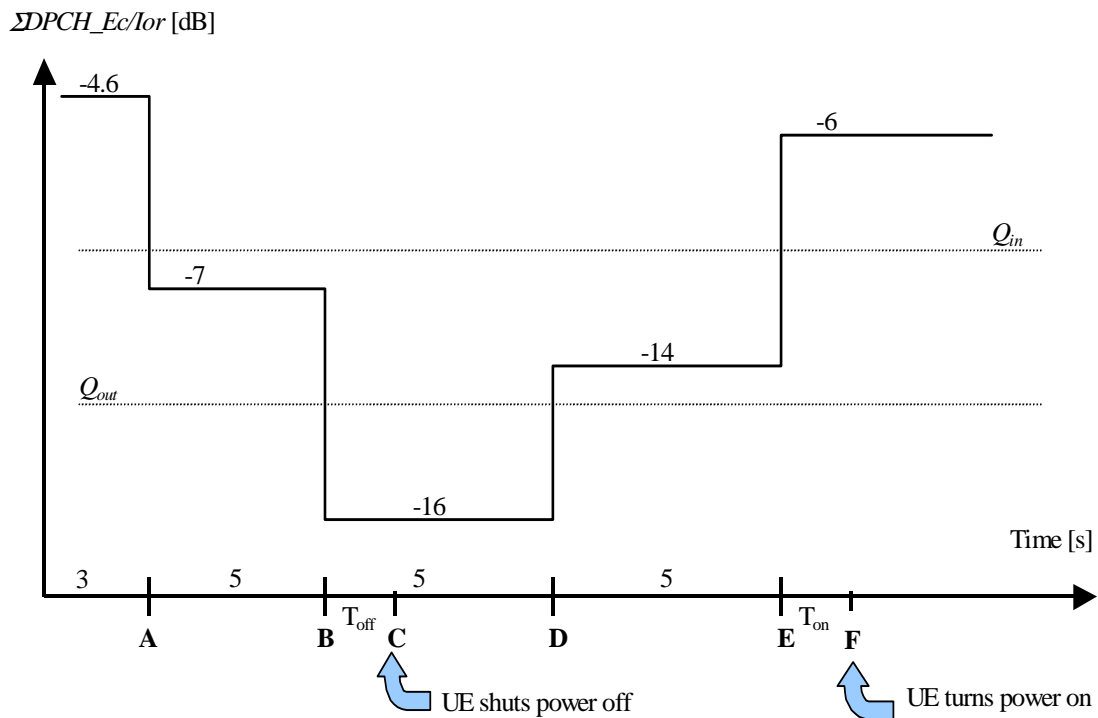

Figure 6.1: Test case for out-of-synch handling in the UE. - 3.84 Mcps TDD option – continuous transmission

In this test case, the requirements for the UE are that

- 1) The UE shall not shut its transmitter off before point B.
- 2) The UE shall shut its transmitter off before point C, which is $T_{\text{off}} = 200$ ms after point B
- 3) The UE shall not turn its transmitter on between points C and E.
- 4) The UE shall turn its transmitter on before point F, which is $T_{\text{on}} = 200$ ms after Point E.

6.4.3.1.2 1.28 Mcps TDD Option

6.4.3.1.2.1 Minimum Requirement

When the UE estimates the DPCH quality over the last 160 ms period to be worse than a threshold Q_{out} , the UE shall shut its transmitter off within 40 ms. The UE shall not turn its transmitter on again until the DPCH quality exceeds an acceptable level Q_{in} . When the UE estimates the DPCH quality over the last 160 ms period to be better than a threshold Q_{in} , the UE shall again turn its transmitter on within 40 ms.

The DPCH quality shall be monitored in the UE and compared to the thresholds Q_{out} and Q_{in} for the purpose of monitoring synchronisation. The threshold Q_{out} should correspond to a level of DPCH quality where no reliable detection of the TPC commands transmitted on the downlink DPCH can be made. This can be at a TPC command error ratio level of e.g. 30%. The threshold Q_{in} should correspond to a level of DPCH quality where detection of the TPC commands transmitted on the downlink DPCH is significantly more reliable than at Q_{out} . This can be at a TPC command error ratio level of e.g. 20%.

The UE transmitter shall be considered "off" if the transmitted power is below the level defined in subclause 6.5.1 (Transmit off power). Otherwise the transmitter shall be considered as "on".

6.4.3.1.2.2 Test case

This subclause specifies a test case, which provides additional information for how the minimum requirement should be interpreted for the purpose of conformance testing in case of continuous transmission for 1.28 Mcps TDD option.

The conditions for the continuous test case are as follows:

The handover triggering level shall be set very high to ensure that the beacon channel power never exceeds the value of 10dB above it. Therefore the averaging time for signal quality will always be 160 milliseconds.

The quality levels at the thresholds Q_{out} and Q_{in} correspond to different signal levels depending on the downlink conditions DCH parameters. For the conditions in Table 6.4, a signal with the quality at the level Q_{out} can be generated by a $\Sigma DPCH_Ec/I_{or}$ ratio of -15 dB, and a signal with Q_{in} by a $\Sigma DPCH_Ec/I_{or}$ ratio of -4.5 dB. In this test, the DL reference measurement channel (12.2) kbps specified in subclause A.2.2, where the CRC bits are replaced by data bits, and with static propagation conditions is used.

Table 6.4AA: DCH parameters for the of Out-of-synch handling test case - 1.28 Mcps TDD option – continuous transmission

| Parameter | Unit | Value |
|----------------------------------|--------------|------------------|
| \hat{I}_{or}/I_{oc} | dB | -1 |
| I_{oc} | dBm/1.28 MHz | -60 |
| $\frac{\Sigma DPCH_Ec}{I_{or}}$ | dB | See figure 6.1AA |
| Information Data Rate | kbps | 12.2 |
| TFCI | - | On |

Figure 6.1AA shows an example scenario where the $\Sigma DPCH_Ec/I_{or}$ ratio varies from a level where the DPCH is demodulated under normal conditions, down to a level below Q_{out} where the UE shall shut its power off and then back up to a level above Q_{in} where the UE shall turn the power back on.

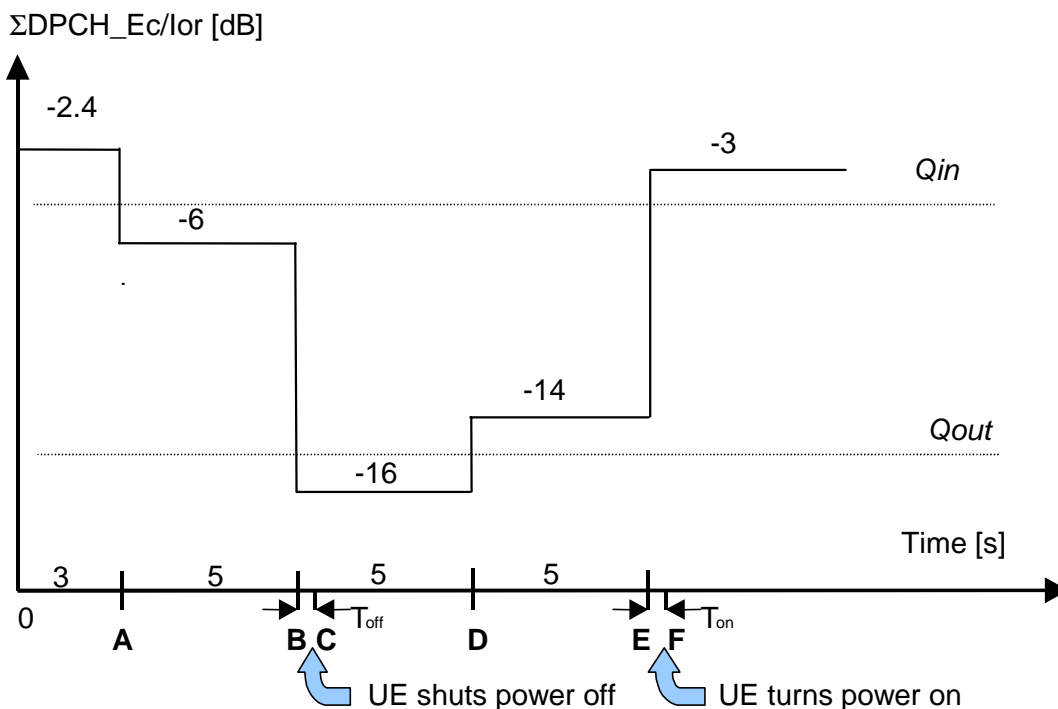

Figure 6.1AA: Test case for out-of-synch handling in the UE - 1.28 Mcps TDD option – continuous transmission

In this test case, the requirements for the UE are that:

- 1) The UE shall not shut its transmitter off before point B.
- 2) The UE shall shut its transmitter off before point C, which is $T_{\text{off}} = 200$ ms after point B
- 3) The UE shall not turn its transmitter on between points C and E.
- 4) The UE shall turn its transmitter on before point F, which is $T_{\text{on}} = 200$ ms after Point E.

6.4.3.2 Requirement for discontinuous transmission

6.4.3.2.1 3.84 Mcps TDD Option

6.4.3.2.1.1 Minimum Requirement

During DTX, there are periods when the UE will receive no data from the UTRAN. As specified in TS 25.224, in order to keep synchronization, Special Bursts shall be transmitted by the UTRAN during these periods of no data.

During these periods, the conditions for when the UE shall shut its transmitter on or off are defined by the power level of the received Special Bursts.

When the UE does not detect at least one special burst with a quality above a threshold Q_{sout} over the last 160 ms period, the UE shall shut its transmitter off within 40 ms. The UE shall not turn its transmitter on again until the special burst quality exceeds an acceptable level Q_{sbin} . When the UE estimates the special burst quality to be better than a threshold Q_{sbin} over the last 160 ms, the UE shall again turn its transmitter on within 40 ms.

The UE transmitter shall be considered "off" if the transmitted power is below the level defined in subclause 6.5.1 (Transmit off power). Otherwise the transmitter shall be considered as "on".

6.4.3.2.1.2 Test case

This subclause specifies a test case, which provides additional information for how the minimum requirement should be interpreted for the purpose of conformance testing in case of discontinuous transmission.

The conditions for the discontinuous test case are as follows:

The handover triggering level shall be set very high to ensure that the beacon channel power never exceeds the value of 10dB above it. Therefore the averaging time for signal quality will always be 160 milliseconds.

The UTRAN transmits Special Bursts as specified in TS 25.224. The Special Burst Scheduling Parameter, SBSP = 4, which means that UTRAN sends a Special Burst at every fourth frame with no data. Therefore, the UTRAN sends a Special Burst in the first frame without data transmission, followed by 3 frames with no transmission; followed by a Special Burst, etc.

The DCH parameters are shown in Table 6.4A.

The quality levels at the thresholds Q_{sout} and Q_{sbin} correspond to different signal levels depending on the downlink conditions DCH parameters. For the conditions in Table 6.4A, a signal with the quality at the level Q_{sout} can be generated by a DPCH_Ec/Ior ratio during received special bursts of -16 dB, and a signal with Q_{sbin} by a DPCH_Ec/Ior ratio during received special bursts of -12 dB.

Table 6.4A: DCH parameters for the of Out-of-synch handling test case – 3.84 Mcps TDD option – discontinuous transmission

| Parameter | Unit | Value |
|----------------------------------|--------------|-----------------|
| \hat{I}_{or}/I_{oc} | dB | 1.1 |
| I_{oc} | dBm/3.84 MHz | -60 |
| $\frac{DPCH_E_c}{I_{or}}$ | dB | See figure 6.1A |
| Bits/burst (including TFCI bits) | bits | 244 |
| TFCI | - | On |

Figure 6.1A shows an example scenario where the special burst quality varies from a level above Q_{sbin} , down to a level below Q_{sbout} where the UE shall shut its power off and then back up to a level above Q_{sbin} where the UE shall turn the power back on.

While the normal data is transmitted using two channelization codes, the Special Burst is transmitted with only one channelization code. Therefore the total energy per chip during Special Bursts is 3 dB lower than for continuous data transmission. The Special Bursts are represented by "SBs" in Figure 6.1A.

During the period of 3 frames with no data, the UE will receive a very low power, which is not shown in the figure. The power shown in the figure is the power of the Special Burst.

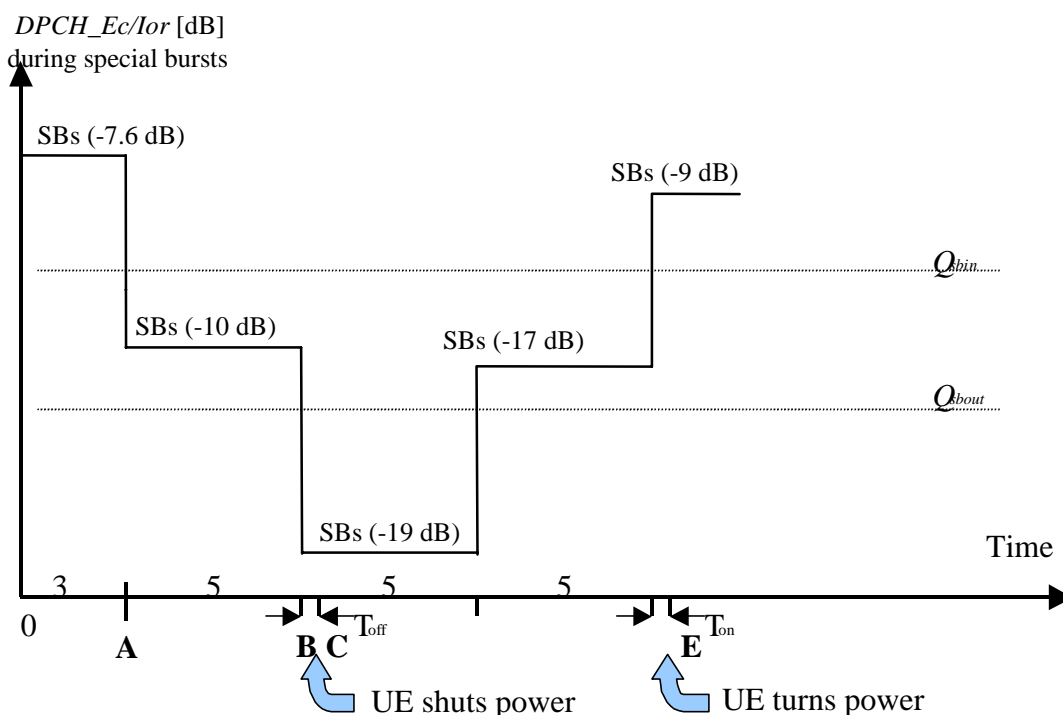

Figure 6.1A. Test case for out-of-synch handling in the UE – 3.84 Mcps TDD option - discontinuous transmission

In this test case, the requirements for the UE are that:

- 1) The UE shall not shut its transmitter off before point B.
- 2) The UE shall shut its transmitter off before point C, which is $T_{off} = 200$ ms after point B.
- 3) The UE shall not turn its transmitter on between points C and E.
- 4) The UE shall turn its transmitter on before point F, which is $T_{on} = 200$ ms after Point E.

6.4.3.2.2 1.28 Mcps TDD Option

6.4.3.2.2.1 Minimum Requirement

During DTX, there are periods when the UE will receive no data from the UTRAN. As specified in TS 25.224, in order to keep synchronization, Special Bursts shall be transmitted by the UTRAN during these periods of no data.

The DPCH quality shall be monitored in the UE and compared to the thresholds Q_{sbout} and Q_{sbin} for the purpose of monitoring synchronisation during downlink DTX. The threshold Q_{sbout} should correspond to a level of DPCH quality where no reliable detection of the TPC commands transmitted on the downlink DPCH can be made. This can be at a TPC command error ratio level of e.g. 30. The threshold Q_{sbin} should correspond to a level of DPCH quality where detection of the TPC commands transmitted on the downlink DPCH is significantly more reliable than at Q_{sbout} . This can be at a TPC command error ratio level of e.g. 20%.

When the UE does not detect at least one special burst with a quality above a threshold Q_{sbout} over the last 160 ms period, the UE shall shut its transmitter off within 40 ms. The UE shall not turn its transmitter on again until the special burst quality exceeds an acceptable level Q_{sbin} . When the UE estimates the special burst quality to be better than a threshold Q_{sbin} over the last 160 ms, the UE shall again turn its transmitter on within 40 ms.

The UE transmitter shall be considered "off" if the transmitted power is below the level defined in subclause 6.5.1 (Transmit off power). Otherwise the transmitter shall be considered as "on".

6.4.3.2.2.2 Test case

This subclause specifies a test case, which provides additional information for how the minimum requirement should be interpreted for the purpose of conformance testing in case of discontinuous transmission.

The conditions for the discontinuous test case are as follows :

The handover triggering level shall be set very high to ensure that the beacon channel power never exceeds the value of 10dB above it. Therefore the averaging time for signal quality will always be 160 milliseconds.

The UTRAN transmits Special Bursts as specified in TS 25.224. The Special Burst Scheduling Parameter, SBSP = 4, which means that UTRAN sends a Special Burst at every fourth frame with no data. Therefore, the UTRAN sends a Special Burst in the first frame without data transmission, followed by 3 frames with no transmission; followed by a Special Burst, etc. Additionally, the Special Burst will be sent in both subframes of the relevant frame designated for the Special Burst.

The DCH parameters are shown in Table 6.4B.

The quality levels at the thresholds Q_{sbout} and Q_{sbin} correspond to different signal levels depending on the downlink conditions DCH parameters. For the conditions in Table 6.4B, a signal with the quality at the level Q_{sbout} can be generated by a DPCH_Ec/Ior ratio during received special bursts of -18 dB, and a signal with Q_{sbin} by a DPCH_Ec/Ior ratio during received special bursts of -7,5 dB.

Table 6.4B: DCH parameters for the of Out-of-synch handling test case - 1.28 Mcps TDD option – discontinuous transmission

| Parameter | Unit | Value |
|-----------------------------------|--------------|---------------------|
| \hat{I}_{or}/I_{oc} | dB | -1 |
| I_{oc} | dBm/1.28 MHz | -60 |
| $\frac{\Sigma DPCH_E_c}{I_{or}}$ | dB | See figure 6.1B |
| Bits/burst (including TFCI bits) | bits | 88 in each subframe |
| TFCI | - | On |

Figure 6.1B shows an example scenario where the DPCH_Ec/Ior ratio during received special bursts varies from a level where the DPCH in DTX mode is demodulated under normal conditions, down to a level below Q_{sbout} where the UE shall shut its power off and then back up to a level above Q_{sbin} where the UE shall turn the power back on.

While the normal data is transmitted using two channelization codes, the Special Burst is transmitted with only one channelization code. Therefore the total energy per chip during Special Bursts is 3 dB lower than for continuous data transmission. The Special Bursts are represented by "SBs" in the figure.

During the period of 3 frames with no data, the UE will receive a very low power, which is not shown in the figure. In the fourth frame the Special Burst will be sent in both subframes designated to carry the Special Burst during DTX. The power shown in the figure is the power of the Special Burst.

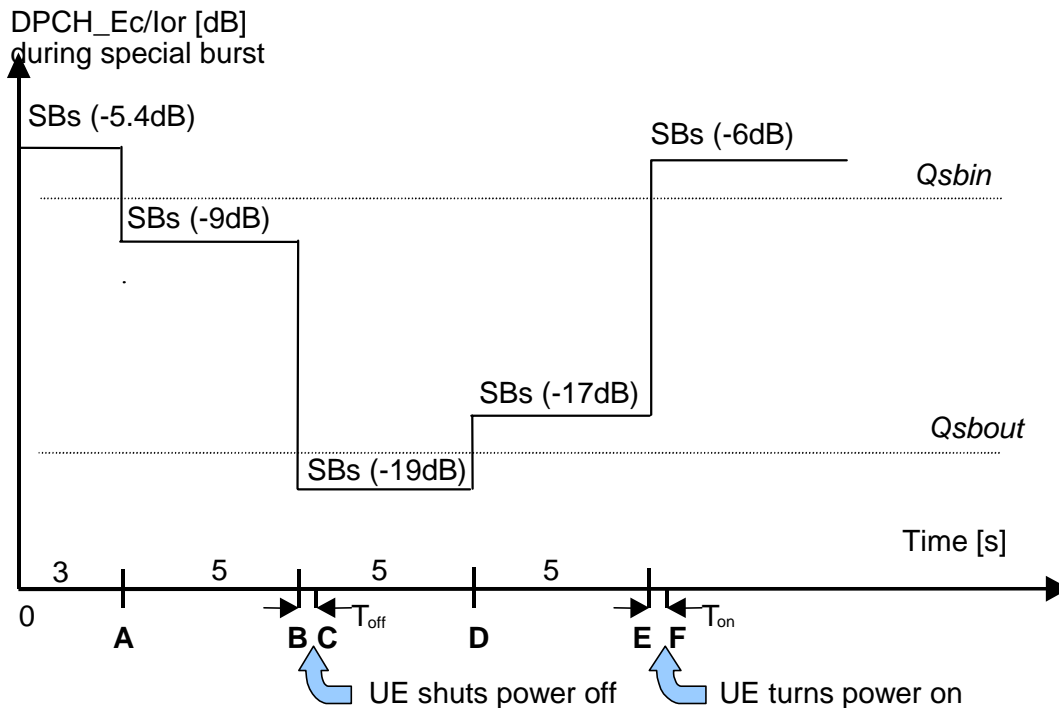

Figure 6.1B: Test case for out-of-synch handling in the UE -1.28 Mcps TDD option - discontinuous transmission

In this test case, the requirements for the UE are that:

- 1) The UE shall not shut its transmitter off before point B.
- 2) The UE shall shut its transmitter off before point C, which is $T_{\text{off}} = 200$ ms after point B.
- 3) The UE shall not turn its transmitter on between points C and E.
- 4) The UE shall turn its transmitter on before point F, which is $T_{\text{on}} = 200$ ms after Point E.

6.5 Transmit ON/OFF power

6.5.1 Transmit OFF power

Transmit OFF power is defined as the RRC filtered mean power measured over one chip when the transmitter is off. The transmit OFF power state is when the UE does not transmit.

6.5.1.1 Minimum Requirement

The requirement for transmit OFF power shall be less than -65 dBm.

6.5.2 Transmit ON/OFF Time mask

The time mask transmit ON/OFF defines the ramping time allowed for the UE between transmit OFF power and transmit ON power.

6.5.2.1 Minimum Requirement

6.5.2.1.1 3.84 Mcps TDD Option

The transmit power level versus time shall meet the mask specified in figure 6.2, where the transmission period refers to the burst without guard period for a single transmission slot, and to the period from the beginning of the burst in the first transmission slot to the end of the burst without guard period in the last transmission timeslot for consecutive transmission slots.

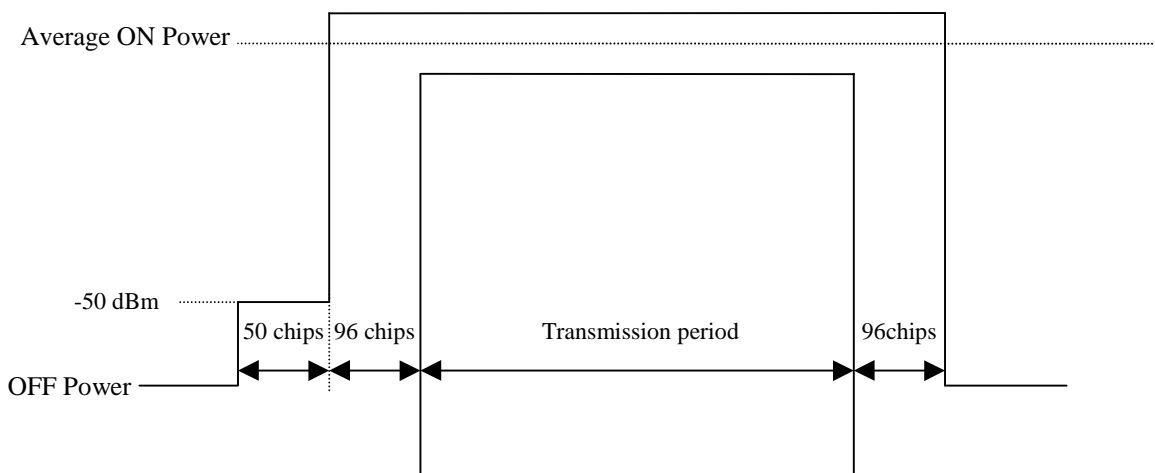

Figure 6.2: Transmit ON/OFF template for 3.84 Mcps TDD Option

6.5.2.1.2 1.28 Mcps TDD Option

The transmit power level versus time shall meet the mask specified in figure 6.2A, where the transmission period refers to the burst without guard period for a single transmission slot, and to the period from the beginning of the burst in the first transmission slot to the end of the burst without guard period in the last transmission timeslot for consecutive transmission slots.

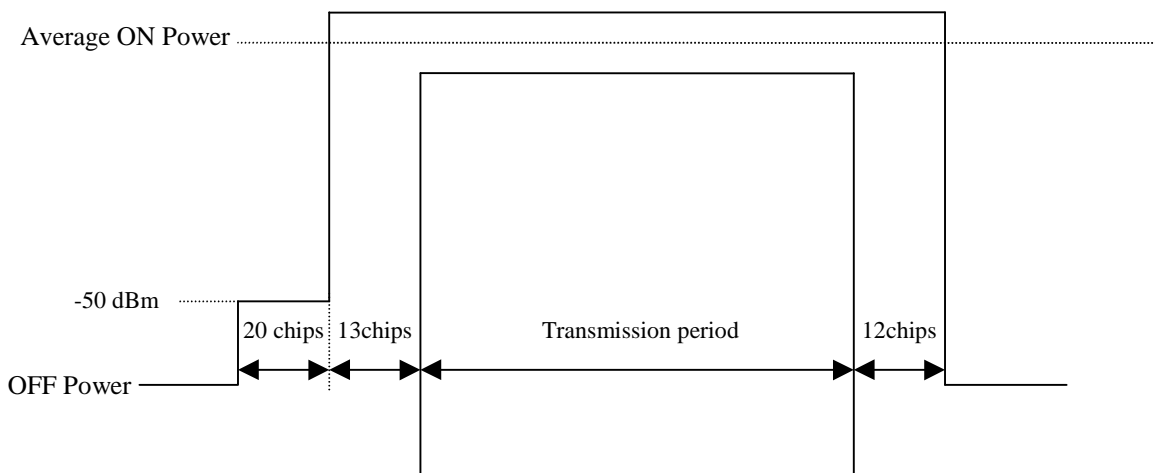

Figure 6.2A: Transmit ON/OFF template for 1.28 Mcps TDD Option

6.6 Output RF spectrum emissions

6.6.1 Occupied bandwidth

6.6.1.1 3.84 Mcps TDD Option

Occupied bandwidth is a measure of the bandwidth containing 99% of the total integrated power of the transmitted spectrum, centred on the assigned channel frequency. The occupied channel bandwidth shall be less than 5 MHz based on a chip rate of 3.84 Mcps.

6.6.1.2 1.28 Mcps TDD Option

Occupied bandwidth is a measure of the bandwidth containing 99% of the total integrated power of the transmitted spectrum, centred on the assigned channel frequency. The occupied channel bandwidth shall be less than 1.6 MHz based on a chip rate of 1.28 Mcps.

6.6.2 Out of band emission

Out of band emissions are unwanted emissions immediately outside the nominal channel resulting from the modulation process and non-linearity in the transmitter but excluding spurious emissions. This out of band emission limit is specified in terms of a spectrum emission mask and adjacent channel leakage power ratio (ACLR).

6.6.2.1 Spectrum emission mask

6.6.2.1.1 3.84 Mcps TDD Option

The spectrum emission mask of the UE applies to frequencies, which are between 2.5 MHz and 12.5MHz from the UE centre carrier frequency. The out of channel emission is specified relative to the RRC filtered mean power of the UE carrier.

6.6.2.1.1.1 Minimum Requirement

The power of any UE emission shall not exceed the levels specified in table 6.5.

Table 6.5: Spectrum Emission Mask Requirement (3.84 Mcps TDD Option)

| Δf^* in MHz | Minimum requirement | Measurement bandwidth |
|---|--|-----------------------|
| 2.5 - 3.5 | $\left\{ -35 - 15 \cdot \left(\frac{\Delta f}{\text{MHz}} - 2.5 \right) \right\} \text{dBc}$ | 30 kHz ** |
| 3.5 - 7.5 | $\left\{ -35 - 1 \cdot \left(\frac{\Delta f}{\text{MHz}} - 3.5 \right) \right\} \text{dBc}$ | 1 MHz *** |
| 7.5 - 8.5 | $\left\{ -39 - 10 \cdot \left(\frac{\Delta f}{\text{MHz}} - 7.5 \right) \right\} \text{dBc}$ | 1 MHz *** |
| 8.5 - 12.5 | -49 dBc | 1 MHz *** |
| * | Δf is the separation between the carrier frequency and the centre of the measuring filter. | |
| ** | The first and last measurement position with a 30 kHz filter is at Δf equals to 2.515 MHz and 3.485 MHz | |
| *** | The first and last measurement position with a 1 MHz filter is at Δf equals to 4 MHz and 12 MHz. As a general rule, the resolution bandwidth of the measuring equipment should be equal to the measurement bandwidth. To improve measurement accuracy, sensitivity and efficiency, the resolution bandwidth can be different from the measurement bandwidth. When the resolution bandwidth is smaller than the measurement bandwidth, the result should be integrated over the measurement bandwidth in order to obtain the equivalent noise bandwidth of the measurement bandwidth. | |
| The lower limit shall be $-50\text{dBm}/3.84\text{ MHz}$ or the minimum requirement presented in this table which ever is the higher. | | |

6.6.2.1.2 1.28 Mcps TDD Option

The spectrum emission mask of the UE applies to frequencies, which are between 0.8MHz and 4.0MHz from the UE centre carrier frequency. The out of channel emission is specified relative to the RRC filtered mean power of the UE carrier.

6.6.2.1.2.1 Minimum Requirement

The power of any UE emission shall not exceed the levels specified in table 6.5A

Table 6.5A: Spectrum Emission Mask Requirement (1.28 Mcps TDD Option)

| Δf^* in MHz | Minimum requirement | Measurement bandwidth |
|---|---|-----------------------|
| 0.8 | -35 dBc | 30 kHz ** |
| 0.8-1.8 | $\left\{ -35 - 14 \cdot \left(\frac{\Delta f}{\text{MHz}} - 0.8 \right) \right\} \text{dBc}$ | 30 kHz ** |
| 1.8-2.4 | $\left\{ -49 - 25 \cdot \left(\frac{\Delta f}{\text{MHz}} - 1.8 \right) \right\} \text{dBc}$ | 30 kHz ** |
| 2.4 – 4.0 | -49 dBc | 1MHz *** |
| * | Δf is the separation between the carrier frequency and the centre of the measuring filter. | |
| ** | The first and last measurement position with a 30 kHz filter is at Δf equals to 0.815 MHz and 2.385 MHz. | |
| *** | The first and last measurement position with a 1 MHz filter is at Δf equals to 2.9MHz and 3.5MHz .As a general rule, the resolution bandwidth of the measuring equipment should be equal to the measurement bandwidth. To improve measurement accuracy, sensitivity and efficiency, the resolution bandwidth can be different from the measurement bandwidth. When the resolution bandwidth is smaller than the measurement bandwidth, the result should be integrated over the measurement bandwidth in order to obtain the equivalent noise bandwidth of the measurement bandwidth. | |
| The lower limit shall be $-55\text{dBm}/1.28\text{ MHz}$ or the minimum requirement presented in this table which ever is the higher. | | |

6.6.2.2 Adjacent Channel Leakage power Ratio (ACLR)

Adjacent Channel Leakage power Ratio (ACLR) is the ratio of the RRC filtered mean power centered on the assigned channel frequency to the RRC filtered mean power centered on an adjacent channel frequency.

6.6.2.2.1 Minimum requirement

6.6.2.2.1.1 3.84 Mcps TDD Option

If the adjacent channel RRC filtered mean power is greater than -50dBm then the ACLR shall be higher than the value specified in Table 6.6.

Table 6.6:UE ACLR (3.84 Mcps TDD Option)

| Power Class | adjacent channel | ACLR limit |
|-------------|-------------------------|------------|
| 2, 3 | UE channel ± 5 MHz | 33 dB |
| 2, 3 | UE channel ± 10 MHz | 43 dB |

NOTE:

- 1) The requirement shall still be met in the presence of switching transients.
- 2) The ACLR requirements reflect what can be achieved with present state of the art technology.
- 3) Requirement on the UE shall be reconsidered when the state of the art technology progresses.

6.6.2.2.1.2 1.28 Mcps TDD Option

If the adjacent channel RRC filtered mean power is greater than -55dBm then the ACLR shall be higher than the value specified in Table 6.6A.

Table 6.6A: UE ACLR (1.28 Mcps TDD Option)

| Power Class | adjacent channel | ACLR limit |
|-------------|--------------------------|------------|
| 2, 3 | UE channel ± 1.6 MHz | 33 dB |
| 2, 3 | UE channel ± 3.2 MHz | 43 dB |

NOTE:

- 1) The requirement shall still be met in the presence of switching transients.
- 2) The ACLR requirements reflect what can be achieved with present state of the art technology.
- 3) Requirement on the UE shall be reconsidered when the state of the art technology progresses.

6.6.3 Spurious emissions

Spurious emissions are emissions which are caused by unwanted transmitter effects such as harmonics emission, parasitic emission, intermodulation products and frequency conversion products, but exclude out of band emissions.

The frequency boundary and the detailed transitions of the limits between the requirement for out band emissions and spectrum emissions are based on ITU-R Recommendations SM.329 [3].

6.6.3.1 Minimum Requirement

6.6.3.1.1 3.84 Mcps TDD Option

These requirements are only applicable for frequencies which are greater than 12.5 MHz away from the UE center carrier frequency.

Table 6.7A: General Spurious emissions requirements (3.84 Mcps TDD Option)

| Frequency Bandwidth | Measurement Bandwidth | Minimum requirement |
|--|-----------------------|---------------------|
| $9\text{ kHz} \leq f < 150\text{ kHz}$ | 1 kHz | -36 dBm |
| $150\text{ kHz} \leq f < 30\text{ MHz}$ | 10 kHz | -36 dBm |
| $30\text{ MHz} \leq f < 1000\text{ MHz}$ | 100 kHz | -36 dBm |
| $1\text{ GHz} \leq f < 12.75\text{ GHz}$ | 1 MHz | -30 dBm |

Table 6.7B: Additional Spurious emissions requirements (3.84 Mcps TDD Option)

| Frequency Bandwidth | Measurement Bandwidth | Minimum requirement |
|---|-----------------------|---------------------|
| $921\text{ MHz} \leq f < 925\text{ MHz}$ | 100 kHz | -60 dBm * |
| $925\text{ MHz} \leq f \leq 935\text{ MHz}$ | 100 kHz | -67 dBm* |
| $935\text{ MHz} < f \leq 960\text{ MHz}$ | 100 kHz | -79 dBm* |
| $1805\text{ MHz} \leq f \leq 1880\text{ MHz}$ | 100 kHz | -71 dBm* |
| $2620\text{ MHz} \leq f \leq 2690\text{ MHz}$ | 3.84 MHz | -37 dBm* |
| * The measurements are made on frequencies which are integer multiples of 200 kHz. As exceptions, up to five measurements with a level up to the applicable requirements defined in Table 6.7A are permitted for each UARFCN used in the measurement. | | |

6.6.3.1.2 1.28 Mcps TDD Option

These requirements are only applicable for frequencies which are greater than 4 MHz away from the UE center carrier frequency.

Table 6.7C: General Spurious emissions requirements (1.28 Mcps TDD Option)

| Frequency Bandwidth | Measurement Bandwidth | Minimum requirement |
|--|-----------------------|---------------------|
| $9 \text{ kHz} \leq f < 150 \text{ kHz}$ | 1 kHz | -36 dBm |
| $150 \text{ kHz} \leq f < 30 \text{ MHz}$ | 10 kHz | -36 dBm |
| $30 \text{ MHz} \leq f < 1000 \text{ MHz}$ | 100 kHz | -36 dBm |
| $1 \text{ GHz} \leq f < 12.75 \text{ GHz}$ | 1 MHz | -30 dBm |

Table 6.7D: Additional Spurious emissions requirements (1.28 Mcps TDD Option)

| Frequency Bandwidth | Measurement Bandwidth | Minimum requirement |
|--|-----------------------|---------------------|
| $921 \text{ MHz} \leq f < 925 \text{ MHz}$ | 100 kHz | -60 dBm * |
| $925 \text{ MHz} \leq f \leq 935 \text{ MHz}$ | 100 kHz | -67 dBm* |
| $935 \text{ MHz} < f \leq 960 \text{ MHz}$ | 100 kHz | -79 dBm* |
| $1805 \text{ MHz} \leq f \leq 1880 \text{ MHz}$ | 100 kHz | -71 dBm* |
| $2620 \text{ MHz} \leq f \leq 2690 \text{ MHz}$ | 3.84 MHz | -37 dBm* |
| Note * The measurements are made on frequencies which are integer multiples of 200 kHz. As exceptions, up to five measurements with a level up to the applicable requirements defined in Table 6.7C are permitted for each UARFCN used in the measurement. | | |

6.7 Transmit intermodulation

The transmit intermodulation performance is a measure of the capability of the transmitter to inhibit the generation of signals in its non linear elements caused by presence of the wanted signal and an interfering signal reaching the transmitter via the antenna.

6.7.1 Minimum requirement

User Equipment(s) transmitting in close vicinity of each other can produce intermodulation products, which can fall into the UE, or BS receive band as an unwanted interfering signal. The UE intermodulation attenuation is defined by the ratio of the RRC filtered mean power of the wanted signal to the RRC filtered mean power of the intermodulation product when an interfering CW signal is added at a level below the wanted signal.

6.7.1.1 3.84 Mcps TDD Option

The requirement of transmitting intermodulation for carrier spacing 5 MHz is prescribed in Table 6.8.

Table 6.8: Transmit Intermodulation (3.84 Mcps TDD Option)

| | | |
|--------------------------------------|---------|--------|
| Interference Signal Frequency Offset | 5MHz | 10MHz |
| Interference Signal Level | -40 dBc | |
| Minimum Requirement | -31dBc | -41dBc |

6.7.1.2 1.28 Mcps TDD Option

The requirement of transmitting intermodulation for carrier spacing 1.6 MHz is prescribed in Table 6.8A.

Table 6.8A: Transmit Intermodulation (1.28 Mcps TDD Option)

| | | |
|---|---------|---------|
| Interference signal frequency offset | 1.6MHz | 3.2MHz |
| Interference signal level | -40dBc | |
| Minimum requirement of intermodulation products | -31 dBc | -41 dBc |

6.8 Transmit Modulation

Transmit modulation defines the modulation quality for expected in-channel RF transmissions from the UE. The requirements apply to all transmissions.

6.8.1 Transmit pulse shape filter

The transmit pulse-shaping filter is a root-raised cosine (RRC) with roll-off $\alpha = 0.22$ in the frequency domain. The impulse response of the chip impulse filter $RC_0(t)$ is

$$RC_0(t) = \frac{\sin\left(\pi \frac{t}{T_c}(1-\alpha)\right) + 4\alpha \frac{t}{T_c} \cos\left(\pi \frac{t}{T_c}(1+\alpha)\right)}{\pi \frac{t}{T_c} \left(1 - \left(4\alpha \frac{t}{T_c}\right)^2\right)}$$

Where the roll-off factor $\alpha = 0.22$ and T_c is the chip duration

6.8.2 Error Vector Magnitude

The Error Vector Magnitude is a measure of the difference between the reference waveform and the measured waveform. This difference is called the error vector. Both waveforms pass through a matched Root Raised Cosine filter with bandwidth corresponding to the considered chip rate and roll-off $\alpha = 0.22$. Both waveforms are then further modified by selecting the frequency, absolute phase, absolute amplitude and chip clock timing so as to minimise the error vector. The EVM result is defined as the square root of the ratio of the mean error vector power to the mean reference power expressed as a %. The period of measurement shall be one transmit timeslot excluding the guard period. See Annex B of TS 34.122 for further details.

6.8.2.1 Minimum Requirement

The Error Vector Magnitude shall not exceed 17.5 % for the parameters specified in Table 6.9.

Table 6.9: Test parameters for Error Vector Magnitude/Peak Code Domain Error

| Parameter | Unit | Level |
|-------------------------|------|-------------------|
| UE Output Power | dBm | ≥ -20 |
| Operating conditions | | Normal conditions |
| Power control step size | dB | 1 |

6.8.3 Peak Code Domain Error

This specification is applicable for multi-code transmission only.

The code domain error is computed by projecting the error vector power onto the code domain at a specific spreading factor. The error power for each code is defined as the ratio to the mean power of the reference waveform expressed in dB. The Peak Code Domain Error is defined as the maximum value for Code Domain Error. The period of measurement shall be one transmit timeslot excluding the guard period, and the midamble.

6.8.3.1 Minimum Requirement

The peak code domain error shall not exceed -21 dB at spreading factor 16 for the parameters specified in Table 6.9.

The requirements are defined using the UL reference measurement channel specified in subclause A.2.7.

7 Receiver characteristics

7.1 General

Unless detailed the receiver characteristic are specified at the antenna connector of the UE. For UE with an integral antenna only, a reference antenna with a gain of 0 dBi is assumed. UE with an integral antenna may be taken into account by converting these power levels into field strength requirements, assuming a 0 dBi gain antenna. Receiver characteristics for UE(s) with multiple antennas/antenna connectors are FFS.

The UE antenna performance has a significant impact on system performance, and minimum requirements on the antenna efficiency are therefore intended to be included in future versions of this specification. It is recognised that different requirements and test methods are likely to be required for the different types of UE.

All the parameters in Section 7 are defined using the DL reference measurement channel specified in Annex A.2.2.

7.2 Diversity characteristics

A suitable receiver structure using coherent reception in both channel impulse response estimation, and code tracking procedures is assumed. Three forms of diversity are considered to be available in UTRA/TDD:

Table 7.1: Diversity characteristics for UTRA/TDD

| | |
|----------------------|--|
| Time diversity | Channel coding and interleaving in both up link and down link |
| Multi-path diversity | Rake receiver or other suitable receiver structure with maximum combining. Additional processing elements can increase the delay-spread performance due to increased capture of signal energy. |
| Antenna diversity | Antenna diversity with maximum ratio combining in the base station and optionally in the mobile stations. Possibility for downlink transmit diversity in the base station. |

7.3 Reference sensitivity level

The reference sensitivity level is the minimum mean power received at the UE antenna port at which the BIT Error Ratio BER shall not exceed a specific value.

7.3.1 Minimum Requirements

7.3.1.1 3.84 Mcps TDD Option

The BER shall not exceed 0.001 for the parameters specified in Table 7.2.

Table 7.2: Test parameters for reference sensitivity (3.84 Mcps TDD Option)

| Parameter | Level | Unit |
|-----------------------------------|-------|--------------|
| $\frac{\Sigma DPCH_{Ec}}{I_{or}}$ | 0 | dB |
| \hat{I}_{or} | -105 | dBm/3.84 MHz |

7.3.1.2 1.28 Mcps TDD Option

The BER shall not exceed 0.001 for the parameters specified in Table 7.2A.

Table 7.2A: Test parameters for reference sensitivity (1.28 Mcps TDD Option)

| Parameter | Level | Unit |
|-----------------------------------|-------|--------------|
| $\frac{\Sigma DPCH_{Ec}}{I_{or}}$ | 0 | dB |
| \hat{I}_{or} | -108 | dBm/1.28 MHz |

7.4 Maximum input level

The maximum input level is defined as the maximum mean power received at the UE antenna port which does not degrade the specified BER performance.

7.4.1 Minimum Requirements

7.4.1.1 3.84 Mcps TDD Option

The BER shall not exceed 0.001 for the parameters specified in Table 7.3.

Table 7.3: Maximum input level (3.84 Mcps TDD Option)

| Parameter | Level | Unit |
|-----------------------------------|-------|--------------|
| $\frac{\Sigma DPCH_{Ec}}{I_{or}}$ | -7 | dB |
| \hat{I}_{or} | -25 | dBm/3.84 MHz |

7.4.1.2 1.28 Mcps TDD Option

The BER shall not exceed 0.001 for the parameters specified in Table 7.3A

Table 7.3A: Maximum input level (1.28 Mcps TDD Option)

| Parameter | Level | Unit |
|-----------------------------------|-------|--------------|
| $\frac{\Sigma DPCH_{Ec}}{I_{or}}$ | -7 | dB |
| \hat{I}_{or} | -25 | dBm/1.28 MHz |

7.5 Adjacent Channel Selectivity (ACS)

Adjacent Channel Selectivity is a measure of a receiver's ability to receive a wanted signal at its assigned channel frequency in the presence of adjacent channel signal at a given frequency offset from the centre frequency of the assigned channel. ACS is the ratio of the receive filter attenuation on the assigned channel frequency to the receiver filter attenuation on the adjacent channel(s).

7.5.1 Minimum Requirement

7.5.1.1 3.84 Mcps TDD Option

The ACS shall be better than the value indicated in Table 7.4 for the test parameters specified in Table 7.5 where the BER shall not exceed 0.001

Table 7.4: Adjacent Channel Selectivity (3.84 Mcps TDD Option)

| Power Class | Unit | ACS |
|-------------|------|-----|
| 2 | dB | 33 |
| 3 | dB | 33 |

Table 7.5: Test parameters for Adjacent Channel Selectivity (3.84 Mcps TDD Option)

| Parameter | Unit | Level |
|----------------------------------|--------------|----------|
| $\frac{\Sigma DPCH_Ec}{I_{or}}$ | dB | 0 |
| \hat{I}_{or} | dBm/3.84 MHz | -91 |
| I_{oac} mean power (modulated) | dBm | -52 |
| F_{uw} offset | MHz | +5 or -5 |

7.5.1.2 1.28 Mcps TDD Option

The ACS shall be better than the value indicated in table 7.4A for the test parameters specified in table 7.5A where the BER shall not exceed 0.001

Table 7.4A: Adjacent Channel Selectivity (1.28 Mcps TDD Option)

| Power Class | Unit | ACS |
|-------------|------|-----|
| 2 | dB | 33 |
| 3 | dB | 33 |

Table 7.5A: Test parameters for Adjacent Channel Selectivity (1.28 Mcps TDD Option)

| Parameter | Unit | Level |
|----------------------------------|-------------|--------------|
| $\frac{\Sigma DPCH_Ec}{I_{or}}$ | dB | 0 |
| \hat{I}_{or} | dBm/1.28MHz | -91 |
| I_{oac} mean power (modulated) | dBm | -54 |
| F_{uw} offset | MHz | +1.6 or -1.6 |

7.6 Blocking characteristics

The blocking characteristics is a measure of the receiver ability to receive a wanted signal at its assigned channel frequency in the presence of an unwanted interferer on frequencies other than those of the spurious response or the adjacent channels without this unwanted input signal causing a degradation of the performance of the receiver beyond a specified limit. The blocking performance shall apply at all frequencies except those at which a spurious response occur.

7.6.1 Minimum Requirement

7.6.1.1 3.84 Mcps TDD Option

The BER shall not exceed 0.001 for the parameters specified in table 7.6 and table 7.7. For table 7.7 up to 24 exceptions are allowed for spurious response frequencies in each assigned frequency channel when measured using a 1MHz step size.

Table 7.6: In-band blocking (3.84 Mcps TDD Option)

| Parameter | Level | | Unit |
|----------------------------------|---|---|--------------|
| $\frac{\Sigma DPCH_Ec}{I_{or}}$ | 0 | | dB |
| \hat{I}_{or} | -102 | | dBm/3.84 MHz |
| I_{ouw} mean power (modulated) | -56 (for F_{uw} offset ± 10 MHz) | -44 (for F_{uw} offset ± 15 MHz) | dBm |

Table 7.7: Out of band blocking (3.84 Mcps TDD Option)

| Parameter | Band 1 | Band 2 | Band 3 | Unit |
|---|--|------------------------------------|----------------------------------|--------------|
| $\frac{\Sigma DPCH_Ec}{I_{or}}$ | 0 | 0 | 0 | dB |
| \hat{I}_{or} | -102 | -102 | -102 | dBm/3.84 MHz |
| I_{ouw} (CW) | -44 | -30 | -15 | dBm |
| F_{uw} For operation in frequency bands as defined in subclause 5.2(a) | 1840 <f < 1885 1935 <f < 1995 2040 <f < 2085 | 1815 <f < 1840 2085 <f < 2110 | 1 < f < 1815 2110 < f < 12750 | MHz |
| F_{uw} For operation in frequency bands as defined in subclause 5.2(b) | 1790 < f < 1835 2005 < f < 2050 | 1765 < f < 1790 2050 < f < 2075 | 1 < f < 1765 2075 < f < 12750 | MHz |
| F_{uw} For operation in frequency bands as defined in subclause 5.2(c) | 1850 < f < 1895 1945 < f < 1990 | 1825 < f < 1850 1990 < f < 2015 | 1 < f < 1825 2015 < f < 12750 | MHz |
| F_{uw} For operation in frequency bands as defined in subclause 5.2(d) | 2510 <f < 2555 2635 <f < 2680 | 2485 <f < 2510 2680 <f < 2705 | 1 <f < 2485 2705 <f < 12750 | MHz |
| 1. | For operation referenced in 5.2(a), from 1885 <f < 1900 MHz, 1920 <f < 1935 MHz, 1995 <f < 2010 MHz and 2025 <f < 2040 MHz, the appropriate in-band blocking in table 7.6 or adjacent channel selectivity in section 7.5.1 shall be applied. | | | |
| 2. | For operation referenced in 5.2(b), from 1835 < f < 1850 MHz and 1990 < f < 2005 MHz, the appropriate in-band blocking in table 7.6 or adjacent channel selectivity in section 7.5.1 shall be applied. | | | |
| 3. | For operation referenced in 5.2(c), from 1895 < f < 1910 MHz and 1930 < f < 1945 MHz, the appropriate in-band blocking in table 7.6 or adjacent channel selectivity in section 7.5.1 shall be applied. | | | |
| 4. | For operation referenced in 5.2(d), from 2555 < f < 2570 MHz and 2620 < f < 2635 MHz, the appropriate in-band blocking in table 7.6 or adjacent channel selectivity in section 7.5.1 shall be applied. | | | |

7.6.1.2 1.28 Mcps TDD Option

The BER shall not exceed 0.001 for the parameters specified in table 7.6A and table 7.7A. For table 7.7A up to 24 exceptions are allowed for spurious response frequencies in each assigned frequency channel when measured using a 1MHz step size.

Table 7.6A: In-band blocking (1.28 Mcps TDD Option)

| Parameter | Level | | Unit |
|----------------------------------|--|--|--------------|
| $\frac{\Sigma DPCH_Ec}{I_{or}}$ | 0 | | dB |
| \hat{I}_{or} | -105 | | dBm/1.28 MHz |
| I_{ouw} mean power (modulated) | -61 (for F_{uw} offset ± 3.2 MHz) | -49 (for F_{uw} offset ± 4.8 MHz) | dBm |

Table 7.7A: Out of band blocking (1.28 Mcps TDD Option)

| Parameter | Band 1 | Band 2 | Band 3 | Unit |
|---|---|------------------------------------|----------------------------------|--------------|
| $\frac{\Sigma DPCH_Ec}{I_{or}}$ | 0 | 0 | 0 | dB |
| \hat{I}_{or} | -105 | -105 | -105 | dBm/1.28 MHz |
| I_{ouw} (CW) | -44 | -30 | -15 | dBm |
| F_{uw} For operation in frequency bands as defined in subclause 5.2(a) | 1840 <f < 1895.2 1924.8 <f < 2005.2 2029.8 <f < 2085 | 1815 <f < 1840 2085 <f < 2110 | 1 < f < 1815 2110 < f < 12750 | MHz |
| F_{uw} For operation in frequency bands as defined in subclause 5.2(b) | 1790 < f < 1845.2 1994.8 < f < 2050 | 1765 < f < 1790 2050 < f < 2075 | 1 < f < 1765 2075 < f < 12750 | MHz |
| F_{uw} For operation in frequency bands as defined in subclause 5.2(c) | 1850 < f < 1905.2 1934.8 < f < 1990 | 1825 < f < 1850 1990 < f < 2015 | 1 < f < 1825 2015 < f < 12750 | MHz |
| F_{uw} For operation in frequency bands as defined in subclause 5.2(d) | 2510 < f < 2565.2 2624.8 < f < 2680 | 2485 < f < 2510 2680 < f < 2705 | 1 < f < 2485 2705 < f < 12750 | MHz |
| 1. | For operation referenced in 5.2(a), from 1895.2 <f < 1900 MHz, 1920 <f < 1924.8 MHz, 2005.2 <f < 2010 MHz and 2025 <f < 2029.8 MHz, the appropriate in-band blocking in table 7.6A or adjacent channel selectivity in section 7.5.1.2 shall be applied. | | | |
| 2. | For operation referenced in 5.2(b), from 1845.2 < f < 1850 MHz and 1990 < f < 1994.8 MHz, the appropriate in-band blocking in table 7.6A or adjacent channel selectivity in section 7.5.1.2 shall be applied. | | | |
| 3. | For operation referenced in 5.2(c), from 1905.2 < f < 1910 MHz and 1930 < f < 1934.8 MHz, the appropriate in-band blocking in table 7.6A or adjacent channel selectivity in section 7.5.1.2 shall be applied. | | | |
| 4. | For operation referenced in 5.2(d), from 2565.2 < f < 2570 MHz and 2620 < f < 2624.8 MHz, the appropriate in-band blocking in table 7.6 or adjacent channel selectivity in section 7.5.1 shall be applied. | | | |

7.7 Spurious response

Spurious response is a measure of the receiver's ability to receive a wanted signal on its assigned channel frequency without exceeding a given degradation due to the presence of an unwanted CW interfering signal at any other frequency at which a response is obtained i.e. for which the blocking limit is not met.

7.7.1 Minimum Requirement

7.7.1.1 3.84 Mcps TDD Option

The BER shall not exceed 0.001 for the parameters specified in Table 7.8.

Table 7.8: Spurious Response (3.84 Mcps TDD Option)

| Parameter | Level | Unit |
|----------------------------------|-------------------------------|--------------|
| $\frac{\Sigma DPCH_Ec}{I_{or}}$ | 0 | dB |
| \hat{I}_{or} | -102 | dBm/3.84 MHz |
| I_{ouw} (CW) | -44 | dBm |
| F_{uw} | Spurious response frequencies | MHz |

7.7.1.2 1.28 Mcps TDD Option

The BER shall not exceed 0.001 for the parameters specified in Table 7.8A.

Table 7.8A: Spurious Response (1.28 Mcps TDD Option)

| Parameter | Level | Unit |
|----------------------------------|-------------------------------|--------------|
| $\frac{\Sigma DPCH_Ec}{I_{or}}$ | 0 | dB |
| \hat{I}_{or} | -105 | dBm/1.28 MHz |
| I_{ouw} (CW) | -44 | dBm |
| F_{uw} | Spurious response frequencies | MHz |

7.8 Intermodulation characteristics

Third and higher order mixing of the two interfering RF signals can produce an interfering signal in the band of the desired channel. Intermodulation response rejection is a measure of the capability of the receiver to receiver a wanted signal on its assigned channel frequency in the presence of two or more interfering signals which have a specific frequency relationship to the wanted signal.

7.8.1 Minimum Requirements

7.8.1.1 3.84 Mcps TDD Option

The BER shall not exceed 0.001 for the parameters specified in table 7.9.

Table 7.9: Receive intermodulation characteristics

| Parameter | Level | Unit |
|-----------------------------------|----------|--------------|
| $\frac{\Sigma DPCH_Ec}{I_{or}}$ | 0 | dB |
| \hat{I}_{or} | -102 | dBm/3.84 MHz |
| I_{ouw1} (CW) | -46 | dBm |
| I_{ouw2} mean power (modulated) | -46 | dBm |
| F_{uw1} (CW) | ± 10 | MHz |
| F_{uw2} (modulated) | ± 20 | MHz |

7.8.1.2 1.28 Mcps TDD Option

The BER shall not exceed 0.001 for the parameters specified in table 7.9A

Table 7.9A: Receive intermodulation characteristics (1.28 Mcps TDD Option)

| Parameter | Level | Unit |
|-----------------------------------|-----------|--------------|
| $\frac{\Sigma DPCH - Ec}{I_{or}}$ | 0 | dB |
| I_{or} | -105 | dBm/1.28 MHz |
| I_{ouw1} (CW) | -46 | dBm |
| I_{ouw2} mean power (modulated) | -46 | dBm/1.28 MHz |
| F_{uw1} (CW) | ± 3.2 | MHz |
| F_{uw2} (modulated) | ± 6.4 | MHz |

7.9 Spurious emissions

The Spurious Emissions Power is the power of emissions generated or amplified in a receiver that appear at the UE antenna connector.

7.9.1 Minimum Requirement

7.9.1.1 3.84 Mcps TDD Option

The power of any spurious emission shall not exceed:

Table 7.10: Receiver spurious emission requirements (3.84 Mcps TDD Option)

| Band | Maximum level | Measurement Bandwidth | Note |
|---|---------------|-----------------------|--|
| 30 MHz – 1 GHz | -57 dBm | 100 kHz | |
| 1 GHz – 1.9 GHz and 1.92 GHz – 2.01 GHz and 2.025 GHz – 2.11 GHz and 2.17 GHz – 2.57 GHz | -47 dBm | 1 MHz | With the exception of frequencies between 12.5MHz below the first carrier frequency and 12.5MHz above the last carrier frequency used by the UE. |
| 1.9 GHz – 1.92 GHz and 2.01 GHz – 2.025 GHz and 2.11 GHz – 2.170 GHz and 2.57 GHz – 2.69 GHz | -60 dBm | 3.84 MHz | With the exception of frequencies between 12.5MHz below the first carrier frequency and 12.5MHz above the last carrier frequency used by the UE. |
| 2.69 GHz – 12.75 GHz | -47 dBm | 1 MHz | |

7.9.1.2 1.28 Mcps TDD Option

The power of any spurious emission shall not exceed:

Table 7.10A: Receiver spurious emission requirements (1.28 Mcps TDD Option)

| Band | Maximum level | Measurement Bandwidth | Note |
|---|---------------|-----------------------|--|
| 30 MHz – 1 GHz | -57 dBm | 100 kHz | |
| 1 GHz – 1.9 GHz and 1.92 GHz – 2.01 GHz and 2.025 GHz – 2.11 GHz and 2.17GHz – 2.57GHz | -47 dBm | 1 MHz | With the exception of frequencies between 4MHz below the first carrier frequency and 4MHz above the last carrier frequency used by the UE. |
| 1.9 GHz – 1.92 GHz and 2.01 GHz – 2.025 GHz and 2.11 GHz – 2.170 GHz and 2.57GHz – 2.69GHz | -64 dBm | 1.28 MHz | With the exception of frequencies between 4MHz below the first carrier frequency and 4MHz above the last carrier frequency used by the UE. |
| 2.69 GHz – 12.75 GHz | -47 dBm | 1 MHz | |

8 Performance requirement

8.1 General

The performance requirements for the UE in this section are specified for the measurement channels specified in Annex A and the propagation condition specified in Annex B.

Table 8.1: Summary of UE performance targets

| Test Chs. | Information Data Rate | Static | Multi-path Case 1 | Multi-path Case 2 | Multi-path Case 3 |
|-----------|-----------------------|--|---|---|---|
| | | Performance metric | | | |
| DCH | 12.2 kbps | BLER<10 ⁻² | BLER<10 ⁻² | BLER<10 ⁻² | BLER<10 ⁻² |
| | 64 kbps | BLER<10 ⁻¹ , 10 ⁻² | BLER<10 ⁻¹ , 10 ⁻² | BLER<10 ⁻¹ , 10 ⁻² | BLER<10 ⁻¹ , 10 ⁻² , 10 ⁻³ |
| | 144 kbps | BLER<10 ⁻¹ , 10 ⁻² | BLER<10 ⁻¹ , 10 ⁻² | BLER<10 ⁻¹ , 10 ⁻² | BLER<10 ⁻¹ , 10 ⁻² , 10 ⁻³ |
| | 384 kbps | BLER<10 ⁻¹ , 10 ⁻² | BLER<10 ⁻¹ , 10 ⁻² | BLER<10 ⁻¹ , 10 ⁻² | BLER<10 ⁻¹ , 10 ⁻² , 10 ⁻³ |
| | 2048 kbps | BLER < 10 ⁻¹ , 10 ⁻² | BLER< 10 ⁻¹ , 10 ⁻² | BLER< 10 ⁻¹ , 10 ⁻² | BLER<10 ⁻¹ , 10 ⁻² , 10 ⁻³ |
| BCH | 12.3kbps | | BLER<10 ⁻² | | |

8.2 Demodulation in static propagation conditions

8.2.1 Demodulation of DCH

The performance requirement of DCH in static propagation conditions is determined by the maximum Block Error Ratio (BLER). The BLER is specified for each individual data rate of the DCH. DCH is mapped into the Dedicated Physical Channel (DPCH).

8.2.1.1 Minimum requirement

8.2.1.1.1 3.84 Mcps TDD Option

For the parameters specified in Table 8.2 the BLER should not exceed the piece-wise linear BLER curve specified in Table 8.3. These requirements are applicable for TFCS size 16.

Table 8.2: DCH parameters in static propagation conditions (3.84 Mcps TDD Option)

| Parameters | Unit | Test 1 | Test 2 | Test 3 | Test 4 | Test 5 |
|------------------------------------|--------------|------------------|-------------------|-------------------|-------------------|--------|
| $\frac{\Sigma DPCH - E_c}{I_{or}}$ | dB | -6 | -3 | 0 | 0 | 0 |
| I_{oc} | dBm/3.84 MHz | -60 | | | | |
| Cell Parameter* | | 0,1 | | | | - |
| DPCH Channelization Codes* | C(k,Q) | C(i,16) i=1,2 | C(i,16) i=1..5 | C(i,16) i=1..9 | C(i,16) i=1..8 | - |
| OCNS Channelization Code* | C(k,Q) | C(3,16) | C(6,16) | - | - | - |
| Information Data Rate | kbps | 12.2 | 64 | 144 | 384 | 2048 |

*Note: Refer to TS 25.223 for definition of channelization codes and cell parameter.

Table 8.3: Performance requirements in AWGN channel (3.84 Mcps TDD Option)

| Test Number | $\frac{\hat{I}_{or}}{I_{oc}}$ [dB] | BLER |
|-------------|------------------------------------|-----------|
| 1 | 1.1 | 10^{-2} |
| 2 | 3.5 | 10^{-1} |
| | 3.8 | 10^{-2} |
| 3 | 3.4 | 10^{-1} |
| | 3.6 | 10^{-2} |
| 4 | 2.7 | 10^{-1} |
| | 3.0 | 10^{-2} |
| 5 | 3.5 | 10^{-1} |
| | 3.6 | 10^{-2} |

8.2.1.1.2 1.28 Mcps TDD Option

For the parameters specified in Table 8.2A the BLER should not exceed the piece-wise linear BLER curve specified in Table 8.3A.

Table 8.2A: DCH parameters in static propagation conditions (1.28 Mcps TDD Option)

| Parameters | Unit | Test 1 | Test 2 | Test 3 | Test 4 |
|---|-------------|-----------------------|-----------------------|-----------------------|--------------------|
| Number of DPCH _o | | 8 | 2 | 2 | 0 |
| Scrambling code and basic midamble code number* | | 0 | 0 | 0 | 0 |
| DPCH Channelization Codes* | C(k,Q) | C(i,16) i=1,2 | C(i,16) i=1..8 | C(i,16) i=1..8 | C(i,16) i=1..10 |
| DPCH _o Channelization Codes* | C(k,Q) | C(i,16) 3 ≤ i ≤ 10 | C(i,16) 9 ≤ i ≤ 10 | C(i,16) 9 ≤ i ≤ 10 | - |
| $\frac{DPCH_o - E_c}{I_{or}}$ | dB | -10 | -10 | -10 | 0 |
| I_{oc} | DBm/1.28MHz | -60 | | | |
| Information Data Rate | Kbps | 12.2 | 64 | 144 | 384 |

*Note: Refer to TS 25.223 for definition of channelization codes, scrambling code and basic midamble code.

Table 8.3A: Performance requirements in AWGN channel (1.28 Mcps TDD Option)

| Test Number | $\frac{\hat{I}_{or}}{I_{oc}}$ [dB] | BLER |
|-------------|------------------------------------|-----------|
| 1 | 3.6 | 10^{-2} |
| 2 | 2.4 | 10^{-1} |
| | 2.7 | 10^{-2} |
| 3 | 2.8 | 10^{-1} |
| | 3.2 | 10^{-2} |
| 4 | 3.2 | 10^{-1} |

8.3 Demodulation of DCH in multipath fading conditions

8.3.1 Multipath fading Case 1

The performance requirement of DCH is determined by the maximum Block Error Ratio (BLER). The BLER is specified for each individual data rate of the DCH. DCH is mapped into the Dedicated Physical Channel (DPCH).

8.3.1.1 Minimum requirement

8.3.1.1.1 3.84 Mcps TDD Option

For the parameters specified in Table 8.4 the BLER should not exceed the piece-wise linear BLER curve specified in Table 8.5. These requirement are applicable for TFCS size 16.

Table 8.4: DCH parameters in multipath Case 1 channel (3.84 Mcps TDD Option)

| Parameters | Unit | Test 1 | Test 2 | Test 3 | Test 4 | Test 5 | |
|-------------------------------------|--------------|------------------|-------------------|-------------------|-------------------|--------|--|
| $\frac{\Sigma DPCH _ E_c}{I_{or}}$ | DB | -6 | -3 | 0 | 0 | 0 | |
| I_{oc} | dBm/3.84 MHz | -60 | | | | | |
| Cell Parameter* | | 0,1 | | | | - | |
| DPCH Channelization Codes* | C(k,Q) | C(i,16) i=1,2 | C(i,16) i=1..5 | C(i,16) i=1..9 | C(i,16) i=1..8 | - | |
| OCNS Channelization Code* | C(k,Q) | C(3,16) | C(6,16) | - | - | - | |
| Information Data Rate | kbps | 12.2 | 64 | 144 | 384 | 2048 | |

*Note: Refer to TS 25.223 for definition of channelization codes and cell parameter.

Table 8.5: Performance requirements in multipath Case 1 channel (3.84 Mcps TDD Option)

| Test Number | $\frac{\hat{I}_{or}}{I_{oc}}$ [dB] | BLER |
|-------------|------------------------------------|-----------|
| 1 | 13.9 | 10^{-2} |
| 2 | 13.7 | 10^{-1} |
| | 19.8 | 10^{-2} |
| 3 | 14.1 | 10^{-1} |
| | 20.6 | 10^{-2} |
| 4 | 13.8 | 10^{-1} |
| | 20.0 | 10^{-2} |
| 5 | 13.2 | 10^{-1} |
| | 17.8 | 10^{-2} |

8.3.1.1.2 1.28 Mcps TDD Option

For the parameters specified in Table 8.4A the BLER should not exceed the piece-wise linear BLER curve specified in Table 8.5A.

Table 8.4A: DCH parameters in multipath Case 1 channel (1.28 Mcps TDD Option)

| Parameters | Unit | Test 1 | Test 2 | Test 3 | Test 4 |
|---|-------------|-----------------------|-----------------------|-----------------------|---------------------|
| Number of DPCH _o | | 8 | 2 | 2 | 0 |
| Scrambling code and basic midamble code number* | | 0 | 0 | 0 | 0 |
| DPCH Channelization Codes* | C(k,Q) | C(i,16) i=1,2 | C(i,16) i=1...8 | C(i,16) i=1...8 | C(i,16) i=1...10 |
| DPCH _o Channelization Codes* | C(k,Q) | C(i,16) 3 ≤ i ≤ 10 | C(i,16) 9 ≤ i ≤ 10 | C(i,16) 9 ≤ i ≤ 10 | - |
| $\frac{DPCH_o - E_c}{I_{or}}$ | DB | -10 | -10 | -10 | 0 |
| I_{oc} | dBm/1.28MHz | -60 | | | |
| Information Data Rate | Kbps | 12.2 | 64 | 144 | 384 |

*Note: Refer to TS 25.223 for definition of channelization codes, scrambling code and basic midamble code.

Table 8.5A: Performance requirements in multipath Case 1 channel (1.28 Mcps TDD Option)

| Test Number | $\frac{\hat{I}_{or}}{I_{oc}}$ [dB] | BLER |
|-------------|------------------------------------|-----------|
| 1 | 22.4 | 10^{-2} |
| 2 | 15.8 | 10^{-1} |
| | 22.9 | 10^{-2} |
| 3 | 16.6 | 10^{-1} |
| | 23.9 | 10^{-2} |
| 4 | 16.5 | 10^{-1} |
| | 23.5 | 10^{-2} |

8.3.2 Multipath fading Case 2

The performance requirement of DCH is determined by the maximum Block Error Ratio (BLER). The BLER is specified for each individual data rate of the DCH. DCH is mapped into the Dedicated Physical Channel (DPCH).

8.3.2.1 Minimum requirement

8.3.2.1.1 3.84 Mcps TDD Option

For the parameters specified in Table 8.6 the BLER should not exceed the piece-wise linear BLER curve specified in Table 8.7. These requirements are applicable for TFCS size 16.

Table 8.6: DCH parameters in multipath Case 2 channel (3.84 Mcps TDD Option)

| Parameters | Unit | Test 1 | Test 2 | Test 3 | Test 4 | Test 5 |
|------------------------------------|--------------|------------------|-------------------|-------------------|-------------------|--------|
| $\frac{\Sigma DPCH - E_c}{I_{or}}$ | DB | -3 | 0 | 0 | 0 | 0 |
| I_{oc} | dBm/3.84 MHz | -60 | | | | |
| Cell Parameter* | | 0,1 | | | | - |
| DPCH Channelization Codes* | C(k,Q) | C(i,16) i=1,2 | C(i,16) i=1..5 | C(i,16) i=1..9 | C(i,16) i=1..8 | - |
| OCNS Channelization Code* | C(k,Q) | C(3,16) | - | - | - | - |
| Information Data Rate | kbps | 12.2 | 64 | 144 | 384 | 2048 |

*Note: Refer to TS 25.223 for definition of channelization codes and cell parameter.

Table 8.7: Performance requirements in multipath Case 2 channel (3.84 Mcps TDD Option)

| Test Number | $\frac{\hat{I}_{or}}{I_{oc}}$ [dB] | BLER |
|-------------|------------------------------------|-----------|
| 1 | 5.8 | 10^{-2} |
| 2 | 5.7 | 10^{-1} |
| | 9.2 | 10^{-2} |
| 3 | 9.3 | 10^{-1} |
| | 12.7 | 10^{-2} |
| 4 | 8.8 | 10^{-1} |
| | 12.0 | 10^{-2} |
| 5 | 10.3 | 10^{-1} |
| | 12.7 | 10^{-2} |

8.3.2.1.2 1.28 Mcps TDD Option

For the parameters specified in Table 8.6A the BLER should not exceed the piece-wise linear BLER curve specified in Table 8.7A.

Table 8.6A: DCH parameters in multipath Case 2 channel (1.28 Mcps TDD Option)

| Parameters | Unit | Test 1 | Test 2 | Test 3 | Test 4 |
|---|-------------|-----------------------|-----------------------|-----------------------|---------------------|
| Number of DPCH _o | | 8 | 2 | 2 | 0 |
| Scrambling code and basic midamble code number* | | 0 | 0 | 0 | 0 |
| DPCH Channelization Codes* | C(k,Q) | C(i,16) i=1,2 | C(i,16) i=1...8 | C(i,16) i=1...8 | C(i,16) i=1...10 |
| DPCH _o Channelization Codes* | C(k,Q) | C(i,16) 3 ≤ i ≤ 10 | C(i,16) 9 ≤ i ≤ 10 | C(i,16) 9 ≤ i ≤ 10 | - |
| $\frac{DPCH_o - E_c}{I_{or}}$ | dB | -10 | -10 | -10 | 0 |
| I_{oc} | dBm/1.28MHz | -60 | | | |
| Information Data Rate | Kbps | 12.2 | 64 | 144 | 384 |

*Note Refer to TS 25.223 for definition of channelization codes, scrambling code and basic midamble code.

Table 8.7A: Performance requirements in multipath Case 2 channel (1.28 Mcps TDD Option)

| Test Number | $\frac{\hat{I}_{or}}{I_{oc}}$ [dB] | BLER |
|-------------|------------------------------------|-----------|
| 1 | 13.6 | 10^{-2} |
| 2 | 9.8 | 10^{-1} |
| | 13.9 | 10^{-2} |
| 3 | 10.3 | 10^{-1} |
| | 14.4 | 10^{-2} |
| 4 | 10.5 | 10^{-1} |
| | 14.4 | 10^{-2} |

8.3.3 Multipath fading Case 3

The performance requirement of DCH is determined by the maximum Block Error Ratio (BLER). The BLER is specified for each individual data rate of the DCH. DCH is mapped into the Dedicated Physical Channel (DPCH).

8.3.3.1 Minimum requirement

8.3.3.1.1 3.84 Mcps TDD Option

For the parameters specified in Table 8.8 the BLER should not exceed the piece-wise linear BLER curve specified in Table 8.9. These requirements are applicable for TFCS size 16.

Table 8.8: DCH parameters in multipath Case 3 channel (3.84 Mcps TDD Option)

| Parameters | Unit | Test 1 | Test 2 | Test 3 | Test 4 | Test 5 |
|------------------------------------|--------------|------------------|-------------------|-------------------|-------------------|--------|
| $\frac{\Sigma DPCH - E_c}{I_{or}}$ | dB | -3 | 0 | 0 | 0 | 0 |
| I_{oc} | dBm/3.84 MHz | -60 | | | | |
| Cell Parameter* | | 0,1 | | | | - |
| DPCH Channelization Codes* | C(k,Q) | C(i,16) i=1,2 | C(i,16) i=1..5 | C(i,16) i=1..9 | C(i,16) i=1..8 | - |
| OCNS Channelization Code* | C(k,Q) | C(3,16) | - | - | - | - |
| Information Data Rate | kbps | 12.2 | 64 | 144 | 384 | 2048 |

*Note: Refer to TS 25.223 for definition of channelization codes and cell parameter.

Table 8.9: Performance requirements in multipath Case 3 channel (3.84 Mcps TDD Option)

| Test Number | $\frac{\hat{I}_{or}}{I_{oc}}$ [dB] | BLER |
|-------------|------------------------------------|-----------|
| 1 | 4.8 | 10^{-2} |
| 2 | 5.8 | 10^{-1} |
| | 8.5 | 10^{-2} |
| | 10.7 | 10^{-3} |
| 3 | 10.3 | 10^{-1} |
| | 13.3 | 10^{-2} |
| | 16.0 | 10^{-3} |
| 4 | 8.9 | 10^{-1} |
| | 11.5 | 10^{-2} |
| | 13.6 | 10^{-3} |
| 5 | 9.4 | 10^{-1} |
| | 11.5 | 10^{-2} |
| | 13.6 | 10^{-3} |

8.3.3.1.2 1.28 Mcps TDD Option

For the parameters specified in Table 8.8A the BLER should not exceed the piece-wise linear BLER curve specified in Table 8.9A.

Table 8.8A: DCH parameters in multipath Case 3 channel (1.28 Mcps TDD Option)

| Parameters | Unit | Test 1 | Test 2 | Test 3 | Test 4 |
|---|-------------|-----------------------|-----------------------|-----------------------|---------------------|
| Number of DPCH _o | | 8 | 2 | 2 | 0 |
| Scrambling code and basic midamble code number* | | 0 | 0 | 0 | 0 |
| DPCH Channelization Codes* | C(k,Q) | C(i,16) i=1,2 | C(i,16) i=1...8 | C(i,16) i=1...8 | C(i,16) i=1...10 |
| DPCH _o Channelization Codes* | C(k,Q) | C(i,16) 3 ≤ i ≤ 10 | C(i,16) 9 ≤ i ≤ 10 | C(i,16) 9 ≤ i ≤ 10 | - |
| $\frac{DPCH_o - E_c}{I_{or}}$ | dB | -10 | -10 | -10 | 0 |
| I_{oc} | dBm/1.28MHz | -60 | | | |
| Information Data Rate | Kbps | 12.2 | 64 | 144 | 384 |

*Note Refer to TS 25.223 for definition of channelization codes, scrambling code and basic midamble code.

Table 8.9A: Performance requirements in multipath Case 3 channel (1.28 Mcps TDD Option)

| Test Number | $\frac{\hat{I}_{or}}{I_{oc}}$ [dB] | BLER |
|-------------|------------------------------------|------------------|
| 1 | 11.7 | 10 ⁻² |
| 2 | 9.0 | 10 ⁻¹ |
| | 11.7 | 10 ⁻² |
| | 14.3 | 10 ⁻³ |
| 3 | 9.1 | 10 ⁻¹ |
| | 11.2 | 10 ⁻² |
| | 12.7 | 10 ⁻³ |
| 4 | 9.3 | 10 ⁻¹ |
| | 10.8 | 10 ⁻² |
| | 12.0 | 10 ⁻³ |

8.4 Base station transmit diversity mode for 3.84 Mcps TDD Option

8.4.1 Demodulation of BCH in SCTD mode

The performance requirement of BCH is determined by the maximum Block Error Rate (BLER). The BLER is specified for the BCH. BCH is mapped into the Primary Common Control Physical Channel (P-CCPCH).

8.4.1.1 Minimum requirement

For the parameters specified in Table 8.10 the BLER should not exceed the BLER specified in Table 8.11.

NOTE: This requirement doesn't need to be tested.

Table 8.10: P-CCPCH parameters in multipath Case 1 channel

| Parameters | Unit | Test 1 |
|------------------------------|--------------|--------|
| $\frac{PCCPCH_E_c}{I_{or}}$ | dB | -3 |
| I | dBm/3.84 MHz | -60 |
| Information Data Rate | Kbps | 12.3 |

Table 8.11: Performance requirements in multipath Case 1 channel

| Test Number | $\frac{\hat{I}_{or}}{I_{oc}}$ [dB] | BLER |
|-------------|------------------------------------|-----------|
| 1 | 8.4 | 10^{-2} |

8.5 Power control in downlink

Power control in the downlink is the ability of the UE receiver to converge to the required link quality set by the network while using minimum downlink power.

8.5.1 Power control in downlink, constant BLER target

8.5.1.1 Minimum requirements 3.84 Mcps TDD option

For the parameters specified in Table 8.12 the downlink \hat{I}_{or}/I_{oc} averaged over one timeslot shall be below the specified value in Table 8.13 more than 90% of the time. BLER shall be as shown in Table 8.13. Downlink power control is ON during the test.

Table 8.12: Test parameters for downlink power control – constant BLER Target (3.84 Mcps TDD option)

| Parameter | Unit | Test 1 |
|--|--------------|--------|
| $\frac{DPCH_E_c}{I_{or}}$ | dB | 0 |
| I_{oc} | dBm/3.84 MHz | -60 |
| Information Data Rate | kbps | 12.2 |
| Target quality value on DTCH | BLER | 0.01 |
| Propagation condition | | Case 1 |
| DL Power Control step size, Δ_{TPC} | dB | 1 |
| Maximum_DL_power * | dB | 0 |
| Minimum_DL_power * | dB | -27 |
| *Note: Refer to TS 25.224 for description and definition | | |

Table 8.13: Requirements for downlink power control – constant BLER Target (3.84 Mcps TDD option)

| Parameter | Unit | Test 1 |
|--------------------------|------|-----------------|
| \hat{I}_{or}/I_{oc} | dB | 8.5 |
| Measured quality on DTCH | BLER | $0.01 \pm 30\%$ |

8.5.1.2 Minimum requirements 1.28 Mcps TDD option

For the parameters specified in Table 8.13A the downlink \hat{I}_{or}/I_{oc} averaged over one timeslot, shall be below the specified value in Table 8.13B more than 90% of the time. BLER shall be as shown in table 8.13B. Downlink power control is ON during the test.

Table 8.13A: Test parameters for downlink power control – constant BLER Target (1.28 Mcps TDD option)

| Parameter | Unit | Value |
|--|--------------|--------|
| $\frac{\Sigma DPCH - E_c}{I_{or}}$ | dB | 0 |
| I_{oc} | dBm/1.28 Mhz | -60 |
| Information data rate | kbps | 12.2 |
| Target quality on DTCH | BLER | 0.01 |
| Propagation condition | | Case 1 |
| DL Power Control step size, Δ_{TPC} | dB | 1 |
| Maximum_DL_power * | dB | 0 |
| Minimum_DL_power * | dB | -27 |

NOTE: Power is compared to P-CCPCH power

Table 8.13B: Requirements for downlink power control – constant BLER Target (1,28 Mcps TDD option)

| Parameter | Unit | Value |
|--------------------------|------|----------|
| \hat{I}_{or}/I_{oc} | dB | 7.5 |
| Measured quality on DTCH | BLER | 0.01±30% |

8.6 Uplink Power Control for 3.84 Mcps TDD Option

Power control in the uplink is the ability of the UE to converge to the required link quality set by the network while using minimum uplink power.

8.6.1 Test Conditions

During period T1, the PCCPCH and a second Beacon Channel are transmitted in the DL in designated slots within each frame and at the same power level.

The UE transmits, using the channel of TS25.105, Annex A.2.1 UL reference measurement channel (12.2 kbps) in one UL slot. For different parts of the test, different UL slots will be designated.

The values of table 8.14, period T1 shall be selected. Then, with the received PCCPCH and Beacon power set at –60 dBm, the value of DPCH constant value shall be adjusted so that the mean UE output power is 5 dBm. These conditions are held steady during period T1.

Periods T1 and T2 are each 5 seconds long.

Table 8.14: UL Power Control Test Conditions

| | | Period T1 | Period T2 |
|-------------------------------------|----------------------|-----------|-----------------------------------|
| I_{BTS} all slots | dBm | | -60 |
| PCCPCH Power -Broadcast | dBm | | 18 |
| PCCPCH power - Received | dBm | -60 | -70 |
| Mean UE transmit power | dBm | 5 | According to tables 8.15 and 8.16 |
| SIR_{TARGET} | dB | | 6 |
| I_{oc} in PCCPCH and Beacon Slots | dBm | | -60 |
| IE (information element) Alpha | As defined in 25.331 | | 1.0 |
| PCCPCH slot position | Integer 0 –14 | | 0 |
| Beacon slot position | Integer 0-14 | | 8 |

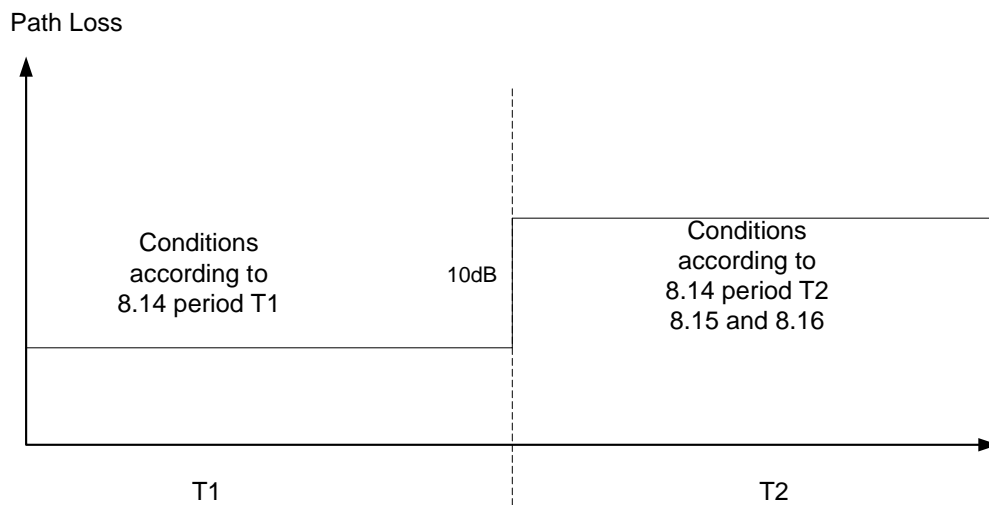

Figure 8.1

8.6.2 Performance

At the end of period T1, the PCCPCH and Beacon Received power shall be simultaneously decreased by 10 dB. These conditions are summarized in table 8.14, period T2.

For the first frame including the change in received power the UE output power shall satisfy the values in table 8.15.

For the 20th frame after the change in received power the UE output power shall satisfy the values in table 8.16.

Table 8.15: Required UE Output Power, Frame Containing Power Level Change

| Parameter | Units | Value | |
|-------------------------------|-------|---------|--------|
| UL transmission slot position | | 1,9 | 7,14 |
| UE output power | dBm | 15 ±4.0 | 5 ±0.5 |

Table 8.16: Required UE Output Power, 20 Frames after Power Level Change

| Parameter | Units | Value | |
|-------------------------------|-------|---------|---------|
| UL transmission slot position | | 1,9 | 7,14 |
| UE output power | dBm | 15 ±4.0 | 15 ±4.0 |

9 Performance requirements (HSDPA)

9.1 Performance requirement for 3.84 Mcps TDD option

The requirements are stated for the HSDPA UE reference combination classes specified in [2] and under the multipath propagation conditions specified in Annex B. The performance metric for HS-DSCH requirements in multi-path propagation conditions is the throughput R measured on HS-DSCH.

9.1.1 HS-DSCH throughput for fixed reference channels

The performance requirements in this subclause apply for the reference measurement channels specified in Annex A.3.2.

During the Fixed Reference Channel tests the behaviour of the Node-B emulator in response to the ACK/NACK signalling field of the HS-SICH is specified in Table 9.1:

Table 9.1: Node-B Emulator Behaviour in response to ACK/NACK/DTX

| HS-SICH ACK/NACK Field State | Node-B Emulator Behaviour |
|------------------------------|---|
| ACK | ACK: new transmission using 1 st redundancy version (RV) |
| NACK | NACK: retransmission using the next RV (up to the maximum permitted number or RV's) |
| DTX | DTX: retransmission using the RV previously transmitted to the same H-ARQ process |

9.1.1.1 Minimum requirement QPSK, Fixed Reference Channel, 7,3 Mbps – Category 8 - UE

For the parameters specified in Table 9.2, the measured throughput R shall exceed the throughput specified in Table 9.3 for each radio condition.

Table 9.2: Test parameters for fixed reference measurement channel requirements for 7,3 Mbps – Category 8 - UE (3,84 Mcps TDD Option) QPSK

| Parameters | Unit | Test 1 | Test 2 | Test 3 | Test 4 |
|--|---|----------------------------|--------|--------|--------------------|
| HS-PDSCH Modulation | - | QPSK | | | |
| Scrambling code and basic midamble code number* | - | 0, 1 | | | |
| Number of TS | - | 8 | | | |
| HS-PDSCH Channelization Codes* | C(k,Q) | C(i,16) i=1..16 | | | C(i,16) i=1..14 |
| Number of Hybrid ARQ processes | - | 4 | | | |
| Maximum number of Hybrid ARQ transmissions | - | 4 | | | |
| Redundancy and constellation version coding sequence** | - | {0,0,0,0} s=1, R=0, b=0 | | | |
| $\frac{HS - PDSCH - E_c}{I_{or}}$ | dB | -12,04 | | | -11.46 |
| $\frac{\sum HS - PDSCH - E_c}{I_{or}}$ | dB | 0 | | | |
| I_{oc} | dBm/3,84 MHz | -60 | | | |
| Note *: | Refer to TS 25.223 for definition of channelization codes, scrambling code and basic midamble code. | | | | |
| Note **: | This sequence implies Chase combining | | | | |

Table 9.3: Performance requirements for fixed reference measurement channel requirement in multipath channels for 7,3 Mbps – Category 8 - UE (3,84 Mcps TDD Option) QPSK

| Test Number | Propagation conditions | $\frac{\hat{I}_{or}}{I_{oc}}$ [dB] | R (Throughput) [kbps] |
|-------------|------------------------|------------------------------------|-----------------------|
| 1 | PA3 | 8,5 | 1300 |
| 2 | PB3 | 9,0 | 1300 |
| 3 | VA30 | 9,75 | 1300 |
| 4 | VA120 | 11,5 | 1400 |

9.1.1.2 Minimum requirement 16QAM, Fixed Reference Channel, 7,3 Mbps – Category 8 - UE

For the parameters specified in Table 9.4, the measured throughput R shall exceed the throughput specified in Table 9.5 for each radio condition.

Table 9.4: Test parameters for fixed reference measurement channel requirements for 7,3 Mbps – Category 8 - UE (3,84 Mcps TDD Option) 16QAM

| Parameters | Unit | Test 1 | Test 2 | Test 3 | Test 4 |
|---|--------------|-----------------------|--------|--------|--------------------|
| HS-PDSCH Modulation | - | 16QAM | | | |
| Scrambling code and basic midamble code number* | - | 0, 1 | | | |
| Number of TS | - | 8 | | | |
| HS-PDSCH Channelization Codes* | C(k,Q) | C(i,16) i=1..16 | | | C(i,16) i=1..14 |
| Number of Hybrid ARQ processes | - | 4 | | | |
| Maximum number of Hybrid ARQ transmissions | - | 4 | | | |
| Redundancy and constellation version coding sequence** | - | {0,0,0,0} s=1, r=0 | | | |
| $\frac{HS - PDSCH - E_c}{I_{or}}$ | dB | -12,04 | | | -11,46 |
| $\sum \frac{HS - PDSCH - E_c}{I_{or}}$ | dB | 0 | | | |
| I_{oc} | dBm/3,84 MHz | -60 | | | |
| Note *: Refer to TS 25.223 for definition of channelization codes, scrambling code and basic midamble code. | | | | | |
| Note **: This sequence implies Chase combining | | | | | |

Table 9.5: Performance requirements for fixed reference measurement channel requirement in multipath channels for 7,3 Mbps – Category 8 - UE (3,84 Mcps TDD Option) 16QAM

| Test Number | Propagation conditions | $\frac{\hat{I}_{or}}{I_{oc}}$ [dB] | R (Throughput) [kbps] |
|-------------|------------------------|------------------------------------|-----------------------|
| 1 | PA3 | 16,0 | 2600 |
| 2 | PB3 | 17,5 | 2600 |
| 3 | VA30 | 18,5 | 2600 |
| 4 | VA120 | 14,5 | 1600 |

9.1.2 HS-DSCH throughput for Variable Reference Channels

9.1.2.1 Minimum requirement Variable Reference Channel, 7,3 Mbps – Category 8 - UE

For the parameters specified in Table 9.6 the measured throughput R shall exceed the throughput specified in Table 9.7 for each radio condition. The Variable Reference Channel is specified in Annex A.3.3.

Table 9.6: Test parameters for variable reference measurement channel requirements for 7,3 Mbps – Category 8 - UE (3,84 Mcps TDD Option)

| Parameters | Unit | Test 1 | Test 2 | Test 3 | Test 4 |
|---|----------------|--------------------|--------|--------|--------|
| Scrambling code and basic midamble code number* | - | 0, 1 | | | |
| Number of TS | - | 8 | | | |
| HS-PDSCH Channelization Codes* | C(k,Q) | C(i,16) i=1..16 | | | |
| Number of Hybrid ARQ processes** | - | 4 | | | |
| Maximum number of Hybrid ARQ transmissions | - | 1 | | | |
| Redundancy and constellation version coding sequence | (Xrv, s, r, b) | (0, 1, 0, 0) | | | |
| HS-PDSCH _i Ec/Ior | dB | -12,04 | | | |
| $\frac{\sum_{i=1}^i HS - PDSCH - Ec_i}{I_{or}}$ | dB | 0 | | | |
| I _{oc} | dBm/3,84MHz | -60 | | | |
| Note *: Refer to TS 25.223 for definition of channelization codes, scrambling code and basic midamble code. | | | | | |
| Note **: For timing requirements, HARQ is not active | | | | | |

Table 9.7: Performance requirements for variable reference measurement channel requirement in multipath channels for 7,3 Mbps – Category 8 - UE (3,84 Mcps TDD Option)

| Test Number | Propagation conditions | $\frac{\hat{I}_{or}}{I_{oc}}$ [dB] | R (Throughput) [kbps] |
|-------------|------------------------|------------------------------------|-----------------------|
| 1 | PA3 | 8,8 | 1240 |
| | | 14,8 | 2500 |
| | | 18,8 | 3600 |
| | | 24,8 | 5000 |
| 2 | PB3 | 8,8 | 1220 |
| | | 14,8 | 2430 |
| | | 20,8 | 4030 |
| | | 24,8 | 5080 |
| 3 | VA30 | 10,1 | 1190 |
| | | 16,1 | 2290 |
| | | 20,1 | 3220 |
| | | 24,1 | 4260 |
| 4 | VA120 | 7,1 | 590 |
| | | 11,1 | 1180 |
| | | 15,1 | 1840 |
| | | 19,1 | 2390 |

9.1.3 Reporting of Channel Quality Indicator

The reporting accuracy of channel quality indicator (CQI) under AWGN environments is determined by the reporting variance and BLER performance using the transport format indicated by the reported median CQI.

9.1.3.1 Minimum requirement Channel Quality Indicator, 7,3 Mbps – Category 8 - UE

For the parameters specified in Table 9.7A the reported CQI value shall be within the range of +/- 10 of the allowable CQIs of the reported median CQI more than 90% of the time. The BLER for the reported median CQI shall be less than 10%.

Table 9.7A: Test parameters for variable reference measurement channel requirements for 7,3 Mbps – Category 8 - UE (3,84 Mcps TDD Option)

| Parameters | Unit | Test 1 | Test 2 |
|--|---|--------------------|--------|
| Scrambling code and basic midamble code number* | - | 0, 1 | |
| Number of TS | - | 8 | |
| HS-PDSCH Channelization Codes* | C(k,Q) | C(i,16) i=1..16 | |
| Number of Hybrid ARQ processes** | - | 4 | |
| Maximum number of Hybrid ARQ transmissions | - | 1 | |
| Redundancy and constellation version coding sequence | (Xrv, s, r, b) | (0, 1, 0, 0) | |
| HS-PDSCH _i Ec/Ior | dB | -12,04 | |
| $\frac{\sum_{i=1}^i HS - PDSCH - Ec_i}{I_{or}}$ | dB | 0 | |
| \hat{I}_{or} / I_{oc} | dB | 5 | 10 |
| I _{oc} | dBm/3,84MHz | -60 | |
| Note*: | Refer to TS 25.223 for definition of channelization codes, scrambling code and basic midamble code. | | |
| Note**: | For timing requirements, HARQ is not active | | |

9.2 Performance requirements for 1.28 Mcps TDD option

The requirements are stated for the HSDPA UE reference combination classes specified in [2] and under the multipath propagation conditions specified in Annex B. The performance metric for HS-DSCH requirements in multi-path propagation conditions is the throughput R measured on HS-DSCH.

9.2.1 HS-DSCH throughput for fixed reference channels

The performance requirements in this subclause apply for the reference measurement channels specified in Annex A.3.2.

During the Fixed Reference Channel tests the behaviour of the Node-B emulator in response to the ACK/NACK signalling field of the HS-SICH is specified in Table 9.8

Table 9.8: Node-B Emulator Behaviour in response to ACK/NACK/DTX

| HS-SICH ACK/NACK Field State | Node-B Emulator Behaviour |
|------------------------------|---|
| ACK | ACK: new transmission using 1 st redundancy version (RV) |
| NACK | NACK: retransmission using the next RV (up to the maximum permitted number or RV"s) |
| DTX | DTX: retransmission using the RV previously transmitted to the same H-ARQ process |

9.2.1.1 Minimum requirement QPSK, Fixed Reference Channel, 1.4 Mbps UE class

For the parameters specified in Table 9.9, the measured throughput R shall exceed the throughput specified in Table 9.10 for each radio condition.

Table 9.9: Test parameters for fixed reference measurement channel requirements for 1.4 Mbps UE class (1.28 Mcps TDD Option) QPSK

| Parameters | Unit | Test 1 | Test 2 | Test 3 | Test 4 |
|--|--------------|--------------------|--------|--------|--------|
| HS-PDSCH Modulation | - | QPSK | | | |
| Scrambling code and basic midamble code number* | - | 0 | | | |
| Number of TS | - | 4 | | | |
| HS-PDSCH Channelization Codes* | C(k,Q) | C(i,16) i=1..10 | | | |
| Number of Hybrid ARQ processes | - | 4 | | | |
| Maximum number of Hybrid ARQ transmissions | - | 4 | | | |
| Redundancy and constellation version coding sequence | - | {0,0,0,0} | | | |
| $\frac{HS - PDSCH - E_c}{I_{or}}$ | dB | -10 | | | |
| I_{oc} | dBm/1.28 MHz | -60 | | | |
| *Note: Refer to TS 25.223 for definition of channelization codes, scrambling code and basic midamble code. | | | | | |

Table 9.10: Performance requirements for fixed reference measurement channel requirement in multipath channels for 1.4 Mbps UE class (1.28 Mcps TDD Option) QPSK

| Test Number | Propagation conditions | $\frac{\hat{I}_{or}}{I_{oc}}$ [dB] | R (Throughput) [kbps] |
|-------------|------------------------|------------------------------------|-----------------------|
| 1 | PA3 | 10 | 375 |
| 2 | PB3 | 10 | 378 |
| 3 | VA30 | 10 | 338 |
| 4 | VA120 | 10 | 281 |

9.2.1.2 Minimum requirement 16QAM, Fixed Reference Channel, 1.4 Mbps UE class

For the parameters specified in Table 9.11, the measured throughput R shall exceed the throughput specified in Table 9.12 for each radio condition.

Table 9.11: Test parameters for fixed reference measurement channel requirements for 1.4 Mbps UE class (1.28 Mcps TDD Option) 16QAM

| Parameters | Unit | Test 1 | Test 2 | Test 3 | Test 4 |
|--|--------------|-------------------|--------|--------|--------|
| HS-PDSCH Modulation | - | 16QAM | | | |
| Scrambling code and basic midamble code number* | - | 0 | | | |
| Number of TS | - | 4 | | | |
| HS-PDSCH Channelization Codes* | C(k,Q) | C(i,16) i=1..9 | | | |
| Number of Hybrid ARQ processes | - | 4 | | | |
| Maximum number of Hybrid ARQ transmissions | - | 4 | | | |
| Redundancy and constellation version coding sequence | - | {6,2,1,5} | | | |
| $\frac{HS - PDSCH - E_c}{I_{or}}$ | dB | -9.5 | | | |
| I_{oc} | dBm/1.28 MHz | -60 | | | |
| *Note: Refer to TS 25.223 for definition of channelization codes, scrambling code and basic midamble code. | | | | | |

Table 9.12: Performance requirements for fixed reference measurement channel requirement in multipath channels for 1.4 Mbps UE class (1.28 Mcps TDD Option) 16QAM

| Test Number | Propagation conditions | $\frac{\hat{I}_{or}}{I_{oc}}$ [dB] | R (Throughput) [kbps] |
|-------------|------------------------|------------------------------------|-----------------------|
| 1 | PA3 | 10 | 379 |
| 2 | PB3 | 10 | 353 |
| 3 | VA30 | 10 | 326 |
| 4 | VA120 | 10 | 289 |

9.2.2 HS-DSCH throughput for Variable Reference Channels

9.2.2.1 Minimum requirement, Variable Reference Channel - 1.4 Mbps UE class

For the parameters specified in Table 9.13 the measured throughput R shall exceed the throughput specified in Table 9.14 for each radio condition. The Variable Reference Channel is specified in Annex A.3.3.

Table 9.13: Test parameters for variable reference measurement channel requirements for 1.4 Mbps UE class (1.28 Mcps TDD Option)

| Parameters | Unit | Test 1 | Test 2 | Test 3 | Test 4 | Test 5 | Test 6 |
|--|---|--------------------|--------|--------|--------------------|--------|--------|
| HS-PDSCH Modulation and transport block size | - | * See note 1 | | | | | |
| Scrambling code and basic midamble code number * See note 2 | - | 0 | | | | | |
| Number of TS | - | 4 | | | | | |
| Number of DPCH ₀ per timeslot | - | 0 | | | 7 | | |
| Number of HS-PDSCH codes per timeslot | - | 10 | | | 3 | | |
| HS-PDSCH Channelization Codes * See note 2 | C(k,Q) | C(i,16) i=1..10 | | | C(l,16) l=1,..3 | | |
| Number of Hybrid ARQ processes | - | 4 | | | | | |
| Maximum number of Hybrid ARQ transmissions | - | 1 | | | | | |
| Redundancy and constellation version coding sequence | Xrv | 0 | | | | | |
| $\frac{HS - PDSCH - E_c}{I_{or}}$ | dB | -10 | | | -10 | | |
| I_{oc} | dBm/1.28 MHz | -60 | | | | | |
| Note 1) | As requested by the last received CQI report | | | | | | |
| Note 2) | Refer to TS 25.223 for definition of channelization codes, scrambling code and basic midamble code. | | | | | | |
| Note 3) | If the indicated CQI is 0, the Node-B emulator shall format the next HS-PDSCH transmission with the transport block size and the modulation scheme that were previously used. | | | | | | |

Table 9.14: Performance requirements for variable reference measurement channel requirement in multipath channels for 1.4 Mbps UE class (1.28 Mcps TDD Option)

| Test Number | Propagation conditions | $\frac{\hat{I}_{or}}{I_{oc}}$ [dB] | R (Throughput) [kbps] |
|-------------|------------------------|------------------------------------|-----------------------|
| 1 | PA3 | 10 | 445 |
| 2 | PB3 | 10 | 446 |
| 3 | VA30 | 10 | 271 |
| 4 | PA3 | 8 | 98 |
| 5 | PB3 | 8 | 100 |
| 6 | VA30 | 8 | 64 |

9.2.3 Reporting of Channel Quality Indicator

The reporting accuracy of channel quality indicator (CQI) under AWGN environments is determined by the reporting variance and the BLER performance using the transport format indicated by the reported CQI median.

9.2.3.1 Minimum Requirement, Channel Quality Indicator – 1.4Mbps UE class

For the parameters specified in Table 9.15, the reported CQI value shall be within +/- x, as specified in Table 9.16, of the reported median CQI for more than Y%, also specified in Table 9.16, of the time.

Table 9.15: Test parameters for CQI reporting measurement channel requirements for 1.4 Mbps UE class (1.28 Mcps TDD Option)

| Parameter | Unit | Value | | | |
|---------------------------------------|--------|------------------|------------------|-------------------|-------------------|
| | | Test1 | Test2 | Test3 | Test4 |
| Number of TS | - | 4 | 4 | 4 | 4 |
| Number of DPCH _o | | 7 | 7 | 0 | 0 |
| Number of HS-PDSCH codes per timeslot | - | 3 | 3 | 10 | 10 |
| HS-PDSCH _i _Ec/Ior | dB | -10 | -10 | -10 | -10 |
| HS-PDSCH Channelization Codes | C(k,Q) | C(i,16) 1≤i≤3 | C(i,16) 1≤i≤3 | C(i,16) 1≤i≤10 | C(i,16) 1≤i≤10 |
| Number of HARQ processes | - | 4 | | | |
| Maximum number of HARQ transmissions | - | 1 | | | |
| \hat{I}_{or}/I_{oc} | dB | 1 | 8 | 1 | 8 |

Table 9.16: Performance requirements for CQI reporting measurement channel requirements for 1.4 Mbps UE class (1.28 Mcps TDD Option)

| Test | Permitted CQI range from median (x) | % of time that CQI must be within +/- x of median (Y) | Maximum BLER for median reported CQI |
|--------|-------------------------------------|---|--------------------------------------|
| Test 1 | +/- 3 | 90 | 10% |
| Test 2 | +/- 2 | 90 | |
| Test 3 | +/- 3 | 90 | |
| Test 4 | +/- 2 | 90 | |

9.2.4 HS-SCCH Detection Performance

The detection performance of the HS-SCCH is determined by the probability of event E_m , which is declared when the UE is signaled on HS-SCCH, but DTX is observed in the corresponding HS-SICH ACK/NACK field. The probability of event E_m is denoted $P(E_m)$.

9.2.4.1 Minimum Requirements for HS-SCCH Detection

For the test parameters specified in Table 9.17, for each value of HS-SCCH \hat{I}_{or}/I_{oc} specified in Table 9.18 the measured $P(E_m)$ shall be less than or equal to the corresponding specified value of $P(E_m)$.

Table 9.17: Test parameters for HS-SCCH detection (1.28Mcps TDD option)

| Parameter | Unit | Test 1 | Test2 |
|---|-------------|--|-------|
| Number of TS under test | - | 1 | |
| Number of HS-SCCH codes per timeslot | - | 8 (4 x2) | |
| Scrambling code and basic midamble code number* | - | 0 | |
| Number of DPCH ₀ | - | 2 | |
| Number of H-ARQ process | - | 4 | |
| HS-SCCH UE Identity ($x_{ue,1}, x_{ue,2}, \dots, x_{ue,16}$) | - | UE1 = 0000000000000000 (UE1 under test) UE2 = 0101010101010101 UE3 = 1010101010101010 UE4 = 1111111111111111 | |
| HS-SCCH Channelization Codes* | C(k,Q) | C(i,16) 1 ≤ i ≤ 8 | |
| HS-SCCH Channelization Codes for UE under test | C(k,Q) | C(i,16) 1 ≤ i ≤ 2 | |
| DPCH ₀ Channelization Codes | C(k,Q) | C(i,16) 9 ≤ i ≤ 10 | |
| $\frac{HS-SCCH_i - E_c}{I_{or}}$ | dB | -10 | |
| I_{oc} | dBm/1.28MHz | -60 | |
| Note *: Refer to TS 25.223 for definition of channelization codes, scrambling code and basic midamble code. | | | |

Table 9.18: Minimum requirement for HS-SCCH detection (1.28Mcps TDD option)

| Test Number | Propagation Conditions | $\frac{\hat{I}_{or}}{I_{oc}}$ (dB) | $P(E_m)$ |
|-------------|------------------------|------------------------------------|----------|
| 1 | PA3 | 16 | 0.01 |
| 2 | VA30 | 12 | 0.01 |

Annex A (normative): Measurement channels

A.1 General

A.2 Reference measurement channel

A.2.1 UL reference measurement channel (12.2 kbps)

A.2.1.1 3.84 Mcps TDD Option

Table A.1

| Parameter | Value |
|---|-------------|
| Information data rate | 12.2 kbps |
| RU's allocated | 2 RU |
| Midamble | 512 chips |
| Interleaving | 20 ms |
| Power control | 2 Bit/user |
| TFCI | 16 Bit/user |
| Inband signalling DCCH | 2 kbps |
| Puncturing level at Code rate 1/3 : DCH of the DTCH / DCH of the DCCH | 10% / 0% |

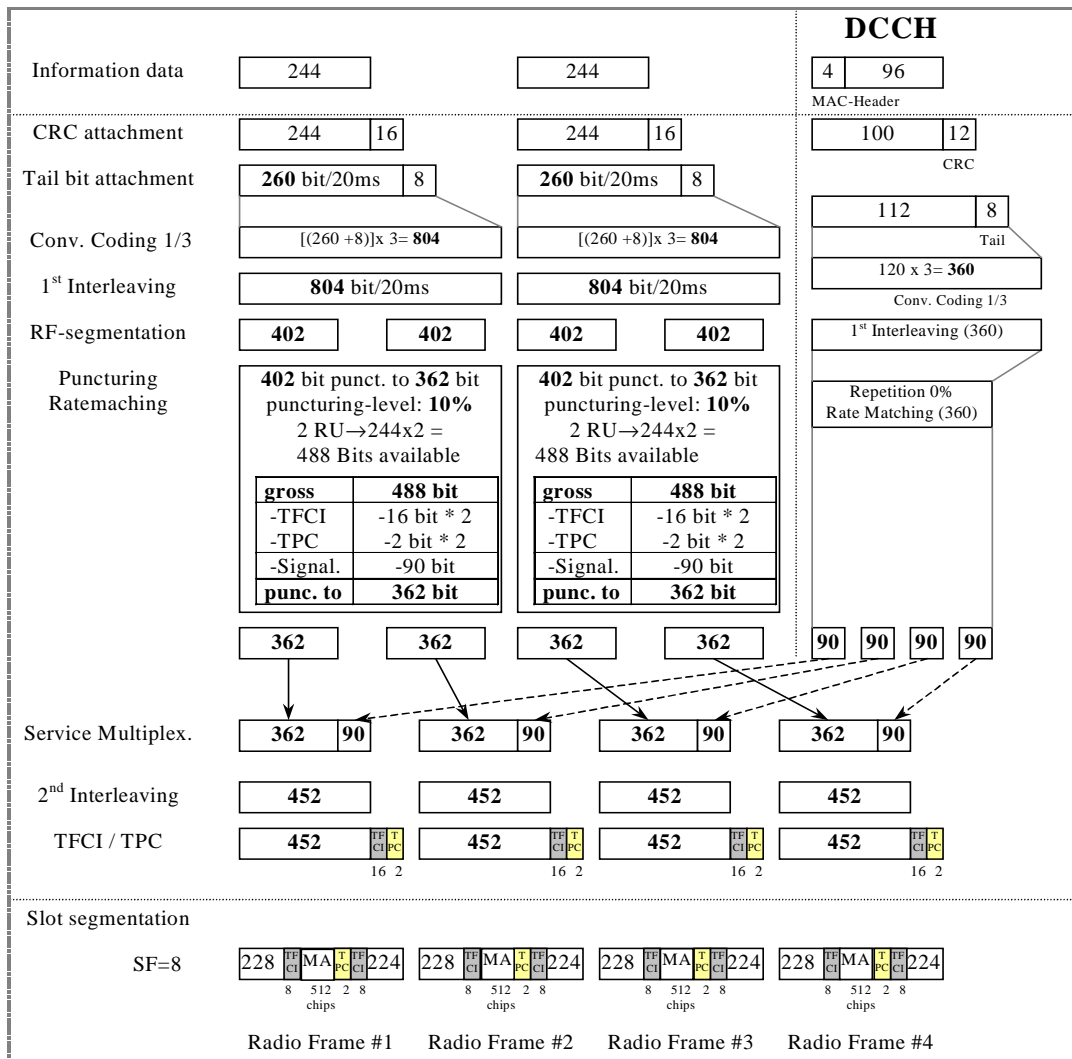

Figure A.1

A.2.1.2 1.28 Mcps TDD Option

Table A.1A

| Parameter | Value |
|---|-----------------------|
| Information data rate | 12.2 kbps |
| RU's allocated | 1TS (1*SF8) = 2RU/5ms |
| Midamble | 144 |
| Interleaving | 20 ms |
| Power control | 4 Bit/user/10ms |
| TFCI | 16 Bit/user/10ms |
| 4 Bit reserved for future use (place of SS) | 4 Bit/user/10ms |
| Inband signalling DCCH | 2.4 kbps |
| Puncturing level at Code rate 1/3 : DCH of the DTCH / DCH of the DCCH | 33% / 33% |

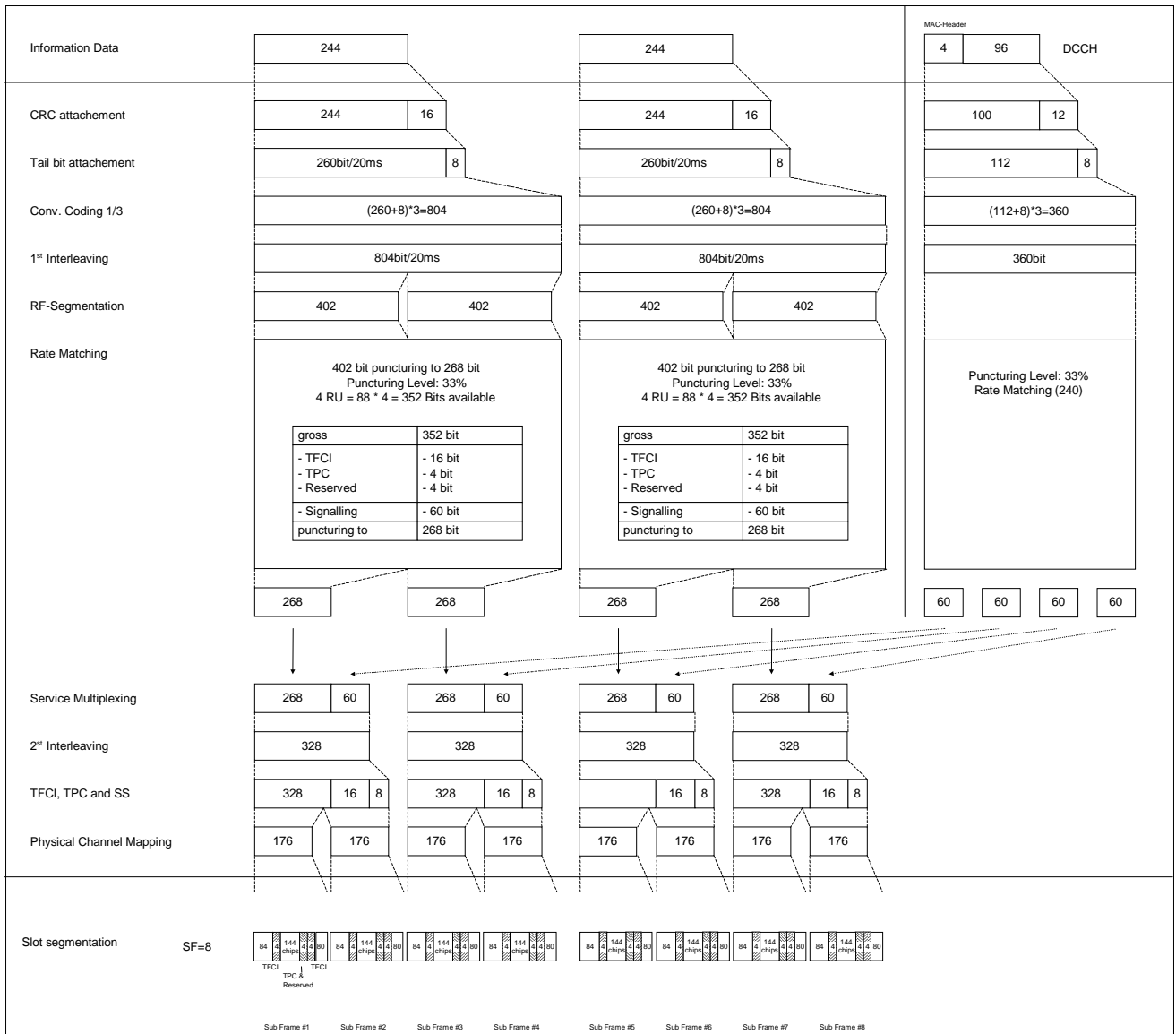

Figure A.1A

A.2.2 DL reference measurement channel (12.2 kbps)

A.2.2.1 3.84 Mcps TDD Option

Table A.2

| Parameter | Value |
|---|-------------|
| Information data rate | 12.2 kbps |
| RU's allocated | 2 RU |
| Midamble | 512 chips |
| Interleaving | 20 ms |
| Power control | 0 Bit/user |
| TFCI | 16 Bit/user |
| Inband signalling DCCH | 2 kbps |
| Puncturing level at Code rate 1/3 : DCH of the DTCH / DCH of the DCCH | 5% / 0 % |

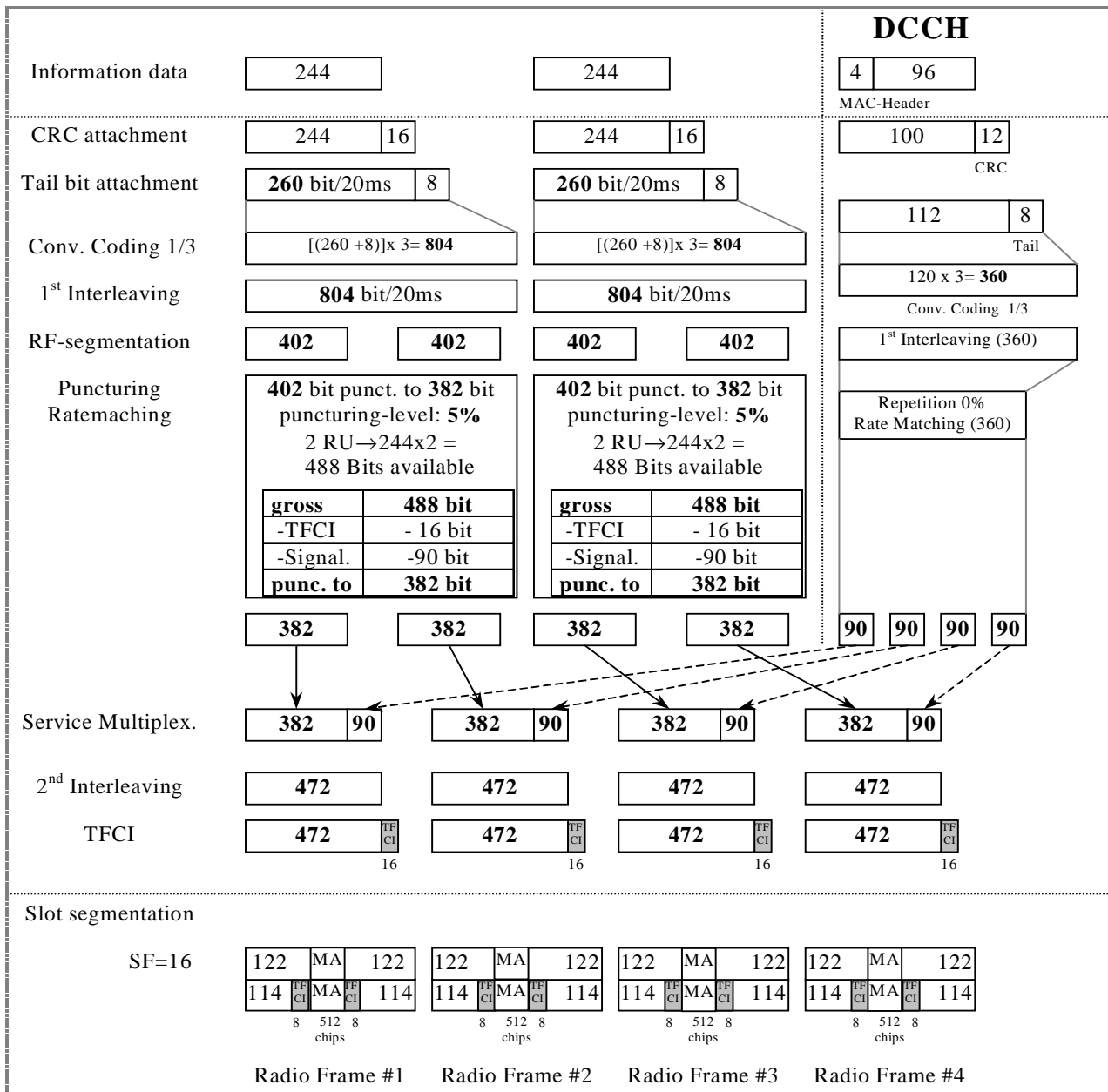

Figure A.2

A.2.2.2 1.28 Mcps TDD Option

Table A.2A

| Parameter | Value |
|--|------------------------|
| Information data rate | 12.2 kbps |
| RU's allocated | 1TS (2*SF16) = 2RU/5ms |
| Midamble | 144 |
| Interleaving | 20 ms |
| Power control (TPC) | 4 Bit/user/10ms |
| TFCI | 16 Bit/user/10ms |
| Synchronisation Shift (SS) | 4 Bit/user/10ms |
| Inband signalling DCCH | 2.4 kbps |
| Puncturing level at Code rate 1/3: DCH of the DTCH / DCH of the DCCH | 33% / 33% |

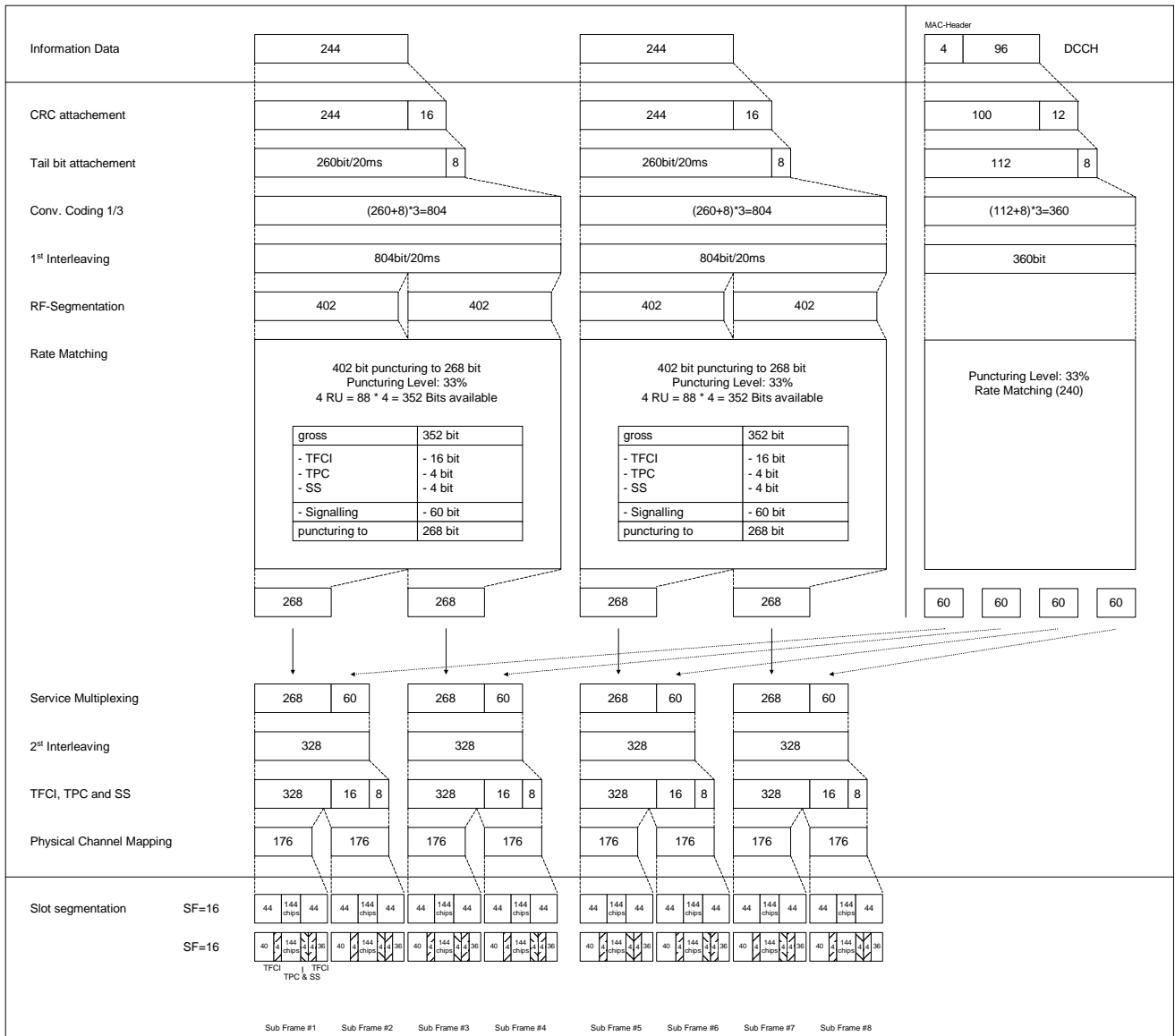

Figure A.2A

A.2.3 DL reference measurement channel (64 kbps)

A.2.3.1 3.84 Mcps TDD Option

Table A.3

| Parameter | Value |
|---|--------------------|
| Information data rate | 64 kbps |
| RU's allocated | 5 codes SF16 = 5RU |
| Midamble | 512 chips |
| Interleaving | 20 ms |
| Power control | 0 Bit/user |
| TFCI | 16 Bit/user |
| Inband signalling DCCH | 2 kbps |
| Puncturing level at Code rate : 1/3 DCH of the DTCH / 1/2 DCH of the DCCH | 41.1% / 10% |

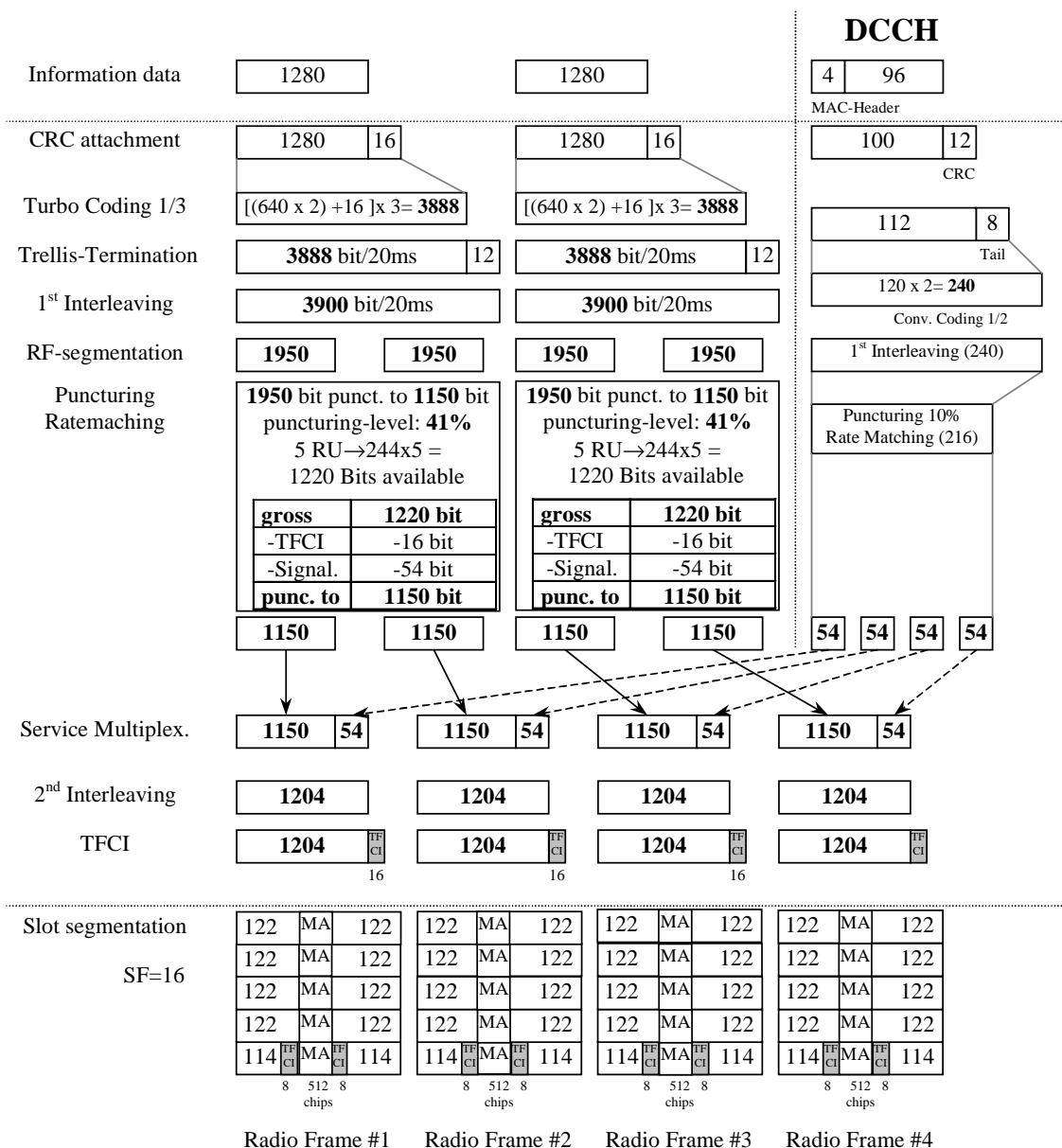

Figure A.3

A.2.3.2 1.28 Mcps TDD Option

Table A.3A

| Parameter | Value |
|--|------------------------|
| Information data rate | 64 kbps |
| RU's allocated | 1TS (8*SF16) = 8RU/5ms |
| Midamble | 144 |
| Interleaving | 20 ms |
| Power control (TPC) | 4 Bit/user/10ms |
| TFCI | 16 Bit/user/10ms |
| Synchronisation Shift (SS) | 4 Bit/user/10ms |
| Inband signalling DCCH | 2.4 kbps |
| Puncturing level at Code rate: 1/3 DCH of the DTCH / 1/2 DCH of the DCCH | 32% / 0 |

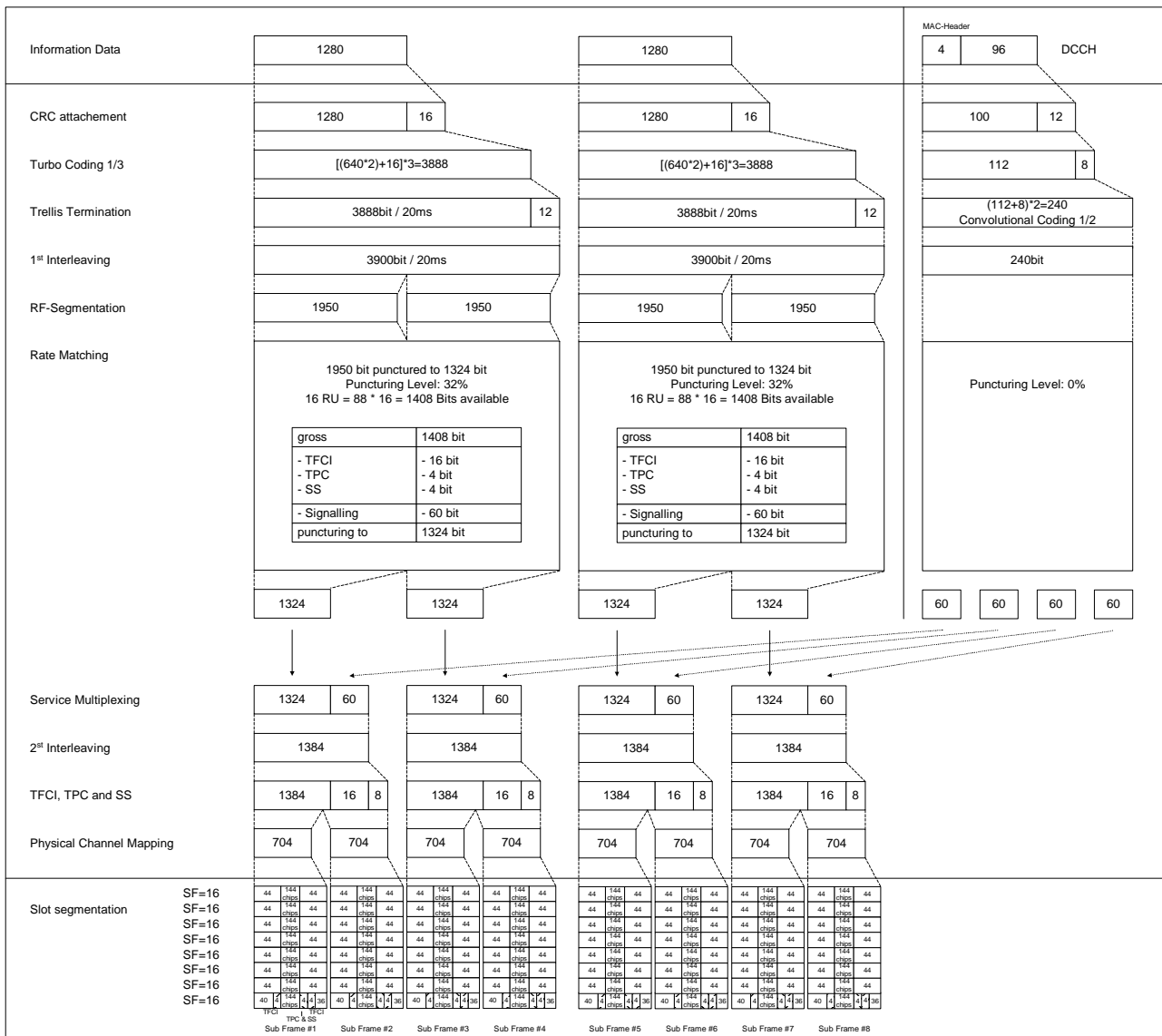

Figure A.3A

A.2.4 DL reference measurement channel (144 kbps)

A.2.4.1 3.84 Mcps TDD Option

Table A.4

| Parameter | Value |
|--|--------------------|
| Information data rate | 144 kbps |
| RU's allocated | 9 codes SF16 = 9RU |
| Midamble | 256 chips |
| Interleaving | 20 ms |
| Power control | 0 Bit/user |
| TFCI | 16 Bit/user |
| Inband signalling DCCH | 2 kbps |
| Puncturing level at Code rate: 1/3 DCH of the DTCH / 1/2 DCH of the DCCH | 44.5% / 16.6% |

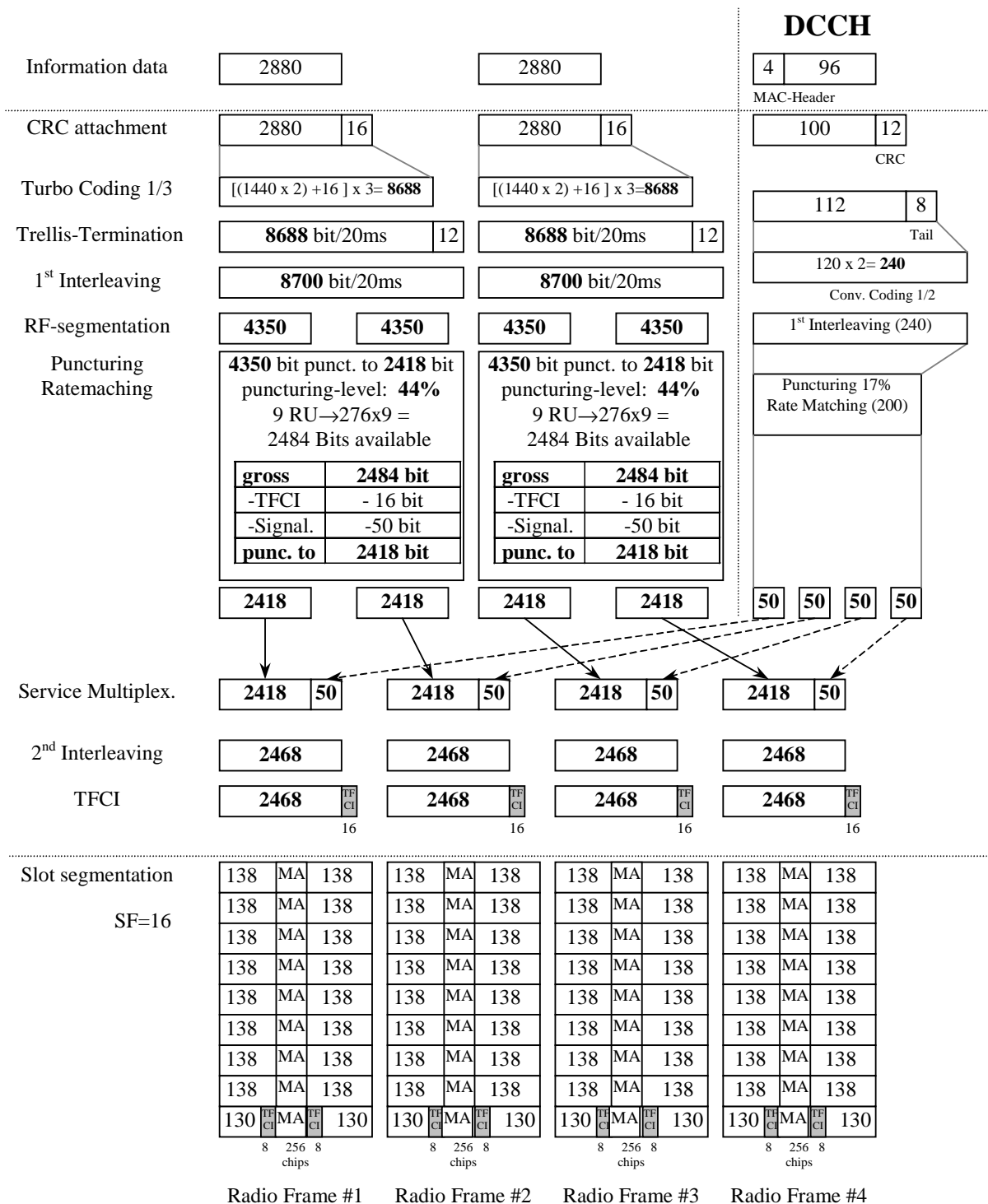

Figure A.4

A.2.4.2 1.28 Mcps TDD Option

Table A.4A

| Parameter | Value |
|--|-------------------------|
| Information data rate | 144 kbps |
| RU's allocated | 2TS (8*SF16) = 16RU/5ms |
| Midamble | 144 |
| Interleaving | 20 ms |
| Power control (TPC) | 8 Bit/user/10ms |
| TFCI | 32 Bit/user/10ms |
| Synchronisation Shift (SS) | 8 Bit/user/10ms |
| Inband signalling DCCH | 2.4 kbps |
| Puncturing level at Code rate: 1/3 DCH of the DTCH / 1/2 DCH of the DCCH | 38% / 7% |

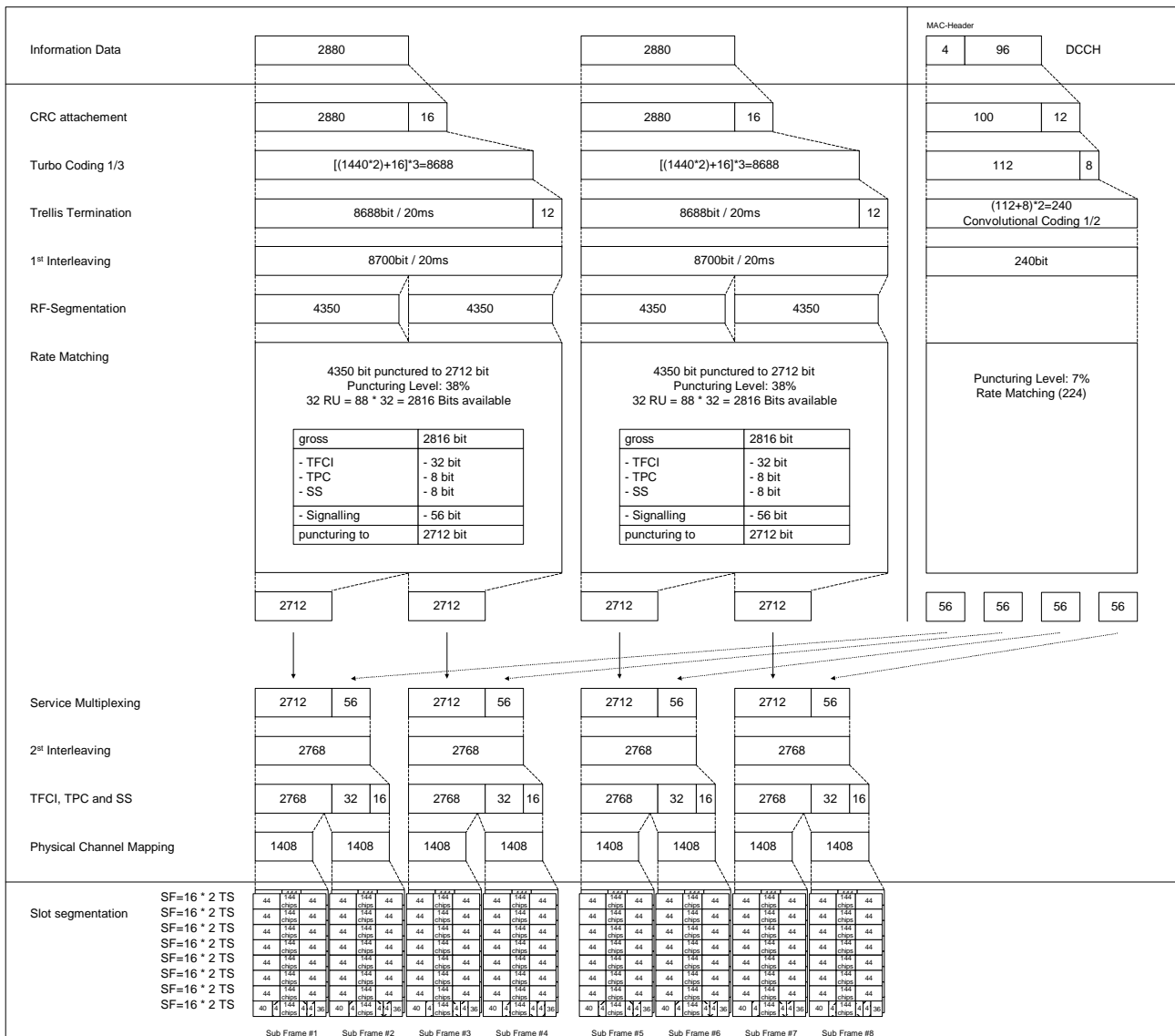

Figure A.4A

A.2.5 DL reference measurement channel (384 kbps)

A.2.5.1 3.84 Mcps TDD Option

Table A.5

| Parameter | Value |
|---|---------------|
| Information data rate | 384 kbps |
| RU's allocated | 8*3TS = 24RU |
| Midamble | 256 chips |
| Interleaving | 20 ms |
| Power control | 0 Bit/user |
| TFCI | 16 Bit/user |
| Inband signalling DCCH | 2 kbps |
| Puncturing level at Code rate : 1/3 DCH of the DTCH / 1/2 DCH of the DCCH | 43.4% / 15.3% |

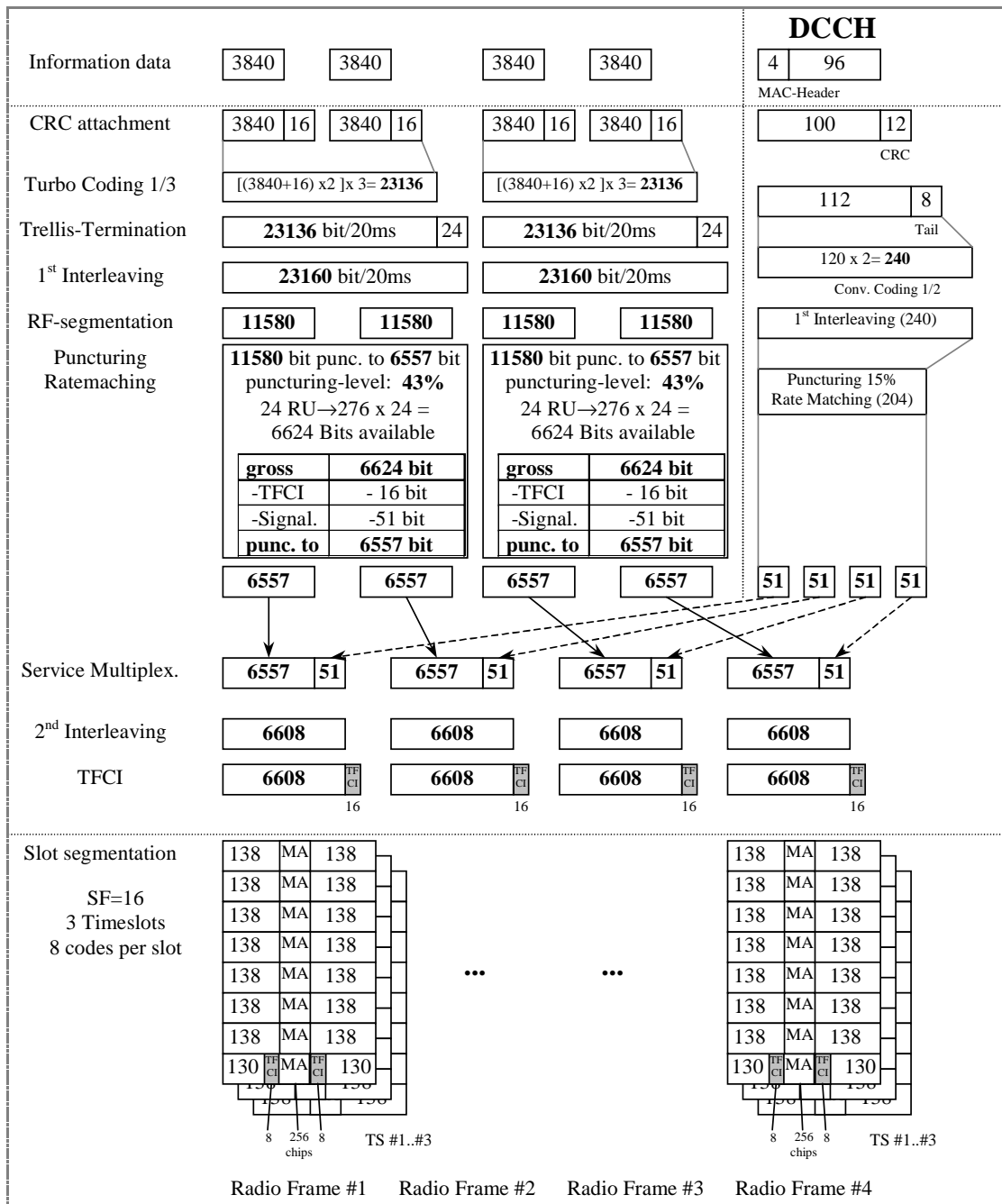

Figure A.5

A.2.5.2 1.28 Mcps TDD Option

Table A.5A

| Parameter | Value |
|--|--------------------------|
| Information data rate | 384 kbps |
| RU's allocated | 4TS (10*SF16) = 40RU/5ms |
| Midamble | 144 |
| Interleaving | 20 ms |
| Power control (TPC) | 16 Bit/user/10ms |
| TFCI | 64 Bit/user/10ms |
| Synchronisation Shift (SS) | 16 Bit/user/10ms |
| Inband signalling DCCH | max.2 kbps |
| Puncturing level at Code rate: 1/3 DCH of the DTCH / 1/2 DCH of the DCCH | 41% / 12% |

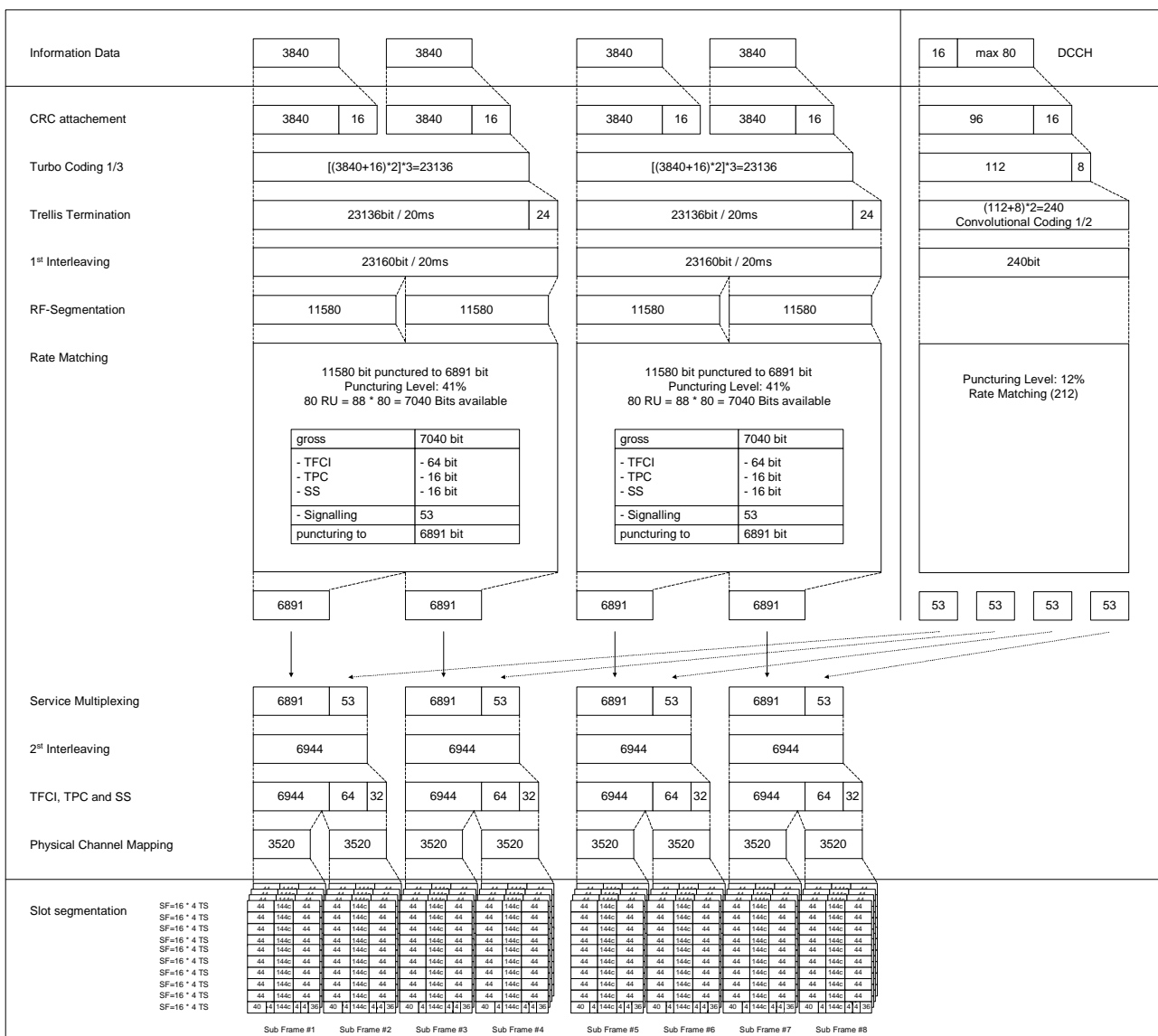

Figure A.5A

A.2.6 BCH reference measurement channel

[mapped to 1 code SF16]

A.2.6.1 3.84 Mcps TDD Option

Table A.6

| Parameter | Value |
|------------------------|-----------|
| Information data rate: | 12.3 kbps |
| RU's allocated | 1 RU |
| Midamble | 512 chips |
| Interleaving | 20 ms |
| Power control | 0 bit |
| TFCI | 0 bit |
| Puncturing level | 10% |

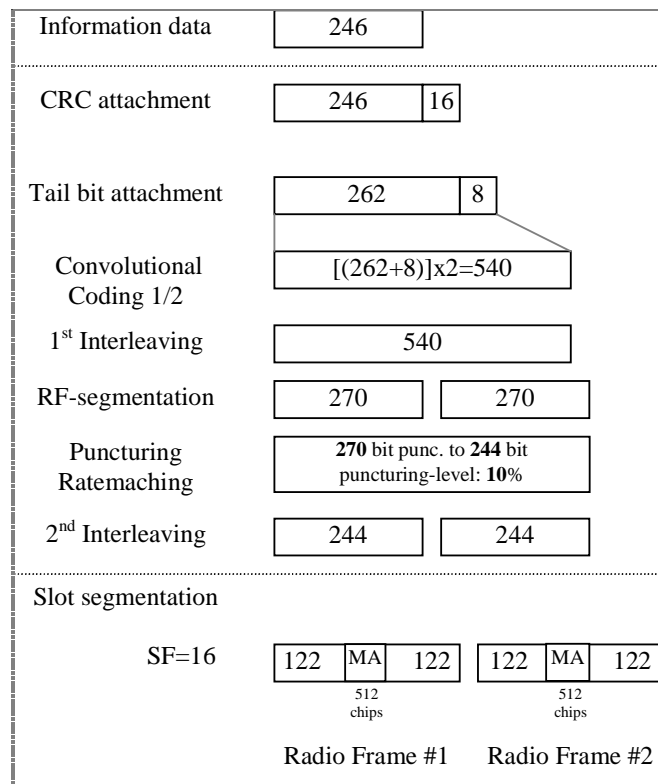

Figure A.6

A.2.6.2 1.28 Mcps TDD Option

Table A.6A

| Parameter | Value |
|------------------------|-----------|
| Information data rate: | 12.3 kbps |
| RU's allocated | 2 RU |
| Midamble | 144 chips |
| Interleaving | 20 ms |
| Power control | 0 bit |
| TFCI | 0 bit |
| Puncturing level | 13% |

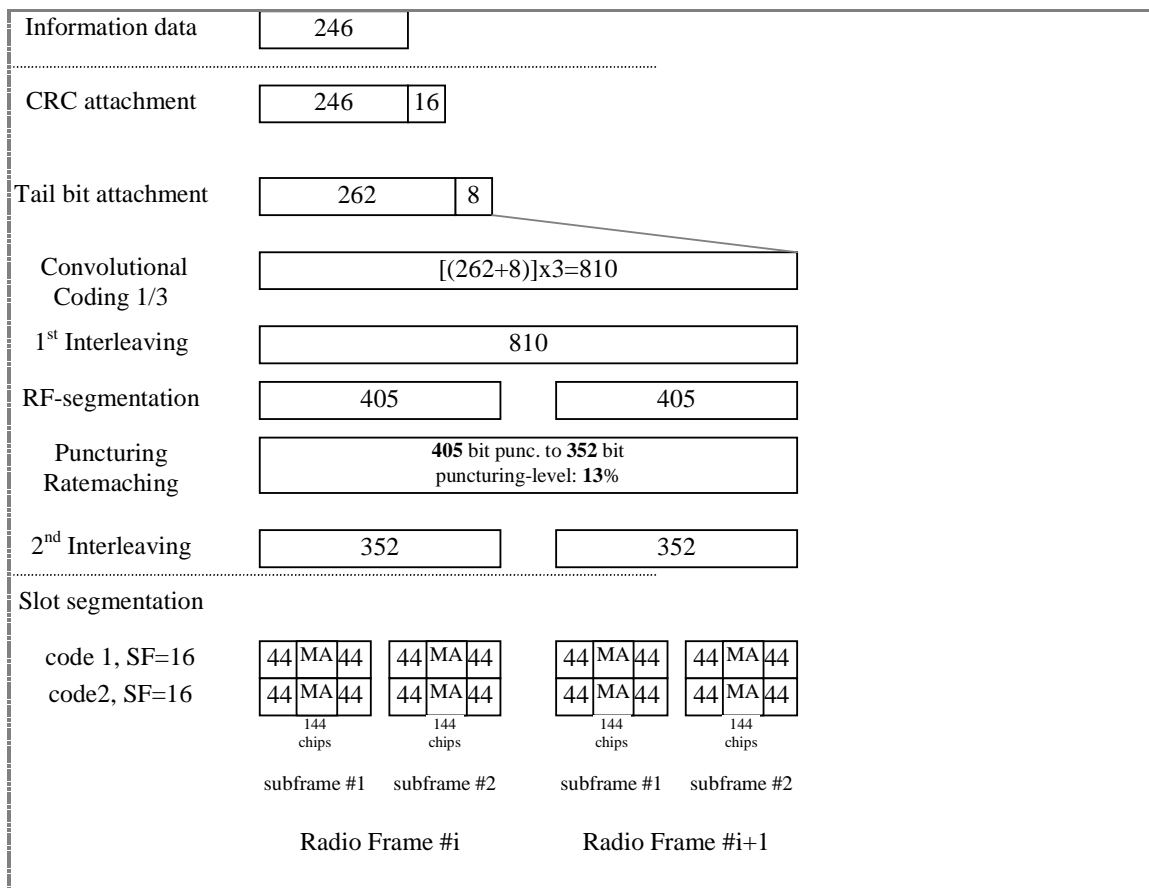

Figure A.6A

A.2.7 UL multi code reference measurement channel (12.2 kbps)

A.2.7.1 3.84 Mcps TDD Option

Table A.7

| Parameter | Value |
|---|-------------|
| Information data rate | 12.2 kbps |
| RU's allocated | 2 RU |
| Midamble | 512 chips |
| Interleaving | 20 ms |
| Power control | 2 Bit/user |
| TFCI | 16 Bit/user |
| Inband signalling DCCH | 2 kbps |
| Puncturing level at Code rate 1/3 : DCH of the DTCH / DCH of the DCCH | 5% / 0 % |

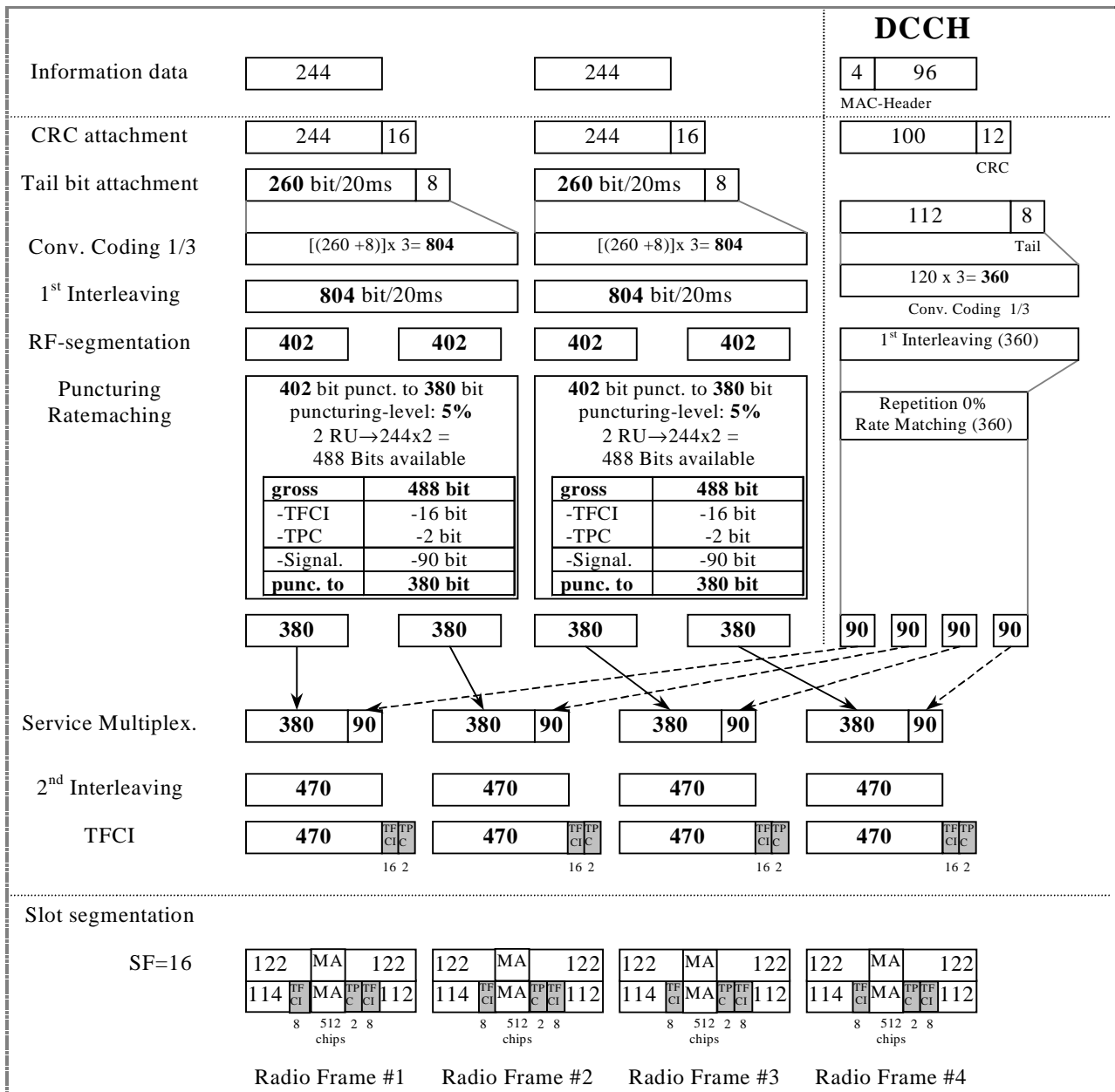

Figure A.7

A.2.7.2 1.28 Mcps TDD Option

Table A.7A

| Parameter | Value |
|--|------------------------|
| Information data rate | 12.2 kbps |
| RU's allocated | 1TS (2*SF16) = 2RU/5ms |
| Midamble | 144 |
| Interleaving | 20 ms |
| Power control (TPC) | 4 Bit/user/10ms |
| TFCI | 16 Bit/user/10ms |
| 4 Bit reserved for future use (place of SS) | 4 Bit/user/10ms |
| Inband signalling DCCH | 2.4 kbps |
| Puncturing level at Code rate 1/3: DCH of the DTCH / DCH of the DCCH | 33% / 33% |

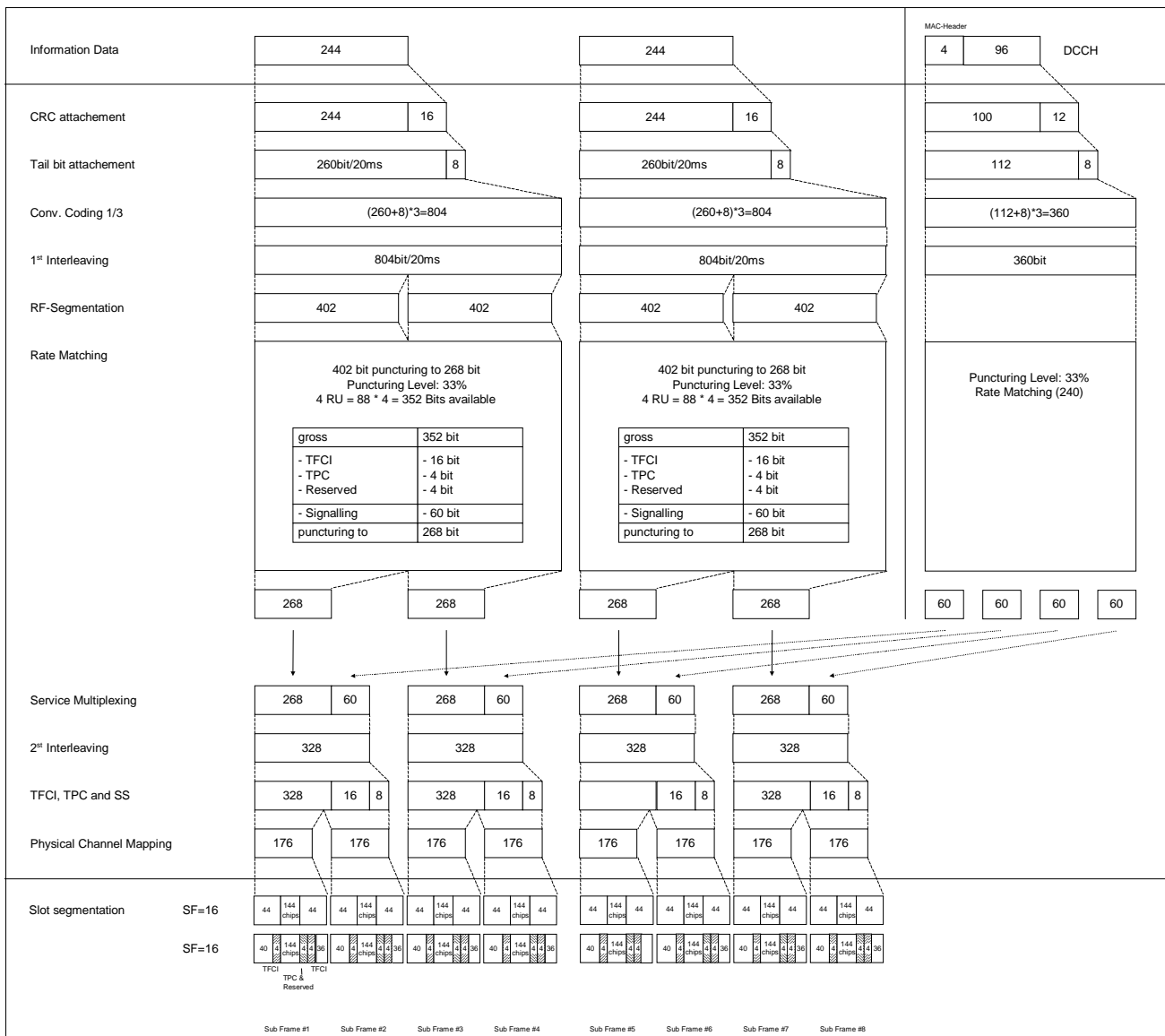

Figure A.7A

A.2.8 DL reference measurement channel (2 Mb/s)

A.2.8.1 3.84 Mcps TDD Option

Table A.8

| Parameter | Value |
|---|-----------------|
| Information data rate | 2048 kbps |
| RU's allocated | 16*12TS = 192RU |
| Midamble | 256 chips |
| Interleaving | 10 ms |
| Power control | 0 Bit/user |
| TFCI | 16 Bit/user |
| Inband signalling DCCH | 2 kbps |
| Puncturing level at Code rate 1/3 : DCH of the DTCH / DCH of the DCCH | 13.9% / 0% |

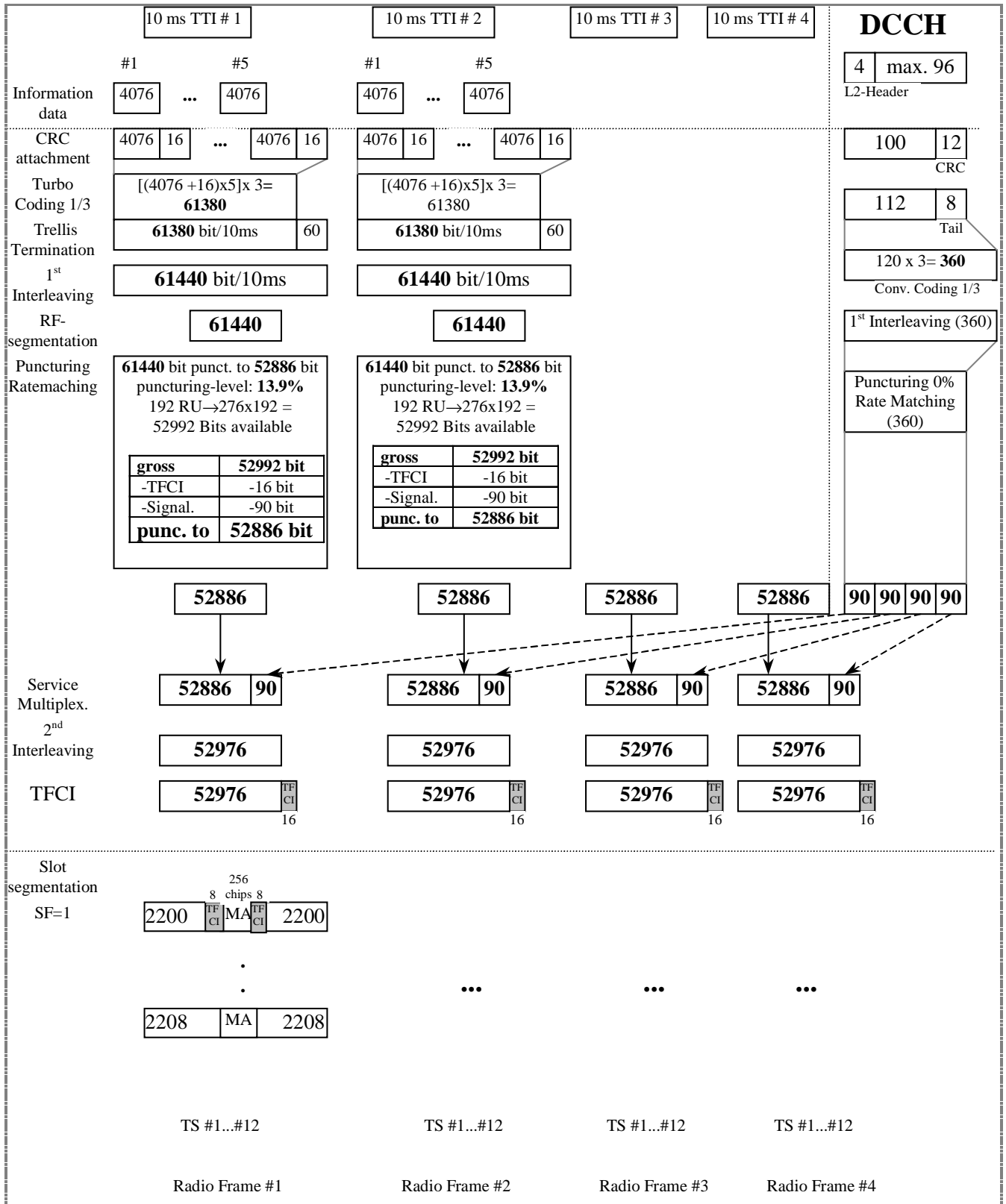

Figure A.8

A.2.8.2 1.28 Mcps TDD Option

Table A.8A

| Parameter | Value |
|----------------------------|------------------------|
| Information data rate | 2048 kbps |
| RU's allocated | 5TS (1*SF1) = 80RU/5ms |
| Midamble | 144 |
| Interleaving | 10 ms |
| Power control (TPC) | 6 Bit/user/10ms |
| TFCI | 48 Bit/user/10ms |
| Synchronisation Shift (SS) | 6 Bit/user/10ms |
| Inband signalling DCCH | no |
| Coding | no |
| Modulation | 8PSK |

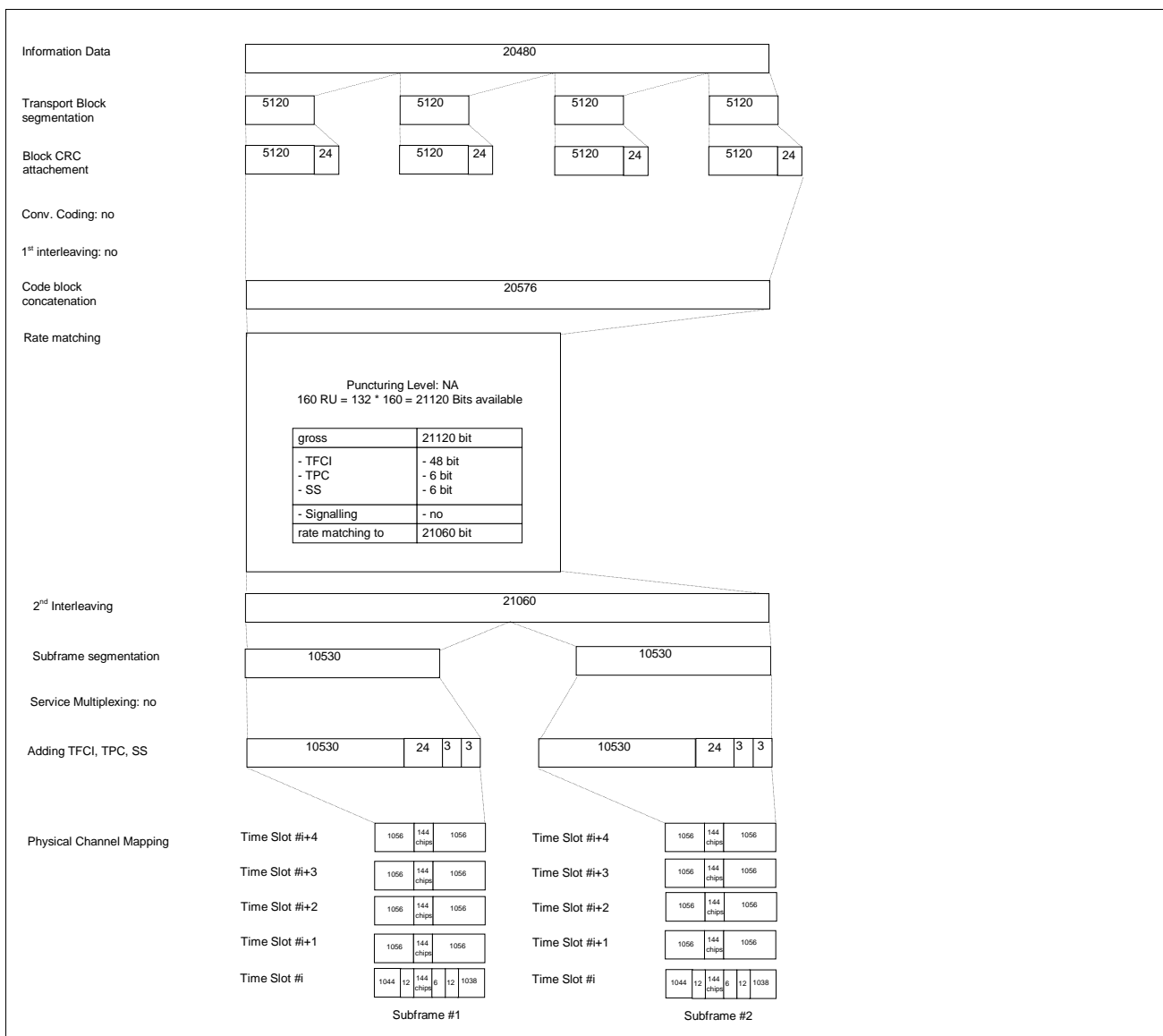

Figure A.8A

A.3 HSDPA reference measurement channels

A.3.1 HSDPA reference measurement channels for 3,84 Mcps TDD option

A.3.1.1 Reference measurement channels for 7,3 Mbps – Category 8 - UE

A.3.1.1.1 QPSK modulation scheme for test 1, 2, 3

Table A.9: HS-PDSCH fixed reference channel for the PA3, PB3, and VA30 Channel models - Category 8

| Parameter | Unit | Value |
|--|-----------|--------|
| Maximum information bit throughput | Mbps | 2,6496 |
| Number of HARQ Processes | Processes | 4 |
| Information Bit Payload (N_{INF}) | Bits | 26496 |
| Number Code Blocks | Blocks | 6 |
| Total Available of Soft Channel bits in UE | Bits | 353280 |
| Number of Soft Channel bit per HARQ Proc. | Bits | 88320 |
| Number of coded bits per TTI | Bits | 35328 |
| Coding Rate | | 3/4 |
| Number of HS-PDSCH Timeslots | Slots | 8 |
| Number of HS-PDSCH codes per TS | Codes | 16 |
| Spreading factor | SF | 16 |

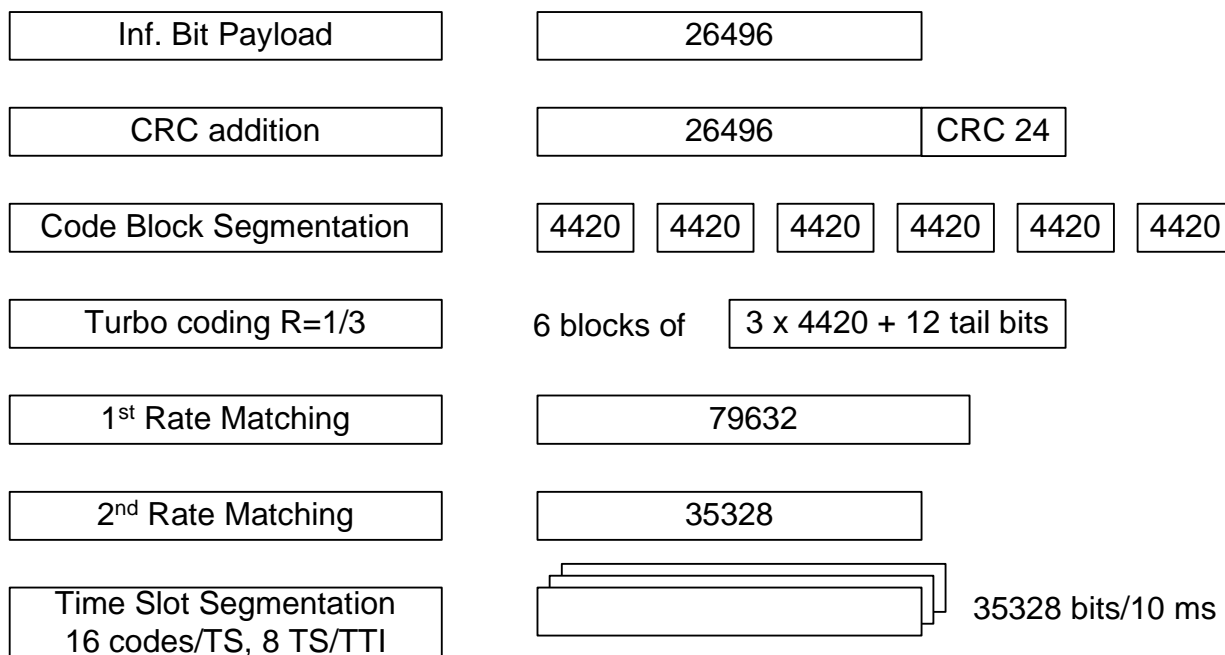

Figure A.9: Coding for HS-PDSCH fixed reference channel with QPSK modulation for the PA3, PB3, and VA30 Channels – Category 8

A.3.1.1.2 QPSK modulation scheme for test 4

Table A.10: HS-PDSCH fixed reference channel for the VA120 Channel model - Category 8

| Parameter | Unit | Value |
|--|-----------|--------|
| Maximum information bit throughput | Mbps | 2,3176 |
| Number of HARQ Processes | Processes | 4 |
| Information Bit Payload (N_{INF}) | Bits | 23176 |
| Number Code Blocks | Blocks | 5 |
| Total Available of Soft Channel bits in UE | Bits | 353280 |
| Number of Soft Channel bit per HARQ Proc. | Bits | 88320 |
| Number of coded bits per TTI | Bits | 30912 |
| Coding Rate | | 3/4 |
| Number of HS-PDSCH Timeslots | Slots | 8 |
| Number of HS-PDSCH codes per TS | Codes | 14 |
| Spreading factor | SF | 16 |

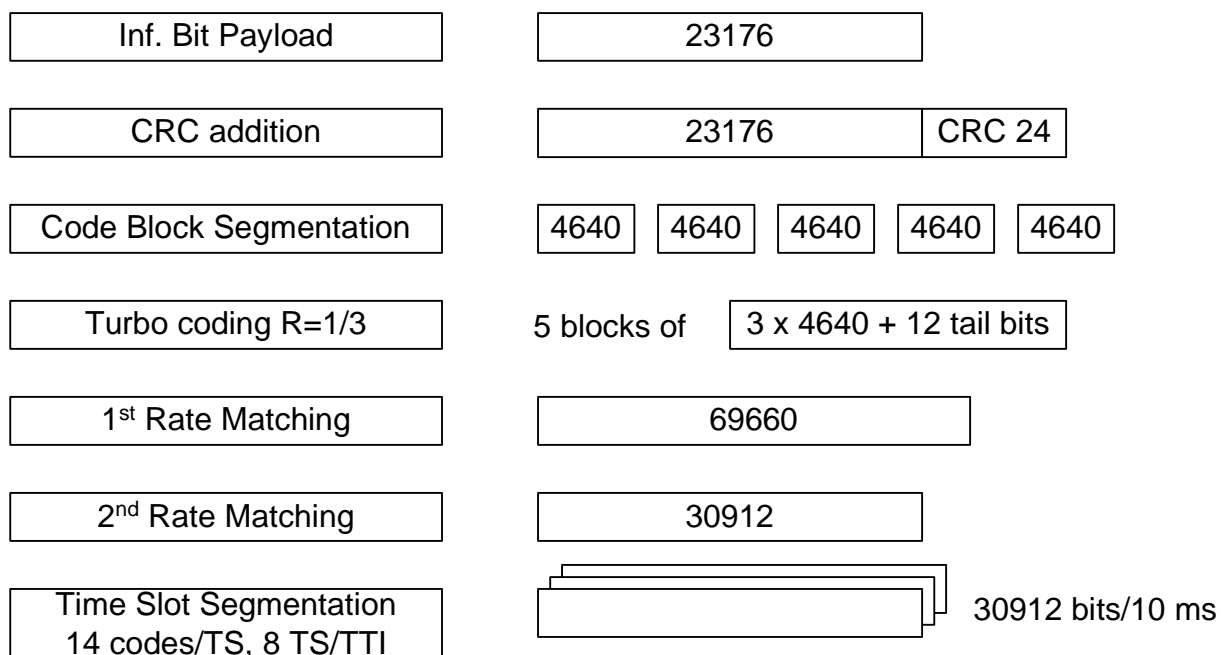

Figure A.10: Coding for HS-PDSCH fixed reference channel with QPSK modulation for the VA120 Channel - Category 8

A.3.1.1.3 16QAM modulation scheme for test 1, 2, 3

Table A.11: HS-PDSCH fixed reference channel for the PA3, PB3, and VA30 Channel models - Category 8

| Parameter | Unit | Value |
|--|-----------|---------------|
| Modulation | | 16-QAM |
| Maximum information bit throughput | Mbps | 5,2996 |
| Number of HARQ Processes | Processes | 4 |
| Information Bit Payload (N_{INF}) | Bits | 52996 |
| Number Code Blocks | Blocks | 11 |
| Total Available of Soft Channel bits in UE | Bits | 353280 |
| Number of Soft Channel bit per HARQ Proc. | Bits | 88320 |
| Number of coded bits per TTI | Bits | 70656 |
| Coding Rate | | 3/4 |
| Number of HS-PDSCH Timeslots | Slots | 8 |
| Number of HS-PDSCH codes per TS | Codes | 16 |
| Spreading factor | SF | 16 |

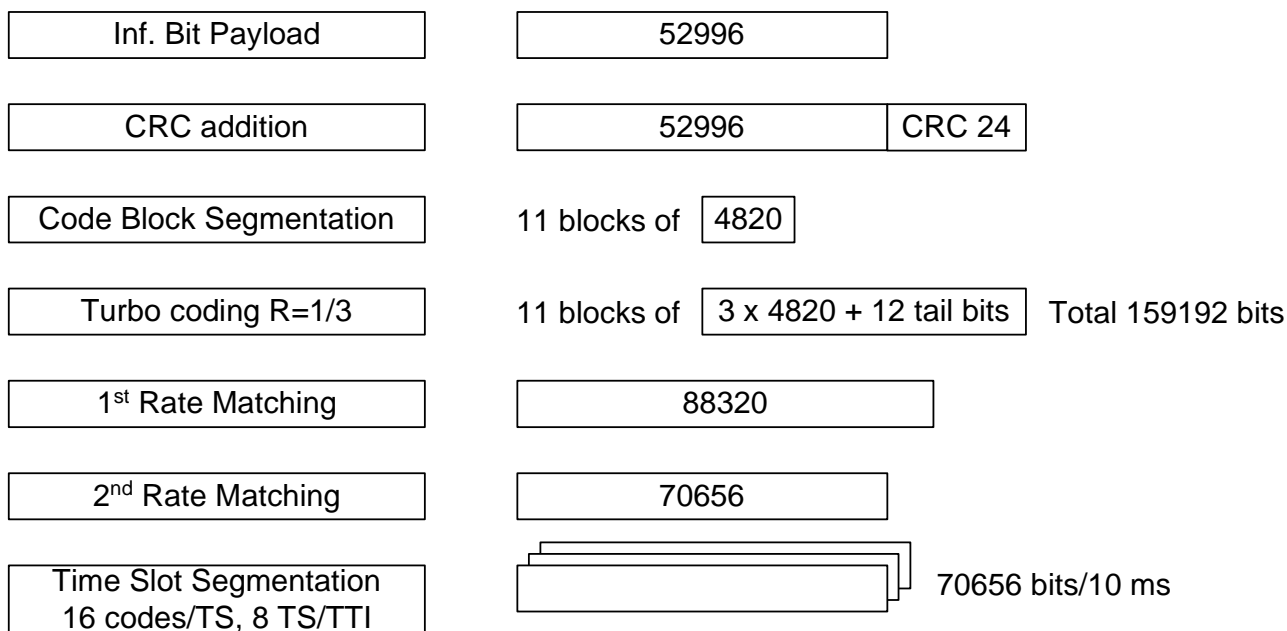

Figure A.11: Coding for HS-PDSCH fixed reference channel with 16-QAM modulation for the PA3 PB3, and VA30 Channels – Category 8

A.3.1.1.4 16QAM modulation scheme for test 4

Table A.12: HS-PDSCH fixed reference channel for the PA3, PB3, and VA30 Channel models - Category 8

| Parameter | Unit | Value |
|--|-----------|---------------|
| Modulation | | 16-QAM |
| Maximum information bit throughput | Mbps | 3,4773 |
| Number of HARQ Processes | Processes | 4 |
| Information Bit Payload (N_{INF}) | Bits | 34773 |
| Number Code Blocks | Blocks | 7 |
| Total Available of Soft Channel bits in UE | Bits | 353280 |
| Number of Soft Channel bit per HARQ Proc. | Bits | 88320 |
| Number of coded bits per TTI | Bits | 61824 |
| Coding Rate | | 9/16 |
| Number of HS-PDSCH Timeslots | Slots | 8 |
| Number of HS-PDSCH codes per TS | Codes | 14 |
| Spreading factor | SF | 16 |

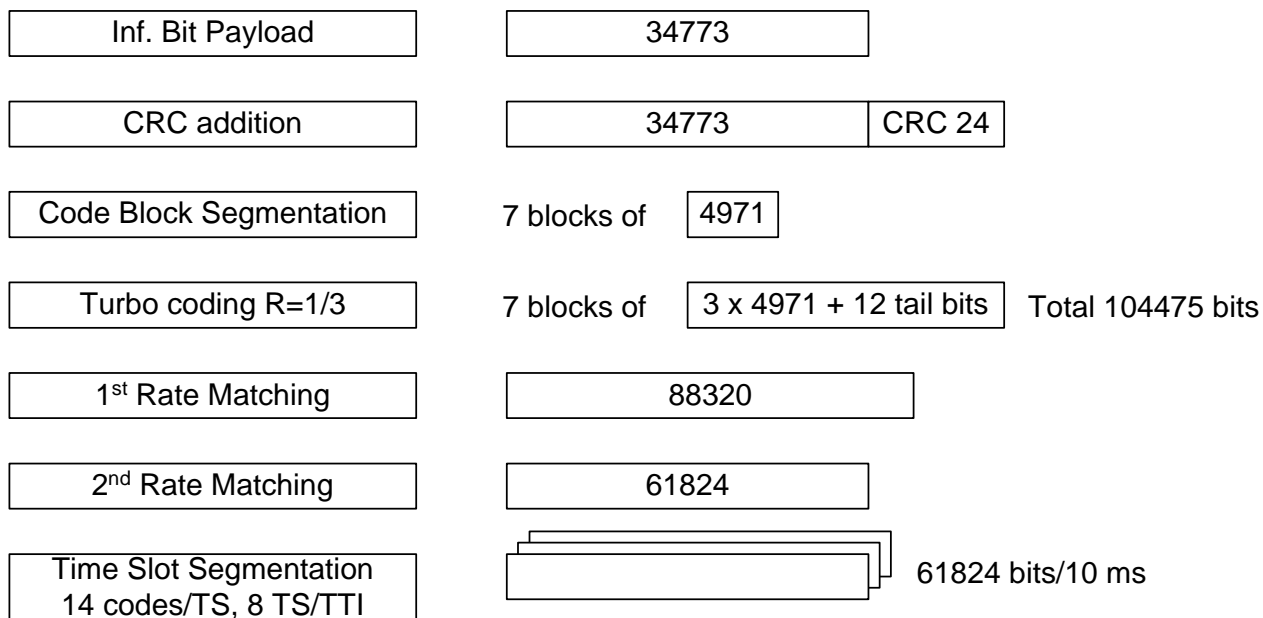

Figure A.12: Coding for HS-PDSCH fixed reference channel with 16-QAM modulation for the VA120 Channel – Category 8

A.3.2 HSDPA reference measurement channels for 1.28 Mcps TDD option

A.3.2.1 Reference measurement channels for 1.4 Mbps UE class

A.3.2.1.1 QPSK modulation scheme

Table A.13

| Parameter | Value |
|--|-----------------------------|
| Maximum information data rate | 526 kbps |
| RU's allocated | 4TS (10*SF16) = 40RU/5ms |
| Midamble | 144 chips |
| Puncturing level at code rate 1/3 : first stage/second stage | 12% / 50% |

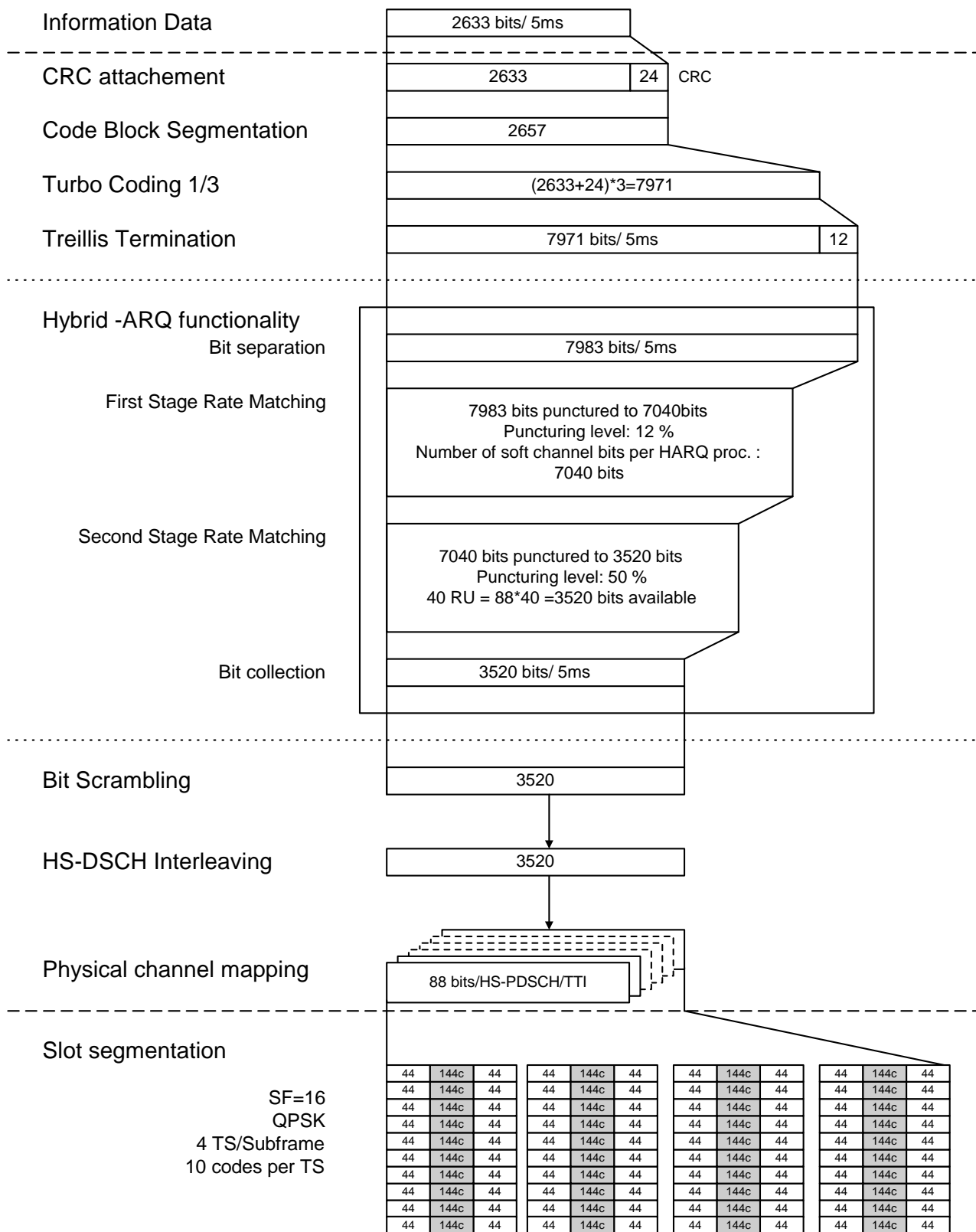

Figure A.13

A.3.2.1.2 16QAM modulation scheme

Table A.14

| Parameter | Value |
|--|----------------------------|
| Maximum information data rate | 730 kbps |
| RU's allocated | 4TS (9*SF16) = 36RU/5ms |
| Midamble | 144 chips |
| Puncturing level at code rate 1/3 : first stage/second stage | 36% / 10% |

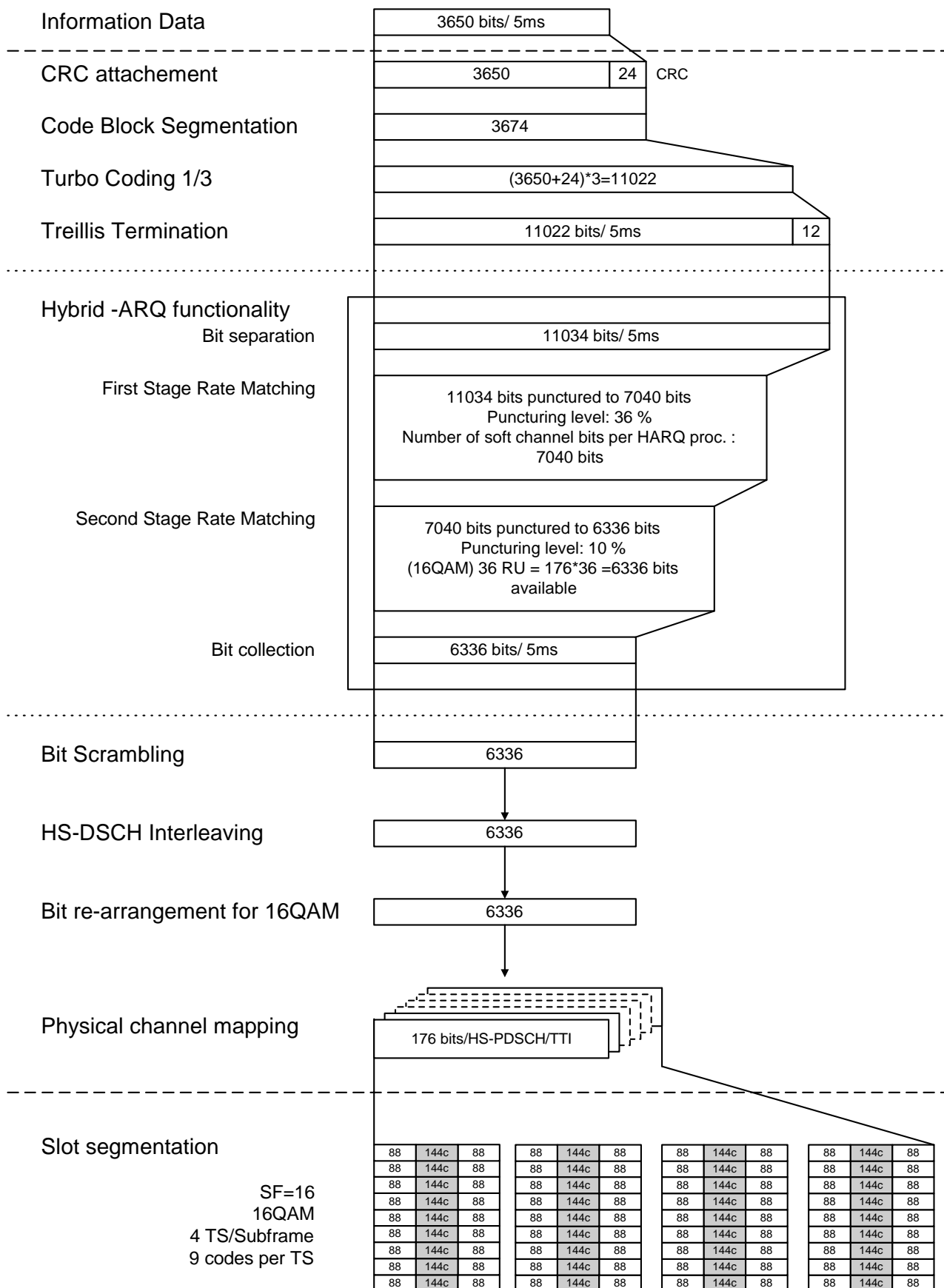

Figure A.14

A.3.3 Variable Reference Channel definition for 3,84 Mcps and 1,28 Mcps TDD options

The variable reference measurement channels are defined by:

- a) The maximum information bit payload that is determined by the UE capability class under test and the allocated resource units (and hence implicitly by the CQI table applicable to the UE under test as derived from TS25.321).
- b) The most recently received UE CQI report.

Annex B (normative): Propagation conditions

B.1 Static propagation condition

The propagation for the static performance measurement is an Additive White Gaussian Noise (AWGN) environment. No fading and multi-paths exist for this propagation model.

B.2 Multi-path fading propagation conditions

B.2.1 3.84 Mcps TDD Option

Table B.1 shows propagation conditions that are used for the performance measurements in multi-path fading environment. All taps have classical Doppler spectrum.

Table B.1: Propagation Conditions for Multi path Fading Environments for operations referenced in 5.2 a), 5.2 b) and 5.2 c)

| Case 1 speed 3km/h | | Case 2 speed 3 km/h | | Case 3 speed 120 km/h | | CASE 4 speed 50 km/h * | |
|-----------------------|--------------------------|------------------------|--------------------------|--------------------------|--------------------------|---------------------------|--------------------------|
| Relative Delay [ns] | Relative Mean Power [dB] | Relative Delay [ns] | Relative Mean Power [dB] | Relative Delay [ns] | Relative Mean Power [dB] | Relative Delay [ns] | Relative Mean Power [dB] |
| 0 | 0 | 0 | 0 | 0 | 0 | 0 | 0 |
| 976 | -10 | 976 | 0 | 260 | -3 | 976 | -10 |
| | | 12000 | 0 | 521 | -6 | | |
| | | | | 781 | -9 | | |

*NOTE: Case 4 is only used in TS25.123.

Table B.1A: Propagation Conditions for Multi-Path Fading Environments for HSDPA Performance Requirements for operations referenced in 5.2 a), 5.2 b) and 5.2 c)

| ITU Pedestrian A Speed 3km/h (PA3) | | ITU Pedestrian B Speed 3Km/h (PB3) | | ITU vehicular A Speed 30km/h (VA30) | | ITU vehicular A Speed 120km/h (VA120) | |
|--|--------------------------|--|--------------------------|---|--------------------------|---|--------------------------|
| Relative Delay [ns] | Relative Mean Power [dB] | Relative Delay [ns] | Relative Mean Power [dB] | Relative Delay [ns] | Relative Mean Power [dB] | Relative Delay [ns] | Relative Mean Power [dB] |
| 0 | 0 | 0 | 0 | 0 | 0 | 0 | 0 |
| 110 | -9.7 | 200 | -0.9 | 310 | -1.0 | 310 | -1.0 |
| 190 | -19.2 | 800 | -4.9 | 710 | -9.0 | 710 | -9.0 |
| 410 | -22.8 | 1200 | -8.0 | 1090 | -10.0 | 1090 | -10.0 |
| | | 2300 | -7.8 | 1730 | -15.0 | 1730 | -15.0 |
| | | 3700 | -23.9 | 2510 | -20 | 2510 | -20 |

Table B.1B: Propagation Conditions for Multi path Fading Environments for operations referenced in 5.2 d)

| Case 1 speed 2.3km/h | | Case 2 speed 2.3 km/h | | Case 3 speed 92 km/h | | Case 4 speed 38 km/h * | |
|-------------------------|--------------------------|--------------------------|--------------------------|-------------------------|--------------------------|---------------------------|--------------------------|
| Relative Delay [ns] | Relative Mean Power [dB] | Relative Delay [ns] | Relative Mean Power [dB] | Relative Delay [ns] | Relative Mean Power [dB] | Relative Delay [ns] | Relative Mean Power [dB] |
| 0 | 0 | 0 | 0 | 0 | 0 | 0 | 0 |
| 976 | -10 | 976 | 0 | 260 | -3 | 976 | -10 |
| | | 12000 | 0 | 521 | -6 | | |
| | | | | 781 | -9 | | |

*NOTE: Case 4 is only used in TS25.123.

Table B.1C: Propagation Conditions for Multi-Path Fading Environments for HSDPA Performance Requirements for operations referenced in 5.2 d)

| ITU Pedestrian A Speed 2.3km/h (PA3) | | ITU Pedestrian B Speed 2.3Km/h (PB3) | | ITU vehicular A Speed 23 km/h (VA30) | | ITU vehicular A Speed 92 km/h (VA120) | |
|--|--------------------------|--|--------------------------|--|--------------------------|---|--------------------------|
| Relative Delay [ns] | Relative Mean Power [dB] | Relative Delay [ns] | Relative Mean Power [dB] | Relative Delay [ns] | Relative Mean Power [dB] | Relative Delay [ns] | Relative Mean Power [dB] |
| 0 | 0 | 0 | 0 | 0 | 0 | 0 | 0 |
| 110 | -9.7 | 200 | -0.9 | 310 | -1.0 | 310 | -1.0 |
| 190 | -19.2 | 800 | -4.9 | 710 | -9.0 | 710 | -9.0 |
| 410 | -22.8 | 1200 | -8.0 | 1090 | -10.0 | 1090 | -10.0 |
| | | 2300 | -7.8 | 1730 | -15.0 | 1730 | -15.0 |
| | | 3700 | -23.9 | 2510 | -20 | 2510 | -20 |

B.2.2 1.28 Mcps TDD Option

Table B.2 shows propagation conditions that are used for the general performance measurements in multi-path fading environment. Table B.3 shows propagation conditions that are used for HSDPA performance measurements in multi-path fading environments. All taps in both tables have classical Doppler spectrum.

Table B.2: Propagation Conditions for Multi-Path Fading Environments operations referenced in 5.2 a), b) and c)

| Case 1, speed 3km/h | | Case 2, speed 3km/h | | Case 3, speed 120km/h | |
|---------------------|--------------------------|---------------------|--------------------------|-----------------------|--------------------------|
| Relative Delay [ns] | Relative Mean Power [dB] | Relative Delay [ns] | Relative Mean Power [dB] | Relative Delay [ns] | Relative Mean Power [dB] |
| 0 | 0 | 0 | 0 | 0 | 0 |
| 2928 | -10 | 2928 | 0 | 781 | -3 |
| | | 12000 | 0 | 1563 | -6 |
| | | | | 2344 | -9 |

Table B.2A: Propagation Conditions for Multi-Path Fading Environments operations referenced in 5.2 d)

| Case 1, speed 2.3km/h | | Case 2, speed 2.3km/h | | Case 3, speed 92km/h | |
|-----------------------|--------------------------|-----------------------|--------------------------|----------------------|--------------------------|
| Relative Delay [ns] | Relative Mean Power [dB] | Relative Delay [ns] | Relative Mean Power [dB] | Relative Delay [ns] | Relative Mean Power [dB] |
| 0 | 0 | 0 | 0 | 0 | 0 |
| 2928 | -10 | 2928 | 0 | 781 | -3 |
| | | 12000 | 0 | 1563 | -6 |
| | | | | 2344 | -9 |

Table B.3: Propagation Conditions for Multi-Path Fading Environments for HSDPA Performance Requirements operations referenced in 5.2 a), b) and c)

| ITU Pedestrian A Speed 3km/h (PA3) | | ITU Pedestrian B Speed 3K/h (PB3) | | ITU vehicular A Speed 30km/h (VA30) | | ITU vehicular A Speed 120km/h (VA120) | |
|--|--------------------------|---|--------------------------|---|--------------------------|---|--------------------------|
| Relative Delay [ns] | Relative Mean Power [dB] | Relative Delay [ns] | Relative Mean Power [dB] | Relative Delay [ns] | Relative Mean Power [dB] | Relative Delay [ns] | Relative Mean Power [dB] |
| 0 | 0 | 0 | 0 | 0 | 0 | 0 | 0 |
| 110 | -9.7 | 200 | -0.9 | 310 | -1.0 | 310 | -1.0 |
| 190 | -19.2 | 800 | -4.9 | 710 | -9.0 | 710 | -9.0 |
| 410 | -22.8 | 1200 | -8.0 | 1090 | -10.0 | 1090 | -10.0 |
| | | 2300 | -7.8 | 1730 | -15.0 | 1730 | -15.0 |
| | | 3700 | -23.9 | 2510 | -20 | 2510 | -20 |

Table B.3A: Propagation Conditions for Multi-Path Fading Environments for HSDPA Performance Requirements operations referenced in 5.2 d)

| ITU Pedestrian A Speed 2.3km/h (PA3) | | ITU Pedestrian B Speed 2.3km/h (PB3) | | ITU vehicular A Speed 23km/h (VA30) | | ITU vehicular A Speed 92km/h (VA120) | |
|--|--------------------------|--|--------------------------|---|--------------------------|--|--------------------------|
| Relative Delay [ns] | Relative Mean Power [dB] | Relative Delay [ns] | Relative Mean Power [dB] | Relative Delay [ns] | Relative Mean Power [dB] | Relative Delay [ns] | Relative Mean Power [dB] |
| 0 | 0 | 0 | 0 | 0 | 0 | 0 | 0 |
| 110 | -9.7 | 200 | -0.9 | 310 | -1.0 | 310 | -1.0 |
| 190 | -19.2 | 800 | -4.9 | 710 | -9.0 | 710 | -9.0 |
| 410 | -22.8 | 1200 | -8.0 | 1090 | -10.0 | 1090 | -10.0 |
| | | 2300 | -7.8 | 1730 | -15.0 | 1730 | -15.0 |
| | | 3700 | -23.9 | 2510 | -20 | 2510 | -20 |

Annex C (normative): Environmental conditions

C.1 General

This normative annex specifies the environmental requirements of the UE. Within these limits the requirements of this specifications shall be fulfilled.

C.2 Environmental requirements for the UE

The requirements in this clause apply to all types of UE(s)

C.2.1 Temperature

The UE shall fulfil all the requirements in the full temperature range of:

Table C.1

| | |
|---------------|---|
| +15°C – +35°C | for normal conditions (with relative humidity of 25 % to 75 %); |
| -10°C - +55°C | for extreme conditions (see IEC publications 68-2-1 and 68-2-2) |

Outside this temperature range the UE, if powered on, shall not make ineffective use of the radio frequency spectrum. In no case shall the UE exceed the transmitted levels as defined in S25.102 for extreme operation.

C.2.2 Voltage

The UE shall fulfil all the requirements in the full voltage range, i.e. the voltage range between the extreme voltages.

The manufacturer shall declare the lower and higher extreme voltages and the approximate shutdown voltage. For the equipment that can be operated from one or more of the power sources listed below, the lower extreme voltage shall not be higher, and the higher extreme voltage shall not be lower than that specified below.

Table C.2

| Power source | Lower extreme voltage | Higher extreme voltage | Normal conditions voltage |
|-----------------------------|-----------------------|------------------------|---------------------------|
| AC mains | 0,9 * nominal | 1,1 * nominal | nominal |
| Regulated lead acid battery | 0,9 * nominal | 1,3 * nominal | 1,1 * nominal |
| Non regulated batteries: | | | |
| Leclanché/lithium | 0,85 * nominal | Nominal | Nominal |
| Mercury/nickel cadmium | 0,90 * nominal | Nominal | Nominal |

Outside this voltage range the UE if powered on, shall not make ineffective use of the radio frequency spectrum. In no case shall the UE exceed the transmitted levels as defined in S4.01A for extreme operation. In particular, the UE shall inhibit all RF transmissions when the power supply voltage is below the manufacturer declared shutdown voltage.

C.2.3 Vibration

The UE shall fulfil all the requirements when vibrated at the following frequency/amplitudes:

Table C.3

| Frequency | ASD (Acceleration Spectral Density) random vibration |
|------------------|---|
| 5 Hz to 20 Hz | 0,96 m ² /s ³ |
| 20 Hz to 500 Hz | 0,96 m ² /s ³ at 20 Hz, thereafter -3 dB/Octave |

Outside the specified frequency range the UE, if powered on, shall not make ineffective use of the radio frequency spectrum. In no case shall the UE exceed the transmitted levels as defined in S4.01A for extreme operation.

Annex D (informative): Terminal capabilities (TDD)

This section provides the UE capabilities related to 25.102.

This section shall be aligned with TS25.306, UE Radio Access Capabilities regarding TDD RF parameters. These RF UE Radio Access capabilities represent options in the UE, that require signalling to the network.

Table D.1 provides the list of UE radio access capability parameters and possible values for 25.102

Table D.1: RF UE Radio Access Capabilities

| | UE radio access capability parameter | Value range |
|-------------------|---|--|
| TDD RF parameters | UE power class (25.102 section 6.2.1) | 2, 3 NOTE: Only power classes 2 and 3 are part of R99 |
| | Radio frequency bands (25.102 section 5.2) | a), b), c), a+b), a+c), b+c, a+b+c) |
| | Chip rate capability (25.102) | 3.84 Mcps, 1.28 Mcps respectively |

Annex E (informative): Change request history

Table E.1: CRs approved at TSG#6

| RAN Doc | Spec | CR | R | Ph | Subject | Cat | Curr | New |
|----------|--------|-----|---|-----|---|-----|-------|-------|
| RP-99775 | 25.102 | 001 | | R99 | Corrections to 25.102 version 3.0.0 | F | 3.0.0 | 3.1.0 |
| RP-99774 | 25.102 | 004 | | R99 | Open item list in Annex D of 25.102v3.0.0 | D | 3.0.0 | 3.1.0 |
| RP-99775 | 25.102 | 003 | | R99 | Receiver spurious emissions for UE TDD | C | 3.0.0 | 3.1.0 |
| RP-99775 | 25.102 | 002 | | R99 | TDD Uplink Power control requirements | F | 3.0.0 | 3.1.0 |
| RP-99775 | 25.102 | 005 | | R99 | Change of propagation conditions recommendations | C | 3.0.0 | 3.1.0 |
| RP-99776 | 25.102 | 006 | | R99 | Performance Requirements | B | 3.0.0 | 3.1.0 |
| RP-99775 | 25.102 | 007 | | R99 | Corrections to 25.102 v.3.0.0 | F | 3.0.0 | 3.1.0 |
| RP-99774 | 25.102 | 008 | | R99 | Editorial changes to 25.102v3.0.0 | D | 3.0.0 | 3.1.0 |
| RP-99776 | 25.102 | 009 | | R99 | Peak Code Domain Error | B | 3.0.0 | 3.1.0 |
| RP-99775 | 25.102 | 010 | | R99 | TDD uplink power control requirements | C | 3.0.0 | 3.1.0 |
| RP-99775 | 25.102 | 011 | | R99 | Update of ITU Region 2 Specific Specifications and proposed universal channel numbering | C | 3.0.0 | 3.1.0 |
| RP-99776 | 25.102 | 012 | | R99 | Transmit Template, should to shall | B | 3.0.0 | 3.1.0 |
| RP-99775 | 25.102 | 013 | | R99 | UE power classes | F | 3.0.0 | 3.1.0 |
| RP-99775 | 25.102 | 014 | | R99 | Update of UE RF capabilities | F | 3.0.0 | 3.1.0 |

Table E.2: CRs approved at TSG#7

| RAN Doc | Spec | CR | R | Ph | Subject | Cat | Curr | New |
|-----------|--------|-----|---|-----|--|-----|-------|-------|
| RP-000016 | 25.102 | 015 | | R99 | Description of Signal Levels for Receiver Characteristics | D | 3.1.0 | 3.2.0 |
| RP-000016 | 25.102 | 016 | | R99 | Editorial corrections | D | 3.1.0 | 3.2.0 |
| RP-000016 | 25.102 | 017 | | R99 | Spurious emission correction | F | 3.1.0 | 3.2.0 |
| RP-000016 | 25.102 | 018 | | R99 | Performance requirement for base station transmit diversity mode | C | 3.1.0 | 3.2.0 |
| RP-000016 | 25.102 | 019 | | R99 | Corrections for UE TDD Blocking Requirements | F | 3.1.0 | 3.2.0 |
| RP-000016 | 25.102 | 020 | | R99 | Correction to the UL power control "differential accuracy, measured input" requirement | F | 3.1.0 | 3.2.0 |
| RP-000016 | 25.102 | 021 | | R99 | Clarification of ACLR | F | 3.1.0 | 3.2.0 |
| RP-000016 | 25.102 | 022 | | R99 | Clock Accuracy | C | 3.1.0 | 3.2.0 |
| RP-000016 | 25.102 | 023 | | R99 | Peak Code Domain Error | C | 3.1.0 | 3.2.0 |
| RP-000016 | 25.102 | 024 | | R99 | Modulation Accuracy | C | 3.1.0 | 3.2.0 |
| RP-000016 | 25.102 | 025 | | R99 | Out-of-synchronization handling of the UE in TS 25.102 | C | 3.1.0 | 3.2.0 |

Table E.3: CRs approved at TSG#8

| RAN Doc | Spec | CR | R | Ph | Subject | Cat | Curr | New |
|-----------|--------|-----|---|-----|---|-----|-------|-------|
| RP-000205 | 25.102 | 026 | | R99 | Correction of DL measurement channels for TDD-mode | F | 3.2.0 | 3.3.0 |
| RP-000205 | 25.102 | 027 | | R99 | Reference Measurement Channel for UE Peak Code Domain Error | F | 3.2.0 | 3.3.0 |
| RP-000205 | 25.102 | 028 | | R99 | Correction for Uplink power control | F | 3.2.0 | 3.3.0 |
| RP-000205 | 25.102 | 029 | | R99 | UE TDD P-CCPCH Block STTD performance requirements | F | 3.2.0 | 3.3.0 |
| RP-000205 | 25.102 | 030 | | R99 | Modification to the handling of UE TDD Measurement Uncertainty | F | 3.2.0 | 3.3.0 |
| RP-000205 | 25.102 | 031 | | R99 | Clarification of the specification on Peak Code Domain Error (PCDE) | F | 3.2.0 | 3.3.0 |

Table E.4: CRs approved at TSG RAN #9

| RAN Doc | Spec | CR | R | Ph | Subject | Cat | Curr | New |
|-----------|--------|----|---|-----|---|-----|-------|-------|
| RP-000395 | 25.102 | 32 | | R99 | Performance requirements with TFCI decoding for TDD UE | F | 3.3.0 | 3.4.0 |
| RP-000395 | 25.102 | 33 | | R99 | Performance test for UE power control in downlink | F | 3.3.0 | 3.4.0 |
| RP-000395 | 25.102 | 34 | | R99 | Definition of period for frequency error | F | 3.3.0 | 3.4.0 |
| RP-000395 | 25.102 | 35 | | R99 | Handling of measurement uncertainties in UE radio conformance testing (TDD) | F | 3.3.0 | 3.4.0 |

Table E.5: CRs approved at TSG RAN #10

| RAN Doc | Spec | CR | R | Ph | Subject | Cat | Curr | New |
|-----------|--------|----|---|-----|--|-----|-------|-------|
| R4-000788 | 25.102 | 36 | | R99 | Correction for 25.102 concerning UE maximum output power classes | F | 3.4.0 | 3.5.0 |
| R4-000789 | 25.102 | 37 | | R99 | Correction for 25.102 concerning the coexistence of TDD and FDD in the same band | F | 3.4.0 | 3.5.0 |
| R4-000830 | 25.102 | 38 | | R99 | Correction of Out-of-Sync criteria in 25.102 | F | 3.4.0 | 3.5.0 |
| R4-000939 | 25.102 | 39 | | R99 | Clarification of the mentioned parameter alpha | F | 3.4.0 | 3.5.0 |
| R4-000982 | 25.102 | 40 | | R99 | Correction for 25.102 concerning the channel number calculation | F | 3.4.0 | 3.5.0 |

Table E.6: Release 1999 CRs approved at TSG RAN #11

| RAN Doc | Spec | CR | R | Ph | Subject | Cat | Curr | New |
|-----------|--------|----|---|-----|---|-----|-------|-------|
| RP-010086 | 25.102 | 41 | | R99 | Relationship between Minimum Requirements and Test Tolerances. | F | 3.5.0 | 3.6.0 |
| RP-010086 | 25.102 | 42 | | R99 | Requirements for out-of-synchronisation handling of output power during DTX | F | 3.5.0 | 3.6.0 |
| RP-010086 | 25.102 | 43 | | R99 | UE Power Control Accuracy | F | 3.5.0 | 3.6.0 |
| RP-010086 | 25.102 | 44 | | R99 | Correction of version number of the ITU-R Recommendation SM.329 | F | 3.5.0 | 3.6.0 |

Table E.7: Release 4 CRs approved at TSG RAN #11

| RAN Doc | Spec | CR | R | Ph | Subject | Cat | Curr | New |
|-----------|--------|----|---|----|---|-----|-------|-------|
| RP-010097 | 25.102 | 45 | | R4 | UTRA (UE) TDD; Radio transmission and Reception | B | 3.6.0 | 4.0.0 |
| RP-010100 | 25.102 | 46 | | R4 | Service Mapping for 2 Mbps | B | 3.6.0 | 4.0.0 |
| RP-010100 | 25.102 | 47 | | R4 | UE Performance Requirements for 2 Mbps | B | 3.6.0 | 4.0.0 |

Table E.8: Release 4 CRs approved at TSG RAN #12

| RAN Doc | Spec | CR | R | Ph | Title | Cat | Curr | New |
|-----------|--------|----|---|-------|--|-----|-------|-------|
| RP-010348 | 25.102 | 49 | | Rel-4 | Correction of signal descriptions in Receiver Characteristics section. | A | 4.0.0 | 4.1.0 |
| RP-010348 | 25.102 | 51 | | Rel-4 | UE EVM definition | A | 4.0.0 | 4.1.0 |
| RP-010348 | 25.102 | 53 | | Rel-4 | Clarification of UARFCN channel number | A | 4.0.0 | 4.1.0 |
| RP-010348 | 25.102 | 55 | | Rel-4 | CR for UE Performance Requirements | A | 4.0.0 | 4.1.0 |
| RP-010348 | 25.102 | 57 | | Rel-4 | Performance Test for Uplink Power Control | A | 4.0.0 | 4.1.0 |
| RP-010348 | 25.102 | 59 | | Rel-4 | Corrections and note status changes from informative to normative | A | 4.0.0 | 4.1.0 |
| RP-010359 | 25.102 | 60 | | Rel-4 | 2MB/Sec downlink reference channel for 1.28 Mcps TDD | F | 4.0.0 | 4.1.0 |
| RP-010359 | 25.102 | 61 | | Rel-4 | Correction in BCH measurement channel description (1.28 Mcps TDD option) | F | 4.0.0 | 4.1.0 |
| RP-010359 | 25.102 | 62 | | Rel-4 | Correction of UE radio capabilities | F | 4.0.0 | 4.1.0 |
| RP-010359 | 25.102 | 63 | | Rel-4 | Out-of-sync handling during DTX for 1.28Mcps TDD Option | F | 4.0.0 | 4.1.0 |
| RP-010348 | 25.102 | 65 | | Rel-4 | BCH performance requirement | A | 4.0.0 | 4.1.0 |
| RP-010359 | 25.102 | 66 | | Rel-4 | Clarification of UARFCN channel number for 1.28 Mcps TDD | F | 4.0.0 | 4.1.0 |

Table E.9: Release 4 CRs approved at TSG RAN #13

| RAN Tdoc | Spec | CR | R | Ph | Title | Cat | Curr | New |
|-----------|--------|----|---|-------|--|-----|-------|-------|
| RP-010615 | 25.102 | 68 | | Rel-4 | Power and ACLR definition corrections. | A | 4.1.0 | 4.2.0 |
| RP-010615 | 25.102 | 70 | | Rel-4 | Out-of-synchronisation handling. | A | 4.1.0 | 4.2.0 |
| RP-010615 | 25.102 | 72 | | Rel-4 | Correction of frequency range for receiver spurious emissions | A | 4.1.0 | 4.2.0 |
| RP-010615 | 25.102 | 74 | | Rel-4 | Clarification in Spectrum emission mask section | A | 4.1.0 | 4.2.0 |
| RP-010625 | 25.102 | 75 | | Rel-4 | Out of synchronisation handling for 1.28 Mcps TDD option | F | 4.1.0 | 4.2.0 |
| RP-010625 | 25.102 | 76 | | Rel-4 | Power control downlink - constant BLER target (1.28 Mcps TDD option) | F | 4.1.0 | 4.2.0 |
| RP-010625 | 25.102 | 77 | | Rel-4 | Correction of frequency range for receiver spurious emissions (1.28 Mcps TDD option) | F | 4.1.0 | 4.2.0 |
| RP-010625 | 25.102 | 78 | | Rel-4 | Clarification in Spectrum emission mask section for 1.28 Mcps TDD option | F | 4.1.0 | 4.2.0 |
| RP-010625 | 25.102 | 79 | | Rel-4 | UE Performance Requirements (1.28Mcps TDD) | F | 4.1.0 | 4.2.0 |
| RP-010625 | 25.102 | 80 | | Rel-4 | Power definition corrections for 1.28 Mcps TDD option. | F | 4.1.0 | 4.2.0 |

Table E.10: Release 4 CRs approved at TSG RAN #14

| RAN Tdoc | Spec | CR | R | Ph | Title | Cat | Curr | New |
|-----------|--------|----|---|-------|---|-----|-------|-------|
| RP-010778 | 25.102 | 82 | | Rel-4 | Tx On/Off Test Requirements for Discontinuous Transmission | A | 4.2.0 | 4.3.0 |
| RP-010778 | 25.102 | 84 | | Rel-4 | Downlink power control - performance requirement for constant BLER target, 3.84 Mcps TDD option | A | 4.2.0 | 4.3.0 |
| RP-010793 | 25.102 | 85 | | Rel-4 | Tx On/Off Test Requirements for Continuous Transmission | F | 4.2.0 | 4.3.0 |

Table E.11: Release 4 CRs approved at TSG RAN #15

| RAN Tdoc | Spec | CR | R | Ph | Title | Cat | Curr | New |
|-----------|--------|----|---|-------|---|-----|-------|-------|
| RP-020015 | 25.102 | 87 | 1 | Rel-4 | Replacement of Block STTD by Space Code Transmit Diversity (SCTD) | A | 4.3.0 | 4.4.0 |
| RP-020015 | 25.102 | 89 | | Rel-4 | UL reference measurement channel (12.2 kbps) puncturing rate and bit length correction | A | 4.3.0 | 4.4.0 |
| RP-020026 | 25.102 | 94 | | Rel-4 | Addition of channelization code, scrambling code and midamble code parameter for UE performance requirements (1.28Mcps TDD) | F | 4.3.0 | 4.4.0 |

Table E.12: Decision at TSG RAN#15

| | Title | Curr | New |
|--------|---|-------|-------|
| 25.102 | Rel-5 version created by TSG RAN decision, no CRs | 4.4.0 | 5.0.0 |
| | Editorial correction, addition of Table E.12 | 5.0.0 | 5.0.1 |

Table E.13: Release 5 CRs approved at TSG RAN #16

| RAN Tdoc | Spec | CR | R | Ph | Title | Cat | Curr | New | Work Item |
|-----------|--------|-----|---|-------|--|-----|-------|-------|-----------|
| RP-020280 | 25.102 | 97 | | Rel-5 | Correction of power terms and definitions | A | 5.0.1 | 5.1.0 | TEI |
| RP-020289 | 25.102 | 99 | | Rel-5 | Correction of power terms and definitions | A | 5.0.1 | 5.1.0 | LCRTDD-RF |
| RP-020280 | 25.102 | 105 | 1 | Rel-5 | Control and monitoring function of UE requirement | A | 5.0.1 | 5.1.0 | TEI |
| RP-020303 | 25.102 | 108 | 1 | Rel-5 | Removal of "AFC on" condition for frequency stability requirement | F | 5.0.1 | 5.1.0 | TEI5 |
| RP-020289 | 25.102 | 110 | 1 | Rel-5 | Correction to power control downlink 1.28 Mcps TDD option | A | 5.0.1 | 5.1.0 | LCRTDD-RF |
| RP-020302 | 25.102 | 111 | 1 | Rel-5 | Inclusion of HSDPA into TS25.102 | B | 5.0.1 | 5.1.0 | HSDPA-RF |
| RP-020280 | 25.102 | 113 | 1 | Rel-5 | Correction of DL power control test for testability | A | 5.0.1 | 5.1.0 | TEI |
| RP-020280 | 25.102 | 117 | | Rel-5 | Addition of Test Case 4 to support 1G intra-frequency fading test case | A | 5.0.0 | 5.1.0 | TEI |

Table E.14: Release 5 CRs approved at TSG RAN #17

| RAN Tdoc | Spec | CR | R | Ph | Title | Cat | Curr | New | Work Item |
|-----------|--------|-----|---|-------|--|-----|-------|-------|-----------|
| RP-020473 | 25.102 | 120 | | Rel-5 | Correction to 3.84 Mcps TDD option downlink power control requirements | A | 5.1.0 | 5.2.0 | TEI |
| RP-020477 | 25.102 | 122 | | Rel-5 | Correction to blocking exceptions for 1.28 Mcps TDD option | A | 5.1.0 | 5.2.0 | LCRTDD-RF |
| RP-020477 | 25.102 | 124 | | Rel-5 | Correction of Out-of-Synchronization test for 1,28 Mcps TDD option | A | 5.1.0 | 5.2.0 | LCRTDD-RF |
| RP-020490 | 25.102 | 125 | | Rel-5 | Update of reference to ITU-R recommendation SM.329-9 | F | 5.1.0 | 5.2.0 | TEI5 |
| RP-020495 | 25.102 | 126 | | Rel-5 | Addition of HSDPA UE requirements for 1.28 Mcps TDD option for 16QAM and QPSK for fixed reference channels | B | 5.1.0 | 5.2.0 | HSDPA-RF |

Table E.15: Release 5 CRs approved at TSG RAN #18

| RAN Tdoc | Spec | CR | R | Ph | Title | Cat | Curr | New | Work Item |
|-----------|--------|-----|---|-------|---|-----|-------|-------|-----------|
| RP-020803 | 25.102 | 127 | 1 | Rel-5 | Addition of HSDPA UE requirements for 3,84 Mcps TDD option for 16QAM and QPSK for fixed reference channels | B | 5.2.0 | 5.3.0 | HSDPA-RF |
| RP-020803 | 25.102 | 128 | 1 | Rel-5 | Addition of HSDPA UE requirements for 3,84 Mcps TDD option for 16QAM and QPSK for variable reference channels | B | 5.2.0 | 5.3.0 | HSDPA-RF |
| RP-020782 | 25.102 | 131 | | Rel-5 | Name correction of logical and transport channels | A | 5.2.0 | 5.3.0 | TEI4 |
| RP-020803 | 25.102 | 132 | 1 | Rel-5 | HSDPA UE requirements for 1.28 Mcps TDD option for 16QAM and QPSK for fixed reference channels | F | 5.2.0 | 5.3.0 | HSDPA-RF |

Table E.16: Release 5 CRs approved at TSG RAN #19

| RAN Tdoc | Spec | CR | R | Ph | Title | Cat | Curr | New | Work Item |
|-----------|--------|-----|---|-------|---|-----|-------|-------|-----------|
| RP-030038 | 25.102 | 133 | 1 | Rel-5 | Transmit modulation quality clarification | F | 5.3.0 | 5.4.0 | TEI5 |
| RP-030047 | 25.102 | 134 | | Rel-5 | Clarification of HSDPA FRC test procedure on HS-SCCH signalling error | F | 5.3.0 | 5.4.0 | HSDPA-RF |
| RP-030047 | 25.102 | 135 | | Rel-5 | Addition of VRC definition for 3.84 Mcps & 1.28 Mcps TDD in Annex A | F | 5.3.0 | 5.4.0 | HSDPA-RF |
| RP-030047 | 25.102 | 136 | | Rel-5 | Additional VRC performance requirement for 1.28 Mcps TDD option | B | 5.3.0 | 5.4.0 | HSDPA-RF |

Table E.17: Release 5 CRs approved at TSG RAN #20

| RAN Tdoc | Spec | CR | R | Ph | Title | Cat | Curr | New | Work Item |
|-----------|--------|-----|---|-------|---|-----|-------|-------|-----------|
| RP-030218 | 25.102 | 137 | 1 | Rel-5 | Specification of HSDPA CQI test for 3.84 Mcps | F | 5.4.0 | 5.5.0 | HSDPA-RF |
| RP-030218 | 25.102 | 138 | | Rel-5 | CQI performance requirements for 1.28 Mcps TDD option | B | 5.4.0 | 5.5.0 | HSDPA-RF |
| RP-030218 | 25.102 | 139 | | Rel-5 | Addition of VRC performance requirements with low resource units for 1.28 Mcps TDD option | B | 5.4.0 | 5.5.0 | HSDPA-RF |
| RP-030218 | 25.102 | 140 | | Rel-5 | Specification of HS-SCCH performance for 1.28 Mcps TDD option | B | 5.4.0 | 5.5.0 | HSDPA-RF |

Table E.18: Release 5 CR approved at TSG RAN #22

| RAN Tdoc | Spec | CR | R | Ph | Title | Cat | Curr | New | Workitem |
|-----------|--------|-----|---|-------|---|-----|-------|-------|----------|
| RP-030596 | 25.102 | 141 | | Rel-5 | Correction of references to ITU recommendations | F | 5.5.0 | 5.6.0 | TEI5 |

Table E.19: Release 6 CR approved at TSG RAN #22

| RAN Tdoc | Spec | CR | R | Ph | Title | Cat | Curr | New | Workitem |
|-----------|--------|-----|---|-------|---|-----|-------|-------|----------|
| RP-030607 | 25.102 | 142 | | Rel-6 | Transmitter and Receiver Spurious emissions for TDD | F | 5.5.0 | 6.0.0 | TEI6 |

Table E.20: Release 6 CR approved at TSG RAN #23

| RAN Tdoc | Spec | CR | R | Ph | Title | Cat | Curr | New | Work Item |
|-----------|--------|-----|---|-------|---|-----|-------|-------|----------------|
| RP-050203 | 25.102 | 148 | | Rel-6 | Correction of parameters for HSDPA fixed reference channel test | A | 6.0.0 | 6.1.0 | TEI5, HSDPA-RF |
| RP-050203 | 25.102 | 150 | | Rel-6 | Correction of parameters for TDD 1.28 Mcps HSDPA fixed and variable reference channel tests | A | 6.0.0 | 6.1.0 | TEI5, HSDPA-RF |

Table E.21: Release 6 CR approved at TSG RAN #29

| RAN Tdoc | Spec | CR | R | Ph | Title | Cat | Curr | New | Work Item |
|-----------|--------|------|---|-------|---|-----|-------|-------|-----------|
| RP-050493 | 25.102 | 0152 | | Rel-6 | Correction to HSDPA test parameters for LCR TDD | A | 6.1.0 | 6.2.0 | LCRTDD-RF |

Table E.22: Release 7 CRs approved at TSG RAN #29

| RAN Tdoc | Spec | CR | R | Ph | Title | Cat | Curr | New | Work Item |
|-----------|--------|------|---|-------|--|-----|-------|-------|--------------------|
| RP-050501 | 25.102 | 0153 | | Rel-7 | Introduction of UMTS 2.6GHz operating band for TDD | B | 6.1.0 | 7.0.0 | RInImp-UMTS2600TDD |
| RP-050501 | 25.102 | 0154 | | Rel-7 | UMTS 2.6 GHz TDD Propagation Conditions | B | 6.1.0 | 7.0.0 | RInImp-UMTS2600TDD |
| RP-050501 | 25.102 | 0155 | | Rel-7 | UMTS 2.6 GHz TDD UE Receiver Specifications | B | 6.1.0 | 7.0.0 | RInImp-UMTS2600TDD |
| RP-050501 | 25.102 | 0156 | 2 | Rel-7 | Channel Raster and UARFCN for 3.84 Mcps TDD in UMTS 2.6 GHz | B | 6.1.0 | 7.0.0 | RInImp-UMTS2600TDD |
| RP-050501 | 25.102 | 0157 | | Rel-7 | Introduction of UMTS 2.6 GHz new operating band for 1.28Mcps TDD | B | 6.1.0 | 7.0.0 | RInImp-UMTS2600TDD |
| RP-050501 | 25.102 | 0158 | | Rel-7 | Introduction of Propagation Conditions for UMTS 2.6 GHz for 1.28Mcps TDD | B | 6.1.0 | 7.0.0 | RInImp-UMTS2600TDD |
| RP-050501 | 25.102 | 0159 | | Rel-7 | Introduction of UMTS 2.6 GHz requirements for blocking and spurious emission of UE receiver for 1.28Mcps TDD | B | 6.1.0 | 7.0.0 | RInImp-UMTS2600TDD |

Table E.23: Release 7 CR approved at TSG RAN #30

| RAN Tdoc | Spec | CR | R | Ph | Title | Cat | Curr | New | Work Item |
|-----------|--------|------|---|-------|--|-----|-------|-------|--------------------|
| RP-050740 | 25.102 | 0160 | 1 | Rel-7 | Additional UE Tx Spurious Emission for co-existence with 2.6 GHz FDD | B | 7.0.0 | 7.1.0 | RInImp-UMTS2600TDD |

History

| Document history | | |
|-------------------------|---------------|-------------|
| V7.1.0 | December 2005 | Publication |
| | | |
| | | |
| | | |
| | | |