

ETSI TS 124 526 V19.4.0 (2026-07)



TECHNICAL SPECIFICATION

**5G;
User Equipment (UE) policies for 5G System (5GS);
Stage 3
(3GPP TS 24.526 version 19.4.0 Release 19)**



Reference

RTS/TSGC-0124526vj40

Keywords

5G

ETSI

650 Route des Lucioles
F-06921 Sophia Antipolis Cedex - FRANCE

Tel.: +33 4 92 94 42 00 Fax: +33 4 93 65 47 16

Siret N° 348 623 562 00017 - APE 7112B
Association à but non lucratif enregistrée à la
Sous-Préfecture de Grasse (06) N° w061004871

Important notice

The present document can be downloaded from the
[ETSI Search & Browse Standards](#) application.

The present document may be made available in electronic versions and/or in print. The content of any electronic and/or print versions of the present document shall not be modified without the prior written authorization of ETSI. In case of any existing or perceived difference in contents between such versions and/or in print, the prevailing version of an ETSI deliverable is the one made publicly available in PDF format on [ETSI deliver](#) repository.

Users should be aware that the present document may be revised or have its status changed, this information is available in the [Milestones listing](#).

If you find errors in the present document, please send your comments to the relevant service listed under [Committee Support Staff](#).

If you find a security vulnerability in the present document, please report it through our [Coordinated Vulnerability Disclosure \(CVD\)](#) program.

Notice of disclaimer & limitation of liability

The information provided in the present deliverable is directed solely to professionals who have the appropriate degree of experience to understand and interpret its content in accordance with generally accepted engineering or other professional standard and applicable regulations.

No recommendation as to products and services or vendors is made or should be implied.

No representation or warranty is made that this deliverable is technically accurate or sufficient or conforms to any law and/or governmental rule and/or regulation and further, no representation or warranty is made of merchantability or fitness for any particular purpose or against infringement of intellectual property rights.

In no event shall ETSI be held liable for loss of profits or any other incidental or consequential damages.

Any software contained in this deliverable is provided "AS IS" with no warranties, express or implied, including but not limited to, the warranties of merchantability, fitness for a particular purpose and non-infringement of intellectual property rights and ETSI shall not be held liable in any event for any damages whatsoever (including, without limitation, damages for loss of profits, business interruption, loss of information, or any other pecuniary loss) arising out of or related to the use of or inability to use the software.

Copyright Notification

No part of this document may be reproduced in any form, by any means and in any media, without the prior written authorization of ETSI and except as expressly permitted below.

By way of exception and when the document is a normative deliverable (European Standard (EN), Technical Specification (TS), Group Specification (GS) or ETSI Standard (ES)), ETSI authorizes to reproduce and incorporate into products, services and technical documentation only those extracts (e.g. templates) that are strictly necessary for the technical implementation of the normative deliverable, to ensure compliance with the latter.

Nothing in this notice shall be construed as limiting any mandatory exceptions to copyright provided by applicable law.

© ETSI 2026.
All rights reserved.

Intellectual Property Rights

Essential patents

IPRs essential or potentially essential to normative deliverables (European Standard (EN), Technical Specification (TS), Group Specification (GS) or ETSI Standard (ES)) may have been declared to ETSI. The declarations pertaining to these essential IPRs, if any, are publicly available for **ETSI members and non-members**, and can be found in ETSI SR 000 314: "*Intellectual Property Rights (IPRs); Essential, or potentially Essential, IPRs notified to ETSI in respect of ETSI standards*", which is available from the ETSI Secretariat. Latest updates are available on the [ETSI IPR online database](#).

Pursuant to the ETSI Directives including the ETSI IPR Policy, no investigation regarding the essentiality of IPRs, including IPR searches, has been carried out by ETSI. No guarantee can be given as to the existence of other IPRs not referenced in ETSI SR 000 314 (or the updates on the ETSI Web server) which are, or may be, or may become, essential to the present document.

Trademarks

The present document may include trademarks and/or tradenames which are asserted and/or registered by their owners. ETSI claims no ownership of these except for any which are indicated as being the property of ETSI, and conveys no right to use or reproduce any trademark and/or tradename. Mention of those trademarks in the present document does not constitute an endorsement by ETSI of products, services or organizations associated with those trademarks.

DECT™, **PLUGTESTS™**, **UMTS™** and the ETSI logo are trademarks of ETSI registered for the benefit of its Members. **3GPP™**, **LTE™** and **5G™** logo are trademarks of ETSI registered for the benefit of its Members and of the 3GPP Organizational Partners. **oneM2M™** logo is a trademark of ETSI registered for the benefit of its Members and of the oneM2M Partners. **GSM®** and the GSM logo are trademarks registered and owned by the GSM Association.

Legal Notice

This Technical Specification (TS) has been produced by ETSI 3rd Generation Partnership Project (3GPP).

The present document may refer to technical specifications or reports using their 3GPP identities. These shall be interpreted as being references to the corresponding ETSI deliverables.

The cross reference between 3GPP and ETSI identities can be found at [3GPP to ETSI numbering cross-referencing](#).

Modal verbs terminology

In the present document "**shall**", "**shall not**", "**should**", "**should not**", "**may**", "**need not**", "**will**", "**will not**", "**can**" and "**cannot**" are to be interpreted as described in clause 3.2 of the [ETSI Drafting Rules](#) (Verbal forms for the expression of provisions).

"**must**" and "**must not**" are **NOT** allowed in ETSI deliverables except when used in direct citation.

Contents

Intellectual Property Rights	2
Legal Notice	2
Modal verbs terminology.....	2
Foreword.....	4
1 Scope	5
2 References	5
3 Definitions, symbols and abbreviations	6
3.1 Definitions	6
3.2 Abbreviations	7
4 Descriptions of UE policies for 5GS	8
4.1 Overview	8
4.2 UE route selection policy (URSP).....	8
4.2.1 General.....	8
4.2.2 Association between an application, an AUN3 device, a connectivity group or a PIN and a PDU session, non-seamless non-3GPP offload or 5G ProSe layer-3 UE-to-network relay offload	10
4.2.2.1 General	10
4.2.2.2 Association between an application or a PIN and a PDU session, non-seamless non-3GPP offload or 5G ProSe layer-3 UE-to-network relay offload by a UE.....	10
4.2.2.3 Association between an application or a device behind 5G-RG and a PDU session by a 5G-RG or a W-AGF acting on behalf of FN-RG.....	18
4.2.3 Unknown or unexpected URSP rules.....	24
4.2.4 Reporting of URSP rule enforcement	24
4.3 Access network discovery and selection policy (ANDSP).....	25
4.3.1 Overview	25
4.3.1A General.....	25
4.3.2 WLAN selection policy (WLANSF)	25
4.3.2.1 General	25
4.3.2.2 WLAN access selection	27
4.3.3 N3AN node configuration information.....	27
4.3.3.1 General	27
4.3.3.2 N3AN node selection	27
4.3.4 Precedence of ANDSP parameters	27
4.4 Interworking with EPC.....	28
4.4.1 Precedence between URSP, ANDSP, ANDSF and RAN rules	28
4.4.2 Use of URSP in EPS	29
4.4.3 Reporting of URSP rule enforcement in EPS	33
5 Encoding of UE policies.....	33
5.1 Overview	33
5.2 Encoding of UE policy part type URSP	33
5.3 Encoding of UE policy part type ANDSP	45
5.3.1 General.....	45
5.3.2 Encoding of WLANSF	47
5.3.3 Encoding of N3AN node configuration information	64
5.3.3.1 General	64
5.3.3.2 N3AN node selection information	66
5.3.3.3 Home N3IWF identifier configuration.....	68
5.3.3.4 Home ePDG identifier configuration	70
5.3.3.5 Extended home N3IWF identifier configuration.....	72
5.3.3.6 Slice-specific N3IWF prefix configuration.....	73
Annex A (informative): Change history	75
History	80

Foreword

This Technical Specification has been produced by the 3rd Generation Partnership Project (3GPP).

The contents of the present document are subject to continuing work within the TSG and may change following formal TSG approval. Should the TSG modify the contents of the present document, it will be re-released by the TSG with an identifying change of release date and an increase in version number as follows:

Version x.y.z

where:

- x the first digit:
 - 1 presented to TSG for information;
 - 2 presented to TSG for approval;
 - 3 or greater indicates TSG approved document under change control.
- y the second digit is incremented for all changes of substance, i.e. technical enhancements, corrections, updates, etc.
- z the third digit is incremented when editorial only changes have been incorporated in the document.

1 Scope

The present document defines UE policies for 5G System (5GS) as specified in 3GPP TS 23.503 [2] including:

- UE route selection policy; and
- Access network discovery and selection policy.

2 References

The following documents contain provisions which, through reference in this text, constitute provisions of the present document.

- References are either specific (identified by date of publication, edition number, version number, etc.) or non-specific.
- For a specific reference, subsequent revisions do not apply.
- For a non-specific reference, the latest version applies. In the case of a reference to a 3GPP document (including a GSM document), a non-specific reference implicitly refers to the latest version of that document *in the same Release as the present document*.

- [1] 3GPP TR 21.905: "Vocabulary for 3GPP Specifications".
- [2] 3GPP TS 23.503: " Policy and Charging Control Framework for the 5G System; Stage 2".
- [3] 3GPP TS 24.502: "Access to the 3GPP 5G Core Network (5GCN) via Non-3GPP Access Networks (N3AN); Stage 3".
- [4] 3GPP TS 23.003: "Numbering, addressing and identification".
- [5] 3GPP TS 25.331: "Radio Resource Control (RRC); Protocol Specification".
- [6] Void
- [6A] 3GPP TS 36.413: "Evolved Universal Terrestrial Radio Access (E-UTRA); S1 Application Protocol (S1AP)".
- [7] 3GPP TS 23.032: "Universal Geographical Area Description (GAD)".
- [8] IEEE Std 802.11™-2020: "Information Technology- Telecommunications and information exchange between systems-Local and metropolitan area networks-Specific requirements-Part 11: Wireless LAN Medium Access Control (MAC) and Physical Layer (PHY) Specifications".
- [9] Wi-Fi Alliance: "Hotspot 2.0 (Release 2) Technical Specification, version 1.0.0", 2014-08-08.
- [10] ITU-T Recommendation E.212: "The international identification plan for public networks and subscriptions", 2016-09-23.
- [11] 3GPP TS 24.501: "Non-Access-Stratum (NAS) protocol for 5G System (5GS); Stage 3".
- [12] IETF RFC 1035: "Domain names - implementation and specification".
- [13] ISO 8601:2004: "Data elements and interchange formats -- Information interchange -- Representation of dates and times".
- [14] 3GPP TS 38.413: "NG-RAN; NG Application Protocol (NGAP)".
- [15] 3GPP TS 23.501: "System Architecture for the 5G System; Stage 2".
- [16] IETF RFC 9562: "Universally Unique IDentifiers (UUIDs)".
- [17] IETF RFC 5905: "Network Time Protocol Version 4: Protocol and Algorithms Specification".

- [18] 3GPP TS 24.588: "Vehicle-to-Everything (V2X) services in 5G System (5GS); User Equipment (UE) policies; Stage 3".
- [18A] 3GPP TS 24.555: "Proximity-services (ProSe) in 5G System (5GS); User Equipment (UE) policies; Stage 3".
- [19] IEEE 1003.1-2017: "IEEE Standard for Information Technology--Portable Operating System Interface (POSIX(TM)) Base Specifications, Issue 7".
- [20] IEEE Std 802.1Q-2022: "IEEE Standard for Local and metropolitan area networks--Bridges and Bridged Networks".
- [21] 3GPP TS 24.554: "Proximity-services (ProSe) in 5G System (5GS) protocol aspects; Stage 3".
- [22] 3GPP TS 24.193: "Access Traffic Steering, Switching and Splitting; Stage 3".
- [23] 3GPP TS 24.514: "Ranging based services and sidelink positioning in 5G system(5GS); Stage 3".
- [24] 3GPP TS 24.578: "Aircraft-to-Everything (A2X) services in 5G System (5GS); UE policies".
- [25] 3GPP TS 23.316: "Wireless and wireline convergence access support for the 5G System (5GS)".
- [26] GSMA PRD NG.135, version 3.0: "E2E Network Slicing Requirements".
- [27] 3GPP TS 23.273: "5G System (5GS) Location Services (LCS); Stage 2".
- [28] 3GPP TS 23.122: "Non-Access-Stratum (NAS) functions related to Mobile Station (MS) in idle mode".
- [29] 3GPP TS 24.301: "Non-Access-Stratum (NAS) protocol for Evolved Packet System (EPS); Stage 3".

3 Definitions, symbols and abbreviations

3.1 Definitions

For the purposes of the present document, the terms and definitions given in 3GPP TR 21.905 [1] apply. A term defined in the present document takes precedence over the definition of the same term, if any, in 3GPP TR 21.905 [1].

Non-subscribed SNPN signalled URSP: URSP rules signalled by a non-subscribed SNPN according to annex D of 3GPP TS 24.501 [11].

PLMN generic (PG) URSP: URSP rules applicable in any PLMN, and determined according to annex D of 3GPP TS 24.501 [11].

VPLMN specific (VPS) URSP of the RPLMN: URSP rules applicable when the UE is registered via one or both accesses and the RPLMN of each access is a VPLMN, and determined according to annex D of 3GPP TS 24.501 [11].

VPLMN specific (VPS) URSP of the equivalent PLMN of the RPLMN: URSP rules applicable when the UE is registered via one or both accesses, the RPLMN of each access is a VPLMN, and the equivalent PLMN is a VPLMN, and determined according to annex D of 3GPP TS 24.501 [11].

For the purposes of the present document, the following terms and definitions given in 3GPP TS 23.501 [15] apply:

Credentials Holder (CH)
non-seamless non-3GPP offload
PIN
PINE

For the purposes of the present document, the following terms and definitions given in 3GPP TS 23.503 [2] apply:

UE local configuration
User preferences on non-3GPP access selection
VPLMN specific (VPS) URSP

For the purposes of the present document, the following terms and definitions given in 3GPP TS 24.501 [11] apply:

5GMM-IDLE mode
PDU session for LADN
SNPN access operation mode

For the purposes of the present document, the following terms and definitions given in 3GPP TS 23.316 [25] apply:

Authenticable Non-3GPP (AUN3) device
Non-Authenticable Non-3GPP (NAUN3) device

For the purposes of the present document, the following terms and definitions given in 3GPP TS 23.122 [28] apply:

Subscribed SNPN

3.2 Abbreviations

For the purposes of the present document, the abbreviations given in 3GPP TR 21.905 [1] and the following apply. An abbreviation defined in the present document takes precedence over the definition of the same abbreviation, if any, in 3GPP TR 21.905 [1].

5GCN	5G Core Network
5GS	5G System
A2XP	A2X Policy
ANDSP	Access Network Discovery and Selection Policy
AUN3	Authenticable Non-3GPP
CH	Credentials Holder
DNN	Data Network Name
ePDG	evolved Packet Data Gateway
FQDN	Fully Qualified Domain Name
H-PCF	A PCF in the HPLMN
IMS	IP Multimedia Subsystem
LADN	Local Area Data Network
MCC	Mobile Country Code
ME	Mobile Equipment
MMS	Multimedia Messaging Service
MNC	Mobile Network Code
N3AN	Non-3GPP Access Network
N3IWF	Non-3GPP InterWorking Function
NAUN3	Non-Authenticable Non-3GPP
OS	Operating System
PCF	Policy Control Function
PIN	Personal IoT Network
PINE	PIN Element
ProSeP	5G ProSe Policy
RSLPP	Ranging and Sidelink Positioning Policy
RSN	Redundancy Sequence Number
S-NSSAI	Single Network Slice Selection Assistance Information
SSC	Session and Service Continuity
SUPI	Subscriber Permanent Identifier
SUPL	Secure User Plane Location
TNAN	Trusted Non-3GPP Access Network
TNGF	Trusted Non-3GPP Gateway Function
URSP	UE Route Selection Policy
USIM	User Services Identity Module
V-PCF	A PCF in the VPLMN
V2XP	V2X Policy
WLANSP	WLAN Selection Policy

4 Descriptions of UE policies for 5GS

4.1 Overview

The UE policies for 5GS include:

- UE route selection policy (URSP) (see clause 4.2);
- Access network discovery and selection policy (ANDSP) (see clause 4.3);
- V2X policy (V2XP);
- 5G ProSe policy (ProSeP);
- Ranging and sidelink positioning policy (RSLPP); and
- A2X policy (A2XP).

The UE policies can be delivered from the PCF to the UE. The UE policy delivery procedure is specified in 3GPP TS 24.501 [11] annex D.

The UE policies can be pre-configured in the ME, the USIM or both. The pre-configured UE policies shall be applied by the UE only when the UE has not received the same type of policy from the PCF. The implementation of pre-configured UE policies is out of scope of this specification. When the UE policies are pre-configured in both the ME and the USIM, the configuration parameters configured in the USIM take precedence over the ones configured in the ME.

The UE policies can be delivered from the PCF to the 5G-RG or a W-AGF acting on behalf of the FN-RG. The UE policy delivery service is specified in 3GPP TS 24.501 [11]. These UE policies include the UE route selection policy (URSP) (see clause 4.2).

The UE policies can also be pre-configured in the 5G-RG or a W-AGF acting on behalf of the FN-RG. The pre-configured policy shall be applied by the 5G-RG or a W-AGF acting on behalf of the FN-RG only when the 5G-RG or a W-AGF acting on behalf of the FN-RG has not received the same type of policy from the PCF. The implementation of pre-configured UE policies is out of scope of this specification.

NOTE 1: In this specification, the UE policies can be delivered to a 5G-RG that is acting as a UE, a 5G-RG that is acting on behalf of AUN3 device, a 5G-RG that is acting on behalf of NAUN3 device.

The UE policies for V2X (V2XP) are specified in 3GPP TS 24.588 [18].

The UE policies for 5G ProSe policy (ProSeP) are specified in 3GPP TS 24.555 [18A].

The UE policies for A2X (A2XP) are specified in 3GPP TS 24.578 [24].

The UE policies for ranging and sidelink positioning (RSLPP) are specified in 3GPP TS 24.514 [23].

For the present specification, the UE shall consider a UE policy as signalled by the HPLMN, if the PLMN ID part of the UE policy section identifier (see annex D.1.1 of 3GPP TS 24.501 [11]) is equal to the HPLMN code derived from the IMSI.

NOTE 2: This is also applicable if the UE has a non-empty EHPLMN list, even if the EHPLMN list does not include the PLMN ID derived from the IMSI.

4.2 UE route selection policy (URSP)

4.2.1 General

The URSP is defined in 3GPP TS 23.503 [2] and is a set of one or more URSP rules, where a URSP rule is composed of:

- a) a precedence value of the URSP rule identifying the precedence of the URSP rule among all the existing URSP rules;
- b) a traffic descriptor, including either:
 - 1) match-all traffic descriptor; or
 - 2) at least one of the following components (see table 6.6.2.1-2 in 3GPP TS 23.503 [2]):
 - A) one or more application identifiers;
 - B) one or more IP descriptors, each consists of a set of IP 3 tuples as defined in 3GPP TS 23.503 [2] i.e. the destination IP address, the destination port number, and the protocol in use above the IP;
 - C) one or more non-IP descriptors, i.e. destination information of non-IP traffic;
 - D) one or more DNNs;
 - E) one or more connection capabilities;
 - F) one or more domain descriptors, i.e. destination FQDN(s) or a regular expression as a domain name matching criteria;
 - G) one PIN ID; and
 - H) one or more connectivity group IDs; and
- c) one or more route selection descriptors each consisting of a precedence value of the route selection descriptor and either
 - 1) one PDU session type and, optionally, one or more of the followings:
 - A) SSC mode;
 - B) one or more S-NSSAIs. If the URSP rule is a part of a non-subscribed SNPN signalled URSP, the S-NSSAI is of the non-subscribed SNPN otherwise the S-NSSAI is of the HPLMN or the subscribed SNPN. Mapped HPLMN SST and mapped HPLMN SD are not included in the S-NSSAI;
 - C) one or more DNNs;
 - D) Void;
 - E) preferred access type;
 - F) multi-access preference;
 - G) a time window;
 - H) location criteria;
 - I) PDU session pair ID;
 - J) RSN; and
 - K) 5G ProSe multi-path preference;
 - 2) non-seamless non-3GPP offload indication; or
 - 3) 5G ProSe layer-3 UE-to-network relay offload indication.

Only one URSP rule in the URSP can be a default URSP rule and the default URSP rule shall contain a match all traffic descriptor. If a default URSP rule and one or more non-default URSP rules are included in the URSP, any non-default URSP rule shall have lower precedence value than (i.e. shall be prioritised over) the default URSP rule.

If a traffic descriptor lists one or more application identifiers together with one or more connection capabilities, the UE shall consider that the application identifiers identify the applications requesting access to the connection capabilities.

NOTE 1: The connection capability identifiers defined in table 5.2.1 are OS independent. It is based on the UE implementation how the UE matches the connection capabilities requested by the applications to the connection capability identifiers in table 5.2.1.

NOTE 2: If the UE has multiple concurrently active OS, the traffic descriptor can list as many multiple OS Ids.

NOTE 3: It is recommended to avoid the combination of more than two components in the traffic descriptor.

4.2.2 Association between an application, an AUN3 device, a connectivity group or a PIN and a PDU session, non-seamless non-3GPP offload or 5G ProSe layer-3 UE-to-network relay offload

4.2.2.1 General

Association between an application, an AUN3 device, a connectivity group or a PIN and a PDU session, non-seamless non-3GPP offload or 5G ProSe Layer-3 UE-to-network relay offload is described separately for a UE and for a 5G-RG or a W-AGF acting on behalf of an FN-RG. Clause 4.2.2.2 is not applicable for the 5G-RG or the W-AGF acting on behalf of the FN-RG.

4.2.2.2 Association between an application or a PIN and a PDU session, non-seamless non-3GPP offload or 5G ProSe layer-3 UE-to-network relay offload by a UE

In order to send a PDU of an application or a PIN, the upper layers require information on the PDU session (e.g. PDU address) via which to send a PDU of an application or a PIN.

NOTE 0: If PAP/CHAP is used, it is recommended that the request from the upper layers includes a DNN.

When the upper layers request information of the PDU session via which to send a PDU of an application;

- information on the non-3GPP access outside of a PDU session shall be provided to the upper layers, without evaluating the URSP rules, if due to UE local configuration non-seamless non-3GPP offload is requested; or
- information on the 5G ProSe layer-3 UE-to-network relay shall be provided to the upper layers, without evaluating the URSP rules, if due to UE local configuration 5G ProSe layer-3 UE-to-network relay offload is requested;

otherwise, the UE shall proceed in the following order:

- a) the UE shall evaluate the URSP rules, except the default URSP rule, with a traffic descriptor matching the application information or the PIN information in increasing order of their precedence values, if any. If the traffic descriptor contains more than one traffic descriptor component type, each of a different type, all of them shall be matched. If the traffic descriptor contains more than one traffic descriptor component of the same traffic descriptor component type, at least one of the traffic descriptor components of the same traffic descriptor component type shall be matched with the application information. A URSP rule is determined not to be applicable when for any given component in the traffic descriptor no corresponding information from the application or no corresponding information for the PIN is available or the corresponding information from the application or no corresponding information for the PIN does not match any of the values in the traffic descriptor component as specified in clause 6.6.2.1 of 3GPP TS 23.503 [2].

If the UE finds the traffic descriptor in a non-default URSP rule matching the application information or the PIN information, and:

- D) if there is an established connection to non-3GPP access, an established connection with a 5G ProSe layer-3 UE-to-network relay UE, or one or more established PDU sessions or any combinations of these, the UE shall evaluate the route selection descriptors of the URSP rule in increasing order as followings:

if:

- 1) the route selection descriptor of the URSP rule contains a non-seamless non-3GPP offload indication and the information on the non-3GPP access outside of a PDU session is available;

the UE shall provide information on the non-3GPP access outside of a PDU session to the upper layers;

- 1a) the route selection descriptor of the URSP rule contains a 5G ProSe layer-3 UE-to-network relay offload indication and the information on 5G ProSe layer-3 UE-to-network relay is available;

the UE shall provide information on the 5G ProSe layer-3 UE-to-network relay to the upper layers;

- 1b) the route selection descriptor of the URSP rule contains a 5G ProSe multi-path preference and the information on 5G ProSe layer-3 UE-to-network relay without N3IWF support is available;

the UE shall provide information on the 5G ProSe layer-3 UE-to-network relay without N3IWF support and the 5G ProSe multi-path preference to the upper layers; and

- 2) there is one or more PDU sessions:

- i) for which the parameters associated with the PDU session, the parameters requested by the UE during the PDU session establishment procedure or the mapped parameters from the parameters requested by the UE during the UE requested PDN connectivity procedure to establish a PDN connection as a user-plane resource of an MA PDU session as specified in clause 5.3.1 of 3GPP TS 24.193 [22] match the route selection descriptors of the URSP rule except the preferred access type and the multi-access preference, if any, wherein:

- a route selection descriptor with PDU session type IPv4v6 matches also with PDU session type IPv4 if the network has sent 5GSM cause value #50 "PDU session type IPv4 only allowed" in the PDU SESSION ESTABLISHMENT ACCEPT message or matches also with PDN type IPv4 if the network has sent ESM cause is #50 "PDN type IPv4 only allowed" in the ACTIVATE DEFAULT EPS BEARER CONTEXT REQUEST message of the PDN connectivity procedure to establish a PDN connection as a user-plane resource of an MA PDU session as specified in clause 5.3.1 of 3GPP TS 24.193 [22];
- the route selection descriptor with PDU session type IPv4v6 matches also with PDU session type IPv6 if the network has sent 5GSM cause value #51 "PDU session type IPv6 only allowed" in the PDU SESSION ESTABLISHMENT ACCEPT message or matches also with PDN type IPv6 if the network has sent ESM cause is #51 "PDN type IPv6 only allowed" in the ACTIVATE DEFAULT EPS BEARER CONTEXT REQUEST message of the PDN connectivity procedure to establish a PDN connection as a user-plane resource of an MA PDU session as specified in clause 5.3.1 of 3GPP TS 24.193 [22];
- the route selection descriptor with PDU session type IPv4v6 matches also with PDU session type IPv6 or IPv4 if the UE requested the PDU session type IPv4v6 but the selected PDU session type is set to IPv4 or IPv6 in the PDU SESSION ESTABLISHMENT ACCEPT message or if the UE requested the PDN type IPv4v6 but the network allocates a PDN address of a PDN type IPv4 or IPv6 in the ACTIVATE DEFAULT EPS BEARER CONTEXT REQUEST message of the PDN connectivity procedure to establish a PDN connection as a user-plane resource of an MA PDU session as specified in clause 5.3.1 of 3GPP TS 24.193 [22]; and
- if the UE is in a non-subscribed SNPN and the URSP rule is a part of the non-subscribed SNPN signalled URSP, or is in the HPLMN or the subscribed SNPN, then a route selection descriptor with an S-NSSAI matches the S-NSSAI of the PDU session, otherwise a route selection descriptor with an S-NSSAI matches the mapped S-NSSAI of the PDU session; and

NOTE 0: If the PDU session is associated with the S-NSSAI to be replaced and the alternative S-NSSAI (see 3GPP TS 24.501 [11] clause 4.6.3.4), the mapped S-NSSAI of PDU session is the mapped S-NSSAI of the S-NSSAI to be replaced.

- ii) established without requesting any parameter for which the matching route selection descriptor of the URSP rule does not provide a route selection descriptor component, except:
- A) the preferred access type;
 - B) the multi-access preference;
 - C) the DNN, if no DNN is included in the route selection descriptor component and the DNN provided by the application is the same as the DNN requested by the UE during the PDU session establishment or the same as the DNN mapped from the APN requested by the UE during the PDN

connectivity procedure to establish a PDN connection as a user-plane resource of an MA PDU session as specified in clause 5.3.1 of 3GPP TS 24.193 [22]; and

D) the S-NSSAI, if the UE has only one S-NSSAI in the allowed NSSAI.

the UE shall provide information on the PDU session that matches the route selection and the 5G ProSe multi-path preference if included in the route selection descriptor to the upper layers; and

if the UE supports reporting of URSP rule enforcement and:

- i) the URSP rule enforcement report indication is included in the URSP rule and is set to "URSP rule enforcement report is required";
- ii) one or more connection capabilities are contained in the traffic descriptor; and
- iii) a URSP rule enforcement report with all the connection capabilities contained in the traffic descriptor has not been sent to the network by the UE during the PDU session establishment or modification procedure,

then the URSP handling layer requests the UE NAS layer to send a URSP rule enforcement report with all the connection capabilities contained in the traffic descriptor to the network using the PDU session modification procedure;

NOTE 1: It is up to the UE implementation which PDU session to select if there exist multiple PDU sessions matching the same route selection descriptor of the lowest precedence value.

II) otherwise:

- 1) the UE shall select a route selection descriptor with the next smallest precedence value which has not yet been evaluated;
- 2) if:
 - i) the selected route selection descriptor contains a non-seamless non-3GPP offload indication:
 - A) if the information on the non-3GPP access outside of a PDU session is available, it shall be provided to the upper layers and the UE shall stop selecting a route selection descriptor matching the application information; or
 - B) if the information about the non-3GPP access outside of a PDU session is not available, or non-3GPP access is not available, the UE shall proceed to step II) 4);
 - ia) the selected route selection descriptor contains a 5G ProSe layer-3 UE-to-network relay offload indication:
 - A) if the information on the 5G ProSe layer-3 UE-to-network relay is available and the UE supports acting as a 5G ProSe layer-3 remote UE as specified in 3GPP TS 24.554 [21], it shall be provided to the upper layers and the UE shall stop selecting a route selection descriptor matching the application information; or
 - B) if the information about the 5G ProSe layer-3 UE-to-network relay is not available, the UE may initiate a UE-to-network relay discovery over PC5 interface as specified in clause 8.2.1 of 3GPP TS 24.554 [21] if the UE supports acting as a 5G ProSe layer-3 remote UE as specified in 3GPP TS 24.554 [21]. If the connection with a 5G ProSe layer-3 UE-to-network relay UE has been successfully established, the UE shall provide information on the 5G ProSe layer-3 UE-to-network relay to the upper layers and the UE shall stop selecting a route selection descriptor matching the application information. If the connection with a 5G ProSe layer-3 UE-to-network relay UE has not been successfully established or the UE does not support acting as a 5G ProSe layer-3 remote UE as specified in 3GPP TS 24.554 [21], the UE shall proceed to step II) 4);
 - ib) the selected route selection descriptor includes the 5G ProSe multi-path preference but the UE does not support acting as a 5G ProSe layer-3 remote UE as specified in 3GPP TS 24.554 [21], the UE shall proceed to step II) 4);
 - ii) the selected route selection descriptor includes a PDU session type or an SSC mode which is not supported by the UE (SSC mode 2 or 3), the UE shall proceed to step II) 4);

- iii) the selected route selection descriptor contains a time window but the time does not match the time window, the UE shall proceed to step II) 4);
- iv) the selected route selection descriptor contains location criteria but the UE location does not match the location criteria, the UE shall proceed to step II) 4);
- v) the selected route selection descriptor includes the multi-access preference but the UE does not support ATSSS, the UE shall proceed to step II) 4);
- va) the selected route selection descriptor includes an SSC mode which either has been rejected by the network with 5GSM cause value #68 "not supported SSC mode" for the same DNN (or no DNN, if no DNN was indicated by the UE) and the same S-NSSAI associated with (if available in roaming scenarios) a mapped S-NSSAI (or no S-NSSAI, if no S-NSSAI was indicated by the UE) or was not included in the Allowed SSC mode IE following a rejection with 5GSM cause value #68 "not supported SSC mode" for the same DNN (or no DNN, if no DNN was indicated by the UE) and the same S-NSSAI associated with (if available in roaming scenarios) a mapped S-NSSAI (or no S-NSSAI, if no S-NSSAI was indicated by the UE), the UE shall proceed to step II) 4); or
- vi) the selected route selection descriptor does not contain a non-seamless non-3GPP offload indication nor a 5G ProSe layer-3 UE-to-network relay offload indication, the URSP handling layer requests the UE NAS layer to establish a PDU session providing the following PDU session attributes based on the selected route selection descriptor:
 - A) SSC mode if there is a SSC mode in the route selection descriptor;

NOTE 2: The SSC mode 3 is only used when the PDU session type is IPv4, IPv6 or IPv4v6.

- B) one S-NSSAI if the S-NSSAI is in the route selection descriptor; and the S-NSSAI is in the allowed NSSAI or in the partially allowed NSSAI. Additionally, if the UE supports LADN per DNN and S-NSSAI, the request is for a PDU session for LADN, the extended LADN information is available for that LADN and the S-NSSAI is associated with that LADN in the service area of that LADN. If none of the S-NSSAI(s) in the route selection descriptor is in the allowed NSSAI or in the partially allowed NSSAI but there is an S-NSSAI in the route selection descriptor which is in an on-demand NSSAI, before requesting the UE NAS layer to establish a PDU session, the URSP handling layer provides one on-demand S-NSSAI to the UE NAS layer. If none of the S-NSSAI(s) in the route selection descriptor is in the allowed NSSAI, the partially allowed NSSAI or the on-demand NSSAI, the UE shall proceed to step II) 4);

NOTE 3: If there are multiple S-NSSAIs in the route selection descriptor, an S-NSSAI is chosen among the S-NSSAIs based on UE implementation.

NOTE 3A: The UE NAS layer includes the on-demand S-NSSAI in the requested NSSAI during the registration procedure as specified in 3GPP TS 24.501 [11] clause 4.6.2.9.

- C) one DNN, if the DNN is in the route selection descriptor; and if the DNN is an LADN DNN and the UE is in the service area of that LADN;

NOTE 4: If one or more DNNs are included in the traffic descriptor and no DNN is included in the route selection descriptor, the DNN provided by the application is selected as one of the PDU session attributes by the URSP handling layer to request the UE NAS layer.

NOTE 5: If there are multiple DNNs in the route selection descriptor, a DNN is chosen based on UE implementation.

- D) the PDU session type of the route selection descriptor;
- E) preferred access type or multi-access preference, if the preferred access type or the multi-access preference is in the route selection descriptor;

NOTE 6: If a preferred access type or a multi-access preference is included in the route selection descriptor of a URSP rule, it is recommended that the UE establishes a PDU session based on the preferred access type or the multi-access preference.

NOTE 6A: If a multi-access preference is included in the route selection descriptor of a URSP rule, the UE is allowed to use a 5G ProSe layer-3 UE-to-network relay with N3IWF support as specified in clause 8.2.7 of 3GPP TS 24.554 [21] to establish an MA PDU session in case that the UE is configured with the corresponding ProSe policy as specified in clause 5.2.5 of 3GPP TS 24.554 [21].

NOTE 7: If a preferred access type is included in the route selection descriptor of a URSP rule and the preferred access type is 3GPP access, the UE is allowed to discover a 5G ProSe layer-2 UE-to-network relay UE as specified in clause 8.2.1 of 3GPP TS 24.554 [21] to access the network in case that the UE is configured with the corresponding ProSe policy as specified in clause 5.2.5 of 3GPP TS 24.554 [21].

NOTE 8: If a preferred access type is included in the route selection descriptor of a URSP rule and the preferred access type is non-3GPP access, the UE is allowed to discover a 5G ProSe layer-3 UE-to-network relay UE with N3IWF support as specified in clause 8.2.7 of 3GPP TS 24.554 [21] to establish a PDU session in case that the UE is configured with the corresponding ProSe policy as specified in clause 5.2.5 of 3GPP TS 24.554 [21].

F) PDU session pair ID if there is a PDU session pair ID in the route selection descriptor; and

G) RSN if there is an RSN in the route selection descriptor, and

if the UE supports reporting of URSP rule enforcement and:

A) the URSP rule enforcement report indication is included in the URSP rule and is set to "URSP rule enforcement report is required"; and

B) one or more connection capabilities are contained in the traffic descriptor,

then the URSP handling layer requests the UE NAS layer to send a URSP rule enforcement report with all the connection capabilities contained in the traffic descriptor to the network during PDU session establishment;

The UE NAS layer indicates the result of the PDU session establishment. Upon successful completion of the PDU session establishment, the UE NAS layer shall additionally indicate the attributes of the established PDU session (e.g. PDU session identity, SSC mode, S-NSSAI, DNN, PDU session type, access type, PDU address) to the URSP handling layer, and shall provide information (e.g. PDU address) of the successfully established PDU session to the upper layers.

NOTE 9: If the PDU session is associated with S-NSSAI to be replaced and the alternative S-NSSAI (see 3GPP TS 24.501 [11] clause 4.6.3.4), the S-NSSAI to be replaced (not alternative S-NSSAI) is used in the URSP handling layer.

If the PDU session establishment is successful, the 5G ProSe multi-path preference is included in the route selection descriptor, and:

A) the information on the 5G ProSe layer-3 UE-to-network relay without N3IWF support is available and the UE supports acting as a 5G ProSe layer-3 remote UE as specified in 3GPP TS 24.554 [21], the UE shall provide the information on the 5G ProSe layer-3 UE-to-network relay without N3IWF support and the 5G ProSe multi-path preference to the upper layers; or

B) the information on the 5G ProSe layer-3 UE-to-network relay is not available, the UE may discover and establish a connection via a 5G ProSe layer-3 UE-to-network relay without N3IWF support as specified in 3GPP TS 24.554 [21]. If the connection via a 5G ProSe layer-3 UE-to-network relay without N3IWF support has been successfully established, the UE shall provide the information on the 5G ProSe layer-3 UE-to-network relay without N3IWF support and the 5G ProSe multi-path preference to the upper layers.

The UE shall stop selecting a route selection descriptor matching the application information or the PIN information. If the PDU session establishment is unsuccessful, the UE shall proceed to step II) 3);

- 3) Based on the rejection cause and if there is another value which can be used for the rejected component in the same route selection descriptor, the UE shall select another combination of values in the currently selected route selection descriptor by using this value of the rejected component and proceed to step II) 2), otherwise the UE shall proceed to step II) 4); and

- 4) if there is any route selection descriptor which has not yet been evaluated, the UE shall proceed to step II) 1). If all route selection descriptors for the matching non-default URSP rule have been evaluated and there is one or more non-default matching URSP rule which has not yet been evaluated, the UE shall proceed to step a). If all non-default matching URSP rules have been evaluated, the UE shall inform the upper layers of the failure.

NOTE 9A: When the UE decides to proceed to step II) 1) or step a), it is up to UE implementation to define a way to evaluate skipping any route selection descriptor(s) which have not yet been evaluated, that contain the same [PDU session type, DNN, S-NSSAI] combinations for which the UE has received rejection with 5GSM cause value #28 "unknown PDU session type" as specified in 3GPP TS 24.501 [11] or ESM cause value #28 "unknown PDN connection type" as specified in 3GPP TS 24.301 [29].

- b) if no non-default matching URSP rule can be found and if UE local configuration for the application or the PIN is available, the UE shall perform the association of the application or the PIN to a PDU session accordingly. If no matching PDU session exists, the UE NAS layer shall attempt to establish a PDU session using UE local configuration; and

NOTE 9: Any missing information in the UE local configuration needed to build the PDU session establishment request can be the appropriate corresponding component from the default URSP rule with the "match-all" traffic descriptor.

NOTE 10: If a DNN was provided by the application and no DNN is included in the UE local configuration, the DNN provided by the application is selected as one of the PDU session attributes by the URSP handling layer to request the UE NAS layer.

NOTE 11: If there are multiple DNNs in the UE local configuration, a DNN is chosen based on UE implementation.

If the PDU session establishment is successful, the UE NAS layer shall provide information (e.g. PDU address) of the successfully established PDU session to the upper layers. Otherwise, the UE shall go to step c);

- c) if no non-default matching URSP rule can be found and if either UE local configuration for the application is not available or the PDU session establishment based on UE local configuration for the application was unsuccessful, the UE shall perform the association of the application to a PDU session, to non-seamless non-3GPP offload or to 5G ProSe layer-3 UE-to-network relay offload according to the default URSP rule with the "match-all" traffic descriptor, if any. If the association is unsuccessful, the UE shall inform the upper layers of the failure.

NOTE 12: If a DNN was provided by the application and no DNN is included in the route selection descriptor of the default URSP rule, the DNN provided by the application is selected as one of the PDU session attributes by the URSP handling layer to request the UE NAS layer. If one or more DNNs are included in the route selection descriptor of the default URSP rule, the DNN in the route selection descriptor is selected as one of the PDU session attributes by the URSP handling layer to request the UE NAS layer. When there are multiple DNNs in the route selection descriptor, the DNN is selected based on UE implementation.

The HPLMN may pre-configure the UE with URSP in the ME, in the USIM or both and the subscribed SNPN(s) may pre-configure the UE with URSP in the corresponding entry of the "list of subscriber data" stored in ME. The HPLMN or subscribed SNPN may pre-configure URSP(s) in the ME for non-subscribed SNPN(s) and associate the URSP(s) with the entry of the subscribed SNPN of the "list of subscriber data" or associate the URSP(s) with the corresponding PLMN subscription of the HPLMN. It is up to implementation how many pre-configured URSP(s) for non-subscribed SNPN(s) per entry of the "list of subscriber data" or per PLMN subscription can be stored in the ME. The HPLMN, the subscribed SNPN(s) and the non-subscribed SNPN(s) may provide URSP to the UE by signalling as described in annex D of 3GPP TS 24.501 [11]. The HPLMN pre-configured URSP in the ME and the HPLMN signalled URSP shall be stored in a non-volatile memory in the ME together with the SUPI from the USIM. The subscribed SNPN(s) signalled URSP shall be stored per SNPN in a non-volatile memory in the ME together with the subscriber identifier and the associated SNPN identity of the SNPN in the "list of subscriber data" configured in the ME. If the UE is in a non-subscribed SNPN using credentials from a PLMN, then the UE shall compose HPLMN signalled URSP from the signalled URSP received when the UE did not operate in SNPN access operation mode, excluding VPS URSP of any VPLMN, if the UE supports VPS URSP. If the UE accepts URSP rules signalled by a non-subscribed SNPN that the UE accesses using credentials from a credential holder (see 3GPP TS 24.501 [11] clause C.2 and D.2), the non-subscribed SNPN(s) signalled URSP shall be stored per non-subscribed SNPN and associated with the selected entry of the "list of subscriber data" or the selected PLMN subscription. It is up to implementation how many signalled URSP(s) for non-subscribed SNPN(s) per entry of the "list of subscriber data" or per PLMN subscription can be stored in the ME. Only the subscribed SNPN(s) pre-configured URSP and the subscribed SNPN(s) signalled URSP shall be used when the selected SNPN identity matches the associated subscribed SNPN identity.

If the UE registered to a subscribed SNPN or a PLMN, has both pre-configured URSP(s) and signalled URSP, the UE shall only use the signalled URSP.

For a UE not operating in SNPN access operation mode, if the UE supports VPS URSP and has signalled URSP, when the upper layers request information of the PDU session via which to send a PDU of an application or a PIN as described above, the UE shall evaluate URSP rules, if available, in accordance with the following order until a matching URSP rule is found:

- 1) if the UE is registered via one or both accesses and the RPLMN of each access is a VPLMN, non-default URSP rules in the VPS URSP of the RPLMN using steps in bullet a) above;
- 2) if the UE is registered via one or both accesses and the RPLMN of each access is a VPLMN, non-default URSP rules in the VPS URSP of the equivalent PLMN of the RPLMN using steps in bullet a) above;
- 3) non-default URSP rules in the PG URSP using steps in bullet a) above;
- 4) UE local configuration for the application or the PIN using steps in bullet b) above;
- 5) if the UE is registered via one or both accesses and the RPLMN of each access is a VPLMN, default URSP rule in the VPS URSP of the RPLMN using steps in bullet c) above;
- 6) if the UE is registered via one or both accesses and the RPLMN of each access is a VPLMN, default URSP rules in the VPS URSP of the equivalent PLMN of the RPLMN using steps in bullet c) above; and
- 7) default URSP rule in the PG URSP using steps in bullet c) above.

For a UE not operating in SNPN access operation mode, if the UE does not have signalled URSP, when the upper layers request information of the PDU session via which to send a PDU of an application as described above, the UE shall evaluate URSP rules, if available, in accordance with the following order until a matching URSP rule is found:

- 1) if there are pre-configured URSP rules of the HPLMN in the USIM;
 - i) non-default URSP rules in the pre-configured URSP rules of the HPLMN in the USIM using steps in bullet a) above;
 - ii) UE local configuration for the application using steps in bullet b) above;
 - iii) default URSP rule in the pre-configured URSP rules of the HPLMN in the USIM using steps in bullet c) above; and
 - iv) shall ignore URSP rules of other PLMN(s) in the USIM; or
- 2) otherwise, if the UE has pre-configured URSP in the ME then:
 - i) non-default URSP rules in the pre-configured URSP rules in the ME using steps in bullet a) above;
 - ii) UE local configuration for the application using steps in bullet b) above; and
 - iii) default URSP rule in the pre-configured URSP rules in the ME using steps in bullet c) above.

When the UE is registered to a non-subscribed SNPN using credentials from a credentials holder then when the upper layers request information of the PDU session via which to send a PDU of an application as described above:

- 1) if the UE has the non-subscribed SNPN signalled URSP associated with the selected entry of the "list of subscriber data" or the selected PLMN subscription, or the subscribed SNPN signalled URSP when the credentials holder is an SNPN or the HPLMN signalled URSP when the credentials holder is a PLMN, the UE shall evaluate URSP rules, if available, in accordance with the following order until a matching URSP rule is found:
 - i) the non-subscribed SNPN signalled non-default URSP rules associated with the selected entry of the "list of subscriber data" or the selected PLMN subscription stored in the ME using steps in bullet a) above;
 - ii) if the credentials holder is:
 - an SNPN, the subscribed SNPN signalled non-default URSP rules stored in the ME using steps in bullet a) above; or

- a PLMN, the HPLMN signalled non-default URSP rules stored in the ME using steps in bullet a) above;
- iii) UE local configuration for the application using steps in bullet b) above;
- iv) the non-subscribed SNPN signalled default URSP rule associated with the selected entry of the "list of subscriber data" or the selected PLMN subscription stored in the ME using steps in bullet c) above; or
- v) if the credentials holder is:
 - an SNPN, the subscribed SNPN signalled default URSP rule stored in the ME using steps in bullet c) above; or
 - a PLMN, the HPLMN signalled default URSP rule stored in the ME using steps in bullet c) above;

NOTE 13: If no matching URSP rule is found, the UE informs the upper layers of the failure.

2) otherwise, if the UE has

- i) URSP pre-configured for the non-subscribed SNPN associated with the selected entry of the "list of subscriber data" or the selected PLMN subscription;
- ii) URSP pre-configured for the subscribed SNPN when the credentials holder is an SNPN or for the HPLMN when the credentials holder is a PLMN; or
- iii) UE local configuration for the application;

then the UE shall evaluate URSP rules, if available, in accordance with the following order until a matching URSP rule is found:

- i) the non-default URSP rules pre-configured for the non-subscribed SNPN and associated with the selected entry of the "list of subscriber data" or the selected PLMN subscription stored in the ME using steps in bullet a) above;
- ii) if the credentials holder is:
 - A) an SNPN, the subscribed SNPN pre-configured non-default URSP rules stored in the ME using steps in bullet a) above; or
 - B) a PLMN:
 - the HPLMN pre-configured non-default URSP rules stored in the in USIM using steps in bullet a) above; or
 - the HPLMN pre-configured non-default URSP rules stored in the in ME using steps in bullet a) above;
- iii) UE local configuration for the application using steps in bullet b) above;
- iv) the default URSP rule pre-configured for the non-subscribed SNPN and associated with the selected entry of the "list of subscriber data" or the selected PLMN subscription stored in the ME using steps in bullet c) above; or
- v) if the credentials holder is:
 - A) an SNPN, the subscribed SNPN pre-configured default URSP rule stored in the ME using steps in bullet c) above; or
 - B) a PLMN:
 - the HPLMN pre-configured default URSP rule stored in the in USIM using steps in bullet c) above; or
 - the HPLMN pre-configured default URSP rule stored in the in ME using steps in bullet c) above.

NOTE 14: If no matching URSP rule is found, the UE informs the upper layers of the failure.

The HPLMN pre-configured URSP in the ME shall be stored until a new URSP is configured by HPLMN or the USIM is removed.

For a UE not operating in SNPN access operation mode, the signalled URSP can be added, modified or deleted by the procedures defined in annex D of 3GPP TS 24.501 [11] and shall be stored in non-volatile memory of the ME according to annex C of 3GPP TS 24.501 [11].

For a UE operating in SNPN access operation mode and registered to a subscribed SNPN, the subscribed SNPN signalled URSP can be added, modified or deleted by the procedures defined in annex D of 3GPP TS 24.501 [11] and shall be stored in non-volatile memory of the ME according to annex C of 3GPP TS 24.501 [11].

For a UE operating in SNPN access operation mode and registered to a non-subscribed SNPN, the non-subscribed SNPN signalled URSP can be added, modified or deleted by the procedures defined in annex D of 3GPP TS 24.501 [11] and shall be stored in non-volatile memory of the ME according to annex C of 3GPP TS 24.501 [11].

The UE may re-evaluate the URSP rules, to check if the change of the association of an application or a PIN to a PDU session is needed, when:

NOTE 15: The time when the UE performs the re-evaluation is up to UE implementation. It is recommended that the UE performs the re-evaluation in a timely manner.

- a) the UE performs periodic URSP rules re-evaluation based on UE implementation;
- b) the UE NAS layer indicates that an existing PDU session used for routing traffic of an application or a PIN based on a URSP rule is released;
- c) the URSP is updated by the PCF;
- d) the UE NAS layer indicates that the UE performs inter-system change from S1 mode to N1 mode;
- e) the UE NAS layer indicates that the UE is successfully registered in N1 mode over 3GPP access or non-3GPP access;
- f) the UE establishes or releases a connection to a WLAN access and transmission of a PDU of the application via non-3GPP access outside of a PDU session becomes available/unavailable;
- g) the allowed NSSAI, the partially allowed NSSAI or the configured NSSAI is changed;
- h) the LADN information or the extended LADN information is changed;
- i) the UE NAS layer indicates that back-off timer T3396, T3584 or T3585 (see 3GPP TS 24.501 [11] clause 6.2.7 and clause 6.2.8) is stopped or expired;
- j) the UE NAS layer indicates the successful change of the PLMN; or
- k) the UE NAS layer indicates that current TAI is in the list of TAs for which the S-NSSAI is allowed (see 3GPP TS 24.501 [11] clause 4.6.3.6).

If the re-evaluation leads to a change of the association of an application or a PIN to a PDU session, the UE may enforce such change immediately or when UE returns to 5GMM-IDLE mode.

NOTE 16: The time when the UE enforces the change of the association of an application or a PIN to a PDU Session is up to UE implementation. It is recommended that the UE performs the enforcement in a timely manner.

The URSP handling layer may request the UE NAS layer to release an existing PDU session after the re-evaluation.

NOTE 17: It is up to UE implementation when the URSP handling layer requests the UE NAS layer to release an existing PDU session after the re-evaluation.

4.2.2.3 Association between an application or a device behind 5G-RG and a PDU session by a 5G-RG or a W-AGF acting on behalf of FN-RG

In order to send a PDU of an application, the upper layers require information on the PDU session (e.g. PDU address) via which to send a PDU of an application.

In order to send a PDU of an AUN3 device behind 5G-RG, the 5G-RG requires information on the PDU session (e.g. PDU address) via which to send a PDU of an AUN3 device behind 5G-RG.

In order to send a PDU of a connectivity group consisting of one or more NAUN3 devices, the 5G-RG requires information on the PDU session (e.g. PDU address) via which to send a PDU of a connectivity group.

NOTE 1: If PAP/CHAP is used, it is recommended that the request from the upper layers includes a DNN.

The 5G-RG or the W-AGF acting on behalf of the FN-RG shall proceed in the following order:

- a) the 5G-RG or the W-AGF acting on behalf of the FN-RG shall evaluate the URSP rules, except the default URSP rule, with a traffic descriptor matching the application information in increasing order of their precedence values, if any. If the traffic descriptor contains more than one traffic descriptor component type, each of a different type, all of them shall be matched. If the traffic descriptor contains more than one traffic descriptor component of the same traffic descriptor component type, at least one of the traffic descriptor components of the same traffic descriptor component type shall be matched with the application information.

For NAUN3 devices behind 5G-RG:

- IP descriptors are matched against header information contained in IP packets sent by NAUN3 devices; IP descriptors are only applicable for traffic from NAUN3 devices if network address translation (NAT) is performed for that traffic;
- non-IP descriptors are matched against header information contained in Ethernet frames sent by NAUN3 devices; and
- connectivity group ID in the traffic descriptor in the URSP rule is matched against the connectivity group ID that the NAUN3 device is associated with.

A URSP rule is determined not to be applicable when for any given component in the traffic descriptor no corresponding information from the application is available or the corresponding information from the application does not match any of the values in the traffic descriptor component as specified in clause 6.6.2.1 of 3GPP TS 23.503 [2]. The 5G-RG or the W-AGF acting on behalf of the FN-RG shall ignore the route selection descriptor of the URSP rule when it includes any route selection descriptor component of type identifier set to PDU session pair ID, RSN or 5G ProSe multi-path preference.

If the 5G-RG or the W-AGF acting on behalf of the FN-RG finds the traffic descriptor in a non-default URSP rule matching the application information or the information for the AUN3 device or connectivity group, and:

I) if there is one or more PDU sessions:

- 1) for which the parameters associated with the PDU session, the parameters requested by the 5G-RG or the W-AGF acting on behalf of the FN-RG during the PDU session establishment procedure or the mapped parameters from the parameters requested by the 5G-RG during the UE requested PDN connectivity procedure to establish a PDN connection as a user-plane resource of an MA PDU session as specified in clause 5.3.1 of 3GPP TS 24.193 [22] match at least one of the route selection descriptors of the URSP rule except the preferred access type and the multi-access preference, if any, wherein:
 - A) a route selection descriptor with PDU session type IPv4v6 matches also with PDU session type IPv4 if the network has sent 5GSM cause value #50 "PDU session type IPv4 only allowed" in the PDU SESSION ESTABLISHMENT ACCEPT message or matches also with PDN type IPv4 if the network has sent ESM cause is #50 "PDN type IPv4 only allowed" in the ACTIVATE DEFAULT EPS BEARER CONTEXT REQUEST message of the PDN connectivity procedure to establish a PDN connection as a user-plane resource of an MA PDU session as specified in clause 5.3.1 of 3GPP TS 24.193 [22];
 - B) a route selection descriptor with PDU session type IPv4v6 matches also with PDU session type IPv6 if the network has sent 5GSM cause value #51 "PDU session type IPv6 only allowed" in the PDU SESSION ESTABLISHMENT ACCEPT message or matches also with PDN type IPv6 if the network has sent ESM cause is #51 "PDN type IPv6 only allowed" in the ACTIVATE DEFAULT EPS BEARER CONTEXT REQUEST message of the PDN connectivity procedure to establish a PDN connection as a user-plane resource of an MA PDU session as specified in clause 5.3.1 of 3GPP TS 24.193 [22];
 - C) a route selection descriptor with PDU session type IPv4v6 matches also with PDU session type IPv6 or IPv4 if the 5G-RG or the W-AGF acting on behalf of the FN-RG requested the PDU session type IPv4v6 but the selected PDU session type is set to IPv4 or IPv6 in the PDU SESSION ESTABLISHMENT ACCEPT message or if the 5G-RG requested the PDN type IPv4v6 but the

network allocates a PDN address of a PDN type IPv4 or IPv6 in the ACTIVATE DEFAULT EPS BEARER CONTEXT REQUEST message of the PDN connectivity procedure to establish a PDN connection as a user-plane resource of an MA PDU session as specified in clause 5.3.1 of 3GPP TS 24.193 [22];

- D) if the 5G-RG is in the HPLMN, then a route selection descriptor with an S-NSSAI matches the S-NSSAI of the PDU session, otherwise a route selection descriptor with an S-NSSAI matches the mapped S-NSSAI of the PDU session; and
 - E) if the W-AGF acts on behalf of the FN-RG, a route selection descriptor with an S-NSSAI matches the S-NSSAI of the PDU session; and
- 2) established without requesting any parameter, except the preferred access type and the multi-access preference, for which the matching route selection descriptor of the URSP rule does not provide a route selection descriptor component,

the 5G-RG or the W-AGF acting on behalf of the FN-RG shall provide information on the PDU session that matches the route selection descriptor of the lowest precedence value to the upper layers;

NOTE 2: It is up to the 5G-RG or the W-AGF acting on behalf of the FN-RG implementation which PDU session to select if there exist multiple PDU sessions matching the same route selection descriptor of the lowest precedence value.

II) otherwise:

- 1) the 5G-RG or the W-AGF acting on behalf of the FN-RG shall select a route selection descriptor with the next smallest precedence value which has not yet been evaluated;
- 2) if:
 - i) the selected route selection descriptor contains a non-seamless non-3GPP offload indication or a 5G ProSe layer-3 UE-to-network relay offload indication, the 5G-RG or the W-AGF acting on behalf of the FN-RG shall proceed to step 4);
 - ii) the selected route selection descriptor includes a PDU session type which is not supported by the 5G-RG or the W-AGF acting on behalf of the FN-RG, the 5G-RG or the W-AGF acting on behalf of the FN-RG shall proceed to step 4);
 - iii) the selected route selection descriptor contains a time window but the time does not match the time window, the 5G-RG or the W-AGF acting on behalf of the FN-RG shall proceed to step 4);
 - iv) the selected route selection descriptor contains location criteria but location of the 5G-RG or the W-AGF acting on behalf of the FN-RG does not match the location criteria, the 5G-RG or the W-AGF acting on behalf of the FN-RG shall proceed to step 4);
 - v) the selected route selection descriptor includes the multi-access preference but the 5G-RG or the W-AGF acting on behalf of the FN-RG does not support ATSSS, the 5G-RG or the W-AGF acting on behalf of the FN-RG shall proceed to step 4);
 - va) the selected route selection descriptor includes an SSC mode which either has been rejected by the network with 5GSM cause value #68 "not supported SSC mode" for the same DNN (or no DNN, if no DNN was indicated by the 5G-RG or the W-AGF acting on behalf of the FN-RG) and the same S-NSSAI associated with (if available in roaming scenarios) a mapped S-NSSAI (or no S-NSSAI, if no S-NSSAI was indicated by the 5G-RG or the W-AGF acting on behalf of the FN-RG) or was not included in the Allowed SSC mode IE following a rejection with 5GSM cause value #68 "not supported SSC mode" for the same DNN (or no DNN, if no DNN was indicated by the 5G-RG or the W-AGF acting on behalf of the FN-RG) and the same S-NSSAI associated with (if available in roaming scenarios) a mapped S-NSSAI (or no S-NSSAI, if no S-NSSAI was indicated by the 5G-RG or the W-AGF acting on behalf of the FN-RG), the 5G-RG or the W-AGF acting on behalf of the FN-RG shall proceed to step 4); or
 - vi) the URSP handling layer requests NAS layer of the 5G-RG or the W-AGF acting on behalf of the FN-RG to establish a PDU session providing at least one of the following PDU session attributes:
 - A) SSC mode if there is a SSC mode in the route selection descriptor;

NOTE 3: The SSC mode 3 is only used when the PDU session type is IPv4, IPv6 or IPv4v6.

- B) one S-NSSAI if the S-NSSAI is in the route selection descriptor; and the S-NSSAI is in the allowed NSSAI. Additionally, if the 5G-RG or the W-AGF acting on behalf of the FN-RG supports LADN per DNN and S-NSSAI, the request is for a PDU session for LADN, the extended LADN information is available for that LADN and the S-NSSAI is associated with that LADN in the service area of that LADN. If none of the S-NSSAI(s) in the route selection descriptor is in the allowed NSSAI, the 5G-RG or the W-AGF acting on behalf of the FN-RG shall proceed to step 4);

NOTE 4: If there are multiple S-NSSAIs in the route selection descriptor, an S-NSSAI is chosen among the S-NSSAIs based on implementation of the 5G-RG or the W-AGF acting on behalf of the FN-RG.

- C) one DNN, if the DNN is in the route selection descriptor; and if the DNN is an LADN DNN and the 5G-RG is in the service area of that LADN;

NOTE 5: The LADN service does not apply for either 5G-RG connected to 5GC via wireline access or the W-AGF acting on behalf of the FN-RG.

NOTE 6: If one or more DNNs are included in the traffic descriptor of a URSP rule and no DNN is included in the route selection descriptor, the DNN provided by the application is selected as one of the PDU session attributes by the URSP handling layer to request the UE NAS layer.

NOTE 7: If there are multiple DNNs in the route selection descriptor, a DNN is chosen based on implementation of the 5G-RG or the W-AGF acting on behalf of the FN-RG.

- D) the PDU session type of the route selection descriptor;
- E) preferred access type or multi-access preference, if the preferred access type or the multi-access preference is in the route selection descriptor;

NOTE 8: If a preferred access type or a multi-access preference is included in the route selection descriptor of a URSP rule, it is recommended that the 5G-RG or the W-AGF acting on behalf of the FN-RG establishes a PDU session based on the preferred access type or the multi-access preference. The preferred access type or the multi-access preference does not apply to the AUN3 device or connectivity group.

- F) PDU session pair ID if there is a PDU session pair ID in the route selection descriptor; and
- G) RSN if there is an RSN in the route selection descriptor, and

The NAS layer of the 5G-RG or the W-AGF acting on behalf of the FN-RG indicates the result of the PDU session establishment. Upon successful completion of the PDU session establishment, the NAS layer of the 5G-RG or the W-AGF acting on behalf of the FN-RG shall additionally indicate the attributes of the established PDU session (e.g. PDU session identity, SSC mode, S-NSSAI, DNN, PDU session type, access type, PDU address) to the URSP handling layer, and shall provide information (e.g. PDU address) of the successfully established PDU session to the upper layers. The 5G-RG or the W-AGF acting on behalf of the FN-RG shall stop selecting a route selection descriptor matching the application information or information of the AUN3 device or connectivity group. If the PDU session establishment is unsuccessful, the 5G-RG or the W-AGF acting on behalf of the FN-RG shall proceed to step 3);

- 3) Based on the rejection cause and if there is another value which can be used for the rejected component in the same route selection descriptor, the 5G-RG or the W-AGF acting on behalf of the FN-RG shall select another combination of values in the currently selected route selection descriptor by using this value of the rejected component and proceed to step 2), otherwise the 5G-RG or the W-AGF acting on behalf of the FN-RG shall proceed to step 4); and
- 4) if there is any route selection descriptor which has not yet been evaluated, the 5G-RG or the W-AGF acting on behalf of the FN-RG shall proceed to step 1). If all route selection descriptors for the matching non-default URSP rule have been evaluated and there is one or more non-default matching URSP rule which has not yet been evaluated, the 5G-RG or the W-AGF acting on behalf of the FN-RG shall proceed to step a). If all non-default matching URSP rules have been evaluated, the 5G-RG or the W-AGF acting on behalf of the FN-RG shall inform the upper layers of the failure.

NOTE 8A: When the 5G-RG or the W-AGF acting on behalf of the FN-RG decides to proceed to step 1) or step a), it is up to the implementation of the 5G-RG or the W-AGF acting on behalf of the FN-RG to define a way to evaluate skipping any route selection descriptor(s) which have not yet been evaluated, that contain the same [PDU session type, DNN, S-NSSAI] combinations for which the UE has received rejection with 5GSM cause value #28 "unknown PDU session type" as specified in 3GPP TS 24.501 [11] or ESM cause value #28 "unknown PDN connection type" as specified in 3GPP TS 24.301 [29].

b) if no non-default matching URSP rule can be found:

- 1) by the 5G-RG and local configuration of the 5G-RG for the application is available, the 5G-RG shall perform the association of the application to a PDU session accordingly. If no matching PDU session exists, the NAS layer of the 5G-RG shall attempt to establish a PDU session using local configuration of the 5G-RG.

NOTE 9: Any missing information in local configuration of the 5G-RG needed to build the PDU session establishment request can be the appropriate corresponding component from the default URSP rule with the "match-all" traffic descriptor.

If the PDU session establishment is successful, the NAS layer of the 5G-RG shall provide information (e.g. PDU address) of the successfully established PDU session to the upper layers. Otherwise, the 5G-RG shall go to step c);

- 2) by the W-AGF acting on behalf of the FN-RG, the W-AGF acting on behalf of the FN-RG shall go to step c); or
- 3) by the 5G-RG acting on behalf of the AUN3 device or connectivity group shall go to step c); and

c) if no non-default matching URSP rule can be found:

- 1) by the 5G-RG and if either local configuration of the 5G-RG for the application is not available or the PDU session establishment based on local configuration of the 5G-RG for the application was unsuccessful, the 5G-RG shall perform the association of the application to a PDU session according to the default URSP rule with the "match-all" traffic descriptor, if any. If the association is unsuccessful, the 5G-RG shall inform the upper layers of the failure;
- 2) by the W-AGF acting on behalf of the FN-RG, the W-AGF acting on behalf of the FN-RG shall perform the association of the application to a PDU session according to the default URSP rule with the "match-all" traffic descriptor, if any. If the association is unsuccessful, and local configuration of the W-AGF acting on behalf of the FN-RG for the application is available, the W-AGF acting on behalf of the FN-RG shall perform the association of the application to a PDU session accordingly. If no matching PDU session exists, the NAS layer of the W-AGF acting on behalf of the FN-RG shall attempt to establish a PDU session using local configuration of the W-AGF acting on behalf of the FN-RG. If the PDU session establishment is successful, the NAS layer of the W-AGF acting on behalf of the FN-RG shall provide information (e.g. PDU address) of the successfully established PDU session to the upper layers. Otherwise, the W-AGF acting on behalf of the FN-RG shall inform the upper layers of the failure; or
- 3) by the 5G-RG acting on behalf of the AUN3 device or connectivity group, the 5G-RG acting on behalf of the AUN3 device or connectivity group shall perform the association of the AUN3 device or connectivity group to a PDU session according to the default URSP rule with the "match-all" traffic descriptor, if any. If the association is unsuccessful, and local configuration of the 5G-RG acting on behalf of the AUN3 device or connectivity group is available, the 5G-RG acting on behalf of the AUN3 device or connectivity group shall perform the association of the AUN3 device or connectivity group to a PDU session accordingly. If no matching PDU session exists, the NAS layer of the 5G-RG acting on behalf of the AUN3 device or connectivity group shall attempt to establish a PDU session using local configuration of the 5G-RG acting on behalf of the AUN3 device or connectivity group. If the PDU session establishment is successful, the NAS layer of the 5G-RG acting on behalf of the AUN3 device or connectivity group shall provide information (e.g. PDU address) of the successfully established PDU session to the upper layers. Otherwise, the 5G-RG acting on behalf of the AUN3 device or connectivity group shall inform the upper layers of the failure.

For a 5G-RG not operating in SNPN access operation mode, if the 5G-RG supports VPS URSP and has signalled URSP, when the upper layers request information of the PDU session via which to send a PDU of an application, an AUN3 device, or a connectivity group as described above, the 5G-RG shall evaluate URSP rules, if available, in accordance with the following order until a matching URSP rule is found:

- 1) if the 5G-RG is registered via one or both accesses and the RPLMN of each access is a VPLMN, non-default URSP rules in the VPS URSP of the RPLMN using steps in bullet a) above;
- 2) if the 5G-RG is registered via one or both accesses and the RPLMN of each access is a VPLMN, non-default URSP rules in the VPS URSP of the equivalent PLMN of the RPLMN using steps in bullet a) above;
- 3) non-default URSP rules in the PG URSP using steps in bullet a) above;
- 4) if local configuration of the 5G-RG for the application, an AUN3 device, or a connectivity group is available, local configuration of the 5G-RG for the application, an AUN3 device, or a connectivity group using steps in bullet b) above;
- 5) if the 5G-RG is registered via one or both accesses and the RPLMN of each access is a VPLMN, default URSP rule in the VPS URSP of the RPLMN using steps in bullet c) above;
- 6) if the 5G-RG is registered via one or both accesses and the RPLMN of each access is a VPLMN, default URSP rules in the VPS URSP of the equivalent PLMN of the RPLMN using steps in bullet c) above; and
- 7) default URSP rule in the PG URSP using steps in bullet c) above.

The HPLMN may pre-configure the 5G-RG or the W-AGF acting on behalf of the FN-RG with URSP or may provide URSP to the 5G-RG or the W-AGF acting on behalf of the FN-RG by signalling as described in annex D of 3GPP TS 24.501 [11]. In the 5G-RG, the pre-configured URSP and the signalled URSP shall be stored in a non-volatile memory in the ME together with the SUPI from the USIM. If the 5G-RG or the W-AGF acting on behalf of the FN-RG has both pre-configured URSP and signalled URSP, the 5G-RG or the W-AGF acting on behalf of the FN-RG shall only use the signalled URSP. The pre-configured URSP shall be stored until a new URSP is configured by HPLMN or the USIM is removed from the 5G-RG. The signalled URSP can be added, modified or deleted by the procedures defined in annex D of 3GPP TS 24.501 [11] and shall be stored in non-volatile memory of the ME according to annex C of 3GPP TS 24.501 [11] or shall be stored until W-AGF acting on behalf of the FN-RG deregisters on behalf of the FN-RG. In the 5G-RG,

- when the 5G-RG acts on behalf of the AUN3 device, the URSP for the AUN3 device can be used if 5G-RG is registered on behalf of the AUN3 device;
- when the 5G-RG acting on cases other than AUN3 device, the URSP can only be used if the SUPI from the USIM matches the SUPI stored in the non-volatile memory of the ME, if the SUPI from the USIM does not match the SUPI stored in the non-volatile memory of the ME, the 5G-RG shall delete the URSP.

The 5G-RG or the W-AGF acting on behalf of the FN-RG may re-evaluate the URSP rules, to check if the change of the association of an application, an AUN3 device or a connectivity group to a PDU session is needed, when:

NOTE 10: The time when the 5G-RG or the W-AGF acting on behalf of the FN-RG performs the re-evaluation is up to implementation of the 5G-RG or the W-AGF acting on behalf of the FN-RG. It is recommended that the 5G-RG or the W-AGF acting on behalf of the FN-RG performs the re-evaluation in a timely manner.

- a) the 5G-RG or the W-AGF acting on behalf of the FN-RG performs periodic URSP rules re-evaluation based on implementation of the 5G-RG or the W-AGF acting on behalf of the FN-RG;
- b) the NAS layer of the 5G-RG or the W-AGF acting on behalf of the FN-RG indicates that an existing PDU session used for routing traffic of an application based on a URSP rule is released;
- c) the URSP is updated by the PCF;
- d) the NAS layer of the 5G-RG indicates that the 5G-RG performs inter-system change from S1 mode to N1 mode;
- e) the NAS layer of the 5G-RG indicates that the 5G-RG is successfully registered in N1 mode over 3GPP access;
- f) the allowed NSSAI or the configured NSSAI is changed;
- g) the LADN information or the extended LADN information is changed for the 5G-RG; or
- h) the NAS layer of the 5G-RG indicates the successful change of the PLMN.

If the re-evaluation leads to a change of the association of an application, an AUN3 device or a connectivity group to a PDU session, the 5G-RG or the W-AGF acting on behalf of the FN-RG may enforce such change immediately or when the 5G-RG or the W-AGF acting on behalf of the FN-RG returns to 5GMM-IDLE mode.

NOTE 11: The time when the 5G-RG or the W-AGF acting on behalf of the FN-RG enforces the change of the association of an application to a PDU Session is up to implementation of the 5G-RG or the W-AGF acting on behalf of the FN-RG. It is recommended that the 5G-RG or the W-AGF acting on behalf of the FN-RG performs the enforcement in a timely manner.

The URSP handling layer may request the NAS layer of the 5G-RG or the W-AGF acting on behalf of the FN-RG to release an existing PDU session after the re-evaluation.

4.2.3 Unknown or unexpected URSP rules

If the network provides URSP rules including any new component in the traffic descriptor or in the route selection descriptor which is not recognized by the UE, the 5G-RG or the W-AGF acting on behalf of an FN-RG, such URSP rules are unknown or unexpected to the UE, the 5G-RG or the W-AGF acting on behalf of an FN-RG. In this case:

- if the traffic descriptor of this URSP rule includes any component which is not recognized by the UE, the UE shall skip this URSP rule when evaluating the URSP rules to associate an application or a PIN with a PDU session, with non-seamless non-3GPP offload or with 5G ProSe layer-3 UE-to-network relay offload;
- if the traffic descriptor of this URSP rule includes any component which is not recognized by the 5G-RG or the W-AGF acting on behalf of an FN-RG, the 5G-RG or the W-AGF acting on behalf of an FN-RG shall skip this URSP rule when evaluating the URSP rules to associate an application, an AUN3 device or a connectivity group with a PDU session; or
- if the route selection descriptor of this URSP rule includes any component which is not recognized by the UE, the 5G-RG or the W-AGF acting on behalf of an FN-RG, the UE, the 5G-RG or the W-AGF acting on behalf of an FN-RG shall skip this route selection descriptor and handle this URSP rule with the remaining route selection descriptors.

If the UE, the 5G-RG or the W-AGF acting on behalf of an FN-RG receives any unknown value within a known traffic descriptor or route selection descriptor component, the value shall be still used to identify a match with the application information, the PIN information, the AUN3 device information or the connectivity group information, when the same unknown value is provided by upper layers. The same handling shall be applied to operator-specific values.

4.2.4 Reporting of URSP rule enforcement

URSP rule enforcement for a specific application and a specific URSP rule can be reported to the network.

Sending of URSP rule enforcement reports to the network when the UE is in EPS is not supported in this release of the specification.

The URSP rule needs to be reported after enforcement if the URSP rule includes URSP rule enforcement report indication set to "URSP rule enforcement report is required" and contains the connection capabilities in the traffic descriptors. A rule with the "match-all" traffic descriptor cannot contain connection capabilities in the traffic descriptor.

URSP rule enforcement report includes all the connection capabilities contained in the traffic descriptor of the associated URSP rule. If several URSP rules for multiple applications are enforced, and these multiple applications' traffic are all associated to a PDU session, several URSP rule enforcement reports can be provided at the same time, each URSP rule enforcement report including all the connection capabilities contained in the traffic descriptor of each URSP rule.

If the UE supports reporting of URSP rule enforcement, the URSP rule matching the application contains the connection capabilities in the traffic descriptor and a URSP rule enforcement report indication, the URSP rule enforcement report indication is set to "URSP rule enforcement report is required", and

- the traffic descriptor of the URSP rule matches the application information of a newly detected application and associates the application with a new PDU session;
- the traffic descriptor of the URSP rule matches the application information of a newly detected application and associates the application with an existing PDU session;
- the re-evaluation leads to a change of the association of an application to a PDU session; or

- the traffic descriptor of the URSP rule matched the application information of a newly detected application and associated the application with a PDN connection in EPS and the UE moves from EPS to 5GS;

the UE shall send URSP rule enforcement report including all the connection capabilities contained in the traffic descriptor of the URSP rule matching the application to the network according to 3GPP TS 24.501 [11].

4.3 Access network discovery and selection policy (ANDSP)

4.3.1 Overview

The ANDSP is used to control the UE behaviour related to access network discovery and selection over non-3GPP access network.

The ANDSP consists of:

- WLAN Selection Policy (WLANSP) which is described in clause 4.3.2; and
- non-3GPP access network (N3AN) node configuration information which is described in clause 4.3.3.

The 5G-RG or a W-AGF acting on behalf of the FN-RG shall ignore any ANDSP information, if received.

4.3.1A General

For a UE not operating in SNPN access operation mode, signalled ANDSP of the HPLMN or of a VPLMN can be added, modified or deleted using the procedures defined in annex D of 3GPP TS 24.501 [11] and N3AN node configuration information of HPLMN signalled ANDSP may be stored in non-volatile memory of the ME according to annex C of 3GPP TS 24.501 [11].

For a UE operating in SNPN access operation mode and registered to a subscribed SNPN, signalled ANDSP of the subscribed SNPN can be added, modified or deleted using the procedures defined in annex D of 3GPP TS 24.501 [11] and N3AN node configuration information of subscribed SNPN signalled ANDSP may be stored in non-volatile memory of the ME according to annex C of 3GPP TS 24.501 [11].

For a UE operating in SNPN access operation mode and registered to a non-subscribed SNPN, signalled ANDSP of the non-subscribed SNPN can be added, modified or deleted using the procedures defined in annex D of 3GPP TS 24.501 [11].

If the UE is in a non-subscribed SNPN using credentials from a PLMN, then the UE shall compose the signalled ANDSP of the HPLMN from the signalled ANDSP received when the UE did not operate in SNPN access operation mode.

4.3.2 WLAN selection policy (WLANSP)

4.3.2.1 General

The WLANSP is used to control UE behaviour related to selection and reselection of a WLAN.

The WLANSP consists of zero or more WLANSP rules.

Each WLANSP rule consists of:

- rule identifier;
- one or more groups of WLAN selection criteria;
- validity area;
- zero or more time of day;
- rule priority;

- roaming.

Each group of WLAN selection criteria contains:

- criteria priority;
- home network indication;
- preferred roaming partner list;
- min backhaul threshold;
- maximum BSS load value;
- required proto port tuple;
- SP exclusion list;
- preferred SSID list; and
- slice-based TNAN list.

The priority of a selection criteria is encoded in the criteria priority field. The WLAN priority defined in the preferred SSID list (see figure 5.3.2.4c) represents the priority of the WLAN matching the selection criteria.

The validity of the WLANSF rule can be restricted by validity conditions. The validity of the WLANSF rule takes into account validity area, roaming, and time of day where each condition shall match in order to make the WLANSF rule valid.

Each validity area consists of:

- 3GPP location;
- WLAN location; and
- Geo location.

Each time of day consists of:

- time start;
- time stop;
- date start;
- date stop; and
- day of week.

When the selection criteria is for slice-based TNAN list, the selection criteria sub entry consists of:

- TNGF ID;
- S-NSSAI list; and
- SSID list.

The S-NSSAI list indicates the list of S-NSSAI(s) that are supported by the indicated TNGF. The SSID list indicates the list of SSID(s) through which the indicated TNGF can be reached.

The WLANSF rule is considered valid if none of the validity conditions exist or all validity conditions match.

There can be multiple valid WLANSF rules at the same time. In addition to validity conditions and selection criteria, there is a rule priority that shall be set for each WLANSF rule. The rule priority is encoded in the rule priority field, and it enables the UE to determine which WLANSF rule, out of potentially several valid WLANSF rules, it should consider as active. A WLANSF rule is active if it is valid and has highest rule priority out of the valid WLANSF rules. At any point in time, there shall be at most one active WLANSF rule. A WLAN that matches a selection criteria of the active WLANSF rule is considered as matching the selection criteria.

If the UE is roaming and WLANSP rules from both HPLMN and VPLMN are available, visited WLANSP rules shall take precedence.

If the UE is in a non-subscribed SNPN and WLANSP rules from both:

- the subscribed SNPN, the CH with AAA server or the HPLMN; and
- the non-subscribed SNPN;

are available, the non-subscribed SNPN's WLANSP rules shall take precedence.

4.3.2.2 WLAN access selection

The procedure of UE selecting WLAN access network based on WLAN selection policy is specified in 3GPP TS 24.502 [3].

The 5G-RG and the W-AGF acting on behalf of an FN-RG shall ignore the WLAN selection policy, if received.

4.3.3 N3AN node configuration information

4.3.3.1 General

Non-3GPP access network (N3AN) node configuration information is used to control UE behaviour related to selection of either N3IWF or ePDG for accessing 5GCN or EPC respectively via non-3GPP access.

The non-3GPP access network (N3AN) node configuration information provisioned by the HPLMN consists of:

- a) Non-3GPP access network (N3AN) node selection information;
- b) optionally, home ePDG identifier configuration;
- c) optionally, home N3IWF identifier configuration;
- d) optionally, extended home N3IWF identifier configuration; and
- e) optionally, slice-specific N3IWF prefix configuration.

The non-3GPP access network (N3AN) node configuration information provisioned by a VPLMN consists of:

- a) slice-specific N3IWF prefix configuration.

NOTE: As an implementation option, the UE can store slice-specific N3IWF prefix configuration provisioned by a PLMN for later use.

4.3.3.2 N3AN node selection

The procedure of UE selecting an N3AN node based on N3AN node configuration information is specified in 3GPP TS 24.502 [3].

4.3.4 Precedence of ANDSP parameters

The ANDSP parameters can be:

- a) pre-configured in the ME;
- b) configured in the USIM;
- c) provided using the UE policy delivery service as specified in 3GPP TS 24.501 [6] annex D; or
- d) a combination of case a), b), or c) above.

The UE shall use the ANDSP parameters in the following order of decreasing precedence:

- a) the configuration parameters provided using the UE policy delivery service as specified in annex D of 3GPP TS 24.501 [6];
- b) the configuration parameters configured in the USIM; and
- c) the configuration parameters pre-configured in the ME.

4.4 Interworking with EPC

4.4.1 Precedence between URSP, ANDSP, ANDSF and RAN rules

If the UE supports both S1 mode and N1 mode:

- the UE shall always use the ANDSP information and applicable user preferences on non-3GPP access selection, if available at the UE, for non-3GPP access node selection;

NOTE: This includes the case when the UE is registered to the 5GCN via 3GPP access, the case when the UE is registered to the EPC via 3GPP access, and the case when the UE is not registered to any CN via 3GPP access.

- if the UE is:
 - a) registered to the 5GCN via 3GPP access and not registered to any CN via non-3GPP access; or
 - b) registered to the 5GCN via 3GPP access and registered to the 5GCN via non-3GPP access,
 the UE shall apply URSP rules and applicable UE local configuration, if available at the UE, to all uplink user data;
- if the UE is registered to the 5GCN via 3GPP access and registered to the EPC via non-3GPP access, the UE shall:
 - a) use the ANDSF rules and RAN rules, if available at the UE, for uplink user data sent via the ePDG; and
 - b) apply URSP rules and applicable UE local configuration, if available at the UE, to all other uplink user data;
- if the UE is:
 - a) registered to the EPC via 3GPP access and not registered to any CN via non-3GPP access; or
 - b) registered to the EPC via 3GPP access and registered to the EPC via non-3GPP access,
 the UE:
 - a) shall use the ANDSF rules and RAN rules, if available at the UE, for all uplink user data for which there is one or more applicable ANDSF rule or RAN rule, except for the rules and parameters related to non-3GPP access node selection; and
 - b) should use the URSP rules, if available at the UE, to derive the parameters to be used in EPS as specified in clause 4.4.2 for all uplink user data for which there is no applicable ANDSF rule or RAN rule except for the rules and parameters related to non-3GPP access node selection and there is no applicable UE local configuration; and
- if the UE is registered to the EPC via 3GPP access and registered to the 5GCN via non-3GPP access, the UE:
 - a) shall apply URSP rules and applicable UE local configuration, if available at the UE, to uplink user data sent via non-3GPP access;
 - b) shall use the ANDSF rules and RAN rules, if available at the UE, for all other uplink user data for which there is one or more applicable ANDSF rule or RAN rule, except for the rules and parameters related to non-3GPP access node selection; and
 - c) should use the URSP rules, if available at the UE, to derive the parameters to be used in EPS as specified in clause 4.4.2 for all uplink user data for which there is no applicable ANDSF rule or RAN rule except for the

rules and parameters related to non-3GPP access node selection, and there is no applicable UE local configuration

4.4.2 Use of URSP in EPS

If the UE:

- supports both S1 mode and N1 mode;
- does not have preconfigured rules for associating an application to a PDN connection, a non-seamless non-3GPP offload or a 5G ProSe layer-3 UE-to-network relay offload (i.e. there are no rules in UE local configuration and no ANDSF rules applicable for the application); and
- is provisioned with URSP,

when in S1 mode, the UE should use a matching URSP rule, if available, to derive the parameters, e.g. APN, using the mapping between the parameters in the URSP rules and the parameters used for PDN connection establishment specified in table 4.4.2.1 and table 4.4.2.2. The URSP rule with the derived EPS parameters are used for associating the application to a PDN connection, non-seamless non-3GPP offload or a 5G ProSe layer-3 UE-to-network relay offload, as specified in clause 4.2.2. If the UE is operating in S1 mode, the UE may select an S-NSSAI from the S-NSSAI(s) in the route selection descriptor. The precedence of URSP rule is reused in EPS.

If the UE supports VPS URSP and has signalled URSP, when in S1 mode, the UE shall use the PG URSP only.

NOTE: VPS URSP of the RPLMN and VPS URSP of the equivalent PLMN of the RPLMN are not applicable when in S1 mode.

The route selection descriptor can include one or more parameters (as specified in table 4.4.2.2). Some of these parameters are not applicable in EPS and some of these parameters are ignored in EPS. If a route selection descriptor for the matching URSP rule includes:

- at least one parameter not applicable in EPS, the UE shall not use the route selection descriptor and shall proceed to evaluate the route selection descriptor with the next lowest precedence value; and
- one or more parameters ignored in EPS, the UE shall evaluate the route selection descriptor without considering the one or more parameters ignored in EPS.

Table 4.4.2.1: Mapping table for traffic descriptor parameters

Traffic descriptor parameter name	Description	Mapped EPS parameter description
Application descriptors	It consists of OSId and OSAppId(s)	OSId and OSAppId(s)
IP descriptors	Destination IP 3 tuple(s) (IP address or IPv6 network prefix, port number, protocol ID of the protocol above IP)	Destination IP 3 tuple(s) (IP address or IPv6 network prefix, port number, protocol ID of the protocol above IP)
Domain descriptors	Destination FQDN(s) or a regular expression as a domain name matching criteria	Destination FQDN(s) or a regular expression as a domain name matching criteria
Non-IP descriptors	Descriptor(s) for destination information of non-IP traffic	Descriptor(s) for destination information of non-IP traffic
DNN	This is matched against the DNN information provided by the application	APN
Connection Capabilities	This is matched against the information provided by a UE application when it requests a network connection with certain capabilities or traffic categories	This is matched against the information provided by a UE application when it requests a network connection with certain capabilities or traffic categories
Connectivity group ID	This is matched against the connectivity group ID that the NAUN3 device is associated with	Not applicable in EPS
PIN ID	This is matched against the PIN information	Not applicable in EPS

Table 4.4.2.2: Mapping table for route selection descriptor parameters

Route selection descriptor parameter name	Description	Mapped EPS parameter description
Route selection descriptor precedence	Determines the order in which the route selection descriptors are to be applied	Determines the order in which the route selection descriptors are to be applied
SSC Mode Selection	One single value of SSC mode	Ignored in EPS if set to SSC mode 1 Not applicable in EPS if set to SSC mode 2 or 3
Network Slice Selection	Either a single value or a list of values of S-NSSAI(s)	Either a single value or a list of values of S-NSSAI(s)
DNN Selection	Either a single value or a list of values of DNN(s)	Either a single value or a list of values of APN(s). Not applicable in EPS if it contains at least one LADN DNN
PDU Session Type Selection	One single value of PDU Session Type	PDN type: - PDU session type "Unstructured" is mapped to PDN type "non-IP". - PDU session type "Ethernet" is mapped to PDN type "Ethernet", if supported by the UE. Otherwise PDU session type "Ethernet" is mapped to PDN type "non-IP"
Non-Seamless Offload indication	Indicates if the traffic of the matching application is to be offloaded to non-3GPP access outside of a PDU session	Indicates if the traffic of the matching application is to be offloaded to non-3GPP access outside of a PDN connection
5G ProSe layer-3 UE-to-network relay offload indication	Indicates if the traffic of the matching application is to be offloaded to 5G ProSe layer-3 UE-to-network relay outside of a PDU session	Not applicable in EPS
Access Type preference	Indicates the preferred Access Type (3GPP or non-3GPP) when the UE establishes a PDU Session for the matching application	preferred Access Type (3GPP or non-3GPP)
Multi-Access preference	Indicates that the PDU session should be established as a multi-access PDU session, using both 3GPP access and non-3GPP access.	Indicates that the PDN connection should be established as a user-plane resource of a multi-access PDU session, if the UE supports MA PDU session and procedures for PDN connection establishment. Otherwise, not applicable in EPS
Time window	The time window when the matching traffic is allowed.	Not applicable in EPS
Location criteria	The UE location where the matching traffic is allowed.	Not applicable in EPS
PDU session pair ID	One single value of PDU session pair ID for redundant PDU session establishment.	Ignored in EPS
RSN	One single value of RSN for redundant PDU session establishment.	Ignored in EPS

5G ProSe multi-path preference	Indicates if the traffic of the matching application is preferred to be sent via a PDU Session over the Uu reference point and a 5G ProSe layer-3 UE-to-network relay outside of a PDU session.	Not applicable in EPS
--------------------------------	---	-----------------------

4.4.3 Reporting of URSP rule enforcement in EPS

If the URSP handling layer detects that a URSP rule enforcement report needs to be sent to the network and the UE is in EPS, then the UE shall send the URSP rule enforcement report only when the UE moves to 5GS according to 3GPP TS 24.501 [11].

5 Encoding of UE policies

5.1 Overview

The content of UE policies is included in the UE policy part contents defined in annex D.6.2 of 3GPP TS 24.501 [11].

The UE policy part contents includes URSP, ANDSP, V2XP, ProSeP, A2XP or RSLPP.

For URSP definition, the encoding is defined in clause 5.2.

For ANDSP definition, it includes encoding of WLANSF and encoding of N3AN node configuration information. The encoding of WLANSF is defined in clause 5.3.2. The encoding of N3AN node configuration information is defined in clause 5.3.3.

For V2XP definition, the coding is specified in 3GPP TS 24.588 [18].

For ProSeP definition, the coding is specified in 3GPP TS 24.555 [18A].

For A2XP definition, the coding is specified in 3GPP TS 24.578 [24].

For RSLPP definition, the coding is specified in 3GPP TS 24.514 [23].

5.2 Encoding of UE policy part type URSP

The UE policy part type URSP contains one or more URSP rules which may be included in the UE policy part contents as defined in annex D.6.2 of 3GPP TS 24.501 [11].

If the UE policy part contents includes one or more URSP rules (i.e. the UE policy part type field is set to "URSP"), the UE policy part contents including URSP rules is encoded as shown in figures 5.2.1 to 5.2.4A and table 5.2.1.

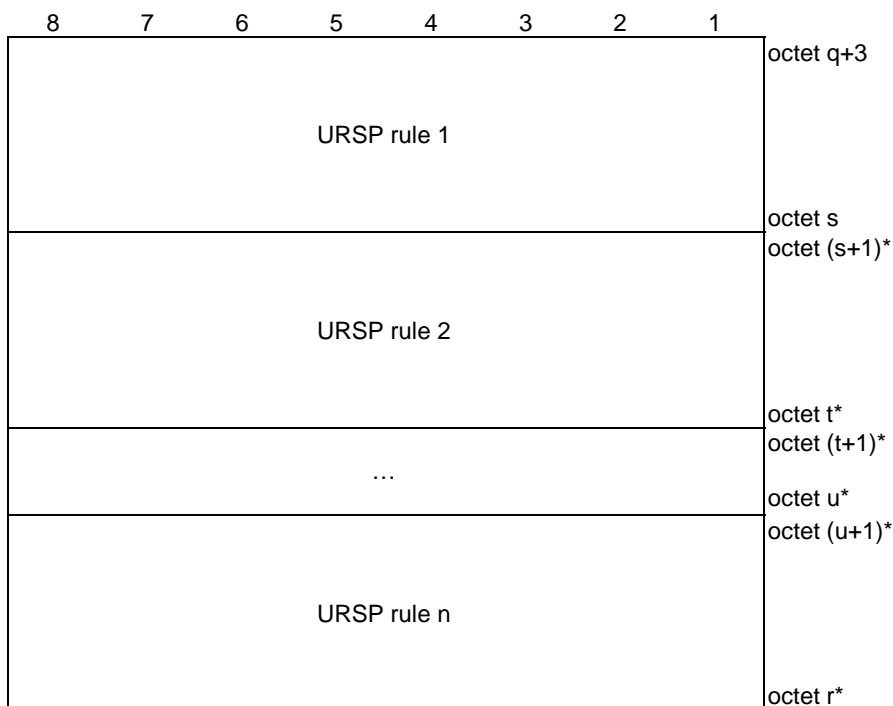

Figure 5.2.1: UE policy part contents including one or more URSP rules

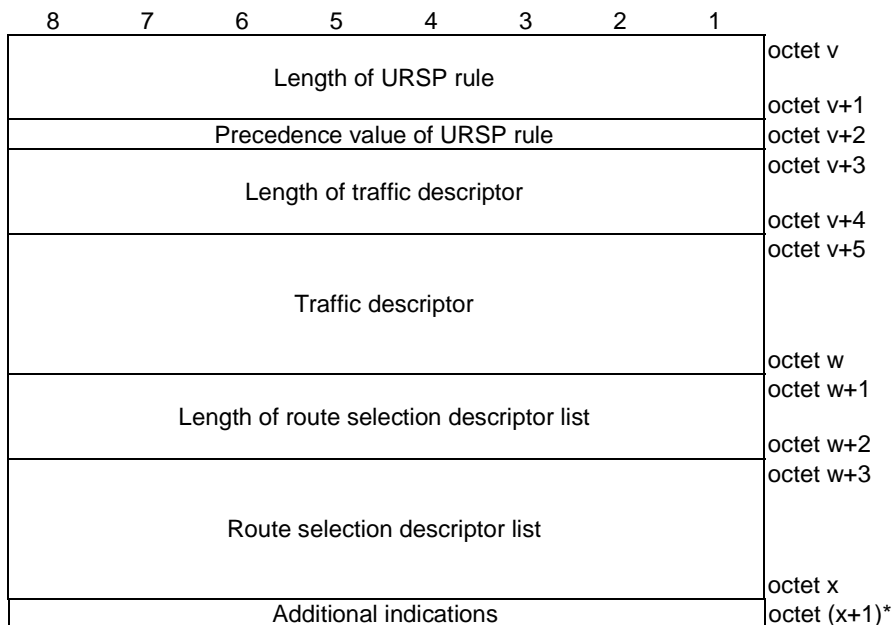

Figure 5.2.2: URSP rule

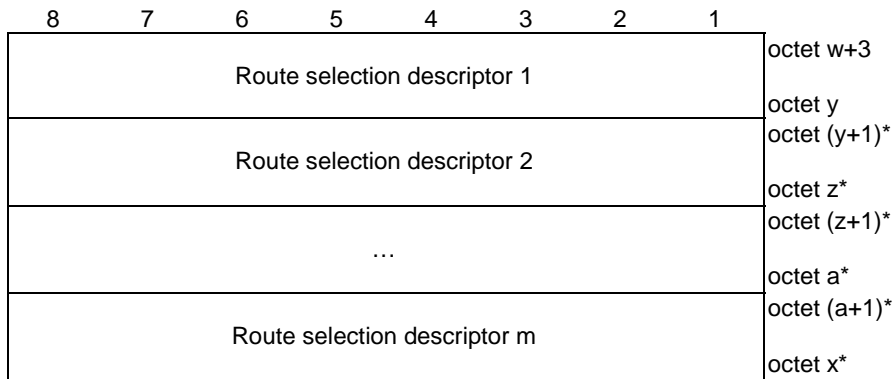

Figure 5.2.3: Route selection descriptor list

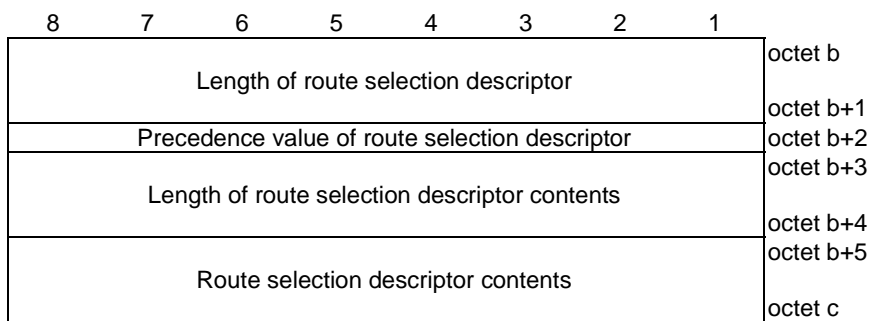

Figure 5.2.4: Route selection descriptor

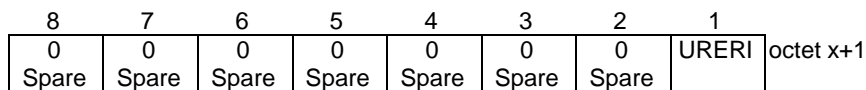

Figure 5.2.4A: Additional indications

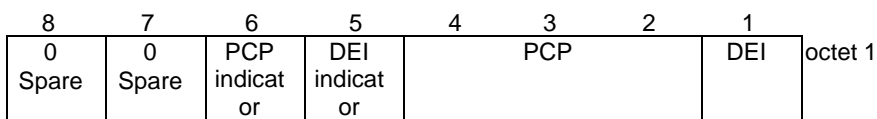

Figure 5.2.4B: Value part of traffic descriptor Extended 802.1Q C-TAG PCP/DEI type

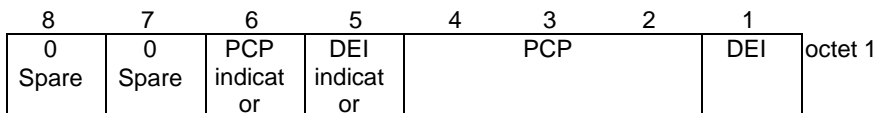

Figure 5.2.4C: Value part of traffic descriptor Extended 802.1Q S-TAG PCP/DEI type

Table 5.2.1: UE policy part contents including a URSP rule

Precedence value of URSP rule (octet v+2)

The precedence value of URSP rule field is used to specify the precedence of the URSP rule among all URSP rules in the URSP. This field includes the binary encoded value of the precedence value in the range from 0 to 255 (decimal). The higher the value of the precedence value field, the lower the precedence of the URSP rule is. Multiple URSP rules in the URSP shall not have the same precedence value (NOTE 10).

Traffic descriptor (octets v+5 to w)

The traffic descriptor field is of variable size and contains a variable number (at least one) of traffic descriptor components. Each traffic descriptor component shall be encoded as a sequence of one octet traffic descriptor component type identifier and a traffic descriptor component value field. The traffic descriptor component type identifier shall be transmitted first.

Traffic descriptor component type identifier

Bits

8	7	6	5	4	3	2	1	
0	0	0	0	0	0	0	1	Match-all type
0	0	0	0	1	0	0	0	OS Id + OS App Id type (NOTE 1)(NOTE 3)
0	0	0	1	0	0	0	0	IPv4 remote address type
0	0	1	0	0	0	0	1	IPv6 remote address/prefix length type
0	0	1	1	0	0	0	0	Protocol identifier/next header type
0	1	0	1	0	0	0	0	Single remote port type (NOTE 6)
0	1	0	1	0	0	0	1	Remote port range type (NOTE 6)
0	1	0	1	0	0	1	0	IP 3 tuple type
0	1	1	0	0	0	0	0	Security parameter index type
0	1	1	1	0	0	0	0	Type of service/traffic class type
1	0	0	0	0	0	0	0	Flow label type
1	0	0	0	0	0	0	1	Destination MAC address type (NOTE 7)
1	0	0	0	0	0	1	1	802.1Q C-TAG VID type (NOTE 4)
1	0	0	0	1	0	0	0	802.1Q S-TAG VID type (NOTE 4)
1	0	0	0	1	0	1	0	802.1Q C-TAG PCP/DEI type (NOTE 4)
1	0	0	0	1	0	1	1	802.1Q S-TAG PCP/DEI type (NOTE 4)
1	0	0	1	0	0	0	0	DNN type (NOTE 3)
1	0	0	1	0	0	1	0	Extended 802.1Q C-TAG PCP/DEI type (NOTE 4)
1	0	0	1	0	1	0	0	Extended 802.1Q S-TAG PCP/DEI type (NOTE 4)
1	0	0	1	0	0	0	0	Connection capabilities type (NOTE 3)
1	0	0	1	0	0	0	1	Destination FQDN type
1	0	0	1	0	0	1	0	Regular expression type
1	0	1	0	0	0	0	0	OS App Id type (NOTE 3)
1	0	1	0	0	0	0	1	Destination MAC address range type (NOTE 7)
1	0	1	0	0	0	1	0	PIN ID type (NOTE 8)
1	0	1	0	0	0	1	1	Connectivity group ID type (NOTE 13)

All other values are spare. If received they shall be interpreted as unknown.

For "match-all type", the traffic descriptor component shall not include the traffic descriptor component value field. The "match-all type" traffic descriptor component shall not appear more than once among all traffic descriptors of the whole URSP rules in the URSP. If the "match-all type" traffic descriptor component is included in a traffic descriptor, there shall be no traffic descriptor component with a type other than "match-all type" in the traffic descriptor.

For "OS Id + OS App Id type", the traffic descriptor component value field shall be encoded as a sequence of a sixteen octet OS Id field, a one octet OS App Id length field, and an OS App Id field. The OS Id field shall be transmitted first. The OS Id field contains a Universally Unique Identifier (UUID) as specified in IETF RFC 9562 [16].

For "IPv4 remote address type", the traffic descriptor component value field shall be encoded as a sequence of a four octet IPv4 address field and a four octet IPv4 address mask field. The IPv4 address field shall be transmitted first.

For "IPv6 remote address/prefix length type", the traffic descriptor component value field shall be encoded as a sequence of a sixteen octet IPv6 address field and one octet prefix length field. The IPv6 address field shall be transmitted first.

For "protocol identifier/next header type", the traffic descriptor component value field shall be encoded as one octet which specifies the IPv4 protocol identifier or IPv6 next header.

For "single remote port type", the traffic descriptor component value field shall be encoded as two octets which specify a port number.

For "remote port range type", the traffic descriptor component value field shall be encoded as a sequence of a two octet port range low limit field and a two octet port range high limit field. The port range low limit field shall be transmitted first.

For "IP 3 tuple type", the traffic descriptor component value field shall be encoded as a sequence of a one octet IP 3 tuple information bitmap field where:

- bit 1 set to zero indicates that the IPv4 address field is absent;
- bit 1 set to one indicates that the IPv4 address field is present;
- bit 2 set to zero indicates that the IPv6 remote address/prefix length field is absent;
- bit 2 set to one indicates that the IPv6 remote address/prefix length field is present;
- bit 3 set to zero indicates that the protocol identifier/next header field is absent;
- bit 3 set to one indicates that the protocol identifier/next header field is present;
- bit 4 set to zero indicates that the single remote port field is absent;
- bit 4 set to one indicates that the single remote port field is present;
- bit 5 set to zero indicates that the remote port range field is absent;
- bit 5 set to one indicates that the remote port range field is present; and
- bits 6,7, and 8 are spare bits;

followed by a four octet IPv4 address field and a four octet IPv4 address mask field, if the IPv4 address field is present;

followed by a sixteen octet IPv6 address field and one octet prefix length field, if the IPv6 remote address/prefix length field is present;

followed by one octet which specifies the IPv4 protocol identifier or IPv6 next header, if the protocol identifier/next header field is present;

followed by two octets which specify a port number, if the single remote port field is present;

followed by a two octet port range low limit field and a two octet port range high limit field, if the remote port range field is present.

The IP 3 tuple information bitmap field shall be transmitted first.

The traffic descriptor component value field shall not contain both the IPv4 address field and the IPv6 remote address/prefix length field. If the traffic descriptor component value field contains both the IPv4 address field and the IPv6 remote address/prefix length field, the receiving entity shall ignore the URSP rule.

The traffic descriptor component value field shall not contain both the single remote port field and the remote port range field. If the traffic descriptor component value field contains both the single remote port field and the remote port range field, the receiving entity shall ignore the URSP rule.

The traffic descriptor component value field shall contain at least one of the IPv4 address field, IPv6 remote address/prefix length field, the protocol identifier/next header field, the single remote port field and the remote port range field, otherwise the receiving entity shall ignore the URSP rule.

For "security parameter index type", the traffic descriptor component value field shall be encoded as four octets which specify the IPsec security parameter index.

For "type of service/traffic class type", the traffic descriptor component value field shall be encoded as a sequence of a one octet type-of-service/traffic class field and a one octet type-of-service/traffic class mask field. The type-of-service/traffic class field shall be transmitted first.

For "flow label type", the traffic descriptor component value field shall be encoded as three octets which specify the IPv6 flow label. The bits 8 through 5 of the first octet shall be spare whereas the remaining 20 bits shall contain the IPv6 flow label.

For "destination MAC address type", the traffic descriptor component value field shall be encoded as 6 octets which specify a MAC address.

For "802.1Q C-TAG VID type", the traffic descriptor component value field shall be encoded as two octets which specify the VID of the customer-VLAN tag (C-TAG) as specified in IEEE Std 802.1Q [20]. The bits 8 through 5 of the first octet shall be spare whereas the remaining 12 bits shall contain the VID.

For "802.1Q S-TAG VID type", the traffic descriptor component value field shall be encoded as two octets which specify the VID of the service-VLAN tag (S-TAG) as specified in IEEE Std 802.1Q [20]. The bits 8 through 5 of the first octet shall be spare whereas the remaining 12 bits shall contain the VID.

For "802.1Q C-TAG PCP/DEI type", the traffic descriptor component value field shall be encoded as one octet which specifies the 802.1Q C-TAG PCP and DEI as specified in IEEE Std 802.1Q [20]. The bits 8 through 5 of the octet shall be spare, and the bits 4 through 2 contain the PCP and bit 1 contains the DEI.

For "extended 802.1Q C-TAG PCP/DEI type", the traffic descriptor component value field shall be encoded as one octet which specifies the 802.1Q C-TAG PCP and DEI as shown in figure 5.2.4B. The bits 8 and 7 of the octet shall be spare and set to 0. The bit 6 indicates the presence of the PCP field. When bit 6 is set to 1, the bits 4 through 2 contain the PCP. When the bit 6 is set to 0, the bits 4 through 2 are spare and not used. The bit 5 indicates the presence of the EDI field. When bit 5 is set to 1, bit 1 contains the DEI. When the bit 5 is set to 0, the bit 1 is spare and not used.

For "802.1Q S-TAG PCP/DEI type", the traffic descriptor component value field shall be encoded as one octet which specifies the 802.1Q S-TAG PCP and DEI as specified in IEEE Std 802.1Q [20]. The bits 8 through 5 of the octet shall be spare, and the bits 4 through 2 contain the PCP and bit 1 contains the DEI.

For "extended 802.1Q S-TAG PCP/DEI type", the traffic descriptor component value field shall be encoded as one octet which specifies the 802.1Q S-TAG PCP and DEI as shown in figure 5.2.4C. The bits 8 and 7 of the octet shall be spare and set to 0. The bit 6 indicates the presence of the PCP field, when bit 6 is set to 1, the bits 4 through 2 contain the PCP. When the bit 6 is set to 0, the bits 4 through 2 are spare and not used. The bit 5 indicates the presence of the EDI field, when bit 5 is set to 1, bit 1 contains the DEI. When the bit 5 is set to 0, the bit 1 is spare and not used.

For "ethertype type", the traffic descriptor component value field shall be encoded as two octets which specify an ethertype.

For "DNN type", the traffic descriptor component value field shall be encoded as a sequence of a one octet DNN length field and a DNN value field of a variable size. The DNN value contains an APN as defined in 3GPP TS 23.003 [4].

For "connection capabilities type", the traffic descriptor component value field shall be encoded as a sequence of one octet for number of connection capabilities followed by one or more octets, each containing a connection capability identifier encoded as follows:

Bits								
8	7	6	5	4	3	2	1	
0	0	0	0	0	0	0	1	IMS (NOTE 17)
0	0	0	0	0	0	1	0	MMS
0	0	0	0	0	1	0	0	SUPL
0	0	0	0	1	0	0	0	Internet (NOTE 17)
0	0	0	1	0	0	0	0	LCS user plane positioning (NOTE 16)
0	0	1	0	0	0	0	0	to Operator specific connection capabilities (NOTE 15)
1	0	1	0	0	0	0	0	IoT delay-tolerant (NOTE 14)
1	0	1	0	0	0	1	0	IoT non-delay-tolerant (NOTE 14)
1	0	1	0	0	0	1	1	Downlink streaming (NOTE 14)
1	0	1	0	0	1	0	0	Uplink streaming (NOTE 14)
1	0	1	0	0	1	0	1	Vehicular communications (NOTE 14)
1	0	1	0	0	1	1	0	Real time interactive (NOTE 14)
1	0	1	0	1	0	0	0	Unified communications (NOTE 14)
1	0	1	0	1	0	0	1	Background (NOTE 14)
1	0	1	0	1	0	0	1	Mission critical communications (NOTE 14)
1	0	1	0	1	0	1	0	Time critical communications (NOTE 14)
1	0	1	0	1	0	1	1	Low latency loss tolerant communications in un-acknowledged mode (NOTE 14)

All other values are spare. If received, they shall be interpreted as unknown.

For "destination FQDN type", the traffic descriptor component value field shall be encoded as a sequence of one octet destination FQDN length field and a destination FQDN value of variable size. The destination FQDN value field shall be encoded as defined in clause 28.3.2.1 in 3GPP TS 23.003 [4].

For "regular expression type", the traffic descriptor component value field shall be encoded as a sequence of one octet regular expression length field and a regular expression value of variable size. The regular expression value field shall take the form of Extended Regular Expressions (ERE) as defined in chapter 9 in IEEE 1003.1 [19].

For "OS App Id type", the traffic descriptor component value field shall be encoded as a one octet OS App Id length field and an OS App Id field.

For "destination MAC address range type", the traffic descriptor component value field shall be encoded as a sequence of a 6 octet destination MAC address range low limit field and a 6 octet destination MAC address range high limit field. The destination MAC address range low limit field shall be transmitted first.

For "PIN ID type", the traffic descriptor component value field shall be encoded as a sequence of a one octet PIN ID value length field and a PIN ID value field of a variable size octet string.

For "connectivity group ID type", the traffic descriptor component value field shall be encoded as a sequence of one octet connectivity group ID length field and a connectivity group ID value field of a variable size which represents a specific connectivity group configured in the 5G-RG.

Precedence value of route selection descriptor (octet b+2)

The precedence value of route selection descriptor field is used to specify the precedence of the route selection descriptor among all route selection descriptors in the URSP rule. This field includes the binary encoded value of the precedence value in the range from 0 to 255 (decimal). The higher the value of the precedence value field, the lower the precedence of the route selection descriptor is.

Route selection descriptor contents (octets b+5 to c)

The route selection descriptor contents field is of variable size and contains a variable number (at least one) of route selection descriptor components. Each route selection descriptor component shall be encoded as a sequence of a one octet route selection descriptor component type identifier and a route selection descriptor component value field. The route selection descriptor component type identifier shall be transmitted first.

Route selection descriptor component type identifier

Bits

8	7	6	5	4	3	2	1	
0	0	0	0	0	0	0	1	SSC mode type
0	0	0	0	0	1	0		S-NSSAI type
0	0	0	0	1	0	0		DNN type
0	0	0	1	0	0	0		PDU session type type
0	0	0	1	0	0	0		Preferred access type type (NOTE 2)
0	0	0	1	0	0	1		Multi-access preference type (NOTE 2)
0	0	1	0	0	0	0		Non-seamless non-3GPP offload indication type (NOTE 9)
0	1	0	0	0	0	0		Location criteria type
1	0	0	0	0	0	0		Time window type
1	0	0	0	0	0	1		5G ProSe layer-3 UE-to-network relay offload indication type (NOTE 9)
1	0	0	0	0	1	0		PDU session pair ID type (NOTE 5, NOTE 9)
1	0	0	0	0	1	1		RSN type (NOTE 5, NOTE 9)
1	0	0	0	1	0	0		5G ProSe multi-path preference type (NOTE 9)

All other values are spare. If received they shall be interpreted as unknown.

For "SSC mode type", the route selection descriptor component value field shall be encoded as a one octet SSC mode field. The bits 8 through 4 of the octet shall be spare, and the bits 3 through 1 shall be encoded as the value part of the SSC mode information element defined in clause 9.11.4.16 of 3GPP TS 24.501 [11]. The "SSC mode type" route selection descriptor component shall not appear more than once in the route selection descriptor.

For "S-NSSAI type", the route selection descriptor component value field shall be encoded as a sequence of a one octet S-NSSAI length field and an S-NSSAI value field of a variable size. The S-NSSAI value shall be encoded as the value part of the S-NSSAI information element defined in clause 9.11.2.8 of 3GPP TS 24.501 [11], without the mapped HPLMN SST field and without the mapped HPLMN SD field.

For "DNN type", the route selection descriptor component value field shall be encoded as a sequence of a one octet DNN length field and a DNN value field of a variable size. The DNN value contains an APN as defined in 3GPP TS 23.003 [4].

For "PDU session type type", the route selection descriptor component value field shall be encoded as a one octet PDU session type field. The bits 8 through 4 of the octet shall be spare, and the bits 3 through 1 shall be encoded as the value part of the PDU session type information element defined in clause 9.11.4.11 of 3GPP TS 24.501 [11]. The "PDU session type type" route selection descriptor component shall not appear more than once in the route selection descriptor.

For "preferred access type type", the route selection descriptor component value field shall be encoded as a one octet preferred access type field. The bits 8 through 3 shall be spare, and the bits 2 and 1 shall be encoded as the value part of the access type information element defined in clause 9.11.2.1A of 3GPP TS 24.501 [11]. The "preferred access type type" route selection descriptor component shall not appear more than once in the route selection descriptor.

For "multi-access preference type", the route selection descriptor component value field shall be of zero length. The "multi-access preference type" route selection descriptor component shall not appear more than once in the route selection descriptor. The "multi-access preference type" route selection descriptor component in the route selection descriptor indicates the multi-access preference.

For "non-seamless non-3GPP offload indication type", the route selection descriptor component shall not include the route selection descriptor component value field. The "non-seamless non-3GPP offload indication type" route selection descriptor component shall not appear more than once in the route selection descriptor. If the "non-seamless non-3GPP offload indication type" route selection descriptor component is included in a route selection descriptor, there shall be no route selection descriptor component with a type other than "non-seamless non-3GPP offload indication type" in the route selection descriptor.

For "location criteria type", the route selection descriptor component value field may contain one or more types of location area and is encoded as shown in Figure 5.2.5 and Table 5.2.2.

For "time window type", the route selection descriptor component value field shall be encoded as a sequence of a Starttime field and a Stoptime field. The Starttime field is represented by the number of seconds since 00:00:00 on 1 January 1970 and is encoded as the 64-bit NTP timestamp format defined in IETF RFC 5905 [17], where binary encoding of the integer part is in the first 32 bits and binary encoding of the fraction part in the last 32 bits. The encoding of the Stoptime field is the same as the Starttime field.

For "5G ProSe layer-3 UE-to-network relay offload indication type", the route selection descriptor component shall not include the route selection descriptor component value field. The "5G ProSe layer-3 UE-to-network relay offload indication type" route selection descriptor component shall not appear more than once in the route selection descriptor. If the "5G ProSe layer-3 UE-to-network relay offload indication type" route selection descriptor component is included in a route selection descriptor, there shall be no route selection descriptor component with a type other than "5G ProSe layer-3 UE-to-network relay offload indication type" in the route selection descriptor. If neither "5G ProSe layer-3 UE-to-network relay offload indication type" nor "5G ProSe multi-path preference" is present, the traffic shall not be routed via a 5G ProSe layer-3 UE-to-network relay outside of a PDU Session.

For "PDU session pair ID type", the route selection descriptor component value field shall be encoded as a one octet PDU session pair ID field. The PDU session pair ID value shall be encoded as defined in clause 9.11.4.32 of 3GPP TS 24.501 [11].

For "RSN type", the route selection descriptor component value field shall be encoded as a one octet RSN field. The RSN value shall be encoded as the value part of the RSN information element defined in clause 9.11.4.33 of 3GPP TS 24.501 [11].

For "5G ProSe multi-path preference type", the route selection descriptor component shall not include the route selection descriptor component value field. The "5G ProSe multi-path preference" route selection descriptor component shall not appear more than once in the route selection descriptor. If the "5G ProSe multi-path preference" route selection descriptor component is included in a route selection descriptor, there shall be no route selection descriptor component with type "5G ProSe layer-3 UE-to-network relay offload indication type" in the route selection descriptor. If neither "5G ProSe layer-3 UE-to-network relay offload indication type" nor "5G ProSe multi-path preference type" is present, the traffic shall not be routed via a 5G ProSe layer-3 UE-to-network relay outside of a PDU Session.

Additional indications (octet x+1) (NOTE 11)

Additional indications field is used to indicate additional indications related to the URSP rule, and is encoded as shown in Figure 5.2.4A.

URSP rule enforcement report indication (URERI) (bit 1 of octet x+1)

URSP rule enforcement report indication indicates whether to report the URSP rule enforcement for the associated URSP rule according to clause 4.2.4 (NOTE 12).

Bit

1

0 URSP rule enforcement report is not required

1 URSP rule enforcement report is required

Bits 2 to 8 of octet x+1 are spare and shall be encoded as zero. If received they shall be interpreted as unknown.

NOTE 1:	For "OS Id + OS App Id type", the traffic descriptor component value field does not specify the OS version number or the version number of the application.
NOTE 2:	The PCF does not include both the "preferred access type type" and the "multi-access preference type" route selection descriptor components in a single route selection descriptor. If there are both "preferred access type type" and "multi-access preference type" route selection descriptor components in a single route selection descriptor, the UE ignores the "preferred access type type" route selection descriptor component.
NOTE 3:	The W-AGF acting on behalf of the FN-RG shall interpret the value as unknown.
NOTE 4:	The traffic descriptor of a URSP rule cannot include more than one instance of this traffic component type.
NOTE 5:	Redundant PDU session is not applicable over non-3GPP access. The UE ignores any route selection descriptor which includes "PDU session pair ID type" or "RSN type" route selection descriptor component and also includes a "preferred access type type" route selection descriptor component set to "non-3GPP access" or a "multi-access preference type" route selection descriptor component.
NOTE 6:	The traffic descriptor of a URSP rule shall not contain both the "Single remote port type" and the "Remote port range type" traffic descriptor components. If the traffic descriptor of a URSP rule contains both the "Single remote port type" and the "Remote port range type" traffic descriptor components, the receiving entity shall ignore the URSP rule.
NOTE 7:	The traffic descriptor of a URSP rule shall not contain both the "Destination MAC address type" and the "Destination MAC address range type" traffic descriptor components. If the traffic descriptor of a URSP rule contains both the "Destination MAC address type" and the "Destination MAC address range type" traffic descriptor components, the receiving entity shall ignore the URSP rule.
NOTE 8:	The traffic descriptor component type "PIN ID type" shall be mutually exclusive to the other traffic descriptor components, i.e. if the traffic descriptor of the URSP rule contains both PIN ID and the other traffic descriptor components, the UE shall ignore the other traffic descriptor component and shall use the PIN ID. The PIN ID uniquely identifies a PIN in the PLMN. The PIN ID is only applicable for the traffic of a PINE.
NOTE 9:	Not applicable for PIN traffic.
NOTE 10:	The precedence value of a URSP rule in a UE policy section associated with network descriptor entry type "one or more VPLMNs" in VPS URSP configuration should be lower than the precedence value of a URSP rule in a UE policy section associated with network descriptor entry type "one or more MCCs" or "any VPLMN" in VPS URSP configuration.
NOTE 11:	Additional indications field is included when the URSP rule includes an octet following octet x.
NOTE 12:	A URSP rule can contain this indication only if the URSP rule includes one or more connection capabilities in traffic descriptor component.
NOTE 13:	The traffic descriptor component type "connectivity group ID" can only be combined with IP descriptors, non-IP descriptors, or both, in the same URSP rule. If the traffic descriptor of the URSP rule contains connectivity group ID and any other traffic descriptor components other than IP descriptors or non-IP descriptors, the receiving entity shall ignore the other traffic descriptor component.
NOTE 14:	These connection capabilities are traffic categories specified in GSMA PRD NG.135 [26].
NOTE 15:	The operator specific connection capability identifier can match against a operator specific traffic category as specified in 3GPP TS 23.503 [2].
NOTE 16:	This indication is included in the connection capability as specified in 3GPP TS 23.273 [27].
NOTE 17:	This connection capability identifier can be used for either a network connection with certain capabilities or a traffic category specified in GSMA PRD NG.135 [26].

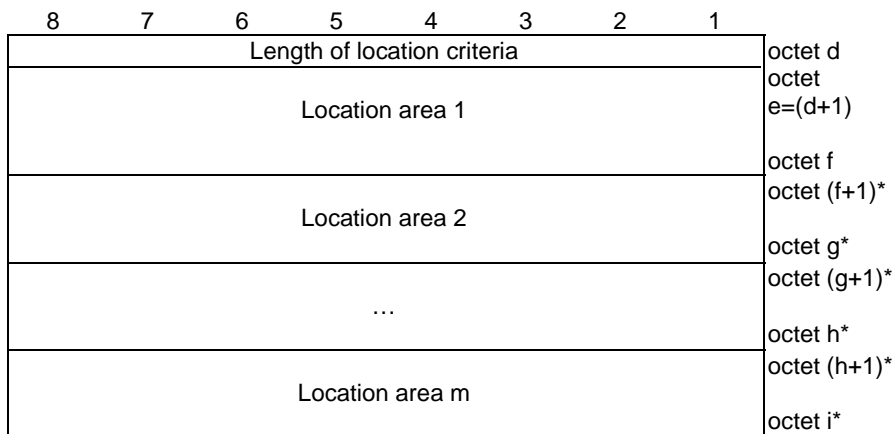

Figure 5.2.5: Location criteria

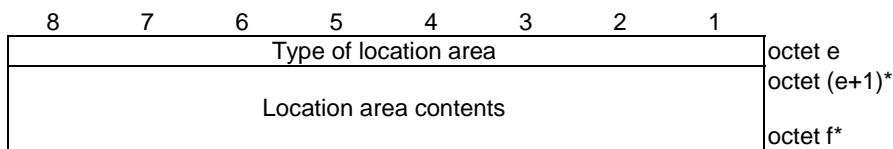

Figure 5.2.6: Location area

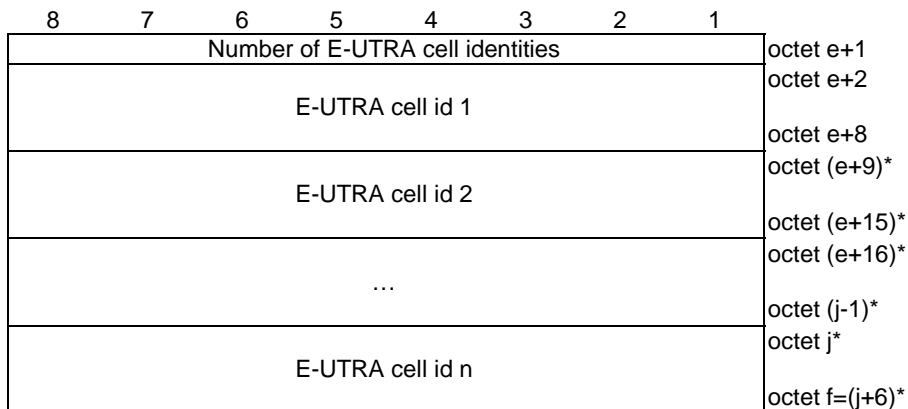

Figure 5.2.7: Location area contents {Type of location area = E-UTRA cell identities list}

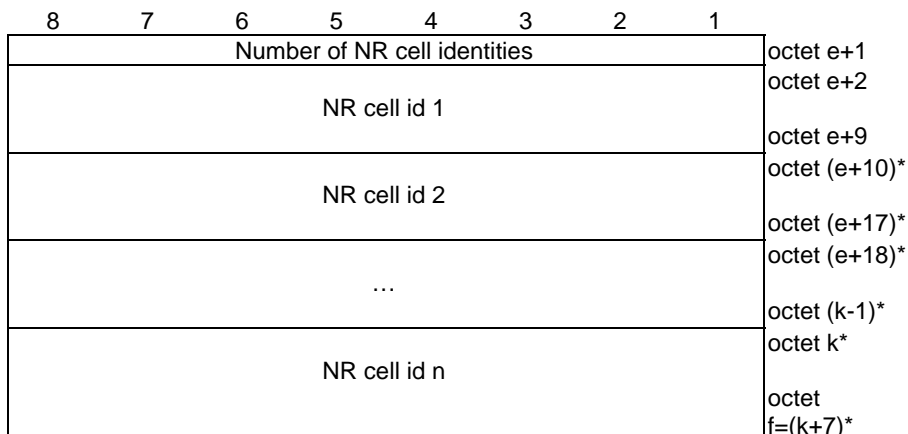

Figure 5.2.8: Location area contents {Type of location area = NR cell identities list}

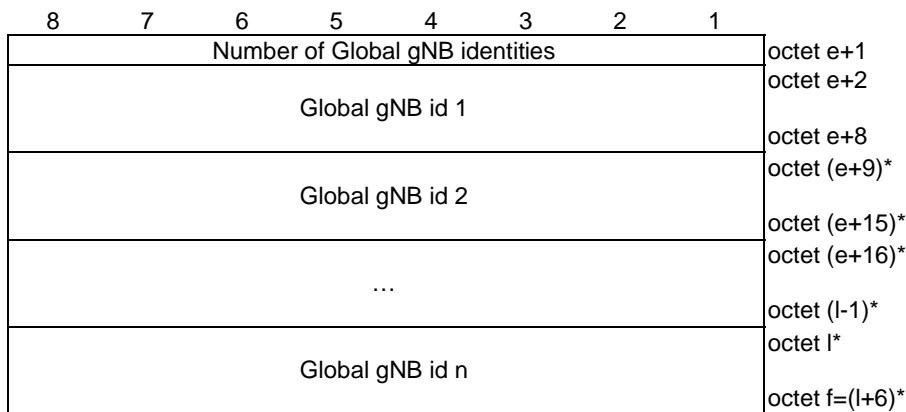

Figure 5.2.9: Location area contents {Type of location area = Global RAN node identities list}

Table 5.2.2: Location criteria

<p>Length of location criteria (octet d) This field indicates the length of the included Location criteria contents.</p> <p>Type of location area is coded as follows.</p> <table border="0"> <tr> <td style="text-align: center;">8</td> <td style="text-align: center;">7</td> <td style="text-align: center;">6</td> <td style="text-align: center;">5</td> <td style="text-align: center;">4</td> <td style="text-align: center;">3</td> <td style="text-align: center;">2</td> <td style="text-align: center;">1</td> <td></td> </tr> <tr> <td style="text-align: center;">0</td> <td style="text-align: center;">0</td> <td style="text-align: center;">0</td> <td style="text-align: center;">0</td> <td style="text-align: center;">0</td> <td style="text-align: center;">0</td> <td style="text-align: center;">0</td> <td style="text-align: center;">1</td> <td>E-UTRA cell identities list</td> </tr> <tr> <td style="text-align: center;">0</td> <td style="text-align: center;">0</td> <td style="text-align: center;">0</td> <td style="text-align: center;">0</td> <td style="text-align: center;">0</td> <td style="text-align: center;">0</td> <td style="text-align: center;">1</td> <td style="text-align: center;">0</td> <td>NR cell identities list</td> </tr> <tr> <td style="text-align: center;">0</td> <td style="text-align: center;">0</td> <td style="text-align: center;">0</td> <td style="text-align: center;">0</td> <td style="text-align: center;">0</td> <td style="text-align: center;">0</td> <td style="text-align: center;">1</td> <td style="text-align: center;">1</td> <td>Global RAN node identities list</td> </tr> <tr> <td style="text-align: center;">0</td> <td style="text-align: center;">0</td> <td style="text-align: center;">0</td> <td style="text-align: center;">0</td> <td style="text-align: center;">0</td> <td style="text-align: center;">1</td> <td style="text-align: center;">0</td> <td style="text-align: center;">0</td> <td>TAI list</td> </tr> </table> <p>All other values are spare.</p> <p>When the type of location area is "E-UTRA cell identities list", the location area contents shall be encoded as in figure 5.2.7. Each E-UTRA cell id field is of 7 octet size and shall be encoded as specified in clause 9.3.1.9 of 3GPP TS 38.413 [14].</p> <p>When the type of location area is "NR cell identities list", the location area contents shall be encoded as in figure 5.2.8. Each NR cell id field is of 8 octet size shall be encoded as specified in clause 9.3.1.7 of 3GPP TS 38.413 [14].</p> <p>When the type of location area is "Global RAN node identities list", the location area contents shall be encoded as in figure 5.2.9. Each Global gNB id field is of 7 octet size shall be encoded as specified in clause 9.3.1.6 of 3GPP TS 38.413 [14]. (NOTE 1)</p> <p>When the type of location area is "TAI list", the location area contents shall be encoded as the 5GS tracking area identity list information element (starting with octet 2) defined in clause 9.11.3.9 of 3GPP TS 24.501 [11].</p> <p>NOTE 1: If the Global gNB id field includes a gNB id with a length of less than 32 bits, the most significant bits of the 4 octets field containing the gNB id are padded with zeros.</p>									8	7	6	5	4	3	2	1		0	0	0	0	0	0	0	1	E-UTRA cell identities list	0	0	0	0	0	0	1	0	NR cell identities list	0	0	0	0	0	0	1	1	Global RAN node identities list	0	0	0	0	0	1	0	0	TAI list
8	7	6	5	4	3	2	1																																														
0	0	0	0	0	0	0	1	E-UTRA cell identities list																																													
0	0	0	0	0	0	1	0	NR cell identities list																																													
0	0	0	0	0	0	1	1	Global RAN node identities list																																													
0	0	0	0	0	1	0	0	TAI list																																													

5.3 Encoding of UE policy part type ANDSP

5.3.1 General

The purpose of the ANDSP is to indicate the WLAN Selection Policy (WLANSPP) and non-3GPP access network (N3AN) node configuration information related to access network discovery and selection and N3AN node selection for non-3GPP access network.

The ANDSP is encoded as shown in figures 5.3.1.1 to 5.3.1.3 and table 5.3.1.1 according to UE policy part top level format (see Annex D of 3GPP TS 24.501 [11]).

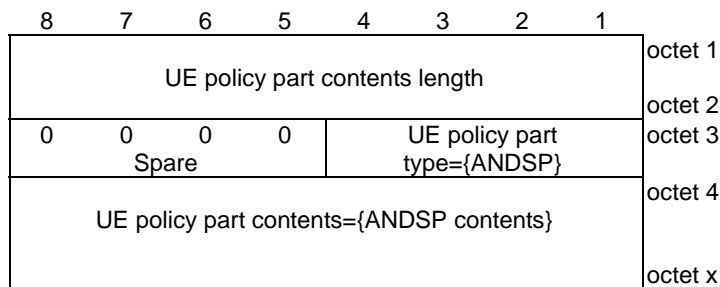

Figure 5.3.1.1: UE policy part when UE policy part type = {ANDSP}

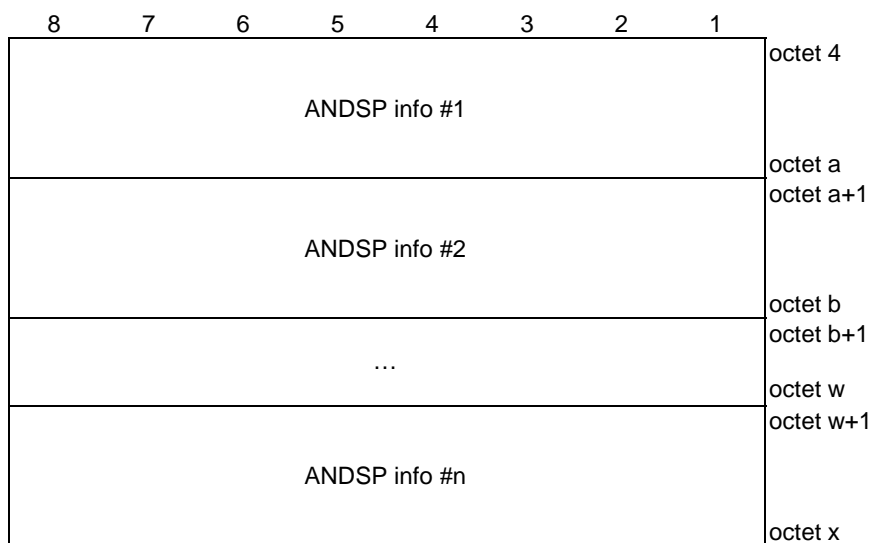

Figure 5.3.1.2: ANDSP contents

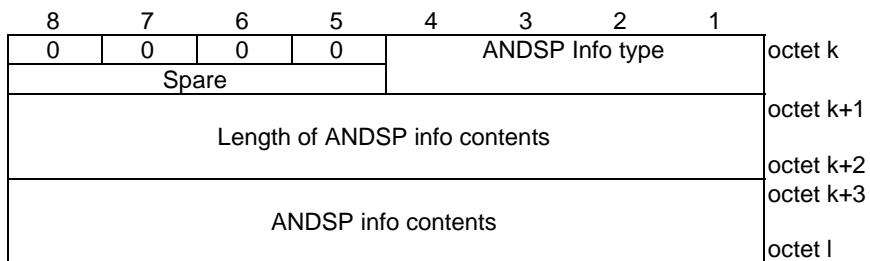

Figure 5.3.1.3: ANDSP Info

Table 5.3.1.1: ANDSP information format

<p>UE policy part type field is set to '0010' (=ANDSP) as specified in 3GPP TS 24.501 [4] Annex D.</p> <p>UE policy part contents length field indicate the length of the ANDSP contents in octets.</p> <p>ANDSP contents (octets 4 to x)</p> <p>ANDSP contents consist of 1 or more ANDSP info (see figure 5.3.1.2).</p> <p>ANDSP Info type (bits 1 to 4 of octet k) shall be set according to the following:</p> <p>Bits</p> <table border="1"> <tr> <td>4</td> <td>3</td> <td>2</td> <td>1</td> <td></td> </tr> <tr> <td>0</td> <td>0</td> <td>0</td> <td>0</td> <td>Reserved</td> </tr> <tr> <td>0</td> <td>0</td> <td>0</td> <td>1</td> <td>WLANSP</td> </tr> <tr> <td>0</td> <td>0</td> <td>1</td> <td>0</td> <td>N3AN node configuration information</td> </tr> </table> <p>All other values are reserved.</p> <p>Bits 8 to 5 of octet k are spare and shall be encoded as zero.</p> <p>Length of ANDSP info contents (octets k+1 to k+2) indicates the length of the ANDSP info contents field.</p> <p>ANDSP info contents (octets k+3 to l) can be WLANSP (see clause 5.3.2) or N3AN node configuration information (see clause 5.3.3).</p>	4	3	2	1		0	0	0	0	Reserved	0	0	0	1	WLANSP	0	0	1	0	N3AN node configuration information
4	3	2	1																	
0	0	0	0	Reserved																
0	0	0	1	WLANSP																
0	0	1	0	N3AN node configuration information																

5.3.2 Encoding of WLANSP

The purpose of the WLANSP field is to indicate the rules related to selection and reselection of a WLAN.

The WLANSP field is encoded as shown in figures 5.3.2.1 to 5.3.2.21 and table 5.3.2.1.

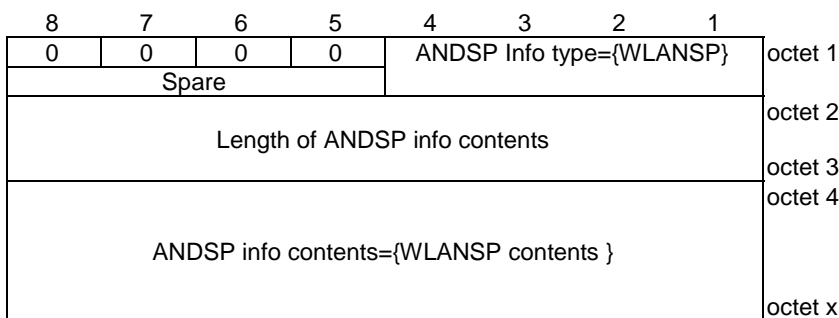

Figure 5.3.2.1: ANDSP Info type = {WLANSP}

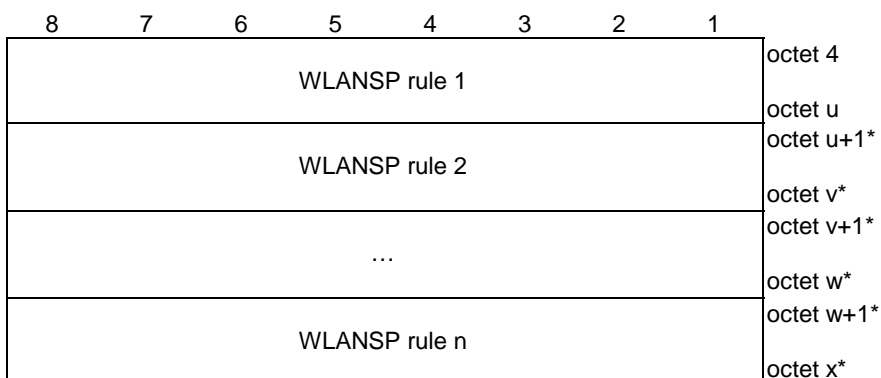

Figure 5.3.2.2: WLANSP contents

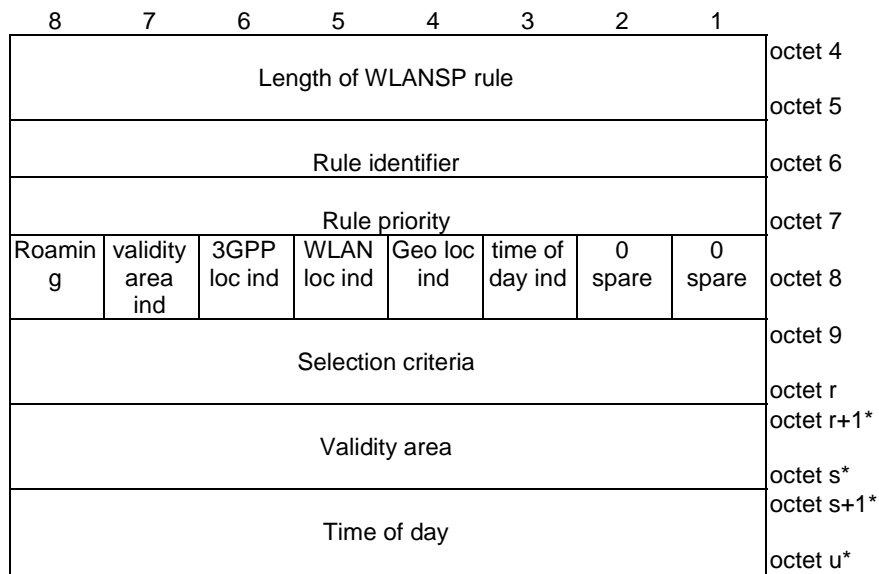

Figure 5.3.2.3: WLANSF rule

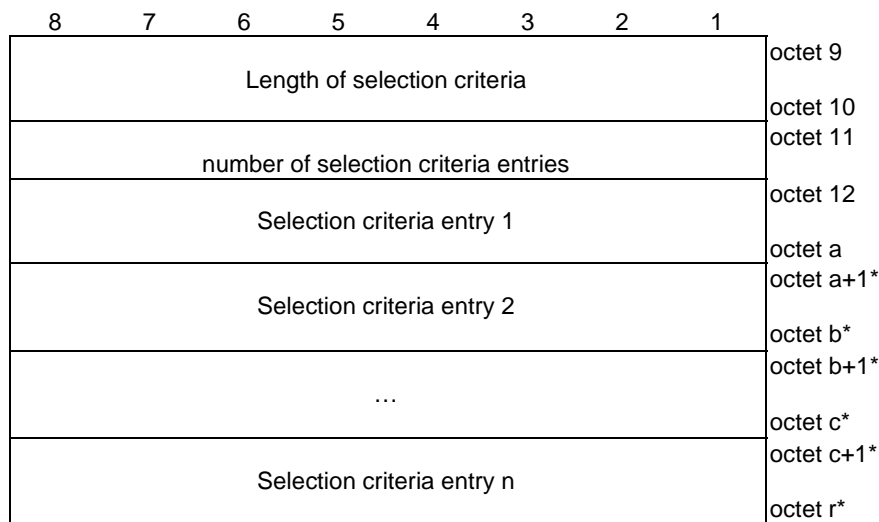

Figure 5.3.2.4: Selection criteria

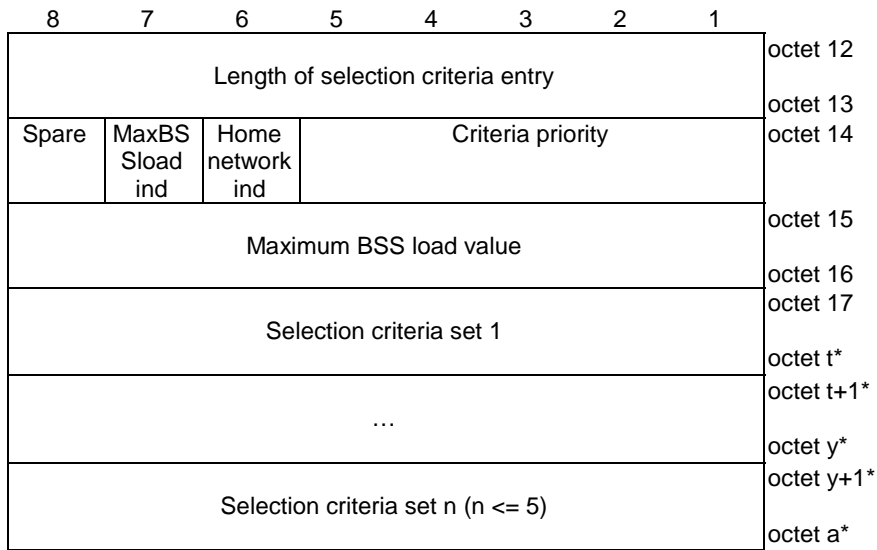

Figure 5.3.2.4a: Selection criteria entry

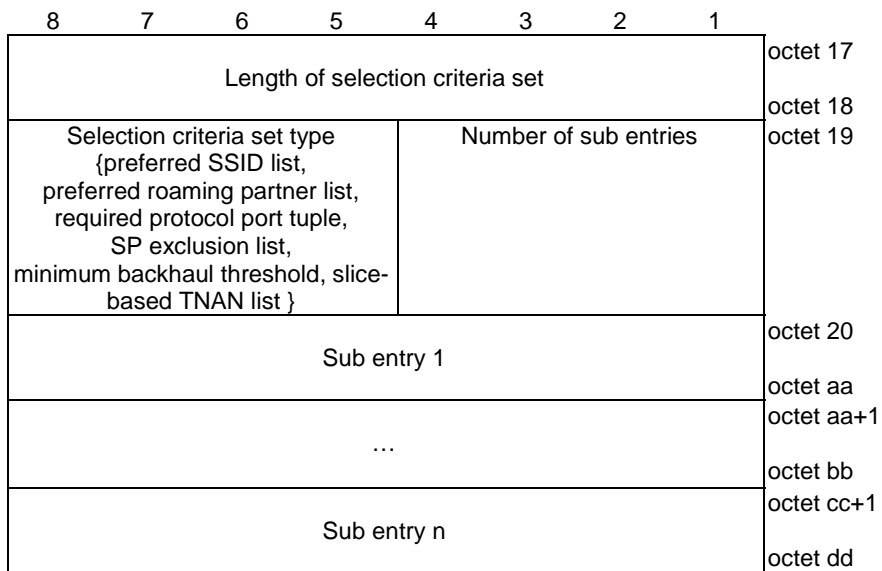

Figure 5.3.2.4b: Selection criteria set

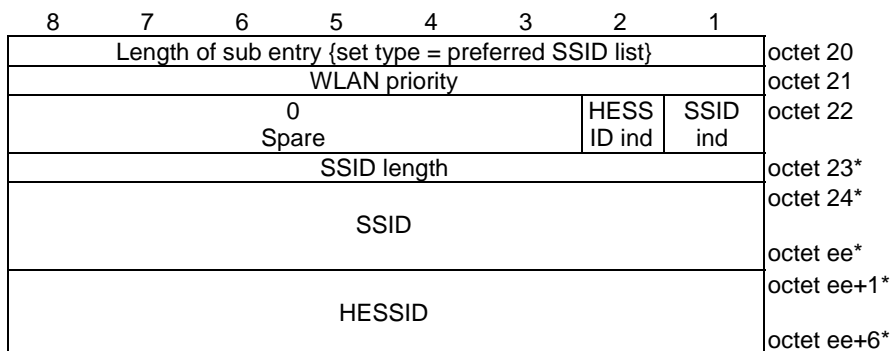

Figure 5.3.2.4c: Selection criteria sub entry {selection criteria set type = preferred SSID list}

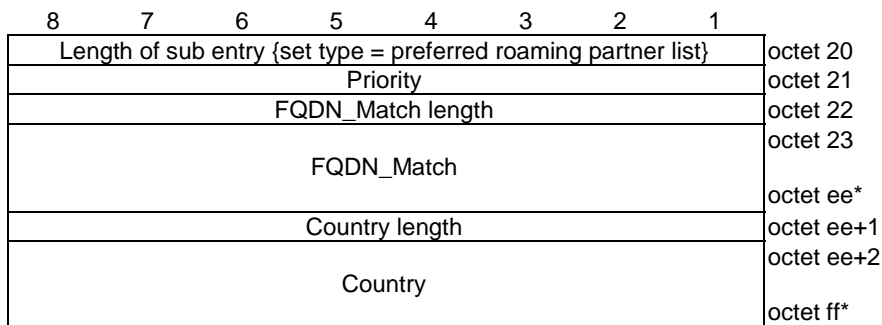

Figure 5.3.2.4d: Selection criteria sub entry {selection criteria set type = preferred roaming partner list}

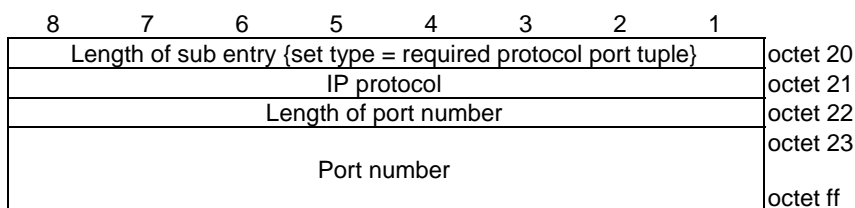

Figure 5.3.2.4e: Selection criteria sub entry {selection criteria set type = required protocol port tuple}

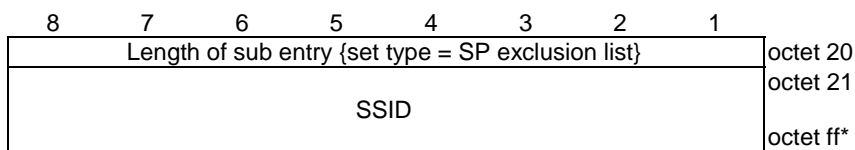

Figure 5.3.2.4f: Selection criteria sub entry {selection criteria set type = SP exclusion list}

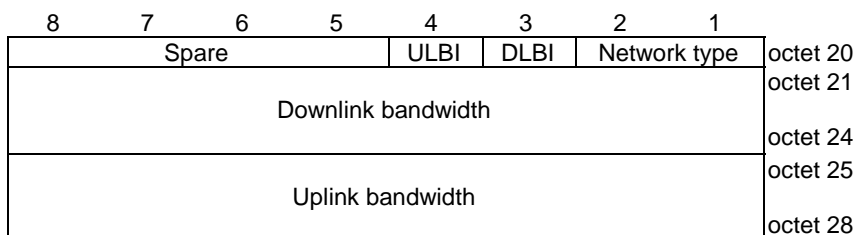

Figure 5.3.2.4g: Selection criteria sub entry {selection criteria set type = minimum backhaul threshold}

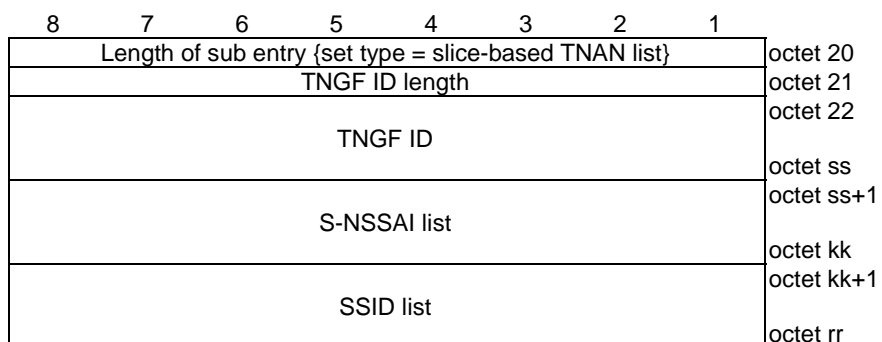

Figure 5.3.2.4h: Selection criteria sub entry {selection criteria set type = slice-based TNAN list}

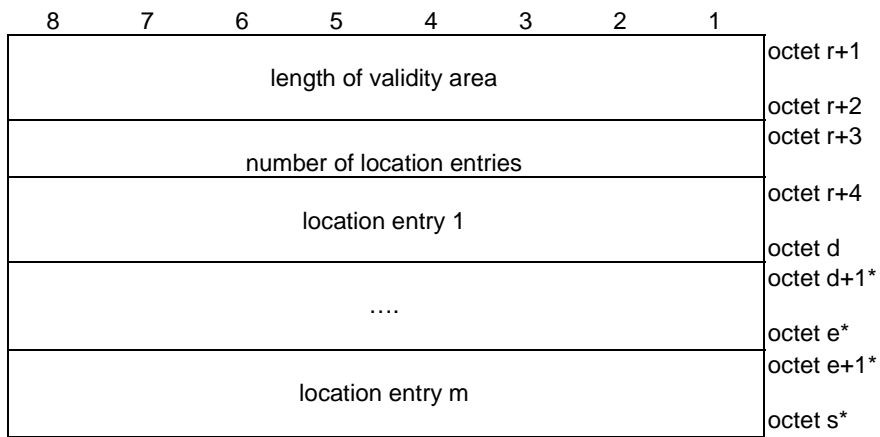

Figure 5.3.2.5: Validity area

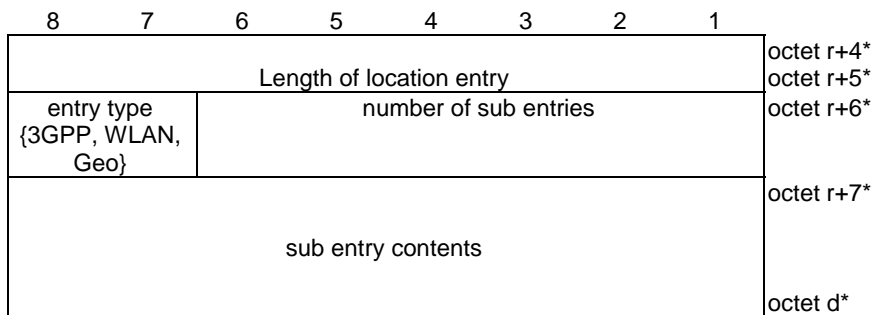

Figure 5.3.2.6: Location entry

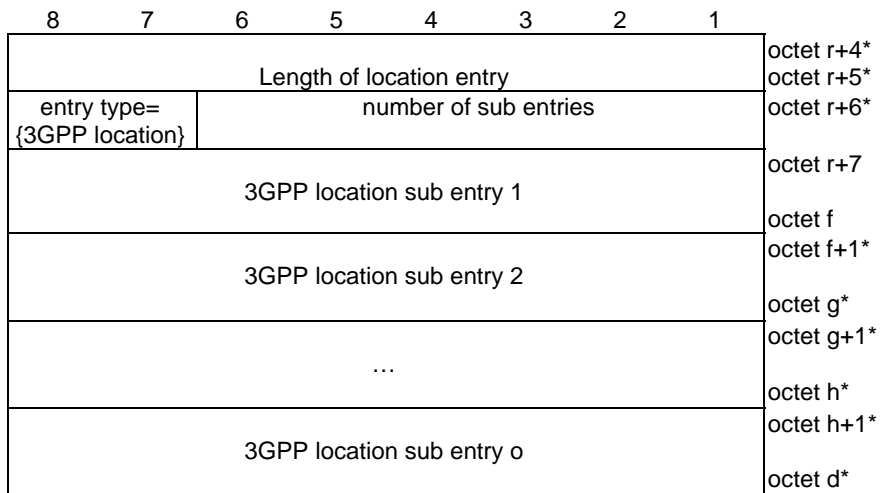

Figure 5.3.2.7: Location entry {entry type =3GPP location}

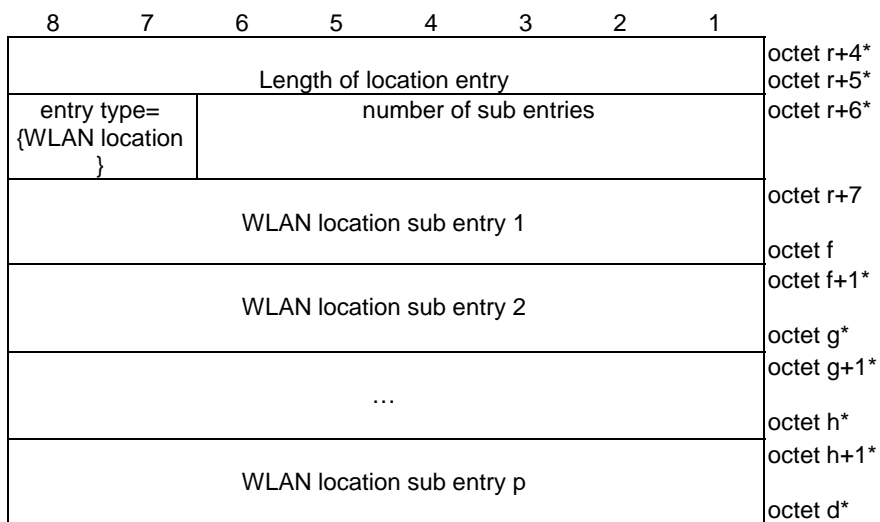

Figure 5.3.2.8: Location entry {entry type =WLAN location}

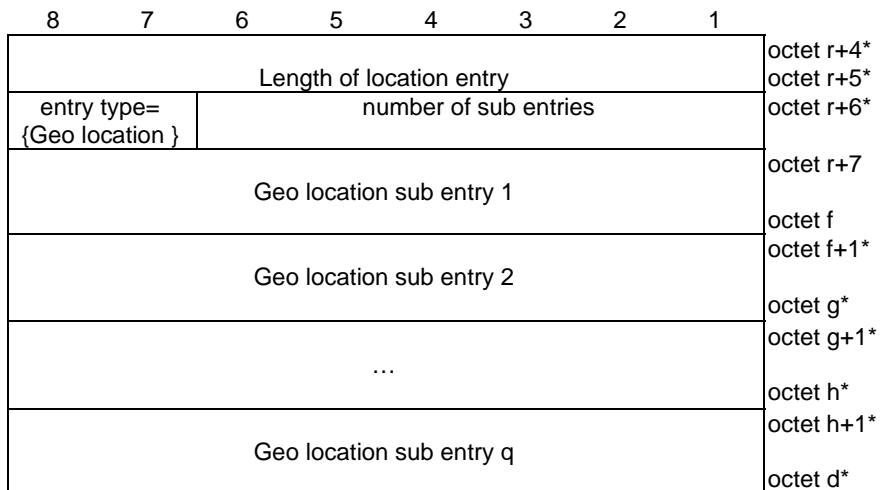

Figure 5.3.2.9: Location entry {entry type =Geo location}

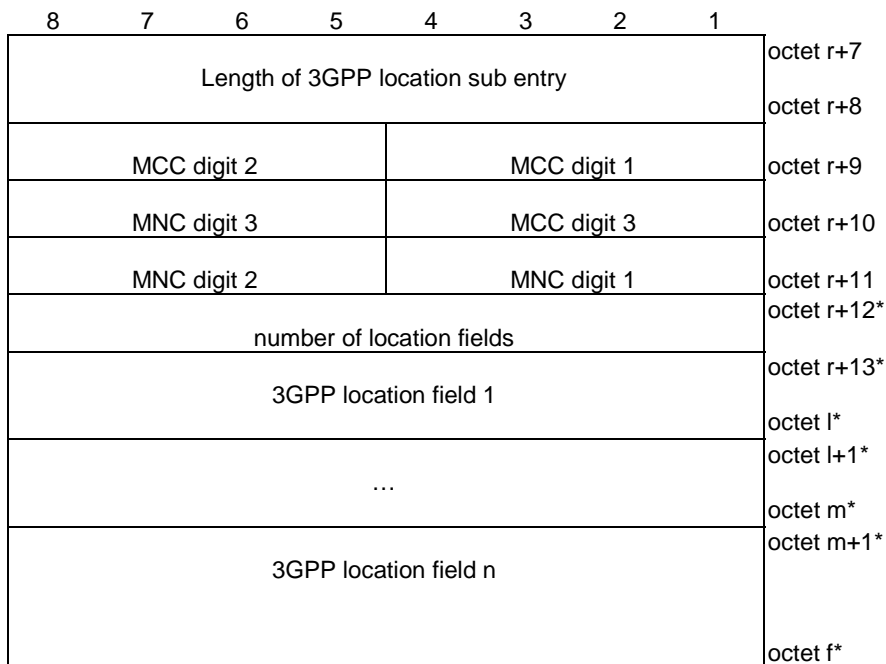

Figure 5.3.2.10: Location sub entry {entry type= 3GPP location}

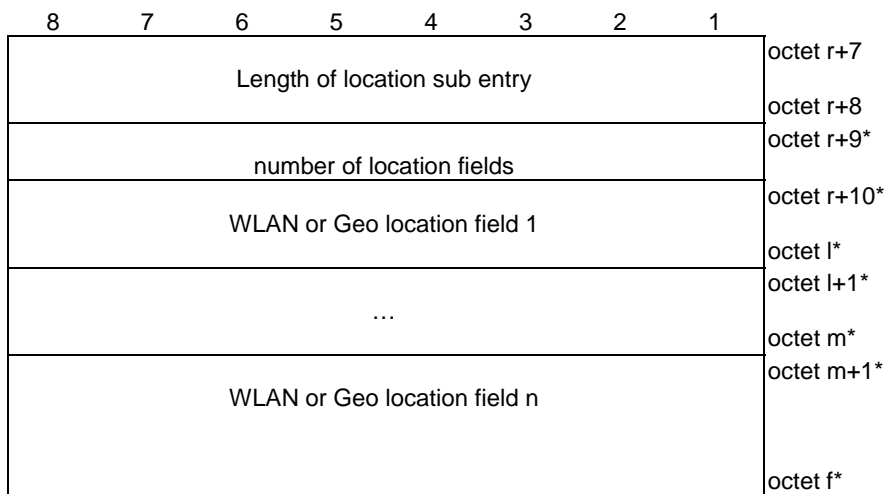

Figure 5.3.2.10a: Location sub entry {entry type= WLAN location or Geo location}

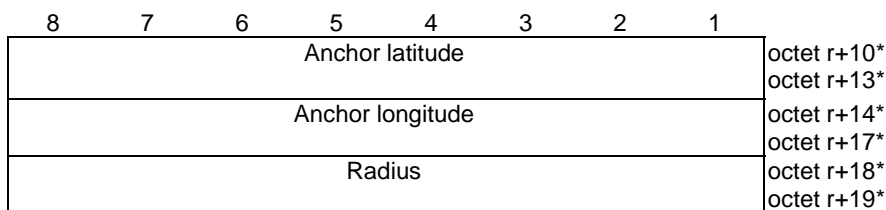

Figure 5.3.2.11a: Location field {entry type= Geo location}

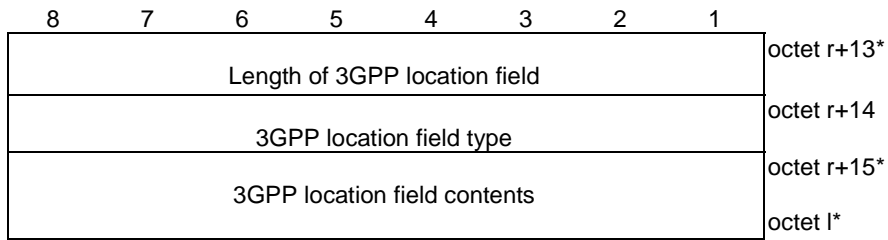

Figure 5.3.2.11b: Location field {entry type= 3GPP location}

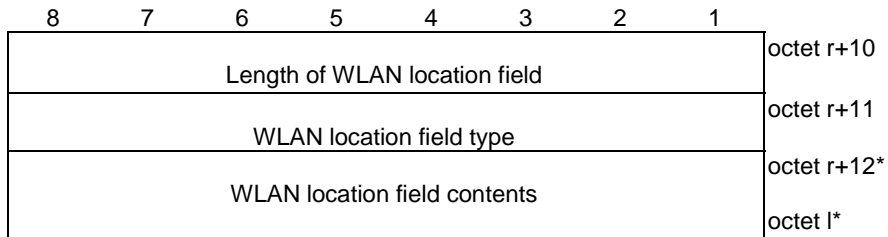

Figure 5.3.2.11c: Location field {entry type= WLAN location}

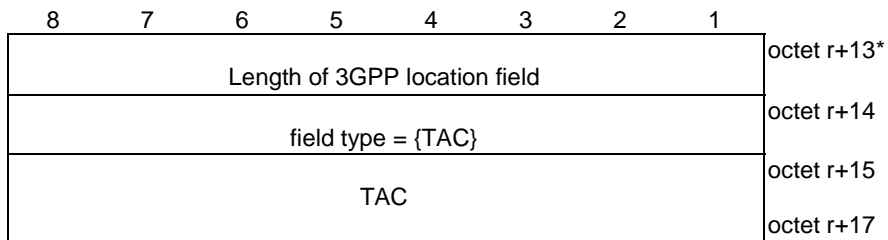

Figure 5.3.2.12: 3GPP location field {field type = TAC}

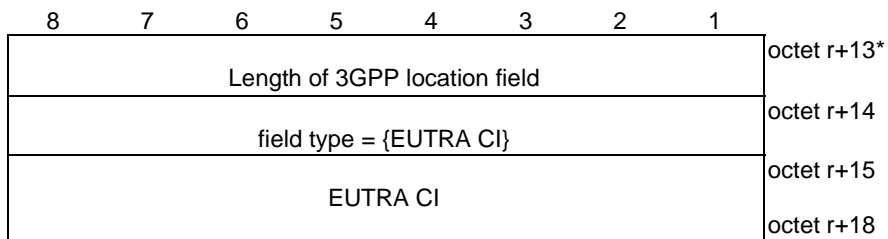

Figure 5.3.2.13: 3GPP location field {field type = EUTRA CI}

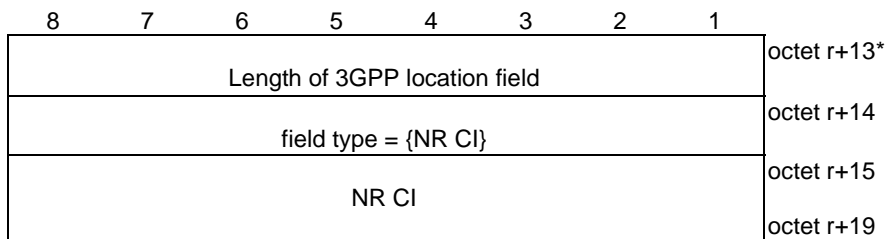

Figure 5.3.2.14: 3GPP location field {field type = NR CI}

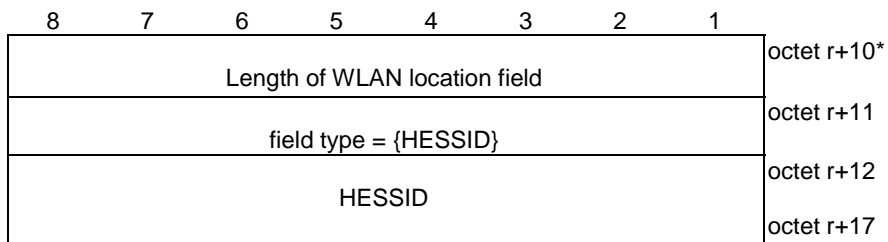

Figure 5.3.2.14a: WLAN location field {field type = HESSID}

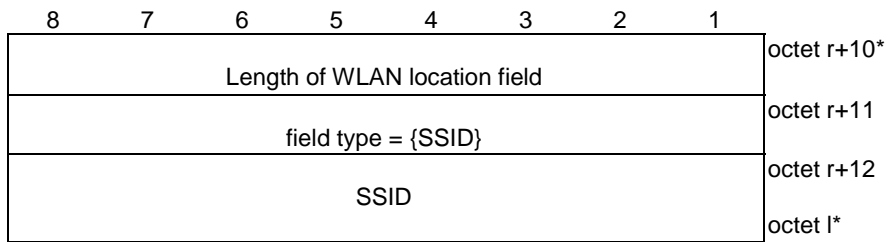

Figure 5.3.2.14b: WLAN location field {field type = SSID}

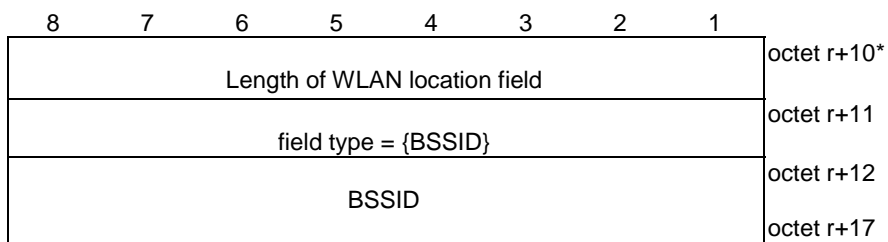

Figure 5.3.2.14c: WLAN location field {field type = BSSID}

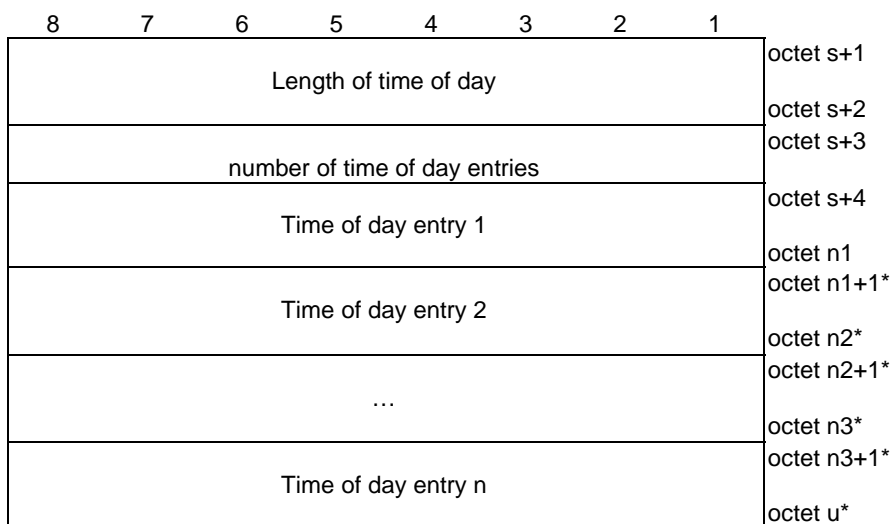

Figure 5.3.2.15: Time of day

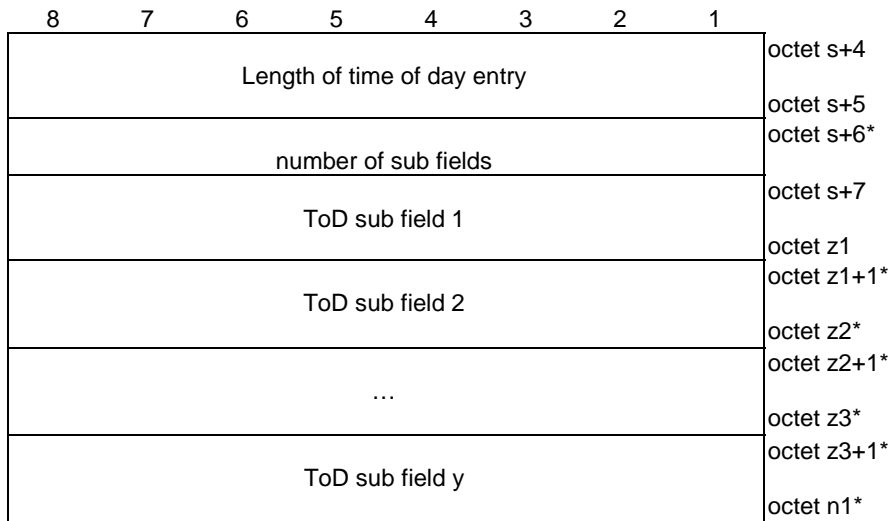

Figure 5.3.2.16: Time of day sub field

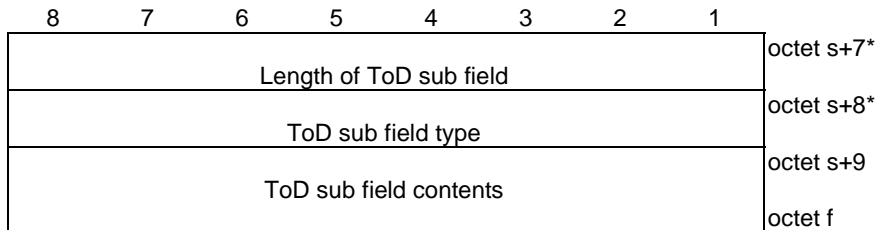

Figure 5.3.2.17: ToD sub field

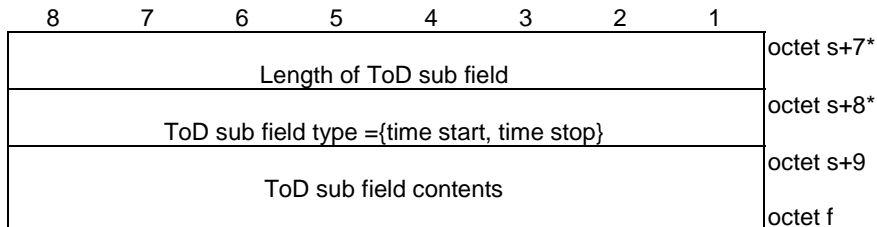

Figure 5.3.2.18: ToD sub field {field type = "time start" or "time stop"}

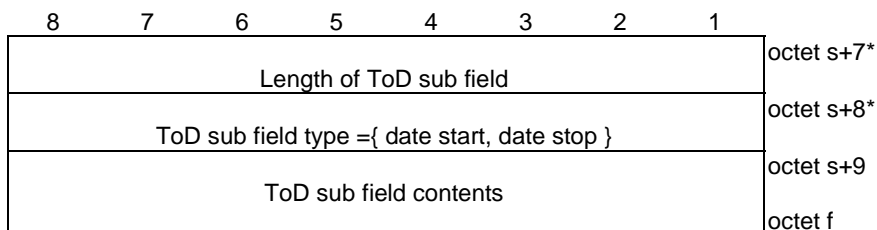

Figure 5.3.2.19: ToD sub field {field type = "date start" or "date stop"}

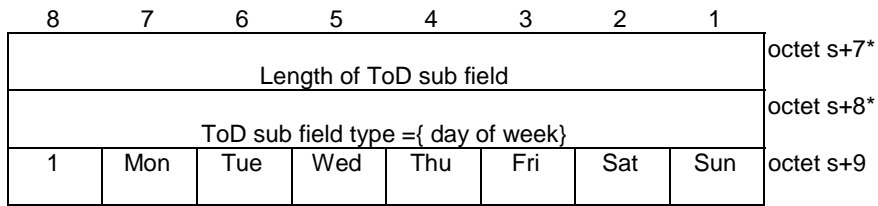

Figure 5.3.2.20: ToD sub field {field type = "day of the week"}

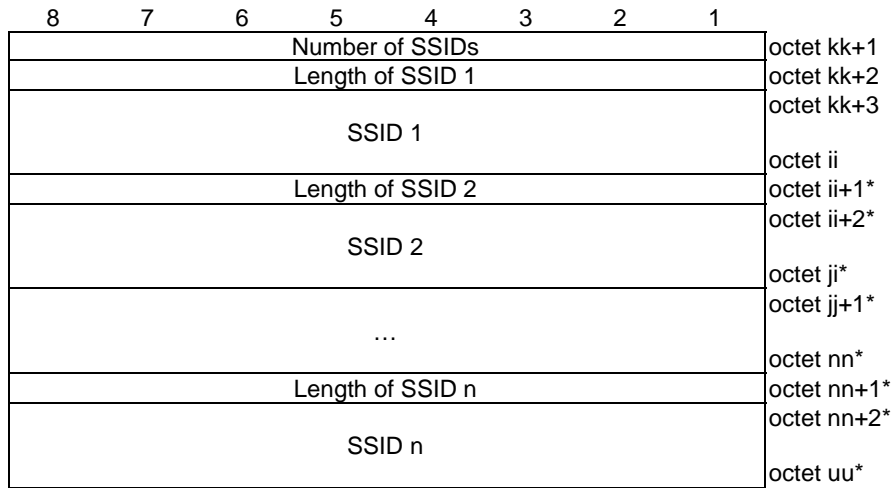

Figure 5.3.2.21: SSID list

Table 5.3.2.1: WLANSF information element

Value part of the WLANSPP information element (octets 4 to x)
ANDSP Info type (bit 1 to 4 of octet 1) shall be set to "0001" (WLANSPP)
Bits 8 to 5 of octet 1 are spare and shall be encoded as zero.
Length of WLANSPP contents (octets 2 to 3)
Length of WLANSPP rule (octets 4 to 5)
Rule Identifier (octet 6)
This field contains the binary encoding of the WLANSPP rule identifier
Rule priority (octet 7)
This field contains the binary encoding of the WLANSPP rule priority
Spare bits and shall be encoded as zero (bits 1 to 2 of octet 8)
Time of day index (bit 3 of octet 8)
Bit
3
0 WLANSPP rule does not include time of day information
1 WLANSPP rule includes time of day information
Geo location index (bit 4 of octet 8)
Bit
4
0 WLANSPP rule does not include Geo location information
1 WLANSPP rule includes Geo location information
The Geo location index field indicates the presence of Geo location information in the Validity area field. When the Geo location index field is set to 1, the entry type of at least one of the location entries shall be set to "Geo location".
WLAN location index (bit 5 of octet 8)
Bit
5
0 WLANSPP rule is not for WLAN location
1 WLANSPP rule is for WLAN location
The WLAN location index field indicates whether the WLANSPP rule is for WLAN location. When the WLAN location index field is set to 1, the entry type of at least one of the location entries in the Validity area field shall be set to "WLAN location".
3GPP location index (bit 6 of octet 8)
Bit
6
0 WLANSPP rule is not for 3GPP location
1 WLANSPP rule is for 3GPP location
The 3GPP location index field indicates whether the WLANSPP rule is for 3GPP location. When the 3GPP location index field is set to 1, the entry type of at least one of the location entries in the Validity area field shall be set to "3GPP location".
Validity area index (bit 7 of octet 8)
Bit
7
0 WLANSPP rule is not for validity area
1 WLANSPP rule is for validity area
Roaming (bit 8 of octet 8) (NOTE 1)
Bit
8
0 WLANSPP rule is only valid when the UE is not roaming
1 WLANSPP rule is only valid when the UE is roaming
Selection criteria (octets 9 to r)

This field contains the binary encoding of the selection criteria for a particular WLANSPP rule.

Selection criteria entry (octets 12 to a) (NOTE 2)

Length of selection criteria entry (octets 12 to 13) indicates length of subsequent fields in the selection criteria entry.

Criteria priority (bits 1-5 of octet 14): the lower value indicates the selection criteria having the higher priority among the selection criteria in the WLANSPP rule.

Home network ind (bit 6 of octet 14): (NOTE 3)

Bit

6

0 all WLANs could match this selection criteria entry.

1 only the WLANs that are operated by the home operator could match this selection criteria entry.

MaxBSSload ind (bit 7 of octet 14):

Bit

7

0 maximum BSS load value (octets 15 to 16) not present

1 maximum BSS load value (octets 15 to 16) present

Maximum BSS load value (octets 15 to 16) is as the node PerProviderSubscription/<X+>/Policy/MaximumBSSLoadValue defined in Hotspot 2.0 (Release 2) Technical Specification [9].

Selection criteria set (octets 17 to dd) contains the contents of a specific criteria set. In this release of specification there can be 5 types of criteria sets.

Selection criteria set type (bits 5-8 of octet 19) is coded as follows. (NOTE 3A, NOTE 3B)

Bits

8 7 6 5

0 0 0 1 preferred SSID list (NOTE 4)

0 0 1 0 preferred roaming partner list (NOTE 5)

0 0 1 1 required protocol port tuple

0 1 0 0 SP exclusion list

0 1 0 1 minimum backhaul threshold

0 1 1 0 slice-based TNAN list

All other values are reserved.

Selection criteria sub entry (octets 20 to ee+6) when set type is "*preferred SSID list*" is coded as follows.

Length of sub entry (octet 20) indicates length of subsequent fields in the selection criteria sub entry.

WLAN priority (octet 21): the lower WLAN priority value indicates the WLAN having the higher priority among the WLANs in the preferred SSID list.

SSID ind (bit 1 of octet 22):

Bit

5

- 0 SSID field (octets 24 to ee) is not present.
- 1 SSID field (octets 24 to ee) is present.

HESSID ind (bit 2 of octet 22):

Bit

6

- 0 HESSID field (octets ee+1 to ee+6) is not present.
- 1 HESSID field (octet ee+1 to ee+6) is present.

SSID length (octet 23) indicates the length of the SSID field.

SSID field (octets 24 to ee) is an Octet String which shall have a maximum length of 32 octets (see IEEE Std 802.11 [8]).

HESSID field (octets ee+1 to ee+6) is a 6 octet MAC address that identifies the homogeneous ESS (see IEEE Std 802.11 [8]).

Selection criteria sub entry (octets 20 to ff) when set type is "*preferred roaming partner list*" is coded as follows.

Length of sub entry (octet 20) indicates length of subsequent fields in the selection criteria sub entry.

Priority (octet 21): the lower priority value indicates the higher priority in the preferred roaming partner list.

FQDN_Match length (octet 22) indicates the length of the FQDN_Match field.

FQDN_Match field (octets 23 to ee) is as the node
PerProviderSubscription/<X+>/Policy/PreferredRoamingPartnerList/<X+>/FQDN_Match defined in Hotspot 2.0 (Release 2) Technical Specification [9].

Country length (octet ee+1) indicates the length of the country field.

Country field (octets ee+2 to ff) is as the node
PerProviderSubscription/<X+>/Policy/PreferredRoamingPartnerList/<X+>/Country defined in Hotspot 2.0 (Release 2) Technical Specification [9].

Selection criteria sub entry (octets 20 to ff) when set type is "*required protocol port tuple*" is coded as follows.

Length of sub entry (octet 20) indicates length of subsequent fields in the selection criteria sub entry.

IP protocol field (octet 21) shall be present in the sub entry and refers to IP protocol field in IPv4 packets or the next header field in IPv6 packets. It is required by operator-supported application(s) on UE as specified in Hotspot 2.0 (Release 2) Technical Specification [9].

Length of port number (octet 22) indicates the length of port number field.

Port number field (octets 23 to ff) is as the node
PerProviderSubscription/<X+>/Policy/RequiredProtoPortTuple/<X+>/PortNumber defined in Hotspot 2.0 (Release 2) Technical Specification [9].

Selection criteria sub entry (octets 20 to ff) when set type is "*SP exclusion list*" is coded as follows.

Length of sub entry (octet 20) indicates length of subsequent fields in the selection criteria sub entry, i.e. the length of SSID field.

SSID field (octets 21 to ff) is as the node
PerProviderSubscription/<X+>/Policy/SPExclusionList/<X+>SSID defined in
Hotspot 2.0 (Release 2) Technical Specification [9].

Selection criteria sub entry (octets 20 to 28) when set type is "*minnum backhaul threshold*" is coded as follows.

Network type (bit 1-2 of octet 20) is coded as follows according to the definition of the node PerProviderSubscription/<X+>/Policy/MinBackhaulThreshold/<X+>/NetworkType in Hotspot 2.0 (Release 2) Technical Specification [9].

Bits

2 1

0 0 home

0 1 roaming

All other values are reserved.

DLBI (bit 3 of octet 20):

Bit

3

0 Downlink bandwidth field (octets 21 to 24) is not present.

1 Downlink bandwidth field (octets 21 to 24) is present.

ULBI (bit 4 of octet 20):

Bit

4

0 Uplink bandwidth field (octets 25 to 28) is not present.

1 Uplink bandwidth field (octets 25 to 28) is present.

Downlink bandwidth field (octets 21 to 24) is as the node
PerProviderSubscription/<X+>/Policy/MinBackhaulThreshold/<X+>/DLBandwidth
defined in Hotspot 2.0 (Release 2) Technical Specification [9].

Uplink bandwidth field (octets 25 to 28) is as the node
PerProviderSubscription/<X+>/Policy/MinBackhaulThreshold/<X+>/ULBandwidth
defined in Hotspot 2.0 (Release 2) Technical Specification [9].

Selection criteria sub entry (octets 20 to rr) when set type is "*slice-based TNAN list*" is coded as follows.

TNGF ID length (octet 21) indicates the length of the TNGF ID field.

TNGF ID (octets 22 to ss)

The TNGF ID field is an octet string that indicates the TNGF ID.

S-NSSAI list (octets ss+1 to kk)

The S-NSSAI list indicates the list of S-NSSAI(s) that are supported by the indicated TNGF. The content of each S-NSSAI list is coded as the NSSAI IE in 3GPP TS 24.501 [11] starting from octet 2.

Number of SSIDs (octet kk+1)

The Number of SSIDs indicates the numbers of SSID entries, where each SSID entry consists of a Length of SSID field and an SSID field.

Length of SSID (octet kk+2) indicates the length of the SSID field.

SSID (octets kk+3 to ii)

The SSID field is an octet string which shall have a maximum length of 32 octets (see IEEE Std 802.11 [8]).

Validity area (octets r+1 to s)

This field contains the binary encoding of the validity area for a particular WLANSF rule.

Entry type (bits 7-8 of octet r+6) is coded as follows:

Bits

8 7

0 1 3GPP location

1 0 WLAN location

1 1 Geo location

All other values are reserved.

Length of 3GPP location sub entry (octets r+7 to r+8)

This field contains the length of the location entry when the WLANSR rule is for validity area of a 3GPP location.

MCC, Mobile country code (octet r+9, and bits 4 to 1 of octet r+10)

The MCC field is coded as in ITU-T Recommendation E.212 [10], annex A.

MNC, Mobile network code (bits 8 to 5 of octet r+10, and octet r+11)

The encoding of this field is the responsibility of each administration but BCD encoding shall be used. The MNC shall consist of 2 or 3 digits. If a network operator may decide to use only two digits in the MNC over the radio interface, MNC digit 3 shall be encoded as "1111".

When the location entry type is "geo location", the location field in this entry has fixed length as shown in figure 5.3.2.11a.

Anchor latitude (octets r+10 to r+13) is defined in clause 6.1 of 3GPP TS 23.032 [7].

Anchor longitude (octets r+14 to r+17) is defined in clause 6.1 of 3GPP TS 23.032 [7].

Radius (octets r+18 to r+19) is given in meters and is defined in clause 6.6 of 3GPP TS 23.032 [7].

Location field type (octet r+14) when entry type is 3GPP location, or

Location field type (octet r+11) when entry type is WLAN location.

This field indicates the type of location field.

Bits

8 7 6 5 4 3 2 1

0 0 0 0 0 0 0 1 TAC

0 0 0 0 0 0 1 0 EUTRA CI

0 0 0 0 0 1 0 0 NR CI

1 0 0 0 0 0 0 1 HESSID

1 0 0 0 0 0 1 0 SSID

1 0 0 0 0 1 0 0 BSSID

All other values are reserved.

When 3GPP location field type is set to "TAC", the TAC field is as defined in 3GPP TS 23.003 [4]. TAC has a length of 3 octets.

When 3GPP location field type is set to "EUTRA CI", the EUTRA CI field is set to the E-UTRAN cell identity part of the E-UTRAN Cell Global Identifier, as defined in 3GPP TS 36.413 [6A]. E-UTRAN cell identity has a length of 28 bits and is represented by 4 octets by zero-padding the most 4 significant bits of the 4th octet.

When 3GPP location field type is set to "NR CI", the NR CI field is set to the NR cell identity part of the NR Cell Global Identifier as defined in 3GPP TS 38.413 [14]. NR cell identity has a length 36 bits and is represented by 5 octets by zero-padding the most 4 significant bits of the 5th octet.

When WLAN location field type is set to "HESSID", the HESSID field is set to a 6 octet MAC address that identifies the homogeneous ESS (see IEEE Std 802.11 [8]).

When WLAN location field type is set to "SSID", the SSID field is set to an Octet String which shall have a maximum length of 32 octets (see IEEE Std 802.11 [8]).

When WLAN location field type is set to "BSSID", the BSSID field is set to an Octet String which shall be 6 octets long (see IEEE Std 802.11 [8]).

Time of day (octets s+1 to u)

This field contains the binary encoding of the time of day condition for a particular WLANSP rule.

ToD sub field type = {time start, time stop, date start, date stop, day of week} (octet s+8)

Bits

8	7	6	5	4	3	2	1	
0	0	0	0	0	0	0	1	time start
0	0	0	0	0	1	0		time stop
0	0	0	0	1	0	0		date start
0	0	0	1	0	0	0		date stop
0	0	1	0	0	0	0		day of the week

All other values are reserved.

when field type is set to "time start" or "time stop", the value of this ToD sub field contents is time of the day represented in string format, as defined in ISO 8601:2004 [13]

When field type is set to "date start" or "date stop", the value of this ToD sub field contents is a date represented in string format, as defined in ISO 8601:2004 [13].

When field type is set to "day of the week", the value of this ToD sub field contents is an 8-bit integer formatted as a bitmap representing days of the week. The most significant bit is set to one. The remaining bits represent days of the week.

NOTE 1: The value of roaming is valid only if the WLANSP rule is provided by the H-PCF.

NOTE 2: The group of selection criteria as described in clause 4.3.2.1 is encoded as selection criteria entry.

NOTE 3: The home network indication shall not be set by V-PCF.

NOTE 3A: The ANDSP info, and hence the selection criteria set types in WLANSP, are present only if the SupportANDSP bit in UE policy classmark is set to "1" as specified in 3GPP TS 24.501 [11] annex D.

NOTE 3B: If the UE does not support the slice-based TNGF selection as specified in 3GPP TS 24.501 [11], the value of selection criteria set types can only be set to "0001", "0010", "0011", "0100", or "0101".

NOTE 4: If the home network indication bit is set to "1", the preferred SSID list shall not be present.

NOTE 5: If the home network indication bit is set to "1", the preferred roaming partner list shall not be present. The preferred roaming partner list is provided by H-PCF only.

5.3.3 Encoding of N3AN node configuration information

5.3.3.1 General

The purpose of the N3AN node configuration information is to indicate the non-3GPP access network (N3AN) node configuration information to the UE for selection of either N3IWF or ePDG for accessing 5GCN or EPC respectively via non-3GPP access.

The N3AN node configuration information is encoded as shown in figure 5.3.3.1.1, table 5.3.3.1.1, figure 5.3.3.1.2, table 5.3.3.1.2.

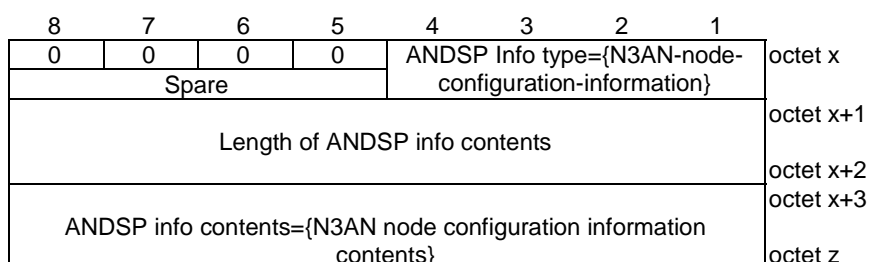

Figure 5.3.3.1.1: ANDSP info containing N3AN node configuration information, where x=k

Table 5.3.3.1.1: N3AN node configuration information

ANDSP Info type (bit 1 to 4 of octet x) shall be set to "0010" (N3AN node configuration information)

Bits 8 to 5 of octet x are spare and shall be encoded as zero.

Length of ANDSP info contents (octets x+1 to x+2) indicates the length of the N3AN node configuration information contents.

8	7	6	5	4	3	2	1	
Length of N3AN node selection information								octet x+3 octet x+4 (see NOTE)
Content of N3AN node selection information								octet (x+5)*
N3AN node configuration information type (type = home N3IWF identifier configuration)								octet (v)* (see NOTE)
Length of home N3IWF identifier configuration								octet v+1*
Content of home N3IWF identifier configuration								octet v+2* octet v+3* octet v+4*
N3AN node configuration information type (type = home ePDG identifier configuration)								octet w*
Length of home ePDG identifier configuration								octet w+1*
Content of home ePDG identifier configuration								octet w+2* octet w+3* octet w+4*
N3AN node configuration information type (type = extended home N3IWF identifier configuration)								octet z*
Length of extended home N3IWF identifier configuration								octet z+1*
Content of extended home N3IWF identifier configuration								octet z+2* octet z+3* octet z+4*
N3AN node configuration information type (type = slice-specific N3IWF prefix configuration)								octet y*
Length of slice-specific N3IWF prefix configuration								octet y+1*
Content of slice-specific N3IWF prefix configuration								octet y+2* octet y+3* octet y+4*
								octet t*

Figure 5.3.3.1.2: N3AN node configuration information contents

Table 5.3.3.1.2: Content of N3AN node configuration information

N3AN node configuration information type is coded as follows (NOTE 1, NOTE 2).								
8	7	6	5	4	3	2	1	
0	0	0	0	0	0	0	1	Home N3IWF identifier configuration
0	0	0	0	0	0	1	0	Home ePDG identifier configuration
0	0	0	0	0	0	1	1	Extended home N3IWF identifier configuration
0	0	0	0	0	1	0	0	Slice-specific N3IWF prefix configuration
All other values are reserved.								
N3AN node selection information field (octet x+5 to v) shall be present and the content is as encoded in clause 5.3.3.2 (NOTE 3).								
Home N3IWF identifier configuration field (octet v+1 to w) may be present and the content is as encoded in clause 5.3.3.3.								
Home ePDG identifier configuration field (octet w+1 to z) may be present and the content is as encoded in clause 5.3.3.4.								
Extended home N3IWF identifier configuration field (octet z+1 to y) may be present and the content is as encoded in clause 5.3.3.5.								
Slice-specific N3IWF prefix configuration field (octet y+1 to t) may be present and the content is as encoded in clause 5.3.3.6.								
NOTE 1: The ANDSP info, and hence the N3AN node configuration information, are present only if the SupportANDSP bit in UE policy classmark is set to "1" as specified in 3GPP TS 24.501 [11] annex D.								
NOTE 2: If the UE does not support the slice-based N3IWF selection as specified in 3GPP TS 24.501 [11], the value of N3AN node configuration information type can only be set to "00000001" or "00000010".								
NOTE 3: If the N3AN node configuration information is provided by VPLMN, then length of N3AN node selection information field shall be set to zero. If the N3AN node configuration information is provided by HPLMN, then length of N3AN node selection information field shall be set to non-zero.								

5.3.3.2 N3AN node selection information

The content of N3AN node selection information contains a sequence of the N3AN node selection information entries. Each N3AN node selection information entry contains a PLMN ID and information for the PLMN ID. The content of N3AN node selection information contains at least an N3AN node selection information entry with information for the HPLMN and an N3AN node selection information entry for "any_PLMN".

NOTE: If N3AN node selection information does not contain at least:

- an N3AN node selection information entry with information for the HPLMN; and
- an N3AN node selection information entry for "any_PLMN";

the N3AN node selection information is handled as a syntactically incorrect IE according to 3GPP TS 24.501 [11].

The content is encoded according to figure 5.3.3.2.1, figure 5.3.3.2.2 and table 5.3.3.2.1.

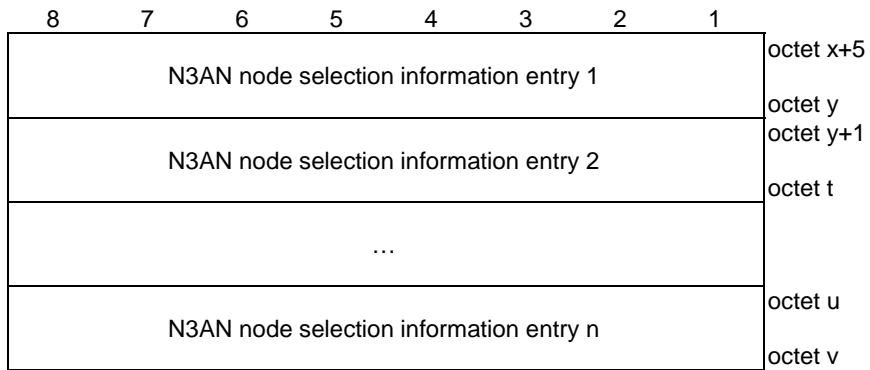

Figure 5.3.3.2.1: Content of N3AN node selection information

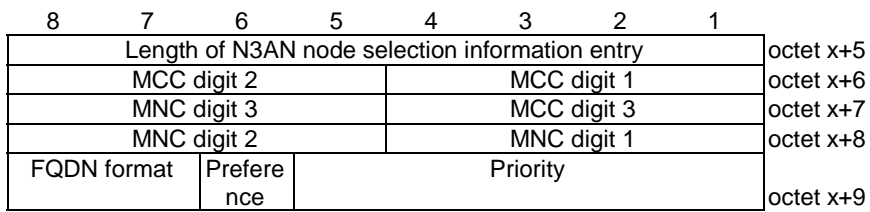

Figure 5.3.3.2.2: N3AN node selection information entry

Table 5.3.3.2.1: N3AN node selection information

<p>Length of N3AN node selection information entry (octet x+5) contains length of subsequent fields in the N3AN node selection information entry.</p> <p>PLMN ID (octet x+6 to x+8) The PLMN ID field shall be set to zero if it indicates "any_PLMN".</p> <p>MCC, Mobile country code (octet x+6, and bits 4 to 1 of octet x+7) The MCC field is encoded as in ITU-T Recommendation E.212 [10], annex A.</p> <p>MNC, Mobile network code (bits 8 to 5 of octet x+7, and octet x+8) The encoding of this field is the responsibility of each administration but BCD coding shall be used. The MNC shall consist of 2 or 3 digits. If a network operator decides to use only two digits in the MNC, MNC digit 3 shall be encoded as "1111".</p> <p>Priority (bits 5 to 1 of octet x+9) The priority field indicates the preference order given to N3AN nodes of a PLMN. The lower value indicates higher priority. If the PLMN is the UE's HPLMN or the PLMN ID indicates "any_PLMN", this priority field shall be ignored by the receiving entity.</p> <p>Preference (bit 6 of octet x+9) The preference field indicates which N3AN node type is preferred in this PLMN and is encoded as follows.</p> <p>6</p> <p>0 N3IWF is preferred 1 ePDG is preferred</p> <p>FQDN format (bits 8 to 7 of octet x+9) The FQDN format indicates format to be used when the FQDN is constructed by the UE. This field is encoded as follows.</p> <p>8 7</p> <p>0 0 Operator identifier based ePDG FQDN format or operator identifier based N3IWF FQDN. 0 1 Tracking/location area identity based ePDG FQDN format or tracking area identity based N3IWF FQDN format. All other values are reserved.</p>
--

5.3.3.3 Home N3IWF identifier configuration

The content of home N3IWF identifier configuration contains a list of home N3IWF identifier entries.

The content of home N3IWF identifier configuration is encoded according to figure 5.3.3.3.1.

The content of each home N3IWF identifier entry is coded according to figure 5.3.3.3.2, figure 5.3.3.3.3 and table 5.3.3.3.1.

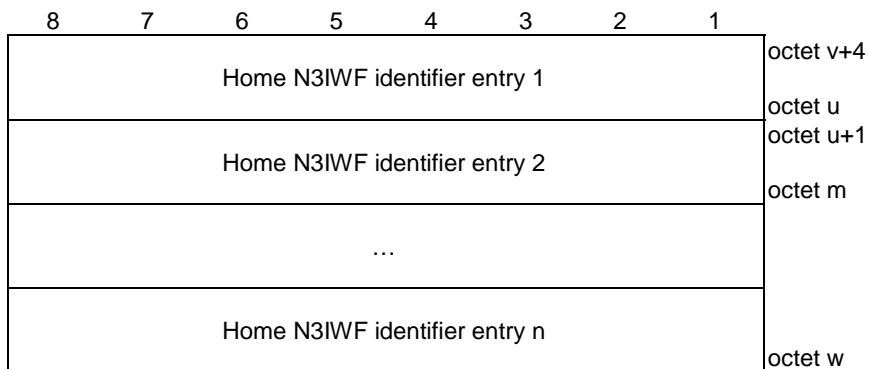

Figure 5.3.3.3.1: Content of home N3IWF identifier configuration

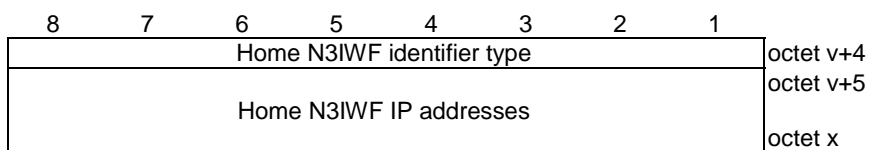

Figure 5.3.3.3.2: Home N3IWF identifier entry (Home N3IWF identifier type = "IPv4", "IPv6" or "IPv4v6")

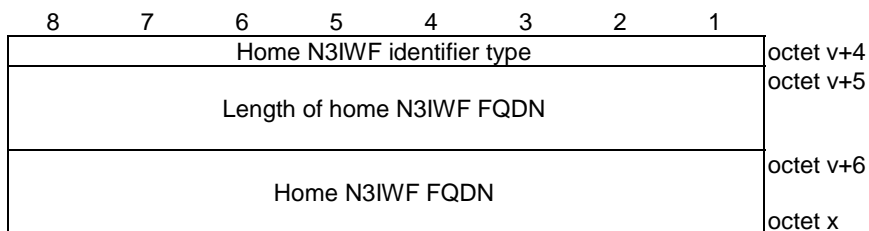

Figure 5.3.3.3.3: Home N3IWF identifier entry (Home N3IWF identifier type = "FQDN")

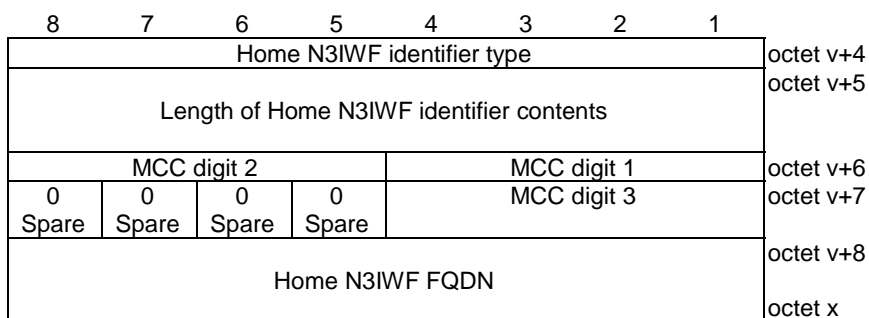

Figure 5.3.3.3.4: Home N3IWF identifier entry (Home N3IWF identifier type = "SNPN FQDN")

Table 5.3.3.3.1: Home N3IWF identifier entry

Home N3IWF identifier type (octet v+4) is set as follows:								
8	7	6	5	4	3	2	1	
0	0	0	0	0	0	0	1	IPv4
0	0	0	0	0	0	1	0	IPv6
0	0	0	0	0	0	1	1	IPv4v6
0	0	0	0	0	1	0	0	FQDN
0	0	0	0	0	1	0	1	SNPN FQDN
All other values are reserved.								
If the home N3IWF identifier type indicates IPv4, then the home N3IWF IP addresses field in figure 5.3.3.3.2 contains an IPv4 address in octet v+5 to octet v+8.								
If the home N3IWF identifier type indicates IPv6, then the home N3IWF IP addresses field in figure 5.3.3.3.2 contains an IPv6 address in octet v+5 to octet v+20.								
If the home N3IWF identifier type indicates IPv4v6, then the home N3IWF IP addresses field in figure 5.3.3.3.2 contains two IP addresses. The first IP address is an IPv4 address in octet v+5 to octet v+8. The second IP address is an IPv6 address in octet v+9) to octet v+24.								
If the home N3IWF identifier type indicates FQDN, the length of the home N3IWF FQDN field (octet v+5) in figure 5.3.3.3.3 indicates the length of home N3IWF FQDN.								
If the home N3IWF identifier type indicates SNPN FQDN for UE in SNPN access operation mode for non-3GPP access, the MCC field (octet v+6 to octet v+7) in figure 5.3.3.3.4 indicates the MCC of the country where the configured N3IWF for the subscribed SNPN is located, the home N3IWF FQDN field indicates the N3IWF FQDN of the subscribed SNPN.								
Home N3IWF FQDN field is encoded as defined in clause 28.3.2.2.2 in 3GPP TS 23.003 [4].								

Table 5.3.3.3.2: Void

5.3.3.4 Home ePDG identifier configuration

The content of home ePDG identifier configuration contains a list of home ePDG identifier entries.

The content of home ePDG identifier configuration is encoded according to figure 5.3.3.4.1.

The content of each home ePDG identifier entry is encoded according to figure 5.3.3.4.2, figure 5.3.3.4.3 and table 5.3.3.4.1.

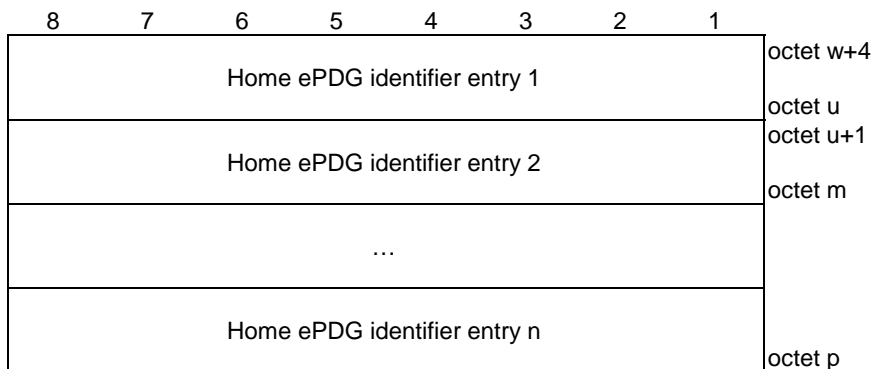

Figure 5.3.3.4.1: Content of home ePDG identifier configuration

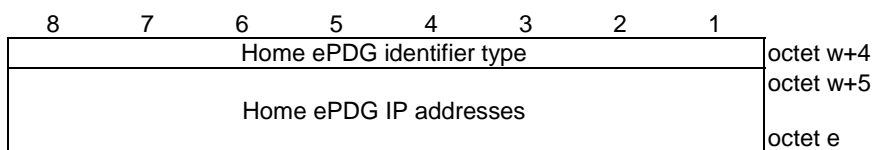

Figure 5.3.3.4.2: Home ePDG identifier entry (Home ePDG identifier type = "IPv4", "IPv6" or "IPv4v6")

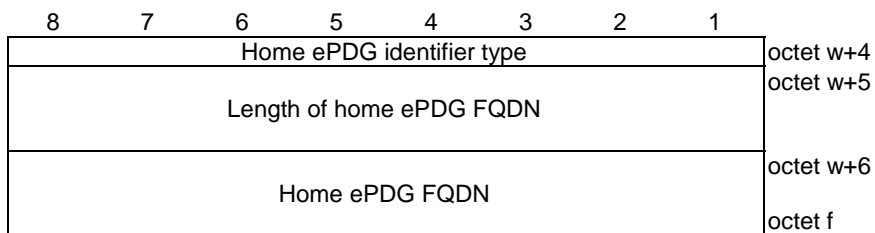

Figure 5.3.3.4.3: Home ePDG identifier entry (Home ePDG identifier type = "FQDN")

Table 5.3.3.4.1: Home ePDG identifier entry

Home ePDG identifier type (octet w+4) is set as follows when the type is IP address.

8	7	6	5	4	3	2	1	
0	0	0	0	0	0	0	1	IPv4
0	0	0	0	0	0	1	0	IPv6
0	0	0	0	0	0	1	1	IPv4v6
0	0	0	0	0	1	0	0	FQDN

All other values are reserved.

If the home ePDG identifier type indicates IPv4, then the home ePDG IP addresses field in figure 5.3.3.4.2 contains an IPv4 address in octet w+5 to octet w+8.

If the home ePDG identifier type indicates IPv6, then the home ePDG IP addresses field in figure 5.3.3.4.2 contains an IPv6 address in octet w+5 to octet w+20.

If the home ePDG identifier type indicates IPv4v6, then the home ePDG IP addresses field in figure 5.3.3.4.2 contains two IP addresses. The first IP address is an IPv4 address in octet w+5 to octet w+8. The second IP address is an IPv6 address in octet w+9 to octet w+24.

If the home ePDG identifier type indicates FQDN, the length of home ePDG FQDN field (octet w+5) in figure 5.3.3.4.3 indicates the length of home ePDG FQDN.

Home ePDG FQDN field (octet w+6 to octet f) is encoded as defined in clause 19.4.2.9.2 in 3GPP TS 23.003 [4].

Table 5.3.3.4.2: Void

5.3.3.5 Extended home N3IWF identifier configuration

The content of extended home N3IWF identifier configuration contains a list of extended home N3IWF identifier entries. The content of the extended home N3IWF identifier configuration is encoded according to figure 5.3.3.5.1.

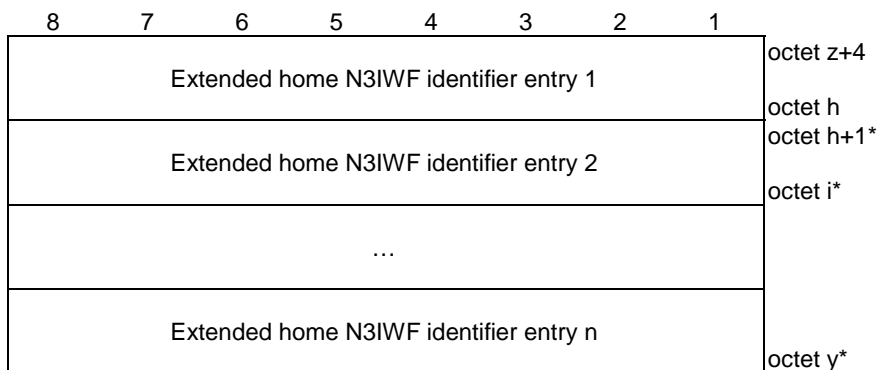

Figure 5.3.3.5.1: Content of extended home N3IWF identifier configuration

The content of each extended home N3IWF identifier entry is coded according to figure 5.3.3.5.2.

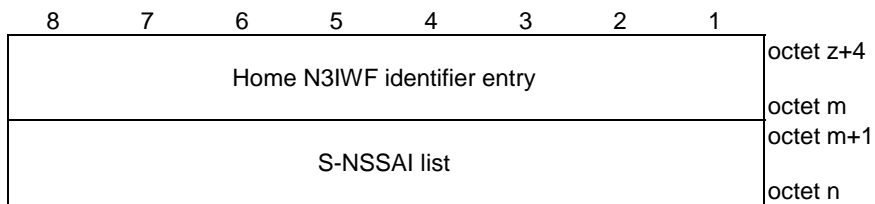

Figure 5.3.3.5.2: Extended home N3IWF identifier entry

The content of each home N3IWF identifier entry is coded according to figure 5.3.3.3.2, figure 5.3.3.3.3 and table 5.3.3.3.1. The S-NSSAI list is the list of one or more S-NSSAIs subscribed by the UE and supported by the N3IWF. The content of each S-NSSAI list is coded as the NSSAI IE in 3GPP TS 24.501 [11], starting from octet 2.

5.3.3.6 Slice-specific N3IWF prefix configuration

The content of slice-specific N3IWF prefix configuration contains a list of slice-specific N3IWF prefix entries. The content of the slice-specific N3IWF prefix configuration is encoded according to figure 5.3.3.6.1.

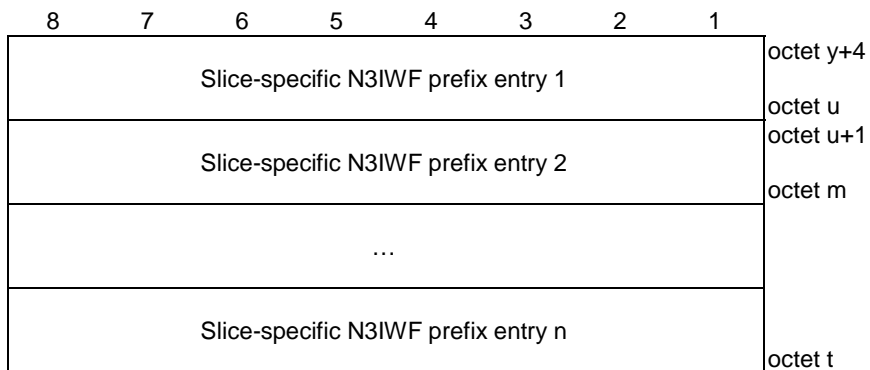

Figure 5.3.3.6.1: Content of slice-specific N3IWF prefix configuration

The content of each slice-specific N3IWF prefix entry is encoded according to figure 5.3.3.6.2 and table 5.3.3.6.1.

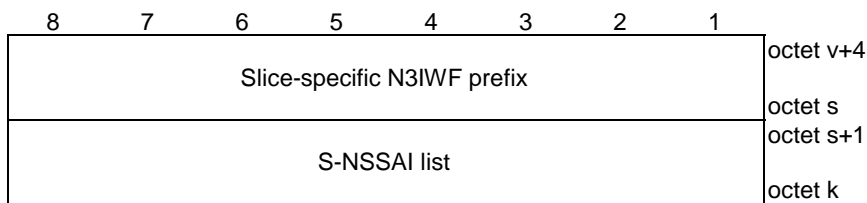

Figure 5.3.3.6.2: slice-specific N3IWF prefix entry

Table 5.3.3.6.1: slice-specific N3IWF prefix entry

<p>Slice-specific N3IWF prefix (octets v+4 through octet s) indicates the prefix to be added to the existing tracking area (TA) or operator identifier (OI) FQDNs, as described in 3GPP TS 23.003 [4]. It has an encoding of an FQDN label, which is specified in 3GPP TS 23.003 [4] clause 28.3.2.1 and in IETF RFC 1035 [12] (NOTE).</p> <p>S-NSSAI list is the list of one or more S-NSSAIs subscribed by UE and indicates the list of one or more S-NSSAI(s) that the prefix is associated with. The content of each S-NSSAI list is coded as the NSSAI IE in 3GPP TS 24.501 [11] starting from octet 2.</p>
<p>NOTE: As specified in 3GPP TS 23.003 [4] clause 28.3.2.1, the encoding of the FQDN label is as specified in 3GPP TS 23.003 [4] clause 19.4.2.1.</p>

Annex A (informative): Change history

Change history							
Date	Meeting	TDoc	CR	Rev	Cat	Subject/Comment	New version
2018-04	CT1#110					TS skeleton is provided by C1-182823. C1-182793, C1-182795, C1-182798, C1-182821, C1-182822 are implemented as Annex A.	0.0.0
2018-05	CT1#111					Includes the following contributions agreed by CT1 at CT#111: C1-183550, C1-183551, C1-183552, C1-183553, C1-183555, C1-183556, C1-183862, C1-183863.	0.1.0
2018-06	CT-80					version 1.0.0 created for presentation for information	1.0.0
2018-07	CT1#111bis					Includes the following contributions agreed by CT1 at CT#111bis: C1-184345, C1-184627, C1-184691, C1-184859, C1-184927, C1-184945, C1-184948.	1.1.0
2018-08	CT1#112					Includes the following contributions agreed by CT1 at CT#112: C1-185149, C1-185630, C1-185636, C1-185641, C1-185679.	1.2.0
2018-09	CT-81	CP-182112				version 2.0.0 created for presentation for approval	2.0.0
2018-09	CT-81					version 15.0.0 created after approval	15.0.0
2018-12	CT-82	CP-183043	0001	2	F	Modifications to ANDSP	15.1.0
2018-12	CT-82	CP-183043	0002	2	F	Aligning the clauses and correcting the reference and requirements	15.1.0
2018-12	CT-82	CP-183043	0003	2	B	Adding connection capabilities in URSP rules	15.1.0
2018-12	CT-82	CP-183043	0004	2	F	Editorial and other changes	15.1.0
2018-12	CT-82	CP-183043	0005	1	B	Coding of WLAN selection criteria entry	15.1.0
2018-12	CT-82	CP-183043	0006	2	B	Complete location entry definition	15.1.0
2018-12	CT-82	CP-183043	0011	2	F	Clarification on PDU session selection	15.1.0
2018-12	CT-82	CP-183043	0013	2	F	Clarification on URSP traffic descriptor and SSC mode	15.1.0
2018-12	CT-82	CP-183043	0015	2	F	OS App Id with a variable length	15.1.0
2019-03	CT-83	CP-190090	0012	7	F	Clarification on UE local configuration and URSP preference	15.2.0
2019-03	CT-83	CP-190210	0016	6	F	PCF does not send OS Id to UE	15.2.0
2019-03	CT-83	CP-190090	0017	1	F	The formats of OS Id	15.2.0
2019-03	CT-83	CP-190090	0018	2	F	Add destination FQDN as additional traffic descriptor	15.2.0
2019-03	CT-83	CP-190090	0019	1	D	Update abbreviations	15.2.0
2019-03	CT-83	CP-190090	0020	3	F	Correcting the name of ITU-T Recommendation E.212	15.2.0
2019-03	CT-83	CP-190090	0021	2	F	Correction on WLANSP rules description	15.2.0
2019-03	CT-83	CP-190090	0022	2	F	Correction to Length of URSP rule and Length of route selection descriptor	15.2.0
2019-03	CT-83	CP-190090	0024	1	F	Clarification on OS Id + OS App Id field of URSP	15.2.0
2019-03	CT-83	CP-190211	0026	2	F	UE with multiple OS Ids	15.2.0
2019-03	CT-83	CP-190090	0027	1	F	Correction to length of location sub entry in WLANSP rule	15.2.0
2019-03	CT-83	CP-190090	0028	2	F	Unknown or unexpected URSP rules	15.2.0
2019-06	CT-84	CP-191125	0030		F	Update of association between application and existing PDU session	15.3.0
2019-06	CT-84	CP-191125	0034	2	F	Correction to Encoding of WLANSP	15.3.0
2019-06	CT-84	CP-191125	0039	2	F	Correction to UE Policy evaluation	15.3.0
2019-06	CT-84	CP-191138	0029	1	B	Multi-access access type preference	16.0.0
2019-06	CT-84	CP-191131	0031		F	Handling of unsupported PDU session type in route selection descriptor	16.0.0
2019-06	CT-84	CP-191131	0032	1	F	Changing "user preferences" to "UE local configuration"	16.0.0
2019-06	CT-84	CP-191131	0033	1	F	Handling of PDU session type	16.0.0
2019-06	CT-84	CP-191131	0036	2	F	Correction on coding of "all other values are spare"	16.0.0
2019-06	CT-84	CP-191136	0037	1	F	Correction to Encoding of WLANSP	16.0.0
2019-06	CT-84	CP-191136	0038	2	F	Reference to IEEE Std 802.11	16.0.0
2019-06	CT-84	CP-191131	0041	1	D	Correction on the route selection descriptor component type identifier of URSP	16.0.0
2019-09	CT-85	CP-192059	0042	1		5G-RG usage of ANDSP	16.1.0
2019-09	CT-85	CP-192074	0043	1	B	Introduction of background data transfer policy information in URSP	16.1.0
2019-09	CT-85	CP-192055	0045		F	Clarification on application information matching	16.1.0
2019-09	CT-85	CP-192055	0046	1	F	Clarification on PDU session association	16.1.0
2019-09	CT-85	CP-192071	0047	3	F	Use of the URSP rules in EPS	16.1.0
2019-09	CT-85	CP-192059	0051	2	F	URSP and ANDP information for wireline 5G access network	16.1.0
2019-09	CT-85	CP-192063	0052	1	B	Specifying and adding reference for V2X Policy	16.1.0
2019-09	CT-85	CP-192060	0053	1	F	Usage of access type preference	16.1.0
2019-09	CT-85	CP-192060	0054	1	F	Occurrence of Preferred access type and Multi-access preference	16.1.0
2019-09	CT-85	CP-192055	0055		F	Handling of S-NSSAI in RSD descriptor but not in the allowed NSSAI	16.1.0
2019-12	CT-86	CP-193092	0056	1	F	Handling of unsupported SSC mode in route selection descriptor	16.2.0
2019-12	CT-86	CP-193092	0057	1	F	Clarification on the DNN in the route selection descriptor	16.2.0
2019-12	CT-86	CP-193092	0058	2	F	Correction on using URSP in EPS	16.2.0
2019-12	CT-86	CP-193092	0059	3	F	Clarification for URSP evaluation	16.2.0
2019-12	CT-86	CP-193092	0061	1	F	Correction to association between an application and an existing PDU session	16.2.0

2019-12	CT-86	CP-193101	0063		F	Correct the reference of access type IE	16.2.0
2019-12	CT-86	CP-193100	0065	1	B	5G-RG and W-AGF acting on behalf of FN-RG usage of URSP	16.2.0
2019-12	CT-86	CP-193092	0066		F	Correction to S-NSSAI RSD component encoding	16.2.0
2019-12	CT-86	CP-193092	0067	1	F	Pre-configured URSP rules in USIM	16.2.0
2020-03	CT-87e	CP-200110	0069	1	F	Matching of SSC mode for association between an application and a PDU session	16.3.0
2020-03	CT-87e	CP-200113	0070		F	LADN service does not apply for RG connected to 5GC via wireline access	16.3.0
2020-06	CT-88e	CP-201101	0071		F	Reference correction in URSP encoding	16.4.0
2020-06	CT-88e	CP-201101	0073	1	F	Clarification on URSP in EPS	16.4.0
2020-06	CT-88e	CP-201101	0075	1	F	Allowed SSC mode for association between an application and a PDU session	16.4.0
2020-06	CT-88e	CP-201101	0077	1	F	Correction to the URSP encoding	16.4.0
2020-06	CT-88e	CP-201101	0079	2	F	Specify UE behavior when pre-configured policy is syntactically incorrect	16.4.0
2020-06	CT-88e	CP-201101	0081	1	F	Domain descriptors in URSP	16.4.0
2020-06	CT-88e	CP-201108	0082	1	D	URSP for RGs editorial fix	16.4.0
2020-06	CT-88e	CP-201101	0084	1	F	Corrections to UE policies specification	16.4.0
2020-09	CT-89e	CP-202149	0087r1	1	F	Removal of Editor's Notes for URSP related capability indications	16.5.0
2020-09	CT-89e	CP-202174	0085r1	1	F	Optimization of handling unknown or unexpected URSP rules	17.0.0
2020-12	CT-90e	CP-203177	0091		A	Correction on association between an application and a PDU session for RG	17.1.0
2020-12	CT-90e	CP-203175	0092	1	F	Clarification on traffic descriptor component type of VLAN tag control information	17.1.0
2020-12	CT-90e	CP-203167	0094	1	A	EN resolution on domain descriptors in URSP	17.1.0
2020-12	CT-90e	CP-203175	0095	1	F	The correction on the process of URSP handling	17.1.0
2020-12	CT-90e	CP-203175	0097	1	F	Optional fields of N3AN node configuration information	17.1.0
2020-12	CT-90e	CP-203176	0100	1	A	Lack of bit encoding of the location entry type in the WLANSF IE	17.1.0
2020-12	CT-90e	CP-203175	0102	1	F	UE behaviour on SNPN URSP stored in ME	17.1.0
2020-12	CT-90e	CP-203205	0103	1	F	DNN setting in the upper layers for PAP/CHAP	17.1.0
2020-12	CT-90e	CP-203175	0105	1	F	Referring to TS 23.003 for FQDN format	17.1.0
2021-03	CT-91e	CP-210116	0108	1	F	Re-use of existing connection to WLAN access when applying URSP	17.2.0
2021-03	CT-91e	CP-210116	0110		F	Avoid unnecessary new PDU session with the same attributes	17.2.0
2021-03	CT-91e	CP-210244	0111	3	A	Encoding of Location Criteria Type	17.2.0
2021-03	CT-91e	CP-210116	0112	1	F	Clarifications on PLMN and SNPN URSP storage - 24.526 part	17.2.0
2021-03	CT-91e	CP-210116	0113	1	F	Clarifications on PLMN URSP stored in USIM	17.2.0
2021-06	CT-92e	CP-211142	0115	2	B	UE policies for 5G ProSe policy	17.3.0
2021-06	CT-92e	CP-211145	0118	-	F	Correction on term SNPN access mode	17.3.0
2021-06	CT-92e	CP-211145	0120	-	F	URSP evaluation upon configured NSSAI update	17.3.0
2021-06	CT-92e	CP-211146	0117	1	F	PDU session type for URSP association	17.3.0
2021-09	CT-93e	CP-212154	0121	1	F	Introduction of MAC address range traffic descriptor component type in URSP rule	17.4.0
2021-09	CT-93e	CP-212134	0122	2	B	Adding the 5G ProSe UE-to-network relay support to the URSP	17.4.0
2021-09	CT-93e	CP-212134	0123	1	B	Mapping of 5G ProSe Layer-3 UE-to-Network Relay offload when moving from N1 mode to S1 mode	17.4.0
2021-12	CT-94e	CP-213045	0128	1	F	5G ProSe Layer-3 UE-to-Network Relay Offload indication for the UEs capable to act as Remote UEs	17.5.0
2021-12	CT-94e	CP-213048	0131	1	F	DNN in URSP traffic descriptor and route selection descriptor	17.5.0
2021-12	CT-94e	CP-213054	0127	1	B	URSP amendment for redundant PDU session	17.5.0
2022-03	CT-95e	CP-220245	0136	1	F	Alignment of ProSe Policy and V2X Policy	17.6.0
2022-03	CT-95e	CP-220247	0137	-	F	Correction on description of preferred access type and multi-access preference	17.6.0
2022-03	CT-95e	CP-220249	0139	1	F	Add support of operator-specific connection capabilities	17.6.0
2022-03	CT-95e	CP-220258	0133	-	F	Inclusion of PDU session pair ID and/or RSN in PDU session establishment request	17.6.0
2022-03	CT-95e	CP-220258	0138	-	D	Referenced clause numbers for PDU session pair and RSN	17.6.0
2022-06	CT-96	CP-221196	0145	1	A	SSC mode support	17.7.0
2022-06	CT-96	CP-221203	0142	1	F	S-NSSAI when URSP rule matches against existing PDU sessions	17.7.0
2022-06	CT-96	CP-221203	0140	3	B	URSPs for Non-Subscribed SNPN 24526 Part	17.7.0
2022-06	CT-96	CP-221210	0141	3	F	Corrections on handling of the RSDs matching the existing connection	17.7.0
2022-06	CT-96	CP-221211	0146	-	D	Correction of the octet number in home ePDG identifier entry figure	17.7.0
2022-06	CT-96	CP-221211	0147	-	F	Destination MAC address range type	17.7.0
2022-06	CT-96	CP-221213	0149	1	F	URSP rule matching with existing PDU sessions	17.7.0
2022-06	CT-96	CP-221213	0150	1	F	Correction on unknown connection capabilities	17.7.0
2022-09	CT-97e	CP-222170	0151	1	F	URSP re-evaluation after backoff timer expiry	18.0.0
2022-09	CT-97e	CP-222170	0152	1	F	Clarification on MAC address range type in URSP	18.0.0
2022-12	CT-98e	CP-223148	0154	1	A	Triggering U2N Relay discovery when the UE matches the RSD containing 5G ProSe Layer-3 UE-to-Network Relay Offload indication	18.1.0

2022-12	CT-98e	CP-223148	0156	1	A	Timing of attempting 5G ProSe L2 U2N relay and L3 U2N relay with N3IWF support when evaluating URSP rules	18.1.0
2022-12	CT-98e	CP-223118	0157	3	B	Extended Home N3IWF identifier configuration	18.1.0
2022-12	CT-98e	CP-223157	0158	2	F	Added reserved values	18.1.0
2022-12	CT-98e	CP-223157	0162	1	F	Clarification of applicability of URSP rule for establishing PDN leg of an MA PDU session	18.1.0
2023-03	CT-99	CP-230285	0164	-	F	Correction on the name of timer regarding re-evaluation of URSP rules	18.2.0
2023-03	CT-99	CP-230222	0166	-	F	Update the condition description on URSP applicable for interworking with EPC	18.2.0
2023-03	CT-99	CP-230260	0167	-	B	URSP updates for LADN per DNN & S-NSSAI	18.2.0
2023-03	CT-99	CP-230217	0171	1	F	PLMN ID in Extended Home N3IWF identifier configuration	18.2.0
2023-03	CT-99	CP-230217	0175	2	B	Introducing the Extended WLANSP in the ANDSP	18.2.0
2023-03	CT-99	CP-230217	0172	1	F	Extended Home N3IWF identifier configuration and/or Slice-specific N3IWF Prefix Configuration to the UE	18.2.0
2023-03	CT-99	CP-230217	0168	2	F	Correction to ANDSP	18.2.0
2023-03	CT-99	CP-230285	0169	-	F	Correcting reference and text	18.2.0
2023-06	CT-100	CP-231238	0183	-	F	Term reference for SNPN access operation mode	18.3.0
2023-06	CT-100	CP-231223	0186	-	F	Correction to the figure of the Content of slice-specific N3IWF prefix configuration	18.3.0
2023-06	CT-100	CP-231265	0181	1	B	Specifying and adding reference for Ranging/SL Positioning Policy	18.3.0
2023-06	CT-100	CP-231243	0177	3	B	URSP Re-evaluation Upon PLMN Change	18.3.0
2023-06	CT-100	CP-231264	0184	1	B	New traffic descriptor component for PIN	18.3.0
2023-06	CT-100	CP-231211	0179	1	B	Addition of ProSe Multi-path Preference	18.3.0
2023-06	CT-100	CP-231277	0180	2	B	Specifying and adding reference for A2X Policy	18.3.0
2023-06	CT-100	CP-231219	0191	-	F	Correction to N3AN node selection	18.3.0
2023-06	CT-100	CP-231217	0192	-	F	Correction to UE policies	18.3.0
2023-06	CT-100	CP-231243	0188	1	B	UE reporting of URSP rule enforcement in TS 24.526	18.3.0
2023-06	CT-100	CP-231243	0176	3	B	VPLMN specific URSP enforcement	18.3.0
2023-06	CT-100	CP-231223	0194	1	B	URSP update for AUN3/NAUN3 device behind 5G-RG	18.3.0
2023-06	CT-100	CP-231219	0193	1	F	Clarification to route selection descriptor for W-AGF acts on behalf of the FN-RG	18.3.0
2023-06	CT-100	CP-231243	0195	2	B	Support for UE reporting of URSP rule enforcement	18.3.0
2023-09	CT-101	CP-232190	0209	-	F	Correction on subject of 4.2.2 and other small fixes	18.4.0
2023-09	CT-101	CP-232237	0210	-	F	Correction to UE policies on RSLPP and A2XP	18.4.0
2023-09	CT-101	CP-232189	0223	1	F	Fix errors in Encoding of UE policy part type URSP	18.4.0
2023-09	CT-101	CP-232200	0197	1	F	5G-RG and VPLMN specific URSP usage	18.4.0
2023-09	CT-101	CP-232190	0200	1	F	Adding bit numbers	18.4.0
2023-09	CT-101	CP-232266	0201	1	B	Support for connectivity group ID in the traffic descriptor of the URSP rule	18.4.0
2023-09	CT-101	CP-232193	0218	1	B	Resolving the ENs related to the impact of 5G ProSe multi-path preference to the URSP handling	18.4.0
2023-09	CT-101	CP-232204	0212	1	F	Clarification on URSP for PIN	18.4.0
2023-09	CT-101	CP-232195	0217	1	F	Clarifications related to the URSP rules evaluation	18.4.0
2023-09	CT-101	CP-232189	0198	1	F	URSP usage clean up	18.4.0
2023-09	CT-101	CP-232266	0207	1	F	Unknown or unexpected URSP for AUN3/NAUN3 device behind 5G-RG	18.4.0
2023-09	CT-101	CP-232200	0211	1	F	Matching EVPLMN URSP rule	18.4.0
2023-09	CT-101	CP-232200	0213	1	F	Prioritization within VPS URSP	18.4.0
2023-09	CT-101	CP-232200	0206	1	B	Indication for reporting URSP rule enforcement	18.4.0
2023-09	CT-101	CP-232200	0220	1	B	Update operator-specific connection capabilities in URSP	18.4.0
2023-09	CT-101	CP-232188	0215	1	B	URSP re-evaluation upon partially S-NSSAI change	18.4.0
2023-09	CT-101	CP-232190	0202	2	F	Correction of the Global gNB ID field length in Table 5.2.2	18.4.0
2023-09	CT-101	CP-232266	0208	2	F	Resolve EN on URSP for NAUN3 device behind 5G-RG	18.4.0
2023-09	CT-101	CP-232200	0170	4	B	Standardized traffic categories in URSP	18.4.0
2023-12	CT-102	CP-233189	0229	-	F	Correction to ANDSP	18.5.0
2023-12	CT-102	CP-233128	0225	1	B	New connection capability for LCS user plane positioning	18.5.0
2023-12	CT-102	CP-233166	0224	1	F	VPS URSP terminology alignment in 24.526	18.5.0
2023-12	CT-102	CP-233166	0231	1	F	Traffic categories is OS independent	18.5.0
2023-12	CT-102	CP-233166	0232	1	F	Correction on traffic categories definition	18.5.0
2023-12	CT-102	CP-233144	0227	1	F	Clarification to WLANSP	18.5.0
2023-12	CT-102	CP-233150	0228	2	F	Correction to general description of URSP	18.5.0
2023-12	CT-102	CP-233164	0233	2	B	URSP re-evaluation upon S-NSSAI available indication in the TA	18.5.0
2023-12	CT-102	CP-233180	0226	1	F	The URSP handling for PIN	18.5.0
2023-12	CT-102	CP-233142	0230	2	F	HPLMN code for UE configured with EHPLMN list	18.5.0
2023-12	CT-102	CP-233162	0244	-	B	WLANSP rules precedence	18.5.0
2023-12	CT-102	CP-233129	0247	-	F	Correction for accessing the network through 5G ProSe layer-2 UE-to-network relay UE	18.5.0
2023-12	CT-102	CP-233150	0237	1	F	Correction to URSP for NAUN3 device	18.5.0
2023-12	CT-102	CP-233150	0216	6	B	Some RSD components are not applicable to 5G-RG or FN-RG	18.5.0
2023-12	CT-102	CP-233150	0245	1	D	Editorial correction related to the connectivity group ID of the NAUN3 device behind the 5G-RG	18.5.0

2023-12	CT-102	CP-233180	0236	1	F	Correction to URSP for PIN	18.5.0
2023-12	CT-102	CP-233132	0248	1	F	Clarification on multi-access preference and 5G ProSe multi-path preference in RSD	18.5.0
2024-03	CT-103	CP-240125	0252	-	F	Correction to IEEE standards references	18.6.0
2024-03	CT-103	CP-240106	0257	1	F	PDU session associated with replaced S-NSSAI	18.6.0
2024-03	CT-103	CP-240108	0251	1	F	Correction on reporting URSP rule enforcement	18.6.0
2024-03	CT-103	CP-240093	0256	1	F	Clarifications for RSD use in EPS	18.6.0
2024-03	CT-103	CP-240097	0259	1	F	UE in subclause specifying 5G-RG or W-AGF acting on behalf of FN-RG	18.6.0
2024-03	CT-103	CP-240093	0262	1	F	Clarification of PDU release condition after re-evaluation of the URSP rules	18.6.0
2024-03	CT-103	CP-240119	0255	1	F	Clarification on PIN	18.6.0
2024-03	CT-103	CP-240106	0253	2	F	URSP rules enforcement taking partially allowed NSSAI into account	18.6.0
2024-03	CT-103	CP-240097	0261	2	F	Correction for the reference of the encoding of the Slice-specific N3IWF prefix	18.6.0
2024-03	CT-103	CP-240106	0254	2	F	URSP rules enforcement taking on-demand NSSAI into account	18.6.0
2024-03	CT-103	CP-240106	0265	2	F	Clarification on URSP rules enforcement	18.6.0
2024-03	CT-103	CP-240094	0246	4	F	RSD evaluation after rejection with 5GSM cause value #28 unknown PDU session type	18.6.0
2024-06	CT-104	CP-241199	0271	-	F	Adding missing reference to connection capability identifier usage	18.7.0
2024-06	CT-104	CP-241177	0274	-	F	Correction on the partially allowed NSSAI	18.7.0
2024-06	CT-104	CP-241165	0266	1	F	Clarification to ANDSP support indication - 24.526	18.7.0
2024-06	CT-104	CP-241165	0268	1	F	Definitions and abbreviations for NAUN3 device and AUN3 device	18.7.0
2024-06	CT-104	CP-241178	0269	1	F	URSP rule enforcement reporting after an inter-system change from S1 mode to N1 mode	18.7.0
2024-06	CT-104	CP-241178	0273	1	F	Conditions for URSP rule enforcement reporting	18.7.0
2024-06	CT-104	CP-241165	0267	2	F	Correction to selection criteria set type for slice based TNGF selection	18.7.0
2024-06	CT-104	CP-241178	0277	-	F	Correction on NOTE on connection capability	18.7.0
2024-06	CT-104	CP-241176	0279	1	F	N3AN node selection for the UE in SNPN access operation mode for non-3GPP access	18.7.0
2024-06	CT-104	CP-241178	0258	2	F	VPLMN specific URSP in EPS	18.7.0
2024-06	CT-104	CP-241160	0278	1	F	Coding correction on location area in URSP	18.7.0
2024-09	CT-105	CP-242185	0280	1	F	Correction for URSP rule enforcement report indication	18.8.0
2024-09	CT-105	CP-242169	0281	-	F	Remove the NOTE in an inappropriate place	19.0.0
2024-12	CT-106	CP-243185	0282	2	F	Correction for URSP and ANDSP	19.1.0
2024-12	CT-106	CP-243196	0283	3	F	Precedence of URSP and ANDSP parameters	19.1.0
2025-03	CT#107	CP-250142	0284	1	B	Provisioning an S-NSSAI via the PDN CONNECTIVITY REQUEST message	19.2.0
2025-03	CT#107	CP-250143	0286	1	F	Correction for URSP and ANDSP of HPLMN when in SNPN access operation mode	19.2.0
2025-06	CT#108	CP-251190	0288	1	F	Encoding Length Fix for NR Cell Id, TAC, EUTRA Cell Id	19.3.0
2025-06	CT#108	CP-251187	0287	2	F	Reference to obsoleted IETF RFC4122	19.3.0
2026-06	CT#112	CP-261104	0290	1	F	Correction to traffic descriptors for Ethernet-24.526	19.4.0

History

Version	Date	Status
V19.3.0	January 2026	Publication
V19.4.0	July 2026	Publication