

ETSI TS 136 521-1 V11.2.0 (2013-10)



Technical Specification

LTE;
Evolved Universal Terrestrial Radio Access (E-UTRA);
User Equipment (UE) conformance specification;
Radio transmission and reception;
Part 1: Conformance testing
(3GPP TS 36.521-1 version 11.2.0 Release 11)



Reference

RTS/TSGR-0536521-1vb20

Keywords

LTE

ETSI

650 Route des Lucioles
F-06921 Sophia Antipolis Cedex - FRANCE

Tel.: +33 4 92 94 42 00 Fax: +33 4 93 65 47 16

Siret N° 348 623 562 00017 - NAF 742 C
Association à but non lucratif enregistrée à la
Sous-Préfecture de Grasse (06) N° 7803/88

Important notice

Individual copies of the present document can be downloaded from:

<http://www.etsi.org>

The present document may be made available in more than one electronic version or in print. In any case of existing or perceived difference in contents between such versions, the reference version is the Portable Document Format (PDF). In case of dispute, the reference shall be the printing on ETSI printers of the PDF version kept on a specific network drive within ETSI Secretariat.

Users of the present document should be aware that the document may be subject to revision or change of status. Information on the current status of this and other ETSI documents is available at

<http://portal.etsi.org/tb/status/status.asp>

If you find errors in the present document, please send your comment to one of the following services:

http://portal.etsi.org/chaicor/ETSI_support.asp

Copyright Notification

No part may be reproduced except as authorized by written permission.
The copyright and the foregoing restriction extend to reproduction in all media.

© European Telecommunications Standards Institute 2013.
All rights reserved.

DECT™, **PLUGTESTS™**, **UMTS™** and the ETSI logo are Trade Marks of ETSI registered for the benefit of its Members.
3GPP™ and **LTE™** are Trade Marks of ETSI registered for the benefit of its Members and of the 3GPP Organizational Partners.
GSM® and the GSM logo are Trade Marks registered and owned by the GSM Association.

Intellectual Property Rights

IPRs essential or potentially essential to the present document may have been declared to ETSI. The information pertaining to these essential IPRs, if any, is publicly available for **ETSI members and non-members**, and can be found in ETSI SR 000 314: *"Intellectual Property Rights (IPRs); Essential, or potentially Essential, IPRs notified to ETSI in respect of ETSI standards"*, which is available from the ETSI Secretariat. Latest updates are available on the ETSI Web server (<http://ipr.etsi.org>).

Pursuant to the ETSI IPR Policy, no investigation, including IPR searches, has been carried out by ETSI. No guarantee can be given as to the existence of other IPRs not referenced in ETSI SR 000 314 (or the updates on the ETSI Web server) which are, or may be, or may become, essential to the present document.

Foreword

This Technical Specification (TS) has been produced by ETSI 3rd Generation Partnership Project (3GPP).

The present document may refer to technical specifications or reports using their 3GPP identities, UMTS identities or GSM identities. These should be interpreted as being references to the corresponding ETSI deliverables.

The cross reference between GSM, UMTS, 3GPP and ETSI identities can be found under <http://webapp.etsi.org/key/queryform.asp>.

Contents

Intellectual Property Rights	2
Foreword.....	2
Foreword.....	32
Introduction	32
1 Scope	33
2 References	34
3 Definitions, symbols and abbreviations	35
3.1 Definitions	35
3.2 Symbols.....	36
3.3 Abbreviations	38
4 General	40
4.1 Categorization of test requirements in CA, UL-MIMO, eDL-MIMO.....	41
5 Frequency bands and channel arrangement.....	42
5.1 General	42
5.2 Operating bands.....	42
5.2A Operating bands for CA	43
5.2B Operating bands for UL-MIMO	44
5.3 TX–RX frequency separation.....	45
5.3A TX–RX frequency separation for CA.....	45
5.4 Channel arrangement.....	45
5.4.1 Channel spacing	45
5.4.1A Channel spacing for CA.....	46
5.4.2 Channel bandwidth	46
5.4.2.1 Channel bandwidths per operating band	47
5.4.2A Channel bandwidth for CA	48
5.4.2A.1 Channel bandwidths per operating band for CA	49
5.4.2B Channel bandwidth for UL-MIMO.....	51
5.4.2B.1 Channel bandwidths per operating band for UL- MIMO.....	51
5.4.3 Channel raster	51
5.4.3A Channel raster for CA.....	51
5.4.4 Carrier frequency and EARFCN.....	51
6 Transmitter Characteristics.....	53
6.1 General	53
6.2 Transmit power	53
6.2.1 Void	53
6.2.2 UE Maximum Output Power	53
6.2.2.1 Test purpose	53
6.2.2.2 Test applicability.....	53
6.2.2.3 Minimum conformance requirements	53
6.2.2.4 Test description	55
6.2.2.4.1 Initial condition	55
6.2.2.4.2 Test procedure	56
6.2.2.4.3 Message contents.....	56
6.2.2.5 Test requirements.....	56
6.2.2_1 Maximum Output Power for HPUE	57
6.2.2_1.1 Test purpose	57
6.2.2_1.2 Test applicability.....	58
6.2.2_1.3 Minimum conformance requirements	58
6.2.2_1.4 Test description	58
6.2.2_1.5 Test requirements.....	59
6.2.2A UE Maximum Output Power for CA	59

6.2.2A.1	UE Maximum Output Power for CA (intra-band contiguous DL CA and UL CA).....	59
6.2.2A.1.1	Test purpose	59
6.2.2A.1.2	Test applicability	59
6.2.2A.1.3	Minimum conformance requirements.....	59
6.2.2A.1.4	Test description	60
6.2.2A.1.5	Test Requirements.....	62
6.2.2B	UE Maximum Output Power for UL-MIMO.....	62
6.2.2B.1	Test purpose	62
6.2.2B.2	Test applicability.....	62
6.2.2B.3	Minimum conformance requirements	62
6.2.2B.4	Test description	64
6.2.2B.4.1	Initial condition	64
6.2.2B.4.2	Test procedure	65
6.2.2B.4.3	Message contents.....	65
6.2.2B.5	Test requirements.....	65
6.2.3	Maximum Power Reduction (MPR)	66
6.2.3.1	Test purpose	66
6.2.3.2	Test applicability.....	67
6.2.3.3	Minimum conformance requirements	67
6.2.3.4	Test description	67
6.2.3.4.1	Initial condition	67
6.2.3.4.2	Test procedure	68
6.2.3.4.3	Message contents.....	68
6.2.3.5	Test requirements.....	69
6.2.3_1	Maximum Power Reduction (MPR) for HPUE	71
6.2.3_1.1	Test purpose	71
6.2.3_1.2	Test applicability.....	71
6.2.3_1.3	Minimum conformance requirements	71
6.2.3_1.4	Test description	71
6.2.3_1.5	Test requirements.....	72
6.2.3A	Maximum Power Reduction (MPR) for CA.....	72
6.2.3A.1	Maximum Power Reduction (MPR) for CA (intra-band contiguous DL CA and UL CA).....	72
6.2.3A.1.1	Test purpose	72
6.2.3A.1.2	Test applicability	72
6.2.3A.1.3	Minimum conformance requirements.....	72
6.2.3A.1.4	Test description	73
6.2.3A.1.5	Test Requirements.....	75
6.2.3B	Maximum Power Reduction (MPR) for UL-MIMO.....	76
6.2.3B.1	Test purpose	76
6.2.3B.2	Test applicability.....	76
6.2.3B.3	Minimum conformance requirements	76
6.2.3B.4	Test description	77
6.2.3B.4.1	Initial condition	77
6.2.3B.4.2	Test procedure	78
6.2.3B.4.3	Message contents.....	78
6.2.3B.5	Test requirements.....	78
6.2.4	Additional Maximum Power Reduction (A-MPR).....	80
6.2.4.1	Test purpose	80
6.2.4.2	Test applicability.....	80
6.2.4.3	Minimum conformance requirements	80
6.2.4.4	Test description	87
6.2.4.4.1	Initial condition	87
6.2.4.4.2	Test procedure	105
6.2.4.4.3	Message contents.....	105
6.2.4.5	Test requirements.....	109
6.2.4_1	Additional Maximum Power Reduction (A-MPR) for HPUE.....	129
6.2.4_1.2	Test applicability.....	129
6.2.4_1.3	Minimum conformance requirements	130
6.2.4_1.4	Test description	130
6.2.4_1.5	Test requirements.....	130
6.2.4A	Additional Maximum Power Reduction (A-MPR) for CA.....	131

6.2.4A.1	Additional Maximum Power Reduction (A-MPR) for CA (intra-band contiguous DL CA and UL CA).....	131
6.2.4A.1.1	Test purpose	131
6.2.4A.1.2	Test applicability	131
6.2.4A.1.3	Minimum conformance requirements.....	131
6.2.4A.1.3.5	A-MPR for CA_NS_05 for CA_38C.....	134
6.2.4A.1.3.6	A-MPR for CA_NS_06 for CA_7C.....	135
6.2.4A.1.4	Test description	136
6.2.4A.1.5	Test requirements	142
6.2.4B	Additional Maximum Power Reduction (A-MPR) for UL-MIMO.....	147
6.2.4B.1	Test purpose	147
6.2.4B.2	Test applicability.....	147
6.2.4B.3	Minimum conformance requirements	147
6.2.4B.4	Test description.....	152
6.2.4B.4.1	Initial condition	152
6.2.4B.4.2	Test procedure	166
6.2.4B.4.3	Message contents.....	167
6.2.4B.5	Test requirements	170
6.2.5	Configured UE transmitted Output Power.....	184
6.2.5.1	Test purpose	184
6.2.5.2	Test applicability.....	184
6.2.5.3	Minimum conformance requirements	184
6.2.5.4	Test description	185
6.2.5.4.1	Initial conditions.....	185
6.2.5.4.2	Test procedure	186
6.2.5.4.3	Message contents.....	186
6.2.5.5	Test requirement	187
6.2.5_1	Configured UE transmitted Output Power for HPUE.....	187
6.2.5_1.1	Test purpose	187
6.2.5_1.2	Test applicability.....	187
6.2.5_1.3	Minimum conformance requirements	187
6.2.5_1.4	Test description	188
6.2.5_1.4.1	Initial conditions.....	188
6.2.5_1.4.2	Test procedure	188
6.2.5_1.4.3	Message contents.....	188
6.2.5_1.5	Test requirement	188
6.2.5A	Configured transmitted power for CA	189
6.2.5A.1	Configured UE transmitted Output Power for CA (intra-band contiguous DL CA and UL CA)	189
6.2.5A.1.1	Test purpose	189
6.2.5A.1.2	Test applicability	189
6.2.5A.1.3	Minimum conformance requirements.....	189
6.2.5A.1.4	Test description	192
6.2.5A.1.5	Test requirement.....	194
6.2.5A.2	Configured UE transmitted Output Power for CA (inter-band DL CA without UL CA)	194
6.2.5A.2.1	Test purpose	194
6.2.5A.2.2	Test applicability	195
6.2.5A.2.3	Minimum conformance requirements.....	195
6.2.5A.2.4	Test description	195
6.2.5A.2.5	Test requirement.....	196
6.2.5B	Configured UE transmitted Output Power for UL-MIMO	196
6.2.5B.1	Test purpose	196
6.2.5B.2	Test applicability.....	197
6.2.5B.3	Minimum conformance requirements	197
6.2.5B.4	Test description	197
6.2.5B.4.1	Initial conditions.....	197
6.2.5B.4.2	Test procedure	198
6.2.5B.4.3	Message contents.....	198
6.2.5B.5	Test requirement	199
6.3	Output Power Dynamics	199
6.3.1	Void	199
6.3.2	Minimum Output Power	199
6.3.2.1	Test purpose	199

6.3.2.2	Test applicability	199
6.3.2.3	Minimum conformance requirements	199
6.3.2.4	Test description	200
6.3.2.4.1	Initial conditions	200
6.3.2.4.2	Test procedure	201
6.3.2.4.3	Message contents	201
6.3.2.5	Test requirement	201
6.3.2A	Minimum Output Power for CA	201
6.3.2A.1	Minimum Output Power for CA (intra-band contiguous DL CA and UL CA)	201
6.3.2A.1.1	Test purpose	201
6.3.2A.1.2	Test applicability	201
6.3.2A.1.3	Minimum conformance requirements	201
6.3.2A.1.4	Test description	202
6.3.2A.1.4.1	Initial conditions	202
6.3.2A.1.4.2	Test procedure	203
6.3.2A.1.4.3	Message contents	203
6.3.2A.1.5	Test requirements	203
6.3.2B	Minimum Output Power for UL-MIMO	203
6.3.2B.1	Test purpose	203
6.3.2B.2	Test applicability	203
6.3.2B.3	Minimum conformance requirements	204
6.3.2B.4	Test description	204
6.3.2B.4.1	Initial conditions	204
6.3.2B.4.2	Test procedure	205
6.3.2B.4.3	Message contents	205
6.3.3	Transmit OFF power	205
6.3.3.1	Test purpose	205
6.3.3.2	Test applicability	205
6.3.3.3	Minimum conformance requirement	205
6.3.3.4	Test description	206
6.3.3.5	Test requirement	206
6.3.3A	UE Transmit OFF power for CA	206
6.3.3A.1	UE Transmit OFF power for CA (intra-band contiguous DL CA and UL CA)	206
6.3.3A.1.1	Test purpose	206
6.3.3A.1.2	Test applicability	206
6.3.3A.1.3	Minimum conformance requirements	206
6.3.3A.1.4	Test description	207
6.3.3A.1.5	Test Requirements	207
6.3.3B	UE Transmit OFF power for UL-MIMO	207
6.3.3B.1	Test purpose	207
6.3.3B.2	Test applicability	207
6.3.3B.3	Minimum conformance requirement	207
6.3.3B.4	Test description	208
6.3.3B.5	Test requirement	208
6.3.4	ON/OFF time mask	208
6.3.4.1	General ON/OFF time mask	208
6.3.4.1.1	Test purpose	208
6.3.4.1.2	Test applicability	208
6.3.4.1.3	Minimum conformance requirement	208
6.3.4.1.4	Test description	209
6.3.4.1.5	Test requirement	211
6.3.4.2	PRACH and SRS time mask	211
6.3.4.2.1	PRACH time mask	211
6.3.4.2.2	SRS time mask	214
6.3.4A	ON/OFF time mask for CA	219
6.3.4A.1	General ON/OFF time mask for CA	219
6.3.4A.1.1	General ON/OFF time mask for CA (intra-band contiguous DL CA and UL CA)	219
6.3.4A.1.1.4.2	Test procedure	221
6.3.4A.1.1.4.3	Message contents	221
6.3.4A.1.1.5	Test requirement	222
6.3.4B	ON/OFF time mask for UL-MIMO	222
6.3.4B.1	General ON/OFF time mask for UL-MIMO	222

6.3.4B.1.1	Test purpose	222
6.3.4B.1.2	Test applicability	222
6.3.4B.1.3	Minimum conformance requirement	222
6.3.4B.1.4	Test description	222
6.3.4B.1.5	Test requirement	224
6.3.5	Power Control	225
6.3.5.1	Power Control Absolute power tolerance	225
6.3.5.1.1	Test purpose	225
6.3.5.1.2	Minimum conformance requirement	225
6.3.5.1.3	Test applicability	225
6.3.5.1.4	Test description	226
6.3.5.1.5	Test requirement	227
6.3.5.2	Power Control Relative power tolerance.....	228
6.3.5.2.1	Test purpose	228
6.3.5.2.2	Test applicability	228
6.3.5.2.3	Minimum conformance requirement	228
6.3.5.2.4	Test description	229
6.3.5.2.5	Test requirement	236
6.3.5.3	Aggregate power control tolerance	247
6.3.5.3.1	Test purpose	247
6.3.5.3.2	Test applicability	247
6.3.5.3.3	Minimum conformance requirement	248
6.3.5.3.4	Test description	248
6.3.5.3.5	Test requirement	250
6.3.5_1	Power Control for HPUE.....	250
6.3.5_1.1	Power Control Absolute power tolerance for HPUE	250
6.3.5_1.1.1	Test purpose	250
6.3.5_1.1.2	Test applicability	251
6.3.5_1.1.3	Minimum conformance requirement	251
6.3.5_1.1.4	Test description	251
6.3.5_1.1.5	Test requirement	251
6.3.5_1.2	Power Control Relative power tolerance for HPUE.....	252
6.3.5_1.2.1	Test purpose	252
6.3.5_1.2.2	Test applicability	252
6.3.5_1.2.3	Minimum conformance requirement	252
6.3.5_1.2.4	Test description	252
6.3.5_1.2.5	Test requirement	252
6.3.5_1.3	Aggregate power control tolerance for HPUE	252
6.3.5_1.3.1	Test purpose	252
6.3.5_1.3.2	Test applicability	252
6.3.5_1.3.3	Minimum conformance requirement	252
6.3.5_1.3.4	Test description	252
6.3.5_1.3.5	Test requirement	252
6.3.5A	Power Control for CA.....	253
6.3.5A.1	Power Control Absolute power tolerance for CA	253
6.3.5A.1.1	Power Control Absolute power tolerance for CA (intra-band contiguous DL CA and UL CA) ...	253
6.3.5A.2	Power Control Relative power tolerance for CA	257
6.3.5A.2.1	Power Control Relative power tolerance for CA (intra-band contiguous DL CA and UL CA) ...	257
6.3.5A.3	Aggregate power control tolerance for CA	271
6.3.5A.3.1	Aggregate power control tolerance for CA (intra-band contiguous DL CA and UL CA).....	271
6.3.5A.3.1.1	Test purpose.....	271
6.3.5A.3.1.2	Test applicability.....	272
6.3.5A.3.1.3	Minimum conformance requirements	272
6.3.5B	Power Control for UL- MIMO	275
6.3.5B.1	Power Control Absolute Power Tolerance for UL- MIMO	275
6.3.5B.1.1	Test purpose	275
6.3.5B.1.2	Minimum conformance requirement	275
6.3.5B.1.3	Test applicability	275
6.3.5B.1.4	Test description	275
6.3.5B.1.5	Test requirement	277
6.3.5B.2	Power Control Relative power tolerance for UL-MIMO	278
6.3.5B.2.1	Test purpose	278

6.3.5B.2.2	Test applicability	278
6.3.5B.2.3	Minimum conformance requirement	278
6.3.5B.2.4	Test description	278
6.3.5B.2.5	Test requirement	285
6.3.5B.3	Aggregate power control tolerance for UL-MIMO	295
6.3.5B.3.1	Test purpose	295
6.3.5B.3.2	Test applicability	295
6.3.5B.3.3	Minimum conformance requirement	295
6.3.5B.3.4	Test description	295
6.3.5B.3.5	Test requirement	297
6.4	Void	298
6.5	Transmit signal quality	299
6.5.1	Frequency Error	299
6.5.1.1	Test purpose	299
6.5.1.2	Test applicability	299
6.5.1.3	Minimum conformance requirements	299
6.5.1.4	Test description	299
6.5.1.4.1	Initial condition	299
6.5.1.4.2	Test procedure	300
6.5.1.4.3	Message contents	301
6.5.1.5	Test requirement	301
6.5.1A	Frequency error for CA	301
6.5.1A.1	Frequency error for CA (intra-band contiguous DL CA and UL CA)	301
6.5.1A.1.1	Test purpose	301
6.5.1A.1.2	Test applicability	301
6.5.1A.1.3	Minimum conformance requirements	301
6.5.1A.1.4	Test description	301
6.5.1A.1.5	Test Requirements	303
6.5.1B	Frequency Error for UL-MIMO	303
6.5.1B.1	Test purpose	303
6.5.1B.2	Test applicability	303
6.5.1B.3	Minimum conformance requirements	303
6.5.1B.4	Test description	303
6.5.1B.4.1	Initial condition	303
6.5.1B.4.2	Test procedure	304
6.5.1B.4.3	Message contents	305
6.5.1B.5	Test requirement	305
6.5.2	Transmit modulation	305
6.5.2.1	Error Vector Magnitude (EVM)	305
6.5.2.1.1	Test Purpose	305
6.5.2.1.2	Test applicability	305
6.5.2.1.3	Minimum conformance requirements	305
6.5.2.1.4	Test description	306
6.5.2.1.5	Test requirement	310
6.5.2.1A	PUSCH-EVM with exclusion period	310
6.5.2.1A.1	Test purpose	310
6.5.2.1A.2	Test applicability	310
6.5.2.1A.3	Minimum conformance requirement	310
6.5.2.1A.4	Test description	310
6.5.2.1A.5	Test requirement	312
6.5.2.2	Carrier leakage	313
6.5.2.2.1	Test Purpose	313
6.5.2.2.2	Test applicability	313
6.5.2.2.3	Minimum conformance requirements	313
6.5.2.2.4	Test description	313
6.5.2.2.5	Test requirement	315
6.5.2.3	In-band emissions for non allocated RB	315
6.5.2.3.1	Test Purpose	315
6.5.2.3.2	Test applicability	315
6.5.2.3.3	Minimum conformance requirements	315
6.5.2.3.4	Test description	316
6.5.2.3.5	Test requirement	319

6.5.2.4	EVM equalizer spectrum flatness	319
6.5.2.4.1	Test Purpose	319
6.5.2.4.2	Test applicability	320
6.5.2.4.3	Minimum conformance requirements.....	320
6.5.2.4.4	Test description	321
6.5.2.4.5	Test requirement	322
6.5.2A	Transmit modulation for CA.....	323
6.5.2A.1	Error Vector Magnitude (EVM) for CA.....	323
6.5.2A.1.1	Error Vector Magnitude (EVM) for CA (intra-band contiguous DL CA and UL CA)	323
6.5.2A.2	Carrier leakage for CA	325
6.5.2A.2.1	Carrier leakage for CA (intra-band contiguous DL CA and UL CA).....	325
6.5.2A.3	In-band emissions for non allocated RB for CA	327
6.5.2A.3.1	In-band emissions for non allocated RB for CA (intra-band contiguous DL CA and UL CA).....	327
6.5.2B	Transmit modulation for UL- MIMO	333
6.5.2B.1	Error Vector Magnitude (EVM) for UL- MIMO	333
6.5.2B.1.1	Test Purpose	333
6.5.2B.1.2	Test applicability	334
6.5.2B.1.3	Minimum conformance requirements.....	334
6.5.2B.1.4	Test description	334
6.5.2B.1.5	Test requirement	336
6.5.2B.2	Carrier leakage for UL-MIMO.....	337
6.5.2B.2.1	Test Purpose	337
6.5.2B.2.2	Test applicability	337
6.5.2B.2.3	Minimum conformance requirements.....	337
6.5.2B.2.4	Test description	337
6.5.2B.2.5	Test requirement	338
6.5.2B.3	In-band emissions for non allocated RB for UL-MIMO	339
6.5.2B.3.1	Test Purpose	339
6.5.2B.3.2	Test applicability	339
6.5.2B.3.3	Minimum conformance requirements.....	339
6.5.2B.3.4	Test description	340
6.5.2B.3.5	Test requirement	342
6.5.2B.4	EVM equalizer spectrum flatness for UL-MIMO	342
6.5.2B.4.1	Test Purpose	342
6.5.2B.4.2	Test applicability	343
6.5.2B.4.3	Minimum conformance requirements.....	343
6.5.2B.4.4	Test description	343
6.5.2B.4.5	Test requirement	344
6.6	Output RF spectrum emissions.....	345
6.6.1	Occupied bandwidth	346
6.6.1.1	Test purpose	346
6.6.1.2	Test applicability	346
6.6.1.2	Minimum conformance requirements	346
6.6.1.4	Test description	346
6.6.1.4.1	Initial conditions	346
6.6.1.4.2	Test procedure	347
6.6.1.4.3	Message contents.....	347
6.6.1.5	Test requirement	347
6.6.1A	Occupied bandwidth for CA	348
6.6.1A.1	Occupied bandwidth for CA (intra-band contiguous DL CA and UL CA).....	348
6.6.1A.1.1	Test purpose	348
6.6.1A.1.2	Test applicability	348
6.6.1A.1.3	Minimum conformance requirements.....	348
6.6.1A.1.4	Test description	348
6.6.1A.1.5	Test Requirements	350
6.6.1B	Occupied bandwidth for UL-MIMO.....	350
6.6.1B.1	Test purpose	350
6.6.1B.2	Test applicability.....	350
6.6.1B.3	Minimum conformance requirements	350
6.6.1B.4	Test description	351
6.6.1B.4.1	Initial conditions	351
6.6.1B.4.2	Test procedure	351

6.6.1B.4.3	Message contents.....	352
6.6.2	Out of band emission	352
6.6.2.1	Spectrum Emission Mask.....	352
6.6.2.1.1	Test purpose	352
6.6.2.1.2	Test applicability	352
6.6.2.1.3	Minimum conformance requirements.....	352
6.6.2.1.4	Test description	353
6.6.2.1.5	Test requirements	355
6.6.2.1A	Spectrum emission mask for CA.....	356
6.6.2.1A.1	Spectrum emission mask for CA (intra-band contiguous DL CA and UL CA)	356
6.6.2.1B	Spectrum Emission Mask for UL-MIMO	360
6.6.2.1B.1	Test purpose	360
6.6.2.1B.2	Test applicability	360
6.6.2.1B.3	Minimum conformance requirements.....	360
6.6.2.1B.4	Test description	361
6.6.2.1B.5	Test requirements	363
6.6.2.2	Additional Spectrum Emission Mask.....	364
6.6.2.2.1	Test purpose	364
6.6.2.2.2	Test applicability	364
6.6.2.2.3	Minimum conformance requirements.....	364
6.6.2.2.4	Test description	366
6.6.2.2.5	Test requirements	375
6.6.2.2A	Additional Spectrum Emission Mask for CA.....	379
6.6.2.2A.1	Additional Spectrum Emission Mask for CA (intra-band contiguous DL CA and UL CA)	379
6.6.2.2B	Additional Spectrum Emission Mask for UL-MIMO	382
6.6.2.2B.1	Test purpose	382
6.6.2.2B.2	Test applicability	382
6.6.2.2B.3	Minimum conformance requirements.....	383
6.6.2.2B.4	Test description	384
6.6.2.2B.5	Test requirements	390
6.6.2.3	Adjacent Channel Leakage power Ratio.....	394
6.6.2.3.1	Test purpose	394
6.6.2.3.2	Test applicability	394
6.6.2.3.3	Minimum conformance requirements.....	394
6.6.2.3.4	Test description	396
6.6.2.3.5	Test requirement.....	398
6.6.2.3_1	Adjacent Channel Leakage power Ratio for HPUE.....	399
6.6.2.3_1.1	Test purpose	399
6.6.2.3_1.2	Test applicability	399
6.6.2.3_1.3	Minimum conformance requirements.....	399
6.6.2.3_1.4	Test description	400
6.6.2.3_1.5	Test requirement.....	400
6.6.2.3A	Adjacent Channel Leakage power Ratio for CA.....	401
6.6.2.3A.1	Adjacent Channel Leakage power Ratio for CA (intra-band contiguous DL CA and UL CA).....	401
6.6.2.3B	Adjacent Channel Leakage power Ratio for UL-MIMO.....	406
6.6.2.3B.1	Test purpose	406
6.6.2.3B.2	Test applicability	406
6.6.2.3B.3	Minimum conformance requirements.....	406
6.6.2.3B.4	Test description	408
6.6.2.3B.5	Test requirement.....	410
6.6.2.4	Void.....	411
6.6.3	Spurious emissions	411
6.6.3.1	Transmitter Spurious emissions	411
6.6.3.1.1	Test purpose	411
6.6.3.1.2	Test applicability	411
6.6.3.1.3	Minimum conformance requirements.....	412
6.6.3.1.4	Test description	412
6.6.3.1.5	Test requirement.....	413
6.6.3.1A	Transmitter Spurious emissions for CA.....	414
6.6.3.1A.1	Transmitter Spurious emissions for CA (intra-band contiguous DL CA and UL CA).....	414
6.6.3.2	Spurious emission band UE co-existence	417
6.6.3.2.1	Test purpose	417

6.6.3.2.2	Test applicability	417
6.6.3.2.3	Minimum conformance requirements.....	417
6.6.3.2.4	Test description	437
6.6.3.2.5	Test requirement	440
6.6.3.2_1	Void.....	443
6.6.3.2A	Spurious emission band UE co-existence for CA	443
6.6.3.2A.1	Spurious emission band UE co-existence for CA (intra-band contiguous DL CA and UL CA) ..	443
6.6.3.3	Additional spurious emissions	447
6.6.3.3.1	Test purpose	447
6.6.3.3.2	Test applicability	447
6.6.3.3.3	Minimum conformance requirements.....	447
6.6.3.3.3.4	Minimum requirement (network signalled value "NS_09").....	448
6.6.3.3.4	Test description	451
6.6.3.3.5	Test requirement	466
6.6.3.3A	Additional spurious emissions for CA	471
6.6.3.3A.1	Additional spurious emissions for CA (intra-band contiguous DL CA and UL CA)	471
6.6.3.3A.1.4	Test description.....	473
6.6.3.3A.1.4.1	Initial conditions	473
6.6.3.3A.1.4.2	Test procedure.....	475
6.6.3.3A.1.4.3	Message contents	475
6.6.3.3A.1.5	Test requirement	476
6.6.3B	Spurious emission for UL-MIMO	477
6.6.3B.1	Transmitter Spurious emissions for UL-MIMO.....	477
6.6.3B.1.1	Test purpose	477
6.6.3B.1.2	Test applicability	477
6.6.3B.1.3	Minimum conformance requirements.....	478
6.6.3B.1.4	Test description	478
6.6.3B.1.5	Test requirement	479
6.6.3B.2	Spurious emission band UE co-existence for UL-MIMO	479
6.6.3B.2.1	Test purpose	479
6.6.3B.2.2	Test applicability	479
6.6.3B.2.3	Minimum conformance requirements.....	480
6.6.3B.2.4	Test description	480
6.6.3B.2.5	Test requirement	482
6.6.3B.3	Additional spurious emissions for UL-MIMO	484
6.6.3B.3.1	Test purpose	484
6.6.3B.3.2	Test applicability	485
6.6.3B.3.3	Minimum conformance requirements.....	485
6.6.3B.3.4	Test description	485
6.6.3B.3.5	Test requirement	499
6.7	Transmit intermodulation	504
6.7.1	Test purpose.....	504
6.7.2	Test applicability	504
6.7.3	Minimum conformance requirements	504
6.7.4	Test description.....	505
6.7.4.1	Initial conditions	505
6.7.4.3	Test procedure.....	506
6.7.4.3	Message contents	506
6.7.5	Test requirement	506
6.7A	Transmit intermodulation for CA	507
6.7A.1	Transmit intermodulation for CA (intra-band contiguous DL CA and UL CA).....	507
6.7A.1.1	Test purpose	507
6.7A.1.2	Test applicability.....	507
6.7A.1.3	Minimum conformance requirements	507
6.7A.1.4	Test description	507
6.7A.1.4.1	Initial conditions	507
6.7A.1.4.2	Test procedure	508
6.7A.1.4.3	Message contents.....	509
6.7A.1.5	Test requirement	509
6.7B	Transmit intermodulation for UL-MIMO.....	509
6.7B.1	Test purpose.....	509
6.7B.2	Test applicability	509

6.7B.3	Minimum conformance requirements	510
6.7B.4	Test description.....	510
6.7B.4.1	Initial conditions	510
6.7B.4.2	Test procedure.....	511
6.7B.4.3	Message contents	511
6.8	Time alignment	511
6.8.1	Void	512
6.8A	Void.....	512
6.8B	Time alignment error for UL-MIMO	512
6.8B.1	Test purpose.....	512
6.8B.2	Test applicability	512
6.8B.3	Minimum conformance requirements	512
6.8B.4	Test description.....	512
6.8B.4.1	Initial condition	512
6.8B.4.2	Test procedure.....	513
6.8B.4.3	Message contents	513
6.8B.5	Test requirements.....	513
7	Receiver Characteristics	513
7.1	General	513
7.2	Diversity characteristics	514
7.3	Reference sensitivity level.....	514
7.3.1	Test purpose.....	514
7.3.2	Test applicability	514
7.3.3	Minimum conformance requirements	515
7.3.4	Test description.....	519
7.3.4.1	Initial conditions	519
7.3.4.2	Test procedure.....	520
7.3.4.3	Message contents	521
7.3.5	Test requirement	521
7.3A	Reference sensitivity level for CA	525
7.3A.1	Reference sensitivity level for CA (intra-band contiguous DL CA and UL CA)	525
7.3A.1.1	Test purpose	525
7.3A.1.2	Test applicability	525
7.3A.1.3	Minimum conformance requirements	525
7.3A.1.4	Test description	530
7.3A.1.4.1	Initial conditions	530
7.3A.1.4.2	Test procedure	531
7.3A.1.4.3	Message contents.....	532
7.3A.1.5	Test requirement	532
7.3A.2	Reference sensitivity level for CA (intra-band contiguous DL CA without UL CA)	533
7.3A.2.1	Test purpose	533
7.3A.2.2	Test applicability.....	533
7.3A.2.3	Minimum conformance requirements	533
7.3A.2.4	Test description	533
7.3A.2.4.1	Initial conditions	533
7.3A.2.4.2	Test procedure	534
7.3A.2.4.3	Message contents.....	534
7.3A.2.5	Test requirement	535
7.3A.3	Reference sensitivity level for CA (inter-band DL CA without UL CA)	535
7.3A.3.1	Test purpose	535
7.3A.3.2	Test applicability.....	535
7.3A.3.3	Minimum conformance requirements	535
7.3A.3.4	Test description	535
7.3A.3.4.1	Initial conditions	535
7.3A.3.4.2	Test procedure	539
7.3A.3.4.3	Message contents.....	539
7.3A.3.5	Test requirement	540
7.3A.4	Reference sensitivity level for CA (intra-band non-contiguous DL CA without UL CA).....	541
7.3A.4.1	Test purpose	542
7.3A.4.2	Test applicability.....	542
7.3A.4.3	Minimum conformance requirements	542

7.3A.4.4	Test description	542
7.3A.4.4.1	Initial conditions	542
7.3A.4.4.2	Test procedure	542
7.3A.4.4.3	Message contents	542
7.3A.4.5	Test requirement	542
7.3B	Reference sensitivity level for UL-MIMO	542
7.3B.1	Test purpose	542
7.3B.2	Test applicability	542
7.3B.3	Minimum conformance requirements	542
7.3B.4	Test description	543
7.3B.4.1	Initial conditions	543
7.3B.4.2	Test procedure	544
7.3B.4.3	Message contents	544
7.3B.4.3.1	Message contents exceptions (network signalled value "NS_01")	544
7.3B.4.3.2	Message contents exceptions (network signalled value "NS_03")	544
7.3B.4.3.3	Message contents exceptions (network signalled value "NS_06")	544
7.3B.4.3.4	Message contents exceptions (network signalled value "NS_[09]")	544
7.3B.5	Test requirement	545
7.4	Maximum input level	549
7.4.1	Test purpose	549
7.4.2	Test applicability	549
7.4.3	Minimum conformance requirements	549
7.4.4	Test description	549
7.4.4.1	Initial conditions	549
7.4.4.2	Test procedure	551
7.4.4.3	Message contents	551
7.4.5	Test requirement	551
7.4A	Maximum input level for CA	552
7.4A.1	Maximum input level for CA (intra-band contiguous DL CA and UL CA)	552
7.4A.1.1	Test purpose	552
7.4A.1.2	Test applicability	552
7.4A.1.3	Minimum conformance requirements	552
7.4A.1.4	Test description	552
7.4A.1.4.1	Initial conditions	552
7.4A.1.4.2	Test procedure	553
7.4A.1.4.3	Message contents	554
7.4A.1.5	Test requirement	554
7.4A.2	Maximum input level for CA (intra-band contiguous DL CA without UL CA)	554
7.4A.2.1	Test purpose	554
7.4A.2.2	Test applicability	554
7.4A.2.3	Minimum conformance requirements	554
7.4A.2.4	Test description	555
7.4A.2.4.1	Initial conditions	555
7.4A.2.4.2	Test procedure	555
7.4A.2.4.3	Message contents	555
7.4A.2.5	Test requirement	556
7.4A.3	Maximum input level for CA (inter-band DL CA without UL CA)	556
7.4A.3.1	Test purpose	556
7.4A.3.2	Test applicability	556
7.4A.3.3	Minimum conformance requirements	556
7.4A.3.4	Test description	556
7.4A.3.4.1	Initial conditions	556
7.4A.3.4.2	Test procedure	557
7.4A.3.4.3	Message contents	558
7.4A.3.5	Test requirement	558
7.4B	Maximum input level for UL-MIMO	558
7.4B.1	Test purpose	558
7.4B.2	Test applicability	558
7.4B.3	Minimum conformance requirements	559
7.4B.4	Test description	559
7.4B.4.1	Initial conditions	559
7.4B.4.2	Test procedure	560

7.4B.4.3	Message contents	560
7.4B.5	Test requirement	560
7.5	Adjacent Channel Selectivity (ACS)	561
7.5.1	Test purpose	561
7.5.2	Test applicability	561
7.5.3	Minimum conformance requirements	561
7.5.4	Test description	562
7.5.4.1	Initial conditions	562
7.5.4.2	Test procedure	563
7.5.4.3	Message contents	564
7.5.5	Test requirement	564
7.5A	Adjacent Channel Selectivity (ACS) for CA	565
7.5A.1	Adjacent Channel Selectivity (ACS) for CA (intra-band contiguous DL CA and UL CA)	565
7.5A.1.1	Test purpose	565
7.5A.1.2	Test applicability	566
7.5A.1.3	Minimum conformance requirements	566
7.5A.1.4	Test description	567
7.5A.1.4.1	Initial conditions	567
7.5A.1.4.2	Test procedure	568
7.5A.1.4.3	Message contents	569
7.5A.1.5	Test Requirements	570
7.5A.2	Adjacent Channel Selectivity (ACS) for CA (intra-band contiguous DL CA without UL CA)	571
7.5A.2.1	Test purpose	571
7.5A.2.2	Test applicability	571
7.5A.2.3	Minimum conformance requirements	571
7.5A.2.4	Test description	572
7.5A.2.4.1	Initial conditions	572
7.5A.2.4.2	Test procedure	572
7.5A.2.4.3	Message contents	573
7.5A.2.5	Test Requirements	573
7.5A.3	Adjacent Channel Selectivity (ACS) for CA (inter-band DL CA without UL CA)	573
7.5A.3.1	Test purpose	573
7.5A.3.2	Test applicability	573
7.5A.3.3	Minimum conformance requirements	573
7.5A.3.4	Test description	574
7.5A.3.4.1	Initial conditions	574
7.5A.3.4.2	Test procedure	574
7.5A.3.4.3	Message contents	575
7.5A.3.5	Test Requirements	575
7.5B	Adjacent Channel Selectivity (ACS) for UL-MIMO	576
7.5B.1	Test purpose	576
7.5B.2	Test applicability	576
7.5B.3	Minimum conformance requirements	576
7.5B.4	Test description	577
7.5B.4.1	Initial conditions	577
7.5B.4.2	Test procedure	577
7.5B.4.3	Message contents	578
7.5B.5	Test requirement	578
7.6	Blocking characteristics	579
7.6.1	In-band blocking	579
7.6.1.1	Test Purpose	579
7.6.1.2	Test Applicability	579
7.6.1.3	Minimum Conformance Requirements	580
7.6.1.4	Test Description	580
7.6.1.4.1	Initial Conditions	580
7.6.1.4.2	Test Procedure	582
7.6.1.4.3	Message Contents	582
7.6.1.5	Test Requirement	583
7.6.1A	In-band blocking for CA	584
7.6.1A.1	In-band blocking for CA (intra-band contiguous DL CA and UL CA)	584
7.6.1A.1.1	Test Purpose	584
7.6.1A.1.2	Test Applicability	584

7.6.1A.1.3	Minimum Conformance Requirements	584
7.6.1A.1.4	Test Description.....	586
7.6.1A.1.5	Test Requirement.....	588
7.6.1A.2	In-band blocking for CA (intra-band contiguous DL CA without UL CA)	588
7.6.1A.2.1	Test Purpose	588
7.6.1A.2.2	Test Applicability	588
7.6.1A.2.3	Minimum Conformance Requirements	589
7.6.1A.2.4	Test Description.....	589
7.6.1A.2.4.1	Initial Conditions	589
7.6.1A.2.4.2	Test Procedure	589
7.6.1A.2.4.3	Message Contents	590
7.6.1A.2.5	Test Requirement.....	590
7.6.1A.3	In-band blocking for CA (inter-band DL CA without UL CA)	590
7.6.1A.3.1	Test Purpose	590
7.6.1A.3.2	Test Applicability	590
7.6.1A.3.3	Minimum Conformance Requirements	590
7.6.1A.3.4	Test Description.....	590
7.6.1A.3.4.1	Initial Conditions	590
7.6.1A.3.4.2	Test Procedure	591
7.6.1A.3.4.3	Message Contents	592
7.6.1A.3.5	Test Requirement.....	592
7.6.1B	In-band blocking for UL-MIMO	593
7.6.1B.1	Test Purpose	593
7.6.1B.2	Test Applicability.....	593
7.6.1B.3	Minimum Conformance Requirements	594
7.6.1B.4	Test Description	594
7.6.1B.4.1	Initial Conditions	594
7.6.1B.4.2	Test Procedure	595
7.6.1B.4.3	Message Contents	595
7.6.1B.5	Test Requirement	596
7.6.2	Out-of-band blocking.....	597
7.6.2.1	Test Purpose	597
7.6.2.2	Test Applicability.....	597
7.6.2.3	Minimum Conformance Requirements	597
7.6.2.4	Test Description	598
7.6.2.4.1	Initial Conditions	598
7.6.2.4.2	Test Procedure	599
7.6.2.4.3	Message Contents	600
7.6.2.5	Test Requirement	600
7.6.2A	Out-of-band blocking for CA.....	601
7.6.2A.1	Out-of-band blocking for CA (intra-band contiguous DL CA and UL CA)	601
7.6.2A.1.1	Test Purpose	601
7.6.2A.1.2	Test Applicability	601
7.6.2A.1.3	Minimum Conformance Requirements	601
7.6.2A.1.4	Test Description.....	603
7.6.2A.1.5	Test Requirement.....	604
7.6.2A.2	Out-of-band blocking for CA (intra-band contiguous DL CA without UL CA)	605
7.6.2A.2.1	Test Purpose	605
7.6.2A.2.2	Test Applicability	605
7.6.2A.2.3	Minimum Conformance Requirements	605
7.6.2A.2.4	Test Description.....	605
7.6.2A.2.4.1	Initial Conditions	605
7.6.2A.2.4.2	Test Procedure	606
7.6.2A.2.4.3	Message Contents	606
7.6.2A.2.5	Test Requirement.....	606
7.6.2A.3	Out-of-band blocking for CA (inter-band DL CA without UL CA)	607
7.6.2A.3.1	Test Purpose	607
7.6.2A.3.2	Test Applicability	607
7.6.2A.3.3	Minimum Conformance Requirements	607
7.6.2A.3.4	Test Description.....	607
7.6.2A.3.4.1	Initial Conditions	607
7.6.2A.3.4.2	Test Procedure	608

7.6.2A.3.4.3	Message Contents	609
7.6.2A.3.5	Test Requirement.....	609
7.6.2B	Out-of-band blocking for UL-MIMO	610
7.6.2B.1	Test Purpose	610
7.6.2B.2	Test Applicability.....	610
7.6.2B.3	Minimum Conformance Requirements	610
7.6.2B.4	Test Description	610
7.6.2B.4.1	Initial Conditions	610
7.6.2B.4.2	Test Procedure.....	611
7.6.2B.4.3	Message Contents.....	612
7.6.2B.5	Test Requirement	612
7.6.3	Narrow band blocking	613
7.6.3.1	Test Purpose.....	613
7.6.3.2	Test Applicability.....	613
7.6.3.3	Minimum Conformance Requirements	613
7.6.3.4	Test Description	614
7.6.3.4.1	Initial Conditions	614
7.6.3.4.2	Test Procedure.....	615
7.6.3.4.3	Message Contents.....	615
7.6.3.5	Test Requirement	615
7.6.3A	Narrow band blocking for CA	616
7.6.3A.1	Narrow band blocking for CA (intra-band contiguous DL CA and UL CA).....	616
7.6.3A.1.1	Test Purpose	616
7.6.3A.1.2	Test Applicability	616
7.6.3A.1.3	Minimum Conformance Requirements	616
7.6.3A.1.4	Test Description.....	617
7.6.3A.1.5	Test Requirement.....	618
7.6.3A.2	Narrow band blocking for CA (intra-band contiguous DL CA without UL CA).....	619
7.6.3A.2.1	Test Purpose	619
7.6.3A.2.2	Test Applicability	619
7.6.3A.2.3	Minimum Conformance Requirements	619
7.6.3A.2.4	Test Description.....	619
7.6.3A.2.4.1	Initial Conditions	619
7.6.3A.2.4.2	Test Procedure	620
7.6.3A.2.4.3	Message Contents	620
7.6.3A.2.5	Test Requirement.....	620
7.6.3A.3	Narrow band blocking for CA (inter-band DL CA without UL CA).....	621
7.6.3A.3.1	Test Purpose	621
7.6.3A.3.2	Test Applicability	621
7.6.3A.3.3	Minimum Conformance Requirements	621
7.6.3A.3.4	Test Description.....	621
7.6.3A.3.4.1	Initial Conditions	621
7.6.3A.3.4.2	Test Procedure	622
7.6.3A.3.4.3	Message Contents	623
7.6.3A.3.5	Test Requirement.....	623
7.6.3B	Narrow band blocking for UL-MIMO	623
7.6.3B.1	Test Purpose.....	623
7.6.3B.2	Test Applicability.....	624
7.6.3B.3	Minimum Conformance Requirements	624
7.6.3B.4	Test Description	624
7.6.3B.4.1	Initial Conditions	624
7.6.3B.4.2	Test Procedure.....	625
7.6.3B.4.3	Message Contents.....	625
7.6.3B.5	Test Requirement	625
7.7	Spurious response.....	626
7.7.1	Test Purpose.....	626
7.7.2	Test Applicability	626
7.7.3	Minimum Conformance Requirements.....	626
7.7.4	Test Description.....	627
7.7.4.1	Initial Conditions.....	627
7.7.4.2	Test Procedure.....	627
7.7.4.3	Message Contents	627

7.7.5	Test Requirement	627
7.7A	Spurious response for CA	628
7.7A.1	Spurious response for CA (intra-band contiguous DL CA and UL CA)	628
7.7A.1.1	Test Purpose	628
7.7A.1.2	Test Applicability	628
7.7A.1.3	Minimum Conformance Requirements	628
7.7A.1.4	Test Description	629
7.7A.1.4.1	Initial Conditions	629
7.7A.1.4.2	Test Procedure	629
7.7A.1.4.3	Message Contents	629
7.7A.1.5	Test Requirement	630
7.7A.2	Spurious response for CA (intra-band contiguous DL CA without UL CA)	630
7.7A.2.1	Test Purpose	630
7.7A.2.2	Test Applicability	630
7.7A.2.3	Minimum Conformance Requirements	630
7.7A.2.4	Test Description	630
7.7A.2.4.1	Initial Conditions	630
7.7A.2.4.2	Test Procedure	630
7.7A.2.4.3	Message Contents	631
7.7A.2.5	Test Requirement	631
7.7A.3	Spurious response for CA (inter-band DL CA without UL CA)	631
7.7A.3.1	Test Purpose	631
7.7A.3.2	Test Applicability	631
7.7A.3.3	Minimum Conformance Requirements	631
7.7A.3.4	Test Description	631
7.7A.3.4.1	Initial Conditions	631
7.7A.3.4.2	Test Procedure	631
7.7A.3.4.3	Message Contents	632
7.7A.3.5	Test Requirement	632
7.7B	Spurious response for UL-MIMO	632
7.7B.1	Test Purpose	632
7.7B.2	Test Applicability	632
7.7B.3	Minimum Conformance Requirements	632
7.7B.4	Test Description	633
7.7B.4.1	Initial Conditions	633
7.7B.4.2	Test Procedure	633
7.7B.4.3	Message Contents	633
7.7B.5	Test Requirement	633
7.8	Intermodulation characteristics	634
7.8.1	Wide band Intermodulation	634
7.8.1.1	Test purpose	634
7.8.1.2	Test applicability	634
7.8.1.3	Minimum conformance requirements	634
7.8.1.4	Test description	635
7.8.1.4.1	Initial condition	635
7.8.1.4.2	Test procedure	636
7.8.1.4.3	Message contents	637
7.8.1.5	Test requirements	637
7.8.1A	Wide band Intermodulation for CA	638
7.8.1A.1	Wideband intermodulation for CA (intra-band contiguous DL CA and UL CA)	638
7.8.1A.1.1	Test purpose	638
7.8.1A.1.2	Test applicability	638
7.8.1A.1.3	Minimum conformance requirements	638
7.8.1A.1.4	Test description	639
7.8.1A.1.4.1	Initial condition	639
7.8.1A.1.4.2	Test procedure	640
7.8.1A.1.4.3	Message contents	640
7.8.1A.1.5	Test requirements	640
7.8.1A.2	Wideband intermodulation for CA (intra-band contiguous DL CA without UL CA)	641
7.8.1A.2.1	Test purpose	641
7.8.1A.2.2	Test applicability	641
7.8.1A.2.3	Minimum conformance requirements	641

7.8.1A.2.4	Test description	641
7.8.1A.2.4.1	Initial condition.....	641
7.8.1A.2.4.2	Test procedure.....	642
7.8.1A.2.4.3	Message contents	643
7.8.1A.2.5	Test requirements	643
7.8.1A.3	Wideband intermodulation for CA (inter-band DL CA without UL CA)	643
7.8.1A.3.1	Test purpose	643
7.8.1A.3.2	Test applicability	643
7.8.1A.3.3	Minimum conformance requirements.....	643
7.8.1A.3.4	Test description	643
7.8.1A.3.4.1	Initial condition.....	643
7.8.1A.3.4.2	Test procedure.....	645
7.8.1A.3.4.3	Message contents	645
7.8.1A.3.5	Test requirements	645
7.8.1B	Wide band Intermodulation for UL-MIMO	646
7.8.1B.1	Test purpose	646
7.8.1B.2	Test applicability	646
7.8.1B.3	Minimum conformance requirements	646
7.8.1B.4	Test description	646
7.8.1B.4.1	Initial condition	646
7.8.1B.4.2	Test procedure	647
7.8.1B.4.3	Message contents.....	648
7.8.1B.5	Test requirements	648
7.8.2	Void	649
7.9	Spurious emissions	649
7.9.1	Test Purpose.....	649
7.9.2	Test Applicability	649
7.9.3	Minimum Conformance Requirements.....	649
7.9.4	Test Description	649
7.9.4.1	Initial Conditions.....	649
7.9.4.2	Test Procedure.....	650
7.9.4.3	Message Contents	650
7.9.5	Test Requirement.....	650
7.10	Void.....	651
7.10A	Receiver image for CA.....	651
8	Performance Requirement	652
8.1	General	652
8.1.1	Dual-antenna receiver capability	652
8.1.1.1	Simultaneous unicast and MBMS operations.....	653
8.1.1.2	Dual-antenna receiver capability in idle mode.....	653
8.2	Demodulation of PDSCH (Cell-Specific Reference Symbols)	653
8.2.1	FDD (Fixed Reference Channel)	653
8.2.1.1	FDD PDSCH Single Antenna Port Performance (Cell-Specific Reference Symbols).....	654
8.2.1.1.1	FDD PDSCH Single Antenna Port Performance.....	654
8.2.1.1.1_1	FDD PDSCH Single Antenna Port Performance (Release 9 and forward)	658
8.2.1.1.1_A	FDD PDSCH Single Antenna Port Performance for CA.....	660
8.2.1.1.1_A.1	FDD PDSCH Single Antenna Port Performance for CA (intra-band contiguous DL CA)	660
8.2.1.1.1_A.2	FDD PDSCH Single Antenna Port Performance for CA (inter-band DL CA).....	663
8.2.1.1.1_A.2.1	Test purpose	663
8.2.1.1.1_A.2.2	Test applicability	663
8.2.1.1.1_A.2.3	Minimum conformance requirements	663
8.2.1.1.1_A.2.4	Test description	663
8.2.1.1.1_A.2.4.1	Initial conditions.....	663
8.2.1.1.1_A.2.4.2	Test procedure.....	663
8.2.1.1.1_A.2.4.3	Message contents.....	663
8.2.1.1.1_A.2.5	Test requirement.....	663
8.2.1.1.2	FDD PDSCH Single Antenna Port Performance with 1 PRB in presence of MBSFN	664
8.2.1.2	FDD PDSCH Transmit Diversity Performance (Cell-Specific Reference Symbols).....	666
8.2.1.2.1_1	FDD PDSCH Transmit Diversity 2x2 (Release 9 and forward).....	668
8.2.1.2.2	FDD PDSCH Transmit Diversity 4x2	669
8.2.1.2.2_1	FDD PDSCH Transmit Diversity 4x2 (Release 9 and forward).....	671

8.2.1.2.3_C	FDD PDSCH Transmit diversity 2x2 for eICIC	672
8.2.1.2.3_C.1	FDD PDSCH Transmit diversity 2x2 for eICIC (non-MBFSN ABS).....	672
8.2.1.3	FDD PDSCH Open Loop Spatial Multiplexing Performance (Cell-Specific Reference Symbols)	676
8.2.1.3.1	FDD PDSCH Open Loop Spatial Multiplexing 2x2.....	676
8.2.1.3.1_A	FDD PDSCH Open Loop Spatial Multiplexing 2x2 for CA	678
8.2.1.3.1_A.1	FDD PDSCH Open Loop Spatial Multiplexing 2x2 for CA (intra-band contiguous DL CA)	678
8.2.1.3.1_A.2	FDD PDSCH Open Loop Spatial Multiplexing 2x2 for CA (inter-band DL CA).....	682
8.2.1.3.1_A.2.1	Test purpose	682
8.2.1.3.1_A.2.2	Test applicability	682
8.2.1.3.1_A.2.3	Minimum conformance requirements	683
8.2.1.3.1_A.2.4	Test description	683
8.2.1.3.1_A.2.4.1	Initial conditions.....	683
8.2.1.3.1_A.2.4.2	Test procedure.....	683
8.2.1.3.1_A.2.4.3	Message contents.....	683
8.2.1.3.1_A.2.5	Test requirement.....	684
8.2.1.3.1_A.2_1	FDD PDSCH Open Loop Spatial Multiplexing 2x2 for CA (inter-band DL CA) (Release 11 and forward).....	684
8.2.1.3.1_A.2_1.1	Test purpose	684
8.2.1.3.1_A.2_1.2	Test applicability	684
8.2.1.3.1_A.2_1.3	Minimum conformance requirements	685
8.2.1.3.1_A.2_1.4	Test description	685
8.2.1.3.1_A.2_1.4.1	Initial conditions.....	685
8.2.1.3.1_A.2_1.4.2	Test procedure.....	685
8.2.1.3.1_A.2_1.4.3	Message contents.....	685
8.2.1.3.1_A.2_1.5	Test requirement.....	686
8.2.1.3.2	FDD PDSCH Open Loop Spatial Multiplexing 4x2.....	687
8.2.1.3.3_C	FDD PDSCH Open Loop Spatial Multiplexing 2x2 for eICIC	690
8.2.1.3.3_C.1	FDD PDSCH Open Loop Spatial Multiplexing 2x2 for eICIC (non-MBSFN ABS)	690
8.2.1.3.3_C.2	FDD PDSCH Open Loop Spatial Multiplexing 2x2 for eICIC (MBSFN ABS)	694
8.2.1.4	FDD PDSCH Closed Loop Spatial Multiplexing Performance (Cell-Specific Reference Symbols)..	698
8.2.1.4.1	FDD PDSCH Closed Loop Single/Multi Layer Spatial Multiplexing 2x2.....	698
8.2.1.4.1_1	FDD PDSCH Closed Loop Single/Multi Layer Spatial Multiplexing 2x2 (Release 9 and forward)	702
8.2.1.4.2	FDD PDSCH Closed Loop Single/Multi Layer Spatial Multiplexing 4x2.....	704
8.2.1.4.2_1	FDD PDSCH Closed Loop Single/Multi Layer Spatial Multiplexing 4x2 (Release 9 and forward)	708
8.2.1.4.2_A	FDD PDSCH Closed Loop Multi Layer Spatial Multiplexing 4x2 for CA.....	709
8.2.1.4.2_A.1	FDD PDSCH Closed Loop Multi Layer Spatial Multiplexing 4x2 for CA (intra-band contiguous DL CA)	709
8.2.1.4.2_A.2	FDD PDSCH Closed Loop Multi Layer Spatial Multiplexing 4x2 for CA (inter-band DL CA) ..	713
8.2.2	TDD (Fixed Reference Channel)	717
8.2.2.1	TDD PDSCH Single Antenna Port Performance (Cell-Specific Reference Symbols).....	719
8.2.2.1.1	TDD PDSCH Single Antenna Port Performance	719
8.2.2.1.1_1	TDD PDSCH Single Antenna Port Performance (Release 9 and forward)	722
8.2.2.1.1_A	TDD PDSCH Single Antenna Port Performance for CA	724
8.2.2.1.1_A.1	TDD PDSCH Single Antenna Port Performance for CA (intra-band contiguous DL CA)	724
8.2.2.1.2	TDD PDSCH Single Antenna Port Performance with 1 PRB in the presence of MBSFN	727
8.2.2.2	TDD PDSCH Transmit Diversity Performance (Cell-Specific Reference Symbols).....	729
8.2.2.2.1	TDD PDSCH Transmit Diversity 2x2	729
8.2.2.2.1_1	TDD PDSCH Transmit Diversity 2x2 (Release 9 and forward).....	731
8.2.2.2.2	TDD PDSCH Transmit Diversity 4x2	732
8.2.2.2.2_1	TDD PDSCH Transmit Diversity 4x2 (Release 9 and forward).....	734
8.2.2.2.3_C	TDD PDSCH Transmit diversity 2x2 for eICIC	735
8.2.2.2.3_C.1	TDD PDSCH Transmit diversity 2x2 for eICIC (non-MBFSN ABS)	735
8.2.2.3	TDD PDSCH Open Loop Spatial Multiplexing Performance (Cell-Specific Reference Symbols)....	739
8.2.2.3.1	TDD PDSCH Open Loop Spatial Multiplexing 2x2	739
8.2.2.3.1_A	TDD PDSCH Open Loop Spatial Multiplexing 2x2 for CA	741
8.2.2.3.1_A.1	TDD PDSCH Open Loop Spatial Multiplexing 2x2 for CA (intra-band contiguous DL CA)	741
8.2.2.3.2	TDD PDSCH Open Loop Spatial Multiplexing 4x2	744
8.2.2.3.3_C	TDD PDSCH Open Loop Spatial Multiplexing 2x2 for eICIC	746

8.2.2.3.3_C.1	TDD PDSCH Open Loop Spatial Multiplexing 2x2 for eICIC (non-MBSFN ABS)	746
8.2.2.3.3_C.2	TDD PDSCH Open Loop Spatial Multiplexing 2x2 for eICIC (MBSFN ABS)	751
8.2.2.4	TDD PDSCH Closed Loop Spatial Multiplexing Performance (Cell-Specific Reference Symbols)	756
8.2.2.4.1	TDD PDSCH Closed Loop Single/Multi Layer Spatial Multiplexing 2x2.....	756
8.2.2.4.1_1	TDD PDSCH Closed Loop Single/Multi Layer Spatial Multiplexing 2x2 (Release 9 and forward)	760
8.2.2.4.1_1.1	Test purpose	760
8.2.2.4.1_1.2	Test applicability	760
8.2.2.4.1_1.3	Minimum conformance requirements.....	761
8.2.2.4.1_1.4	Test description	761
8.2.2.4.2	TDD PDSCH Closed Loop Single/Multi Layer Spatial Multiplexing 4x2.....	762
8.2.2.4.2_1	TDD PDSCH Closed Loop Multi Layer Spatial Multiplexing 4x2 (Release 9 and forward).....	766
8.2.2.4.2_A	TDD PDSCH Closed Loop Multi Layer Spatial Multiplexing 4x2 for CA.....	768
8.2.2.4.2_A.1	TDD PDSCH Closed Loop Multi Layer Spatial Multiplexing 4x2 for CA (intra-band contiguous DL CA)	768
8.3	Demodulation of PDSCH (User-Specific Reference Symbols).....	773
8.3.1	FDD	773
8.3.1.1	FDD PDSCH Single-layer Spatial Multiplexing Performance (UE-Specific Reference Symbols)	773
8.3.1.1.1_D	FDD PDSCH Single-layer Spatial Multiplexing on antenna ports 7 or 8 without a simultaneous transmission for eDL-MIMO.....	773
8.3.1.1.1_D.1	Test purpose.....	773
8.3.1.1.1_D.2	Test applicability.....	773
8.3.1.1.1_D.3	Minimum conformance requirements	773
8.3.1.1.1_D.4	Test description.....	775
8.3.1.1.2_D	FDD PDSCH Single-layer Spatial Multiplexing on antenna ports 7 or 8 with a simultaneous transmission for eDL-MIMO.....	777
8.3.1.1.2_D.1	Test purpose.....	777
8.3.1.1.2_D.2	Test applicability.....	777
8.3.1.1.2_D.3	Minimum conformance requirements	777
8.3.1.1.2_D.4	Test description.....	779
8.3.1.1.3	FDD PDSCH Single-layer Spatial Multiplexing on antenna ports 7 or 8 with TM9 Interference Model - Enhanced Performance Requirement Type A.....	781
8.3.1.1.3.1	Test purpose.....	781
8.3.1.1.3.2	Test applicability.....	781
8.3.1.1.3.3	Minimum conformance requirements	781
8.3.1.1.3.4	Test description.....	783
8.3.1.2	FDD PDSCH Dual-layer Spatial Multiplexing Performance (UE-Specific Reference Symbols).....	786
8.3.1.2.1_D	FDD PDSCH Dual-layer Spatial Multiplexing for eDL-MIMO	786
8.3.1.2.1_D.1	Test purpose.....	786
8.3.1.2.1_D.2	Test applicability.....	786
8.3.1.2.1_D.3	Minimum conformance requirements	786
8.3.1.2.1_D.4	Test description.....	787
8.3.1.2.1_D.4.2	Test procedure.....	788
8.3.1.2.1_D.4.3	Message contents.....	788
8.3.1.2.1_D.5	Test requirement.....	789
8.3.2	TDD	790
8.3.2.1	TDD PDSCH Single-layer Spatial Multiplexing Performance (UE-Specific Reference Symbols)	791
8.3.2.1.1	TDD PDSCH Single-layer Spatial Multiplexing on antenna port 5 (Release 8 and forward).....	791
8.3.2.1.1_1	TDD PDSCH Single-layer Spatial Multiplexing on antenna port 5 (Release 9 and forward).....	793
8.3.2.1.2	TDD PDSCH Single-layer Spatial Multiplexing on antenna port 7 or 8 without a simultaneous transmission.....	795
8.3.2.1.2_D	TDD PDSCH Single-layer Spatial Multiplexing on antenna ports 7 or 8 without a simultaneous transmission for eDL-MIMO.....	798
8.3.2.1.3	TDD PDSCH Single-layer Spatial Multiplexing on antenna port 7 or 8 with a simultaneous transmission.....	802
8.3.2.1.4	TDD PDSCH Single-layer Spatial Multiplexing on antenna ports 7 or 8 with TM9 Interference Model - Enhanced Performance Requirement Type A.....	808
8.3.2.1.4.1	Test purpose.....	808
8.3.2.1.4.2	Test applicability.....	808
8.3.2.1.4.3	Minimum conformance requirements	808
8.3.2.1.4.4	Test description.....	810

8.3.2.1.4.5	Test requirement	813
8.3.2.2	TDD PDSCH Dual-layer Spatial Multiplexing Performance (UE-Specific Reference Symbols)	813
8.3.2.2.1	TDD PDSCH Dual-layer Spatial Multiplexing	813
8.3.2.2.1_D	TDD PDSCH Dual-layer Spatial Multiplexing for eDL-MIMO	816
8.3.2.2.1_D.1	Test purpose	816
8.3.2.2.1_D.2	Test applicability	816
8.3.2.2.1_D.3	Minimum conformance requirements	816
8.3.2.2.1_D.4	Test description	817
8.3.2.2.1_D.4.2	Test procedure	818
8.3.2.2.1_D.4.3	Message contents	818
8.3.2.2.1_D.5	Test requirement	819
8.4	Demodulation of PCFICH/PDCCH	820
8.4.1	FDD	820
8.4.1.1	FDD PCFICH/PDCCH Single-antenna Port Performance	820
8.4.1.1.1	Test purpose	820
8.4.1.1.2	Test applicability	820
8.4.1.1.3	Minimum conformance requirements	820
8.4.1.1.4	Test description	821
8.4.1.1.5	Test requirement	822
8.4.1.2	FDD PCFICH/PDCCH Transmit Diversity Performance	822
8.4.1.2.1	FDD PCFICH/PDCCH Transmit Diversity 2x2	822
8.4.1.2.1_1	FDD PCFICH/PDCCH Transmit Diversity 2x2 (Release 9 and forward)	824
8.4.1.2.2	FDD PCFICH/PDCCH Transmit Diversity 4x2	827
8.4.1.2.2_1	FDD PCFICH/PDCCH Transmit Diversity 4x2 (Release 9 and forward)	829
8.4.1.2.3_C	FDD PCFICH/PDCCH Transmit Diversity 2x2 for eICIC	832
8.4.1.2.3_C.1	FDD PCFICH/PDCCH Transmit Diversity 2x2 for eICIC (non-MBSFN ABS)	832
8.4.1.2.3_C.2	FDD PCFICH/PDCCH Transmit Diversity 2x2 for eICIC (MBSFN ABS)	836
8.4.2	TDD	841
8.4.2.1	TDD PCFICH/PDCCH Single-antenna Port Performance	841
8.4.2.1.1	Test purpose	841
8.4.2.1.2	Test applicability	841
8.4.2.1.3	Minimum conformance requirements	841
8.4.2.1.4	Test description	842
8.4.2.1.5	Test requirement	843
8.4.2.2	TDD PCFICH/PDCCH Transmit Diversity Performance	844
8.4.2.2.1	TDD PCFICH/PDCCH Transmit Diversity 2x2	844
8.4.2.2.1_1	TDD PCFICH/PDCCH Transmit Diversity 2x2 (Release 9 and forward)	846
8.4.2.2.1_1.2	Test applicability	846
8.4.2.2.2	TDD PCFICH/PDCCH Transmit Diversity 4x2	849
8.4.2.2.2_1	TDD PCFICH/PDCCH Transmit Diversity 4x2 (Release 9 and forward)	852
8.4.2.2.3_C	TDD PCFICH/PDCCH Transmit Diversity 2x2 for eICIC	854
8.4.2.2.3_C.1	TDD PCFICH/PDCCH Transmit Diversity 2x2 for eICIC (non-MBSFN ABS)	854
8.4.2.2.3_C.2	TDD PCFICH/PDCCH Transmit Diversity 2x2 for eICIC (MBSFN ABS)	859
8.5	Demodulation of PHICH	864
8.5.1	FDD	864
8.5.1.1	FDD PHICH Single-antenna Port Performance	864
8.5.1.1.1	Test purpose	864
8.5.1.1.2	Test applicability	864
8.5.1.1.3	Minimum conformance requirements	864
8.5.1.1.4	Test description	865
8.5.1.1.5	Test requirement	867
8.5.1.2	FDD PHICH Transmit Diversity Performance	867
8.5.1.2.1	FDD PHICH Transmit Diversity 2x2	867
8.5.1.2.1_1	FDD PHICH Transmit Diversity 2x2 (Release 9 and forward)	870
8.5.1.2.2	FDD PHICH Transmit Diversity 4x2	872
8.5.1.2.2_1	FDD PHICH Transmit Diversity 4x2 (Release 9 and forward)	875
8.5.1.2.3_C	FDD PHICH Transmit Diversity 2x2 for eICIC	877
8.5.1.2.3_C.1	FDD PHICH Transmit Diversity 2x2 for eICIC (non-MBSFN ABS)	877
8.5.2	TDD	881
8.5.2.1	TDD PHICH Single-antenna Port Performance	881
8.5.2.1.1	Test purpose	881
8.5.2.1.2	Test applicability	881

8.5.2.1.3	Minimum conformance requirements.....	881
8.5.2.1.4	Test description	882
8.5.2.1.5	Test requirement	884
8.5.2.2	TDD PHICH Transmit Diversity Performance	884
8.5.2.2.1	TDD PHICH Transmit Diversity 2x2.....	884
8.5.2.2.1_1	TDD PHICH Transmit Diversity 2x2 (Release 9 and forward).....	887
8.5.2.2.2	TDD PHICH Transmit Diversity 4x2.....	890
8.5.2.2.2_1	TDD PHICH Transmit Diversity 4x2 (Release 9 and forward).....	892
8.5.2.2.3_C	TDD PHICH Transmit Diversity 2x2 for eICIC	895
8.5.2.2.3_C.1	TDD PHICH Transmit Diversity 2x2 for eICIC (non-MBSFN ABS)	895
8.6	Demodulation of PBCH	899
8.7	Sustained downlink data rate provided by lower layers	899
8.7.1	FDD	899
8.7.1.1	FDD sustained data rate performance	899
8.7.1.1.1	Test purpose	899
8.7.1.1.2	Test applicability	900
8.7.1.1.3	Minimum requirements	900
8.7.1.1.4	Test description	902
8.7.1.1.5	Test requirement	904
8.7.1.1_A	FDD sustained data rate performance for CA	905
8.7.1.1_A.1	FDD Sustained data rate performance for CA (intra-band contiguous DL CA).....	905
8.7.1.1_A.1.1	Test purpose	905
8.7.1.1_A.1.2	Test applicability	905
8.7.1.1_A.1.3	Minimum requirements	905
8.7.1.1_A.1.4	Test description	907
8.7.1.1_A.1.5	Test requirement	909
8.7.1.1_A.2	FDD Sustained data rate performance for CA (inter-band DL CA).....	909
8.7.1.1_A.2.1	Test purpose	909
8.7.1.1_A.2.2	Test applicability	909
8.7.1.1_A.2.3	Minimum requirements	909
8.7.1.1_A.2.4	Test description	911
8.7.1.1_A.2.5	Test requirement	913
8.7.1.1_A.2_1	FDD Sustained data rate performance for CA (inter-band DL CA) (Release 11 and forward).....	914
8.7.1.1_A.2_1.1	Test purpose	914
8.7.1.1_A.2_1.2	Test applicability	914
8.7.1.1_A.2_1.3	Minimum requirements	914
8.7.1.1_A.2_1.4	Test description	915
8.7.1.1_A.2_1.5	Test requirement	917
8.7.2	TDD.....	918
8.7.2.1	TDD sustained data rate performance	918
8.7.2.1.1	Test purpose	918
8.7.2.1.2	Test applicability	919
8.7.2.1.3	Minimum requirements	919
8.7.2.1.4	Test description	921
8.7.2.1.5	Test requirement	923
8.7.2.1_1	TDD sustained data rate performance (Rel-10 and forward)	924
8.7.2.1_1.1	Test purpose	924
8.7.2.1_1.2	Test applicability	924
8.7.2.1_1.3	Minimum requirements	924
8.7.2.1_1.4	Test description	925
8.7.2.1_1.5	Test requirement	926
8.7.2.1_A	TDD sustained data rate performance for CA.....	926
8.7.2.1_A.1	TDD sustained data rate performance for CA (intra-band contiguous DL CA).....	926
8.7.2.1_A.1.1	Test purpose	927
8.7.2.1_A.1.2	Test applicability	927
8.7.2.1_A.1.3	Minimum requirements	927
8.7.2.1_A.1.4	Test description	929
8.7.2.1_A.1.5	Test requirement	930
9	Reporting of Channel State Information	931
9.1	General	931
9.2	CQI Reporting under AWGN conditions	931

9.2.1	CQI Reporting under AWGN conditions - PUCCH 1-0 (Cell-Specific Reference Symbols)	931
9.2.1.1	FDD CQI Reporting under AWGN conditions – PUCCH 1-0	931
9.2.1.1.1	Test purpose	931
9.2.1.1.2	Test applicability	931
9.2.1.1.3	Minimum conformance requirements.....	931
9.2.1.1.4	Test description	932
9.2.1.1.5	Test requirement.....	934
9.2.1.2	TDD CQI Reporting under AWGN conditions – PUCCH 1-0	934
9.2.1.2.1	Test purpose	934
9.2.1.2.2	Test applicability	934
9.2.1.2.3	Minimum conformance requirements.....	934
9.2.1.2.4	Test description	935
9.2.1.2.5	Test requirement.....	937
9.2.1.3	937	
9.2.1.3_C	FDD CQI Reporting under AWGN conditions – PUCCH 1-0 for eICIC	937
9.2.1.3_C.1	FDD CQI Reporting under AWGN conditions – PUCCH 1-0 for eICIC (non-MBSFN ABS)	937
9.2.1.3_C.1.1	Test purpose	938
9.2.1.3_C.1.2	Test applicability	938
9.2.1.3_C.1.3	Minimum conformance requirements.....	938
9.2.1.3_C.1.4	Test description	940
9.2.1.3_C.1.5	Test requirement.....	942
9.2.1.4	942
9.2.1.4_C	TDD CQI Reporting under AWGN conditions – PUCCH 1-0 for eICIC.....	942
9.2.1.4_C.1	TDD CQI Reporting under AWGN conditions – PUCCH 1-0 for eICIC (non-MBSFN ABS).....	942
9.2.2	CQI Reporting under AWGN conditions - PUCCH 1-1 (Cell-Specific Reference Symbols)	947
9.2.2.1	FDD CQI Reporting under AWGN conditions – PUCCH 1-1	947
9.2.2.1.1	Test purpose	947
9.2.2.1.2	Test applicability	948
9.2.2.1.3	Minimum conformance requirements.....	948
9.2.2.1.4	Test description	949
9.2.2.1.5	Test requirement.....	951
9.2.2.1_D.5	Test requirement.....	951
9.2.2.2	TDD CQI Reporting under AWGN conditions – PUCCH 1-1	951
9.2.2.2.1	Test purpose	951
9.2.2.2.2	Test applicability	951
9.2.2.2.3	Minimum conformance requirements.....	951
9.2.2.2.4	Test description	952
9.2.2.2.5	Test requirement.....	955
9.2.3	CQI Reporting under AWGN conditions - PUCCH 1-1 (CSI Reference Symbols)	955
9.2.3.1_D	FDD CQI Reporting under AWGN conditions – PUCCH 1-1 for eDL-MIMO	955
9.2.3.1_D.1	Test purpose	955
9.2.3.1_D.2	Test applicability	955
9.2.3.1_D.3	Minimum conformance requirements.....	955
9.2.3.1_D.4	Test description	956
9.2.3.1_D.5	Test requirement.....	960
9.2.3.2_D	TDD CQI Reporting under AWGN conditions – PUCCH 1-1 for eDL-MIMO	960
9.2.3.2_D.1	Test purpose	960
9.2.3.2_D.2	Test applicability	960
9.2.3.2_D.3	Minimum conformance requirements.....	960
9.2.3.2_D.4	Test description	962
9.2.3.2_D.5	Test requirement.....	965
9.3	CQI Reporting under fading conditions	966
9.3.1	Frequency-selective scheduling mode	966
9.3.1.1	CQI Reporting under fading conditions – PUSCH 3-0 (Cell-Specific Reference Symbols).....	966
9.3.1.1.1	FDD CQI Reporting under fading conditions – PUSCH 3-0.....	966
9.3.1.1.2	TDD CQI Reporting under fading conditions – PUSCH 3-0	969
9.3.1.2	CQI Reporting under fading conditions – PUSCH 3-1 (CSI Reference Symbols)	973
9.3.1.2.1_D	FDD CQI Reporting under fading conditions – PUSCH 3-1 for eDL MIMO.....	973
9.3.1.2.2_D	TDD CQI Reporting under fading conditions – PUSCH 3-1 for eDL MIMO	977
9.3.2	Frequency non-selective scheduling mode	982
9.3.2.1	CQI Reporting under fading conditions – PUCCH 1-0 (Cell-Specific Reference Symbols).....	983
9.3.2.1.1	FDD CQI Reporting under fading conditions – PUCCH 1-0	983

9.3.2.1.1_1	FDD CQI Reporting under fading conditions - PUCCH 1-0 (Release 9 and forward).....	986
9.3.2.1.2	TDD CQI Reporting under fading conditions – PUCCH 1-0.....	987
9.3.2.2	CQI Reporting under fading conditions – PUCCH 1-1 (CSI Reference Symbols).....	992
9.3.2.2.1_D	FDD CQI Reporting under fading conditions – PUCCH 1-1 for eDL-MIMO.....	992
9.3.2.2.1_D.1	Test purpose.....	992
9.3.2.2.1_D.2	Test applicability.....	992
9.3.2.2.1_D.3	Minimum conformance requirements.....	992
9.3.2.2.1_D.4	Test description.....	993
9.3.2.2.1_D.4.2	Test procedure.....	994
9.3.2.2.1_D.4.3	Message contents.....	995
9.3.2.2.1_D.5	Test requirement.....	996
9.3.2.2.2_D	TDD CQI Reporting under fading conditions – PUCCH 1-1 for eDL-MIMO.....	997
9.3.2.2.2_D.1	Test purpose.....	997
9.3.2.2.2_D.2	Test applicability.....	997
9.3.2.2.2_D.3	Minimum conformance requirements.....	997
9.3.2.2.2_D.4	Test description.....	999
9.3.2.2.2_D.4.2	Test procedure.....	999
9.3.2.2.2_D.4.3	Message contents.....	1000
9.3.2.2.2_D.5	Test requirement.....	1002
9.3.3	Frequency-selective interference.....	1002
9.3.3.1	CQI Reporting under fading conditions and frequency-selective interference – PUSCH 3-0 (Cell-Specific Reference Symbols).....	1003
9.3.3.1.1	FDD CQI Reporting under fading conditions and frequency-selective interference – PUSCH 3-0.....	1003
9.3.3.1.2	TDD CQI Reporting under fading conditions and frequency-selective interference – PUSCH 3-0.....	1006
9.3.4	UE-selected subband CQI.....	1009
9.3.4.1	CQI Reporting under fading conditions – PUSCH 2-0 (Cell-Specific Reference Symbols).....	1010
9.3.4.1.1	FDD CQI Reporting under fading conditions – PUSCH 2-0.....	1010
9.3.4.1.2	TDD CQI Reporting under fading conditions – PUSCH 2-0.....	1012
9.3.4.2	CQI Reporting under fading conditions – PUCCH 2-0 (Cell-Specific Reference Symbols).....	1015
9.3.4.2.1	FDD CQI Reporting under fading conditions – PUCCH 2-0.....	1015
9.3.4.2.2	TDD CQI Reporting under fading conditions – PUCCH 2-0.....	1019
9.3.5	Additional requirements for enhanced receiver Type A.....	1024
9.3.5.1	PUCCH 1-0 (Cell-Specific Reference Symbol).....	1024
9.3.5.1.1	FDD CQI Reporting under fading conditions - PUCCH 1-0 - Enhanced Performance Requirement Type A.....	1024
9.4	Reporting of Precoding Matrix Indicator (PMI).....	1027
9.4.1	Single PMI.....	1028
9.4.1.1	PMI Reporting – PUSCH 3-1 (Single PMI) (Cell-Specific Reference Symbols).....	1028
9.4.1.1.1	FDD PMI Reporting – PUSCH 3-1 (Single PMI).....	1028
9.4.1.1.2	TDD PMI Reporting – PUSCH 3-1 (Single PMI).....	1031
9.4.1.2	PMI Reporting – PUCCH 2-1 (Single PMI) (Cell-Specific Reference Symbols).....	1034
9.4.1.2.1	FDD PMI Reporting – PUCCH 2-1 (Single PMI).....	1034
9.4.1.2.2	TDD PMI Reporting – PUCCH 2-1 (Single PMI).....	1038
9.4.1.3	PMI Reporting – PUSCH 3-1 (Single PMI) (CSI Reference Symbols).....	1042
9.4.1.3.1	1042
9.4.1.3.1_D	FDD Reporting of PMI – PUSCH 3-1 (Single PMI) for eDL MIMO.....	1042
9.4.1.3.1_D.4.2	Test procedure.....	1044
9.4.1.3.2_D	TDD Reporting of PMI – PUSCH 3-1 (Single PMI) for eDL-MIMO.....	1046
9.4.1.3.2_D.4.2	Test procedure.....	1048
9.4.2	Multiple PMI.....	1051
9.4.2.1	PMI Reporting – PUSCH 1-2 (Multiple PMI) (Cell-Specific Reference Symbols).....	1051
9.4.2.1.1	FDD PMI Reporting – PUSCH 1-2 (Multiple PMI).....	1051
9.4.2.1.1_1	FDD PMI Reporting – PUSCH 1-2 (Multiple PMI) (Release 9 and forward).....	1053
9.4.2.1.2	TDD PMI Reporting – PUSCH 1-2 (Multiple PMI).....	1056
9.4.2.1.2_1	TDD PMI Reporting – PUSCH 1-2 (Multiple PMI) (Release 9 and forward).....	1059
9.4.2.2	PMI Reporting – PUSCH 2-2 (Multiple PMI) (Cell-Specific Reference Symbols).....	1062
9.4.2.2.1	FDD PMI Reporting – PUSCH 2-2 (Multiple PMI).....	1062
9.4.2.2.2	TDD PMI Reporting – PUSCH 2-2 (Multiple PMI).....	1065
9.4.2.3	PMI Reporting – PUSCH 1-2 (Multiple PMI) (CSI Reference Symbols).....	1068
9.4.2.3.1	1068

9.4.2.3.1_D	FDD PMI Reporting - PUSCH 1-2 (Multiple PMI) for eDL-MIMO	1068
9.4.2.3.2_D	TDD PMI Reporting - PUSCH 1-2 (Multiple PMI) for eDL-MIMO	1072
9.5	Reporting of Rank Indicator (RI)	1077
9.5.1	RI Reporting (Cell-Specific Reference Symbols)	1077
9.5.1.1	FDD RI Reporting– PUCCH 1-1	1077
9.5.1.1.1	Test purpose	1077
9.5.1.1.2	Test applicability	1077
9.5.1.1.3	Minimum conformance requirements	1077
9.5.1.1.4	Test description	1079
9.5.1.1.5	Test requirement	1081
9.5.1.1_1	FDD RI Reporting– PUCCH 1-1 (Release 10)	1081
9.5.1.1_1.1	Test purpose	1081
9.5.1.1_1.2	Test applicability	1081
9.5.1.1_1.3	Minimum conformance requirements	1081
9.5.1.1_1.4	Test description	1082
9.5.1.1_1.5	Test requirement	1084
9.5.1.1_2	FDD RI Reporting– PUCCH 1-1 (Release 11)	1084
9.5.1.1_2.1	Test purpose	1084
9.5.1.1_2.2	Test applicability	1084
9.5.1.1_2.3	Minimum conformance requirements	1084
9.5.1.1_2.4	Test description	1085
9.5.1.1_2.5	Test requirement	1086
9.5.1.2	TDD RI Reporting – PUSCH 3-1	1086
9.5.1.2.1	Test purpose	1086
9.5.1.2.2	Test applicability	1086
9.5.1.2.3	Minimum conformance requirements	1086
9.5.1.2.4	Test description	1087
9.5.1.2.5	Test requirement	1090
9.5.1.2_1	TDD RI Reporting – PUSCH 3-1 (Release 10)	1090
9.5.1.2_1.1	Test purpose	1090
9.5.1.2_1.2	Test applicability	1090
9.5.1.2_1.3	Minimum conformance requirements	1090
9.5.1.2_1.4	Test description	1091
9.5.1.2_1.5	Test requirement	1092
9.5.1.2_2	TDD RI Reporting – PUSCH 3-1 (Release 11)	1092
9.5.1.2_2.1	Test purpose	1092
9.5.1.2_2.2	Test applicability	1093
9.5.1.2_2.3	Minimum conformance requirements	1093
9.5.1.2_2.4	Test description	1093
9.5.1.2_2.5	Test requirement	1094
9.5.2	RI Reporting (CSI Reference Symbols)	1094
9.5.2.1	1094
9.5.2.1_D	FDD RI Reporting- PUCCH 1-1 for eDL-MIMO	1094
9.5.2.1_D.1	Test purpose	1094
9.5.2.1_D.2	Test applicability	1094
9.5.2.1_D.3	Minimum conformance requirements	1094
9.5.2.1_D.4	Test description	1096
9.5.2.1_D.5	Test requirement	1098
9.5.2.2_D	TDD RI Reporting- PUCCH 1-1 for eDL-MIMO	1099
9.5.2.2_D.1	Test purpose	1099
9.5.2.2_D.2	Test applicability	1099
9.5.2.2_D.3	Minimum conformance requirements	1099
9.5.2.2_D.4	Test description	1101
9.5.2.2_D.5	Test requirement	1104
9.5.3	RI Reporting (Cell-Specific Reference Symbols)	1104
9.5.3.1_C	FDD RI Reporting – PUCCH 1-0 for eICIC	1104
9.5.3.1_C.1	FDD RI Reporting – PUCCH 1-0 for eICIC (non-MBSFN ABS)	1104
9.5.3.1_C.1.1	Test purpose	1104
9.5.3.1_C.1.2	Test applicability	1105
9.5.3.1_C.1.3	Minimum conformance requirements	1105
9.5.3.1_C.1.4	Test description	1107
9.5.3.1_C.1.4.1	Initial conditions	1107

9.5.3.1_C.1.4.2	Test procedure	1108
9.5.3.1_C.1.4.3	Message contents.....	1108
9.5.3.1_C.1.5	Test requirement	1108
9.5.3.2_C	TDD RI Reporting – PUCCH 1-0 for eICIC.....	1108
9.5.3.2_C.1	TDD RI Reporting – PUCCH 1-0 for eICIC (non-MBSFN ABS).....	1108
9.5.3.2_C.1.1	Test purpose.....	1109
9.5.3.2_C.1.2	Test applicability.....	1109
9.5.3.2_C.1.3	Minimum conformance requirements	1109
9.5.3.2_C.1.4	Test description.....	1111
9.5.3.2_C.1.4.1	Initial conditions.....	1111
9.5.3.2_C.1.4.2	Test procedure.....	1112
9.5.3.2_C.1.4.3	Message contents.....	1112
9.5.3.2_C.1.5	Test requirement	1112
9.6	Additional requirements for carrier aggregation	1113
9.6.1	Periodic reporting on multiple cells (Cell-Specific Reference Symbols)	1113
9.6.1.1_A	FDD CQI Reporting under AWGN conditions – PUCCH 1-0 for CA	1113
9.6.1.1_A.1	FDD CQI Reporting under AWGN conditions – PUCCH 1-0 for CA (intra band contiguous DL CA).....	1113
9.6.1.1_A.2	FDD CQI Reporting under AWGN conditions – PUCCH 1-0 for CA (inter band DL CA)	1113
9.6.1.1_A.2.1	Test purpose.....	1113
9.6.1.1_A.2.2	Test applicability.....	1113
9.6.1.1_A.2.3	Minimum conformance requirements	1113
9.6.1.1_A.2.4	Test description.....	1114
9.6.1.1_A.2.4.1	Initial conditions.....	1114
9.6.1.1_A.2.4.2	Test procedure.....	1114
9.6.1.1_A.2.4.3	Message contents.....	1115
9.6.1.1_A.2.5	Test requirement	1115
9.6.1.2_A	TDD CQI Reporting under AWGN conditions – PUCCH 1-0 for CA	1115
9.6.1.2_A.1	TDD CQI Reporting under AWGN conditions – PUCCH 1-0 for CA (intra band contiguous DL CA).....	1115
9.6.1.2_A.1.1	Test purpose.....	1115
9.6.1.2_A.1.2	Test applicability.....	1115
9.6.1.2_A.1.3	Minimum conformance requirements	1115
9.6.1.2_A.1.4	Test description.....	1116
9.6.1.2_A.1.4.1	Initial conditions.....	1116
9.6.1.2_A.1.4.2	Test procedure.....	1116
9.6.1.2_A.1.4.3	Message contents.....	1117
9.6.1.2_A.1.5	Test requirement	1117
9.6.1.2_A.2	TDD CQI Reporting under AWGN conditions – PUCCH 1-0 for CA (inter band DL CA)	1117
10	MBMS Performance.....	1117
10.1	FDD MBMS performance (Fixed Reference Channel).....	1117
10.1.1	Test purpose.....	1117
10.1.2	Test applicability	1117
10.1.3	Minimum conformance requirements	1117
10.1.4	Test description.....	1118
10.1.4.1	Initial conditions	1118
10.1.4.2	Test procedure.....	1119
10.1.4.3	Message contents	1119
10.1.5	Test requirement	1121
10.2	TDD MBMS performance (Fixed Reference Channel).....	1121
10.2.1	Test purpose.....	1121
10.2.2	Test applicability	1121
10.2.3	Minimum conformance requirements	1121
10.2.4	Test description.....	1122
10.2.4.1	Initial conditions	1122
10.2.4.2	Test procedure.....	1123
10.2.4.3	Message contents	1123
10.2.5	Test requirement	1125
Annex A (normative):	Measurement Channels.....	1126
A.1	General	1126

A.2	UL reference measurement channels	1127
A.2.1	General	1127
A.2.1.1	Applicability and common parameters	1127
A.2.1.2	Determination of payload size	1127
A.2.1.3	Overview of UL reference measurement channels	1128
A.2.2	Reference measurement channels for FDD	1135
A.2.2.1	Full RB allocation.....	1135
A.2.2.1.1	QPSK	1135
A.2.2.1.2	16-QAM.....	1135
A.2.2.2	Partial RB allocation.....	1135
A.2.2.2.1	QPSK	1136
A.2.2.2.2	16-QAM.....	1140
A.2.2.3	Reference measurement channels for sustained downlink data rate provided by lower layers.....	1143
A.2.3	Reference measurement channels for TDD.....	1143
A.2.3.1	Full RB allocation.....	1143
A.2.3.1.1	QPSK	1143
A.2.3.1.2	16-QAM.....	1144
A.2.3.2	Partial RB allocation.....	1144
A.2.3.2.1	QPSK	1144
A.2.3.2.2	16-QAM.....	1151
A.2.3.3	Reference measurement channels for sustained downlink data rate provided by lower layers.....	1154
A.3	DL reference measurement channels	1154
A.3.1	General	1154
A.3.1.1	Overview of DL reference measurement channels	1155
A.3.2	Reference measurement channel for receiver characteristics	1161
A.3.2A	Downlink Reference measurement channel for TX characteristics.....	1167
A.3.3	Reference measurement channel for PDSCH performance requirements (FDD)	1170
A.3.3.1	Single-antenna transmission (Common Reference Symbols)	1170
A.3.3.2	Multi-antenna transmission (Common Reference Symbols)	1174
A.3.3.2.1	Two antenna ports.....	1174
A.3.3.2.2	Four antenna ports.....	1176
A.3.3.3	Reference Measurement Channel for UE-Specific Reference Symbols	1176
A.3.3.3.1	Two antenna port (CSI-RS)	1176
A.3.3.3.2	Four antenna ports (CSI-RS).....	1177
A.3.4	Reference measurement channel for PDSCH performance requirements (TDD)	1180
A.3.4.1	Single-antenna transmission (Common Reference Symbols).....	1180
A.3.4.2	Multi-antenna transmission (Common Reference Symbols)	1186
A.3.4.2.1	Two antenna ports.....	1186
A.3.4.2.2	Four antenna ports.....	1188
A.3.4.3	Reference Measurement Channels for UE-Specific Reference Symbols	1188
A.3.4.3.3	Two antenna ports (CSI-RS).....	1190
A.3.4.3.4	Four antenna ports (CSI-RS).....	1191
A.3.4.3.5	Eight antenna ports (CSI-RS).....	1192
A.3.5	Reference measurement channels for PDCCH/PCFICH performance requirements	1195
A.3.5.1	FDD	1195
A.3.5.2	TDD.....	1196
A.3.6	Reference measurement channels for PHICH performance requirements	1197
A.3.7	[FFS]	1198
A.3.8	Reference measurement channels for MBMS performance requirements	1198
A.3.8.1	FDD	1198
A.3.8.2	TDD.....	1199
A.3.9	Reference measurement channels for sustained downlink data rate provided by lower layers	1201
A.3.9.1	FDD	1201
A.3.9.2	TDD.....	1202
A.4	CQI reference measurement channels.....	1203
A.4.1	Additional CSI reference measurement channels.....	1213
A.5	OFDMA Channel Noise Generator (OCNG).....	1214
A.5.1	OCNG Patterns for FDD	1214
A.5.1.1	OCNG FDD pattern 1: One sided dynamic OCNG FDD pattern	1215
A.5.1.2	OCNG FDD pattern 2: Two sided dynamic OCNG FDD pattern	1215

A.5.1.3	OCNG FDD pattern 3: 49 RB OCNG allocation with MBSFN in 10 MHz	1216
A.5.1.4	OCNG FDD pattern 4: One sided dynamic OCNG FDD pattern for MBMS transmission	1217
A.5.1.5	OCNG FDD pattern 5: One sided dynamic 16QAM modulated OCNG FDD pattern	1217
A.5.1.6	OCNG FDD pattern 6: dynamic OCNG FDD pattern when user data is in 2 non-contiguous blocks....	1218
A.5.2	OCNG Patterns for TDD	1219
A.5.2.1	OCNG TDD pattern 1: One sided dynamic OCNG TDD pattern.....	1219
A.5.2.2	OCNG TDD pattern 2: Two sided dynamic OCNG TDD pattern	1219
A.5.2.3	OCNG TDD pattern 3: 49 RB OCNG allocation with MBSFN in 10 MHz.....	1220
A.5.2.4	OCNG TDD pattern 4: One sided dynamic OCNG TDD pattern for MBMS transmission	1221
A.5.2.5	OCNG TDD pattern 5: One sided dynamic 16QAM modulated OCNG TDD pattern.....	1222
A.5.2.6	OCNG TDD pattern 6: dynamic OCNG TDD pattern when user data is in 2 non-contiguous blocks ...	1222

Annex B (normative): Propagation Conditions.....1224

B.0	No interference.....	1224
B.1	Static propagation condition.....	1224
B.1.1	Definition of Additive White Gaussian Noise (AWGN) Interferer.....	1224
B.2	Multi-path fading Propagation Conditions.....	1224
B.2.1	Delay profiles	1225
B.2.2	Combinations of channel model parameters	1226
B.2.3	MIMO Channel Correlation Matrices	1226
B.2.3.1	Definition of MIMO Correlation Matrices	1226
B.2.3.2	MIMO Correlation Matrices at High, Medium and Low Level.....	1227
B.2.3A	MIMO Channel Correlation Matrices using cross polarized antennas	1229
B.2.3A.1	Definition of MIMO Correlation Matrices using cross polarized antennas	1230
B.2.3A.2	Spatial Correlation Matrices using cross polarized antennas at eNB and UE sides	1230
B.2.3A.2.1	Spatial Correlation Matrices at eNB side	1230
B.2.3A.2.2	Spatial Correlation Matrices at UE side	1230
B.2.3A.3	MIMO Correlation Matrices using cross polarized antennas	1231
B.2.3A.4	Beam steering approach	1231
B.2.4	Propagation conditions for CQI tests.....	1232
B.2.5	FFS	1232
B.2.6	MBSFN Propagation Channel Profile	1232
B.3	High speed train scenario	1233
B.4	Beamforming Model	1234
B.4.1	Single-layer random beamforming (Antenna port 5, 7 or 8)	1234
B.4.2	Dual-layer random beamforming (antenna ports 7 and 8).....	1235
B.4.3	Generic beamforming model (antenna ports 7-14)	1235
B.5	Interference models for enhanced performance requirements Type-A	1236
B.5.1	Dominant interferer proportion	1236
B.5.2	Transmission mode 3 interference model.....	1236
B.5.3	Transmission mode 4 interference model.....	1236
B.5.4	Transmission mode 9 interference model.....	1237

Annex C (normative): Downlink Physical Channels.....1238

C.0	Downlink signal levels	1238
C.1	General	1238
C.2	Set-up	1241
C.3	Connection	1242
C.3.0	Measurement of Transmitter Characteristics.....	1242
C.3.1	Measurement of Receiver Characteristics	1243
C.3.2	Measurement of Performance requirements.....	1244
C.3.3	Aggressor cell power allocation for Measurement of Performance Requirements when ABS is Configured.....	1245

Annex D (normative): Characteristics of the Interfering Signal1247

D.1	General	1247
D.2	Interference signals.....	1247
Annex E (normative): Global In-Channel TX-Test		1248
E.1	General	1248
E.2	Signals and results	1248
E.2.1	Basic principle.....	1248
E.2.2	Output signal of the TX under test	1248
E.2.3	Reference signal	1249
E.2.4	Measurement results.....	1249
E.2.5	Measurement points	1249
E.3	Signal processing.....	1250
E.3.1	Pre FFT minimization process.....	1250
E.3.2	Timing of the FFT window	1250
E.3.3	Post FFT equalisation.....	1251
E.4	Derivation of the results	1252
E.4.1	EVM.....	1252
E.4.2	Averaged EVM	1253
E.4.3	In-band emissions measurement.....	1253
E.4.4	EVM equalizer spectrum flatness.....	1255
E.4.5	Frequency error and Carrier leakage	1255
E.4.6	EVM of Demodulation reference symbols (EVM _{DMRS})	1256
E.4.6.1	1 st average for EVM _{DMRS}	1256
E.4.6.2	Final average for EVM _{DMRS}	1257
E.5	EVM and inband emissions for PUCCH.....	1257
E.5.1	Basic principle.....	1257
E.5.2	Output signal of the TX under test	1257
E.5.3	Reference signal	1257
E.5.4	Measurement results.....	1257
E.5.5	Measurement points	1257
E.5.6	Pre FFT minimization process.....	1258
E.5.7	Timing of the FFT window	1258
E.5.8	Post FFT equalisation.....	1258
E.5.9	Derivation of the results	1259
E.5.9.1	EVM _{PUCCH}	1259
E.5.9.2	Averaged EVM _{PUCCH}	1259
E.5.9.3	In-band emissions measurement	1260
E.6	EVM for PRACH	1261
E.6.1	Basic principle.....	1261
E.6.2	Output signal of the TX under test	1261
E.6.3	Reference signal	1261
E.6.4	Measurement results.....	1261
E.6.5	Measurement points	1262
E.6.6	Pre FFT minimization process.....	1262
E.6.7	Timing of the FFT window	1262
E.6.8	Post FFT equalisation.....	1263
E.6.9	Derivation of the results	1263
E.6.9.1	EVM _{PRACH}	1263
E.6.9.2	Averaged EVM _{PRACH}	1264
E.7	EVM with exclusion period	1264
E.7.1	General	1264
E.7.2	The model.....	1264
E.7.3	Illustration	1265
E.7.4	Formula	1268
Annex F (normative): Measurement uncertainties and Test Tolerances		1270

F.1	Acceptable uncertainty of Test System (normative)	1270
F.1.1	Measurement of test environments	1270
F.1.2	Measurement of transmitter	1271
F.1.3	Measurement of receiver	1276
F.1.4	Measurement of performance requirements	1282
F.1.5	Measurement of Channel State Information reporting	1293
F.2	Interpretation of measurement results (normative)	1297
F.3	Test Tolerance and Derivation of Test Requirements (informative).....	1298
F.3.1	Measurement of test environments.....	1298
F.3.2	Measurement of transmitter.....	1299
F.3.3	Measurement of receiver.....	1312
F.3.4	Measurement of performance requirements	1320
F.3.5	Measurement of Channel State Information reporting	1323
Annex G (normative): Statistical Testing.....		1327
G.1	General	1327
G.2	Statistical testing of receiver characteristics.....	1327
G.2.1	General	1327
G.2.2	Mapping throughput to error ratio	1327
G.2.3	Design of the test.....	1328
G.2.4	Numerical definition of the pass fail limits	1328
G.2.5	Pass fail decision rules	1329
G.2.6	Test conditions for receiver tests	1330
G.2A	Statistical testing of receiver characteristics with CA.....	1330
G.2A.1	General	1330
G.2A.2	Mapping throughput to error ratio.....	1330
G.2A.4	Pass fail limits	1331
G.2A.5	void.....	1331
G.2A.6	Test conditions for receiver tests with CA	1332
G.3	Statistical testing of Performance Requirements with throughput	1332
G.3.1	General	1332
G.3.2	Mapping throughput to error ratio	1333
G.3.3	Design of the test.....	1333
G.3.4	Pass Fail limit	1333
G.3.5	Minimum Test time	1334
G.3.6	Test conditions for receiver performance tests	1344
G.3A	Statistical testing of Performance Requirements with throughput for CA.....	1350
G.3A.1	General	1350
G.3A.2	Mapping throughput to error ratio.....	1350
G.3A.3	Design of the test.....	1351
G.3A.4	Pass Fail limit	1351
G.3A.5	Minimum test time	1351
G.3A.6	Test conditions.....	1356
G.4	Statistical testing of Performance Requirements with probability of misdetection	1357
G.4.1	General	1357
G.4.2	Mapping the UE reaction to error ratio	1357
G.4.3	Design of the test.....	1357
G.4.4	Numerical definition of the pass fail limits	1358
G.4.5	Pass fail decision rules	1359
G.4.6	Minimum Test time	1360
G.4.7	Test conditions for receiver performance tests	1362
G.5	Measuring throughput ratio	1363
G.5.1	General	1363
G.5.2	Establishing t_{md}	1363
G.5.3	Measuring T-put	1363

G.5.4	Number of samples for throughput ratios	1363
G.6	Statistical testing of MBMS Performance	1366
G.6.1	General	1366
G.6.2	Mapping of MBMS Packet ratio to BLER	1367
G.6.3	Design of the test	1367
G.6.4	Test time for MBMS performance tests	1367
G.X	Theory to derive the numbers in Table G.2.4-1 (Informative)	1368
G.X.1	Error Ratio (ER)	1368
G.X.2	Test Design	1368
G.X.3	Confidence level	1368
G.X.4	Introduction: Supplier Risk versus Customer Risk	1368
G.X.5	Supplier Risk versus Customer Risk	1369
G.X.6	Introduction: Standard test versus early decision concept	1369
G.X.7	Standard test versus early decision concept	1370
G.X.8	Selectivity	1370
G.X.9	Design of the test	1371
G.X.10	Simulation to derive the pass fail limits in Table G.2.4-1	1371
Annex H (normative): Uplink Physical Channels		1373
H.0	Uplink Signal Levels	1373
H.1	General	1373
H.2	Set-up	1374
H.3	Connection	1374
H.3.0	Measurement of Transmitter Characteristics	1374
H.3.1	Measurement of Receiver Characteristics	1375
H.3.2	Measurement of Performance Requirements	1375
Annex I (informative): Handling requirements and tests for different releases and UE capabilities		1376
I.1	General considerations	1376
I.2	Concrete scenarios	1377
I.2.1	Tests for minimum requirements varying between releases, without introduction of new features	1377
I.2.2	Tests for CA (Carrier aggregation)	1378
I.2.2.1	CA Tx tests (Chapter 6)	1378
I.2.2.2	CA Rx tests (Chapter 7)	1379
I.2.2.3	CA Performance tests (Chapter 8)	1379
I.2.3	Tests for UL-MIMO (Uplink Multiple Antenna Transmission)	1380
I.2.3.1	UL-MIMO Tx tests (Chapter 6)	1380
I.2.3.2	UL-MIMO Rx tests (Chapter 7)	1380
I.2.4	Tests for eDL-MIMO (Enhanced Downlink Multiple Antenna Transmission)	1381
I.2.4.1	eDL MIMO Performance tests (Chapter 8)	1381
I.2.4.2	eDL MIMO CSI tests (Chapter 9)	1381
Annex J (informative): Change history		1383
History	1415

Foreword

This Technical Specification has been produced by the 3rd Generation Partnership Project (3GPP).

The contents of the present document are subject to continuing work within the TSG and may change following formal TSG approval. Should the TSG modify the contents of the present document, it will be re-released by the TSG with an identifying change of release date and an increase in version number as follows:

Version x.y.z

where:

- x the first digit:
 - 1 presented to TSG for information;
 - 2 presented to TSG for approval;
 - 3 or greater indicates TSG approved document under change control.
- y the second digit is incremented for all changes of substance, i.e. technical enhancements, corrections, updates, etc.
- z the third digit is incremented when editorial only changes have been incorporated in the document.

Introduction

The present document is part 1 of a multi-parts TS:

3GPP TS 36.521-1: Evolved Universal Terrestrial Radio Access (E-UTRA); User Equipment (UE) conformance specification Radio transmission and reception; Part 1: Conformance Testing.

3GPP TS 36.521-2 [11]: Evolved Universal Terrestrial Radio Access (E-UTRA); User Equipment (UE) conformance specification Radio transmission and reception; Part 2: Implementation Conformance Statement (ICS).

3GPP TS 36.521-3 [12]: Evolved Universal Terrestrial Radio Access (E-UTRA); User Equipment (UE) conformance specification Radio transmission and reception; Part 3: Radio Resource Management (RRM) conformance testing.

1 Scope

The present document specifies the measurement procedures for the conformance test of the user equipment (UE) that contain transmitting characteristics, receiving characteristics and performance requirements as part of the 3G Long Term Evolution (3G LTE). Conformance test for the support of RRM (Radio Resource Management) are specified in TS 36.521-3 [12].

The requirements are listed in different clauses only if the corresponding parameters deviate. More generally, tests are only applicable to those mobiles that are intended to support the appropriate functionality. To indicate the circumstances in which tests apply, this is noted in the "*definition and applicability*" part of the test.

For example only Release 8 and later UE declared to support LTE shall be tested for this functionality. In the event that for some tests different conditions apply for different releases, this is indicated within the text of the test itself.

2 References

The following documents contain provisions which, through reference in this text, constitute provisions of the present document.

- References are either specific (identified by date of publication, edition number, version number, etc.) or non-specific.
- For a specific reference, subsequent revisions do not apply.
- For a non-specific reference, the latest version applies. In the case of a reference to a 3GPP document (including a GSM document), a non-specific reference implicitly refers to the latest version of that document *in the same Release as the present document*.

- [1] 3GPP TR 21.905: "Vocabulary for 3GPP Specifications".
- [2] 3GPP TS 36.101: "E-UTRA UE radio transmission and reception".
- [3] ITU-R Recommendation SM.329-10, "Unwanted emissions in the spurious domain"
- [4] 3GPP TS 36.133: "E-UTRA requirements for support of radio resource management".
- [5] 3GPP TS 36.331: "E-UTRA Radio Resource Control (RRC): protocol specification".
- [6] 3GPP TS 36.304: "E-UTRA UE procedures in idle mode".
- [7] 3GPP TS 36.508: "Common test environments for User Equipment (UE)".
- [8] 3GPP TS 36.211: "Physical Channels and Modulation".
- [9] 3GPP TS 36.212: "E-UTRA Multiplexing and channel coding".
- [10] 3GPP TS 36.213: "E-UTRA Physical layer procedures".
- [11] 3GPP TS 36.521-2: "Evolved Universal Terrestrial Radio Access (E-UTRA); User Equipment (UE) conformance specification; Radio transmission and reception; Part 2: Implementation Conformance Statement (ICS)".
- [12] 3GPP TS 36.521-3: "Evolved Universal Terrestrial Radio Access (E-UTRA); User Equipment (UE) conformance specification; Radio transmission and reception; Part 3: Radio Resource Management (RRM) conformance testing".
- [13] 3GPP TS 36.321: "Evolved Universal Terrestrial Radio Access (E-UTRA); Medium Access Control (MAC) protocol specification".
- [14] 3GPP TS 36.423: "X2 application protocol (X2AP)".
- [15] 3GPP TS 36.306: "E-UTRA User Equipment (UE) radio access capabilities".
- [16] 3GPP TS 36.307: "Requirements on User Equipments (UEs) Supporting a release-independent frequency band".

3 Definitions, symbols and abbreviations

3.1 Definitions

For the purposes of the present document, the terms and definitions given in TR 21.905 [1] and the following apply. A term defined in the present document takes precedence over the definition of the same term, if any, in TR 21.905 [1].

Aggregated Channel Bandwidth: The RF bandwidth in which a UE transmits and receives multiple contiguously aggregated carriers.

Aggregated Transmission Bandwidth Configuration: The number of resource block allocated within the aggregated channel bandwidth.

Carrier aggregation: Aggregation of two or more component carriers in order to support wider transmission bandwidths.

Carrier aggregation band: A set of one or more operating bands across which multiple carriers are aggregated with a specific set of technical requirements.

Carrier aggregation bandwidth class: A class defined by the aggregated transmission bandwidth configuration and maximum number of component carriers supported by a UE.

Carrier aggregation configuration: A combination of CA operating band(s) and CA bandwidth class(es) supported by a UE.

Channel edge: The lowest and highest frequency of the carrier, separated by the channel bandwidth.

Channel bandwidth: The RF bandwidth supporting a single E-UTRA RF carrier with the transmission bandwidth configured in the uplink or downlink of a cell. The channel bandwidth is measured in MHz and is used as a reference for transmitter and receiver RF requirements.

Contiguous carriers: A set of two or more carriers configured in a spectrum block where there are no RF requirements based on co-existence for un-coordinated operation within the spectrum block.

Enhanced performance requirements type A: This defines performance requirements assuming as baseline receiver reference symbol based linear minimum mean square error interference rejection combining.

Inter-band carrier aggregation: Carrier aggregation of component carriers in different operating bands.

NOTE: Carriers aggregated in each band can be contiguous or non-contiguous.

Intra-band contiguous carrier aggregation: Contiguous carriers aggregated in the same operating band.

Intra-band non-contiguous carrier aggregation: Non-contiguous carriers aggregated in the same operating band.

Maximum Output Power: The mean power level per carrier of UE measured at the antenna connector in a specified reference condition.

Mean power: When applied to E-UTRA transmission this is the power measured in the operating system bandwidth of the carrier. The period of measurement shall be at least one subframe (1ms) unless otherwise stated.

Occupied bandwidth: The width of a frequency band such that, below the lower and above the upper frequency limits, the mean powers emitted are each equal to a specified percentage $\beta/2$ of the total mean power of a given emission.

Output power: The mean power of one carrier of the UE, delivered to a load with resistance equal to the nominal load impedance of the transmitter.

PMI delay: The rate in basic time unit at which PMI is updated.

Reference bandwidth: The bandwidth in which an emission level is specified.

Synchronized operation: Operation of TDD in two different systems, where no simultaneous uplink and downlink occur.

Transmission bandwidth: Bandwidth of an instantaneous transmission from a UE or BS, measured in Resource Block units.

Transmission bandwidth configuration: The highest transmission bandwidth allowed for uplink or downlink in a given channel bandwidth, measured in Resource Block units.

Transmit Diversity: Transmit diversity is based on space-frequency block coding techniques complemented with frequency-shift time diversity when four transmit antennas is used.

Unsynchronized operation: Operation of TDD in two different systems, where the conditions for synchronized operation

3.2 Symbols

For the purposes of the present document, the following symbols apply:

BW_{Channel}	Channel bandwidth
$BW_{\text{Channel_CA}}$	Aggregated channel bandwidth, expressed in MHz.
BW_{GB}	Virtual guard band to facilitate transmitter (receiver) filtering above / below edge CCs.
E_{RS}	Transmitted energy per RE for reference symbols during the useful part of the symbol, i.e. excluding the cyclic prefix, (average power normalized to the subcarrier spacing) at the eNode B transmit antenna connector
\hat{E}_s	The averaged received energy per RE of the wanted signal during the useful part of the symbol, i.e. excluding the cyclic prefix, at the UE antenna connector; average power is computed within a set of REs used for the transmission of physical channels (including user specific RSs when present), divided by the number of REs within the set, and normalized to the subcarrier spacing
	Frequency
$F_{\text{Interferer (offset)}}$	Frequency offset of the interferer
$F_{\text{Interferer}}$	Frequency of the interferer
F_C	Frequency of the carrier centre frequency
F_{CA_low}	The centre frequency of the <i>lowest carrier</i> , expressed in MHz.
F_{CA_high}	The centre frequency of the <i>highest carrier</i> , expressed in MHz.
F_{DL_low}	The lowest frequency of the downlink operating band
F_{DL_high}	The highest frequency of the downlink operating band
F_{UL_low}	The lowest frequency of the uplink operating band
F_{UL_high}	The highest frequency of the uplink operating band
$F_{\text{edge_low}}$	The <i>lower edge</i> of aggregated channel bandwidth, expressed in MHz.
$F_{\text{edge_high}}$	The <i>higher edge</i> of aggregated channel bandwidth, expressed in MHz.
F_{offset}	Frequency offset from F_{C_high} to the <i>higher edge</i> or F_{C_low} to the <i>lower edge</i> .
I_o	The power spectral density of the total input signal (power averaged over the useful part of the symbols within the transmission bandwidth configuration, divided by the total number of RE for this configuration and normalised to the subcarrier spacing) at the UE antenna connector, including the own-cell downlink signal
I_{or}	The total transmitted power spectral density of the own-cell downlink signal (power averaged over the useful part of the symbols within the transmission bandwidth configuration, divided by the total number of RE for this configuration and normalised to the subcarrier spacing) at the eNode B transmit antenna connector
\hat{I}_{or}	The total received power spectral density of the own-cell downlink signal (power averaged over the useful part of the symbols within the transmission bandwidth configuration, divided by the total number of RE for this configuration and normalised to the subcarrier spacing) at the UE antenna connector
I_{ot}	The received power spectral density of the total noise and interference for a certain RE (average power obtained within the RE and normalized to the subcarrier spacing) as measured at the UE antenna connector
L_{CRB}	Transmission bandwidth which represents the length of a contiguous resource block allocation
	expressed in units of resource blocks N_{cp} Cyclic prefix length
N_{DL}	Downlink EARFCN

N_{oc}	The power spectral density of a white noise source (average power per RE normalised to the subcarrier spacing), simulating interference from cells that are not defined in a test procedure, as measured at the UE antenna connector.
N_{oc1}	The power spectral density of a white noise source (average power per RE normalized to the subcarrier spacing), simulating interference in non-CRS symbols in ABS subframe from cells that are not defined in a test procedure, as measured at the UE antenna connector.
N_{oc2}	The power spectral density of a white noise source (average power per RE normalized to the subcarrier spacing), simulating interference in CRS symbols in ABS subframe from all cells that are not defined in a test procedure, as measured at the UE antenna connector.
N_{oc3}	The power spectral density of a white noise source (average power per RE normalised to the subcarrier spacing), simulating interference in non-ABS subframe from cells that are not defined in a test procedure, as measured at the UE antenna connector.
N_{oc}'	The power spectral density (average power per RE normalised to the subcarrier spacing) of the summation of the received power spectral densities of the strongest interfering cells explicitly defined in a test procedure plus N_{oc} , as measured at the UE antenna connector. The respective power spectral density of each interfering cell relative to N_{oc}' is defined by its associated DIP value.
$N_{\text{Offis-DL}}$	Offset used for calculating downlink EARFCN
$N_{\text{Offis-UL}}$	Offset used for calculating uplink EARFCN
N_{otx}	The power spectral density of a white noise source (average power per RE normalised to the subcarrier spacing) simulating eNode B transmitter impairments as at the eNode B transmit antenna connector
N_{RB}	Transmission bandwidth configuration, expressed in units of resource blocks
N_{RB_agg}	Aggregated Transmission Bandwidth Configuration The number of the aggregated RBs within the fully allocated Aggregated Channel bandwidth.
N_{RB_alloc}	Total number of simultaneously transmitted resource blocks in Aggregated Channel Bandwidth configuration.
N_{UL}	Uplink EARFCN
P	Number of cell-specific antenna ports
p	Antenna port number
P_{CMAX}	The measured configured maximum UE output power.
$P_{CMAX,c}$	The configured maximum UE output power for serving cell c .
P_{EMAX}	Maximum allowed UE output power signalled by higher layers. Same as IE $P\text{-Max}$, defined in [5].
$P_{EMAX,c}$	Maximum allowed UE output power signalled by higher layers for serving cell c . Same as IE $P\text{-Max}$, defined in [7].
$P_{\text{Interferer}}$	Modulated mean power of the interferer
$P_{\text{PowerClass}}$	$P_{\text{PowerClass}}$ is the nominal UE power (i.e., no tolerance).
P_{UMAX}	Maximum UE Power with possible power reduction due to modulation type, network signalling values and location near the edge of the band; it equals P_{CMAX} when the IE $P\text{-Max}$, defined in [5], is not signalled.
R_{av}	Minimum average throughput per RB
$RB \#$	Position of the RB in the channel bandwidth.
RB_{start}	Indicates the lowest RB index of transmitted resource blocks.
RB_{end}	Indicates the highest RB index of transmitted resource blocks.
ΔF_{OOB}	Δ Frequency of Out Of Band emission
$\Delta R_{\text{IB},c}$	Allowed reference sensitivity relaxation due to support for inter-band CA operation, for serving cell c .
$\Delta T_{\text{IB},c}$	Allowed maximum configured output power relaxation due to support for inter-band CA operation, for serving cell c .
ΔT_{C}	Allowed operating band edge transmission power relaxation.
$\Delta T_{\text{C},c}$	Allowed operating band edge transmission power relaxation for serving cell c .
σ	Test specific auxiliary variable used for the purpose of downlink power allocation, defined in Annex C.3.2.

3.3 Abbreviations

For the purposes of the present document, the abbreviations given in TR 21.905 [1] and the following apply. An abbreviation defined in the present document takes precedence over the definition of the same abbreviation, if any, in TR 21.905 [1].

ABS	Almost Blank Subframe
ACLR	Adjacent Channel Leakage Ratio
ACS	Adjacent Channel Selectivity
A-MPR	Additional Maximum Power Reduction
AWGN	Additive White Gaussian Noise
BCCH	Broadcast Control Channel
BCH	Broadcast Channel
BS	Base Station
CA	Carrier Aggregation
CA _X	CA for band X where X is the applicable E-UTRA operating band
CA _{X-X}	Non-contiguous intra band CA for band X where X is the applicable E-UTRA operating band
CA _{X-Y}	CA for band X and Band Y where X and Y are the applicable E-UTRA operating band
CC	Component Carriers
CP	Cyclic Prefix
CPE	Customer Premise Equipment
CPE _X	Customer Premise Equipment for E-UTRA operating band X
CQI	Channel Quality Indicator
CW	Continuous Wave
DCI	Downlink Control Information
DIP	Dominant Interferer Proportion
eDL-MIMO	Down Link Multiple Antenna transmission
DL	Downlink
DTX	Discontinuous Transmission
DwPTS	Downlink Pilot Time-Slot
EARFCN	E-UTRA Absolute Radio Frequency Channel Number
EPRE	Energy Per Resource Element
E-UTRA	Evolved UMTS Terrestrial Radio Access
EUTRAN	Evolved UMTS Terrestrial Radio Access Network
EVM	Error Vector Magnitude
FDD	Frequency Division Duplex
FRC	Fixed Reference Channel
FSTD	Frequency-Shift Time Diversity
HARQ	Hybrid ARQ
HD-FDD	Half- Duplex FDD
MAC	Medium Access Control
MBMS	Multimedia Broadcast Multicast Service
MCS	Modulation and Coding Scheme
MOP	Maximum Output Power
MPR	Maximum Power Reduction
MSR	Maximum Sensitivity Reduction
OCNG	OFDMA Channel Noise Generator
OFDMA	Orthogonal Frequency Division Multiple Access
OOB	Out-of-band
P-MPR	Power Management Maximum Power Reduction
PA	Power Amplifier
PBCH	Physical Broadcast Channel
PCC	Primary Component Carrier
PCCH	Paging Control Channel
PCFICH	Physical Control Format Indicator Channel
PDCCH	Physical Downlink Control Channel
PDSCH	Physical Downlink Shared Channel
PDU	Packet Data Unit
PHICH	Physical Hybrid ARQ Indicator Channel
Pm-dsg	Probability of miss-detection of the Downlink Scheduling Grant
PMI	Precoding Matrix Indicator
PRACH	Physical Random Access Channel

PRB	Physical Resource Block
PSS	Primary Synchronization Signal
PSS_RA	PSS-to-EPRE ratio for the channel PSS
PUCCH	Physical Uplink Control Channel
PUSCH	Physical Uplink Shared Channel
RE	Resource Element
REFSENS	Reference Sensitivity power level
RI	Rank Indicator
RLC	Radio Link Control
RMC	Reference Measurement Channel
r.m.s	Root Mean Square
RNTI	Radio Network Temporary Identifier
RRC	Radio Resource Control
RS	Reference Signal
RSRP	Reference Signal Received Power
SCC	Secondary Component Carrier
SCH	Synchronization Channel
SDU	Service Data Unit
SFBC	Space-Frequency Block Coding
SINR	Signal-to-Interference-and-Noise Ratio
SNR	Signal-to-Noise Ratio
SRS	Sounding Reference Signal
SSS	Secondary Synchronization Signal
SSS_RA	SSS-to-RS EPRE ratio for the channel SSS
TDD	Time Division Duplex
TPC	Transmit Power Control
TPMI	Transmitted Precoding Matrix Indicator
TTI	Transmission Time Interval
UE	User Equipment
UL	Uplink
UL-MIMO	Up Link Multiple Antenna transmission
UMTS	Universal Mobile Telecommunications System
UpPTS	Uplink Pilot Time-Slot
UTRA	UMTS Terrestrial Radio Access
UTRAN	UMTS Terrestrial Radio Access Network
xCH_RA	xCH-to-RS EPRE ratio for the channel xCH in all transmitted OFDM symbols not containing RS
xCH_RB	xCH-to-RS EPRE ratio for the channel xCH in all transmitted OFDM symbols containing RS

4 General

Unless otherwise stated, the following reference conditions used by all test cases in this document are specified in TS 36.508 [7]:

- Connection Diagrams,
- Test Frequencies,
- Cell Settings,
- Reference Environments,
- Environmental Conditions,
- Generic Connection Setup Procedures,
- System Information (SI),
- Message Contents.

Where a test requires one of the above reference conditions that are different, this will be specified within the test itself.

The Minimum Requirements defined in each test make no allowance for Measurement Uncertainty. Therefore, Test Tolerances are used to relax the Minimum Requirements. If the Test Requirement differs from the Minimum Requirement then the Test Tolerance applied for that test is non-zero. For each test the Test Tolerances are individually calculated to create the Test Requirements. The Test Tolerance for each test and the explanation of how the Minimum Requirement has been relaxed by the Test Tolerance is given in Annex F.3.

Downlink and Uplink transmissions are organized into radio frames with $T_f = 307200 \times T_s = 10$ ms duration. Two radio frame structures are supported in this document:

- Type 1, applicable to FDD,
- Type 2, applicable to TDD.

In clauses 6 and 7 TX and RX test cases for FDD/TDD test cases are defined. FDD and TDD test scenarios/requirements are included within the same test case. For test cases with any difference between the FDD and TDD branches the test description part of the test case has been separated in two sections to cover the two technologies. The applicability for the FDD and TDD branches are specified in TS 36.521-2.

In clause 8 the performance requirement test cases are defined. FDD and TDD performance requirement test cases are defined in different clauses accordingly to the requirements specified in TS 36.101.

Unless otherwise stated, each test case is tested for every operating band supported by the UE and repeated with the applicable test configurations (i.e. test environment, test frequencies, test channel bandwidths, channel bandwidth parameters) indicated in each test case. For test cases in clauses 6, 7, 8 the initial conditions of the downlink physical channels signal levels and downlink physical channels required are specified in Annex C.0, Annex C.1 and Annex C.2.

For test cases in clauses 6 and 7 that require measurements with maximum output power, the UE shall transmit at its maximum output power state with output power level of P_{UMAX} level. This range of maximum output power shall not be modified for any further additional relaxation.

For UL-MIMO cases, the UE output power is the sum of mean powers as measured at each antenna connector unless otherwise stated.

For test cases in clauses 6 and 7, the partial RB allocations refer to any RB allocation less than full RB allocation except 1 RB allocation.

4.1 Categorization of test requirements in CA, UL-MIMO, eDL-MIMO

The test requirements for Clauses 6 (Tx Characteristics) and 7 (Rx Characteristics), which are specific to CA, UL-MIMO, and eDL-MIMO are specified as suffix A, B, C, D where;

- a) Suffix A additional requirements need to support CA
- b) Suffix B additional requirements need to support UL-MIMO
- c) Suffix C additional requirements need to support TBD
- d) Suffix D additional requirements need to support eDL-MIMO

A terminal which supports the above features needs to meet both the general requirements and the additional requirement applicable to the additional sub-clause (suffix A, B, C and D).

A terminal which supports more than one feature (CA, UL-MIMO, and eDL-MIMO) shall meet all of the separate corresponding requirements.

NOTE 1: Test Case 6.5.2.1A, PUSCH-EVM with exclusion period, is a Release 8 non-CA test case and does not indicate a requirement to support CA.

NOTE 2: This categorization of test requirements reflects only the categorization of minimum requirements as done by RAN4 in 3GPP TS 36.101. For the categorization of the tests requirements done on behalf of RAN5 follow the information given in Annex I.

The frequency bands and channel arrangement for CA, UL-MIMO, and eDL-MIMO are specified in Clause 5, where;

- a) The clauses with suffix A specify the operating bands and channel arrangement related information for CA
- b) The clauses with suffix B specify the operating bands and channel arrangement related information for UL-MIMO
- c) The clauses with suffix C specify the operating bands and channel arrangement related information for [TBD]
- d) The clauses with suffix D specify the operating bands and channel arrangement related information for eDL-MIMO

5 Frequency bands and channel arrangement

5.1 General

The channel arrangements presented in this clause are based on the frequency bands and channel bandwidths defined in the present release of specifications.

NOTE: Other operating bands and channel bandwidths may be considered in future releases.

5.2 Operating bands

E-UTRA is designed to operate in the operating bands defined in Table 5.2-1.

Table 5.2-1: E-UTRA operating bands

E-UTRA Operating Band	Uplink (UL) eNode B receive UE transmit	Downlink (DL) eNode B transmit UE receive	Duplex Mode
	$F_{UL,low} - F_{UL,high}$	$F_{DL,low} - F_{DL,high}$	

1	1920 MHz – 1980 MHz	2110 MHz – 2170 MHz	FDD
2	1850 MHz – 1910 MHz	1930 MHz – 1990 MHz	FDD
3	1710 MHz – 1785 MHz	1805 MHz – 1880 MHz	FDD
4	1710 MHz – 1755 MHz	2110 MHz – 2155 MHz	FDD
5	824 MHz – 849 MHz	869 MHz – 894 MHz	FDD
6 ¹	830 MHz – 840 MHz	875 MHz – 885 MHz	FDD
7	2500 MHz – 2570 MHz	2620 MHz – 2690 MHz	FDD
8	880 MHz – 915 MHz	925 MHz – 960 MHz	FDD
9	1749.9 MHz – 1784.9 MHz	1844.9 MHz – 1879.9 MHz	FDD
10	1710 MHz – 1770 MHz	2110 MHz – 2170 MHz	FDD
11	1427.9 MHz – 1447.9 MHz	1475.9 MHz – 1495.9 MHz	FDD
12	699 MHz – 716 MHz	729 MHz – 746 MHz	FDD
13	777 MHz – 787 MHz	746 MHz – 756 MHz	FDD
14	788 MHz – 798 MHz	758 MHz – 768 MHz	FDD
15	Reserved	Reserved	FDD
16	Reserved	Reserved	FDD
17	704 MHz – 716 MHz	734 MHz – 746 MHz	FDD
18	815 MHz – 830 MHz	860 MHz – 875 MHz	FDD
19	830 MHz – 845 MHz	875 MHz – 890 MHz	FDD
20	832 MHz – 862 MHz	791 MHz – 821 MHz	FDD
21	1447.9 MHz – 1462.9 MHz	1495.9 MHz – 1510.9 MHz	FDD
22	3410 MHz – 3490 MHz	3510 MHz – 3590 MHz	FDD
23	2000 MHz – 2020 MHz	2180 MHz – 2200 MHz	FDD
24	1626.5 MHz – 1660.5 MHz	1525 MHz – 1559 MHz	FDD
25	1850 MHz – 1915 MHz	1930 MHz – 1995 MHz	FDD
26	814 MHz – 849 MHz	859 MHz – 894 MHz	FDD
27	807 MHz – 824 MHz	852 MHz – 869 MHz	FDD
28	703 MHz – 748 MHz	758 MHz – 803 MHz	FDD
29	NA	717 MHz – 728 MHz	FDD ²
31	452.5 MHz – 457.5 MHz	462.5 MHz – 467.5 MHz	FDD
...			
33	1900 MHz – 1920 MHz	1900 MHz – 1920 MHz	TDD
34	2010 MHz – 2025 MHz	2010 MHz – 2025 MHz	TDD
35	1850 MHz – 1910 MHz	1850 MHz – 1910 MHz	TDD
36	1930 MHz – 1990 MHz	1930 MHz – 1990 MHz	TDD
37	1910 MHz – 1930 MHz	1910 MHz – 1930 MHz	TDD
38	2570 MHz – 2620 MHz	2570 MHz – 2620 MHz	TDD
39	1880 MHz – 1920 MHz	1880 MHz – 1920 MHz	TDD
40	2300 MHz – 2400 MHz	2300 MHz – 2400 MHz	TDD
41	2496 MHz – 2690 MHz	2496 MHz – 2690 MHz	TDD
42	3400 MHz – 3600 MHz	3400 MHz – 3600 MHz	TDD
43	3600 MHz – 3800 MHz	3600 MHz – 3800 MHz	TDD
44	703 MHz – 803 MHz	703 MHz – 803 MHz	TDD

Note 1: Band 6 is not applicable.
Note 2: Restricted to E-UTRA operation when carrier aggregation is configured. The downlink operating band is paired with the uplink operating band (external) of the carrier aggregation configuration that is supporting the configured Pcell.

5.2A Operating bands for CA

E-UTRA carrier aggregation is designed to operate in the operating bands defined in Tables 5.2A-1 and 5.2A-2.

Table 5.2A-1: Intra-band contiguous CA operating bands

E-UTRA CA Band	E-UTRA Band	Uplink (UL) operating band			Downlink (DL) operating band			Duplex Mode
		BS receive / UE transmit			BS transmit / UE receive			
		$F_{UL_low} - F_{UL_high}$			$F_{DL_low} - F_{DL_high}$			
CA_1	1	1920 MHz	–	1980 MHz	2110 MHz	–	2170 MHz	FDD
CA_7	7	2500 MHz	–	2570 MHz	2620 MHz	–	2690 MHz	FDD
CA_38	38	2570 MHz	–	2620 MHz	2570 MHz	–	2620 MHz	TDD

CA_40	40	2300 MHz	–	2400 MHz	2300 MHz	–	2400 MHz	TDD
CA_41	41	2496 MHz	–	2690 MHz	2496 MHz	–	2690 MHz	TDD

Table 5.2A-2: Inter-band CA operating bands

E-UTRA CA Band	E-UTRA Band	Uplink (UL) operating band		Downlink (DL) operating band		Duplex Mode		
		BS receive / UE transmit		BS transmit / UE receive				
		F_{UL_low}	F_{UL_high}	F_{DL_low}	F_{DL_high}			
CA_1-5	1	1920 MHz	–	1980 MHz	2110 MHz	–	2170 MHz	FDD
	5	824 MHz	–	849 MHz	869 MHz	–	894 MHz	
CA_1-18	1	1920 MHz	–	1980 MHz	2110 MHz	–	2170 MHz	FDD
	18	815 MHz	–	830 MHz	860 MHz	–	875 MHz	
CA_1-19	1	1920 MHz	–	1980 MHz	2110 MHz	–	2170 MHz	FDD
	19	830 MHz	–	845 MHz	875 MHz	–	890 MHz	
CA_1-21	1	1920 MHz	–	1980 MHz	2110 MHz	–	2170 MHz	FDD
	21	1447.9 MHz	–	1462.9 MHz	1495.9 MHz	–	1510.9 MHz	
CA_2-17	2	1850 MHz	–	1910 MHz	1930 MHz	–	1990 MHz	FDD
	17	704 MHz	–	716 MHz	734 MHz	–	746 MHz	
CA_2-29	2	1850 MHz	–	1910 MHz	1930 MHz	–	1990 MHz	FDD
	29	N/A		717 MHz	–	728 MHz		
CA_3-5	3	1710 MHz	–	1785 MHz	1805 MHz	–	1880 MHz	FDD
	5	824 MHz	–	849 MHz	869 MHz	–	894 MHz	
CA_3-7	3	1710 MHz	–	1785 MHz	1805 MHz	–	1880 MHz	FDD
	7	2500 MHz	–	2570 MHz	2620 MHz	–	2690 MHz	
CA_3-8	3	1710 MHz	–	1785 MHz	1805 MHz	–	1880 MHz	FDD
	8	880 MHz	–	915 MHz	925 MHz	–	960 MHz	
CA_3-20	3	1710 MHz	–	1785 MHz	1805 MHz	–	1880 MHz	FDD
	20	832 MHz	–	862 MHz	791 MHz	–	821 MHz	
CA_4-5	4	1710 MHz	–	1755 MHz	2110 MHz	–	2155 MHz	FDD
	5	824 MHz	–	849 MHz	869 MHz	–	894 MHz	
CA_4-7	4	1710 MHz	–	1755 MHz	2110 MHz	–	2155 MHz	FDD
	7	2500 MHz	–	2570 MHz	2620 MHz	–	2690 MHz	
CA_4-12	4	1710 MHz	–	1755 MHz	2110 MHz	–	2155 MHz	FDD
	12	699 MHz	–	716 MHz	729 MHz	–	746 MHz	
CA_4-13	4	1710 MHz	–	1755 MHz	2110 MHz	–	2155 MHz	FDD
	13	777 MHz	–	787 MHz	746 MHz	–	756 MHz	
CA_4-17	4	1710 MHz	–	1755 MHz	2110 MHz	–	2155 MHz	FDD
	17	704 MHz	–	716 MHz	734 MHz	–	746 MHz	
CA_4-29	4	1710 MHz	–	1755 MHz	2110 MHz	–	2155 MHz	FDD
	29	N/A		717 MHz	–	728 MHz		
CA_5-12	5	824 MHz	–	849 MHz	869 MHz	–	894 MHz	FDD
	12	699 MHz	–	716 MHz	729 MHz	–	746 MHz	
CA_5-17	5	824 MHz	–	849 MHz	869 MHz	–	894 MHz	FDD
	17	704 MHz	–	716 MHz	734 MHz	–	746 MHz	
CA_7-20	7	2500 MHz	–	2570 MHz	2620 MHz	–	2690 MHz	FDD
	20	832 MHz	–	862 MHz	791 MHz	–	821 MHz	
CA_8-20	8	880 MHz	–	915 MHz	925 MHz	–	960 MHz	FDD
	20	832 MHz	–	862 MHz	791 MHz	–	821 MHz	
CA_11-18	11	1427.9 MHz	–	1447.9 MHz	1475.9 MHz	–	1495.9 MHz	FDD
	18	815 MHz	–	830 MHz	860 MHz	–	875 MHz	

5.2B Operating bands for UL-MIMO

E-UTRA UL-MIMO in Rel-10 is designed to operate in the operating bands defined in Table 5.2-1.

5.3 TX–RX frequency separation

- a) The default EUTRA TX channel (carrier centre frequency) to RX channel (carrier centre frequency) separation is specified in Table 5.3-1 for the TX and RX channel bandwidths defined in Table 5.4.2.1-1

Table 5.3-1: Default UE TX-RX frequency separation

E-UTRA Operating Band	TX - RX carrier centre frequency separation
1	190 MHz
2	80 MHz
3	95 MHz
4	400 MHz
5	45 MHz
6	45 MHz
7	120 MHz
8	45 MHz
9	95 MHz
10	400 MHz
11	48 MHz
12	30 MHz
13	-31 MHz
14	-30 MHz
17	30 MHz
18	45 MHz
19	45 MHz
20	-41 MHz
21	48 MHz
22	100 MHz
23	180 MHz
24	-101.5 MHz
25	80 MHz
26	45 MHz
27	45 MHz
28	55MHz
31	10 MHz

- b) The use of other TX channel to RX channel carrier centre frequency separation is not precluded and is intended to form part of a later release.

5.3A TX–RX frequency separation for CA

For intra-band contiguous carrier aggregation, the same TX-RX frequency separation as specified in Table 5.3-1 is applied to PCC and SCC, respectively.

5.4 Channel arrangement

5.4.1 Channel spacing

The spacing between carriers will depend on the deployment scenario, the size of the frequency block available and the channel bandwidths. The nominal channel spacing between two adjacent E-UTRA carriers is defined as following:

$$\text{Nominal Channel spacing} = (\text{BW}_{\text{Channel}(1)} + \text{BW}_{\text{Channel}(2)})/2$$

where $\text{BW}_{\text{Channel}(1)}$ and $\text{BW}_{\text{Channel}(2)}$ are the channel bandwidths of the two respective E-UTRA carriers. The channel spacing can be adjusted to optimize performance in a particular deployment scenario.

5.4.1A Channel spacing for CA

For intra-band contiguous carrier aggregation bandwidth class C, the nominal channel spacing between two adjacent E-UTRA component carriers is defined as the following:

$$\text{Nominal channel spacing} = \left\lfloor \frac{BW_{\text{Channel}(1)} + BW_{\text{Channel}(2)} - 0.1|BW_{\text{Channel}(1)} - BW_{\text{Channel}(2)}|}{0.6} \right\rfloor 0.3 \text{ [MHz]}$$

where $BW_{\text{Channel}(1)}$ and $BW_{\text{Channel}(2)}$ are the channel bandwidths of the two respective E-UTRA component carriers according to Table 5.4.2-1 with values in MHz. The channel spacing for intra-band contiguous carrier aggregation can be adjusted to any multiple of 300 kHz less than the nominal channel spacing to optimize performance in a particular deployment scenario.

For intra-band non-contiguous carrier aggregation the minimum channel spacing between E-UTRA component carriers shall be larger than the nominal channel spacing defined in this subclause.

5.4.2 Channel bandwidth

Requirements in present document are specified for the channel bandwidths listed in Table 5.4.2-1

Table 5.4.2-1: Transmission bandwidth configuration N_{RB} in E-UTRA channel bandwidths

Channel bandwidth BW_{Channel} [MHz]	1.4	3	5	10	15	20
Transmission bandwidth configuration N_{RB}	6	15	25	50	75	100

Figure 5.4.2-1 shows the relation between the Channel bandwidth (BW_{Channel}) and the Transmission bandwidth configuration (N_{RB}). The channel edges are defined as the lowest and highest frequencies of the carrier separated by the channel bandwidth, i.e. at $F_C \pm BW_{\text{Channel}}/2$.

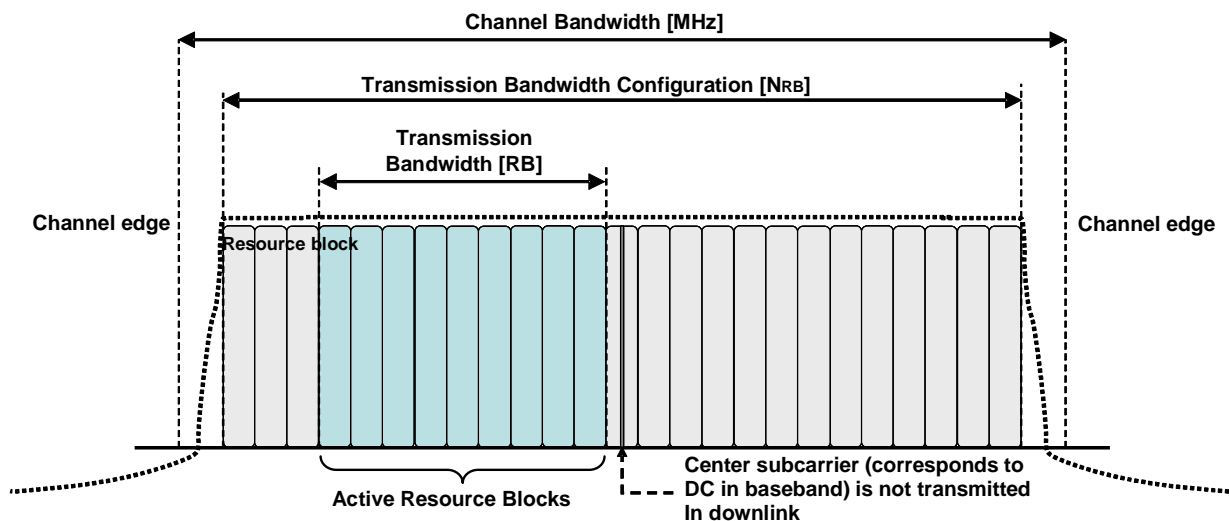

Figure 5.4.2-1: Definition of channel bandwidth and transmission bandwidth configuration for one E-UTRA carrier

5.4.2.1 Channel bandwidths per operating band

- a) The requirements in this specification apply to the combination of channel bandwidths and operating bands shown in Table 5.4.2.1-1. The transmission bandwidth configuration in Table 5.4.2-1 shall be supported for each of the specified supported channel bandwidths. The same (symmetrical) channel bandwidth is specified for both the TX and RX path.

Table 5.4.2.1-1: E-UTRA channel bandwidth

E-UTRA band / channel bandwidth						
E-UTRA Band	1.4 MHz	3 MHz	5 MHz	10 MHz	15 MHz	20 MHz
1			Yes	Yes	Yes	Yes
2	Yes	Yes	Yes	Yes	Yes ¹	Yes ¹
3	Yes	Yes	Yes	Yes	Yes ¹	Yes ¹
4	Yes	Yes	Yes	Yes	Yes	Yes
5	Yes	Yes	Yes	Yes ¹		
6			Yes	Yes ¹		
7			Yes	Yes	Yes ³	Yes ^{1, 3]}
8	Yes	Yes	Yes	Yes ^[1]		
9			Yes	Yes	Yes ¹	Yes ¹
10			Yes	Yes	Yes	Yes
11			Yes	Yes ¹		
12	Yes	Yes	Yes ¹	Yes ¹		
13			Yes ¹	Yes ¹		
14			Yes ¹	Yes ¹		
...						
17			Yes ¹	Yes ¹		
18			Yes	Yes ¹	Yes ¹	
19			Yes	Yes ¹	Yes ¹	
20			Yes	Yes ¹	Yes ¹	Yes ¹
21			Yes	Yes ¹	Yes ¹	
22			Yes	Yes	Yes ¹	Yes ¹
23	Yes	Yes	Yes	Yes	Yes ^[1]	Yes ^[1]
24			Yes	Yes		
25	Yes	Yes	Yes	Yes	Yes ^[1]	Yes ^[1]
26	Yes	Yes	Yes	Yes ¹	Yes ¹	
27	Yes	Yes	Yes	Yes ¹		
28		Yes	Yes	Yes ¹	Yes ¹	Yes ^{1, 2}
31	Yes	Yes ¹	Yes ¹			
...						
33			Yes	Yes	Yes	Yes
34			Yes	Yes	Yes	
35	Yes	Yes	Yes	Yes	Yes	Yes
36	Yes	Yes	Yes	Yes	Yes	Yes
37			Yes	Yes	Yes	Yes
38			Yes	Yes	Yes ³	Yes ³
39			Yes	Yes	Yes	Yes
40			Yes	Yes	Yes	Yes
41			Yes	Yes	Yes	Yes
42			Yes	Yes	Yes	Yes
43			Yes	Yes	Yes	Yes
44		Yes	Yes	Yes	Yes	Yes
Note 1:	refers to the bandwidth for which a relaxation of the specified UE receiver sensitivity requirement (Clause 7.3) is allowed.					
Note 2:	For the 20 MHz bandwidth, the minimum requirements are specified for E-UTRA UL carrier frequencies confined to either 713-723 MHz or 728-738 MHz					
Note 3:	refers to bandwidth for which the uplink transmission bandwidth can be restricted by the network for some channel assignments in FDD/TDD co-existence scenarios in order to meet unwanted emissions requirements (Clause 6.6.3.2).					

- b) The use of different (asymmetrical) channel bandwidth for the TX and RX is not precluded and is intended to form part of a later release.

5.4.2A Channel bandwidth for CA

For intra-band contiguous carrier aggregation *Aggregated Channel Bandwidth*, *Aggregated Transmission Bandwidth Configuration* and *Guard Bands* are defined as follows, see Figure 5.4.2A-1.

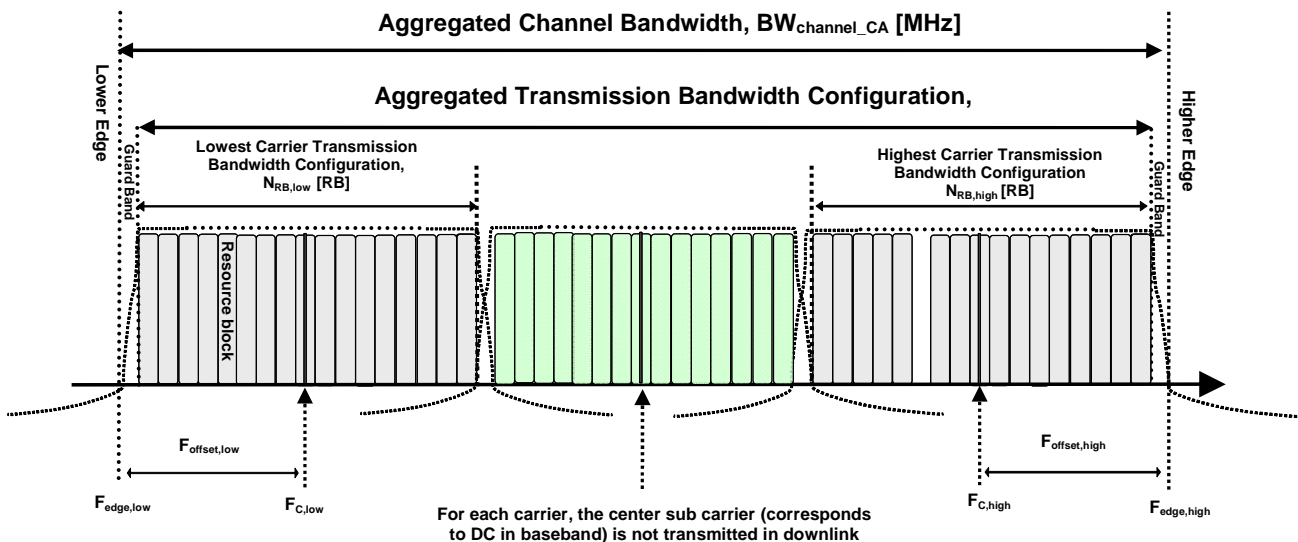

Figure 5.4.2A-1: Definition of Aggregated channel bandwidth and aggregated channel bandwidth edges

The *aggregated channel bandwidth*, $BW_{\text{Channel_CA}}$, is defined as

$$BW_{\text{Channel_CA}} = F_{\text{edge,high}} - F_{\text{edge,low}} \quad [\text{MHz}].$$

The lower bandwidth edge $F_{\text{edge,low}}$ and the upper bandwidth edge $F_{\text{edge,high}}$ of the aggregated channel bandwidth are used as frequency reference points for transmitter and receiver requirements and are defined by

$$F_{\text{edge,low}} = F_{\text{C,low}} - F_{\text{offset,low}}$$

$$F_{\text{edge,high}} = F_{\text{C,high}} + F_{\text{offset,high}}$$

The lower and upper frequency offsets depend on the transmission bandwidth configurations of the lowest and highest assigned edge component carrier and are defined as

$$F_{\text{offset,low}} = 0.18N_{\text{RB,low}}/2 + BW_{\text{GB}} \quad [\text{MHz}]$$

$$F_{\text{offset,high}} = 0.18N_{\text{RB,high}}/2 + BW_{\text{GB}} \quad [\text{MHz}]$$

where $N_{\text{RB,low}}$ and $N_{\text{RB,high}}$ are the transmission bandwidth configurations according to Table 5.4.2-1 for the lowest and highest assigned component carrier, respectively. BW_{GB} denotes the *Nominal Guard Band* and is defined in Table 5.4.2A-1, and the factor 0.18 is the PRB bandwidth in MHz.

NOTE: The values of $BW_{\text{Channel_CA}}$ for UE and BS are the same if the lowest and the highest component carriers are identical.

Aggregated Transmission Bandwidth Configuration is the number of the aggregated RBs within the fully allocated *Aggregated Channel bandwidth* and is defined per CA Bandwidth Class (Table 5.4.2A-1).

Table 5.4.2A-1: CA bandwidth classes and corresponding nominal guard bands

CA Bandwidth Class	Aggregated Transmission Bandwidth Configuration	Maximum number of CC	Nominal Guard Band BW_{GB}
A	$N_{RB,agg} \leq 100$	1	$0.05BW_{Channel(1)}$
B	$N_{RB,agg} \leq 100$	2	FFS
C	$100 < N_{RB,agg} \leq 200$	2	$0.05 \max(BW_{Channel(1)}, BW_{Channel(2)})$
D	$200 < N_{RB,agg} \leq [300]$	FFS	FFS
E	$[300] < N_{RB,agg} \leq [400]$	FFS	FFS
F	$[400] < N_{RB,agg} \leq [500]$	FFS	FFS
Note 1: $BW_{Channel(1)}$ and $BW_{Channel(2)}$ are channel bandwidths of two E-UTRA component carriers according to Table 5.4.2-1.			

The channel spacing between centre frequencies of contiguously aggregated component carriers is defined in subclause 5.4.1A.

5.4.2A.1 Channel bandwidths per operating band for CA

The requirements for carrier aggregation in this specification are defined for carrier aggregation configurations with associated bandwidth combination sets. For inter-band carrier aggregation, a *carrier aggregation configuration* is a combination of operating bands, each supporting a carrier aggregation bandwidth class. For intra-band contiguous carrier aggregation, a carrier aggregation configuration is a single operating band supporting a carrier aggregation bandwidth class.

For each carrier aggregation configuration, requirements are specified for all bandwidth combinations contained in a *bandwidth combination set*, which is indicated per supported band combination in the UE radio access capability. A UE can indicate support of several bandwidth combination sets per band combination. Furthermore, if the UE indicates support of a bandwidth combination set that is a superset of another applicable bandwidth combination set, the latter is supported by the UE even if not indicated.

Requirements for intra-band contiguous carrier aggregation are defined for the carrier aggregation configurations and bandwidth combination sets specified in Table 5.4.2A.1-1. Requirements for inter-band carrier aggregation are defined for the carrier aggregation configurations and bandwidth combination sets specified in Table 5.4.2A.1-2.

DL component carrier combinations for a given CA configuration shall be symmetrical in relation to channel centre unless stated otherwise in table 5.4.2A.1-1 or 5.4.2A.1-2.

Table 5.4.2A.1-1: E-UTRA CA configurations and bandwidth combination sets defined for intra-band contiguous CA

E-UTRA CA Configuration / Bandwidth combination set							
E-UTRA CA Configuration	E-UTRA Band	50RB+100RB (10 MHz + 20 MHz)	75RB+75RB (15 MHz + 15 MHz)	75RB+100RB (15MHz + 20 MHz)	100RB+100RB (20 MHz + 20 MHz)	Maximum aggregated bandwidth [MHz]	Bandwidth Combination Set
CA_1C	1		Yes		Yes	40	0
CA_7C	7		Yes		Yes	40	0
CA_38C	38		Yes		Yes	40	0
CA_40C	40	Yes	Yes		Yes	40	0
CA_41C	41	Yes	Yes	Yes	Yes	40	0
NOTE 1: The CA Configuration refers to an operating band and a CA bandwidth class specified in Table 5.4.2A-1 (the indexing letter). Absence of a CA bandwidth class for an operating band implies support of all classes.							
NOTE 2: For the supported CC bandwidth combinations, the CC downlink and uplink bandwidths are equal							

Table 5.4.2A.1-2: E-UTRA CA configurations and bandwidth combination sets defined for inter-band CA

E-UTRA CA configuration / Bandwidth combination set											
E-UTRA CA Configuration	E-UTRA Bands	1.4 MHz	3 MHz	5 MHz	10 MHz	15 MHz	20 MHz	Maximum aggregated bandwidth [MHz]	Bandwidth combination set		
CA_1A-5A	1				Yes			20	0		
	5				Yes						
CA_1A-18A	1			Yes	Yes	Yes	Yes	35	0		
	18			Yes	Yes	Yes					
CA_1A-19A	1			Yes	Yes	Yes	Yes	35	0		
	19			Yes	Yes	Yes					
CA_1A-21A	1			Yes	Yes	Yes	Yes	35	0		
	21			Yes	Yes	Yes					
CA_2A-17A	2			Yes	Yes			20	0		
	17			Yes	Yes						
CA_2A-29A	2			Yes	Yes			20	0		
	29		Yes	Yes	Yes			20	0		
CA_3A-5A	3				Yes	Yes	Yes	30	0		
	5			Yes	Yes						
	3				Yes					20	1
CA_3A-7A	5			Yes	Yes			40	0		
	3			Yes	Yes	Yes	Yes				
CA_3A-8A	7				Yes	Yes	Yes	30	0		
	3				Yes						
	8			Yes	Yes					20	1
	8			Yes	Yes						
CA_3A-20A	3			Yes	Yes	Yes	Yes	30	0		
	20			Yes	Yes						
CA_4A-5A	4			Yes	Yes			20	0		
	5			Yes	Yes						
CA_4A-7A	4			Yes	Yes			30	0		
	7			Yes	Yes	Yes	Yes				
CA_4A-12A	4	Yes	Yes	Yes	Yes			20	0		
	12			Yes	Yes						
CA_4A-13A	4			Yes	Yes	Yes	Yes	30	0		
	13				Yes						
CA_4A-17A	4			Yes	Yes			20	0		
	17			Yes	Yes						
CA_4A-29A	4			Yes	Yes			20	0		
	29		Yes	Yes	Yes						
CA_5A-12A	5			Yes	Yes			20	0		
	12			Yes	Yes						
CA_5A-17A	5			Yes	Yes			20	0		
	17			Yes	Yes						
CA_7A-20A	7				Yes	Yes	Yes	30	0		
	20			Yes	Yes						
CA_8A-20A	8			Yes	Yes			20	0		
	20			Yes	Yes						
CA_11A-18A	11			Yes	Yes			25	0		
	18			Yes	Yes	Yes					

NOTE 1: The CA Configuration refers to a combination of an operating band and a CA bandwidth class specified in Table 5.4.2A-1 (the indexing letter). Absence of a CA bandwidth class for an operating band implies support of all classes.

NOTE 2: For each band combination, all combinations of indicated bandwidths belong to the set

NOTE 3: For the supported CC bandwidth combinations, the CC downlink and uplink bandwidths are equal

5.4.2B Channel bandwidth for UL-MIMO

5.4.2B.1 Channel bandwidths per operating band for UL- MIMO

For UL-MIMO, the channel bandwidths specified in Table 5.4.2.1-1 in present document apply for the UL-MIMO operating bands.

5.4.3 Channel raster

The channel raster is 100 kHz for all bands, which means that the carrier centre frequency must be an integer multiple of 100 kHz.

5.4.3A Channel raster for CA

For carrier aggregation the channel raster is 100 kHz for all bands, which means that the carrier centre frequency must be an integer multiple of 100 kHz.

5.4.4 Carrier frequency and EARFCN

The carrier frequency in the uplink and downlink is designated by the E-UTRA Absolute Radio Frequency Channel Number (EARFCN) in the range 0 - 65535. The relation between EARFCN and the carrier frequency in MHz for the downlink is given by the following equation, where F_{DL_low} and $N_{Offs-DL}$ are given in Table 5.4.4-1 and N_{DL} is the downlink EARFCN.

$$F_{DL} = F_{DL_low} + 0.1(N_{DL} - N_{Offs-DL})$$

The relation between EARFCN and the carrier frequency in MHz for the uplink is given by the following equation where F_{UL_low} and $N_{Offs-UL}$ are given in Table 5.4.4-1 and N_{UL} is the uplink EARFCN.

$$F_{UL} = F_{UL_low} + 0.1(N_{UL} - N_{Offs-UL})$$

Table 5.4.4-1: E-UTRA channel numbers

Band	Downlink			Uplink		
	F _{DL_low} (MHz)	N _{Offs-DL}	Range of N _{DL}	F _{UL_low} (MHz)	N _{Offs-UL}	Range of N _{UL}
1	2110	0	0 – 599	1920	18000	18000 – 18599
2	1930	600	600 – 1199	1850	18600	18600 – 19199
3	1805	1200	1200 – 1949	1710	19200	19200 – 19949
4	2110	1950	1950 – 2399	1710	19950	19950 – 20399
5	869	2400	2400 – 2649	824	20400	20400 – 20649
6	875	2650	2650 – 2749	830	20650	20650 – 20749
7	2620	2750	2750 – 3449	2500	20750	20750 – 21449
8	925	3450	3450 – 3799	880	21450	21450 – 21799
9	1844.9	3800	3800 – 4149	1749.9	21800	21800 – 22149
10	2110	4150	4150 – 4749	1710	22150	22150 – 22749
11	1475.9	4750	4750 – 4949	1427.9	22750	22750 – 22949
12	729	5010	5010 – 5179	699	23010	23010 – 23179
13	746	5180	5180 – 5279	777	23180	23180 – 23279
14	758	5280	5280 – 5379	788	23280	23280 – 23379
...						
17	734	5730	5730 – 5849	704	23730	23730 – 23849
18	860	5850	5850 – 5999	815	23850	23850 – 23999
19	875	6000	6000 – 6149	830	24000	24000 – 24149
20	791	6150	6150 – 6449	832	24150	24150 – 24449
21	1495.9	6450	6450 – 6599	1447.9	24450	24450 – 24599
22	3510	6600	6600 – 7399	3410	24600	24600 – 25399
23	2180	7500	7500 – 7699	2000	25500	25500 – 25699
24	1525	7700	7700 - 8039	1626.5	25700	25700 – 26039
25	1930	8040	8040 - 8689	1850	26040	26040 - 26689
26	859	8690	8690 - 9039	814	26690	26690 - 27039
27	852	9040	9040 – 9209	807	27040	27040 – 27209
28	758	9210	9210 – 9659	703	27210	27210 – 27659
29 ²	717	9660	9660 – 9769	N/A		
31	462.5	9870	9870 – 9919	452.5	27760	27760 – 27809
...						
33	1900	36000	36000 – 36199	1900	36000	36000 – 36199
34	2010	36200	36200 – 36349	2010	36200	36200 – 36349
35	1850	36350	36350 – 36949	1850	36350	36350 – 36949
36	1930	36950	36950 – 37549	1930	36950	36950 – 37549
37	1910	37550	37550 – 37749	1910	37550	37550 – 37749
38	2570	37750	37750 – 38249	2570	37750	37750 – 38249
39	1880	38250	38250 – 38649	1880	38250	38250 – 38649
40	2300	38650	38650 – 39649	2300	38650	38650 – 39649
41	2496	39650	39650 - 41589	2496	39650	39650 - 41589
42	3400	41590	41590 – 43589	3400	41590	41590 – 43589
43	3600	43590	43590 – 45589	3600	43590	43590 – 45589
44	703	45590	45590 – 46589	703	45590	45590 – 46589

Note 1: The channel numbers that designate carrier frequencies so close to the operating band edges that the carrier extends beyond the operating band edge shall not be used. This implies that the first 7, 15, 25, 50, 75 and 100 channel numbers at the lower operating band edge and the last 6, 14, 24, 49, 74 and 99 channel numbers at the upper operating band edge shall not be used for channel bandwidths of 1.4, 3, 5, 10, 15 and 20 MHz respectively.

Note 2: Restricted to E-UTRA operation when carrier aggregation is configured.

6 Transmitter Characteristics

6.1 General

Unless otherwise stated, the transmitter characteristics are specified at the antenna connector of the UE with a single transmit antenna. For UE with integral antenna only, a reference antenna with a gain of 0 dBi is assumed.

The transient periods due to power steps, OFF/ON and ON/OFF transitions could occur at slot or symbol boundary with transients, on one or both sides of the boundary. The measurement period and whether to exclude the transient periods are specified in the respective sections below.

Unless otherwise stated, the Test Equipment shall be synchronised to the Uplink signal for measurement of TDD transmitter characteristics.

For CA tests, Cell ID = 0 applies to P-Cell, and Cell ID = 1 is used for S-Cell.

Parameters given in table 6.1-1 are used throughout this section for CA, unless otherwise stated by the test case.

Table 6.1-1: Common Test Parameters

Parameter	Value	Comments
Cross carrier scheduling	Not configured	

6.2 Transmit power

6.2.1 Void

Editor's note: This "void" section was introduced because TS 36.101 v8.1.0 also contains a "void" sub-clause with in the transmit power clause 6.2, and there is a strong desire in RAN5 to keep the test cases clauses numbering matching their specific core requirements as much as possible.

6.2.2 UE Maximum Output Power

6.2.2.1 Test purpose

To verify that the error of the UE maximum output power does not exceed the range prescribed by the specified nominal maximum output power and tolerance.

An excess maximum output power has the possibility to interfere to other channels or other systems. A small maximum output power decreases the coverage area.

6.2.2.2 Test applicability

This test case applies to all types of E-UTRA UE release 8 and forward.

6.2.2.3 Minimum conformance requirements

The following UE Power Classes defines the maximum output power for any transmission bandwidth within the channel bandwidth. The period of measurement shall be at least one sub frame (1ms).

Table 6.2.2.3-1: UE Power Class

EUTRA band	Class 1 (dBm)	Tolerance (dB)	Class 2 (dBm)	Tolerance (dB)	Class 3 (dBm)	Tolerance (dB)	Class 4 (dBm)	Tolerance (dB)
1					23	± 2		
2					23	$\pm 2^2$		
3					23	$\pm 2^2$		
4					23	± 2		
5					23	± 2		
6					23	± 2		
7					23	$\pm 2^2$		
8					23	$\pm 2^2$		
9					23	± 2		
10					23	± 2		
11					23	± 2		
12					23	$\pm 2^2$		
13					23	± 2		
14					23	± 2		
...								
17					23	± 2		
18					23	$\pm 2^6$		
19					23	± 2		
20					23	$\pm 2^2$		
21					23	± 2		
22					23	$+2/-3.5^2$		
23					23^5	$\pm 2^5$		
24					23	± 2		
25					23	$\pm 2^2$		
26					23	$\pm 2^2$		
27					23	± 2		
28					23	$+2/-2.5$		
31					23	± 2		
...								
33					23	± 2		
34					23	± 2		
35					23	± 2		
36					23	± 2		
37					23	± 2		
38					23	± 2		
39					23	± 2		
40					23	± 2		
41					23	$\pm 2^2$		
42					23	$+2/-3$		
43					23	$+2/-3$		
44					23	$+2/[-3]$		
...								
Note 1:	The above tolerances are applicable for UE(s) that support up to 4 E-UTRA operating bands. For UE(s) that support 5 or more E-UTRA bands the maximum output power is expected to decrease with each additional band and is FFS							
Note 2:	For transmission bandwidths (Figure 5.4.2-1) confined within F_{UL_low} and $F_{UL_low} + 4$ MHz or $F_{UL_high} - 4$ MHz and F_{UL_high} , the maximum output power requirement is relaxed by reducing the lower tolerance limit by 1.5 dB							
Note 3:	$P_{PowerClass}$ is the maximum UE power specified without taking into account the tolerance							
Note 4:	For the UE which supports both Band 11 and Band 21 operating frequencies, the tolerance is FFS.							
Note 5:	When NS_20 is signalled, the total output power within 2000-2005 MHz shall be limited to 7 dBm.							
Note 6:	For a UE that supports both Band 18 and Band 26, the maximum output power requirement is relaxed by reducing the lower tolerance limit by 1.5dB for transmission bandwidths confined within 815 MHz and 818 MHz							

The normative reference for this requirement is TS 36.101 clause 6.2.2.

6.2.2.4 Test description

6.2.2.4.1 Initial condition

Initial conditions are a set of test configurations the UE needs to be tested in and the steps for the SS to take with the UE to reach the correct measurement state.

The initial test configurations consist of environmental conditions, test frequencies, and channel bandwidths based on E-UTRA operating bands specified in table 5.4.2.1-1. All of these configurations shall be tested with applicable test parameters for each channel bandwidth, and are shown in table 6.2.2.4.1-1. The details of the uplink reference measurement channels (RMCs) are specified in Annex A.2. Configurations of PDSCH and PDCCH before measurement are specified in Annex C.2.

Table 6.2.2.4.1-1: Test Configuration Table

Initial Conditions					
Test Environment as specified in TS 36.508[7] subclause 4.1		Normal, TL/VL, TL/VH, TH/VL, TH/VH			
Test Frequencies as specified in TS36.508 [7] subclause 4.3.1		Low range, Mid range, High range			
Test Channel Bandwidths as specified in TS 36.508 [7] subclause 4.3.1		Lowest, 5MHz, Highest			
Test Parameters for Channel Bandwidths					
	Downlink Configuration		Uplink Configuration		
Ch BW	N/A for Max UE output power testing		Mod'n	RB allocation	
				FDD	TDD
1.4MHz			QPSK	1	1
1.4MHz			QPSK	5	5
3MHz			QPSK	1	1
3MHz			QPSK	4	4
5MHz			QPSK	1	1
5MHz			QPSK	8	8
10MHz			QPSK	1	1
10MHz			QPSK	12	12
15MHz			QPSK	1	1
15MHz			QPSK	16	16
20MHz			QPSK	1	1
20MHz			QPSK	18	18
<p>Note 1: Test Channel Bandwidths are checked separately for each E-UTRA band, the applicable channel bandwidths are specified in Table 5.4.2.1-1.</p> <p>Note 2: For E-UTRA bands not applied with Note 2 in Table 6.2.2.3-1:</p> <ul style="list-style-type: none"> - The 1 RB allocation shall be tested at RB#0 for low and mid range, RB #max for high range test frequency. - The RBstart of non-1RB allocation shall be RB #0 for low and mid range, RB# (max +1 - RB allocation) for high range test frequency. <p>Note 3: For E-UTRA bands applied with Note 2 in Table 6.2.2.3-1:</p> <ul style="list-style-type: none"> - If the test channel bandwidth is larger than 4MHz, then the 1 RB allocation shall be tested at both RB #0 and RB #max. - If the test channel bandwidth is smaller or equal to 4MHz, then the 1 RB allocation shall be tested at RB #0. - If the test channel bandwidth = (FUL_high - FUL_low) specified by the operating band, then only one frequency range shall be tested and the 1 RB allocation shall be tested at RB #0, RB # $\lceil N_{RB}^{UL} / 2 \rceil$ and RB #max. - For non-1RB allocation, test frequency is middle range, and the RBstart shall be RB #0. <p>Note 4: For E-UTRA band 28, when the test frequency is high range for lower duplexer, 20MHz bandwidth is only testable.</p>					

1. Connect the SS to the UE antenna connectors as shown in TS 36.508[7] Annex A Figure A.3.
2. The parameter settings for the cell are set up according to TS 36.508 [7] subclause 4.4.3.

3. Downlink signals are initially set up according to Annex C.0, C.1, and C.3.0, and uplink signals according to Annex H.1 and H.3.0.
4. The UL Reference Measurement channel is set according to Table 6.2.2.4.1-1.
5. Propagation conditions are set according to Annex B.0.
6. Ensure the UE is in State 3A-RF according to TS 36.508 [7] clause 5.2A.2. Message contents are defined in clause 6.2.2.4.3.

6.2.2.4.2 Test procedure

1. SS sends uplink scheduling information for each UL HARQ process via PDCCH DCI format 0 for C_RNTI to schedule the UL RMC according to Table 6.2.2.4.1-1. Since the UE has no payload and no loopback data to send the UE sends uplink MAC padding bits on the UL RMC.
2. Send continuously uplink power control "up" commands in every uplink scheduling information to the UE; allow at least 200ms for the UE to reach P_{UMAX} level.
3. Measure the mean power of the UE in the channel bandwidth of the radio access mode. The period of measurement shall be at least the continuous duration of one sub-frame (1ms). For TDD slots with transient periods are not under test.

6.2.2.4.3 Message contents

Message contents are according to TS 36.508 [7] subclause 4.6.

6.2.2.5 Test requirements

The maximum output power, derived in step 3 shall be within the range prescribed by the nominal maximum output power and tolerance in Table 6.2.2.5-1.

Table 6.2.2.5-1: UE Power Class test requirements

EUTRA band	Class 1 (dBm)	Tolerance (dB)	Class 2 (dBm)	Tolerance (dB)	Class 3 (dBm)	Tolerance (dB)	Class 4 (dBm)	Tolerance (dB)
1					23	±2.7		
2					23	±2.7 ²		
3					23	±2.7 ²		
4					23	±2.7		
5					23	±2.7		
6					23	±2.7		
7					23	±2.7 ²		
8					23	±2.7 ²		
9					23	±2.7		
10					23	±2.7		
11					23	±2.7		
12					23	±2.7 ²		
13					23	±2.7		
14					23	±2.7		
...								
17					23	±2.7		
18					23	±2.7 ⁶		
19					23	±2.7		
20					23	±2.7 ²		
21					23	±2.7		
22					23	+3.0/-4.5		
23					23 ⁵	±2.7 ⁵		
24					23	±2.7		
25					23	±2.7 ²		
26					23	±2.7 ²		
27					23	±2.7		
28					23	+2.7/-3.2		
31					23	±2.7		
...								
33					23	±2.7		
34					23	±2.7		
35					23	±2.7		
36					23	±2.7		
37					23	±2.7		
38					23	±2.7		
39					23	±2.7		
40					23	±2.7		
41					23	±2.7 ²		
42					23	+3.0/-4.0		
43					23	+3.0/-4.0		
44					23	+2.7/[-3.7]		
...								
Note 1:	The above tolerances are applicable for UE(s) that support up to 4 E-UTRA operating bands. For UE(s) that support 5 or more E-UTRA bands the maximum output power is expected to decrease with each additional band and is FFS							
Note 2:	For transmission bandwidths (Figure 5.4.2-1, Table 5.4.4-1) confined within F_{UL_low} and $F_{UL_low} + 4$ MHz or $F_{UL_high} - 4$ MHz and F_{UL_high} , the maximum output power requirement is relaxed by reducing the lower tolerance limit by 1.5 dB							
Note 3:	$P_{PowerClass}$ is the maximum UE power specified without taking into account the tolerance.							
Note 4:	For the UE which supports both Band 11 and Band 21 operating frequencies, the tolerance is FFS.							
Note 5:	When NS_20 is signalled, the total output power within 2000-2005 MHz shall be limited to 7 dBm.							
Note 6:	For a UE that supports both Band 18 and Band 26, the maximum output power requirement is relaxed by reducing the lower tolerance limit by 1.5dB for transmission bandwidths confined within 815 MHz and 818 MHz.							

6.2.2_1 Maximum Output Power for HPUE

6.2.2_1.1 Test purpose

Same test purpose as in clause 6.2.2.1.

6.2.2_1.2 Test applicability

This test case applies to all types of E-UTRA UE Power Class 1 release 11 and forward.

6.2.2_1.3 Minimum conformance requirements

The following defines the maximum output power for any transmission bandwidth within the channel bandwidth for Power Class 1 UE. The period of measurement shall be at least one sub frame (1ms).

Table 6.2.2_1.3-1: HPUE Power Class

EUTRA band	Class 1 (dBm)	Tolerance (dB)	Class 2 (dBm)	Tolerance (dB)	Class 3 (dBm)	Tolerance (dB)	Class 4 (dBm)	Tolerance (dB)
14	31	+2/-3	N/A	N/A	N/A	N/A	N/A	N/A
Note 1: The above tolerances are applicable for UE(s) that support up to 4 E-UTRA operating bands. For UE(s) that support 5 or more E-UTRA bands the maximum output power is expected to decrease with each additional band and is FFS Note 2-3: N/A Note 4: $P_{PowerClass}$ is the maximum UE power specified without taking into account the tolerance Note 5-6: N/A								

The normative reference for this requirement is TS 36.101 clause 6.2.2.

6.2.2_1.4 Test description

Same test description as in clause 6.2.2.4 with the following exception:

- Instead of Table 6.2.2.4.1-1 → use Table 6.2.2_1.4-1

Table 6.2.2_1.4-1: Test Configuration Table

Initial Conditions				
Test Environment as specified in TS 36.508[7] subclause 4.1	Normal, TL/VL, TL/VH, TH/VL, TH/VH			
Test Frequencies as specified in TS36.508 [7] subclause 4.3.1	Low range, Mid range, High range			
Test Channel Bandwidths as specified in TS 36.508 [7] subclause 4.3.1	Lowest, 5MHz, Highest			
Test Parameters for Channel Bandwidths				
Ch BW	Downlink Configuration		Uplink Configuration	
	N/A for Max UE output power testing		Mod'n	RB allocation
			FDD	TDD
1.4MHz			QPSK	1
1.4MHz			QPSK	5
3MHz			QPSK	1
3MHz			QPSK	4
5MHz			QPSK	1
5MHz			QPSK	8
10MHz			QPSK	1
10MHz			QPSK	12
15MHz			QPSK	1
15MHz			QPSK	16
20MHz			QPSK	1
20MHz			QPSK	18
Note 1: Test Channel Bandwidths are checked separately for each E-UTRA band, the applicable channel bandwidths are specified in Table 5.4.2.1-1. Note 2: The 1 RB allocation shall be tested at RB#0 for low and mid range, RB #max for high range test frequency. The RBstart of non-1RB allocation shall be RB #0 for low and mid range, RB# (max +1 - RB allocation) for high range test frequency.				

6.2.2_1.5 Test requirements

The maximum output power, derived in step 3 shall be within the range prescribed by the nominal maximum output power and tolerance in Table 6.2.2_1.5-1

Table 6.2.2_1.5-1: HPUE Power Class test requirements

EUTRA band	Class 1 (dBm)	Tolerance (dB)	Class 2 (dBm)	Tolerance (dB)	Class 3 (dBm)	Tolerance (dB)	Class 4 (dBm)	Tolerance (dB)
14	31	+2.7/-3.7	N/A	N/A	N/A	N/A	N/A	N/A
Note 1: The above tolerances are applicable for UE(s) that support up to 4 E-UTRA operating bands. For UE(s) that support 5 or more E-UTRA bands the maximum output power is expected to decrease with each additional band and is FFS								

6.2.2A UE Maximum Output Power for CA

6.2.2A.1 UE Maximum Output Power for CA (intra-band contiguous DL CA and UL CA)

6.2.2A.1.1 Test purpose

To verify that the error of UE maximum output power in intra-band contiguous carrier aggregation does not exceed the range prescribed by the specified CA Power Class and tolerance.

An excess maximum output power has the possibility to interfere to other channels or other systems. A small maximum output power decreases the coverage area.

6.2.2A.1.2 Test applicability

This test case applies to all types of E-UTRA UE release 10 and forward that support intra-band contiguous DL CA and UL CA.

6.2.2A.1.3 Minimum conformance requirements

The following UE Power Classes define the maximum output power for any transmission bandwidth within the aggregated channel bandwidth.

- For inter-band carrier aggregation with uplink assigned to one E-UTRA band the requirements in subclause 6.2.2 apply.
- For intra-band contiguous carrier aggregation the maximum output power is specified in Table 6.2.2A.1.3-1.

The maximum output power is measured as the sum of the maximum output power at each UE antenna connector. The period of measurement shall be at least one sub frame (1 ms).

Table 6.2.2A.1.3-1: CA UE Power Class

E-UTRA CA Configuration	Class 1 (dBm)	Tolerance (dB)	Class 2 (dBm)	Tolerance (dB)	Class 3 (dBm)	Tolerance (dB)	Class 4 (dBm)	Tolerance (dB)
CA_1C					23	+2/-2		
CA_7C					23	+2/-2 ²		
CA_38C					23	+2/-2		
CA_40C					23	+2/-2		
CA_41C					23	+2/-2 ²		
<p>Note 1: The above tolerances are applicable for UE(s) that support up to 4 E-UTRA operating bands. For UE(s) that support 5 or more E-UTRA bands the maximum output power is expected to decrease with each additional band and is FFS</p> <p>Note 2: For transmission bandwidths (Figure 5.4.2-1) confined within F_{UL_low} and $F_{UL_low} + 4$ MHz or $F_{UL_high} - 4$ MHz and F_{UL_high}, the maximum output power requirement is relaxed by reducing the lower tolerance limit by 1.5 dB</p> <p>Note 3: $P_{PowerClass}$ is the maximum UE power specified without taking into account the tolerance</p> <p>Note 4: For intra-band contiguous carrier aggregation the maximum power requirement should apply to the total transmitted power over all component carriers (per UE).</p>								

The normative reference for this requirement is in TS 36.101 [2] clause 6.2.2A.

6.2.2A.1.4 Test description

6.2.2A.1.4.1 Initial conditions

Initial conditions are a set of test configurations the UE needs to be tested in and the steps for the SS to take with the UE to reach the correct measurement state.

The initial test configurations consist of environmental conditions, test frequencies, and CC combinations based on E-UTRA CA configurations specified in table 5.4.2A.1-1. All of these configurations shall be tested with applicable test parameters for each CA Configuration, and are shown in table 6.2.2A.1.4.1-1. The details of the uplink reference measurement channels (RMCs) are specified in Annex A.2. Configurations of PDSCH and PDCCH before measurement are specified in Annex C.2.

Table 6.2.2A.1.4.1-1: Test Configuration Table

Initial Conditions								
Test Environment as specified in TS 36.508[7] subclause 4.1					NC, TL/VL, TL/VH, TH/VL, TH/VH			
Test Frequencies as specified in TS36.508 [7] subclause 4.3.1 for different CA bandwidth classes.					C: Low and High range			
Test CC Combination setting (N_{RB_agg}) as specified in subclause 5.4.2A.1 for the CA Configuration across bandwidth combination sets supported by the UE.					Lowest N_{RB_agg} Highest N_{RB_agg}			
Test Parameters for CA Configurations								
CA Configuration / N_{RB_agg}		DL Allocation	CC MOD	UL Allocation				
PCC N_{RB}	SCCs N_{RB}	PCC & SCC RB allocation		N_{RB_alloc}	PCC & SCC RB allocations (L_{CRB} @ RB_{start})			
75	75	N/Afor this test	QPSK	1	P_1@0	S_0@0	-	-
75	75		QPSK	16	P_16@0	S_0@0	-	-
100	50		QPSK	1	P_1@0	S_0@0	-	-
100	50		QPSK	12	P_12@0	S_0@0	-	-
100	75		QPSK	1	P_1@0	S_0@0		
100	75		QPSK	16	P_16@0	S_0@0		
100	100		QPSK	1	P_1@0	S_0@0	-	-
100	100		QPSK	18	P_18@0	S_0@0	-	-
Note 1: CA Configuration Test CC Combination settings are checked separately for each CA Configuration, which applicable aggregated channel bandwidths are specified in Table 5.4.2A.1-1								

1. Connect the SS to the UE antenna connectors as shown in TS 36.508[7] Annex A Figure group A.32 as appropriate.
2. The parameter settings for the cell are set up according to TS 36.508 [7] subclause 4.4.3.
3. Downlink signals for PCC are initially set up according to Annex C.0, C.1, and C.3.0, and uplink signals according to Annex H.1 and H.3.0.
4. The UL Reference Measurement channel is set according to Table 6.2.2A.1.4.1-1.
5. Propagation conditions are set according to Annex B.0.
6. Ensure the UE is in State 3A-RF according to TS 36.508 [7] clause 5.2A.2. Message contents are defined in clause 6.2.2A.1.4.3.

6.2.2A.1.4.2 Test procedure

1. Configure SCC according to Annex C.0, C.1 and Annex C.3.0 for all downlink physical channels except PHICH.
2. The SS shall configure SCC as per TS 36.508 [7] clause 5.2A.4. Message contents are defined in clause 6.2.2A.1.4.3.
3. SS activates SCC by sending the activation MAC-CE (Refer TS 36.321 [13], clauses 5.13, 6.1.3.8). Wait for at least 2 seconds (Refer TS 36.133, clauses 8.3.3.2).

4. SS sends uplink scheduling information for each UL HARQ process via PDCCH DCI format 0 for C_RNTI to schedule the UL RMC according to Table 6.2.2A.1.4.1-1 on both PCC and SCC. Since the UE has no payload and no loopback data to send the UE sends uplink MAC padding bits on the UL RMC.
5. Send continuously uplink power control "up" commands in every uplink scheduling information to the UE; allow at least 200ms for the UE to reach P_{UMAX} level.
6. Measure the mean transmitted power over all component carriers in the CA configuration of the radio access mode. The period of measurement shall be at least the continuous duration of one sub-frame (1ms). For TDD slots with transient periods are not under test.

6.2.2A.1.4.3 Message contents

Message contents are according to TS 36.508 [7] subclause 4.6. In test procedure step 2, for SCC configuration there are no additional message contents.

6.2.2A.1.5 Test Requirements

The maximum output power for the CA configuration, derived in step 3 shall be within the range prescribed by the CA UE Power Class and tolerance in Table 6.2.2A.1.5-1.

Table 6.2.2A.1.5-1: CA UE Power Class test requirements

CA Conf	Class 1 (dBm)	Tolerance (dB)	Class 2 (dBm)	Tolerance (dB)	Class 3 (dBm)	Tolerance (dB)	Class 4 (dBm)	Tolerance (dB)
CA_1C					23	± 2.7		
CA_7C					23	$\pm 2.7^2$		
CA_38C					23	± 2.7		
CA_40C					23	± 2.7		
CA_41C					23	$\pm 2.7^2$		
Note 1:	The above tolerances are applicable for UE(s) that support up to 4 E-UTRA operating bands. For UE(s) that support 5 or more E-UTRA bands the maximum output power is expected to decrease with each additional band and is FFS							
Note 2:	For transmission bandwidths (Figure 5.4.2-1) confined within F_{UL_low} and $F_{UL_low} + 4$ MHz or $F_{UL_high} - 4$ MHz and F_{UL_high} , the maximum output power requirement is relaxed by reducing the lower tolerance limit by 1.5 dB							
Note 3:	$P_{PowerClass}$ is the maximum UE power specified without taking into account the tolerance							
Note 4:	For intra-band contiguous carrier aggregation the maximum power requirement should apply to the total transmitted power over all component carriers (per UE).							

6.2.2B UE Maximum Output Power for UL-MIMO

6.2.2B.1 Test purpose

To verify that the error of UE maximum output power in UL MIMO does not exceed the range prescribed by the specified UL MIMO Power Class and tolerance.

An excess maximum output power has the possibility to interfere to other channels or other systems. A small maximum output power decreases the coverage area.

6.2.2B.2 Test applicability

This test case applies to all types of E-UTRA UE release 10 and forward that support UL MIMO.

6.2.2B.3 Minimum conformance requirements

For UE with two transmit antenna connectors in closed-loop spatial multiplexing scheme, the maximum output power for any transmission bandwidth within the channel bandwidth is specified in Table 6.2.2B.3-1 with the UL-MIMO configurations specified in Table 6.2.2B.3-2. The maximum output power is measured as the sum of the maximum output power at each UE antenna connector. The period of measurement shall be at least one sub frame (1ms).

Table 6.2.2B.3-1: UE Power Class for UL-MIMO in closed loop spatial multiplexing scheme

EUTRA band	Class 1 (dBm)	Tolerance (dB)	Class 2 (dBm)	Tolerance (dB)	Class 3 (dBm)	Tolerance (dB)	Class 4 (dBm)	Tolerance (dB)
1					23	+2/-3		
2					23	+2/-3 ²		
3					23	+2/-3 ²		
4					23	+2/-3		
5					23	+2/-3		
6					23	+2/-3		
7					23	+2/-3 ²		
8					23	+2/-3 ²		
9					23	+2/-3		
10					23	+2/-3		
11					23	+2/-3		
12					23	+2/-3 ²		
13					23	+2/-3		
14					23	+2/-3		
...								
17					23	+2/-3		
18					23	+2/-3		
19					23	+2/-3		
20					23	+2/-3 ²		
21					23	+2/-3		
22					23	+2/-4.5 ²		
23					23	+2/-3		
24					23	+2/-3		
25					23	+2/-3 ²		
26					23	+2/-3 ²		
27					23	+2/-3		
28					23	+2/[-3]		
31					23	+2/-3		
...								
33					23	+2/-3		
34					23	+2/-3		
35					23	+2/-3		
36					23	+2/-3		
37					23	+2/-3		
38					23	+2/-3		
39					23	+2/-3		
40					23	+2/-3		
41					23	+2/-3 ²		
42					23	+2/-4		
43					23	+2/-4		
44					23	+2/[-3]		
Note 1:	Void							
Note 2:	For transmission bandwidths (Figure 5.4.2-1) confined within F_{UL_low} and $F_{UL_low} + 4$ MHz or $F_{UL_high} - 4$ MHz and F_{UL_high} , the maximum output power requirement is relaxed by reducing the lower tolerance limit by 1.5 dB							
Note 3:	For the UE which supports both Band 11 and Band 21 operating frequencies, the tolerance is FFS.							
Note 4:	$P_{PowerClass}$ is the maximum UE power specified without taking into account the tolerance							

Table 6.2.2B.3-2: UL-MIMO configuration in closed-loop spatial multiplexing scheme

Transmission mode	DCI format	Codebook Index
Mode 2	DCI format 4	Codebook index 0

The normative reference for this requirement is TS 36.101 clause 6.2.2B.

6.2.2B.4 Test description

6.2.2B.4.1 Initial condition

Initial conditions are a set of test configurations the UE needs to be tested in and the steps for the SS to take with the UE to reach the correct measurement state.

The initial test configurations consist of environmental conditions, test frequencies, and channel bandwidths based on E-UTRA operating bands specified in table 5.4.2.1-1. All of these configurations shall be tested with applicable test parameters for each channel bandwidth, and are shown in table 6.2.2B.4.1-1. The details of the uplink reference measurement channels (RMCs) are specified in Annex A.2. Configurations of PDSCH and PDCCH before measurement are specified in Annex C.2.

Table 6.2.2B.4.1-1: Test Configuration Table

Initial Conditions				
Test Environment as specified in TS 36.508[7] subclause 4.1		Normal, TL/VL, TL/VH, TH/VL, TH/VH		
Test Frequencies as specified in TS36.508 [7] subclause 4.3.1		Low range, Mid range, High range		
Test Channel Bandwidths as specified in TS 36.508 [7] subclause 4.3.1		Lowest, 5MHz, Highest		
Test Parameters for Channel Bandwidths				
Ch BW	Downlink Configuration		Uplink Configuration	
	N/A for Max UE output power testing		Mod'n	RB allocation
			FDD	TDD
1.4MHz			QPSK	1
1.4MHz			QPSK	5
3MHz			QPSK	1
3MHz			QPSK	4
5MHz			QPSK	1
5MHz			QPSK	8
10MHz			QPSK	1
10MHz			QPSK	12
15MHz			QPSK	1
15MHz			QPSK	16
20MHz			QPSK	1
20MHz			QPSK	18
<p>Note 1: Test Channel Bandwidths are checked separately for each E-UTRA band, the applicable channel bandwidths are specified in Table 5.4.2.1-1.</p> <p>Note 2: For E-UTRA bands not applied with Note 2 in Table 6.2.2B.3-1:</p> <ul style="list-style-type: none"> - The 1 RB allocation shall be tested at RB#0 for low and mid range, RB #max for high range test frequency. - The starting resource block of non-1RB allocation shall be RB #0 for low and mid range, RB# (max +1 - RB allocation) for high range test frequency. <p>Note 3: For E-UTRA bands applied with Note 2 in Table 6.2.2B.3-1:</p> <ul style="list-style-type: none"> - If the test channel bandwidth is larger than 4MHz, then the 1 RB allocation shall be tested at both RB #0 and RB #max. - If the test channel bandwidth is smaller or equal to 4MHz, then the 1 RB allocation shall be tested at RB #0. - If the test channel bandwidth = $(F_{UL_high} - F_{UL_low})$ specified by the operating band, then only one frequency range shall be tested and the 1 RB allocation shall be tested at RB #0, RB # $\lceil N_{RB}^{UL} / 2 \rceil$ and RB #max. - For non-1RB allocation, test frequency is middle range, and the starting resource block shall be RB #0. 				

1. Connect the SS to the UE antenna connectors as shown in TS 36.508[7] Annex A Figure A.28.
2. The parameter settings for the cell are set up according to TS 36.508 [7] subclause 4.4.3.
3. Downlink signals are initially set up according to Annex C.0, C.1, and C.3.0, and uplink signals according to Annex H.1 and H.3.0.
4. The UL Reference Measurement channel is set according to Table 6.2.2B.4.1-1.

5. Propagation conditions are set according to Annex B.0.
6. Ensure the UE is in State 3A-RF according to TS 36.508 [7] clause 5.2A.2. Message contents are defined in clause 6.2.2B.4.3.

6.2.2B.4.2 Test procedure

1. SS sends uplink scheduling information for each UL HARQ process via PDCCH DCI format 4 for C_RNTI to schedule the UL RMC according to Table 6.2.2B.4.1-1. Since the UE has no payload and no loopback data to send the UE sends uplink MAC padding bits on the UL RMC.
2. Send continuously uplink power control "up" commands in every uplink scheduling information to the UE; allow at least 200ms for the UE to reach P_{UMAX} level.
3. Measure the mean sum power of the UE in the channel bandwidth of the radio access mode. The period of measurement shall be at least the continuous duration of one sub-frame (1ms). For TDD slots with transient periods are not under test.

6.2.2B.4.3 Message contents

Message contents are according to TS 36.508 [7] clause 4.6.

6.2.2B.5 Test requirements

The maximum output power, derived in step 3 shall be within the range prescribed by the nominal maximum output power and tolerance in Table 6.2.2B.5-1.

Table 6.2.2B.5-1: UE Power Class for UL-MIMO in closed loop spatial multiplexing scheme

EUTRA band	Class 1 (dBm)	Tolerance (dB)	Class 2 (dBm)	Tolerance (dB)	Class 3 (dBm)	Tolerance (dB)	Class 4 (dBm)	Tolerance (dB)
1					23	+2.7/-3.7		
2					23	+2.7/-3.7 ²		
3					23	+2.7/-3.7 ²		
4					23	+2.7/-3.7		
5					23	+2.7/-3.7		
6					23	+2.7/-3.7		
7					23	+2.7/-3.7 ²		
8					23	+2.7/-3.7 ²		
9					23	+2.7/-3.7		
10					23	+2.7/-3.7		
11					23	+2.7/-3.7		
12					23	+2.7/-3.7 ²		
13					23	+2.7/-3.7		
14					23	+2.7/-3.7		
...								
17					23	+2.7/-3.7		
18					23	+2.7/-3.7		
19					23	+2.7/-3.7		
20					23	+2.7/-3.7 ²		
21					23	+2.7/-3.7		
22					23	+3/-5.5 ²		
23					23	+2.7/-3.7		
24					23	+2.7/-3.7		
25					23	+2.7/-3.7 ²		
26					23	+2.7/-3.7		
27					23	+2.7/-3.7		
28					23	+2.7/[-3.7]		
31					23	+2.7/-3.7		
...								
33					23	+2.7/-3.7		
34					23	+2.7/-3.7		
35					23	+2.7/-3.7		
36					23	+2.7/-3.7		
37					23	+2.7/-3.7		
38					23	+2.7/-3.7		
39					23	+2.7/-3.7		
40					23	+2.7/-3.7		
41					23	+2.7/-3.7 ²		
42					23	+3/-5		
43					23	+3/-5		
44					23	+2.7/[-3.7]		
Note 1:	Void							
Note 2:	For transmission bandwidths (Figure 5.4.2-1) confined within F_{UL_low} and $F_{UL_low} + 4$ MHz or $F_{UL_high} - 4$ MHz and F_{UL_high} , the maximum output power requirement is relaxed by reducing the lower tolerance limit by 1.5 dB							
Note 3:	For the UE which supports both Band 11 and Band 21 operating frequencies, the tolerance is FFS.							
Note 4:	$P_{PowerClass}$ is the maximum UE power specified without taking into account the tolerance							

6.2.3 Maximum Power Reduction (MPR)

Editor's note:

- Requirement for Band 44 is not yet finalised due to square brackets in core specification TS 36.101 Table 6.2.2-1.

6.2.3.1 Test purpose

The number of RB identified in Table 6.2.3.3-1 is based on meeting the requirements for adjacent channel leakage ratio and the maximum power reduction (MPR) due to Cubic Metric (CM).

Simple scaling can be used to derive the requirement for other bandwidth based on the previously agreed value for 5MHz channel bandwidth.

6.2.3.2 Test applicability

The requirements of this test apply in test cases 6.6.2.3 Adjacent Channel Leakage power Ratio to all types of E-UTRA UE release 8 and forward.

6.2.3.3 Minimum conformance requirements

For UE Power Class 3, the allowed Maximum Power Reduction (MPR) for the maximum output power in Table 6.2.2.3-1 due to higher order modulation and transmit bandwidth configuration (resource blocks) is specified in Table 6.2.3.3-1.

Table 6.2.3.3-1: Maximum Power Reduction (MPR) for Power Class 3

Modulation	Channel bandwidth / Transmission bandwidth configuration [RB]						MPR (dB)
	1.4 MHz	3.0 MHz	5 MHz	10 MHz	15 MHz	20 MHz	
QPSK	> 5	> 4	> 8	> 12	> 16	> 18	≤ 1
16 QAM	≤ 5	≤ 4	≤ 8	≤ 12	≤ 16	≤ 18	≤ 1
16 QAM	> 5	> 4	> 8	> 12	> 16	> 18	≤ 2

For the UE maximum output power modified by MPR, the power limits specified in subclause 6.2.5.3 apply.

The normative reference for this requirement is TS 36.101 clause 6.2.3.

6.2.3.4 Test description

6.2.3.4.1 Initial condition

Initial conditions are a set of test configurations the UE needs to be tested in and the steps for the SS to take with the UE to reach the correct measurement state.

The initial test configurations consist of environmental conditions, test frequencies, and channel bandwidths based on E-UTRA operating bands specified in table 5.4.2.1-1. All of these configurations shall be tested with applicable test parameters for each channel bandwidth, and are shown in table 6.2.3.4.1-1. The details of the uplink reference measurement channels (RMCs) are specified in Annexes A.2. Configurations of PDSCH and PDCCH before measurement are specified in Annex C.2.

Table 6.2.3.4.1-1: Test Configuration Table

Initial Conditions				
Test Environment as specified in TS 36.508[7] subclause 4.1		Normal, TL/VL, TL/VH, TH/VL, TH/VH		
Test Frequencies as specified in TS36.508 [7] subclause 4.3.1		Low range, Mid range, High range		
Test Channel Bandwidths as specified in TS 36.508 [7] subclause 4.3.1		Lowest, 5MHz, 10MHz, Highest		
Test Parameters for Channel Bandwidths				
	Downlink Configuration		Uplink Configuration	
Ch BW	N/A for Maximum Power Reduction (MPR) test case		Mod'n	RB allocation
				FDD

1.4MHz		QPSK	5	5
1.4MHz		QPSK	6	6
1.4MHz		16QAM	5	5
1.4MHz		16QAM	6	6
3.0MHz		QPSK	4	4
3.0MHz		QPSK	15	15
3.0MHz		16QAM	4	4
3.0MHz		16QAM	15	15
5MHz		QPSK	8	8
5MHz		QPSK	25	25
5MHz		16QAM	8	8
5MHz		16QAM	25	25
10MHz		QPSK	12	12
10MHz		QPSK	50	50
10MHz		16QAM	12	12
10MHz		16QAM	50	50
			(Note 3)	(Note 3)
15MHz		QPSK	16	16
15MHz		QPSK	75	75
15MHz		16QAM	16	16
15MHz		16QAM	75	75
			(Note 3)	(Note 3)
20MHz		QPSK	18	18
20MHz		QPSK	100	100
20MHz		16QAM	18	18
20MHz		16QAM	100	100
			(Note 3)	(Note 3)
Note 1: Test Channel Bandwidths are checked separately for each E-UTRA band, the applicable channel bandwidths are specified in Table 5.4.2.1-1.				
Note 2: The RB _{start} of partial RB allocation shall be RB#0 and RB# (max + 1 - RB allocation) of the channel bandwidth.				
Note 3: Applies only for UE-Categories ≥2.				

1. Connect the SS and interfering sources to the UE antenna connectors as shown in TS 36.508[7] Annex A Figure A.3.
2. The parameter settings for the cell are set up according to TS 36.508 [7] subclause 4.4.3.
3. Downlink signals are initially set up according to Annex C.0, C.1, and C.3.0, and uplink signals according to Annex H.1 and H.3.0.
4. The UL Reference Measurement channels are set according to Table 6.2.3.4.1-1.
5. Ensure the UE is in State 3A-RF according to TS 36.508 [7] clause 5.2A.2. Message contents are defined in clause 6.2.2.4.3.

6.2.3.4.2 Test procedure

1. SS sends uplink scheduling information for each UL HARQ process via PDCCH DCI format 0 for C_RNTI to schedule the UL RMC according to Table 6.2.3.4.1-1. Since the UE has no payload and no loopback data to send the UE sends uplink MAC padding bits on the UL RMC
2. Send continuously uplink power control "up" commands in the uplink scheduling information to the UE to ensure that the UE transmits at P_{UMAX level}.
3. Measure the mean power of the UE in the channel bandwidth of the radio access mode. The period of measurement shall be at least the continuous duration one sub-frame (1ms). For TDD slots with transient periods are not under test.

6.2.3.4.3 Message contents

Message contents are according to TS 36.508 [7] subclause 4.6.

6.2.3.5 Test requirements

The maximum output power, derived in step 2 shall be within the range prescribed by the nominal maximum output power and tolerance in Table 6.2.3.5-1.

Table 6.2.3.5-1: UE Power Class test requirements

E-UTRA Band	Class 1 (dBm)	Tol. (Db)	Class 2 (dBm)	Tol. (dB)	Class 3 (dBm)	QPSK partial RB allocation Tol. (dB)	QPSK full RB allocation Tol. (dB)	16QAM partial RB allocation Tol. (dB)	16QAM full RB allocation Tol. (dB)
1					23	±2.7	+2.7 / -3.7	+2.7 / -3.7	+2.7 / -4.7
2					23	±2.7 ¹	+2.7 / ^{1,2} -3.7	+2.7 / ^{1,2} -3.7	+2.7 / ^{1,2} -4.7
3					23	±2.7 ¹	+2.7 / ^{1,2} -3.7	+2.7 / ^{1,2} -3.7	+2.7 / ^{1,2} -4.7
4					23	±2.7	+2.7 / -3.7	+2.7 / -3.7	+2.7 / -4.7
5					23	±2.7	+2.7 / -3.7	+2.7 / -3.7	+2.7 / -4.7
6					23	±2.7	+2.7 / -3.7	+2.7 / -3.7	+2.7 / -4.7
7					23	±2.7 ¹	+2.7 / ^{1,2} -3.7	+2.7 / ^{1,2} -3.7	+2.7 / ^{1,2} -4.7
8					23	±2.7 ¹	+2.7 / ^{1,2} -3.7	+2.7 / ^{1,2} -3.7	+2.7 / ^{1,2} -4.7
9					23	±2.7	+2.7 / -3.7	+2.7 / -3.7	+2.7 / -4.7
10					23	±2.7	+2.7 / -3.7	+2.7 / -3.7	+2.7 / -4.7
11					23	±2.7	+2.7 / -3.7	+2.7 / -3.7	+2.7 / -4.7
12					23	±2.7 ¹	+2.7 / ^{1,2} -3.7	+2.7 / ^{1,2} -3.7	+2.7 / ^{1,2} -4.7
13					23	±2.7	+2.7 / -3.7	+2.7 / -3.7	+2.7 / -4.7
14					23	±2.7	+2.7 / -3.7	+2.7 / -3.7	+2.7 / -4.7
...									
17					23	±2.7	+2.7 / -3.7	+2.7 / -3.7	+2.7 / -4.7
18					23	±2.7	+2.7 / -3.7	+2.7 / -3.7	+2.7 / -4.7
19					23	±2.7	+2.7 / -3.7	+2.7 / -3.7	+2.7 / -4.7
20					23	±2.7 ¹	+2.7 / ^{1,2} -3.7	+2.7 / ^{1,2} -3.7	+2.7 / ^{1,2} -4.7
21					23	±2.7	+2.7 / -3.7	+2.7 / -3.7	+2.7 / -4.7
22					23	+3.0/-4.5	+3.0/-5.5	+3.0/-5.5	+3.0/-6.5
23					23	±2.7	+2.7 / -3.7	+2.7 / -3.7	+2.7 / -4.7
24					23	±2.7	+2.7 / -3.7	+2.7 / -3.7	+2.7 / -4.7
25					23	±2.7 ¹	+2.7 / ^{1,2} -3.7	+2.7 / ^{1,2} -3.7	+2.7 / ^{1,2} -4.7
26					23	±2.7 ¹	+2.7 / ^{1,2} -3.7	+2.7 / ^{1,2} -3.7	+2.7 / ^{1,2} -4.7
27					23	±2.7	+2.7 / -3.7	+2.7 / -3.7	+2.7 / -4.7
28					23	+2.7/-3.2	+2.7/-4.2	+2.7/-4.2	+2.7/-5.2
31					23	±2.7	+2.7 / -3.7	+2.7 / -3.7	+2.7 / -4.7
...									
33					23	±2.7	+2.7 / -3.7	+2.7 / -3.7	+2.7 / -4.7
34					23	±2.7	+2.7 / -3.7	+2.7 / -3.7	+2.7 / -4.7
35					23	±2.7	+2.7 / -3.7	+2.7 / -3.7	+2.7 / -4.7

							-3.7	-3.7	-4.7
36				23	± 2.7	+2.7 / -3.7	+2.7 / -3.7	+2.7 / -3.7	+2.7 / -4.7
37				23	± 2.7	+2.7 / -3.7	+2.7 / -3.7	+2.7 / -3.7	+2.7 / -4.7
38				23	± 2.7	+2.7 / -3.7	+2.7 / -3.7	+2.7 / -3.7	+2.7 / -4.7
39				23	± 2.7	+2.7 / -3.7	+2.7 / -3.7	+2.7 / -3.7	+2.7 / -4.7
40				23	± 2.7	+2.7 / -3.7	+2.7 / -3.7	+2.7 / -3.7	+2.7 / -4.7
41				23	$\pm 2.7^1$	+2.7 / ^{1,2} -3.7	+2.7 / ^{1,2} -3.7	+2.7 / ^{1,2} -3.7	+2.7 / ^{1,2} -4.7
42				23	+3.0 / -4.0	+3.0 / -5.0	+3.0 / -5.0	+3.0 / -5.0	+3.0 / -6.0
43				23	+3.0 / -4.0	+3.0 / -5.0	+3.0 / -5.0	+3.0 / -5.0	+3.0 / -6.0
44				23	+2.7 / [-3.7]	+2.7 / [-4.7]	+2.7 / [-4.7]	+2.7 / [-4.7]	+2.7 / [-5.7]
Note 1: For transmission bandwidths (Figure 5.4.2-1) confined within FUL_low and FUL_low + 4 MHz or FUL_high – 4 MHz and FUL_high, the maximum output power requirement is relaxed by reducing the lower tolerance limit by 1.5 dB. Note 2: For the UE maximum output power modified by MPR, the power limits specified in Table 6.2.5.3-1 apply									

6.2.3_1 Maximum Power Reduction (MPR) for HPUE

6.2.3_1.1 Test purpose

Same test purpose as in clause 6.2.3.1 with the following exception:

- Instead of Table 6.2.3.3-1 → use Table 6.2.3_1.3-1

6.2.3_1.2 Test applicability

The requirements of this test apply in test cases 6.6.2.3_1 Adjacent Channel Leakage power Ratio for HPUE to all types of E-UTRA Power Class 1 UE release 11 and forward.

6.2.3_1.3 Minimum conformance requirements

For UE Power Class 1, the allowed Maximum Power Reduction (MPR) for the maximum output power in Table 6.2.2_1.3-1 due to higher order modulation and transmit bandwidth configuration (resource blocks) is specified in Table 6.2.3_1.3-1.

Table 6.2.3_1.3-1: Maximum Power Reduction (MPR) for Power Class 1

Modulation	Channel bandwidth / Transmission bandwidth configuration [RB]						MPR (dB)
	1.4 MHz	3.0 MHz	5 MHz	10 MHz	15 MHz	20 MHz	
QPSK	> 5	> 4	> 8	> 12	> 16	> 18	≤ 1
16 QAM	≤ 5	≤ 4	≤ 8	≤ 12	≤ 16	≤ 18	≤ 1
16 QAM	> 5	> 4	> 8	> 12	> 16	> 18	≤ 2

For the UE maximum output power modified by MPR, the power limits specified in subclause 6.2.5_1.3 apply.

The normative reference for this requirement is TS 36.101 clause 6.2.3.

6.2.3_1.4 Test description

Same test description as in clause 6.2.3.4.

6.2.3_1.5 Test requirements

Same test requirements as in clause 6.2.3.5 with the following exceptions:

- Instead of Table 6.2.3.5-1 → use Table 6.2.3_1.5-1

Table 6.2.3_1.5-1: UE Power Class 1 test requirements

E-UTRA Band	Class 1 (dBm)	QPSK partial RB allocation Tol. (dB)	QPSK full RB allocation Tol. (dB)	16QAM partial RB allocation Tol. (dB)	16QAM full RB allocation Tol. (dB)
14	31	+2.7/ -3.7	+2.7 / -4.7	+2.7 / -4.7	+2.7 / -5.7
Note 1: For transmission bandwidths (Figure 5.4.2-1) confined within FUL_low and FUL_low + 4 MHz or FUL_high – 4 MHz and FUL_high, the maximum output power requirement is relaxed by reducing the lower tolerance limit by 1.5 dB. Note 2: For the UE maximum output power modified by MPR, the power limits specified in Table 6.2.5_1.3-1 apply					

6.2.3A Maximum Power Reduction (MPR) for CA

6.2.3A.1 Maximum Power Reduction (MPR) for CA (intra-band contiguous DL CA and UL CA)

6.2.3A.1.1 Test purpose

The number of RB identified in Table 6.2.3A.1.3-1 is based on meeting the requirements for Adjacent Channel Leakage power Ratio (ACLR) for CA and the maximum power reduction (MPR) for intra-band contiguous CA Bandwidth Class C due to Cubic Metric (CM).

6.2.3A.1.2 Test applicability

The requirements of this test apply in test case 6.6.2.3A.1 Adjacent Channel Leakage power Ratio (ACLR) for CA to all types of E-UTRA UE release 10 and forward that support intra-band contiguous DL CA and UL CA.

6.2.3A.1.3 Minimum conformance requirements

The following is specified for maximum power reduction (MPR) for CA.

- For inter-band carrier aggregation with uplink assigned to one E-UTRA band (Table 5.4.2A-1) the requirements in clause 6.2.3 apply.
- For intra-band contiguous carrier aggregation the allowed Maximum Power Reduction (MPR) for the maximum output power in Table 6.2.2A.1.3-1 due to higher order modulation and contiguously aggregated transmits bandwidth configuration (resource blocks) is specified in Table 6.2.3A.1.3-1. In case the modulation format is different on different component carriers then the MPR is determined by the rules applied to higher order of those modulations.

Table 6.2.3A.1.3-1: Maximum Power Reduction (MPR) for Power Class 3

Modulation	CA bandwidth Class C				MPR (dB)
	50 RB + 100 RB	75 RB + 75 RB	75 RB + 100 RB	100 RB + 100 RB	
QPSK	> 12 and ≤ 50	> 16 and ≤ 75	> 16 and ≤ 75	> 18 and ≤ 100	≤ 1
QPSK	> 50	> 75	> 75	> 100	≤ 2
16 QAM	≤ 12	≤ 16	≤ 16	≤ 18	≤ 1
16 QAM	> 12 and ≤ 50	> 16 and ≤ 75	> 16 and ≤ 75	> 18 and ≤ 100	≤ 2
16 QAM	> 50	> 75	> 75	> 100	≤ 3

For intra-band contiguous CA Bandwidth Class C the allowed Maximum Power Reduction (MPR) for the maximum output power in Table 6.2.2A.1.3-1 due to multi-cluster transmission is specified as follows:

$$\text{MPR} = \text{CEIL} \{M_A, 0.5\}$$

Where M_A is defined as follows:

$$M_A = 8.2; 0 \leq A < 0.025,$$

$$9.2 - 40A; 0.025 \leq A < 0.05,$$

$$8 - 16A; 0.05 \leq A < 0.25,$$

$$4.83 - 3.33A; 0.25 \leq A \leq 0.4,$$

$$3.83 - 0.83A; 0.4 \leq A \leq 1$$

Where

$$A = N_{\text{RB_alloc}} / N_{\text{RB_agg}}$$

$\text{CEIL} \{M_A, 0.5\}$ means rounding upwards to closest 0.5dB, i.e. $\text{MPR} \in [3.0, 3.5, 4.0, 4.5, 5.0, 5.5, 6.0, 6.5, 7.0, 7.5, 8.0, 8.5]$

For intra-band non-contiguous carrier aggregation with uplink carrier on the PCC, the requirements in subclause 6.2.3 apply. For the UE maximum output power modified by MPR, the power limits specified in sub-clause 6.2.5A.1 apply.

The normative reference for this requirement is in TS 36.101 [2] clause 6.2.3A.

6.2.3A.1.4 Test description

6.2.3A.1.4.1 Initial condition

Initial conditions are a set of test configurations the UE needs to be tested in and the steps for the SS to take with the UE to reach the correct measurement state.

The initial test configurations consist of environmental conditions, test frequencies, and channel bandwidths based on E-UTRA CA configurations specified in table 5.4.2A.1-1. All of these configurations shall be tested with applicable test parameters for each channel bandwidth, and are shown in table 6.2.3A.1.4.1-1. The details of the uplink reference measurement channels (RMCs) are specified in Annexes A.2. Configurations of PDSCH and PDCCH before measurement are specified in Annex C.2.

Table 6.2.3A.1.4.1-1: Test Configuration Table

Initial Conditions											
Test Environment as specified in TS 36.508[7] subclause 4.1					NC, TL/VL, TL/VH, TH/VL, TH/VH						
Test Frequencies as specified in TS36.508 [7] subclause 4.3.1 for different CA bandwidth classes.					C: Low and High range						
Test CC Combination setting (N_{RB_agg}) as specified in subclause 5.4.2A.1 for the CA Configuration across bandwidth combination sets supported by the UE.					Lowest N_{RB_agg} Highest N_{RB_agg}						
Test Parameters for CA Configurations											
CA Configuration / N_{RB_agg}			DL Allocation		CC MOD	UL Allocation					
ID	PCC N_{RB}	SCCs N_{RB}	PCC & SCC RB allocation			N_{RB_alloc}	PCC & SCC RB allocations (L _{CRB} @ RB _{start})				
1	75	75	N/A for this test		QPSK	16	P_16@0	S_0@0			
2	75	75				QPSK	75	P_75@0	S_0@0		
3	75	75				QPSK	150	P_75@0	S_75@0		
4	75	75				16QAM	16	P_16@0	S_0@0		
5	75	75				16QAM	75	P_75@0	S_0@0		
6	75	75				16QAM	150	P_75@0	S_75@0		
7	75	75				QPSK	2	P_1@0	S_1@74		
8	75	75				QPSK	8	P_2@0	P_2@73	S_2@0	S_2@73
9	75	75				QPSK	60	P_15@0	P_15@60	S_15@0	S_15@60
10	100	50				QPSK	12	P_12@0	S_0@0		
11	100	50				QPSK	50	P_50@0	S_0@0		
12	100	50				QPSK	150	P_100@0	S_50@0		
13	100	50				16QAM	12	P_12@0	S_0@0		
14	100	50				16QAM	50	P_50@0	S_0@0		
15	100	50				16QAM	150	P_100@0	S_50@0		
16	100	50				QPSK	2	P_1@0	S_1@49		
17	100	50				QPSK	8	P_2@0	P_2@60	S_2@10	S_2@48
18	100	50				QPSK	60	P_15@0	P_15@50	S_15@0	S_15@35
19	100	100				QPSK	18	P_18@0	S_0@0		
20	100	100				QPSK	100	P_100@0	S_0@0		
21	100	100				QPSK	200	P_100@0	S_100@0		
22	100	100				16QAM	18	P_18@0	S_0@0		
23	100	100				16QAM	100	P_100@0	S_0@0		
24	100	100				16QAM	200	P_100@0	S_100@0		
25	100	100				QPSK	2	P_1@0	S_1@99		
26	100	100				QPSK	10	P_3@0	P_2@70	S_3@30	S_2@98
27	100	100				QPSK	80	P_20@0	P_20@80	S_20@0	S_20@80

NOTE 1: CA Configuration Test CC Combination settings are checked separately for each CA Configuration, which applicable aggregated channel bandwidths are specified in Table 5.4.2A.1-1.

1. Connect the SS and interfering sources to the UE antenna connectors as shown in TS 36.508[7] Annex A, Figure group A.32 as appropriate.
2. The parameter settings for the cell are set up according to TS 36.508 [7] subclause 4.4.3.
3. Downlink signals for PCC are initially set up according to Annex C.0, C.1, and C.3.0, and uplink signals according to Annex H.1 and H.3.0.
4. The UL Reference Measurement channel is set according to Table 6.2.3A.1.4.1-1.
5. Propagation conditions are set according to Annex B.0.
6. Ensure the UE is in State 3A-RF according to TS 36.508 [7] clause 5.2A.2. Message contents are defined in clause 6.2.3A.1.4.3.

6.2.3A.1.4.2 Test procedure

1. Configure SCC according to Annex C.0, C.1, and Annex C.3.0 for all downlink physical channels except PHICH.
2. The SS shall configure SCC as per TS 36.508 [7] clause 5.2A.4. Message contents are defined in clause 6.2.3A.1.4.3.
3. SS activates SCC by sending the MAC-CE according to TS 36.321 [13] clauses 5.13 and 6.1.3.8. Wait for at least 2 seconds as per TS 36.133 [4] clause 8.3.3.2.
4. SS sends uplink scheduling information for each UL HARQ process via PDCCH DCI format 0 for C_RNTI to schedule the UL RMC according to Table 6.2.5A.1.4.1-1 on both PCC and SCC. Since the UE has no payload and no loopback data to send the UE sends uplink MAC padding bits on the UL RMC.
5. Send continuously uplink power control “up” commands in the uplink scheduling information to the UE to ensure that the UE transmits at P_{UMAX} level.
6. Measure the mean power over all component carriers in the CA configuration of the radio access mode. The period of measurement shall be at least the continuous duration one sub-frame (1ms). For TDD slots with transient periods are not under test.

6.2.3A.1.4.3 Message contents

Message contents are according to TS 36.508 [7] subclause 4.6. In test procedure step 2, for SCC configuration there are no additional message contents.

6.2.3A.1.5 Test Requirements

The maximum output power, derived in step 2 shall be within the range prescribed by the nominal maximum output power and tolerance in Table 6.2.3A.1.5-1.

Table 6.2.3A.1.5-1: CA UE Power Class test requirements

Configuration ID	Class 1 (dBm)	Tol. (dB)	Class 2 (dBm)	Tol. (dB)	Class 3 (dBm)	Tol. (dB)
1					23	+2.7/-3.7
2					23	+2.7/-3.7
3					23	+2.7/-4.7
4					23	+2.7/-3.7
5					23	+2.7/-4.7
6					23	+2.7/-5.7
7					23	+2.7/-11.2
8					23	+2.7/-10.2
9					23	+2.7/-6.2
10					23	+2.7/-3.7
11					23	+2.7/-3.7
12					23	+2.7/-4.7
13					23	+2.7/-3.7
14					23	+2.7/-4.7
15					23	+2.7/-5.7
16					23	+2.7/-11.2
17					23	+2.7/-10.2
18					23	+2.7/-6.2
19					23	+2.7/-3.7
20					23	+2.7/-3.7
21					23	+2.7/-4.7
22					23	+2.7/-3.7
23					23	+2.7/-4.7
24					23	+2.7/-5.7
25					23	+2.7/-11.2
26					23	+2.7/-10.2
27					23	+2.7/-6.2

6.2.3B Maximum Power Reduction (MPR) for UL-MIMO

6.2.3B.1 Test purpose

The number of RB identified in Table 6.2.3B.3-1 is based on meeting the requirements for adjacent channel leakage ratio for UL-MIMO and the maximum power reduction (MPR) for UL-MIMO due to Cubic Metric (CM).

6.2.3B.2 Test applicability

The requirements of this test apply in test cases 6.6.2.3B Adjacent Channel Leakage power Ratio to all types of E-UTRA UE release 10 and forward that support UL-MIMO.

6.2.3B.3 Minimum conformance requirements

For UE with two transmit antenna connectors in closed-loop spatial multiplexing scheme, the maximum output power is measured as the sum of the maximum output power at each UE antenna connector. For UE Power Class 3, the allowed Maximum Power Reduction (MPR) for the maximum output power in Table 6.2.2B.3-1 due to higher order modulation and transmit bandwidth configuration (resource blocks) is specified in Table 6.2.3B.3-1 with UL-MIMO configurations defined in Table 6.2.2B.3-2.

Table 6.2.3B.3-1: Maximum Power Reduction (MPR) for Power Class 3

Modulation	Channel bandwidth / Transmission bandwidth configuration [RB]						MPR (dB)
	1.4 MHz	3.0 MHz	5 MHz	10 MHz	15 MHz	20 MHz	
QPSK	> 5	> 4	> 8	> 12	> 16	> 18	≤ 1
16 QAM	≤ 5	≤ 4	≤ 8	≤ 12	≤ 16	≤ 18	≤ 1
16 QAM	> 5	> 4	> 8	> 12	> 16	> 18	≤ 2

For the UE maximum output power modified by MPR, the power limits specified in clause 6.2.5B.3 apply.

The normative reference for this requirement is TS 36.101 clause 6.2.3B.

6.2.3B.4 Test description

6.2.3B.4.1 Initial condition

Initial conditions are a set of test configurations the UE needs to be tested in and the steps for the SS to take with the UE to reach the correct measurement state.

The initial test configurations consist of environmental conditions, test frequencies, and channel bandwidths based on E-UTRA operating bands specified in clause 5.4.2B.1. All of these configurations shall be tested with applicable test parameters for each channel bandwidth, and are shown in table 6.2.3B.4.1-1. The details of the uplink reference measurement channels (RMCs) are specified in Annexes A.2. Configurations of PDSCH and PDCCH before measurement are specified in Annex C.2.

Table 6.2.3B.4.1-1: Test Configuration Table

Initial Conditions				
Test Environment as specified in TS 36.508[7] clause 4.1		Normal, TL/VL, TL/VH, TH/VL, TH/VH		
Test Frequencies as specified in TS36.508 [7] clause 4.3.1		Low range, Mid range, High range		
Test Channel Bandwidths as specified in TS 36.508 [7] clause 4.3.1		Lowest, 5MHz, 10MHz, Highest		
Test Parameters for Channel Bandwidths				
Ch BW	Downlink Configuration		Uplink Configuration	
	N/A for Maximum Power Reduction (MPR) test case		Mod'n	RB allocation
			FDD	TDD
1.4MHz		QPSK	5	5
1.4MHz		QPSK	6	6
1.4MHz		16QAM	5	5
1.4MHz		16QAM	6	6
3.0MHz		QPSK	4	4
3.0MHz		QPSK	15	15
3.0MHz		16QAM	4	4
3.0MHz		16QAM	15	15
5MHz		QPSK	8	8
5MHz		QPSK	25	25
5MHz		16QAM	8	8
5MHz		16QAM	25	25
10MHz		QPSK	12	12
10MHz		QPSK	50	50
10MHz		16QAM	12	12
10MHz		16QAM	50	50
			(Note 3)	(Note 3)
15MHz		QPSK	16	16
15MHz		QPSK	75	75
15MHz		16QAM	16	16
15MHz		16QAM	75	75
			(Note 3)	(Note 3)
20MHz		QPSK	18	18
20MHz		QPSK	100	100
20MHz		16QAM	18	18
20MHz		16QAM	100	100
			(Note 3)	(Note 3)
Note 1: Test Channel Bandwidths are checked separately for each E-UTRA band, the applicable channel bandwidths are specified in Table 5.4.2.1-1.				
Note 2: The RB _{start} of partial RB allocation shall be RB#0 and RB# (max + 1 - RB allocation) of the channel bandwidth.				
Note 3: Applies only for UE-Categories ≥2.				

1. Connect the SS and interfering sources to the UE antenna connectors as shown in TS 36.508[7] Annex A Figure A.28.
2. The parameter settings for the cell are set up according to TS 36.508 [7] clause 4.4.3.
3. Downlink signals are initially set up according to Annex C.0, C.1, and C.3.0, and uplink signals according to Annex H.1 and H.3.0.
4. The UL Reference Measurement channels are set according to Table 6.2.3B.4.1-1.
5. Ensure the UE is in State 3A-RF according to TS 36.508 [7] clause 5.2A.2. Message contents are defined in clause 6.2.3B.4.3.

6.2.3B.4.2 Test procedure

1. SS sends uplink scheduling information for each UL HARQ process via PDCCH DCI format 4 for C_RNTI to schedule the UL RMC according to Table 6.2.3B.4.1-1. Since the UE has no payload and no loopback data to send the UE sends uplink MAC padding bits on the UL RMC.
2. Send continuously uplink power control "up" commands in the uplink scheduling information to the UE to ensure that the UE transmits at PUMAX level.
3. Measure the sum of mean power of the UE at each transmit antenna connector in the channel bandwidth of the radio access mode. The period of measurement shall be at least the continuous duration one sub-frame (1ms). For TDD slots with transient periods are not under test.

6.2.3B.4.3 Message contents

Message contents are according to TS 36.508 [7] subclause 4.6.

6.2.3B.5 Test requirements

The maximum output power, derived in step 2 shall be within the range prescribed by the nominal maximum output power and tolerance in Table 6.2.3B.5-1.

Table 6.2.3B.5-1: UE Power Class test requirements

E- UTRA Band	Class 1 (dBm)	Tol. (Db)	Class 2 (dBm)	Tol. (dB)	Class 3 (dBm)	QPSK partial RB allocation Tol. (dB)	QPSK full RB allocation Tol. (dB)	16QAM partial RB allocation Tol. (dB)	16QAM full RB allocation Tol. (dB)
1					23	+2.7/-3.7	+2.7/-4.7	+2.7/-4.7	+2.7/-5.7
2					23	+2.7/-3.7 ¹	+2.7/- 4.7 ^{1,2}	+2.7/- 4.7 ^{1,2}	+2.7/- 5.7 ^{1,2}
3					23	+2.7/-3.7 ¹	+2.7/- 4.7 ^{1,2}	+2.7/- 4.7 ^{1,2}	+2.7/- 5.7 ^{1,2}
4					23	+2.7/-3.7	+2.7/-4.7	+2.7/-4.7	+2.7/-5.7
5					23	+2.7/-3.7	+2.7/-4.7	+2.7/-4.7	+2.7/-5.7
6					23	+2.7/-3.7	+2.7/-4.7	+2.7/-4.7	+2.7/-5.7
7					23	+2.7/-3.7 ¹	+2.7/- 4.7 ^{1,2}	+2.7/- 4.7 ^{1,2}	+2.7/- 5.7 ^{1,2}
8					23	+2.7/-3.7 ¹	+2.7/- 4.7 ^{1,2}	+2.7/- 4.7 ^{1,2}	+2.7/- 5.7 ^{1,2}
9					23	+2.7/-3.7	+2.7/-4.7	+2.7/-4.7	+2.7/-5.7
10					23	+2.7/-3.7	+2.7/-4.7	+2.7/-4.7	+2.7/-5.7
11					23	+2.7/-3.7	+2.7/-4.7	+2.7/-4.7	+2.7/-5.7
12					23	+2.7/-3.7 ¹	+2.7/- 4.7 ^{1,2}	+2.7/- 4.7 ^{1,2}	+2.7/- 5.7 ^{1,2}
13					23	+2.7/-3.7	+2.7/-4.7	+2.7/-4.7	+2.7/-5.7
14					23	+2.7/-3.7	+2.7/-4.7	+2.7/-4.7	+2.7/-5.7
...									
17					23	+2.7/-3.7	+2.7/-4.7	+2.7/-4.7	+2.7/-5.7
18					23	+2.7/-3.7	+2.7/-4.7	+2.7/-4.7	+2.7/-5.7
19					23	+2.7/-3.7	+2.7/-4.7	+2.7/-4.7	+2.7/-5.7
20					23	+2.7/-3.7 ¹	+2.7/- 4.7 ^{1,2}	+2.7/- 4.7 ^{1,2}	+2.7/- 5.7 ^{1,2}
21					23	+2.7/-3.7	+2.7/-4.7	+2.7/-4.7	+2.7/-5.7
22					23	+3.0/-5.5	+3.0/-6.5	+3.0/-6.5	+3.0/-7.5
...									
23					23	+2.7/-3.7	+2.7/-4.7	+2.7/-4.7	+2.7/-5.7
24					23	+2.7/-3.7	+2.7/-4.7	+2.7/-4.7	+2.7/-5.7
25					23	+2.7/-3.7 ¹	+2.7/- [4.7] ^{1,2}	+2.7/- [4.7] ^{1,2}	+2.7/- [5.7] ^{1,2}
26					23	+2.7/-3.7	+2.7/-4.7	+2.7/-4.7	+2.7/-5.7
27					23	+2.7/-3.7	+2.7/-4.7	+2.7/-4.7	+2.7/-5.7

28					23	+2.7/[-3.7]	+2.7/[-4.7]	+2.7/[-4.7]	+2.7/[-5.7]
31					23	+2.7/-3.7	+2.7/-4.7	+2.7/-4.7	+2.7/-5.7
...									
33					23	+2.7/-3.7	+2.7/-4.7	+2.7/-4.7	+2.7/-5.7
34					23	+2.7/-3.7	+2.7/-4.7	+2.7/-4.7	+2.7/-5.7
35					23	+2.7/-3.7	+2.7/-4.7	+2.7/-4.7	+2.7/-5.7
36					23	+2.7/-3.7	+2.7/-4.7	+2.7/-4.7	+2.7/-5.7
37					23	+2.7/-3.7	+2.7/-4.7	+2.7/-4.7	+2.7/-5.7
38					23	+2.7/-3.7	+2.7/-4.7	+2.7/-4.7	+2.7/-5.7
39					23	+2.7/-3.7	+2.7/-4.7	+2.7/-4.7	+2.7/-5.7
40					23	+2.7/-3.7	+2.7/-4.7	+2.7/-4.7	+2.7/-5.7
41					23	+2.7/-3.7 ¹	+2.7/-4.7	+2.7/-4.7	+2.7/-5.7
42					23	+3.0/-5.0	+3.0/-6.0 ^{1,2}	+3.0/-6.0 ^{1,2}	+3.0/-7.0 ^{1,2}
43					23	+3.0/-5.0	+3.0/-6.0	+3.0/-6.0	+3.0/-7.0 ^{1,2}
44					23	+2.7/[-3.7]	+2.7/[-4.7]	+2.7/[-4.7]	+2.7/[-5.7]
<p>Note 1: For transmission configurations (Figure 5.4.2-1) confined within FUL_low and FUL_low + 4 MHz or FUL_high – 4 MHz and FUL_high, the maximum output power requirement is relaxed by reducing the lower tolerance limit by 1.5 dB.</p> <p>Note 2: For the UE maximum output power modified by MPR, the power limits specified in Table 6.2.5B.3-1 apply</p>									

6.2.4 Additional Maximum Power Reduction (A-MPR)

6.2.4.1 Test purpose

Additional ACLR and spectrum emission requirements can be signalled by the network to indicate that the UE shall also meet additional requirements in a specific deployment scenario. To meet these additional requirements, Additional Maximum Power Reduction A-MPR is allowed for the output power as specified in Table 6.2.2.3-1. Unless stated otherwise, an A-MPR of 0 dB shall be used.

6.2.4.2 Test applicability

The requirements of this test apply in test case 6.6.2.2 Additional Spectrum Emission Mask for network signalled values NS_03, NS_04, NS_06, NS_07, NS_11, and NS_20 to all types of E-UTRA UE release 8 and forward.

The requirements of this test apply in test case 6.6.3.3 Additional Spurious Emissions for network signalled values NS_05, NS_07, NS_08, NS_09, NS_12, NS_13, NS_14, NS_15, NS_16, NS_17 and NS_18 to all types of E-UTRA UE release 8 and forward.

6.2.4.3 Minimum conformance requirements

For UE Power Class 3 the specific requirements and identified sub-clauses are specified in Table 6.2.4.3-1 along with the allowed A-MPR values that may be used to meet these requirements. The allowed A-MPR values specified below in

Table 6.2.4.3.-1 to 6.2.4.3-15 are in addition to the allowed MPR requirements specified in clause 6.2.3. For the UE maximum output power modified by A-MPR, the power limits specified in clause 6.2.5 apply.

Table 6.2.4.3-1: Additional Maximum Power Reduction (A-MPR) / Spectrum Emission requirements

Network Signalling value	Requirements (sub-clause)	E-UTRA Band	Channel bandwidth (MHz)	Resources Blocks (N_{RB})	A-MPR (dB)
NS_01	6.6.2.1.1	Table 5.2-1	1.4,3,5,10,15,20	Table 5.4.2-1	N/A
NS_03	6.6.2.2.3.1	2,4,10, 23, 25,35,36	3	>5	≤ 1
			5	>6	≤ 1
			10	>6	≤ 1
			15	>8	≤ 1
			20	>10	≤ 1
NS_04	6.6.2.2.3.2	41	5	>6	≤ 1
			10, 15, 20	Table 6.2.4.3-4	
NS_05	6.6.3.3.3.1	1	10,15,20	≥ 50	≤ 1
NS_06	6.6.2.2.3.3	12, 13, 14, 17	1.4, 3, 5, 10	Table 5.4.2-1	N/A
NS_07	6.6.2.2.3.3 6.6.3.3.3.2	13	10	Table 6.2.4.3-2	Table 6.2.4.3-2
NS_08	6.6.3.3.3.3	19	10, 15	> 44	≤ 3
NS_09	6.6.3.3.3.4	21	10, 15	> 40	≤ 1
				> 55	≤ 2
NS_10		20	15, 20	Table 6.2.4.3-3	Table 6.2.4.3-3
NS_11	6.6.2.2.1	23 ¹	1.4, 3, 5, 10,15,20	Table 6.2.4.3-5	Table 6.2.4.3-5
NS_12	6.6.3.3.5	26	1.4, 3, 5	Table 6.2.4.3-6	Table 6.2.4.3-6
NS_13	6.6.3.3.6	26	5	Table 6.2.4.3-7	Table 6.2.4.3-7
NS_14	6.6.3.3.7	26	10, 15	Table 6.2.4.3-8	Table 6.2.4.3-8
NS_15	6.6.3.3.8	26	1.4, 3, 5, 10, 15	Table 6.2.4.3-9 Table 6.2.4.3-10	Table 6.2.4.3-9, Table 6.2.4.3-10
NS_16	6.6.3.3.9	27	3, 5, 10	Table 6.2.4.3-11, Table 6.2.4.3-12, Table 6.2.4.3-13	
NS_17	6.6.3.3.10	28	5, 10	Table 5.4.2-1	N/A
NS_18	6.6.3.3.11	28	5	≥ 2	≤ 1
			10, 15, 20	≥ 1	≤ 4
..					
NS_20	6.2.2, 6.6.2.2.1, 6.6.3.2	23	5, 10, 15, 20	Table 6.2.4.3-14	Table 6.2.4.3-14
NS_32	-	-	-	-	-

Table 6.2.4.3-2: A-MPR for "NS_07"

Parameters	Region A		Region B				Region C	
	0 – 12		13 – 18		19 – 42		43 – 49	
RB_{start} ¹	0 – 12		13 – 18		19 – 42		43 – 49	
L_{CRB} ² [RBs]	6 – 8	1 to 5 and 9-50	<8	≥ 8	<18	≥ 18	≤ 2	>2
A-MPR [dB]	≤ 8	≤ 12	0	≤ 12	0	≤ 6	≤ 3	0
Note 1:	RB_{start} indicates the lowest RB index of transmitted resource blocks							
Note 2:	L_{CRB} is the length of a contiguous resource block allocation							
Note 3:	For intra-subframe frequency hopping between two regions, notes 1 and 2 apply on a per slot basis.							
Note 4:	For intra-subframe frequency hopping between two regions, the larger A-MPR value of the two regions may be applied for both slots in the subframe.							

Table 6.2.4.3-3: A-MPR for "NS_10"

Channel bandwidth [MHz]	Parameters	Region A
15	RB_{start}^1	0 – 10
	L_{CRB} [RBs]	1 -20
	A-MPR [dB]	≤ 2
20	RB_{start}^1	0 – 15
	L_{CRB} [RBs]	1 -20
	A-MPR [dB]	≤ 5
Note 1: RB_{start} indicates the lowest RB index of transmitted resource blocks. Note 2: L_{CRB} is the length of a contiguous resource block allocation. Note 3: For intra-subframe frequency hopping which intersects Region A, notes 1 and 2 apply on a per slot basis. Note 4: For intra-subframe frequency hopping which intersect Region A, the larger A-MPR value may be applied for both slots in the subframe.		

Table 6.2.4.3-4: A-MPR for NS_04 for bandwidths > 5MHz

Channel bandwidth [MHz]	Parameters	Region A	Region B	Region C	
10	RB_{start}^1	0 – 12	13 – 36		37 – 49
	$RB_{start}^1 + L_{CRB}^2$ [RBs]	N/A (Note 3)	14 - 37	>37	N/A (Note 3)
	A-MPR [dB]	≤ 3 dB	0	≤ 2 dB	≤ 3 dB
15	RB_{start}^1	0 – 18	19 – 55		56 – 74
	$RB_{start}^1 + L_{CRB}^2$ [RBs]	N/A (Note 3)	20 - 56	>56	N/A (Note 3)
	A-MPR [dB]	≤ 3 dB	0	≤ 2 dB	≤ 3 dB
20	RB_{start}^1	0 – 24	25 – 74		75 – 99
	$RB_{start}^1 + L_{CRB}^2$ [RBs]	N/A (Note 3)	26 - 75	>75	N/A (Note 3)
	A-MPR [dB]	≤ 3 dB	0	≤ 2 dB	≤ 3 dB
Note 1: RB_{start} indicates the lowest RB index of transmitted resource blocks. Note 2: L_{CRB} is the length of a contiguous resource block allocation. Note 3: Any RB allocation that starts in Region A or C is allowed the specified A-MPR. Note 4: For intra-subframe frequency hopping which intersects regions, notes 1 and 2 apply on a per slot basis. Note 5: For intra-subframe frequency hopping which intersects regions, the larger A-MPR value may be applied for both slots in the subframe.					

Table 6.2.4.3-5: A-MPR for NS_11

Channel Bandwidth [MHz]	Parameters						
	3	F _c [MHz]	<2004		≥2004		
L _{CRB} [RBs]		1-15		>5			
A-MPR [dB]		≤5		≤1			
5	F _c [MHz]	<2004		2004 ≤ F _c <2007		≥2007	
	L _{CRB} [RBs]	1-25		1-6 & 15-25	8-12	>6	
	A-MPR [dB]	≤7		≤4	0	≤1	
10	F _c [MHz]	2005 ≤ F _c <2015			2015		
	RB _{start}	0-49			0-49		
	L _{CRB} [RBs]	1-50			1-50		
	A-MPR [dB]	≤12			0		
15	F _c [MHz]	<2012.5					
	RB _{start}	0-4	5-21		22-56	57-74	
	L _{CRB} [RBs]	≥1	7-50	0-6 & ≥50	≤25	>25	>0
	A-MPR [dB]	≤15	≤7	≤10	0	≤6	≤15
	F _c [MHz]	2012.5					
	RB _{start}	0-12	13-39		40-65	66-74	
	L _{CRB} [RBs]	≥1	≥30	<30	≥ (69 – RB _{start})	≥1	
	A-MPR [dB]	≤10	≤6	0	≤2	≤6.5	
20	F _c [MHz]	2010					
	RB _{start}	0-12	13-29		30-68	69-99	
	L _{CRB} [RBs]	≥1	10-60	1-9 & >60	1-24	≥25	≥1
	A-MPR [dB]	≤15	≤7	≤10	0	≤7	≤15

Table 6.2.4.3-6: A-MPR for "NS_12"

Channel bandwidth [MHz]	Parameters	Region A		Region B
		RB _{start}	0	
1.4	L _{CRB} [RBs]	≤3	≥4	≥4
	A-MPR [dB]	≤3	≤6	≤3
	RB _{start}	0-3		4-5
3	L _{CRB} [RBs]	4-9	1-3 and 10-15	≥9
	A-MPR [dB]	≤4	≤3	≤3
	RB _{start}	0-6		7-9
5	L _{CRB} [RBs]	≤8	≥9	≥15
	A-MPR [dB]	≤5	≤3	≤3

Table 6.2.4.3-7: A-MPR for "NS_13"

Channel bandwidth [MHz]	Parameters	Region A	
5	RB _{start}	0-2	
	L _{CRB} [RBs]	≤5	≥18
	A-MPR [dB]	≤3	≤2

Table 6.2.4.3-8: A-MPR for "NS_14"

Channel bandwidth [MHz]	Parameters	Region A	
10	RB _{start}	0	
	L _{CRB} [RBs]	≤5	≥50
	A-MPR [dB]	≤3	≤1
15	RB _{start}	≤8	
	L _{CRB} [RBs]	≤16	≥50
	A-MPR [dB]	≤3	≤1

Table 6.2.4.3-9: A-MPR for "NS_15" for E-UTRA highest channel edge > 845 MHz and ≤ 849 MHz

Channel bandwidth [MHz]	Parameters	Region A	Region B	Region C
1.4	RB _{end} [RB]			4-5
	A-MPR [dB]			≤3
3	RB _{end} [RB]	0-1	8-12	13-14
	L _{CRB} [RB]	≤2	≥8	>0
	A-MPR [dB]	≤4	≤4	≤9
5	RB _{end} [RB]	0-4	12-19	20-24
	L _{CRB} [RB]	≤2	≥8	>0
	A-MPR [dB]	≤4	≤5	≤9
10	RB _{end} [RB]	0-12	23-36	37-49
	L _{CRB} [RB]	≤2	≥15	>0
	A-MPR [dB]	≤4	≤6	≤9
15	RB _{end} [RB]	0-20	26-53	54-74
	L _{CRB} [RB]	≤2	≥20	>0
	A-MPR [dB]	≤4	≤5	≤9

Table 6.2.4.3-10: A-MPR for "NS_15" for E-UTRA highest channel edge ≤ 845 MHz

Channel bandwidth [MHz]	Parameters	Region A	Region B	Region C
5	RB _{end} [RB]			19-24
	L _{CRB} [RB]			≥18
	A-MPR [dB]			≤2
10	RB _{end} [RB]	0-4	29-44	45-49
	L _{CRB} [RB]	≤2	≥24	>0
	A-MPR [dB]	≤4	≤4	≤9
15	RB _{end} [RB]	0-12	44-61	62-74
	L _{CRB} [RB]	≤2	≥20	>0
	A-MPR [dB]	≤4	≤5	≤9

Table 6.2.4.3-11: A-MPR for “NS_16” with channel lower edge at ≥ 807 MHz and < 808.5 MHz

Channel bandwidth [MHz]	Parameter	Region A	Region B	Region C	Region D	Region E
3 MHz	RB_{start}	0	1-2			
	L_{CRB} [RBs]	≥ 12	12			
	A-MPR [dB]	≤ 2	≤ 1			
5 MHz	RB_{start}	0-1	2	2-9	2-5	
	L_{CRB} [RBs]	1 - 25	12	15-18	20	
	A-MPR [dB]	≤ 5	≤ 1	≤ 2	≤ 3	
10 MHz	RB_{start}	0 - 8	0-14		15-20	15-24
	L_{CRB} [RBs]	1 - 12	15-20	≥ 24	≥ 30	24-27
	A-MPR [dB]	≤ 5	≤ 3	≤ 7	≤ 3	≤ 1

Table 6.2.4.3-12: A-MPR for “NS_16” with channel lower edge at ≥ 808.5 MHz and < 812 MHz

Channel bandwidth [MHz]	Parameter	Region A	Region B	Region C	Region D	Region E
5 MHz	RB_{start}	0	0-1	1-5		
	L_{CRB} [RBs]	16-20	≥ 24	16-20		
	A-MPR [dB]	≤ 2	≤ 3	≤ 1		
10 MHz	RB_{start}	0-6		0-10	0-14	11-20
	L_{CRB} [RBs]	1-12	15-20	24-32	≥ 36	24-32
	A-MPR [dB]	≤ 5	≤ 2	≤ 4	≤ 5	≤ 1

Table 6.2.4.3-13: A-MPR for “NS_16” with channel lower edge at ≥ 812 MHz

Channel bandwidth [MHz]	Parameter	Region A	Region B	Region C	Region D
10 MHz	RB_{start}	0 - 9	0	1-14	0-5
	L_{CRB} [RBs]	27-32	36-40	36-40	≥ 45
	A-MPR [dB]	≤ 1	≤ 2	≤ 1	≤ 3

Table 6.2.4.3-14: A-MPR for “NS_20”

Channel bandwidth [MHz]	Parameters							
5	F _C (MHz)	< 2007.5		2007.5 ≤ F _C < 2012.5		2012.5 ≤ F _C ≤ 2017.5		
	RB _{start}	≤24		0-3	4-6	≤24		
	L _{CRB} (RBs)	>0		15-19	≥20	≥18	1-25	
	A-MPR [dB]	≤17		≤1	≤4	≤2	≤0	
10	F _C (MHz)	2005						
	RB _{start}	0-25		26-34		35-49		
	L _{CRB} (RBs)	>0		8-15	>15	>0		
	A-MPR [dB]	≤16		≤2	≤5	≤6		
	F _C (MHz)	2015						
	RB _{start}	0-5			6-10			
	L _{CRB} (RBs)	≥32			≥40			
	A-MPR [dB]	≤4			≤2			
15	F _C (MHz)	2012.5						
	RB _{start}	0-14		15-24		25-39	61-74	
	L _{CRB} (RBs)	1-9 & 40-75	10-39	24-29	≥30	≥36	≤6	
	A-MPR [dB]	≤11	≤6	≤1	≤7	≤5	≤6	
20	F _C (MHz)	2010						
	RB _{start}	0-21	22-31		32-38	39-49	50-69	70-99
	L _{CRB} (RBs)	>0	1-9 & 31-75	10-30	≥15	≥24	≥25	>0
	A-MPR [dB]	≤17	≤12	≤6	≤9	≤7	≤5	≤16

NOTE 1: When NS_20 is signalled the minimum requirements for the 10 MHz bandwidth are specified for E-UTRA UL carrier centre frequencies of 2005 MHz or 2015 MHz.

NOTE 2: When NS_20 is signalled the minimum requirements for the 15 MHz channel bandwidth are specified for E-UTRA UL carrier centre frequency of 2012.5 MHz.

Table 6.2.4.3-15: A-MPR for “NS_19”

Channel bandwidth [MHz]	Parameters	Region A		Region B
10	RB _{start}			0-6
	L _{CRB} [RBs]			≥40
	A-MPR [dB]			≤1
15	RB _{start}	0-6		7-20
	L _{CRB} [RBs]	≤18	≥36	≥42
	A-MPR [dB]	≤2	≤3	≤2
20	RB _{start}	0-14		15-30
	L _{CRB} [RBs]	≤40	≥45	≥50
	A-MPR [dB]	≤2	≤3	≤2

The normative reference for this requirement is TS 36.101 clause 6.2.4.

6.2.4.4 Test description

6.2.4.4.1 Initial condition

Initial conditions are a set of test configurations the UE needs to be tested in and the steps for the SS to take with the UE to reach the correct measurement state.

The initial test configurations consist of environmental conditions, test frequencies, and channel bandwidths based on E-UTRA operating bands specified in table 5.4.2.1-1. All of these configurations shall be tested with applicable test parameters for each channel bandwidth, and are shown in table 6.2.4.4.1-1 through table 6.2.4.4.1-13. The details of the uplink reference measurement channels (RMCs) are specified in Annex A.2. Configurations of PDSCH and PDCCH before measurement are specified in Annex C.2.

Table 6.2.4.4.1-1: Test Configuration Table (network signalled value "NS_03")

Initial Conditions							
Test Environment (as specified in TS 36.508 [7] subclause 4.1)				NC			
Test Frequencies (as specified in TS36.508 [7] subclause 4.3.1)				Low range, Mid range, High range			
Test Channel Bandwidths (as specified in TS 36.508 [7] subclause 4.3.1)				Lowest, 5MHz, 10MHz, Highest			
Test Parameters for NS_03 A-MPR							
		Downlink Configuration			Uplink Configuration		
Configuration ID	Ch BW	Mod'n	RB allocation		Mod'n	RB allocation	
			FDD	TDD		FDD	TDD

1	1.4MHz	N/A for A-MPR testing.	QPSK	6	6
2	1.4MHz		QPSK	5	5
3	1.4MHz		16QAM	5	5
4	3MHz		QPSK	15	15
5	3MHz		QPSK	4	4
6	3MHz		16QAM	15	15
7	3MHz		16QAM	4	4
8	5MHz		QPSK	25	25
9	5MHz		QPSK	8	8
10	5MHz		QPSK	6	6
11	5MHz		16QAM	25	25
12	5MHz		16QAM	8	8
13	10MHz		QPSK	50	50
14	10MHz		QPSK	12	12
15	10MHz		QPSK	6	6
16	10MHz		16QAM	50 (Note 4)	50 (Note 4)
17	10MHz		16QAM	12	12
18	15MHz		QPSK	75	75
19	15MHz		QPSK	16	16
20	15MHz		QPSK	8	8
21	15MHz		16QAM	75 (Note 4)	75 (Note 4)
22	15MHz		16QAM	16	16
23	20MHz		QPSK	100	100
24	20MHz		QPSK	18	18
25	20MHz		QPSK	10	10
26	20MHz		16QAM	100 (Note 4)	100 (Note 4)
27	20MHz		16QAM	18	18
<p>Note 1: Test Channel Bandwidths are checked separately for each E-UTRA band, the applicable channel bandwidths are specified in Table 5.4.2.1-1.</p> <p>Note 2: The Configuration ID will be used to map the applicable Test Configuration to the corresponding Test Requirement in subclause 6.2.4.5 as not all combinations are necessarily required based on the applicability of the UE.</p> <p>Note 3: The RB_{start} of partial RB allocation shall be RB# 0 and RB# (max +1 - RB allocation) of the channel bandwidth.</p> <p>Note 4: Applies only for UE-Categories ≥ 2.</p> <p>Note 5: For band 23, above table only applies to mid and high range test frequencies. Low range test frequencies will be covered by NS_11 test configuration table.</p>					

Table 6.2.4.4.1-2: Test Configuration Table (network signalled value "NS_04")

Initial Conditions						
Test Environment (as specified in TS 36.508 [7] subclause 4.1)				NC		
Test Frequencies (as specified in TS36.508 [7] subclause 4.3.1)				Low range, Mid range, High range		
Test Channel Bandwidths (as specified in TS 36.508 [7] subclause 4.3.1)				5MHz, 10 MHz, 15 MHz, 20MHz		
Test Parameters for NS_04 A-MPR						
Configuration ID	Ch BW	Downlink Configuration		Uplink Configuration		
		Mod'n	RB allocation TDD	Mod'n	RB allocation TDD	RB _{start} TDD
1	5MHz	N/A for A-MPR testing		QPSK	25	Note 3
2	5MHz			QPSK	8	Note 3
3	5MHz			QPSK	6	Note 3
4	5MHz			16QAM	25	Note 3
5	5MHz			16QAM	8	Note 3
6	10MHz			QPSK	1	0
7	10MHz			QPSK	12	0
8	10MHz			QPSK	50	0
9	10MHz			16QAM	50 (Note 4)	0
10	10MHz			QPSK	24	13
11	10MHz			16QAM	24	13
12	10MHz			QPSK	36	13
13	10MHz			QPSK	12	37
14	10MHz			QPSK	1	49
15	15MHz			QPSK	1	0
16	15MHz			QPSK	16	0
17	15MHz			QPSK	75	0
18	15MHz			16QAM	75 (Note 4)	0
19	15MHz			QPSK	36	19
20	15MHz			16QAM	36 (Note 4)	19
21	15MHz			QPSK	50	19
22	15MHz			QPSK	18	56
23	15MHz			QPSK	1	74
24	20MHz			QPSK	1	0
25	20MHz			QPSK	18	0
26	20MHz			QPSK	100	0
27	20MHz			16QAM	100 (Note 4)	0
28	20MHz			QPSK	50	25
29	20MHz			16QAM	50 (Note 4)	25
30	20MHz			QPSK	75	25
31	20MHz			QPSK	25	75
32	20MHz			QPSK	1	99
Note 1:	Test Channel Bandwidths are checked separately for E-UTRA band, the applicable channel bandwidths are specified in Table 5.4.2.1-1.					
Note 2:	The configuration ID will be used to map the applicable Test Configuration to be corresponding Test Requirement in subclause 6.2.4 as not all combinations are necessarily required based on the applicability of the UE.					
Note 3:	The RB _{start} of partial RB allocation shall be RB# 0 and RB# (max +1 - RB allocation) of the channel bandwidth.					
Note 4:	Applies only for UE-Categories ≥2.					

Table 6.2.4.4.1-3: Test Configuration Table (network signalled value "NS_05")

Initial Conditions	
Test Environment (as specified in TS 36.508 [7] subclause 4.1)	Normal
Test Frequencies (as specified in TS36.508 [7] subclause 4.3.1)	Low range, Mid range In case of Low range: - For 5MHz Channel Bandwidth: 1927.2MHz (NUL = 18072) - For 10 MHz Channel Bandwidth: 1934.7 MHz (NUL = 18147) - For 15 MHz Channel Bandwidth: 1932.5 MHz (NUL = 18125) - For 20 MHz Channel Bandwidth: 1930 MHz (NUL = 18100)
Test Channel Bandwidths (as specified in TS 36.508 [7] subclause 4.3.1)	5MHz, 10MHz, 15MHz, 20MHz
Test Parameters for NS_05 A-MPR	
	Downlink Configuration
	Uplink Configuration

Configuration ID	Ch BW	Mod'n	RB allocation FDD	Mod'n	RB allocation FDD
1	5MHz	N/A for A-MPR testing		QPSK	1
2	5MHz			QPSK	25
3	10MHz			QPSK	1
4	10MHz			QPSK	12
5	10MHz			QPSK	48
6	10MHz			QPSK	50
7	10MHz			16QAM	50 (Note 4)
8	15MHz			QPSK	1
9	15MHz			QPSK	16
10	15MHz			QPSK	30 (Note 5)
11	15MHz			QPSK	48 (Note 6)
12	15MHz			QPSK	75 (Note 6)
13	15MHz			16QAM	75 (Note 4, 6)
14	20MHz			QPSK	1
15	20MHz			QPSK	18
16	20MHz			QPSK	24 (Note 5)
17	20MHz			QPSK	48 (Note 6)
18	20MHz			QPSK	100 (Note 6)
19	20MHz			16QAM	100 (Note 4, 6)
<p>Note 1: The 1 RB allocation shall be tested at both RB #0 and RB #max except for 15MHz and 20MHz of Low Range. For 15MHz of Low Range, the 1 RB allocation shall be tested at both RB#8 and RB#66. For 20MHz of Low Range, the 1 RB allocation shall be tested at both RB#24 and RB#75.</p> <p>Note 2: The RB_{start} of partial RB allocation shall be RB# 0 and RB# (max +1 - RB allocation) of the channel bandwidth except for 15MHz and 20MHz of Low Range. For 15MHz of Low Range, the RB_{start} shall be RB#8 and RB# (67 - RB allocation). For 20MHz of Low Range, the RB_{start} shall be RB#24 and RB# (76 - RB allocation)..</p> <p>Note 3: The Configuration ID will be used to map the applicable Test Configuration to the corresponding Test Requirement in subclause 6.2.4.5 as not all combinations are necessarily required based on the applicability of the UE.</p> <p>Note 4: Applies only for UE-Categories ≥2.</p> <p>Note 5: Required for Low Range only.</p> <p>Note 6: Not available for Low Range.</p>					

Table 6.2.4.4.1-4: Test Configuration Table (network signalled value "NS_06")

Initial Conditions					
Test Environment (as specified in TS 36.508 [7] subclause 4.1)	Normal				
Test Frequencies (as specified in TS36.508 [7] subclause 4.3.1)	Low range, Mid range, High range				
Test Channel Bandwidths (as specified in TS 36.508 [7] subclause 4.3.1)	Lowest, 5MHz, 10MHz, Highest				
Test Parameters for NS_06 A-MPR					
	<table border="1"> <thead> <tr> <th>Downlink Configuration</th> <th>Uplink Configuration</th> </tr> </thead> <tbody> <tr> <td> </td> <td> </td> </tr> </tbody> </table>	Downlink Configuration	Uplink Configuration		
Downlink Configuration	Uplink Configuration				

Configuration ID	Ch BW	Mod'n	RB allocation FDD	Mod'n	RB allocation FDD
1	1.4MHz	N/A for A-MPR testing		QPSK	6
2	1.4MHz			QPSK	5
3	1.4MHz			16QAM	5
4	3MHz			QPSK	15
5	3MHz			QPSK	4
6	3MHz			16QAM	4
7	5MHz			QPSK	25
8	5MHz			QPSK	8
9	5MHz			16QAM	8
10	10MHz			QPSK	50
11	10MHz			QPSK	12
12	10MHz			16QAM	12
13	15MHz			QPSK	75
14	15MHz			QPSK	16
15	15MHz			16QAM	16
16	20MHz			QPSK	100
17	20MHz			QPSK	18
18	20MHz			16QAM	18

Note 1: Test Channel Bandwidths are checked separately for each E-UTRA band, the applicable channel bandwidths are specified in Table 5.4.2.1-1.

Note 2: The Configuration ID will be used to map the applicable Test Configuration to the corresponding Test Requirement in subclause 6.2.4.5 as not all combinations are necessarily required based on the applicability of the UE.

Note 3: The RB_{start} of partial RB allocation shall be RB# 0 and RB# (max +1 - RB allocation) of the channel bandwidth.

Table 6.2.4.4.1-5: Test Configuration Table (network signalled value "NS_07")

Initial Conditions	
Test Environment (as specified in TS 36.508 [7] subclause 4.1)	NC
Test Frequencies (as specified in TS36.508 [7] subclause 4.3.1)	Mid range
Test Channel Bandwidths (as specified in TS 36.508 [7] subclause 4.3.1)	10MHz
Test Parameters for NS_07 A-MPR	
Downlink Configuration	Uplink Configuration

Configuration ID	Ch BW	Mod'n	RB allocation FDD	Mod'n	RB allocation FDD	RB _{start} FDD
1	10MHz	N/A for A-MPR testing		QPSK	1	0
2	10MHz			QPSK	8	0
3	10MHz			QPSK	6	13
4	10MHz			QPSK	20	13
5	10MHz			QPSK	12	13
6	10MHz			16QAM	36 (Note 2)	13
7	10MHz			QPSK	16	19
8	10MHz			QPSK	12	19
9	10MHz			16QAM	16	19
10	10MHz			QPSK	30	19
11	10MHz			16QAM	30 (Note 2)	19
12	10MHz			QPSK	6	43
13	10MHz			QPSK	2	48
14	10MHz			QPSK	50	0
15	10MHz			QPSK	12	0
16	10MHz			16QAM	50 (Note 2)	0

Note 1: The Configuration ID will be used to map the applicable Test Configuration to the corresponding Test Requirement in subclause 6.2.4.5 as not all combinations are necessarily required based on the applicability of the UE.

Note 2: Applies only for UE-Categories ≥2.

Table 6.2.4.4.1-6: Test Configuration Table (network signalled value "NS_08")

Initial Conditions					
Test Environment (as specified in TS 36.508 [7] subclause 4.1)			Normal		
Test Frequencies (as specified in TS36.508 [7] subclause 4.3.1)			High range		
Test Channel Bandwidths (as specified in TS 36.508 [7] subclause 4.3.1)			5MHz, 10MHz, 15MHz		
Test Parameters for NS_08 A-MPR					
		Downlink Configuration		Uplink Configuration	
Configuration ID	Ch BW	Mod'n	RB allocation FDD	Mod'n	RB allocation FDD
1	5MHz	N/A for A-MPR testing		QPSK	1
2	5MHz			QPSK	8
3	5MHz			QPSK	25
4	10MHz			QPSK	1
5	10MHz			QPSK	12
6	10MHz			QPSK	40
7	10MHz			QPSK	50
8	10MHz			16QAM	50 (Note 4)
9	15MHz			QPSK	1
10	15MHz			QPSK	16
11	15MHz			QPSK	40
12	15MHz			QPSK	75
13	15MHz			16QAM	75 (Note 4)

Note 1: The Configuration ID will be used to map the applicable Test Configuration to the corresponding Test Requirement in subclause 6.2.4.5 as not all combinations are necessarily required based on the applicability of the UE.

Note 2: The 1 RB allocation shall be tested at both RB #0 and RB #max.

Note 3: The RB_{start} of partial RB allocation shall be RB# 0 and RB# (max + 1 - RB allocation) of the channel bandwidth

Note 4: Applies only for UE-Categories ≥2.

Table 6.2.4.4.1-7: Test Configuration Table (network signalled value "NS_09")

Initial Conditions					
Test Environment (as specified in TS 36.508 [7] subclause 4.1)			Normal		
Test Frequencies (as specified in TS36.508 [7] subclause 4.3.1)			High range		
Test Channel Bandwidths (as specified in TS 36.508 [7] subclause 4.3.1)			5MHz, 10MHz, 15MHz		
Test Parameters for Channel Bandwidths					
		Downlink Configuration		Uplink Configuration	
Configuration ID	Ch BW	Mod'n	RB allocation FDD	Mod'n	RB allocation FDD
1	5MHz	N/A for A-MPR testing		QPSK	1
2	5MHz			QPSK	8
3	5MHz			QPSK	25
4	10MHz			QPSK	1
5	10MHz			QPSK	12
6	10MHz			QPSK	40
7	10MHz			QPSK	50
8	10MHz			16QAM	50 (Note 4)
9	15MHz			QPSK	1
10	15MHz			QPSK	16
11	15MHz			QPSK	40
12	15MHz			QPSK	54
13	15MHz			QPSK	75
14	15MHz			16QAM	75 (Note 4)
<p>Note 1: The Configuration ID will be used to map the applicable Test Configuration to the corresponding Test Requirement in subclause 6.2.4.5 as not all combinations are necessarily required based on the applicability of the UE.</p> <p>Note 2: The 1 RB allocation shall be tested at both RB #0 and RB #max.</p> <p>Note 3: The RB_{start} of partial RB allocation shall be RB# 0 and RB# (max + 1 - RB allocation) of the channel bandwidth</p> <p>Note 4: Applies only for UE-Categories ≥2.</p>					

Table 6.2.4.4.1-8: Test Configuration Table (network signalled value "NS_10")

Void, not tested

Table 6.2.4.4.1-9: Test Configuration Table (network signalled value "NS_11")

Initial Conditions					
Test Environment (as specified in TS 36.508 [7] subclause 4.1)			Normal		
Test Frequencies (as specified in TS36.508 [7] subclause 4.3.1)			Low range, Mid range, High range For 3 MHz Channel Bandwidth: a. 2001.5 MHz ($N_{UL} = 25515$) b. 2004.5 MHz ($N_{UL} = 25545$) For 5 MHz Channel Bandwidth a. 2002.5 MHz ($N_{UL} = 25525$) b. 2004.5 MHz ($N_{UL} = 25545$) c. 2007.5 MHz ($N_{UL} = 25575$) For 10 MHz Channel Bandwidth a. 2005 MHz ($N_{UL} = 25550$) b. 2005.5 MHz ($N_{UL} = 25555$) c. 2015 MHz ($N_{UL} = 25650$) For 15 MHz Channel Bandwidth a. 2007.5 MHz ($N_{UL} = 25575$) b. 2012.5 MHz ($N_{UL} = 25625$) For 20 MHz Channel Bandwidth a. 2010 MHz ($N_{UL} = 25600$)		
Test Channel Bandwidths (as specified in TS 36.508 [7] subclause 4.3.1)			3MHz, 5MHz, 10MHz, 15MHz, 20MHz		
Test Parameters for NS_11 A-MPR					
Configuration ID	Ch BW	Downlink Configuration		Uplink Configuration	
		Mod'n	RB allocation FDD	Mod'n	RB allocation FDD
1	3MHz	N/A for A-MPR testing		QPSK	6
2	3MHz	N/A for A-MPR testing		QPSK	15
3	3MHz	N/A for A-MPR testing		16QAM	6
4	3MHz	N/A for A-MPR testing		16QAM	15
5	5MHz	N/A for A-MPR testing		QPSK	1
6	5MHz	N/A for A-MPR testing		QPSK	8
7	5MHz	N/A for A-MPR testing		QPSK	25
8	5MHz	N/A for A-MPR testing		16QAM	8
9	5MHz	N/A for A-MPR testing		16QAM	25
10	10MHz	N/A for A-MPR testing		QPSK	1
11	10MHz	N/A for A-MPR testing		QPSK	12
12	10MHz	N/A for A-MPR testing		QPSK	50
13	10MHz	N/A for A-MPR testing		16QAM	12
14	10MHz	N/A for A-MPR testing		16QAM	50 (Note 3)
15	15MHz	N/A for A-MPR testing		QPSK	1
16	15MHz	N/A for A-MPR testing		QPSK	7
17	15MHz	N/A for A-MPR testing		QPSK	25

18	15MHz	QPSK	30
19	15MHz	QPSK	75
20	15MHz	16QAM	7
21	15MHz	16QAM	25
22	15MHz	16QAM	30
23	15MHz	16QAM	75
24	20MHz	QPSK	1
25	20MHz	QPSK	10
26	20MHz	QPSK	25
27	20MHz	QPSK	100
28	20MHz	16QAM	10
29	20MHz	16QAM	25
30	20MHz	16QAM	100
<p>Note 1: The Configuration ID will be used to map the applicable Test Configuration to the corresponding Test Requirement in subclause 6.2.4.5 as not all combinations are necessarily required based on the applicability of the UE.</p> <p>Note 2: The RB_{start} of partial RB allocation shall be RB# 0 and RB# (max +1 - RB allocation) of the channel bandwidth.</p> <p>Note 3: Applies only for UE-Categories ≥ 2.</p>			

Table 6.2.4.4.1-10: Test Configuration Table (network signalled value "NS_12")

Initial Conditions						
Test Environment (as specified in TS 36.508 [7] subclause 4.1)				NC		
Test Frequencies (as specified in TS36.508 [7] subclause 4.3.1)				Mid range		
Test Channel Bandwidths (as specified in TS 36.508 [7] subclause 4.3.1)				1.4 MHz, 3 MHz and 5 MHz		
Test Parameters for Channel Bandwidths						
Configuration ID	Ch BW	Downlink Configuration		Uplink Configuration		
		Mod'n	RB allocation	Mod'n	RB allocation FDD	RBstart FDD
1	1.4 MHz	N/A for A-MPR testing.		QPSK	1	0
2	1.4 MHz			QPSK	6	0
3	1.4 MHz			QPSK	1	1
4	1.4 MHz			QPSK	5	1
5	1.4 MHz			16QAM	6	0
6	3 MHz			QPSK	4	0
7	3 MHz			QPSK	10	0
8	3 MHz			QPSK	4	4
9	3 MHz			QPSK	10	4
10	3 MHz			16QAM	15	0
11	5 MHz			QPSK	8	0
12	5 MHz			QPSK	15	0
13	5 MHz			QPSK	8	7
14	5 MHz			QPSK	15	7
15	5 MHz			16QAM	25	0

Table 6.2.4.4.1-11: Test Configuration Table (network signalled value "NS_13")

Initial Conditions						
Test Environment (as specified in TS 36.508 [7] subclause 4.1)				NC		
Test Frequencies (as specified in TS36.508 [7] subclause 4.3.1)				Mid range		
Test Channel Bandwidths (as specified in TS 36.508 [7] subclause 4.3.1)				5 MHz		
Test Parameters for Channel Bandwidths						
Configuration ID	Ch BW	Downlink Configuration		Uplink Configuration		
		Mod'n	RB allocation	Mod'n	RB allocation FDD	RBstart FDD
1	5 MHz	N/A for A-MPR testing.		QPSK	1	0
2	5 MHz			QPSK	25	0
3	5 MHz			QPSK	15	0
4	5 MHz			QPSK	15	7
5	5 MHz			16QAM	25	0

Table 6.2.4.4.1-12: Test Configuration Table (network signalled value "NS_14")

Initial Conditions						
Test Environment (as specified in TS 36.508 [7] subclause 4.1)				NC		
Test Frequencies (as specified in TS36.508 [7] subclause 4.3.1)				Mid range		
Test Channel Bandwidths (as specified in TS 36.508 [7] subclause 4.3.1)				10 MHz, 15 MHz		
Test Parameters for Channel Bandwidths						
Configuration ID	Ch BW	Downlink Configuration		Uplink Configuration		
		Mod'n	RB allocation	Mod'n	RB allocation FDD	RBstart FDD
1	10 MHz	N/A for A-MPR testing.		QPSK	1	0
2	10 MHz			QPSK	25	0
3	10 MHz			QPSK	50	0
4	10 MHz			QPSK	25	1
5 (Note 1)	10 MHz			16QAM	50	0
6	15 MHz			QPSK	8	0
7	15 MHz			QPSK	25	0
8	15 MHz			QPSK	75	0
9	15 MHz			QPSK	50	15
10 (Note 1)	15 MHz			16QAM	75	0
Note 1: Applies only for UE-Categories ≥ 2 .						

Table 6.2.4.4.1-13: Test Configuration Table (network signalled value "NS_15")

Initial Conditions						
Test Environment (as specified in TS 36.508 [7] subclause 4.1)		NC				
Test Frequencies (as specified in TS36.508 [7] subclause 4.3.1)		For 1.4 MHz Channel Bandwidth: High range For 3 MHz Channel Bandwidth: UL 843.5 MHz ($N_{UL} = 26985$) or High range For 5 MHz Channel Bandwidth: UL 842.5 MHz ($N_{UL} = 26975$) or High range For 10 MHz Channel Bandwidth: UL 840 MHz ($N_{UL} = 26950$) or High range For 15 MHz Channel Bandwidth: UL 837.5 MHz ($N_{UL} = 26925$) or High range				
Test Channel Bandwidths (as specified in TS 36.508 [7] subclause 4.3.1)		1.4 MHz, 3 MHz, 5 MHz, 10 MHz, 15 MHz				
Test Parameters for Channel Bandwidths						
Configuration ID	Ch BW	Downlink Configuration		Uplink Configuration		
		Mod'n	RB allocation	Mod'n	RB allocation FDD	RBstart FDD
1 (note 3)	1.4 MHz	N/A for A-MPR testing.		QPSK	4	0
2 (note 3)	1.4 MHz			16QAM	6	0
3 (note 3)	3 MHz			QPSK	6	7
4 (note 3)	3 MHz			QPSK	12	1
5 (note 3)	3 MHz			16QAM	15	0
6 (note 2)	3 MHz			QPSK	15	0
7 (note 3)	5 MHz			QPSK	6	14
8 (note 3)	5 MHz			QPSK	20	0
9 (note 3)	5 MHz			16QAM	25	0
10 (note 2)	5 MHz			QPSK	16	9
11 (note 2)	5 MHz			QPSK	25	0
12 (note 3)	10 MHz			QPSK	1	39
13 (note 3)	10 MHz			QPSK	1	10
14 (note 3)	10 MHz			QPSK	3	0
15 (note 3)	10 MHz			QPSK	20	3
16 (note 3)	10 MHz			QPSK	36	1
17 (note 3)	10 MHz			QPSK	50	0
18 (note 1, 3)	10 MHz			16QAM	50	0
19 (note 2)	10 MHz			QPSK	20	25
20 (note 2)	10 MHz			QPSK	45	0
21 (note 3)	15 MHz			QPSK	18	36
22 (note 3)	15 MHz			QPSK	25	1
23 (note 3)	15 MHz			QPSK	54	0
24 (note 1, 3)	15 MHz			16QAM	75	0
25 (note 2)	15 MHz			QPSK	18	44

26 (note 2)	15 MHz		QPSK	60	2
Note 1: Applies only for UE-Categories ≥ 2 .					
Note 2: Applicable only test frequency < high range.					
Note 3: Applicable only to high range frequency testing.					

Table 6.2.4.4.1-14: Test Configuration Table (network signalled value "NS_16")

Initial Conditions						
Test Environment (as specified in TS 36.508 [7] subclause 4.1)			NC			
Test Frequencies (as specified in TS36.508 [7] subclause 4.3.1)			For 1.4 MHz Channel Bandwidth: Low range For 3 MHz Channel Bandwidth: Low range, 810 MHz (N _{UL} = 27070) For 5 MHz Channel Bandwidth: Low range, 811 MHz (N _{UL} = 27080), 814.5 MHz (N _{UL} = 27115) For 10 MHz Channel Bandwidth: Low range, 813.5 MHz (N _{UL} = 27105), 817 MHz (N _{UL} = 27140)			
Test Channel Bandwidths (as specified in TS 36.508 [7] subclause 4.3.1)			1.4 MHz, 3 MHz, 5 MHz, 10 MHz			
Test Parameters for Channel Bandwidths						
Configuration ID	Ch BW	Downlink Configuration		Uplink Configuration		
		Mod'n	RB allocation	Mod'n	RB allocation FDD	RBstart FDD
1	1.4 MHz	N/A for A-MPR testing.		QPSK	1	0
2	1.4 MHz			QPSK	6	0
3	1.4 MHz			16QAM	6	0
4	3 MHz			QPSK	1	0
5	3 MHz			QPSK	12	1
6	3 MHz			QPSK	15	0
7	3 MHz			16QAM	15	0
8	5 MHz			QPSK	1	0
9	5 MHz			QPSK	12	2
10	5 MHz			QPSK	18	2
11	5 MHz			QPSK	20	0
12	5 MHz			QPSK	20	2
13	5 MHz			QPSK	25	0
14	5 MHz			16QAM	25	0
15	10 MHz			QPSK	1	0
16 (Note 2)	10 MHz			QPSK	1	10

17 (Note 2)	10 MHz	QPSK	20	0
18 (Note 2)	10 MHz	QPSK	27	15
19 (Note 2)	10 MHz	QPSK	32	15
20	10 MHz	QPSK	32	0
21	10 MHz	QPSK	50	0
22 (Note 1)	10 MHz	16QAM	50	0
23 (Note 3)	10 MHz	QPSK	40	0
24 (Note 3)	10 MHz	QPSK	40	1

Note 1: Applies only for UE-Categories ≥ 2 .
 Note 2: Applies only for 10 MHz channel for Low Range, and 813.5 MHz
 Note 3: Applies only for 10 MHz channel for 817 MHz range

Table 6.2.4.4.1-15: Test Configuration Table (network signalled value "NS_17")

Initial Conditions					
Test Environment (as specified in TS 36.508[7] subclause 4.1)			Normal		
Test Frequencies (as specified in TS36.508 [7] subclause 4.3.1)			Low range		
Test Channel Bandwidths (as specified in TS 36.508 [7] subclause 4.3.1)			5MHz, 10MHz		
Test Parameters for Channel Bandwidths					
Configuration ID	Ch BW	Downlink Configuration		Uplink Configuration	
		Mod'n	RB allocation FDD	Mod'n	RB allocation FDD
1	5MHz	N/A for A-MPR testing		QPSK	1
2	5MHz			QPSK	8
3	5MHz			QPSK	25
4	5MHz			16QAM	25 (Note 3)
5	10MHz			QPSK	1
6	10MHz			QPSK	12
7	10MHz			QPSK	50
8	10MHz			16QAM	50 (Note 3)

Note 1: The 1 RB allocation shall be tested at both RB #0 and RB #max.
 Note 2: The RBstart of partial RB allocation shall be RB# 0 and RB# (max +1 - RB allocation) of the channel bandwidth.
 Note 3: Applies only for UE-Categories ≥ 2 .

Table 6.2.4.4.1-16: Test Configuration Table (network signalled value "NS_18")

Initial Conditions

Test Environment (as specified in TS 36.508[7] subclause 4.1)		Normal			
Test Frequencies (as specified in TS36.508 [7] subclause 4.3.1)		Low range			
Test Channel Bandwidths (as specified in TS 36.508 [7] subclause 4.3.1)		5MHz, 10MHz, 15MHz, 20MHz			
Test Parameters for Channel Bandwidths					
Configuration ID	Ch BW	Downlink Configuration		Uplink Configuration	
		Mod'n	RB allocation FDD	Mod'n	RB allocation FDD
1	5MHz	N/A for A-MPR testing		QPSK	1
2	5MHz			QPSK	8
3	5MHz			QPSK	25
4	5MHz			16QAM	25 (Note 3)
5	10MHz			QPSK	1
6	10MHz			QPSK	12
7	10MHz			QPSK	50
8	10MHz			16QAM	50 (Note 3)
9	15MHz			QPSK	1
10	15MHz			QPSK	16
11	15MHz			QPSK	75
12	15MHz			16QAM	75 (Note 3)
13	20MHz			QPSK	1
14	20MHz			QPSK	18
15	20MHz			QPSK	100
16	20MHz			16QAM	100 (Note 3)
<p>Note 1: The 1 RB allocation shall be tested at both RB #0 and RB #max.</p> <p>Note 2: The RBstart of partial RB allocation shall be RB# 0 and RB# (max +1 - RB allocation) of the channel bandwidth.</p> <p>Note 3: Applies only for UE-Categories ≥ 2.</p>					

Table 6.2.4.4.1-17: Test Configuration Table (network signalled value "NS_20")

Initial Conditions					
Test Environment (as specified in TS 36.508 [7] subclause 4.1)			Normal		
Test Frequencies (as specified in TS36.508 [7] subclause 4.3.1)			Low range, Mid range, High range For 5 MHz Channel Bandwidth a. 2002.5 MHz (N _{UL} = 25525) b. 2007.5 MHz (N _{UL} = 25575) c. 2012.5 MHz (N _{UL} = 25625) d. 2017.5 MHz (N _{UL} = 25675) For 10 MHz Channel Bandwidth a. 2005 MHz (N _{UL} = 25550) b. 2015 MHz (N _{UL} = 25650) For 15 MHz Channel Bandwidth a. 2012.5 MHz (N _{UL} = 25625) For 20 MHz Channel Bandwidth a. 2010 MHz (N _{UL} = 25600)		
Test Channel Bandwidths (as specified in TS 36.508 [7] subclause 4.3.1)			5MHz, 10MHz, 15MHz, 20MHz		
Test Parameters for NS_20 A-MPR					
Configuration ID	Ch BW	Downlink Configuration		Uplink Configuration	
		Mod'n	RB allocation FDD	Mod'n	RB allocation FDD
1	5MHz	N/A for A-MPR testing		QPSK	8
2	5MHz	N/A for A-MPR testing		QPSK	15
3	5MHz	N/A for A-MPR testing		QPSK	25
4	5MHz	N/A for A-MPR testing		16QAM	15
5	5MHz	N/A for A-MPR testing		16QAM	25
6	10MHz	N/A for A-MPR testing		QPSK	8
7	10MHz	N/A for A-MPR testing		QPSK	12
8	10MHz	N/A for A-MPR testing		QPSK	50
9	10MHz	N/A for A-MPR testing		16QAM	12
10	10MHz	N/A for A-MPR testing		16QAM	50 (Note 3)
11	15MHz	N/A for A-MPR testing		QPSK	6
12	15MHz	N/A for A-MPR testing		QPSK	25
13	15MHz	N/A for A-MPR testing		QPSK	36
14	15MHz	N/A for A-MPR testing		QPSK	75
15	15MHz	N/A for A-MPR testing		16QAM	25
16	15MHz	N/A for A-MPR testing		16QAM	36
17	15MHz	N/A for A-MPR testing		16QAM	75
18	20MHz	N/A for A-MPR testing		QPSK	8
19	20MHz	N/A for A-MPR testing		QPSK	18
20	20MHz	N/A for A-MPR testing		QPSK	25

21	20MHz	QPSK	75
22	20MHz	QPSK	100
23	20MHz	16QAM	18
24	20MHz	16QAM	25
25	20MHz	16QAM	75
26	20MHz	16QAM	100
<p>Note 1: The Configuration ID will be used to map the applicable Test Configuration to the corresponding Test Requirement in subclause 6.2.4.5 as not all combinations are necessarily required based on the applicability of the UE.</p> <p>Note 2: The RB_{start} of partial RB allocation shall be RB# 0 and RB# (max +1 - RB allocation) of the channel bandwidth.</p> <p>Note 3: Applies only for UE-Categories ≥2.</p>			

Editor's note: The following lines belong at the end of section 6.2.4.4.1. As new tables are added to this section, these lines should always follow the tables.

1. Connect the SS to the UE antenna connectors as shown in Figure TS 36.508 [7] Annex A, Figure A.3.
2. The parameter settings for the cell are set up according to TS 36.508 [7] clause 4.4.3.
3. Downlink signals are initially set up according to Annex C.0, C.1, and C.3.0, and uplink signals according to Annex H.1 and H.3.0.
4. The UL Reference Measurement channels are set according to the applicable table from Table 6.2.4.4.1-1 to Table 6.2.4.4.1-6.
5. Propagation conditions are set according to Annex B.0.
6. Ensure the UE is in State 3A-RF according to TS 36.508 [7] clause 5.2A.2. Message contents are defined in clause 6.2.4.4.3.

6.2.4.4.2 Test procedure

1. SS sends uplink scheduling information for each UL HARQ process via PDCCH DCI format 0 for C_RNTI to schedule the UL RMC according to the applicable table from Table 6.2.4.4.1-1 to Table 6.2.4.4.1-17. Since the UE has no payload data to send, the UE transmits uplink MAC padding bits on the UL RMC.
2. Send continuously uplink power control "up" commands in the uplink scheduling information to the UE until the UE transmits at P_{UMAX} level.
3. Measure the mean power of the UE in the channel bandwidth of the radio access mode. The period of measurement shall be at least the continuous duration one sub-frame (1ms). For TDD slots with transient periods are not under test.

6.2.4.4.3 Message contents

Message contents are according to TS 36.508 [7] subclause 4.6, with the following exceptions for each network signalled value.

6.2.4.4.3.1 Message contents exceptions (network signalled value "NS_03")

1. Information element `additionalSpectrumEmission` is set to NS_03. This can be set in the `SystemInformationBlockType2` as part of the cell broadcast message. This exception indicates that the UE shall meet the additional spurious emission requirement for a specific deployment scenario.

Table 6.2.4.4.3.1-1: SystemInformationBlockType2: Additional spurious emissions test requirement for "NS_03"

Derivation Path: TS 36.508 [7] clause 4.4.3.3, Table 4.4.3.3-1			
Information Element	Value/remark	Comment	Condition
additionalSpectrumEmission	3 (NS_03)		

6.2.4.4.3.2 Message contents exceptions (network signalled value "NS_04")

- Information element additionalSpectrumEmission is set to NS_04. This can be set in the *SystemInformationblockType2* as part of the cell broadcast message. This exception indicates that the UE shall meet the additional spurious emission requirement for a specific deployment scenario.

Table 6.2.4.4.3.2-1: SystemInformationBlockType2: Additional spurious emissions test requirement for "NS_04"

Derivation Path: TS 36.508 [7] clause 4.4.3.3, Table 4.4.3.3-1			
Information Element	Value/remark	Comment	Condition
additionalSpectrumEmission	4 (NS_04)		

6.2.4.4.3.3 Message contents exceptions (network signalled value "NS_05")

- Information element additionalSpectrumEmission is set to NS_05. This can be set in the *SystemInformationblockType2* as part of the cell broadcast message. This exception indicates that the UE shall meet the additional spurious emission requirement for a specific deployment scenario.

Table 6.2.4.4.3.3-1: SystemInformationBlockType2: Additional spurious emissions test requirement for "NS_05"

Derivation Path: TS 36.508 [7] clause 4.4.3.3, Table 4.4.3.3-1			
Information Element	Value/remark	Comment	Condition
additionalSpectrumEmission	5 (NS_05)		

6.2.4.4.3.4 Message contents exceptions (network signalled value "NS_06")

- Information element additionalSpectrumEmission is set to NS_06. This can be set in the *SystemInformationblockType2* as part of the cell broadcast message. This exception indicates that the UE shall meet the additional spurious emission requirement for a specific deployment scenario.

Table 6.2.4.4.3.4-1: SystemInformationBlockType2: Additional spurious emissions test requirement for "NS_06"

Derivation Path: TS 36.508 [7] clause 4.4.3.3, Table 4.4.3.3-1			
Information Element	Value/remark	Comment	Condition
additionalSpectrumEmission	6 (NS_06)		

6.2.4.4.3.5 Message contents exceptions (network signalled value "NS_07")

- Information element additionalSpectrumEmission is set to NS_07. This can be set in the *SystemInformationblockType2* as part of the cell broadcast message. This exception indicates that the UE shall meet the additional spurious emission requirement for a specific deployment scenario.

Table 6.2.4.4.3.5-1: SystemInformationBlockType2: Additional spurious emissions test requirement for "NS_07"

Derivation Path: TS 36.508 [7] clause 4.4.3.3, Table 4.4.3.3-1			
Information Element	Value/remark	Comment	Condition
additionalSpectrumEmission	7 (NS_07)		

6.2.4.4.3.6 Message contents exceptions (network signalled value "NS_08")

- Information element additionalSpectrumEmission is set to NS_08. This can be set in the *SystemInformationblockType2* as part of the cell broadcast message. This exception indicates that the UE shall meet the additional spurious emission requirement for a specific deployment scenario.

Table 6.2.4.4.3.6-1: SystemInformationBlockType2: Additional spurious emissions test requirement for "NS_08"

Derivation Path: TS 36.508 [7] clause 4.4.3.3, Table 4.4.3.3-1			
Information Element	Value/remark	Comment	Condition
additionalSpectrumEmission	8 (NS_08)		

6.2.4.4.3.7 Message contents exceptions (network signalled value "NS_09")

- Information element additionalSpectrumEmission is set to NS_09. This can be set in the *SystemInformationblockType2* as part of the cell broadcast message. This exception indicates that the UE shall meet the additional spurious emission requirement for a specific deployment scenario.

Table 6.2.4.4.3.7-1: SystemInformationBlockType2: Additional spurious emissions test requirement for "NS_09"

Derivation Path: TS 36.508 [7] clause 4.4.3.3, Table 4.4.3.3-1			
Information Element	Value/remark	Comment	Condition
additionalSpectrumEmission	9 (NS_09)		

6.2.4.4.3.8 Message contents exceptions (network signalled value "NS_10")

Void

6.2.4.4.3.9 Message contents exceptions (network signalled value "NS_11")

- Information element additionalSpectrumEmission is set to NS_11. This can be set in the *SystemInformationblockType2* as part of the cell broadcast message. This exception indicates that the UE shall meet the additional spurious emission requirement for a specific deployment scenario.

Table 6.2.4.4.3.9-1: SystemInformationBlockType2: Additional spurious emissions test requirement for "NS_11"

Derivation Path: TS 36.508 [7] clause 4.4.3.3, Table 4.4.3.3-1			
Information Element	Value/remark	Comment	Condition
additionalSpectrumEmission	11 (NS_11)		

6.2.4.4.3.10 Message contents exceptions (network signalled value "NS_12")

- Information element additionalSpectrumEmission is set to NS_12. This can be set in the *SystemInformationblockType2* as part of the cell broadcast message. This exception indicates that the UE shall meet the additional spurious emission requirement for a specific deployment scenario.

Table 6.2.4.4.3.10-1: SystemInformationBlockType2: Additional spurious emissions test requirement for "NS_12"

Derivation Path: TS 36.508 [7] clause 4.4.3.3, Table 4.4.3.3-1			
Information Element	Value/remark	Comment	Condition
additionalSpectrumEmission	12 (NS_12)		

6.2.4.4.3.11 Message contents exceptions (network signalled value "NS_13")

- Information element additionalSpectrumEmission is set to NS_13. This can be set in the *SystemInformationblockType2* as part of the cell broadcast message. This exception indicates that the UE shall meet the additional spurious emission requirement for a specific deployment scenario.

Table 6.2.4.4.3.11-1: SystemInformationBlockType2: Additional spurious emissions test requirement for "NS_13"

Derivation Path: TS 36.508 [7] clause 4.4.3.3, Table 4.4.3.3-1			
Information Element	Value/remark	Comment	Condition
additionalSpectrumEmission	13 (NS_13)		

6.2.4.4.3.12 Message contents exceptions (network signalled value "NS_14")

- Information element additionalSpectrumEmission is set to NS_14. This can be set in the *SystemInformationblockType2* as part of the cell broadcast message. This exception indicates that the UE shall meet the additional spurious emission requirement for a specific deployment scenario.

Table 6.2.4.4.3.12-1: SystemInformationBlockType2: Additional spurious emissions test requirement for "NS_14"

Derivation Path: TS 36.508 [7] clause 4.4.3.3, Table 4.4.3.3-1			
Information Element	Value/remark	Comment	Condition
additionalSpectrumEmission	14 (NS_14)		

6.2.4.4.3.13 Message contents exceptions (network signalled value "NS_15")

- Information element additionalSpectrumEmission is set to NS_15. This can be set in the *SystemInformationblockType2* as part of the cell broadcast message. This exception indicates that the UE shall meet the additional spurious emission requirement for a specific deployment scenario.

Table 6.2.4.4.3.13-1: SystemInformationBlockType2: Additional spurious emissions test requirement for "NS_15"

Derivation Path: TS 36.508 [7] clause 4.4.3.3, Table 4.4.3.3-1			
Information Element	Value/remark	Comment	Condition
additionalSpectrumEmission	15 (NS_15)		

6.2.4.4.3.14 Message contents exceptions (network signalled value "NS_16")

- Information element additionalSpectrumEmission is set to NS_16. This can be set in the *SystemInformationblockType2* as part of the cell broadcast message. This exception indicates that the UE shall meet the additional spurious emission requirement for a specific deployment scenario.

Table 6.2.4.4.3.14-1: SystemInformationBlockType2: Additional spurious emissions test requirement for "NS_16"

Derivation Path: TS 36.508 [7] clause 4.4.3.3, Table 4.4.3.3-1			
Information Element	Value/remark	Comment	Condition
additionalSpectrumEmission	16 (NS_16)		

6.2.4.4.3.15 Message contents exceptions (network signalled value "NS_17")

1. Information element `additionalSpectrumEmission` is set to NS_17. This can be set in the *SystemInformationBlockType2* as part of the cell broadcast message. This exception indicates that the UE shall meet the additional spurious emission requirement for a specific deployment scenario.

Table 6.2.4.4.3.15-1: SystemInformationBlockType2: Additional spurious emissions test requirement for "NS_17"

Derivation Path: TS 36.508 [7] clause 4.4.3.3, Table 4.4.3.3-1			
Information Element	Value/remark	Comment	Condition
<code>additionalSpectrumEmission</code>	17 (NS_17)		

6.2.4.4.3.16 Message contents exceptions (network signalled value "NS_18")

1. Information element `additionalSpectrumEmission` is set to NS_18. This can be set in the *SystemInformationBlockType2* as part of the cell broadcast message. This exception indicates that the UE shall meet the additional spurious emission requirement for a specific deployment scenario.

Table 6.2.4.4.3.16-1: SystemInformationBlockType2: Additional spurious emissions test requirement for "NS_18"

Derivation Path: TS 36.508 [7] clause 4.4.3.3, Table 4.4.3.3-1			
Information Element	Value/remark	Comment	Condition
<code>additionalSpectrumEmission</code>	18 (NS_18)		

6.2.4.5 Test requirements

The maximum output power, derived in step 2 shall be within the range prescribed by the nominal maximum output power and tolerance in the applicable table from Table 6.2.4.5-1 to Table 6.2.4.5-16. The allowed A-MPR values specified in Table 6.2.4.3-1 are in addition to the allowed MPR requirements specified in clause 6.2.3. For the UE maximum output power modified by MPR and/or A-MPR, the power limits specified in Table 6.2.5.3-1 apply.

**Table 6.2.4.5-1: UE Power Class test requirements (network signalled value "NS_03")
(for Bands 4, 10, 23, 35, and 36)**

Configuration ID	EUTRA band	Class 1 (dBm)	Tol. (dB)	Class 2 (dBm)	Tol. (dB)	Class 3 (dBm)	Tol. (dB)
1	4,10,23,35,36					23	+2.7 / -3.7
2	4,10,23,35,36					23	+2.7 / -2.7
3	4,10,23,35,36					23	+2.7 / -3.7
4	4,10,23,35,36					23	+2.7 / -4.7
5	4,10,23,35,36					23	+2.7 / -2.7
6	4,10,23,35,36					23	+2.7 / -6.2
7	4,10,23,35,36					23	+2.7 / -3.7
8	4,10,23,35,36					23	+2.7 / -4.7
9	4,10,23,35,36					23	+2.7 / -3.7
10	4,10,23,35,36					23	+2.7 / -2.7
11	4,10,23,35,36					23	+2.7 / -6.2
12	4,10,23,35,36					23	+2.7 / -4.7
13	4,10,23,35,36					23	+2.7 / -4.7
14	4,10,23,35,36					23	+2.7 / -3.7
15	4,10,23,35,36					23	+2.7 / -2.7
16	4,10,23,35,36					23	+2.7 / -6.2
17	4,10,23,35,36					23	+2.7 / -4.7
18	4,10,35,36					23	+2.7 / -4.7
19	4,10,35,36					23	+2.7 / -3.7
20	4,10,35,36					23	+2.7 / -2.7
21	4,10,35,36					23	+2.7 / -6.2
22	4,10,35,36					23	+2.7 / -4.7
23	4,10,35,36					23	+2.7 / -4.7
24	4,10,35,36					23	+2.7 / -3.7
25	4,10,35,36					23	+2.7 / -2.7
26	4,10,35,36					23	+2.7 / -6.2
27	4,10,35,36					23	+2.7 / -4.7

**Table 6.2.4.5-2: UE Power Class test requirements (network signalled value "NS_03")
(for Bands 2 and 25)**

Configuration ID	EUTRA band	Test Freq.	Class 1 (dBm)	Tol. (dB)	Class 2 (dBm)	Tol. (dB)	Class 3 (dBm)	Tol. (dB)
1	2, 25	Mid					23	+2.7 / -3.7
1	2, 25	Low, High					23	+2.7 / -5.7
2	2, 25	Mid					23	+2.7 / -2.7
2	2, 25	Low, High					23	+2.7 / -4.2
3	2, 25	Mid					23	+2.7 / -3.7
3	2, 25	Low, High					23	+2.7 / -5.7
4	2, 25	Mid					23	+2.7 / -4.7
4	2, 25	Low, High					23	+2.7 / -7.7
5	2, 25	Mid					23	+2.7 / -2.7
5	2, 25	Low, High					23	+2.7 / -4.2
6	2, 25	Mid					23	+2.7 / -6.2
6	2, 25	Low, High					23	+2.7 / -9.2
7	2, 25	Mid					23	+2.7 / -3.7
7	2, 25	Low, High					23	+2.7 / -5.7
8	2, 25	All					23	+2.7 / -4.7
9	2, 25	Low @ RB#(max+1-RB allocation), Mid, High @ RB#0					23	+2.7 / -3.7
9	2, 25	Low @ RB#0, High @ RB#(max+1-RB allocation)					23	+2.7 / -5.7
10	2, 25	Low @ RB#(max+1-RB allocation), Mid, High @ RB#0					23	+2.7 / -2.7
10	2, 25	Low @ RB#0, High @ RB#(max+1-RB allocation)					23	+2.7 / -4.2
11	2, 25	All					23	+2.7 / -6.2
12	2, 25	Low @ RB#(max+1-RB allocation), Mid, High @ RB#0					23	+2.7 / -4.7
12	2, 25	Low @ RB#0, High @ RB#(max+1-RB allocation)					23	+2.7 / -7.7
13	2, 25	All					23	+2.7 / -4.7
14	2, 25	Low @ RB#(max+1-RB allocation), Mid, High @ RB#0					23	+2.7 / -3.7
14	2, 25	Low @ RB#0, High @ RB#(max+1-RB					23	+2.7 / -5.7

		allocation)						
15	2, 25	Low @ RB#(max+1-RB allocation), Mid, High @ RB#0					23	+2.7 / -2.7
15	2, 25	Low @ RB#0, High @ RB#(max+1-RB allocation)					23	+2.7 / -4.2
16	2, 25	All					23	+2.7 / -6.2
17	2, 25	Low @ RB#(max+1-RB allocation), Mid, High @ RB#0					23	+2.7 / -4.7
17	2, 25	Low @ RB#0, High @ RB#(max+1-RB allocation)					23	+2.7 / -7.7
18	2, 25	All					23	+2.7 / -4.7
19	2, 25	Low @ RB#(max+1-RB allocation), Mid, High @ RB#0					23	+2.7 / -3.7
19	2, 25	Low @ RB#0, High @ RB#(max+1-RB allocation)					23	+2.7 / -5.7
20	2, 25	Low @ RB#(max+1-RB allocation), Mid, High @ RB#0					23	+2.7 / -2.7
20	2, 25	Low @ RB#0, High @ RB#(max+1-RB allocation)					23	+2.7 / -4.2
21	2, 25	All					23	+2.7 / -6.2
22	2, 25	Low @ RB#(max+1-RB allocation), Mid, High @ RB#0					23	+2.7 / -4.7
22	2, 25	Low @ RB#0, High @ RB#(max+1-RB allocation)					23	+2.7 / -7.7
23	2, 25	All					23	+2.7 / -4.7
24	2, 25	All					23	+2.7 / -3.7
25	2, 25	Low @ RB#(max+1-RB allocation), Mid, High @ RB#0					23	+2.7 / -2.7
25	2, 25	Low @ RB#0, High @ RB#(max+1-RB allocation)					23	+2.7 / -4.2
26	2, 25	All					23	+2.7 / -6.2
27	2, 25	All					23	+2.7 / -4.7

Table 6.2.4.5-3: UE Power Class test requirements (network signalled value "NS_04")

Configuration ID	EUTRA band	Bandwidth (MHz)	Class 3 (dBm)	Tol. (dB)
1	41	5 MHz	23	+2.7 / -4.7
2	41	5 MHz	23	+2.7 / -3.7
3	41	5 MHz	23	+2.7 / -2.7
4	41	5 MHz	23	+2.7 / -6.2
5	41	5 MHz	23	+2.7 / -4.7
6	41	10MHz	23	+2.7 / -6.2
7	41	10MHz	23	+2.7 / -6.2
8	41	10MHz	23	+2.7 / -8.2
9	41	10MHz	23	+2.7 / -9.7
10	41	10MHz	23	+2.7 / -3.7
11	41	10MHz	23	+2.7 / -4.7
12	41	10MHz	23	+2.7 / -6.2
13	41	10MHz	23	+2.7 / -6.2
14	41	10MHz	23	+2.7 / -6.2
15	41	15MHz	23	+2.7 / -6.2
16	41	15MHz	23	+2.7 / -6.2
17	41	15MHz	23	+2.7 / -8.2
18	41	15MHz	23	+2.7 / -9.7
19	41	15MHz	23	+2.7 / -3.7
20	41	15MHz	23	+2.7 / -4.7
21	41	15MHz	23	+2.7 / -6.2
22	41	15MHz	23	+2.7 / -8.2
23	41	15MHz	23	+2.7 / -6.2
24	41	20MHz	23	+2.7 / -6.2
25	41	20MHz	23	+2.7 / -6.2
26	41	20MHz	23	+2.7 / -8.2
27	41	20MHz	23	+2.7 / -9.7
28	41	20MHz	23	+2.7 / -3.7
29	41	20MHz	23	+2.7 / -4.7
30	41	20MHz	23	+2.7 / -6.2
31	41	20MHz	23	+2.7 / -8.2
32	41	20MHz	23	+2.7 /

				-6.2
--	--	--	--	------

Table 6.2.4.5-4: UE Power Class test requirements (network signalled value "NS_05")

Configuration ID	EUTRA band	Class 1 (dBm)	Tol. (dB)	Class 2 (dBm)	Tol. (dB)	Class 3 (dBm)	Tol. (dB)
1	1					23	+2.7 / -2.7
2	1					23	+2.7 / -3.7
3	1					23	+2.7 / -2.7
4	1					23	+2.7 / -2.7
5	1					23	+2.7 / -3.7
6	1					23	+2.7 / -4.7
7	1					23	+2.7 / -6.2
8	1					23	+2.7 / -2.7
9	1					23	+2.7 / -2.7
10	1					23	+2.7 / -3.7
11	1					23	+2.7 / -3.7
12	1					23	+2.7 / -4.7
13	1					23	+2.7 / -6.2
14	1					23	+2.7 / -2.7
15	1					23	+2.7 / -2.7
16	1					23	+2.7 / -3.7
17	1					23	+2.7 / -3.7
18	1					23	+2.7 / -4.7
19	1					23	+2.7 / -6.2

**Table 6.2.4.5-5: UE Power Class test requirements (network signalled value "NS_06")
(for Bands 13, 14, and 17)**

Configuration ID	EUTRA band	Class 1 (dBm)	Tol. (dB)	Class 2 (dBm)	Tol. (dB)	Class 3 (dBm)	Tol. (dB)
1	13,14,17					23	+2.7 / -3.7
2	13,14,17					23	+2.7 / -2.7
3	13,14,17					23	+2.7 / -2.7
4	13,14,17					23	+2.7 / -3.7
5	13,14,17					23	+2.7 / -2.7
6	13,14,17					23	+2.7 / -3.7
7	13,14,17					23	+2.7 / -3.7
8	13,14,17					23	+2.7 / -2.7
9	13,14,17					23	+2.7 / -3.7
10	13,14,17					23	+2.7 / -3.7
11	13,14,17					23	+2.7 / -2.7
12	13,14,17					23	+2.7 / -3.7
13	13,14,17					23	+2.7 / -3.7
14	13,14,17					23	+2.7 / -2.7
15	13,14,17					23	+2.7 / -3.7
16	13,14,17					23	+2.7 / -3.7
17	13,14,17					23	+2.7 / -2.7
18	13,14,17					23	+2.7 / -3.7

**Table 6.2.4.5-6: UE Power Class test requirements (network signalled value "NS_06")
(for Band 12)**

Configuration ID	EUTRA band	Test Freq.	Class 1 (dBm)	Tol. (dB)	Class 2 (dBm)	Tol. (dB)	Class 3 (dBm)	Tol. (dB)
1	12	Mid					23	+2.7 / -3.7
1	12	Low, High					23	+2.7 / -5.7
2	12	Mid					23	+2.7 / -2.7
2	12	Low, High					23	+2.7 / -4.2
3	12	Mid					23	+2.7 / -2.7
3	12	Low, High					23	+2.7 / -4.2
4	12	Mid					23	+2.7 / -3.7
4	12	Low, High					23	+2.7 / -5.7
5	12	Mid					23	+2.7 / -2.7
5	12	Low, High					23	+2.7 / -4.2
6	12	Mid					23	+2.7 / -3.7
6	12	Low, High					23	+2.7 / -5.7
7	12	All					23	+2.7 / -3.7
8	12	Low @ RB#(max+1-RB allocation), Mid, High @ RB#0					23	+2.7 / -2.7
8	12	Low @ RB#0, High @ RB#(max+1-RB allocation)					23	+2.7 / -4.2
9	12	Low @ RB#(max+1-RB allocation), Mid, High @ RB#0					23	+2.7 / -3.7
9	12	Low @ RB#0, High @ RB#(max+1-RB allocation)					23	+2.7 / -5.7
10	12	All					23	+2.7 / -3.7
11	12	Low @ RB#(max+1-RB allocation), Mid, High @ RB#0					23	+2.7 / -2.7
11	12	Low @ RB#0, High @ RB#(max+1-RB allocation)					23	+2.7 / -4.2
12	12	Low @ RB#(max+1-RB allocation), Mid, High @ RB#0					23	+2.7 / -3.7
12	12	Low @ RB#0, High @ RB#(max+1-RB allocation)					23	+2.7 / -5.7

Table 6.2.4.5-7: UE Power Class test requirements (network signalled value "NS_07")

Configuration ID	EUTRA band	Class 1 (dBm)	Tol. (dB)	Class 2 (dBm)	Tol. (dB)	Class 3 (dBm)	Tol. (dB)
1	13					23	+2.7 / -18.7
2	13					23	+2.7 / -13.7
3	13					23	+2.7 / -2.7
4	13					23	+2.7 / -19.7
5	13					23	+2.7 / -18.7
6	13					23	+2.7 / -20.7
7	13					23	+2.7 / -3.7
8	13					23	+2.7 / -2.7
9	13					23	+2.7 / -4.7
10	13					23	+2.7 / -12.7
11	13					23	+2.7 / -13.7
12	13					23	+2.7 / -2.7
13	13					23	+2.7 / -6.2
14	13					23	+2.7 / -19.7
15	13					23	+2.7 / -18.7
16	13					23	+2.7 / -20.7

Table 6.2.4.5-8: UE Power Class test requirements (network signalled value "NS_08")

Configuration ID	EUTRA band	Class 1 (dBm)	Tol. (dB)	Class 2 (dBm)	Tol. (dB)	Class 3 (dBm)	Tol. (dB)
1	19					23	+2.7 / -2.7
2	19					23	+2.7 / -2.7
3	19					23	+2.7 / -3.7
4	19					23	+2.7 / -2.7
5	19					23	+2.7 / -2.7
6	19					23	+2.7 / -3.7
7	19					23	+2.7 / -8.2
8	19					23	+2.7 / -9.7
9	19					23	+2.7 / -2.7
10	19					23	+2.7 / -2.7
11	19					23	+2.7 / -3.7
12	19					23	+2.7 / -8.2
13	19					23	+2.7 / -9.7

Table 6.2.4.5-9: UE Power Class test requirements (network signalled value "NS_09")

Configuration ID	EUTRA band	Class 1 (dBm)	Tol. (dB)	Class 2 (dBm)	Tol. (dB)	Class 3 (dBm)	Tol. (dB)
1	21					23	+2.7 / -2.7
2	21					23	+2.7 / -2.7
3	21					23	+2.7 / -3.7
4	21					23	+2.7 / -2.7
5	21					23	+2.7 / -2.7
6	21					23	+2.7 / -3.7
7	21					23	+2.7 / -4.7
8	21					23	+2.7 / -6.2
9	21					23	+2.7 / -2.7
19	21					23	+2.7 / -2.7
11	21					23	+2.7 / -3.7
12	21					23	+2.7 / -4.7
13	21					23	+2.7 / -6.2
14	21					23	+2.7 / -8.2

Table 6.2.4.5-10: UE Power Class test requirements (network signalled value "NS_10")

Void, not tested

Table 6.2.4.5-11: UE Power Class test requirements (network signalled value "NS_11 for Band 23")

Configuration ID	EUTRA Band	Centre Frequency	Class 1 (dBm)	Tol. (dB)	Class 2 (dBm)	Tol. (dB)	Class 3 (dBm)	Tol. (dB)
1a	23	2001.5 MHz						+ 2.7 / -11.7
1b	23	2004.5 MHz						+ 2.7 / -4.7
2a	23	2001.5 MHz						+ 2.7 / -11.7
2b	23	2004.5 MHz						+ 2.7 / -4.7
3a	23	2001.5 MHz						+ 2.7 / -12.7
3b	23	2004.5 MHz						+ 2.7 / -6.2
4a	23	2001.5 MHz						+ 2.7 / -12.7
4b	23	2004.5 MHz						+ 2.7 / -6.2
5a	23	2002.5 MHz						+ 2.7 / -12.7
5b	23	2004.5 MHz						+ 2.7 / -8.2
5c	23	2007.5 MHz						+ 2.7 / -2.7
6a	23	2002.5 MHz						+ 2.7 / -12.7
6b	23	2004.5 MHz						+ 2.7 / -2.7
6c	23	2007.5 MHz						+ 2.7 / -3.7
7a	23	2002.5 MHz						+ 2.7 / -13.7
7b	23	2004.5 MHz						+ 2.7 / -9.7
7c	23	2007.5 MHz						+ 2.7 / -4.7
8a	23	2002.5 MHz						+ 2.7 / -13.7
8b	23	2004.5 MHz						+ 2.7 / -3.7
8c	23	2007.5 MHz						+ 2.7 / -4.7
9a	23	2002.5 MHz						+ 2.7 / -14.7
9b	23	2004.5 MHz						+ 2.7 / -11.7
9c	23	2007.5 MHz						+ 2.7 / -6.2
10a	23	2005 MHz						+ 2.7 / -17.7
10b	23	2005.5 MHz						+ 2.7 /

Configuration ID	EUTRA Band	Centre Frequency	Class 1 (dBm)	Tol. (dB)	Class 2 (dBm)	Tol. (dB)	Class 3 (dBm)	Tol. (dB)
								-17.7
10c	23	2015 MHz						+ 2.7 / -2.7
11a	23	2005 MHz						+ 2.7 / -17.7
11b	23	2005.5 MHz						+ 2.7 / -17.7
11c	23	2015 MHz						+ 2.7 / -2.7
12a	23	2005 MHz						+ 2.7 / -18.7
12b	23	2005.5 MHz						+ 2.7 / -18.7
12c	23	2015 MHz						+ 2.7 / -3.7
13a	23	2005 MHz						+ 2.7 / -18.7
13b	23	2005.5 MHz						+ 2.7 / -18.7
13c	23	2015 MHz						+ 2.7 / -3.7
14a	23	2005 MHz						+ 2.7 / -20.7
14b	23	2005.5 MHz						+ 2.7 / -20.7
14c	23	2015 MHz						+ 2.7 / -4.7
15a	23	2007.5 MHz						+ 2.7 / -21.7
15b	23	2012.5 MHz						+ 2.7 / -16.7
16a	23	2007.5 MHz						+ 2.7 / -13.7
16b	23	2012.5 MHz						+ 2.7 / -13.2
17a	23	2007.5 MHz						+ 2.7 / -3.7
17b	23	2012.5 MHz						+ 2.7 / -3.7
18a	23	2007.5 MHz						+ 2.7 / -12.7
18b	23	2012.5 MHz						+ 2.7 / -12.7
19a	23	2007.5 MHz						+ 2.7 / -16.7
19b	23	2012.5 MHz						+ 2.7 / -8.7
20a	23	2007.5 MHz						+ 2.7 / -13.7
20b	23	2012.5 MHz						+ 2.7 / -13.2
21a	23	2007.5 MHz						+ 2.7 / -4.7
21b	23	2012.5 MHz						+ 2.7 / -3.7
22a	23	2007.5 MHz						+ 2.7 / -13.7
22b	23	2012.5 MHz						+ 2.7 / -13.7

Configuration ID	EUTRA Band	Centre Frequency	Class 1 (dBm)	Tol. (dB)	Class 2 (dBm)	Tol. (dB)	Class 3 (dBm)	Tol. (dB)
23a	23	2007.5 MHz						+ 2.7 / -17.7
23b	23	2012.5 MHz						+ 2.7 / -9.7
24	23	2010 MHz						+ 2.7 / -20.7
25	23	2010 MHz						+ 2.7 / -2.7
26	23	2010 MHz						+ 2.7 / -13.7
27	23	2010 MHz						+ 2.7 / -16.7
28	23	2010 MHz						+ 2.7 / -3.7
29	23	2010 MHz						+ 2.7 / -14.7
30	23	2010 MHz						+ 2.7 / -17.7

Table 6.2.4.5-12: UE Power Class test requirements (network signalled value "NS_12")

Configuration ID	EUTRA band	Class 1 (dBm)	Tol. (dB)	Class 2 (dBm)	Tol. (dB)	Class 3 (dBm)	Tol. (dB)
1	26					23	+2.7 / -6.2
2	26					23	+2.7 / -12.7
3	26					23	+2.7 / -2.7
4	26					23	+2.7 / -6.2
5	26					23	+2.7 / -13.7
6	26					23	+2.7 / -8.2
7	26					23	+2.7 / -8.2
8	26					23	+2.7 / -2.7
9	26					23	+2.7 / -8.2
10	26					23	+2.7 / -9.7
11	26					23	+2.7 / -9.7
12	26					23	+2.7 / -8.2
13	26					23	+2.7 / -2.7
14	26					23	+2.7 / -8.2
15	26					23	+2.7 / -9.7

Table 6.2.4.5-13: UE Power Class test requirements (network signalled value "NS_13")

Configuration ID	EUTRA band	Class 1 (dBm)	Tol. (dB)	Class 2 (dBm)	Tol. (dB)	Class 3 (dBm)	Tol. (dB)
1	26					23	+2.7 / -6.2
2	26					23	+2.7 / -6.2
3	26					23	+2.7 / -3.7
4	26					23	+2.7 / -3.7
5	26					23	+2.7 / -8.2

Table 6.2.4.5-14: UE Power Class test requirements (network signalled value "NS_14")

Configuration ID	EUTRA band	Class 1 (dBm)	Tol. (dB)	Class 2 (dBm)	Tol. (dB)	Class 3 (dBm)	Tol. (dB)
1	26					23	+2.7 / -6.2
2	26					23	+2.7 / -3.7
3	26					23	+2.7 / -4.7
4	26					23	+2.7 / -3.7
5	26					23	+2.7 / -6.2
6	26					23	+2.7 / -6.2
7	26					23	+2.7 / -3.7
8	26					23	+2.7 / -4.7
9	26					23	+2.7 / -3.7
10	26					23	+2.7 / -6.2

Table 6.2.4.5-15: UE Power Class test requirements (network signalled value "NS_15")

Configuration ID	EUTRA band	Class 1 (dBm)	Tol. (dB)	Class 2 (dBm)	Tol. (dB)	Class 3 (dBm)	Tol. (dB)
1	26					23	+2.7 / -3.2
2	26					23	+2.7 / -8.2
3	26					23	+2.7 / -4.2
4	26					23	+2.7 / -8.2
5	26					23	+2.7 / -14.2
6	26					23	+2.7 / -4.2
7	26					23	+2.7 / -3.2
8	26					23	+2.7 / -9.2
9	26					23	+2.7 / -14.2
10	26					23	+2.7 / -4.2
11	26					23	+2.7 / -6.2
12	26					23	+2.7 / -12.2
13	26					23	+2.7 / -7.2
14	26					23	+2.7 / -3.2
15	26					23	+2.7 / -4.2
16	26					23	+2.7 / -8.2
17	26					23	+2.7 / -3.2
18	26					23	+2.7 / -12.2
19	26					23	+2.7 / -4.2
20	26					23	+2.7 / -8.2
21	26					23	+2.7 / -3.2
22	26					23	+2.7 / -4.2
23	26					23	+2.7 / -9.2
24	26					23	+2.7 / -14.2
25	26					23	+2.7 / -3.2
26	26					23	+2.7 / -9.2

Table 6.2.4.5-16A: UE Power Class test requirements (network signalled value "NS_16") when lower channel edge is at 807 MHz

Configuration ID	EUTRA band	Class 1 (dBm)	Tol. (dB)	Class 2 (dBm)	Tol. (dB)	Class 3 (dBm)	Tol. (dB)
1	27					23	+2.7/-2.7
2	27					23	+2.7/-3.7
3	27					23	+2.7-4.7
4	27					23	+2.7/-2.7
5	27					23	+2.7 / -4.7
6	27					23	+2.7 / -6.2
7	27					23	+2.7 / -8.2
8	27					23	+2.7 / -9.7
9	27					23	+2.7 / -4.7
10	27					23	+2.7 / -6.2
11	27					23	+2.7 / -11.7
12	27					23	+2.7 / -8.2
13	27					23	+2.7 / -11.7
14	27					23	+2.7 / -12.7
15	27					23	+2.7 / -9.7
16	27					23	+2.7/-2.7
17	27					23	+2.7 / -8.2
18	27					23	+2.7 / -4.7
19	27					23	+2.7 / -8.2
20	27					23	+2.7 / -13.7
21	27					23	+2.7 / -13.7
22	27					23	+2.7 / -14.7
23	27					23	+2.7 / -13.7
24	27					23	+2.7 / -13.7

Table 6.2.4.5-16B: UE Power Class test requirements (network signalled value "NS_16") when lower channel edge is at 808.5 MHz

Configuration ID	EUTRA band	Class 1 (dBm)	Tol. (dB)	Class 2 (dBm)	Tol. (dB)	Class 3 (dBm)	Tol. (dB)
1	27					23	+2.7/-2.7
2	27					23	+2.7/-3.7
3	27					23	+2.7/-5.2
4	27					23	+2.7/-2.7
5	27					23	+2.7 / -3.7
6	27					23	+2.7 / -3.7
7	27					23	+2.7 / -4.7
8	27					23	+2.7 / -2.7
9	27					23	+2.7 / -3.7
10	27					23	+2.7 / -4.7
11	27					23	+2.7 / -6.2
12	27					23	+2.7 / -6.2
13	27					23	+2.7 / -8.2
14	27					23	+2.7 / -9.7
15	27					23	+2.7 / -9.7
16	27					23	+2.7/-2.7
17	27					23	+2.7 / -6.2
18	27					23	+2.7 / -4.7
19	27					23	+2.7 / -4.7
20	27					23	+2.7 / -9.7
21	27					23	+2.7 / -11.7
22	27					23	+2.7 / -12.7
23	27					23	+2.7 / -11.7
24	27					23	+2.7 / -11.7

Table 6.2.4.5-16C: UE Power Class test requirements (network signalled value "NS_16") when lower channel edge is at 812 MHz

Configuration ID	EUTRA band	Class 1 (dBm)	Tol. (dB)	Class 2 (dBm)	Tol. (dB)	Class 3 (dBm)	Tol. (dB)
1	27					23	+2.7/-2.7
2	27					23	+2.7/-3.7
3	27					23	+2.7/-4.7
4	27					23	+2.7/-2.7
5	27					23	+2.7 / -3.7
6	27					23	+2.7 / -3.7
7	27					23	+2.7 / -4.7
8	27					23	+2.7 / -2.7
9	27					23	+2.7 / -3.7
10	27					23	+2.7 / -3.7
11	27					23	+2.7 / -3.7
12	27					23	+2.7 / -3.7
13	27					23	+2.7 / -3.7
14	27					23	+2.7 / -4.7
15	27					23	+2.7 / -2.7
16						23	+2.7/-2.7
17	27					23	+2.7 / -3.7
18	27					23	+2.7 / -3.7
19	27					23	+2.7 / -3.7
20	27					23	+2.7 / -4.7
21	27					23	+2.7 / -8.2
22	27					23	+2.7 / -9.7
23	27					23	+2.7 / -6.2
24	27					23	+2.7 / -4.7

Table 6.2.4.5-17: UE Power Class test requirements (network signalled value "NS_17")

Configuration ID	EUTRA band	Class 1 (dBm)	Tol. (dB)	Class 2 (dBm)	Tol. (dB)	Class 3 (dBm)	Tol. (dB)
1	28					23	+2.7 / -3.2
2	28					23	+2.7 / -3.2
3	28					23	+2.7 / -4.2
4	28					23	+2.7 / -5.2
5	28					23	+2.7 / -3.2
6	28					23	+2.7 / -3.2
7	28					23	+2.7 / -4.2
8	28					23	+2.7 / -5.2

Table 6.2.4.5-18: UE Power Class test requirements (network signalled value "NS_18")

Configuration ID	EUTRA band	Class 1 (dBm)	Tol. (dB)	Class 2 (dBm)	Tol. (dB)	Class 3 (dBm)	Tol. (dB)
------------------	------------	---------------	-----------	---------------	-----------	---------------	-----------

1	28					23	+2.7 / -3.2
2	28					23	+2.7 / -4.2
3	28					23	+2.7 / -5.2
4	28					23	+2.7 / -6.2
5	28					23	+2.7 / -7.2
6	28					23	+2.7 / -7.2
7	28					23	+ 2.7 / -8.7
8	28					23	+2.7 / -9.2
9	28					23	+2.7 / -7.2
10	28					23	+2.7 / -7.2
11	28					23	+2.7 / -8.7
12	28					23	+2.7 / -9.2
13	28					23	+2.7 / -7.2
14	28					23	+2.7 / -7.2
15	28					23	+2.7 / -8.7
16	28					23	+2.7 / -9.2

Table 6.2.4.5-17: UE Power Class test requirements (network signalled value "NS_20 for Band 23")

Configuration ID	EUTRA Band	Centre Frequency	Class 1 (dBm)	Tol. (dB)	Class 2 (dBm)	Tol. (dB)	Class 3 (dBm)	Tol. (dB)
1a	23	2002.5 MHz						+ 2.7 / -22.7
1b	23	2007.5 MHz						+ 2.7 / -2.7
1c	23	2012.5 MHz						+ 2.7 / -2.7
1d	23	2017.5 MHz						+ 2.7 / -2.7
2a	23	2002.5 MHz						+ 2.7 / -23.7
2b	23	2007.5 MHz						+ 2.7 / -7.7
2c	23	2012.5 MHz						+ 2.7 / -7.7
2d	23	2017.5 MHz						+ 2.7 / -3.7
3a	23	2002.5 MHz						+ 2.7 / -23.7
3b	23	2007.5 MHz						+ 2.7 / -11.7
3c	23	2012.5 MHz						+ 2.7 / -11.7
3d	23	2017.5 MHz						+ 2.7 / -3.7
4a	23	2002.5 MHz						+ 2.7 / -23.7
4b	23	2007.5 MHz						+ 2.7 / -7.7
4c	23	2012.5 MHz						+ 2.7 / -7.7
4d	23	2017.5 MHz						+ 2.7 / -3.7
5a	23	2002.5 MHz						+ 2.7 / -23.7
5b	23	2007.5 MHz						+ 2.7 / -11.7
5c	23	2012.5 MHz						+ 2.7 / -11.7
5d	23	2017.5 MHz						+ 2.7 / -3.7
6a	23	2005 MHz						+ 2.7 / -21.7
6b	23	2015 MHz						+ 2.7 / -2.7
7a	23	2005 MHz						+ 2.7 / -7.7
7b	23	2015 MHz						+ 2.7 / -2.7

Configuration ID	EUTRA Band	Centre Frequency	Class 1 (dBm)	Tol. (dB)	Class 2 (dBm)	Tol. (dB)	Class 3 (dBm)	Tol. (dB)
8a	23	2005 MHz						+ 2.7 / -11.7
8b	23	2015 MHz						+ 2.7 / -8.7
9a	23	2005 MHz						+ 2.7 / -8.7
9b	23	2015 MHz						+ 2.7 / -3.7
10a	23	2005 MHz						+ 2.7 / -11.7
10b	23	2005 MHz						+ 2.7 / -8.7
11	23	2012.5 MHz						+ 2.7 / -11.7
12	23	2012.5 MHz						+ 2.7 / -7.7
13	23	2012.5 MHz						+ 2.7 / -11.7
14	23	2012.5 MHz						+ 2.7 / -17.7
15	23	2012.5 MHz						+ 2.7 / -8.7
16	23	2012.5 MHz						+ 2.7 / -12.7
17	23	2012.5 MHz						+ 2.7 / -18.7
18	23	2010 MHz						+ 2.7 / -22.7
19	23	2010 MHz						+ 2.7 / -14.7
20	23	2010 MHz						+ 2.7 / -13.7
21	23	2010 MHz						+ 2.7 / -8.7
22	23	2010 MHz						+ 2.7 / -11.7
23	23	2010 MHz						+ 2.7 / -15.7
24	23	2010 MHz						+ 2.7 / -14.7
25	23	2010 MHz						+ 2.7 / -19.7
26	23	2010 MHz						+ 2.7 / -12.7

6.2.4_1 Additional Maximum Power Reduction (A-MPR) for HPUE

6.2.4_1.1 Test purpose

Same test purpose as in clause 6.2.4.1 with the follow exception:

- Instead of Table 6.2.2.3-1 → use Table 6.2.2_1.3-1

6.2.4_1.2 Test applicability

The requirements of this test apply in test case 6.6.2.2 Additional Spectrum Emission Mask for network signalled values NS_06, to all types of E-UTRA Power Class 1 UE release 11 and forward.

6.2.4_1.3 Minimum conformance requirements

For UE Power Class 1 the specific requirements and identified sub-clauses are specified in Table 6.2.4.3-1 along with the allowed A-MPR values that may be used to meet these requirements. The allowed A-MPR values specified in Table 6.2.4.3-1 are in addition to the allowed MPR requirements specified in clause 6.2.3_1. For the UE maximum output power modified by A-MPR, the power limits specified in clause 6.2.5_1 apply.

The normative reference for this requirement is TS 36.101 clause 6.2.4.

6.2.4_1.4 Test description

Same test description as in clause 6.2.4.4 with the following exceptions:

- Instead of Table 6.2.4.4.1-4 → use Table 6.2.4_1.4.1-1

Table 6.2.4_1.4.1-1: Test Configuration Table (network signalled value "NS_06")

Initial Conditions					
Test Environment (as specified in TS 36.508 [7] subclause 4.1)				Normal	
Test Frequencies (as specified in TS36.508 [7] subclause 4.3.1)				Low range, Mid range, High range	
Test Channel Bandwidths (as specified in TS 36.508 [7] subclause 4.3.1)				Lowest, 5MHz, 10MHz, Highest	
Test Parameters for NS_06 A-MPR					
Configuration ID	Ch BW	Downlink Configuration		Uplink Configuration	
		Mod'n	RB allocation FDD	Mod'n	RB allocation FDD
1	5MHz	N/A for A-MPR testing		QPSK	25
2	5MHz			QPSK	8
3	5MHz			16QAM	8
4	10MHz			QPSK	50
5	10MHz			QPSK	12
6	10MHz			16QAM	12
Note 1: Test Channel Bandwidths are checked separately for each E-UTRA band, the applicable channel bandwidths are specified in Table 5.4.2.1-1.					
Note 2: The Configuration ID will be used to map the applicable Test Configuration to the corresponding Test Requirement in subclause 6.2.4.5 as not all combinations are necessarily required based on the applicability of the UE.					
Note 3: The RB _{start} of partial RB allocation shall be RB# 0 and RB# (max +1 - RB allocation) of the channel bandwidth.					

6.2.4_1.5 Test requirements

The maximum output power, derived in step 2 of clause 6.2.4_1.4.2 shall be within the range prescribed by the nominal maximum output power and tolerance in Table 6.2.4_1.5-1. The allowed A-MPR values specified in Table 6.2.4.3-1 are in addition to the allowed MPR requirements specified in clause 6.2.3_1. For the UE maximum output power modified by MPR and/or A-MPR, the power limits specified in Table 6.2.5_1.3-1 apply.

Table 6.2.4_1.5-1: HPUE Power Class test requirements (network signalled value "NS_06")

Configuration ID	EUTRA band	Class 1 (dBm)	Tol. (dB)
1	14	31	+2.7 / -4.7
2	14	31	+2.7 / -3.7
3	14	31	+2.7 / -4.7
4	14	31	+2.7 / -4.7
5	14	31	+2.7 / -3.7
6	14	31	+2.7 / -4.7

6.2.4A Additional Maximum Power Reduction (A-MPR) for CA

6.2.4A.1 Additional Maximum Power Reduction (A-MPR) for CA (intra-band contiguous DL CA and UL CA)

Editor's notes: The following items are missing or incomplete:

- For CA_NS_02 and CA_NS_03 and CA_NS_06 the UL multicarrier allocation A-MPR requirements are TBD

6.2.4A.1.1 Test purpose

Additional ACLR, spectrum emission and spurious emission requirements for carrier aggregation can be signalled by the network to indicate that the UE shall also meet additional requirements in a specific deployment scenario. To meet these additional requirements, Additional Maximum Power Reduction (A-MPR) is allowed for the CA Power Class as specified in Table 6.2.2A-1.

6.2.4A.1.2 Test applicability

The requirements of this test apply in test case 6.6.2.2A.1 Additional Spectrum Emission Mask for CA (intra-band contiguous DL CA and UL CA) for network signalled value NS_04 to all types of E-UTRA UE release 8 and forward.

The requirements of this test apply in test case 6.6.3.3A.1 Additional spurious emissions for CA (intra-band contiguous DL CA and UL CA) for network signalled values CA_NS_01, CA_NS_02 and CA_NS_03, CA_NS_05, CA_NS_06 to all types of E-UTRA UE release 10 and forward that support intra-band contiguous DL CA and UL CA.

6.2.4A.1.3 Minimum conformance requirements

If the UE is configured for carrier aggregation and receives CA_NS value indicated by IE *additionalSpectrumEmissionSCell-r10*, the allowed maximum output power reduction is specified in Table 6.2.4A.1.3-1 and clause 6.2.3A.1 does not apply, i.e. carrier aggregation MPR = 0.

Table 6.2.4A.1.3-1: Additional Maximum Power Reduction (A-MPR) for CA

CA Network Signalling value	Requirements (clause)	Uplink CA Configuration	A-MPR [dB] (subclause)
CA_NS_01	6.6.3.3A.1.3.1	CA_1C	6.2.4A.1.3.1
CA_NS_02	6.6.3.3A.1.3.2	CA_1C	6.2.4A.1.3.2
CA_NS_03	6.6.3.3A.1.3.3	CA_1C	6.2.4A.1.3.3
CA_NS_04	6.6.2.2A.1.3.1	CA_41C	6.2.4A.1.3.4
CA_NS_05	6.6.3.3A.1.3.4	CA_38C	6.2.4A.1.3.5
CA_NS_06	6.6.3.3A.1.3.5	CA_7C	6.2.4A.1.3.6

For intra-band contiguous carrier aggregation if the UE is configured for CA and it receives CA_NS value indicated by IE *additionalSpectrumEmissionSCell-r10* and if UE has configured the transmitter for transmissions within the aggregated channel bandwidth the requirements for applicable CA_NS value indicated by IE *additionalSpectrumEmissionSCell-r10* according to Table 6.2.4A.1.3-1 apply. If UE has configured the transmitter for transmissions within E-UTRA channel bandwidths the requirements for NS value indicated in the PCC IE *additionalSpectrumEmission* according to subclause 6.2.4 apply. For the UE maximum output power modified by A-MPR specified in table 6.2.4A.1.3-1, the power limits specified in subclause 6.2.5A.1 apply.

6.2.4A.1.3.1 A-MPR for CA_NS_01 for CA_1C

If the UE is configured to CA_1C and it receives IE CA_NS_01 the allowed maximum output power reduction applied to transmissions on the PCC and the SCC for contiguously aggregated signals is specified in table 6.2.4A.1.3.1-1.

Table 6.2.4A.1.3.1-1: Contiguous allocation A-MPR for CA_NS_01

CA_1C: CA_NS_01	RB _{start}	L _{CRB} [RBs]	RB _{start} + L _{CRB} [RBs]	A-MPR for QPSK and 16-QAM [dB]
100 RB / 100 RB	0 – 23 and 176 - 199	> 0	N/A	≤ 12.0
	24 – 105	> 64	N/A	≤ 6.0
	106 – 175	N/A	> 175	≤ 5.0
75 RB / 75 RB	0 – 6 and 143 – 149	0 < L _{CRB} ≤ 10	N/A	≤ 11.0
		> 10	N/A	≤ 6.0
	7 – 90	> 44	N/A	≤ 5.0
	91 – 142	N/A	> 142	≤ 2.0

NOTE 1: RB_start indicates the lowest RB index of transmitted resource blocks

NOTE 2: L_CRB is the length of a contiguous resource block allocation

NOTE 3: For intra-subframe frequency hopping which intersects regions, notes 1 and 2 apply on a per slot basis

NOTE 4: For intra-subframe frequency hopping which intersects regions, the larger A-MPR value may be applied for both slots in the subframe

If the UE is configured to CA_1C and it receives IE CA_NS_01 the allowed maximum output power reduction applied to transmissions on the PCell and the SCell due to multi-cluster transmission is defined as follows

$$A\text{-MPR} = \text{CEIL} \{M_A, 0.5\}$$

Where M_A is defined as follows.

$$M_A = -22.5 A + 17 \quad ; 0 \leq A < 0.20$$

$$-11.0 A + 14.7 \quad ; 0.20 \leq A < 0.70$$

$$-1.7 A + 8.2 \quad ; 0.70 \leq A \leq 1$$

Where $A = N_{\text{RB_alloc}} / N_{\text{RB_agg}}$

The normative reference for requirement is in TS 36.101 [2] clause 6.2.4A

6.2.4A.1.3.2 A-MPR for CA_NS_02 for CA_1C

If the UE is configured to CA_1C and it receives IE CA_NS_02 the allowed maximum output power reduction applied to transmission on the PCC and the SCC for contiguously aggregated signals is specified in Table 6.2.4A.1.3.2-1.

Table 6.2.4A.1.3.2-1: Contiguous allocation A-MPR for CA_NS_02

CA_1C: CA_NS_02	RB _{end}	L _{CRB} [RBs]	A-MPR for QPSK and 16-QAM [dB]
100 RB / 100 RB	0 – 20	> 0	≤ 4 dB
	21 – 46	> 0	≤ 3 dB
	47 – 99	> RB _{end} – 20	≤ 3 dB
	100 – 184	> 75	≤ 6 dB
	185 – 199	> 0	≤ 10 dB
75 RB / 75 RB	0 – 48	> 0	≤ 2 dB
	49 – 80	> RB _{end} – 20	≤ 3 dB
	81 – 129	> 60	≤ 5 dB
	130 – 149	> 85	≤ 6 dB
	130 – 149	1 – 84	≤ 2 dB

If the UE is configured to CA_1C and it receives IE CA_NS_02 the allowed maximum output power reduction applied to transmissions on the PCell and the SCell due to multi-cluster transmission is defined as follows:

$$\text{A-MPR} = \text{CEIL} \{M_A, 0.5\}$$

Where M_A is defined as follows

$$\begin{aligned} [M_A &= -22.5 A + 17 && ; 0 \leq A < 0.20 \\ -11.0 A + 14.7 &&& ; 0.20 \leq A < 0.70 \\ -1.7 A + 8.2 &&& ; 0.70 \leq A \leq 1] \end{aligned}$$

Where $A = N_{\text{RB_alloc}} / N_{\text{RB_agg}}$.

6.2.4A.1.3.3 A-MPR for CA_NS_03 for CA_1C

If the UE is configured to CA_1C and it receives IE CA_NS_03 the allowed maximum output power reduction applied to transmission on the PCC and the SCC for contiguously aggregated signals is specified in Table 6.2.4A.1.3.3-1.

Table 6.2.4A.1.3.3-1: Contiguous allocation A-MPR for CA_NS_03

CA_1C: CA_NS_03	RB _{end}	L _{CRB} [RBs]	A-MPR for QPSK and 16-QAM [dB]
100 RB / 100 RB	0 – 26	> 0	≤ 10 dB
	27 – 63	≥ RB _{end} – 27	≤ 6 dB
	27 – 63	< RB _{end} – 27	≤ 1 dB
	64 – 100	> RB _{end} – 20	≤ 4 dB
	101 – 171	> 68	≤ 7 dB
	172 – 199	> 0	≤ 10 dB
75 RB / 75 RB	0 – 20	> 0	≤ 10 dB
	21 – 45	> 0	≤ 4 dB
	46 – 75	> RB _{end} – 13	≤ 2 dB
	76 – 95	> 45	≤ 5 dB
	96 – 149	> 43	≤ 8 dB
	120 – 149	1 – 43	≤ 6 dB

If the UE is configured to CA_1C and it receives IE CA_NS_03 the allowed maximum output power reduction applied to transmissions on the PCell and the SCell due to multi-cluster transmission is defined as follows:

$$A\text{-MPR} = \text{CEIL} \{M_A, 0.5\}$$

Where M_A is defined as follows

$$\begin{aligned} [M_A &= -23.33A + 17.5 && ; 0 \leq A < 0.15 \\ &= -7.65A + 15.15 && ; 0.15 \leq A \leq 1] \end{aligned}$$

Where $A = N_{\text{RB_alloc}} / N_{\text{RB_agg}}$.

6.2.4A.1.3.4 A-MPR for CA_NS_04 for CA_41C

If the UE is configured to CA_41C and it receives IE CA_NS_04 the allowed maximum output power reduction applied to transmission on the PCC and the SCC for contiguously aggregated signals is specified in Table 6.2.4A.1.3.4-1.

Table 6.2.4A.1.3.4-1: Contiguous Allocation A-MPR for CA_NS_04

CA Bandwidth Class C	RB _{Start}	L _{CRB} [RBs]	RB _{Start} + L _{CRB} [RBs]	A-MPR for QPSK [dB]	A-MPR for 16QAM [dB]
50RB / 100 RB	0 – 44 and 105 – 149	>0	N/A	≤4dB	≤4dB
	45 – 104	N/A	>105	≤3dB	≤4dB
75 RB / 75 RB	0 – 44 and 105 – 149	>0	N/A	≤4dB	≤4dB
	45 – 104	N/A	>105	≤4dB	≤4dB
100 RB / 75 RB	0 – 49 and 125 – 174	>0	N/A	≤4dB	≤4dB
	50 - 124	N/A	>125	≤3dB	≤4dB
100 RB / 100 RB	0 – 59 and 140 – 199	>0	N/A	≤3dB	≤4dB
	60– 139	N/A	>140	≤3dB	≤4dB

NOTE 1: RB_{start} indicates the lowest RB index of transmitted resource blocks
NOTE 2: L_{CRB} is the length of a contiguous resource block allocation
NOTE 3: For intra-subframe frequency hopping which intersects regions, notes 1 and 2 apply on a per slot basis
NOTE 4: For intra-subframe frequency hopping which intersects regions, the larger A-MPR value may be applied for both slots in the subframe

If the UE is configured to CA_41C and it receives IE CA_NS_04 the allowed maximum output power reduction applied to transmissions on the PCell and the SCell due to multi-cluster transmission is defined as follows

$$A\text{-MPR} = \text{CEIL} \{M_A, 0.5\}$$

Where M_A is defined as follows

$$\begin{aligned} M_A &= 10.5, && 0 \leq A < 0.05 \\ &= -50.0A + 13.00, && 0.05 \leq A < 0.15 \\ &= -4.0A + 6.10, && 0.15 \leq A < 0.40 \\ &= -0.83A + 4.83, && 0.40 \leq A \leq 1 \end{aligned}$$

Where $A = N_{\text{RB_alloc}} / N_{\text{RB_agg}}$.

6.2.4A.1.3.5 A-MPR for CA_NS_05 for CA_38C

If the UE is configured to CA_38C and it receives IE CA_NS_05 the allowed maximum output power reduction applied to transmission on the PCC and the SCC for contiguously aggregated signals is specified in Table 6.2.4A.1.3.5-1.

Table 6.2.4A.1.3.5-1: Contiguous Allocation A-MPR for CA_NS_05

CA_38C	RB _{end}	L _{CRB} [RBs]	A-MPR for QPSK and 16-QAM [dB]
100RB/100RB	0 – 12	>0	≤ 5 dB
	13 – 79	> RB _{end} – 13	≤ 2 dB
	80 – 180	>60	≤ 6 dB
	181 – 199	> 0	≤ 11 dB
75RB/75RB	0 – 70	> max(0, RB _{end} -10)	≤ 2 dB
	71- 108	> 60	≤ 5 dB
	109 – 140	>0	≤ 5 dB
	140 – 149	≤ 70	≤ 2 dB
	140 – 149	>70	≤ 6 dB
NOTE 1: RB _{end} indicates the highest RB index of transmitted resource blocks NOTE 2: L _{CRB} is the length of a contiguous resource block allocation NOTE 3: For intra-subframe frequency hopping which intersects regions, notes 1 and 2 apply on a per slot basis NOTE 4: For intra-subframe frequency hopping which intersects regions, the larger A-MPR value may be applied for both slots in the subframe			

If the UE is configured to CA_38C and it receives IE CA_NS_05 the allowed maximum output power reduction applied to transmissions on the PCell and the SCell due to multi-cluster transmission is defined as follows

$$A\text{-MPR} = \text{CEIL} \{M_A, 0.5\}$$

Where MA is defined as follows

$$M_A = -14.17 A + 16.50 \quad ; 0 \leq A < 0.60$$

$$-2.50 A + 9.50 \quad ; 0.60 \leq A \leq 1$$

Where $A = N_{\text{RB_alloc}} / N_{\text{RB_agg}}$.

6.2.4A.1.3.6 A-MPR for CA_NS_06 for CA_7C

If the UE is configured to CA_7C and it receives IE CA_NS_06 the allowed maximum output power reduction applied to transmission on the PCC and the SCC for contiguously aggregated signals is specified in Table 6.2.4A.1.3.6-1.

Table 6.2.4A.1.3.6-1: Contiguous Allocation A-MPR for CA_NS_06

CA Bandwidth Class C	RB _{end}	L _{CRB} [RBs]	A-MPR for QPSK and 16-QAM [dB]
100RB/100RB	[0 – 22]	>[0]	≤ [4] dB
	[23 – 33]	> [RB _{end} – 10]	≤ [2] dB
	[106 – 142]	> [75]	≤ [3] dB
	[143 – 178]	>[70]	≤ [5] dB
	[179 – 199]	> [0]	≤ [10] dB
75RB/75RB	[0 – 7]	>[0]	≤ [5] dB
	[20- 75]	> [RB _{end} – 10]	≤ [2] dB
	[75 – 110]	>[64]	≤ [2] dB
	[110 – 144]	>[35]	≤ [6] dB
	[145 – 149]	>[0]	≤ [10] dB

If the UE is configured to CA_7C and it receives IE CA_NS_06 the allowed maximum output power reduction applied to transmissions on the PCell and the SCell due to multi-cluster transmission is defined as follows:

$$A\text{-MPR} = \text{CEIL} \{M_A, 0.5\}$$

Where M_A is defined as follows

$$M_A = [-23.33A + 17.5; 0 \leq A < 0.15 \\ -7.65A + 15.15; 0.15 \leq A \leq 1]$$

Where $A = N_{RB_alloc} / N_{RB_agg}$.

6.2.4A.1.4 Test description

6.2.4A.1.4.1 Initial conditions

Initial conditions are a set of test configurations the UE needs to be tested in and the steps for the SS to take with the UE to reach the correct measurement state.

The initial test configurations consist of environmental conditions, test frequencies, and CC combinations based on E-UTRA CA configurations specified in table 5.4.2A.1-1. All of these configurations shall be tested with applicable test parameters for each CA Configuration, and are shown in table 6.2.4A.1.4.1-1 to 6.2.4A.1.4.1-5. The details of the uplink reference measurement channels (RMCs) are specified in Annex A.2. Configurations of PDSCH and PDCCH before measurement are specified in Annex C.2.

Table 6.2.4A.1.4.1-1: Test Configuration Table (network signalled value "CA_NS_01")

Initial Conditions									
Test Environment as specified in TS 36.508[7] subclause 4.1					NC				
Test Frequencies as specified in TS36.508 [7] subclause 4.3.1 for different CA bandwidth classes.					C: Low and High range				
Test CC Combination setting (N_{RB_agg}) as specified in subclause 5.4.2A.1 for the CA Configuration across bandwidth combination sets supported by the UE.					As in Table 6.2.4A.1.3.1-1				
Test Parameters for CA Configurations									
ID	CA Configuration / N_{RB_agg}		DL Allocation (PDCCH on PCC)	CC MOD	UL Allocation				
	PCC N_{RB}	SCCs N_{RB}	PCC & SCC RB allocation		N_{RB_alloc}	PCC & SCC RB allocations (L_{CRB} @ RB_{start})			
1	75	75	N/A	QPSK	1	P_1@0	S_0@0		
2	75	75		QPSK	150	P_75@0	S_75@0		
3	75	75		QPSK	45	P_45@7	S_0@0		
4	75	75		QPSK	8	P_0@0	S_8@67		
5	75	75		QPSK	128	P_75@0	S_53@0		
6	75	75		QPSK	2	P_1@0	S_1@74		
7	75	75		QPSK	30	P_10@0	P_5@50	S_5@25	S_10@65
8	75	75		QPSK	105	P_35@0	P_20@55	S_15@0	S_35@40
9	100	100		QPSK	200	P_100@0	S_100@0		
10	100	100		QPSK	1	P_1@0	S_0@0		
11	100	100		QPSK	175	P_75@25	S_100@0		
12	100	100		QPSK	25	P_0@0	S_25@75		
13	100	100		QPSK	64	P_64@24	S_0@0		
14	100	100		QPSK	2	P_1@0	S_1@99		
15	100	100		QPSK	40	P_10@0	P_10@65	S_10@35	S_10@90
16	100	100		QPSK	150	P_40@0	P_35@65	S_35@0	S_40@60

Note 1: CA Configuration Test CC Combination settings are checked separately for each CA Configuration which applicable aggregated channel bandwidths are specified in Table 5.4.2A.1-1

Table 6.2.4A.1.4.1-2: Test Configuration Table (network signalled value "CA_NS_02")

Initial Conditions								
Test Environment as specified in TS 36.508[7] subclause 4.1					NC			
Test Frequencies as specified in TS36.508 [7] subclause 4.3.1 for different CA bandwidth classes.					C: Low and High range			
Test CC Combination setting (N_{RB_agg}) as specified in subclause 5.4.2A.1 for the CA Configuration across bandwidth combination sets supported by the UE.					As in Table 6.2.4A.1.3.2-1			
Test Parameters for CA Configurations								
ID	CA Configuration / N_{RB_agg}		DL Allocation (PDCCH on PCC)	CC MOD	UL Allocation			
	PCC N_{RB}	SCCs N_{RB}			PCC & SCC RB allocation	N_{RB_alloc}	PCC & SCC RB allocations (L_{CRB} @ RB_{start})	
1	75	75	N/A	QPSK			1	P_1@0
2	75	75		QPSK	75	P_75@0	S_0@0	
3	75	75		QPSK	128	P_75@0	S_53@0	
4	75	75		QPSK	128	P_53@22	S_75@0	
5	75	75		QPSK	1	P_0@0	S_1@74	
6	75	75		QPSK	1	P_0@0	S_1@54	
7	75	75		QPSK	TBD	TBD	TBD	
8	75	75		QPSK	TBD	TBD	TBD	
9	100	100		QPSK	1	P_1@0	S_0@0	
10	100	100		QPSK	1	P_1@21	S_0@0	
11	100	100		QPSK	90	P_90@0	S_0@0	
12	100	100		QPSK	180	P_100@0	S_80@0	
13	100	100		QPSK	1	P_0@0	S_1@99	
14	100	100		QPSK	1	P_0@0	S_1@83	
15	100	100		QPSK	TBD	TBD	TBD	
16	100	100		QPSK	TBD	TBD	TBD	
Note 1: CA Configuration Test CC Combination settings are checked separately for each CA Configuration which applicable aggregated channel bandwidths are specified in Table 5.4.2A.1-1								

Table 6.2.4A.1.4.1-3: Test Configuration Table (network signalled value "CA_NS_03")

Initial Conditions								
Test Environment as specified in TS 36.508[7] subclause 4.1					NC			
Test Frequencies as specified in TS36.508 [7] subclause 4.3.1 for different CA bandwidth classes.					C: Low and High range			
Test CC Combination setting (N_{RB_agg}) as specified in subclause 5.4.2A.1 for the CA Configuration across bandwidth combination sets supported by the UE.					As in Table 6.2.4A.1.3.3-1			
Test Parameters for CA Configurations								
ID	CA Configuration / N_{RB_agg}		DL Allocation (PDCCH on PCC)	CC MOD	UL Allocation			
	PCC N_{RB}	SCCs N_{RB}			PCC & SCC RB allocation	N_{RB_alloc}	PCC & SCC RB allocations (L_{CRB} @ RB_{start})	
1	75	75	N/A	QPSK			1	P_1@0
2	75	75		QPSK	1	P_1@21	S_0@0	
3	75	75		QPSK	75	P_75@0	S_0@0	
4	75	75		QPSK	90	P_75@0	S_15@0	
5	75	75		QPSK	150	P_75@0	S_75@0	
6	75	75		QPSK	1	P_0@0	S_1@74	
7	75	75		QPSK	1	P_0@0	S_1@44	
8	75	75		QPSK	TBD	TBD	TBD	
9	100	100		QPSK	1	P_1@0	S_0@0	
10	100	100		QPSK	60	P_60@0	S_0@0	
11	100	100		QPSK	1	P_1@63	S_0@0	
12	100	100		QPSK	90	P_90@0	S_0@0	

13	100	100		QPSK	162	P_100@0	S_62@0		
14	100	100		QPSK	1	P_0@0	S_1@99		
15	100	100		QPSK	1	P_0@0	S_1@70		
16	100	100		QPSK	TBD	TBD	TBD		
Note 1: CA Configuration Test CC Combination settings are checked separately for each CA Configuration which applicable aggregated channel bandwidths are specified in Table 5.4.2A.1-1									

Table 6.2.4A.1.4.1-4: Test Configuration Table (network signalled value "CA_NS_04")

Initial Conditions									
Test Environment as specified in TS 36.508[7] subclause 4.1					NC				
Test Frequencies as specified in TS36.508 [7] subclause 4.3.1 for different CA bandwidth classes.					C: Low and High range				
Test CC Combination setting (N _{RB_agg}) as specified in subclause 5.4.2A.1 for the CA Configuration across bandwidth combination sets supported by the UE.					As in Table 6.2.4A.1.3.4-1				
Test Parameters for CA Configurations									
ID	CA Configuration / N _{RB_agg}		DL Allocation (PDCCH on PCC)	CC MOD	UL Allocation				
	PCC N _{RB}	SCCs N _{RB}			PCC & SCC RB allocation	N _{RB_alloc}	PCC & SCC RB allocations (L _{CRB} @ RB _{start})		
1	100	50	N/A	QPSK			10	P_10@20	S_0@0
2	100	50		QPSK	60	P_50@50	S_10@0		
3	100	50		16QAM	15	P_0@0	S_15@0		
4	100	50		QPSK	2	P_1@0	S_1@49		
5	100	50		QPSK	24	P_6@0	P_6@50	S_6@0	S_6@44
6	100	50		QPSK	60	P_20@0	P_20@50	S_10@0	S_10@40
7	75	75		QPSK	10	P_10@20	S_0@0		
8	75	75		QPSK	75	P_30@45	S_45@0		
9	75	75		QPSK	2	P_1@0	S_1@74		
10	75	75		QPSK	24	P_6@0	P_6@60	S_6@10	S_6@69
11	75	75		QPSK	60	P_15@0	P_15@45	S_15@15	S_15@60
12	100	75		QPSK	10	P_10@20	S_0@0		
13	100	75		QPSK	80	P_50@50	S_30@0		
14	100	75		16QAM	20	P_0@0	S_20@15		
15	100	75		QPSK	2	P_1@0	S_1@74		
16	100	75		QPSK	28	P_8@0	P_8@60	S_6@10	S_6@69
17	100	75		QPSK	75	P_25@0	P_20@55	S_15@10	S_15@60
18	100	100		QPSK	10	P_10@25	S_0@0		
19	100	100		QPSK	90	P_40@60	S_50@0		
20	100	100		16QAM	15	P_0@0	S_15@40		
21	100	100		16QAM	20	P_0@0	S_20@30		
22	100	100		QPSK	2	P_1@0	S_1@99		
23	100	100		QPSK	30	P_10@0	P_5@65	S_10@30	S_5@95
24	100	100		QPSK	80	P_20@0	P_20@60	S_20@20	S_20@80
Note 1: CA Configuration Test CC Combination settings are checked separately for each CA Configuration which applicable aggregated channel bandwidths are specified in Table 5.4.2A.1-1									

Table 6.2.4A.1.4.1-5: Test Configuration Table (network signalled value "CA_NS_05")

Initial Conditions									
Test Environment as specified in TS 36.508[7] subclause 4.1					NC				
Test Frequencies as specified in TS36.508 [7] subclause 4.3.1 for different CA bandwidth classes.					C: Low and High range				
Test CC Combination setting (N_{RB_agg}) as specified in subclause 5.4.2A.1 for the CA Configuration across bandwidth combination sets supported by the UE.					As in Table 6.2.4A.1.3.5-1				
Test Parameters for CA Configurations									
ID	CA Configuration / N_{RB_agg}		DL Allocation (PDCCH on PCC)	CC MOD	UL Allocation				
	PCC N_{RB}	SCCs N_{RB}	PCC & SCC RB allocation		N_{RB_alloc}	PCC & SCC RB allocations (L_{CRB} @ RB_{start})			
1	75	75	N/A	QPSK	40	P_40@0	S_0@0		
2	75	75		QPSK	80	P_50@25	S_30@0		
3	75	75		QPSK	60	P_10@65	S_50@0		
4	75	75		QPSK	64	P_1@74	S_63@0		
5	75	75		QPSK	90	P_20@55	S_70@0		
6	75	75		QPSK	2	P_1@0	S_1@74		
7	75	75		QPSK	90	P_30@0	P_15@40	S_15@25	S_30@45
8	100	100		QPSK	8	P_8@0	S_0@0		
9	100	100		QPSK	40	P_40@0	S_0@0		
10	100	100		QPSK	80	P_50@50	S_30@0		
11	100	100		QPSK	150	P_60@40	S_90@0		
12	100	100		QPSK	2	P_1@0	S_1@99		
13	100	100		QPSK	120	P_30@0	P_30@45	S_30@25	S_30@70

Note 1: CA Configuration Test CC Combination settings are checked separately for each CA Configuration which applicable aggregated channel bandwidths are specified in Table 5.4.2A.1-1

Table 6.2.4A.1.4.1-6: Test Configuration Table (network signalled value "CA_NS_06")

Initial Conditions									
Test Environment as specified in TS 36.508[7] subclause 4.1					NC				
Test Frequencies as specified in TS36.508 [7] subclause 4.3.1 for different CA bandwidth classes.					C: Low and High range				
Test CC Combination setting (N_{RB_agg}) as specified in subclause 5.4.2A.1 for the CA Configuration					As in Table 6.2.4A.1.3.6-1				
Test Parameters for CA Configurations									
ID	CA Configuration / N_{RB_agg}		DL Allocation (PDCCH on PCC)	CC MOD	UL Allocation				
	PCC N_{RB}	SCCs N_{RB}	PCC & SCC RB allocation		N_{RB_alloc}	PCC & SCC RB allocations (L_{CRB} @ RB_{start})			
1	75	75	N/A	QPSK	5	P_5@0	S_0@0		
2	75	75		QPSK	45	P_45@0	S_0@0		
3	75	75		QPSK	75	P_60@15	S_15@0		
4	75	75		QPSK	60	P_10@65	S_50@0		
5	75	75		QPSK	90	P_18@57	S_72@0		
6	75	75		QPSK	2	P_1@0	S_1@74		
7	75	75		QPSK	24	P_6@0	P_6@40	S_6@5	S_6@45
8	100	100		QPSK	10	P_10@0	S_0@0		
9	100	100		QPSK	30	P_30@0	S_0@0		
10	100	100		QPSK	100	P_75@25	S_25@0		
11	100	100		QPSK	90	P_40@60	S_50@0		
12	100	100		QPSK	100	P_15@85	S_85@0		
13	100	100		QPSK	2	P_1@0	S_1@99		
14	100	100		QPSK	32	P_8@0	P_8@50	S_8@0	S_8@50

Note 1: CA Configuration Test CC Combination settings are checked separately for each CA Configuration which applicable aggregated channel bandwidths are specified in Table 5.4.2A.1-1

1. Connect the SS to the UE antenna connectors as shown in TS 36.508[7] Annex A Figure group A.32 as appropriate.
2. The parameter settings for the cell are set up according to TS 36.508 [7] subclause 4.4.3.
3. Downlink signals for PCC are initially set up according to Annex C.0, C.1, and C.3.0, and uplink signals according to Annex H.1 and H.3.0.
4. The UL Reference Measurement channel is set according to the applicable table from Table 6.2.4A.1.1.4.1-1 to 6.2.4A.1.4.1-3.
5. Propagation conditions are set according to Annex B.0.
6. Ensure the UE is in State 3A-RF according to TS 36.508 [7] clause 5.2A.2. Message contents are defined in clause 6.2.4A.1.4.3.

6.2.4A.1.4.2 Test procedure

1. Configure SCC according to Annex C.0, C.1 and Annex C.3.0 for all downlink physical channels except PHICH.
2. The SS shall configure SCC as per TS 36.508 [7] clause 5.2A.4. Message contents are defined in clause 6.2.4A.1.4.3.
3. SS activates SCC by sending the activation MAC-CE (Refer TS 36.321 [13], clauses 5.13, 6.1.3.8). Wait for at least 2 seconds (Refer TS 36.133, clauses 8.3.3.2).
4. SS sends uplink scheduling information for each UL HARQ process via PDCCH DCI format 0 for C_RNTI to schedule the UL RMC according to the applicable from Table 6.2.4A.1.4.1-1 to Table 6.2.4A.1.4.1-5 on both PCC and SCC. Since the UE has no payload and no loopback data to send the UE sends uplink MAC padding bits on the UL RMC.
5. Send continuously uplink power control "up" commands in every uplink scheduling information to the UE; allow at least 200ms for the UE to reach P_{UMAX} level.
6. Measure the mean transmitted power over all component carriers in the CA configuration of the radio access mode. The period of measurement shall be at least the continuous duration of one sub-frame (1ms). For TDD slots with transient periods are not under test.

6.2.4A.1.4.3 Message contents

Message contents are according to TS 36.508 [7] subclause 4.6. The following exceptions apply for each network signalled value.

6.2.4A.1.4.3.1 Message contents exceptions (network signalled value "CA_NS_01")

1. Information element `additionalSpectrumEmissionSCell-r10` is set to `CA_NS_01`. This can be set in the *RadioResourceConfigCommonSCell-r10-DEFAULT* as part of the common RRC messages. This exception indicates that the UE shall meet the additional spectrum emission requirement for a specific deployment scenario.

Table 6.2.4A.1.4.3.1-1: *RadioResourceConfigCommonSCell-r10-DEFAULT*: Additional spectrum emission test requirement for "CA_NS_01"

Derivation Path: TS 36.508 [7] clause 4.6.3, Table 4.6.3-13A			
Information Element	Value/remark	Comment	Condition
<code>additionalSpectrumEmissionSCell-r10</code>	1 (CA_NS_01)		

6.2.4A.1.4.3.2 Message contents exceptions (network signalled value "CA_NS_02")

1. Information element `additionalSpectrumEmissionSCell-r10` is set to `CA_NS_02`. This can be set in the *RadioResourceConfigCommonSCell-r10-DEFAULT* as part of the common RRC messages. This exception indicates that the UE shall meet the additional spectrum emission requirement for a specific deployment scenario.

Table 6.2.4A.1.4.3.2-1: *RadioResourceConfigCommonSCell-r10-DEFAULT*: Additional spectrum emission test requirement for "CA_NS_02"

Derivation Path: TS 36.508 [7] clause 4.6.3, Table 4.6.3-13A			
Information Element	Value/remark	Comment	Condition
<code>additionalSpectrumEmissionSCell-r10</code>	2 (CA_NS_02)		

6.2.4A.1.4.3.3 Message contents exceptions (network signalled value "CA_NS_03")

1. Information element `additionalSpectrumEmissionSCell-r10` is set to `CA_NS_03`. This can be set in the *RadioResourceConfigCommonSCell-r10-DEFAULT* as part of the common RRC messages. This exception indicates that the UE shall meet the additional spectrum emission requirement for a specific deployment scenario.

Table 6.2.4A.1.4.3.3-1: *RadioResourceConfigCommonSCell-r10-DEFAULT*: Additional spectrum emission test requirement for "CA_NS_03"

Derivation Path: TS 36.508 [7] clause 4.6.3, Table 4.6.3-13A			
Information Element	Value/remark	Comment	Condition
<code>additionalSpectrumEmissionSCell-r10</code>	3 (CA_NS_03)		

6.2.4A.1.4.3.4 Message contents exceptions (network signalled value "CA_NS_04")

1. Information element `additionalSpectrumEmissionSCell-r10` is set to `CA_NS_04`. This can be set in the *RadioResourceConfigCommonSCell-r10-DEFAULT* as part of the common RRC messages. This exception indicates that the UE shall meet the additional spectrum emission requirement for a specific deployment scenario.

Table 6.2.4A.1.4.3.4-1: *RadioResourceConfigCommonSCell-r10-DEFAULT*: Additional spectrum emission test requirement for "CA_NS_04"

Derivation Path: TS 36.508 [7] clause 4.6.3, Table 4.6.3-13A			
Information Element	Value/remark	Comment	Condition
<code>additionalSpectrumEmissionSCell-r10</code>	4 (CA_NS_04)		

6.2.4A.1.4.3.5 Message contents exceptions (network signalled value "CA_NS_05")

1. Information element `additionalSpectrumEmissionSCell-r10` is set to `CA_NS_05`. This can be set in the *RadioResourceConfigCommonSCell-r10-DEFAULT* as part of the common RRC messages. This exception indicates that the UE shall meet the additional spectrum emission requirement for a specific deployment scenario.

Table 6.2.4A.1.4.3.5-1: *RadioResourceConfigCommonSCell-r10-DEFAULT*: Additional spectrum emission test requirement for "CA_NS_05"

Derivation Path: TS 36.508 [7] clause 4.6.3, Table 4.6.3-13A			
Information Element	Value/remark	Comment	Condition
<code>additionalSpectrumEmissionSCell-r10</code>	5 (CA_NS_05)		

6.2.4A.1.5 Test requirements

The maximum output power, derived in step 3 shall be within the range prescribed by the nominal maximum output power and tolerance in the applicable table from Table 6.2.4A.1.5-1 to Table 6.2.4A.1.5-3. The allowed maximum output power reduction is specified in Table 6.2.4A.1.3-1 and clause 6.2.3A.1 does not apply, i.e. carrier aggregation MPR = 0. For the UE maximum output power modified by A-MPR specified in table 6.2.4A.1.3-1, the power limits specified in Table 6.2.5A.1.3-2 apply.

Table 6.2.4A.1.5-1: Test requirement (network signalled value "CA_NS_01")

Configuration ID	Class 1 (dBm)	Tol. (dB)	Class 2 (dBm)	Tol. (dB)	Class 3 (dBm)	Tol. (dB)
1					23	+2.7 / -17.7
2					23	+2.7 / -11.7
3					23	+2.7 / -9.7
4					23	+2.7 / -4.7
5					23	+2.7 / -2.7
6					23	+2.7 / -23.7
7					23	+2.7 / -20.2
8					23	+2.7 / -13.2
9					23	+2.7 / -18.7
10					23	+2.7 / -18.7
11					23	+2.7 / -11.7
12					23	+2.7 / -9.7
13					23	+2.7 / -2.7
14					23	+2.7 / -23.7
15					23	+2.7 / -20.2
16					23	+2.7 / -12.7

Table 6.2.4A.1.5-2: Test requirement (network signalled value "CA_NS_02")

Configuration ID	Class 1 (dBm)	Tol. (dB)	Class 2 (dBm)	Tol. (dB)	Class 3 (dBm)	Tol. (dB)
1					23	+2.7 / -4.7
2					23	+2.7 / -5.2
3					23	+2.7 / -9.7
4					23	+2.7 / -11.7
5					23	+2.7 / -4.7
6					23	+2.7 / -2.7
7					23	TBD
8					23	TBD
9					23	+2.7 / -8.2
10					23	+2.7 / -5.2
11					23	+2.7 / -5.2
12					23	+2.7 / -11.7
13					23	+2.7 / -15.7
14					23	+2.7 / -2.7
15					23	TBD
16					23	TBD

Table 6.2.4A.1.5-3: Test requirement (network signalled value "CA_NS_03")

Configuration ID	Class 1 (dBm)	Tol. (dB)	Class 2 (dBm)	Tol. (dB)	Class 3 (dBm)	Tol. (dB)
1					23	+2.7 / -15.7
2					23	+2.7 / -8.2
3					23	+2.7 / -4.7
4					23	+2.7 / -9.7
5					23	+2.7 / -13.7
6					23	+2.7 / -11.7
7					23	+2.7 / -2.7
8					23	TBD
9					23	+2.7 / -15.7
10					23	+2.7 / -11.7
11					23	+2.7 / -3.7
12					23	+2.7 / -8.2
13					23	+2.7 / -12.7
14					23	+2.7 / -15.7
15					23	+2.7 / -2.7
16					23	TBD

Table 6.2.4A.1.5-4: Test requirement (network signalled value "CA_NS_04")

Configuration ID	Class 1 (dBm)	Tol. (dB)	Class 2 (dBm)	Tol. (dB)	Class 3 (dBm)	Tol. (dB)
1					23	+2.7 / -8.2
2					23	+2.7 / -6.2
3					23	+2.7 / -8.2
4					23	+2.7 / -17.2
5					23	+2.7 / -11.2
6					23	+2.7 / -9.2
7					23	+2.7 / -8.2
8					23	+2.7 / -8.2
9					23	+2.7 / -17.2
10					23	+2.7 / -11.2
11					23	+2.7 / -9.2
12					23	+2.7 / -8.2
13					23	+2.7 / -6.2
14					23	+2.7 / -8.2
15					23	+2.7 / -17.2
16					23	+2.7 / -11.2
17					23	+2.7 / -9.2
18					23	+2.7 / -6.2
19					23	+2.7 / -6.2
20					23	+2.7 / -8.2
21					23	+2.7 / -8.2
22					23	+2.7 / -17.2
23					23	+2.7 / -11.2
24					23	+2.7 / -9.2

Table 6.2.4A.1.5-5: Test requirement (network signalled value "CA_NS_05")

Configuration ID	Class 1 (dBm)	Tol. (dB)	Class 2 (dBm)	Tol. (dB)	Class 3 (dBm)	Tol. (dB)
1					23	+2.7 / -6.2
2					23	+2.7 / -12.7
3					23	+2.7 / -11.7
4					23	+2.7 / -6.2
5					23	+2.7 / -13.7
6					23	+2.7 / -32.7
7					23	+2.7 / -18.2
8					23	+2.7 / -9.7
9					23	+2.7 / -6.2
10					23	+2.7 / -12.7
11					23	+2.7 / -19.7
12					23	+2.7 / -32.7
13					23	+2.7 / -18.2

Table 6.2.4A.1.5-6: Test requirement (network signalled value "CA_NS_06")

Configuration ID	Class 1 (dBm)	Tol. (dB)	Class 2 (dBm)	Tol. (dB)	Class 3 (dBm)	Tol. (dB)
1					23	+2.7 / -9.7
2					23	+2.7 / -4.7
3					23	+2.7 / -4.7
4					23	+2.7 / -11.7
5					23	+2.7 / -15.7
6					23	+2.7 / -24.7
7					23	+2.7 / -20.7
8					23	+2.7 / -8.2
9					23	+2.7 / -4.7
10					23	+2.7 / -6.2
11					23	+2.7 / -9.7
12					23	+2.7 / -15.7
13					23	+2.7 / -24.7
14					23	+2.7 / -20.7

6.2.4B Additional Maximum Power Reduction (A-MPR) for UL-MIMO

6.2.4B.1 Test purpose

Additional ACLR and spectrum emission requirements can be signalled by the network to indicate that the UE shall also meet additional requirements in a specific deployment scenario. To meet these additional requirements, Additional Maximum Power Reduction A-MPR is allowed for the sum output power at each antenna connector as specified in Table 6.2.2B.3-1. Unless stated otherwise, an A-MPR of 0 dB shall be used.

6.2.4B.2 Test applicability

The requirements of this test apply in test case 6.6.2.2 Additional Spectrum Emission Mask for network signalled values NS_03, NS_04, NS_06 and NS_07 to all types of E-UTRA UE release 10 and forward that support UL MIMO.

The requirements of this test apply in test case 6.6.3.3 Additional Spurious Emissions for network signalled values NS_05, NS_07 and NS_08, NS_09 to all types of E-UTRA UE release 10 and forward that support UL MIMO.

6.2.4B.3 Minimum conformance requirements

For UE Power Class 3 the specific requirements and identified clauses are specified in Table 6.2.4B.3-1 along with the allowed A-MPR values that may be used to meet these requirements. The allowed A-MPR values specified below in Table 6.2.4B.3-1 and 6.2.4B.3-2 are in addition to the allowed MPR requirements specified in clause 6.2.3B. For the UE maximum output power modified by A-MPR, the power limits specified in clause 6.2.5B apply.

Table 6.2.4B.3-1: Additional Maximum Power Reduction (A-MPR) / Spectrum Emission requirements

Network Signalling value	Requirements (sub-clause)	E-UTRA Band	Channel bandwidth (MHz)	Resources Blocks (N_{RB})	A-MPR (dB)
NS_01	6.6.2.1.1	Table 5.2-1	1.4,3,5,10,15,20	Table 5.4.2-1	NA
NS_03	6.6.2.2.3.1	2,4,10, 23, 25,35,36	3	>5	≤ 1
			5	>6	≤ 1
			10	>6	≤ 1
			15	>8	≤ 1
			20	>10	≤ 1
NS_04	6.6.2.2.3.2	41	5	>6	≤ 1
			10, 15, 20	See Table 6.2.4B.3-4	
NS_05	6.6.3.3.3.1	1	10,15,20	≥ 50	≤ 1
NS_06	6.6.2.2.3.3	12, 13, 14, 17	1.4, 3, 5, 10	Table 5.4.2-1	n/a
NS_07	6.6.2.2.3.3	13	10	Table 6.2.4B.3-2	Table 6.2.4B.3-2
	6.6.3.3.3.2				
NS_08	6.6.3.3.3.3	19	10, 15	> 44	≤ 3
NS_09	6.6.3.3.3.4	21	10, 15	> 40	≤ 1
				> 55	≤ 2
				Table 6.2.4B.3-3	Table 6.2.4B.3-3
NS_11	6.6.2.2.1	23	1.4, 3, 5, 10, 15, 20	Table 6.2.4B.3-5	Table 6.2.4B.3-5
NS_12	6.6.3.3.5	26	1.4, 3, 5	Table 6.2.4B.3-6	Table 6.2.4B.3-6
NS_13	6.6.3.3.6	26	5	Table 6.2.4B.3-7	Table 6.2.4B.3-7
NS_14	6.6.3.3.7	26	10, 15	Table 6.2.4B.3-8	Table 6.2.4B.3-8
NS_15	6.6.3.3.9	26	1.4, 3, 5, 10, 15	Table 6.2.4B.3-9	Table 6.2.4B.3-9, Table 6.2.4B.3-10
				Table 6.2.4B.3-10	
NS_16	6.6.3.3.9	27	3, 5, 10	Table 6.2.4B.3-11, Table 6.2.4B.3-12, Table 6.2.4B.3-13	
..					
NS_20	6.2.2, .6.2.2.1, 6.6.3.2	23	5, 10, 15, 20	Table 6.2.4B.3-14	Table 6.2.4B.3-14
NS_32	-	-	-	-	-

Note 1: Applies to the lower block of Band 23, i.e. a carrier placed in the 2000-2010 MHz region.

Table 6.2.4B.3-2: A-MPR for "NS_07"

Parameters	Region A		Region B				Region C	
RB_{start}^1	0 – 12		13 – 18		19 – 42		43 – 49	
L_{CRB}^2 [RBs]	6 – 8	1 to 5 and 9-50	<8	≥8	<18	≥18	≤2	>2
A-MPR [dB]	≤8	≤12	0	≤12	0	≤6	≤3	0
Note 1: RB_{start} indicates the lowest RB index of transmitted resource blocks Note 2: L_{CRB} is the length of a contiguous resource block allocation Note 3: For intra-subframe frequency hopping between two regions, notes 1 and 2 apply on a per slot basis. Note 4: For intra-subframe frequency hopping between two regions, the larger A-MPR value of the two regions may be applied for both slots in the subframe.								

Table 6.2.4B.3-3: A-MPR for "NS_10"

Channel BW	Parameters	Region A
15	RB_{start}^1	0 – 10
	L_{CRB} [RBs]	1 -20
	A-MPR [dB]	≤ 2
20	RB_{start}^1	0 – 15
	L_{CRB} [RBs]	1 -20
	A-MPR [dB]	≤ 5
Note 1: RB_{start} indicates the lowest RB index of transmitted resource blocks. Note 2: L_{CRB} is the length of a contiguous resource block allocation. Note 3: For intra-subframe frequency hopping which intersects Region A, notes 1 and 2 apply on a per slot basis. Note 4: For intra-subframe frequency hopping which intersect Region A, the larger A-MPR value may be applied for both slots in the subframe.		

Table 6.2.4B.3-4: A-MPR for NS_04 for bandwidths > 5MHz

Channel BW	Parameters	Region A	Region B		Region C
10	RB_{start}^1	0 – 12	13 – 36		37 – 49
	$RB_{start}^1 + L_{CRB}^2$ [RBs]	NA (Note 3)	14 - 37	>37	NA (Note 3)
	A-MPR [dB]	≤3dB	0	≤2dB	≤3dB
15	RB_{start}^1	0 – 18	19 – 55		56 – 74
	$RB_{start}^1 + L_{CRB}^2$ [RBs]	NA (Note 3)	20 - 56	>56	NA (Note 3)
	A-MPR [dB]	≤3dB	0	≤2dB	≤3dB
20	RB_{start}^1	0 – 24	25 – 74		75 – 99
	$RB_{start}^1 + L_{CRB}^2$ [RBs]	NA (Note 3)	26 - 75	>75	NA (Note 3)
	A-MPR [dB]	≤3dB	0	≤2dB	≤3dB
Note 1: RB_{start} indicates the lowest RB index of transmitted resource blocks. Note 2: L_{CRB} is the length of a contiguous resource block allocation. Note 3: Any RB allocation that starts in Region A or C is allowed the specified A-MPR. Note 4: For intra-subframe frequency hopping which intersects regions, notes 1 and 2 apply on a per slot basis. Note 5: For intra-subframe frequency hopping which intersects regions, the larger A-MPR value may be applied for both slots in the subframe.					

Table 6.2.4B.3-5: A-MPR for "NS_11"

Channel Bandwidth	Parameters						
3	Fc (MHz)	<2004		≥2004			
	L _{CRB} (RBs)	1-15		>5			
	A-MPR	≤5		≤1			
5	Fc (MHz)	<2004		2004 ≤ Fc <2007		≥2007	
	L _{CRB} (RBs)	1-25		1-6 & 15-25	8-12	>6	
	A-MPR	≤7		≤4	0	≤1	
10	Fc (MHz)	2005					
	RB _{start} (RBs)	0-49					
	L _{CRB} (RBs)	1-50					
	A-MPR	≤12					
15	Fc (MHz)	[<2012.5]					
	RB _{start} (RBs)	[0-4]	[5-21]		[22-56]	[57-74]	
	L _{CRB} (RBs)	≥1	[7-50]	[0-6 & ≥50]	≤25	>25	>0
	A-MPR	≤15	≤7	≤10	[0]	≤6	≤15
	Fc (MHz)	[2012.5]					
	RB _{start} (RBs)	[0-12]	[13-39]		[40-65]	[66-74]	
	L _{CRB} (RBs)	≥1	≥30	<30	≥ (69 – RB _{start})	≥1	
	A-MPR	≤10	≤6	[0]	≤2	≤6.5	
20	Fc (MHz)	2010					
	RB _{start} (RBs)	[0-12]	[13-29]		[30-68]	[69-99]	
	L _{CRB} (RBs)	≥1	[10-60]	[1-9 & >60]	[1-24]	≥25	≥1
	A-MPR	≤15	≤7	≤10	[0]	≤7	≤15

Table 6.2.4B.3-6: A-MPR for "NS_12"

Channel BW	Parameters	Region A		Region B
1.4	RB _{start}	0		1-2
	L _{CRB} [RBs]	≤3	≥4	≥4
	A-MPR [dB]	≤3	≤6	≤3
3	RB _{start}	0-3		4-5
	L _{CRB} [RBs]	4-9	1-3 and 10-15	≥9
	A-MPR [dB]	≤4	≤3	≤3
5	RB _{start}	0-6		7-9
	L _{CRB} [RBs]	≤8	≥9	≥15
	A-MPR [dB]	≤5	≥3	≤3

Table 6.2.4B.3-7: A-MPR for "NS_13"

Channel BW	Parameters	Region A	
5	RB _{start}	0-2	
	L _{CRB} [RBs]	≤5	≥18
	A-MPR [dB]	≤3	≤2

Table 6.2.4B.3-8: A-MPR for "NS_14"

Channel BW	Parameters	Region A	
10	RB _{start}	0	
	L _{CRB} [RBs]	≤5	≥50
	A-MPR [dB]	≤3	≤1
15	RB _{start}	≤8	
	L _{CRB} [RBs]	≤16	≥50
	A-MPR [dB]	≤3	≤1

Table 6.2.4B.3-9: A-MPR for "NS_15" for E-UTRA highest channel edge > 845 MHz and ≤ 849 MHz

E-UTRA Channel bandwidth [MHz]	Parameters	Region A	Region B	Region C
1.4	RB _{end} [RB]			4-5
	A-MPR [dB]			≤3
3	RB _{end} [RB]	0-1	8-12	13-14
	L _{CRB} [RB]	≤2	≥8	>0
	A-MPR [dB]	≤4	≤4	≤9
5	RB _{end} [RB]	0-4	12-19	20-24
	L _{CRB} [RB]	≤2	≥8	>0
	A-MPR [dB]	≤4	≤5	≤9
10	RB _{end} [RB]	0-12	23-36	37-49
	L _{CRB} [RB]	≤2	≥15	>0
	A-MPR [dB]	≤4	≤6	≤9
15	RB _{end} [RB]	0-20	26-53	54-74
	L _{CRB} [RB]	≤2	≥20	>0
	A-MPR [dB]	≤4	≤5	≤9

Table 6.2.4B.3-10: A-MPR for "NS_15" for E-UTRA highest channel edge ≤ 845 MHz

E-UTRA Channel bandwidth [MHz]	Parameters	Region A	Region B	Region C
5	RB _{end} [RB]			19-24
	L _{CRB} [RB]			≥18
	A-MPR [dB]			≤2
10	RB _{end} [RB]	0-4	29-44	45-49
	L _{CRB} [RB]	≤2	≥24	>0
	A-MPR [dB]	≤4	≤4	≤9
15	RB _{end} [RB]	0-12	44-61	62-74
	L _{CRB} [RB]	≤2	≥20	>0
	A-MPR [dB]	≤4	≤5	≤9

Table 6.2.4B.3-11: A-MPR for “NS_16” with channel lower edge at ≥ 807 MHz and < 808.5 MHz

CBW	Parameter	Region A	Region B	Region C	Region D	Region E
3 MHz	RB_{start}	0	1-2			
	L_{CRB} [RBs]	≥ 12	12			
	A-MPR [dB]	≤ 2	≤ 1			
5 MHz	RB_{start}	0-1	2	2-9	2-5	
	L_{CRB} [RBs]	1 - 25	12	15-18	20	
	A-MPR [dB]	≤ 5	≤ 1	≤ 2	≤ 3	
10 MHz	RB_{start}	0 - 8	0-14		15-20	15-24
	L_{CRB} [RBs]	1 - 12	15-20	≥ 24	≥ 30	24-27
	A-MPR [dB]	≤ 5	≤ 3	≤ 7	≤ 3	≤ 1

Table 6.2.4B.3-12: A-MPR for “NS_16” with channel lower edge at ≥ 808.5 MHz and < 812 MHz

CBW	Parameter	Region A	Region B	Region C	Region D	Region E
5 MHz	RB_{start}	0	0-1	1-5		
	L_{CRB} [RBs]	16-20	≥ 24	16-20		
	A-MPR [dB]	≤ 2	≤ 3	≤ 1		
10 MHz	RB_{start}	0-6		0-10	0-14	11-20
	L_{CRB} [RBs]	1-12	15-20	24-32	≥ 36	24-32
	A-MPR [dB]	≤ 5	≤ 2	≤ 4	≤ 5	≤ 1

Table 6.2.4B.3-13: A-MPR for “NS_16” with channel lower edge at ≥ 812 MHz

CBW	Parameter	Region A	Region B	Region C	Region D
10 MHz	RB_{start}	0 - 9	0	1-14	0-5
	L_{CRB} [RBs]	27-32	36-40	36-40	≥ 45
	A-MPR [dB]	≤ 1	≤ 2	≤ 1	≤ 3

Table 6.2.4B.3-14: A-MPR for “NS_20”

Channel Bandwidth	Parameters							
5	F _C (MHz)	< 2007.5		2007.5 ≤ F _C < 2012.5		2012.5 ≤ F _C ≤ 2017.5		
	RB _{start} (RBs)	≤24		0-3	4-6	≤24		
	L _{CRB} (RBs)	>0		15-19	≥20	≥18	1-25	
	A-MPR	≤17		≤1	≤4	≤2	≤0	
10	F _C (MHz)	2005						
	RB _{start} (RBs)	0-25		26-34		35-49		
	L _{CRB} (RBs)	>0		8-15	>15	>0		
	A-MPR	≤16		≤2	≤5	≤6		
	F _C (MHz)	2015						
	RB _{start} (RBs)	0-5			6-10			
	L _{CRB} (RBs)	≥32			≥40			
	A-MPR	≤4			≤2			
15	F _C (MHz)	2012.5						
	RB _{start} (RBs)	0-14		15-24		25-39	61-74	
	L _{CRB} (RBs)	1-9 & 40-75	10-39	24-29	≥30	≥36	≤6	
	A-MPR	≤11	≤6	≤1	≤7	≤5	≤6	
20	F _C (MHz)	2010						
	RB _{start} (RBs)	0-21	22-31		32-38	39-49	50-69	70-99
	L _{CRB} (RBs)	>0	1-9 & 31-75	10-30	≥15	≥24	≥25	>0
	A-MPR	≤17	≤12	≤6	≤9	≤7	≤5	≤16
NOTE 1: When NS_20 is signalled the minimum requirements for the 10 MHz bandwidth are specified for E-UTRA UL carrier centre frequencies of 2005 MHz or 2015 MHz.								
NOTE 2: When NS_20 is signalled the minimum requirements for the 15 MHz channel bandwidth are specified for E-UTRA UL carrier centre frequency of 2012.5 MHz.								

6.2.4B.4 Test description

6.2.4B.4.1 Initial condition

Initial conditions are a set of test configurations the UE needs to be tested in and the steps for the SS to take with the UE to reach the correct measurement state.

The initial test configurations consist of environmental conditions, test frequencies, and channel bandwidths based on E-UTRA operating bands specified in table 5.4.2.1-1. All of these configurations shall be tested with applicable test parameters for each channel bandwidth, and are shown in table 6.2.4B.4.1-1 through table 6.2.4B.4.1-12. The details of the uplink reference measurement channels (RMCs) are specified in Annex A.2. Configurations of PDSCH and PDCCH before measurement are specified in Annex C.2.

Table 6.2.4B.4.1-1: Test Configuration Table (network signalled value "NS_03")

Initial Conditions							
Test Environment (as specified in TS 36.508 [7] clause 4.1)			NC				
Test Frequencies (as specified in TS 36.508 [7] clause 4.3.1)			Low range, Mid range, High range				
Test Channel Bandwidths (as specified in TS 36.508 [7] clause 4.3.1)			Lowest, 5MHz, 10MHz, Highest				
Test Parameters for NS_03 A-MPR							
Configuration ID	Ch BW	Downlink Configuration			Uplink Configuration		
		Mod'n	RB allocation		Mod'n	RB allocation	
			FDD	TDD		FDD	TDD
1	1.4MHz	N/A for A-MPR testing.			QPSK	6	6
2	1.4MHz				QPSK	5	5
3	1.4MHz				16QAM	5	5
4	3MHz				QPSK	15	15
5	3MHz				QPSK	4	4
6	3MHz				16QAM	15	15
7	3MHz				16QAM	4	4
8	5MHz				QPSK	25	25
9	5MHz				QPSK	8	8
10	5MHz				QPSK	6	6
11	5MHz				16QAM	25	25
12	5MHz				16QAM	8	8
13	10MHz				QPSK	50	50
14	10MHz				QPSK	12	12
15	10MHz				QPSK	6	6
16	10MHz				16QAM	50	50
17	10MHz				16QAM	12	12
18	15MHz				QPSK	75	75
19	15MHz				QPSK	16	16
20	15MHz				QPSK	8	8
21	15MHz				16QAM	75	75
22	15MHz				16QAM	16	16
23	20MHz				QPSK	100	100
24	20MHz				QPSK	18	18
25	20MHz				QPSK	10	10
26	20MHz				16QAM	100	100
27	20MHz				16QAM	18	18

Note 1: Test Channel Bandwidths are checked separately for each E-UTRA band, the applicable channel bandwidths are specified in Table 5.4.2.1-1.

Note 2: The Configuration ID will be used to map the applicable Test Configuration to the corresponding Test Requirement in clause 6.2.4B.5 as not all combinations are necessarily required based on the applicability of the UE.

Note 3: The RB_{start} of partial RB allocation shall be RB# 0 and RB# (max +1 - RB allocation) of the channel bandwidth.

Note 4: For band 23, above table only applies to mid and high range test frequencies. Low range test frequencies will be covered by NS_11 test configuration table.

Table 6.2.4B.4.1-2: Test Configuration Table (network signalled value "NS_04")

Initial Conditions						
Test Environment (as specified in TS 36.508 [7] clause 4.1)				NC		
Test Frequencies (as specified in TS 36.508 [7] clause 4.3.1)				Low range, Mid range, High range		
Test Channel Bandwidths (as specified in TS 36.508 [7] clause 4.3.1)				Lowest, 5MHz, 10MHz, Highest		
Test Parameters for NS_03 A-MPR						
Configuration ID	Ch BW	Downlink Configuration		Uplink Configuration		
		Mod'n	RB allocation TDD	Mod'n	RB allocation TDD	RB _{start} TDD
1	5MHz	N/A for A-MPR testing.		QPSK	25	Note 3
2	5MHz			QPSK	8	Note 3
3	5MHz			QPSK	6	Note 3
4	5MHz			16QAM	25	Note 3
5	5MHz			16QAM	8	Note 3
6	10MHz			QPSK	1	0
7	10MHz			QPSK	12	0
8	10MHz			QPSK	50	0
9	10MHz			16QAM	50	0
10	10MHz			QPSK	24	13
11	10MHz			16QAM	24	13
12	10MHz			QPSK	36	13
13	10MHz			QPSK	12	37
14	10MHz			QPSK	1	49
15	15MHz			QPSK	1	0
16	15MHz			QPSK	16	0
17	15MHz			QPSK	75	0
18	15MHz			16QAM	75	0
19	15MHz			QPSK	36	19
20	15MHz			16QAM	36	19
21	15MHz			QPSK	50	19
22	15MHz			QPSK	18	56
23	15MHz			QPSK	1	74
24	20MHz			QPSK	1	0
25	20MHz			QPSK	18	0
26	20MHz			QPSK	100	0
27	20MHz			16QAM	100	0
28	20MHz			QPSK	50	25
29	20MHz			16QAM	50	25
30	20MHz			QPSK	75	25
31	20MHz			QPSK	25	75
32	20MHz			QPSK	1	99

Note 1: Test Channel Bandwidths are checked separately for E-UTRA band, the applicable channel bandwidths are specified in Table 5.4.2.1-1.

Note 2: The configuration ID will be used to map the applicable Test Configuration to be corresponding Test Requirement in clause 6.2.4B as not all combinations are necessarily required based on the applicability of the UE.

Note 3: The RB_{start} of partial RB allocation shall be RB# 0 and RB# (max +1 - RB allocation) of the channel bandwidth.

Table 6.2.4B.4.1-3: Test Configuration Table (network signalled value "NS_05")

Initial Conditions					
Test Environment (as specified in TS 36.508 [7] clause 4.1)			Normal		
Test Frequencies (as specified in TS 36.508 [7] clause 4.3.1)			Low range, Mid range In case of Low range: - For 5MHz Channel Bandwidth: 1927.2MHz (NUL = 18072) - For 10MHz Channel Bandwidth: 1934.7MHz (NUL = 18147) - For 15 MHz Channel Bandwidth: 1932.5 MHz (NUL = 18125) - For 20MHz Channel Bandwidth: 1930 MHz (NUL = 18100)		
Test Channel Bandwidths (as specified in TS 36.508 [7] clause 4.3.1)			5MHz, 10MHz, 15MHz, 20MHz		
Test Parameters for NS_05 A-MPR					
Configuration ID	Ch BW	Downlink Configuration		Uplink Configuration	
		Mod'n	RB allocation FDD	Mod'n	RB allocation FDD
1	5MHz	N/A for A-MPR testing		QPSK	1
2	5MHz			QPSK	25
3	10MHz			QPSK	1
4	10MHz			QPSK	12
5	10MHz			QPSK	48
6	10MHz			QPSK	50
7	10MHz			16QAM	50
8	15MHz			QPSK	1
9	15MHz			QPSK	16
10	15MHz			QPSK	48
11	15MHz			QPSK	75
12	15MHz			16QAM	75
13	20MHz			QPSK	1
14	20MHz			QPSK	18
15	20MHz			QPSK	48
16	20MHz			QPSK	100
17	20MHz			16QAM	100
Note 1: The 1 RB allocation shall be tested at both RB #0 and RB #max. Note 2: The RB _{start} of partial RB allocation shall be RB# 0 and RB# (max +1 - RB allocation) of the channel bandwidth. Note 3: The Configuration ID will be used to map the applicable Test Configuration to the corresponding Test Requirement in clause 6.2.4B.5 as not all combinations are necessarily required based on the applicability of the UE.					

Table 6.2.4B.4.1-4: Test Configuration Table (network signalled value "NS_06")

Initial Conditions					
Test Environment (as specified in TS 36.508 [7] clause 4.1)			Normal		
Test Frequencies (as specified in TS 36.508 [7] clause 4.3.1)			Low range, Mid range, High range		
Test Channel Bandwidths (as specified in TS 36.508 [7] clause 4.3.1)			Lowest, 5MHz, 10MHz, Highest		
Test Parameters for NS_05 A-MPR					
Configuration ID	Ch BW	Downlink Configuration		Uplink Configuration	
		Mod'n	RB allocation FDD	Mod'n	RB allocation FDD
1	1.4MHz	N/A for A-MPR testing		QPSK	6
2	1.4MHz			QPSK	5
3	1.4MHz			16QAM	5
4	3MHz			QPSK	15
5	3MHz			QPSK	4
6	3MHz			16QAM	4
7	5MHz			QPSK	25
8	5MHz			QPSK	8
9	5MHz			16QAM	8
10	10MHz			QPSK	50
11	10MHz			QPSK	12
12	10MHz			16QAM	12
13	15MHz			QPSK	75
14	15MHz			QPSK	16
15	15MHz			16QAM	16
16	20MHz			QPSK	100
17	20MHz			QPSK	18
18	20MHz			16QAM	18
Note 1:	Test Channel Bandwidths are checked separately for each E-UTRA band, the applicable channel bandwidths are specified in Table 5.4.2.1-1.				
Note 2:	The Configuration ID will be used to map the applicable Test Configuration to the corresponding Test Requirement in clause 6.2.4B.5 as not all combinations are necessarily required based on the applicability of the UE.				
Note 3:	The RBstart of partial RB allocation shall be RB# 0 and RB# (max +1 - RB allocation) of the channel bandwidth.				

Table 6.2.4B.4.1-5: Test Configuration Table (network signalled value "NS_07")

Initial Conditions						
Test Environment (as specified in TS 36.508 [7] clause 4.1)				NC		
Test Frequencies (as specified in TS 36.508 [7] clause 4.3.1)				Mid range		
Test Channel Bandwidths (as specified in TS 36.508 [7] clause 4.3.1)				10MHz		
Test Parameters for NS_07 A-MPR						
Configuration ID	Ch BW	Downlink Configuration		Uplink Configuration		
		Mod'n	RB allocation FDD	Mod'n	RB allocation FDD	RB _{start} FDD
1	10MHz	N/A for A-MPR testing		QPSK	1	0
2	10MHz			QPSK	8	0
3	10MHz			QPSK	6	13
4	10MHz			QPSK	20	13
5	10MHz			QPSK	12	13
6	10MHz			16QAM	36	13
7	10MHz			QPSK	16	19
8	10MHz			QPSK	12	19
9	10MHz			16QAM	16	19
10	10MHz			QPSK	30	19
11	10MHz			16QAM	30	19
12	10MHz			QPSK	6	43
13	10MHz			QPSK	2	48
14	10MHz			QPSK	50	0
15	10MHz			QPSK	12	0
16	10MHz			16QAM	50	0
Note 1: The Configuration ID will be used to map the applicable Test Configuration to the corresponding Test Requirement in clause 6.2.4B.5 as not all combinations are necessarily required based on the applicability of the UE.						

Table 6.2.4B.4.1-6: Test Configuration Table (network signalled value "NS_08")

Initial Conditions					
Test Environment (as specified in TS 36.508 [7] clause 4.1)			Normal		
Test Frequencies (as specified in TS 36.508 [7] clause 4.3.1)			High range		
Test Channel Bandwidths (as specified in TS 36.508 [7] clause 4.3.1)			5MHz, 10MHz, 15MHz		
Test Parameters for NS_08 A-MPR					
Configuration ID	Ch BW	Downlink Configuration		Uplink Configuration	
		Mod'n	RB allocation FDD	Mod'n	RB allocation FDD
1	5MHz	N/A for A-MPR testing		QPSK	1
2	5MHz			QPSK	8
3	5MHz			QPSK	25
4	10MHz			QPSK	1
5	10MHz			QPSK	12
6	10MHz			QPSK	40
7	10MHz			QPSK	50
8	10MHz			16QAM	50
9	15MHz			QPSK	1
10	15MHz			QPSK	16
11	15MHz			QPSK	40
12	15MHz			QPSK	75
13	15MHz			16QAM	75
Note 1:	The Configuration ID will be used to map the applicable Test Configuration to the corresponding Test Requirement in clause 6.2.4B.5 as not all combinations are necessarily required based on the applicability of the UE.				
Note 2:	The 1 RB allocation shall be tested at both RB #0 and RB #max.				
Note 3:	The RB _{start} of partial RB allocation shall be RB# 0 and RB# (max + 1 - RB allocation) of the channel bandwidth.				

Table 6.2.4B.4.1-7: Test Configuration Table (network signalled value “NS_09”)

Initial Conditions					
Test Environment (as specified in TS 36.508 [7] clause 4.1)			Normal		
Test Frequencies (as specified in TS 36.508 [7] clause 4.3.1)			High range		
Test Channel Bandwidths (as specified in TS 36.508 [7] clause 4.3.1)			5MHz, 10MHz, 15MHz		
Test Parameters for Channel Bandwidths					
Configuration ID	Ch BW	Downlink Configuration		Uplink Configuration	
		Mod'n	RB allocation FDD	Mod'n	RB allocation FDD
1	5MHz	N/A for A-MPR testing		QPSK	1
2	5MHz			QPSK	8
3	5MHz			QPSK	25
4	10MHz			QPSK	1
5	10MHz			QPSK	12
6	10MHz			QPSK	40
7	10MHz			QPSK	50
8	10MHz			16QAM	50
9	15MHz			QPSK	1
10	15MHz			QPSK	16
11	15MHz			QPSK	40
12	15MHz			QPSK	54
13	15MHz			QPSK	75
14	15MHz			16QAM	75
<p>Note 1: The Configuration ID will be used to map the applicable Test Configuration to the corresponding Test Requirement in clause 6.2.4B.5 as not all combinations are necessarily required based on the applicability of the UE.</p> <p>Note 2: The 1 RB allocation shall be tested at both RB #0 and RB #max.</p> <p>Note 3: The RB_{start} of partial RB allocation shall be RB# 0 and RB# (max + 1 - RB allocation) of the channel bandwidth.</p>					

Table 6.2.4B.4.1-8: Test Configuration Table (network signalled value "NS_11")

Initial Conditions					
Test Environment (as specified in TS 36.508 [7] clause 4.1)			Normal		
Test Frequencies (as specified in TS 36.508 [7] clause 4.3.1)			Low range For 3 MHz Channel Bandwidth: a. UL 2001.5 MHz (N_UL=25515), DL 2181.5 MHz(N_DL=7515) b. UL 2004.5 MHz (N_UL=25545), DL 2184.5 (N_DL=7545) For 5 MHz Channel Bandwidth: a. UL 2002.5 MHz (N_UL=25525), DL 2182.5 MHz(N_DL=7525) b. UL 2004.5 MHz (N_UL=25545), DL 2184.5 MHz(N_DL=7545) c. UL 2007.5 MHz (N_UL=25575), DL 2187.5 MHz(N_DL=7575) For 10 MHz Channel Bandwidth: UL 2005 MHz (N_UL=25550), DL 2185 MHz (N_DL=7550)		
Test Channel Bandwidths (as specified in TS 36.508 [7] clause 4.3.1)			1.4MHz, 3MHz, 5MHz, 10MHz		
Test Parameters for NS_11 A-MPR					
Configuration ID	Ch BW	Downlink Configuration		Uplink Configuration	
		Mod'n	RB allocation FDD	Mod'n	RB allocation FDD
1	3MHz	N/A for A-MPR testing		QPSK	6
2	3MHz			QPSK	15
3	3MHz			16QAM	6
4	3MHz			16QAM	15
5	5MHz			QPSK	1
6	5MHz			QPSK	8
7	5MHz			QPSK	25
8	5MHz			16QAM	8
9	5MHz			16QAM	25
10	10MHz			QPSK	1
11	10MHz			QPSK	12
12	10MHz			QPSK	50
13	10MHz			16QAM	12
14	10MHz			16QAM	50
Note 1: The Configuration ID will be used to map the applicable Test Configuration to the corresponding Test Requirement in clause 6.2.4B.5 as not all combinations are necessarily required based on the applicability of the UE. Note 2: The RB _{start} of partial RB allocation shall be RB# 0 and RB# (max +1 - RB allocation) of the channel bandwidth.					

Table 6.2.4B.4.1-9: Test Configuration Table (network signalled value "NS_12")

Initial Conditions						
Test Environment (as specified in TS 36.508 [7] clause 4.1)				NC		
Test Frequencies (as specified in TS 36.508 [7] clause 4.3.1)				Mid range		
Test Channel Bandwidths (as specified in TS 36.508 [7] clause 4.3.1)				1.4 MHz, 3 MHz and 5 MHz		
Test Parameters for Channel Bandwidths						
Test Number	Ch BW	Downlink Configuration		Uplink Configuration		
		Mod'n	RB allocation	Mod'n	RB allocation FDD	RBstart FDD
1	1.4 MHz	N/A for A-MPR testing.		QPSK	1	0
2	1.4 MHz			QPSK	6	0
3	1.4 MHz			QPSK	1	1
4	1.4 MHz			QPSK	5	1
5	1.4 MHz			16QAM	6	0
6	3 MHz			QPSK	4	0
7	3 MHz			QPSK	6	0
8	3 MHz			QPSK	4	4
9	3 MHz			QPSK	6	4
10	3 MHz			16QAM	15	0
11	5 MHz			QPSK	8	0
12	5 MHz			QPSK	15	0
13	5 MHz			QPSK	8	7
14	5 MHz			QPSK	15	7
15	5 MHz			16QAM	25	0

Table 6.2.4B.4.1-10: Test Configuration Table (network signalled value "NS_13")

Initial Conditions						
Test Environment (as specified in TS 36.508 [7] clause 4.1)				NC		
Test Frequencies (as specified in TS 36.508 [7] clause 4.3.1)				Mid range		
Test Channel Bandwidths (as specified in TS 36.508 [7] clause 4.3.1)				5 MHz		
Test Parameters for Channel Bandwidths						
Test Number	Ch BW	Downlink Configuration		Uplink Configuration		
		Mod'n	RB allocation	Mod'n	RB allocation FDD	RBstart FDD
1	5 MHz	N/A for A-MPR testing.		QPSK	1	0
2	5 MHz			QPSK	25	0
3	5 MHz			QPSK	15	0
4	5 MHz			QPSK	15	7
5	5 MHz			16QAM	25	0

Table 6.2.4B.4.1-11: Test Configuration Table (network signalled value "NS_14")

Initial Conditions						
Test Environment (as specified in TS 36.508 [7] clause 4.1)				NC		
Test Frequencies (as specified in TS 36.508 [7] clause 4.3.1)				Mid range		
Test Channel Bandwidths (as specified in TS 36.508 [7] clause 4.3.1)				10 MHz, 15 MHz		
Test Parameters for Channel Bandwidths						
Test Number	Ch BW	Downlink Configuration		Uplink Configuration		
		Mod'n	RB allocation	Mod'n	RB allocation FDD	RBstart FDD
1	10 MHz	N/A for A-MPR testing.		QPSK	1	0
2	10 MHz			QPSK	25	0
3	10 MHz			QPSK	50	0
4	10 MHz			QPSK	25	1
5	10 MHz			16QAM	50	0
6	15 MHz			QPSK	8	0
7	15 MHz			QPSK	25	0
8	15 MHz			QPSK	75	0
9	15 MHz			QPSK	50	15
10	15 MHz			16QAM	75	0

Table 6.2.4B.4.1-12: Test Configuration Table (network signalled value "NS_15")

Initial Conditions						
Test Environment (as specified in TS 36.508 [7] subclause 4.1)		NC				
Test Frequencies (as specified in TS36.508 [7] subclause 4.3.1)		For 1.4 MHz Channel Bandwidth: High range For 3 MHz Channel Bandwidth: UL 843.5 MHz ($N_{UL} = 26985$) or High range For 5 MHz Channel Bandwidth: UL 842.5 MHz ($N_{UL} = 26975$) or High range For 10 MHz Channel Bandwidth: UL 840 MHz ($N_{UL} = 26950$) or High range For 15 MHz Channel Bandwidth: UL 837.5 MHz ($N_{UL} = 26925$) or High range				
Test Channel Bandwidths (as specified in TS 36.508 [7] subclause 4.3.1)		1.4 MHz, 3 MHz, 5 MHz, 10 MHz, 15 MHz				
Test Parameters for Channel Bandwidths						
Configuration ID	Ch BW	Downlink Configuration		Uplink Configuration		
		Mod'n	RB allocation	Mod'n	RB allocation FDD	RBstart FDD
1 (note 3)	1.4 MHz	N/A for A-MPR testing.		QPSK	4	0
2 (note 3)	1.4 MHz			16QAM	6	0
3 (note 3)	3 MHz			QPSK	6	7
4 (note 3)	3 MHz			QPSK	12	1
5 (note 3)	3 MHz			16QAM	15	0
6 (note 2)	3 MHz			QPSK	15	0
7 (note 3)	5 MHz			QPSK	6	14
8 (note 3)	5 MHz			QPSK	20	0
9 (note 3)	5 MHz			16QAM	25	0
10 (note 2)	5 MHz			QPSK	16	9
11 (note 2)	5 MHz			QPSK	25	0
12 (note 3)	10 MHz			QPSK	1	39
13 (note 3)	10 MHz			QPSK	1	10
14 (note 3)	10 MHz			QPSK	3	0
15 (note 3)	10 MHz			QPSK	20	3
16 (note 3)	10 MHz			QPSK	36	1
17 (note 3)	10 MHz			QPSK	50	0
18 (note 1, 3)	10 MHz			16QAM	50	0
19 (note 2)	10 MHz			QPSK	20	25
20 (note 2)	10 MHz			QPSK	45	0
21 (note 3)	15 MHz			QPSK	18	36
22 (note 3)	15 MHz			QPSK	25	1
23 (note 3)	15 MHz			QPSK	54	0
24 (note 1, 3)	15 MHz			16QAM	75	0
25 (note 2)	15 MHz			QPSK	18	44

26 (note 2)	15 MHz		QPSK	60	2
Note 1: Applies only for UE-Categories ≥ 2 .					
Note 2: Applicable only test frequency < high range					
Note 3: Applicable only to high range frequency testing					

Table 6.2.4B.4.1-13: Test Configuration Table (network signalled value "NS_16")

Initial Conditions						
Test Environment (as specified in TS 36.508 [7] subclause 4.1)			NC			
Test Frequencies (as specified in TS36.508 [7] subclause 4.3.1)			For 1.4 MHz Channel Bandwidth: Low range For 3 MHz Channel Bandwidth: Low range, 810 MHz (N _{UL} = 27070) For 5 MHz Channel Bandwidth: Low range, 811 MHz (N _{UL} = 27080), 814.5 MHz (N _{UL} = 27115) For 10 MHz Channel Bandwidth: Low range, 813.5 MHz (N _{UL} = 27105), 817 MHz (N _{UL} = 27140)			
Test Channel Bandwidths (as specified in TS 36.508 [7] subclause 4.3.1)			1.4 MHz, 3 MHz, 5 MHz, 10 MHz			
Test Parameters for Channel Bandwidths						
Configuration ID	Ch BW	Downlink Configuration		Uplink Configuration		
		Mod'n	RB allocation	Mod'n	RB allocation FDD	RBstart FDD
1	1.4 MHz	N/A for A-MPR testing.		QPSK	1	0
2	1.4 MHz			QPSK	6	0
3	1.4 MHz			16QAM	6	0
4	3 MHz			QPSK	1	0
5	3 MHz			QPSK	12	1
62	3 MHz			QPSK	15	0
7	3 MHz			16QAM	15	0
8	5 MHz			QPSK	1	0
95	5 MHz			QPSK	12	2
10	5 MHz			QPSK	18	2
11	5 MHz			QPSK	20	0
12	5 MHz			QPSK	20	2
13	5 MHz			QPSK	25	0
14	5 MHz			16QAM	25	0
15	10 MHz			QPSK	1	0
16 (Note 2)	10 MHz			QPSK	1	10

17 (Note 2)	10 MHz	QPSK	20	0
18 (Note 2)	10 MHz	QPSK	27	15
19 (Note 2)	10 MHz	QPSK	32	15
20	10 MHz	QPSK	32	0
21	10 MHz	QPSK	50	0
22 (Note 1)	10 MHz	16QAM	50	0
23 (Note 3)	10 MHz	QPSK	40	0
24 (Note 3)	10 MHz	QPSK	40	1
Note 1: Applies only for UE-Categories ≥ 2 . Note 2: Applies only for 10 MHz channel for Low Range, and 813.5 MHz Note 3: Applies only for 10 MHz channel for 817 MHz range				

Table 6.2.4B.4.1-14: Test Configuration Table (network signalled value "NS_20")

TBD

Editor's note: The following lines belong at the end of section 6.2.4B.4.1. As new tables are added to this section, these lines should always follow the tables.

1. Connect the SS to the UE antenna connectors as shown in Figure TS 36.508 [7] Annex A, Figure A.3.
2. The parameter settings for the cell are set up according to TS 36.508 [7] clause 4.4.3.
3. Downlink signals are initially set up according to Annex C.0, C.1, and C.3.0, and uplink signals according to Annex H.1 and H.3.0.
4. The UL Reference Measurement channels are set according to the applicable table from Table 6.2.4.4.1-1 to Table 6.2.4.4.1-6.
5. Propagation conditions are set according to Annex B.0.
6. Ensure the UE is in State 3A-RF according to TS 36.508 [7] clause 5.2A.2. Message contents are defined in clause 6.2.4.4.3.

6.2.4B.4.2 Test procedure

1. SS sends uplink scheduling information for each UL HARQ process via PDCCH DCI format 0 for C_RNTI to schedule the UL RMC according to the applicable table from Table 6.2.4B.4.1-1 to Table 6.2.4B.4.1-6. Since the UE has no payload data to send, the UE transmits uplink MAC padding bits on the UL RMC.
2. Send continuously uplink power control "up" commands in the uplink scheduling information to the UE until the UE transmits at P_{UMAX} level.
3. Measure the output power for UE in the channel bandwidth of the radio access mode. The period of measurement shall be at least the continuous duration one sub-frame (1ms). For TDD slots with transient periods are not under test.

6.2.4B.4.3 Message contents

Message contents are according to TS 36.508 [7] clause 4.6, with the following exceptions for each network signalled value.

6.2.4B.4.3.1 Message contents exceptions (network signalled value "NS_03")

1. Information element `additionalSpectrumEmission` is set to NS_03. This can be set in the *SystemInformationBlockType2* as part of the cell broadcast message. This exception indicates that the UE shall meet the additional spurious emission requirement for a specific deployment scenario.

Table 6.2.4B.4.3.1-1: SystemInformationBlockType2: Additional spurious emissions test requirement for "NS_03"

Derivation Path: TS 36.508 [7] clause 4.4.3.3, Table 4.4.3.3-1			
Information Element	Value/remark	Comment	Condition
<code>additionalSpectrumEmission</code>	3 (NS_03)		

6.2.4B.4.3.2 Message contents exceptions (network signalled value "NS_04")

1. Information element `additionalSpectrumEmission` is set to NS_04. This can be set in the *SystemInformationBlockType2* as part of the cell broadcast message. This exception indicates that the UE shall meet the additional spurious emission requirement for a specific deployment scenario.

Table 6.2.4B.4.3.2-1: SystemInformationBlockType2: Additional spurious emissions test requirement for "NS_04"

Derivation Path: TS 36.508 [7] clause 4.4.3.3, Table 4.4.3.3-1			
Information Element	Value/remark	Comment	Condition
<code>additionalSpectrumEmission</code>	4 (NS_04)		

6.2.4B.4.3.3 Message contents exceptions (network signalled value "NS_05")

1. Information element `additionalSpectrumEmission` is set to NS_05. This can be set in the *SystemInformationBlockType2* as part of the cell broadcast message. This exception indicates that the UE shall meet the additional spurious emission requirement for a specific deployment scenario.

Table 6.2.4B.4.3.3-1: SystemInformationBlockType2: Additional spurious emissions test requirement for "NS_05"

Derivation Path: TS 36.508 [7] clause 4.4.3.3, Table 4.4.3.3-1			
Information Element	Value/remark	Comment	Condition
<code>additionalSpectrumEmission</code>	5 (NS_05)		

6.2.4B.4.3.4 Message contents exceptions (network signalled value "NS_06")

1. Information element `additionalSpectrumEmission` is set to NS_06. This can be set in the *SystemInformationBlockType2* as part of the cell broadcast message. This exception indicates that the UE shall meet the additional spurious emission requirement for a specific deployment scenario.

Table 6.2.4B.4.3.4-1: SystemInformationBlockType2: Additional spurious emissions test requirement for "NS_06"

Derivation Path: TS 36.508 [7] clause 4.4.3.3, Table 4.4.3.3-1			
Information Element	Value/remark	Comment	Condition
<code>additionalSpectrumEmission</code>	6 (NS_06)		

6.2.4B.4.3.5 Message contents exceptions (network signalled value "NS_07")

1. Information element `additionalSpectrumEmission` is set to NS_07. This can be set in the *SystemInformationBlockType2* as part of the cell broadcast message. This exception indicates that the UE shall meet the additional spurious emission requirement for a specific deployment scenario.

Table 6.2.4B.4.3.5-1: SystemInformationBlockType2: Additional spurious emissions test requirement for "NS_07"

Derivation Path: TS 36.508 [7] clause 4.4.3.3, Table 4.4.3.3-1			
Information Element	Value/remark	Comment	Condition
additionalSpectrumEmission	7 (NS_07)		

6.2.4B.4.3.6 Message contents exceptions (network signalled value "NS_08")

- Information element additionalSpectrumEmission is set to NS_08. This can be set in the *SystemInformationblockType2* as part of the cell broadcast message. This exception indicates that the UE shall meet the additional spurious emission requirement for a specific deployment scenario.

Table 6.2.4B.4.3.6-1: SystemInformationBlockType2: Additional spurious emissions test requirement for "NS_08"

Derivation Path: TS 36.508 [7] clause 4.4.3.3, Table 4.4.3.3-1			
Information Element	Value/remark	Comment	Condition
additionalSpectrumEmission	8 (NS_08)		

6.2.4B.4.3.7 Message contents exceptions (network signalled value "NS_09")

- Information element additionalSpectrumEmission is set to NS_09. This can be set in the *SystemInformationblockType2* as part of the cell broadcast message. This exception indicates that the UE shall meet the additional spurious emission requirement for a specific deployment scenario.

Table 6.2.4B.4.3.7-1: SystemInformationBlockType2: Additional spurious emissions test requirement for "NS_09"

Derivation Path: TS 36.508 [7] clause 4.4.3.3, Table 4.4.3.3-1			
Information Element	Value/remark	Comment	Condition
additionalSpectrumEmission	9 (NS_09)		

6.2.4B.4.3.8 Message contents exceptions (network signalled value "NS_11")

- Information element additionalSpectrumEmission is set to NS_11. This can be set in the *SystemInformationblockType2* as part of the cell broadcast message. This exception indicates that the UE shall meet the additional spurious emission requirement for a specific deployment scenario.

Table 6.2.4B.4.3.8-1: SystemInformationBlockType2: Additional spurious emissions test requirement for "NS_11"

Derivation Path: TS 36.508 [7] clause 4.4.3.3, Table 4.4.3.3-1			
Information Element	Value/remark	Comment	Condition
additionalSpectrumEmission	11 (NS_11)		

6.2.4B.4.3.9 Message contents exceptions (network signalled value "NS_12")

- Information element additionalSpectrumEmission is set to NS_12. This can be set in the *SystemInformationblockType2* as part of the cell broadcast message. This exception indicates that the UE shall meet the additional spurious emission requirement for a specific deployment scenario.

Table 6.2.4B.4.3.9-1: SystemInformationBlockType2: Additional spurious emissions test requirement for "NS_12"

Derivation Path: TS 36.508 [7] clause 4.4.3.3, Table 4.4.3.3-1			
Information Element	Value/remark	Comment	Condition
additionalSpectrumEmission	12 (NS_12)		

6.2.4B.4.3.10 Message contents exceptions (network signalled value "NS_13")

1. Information element `additionalSpectrumEmission` is set to NS_13. This can be set in the *SystemInformationBlockType2* as part of the cell broadcast message. This exception indicates that the UE shall meet the additional spurious emission requirement for a specific deployment scenario.

Table 6.2.4B.4.3.10-1: SystemInformationBlockType2: Additional spurious emissions test requirement for "NS_13"

Derivation Path: TS 36.508 [7] clause 4.4.3.3, Table 4.4.3.3-1			
Information Element	Value/remark	Comment	Condition
<code>additionalSpectrumEmission</code>	13 (NS_13)		

6.2.4B.4.3.11 Message contents exceptions (network signalled value "NS_14")

1. Information element `additionalSpectrumEmission` is set to NS_14. This can be set in the *SystemInformationBlockType2* as part of the cell broadcast message. This exception indicates that the UE shall meet the additional spurious emission requirement for a specific deployment scenario.

Table 6.2.4B.4.3.11-1: SystemInformationBlockType2: Additional spurious emissions test requirement for "NS_14"

Derivation Path: TS 36.508 [7] clause 4.4.3.3, Table 4.4.3.3-1			
Information Element	Value/remark	Comment	Condition
<code>additionalSpectrumEmission</code>	14 (NS_14)		

6.2.4B.4.3.12 Message contents exceptions (network signalled value "NS_15")

1. Information element `additionalSpectrumEmission` is set to NS_15. This can be set in the *SystemInformationBlockType2* as part of the cell broadcast message. This exception indicates that the UE shall meet the additional spurious emission requirement for a specific deployment scenario.

Table 6.2.4B.4.3.12-1: SystemInformationBlockType2: Additional spurious emissions test requirement for "NS_15"

Derivation Path: TS 36.508 [7] clause 4.4.3.3, Table 4.4.3.3-1			
Information Element	Value/remark	Comment	Condition
<code>additionalSpectrumEmission</code>	15 (NS_15)		

6.2.4B.4.3.13 Message contents exceptions (network signalled value "NS_16")

1. Information element `additionalSpectrumEmission` is set to NS_16. This can be set in the *SystemInformationBlockType2* as part of the cell broadcast message. This exception indicates that the UE shall meet the additional spurious emission requirement for a specific deployment scenario.

Table 6.2.4B.4.3.13-1: SystemInformationBlockType2: Additional spurious emissions test requirement for "NS_16"

Derivation Path: TS 36.508 [7] clause 4.4.3.3, Table 4.4.3.3-1			
Information Element	Value/remark	Comment	Condition
<code>additionalSpectrumEmission</code>	16 (NS_16)		

6.2.4B.4.3.14 Message contents exceptions (network signalled value "NS_20")

1. Information element `additionalSpectrumEmission` is set to NS_20. This can be set in the *SystemInformationBlockType2* as part of the cell broadcast message. This exception indicates that the UE shall meet the additional spurious emission requirement for a specific deployment scenario.

Table 6.2.4B.4.3.14-1: SystemInformationBlockType2: Additional spurious emissions test requirement for "NS_20"

Derivation Path: TS 36.508 [7] clause 4.4.3.3, Table 4.4.3.3-1			
Information Element	Value/remark	Comment	Condition
additionalSpectrumEmission	20 (NS_20)		

6.2.4B.5 Test requirements

The maximum output power, derived in step 2 shall be within the range prescribed by the nominal maximum output power and tolerance in the applicable table from Table 6.2.4B.5-1 to Table 6.2.4B.5-15. The allowed A-MPR values specified in Table 6.2.4B.3-1 are in addition to the allowed MPR requirements specified in clause 6.2.3B. For the UE maximum output power modified by MPR and/or A-MPR, the power limits specified in Table 6.2.5B.3-1 apply.

**Table 6.2.4B.5-1: UE Power Class test requirements (network signalled value "NS_03")
(for Bands 4, 10, 23, 35, and 36)**

Configuration ID	EUTRA band	Class 1 (dBm)	Tol. (dB)	Class 2 (dBm)	Tol. (dB)	Class 3 (dBm)	Tol. (dB)
1	4,10,23,35,36					23	+2.7 / -3.7
2	4,10,23,35,36					23	+2.7 / -2.7
3	4,10,23,35,36					23	+2.7 / -3.7
4	4,10,23,35,36					23	2.7 / -4.7
5	4,10,23,35,36					23	+2.7 / -2.7
6	4,10,23,35,36					23	+2.7 / -6.2
7	4,10,23,35,36					23	+2.7 / -3.7
8	4,10,23,35,36					23	2.7 / -4.7
9	4,10,23,35,36					23	+2.7 / -3.7
10	4,10,23,35,36					23	+2.7 / -2.7
11	4,10,23,35,36					23	+2.7 / -6.2
12	4,10,23,35,36					23	2.7 / -4.7
13	4,10,23,35,36					23	2.7 / -4.7
14	4,10,23,35,36					23	+2.7 / -3.7
15	4,10,23,35,36					23	+2.7 / -2.7
16	4,10,23,35,36					23	+2.7 / -6.2
17	4,10,23,35,36					23	2.7 / -4.7
18	4,10,35,36					23	2.7 / -4.7
19	4,10,35,36					23	+2.7 / -3.7
20	4,10,35,36					23	+2.7 / -2.7
21	4,10,35,36					23	+2.7 / -6.2
22	4,10,35,36					23	2.7 / -4.7
23	4,10,35,36					23	2.7 / -4.7
24	4,10,35,36					23	+2.7 / -3.7
25	4,10,35,36					23	+2.7 / -2.7
26	4,10,35,36					23	+2.7 / -6.2
27	4,10,35,36					23	2.7 / -4.7

**Table 6.2.4B.5-2: UE Power Class test requirements (network signalled value "NS_03")
(for Bands 2 and 25)**

Configuration ID	EUTRA band	Test Freq.	Class 1 (dBm)	Tol. (dB)	Class 2 (dBm)	Tol. (dB)	Class 3 (dBm)	Tol. (dB)
1	2, 25	Mid					23	+2.7 / -3.7
1	2, 25	Low, High					23	+2.7 / -5.7
2	2, 25	Mid					23	+2.7 / -2.7
2	2, 25	Low, High					23	+2.7 / -4.2
3	2, 25	Mid					23	+2.7 / -3.7
3	2, 25	Low, High					23	+2.7 / -5.7
4	2, 25	Mid					23	+2.7 / -4.7
4	2, 25	Low, High					23	+2.7 / -7.7
5	2, 25	Mid					23	+2.7 / -2.7
5	2, 25	Low, High					23	+2.7 / -4.2
6	2, 25	Mid					23	+2.7 / -6.2
6	2, 25	Low, High					23	+2.7 / -9.2
7	2, 25	Mid					23	+2.7 / -3.7
7	2, 25	Low, High					23	+2.7 / -5.7
8	2, 25	All					23	+2.7 / -4.7
9	2, 25	Low @ RB#(max+1-RB allocation), Mid, High @ RB#0					23	+2.7 / -3.7
9	2, 25	Low @ RB#0, High @ RB#(max+1-RB allocation)					23	+2.7 / -5.7
10	2, 25	Low @ RB#(max+1-RB allocation), Mid, High @ RB#0					23	+2.7 / -2.7
10	2, 25	Low @ RB#0, High @ RB#(max+1-RB allocation)					23	+2.7 / -4.2
11	2, 25	All					23	+2.7 / -6.2
12	2, 25	Low @ RB#(max+1-RB allocation), Mid, High @ RB#0					23	+2.7 / -4.7
12	2, 25	Low @ RB#0, High @ RB#(max+1-RB allocation)					23	+2.7 / -7.7
13	2, 25	All					23	+2.7 / -4.7
14	2, 25	Low @ RB#(max+1-RB allocation), Mid, High @ RB#0					23	+2.7 / -3.7
14	2, 25	Low @ RB#0, High @ RB#(max+1-RB					23	+2.7 / -5.7

		allocation)						
15	2, 25	Low @ RB#(max+1-RB allocation), Mid, High @ RB#0					23	+2.7 / -2.7
15	2, 25	Low @ RB#0, High @ RB#(max+1-RB allocation)					23	+2.7 / -4.2
16	2, 25	All					23	+2.7 / -6.2
17	2, 25	Low @ RB#(max+1-RB allocation), Mid, High @ RB#0					23	+2.7 / -4.7
17	2, 25	Low @ RB#0, High @ RB#(max+1-RB allocation)					23	+2.7 / -7.7
18	2, 25	All					23	+2.7 / -4.7
19	2, 25	Low @ RB#(max+1-RB allocation), Mid, High @ RB#0					23	+2.7 / -3.7
19	2, 25	Low @ RB#0, High @ RB#(max+1-RB allocation)					23	+2.7 / -5.7
20	2, 25	Low @ RB#(max+1-RB allocation), Mid, High @ RB#0					23	+2.7 / -2.7
20	2, 25	Low @ RB#0, High @ RB#(max+1-RB allocation)					23	+2.7 / -4.2
21	2, 25	All					23	+2.7 / -6.2
22	2, 25	Low @ RB#(max+1-RB allocation), Mid, High @ RB#0					23	+2.7 / -4.7
22	2, 25	Low @ RB#0, High @ RB#(max+1-RB allocation)					23	+2.7 / -7.7
23	2, 25	All					23	+2.7 / -4.7
24	2, 25	All					23	+2.7 / -3.7
25	2, 25	Low @ RB#(max+1-RB allocation), Mid, High @ RB#0					23	+2.7 / -2.7
25	2, 25	Low @ RB#0, High @ RB#(max+1-RB allocation)					23	+2.7 / -4.2
26	2, 25	All					23	+2.7 / -6.2
27	2, 25	All					23	+2.7 / -4.7

Table 6.2.4B.5-3: UE Power Class test requirements (network signalled value "NS_04")

Configuration ID	EUTRA band	Bandwidth (MHz)	Class 3 (dBm)	Tol. (dB)
1	41	5 MHz	23	+2.7 / -4.7
2	41	5 MHz	23	+2.7 / -3.7
3	41	5 MHz	23	+2.7 / -2.7
4	41	5 MHz	23	+2.7 / -6.2
5	41	5 MHz	23	+2.7 / -4.7
6	41	10MHz	23	+2.7 / -6.2
7	41	10MHz	23	+2.7 / -6.2
8	41	10MHz	23	+2.7 / -8.2
9	41	10MHz	23	+2.7 / -9.7
10	41	10MHz	23	+2.7 / -3.7
11	41	10MHz	23	+2.7 / -4.7
12	41	10MHz	23	+2.7 / -6.2
13	41	10MHz	23	+2.7 / -6.2
14	41	10MHz	23	+2.7 / -6.2
15	41	15MHz	23	+2.7 / -6.2
16	41	15MHz	23	+2.7 / -6.2
17	41	15MHz	23	+2.7 / -8.2
18	41	15MHz	23	+2.7 / -9.7
19	41	15MHz	23	+2.7 / -3.7
20	41	15MHz	23	+2.7 / -4.7
21	41	15MHz	23	+2.7 / -6.2
22	41	15MHz	23	+2.7 / -8.2
23	41	15MHz	23	+2.7 / -6.2
24	41	20MHz	23	+2.7 / -6.2
25	41	20MHz	23	+2.7 / -6.2
26	41	20MHz	23	+2.7 / -8.2
27	41	20MHz	23	+2.7 / -9.7
28	41	20MHz	23	+2.7 / -3.7
29	41	20MHz	23	+2.7 / -4.7
30	41	20MHz	23	+2.7 / -6.2
31	41	20MHz	23	+2.7 / -8.2
32	41	20MHz	23	+2.7 /

				-6.2
--	--	--	--	------

Table 6.2.4B.5-4: UE Power Class test requirements (network signalled value "NS_05")

Configuration ID	EUTRA band	Class 1 (dBm)	Tol. (dB)	Class 2 (dBm)	Tol. (dB)	Class 3 (dBm)	Tol. (dB)
1	1					23	+2.7 / -2.7
2	1					23	+2.7 / -3.7
3	1					23	+2.7 / -2.7
4	1					23	+2.7 / -2.7
5	1					23	+2.7 / -3.7
6	1					23	+2.7 / -4.7
7	1					23	+2.7 / -6.2
8	1					23	+2.7 / -2.7
9	1					23	+2.7 / -2.7
10	1					23	+2.7 / -3.7
11	1					23	+2.7 / -4.7
12	1					23	+2.7 / -6.2
13	1					23	+2.7 / -2.7
14	1					23	+2.7 / -2.7
15	1					23	+2.7 / -3.7
16	1					23	+2.7 / -4.7
17	1					23	+2.7 / -6.2

**Table 6.2.4B.5-5: UE Power Class test requirements (network signalled value "NS_06")
(for Bands 13, 14, and 17)**

Configuration ID	EUTRA band	Class 1 (dBm)	Tol. (dB)	Class 2 (dBm)	Tol. (dB)	Class 3 (dBm)	Tol. (dB)
1	13,14,17					23	+2.7 / -3.7
2	13,14,17					23	+2.7 / -2.7
3	13,14,17					23	+2.7 / -2.7
4	13,14,17					23	+2.7 / -3.7
5	13,14,17					23	+2.7 / -2.7
6	13,14,17					23	+2.7 / -3.7
7	13,14,17					23	+2.7 / -3.7
8	13,14,17					23	+2.7 / -2.7
9	13,14,17					23	+2.7 / -3.7
10	13,14,17					23	+2.7 / -3.7
11	13,14,17					23	+2.7 / -2.7
12	13,14,17					23	+2.7 / -3.7
13	13,14,17					23	+2.7 / -3.7
14	13,14,17					23	+2.7 / -2.7
15	13,14,17					23	+2.7 / -3.7
16	13,14,17					23	+2.7 / -3.7
17	13,14,17					23	+2.7 / -2.7
18	13,14,17					23	+2.7 / -3.7

**Table 6.2.4B.5-6: UE Power Class test requirements (network signalled value "NS_06")
(for Band 12)**

Configuration ID	EUTRA band	Test Freq.	Class 1 (dBm)	Tol. (dB)	Class 2 (dBm)	Tol. (dB)	Class 3 (dBm)	Tol. (dB)
1	12	Mid					23	+2.7 / -3.7
1	12	Low, High					23	+2.7 / -5.7
2	12	Mid					23	+2.7 / -2.7
2	12	Low, High					23	+2.7 / -4.2
3	12	Mid					23	+2.7 / -2.7
3	12	Low, High					23	+2.7 / -4.2
4	12	Mid					23	+2.7 / -3.7
4	12	Low, High					23	+2.7 / -5.7
5	12	Mid					23	+2.7 / -2.7
5	12	Low, High					23	+2.7 / -4.2
6	12	Mid					23	+2.7 / -3.7
6	12	Low, High					23	+2.7 / -5.7
7	12	All					23	+2.7 / -3.7
8	12	Low @ RB#(max+1-RB allocation), Mid, High @ RB#0					23	+2.7 / -2.7
8	12	Low @ RB#0, High @ RB#(max+1-RB allocation)					23	+2.7 / -4.2
9	12	Low @ RB#(max+1-RB allocation), Mid, High @ RB#0					23	+2.7 / -3.7
9	12	Low @ RB#0, High @ RB#(max+1-RB allocation)					23	+2.7 / -5.7
10	12	All					23	+2.7 / -3.7
11	12	Low @ RB#(max+1-RB allocation), Mid, High @ RB#0					23	+2.7 / -2.7
11	12	Low @ RB#0, High @ RB#(max+1-RB allocation)					23	+2.7 / -4.2
12	12	Low @ RB#(max+1-RB allocation), Mid, High @ RB#0					23	+2.7 / -3.7
12	12	Low @ RB#0, High @ RB#(max+1-RB allocation)					23	+2.7 / -5.7

Table 6.2.4B.5-7: UE Power Class test requirements (network signalled value "NS_07")

Configuration ID	EUTRA band	Class 1 (dBm)	Tol. (dB)	Class 2 (dBm)	Tol. (dB)	Class 3 (dBm)	Tol. (dB)
1	13					23	+2.7 / -18.7
2	13					23	+2.7 / -13.7
3	13					23	+2.7 / -2.7
4	13					23	+2.7 / -19.7
5	13					23	+2.7 / -18.7
6	13					23	+2.7 / -20.7
7	13					23	+2.7 / -3.7
8	13					23	+2.7 / -2.7
9	13					23	+2.7 / -4.7
10	13					23	+2.7 / -12.7
11	13					23	+2.7 / -13.7
12	13					23	+2.7 / -2.7
13	13					23	+2.0 / -5.5±TT
14	13					23	+2.7 / -19.7
15	13					23	+2.7 / -18.7
16	13					23	+2.7 / -20.7

Table 6.2.4B.5-8: UE Power Class test requirements (network signalled value "NS_08")

Configuration ID	EUTRA band	Class 1 (dBm)	Tol. (dB)	Class 2 (dBm)	Tol. (dB)	Class 3 (dBm)	Tol. (dB)
1	19					23	+2.7 / -2.7
2	19					23	+2.7 / -2.7
3	19					23	+2.7 / -3.7
4	19					23	+2.7 / -2.7
5	19					23	+2.7 / -2.7
6	19					23	+2.7 / -3.7
7	19					23	+2.7 / -8.2
8	19					23	+2.7 / -9.7
9	19					23	+2.7 / -2.7
10	19					23	+2.7 / -2.7
11	19					23	+2.7 / -3.7
12	19					23	+2.7 / -8.2
13	19					23	+2.7 / -9.7

Table 6.2.4B.5-9: UE Power Class test requirements (network signalled value "NS_09")

Configuration ID	EUTRA band	Class 1 (dBm)	Tol. (dB)	Class 2 (dBm)	Tol. (dB)	Class 3 (dBm)	Tol. (dB)
1	21					23	+2.7 / -2.7
2	21					23	+2.7 / -2.7
3	21					23	+2.7 / -3.7
4	21					23	+2.7 / -2.7
5	21					23	+2.7 / -2.7
6	21					23	+2.7 / -3.7
7	21					23	+2.7 / -4.7
8	21					23	+2.7 / -6.2
9	21					23	+2.7 / -2.7
19	21					23	+2.7 / -2.7
11	21					23	+2.7 / -3.7
12	21					23	+2.7 / -4.7
13	21					23	+2.7 / -6.2
14	21					23	+2.7 / -8.2

Table 6.2.4B.5-10: UE Power Class test requirements (network signalled value "NS_11 for Band 23")

Configuration ID	EUTRA band	Centre Frequency	Class 1 (dBm)	Tol. (dB)	Class 2 (dBm)	Tol. (dB)	Class 3 (dBm)	Tol. (dB)
1a	23	UL 2001.5 MHz DL 2181.5 MHz						+2.7 / -11.7
1b	23	UL 2004.5 MHz DL 2184.5 MHz						+2.7 / -4.7
2a	23	UL 2001.5 MHz DL 2181.5 MHz						+2.7 / -11.7
2b	23	UL 2004.5 MHz DL 2184.5 MHz						+2.7 / -4.7
3a	23	UL 2001.5 MHz DL 2181.5 MHz						+2.7 / -12.7
3b	23	UL 2004.5 MHz DL 2184.5 MHz						+2.7 / -6.2
4a	23	UL 2001.5 MHz DL 2181.5 MHz						+2.7 / -12.7
4b	23	UL 2004.5 MHz DL 2184.5 MHz						+2.7 / -6.2
5a	23	UL 2002.5 MHz DL 2182.5 MHz						+2.7 / -12.7
5b	23	UL 2004.5 MHz DL 2184.5 MHz						+2.7 / -8.2
5c	23	UL 2007.5 MHz DL 2187.5 MHz						+2.7 / -2.7
6a	23	UL 2002.5 MHz DL 2182.5 MHz						+2.7 / -12.7
6b	23	UL 2004.5 MHz DL 2184.5 MHz						+2.7 / -2.7
6c	23	UL 2007.5 MHz DL 2187.5 MHz						+2.7 / -3.7
7a	23	UL 2002.5 MHz DL 2182.5 MHz						+2.7 / -13.7
7b	23	UL 2004.5 MHz DL 2184.5 MHz						+2.7 / -9.7
7c	23	UL 2007.5 MHz DL 2187.5 MHz						+2.7 / -4.7
8a	23	UL 2002.5 MHz DL 2182.5 MHz						+2.7 / -13.7
8b	23	UL 2004.5 MHz DL 2184.5 MHz						+2.7 / -3.7
8c	23	UL 2007.5 MHz DL 2187.5 MHz						+2.7 / -4.7
9a	23	UL 2002.5 MHz DL 2182.5 MHz						+2.7 / -14.7
9b	23	UL 2004.5 MHz DL 2184.5 MHz						+2.7 / -11.7
9c	23	UL 2007.5 MHz DL 2187.5 MHz						+2.7 / -6.2
10	23	UL 2005 MHz DL 2185 MHz						+2.7 / -18.7
11	23	UL 2005 MHz DL 2185 MHz						+2.7 / -18.7
12	23	UL 2005 MHz DL 2185 MHz						+2.7 / -19.7
13	23	UL 2005 MHz DL 2185 MHz						+2.7 / -19.7
14	23	UL 2005 MHz DL 2185 MHz						+2.7 / -20.7

Table 6.2.4B.5-11: UE Power Class test requirements (network signalled value "NS_12")

Configuration ID	EUTRA band	Class 1 (dBm)	Tol. (dB)	Class 2 (dBm)	Tol. (dB)	Class 3 (dBm)	Tol. (dB)
1	26					23	+2.7 / -6.2
2	26					23	+2.7 / -12.7
3	26					23	+2.7 / -2.7
4	26					23	+2.7 / -6.2
5	26					23	+2.7 / -13.7
6	26					23	+2.7 / -8.2
7	26					23	+2.7 / -8.2
8	26					23	+2.7 / -2.7
9	26					23	+2.7 / -8.2
10	26					23	+2.7 / -11.7
11	26					23	+2.7 / -9.7
12	26					23	+2.7 / -8.2
13	26					23	+2.7 / -2.7
14	26					23	+2.7 / -8.2
15	26					23	+2.7 / -9.7

Table 6.2.4B.5-12: UE Power Class test requirements (network signalled value "NS_13")

Configuration ID	EUTRA band	Class 1 (dBm)	Tol. (dB)	Class 2 (dBm)	Tol. (dB)	Class 3 (dBm)	Tol. (dB)
1	26					23	+2.7 / -6.2
2	26					23	+2.7 / -6.2
3	26					23	+2.7 / -3.7
4	26					23	+2.7 / -3.7
5	26					23	+2.7 / -8.2

Table 6.2.4B.5-13: UE Power Class test requirements (network signalled value "NS_14")

Configuration ID	EUTRA band	Class 1 (dBm)	Tol. (dB)	Class 2 (dBm)	Tol. (dB)	Class 3 (dBm)	Tol. (dB)
1	26					23	+2.7 / -6.2
2	26					23	+2.7 / -3.7
3	26					23	+2.7 / -4.7
4	26					23	+2.7 / -3.7
5	26					23	+2.7 / -6.2
6	26					23	+2.7 / -6.2
7	26					23	+2.7 / -3.7
8	26					23	+2.7 / -4.7
9	26					23	+2.7 / -3.7
10	26					23	+2.7 / -6.2

Table 6.2.4B.5-14: UE Power Class test requirements (network signalled value "NS_15")

Configuration ID	EUTRA band	Class 1 (dBm)	Tol. (dB)	Class 2 (dBm)	Tol. (dB)	Class 3 (dBm)	Tol. (dB)
1	26					23	+2.7 / -3.2
2	26					23	+2.7 / -8.2
3	26					23	+2.7 / -4.2
4	26					23	+2.7 / -8.2
5	26					23	+2.7 / -14.2
6	26					23	+2.7 / -4.2
7	26					23	+2.7 / -3.2
8	26					23	+2.7 / -9.2
9	26					23	+2.7 / -14.2
10	26					23	+2.7 / -4.2
11	26					23	+2.7 / -6.2
12	26					23	+2.7 / -12.2
13	26					23	+2.7 / -7.2
14	26					23	+2.7 / -3.2
15	26					23	+2.7 / -4.2
16	26					23	+2.7 / -8.2
17	26					23	+2.7 / -3.2
18	26					23	+2.7 / -12.2
19	26					23	+2.7 / -4.2
20	26					23	+2.7 / -8.2
21	26					23	+2.7 / -3.2
22	26					23	+2.7 / -4.2
23	26					23	+2.7 / -9.2
24	26					23	+2.7 / -14.2
25	26					23	+2.7 / -3.2
26	26					23	+2.7 / -9.2

Table 6.2.4B.5-15A: UE Power Class test requirements (network signalled value "NS_16") when lower channel edge is at 807 MHz

Configuration ID	EUTRA band	Class 1 (dBm)	Tol. (dB)	Class 2 (dBm)	Tol. (dB)	Class 3 (dBm)	Tol. (dB)
1	27					23	+2.7 / -2.7
2	27					23	+2.7 / -3.7
3	27					23	+2.7 / -4.7
4	27					23	+2.7 / -2.7
5	27					23	+2.7 / -4.7
6	27					23	+2.7 / -6.2
7	27					23	+2.7 / -8.2
8	27					23	+2.7 / -9.7
9	27					23	+2.7 / -4.7
10	27					23	+2.7 / -6.2
11	27					23	+2.7 / -11.7
12	27					23	+2.7 / -8.2
13	27					23	+2.7 / -11.7
14	27					23	+2.7 / -12.7
15	27					23	+2.7 / -9.7
16	27					23	+2.7 / -2.7
17	27					23	+2.7 / -8.2
18	27					23	+2.7 / -4.7
19	27					23	+2.7 / -8.2
20	27					23	+2.7 / -13.7
21	27					23	+2.7 / -13.7
22	27					23	+2.7 / -14.7
23	27					23	+2.7 / -13.7
24	27					23	+2.7 / -13.7

Table 6.2.4B.5-15B: UE Power Class test requirements (network signalled value "NS_16") when lower channel edge is at 808.5 MHz

Configuration ID	EUTRA band	Class 1 (dBm)	Tol. (dB)	Class 2 (dBm)	Tol. (dB)	Class 3 (dBm)	Tol. (dB)
1	27					23	+2.7 / -2.7
2	27					23	+2.7 / -3.7
3	27					23	+2.7 / -5.2
4	27					23	+2.7 / -2.7
5	27					23	+2.7 / -3.7
6	27					23	+2.7 / -3.7
7	27					23	+2.7 / -4.7
8	27					23	+2.7 / -2.7
9	27					23	+2.7 / -3.7
10	27					23	+2.7 / -4.7
11	27					23	+2.7 / -6.2
12	27					23	+2.7 / -6.2
13	27					23	+2.7 / -8.2
14	27					23	+2.7 / -9.7
15	27					23	+2.7 / -9.7
16	27					23	+2.7 / -2.7
17	27					23	+2.7 / -6.2
18	27					23	+2.7 / -4.7
19	27					23	+2.7 / -4.7
20	27					23	+2.7 / -9.7
21	27					23	+2.7 / -11.7
22	27					23	+2.7 / -12.7
23	27					23	+2.7 / -11.7
24	27					23	+2.7 / -11.7

Table 6.2.4B.5-15C: UE Power Class test requirements (network signalled value "NS_16") when lower channel edge is at 812 MHz

Configuration ID	EUTRA band	Class 1 (dBm)	Tol. (dB)	Class 2 (dBm)	Tol. (dB)	Class 3 (dBm)	Tol. (dB)
1	27					23	+2.7 / - 2.7
2	27					23	+2.7 / - 3.7
3	27					23	+2.7 / - 4.7
4	27					23	+2.7 / - 2.7
5	27					23	+2.7 / -3.7
6	27					23	+2.7 / -3.7
7	27					23	+2.7 / -4.7
8	27					23	+2.7 / -2.7
9	27					23	+2.7 / -3.7
10	27					23	+2.7 / -3.7
11	27					23	+2.7 / -3.7
12	27					23	+2.7 / -3.7
13	27					23	+2.7 / -3.7
14	27					23	+2.7 / -4.7
15	27					23	+2.7 / -2.7
16	27					23	+2.7 / -2.7
17	27					23	+2.7 / -3.7
18	27					23	+2.7 / -3.7
19	27					23	+2.7 / -3.7
20	27					23	+2.7 / -4.7
21	27					23	+2.7 / -8.2
22	27					23	+2.7 / -9.7
23	27					23	+2.7 / -6.2
24	27					23	+2.7 / -4.7

Table 6.2.4B.5-16: UE Power Class test requirements (network signalled value "NS_20 for Band 23")

TBD

6.2.5 Configured UE transmitted Output Power

6.2.5.1 Test purpose

To verify the UE does not exceed the minimum between the P_{EMAX} maximum allowed UL TX Power signalled by the E-UTRAN and the P_{UMAX} maximum UE power for the UE power class.

6.2.5.2 Test applicability

This test applies to all types of E-UTRA UE release 8 and forward.

6.2.5.3 Minimum conformance requirements

The UE is allowed to set its configured maximum output power P_{CMAX} . The configured maximum output power P_{CMAX} is set within the following bounds:

$$P_{CMAX_L} \leq P_{CMAX} \leq P_{CMAX_H}$$

Where

- $P_{CMAX_L} = \text{MIN} \{ P_{EMAX} - \Delta T_C, P_{PowerClass} - \text{MAX}(MPR + A-MPR + \Delta T_{IB,c}, P-MPR) - \Delta T_C \}$
- $P_{CMAX_H} = \text{MIN} \{ P_{EMAX}, P_{PowerClass} \}$
- P_{EMAX} is the value given to IE *P-Max*, defined in [5]
- $P_{PowerClass}$ is the maximum UE power specified in Table 6.2.2.3-1 without taking into account the tolerance specified in the Table 6.2.2.3-1

- MRP and A-MPR are specified in Section 6.2.3 and Section 6.2.4, respectively
- $\Delta T_{IB,c}$ is the additional tolerance for serving cell c as specified in Table 6.2.5A.1.3-3.
- P-MPR is the allowed maximum output power reduction for;
 - a) Ensuring compliance with applicable electromagnetic energy absorption requirements and addressing unwanted emissions / self defence requirements in case of simultaneous transmissions on multiple RAT(s) for scenarios not in scope of 3GPP RAN specifications.
 - b) Ensuring compliance with applicable electromagnetic energy absorption requirements in case of proximity detection is used to address such requirements that require a lower maximum output power.

The UE shall apply P-MPR only for the above cases. For UE conducted conformance testing P-MPR shall be 0 dB

NOTE 1: P-MPR was introduced in the P_{CMAX} equation such that the UE can report to the eNB the available maximum output transmit power. This information can be used by the eNB for scheduling decisions.

NOTE 2: P-MPR may impact the maximum uplink performance for the selected UL transmission path.

- $\Delta T_C = 1.5$ dB when Note 2 in Table 6.2.2.3-1 applies
- $\Delta T_C = 0$ dB when Note 2 in Table 6.2.2.3-1 does not apply

The measured maximum output power P_{CMAX} shall be within the following bounds:

$$P_{CMAX_L} - \text{MAX}\{T_L, T(P_{CMAX_L})\} \leq P_{CMAX} \leq P_{CMAX_H} + T(P_{CMAX_H})$$

Where $T(P_{CMAX})$ is defined by the tolerance table below and applies to P_{CMAX_L} and P_{CMAX_H} separately, while T_L is the absolute value of the lower tolerance in Table 6.2.2.3-1 for the applicable operating band.

Table 6.2.5.3-1: P_{CMAX} tolerance

P_{CMAX} (dBm)	Tolerance $T(P_{CMAX})$ (dB)
$21 \leq P_{CMAX} \leq 23$	2.0
$20 \leq P_{CMAX} < 21$	2.5
$19 \leq P_{CMAX} < 20$	3.5
$18 \leq P_{CMAX} < 19$	4.0
$13 \leq P_{CMAX} < 18$	5.0
$8 \leq P_{CMAX} < 13$	6.0
$-40 \leq P_{CMAX} < 8$	7.0

The normative reference for this requirement is TS 36.101 [2] clause 6.2.5.

6.2.5.4 Test description

6.2.5.4.1 Initial conditions

Initial conditions are a set of test configurations the UE needs to be tested in and the steps for the SS to take with the UE to reach the correct measurement state.

The initial test configurations consist of environmental conditions, test frequencies, and channel bandwidths based on E-UTRA operating bands specified in table 5.4.2.1-1. All of these configurations shall be tested with applicable test parameters for each channel bandwidth, and are shown in table 6.2.5.4.1-1. The details of the uplink reference measurement channels (RMCs) are specified in Annex A.2. Configurations of PDSCH and PDCCH before measurement are specified in Annex C.2.

Table 6.2.5.4.1-1: Test Configuration Table

Initial Conditions				
Test Environment as specified in TS 36.508[7] subclause 4.1		Normal, TL/VL, TL/VH, TH/VL, TH/VH		
Test Frequencies as specified in TS36.508 [7] subclause 4.3.1		Mid range		
Test Channel Bandwidths as specified in TS 36.508 [7] subclause 4.3.1		Lowest, 5MHz, Highest		
Test Parameters for Channel Bandwidths				
Downlink Configuration		Uplink Configuration		
Ch BW	N/A for Configured UE transmitted Output Power test case	Mod'n	RB allocation	
			FDD	TDD
1.4MHz		QPSK	5	5
3MHz		QPSK	4	4
5MHz		QPSK	8	8
10MHz		QPSK	12	12
15MHz		QPSK	16	16
20MHz		QPSK	18	18
Note 1: Test Channel Bandwidths are checked separately for each E-UTRA band, the applicable channel bandwidths are specified in Table 5.4.2.1-1.				
Note 2: For the uplink RB allocation the RB _{start} shall be RB #0.				

1. Connect the SS to the UE antenna connectors as shown in TS 36.508 [7] Annex A, in Figure A.3.
2. The parameter settings for the cell are set up according to TS 36.508 [7] subclause 4.4.3.
3. Downlink signals are initially set up according to Annex C.0, C.1, and C.3.0, and uplink signals according to Annex H.1 and H.3.0.
4. The UL Reference Measurement channel is set according to Table 6.2.5.4.1-1
5. Propagation conditions are set according to Annex B.0.
6. Ensure the UE is in State 3A-RF according to TS 36.508 [7] clause 5.2A.2. Message contents are defined in clause 6.2.5.4.3.

6.2.5.4.2 Test procedure

1. SS sends uplink scheduling information for each UL HARQ process via PDCCH DCI format 0 for C_RNTI to schedule the UL RMC according to Table 6.2.5.4.1-1. Since the UE has no payload and no loopback data to send the UE sends uplink MAC padding bits on the UL RMC.
2. Send transmit uplink power control "up" commands in every uplink scheduling information to the UE; allow at least 200ms for the UE to reach the P_{max} level of the test point.
3. Measure the mean power of the UE in the channel bandwidth for each test point in table 6.2.5.5-1 according to the test configuration from Table 6.2.5.4.1-1. The period of measurement shall be at least continuous duration of one sub-frame (1ms). For TDD slots with transient periods are not under test.

6.2.5.4.3 Message contents

Message contents are according to TS 36.508 [7] subclause 4.6 with the following exceptions:

Table 6.2.5.4.3-1: SystemInformationBlockType1: Test point 1

Derivation Path: TS 36.508 [7] clause 4.4.3.2, Table 4.4.3.2-3 SystemInformationBlockType1			
Information Element	Value/remark	Comment	Condition
p-Max	-10		

Table 6.2.5.4.3-2: SystemInformationBlockType1: Test point 2

Derivation Path: TS 36.508 [7] clause 4.4.3.2, Table 4.4.3.2-3 SystemInformationBlockType1			
Information Element	Value/remark	Comment	Condition
p-Max	10		

Table 6.2.5.4.3-3: SystemInformationBlockType1: Test point 3

Derivation Path: TS 36.508 [7] clause 4.4.3.2, Table 4.4.3.2-3 SystemInformationBlockType1			
Information Element	Value/remark	Comment	Condition
p-Max	15		

6.2.5.5 Test requirement

The maximum output power measured shall not exceed the values specified in Table 6.2.5.5-1.

Table 6.2.5.5-1: P_{C_{MAX}} configured UE output power

	Channel bandwidth / maximum output power					
	1.4 MHz	3.0 MHz	5 MHz	10 MHz	15 MHz	20 MHz
Measured UE output power test point 1	For carrier frequency $f \leq 3.0\text{GHz}$: $-10 \text{ dBm} \pm 7.7$ For carrier frequency $3.0\text{GHz} < f \leq 4.2\text{GHz}$: $-10 \text{ dBm} \pm 8.0$					
Measured UE output power test point 2	For carrier frequency $f \leq 3.0\text{GHz}$: $10 \text{ dBm} \pm 6.7$ For carrier frequency $3.0\text{GHz} < f \leq 4.2\text{GHz}$: $10 \text{ dBm} \pm 7.0$					
Measured UE output power test point 3	For carrier frequency $f \leq 3.0\text{GHz}$: $15 \text{ dBm} \pm 5.7$ For carrier frequency $3.0\text{GHz} < f \leq 4.2\text{GHz}$: $15 \text{ dBm} \pm 6.0$					
Note:	In addition note 2 in Table 6.2.2.3-1 shall apply to the tolerances.					

6.2.5_1 Configured UE transmitted Output Power for HPUE

6.2.5_1.1 Test purpose

Same test purpose as in clause 6.2.5.1

6.2.5_1.2 Test applicability

This test applies to all types of E-UTRA power Class 1 UE release 11 and forward.

6.2.5_1.3 Minimum conformance requirements

Same minimum conformance requirements as in clause 6.2.5.3 with the following exceptions:

- stead of Table 6.2.2.3-1 → use Table 6.2.2_1.3-1
- stead of Section 6.2.3 → use Section 6.2.3_1
- stead of Section 6.2.4 → use Section 6.2.4_1
- stead of Table 6.2.5.3-1 → use Table 6.2.5_1.3-1

Table 6.2.5_1.3-1: P_{C_{MAX}} tolerance

P _{C_{MAX}} (dBm)	Tolerance T(P _{C_{MAX}}) (dB)
23 < P _{C_{MAX}} ≤ 33	2.0
21 ≤ P _{C_{MAX}} ≤ 23	2.0
20 ≤ P _{C_{MAX}} < 21	2.5
19 ≤ P _{C_{MAX}} < 20	3.5
18 ≤ P _{C_{MAX}} < 19	4.0
13 ≤ P _{C_{MAX}} < 18	5.0
8 ≤ P _{C_{MAX}} < 13	6.0
-40 ≤ P _{C_{MAX}} < 8	7.0

The normative reference for this requirement is TS 36.101 [2] clause 6.2.5.

6.2.5_1.4 Test description

6.2.5_1.4.1 Initial conditions

Same initial conditions as in clause 6.2.5.4.1 with the following exceptions

- stead of clause 6.2.5.4.3 → use clause 6.2.5_1.4.3

6.2.5_1.4.2 Test procedure

Same test procedure as in clause 6.2.5.4.2 with the following exceptions:

- stead of Table 6.2.5.5-1 → use Table 6.2.5_1.5-1

6.2.5_1.4.3 Message contents

Same message contents as in clause 6.2.5.4.3 with the following additional test point:

Table 6.2.5_1.4.3-1: SystemInformationBlockType1: Test point 4

Derivation Path: TS 36.508 [7] clause 4.4.3.2, Table 4.4.3.2-3 SystemInformationBlockType1			
Information Element	Value/remark	Comment	Condition
p-Max	20		

6.2.5_1.5 Test requirement

The maximum output power measured shall not exceed the values specified in Table 6.2.5_1.5-1.

Table 6.2.5_1.5-1: P_{C_{MAX}} configured HPUE output power

	Channel bandwidth / maximum output power	
	5MHz	10MHz
Measured UE output power test point 1	-10 dBm ± 7.7	
Measured UE output power test point 2	10 dBm ± 6.7	
Measured UE output power test point 3	15 dBm ± 5.7	
Measured UE output power test point 4	20dBm ± 5.7	
Note:	In addition note 2 in Table 6.2.2_1.3-1 shall apply to the tolerances.	

6.2.5A Configured transmitted power for CA

6.2.5A.1 Configured UE transmitted Output Power for CA (intra-band contiguous DL CA and UL CA)

6.2.5A.1.1 Test purpose

To verify the UE does not exceed the minimum between the $P_{EMAX,c}$ maximum allowed UL TX Power signalled by the E-UTRAN and the P_{UMAX} maximum UE power for the UE power class.

6.2.5A.1.2 Test applicability

This test applies to all types of E-UTRA UE release 10 and forward that support intra-band contiguous DL CA and UL CA.

6.2.5A.1.3 Minimum conformance requirements

For carrier aggregation the UE is allowed to set its configured maximum output power $P_{CMAX,c}$ on serving cell c and its total configured maximum output power P_{CMAX} .

The configured maximum output power on serving cell c shall be set within the following bounds:

$$P_{CMAX_L,c} \leq P_{CMAX,c} \leq P_{CMAX_H,c}$$

For intra-band contiguous carrier aggregation:

$$- P_{CMAX_L,c} = \text{MIN} \{ P_{EMAX,c} - \Delta T_{C,c}, P_{PowerClass} - \text{MAX}(MPR_c + A-MPR_c + \Delta T_{IB,c}, P-MPR_c) - \Delta T_{C,c} \}$$

For inter-band carrier aggregation:

$$- P_{CMAX_L,c} = \text{MIN} \{ P_{EMAX,c} - \Delta T_{C,c}, P_{PowerClass} - \text{MAX}(MPR_c + A-MPR_c + \Delta T_{IB,c}, P-MPR_c) - \Delta T_{C,c} \}$$

$$- P_{CMAX_H,c} = \text{MIN} \{ P_{EMAX,c}, P_{PowerClass} \}$$

- $P_{EMAX,c}$ is the value given by IE *P-Max* for serving cell c in [5].

- $P_{PowerClass}$ is the maximum UE power specified in Table 6.2.2.3-1 without taking into account the tolerance specified in the Table 6.2.2.3-1.

- $\Delta T_{IB,c}$ is the additional tolerance for serving cell c as specified in Table 6.2.5A.1.3-3.

For inter-band carrier aggregation, MPR_c and $A-MPR_c$ apply per serving cell c and are specified in clause 6.2.3 and clause 6.2.4, respectively. For intra-band contiguous carrier aggregation, $MPR_c = MPR$ and $A-MPR_c = A-MPR$ with MPR and $A-MPR$ specified in clause 6.2.3A and clause 6.2.4A respectively.

- $P-MPR_c$ accounts for power management for serving cell c . For intra-band contiguous carrier aggregation, there is one power management term for the UE, $P-MPR$, and $P-MPR_c = P-MPR$.

- $\Delta T_{C,c} = 1.5$ dB when Note 2 in Table 6.2.2.3-1 applies to the serving cell c .

- $\Delta T_{C,c} = 0$ dB when Note 2 in Table 6.2.2.3-1 does not apply to the serving cell c .

For inter-band carrier aggregation with one UL serving cell the total configured maximum output power P_{CMAX} shall be set within the following bounds:

$$P_{CMAX_L} \leq P_{CMAX} \leq P_{CMAX_H}$$

where

$$- P_{CMAX_L} = P_{CMAX_L,c}$$

$$- P_{CMAX_H} = P_{CMAX_H,c}$$

For intra-band contiguous carrier aggregation, $P_{\text{CMAX},c}$ is calculated under the assumption that the transmit power is increased by the same amount in dB on all component carriers.

For inter-band carrier aggregation, $P_{\text{CMAX},c}$ is calculated under the assumption that the transmit power is increased independently on all component carriers.

The measured maximum output power P_{UMAX} shall be within the following bounds:

$$P_{\text{CMAX}_L} - \text{MAX}\{T_L, T(P_{\text{CMAX}_L})\} \leq P_{\text{UMAX}} \leq P_{\text{CMAX}_H} + T(P_{\text{CMAX}_H})$$

Where $T(P_{\text{CMAX}})$ is defined by the table below and applies to P_{CMAX_L} and P_{CMAX_H} separately, while T_L is the absolute value of the lower tolerance in Table 6.2.2.3-1 for the applicable operating band.

Table 6.2.5A.1.3-1: P_{CMAX} tolerance

P_{CMAX} (dBm)	Tolerance $T(P_{\text{CMAX}})$ (dB)
$21 \leq P_{\text{CMAX}} \leq 23$	2.0
$20 \leq P_{\text{CMAX}} < 21$	2.5
$19 \leq P_{\text{CMAX}} < 20$	3.5
$18 \leq P_{\text{CMAX}} < 19$	4.0
$13 \leq P_{\text{CMAX}} < 18$	5.0
$8 \leq P_{\text{CMAX}} < 13$	6.0
$-40 \leq P_{\text{CMAX}} < 8$	7.0

For carrier aggregation with two UL serving cells, the total configured maximum output power P_{CMAX} shall be set within the following bounds:

$$P_{\text{CMAX}_L_CA} \leq P_{\text{CMAX}} \leq P_{\text{CMAX}_H_CA}$$

For intra-band contiguous carrier aggregation,

$$P_{\text{CMAX}_L_CA} = \text{MIN}\{10 \log_{10} \sum P_{\text{EMAX},c} - \Delta T_C, P_{\text{PowerClass}} - \text{MAX}(\text{MPR} + \text{A-MPR} + \Delta T_{\text{IB},c}, \text{P-MPR}) - \Delta T_C\}$$

$$P_{\text{CMAX}_H_CA} = \text{MIN}\{10 \log_{10} \sum P_{\text{EMAX},c}, P_{\text{PowerClass}}\}$$

where

- $P_{\text{EMAX},c}$ is the linear value of $P_{\text{EMAX},c}$ which is given by IE *P-Max* for serving cell c in [5].
- $P_{\text{PowerClass}}$ is the maximum UE power specified in Table 6.2.2A.1.3-1 without taking into account the tolerance specified in the Table 6.2.2A.1.3-1.
- MPR and A-MPR specified in clause 6.2.3A and clause 6.2.4A respectively.
- $\Delta T_{\text{IB},c}$ is the additional tolerance for serving cell c as specified in Table 6.2.5A.1.3-3.
- P-MPR is the power management term for the UE.
- ΔT_C is the highest value $\Delta T_{C,c}$ among all serving cells c in the subframe over both timeslots. $\Delta T_{C,c} = 1.5$ dB when Note 2 in Table 6.2.2A.3-1 applies to the serving cell c . $\Delta T_{C,c} = 0$ dB when Note 2 in Table 6.2.2A.1.3-1 does not apply to the serving cell c .

For inter-band carrier aggregation with up to one serving cell c per operating band:

$$P_{\text{CMAX}_L_CA} = \text{MIN}\{10 \log_{10} \sum \text{MIN}[P_{\text{EMAX},c}/(\Delta t_{C,c}), P_{\text{PowerClass}}/(\text{mpr}_c - \text{a-mpr}_c - \Delta t_{C,c} - \Delta t_{\text{IB},c}), P_{\text{PowerClass}}/(\text{pmpr}_c - \Delta t_{C,c})], P_{\text{PowerClass}}\}$$

$$P_{\text{CMAX}_H_CA} = \text{MIN}\{10 \log_{10} \sum P_{\text{EMAX},c}, P_{\text{PowerClass}}\}$$

where

- $P_{\text{EMAX},c}$ is the linear value of $P_{\text{EMAX},c}$ which is given by IE *P-Max* for serving cell c in [5].

- $P_{\text{PowerClass}}$ is the maximum UE power specified in Table 6.2.2A.1.3-1 without taking into account the tolerance specified in the Table 6.2.2A.1.3-1. $P_{\text{PowerClass}}$ is the linear value of $P_{\text{PowerClass}}$.
- MPR_c and A-MPR_c apply per serving cell c and are specified in clause 6.2.3 and clause 6.2.4, respectively. mpr_c is the linear value of MPR_c , a-mpr_c is the linear value of A-MPR_c .
- P-MPR_c accounts for power management for serving cell c . pmpr_c is the linear value of P-MPR_c .
- $\Delta t_{c,c} = 1.41$ when Note 2 in Table 6.2.2.3-1 applies for a serving cell c
- $\Delta t_{c,c} = 1$ when Note 2 in Table 6.2.2.3-1 does not apply for a serving cell c
- $\Delta t_{\text{IB},c}$ is the linear value of the inter-band relaxation term of the serving cell c $\Delta T_{\text{IB},c}$. $\Delta t_{\text{IB},c} = 1$ when no inter-band relaxation is allowed..

The measured maximum output power P_{UMAX} over all serving cells shall be within the following range:

$$P_{\text{CMAX_L_CA}} - T(P_{\text{CMAX_L_CA}}) \leq P_{\text{UMAX}} \leq P_{\text{CMAX_H_CA}} + T(P_{\text{CMAX_H_CA}})$$

$$P_{\text{UMAX}} = 10 \log_{10} \sum P_{\text{UMAX},c}$$

where

- $P_{\text{UMAX},c}$ denotes the measured maximum output power for serving cell c expressed in linear scale.

The tolerance $T(P_{\text{CMAX}})$ is defined by the table below and applies to $P_{\text{CMAX_L_CA}}$ and $P_{\text{CMAX_H_CA}}$ separately.

Table 6.2.5A.1.3-2: P_{CMAX} tolerance

P_{CMAX} (dBm)	Tolerance $T(P_{\text{CMAX}})$ Intra-band with two active UL serving cells (dB)	Tolerance $T(P_{\text{CMAX}})$ Inter-band with two active UL serving cells (dB)
$21 \leq P_{\text{CMAX}} \leq 23$	2.0	2.0
$20 \leq P_{\text{CMAX}} < 21$	[2.5]	TBD
$19 \leq P_{\text{CMAX}} < 20$	[3.5]	TBD
$18 \leq P_{\text{CMAX}} < 19$	[4.0]	TBD
$13 \leq P_{\text{CMAX}} < 18$	[5.0]	TBD
$8 \leq P_{\text{CMAX}} < 13$	[6.0]	TBD
$-40 \leq P_{\text{CMAX}} < 8$	[7.0]	TBD

For the UE which supports inter-band carrier aggregation configurations with uplink assigned to one E-UTRA band the $\Delta T_{\text{IB},c}$ is defined for applicable bands in Table 6.2.5A.1.3-3.

Table 6.2.5A.1.3-3: $\Delta T_{\text{IB},c}$

Inter-band CA Configuration	E-UTRA Band	$\Delta T_{\text{IB},c}$ [dB]
CA_1A-5A	1	0.3
	5	0.3
CA_1A-18A	1	0.3
	18	0.3
CA_1A-19A	1	0.3
	19	0.3
CA_1A-21A	1	0.3
	21	0.3
CA_2A-17A	2	0.3
	17	0.8
CA_2A-29A	2	0.3
CA_3A-7A	3	0.5
	7	0.5
CA_3A-8A	3	0.3
	8	0.3

CA_4A-12A	4	0.3
	12	0.8
CA_4A-17A	4	0.3
	17	0.8
CA_4A-5A	4	0.3
	5	0.3
CA_4A-13A	4	0.3
	13	0.3
CA_5A-12A	5	0.8
	12	0.4
CA_7A-20A	7	0.3
	20	0.3
CA_11A-18A	11	0.3
	18	0.3
<p>NOTE 1: The above additional tolerances are only applicable for the E-UTRA operating bands that belong to the supported inter-band carrier aggregation configurations</p> <p>NOTE 2: The above additional tolerances also apply in non-aggregated operation for the supported E-UTRA operating bands that belong to the supported inter-band carrier aggregation configurations</p> <p>NOTE 3: In case the UE supports more than one of the above inter-band carrier aggregation configurations and a E-UTRA operating band belongs to more than one inter-band carrier aggregation configurations then:</p> <ul style="list-style-type: none"> - When the E-UTRA operating band frequency range is ≤ 1GHz, the applicable additional tolerance shall be the average of the tolerances in Table 6.2.5A-3, truncated to one decimal place for that operating band among the supported CA configurations. In case there is a harmonic relation between low band UL and high band DL, then the maximum tolerance among the different supported carrier aggregation configurations involving such band shall be applied - When the E-UTRA operating band frequency range is >1GHz, the applicable additional tolerance shall be the maximum tolerance in Table 6.2.5A-3 that applies for that operating band among the supported CA configurations. 		

NOTE 1: The above additional tolerances do not apply to supported UTRA operating bands with frequency range below 1 GHz that correspond to the E-UTRA operating bands that belong to the supported inter-band carrier aggregation configurations when such bands are belonging only to band combination(s) where one band is <1 GHz and another band is >1.7 GHz and there is no harmonic relationship between the low band UL and high band DL. Otherwise the above additional tolerances also apply to supported UTRA operating bands that correspond to the E-UTRA operating bands that belong to the supported inter-band carrier aggregation configurations.

NOTE 2: To meet the $\Delta T_{IB,c}$ requirements for CA_3A-7A with state-of-the-art technology, an increase in power consumption of the UE may be required. It is also expected that as the state-of-the-art technology evolves in the future, this possible power consumption increase can be reduced or eliminated.

The normative reference for this requirement is TS 36.101 [2] clause 6.2.5A.

6.2.5A.1.4 Test description

6.2.5A.1.4.1 Initial conditions

Initial conditions are a set of test configurations the UE needs to be tested in and the steps for the SS to take with the UE to reach the correct measurement state.

The initial test configurations consist of environmental conditions, test frequencies, and channel bandwidths based on E-UTRA CA configurations specified in table 5.4.2A.1-1. All of these configurations shall be tested with applicable test parameters for each channel bandwidth, and are shown in table 6.2.5A.1.4.1-1. The details of the uplink reference measurement channels (RMCs) are specified in Annex A.2. Configurations of PDSCH and PDCCH before measurement are specified in Annex C.2.

Table 6.2.5A.1.4.1-1: Test Configuration Table

Initial Conditions								
Test Environment as specified in TS 36.508[7] subclause 4.1					NC, TL/VL, TL/VH, TH/VL, TH/VH			
Test Frequencies as specified in TS36.508 [7] subclause 4.3.1 for different CA bandwidth classes.					C: Mid range			
Test CC Combination setting (N_{RB_agg}) as specified in subclause 5.4.2A.1 for the CA Configuration across bandwidth combination sets supported by the UE.					Lowest N_{RB_agg} Highest N_{RB_agg}			
Test Parameters for CA Configurations								
CA Configuration / N_{RB_agg}		DL Allocation	CC MOD	UL Allocation				
PCC N_{RB}	SCCs N_{RB}	PCC & SCC RB allocation		N_{RB_alloc}	PCC & SCC RB allocations (L_{CRB} @ RB_{start})			
75	75	N/A for this test	QPSK	16	P_16@0	S_0@0	-	-
100	50		QPSK	12	P_12@0	S_0@0	-	-
100	100		QPSK	18	P_18@0	S_0@0	-	-
Note 1: CA Configuration Test CC Combination settings are checked separately for each CA Configuration, which applicable aggregated channel bandwidths are specified in Table 5.4.2A.1-1								

1. Connect the SS to the UE antenna connectors as shown in TS 36.508 [7] Annex A, Figure group A.32 as appropriate.
2. The parameter settings for the cell are set up according to TS 36.508 [7] subclause 4.4.3.
3. Downlink signals for PCC are initially set up according to Annex C.0, C.1, and C.3.0, and uplink signals according to Annex H.1 and H.3.0.
4. The UL Reference Measurement channel is set according to Table 6.2.5A.1.4.1-1
5. Propagation conditions are set according to Annex B.0.
6. Ensure the UE is in State 3A-RF according to TS 36.508 [7] clause 5.2A.2. Message contents are defined in clause 6.2.5A.1.4.3.

6.2.5A.1.4.2 Test procedure

1. Configure SCC according to Annex C.0, C.1, and Annex C.3.0 for all downlink physical channels except PHICH.
2. The SS shall configure SCC as per TS 36.508 [7] clause 5.2A.4. Message contents are defined in clause 6.2.5A.1.4.3.
3. SS activates SCC by sending the MAC-CE according to TS 36.321 [13] clauses 5.13 and 6.1.3.8. Wait for at least 2 seconds as per TS 36.133 [4] clause 8.3.3.2.
4. SS sends uplink scheduling information for each UL HARQ process via PDCCH DCI format 0 for C_RNTI to schedule the UL RMC according to Table 6.2.5A.1.4.1-1 on both PCC and SCC. Since the UE has no payload and no loopback data to send the UE sends uplink MAC padding bits on the UL RMC.
5. Send transmit uplink power control "up" commands in every uplink scheduling information to the UE; allow at least 200ms for the UE to reach the P_{UMAX} level of the test point.

6. Measure the mean power over all component carriers in the CA configuration for each test point in table 6.2.5A.1.5-1 according to the test configuration from Table 6.2.5A.1.4.1-1. The period of measurement shall be at least continuous duration of one sub-frame (1ms). For TDD slots with transient periods are not under test.

6.2.5A.1.4.3 Message contents

Message contents are according to TS 36.508 [7] subclause 4.6 with the following exceptions. In test procedure step 2, for SCC configuration there are no additional message contents.

Table 6.2.5A.1.4.3-1: SystemInformationBlockType1: Test point 1

Derivation Path: TS 36.508 [7] clause 4.4.3.2, Table 4.4.3.2-3 SystemInformationBlockType1			
Information Element	Value/remark	Comment	Condition
p-Max	-10		

Table 6.2.5A.1.4.3-2: SystemInformationBlockType1: Test point 2

Derivation Path: TS 36.508 [7] clause 4.4.3.2, Table 4.4.3.2-3 SystemInformationBlockType1			
Information Element	Value/remark	Comment	Condition
p-Max	10		

Table 6.2.5A.1.4.3-3: SystemInformationBlockType1: Test point 3

Derivation Path: TS 36.508 [7] clause 4.4.3.2, Table 4.4.3.2-3 SystemInformationBlockType1			
Information Element	Value/remark	Comment	Condition
p-Max	15		

6.2.5A.1.5 Test requirement

The maximum output power measured shall not exceed the values specified in Table 6.2.5A.1.5-1.

Table 6.2.5A.1.5-1: P_{C_{MAX}} configured UE output power

	Channel bandwidth / maximum output power		
	50RB+100RB (10 MHz + 20 MHz)	75RB + 75RB (15 MHz + 15 MHz)	100RB + 100RB (20 MHz + 20 MHz)
Measured UE output power test point 1	For carrier frequency $f \leq 3.0\text{GHz}$: $-10 \text{ dBm} \pm 7.7$ For carrier frequency $3.0\text{GHz} < f \leq 4.2\text{GHz}$: $-10 \text{ dBm} \pm 8.0$		
Measured UE output power test point 2	For carrier frequency $f \leq 3.0\text{GHz}$: $10 \text{ dBm} \pm 6.7$ For carrier frequency $3.0\text{GHz} < f \leq 4.2\text{GHz}$: $10 \text{ dBm} \pm 7.0$		
Measured UE output power test point 3	For carrier frequency $f \leq 3.0\text{GHz}$: $15 \text{ dBm} \pm 5.7$ For carrier frequency $3.0\text{GHz} < f \leq 4.2\text{GHz}$: $15 \text{ dBm} \pm 6.0$		
Note:	In addition Note 2 in Table 6.2.2A.1.3-1 shall apply to the tolerances.		

6.2.5A.2 Configured UE transmitted Output Power for CA (inter-band DL CA without UL CA)

6.2.5A.2.1 Test purpose

Same as in clause 6.2.5A.1.1.

6.2.5A.2.2 Test applicability

This test case applies to all types of E-UTRA UE release 10 and forward that support inter-band DL CA but no UL CA.

6.2.5A.2.3 Minimum conformance requirements

Same as in clause 6.2.5A.1.3.

6.2.5A.2.4 Test description

6.2.5A.2.4.1 Initial conditions

Same as in clause 6.2.5A.1.4.1 with the following exceptions:

- Instead of Table 6.2.5A.1.4.1-1 → use Table 6.2.5A.2.4.1-1.

Table 6.2.5A.2.4.1-1: Test Configuration Table

Initial Conditions						
Test Environment as specified in TS 36.508[7] subclause 4.1				NC[, TL/VL, TL/VH, TH/VL, TH/VH]		
Test Frequencies as specified in TS36.508 [7] subclause 4.3.1 for different CA bandwidth classes.				A: Mid range for PCC and SCC		
Test CC Combination setting (N_{RB_agg}) as specified in subclause 5.4.2A.1 for the CA Configuration across bandwidth combination sets supported by the UE.				Lowest N_{RB_agg} Highest N_{RB_agg}		
Test Parameters for CA Configurations						
CA Configuration / N_{RB_agg}		DL Allocation	CC MOD	UL Allocation		
PCC N_{RB}	SCCs N_{RB}	PCC & SCC RB allocation		N_{RB_alloc}	PCC RB allocations (L_{CRB} @ RB_{start})	
6	25	N/A for this test	QPSK	5	P_5@0	-
15	25		QPSK	4	P_4@0	-
25	25		QPSK	8	P_8@0	-
25	50		QPSK	8	P_8@0	-
50	50		QPSK	12	P_12@0	-
50	75		QPSK	12	P_12@0	-
75	100		QPSK	16	P_16@0	-
100	75		QPSK	18	P_18@0	-
Note 1: CA Configuration Test CC Combination settings are checked separately for each CA Configuration, which applicable aggregated channel bandwidths are specified in Table 5.4.2A.1-1						
Note 2: The frequencies of PCC and SCC shall be switched and tested in each configuration.						

6.2.5A.2.4.2 Test procedure

1. Configure SCC according to Annex C.0, C.1, and Annex C.3.0 for all downlink physical channels except PHICH.
2. The SS shall configure SCC as per TS 36.508 [7] clause 5.2A.4. Message contents are defined in clause 6.2.5A.2.4.3.

3. SS activates SCC by sending the MAC-CE according to TS 36.321 [13] clauses 5.13 and 6.1.3.8. Wait for at least 2 seconds as per TS 36.133 [4] clause 8.3.3.2.
4. SS sends uplink scheduling information for each UL HARQ process via PDCCH DCI format 0 for C_RNTI to schedule the UL RMC according to Table 6.2.5A.2.4.1-1 on PCC. Since the UE has no payload and no loopback data to send the UE sends uplink MAC padding bits on the UL RMC.
5. Send transmit uplink power control "up" commands in every uplink scheduling information to the UE; allow at least 200ms for the UE to reach the P_{UMAX} level of the test point.
6. Measure the mean power over all component carriers in the CA configuration for each test point in table 6.2.5A.2.5-1 according to the test configuration from Table 6.2.5A.2.4.1-1. The period of measurement shall be at least continuous duration of one sub-frame (1ms). For TDD slots with transient periods are not under test.

6.2.5A.2.4.3 Message contents

Same as in clause 6.2.5A.1.1.

6.2.5A.2.5 Test requirement

The maximum output power measured shall not exceed the values specified in Table 6.2.5A.2.5-1.

Table 6.2.5A.2.5-1: P_{CMAX} configured UE output power

	Channel bandwidth / maximum output power					
	6RB 1.4 MHz	15 RB 3.0 MHz	25RB 5 MHz	50 RB 10 MHz	75 RB 15 MHz	100 RB 20 MHz
Measured UE output power test point 1	-10 dBm					
Power tolerance $f \leq 3.0\text{GHz}$ $3.0\text{GHz} < f \leq 4.2\text{GHz}$	$\pm 7.7\text{dB}$ $\pm 8.0\text{dB}$					
Measured UE output power test point 2	10 dBm					
Power tolerance $f \leq 3.0\text{GHz}$ $3.0\text{GHz} < f \leq 4.2\text{GHz}$	$\pm 6.7\text{dB}$ $\pm 7.0\text{dB}$					
Measured UE output power test point 3	15 dBm					
Power tolerance $f \leq 3.0\text{GHz}$ $3.0\text{GHz} < f \leq 4.2\text{GHz}$	$\pm 5.7\text{dB}$ $\pm 6.0\text{dB}$					
Note 1:	In addition note 2 in Table 6.2.2.3-1 shall apply to the tolerances.					
Note 2:	$\Delta T_{IB,c}$ in Table 6.2.5A.1.3-3 shall be applied.					

6.2.5B Configured UE transmitted Output Power for UL-MIMO

Editor's notes: The following items are missing or incomplete:

- Test Tolerance

6.2.5B.1 Test purpose

To verify the UE does not exceed the minimum between the P_{EMAX} maximum allowed UL TX Power for UL-MIMO signalled by the E-UTRAN and the P_{UMAX} maximum UE power for the UE power class.

6.2.5B.2 Test applicability

This test applies to all types of E-UTRA UE release 10 and forward that support UL- MIMO.

6.2.5B.3 Minimum conformance requirements

For UE with multiple transmit antenna connectors, the transmitted power is configured per each UE.

The definitions of configured maximum output power P_{CMAX} , the lower bound $P_{\text{CMAX,L}}$, and the higher bound $P_{\text{CMAX,H}}$ specified in Section 6.2.5 shall apply to UE with multiple transmit antenna connectors, where

- $P_{\text{PowerClass}}$ and ΔT_{C} are specified in Section 6.2.2B
- MPR is specified in Section 6.2.3B
- A-MPR is specified in Section 6.2.4B

The measured configured maximum output power P_{UMAX} shall be within the following bounds:

$$P_{\text{CMAX,L}} - \text{MAX}\{T_{\text{L}}, T_{\text{LOW}}(P_{\text{CMAX,L}})\} \leq P_{\text{UMAX}} \leq P_{\text{CMAX,H}} + T_{\text{HIGH}}(P_{\text{CMAX,H}})$$

where $T_{\text{LOW}}(P_{\text{CMAX,L}})$ and $T_{\text{HIGH}}(P_{\text{CMAX,H}})$ are defined as the tolerance and applies to $P_{\text{CMAX,L}}$ and $P_{\text{CMAX,H}}$ separately, while T_{L} is the absolute value of the lower tolerance in Table 6.2.2B.3-1 for the applicable operating band.

For UE with two transmit antenna connectors, the tolerance is specified in Table 6.2.5B.3-1 with UL-MIMO configurations specified in Table 6.2.2B.3-2.

Table 6.2.5B.3-1: P_{CMAX} tolerance in closed-loop spatial multiplexing scheme

P_{CMAX} (dBm)	Tolerance $T_{\text{LOW}}(P_{\text{CMAX,L}})$ (dB)	Tolerance $T_{\text{HIGH}}(P_{\text{CMAX,H}})$ (dB)
$P_{\text{CMAX}}=23$	3.0	2.0
$[22] \leq P_{\text{CMAX}} < [23]$	[5.0]	[2.0]
$[21] \leq P_{\text{CMAX}} < [22]$	[5.0]	[3.0]
$[20] \leq P_{\text{CMAX}} < [21]$	[6.0]	[4.0]
$[16] \leq P_{\text{CMAX}} < [20]$	[5.0]	
$[11] \leq P_{\text{CMAX}} < [16]$	[6.0]	
$[-40] \leq P_{\text{CMAX}} < [11]$	[7.0]	

The normative reference for this requirement is TS 36.101 [2] clause 6.2.5B.

6.2.5B.4 Test description

6.2.5B.4.1 Initial conditions

Initial conditions are a set of test configurations the UE needs to be tested in and the steps for the SS to take with the UE to reach the correct measurement state.

The initial test configurations consist of environmental conditions, test frequencies, and channel bandwidths based on E-UTRA operating bands specified in table 5.4.2.1-1. All of these configurations shall be tested with applicable test parameters for each channel bandwidth, and are shown in table 6.2.5B.4.1-1. The details of the uplink reference measurement channels (RMCs) are specified in Annex A.2. Configurations of PDSCH and PDCCH before measurement are specified in Annex C.2.

Table 6.2.5B.4.1-1: Test Configuration Table

Initial Conditions					
Test Environment as specified in TS 36.508[7] subclause 4.1		Normal, TL/VL, TL/VH, TH/VL, TH/VH			
Test Frequencies as specified in TS36.508 [7] subclause 4.3.1		Mid range			
Test Channel Bandwidths as specified in TS 36.508 [7] subclause 4.3.1		Lowest, 5MHz, Highest			
Test Parameters for Channel Bandwidths					
Ch BW	Downlink Configuration		Uplink Configuration		
	N/A for Configured UE transmitted Output Power test case		Mod'n	RB allocation	
1.4MHz				FDD	TDD
3MHz			QPSK	5	5
5MHz			QPSK	4	4
10MHz			QPSK	8	8
15MHz			QPSK	12	12
20MHz			QPSK	16	16
			QPSK	18	18
Note 1: Test Channel Bandwidths are checked separately for each E-UTRA band, the applicable channel bandwidths are specified in Table 5.4.2.1-1.					
Note 2: For the uplink RB allocation the RB _{start} shall be RB #0.					

1. Connect the SS to the UE antenna connectors as shown in TS 36.508 [7] Annex A, in Figure A.28.
2. The parameter settings for the cell are set up according to TS 36.508 [7] subclause 4.4.3.
3. Downlink signals are initially set up according to Annex C.0, C.1, and C.3.0, and uplink signals according to Annex H.1 and H.3.0.
4. The UL Reference Measurement channel is set according to Table 6.2.5B.4.1-1
5. Propagation conditions are set according to Annex B.0.
6. Ensure the UE is in State 3A-RF according to TS 36.508 [7] clause 5.2A.2. Message contents are defined in clause 6.2.5B.4.3.

6.2.5B.4.2 Test procedure

1. SS sends uplink scheduling information for each UL HARQ process via PDCCH DCI format 4 for C_RNTI to schedule the UL RMC according to Table 6.2.5B.4.1-1. Since the UE has no payload and no loopback data to send the UE sends uplink MAC padding bits on the UL RMC.
2. Send transmit uplink power control "up" commands in every uplink scheduling information to the UE; allow at least 200ms for the UE to reach the P_{umax} level of the test point.
3. Measure the sum mean power of the UE at each UE antenna connector in the associated measurement bandwidth for each test point in table 6.2.5B.5-1 according to the test configuration from Table 6.2.5B.4.1-1. The period of measurement shall be at least continuous duration of one sub-frame (1ms). For TDD slots with transient periods are not under test.

6.2.5B.4.3 Message contents

Message contents are according to TS 36.508 [7] clause 4.6 with the following exceptions:

Table 6.2.5B.4.3-1: SystemInformationBlockType1: Test point 1

Derivation Path: TS 36.508 [7] clause 4.4.3.2, Table 4.4.3.2-3 SystemInformationBlockType1			
Information Element	Value/remark	Comment	Condition
p-Max	-10		

Table 6.2.5B.4.3-2: SystemInformationBlockType1: Test point 2

Derivation Path: TS 36.508 [7] clause 4.4.3.2, Table 4.4.3.2-3 SystemInformationBlockType1			
Information Element	Value/remark	Comment	Condition
p-Max	13		

Table 6.2.5B.4.3-3: SystemInformationBlockType1: Test point 3

Derivation Path: TS 36.508 [7] clause 4.4.3.2, Table 4.4.3.2-3 SystemInformationBlockType1			
Information Element	Value/remark	Comment	Condition
p-Max	18		

6.2.5B.5 Test requirement

The maximum output power measured shall not exceed the values specified in Table 6.2.5B.5-1.

Table 6.2.5B.5-1: P_{CMAX} configured UE output power

	Channel bandwidth / maximum output power					
	1.4 MHz	3.0 MHz	5 MHz	10 MHz	15 MHz	20 MHz
Measured UE output power test point 1	For carrier frequency $f \leq 3.0\text{GHz}$: $-10 \text{ dBm} \pm [7.7]$ For carrier frequency $3.0\text{GHz} < f \leq 4.2\text{GHz}$: $-10 \text{ dBm} \pm [8]$					
Measured UE output power test point 2	For carrier frequency $f \leq 3.0\text{GHz}$: $13 \text{ dBm} \pm [6.7]$ For carrier frequency $3.0\text{GHz} < f \leq 4.2\text{GHz}$: $13 \text{ dBm} \pm [7]$					
Measured UE output power test point 3	For carrier frequency $f \leq 3.0\text{GHz}$: $18 \text{ dBm} \pm [5.7]$ For carrier frequency $3.0\text{GHz} < f \leq 4.2\text{GHz}$: $18 \text{ dBm} \pm [6]$					
Note:	In addition note 2 in Table 6.2.2B.3-1 shall apply to the tolerances.					

6.3 Output Power Dynamics

6.3.1 Void

6.3.2 Minimum Output Power

6.3.2.1 Test purpose

To verify the UE's ability to transmit with a broadband output power below the value specified in the test requirement when the power is set to a minimum value.

6.3.2.2 Test applicability

This test applies to all types of E-UTRA UE release 8 and forward.

6.3.2.3 Minimum conformance requirements

The minimum output power is defined as the mean power in one sub-frame (1ms). The minimum output power shall not exceed the values specified in Table 6.3.2.3-1.

Table 6.3.2.3-1: Minimum output power

	Channel bandwidth / minimum output power / measurement bandwidth					
	1.4 MHz	3.0 MHz	5 MHz	10 MHz	15 MHz	20 MHz

Minimum output power	-40 dBm					
Measurement bandwidth	1.08 MHz	2.7 MHz	4.5 MHz	9.0 MHz	13.5 MHz	18 MHz

The normative reference for this requirement is TS 36.101 [2] clause 6.3.2.1.

Minimum output power test verifies the UE's ability to transmit with a broadband output power below the specified limit when the power is set to a minimum value. The broadband output power is defined as the power in the channel bandwidth, for all transmit bandwidth configurations (resource blocks).

An excess minimum output power potentially increases the Rise Over Thermal (RoT) and therefore reduces the cell coverage area for other UEs.

6.3.2.4 Test description

6.3.2.4.1 Initial conditions

Initial conditions are a set of test configurations the UE needs to be tested in and the steps for the SS to take with the UE to reach the correct measurement state.

The initial test configurations consist of environmental conditions, test frequencies, and channel bandwidths based on E-UTRA operating bands specified in table 5.4.2.1-1. All of these configurations shall be tested with applicable test parameters for each channel bandwidth, and are shown in table 6.3.2.4.1-1. The details of the uplink reference measurement channels (RMCs) are specified in Annexes A.2. Configurations of PDSCH and PDCCH before measurement are specified in Annex C.2.

Table 6.3.2.4.1-1: Test Configuration Table

Initial Conditions				
Test Environment as specified in TS 36.508[7] subclause 4.1		Normal, TL/VL, TL/VH, TH/VL, TH/VH		
Test Frequencies as specified in TS36.508 [7] subclause 4.3.1		Low range, Mid range, High range		
Test Channel Bandwidths as specified in TS 36.508 [7] subclause 4.3.1		Lowest, 5MHz, Highest		
Test Parameters for Channel Bandwidths				
	Downlink Configuration	Uplink Configuration		
Ch BW	N/A for min output power test	Mod'n	RB allocation	
			FDD	TDD
1.4MHz		QPSK	6	6
3MHz		QPSK	15	15
5MHz		QPSK	25	25
10MHz		QPSK	50	50
15MHz		QPSK	75	75
20MHz		QPSK	100	100
Note 1: Test Channel Bandwidths are checked separately for each E-UTRA band, the applicable channel bandwidths are specified in Table 5.4.2.1-1.				

1. Connect the SS to the UE antenna connectors as shown in TS 36.508 [7] Annex A, in Figure A.3.
2. The parameter settings for the cell are set up according to TS 36.508 [7] subclause 4.4.3.
3. Downlink signals are initially set up according to Annex C.0, C.1, and C.3.0, and uplink signals according to Annex H.1 and H.3.0.
4. The UL Reference Measurement channel is set according to Table 6.3.2.4.1-1.
5. Propagation conditions are set according to Annex B.0.
6. Ensure the UE is in State 3A-RF according to TS 36.508 [7] clause 5.2A.2. Message contents are defined in clause 6.3.2.4.3.

6.3.2.4.2 Test procedure

SS sends uplink scheduling information for each UL HARQ process via PDCCH DCI format 0 for C_RNTI to schedule the UL RMC according to Table 6.3.2.1.4.1-1. Since the UE has no payload and no loopback data to send the UE sends uplink MAC padding bits on the UL RMC

2. Send continuous uplink power control "down" commands in the uplink scheduling information to the UE to ensure that the UE transmits at its minimum output power.
3. Measure the mean power of the UE in the associated measurement bandwidth specified in Table 6.3.2.5-1 for the specific channel bandwidth under test. The period of measurement shall be the continuous duration of one sub-frame (1ms). For TDD slots with transient periods are not under test.

6.3.2.4.3 Message contents

Message contents are according to TS 36.508 [7] subclause 4.6.

6.3.2.5 Test requirement

The minimum output power measured shall not exceed the values specified in Table 6.3.2.5-1.

Table 6.3.2.5-1: Minimum output power

	Channel bandwidth / minimum output power / measurement bandwidth					
	1.4 MHz	3.0 MHz	5 MHz	10 MHz	15 MHz	20 MHz
Minimum output power	For carrier frequency $f \leq 3.0\text{GHz}$: ≤ -39 dBm For carrier frequency $3.0\text{GHz} < f \leq 4.2\text{GHz}$: ≤ -38.7 dBm					
Measurement bandwidth (Note 1)	1.08 MHz	2.7 MHz	4.5 MHz	9.0 MHz	13.5 MHz	18 MHz
Note 1:	Different implementations such as FFT or spectrum analyzer approach are allowed. For spectrum analyzer approach the measurement bandwidth is defined as an equivalent noise bandwidth.					

6.3.2A Minimum Output Power for CA

6.3.2A.1 Minimum Output Power for CA (intra-band contiguous DL CA and UL CA)

6.3.2A.1.1 Test purpose

To verify the UE's ability to transmit with a broadband output power below the value specified in the test requirement when the power on each component carrier is set to a minimum value.

6.3.2A.1.2 Test applicability

This test case applies to all types of E-UTRA UE release 10 and forward that support intra-band contiguous DL CA and UL CA.

6.3.2A.1.3 Minimum conformance requirements

For intra-band contiguous carrier aggregation, the minimum controlled output power of the UE is defined as the transmit power of the UE per component carrier, i.e., the power in the channel bandwidth of each component carrier for all transmit bandwidth configurations (resource blocks), when the power on both component carriers are set to a minimum value.

For intra-band contiguous carrier aggregation the minimum output power is defined as the mean power in one sub-frame (1ms). The minimum output power shall not exceed the values specified in Table 6.3.2A.1.3-1.

Table 6.3.2A.1.3-1: Minimum output power for intra-band contiguous CA UE

	CC Channel bandwidth / Minimum output power / Measurement bandwidth					
	1.4 MHz	3.0 MHz	5 MHz	10 MHz	15 MHz	20 MHz
Minimum output power	-40 dBm					
Measurement bandwidth				9.0 MHz	13.5 MHz	18 MHz

The normative reference for this requirement is TS 36.101 [2] clause 6.3.2A.

6.3.2A.1.4 Test description

6.3.2A.1.4.1 Initial conditions

Initial conditions are a set of test configurations the UE needs to be tested in and the steps for the SS to take with the UE to reach the correct measurement state.

The initial test configurations consist of environmental conditions, test frequencies, and CC combinations based on E-UTRA CA configurations specified in table 5.4.2A.1-1. All of these configurations shall be tested with applicable test parameters for each CA Configuration, and are shown in table 6.3.2A.1.4.1-1. The details of the uplink reference measurement channels (RMCs) are specified in Annex A.2. Configurations of PDSCH and PDCCH before measurement are specified in Annex C.2.

Table 6.3.2A.1.4.1-1: Test Configuration Table

Initial Conditions								
Test Environment as specified in TS 36.508[7] subclause 4.1				NC, TL/VL, TL/VH, TH/VL, TH/VH				
Test Frequencies as specified in TS36.508 [7] subclause 4.3.1 for different CA bandwidth classes.				C: Low and High range				
Test CC Combination setting (N_{RB_agg}) as specified in subclause 5.4.2A.1 for the CA Configuration across bandwidth combination sets supported by the UE.				Lowest N_{RB_agg} Highest N_{RB_agg}				
Test Parameters for CA Configurations								
CA Configuration / N_{RB_agg}		DL Allocation	CC MOD	UL Allocation				
PCC N_{RB}	SCCs N_{RB}	PCC & SCC RB allocation		N_{RB_alloc}	PCC & SCC RB allocations (L_{CRB} @ RB_{start})			
75	75		QPSK	150	P_75@0	S_75@0	-	-
100	50		QPSK	150	P_100@0	S_50@0	-	-
100	100		QPSK	200	P_100@0	S_100@0	-	-
Note 1: CA Configuration Test CC Combination settings are checked separately for each CA Configuration, which applicable aggregated channel bandwidths are specified in Table 5.4.2A.1-1								

1. Connect the SS to the UE antenna connectors as shown in TS 36.508[7] Annex A Figure group A.32 as appropriate.
2. The parameter settings for the cell are set up according to TS 36.508 [7] subclause 4.4.3.
3. Downlink signals for PCC are initially set up according to Annex C.0, C.1, and C.3.0, and uplink signals according to Annex H.1 and H.3.0.

4. The UL Reference Measurement channel is set according to Table 6.3.2A.1.4.1-1.
5. Propagation conditions are set according to Annex B.0.
6. Ensure the UE is in State 3A-RF according to TS 36.508 [7] clause 5.2A.2. Message contents are defined in clause 6.3.2A.1.4.3.

6.3.2A.1.4.2 Test procedure

1. Configure SCC according to Annex C0, C.1 and Annex C.3.2 for all downlink physical channels except PHICH.
2. The SS shall configure SCC as per TS 36.508 [7] clause 5.2A.4. Message contents are defined in clause 6.3.2A.1.4.3.
3. SS activates SCC by sending the activation MAC-CE (Refer TS 36.321 [13], clauses 5.13, 6.1.3.8). Wait for at least 2 seconds (Refer TS 36.133, clauses 8.3.3.2).
4. SS sends uplink scheduling information for each UL HARQ process via PDCCH DCI format 0 for C_RNTI to schedule the UL RMC according to Table 6.3.2A.1.4.1-1 on both PCC and SCC. Since the UE has no payload and no loopback data to send the UE sends uplink MAC padding bits on the UL RMC.
5. Send continuously uplink power control "down" commands in every uplink scheduling information to the UE to ensure that the UE transmits at its minimum output power.
6. Measure the mean transmitted power of each component carrier in the CA configuration of the radio access mode. The period of measurement shall be at least the continuous duration of one sub-frame (1ms). For TDD slots with transient periods are not under test.

6.3.2A.1.4.3 Message contents

Message contents are according to TS 36.508 [7] subclause 4.6. In test procedure step 2, for SCC configuration there are no additional message contents.

6.3.2A.1.5 Test requirements

For each component carrier, the minimum output power measured shall not exceed the values specified in Table 6.3.2A.1.5-1.

Table 6.3.2A.1.5-1: Minimum output power for intra-band contiguous CA UE

	CC Channel bandwidth / Minimum output power / Measurement bandwidth					
	1.4 MHz	3.0 MHz	5 MHz	10 MHz	15 MHz	20 MHz
Minimum output power	For carrier frequency $f \leq 3.0\text{GHz}$: ≤ -39 dBm For carrier frequency $3.0\text{GHz} < f \leq 4.2\text{GHz}$: ≤ -38.7 dBm					
Measurement bandwidth				9.0 MHz	13.5 MHz	18 MHz
Note 1:	Different implementations such as FFT or spectrum analyzer approach are allowed. For spectrum analyzer approach the measurement bandwidth is defined as an equivalent noise bandwidth.					

6.3.2B Minimum Output Power for UL-MIMO

6.3.2B.1 Test purpose

To verify the UE's ability to transmit with a UL-MIMO broadband output power below the value specified in the test requirement when the power is set to a minimum value.

6.3.2B.2 Test applicability

This test applies to all types of E-UTRA UE release 10 and forward that support UL-MIMO

6.3.2B.3 Minimum conformance requirements

For UE with two transmit antenna connectors in closed-loop spatial multiplexing scheme, the minimum output power is defined as the sum of the mean power at each UE antenna connector in one sub-frame (1ms). The minimum output power shall not exceed the values specified in Table 6.3.2B.3-1.

Table 6.3.2B.3-1: Minimum output power

	Channel bandwidth / Minimum output power / Measurement bandwidth					
	1.4 MHz	3.0 MHz	5 MHz	10 MHz	15 MHz	20 MHz
Minimum output power	-40 dBm					
Measurement bandwidth	1.08 MHz	2.7 MHz	4.5 MHz	9.0 MHz	13.5 MHz	18 MHz

The normative reference for this requirement is TS 36.101 [2] clause 6.3.2B.1.

6.3.2B.4 Test description

6.3.2B.4.1 Initial conditions

Initial conditions are a set of test configurations the UE needs to be tested in and the steps for the SS to take with the UE to reach the correct measurement state.

The initial test configurations consist of environmental conditions, test frequencies, and channel bandwidths based on E-UTRA operating bands specified in table 5.4.2.1-1. All of these configurations shall be tested with applicable test parameters for each channel bandwidth, and are shown in table 6.3.2B.4.1-1. The details of the uplink reference measurement channels (RMCs) are specified in Annexes A.2. Configurations of PDSCH and PDCCH before measurement are specified in Annex C.2.

Table 6.3.2B.4.1-1: Test Configuration Table

Initial Conditions					
Test Environment as specified in TS 36.508[7] subclause 4.1		Normal, TL/VL, TL/VH, TH/VL, TH/VH			
Test Frequencies as specified in TS36.508 [7] subclause 4.3.1		Low range, Mid range, High range			
Test Channel Bandwidths as specified in TS 36.508 [7] subclause 4.3.1		Lowest, 5MHz, Highest			
Test Parameters for Channel Bandwidths					
Ch BW	Downlink Configuration		Uplink Configuration		
	N/A for min output power test		Mod'n	RB allocation	
			FDD	TDD	
1.4MHz			QPSK	6	6
3MHz			QPSK	15	15
5MHz			QPSK	25	25
10MHz			QPSK	50	50
15MHz			QPSK	75	75
20MHz			QPSK	100	100
Note 1: Test Channel Bandwidths are checked separately for each E-UTRA band, the applicable channel bandwidths are specified in Table 5.4.2.1-1.					

1. Connect the SS to the UE antenna connectors as shown in TS 36.508 [7] Annex A, in Figure A.28.
2. The parameter settings for the cell are set up according to TS 36.508 [7] subclause 4.4.3.
3. Downlink signals are initially set up according to Annex C.0, C.1, and C.3.0, and uplink signals according to Annex H.1 and H.3.0.
4. The UL Reference Measurement channel is set according to Table 6.3.2B.4.1-1.

5. Propagation conditions are set according to Annex B.0.
6. Ensure the UE is in State 3A-RF according to TS 36.508 [7] clause 5.2A.2. Message contents are defined in clause 6.3.2B.4.3.

6.3.2B.4.2 Test procedure

1. SS sends uplink scheduling information for each UL HARQ process via PDCCH DCI format 4 for C_RNTI to schedule the UL RMC according to Table 6.3.2B.4.1-1. Since the UE has no payload and no loopback data to send the UE sends uplink MAC padding bits on the UL RMC.
2. Send continuous uplink power control "down" commands in the uplink scheduling information to the UE to ensure that the UE transmits at its minimum output power.
3. Measure the sum of mean power of the UE at each UE antenna connector in the associated measurement bandwidth specified in Table 6.3.2B.5-1 for the specific channel bandwidth under test. The period of measurement shall be the continuous duration of one sub-frame (1ms). For TDD slots with transient periods are not under test.

6.3.2B.4.3 Message contents

Message contents are according to TS 36.508 [7] clause 4.6.6.3.2B.5 Test requirement

The minimum sum of mean output power of the UE at each antenna connector measured shall not exceed the values specified in Table 6.3.2B.5-1.

Table 6.3.2B.5-1: Minimum output power

	Channel bandwidth / minimum output power / measurement bandwidth					
	1.4 MHz	3.0 MHz	5 MHz	10 MHz	15 MHz	20 MHz
Minimum output power	For carrier frequency $f \leq 3.0\text{GHz}$: $\leq -40 + \text{TT dBm}$ For carrier frequency $3.0\text{GHz} < f \leq 4.2\text{GHz}$: $\leq -40 + \text{TT dBm}$					
Measurement bandwidth (Note 1)	1.08 MHz	2.7 MHz	4.5 MHz	9.0 MHz	13.5 MHz	18 MHz
Note 1:	Different implementations such as FFT or spectrum analyzer approach are allowed. For spectrum analyzer approach the measurement bandwidth is defined as an equivalent noise bandwidth.					

6.3.3 Transmit OFF power

6.3.3.1 Test purpose

To verify that the UE transmit OFF power is lower than the value specified in the test requirement.

6.3.3.2 Test applicability

The requirements of this test apply in test cases 6.3.4.1 General ON/OFF time mask and 6.3.4.2 PRACH and SRS time mask to all types of E-UTRA UE release 8 and forward.

6.3.3.3 Minimum conformance requirement

The transmit OFF power is defined as the mean power in a duration of at least one sub-frame (1ms) excluding any transient periods. The requirement for the transmit OFF power shall not exceed the values specified in Table 6.3.3.3-1.

Table 6.3.3.3-1: Transmit OFF power

	Channel bandwidth / Transmit OFF power / measurement bandwidth					
	1.4 MHz	3.0 MHz	5 MHz	10 MHz	15 MHz	20 MHz

Transmit OFF power	-50 dBm					
Measurement bandwidth	1.08 MHz	2.7 MHz	4.5 MHz	9.0 MHz	13.5 MHz	18 MHz

The normative reference for this requirement is TS 36.101 [2] clause 6.3.3.

Transmit OFF power is defined as the mean power when the transmitter is OFF. The transmitter is considered to be OFF when the UE is not allowed to transmit or during periods when the UE is not transmitting a sub-frame. During DTX and measurements gaps, the UE is not considered to be OFF.

An excess transmit OFF power potentially increases the Rise Over Thermal (RoT) and therefore reduces the cell coverage area for other UEs

6.3.3.4 Test description

This test is covered by clause 6.3.4.1 General ON/OFF time mask and 6.3.4.2 PRACH and SRS time mask.

6.3.3.5 Test requirement

The requirement for the transmit OFF power shall not exceed the values specified in Table 6.3.3.5-1.

Table 6.3.3.5-1: Transmit OFF power

	Channel bandwidth / Transmit OFF power / measurement bandwidth					
	1.4 MHz	3.0 MHz	5 MHz	10 MHz	15 MHz	20 MHz
Transmit OFF power	For carrier frequency $f \leq 3.0\text{GHz}$: ≤ -48.5 dBm For carrier frequency $3.0\text{GHz} < f \leq 4.2\text{GHz}$: ≤ -48.2 dBm					
Measurement bandwidth	1.08 MHz	2.7 MHz	4.5 MHz	9.0 MHz	13.5 MHz	18 MHz

6.3.3A UE Transmit OFF power for CA

6.3.3A.1 UE Transmit OFF power for CA (intra-band contiguous DL CA and UL CA)

6.3.3A.1.1 Test purpose

For intra-band contiguous carrier aggregation the transmit OFF power is defined as the mean power per component carrier when the transmitter is OFF on both component carriers. The transmitter is considered to be OFF when the UE is not allowed to transmit or during periods when the UE is not transmitting a sub-frame. During measurements gaps, the UE is not considered to be OFF.

To verify that the UE transmit OFF power for CA is lower than the value specified in the test requirement.

6.3.3A.1.2 Test applicability

The requirements of this test case apply in test cases 6.3.4A.1 General ON/OFF time mask for CA and 6.3.4.2 PRACH and SRS time mask to all types of E-UTRA UE release 10 and forward that support intra-band contiguous DL CA and UL CA.

6.3.3A.1.3 Minimum conformance requirements

For intra-band contiguous carrier aggregation the transmit OFF power is defined as the mean power in a duration of at least one sub-frame (1ms) excluding any transient periods. The transmit OFF power shall not exceed the values specified in Table 6.3.3A.1.3-1.

Table 6.3.3A.1.3-1: Transmit OFF power for intra-band contiguous CA UE

	Channel bandwidth / Minimum output power / measurement
--	--

	bandwidth					
	1.4 MHz	3.0 MHz	5 MHz	10 MHz	15 MHz	20 MHz
Transmit OFF power	-50 dBm					
Measurement bandwidth				9.0 MHz	13.5 MHz	18 MHz

The normative reference for this requirement is TS 36.101[2] clause 6.3.3A

6.3.3A.1.4 Test description

This test is covered by clause 6.3.4A.1.1 General ON/OFF time mask for CA and 6.3.4.2 PRACH and SRS time mask.

6.3.3A.1.5 Test Requirements

Table 6.3.3A.1.5-1: Transmit OFF power for intra-band contiguous CA UE

	Channel bandwidth / Minimum output power / Measurement bandwidth					
	1.4 MHz	3.0 MHz	5 MHz	10 MHz	15 MHz	20 MHz
Transmit OFF power	-48.5 dBm					
Measurement bandwidth				9.0 MHz	13.5 MHz	18 MHz

6.3.3B UE Transmit OFF power for UL-MIMO

6.3.3B.1 Test purpose

To verify that the UE transmit OFF power for UL-MIMO is lower than the value specified in the test requirement.

Transmission of the wrong power increases interference to other channels, or increases transmission errors in the uplink channel.

6.3.3B.2 Test applicability

The requirements of this test apply in test cases 6.3.4B.1 General ON/OFF time mask to all types of E-UTRA UE release 10 and forward that support UL-MIMO

6.3.3B.3 Minimum conformance requirement

The transmit OFF power is defined as the mean power at each transmit connector in a duration of at least one sub-frame (1ms) excluding any transient periods. The transmit OFF power at each transmit connector shall not exceed the values specified in Table 6.3.3B.3-1.

Table 6.3.3B.3-1: Transmit OFF power per antenna port

	Channel bandwidth / Minimum output power / Measurement bandwidth					
	1.4 MHz	3.0 MHz	5 MHz	10 MHz	15 MHz	20 MHz
Transmit OFF power	-50 dBm					
Measurement bandwidth	1.08 MHz	2.7 MHz	4.5 MHz	9.0 MHz	13.5 MHz	18 MHz

The normative reference for this requirement is TS 36.101 [2] clause 6.3.3B.1.

6.3.3B.4 Test description

This test is covered by clause 6.3.4B.1 General ON/OFF time mask.

6.3.3B.5 Test requirement

The requirement for the transmit OFF power at each transmit antenna connector shall not exceed the values specified in Table 6.3.3B.5-1.

Table 6.3.3B.5-1: Transmit OFF power

	Channel bandwidth / Transmit OFF power / measurement bandwidth					
	1.4 MHz	3.0 MHz	5 MHz	10 MHz	15 MHz	20 MHz
Transmit OFF power	For carrier frequency $f \leq 3.0\text{GHz}$: ≤ -48.5 dBm For carrier frequency $3.0\text{GHz} < f \leq 4.2\text{GHz}$: ≤ -48.2 dBm					
Measurement bandwidth	1.08 MHz	2.7 MHz	4.5 MHz	9.0 MHz	13.5 MHz	18 MHz

6.3.4 ON/OFF time mask

6.3.4.1 General ON/OFF time mask

Editor's note: The measurement period in the minimum requirement is defined to be 1 subframe (14 symbols). Due to practical reasons the TDD measurement period for off power prior the PUSCH is 10 symbols. It is FFS, if this deviation is acceptable.

6.3.4.1.1 Test purpose

To verify that the general ON/OFF time mask meets the requirements given in 6.3.4.1.5.

The time mask for transmit ON/OFF defines the ramping time allowed for the UE between transmit OFF power and transmit ON power.

Transmission of the wrong power increases interference to other channels, or increases transmission errors in the uplink channel.

6.3.4.1.2 Test applicability

This test applies to all types of E-UTRA UE release 8 and forward.

6.3.4.1.3 Minimum conformance requirement

The General ON/OFF time mask defines the observation period between Transmit OFF and ON power and between Transmit ON and OFF power. ON/OFF scenarios include; the beginning or end of DTX, measurement gap, contiguous, and non contiguous transmission

The OFF power measurement period is defined in a duration of at least one sub-frame excluding any transient periods. The ON power is defined as the mean power over one sub-frame excluding any transient period.

There are no additional requirements on UE transmit power beyond that which is required in clause 6.2.2 and clause 6.6.2.3.

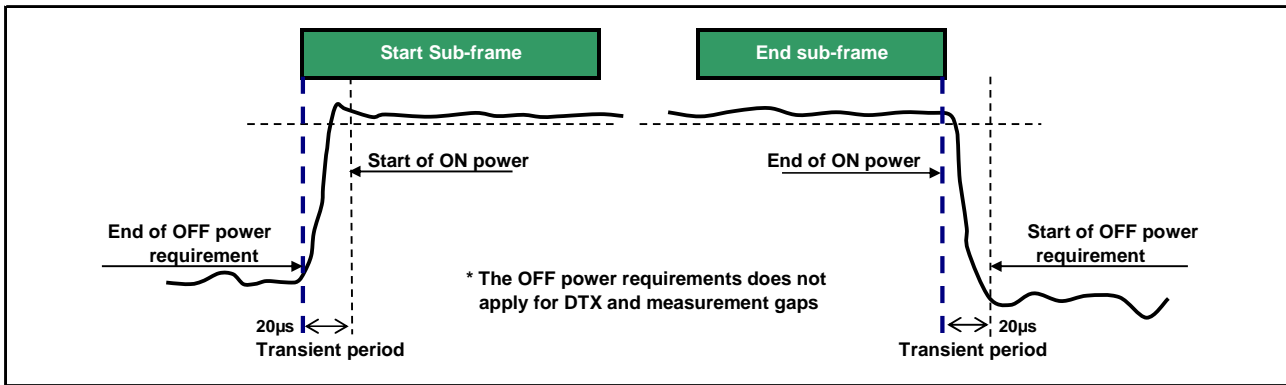

Figure 6.3.4.1.3-1: General ON/OFF time mask

The normative reference for this requirement is TS 36.101 [2] clause 6.3.4.1.

6.3.4.1.4 Test description

6.3.4.1.4.1 Initial conditions

Initial conditions are a set of test configurations the UE needs to be tested in and the steps for the SS to take with the UE to reach the correct measurement state.

The initial test configurations consist of environmental conditions, test frequencies, and channel bandwidths based on E-UTRA operating bands specified in table 5.4.2.1-1. All of these configurations shall be tested with applicable test parameters for each channel bandwidth, and are shown in table 6.3.4.1.4.1-1. The details of the uplink reference measurement channels (RMCs) are specified in Annexes A.2. Configurations of PDSCH and PDCCH before measurement are specified in Annex C.2

Table 6.3.4.1.4.1-1: Test Configuration Table

Initial Conditions					
Test Environment as specified in TS 36.508[7] subclause 4.1		Normal, TL/VL, TL/VH, TH/VL, TH/VH			
Test Frequencies as specified in TS36.508 [7] subclause 4.3.1		Low range, Mid range, High range			
Test Channel Bandwidths as specified in TS 36.508 [7] subclause 4.3.1		Lowest, 5MHz, Highest			
Test Parameters for Channel Bandwidths					
	Downlink Configuration		Uplink Configuration		
Ch BW	N/A for General On/Off Time Mask test case		Mod'n	RB allocation	
				FDD	TDD
1.4MHz			QPSK	6	6
3MHz			QPSK	15	15
5MHz			QPSK	25	25
10MHz			QPSK	50	50
15MHz			QPSK	75	75
20MHz			QPSK	100	100
Note 1: Test Channel Bandwidths are checked separately for each E-UTRA band, the applicable channel bandwidths are specified in Table 5.4.2.1-1.					

1. Connect the SS to the UE antenna connectors as shown in TS 36.508 [7] Annex A, Figure A.3.
2. The parameter settings for the cell are set up according to TS 36.508 [7] subclause 4.4.3.
3. Downlink signals are initially set up according to Annex C.0, C.1 and C.3.0, and uplink signals according to Annex H.1 and H.3.0.

4. The UL and DL Reference Measurement channels are set according to Table 6.3.4.1.4.1-1.
5. Propagation conditions are set according to Annex B.0.
6. Ensure the UE is in State 3A-RF according to TS 36.508 [7] clause 5.2A.2. Message contents are defined in clause 6.3.4.1.4.3. Note that PDCCH DCI format 0 sent after resetting uplink power with RRC Connection Reconfiguration, should have TPC command 0dB.

6.3.4.1.4.2 Test procedure

1. SS sends uplink scheduling information via PDCCH DCI format 0 with TPC command 0dB for C_RNTI to schedule the UL RMC according to Table 6.3.4.1.4.1-1. Since the UE has no payload and no loopback data to send the UE sends uplink MAC padding bits on the UL RMC. The UL assignment is such that the UE transmits on UL sub-frame 2 of every radio frame.
2. For FDD: Measure the UE transmission OFF power during the sub-frame prior to the PUSCH subframe. For TDD: Measure the UE transmission OFF power during the 10 SCFDMA symbols prior to the PUSCH subframe.
3. Measure the output power of the UE PUSCH transmission during one sub-frame, excluding a transient period of 20 μs at the beginning of the subframe.
4. Measure the UE transmission OFF power during one sub-frame following the PUSCH subframe, excluding a transient period of 20 μs at the beginning of the subframe.

6.3.4.1.4.3 Message contents

Message contents are according to TS 36.508 [7] subclause 4.6 with the following exceptions:

Table 6.3.4.1.4.3-1: UplinkPowerControlCommon: Test point 1

Derivation Path: TS 36.508 [7] clause 4.6.3, Table 4.6.3-25 UplinkPowerControlCommon-DEFAULT			
Information Element	Value/remark	Comment	Condition
UplinkPowerControlCommon-DEFAULT ::= SEQUENCE { p0-NominalPUSCH	-105	Test point 1 to verify a UE relative low initial power transmission	

Table 6.3.4.1.4.3-2: PhysicalConfigDedicated

Derivation Path: TS 36.508 [7] clause 5.5.1.2, Table 5.5.1.2.1 PhysicalConfigDedicated-DEFAULT			
Information Element	Value/remark	Comment	Condition
PhysicalConfigDedicated-DEFAULT ::= SEQUENCE { UplinkPowerControlDedicated	UplinkPowerControlDedicated-DEFAULT	See subclause 4.6.3	SRB1
	UplinkPowerControlDedicated-DEFAULT	See subclause 4.6.3	RBC

Table 6.3.4.1.4.3-3: UplinkPowerControlDedicated

Derivation Path: TS 36.508 [7] clause 4.6.3, Table 4.6.3-26 UplinkPowerControlDedicated-DEFAULT			
Information Element	Value/remark	Comment	Condition
UplinkPowerControlDedicated-DEFAULT ::= SEQUENCE { p0-UE-PUSCH	1		SRB1
	0		RBC
}			

Table 6.3.4.1.3-4: TDD-Config-DEFAULT: On/OFF time mask measurement

Derivation Path: 36.508 clause 5.3.1 Table 5.3.1-1 (<i>SystemInformationBlockType1</i>)			
Information Element	Value/remark	Comment	Condition
TDD-Config-DEFAULT ::= SEQUENCE {			
subframeAssignment	sa1		
specialSubframePatterns	ssp5	To enable two symbol UpPTS, and to have 9 symbols GP.	
}			

6.3.4.1.5 Test requirement

The requirement for the power measured in steps (2), (3) and (4) of the test procedure shall not exceed the values specified in Table 6.3.4.1.5-1.

Table 6.3.4.1.5-1: General ON/OFF time mask

	Channel bandwidth / minimum output power / measurement bandwidth					
	1.4 MHz	3.0 MHz	5 MHz	10 MHz	15 MHz	20 MHz
Transmit OFF power	For carrier frequency $f \leq 3.0\text{GHz}$: ≤ -48.5 dBm For carrier frequency $3.0\text{GHz} < f \leq 4.2\text{GHz}$: ≤ -48.2 dBm					
Transmission OFF Measurement bandwidth	1.08 MHz	2.7 MHz	4.5 MHz	9.0 MHz	13.5 MHz	18 MHz
Expected Transmission ON Measured power	-14.8 dBm	-10.8 dBm	-8.6 dBm	-5.6 dBm	-3.9 dBm	-2.6 dBm
ON power tolerance $f \leq 3.0\text{GHz}$ $3.0\text{GHz} < f \leq 4.2\text{GHz}$	$\pm 7.5\text{dB}$ $\pm 7.8\text{dB}$	$\pm 7.5\text{dB}$ $\pm 7.8\text{dB}$	$\pm 7.5\text{dB}$ $\pm 7.8\text{dB}$	$\pm 7.5\text{dB}$ $\pm 7.8\text{dB}$	$\pm 7.5\text{dB}$ $\pm 7.8\text{dB}$	$\pm 7.5\text{dB}$ $\pm 7.8\text{dB}$

6.3.4.2 PRACH and SRS time mask

6.3.4.2.1 PRACH time mask

6.3.4.2.1.1 Test purpose

To verify that the PRACH time mask meets the requirements given in 6.3.4.2.1.5.

The time mask for PRACH time mask defines the ramping time allowed for the UE between transmit OFF power and transmit ON power when transmitting the PRACH.

Transmission of the wrong power increases interference to other channels, or increases transmission errors in the uplink channel.

6.3.4.2.1.2 Test applicability

This test applies to all types of E-UTRA UE release 8 and forward.

6.3.4.2.1.3 Minimum conformance requirement

For the PRACH Power / Time mask defines the observation period for PRACH transmissions. The PRACH ON power is specified as the mean power over the PRACH measurement period excluding any transient periods. The measurement period for different PRACH preamble format is specified in Table 6.3.4.2.1.3-1.

There are no additional requirements on UE transmit power beyond that which is required in clause 6.2.2 and clause 6.6.2.3

Table 6.3.4.2.1.3-1: PRACH ON power measurement period

PRACH preamble format	Measurement period (ms)
0	0.9031
1	1.4844
2	1.8031
3	2.2844
4	0.1479

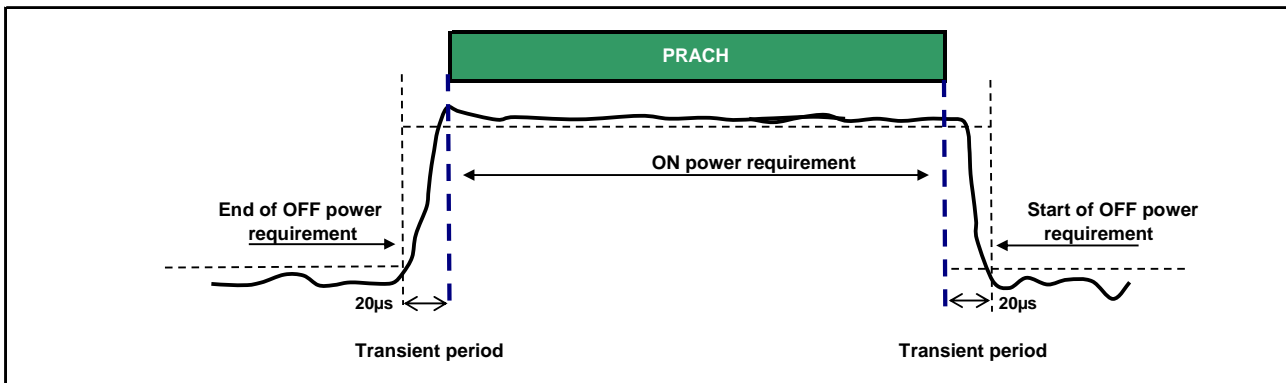

Figure 6.3.4.2.1.3-1: PRACH ON/OFF time mask

The normative reference for this requirement is TS 36.101 [2] clause 6.3.4.2.1.

6.3.4.2.1.4 Test description

6.3.4.2.1.4.1 Initial conditions

Initial conditions are a set of test configurations the UE needs to be tested in and the steps for the SS to take with the UE to reach the correct measurement state.

The initial test configurations consist of environmental conditions, test frequencies, and channel bandwidths based on E-UTRA operating bands specified in table 5.4.2.1-1. All of these configurations shall be tested with applicable test parameters for each channel bandwidth, and are shown in table 6.3.4.2.1.4.1-1. The details of the uplink and downlink reference measurement channels (RMCs) are specified in Annexes A.2 and A.3.

Table 6.3.4.2.1.4.1-1: Test Configuration Table

Initial Conditions		
Test Environment (as specified in TS 36.508 [7] subclause 4.1)	Normal, TL/VL, TL/VH, TH/VL, TH/VH	
Test Frequencies (as specified in TS36.508 [7] subclause 4.3.1)	Mid range	
Test Channel Bandwidths (as specified in TS 36.508 [7] subclause 4.3.1)	Lowest, 5MHz, Highest	
PRACH preamble format		
	FDD	TDD
PRACH Configuration Index	3	51

1. Connect the SS to the UE antenna connectors as shown in TS 36.508 [7] Annex A, Figure A3.
2. The parameter settings for the cell are set up according to TS 36.508 [7] subclause 4.4.3.

3. Downlink signals are initially set up according to Annex C.0, C.1 and C.3.0, and uplink signals according to Annex H.1 and H.3.0.
4. Propagation conditions are set according to Annex B.0.
5. Ensure the UE is in State 3A-RF according to TS 36.508 [7] clause 5.2A.2. Message contents are defined in clause 6.3.4.2.1.4.3.

6.3.4.2.1.4.2 Test procedure

1. The SS shall signal a Random Access Preamble ID via a PDCCH order to the UE and initiate a Non-contention based Random Access procedure.
2. The UE shall send the signalled preamble to the SS.
3. For FDD UE, the SS measure the UE transmission OFF power during the sub-frame preceding the PRACH preamble excluding a transient period of 20 μ s according to Figure 6.3.4.2.1.3-1. For TDD UE, the SS measure the UE transmission OFF power starting (20 μ s+the duration of 8 OFDM symbols) before the PRACH starts, and ending 20 μ s before PRACH starts. Note, the nominal PRACH timing for TDD is not aligned with the sub frame and symbol raster.
4. Measure the output power of the transmitted PRACH preamble according to Figure 6.3.4.2.1.3-1.
5. Measure the UE transmission OFF power, starting 20 μ s after the PRACH preamble ends for a measurement period of 980 μ s..

6.3.4.2.1.4.3 Message contents

Message contents are according to TS 36.508 [7] subclause 4.6 with the following exceptions:

Table 6.3.4.2.1.4.3-1: RACH-ConfigCommon-DEFAULT: PRACH measurement

Derivation Path: TS 36.508 [7] clause 4.6.3, Table 4.6.3-12 RACH-ConfigCommon-DEFAULT			
Information Element	Value/remark	Comment	Condition
RACH-ConfigCommon-DEFAULT ::= SEQUENCE {			
powerRampingParameters SEQUENCE {			
powerRampingStep	dB0		
preambleInitialReceivedTargetPower	dBm-104		PRACH Format 0
	dBm-112		PRACH Format 4
}			
}			

Table 6.3.4.2.1.4.3-2: PRACH-Config-DEFAULT: PRACH measurement for TDD

Derivation Path: TS 36.508 [7] clause 5.3.1, Table 5.3.1-3: PRACH-Config-DEFAULT			
Information Element	Value/remark	Comment	Condition
PRACH-Config-DEFAULT ::= SEQUENCE {			
prach-ConfigIndex	51		TDD
}			

Table 6.3.4.2.1.4.3-3: TDD-Config-DEFAULT: PRACH measurement for TDD

Derivation Path: TS 36.508 [7] clause 5.3.1, Table 5.3.1-1: TDD-Config-DEFAULT			
Information Element	Value/remark	Comment	Condition
TDD-Config-DEFAULT ::= SEQUENCE {			
subframeAssignment	sa1		
specialSubframePatterns	ssp5	To enable two symbol UpPTS, and to have 9 symbols GP.	
}			

6.3.4.2.1.5 Test requirement

The requirement for the power measured in steps (3), (4) and (5) of the test procedure shall not exceed the values specified in Table 6.3.4.2.1.5-1.

Table 6.3.4.2.1.5-1: PRACH time mask

	Channel bandwidth / Output Power [dBm] / measurement bandwidth					
	1.4 MHz	3.0 MHz	5 MHz	10 MHz	15 MHz	20 MHz
Transmit OFF power	For carrier frequency $f \leq 3.0\text{GHz}$: $\leq -48.5\text{ dBm}$ For carrier frequency $3.0\text{GHz} < f \leq 4.2\text{GHz}$: $\leq -48.2\text{ dBm}$					
Transmission OFF Measurement bandwidth	1.08 MHz	2.7 MHz	4.5 MHz	9.0 MHz	13.5 MHz	18 MHz
Expected PRACH Transmission ON Measured power	-1 dBm	-1 dBm	-1 dBm	-1 dBm	-1 dBm	-1 dBm
ON power tolerance $f \leq 3.0\text{GHz}$ $3.0\text{GHz} < f \leq 4.2\text{GHz}$	$\pm 7.5\text{dB}$ $\pm 7.8\text{dB}$	$\pm 7.5\text{dB}$ $\pm 7.8\text{dB}$	$\pm 7.5\text{dB}$ $\pm 7.8\text{dB}$	$\pm 7.5\text{dB}$ $\pm 7.8\text{dB}$	$\pm 7.5\text{dB}$ $\pm 7.8\text{dB}$	$\pm 7.5\text{dB}$ $\pm 7.8\text{dB}$

6.3.4.2.2 SRS time mask

6.3.4.2.2.1 Test purpose

To verify that the SRS time mask meets the requirements given in 6.3.4.2.2.5.

The time mask for SRS time mask defines the ramping time allowed for the UE between transmit OFF power and transmit ON power when transmitting the SRS.

Transmission of the wrong power increases interference to other channels, or increases transmission errors in the uplink channel.

6.3.4.2.2.2 Test applicability

This test applies to all types of E-UTRA UE release 8 and forward.

6.3.4.2.2.3 Minimum conformance requirement

In the case a single SRS transmission, the ON power is defined as the mean power for each symbol duration excluding any transient period. Figure 6.3.4.2.2.3-1.

In the case a dual SRS transmission, the ON power is defined as the mean power for each symbol duration excluding any transient period. Figure 6.3.4.2.2.3-2.

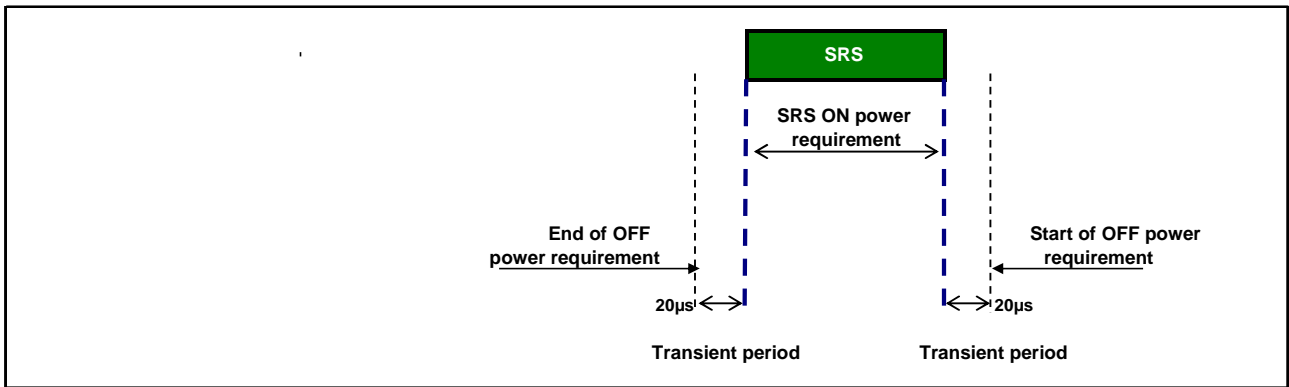

Figure 6.3.4.2.2.3-1: Single SRS time mask

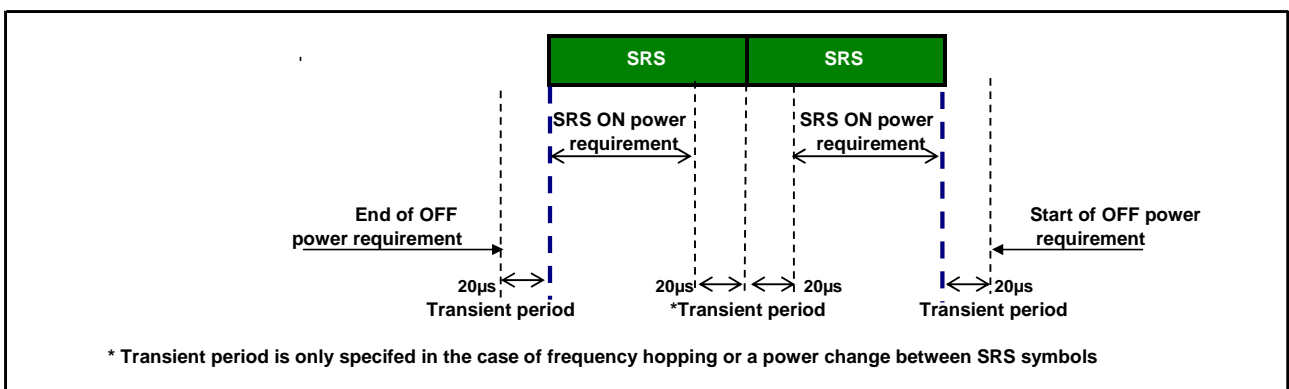

Figure 6.3.4.2.2.3-2: Dual SRS time mask for the case of UpPTS transmissions

6.3.4.2.2.4 Test description

6.3.4.2.2.4.1 Initial conditions

Initial conditions are a set of test configurations the UE needs to be tested in and the steps for the SS to take with the UE to reach the correct measurement state.

The initial test configurations consist of environmental conditions, test frequencies, and channel bandwidths based on E-UTRA operating bands specified in table 5.4.2.1-1. All of these configurations shall be tested with applicable test parameters for each channel bandwidth, and are shown in table 6.3.4.2.2.4.1-1. The details of the uplink and downlink reference measurement channels (RMCs) are specified in Annexes A.2 and A.3.

Table 6.3.4.2.2.4.1-1: Test Configuration Table

Initial Conditions		
Test Environment (as specified in TS 36.508 [7] subclause 4.1)	Normal, TL/VL, TL/VH, TH/VL, TH/VH	
Test Frequencies (as specified in TS36.508 [7] subclause 4.3.1)	Mid range	
Test Channel Bandwidths (as specified in TS 36.508 [7] subclause 4.3.1)	Lowest, 5MHz, Highest	
SRS configuration		
	FDD	TDD
srs-BandwidthConfig	bw7	bw7 (for BW 1.4 MHz) bw5 (for BW 3 MHz) bw2 (for BW 5 MHz) bw0 (for BW 10, 15, 20 MHz)
srs-SubframeConfig	sc3	sc0
ackNackSRS-SimultaneousTransmission	FALSE	FALSE
srsMaxUpPts	N/A	N/A
srs-Bandwidth	bw3	bw3
srs-HoppingBandwidth	hbw3	hbw0
freqDomainPosition	0	0
Duration	TRUE	TRUE
srs-ConfigIndex	7	0
transmissionComb	0	0
cyclicShift	cs0	cs0

1. Connect the SS to the UE antenna connectors as shown in TS 36.508 [7] Annex A, Figure A.3.
2. The parameter settings for the cell are set up according to TS 36.508 [7] subclause 4.4.3.
3. Downlink signals are initially set up according to Annex C.0, C.1 and C.3.0, and uplink signals according to Annex H.1 and H.3.0.
4. Propagation conditions are set according to Annex B.0.
5. Ensure the UE is in State 3A-RF according to TS 36.508 [7] clause 5.2A.2. Message contents are defined in clause 6.3.4.2.2.4.3. Note that PDCCH DCI format 0 sent after resetting uplink power with RRC Connection Reconfiguration, should have TPC command 0dB.

6.3.4.2.2.4.2 Test procedure

1. For FDD UE, the SS measure the UE transmission OFF power during the 13 symbols preceding the SRS symbol excluding a transient period of 20 μ s according to Figure 6.3.4.2.2.3-1. For TDD UE, the SS measure the UE transmission OFF power during the 8 symbols preceding the two SRS symbols excluding a transient period of 20 μ s according to Figure 6.3.4.2.2.3-2.
2. Measure the output power of the transmitted SRS according to Figure 6.3.4.2.2.3-1 for FDD UE and according to Figure 6.3.4.2.2.3-2 for TDD UE, The transient periods are excluded from measurement accordingly.
3. Measure the UE transmission OFF power during the sub-frame following the SRS under test, excluding a transient period of 20 μ s according to Figure 6.3.4.2.2.3-1 for FDD UE and according to Figure 6.3.4.2.2.3-2 for TDD UE.

6.3.4.2.2.4.3 Message contents

Message contents are according to TS 36.508 [7] subclause 4.6 with the following exceptions:

Table 6.3.4.2.2.4.3-1: RadioResourceConfigCommonSIB-DEFAULT: SRS measurement

Derivation Path: 36.508 clause 5.3.1 Table 5.3.1-2 RadioResourceConfigCommonSIB-DEFAULT			
Information Element	Value/remark	Comment	Condition
RadioResourceConfigCommon-DEFAULT ::= SEQUENCE {			
rach-ConfigCommon	RACH-ConfigCommon-DEFAULT		
bcch-Config	BCCH-Config-DEFAULT		
pcch-Config	PCCH-Config-DEFAULT		
prach-Config	PRACH-ConfigSIB-DEFAULT		
pdsch-ConfigCommon	PDSCH-ConfigCommon-DEFAULT		
pusch-ConfigCommon	PUSCH-ConfigCommon-DEFAULT		
pucch-ConfigCommon	PUCCH-ConfigCommon-DEFAULT		
soundingRSUL-ConfigCommon	<i>SoundingRS-UL-ConfigCommon-DEFAULT</i>		
uplinkPowerControlCommon	UplinkPowerControlCommon-DEFAULT		
ul-CyclicPrefixLength	len1		
}			

Table 6.3.4.2.2.4.3-2: SoundingRS-UL-ConfigCommon-DEFAULT: SRS time mask measurement

Derivation Path: TS 36.508 [7] clause 4.6.3, Table 4.6.3-21 SoundingRS-UL-ConfigCommon-DEFAULT			
Information Element	Value/remark	Comment	Condition
SoundingRS-UL-ConfigCommon-DEFAULT ::= SEQUENCE {			
setup SEQUENCE {			
srs-BandwidthConfig	bw7		FDD
	bw7		TDD (BW 1.4 MHz)
	bw5		TDD (BW 3 MHz)
	bw2		TDD (BW 5 MHz)
	bw0		TDD (BW 10, 15, 20 MHz)
srs-SubframeConfig	sc3	Periodicity of 5ms, with offset of 0.	FDD
	sc0	Periodicity of 5ms, with offset of 1.	TDD
ackNackSRS-SimultaneousTransmission	FALSE		
srsMaxUpPts	Not present		
}			
}			

Table 6.3.4.2.2.4.3-3: PhysicalConfigDedicated-DEFAULT: SRS time mask measurement

Derivation Path: 36.508 clause 5.5.1 Table 5.5.1.2-1: PhysicalConfigDedicated-DEFAULT			
Information Element	Value/remark	Comment	Condition
PhysicalConfigDedicated-DEFAULT ::= SEQUENCE {			
cqi-ReportConfig	Not present		
soundingRS-UL-ConfigDedicated	<i>SoundingRSUL-ConfigDedicated-DEFAULT</i>		
}			

Table 6.3.4.2.2.4.3-4: SoundingRSUL-ConfigDedicated-DEFAULT: SRS time mask measurement

Derivation Path: TS 36.508 [7] clause 4.6.3, Table 4.6.3-22 SoundingRS-UL-ConfigDedicated-DEFAULT			
Information Element	Value/remark	Comment	Condition
SoundingRS-UL-ConfigDedicated-DEFAULT ::= CHOICE {			
setup SEQUENCE {			
srs-Bandwidth	bw3	bw3 used to ensure that the bandwidth is constantly 4 RBs irrespective of channel bandwidth.	
srs-HoppingBandwidth	hbw3	This is selected so that hopping is disabled	FDD
	hbw0	This is selected so that hopping is enabled	TDD
freqDomainPosition	0		
Duration	TRUE	Indefinite duration	
srs-ConfigIndex	7	SRS periodicity of 10ms, Toffset=0.	FDD
	0	SRS periodicity of 2ms, Ksrs=0,1, this is two symbols UpPTS in first half subframe.	TDD
transmissionComb	0		
cyclicShift	cs0	No cyclic shift	
}			
}			

Table 6.3.4.2.2.4.3-5: TDD-Config-DEFAULT: SRS time mask measurement

Derivation Path: 36.508 331 clause 65.3.21 Table 5.3.1-1 (<i>SystemInformationBlockType1</i>)			
Information Element	Value/remark	Comment	Condition
TDD-Config-DEFAULT ::= SEQUENCE {			
subframeAssignment	sa1		
specialSubframePatterns	ssp5	To enable two symbol UpPTS, and to have 9 symbols GP.	
}			

Table 6.3.4.2.2.4.3-6: PhysicalConfigDedicated

Derivation Path: TS 36.508 [7] clause 5.5.1.2, Table 5.5.1.2.1 PhysicalConfigDedicated-DEFAULT			
Information Element	Value/remark	Comment	Condition
PhysicalConfigDedicated-DEFAULT ::= SEQUENCE {			
uplinkPowerControlDedicated	UplinkPowerControlDedicated-DEFAULT	See subclause 4.6.3	SRB1
	UplinkPowerControlDedicated-DEFAULT	See subclause 4.6.3	RBC

Table 6.3.4.2.2.4.3-7: UplinkPowerControlDedicated

Derivation Path: TS 36.508 [7] clause 4.6.3, Table 4.6.3-26 UplinkPowerControlDedicated-DEFAULT			
Information Element	Value/remark	Comment	Condition
UplinkPowerControlDedicated-DEFAULT ::= SEQUENCE {			
p0-UE-PUSCH	1		SRB1
	0		RBC
}			

Condition	Explanation
FDD	FDD cell environment
TDD	TDD cell environment

6.3.4.2.2.5 Test requirement

The requirement for the power measured in steps (1), (2) and (3) of the test procedure shall not exceed the values specified in Table 6.3.4.2.2.5-1.

Table 6.3.4.2.2.5-1: SRS time mask

	Channel bandwidth / Output Power [dBm] / measurement bandwidth					
	1.4 MHz	3.0 MHz	5 MHz	10 MHz	15 MHz	20 MHz
Transmit OFF power	For carrier frequency $f \leq 3.0\text{GHz}$: $\leq -48.5\text{ dBm}$ For carrier frequency $3.0\text{GHz} < f \leq 4.2\text{GHz}$: $\leq -48.2\text{ dBm}$					
Transmission OFF Measurement bandwidth	1.08 MHz	2.7 MHz	4.5 MHz	9.0 MHz	13.5 MHz	18 MHz
Expected SRS Transmission ON Measured power	-2.6 dBm	-2.6 dBm	-2.6 dBm	-2.6 dBm	-2.6 dBm	-2.6 dBm
ON power tolerance $f \leq 3.0\text{GHz}$ $3.0\text{GHz} < f \leq 4.2\text{GHz}$	$\pm 7.5\text{dB}$ $\pm 7.8\text{dB}$	$\pm 7.5\text{dB}$ $\pm 7.8\text{dB}$	$\pm 7.5\text{dB}$ $\pm 7.8\text{dB}$	$\pm 7.5\text{dB}$ $\pm 7.8\text{dB}$	$\pm 7.5\text{dB}$ $\pm 7.8\text{dB}$	$\pm 7.5\text{dB}$ $\pm 7.8\text{dB}$

6.3.4A ON/OFF time mask for CA

6.3.4A.1 General ON/OFF time mask for CA

6.3.4A.1.1 General ON/OFF time mask for CA (intra-band contiguous DL CA and UL CA)

6.3.4A.1.1.1 Test purpose

To verify that the general ON/OFF time mask for CA meets the requirements given in 6.3.4A.1.1.5.

The time mask for transmit ON/OFF for CA defines the ramping time allowed for the UE between transmit OFF power and transmit ON power for CA.

Transmission of the wrong power increases interference to other channels, or increases transmission errors in the uplink channel.

6.3.4A.1.1.2 Test applicability

This test case applies to all types of E-UTRA UE release 10 and forward that support intra-band contiguous DL CA and UL CA.

6.3.4A.1.1.3 Minimum conformance requirements

For intra-band contiguous carrier aggregation, the general output power ON/OFF time mask specified in subclause 6.3.4.1.3 is applicable for each component carrier during the ON power period and transient period. The OFF period as specified in subclause 6.3.4.1.3 shall only be applicable for each component carrier when all the component carriers are OFF.

The normative reference for this requirement is TS 36.101[2] clause 6.3.4A.

6.3.4A.1.1.4 Test description

6.3.4A.1.1.4.1 Initial conditions

Initial conditions are a set of test configurations the UE needs to be tested in and the steps for the SS to take with the UE to reach the correct measurement state.

The initial test configurations consist of environmental conditions, test frequencies, and CC combinations based on E-UTRA CA configurations specified in table 5.4.2A.1-1. All of these configurations shall be tested with applicable test parameters for each CA Configuration, and are shown in table 6.3.4A.1.1.4.1-1. The details of the uplink and downlink reference measurement channels (RMCs) are specified in Annex A.2 and A.3. Configurations of PDSCH and PDCCH before measurement are specified in Annex C.2.

Table 6.3.4A.1.1.4.1-1: Test Configuration Table

Initial Conditions									
Test Environment as specified in TS 36.508 [7] clause 4.1				NC, TL/VL, TL/VH, TH/VL, TH/VH					
Test Frequencies as specified in TS 36.508 [7] clause 4.3.1 for different CA bandwidth classes.				C: Low range, High range					
Test CC Combination setting (N_{RB_agg}) as specified in clause 5.4.2A.1 for the CA Configuration across bandwidth combination sets supported by the UE.				Lowest N_{RB_agg} Highest N_{RB_agg}					
Test Parameters for CA Configurations									
CA Configuration / N_{RB_agg}		DL Allocation		UL Allocation					
PCC N_{RB}	SCCs N_{RB}	PCC & SCC RB allocation		CC MOD	N_{RB_alloc}	PCC & SCC RB allocations (L_{CRB} @ RB_{start})			
75	75	N/A for this test		QPSK	150	P_75@0	S_75@0	-	-
100	50			QPSK	150	P_100@0	S_50@0	-	-
100	100			QPSK	200	P_100@0	S_100@0	-	-
Note 1: CA Configuration Test CC Combination settings are checked separately for each CA Configuration, which applicable aggregated channel bandwidths are specified in Table 5.4.2A.1-1									

1. Connect the SS to the UE antenna connectors as shown in TS 36.508[7] Annex A Figure group A.32 as appropriate.
2. The parameter settings for the cell are set up according to TS 36.508 [7] clause 4.4.3.
3. Downlink signals for PCC are initially set up according to Annex C.0, C.1, and C.3.0, and uplink signals according to Annex H.1 and H.3.0.
4. The UL Reference Measurement channel is set according to Table 6.3.4A.1.1.4.1-1.
5. Propagation conditions are set according to Annex B.0.
6. Ensure the UE is in State 3A-RF according to TS 36.508 [7] clause 5.2A.2. Message contents are defined in clause 6.3.4A.1.1.4.3.

6.3.4A.1.1.4.2 Test procedure

1. Configure SCC according to Annex C.0, C.1 and Annex C.3.0 for all downlink physical channels except PHICH.
2. The SS shall configure SCC as per TS 36.508 [7] clause 5.2A.4. Message contents are defined in clause 6.5.1A 3.4A.1.1.4.3
3. SS activates SCC by sending the activation MAC-CE (Refer TS 36.321 [13], clauses 5.13, 6.1.3.8). Wait for at least 2 seconds (Refer TS 36.133, clauses 8.3.3.2).
4. SS sends uplink scheduling information for each UL HARQ process via PDCCH DCI format 0 for C_RNTI to schedule the UL RMC according to Table 6.2.2A.4.1-1 on both PCC and SCC. Since the UE has no payload and no loopback data to send the UE sends uplink MAC padding bits on the UL RMC. The each UL assignment is such that the UE transmits on UL sub-frame 2 of every radio frame.
5. For FDD: Measure the UE transmission OFF power for each component carrier during the sub-frame prior to the PUSCH subframe. For TDD: Measure the UE transmission OFF power during the 10 SCFDMA symbols prior to the PUSCH subframe.
6. Measure the output power of the UE PUSCH transmission for each component carrier during one sub-frame, excluding a transient period of 20 μ s at the beginning of the subframe.
7. Measure the UE transmission OFF power for each component carrier during one sub-frame following the PUSCH subframe, excluding a transient period of 20 μ s at the beginning of the subframe.

6.3.4A.1.1.4.3 Message contents

Message contents are according to TS 36.508 [7] clause 4.6 with the following exceptions:

Table 6.3.4A.1.1.4.3-1: UplinkPowerControlCommon: Test point 1

Derivation Path: TS 36.508 [7] clause 4.6.3, Table 4.6.3-25 UplinkPowerControlCommon-DEFAULT			
Information Element	Value/remark	Comment	Condition
UplinkPowerControlCommon-DEFAULT ::= SEQUENCE { p0-NominalPUSCH	-105	Test point 1 to verify a UE relative low initial power transmission for PCC	

Table 6.3.4A.1.1.4.3-2: PhysicalConfigDedicated

Derivation Path: TS 36.508 [7] clause 5.5.1.2, Table 5.5.1.2.1 PhysicalConfigDedicated-DEFAULT			
Information Element	Value/remark	Comment	Condition
PhysicalConfigDedicated-DEFAULT ::= SEQUENCE { UplinkPowerControlDedicated	UplinkPowerControlDedicated-DEFAULT	See subclause 4.6.3	RBC
	UplinkPowerControlDedicated-DEFAULT	See subclause 4.6.3	UL CA

Table 6.3.4A.1.1.4.3-3: UplinkPowerControlDedicated

Derivation Path: TS 36.508 [7] clause 4.6.3, Table 4.6.3-26 UplinkPowerControlDedicated-DEFAULT			
Information Element	Value/remark	Comment	Condition
UplinkPowerControlDedicated-DEFAULT ::= SEQUENCE { p0-UE-PUSCH	1		RBC
	0		UL CA
}			

Table 6.3.4A.1.1.4.3-4: UplinkPowerControlCommonSCell-r10: Test point 1

Derivation Path: TS 36.508 [7] clause 4.6.3, Table 4.6.3-25A UplinkPowerControlCommonSCell-r10-DEFAULT			
Information Element	Value/remark	Comment	Condition
UplinkPowerControlCommonSCell-r10 ::= SEQUENCE {			
p0-NominalPUSCH-r10	-105	Test point 1 to verify a UE relative low initial power transmission for SCC	

6.3.4A.1.1.5 Test requirement

The requirement for the power measured in steps 5, 6 and 7 of the test procedure shall not exceed the values specified in Table 6.3.4.1.5-1.6.3.4B ON/OFF time mask for UL-MIMO

6.3.4B ON/OFF time mask for UL-MIMO

6.3.4B.1 General ON/OFF time mask for UL-MIMO

Editor's note: The measurement period in the minimum requirement is defined to be 1 subframe (14 symbols). Due to practical reasons the TDD measurement period for off power prior the PUSCH is 10 symbols. It is FFS, if this deviation is acceptable.

Editor's notes: The following items are missing or incomplete:

- The initial conditions and test procedure are subject to further investigation

6.3.4B.1.1 Test purpose

To verify that the general ON/OFF time mask for UL-MIMO meets the requirements given in 6.3.4B.1.5.

The time mask for transmit ON/OFF defines the ramping time allowed for each transmit antenna of UE between transmit OFF power and transmit ON power.

Transmission of the wrong power increases interference to other channels, or increases transmission errors in the uplink channel.

6.3.4B.1.2 Test applicability

This test applies to all types of E-UTRA UE release 10 and forward that support UL-MIMO

6.3.4B.1.3 Minimum conformance requirement

For UE with multiple transmit antenna connectors, the ON/OFF time mask requirements in subclause 6.3.4.1.3 apply to each transmit antenna connector.

For UE with two transmit antenna connectors in closed-loop spatial multiplexing scheme, the general ON/OFF time mask requirements specified in subclause 6.3.4.1.3 apply to each transmit antenna connector with the UL-MIMO configurations specified in Table 6.2.2B.3-2.

The normative reference for this requirement is TS 36.101 [2] clause 6.3.4B

6.3.4B.1.4 Test description

6.3.4B.1.4.1 Initial conditions

Initial conditions are a set of test configurations the UE needs to be tested in and the steps for the SS to take with the UE to reach the correct measurement state.

The initial test configurations consist of environmental conditions, test frequencies, and channel bandwidths based on E-UTRA operating bands specified in table 5.4.2.1-1. All of these configurations shall be tested with applicable test parameters for each channel bandwidth, and are shown in table 6.3.4B.1.4.1-1. The details of the uplink reference measurement channels (RMCs) are specified in Annexes A.2. Configurations of PDSCH and PDCCH before measurement are specified in Annex C.2

Table 6.3.4B.1.4.1-1: Test Configuration Table

Initial Conditions				
Test Environment as specified in TS 36.508[7] subclause 4.1		Normal, TL/VL, TL/VH, TH/VL, TH/VH		
Test Frequencies as specified in TS36.508 [7] subclause 4.3.1		Low range, Mid range, High range		
Test Channel Bandwidths as specified in TS 36.508 [7] subclause 4.3.1		Lowest, 5MHz, Highest		
Test Parameters for Channel Bandwidths				
	Downlink Configuration	Uplink Configuration		
Ch BW	N/A for General On/Off Time Mask test case	Mod'n	RB allocation	
			FDD	TDD
1.4MHz		QPSK	6	6
3MHz		QPSK	15	15
5MHz		QPSK	25	25
10MHz		QPSK	50	50
15MHz		QPSK	75	75
20MHz		QPSK	100	100
Note 1: Test Channel Bandwidths are checked separately for each E-UTRA band, the applicable channel bandwidths are specified in Table 5.4.2.1-1.				

1. Connect the SS to the UE antenna connectors as shown in TS 36.508 [7] Annex A, Figure A.28.
2. The parameter settings for the cell are set up according to TS 36.508 [7] subclause 4.4.3.
3. Downlink signals are initially set up according to Annex C.0, C.1 and C.3.0, and uplink signals according to Annex H.1 and H.3.0.
4. The UL and DL Reference Measurement channels are set according to Table 6.3.4B.1.4.1-1.
5. Propagation conditions are set according to Annex B.0.
6. Ensure the UE is in State 3A-RF according to TS 36.508 [7] clause 5.2A.2. Message contents are defined in clause 6.3.4B.1.4.3. Note that PDCCH DCI format 4 sent after resetting uplink power with RRC Connection Reconfiguration, should have TPC command 0dB.

6.3.4B.1.4.2 Test procedure

1. SS sends uplink scheduling information via PDCCH with DCI format 4 and TPC command 0dB for C_RNTI to schedule the UL RMC according to Table 6.3.4B.1.4.1-1. Since the UE has no payload and no loopback data to send the UE sends uplink MAC padding bits on the UL RMC. The UL assignment is such that the UE transmits on UL sub-frame 2 of every radio frame.
2. For FDD: Measure the UE transmission OFF power during the sub-frame prior to the PUSCH subframe. For TDD: Measure the UE transmission OFF power during the 10 SCFDMA symbols prior to the PUSCH subframe.
3. Measure the output power of the UE PUSCH transmission during one sub-frame, excluding a transient period of 20 μ s at the beginning of the subframe.
4. Measure the UE transmission OFF power during one sub-frame following the PUSCH subframe, excluding a transient period of 20 μ s at the beginning of the subframe.
5. Repeat step 2) until 4) for each of transmit antenna of the UE.

6.3.4B.1.4.3 Message contents

Message contents are according to TS 36.508 [7] clause 4.6 with the following exceptions:

Table 6.3.4B.1.4.3-1: UplinkPowerControlCommon: Test point 1

Derivation Path: TS 36.508 [7] clause 4.6.3, Table 4.6.3-25 UplinkPowerControlCommon-DEFAULT			
Information Element	Value/remark	Comment	Condition
UplinkPowerControlCommon-DEFAULT ::= SEQUENCE { p0-NominalPUSCH	-105	Test point 1 to verify a UE relative low initial power transmission	

Table 6.3.4B.1.4.3-2: PhysicalConfigDedicated

Derivation Path: TS 36.508 [7] clause 5.5.1.2, Table 5.5.1.2.1 PhysicalConfigDedicated-DEFAULT			
Information Element	Value/remark	Comment	Condition
PhysicalConfigDedicated-DEFAULT ::= SEQUENCE {			
UplinkPowerControlDedicated	UplinkPowerControlDedicated-DEFAULT	See clause 4.6.3	SRB1
	UplinkPowerControlDedicated-DEFAULT	See clause 4.6.3	RBC

Table 6.3.4B.1.4.3-3: UplinkPowerControlDedicated

Derivation Path: TS 36.508 [7] clause 4.6.3, Table 4.6.3-26 UplinkPowerControlDedicated-DEFAULT			
Information Element	Value/remark	Comment	Condition
UplinkPowerControlDedicated-DEFAULT ::= SEQUENCE {			
p0-UE-PUSCH	1		SRB1
	0		RBC
}			

Table 6.3.4B.1.3-4: TDD-Config-DEFAULT: On/OFF time mask measurement

Derivation Path: 36.508 clause 5.3.1 Table 5.3.1-1 (<i>SystemInformationBlockType1</i>)			
Information Element	Value/remark	Comment	Condition
TDD-Config-DEFAULT ::= SEQUENCE {			
subframeAssignment	sa1		
specialSubframePatterns	ssp5	To enable two symbol UpPTS, and to have 9 symbols GP.	
}			

6.3.4B.1.5 Test requirement

The requirement for the power measured in steps (2), (3) and (4) of the test procedure shall not exceed the values specified in Table 6.3.4B.1.5-1.

Table 6.3.4B.1.5-1: General ON/OFF time mask

	Channel bandwidth / minimum output power / measurement bandwidth					
	1.4 MHz	3.0 MHz	5 MHz	10 MHz	15 MHz	20 MHz
Transmit OFF power	For carrier frequency $f \leq 3.0\text{GHz}$: ≤ -48.5 dBm For carrier frequency $3.0\text{GHz} < f \leq 4.2\text{GHz}$: ≤ -48.2 dBm					
Transmission OFF Measurement bandwidth	1.08 MHz	2.7 MHz	4.5 MHz	9.0 MHz	13.5 MHz	18 MHz
Expected Transmission ON Measured power	-14.8 dBm	-10.8 dBm	-8.6 dBm	-5.6 dBm	-3.9 dBm	-2.6 dBm
ON power tolerance $f \leq 3.0\text{GHz}$ $3.0\text{GHz} < f \leq 4.2\text{GHz}$	7.5 dB $\pm 7.8\text{dB}$	7.5 dB $\pm 7.8\text{dB}$	7.5dB $\pm 7.8\text{dB}$	7.5dB $\pm 7.8\text{dB}$	7.5dB $\pm 7.8\text{dB}$	7.5dB $\pm 7.8\text{dB}$

6.3.5 Power Control

Power control is used to limit the interference level and compensate the channel fading. The UE power is defined as the mean power in a subframe or ON power duration, whichever is available.

The UE transmission can be in two contiguity modes, i.e. contiguous transmission and non-contiguous transmission. The former has a transmission gap of 0 and the later has a transmission gap larger than 0. The transmission gap is the time interval between the end of the last UE transmission subframe and the beginning of the next UE transmission subframe or the UpPTS (for TDD).

6.3.5.1 Power Control Absolute power tolerance

6.3.5.1.1 Test purpose

To verify the ability of the UE transmitter to set its initial output power to a specific value at the start of a contiguous transmission or non-contiguous transmission with a long transmission gap, i.e. transmission gap is larger than 20 ms.

6.3.5.1.2 Minimum conformance requirement

Absolute power tolerance is the ability of the UE transmitter to set its initial output power to a specific value for the first sub-frame at the start of a contiguous transmission or non-contiguous transmission with a transmission gap larger than 20ms.

The minimum requirement on absolute power tolerance is given in Table 6.3.5.1.2-1 over the power range bounded by the Maximum output power as defined in sub-clause 6.2.2 and the Minimum output power as defined in sub clause 6.3.2.

For operating bands under Note 2 in Table 6.2.2.3-1, the absolute power tolerance as specified in Table 6.3.5.1.2-1 is relaxed by reducing the lower limit by 1.5 dB when the transmission bandwidth is confined within F_{UL_low} and $F_{UL_low} + 4$ MHz or $F_{UL_high} - 4$ MHz and F_{UL_high} .

Table 6.3.5.1.2-1: Absolute power tolerance

Conditions	Tolerance
Normal conditions	± 9.0 dB
Extreme conditions	± 12.0 dB

The normative reference for this requirement is TS 36.101 [2] clause 6.3.5.1.1.

6.3.5.1.3 Test applicability

This test applies to all types of E-UTRA UE release 8 and forward.

6.3.5.1.4 Test description

6.3.5.1.4.1 Initial conditions

Initial conditions are a set of test configurations the UE needs to be tested in and the steps for the SS to take with the UE to reach the correct measurement state.

The initial test configurations consist of environmental conditions, test frequencies, and channel bandwidths based on E-UTRA operating bands specified in table 5.4.2.1-1. All of these configurations shall be tested with applicable test parameters for each channel bandwidth, and are shown in table 6.3.5.1.4.1-1. The details of the uplink reference measurement channel (RMCs) are specified in Annexes A.2. Configurations of PDSCH and PDCCH before measurement are specified in Annex C.2.

Table 6.3.5.1.4.1-1: Test Configuration Table

Initial Conditions					
Test Environment as specified in TS 36.508[7] subclause 4.1		Normal, TL/VL, TL/VH, TH/VL, TH/VH			
Test Frequencies as specified in TS36.508 [7] subclause 4.3.1		Mid range			
Test Channel Bandwidths as specified in TS 36.508 [7] subclause 4.3.1		Lowest, 5MHz, Highest			
Test Parameters for Channel Bandwidths					
	Downlink Configuration		Uplink Configuration		
Ch BW	N/A for Power Control Absolute power tolerance test case		Mod'n	RB allocation	
				FDD	TDD
1.4MHz			QPSK	6	6
3MHz			QPSK	15	15
5MHz			QPSK	25	25
10MHz			QPSK	50	50
15MHz			QPSK	75	75
20MHz			QPSK	100	100
Note 1: Test Channel Bandwidths are checked separately for each E-UTRA band, the applicable channel bandwidths are specified in Table 5.4.2.1-1.					

1. Connect the SS to the UE antenna connectors as shown in TS 36.508 [7] Annex A, Figure A.3.
2. The parameter settings for the cell are set up according to TS 36.508 [7] subclause 4.4.3.
3. Downlink signals are initially set up according to Annex C.0, C.1 and C.3.0, and uplink signals according to Annex H.1 and H.3.0.
4. The UL Reference Measurement channel is set according to Table 6.3.5.1.4.1-1.
5. Ensure the UE is in State 3A-RF according to TS 36.508 [7] clause 5.2A.2. Message contents are defined in clause 6.3.5.1.4.3. Note that PDCCH DCI format 0 sent after resetting uplink power with RRC Connection Reconfiguration, should have TPC command 0dB.

6.3.5.1.4.2 Test procedure

1. SS sends uplink scheduling information via PDCCH DCI format 0 with TPC command 0dB for C_RNTI to schedule the UL RMC according to Table 6.3.5.1.4.1-1. Since the UE has no payload and no loopback data to send the UE sends uplink MAC padding bits on the UL RMC.
2. Measure the initial output power of the first subframe of UE PUSCH first transmission. The transient periods of 20us are excluded.
3. Repeat for the two test points as indicated in section 6.3.5.1.4.3. The timing of the execution between the two test points shall be larger than 20ms.

6.3.5.1.4.3 Message contents

Message contents are according to TS 36.508 [7] subclause 4.6 with the following exceptions:

Table 6.3.5.1.4.3-1: UplinkPowerControlCommon: Test point 1

Derivation Path: TS 36.508 [7] clause 4.6.3, Table 4.6.3-25 UplinkPowerControlCommon-DEFAULT			
Information Element	Value/remark	Comment	Condition
UplinkPowerControlCommon-DEFAULT ::= SEQUENCE { p0-NominalPUSCH	-105	Test point 1 to verify a UE relative low initial power transmission	

Table 6.3.5.1.4.3-2: UplinkPowerControlCommon: Test point 2

Derivation Path: TS 36.508 [7] clause 4.6.3, Table 4.6.3-25 UplinkPowerControlCommon-DEFAULT			
Information Element	Value/remark	Comment	Condition
UplinkPowerControlCommon-DEFAULT ::= SEQUENCE { p0-NominalPUSCH	-93	Test point 2 to verify a UE relative high initial power transmission	

Table 6.3.5.1.4.3-3: PhysicalConfigDedicated

Derivation Path: TS 36.508 [7] clause 5.5.1.2, Table 5.5.1.2.1 PhysicalConfigDedicated-DEFAULT			
Information Element	Value/remark	Comment	Condition
PhysicalConfigDedicated-DEFAULT ::= SEQUENCE {			
uplinkPowerControlDedicated	UplinkPowerControlDedicated-DEFAULT	See subclause 4.6.3	SRB1
	UplinkPowerControlDedicated-DEFAULT	See subclause 4.6.3	RBC

Table 6.3.5.1.4.3-4: UplinkPowerControlDedicated

Derivation Path: TS 36.508 [7] clause 4.6.3, Table 4.6.3-26 UplinkPowerControlDedicated-DEFAULT			
Information Element	Value/remark	Comment	Condition
UplinkPowerControlDedicated-DEFAULT ::= SEQUENCE {			
p0-UE-PUSCH	1		SRB1
	0		RBC
}			

6.3.5.1.5 Test requirement

The requirement for the power measured in step (2) of the test procedure is not to exceed the values specified in Table 6.3.5.1.5-1 and 6.3.5.1.5-2.

Table 6.3.5.1.5-1: Absolute power tolerance: test point 1

	Channel bandwidth / expected output power (dBm)					
	1.4 MHz	3.0 MHz	5 MHz	10 MHz	15 MHz	20 MHz

Expected Measured power Normal conditions	-14.8 dBm	-10.8 dBm	-8.6 dBm	-5.6 dBm	-3.9 dBm	-2.6 dBm
Power tolerance $f \leq 3.0\text{GHz}$ $3.0\text{GHz} < f \leq 4.2\text{GHz}$	$\pm 10.0\text{dB}$ $\pm 10.4\text{dB}$	$\pm 10.0\text{dB}$ $\pm 10.4\text{dB}$	$\pm 10.0\text{dB}$ $\pm 10.4\text{dB}$	$\pm 10.0\text{dB}$ $\pm 10.4\text{dB}$	$\pm 10.0\text{dB}$ $\pm 10.4\text{dB}$	$\pm 10.0\text{dB}$ $\pm 10.4\text{dB}$
Expected Measured power Extreme conditions	-14.8 dBm	-10.8 dBm	-8.6 dBm	-5.6 dBm	-3.9 dBm	-2.6 dBm
Power tolerance $f \leq 3.0\text{GHz}$ $3.0\text{GHz} < f \leq 4.2\text{GHz}$	$\pm 13.0\text{dB}$ $\pm 13.4\text{dB}$	$\pm 13.0\text{dB}$ $\pm 13.4\text{dB}$	$\pm 13.0\text{dB}$ $\pm 13.4\text{dB}$	$\pm 13.0\text{dB}$ $\pm 13.4\text{dB}$	$\pm 13.0\text{dB}$ $\pm 13.4\text{dB}$	$\pm 13.0\text{dB}$ $\pm 13.4\text{dB}$
Note 1: The lower power limit shall not exceed the minimum output power requirements defined in sub-clause 6.3.2.3						

Table 6.3.5.1.5-2: Absolute power tolerance: test point 2

	Channel bandwidth / expected output power (dBm)					
	1.4 MHz	3.0 MHz	5 MHz	10 MHz	15 MHz	20 MHz
Expected Measured power Normal conditions	-2.8 dBm	1.2 dBm	3.4 dBm	6.4 dBm	8.2 dBm	9.4 dBm
Power tolerance $f \leq 3.0\text{GHz}$ $3.0\text{GHz} < f \leq 4.2\text{GHz}$	$\pm 10.0\text{dB}$ $\pm 10.4\text{dB}$	$\pm 10.0\text{dB}$ $\pm 10.4\text{dB}$	$\pm 10.0\text{dB}$ $\pm 10.4\text{dB}$	$\pm 10.0\text{dB}$ $\pm 10.4\text{dB}$	$\pm 10.0\text{dB}$ $\pm 10.4\text{dB}$	$\pm 10.0\text{dB}$ $\pm 10.4\text{dB}$
Expected Measured power Extreme conditions	-2.8 dBm	1.2 dBm	3.4 dBm	6.4 dBm	8.2 dBm	9.4 dBm
Power tolerance $f \leq 3.0\text{GHz}$ $3.0\text{GHz} < f \leq 4.2\text{GHz}$	$\pm 13.0\text{dB}$ $\pm 13.4\text{dB}$	$\pm 13.0\text{dB}$ $\pm 13.4\text{dB}$	$\pm 13.0\text{dB}$ $\pm 13.4\text{dB}$	$\pm 13.0\text{dB}$ $\pm 13.4\text{dB}$	$\pm 13.0\text{dB}$ $\pm 13.4\text{dB}$	$\pm 13.0\text{dB}$ $\pm 13.4\text{dB}$
Note 1: The lower power limit shall not exceed the minimum output power requirements defined in sub-clause 6.3.2.3						

6.3.5.2 Power Control Relative power tolerance

6.3.5.2.1 Test purpose

To verify the ability of the UE transmitter to set its output power relatively to the power in a target sub-frame relatively to the power of the most recently transmitted reference sub-frame if the transmission gap between these sub-frames is ≤ 20 ms.

6.3.5.2.2 Test applicability

This test applies to all types of E-UTRA UE release 8 and forward.

6.3.5.2.3 Minimum conformance requirement

The UE shall meet the requirements specified in Table 6.3.5.2.3-1.

To account for RF Power amplifier mode changes 2 exceptions are allowed for each of two test patterns. The test patterns are a monotonically increasing power sweep and a monotonically decreasing power sweep over a range bounded by the requirements of minimum power and maximum power specified in clauses 6.3.2.3 and 6.2.2.3. For these exceptions the power tolerance limit is a maximum of ± 6.0 dB in Table 6.3.5.2.3-1.

Table 6.3.5.2.3-1 Relative Power Tolerance for Transmission (normal conditions)

Power step ΔP (Up or down) [dB]	All combinations of PUSCH and PUCCH transitions [dB]	All combinations of PUSCH/PUCCH and SRS transitions between sub- frames [dB]	PRACH [dB]
$\Delta P < 2$	± 2.5 (Note 3)	± 3.0	± 2.5
$2 \leq \Delta P < 3$	± 3.0	± 4.0	± 3.0
$3 \leq \Delta P < 4$	± 3.5	± 5.0	± 3.5
$4 \leq \Delta P \leq 10$	± 4.0	± 6.0	± 4.0
$10 \leq \Delta P < 15$	± 5.0	± 8.0	± 5.0
$15 \leq \Delta P$	± 6.0	± 9.0	± 6.0
<p>Note 1: For extreme conditions an additional ± 2.0 dB relaxation is allowed</p> <p>Note 2: For operating bands under Note 2 in Table 6.2.2.3-1, the relative power tolerance is relaxed by increasing the upper limit by 1.5 dB if the transmission bandwidth of the reference sub-frames is confined within F_{UL_low} and $F_{UL_low} + 4$ MHz or $F_{UL_high} - 4$ MHz and F_{UL_high} and the target sub-frame is not confined within any one of these frequency ranges; if the transmission bandwidth of the target sub-frame is confined within F_{UL_low} and $F_{UL_low} + 4$ MHz or $F_{UL_high} - 4$ MHz and F_{UL_high} and the reference sub-frame is not confined within any one of these frequency ranges, then the tolerance is relaxed by reducing the lower limit by 1.5 dB.</p> <p>Note 3: For PUSCH to PUSCH transitions with the allocated resource blocks fixed in frequency and no transmission gaps other than those generated by downlink subframes, DwPTS fields or Guard Periods for TDD: for a power step $\Delta P \leq 1$ dB, the relative power tolerance for transmission is ± 1.0 dB.</p>			

The power step (ΔP) is defined as the difference in the calculated setting of the UE Transmit power between the target and reference sub-frames with the power setting according to Clause 5.1 of TS 36.213. The error is the difference between ΔP and the power change measured at the UE antenna port with the power of the cell-specific reference signals kept constant. The error shall be less than the relative power tolerance specified in Table 6.3.5.2.3-1.

The normative reference for this requirement is TS 36.101 clause 6.3.5.2.

6.3.5.2.4 Test description

6.3.5.2.4.1 Initial conditions

Initial conditions are a set of test configurations the UE needs to be tested in and the steps for the SS to take with the UE to reach the correct measurement state.

The initial test configurations consist of environmental conditions, test frequencies, and channel bandwidths based on E-UTRA operating bands specified in table 5.4.2.1-1. All of these configurations shall be tested with applicable test parameters for each channel bandwidth, and are shown in table 6.3.5.2.4.1-1. The details of the uplink reference measurement channels (RMCs) are specified in Annexes A.2. Configurations of PDSCH and PDCCH before measurement are specified in Annex C.2.

Table 6.3.5.2.4.1-1: Test Configuration Table

Initial Conditions	
Test Environment as specified in TS 36.508[7] subclause 4.1	Normal, TL/VL, TL/VH, TH/VL, TH/VH
Test Frequencies as specified in TS36.508 [7] subclause 4.3.1	Low range
Test Channel Bandwidths as specified in TS 36.508 [7] subclause 4.3.1	Lowest, 5MHz, Highest
Test Parameters for Channel Bandwidths	
	Downlink Configuration Uplink Configuration

Ch BW	N/A for Power Control Relative power tolerance test case	Mod'n	RB allocation	
			FDD	TDD
1.4MHz		QPSK	See table 6.3.5.2.5-1 6.3.5.2.5-2 6.3.5.2.5-13	See table 6.3.5.2.5-1 6.3.5.2.5-2 6.3.5.2.5-13
3MHz		QPSK	See table 6.3.5.2.5-3 6.3.5.2.5-4 6.3.5.2.5-13	See table 6.3.5.2.5-3 6.3.5.2.5-4 6.3.5.2.5-13
5MHz		QPSK	See table 6.3.5.2.5-5 6.3.5.2.5-6 6.3.5.2.5-13	See table 6.3.5.2.5-5 6.3.5.2.5-6 6.3.5.2.5-13
10MHz		QPSK	See table 6.3.5.2.5-7 6.3.5.2.5-8 6.3.5.2.5-13	See table 6.3.5.2.5-7 6.3.5.2.5-8 6.3.5.2.5-13
15MHz		QPSK	See table 6.3.5.2.5-9 6.3.5.2.5-10 6.3.5.2.5-13	See table 6.3.5.2.5-9 6.3.5.2.5-10 6.3.5.2.5-13
20MHz		QPSK	See table 6.3.5.2.5-11 6.3.5.2.5-12 6.3.5.2.5-13	See table 6.3.5.2.5-11 6.3.5.2.5-12 6.3.5.2.5-13
Note 1: Test Channel Bandwidths are checked separately for each E-UTRA band, the applicable channel bandwidths are specified in Table 5.4.2.1-1 Note 2: The starting resource block shall be RB# 0.				

1. Connect the SS to the UE antenna connectors as shown in TS 36.508 [7] Annex A, Figure A.3.
2. The parameter settings for the cell are set up according to TS 36.508 [7] subclause 4.4.3.
3. Downlink signals are initially set up according to Annex C.0, C.1 and C.3.0, and uplink signals according to Annex H.1 and H.3.0.
4. The UL Reference Measurement channel is set according to table 6.3.5.2.4.1-1
5. Propagation conditions are set according to Annex B.0.
6. Ensure the UE is in State 3A-RF according to TS 36.508 [7] clause 5.2A.2. Message contents are defined in clause 6.3.5.2.4.3.

6.3.5.2.4.2 Test procedure

The procedure is separated in various subtests to verify different aspects of relative power control. The power patterns of the subtests are described in figure 6.3.5.2.4.2-1.

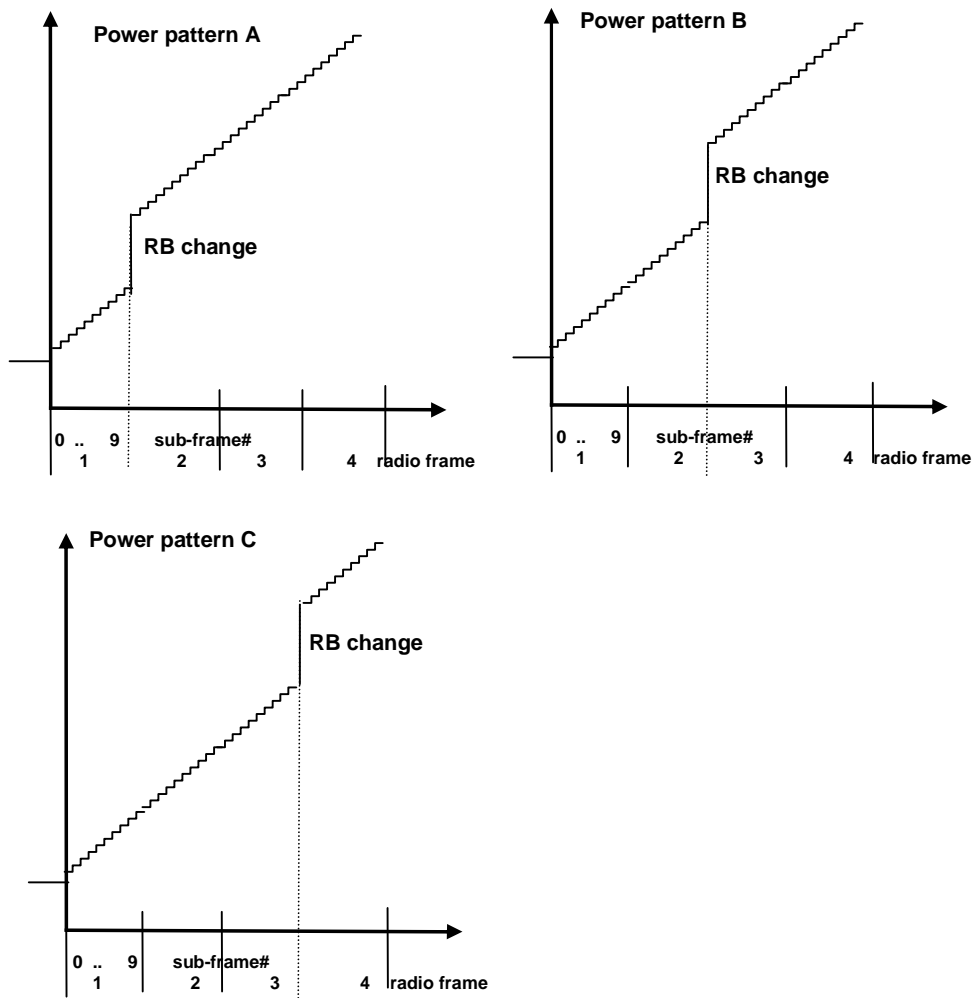

Figure 6.3.5.2.4.2-1: FDD ramping up test power patterns

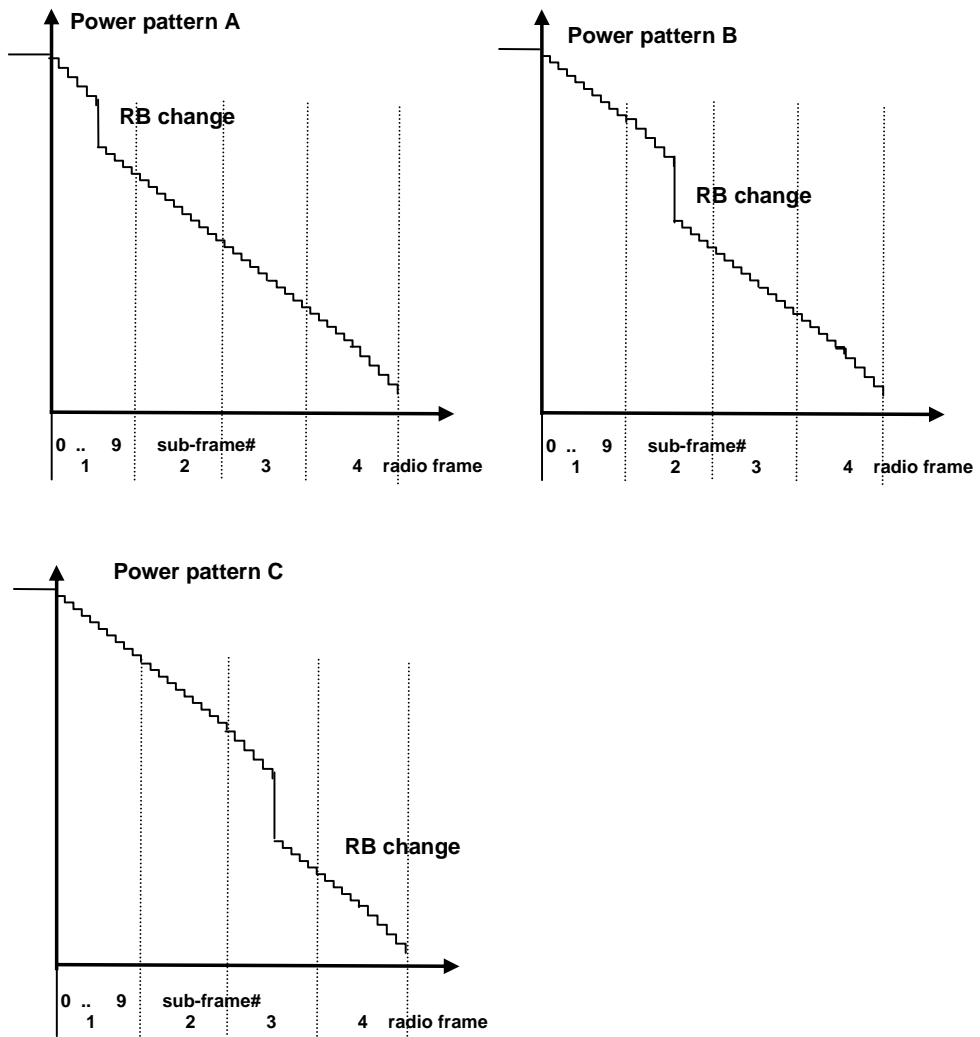

Figure 6.3.5.2.4.2-2: FDD ramping down test power patterns

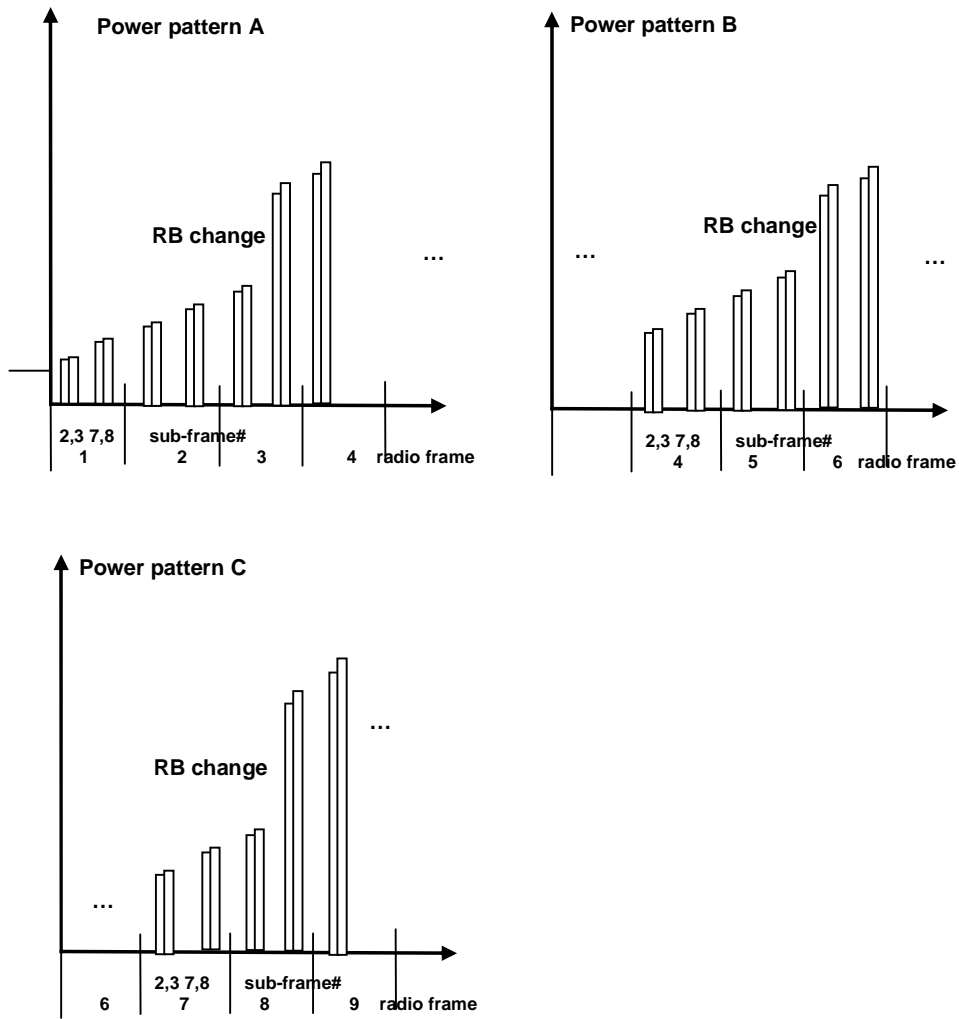

Figure 6.3.5.2.4.2-3: TDD ramping up test power patterns

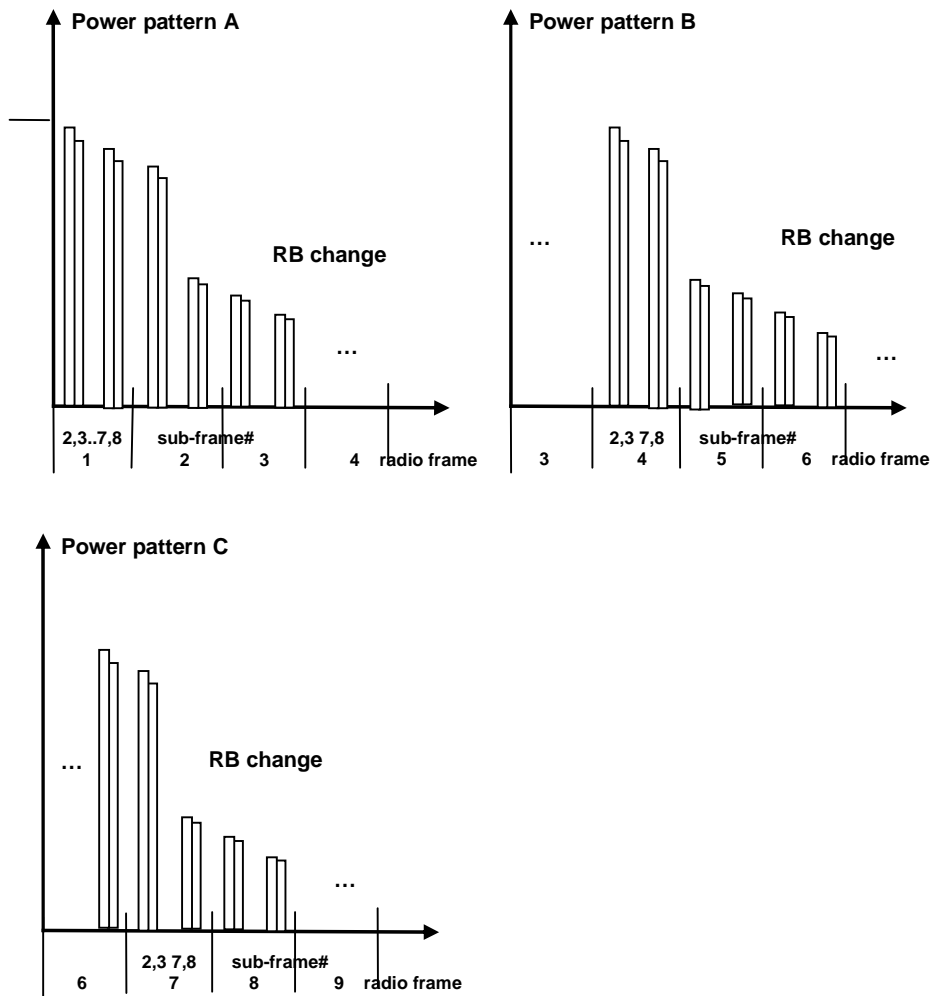

Figure 6.3.5.2.4.2-4: TDD ramping down test power patterns

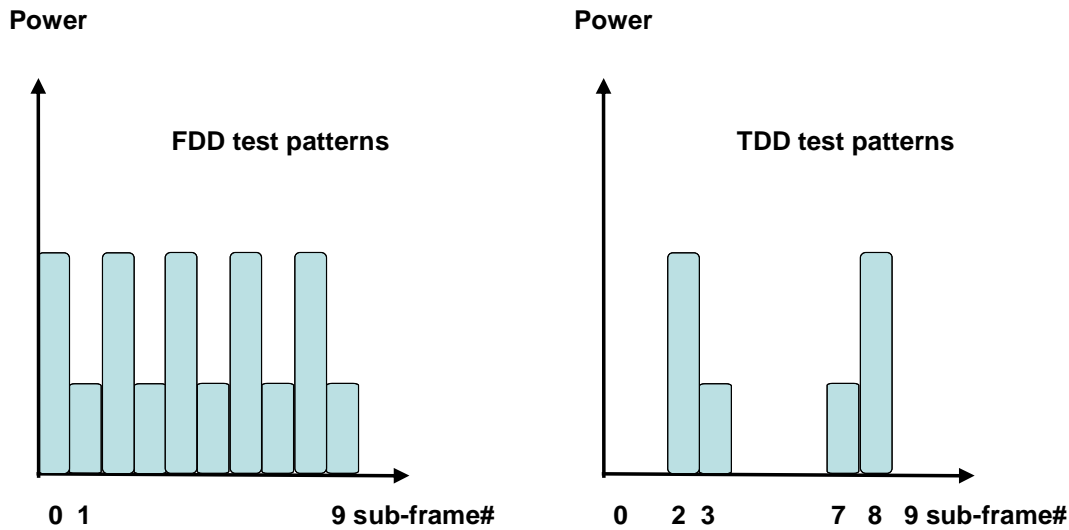

Figure 6.3.5.2.4.2-5: Alternating Test Power patterns

1. Sub test: ramping up pattern

- 1.1. SS sends uplink scheduling information for each UL HARQ process via PDCCH DCI format 0 for C_RNTI to schedule the PUSCH. Since the UE has no payload and no loopback data to send the UE sends uplink MAC padding bits on the UL RMC. Send the appropriate TPC commands for PUSCH to the UE to ensure that the UE transmits PUSCH at $-36.8\text{dBm} \pm 3.2\text{ dB}$ for carrier frequency $f \leq 3.0\text{GHz}$ or at $-36.5\text{dBm} \pm 3.5\text{ dB}$ for carrier frequency $3.0\text{GHz} < f \leq 4.2\text{GHz}$.
- 1.2. Schedule the UE's PUSCH data transmission as described in Figure 6.3.5.2.4.2-1 (FDD pattern A: sub-test is divided in 4 arbitrary radio frames with 10 active uplink sub-frames per radio frame) and Figure 6.3.5.2.4.2-3 (TDD pattern A: sub-test is divided in 10 arbitrary radio frames with 4 active uplink sub-frames per radio frame) with an uplink RB allocation as defined in tables 6.3.5.2.5-1 thru 6.3.5.2.5-12 depending on channel bandwidth. On the PDCCH format 0 for the scheduling of the PUSCH the SS will transmit a +1dB TPC command. Note that the measurement need not be done continuously, provided that interruptions are whole numbers of frames, and TPC commands of 0dB are sent during the interruption.
- 1.3. Measure the power of PUSCH transmissions to verify the UE relative power control meet test requirements 6.3.5.2.5. For power transients between subframes, transient periods of 40us between subframes are excluded. For ON/OFF or OFF/OFF transients, transient periods of 20 us at the beginning of the subframe are excluded.
- 1.4. Repeat the subtest different pattern B, C to move the RB allocation change at different points in the pattern as described in Table 6.3.5.2.5-1 thru Table 6.3.5.2.5-12 to force bigger UE power steps at various points in the power range.

2. Sub test: ramping down pattern

- 2.1. SS sends uplink scheduling information for each UL HARQ process via PDCCH DCI format 0 for C_RNTI to schedule the PUSCH. Since the UE has no payload and no loopback data to send the UE sends uplink MAC padding bits on the UL RMC. Send the appropriate TPC commands for PUSCH to the UE to ensure that the UE transmits PUSCH at $+18.0\text{dBm} \pm 3.2\text{ dB}$ for carrier frequency $f \leq 3.0\text{GHz}$ or at $+17.7\text{dBm} \pm 3.5\text{ dB}$ for carrier frequency $3.0\text{GHz} < f \leq 4.2\text{GHz}$.
- 2.2. Schedule the UE's PUSCH data transmission as described in Figure 6.3.5.2.4.2-2 (FDD pattern A: sub-test is divided in 4 arbitrary radio frames with 10 active uplink sub-frames per radio frame) and Figure 6.3.5.2.4.2-4 (TDD pattern A: sub-test is divided in 10 arbitrary radio frames with 4 active uplink sub-frames per radio frame) with an uplink RB allocation as defined in tables 6.3.5.2.5-1 thru 6.3.5.2.5-12 depending on channel bandwidth. On the PDCCH format 0 for the scheduling of the PUSCH the SS will transmit a -1dB TPC command. Note that the measurement need not be done continuously, provided that interruptions are whole numbers of frames, and TPC commands of 0dB are sent during the interruption.

- 2.3. Measure the power of PUSCH transmissions to verify the UE relative power control meet test requirements 6.3.5.2.5. For power transients between subframes, transient periods of 40us between subframes are excluded. For ON/OFF or OFF/OFF transients, transient periods of 20 us at the beginning of the subframe are excluded.
- 2.4. Repeat the subtest different pattern B, C to move the RB allocation change at different points in the pattern as described in Table 6.3.5.2.5-1 thru Table 6.3.5.2.5-12 to force bigger UE power steps at various points in the power range.
3. Sub test: alternating pattern
- 3.1 SS sends uplink scheduling information for each UL HARQ process via PDCCH DCI format 0 for C_RNTI to schedule the PUSCH. Since the UE has no payload and no loopback data to send the UE sends uplink MAC padding bits on the UL RMC. Send the appropriate TPC commands for PUSCH to the UE to ensure that the UE transmits PUSCH at -10dBm +/- 3.2 dB for carrier frequency $f \leq 3.0\text{GHz}$ or at -10dBm +/- 3.5 dB for carrier frequency $3.0\text{GHz} < f \leq 4.2\text{GHz}$. The initial uplink RB allocation is defined as the smaller uplink RB allocation value specified in tables 6.3.5.2.5-13. The power level and RB allocation are reset for each sub-test.
- 3.2. Schedule the UE's PUSCH data transmission as described in Figure 6.3.5.2.4.2-5for 10 sub-frames with an uplink RB allocation alternating pattern as defined in table 6.3.5.2.5-13 while transmitting 0dB TPC command for PUSCH via the PDCCH.
- 3.3. Measure the power of PUSCH transmissions to verify the UE relative power control meet test requirements specified in clause 6.3.5.2.5. For power transients between subframes, transient periods of 40us between subframes are excluded. For ON/OFF or OFF/OFF transients, transient periods of 20 us at the beginning of the subframe are excluded.

6.3.5.2.4.3 Message contents

Message contents are according to TS 36.508 [7] subclause 4.6.

6.3.5.2.5 Test requirement

Each UE power step measured in the test procedure 6.3.5.2.4.2 should satisfy the test requirements specified in Table 6.3.5.2.5-1, thru 6.3.5.2.5-13 for normal conditions; for extreme conditions an additional ± 2.0 dB relaxation is allowed.

To account for RF Power amplifier mode changes 2 exceptions are allowed for each of ramping up and ramping down test patterns. For these exceptions the power tolerance limit is a maximum of ± 6.7 dB. If there is an exception in the power step caused by the RB change for all test patterns (A, B, C) then fail the UE.

Table 6.3.5.2.5-1: Test Requirements Relative Power Tolerance for Transmission (normal conditions – Note 5) channel bandwidth 1.4MHz (ramping up)

Sub-test (ramp up)	Uplink RB allocation	TPC command	Expected power step size (Up) ΔP [dB]	Power step size range (Up) ΔP [dB]	PUSCH [dB]

Subframes before RB change	Fixed = 1	TPC=+1dB	1	$\Delta P < 2$	$1 \pm (1.7)$
RB change	Change from 1 to 6 RBs	TPC=+1dB	8.78	$4 \leq \Delta P < 10$	$8.78 \pm (4.7)$ Note 2 $8.78 +6.2/-4.7$ Note 3
Subframes after RB change	Fixed = 6	TPC=+1dB	1	$\Delta P < 2$	$1 \pm (1.7)$
<p>Note 1: Position of RB change: Pattern A the position of RB uplink allocation change is after 10 active uplink subframes Pattern B the position of RB uplink allocation change is after 20 active uplink subframes Pattern C the position of RB uplink allocation change is after 30 active uplink subframes</p> <p>Note 2: When Note 3 does not apply.</p> <p>Note 3: For operating bands under Note 2 in Table 6.2.2.3-1, if the transmission bandwidth of the reference sub-frames is confined within F_{UL_low} and $F_{UL_low} + 4$ MHz or $F_{UL_high} - 4$ MHz and F_{UL_high} and the target sub-frame is not confined within any one of these frequency ranges.</p> <p>Note 4: N/A</p> <p>Note 5: For extreme conditions an additional ± 2.0 dB relaxation is allowed.</p> <p>Note 6: The starting resource block shall be RB# 0.</p>					

Table 6.3.5.2.5-2: Test Requirements Relative Power Tolerance for Transmission (normal conditions – Note 5) channel bandwidth 1.4MHz (ramping down)

Sub-test (ramp down)	Uplink RB allocation	TPC command	Expected power step size (down) ΔP [dB]	Power step size range (down) ΔP [dB]	PUSCH [dB]
Subframes before RB change	Fixed = 5	TPC=-1dB	1	$\Delta P < 2$	$1 \pm (1.7)$
RB change	Change from 5 to 1 RBs	TPC=-1dB	7.99	$4 \leq \Delta P < 1$	$7.99 \pm (4.7)$ Note 2 $7.99 +4.7/-6.2$ Note 4
Subframes after RB change	Fixed = 1	TPC=-1dB	1	$\Delta P < 2$	$1 \pm (1.7)$
<p>Note 1: Position of RB change: Pattern A the position of RB uplink allocation change is after 6 active uplink subframes Pattern B the position of RB uplink allocation change is after 16 active uplink subframes Pattern C the position of RB uplink allocation change is after 26 active uplink subframes</p> <p>Note 2: When Note 4 does not apply.</p> <p>Note 3: N/A</p> <p>Note 4: For operating bands under Note 2 in Table 6.2.2.3-1, if the transmission bandwidth of the target sub-frame is confined within F_{UL_low} and $F_{UL_low} + 4$ MHz or $F_{UL_high} - 4$ MHz and F_{UL_high} and the reference sub-frame is not confined within any one of these frequency ranges.</p> <p>Note 5: For extreme conditions an additional ± 2.0 dB relaxation is allowed.</p> <p>Note 6: The starting resource block shall be RB# 0.</p>					

Table 6.3.5.2.5-3: Test Requirements Relative Power Tolerance for Transmission (normal conditions – Note 5) channel bandwidth 3MHz (ramping up)

Sub-test (ramp up)	Uplink RB allocation	TPC command	Expected power step size (Up) ΔP [dB]	Power step size range (Up) ΔP [dB]	PUSCH [dB]
Subframes before RB change	Fixed = 1	TPC=+1dB	1	$\Delta P < 2$	$1 \pm (1.7)$
RB change	Change from 1 to 4 RBs	TPC=+1dB	7.02	$4 \leq \Delta P < 10$	$7.02 \pm (4.7)$ Note 2 $7.02 +6.2/-4.7$ Note 3
Subframes after RB change	Fixed =4	TPC=+1dB	1	$\Delta P < 2$	$1 \pm (1.7)$
<p>Note 1: Position of RB change: Pattern A the position of RB uplink allocation change is after 10 active uplink subframes Pattern B the position of RB uplink allocation change is after 20 active uplink subframes Pattern C the position of RB uplink allocation change is after 30 active uplink subframes</p> <p>Note 2: When Note 3 does not apply.</p> <p>Note 3: For operating bands under Note 2 in Table 6.2.2.3-1, if the transmission bandwidth of the reference sub-frames is confined within F_{UL_low} and $F_{UL_low} + 4$ MHz or $F_{UL_high} - 4$ MHz and F_{UL_high} and the target sub-frame is not confined within any one of these frequency ranges.</p> <p>Note 4: N/A</p> <p>Note 5: For extreme conditions an additional ± 2.0 dB relaxation is allowed.</p> <p>Note 6: The starting resource block shall be RB# 0.</p>					

Table 6.3.5.2.5-4: Test Requirements Relative Power Tolerance for Transmission (normal conditions – Note 5) channel bandwidth 3MHz (ramping down)

Sub-test (ramp down)	Uplink RB allocation	TPC command	Expected power step size (down) ΔP [dB]	Power step size range (down) ΔP [dB]	PUSCH [dB]
----------------------	----------------------	-------------	--	---	-------------------

Subframes before RB change	Fixed = 15	TPC=-1dB	1	$\Delta P < 2$	$1 \pm (1.7)$
RB change	Change from 15 to 1 RBs	TPC=-1dB	12.76	$10 \leq \Delta P < 15$	$12.76 \pm (5.7)$ Note 2 $12.76 +5.7/-7.2$ Note 4
Subframes after RB change	Fixed =1	TPC=-1dB	1	$\Delta P < 2$	$1 \pm (1.7)$
<p>Note 1: Position of RB change: Pattern A the position of RB uplink allocation change is after 6 active uplink subframes Pattern A the position of RB uplink allocation change is after 16 active uplink subframes Pattern C the position of RB uplink allocation change is after 26 active uplink subframes</p> <p>Note 2: When Note 4 does not apply.</p> <p>Note 3: N/A</p> <p>Note 4: For operating bands under Note 2 in Table 6.2.2.3-1, if the transmission bandwidth of the target sub-frame is confined within F_{UL_low} and $F_{UL_low} + 4$ MHz or $F_{UL_high} - 4$ MHz and F_{UL_high} and the reference sub-frame is not confined within any one of these frequency ranges.</p> <p>Note 5: For extreme conditions an additional ± 2.0 dB relaxation is allowed.</p> <p>Note 6: The starting resource block shall be RB# 0.</p>					

Table 6.3.5.2.5-5: Test Requirements Relative Power Tolerance for Transmission (normal conditions – Note 5) channel bandwidth 5MHz (ramping up)

Sub-test (ramp up)	Uplink RB allocation	TPC command	Expected power step size (Up) ΔP [dB]	Power step size range (Up) ΔP [dB]	PUSCH [dB]
Subframes before RB change	Fixed = 1	TPC=+1dB	1	$\Delta P < 2$	$1 \pm (1.7)$
RB change	Change from 1 to 20	TPC=+1dB	14.01	$10 \leq \Delta P < 15$	$14.01 \pm (5.7)$ Note 2 $14.01 +7.2/-5.7$ Note 3
Subframes after RB change	Fixed = 20	TPC=+1dB	1	$\Delta P < 2$	$1 \pm (1.7)$
<p>Note 1: Position of RB change: Pattern A the position of RB uplink allocation change is after 10 active uplink subframes Pattern B the position of RB uplink allocation change is after 20 active uplink subframes Pattern C the position of RB uplink allocation change is after 30 active uplink subframes</p> <p>Note 2: When Note 3 does not apply.</p> <p>Note 3: For operating bands under Note 2 in Table 6.2.2.3-1, if the transmission bandwidth of the reference sub-frames is confined within F_{UL_low} and $F_{UL_low} + 4$ MHz or $F_{UL_high} - 4$ MHz and F_{UL_high} and the target sub-frame is not confined within any one of these frequency ranges.</p> <p>Note 4: N/A</p> <p>Note 5: For extreme conditions an additional ± 2.0 dB relaxation is allowed.</p> <p>Note 6: The starting resource block shall be RB# 0.</p>					

Table 6.3.5.2.5-6: Test Requirements Relative Power Tolerance for Transmission (normal conditions – Note 5) channel bandwidth 5MHz (ramping down)

Sub-test (ramp down)	Uplink RB allocation	TPC command	Expected power step size (down) ΔP [dB]	Power step size range (down) ΔP [dB]	PUSCH [dB]
Subframes before RB change	Fixed = 25	TPC=-1dB	1	$\Delta P < 2$	$1 \pm (1.7)$
RB change	Change from 25 to 1	TPC=-1dB	14.98	$10 \leq \Delta P < 15$	$14.98 \pm (5.7)$ Note 2 $14.98 +5.7/-7.2$ Note 4
Subframes after RB change	Fixed = 1	TPC=-1dB	1	$\Delta P < 2$	$1 \pm (1.7)$
<p>Note 1: Position of RB change: Pattern A the position of RB uplink allocation change is after 6 active uplink subframes Pattern B the position of RB uplink allocation change is after 16 active uplink subframes Pattern C the position of RB uplink allocation change is after 26 active uplink subframes</p> <p>Note 2: When Note 4 does not apply.</p> <p>Note 3: N/A</p> <p>Note 4: For operating bands under Note 2 in Table 6.2.2.3-1, if the transmission bandwidth of the target sub-frame is confined within F_{UL_low} and $F_{UL_low} + 4$ MHz or $F_{UL_high} - 4$ MHz and F_{UL_high} and the reference sub-frame is not confined within any one of these frequency ranges.</p> <p>Note 5: For extreme conditions an additional ± 2.0 dB relaxation is allowed.</p> <p>Note 6: The starting resource block shall be RB# 0.</p>					

Table 6.3.5.2.5-7: Test Requirements Relative Power Tolerance for Transmission (normal conditions – Note 5) channel bandwidth 10MHz (ramping up)

Sub-test (ramp up)	Uplink RB allocation	TPC command	Expected power step size (Up) ΔP [dB]	Power step size range (Up) ΔP [dB]	PUSCH [dB]
--------------------	----------------------	-------------	--	---	-------------------

Subframes before RB change	Fixed = 1	TPC=+1dB	1	$\Delta P < 2$	$1 \pm (1.7)$
RB change	Change from 1 to 25	TPC=+1dB	14.98	$10 \leq \Delta P < 15$	$14.98 \pm (5.7)$ Note 2 $14.98 +7.2/-5.7$ Note 3
Subframes after RB change	Fixed = 25	TPC=+1dB	1	$\Delta P < 2$	$1 \pm (1.7)$
<p>Note 1: Position of RB change: Pattern A the position of RB uplink allocation change is after 10 active uplink subframes Pattern B the position of RB uplink allocation change is after 20 active uplink subframes Pattern C the position of RB uplink allocation change is after 30 active uplink subframes</p> <p>Note 2: When Note 3 does not apply.</p> <p>Note 3: For operating bands under Note 2 in Table 6.2.2.3-1, if the transmission bandwidth of the reference sub-frames is confined within F_{UL_low} and $F_{UL_low} + 4$ MHz or $F_{UL_high} - 4$ MHz and F_{UL_high} and the target sub-frame is not confined within any one of these frequency ranges.</p> <p>Note 4: N/A</p> <p>Note 5: For extreme conditions an additional ± 2.0 dB relaxation is allowed.</p> <p>Note 6: The starting resource block shall be RB# 0.</p>					

Table 6.3.5.2.5-8: Test Requirements Relative Power Tolerance for Transmission (normal conditions – Note 5) channel bandwidth 10MHz (ramping down)

Sub-test (ramp down)	Uplink RB allocation	TPC command	Expected power step size (down) ΔP [dB]	Power step size range (down) ΔP [dB]	PUSCH [dB]
----------------------	----------------------	-------------	--	---	-------------------

Subframes before RB change	Fixed = 50 (UE- Categories ≥2) Fixed = 48 (UE Cat 1)	TPC=-1dB	1	$\Delta P < 2$	$1 \pm (1.7)$
RB change	Change from 50 to 1 (UE- Categories ≥2) Change from 48 to 1 (UE cat 1)	TPC=-1dB	17.99 17.81	$15 \leq \Delta$	$17.99 \pm (6.7)$ Note 2 $17.99 +6.7/-8.2$ Note 4 $17.81 \pm (6.7)$ Note 2 $17.81 +6.7/-8.2$ Note 4
Subframes after RB change	Fixed = 1	TPC=-1dB	1	$\Delta P < 2$	$1 \pm (1.7)$
<p>Note 1: Position of RB change: Pattern A the position of RB uplink allocation change is after 6 active uplink subframes Pattern B the position of RB uplink allocation change is after 16 active uplink subframes Pattern C the position of RB uplink allocation change is after 26 active uplink subframes</p> <p>Note 2: When Note 4 does not apply.</p> <p>Note 3: N/A</p> <p>Note 4: For operating bands under Note 2 in Table 6.2.2.3-1, if the transmission bandwidth of the target sub-frame is confined within F_{UL_low} and $F_{UL_low} + 4$ MHz or $F_{UL_high} - 4$ MHz and F_{UL_high} and the reference sub-frame is not confined within any one of these frequency ranges.</p> <p>Note 5: For extreme conditions an additional ± 2.0 dB relaxation is allowed.</p> <p>Note 6: The starting resource block shall be RB# 0.</p>					

Table 6.3.5.2.5-9: Test Requirements Relative Power Tolerance for Transmission (normal conditions – Note 5) channel bandwidth 15MHz (ramping up)

Sub-test (ramp up)	Uplink RB allocation	TPC command	Expected power step size (Up) ΔP [dB]	Power step size range (Up) ΔP [dB]	PUSCH [dB]
--------------------	----------------------	-------------	--	---	-------------------

Subframes before RB change	Fixed = 1	TPC=+1dB	1	$\Delta P < 2$	$1 \pm (1.7)$
RB change	Change from 1 to 50	TPC=+1dB	17.99	$15 \leq \Delta P$	$17.99 \pm (6.7)$ Note 2 $17.99 + 8.2 / - 6.7$ Note 3
Subframes after RB change	Fixed = 50	TPC=+1dB	1	$\Delta P < 2$	$1 \pm (1.7)$
<p>Note 1: Position of RB change: Pattern A the position of RB uplink allocation change is after 10 active uplink subframes Pattern B the position of RB uplink allocation change is after 20 active uplink subframes Pattern C the position of RB uplink allocation change is after 30 active uplink subframes</p> <p>Note 2: When Note 3 does not apply.</p> <p>Note 3: For operating bands under Note 2 in Table 6.2.2.3-1, if the transmission bandwidth of the reference sub-frames is confined within F_{UL_low} and $F_{UL_low} + 4$ MHz or $F_{UL_high} - 4$ MHz and F_{UL_high} and the target sub-frame is not confined within any one of these frequency ranges.</p> <p>Note 4: N/A</p> <p>Note 5: For extreme conditions an additional ± 2.0 dB relaxation is allowed.</p> <p>Note 6: The starting resource block shall be RB# 0.</p>					

Table 6.3.5.2.5-10: Test Requirements Relative Power Tolerance for Transmission (normal conditions – Note 5) channel bandwidth 15MHz (ramping down)

Sub-test (ramp down)	Uplink RB allocation	TPC command	Expected power step size (down) ΔP [dB]	Power step size range (down) ΔP [dB]	PUSCH [dB]
----------------------	----------------------	-------------	--	---	-------------------

Subframes before RB change	Fixed = 75 (UE-Categories ≥2) Fixed = 50 (UE Cat 1)	TPC=-1dB	1	$\Delta P < 2$	$1 \pm (1.7)$
RB change	Change from 75 to 1 (UE-Categories ≥2) Change from 50 to 1 (UE Cat 1)	TPC=-1dB	19.75 17.99	$15 \leq \Delta P$	$19.75 \pm (6.7)$ Note 2 $19.75 +6.7/-8.2$ Note 4 $17.99 \pm (6.7)$ Note 2 $17.99 +6.7/-8.2$ Note 4
Subframes after RB change	Fixed = 1	TPC=-1dB	1	$\Delta P < 2$	$1 \pm (1.7)$
<p>Note 1: Position of RB change: Pattern A the position of RB uplink allocation change is after 6 active uplink subframes Pattern B the position of RB uplink allocation change is after 16 active uplink subframes Pattern C the position of RB uplink allocation change is after 26 active uplink subframes</p> <p>Note 2: When Note 4 does not apply.</p> <p>Note 3: N/A</p> <p>Note 4: For operating bands under Note 2 in Table 6.2.2.3-1, if the transmission bandwidth of the target sub-frame is confined within F_{UL_low} and $F_{UL_low} + 4$ MHz or $F_{UL_high} - 4$ MHz and F_{UL_high} and the reference sub-frame is not confined within any one of these frequency ranges.</p> <p>Note 5: For extreme conditions an additional ± 2.0 dB relaxation is allowed.</p> <p>Note 6: The starting resource block shall be RB# 0.</p>					

Table 6.3.5.2.5-11: Test Requirements Relative Power Tolerance for Transmission (normal conditions – Note 5) channel bandwidth 20MHz (ramping up)

Sub-test (ramp up)	Uplink RB allocation	TPC command	Expected power step size (Up) ΔP [dB]	Power step size range (Up) ΔP [dB]	PUSCH [dB]
--------------------	----------------------	-------------	--	---	-------------------

Subframes before RB change	Fixed = 1	TPC=+1dB	1	$\Delta P < 2$	$1 \pm (1.7)$
RB change	Change from 1 to 75	TPC=+1dB	19.75	$15 \leq \Delta P$	$19.75 \pm (6.7)$ Note 2 $19.75 + 8.2/-6.7$ Note 3
Subframes after RB change	Fixed = 75	TPC=+1dB	1	$\Delta P < 2$	$1 \pm (1.7)$
<p>Note 1: Position of RB change: Pattern A the position of RB uplink allocation change is after 10 active uplink subframes Pattern B the position of RB uplink allocation change is after 20 active uplink subframes Pattern C the position of RB uplink allocation change is after 30 active uplink subframes</p> <p>Note 2: When Note 3 does not apply.</p> <p>Note 3: For operating bands under Note 2 in Table 6.2.2.3-1, if the transmission bandwidth of the reference sub-frames is confined within F_{UL_low} and $F_{UL_low} + 4$ MHz or $F_{UL_high} - 4$ MHz and F_{UL_high} and the target sub-frame is not confined within any one of these frequency ranges.</p> <p>Note 4: N/A</p> <p>Note 5: For extreme conditions an additional ± 2.0 dB relaxation is allowed.</p> <p>Note 6: The starting resource block shall be RB# 0.</p>					

Table 6.3.5.2.5-12: Test Requirements Relative Power Tolerance for Transmission (normal conditions – Note 5) channel bandwidth 20MHz (ramping down)

Sub-test (ramp down)	Uplink RB allocation	TPC command	Expected power step size (down) ΔP [dB]	Power step size range (down) ΔP [dB]	PUSCH [dB]
----------------------	----------------------	-------------	--	---	-------------------

Subframes before RB change	Fixed = 100 (UE- Categories ≥2) Fixed = 75 (UE Cat 1)	TPC=-1dB	1	$\Delta P < 2$	$1 \pm (1.7)$
RB change	Change from 100 to 1 (UE- Categories ≥2) Change from 75 to 1 (UE Cat 1)	TPC=-1dB	21.0 19.75	$15 \leq \Delta P$	$21.0 \pm (6.7)$ Note 2 $21.0 +6.7/-8.2$ Note 4 $19.75 \pm (6.7)$ Note 2 $19.75 +6.7/-8.2$ Note 4
Subframes after RB change	Fixed = 1	TPC=-1dB	1	$\Delta P < 2$	$1 \pm (1.7)$
<p>Note 1: Position of RB change: Pattern A the position of RB uplink allocation change is after 6 active uplink subframes Pattern B the position of RB uplink allocation change is after 16 active uplink subframes Pattern C the position of RB uplink allocation change is after 26 active uplink subframes</p> <p>Note 2: When Note 4 does not apply.</p> <p>Note 3: N/A</p> <p>Note 4: For operating bands under Note 2 in Table 6.2.2.3-1, if the transmission bandwidth of the target sub-frame is confined within F_{UL_low} and $F_{UL_low} + 4$ MHz or $F_{UL_high} - 4$ MHz and F_{UL_high} and the reference sub-frame is not confined within any one of these frequency ranges.</p> <p>Note 5: For extreme conditions an additional ± 2.0 dB relaxation is allowed.</p> <p>Note 6: The starting resource block shall be RB# 0.</p>					

Table 6.3.5.2.5-13: Test Requirements Relative Power Tolerance for Transmission (normal conditions – Note 5) (Alternating pattern)

Sub-test	Uplink RB allocation	TPC command	Expected power step size (Up or down) ΔP [dB]	Power step size range (Up or down) ΔP [dB]	PUSCH [dB]
----------	----------------------	-------------	--	---	-------------------

1.4 MHz	Alternating 1 and 6	TPC=0dB	7.78	$4 \leq \Delta P < 10$	7.78 ± (6.7) Note 1,2 7.78 +8.2/-6.7 Note 3 7.78 +6.7/-8.2 Note 4
3 MHz	Alternating 1 and 15	TPC=0dB	11.76	$10 \leq \Delta P < 15$	11.76 ± (6.7) Note 1,2 11.76 +8.2/-6.7 Note 3 11.76 +6.7/-8.2 Note 4
5 MHz	Alternating 1 and 25	TPC=0dB	13.98	$10 \leq \Delta P < 15$	13.98 ± (6.7) Note 1,2 13.98 +8.2/-6.7 Note 3 13.98 +6.7/-8.2 Note 4
10 MHz	Alternating 1 and 50 (UE- Categories ≥2)	TPC=0dB	16.99	$15 \leq \Delta P$	16.99 ± (6.7) Note 1,2 16.99 +8.2/-6.7 Note 3 16.99 +6.7/-8.2 Note 4
	Alternating 1 and 48 (UE Cat 1)		16,81		16.81 ± (6.7) Note 1,2 16.81 +8.2/-6.7 Note 3 16.81 +6.7/-8.2 Note 4
15 MHz	Alternating 1 and 75 (UE- Categories ≥2)	TPC=0dB	18.75	$15 \leq \Delta P$	18.75 ± (6.7) Note 1,2 18.75 +8.2/-6.7 Note 3 18.75 +6.7/-8.2 Note 4
	Alternating 1 and 50 (UE Cat 1)		16.99		16.99 ± (6.7) Note 1,2 16.99 +8.2/-6.7 Note 3 16.99 +6.7/-8.2 Note 4
20 MHz	Alternating 1 and 100 (UE- Categories ≥2)	TPC=0dB	20.00	$15 \leq \Delta P$	20.00 ± (6.7) Note 1,2 20.00 +8.2/-6.7 Note 3 20.00 +6.7/-8.2 Note 4
	Alternating 1 and 75 (UE Cat 1)		18.75		18.75 ± (6.7) Note 1,2 18.75 +8.2/-6.7 Note 3 18.75 +6.7/-8.2 Note 4
<p>Note 1: Test tolerance +/- 6.7 dB was selected to allow PA switch possible exceptions to occur.</p> <p>Note 2: When neither Note 3 nor Note 4 applies.</p> <p>Note 3: For operating bands under Note 2 in Table 6.2.2.3-1, if the transmission bandwidth of the reference sub-frames is confined within F_{UL_low} and $F_{UL_low} + 4$ MHz or $F_{UL_high} - 4$ MHz and F_{UL_high} and the target sub-frame is not confined within any one of these frequency ranges.</p> <p>Note 4: For operating bands under Note 2 in Table 6.2.2.3-1, if the transmission bandwidth of the target sub-frame is confined within F_{UL_low} and $F_{UL_low} + 4$ MHz or $F_{UL_high} - 4$ MHz and F_{UL_high} and the reference sub-frame is not confined within any one of these frequency ranges.</p> <p>Note 5: For extreme conditions an additional ± 2.0 dB relaxation is allowed.</p> <p>Note 6: The starting resource block shall be RB# 0.</p>					

6.3.5.3 Aggregate power control tolerance

6.3.5.3.1 Test purpose

To verify the ability of the UE to maintain its power level in non-contiguous transmission within 21 ms in response to 0 dB TPC commands with respect to the first UE transmission, when the power control parameters specified in TS 36.213 are constant.

6.3.5.3.2 Test applicability

This test applies to all types of E-UTRA UE release 8 and forward.

6.3.5.3.3 Minimum conformance requirement

The UE shall meet the requirements specified in Table 6.3.5.3.3-1 for relative power control over the power range bounded by the minimum output power as defined in sub clause 6.3.2 and the maximum output power in sub-clause 6.2.2.

Table 6.3.5.3.3-1: Power control tolerance

TPC command	UL channel	Aggregate power tolerance within 21 ms
0 dB	PUCCH	±2.5 dB
0 dB	PUSCH	±3.5 dB
Note 1: The UE transmission gap is 4 ms. TPC command is transmitted via PDCCH 4 subframes preceding each PUCCH/PUSCH transmission.		

The normative reference for this requirement is TS 36.101 [2] clause 6.3.5.3.1.

6.3.5.3.4 Test description

6.3.5.3.4.1 Initial conditions

Initial conditions are a set of test configurations the UE needs to be tested in and the steps for the SS to take with the UE to reach the correct measurement state.

The initial test configurations consist of environmental conditions, test frequencies, and channel bandwidths based on E-UTRA operating bands specified in table 5.4.2.1-1. All of these configurations shall be tested with applicable test parameters for each channel bandwidth, and are shown in table 6.3.5.3.4.1-1. The details of the uplink and downlink reference measurement channels (RMCs) are specified in Annexes A.2 and A.3. Configurations of PDSCH and PDCCH before measurement are specified in Annex C.2.

Table 6.3.5.3.4.1-1: Test Configuration Table: PUCCH sub-test

Initial Conditions				
Test Environment as specified in TS 36.508[7] subclause 4.1			Normal	
Test Frequencies as specified in TS36.508 [7] subclause 4.3.1			Mid range	
Test Channel Bandwidths as specified in TS 36.508 [7] subclause 4.3.1			Lowest, 5MHz, Highest	
Test Parameters for Channel Bandwidths				
Downlink Configuration			Uplink Configuration	
Ch BW	Mod'n	RB allocation		FDD: PUCCH format = Format 1a TDD: PUCCH format = Format 1a/1b
		FDD	TDD	
1.4MHz	QPSK	3	3	
3MHz	QPSK	4	4	
5MHz	QPSK	8	8	
10MHz	QPSK	16	16	
15MHz	QPSK	25	25	
20MHz	QPSK	30	30	
Note 1: Test Channel Bandwidths are checked separately for each E-UTRA band, the applicable channel bandwidths are specified in Table 5.4.2.1-1.				

Table 6.3.5.3.4.1-2: Test Configuration Table: PUSCH sub-test

Initial Conditions					
Test Environment as specified in TS 36.508[7] subclause 4.1		Normal			
Test Frequencies as specified in TS36.508 [7] subclause 4.3.1		Mid range			
Test Channel Bandwidths as specified in TS 36.508 [7] subclause 4.3.1		Lowest, 5MHz, Highest			
Test Parameters for Channel Bandwidths					
Ch BW	Downlink Configuration		Uplink Configuration		
	N/A for PUSCH sub-test		Mod'n	RB allocation	
				FDD	TDD
1.4MHz			QPSK	1	1
3MHz			QPSK	4	4
5MHz			QPSK	8	8
10MHz			QPSK	12	12
15MHz			QPSK	16	16
20MHz			QPSK	18	18
Note 1: Test Channel Bandwidths are checked separately for each E-UTRA band, the applicable channel bandwidths are specified in Table 5.4.2.1-1.					

1. Connect the SS to the UE antenna connectors as shown in TS 36.508 [7] Annex A, Figure A.3.
2. The parameter settings for the cell are set up according to TS 36.508 [7] subclause 4.4.3.
3. Downlink signals are initially set up according to Annex C0, C.1 and C.3.0, and uplink signals according to Annex H.1 and H.3.0.
4. The UL and DL Reference Measurement channels are set according to Table 6.3.5.3.4.1-1 (PUCCH sub-test) and Table 6.3.5.3.4.1-2 (PUSCH sub-test).
5. Ensure the UE is in State 3A-RF according to TS 36.508 [7] clause 5.2A.2. Message contents are defined in clause 6.3.5.3.4.3.

6.3.5.3.4.2 Test procedure

The procedure is separated in two subtests to verify PUCCH and PUSCH aggregate power control tolerance respectively. The uplink transmission patterns are described in figure 6.3.5.3.4.2-1.

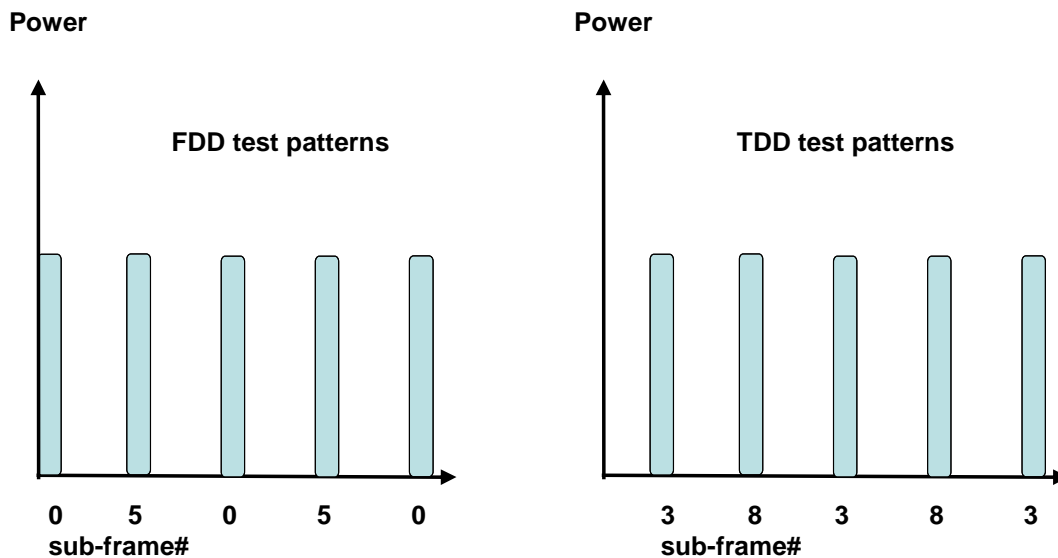

Figure 6.3.5.3.4.2-1 Test uplink transmission

1. PUCCH sub test:

- 1.1 The SS transmits PDSCH via PDCCH DCI format 1A for C_RNTI to transmit the DL RMC according to Table 6.3.5.3.4.1-1. The SS sends downlink MAC padding bits on the DL RMC. The transmission of PDSCH will make the UE send uplink ACK/NACK using PUCCH. Send the appropriate TPC commands for PUCCH to the UE to ensure that the UE transmits PUCCH at 0dBm +/- 3.2 dB for carrier frequency $f \leq 3.0\text{GHz}$ or at 0dBm +/- 3.5 dB for carrier frequency $3.0\text{GHz} < f \leq 4.2\text{GHz}$.
- 1.2. Every 5 subframes transmit to the UE downlink PDSCH MAC padding bits as well as 0 dB TPC command for PUCCH via the PDCCH to make the UE transmit ACK/NACK on the PUCCH with transmission gap of 4 subframes. The downlink transmission is scheduled in the appropriate sub-frames to make the UE transmit PUCCH as described in figure 6.3.5.3.4.2-1.
- 1.3. Measure the power of 5 consecutive PUCCH transmissions to verify the UE transmitted PUCCH power is maintained within 21 ms. The transient periods of 20us are excluded from the power measurement.

2. PUSCH sub test:

- 2.1. The SS sends uplink scheduling information via PDCCH DCI format 0 for C_RNTI to schedule the PUSCH. Since the UE has no payload and no loopback data to send the UE sends uplink MAC padding bits on the UL RMC. Send the appropriate TPC commands for PUSCH to the UE to ensure that the UE transmits PUSCH at 0dBm +/- 3.2.dB for carrier frequency $f \leq 3.0\text{GHz}$ or at 0dBm +/- 3.5 dB for carrier frequency $3.0\text{GHz} < f \leq 4.2\text{GHz}$.
- 2.2. Every 5 subframes schedule the UE's PUSCH data transmission and transmit 0 dB TPC command for PUSCH via the PDCCH to make the UE transmit PUSCH with 4 subframes gap. The uplink transmission patterns are described in figure 6.3.5.3.4.2-1.
- 2.3. Measure the power of 5 consecutive PUSCH transmissions to verify the UE transmitted PUSCH power is maintained within 21 ms. The transient periods of 20us are excluded from the power measurement.

6.3.5.3.4.3 Message contents

Message contents are according to TS 36.508 [7] subclause 4.6.

6.3.5.3.5 Test requirement

The requirement for the power measurements made in step (1.3) and (2.3) of the test procedure shall not exceed the values specified in Table 6.3.5.3.5-1. The power measurement period shall be 1 sub-frame excluding transient periods.

Table 6.3.5.3.5-1: Power control tolerance

TPC command	UL channel	Test requirement measured power
0 dB	PUCCH	Given 5 power measurements in the pattern, the 2 nd , 3 rd , 4 th , and 5 th measurements shall be within ± 3.2 dB of the 1 st measurement.
0 dB	PUSCH	Given 5 power measurements in the pattern, the 2 nd , 3 rd , 4 th , and 5 th measurements shall be within ± 4.2 dB of the 1 st measurement.
Note 1: The UE transmission gap is 4 ms. TPC command is transmitted via PDCCH 4 subframes preceding each PUCCH/PUSCH transmission.		

6.3.5_1 Power Control for HPUE

Same text as in clause 6.3.5.

6.3.5_1.1 Power Control Absolute power tolerance for HPUE

6.3.5_1.1.1 Test purpose

Same test purpose as in clause 6.3.5.1.1.

6.3.5_1.1.2 Test applicability

This test applies to all types of E-UTRA Power Class 1 UE release 11 and forward.

6.3.5_1.1.3 Minimum conformance requirement

Same minimum conformance requirement as in clause 6.3.5.1.2 with the following exceptions:

- of sub-clause 6.2.2 → use sub-clause 6.2.2_1

The normative reference for this requirement is TS 36.101 [2] clause 6.3.5.1.1.

6.3.5_1.1.4 Test description

Same test description as in clause 6.3.5.1.4 with the following exceptions:

- For test point 2, instead of Table 6.3.5.1.4.3-2 → use Table 6.3.5_1.1.4.3-1

Table 6.3.5_1.1.4.3-1: UplinkPowerControlCommon: Test point 2

Derivation Path: TS 36.508 [7] clause 4.6.3, Table 4.6.3-25 UplinkPowerControlCommon-DEFAULT			
Information Element	Value/remark	Comment	Condition
UplinkPowerControlCommon-DEFAULT ::= SEQUENCE { p0-NominalPUSCH	-85	Test point 2 to verify a UE relative high initial power transmission	

6.3.5_1.1.5 Test requirement

The requirement for the power measured in step (2) of the test procedure is not to exceed the values specified in Table 6.3.5_1.1.5-1 and 6.3.5_1.1.5-2.

Table 6.3.5_1.1.5-1: Absolute power tolerance: test point 1

	Channel bandwidth / expected output power (dBm)	
	5 MHz	10 MHz
Expected Measured power Normal conditions	-8.6 dBm	-5.6 dBm
Power tolerance	± 10.0dB	± 10.0dB
Expected Measured power Extreme conditions	-8.6 dBm	-5.6 dBm
Power tolerance	± 13.0dB	± 13.0dB
Note 1: The lower power limit shall not exceed the minimum output power requirements defined in sub-clause 6.3.2.3		

Table 6.3.5_1.1.5-2: Absolute power tolerance: test point 2

	Channel bandwidth / expected output power (dBm)	
	5 MHz	10 MHz
Expected Measured power Normal conditions	11.4 dBm	14.4 dBm
Power tolerance	± 10.0dB	± 10.0dB
Expected Measured power Extreme conditions	11.4 dBm	14.4 dBm
Power tolerance	± 13.0dB	± 13.0dB
Note 1: The lower power limit shall not exceed the minimum output power requirements defined in sub-clause 6.3.2.3		

6.3.5_1.2 Power Control Relative power tolerance for HPUE

6.3.5_1.2.1 Test purpose

Same test purpose as in clause 6.3.5.2.1.

6.3.5_1.2.2 Test applicability

This test applies to all types of E-UTRA Power Class 1 UE release 11 and forward.

6.3.5_1.2.3 Minimum conformance requirement

Same minimum conformance requirement as in clause 6.3.5.2.3 with the following exceptions

- instead of clause 6.2.2.3 → use sub-clause 6.2.2_1.3

The normative reference for this requirement is TS 36.101 [2] clause 6.3.5.2.

6.3.5_1.2.4 Test description

Same test description as in clause 6.3.5.2.4 with the following exceptions:

- clause 6.3.5.2.4.2, test step 2.1, setting the UE PUSCH power at +26dBm +/-3.2dB instead of +18.0dBm +/-3.2dB

6.3.5_1.2.5 Test requirement

Same test requirement as in clause 6.3.5.2.5.

6.3.5_1.3 Aggregate power control tolerance for HPUE

6.3.5_1.3.1 Test purpose

Same test purpose as in clause 6.3.5.3.1.

6.3.5_1.3.2 Test applicability

This test applies to all types of E-UTRA Power Class 1 UE release 11 and forward.

6.3.5_1.3.3 Minimum conformance requirement

Same minimum conformance requirement as in clause 6.3.5.3.3 with the following exception:

- Instead of sub-clause 6.2.2 → use sub-clause 6.2.2_1

The normative reference for this requirement is TS 36.101 [2] clause 6.3.5.3.1.

6.3.5_1.3.4 Test description

Same test description as in clause 6.3.5.3.4.

6.3.5_1.3.5 Test requirement

Same test requirement as in clause 6.3.5.3.5.

6.3.5A Power Control for CA

6.3.5A.1 Power Control Absolute power tolerance for CA

6.3.5A.1.1 Power Control Absolute power tolerance for CA (intra-band contiguous DL CA and UL CA)

6.3.5A.1.1.1 Test purpose

To verify the ability of the UE transmitter to set its initial output power to a specific value for the first sub-frame at the start of a contiguous transmission or non-contiguous transmission with a transmission gap on each active component carriers larger than 20ms.

6.3.5A.1.1.2 Test applicability

This test applies to all types of E-UTRA UE release 10 and forward that support intra-band contiguous DL CA and UL CA.

6.3.5A.1.1.3 Minimum conformance requirements

The absolute power tolerance is the ability of the UE transmitter to set its initial output power to a specific value for the first sub-frame at the start of a contiguous transmission or non-contiguous transmission with a transmission gap on each active component carriers larger than 20ms. The requirement can be tested by time aligning any transmission gaps on the component carriers.

For intra-band contiguous carrier aggregation bandwidth class C the absolute power control tolerance per component carrier is given in Table 6.3.5A.1.1.3-1.

The requirements apply for one single PUCCH, PUSCH or SRS transmission of contiguous PRB allocation per component carrier.

Table 6.3.5A.1.1.3-1: Absolute power tolerance for intra-band contiguous CA

Conditions	Tolerance
Normal conditions	± 9.0 dB
Extreme conditions	± 12.0 dB

The normative reference for this requirement is TS 36.101 [2] clause 6.3.5A.1.1.

6.3.5A.1.1.4 Test description

6.3.5A.1.1.4.1 Initial conditions

Initial conditions are a set of test configurations the UE needs to be tested in and the steps for the SS to take with the UE to reach the correct measurement state.

The initial test configurations consist of environmental conditions, test frequencies, and CC combinations based on E-UTRA CA configurations specified in table 5.4.2A.1-1. All of these configurations shall be tested with applicable test parameters for each CA Configuration, and are shown in table 6.3.5A.1.1.4.1-1. The details of the uplink reference measurement channel (RMCs) are specified in Annexes A.2. Configurations of PDSCH and PDCCH before measurement are specified in Annex C.2.

Table 6.3.5A.1.1.4.1-1: Test Configuration Table

Initial Conditions							
Test Environment as specified in TS 36.508[7] clause 4.1				Normal, TL/VL, TL/VH, TH/VL, TH/VH			
Test Frequencies as specified in TS36.508 [7] clause [4.3.1] for different CA bandwidth classes.				C: Mid range			
Test CC Combination setting (NRB_agg) as specified in clause 5.4.2A.1 for the CA Configuration across bandwidth combination sets supported by the UE.				Lowest N _{RB_agg} Highest N _{RB_agg}			
Test Parameters for CA Configurations							
CA Configuration / N _{RB_agg}		DL Allocation	CC MOD	UL Allocation			
PCC N _{RB}	SCCs N _{RB}	PCC & SCC RB allocation		N _{RB_alloc}	PCC & SCC RB allocations (L _{CRB} @ RB _{start})		
75	75	N/A for this test	QPSK	150	P_75@0	S_75@0	
100	50		QPSK	150	P_100@0	S_50@0	
100	100		QPSK	200	P_100@0	S_100@0	
Note 1: CA Configuration Test CC Combination settings are checked separately for each CA Configuration, which applicable aggregated channel bandwidths are specified in Table 5.4.2A.1-1.							

1. Connect the SS to the UE antenna connectors as shown in TS 36.508 [7] Annex A, Figure group A.32 as appropriate group A.32 as appropriate.
2. The parameter settings for the cell are set up according to TS 36.508 [7] clause 4.4.3.
3. Downlink signals for PCC are initially set up according to Annex C.0, C.1 and C.3.0, and uplink signals according to Annex H.1 and H.3.0.
4. The UL Reference Measurement channel is set according to Table 6.3.5A.1.1.4.1-1.
5. Propagation conditions are set according to Annex B.0.
6. Ensure the UE is in State 3A-RF according to TS 36.508 [7] clause 5.2A.2. Message contents are defined in clause 6.3.5A.1.1.4.3. Any PDCCH DCI format 0 sent to the UE during the configuration should have TPC command 0dB.

6.3.5A.1.1.4.2 Test procedure

1. Configure SCC according to Annex C.0, C.1 and Annex C.3.0 for all downlink physical channels except PHICH.
2. The SS shall configure SCC as per TS 36.508 [7] clause 5.2A.4. Message contents for UplinkPowerControlCommonSCell-r10 are defined in tables 6.3.5A.1.1.4.3-2, 6.3.5A.1.1.4.3-4 and 6.3.5A.1.1.4.3-7. Any PDCCH DCI format 0 sent to the UE during the configuration should have TPC command 0dB.
3. SS activates SCC by sending the activation MAC-CE (Refer TS 36.321 [13], clauses 5.13, 6.1.3.8). Wait for at least 2 seconds (Refer TS 36.133, clauses 8.3.3.2).
4. SS sends uplink scheduling information for each UL HARQ process via PDCCH DCI format 0 with TPC command 0dB for C_RNTI to schedule the UL RMC according to Table 6.3.5A.1.1.4.1-1 on both PCC and SCC. Since the UE has no payload and no loopback data to send the UE sends uplink MAC padding bits on the UL RMC.
5. Measure the initial output power of the first subframe of the UE PUSH first transmission for each component carrier. The transient periods of 20us are excluded.
6. Repeat for the two test points as indicated in section 6.3.5A.1.1.4.3. The timing of the execution between the two test points shall be larger than 20ms.

6.3.5A.1.1.4.3 Message contents

Message contents are according to TS 36.508 [7] subclause 4.6 with the following exceptions.

Table 6.3.5A.1.1.4.3-1: UplinkPowerControlCommon: Test point 1

Derivation Path: TS 36.508 [7] clause 6.3.2, Table 4.6.3-25 UplinkPowerControlCommon-DEFAULT			
Information Element	Value/remark	Comment	Condition
UplinkPowerControlCommon-DEFAULT ::= SEQUENCE { p0-NominalPUSCH	-105	Test point 1 to verify a UE relative low initial power transmission	

Table 6.3.5A.1.1.4.3-2: UplinkPowerControlCommonSCell-r10: Test point 1

Derivation Path: TS 36.508 [7] clause 6.3.2, Table 4.6.3-25A UplinkPowerControlCommonSCell-r10-DEFAULT			
Information Element	Value/remark	Comment	Condition
UplinkPowerControlCommonSCell-r10 ::= SEQUENCE { p0-NominalPUSCH	-105	Test point 1 to verify a UE relative low initial power transmission	

Table 6.3.5A.1.1.4.3-3: UplinkPowerControlCommon: Test point 2

Derivation Path: TS 36.508 [7] clause 6.3.2, Table 4.6.3-25 UplinkPowerControlCommon-DEFAULT			
Information Element	Value/remark	Comment	Condition
UplinkPowerControlCommon-DEFAULT ::= SEQUENCE { p0-NominalPUSCH	-93	Test point 2 to verify a UE relative high initial power transmission	

Table 6.3.5A.1.1.4.3-4: UplinkPowerControlCommonSCell-r10: Test point 2

Derivation Path: TS 36.508 [7] clause 6.3.2, Table 4.6.3-25A UplinkPowerControlCommonSCell-r10-DEFAULT			
Information Element	Value/remark	Comment	Condition
UplinkPowerControlCommonSCell-r10 ::= SEQUENCE { p0-NominalPUSCH	-93	Test point 2 to verify a UE relative high initial power transmission	

Table 6.3.5A.1.1.4.3-5: PhysicalConfigDedicated

Derivation Path: TS 36.508 [7] clause 6.3.2, Table 5.5.1.2.1 PhysicalConfigDedicated-DEFAULT			
Information Element	Value/remark	Comment	Condition
PhysicalConfigDedicated-DEFAULT ::= SEQUENCE {			
uplinkPowerControlDedicated	UplinkPowerControlDedicated-DEFAULT	See subclause 4.6.3	SRB1
	UplinkPowerControlDedicated-DEFAULT	See subclause 4.6.3	RBC

Table 6.3.5A.1.1.4.3-6: UplinkPowerControlDedicated

Derivation Path: TS 36.508 [7] clause 6.3.2, Table 4.6.3-26 UplinkPowerControlDedicated-DEFAULT			
Information Element	Value/remark	Comment	Condition
UplinkPowerControlDedicated-DEFAULT ::= SEQUENCE {			
p0-UE-PUSCH	1		SRB1
	0		RBC
}			

Table 6.3.5A.1.1.4.3-7: UplinkPowerControlDedicatedSCell-r10

Derivation Path: TS 36.508 [7] clause 6.3.2, Table 4.6.3-26B UplinkPowerControlDedicatedSCell-r10-DEFAULT			
Information Element	Value/remark	Comment	Condition
UplinkPowerControlDedicatedSCell-r10 ::= SEQUENCE {			
p0-UE-PUSCH	1		SRB1
	0		RBC
}			

6.3.5A.1.1.5 Test requirement

For intra-band contiguous carrier aggregation bandwidth class C, the absolute power control tolerance per component carrier measured in step (5) of the test procedure is not to exceed the values specified in Table 6.3.5A.1.1.5-1 and 6.3.5A.1.1.5-2. The test requirement tables are originated from tables 6.3.5.1.5-1 and 6.3.5.1.5-2.

Table 6.3.5A.1.1.5-1: Absolute power tolerance for intra-band contiguous CA: test point 1

	Channel bandwidth / expected output power (dBm)					
	1.4 MHz	3.0 MHz	5 MHz	10 MHz	15 MHz	20 MHz
Expected Measured power Normal conditions	-14.8 dBm	-10.8 dBm	-8.6 dBm	-5.6 dBm	-3.9 dBm	-2.6 dBm
Power tolerance f ≤ 3.0GHz 3.0GHz < f ≤ 4.2GHz	± 10.0dB ± 10.4dB	± 10.0dB ± 10.4dB	± 10.0dB ± 10.4dB	± 10.0dB ± 10.4dB	± 10.0dB ± 10.4dB	± 10.0dB ± 10.4dB
Expected Measured power Extreme conditions	-14.8 dBm	-10.8 dBm	-8.6 dBm	-5.6 dBm	-3.9 dBm	-2.6 dBm
Power tolerance f ≤ 3.0GHz 3.0GHz < f ≤ 4.2GHz	± 13.0dB ± 13.4dB	± 13.0dB ± 13.4dB	± 13.0dB ± 13.4dB	± 13.0dB ± 13.4dB	± 13.0dB ± 13.4dB	± 13.0dB ± 13.4dB
Note 1: The lower power limit shall not exceed the minimum output power requirements defined in sub-clause 6.3.2.3						

Table 6.3.5A.1.1.5-2: Absolute power tolerance for intra-band contiguous CA: test point 2

	Channel bandwidth / expected output power (dBm)					
	1.4 MHz	3.0 MHz	5 MHz	10 MHz	15 MHz	20 MHz
Expected Measured power Normal conditions	-2.8 dBm	1.2 dBm	3.4 dBm	6.4 dBm	8.2 dBm	9.4 dBm
Power tolerance f ≤ 3.0GHz 3.0GHz < f ≤ 4.2GHz	± 10.0dB ± 10.4dB	± 10.0dB ± 10.4dB	± 10.0dB ± 10.4dB	± 10.0dB ± 10.4dB	± 10.0dB ± 10.4dB	± 10.0dB ± 10.4dB
Expected Measured power Extreme conditions	-2.8 dBm	1.2 dBm	3.4 dBm	6.4 dBm	8.2 dBm	9.4 dBm
Power tolerance f ≤ 3.0GHz 3.0GHz < f ≤ 4.2GHz	± 13.0dB ± 13.4dB	± 13.0dB ± 13.4dB	± 13.0dB ± 13.4dB	± 13.0dB ± 13.4dB	± 13.0dB ± 13.4dB	± 13.0dB ± 13.4dB
Note 1: The lower power limit shall not exceed the minimum output power requirements defined in sub-clause 6.3.2.3						

6.3.5A.2 Power Control Relative power tolerance for CA

6.3.5A.2.1 Power Control Relative power tolerance for CA (intra-band contiguous DL CA and UL CA)

In the minimum conformance paragraph and in the test procedure the alignment ($\pm[2]$) of the two component carriers needs to be confirmed.

6.3.5A.2.1.1 Test purpose

To verify the ability of the UE transmitter to change the output power in both assigned component carrier in the uplink with a defined power step sizes between sub-frames on the two respective component carrier.

6.3.5A.2.1.2 Test applicability

This test applies to all types of E-UTRA UE release 10 and forward that support intra-band contiguous DL CA and UL CA.

6.3.5A.2.1.3 Minimum conformance requirement

The requirements apply when the power of the target and reference sub-frames on each component carrier exceed the minimum output power as defined in subclause 6.3.2A and the total power is limited by P_{UMAX} as defined in subclause 6.2.5A.

For intra-band contiguous carrier aggregation bandwidth class C, the UE transmitter shall have the capability of changing the output power in both assigned component carrier in the uplink with a step sizes of ΔP between subframes on the two respective component carrier as follows

- a) The requirements for all combinations of PUSCH and PUCCH transitions per component carrier is given in Table 6.3.5A.2.1.3-1, when the average transmit power per PRB for the transmission on the assigned carriers are aligned to within $\pm[2]$ dB in the reference sub-frame and the target subframe after the transition.
- b) For SRS the requirements for combinations of PUSCH/PUCCH and SRS transitions between sub-frames given in Table 6.3.5A.2.1.3-1 apply per component carrier when the target and reference subframes are configured for either simultaneous SRS or simultaneous PUSCH and with the average transmit power per PRB for the transmissions on the assigned carrier aligned to within $\pm[2]$ dB in the reference sub-frame and the target subframe after the transition.
- c) For RACH the requirements apply for the primary cell and are given in Table 6.3.5A.2.1.3-1.

Table 6.3.5A.2.1.3-1 Relative Power Tolerance for Transmission (normal conditions)

Power step ΔP (Up or down) [dB]	All combinations of PUSCH and PUCCH transitions [dB]	All combinations of PUSCH/PUCCH and SRS transitions between sub- frames [dB]	PRACH [dB]
$\Delta P < 2$	± 2.5 (Note 3)	± 3.0	± 2.5
$2 \leq \Delta P < 3$	± 3.0	± 4.0	± 3.0
$3 \leq \Delta P < 4$	± 3.5	± 5.0	± 3.5
$4 \leq \Delta P \leq 10$	± 4.0	± 6.0	± 4.0
$10 \leq \Delta P < 15$	± 5.0	± 8.0	± 5.0
$15 \leq \Delta P$	± 6.0	± 9.0	± 6.0
<p>Note 1: For extreme conditions an additional ± 2.0 dB relaxation is allowed</p> <p>Note 2: For operating bands under Note 2 in Table 6.2.2.3-1, the relative power tolerance is relaxed by increasing the upper limit by 1.5 dB if the transmission bandwidth of the reference sub-frames is confined within F_{UL_low} and $F_{UL_low} + 4$ MHz or $F_{UL_high} - 4$ MHz and F_{UL_high} and the target sub-frame is not confined within any one of these frequency ranges; if the transmission bandwidth of the target sub-frame is confined within F_{UL_low} and $F_{UL_low} + 4$ MHz or $F_{UL_high} - 4$ MHz and F_{UL_high} and the reference sub-frame is not confined within any one of these frequency ranges, then the tolerance is relaxed by reducing the lower limit by 1.5 dB.</p> <p>Note 3: For PUSCH to PUSCH transitions with the allocated resource blocks fixed in frequency and no transmission gaps other than those generated by downlink subframes, DwPTS fields or Guard Periods for TDD: for a power step $\Delta P \leq 1$ dB, the relative power tolerance for transmission is ± 1.0 dB.</p>			

The power step (ΔP) is defined as the difference in the calculated setting of the UE Transmit power between the target and reference sub-frames with the power setting according to Clause 5.1 of TS 36.213. The error is the difference between ΔP and the power change measured at the UE antenna port with the power of the cell-specific reference signals kept constant. The error shall be less than the relative power tolerance specified in Table 6.3.5A.2.1.3-1.

The normative reference for this requirement is TS 36.101 clause 6.3.5A.2.

6.3.5A.2.1.4 Test description

6.3.5A.2.1.4.1 Initial conditions

Initial conditions are a set of test configurations the UE needs to be tested in and the steps for the SS to take with the UE to reach the correct measurement state.

The initial test configurations consist of environmental conditions, test frequencies, and CC combinations based on E-UTRA CA configurations specified in table 5.4.2A.1-1. All of these configurations shall be tested with applicable test parameters for each CA Configuration, and are shown in table 6.3.5A.2.1.4.1-1. The details of the uplink reference measurement channels (RMCs) are specified in Annexes A.2. Configurations of PDSCH and PDCCH before measurement are specified in Annex C.2.

Table 6.3.5A.2.1.4.1-1: Test Configuration Table

Initial Conditions								
Test Environment as specified in TS 36.508[7] clause 4.1				Normal, TL/VL, TL/VH, TH/VL, TH/VH				
Test Frequencies as specified in TS36.508 [7] clause [4.3.1] for different CA bandwidth classes.				C: Mid range				
Test CC Combination setting (NRB_agg) as specified in clause 5.4.2A.1 for the CA Configuration across bandwidth combination sets supported by the UE.				Lowest N _{RB_agg} Highest N _{RB_agg}				
Test Parameters for CA Configurations								
CA Configuration / N _{RB_agg}		DL Allocation	CC MOD	UL Allocation				
PCC N _{RB}	SCCs N _{RB}	PCC & SCC RB allocation		N _{RB_alloc}	PCC & SCC RB allocations (L _{CRB} @ RB _{start})			
75	75	N/A for this test	QPSK	150	P_75@0	S_75@0	-	-
100	50		QPSK	150	P_100@0	S_50@0	-	-
100	100		QPSK	200	P_100@0	S_100@0	-	-
Note 1: CA Configuration Test CC Combination settings are checked separately for each CA Configuration, which applicable aggregated channel bandwidths are specified in Table 5.4.2A.1-1								

1. Connect the SS to the UE antenna connectors as shown in TS 36.508 [7] Annex A, Figure group A.32 as appropriate .
2. The parameter settings for the cell are set up according to TS 36.508 [7] clause 4.4.3.
3. Downlink signals for PCC are initially set up according to Annex C.0, C.1 and C.3.0, and uplink signals according to Annex H.1 and H.3.0.
4. The UL Reference Measurement channel is set according to table 6.3.5A.2.1.4.1-1
5. Propagation conditions are set according to Annex B.0.
6. Ensure the UE is in State 3A-RF according to TS 36.508 [7] clause 5.2A.2. Message contents are defined in clause 6.3.5A.2.1.4.3.

6.3.5A.2.1.4.2 Test procedure

1. Configure SCC according to Annex C.0, C.1 and Annex C.3.0 for all downlink physical channels except PHICH.
2. The SS shall configure SCC as per TS 36.508 [7] clause 5.2A.4.
3. SS activates SCC by sending the activation MAC-CE (Refer TS 36.321 [13], clauses 5.13, 6.1.3.8). Wait for at least 2 seconds (Refer TS 36.133, clauses 8.3.3.2).
4. The procedure is separated in various subtests to verify different aspects of relative power control. The power patterns of the subtests are described in figure 6.3.5.2.4.2-1, 6.3.5.2.4.2-2, 6.3.5.2.4.2-3, 6.3.5.2.4.2-4 and 6.3.5.2.4.2-5.
5. Sub test: ramping up pattern
 - 5.1. SS sends uplink scheduling information for each UL HARQ process via PDCCH DCI format 0 for C_RNTI to schedule the UL RMC according to Table 6.3.5A.1.1.4.1-1 on both PCC and SCC. Since the UE has no payload and no loopback data to send the UE sends uplink MAC padding bits on the UL RMC. Send the appropriate TPC commands for PUSCH on each component carrier to the UE to ensure that the UE transmits PUSCH at -36.8dBm +/- 3.2 dB for carrier frequency $f \leq 3.0\text{GHz}$ or at -36.5dBm +/- 3.5 dB for carrier frequency $3.0\text{GHz} < f \leq 4.2\text{GHz}$. In addition, considering that PCC and SCC uplink RB allocations are both active, the average transmit power per PRB for the transmission on the assigned carriers shall aligned within $\pm[2]$ dB in the reference sub-frame and the target subframe after the transition. In case they are not aligned, SS shall send appropriate TPC commands for PUSCH on the relevant component in order to be aligned before continuing the test.
 - 5.2. Schedule the UE's PUSCH data transmission on each component carrier as described in Figure 6.3.5.2.4.2-1 (FDD pattern A: sub-test is divided in 4 arbitrary radio frames with 10 active uplink sub-frames per radio frame)

and Figure 6.3.5.2.4.2-3 (TDD pattern A: sub-test is divided in 10 arbitrary radio frames with 4 active uplink sub-frames per radio frame) with an uplink RB allocation as defined in tables 6.3.5.2.5-1 thru 6.3.5.2.5-12 depending on channel bandwidth. On the PDCCH format 0 for the scheduling of the PUSCH of each component carrier the SS will transmit a +1dB TPC command. Note that the measurement need not be done continuously, provided that interruptions are whole numbers of frames, and TPC commands of 0dB are sent during the interruption.

- 5.3. Measure the power of PUSCH transmissions on each component carrier to verify the UE relative power control meet test requirements 6.3.5.2.5. For power transients between subframes, transient periods of 40us between subframes are excluded. For ON/OFF or OFF/ON transients, transient periods of 20 us at the beginning of the subframe are excluded.
- 5.4. Repeat the subtest different pattern B, C to move the RB allocation change at different points in the pattern as described in Table 6.3.5.2.5-1 thru Table 6.3.5.2.5-12 to force bigger UE power steps at various points in the power range on each component carrier.
6. Sub test: ramping down pattern
 - 6.1. SS sends uplink scheduling information for each UL HARQ process via PDCCH DCI format 0 for C_RNTI to schedule the UL RMC according to Table 6.3.5A.1.1.4.1-1 on both PCC and SCC. Since the UE has no payload and no loopback data to send the UE sends uplink MAC padding bits on the UL RMC. Send the appropriate TPC commands for PUSCH on each component carrier to the UE to ensure that the UE transmits PUSCH at +18.0dBm +/- 3.2 dB for carrier frequency $f \leq 3.0\text{GHz}$ or at +17.7dBm +/- 3.5 dB for carrier frequency $3.0\text{GHz} < f \leq 4.2\text{GHz}$. In addition, considering that PCC and SCC uplink RB allocations are both active, the average transmit power per PRB for the transmission on the assigned carriers shall aligned within $\pm[2]$ dB in the reference sub-frame and the target subframe after the transition. In case they are not aligned, SS shall send appropriate TPC commands for PUSCH on the relevant component in order to be aligned before continuing the test.
 - 6.2. Schedule the UE's PUSCH data transmission on each component carrier as described in Figure 6.3.5.2.4.2-2 (FDD pattern A: sub-test is divided in 4 arbitrary radio frames with 10 active uplink sub-frames per radio frame) and Figure 6.3.5.2.4.2-4 (TDD pattern A: sub-test is divided in 10 arbitrary radio frames with 4 active uplink sub-frames per radio frame) with an uplink RB allocation as defined in tables 6.3.5.2.5-1 thru 6.3.5.2.5-12 depending on channel bandwidth. On the PDCCH format 0 for the scheduling of the PUSCH of each component carrier the SS will transmit a -1dB TPC command. Note that the measurement need not be done continuously, provided that interruptions are whole numbers of frames, and TPC commands of 0dB are sent during the interruption.
 - 6.3. Measure the power of PUSCH transmissions on each component carrier to verify the UE relative power control meet test requirements 6.3.5.2.5. For power transients between subframes, transient periods of 40us between subframes are excluded. For ON/OFF or OFF/ON transients, transient periods of 20 us at the beginning of the subframe are excluded.
 - 6.4. Repeat the subtest different pattern B, C to move the RB allocation change at different points in the pattern as described in Table 6.3.5.2.5-1 thru Table 6.3.5.2.5-12 to force bigger UE power steps at various points in the power range on each component carrier.
7. Sub test: alternating pattern
 - 7.1. SS sends uplink scheduling information for each UL HARQ process via PDCCH DCI format 0 for C_RNTI to schedule the UL RMC according to Table 6.3.5A.1.1.4.1-1 on both PCC and SCC. Since the UE has no payload and no loopback data to send the UE sends uplink MAC padding bits on the UL RMC. Send the appropriate TPC commands for PUSCH on each component carrier to the UE to ensure that the UE transmits PUSCH at -10dBm +/- 3.2 dB for carrier frequency $f \leq 3.0\text{GHz}$ or at -10dBm +/- 3.5 dB for carrier frequency $3.0\text{GHz} < f \leq 4.2\text{GHz}$. The initial uplink RB allocation is defined as the smaller uplink RB allocation value specified in tables 6.3.5.2.5-13. The power level and RB allocation are reset for each sub-test.
 - 7.2. Schedule the UE's PUSCH data transmission on each component carrier as described in Figure 6.3.5.2.4.2-5 for 10 sub-frames with an uplink RB allocation alternating pattern as defined in table 6.3.5.2.5-13 while transmitting 0dB TPC command for PUSCH via the PDCCH.
 - 7.3. Measure the power of PUSCH transmissions on each component carrier to verify the UE relative power control meet test requirements specified in clause 6.3.5.2.5. For power transients between subframes, transient

periods of 40us between subframes are excluded. For ON/OFF or OFF/ON transients, transient periods of 20 us at the beginning of the subframe are excluded.

6.3.5A.2.1.4.3 Message contents

Message contents are according to TS 36.508 [7] subclause 4.6.

6.3.5A.2.1.5 Test requirement

For intra-band contiguous carrier aggregation bandwidth class C, the relative power control tolerance per component carrier measured in steps (5), (6) and (7) of the test procedure should satisfy the test requirements specified in Tables 6.3.5A.2.1.5-1, thru 6.3.5A.2.1.5-13 for normal conditions; for extreme conditions an additional ± 2.0 dB relaxation is allowed. The test requirement tables are originated from tables 6.3.5.2.5-1, thru 6.3.5.2.5-13.

To account for RF Power amplifier mode changes 2 exceptions are allowed for each of ramping up and ramping down test patterns. For these exceptions the power tolerance limit is a maximum of ± 6.7 dB. If there is an exception in the power step caused by the RB change for all test patterns (A, B, C) then fail the UE.

Table 6.3.5A.2.1.5-1: Test Requirements Relative Power Tolerance for Transmission (normal conditions – Note 5) channel bandwidth 1.4MHz (ramping up) for intra-band contiguous DL CA and UL CA

Sub-test (ramp up)	Uplink RB allocation	TPC command	Expected power step size (Up) ΔP [dB]	Power step size range (Up) ΔP [dB]	PUSCH [dB]
Subframes before RB change	Fixed = 1	TPC=+1dB	1	$\Delta P < 2$	$1 \pm (1.7)$
RB change	Change from 1 to 6 RBs	TPC=+1dB	8.78	$4 \leq \Delta P < 10$	$8.78 \pm (4.7)$ Note 2 $8.78 +6.2/-4.7$ Note 3
Subframes after RB change	Fixed = 6	TPC=+1dB	1	$\Delta P < 2$	$1 \pm (1.7)$
Note 1: Position of RB change: Pattern A the position of RB uplink allocation change is after 10 active uplink subframes Pattern B the position of RB uplink allocation change is after 20 active uplink subframes Pattern C the position of RB uplink allocation change is after 30 active uplink subframes Note 2: When Note 3 does not apply. Note 3: For operating bands under Note 2 in Table 6.2.2.3-1, if the transmission bandwidth of the reference sub-frames is confined within F_{UL_low} and $F_{UL_low} + 4$ MHz or $F_{UL_high} - 4$ MHz and F_{UL_high} and the target sub-frame is not confined within any one of these frequency ranges. Note 4: N/A Note 5: For extreme conditions an additional ± 2.0 dB relaxation is allowed. Note 6: The starting resource block shall be RB# 0.					

Table 6.3.5A.2.1.5-2: Test Requirements Relative Power Tolerance for Transmission (normal conditions – Note 5) channel bandwidth 1.4MHz (ramping down) for intra-band contiguous DL CA and UL CA

Sub-test (ramp down)	Uplink RB allocation	TPC command	Expected power step size (down) ΔP [dB]	Power step size range (down) ΔP [dB]	PUSCH [dB]

Subframes before RB change	Fixed = 5	TPC=-1dB	1	$\Delta P < 2$	$1 \pm (1.7)$
RB change	Change from 5 to 1 RBs	TPC=-1dB	7.99	$4 \leq \Delta P < 1$	$7.99 \pm (4.7)$ Note 2 $7.99 + 4.7/-6.2$ Note 4
Subframes after RB change	Fixed = 1	TPC=-1dB	1	$\Delta P < 2$	$1 \pm (1.7)$
<p>Note 1: Position of RB change: Pattern A the position of RB uplink allocation change is after 6 active uplink subframes Pattern B the position of RB uplink allocation change is after 16 active uplink subframes Pattern C the position of RB uplink allocation change is after 26 active uplink subframes</p> <p>Note 2: When Note 4 does not apply.</p> <p>Note 3: N/A</p> <p>Note 4: For operating bands under Note 2 in Table 6.2.2.3-1, if the transmission bandwidth of the target sub-frame is confined within F_{UL_low} and $F_{UL_low} + 4$ MHz or $F_{UL_high} - 4$ MHz and F_{UL_high} and the reference sub-frame is not confined within any one of these frequency ranges.</p> <p>Note 5: For extreme conditions an additional ± 2.0 dB relaxation is allowed.</p> <p>Note 6: The starting resource block shall be RB# 0.</p>					

Table 6.3.5A.2.1.5-3: Test Requirements Relative Power Tolerance for Transmission (normal conditions – Note 5) channel bandwidth 3MHz (ramping up) for intra-band contiguous DL CA and UL CA

Sub-test (ramp up)	Uplink RB allocation	TPC command	Expected power step size (Up) ΔP [dB]	Power step size range (Up) ΔP [dB]	PUSCH [dB]
Subframes before RB change	Fixed = 1	TPC=+1dB	1	$\Delta P < 2$	$1 \pm (1.7)$
RB change	Change from 1 to 4 RBs	TPC=+1dB	7.02	$4 \leq \Delta P < 10$	$7.02 \pm (4.7)$ Note 2 $7.02 + 6.2/-4.7$ Note 3
Subframes after RB change	Fixed =4	TPC=+1dB	1	$\Delta P < 2$	$1 \pm (1.7)$
<p>Note 1: Position of RB change: Pattern A the position of RB uplink allocation change is after 10 active uplink subframes Pattern B the position of RB uplink allocation change is after 20 active uplink subframes Pattern C the position of RB uplink allocation change is after 30 active uplink subframes</p> <p>Note 2: When Note 3 does not apply.</p> <p>Note 3: For operating bands under Note 2 in Table 6.2.2.3-1, if the transmission bandwidth of the reference sub-frames is confined within F_{UL_low} and $F_{UL_low} + 4$ MHz or $F_{UL_high} - 4$ MHz and F_{UL_high} and the target sub-frame is not confined within any one of these frequency ranges.</p> <p>Note 4: N/A</p> <p>Note 5: For extreme conditions an additional ± 2.0 dB relaxation is allowed.</p> <p>Note 6: The starting resource block shall be RB# 0.</p>					

Table 6.3.5A.2.1.5-4: Test Requirements Relative Power Tolerance for Transmission (normal conditions – Note 5) channel bandwidth 3MHz (ramping down) for intra-band contiguous DL CA and UL CA

Sub-test (ramp down)	Uplink RB allocation	TPC command	Expected power step size (down) ΔP [dB]	Power step size range (down) ΔP [dB]	PUSCH [dB]
Subframes before RB change	Fixed = 15	TPC=-1dB	1	$\Delta P < 2$	$1 \pm (1.7)$
RB change	Change from 15 to 1 RBs	TPC=-1dB	12.76	$10 \leq \Delta P < 15$	$12.76 \pm (5.7)$ Note 2 $12.76 +5.7/-7.2$ Note 4
Subframes after RB change	Fixed =1	TPC=-1dB	1	$\Delta P < 2$	$1 \pm (1.7)$
<p>Note 1: Position of RB change: Pattern A the position of RB uplink allocation change is after 6 active uplink subframes Pattern A the position of RB uplink allocation change is after 16 active uplink subframes Pattern C the position of RB uplink allocation change is after 26 active uplink subframes</p> <p>Note 2: When Note 4 does not apply.</p> <p>Note 3: N/A</p> <p>Note 4: For operating bands under Note 2 in Table 6.2.2.3-1, if the transmission bandwidth of the target sub-frame is confined within F_{UL_low} and $F_{UL_low} + 4$ MHz or $F_{UL_high} - 4$ MHz and F_{UL_high} and the reference sub-frame is not confined within any one of these frequency ranges.</p> <p>Note 5: For extreme conditions an additional ± 2.0 dB relaxation is allowed.</p> <p>Note 6: The starting resource block shall be RB# 0.</p>					

Table 6.3.5A.2.1.5-5: Test Requirements Relative Power Tolerance for Transmission (normal conditions – Note 5) channel bandwidth 5MHz (ramping up) for intra-band contiguous DL CA and UL CA

Sub-test (ramp up)	Uplink RB allocation	TPC command	Expected power step size (Up) ΔP [dB]	Power step size range (Up) ΔP [dB]	PUSCH [dB]
--------------------	----------------------	-------------	--	---	-------------------

Subframes before RB change	Fixed = 1	TPC=+1dB	1	$\Delta P < 2$	$1 \pm (1.7)$
RB change	Change from 1 to 20	TPC=+1dB	14.01	$10 \leq \Delta P < 15$	$14.01 \pm (5.7)$ Note 2 $14.01 +7.2/-5.7$ Note 3
Subframes after RB change	Fixed = 20	TPC=+1dB	1	$\Delta P < 2$	$1 \pm (1.7)$
<p>Note 1: Position of RB change: Pattern A the position of RB uplink allocation change is after 10 active uplink subframes Pattern B the position of RB uplink allocation change is after 20 active uplink subframes Pattern C the position of RB uplink allocation change is after 30 active uplink subframes</p> <p>Note 2: When Note 3 does not apply.</p> <p>Note 3: For operating bands under Note 2 in Table 6.2.2.3-1, if the transmission bandwidth of the reference sub-frames is confined within F_{UL_low} and $F_{UL_low} + 4$ MHz or $F_{UL_high} - 4$ MHz and F_{UL_high} and the target sub-frame is not confined within any one of these frequency ranges.</p> <p>Note 4: N/A</p> <p>Note 5: For extreme conditions an additional ± 2.0 dB relaxation is allowed.</p> <p>Note 6: The starting resource block shall be RB# 0.</p>					

Table 6.3.5A.2.1.5-6: Test Requirements Relative Power Tolerance for Transmission (normal conditions – Note 5) channel bandwidth 5MHz (ramping down) for intra-band contiguous DL CA and UL CA

Sub-test (ramp down)	Uplink RB allocation	TPC command	Expected power step size (down) ΔP [dB]	Power step size range (down) ΔP [dB]	PUSCH [dB]
Subframes before RB change	Fixed = 25	TPC=-1dB	1	$\Delta P < 2$	$1 \pm (1.7)$
RB change	Change from 25 to 1	TPC=-1dB	14.98	$10 \leq \Delta P < 15$	$14.98 \pm (5.7)$ Note 2 $14.98 +5.7/-7.2$ Note 4
Subframes after RB change	Fixed = 1	TPC=-1dB	1	$\Delta P < 2$	$1 \pm (1.7)$
<p>Note 1: Position of RB change: Pattern A the position of RB uplink allocation change is after 6 active uplink subframes Pattern B the position of RB uplink allocation change is after 16 active uplink subframes Pattern C the position of RB uplink allocation change is after 26 active uplink subframes</p> <p>Note 2: When Note 4 does not apply.</p> <p>Note 3: N/A</p> <p>Note 4: For operating bands under Note 2 in Table 6.2.2.3-1, if the transmission bandwidth of the target sub-frame is confined within F_{UL_low} and $F_{UL_low} + 4$ MHz or $F_{UL_high} - 4$ MHz and F_{UL_high} and the reference sub-frame is not confined within any one of these frequency ranges.</p> <p>Note 5: For extreme conditions an additional ± 2.0 dB relaxation is allowed.</p> <p>Note 6: The starting resource block shall be RB# 0.</p>					

Table 6.3.5A.2.1.5-7: Test Requirements Relative Power Tolerance for Transmission (normal conditions – Note 5) channel bandwidth 10MHz (ramping up) for intra-band contiguous DL CA and UL CA

Sub-test (ramp up)	Uplink RB allocation	TPC command	Expected power step size (Up) ΔP [dB]	Power step size range (Up) ΔP [dB]	PUSCH [dB]
Subframes before RB change	Fixed = 1	TPC=+1dB	1	$\Delta P < 2$	$1 \pm (1.7)$
RB change	Change from 1 to 25	TPC=+1dB	14.98	$10 \leq \Delta P < 15$	$14.98 \pm (5.7)$ Note 2 $14.98 +7.2/-5.7$ Note 3
Subframes after RB change	Fixed = 25	TPC=+1dB	1	$\Delta P < 2$	$1 \pm (1.7)$
<p>Note 1: Position of RB change: Pattern A the position of RB uplink allocation change is after 10 active uplink subframes Pattern B the position of RB uplink allocation change is after 20 active uplink subframes Pattern C the position of RB uplink allocation change is after 30 active uplink subframes</p> <p>Note 2: When Note 3 does not apply.</p> <p>Note 3: For operating bands under Note 2 in Table 6.2.2.3-1, if the transmission bandwidth of the reference sub-frames is confined within F_{UL_low} and $F_{UL_low} + 4$ MHz or $F_{UL_high} - 4$ MHz and F_{UL_high} and the target sub-frame is not confined within any one of these frequency ranges.</p> <p>Note 4: N/A</p> <p>Note 5: For extreme conditions an additional ± 2.0 dB relaxation is allowed.</p> <p>Note 6: The starting resource block shall be RB# 0.</p>					

Table 6.3.5A.2.1.5-8: Test Requirements Relative Power Tolerance for Transmission (normal conditions – Note 5) channel bandwidth 10MHz (ramping down) for intra-band contiguous DL CA and UL CA

Sub-test (ramp down)	Uplink RB allocation	TPC command	Expected power step size (down) ΔP [dB]	Power step size range (down) ΔP [dB]	PUSCH [dB]
----------------------	----------------------	-------------	--	---	-------------------

Subframes before RB change	Fixed = 50 (UE- Categories ≥2) Fixed = 48 (UE Cat 1)	TPC=-1dB	1	$\Delta P < 2$	$1 \pm (1.7)$
RB change	Change from 50 to 1 (UE- Categories ≥2) Change from 48 to 1 (UE cat 1)	TPC=-1dB	17.99 17.81	$15 \leq \Delta$	$17.99 \pm (6.7)$ Note 2 $17.99 +6.7/-8.2$ Note 4 $17.81 \pm (6.7)$ Note 2 $17.81 +6.7/-8.2$ Note 4
Subframes after RB change	Fixed = 1	TPC=-1dB	1	$\Delta P < 2$	$1 \pm (1.7)$
<p>Note 1: Position of RB change: Pattern A the position of RB uplink allocation change is after 6 active uplink subframes Pattern B the position of RB uplink allocation change is after 16 active uplink subframes Pattern C the position of RB uplink allocation change is after 26 active uplink subframes</p> <p>Note 2: When Note 3 does not apply.</p> <p>Note 3: N/A</p> <p>Note 4: For operating bands under Note 2 in Table 6.2.2.3-1, if the transmission bandwidth of the target sub-frame is confined within F_{UL_low} and $F_{UL_low} + 4$ MHz or $F_{UL_high} - 4$ MHz and F_{UL_high} and the reference sub-frame is not confined within any one of these frequency ranges.</p> <p>Note 5: For extreme conditions an additional ± 2.0 dB relaxation is allowed.</p> <p>Note 6: The starting resource block shall be RB# 0.</p>					

Table 6.3.5A.2.1.5-9: Test Requirements Relative Power Tolerance for Transmission (normal conditions – Note 5) channel bandwidth 15MHz (ramping up) for intra-band contiguous DL CA and UL CA

Sub-test (ramp up)	Uplink RB allocation	TPC command	Expected power step size (Up) ΔP [dB]	Power step size range (Up) ΔP [dB]	PUSCH [dB]
--------------------	----------------------	-------------	--	---	-------------------

Subframes before RB change	Fixed = 1	TPC=+1dB	1	$\Delta P < 2$	$1 \pm (1.7)$
RB change	Change from 1 to 50	TPC=+1dB	17.99	$15 \leq \Delta P$	$17.99 \pm (6.7)$ Note 2 $17.99 + 8.2 / - 6.7$ Note 3
Subframes after RB change	Fixed = 50	TPC=+1dB	1	$\Delta P < 2$	$1 \pm (1.7)$
<p>Note 1: Position of RB change: Pattern A the position of RB uplink allocation change is after 10 active uplink subframes Pattern B the position of RB uplink allocation change is after 20 active uplink subframes Pattern C the position of RB uplink allocation change is after 30 active uplink subframes</p> <p>Note 2: When Note 3 does not apply.</p> <p>Note 3: For operating bands under Note 2 in Table 6.2.2.3-1, if the transmission bandwidth of the reference sub-frames is confined within F_{UL_low} and $F_{UL_low} + 4$ MHz or $F_{UL_high} - 4$ MHz and F_{UL_high} and the target sub-frame is not confined within any one of these frequency ranges.</p> <p>Note 4: N/A</p> <p>Note 5: For extreme conditions an additional ± 2.0 dB relaxation is allowed.</p> <p>Note 6: The starting resource block shall be RB# 0.</p>					

Table 6.3.5A.2.1.5-10: Test Requirements Relative Power Tolerance for Transmission (normal conditions – Note 5) channel bandwidth 15MHz (ramping down) for intra-band contiguous DL CA and UL CA

Sub-test (ramp down)	Uplink RB allocation	TPC command	Expected power step size (down) ΔP [dB]	Power step size range (down) ΔP [dB]	PUSCH [dB]
----------------------	----------------------	-------------	--	---	---------------

Subframes before RB change	Fixed = 75 (UE- Categories ≥ 2) Fixed = 50 (UE Cat 1)	TPC=-1dB	1	$\Delta P < 2$	$1 \pm (1.7)$
RB change	Change from 75 to 1 (UE- Categories ≥ 2) Change from 50 to 1 (UE Cat 1)	TPC=-1dB	19.75 17.99	$15 \leq \Delta P$	$19.75 \pm (6.7)$ Note 2 $19.75 +6.7/-8.2$ Note 4 $17.99 \pm (6.7)$ Note 2 $17.99 +6.7/-8.2$ Note 4
Subframes after RB change	Fixed = 1	TPC=-1dB	1	$\Delta P < 2$	$1 \pm (1.7)$
<p>Note 1: Position of RB change: Pattern A the position of RB uplink allocation change is after 6 active uplink subframes Pattern B the position of RB uplink allocation change is after 16 active uplink subframes Pattern C the position of RB uplink allocation change is after 26 active uplink subframes</p> <p>Note 2: When Note 4 does not apply.</p> <p>Note 3: N/A</p> <p>Note 4: For operating bands under Note 2 in Table 6.2.2.3-1, if the transmission bandwidth of the target sub-frame is confined within F_{UL_low} and $F_{UL_low} + 4$ MHz or $F_{UL_high} - 4$ MHz and F_{UL_high} and the reference sub-frame is not confined within any one of these frequency ranges.</p> <p>Note 5: For extreme conditions an additional ± 2.0 dB relaxation is allowed.</p> <p>Note 6: The starting resource block shall be RB# 0.</p>					

Table 6.3.5A.2.1.5-11: Test Requirements Relative Power Tolerance for Transmission (normal conditions – Note 5) channel bandwidth 20MHz (ramping up) for intra-band contiguous DL CA and UL CA

Sub-test (ramp up)	Uplink RB allocation	TPC command	Expected power step size (Up) ΔP [dB]	Power step size range (Up) ΔP [dB]	PUSCH [dB]
--------------------	----------------------	-------------	--	---	-------------------

Subframes before RB change	Fixed = 1	TPC=+1dB	1	$\Delta P < 2$	$1 \pm (1.7)$
RB change	Change from 1 to 75	TPC=+1dB	19.75	$15 \leq \Delta P$	$19.75 \pm (6.7)$ Note 2 $19.75 + 8.2/-6.7$ Note 3
Subframes after RB change	Fixed = 75	TPC=+1dB	1	$\Delta P < 2$	$1 \pm (1.7)$
<p>Note 1: Position of RB change: Pattern A the position of RB uplink allocation change is after 10 active uplink subframes Pattern B the position of RB uplink allocation change is after 20 active uplink subframes Pattern C the position of RB uplink allocation change is after 30 active uplink subframes</p> <p>Note 2: When Note 3 does not apply.</p> <p>Note 3: For operating bands under Note 2 in Table 6.2.2.3-1, if the transmission bandwidth of the reference sub-frames is confined within F_{UL_low} and $F_{UL_low} + 4$ MHz or $F_{UL_high} - 4$ MHz and F_{UL_high} and the target sub-frame is not confined within any one of these frequency ranges.</p> <p>Note 4: N/A</p> <p>Note 5: For extreme conditions an additional ± 2.0 dB relaxation is allowed.</p> <p>Note 6: The starting resource block shall be RB# 0.</p>					

Table 6.3.5A.2.1.5-12: Test Requirements Relative Power Tolerance for Transmission (normal conditions – Note 5) channel bandwidth 20MHz (ramping down) for intra-band contiguous DL CA and UL CA

Sub-test (ramp down)	Uplink RB allocation	TPC command	Expected power step size (down) ΔP [dB]	Power step size range (down) ΔP [dB]	PUSCH [dB]
----------------------	----------------------	-------------	--	---	---------------

Subframes before RB change	Fixed = 100 (UE- Categories ≥2) Fixed = 75 (UE Cat 1)	TPC=-1dB	1	$\Delta P < 2$	$1 \pm (1.7)$
RB change	Change from 100 to 1 (UE- Categories ≥2) Change from 75 to 1 (UE Cat 1)	TPC=-1dB	21.0 19.75	$15 \leq \Delta P$	$21.0 \pm (6.7)$ Note 2 $21.0 +6.7/-8.2$ Note 4 $19.75 \pm (6.7)$ Note 2 $19.75 +6.7/-8.2$ Note 4
Subframes after RB change	Fixed = 1	TPC=-1dB	1	$\Delta P < 2$	$1 \pm (1.7)$
<p>Note 1: Position of RB change: Pattern A the position of RB uplink allocation change is after 6 active uplink subframes Pattern B the position of RB uplink allocation change is after 16 active uplink subframes Pattern C the position of RB uplink allocation change is after 26 active uplink subframes</p> <p>Note 2: When Note 4 does not apply.</p> <p>Note 3: N/A</p> <p>Note 4: For operating bands under Note 2 in Table 6.2.2.3-1, if the transmission bandwidth of the target sub-frame is confined within F_{UL_low} and $F_{UL_low} + 4$ MHz or $F_{UL_high} - 4$ MHz and F_{UL_high} and the reference sub-frame is not confined within any one of these frequency ranges.</p> <p>Note 5: For extreme conditions an additional ± 2.0 dB relaxation is allowed.</p> <p>Note 6: The starting resource block shall be RB# 0.</p>					

Table 6.3.5A.2.1.5-13: Test Requirements Relative Power Tolerance for Transmission (normal conditions – Note 5) (Alternating pattern) for intra-band contiguous DL CA and UL CA

Sub-test	Uplink RB allocation	TPC command	Expected power step size (Up or down) ΔP [dB]	Power step size range (Up or down) ΔP [dB]	PUSCH [dB]
----------	----------------------	-------------	--	---	-------------------

1.4 MHz	Alternating 1 and 6	TPC=0dB	7.78	$4 \leq \Delta P < 10$	7.78 ± (6.7) Note 1,2 7.78 +8.2/-6.7 Note 3 7.78 +6.7/-8.2 Note 4
3 MHz	Alternating 1 and 15	TPC=0dB	11.76	$10 \leq \Delta P < 15$	11.76 ± (6.7) Note 1,2 11.76 +8.2/-6.7 Note 3 11.76 +6.7/-8.2 Note 4
5 MHz	Alternating 1 and 25	TPC=0dB	13.98	$10 \leq \Delta P < 15$	13.98 ± (6.7) Note 1,2 13.98 +8.2/-6.7 Note 3 13.98 +6.7/-8.2 Note 4
10 MHz	Alternating 1 and 50 (UE- Categories ≥2)	TPC=0dB	16.99	$15 \leq \Delta P$	16.99 ± (6.7) Note 1,2 16.99 +8.2/-6.7 Note 3 16.99 +6.7/-8.2 Note 4
	Alternating 1 and 48 (UE Cat 1)		16,81		16.81 ± (6.7) Note 1,2 16.81 +8.2/-6.7 Note 3 16.81 +6.7/-8.2 Note 4
15 MHz	Alternating 1 and 75 (UE- Categories ≥2)	TPC=0dB	18.75	$15 \leq \Delta P$	18.75 ± (6.7) Note 1,2 18.75 +8.2/-6.7 Note 3 18.75 +6.7/-8.2 Note 4
	Alternating 1 and 50 (UE Cat 1)		16.99		16.99 ± (6.7) Note 1,2 16.99 +8.2/-6.7 Note 3 16.99 +6.7/-8.2 Note 4
20 MHz	Alternating 1 and 100 (UE Cat 2-5)	TPC=0dB	20.00	$15 \leq \Delta P$	20.00 ± (6.7) Note 1,2 20.00 +8.2/-6.7 Note 3 20.00 +6.7/-8.2 Note 4
	Alternating 1 and 75 (UE Cat 1)		18.75		18.75 ± (6.7) Note 1,2 18.75 +8.2/-6.7 Note 3 18.75 +6.7/-8.2 Note 4
<p>Note 1: Test tolerance +/- 6.7 dB was selected to allow PA switch possible exceptions to occur.</p> <p>Note 2: When neither Note 3 nor Note 4 applies.</p> <p>Note 3: For operating bands under Note 2 in Table 6.2.2.3-1, if the transmission bandwidth of the reference sub-frames is confined within F_{UL_low} and $F_{UL_low} + 4$ MHz or $F_{UL_high} - 4$ MHz and F_{UL_high} and the target sub-frame is not confined within any one of these frequency ranges.</p> <p>Note 4: For operating bands under Note 2 in Table 6.2.2.3-1, if the transmission bandwidth of the target sub-frame is confined within F_{UL_low} and $F_{UL_low} + 4$ MHz or $F_{UL_high} - 4$ MHz and F_{UL_high} and the reference sub-frame is not confined within any one of these frequency ranges.</p> <p>Note 5: For extreme conditions an additional ± 2.0 dB relaxation is allowed.</p> <p>Note 6: The starting resource block shall be RB# 0.</p>					

6.3.5A.3 Aggregate power control tolerance for CA

6.3.5A.3.1 Aggregate power control tolerance for CA (intra-band contiguous DL CA and UL CA)

6.3.5A.3.1.1 Test purpose

To verify the ability of a UE to maintain its power in non-contiguous transmission within 21 ms in response to 0 dB TPC commands with respect to the first UE transmission, when the power control parameters specified in [TS 36.213] are constant on all active component carriers.

6.3.5A.3.1.2 Test applicability

This test applies to all types of E-UTRA UE release 10 and forward that support intra-band contiguous DL CA and UL CA.

6.3.5A.3.1.3 Minimum conformance requirements

For intra-band contiguous carrier aggregation bandwidth class C, the aggregate power tolerance per component carrier is given in Table 6.3.5A.3.1.3-1 with simultaneous PUCCH and PUSCH configured if supported. The requirement can be tested with the transmission gaps time aligned between component carriers.

Table 6.3.5A.3.1.3-1: Aggregate power control tolerance for intra-band contiguous CA

TPC command	UL channel	Aggregate power tolerance within 21 ms
0 dB	PUCCH	± 2.5 dB
0 dB	PUSCH	± 3.5 dB
NOTE: The UE transmission gap is 4 ms. TPC command is transmitted via PDCCH 4 subframes preceding each PUCCH/PUSCH transmission.		

The normative reference for this requirement is TS 36.101 [2] clause 6.3.5A.3.1.

6.3.5A.3.1.4 Test description

6.3.5A.3.1.4.1 Initial conditions

Initial conditions are a set of test configurations the UE needs to be tested in and the steps for the SS to take with the UE to reach the correct measurement state.

The initial test configurations consist of environmental conditions, test frequencies, and CC combinations based on E-UTRA CA configurations specified in table 5.4.2A.1-1. All of these configurations shall be tested with applicable test parameters for each CA Configuration, and are shown in table 6.3.5A.3.1.4.1-1 and table 6.3.5A.3.1.4.1-2. The details of the uplink reference measurement channel (RMCs) are specified in Annexes A.2. Configurations of PDSCH and PDCCH before measurement are specified in Annex C.2.

Table 6.3.5A.3.1.4.1-1: Test Configuration Table: PUCCH sub-test

Initial Conditions				
Test Environment as specified in TS 36.508[7] subclause 4.1			Normal	
Test Frequencies as specified in TS36.508 [7] subclause 4.3.1 for different CA bandwidth classes.			C: Mid range	
Test CC Combination setting (N_{RB_agg}) as specified in subclause 5.4.2A.1 for the CA Configuration across bandwidth combination sets supported by the UE.			Lowest N_{RB_agg} Highest N_{RB_agg}	
Test Parameters for CA Configurations				
CA Configuration / N_{RB_agg}		DL Allocation		Uplink Configuration
PCC N_{RB}	SCCs N_{RB}	CC Mod	PCC & SCC RB allocation	FDD: PUCCH format = Format 1b with channel selection/Format 3 TDD: PUCCH format = Format 1b with channel selection/Format 3
75	75	QPSK	75+75	
100	50	QPSK	100+50	
100	100	QPSK	100+100	
Note 1 :CA Configuration Test CC Combination settings are checked separately for each CA Configuration, which applicable aggregated channel bandwidths are specified in Table 5.4.2A.1-1				

Table 6.3.5A.3.1.4.1-2: Test Configuration Table: PUSCH sub-test

Initial Conditions							
Test Environment as specified in TS 36.508[7] clause 4.1				Normal			
Test Frequencies as specified in TS36.508 [7] clause 4.3.1 for different CA bandwidth classes.				C: Mid range			
Test CC Combination setting (NRB_agg) as specified in clause 5.4.2A.1 for the CA Configuration				Lowest N _{RB_agg} Highest N _{RB_agg}			
Test Parameters for CA Configurations							
CA Configuration / N _{RB_agg}		DL Allocation	CC MOD	UL Allocation			
PCC N _{RB}	SCCs N _{RB}	PCC & SCC RB allocation		N _{RB_alloc}	PCC & SCC RB allocations (L _{CRB} @ RB _{start})		
75	75	N/A	QPSK	150	P_75@0	S_75@0	
100	50		QPSK	150	P_100@0	S_50@0	
100	100		QPSK	200	P_100@0	S_100@0	
Note 1: CA Configuration Test CC Combination settings are checked separately for each CA Configuration, which applicable aggregated channel bandwidths are specified in Table 5.4.2A.1-1							

1. Connect the SS to the UE antenna connectors as shown in TS 36.508 [7] Annex A, Figure group A.32 as appropriate.
2. The parameter settings for the cell are set up according to TS 36.508 [7] clause 4.4.3.
3. Downlink signals for PCC are initially set up according to Annex C.0, C.1 and Annex C.3.0, and uplink signals according to Annex H.1 and H.3.0.
4. The UL and DL Reference Measurement channel is set according to Table 6.3.5A.3.1.4.1-1 (PUCCH sub-test) and Table 6.3.5A.3.1.4.1-2 (PUSCH sub-test).
5. Propagation conditions are set according to Annex B.0.
6. Ensure the UE is in State 3A-RF according to TS 36.508 [7] clause 5.2A.2. Message contents are defined in clause 6.3.5A.3.1.4.3.

6.3.5A.3.1.4.2 Test procedure

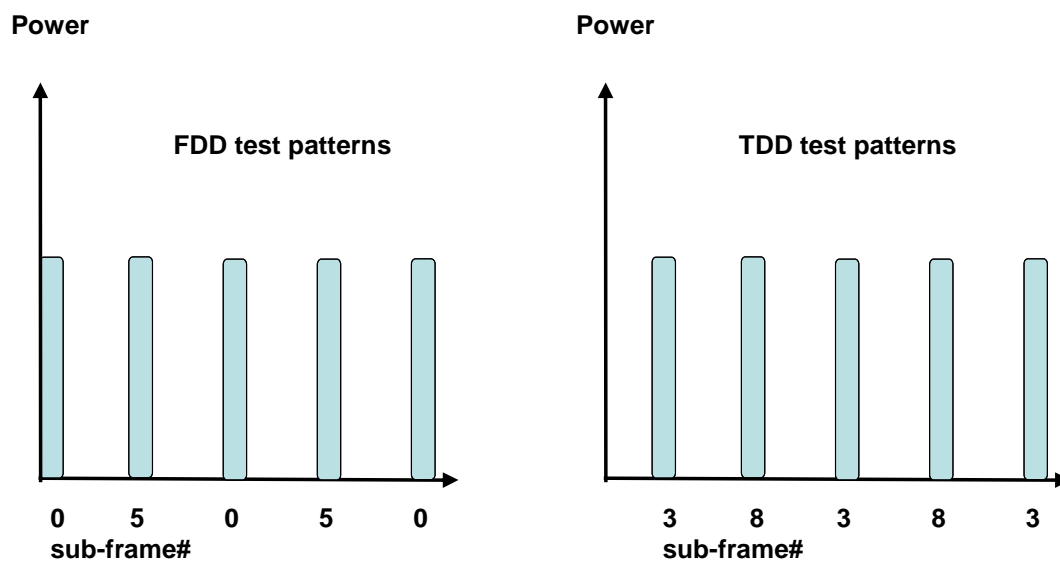

Figure 6.3.5A.3.1.4.2-1: Test uplink transmission

1. Configure SCC according to Annex C.0, C.1 and Annex C.3.0 for all downlink physical channels except PHICH.
2. The SS shall configure SCC as per TS 36.508 [7] clause 5.2A.4.
3. SS activates SCC by sending the activation MAC-CE (Refer TS 36.321 [13], clauses 5.13, 6.1.3.8). Wait for at least 2 seconds (Refer TS 36.133, clauses 8.3.3.2).
4. The procedure is separated in two subtests to verify PUCCH and PUSCH aggregate power control tolerance respectively. The uplink transmission patterns are described in figure 6.3.5A.3.1.4.2-1.
5. PUCCH sub test:
 - 5.1 The SS transmits PDSCH via PDCCH DCI format 1A for C_RNTI to transmit the DL RMC according to Table 6.3.5A.3.1.4.1-1 on both PCC and SCC. The SS sends downlink MAC padding bits on the DL RMC. The transmission of PDSCH will make the UE send uplink ACK/NACK using PUCCH on PCC. Send the appropriate TPC commands for PUCCH to the UE to ensure that the UE transmits PUCCH at 0dBm +/- 3.2 dB for carrier frequency $f \leq 3.0\text{GHz}$ or at 0dBm +/- 3.5 dB for carrier frequency $3.0\text{GHz} < f \leq 4.2\text{GHz}$.
 - 5.2 Every 5 subframes transmit to the UE downlink PDSCH MAC padding bits as well as 0 dB TPC command for PUCCH via the PDCCH to make the UE transmit ACK/NACK on the PUCCH with transmission gap of 4 subframes. The downlink transmission is scheduled in the appropriate sub-frames to make the UE transmit PUCCH as described in figure 6.3.5A.3.1.4.2-1.
 - 5.3 Measure the power of 5 consecutive PUCCH transmissions on PCC to verify the UE transmitted PUCCH power is maintained within 21 ms. The transient periods of 20us are excluded from the power measurement.
6. PUSCH sub test:
 - 6.1 The SS sends uplink scheduling information for each UL HARQ process via PDCCH DCI format 0 for C_RNTI to schedule the UL RMC according to Table 6.3.5A.3.1.4.1-2 on both PCC and SCC. Since the UE has no payload and no loopback data to send the UE sends uplink MAC padding bits on the UL RMC. Send the appropriate TPC commands for PUSCH to the UE to ensure that the UE transmits PUSCH at 0dBm +/- 3.2dB for carrier frequency $f \leq 3.0\text{GHz}$ or at 0dBm +/- 3.5 dB for carrier frequency $3.0\text{GHz} < f \leq 4.2\text{GHz}$.
 - 6.2 Every 5 subframes schedule the UE's PUSCH data transmission and transmit 0 dB TPC command for PUSCH via the PDCCH to make the UE transmit PUSCH with 4 subframes gap. The uplink transmission patterns are described in figure 6.3.5A.3.1.4.2-1.
 - 6.3 Measure the power on both PCC and SCC of 5 consecutive PUSCH transmissions to verify the UE transmitted PUSCH power is maintained within 21 ms on each component carrier. The transient periods of 20us are excluded from the power measurement.

6.3.5A.3.1.4.3 Message contents

Message contents are according to TS 36.508 [7] subclause 4.6.

6.3.5A.3.1.5 Test requirement

For intra-band contiguous carrier aggregation bandwidth class C, the aggregate power control tolerance per component carrier measured in step (2) of the test procedure is not to exceed the values specified in Table 6.3.5A.3.1.5-1.

Table 6.3.5A.3.1.5-1: Aggregate power control tolerance for intra-band contiguous CA

TPC command	UL channel	Aggregate power tolerance within 21 ms
0 dB	PUCCH	±3.2 dB
0 dB	PUSCH	±4.2 dB
NOTE: The UE transmission gap is 4 ms. TPC command is transmitted via PDCCH 4 subframes preceding each PUCCH/PUSCH transmission.		

6.3.5B Power Control for UL- MIMO

6.3.5B.1 Power Control Absolute Power Tolerance for UL- MIMO

6.3.5B.1.1 Test purpose

To verify the ability of the UE transmitter for UL-MIMO to set its initial output power to a specific value at the start of a contiguous transmission or non-contiguous transmission with a long transmission gap, i.e. transmission gap is larger than 20 ms.

6.3.5B.1.2 Minimum conformance requirement

For UE with multiple transmit antenna connectors, the power control tolerance applies to the sum of output power at each transmit antenna connector.

The power control requirements specified in subclause 6.3.5 apply to UE with two transmit antenna connectors with UL-MIMO configurations specified in Table 6.2.2B.3-2 for closed-loop spatial multiplexing scheme, wherein

- The Maximum output power requirements for UL-MIMO are specified in subclause 6.2.2B
- The Minimum output power requirements for UL-MIMO are specified in subclause 6.3.2B

The normative reference for this requirement is TS 36.101 [2] clause 6.3.5B.

6.3.5B.1.3 Test applicability

This test applies to all types of E-UTRA UE release 10 and forward that support UL- MIMO.

6.3.5B.1.4 Test description

6.3.5B.1.4.1 Initial conditions

Initial conditions are a set of test configurations the UE needs to be tested in and the steps for the SS to take with the UE to reach the correct measurement state.

The initial test configurations consist of environmental conditions, test frequencies, and channel bandwidths based on E-UTRA operating bands specified in table 5.4.2.1-1. All of these configurations shall be tested with applicable test parameters for each channel bandwidth, and are shown in table 6.3.5B.1.4.1-1. The details of the uplink reference measurement channel (RMCs) are specified in Annexes A.2. Configurations of PDSCH and PDCCH before measurement are specified in Annex C.2.

Table 6.3.5B.1.4.1-1: Test Configuration Table

Initial Conditions					
Test Environment as specified in TS 36.508[7] subclause 4.1	Normal, TL/VL, TL/VH, TH/VL, TH/VH				
Test Frequencies as specified in TS36.508 [7] subclause 4.3.1	Mid range				
Test Channel Bandwidths as specified in TS 36.508 [7] subclause 4.3.1	Lowest, 5MHz, Highest				
Test Parameters for Channel Bandwidths					
Ch BW	Downlink Configuration		Uplink Configuration		
	N/A for Power Control Absolute power tolerance test case		Mod'n	RB allocation	
			FDD	TDD	
1.4MHz			QPSK	6	6
3MHz			QPSK	15	15
5MHz			QPSK	25	25
10MHz			QPSK	50	50
15MHz			QPSK	75	75
20MHz			QPSK	100	100
Note 1: Test Channel Bandwidths are checked separately for each E-UTRA band, the applicable channel bandwidths are specified in Table 5.4.2.1-1.					

1. Connect the SS to the UE antenna connectors as shown in TS 36.508 [7] Annex A, Figure A.28.
2. The parameter settings for the cell are set up according to TS 36.508 [7] subclause 4.4.3.
3. Downlink signals are initially set up according to Annex C.0, C.1 and C.3.0, and uplink signals according to Annex H.1 and H.3.0.
4. The UL Reference Measurement channel is set according to Table 6.3.5B.1.4.1-1.
5. Ensure the UE is in State 3A-RF according to TS 36.508 [7] clause 5.2A.2. Message contents are defined in clause 6.3.5B.1.4.3. Note that PDCCH DCI format 4 sent after resetting uplink power with RRC Connection Reconfiguration, should have TPC command 0dB.

6.3.5B.1.4.2 Test procedure

1. SS sends uplink scheduling information via PDCCH DCI format 4 with TPC command 0dB for C_RNTI to schedule the UL RMC according to Table 6.3.5B.1.4.1-1. Since the UE has no payload and no loopback data to send the UE sends uplink MAC padding bits on the UL RMC.
2. Measure the initial sum power of the first subframe of UE PUSCH first transmission at each UE antenna connector. The transient periods of 20us are excluded.
3. Repeat for the two test points as indicated in section 6.3.5B.1.4.3. The timing of the execution between the two test points shall be larger than 20ms.

6.3.5B.1.4.3 Message contents

Message contents are according to TS 36.508 [7] clause 4.6 with the following exceptions:

Table 6.3.5B.1.4.3-1: UplinkPowerControlCommon: Test point 1

Derivation Path: TS 36.508 [7] clause 4.6.3, Table 4.6.3-25 UplinkPowerControlCommon-DEFAULT			
Information Element	Value/remark	Comment	Condition
UplinkPowerControlCommon-DEFAULT ::= SEQUENCE { p0-NominalPUSCH	-105	Test point 1 to verify a UE relative low initial power transmission	

Table 6.3.5B.1.4.3-2: UplinkPowerControlCommon: Test point 2

Derivation Path: TS 36.508 [7] clause 4.6.3, Table 4.6.3-25 UplinkPowerControlCommon-DEFAULT			
Information Element	Value/remark	Comment	Condition
PhysicalConfigDedicated-DEFAULT ::= SEQUENCE {	-93	Test point 2 to verify a UE relative high initial power transmission	

Table 6.3.5B.1.4.3-3: PhysicalConfigDedicated

Derivation Path: TS 36.508 [7] clause 5.5.1.2, Table 5.5.1.2.1 PhysicalConfigDedicated-DEFAULT			
Information Element	Value/remark	Comment	Condition
UplinkPowerControlCommon-DEFAULT ::= SEQUENCE { p0-NominalPUSCH			
uplinkPowerControlDedicated	UplinkPowerControlDedicated-DEFAULT	See clause 4.6.3	SRB1
	UplinkPowerControlDedicated-DEFAULT	See clause 4.6.3	RBC

Table 6.3.5B.1.4.3-4: UplinkPowerControlDedicated

Derivation Path: TS 36.508 [7] clause 4.6.3, Table 4.6.3-26 UplinkPowerControlDedicated-DEFAULT			
Information Element	Value/remark	Comment	Condition
UplinkPowerControlDedicated-DEFAULT ::= SEQUENCE {			
p0-UE-PUSCH	1		SRB1
	0		RBC
}			

6.3.5B.1.5 Test requirement

The requirement for the power measured in step (2) of the test procedure is not to exceed the values specified in Table 6.3.5B.1.5-1 and 6.3.5B.1.5-2.

Table 6.3.5B.1.5-1: Absolute power tolerance: test point 1

	Channel bandwidth / expected output power (dBm)					
	1.4 MHz	3.0 MHz	5 MHz	10 MHz	15 MHz	20 MHz
Expected Measured power Normal conditions	-14.8 dBm	-10.8 dBm	-8.6 dBm	-5.6 dBm	-3.9 dBm	-2.6 dBm
Power tolerance f ≤ 3.0GHz 3.0GHz < f ≤ 4.2GHz	± 10.0dB ± 10.4dB	± 10.0dB ± 10.4dB	± 10.0dB ± 10.4dB	± 10.0dB ± 10.4dB	± 10.0dB ± 10.4dB	± 10.0dB ± 10.4dB
Expected Measured power Extreme conditions	-14.8 dBm	-10.8 dBm	-8.6 dBm	-5.6 dBm	-3.9 dBm	-2.6 dBm
Power tolerance f ≤ 3.0GHz 3.0GHz < f ≤ 4.2GHz	± 13.0dB ± 13.4dB	± 13.0dB ± 13.4dB	± 13.0dB ± 13.4dB	± 13.0dB ± 13.4dB	± 13.0dB ± 13.4dB	± 13.0dB ± 13.4dB
Note 1:	The lower power limit shall not exceed the minimum output power requirements defined in sub-clause 6.3.2.3					

Table 6.3.5B.1.5-2: Absolute power tolerance: test point 2

	Channel bandwidth / expected output power (dBm)					
	1.4 MHz	3.0 MHz	5 MHz	10 MHz	15 MHz	20 MHz

Expected Measured power Normal conditions	-2.8 dBm	1.2 dBm	3.4 dBm	6.4 dBm	8.2 dBm	9.4 dBm
Power tolerance $f \leq 3.0\text{GHz}$ $3.0\text{GHz} < f \leq 4.2\text{GHz}$	$\pm 10.0\text{dB}$ $\pm 10.4\text{dB}$	$\pm 10.0\text{dB}$ $\pm 10.4\text{dB}$	$\pm 10.0\text{dB}$ $\pm 10.4\text{dB}$	$\pm 10.0\text{dB}$ $\pm 10.4\text{dB}$	$\pm 10.0\text{dB}$ $\pm 10.4\text{dB}$	$\pm 10.0\text{dB}$ $\pm 10.4\text{dB}$
Expected Measured power Extreme conditions	-2.8 dBm	1.2 dBm	3.4 dBm	6.4 dBm	8.2 dBm	9.4 dBm
Power tolerance $f \leq 3.0\text{GHz}$ $3.0\text{GHz} < f \leq 4.2\text{GHz}$	$\pm 13.0\text{dB}$ $\pm 13.4\text{dB}$	$\pm 13.0\text{dB}$ $\pm 13.4\text{dB}$	$\pm 13.0\text{dB}$ $\pm 13.4\text{dB}$	$\pm 13.0\text{dB}$ $\pm 13.4\text{dB}$	$\pm 13.0\text{dB}$ $\pm 13.4\text{dB}$	$\pm 13.0\text{dB}$ $\pm 13.4\text{dB}$
Note 1: The lower power limit shall not exceed the minimum output power requirements defined in sub-clause 6.3.2.3						

6.3.5B.2 Power Control Relative power tolerance for UL-MIMO

6.3.5B.2.1 Test purpose

To verify the ability of the UE transmitter to set its output power relatively to the power in a target sub-frame relatively to the power of the most recently transmitted reference sub-frame if the transmission gap between these sub-frames is ≤ 20 ms.

6.3.5B.2.2 Test applicability

This test case applies to all types of E-UTRA UE release 10 and forward that support UL MIMO.

6.3.5B.2.3 Minimum conformance requirement

For UE with multiple transmit antenna connectors, the power control tolerance applies to the sum of output power at each transmit antenna connector.

The power control requirements specified in clause 6.3.5 apply to UE with two transmit antenna connectors with UL-MIMO configurations specified in Table 6.2.2B.3-2 for closed-loop spatial multiplexing scheme, wherein:

- The Maximum output power requirements for UL-MIMO are specified in clause 6.2.2B
- The Minimum output power requirements for UL-MIMO are specified in clause 6.3.2B

The normative reference for this requirement is TS 36.101 [2] clause 6.3.5B.

6.3.5B.2.4 Test description

6.3.5B.2.4.1 Initial conditions

Initial conditions are a set of test configurations the UE needs to be tested in and the steps for the SS to take with the UE to reach the correct measurement state.

The initial test configurations consist of environmental conditions, test frequencies, and channel bandwidths based on E-UTRA operating bands specified in table 5.4.2.1-1. All of these configurations shall be tested with applicable test parameters for each channel bandwidth, and are shown in table 6.3.5B.2.4.1-1. The details of the uplink reference measurement channels (RMCs) are specified in Annexes A.2. Configurations of PDSCH and PDCCH before measurement are specified in Annex C.2.

Table 6.3.5B.2.4.1-1: Test Configuration Table

Initial Conditions				
Test Environment as specified in TS 36.508 [7] clause 4.1		Normal, TL/VL, TL/VH, TH/VL, TH/VH		
Test Frequencies as specified in TS 36.508 [7] clause 4.3.1		Low range		
Test Channel Bandwidths as specified in TS 36.508 [7] clause 4.3.1		Lowest, 5MHz, Highest		
Test Parameters for Channel Bandwidths				
Ch BW	Downlink Configuration		Uplink Configuration	
	N/A for Power Control Relative power tolerance test case		Mod'n	RB allocation
			FDD	TDD
1.4MHz		QPSK	See table 6.3.5B.2.5-1 6.3.5B.2.5-2 6.3.5B.2.5-13	See table 6.3.5B.2.5-1 6.3.5B.2.5-2 6.3.5B.2.5-13
3MHz		QPSK	See table 6.3.5B.2.5-3 6.3.5B.2.5-4 6.3.5B.2.5-13	See table 6.3.5B.2.5-3 6.3.5B.2.5-4 6.3.5B.2.5-13
5MHz		QPSK	See table 6.3.5B.2.5-5 6.3.5B.2.5-6 6.3.5B.2.5-13	See table 6.3.5B.2.5-5 6.3.5B.2.5-6 6.3.5B.2.5-13
10MHz		QPSK	See table 6.3.5B.2.5-7 6.3.5B.2.5-8 6.3.5B.2.5-13	See table 6.3.5B.2.5-7 6.3.5B.2.5-8 6.3.5B.2.5-13
15MHz		QPSK	See table 6.3.5B.2.5-9 6.3.5B.2.5-10 6.3.5B.2.5-13	See table 6.3.5B.2.5-9 6.3.5B.2.5-10 6.3.5B.2.5-13
20MHz		QPSK	See table 6.3.5B.2.5-11 6.3.5B.2.5-12 6.3.5B.2.5-13	See table 6.3.5B.2.5-11 6.3.5B.2.5-12 6.3.5B.2.5-13
Note 1: Test Channel Bandwidths are checked separately for each E-UTRA band, the applicable channel bandwidths are specified in Table 5.4.2.1-1				
Note 2: The starting resource block shall be RB# 0.				

1. Connect the SS to the UE antenna connectors as shown in TS 36.508 [7] Annex A, Figure A.28.
2. The parameter settings for the cell are set up according to TS 36.508 [7] clause 4.4.3.
3. Downlink signals are initially set up according to Annex C.0, C.1 and C.3.0, and uplink signals according to Annex H.1 and H.3.0.
4. The UL Reference Measurement channel is set according to table 6.3.5B.2.4.1-1.
5. Propagation conditions are set according to Annex B.0.
6. Ensure the UE is in State 3A-RF according to TS 36.508 [7] clause 5.2A.2. Message contents are defined in clause 6.3.5B.2.4.3.

6.3.5B.2.4.2 Test procedure

The procedure is separated in various subtests to verify different aspects of relative power control. The power patterns of the subtests are described in figure 6.3.5B.2.4.2-1.

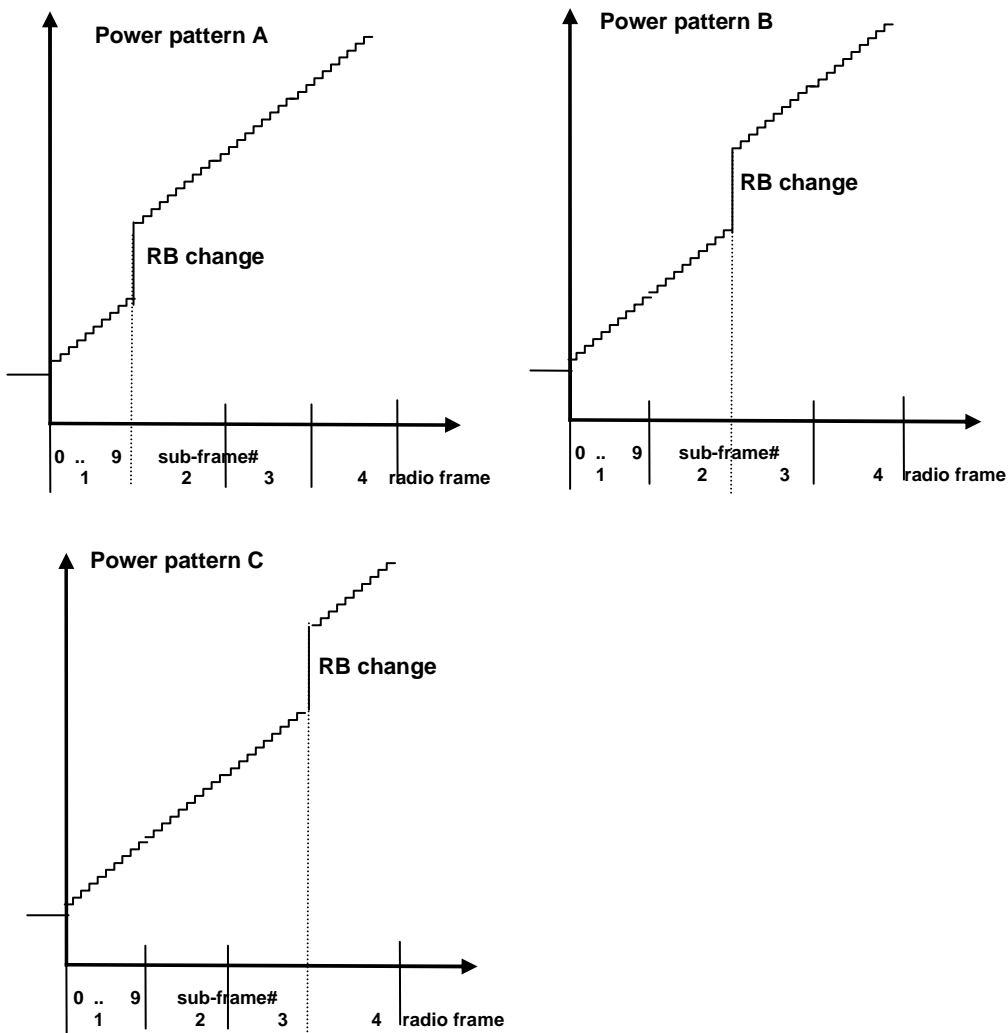

Figure 6.3.5B.2.4.2-1: FDD ramping up test power patterns

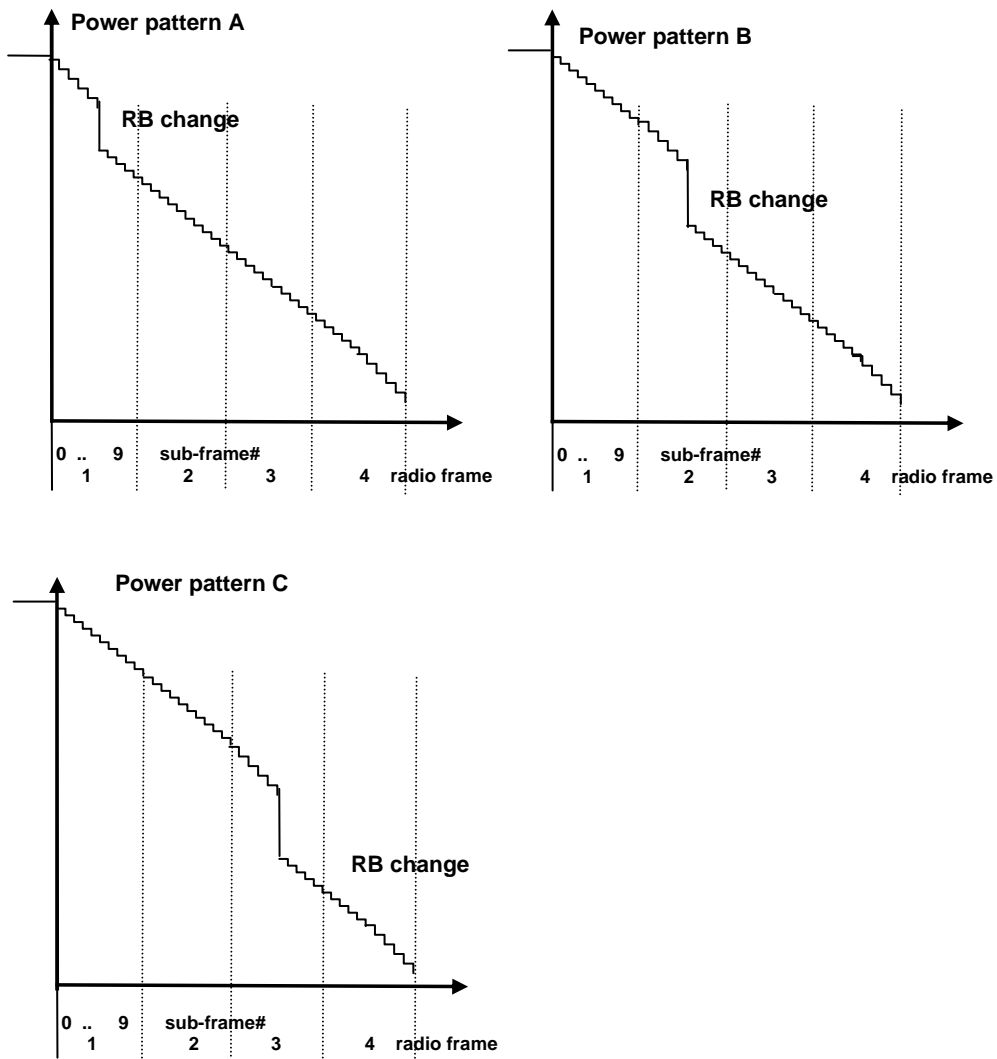

Figure 6.3.5B.2.4.2-2: FDD ramping down test power patterns

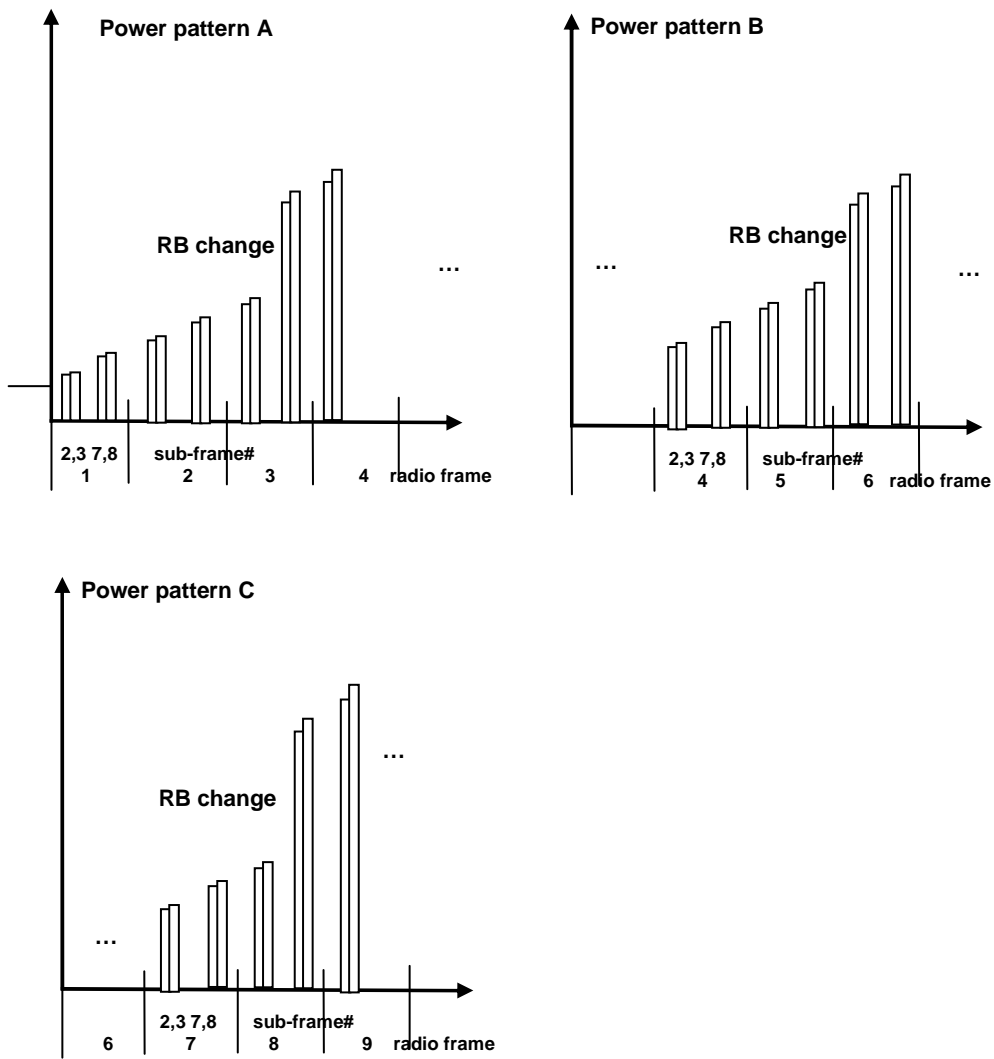

Figure 6.3.5B.2.4.2-3: TDD ramping up test power patterns

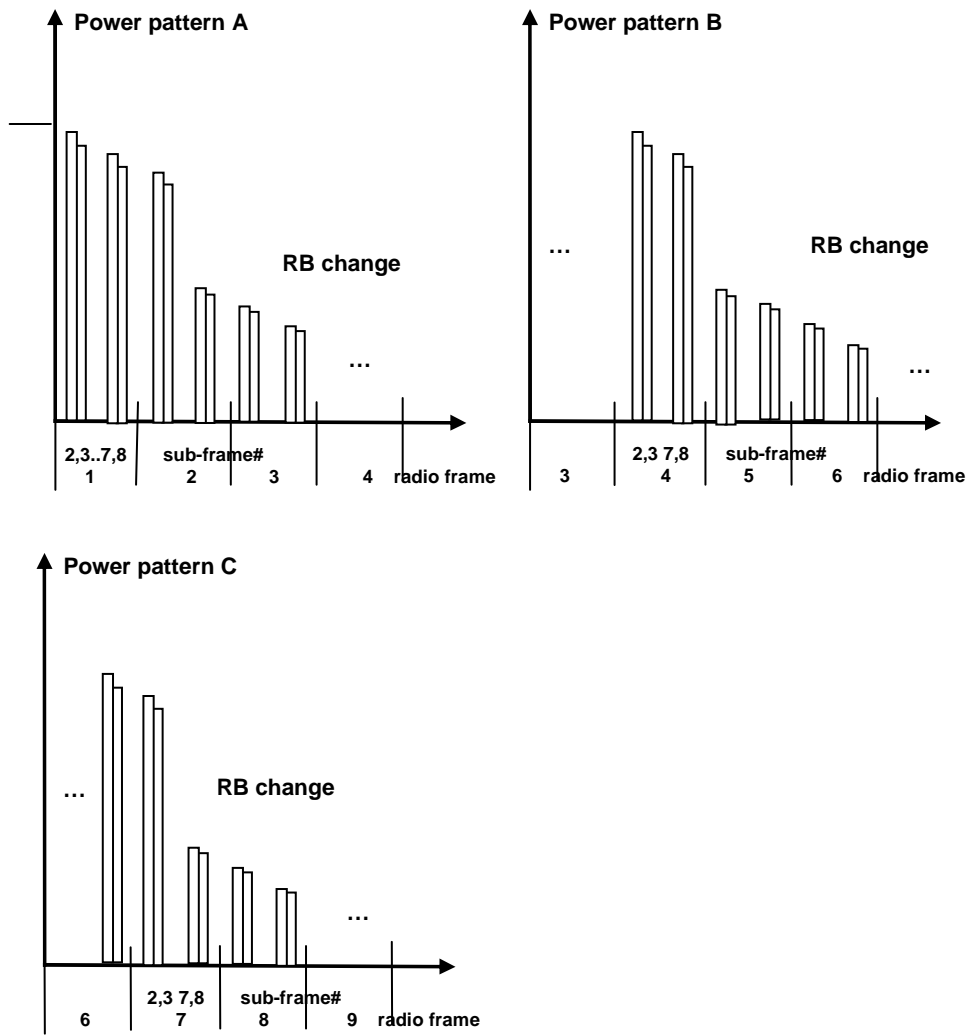

Figure 6.3.5B.2.4.2-4: TDD ramping down test power patterns

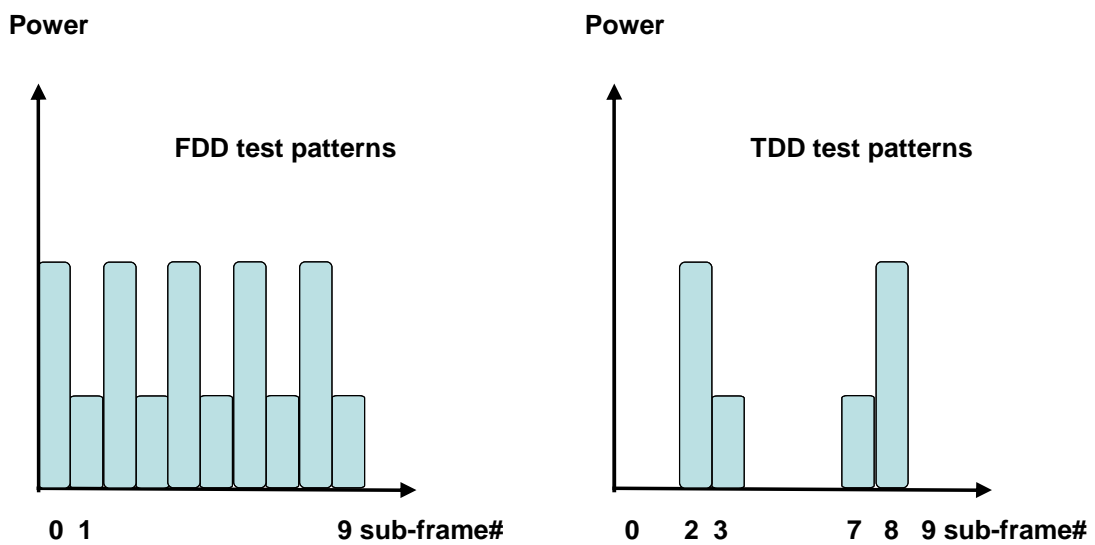

Figure 6.3.5B.2.4.2-5: Alternating Test Power patterns

1. Sub test: ramping up pattern

- 1.1. SS sends uplink scheduling information for each UL HARQ process via PDCCH DCI format 4 for C_RNTI to schedule the UL RMC according to Table 6.3.5B.2.4.1-1. Since the UE has no payload and no loopback data to send the UE sends uplink MAC padding bits on the UL RMC. Send the appropriate TPC commands for PUSCH to the UE to ensure that the UE transmits PUSCH at -36.8dBm +/- 3.2 dB for carrier frequency $f \leq 3.0\text{GHz}$ or at -36.5dBm +/- 3.5 dB for carrier frequency $3.0\text{GHz} < f \leq 4.2\text{GHz}$.
- 1.2. Schedule the UE's PUSCH data transmission as described in Figure 6.3.5B.2.4.2-1 (FDD pattern A: sub-test is divided in 4 arbitrary radio frames with 10 active uplink sub-frames per radio frame) and Figure 6.3.5B.2.4.2-3 (TDD pattern A: sub-test is divided in 10 arbitrary radio frames with 4 active uplink sub-frames per radio frame) with an uplink RB allocation as defined in tables 6.3.5B.2.5-1 thru 6.3.5B.2.5-12 depending on channel bandwidth. On the PDCCH format 4 for the scheduling of the PUSCH the SS will transmit a +1dB TPC command. Note that the measurement need not be done continuously, provided that interruptions are whole numbers of frames, and TPC commands of 0dB are sent during the interruption.
- 1.3. Measure the mean sum power at each antenna connector for PUSCH transmissions to verify the UE relative power control meet test requirements 6.3.5B.2.5. For power transients between subframes, transient periods of 40us between subframes are excluded. For ON/OFF or OFF/ON transients, transient periods of 20 us at the beginning of the subframe are excluded.
- 1.4. Repeat the subtest different pattern B, C to move the RB allocation change at different points in the pattern as described in Table 6.3.5B.2.5-1 thru Table 6.3.5B.2.5-12 to force bigger UE power steps at various points in the power range.

2. Sub test: ramping down pattern

- 2.1. SS sends uplink scheduling information for each UL HARQ process via PDCCH DCI format 4 for C_RNTI to schedule the UL RMC according to Table 6.3.5B.2.4.1-1. Since the UE has no payload and no loopback data to send the UE sends uplink MAC padding bits on the UL RMC. Send the appropriate TPC commands for PUSCH to the UE to ensure that the UE transmits PUSCH at +18.0dBm +/- 3.2 dB for carrier frequency $f \leq 3.0\text{GHz}$ or at +17.7dBm +/- 3.5 dB for carrier frequency $3.0\text{GHz} < f \leq 4.2\text{GHz}$.
- 2.2. Schedule the UE's PUSCH data transmission as described in Figure 6.3.5B.2.4.2-2 (FDD pattern A: sub-test is divided in 4 arbitrary radio frames with 10 active uplink sub-frames per radio frame) and Figure 6.3.5B.2.4.2-4 (TDD pattern A: sub-test is divided in 10 arbitrary radio frames with 4 active uplink sub-frames per radio frame) with an uplink RB allocation as defined in tables 6.3.5B.2.5-1 thru 6.3.5B.2.5-12 depending on channel bandwidth. On the PDCCH format 4 for the scheduling of the PUSCH the SS will transmit a -1dB TPC command. Note that the measurement need not be done continuously, provided that interruptions are whole numbers of frames, and TPC commands of 0dB are sent during the interruption.
- 2.3. Measure the mean sum power at each antenna connector for PUSCH transmissions to verify the UE relative power control meet test requirements 6.3.5B.2.5. For power transients between subframes, transient periods of 40us between subframes are excluded. For ON/OFF or OFF/ON transients, transient periods of 20 us at the beginning of the subframe are excluded.
- 2.4. Repeat the subtest different pattern B, C to move the RB allocation change at different points in the pattern as described in Table 6.3.5B.2.5-1 thru Table 6.3.5B.2.5-12 to force bigger UE power steps at various points in the power range.

3. Sub test: alternating pattern

- 3.1. SS sends uplink scheduling information for each UL HARQ process via PDCCH DCI format 4 for C_RNTI to schedule the UL RMC according to Table 6.3.5B.2.4.1-1. Since the UE has no payload and no loopback data to send the UE sends uplink MAC padding bits on the UL RMC. Send the appropriate TPC commands for PUSCH to the UE to ensure that the UE transmits PUSCH at -10dBm +/- 3.2 dB for carrier frequency $f \leq 3.0\text{GHz}$ or at -10dBm +/- 3.5 dB for carrier frequency $3.0\text{GHz} < f \leq 4.2\text{GHz}$. The initial uplink RB allocation is defined as the smaller uplink RB allocation value specified in tables 6.3.5B.2.5-13. The power level and RB allocation are reset for each sub-test.
- 3.2. Schedule the UE's PUSCH data transmission as described in Figure 6.3.5B.2.4.2-5 for 10 sub-frames with an uplink RB allocation alternating pattern as defined in table 6.3.5B.2.5-13 while transmitting 0dB TPC command for PUSCH via the PDCCH.

- 3.3. Measure the mean sum power of each antenna connector for PUSCH transmissions to verify the UE relative power control meet test requirements specified in clause 6.3.5B.2.5. For power transients between subframes, transient periods of 40us between subframes are excluded. For ON/OFF or OFF/ON transients, transient periods of 20 us at the beginning of the subframe are excluded.

6.3.5B.2.4.3 Message contents

Message contents are according to TS 36.508 [7] clause 4.6.

6.3.5B.2.5 Test requirement

Each UE power step measured in the test procedure 6.3.5B.2.4.2 should satisfy the test requirements specified in Table 6.3.5B.2.5-1, thru 6.3.5B.2.5-13 for normal conditions; for extreme conditions an additional ± 2.0 dB relaxation is allowed.

To account for RF Power amplifier mode changes 2 exceptions are allowed for each of ramping up and ramping down test patterns. For these exceptions the power tolerance limit is a maximum of ± 6.7 dB. If there is an exception in the power step caused by the RB change for all test patterns (A, B, C) then fail the UE.

Table 6.3.5B.2.5-1: Test Requirements Relative Power Tolerance for Transmission (normal conditions - Note 5) channel bandwidth 1.4MHz (ramping up)

Sub-test (ramp up)	Uplink RB allocation	TPC command	Expected power step size (Up) ΔP [dB]	Power step size range (Up) ΔP [dB]	PUSCH [dB]
Subframes before RB change	Fixed = 1	TPC=+1dB	1	$\Delta P < 2$	1 ± 1.7
RB change	Change from 1 to 6 RBs	TPC=+1dB	8.78	$4 \leq \Delta P < 10$	8.78 ± 4.7 Note 2 $8.78 + 6.2 / - 4.7$ Note 3
Subframes after RB change	Fixed = 6	TPC=+1dB	1	$\Delta P < 2$	1 ± 1.7
<p>Note 1: Position of RB change: Pattern A the position of RB uplink allocation change is after 10 active uplink subframes. Pattern B the position of RB uplink allocation change is after 20 active uplink subframes. Pattern C the position of RB uplink allocation change is after 30 active uplink subframes.</p> <p>Note 2: When Note 3 does not apply.</p> <p>Note 3: For operating bands under Note 2 in Table 6.2.2.3-1, if the transmission bandwidth of the reference sub-frames is confined within F_{UL_low} and $F_{UL_low} + 4$ MHz or $F_{UL_high} - 4$ MHz and F_{UL_high} and the target sub-frame is not confined within any one of these frequency ranges.</p> <p>Note 4: N/A.</p> <p>Note 5: For extreme conditions an additional ± 2.0 dB relaxation is allowed.</p> <p>Note 6: The starting resource block shall be RB# 0.</p>					

Table 6.3.5B.2.5-2: Test Requirements Relative Power Tolerance for Transmission (normal conditions - Note 5) channel bandwidth 1.4MHz (ramping down)

Sub-test (ramp down)	Uplink RB allocation	TPC command	Expected power step size (down) ΔP [dB]	Power step size range (down) ΔP [dB]	PUSCH [dB]
Subframes before RB change	Fixed = 5	TPC=-1dB	1	$\Delta P < 2$	1 ± 1.7
RB change	Change from 5 to 1 RBs	TPC=-1dB	7.99	$4 \leq \Delta P < 1$	7.99 ± 4.7 Note 2 $7.99 + 4.7/-6.2$ Note 4
Subframes after RB change	Fixed = 1	TPC=-1dB	1	$\Delta P < 2$	1 ± 1.7
<p>Note 1: Position of RB change: Pattern A the position of RB uplink allocation change is after 6 active uplink subframes. Pattern B the position of RB uplink allocation change is after 16 active uplink subframes. Pattern C the position of RB uplink allocation change is after 26 active uplink subframes.</p> <p>Note 2: When Note 4 does not apply.</p> <p>Note 3: N/A.</p> <p>Note 4: For operating bands under Note 2 in Table 6.2.2.3-1, if the transmission bandwidth of the target sub-frame is confined within F_{UL_low} and $F_{UL_low} + 4$ MHz or $F_{UL_high} - 4$ MHz and F_{UL_high} and the reference sub-frame is not confined within any one of these frequency ranges.</p> <p>Note 5: For extreme conditions an additional ± 2.0 dB relaxation is allowed.</p> <p>Note 6: The starting resource block shall be RB# 0.</p>					

Table 6.3.5B.2.5-3: Test Requirements Relative Power Tolerance for Transmission (normal conditions - Note 5) channel bandwidth 3MHz (ramping up)

Sub-test (ramp up)	Uplink RB allocation	TPC command	Expected power step size (Up) ΔP [dB]	Power step size range (Up) ΔP [dB]	PUSCH [dB]
Subframes before RB change	Fixed = 1	TPC=+1dB	1	$\Delta P < 2$	1 ± 1.7
RB change	Change from 1 to 4 RBs	TPC=+1dB	7.02	$4 \leq \Delta P < 10$	7.02 ± 4.7 Note 2 $7.02 + 6.2/-4.7$ Note 3
Subframes after RB change	Fixed =4	TPC=+1dB	1	$\Delta P < 2$	1 ± 1.7
<p>Note 1: Position of RB change: Pattern A the position of RB uplink allocation change is after 10 active uplink subframes. Pattern B the position of RB uplink allocation change is after 20 active uplink subframes. Pattern C the position of RB uplink allocation change is after 30 active uplink subframes.</p> <p>Note 2: When Note 3 does not apply.</p> <p>Note 3: For operating bands under Note 2 in Table 6.2.2.3-1, if the transmission bandwidth of the reference sub-frames is confined within F_{UL_low} and $F_{UL_low} + 4$ MHz or $F_{UL_high} - 4$ MHz and F_{UL_high} and the target sub-frame is not confined within any one of these frequency ranges.</p> <p>Note 4: N/A.</p> <p>Note 5: For extreme conditions an additional ± 2.0 dB relaxation is allowed.</p> <p>Note 6: The starting resource block shall be RB# 0.</p>					

Table 6.3.5B.2.5-4: Test Requirements Relative Power Tolerance for Transmission (normal conditions - Note 5) channel bandwidth 3MHz (ramping down)

Sub-test (ramp down)	Uplink RB allocation	TPC command	Expected power step size (down) ΔP [dB]	Power step size range (down) ΔP [dB]	PUSCH [dB]
Subframes before RB change	Fixed = 15	TPC=-1dB	1	$\Delta P < 2$	1 ± 1.7
RB change	Change from 15 to 1 RBs	TPC=-1dB	12.76	$10 \leq \Delta P < 15$	12.76 ± 5.7 Note 2 $12.76 + 5.7/-7.2$ Note 4
Subframes after RB change	Fixed =1	TPC=-1dB	1	$\Delta P < 2$	1 ± 1.7
<p>Note 1: Position of RB change: Pattern A the position of RB uplink allocation change is after 6 active uplink subframes. Pattern B the position of RB uplink allocation change is after 16 active uplink subframes. Pattern C the position of RB uplink allocation change is after 26 active uplink subframes.</p> <p>Note 2: When Note 4 does not apply.</p> <p>Note 3: N/A.</p> <p>Note 4: For operating bands under Note 2 in Table 6.2.2.3-1, if the transmission bandwidth of the target sub-frame is confined within F_{UL_low} and $F_{UL_low} + 4$ MHz or $F_{UL_high} - 4$ MHz and F_{UL_high} and the reference sub-frame is not confined within any one of these frequency ranges.</p> <p>Note 5: For extreme conditions an additional ± 2.0 dB relaxation is allowed.</p> <p>Note 6: The starting resource block shall be RB# 0.</p>					

Table 6.3.5B.2.5-5: Test Requirements Relative Power Tolerance for Transmission (normal conditions - Note 5) channel bandwidth 5MHz (ramping up)

Sub-test (ramp up)	Uplink RB allocation	TPC command	Expected power step size (Up) ΔP [dB]	Power step size range (Up) ΔP [dB]	PUSCH [dB]
Subframes before RB change	Fixed = 1	TPC=+1dB	1	$\Delta P < 2$	1 ± 1.7
RB change	Change from 1 to 20	TPC=+1dB	14.01	$10 \leq \Delta P < 15$	14.01 ± 5.7 Note 2 $14.01 + 7.2/-5.7$ Note 3
Subframes after RB change	Fixed = 20	TPC=+1dB	1	$\Delta P < 2$	1 ± 1.7
<p>Note 1: Position of RB change: Pattern A the position of RB uplink allocation change is after 10 active uplink subframes. Pattern B the position of RB uplink allocation change is after 20 active uplink subframes. Pattern C the position of RB uplink allocation change is after 30 active uplink subframes.</p> <p>Note 2: When Note 3 does not apply.</p> <p>Note 3: For operating bands under Note 2 in Table 6.2.2.3-1, if the transmission bandwidth of the reference sub-frames is confined within F_{UL_low} and $F_{UL_low} + 4$ MHz or $F_{UL_high} - 4$ MHz and F_{UL_high} and the target sub-frame is not confined within any one of these frequency ranges.</p> <p>Note 4: N/A.</p> <p>Note 5: For extreme conditions an additional ± 2.0 dB relaxation is allowed.</p> <p>Note 6: The starting resource block shall be RB# 0.</p>					

Table 6.3.5B.2.5-6: Test Requirements Relative Power Tolerance for Transmission (normal conditions - Note 5) channel bandwidth 5MHz (ramping down)

Sub-test (ramp down)	Uplink RB allocation	TPC command	Expected power step size (down) ΔP [dB]	Power step size range (down) ΔP [dB]	PUSCH [dB]
Subframes before RB change	Fixed = 25	TPC=-1dB	1	$\Delta P < 2$	1 ± 1.7
RB change	Change from 25 to 1	TPC=-1dB	14.98	$10 \leq \Delta P < 15$	14.98 ± 5.7 Note 2 $14.98 + 5.7/-7.2$ Note 4
Subframes after RB change	Fixed = 1	TPC=-1dB	1	$\Delta P < 2$	1 ± 1.7
<p>Note 1: Position of RB change: Pattern A the position of RB uplink allocation change is after 6 active uplink subframes. Pattern B the position of RB uplink allocation change is after 16 active uplink subframes. Pattern C the position of RB uplink allocation change is after 26 active uplink subframes.</p> <p>Note 2: When Note 4 does not apply.</p> <p>Note 3: N/A.</p> <p>Note 4: For operating bands under Note 2 in Table 6.2.2.3-1, if the transmission bandwidth of the target sub-frame is confined within F_{UL_low} and $F_{UL_low} + 4$ MHz or $F_{UL_high} - 4$ MHz and F_{UL_high} and the reference sub-frame is not confined within any one of these frequency ranges.</p> <p>Note 5: For extreme conditions an additional ± 2.0 dB relaxation is allowed.</p> <p>Note 6: The starting resource block shall be RB# 0.</p>					

Table 6.3.5B.2.5-7: Test Requirements Relative Power Tolerance for Transmission (normal conditions - Note 5) channel bandwidth 10MHz (ramping up)

Sub-test (ramp up)	Uplink RB allocation	TPC command	Expected power step size (Up) ΔP [dB]	Power step size range (Up) ΔP [dB]	PUSCH [dB]
Subframes before RB change	Fixed = 1	TPC=+1dB	1	$\Delta P < 2$	1 ± 1.7
RB change	Change from 1 to 25	TPC=+1dB	14.98	$10 \leq \Delta P < 15$	14.98 ± 5.7 Note 2 $14.98 + 7.2/-5.7$ Note 3
Subframes after RB change	Fixed = 25	TPC=+1dB	1	$\Delta P < 2$	1 ± 1.7
<p>Note 1: Position of RB change: Pattern A the position of RB uplink allocation change is after 10 active uplink subframes. Pattern B the position of RB uplink allocation change is after 20 active uplink subframes. Pattern C the position of RB uplink allocation change is after 30 active uplink subframes.</p> <p>Note 2: When Note 3 does not apply.</p> <p>Note 3: For operating bands under Note 2 in Table 6.2.2.3-1, if the transmission bandwidth of the reference sub-frames is confined within F_{UL_low} and $F_{UL_low} + 4$ MHz or $F_{UL_high} - 4$ MHz and F_{UL_high} and the target sub-frame is not confined within any one of these frequency ranges.</p> <p>Note 4: N/A.</p> <p>Note 5: For extreme conditions an additional ± 2.0 dB relaxation is allowed.</p> <p>Note 6: The starting resource block shall be RB# 0.</p>					

Table 6.3.5B.2.5-8: Test Requirements Relative Power Tolerance for Transmission (normal conditions – Note 5) channel bandwidth 10MHz (ramping down)

Sub-test (ramp down)	Uplink RB allocation	TPC command	Expected power step size (down) ΔP [dB]	Power step size range (down) ΔP [dB]	PUSCH [dB]
Subframes before RB change	Fixed = 50 (UE- Categories ≥ 2) Fixed = 48 (UE Cat 1)	TPC=-1dB	1	$\Delta P < 2$	1 ± 1.7
RB change	Change from 50 to 1 (UE- Categories ≥ 2) Change from 48 to 1 (UE cat 1)	TPC=-1dB	17.99 17.81	$15 \leq \Delta$	17.99 ± 6.7 Note 2 $17.99 +6.7/-8.2$ Note 4 17.81 ± 6.7 Note 2 $17.81 +6.7/-8.2$ Note 4
Subframes after RB change	Fixed = 1	TPC=-1dB	1	$\Delta P < 2$	1 ± 1.7
<p>Note 1: Position of RB change: Pattern A the position of RB uplink allocation change is after 6 active uplink subframes. Pattern B the position of RB uplink allocation change is after 16 active uplink subframes. Pattern C the position of RB uplink allocation change is after 26 active uplink subframes.</p> <p>Note 2: When Note 3 does not apply.</p> <p>Note 3: N/A.</p> <p>Note 4: For operating bands under Note 2 in Table 6.2.2.3-1, if the transmission bandwidth of the target sub-frame is confined within F_{UL_low} and $F_{UL_low} + 4$ MHz or $F_{UL_high} - 4$ MHz and F_{UL_high} and the reference sub-frame is not confined within any one of these frequency ranges.</p> <p>Note 5: For extreme conditions an additional ± 2.0 dB relaxation is allowed.</p> <p>Note 6: The starting resource block shall be RB# 0.</p>					

Table 6.3.5B.2.5-9: Test Requirements Relative Power Tolerance for Transmission (normal conditions – Note 5) channel bandwidth 15MHz (ramping up)

Sub-test (ramp up)	Uplink RB allocation	TPC command	Expected power step size (Up) ΔP [dB]	Power step size range (Up) ΔP [dB]	PUSCH [dB]
Subframes before RB change	Fixed = 1	TPC=+1dB	1	$\Delta P < 2$	1 ± 1.7
RB change	Change from 1 to 50	TPC=+1dB	17.99	$15 \leq \Delta P$	17.99 \pm 6.7 Note 2 17.99 +8.2/-6.7 Note 3
Subframes after RB change	Fixed = 50	TPC=+1dB	1	$\Delta P < 2$	1 ± 1.7
<p>Note 1: Position of RB change: Pattern A the position of RB uplink allocation change is after 10 active uplink subframes. Pattern B the position of RB uplink allocation change is after 20 active uplink subframes. Pattern C the position of RB uplink allocation change is after 30 active uplink subframes.</p> <p>Note 2: When Note 3 does not apply.</p> <p>Note 3: For operating bands under Note 2 in Table 6.2.2.3-1, if the transmission bandwidth of the reference sub-frames is confined within F_{UL_low} and $F_{UL_low} + 4$ MHz or $F_{UL_high} - 4$ MHz and F_{UL_high} and the target sub-frame is not confined within any one of these frequency ranges.</p> <p>Note 4: N/A.</p> <p>Note 5: For extreme conditions an additional ± 2.0 dB relaxation is allowed.</p> <p>Note 6: The starting resource block shall be RB# 0.</p>					

Table 6.3.5B.2.5-10: Test Requirements Relative Power Tolerance for Transmission (normal conditions – Note 5) channel bandwidth 15MHz (ramping down)

Sub-test (ramp down)	Uplink RB allocation	TPC command	Expected power step size (down) ΔP [dB]	Power step size range (down) ΔP [dB]	PUSCH [dB]
Subframes before RB change	Fixed = 75 (UE- Categories ≥ 2) Fixed = 50 (UE Cat 1)	TPC=-1dB	1	$\Delta P < 2$	1 ± 1.7
RB change	Change from 75 to 1 (UE- Categories ≥ 2) Change from 50 to 1 (UE Cat 1)	TPC=-1dB	19.75 17.99	$15 \leq \Delta P$	19.75 ± 6.7 Note 2 $19.75 + 6.7/8.2 \pm TT$ Note 4 17.99 ± 6.7 Note 2 $17.99 + 6.7/-8.2$ Note 4
Subframes after RB change	Fixed = 1	TPC=-1dB	1	$\Delta P < 2$	1 ± 1.7
<p>Note 1: Position of RB change: Pattern A the position of RB uplink allocation change is after 6 active uplink subframes. Pattern B the position of RB uplink allocation change is after 16 active uplink subframes. Pattern C the position of RB uplink allocation change is after 26 active uplink subframes.</p> <p>Note 2: When Note 4 does not apply.</p> <p>Note 3: N/A.</p> <p>Note 4: For operating bands under Note 2 in Table 6.2.2.3-1, if the transmission bandwidth of the target sub-frame is confined within F_{UL_low} and $F_{UL_low} + 4$ MHz or $F_{UL_high} - 4$ MHz and F_{UL_high} and the reference sub-frame is not confined within any one of these frequency ranges.</p> <p>Note 5: For extreme conditions an additional ± 2.0 dB relaxation is allowed.</p> <p>Note 6: The starting resource block shall be RB# 0.</p>					

Table 6.3.5B.2.5-11: Test Requirements Relative Power Tolerance for Transmission (normal conditions – Note 5) channel bandwidth 20MHz (ramping up)

Sub-test (ramp up)	Uplink RB allocation	TPC command	Expected power step size (Up) ΔP [dB]	Power step size range (Up) ΔP [dB]	PUSCH [dB]
Subframes before RB change	Fixed = 1	TPC=+1dB	1	$\Delta P < 2$	1 ± 1.7
RB change	Change from 1 to 75	TPC=+1dB	19.75	$15 \leq \Delta P$	19.75 ± 6.7 Note 2 $19.75 + 8.2 / - 6.7$ Note 3
Subframes after RB change	Fixed = 75	TPC=+1dB	1	$\Delta P < 2$	1 ± 1.7
<p>Note 1: Position of RB change: Pattern A the position of RB uplink allocation change is after 10 active uplink subframes. Pattern B the position of RB uplink allocation change is after 20 active uplink subframes. Pattern C the position of RB uplink allocation change is after 30 active uplink subframes.</p> <p>Note 2: When Note 3 does not apply.</p> <p>Note 3: For operating bands under Note 2 in Table 6.2.2.3-1, if the transmission bandwidth of the reference sub-frames is confined within F_{UL_low} and $F_{UL_low} + 4$ MHz or $F_{UL_high} - 4$ MHz and F_{UL_high} and the target sub-frame is not confined within any one of these frequency ranges.</p> <p>Note 4: N/A.</p> <p>Note 5: For extreme conditions an additional ± 2.0 dB relaxation is allowed.</p> <p>Note 6: The starting resource block shall be RB# 0.</p>					

Table 6.3.5B.2.5-12: Test Requirements Relative Power Tolerance for Transmission (normal conditions – Note 5) channel bandwidth 20MHz (ramping down)

Sub-test (ramp down)	Uplink RB allocation	TPC command	Expected power step size (down) ΔP [dB]	Power step size range (down) ΔP [dB]	PUSCH [dB]
Subframes before RB change	Fixed = 100 (UE- Categories ≥ 2) Fixed = 75 (UE Cat 1)	TPC=-1dB	1	$\Delta P < 2$	1 ± 1.7
RB change	Change from 100 to 1 (UE- Categories ≥ 2) Change from 75 to 1 (UE Cat 1)	TPC=-1dB	21.0 19.75	$15 \leq \Delta P$	21.0 ± 6.7 Note 2 $21.0 +6.7/-8.2$ Note 4 19.75 ± 6.7 Note 2 $19.75 +6.7/-8.2$ Note 4
Subframes after RB change	Fixed = 1	TPC=-1dB	1	$\Delta P < 2$	1 ± 1.7
<p>Note 1: Position of RB change: Pattern A the position of RB uplink allocation change is after 6 active uplink subframes. Pattern B the position of RB uplink allocation change is after 16 active uplink subframes. Pattern C the position of RB uplink allocation change is after 26 active uplink subframes.</p> <p>Note 2: When Note 4 does not apply.</p> <p>Note 3: N/A.</p> <p>Note 4: For operating bands under Note 2 in Table 6.2.2.3-1, if the transmission bandwidth of the target sub-frame is confined within F_{UL_low} and $F_{UL_low} + 4$ MHz or $F_{UL_high} - 4$ MHz and F_{UL_high} and the reference sub-frame is not confined within any one of these frequency ranges.</p> <p>Note 5: For extreme conditions an additional ± 2.0 dB relaxation is allowed.</p> <p>Note 6: The starting resource block shall be RB# 0.</p>					

Table 6.3.5B.2.5-13: Test Requirements Relative Power Tolerance for Transmission (normal conditions – Note 5) (Alternating pattern)

Sub-test	Uplink RB allocation	TPC command	Expected power step size (Up or down) ΔP [dB]	Power step size range (Up or down) ΔP [dB]	PUSCH [dB]
1.4 MHz	Alternating 1 and 6	TPC=0dB	7.78	$4 \leq \Delta P < 10$	7.78 \pm 6.7 Note 1,2 7.78 +8.2/-6.7 Note 3 7.78 +6.7/-8.2 Note 4
3 MHz	Alternating 1 and 15	TPC=0dB	11.76	$10 \leq \Delta P < 15$	11.76 \pm 6.7 Note 1,2 11.76 +8.2/-6.7 Note 3 11.76 +6.7/-8.2 Note 4
5 MHz	Alternating 1 and 25	TPC=0dB	13.98	$10 \leq \Delta P < 15$	13.98 \pm 6.7 Note 1 13.98 +8.2/-6.7 Note 2 13.98 +6.7/-8.2 Note 3
10 MHz	Alternating 1 and 50 (UE- Categories ≥ 2)	TPC=0dB	16.99	$15 \leq \Delta P$	16.99 \pm 6.7 Note 1,2 16.99 +8.2/-6.7 Note 3 16.99 +6.7/-8.2 Note 4
	Alternating 1 and 48 (UE Cat 1)		16,81		16.81 \pm 6.7 Note 1,2 16.81 +8.2/-6.7 Note 3 16.81 +6.7/-8.2 Note 4
15 MHz	Alternating 1 and 75 (UE- Categories ≥ 2)	TPC=0dB	18.75	$15 \leq \Delta P$	18.75 \pm 6.7 Note 1,2 18.75 +8.2/-6.7 Note 3 18.75 +6.7/-8.2 Note 4
	Alternating 1 and 50 (UE Cat 1)		16.99		16.99 \pm 6.7 Note 1,2 16.99 +8.2/-6.7 Note 3 16.99 +6.7/-8.2 Note 4
20 MHz	Alternating 1 and 100 (UE- Categories ≥ 2)	TPC=0dB	20.00	$15 \leq \Delta P$	20.00 \pm 6.7 Note 1,2 20.00 +8.2/-6.7 Note 3 20.00 +6.7/-8.2 Note 4
	Alternating 1 and 75 (UE Cat 1)		18.75		18.75 \pm 6.7 Note 1,2 18.75 +8.2/-6.7 Note 3 18.75 +6.7/-8.2 Note 4
<p>Note 1: Test tolerance +/- 6.7 dB was selected to allow PA switch possible exceptions to occur.</p> <p>Note 2: When neither Note 3 nor Note 4 applies.</p> <p>Note 3: For operating bands under Note 2 in Table 6.2.2.3-1, if the transmission bandwidth of the reference sub-frames is confined within F_{UL_low} and $F_{UL_low} + 4$ MHz or $F_{UL_high} - 4$ MHz and F_{UL_high} and the target sub-frame is not confined within any one of these frequency ranges.</p> <p>Note 4: For operating bands under Note 2 in Table 6.2.2.3-1, if the transmission bandwidth of the target sub-frame is confined within F_{UL_low} and $F_{UL_low} + 4$ MHz or $F_{UL_high} - 4$ MHz and F_{UL_high} and the reference sub-frame is not confined within any one of these frequency ranges.</p> <p>Note 5: For extreme conditions an additional ± 2.0 dB relaxation is allowed.</p> <p>Note 6: The starting resource block shall be RB# 0.</p>					

6.3.5B.3 Aggregate power control tolerance for UL-MIMO

6.3.5B.3.1 Test purpose

To verify the ability of the UE with UL-MIMO to maintain its power level in non-contiguous transmission within 21 ms in response to 0 dB TPC commands with respect to the first UE transmission, when the power control parameters specified in TS 36.213 are constant.

6.3.5B.3.2 Test applicability

This test case applies to all types of E-UTRA UE release 10 and forward that support UL MIMO.

6.3.5B.3.3 Minimum conformance requirement

For UE with multiple transmit antenna connectors, the power control tolerance applies to the sum of output power at each transmit antenna connector.

The power control requirements specified in clause 6.3.5 apply to UE with two transmit antenna connectors with UL-MIMO configurations specified in Table 6.2.2B.3-2 for closed-loop spatial multiplexing scheme, wherein:

- The Maximum output power requirements for UL-MIMO are specified in clause 6.2.2B.
- The Minimum output power requirements for UL-MIMO are specified in clause 6.3.2B.

The normative reference for this requirement is TS 36.101 [2] clause 6.3.5B.

6.3.5B.3.4 Test description

6.3.5B.3.4.1 Initial conditions

Initial conditions are a set of test configurations the UE needs to be tested in and the steps for the SS to take with the UE to reach the correct measurement state.

The initial test configurations consist of environmental conditions, test frequencies, and channel bandwidths based on E-UTRA operating bands specified in table 5.4.2.1-1. All of these configurations shall be tested with applicable test parameters for each channel bandwidth, and are shown in table 6.3.5B.3.4.1-1. The details of the uplink and downlink reference measurement channels (RMCs) are specified in Annexes A.2 and A.3. Configurations of PDSCH and PDCCH before measurement are specified in Annex C.2.

Table 6.3.5B.3.4.1-1: Test Configuration Table: PUCCH sub-test

Initial Conditions				
Test Environment as specified in TS 36.508[7] subclause 4.1		Normal		
Test Frequencies as specified in TS36.508 [7] subclause 4.3.1		Mid range		
Test Channel Bandwidths as specified in TS 36.508 [7] subclause 4.3.1		Lowest, 5MHz, Highest		
Test Parameters for Channel Bandwidths				
Ch BW	Downlink Configuration			Uplink Configuration
	Mod'n	RB allocation		
		FDD	TDD	FDD: PUCCH format = Format 1a TDD: PUCCH format = Format 1a/1b
1.4MHz	QPSK	3	3	
3MHz	QPSK	4	4	
5MHz	QPSK	8	8	
10MHz	QPSK	16	16	
15MHz	QPSK	25	25	
20MHz	QPSK	30	30	
Note 1: Test Channel Bandwidths are checked separately for each E-UTRA band, the applicable channel bandwidths are specified in Table 5.4.2.1-1.				

Table 6.3.5B.3.4.1-2: Test Configuration Table: PUSCH sub-test

Initial Conditions				
Test Environment as specified in TS 36.508[7] subclause 4.1		Normal		
Test Frequencies as specified in TS36.508 [7] subclause 4.3.1		Mid range		
Test Channel Bandwidths as specified in TS 36.508 [7] subclause 4.3.1		Lowest, 5MHz, Highest		
Test Parameters for Channel Bandwidths				
Ch BW	Downlink Configuration	Uplink Configuration		
	N/A for PUSCH sub-test	Mod'n	RB allocation	
			FDD	TDD
1.4MHz		QPSK	1	1
3MHz		QPSK	4	4
5MHz		QPSK	8	8
10MHz		QPSK	12	12
15MHz		QPSK	16	16
20MHz		QPSK	18	18
Note 1: Test Channel Bandwidths are checked separately for each E-UTRA band, the applicable channel bandwidths are specified in Table 5.4.2.1-1.				

1. Connect the SS to the UE antenna connectors as shown in TS 36.508 [7] Annex A, Figure A.28.
2. The parameter settings for the cell are set up according to TS 36.508 [7] clause 4.4.3.
3. Downlink signals are initially set up according to Annex C0, C.1 and C.3.0, and uplink signals according to Annex H.1 and H.3.0.
4. The UL and DL Reference Measurement channels are set according to Table 6.3.5B.3.4.1-1 (PUCCH sub-test) and Table 6.3.5B.3.4.1-2 (PUSCH sub-test).
5. Ensure the UE is in State 3A-RF according to TS 36.508 [7] clause 5.2A.2. Message contents are defined in clause 6.3.5B.3.4.3.

6.3.5B.3.4.2 Test procedure

The procedure is separated in two subtests to verify PUCCH and PUSCH aggregate power control tolerance respectively. The uplink transmission patterns are described in figure 6.3.5B.3.4.2-1.

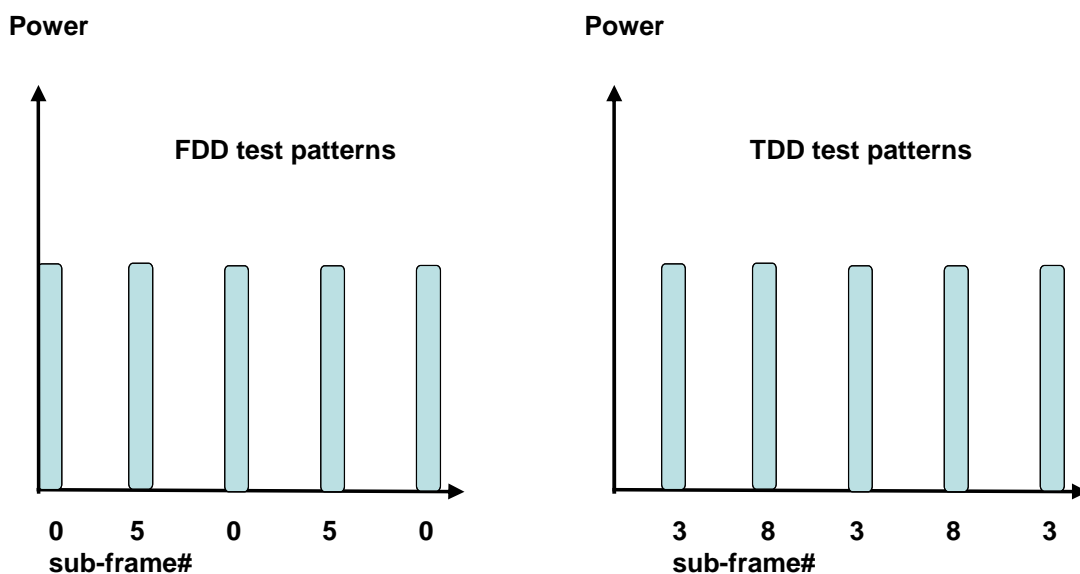

Figure 6.3.5B.3.4.2-1 Test uplink transmission

1. PUCCH sub test:

- 1.1 The SS transmits PDSCH via PDCCH DCI format 1A for C_RNTI to transmit the DL RMC according to Table 6.3.5B.3.4.1-1. The SS sends downlink MAC padding bits on the DL RMC. The transmission of PDSCH will make the UE send uplink ACK/NACK using PUCCH. Send the appropriate TPC commands for PUCCH to the UE to ensure that the UE transmits PUCCH at 0dBm +/- 3.2 dB for carrier frequency $f \leq 3.0\text{GHz}$ or at 0dBm +/- 3.5 dB for carrier frequency $3.0\text{GHz} < f \leq 4.2\text{GHz}$.
- 1.2. Every 5 subframes transmit to the UE downlink PDSCH MAC padding bits as well as 0 dB TPC command for PUCCH via the PDCCH to make the UE transmit ACK/NACK on the PUCCH with transmission gap of 4 subframes. The downlink transmission is scheduled in the appropriate sub-frames to make the UE transmit PUCCH as described in figure 6.3.5B.3.4.2-1.
- 1.3. Measure the mean sum power at each antenna connector for UE of 5 consecutive PUCCH transmissions to verify the UE transmitted PUCCH power is maintained within 21 ms. The transient periods of 20us are excluded from the power measurement.
2. PUSCH sub test:
- 2.1. The SS sends uplink scheduling information via PDCCH DCI format 4 for C_RNTI to schedule the UL RMC according to Table 6.3.5B.3.4.1-2. Since the UE has no payload and no loopback data to send the UE sends uplink MAC padding bits on the UL RMC. Send the appropriate TPC commands for PUSCH to the UE to ensure that the UE transmits PUSCH at 0dBm +/- 3.2.dB for carrier frequency $f \leq 3.0\text{GHz}$ or at 0dBm +/- 3.5 dB for carrier frequency $3.0\text{GHz} < f \leq 4.2\text{GHz}$.
- 2.2. Every 5 subframes schedule the UE's PUSCH data transmission and transmit 0 dB TPC command for PUSCH via the PDCCH to make the UE transmit PUSCH with 4 subframes gap. The uplink transmission patterns are described in figure 6.3.5B.3.4.2-1.
- 2.3. Measure the mean sum power at each antenna connector for UE of 5 consecutive PUSCH transmissions to verify the UE transmitted PUSCH power is maintained within 21 ms. The transient periods of 20us are excluded from the power measurement.

6.3.5B.3.4.3 Message contents

Message contents are according to TS 36.508 [7] clause 4.6 with the following exceptions:

Table 6.3.5B.3.4.3-1: PUCCH-ConfigDedicated-v1020-DEFAULT

Derivation Path: TS 36.508 [7] clause 4.6.3, Table 4.6.3-9A: PUCCH-ConfigDedicated-v1020-DEFAULT			
Information Element	Value/remark	Comment	Condition
PUCCH-ConfigDedicated-v1020 ::= SEQUENCE {			
twoAntennaPortActivatedPUCCH-Format1a1b-r10	true		
}			

6.3.5B.3.5 Test requirement

The requirement for the power measurements made in step (1.3) and (2.3) of the test procedure shall not exceed the values specified in Table 6.3.5B.3.5-1. The power measurement period shall be 1 sub-frame excluding transient periods.

Table 6.3.5B.3.5-1: Power control tolerance

TPC command	UL channel	Test requirement measured power
0 dB	PUCCH	Given 5 power measurements in the pattern, the 2 nd , 3 rd , 4 th , and 5 th measurements shall be within ± 3.2 dB of the 1 st measurement.
0 dB	PUSCH	Given 5 power measurements in the pattern, the 2 nd , 3 rd , 4 th , and 5 th measurements shall be within ± 4.2 dB of the 1 st measurement.
Note 1: The UE transmission gap is 4 ms. TPC command is transmitted via PDCCH 4 subframes preceding each PUCCH/PUSCH transmission.		

6.4 Void

6.5 Transmit signal quality

Editor's note: The test cases for transmit signal quality : frequency error, EVM, carrier leakage, IBE, EVM equalizer spectrum flatness are complete, except the following aspect is not determined:

- Reference signal EVM and PRACH EVM minimum requirements from the core specification are still in brackets

In this clause a multitude of results are derived, all using one common algorithm returning these results: Global In-Channels TX-Test (Annex E). Each sub clause of this clause contains a procedure and test requirements described for a specific measurement. If all relevant test parameters in different sub clauses are the same, then the results, returned by the Global In-Channel TX-Test, may be used across the applicable sub clauses.

6.5.1 Frequency Error

6.5.1.1 Test purpose

This test verifies the ability of both, the receiver and the transmitter, to process frequency correctly.

Receiver: to extract the correct frequency from the stimulus signal, offered by the System simulator, under ideal propagation conditions and low level.

Transmitter: to derive the correct modulated carrier frequency from the results, gained by the receiver.

6.5.1.2 Test applicability

This test case applies to all types of E-UTRA UE release 8 and forward.

6.5.1.3 Minimum conformance requirements

The UE modulated carrier frequency shall be accurate to within ± 0.1 PPM observed over a period of one time slot (0.5ms) compared to the carrier frequency received from the E-UTRA Node B.

The normative reference for this requirement is TS 36.101 clause 6.5.1

6.5.1.4 Test description

6.5.1.4.1 Initial condition

Initial conditions are a set of test configurations the UE needs to be tested in and the steps for the SS to take with the UE to reach the correct measurement state.

The initial test configurations consist of environmental conditions, test frequencies, and channel bandwidths based on E-UTRA bands specified in table 5.4.2.1-1. All of these configurations shall be tested with applicable test parameters for each channel bandwidth, and are shown in table 6.5.1.4.1-1. The details of the uplink and downlink reference measurement channels (RMCs) are specified in Annexes A.2 and A.3. Configurations of PDSCH and PDCCH before measurement are specified in Annex C.2.

Table 6.5.1.4.1-1: Test Configuration Table

Initial Conditions						
Test Environment as specified in TS 36.508[7] subclause 4.1			NC, TL/VL, TL/VH, TH/VL, TH/VH			
Test Frequencies as specified in TS36.508 [7] subclause 4.3.1			Low range, Mid range, High range			
Test Channel Bandwidths as specified in TS 36.508 [7] subclause 4.3.1			Lowest, 5MHz, Highest			
Test Parameters for Channel Bandwidths						
Ch BW	Downlink Configuration			Uplink Configuration		
	Mod'n	RB allocation		Mod'n	RB allocation	
		FDD	TDD		FDD	TDD
1.4MHz	QPSK	6	6	QPSK	6	6
3MHz	QPSK	15	15	QPSK	15	15
5MHz	QPSK	25	25	QPSK	25	25
5MHz	QPSK	25	N/A	QPSK	20	N/A
5MHz	QPSK	25	N/A	QPSK	15	N/A
10MHz	QPSK	50	50	QPSK	50	50
10MHz	QPSK	50	N/A	QPSK	25	N/A
10MHz	QPSK	50	N/A	QPSK	20	N/A
10MHz	QPSK	50	N/A	QPSK	15	N/A
15MHz	QPSK	75	75	QPSK	75	75
15MHz	QPSK	75	N/A	QPSK	50	N/A
15MHz	QPSK	75	N/A	QPSK	25	N/A
15MHz	QPSK	75	N/A	QPSK	20	N/A
20MHz	QPSK	100	100	QPSK	100	100
20MHz	QPSK	100	N/A	QPSK	75	N/A
20MHz	QPSK	100	N/A	QPSK	50	N/A
20MHz	QPSK	100	N/A	QPSK	25	N/A
20MHz	QPSK	100	N/A	QPSK	20	N/A
Note 1: Test Channel Bandwidths are checked separately for each E-UTRA band, which applicable channel bandwidths are specified in Table 5.4.2.1-1.						
Note 2: Depending on E-UTRA band, only the appropriate Uplink RB allocation value according to table 7.3.3-2 is tested per Test Channel Bandwidth.						

1. Connect the SS to the UE to the UE antenna connectors as shown in TS 36.508 [7] Annex A, Figure A.3.
2. The parameter settings for the cell are set up according to TS 36.508[7] subclause 4.4.3.
3. Downlink signals are initially set up according to Annex C0, C.1 and C.3.0, and uplink signals according to Annex H.1 and H.3.0.
4. The UL and DL Reference Measurement channels are set according to Table 6.5.1.4.1-1.
5. Propagation conditions are set according to Annex B.0
6. Ensure the UE is in State 3A-RF according to TS 36.508 [7] clause 5.2A.2. Message contents are defined in clause 6.5.1.4.3.

6.5.1.4.2 Test procedure

1. SS transmits PDSCH via PDCCH DCI format 1A for C_RNTI to transmit the DL RMC according to Table 6.5.1.4.1-1. The SS sends downlink MAC padding bits on the DL RMC.
2. SS sends uplink scheduling information for each UL HARQ process via PDCCH DCI format 0 for C_RNTI to schedule the UL RMC according to Table 6.5.1.4.1-1, since the UE has no payload data to send, the UE transmit uplink MAC padding bits on the UL RMC
3. Set the Downlink signal level to the appropriate REFSSENS value defined in Table 7.3.5-1. Send continuously uplink power control "up" commands to the UE in every uplink scheduling information to the UE so that the UE transmits at P_{UMAX} level for the duration of the test.
4. Measure the Frequency Error using Global In-Channel Tx-Test (Annex E). For TDD slots with transient periods are not under test.

6.5.1.4.3 Message contents

Message contents are according to TS 36.508 [7] subclause 4.6 with the exceptions in subclause 7.3.4.3 and Table 7.3.3-3.

6.5.1.5 Test requirement

The 20 frequency error Δf results must fulfil the test requirement:

$$|\Delta f| \leq (0.1 \text{ PPM} + 15 \text{ Hz})$$

6.5.1A Frequency error for CA

6.5.1A.1 Frequency error for CA (intra-band contiguous DL CA and UL CA)

6.5.1A.1.1 Test purpose

This test verifies the ability of both, receiver and the transmitter, to process frequency for intra-band CA correctly.

Receiver: to extract the correct frequency from the stimulus signal, offered by the System simulator, under ideal propagation conditions and low level.

Transmitter: to derive the correct modulated carrier frequency from the results, gained by the receiver.

6.5.1A.1.2 Test applicability

This test case applies to all types of E-UTRA UE release 10 and forward that support intra-band contiguous DL CA and UL CA.

6.5.1A.1.3 Minimum conformance requirements

For intra-band contiguous carrier aggregation the UE modulated carrier frequencies per band shall be accurate to within ± 0.1 PPM observed over a period of one timeslot compared to the carrier frequency of primary component carrier received from the E-UTRA in the corresponding band.

The normative reference for this requirement is TS 36.101[2] clause 6.5.1A.

6.5.1A.1.4 Test description

6.5.1A.1.4.1 Initial condition

Initial conditions are a set of test configurations the UE needs to be tested in and the steps for the SS to take with the UE to reach the correct measurement state.

The initial test configurations consist of environmental conditions, test frequencies, and CC combinations based on E-UTRA CA configurations specified in table 5.4.2A.1-1. All of these configurations shall be tested with applicable test parameters for each CA Configuration, and are shown in table 6.5.1A.1.4.1-1. The details of the uplink and downlink reference measurement channels (RMCs) are specified in Annex A.2 and A3. Configurations of PDSCH and PDCCH before measurement are specified in Annex C.2.

Table 6.5.1A.1.4.1-1: Test Configuration Table

Initial Conditions									
Test Environment as specified in TS 36.508[7] subclause 4.1					NC, TL/VL, TL/VH, TH/VL, TH/VH				
Test Frequencies as specified in TS36.508 [7] subclause 4.3.1 for different CA bandwidth classes.					C: Low range, High range				
Test CC Combination setting (N_{RB_agg}) as specified in subclause 5.4.2A.1 for the CA Configuration					Lowest N_{RB_agg} Highest N_{RB_agg}				
Test Parameters for CA Configurations									
CA Configuration / N_{RB_agg}		DL Allocation			UL Allocation				
PCC N_{RB}	SCCs N_{RB}	CC Mod	PCC & SCC RB allocation	CC MOD	N_{RB_alloc}	PCC & SCC RB allocations (L _{CRB} @ RB _{start})			
75	75	QPSK	75+75	QPSK	130	P_75@0	S_55@0	-	-
75	75	QPSK	75+75	QPSK	150	P_75@0	S_75@0	-	-
100	50	QPSK	100+50	QPSK	150	P_100@0	S_50@0	-	-
100	75	QPSK	100+75	QPSK	175	P_100@0	S_75@0	-	-
100	100	QPSK	100+100	QPSK	130	P_100@0	S_30@0	-	-
100	100	QPSK	100+100	QPSK	75	P_75@0	S_0@0	-	-
Note 1: CA Configuration Test CC Combination settings are checked separately for each CA Configuration, which applicable aggregated channel bandwidths are specified in Table 5.4.2A.1-1									
Note 2: Depending on CA configurations, only the appropriate Uplink RB allocation value according to table 7.3A.3-1 for UE supporting two uplink carriers is tested per Test CA configuration.									

1. Connect the SS to the UE antenna connectors as shown in TS 36.508[7] Annex A Figure group A.32 as appropriate.
2. The parameter settings for the cell are set up according to TS 36.508 [7] subclause 4.4.3.
3. Downlink signals for PCC are initially set up according to Annex C.0, C.1, and C.3.0, and uplink signals according to Annex H.1 and H.3.0.
4. The UL and DL Reference Measurement channel is set according to Table 6.5.1A.1.4.1-1.
5. Propagation conditions are set according to Annex B.0.
6. Ensure the UE is in State 3A-RF according to TS 36.508 [7] clause 5.2A. 2. Message contents are defined in clause 6.5.1A.1.4.3.

6.5.1A.1.4.2 Test procedure

1. Configure SCC according to Annex C0, C.1 and Annex C.3.0 for all downlink physical channels except PHICH.
2. The SS shall configure SCC as per TS 36.508 [7] clause 5.2A.4. Message contents are defined in clause 6.5.1A.1.4.3
3. SS activates SCC by sending the activation MAC-CE (Refer TS 36.321 [13], clauses 5.13, 6.1.3.8). Wait for at least 2 seconds (Refer TS 36.133, clauses 8.3.3.2).
4. SS transmits PDSCH via PDCCH DCI format 1A for C_RNTI to transmit the DL RMC according to Tables 6.5.1A.1.4.1-1 on both PCC and SCC. The SS sends downlink MAC padding bits on the DL RMC.
5. SS sends uplink scheduling information for each UL HARQ process via PDCCH DCI format 0 for C_RNTI to schedule the UL RMC according to Table 6.5.1A.1.4.1-1 on both PCC and SCC. Since the UE has no payload and no loopback data to send the UE sends uplink MAC padding bits on the UL RMC.

6. Set the Downlink signal level for PCC and SCC to the appropriate REFSENS value defined in Table 7.3A.2.5-1. Send continuously uplink power control "up" commands in every uplink scheduling information to the UE to ensure the UE transmits P_{UMAX} level for at least the duration of the test.
7. Measure the Frequency Error on PCC and SCC using Global In-Channel Tx-Test (Annex E) respectively. For TDD slots with transient periods are not under test.

6.5.1A.1.4.3 Message contents

Message contents are according to TS 36.508 [7] subclause 4.6. In test procedure step 2, for SCC configuration there are no additional message contents.

6.5.1A.1.5 Test Requirements

The 20 frequency error Δf results per test point must fulfil the test requirement:

$|\Delta f| \leq (0.1 \text{ PPM} + 15 \text{ Hz})$ for each test point.

6.5.1B Frequency Error for UL-MIMO

6.5.1B.1 Test purpose

This test verifies the ability of both, the receiver and the transmitter for UL-MIMO, to process frequency correctly.

Receiver: to extract the correct frequency from the stimulus signal, offered by the System simulator, under ideal propagation conditions and low level.

Transmitter: to derive the correct modulated carrier frequency for each transmitter connector from the results, gained by the receiver.

6.5.1B.2 Test applicability

This test applies to all types of E-UTRA UE release 10 and forward that support UL-MIMO.

6.5.1B.3 Minimum conformance requirements

The UE modulated carrier frequency for each transmit antenna shall be accurate to within ± 0.1 PPM observed over a period of one time slot (0.5ms) compared to the carrier frequency received from the E-UTRA Node B.

The normative reference for this requirement is TS 36.101 clause 6.5.1B

6.5.1B.4 Test description

6.5.1B.4.1 Initial condition

Initial conditions are a set of test configurations the UE needs to be tested in and the steps for the SS to take with the UE to reach the correct measurement state.

The initial test configurations consist of environmental conditions, test frequencies, and channel bandwidths based on E-UTRA bands specified in table 5.4.2.1-1. All of these configurations shall be tested with applicable test parameters for each channel bandwidth, and are shown in table 6.5.1B.4.1-1. The details of the uplink and downlink reference measurement channels (RMCs) are specified in Annexes A.2 and A.3. Configurations of PDSCH and PDCCH before measurement are specified in Annex C.2.

Table 6.5.1B.4.1-1: Test Configuration Table

Initial Conditions						
Test Environment as specified in TS 36.508[7] subclause 4.1			NC, TL/VL, TL/VH, TH/VL, TH/VH			
Test Frequencies as specified in TS36.508 [7] subclause 4.3.1			Low range, Mid range, High range			
Test Channel Bandwidths as specified in TS 36.508 [7] subclause 4.3.1			Lowest, 5MHz, Highest			
Test Parameters for Channel Bandwidths						
Ch BW	Downlink Configuration			Uplink Configuration		
	Mod'n	RB allocation		Mod'n	RB allocation	
		FDD	TDD		FDD	TDD
1.4MHz	QPSK	6	6	QPSK	6	6
3MHz	QPSK	15	15	QPSK	15	15
5MHz	QPSK	25	25	QPSK	25	25
5MHz	QPSK	25	N/A	QPSK	20	N/A
5MHz	QPSK	25	N/A	QPSK	15	N/A
10MHz	QPSK	50	50	QPSK	50	50
10MHz	QPSK	50	N/A	QPSK	25	N/A
10MHz	QPSK	50	N/A	QPSK	20	N/A
10MHz	QPSK	50	N/A	QPSK	15	N/A
15MHz	QPSK	75	75	QPSK	75	75
15MHz	QPSK	75	N/A	QPSK	50	N/A
15MHz	QPSK	75	N/A	QPSK	25	N/A
15MHz	QPSK	75	N/A	QPSK	20	N/A
20MHz	QPSK	100	100	QPSK	100	100
20MHz	QPSK	100	N/A	QPSK	75	N/A
20MHz	QPSK	100	N/A	QPSK	50	N/A
20MHz	QPSK	100	N/A	QPSK	25	N/A
20MHz	QPSK	100	N/A	QPSK	20	N/A
Note 1: Test Channel Bandwidths are checked separately for each E-UTRA band, which applicable channel bandwidths are specified in Table 5.4.2.1-1.						
Note 2: Depending on E-UTRA band, only the appropriate Uplink RB allocation value according to table 7.3.3-2 is tested per Test Channel Bandwidth.						

1. Connect the SS to the UE to the UE antenna connectors as shown in TS 36.508 [7] Annex A, Figure A.28.
2. The parameter settings for the cell are set up according to TS 36.508[7] subclause 4.4.3.
3. Downlink signals are initially set up according to Annex C0, C.1 and C.3.0, and uplink signals according to Annex H.1 and H.3.0.
4. The UL and DL Reference Measurement channels are set according to Table 6.5.1B.4.1-1.
5. Propagation conditions are set according to Annex B.0
6. Ensure the UE is in State 3A-RF according to TS 36.508 [7] clause 5.2A.2. Message contents are defined in clause 6.5.1B.4.3.

6.5.1B.4.2 Test procedure

1. SS transmits PDSCH via PDCCH DCI format 1A for C_RNTI to transmit the DL RMC according to Table 6.5.1B.4.1-1. The SS sends downlink MAC padding bits on the DL RMC.
2. SS sends uplink scheduling information for each UL HARQ process via PDCCH DCI format 4 for C_RNTI to schedule the UL RMC according to Table 6.5.1B.4.1-1, since the UE has no payload data to send, the UE transmit uplink MAC padding bits on the UL RMC.
3. Set the Downlink signal level to the appropriate REFSENS value defined in Table 7.3B.5-1. Send continuously uplink power control "up" commands to the UE in every uplink scheduling information to the UE so that the UE transmits at PUMAX level for the duration of the test.

4. Measure the Frequency Error using Global In-Channel Tx-Test (Annex E) for each of transmit antenna of the UE. For TDD slots with transient periods are not under test.

6.5.1B.4.3 Message contents

Message contents are according to TS 36.508 [7] clause 4.6 with the exceptions in clause 7.3.4.3 and Table 7.3.3-3.

6.5.1B.5 Test requirement

The requirements apply to each transmit antenna connector.

The 20 frequency error Δf results must fulfil the test requirement:

$$|\Delta f| \leq (0.1\text{PPM} + 15 \text{ Hz})$$

6.5.2 Transmit modulation

Transmit modulation defines the modulation quality for expected in-channel RF transmissions from the UE. This transmit modulation limit is specified in terms of:

- Error Vector Magnitude (EVM) for the allocated resources blocks (RB),
- EVM equalizer spectrum flatness derived from the equalizer coefficients generated by the EVM measurement process
- Carrier leakage (caused by IQ offset)

In-band emissions for the non-allocated RB

6.5.2.1 Error Vector Magnitude (EVM)

6.5.2.1.1 Test Purpose

The Error Vector Magnitude is a measure of the difference between the reference waveform and the measured waveform. This difference is called the error vector. Before calculating the EVM the measured waveform is corrected by the sample timing offset and RF frequency offset. Then the IQ origin offset shall be removed from the measured waveform before calculating the EVM.

The measured waveform is further modified by selecting the absolute phase and absolute amplitude of the Tx chain. The EVM result is defined after the front-end IDFT as the square root of the ratio of the mean error vector power to the mean reference power expressed as a %.

The basic EVM measurement interval in the time domain is one preamble sequence for the PRACH and is one slot for the PUCCH and PUSCH in the time domain. When the PUSCH or PUCCH transmission slot is shortened due to multiplexing with SRS, the EVM measurement interval is reduced by one symbol, accordingly. The PUSCH or PUCCH EVM measurement interval is also reduced when the mean power, modulation or allocation between slots is expected to change. In the case of PUSCH transmission, the measurement interval is reduced by a time interval equal to the sum of 5 μs and the applicable exclusion period defined in subclause 6.3.4, adjacent to the boundary where the power change is expected to occur. The PUSCH exclusion period is applied to the signal obtained after the front-end IDFT. In the case of PUCCH transmission, the PUCCH EVM measurement interval is reduced by one symbol adjacent to the slot boundary.

6.5.2.1.2 Test applicability

This test case applies to all types of E-UTRA UE release 8 and forward.

6.5.2.1.3 Minimum conformance requirements

EVM measurements are evaluated for 10 uplink sub-frames excluding any transient period for the average EVM case, and 60 subframes excluding any transient period for the reference signal EVM case, the different modulations schemes shall not exceed the values specified in Table 6.5.2.1.3-1 for the parameters defined in Table 6.5.2.1.3-2. For EVM

evaluation purposes, [all PRACH preamble formats 0-4 and] all PUCCH formats 1, 1a, 1b, 2, 2a and 2b are considered to have the same EVM requirement as QPSK modulated.

Table 6.5.2.1.3-1: Minimum requirements for Error Vector Magnitude

Parameter	Unit	Average EVM Level	Reference Signal EVM Level
QPSK or BPSK	%	17.5	[17.5]
16QAM	%	12.5	[12.5]

Table 6.5.2.1.3-2: Parameters for Error Vector Magnitude

Parameter	Unit	Level
UE Output Power	dBm	≥ -40
Operating conditions		Normal conditions

The normative reference for this requirement is TS 36.101 [2] clause 6.5.2.1.1.

6.5.2.1.4 Test description

6.5.2.1.4.1 Initial conditions

Initial conditions are a set of test configurations the UE needs to be tested in and the steps for the SS to take with the UE to reach the correct measurement state.

The initial test configurations consist of environmental conditions, test frequencies, and channel bandwidths based on E-UTRA bands specified in table 5.4.2.1-1. All of these configurations shall be tested with applicable test parameters for each channel bandwidth, and are shown in table 6.5.2.1.4.1-1. The details of the uplink reference measurement channels (RMCs) are specified in Annex A.2. Configurations of PDSCH and PDCCH before measurement are specified in Annex C.2.

Table 6.5.2.1.4.1-1: Test Configuration Table for PUSCH

Initial Conditions				
Test Environment (as specified in TS 36.508 [7] subclause 4.1)		NC		
Test Frequencies (as specified in TS36.508 [7] subclause 4.3.1)		See Table 6.5.1.4.1-1		
Test Channel Bandwidths (as specified in TS 36.508 [7] subclause 4.3.1)		See Table 6.5.1.4.1-1		
Test Parameters for Channel Bandwidths				
Downlink Configuration		Uplink Configuration		
Ch BW	N/A for PUSCH EVM testing	Mod'n	RB allocation	
			FDD	TDD

1.4MHz		QPSK	6	6
1.4MHz		QPSK	1	1
1.4MHz		16QAM	6	6
1.4MHz		16QAM	1	1
3MHz		QPSK	15	15
3MHz		QPSK	4	4
3MHz		16QAM	15	15
3MHz		16QAM	4	4
5MHz		QPSK	25	25
5MHz		QPSK	8	8
5MHz		16QAM	25	25
5MHz		16QAM	8	8
10MHz		QPSK	50	50
10MHz		QPSK	12	12
10MHz		16QAM	50	50
			(Note 3)	(Note 3)
10MHz		16QAM	12	12
15MHz		QPSK	75	75
15MHz		QPSK	16	16
15MHz		16QAM	75	75
			(Note 3)	(Note 3)
15MHz		16QAM	16	16
20MHz		QPSK	100	100
20MHz		QPSK	18	18
20MHz		16QAM	100	100
			(Note 3)	(Note 3)
20MHz		16QAM	18	18

Note 1: Test Channel Bandwidths are checked separately for each E-UTRA band, which applicable channel bandwidths are specified in Table 5.4.2.1-1.

Note 2: For partial RB allocation, the RB_{start} shall be RB #0 and RB# (max+1 - RB allocation) of the channel bandwidth.

Note 3: Applies only for UE-Categories ≥2

Table 6.5.2.1.4.1-2: Test Configuration Table for PUCCH

Initial Conditions				
Test Environment as specified in TS 36.508[7] subclause 4.1		NC		
Test Frequencies as specified in TS36.508 [7] subclause 4.3.1		See Table 6.5.1.4.1-1		
Test Channel Bandwidths as specified in TS 36.508 [7] subclause 4.3.1		See Table 6.5.1.4.1-1		
Test Parameters for Channel Bandwidths				
Ch BW	Downlink Configuration			Uplink Configuration
	Mod'n	RB allocation		
		FDD	TDD	FDD: PUCCH format = Format 1a TDD: PUCCH format = Format 1a / 1b
1.4MHz	QPSK	3	3	
3MHz	QPSK	4	4	
5MHz	QPSK	8	8	
10MHz	QPSK	16	16	
15MHz	QPSK	25	25	
20MHz	QPSK	30	30	
Note 1: Test Channel Bandwidths are checked separately for each E-UTRA band, the applicable channel bandwidths are specified in Table 5.4.2.1-1.				

Table 6.5.2.1.4.1-3: Test Configuration for PRACH

Initial Conditions		
Test Environment (as specified in TS 36.508 [7] subclause 4.1)	NC	
Test Frequencies (as specified in TS36.508 [7] subclause 4.3.1)	See Table 6.5.1.4.1-1	
Test Channel Bandwidths (as specified in TS 36.508 [7] subclause 4.3.1)	See Table 6.5.1.4.1-1	
PRACH preamble format		
	FDD	TDD
PRACH Configuration Index	4	53
RS EPRE setting for test point 1 (dBm/15kHz)	-71	-63
RS EPRE setting for test point 2 (dBm/15kHz)	-86	-78

1. Connect the SS to the UE to the UE antenna connectors as shown in TS 36.508 [7] Annex A, Figure A.3.
2. The parameter settings for the cell are set up according to TS 36.508[7] subclause 4.4.3.
3. Downlink signals are initially set up according to Annex C0, C.1 and C.3.0, and uplink signals according to Annex H.1 and H.3.0.
4. The UL Reference Measurement channels are set according to in Table 6.5.2.1.4.1-1.
5. Propagation conditions are set according to Annex B.0
6. Ensure the UE is in State 3A-RF according to TS 36.508 [7] clause 5.2A.2. Message contents are defined in clause 6.5.2.1.4.3.

6.5.2.1.4.2 Test procedure

Test procedure for PUSCH:

- 1.1. SS sends uplink scheduling information for each UL HARQ process via PDCCH DCI format 0 for C_RNTI to schedule the UL RMC according to Table 6.5.2.1.4.1-1. Since the UE has no payload data to send, the UE transmits uplink MAC padding bits on the UL RMC.
- 1.2 Send continuously uplink power control "up" commands in the uplink scheduling information to the UE until the UE transmits at P_{UMAX} level.
- 1.3 Measure the EVM and \overline{EVM}_{DMRS} using Global In-Channel Tx-Test (Annex E).
- 1.4 Send the appropriate TPC commands in the uplink scheduling information to the UE until UE output power is $-36.8\text{dBm} \pm 3.2\text{dB}$ for carrier frequency $f \leq 3.0\text{GHz}$ or $-36.5\text{dBm} \pm 3.5\text{ dB}$ for carrier frequency $3.0\text{GHz} < f \leq 4.2\text{GHz}$.
- 1.5 Measure the EVM and \overline{EVM}_{DMRS} using Global In-Channel Tx-Test (Annex E).

Test procedure for PUCCH:

- 2.1 PUCCH are set according to Table 6.5.2.1.4.1-2.
- 2.2 SS transmits PDSCH via PDCCH DCI format 1A for C_RNTI to transmit the DL RMC according to Table 6.5.2.1.4.1-2. The SS sends downlink MAC padding bits on the DL RMC. The transmission of PDSCH will make the UE send uplink ACK/NACK using PUCCH. There is no PUSCH transmission.
- 2.3 SS send appropriate TPC commands for PUCCH to the UE until the UE transmit PUCCH at P_{UMAX} level.
- 2.4 Measure PUCCH EVM using Global In-Channel Tx-Test (Annex E).
- 2.5 Send the appropriate TPC commands for PUCCH to the UE until the UE transmits PUCCH at $-36.8\text{dBm} \pm 3.2\text{dB}$ for carrier frequency $f \leq 3.0\text{GHz}$ or $-36.5\text{dBm} \pm 3.5\text{ dB}$ for carrier frequency $3.0\text{GHz} < f \leq 4.2\text{GHz}$.
- 2.6 Measure PUCCH EVM using Global In-Channel Tx-Test (Annex E).

Test procedure for PRACH:

3.1 The SS shall set RS EPRE according to Table 6.5.2.1.4.1-3.

3.2 PRACH is set according to Table 6.5.2.1.4.1-3.

3.3 The SS shall signal a Random Access Preamble ID via a PDCCH order to the UE and initiate a Non-contention based Random Access procedure

3.4 The UE shall send the signalled preamble to the SS.

3.5 In response to the preamble, the SS shall transmit a random access response not corresponding to the transmitted random access preamble, or send no response.

3.6 The UE shall consider the random access response reception not successful then re-transmit the preamble with the calculated PRACH transmission power.

3.7 Repeat step 5 and 6 until the SS collect enough PRACH preambles (2 preambles for format 0 and 10 preambles for format 4). Measure the EVM in PRACH channel using Global In-Channel Tx-Test (Annex E).

6.5.2.1.4.3 Message contents

Message contents are according to TS 36.508 [7] subclause 4.6 with the following exceptions:

Table 6.5.2.1.4.3-1: PRACH-ConfCommonDEFAULT: PRACH EVM measurement for FDD

Derivation Path: TS 36.508 [7] clause 4.6.3, Table 4.6.3-7 PRACH-ConfCommonDEFAULT			
Information Element	Value/remark	Comment	Condition
PRACH-ConfigInfo SEQUENCE {			
prach-ConfigIndex	4		

Table 6.5.2.1.4.3-2: PRACH-ConfCommonDEFAULT: PRACH EVM measurement for TDD

Derivation Path: TS 36.508 [7] clause 5.3.1, Table 5.3.1-1 PRACH-ConfCommonDEFAULT			
Information Element	Value/remark	Comment	Condition
PRACH-ConfigInfo SEQUENCE {			
prach-ConfigIndex	53		

Table 6.5.2.1.4.3-4: RACH-ConfigCommon-DEFAULT: PRACH EVM measurement

Derivation Path: TS 36.508 [7] clause 4.6.3, Table 4.6.3-12 RACH-ConfigCommon-DEFAULT			
Information Element	Value/remark	Comment	Condition
RACH-ConfigCommon-DEFAULT ::= SEQUENCE {			
preambleInfo SEQUENCE {			
numberOfRA-Preambles	n52		
preamblesGroupAConfig SEQUENCE {	Not present		
}			
powerRampingParameters SEQUENCE {			
powerRampingStep	dB0		
preambleInitialReceivedTargetPower	dBm-120 Test point 1 dBm-90 Test point 2		
}			
ra-SupervisionInfo SEQUENCE {			
preambleTransMax	n10 n20		FDD TDD
ra-ResponseWindowSize	Sf10		
mac-ContentionResolutionTimer	sf48		
}			
ra-SupervisionInfo SEQUENCE {			

Table 6.5.2.1.4.3-5: TDD-Config-DEFAULT: PRACH EVM measurement for TDD

Derivation Path: TS 36.508 [7] clause 5.3.1, Table 5.3.1-1: TDD-Config-DEFAULT			
Information Element	Value/remark	Comment	Condition
TDD-Config-DEFAULT ::= SEQUENCE {			
subframeAssignment	sa1		
specialSubframePatterns	ssp5	To enable two symbol UpPTS, and to have 9 symbols GP.	
}			

6.5.2.1.5 Test requirement

The PUSCH EVM derived in E.4.2 shall not exceed 17,5 % for QPSK and BPSK, 12,5% for 16 QAM.

The PUSCH \overline{EVM}_{DMRS} derived in E.4.6.2 shall not exceed [17,5 %] when embedded with data symbols of QPSK and BPSK, [12,5%] for 16 QAM.

The PUCCH EVM and derived in E.5.9.2 shall not exceed 17,5 %.

The PRACH EVM derived in FFS shall not exceed 17.5%.

6.5.2.1A PUSCH-EVM with exclusion period

6.5.2.1A.1 Test purpose

To verify the ability of the UE transmitter to keep the EVM minimum requirements, even in the presence of transients according to subclause 6.5.2.1.1 third paragraph:

.....In the case of PUSCH transmission, the measurement interval is reduced by a time interval equal to the sum of 5 μ s and the applicable exclusion period defined in subclause 6.3.4, adjacent to the boundary where the power change is expected to occur. The PUSCH exclusion period is applied to the signal obtained after the front-end IDFT.

6.5.2.1A.2 Test applicability

This test applies to all types of E-UTRA UE release 8 and forward.

6.5.2.1A.3 Minimum conformance requirement

EVM measurements are evaluated for 10 uplink sub-frames in a reduced time interval due to exclusion periods for the average EVM. The different modulations schemes shall not exceed the values specified in Table 6.5.2.1.3-1 for the parameters defined in Table 6.5.2.1.3-2.

6.5.2.1A.4 Test description

6.5.2.1A.4.1 Initial conditions

Initial conditions are a set of test configurations the UE needs to be tested in and the steps for the SS to take with the UE to reach the correct measurement state.

The initial test configurations consist of environmental conditions, test frequencies, and channel bandwidths based on E-UTRA operating bands specified in table 5.4.2.1-1. All of these configurations shall be tested with applicable test parameters for each channel bandwidth, and are shown in table 6.5.2.1A.4.1-1. The details of the uplink reference measurement channels (RMCs) are specified in Annexes A.2. Configurations of PDSCH and PDCCH before measurement are specified in Annex C.2.

Table 6.5.2.1A.4.1-1: Test Configuration Table

Initial Conditions			
Test Environment as specified in TS 36.508[7] subclause 4.1		Normal Conditions	
Test Frequencies as specified in TS36.508 [7] subclause 4.3.1		Low range	
Test Channel Bandwidths as specified in TS 36.508 [7] subclause 4.3.1		10 MHz	
Test Parameters for Channel Bandwidths			
Ch BW	Downlink Configuration	Uplink Configuration	
		Mod'n	RB allocation
	N/A		FDD
10MHz		QPSK	Alternating 12 and 1 (as shown in Figure 6.5.2.1A.4.2-1)
10MHz		16 QAM	Alternating 12 and 1 (as shown in Figure 6.5.2.1A.4.2-1)
			TDD
			Alternating 12 and 1 (as shown in Figure 6.5.2.1A.4.2-1)

1. Connect the SS to the UE antenna connectors as shown in TS 36.508 [7] Annex A, Figure A.3.
2. The parameter settings for the cell are set up according to TS 36.508 [7] subclause 4.4.3.
3. Downlink signals are initially set up according to Annex C.0, C.1 and C.3.0, and uplink signals according to Annex H.1 and H.3.0.
4. The UL Reference Measurement channel is set according to table 6.5.2.1A.4.1-1
5. Propagation conditions are set according to Annex B.0.
6. Ensure the UE is in State 3A-RF according to TS 36.508 [7] clause 5.2A.2. Message contents are defined in clause 6.3.5.2.4.3.

6.5.2.1A.4.2 Test procedure

The test pattern is illustrated in figure 6.5.2.1A.4.2-1.

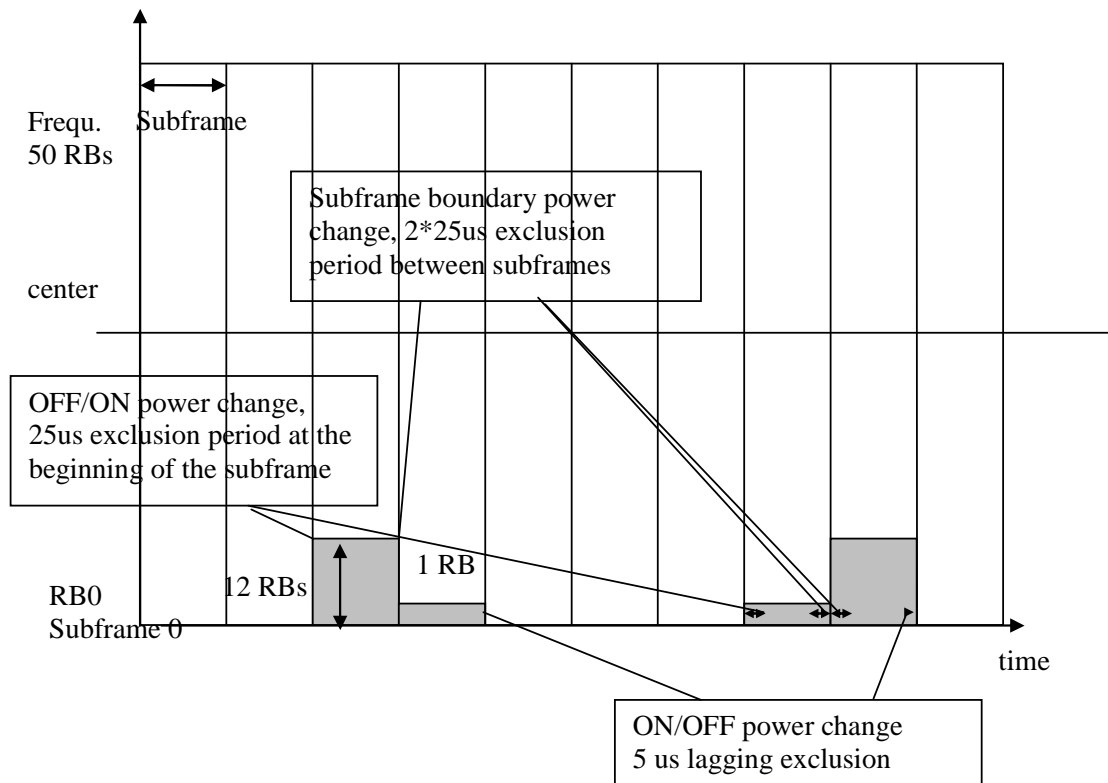

Figure 6.5.2.1A.4.2-1: Test pattern

NOTE 1: In TDD the free subframes are special subframes or DL, in FDD the free subframes are OFF.

1. SS sends uplink scheduling information for each UL HARQ process via PDCCH DCI format 0 for C_RNTI to schedule the PUSCH... Since the UE has no payload data to send, the UE transmits uplink MAC padding bits on the UL RMC. The initial uplink RB allocation is 12. Send appropriate TPC commands for PUSCH to the UE to ensure the UE transmits PUSCH at $0\text{dBm} \pm 3.2\text{dB}$ for carrier frequency $f \leq 3.0\text{GHz}$ or $0\text{dBm} \pm 3.5\text{dB}$ for carrier frequency $3.0\text{GHz} < f \leq 4.2\text{GHz}$.
2. Schedule the UE's PUSCH data transmission as described in Figure 6.5.2.1A.4.2-1 for $16^{1)}$ active time slots with an uplink RB allocation alternating pattern as described in table 6.5.2.1A.4.1-1 while transmitting 0dB TPC command for PUSCH via the PDCCH.
3. Measure the EVM using Global In-Channel Tx-Test. The averaging across $16^{1)}$ timeslots is done across mixed RB allocations, as illustrated in Figure 6.5.2.1A.4.2-1

NOTE 1: Averaging across 16 timeslots is used to represent each type of transition equally in the average.

6.5.2.1A.5 Test requirement

The PUSCH EVM derived in Annex E.4.2 taking into account Annex E.7 shall not exceed 17,5 % for QPSK and 12,5% for 16 QAM. The test requirements shall be fulfilled for early and late EVM window.

6.5.2.2 Carrier leakage

6.5.2.2.1 Test Purpose

Carrier leakage (the I/Q origin offset) is an interference caused by crosstalk or DC offset and expresses itself as unmodulated sine wave with the carrier frequency. It is an interference of approximately constant amplitude and independent of the amplitude of the wanted signal. I/Q origin offset interferes with the centre sub carriers of the UE under test (if allocated), especially, when their amplitude is small. The measurement interval is defined over one slot in the time domain.

The purpose of this test is to exercise the UE transmitter to verify its modulation quality in terms of carrier leakage.

6.5.2.2.2 Test applicability

This test case applies to all types of E-UTRA UE release 8 and forward.

6.5.2.2.3 Minimum conformance requirements

The relative carrier leakage power (IQ origin offset power) is a power ratio of the additive sinusoid waveform and the modulated waveform. The relative carrier leakage power shall not exceed the values specified in Table 6.5.2.2.3-1.

Table 6.5.2.2.3-1: Minimum requirements for Relative Carrier Leakage Power

LO Leakage	Parameters		Relative Limit (dBc)	
	Output power >0 dBm			-25
	-30 dBm ≤ Output power ≤ 0 dBm			-20
	-40 dBm ≤ Output power < -30 dBm			-10

The normative reference for this requirement is TS 36.101 clause 6.5.2.2.1

6.5.2.2.4 Test description

6.5.2.2.4.1 Initial conditions

Initial conditions are a set of test configurations the UE needs to be tested in and the steps for the SS to take with the UE to reach the correct measurement state.

The initial test configurations consist of environmental conditions, test frequencies, and channel bandwidths based on E-UTRA bands specified in table 5.4.2.1-1. All of these configurations shall be tested with applicable test parameters for each channel bandwidth, and are shown in table 6.5.2.2.4.1-1. The details of the uplink reference measurement channels (RMCs) are specified in Annexes A.2. Configurations of PDSCH and PDCCH before measurement are specified in Annex C.2.

Table 6.5.2.2.4.1-1: Test Configuration Table

Initial Conditions				
Test Environment (as specified in TS 36.508 [7] subclause 4.1)		See Table 6.5.1.4.1-1		
Test Frequencies (as specified in TS36.508 [7] subclause 4.3.1)		See Table 6.5.1.4.1-1		
Test Channel Bandwidths (as specified in TS 36.508 [7] subclause 4.3.1)		See Table 6.5.1.4.1-1		
Test Parameters for Channel Bandwidths				
Ch BW	Downlink Configuration	Uplink Configuration		
	N/A for carrier leakage testing	Mod'n	RB allocation	
1.4MHz			FDD	TDD
3MHz		QPSK	1	1
5MHz		QPSK	4	4
10MHz		QPSK	8	8
15MHz		QPSK	12	12
20MHz		QPSK	16	16
		QPSK	18	18
Note 1: Test Channel Bandwidths are checked separately for each E-UTRA band, which applicable channel bandwidths are specified in Table 5.4.2.1-1.				
Note 2: For partial RB allocation, the RB _{start} shall be RB #0 and RB# (max +1- RB allocation) of the channel bandwidth.				

1. Connect the SS to the UE to the UE antenna connectors as shown in TS 36.508 [7] Annex A, Figure A.3.
2. The parameter settings for the cell are set up according to TS 36.508[7] subclause 4.4.3.
3. Downlink signals are initially set up according to Annex C0, C.1 and C.3.0, and uplink signals according to Annex H.1 and H.3.0.
4. The UL Reference Measurement channels are set according to in Table 6.5.2.2.4.1-1.
5. Propagation conditions are set according to Annex B.0
6. Ensure the UE is in State 3A-RF according to TS 36.508 [7] clause 5.2A.2. Message contents are defined in clause 6.5.2.2.4.3.

6.5.2.2.4.2 Test procedure

SS sends uplink scheduling information for each UL HARQ process via PDCCH DCI format 0 for C_RNTI to schedule the UL RMC according to Table 6.5.2.2.4.1-1. Since the UE has no payload and no loopback data to send the UE sends uplink MAC padding bits on the UL RMC

Send the appropriate TPC commands in the uplink scheduling information to the UE until UE output power is 3.2 dBm \pm 3.2dB for carrier frequency $f \leq 3.0\text{GHz}$ or 3.5dBm \pm 3.5 dB for carrier frequency $3.0\text{GHz} < f \leq 4.2\text{GHz}$.

Measure carrier leakage using Global In-Channel Tx-Test (Annex E). For TDD slots with transient periods are not under test.

4. Send the appropriate TPC commands in the uplink scheduling information to the UE until UE output power is -26.8 dBm \pm 3.2dB for carrier frequency $f \leq 3.0\text{GHz}$ or -26.5dBm \pm 3.5 dB for carrier frequency $3.0\text{GHz} < f \leq 4.2\text{GHz}$.
5. Measure carrier leakage using Global In-Channel Tx-Test (Annex E). For TDD slots with transient periods are not under test
6. Send the appropriate TPC commands in the uplink scheduling information to the UE until UE output power is -36.8dBm \pm 3.2dB for carrier frequency $f \leq 3.0\text{GHz}$ or -36.5dBm \pm 3.5 dB for carrier frequency $3.0\text{GHz} < f \leq 4.2\text{GHz}$.
7. Measure carrier leakage using Global In-Channel Tx-Test (Annex E). For TDD slots with transient periods are not under test

6.5.2.2.4.3 Message contents

Message contents are according to TS 36.508 [7] subclause 4.6.

6.5.2.2.5 Test requirement

Each of the 20 IQ offset results, derived in Annex E.3.1, shall not exceed the values in table 6.5.2.2.5-1

Table 6.5.2.2.5-1: Test requirements for Relative Carrier Leakage Power

LO Leakage	Parameters	Relative Limit (dBc)
	f ≤ 3.0GHz: 3.2 dBm ±3.2dB 3.0GHz < f ≤ 4.2GHz: 3.5 dBm ±3.5dB	-24.2
	f ≤ 3.0GHz: -26.8 dBm ±3.2dB 3.0GHz < f ≤ 4.2GHz: -26.5 dBm ±3.5dB	-19.2
	f ≤ 3.0GHz: -36.8dBm±3.2dB 3.0GHz < f ≤ 4.2GHz: -36.5 dBm ±3.5dB	-9.2

6.5.2.3 In-band emissions for non allocated RB

6.5.2.3.1 Test Purpose

The in-band emissions are a measure of the interference falling into the non-allocated resources blocks

The in-band emission is defined as the average across 12 sub-carrier and as a function of the RB offset from the edge of the allocated UL transmission bandwidth. The in-band emission is measured as the ratio of the UE output power in a non-allocated RB to the UE output power in an allocated RB. The basic in-band emissions measurement interval is defined over one slot in the time domain. When the PUSCH or PUCCH transmission slot is shortened due to multiplexing with SRS, the in-band emissions measurement interval is reduced by one SC-FDMA symbol, accordingly.

6.5.2.3.2 Test applicability

This test case applies to all types of E-UTRA UE release 8 and forward.

6.5.2.3.3 Minimum conformance requirements

The relative in-band emission shall not exceed the values specified in Table 6.5.2.3.3-1.

Table 6.5.2.3.3-1: Minimum requirements for in-band emissions

Parameter Description	Unit	Limit (Note 1)		Applicable Frequencies
General	dB	$\max \left\{ -25 - 10 \cdot \log_{10} (N_{RB} / L_{CRB}), \right.$ $20 \cdot \log_{10} EVM - 3 - 5 \cdot (\Delta_{RB} - 1) / L_{CRB},$ $\left. -57 \text{ dBm} / 180 \text{ kHz} - P_{RB} \right\}$		Any non-allocated (Note 2)
IQ Image	dB	-25		Image frequencies (Notes 2, 3)
Carrier leakage	dBc	-25	Output power > 0 dBm	LO frequency (Notes 4, 5)
		-20	-30 dBm ≤ Output power ≤ 0 dBm	
		-10	-40 dBm ≤ Output power < -30 dBm	
<p>Note 1: An in-band emissions combined limit is evaluated in each non-allocated RB. For each such RB, the minimum requirement is calculated as the higher of $P_{RB} - 30$ dB and the power sum of all limit values (General, IQ Image or Carrier leakage) that apply. P_{RB} is defined in Note 10.</p> <p>Note 2: The measurement bandwidth is 1 RB and the limit is expressed as a ratio of measured power in one non-allocated RB to the measured average power per allocated RB, where the averaging is done across all allocated RBs.</p> <p>Note 3: The applicable frequencies for this limit are those that are enclosed in the reflection of the allocated bandwidth, based on symmetry with respect to the centre carrier frequency, but excluding any allocated RBs.</p> <p>Note 4: The measurement bandwidth is 1 RB and the limit is expressed as a ratio of measured power in one non-allocated RB to the measured total power in all allocated RBs.</p> <p>Note 5: The applicable frequencies for this limit are those that are enclosed in the RBs containing the DC frequency if N_{RB} is odd, or in the two RBs immediately adjacent to the DC frequency if N_{RB} is even, but excluding any allocated RB.</p> <p>Note 6: L_{CRB} is the Transmission Bandwidth (see Figure 5.4.2-1).</p> <p>Note 7: N_{RB} is the Transmission Bandwidth Configuration (see Figure 5.4.2-1).</p> <p>Note 8: EVM is the limit specified in Table 6.5.2.1.1-1 for the modulation format used in the allocated RBs.</p> <p>Note 9: Δ_{RB} is the starting frequency offset between the allocated RB and the measured non-allocated RB (e.g. $\Delta_{RB} = 1$ or $\Delta_{RB} = -1$ for the first adjacent RB outside of the allocated bandwidth).</p> <p>Note 10: P_{RB} is the transmitted power per 180 kHz in allocated RBs, measured in dBm.</p>				

The normative reference for this requirement is TS 36.101 [2] clause 6.5.2.3.1.

The in-band emission is defined as the average across 12 sub-carrier and as a function of the RB offset from the edge of the allocated UL transmission bandwidth. The in-band emission is measured as the ratio of the UE output power in a non-allocated RB to the UE output power in an allocated RB. The basic in-band emissions measurement interval is defined over one slot in the time domain.

6.5.2.3.4 Test description

6.5.2.3.4.1 Initial conditions

Initial conditions are a set of test configurations the UE needs to be tested in and the steps for the SS to take with the UE to reach the correct measurement state.

The initial test configurations consist of environmental conditions, test frequencies, and channel bandwidths based on E-UTRA bands specified in table 5.4.2.1-1. All of these configurations shall be tested with applicable test parameters for each channel bandwidth, and are shown in table 6.5.2.3.4.1-1. The details of the uplink reference measurement channels (RMCs) are specified in Annexes A.2. Configurations of PDSCH and PDCCH before measurement are specified in Annex C.2.

Table 6.5.2.3.4.1-1: Test Configuration Table for PUSCH

Initial Conditions				
Test Environment (as specified in TS 36.508 [7] subclause 4.1)		See Table 6.5.1.4.1-1		
Test Frequencies (as specified in TS36.508 [7] subclause 4.3.1)		See Table 6.5.1.4.1-1		
Test Channel Bandwidths (as specified in TS 36.508 [7] subclause 4.3.1)		See Table 6.5.1.4.1-1		
Test Parameters for Channel Bandwidths				
Ch BW	Downlink Configuration		Uplink Configuration	
	N/A for in-band emissions testing		Mod'n	RB allocation
			FDD	TDD
1.4MHz		QPSK	1	1
3MHz		QPSK	4	4
5MHz		QPSK	8	8
10MHz		QPSK	12	12
15MHz		QPSK	16	16
20MHz		QPSK	18	18
Note 1: Test Channel Bandwidths are checked separately for each E-UTRA band, which applicable channel bandwidths are specified in Table 5.4.2.1-1.				
Note 2: For partial RB allocation, the starting resource block shall be RB #0 and RB# (max+1 - RB allocation) of the channel bandwidth.				

Table 6.5.2.3.4.1-2: Test Configuration Table for PUCCH

Initial Conditions				
Test Environment as specified in TS 36.508[7] subclause 4.1		See Table 6.5.1.4.1-1		
Test Frequencies as specified in TS36.508 [7] subclause 4.3.1		See Table 6.5.1.4.1-1		
Test Channel Bandwidths as specified in TS 36.508 [7] subclause 4.3.1		See Table 6.5.1.4.1-1		
Test Parameters for Channel Bandwidths				
Ch BW	Downlink Configuration		Uplink Configuration	
	Mod'n	RB allocation	FDD: PUCCH format = Format 1a TDD: PUCCH format = Format 1a / 1b	
		FDD	TDD	
1.4MHz	QPSK	3	3	
3MHz	QPSK	4	4	
5MHz	QPSK	8	8	
10MHz	QPSK	16	16	
15MHz	QPSK	25	25	
20MHz	QPSK	30	30	
Note 1: Test Channel Bandwidths are checked separately for each E-UTRA band, the applicable channel bandwidths are specified in Table 5.4.2.1-1.				

1. Connect the SS to the UE antenna connectors as shown in TS 36.508 [7] Figure A.3.
2. The parameter settings for the cell are set up according to TS 36.508 [7] subclause 4.4.3.
3. Downlink signals are initially set up according to Annex C.0, C.1, and C.3.0, and uplink signals according to Annex H.1 and H.3.0.
4. The UL Reference Measurement channels are set according to in Table 6.5.2.3.4.1-1.
5. Propagation conditions are set according to Annex B.0
6. Ensure the UE is in State 3A-RF according to TS 36.508 [7] clause 5.2A.2. Message contents are defined in clause 6.5.2.3.4.3.

6.5.2.3.4.2 Test procedure

Test procedure for PUSCH:

- 1.1 SS sends uplink scheduling information for each UL HARQ process via PDCCH DCI format 0 for C_RNTI to schedule the UL RMC according to Table 6.5.2.3.4.1-1. Since the UE has no payload and no loopback data to send the UE sends uplink MAC padding bits on the UL RMC
- 1.2 Send the appropriate TPC commands in the uplink scheduling information to the UE until UE output power is 3.2 dBm \pm 3.2dB for carrier frequency $f \leq 3.0\text{GHz}$ or 3.5dBm \pm 3.5 dB for carrier frequency $3.0\text{GHz} < f \leq 4.2\text{GHz}$.
- 1.3 Measure In-band emission using Global In-Channel Tx-Test (Annex E)
- 1.4 Send the appropriate TPC commands in the uplink scheduling information to the UE until UE output power is -26.8 dBm \pm 3.2dB for carrier frequency $f \leq 3.0\text{GHz}$ or -36.5dBm \pm 3.5 dB for carrier frequency $3.0\text{GHz} < f \leq 4.2\text{GHz}$.
- 1.5 Measure In-band emission using Global In-Channel Tx-Test (Annex E). For TDD slots with transient periods are not under test
- 1.6 Send the appropriate TPC commands in the uplink scheduling information to the UE until UE output power is to -36.8 dBm \pm 3.2dB for carrier frequency $f \leq 3.0\text{GHz}$ or -36.5dBm \pm 3.5 dB for carrier frequency $3.0\text{GHz} < f \leq 4.2\text{GHz}$.
- 1.7 Measure In-band emission using Global In-Channel Tx-Test (Annex E). For TDD slots with transient periods are not under test

Test procedure for PUCCH:

- 2.1 PUCCH is set according to Table 6.5.2.3.4.1-2. SS transmits PDSCH via PDCCH DCI format 1A for C_RNTI to transmit the DL RMC according to Table 6.5.2.3.4.1-2. The SS sends downlink MAC padding bits on the DL RMC. The transmission of PDSCH will make the UE send uplink ACK/NACK using PUCCH.
- 2.2 Send the appropriate TPC commands in the uplink scheduling information for PUCCH to the UE until UE output power is 3.2 dBm \pm 3.2dB for carrier frequency $f \leq 3.0\text{GHz}$ or 3.5dBm \pm 3.5 dB for carrier frequency $3.0\text{GHz} < f \leq 4.2\text{GHz}$.
- 2.3 Measure In-band emission using Global In-Channel Tx-Test (Annex E)
- 2.4 Send the appropriate TPC commands for PUCCH in the uplink scheduling information to the UE until UE output power is -26.8 dBm \pm 3.2dB for carrier frequency $f \leq 3.0\text{GHz}$ or -26.5dBm \pm 3.5 dB for carrier frequency $3.0\text{GHz} < f \leq 4.2\text{GHz}$.
- 2.5 Measure In-band emission using Global In-Channel Tx-Test (Annex E)
- 2.6 Send the appropriate TPC commands for PUCCH in the uplink scheduling information to the UE until UE output power is to -36.8 dBm \pm 3.2dB for carrier frequency $f \leq 3.0\text{GHz}$ or -36.5dBm \pm 3.5 dB for carrier frequency $3.0\text{GHz} < f \leq 4.2\text{GHz}$.
- 2.7 Measure In-band emission using Global In-Channel Tx-Test (Annex E)

6.5.2.3.4.3 Message contents

Message contents are according to TS 36.508 [7] subclause 4.6 with the following exceptions:

Table 4.6.3-8: PUCCH-ConfigCommon: PUCCH in-band emissions measurement

Derivation Path: 36.331 clause 6.3.2, Table 4.6.3-8: PUCCH-ConfigCommon-DEFAULT			
Information Element	Value/remark	Comment	Condition
PUCCH-ConfigCommon-DEFAULT ::= SEQUENCE {			
nRB-CQI	0		
}			

6.5.2.3.5 Test requirement

Each of the 20 In-band emissions results, derived in Annex E.4.3 shall not exceed the corresponding values in Table 6.5.2.3.5-1

Table 6.5.2.3.5-1: Test requirements for in-band emissions

Parameter Description	Unit	Limit (Note 1)		Applicable Frequencies
General	dB	$\max \left\{ -25 - 10 \cdot \log_{10} (N_{RB} / L_{CRBs}), \right.$ $20 \cdot \log_{10} EVM - 3 - 5 \cdot (\Delta_{RB} - 1) / L_{CRBs}, \quad +0.8$ $\left. - 57 \text{ dBm} / 180 \text{ kHz} - P_{RB} \right\}$		Any non-allocated (Note 2)
IQ Image	dB	-24.2		Image frequencies (Notes 2, 3)
DC	dBc	-24.2	Output power $f \leq 3.0\text{GHz}$: 3.2dBm $\pm 3.2\text{dB}$ $3.0\text{GHz} < f \leq 4.2\text{GHz}$: 3.5 dBm $\pm 3.5\text{dB}$	LO frequency (Notes 4, 5)
		-19.2	Output power $f \leq 3.0\text{GHz}$: -26.8 dBm $\pm 3.2\text{dB}$ $3.0\text{GHz} < f \leq 4.2\text{GHz}$: -26.5 dBm $\pm 3.5\text{dB}$	
		-9.2	Output power $f \leq 3.0\text{GHz}$: -36.8 dBm $\pm 3.2\text{dB}$ $3.0\text{GHz} < f \leq 4.2\text{GHz}$: -36.5 dBm $\pm 3.5\text{dB}$	
<p>Note 1: An in-band emissions combined limit is evaluated in each non-allocated RB. For each such RB, the test requirement is calculated as the higher of $P_{RB} - 29.2$ dB and the power sum of all limit values (General, IQ Image or Carrier leakage) that apply. P_{RB} is defined in Note 10.</p> <p>Note 2: The measurement bandwidth is 1 RB and the limit is expressed as a ratio of measured power in one non-allocated RB to the measured average power per allocated RB, where the averaging is done across all allocated RBs.</p> <p>Note 3: The applicable frequencies for this limit are those that are enclosed in the reflection of the allocated bandwidth, based on symmetry with respect to the centre carrier frequency, but excluding any allocated RBs.</p> <p>Note 4: The measurement bandwidth is 1 RB and the limit is expressed as a ratio of measured power in one non-allocated RB to the measured total power in all allocated RBs.</p> <p>Note 5: The applicable frequencies for this limit are those that are enclosed in the RBs containing the DC frequency if N_{RB} is odd, or in the two RBs immediately adjacent to the DC frequency if N_{RB} is even, but excluding any allocated RB.</p> <p>Note 6: L_{CRBs} is the Transmission Bandwidth (see Figure 5.4.2-1).</p> <p>Note 7: N_{RB} is the Transmission Bandwidth Configuration (see Figure 5.4.2-1).</p> <p>Note 8: EVM is the limit specified in Table 6.5.2.1.1-1 for the modulation format used in the allocated RBs.</p> <p>Note 9: Δ_{RB} is the starting frequency offset between the allocated RB and the measured non-allocated RB (e.g. $\Delta_{RB} = 1$ or $\Delta_{RB} = -1$ for the first adjacent RB outside of the allocated bandwidth).</p> <p>Note 10: P_{RB} is the transmitted power per 180 kHz in allocated RBs, measured in dBm.</p>				

6.5.2.4 EVM equalizer spectrum flatness

6.5.2.4.1 Test Purpose

The zero-forcing equalizer correction applied in the EVM measurement process (as described in Annex E) must meet a spectrum flatness requirement for the EVM measurement to be valid. The EVM equalizer spectrum flatness is defined in terms of the maximum peak-to-peak ripple of the equalizer coefficients (dB) across the allocated uplink block variation in dB of the equalizer coefficients generated by the EVM measurement process. The EVM equalizer spectrum flatness requirement does not limit the correction applied to the signal in the EVM measurement process but for the EVM result to be valid, the equalizer correction that was applied must meet the EVM equalizer spectrum flatness minimum requirements. The basic measurement interval is the same as for EVM.

6.5.2.4.2 Test applicability

This test case applies to all types of E-UTRA UE release 8 and forward.

6.5.2.4.3 Minimum conformance requirements

The peak-to-peak variation of the EVM equalizer coefficients contained within the frequency range of the uplink allocation shall not exceed the maximum ripple. The EVM equalizer spectrum flatness shall not exceed the values specified in Table 6.5.2.4.3-1 for normal conditions. For uplink allocations contained within both Range 1 and Range 2, the coefficients evaluated within each of these frequency ranges shall meet the corresponding ripple requirement and the following additional requirement: the relative difference between the maximum coefficient in Range 1 and the minimum coefficient in Range 2 must not be larger than 5 dB, and the relative difference between the maximum coefficient in Range 2 and the minimum coefficient in Range 1 must not be larger than 7 dB (see Figure 6.5.2.4.3-1).

The EVM equalizer spectrum flatness shall not exceed the values specified in Table 6.5.2.4.3-2 for extreme conditions. For uplink allocations contained within both Range 1 and Range 2, the coefficients evaluated within each of these frequency ranges shall meet the corresponding ripple requirement and the following additional requirement: the relative difference between the maximum coefficient in Range 1 and the minimum coefficient in Range 2 must not be larger than 6 dB, and the relative difference between the maximum coefficient in Range 2 and the minimum coefficient in Range 1 must not be larger than 10 dB (see Figure 6.5.2.4.3-1).

Table 6.5.2.4.3-1: Minimum requirements for EVM equalizer spectrum flatness (normal conditions)

Frequency Range	Maximum Ripple [dB]
$F_{UL_Meas} - F_{UL_Low} \geq 3$ MHz and $F_{UL_High} - F_{UL_Meas} \geq 3$ MHz (Range 1)	4 (p-p)
$F_{UL_Meas} - F_{UL_Low} < 3$ MHz or $F_{UL_High} - F_{UL_Meas} < 3$ MHz (Range 2)	8 (p-p)
Note 1: F_{UL_Meas} refers to the sub-carrier frequency for which the equalizer coefficient is evaluated Note 2: F_{UL_Low} and F_{UL_High} refer to each E-UTRA frequency band specified in Table 5.2-1	

Table 6.5.2.4.3-2: Minimum requirements for EVM equalizer spectrum flatness (extreme conditions)

$F_{UL_Meas} - F_{UL_Low} \geq 5$ MHz and $F_{UL_High} - F_{UL_Meas} \geq 5$ MHz (Range 1)	4 (p-p)
$F_{UL_Meas} - F_{UL_Low} < 5$ MHz or $F_{UL_High} - F_{UL_Meas} < 5$ MHz (Range 2)	12 (p-p)
Note 1: F_{UL_Meas} refers to the sub-carrier frequency for which the equalizer coefficient is evaluated Note 2: F_{UL_Low} and F_{UL_High} refer to each E-UTRA frequency band specified in Table 5.2-1	

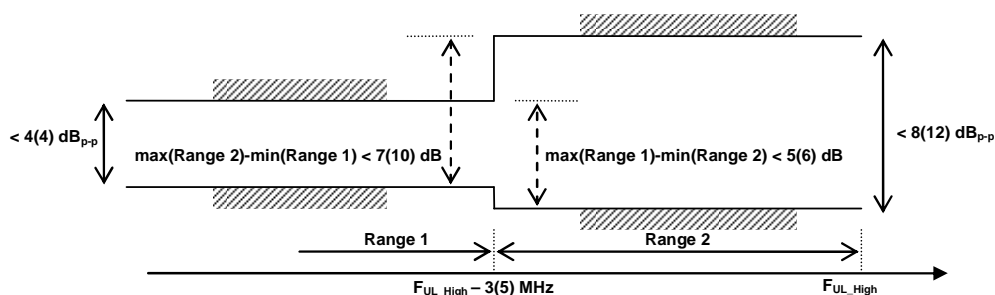

Figure 6.5.2.4.3-1: The limits for EVM equalizer spectrum flatness with the maximum allowed variation of the coefficients indicated (the ETC minimum requirement within brackets).

The normative reference for this requirement is TS 36.101 clause 6.5.2.4.1.

6.5.2.4.4 Test description

6.5.2.4.4.1 Initial conditions

Initial conditions are a set of test configurations the UE needs to be tested in and the steps for the SS to take with the UE to reach the correct measurement state.

The initial test configurations consist of environmental conditions, test frequencies, and channel bandwidths based on E-UTRA bands specified in table 5.4.2.1-1. All of these configurations shall be tested with applicable test parameters for each channel bandwidth, and are shown in table 6.4.2.4.4.1-1. The details of the uplink reference measurement channels (RMCs) are specified in A.2. Configurations of PDSCH and PDCCH before measurement are specified in Annex C.2.

Table 6.5.2.4.4.1-1: Test Configuration Table

Initial Conditions				
Test Environment (as specified in TS 36.508 [7] subclause 4.1)		See Table 6.5.1.4.1-1		
Test Frequencies (as specified in TS36.508 [7] subclause 4.3.1)		See Table 6.5.1.4.1-1		
Test Channel Bandwidths (as specified in TS 36.508 [7] subclause 4.3.1)		See Table 6.5.1.4.1-1		
Test Parameters for Channel Bandwidths				
		Downlink Configuration		Uplink Configuration
Ch BW	N/A for EVM equalizer spectrum flatness testing	Mod'n	RB allocation	
			FDD	TDD
1.4MHz		QPSK	6	6
3MHz		QPSK	15	15
5MHz		QPSK	25	25
10MHz		QPSK	50	50
15MHz		QPSK	75	75
20MHz		QPSK	100	100
Note 1: Test Channel Bandwidths are checked separately for each E-UTRA band, which applicable channel bandwidths are specified in Table 5.4.2.1-1.				

1. Connect the SS to the UE antenna connectors as shown in TS 36.508 [7] Figure A.3.
2. The parameter settings for the cell are set up according to TS 36.508 [7] subclause 4.4.3.
3. Downlink signals are initially set up according to Annex C0, C.1 and C.3.0, and uplink signals according to Annex H.1 and H.3.0.
4. The UL Reference Measurement channels are set according to in Table 6.5.2.4.4.1-1.
5. Propagation conditions are set according to Annex B.0
6. Ensure the UE is in State 3A-RF according to TS 36.508 [7] clause 5.2A.2. Message contents are defined in clause 6.5.2.4.4.3.

6.5.2.4.4.2 Test procedure

1. SS sends uplink scheduling information for each UL HARQ process via PDCCH DCI format 0 for C_RNTI to schedule the UL RMC according to Table 6.5.2.4.4.1-1. Since the UE has no payload and no loopback data to send the UE sends uplink MAC padding bits on the UL RMC
2. Send continuously uplink power control "up" commands in the uplink scheduling information to the UE until the UE transmits at P_{UMAX} level.
3. Measure spectrum flatness using Global In-Channel Tx-Test (Annex E). For TDD slots with transient periods are not under test.

6.5.2.4.4.3 Message contents

Message contents are according to TS 36.508 [7] subclause 4.6.

6.5.2.4.5 Test requirement

Each of the 20 spectrum flatness functions, shall derive four ripple results in Annex E.4.4, The derived results shall not exceed the values in Figure 6.5.2.4.5-1:

For normal conditions, the maximum ripple in Range 1 and Range 2 shall not exceed the values specified in Table 6.5.2.4.5-1 and the following additional requirement: the relative difference between the maximum coefficient in Range 1 and the minimum coefficient in Range 2 must not be larger than 6.4 dB, and the relative difference between the maximum coefficient in Range 2 and the minimum coefficient in Range 1 must not be larger than 8.4 dB (see Figure 6.5.2.4.5-1).

For extreme conditions, the maximum ripple in Range 1 and Range 2 shall not exceed the values specified in Table 6.5.2.4.5-2 and the following additional requirement: the relative difference between the maximum coefficient in Range 1 and the minimum coefficient in Range 2 must not be larger than 7.4 dB, and the relative difference between the maximum coefficient in Range 2 and the minimum coefficient in Range 1 must not be larger than 11.4 dB (see Figure 6.5.2.4.5-1).

Table 6.5.2.4.5-1: Test requirements for EVM equalizer spectrum flatness (normal conditions)

Frequency Range	Maximum Ripple [dB]
$F_{UL_Meas} - F_{UL_Low} \geq 3 \text{ MHz}$ and $F_{UL_High} - F_{UL_Meas} \geq 3 \text{ MHz}$ (Range 1)	5.4 (p-p)
$F_{UL_Meas} - F_{UL_Low} < 3 \text{ MHz}$ or $F_{UL_High} - F_{UL_Meas} < 3 \text{ MHz}$ (Range 2)	9.4 (p-p)
Note 1: F_{UL_Meas} refers to the sub-carrier frequency for which the equalizer coefficient is evaluated	
Note 2: F_{UL_Low} and F_{UL_High} refer to each E-UTRA frequency band specified in Table 5.2-1	

Table 6.5.2.4.5-2: Test requirements for spectrum flatness (extreme conditions)

Frequency Range	Maximum Ripple [dB]
$F_{UL_Meas} - F_{UL_Low} \geq 5 \text{ MHz}$ and $F_{UL_High} - F_{UL_Meas} \geq 5 \text{ MHz}$ (Range 1)	5.4 (p-p)
$F_{UL_Meas} - F_{UL_Low} < 5 \text{ MHz}$ or $F_{UL_High} - F_{UL_Meas} < 5 \text{ MHz}$ (Range 2)	13.4 (p-p)
Note 1: F_{UL_Meas} refers to the sub-carrier frequency for which the equalizer coefficient is evaluated	
Note 2: F_{UL_Low} and F_{UL_High} refer to each E-UTRA frequency band specified in Table 5.2-1	

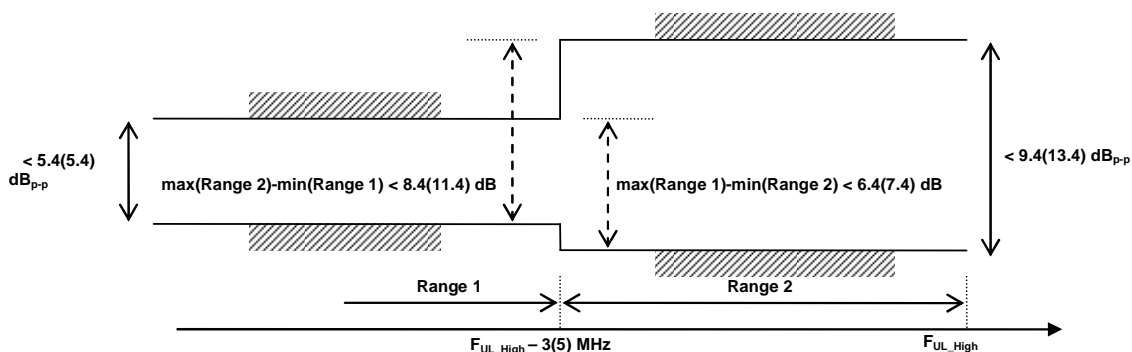

Figure 6.5.2.4.5-1: The limits for EVM equalizer spectrum flatness with the maximum allowed variation of the coefficients indicated (the ETC minimum requirement within brackets).

6.5.2A Transmit modulation for CA

The requirements in this clause apply with PCC and SCC in the UL configured and activated: PCC with PRB allocation and SCC without PRB allocation and without CSI reporting and SRS configured.

6.5.2A.1 Error Vector Magnitude (EVM) for CA

6.5.2A.1.1 Error Vector Magnitude (EVM) for CA (intra-band contiguous DL CA and UL CA)

Editor's notes: The following items are missing or incomplete:

- Initial conditions (test setup for SCC is FFS, references need update, test state for CA RF testing is FFS)
- Test procedure (incomplete, references need update)
- Message Contents
- Connection diagram is missing

6.5.2A.1.1.1 Test Purpose

For the intra-band contiguous carrier aggregation, the Error Vector Magnitude requirement should be defined for each component carrier. Requirement applies for the allocated component carrier, when all other component carriers are activated, but not allocated.

6.5.2A.1.1.2 Test applicability

This test case applies to all types of E-UTRA UE release 10 and forward that support intra-band contiguous DL CA and UL CA.

6.5.2A.1.1.3 Minimum conformance requirements

When a single component carrier is configured Table 6.5.2.1.4.1-1 apply.

The EVM requirements are according to Table 6.5.2A.1.1.3-1 if CA is configured in uplink.

Table 6.5.2A.1.1.3-1: Minimum requirements for Error Vector Magnitude

Parameter	Unit	Average EVM Level per CC	Reference Signal EVM Level
QPSK or BPSK	%	17.5	17.5
16QAM	%	12.5	12.5

6.5.2A.1.1.4 Test description

6.5.2A.1.1.4.1 Initial conditions

Initial conditions are a set of test configurations the UE needs to be tested in and the steps for the SS to take with the UE to reach the correct measurement state.

The initial test configurations consist of environmental conditions, test frequencies, and CC combinations based on E-UTRA CA configurations specified in table 5.4.2A.1-1. All of these configurations shall be tested with applicable test parameters for each CA Configuration, and are shown in table 6.5.2A.1.1.4.1-1. The details of the uplink reference measurement channels (RMCs) are specified in Annex A.2. Configurations of PDSCH and PDCCH before measurement are specified in Annex C.2.

Table 6.5.2A.1.1.4.1-1: Test Configuration Table

Initial Conditions									
Test Environment as specified in TS 36.508[7] subclause 4.1					NC				
Test Frequencies as specified in TS36.508 [7] subclause 4.3.1 for different CA bandwidth classes.					See Table 6.5.1A.4.1-1:				
Test CC Combination setting (N_{RB_agg}) as specified in subclause 5.4.2A.1 for the CA Configuration					See Table 6.5.1A.4.1-1:				
Test Parameters for CA Configurations									
Config ID	CA Configuration / N_{RB_agg}		DL Allocation (PDCCH on PCC)	CC MOD	UL Allocation				
	PCC N_{RB} Note 2	SCCs N_{RB} Note 2	PCC & SCC RB allocation		N_{RB_alloc}	PCC & SCC RB allocations (L_{CRB} @ RB_{start})			
1	75	75	N.A.	QPSK	75	P_75@0	S_0@0	-	-
2	75	75		QPSK	16	P_16@0	S_0@0	-	-
3	75	75		QPSK	16	P_16@59	S_0@0	-	-
4	75	75		16QAM	75	P_75@0	S_0@0	-	-
5	75	75		16QAM	16	P_16@0	S_0@0	-	-
6	75	75		16QAM	16	P_16@59	S_0@0	-	-
7	100	50		QPSK	100	P_100@0	S_0@0	-	-
8	100	50		QPSK	50	P_50@0	S_0@0	-	-
9	100	50		QPSK	50	P_50@50	S_0@0	-	-
10	100	50		QPSK	12	P_12@0	S_0@0	-	-
11	100	50		QPSK	12	P_12@88	S_0@0	-	-
12	100	50		16QAM	100	P_100@0	S_0@0	-	-
13	100	50		16QAM	50	P_50@0	S_0@0	-	-
14	100	50		16QAM	50	P_50@50	S_0@0	-	-
15	100	50		16QAM	12	P_12@0	S_0@0	-	-
16	100	50		16QAM	12	P_12@88	S_0@0	-	-
17	50	100		QPSK	50	P_50@0	S_0@0	-	-
18	50	100		QPSK	12	P_12@0	S_0@0	-	-
19	50	100		QPSK	12	P_12@38	S_0@0	-	-
20	50	100		16QAM	50	P_50@0	S_0@0	-	-
21	50	100		16QAM	12	P_12@0	S_0@0	-	-
22	50	100		16QAM	12	P_12@38	S_0@0	-	-
23	100	100		QPSK	100	P_100@0	S_0@0	-	-
24	100	100		QPSK	18	P_18@0	S_0@0	-	-
25	100	100		QPSK	18	P_18@82	S_0@0	-	-
26	100	100		16QAM	100	P_100@0	S_0@0	-	-
27	100	100		16QAM	18	P_18@0	S_0@0	-	-
28	100	100		16QAM	18	P_18@82	S_0@0	-	-
Note 1: CA Configuration Test CC Combination settings are checked separately for each CA Configuration which applicable aggregated channel bandwidths are specified in Table 5.4.2A.1-1									
Note 2: The frequencies of PCC and SCC shall be switched and tested in each configuration.									

1. Connect the SS to the UE antenna connectors as shown in TS 36.508[7] Annex A, Figure group A.32 as appropriate.
2. The parameter settings for the cell are set up according to TS 36.508 [7] subclause 4.4.3.
3. Downlink signals are initially set up according to Annex C.0, C.1, and C.3.0, and uplink signals according to Annex H.1 and H.3.0.
4. The UL Reference Measurement channel is set according to Table 6.5.2A.1.1.4.1-1.
5. Propagation conditions are set according to Annex B.0.
6. Ensure the UE is in [State 3A-RF] according to TS 36.508 [7] clause [5.2A.2]. Message contents are defined in clause 6.5.2A.1.1.4.3.

6.5.2A.1.1.4.2 Test procedure

1. SS sends uplink scheduling information for each UL HARQ process via PDCCH DCI format 0 for C_RNTI to schedule the UL RMC according to Table 6.5.2A.1.1.4.1-1. Since the UE has no payload data to send, the UE transmits uplink MAC padding bits on the UL RMC.
2. Send continuously uplink power control "up" commands in the uplink scheduling information to the UE until the UE transmits at $P_{UMAX \text{ level}}$.
3. Measure the EVM and \overline{EVM}_{DMRS} on PCC using Global In-Channel Tx-Test (Annex E).
4. Send the appropriate TPC commands in the uplink scheduling information to the UE until UE output power is $-36.8\text{dBm} \pm 3.2\text{dB}$ for carrier frequency $f \leq 3.0\text{GHz}$ or $-36.5\text{dBm} \pm 3.5\text{ dB}$ for carrier frequency $3.0\text{GHz} < f \leq 4.2\text{GHz}$.
5. Measure the EVM and \overline{EVM}_{DMRS} on PCC using Global In-Channel Tx-Test (Annex E).

6.5.2A.1.1.4.3 Message contents

FFS.

6.5.2A.1.1.5 Test requirement

The PUSCH EVM derived in E.4.2 shall not exceed 17,5 % for QPSK and BPSK, 12,5% for 16 QAM.

The PUSCH \overline{EVM}_{DMRS} derived in E.4.6.2 shall not exceed [17,5 %] when embedded with data symbols of QPSK and BPSK, [12,5%] for 16 QAM.

6.5.2A.2 Carrier leakage for CA

6.5.2A.2.1 Carrier leakage for CA (intra-band contiguous DL CA and UL CA)

Editor's notes: The following items are missing or incomplete:

- Initial conditions (test setup for SCC is FFS, references need update, test state for CA RF testing is FFS)
- Test procedure (incomplete, references need update)
- Message Contents
- Test tolerances not yet in the annex
- Connection diagram is missing

6.5.2A.2.1.1 Test Purpose

Carrier leakage (The IQ origin offset) is an additive sinusoid waveform that has the same frequency as the modulated waveform carrier frequency. Carrier leakage is defined for each component carrier and is measured on the carrier with PRBs allocated. The measurement interval is one slot in the time domain.

6.5.2A.2.1.2 Test applicability

This test case applies to all types of E-UTRA UE release 10 and forward that support intra-band contiguous DL CA and UL CA.

6.5.2A.2.1.3 Minimum conformance requirements

The relative carrier leakage power is a power ratio of the additive sinusoid waveform and the modulated waveform. The relative carrier leakage power shall not exceed the values specified in Table 6.5.2A.2.1.3-1.

Table 6.5.2A.2.1.3-1: Minimum requirements for Relative Carrier Leakage Power

	Parameters	Relative Limit (dBc)
	Output power >0 dBm	-25
	-30 dBm ≤ Output power ≤0 dBm	-20
	-40 dBm ≤ Output power < -30 dBm	-10

6.5.2A.2.1.4 Test description

6.5.2A.2.1.4.1 Initial conditions

Initial conditions are a set of test configurations the UE needs to be tested in and the steps for the SS to take with the UE to reach the correct measurement state.

The initial test configurations consist of environmental conditions, test frequencies, and CC combinations based on E-UTRA CA configurations specified in table 5.4.2A.1-1. All of these configurations shall be tested with applicable test parameters for each CA Configuration, and are shown in table 6.5.2A.2.1.4.1-1. The details of the uplink reference measurement channels (RMCs) are specified in Annex A.2. Configurations of PDSCH and PDCCH before measurement are specified in Annex C.2.

Table 6.5.2A.2.1.4.1-1: Test Configuration Table

Initial Conditions									
Test Environment as specified in TS 36.508[7] subclause 4.1					NC				
Test Frequencies as specified in TS36.508 [7] subclause [4.3.1] for different CA bandwidth classes.					See Table 6.5.1A.4.1-1:				
Test CC Combination setting (N_{RB_agg}) as specified in subclause 5.4.2A.1 for the CA Configuration					See Table 6.5.1A.4.1-1:				
Test Parameters for CA Configurations									
Config ID	CA Configuration / N_{RB_agg}		DL Allocation (PDCCH on PCC)	CC MOD	UL Allocation				
	PCC N_{RB} Note 2	SCCs N_{RB} Note 2	PCC & SCC RB allocation		N_{RB_alloc}	PCC & SCC RB allocations (L_{CRB} @ RB_{start})			
1	75	75	NA	QPSK	16	P_16@0	S_0@0	-	-
2	75	75		QPSK	16	P_16@59	S_0@0	-	-
3	100	50		QPSK	12	P_12@0	S_0@0	-	-
4	100	50		QPSK	12	P_12@88	S_0@0	-	-
5	50	100		QPSK	12	P_12@0	S_0@0	-	-
6	50	100		QPSK	12	P_12@38	S_0@0	-	-
7	100	100		QPSK	18	P_18@0	S_0@0	-	-
8	100	100		QPSK	18	P_18@82	S_0@0	-	-
Note 1: CA Configuration Test CC Combination settings are checked separately for each CA Configuration, which applicable aggregated channel bandwidths are specified in Table 5.4.2A.1-1									
Note 2: The frequencies of PCC and SCC shall be switched and tested in each configuration.									

1. Connect the SS to the UE to the UE antenna connectors as shown in TS 36.508 [7] Annex A, Figure group A.32 as appropriate.
2. The parameter settings for the cell are set up according to TS 36.508[7] subclause 4.4.3.
3. Downlink signals are initially set up according to Annex C0, C.1 and C.3.0, and uplink signals according to Annex H.1 and H.3.0.
4. The UL Reference Measurement channels are set according to in Table 6.5.2A.2.1.4.1-1.
5. Propagation conditions are set according to Annex B.0
6. Ensure the UE is in [State 3A-RF] according to TS 36.508 [7] clause 5.2A.2. Message contents are defined in clause 6.5.2A.2.1.4.3.

6.5.2A.2.1.4.2 Test procedure

1. SS sends uplink scheduling information for each UL HARQ process via PDCCH DCI format 0 for C_RNTI to schedule the UL RMC according to Table 6.5.2A.2.1.4.1-1. Since the UE has no payload and no loopback data to send the UE sends uplink MAC padding bits on the UL RMC.
2. Send the appropriate TPC commands in the uplink scheduling information to the UE until UE output power is 3.2 dBm \pm 3.2dB for carrier frequency $f \leq 3.0\text{GHz}$ or 3.5dBm \pm 3.5 dB for carrier frequency $3.0\text{GHz} < f \leq 4.2\text{GHz}$.
3. Measure carrier leakage on PCC using Global In-Channel Tx-Test (Annex E). For TDD slots with transient periods are not under test.
4. Send the appropriate TPC commands in the uplink scheduling information to the UE until UE output power is -26.8 dBm \pm 3.2dB for carrier frequency $f \leq 3.0\text{GHz}$ or -26.5dBm \pm 3.5 dB for carrier frequency $3.0\text{GHz} < f \leq 4.2\text{GHz}$.
5. Measure carrier leakage on PCC using Global In-Channel Tx-Test (Annex E). For TDD slots with transient periods are not under test.
6. Send the appropriate TPC commands in the uplink scheduling information to the UE until UE output power is -36.8dBm \pm 3.2dB for carrier frequency $f \leq 3.0\text{GHz}$ or -36.5dBm \pm 3.5 dB for carrier frequency $3.0\text{GHz} < f \leq 4.2\text{GHz}$.
7. Measure carrier leakage on PCC using Global In-Channel Tx-Test (Annex E). For TDD slots with transient periods are not under test.

6.5.2A.2.1.4.3 Message contents

FFS.

6.5.2A.2.1.5 Test requirement

Each of the 20 IQ offset results, derived in Annex E.3.1, shall not exceed the values in table 6.5.2A.2.1.5-1.

Table 6.5.2A.2.1.5-1: Test requirements for Relative Carrier Leakage Power

Carrier Leakage	Parameters	Relative Limit (dBc)
	$f \leq 3.0\text{GHz}$: 3.2 dBm \pm 3.2dB $3.0\text{GHz} < f \leq 4.2\text{GHz}$: 3.5 dBm \pm 3.5dB	-24.2
	$f \leq 3.0\text{GHz}$: -26.8 dBm \pm 3.2dB $3.0\text{GHz} < f \leq 4.2\text{GHz}$: -26.5 dBm \pm 3.5dB	-19.2
	$f \leq 3.0\text{GHz}$: -36.8dBm \pm 3.2dB $3.0\text{GHz} < f \leq 4.2\text{GHz}$: -36.5 dBm \pm 3.5dB	-9.2

6.5.2A.3 In-band emissions for non allocated RB for CA

6.5.2A.3.1 In-band emissions for non allocated RB for CA (intra-band contiguous DL CA and UL CA)

Editor's notes: The following items are missing or incomplete:

- Test procedure(incomplete, references need update)
- Test tolerances not yet in the annex

6.5.2A.3.1.1 Test Purpose

The in-band emissions are a measure of the interference falling into the non-allocated resources blocks.

For an allocated component carrier, the in-band emission is defined as the average across 12 sub-carrier and as a function of the RB offset from the edge of the allocated UL transmission bandwidth. The in-band emission is measured as the ratio of the UE output power in a non-allocated RB to the UE output power in an allocated RB. The basic in-band emissions measurement interval is defined over one slot in the time domain. When the PUSCH or PUCCH transmission slot is shortened due to multiplexing with SRS, the in-band emissions measurement interval is reduced by one SC-FDMA symbol, accordingly.

For a non allocated component carrier a spectral measurement is specified.

6.5.2A.3.1.2 Test applicability

This test case applies to all types of E-UTRA UE release 10 and forward that support intra-band contiguous DL CA and UL CA.

6.5.2A.3.1.3 Minimum conformance requirements

For intra-band contiguous carrier aggregation, the requirements in Table 6.5.2A.3.1.3-1 and 6.5.2A.3.1.3-2 apply within the aggregated transmission bandwidth configuration with both component carrier (s) active and one single contiguous PRB allocation of bandwidth L_{CRB} at the edge of the aggregated transmission bandwidth configuration.

The in-band emission is defined as the interference falling into the non allocated resource blocks for all component carriers. The measurement method for the in band emissions in the component carrier with PRB allocation is specified in Annex E Global In-Channel Tx-Test. For a non allocated component carrier a spectral measurement is specified.

Table 6.5.2A.3.1.3-1: Minimum requirements for in-band emissions (allocated component carrier)

Parameter	Unit	Limit	Applicable Frequencies	
General	dB	$\max \left\{ -25 - 10 \cdot \log_{10} (N_{RB} / L_{CRB}), \right.$ $20 \cdot \log_{10} EVM - 3 - 5 \cdot (\Delta_{RB} - 1) / L_{CRB},$ $\left. -57 \text{ dBm} / 180 \text{ kHz} - P_{RB} \right\}$	Any non-allocated (Note 1)	
IQ Image	dB	-25	Exception for IQ image (Note 2)	
Carrier leakage	dBc	-25	Exception for Carrier frequency (Note 3)	
		-20		Output power > 0 dBm
		-10		$-30 \text{ dBm} \leq \text{Output power} \leq 0 \text{ dBm}$ $-40 \text{ dBm} \leq \text{Output power} < -30 \text{ dBm}$
<p>Note 1: An in-band emissions combined limit is evaluated in each non-allocated RB in the allocated component carrier. For each such RB, the minimum requirement is calculated as the higher of $P_{RB} - 30$ dB and the power sum of all limit values (General, IQ Image or Carrier leakage) that apply. P_{RB} is defined in Note 8. The limit is evaluated in each non-allocated RB. The measurement bandwidth is 1 RB and the limit is expressed as a ratio of measured power in one non-allocated RB to the measured average power per allocated RB, where the averaging is done across all allocated RBs</p> <p>Note 2: Exceptions to the general limit are allowed for up to L_{CRB} RBs within a contiguous width of L_{CRB} non-allocated RBs in the allocated component carrier. The measurement bandwidth is 1 RB. The measurement bandwidth is 1 RB.</p> <p>Note 3: Exceptions to the general limit are allowed for up to two contiguous non-allocated RBs in the allocated component carrier. The measurement bandwidth is 1 RB and the limit is expressed as a ratio of measured power in the non-allocated RB to the measured total power in all allocated RBs.</p> <p>Note 4: L_{CRB} is the Transmission Bandwidth (see Figure 5.4.2-1) not exceeding $\lfloor N_{RB} / 2 - 1 \rfloor$</p> <p>Note 5: N_{RB} is the Transmission Bandwidth Configuration (see Figure 5.4.2-1) of the component carrier with RBs allocated.</p> <p>Note 6: EVM is the limit specified in Table 6.5.2.1.3-1 for the modulation format used in the allocated RBs.</p> <p>Note 7: Δ_{RB} is the starting frequency offset between the allocated RB and the measured non-allocated RB in the allocated component carrier (e.g. $\Delta_{RB} = 1$ or $\Delta_{RB} = -1$ for the first adjacent RB outside of the allocated bandwidth).</p> <p>Note 8: P_{RB} is the transmitted power per 180 kHz in allocated RBs, measured in dBm.</p>				

Table 6.5.2A.3.1.3-2: Minimum requirements for in-band emissions (not allocated component carrier)

Parameter	Unit	Meas BW Note 1	Limit	remark	Applicable Frequencies	
General	dB	BW of 1 RB (180KHz rectangular)	$\max \left\{ -25 - 10 \cdot \log_{10} (N_{RB} / L_{CRB}), \right.$ $20 \cdot \log_{10} EVM - 3 - 5 \cdot (\Delta_{RB} - 1) / L_{CRB}$ $\left. - 57 \text{ dBm} / 180 \text{ kHz} - P_{RB} \right\}$	The reference value is the average power per allocated RB in the allocated component carrier	Any RB in the non allocated component carrier. The frequency raster of the RBs is derived when this component carrier is allocated with RBs	
IQ Image	dB	BW of 1 RB (180KHz rectangular)	-25 Note 2	The reference value is the average power per allocated RB in the allocated component carrier	The frequencies of the L_{CRB} contiguous non-allocated RBs are unknown. The frequency raster of the RBs is derived when this component carrier is allocated with RBs	
Carrier leakage	dBc	BW of 1 RB (180KHz rectangular)	Note 3		The reference value is the total power of the allocated RBs in the allocated component carrier	The frequencies of the up to 2 non-allocated RBs are unknown. The frequency raster of the RBs is derived when this component carrier is allocated with RBs
			-25	Output power > 0 dBm		
			-20	-30 dBm ≤ Output power ≤ 0 dBm		
			-10	-40 dBm ≤ Output power < -30 dBm		
<p>Note1: Resolution BWs smaller than the measurement BW may be integrated to achieve the measurement bandwidth.</p> <p>Note 2: Exceptions to the general limit are allowed for up to L_{CRB} RBs within a contiguous width of L_{CRB} non-allocated RBs.</p> <p>Note 3: Exceptions to the general limit are allowed for up to two contiguous non-allocated RBs</p> <p>Note 4: Note 4 and note 8 from Table 6.5.2A.3.3-1 apply for Table 6.5.2A.3.1-2 as well.</p> <p>Note 5: Δ_{RB} is the starting frequency offset between the allocated RB in the allocated component carrier and the measured non-allocated RB in the non allocated component carrier. For non allocated component carrier, Δ_{RB} may take non-integer values when the carrier spacing between the CCs is not a multiple of RB.</p>						

6.5.2A.3.1.4 Test description

6.5.2A.3.1.4.1 Initial conditions

Initial conditions are a set of test configurations the UE needs to be tested in and the steps for the SS to take with the UE to reach the correct measurement state.

The initial test configurations consist of environmental conditions, test frequencies, and CC combinations based on E-UTRA CA configurations specified in table 5.4.2A.1-1. All of these configurations shall be tested with applicable test

parameters for each CA Configuration, and are shown in table 6.5.2A.3.1.4.1-1. The details of the uplink reference measurement channels (RMCs) are specified in Annex A.2. Configurations of PDSCH and PDCCH before measurement are specified in Annex C.2.

Table 6.5.2A.3.1.4.1-1: Test Configuration Table

Initial Conditions									
Test Environment as specified in TS 36.508[7] subclause 4.1					NC				
Test Frequencies as specified in TS36.508 [7] subclause 4.3.1 for different CA bandwidth classes.					See Table 6.5.1A.4.1-1:				
Test CC Combination setting (N_{RB_agg}) as specified in subclause 5.4.2A.1 for the CA Configuration					See Table 6.5.1A.4.1-1:				
Test Parameters for CA Configurations									
Config ID	CA Configuration / N_{RB_agg}		DL Allocation (PDCCH on PCC)	CC MOD	UL Allocation				
	PCC	SCC	PCC & SCC RB allocation		N_{RB_alloc}	PCC & SCC RB allocations ($L_{CRB} @ RB_{start}$)			
1 Note 2	75	75	N.A.	QPSK	16	P_16@0	S_0@0	-	-
2 Note 3	75	75		QPSK	16	P_16@59	S_0@0	-	-
3 Note 2	100	50		QPSK	12	P_12@0	S_0@0	-	-
4 Note 3	100	50		QPSK	12	P_12@88	S_0@0	-	-
5 Note 2	50	100		QPSK	12	P_12@0	S_0@0	-	-
6 Note 3	50	100		QPSK	12	P_12@38	S_0@0	-	-
7 Note 2	100	100		QPSK	18	P_18@0	S_0@0	-	-
8 Note 3	100	100		QPSK	18	P_18@82	S_0@0	-	-
Note 1: CA Configuration Test CC Combination settings are checked separately for each CA Configuration, which applicable aggregated channel bandwidths are specified in Table 5.4.2A.1-1. Note 2: PCC at low frequency, SCC at high frequency. Note 3: PCC at high frequency, SCC at low frequency.									

1. Connect the SS to the UE to the UE antenna connectors as shown in TS 36.508 [7] Annex A, Figure group A.32 as appropriate.
2. The parameter settings for the cell are set up according to TS 36.508[7] subclause 4.4.3.
3. Downlink signals for PCC are initially set up according to Annex C0, C.1 and C.3.0, and uplink signals according to Annex H.1 and H.3.0.
4. The UL Reference Measurement channels are set according to in Table 6.5.2A.3.1.4.1-1.
5. Propagation conditions are set according to Annex B.0.
6. Ensure the UE is in State 3A-RF according to TS 36.508 [7] clause 5.2A.2. Message contents are defined in clause 6.5.2A.3.1.4.3.

6.5.2A.3.1.4.2 Test procedure

1. Configure SCC according to Annex C.0, C.1 and Annex C.3.0 for all downlink physical channels except PHICH.
2. The SS shall configure SCC as per TS 36.508 [7] clause 5.2A.4. Message contents are defined in clause 6.5.2A.3.1.4.3.
3. SS activates SCC by sending the activation MAC-CE (Refer TS 36.321 [13], clauses 5.13, 6.1.3.8). Wait for at least 2 seconds (Refer TS 36.133, clauses 8.3.3.2).
4. SS sends uplink scheduling information for each UL HARQ process via PDCCH DCI format 0 for C_RNTI to schedule the UL RMC according to Table 6.5.2A.3.1.4.1-1. Since the UE has no payload and no loopback data to send the UE sends uplink MAC padding bits on the UL RMC.

5. Send the appropriate TPC commands in the uplink scheduling information to the UE until UE output power is $3.2 \text{ dBm} \pm 3.2 \text{ dB}$ for carrier frequency $f \leq 3.0 \text{ GHz}$ or $3.5 \text{ dBm} \pm 3.5 \text{ dB}$ for carrier frequency $3.0 \text{ GHz} < f \leq 4.2 \text{ GHz}$.
6. Measure In-band emission on PCC using Global In-Channel Tx-Test (Annex E). Measure power spectral density on the SCC. For TDD slots with transient periods are not under test.
7. Send the appropriate TPC commands in the uplink scheduling information to the UE until UE output power is $-26.8 \text{ dBm} \pm 3.2 \text{ dB}$ for carrier frequency $f \leq 3.0 \text{ GHz}$ or $-36.5 \text{ dBm} \pm 3.5 \text{ dB}$ for carrier frequency $3.0 \text{ GHz} < f \leq 4.2 \text{ GHz}$.
8. Measure In-band emission on PCC using Global In-Channel Tx-Test (Annex E). Measure power spectral density on the SCC. For TDD slots with transient periods are not under test.
9. Send the appropriate TPC commands in the uplink scheduling information to the UE until UE output power is to $-36.8 \text{ dBm} \pm 3.2 \text{ dB}$ for carrier frequency $f \leq 3.0 \text{ GHz}$ or $-36.5 \text{ dBm} \pm 3.5 \text{ dB}$ for carrier frequency $3.0 \text{ GHz} < f \leq 4.2 \text{ GHz}$.
10. Measure In-band emission on PCC using Global In-Channel Tx-Test (Annex E). Measure power spectral density on the SCC. For TDD slots with transient periods are not under test.

6.5.2A.3.1.4.3 Message contents

Message contents are according to TS 36.508 [7] clause 4.6. In test procedure step 2, for SCC configuration there are no additional message contents.

6.5.2A.3.1.5 Test requirement

Each of the 20 In-band emissions results, derived in Annex E.4.3 shall not exceed the corresponding values in Table 6.5.2A.3.1.5-1.

Table 6.5.2A.3.1.5-1: Test requirements for in-band emissions (allocated component carrier)

Parameter Description	Unit	Limit (Note 1)		Applicable Frequencies
General	dB	$\max \left\{ -25 - 10 \cdot \log_{10} (N_{RB} / L_{CRBs}), \right.$ $20 \cdot \log_{10} EVM - 3 - 5 \cdot (\Delta_{RB} - 1) / L_{CRBs}, \quad +0.8$ $\left. -57 \text{ dBm} / 180 \text{ kHz} - P_{RB} \right\}$		Any non-allocated (Note 2)
IQ Image	dB	-24.2		Image frequencies (Notes 2, 3)
DC	dBc	-24.2	Output power $f \leq 3.0\text{GHz}$: 3.2dBm $\pm 3.2\text{dB}$ $3.0\text{GHz} < f \leq 4.2\text{GHz}$: 3.5 dBm $\pm 3.5\text{dB}$	LO frequency (Notes 4, 5)
		-19.2	Output power $f \leq 3.0\text{GHz}$: -26.8 dBm $\pm 3.2\text{dB}$ $3.0\text{GHz} < f \leq 4.2\text{GHz}$: -26.5 dBm $\pm 3.5\text{dB}$	
		-9.2	Output power $f \leq 3.0\text{GHz}$: -36.8 dBm $\pm 3.2\text{dB}$ $3.0\text{GHz} < f \leq 4.2\text{GHz}$: -36.5 dBm $\pm 3.5\text{dB}$	
<p>Note 1: An in-band emissions combined limit is evaluated in each non-allocated RB. For each such RB, the test requirement is calculated as the higher of $P_{RB} - 29.2$ dB and the power sum of all limit values (General, IQ Image or Carrier leakage) that apply. P_{RB} is defined in Note 10.</p> <p>Note 2: The measurement bandwidth is 1 RB and the limit is expressed as a ratio of measured power in one non-allocated RB to the measured average power per allocated RB, where the averaging is done across all allocated RBs.</p> <p>Note 3: The applicable frequencies for this limit are not known due to unknown LO frequency. See Note 2 in Table 6.5.2A.3.3-1.</p> <p>Note 4: The measurement bandwidth is 1 RB and the limit is expressed as a ratio of measured power in one non-allocated RB to the measured total power in all allocated RBs.</p> <p>Note 5: The applicable frequencies for this limit are not known due to unknown LO frequency. See Note 3 in Table 6.5.2A.3.3-1.</p> <p>Note 6: L_{CRB} is the Transmission Bandwidth (see Figure 5.4.2-1).</p> <p>Note 7: N_{RB} is the Transmission Bandwidth Configuration (see Figure 5.4.2-1).</p> <p>Note 8: EVM is the limit specified in Table 6.5.2.1.1-1 for the modulation format used in the allocated RBs.</p> <p>Note 9: Δ_{RB} is the starting frequency offset between the allocated RB and the measured non-allocated RB (e.g. $\Delta_{RB} = 1$ or $\Delta_{RB} = -1$ for the first adjacent RB outside of the allocated bandwidth).</p> <p>Note 10: P_{RB} is the transmitted power per 180 kHz in allocated RBs, measured in dBm.</p>				

The in-band emissions results, measured with the spectral test shall not exceed the corresponding values in Table 6.5.2A.3.5-2

Table 6.5.2A.3.1.5-2: Test requirements for in-band emissions (not allocated component carrier)

Parameter	Unit	Meas BW Note 1	Limit	remark	Applicable Frequencies	
General	dB	BW of 1 RB (180KHz rectangular)	$\max \left\{ -25 - 10 \cdot \log_{10} (N_{RB} / L_{CRBs}), \right.$ $20 \cdot \log_{10} EVM - 3 - 5 \cdot (\Delta_{RB} - 1) / L_{CRBs},$ $\left. -57 \text{ dBm} / 180 \text{ kHz} - P_{RB} \right\}$	The reference value is the average power per allocated RB in the allocated component carrier	Any RB in the non allocated component carrier. The frequency raster of the RBs is derived when this component carrier is allocated with RBs	
IQ Image	dB	BW of 1 RB (180KHz rectangular)	-24.2 Note 2	The reference value is the average power per allocated RB in the allocated component carrier	The frequencies of the L_{CRB} contiguous non-allocated RBs are unknown. The frequency raster of the RBs is derived when this component carrier is allocated with RBs	
Carrier leakage	dBc	BW of 1 RB (180KHz rectangular)	Note 3		The reference value is the total power of the allocated RBs in the allocated component carrier	The frequencies of the up to 2 non-allocated RBs are unknown. The frequency raster of the RBs is derived when this component carrier is allocated with RBs
			-24.2	Output power > 0 dBm		
			-19.2	-30 dBm ≤ Output power ≤ 0 dBm		
			-9.2	-40 dBm ≤ Output power < -30 dBm		
Note1:	Resolution BWs smaller than the measurement BW may be integrated to achieve the measurement bandwidth.					
Note 2:	Exceptions to the general limit are allowed for up to L_{CRB} RBs within a contiguous width of L_{CRB} non-allocated RBs.					
Note 3:	Exceptions to the general limit are allowed for up to two contiguous non-allocated RBs.					
Note 4:	Note 4 and note 8 from Table 6.5.2A.3.3-1 apply for Table 6.5.2A.3.1-2 as well.					
Note 5:	Δ_{RB} is the starting frequency offset between the allocated RB in the allocated component carrier and the measured non-allocated RB in the non allocated component carrier. For non allocated component carrier, Δ_{RB} may take non-integer values when the carrier spacing between the CCs is not a multiple of RB.					

6.5.2B Transmit modulation for UL- MIMO

6.5.2B.1 Error Vector Magnitude (EVM) for UL- MIMO

6.5.2B.1.1 Test Purpose

The Error Vector Magnitude is a measure of the difference between the reference waveform and the measured waveform. This difference is called the error vector. Before calculating the EVM the measured waveform is corrected

by the sample timing offset and RF frequency offset. Then the IQ origin offset shall be removed from the measured waveform before calculating the EVM.

The measured waveform is further modified by selecting the absolute phase and absolute amplitude of the Tx chain. The EVM result is defined after the front-end IDFT as the square root of the ratio of the mean error vector power to the mean reference power expressed as a %.

When the PUSCH or PUCCH transmission slot is shortened due to multiplexing with SRS, the EVM measurement interval is reduced by one symbol, accordingly. The PUSCH or PUCCH EVM measurement interval is also reduced when the mean power, modulation or allocation between slots is expected to change. In the case of PUSCH transmission, the measurement interval is reduced by a time interval equal to the sum of 5 μ s and the applicable exclusion period defined in subclause 6.3.4, adjacent to the boundary where the power change is expected to occur. The PUSCH exclusion period is applied to the signal obtained after the front-end IDFT. In the case of PUCCH transmission, the PUCCH EVM measurement interval is reduced by one symbol adjacent to the slot boundary.

6.5.2B.1.2 Test applicability

This test case applies to all types of E-UTRA UE release 10 and forward that support UL-MIMO.

6.5.2B.1.3 Minimum conformance requirements

For UE with two transmit antenna connectors in closed-loop spatial multiplexing scheme, the Error Vector Magnitude requirements specified in Table 6.5.2.1.1-1 which is defined in sub-clause 6.5.2.1 apply to each transmit antenna connector with the UL-MIMO configurations specified in Table 6.2.2B-2.

The normative reference for this requirement is TS 36.101 [2] clause 6.5.2B.1.1.

6.5.2B.1.4 Test description

6.5.2B.1.4.1 Initial conditions

Initial conditions are a set of test configurations the UE needs to be tested in and the steps for the SS to take with the UE to reach the correct measurement state.

The initial test configurations consist of environmental conditions, test frequencies, and channel bandwidths based on E-UTRA bands specified in table 5.4.2.1-1. All of these configurations shall be tested with applicable test parameters for each channel bandwidth, and are shown in table 6.5.2B.1.4.1-1. The details of the uplink reference measurement channels (RMCs) are specified in Annex A.2. Configurations of PDSCH and PDCCH before measurement are specified in Annex C.2.

Table 6.5.2B.1.4.1-1: Test Configuration Table for PUSCH

Initial Conditions				
Test Environment (as specified in TS 36.508 [7] subclause 4.1)		NC		
Test Frequencies (as specified in TS36.508 [7] subclause 4.3.1)		See Table 6.5.1.4.1-1		
Test Channel Bandwidths (as specified in TS 36.508 [7] subclause 4.3.1)		See Table 6.5.1.4.1-1		
Test Parameters for Channel Bandwidths				
Downlink Configuration		Uplink Configuration		
Ch BW	N/A for PUSCH EVM testing	Mod'n	RB allocation	
			FDD	TDD

1.4MHz		QPSK	6	6
1.4MHz		QPSK	1	1
1.4MHz		16QAM	6	6
1.4MHz		16QAM	1	1
3MHz		QPSK	15	15
3MHz		QPSK	4	4
3MHz		16QAM	15	15
3MHz		16QAM	4	4
5MHz		QPSK	25	25
5MHz		QPSK	8	8
5MHz		16QAM	25	25
5MHz		16QAM	8	8
10MHz		QPSK	50	50
10MHz		QPSK	12	12
10MHz		16QAM	50	50
			(Note 3)	(Note 3)
10MHz		16QAM	12	12
15MHz		QPSK	75	75
15MHz		QPSK	16	16
15MHz		16QAM	75	75
			(Note 3)	(Note 3)
15MHz		16QAM	16	16
20MHz		QPSK	100	100
20MHz		QPSK	18	18
20MHz		16QAM	100	100
			(Note 3)	(Note 3)
20MHz		16QAM	18	18
Note 1: Test Channel Bandwidths are checked separately for each E-UTRA band, which applicable channel bandwidths are specified in Table 5.4.2.1-1.				
Note 2: For partial RB allocation, the RB _{start} shall be RB #0 and RB# (max+1 - RB allocation) of the channel bandwidth.				
Note 3: Applies only for UE-Categories [FFS].				

Table 6.5.2B.1.4.1-2: Test Configuration Table for PUCCH

Initial Conditions				
Test Environment as specified in TS 36.508[7] subclause 4.1			NC	
Test Frequencies as specified in TS36.508 [7] subclause 4.3.1			See Table 6.5.1.4.1-1	
Test Channel Bandwidths as specified in TS 36.508 [7] subclause 4.3.1			See Table 6.5.1.4.1-1	
Test Parameters for Channel Bandwidths				
Downlink Configuration				Uplink Configuration
Ch BW	Mod'n	RB allocation		FDD: PUCCH format = Format 1a TDD: PUCCH format = Format 1a / 1b
		FDD	TDD	
1.4MHz	QPSK	3	3	
3MHz	QPSK	4	4	
5MHz	QPSK	8	8	
10MHz	QPSK	16	16	
15MHz	QPSK	25	25	
20MHz	QPSK	30	30	
Note 1: Test Channel Bandwidths are checked separately for each E-UTRA band, the applicable channel bandwidths are specified in Table 5.4.2.1-1.				

1. Connect the SS to the UE to the UE antenna connectors as shown in TS 36.508 [7] Annex A, Figure A.28.
2. The parameter settings for the cell are set up according to TS 36.508[7] subclause 4.4.3.
3. Downlink signals are initially set up according to Annex C0, C.1 and C.3.0, and uplink signals according to Annex H.1 and H.3.0.
4. The UL Reference Measurement channels are set according to in Table 6.5.2B.1.4.1-1.

5. Propagation conditions are set according to Annex B.0
6. Ensure the UE is in State 3A-RF according to TS 36.508 [7] clause 5.2A.2. Message contents are defined in clause 6.5.2B.1.4.3.

6.5.2B.1.4.2 Test procedure

Test procedure for PUSCH:

- 1.1. SS sends uplink scheduling information for each UL HARQ process via PDCCH DCI format 4 for C_RNTI to schedule the UL RMC according to Table 6.5.2B.1.4.1-1. Since the UE has no payload data to send, the UE transmits uplink MAC padding bits on the UL RMC.
- 1.2 Send continuously uplink power control "up" commands in the uplink scheduling information to the UE until the UE transmits at P_{UMAX} level.
- 1.3 Measure the EVM and \overline{EVM}_{DMRS} using Global In-Channel Tx-Test (Annex E) for each of transmit antenna of the UE.
- 1.4 Send the appropriate TPC commands in the uplink scheduling information to the UE until UE output power is $-36.8\text{dBm} \pm 3.2\text{dB}$ for carrier frequency $f \leq 3.0\text{GHz}$ or $-36.5\text{dBm} \pm 3.5\text{dB}$ for carrier frequency $3.0\text{GHz} < f \leq 4.2\text{GHz}$.
- 1.5 Measure the EVM and \overline{EVM}_{DMRS} using Global In-Channel Tx-Test (Annex E) for each of transmit antenna of the UE.

Test procedure for PUCCH:

- 2.1 PUCCH are set according to Table 6.5.2B.1.4.1-2.
- 2.2 SS transmits PDSCH via PDCCH DCI format 1A for C_RNTI to transmit the DL RMC according to Table 6.5.2B.1.4.1-2. The SS sends downlink MAC padding bits on the DL RMC. The transmission of PDSCH will make the UE send uplink ACK/NACK using PUCCH. There is no PUSCH transmission.
- 2.3 SS send appropriate TPC commands for PUCCH to the UE until the UE transmit PUCCH at P_{UMAX} level.
- 2.4 Measure PUCCH EVM using Global In-Channel Tx-Test (Annex E) for each of transmit antenna of the UE.
- 2.5 Send the appropriate TPC commands for PUCCH to the UE until the UE transmits PUCCH at $-36.8\text{dBm} \pm 3.2\text{dB}$ for carrier frequency $f \leq 3.0\text{GHz}$ or $-36.5\text{dBm} \pm 3.5\text{dB}$ for carrier frequency $3.0\text{GHz} < f \leq 4.2\text{GHz}$.
- 2.6 Measure PUCCH EVM using Global In-Channel Tx-Test (Annex E) for each of transmit antenna of the UE.

6.5.2B.1.4.3 Message contents

Message contents are according to TS 36.508 [7] clause 4.6 with the following exceptions:

Table 6.5.2B.1.4.3-1: PUCCH-ConfigDedicated-v1020-DEFAULT

Derivation Path: TS 36.508 [7] clause 4.6.3, Table 4.6.3-9A: PUCCH-ConfigDedicated-v1020-DEFAULT			
Information Element	Value/remark	Comment	Condition
PUCCH-ConfigDedicated-v1020 ::= SEQUENCE {			
twoAntennaPortActivatedPUCCH-Format1a1b-r10	true		
}			

6.5.2B.1.5 Test requirement

The requirements apply to each transmit antenna connector.

The PUSCH EVM derived in E.4.2 shall not exceed 17.5 % for QPSK and BPSK, 12.5% for 16 QAM.

The PUSCH \overline{EVM}_{DMRS} derived in E.4.6.2 shall not exceed [17.5 %] when embedded with data symbols of QPSK and BPSK, [12,5%] for 16 QAM.

The PUCCH EVM and derived in E.5.9.2 shall not exceed 17.5 %.

6.5.2B.2 Carrier leakage for UL-MIMO

6.5.2B.2.1 Test Purpose

The purpose of this test is to exercise the transmitter of UE that support UL-MIMO to verify its modulation quality in terms of carrier leakage for UL-MIMO.

6.5.2B.2.2 Test applicability

This test case applies to all types of E-UTRA UE release 10 and forward that support UL-MIMO.

6.5.2B.2.3 Minimum conformance requirements

For UE with two transmit antenna connectors in closed-loop spatial multiplexing scheme, the Relative Carrier Leakage Power requirements specified in Table 6.5.2.2.3-1 which is defined in subclause 6.5.2.2 apply to each transmit antenna connector with the UL-MIMO configurations specified in Table 6.2.2B.3-2.

The normative reference for this requirement is TS 36.101 clause 6.5.2B.2

6.5.2B.2.4 Test description

6.5.2B.2.4.1 Initial conditions

Initial conditions are a set of test configurations the UE needs to be tested in and the steps for the SS to take with the UE to reach the correct measurement state.

The initial test configurations consist of environmental conditions, test frequencies, and channel bandwidths based on E-UTRA bands specified in table 5.4.2.1-1. All of these configurations shall be tested with applicable test parameters for each channel bandwidth, and are shown in table 6.5.2.2B.4.1-1. The details of the uplink reference measurement channels (RMCs) are specified in Annexes A.2. Configurations of PDSCH and PDCCH before measurement are specified in Annex C.2.

Table 6.5.2.2B.4.1-1: Test Configuration Table

Initial Conditions				
Test Environment (as specified in TS 36.508 [7] subclause 4.1)		See Table 6.5.1.4.1-1		
Test Frequencies (as specified in TS36.508 [7] subclause 4.3.1)		See Table 6.5.1.4.1-1		
Test Channel Bandwidths (as specified in TS 36.508 [7] subclause 4.3.1)		See Table 6.5.1.4.1-1		
Test Parameters for Channel Bandwidths				
	Downlink Configuration	Uplink Configuration		
Ch BW	N/A for carrier leakage testing	Mod'n	RB allocation	
			FDD	TDD
1.4MHz		QPSK	1	1
3MHz		QPSK	4	4
5MHz		QPSK	8	8
10MHz		QPSK	12	12
15MHz		QPSK	16	16
20MHz		QPSK	18	18
Note 1: Test Channel Bandwidths are checked separately for each E-UTRA band, which applicable channel bandwidths are specified in Table 5.4.2.1-1.				
Note 2: For partial RB allocation, the RB _{start} shall be RB #0 and RB# (max +1- RB allocation) of the channel bandwidth.				

1. Connect the SS to the UE to the UE antenna connectors as shown in TS 36.508 [7] Annex A, Figure A.28.
2. The parameter settings for the cell are set up according to TS 36.508[7] subclause 4.4.3.

3. Downlink signals are initially set up according to Annex C0, C.1 and C.3.0, and uplink signals according to Annex H.1 and H.3.0.
4. The UL Reference Measurement channels are set according to in Table 6.5.2B.2.4.1-1.
5. Propagation conditions are set according to Annex B.0
6. Ensure the UE is in State 3A-RF according to TS 36.508 [7] clause 5.2A.2. Message contents are defined in clause 6.5.2B.2.4.3.

6.5.2B.2.4.2 Test procedure

1. SS sends uplink scheduling information for each UL HARQ process via PDCCH DCI format 4 for C_RNTI to schedule the UL RMC according to Table 6.5.2B.2.4.1-1. Since the UE has no payload and no loopback data to send the UE sends uplink MAC padding bits on the UL RMC
2. Send the appropriate TPC commands in the uplink scheduling information to the UE until UE output power is 3.2 dBm \pm 3.2dB for carrier frequency $f \leq 3.0\text{GHz}$ or 3.5dBm \pm 3.5 dB for carrier frequency $3.0\text{GHz} < f \leq 4.2\text{GHz}$.
3. Measure carrier leakage using Global In-Channel Tx-Test (Annex E) for each of transmit antenna of the UE. For TDD slots with transient periods are not under test.
4. Send the appropriate TPC commands in the uplink scheduling information to the UE until UE output power is -26.8 dBm \pm 3.2dB for carrier frequency $f \leq 3.0\text{GHz}$ or -26.5dBm \pm 3.5 dB for carrier frequency $3.0\text{GHz} < f \leq 4.2\text{GHz}$.
5. Measure carrier leakage using Global In-Channel Tx-Test (Annex E) for each of transmit antenna of the UE. For TDD slots with transient periods are not under test.
6. Send the appropriate TPC commands in the uplink scheduling information to the UE until UE output power is -36.8dBm \pm 3.2dB for carrier frequency $f \leq 3.0\text{GHz}$ or -36.5dBm \pm 3.5 dB for carrier frequency $3.0\text{GHz} < f \leq 4.2\text{GHz}$.
7. Measure carrier leakage using Global In-Channel Tx-Test (Annex E) for each of transmit antenna of the UE. For TDD slots with transient periods are not under test

6.5.2B.2.4.3 Message contents

Message contents are according to TS 36.508 [7] clause 4.6.

6.5.2B.2.5 Test requirement

The requirements apply to each transmit antenna connector.

Each of the 20 IQ offset results, derived in Annex E.3.1, shall not exceed the values in table 6.5.2B.2.5-1

Table 6.5.2B.2.5-1: Test requirements for Relative Carrier Leakage Power

LO Leakage	Parameters	Relative Limit (dBc)
	$f \leq 3.0\text{GHz}$: 3.2 dBm \pm 3.2dB $3.0\text{GHz} < f \leq 4.2\text{GHz}$: 3.5 dBm \pm 3.5dB	24.2
	$f \leq 3.0\text{GHz}$: -26.8 dBm \pm 3.2dB $3.0\text{GHz} < f \leq 4.2\text{GHz}$: -26.5 dBm \pm 3.5dB	19.2
	$f \leq 3.0\text{GHz}$: -36.8dBm \pm 3.2dB $3.0\text{GHz} < f \leq 4.2\text{GHz}$: -36.5 dBm \pm 3.5dB	9.2

6.5.2B.3 In-band emissions for non allocated RB for UL-MIMO

6.5.2B.3.1 Test Purpose

The in-band emissions are a measure of the interference falling into the non-allocated resources blocks.

The in-band emission is defined as the average across 12 sub-carrier and as a function of the RB offset from the edge of the allocated UL transmission bandwidth. The in-band emission for UL-MIMO is measured as the ratio of the output power of UE that support UL-MIMO in a non-allocated RB to the output power of UE that support UL-MIMO in an allocated RB. The basic in-band emissions measurement interval is defined over one slot in the time domain. When the PUSCH or PUCCH transmission slot is shortened due to multiplexing with SRS, the in-band emissions measurement interval is reduced by one SC-FDMA symbol, accordingly.

6.5.2B.3.2 Test applicability

This test case applies to all types of E-UTRA UE release 10 and forward that support UL-MIMO.

6.5.2B.3.3 Minimum conformance requirements

The relative in-band emission shall not exceed the values specified in Table 6.5.2B.3.3-1.

Table 6.5.2B.3.3-1: Minimum requirements for in-band emissions

Parameter Description	Unit	Limit (Note 1)		Applicable Frequencies
General	dB	$\max \left\{ -25 - 10 \cdot \log_{10} (N_{RB} / L_{CRBs}), \right.$ $20 \cdot \log_{10} EVM - 3 - 5 \cdot (\Delta_{RB} - 1) / L_{CRBs},$ $\left. -57 \text{ dBm} / 180 \text{ kHz} - P_{RB} \right\}$		Any non-allocated (Note 2)
IQ Image	dB	-25		Image frequencies (Notes 2, 3)
Carrier leakage	dBc	-25	Output power > 0 dBm	LO frequency (Notes 4, 5)
		-20	-30 dBm ≤ Output power ≤ 0 dBm	
		-10	-40 dBm ≤ Output power < -30 dBm	
<p>Note 1: An in-band emissions combined limit is evaluated in each non-allocated RB. For each such RB, the minimum requirement is calculated as the higher of $P_{RB} - 30$ dB and the power sum of all limit values (General, IQ Image or Carrier leakage) that apply. P_{RB} is defined in Note 10.</p> <p>Note 2: The measurement bandwidth is 1 RB and the limit is expressed as a ratio of measured power in one non-allocated RB to the measured average power per allocated RB, where the averaging is done across all allocated RBs.</p> <p>Note 3: The applicable frequencies for this limit are those that are enclosed in the reflection of the allocated bandwidth, based on symmetry with respect to the centre carrier frequency, but excluding any allocated RBs.</p> <p>Note 4: The measurement bandwidth is 1 RB and the limit is expressed as a ratio of measured power in one non-allocated RB to the measured total power in all allocated RBs.</p> <p>Note 5: The applicable frequencies for this limit are those that are enclosed in the RBs containing the DC frequency if N_{RB} is odd, or in the two RBs immediately adjacent to the DC frequency if N_{RB} is even, but excluding any allocated RB.</p> <p>Note 6: L_{CRBs} is the Transmission Bandwidth (see Figure 5.4.2-1).</p> <p>Note 7: N_{RB} is the Transmission Bandwidth Configuration (see Figure 5.4.2-1).</p> <p>Note 8: EVM is the limit specified in Table 6.5.2.1.1-1 for the modulation format used in the allocated RBs.</p> <p>Note 9: Δ_{RB} is the starting frequency offset between the allocated RB and the measured non-allocated RB (e.g. $\Delta_{RB} = 1$ or $\Delta_{RB} = -1$ for the first adjacent RB outside of the allocated bandwidth).</p> <p>Note 10: P_{RB} is the transmitted power per 180 kHz in allocated RBs, measured in dBm.</p>				

The normative reference for this requirement is TS 36.101 [2] clause 6.5.2B.3.

The in-band emission is defined as the average across 12 sub-carrier and as a function of the RB offset from the edge of the allocated UL transmission bandwidth. The in-band emission is measured as the ratio of the UE output power in a non-allocated RB to the UE output power in an allocated RB. The basic in-band emissions measurement interval is defined over one slot in the time domain.

6.5.2B.3.4 Test description

6.5.2B.3.4.1 Initial conditions

Initial conditions are a set of test configurations the UE needs to be tested in and the steps for the SS to take with the UE to reach the correct measurement state.

The initial test configurations consist of environmental conditions, test frequencies, and channel bandwidths based on E-UTRA bands specified in table 5.4.2.1-1. All of these configurations shall be tested with applicable test parameters for each channel bandwidth, and are shown in table 6.5.2B.3.4.1-1. The details of the uplink reference measurement channels (RMCs) are specified in Annexes A.2. Configurations of PDSCH and PDCCH before measurement are specified in Annex C.2.

Table 6.5.2B.3.4.1-1: Test Configuration Table for PUSCH

Initial Conditions				
Test Environment (as specified in TS 36.508 [7] subclause 4.1)		See Table 6.5.1.4.1-1		
Test Frequencies (as specified in TS36.508 [7] subclause 4.3.1)		See Table 6.5.1.4.1-1		
Test Channel Bandwidths (as specified in TS 36.508 [7] subclause 4.3.1)		See Table 6.5.1.4.1-1		
Test Parameters for Channel Bandwidths				
Ch BW	Downlink Configuration		Uplink Configuration	
	N/A for in-band emissions testing		Mod'n	RB allocation
			FDD	TDD
1.4MHz		QPSK	1	1
3MHz		QPSK	4	4
5MHz		QPSK	8	8
10MHz		QPSK	12	12
15MHz		QPSK	16	16
20MHz		QPSK	18	18
Note 1: Test Channel Bandwidths are checked separately for each E-UTRA band, which applicable channel bandwidths are specified in Table 5.4.2.1-1.				
Note 2: For partial RB allocation, the starting resource block shall be RB #0 and RB# (max+1 - RB allocation) of the channel bandwidth.				

Table 6.5.2B.3.4.1-2: Test Configuration Table for PUCCH

Initial Conditions			
Test Environment as specified in TS 36.508[7] subclause 4.1		See Table 6.5.1.4.1-1	
Test Frequencies as specified in TS36.508 [7] subclause 4.3.1		See Table 6.5.1.4.1-1	
Test Channel Bandwidths as specified in TS 36.508 [7] subclause 4.3.1		See Table 6.5.1.4.1-1	
Test Parameters for Channel Bandwidths			
Ch BW	Downlink Configuration		Uplink Configuration
	Mod'n	RB allocation	
		FDD	TDD
1.4MHz	QPSK	3	3
3MHz	QPSK	4	4
5MHz	QPSK	8	8
10MHz	QPSK	16	16
15MHz	QPSK	25	25
20MHz	QPSK	30	30
Note 1: Test Channel Bandwidths are checked separately for each E-UTRA band, the applicable channel bandwidths are specified in Table 5.4.2.1-1.			

1. Connect the SS to the UE antenna connectors as shown in TS 36.508 [7] Figure A.28.
2. The parameter settings for the cell are set up according to TS 36.508 [7] subclause 4.4.3.
3. Downlink signals are initially set up according to Annex C.0, C.1, and C.3.0, and uplink signals according to Annex H.1 and H.3.0.
4. The UL Reference Measurement channels are set according to in Table 6.5.2B.3.4.1-1.
5. Propagation conditions are set according to Annex B.0
6. Ensure the UE is in State 3A-RF according to TS 36.508 [7] clause 5.2A.2. Message contents are defined in clause 6.5.2B.3.4.3.

6.5.2B.3.4.2 Test procedure

Test procedure for PUSCH:

- 1.1 SS sends uplink scheduling information for each UL HARQ process via PDCCH DCI format 4 for C_RNTI to schedule the UL RMC according to Table 6.5.2B.3.4.1-1. Since the UE has no payload and no loopback data to send the UE sends uplink MAC padding bits on the UL RMC.
- 1.2 Send the appropriate TPC commands in the uplink scheduling information to the UE until UE output power is 3.2 dBm \pm 3.2dB for carrier frequency $f \leq 3.0$ GHz or 3.5dBm \pm 3.5 dB for carrier frequency 3.0 GHz $< f \leq 4.2$ GHz.
- 1.3 Measure In-band emission using Global In-Channel Tx-Test (Annex E) for each of transmit antennas of the UE.
- 1.4 Send the appropriate TPC commands in the uplink scheduling information to the UE until UE output power is -26.8 dBm \pm 3.2dB for carrier frequency $f \leq 3.0$ GHz or -36.5dBm \pm 3.5 dB for carrier frequency 3.0 GHz $< f \leq 4.2$ GHz.
- 1.5 Measure In-band emission using Global In-Channel Tx-Test (Annex E) for each of transmit antennas of the UE. For TDD slots with transient periods are not under test.
- 1.6 Send the appropriate TPC commands in the uplink scheduling information to the UE until UE output power is to -36.8 dBm \pm 3.2dB for carrier frequency $f \leq 3.0$ GHz or -36.5dBm \pm 3.5 dB for carrier frequency 3.0 GHz $< f \leq 4.2$ GHz.
- 1.7 Measure In-band emission using Global In-Channel Tx-Test (Annex E) for each of transmit antennas of the UE. For TDD slots with transient periods are not under test.

Test procedure for PUCCH:

- 2.1 PUCCH is set according to Table 6.5.2B.3.4.1-2. SS transmits PDSCH via PDCCH DCI format 1A for C_RNTI to transmit the DL RMC according to Table 6.5.2B.3.4.1-2. The SS sends downlink MAC padding bits on the DL RMC. The transmission of PDSCH will make the UE send uplink ACK/NACK using PUCCH.
- 2.2 Send the appropriate TPC commands in the uplink scheduling information for PUCCH to the UE until UE output power is 3.2 dBm \pm 3.2dB for carrier frequency $f \leq 3.0$ GHz or 3.5dBm \pm 3.5 dB for carrier frequency 3.0 GHz $< f \leq 4.2$ GHz.
- 2.3 Measure In-band emission using Global In-Channel Tx-Test (Annex E) for each of transmit antennas of the UE.
- 2.4 Send the appropriate TPC commands for PUCCH in the uplink scheduling information to the UE until UE output power is -26.8 dBm \pm 3.2dB for carrier frequency $f \leq 3.0$ GHz or -26.5dBm \pm 3.5 dB for carrier frequency 3.0 GHz $< f \leq 4.2$ GHz.
- 2.5 Measure In-band emission using Global In-Channel Tx-Test (Annex E) for each of transmit antennas of the UE.
- 2.6 Send the appropriate TPC commands for PUCCH in the uplink scheduling information to the UE until UE output power is to -36.8 dBm \pm 3.2dB for carrier frequency $f \leq 3.0$ GHz or -36.5dBm \pm 3.5 dB for carrier frequency 3.0 GHz $< f \leq 4.2$ GHz.
- 2.7 Measure In-band emission using Global In-Channel Tx-Test (Annex E) for each of transmit antennas of the UE.

6.5.2B.3.4.3 Message contents

Message contents are according to TS 36.508 [7] clause 4.6 with the following exceptions:

Table 6.5.2B.3.4.3-1: PUCCH-ConfigDedicated-v1020-DEFAULT

Derivation Path: TS 36.508 [7] clause 4.6.3, Table 4.6.3-9A: PUCCH-ConfigDedicated-v1020-DEFAULT			
Information Element	Value/remark	Comment	Condition
PUCCH-ConfigDedicated-v1020 ::= SEQUENCE {			
twoAntennaPortActivatedPUCCH-Format1a1b-r10	true		
}			

6.5.2B.3.5 Test requirement

The requirements apply to each transmit antenna connector.

Each of the 20 In-band emissions results, derived in Annex E.4.3 shall not exceed the corresponding values in Table 6.5.2B.3.5-1.

Table 6.5.2B.3.5-1: Test requirements for in-band emissions

Parameter Description	Unit	Limit (Note 1)		Applicable Frequencies
General	dB	$\max \left\{ -25 - 10 \cdot \log_{10} (N_{RB} / L_{CRBs}), \right.$ $20 \cdot \log_{10} EVM - 3 - 5 \cdot (\Delta_{RB} - 1) / L_{CRBs}, \quad +0.8$ $\left. -57 \text{ dBm} / 180 \text{ kHz} - P_{RB} \right\}$		Any non-allocated (Note 2)
IQ Image	dB	-24.2		Image frequencies (Notes 2, 3)
Carrier leakage	dBc	-24.2	Output power > 0 dBm	LO frequency (Notes 4, 5)
		-19.2	-30 dBm ≤ Output power ≤ 0 dBm	
		-9.2	-40 dBm ≤ Output power < -30 dBm	
<p>Note 1: An in-band emissions combined limit is evaluated in each non-allocated RB. For each such RB, the minimum requirement is calculated as the higher of $P_{RB} - 30$ dB and the power sum of all limit values (General, IQ Image or Carrier leakage) that apply. P_{RB} is defined in Note 10.</p> <p>Note 2: The measurement bandwidth is 1 RB and the limit is expressed as a ratio of measured power in one non-allocated RB to the measured average power per allocated RB, where the averaging is done across all allocated RBs.</p> <p>Note 3: The applicable frequencies for this limit are those that are enclosed in the reflection of the allocated bandwidth, based on symmetry with respect to the centre carrier frequency, but excluding any allocated RBs.</p> <p>Note 4: The measurement bandwidth is 1 RB and the limit is expressed as a ratio of measured power in one non-allocated RB to the measured total power in all allocated RBs.</p> <p>Note 5: The applicable frequencies for this limit are those that are enclosed in the RBs containing the DC frequency if N_{RB} is odd, or in the two RBs immediately adjacent to the DC frequency if N_{RB} is even, but excluding any allocated RB.</p> <p>Note 6: L_{CRBs} is the Transmission Bandwidth (see Figure 5.4.2-1).</p> <p>Note 7: N_{RB} is the Transmission Bandwidth Configuration (see Figure 5.4.2-1).</p> <p>Note 8: EVM is the limit specified in Table 6.5.2.1.1-1 for the modulation format used in the allocated RBs.</p> <p>Note 9: Δ_{RB} is the starting frequency offset between the allocated RB and the measured non-allocated RB (e.g. $\Delta_{RB} = 1$ or $\Delta_{RB} = -1$ for the first adjacent RB outside of the allocated bandwidth).</p> <p>Note 10: P_{RB} is the transmitted power per 180 kHz in allocated RBs, measured in dBm.</p>				

6.5.2B.4 EVM equalizer spectrum flatness for UL-MIMO

6.5.2B.4.1 Test Purpose

The zero-forcing equalizer correction applied in the EVM measurement process (as described in Annex E) must meet a spectrum flatness requirement for the EVM measurement to be valid. The EVM equalizer spectrum flatness is defined

in terms of the maximum peak-to-peak ripple of the equalizer coefficients (dB) across the allocated uplink block variation in dB of the equalizer coefficients generated by the EVM measurement process. The EVM equalizer spectrum flatness requirement does not limit the correction applied to the signal in the EVM measurement process but for the EVM result to be valid, the equalizer correction that was applied must meet the EVM equalizer spectrum flatness minimum requirements. The basic measurement interval is the same as for EVM.

6.5.2B.4.2 Test applicability

This test case applies to all types of E-UTRA UE release 10 and forward that support UL-MIMO.

6.5.2B.4.3 Minimum conformance requirements

For UE with two transmit antenna connectors in closed-loop spatial multiplexing scheme, the EVM Equalizer Spectrum Flatness requirements specified in Table 6.5.2B.4.3-1 and Table 6.5.2B.4.3-2 which are defined in sub-clause 6.5.2B.4 apply to each transmit antenna connector with the UL-MIMO configurations specified in Table 6.2.2B.3-2.

The normative reference for this requirement is TS 36.101 clause 6.5.2B.4.

6.5.2B.4.4 Test description

6.5.2B.4.4.1 Initial conditions

Initial conditions are a set of test configurations the UE needs to be tested in and the steps for the SS to take with the UE to reach the correct measurement state.

The initial test configurations consist of environmental conditions, test frequencies, and channel bandwidths based on E-UTRA bands specified in table 5.4.2.1-1. All of these configurations shall be tested with applicable test parameters for each channel bandwidth, and are shown in table 6.5.2B.4.4.1-1. The details of the uplink reference measurement channels (RMCs) are specified in A.2. Configurations of PDSCH and PDCCH before measurement are specified in Annex C.2.

Table 6.5.2B.4.4.1-1: Test Configuration Table

Initial Conditions				
Test Environment (as specified in TS 36.508 [7] subclause 4.1)		See Table 6.5.1.4.1-1		
Test Frequencies (as specified in TS36.508 [7] subclause 4.3.1)		See Table 6.5.1.4.1-1		
Test Channel Bandwidths (as specified in TS 36.508 [7] subclause 4.3.1)		See Table 6.5.1.4.1-1		
Test Parameters for Channel Bandwidths				
Ch BW	Downlink Configuration	Uplink Configuration		
		Mod'n	RB allocation	
	N/A for EVM equalizer spectrum flatness testing		FDD	TDD
1.4MHz		QPSK	6	6
3MHz		QPSK	15	15
5MHz		QPSK	25	25
10MHz		QPSK	50	50
15MHz		QPSK	75	75
20MHz		QPSK	100	100
Note 1: Test Channel Bandwidths are checked separately for each E-UTRA band, which applicable channel bandwidths are specified in Table 5.4.2.1-1.				

1. Connect the SS to the UE antenna connectors as shown in TS 36.508 [7] Figure A.28.
2. The parameter settings for the cell are set up according to TS 36.508 [7] subclause 4.4.3.
3. Downlink signals are initially set up according to Annex C0, C.1 and C.3.0, and uplink signals according to Annex H.1 and H.3.0.
4. The UL Reference Measurement channels are set according to in Table 6.5.2B.4.4.1-1.
5. Propagation conditions are set according to Annex B.0.

6. Ensure the UE is in State 3A-RF according to TS 36.508 [7] clause 5.2A.2. Message contents are defined in clause 6.5.2B.4.4.3.

6.5.2B.4.4.2 Test procedure

1. SS sends uplink scheduling information for each UL HARQ process via PDCCH DCI format 4 for C_RNTI to schedule the UL RMC according to Table 6.5.2B.4.4.1-1. Since the UE has no payload and no loopback data to send the UE sends uplink MAC padding bits on the UL RMC.
2. Send continuously uplink power control "up" commands in the uplink scheduling information to the UE until the UE transmits at P_{UMAX} level.
3. Measure spectrum flatness using Global In-Channel Tx-Test (Annex E) for each of transmit antennas of the UE. For TDD slots with transient periods are not under test.

6.5.2B.4.4.3 Message contents

Message contents are according to TS 36.508 [7] clause 4.6.

6.5.2B.4.5 Test requirement

The requirements apply to each transmit antenna connector.

Each of the 20 spectrum flatness functions, shall derive four ripple results in Annex E.4.4, The derived results shall not exceed the values in Figure 6.5.2B.4.5-1:

For normal conditions, the maximum ripple in Range 1 and Range 2 shall not exceed the values specified in Table 6.5.2B.4.5-1 and the following additional requirement: the relative difference between the maximum coefficient in Range 1 and the minimum coefficient in Range 2 must not be larger than 6.4 dB, and the relative difference between the maximum coefficient in Range 2 and the minimum coefficient in Range 1 must not be larger than 8.4 dB (see Figure 6.5.2B.4.5-1).

For extreme conditions, the maximum ripple in Range 1 and Range 2 shall not exceed the values specified in Table 6.5.2B.4.5-2 and the following additional requirement: the relative difference between the maximum coefficient in Range 1 and the minimum coefficient in Range 2 must not be larger than 7.4 dB, and the relative difference between the maximum coefficient in Range 2 and the minimum coefficient in Range 1 must not be larger than 11.4 dB (see Figure 6.5.2B.4.5-1).

Table 6.5.2B.4.5-1: Test requirements for EVM equalizer spectrum flatness (normal conditions)

Frequency Range	Maximum Ripple [dB]
$F_{UL_Meas} - F_{UL_Low} \geq 3 \text{ MHz}$ and $F_{UL_High} - F_{UL_Meas} \geq 3 \text{ MHz}$ (Range 1)	5.4 (p-p)
$F_{UL_Meas} - F_{UL_Low} < 3 \text{ MHz}$ or $F_{UL_High} - F_{UL_Meas} < 3 \text{ MHz}$ (Range 2)	9.4 (p-p)
Note 1: F_{UL_Meas} refers to the sub-carrier frequency for which the equalizer coefficient is evaluated	
Note 2: F_{UL_Low} and F_{UL_High} refer to each E-UTRA frequency band specified in Table 5.2-1	

Table 6.5.2B.4.5-2: Test requirements for spectrum flatness (extreme conditions)

$F_{UL_Meas} - F_{UL_Low} \geq 5 \text{ MHz}$ and $F_{UL_High} - F_{UL_Meas} \geq 5 \text{ MHz}$ (Range 1)	5.4 (p-p)
$F_{UL_Meas} - F_{UL_Low} < 5 \text{ MHz}$ or $F_{UL_High} - F_{UL_Meas} < 5 \text{ MHz}$ (Range 2)	13.4 (p-p)
Note 1: F_{UL_Meas} refers to the sub-carrier frequency for which the equalizer coefficient is evaluated	
Note 2: F_{UL_Low} and F_{UL_High} refer to each E-UTRA frequency band specified in Table 5.2-1	

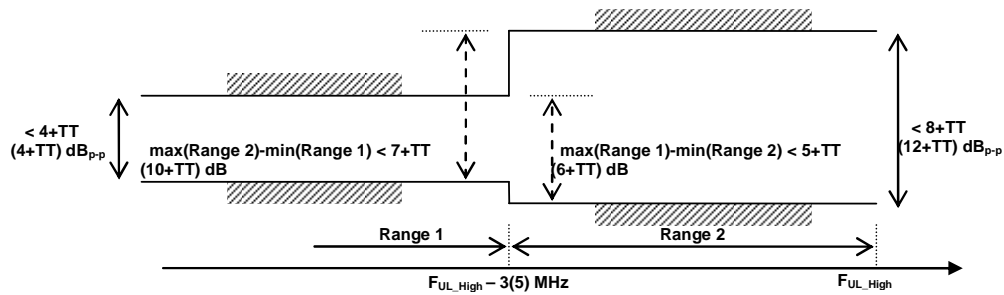

Figure 6.5.2B.4.5-1: The limits for EVM equalizer spectrum flatness with the maximum allowed variation of the coefficients indicated (the ETC minimum requirement within brackets).

6.6 Output RF spectrum emissions

Unwanted emissions are divided into "Out-of-band emission" and "Spurious emissions" in 3GPP RF specifications. This notation is in line with ITU-R recommendations such as SM.329 [2] and the Radio Regulations [3].

ITU defines:

Out-of-band emission = Emission on a frequency or frequencies immediately outside the necessary bandwidth which results from the modulation process, but excluding spurious emissions.

Spurious emission = Emission on a frequency, or frequencies, which are outside the necessary bandwidth and the level of which may be reduced without affecting the corresponding transmission of information. Spurious emissions include harmonic emissions, parasitic emissions, intermodulation products and frequency conversion products but exclude out-of-band emissions.

Unwanted emissions = Consist of spurious emissions and out-of-band emissions.

The UE transmitter spectrum emission consists of the three components; the occupied bandwidth (channel bandwidth), the Out Of Band (OOB) emissions and the far out spurious emission domain.

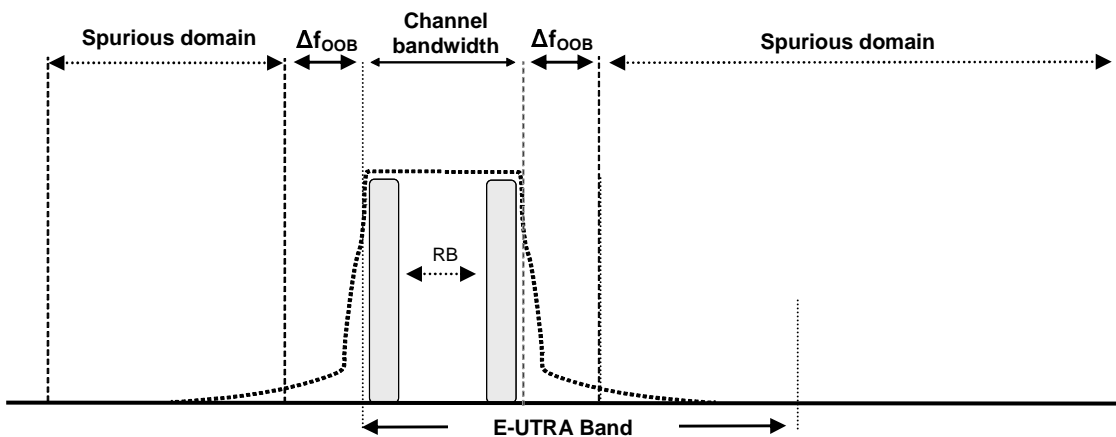

Figure 6.6-1: Transmitter RF spectrum

6.6.1 Occupied bandwidth

6.6.1.1 Test purpose

To verify that the UE occupied bandwidth for all transmission bandwidth configurations supported by the UE are less than their specific limits

6.6.1.2 Test applicability

This test applies to all types of E-UTRA UE release 8 and forward.

6.6.1.2 Minimum conformance requirements

Occupied bandwidth is a measure of the bandwidth containing 99 % of the total integrated mean power of the transmitted spectrum on the assigned channel. The occupied channel bandwidth for all transmission bandwidth configurations (Resources Blocks) should be less than the channel bandwidth specified in Table 6.6.1.2-1

Table 6.6.1.2-1: Occupied channel bandwidth

	Occupied channel bandwidth / channel bandwidth					
	1.4 MHz	3.0 MHz	5 MHz	10 MHz	15 MHz	20 MHz
Channel bandwidth [MHz]	1.4	3	5	10	15	20

The normative reference for this requirement is TS 36.101 [2] clause 6.6.1.

6.6.1.4 Test description

6.6.1.4.1 Initial conditions

Initial conditions are a set of test configurations the UE needs to be tested in and the steps for the SS to take with the UE to reach the correct measurement state.

The initial test configurations consist of environmental conditions, test frequencies, and channel bandwidths based on E-UTRA operating bands specified in table 5.4.2.1-1. All of these configurations shall be tested with applicable test parameters for each channel bandwidth, and are shown in table 6.6. 1.4.1-1. The details of the uplink reference measurement channels (RMCs) are specified in Annexes A.2. Configurations of PDSCH and PDCCH before measurement are specified in Annex C.2.

Table 6.6.1.4.1-1: Test Configuration Table

Initial Conditions				
Test Environment as specified in TS 36.508[7] subclause 4.1	Normal			
Test Frequencies as specified in TS36.508 [7] subclause 4.3.1	Mid range			
Test Channel Bandwidths as specified in TS 36.508 [7] subclause 4.3.1	All			
Test Parameters for Channel Bandwidths				
	Downlink Configuration		Uplink Configuration	
Ch BW	N/A for Occupied bandwidth		Mod'n	RB allocation
				FDD

1.4MHz		QPSK	6	6
3MHz		QPSK	15	15
5MHz		QPSK	25	25
10MHz		QPSK	50	50
15MHz		QPSK	75	75
20MHz		QPSK	100	100
Note 1: Test Channel Bandwidths are checked separately for each E-UTRA band, the applicable channel bandwidths are specified in Table 5.4.2.1-1.				

1. Connect the SS to the UE antenna connectors as shown in TS 36.508 [7] Annex A, Figure A.3.
2. The parameter settings for the cell are set up according to TS 36.508 [7] subclause 4.4.3.
3. Downlink signals are initially set up according to Annex C0, C.1 and C.3.0, and uplink signals according to Annex H.1 and H.3.0.
4. The UL Reference Measurement channels are set according to Table 6.6.1.4.1-1.
5. Propagation conditions are set according to Annex B.0
6. Ensure the UE is in State 3A-RF according to TS 36.508 [7] clause 5.2A.2. Message contents are defined in clause 6.6.1.4.3

6.6.1.4.2 Test procedure

SS sends uplink scheduling information for each UL HARQ process via PDCCH DCI format 0 for C_RNTI to schedule the UL RMC according to Table 6.6.1.4.1-1. Since the UE has no payload and no loopback data to send the UE sends uplink MAC padding bits on the UL RMC.

Send continuously power control "up" commands to the UE until the UE transmits at P_{UMAX} level.

Measure the power spectrum distribution within two times or more range over the requirement for Occupied Bandwidth specification centring on the current carrier frequency. The characteristic of the filter shall be approximately Gaussian (typical spectrum analyzer filter). Other methods to measure the power spectrum distribution are allowed. The measuring duration is one active uplink subframe. For TDD slots with transient periods are not under test.

Calculate the total power within the range of all frequencies measured in '3)' and save this value as "Total Power".

Sum up the power upward from the lower boundary of the measured frequency range in '3)' and seek the limit frequency point by which this sum becomes 0,5 % of "Total Power" and save this point as "Lower Frequency".

Sum up the power downward from the upper boundary of the measured frequency range in '3)' and seek the limit frequency point by which this sum becomes 0,5 % of "Total Power" and save this point as "Upper Frequency".

Calculate the difference ("Upper Frequency" – "Lower Frequency" = "Occupied Bandwidth") between two limit frequencies obtained in '5)' and '6)'.

6.6.1.4.3 Message contents

Message contents are according to TS 36.508 [7] subclause 4.6

6.6.1.5 Test requirement

The measured Occupied Bandwidth shall not exceed values in Table 6.6.1.5-1.

Table 6.6.1.5-1: Occupied channel bandwidth

	Occupied channel bandwidth / channel bandwidth					
	1.4 MHz	3.0 MHz	5 MHz	10 MHz	15 MHz	20 MHz
Channel bandwidth [MHz]	1.4	3	5	10	15	20

6.6.1A Occupied bandwidth for CA

6.6.1A.1 Occupied bandwidth for CA (intra-band contiguous DL CA and UL CA)

6.6.1A.1.1 Test purpose

To verify that the UE occupied bandwidth for intra-band contiguous CA for all transmission bandwidth configurations supported by the UE are less than their specific limits

6.6.1A.1.2 Test applicability

This test case applies to all types of E-UTRA UE release 10 and forward that support intra-band contiguous DL CA and UL CA.

6.6.1A.1.3 Minimum conformance requirements

For intra-band contiguous carrier aggregation, occupied bandwidth is a measure of the bandwidth containing 99 % of the total integrated power of the transmitted spectrum. The OBW shall be less than the aggregated channel bandwidth defined in section 5.4.2A.

The normative reference for this requirement is TS 36.101[2] clause 6.6.1A.

6.6.1A.1.4 Test description

6.6.1A.1.4.1 Initial condition

Initial conditions are a set of test configurations the UE needs to be tested in and the steps for the SS to take with the UE to reach the correct measurement state.

The initial test configurations consist of environmental conditions, test frequencies, and CC combinations based on E-UTRA CA configurations specified in table 5.4.2A.1-1. All of these configurations shall be tested with applicable test parameters for each CA configuration, and are shown in table 6.6.1A.1.4.1-1. The details of the uplink reference measurement channels (RMCs) are specified in Annexes A.2. Configurations of PDSCH and PDCCH before measurement are specified in Annex C.2.

Table 6.6.1A.1.4.1-1: Test Configuration Table

Initial Conditions									
Test Environment as specified in TS 36.508[7] subclause 4.1					NC				
Test Frequencies as specified in TS36.508 [7] subclause 4.3.1 for different CA bandwidth classes.					C: Mid range				
Test CC Combination setting (N_{RB_agg}) as specified in subclause 5.4.2A.1 for the CA Configuration					C: All				
Test Parameters for CA Configurations									
CA Configuration / N_{RB_agg}		DL Allocation		CC MOD	UL Allocation				
PCC N_{RB}	SCCs N_{RB}	PCC & SCC RB allocation			N_{RB_alloc}	PCC & SCC RB allocations (LCRB @ RB_{start})			
75	75	N/A for this test		QPSK	150	P_75@0	S_75@0	-	-
100	50			QPSK	150	P_100@0	S_50@0	-	-
100	75			QPSK	175	P_100@0	S_75@0	-	-
100	100			QPSK	200	P_100@0	S_100@0	-	-
Note 1: CA Configuration Test CC Combination settings are checked separately for each CA Configuration, which applicable aggregated channel bandwidths are specified in Table 5.4.2A.1-1.									

1. Connect the SS to the UE antenna connectors as shown in TS 36.508[7] Annex A Figure group A.32 as appropriate .
2. The parameter settings for the cell are set up according to TS 36.508 [7] subclause 4.4.3.
3. Downlink signals for PCC are initially set up according to Annex C.0, C.1, and C.3.0, and uplink signals according to Annex H.1 and H.3.0.
4. The UL Reference Measurement channel is set according to Table 6.6.1A.1.4.1-1.
5. Propagation conditions are set according to Annex B.0.
6. Ensure the UE is in State 3A-RF according to TS 36.508 [7] clause 5.2A.2. Message contents are defined in clause 6.6.1A.1.4.3.

6.6.1A.1.4.2 Test procedure

1. Configure SCC according to Annex C.0, C.1 and Annex C.3.0 for all downlink physical channels except PHICH.
2. The SS shall configure SCC as per TS 36.508 [7] clause 5.2A.4. Message contents are defined in clause 6.6.1A.1.4.3
3. SS activates SCC by sending the activation MAC-CE (Refer TS 36.321 [13], clauses 5.13, 6.1.3.8). Wait for at least 2 seconds (Refer TS 36.133, clauses 8.3.3.2).
4. SS sends uplink scheduling information for each UL HARQ process via PDCCH DCI format 0 for C_RNTI to schedule the UL RMC according to Table 6.2.2A.4.1-1 on both PCC and SCC. Since the UE has no payload and no loopback data to send the UE sends uplink MAC padding bits on the UL RMC.
5. Send continuously uplink power control "up" commands to the UE until the UE transmits at P_{UMAX} level.
6. Measure the power spectrum distribution over all component carriers within two times or more range over the requirement for Occupied Bandwidth for CA specification centring on the current carrier frequency in CA configuration. The characteristic of the filter shall be approximately Gaussian (typical spectrum analyzer filter).

Other methods to measure the power spectrum distribution are allowed. The measuring duration is one active uplink subframe. For TDD slots with transient periods are not under test.

7. Calculate the total power for the total integrated power of the transmitted spectrum within the range of all frequencies measured in '3)' and save this values as "Total Power".
8. Sum up the power upward from the lower boundary of the measured frequency range in '3)' and seek the limit frequency point by which this sum becomes 0,5 % of "Total Power" and save this point as "Lower Frequency".
9. Sum up the power downward from the upper boundary of the measured frequency range in '3)' and seek the limit frequency point by which this sum becomes 0,5 % of "Total Power" and save this point as "Upper Frequency".
10. Calculate the difference ("Upper Frequency" – "Lower Frequency" = "Occupied Bandwidth") between two limit frequencies obtained in '5)' and '6)'.

6.6.1A.1.4.3 Message contents

Message contents are according to TS 36.508 [7] subclause 4.6. In test procedure step 2, for SCC configuration there are no additional message contents.

6.6.1A.1.5 Test Requirements

The measured Occupied Bandwidth shall not exceed values in Table 5.4.2.A.

6.6.1B Occupied bandwidth for UL-MIMO

6.6.1B.1 Test purpose

To verify that the UE occupied bandwidth for all transmission bandwidth configurations supported by each of transmit antenna of the UE are less than their specific limits.

6.6.1B.2 Test applicability

This test applies to all types of E-UTRA UE release 10 and forward that support UL-MIMO.

6.6.1B.3 Minimum conformance requirements

For UE with multiple transmit antenna connectors, the requirements for occupied bandwidth is specified at each transmit antenna connector. The occupied bandwidth is defined as the bandwidth containing 99 % of the total integrated mean power of the transmitted spectrum on the assigned channel at each transmit antenna connector.

For UE with two transmit antenna connectors in closed-loop spatial multiplexing scheme, the occupied bandwidth at each transmitter antenna shall be less than the channel bandwidth specified in Table 6.6.1B.3-1 with the UL-MIMO configurations specified in Table 6.2.2B.3-2.

Table 6.6.1B.3-1: Occupied channel bandwidth

	Occupied channel bandwidth / Channel bandwidth					
	1.4 MHz	3.0 MHz	5 MHz	10 MHz	15 MHz	20 MHz
Channel bandwidth (MHz)	1.4	3	5	10	15	20

The normative reference for this requirement is TS 36.101 [2] clause 6.6.1B.

6.6.1B.4 Test description

6.6.1B.4.1 Initial conditions

Initial conditions are a set of test configurations the UE needs to be tested in and the steps for the SS to take with the UE to reach the correct measurement state.

The initial test configurations consist of environmental conditions, test frequencies, and channel bandwidths based on E-UTRA operating bands specified in table 5.4.2.1-1. All of these configurations shall be tested with applicable test parameters for each channel bandwidth, and are shown in table 6.6. 1B.4.1-1. The details of the uplink reference measurement channels (RMCs) are specified in Annexes A.2. Configurations of PDSCH and PDCCH before measurement are specified in Annex C.2.

Table 6.6.1B.4.1-1: Test Configuration Table

Initial Conditions				
Test Environment as specified in TS 36.508[7] subclause 4.1	Normal			
Test Frequencies as specified in TS36.508 [7] subclause 4.3.1	Mid range			
Test Channel Bandwidths as specified in TS 36.508 [7] subclause 4.3.1	All			
Test Parameters for Channel Bandwidths				
Ch BW	Downlink Configuration	Uplink Configuration		
	N/A for Occupied bandwidth	Mod'n	RB allocation	
			FDD	TDD
1.4MHz		QPSK	6	6
3MHz		QPSK	15	15
5MHz		QPSK	25	25
10MHz		QPSK	50	50
15MHz		QPSK	75	75
20MHz		QPSK	100	100
Note 1: Test Channel Bandwidths are checked separately for each E-UTRA band, the applicable channel bandwidths are specified in Table 5.4.2.1-1.				

1. Connect the SS to the UE antenna connectors as shown in TS 36.508 [7] Annex A, Figure A.28.
2. The parameter settings for the cell are set up according to TS 36.508 [7] subclause 4.4.3.
3. Downlink signals are initially set up according to Annex C0, C.1 and C.3.0, and uplink signals according to Annex H.1 and H.3.0.
4. The UL Reference Measurement channels are set according to Table 6.6.1B.4.1-1.
5. Propagation conditions are set according to Annex B.0.
6. Ensure the UE is in State 3A-RF according to TS 36.508 [7] clause 5.2A.2. Message contents are defined in clause 6.6.1B.4.3.

6.6.1B.4.2 Test procedure

1. SS sends uplink scheduling information for each UL HARQ process via PDCCH DCI format 4 for C_RNTI to schedule the UL RMC according to Table 6.6.1B.4.1-1. Since the UE has no payload and no loopback data to send the UE sends uplink MAC padding bits on the UL RMC.
2. Send continuously power control "up" commands to the UE until the UE transmits at P_{UMAX} level.
3. Measure the power spectrum distribution within two times or more range over the requirement for Occupied Bandwidth specification centring on the current carrier frequency. The characteristic of the filter shall be approximately Gaussian (typical spectrum analyzer filter). Other methods to measure the power spectrum distribution are allowed. The measuring duration is one active uplink subframe. For TDD slots with transient periods are not under test.

4. Calculate the total power within the range of all frequencies measured in '3)' and save this value as "Total Power".
5. Sum up the power upward from the lower boundary of the measured frequency range in '3)' and seek the limit frequency point by which this sum becomes 0,5 % of "Total Power" and save this point as "Lower Frequency".
6. Sum up the power downward from the upper boundary of the measured frequency range in '3)' and seek the limit frequency point by which this sum becomes 0,5 % of "Total Power" and save this point as "Upper Frequency".
7. Calculate the difference ("Upper Frequency" – "Lower Frequency" = "Occupied Bandwidth") between two limit frequencies obtained in '5)' and '6)'.
8. Repeat step 3) until 7) for each of transmit antenna of the UE.

6.6.1B.4.3 Message contents

Message contents are according to TS 36.508 [7] clause 4.6.6.6.1B.5 Test requirement

The measured Occupied Bandwidth at each transmit antenna of UE shall not exceed values in Table 6.6.1B.5-1.

Table 6.6.1B.5-1: Occupied channel bandwidth

	Occupied channel bandwidth / channel bandwidth					
	1.4 MHz	3.0 MHz	5 MHz	10 MHz	15 MHz	20 MHz
Channel bandwidth [MHz]	1.4	3	5	10	15	20

6.6.2 Out of band emission

Out of band emissions are unwanted emissions immediately outside the nominal channel resulting from the modulation process and non-linearity in the transmitter but excluding spurious emissions. This out of band emission limit is specified in terms of a Spectrum Emission Mask and Adjacent Channel Leakage power Ratio.

6.6.2.1 Spectrum Emission Mask

6.6.2.1.1 Test purpose

To verify that the power of any UE emission shall not exceed specified lever for the specified channel bandwidth.

6.6.2.1.2 Test applicability

This test case applies to all types of E-UTRA UE release 8 and forward.

6.6.2.1.3 Minimum conformance requirements

The spectrum emission mask of the UE applies to frequencies (Δf_{OOB}) starting from the edge of the assigned E-UTRA channel bandwidth. For frequencies greater than (Δf_{OOB}) as specified in Table 6.6.2.1.3-1 the spurious requirements in clause 6.6.3 are applicable.

The power of any UE emission shall not exceed the levels specified in Table 6.6.2.1.3-1 for the specified channel bandwidth.

Table 6.6.2.1.3-1: General E-UTRA spectrum emission mask

Δf_{OoB} (MHz)	Spectrum emission limit (dBm)/ Channel bandwidth						Measurement bandwidth
	1.4 MHz	3.0 MHz	5 MHz	10 MHz	15 MHz	20 MHz	
$\pm 0-1$	-10	-13	-15	-18	-20	-21	30 kHz
$\pm 1-2.5$	-10	-10	-10	-10	-10	-10	1 MHz
$\pm 2.5-2.8$	-25	-10	-10	-10	-10	-10	1 MHz
$\pm 2.8-5$		-10	-10	-10	-10	-10	1 MHz
$\pm 5-6$		-25	-13	-13	-13	-13	1 MHz
$\pm 6-10$			-25	-13	-13	-13	1 MHz
$\pm 10-15$				-25	-13	-13	1 MHz
$\pm 15-20$					-25	-13	1 MHz
$\pm 20-25$						-25	1 MHz

NOTE: As a general rule, the resolution bandwidth of the measuring equipment should be equal to the measurement bandwidth. However, to improve measurement accuracy, sensitivity and efficiency, the resolution bandwidth may be smaller than the measurement bandwidth. When the resolution bandwidth is smaller than the measurement bandwidth, the result should be integrated over the measurement bandwidth in order to obtain the equivalent noise bandwidth of the measurement bandwidth.

The normative reference for this requirement is TS 36.101 [2] clause 6.6.2.1.

6.6.2.1.4 Test description

6.6.2.1.4.1 Initial conditions

Initial conditions are a set of test configurations the UE needs to be tested in and the steps for the SS to take with the UE to reach the correct measurement state.

The initial test configurations consist of environmental conditions, test frequencies, and channel bandwidths based on E-UTRA bands specified in table 5.4.2.1-1. All of these configurations shall be tested with applicable test parameters for each channel bandwidth, and are shown in table 6.6.2.1.4.1-1. The details of the uplink reference measurement channels (RMCs) are specified in Annexes A.2 respectively. Configurations of PDSCH and PDCCH before measurement are specified in Annex C.2.

Table 6.6.2.1.4.1-1: Test Configuration Table

Initial Conditions				
Test Environment (as specified in TS 36.508 [7] subclause 4.1)		NC		
Test Frequencies (as specified in TS36.508 [7] subclause 4.3.1)		Low range, Mid range, High range		
Test Channel Bandwidths (as specified in TS 36.508 [7] subclause 4.3.1)		Lowest, 5MHz, 10MHz, Highest		
Test Parameters for Channel Bandwidths				
Ch BW	Downlink Configuration	Uplink Configuration		
	N/A for SEM testing	Mod'n	RB allocation	
			FDD	TDD
1.4MHz		QPSK	6	6
1.4MHz		QPSK	5	5
1.4MHz		16QAM	5	5
1.4MHz		16QAM	6	6
3MHz		QPSK	15	15
3MHz		QPSK	4	4
3MHz		16QAM	4	4
3MHz		16QAM	15	15
5MHz		QPSK	25	25
5MHz		QPSK	8	8
5MHz		16QAM	8	8
5MHz		16QAM	25	25
10MHz		QPSK	50	50
10MHz		QPSK	12	12
10MHz		16QAM	12	12
10MHz		16QAM	50 (Note 4)	50 (Note 4)
15MHz		QPSK	75	75
15MHz		QPSK	16	16
15MHz		16QAM	16	16
15MHz		16QAM	75 (Note 4)	75 (Note 4)
20MHz		QPSK	100	100
20MHz		QPSK	18	18
20MHz		16QAM	18	18
20MHz		16QAM	100 (Note 4)	100 (Note 4)
Note 1: Test Channel Bandwidths are checked separately for each E-UTRA band, which applicable channel bandwidths are specified in Table 5.4.2.1-1.				
Note 2: The allowed MPR for maximum output power UE might apply is described in clause 6.2.3.3.				
Note 3: The RB _{start} of partial RB allocation shall be RB#0 and RB# (max+1 - RB allocation) of the channel bandwidth.				
Note 4: Applies only for UE-Categories ≥2				

1. Connect the SS to the UE antenna connectors as shown in Figure TS 36.508 [7] Annex A, Figure A.3.
2. The parameter settings for the cell are set up according to TS 36.508 [7] subclause 4.4.3.
3. Downlink signals are initially set up according to Annex C0, C.1 and C.3.0, and uplink signals according to Annex H.1 and H.3.0.
4. The UL Reference Measurement channels are set according to Table 6.6.2.1.4.1-1.
5. Propagation conditions are set according to Annex B.0.
6. Ensure the UE is in State 3A-RF according to TS 36.508 [7] clause 5.2A.2. Message contents are defined in clause 6.6.2.1.4.3.

6.6.2.1.4.2 Test procedure

SS sends uplink scheduling information via PDCCH DCI format 0 for C_RNTI to schedule the UL RMC according to Table 6.6.2.1.4.1-1. Since the UE has no payload data to send, the UE transmits uplink MAC padding bits on the UL RMC.

2. Send continuously uplink power control "up" commands in the uplink scheduling information to the UE until the UE transmits at P_{UMAX} level.
3. Measure the mean power of the UE in the channel bandwidth of the radio access mode according to the test configuration, which shall meet the requirements described in Table 6.2.3.5-1. The period of the measurement shall be at least the continuous duration of one sub-frame (1ms). For TDD slots with transient periods are not under test.
4. Measure the power of the transmitted signal with a measurement filter of bandwidths according to table 6.6.2.1.5-1 or 6.6.2.1.5-2, as applicable. The centre frequency of the filter shall be stepped in continuous steps according to the same table. The measured power shall be recorded for each step. The measurement period shall capture the active TSs.

6.6.2.1.4.3 Message contents

Message contents are according to TS 36.508 [7] subclause 4.6.

6.6.2.1.5 Test requirements

The measured UE mean power in the channel bandwidth, derived in step 3, shall fulfil requirements in Table 6.2.3.5-1 as appropriate, and the power of any UE emission shall fulfil requirements in Table.6.6.2.1.5-1 or Table.6.6.2.1.5-2, as applicable.

Table 6.6.2.1.5-1: General E-UTRA spectrum emission mask, E-UTRA bands ≤ 3GHz

Δf _{oob} (MHz)	Spectrum emission limit (dBm)/ Channel bandwidth						Measurement bandwidth
	1.4 MHz	3.0 MHz	5 MHz	10 MHz	15 MHz	20 MHz	
0-1	-8.5	-11.5	-13.5	-16.5	-18.5	-19.5	30 kHz
1-2.5	-8.5	-8.5	-8.5	-8.5	-8.5	-8.5	1 MHz
2.5-2.8	-23.5						1 MHz
2.8-5							1 MHz
5-6		-23.5	-11.5	-11.5	-11.5	-11.5	1 MHz
6-10			-23.5				1 MHz
10-15				-23.5			1 MHz
15-20					-23.5		1 MHz
20-25						-23.5	1 MHz
Note 1:	The first and last measurement position with a 30 kHz filter is at Δf _{oob} equals to 0.015 MHz and 0.985 MHz.						
Note 2:	At the boundary of spectrum emission limit, the first and last measurement position with a 1 MHz filter is the inside of +0.5MHz and -0.5MHz, respectively.						
Note 3:	The measurements are to be performed above the upper edge of the channel and below the lower edge of the channel						
Note 4:	For the 2.5-2.8 MHz offset range with 1.4 MHz channel bandwidth, the measurement position is at Δf _{oob} equals to 3 MHz.						

Table 6.6.2.1.5-2: General E-UTRA spectrum emission mask, 3GHz < E-UTRA bands ≤ 4.2GHz

	Spectrum emission limit (dBm)/ Channel bandwidth
--	--

Δf_{OoB} (MHz)	1.4 MHz	3.0 MHz	5 MHz	10 MHz	15 MHz	20 MHz	Measurement bandwidth
0-1	-8.2	-11.2	-13.2	-16.2	-18.2	-19.2	30 kHz
1-2.5	-8.2	-8.2	-8.2	-8.2	-8.2	-8.2	1 MHz
2.5-2.8	-23.2						1 MHz
2.8-5							1 MHz
5-6		-23.2	-11.2	-11.2	-11.2	-11.2	1 MHz
6-10			-23.2				1 MHz
10-15				-23.2			1 MHz
15-20					-23.2		1 MHz
20-25						-23.2	1 MHz
Note 1:	The first and last measurement position with a 30 kHz filter is at Δf_{OoB} equals to 0.015 MHz and 0.985 MHz.						
Note 2:	At the boundary of spectrum emission limit, the first and last measurement position with a 1 MHz filter is the inside of +0.5MHz and -0.5MHz, respectively.						
Note 3:	The measurements are to be performed above the upper edge of the channel and below the lower edge of the channel						
Note 4:	For the 2.5-2.8 MHz offset range with 1.4 MHz channel bandwidth, the measurement position is at Δf_{OoB} equals to 3 MHz.						

NOTE: As a general rule, the resolution bandwidth of the measuring equipment should be equal to the measurement bandwidth. However, to improve measurement accuracy, sensitivity and efficiency, the resolution bandwidth may be smaller than the measurement bandwidth. When the resolution bandwidth is smaller than the measurement bandwidth, the result should be integrated over the measurement bandwidth in order to obtain the equivalent noise bandwidth of the measurement bandwidth.

6.6.2.1A Spectrum emission mask for CA

6.6.2.1A.1 Spectrum emission mask for CA (intra-band contiguous DL CA and UL CA)

6.6.2.1A.1.1 Test purpose

To verify that the power of any UE emission shall not exceed specified level for the specified channel bandwidth for CA.

6.6.2.1A.1.2 Test applicability

This test case applies to all types of E-UTRA UE release 10 and forward that support intra-band contiguous DL CA and UL CA.

6.6.2.1A.1.3 Minimum conformance requirements

For inter-band carrier aggregation with uplink assigned to one E-UTRA band, the power of any UE emission shall not exceed the levels specified in Table 6.6.2.1.3-1.

For intra-band contiguous carrier aggregation the spectrum emission mask of the UE applies to frequencies (Δf_{OoB}) starting from the \pm edge of the aggregated channel bandwidth (Table 5.4.2A-1) For intra-band contiguous carrier aggregation the bandwidth class C, the power of any UE emission shall not exceed the levels specified in Table 6.6.2.1A.1.3-1 for the specified channel bandwidth.

Table 6.6.2.1A.1.3-1: General E-UTRA CA spectrum emission mask for Bandwidth Class C

Spectrum emission limit [dBm]/BWChannel_CA					
Δf_{OoB} (MHz)	50RB+100RB (29.9 MHz)	75RB+75RB (30 MHz)	75RB+100RB (34.85 MHz)	100RB+100RB (39.8 MHz)	Measurement bandwidth
± 0 -1	-22.5	-22.5	-23.5	-24	30 kHz
± 1 -5	-10	-10	-10	-10	1 MHz
± 5 -29.9	-13	-13	-13	-13	1 MHz
± 29.9 -30	-25	-13	-13	-13	1 MHz
± 30 -34.85	-25	-25	-13	-13	1 MHz
± 34.85 -34.9	-25	-25	-25	-13	1 MHz
± 34.9 -35		-25	-25	-13	1 MHz
± 35 -39.8			-25	-13	1 MHz
± 39.8 -39.85			-25	-25	1 MHz
± 39.85 -44.8				-25	1 MHz

The normative reference for this requirement is TS 36.101 subclause 6.6.2.1A.

6.6.2.1A.1.4 Test description

6.6.2.1A.1.4.1 Initial condition

Initial conditions are a set of test configurations the UE needs to be tested in and the steps for the SS to take with the UE to reach the correct measurement state.

The initial test configurations consist of environmental conditions, test frequencies, and channel bandwidths based on E-UTRA CA configurations specified in table 5.4.2A.1-1. All of these configurations shall be tested with applicable test parameters for each channel bandwidth, and are shown in table 6.6.2.1A.1.4.1-1. The details of the uplink reference measurement channels (RMCs) are specified in Annex A.2. Configurations of PDSCH and PDCCH before measurement are specified in Annex C.2.

Table 6.6.2.1A.1.4.1-1: Test Configuration Table

Initial Conditions								
Test Environment as specified in TS 36.508 [7] clause 4.1				NC, TL/VL, TL/VH, TH/VL, TH/VH				
Test Frequencies as specified in TS 36.508 [7] clause 4.3.1 for different CA bandwidth classes.				C: Low range, High range				
Test CC Combination setting (N_{RB_agg}) as specified in clause 5.4.2A.1 for the CA Configuration				Lowest N_{RB_agg} , Highest N_{RB_agg}				
Test Parameters for CA Configurations								
CA Configuration / N_{RB_agg}		DL Allocation	CC MOD	UL Allocation				
PCC N_{RB}	SCCs N_{RB}	PCC & SCC RB allocation		N_{RB_alloc}	PCC & SCC RB allocations(L_{CRB} @ RB_{start})			
75	75	N/A for this test	QPSK	75	P_75@0	S_0@0	-	-
75	75		QPSK	16	P_16@0	S_0@0	-	-
75	75		QPSK	130	P_75@0	S_55@0	-	-
75	75		QPSK	150	P_75@0	S_75@0	-	-
75	75		16QAM	75	P_75@0	S_0@0	-	-
75	75		16QAM	16	P_16@0	S_0@0	-	-
75	75		16QAM	130	P_75@0	S_55@0	-	-
75	75		16QAM	150	P_75@0	S_75@0	-	-
75	75		QPSK	2	P_1@0	S_1@74	-	-
75	75		QPSK	15	P_5@0	P_5@35	S_5@0	-
75	75		QPSK	75	P_25@0	P_20@35	S_15@0	S_15@34
100	50		QPSK	100	P_100@0	S_0@0	-	-
100	50		QPSK	12	P_12@0	S_0@0	-	-
100	50		QPSK	150	P_100@0	S_50@0	-	-
100	50		16QAM	100	P_100@0	S_0@0	-	-
100	50		16QAM	12	P_12@0	S_0@0	-	-
100	50		16QAM	150	P_100@0	S_50@0	-	-
100	50		QPSK	2	P_1@0	S_1@49	-	-
100	50		QPSK	15	P_5@0	P_5@50	S_5@0	-
100	50		QPSK	75	P_25@0	P_20@34	S_15@0	S_15@34
100	100		QPSK	100	P_100@0	S_0@0	-	-
100	100		QPSK	18	P_18@0	S_0@0	-	-
100	100		QPSK	130	P_100@0	S_30@0	-	-
100	100		QPSK	200	P_100@0	S_100@0	-	-
100	100		16QAM	100	P_100@0	S_0@0	-	-
100	100		16QAM	18	P_18@0	S_0@0	-	-
100	100		16QAM	130	P_100@0	S_30@0	-	-
100	100		16QAM	200	P_100@0	S_100@0	-	-
100	100		QPSK	2	P_1@0	S_1@99	-	-
100	100		QPSK	20	P_5@0	P_5@50	S_5@0	S_5@50
100	100	QPSK	100	P_25@0	P_25@50	S_25@0	S_25@50	

Note 1: CA Configuration Test CC Combination settings are checked separately for each CA Configuration, which applicable aggregated channel bandwidths are specified in Table 5.4.2A.1-1.

1. Connect the SS to the UE antenna connectors as shown in Figure TS 36.508 [7] Annex A, Figure group A.32 as appropriate.
2. The parameter settings for the cell are set up according to TS 36.508 [7] clause 4.4.3.
3. Downlink signals for PCC are initially set up according to Annex C0, C.1 and C.3.0, and uplink signals according to Annex H.1 and H.3.0.
4. The UL Reference Measurement channels are set according to Table 6.6.2.1A.1.4.1-1.
5. Propagation conditions are set according to Annex B.0.
6. Ensure the UE is in State 3A-RF according to TS 36.508 [7] clause 5.2A.2. Message contents are defined in clause 6.6.2.1A.1.4.3.

6.6.2.1A.1.4.2 Test procedure

1. Configure SCC according to Annex C.0, C.1 and Annex C.3.0 for all downlink physical channels except PHICH.
2. The SS shall configure SCC as per TS 36.508 [7] clause 5.2A.4. Message contents are defined in clause 6.6.2.1A.1.4.3.
3. SS activates SCC by sending the activation MAC-CE (Refer TS 36.321 [13], clauses 5.13, 6.1.3.8). Wait for at least 2 seconds (Refer TS 36.133, clauses 8.3.3.2).
4. SS sends uplink scheduling information via PDCCH DCI format 0 for C_RNTI to schedule the UL RMC according to Table 6.6.2.1.4.1-1 on both PCC and SCC. Since the UE has no payload data to send, the UE transmits uplink MAC padding bits on the UL RMC.
5. Send continuously uplink power control "up" commands in the uplink scheduling information to the UE until the UE transmits at P_{UMAX} level.
6. Measure the mean power over all component carriers in the CA configuration of the radio access mode, which shall meet the requirements described in Table 6.2.3A.1.5-1. The period of the measurement shall be at least the continuous duration of one sub-frame (1 ms). For TDD slots with transient periods are not under test.
7. Measure the power of the transmitted signal with a measurement filter of bandwidths according to table 6.6.2.1A.1.5-1 or 6.6.2.1A.1.5-2, as applicable. The centre frequency of the filter shall be stepped in continuous steps according to the same table. The measured power shall be recorded for each step. The measurement period shall capture the active TSs.

6.6.2.1A.1.4.3 Message contents

Message contents are according to TS 36.508 [7] clause 4.6 . In test procedure step 2, for SCC configuration there are no additional message contents.

6.6.2.1A.1.5 Test Requirements

The measured UE mean power with the aggregated channel bandwidth as specified in clause 5.4.2A, derived in step [FFS], shall fulfil requirements in Table 6.2.3A.1.5-1 as appropriate,

and

the power of any UE emission shall fulfil requirements in Table.6.6.2.1A.1.5-1 or Table.6.6.2.1A.1.5-2, as applicable.

Table 6.6.2.1A.1.5-1: General E-UTRA spectrum emission mask for CA, E UTRA bands \leq 3GHz

Spectrum emission limit [dBm]/ $BW_{Channel_CA}$					
Δf_{OOB} (MHz)	50RB+100RB (29.9 MHz)	75RB+75RB (30 MHz)	75RB+100RB (34.85 MHz)	100RB+100RB (39.8 MHz)	Measurement bandwidth
$\pm 0-1$	-21	-21	-22	-22.5	30 kHz
$\pm 1-5$	-8.5	-8.5	-8.5	-8.5	1 MHz
$\pm 5-29.9$	-11.5	-11.5	-11.5	-11.5	1 MHz
$\pm 29.9-30$	-23.5	-23.5	-23.5	-23.5	1 MHz
$\pm 30-34.85$					1 MHz
$\pm 34.85-34.9$					1 MHz
$\pm 34.9-35$					1 MHz
$\pm 35-39.8$					1 MHz
$\pm 39.8-39.85$				-23.5	1 MHz
$\pm 39.85-44.8$					1 MHz

Table 6.6.2.1A.1.5-2: General E-UTRA spectrum emission mask for CA, 3GHz < E UTRA bands ≤ 4.2GHz

Spectrum emission limit [dBm]/BW _{Channel_CA}					
Δf_{OOB} (MHz)	50RB+100RB (29.9 MHz)	75RB+75RB (30 MHz)	75RB+100RB (34.85 MHz)	100RB+100RB (39.8 MHz)	Measurement bandwidth
± 0-1	-20.7	-20.7	-21.7	-22.2	30 kHz
± 1-5	-8.2	-8.2	-8.2	-8.2	1 MHz
± 5-29.9	-11.2	-11.2	-11.2	-11.2	1 MHz
± 29.9-30	-23.2	-23.2	-23.2	-23.2	1 MHz
± 30-34.85					1 MHz
± 34.85-34.9					1 MHz
± 34.9-35					1 MHz
± 35-39.8					1 MHz
±39.8-39.85				-23.2	1 MHz
± 39.85-44.8					1 MHz

NOTE: As a general rule, the resolution bandwidth of the measuring equipment should be equal to the measurement bandwidth. However, to improve measurement accuracy, sensitivity and efficiency, the resolution bandwidth may be smaller than the measurement bandwidth. When the resolution bandwidth is smaller than the measurement bandwidth, the result should be integrated over the measurement bandwidth in order to obtain the equivalent noise bandwidth of the measurement bandwidth.

6.6.2.1B Spectrum Emission Mask for UL-MIMO

6.6.2.1B.1 Test purpose

To verify that the power of any UE emission at each transmit antenna shall not exceed specified level for the specified channel bandwidth.

6.6.2.1B.2 Test applicability

This test case applies to all types of E-UTRA UE release 10 and forward that support UL-MIMO.

6.6.2.1B.3 Minimum conformance requirements

For UE with multiple transmit antenna connectors, the requirements for the spectrum emission mask are specified at each transmit antenna connector. The spectrum emission mask of the UE applies to frequencies (Δf_{OOB}) starting from the edge of the assigned E-UTRA channel bandwidth. For frequencies greater than (Δf_{OOB}) as specified in Table 6.6.2.1B.3-1.

For UEs with two transmit antenna connectors in closed-loop spatial multiplexing scheme, the requirements in Table 6.6.2.1B.3-1 apply to each transmit antenna connector with the UL-MIMO configurations specified in Table 6.2.2B.3-2.

Table 6.6.2.1B.3-1: General E-UTRA spectrum emission mask

Spectrum emission limit (dBm)/ Channel bandwidth							
Δf_{OOB} (MHz)	1.4 MHz	3.0 MHz	5 MHz	10 MHz	15 MHz	20 MHz	Measurement bandwidth
± 0-1	-10	-13	-15	-18	-20	-21	30 kHz
± 1-2.5	-10	-10	-10	-10	-10	-10	1 MHz
± 2.5-2.8	-25	-10	-10	-10	-10	-10	1 MHz
± 2.8-5		-10	-10	-10	-10	-10	1 MHz
± 5-6		-25	-13	-13	-13	-13	1 MHz
± 6-10			-25	-13	-13	-13	1 MHz
± 10-15				-25	-13	-13	1 MHz
± 15-20					-25	-13	1 MHz
± 20-25						-25	1 MHz

NOTE: As a general rule, the resolution bandwidth of the measuring equipment should be equal to the measurement bandwidth. However, to improve measurement accuracy, sensitivity and efficiency, the resolution bandwidth may be smaller than the measurement bandwidth. When the resolution bandwidth is smaller than the measurement bandwidth, the result should be integrated over the measurement bandwidth in order to obtain the equivalent noise bandwidth of the measurement bandwidth.

The normative reference for this requirement is TS 36.101 clause 6.6.2B.

6.6.2.1B.4 Test description

6.6.2.1B.4.1 Initial conditions

Initial conditions are a set of test configurations the UE needs to be tested in and the steps for the SS to take with the UE to reach the correct measurement state.

The initial test configurations consist of environmental conditions, test frequencies, and channel bandwidths based on E-UTRA bands specified in table 5.4.2.1-1. All of these configurations shall be tested with applicable test parameters for each channel bandwidth, and are shown in table 6.6.2.1B.4.1-1. The details of the uplink reference measurement channels (RMCs) are specified in Annexes A.2 respectively. Configurations of PDSCH and PDCCH before measurement are specified in Annex C.2.

Table 6.6.2.1B.4.1-1: Test Configuration Table

Initial Conditions				
Test Environment (as specified in TS 36.508 [7] clause 4.1)		NC		
Test Frequencies (as specified in TS 36.508 [7] clause 4.3.1)		Low range, Mid range, High range		
Test Channel Bandwidths (as specified in TS 36.508 [7] clause 4.3.1)		Lowest, 5MHz, 10MHz, Highest		
Test Parameters for Channel Bandwidths				
Downlink Configuration		Uplink Configuration		
Ch BW	N/A for SEM testing	Mod'n	RB allocation	
		FDD	TDD	
1.4MHz		QPSK	6	6
1.4MHz		QPSK	5	5
1.4MHz		16QAM	5	5
1.4MHz		16QAM	6	6
3MHz		QPSK	15	15
3MHz		QPSK	4	4
3MHz		16QAM	4	4
3MHz		16QAM	15	15
5MHz		QPSK	25	25
5MHz		QPSK	8	8
5MHz		16QAM	8	8
5MHz		16QAM	25	25
10MHz		QPSK	50	50
10MHz		QPSK	12	12
10MHz		16QAM	12	12
10MHz		16QAM	50 (Note 4)	50 (Note 4)
15MHz		QPSK	75	75
15MHz		QPSK	16	16
15MHz	16QAM	16	16	
15MHz	16QAM	75 (Note 4)	75 (Note 4)	
20MHz	QPSK	100	100	
20MHz	QPSK	18	18	
20MHz	16QAM	18	18	
20MHz	16QAM	100 (Note 4)	100 (Note 4)	
Note 1: Test Channel Bandwidths are checked separately for each E-UTRA band, which applicable channel bandwidths are specified in Table 5.4.2.1-1. Note 2: The allowed MPR for maximum output power UE might apply is described in clause 6.2.3B.3. Note 3: The RB _{start} of partial RB allocation shall be RB#0 and RB# (max+1 - RB allocation) of the channel bandwidth. Note 4: Applies only for UE-Categories [FFS].				

1. Connect the SS to the UE antenna connectors as shown in Figure TS 36.508 [7] Annex A, Figure A.28.
2. The parameter settings for the cell are set up according to TS 36.508 [7] clause 4.4.3.
3. Downlink signals are initially set up according to Annex C0, C.1 and C.3.0, and uplink signals according to Annex H.1 and H.3.0.
4. The UL Reference Measurement channels are set according to Table 6.6.2.1B.4.1-1.
5. Propagation conditions are set according to Annex B.0.
6. Ensure the UE is in State 3A-RF according to TS 36.508 [7] clause 5.2A.2. Message contents are defined in clause 6.6.2.1B.4.3.

6.6.2.1B.4.2 Test procedure

1. SS sends uplink scheduling information via PDCCH DCI format 4 for C_RNTI to schedule the UL RMC according to Table 6.6.2.1B.4.1-1. Since the UE has no payload data to send, the UE transmits uplink MAC padding bits on the UL RMC.
2. Send continuously uplink power control "up" commands in the uplink scheduling information to the UE until the UE transmits at PUMAX level.
3. Measure the sum of the mean power at each antenna connector of UE in the channel bandwidth of the radio access mode according to the test configuration, which shall meet the requirements described in clause 6.2.3B.5. The period of the measurement shall be at least the continuous duration of one sub-frame (1ms). For TDD slots with transient periods are not under test.
4. Measure the power of the transmitted signal at each antenna connector of UE with a measurement filter of bandwidths according to table 6.6.2.1B.5-1 or 6.6.2.1B.5-2 as applicable. The centre frequency of the filter shall be stepped in continuous steps according to the same table. The measured power shall be recorded for each step. The measurement period shall capture the active TSs.

6.6.2.1B.4.3 Message contents

Message contents are according to TS 36.508 [7] subclause 4.6.

6.6.2.1B.5 Test requirements

The measured sum of mean power at each antenna connector of UE in the channel bandwidth, derived in step 3, shall fulfil requirements in clause 6.2.3B.5 as appropriate,

And the power of any UE emission at each transmit antenna connector shall fulfil requirements in Table.6.6.2.1B.5-1 or Table.6.6.2.1B.5-2 as applicable.

Table 6.6.2.1B.5-1: General E-UTRA spectrum emission mask, E UTRA bands \leq 3GHz

Spectrum emission limit (dBm)/ Channel bandwidth							
Δf_{OoB} (MHz)	1.4 MHz	3.0 MHz	5 MHz	10 MHz	15 MHz	20 MHz	Measurement bandwidth
0-1	-8.5	-11.5	-13.5	-16.5	-18.5	-19.5	30 kHz
1-2.5	-8.5	-8.5	-8.5	-8.5	-8.5	-8.5	1 MHz
2.5-2.8	-23.5						1 MHz
2.8-5							1 MHz
5-6		-23.5	-11.5	-11.5	-11.5	-11.5	1 MHz
6-10							-23.5
10-15				-23.5			1 MHz
15-20					-23.5		1 MHz
20-25						-23.5	1 MHz
Note 1:	The first and last measurement position with a 30 kHz filter is at Δf_{OoB} equals to 0.015 MHz and 0.985 MHz.						
Note 2:	At the boundary of spectrum emission limit, the first and last measurement position with a 1 MHz filter is the inside of +0.5MHz and -0.5MHz, respectively.						
Note 3:	The measurements are to be performed above the upper edge of the channel and below the lower edge of the channel						
Note 4:	For the 2.5-2.8 MHz offset range with 1.4 MHz channel bandwidth, the measurement position is at Δf_{OoB} equals to 3 MHz.						

Table 6.6.2.1B.5-2: General E-UTRA spectrum emission mask, 3GHz < E UTRA bands ≤ 4.2GHz

Spectrum emission limit (dBm)/ Channel bandwidth							
Δf_{OOB} (MHz)	1.4 MHz	3.0 MHz	5 MHz	10 MHz	15 MHz	20 MHz	Measurement bandwidth
0-1	-8.2	-11.2	-13.2	-16.2	-18.2	-19.2	30 kHz
1-2.5	-8.2	-8.2	-8.2	-8.2	-8.2	-8.2	1 MHz
2.5-2.8	-23.2						1 MHz
2.8-5							1 MHz
5-6		-23.2	-11.2	-11.2	-11.2	-11.2	1 MHz
6-10			-23.2				1 MHz
10-15				-23.2			1 MHz
15-20					-23.2		1 MHz
20-25						-23.2	1 MHz
Note 1:	The first and last measurement position with a 30 kHz filter is at Δf_{OOB} equals to 0.015 MHz and 0.985 MHz.						
Note 2:	At the boundary of spectrum emission limit, the first and last measurement position with a 1 MHz filter is the inside of +0.5MHz and -0.5MHz, respectively.						
Note 3:	The measurements are to be performed above the upper edge of the channel and below the lower edge of the channel						
Note 4:	For the 2.5-2.8 MHz offset range with 1.4 MHz channel bandwidth, the measurement position is at Δf_{OOB} equals to 3 MHz.						

NOTE: As a general rule, the resolution bandwidth of the measuring equipment should be equal to the measurement bandwidth. However, to improve measurement accuracy, sensitivity and efficiency, the resolution bandwidth may be smaller than the measurement bandwidth. When the resolution bandwidth is smaller than the measurement bandwidth, the result should be integrated over the measurement bandwidth in order to obtain the equivalent noise bandwidth of the measurement bandwidth.

6.6.2.2 Additional Spectrum Emission Mask

6.6.2.2.1 Test purpose

To verify that the power of any UE emission shall not exceed specified level for the specified channel bandwidth under the deployment scenarios where additional requirements are specified.

6.6.2.2.2 Test applicability

This test case applies to all types of E-UTRA UE release 8 and forward.

6.6.2.2.3 Minimum conformance requirements

6.6.2.2.3.1 Minimum requirement (network signalled value "NS_03", "NS_11", and "NS_20")

When "NS_03", "NS_11" or "NS_20" is indicated in the cell, the power of any UE emission shall not exceed the levels specified in Table 6.6.2.2.3.1-1.

Table 6.6.2.2.3.1-1: Additional requirements (network signalled value "NS_03", "NS_11", and "NS_20")

	Spectrum emission limit (dBm)/ Channel bandwidth
--	--

Δf_{OoB} (MHz)	1.4 MHz	3.0 MHz	5 MHz	10 MHz	15 MHz	20 MHz	Measurement bandwidth
$\pm 0-1$	-10	-13	-15	-18	-20	-21	30 kHz
$\pm 1-2.5$	-13	-13	-13	-13	-13	-13	1 MHz
$\pm 2.5-2.8$	-25	-13	-13	-13	-13	-13	1 MHz
$\pm 2.8-5$		-13	-13	-13	-13	-13	1 MHz
$\pm 5-6$		-25	-13	-13	-13	-13	1 MHz
$\pm 6-10$			-25	-13	-13	-13	1 MHz
$\pm 10-15$				-25	-13	-13	1 MHz
$\pm 15-20$					-25	-13	1 MHz
$\pm 20-25$						-25	1 MHz

NOTE: As a general rule, the resolution bandwidth of the measuring equipment should be equal to the measurement bandwidth. However, to improve measurement accuracy, sensitivity and efficiency, the resolution bandwidth may be smaller than the measurement bandwidth. When the resolution bandwidth is smaller than the measurement bandwidth, the result should be integrated over the measurement bandwidth in order to obtain the equivalent noise bandwidth of the measurement bandwidth.

The normative reference for this requirement is TS 36.101 [2] clause 6.6.2.2.1.

6.6.2.2.3.2 Minimum requirement (network signalled value "NS_04")

When "NS_04" is indicated in the cell, the power of any UE emission shall not exceed the levels specified in Table 6.6.2.2.3.2-1.

Table 6.6.2.2.3.2-1: Additional requirements (network signalled value "NS_04")

Δf_{OoB} (MHz)	Spectrum emission limit (dBm)/ Channel bandwidth						
	1.4 MHz	3.0 MHz	5 MHz	10 MHz	15 MHz	20 MHz	Measurement bandwidth
$\pm 0-1$	-10	-13	-15	-18	-20	-21	30 kHz
$\pm 1-2.5$	-13	-13	-13	-13	-13	-13	1 MHz
$\pm 2.5-2.8$	-25	-13	-13	-13	-13	-13	1 MHz
$\pm 2.8-5$		-13	-13	-13	-13	-13	1 MHz
$\pm 5-6$		-25	-25	-25	-25	-25	1 MHz
$\pm 6-10$			-25	-25	-25	-25	1 MHz
$\pm 10-15$				-25	-25	-25	1 MHz
$\pm 15-20$					-25	-25	1 MHz
$\pm 20-25$						-25	1 MHz

NOTE: As a general rule, the resolution bandwidth of the measuring equipment should be equal to the measurement bandwidth. However, to improve measurement accuracy, sensitivity and efficiency, the resolution bandwidth may be smaller than the measurement bandwidth. When the resolution bandwidth is smaller than the measurement bandwidth, the result should be integrated over the measurement bandwidth in order to obtain the equivalent noise bandwidth of the measurement bandwidth.

The normative reference for this requirement is TS 36.101 [2] clause 6.6.2.2.2.

6.6.2.2.3.3 Minimum requirement (network signalled value "NS_06" or NS_07)

When "NS_06" or "NS_07" is indicated in the cell, the power of any UE emission shall not exceed the levels specified in Table 6.6.2.2.3.3-1.

Table 6.6.2.2.3.3-1: Additional requirements (network signalled value "NS_06" or "NS_07")

Δf_{OoB} (MHz)	Spectrum emission limit (dBm)/ Channel bandwidth				
	1.4 MHz	3.0 MHz	5 MHz	10 MHz	Measurement bandwidth
$\pm 0-0.1$	-13	-13	-15	-18	30 kHz
$\pm 0.1-1$	-13	-13	-13	-13	100 kHz
$\pm 1-2.5$	-13	-13	-13	-13	1 MHz
$\pm 2.5-2.8$	-25	-13	-13	-13	1 MHz
$\pm 2.8-5$		-13	-13	-13	1 MHz
$\pm 5-6$		-25	-13	-13	1 MHz
$\pm 6-10$			-25	-13	1 MHz
$\pm 10-15$				-25	1 MHz

NOTE: As a general rule, the resolution bandwidth of the measuring equipment should be equal to the measurement bandwidth. However, to improve measurement accuracy, sensitivity and efficiency, the resolution bandwidth may be smaller than the measurement bandwidth. When the resolution bandwidth is smaller than the measurement bandwidth, the result should be integrated over the measurement bandwidth in order to obtain the equivalent noise bandwidth of the measurement bandwidth.

The normative reference for this requirement is TS 36.101 [2] clause 6.6.2.2.3.

6.6.2.2.4 Test description

6.6.2.2.4.1 Initial conditions

Initial conditions are a set of test configurations the UE needs to be tested in and the steps for the SS to take with the UE to reach the correct measurement state.

The initial test configurations consist of environmental conditions, test frequencies, and channel bandwidths based on E-UTRA bands specified in table 5.4.2.1-1. All of these configurations shall be tested with applicable test parameters for each channel bandwidth, and are shown in Tables 6.6.2.2.4.1-1, 6.6.2.2.4.1-2, and 6.6.2.2.4.1-3. The details of the uplink reference measurement channels (RMCs) are specified in Annex A.2 respectively. Configurations of PDSCH and PDCCH before measurement are specified in Annex C.2.

Table 6.6.2.2.4.1-1: Test Configuration Table (network signalled value "NS_03")

Initial Conditions						
Test Environment (as specified in TS 36.508 [7] subclause 4.1)				NC		
Test Frequencies (as specified in TS36.508 [7] subclause 4.3.1)				Low range, Mid range, High range		
Test Channel Bandwidths (as specified in TS 36.508 [7] subclause 4.3.1)				Lowest, 5MHz, 10MHz, Highest		
Test Parameters for Channel Bandwidths						
Ch BW	Downlink Configuration			Uplink Configuration		
	Mod'n	RB allocation		Mod'n	RB allocation	
		FDD	TDD		FDD	TDD
1.4MHz	N/A for Additional Spectrum Emission Mask testing.			QPSK	6	6
1.4MHz				QPSK	5	5
1.4MHz				16QAM	5	5
3MHz				QPSK	15	15
3MHz				QPSK	4	4
3MHz				16QAM	15	15
3MHz				16QAM	4	4
5MHz				QPSK	25	25
5MHz				QPSK	8	8
5MHz				QPSK	6	6
5MHz				16QAM	25	25
5MHz				16QAM	8	8
10MHz				QPSK	50	50
10MHz				QPSK	12	12
10MHz				QPSK	6	6
10MHz				16QAM	50 (Note 3)	50 (Note 3)
10MHz				16QAM	12	12
15MHz				QPSK	75	75
15MHz				QPSK	16	16
15MHz				QPSK	8	8
15MHz			16QAM	75 (Note 3)	75 (Note 3)	
15MHz			16QAM	16	16	
20MHz			QPSK	100	100	
20MHz			QPSK	18	18	
20MHz			QPSK	10	10	
20MHz			16QAM	100 (Note 3)	100 (Note 3)	
20MHz			16QAM	18	18	
Note 1: Test Channel Bandwidths are checked separately for each E-UTRA band, the applicable channel bandwidths are specified in Table 5.4.2.1-1. Note 2: The RB _{start} of partial RB allocation shall be RB# 0 and RB# (max +1 - RB allocation) of the channel bandwidth. Note 3: Applies only for UE-Categories ≥2						

Table 6.6.2.2.4.1-2: Test Configuration Table (network signalled value "NS_06")

Initial Conditions						
Test Environment (as specified in TS 36.508 [7] subclause 4.1)				NC		
Test Frequencies (as specified in TS36.508 [7] subclause 4.3.1)				Low range, Mid range, High range		
Test Channel Bandwidths (as specified in TS 36.508 [7] subclause 4.3.1)				Lowest, 5MHz, 10MHz, Highest		
Test Parameters for Channel Bandwidths						
Ch BW	Downlink Configuration			Uplink Configuration		
	Mod'n	RB allocation		Mod'n	RB allocation	
		FDD	TDD		FDD	TDD
1.4MHz	N/A for Additional Spectrum Emission Mask testing.			QPSK	6	NA
1.4MHz				QPSK	5	
1.4MHz				16QAM	5	
3MHz				QPSK	15	
3MHz				QPSK	4	
3MHz				16QAM	4	
5MHz				QPSK	25	
5MHz				QPSK	8	
5MHz				16QAM	8	
10MHz				QPSK	50	
10MHz				QPSK	12	
10MHz				16QAM	12	
15MHz				QPSK	75	
15MHz				QPSK	16	
15MHz				16QAM	16	
20MHz				QPSK	100	
20MHz				QPSK	18	
20MHz			16QAM	18		
<p>Note 1: Test Channel Bandwidths are checked separately for each E-UTRA band, the applicable channel bandwidths are specified in Table 5.4.2.1-1.</p> <p>Note 2: The RB_{start} of partial RB allocation shall be RB# 0 and RB# (max +1 – RB allocation) of the channel bandwidth.</p>						

Table 6.6.2.2.4.1-3: Test Configuration Table (network signalled value "NS_07")

Initial Conditions						
Test Environment (as specified in TS 36.508 [7] subclause 4.1)				NC		
Test Frequencies (as specified in TS36.508 [7] subclause 4.3.1)				Mid range		
Test Channel Bandwidths (as specified in TS 36.508 [7] subclause 4.3.1)				10MHz		
Test Parameters for Channel Bandwidths						
Test Number	Ch BW	Downlink Configuration		Uplink Configuration		
		Mod'n	RB allocation FDD	Mod'n	RB allocation FDD	RB _{start}
1	10MHz	N/A for Additional Spectrum Emission Mask testing.		QPSK	1	0
2	10MHz			QPSK	8	0
3	10MHz			QPSK	6	13
4	10MHz			QPSK	20	13
5	10MHz			QPSK	12	13
6	10MHz			16QAM	36 (Note 1)	13
7	10MHz			QPSK	16	19
8	10MHz			QPSK	12	19
9	10MHz			16QAM	16	19
10	10MHz			QPSK	30	19
11	10MHz			16QAM	30 (Note 1)	19
12	10MHz			QPSK	6	43
13	10MHz			QPSK	2	48
14	10MHz			QPSK	50	0
15	10MHz			QPSK	12	0
16	10MHz			16QAM	50 (Note 1)	0
Note 1: Applies only for UE-Categories 2-5						

Table 6.6.2.2.4.1-4: Test Configuration Table (network signalled value "NS_04")

Initial Conditions			
Test Environment (as specified in TS 36.508 [7] subclause 4.1)		NC	
Test Frequencies (as specified in TS36.508 [7] subclause 4.3.1)		Low range, Mid range, High range	
Test Channel Bandwidths (as specified in TS 36.508 [7] subclause 4.3.1)		5MHz, 10 MHz, 15 MHz, 20MHz	
Test Parameters for NS_04 A-MPR			
		Downlink Configuration	Uplink Configuration

Configuration ID	Ch BW	Mod'n	RB allocation TDD	Mod'n	RB allocation TDD	RB _{start} TDD
1	5MHz	N/A for Additional Spectrum Emission Mask testing.		QPSK	25	Note 2
2	5MHz			QPSK	8	Note 2
3	5MHz			QPSK	6	Note 2
4	5MHz			16QAM	25	Note 2
5	5MHz			16QAM	8	Note 2
6	10MHz			QPSK	1	0
7	10MHz			QPSK	12	0
8	10MHz			QPSK	50	0
9	10MHz			16QAM	50 (Note 3)	0
10	10MHz			QPSK	24	13
11	10MHz			16QAM	24	13
12	10MHz			QPSK	36	13
13	10MHz			QPSK	12	37
14	10MHz			QPSK	1	49
15	15MHz			QPSK	1	0
16	15MHz			QPSK	16	0
17	15MHz			QPSK	75	0
18	15MHz			16QAM	75 (Note 3)	0
19	15MHz			QPSK	36	19
20	15MHz			16QAM	36 (Note 3)	19
21	15MHz			QPSK	50	19
22	15MHz			QPSK	18	56
23	15MHz			QPSK	1	74
24	20MHz			QPSK	1	0
25	20MHz			QPSK	18	0
26	20MHz			QPSK	100	0
27	20MHz			16QAM	100 (Note 3)	0
28	20MHz			QPSK	50	25
29	20MHz			16QAM	50 (Note 3)	25
30	20MHz			QPSK	75	25
31	20MHz			QPSK	25	75
32	20MHz			QPSK	1	99

Note 1: Test Channel Bandwidths are checked separately for E-UTRA band, the applicable channel bandwidths are specified in Table 5.4.2.1-1.

Note 2: The RB_{start} of partial RB allocation shall be RB# 0 and RB# (max +1 - RB allocation) of the channel bandwidth.

Note 3: Applies only for UE-Categories 2-5

Table 6.6.2.2.4.1-5: Test Configuration Table (network signalled value "NS_11")

Initial Conditions	
Test Environment (as specified in TS 36.508 [7] subclause 4.1)	Normal

Test Frequencies (as specified in TS36.508 [7] subclause 4.3.1)		Low range, Mid range, High range For 3 MHz Channel Bandwidth: a. 2001.5 MHz ($N_{UL} = 25515$) b. 2004.5 MHz ($N_{UL} = 25545$) For 5 MHz Channel Bandwidth a. 2002.5 MHz ($N_{UL} = 25525$) b. 2004.5 MHz ($N_{UL} = 25545$) c. 2007.5 MHz ($N_{UL} = 25575$) For 10 MHz Channel Bandwidth a. 2005 MHz ($N_{UL} = 25550$) b. 2005.5 MHz ($N_{UL} = 25555$) c. 2015 MHz ($N_{UL} = 25650$) For 15 MHz Channel Bandwidth a. 2007.5 MHz ($N_{UL} = 25575$) b. 2012.5 MHz ($N_{UL} = 25625$) For 20 MHz Channel Bandwidth a. 2010 MHz ($N_{UL} = 25600$)			
Test Channel Bandwidths (as specified in TS 36.508 [7] subclause 4.3.1)		3MHz, 5MHz, 10MHz, 15MHz, 20MHz			
Test Parameters for NS_11 A-MPR					
		Downlink Configuration		Uplink Configuration	
Configuration ID	Ch BW	Mod'n	RB allocation FDD	Mod'n	RB allocation FDD
1	3MHz	N/A for A-MPR testing		QPSK	6
2	3MHz			QPSK	15
3	3MHz			16QAM	6
4	3MHz			16QAM	15
5	5MHz			QPSK	1
6	5MHz			QPSK	8
7	5MHz			QPSK	25
8	5MHz			16QAM	8
9	5MHz			16QAM	25
10	10MHz			QPSK	1
11	10MHz			QPSK	12
12	10MHz			QPSK	50
13	10MHz			16QAM	12
14	10MHz			16QAM	50 (Note 3)
15	15MHz			QPSK	1
16	15MHz			QPSK	7
17	15MHz			QPSK	25
18	15MHz			QPSK	30
19	15MHz			QPSK	75
20	15MHz			16QAM	7

21	15MHz	16QAM	25
22	15MHz	16QAM	30
23	15MHz	16QAM	75
24	20MHz	QPSK	1
25	20MHz	QPSK	10
26	20MHz	QPSK	25
27	20MHz	QPSK	100
28	20MHz	16QAM	10
29	20MHz	16QAM	25
30	20MHz	16QAM	100

Note 1: The Configuration ID will be used to map the applicable Test Configuration to the corresponding Test Requirement in subclause 6.2.4.5 as not all combinations are necessarily required based on the applicability of the UE.

Note 2: The RB_{start} of partial RB allocation shall be RB# 0 and RB# (max +1 - RB allocation) of the channel bandwidth.

Note 3: Applies only for UE-Categories ≥2.

Table 6.6.2.4.1-6: Test Configuration Table (network signalled value "NS_20")

Initial Conditions	
Test Environment (as specified in TS 36.508 [7] subclause 4.1)	Normal
Test Frequencies (as specified in TS36.508 [7] subclause 4.3.1)	Low range, Mid range, High range For 5 MHz Channel Bandwidth a. 2002.5 MHz (N _{UL} = 25525) b. 2007.5 MHz (N _{UL} = 25575) c. 2012.5 MHz (N _{UL} = 25625) d. 2017.5 MHz (N _{UL} = 25675) For 10 MHz Channel Bandwidth a. 2005 MHz (N _{UL} = 25550) b. 2015 MHz (N _{UL} = 25650) For 15 MHz Channel Bandwidth a. 2012.5 MHz (N _{UL} = 25625) For 20 MHz Channel Bandwidth a. 2010 MHz (N _{UL} = 25600)
Test Channel Bandwidths (as specified in TS 36.508 [7] subclause 4.3.1)	5MHz, 10MHz, 15MHz, 20MHz
Test Parameters for NS_20 A-MPR	
Downlink Configuration	Uplink Configuration

Configuration ID	Ch BW	Mod'n	RB allocation FDD	Mod'n	RB allocation FDD
1	5MHz	N/A for A-MPR testing		QPSK	8
2	5MHz			QPSK	15
3	5MHz			QPSK	25
4	5MHz			16QAM	15
5	5MHz			16QAM	25
6	10MHz			QPSK	8
7	10MHz			QPSK	12
8	10MHz			QPSK	50
9	10MHz			16QAM	12
10	10MHz			16QAM	50 (Note 3)
11	15MHz			QPSK	6
12	15MHz			QPSK	25
13	15MHz			QPSK	36
14	15MHz			QPSK	75
15	15MHz			16QAM	25
16	15MHz			16QAM	36
17	15MHz			16QAM	75
18	20MHz			QPSK	8
19	20MHz			QPSK	18
20	20MHz			QPSK	25
21	20MHz			QPSK	75
22	20MHz			QPSK	100
23	20MHz			16QAM	18
24	20MHz			16QAM	25
25	20MHz			16QAM	75
26	20MHz			16QAM	100
<p>Note 1: The Configuration ID will be used to map the applicable Test Configuration to the corresponding Test Requirement in subclause 6.2.4.5 as not all combinations are necessarily required based on the applicability of the UE.</p> <p>Note 2: The RB_{start} of partial RB allocation shall be RB# 0 and RB# (max +1 - RB allocation) of the channel bandwidth.</p> <p>Note 3: Applies only for UE-Categories ≥2.</p>					

1. Connect the SS to the UE antenna connectors as shown in TS 36.508 [7] Annex A, Figure A.3.
2. The parameter settings for the cell are set up according to TS 36.508 [7] subclause 4.4.3.
3. Downlink signals are initially set up according to Annex C0, C.1 and C.3.0, and uplink signals according to Annex H.1 and H.3.0.

4. The DL Reference Measurement channels are set according to Tables 6.6.2.2.4.1-1, 6.6.2.2.4.1-2, 6.6.2.2.4.1-3 and 6.6.2.2.4.1-4.
5. Propagation conditions are set according to Annex B.0.
6. Ensure the UE is in State 3A-RF according to TS 36.508 [7] clause 5.2A.2. Message contents are defined in clause 6.6.2.2.4.3.

6.6.2.2.4.2 Test procedure

1. SS sends uplink scheduling information for each UL HARQ process via PDCCH DCI format 0 for C_RNTI to schedule the UL RMC according to applicable table from Table 6.6.2.2.4.1-1 to 6.6.2.2.4.1-6., Since the UE has no payload data to send, the UE transmits uplink MAC padding bits on the UL RMC.
2. Send continuously uplink power control "up" commands in the uplink scheduling information to the UE until the UE transmits at P_{UMAX} level.
3. Measure the mean power of the UE in the channel bandwidth of the radio access mode according to the test configuration, which shall meet the requirements described in Table 6.2.4.5-1 to 6.2.4.5-9 as appropriate. The period of the measurement shall be at least one sub-frame (1ms).
4. Measure the power of the transmitted signal with a measurement filter of bandwidths according to Table 6.6.2.2.5.1-1, 6.6.2.2.5.2-1, 6.6.2.2.5.3-1 or Table 6.6.2.2.5.1-2, 6.6.2.2.5.2-2, 6.6.2.2.5.3-2, as applicable. The centre frequency of the filter shall be stepped in continuous steps according to the same table. The measured power shall be recorded for each step. The measurement period shall capture the active TSs.

6.6.2.2.4.3 Message contents

Message contents are according to TS 36.508 [7] subclause 4.6, with the following exceptions for each network signalled value.

6.6.2.2.4.3.1 Message contents exceptions (network signalled value "NS_03")

1. Information element `additionalSpectrumEmission` is set to NS_03. This can be set in the *SystemInformationBlockType2* as part of the cell broadcast message. This exception indicates that the UE shall meet the additional spurious emission requirement for a specific deployment scenario.

Table 6.6.2.2.4.3.1-1: SystemInformationBlockType2 :Additional spurious emissions requirement

Derivation Path: TS 36.508 [7] clause 4.4.3.3, Table 4.4.3.3-1			
Information Element	Value/remark	Comment	Condition
<code>additionalSpectrumEmission</code>	3 (NS_03)		

6.6.2.2.4.3.2 Message contents exceptions (network signalled value "NS_04")

1. Information element `additionalSpectrumEmission` is set to NS_04. This can be set in the *SystemInformationBlockType2* as part of the cell broadcast message. This exception indicates that the UE shall meet the additional spurious emission requirement for a specific deployment scenario.

Table 6.6.2.2.4.3.2-1: SystemInformationBlockType2 :Additional spurious emissions requirement

Derivation Path: TS 36.508 [7] clause 4.4.3.3, Table 4.4.3.3-1			
Information Element	Value/remark	Comment	Condition
<code>additionalSpectrumEmission</code>	4 (NS_04)		

6.6.2.2.4.3.3 Message contents exceptions (network signalled value "NS_06")

1. Information element `additionalSpectrumEmission` is set to NS_06. This can be set in the *SystemInformationBlockType2* as part of the cell broadcast message. This exception indicates that the UE shall meet the additional spurious emission requirement for a specific deployment scenario.

Table 6.6.2.2.4.3.3-1: SystemInformationBlockType2 :Additional spurious emissions requirement

Derivation Path: TS 36.508 [7] clause 4.4.3.3, Table 4.4.3.3-1			
Information Element	Value/remark	Comment	Condition
additionalSpectrumEmission	6 (NS_06)		

6.6.2.2.4.3.4 Message contents exceptions (network signalled value "NS_07")

1. Information element additionalSpectrumEmission is set to NS_07. This can be set in the *SystemInformationblockType2* as part of the cell broadcast message. This exception indicates that the UE shall meet the additional spurious emission requirement for a specific deployment scenario.

Table 6.6.2.2.4.3.4-1: SystemInformationBlockType2 :Additional spurious emissions requirement

Derivation Path: TS 36.508 [7] clause 4.4.3.3, Table 4.4.3.3-1			
Information Element	Value/remark	Comment	Condition
additionalSpectrumEmission	7 (NS_07)		

6.6.2.2.4.3.5 Message contents exceptions (network signalled value "NS_11")

1. Information element additionalSpectrumEmission is set to NS_11. This can be set in the *SystemInformationblockType2* as part of the cell broadcast message. This exception indicates that the UE shall meet the additional spurious emission requirement for a specific deployment scenario.

Table 6.6.2.2.4.3.5-1: SystemInformationBlockType2 :Additional spurious emissions requirement

Derivation Path: TS 36.508 [7] clause 4.4.3.3, Table 4.4.3.3-1			
Information Element	Value/remark	Comment	Condition
additionalSpectrumEmission	11 (NS_11)		

6.6.2.2.4.3.6 Message contents exceptions (network signalled value "NS_20")

1. Information element additionalSpectrumEmission is set to NS_20. This can be set in the *SystemInformationblockType2* as part of the cell broadcast message. This exception indicates that the UE shall meet the additional spurious emission requirement for a specific deployment scenario.

Table 6.6.2.2.4.3.6-1: SystemInformationBlockType2 :Additional spurious emissions requirement

Derivation Path: TS 36.508 [7] clause 4.4.3.3, Table 4.4.3.3-1			
Information Element	Value/remark	Comment	Condition
additionalSpectrumEmission	20 (NS_20)		

6.6.2.2.5 Test requirements

6.6.2.2.5.1 Test requirements (network signalled value "NS_03", "NS_11", and "NS_20")

When "NS_03" or "NS_11" or "NS_20" is indicated in the cell:

- the measured UE mean power in the channel bandwidth, derived in step 3, shall fulfil requirements in Table 6.2.4.5-1 and 6.2.4.5-2 as appropriate,

and

- the power of any UE emission shall fulfil requirements in Table 6.6.2.2.5.1-1 or 6.6.2.2.5.1-2, as applicable.

Table 6.6.2.2.5.1-1: Additional requirements (network signalled value "NS_03", "NS_11", and "NS_20"), E-UTRA bands ≤ 3GHz

Spectrum emission limit (dBm)/ Channel bandwidth							
Δf_{OOB} (MHz)	1.4 MHz	3.0 MHz	5 MHz	10 MHz	15 MHz	20 MHz	Measurement bandwidth
0-1	-8.5	-11.5	-13.5	-16.5	-18.5	-19.5	30 kHz
1-2.5	-11.5	-11.5	-11.5	-11.5	-11.5	-11.5	1 MHz
2.5-2.8	-23.5						1 MHz
2.8-5							1 MHz
5-6							1 MHz
6-10			-23.5				1 MHz
10-15				-23.5			1 MHz
15-20					-23.5		1 MHz
20-25						-23.5	1 MHz
Note 1:	The first and last measurement position with a 30 kHz filter is at Δf_{OOB} equals to 0.015 MHz and 0.985 MHz.						
Note 2:	At the boundary of spectrum emission limit, the first and last measurement position with a 1 MHz filter is the inside of +0.5MHz and -0.5MHz, respectively.						
Note 3:	The measurements are to be performed above the upper edge of the channel and below the lower edge of the channel						
Note 4:	Above SEM requirement applies to bands corresponding to network signalling value NS_03 as defined in TS 36.101 [2] subclause 6.2.4 Table 6.2.4-1.						
Note 5:	For the 2.5-2.8 MHz offset range with 1.4 MHz channel bandwidth, the measurement position is at Δf_{OOB} equals to 3 MHz.						

Table 6.6.2.2.5.1-2: Additional requirements (network signalled value "NS_03", "NS_11", and "NS_20"), 3GHz < E-UTRA bands ≤ 4.2GHz

Spectrum emission limit (dBm)/ Channel bandwidth							
Δf_{OOB} (MHz)	1.4 MHz	3.0 MHz	5 MHz	10 MHz	15 MHz	20 MHz	Measurement bandwidth
0-1	-8.2	-11.2	-13.2	-16.2	-18.2	-19.2	30 kHz
1-2.5	-11.2	-11.2	-11.2	-11.2	-11.2	-11.2	1 MHz
2.5-2.8	-23.2						1 MHz
2.8-5							1 MHz
5-6							1 MHz
6-10			-23.2				1 MHz
10-15				-23.2			1 MHz
15-20					-23.2		1 MHz
20-25						-23.2	1 MHz
Note 1:	The first and last measurement position with a 30 kHz filter is at Δf_{OOB} equals to 0.015 MHz and 0.985 MHz.						
Note 2:	At the boundary of spectrum emission limit, the first and last measurement position with a 1 MHz filter is the inside of +0.5MHz and -0.5MHz, respectively.						
Note 3:	The measurements are to be performed above the upper edge of the channel and below the lower edge of the channel						
Note 4:	Above SEM requirement applies to bands corresponding to network signalling value NS_03 as defined in TS 36.101 [2] subclause 6.2.4 Table 6.2.4-1.						
Note 5:	For the 2.5-2.8 MHz offset range with 1.4 MHz channel bandwidth, the measurement position is at Δf_{OOB} equals to 3 MHz.						

NOTE (only for emission measurement):

As a general rule, the resolution bandwidth of the measuring equipment should be equal to the measurement bandwidth. However, to improve measurement accuracy, sensitivity and efficiency, the resolution bandwidth may be smaller than the measurement bandwidth. When the resolution bandwidth is smaller than the measurement bandwidth, the result should be integrated over the measurement bandwidth in order to obtain the equivalent noise bandwidth of the measurement bandwidth.

6.6.2.2.5.2 Test requirements (network signalled value "NS_04")

When "NS_04" is indicated in the cell:

- the measured UE mean power in the channel bandwidth, derived in step 3, shall fulfil requirements in Table 6.2.4.5-3 as appropriate,

and

- the power of any UE emission shall fulfil requirements in Table 6.6.2.5.2-1 or Table.6.6.2.5.2-2, as applicable.

Table 6.6.2.5.2-1: Additional requirements (network signalled value "NS_04"), E-UTRA bands ≤ 3GHz

Δf_{OOB} (MHz)	Spectrum emission limit (dBm)/ Channel bandwidth						Measurement bandwidth
	1.4 MHz	3.0 MHz	5 MHz	10 MHz	15 MHz	20 MHz	
0-1	-8.5	-11.5	-13.5	-16.5	-18.5	-19.5	30 kHz
1-2.5	-11.5	-11.5	-11.5	-11.5	-11.5	-11.5	1 MHz
2.5-2.8	-23.5						1 MHz
2.8-5							1 MHz
5-6		-23.5	-23.5	-23.5	-23.5	-23.5	1 MHz
6-10							1 MHz
10-15							1 MHz
15-20							1 MHz
20-25							1 MHz
Note 1:	The first and last measurement position with a 30 kHz filter is at Δf_{OOB} equals to 0.015 MHz and 0.985 MHz.						
Note 2:	At the boundary of spectrum emission limit, the first and last measurement position with a 1 MHz filter is the inside of +0.5MHz and -0.5MHz, respectively.						
Note 3:	The measurements are to be performed above the upper edge of the channel and below the lower edge of the channel						
Note 4:	Above SEM requirement applies to bands corresponding to network signalling value NS_04 as defined in TS 36.101 [2] subclause 6.2.4 Table 6.2.4-1.						
Note 5:	For the 2.5-2.8 MHz offset range with 1.4 MHz channel bandwidth, the measurement position is at Δf_{OOB} equals to 3 MHz.						

Table 6.6.2.5.2-2: Additional requirements (network signalled value "NS_04"), 3GHz < E-UTRA bands ≤ 4.2GHz

Δf_{OOB} (MHz)	Spectrum emission limit (dBm)/ Channel bandwidth						Measurement bandwidth
	1.4 MHz	3.0 MHz	5 MHz	10 MHz	15 MHz	20 MHz	
0-1	-8.2	-11.2	-13.2	-16.2	-18.2	-19.2	30 kHz
1-2.5	-11.2	-11.2	-11.2	-11.2	-11.2	-11.2	1 MHz
2.5-2.8	-23.2						1 MHz
2.8-5							1 MHz
5-6		-23.2	-23.2	-23.2	-23.2	-23.2	1 MHz
6-10							1 MHz
10-15							1 MHz
15-20							1 MHz
20-25							1 MHz
Note 1:	The first and last measurement position with a 30 kHz filter is at Δf_{OOB} equals to 0.015 MHz and 0.985 MHz.						
Note 2:	At the boundary of spectrum emission limit, the first and last measurement position with a 1 MHz filter is the inside of +0.5MHz and -0.5MHz, respectively.						
Note 3:	The measurements are to be performed above the upper edge of the channel and below the lower edge of the channel						
Note 4:	Above SEM requirement applies to bands corresponding to network signalling value NS_04 as defined in TS 36.101 [2] subclause 6.2.4 Table 6.2.4-1.						
Note 5:	For the 2.5-2.8 MHz offset range with 1.4 MHz channel bandwidth, the measurement position is at Δf_{OOB} equals to 3 MHz.						

NOTE (only for emission measurement):

As a general rule, the resolution bandwidth of the measuring equipment should be equal to the measurement bandwidth. However, to improve measurement accuracy, sensitivity and efficiency, the resolution bandwidth may be smaller than the measurement bandwidth. When the resolution bandwidth is smaller than the measurement bandwidth, the result should be integrated over the measurement bandwidth in order to obtain the equivalent noise bandwidth of the measurement bandwidth.

Test requirements (network signalled value "NS_06" or "NS_07")

When "NS_06" or "NS_07" is indicated in the cell:

- the measured UE mean power in the channel bandwidth, derived in step 3, shall fulfil requirements in Table 6.2.4.5-5, 6.2.4.5-6 and 6.2.4.5-7 as appropriate 1,

and

- the power of any UE emission shall fulfil requirements in Table 6.6.2.2.5.3-1 or Table.6.6.2.2.5.3-2, as applicable.

Table 6.6.2.2.5.3-1: Additional requirements (network signalled value "NS_06" or "NS_07"), E-UTRA bands ≤ 3GHz

Δf_{OOB} (MHz)	Spectrum emission limit (dBm)/ Channel bandwidth				
	1.4 MHz	3.0 MHz	5 MHz	10 MHz	Measurement bandwidth
0-0.1	-11.5	-11.5	-13.5	-16.5	30 kHz
0.1-1	-11.5	-11.5	-11.5	-11.5	100 kHz
1-2.5	-11.5	-11.5	-11.5	-11.5	1 MHz
2.5-2.8	-23.5				1 MHz
2.8-5					1 MHz
5-6		-23.5			1 MHz
6-10			-23.5		1 MHz
10-15				-23.5	1 MHz
Note 1:	The first and last measurement position with a 30 kHz filter is at Δf_{OOB} equals to 0.015 MHz and 0.085 MHz. The first and last measurement position with a 100 kHz filter is at Δf_{OOB} equals to 0.15 MHz and 0.95 MHz.				
Note 2:	At the boundary of spectrum emission limit, the first and last measurement position with a 1 MHz filter is the inside of +0.5MHz and -0.5MHz, respectively.				
Note 3:	The measurements are to be performed above the upper edge of the channel and below the lower edge of the channel				
Note 4:	Above SEM requirement applies to bands corresponding to network signalling value NS_06 and NS_07 as defined in TS 36.101 [2] subclause 6.2.4 Table 6.2.4-1.				
Note 5:	For the 2.5-2.8 MHz offset range with 1.4 MHz channel bandwidth, the measurement position is at Δf_{OOB} equals to 3 MHz.				

Table 6.6.2.2.5.3-2: Additional requirements (network signalled value "NS_06" or "NS_07"), 3GHz < E-UTRA bands ≤ 4.2GHz

	Spectrum emission limit (dBm)/ Channel bandwidth

Δf_{OOB} (MHz)	1.4 MHz	3.0 MHz	5 MHz	10 MHz	Measurement bandwidth
0-0.1	-11.2	-11.2	-13.2	-16.2	30 kHz
0.1-1	-11.2	-11.2	-11.2	-11.2	100 kHz
1-2.5	-11.2	-11.2	-11.2	-11.2	1 MHz
2.5-2.8	-23.2				1 MHz
2.8-5					1 MHz
5-6		-23.2			1 MHz
6-10			-23.2		1 MHz
10-15				-23.2	1 MHz
Note 1:	The first and last measurement position with a 30 kHz filter is at Δf_{OOB} equals to 0.015 MHz and 0.085 MHz. The first and last measurement position with a 100 kHz filter is at Δf_{OOB} equals to 0.15 MHz and 0.95 MHz.				
Note 2:	At the boundary of spectrum emission limit, the first and last measurement position with a 1 MHz filter is the inside of +0.5MHz and -0.5MHz, respectively.				
Note 3:	The measurements are to be performed above the upper edge of the channel and below the lower edge of the channel				
Note 4:	Above SEM requirement applies to bands corresponding to network signalling value NS_06 and NS_07 as defined in TS 36.101 [2] subclause 6.2.4 Table 6.2.4-1.				
Note 5:	For the 2.5-2.8 MHz offset range with 1.4 MHz channel bandwidth, the measurement position is at Δf_{OOB} equals to 3 MHz.				

NOTE (only for emission measurement):

As a general rule, the resolution bandwidth of the measuring equipment should be equal to the measurement bandwidth. However, to improve measurement accuracy, sensitivity and efficiency, the resolution bandwidth may be smaller than the measurement bandwidth. When the resolution bandwidth is smaller than the measurement bandwidth, the result should be integrated over the measurement bandwidth in order to obtain the equivalent noise bandwidth of the measurement bandwidth.

6.6.2.2A Additional Spectrum Emission Mask for CA

6.6.2.2A.1 Additional Spectrum Emission Mask for CA (intra-band contiguous DL CA and UL CA)

Editor's notes: The following items are missing or incomplete:

- Need to update Annex F and 36.521-2 with this new test case.

6.6.2.2A.1.1 Test purpose

To verify that the power of any UE emission shall not exceed specified level for the specified channel bandwidth for CA under the deployment scenarios where additional requirements are specified.

6.6.2.2A.1.2 Test applicability

This test case applies to all types of E-UTRA UE release 10 and forward that support intra-band contiguous DL CA and UL CA.

6.6.2.2A.1.3 Minimum conformance requirements

6.6.2.2A.1.3.1 Minimum requirements (network signalled value "CA_NS_04")

Additional spectrum emission requirements are signalled by the network to indicate that the UE shall meet an additional requirement for a specific deployment scenario as part of the cell handover/broadcast message.

When "CA_NS_04" is indicated in the cell, the power of any UE emission shall not exceed the levels specified in Table 6.6.2.2A.1.3.1-1.

Table 6.6.2.2A.1.3.1-1: Additional requirements

Spectrum emission limit [dBm]/BW _{Channel_CA}					
Δf_{OOB} (MHz)	50+100RB (29.9 MHz)	75+75B (30 MHz)	75+100RB (34.85 MHz)	100+100RB (39.8 MHz)	Measurement bandwidth
± 0-1	-22.5	-22.5	-23.5	-24	30 kHz
± 1-5.5	-13	-13	-13	-13	1 MHz
± 5.5-34.9	-25	-25	-25	-25	1 MHz
± 34.9-35		-25	-25	-25	1 MHz
± 35-39.85			-25	-25	1 MHz
± 39.85-44.8				-25	1 MHz

NOTE: As a general rule, the resolution bandwidth of the measuring equipment should be equal to the measurement bandwidth. However, to improve measurement accuracy, sensitivity and efficiency, the resolution bandwidth may be smaller than the measurement bandwidth. When the resolution bandwidth is smaller than the measurement bandwidth, the result should be integrated over the measurement bandwidth in order to obtain the equivalent noise bandwidth of the measurement bandwidth.

The normative reference for this requirement is TS 36.101[2] subclause 6.6.2.2A.

6.6.2.2A.1.4 Test description

6.6.2.2A.1.4.1 Initial condition

Initial conditions are a set of test configurations the UE needs to be tested in and the steps for the SS to take with the UE to reach the correct measurement state.

The initial test configurations consist of environmental conditions, test frequencies, and channel bandwidths based on E-UTRA CA configurations specified in table 5.4.2A.1-1. All of these configurations shall be tested with applicable test parameters for each channel bandwidth, and are shown in table 6.6.2.2A.1.4.1-1. The details of the uplink reference measurement channels (RMCs) are specified in Annex A.2. Configurations of PDSCH and PDCCH before measurement are specified in Annex C.2.

Table 6.6.2.2A.1.4.1-1: Test Configuration Table

Initial Conditions									
Test Environment as specified in TS 36.508[7] subclause 4.1						NC			
Test Frequencies as specified in TS36.508 [7] subclause 4.3.1 for different CA bandwidth classes.						C: Low and High range			
Test CC Combination setting (N_{RB_agg}) as specified in subclause 5.4.2A.1 for the CA Configuration						As in Table 6.6.2.2A.1.3.1-1			
Test Parameters for CA Configurations									
ID	CA Configuration / N_{RB_agg}		DL Allocation (PDCCH on PCC)	CC MOD	UL Allocation				
	PCC N_{RB}	SCCs N_{RB}	PCC & SCC RB allocation		N_{RB_alloc}	PCC & SCC RB allocations (L_{CRB} @ RB_{start})			
1	100	50	N/A	QPSK	10	P_10@20	S_0@0		
2	100	50		QPSK	60	P_50@50	S_10@0		
3	100	50		16QAM	15	P_0@0	S_15@0		
4	100	50		QPSK	2	P_1@0	S_1@49		
5	100	50		QPSK	24	P_6@0	P_6@50	S_6@0	S_6@44
6	100	50		QPSK	60	P_20@0	P_20@50	S_10@0	S_10@40
7	75	75		QPSK	10	P_10@20	S_0@0		
8	75	75		QPSK	75	P_30@45	S_45@0		
9	75	75		QPSK	2	P_1@0	S_1@74		
10	75	75		QPSK	24	P_6@0	P_6@60	S_6@10	S_6@69
11	75	75		QPSK	60	P_15@0	P_15@45	S_15@15	S_15@60
12	100	75		QPSK	10	P_10@20	S_0@0		
13	100	75		QPSK	80	P_50@50	S_30@0		
14	100	75		16QAM	20	P_0@0	S_20@15		

15	100	75		QPSK	2	P_1@0	S_1@74		
16	100	75		QPSK	28	P_8@0	P_8@60	S_6@10	S_6@69
17	100	75		QPSK	75	P_25@0	P_20@55	S_15@10	S_15@60
18	100	100		QPSK	10	P_10@25	S_0@0		
19	100	100		QPSK	90	P_40@60	S_50@0		
20	100	100		16QAM	15	P_0@0	S_15@40		
21	100	100		16QAM	20	P_0@0	S_20@30		
22	100	100		QPSK	2	P_1@0	S_1@99		
23	100	100		QPSK	30	P_10@0	P_5@65	S_10@30	S_5@95
24	100	100		QPSK	80	P_20@0	P_20@60	S_20@20	S_20@80

Note 1: CA Configuration Test CC Combination settings are checked separately for each CA Configuration which applicable aggregated channel bandwidths are specified in Table 5.4.2A.1-1

1. Connect the SS to the UE antenna connectors as shown in Figure TS 36.508 [7] Annex A, Figure group A.32 as appropriate.
2. The parameter settings for the cell are set up according to TS 36.508 [7] clause 4.4.3.
3. Downlink signals for PCC are initially set up according to Annex C0, C.1 and C.3.0, and uplink signals according to Annex H.1 and H.3.0.
4. The UL Reference Measurement channels are set according to Table 6.6.2.2A.1.4.1-1.
5. Propagation conditions are set according to Annex B.0.
6. Ensure the UE is in State 3A-RF according to TS 36.508 [7] clause 5.2A.2. Message contents are defined in clause 6.6.2.2A.1.4.3.

6.6.2.2A.1.4.2 Test procedure

1. Configure SCC according to Annex C.0, C.1 and Annex C.3.0 for all downlink physical channels except PHICH.
2. The SS shall configure SCC as per TS 36.508 [7] clause 5.2A.4. Message contents are defined in clause 6.6.2.2A.1.4.3.
3. SS activates SCC by sending the activation MAC-CE (Refer TS 36.321 [13], clauses 5.13, 6.1.3.8). Wait for at least 2 seconds (Refer TS 36.133, clauses 8.3.3.2).
4. SS sends uplink scheduling information via PDCCH DCI format 0 for C_RNTI to schedule the UL RMC according to Table 6.6.2.2A.1.4.1-1 on both PCC and SCC. Since the UE has no payload data to send, the UE transmits uplink MAC padding bits on the UL RMC.
5. Send continuously uplink power control "up" commands in the uplink scheduling information to the UE until the UE transmits at P_{UMAX} level.
6. Measure the mean power over all component carriers in the CA configuration of the radio access mode, which shall meet the requirements described in Table 6.2.4A.1.5-4. The period of the measurement shall be at least the continuous duration of one sub-frame (1ms). For TDD slots with transient periods are not under test.
7. Measure the power of the transmitted signal with a measurement filter of bandwidths according to table 6.6.2.2A.1.5.1-1. The centre frequency of the filter shall be stepped in continuous steps according to the same table. The measured power shall be recorded for each step. The measurement period shall capture the active TSs.

6.6.2.2A.1.4.3 Message contents

Message contents are according to TS 36.508 [7] clause 4.6. The following exceptions apply for each network signalled value.

6.6.2.2A.1.4.3.1 Message contents exceptions (network signalled value "CA_NS_04")

1. Information element additionalSpectrumEmissionSCell-r10 is set to CA_NS_04. This can be set in the *RadioResourceConfigCommonSCell-r10-DEFAULT* as part of the common RRC messages. This exception indicates that the UE shall meet the additional spectrum emission requirement for a specific deployment scenario.

Table 6.6.2.2A.1.4.3.1-1: RadioResourceConfigCommonSCell-r10-DEFAULT: Additional spectrum emission test requirement for "CA_NS_04"

Derivation Path: TS 36.508 [7] clause 4.6.3, Table 4.6.3-13A			
Information Element	Value/remark	Comment	Condition
additionalSpectrumEmissionSCell-r10	4 (CA_NS_04)		

6.6.2.2A.1.5 Test Requirements

6.6.2.2A.1.5.1 Test requirement for CA (network signalled value "CA_NS_04")

When "CA_NS_04" is indicated in the cell

- the measured UE mean power with the aggregated channel bandwidth as specified in clause 5.4.2A, derived in step 6, shall fulfil requirements in Table 6.2.4A.1.5-4 as appropriate,

and

- the power of any UE emission shall not exceed the levels specified in Table 6.6.2.2A.1.5.1-1.

Table 6.6.2.2A.1.5.1-1: Additional requirements

Spectrum emission limit [dBm]/BW _{Channel_CA}					
Δf_{OOB} (MHz)	50+100RB (29.9 MHz)	75+75B (30 MHz)	75+100RB (34.85 MHz)	100+100RB (39.8 MHz)	Measurement bandwidth
$\pm 0-1$	-21	-21	-22	-22.5	30 kHz
$\pm 1-5.5$	-11.5	-11.5	-11.5	-11.5	1 MHz
$\pm 5.5-34.9$	-23.5	-23.5	-23.5	-23.5	1 MHz
$\pm 34.9-35$		-23.5	-23.5	-23.5	1 MHz
$\pm 35-39.85$			-23.5	-23.5	1 MHz
$\pm 39.85-44.8$				-23.5	1 MHz
Note 1:	The first and last measurement position with a 30 kHz filter is at Δf_{OOB} equals to 0.015 MHz and 0.985 MHz.				
Note 2:	At the boundary of spectrum emission limit, the first and last measurement position with a 1 MHz filter is the inside of +0.5MHz and -0.5MHz, respectively.				
Note 3:	The measurements are to be performed above the upper edge of the channel and below the lower edge of the channel				
Note 4:	Above SEM requirement applies to bands corresponding to network signalling value CA_NS_04 as defined in TS 36.101 [2] subclause 6.6.2.2A Table 6.2.2A-1.				

NOTE: As a general rule, the resolution bandwidth of the measuring equipment should be equal to the measurement bandwidth. However, to improve measurement accuracy, sensitivity and efficiency, the resolution bandwidth may be smaller than the measurement bandwidth. When the resolution bandwidth is smaller than the measurement bandwidth, the result should be integrated over the measurement bandwidth in order to obtain the equivalent noise bandwidth of the measurement bandwidth.

6.6.2.2B Additional Spectrum Emission Mask for UL-MIMO

6.6.2.2B.1 Test purpose

To verify that the power of any UE emission at each transmit antenna shall not exceed specified level for the specified channel bandwidth under the deployment scenarios where additional requirements are specified.

6.6.2.2B.2 Test applicability

This test case applies to all types of E-UTRA UE release 10 and forward that support UL-MIMO

6.6.2.2B.3 Minimum conformance requirements

6.6.2.2B.3.1 Minimum requirement (network signalled value "NS_03", "NS_11", and "NS_20")

For UEs with two transmit antenna connectors in closed-loop spatial multiplexing scheme, the requirements in Table 6.6.2.2B.3.1-1 apply to each transmit antenna connector with the UL-MIMO configurations specified in Table 6.2.2B.3-2.

When "NS_03", "NS_11" or "NS_20" is indicated in the cell, the power of any UE emission shall not exceed the levels specified in Table 6.6.2.2B.3.1-1.

Table 6.6.2.2B.3.1-1: Additional requirements (network signalled value "NS_03", "NS_11", and "NS_20")

Spectrum emission limit (dBm)/ Channel bandwidth							
Δf_{OoB} (MHz)	1.4 MHz	3.0 MHz	5 MHz	10 MHz	15 MHz	20 MHz	Measurement bandwidth
$\pm 0-1$	-10	-13	-15	-18	-20	-21	30 kHz
$\pm 1-2.5$	-13	-13	-13	-13	-13	-13	1 MHz
$\pm 2.5-2.8$	-25	-13	-13	-13	-13	-13	1 MHz
$\pm 2.8-5$		-13	-13	-13	-13	-13	1 MHz
$\pm 5-6$		-25	-13	-13	-13	-13	1 MHz
$\pm 6-10$			-25	-13	-13	-13	1 MHz
$\pm 10-15$				-25	-13	-13	1 MHz
$\pm 15-20$					-25	-13	1 MHz
$\pm 20-25$						-25	1 MHz

NOTE: As a general rule, the resolution bandwidth of the measuring equipment should be equal to the measurement bandwidth. However, to improve measurement accuracy, sensitivity and efficiency, the resolution bandwidth may be smaller than the measurement bandwidth. When the resolution bandwidth is smaller than the measurement bandwidth, the result should be integrated over the measurement bandwidth in order to obtain the equivalent noise bandwidth of the measurement bandwidth.

The normative reference for this requirement is TS 36.101 clause 6.6.2B.

6.6.2.2B.3.2 Minimum requirement (network signalled value "NS_04")

For UEs with two transmit antenna connectors in closed-loop spatial multiplexing scheme, the requirements in Table 6.6.2.2B.3.2-1 apply to each transmit antenna connector with the UL-MIMO configurations specified in Table 6.2.2B.3-2.

When "NS_04" is indicated in the cell, the power of any UE emission shall not exceed the levels specified in Table 6.6.2.2B.3.2-1.

Table 6.6.2.2B.3.2-1: Additional requirements (network signalled value "NS_04")

Spectrum emission limit (dBm)/ Channel bandwidth							
Δf_{OoB} (MHz)	1.4 MHz	3.0 MHz	5 MHz	10 MHz	15 MHz	20 MHz	Measurement bandwidth
$\pm 0-1$	-10	-13	-15	-18	-20	-21	30 kHz
$\pm 1-2.5$	-13	-13	-13	-13	-13	-13	1 MHz
$\pm 2.5-2.8$	-25	-13	-13	-13	-13	-13	1 MHz
$\pm 2.8-5$		-13	-13	-13	-13	-13	1 MHz
$\pm 5-6$		-25	-25	-25	-25	-25	1 MHz
$\pm 6-10$			-25	-25	-25	-25	1 MHz
$\pm 10-15$				-25	-25	-25	1 MHz
$\pm 15-20$					-25	-25	1 MHz
$\pm 20-25$						-25	1 MHz

NOTE: As a general rule, the resolution bandwidth of the measuring equipment should be equal to the measurement bandwidth. However, to improve measurement accuracy, sensitivity and efficiency, the resolution bandwidth may be smaller than the measurement bandwidth. When the resolution bandwidth is smaller than the measurement bandwidth, the result should be integrated over the measurement bandwidth in order to obtain the equivalent noise bandwidth of the measurement bandwidth.

The normative reference for this requirement is TS 36.101 clause 6.6.2B.

6.6.2.2B.3.3 Minimum requirement (network signalled value "NS_06" or "NS_07")

For UEs with two transmit antenna connectors in closed-loop spatial multiplexing scheme, the requirements in Table 6.6.2.2B.3.3-1 apply to each transmit antenna connector with the UL-MIMO configurations specified in Table 6.2.2B.3-2.

When "NS_06" or "NS_07" is indicated in the cell, the power of any UE emission shall not exceed the levels specified in Table 6.6.2.2B.3.3-1.

Table 6.6.2.2B.3.3-1: Additional requirements (network signalled value "NS_06" or "NS_07")

Δf_{OoB} (MHz)	Spectrum emission limit (dBm)/ Channel bandwidth				Measurement bandwidth
	1.4 MHz	3.0 MHz	5 MHz	10 MHz	
$\pm 0-0.1$	-13	-13	-15	-18	30 kHz
$\pm 0.1-1$	-13	-13	-13	-13	100 kHz
$\pm 1-2.5$	-13	-13	-13	-13	1 MHz
$\pm 2.5-2.8$	-25	-13	-13	-13	1 MHz
$\pm 2.8-5$		-13	-13	-13	1 MHz
$\pm 5-6$		-25	-13	-13	1 MHz
$\pm 6-10$			-25	-13	1 MHz
$\pm 10-15$				-25	1 MHz

NOTE: As a general rule, the resolution bandwidth of the measuring equipment should be equal to the measurement bandwidth. However, to improve measurement accuracy, sensitivity and efficiency, the resolution bandwidth may be smaller than the measurement bandwidth. When the resolution bandwidth is smaller than the measurement bandwidth, the result should be integrated over the measurement bandwidth in order to obtain the equivalent noise bandwidth of the measurement bandwidth.

The normative reference for this requirement is TS 36.101 clause 6.6.2B.

6.6.2.2B.4 Test description

6.6.2.2B.4.1 Initial conditions

Initial conditions are a set of test configurations the UE needs to be tested in and the steps for the SS to take with the UE to reach the correct measurement state.

The initial test configurations consist of environmental conditions, test frequencies, and channel bandwidths based on E-UTRA bands specified in table 5.4.2.1-1. All of these configurations shall be tested with applicable test parameters for each channel bandwidth, and are shown in table 6.6.2.2B.4.1-1, 6.6.2.2B.4.1-2, 6.6.2.2B.4.1-3 and 6.6.2.2B.4.1-4. The details of the uplink reference measurement channels (RMCs) are specified in Annexes A.2 respectively. Configurations of PDSCH and PDCCH before measurement are specified in Annex C.2.

Table 6.6.2B.4.1-1: Test Configuration Table (network signalled value "NS_03", "NS_11", and "NS_20")

Initial Conditions						
Test Environment (as specified in TS 36.508 [7] clause 4.1)				NC		
Test Frequencies (as specified in TS 36.508 [7] clause 4.3.1)				Low range, Mid range, High range		
Test Channel Bandwidths (as specified in TS 36.508 [7] clause 4.3.1)				Lowest, 5MHz, 10MHz, Highest		
Test Parameters for Channel Bandwidths						
Ch BW	Downlink Configuration			Uplink Configuration		
	Mod'n	RB allocation		Mod'n	RB allocation	
		FDD	TDD		FDD	TDD
1.4MHz	N/A for Additional Spectrum Emission Mask testing.			QPSK	6	6
1.4MHz				QPSK	5	5
1.4MHz				16QAM	5	5
3MHz				QPSK	15	15
3MHz				QPSK	4	4
3MHz				16QAM	15	15
3MHz				16QAM	4	4
5MHz				QPSK	25	25
5MHz				QPSK	8	8
5MHz				QPSK	6	6
5MHz				16QAM	25	25
5MHz				16QAM	8	8
10MHz				QPSK	50	50
10MHz				QPSK	12	12
10MHz				QPSK	6	6
10MHz				16QAM	50 (Note 3)	50 (Note 3)
10MHz				16QAM	12	12
15MHz				QPSK	75	75
15MHz				QPSK	16	16
15MHz				16QAM	75 (Note 3)	75 (Note 3)
15MHz			16QAM	16	16	
20MHz			QPSK	100	100	
20MHz			QPSK	18	18	
20MHz			QPSK	10	10	
20MHz			16QAM	100 (Note 3)	100 (Note 3)	
20MHz			16QAM	18	18	
<p>Note 1: Test Channel Bandwidths are checked separately for each E-UTRA band, the applicable channel bandwidths are specified in Table 5.4.2.1-1.</p> <p>Note 2: The RB_{start} of partial RB allocation shall be RB# 0 and RB# (max +1 - RB allocation) of the channel bandwidth.</p> <p>Note 3: Applies only for UE-Categories [FFS].</p>						

Table 6.6.2B.4.1-2: Test Configuration Table (network signalled value "NS_06")

Initial Conditions						
Test Environment (as specified in TS 36.508 [7] clause 4.1)				NC		
Test Frequencies (as specified in TS 36.508 [7] clause 4.3.1)				Low range, Mid range, High range		
Test Channel Bandwidths (as specified in TS 36.508 [7] clause 4.3.1)				Lowest, 5MHz, 10MHz, Highest		
Test Parameters for Channel Bandwidths						
Ch BW	Downlink Configuration			Uplink Configuration		
	Mod'n	RB allocation		Mod'n	RB allocation	
		FDD	TDD		FDD	TDD
1.4MHz	N/A for Additional Spectrum Emission Mask testing.			QPSK	6	NA
1.4MHz				QPSK	5	
1.4MHz				16QAM	5	
3MHz				QPSK	15	
3MHz				QPSK	4	
3MHz				16QAM	4	
5MHz				QPSK	25	
5MHz				QPSK	8	
5MHz				16QAM	8	
10MHz				QPSK	50	
10MHz				QPSK	12	
10MHz				16QAM	12	
15MHz				QPSK	75	
15MHz				QPSK	16	
15MHz				16QAM	16	
20MHz				QPSK	100	
20MHz				QPSK	18	
20MHz			16QAM	18		
<p>Note 1: Test Channel Bandwidths are checked separately for each E-UTRA band, the applicable channel bandwidths are specified in Table 5.4.2.1-1.</p> <p>Note 2: The RB_{start} of partial RB allocation shall be RB# 0 and RB# (max +1 - RB allocation) of the channel bandwidth.</p>						

Table 6.6.2B.4.1-3: Test Configuration Table (network signalled value "NS_07")

Initial Conditions						
Test Environment (as specified in TS 36.508 [7] clause 4.1)				NC		
Test Frequencies (as specified in TS 36.508 [7] clause 4.3.1)				Mid range		
Test Channel Bandwidths (as specified in TS 36.508 [7] clause 4.3.1)				10MHz		
Test Parameters for Channel Bandwidths						
Test Number	Ch BW	Downlink Configuration		Uplink Configuration		
		Mod'n	RB allocation	Mod'n	RB allocation	RB _{start}
1	10MHz	N/A for Additional Spectrum Emission Mask testing.		QPSK	1	0
2	10MHz			QPSK	8	0
3	10MHz			QPSK	6	13
4	10MHz			QPSK	20	13
5	10MHz			QPSK	12	13
6	10MHz			16QAM	36 (Note 1)	13
7	10MHz			QPSK	16	19
8	10MHz			QPSK	12	19
9	10MHz			16QAM	16	19
10	10MHz			QPSK	30	19
11	10MHz			16QAM	30 (Note 1)	19
12	10MHz			QPSK	6	43
13	10MHz			QPSK	2	48
14	10MHz			QPSK	50	0
15	10MHz			QPSK	12	0
16	10MHz			16QAM	50 (Note 1)	0
Note 1: Applies only for UE-Categories[FFS].						

Table 6.6.2B.4.1-4: Test Configuration Table (network signalled value "NS_04")

Initial Conditions						
Test Environment (as specified in TS 36.508 [7] clause 4.1)			NC			
Test Frequencies (as specified in TS 36.508 [7] clause 4.3.1)			Low range, Mid range, High range			
Test Channel Bandwidths (as specified in TS 36.508 [7] clause 4.3.1)			5MHz, 10 MHz, 15 MHz, 20MHz			
Test Parameters for NS_04 A-MPR						
Configuration ID	Ch BW	Downlink Configuration		Uplink Configuration		
		Mod'n	RB allocation TDD	Mod'n	RB allocation TDD	RB _{start} TDD
1	5MHz	N/A for Additional Spectrum Emission Mask testing.		QPSK	25	Note 2
2	5MHz			QPSK	8	Note 2
3	5MHz			QPSK	6	Note 2
4	5MHz			16QAM	25	Note 2
5	5MHz			16QAM	8	Note 2
6	10MHz			QPSK	1	0
7	10MHz			QPSK	12	0
8	10MHz			QPSK	50	0
9	10MHz			16QAM	50 (Note 3)	0
10	10MHz			QPSK	24	13
11	10MHz			16QAM	24	13
12	10MHz			QPSK	36	13
13	10MHz			QPSK	12	37
14	10MHz			QPSK	1	49
15	15MHz			QPSK	1	0
16	15MHz			QPSK	16	0
17	15MHz			QPSK	75	0
18	15MHz			16QAM	75 (Note 3)	0
19	15MHz			QPSK	36	19
20	15MHz			16QAM	36 (Note 3)	19
21	15MHz			QPSK	50	19
22	15MHz			QPSK	18	56
23	15MHz			QPSK	1	74
24	20MHz			QPSK	1	0
25	20MHz			QPSK	18	0
26	20MHz			QPSK	100	0
27	20MHz			16QAM	100 (Note 3)	0
28	20MHz			QPSK	50	25
29	20MHz			16QAM	50 (Note 3)	25
30	20MHz			QPSK	75	25
31	20MHz			QPSK	25	75
32	20MHz			QPSK	1	99
Note 1: Test Channel Bandwidths are checked separately for E-UTRA band, the applicable channel bandwidths are specified in Table 5.4.2.1-1.						
Note 2: The RB _{start} of partial RB allocation shall be RB# 0 and RB# (max +1 - RB allocation) of the channel bandwidth.						
Note 3: Applies only for UE-Categories [FFS].						

1. Connect the SS to the UE antenna connectors as shown in Figure TS 36.508 [7] Annex A, Figure A.28.
2. The parameter settings for the cell are set up according to TS 36.508 [7] clause 4.4.3.
3. Downlink signals are initially set up according to Annex C0, C.1 and C.3.0, and uplink signals according to Annex H.1 and H.3.0.
4. The UL Reference Measurement channels are set according to Table 6.6.2B.4.1-1, 6.6.2B.4.1-2, 6.6.2B.4.1-3 and 6.6.2B.4.1-4.

5. Propagation conditions are set according to Annex B.0.
6. Ensure the UE is in State 3A-RF according to TS 36.508 [7] clause 5.2A.2. Message contents are defined in clause 6.6.2.2B.4.3.

6.6.2.2B.4.2 Test procedure

1. SS sends uplink scheduling information via PDCCH DCI format 4 for C_RNTI to schedule the UL RMC according to Table 6.6.2.1B.4.1-1, 6.6.2.2B.4.1-2, 6.6.2.2B.4.1-3 or 6.6.2.2B.4.1-4. Since the UE has no payload data to send, the UE transmits uplink MAC padding bits on the UL RMC.
2. Send continuously uplink power control "up" commands in the uplink scheduling information to the UE until the UE transmits at PUMAX level.
3. Measure the sum of the mean power at each antenna connector of UE in the channel bandwidth of the radio access mode according to the test configuration, which shall meet the requirements described in Table 6.2.3B.5-1. The period of the measurement shall be at least the continuous duration of one sub-frame (1ms). For TDD slots with transient periods are not under test.
4. Measure the power of the transmitted signal at each antenna connector of UE with a measurement filter of bandwidths according to table 6.6.2.2B5.1-1, 6.6.2.2B.5.2-1, 6.6.2.2B.5.3-1 or Table 6.6.2.2B.5.1-2, 6.6.2.2B.5.2-2, and 6.6.2.2B.5.3-2 as applicable. The centre frequency of the filter shall be stepped in continuous steps according to the same table. The measured power shall be recorded for each step. The measurement period shall capture the active TSs.

6.6.2.2B.4.3 Message contents

Message contents are according to TS 36.508 [7] subclause 4.6, with the following exceptions for each network signalled value.

6.6.2.2B.4.3.1 Message contents exceptions (network signalled value "NS_03")

1. Information element `additionalSpectrumEmission` is set to NS_03. This can be set in the *SystemInformationBlockType2* as part of the cell broadcast message. This exception indicates that the UE shall meet the additional spurious emission requirement for a specific deployment scenario.

Table 6.6.2.2B.4.3.1-1: *SystemInformationBlockType2* :Additional spurious emissions requirement

Derivation Path: TS 36.508 [7] clause 4.4.3.3, Table 4.4.3.3-1			
Information Element	Value/remark	Comment	Condition
<code>additionalSpectrumEmission</code>	3 (NS_03)		

6.6.2.2B.4.3.2 Message contents exceptions (network signalled value "NS_04")

1. Information element `additionalSpectrumEmission` is set to NS_04. This can be set in the *SystemInformationBlockType2* as part of the cell broadcast message. This exception indicates that the UE shall meet the additional spurious emission requirement for a specific deployment scenario.

Table 6.6.2.2B.4.3.2-1: *SystemInformationBlockType2* :Additional spurious emissions requirement

Derivation Path: TS 36.508 [7] clause 4.4.3.3, Table 4.4.3.3-1			
Information Element	Value/remark	Comment	Condition
<code>additionalSpectrumEmission</code>	4 (NS_04)		

6.6.2.2B.4.3.3 Message contents exceptions (network signalled value "NS_06")

1. Information element `additionalSpectrumEmission` is set to NS_06. This can be set in the *SystemInformationBlockType2* as part of the cell broadcast message. This exception indicates that the UE shall meet the additional spurious emission requirement for a specific deployment scenario.

Table 6.6.2B.4.3.3-1: SystemInformationBlockType2 :Additional spurious emissions requirement

Derivation Path: TS 36.508 [7] clause 4.4.3.3, Table 4.4.3.3-1			
Information Element	Value/remark	Comment	Condition
additionalSpectrumEmission	6 (NS_06)		

6.6.2B.4.3.4 Message contents exceptions (network signalled value "NS_07")

1. Information element additionalSpectrumEmission is set to NS_07. This can be set in the *SystemInformationblockType2* as part of the cell broadcast message. This exception indicates that the UE shall meet the additional spurious emission requirement for a specific deployment scenario.

Table 6.6.2B.4.3.4-1: SystemInformationBlockType2 :Additional spurious emissions requirement

Derivation Path: TS 36.508 [7] clause 4.4.3.3, Table 4.4.3.3-1			
Information Element	Value/remark	Comment	Condition
additionalSpectrumEmission	7 (NS_07)		

6.6.2B.4.3.5 Message contents exceptions (network signalled value "NS_11")

1. Information element additionalSpectrumEmission is set to NS_11. This can be set in the *SystemInformationblockType2* as part of the cell broadcast message. This exception indicates that the UE shall meet the additional spurious emission requirement for a specific deployment scenario.

Table 6.6.2B.4.3.5-1: SystemInformationBlockType2 :Additional spurious emissions requirement

Derivation Path: TS 36.508 [7] clause 4.4.3.3, Table 4.4.3.3-1			
Information Element	Value/remark	Comment	Condition
additionalSpectrumEmission	11(NS_11)		

6.6.2B.4.3.6 Message contents exceptions (network signalled value "NS_20")

1. Information element additionalSpectrumEmission is set to NS_20. This can be set in the *SystemInformationblockType2* as part of the cell broadcast message. This exception indicates that the UE shall meet the additional spurious emission requirement for a specific deployment scenario.

Table 6.6.2B.4.3.6-1: SystemInformationBlockType2 :Additional spurious emissions requirement

Derivation Path: TS 36.508 [7] clause 4.4.3.3, Table 4.4.3.3-1			
Information Element	Value/remark	Comment	Condition
additionalSpectrumEmission	20 (NS_20)		

6.6.2B.5 Test requirements

6.6.2B.5.1 Test requirements (network signalled value "NS_03", "NS_11", and "NS_20")

When "NS_03" is indicated in the cell:

- the measured sum of mean power at each antenna connector of UE in the channel bandwidth, derived in step 3, shall fulfil requirements in clause 6.2.4B Table [TBD] as appropriate,

and

- the power of any UE emission at each transmit antenna connector shall fulfil requirements in Table 6.6.2B.5.1-1 or 6.6.2B.5.1-2, as applicable.

Table 6.6.2B.5.1-1: Additional requirements (network signalled value "NS_03", "NS_11", and "NS_20"), E UTRA bands \leq 3GHz

Spectrum emission limit (dBm)/ Channel bandwidth							
Δf_{OoB} (MHz)	1.4 MHz	3.0 MHz	5 MHz	10 MHz	15 MHz	20 MHz	Measurement bandwidth
0-1	-8.5	-11.5	-13.5	-16.5	-18.5	-19.5	30 kHz
1-2.5	-11.5	-11.5	-11.5	-11.5	-11.5	-11.5	1 MHz
2.5-2.8	-23.5						1 MHz
2.8-5							1 MHz
5-6		-23.5					1 MHz
6-10			-23.5				1 MHz
10-15				-23.5			1 MHz
15-20					-23.5		1 MHz
20-25						-23.5	1 MHz

Note 1: The first and last measurement position with a 30 kHz filter is at Δf_{OoB} equals to 0.015 MHz and 0.985 MHz.

Note 2: At the boundary of spectrum emission limit, the first and last measurement position with a 1 MHz filter is the inside of +0.5MHz and -0.5MHz, respectively.

Note 3: The measurements are to be performed above the upper edge of the channel and below the lower edge of the channel

Note 4: Above SEM requirement applies to bands corresponding to network signalling value NS_03 as defined in TS 36.101 [2] clause 6.2.4B

Note 5: For the 2.5-2.8 MHz offset range with 1.4 MHz channel bandwidth, the measurement position is at Δf_{OoB} equals to 3 MHz.

Table 6.6.2B.5.1-2: Additional requirements (network signalled value "NS_03", "NS_11", and "NS_20"), 3GHz < E UTRA bands \leq 4.2GHz

Spectrum emission limit (dBm)/ Channel bandwidth							
Δf_{OoB} (MHz)	1.4 MHz	3.0 MHz	5 MHz	10 MHz	15 MHz	20 MHz	Measurement bandwidth
0-1	-8.2	-11.2	-13.2	-16.2	-18.2	-19.2	30 kHz
1-2.5	-11.2	-11.2	-11.2	-11.2	-11.2	-11.2	1 MHz
2.5-2.8	-23.2						1 MHz
2.8-5							1 MHz
5-6		-23.2					1 MHz
6-10			-23.2				1 MHz
10-15				-23.2			1 MHz
15-20					-23.2		1 MHz
20-25						-23.2	1 MHz

Note 1: The first and last measurement position with a 30 kHz filter is at Δf_{OoB} equals to 0.015 MHz and 0.985 MHz.

Note 2: At the boundary of spectrum emission limit, the first and last measurement position with a 1 MHz filter is the inside of +0.5MHz and -0.5MHz, respectively.

Note 3: The measurements are to be performed above the upper edge of the channel and below the lower edge of the channel

Note 4: Above SEM requirement applies to bands corresponding to network signalling value NS_03 as defined in TS 36.101 [2] clause 6.2.4B

Note 5: For the 2.5-2.8 MHz offset range with 1.4 MHz channel bandwidth, the measurement position is at Δf_{OoB} equals to 3 MHz.

NOTE (only for emission measurement):

As a general rule, the resolution bandwidth of the measuring equipment should be equal to the measurement bandwidth. However, to improve measurement accuracy, sensitivity and efficiency, the resolution bandwidth may be smaller than the measurement bandwidth. When the resolution bandwidth is smaller than the measurement bandwidth, the result should be integrated over the measurement bandwidth in order to obtain the equivalent noise bandwidth of the measurement bandwidth.

6.6.2B.5.2 Test requirements (network signalled value "NS_04")

When "NS_04" is indicated in the cell:

- the measured sum of mean power at each antenna connector of UE in the channel bandwidth, derived in step 3, shall fulfil requirements in clause 6.2.4B Table [TBD] as appropriate,

and

- the power of any UE emission at each antenna connector shall fulfil requirements in Table 6.6.2.2B.5.2-1 or Table 6.6.2.2B.5.2-2, as applicable.

Table 6.6.2.2B.5.2-1: Additional requirements (network signalled value "NS_04"), E UTRA bands ≤ 3GHz

Spectrum emission limit (dBm)/ Channel bandwidth							
Δf_{OoB} (MHz)	1.4 MHz	3.0 MHz	5 MHz	10 MHz	15 MHz	20 MHz	Measurement bandwidth
0-1	-8.5	-11.5	-13.5	-16.5	-18.5	-19.5	30 kHz
1-2.5	-11.5	-11.5		-11.5	-11.5	-11.5	1 MHz
2.5-2.8	-23.5						1 MHz
2.8-5							1 MHz
5-6		-23.5	-23.5	-23.5	-23.5	-23.5	1 MHz
6-10							1 MHz
10-15							1 MHz
15-20							1 MHz
20-25							1 MHz
Note 1:	The first and last measurement position with a 30 kHz filter is at Δf_{OoB} equals to 0.015 MHz and 0.985 MHz.						
Note 2:	At the boundary of spectrum emission limit, the first and last measurement position with a 1 MHz filter is the inside of +0.5MHz and -0.5MHz, respectively.						
Note 3:	The measurements are to be performed above the upper edge of the channel and below the lower edge of the channel.						
Note 4:	Above SEM requirement applies to bands corresponding to network signalling value NS_04 as defined in TS 36.101 [2] clause 6.2.4B.						
Note 5:	For the 2.5-2.8 MHz offset range with 1.4 MHz channel bandwidth, the measurement position is at Δf_{OoB} equals to 3 MHz.						

Table 6.6.2.2B.5.2-2: Additional requirements (network signalled value "NS_04"), 3GHz < E UTRA bands ≤ 4.2GHz

Spectrum emission limit (dBm)/ Channel bandwidth							
Δf_{OoB} (MHz)	1.4 MHz	3.0 MHz	5 MHz	10 MHz	15 MHz	20 MHz	Measurement bandwidth
0-1	-8.2	-11.2	-13.2	-16.2	-18.2	-19.2	30 kHz
1-2.5	-11.2	-11.2	-11.2	-11.2	-11.2	-11.2	1 MHz
2.5-2.8	-23.2						1 MHz
2.8-5							1 MHz
5-6		-23.2	-23.2	-23.2	-23.2	-23.2	1 MHz
6-10							1 MHz
10-15							1 MHz
15-20							1 MHz
20-25							1 MHz
Note 1:	The first and last measurement position with a 30 kHz filter is at Δf_{OoB} equals to 0.015 MHz and 0.985 MHz.						
Note 2:	At the boundary of spectrum emission limit, the first and last measurement position with a 1 MHz filter is the inside of +0.5MHz and -0.5MHz, respectively.						
Note 3:	The measurements are to be performed above the upper edge of the channel and below the lower edge of the channel.						
Note 4:	Above SEM requirement applies to bands corresponding to network signalling value NS_04 as defined in TS 36.101 [2] clause 6.2.4 Table 6.2.4-1.						
Note 5:	For the 2.5-2.8 MHz offset range with 1.4 MHz channel bandwidth, the measurement position is at Δf_{OoB} equals to 3 MHz.						

NOTE (only for emission measurement):

As a general rule, the resolution bandwidth of the measuring equipment should be equal to the measurement bandwidth. However, to improve measurement accuracy, sensitivity and efficiency, the resolution bandwidth may be smaller than the measurement bandwidth. When the resolution bandwidth is smaller than the measurement bandwidth, the result should be integrated over the measurement bandwidth in order to obtain the equivalent noise bandwidth of the measurement bandwidth.

6.6.2.2B.5.3 Test requirements (network signalled value "NS_06" or "NS_07")

When "NS_06" or "NS_07" is indicated in the cell:

- the measured sum of mean power at each antenna connector of UE in the channel bandwidth, derived in step 3, shall fulfil requirements in clause 6.2.4B Table [TBD] as appropriate 1,

and

- the power of any UE emission at each antenna connector shall fulfil requirements in Table 6.6.2.2B.5.3-1 or Table.6.6.2.2B.5.3-2, as applicable.

Table 6.6.2.2B.5.3-1: Additional requirements (network signalled value "NS_06" or "NS_07") , E UTRA bands \leq 3GHz

Δf_{OOB} (MHz)	Spectrum emission limit (dBm)/ Channel bandwidth				Measurement bandwidth
	1.4 MHz	3.0 MHz	5 MHz	10 MHz	
0-0.1	-11.5	-11.5	-13.5	-16.5	30 kHz
0.1-1	-11.5	-11.5	-11.5	-11.5	100 kHz
1-2.5	-11.5	-11.5	-11.5	-11.5	1 MHz
2.5-2.8	-23.5				1 MHz
2.8-5					1 MHz
5-6	-23.5				1 MHz
6-10			-23.5		1 MHz
10-15				-23.5	1 MHz
Note 1:	The first and last measurement position with a 30 kHz filter is at Δf_{OOB} equals to 0.015 MHz and 0.085 MHz. The first and last measurement position with a 100 kHz filter is at Δf_{OOB} equals to 0.15 MHz and 0.95 MHz.				
Note 2:	At the boundary of spectrum emission limit, the first and last measurement position with a 1 MHz filter is the inside of +0.5MHz and -0.5MHz, respectively.				
Note 3:	The measurements are to be performed above the upper edge of the channel and below the lower edge of the channel.				
Note 4:	Above SEM requirement applies to bands corresponding to network signalling value NS_06 and NS_07 as defined in TS 36.101 [2] clause 6.2.4B.				
Note 5:	For the 2.5-2.8 MHz offset range with 1.4 MHz channel bandwidth, the measurement position is at Δf_{OOB} equals to 3 MHz.				

Table 6.6.2.2B.5.3-2: Additional requirements (network signalled value "NS_06" or "NS_07") , 3GHz < E UTRA bands ≤ 4.2GHz

Δf_{OoB} (MHz)	Spectrum emission limit (dBm)/ Channel bandwidth				Measurement bandwidth
	1.4 MHz	3.0 MHz	5 MHz	10 MHz	
0-0.1	-11.2	-11.2	-13.2	-16.2	30 kHz
0.1-1	-11.2	-11.2	-11.2	-11.2	100 kHz
1-2.5	-11.2	-11.2	-11.2	-111.2	1 MHz
2.5-2.8	-23.2				1 MHz
2.8-5					1 MHz
5-6	-23.2				1 MHz
6-10			-23.2		1 MHz
10-15				-23.2	1 MHz
<p>Note 1: The first and last measurement position with a 30 kHz filter is at Δf_{OoB} equals to 0.015 MHz and 0.085 MHz. The first and last measurement position with a 100 kHz filter is at Δf_{OoB} equals to 0.15 MHz and 0.95 MHz.</p> <p>Note 2: At the boundary of spectrum emission limit, the first and last measurement position with a 1 MHz filter is the inside of +0.5MHz and -0.5MHz, respectively.</p> <p>Note 3: The measurements are to be performed above the upper edge of the channel and below the lower edge of the channel.</p> <p>Note 4: Above SEM requirement applies to bands corresponding to network signalling value NS_06 and NS_07 as defined in TS 36.101 [2] clause 6.2.4B.</p> <p>Note 5: For the 2.5-2.8 MHz offset range with 1.4 MHz channel bandwidth, the measurement position is at Δf_{OoB} equals to 3 MHz.</p>					

NOTE (only for emission measurement):

As a general rule, the resolution bandwidth of the measuring equipment should be equal to the measurement bandwidth. However, to improve measurement accuracy, sensitivity and efficiency, the resolution bandwidth may be smaller than the measurement bandwidth. When the resolution bandwidth is smaller than the measurement bandwidth, the result should be integrated over the measurement bandwidth in order to obtain the equivalent noise bandwidth of the measurement bandwidth.

6.6.2.3 Adjacent Channel Leakage power Ratio

6.6.2.3.1 Test purpose

To verify that UE transmitter does not cause unacceptable interference to adjacent channels in terms of Adjacent Channel Leakage power Ratio (ACLR).

6.6.2.3.2 Test applicability

This test case applies to all types of E-UTRA UE release 8 and forward.

6.6.2.3.3 Minimum conformance requirements

ACLR requirements are specified for two scenarios for an adjacent E -UTRA_{ACLR} and UTRA_{ACLR1/2} as shown in Figure 6.6.2.3.3-1.

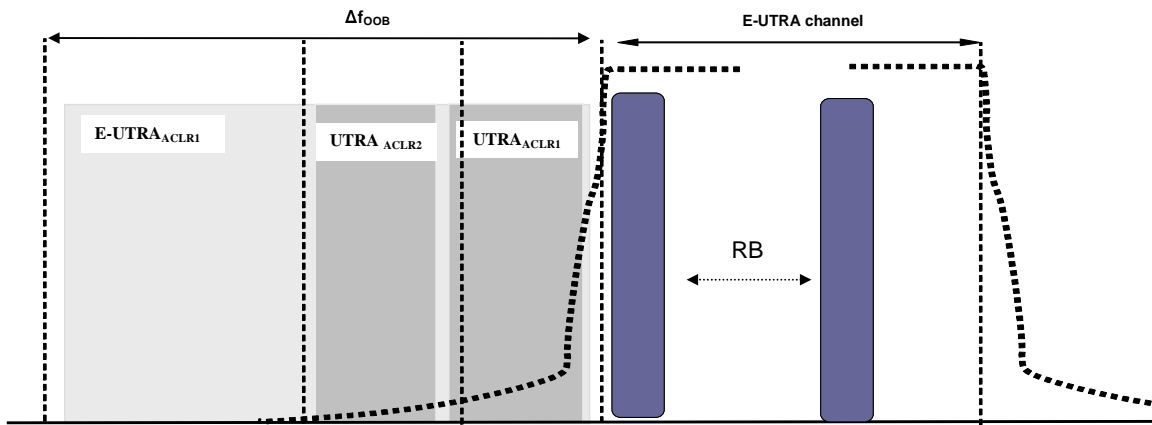

Figure 6.6.2.3.3-1: Adjacent Channel Leakage Power Ratio requirements

6.6.2.3.3.1 Minimum conformance requirements for E-UTRA

E-UTRA ACLR ($E-UTRA_{ACLR}$) is the ratio of the filtered mean power centred on the assigned channel frequency to the filtered mean power centred on an adjacent channel frequency at nominal channel spacing. The assigned E-UTRA channel power and adjacent E-UTRA channel power are measured with rectangular filters with measurement bandwidth specified in Table 6.6.2.3.3.1-1.

If the measured adjacent channel power is greater than -50dBm then the $E-UTRA_{ACLR}$ shall be higher than the valued specified in Table 6.6.2.3.3.1-1.

Table 6.6.2.3.3.1-1: General requirements for $E-UTRA_{ACLR}$

	Channel bandwidth / $E-UTRA_{ACLR1}$ / measurement bandwidth					
	1.4 MHz	3.0 MHz	5 MHz	10 MHz	15 MHz	20 MHz
$E-UTRA_{ACLR1}$	30 dB	30 dB	30 dB	30 dB	30 dB	30 dB
E-UTRA channel Measurement bandwidth	1.08 MHz	2.7 MHz	4.5 MHz	9.0 MHz	13.5 MHz	18 MHz

The normative reference for this requirement is TS 36.101 [2] subclause 6.6.2.3.1.

6.6.2.3.3.2 Minimum conformance requirements for UTRA

UTRA ACLR ($UTRA_{ACLR}$) is the ratio of the filtered mean power centred on the assigned E-UTRA channel frequency to the filtered mean power centred on an adjacent UTRA channel frequency.

UTRA ACLR is specified for both the first UTRA adjacent channel ($UTRA_{ACLR1}$) and the 2nd UTRA adjacent channel ($UTRA_{ACLR2}$). The UTRA channel power is measured with a RRC bandwidth filter with roll-off factor $\alpha = 0.22$. The assigned E-UTRA channel power is measured with a rectangular filter with measurement bandwidth specified in Table 6.6.2.3.3.2-1.

If the measured UTRA channel power is greater than -50dBm then the $UTRA_{ACLR1}$, and $UTRA_{ACLR2}$ shall be higher than the valued specified in Table 6.6.2.3.3.2-1.

Table 6.6.2.3.3.2-1: General requirements for $UTRA_{ACLR1/2}$

	Channel bandwidth / $UTRA_{ACLR1/2}$ / measurement bandwidth					
	1.4 MHz	3.0 MHz	5 MHz	10 MHz	15 MHz	20 MHz

UTRA_{ACL}R1	33 dB	33 dB	33 dB	33 dB	33 dB	33 dB
Adjacent channel centre frequency offset (in MHz)	$0.7+BW_U$ $TR_A/2$ / -0.7- $BW_{UTRA}/2$	$1.5+BW_U$ $TR_A/2$ / -1.5- $BW_{UTRA}/2$	$2.5+BW_U$ $TR_A/2$ / -2.5- $BW_{UTRA}/2$	$5+BW_{UTR}$ $A/2$ / -5- $BW_{UTRA}/2$	$7.5+BW_U$ $TR_A/2$ / -7.5- $BW_{UTRA}/2$	$10+BW_{UT}$ $RA/2$ / -10- $BW_{UTRA}/2$
UTRA_{ACL}R2	-	-	36 dB	36 dB	36 dB	36 dB
Adjacent channel centre frequency offset (in MHz)	-	-	$2.5+3*B$ $W_{UTRA}/2$ / -2.5- $3*BW_{UTR}$ $A/2$	$5+3*BW_U$ $TR_A/2$ / -5- $3*BW_{UTR}$ $A/2$	$7.5+3*B$ $W_{UTRA}/2$ / -7.5- $3*BW_{UTR}$ $A/2$	$10+3*BW$ $UTRA/2$ / -10- $3*BW_{UTR}$ $A/2$
E-UTRA channel Measurement bandwidth	1.08 MHz	2.7 MHz	4.5 MHz	9.0 MHz	13.5 MHz	18 MHz
UTRA 5MHz channel Measurement bandwidth¹	3.84 MHz	3.84 MHz	3.84 MHz	3.84 MHz	3.84 MHz	3.84 MHz
UTRA 1.6MHz channel measurement bandwidth²	1.28 MHz	1.28 MHz	1.28 MHz	1.28 MHz	1.28 MHz	1.28 MHz
Note 1: Applicable for E-UTRA FDD co-existence with UTRA FDD in paired spectrum. Note 2: Applicable for E-UTRA TDD co-existence with UTRA TDD in unpaired spectrum.						

The normative reference for this requirement is TS 36.101 subclause 6.6.2.3.2.

6.6.2.3.4 Test description

6.6.2.3.4.1 Initial conditions

Initial conditions are a set of test configurations the UE needs to be tested in and the steps for the SS to take with the UE to reach the correct measurement state.

The initial test configurations consist of environmental conditions, test frequencies, and channel bandwidths based on E-UTRA bands specified in table 5.4.2.1-1. All of these configurations shall be tested with applicable test parameters for each channel bandwidth, and are shown in table 6.6.2.3.4.1-1. The details of the uplink reference measurement channels (RMCs) are specified in Annex A.2. Configurations of PDSCH and PDCCH before measurement are specified in Annex C.2.

Table 6.6.2.3.4.1-1: Test Configuration Table

Initial Conditions						
Test Environment (as specified in TS 36.508 [7] subclause 4.1)			NC, TL/VL, TL/VH, TH/VL, TH/VH			
Test Frequencies (as specified in TS36.508 [7] subclause 4.3.1)			Low range, Mid range, High range			
Test Channel Bandwidths (as specified in TS 36.508 [7] subclause 4.3.1)			Lowest, 5MHz, 10MHz, Highest			
Test Parameters for Channel Bandwidths						
Downlink Configuration			Uplink Configuration			
Ch BW	Mod'n	RB allocation		Mod'n	RB allocation	
		FDD	TDD		FDD	TDD

1.4MHz	N/A for ACLR testing	QPSK	6	6
1.4MHz		QPSK	5	5
1.4MHz		16QAM	6	6
1.4MHz		16QAM	5	5
3MHz		QPSK	15	15
3MHz		QPSK	4	4
3MHz		16QAM	15	15
3MHz		16QAM	4	4
5MHz		QPSK	25	25
5MHz		QPSK	8	8
5MHz		16QAM	25	25
5MHz		16QAM	8	8
10MHz		QPSK	50	50
10MHz		QPSK	12	12
10MHz		16QAM	50 (Note 3)	50 (Note 3)
10MHz		16QAM	12	12
15MHz		QPSK	75	75
15MHz		QPSK	16	16
15MHz		16QAM	75 (Note 3)	75 (Note 3)
15MHz		16QAM	16	16
20MHz	QPSK	100	100	
20MHz	QPSK	18	18	
20MHz	16QAM	100 (Note 3)	100 (Note 3)	
20MHz	16QAM	18	18	
<p>Note 1: Test Channel Bandwidths are checked separately for each E-UTRA band, which applicable channel bandwidths are specified in Table 5.4.2.1-1.</p> <p>Note 2: The RB_{start} of partial RB allocation shall be RB#0 and RB# (max + 1 – RB allocation) of the channel bandwidth.</p> <p>Note 3: Applies only for UE-Categories 2-5</p>				

1. Connect the SS to the UE antenna connectors as shown in Figure TS 36.508 [7] Annex A, Figure A.3.
2. The parameter settings for the cell are set up according to TS 36.508 [7] subclause 4.4.3.
3. Downlink signals are initially set up according to Annex C0, C.1 and C.3.0, and uplink signals according to Annex H.1 and H.3.0.
4. The UL Reference Measurement channels are set according to Table 6.6.2.3.4.1-1.
5. Propagation conditions are set according to Annex B.0.
6. Ensure the UE is in State 3A-RF according to TS 36.508 [7] clause 5.2A.2. Message contents are defined in clause 6.6.2.3.4.3.

6.6.2.3.4.2 Test procedure

1. SS sends uplink scheduling information for each UL HARQ process via PDCCH DCI format 0 for C_RNTI to schedule the UL RMC according to Table 6.6.2.3.4.1-1. Since the UE has no payload data to send, the UE transmits uplink MAC padding bits on the UL RMC.
2. Send continuously uplink power control "up" commands in the uplink scheduling information to the UE until the UE transmits at P_{UMAX} level.
3. Measure the mean power of the UE in the channel bandwidth of the radio access mode according to the test configuration, which shall meet the requirements described in Table 6.2.3.5-1. The period of the measurement shall be at least the continuous duration of one sub-frame (1ms). For TDD slots with transient periods are not under test.
4. Measure the rectangular filtered mean power for E-UTRA.
5. Measure the rectangular filtered mean power of the first E-UTRA adjacent channel on both lower and upper side of the E-UTRA channel, respectively.

6. Measure the RRC filtered mean power of the first and the second UTRA adjacent channel on both lower and upper side of the E-UTRA channel, respectively.
7. Calculate the ratios of the power between the values measured in step 4 over step 5 for lower and upper E-UTRA_{ACLR}, respectively.
8. Calculated the ratios of the power between the values measured in step 4 over step 6 for lower and upper UTRA_{ACLR1}, UTRA_{ACLR2}, respectively.

6.6.2.3.4.3 Message contents

Message contents are according to TS 36.508 [7] subclause 4.6.

6.6.2.3.5 Test requirement

6.6.2.3.5.1 Test requirements E-UTRA

- The measured UE mean power in the channel bandwidth, derived in step 3, shall fulfil requirements in Table 6.2.3.5-1 as appropriate,

and

- if the measured adjacent channel power is greater than -50 dBm then the measured E-UTRA_{ACLR}, derived in step 7, shall be higher than the limits in table 6.6.2.3.5.1-1.

Table 6.6.2.3.5.1-1: E-UTRA UE ACLR

	Channel bandwidth / E-UTRA _{ACLR1} / measurement bandwidth					
	1.4 MHz	3.0 MHz	5 MHz	10 MHz	15 MHz	20 MHz
E-UTRA_{ACLR1}	29.2 dB	29.2 dB	29.2 dB	29.2 dB	29.2 dB	29.2 dB
E-UTRA channel Measurement bandwidth	1.08 MHz	2.7 MHz	4.5 MHz	9.0 MHz	13.5 MHz	18 MHz
UE channel	+1.4 MHz or -1.4 MHz	+3 MHz or -3 MHz	+5MHz or -5MHz	+10MHz or -10MHz	+15MHz or -15MHz	+20MHz or -20MHz

Test requirements UTRA

If the measured UTRA channel power is greater than -50 dBm then the measured UTRA_{ACLR1}, UTRA_{ACLR2}, derived in step 8, shall be higher than the limits in table 6.6.2.3.5.2-1.

Table 6.6.2.3.5.2-1: UTRA UE ACLR

	Channel bandwidth / UTRA _{ACLR1/2} / measurement bandwidth					
	1.4 MHz	3.0 MHz	5 MHz	10 MHz	15 MHz	20 MHz

UTRA_{ACLR1}	32.2 dB	32.2 dB	32.2 dB	32.2 dB	32.2 dB	32.2 dB
Adjacent channel centre frequency offset (in MHz)	$0.7+B_{UTR}/2$ / -0.7- $B_{UTR}/2$	$1.5+B_{UTR}/2$ / -1.5- $B_{UTR}/2$	$2.5+B_{UTR}/2$ / -2.5- $B_{UTR}/2$	$5+B_{UTR}/2$ / -5- $B_{UTR}/2$	$7.5+B_{UTR}/2$ / -7.5- $B_{UTR}/2$	$10+B_{UTR}/2$ / -10- $B_{UTR}/2$
UTRA_{ACLR2}	-	-	35.2 dB	35.2 dB	35.2 dB	35.2 dB
Adjacent channel centre frequency offset (in MHz)	-	-	$2.5+3*B_{UTR}/2$ / -2.5- $3*B_{UTR}/2$	$5+3*B_{UTR}/2$ / -5- $3*B_{UTR}/2$	$7.5+3*B_{UTR}/2$ / -7.5- $3*B_{UTR}/2$	$10+3*B_{UTR}/2$ / -10- $3*B_{UTR}/2$
E-UTRA channel Measurement bandwidth	1.08 MHz	2.7 MHz	4.5 MHz	9.0 MHz	13.5 MHz	18 MHz
UTRA 5MHz channel Measurement bandwidth¹	3.84 MHz	3.84 MHz	3.84 MHz	3.84 MHz	3.84 MHz	3.84 MHz
UTRA 1.6MHz channel measurement bandwidth²	1.28 MHz	1.28 MHz	1.28 MHz	1.28 MHz	1.28 MHz	1.28 MHz
Note 1: Applicable for E-UTRA FDD co-existence with UTRA FDD in paired spectrum. Note 2: Applicable for E-UTRA TDD co-existence with UTRA TDD in unpaired spectrum. Note 3: B_{UTR} for UTRA FDD is 5MHz and for UTRA TDD is 1.6MHz.						

6.6.2.3_1 Adjacent Channel Leakage power Ratio for HPUE

6.6.2.3_1.1 Test purpose

To verify that HPUE transmitter does not cause unacceptable interference to adjacent channels in terms of Adjacent Channel Leakage power Ratio (ACLR).

6.6.2.3_1.2 Test applicability

This test case applies to all types of E-UTRA Power Class 1 UE release 11 and forward.

6.6.2.3_1.3 Minimum conformance requirements

ACLR requirements are specified for an adjacent E-UTRA_{ACLR} as shown in Figure 6.6.2.3_1.3-1.

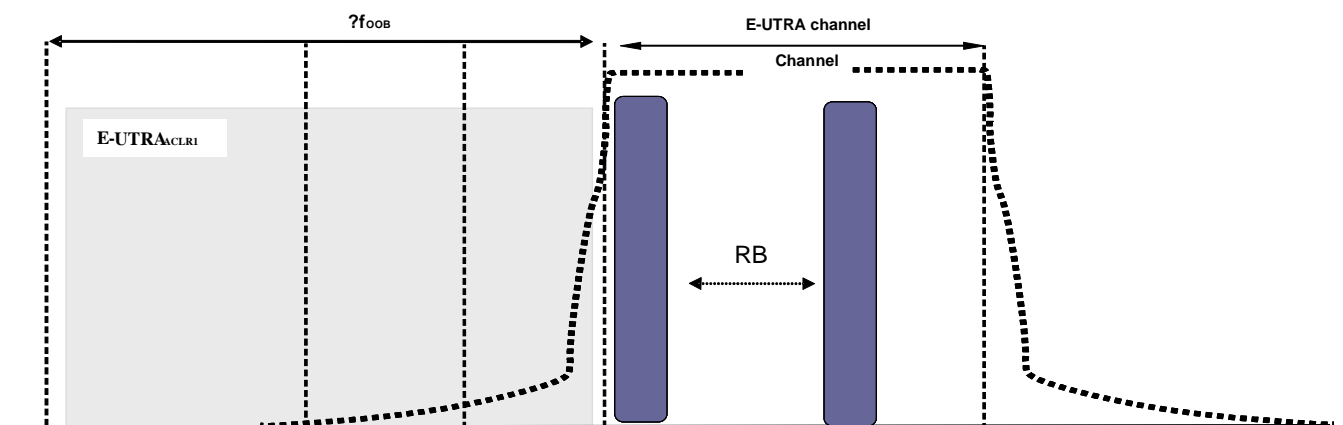

Figure 6.6.2.3_1.3-1: Adjacent Channel Leakage Power Ratio requirements

6.6.2.3_1.3.1 Minimum conformance requirements for E-UTRA for HPUE

Same minimum conformance requirements as in clause 6.6.2.3.3.1 with for following exceptions:

- Instead of Table 6.6.2.3.3.1-1 → use Table 6.6.2.3_1.3.1-1

Table 6.6.2.3_1.3.1-1: Additional E-UTRA_{ACLR} requirements for Power Class 1

	Channel bandwidth / E-UTRA _{ACLR1} / Measurement bandwidth					
	1.4 MHz	3.0 MHz	5 MHz	10 MHz	15 MHz	20 MHz
E-UTRA _{ACLR1}	N/A	N/A	37 dB	37 dB	N/A	N/A
E-UTRA channel Measurement bandwidth	N/A	N/A	4.5 MHz	9.0 MHz	N/A	N/A
Adjacent channel centre frequency offset [MHz]	N/A	N/A	+5 / -5	+10 / -10	N/A	N/A
NOTE 1: E-UTRA _{ACLR1} shall be applicable for >23dBm						

The normative reference for this requirement is TS 36.101 [2] clause 6.6.2.1.

6.6.2.3_1.4 Test description

6.6.2.3_1.4.1 Initial conditions

Same initial conditions as in clause 6.6.2.3.4.1.

6.6.2.3_1.4.2 Test procedure

1. SS sends uplink scheduling information for each UL HARQ process via PDCCH DCI format 0 for C_RNTI to schedule the UL RMC according to Table 6.6.2.3.4.1-1. Since the UE has no payload data to send, the UE transmits uplink MAC padding bits on the UL RMC.
2. Send continuously uplink power control "up" commands in the uplink scheduling information to the UE until the UE transmits at P_{UMAX} level.
3. Measure the mean power of the UE in the channel bandwidth of the radio access mode according to the test configuration, which shall meet the requirements described in Table 6.2.3_1.5-1. The period of the measurement shall be at least the continuous duration of one sub-frame (1ms). For TDD slots with transient periods are not under test.
4. Measure the rectangular filtered mean power for E-UTRA.
5. Measure the rectangular filtered mean power of the first E-UTRA adjacent channel on both lower and upper side of the E-UTRA channel, respectively.
6. Calculate the ratios of the power between the values measured in step 4 over step 5 for lower and upper E-UTRA_{ACLR}, respectively.

6.6.2.3_1.4.3 Message contents

Same message contents as in clause 6.6.2.3.4.3

6.6.2.3_1.5 Test requirement

6.6.2.3_1.5.1 Test requirements E-UTRA

- The measured UE mean power in the channel bandwidth, derived in step 3, shall fulfil requirements in Table 6.2.3_1.5-1 as appropriate,

and

- if the measured adjacent channel power is greater than -50 dBm then the measured E-UTRA_{ACLR}, derived in step 7, shall be higher than the limits in table 6.6.2.3_1.4.1-1.

Table 6.6.2.3_1.4.1-1: E-UTRA UE ACLR

	Channel bandwidth / E-UTRA _{ACLR1} / measurement bandwidth					
	1.4 MHz	3.0 MHz	5 MHz	10 MHz	15 MHz	20 MHz
E-UTRA _{ACLR1}	N/A	N/A	36.2 dB	36.2 dB	N/A	N/A
E-UTRA channel Measurement bandwidth	N/A	N/A	4.5 MHz	9.0 MHz	N/A	N/A
UE channel	N/A	N/A	+5MHz or -5MHz	+10MHz or -10MHz	N/A	N/A

6.6.2.3A Adjacent Channel Leakage power Ratio for CA

6.6.2.3A.1 Adjacent Channel Leakage power Ratio for CA (intra-band contiguous DL CA and UL CA)

6.6.2.3A.1.1 Test purpose

To verify that UE transmitter does not cause unacceptable interference to adjacent channels in terms of Adjacent Channel Leakage power Ratio (ACLR) for CA.

6.6.2.3A.1.2 Test applicability

This test case applies to all types of E-UTRA UE release 10 and forward that support intra band contiguous DL CA and UL CA.

6.6.2.3A.1.3 Minimum conformance requirements

ACLR for CA requirements are specified for two scenarios for an adjacent E-UTRA_{ACLR} and UTRA_{ACLR1/2} as shown in Figure 6.6.2.3A.1.3-1.

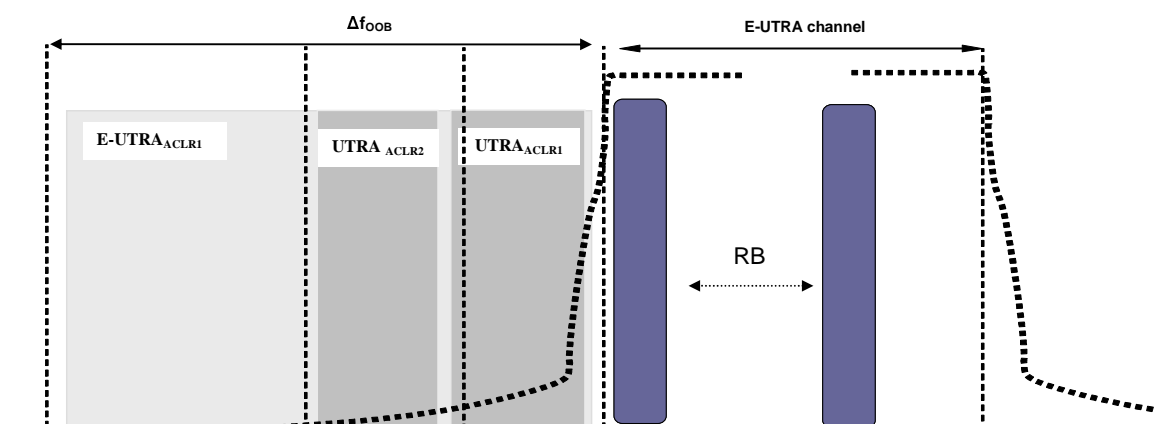

Figure 6.6.2.3A.1.3-1: Adjacent Channel Leakage Power Ratio for CA requirements

6.6.2.3A.1.3.1 Minimum conformance requirements of UTRA for CA

For intra-band contiguous carrier aggregation the UTRA Adjacent Channel Leakage power Ratio ($UTRA_{ACLR}$) is the ratio of the filtered mean power centred on the assigned carrier aggregated channel bandwidth to the filtered mean power centred on an adjacent(s) UTRA channel frequency.

UTRA Adjacent Channel Leakage power Ratio is specified for both the first UTRA adjacent channel ($UTRA_{ACLR1}$) and the 2nd UTRA adjacent channel ($UTRA_{ACLR2}$). The UTRA channel power is measured with a RRC bandwidth filter with roll-off factor $\alpha = 0.22$. The assigned aggregated channel bandwidth power is measured with a rectangular filter with measurement bandwidth specified in Table 6.6.2.3A.1.3.1-1. If the measured UTRA channel power is greater than – 50dBm then the $UTRA_{ACLR1}$ shall be higher than the valued specified in Table 6.6.2.3A.1.3.1-1.

Table 6.6.2.3A.1.3.1-1: General requirements of $UTRA_{ACLR1/2}$ for CA

	CA bandwidth class / $UTRA_{ACLR1/2}$ / measurement bandwidth
	CA bandwidth class C
$UTRA_{ACLR1}$	33 dB
Adjacent channel centre frequency offset (in MHz)	$\frac{+ BW_{Channel_CA} / 2 + BW_{UTRA} / 2}{- BW_{Channel_CA} / 2 - BW_{UTRA} / 2}$
$UTRA_{ACLR2}$	36 dB
Adjacent channel centre frequency offset (in MHz)	$\frac{+ BW_{Channel_CA} / 2 + 3 * BW_{UTRA} / 2}{- BW_{Channel_CA} / 2 - 3 * BW_{UTRA} / 2}$
CA E-UTRA channel Measurement bandwidth	$BW_{Channel_CA} - 2 * BW_{GB}$
UTRA 5MHz channel Measurement bandwidth*	3.84 MHz
UTRA 1.6MHz channel measurement bandwidth**	1.28 MHz
* Note: Applicable for E-UTRA FDD co-existence with UTRA FDD in paired spectrum.	
** Note: Applicable for E-UTRA TDD co-existence with UTRA TDD in unpaired spectrum.	

The normative reference for this requirement is TS 36.101 [2] subclause 6.6.2.3.2A.

6.6.2.3A.1.3.2 Minimum conformance requirements of CA E-UTRA

For intra-band contiguous carrier aggregation the carrier aggregation E-UTRA Adjacent Channel Leakage power Ratio ($CA\ E\text{-}UTRA_{ACLR}$) is the ratio of the filtered mean power centred on the aggregated channel bandwidth to the filtered mean power centred on an adjacent aggregated channel bandwidth at nominal channel spacing. The assigned aggregated channel bandwidth power and adjacent aggregated channel bandwidth power are measured with rectangular filters with measurement bandwidth specified in Table 6.6.2.3A.1.3.2-1.

If the measured adjacent channel power is greater than –50dBm then the $E\text{-}UTRA_{ACLR}$ shall be higher than the value specified in Table 6.6.2.3A.1.3.2-1.

Table 6.6.2.3A.1.3.2-1: General requirements of $E\text{-}UTRA_{ACLR}$ for CA

	CA bandwidth class / CA E- $UTRA_{ACLR}$ / measurement bandwidth
	CA bandwidth class C
CA E- $UTRA_{ACLR}$	30 dB
CA E-UTRA channel Measurement bandwidth	$BW_{Channel_CA} - 2 * BW_{GB}$
Adjacent channel centre frequency offset (in MHz)	$\frac{+ BW_{Channel_CA}}{- BW_{Channel_CA}}$

The normative reference for this requirement is TS 36.101 [2] subclause 6.6.2.3.3A.

6.6.2.3A.1.4 Test description

6.6.2.3A.1.4.1 Initial condition

Initial conditions are a set of test configurations the UE needs to be tested in and the steps for the SS to take with the UE to reach the correct measurement state.

The initial test configurations consist of environmental conditions, test frequencies, and channel bandwidths based on E-UTRA CA configurations specified in table 5.4.2A.1-1. All of these configurations shall be tested with applicable test parameters for each channel bandwidth, and are shown in table 6.6.2.3A.1.4.1-1. The details of the uplink reference measurement channels (RMCs) are specified in Annex A.2. Configurations of PDSCH and PDCCH before measurement are specified in Annex C.2.

Table 6.6.2.3A.1.4.1-1: Test Configuration Table

Initial Conditions								
Test Environment as specified in TS 36.508[7] subclause 4.1				NC, TL/VL, TL/VH, TH/VL, TH/VH				
Test Frequencies as specified in TS36.508 [7] subclause 4.3.1 for different CA bandwidth classes.				C: Low range, High range				
Test CC Combination setting (N_{RB_agg}) as specified in subclause 5.4.2A.1 for the CA Configuration				Lowest N_{RB_agg} , Highest N_{RB_agg}				
Test Parameters for CA Configurations								
CA Configuration / N_{RB_agg}		DL Allocation	CC MOD	UL Allocation				
PCC N_{RB}	SCCs N_{RB}	PCC & SCC RB allocation		N_{RB_alloc}	PCC & SCC RB allocations(L_{CRB} @ RB_{start})			
75	75	N/A for this test	QPSK	75	P_75@0	S_0@0	-	-
75	75		QPSK	16	P_16@0	S_0@0	-	-
75	75		QPSK	130	P_75@0	S_55@0	-	-
75	75		QPSK	150	P_75@0	S_75@0	-	-
75	75		16QAM	75	P_75@0	S_0@0	-	-
75	75		16QAM	16	P_16@0	S_0@0	-	-
75	75		16QAM	130	P_75@0	S_55@0	-	-
75	75		16QAM	150	P_75@0	S_75@0	-	-
75	75		QPSK	2	P_1@0	S_1@74	-	-
75	75		QPSK	15	P_5@0	P_5@35	S_5@0	-
75	75		QPSK	75	P_25@0	P_20@35	S_15@0	S_15@34
100	50		QPSK	100	P_100@0	S_0@0	-	-
100	50		QPSK	12	P_12@0	S_0@0	-	-
100	50		QPSK	150	P_100@0	S_50@0	-	-
100	50		16QAM	100	P_100@0	S_0@0	-	-
100	50		16QAM	12	P_12@0	S_0@0	-	-
100	50		16QAM	150	P_100@0	S_50@0	-	-
100	50		QPSK	2	P_1@0	S_1@49	-	-
100	50		QPSK	15	P_5@0	P_5@50	S_5@0	-
100	50		QPSK	75	P_25@0	P_20@34	S_15@0	S_15@34
100	100		QPSK	100	P_100@0	S_0@0	-	-
100	100		QPSK	18	P_18@0	S_0@0	-	-
100	100		QPSK	130	P_100@0	S_30@0	-	-
100	100		QPSK	200	P_100@0	S_100@0	-	-
100	100		16QAM	100	P_100@0	S_0@0	-	-
100	100		16QAM	18	P_18@0	S_0@0	-	-
100	100		16QAM	130	P_100@0	S_30@0	-	-
100	100		16QAM	200	P_100@0	S_100@0	-	-
100	100		QPSK	2	P_1@0	S_1@99	-	-
100	100		QPSK	20	P_5@0	P_5@50	S_5@0	S_5@50
100	100		QPSK	100	P_25@0	P_25@50	S_25@0	S_25@50

Note 1: CA Configuration Test CC Combination settings are checked separately for each CA Configuration, which applicable aggregated channel bandwidths are specified in Table 5.4.2A.1-1.

1. Connect the SS to the UE antenna connectors as shown in Figure TS 36.508 [7] Annex A, Figure group A.32 as appropriate.
2. The parameter settings for the cell are set up according to TS 36.508 [7] subclause 4.4.3.
3. Downlink signals for PCC are initially set up according to Annex C.0, C.1 and C.3.0, and uplink signals according to Annex H.1 and H.3.0.
4. The UL Reference Measurement channels are set according to Table 6.6.2.3A.1.4.1-1.
5. Propagation conditions are set according to Annex B.0.
6. Ensure the UE is in State 3A-RF according to TS 36.508 [7] clause 5.2A.2. Message contents are defined in clause 6.6.2.3A.1.4.3.

6.6.2.3A.1.4.2 Test procedure

1. Configure SCC according to Annex C.0, C.1 and Annex C.3.0 for all downlink physical channels except PHICH.
2. The SS shall configure SCC as per TS 36.508 [7] clause 5.2A.4. Message contents are defined in clause 6.6.2.3A.1.4.3
3. SS activates SCC by sending the activation MAC-CE (Refer TS 36.321 [13], clauses 5.13, 6.1.3.8). Wait for at least 2 seconds (Refer TS 36.133, clauses 8.3.3.2).
4. SS sends uplink scheduling information for each UL HARQ process via PDCCH DCI format 0 for C_RNTI to schedule the UL RMC according to Table 6.6.2.3A.1.4.1-1 on both PCC and SCC. Since the UE has no payload and no loopback data to send the UE sends uplink MAC padding bits on the UL RMC.
5. Send continuously uplink power control “up” commands in every uplink scheduling information to the UE until the UE transmits at P_{UMAX} level.
6. Measure the mean power over all component carriers of the UE in the CA configuration of the radio access mode according to the test configuration, which shall meet the requirements described in Table 6.2.3A.1.5-1. The period of the measurement shall be at least the continuous duration of one sub-frame (1ms). For TDD slots with transient periods are not under test.
7. Measure the rectangular filtered mean power for CA E-UTRA.
8. Measure the rectangular filtered mean power of the first CA E-UTRA adjacent channel on both lower and upper side of the CA E-UTRA channel, respectively.
9. Measure the RRC filtered mean power of the first and the second UTRA adjacent channel on both lower and upper side of the CA E-UTRA channel, respectively.
10. Calculate the ratio of the power between the values measured in step 7 over step 8 for CA E-UTRA_{ACLR}.
11. Calculate the ratio of the power between the values measured in step 7 over step 9 for UTRA_{ACLR1}, UTRA_{ACLR2}.

6.6.2.3A.1.4.3 Message contents

Message contents are according to TS 36.508 [7] subclause 4.6. In test procedure step 2, for SCC configuration there are no additional message contents.

6.6.2.3A.1.5 Test Requirements

6.6.2.3A.1.5.1 Test requirements of UTRA for CA

If the measured UTRA channel power is greater than -50dBm then the measured UTRA_{ACLR1} and UTRA_{ACLR2}, derived in step 11, shall be higher than the limits in table 6.6.2.3A.1.5.1-1.

Table 6.6.2.3A.1.5.1-1: UTRA UE ACLR for CA

	CA bandwidth class / UTRA _{ACLR1/2} / measurement bandwidth
--	--

CA bandwidth class C	
UTRA _{ACLR1}	32.2 dB
Adjacent channel centre frequency offset (in MHz)	$\frac{+ BW_{\text{Channel_CA}}/2 + BW_{\text{UTRA}}/2}{- BW_{\text{Channel_CA}}/2 - BW_{\text{UTRA}}/2}$
UTRA _{ACLR2}	35.2 dB
Adjacent channel centre frequency offset (in MHz)	$\frac{+ BW_{\text{Channel_CA}}/2 + 3*BW_{\text{UTRA}}/2}{- BW_{\text{Channel_CA}}/2 - 3*BW_{\text{UTRA}}/2}$
CA E-UTRA channel Measurement bandwidth	$BW_{\text{Channel_CA}} - 2* BW_{\text{GB}}$
UTRA 5MHz channel Measurement bandwidth (Note 1)	3.84 MHz
UTRA 1.6MHz channel measurement bandwidth (Note 2)	1.28 MHz
NOTE 1: Applicable for E-UTRA FDD co-existence with UTRA FDD in paired spectrum.	
NOTE 2: Applicable for E-UTRA TDD co-existence with UTRA TDD in unpaired spectrum.	

6.6.2.3A.1.5.2 Test requirements of CA E-UTRA

- The measured UE mean power in the channel bandwidth as specified in clause 5.4.2A, derived in step 6, shall fulfil requirements in Table 6.2.3A.1.5-1 as appropriate,

and

- if the measured adjacent channel power is greater than -50 dBm then the measured CA E-UTRA_{ACLR}, derived in step 10, shall be higher than the limits in table 6.6.2.3A.1.5.2-1.

Table 6.6.2.3A.1.5.2-1: CA E-UTRA ACLR

	CA bandwidth class / CA E-UTRA_{ACLR} / Measurement bandwidth
	CA bandwidth class C
CA E-UTRA _{ACLR}	29.2 dB
CA E-UTRA channel Measurement bandwidth	$BW_{\text{Channel_CA}} - 2* BW_{\text{GB}}$
Adjacent channel centre frequency offset (in MHz)	$\frac{+ BW_{\text{Channel_CA}}}{- BW_{\text{Channel_CA}}}$

6.6.2.3B Adjacent Channel Leakage power Ratio for UL-MIMO

6.6.2.3B.1 Test purpose

To verify that UE transmitter does not cause unacceptable interference to adjacent channels in terms of Adjacent Channel Leakage power Ratio (ACLR) for UL-MIMO.

6.6.2.3B.2 Test applicability

This test case applies to all types of E-UTRA UE release 10 and forward that support UL-MIMO.

6.6.2.3B.3 Minimum conformance requirements

For UE with multiple transmit antenna connectors, the requirements for ACLR are specified at each transmit antenna connector. ACLR requirements are specified for two scenarios for an adjacent E-UTRA_{ACLR} and UTRA_{ACLR1/2} as shown in Figure 6.6.2.3B.3-1.

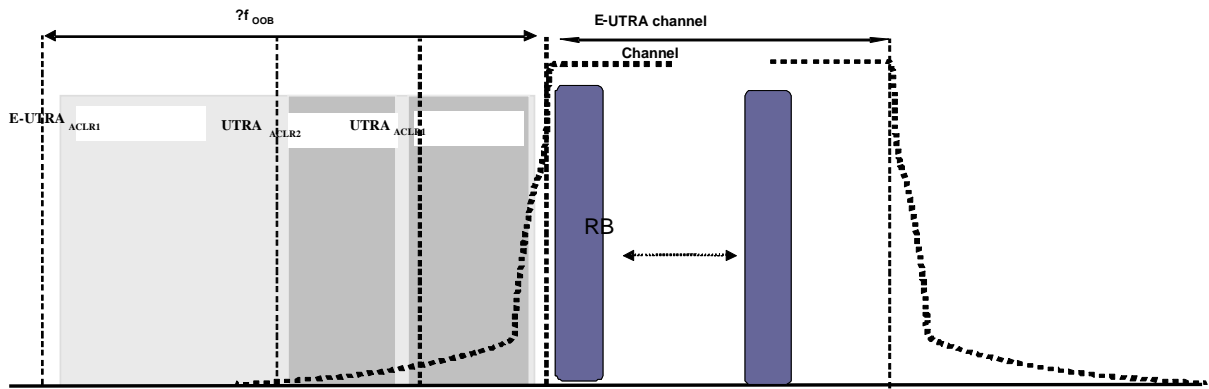

Figure 6.6.2.3B.3-1: Adjacent Channel Leakage Power Ratio requirements

6.6.2.3B.3.1 Minimum conformance requirements for E-UTRA

E-UTRA ACLR (E-UTRAACLR) is the ratio of the filtered mean power centred on the assigned channel frequency to the filtered mean power centred on an adjacent channel frequency at nominal channel spacing. The assigned E-UTRA channel power and adjacent E-UTRA channel power are measured with rectangular filters with measurement bandwidth specified in Table 6.6.2.3B.3.1-1.

For UEs with two transmit antenna connectors in closed-loop spatial multiplexing scheme, the requirements in Table 6.6.2.3B.3.1-1 apply to each transmit antenna connector with the UL-MIMO configurations specified in Table 6.2.2B.3-2.

If the measured adjacent channel power is greater than -50dBm then the E-UTRAACLR shall be higher than the valued specified in Table 6.6.2.3B.3.1-1.

Table 6.6.2.3B.3.1-1: General requirements for E-UTRA_{ACLR}

	Channel bandwidth / E-UTRA _{ACLR1} / measurement bandwidth					
	1.4 MHz	3.0 MHz	5 MHz	10 MHz	15 MHz	20 MHz
E-UTRA_{ACLR1}	30 dB	30 dB	30 dB	30 dB	30 dB	30 dB
E-UTRA channel Measurement bandwidth	1.08 MHz	2.7 MHz	4.5 MHz	9.0 MHz	13.5 MHz	18 MHz

The normative reference for this requirement is TS 36.101 clause 6.6.2B.

6.6.2.3B.3.2 Minimum conformance requirements for UTRA

UTRA ACLR (UTRA_{ACLR}) is the ratio of the filtered mean power centred on the assigned E-UTRA channel frequency to the filtered mean power centred on an adjacent UTRA channel frequency.

UTRA ACLR is specified for both the first UTRA adjacent channel (UTRA_{ACLR1}) and the 2nd UTRA adjacent channel (UTRA_{ACLR2}). The UTRA channel power is measured with a RRC bandwidth filter with roll-off factor $\alpha=0.22$. The assigned E-UTRA channel power is measured with a rectangular filter with measurement bandwidth specified in Table 6.6.2.3B.3.2-1.

For UEs with two transmit antenna connectors in closed-loop spatial multiplexing scheme, the requirements in Table 6.6.2.3B.3.2-1 apply to each transmit antenna connector with the UL-MIMO configurations specified in Table 6.2.2B.3-2.

If the measured UTRA channel power is greater than -50dBm then the UTRA_{ACLR1}, and UTRA_{ACLR2} shall be higher than the valued specified in Table 6.6.2.3B.3.2-1.

Table 6.6.2.3B.3.2-1: General requirements for UTRA_{ACLR1/2}

	Channel bandwidth / E-UTRA _{ACLR1/2} / measurement bandwidth					
	1.4 MHz	3.0 MHz	5 MHz	10 MHz	15 MHz	20 MHz
E-UTRA_{ACLR1}	33 dB	33 dB	33 dB	33 dB	33 dB	33 dB
Adjacent channel centre frequency offset (in MHz)	$0.7+BW_{UTRA}/2$ / $-0.7-BW_{UTRA}/2$	$1.5+BW_{UTRA}/2$ / $-1.5-BW_{UTRA}/2$	$2.5+BW_{UTRA}/2$ / $-2.5-BW_{UTRA}/2$	$5+BW_{UTRA}/2$ / $-5-BW_{UTRA}/2$	$7.5+BW_{UTRA}/2$ / $-7.5-BW_{UTRA}/2$	$10+BW_{UTRA}/2$ / $-10-BW_{UTRA}/2$
UTRA_{ACLR2}	-	-	36 dB	36 dB	36 dB	36 dB
Adjacent channel centre frequency offset (in MHz)	-	-	$2.5+3*BW_{UTRA}/2$ / $-2.5-3*BW_{UTRA}/2$	$5+3*BW_{UTRA}/2$ / $-5-3*BW_{UTRA}/2$	$7.5+3*BW_{UTRA}/2$ / $-7.5-3*BW_{UTRA}/2$	$10+3*BW_{UTRA}/2$ / $-10-3*BW_{UTRA}/2$
E-UTRA channel Measurement bandwidth	1.08 MHz	2.7 MHz	4.5 MHz	9.0 MHz	13.5 MHz	18 MHz
UTRA 5MHz channel Measurement bandwidth¹	3.84 MHz	3.84 MHz	3.84 MHz	3.84 MHz	3.84 MHz	3.84 MHz
UTRA 1.6MHz channel measurement bandwidth²	1.28 MHz	1.28 MHz	1.28 MHz	1.28 MHz	1.28 MHz	1.28 MHz
Note 1: Applicable for E-UTRA FDD co-existence with UTRA FDD in paired spectrum.						
Note 2: Applicable for E-UTRA TDD co-existence with UTRA TDD in unpaired spectrum.						

The normative reference for this requirement is TS 36.101 clause 6.6.2B.

6.6.2.3B.4 Test description

6.6.2.3B.4.1 Initial conditions

Initial conditions are a set of test configurations the UE needs to be tested in and the steps for the SS to take with the UE to reach the correct measurement state.

The initial test configurations consist of environmental conditions, test frequencies, and channel bandwidths based on E-UTRA bands specified in table 5.4.2.1-1. All of these configurations shall be tested with applicable test parameters for each channel bandwidth, and are shown in table 6.6.2.3B.4.1-1. The details of the uplink reference measurement channels (RMCs) are specified in Annex A.2. Configurations of PDSCH and PDCCH before measurement are specified in Annex C.2.

Table 6.6.2.3B.4.1-1: Test Configuration Table

Initial Conditions						
Test Environment (as specified in TS 36.508 [7] clause 4.1)				NC, TL/VL, TL/VH, TH/VL, TH/VH		
Test Frequencies (as specified in TS 36.508 [7] clause 4.3.1)				Low range, Mid range, High range		
Test Channel Bandwidths (as specified in TS 36.508 [7] clause 4.3.1)				Lowest, 5MHz, 10MHz, Highest		
Test Parameters for Channel Bandwidths						
Ch BW	Downlink Configuration			Uplink Configuration		
	Mod'n	RB allocation		Mod'n	RB allocation	
		FDD	TDD		FDD	TDD
1.4MHz	N/A for ACLR testing			QPSK	6	6
1.4MHz				QPSK	5	5
1.4MHz				16QAM	6	6
1.4MHz				16QAM	5	5
3MHz				QPSK	15	15
3MHz				QPSK	4	4
3MHz				16QAM	15	15
3MHz				16QAM	4	4
5MHz				QPSK	25	25
5MHz				QPSK	8	8
5MHz				16QAM	25	25
5MHz				16QAM	8	8
10MHz				QPSK	50	50
10MHz				QPSK	12	12
10MHz				16QAM	50 (Note 3)	50 (Note 3)
10MHz				16QAM	12	12
15MHz				QPSK	75	75
15MHz				QPSK	16	16
15MHz				16QAM	75 (Note 3)	75 (Note 3)
15MHz				16QAM	16	16
20MHz				QPSK	100	100
20MHz				QPSK	18	18
20MHz				16QAM	100 (Note 3)	100 (Note 3)
20MHz				16QAM	18	18
Note 1: Test Channel Bandwidths are checked separately for each E-UTRA band, which applicable channel bandwidths are specified in Table 5.4.2.1-1. Note 2: The RBstart of partial RB allocation shall be RB#0 and RB# (max + 1 - RB allocation) of the channel bandwidth. Note 3: Applies only for UE-Categories [FFS].						

1. Connect the SS to the UE antenna connectors as shown in Figure TS 36.508 [7] Annex A, Figure A.28.
2. The parameter settings for the cell are set up according to TS 36.508 [7] clause 4.4.3.
3. Downlink signals are initially set up according to Annex C0, C.1 and C.3.0, and uplink signals according to Annex H.1 and H.3.0.
4. The UL Reference Measurement channels are set according to Table 6.6.2.3B.4.1-1.
5. Propagation conditions are set according to Annex B.0.
6. Ensure the UE is in State 3A-RF according to TS 36.508 [7] clause 5.2A.2. Message contents are defined in clause 6.6.2.3B.4.3.

6.6.2.3B.4.2 Test procedure

1. SS sends uplink scheduling information for each UL HARQ process via PDCCH DCI format 4 for C_RNTI to schedule the UL RMC according to Table 6.6.2.3B.4.1-1. Since the UE has no payload data to send, the UE transmits uplink MAC padding bits on the UL RMC.

2. Send continuously uplink power control "up" commands in the uplink scheduling information to the UE until the UE transmits at P_{UMAX} level.
3. Measure the sum of the mean power at each antenna connector of UE in the channel bandwidth of the radio access mode according to the test configuration, which shall meet the requirements described in clause 6.2.3B.5. The period of the measurement shall be at least the continuous duration of one sub-frame (1ms). For TDD slots with transient periods are not under test.
4. Measure the rectangular filtered mean power for E-UTRA at each antenna connector of UE.
5. Measure the rectangular filtered mean power of the first E-UTRA adjacent channel at each antenna connector of UE.
6. Measure the RRC filtered mean power of the first and the second UTRA adjacent channel at each antenna connector of UE.
7. Calculate the ratio of the power between the values measured in step 4 over step 5 for $E-UTRA_{ACLR}$.
8. Calculated the ratio of the power between the values measured in step 4 over step 6 for $UTRA_{ACLR1}$, $UTRA_{ACLR2}$.

6.6.2.3B.4.3 Message contents

Message contents are according to TS 36.508 [7] subclause 4.6.

6.6.2.3B.5 Test requirement

6.6.2.3B.5.1 Test requirements E-UTRA

- The measured sum of mean power at each transmit antenna connector for UE in the channel bandwidth, derived in step 3, shall fulfil requirements in clause 6.2.3B.5 as appropriate,
- and
- The requirements apply to each transmit antenna connector.
 - if the measured adjacent channel power is greater than -50 dBm then the measured $E-UTRA_{ACLR}$, derived in step 7, shall be higher than the limits in table 6.6.2.3B.5.1-1.

Table 6.6.2.3B.5.1-1: E-UTRA UE ACLR

	Channel bandwidth / E-UTRA _{ACLR1} / measurement bandwidth					
	1.4 MHz	3.0 MHz	5 MHz	10 MHz	15 MHz	20 MHz
E-UTRA_{ACLR1}	29.2 dB	29.2 dB	29.2 dB	29.2 dB	29.2 dB	29.2 dB
E-UTRA channel Measurement bandwidth	1.08 MHz	2.7 MHz	4.5 MHz	9.0 MHz	13.5 MHz	18 MHz
UE channel	+1.4 MHz or -1.4 MHz	+3 MHz or -3 MHz	+5MHz or -5MHz	+10MHz or -10MHz	+15MHz or -15MHz	+20MHz or -20MHz

6.6.2.3B.5.2 Test requirements UTRA

The requirements apply to each transmit antenna connector.

If the measured UTRA channel power is greater than -50dBm then the measured $UTRA_{ACLR1}$, $UTRA_{ACLR2}$, derived in step 8, shall be higher than the limits in table 6.6.2.3B.5.2-1.

Table 6.6.2.3B.5.2-1: UTRA UE ACLR

	Channel bandwidth / E-UTRA _{ACLR1/2} / measurement bandwidth					
	1.4 MHz	3.0 MHz	5 MHz	10 MHz	15 MHz	20 MHz
UTRA _{ACLR1}	32.2 dB	32.2 dB	32.2 dB	32.2 dB	32.2 dB	32.2 dB
Adjacent channel centre frequency offset (in MHz)	$0.7+BW_{UTRA}/2$ / -0.7- $BW_{UTRA}/2$	$1.5+BW_{UTR}$ / -1.5- $BW_{UTRA}/2$	$2.5+BW_{UTR}$ / -2.5- $BW_{UTRA}/2$	$5+BW_{UTRA}/2$ / -5- $BW_{UTRA}/2$	$7.5+BW_{UTRA}/2$ / -7.5- $BW_{UTRA}/2$	$10+BW_{UTRA}/2$ / -10- $BW_{UTRA}/2$
UTRA _{ACLR2}	-	-	35.2 dB	35.2 dB	35.2 dB	35.2 dB
Adjacent channel centre frequency offset (in MHz)	-	-	$2.5+3*BW_U$ / -2.5- $3*BW_{UTRA}/2$	$5+3*BW_{UTR}$ / -5- $3*BW_{UTRA}/2$	$7.5+3*BW_{UT}$ / -7.5- $3*BW_{UTRA}/2$	$10+3*BW_{UT}$ / -10- $3*BW_{UTRA}/2$
E-UTRA channel Measurement bandwidth	1.08 MHz	2.7 MHz	4.5 MHz	9.0 MHz	13.5 MHz	18 MHz
UTRA 5MHz channel Measurement bandwidth ¹	3.84 MHz	3.84 MHz	3.84 MHz	3.84 MHz	3.84 MHz	3.84 MHz
UTRA 1.6MHz channel measurement bandwidth ²	1.28 MHz	1.28 MHz	1.28 MHz	1.28 MHz	1.28 MHz	1.28 MHz
Note 1:	Applicable for E-UTRA FDD co-existence with UTRA FDD in paired spectrum.					
Note 2:	Applicable for E-UTRA TDD co-existence with UTRA TDD in unpaired spectrum.					
Note 3:	BW _{UTRA} for UTRA FDD is 5MHz and for UTRA TDD is 1.6MHz.					

6.6.2.4 Void

6.6.3 Spurious emissions

Spurious emissions are emissions which are caused by unwanted transmitter effects such as harmonics emission, parasitic emissions, intermodulation products and frequency conversion products, but exclude out of band emissions. The spurious emission limits are specified in terms of general requirements inline with SM.329 [3] and E-UTRA operating band requirement to address UE co-existence.

Unless otherwise stated, the spurious emission limits apply for the frequency ranges that are more than Δf_{OOB} (MHz) in Table 6.6.3.1.3-1 from the edge of the channel bandwidth. To improve measurement accuracy, sensitivity and efficiency, the resolution bandwidth may be smaller than the measurement bandwidth. When the resolution bandwidth is smaller than the measurement bandwidth, the result should be integrated over the measurement bandwidth in order to obtain the equivalent noise bandwidth of the measurement bandwidth.

6.6.3.1 Transmitter Spurious emissions

6.6.3.1.1 Test purpose

To verify that UE transmitter does not cause unacceptable interference to other channels or other systems in terms of transmitter spurious emissions.

6.6.3.1.2 Test applicability

This test case applies to all types of E-UTRA UE release 8 and forward.

6.6.3.1.3 Minimum conformance requirements

The spurious emission limits apply for the frequency ranges that are more than Δf_{OOB} (MHz) from the edge of the channel bandwidth.

Table 6.6.3.1.3-1: Δf_{OOB} boundary between E-UTRA channel and spurious emission domain

Channel bandwidth	1.4 MHz	3.0 MHz	5 MHz	10 MHz	15 MHz	20 MHz
Δf_{OOB} (MHz)	2.8	6	10	15	20	25

The spurious emission limits in Table 6.6.3.1.3-2 apply for all transmitter band configurations (RB) and channel bandwidths.

NOTE: In order that the measurement of spurious emissions falls within the frequency ranges that are more than Δf_{OOB} (MHz) from the edge of the channel bandwidth, the minimum offset of the measurement frequency from each edge of the channel should be $\Delta f_{\text{OOB}} + \text{MBW}/2$. MBW denotes the measurement bandwidth defined in Table 6.6.3.1.3-2.

Table 6.6.3.1.3-2: Spurious emissions limits

Frequency Range	Maximum Level	Measurement Bandwidth	Notes
$9 \text{ kHz} \leq f < 150 \text{ kHz}$	-36 dBm	1 kHz	
$150 \text{ kHz} \leq f < 30 \text{ MHz}$	-36 dBm	10 kHz	
$30 \text{ MHz} \leq f < 1000 \text{ MHz}$	-36 dBm	100 kHz	
$1 \text{ GHz} \leq f < 12.75 \text{ GHz}$	-30 dBm	1 MHz	
$12.75 \text{ GHz} \leq f < 5^{\text{th}}$ harmonic of the upper frequency edge of the UL operating band in GHz	-30 dBm	1 MHz	Note 1
Note 1: Applies for Band 22, Band 42 and Band 43			

The normative reference for this requirement is TS 36.101 [2] subclause 6.6.3.1.

6.6.3.1.4 Test description

6.6.3.1.4.1 Initial conditions

Initial conditions are a set of test configurations the UE needs to be tested in and the steps for the SS to take with the UE to reach the correct measurement state.

The initial test configurations consist of environmental conditions, test frequencies, and channel bandwidths based on E-UTRA bands specified in Table 5.4.2.1-1. All of these configurations shall be tested with applicable test parameters for each channel bandwidth, and are shown in Table 6.6.3.1.4.1-1. The details of the uplink reference measurement channels (RMCs) are specified in Annex A.2. Configurations of PDSCH and PDCCH before measurement are specified in Annex C.2.

Table 6.6.3.1.4.1-1: Test Configuration Table

Initial Conditions						
Test Environment (as specified in TS 36.508 [7] subclause 4.1)				NC		
Test Frequencies (as specified in TS36.508 [7] subclause 4.3.1)				Low range, Mid range, High range		
Test Channel Bandwidths (as specified in TS 36.508 [7] subclause 4.3.1)				Lowest, 5MHz, Highest		
Test Parameters for Channel Bandwidths						
Ch BW	Downlink Configuration			Uplink Configuration		
	Mod'n	RB allocation		Mod'n	RB allocation	
		FDD	TDD		FDD	TDD
1.4MHz	N/A for Spurious Emissions testing			QPSK	6	6
1.4MHz				QPSK	1	1
3MHz				QPSK	15	15
3MHz				QPSK	1	1
5MHz				QPSK	25	25
5MHz				QPSK	1	1
10MHz				QPSK	50	50
10MHz				QPSK	1	1
15MHz				QPSK	75	75
15MHz				QPSK	1	1
20MHz				QPSK	100	100
20MHz				QPSK	1	1
Note 1: Test Channel Bandwidths are checked separately for each E-UTRA band, which applicable channel bandwidths are specified in Table 5.4.2.1-1.						
Note 2: The 1 RB allocation shall be tested at both RB #0 and RB #max.						

1. Connect the SS to the UE antenna connectors as shown in Figure TS 36.508 [7] Annex A, Figure A.7.
2. The parameter settings for the cell are set up according to TS 36.508 [7] subclause 4.4.3.
3. Downlink signals are initially set up according to Annex C0, C.1 and C.3.0, and uplink signals according to Annex H.1 and H.3.0.
4. The UL Reference Measurement channels are set according to Table 6.6.3.1.4.1-1.
5. Propagation conditions are set according to Annex B.0.
6. Ensure the UE is in State 3A-RF according to TS 36.508 [7] clause 5.2A.2. Message contents are defined in clause 6.6.3.1.4.3.

6.6.3.1.4.2 Test procedure

1. SS sends uplink scheduling information for each UL HARQ process via PDCCH DCI format 0 for C_RNTI to schedule the UL RMC according to Table 6.6.3.1.4.1-1. Since the UE has no payload data to send, the UE transmits uplink MAC padding bits on the UL RMC.
2. Send continuously uplink power control "up" commands in the uplink scheduling information to the UE until the UE transmits at P_{UMAX} level.
3. Measure the power of the transmitted signal with a measurement filter of bandwidths according to table 6.6.3.1.5-1. The centre frequency of the filter shall be stepped in contiguous steps according to table 6.6.3.1.5-1. The measured power shall be verified for each step. The measurement period shall capture the active time slots.

6.6.3.1.4.3 Message contents

Message contents are according to TS 36.508 [7] subclause 4.6.

6.6.3.1.5 Test requirement

The measured average power of spurious emission, derived in step 3, shall not exceed the described value in Table 6.6.3.1.5-1.

The spurious emission limits apply for the frequency ranges that are more than Δf_{OOB} (MHz) from the edge of the channel bandwidth shown in Table 6.6.3.1.3-1.

Table 6.6.3.1.5-1: General spurious emissions test requirements

Frequency Range	Maximum Level	Measurement Bandwidth	Notes
$9 \text{ kHz} \leq f < 150 \text{ kHz}$	-36 dBm	1 kHz	
$150 \text{ kHz} \leq f < 30 \text{ MHz}$	-36 dBm	10 kHz	
$30 \text{ MHz} \leq f < 1000 \text{ MHz}$	-36 dBm	100 kHz	
$1 \text{ GHz} \leq f < 12.75 \text{ GHz}$	-30 dBm	1 MHz	
$12.75 \text{ GHz} \leq f < 5^{\text{th}}$ harmonic of the upper frequency edge of the UL operating band in GHz	-30 dBm	1 MHz	Note 1
Note 1: Applies for Band 22, Band 42 and Band 43			

NOTE: In order that the measurement of spurious emissions falls within the frequency ranges that are more than Δf_{OOB} (MHz) from the edge of the channel bandwidth, the minimum offset of the measurement frequency from each edge of the channel should be $\Delta f_{\text{OOB}} + \text{MBW}/2$. MBW denotes the measurement bandwidth defined in Table 6.6.3.1.3-2.

6.6.3.1A Transmitter Spurious emissions for CA

6.6.3.1A.1 Transmitter Spurious emissions for CA (intra-band contiguous DL CA and UL CA)

6.6.3.1A.1.1 Test purpose

To verify that transmitter of UE that support CA does not cause unacceptable interference to other channels or other systems in terms of transmitter spurious emissions.

6.6.3.1A.1.2 Test applicability

This test case applies to all types of E-UTRA UE release 10 and forward that support intra-band contiguous DL CA and UL CA.

6.6.3.1A.1.3 Minimum conformance requirements

For intra-band contiguous carrier aggregation the spurious emission limits apply for the frequency ranges that are more than Δf_{OOB} (MHz) in Table 6.6.3.1A.1.3-1 from the \pm edge of the aggregated channel bandwidth (Table 5.4.2A-1). For frequencies Δf_{OOB} greater than F_{OOB} as specified in Table 6.6.3.1A.1.3-1 the spurious requirements in Table 6.6.3.1.3-2 are applicable.

Table 6.6.3.1A.1.3-1: Boundary between E-UTRA Δf_{OOB} and spurious emission domain for intra-band contiguous carrier aggregation

CA Bandwidth Class	OOB boundary F_{OOB} [(MHz)]
A	Table 6.6.3.1.3-1
B	FFS
C	$\text{BW}_{\text{Channel, CA}} + 5$

To improve measurement accuracy, sensitivity and efficiency, the resolution bandwidth may be smaller than the measurement bandwidth. When the resolution bandwidth is smaller than the measurement bandwidth, the result should be integrated over the measurement bandwidth in order to obtain the equivalent noise bandwidth of the measurement bandwidth.

NOTE: In order that the measurement of spurious emissions falls within the frequency ranges that are more than Δf_{OOB} (MHz) from the edge of the channel bandwidth, the minimum offset of the measurement frequency from each edge of the channel should be $\Delta f_{OOB} + MBW/2$. MBW denotes the measurement bandwidth defined in Table 6.6.3.1.3-2.

The normative reference for this requirement is TS 36.101[2] clause 6.6.3.1A

6.6.3.1A.1.4 Test description

6.6.3.1A.1.4.1 Initial condition

Initial conditions are a set of test configurations the UE needs to be tested in and the steps for the SS to take with the UE to reach the correct measurement state.

The initial test configurations consist of environmental conditions, test frequencies, and CC combinations based on E-UTRA CA bands specified in table 5.4.2A.1-1. All of these configurations shall be tested with applicable test parameters for each CA configuration, and are shown in table 6.6.3.1A.1.4.1-1. The details of the uplink and downlink reference measurement channels (RMCs) are specified in Annexes A.2 and A.3. Configurations of PDSCH and PDCCH before measurement are specified in Annex C.2.

Table 6.6.3.1A.1.4.1-1: Test Configuration Table

Initial Conditions									
Test Environment as specified in TS 36.508[7] subclause 4.1					NC				
Test Frequencies as specified in TS36.508 [7] subclause 4.3.1 for different CA bandwidth classes.					C: Low range, High range				
Test CC Combination setting (N_{RB_agg}) as specified in subclause 5.4.2A.1 for the CA Configuration					Lowest N_{RB_agg} , Highest N_{RB_agg}				
Test Parameters for CA Configurations									
CA Configuration / N_{RB_agg}		DL Allocation		CC MOD	UL Allocation				
PCC N_{RB}	SCCs N_{RB}	PCC & SCC RB allocation			N_{RB_alloc}	PCC & SCC RB allocations (L_{CRB} @ RB_{start})			
75	75	N/A for Spurious Emissions testing		QPSK	75	P_75@0	S_0@0	-	-
75	75			QPSK	1	P_1@0	S_0@0	-	-
75	75			QPSK	1	P_1@74	S_0@0	-	-
75	75			QPSK	2	P_1@0	S_1@74	-	-
75	75			QPSK	150	P_75@0	S_75@0	-	-
100	50			QPSK	50	P_50@0	S_0@0	-	-
100	50			QPSK	1	P_1@0	S_0@0	-	-
100	50			QPSK	1	P_1@99	S_0@0	-	-
100	50			QPSK	2	P_1@0	S_1@49	-	-
100	50			QPSK	150	P_100@0	S_50@0	-	-
100	100			QPSK	100	P_100@0	S_0@0	-	-
100	100			QPSK	1	P_1@0	S_0@0	-	-
100	100			QPSK	1	P_1@99	S_0@0	-	-
100	100			QPSK	2	P_1@0	S_1@99	-	-
100	100	QPSK	200	P_100@0	S_100@0	-	-		

Note 1: CA Configuration Test CC Combination settings are checked separately for each CA Configuration, which applicable aggregated channel bandwidths are specified in Table 5.4.2A.1-1

1. Connect the SS to the UE antenna connectors as shown in TS 36.508[7] Annex A Figure group A.33 as appropriate.

2. The parameter settings for the cell are set up according to TS 36.508 [7] subclause 4.4.3.
3. Downlink signals for PCC are initially set up according to Annex C.0, C.1, and C.3.0, and uplink signals according to Annex H.1 and H.3.0.
4. The UL Reference Measurement channel is set according to Table 6.6.3.1A.1.4.1-1.
5. Propagation conditions are set according to Annex B.0.
6. Ensure the UE is in State 3A-RF according to TS 36.508 [7] clause 5.2A.2. Message contents are defined in clause 6.6.3.1A.1.4.3.

6.6.3.1A.1.4.2 Test procedure

1. Configure SCC according to Annex C.0, C.1 and Annex C.3.0 for all downlink physical channels except PHICH.
2. The SS shall configure SCC as per TS 36.508 [7] clause 5.2A.4. Message contents are defined in clause 6.6.3.1A.1.4.3
3. SS activates SCC by sending the activation MAC-CE (Refer TS 36.321 [13], clauses 5.13, 6.1.3.8). Wait for at least 2 seconds (Refer TS 36.133, clauses 8.3.3.2).
4. SS sends uplink scheduling information for each UL HARQ process via PDCCH DCI format 0 for C_RNTI to schedule the UL RMC according to Table 6.6.3.1A.1.4.1-1 on both PCC and SCC. Since the UE has no payload and no loopback data to send the UE sends uplink MAC padding bits on the UL RMC.
5. Send continuously uplink power control “up” commands in every uplink scheduling information to the UE until the UE transmits at P_{UMAX} level.
6. Measure the power of the transmitted signal with a measurement filter of bandwidths according to Table 6.6.3.1A.1.5-1 for each component carrier. The centre frequency of the filter shall be stepped in contiguous steps according to Table 6.6.3.1A.1.5-1. The measured power shall be verified for each step. The measurement period shall capture the active time slots.

6.6.3.1A.1.4.3 Message contents

Message contents are according to TS 36.508 [7] subclause 4.6. In test procedure step 2, for SCC configuration there are no additional message contents.

6.6.3.1A.1.5 Test Requirements

For frequencies Δf_{OOB} greater than F_{OOB} as specified in Table 6.6.3.1A.1.3-1 the measured average power of spurious emission, derived in step 6, shall not exceed the described value in Table 6.6.3.1A.1.5-1.

Table 6.6.3.1A.1.5-1: Spurious emissions limits

Frequency Range	Maximum Level	Measurement Bandwidth	Notes
$9 \text{ kHz} \leq f < 150 \text{ kHz}$	-36 dBm	1 kHz	
$150 \text{ kHz} \leq f < 30 \text{ MHz}$	-36 dBm	10 kHz	
$30 \text{ MHz} \leq f < 1000 \text{ MHz}$	-36 dBm	100 kHz	
$1 \text{ GHz} \leq f < 12.75 \text{ GHz}$	-30 dBm	1 MHz	
$12.75 \text{ GHz} \leq f < 5^{\text{th}}$ harmonic of the upper frequency edge of the UL operating band in GHz	-30 dBm	1 MHz	Note 1
Note1: Applicability of this test requirement is FFS.			

NOTE: In order that the measurement of spurious emissions falls within the frequency ranges that are more than Δf_{OOB} (MHz) from the edge of the channel bandwidth, the minimum offset of the measurement frequency from each edge of the channel should be $\Delta f_{OOB} + MBW/2$. MBW denotes the measurement bandwidth defined in Table 6.6.3.1A.1.5-1.

6.6.3.2 Spurious emission band UE co-existence

Editor's note: This test case contains different requirements for different UE releases

6.6.3.2.1 Test purpose

To verify that UE transmitter does not cause unacceptable interference to co-existing systems for the specified bands which has specific requirements in terms of transmitter spurious emissions.

6.6.3.2.2 Test applicability

This test case applies to all types of E-UTRA UE release 8 and forward.

6.6.3.2.3 Minimum conformance requirements

This clause specifies the requirements for the specified E-UTRA band for coexistence with protected bands as indicated in Table 6.6.3.2.3-1.

NOTE: For measurement conditions at the edge of each frequency range, the lowest frequency of the measurement position in each frequency range should be set at the lowest boundary of the frequency range plus MBW/2. The highest frequency of the measurement position in each frequency range should be set at the highest boundary of the frequency range minus MBW/2. MBW denotes the measurement bandwidth defined for the protected band.

Table 6.6.3.2.3-1: Spurious emission band UE co-existence limits Rel-8

E-UTRA Band	Spurious emission						
	Protected band	Frequency range (MHz)			Maximum Level (dBm)	MBW (MHz)	Comment
1	E-UTRA Band 1, 3, 7, 8, 9, 11, 34, 38, 40	FDL_low	-	FDL_high	-50	1	
	Frequency range	860	-	895	-50	1	
	Frequency range	1475.9	-	1510.9	-50	1	
	Frequency range	1884.5	-	1915.7	-41	0.3	Note ⁶ , Note ⁸ , Note ¹⁴
	Frequency range	1895	-	1915	-15.5	5	Note ¹⁴ , Note ¹⁷
	Frequency range	1915	-	1920	+1.6	5	Note ¹⁴ , Note ¹⁷
2	E-UTRA Band 4, 5, 10, 12, 13, 14, 17	FDL_low	-	FDL_high	-50	1	
	E-UTRA Band 2	FDL_low	-	FDL_high	-50		Note ¹⁴
3	E-UTRA Band 1, 7, 8, 33, 34, 38	FDL_low	-	FDL_high	-50	1	
	E-UTRA Band 3	FDL_low	-	FDL_high	-50		Note ¹⁴
	Frequency range	860	-	895	-50	1	Note ¹³
	Frequency range	1475.9	-	1510.9	-50	1	Note ¹³
4	E-UTRA Band 2, 4, 5, 10, 12, 13, 14, 17	FDL_low	-	FDL_high	-50	1	
	E-UTRA Band 2, 4, 5, 10, 12, 13, 14, 17	FDL_low	-	FDL_high	-50	1	
6	E-UTRA Band 1, 9, 11, 34	FDL_low	-	FDL_high	-50	1	
	Frequency range	860	-	875	-37	1	
	Frequency range	875	-	895	-50	1	
	Frequency range	1884.5	-	1919.6	-41	0.3	Note ⁷
		1884.5	-	1915.7			Note ⁸
7	E-UTRA Band 1, 3, 7, 8, 33, 34	FDL_low	-	FDL_high	-50	1	
	Frequency range	2570	-	2575	+1.6	5	Note ¹⁴ , Note ¹⁵ , Note ¹⁸
	Frequency range	2575	-	2595	-15.5	5	Note ¹⁴ , Note ¹⁵ , Note ¹⁸
8	E-UTRA Band 1, 33, 34, 38, 39, 40	FDL_low	-	FDL_high	-50	1	
	E-UTRA band 3	FDL_low	-	FDL_high	-50	1	Note ²
	E-UTRA band 7	FDL_low	-	FDL_high	-50	1	Note ²
	E-UTRA Band 8	FDL_low	-	FDL_high	-50	1	Note ¹⁴
9	E-UTRA Band 1, 9, 11, 34	FDL_low	-	FDL_high	-50	1	
	Frequency range	860	-	895	-50	1	
	Frequency range	1475.9	-	1510.9	-50	1	
	Frequency range	1884.5	-	1915.7	-41	0.3	Note ⁸
10	E-UTRA Band 2, 4, 5, 10, 12, 13, 14, 17	FDL_low	-	FDL_high	-50	1	
11	E-UTRA Band 1, 9, 11, 34	FDL_low	-	FDL_high	-50	1	
	Frequency range	1457.9	-	1510.9	-50	1	
	Frequency range	860	-	895	-50	1	
	Frequency range	1884.5	-	1915.7	-41	0.3	Note ⁸
12	E-UTRA Band 2, 5, 13, 14, 17	FDL_low	-	FDL_high	-50	1	
	E-UTRA Band 4, 10	FDL_low	-	FDL_high	-50	1	Note ²

	E-UTRA Band 12	FDL_low	-	FDL_high	-50	1	Note ¹⁴
13	E-UTRA Band 2, 4, 5, 10, 12, 13, 17	FDL_low	-	FDL_high	-50	1	
	E-UTRA Band 14	FDL_low	-	FDL_high	-50	1	Note ¹⁴
	Frequency range	769	-	775	-35	0.00625	Note ¹⁴
	Frequency range	799	-	805	-35	0.00625	Note ¹¹ , Note ¹⁴
14	E-UTRA Band 2, 4, 5, 10, 12, 13, 14, 17	FDL_low	-	FDL_high	-50	1	
	Frequency range	769	-	775	-35	0.00625	Note ¹² , Note ¹⁴
	Frequency range	799	-	805	-35	0.00625	Note ¹¹ , Note ¹² , Note ¹⁴
17	E-UTRA Band 2, 5, 13, 14, 17	FDL_low	-	FDL_high	-50	1	
	E-UTRA Band 4, 10	FDL_low	-	FDL_high	-50	1	Note ²
	E-UTRA Band 12	FDL_low	-	FDL_high	-50	1	Note ¹⁴
...							
33	E-UTRA Band 1, 7, 8, 34, 38, 39, 40	FDL_low	-	FDL_high	-50	1	Note ⁵
	E-UTRA Band 3	FDL_low	-	FDL_high	-50	1	Note ¹⁴
34	E-UTRA Band 1, 3, 7, 8, 9, 11, 33, 38, 39, 40	FDL_low	-	FDL_high	-50	1	Note ⁵
	Frequency range	860	-	895	-50	1	
	Frequency range	1475.9	-	1510.9	-50	1	
	Frequency range	1884.5	-	1915.7	-41	0.3	Note ⁸
35							
36							
37			-				
38	E-UTRA Band 1, 3, 8, 33, 34	FDL_low	-	FDL_high	-50	1	
	Frequency range	2620	-	2645	-15.5	5	Note ¹⁴ , Note ¹⁶ , Note ¹⁸
39	E-UTRA Band 34, 40	FDL_low	-	FDL_high	-50	1	
40	E-UTRA Band 1, 3, 33, 34, 39	FDL_low	-	FDL_high	-50	1	

Note 1: FDL_low and FDL_high refer to each E-UTRA frequency band specified in Table 5.2-1

Note 2: As exceptions, measurements with a level up to the applicable requirements defined in Table 6.6.3.1.3-2 are permitted for each assigned E-UTRA carrier used in the measurement due to 2nd or 3rd harmonic spurious emissions. An exception is allowed if there is at least one individual RE within the transmission bandwidth (see Figure 5.4.2-1) for which the 2nd or 3rd harmonic, i.e. the frequency equal to two or three times the frequency of that RE, is within the measurement bandwidth (MBW).

Note 3: To meet these requirements some restriction will be needed for either the operating band or protected band

Note 4: N/A

Note 5: For non synchronised TDD operation to meet these requirements some restriction will be needed for either the operating band or protected band

Note 6: Applicable when NS_05 in section 6.6.3.3.3.1 is signalled by the network.

Note 7: Applicable when co-existence with PHS system operating in 1884.5-1919.6MHz.

Note 8: Applicable when co-existence with PHS system operating in 1884.5-1915.7MHz.

Note 9: N/A

Note 10: N/A

Note 11: Whether the applicable frequency range should be 793-805MHz instead of 799-805MHz is TBD

Note 12: The emissions measurement shall be sufficiently power averaged to ensure a standard deviation < 0.5 dB

Note 13: Applicable when UE transmits anywhere within 1749.9 – 1784.9MHz. Applicable when the assigned E-UTRA UL operating channel is ≥ 1749.9 MHz and ≤ 1784.9 MHz.

Note 14: These requirements also apply for the frequency ranges that are less than Δf_{OOB} (MHz) in Table 6.6.3.1.3-1 from the edge of the channel bandwidth.

Note 15: This requirement is applicable for an uplink transmission bandwidth less than or equal to 54 RB for carriers of 15 MHz bandwidth when carrier centre frequency is within the range 2560.5 - 2562.5 MHz and for carriers of 20 MHz bandwidth when carrier centre frequency is within the range 2552 - 2560 MHz. This requirement is applicable without any other uplink transmission bandwidth restriction for channel bandwidths within the range 2500 - 2570 MHz.

Note 16: This requirement is applicable for an uplink transmission bandwidth less than or equal to 54 RB for carriers of 15 MHz bandwidth when carrier centre frequency is within the range 2605.5 - 2607.5 MHz and for carriers of 20 MHz bandwidth when carrier centre frequency is within the range 2597 – 2605 MHz. This requirement is applicable without any other uplink transmission bandwidth restriction for channel bandwidths within the range

2570 – 2615 MHz. For assigned carriers with bandwidths overlapping the frequency range 2615-2620 MHz the requirements apply with the maximum output power configured to +20 dBm in the IE *P-Max*.

Note 17: This requirement is applicable for an uplink transmission bandwidth less than or equal to 54 RB for carriers of 15 MHz bandwidth when carrier centre frequency is within the range 1927.5 - 1929.5 MHz and for carriers of 20 MHz bandwidth when carrier centre frequency is within the range 1930 - 1938 MHz. This requirement is applicable without any other uplink transmission bandwidth restriction for channel bandwidths within the range 1920 - 1980 MHz.

Note 18: For these adjacent bands, the emission limit could imply risk of harmful interference to UE(s) operating in the protected operating band.

NOTE: The restriction on the maximum uplink transmission to 54 RB in Notes 15, 16, and 17 of Table 6.6.3.2.3-1 is intended for conformance testing and may be applied to network operation to facilitate coexistence when the aggressor and victim bands are deployed in the same geographical area. The applicable spurious emission requirement of -15.5 dBm/5MHz is a least restrictive technical condition for FDD/TDD coexistence and may have to be revised in the future.

Table 6.6.3.2.3-1A: Spurious emission band UE co-existence limits Rel-9

E-UTRA Band	Spurious emission						
	Protected band	Frequency range (MHz)		Maximum level (dBm)	MBW (MHz)	NOTE	
1	E-UTRA Band 1, 3, 7, 8, 11, 20, 21, 34, 38, 40	F _{DL_low}	-	F _{DL_high}	-50	1	
	Frequency range	860	-	895	-50	1	
	Frequency range	1880	-	1895	-40	1	14,18
	Frequency range	1839.9	-	1879.9	-50	1	
	Frequency range	1895	-	1915	-15.5	5	14,18,19
	Frequency range	1915	-	1920	+1.6	5	14,18,19
	Frequency range	1884.5	-	1915.7	-41	0.3	6, 8, 14
2	E-UTRA Band 4, 5, 10, 12, 13, 14, 17	F _{DL_low}	-	F _{DL_high}	-50	1	
	E-UTRA Band 2	F _{DL_low}	-	F _{DL_high}	-50	1	14
3	E-UTRA Band 1, 7, 8, 20, 33, 34, 38	F _{DL_low}	-	F _{DL_high}	-50	1	
	E-UTRA Band 3	F _{DL_low}	-	F _{DL_high}	-50	1	14
	E-UTRA Band 11, 21	F _{DL_low}	-	F _{DL_high}	-50	1	13
	Frequency range	860	-	895	-50	1	13
	Frequency range	1884.5	-	1915.7	-41	0.3	13
4	E-UTRA Band 2, 4, 5, 10, 12, 13, 14, 17	F _{DL_low}	-	F _{DL_high}	-50	1	
5	E-UTRA Band 2, 4, 5, 10, 12, 13, 14, 17	F _{DL_low}	-	F _{DL_high}	-50	1	
6	E-UTRA Band 1, 9, 11, 34	F _{DL_low}	-	F _{DL_high}	-50	1	
	Frequency range	860	-	875	-37	1	
	Frequency range	875	-	895	-50	1	
	Frequency range	1884.5	-	1919.6	-41	0.3	7
	Frequency range	1884.5	-	1915.7			8
7	E-UTRA Band 1, 3, 7, 8, 20, 33, 34	F _{DL_low}	-	F _{DL_high}	-50	1	
	Frequency range	2570	-	2575	+1.6	5	14, 15, 19
	Frequency range	2575	-	2595	-15.5	5	14, 15, 19
	Frequency range	2595	-	2620	-40	1	14, 15
8	E-UTRA Band 1, 20, 33, 34, 38, 39, 40	F _{DL_low}	-	F _{DL_high}	-50	1	
	E-UTRA band 3	F _{DL_low}	-	F _{DL_high}	-50	1	2
	E-UTRA band 7	F _{DL_low}	-	F _{DL_high}	-50	1	2
	E-UTRA Band 8	F _{DL_low}	-	F _{DL_high}	-50	1	14
	E-UTRA Band 11, 21	F _{DL_low}	-	F _{DL_high}	-50	1	17
	Frequency range	860	-	890	-40	1	14, 17
	Frequency range	1884.5	-	1915.7	-41	0.3	8, 17
9	E-UTRA Band 1, 11, 21, 34	F _{DL_low}	-	F _{DL_high}	-50	1	
	Frequency range	860	-	895	-50	1	
	Frequency range	1884.5	-	1915.7	-41	0.3	8
	Frequency range	945	-	960	-50	1	
	Frequency range	1839.9	-	1879.9	-50	1	
10	E-UTRA Band 2, 4, 5, 10, 12, 13, 14, 17	F _{DL_low}	-	F _{DL_high}	-50	1	
11	E-UTRA Band 1, 9, 11, 21, 34	F _{DL_low}	-	F _{DL_high}	-50	1	
	Frequency range	860	-	895	-50	1	
	Frequency range	1884.5	-	1915.7	-41	0.3	8
	Frequency range	945	-	960	-50	1	
12	E-UTRA Band 2, 5, 13, 14, 17	F _{DL_low}	-	F _{DL_high}	-50	1	
	E-UTRA Band 4, 10	F _{DL_low}	-	F _{DL_high}	-50	1	2
	E-UTRA Band 12	F _{DL_low}	-	F _{DL_high}	-50	1	14
13	E-UTRA Band 2, 4, 5, 10, 12, 13, 17	F _{DL_low}	-	F _{DL_high}	-50	1	
	E-UTRA Band 14	F _{DL_low}	-	F _{DL_high}	-50	1	14
	Frequency range	769	-	775	-35	0.00625	14
	Frequency range	799	-	805	-35	0.00625	11, 14
14	E-UTRA Band 2, 4, 5, 10, 12, 13, 14, 17	F _{DL_low}	-	F _{DL_high}	-50	1	
	Frequency range	769	-	775	-35	0.00625	12, 14

	Frequency range	799	-	805	-35	0.00625	11, 12, 14
17	E-UTRA Band 2, 5, 13, 14, 17	F _{DL_low}	-	F _{DL_high}	-50	1	
	E-UTRA Band 4, 10	F _{DL_low}	-	F _{DL_high}	-50	1	2
	E-UTRA Band 12	F _{DL_low}	-	F _{DL_high}	-50	1	14
18	E-UTRA Band 1, 11, 21, 34	F _{DL_low}	-	F _{DL_high}	-50	1	
	Frequency range	860	-	895	-40	1	
	Frequency range	1884.5	-	1915.7	-41	0.3	8
	Frequency range	945	-	960	-50	1	
	Frequency range	1839.9	-	1879.9	-50	1	
19	E-UTRA Band 1, 11, 21, 34	F _{DL_low}	-	F _{DL_high}	-50	1	
	Frequency range	860	-	895	-40	1	9, 14
	Frequency range	1884.5	-	1915.7	-41	0.3	8
	Frequency range	945	-	960	-50	1	
	Frequency range	1839.9	-	1879.9	-50	1	
20	E-UTRA Band 1, 3, 7, 8, 33, 34,	F _{DL_low}	-	F _{DL_high}	-50	1	
	E-UTRA Band 20	F _{DL_low}	-	F _{DL_high}	-50	1	14
	E-UTRA Band 38	F _{DL_low}	-	F _{DL_high}	-50	1	2
21	E-UTRA Band 11	F _{DL_low}	-	F _{DL_high}	-35	1	10, 14
	E-UTRA Band 1, 34	F _{DL_low}	-	F _{DL_high}	-50	1	
	E-UTRA Band 21	F _{DL_low}	-	F _{DL_high}	-35	1	10
	Frequency range	860	-	895	-50	1	
	Frequency range	1884.5	-	1915.7	-41	0.3	8
	Frequency range	945	-	960	-50	1	
	Frequency range	1839.9	-	1879.9	-50	1	
...			-				
33	E-UTRA Band 1, 7, 8, 20, 34, 38, 39, 40	F _{DL_low}	-	F _{DL_high}	-50	1	5
	E-UTRA Band 3	F _{DL_low}	-	F _{DL_high}	-50	1	14
34	E-UTRA Band 1, 3, 7, 8, 11, 20, 21, 33, 38,39, 40	F _{DL_low}	-	F _{DL_high}	-50	1	5
	Frequency range	860	-	895	-50	1	
	Frequency range	1884.5	-	1915.7	-41	0.3	8
	Frequency range	1839.9	-	1879.9	-50	1	5
35			-				
36			-				
37			-				
38	E-UTRA Band 1,3, 8, 20, 33, 34	F _{DL_low}	-	F _{DL_high}	-50	1	
	Frequency range	2620	-	2645	-15.5	5	14, 16, 19
	Frequency range	2645	-	2690	-40	1	14, 16
39	E-UTRA Band 34, 40	F _{DL_low}	-	F _{DL_high}	-50	1	
40	E-UTRA Band 1, 3, 33, 34, 39	F _{DL_low}	-	F _{DL_high}	-50	1	
NOTE 1: FDL_low and FDL_high refer to each E-UTRA frequency band specified in Table 5.2-1							
NOTE 2: As exceptions, measurements with a level up to the applicable requirements defined in Table 6.6.3.1.3-2 are permitted for each assigned E-UTRA carrier used in the measurement due to 2nd or 3rd harmonic spurious emissions. An exception is allowed if there is at least one individual RE within the transmission bandwidth (see Figure 5.4.2-1) for which the 2nd or 3rd harmonic, i.e. the frequency equal to two or three times the frequency of that RE, is within the measurement bandwidth (MBW).							
NOTE 3: To meet these requirements some restriction will be needed for either the operating band or protected band							
NOTE 4: N/A							
NOTE 5: For non synchronised TDD operation to meet these requirements some restriction will be needed for either the operating band or protected band							
NOTE 6: Applicable when NS_05 in section 6.6.3.3.3.1 is signalled by the network.							
NOTE 7: Applicable when co-existence with PHS system operating in 1884.5-1919.6MHz.							
NOTE 8: Applicable when co-existence with PHS system operating in 1884.5 -1915.7MHz.							
NOTE 9: Applicable when NS_08 in section 6.6.3.3.3.3 is signalled by the network							
NOTE 10: Applicable when NS_09 in section 6.6.3.3.3.4 is signalled by the network							
NOTE 11: Whether the applicable frequency range should be 793-805MHz instead of 799-805MHz is TBD							
NOTE 12: The emissions measurement shall be sufficiently power averaged to ensure a standard deviation < 0.5 dB							
NOTE 13: Applicable when the assigned E-UTRA UL operating channel is ≥1744.9MHz and ≤ 1784.9MHz.							
NOTE 14: These requirements also apply for the frequency ranges that are less than Δf _{00B} (MHz) in Table 6.6.3.1-1 from the edge of the channel bandwidth.							
NOTE 15: This requirement is applicable for an uplink transmission bandwidth less than or equal to 54 RB for carriers of 15 MHz bandwidth when carrier centre frequency is within the range 2560.5 - 2562.5 MHz and for carriers of 20 MHz bandwidth when carrier centre frequency is within the range 2552 - 2560 MHz. This requirement is							

applicable without any other uplink transmission bandwidth restriction for channel bandwidths within the range 2500 - 2570 MHz.

NOTE 16: This requirement is applicable for an uplink transmission bandwidth less than or equal to 54 RB for carriers of 15 MHz bandwidth when carrier centre frequency is within the range 2605.5 - 2607.5 MHz and for carriers of 20 MHz bandwidth when carrier centre frequency is within the range 2597 – 2605 MHz. This requirement is applicable without any other uplink transmission bandwidth restriction for channel bandwidths within the range 2570 – 2615 MHz. For assigned carriers with bandwidths overlapping the frequency range 2615-2620 MHz the requirements apply with the maximum output power configured to +20 dBm in the IE *P-Max*.

NOTE 17: For carriers of 5 MHz channel bandwidth with carrier centre frequencies (F_c) in the range $902.5\text{MHz} \leq F_c < 907.5\text{ MHz}$, the requirement applies for uplink transmission bandwidths less than or equal to 20 RB. No restrictions apply in the range $907.5\text{ MHz} \leq F_c \leq 912.5\text{ MHz}$. For carriers of 10 MHz channel bandwidth, the requirement only applies for $F_c = 910\text{ MHz}$ and uplink transmission bandwidths less than or equal to 32 RB with $\text{RB}_{\text{start}} > 3$.

NOTE 18: This requirement is applicable for an uplink transmission bandwidth less than or equal to 54 RB for carriers of 15 MHz bandwidth when carrier centre frequency is within the range 1927.5 - 1929.5 MHz and for carriers of 20 MHz bandwidth when carrier centre frequency is within the range 1930 - 1938 MHz. This requirement is applicable without any other uplink transmission bandwidth restriction for channel bandwidths within the range 1920 - 1980 MHz.

NOTE 19: For these adjacent bands, the emission limit could imply risk of harmful interference to UE(s) operating in the protected operating band.

NOTE: The restriction on the maximum uplink transmission to 54 RB in Notes 15, 16 and 18 of Table 6.6.3.2.3-1A is intended for conformance testing and may be applied to network operation to facilitate coexistence when the aggressor and victim bands are deployed in the same geographical area. The applicable spurious emission requirement of -15.5 dBm/5MHz is a least restrictive technical condition for FDD/TDD coexistence and may have to be revised in the future.

Table 6.6.3.2.3-1B: Spurious emission band UE co-existence limits Rel-10

E-UTRA Band	Spurious emission						
	Protected band	Frequency range (MHz)		Maximum Level (dBm)	MBW (MHz)	Note	
1	E-UTRA Band 1, 7, 8, 11, 18, 19, 20, 21, 22, 38, 40, 42, 43	F _{DL_low}	-	F _{DL_high}	-50	1	
	E-UTRA Band 3, 34	F _{DL_low}	-	F _{DL_high}	-50	1	15
	Frequency range	1880	-	1895	-40	1	15,19
	Frequency range	1895	-	1915	-15.5	5	15,19,20
	Frequency range	1915	-	1920	+1.6	5	15,19,20
	Frequency range	1884.5	-	1915.7	-41	0.3	6, 8, 15
2	E-UTRA Band 4, 5, 10, 12, 13, 14, 17, 22, 23, 24, 41, 42	F _{DL_low}	-	F _{DL_high}	-50	1	
	E-UTRA Band 2, 25	F _{DL_low}	-	F _{DL_high}	-50	1	15
	E-UTRA Band 43	F _{DL_low}	-	F _{DL_high}	-50	1	2
3	E-UTRA Band 1, 7, 8, 20, 33, 34, 38, 43	F _{DL_low}	-	F _{DL_high}	-50	1	
	E-UTRA Band 3	F _{DL_low}	-	F _{DL_high}	-50	1	15
	E-UTRA Band 11, 18, 19, 21	F _{DL_low}	-	F _{DL_high}	-50	1	13
	E-UTRA Band 22, 42	F _{DL_low}	-	F _{DL_high}	-50	1	2
	Frequency range	1884.5	-	1915.7	-41	0.3	13
4	E-UTRA Band 2, 4, 5, 10, 12, 13, 14, 17, 22, 23, 24, 25, 41, 43	F _{DL_low}	-	F _{DL_high}	-50	1	
	E-UTRA Band 42	F _{DL_low}	-	F _{DL_high}	-50	1	2
5	E-UTRA Band 2, 4, 5, 10, 12, 13, 14, 17, 22, 23, 24, 25, 42, 43	F _{DL_low}	-	F _{DL_high}	-50	1	
	E-UTRA Band 41	F _{DL_low}	-	F _{DL_high}	-50	1	2
6	E-UTRA Band 1, 9, 11, 34	F _{DL_low}	-	F _{DL_high}	-50	1	
	Frequency range	860	-	875	-37	1	
	Frequency range	875	-	895	-50	1	
	Frequency range	1884.5	-	1919.6	-41	0.3	7
	Frequency range	1884.5	-	1915.7	-41	0.3	8
7	E-UTRA Band 1, 3, 7, 8, 20, 22, 33, 34, 42, 43	F _{DL_low}	-	F _{DL_high}	-50	1	
	Frequency range	2570	-	2575	+1.6	5	15, 16, 20
	Frequency range	2575	-	2595	-15.5	5	15, 16, 20
	Frequency range				-40	1	15, 16
8	E-UTRA Band 1, 20, 33, 34, 38, 39, 40	F _{DL_low}	-	F _{DL_high}	-50	1	
	E-UTRA band 3	F _{DL_low}	-	F _{DL_high}	-50	1	2
	E-UTRA band 7	F _{DL_low}	-	F _{DL_high}	-50	1	2
	E-UTRA Band 8	F _{DL_low}	-	F _{DL_high}	-50	1	15
	E-UTRA Band 22, 42, 43	F _{DL_low}	-	F _{DL_high}	-50	1	2
	E-UTRA Band 11, 21	F _{DL_low}	-	F _{DL_high}	-50	1	18
	Frequency range	860	-	890	-40	1	15, 18
	Frequency range	1884.5	-	1915.7	-41	0.3	8, 18
9	E-UTRA Band 1, 11, 18, 19, 21, 34	F _{DL_low}	-	F _{DL_high}	-50	1	
	Frequency range	1884.5	-	1915.7	-41	0.3	8
	Frequency range	945	-	960	-50	1	
	Frequency range	1839.9	-	1879.9	-50	1	
10	E-UTRA Band 2, 4, 5, 10, 12, 13, 14, 17, 23, 24, 25, 41, 43	F _{DL_low}	-	F _{DL_high}	-50	1	
	E-UTRA Band 22, 42	F _{DL_low}	-	F _{DL_high}	-50	1	2
11	E-UTRA Band 1, 11, 18, 19, 21, 34	F _{DL_low}	-	F _{DL_high}	-50	1	
	Frequency range	1884.5	-	1915.7	-41	0.3	8
	Frequency range	945	-	960	-50	1	
	Frequency range	1839.9	-	1879.9	-50	1	
12	E-UTRA Band 2, 5, 13, 14, 17, 23, 24, 25, 41	F _{DL_low}	-	F _{DL_high}	-50	1	
	E-UTRA Band 4, 10	F _{DL_low}	-	F _{DL_high}	-50	1	2
	E-UTRA Band 12	F _{DL_low}	-	F _{DL_high}	-50	1	15
13	E-UTRA Band 2, 4, 5, 10, 12, 13, 17, 23, 25, 41	F _{DL_low}	-	F _{DL_high}	-50	1	

	Frequency range	769	-	775	-35	0.00625	15
	Frequency range	799	-	805	-35	0.00625	11, 15
	E-UTRA Band 14	F _{DL_low}	-	F _{DL_high}	-50	1	15
	E-UTRA Band 24	F _{DL_low}	-	F _{DL_high}	-50	1	2
14	E-UTRA Band 2, 4, 5, 10, 12, 13, 14, 17, 23, 24, 25, 41	F _{DL_low}	-	F _{DL_high}	-50	1	
	Frequency range	769	-	775	-35	0.00625	12, 15
	Frequency range	799	-	805	-35	0.00625	11, 12, 15
17	E-UTRA Band 2, 5, 13, 14, 17, 23, 24, 25, 41	F _{DL_low}	-	F _{DL_high}	-50	1	
	E-UTRA Band 4, 10	F _{DL_low}	-	F _{DL_high}	-50	1	2
	E-UTRA Band 12	F _{DL_low}	-	F _{DL_high}	-50	1	15
18	E-UTRA Band 1, 11, 21, 34	F _{DL_low}	-	F _{DL_high}	-50	1	
	Frequency range	860	-	890	-40	1	
	Frequency range	1884.5	-	1915.7	-41	0.3	8
	Frequency range	945	-	960	-50	1	
	Frequency range	1839.9	-	1879.9	-50	1	
19	E-UTRA Band 1, 11, 21, 34	F _{DL_low}	-	F _{DL_high}	-50	1	
	Frequency range	860	-	890	-40	1	9, 15
	Frequency range	1884.5	-	1915.7	-41	0.3	8
	Frequency range	945	-	960	-50	1	
	Frequency range	1839.9	-	1879.9	-50	1	
20	E-UTRA Band 1, 3, 7, 8, 20, 22, 33, 34, 43	F _{DL_low}	-	F _{DL_high}	-50	1	
	E-UTRA Band 20	F _{DL_low}	-	F _{DL_high}	-50	1	15
	E-UTRA Band 38, 42	F _{DL_low}	-	F _{DL_high}	-50	1	2
21	E-UTRA Band 11	F _{DL_low}	-	F _{DL_high}	-35	1	10, 15
	E-UTRA Band 1, 34	F _{DL_low}	-	F _{DL_high}	-50	1	
	E-UTRA Band 21	F _{DL_low}	-	F _{DL_high}	-50	1	10
	Frequency range	1884.5	-	1915.7	-41	0.3	8
	Frequency range	945	-	960	-50	1	
	Frequency range	1839.9	-	1879.9	-50	1	
22	E-UTRA Band 1, 3, 7, 8, 20, 33, 34, 38, 39, 40, 43	F _{DL_low}	-	F _{DL_high}	-50	1	
	Frequency range	3510	-	3525	-40	1	15
	Frequency range	3525	-	3590	-50	1	
23	E-UTRA Band 4, 5, 10, 12, 13, 14, 17, 23, 24, 41	F _{DL_low}	-	F _{DL_high}	-50	1	
	E-UTRA Band 2	F _{DL_low}	-	F _{DL_high}	-50	1	14, 15
	Frequency range	1998	-	1999	-21	1	14, 15
	Frequency range	1997	-	1998	-27	1	14, 15
	Frequency range	1996	-	1997	-32	1	14, 15
	Frequency range	1995	-	1996	-37	1	14, 15
	Frequency range	1990	-	1995	-40	1	14, 15
	Frequency range	1990	-	1999	-40	1	15, 21
	Frequency range	1999	-	2000	-40	Note 22	15, 21

24	E-UTRA Band 2, 4, 5, 10, 12, 13, 14, 17, 23, 24, 25, 41	F_{DL_low}	-	F_{DL_high}	-50	1	
25	E-UTRA Band 4, 5, 10,12, 13, 14, 17, 22, 23, 24, 41, 42	F_{DL_low}	-	F_{DL_high}	-50	1	
	E-UTRA Band 2	F_{DL_low}	-	F_{DL_high}	-50	1	15
	E-UTRA Band 25	F_{DL_low}	-	F_{DL_high}	-50	1	15
	E-UTRA Band 43	F_{DL_low}	-	F_{DL_high}	-50	1	2
...							
33	E-UTRA Band 1, 7, 8, 20, 22, 34, 38, 39, 40, 42, 43	F_{DL_low}	-	F_{DL_high}	-50	1	5
	E-UTRA Band 3	F_{DL_low}	-	F_{DL_high}	-50	1	15
34	E-UTRA Band 1, 3, 7, 8, 11, 18, 19, 20, 21, 22, 33, 38,39, 40, 42, 43	F_{DL_low}	-	F_{DL_high}	-50	1	5
	Frequency range	1884.5	-	1915.7	-41	0.3	8
	Frequency range	1839.9	-	1879.9	-50	1	5
35							
36							
37			-				
38	E-UTRA Band 1,3, 8, 20, 22, 33, 34, 42, 43	F_{DL_low}	-	F_{DL_high}	-50	1	
	Frequency range	2620	-	2645	-15.5	5	15, 17, 20
	Frequency range	2645	-	2690	-40	1	15, 17
39	E-UTRA Band 22, 34, 40, 42	F_{DL_low}	-	F_{DL_high}	-50	1	
	E-UTRA Band 43	F_{DL_low}	-	F_{DL_high}	-50	1	2
40	E-UTRA Band 1, 3, 22, 33, 34, 39, 42, 43	F_{DL_low}	-	F_{DL_high}	-50	1	
41	E-UTRA Band 2, 4, 5, 10, 12, 13, 14, 17, 23, 24, 25	F_{DL_low}	-	F_{DL_high}	-50	1	
42	E-UTRA Band 1, 2, 3, 4, 5, 7, 8, 10, 20, 25, 33, 34, 38, 40	F_{DL_low}	-	F_{DL_high}	-50	1	
	E-UTRA Band 43	F_{DL_low}	-	F_{DL_high}	-50	1	3
43	E-UTRA Band 1, 2, 3, 4, 5, 7, 8, 10, 20, 25, 33, 34, 38, 40	F_{DL_low}	-	F_{DL_high}	-50	1	
	E-UTRA Band 42	F_{DL_low}	-	F_{DL_high}	-50	1	3
	E-UTRA Band 22	F_{DL_low}	-	F_{DL_high}	[-50]	[1]	3

NOTE 1:	F_{DL_low} and F_{DL_high} refer to each E-UTRA frequency band specified in Table 5.2-1
NOTE 2:	As exceptions, measurements with a level up to the applicable requirements defined in Table 6.6.3.1.3-2 are permitted for each assigned E-UTRA carrier used in the measurement due to 2 nd , 3 rd or 4 th harmonic spurious emissions. An exception is allowed if there is at least one individual RB within the transmission bandwidth (see Figure 5.4.2-1) for which the 2 nd , 3 rd or 4 th harmonic totally or partially overlaps the measurement bandwidth (MBW).
NOTE 3:	To meet these requirements some restriction will be needed for either the operating band or protected band
NOTE 4:	N/A
NOTE 5:	For non synchronised TDD operation to meet these requirements some restriction will be needed for either the operating band or protected band
NOTE 6:	Applicable when NS_05 in section 6.6.3.3.3.1 is signalled by the network.
NOTE 7:	Applicable when co-existence with PHS system operating in 1884.5-1919.6MHz.
NOTE 8:	Applicable when co-existence with PHS system operating in 1884.5 -1915.7MHz.
NOTE 9:	Applicable when NS_08 in section 6.6.3.3.3.3 is signalled by the network
NOTE 10:	Applicable when NS_09 in section 6.6.3.3.3.4 is signalled by the network
NOTE 11:	Whether the applicable frequency range should be 793-805MHz instead of 799-805MHz is TBD
NOTE 12:	The emissions measurement shall be sufficiently power averaged to ensure a standard deviation < 0.5 dB
NOTE 13:	This requirement applies for 5, 10, 15 and 20 MHz E-UTRA channel bandwidth allocated within 1744.9MHz and 1784.9MHz.
NOTE 14:	To meet this requirement NS_11 value shall be signalled when operating in 2000-2020 MHz
NOTE 15:	These requirements also apply for the frequency ranges that are less than F_{OoB} (MHz) in Table 6.6.3.1.3-1 and Table 6.6.3.1A.1.3-1 from the edge of the channel bandwidth.
NOTE 16:	This requirement is applicable for an uplink transmission bandwidth less than or equal to 54 RB for carriers of 15 MHz bandwidth when carrier centre frequency is within the range 2560.5 - 2562.5 MHz and for carriers of 20 MHz bandwidth when carrier centre frequency is within the range 2552 - 2560 MHz. No other restrictions apply for carriers with bandwidths confined in 2500-2570 MHz.
NOTE 17:	This requirement is applicable for an uplink transmission bandwidth less than or equal to 54 RB for carriers of 15 MHz bandwidth when carrier centre frequency is within the range 2605.5 - 2607.5 MHz and for carriers of 20 MHz bandwidth when carrier centre frequency is within the range 2597 – 2605 MHz. No other restrictions apply for carriers with bandwidths confined in 2570-2615 MHz. For assigned carriers with bandwidths overlapping the frequency range 2615-2620 MHz the requirements apply with the maximum output power configured to +20 dBm in the IE <i>P-Max</i> .
NOTE 18:	For carriers of 5 MHz channel bandwidth with carrier centre frequencies (F_c) in the range $902.5\text{MHz} \leq F_c < 907.5\text{MHz}$, the requirement applies for uplink transmission bandwidths less than or equal to 20 RB. No restrictions apply in the range $907.5\text{MHz} \leq F_c \leq 912.5\text{MHz}$. For carriers of 10 MHz channel bandwidth, the requirement only applies for $F_c = 910\text{MHz}$ and uplink transmission bandwidths less than or equal to 32 RB with $RB_{start} > 3$.
NOTE 19:	This requirement is applicable for an uplink transmission bandwidth less than or equal to 54 RB for carriers of 15 MHz bandwidth when carrier centre frequency is within the range 1927.5 - 1929.5 MHz and for carriers of 20 MHz bandwidth when carrier centre frequency is within the range 1930 - 1938 MHz. This requirement is applicable without any other uplink transmission bandwidth restriction for channel bandwidths within the range 1920 - 1980 MHz.
NOTE 20:	For these adjacent bands, the emission limit could imply risk of harmful interference to UE(s) operating in the protected operating band.
NOTE 21:	Applicable when NS_20 is signalled by the network.
NOTE 22:	The measurement bandwidth is 1% of the applicable E-UTRA channel bandwidth (Table 5.4.2-1).

NOTE: The restriction on the maximum uplink transmission to 54 RB in Notes 16, 17, and 19 of Table 6.6.3.2.3-1B is intended for conformance testing and may be applied to network operation to facilitate coexistence when the aggressor and victim bands are deployed in the same geographical area. The applicable spurious emission requirement of -15.5 dBm/5MHz is a least restrictive technical condition for FDD/TDD coexistence and may have to be revised in the future.

Table 6.6.3.2.3-1C: Spurious emission band UE co-existence limits Rel-11

E-UTRA Band	Spurious emission						
	Protected band	Frequency range (MHz)			Maximum Level (dBm)	MBW (MHz)	Note
1	E-UTRA Band 1, 7, 8, 11, 18, 19, 20, 21, 22, 26, 27, 28, 38, 40, 41, 42, 43, 44	F _{DL_low}	-	F _{DL_high}	-50	1	
	E-UTRA Band 3, 34	F _{DL_low}	-	F _{DL_high}	-50	1	15
	Frequency range	1880		1895	-40	1	15,27
	Frequency range	1895		1915	-15.5	5	15, 26, 27
	Frequency range	1915		1920	+1.6	5	15, 26, 27
	Frequency range	1884.5	-	1915.7	-41	0.3	6, 8, 15
	Frequency range	1839.9	-	1879.9	-50	1	15
2	E-UTRA Band 4, 5, 10, 12, 13, 14, 17, 22, 23, 24, 26, 27, 28, 29, 41, 42	F _{DL_low}	-	F _{DL_high}	-50	1	
	E-UTRA Band 2, 25	F _{DL_low}	-	F _{DL_high}	-50	1	15
	E-UTRA Band 43	F _{DL_low}	-	F _{DL_high}	-50	1	2
3	E-UTRA Band 1, 7, 8, 20, 26, 27, 28, 33, 34, 38, 41, 43, 44	F _{DL_low}	-	F _{DL_high}	-50	1	
	E-UTRA Band 3	F _{DL_low}	-	F _{DL_high}	-50	1	15
	E-UTRA Band 11, 18, 19, 21	F _{DL_low}	-	F _{DL_high}	-50	1	13
	E-UTRA Band 22, 42	F _{DL_low}	-	F _{DL_high}	-50	1	2
	Frequency range	1884.5	-	1915.7	-41	0.3	13
4	E-UTRA Band 2, 4, 5, 10, 12, 13, 14, 17, 22, 23, 24, 25, 26, 27, 28, 29, 41, 43	F _{DL_low}	-	F _{DL_high}	-50	1	
	E-UTRA Band 42	F _{DL_low}	-	F _{DL_high}	-50	1	2
5	E-UTRA Band 2, 4, 5, 10, 12, 13, 14, 17, 22, 23, 24, 25, 28, 29,42, 43	F _{DL_low}	-	F _{DL_high}	-50	1	
	E-UTRA Band 41	F _{DL_low}	-	F _{DL_high}	-50	1	2
	E-UTRA Band 26	859	-	869	-27	1	
6	E-UTRA Band 1, 9, 11, 34	F _{DL_low}	-	F _{DL_high}	-50	1	
	Frequency range	860	-	875	-37	1	
	Frequency range	875	-	895	-50	1	
	Frequency range	1884.5	-	1919.6	-41	0.3	7
	Frequency range	1884.5	-	1915.7			8
7	E-UTRA Band 1, 3, 7, 8, 20, 22, 27, 28, 29, 33, 34, 42, 43	F _{DL_low}	-	F _{DL_high}	-50	1	
	Frequency range	2570	-	2575	+1.6	5	15, 21, 26
	Frequency range	2575	-	2595	-15.5	5	15, 21, 26
	Frequency range	2595	-	2620	-40	1	15, 21
8	E-UTRA Band 1, 20, 28, 33, 34, 38, 39, 40	F _{DL_low}	-	F _{DL_high}	-50	1	
	E-UTRA band 3	F _{DL_low}	-	F _{DL_high}	-50	1	2
	E-UTRA band 7	F _{DL_low}	-	F _{DL_high}	-50	1	2
	E-UTRA Band 8	F _{DL_low}	-	F _{DL_high}	-50	1	15
	E-UTRA Band 22, 41, 42, 43	F _{DL_low}	-	F _{DL_high}	-50	1	2
	E-UTRA Band 11, 21	F _{DL_low}	-	F _{DL_high}	-50	1	23
	Frequency range	860	-	890	-40	1	15, 23
	Frequency range	1884.5	-	1915.7	-41	0.3	8, 23
9	E-UTRA Band 1, 11, 18, 19, 21, 26, 28, 34	F _{DL_low}	-	F _{DL_high}	-50	1	
	Frequency range	1884.5	-	1915.7	-41	0.3	8
	Frequency range	945	-	960	-50	1	
	Frequency range	1839.9	-	1879.9	-50	1	
	Frequency range	2545	-	2575	-50	1	
10	E-UTRA Band 2, 4, 5, 10, 12, 13, 14, 17, 23, 24, 25, 26, 27, 28, 29, 41, 43	F _{DL_low}	-	F _{DL_high}	-50	1	
	E-UTRA Band 22, 42	F _{DL_low}	-	F _{DL_high}	-50	1	2
11	E-UTRA Band 1, 11, 18, 19, 21, 28, 34	F _{DL_low}	-	F _{DL_high}	-50	1	
	Frequency range	1884.5	-	1915.7	-41	0.3	8
	Frequency range	945	-	960	-50	1	

	Frequency range	1839.9	-	1879.9	-50	1	
	Frequency range	2545	-	2575	-50	1	
12	E-UTRA Band 2, 5, 13, 14, 17, 23, 24, 25, 26, 27, 41	F _{DL_low}	-	F _{DL_high}	-50	1	
	E-UTRA Band 4, 10	F _{DL_low}	-	F _{DL_high}	-50	1	2
	E-UTRA Band 12	F _{DL_low}	-	F _{DL_high}	-50	1	15
13	E-UTRA Band 2, 4, 5, 10, 12, 13, 17, 23, 25, 26, 27, 29, 41	F _{DL_low}	-	F _{DL_high}	-50	1	
	Frequency range	769	-	775	-35	0.00625	15
	Frequency range	799	-	805	-35	0.00625	11, 15
	E-UTRA Band 14	F _{DL_low}	-	F _{DL_high}	-50	1	15
	E-UTRA Band 24	F _{DL_low}	-	F _{DL_high}	-50	1	2
14	E-UTRA Band 2, 4, 5, 10, 12, 13, 14, 17, 23, 24, 25, 26, 27, 29, 41	F _{DL_low}	-	F _{DL_high}	-50	1	
	Frequency range	769	-	775	-35	0.00625	12, 15
	Frequency range	799	-	805	-35	0.00625	11, 12, 15
17	E-UTRA Band 2, 5, 13, 14, 17, 23, 24, 25, 26, 27, 41	F _{DL_low}	-	F _{DL_high}	-50	1	
	E-UTRA Band 4, 10	F _{DL_low}	-	F _{DL_high}	-50	1	2
	E-UTRA Band 12	F _{DL_low}	-	F _{DL_high}	-50	1	15
18	E-UTRA Band 1, 11, 21, 34	F _{DL_low}	-	F _{DL_high}	-50	1	
	Frequency range	860	-	890	-40	1	
	Frequency range	1884.5	-	1915.7	-41	0.3	8
	Frequency range	758	-	799	-50	1	
	Frequency range	799	-	803	-40	1	15
	Frequency range	945	-	960	-50	1	
	Frequency range	1839.9	-	1879.9	-50	1	
	Frequency range	2545	-	2575	-50	1	
19	E-UTRA Band 1, 11, 21, 28, 34	F _{DL_low}	-	F _{DL_high}	-50	1	
	Frequency range	860	-	890	-40	1	9, 15
	Frequency range	1884.5	-	1915.7	-41	0.3	8
	Frequency range	945	-	960	-50	1	
	Frequency range	1839.9	-	1879.9	-50	1	
	Frequency range	2545	-	2575	-50	1	
20	E-UTRA Band 1, 3, 7, 8, 20, 22, 33, 34, 43	F _{DL_low}	-	F _{DL_high}	-50	1	
	E-UTRA Band 20	F _{DL_low}	-	F _{DL_high}	-50	1	15
	E-UTRA Band 38, 42	F _{DL_low}	-	F _{DL_high}	-50	1	2
21	E-UTRA Band 11	F _{DL_low}	-	F _{DL_high}	-35	1	10, 15
	E-UTRA Band 1, 18, 19, 28, 34	F _{DL_low}	-	F _{DL_high}	-50	1	
	E-UTRA Band 21	F _{DL_low}	-	F _{DL_high}	-50	1	10
	Frequency range	1884.5	-	1915.7	-41	0.3	8
	Frequency range	945	-	960	-50	1	
	Frequency range	1839.9	-	1879.9	-50	1	
	Frequency range	2545	-	2575	-50	1	
22	E-UTRA Band 1, 3, 7, 8, 20, 26, 27, 28, 33, 34, 38, 39, 40, 43	F _{DL_low}	-	F _{DL_high}	-50	1	
	Frequency range	3510	-	3525	-40	1	15
	Frequency range	3525	-	3590	-50	1	
23	E-UTRA Band 4, 5, 10, 12, 13, 14, 17, 23, 24, 26, 27, 29, 41	F _{DL_low}	-	F _{DL_high}	-50	1	
	E-UTRA Band 2	F _{DL_low}	-	F _{DL_high}	-50	1	14, 15
	Frequency range	1998	-	1999	-21	1	14, 15
	Frequency range	1997	-	1998	-27	1	14, 15
	Frequency range	1996	-	1997	-32	1	14, 15
	Frequency range	1995	-	1996	-37	1	14, 15
	Frequency range	1990	-	1995	-40	1	14, 15
	Frequency range	1990	-	1999	-40	1	15, 28
	Frequency range	1999	-	2000	-40	Note 29	15, 28
24	E-UTRA Band 2, 4, 5, 10, 12, 13, 14, 17, 23, 24, 25, 26, 29, 41	F _{DL_low}	-	F _{DL_high}	-50	1	
25	E-UTRA Band 4, 5, 10, 12, 13, 14, 17, 22, 23, 24, 26, 27, 28, 29, 41, 42	F _{DL_low}	-	F _{DL_high}	-50	1	
	E-UTRA Band 2	F _{DL_low}	-	F _{DL_high}	-50	1	15

	E-UTRA Band 25	F_{DL_low}	-	F_{DL_high}	-50	1	15
	E-UTRA Band 43	F_{DL_low}	-	F_{DL_high}	-50	1	2
26	E-UTRA Band 1, 2, 3, 4, 5, 10, 11, 12, 13, 14, 17, 18, 19, 21, 22, 23, 24, 25, 26, 29, 34, 40, 42, 43	F_{DL_low}	-	F_{DL_high}	-50	1	
	E-UTRA Band 41	F_{DL_low}	-	F_{DL_high}	-50	1	2
	Frequency range	1884.5	-	1915.7	-41	0.3	8
	Frequency range	703	-	799	-50	1	
		799	-	803	-40	1	15
	Frequency range	851	-	859	-53	0.00625	20
	E-UTRA Band 27	F_{DL_low}	-	859	-32	1	20
	Frequency range	945	-	960	-50	1	
	Frequency range	1839.9	-	1879.9	-50	1	
27	E-UTRA Band 1, 2, 3, 4, 5, 7, 10, 12, 13, 14, 17, 22, 23, 25, 26, 27, 29, 41, 42, 43	F_{DL_low}	-	F_{DL_high}	-50	1	
	Frequency range	799	-	805	-35	0.00625	
		790	-	F_{DL_high}	-32	1	16
	E-UTRA Band 28	F_{DL_low}	-	790	-50	1	
28	E-UTRA Band 2, 3, 5, 7, 8, 18, 19, 25, 26, 27, 34, 38, 41	F_{DL_low}	-	F_{DL_high}	-50	1	
	E-UTRA Band 1, 4, 10, 22, 42, 43	F_{DL_low}	-	F_{DL_high}	-50	1	2
	E-UTRA Band 11, 21	F_{DL_low}	-	F_{DL_high}	-50	1	19, 24
	E-UTRA Band 1	F_{DL_low}	-	F_{DL_high}	-50	1	19, 25
	Frequency range	758	-	773	-32	1	15
	Frequency range	773	-	803	-50	1	
	Frequency range	662	-	694	-26.2	6	15
	Frequency range	1884.5	-	1915.7	-41	0.3	8, 19
	Frequency range	1839.9	-	1879.9	-50	1	
...							
33	E-UTRA Band 1, 7, 8, 20, 22, 34, 38, 39, 40, 42, 43	F_{DL_low}	-	F_{DL_high}	-50	1	5
	E-UTRA Band 3	F_{DL_low}	-	F_{DL_high}	-50	1	15
34	E-UTRA Band 1, 3, 7, 8, 11, 18, 19, 20, 21, 22, 26, 28, 33, 38, 39, 40, 41, 42, 43, 44	F_{DL_low}	-	F_{DL_high}	-50	1	5
	Frequency range	1884.5	-	1915.7	-41	0.3	8
	Frequency range	1839.9	-	1879.9	-50	1	5
35							
36							
37			-				
38	E-UTRA Band 1, 3, 8, 20, 22, 28, 29, 33, 34, 42, 43	F_{DL_low}	-	F_{DL_high}	-50	1	
	Frequency range	2620	-	2645	-15.5	5	15, 22, 26
	Frequency range	2645	-	2690	-40	1	15, 22
39	E-UTRA Band 22, 34, 40, 41, 42, 44	F_{DL_low}	-	F_{DL_high}	-50	1	
40	E-UTRA Band 1, 3, 22, 26, 27, 33, 34, 39, 41, 42, 43, 44	F_{DL_low}	-	F_{DL_high}	-50	1	
41	E-UTRA Band 1, 2, 3, 4, 5, 8, 10, 12, 13, 14, 17, 23, 24, 25, 26, 27, 28, 29, 34, 39, 40, 42, 44	F_{DL_low}	-	F_{DL_high}	-50	1	
	E-UTRA Band 9, 11, 18, 19, 21	F_{DL_low}	-	F_{DL_high}	-50	1	30
	Frequency range	1839.9		1879.9	-50	1	30
	Frequency range	1884.5		1915.7	-41	0.3	8, 30
42	E-UTRA Band 1, 2, 3, 4, 5, 7, 8, 10, 20, 25, 26, 27, 28, 33, 34, 38, 40, 41, 44	F_{DL_low}	-	F_{DL_high}	-50	1	
	E-UTRA Band 43	F_{DL_low}	-	F_{DL_high}	-50	1	3
43	E-UTRA Band 1, 2, 3, 4, 5, 7, 8, 10, 20, 25, 26, 27, 28, 33, 34, 38, 40	F_{DL_low}	-	F_{DL_high}	-50	1	
	E-UTRA Band 42	F_{DL_low}	-	F_{DL_high}	-50	1	3
	E-UTRA Band 22	F_{DL_low}	-	F_{DL_high}	[-50]	[1]	3
44	E-UTRA Band 3, 5, 8, 34, 39, 41	F_{DL_low}	-	F_{DL_high}	-50	1	
	E-UTRA Band 1, 40, 42	F_{DL_low}	-	F_{DL_high}		-50	2

- NOTE 1: F_{DL_low} and F_{DL_high} refer to each E-UTRA frequency band specified in Table 5.2-1
- NOTE 2: As exceptions, measurements with a level up to the applicable requirements defined in Table 6.6.3.1.3-2 are permitted for each assigned E-UTRA carrier used in the measurement due to 2nd, 3rd, 4th [or 5th] harmonic spurious emissions. An exception is allowed if there is at least one individual RB within the transmission bandwidth (see Figure 5.4.2-1) for which the 2nd, 3rd or 4th harmonic totally or partially overlaps the measurement bandwidth (MBW).
- NOTE 3: To meet these requirements some restriction will be needed for either the operating band or protected band
- NOTE 4: N/A
- NOTE 5: For non synchronised TDD operation to meet these requirements some restriction will be needed for either the operating band or protected band
- NOTE 6: Applicable when NS_05 in section 6.6.3.3.3.1 is signalled by the network.
- NOTE 7: Applicable when co-existence with PHS system operating in 1884.5-1919.6MHz.
- NOTE 8: Applicable when co-existence with PHS system operating in 1884.5 -1915.7MHz.
- NOTE 9: Applicable when NS_08 in subclause 6.6.3.3.3.3 is signalled by the network
- NOTE 10: Applicable when NS_09 in subclause 6.6.3.3.3.4 is signalled by the network
- NOTE 11: Whether the applicable frequency range should be 793-805MHz instead of 799-805MHz is TBD
- NOTE 12: The emissions measurement shall be sufficiently power averaged to ensure a standard deviation < 0.5 dB
- NOTE 13: This requirement applies for 5, 10, 15 and 20 MHz E-UTRA channel bandwidth allocated within 1744.9MHz and 1784.9MHz.
- NOTE 14: To meet this requirement NS_11 value shall be signalled when operating in 2000-2020 MHz
- NOTE 15: These requirements also apply for the frequency ranges that are less than F_{OOB} (MHz) in Table 6.6.3.1.3-1 and Table 6.6.3.1A.1.3-1 from the edge of the channel bandwidth.
- NOTE 16: Applicable when NS_16 in subclause 6.6.3.3.3.9 is signalled by the network.
- NOTE 17: N/A
- NOTE 18: N/A
- NOTE 19: Applicable when the assigned E-UTRA carrier is confined within 718 MHz and 748 MHz and when the channel bandwidth used is 5 or 10 MHz.
- NOTE 20: Applicable when NS_15 in subclause 6.6.3.3.3.8 is signalled by the network.
- NOTE 21: This requirement is applicable for an uplink transmission bandwidth less than or equal to 54 RB for carriers of 15 MHz bandwidth when carrier centre frequency is within the range 2560.5 - 2562.5 MHz and for carriers of 20 MHz bandwidth when carrier centre frequency is within the range 2552 - 2560 MHz. No other restrictions apply for carriers with bandwidths confined in 2500-2570 MHz.
- NOTE 22: This requirement is applicable for an uplink transmission bandwidth less than or equal to 54 RB for carriers of 15 MHz bandwidth when carrier centre frequency is within the range 2605.5 - 2607.5 MHz and for carriers of 20 MHz bandwidth when carrier centre frequency is within the range 2597 - 2605 MHz. No other restrictions apply for carriers with bandwidths confined in 2570-2615 MHz. For assigned carriers with bandwidths overlapping the frequency range 2615-2620 MHz the requirements apply with the maximum output power configured to +20 dBm in the IE *P-Max*.
- NOTE 23: For carriers of 5 MHz channel bandwidth with carrier centre frequencies (F_c) in the range $902.5\text{MHz} \leq F_c < 907.5\text{MHz}$, the requirement applies for uplink transmission bandwidths less than or equal to 20 RB. No restrictions apply in the range $907.5\text{MHz} \leq F_c \leq 912.5\text{MHz}$. For carriers of 10 MHz channel bandwidth, the requirement only applies for $F_c = 910\text{MHz}$ and uplink transmission bandwidths less than or equal to 32 RB with $RB_{start} > 3$.
- NOTE 24: As exceptions, measurements with a level up to the applicable requirement of -38 dBm/MHz is permitted for each assigned E-UTRA carrier used in the measurement due to 2nd harmonic spurious emissions. An exception is allowed if there is at least one individual RB within the transmission bandwidth (see Figure 5.6-1) for which the 2nd harmonic totally or partially overlaps the measurement bandwidth (MBW).
- NOTE 25: As exceptions, measurements with a level up to the applicable requirement of -36 dBm/MHz is permitted for each assigned E-UTRA carrier used in the measurement due to 3rd harmonic spurious emissions. An exception is allowed if there is at least one individual RB within the transmission bandwidth (see Figure 5.6-1) for which the 3rd harmonic totally or partially overlaps the measurement bandwidth (MBW).
- NOTE 26: For these adjacent bands, the emission limit could imply risk of harmful interference to UE(s) operating in the protected operating band.
- NOTE 27: This requirement is applicable for an uplink transmission bandwidth less than or equal to 54 RB for carriers of 15 MHz bandwidth when carrier centre frequency is within the range 1927.5 - 1929.5 MHz and for carriers of 20 MHz bandwidth when carrier centre frequency is within the range 1930 - 1938 MHz. This requirement is applicable without any other uplink transmission bandwidth restriction for channel bandwidths within the range 1920 - 1980 MHz.
- NOTE 28: Applicable when NS_20 is signalled by the network.
- NOTE 29: The measurement bandwidth is 1% of the applicable E-UTRA channel bandwidth (Table 5.4.2-1).
- NOTE 30: This requirement applies when the E-UTRA carrier is confined within 2545-2575 MHz and the channel bandwidth is 10 or 20 MHz

Table 6.6.3.2.3-1D: Spurious emission band UE co-existence limits Rel-12

E-UTRA Band	Spurious emission						
	Protected band	Frequency range (MHz)			Maximum Level (dBm)	MBW (MHz)	Note
1	E-UTRA Band 1, 7, 8, 11, 18, 19, 20, 21, 22, 26, 27, 28, 31, 38, 40, 41, 42, 43, 44	F _{DL_low}	-	F _{DL_high}	-50	1	
	E-UTRA Band 3, 34	F _{DL_low}	-	F _{DL_high}	-50	1	15
	Frequency range	1880		1895	-40	1	15,27
	Frequency range	1895		1915	-15.5	5	15, 26, 27
	Frequency range	1915		1920	+1.6	5	15, 26, 27
	Frequency range	1884.5	-	1915.7	-41	0.3	6, 8, 15
	Frequency range	1839.9	-	1879.9	-50	1	15
2	E-UTRA Band 4, 5, 10, 12, 13, 14, 17, 22, 23, 24, 26, 27, 28, 29, 41, 42	F _{DL_low}	-	F _{DL_high}	-50	1	
	E-UTRA Band 2, 25	F _{DL_low}	-	F _{DL_high}	-50	1	15
	E-UTRA Band 43	F _{DL_low}	-	F _{DL_high}	-50	1	2
3	E-UTRA Band 1, 7, 8, 20, 26, 27, 28, 31, 33, 34, 38, 41, 43, 44	F _{DL_low}	-	F _{DL_high}	-50	1	
	E-UTRA Band 3	F _{DL_low}	-	F _{DL_high}	-50	1	15
	E-UTRA Band 11, 18, 19, 21	F _{DL_low}	-	F _{DL_high}	-50	1	13
	E-UTRA Band 22, 42	F _{DL_low}	-	F _{DL_high}	-50	1	2
	Frequency range	1884.5	-	1915.7	-41	0.3	13
4	E-UTRA Band 2, 4, 5, 10, 12, 13, 14, 17, 22, 23, 24, 25, 26, 27, 28, 29, 41, 43	F _{DL_low}	-	F _{DL_high}	-50	1	
	E-UTRA Band 42	F _{DL_low}	-	F _{DL_high}	-50	1	2
5	E-UTRA Band 2, 4, 5, 10, 12, 13, 14, 17, 22, 23, 24, 25, 28, 29, 31, 42, 43	F _{DL_low}	-	F _{DL_high}	-50	1	
	E-UTRA Band 41	F _{DL_low}	-	F _{DL_high}	-50	1	2
	E-UTRA Band 26	859	-	869	-27	1	
6	E-UTRA Band 1, 9, 11, 34	F _{DL_low}	-	F _{DL_high}	-50	1	
	Frequency range	860	-	875	-37	1	
	Frequency range	875	-	895	-50	1	
	Frequency range	1884.5	-	1919.6	-41	0.3	7
	Frequency range	1884.5	-	1915.7			8
7	E-UTRA Band 1, 3, 7, 8, 20, 22, 27, 28, 29, 31, 33, 34, 42, 43	F _{DL_low}	-	F _{DL_high}	-50	1	
	Frequency range	2570	-	2575	+1.6	5	15, 21, 26
	Frequency range	2575	-	2595	-15.5	5	15, 21, 26
	Frequency range	2595	-	2620	-40	1	15, 21
8	E-UTRA Band 1, 20, 28, 31, 33, 34, 38, 39, 40	F _{DL_low}	-	F _{DL_high}	-50	1	
	E-UTRA band 3	F _{DL_low}	-	F _{DL_high}	-50	1	2
	E-UTRA band 7	F _{DL_low}	-	F _{DL_high}	-50	1	2
	E-UTRA Band 8	F _{DL_low}	-	F _{DL_high}	-50	1	15
	E-UTRA Band 22, 41, 42, 43	F _{DL_low}	-	F _{DL_high}	-50	1	2
	E-UTRA Band 11, 21	F _{DL_low}	-	F _{DL_high}	-50	1	23
	Frequency range	860	-	890	-40	1	15, 23
	Frequency range	1884.5	-	1915.7	-41	0.3	8, 23
9	E-UTRA Band 1, 11, 18, 19, 21, 26, 28, 34	F _{DL_low}	-	F _{DL_high}	-50	1	
	Frequency range	1884.5	-	1915.7	-41	0.3	8
	Frequency range	945	-	960	-50	1	
	Frequency range	1839.9	-	1879.9	-50	1	
	Frequency range	2545	-	2575	-50	1	
10	E-UTRA Band 2, 4, 5, 10, 12, 13, 14, 17, 23, 24, 25, 26, 27, 28, 29, 41, 43	F _{DL_low}	-	F _{DL_high}	-50	1	
	E-UTRA Band 22, 42	F _{DL_low}	-	F _{DL_high}	-50	1	2
11	E-UTRA Band 1, 11, 18, 19, 21, 28, 34	F _{DL_low}	-	F _{DL_high}	-50	1	
	Frequency range	1884.5	-	1915.7	-41	0.3	8
	Frequency range	945	-	960	-50	1	

	Frequency range	1839.9	-	1879.9	-50	1	
	Frequency range	2545	-	2575	-50	1	
12	E-UTRA Band 2, 5, 13, 14, 17, 23, 24, 25, 26, 27, 41	F _{DL_low}	-	F _{DL_high}	-50	1	
	E-UTRA Band 4, 10	F _{DL_low}	-	F _{DL_high}	-50	1	2
	E-UTRA Band 12	F _{DL_low}	-	F _{DL_high}	-50	1	15
13	E-UTRA Band 2, 4, 5, 10, 12, 13, 17, 23, 25, 26, 27, 29, 41	F _{DL_low}	-	F _{DL_high}	-50	1	
	Frequency range	769	-	775	-35	0.00625	15
	Frequency range	799	-	805	-35	0.00625	11, 15
	E-UTRA Band 14	F _{DL_low}	-	F _{DL_high}	-50	1	15
	E-UTRA Band 24	F _{DL_low}	-	F _{DL_high}	-50	1	2
14	E-UTRA Band 2, 4, 5, 10, 12, 13, 14, 17, 23, 24, 25, 26, 27, 29, 41	F _{DL_low}	-	F _{DL_high}	-50	1	
	Frequency range	769	-	775	-35	0.00625	12, 15
	Frequency range	799	-	805	-35	0.00625	11, 12, 15
17	E-UTRA Band 2, 5, 13, 14, 17, 23, 24, 25, 26, 27, 41	F _{DL_low}	-	F _{DL_high}	-50	1	
	E-UTRA Band 4, 10	F _{DL_low}	-	F _{DL_high}	-50	1	2
	E-UTRA Band 12	F _{DL_low}	-	F _{DL_high}	-50	1	15
18	E-UTRA Band 1, 11, 21, 34	F _{DL_low}	-	F _{DL_high}	-50	1	
	Frequency range	860	-	890	-40	1	
	Frequency range	1884.5	-	1915.7	-41	0.3	8
	Frequency range	758	-	799	-50	1	
	Frequency range	799	-	803	-40	1	15
	Frequency range	945	-	960	-50	1	
	Frequency range	1839.9	-	1879.9	-50	1	
	Frequency range	2545	-	2575	-50	1	
19	E-UTRA Band 1, 11, 21, 28, 34	F _{DL_low}	-	F _{DL_high}	-50	1	
	Frequency range	860	-	890	-40	1	9, 15
	Frequency range	1884.5	-	1915.7	-41	0.3	8
	Frequency range	945	-	960	-50	1	
	Frequency range	1839.9	-	1879.9	-50	1	
	Frequency range	2545	-	2575	-50	1	
20	E-UTRA Band 1, 3, 7, 8, 20, 22, 33, 34, 43	F _{DL_low}	-	F _{DL_high}	-50	1	
	E-UTRA Band 20	F _{DL_low}	-	F _{DL_high}	-50	1	15
	E-UTRA Band 38, 42	F _{DL_low}	-	F _{DL_high}	-50	1	2
21	E-UTRA Band 11	F _{DL_low}	-	F _{DL_high}	-35	1	10, 15
	E-UTRA Band 1, 18, 19, 28, 34	F _{DL_low}	-	F _{DL_high}	-50	1	
	E-UTRA Band 21	F _{DL_low}	-	F _{DL_high}	-50	1	10
	Frequency range	1884.5	-	1915.7	-41	0.3	8
	Frequency range	945	-	960	-50	1	
	Frequency range	1839.9	-	1879.9	-50	1	
	Frequency range	2545	-	2575	-50	1	
22	E-UTRA Band 1, 3, 7, 8, 20, 26, 27, 28, 33, 34, 38, 39, 40, 43	F _{DL_low}	-	F _{DL_high}	-50	1	
	Frequency range	3510	-	3525	-40	1	15
	Frequency range	3525	-	3590	-50	1	
23	E-UTRA Band 4, 5, 10, 12, 13, 14, 17, 23, 24, 26, 27, 29, 41	F _{DL_low}	-	F _{DL_high}	-50	1	
	E-UTRA Band 2	F _{DL_low}	-	F _{DL_high}	-50	1	14, 15
	Frequency range	1998	-	1999	-21	1	14, 15
	Frequency range	1997	-	1998	-27	1	14, 15
	Frequency range	1996	-	1997	-32	1	14, 15
	Frequency range	1995	-	1996	-37	1	14, 15
	Frequency range	1990	-	1995	-40	1	14, 15
	Frequency range	1990	-	1999	-40	1	15, 28
	Frequency range	1999	-	2000	-40	Note 29	15, 28
24	E-UTRA Band 2, 4, 5, 10, 12, 13, 14, 17, 23, 24, 25, 26, 29, 41	F _{DL_low}	-	F _{DL_high}	-50	1	
25	E-UTRA Band 4, 5, 10, 12, 13, 14, 17, 22, 23, 24, 26, 27, 28, 29, 41, 42	F _{DL_low}	-	F _{DL_high}	-50	1	
	E-UTRA Band 2	F _{DL_low}	-	F _{DL_high}	-50	1	15

	E-UTRA Band 25	F_{DL_low}	-	F_{DL_high}	-50	1	15
	E-UTRA Band 43	F_{DL_low}	-	F_{DL_high}	-50	1	2
26	E-UTRA Band 1, 2, 3, 4, 5, 10, 11, 12, 13, 14, 17, 18, 19, 21, 22, 23, 24, 25, 26, 29, 31, 34, 40, 42, 43	F_{DL_low}	-	F_{DL_high}	-50	1	
	E-UTRA Band 41	F_{DL_low}	-	F_{DL_high}	-50	1	2
	Frequency range	1884.5	-	1915.7	-41	0.3	8
	Frequency range	703	-	799	-50	1	
		799	-	803	-40	1	15
	Frequency range	851	-	859	-53	0.00625	20
	E-UTRA Band 27	F_{DL_low}	-	859	-32	1	20
	Frequency range	945	-	960	-50	1	
Frequency range	1839.9	-	1879.9	-50	1		
27	E-UTRA Band 1, 2, 3, 4, 5, 7, 10, 12, 13, 14, 17, 22, 23, 25, 26, 27, 29, 31, 41, 42, 43	F_{DL_low}	-	F_{DL_high}	-50	1	
	Frequency range	799	-	805	-35	0.00625	
		790	-	F_{DL_high}	-32	1	16
	E-UTRA Band 28	F_{DL_low}	-	790	-50	1	
28	E-UTRA Band 2, 3, 5, 7, 8, 18, 19, 25, 26, 27, 31, 34, 38, 41	F_{DL_low}	-	F_{DL_high}	-50	1	
	E-UTRA Band 1, 4, 10, 22, 42, 43	F_{DL_low}	-	F_{DL_high}	-50	1	2
	E-UTRA Band 11, 21	F_{DL_low}	-	F_{DL_high}	-50	1	19, 24
	E-UTRA Band 1	F_{DL_low}	-	F_{DL_high}	-50	1	19, 25
	Frequency range	758	-	773	-32	1	15
	Frequency range	773	-	803	-50	1	
	Frequency range	662	-	694	-26.2	6	15
	Frequency range	1884.5	-	1915.7	-41	0.3	8, 19
	Frequency range	1839.9	-	1879.9	-50	1	
31	E-UTRA Band 1, 5, 7, 8, 26, 27, 28, 38, 42	F_{DL_low}	-	F_{DL_high}	-50	1	
	E-UTRA Band 3	F_{DL_low}	-	F_{DL_high}	-50	1	2
...							
33	E-UTRA Band 1, 7, 8, 20, 22, 34, 38, 39, 40, 42, 43	F_{DL_low}	-	F_{DL_high}	-50	1	5
	E-UTRA Band 3	F_{DL_low}	-	F_{DL_high}	-50	1	15
34	E-UTRA Band 1, 3, 7, 8, 11, 18, 19, 20, 21, 22, 26, 28, 33, 38, 39, 40, 41, 42, 43, 44	F_{DL_low}	-	F_{DL_high}	-50	1	5
	Frequency range	1884.5	-	1915.7	-41	0.3	8
	Frequency range	1839.9	-	1879.9	-50	1	5
35							
36							
37			-				
38	E-UTRA Band 1, 3, 8, 20, 22, 28, 29, 31, 33, 34, 42, 43	F_{DL_low}	-	F_{DL_high}	-50	1	
	Frequency range	2620	-	2645	-15.5	5	15, 22, 26
	Frequency range	2645	-	2690	-40	1	15, 22
39	E-UTRA Band 22, 34, 40, 41, 42, 44	F_{DL_low}	-	F_{DL_high}	-50	1	
40	E-UTRA Band 1, 3, 22, 26, 27, 33, 34, 39, 41, 42, 43, 44	F_{DL_low}	-	F_{DL_high}	-50	1	
41	E-UTRA Band 1, 2, 3, 4, 5, 8, 10, 12, 13, 14, 17, 23, 24, 25, 26, 27, 28, 29, 34, 39, 40, 42, 44	F_{DL_low}	-	F_{DL_high}	-50	1	
	E-UTRA Band 9, 11, 18, 19, 21	F_{DL_low}	-	F_{DL_high}	-50	1	30
	Frequency range	1839.9		1879.9	-50	1	30
	Frequency range	1884.5		1915.7	-41	0.3	8, 30
42	E-UTRA Band 1, 2, 3, 4, 5, 7, 8, 10, 20, 25, 26, 27, 28, 31, 33, 34, 38, 40, 41, 44	F_{DL_low}	-	F_{DL_high}	-50	1	
	E-UTRA Band 43	F_{DL_low}	-	F_{DL_high}	-50	1	3
43	E-UTRA Band 1, 2, 3, 4, 5, 7, 8, 10, 20, 25, 26, 27, 28, 33, 34, 38, 40	F_{DL_low}	-	F_{DL_high}	-50	1	
	E-UTRA Band 42	F_{DL_low}	-	F_{DL_high}	-50	1	3

	E-UTRA Band 22	F_{DL_low}	-	F_{DL_high}	[-50]	[1]	3
44	E-UTRA Band 3, 5, 8, 34, 39, 41	F_{DL_low}	-	F_{DL_high}	-50	1	
	E-UTRA Band 1, 40, 42	F_{DL_low}	-	F_{DL_high}		-50	2

- Note 1: F_{DL_low} and F_{DL_high} refer to each E-UTRA frequency band specified in Table 5.5-1
- Note 2: As exceptions, measurements with a level up to the applicable requirements defined in Table 6.6.3.1.3-2 are permitted for each assigned E-UTRA carrier used in the measurement due to 2nd, 3rd, 4th [or 5th] harmonic spurious emissions. An exception is allowed if there is at least one individual RB within the transmission bandwidth (see Figure 5.6-1) for which the 2nd, 3rd or 4th harmonic totally or partially overlaps the measurement bandwidth (MBW).
- Note 3: To meet these requirements some restriction will be needed for either the operating band or protected band
- Note 4: N/A
- Note 5: For non synchronised TDD operation to meet these requirements some restriction will be needed for either the operating band or protected band
- Note 6: Applicable when NS_05 in section 6.6.3.3.3.1 is signalled by the network.
- Note 7: Applicable when co-existence with PHS system operating in 1884.5-1919.6MHz.
- Note 8: Applicable when co-existence with PHS system operating in 1884.5 -1915.7MHz.
- Note 9: Applicable when NS_08 in subclause 6.6.3.3.3.3 is signalled by the network
- Note 10: Applicable when NS_09 in subclause 6.6.3.3.3.4 is signalled by the network
- Note 11: Whether the applicable frequency range should be 793-805MHz instead of 799-805MHz is TBD
- Note 12: The emissions measurement shall be sufficiently power averaged to ensure a standard deviation < 0.5 dB
- Note 13: This requirement applies for 5, 10, 15 and 20 MHz E-UTRA channel bandwidth allocated within 1744.9MHz and 1784.9MHz.
- Note 14: To meet this requirement NS_11 value shall be signalled when operating in 2000-2020 MHz
- Note 15: These requirements also apply for the frequency ranges that are less than F_{OOB} (MHz) in Table 6.6.3.1.3-1 and Table 6.6.3.1A.1.3-1 from the edge of the channel bandwidth.
- Note 16: Applicable when NS_16 in subclause 6.6.3.3.3.9 is signalled by the network.
- Note 17: N/A
- Note 18: N/A
- Note 19: Applicable when the assigned E-UTRA carrier is confined within 718 MHz and 748 MHz and when the channel bandwidth used is 5 or 10 MHz.
- Note 20: Applicable when NS_15 in subclause 6.6.3.3.3.8 is signalled by the network.
- Note 21: This requirement is applicable for an uplink transmission bandwidth less than or equal to 54 RB for carriers of 15 MHz bandwidth when carrier centre frequency is within the range 2560.5 - 2562.5 MHz and for carriers of 20 MHz bandwidth when carrier centre frequency is within the range 2552 - 2560 MHz. No other restrictions apply for carriers with bandwidths confined in 2500-2570 MHz.
- Note 22: This requirement is applicable for an uplink transmission bandwidth less than or equal to 54 RB for carriers of 15 MHz bandwidth when carrier centre frequency is within the range 2605.5 - 2607.5 MHz and for carriers of 20 MHz bandwidth when carrier centre frequency is within the range 2597 - 2605 MHz. No other restrictions apply for carriers with bandwidths confined in 2570-2615 MHz. For assigned carriers with bandwidths overlapping the frequency range 2615-2620 MHz the requirements apply with the maximum output power configured to +20 dBm in the IE *P-Max*.
- Note 23: For carriers of 5 MHz channel bandwidth with carrier centre frequencies (F_c) in the range $902.5\text{MHz} \leq F_c < 907.5\text{MHz}$, the requirement applies for uplink transmission bandwidths less than or equal to 20 RB. No restrictions apply in the range $907.5\text{MHz} \leq F_c \leq 912.5\text{MHz}$. For carriers of 10 MHz channel bandwidth, the requirement only applies for $F_c = 910\text{MHz}$ and uplink transmission bandwidths less than or equal to 32 RB with $RB_{start} > 3$.
- Note 24: As exceptions, measurements with a level up to the applicable requirement of -38 dBm/MHz is permitted for each assigned E-UTRA carrier used in the measurement due to 2nd harmonic spurious emissions. An exception is allowed if there is at least one individual RB within the transmission bandwidth (see Figure 5.6-1) for which the 2nd harmonic totally or partially overlaps the measurement bandwidth (MBW).
- Note 25: As exceptions, measurements with a level up to the applicable requirement of -36 dBm/MHz is permitted for each assigned E-UTRA carrier used in the measurement due to 3rd harmonic spurious emissions. An exception is allowed if there is at least one individual RB within the transmission bandwidth (see Figure 5.6-1) for which the 3rd harmonic totally or partially overlaps the measurement bandwidth (MBW).
- Note 26: For these adjacent bands, the emission limit could imply risk of harmful interference to UE(s) operating in the protected operating band.
- Note 27: This requirement is applicable for an uplink transmission bandwidth less than or equal to 54 RB for carriers of 15 MHz bandwidth when carrier centre frequency is within the range 1927.5 - 1929.5 MHz and for carriers of 20 MHz bandwidth when carrier centre frequency is within the range 1930 - 1938 MHz. This requirement is applicable without any other uplink transmission bandwidth restriction for channel bandwidths within the range 1920 - 1980 MHz.
- Note 28: Applicable when NS_20 is signalled by the network.
- Note 29: The measurement bandwidth is 1% of the applicable E-UTRA channel bandwidth (Table 5.4.2-1).
- Note 30: This requirement applies when the E-UTRA carrier is confined within 2545-2575 MHz and the channel bandwidth is 10 or 20 MHz

The normative reference for this requirement is TS 36.101 [2] subclause 6.6.3.2.

This test use minimum requirements from many releases of TS 36.101 [2] due to release independence defined in TS 36.307 [16]

6.6.3.2.4 Test description

6.6.3.2.4.1 Initial conditions

Initial conditions are a set of test configurations the UE needs to be tested in and the steps for the SS to take with the UE to reach the correct measurement state.

The initial test configurations consist of environmental conditions, test frequencies, and channel bandwidths based on E-UTRA bands specified in Table 5.4.2.1-1. All of these configurations shall be tested with applicable test parameters for each channel bandwidth, and are shown in Table 6.6.3.2.4.1-1. The details of the uplink reference measurement channels (RMCs) are specified in Annex A.2. Configurations of PDSCH and PDCCH before measurement are specified in Annex C.2.

Table 6.6.3.2.4.1-1: Test Configuration Table

Initial Conditions						
Test Environment (as specified in TS 36.508 [7] subclause 4.1)			NC			
Test Frequencies (as specified in TS36.508 [7] subclause 4.3.1) (Note 6, Note 7)			Low range, Mid range, High range (Note 6, Note 7)			
Test Channel Bandwidths (as specified in TS 36.508 [7] subclause 4.3.1)			Lowest, 5MHz, Highest			
Test Parameters for Channel Bandwidths						
Ch BW	Downlink Configuration			Uplink Configuration		
	Mod'n	RB allocation		Mod'n	RB allocation	
		FDD	TDD		FDD	TDD
1.4MHz	N/A for Spurious Emissions testing			QPSK	6	6
1.4MHz				QPSK	1	1
3MHz				QPSK	15	15
3MHz				QPSK	1	1
5MHz				QPSK	25	25 ¹²
5MHz				QPSK	1	1 ¹²
5MHz				QPSK	20 ⁸	-
10MHz				QPSK	50	50
10MHz				QPSK	1	1
10MHz				QPSK	32 ⁹	-
10MHz				QPSK	1 ¹⁰	-
15MHz				QPSK	75	75
15MHz				QPSK	54 ^{3, 11}	54 ⁴
15MHz				QPSK	1 ⁵	1 ⁵
20MHz				QPSK	100	100
20MHz				QPSK	54 ^{3, 11}	54 ⁴
20MHz				QPSK	1 ⁵	1 ⁵
<p>Note 1: Test Channel Bandwidths are checked separately for each E-UTRA band, which applicable channel bandwidths are specified in Table 5.4.2.1-1.</p> <p>Note 2: The 1 RB allocation shall be tested at both RB #0 and RB #max.</p> <p>Note 3: To be used for requirements under note 15 in table 6.6.3.2.3-1 and table 6.6.3.2.3-1A, note 16 in table 6.6.3.2.3-1B, note 21 in table 6.6.3.2.3-1C in high channel at RB#(full allocation – 54), instead of full allocation.</p> <p>Note 4: To be used for requirements under note 16 in table 6.6.3.2.3-1 and table 6.6.3.2.3-1A, note 17 in table 6.6.3.2.3-1B, note 22 in table 6.6.3.2.3-1C in high channel - 5MHz at RB#(full allocation – 54), instead of full allocation.</p> <p>Note 5: For requirements under note 15 in table 6.6.3.2.3-1 and table 6.6.3.2.3-1A, note 16 in table 6.6.3.2.3-1B, note 21 in table 6.6.3.2.3-1C the allocation in high channel shall be only at RB#max. For requirements under note 16 in table 6.6.3.2.-1 and table 6.6.3.2.3-1A, note 17 in table 6.6.3.2.3-1B, note 22 in table 6.6.3.2.3-1C (high channel – 5MHz) is tested instead of high channel. The allocation in (high channel – 5MHz) shall be only at RB#max. For requirements under note 17 in table 6.6.3.2.-1, note 18 in table 6.6.3.2.-1A, note 19 in table 6.6.3.2.-1B and note 27 in table 6.6.3.2.-1C the allocation in low channel shall be only at RB#0.</p> <p>Note 6: Do not apply for requirements under Note 13 in Tables 6.6.3.2.3-1 to 6.6.3.2.3-1C. Test frequencies for these requirements are defined in Table 6.6.3.2.4.1-2.</p> <p>Note 7: For E-UTRA band 28, when the test frequency is low range of upper duplexer (as shown in TS 36.508[7] Table 4.3.1.1.28-2) and CBW is 5MHz and 10MHz, the test shall be conducted under NS_17 in Table 6.2.4.3-1.</p> <p>Note 8: For requirements under note 17 in table 6.6.3.2. 3-1A, note 18 in table 6.6.3.2.3-1B, note 23 in table 6.6.3.2.3-1C (high channel – 10MHz) is tested with RB #0 to RB #19 used.</p> <p>Note 9: For requirements under note 17 in table 6.6.3.2.3-1A, note 18 in table 6.6.3.2.3-1B, note 23 in table 6.6.3.2.3-1C high channel is tested with RB #4 to RB #35 used.</p> <p>Note 10: For requirements under note 17 in table 6.6.3.2.3-1A, note 18 in table 6.6.3.2.3-1B, note 23 in table 6.6.3.2.3-1C high channel is tested with RB #4 and (RB#max -4) used.</p> <p>Note 11: To be used for requirements under note 17 in table 6.6.3.2.3-1, note 18 in table 6.6.3.2.3-1A, note 19 in table 6.6.3.2.3-1B and note 27 in table 6.6.3.2.3-1C in low channel at RB#0, instead of full allocation.</p> <p>Note 12: For requirements under note 16 in table 6.6.3.2.3-1 and table 6.6.3.2.3-1A, note 17 in table 6.6.3.2.3-1B, note 22 in table 6.6.3.2.3-1C, the message exception in Table 6.6.3.2.4.3-1 is used to test with the high channel.</p>						

Table 6.6.3.2.4.1-2: Test frequencies for E-UTRA channel bandwidth for operating band 3 with Note 13 (in Tables 6.6.3.2.3-1 to 6.6.3.2.3-1D)

Bandwidth [MHz]	N _{UL}	Frequency of Uplink [MHz]	N _{DL}	Frequency of Downlink [MHz]
1.4	19942	1784.2	1942	1879.2
3	19934	1783.4	1934	1878.4
5	19924	1782.4	1924	1877.4
10	19899	1779.9	1899	1874.9
15	19874	1777.4	1874	1872.4
20	19849	1774.9	1849	1869.9

Note: 1.4 and 3 MHz only tested for Rel8 and Rel9.

1. Connect the SS to the UE to the UE antenna connectors as shown in Figure TS 36.508 [7] Annex A, Figure A.7.
2. The parameter settings for the cell are set up according to TS 36.508 [7] subclause 4.4.3.
3. Downlink signals are initially set up according to Annex C0, C.1 and C.3.0, and uplink signals according to Annex H.1 and H.3.0.
4. The UL Reference Measurement channels are set according to Table 6.6.3.2.4.1-1.
5. Propagation conditions are set according to Annex B.0.
6. Ensure the UE is in State 3A-RF according to TS 36.508 [7] clause 5.2A.2. Message contents are defined in clause 6.6.3.2.4.3.

6.6.3.2.4.2 Test procedure

1. SS sends uplink scheduling information for each UL HARQ process via PDCCH DCI format 0 for C_RNTI to schedule the UL RMC according to Table 6.6.3.2.4.1-1. Since the UE has no payload data to send, the UE transmits uplink MAC padding bits on the UL RMC.
2. Send continuously uplink power control "up" commands in the uplink scheduling information to the UE until the UE transmits at P_{UMAX} level.
3. Measure the power of the transmitted signal with a measurement filter of bandwidths according to table 6.6.3.2.3-1 to 6.6.3.2.3-1C. For band 14 measurements made in a bandwidth of 6.25kHz, measurement parameter settings defined in table 6.6.3.2.4.2-1 shall be used. The centre frequency of the filter shall be stepped in contiguous steps according to table 6.6.3.2.5-1. The measured power shall be verified for each step. The measurement period shall capture the active time slots.

Table 6.6.3.2.4-1: Measurement setup for band 14

	Option 1: Measurement with No RMS VBW available	Option2 Measurement with VBW Filtering on Power scale
VBW	>=62.5 kHz (10 times or more the RBW)	<=43Hz
RBW	<=6.25kHz	<=6.25kHz
Detector type	Averages signal envelope during each measurement point, such as "RMS detector"	Peak
Averaging mode (Trace averaging)	Power (RMS voltage)	Power (RMS voltage), as controlled by "Average Type"
Average Type (applies to detector)	Power (RMS voltage) (automatically occurs with "RMS detector")	Not applicable
Average Type (applies to VBW filter)	Not applicable	Power (RMS voltage)
Number of averages	30, to reduce variance as required, or use an even longer sweep time	1 or use an even narrower VBW filter, thus a longer sweep time
Sweep time	[Don't specify]	Sweep rate (span divided by sweep time) <= 0.8 * RBW*VBW

6.6.3.2.4.3 Message contents

Message contents are according to TS 36.508 [7] subclause 4.6 with the following exceptions:

**Table 6.6.3.2.4.3-1: SystemInformationBlockType1
for Note 16 in table 6.6.3.2.3-1 and table 6.6.3.2.3-1A,
Note 17 in table 6.6.3.2.3-1B, Note 22 in table 6.6.3.2.3-1C**

Derivation Path: TS 36.508 [7] clause 4.4.3.2, Table 4.4.3.2-3 SystemInformationBlockType1			
Information Element	Value/remark	Comment	Condition
p-Max	20		

6.6.3.2.5 Test requirement

Test requirements for Spurious Emissions UE Co-existence are the same as the minimum requirements and are not repeated in this section.

The measured average power of spurious emission, derived in step 3, shall not exceed the described value in tables 6.6.3.2.3-1 to 6.6.3.2.3-1C according to the following rule:

The requirements for the UE are release specific and can be found in Tables 6.6.3.2.3-1 to 6.6.3.2.3-1C. If the UE support a band, which is not defined in the table corresponding UE's release, the requirements for this band are taken from the table of earliest release where requirements for this band are defined. This has been described in following Table 6.6.3.2.5-1.

Table 6.6.3.2.5-1: UE Requirements according to UE E-UTRA release and supported E-UTRA band

Band	UE Requirements per release				
	Rel-8	Rel-9	Rel-10	Rel-11	Rel-12
1	Table 6.6.3.2.3-1	Table 6.6.3.2.3-1A	Table 6.6.3.2.3-1B	Table 6.6.3.2.3-1C	Table 6.6.3.2.3-1D
2	Table 6.6.3.2.3-1	Table 6.6.3.2.3-1A	Table 6.6.3.2.3-1B	Table 6.6.3.2.3-1C	Table 6.6.3.2.3-1D
3	Table 6.6.3.2.3-1	Table 6.6.3.2.3-1A	Table 6.6.3.2.3-1B	Table 6.6.3.2.3-1C	Table 6.6.3.2.3-1D
4	Table 6.6.3.2.3-1	Table 6.6.3.2.3-1A	Table 6.6.3.2.3-1B	Table 6.6.3.2.3-1C	Table 6.6.3.2.3-1D
5	Table 6.6.3.2.3-1	Table 6.6.3.2.3-1A	Table 6.6.3.2.3-1B	Table 6.6.3.2.3-1C	Table 6.6.3.2.3-1D
6	Table 6.6.3.2.3-1	Table 6.6.3.2.3-1A	Table 6.6.3.2.3-1B	Table 6.6.3.2.3-1C	Table 6.6.3.2.3-1D
7	Table 6.6.3.2.3-1	Table 6.6.3.2.3-1A	Table 6.6.3.2.3-1B	Table 6.6.3.2.3-1C	Table 6.6.3.2.3-1D
8	Table 6.6.3.2.3-1	Table 6.6.3.2.3-1A	Table 6.6.3.2.3-1B	Table 6.6.3.2.3-1C	Table 6.6.3.2.3-1D
9	Table 6.6.3.2.3-1	Table 6.6.3.2.3-1A	Table 6.6.3.2.3-1B	Table 6.6.3.2.3-1C	Table 6.6.3.2.3-1D
10	Table 6.6.3.2.3-1	Table 6.6.3.2.3-1A	Table 6.6.3.2.3-1B	Table 6.6.3.2.3-1C	Table 6.6.3.2.3-1D
11	Table 6.6.3.2.3-1	Table 6.6.3.2.3-1A	Table 6.6.3.2.3-1B	Table 6.6.3.2.3-1C	Table 6.6.3.2.3-1D
12	Table 6.6.3.2.3-1	Table 6.6.3.2.3-1A	Table 6.6.3.2.3-1B	Table 6.6.3.2.3-1C	Table 6.6.3.2.3-1D
13	Table 6.6.3.2.3-1	Table 6.6.3.2.3-1A	Table 6.6.3.2.3-1B	Table 6.6.3.2.3-1C	Table 6.6.3.2.3-1D
14	Table 6.6.3.2.3-1	Table 6.6.3.2.3-1A	Table 6.6.3.2.3-1B	Table 6.6.3.2.3-1C	Table 6.6.3.2.3-1D
...					
17	Table 6.6.3.2.3-1	Table 6.6.3.2.3-1A	Table 6.6.3.2.3-1B	Table 6.6.3.2.3-1C	Table 6.6.3.2.3-1D
18	Table 6.6.3.2.3-1A	Table 6.6.3.2.3-1A	Table 6.6.3.2.3-1B	Table 6.6.3.2.3-1C	Table 6.6.3.2.3-1D
19	Table 6.6.3.2.3-1A	Table 6.6.3.2.3-1A	Table 6.6.3.2.3-1B	Table 6.6.3.2.3-1C	Table 6.6.3.2.3-1D
20	Table 6.6.3.2.3-1A	Table 6.6.3.2.3-1A	Table 6.6.3.2.3-1B	Table 6.6.3.2.3-1C	Table 6.6.3.2.3-1D
21	Table 6.6.3.2.3-1A	Table 6.6.3.2.3-1A	Table 6.6.3.2.3-1B	Table 6.6.3.2.3-1C	Table 6.6.3.2.3-1D
22	Table 6.6.3.2.3-1B	Table 6.6.3.2.3-1B	Table 6.6.3.2.3-1B	Table 6.6.3.2.3-1C	Table 6.6.3.2.3-1D

23	Table 6.6.3.2.3- 1B	Table 6.6.3.2.3- 1B	Table 6.6.3.2.3- 1B	Table 6.6.3.2.3- 1C	Table 6.6.3.2.3- 1D
24	Table 6.6.3.2.3- 1B	Table 6.6.3.2.3- 1B	Table 6.6.3.2.3- 1B	Table 6.6.3.2.3- 1C	Table 6.6.3.2.3- 1D
25	Table 6.6.3.2.3- 1B	Table 6.6.3.2.3- 1B	Table 6.6.3.2.3- 1B	Table 6.6.3.2.3- 1C	Table 6.6.3.2.3- 1D
26	Table 6.6.3.2.3- 1C	Table 6.6.3.2.3- 1C	Table 6.6.3.2.3- 1C	Table 6.6.3.2.3- 1C	Table 6.6.3.2.3- 1D
27	Table 6.6.3.2.3- 1C	Table 6.6.3.2.3- 1C	Table 6.6.3.2.3- 1C	Table 6.6.3.2.3- 1C	Table 6.6.3.2.3- 1D
28	Table 6.6.3.2.3- 1C	Table 6.6.3.2.3- 1C	Table 6.6.3.2.3- 1C	Table 6.6.3.2.3- 1C	Table 6.6.3.2.3- 1D
31	Table 6.6.3.2.3- 1D	Table 6.6.3.2.3- 1D	Table 6.6.3.2.3- 1D	Table 6.6.3.2.3- 1D	Table 6.6.3.2.3- 1D
...					
33	Table 6.6.3.2.3-1	Table 6.6.3.2.3- 1A	Table 6.6.3.2.3- 1B	Table 6.6.3.2.3- 1C	Table 6.6.3.2.3- 1D
34	Table 6.6.3.2.3-1	Table 6.6.3.2.3- 1A	Table 6.6.3.2.3- 1B	Table 6.6.3.2.3- 1C	Table 6.6.3.2.3- 1D
35					
36					
37					
38	Table 6.6.3.2.3-1	Table 6.6.3.2.3- 1A	Table 6.6.3.2.3- 1B	Table 6.6.3.2.3- 1C	Table 6.6.3.2.3- 1D
39	Table 6.6.3.2.3-1	Table 6.6.3.2.3- 1A	Table 6.6.3.2.3- 1B	Table 6.6.3.2.3- 1C	Table 6.6.3.2.3- 1D
40	Table 6.6.3.2.3-1	Table 6.6.3.2.3- 1A	Table 6.6.3.2.3- 1B	Table 6.6.3.2.3- 1C	Table 6.6.3.2.3- 1D
41	Table 6.6.3.2.3- 1B	Table 6.6.3.2.3- 1B	Table 6.6.3.2.3- 1B	Table 6.6.3.2.3- 1C	Table 6.6.3.2.3- 1D
42	Table 6.6.3.2.3- 1B	Table 6.6.3.2.3- 1B	Table 6.6.3.2.3- 1B	Table 6.6.3.2.3- 1C	Table 6.6.3.2.3- 1D
43	Table 6.6.3.2.3- 1B	Table 6.6.3.2.3- 1B	Table 6.6.3.2.3- 1B	Table 6.6.3.2.3- 1C	Table 6.6.3.2.3- 1D
44	Table 6.6.3.2.3- 1C	Table 6.6.3.2.3- 1C	Table 6.6.3.2.3- 1C	Table 6.6.3.2.3- 1C	Table 6.6.3.2.3- 1D

NOTE: The frequency range applicable with network signalled values of NS_05, NS_08, NS_09, NS_15 and NS_16 are covered in 6.6.3.3 Additional Spurious Emissions.

NOTE 3: The restriction on the maximum uplink transmission to 54 RB in Notes 14 and 15 of Table 6.6.3.2.5-1 is intended for conformance testing and may be applied to network operation to facilitate coexistence when the aggressor and victim bands are deployed in the same geographical area. The applicable spurious emission requirement of -15.5 dBm/5MHz is a least restrictive technical condition for FDD/TDD coexistence and may have to be revised in the future.

6.6.3.2_1 Void

6.6.3.2A Spurious emission band UE co-existence for CA

6.6.3.2A.1 Spurious emission band UE co-existence for CA (intra-band contiguous DL CA and UL CA)

6.6.3.2A.1.1 Test purpose

To verify that UE transmitter does not cause unacceptable interference to co-existing systems for the specified bands which has specific requirements in terms of transmitter spurious emissions for intra-band contiguous DL CA and UL CA.

6.6.3.2A.1.2 Test applicability

This test case applies to all types of E-UTRA UE release 10 and forward that support intra-band contiguous DL CA and UL CA.

6.6.3.2A.1.3 Minimum conformance requirements

This clause specifies the requirements for the specified carrier aggregation configurations for coexistence with protected bands

NOTE: For measurement conditions at the edge of each frequency range, the lowest frequency of the measurement position in each frequency range should be set at the lowest boundary of the frequency range plus $MBW/2$. The highest frequency of the measurement position in each frequency range should be set at the highest boundary of the frequency range minus $MBW/2$. MBW denotes the measurement bandwidth defined for the protected band.

Table 6.6.3.2A.1.3-1: Spurious emission band UE co-existence for CA (intra-band contiguous DL CA and UL CA) limits

E-UTRA CA Configuration	Spurious emission						
	Protected band	Frequency range (MHz)			Maximum Level (dBm)	MBW (MHz)	Note
CA_1C	E-UTRA Band 1, 3, 7, 8, 9, 11, 18, 19, 20, 21, 22, 38, 40, 41, 42, 43	F_{DL_low}	-	F_{DL_high}	-50	1	
	E-UTRA band 34	F_{DL_low}	-	F_{DL_high}	-50	1	4, 6, 7
	Frequency range	1900	-	1915	-15.5	5	6, 10, 12
	Frequency range	1915	-	1920	+1.6	5	6, 7, 10, 12
	Frequency range	1880		1895	-40	1	7,10
	Frequency range	1895		1915	-15.5	5	7,10
	Frequency range	1884.5	-	1915.7	-41	0.3	4, 5
CA_7C	E-UTRA Band 1, 3, 7, 8, 20, 22, 33, 34, 42, 43	F_{DL_low}	-	F_{DL_high}	-50	1	
	Frequency range	2570	-	2575	+1.6	5	12
	Frequency range	2575	-	2595	-15.5	5	8, 12
	Frequency range	2595	-	2620	-40	1	8
CA_38C	E-UTRA Band 1,3, 8, 20, 22, 33, 34, 42, 43	F_{DL_low}	-	F_{DL_high}	-50	1	
	Frequency range	2620	-	2645	-15.5	5	9, 10, 11, 12
	Frequency range	2645	-	2690	-40	1	9, 10,11
CA_40C	E-UTRA Band 1, 3, 33, 34, 39, 41, 42, 43	F_{DL_low}	-	F_{DL_high}	-50	1	
CA_41C	E-UTRA Band 1, 2, 3, 4, 5, 8, 10, 12, 13, 14, 17, 23, 24, 25, 26, 34, 39, 40, 42, 44	F_{DL_low}	-	F_{DL_high}	-50	1	
NOTE 1: F_{DL_low} and F_{DL_high} refer to each E-UTRA frequency band specified in Table 5.2-1							
NOTE 2: As exceptions, measurements with a level up to the applicable requirements defined in Table 6.6.3.1.3-2 are permitted for each assigned E-UTRA carrier used in the measurement due to 2nd or 3rd harmonic spurious emissions. An exception is allowed if there is at least one individual RE within the transmission bandwidth (see Figure 5.4.2-1) for which the 2nd or 3rd harmonic, i.e. the frequency equal to two or three times the frequency of that RE, is within the measurement bandwidth (MBW).							
NOTE 3: To meet these requirements some restriction will be needed for either the operating band or protected band							
NOTE 4: Applicable when CA_NS_01 in section 6.6.3.3A.1.3.1 is signalled by the network.							
NOTE 5: Applicable when co-existence with PHS system operating in 1884.5 -1915.7MHz.							
NOTE 6: Applicable when CA_NS_02 in section 6.6.3.3A.1.3.2 is signalled by the network.							
NOTE 7: Applicable when CA_NS_03 in section 6.6.3.3A.1.3.3 is signalled by the network.							
NOTE 8: Applicable when CA_NS_06 in section 6.6.3.3A.1.3.5 is signalled by the network.							
NOTE 9: Applicable when CA_NS_05 in section 6.6.3.3A.1.3.4 is signalled by the network.							
NOTE 10: The requirement also applies for the frequency ranges that are less than F_{OOB} (MHz) in Table 6.6.3.1.3-1 and Table 6.6.3.1A.1.3-1 from the edge of the channel bandwidth.							
NOTE 11: This requirement is applicable for carriers with bandwidths confined in 2570-2615 MHz. For assigned carriers with bandwidths overlapping the frequency range 2615-2620 MHz the requirements apply with the maximum output power configured to +20 dBm in the IE P-Max.							
NOTE 12: For these adjacent bands, the emission limit could imply risk of harmful interference to UE(s) operating in the protected operating band.							

The normative reference for this requirement is TS 36.101 [2] subclause 6.6.3.2A.

6.6.3.2A.1.4 Test description

6.6.3.2A.1.4.1 Initial conditions

Initial conditions are a set of test configurations the UE needs to be tested in and the steps for the SS to take with the UE to reach the correct measurement state.

The initial test configurations consist of environmental conditions, test frequencies, and channel bandwidths based on E-UTRA bands specified in Table 5.4.2.1-1. All of these configurations shall be tested with applicable test parameters for each channel bandwidth, and are shown in Table 6.6.3.2A.1.4.1-1. The details of the uplink reference measurement channels (RMCs) are specified in Annex A.2. Configurations of PDSCH and PDCCH before measurement are specified in Annex C.2.

Table 6.6.3.2A.1.4.1-1: Test Configuration Table

Initial Conditions							
Test Environment as specified in TS 36.508[7] clause 4.1				NC			
Test Frequencies as specified in TS36.508 [7] clause 4.3.1 for different CA bandwidth classes.				C: <u>Low range, High range</u>			
Test CC Combination setting (NRB_agg) as specified in clause 5.4.2A.1 for the CA Configuration				Lowest N _{RB_agg} Highest N _{RB_agg}			
Test Parameters for CA Configurations							
CA Configuration / N _{RB_agg}		DL Allocation	CC MOD	UL Allocation			
PCC N _{RB}	SCCs N _{RB}	PCC & SCC RB allocation		N _{RB_alloc}	PCC & SCC RB allocations (L _{CRB} @ RB _{start})		
75	75		QPSK	2	P_1@0	S_1@74	
75	75		QPSK	150	P_75@0	S_75@0	
100	50		QPSK	2	P_1@0	S_1@49	
100	50		QPSK	150	P_100@0	S_50@0	
100	100		QPSK	2	P_1@0	S_1@99	
100	100		QPSK	200	P_100@0	S_100@0	
Note 1: CA Configuration Test CC Combination settings are checked separately for each CA Configuration, which applicable aggregated channel bandwidths are specified in Table 5.4.2A.1-1.							

1. Connect the SS to the UE antenna connectors as shown in Figure TS 36.508 [7] Annex A, Figure group A.33 as appropriate.
2. The parameter settings for the cell are set up according to TS 36.508 [7] subclause 4.4.3.
3. Downlink signals for PCC are initially set up according to Annex C.0, C.1 and Annex C.3.0, and uplink signals according to Annex H.1 and H.3.0.
4. The UL Reference Measurement channels are set according to Table 6.6.3.2A.1.4.1-1.
5. Propagation conditions are set according to Annex B.0.
6. Ensure the UE is in State 3A-RF according to TS 36.508 [7] clause 5.2A.2. Message contents are defined in clause 6.6.3.2A.1.4.3.

6.6.3.2A.1.4.2 Test procedure

1. Configure SCC according to Annex C.0, C.1 and Annex C.3.0 for all downlink physical channels except PHICH.
2. The SS shall configure SCC as per TS 36.508 [7] clause 5.2A.4. Message contents are defined in clause 6.6.3.2A.1.4.3
3. SS activates SCC by sending the activation MAC-CE (Refer TS 36.321 [13], clauses 5.13, 6.1.3.8). Wait for at least 2 seconds (Refer TS 36.133, clauses 8.3.3.2).
4. SS sends uplink scheduling information for each UL HARQ process via PDCCH DCI format 0 for C_RNTI to schedule the UL RMC according to Table 6.6.3.2A.1.4.1-1 on both PCC and SCC. Since the UE has no payload and no loopback data to send the UE sends uplink MAC padding bits on the UL RMC.
5. Send continuously uplink power control “up” commands in every uplink scheduling information to the UE until the UE transmits at P_{UMAX} level.
6. Measure the power of the transmitted signal with a measurement filter of bandwidths according to Table 6.6.3.2A.1.5-1. The centre frequency of the filter shall be stepped in contiguous steps according to Table 6.6.3.2A.1.5-1. The measured power shall be verified for each step. The measurement period shall capture the active time slots.

6.6.3.2A.1.4.3 Message contents

Message contents are according to TS 36.508 [7] subclause subclause 4.6 with the following exceptions:

Table 6.6.3.2A.1.4.3-1: SystemInformationBlockType1 with Note 11 in table 6.6.3.2A.1.3-1

Derivation Path: TS 36.508 [7] clause 4.4.3.2, Table 4.4.3.2-3 SystemInformationBlockType1			
Information Element	Value/remark	Comment	Condition
p-Max	20		

6.6.3.2A.1.5 Test requirement

The measured average power of spurious emission, derived in step 6, shall not exceed the described value in Tables 6.6.3.2A.1.5-1.

Table 6.6.3.2A.1.5-1: Spurious emission band UE co-existence for CA (intra-band contiguous DL CA and UL CA) limits

E-UTRA CA Configuration	Spurious emission						
	Protected band	Frequency range (MHz)		Maximum Level (dBm)	MBW (MHz)	Note	
CA_1C	E-UTRA Band 1, 3, 7, 8, 9, 11, 18, 19, 20, 21, 22, 38, 40, 41, 42, 43	F _{DL_low}	-	F _{DL_high}	-50	1	
	E-UTRA band 34	F _{DL_low}	-	F _{DL_high}	-50	1	4, 6, 7
	Frequency range	1900	-	1915	-15.5	5	6, 10, 12
	Frequency range	1915	-	1920	+1.6	5	6, 7, 10, 12
	Frequency range	1880		1895	-40	1	7,10
	Frequency range	1895		1915	-15.5	5	7,10
	Frequency range	1884.5	-	1915.7	-41	0.3	4, 5
CA_7C	E-UTRA Band 1, 3, 7, 8, 20, 22, 33, 34, 42, 43	F _{DL_low}	-	F _{DL_high}	-50	1	
	Frequency range	2570	-	2575	+1.6	5	12
	Frequency range	2575	-	2595	-15.5	5	8, 12
	Frequency range	2595	-	2620	-40	1	8
CA_38C	E-UTRA Band 1,3, 8, 20, 22, 33, 34, 42, 43	F _{DL_low}	-	F _{DL_high}	-50	1	
	Frequency range	2620	-	2645	-15.5	5	9, 10, 11, 12
	Frequency range	2645	-	2690	-40	1	9, 10,11
CA_40C	E-UTRA Band 1, 3, 33, 34, 39, 41, 42, 43	F _{DL_low}	-	F _{DL_high}	-50	1	
CA_41C	E-UTRA Band 1, 2, 3, 4, 5, 8, 10, 12, 13, 14, 17, 23, 24, 25, 26, 34, 39, 40, 42, 44	F _{DL_low}	-	F _{DL_high}	-50	1	

NOTE 1: F_{DL_low} and F_{DL_high} refer to each E-UTRA frequency band specified in Table 5.2-1

NOTE 2: As exceptions, measurements with a level up to the applicable requirements defined in Table 6.6.3.1.3-2 are permitted for each assigned E-UTRA carrier used in the measurement due to 2nd or 3rd harmonic spurious emissions. An exception is allowed if there is at least one individual RE within the transmission bandwidth (see Figure 5.4.2-1) for which the 2nd or 3rd harmonic, i.e. the frequency equal to two or three times the frequency of that RE, is within the measurement bandwidth (MBW).

NOTE 3: To meet these requirements some restriction will be needed for either the operating band or protected band

NOTE 4: Applicable when CA_NS_01 in section 6.6.3.3A.1.3.1 is signalled by the network.

NOTE 5: Applicable when co-existence with PHS system operating in 1884.5 -1915.7MHz.

NOTE 6: Applicable when CA_NS_02 in section 6.6.3.3A.1.3.2 is signalled by the network.

NOTE 7: Applicable when CA_NS_03 in section 6.6.3.3A.1.3.3 is signalled by the network.

NOTE 8: Applicable when CA_NS_06 in section 6.6.3.3A.1.3.5 is signalled by the network.

NOTE 9: Applicable when CA_NS_05 in section 6.6.3.3A.1.3.4 is signalled by the network.

NOTE 10: The requirement also applies for the frequency ranges that are less than F_{OOB} (MHz) in Table 6.6.3.1.3-1 and Table 6.6.3.1A.1.3-1 from the edge of the channel bandwidth.

NOTE 11: This requirement is applicable for carriers with bandwidths confined in 2570-2615 MHz. For assigned carriers with bandwidths overlapping the frequency range 2615-2620 MHz the requirements apply with the maximum output power configured to +20 dBm in the IE P-Max.

NOTE 12: For these adjacent bands, the emission limit could imply risk of harmful interference to UE(s) operating in the protected operating band.

NOTE: The frequency range applicable with network signalled values of CA_NS_01, CA_NS_02, and CA_NS_03 are covered in 6.6.3.3A Additional spurious emissions for CA.

6.6.3.3 Additional spurious emissions

6.6.3.3.1 Test purpose

To verify that UE transmitter does not cause unacceptable interference to other channels or other systems in terms of transmitter spurious emissions under the deployment scenarios where additional requirements are specified.

6.6.3.3.2 Test applicability

This test case applies to all types of E-UTRA UE release 8 and forward.

6.6.3.3.3 Minimum conformance requirements

6.6.3.3.3.1 Minimum conformance requirements (network signalled value "NS_05")

When "NS_05" is indicated in the cell, the power of any UE emission shall not exceed the levels specified in Table 6.6.3.3.3.1-1. This requirement also applies for the frequency ranges that are less than Δf_{OoB} (MHz) in Table 6.6.3.1.3-1 from the edge of the channel bandwidth.

Table 6.6.3.3.3.1-1: Additional requirements (PHS)

Frequency band (MHz)	Channel bandwidth / Spectrum emission limit (dBm)				Measurement bandwidth
	5 MHz	10 MHz	15 MHz	20 MHz	
$1884.5 \leq f \leq 1915.7^{*1}$	-41	-41	-41	-41	300 KHz
Note 1: Applicable when the lower edge of the assigned E-UTRA UL channel bandwidth frequency is larger than or equal to the upper edge of PHS band (1915.7 MHz) + 4 MHz + the Channel BW assigned, where Channel BW is as defined in sub-clause 5.4.2. Additional restrictions apply for operations below this point.					

The requirements in Table 6.6.3.3.3.1-1 apply with the additional restrictions specified in Table 6.6.3.3.3.1-2 when the lower edge of the assigned E-UTRA UL channel bandwidth frequency is less than the upper edge of PHS band (1915.7 MHz) + 4 MHz + the channel BW assigned.

Table 6.6.3.3.3.1-2: RB restrictions for additional requirement (PHS)

15 MHz channel bandwidth with $f_c = 1932.5$ MHz			
RB _{start}	0-7	8-66	67-74
LCRB	N/A	$\leq \text{MIN}(30, 67 - \text{RB}_{\text{start}})$	N/A
20 MHz channel bandwidth with $f_c = 1930$ MHz			
RB _{start}	0-23	24-75	76-99
LCRB	N/A	$\leq \text{MIN}(24, 76 - \text{RB}_{\text{start}})$	N/A

NOTE 1: For measurement conditions at the edge of each frequency range, the lowest frequency of the measurement position in each frequency range should be set at the lowest boundary of the frequency range plus MBW/2. The highest frequency of the measurement position in each frequency range should be set at the highest boundary of the frequency range minus MBW/2. MBW denotes the measurement bandwidth (300 kHz).

The normative reference for this requirement is TS 36.101[2] subclause 6.6.3.3.1.

6.6.3.3.3.2 Minimum conformance requirements (network signalled value "NS_07")

When "NS_07" is indicated in the cell, the power of any UE emission shall not exceed the levels specified in Table 6.6.3.3.3.2-1. These requirements also apply for the frequency ranges that are less than Δf_{OOB} (MHz) in Table 6.6.3.1.3-1 from the edge of the channel bandwidth.

Table 6.6.3.3.3.2-1: Additional requirements

Frequency band (MHz)	Channel bandwidth / Spectrum emission limit (dBm)		Measurement bandwidth
	10 MHz		
$769 \leq f \leq 775$	-57		6.25 kHz
Note: The emissions measurement shall be sufficiently power averaged to ensure a standard deviation < 0.5 dB.			

NOTE: For measurement conditions at the edge of each frequency range, the lowest frequency of the measurement position in each frequency range should be set at the lowest boundary of the frequency range plus MBW/2. The highest frequency of the measurement position in each frequency range should be set at the highest boundary of the frequency range minus MBW/2. MBW denotes the measurement bandwidth (6.25 kHz).

The normative reference for this requirement is TS 36.101[2] subclause 6.6.3.3.2.

6.6.3.3.3.3 Minimum requirement (network signalled value "NS_08")

When "NS_08" is indicated in the cell, the power of any UE emission shall not exceed the levels specified in Table 6.6.3.3.3-1. This requirement also applies for the frequency ranges that are less than Δf_{OOB} (MHz) in Table 6.6.3.1.3-1 from the edge of the channel bandwidth.

Table 6.6.3.3.3-1: Additional requirement

Frequency band (MHz)	Channel bandwidth / Spectrum emission limit (dBm)			Measurement bandwidth
	5MHz	10MHz	15MHz	
$860 \leq f \leq 895$	-40	-40	-40	1 MHz

NOTE: For measurement conditions at the edge of each frequency range, the lowest frequency of the measurement position in each frequency range should be set at the lowest boundary of the frequency range plus MBW/2. The highest frequency of the measurement position in each frequency range should be set at the highest boundary of the frequency range minus MBW/2. MBW denotes the measurement bandwidth (1 MHz).

6.6.3.3.3.4 Minimum requirement (network signalled value "NS_09")

When "NS_09" is indicated in the cell, the power of any UE emission shall not exceed the levels specified in Table 6.6.3.3.3.4-1. This requirement also applies for the frequency ranges that are less than Δf_{OOB} (MHz) in Table 6.6.3.1.3-1 from the edge of the channel bandwidth.

Table 6.6.3.3.3.4-1: Additional requirement

Frequency band (MHz)	Channel bandwidth / Spectrum emission limit (dBm)			Measurement bandwidth
	5MHz	10MHz	15MHz	
$1475.9 \leq f \leq 1510.9$	-35	-35	-35	1 MHz

NOTE 1: For measurement conditions at the edge of each frequency range, the lowest frequency of the measurement position in each frequency range should be set at the lowest boundary of the frequency range plus MBW/2. The highest frequency of the measurement position in each frequency range should be set at the highest boundary of the frequency range minus MBW/2. MBW denotes the measurement bandwidth (1 MHz).

NOTE 2: To improve measurement accuracy, A-MPR values for NS_09 specified in Table 6.2.4.3-1 in sub-clause 6.2.4 are derived based on both the above NOTE 1 and 100 kHz RBW.

6.6.3.3.3.5 Minimum requirement (network signalled value "NS_12")

When "NS 12" is indicated in the cell, the power of any UE emission shall not exceed the levels specified in Table 6.6.3.3.5-1. This requirement also applies for the frequency ranges that are less than Δf_{OOB} (MHz) in Table 6.6.3.1.3-1 from the edge of the channel bandwidth.

Table 6.6.3.3.5-1: Additional requirements

Frequency band (MHz)	Channel bandwidth / Spectrum emission limit (dBm)	Measurement bandwidth	Note
	1.4, 3, 5 MHz		
$806 \leq f \leq 813.5$	-42	6.25 kHz	1
NOTE 1: The emission limit applies at an offset of 0.7 MHz below any block of E-UTRA carriers			

6.6.3.3.3.6 Minimum requirement (network signalled value "NS_13")

When "NS 13" is indicated in the cell, the power of any UE emission shall not exceed the levels specified in Table 6.6.3.3.6-1. This requirement also applies for the frequency ranges that are less than Δf_{OOB} (MHz) in Table 6.6.3.1.3-1 from the edge of the channel bandwidth.

Table 6.6.3.3.6-1: Additional requirements

Frequency band (MHz)	Channel bandwidth / Spectrum emission limit (dBm)	Measurement bandwidth	Note
	5 MHz		
$806 \leq f \leq 816$	-42	6.25 kHz	1
NOTE 1: The emission limit applies at an offset of 3 MHz below any block of E-UTRA carriers			

6.6.3.3.3.7 Minimum requirement (network signalled value "NS_14")

When "NS 14" is indicated in the cell, the power of any UE emission shall not exceed the levels specified in Table 6.6.3.3.7-1. This requirement also applies for the frequency ranges that are less than Δf_{OOB} (MHz) in Table 6.6.3.1.3-1 from the edge of the channel bandwidth.

Table 6.6.3.3.7-1: Additional requirements

Frequency band (MHz)	Channel bandwidth / Spectrum emission limit (dBm)	Measurement bandwidth	Note
	10, 15 MHz		
$806 \leq f \leq 816$	-42	6.25 kHz	1
NOTE 1: The emission limit applies at an offset of 8 MHz below any block of E-UTRA carriers			

6.6.3.3.3.8 Minimum requirement (network signalled value "NS_15")

When "NS 15" is indicated in the cell, the power of any UE emission shall not exceed the levels specified in Table 6.6.3.3.8-1. This requirement also applies for the frequency ranges that are less than Δf_{OOB} (MHz) in Table 6.6.3.1.3-1 from the edge of the channel bandwidth.

Table 6.6.3.3.8-1: Additional requirements

Frequency band (MHz)	Channel bandwidth / Spectrum emission limit (dBm)	Measurement bandwidth	Note
	1.4, 3, 5, 10, 15 MHz		
$851 \leq f \leq 859$	-53	6.25 kHz	1
$852 \leq f \leq 859$	-32	1 MHz	1

NOTE 1: The emissions measurement shall be sufficiently power averaged to ensure standard deviation < 0.5 dB.

6.6.3.3.3.9 Minimum requirement (network signalled value "NS_16")

When "NS_16" is indicated in the cell, the power of any UE emission shall not exceed the levels specified in Table 6.6.3.3.9-1. This requirement also applies for the frequency ranges that are less than Δf_{OOB} (MHz) in Table 6.6.3.1-1 from the edge of the channel bandwidth.

Table 6.6.3.3.3.9-1: Additional requirements

Frequency band (MHz)	Channel bandwidth / Spectrum emission limit (dBm)	Measurement bandwidth	Note
	1.4, 3, 5, 10 MHz		
$790 \leq f \leq 803$	-32	1 MHz	

6.6.3.3.3.10 Minimum requirement (network signalled value "NS_17")

When "NS_17" is indicated in the cell, the power of any UE emission shall not exceed the levels specified in Table 6.6.3.3.3.10-1. This requirement also applies for the frequency ranges that are less than Δf_{OOB} (MHz) in Table 6.6.3.3.3.10-1 from the edge of the channel bandwidth.

Table 6.6.3.3.3.10-1: Additional requirements

Frequency band (MHz)	Channel bandwidth / Spectrum emission limit (dBm)	Measurement bandwidth	Note
	5, 10 MHz		
$470 \leq f \leq 710$	-26.2	6 MHz	1

NOTE 1: Applicable when the assigned E-UTRA carrier is confined within 718 MHz and 748 MHz and when the channel bandwidth used is 5 or 10 MHz.

6.6.3.3.3.11 Minimum requirement (network signalled value "NS_18")

When "NS_18" is indicated in the cell, the power of any UE emission shall not exceed the levels specified in Table 6.6.3.3.3.11-1. This requirement also applies for the frequency ranges that are less than Δf_{OOB} (MHz) in Table 6.6.3.3.3.11-1 from the edge of the channel bandwidth.

Table 6.6.3.3.3.11-1: Additional requirements

Frequency band (MHz)	Channel bandwidth / Spectrum emission limit (dBm)	Measurement bandwidth	Note
	5, 10, 15, 20 MHz		
692-698	-26.2	6 MHz	

6.6.3.3.4 Test description

6.6.3.3.4.1 Initial conditions

Initial conditions are a set of test configurations the UE needs to be tested in and the steps for the SS to take with the UE to reach the correct measurement state.

The initial test configurations consist of environmental conditions, test frequencies, and channel bandwidths based on E-UTRA operating bands specified in table 5.4.2.1-1. All of these configurations shall be tested with applicable test parameters for each channel bandwidth, and are shown in tables 6.6.3.3.4.1-1 through table, 6.6.3.3.4.1-8. The details of the uplink reference measurement channels (RMCs) are specified in Annexes A.2. Configurations of PDSCH and PDCCH before measurement are specified in Annex C.2.

Table 6.6.3.3.4.1-1: Test Configuration Table (network signalled value "NS_05")

Initial Conditions						
Test Environment as specified in TS 36.508[7] subclause 4.1			Normal			
Test Frequencies as specified in TS36.508 [7] subclause 4.3.1			Low range, Mid range In case of Low range: <ul style="list-style-type: none"> - For 5MHz Channel Bandwidth: 1927.2MHz (N_{UL} = 18072) - For 10MHz Channel Bandwidth: 1934.7MHz (N_{UL} = 18147) - For 15MHz Channel Bandwidth: 1932.5MHz (N_{UL} = 18125) - For 20MHz Channel Bandwidth: 1930MHz (N_{UL} = 18100) 			
Test Channel Bandwidths as specified in TS 36.508 [7] subclause 4.3.1			5MHz, 10MHz, 15MHz, 20MHz			
Test Parameters for Channel Bandwidths						
Ch BW	Downlink Configuration			Uplink Configuration		
	Mod'n	RB allocation		Mod'n	RB allocation	
		FDD	TDD		FDD	TDD
5MHz	N/A for Additional Spurious Emissions testing			QPSK	1	N/A
5MHz				QPSK	25	
10MHz				QPSK	1	
10MHz				QPSK	12	
10MHz				QPSK	48	
10MHz				QPSK	50	
10MHz				16QAM	50 (Note 3)	
15MHz				QPSK	1	
15MHz				QPSK	16	
15MHz				QPSK	30 (Note 4)	
15MHz				QPSK	48 (Note 5)	
15MHz				QPSK	75 (Note 5)	
15MHz				16QAM	75 (Note 3, 5)	
20MHz				QPSK	1	
20MHz				QPSK	18	
20MHz				QPSK	24 (Note 4)	
20MHz				QPSK	48 (Note 5)	
20MHz				QPSK	100 (Note 5)	
20MHz				16QAM	100 (Note 3, 5)	
Note 1: The 1 RB allocation shall be tested at both RB #0 and RB #max except for 15MHz and 20MHz of Low Range. For 15MHz of Low Range, the 1 RB allocation shall be tested at both RB#8 and RB#66. For 20MHz of Low Range, the 1 RB allocation shall be tested at both RB#24 and RB#75. Note 2: The RB _{start} of partial RB allocation shall be RB# 0 and RB# (max +1 - RB allocation) of the channel bandwidth except for 15MHz and 20MHz of Low Range. For 15MHz of Low Range, the RB _{start} shall be RB#8 and RB# (67 - RB allocation). For 20MHz of Low Range, the RB _{start} shall be RB#24 and RB# (76 - RB allocation). Note 3: Applies only for UE-Categories ≥2. Note 4: Required for Low Range only. Note 5: Not available for Low Range.						

Table 6.6.3.3.4.1-2: Test Configuration Table (network signalled value "NS_07")

Initial Conditions						
Test Environment (as specified in TS 36.508 [7] subclause 4.1)				NC		
Test Frequencies (as specified in TS36.508 [7] subclause 4.3.1)				Mid range		
Test Channel Bandwidths (as specified in TS 36.508 [7] subclause 4.3.1)				10MHz		
Test Parameters for Channel Bandwidths						
Test Number	Ch BW	Downlink Configuration		Uplink Configuration		
		Mod'n	RB allocation	Mod'n	RB allocation	RB _{start}
1	10MHz	N/A for Additional Spurious Emissions testing.		QPSK	1	0
2	10MHz			QPSK	8	0
3	10MHz			QPSK	6	13
4	10MHz			QPSK	20	13
5	10MHz			QPSK	12	13
6	10MHz			16QAM	36 (Note 1)	13
7	10MHz			QPSK	16	19
8	10MHz			QPSK	12	19
9	10MHz			16QAM	16	19
10	10MHz			QPSK	30	19
11	10MHz			16QAM	30 (Note 1)	19
12	10MHz			QPSK	6	43
13	10MHz			QPSK	2	48
14	10MHz			QPSK	50	0
15	10MHz			QPSK	12	0
16	10MHz			16QAM	50 (Note 1)	0

Note 1: Applies only for UE-Categories ≥ 2 .

Table 6.6.3.3.4.1-3: Test Configuration Table (network signalled value "NS_08")

Initial Conditions						
Test Environment as specified in TS 36.508[7] subclause 4.1			Normal			
Test Frequencies as specified in TS36.508 [7] subclause 4.3.1			High range			
Test Channel Bandwidths as specified in TS 36.508 [7] subclause 4.3.1			5MHz, 10MHz, 15MHz			
Test Parameters for Channel Bandwidths						
Ch BW	Downlink Configuration			Uplink Configuration		
	Mod'n	RB allocation		Mod'n	RB allocation	
		FDD	TDD		FDD	TDD
5MHz	N/A for Additional Spurious Emissions testing			QPSK	1	N/A
5MHz				QPSK	8	
5MHz				QPSK	25	
10MHz				QPSK	1	
10MHz				QPSK	12	
10MHz				QPSK	40	
10MHz				QPSK	50	
10MHz				16QAM	50 (Note 3)	
15MHz				QPSK	1	
15MHz				QPSK	16	
15MHz				QPSK	40	
15MHz				QPSK	75	
15MHz				16QAM	75 (Note 3)	
Note 1: The 1 RB allocation shall be tested at both RB #0 and RB #max. Note 2: The RB _{start} of partial RB allocation shall be RB#0 and RB# (max + 1 - RB allocation) of the channel bandwidth Note 3: Applies only for UE-Categories ≥2.						

Table 6.6.3.3.4.1-4: Test Configuration Table (network signalled value "NS_09")

Initial Conditions								
Test Environment as specified in TS 36.508[7] subclause 4.1			Normal					
Test Frequencies as specified in TS36.508 [7] subclause 4.3.1			High range					
Test Channel Bandwidths as specified in TS 36.508 [7] subclause 4.3.1			5MHz, 10MHz, 15MHz					
Test Parameters for Channel Bandwidths								
Ch BW	Downlink Configuration			Uplink Configuration				
	Mod'n	RB allocation		Mod'n	RB allocation			
		FDD	TDD		FDD	TDD		
5MHz	N/A for Additional Spurious Emissions testing			QPSK	1	N/A		
5MHz				QPSK	8			
5MHz				QPSK	25			
10MHz				QPSK	1			
10MHz				QPSK	12			
10MHz				QPSK	40			
10MHz				QPSK	50			
10MHz				16QAM	50 (Note 3)			
15MHz				QPSK	1			
15MHz				QPSK	16			
15MHz				QPSK	40			
15MHz				QPSK	54			
15MHz				QPSK	75			
15MHz				16QAM	75 (Note 3)			
Note 1: The 1 RB allocation shall be tested at both RB #0 and RB #max. Note 2: The RB _{start} of partial RB allocation shall be RB#0 and RB# (max + 1 - RB allocation) of the channel bandwidth Note 3: Applies only for UE-Categories ≥2.								

Table 6.6.3.3.4.1-5: Test Configuration Table (network signalled value "NS_12")

Initial Conditions	
Test Environment (as specified in TS 36.508 [7] subclause 4.1)	NC
Test Frequencies (as specified in TS36.508 [7] subclause 4.3.1)	Mid range
Test Channel Bandwidths (as specified in TS 36.508 [7] subclause 4.3.1)	1.4 MHz, 3 MHz and 5 MHz
Test Parameters for Channel Bandwidths	
Downlink Configuration	Uplink Configuration

Test Number	Ch BW	Mod'n	RB allocation	Mod'n	RB allocation FDD	RBstart FDD
1	1.4 MHz	N/A for Additional Spurious Emissions testing		QPSK	1	0
2	1.4 MHz			QPSK	6	0
3	1.4 MHz			QPSK	1	1
4	1.4 MHz			QPSK	5	1
5	1.4 MHz			16QAM	6	0
6	3 MHz			QPSK	4	0
7	3 MHz			QPSK	10	0
8	3 MHz			QPSK	4	4
9	3 MHz			QPSK	10	4
10	3 MHz			16QAM	15	0
11	5 MHz			QPSK	8	0
12	5 MHz			QPSK	15	0
13	5 MHz			QPSK	8	7
14	5 MHz			QPSK	15	7
15	5 MHz			16QAM	25	0

Table 6.6.3.3.4.1-6: Test Configuration Table (network signalled value "NS_13")

Initial Conditions						
Test Environment (as specified in TS 36.508 [7] subclause 4.1)				NC		
Test Frequencies (as specified in TS36.508 [7] subclause 4.3.1)				Mid range		
Test Channel Bandwidths (as specified in TS 36.508 [7] subclause 4.3.1)				5 MHz		
Test Parameters for Channel Bandwidths						
		Downlink Configuration		Uplink Configuration		
Test Number	Ch BW	Mod'n	RB allocation	Mod'n	RB allocation FDD	RBstart FDD
1	5 MHz	N/A for Additional Spurious Emissions testing		QPSK	1	0
2	5 MHz			QPSK	25	0
3	5 MHz			QPSK	15	0
4	5 MHz			QPSK	15	7
5	5 MHz			16QAM	25	0

Table 6.6.3.3.4.1-7: Test Configuration Table (network signalled value "NS_14")

Initial Conditions						
Test Environment (as specified in TS 36.508 [7] subclause 4.1)				NC		
Test Frequencies (as specified in TS36.508 [7] subclause 4.3.1)				Mid range		
Test Channel Bandwidths (as specified in TS 36.508 [7] subclause 4.3.1)				10 MHz, 15 MHz		
Test Parameters for Channel Bandwidths						
		Downlink Configuration		Uplink Configuration		
Test Number	Ch BW	Mod'n	RB allocation	Mod'n	RB allocation FDD	RBstart FDD

Test Number	Ch BW	Mod'n	RB allocation	Mod'n	RB allocation FDD	RBstart FDD
1	10 MHz	N/A for Additional Spurious Emissions testing		QPSK	1	0
2	10 MHz			QPSK	25	0
3	10 MHz			QPSK	50	0
4	10 MHz			QPSK	25	1
5 (Note 1)	10 MHz			16QAM	50	0
6	15 MHz			QPSK	8	0
7	15 MHz			QPSK	25	0
8	15 MHz			QPSK	75	0
9	15 MHz			QPSK	50	15
10 (Note 1)	15 MHz			16QAM	75	0
Note 1: Applies only for UE-Categories ≥ 2 .						

Table 6.6.3.3.4.1-8: Test Configuration Table (network signalled value "NS_15")

Initial Conditions						
Test Environment (as specified in TS 36.508 [7] subclause 4.1)		NC				
Test Frequencies (as specified in TS36.508 [7] subclause 4.3.1)		For 1.4 MHz Channel Bandwidth: High range For 3 MHz Channel Bandwidth: 843.5 MHz ($N_{UL} = 26985$) or High range For 5 MHz Channel Bandwidth: 842.5 MHz ($N_{UL} = 26975$) or High range For 10 MHz Channel Bandwidth: 840 MHz ($N_{UL} = 26950$) or High range For 15 MHz Channel Bandwidth: 837.5 MHz ($N_{UL} = 26925$) or High range				
Test Channel Bandwidths (as specified in TS 36.508 [7] subclause 4.3.1)		1.4 MHz, 3 MHz, 5 MHz, 10 MHz, 15 MHz				
Test Parameters for Channel Bandwidths						
Configuration ID	Ch BW	Downlink Configuration		Uplink Configuration		
		Mod'n	RB allocation	Mod'n	RB allocation FDD	RBstart FDD
1 (note 3)	1.4 MHz	N/A for A-MPR testing.		QPSK	4	0
2 (note 3)	1.4 MHz			16QAM	6	0
3 (note 3)	3 MHz			QPSK	6	7
4 (note 3)	3 MHz			QPSK	12	1
5 (note 3)	3 MHz			16QAM	15	0
6 (note 2)	3 MHz			QPSK	15	0
7 (note 3)	5 MHz			QPSK	6	14
8 (note 3)	5 MHz			QPSK	20	0
9 (note 3)	5 MHz			16QAM	25	0
10 (note 2)	5 MHz			QPSK	16	9
11 (note 2)	5 MHz			QPSK	25	0
12 (note 3)	10 MHz			QPSK	1	39
13 (note 3)	10 MHz			QPSK	1	10
14 (note 3)	10 MHz			QPSK	3	0
15 (note 3)	10 MHz			QPSK	20	3
16 (note 3)	10 MHz			QPSK	36	1
17 (note 3)	10 MHz			QPSK	50	0
18 (note 3)	10 MHz			16QAM	50	0
19 (note 2)	10 MHz			QPSK	20	25
20 (note 2)	10 MHz			QPSK	45	0
21 (note 3)	15 MHz			QPSK	18	36
22 (note 3)	15 MHz			QPSK	25	1
23 (note 3)	15 MHz			QPSK	54	0
24 (note 3)	15 MHz			16QAM	75	0

25 (note 2)	15 MHz	QPSK	18	44
26 (note 2)	15 MHz	QPSK	60	2
Note 1: Applies only for UE-Categories ≥ 2 .				
Note 2: Applicable only test frequency < high range				
Note 3: Applicable only to high range frequency testing				

Table 6.6.3.3.4.1-9: Test Configuration Table (network signalled value "NS_16")

Initial Conditions						
Test Environment (as specified in TS 36.508 [7] subclause 4.1)				NC		
Test Frequencies (as specified in TS36.508 [7] subclause 4.3.1)				For 1.4 MHz Channel Bandwidth: Low range For 3 MHz Channel Bandwidth: Low range, 810 MHz ($N_{UL}= 27070$) For 5 MHz Channel Bandwidth: Low range, 811 MHz ($N_{UL}= 27080$) , 814.5 MHz ($N_{UL}= 27115$) For 10 MHz Channel Bandwidth: Low range, 813.5 MHz ($N_{UL}= 27105$), 817 MHz ($N_{UL}= 27140$)		
Test Channel Bandwidths (as specified in TS 36.508 [7] subclause 4.3.1)				1.4 MHz, 3 MHz, 5 MHz, 10 MHz		
Test Parameters for Channel Bandwidths						
Configuration ID	Ch BW	Downlink Configuration		Uplink Configuration		
		Mod'n	RB allocation	Mod'n	RB allocation FDD	RBstart FDD
1	1.4 MHz	N/A for Additional Spurious Emissions testing.		QPSK	1	0
2	1.4 MHz			QPSK	6	0
3 (Note 1)	1.4 MHz			16QAM	6	0
4	3 MHz			QPSK	1	0
5	3 MHz			QPSK	12	1
6	3 MHz			QPSK	15	0
7 (Note 1)	3 MHz			16QAM	15	0
8	5 MHz			QPSK	1	0
9	5 MHz			QPSK	12	2
10	5 MHz			QPSK	18	2
11	5 MHz			QPSK	20	0
12	5 MHz			QPSK	20	2
13	5 MHz			QPSK	25	0
14 (Note 1)	5 MHz			16QAM	25	0
15	10 MHz			QPSK	1	0
16 (Note 2)	10 MHz			QPSK	1	10

17 (Note 2)	10 MHz	QPSK	20	0
18 (Note 2)	10 MHz	QPSK	27	15
19 (Note 2)	10 MHz	QPSK	32	15
20	10 MHz	QPSK	32	0
21	10 MHz	QPSK	50	0
22 (Note 1)	10 MHz	16QAM	50	0
23 (Note 3)	10 MHz	QPSK	40	0
24 (Note 3)	10 MHz	QPSK	40	1
Note 1: Applies only for UE-Categories ≥ 2 . Note 2: Applies only for 10 MHz channel for Low Range, and 813.5 MHz Note 3: Applies only for 10 MHz channel for 817 MHz range				

Table 6.6.3.3.4.1-10: Test Configuration Table (network signalled value "NS_17")

Initial Conditions					
Test Environment (as specified in TS 36.508[7] subclause 4.1)				Normal	
Test Frequencies (as specified in TS 36.508 [7] subclause 4.3.1)				Low range	
Test Channel Bandwidths (as specified in TS 36.508 [7] subclause 4.3.1)				5MHz, 10MHz	
Test Parameters for Channel Bandwidths					
Configuration ID	Ch BW	Downlink Configuration		Uplink Configuration	
		Mod'n	RB allocation FDD	Mod'n	RB allocation FDD
1	5MHz	N/A for Additional Spurious Emissions testing		QPSK	1
2	5MHz			QPSK	8
3	5MHz			QPSK	25
4	5MHz			16QAM	25 (Note 3)
5	10MHz			QPSK	1
6	10MHz			QPSK	12
7	10MHz			QPSK	50
8	10MHz			16QAM	50 (Note 3)
Note 1: The 1 RB allocation shall be tested at both RB #0 and RB #max. Note 2: The RBstart of partial RB allocation shall be RB# 0 and RB# (max +1 - RB allocation) of the channel bandwidth. Note 3: Applies only for UE-Categories ≥ 2 .					

Table 6.6.3.3.4.1-11: Test Configuration Table (network signalled value "NS_18")

Initial Conditions

Test Environment (as specified in TS 36.508[7] subclause 4.1)				Normal	
Test Frequencies (as specified in TS 36.508 [7] subclause 4.3.1)				Low range	
Test Channel Bandwidths (as specified in TS 36.508 [7] subclause 4.3.1)				5MHz, 10MHz, 15MHz, 20MHz	
Test Parameters for Channel Bandwidths					
Configuration ID	Ch BW	Downlink Configuration		Uplink Configuration	
		Mod'n	RB allocation FDD	Mod'n	RB allocation FDD
1	5MHz	N/A for Additional Spurious Emissions testing		QPSK	1
2	5MHz			QPSK	8
3	5MHz			QPSK	25
4	5MHz			16QAM	25 (Note 3)
5	10MHz			QPSK	1
6	10MHz			QPSK	12
7	10MHz			QPSK	50
8	10MHz			16QAM	50 (Note 3)
9	15MHz			QPSK	1
10	15MHz			QPSK	16
11	15MHz			QPSK	75
12	15MHz			16QAM	75 (Note 3)
13	20MHz			QPSK	1
14	20MHz			QPSK	18
15	20MHz			QPSK	100
16	20MHz			16QAM	100 (Note 3)
<p>Note 1: The 1 RB allocation shall be tested at both RB #0 and RB #max.</p> <p>Note 2: The RBstart of partial RB allocation shall be RB# 0 and RB# (max +1 - RB allocation) of the channel bandwidth.</p> <p>Note 3: Applies only for UE-Categories ≥ 2.</p>					

Editor's note: The following lines belong at the end of section 6.2.4.4.1. As new tables are added to this section, these lines should always follow the tables.

1. Connect the SS to the UE to the UE antenna connectors as shown in Figure TS 36.508 [7] Annex A, Figure A.7.
2. The parameter settings for the cell are set up according to TS 36.508 [7] subclause 4.4.3.
3. Downlink signals are initially set up according to Annex C0, C.1 and C.3.0, and uplink signals according to Annex H.1 and H.3.0.
4. The UL Reference Measurement channels are set according to Table 6.6.3.3.4.1-1, Table 6.6.3.3.4.1-2 or Table 6.6.3.3.4.1-3 depending on network signal value.
5. Propagation conditions are set according to Annex B.0.
6. Ensure the UE is in State 3A-RF according to TS 36.508 [7] clause 5.2A.2. Message contents are defined in clause 6.6.3.3.4.3.

6.6.3.3.4.2 Test procedure

1. SS sends uplink scheduling information for each UL HARQ process via PDCCH DCI format 0 for C_RNTI to schedule the UL RMC according to Table 6.6.3.3.4.1-1 and Table 6.6.3.3.4.1-2. Since the UE has no payload and no loopback data to send the UE sends uplink MAC padding bits on the UL RMC.
2. Send continuously uplink power control "up" commands in the uplink scheduling information to the UE until the UE transmits at P_{UMAX} level.
3. Measure the mean power of the UE in the channel bandwidth of the radio access mode according to the test configuration, which shall meet the requirements described in Tables 6.2.4.5-1 to 6.2.4.5-9 as appropriate. The period of the measurement shall be at least one sub-frame (1ms).
4. Measure the power of the transmitted signal with a measurement filter of bandwidths according to Table 6.6.3.3.5.1-1, 6.6.3.3.5.2-1, 6.6.3.3.5.3-1, 6.6.3.3.5.4-1, 6.6.3.3.5.5-1, 6.6.3.3.5.6-1, 6.6.3.3.5.7-1, 6.6.3.3.5.8-1, 6.6.3.3.5.9-1, 6.6.3.3.5.10-1 and 6.6.3.3.5.11-1 as appropriate. The centre frequency of the filter shall be stepped in contiguous steps according to the same table. For NS_07 measurements made in a bandwidth of 6.25kHz, measurement parameter settings defined in table 6.6.3.3.4.2-1 shall be used. The measured power shall be verified for each step. The measurement period shall capture the active time slots.

Table 6.6.3.3.4.2-1: Measurement setup for NS_07

	Option 1: Measurement with No RMS VBW available	Option2 Measurement with VBW Filtering on Power scale
VBW	≥ 62.5 kHz (10 times or more the RBW)	≤ 43 Hz
RBW	≤ 6.25 kHz	≤ 6.25 kHz
Detector type	Averages signal envelope during each measurement point, such as "RMS detector"	Peak
Averaging mode (Trace averaging)	Power (RMS voltage)	Power (RMS voltage), as controlled by "Average Type"
Average Type (applies to detector)	Power (RMS voltage) (automatically occurs with "RMS detector")	Not applicable
Average Type (applies to VBW filter)	Not applicable	Power (RMS voltage)
Number of averages	30, to reduce variance as required, or use an even longer sweep time	1 or use an even narrower VBW filter, thus a longer sweep time
Sweep time	[Don't specify]	Sweep rate (span divided by sweep time) ≤ 0.8 * RBW*VBW

6.6.3.3.4.3 Message contents

6.6.3.3.4.3.1 Message contents (network signalled value "NS_05")

Message contents are according to TS 36.508 [7] subclause 4.6, with the following exceptions:

1. Information element additionalSpectrumEmission is set to NS_05. This can be set in the *SystemInformationblockType2* as part of the cell broadcast message. This exception indicates that the UE shall meet the additional spurious emission requirement for a specific deployment scenario.

Table 6.6.3.3.4.3.1-1: SystemInformationBlockType2 :Additional spurious emissions requirement

Derivation Path: TS 36.508 [7] clause 4.4.3.3, Table 4.4.3.3-1			
Information Element	Value/remark	Comment	Condition
additionalSpectrumEmission	5 (NS_05)		

6.6.3.3.4.3.2 Message contents (network signalled value "NS_07")

Message contents are according to TS 36.508 [7] subclause 4.6, with the following exceptions:

1. Information element additionalSpectrumEmission is set to NS_07. This can be set in the *SystemInformationblockType2* as part of the cell broadcast message. This exception indicates that the UE shall meet the additional spurious emission requirement for a specific deployment scenario.

Table 6.6.3.3.4.3.2-1: SystemInformationBlockType2 :Additional spurious emissions requirement

Derivation Path: TS 36.508 [7] clause 4.4.3.3, Table 4.4.3.3-1			
Information Element	Value/remark	Comment	Condition
additionalSpectrumEmission	7 (NS_07)		

6.6.3.3.4.3.3 Message contents (network signalled value "NS_08")

Message contents are according to TS 36.508 [7] subclause 4.6, with the following exceptions:

1. Information element additionalSpectrumEmission is set to NS_08. This can be set in the *SystemInformationblockType2* as part of the cell broadcast message. This exception indicates that the UE shall meet the additional spurious emission requirement for a specific deployment scenario.

Table 6.6.3.3.4.3.3-1: SystemInformationBlockType2 :Additional spurious emissions requirement

Derivation Path: TS 36.508 [7] clause 4.4.3.3, Table 4.4.3.3-1			
Information Element	Value/remark	Comment	Condition
additionalSpectrumEmission	8 (NS_08)		

6.6.3.3.4.3.4 Message contents (network signalled value "NS_09")

Message contents are according to TS 36.508 [7] subclause 4.6, with the following exceptions:

1. Information element additionalSpectrumEmission is set to NS_09. This can be set in the *SystemInformationblockType2* as part of the cell broadcast message. This exception indicates that the UE shall meet the additional spurious emission requirement for a specific deployment scenario.

Table 6.6.3.3.4.3.4-1: SystemInformationBlockType2 :Additional spurious emissions requirement

Derivation Path: TS 36.508 [7] clause 4.4.3.3, Table 4.4.3.3-1			
Information Element	Value/remark	Comment	Condition
additionalSpectrumEmission	9 (NS_09)		

6.6.3.3.4.3.5 Message contents exceptions (network signalled value "NS_12")

1. Information element additionalSpectrumEmission is set to NS_12. This can be set in the *SystemInformationblockType2* as part of the cell broadcast message. This exception indicates that the UE shall meet the additional spurious emission requirement for a specific deployment scenario.

Table 6.6.3.3.4.3.5-1: SystemInformationBlockType2 :Additional spurious emissions test requirement for "NS_12"

Derivation Path: TS 36.508 [7] clause 4.4.3.3, Table 4.4.3.3-1			
Information Element	Value/remark	Comment	Condition
additionalSpectrumEmission	12 (NS_12)		

6.6.3.3.4.3.6 Message contents exceptions (network signalled value "NS_13")

- Information element additionalSpectrumEmission is set to NS_13. This can be set in the *SystemInformationblockType2* as part of the cell broadcast message. This exception indicates that the UE shall meet the additional spurious emission requirement for a specific deployment scenario.

Table 6.6.3.3.4.3.6-1: SystemInformationBlockType2 :Additional spurious emissions test requirement for "NS_13"

Derivation Path: TS 36.508 [7] clause 4.4.3.3, Table 4.4.3.3-1			
Information Element	Value/remark	Comment	Condition
additionalSpectrumEmission	13 (NS_13)		

6.6.3.3.4.3.7 Message contents exceptions (network signalled value "NS_14")

- Information element additionalSpectrumEmission is set to NS_14. This can be set in the *SystemInformationblockType2* as part of the cell broadcast message. This exception indicates that the UE shall meet the additional spurious emission requirement for a specific deployment scenario.

Table 6.6.3.3.4.3.7-1: SystemInformationBlockType2 :Additional spurious emissions test requirement for "NS_14"

Derivation Path: TS 36.508 [7] clause 4.4.3.3, Table 4.4.3.3-1			
Information Element	Value/remark	Comment	Condition
additionalSpectrumEmission	14 (NS_14)		

6.6.3.3.4.3.8 Message contents exceptions (network signalled value "NS_15")

- Information element additionalSpectrumEmission is set to NS_15. This can be set in the *SystemInformationblockType2* as part of the cell broadcast message. This exception indicates that the UE shall meet the additional spurious emission requirement for a specific deployment scenario.

Table 6.6.3.3.4.3.8-1: SystemInformationBlockType2 :Additional spurious emissions test requirement for "NS_15"

Derivation Path: TS 36.508 [7] clause 4.4.3.3, Table 4.4.3.3-1			
Information Element	Value/remark	Comment	Condition
additionalSpectrumEmission	15 (NS_15)		

6.6.3.3.4.3.9 Message contents exceptions (network signalled value "NS_16")

- Information element additionalSpectrumEmission is set to NS_16. This can be set in the *SystemInformationblockType2* as part of the cell broadcast message. This exception indicates that the UE shall meet the additional spurious emission requirement for a specific deployment scenario.

Table 6.6.3.3.4.3.9-1: SystemInformationBlockType2 :Additional spurious emissions test requirement for "NS_16"

Derivation Path: TS 36.508 [7] clause 4.4.3.3, Table 4.4.3.3-1			
Information Element	Value/remark	Comment	Condition
additionalSpectrumEmission	16 (NS_16)		

6.6.3.3.4.3.10 Message contents exceptions (network signalled value "NS_17")

- Information element `additionalSpectrumEmission` is set to NS_17. This can be set in the *SystemInformationBlockType2* as part of the cell broadcast message. This exception indicates that the UE shall meet the additional spurious emission requirement for a specific deployment scenario.

Table 6.6.3.3.4.3.10-1: SystemInformationBlockType2 :Additional spurious emissions test requirement for "NS_17"

Derivation Path: TS 36.508 [7] clause 4.4.3.3, Table 4.4.3.3-1			
Information Element	Value/remark	Comment	Condition
<code>additionalSpectrumEmission</code>	17 (NS_17)		

6.6.3.3.4.3.11 Message contents exceptions (network signalled value "NS_18")

- Information element `additionalSpectrumEmission` is set to NS_18. This can be set in the *SystemInformationBlockType2* as part of the cell broadcast message. This exception indicates that the UE shall meet the additional spurious emission requirement for a specific deployment scenario.

Table 6.6.3.3.4.3.11-1: SystemInformationBlockType2 :Additional spurious emissions test requirement for "NS_18"

Derivation Path: TS 36.508 [7] clause 4.4.3.3, Table 4.4.3.3-1			
Information Element	Value/remark	Comment	Condition
<code>additionalSpectrumEmission</code>	18 (NS_18)		

6.6.3.3.5 Test requirement

6.6.3.3.5.1 Test requirement (network signalled value "NS_05")

When "NS_05" is indicated in the cell:

- the measured UE mean power in the channel bandwidth, derived in step 3, shall fulfil requirements in Table 6.2.4.5-4 as appropriate,

and

the measured average power of spurious emission, derived in step 2, shall not exceed the described value in Table 6.6.3.3.5.1-1. This requirement also applies for the frequency ranges that are less than Δf_{OOB} (MHz) in Table 6.6.3.1.3-1 from the edge of the channel bandwidth.

Table 6.6.3.3.5.1-1: Additional requirements (PHS) test requirements

Frequency band (MHz)	Channel bandwidth / Spectrum emission limit (dBm)				Measurement bandwidth
	5 MHz	10 MHz	15 MHz	20 MHz	
$1884.5 \leq f \leq 1915.7^{*1}$	-41	-41	-41	-41	300 KHz
Note 1: Applicable when the lower edge of the assigned E-UTRA UL channel bandwidth frequency is larger than or equal to the upper edge of PHS band (1915.7 MHz) + 4 MHz + the Channel BW assigned, where Channel BW is as defined in sub-clause 5.4.2. Additional restrictions apply for operations below this point.					

The requirements in Table 6.6.3.3.5.1-1 apply with the additional restrictions specified in Table 6.6.3.3.5.1-2 when the lower edge of the assigned E-UTRA UL channel bandwidth frequency is less than the upper edge of PHS band (1915.7 MHz) + 4 MHz + the channel BW assigned.

Table 6.6.3.3.5.1-2: RB restrictions for additional requirement (PHS)

15 MHz channel bandwidth with $f_c = 1932.5$ MHz			
RB _{start}	0-7	8-66	67-74
LCRB	N/A	$\leq \text{MIN}(30, 67 - \text{RB}_{\text{start}})$	N/A
20 MHz channel bandwidth with $f_c = 1930$ MHz			
RB _{start}	0-23	24-75	76-99
LCRB	N/A	$\leq \text{MIN}(24, 76 - \text{RB}_{\text{start}})$	N/A

NOTE 1: (only for testing requirements in Table 6.6.3.3.5.1-1): For measurement conditions at the edge of each frequency range, the lowest frequency of the measurement position in each frequency range should be set at the lowest boundary of the frequency range plus MBW/2. The highest frequency of the measurement position in each frequency range should be set at the highest boundary of the frequency range minus MBW/2. MBW denotes the measurement bandwidth (300 kHz).

6.6.3.3.5.2 Test requirement (network signalled value "NS_07")

When "NS_07" is indicated in the cell:

- the measured UE mean power in the channel bandwidth, derived in step 3, shall fulfil requirements in Table 6.2.4.5-7 as appropriate,

and

- the measured average power of spurious emission, derived in step 4, shall not exceed the described value in Table 6.6.3.3.5.2-1. These requirements also apply for the frequency ranges that are less than Δf_{OOB} (MHz) in Table 6.6.3.1.3-1 from the edge of the channel bandwidth.

Table 6.6.3.3.5.2-1: Additional requirements (network signalled value "NS_07")

Frequency band (MHz)	Channel bandwidth / Spectrum emission limit (dBm)		Measurement bandwidth
	10 MHz		
$769 \leq f \leq 775$	-55.5		6.25 kHz
Note: The emissions measurement shall be sufficiently power averaged to ensure a standard deviation < 0.5 dB			

NOTE (only for testing requirements in Table 6.6.3.3.5.2-1): For measurement conditions at the edge of each frequency range, the lowest frequency of the measurement position in each frequency range should be set at the lowest boundary of the frequency range plus MBW/2. The highest frequency of the measurement position in each frequency range should be set at the highest boundary of the frequency range minus MBW/2. MBW denotes the measurement bandwidth (6.25 kHz).

6.6.3.3.5.3 Test requirement (network signalled value "NS_08")

When "NS_08" is indicated in the cell:

- the measured UE mean power in the channel bandwidth, derived in step 3, shall fulfil requirements in Table 6.2.4.5-8 as appropriate,

and

the measured average power of spurious emission, derived in step 4, shall not exceed the described value in Table 6.6.3.3.5.3-1. This requirement also applies for the frequency ranges that are less than Δf_{OOB} (MHz) in Table 6.6.3.1.3-1 from the edge of the channel bandwidth.

Table 6.6.3.3.5.3-1: Additional requirements (network signalled value "NS_08")

Frequency band (MHz)	Channel bandwidth / Spectrum emission limit (dBm)			Measurement bandwidth
	5MHz	10MHz	15MHz	

$860 \leq f \leq 895$	-40	-40	-40	1 MHz
-----------------------	-----	-----	-----	-------

NOTE (only for testing requirements in Table 6.6.3.3.5.3-1): For measurement conditions at the edge of each frequency range, the lowest frequency of the measurement position in each frequency range should be set at the lowest boundary of the frequency range plus MBW/2. The highest frequency of the measurement position in each frequency range should be set at the highest boundary of the frequency range minus MBW/2. MBW denotes the measurement bandwidth (1 MHz).

6.6.3.3.5.4 Test requirement (network signalled value "NS_09")

When "NS_09" is indicated in the cell:

- the measured UE mean power in the channel bandwidth, derived in step 3, shall fulfil requirements in Table 6.2.4.5-9 as appropriate,

and

- the measured average power of spurious emission, derived in step 4, shall not exceed the described value in table 6.6.3.3.5.4-1. This requirement also applies for the frequency ranges that are less than Δf_{OoB} (MHz) in Table 6.6.3.1.3-1 from the edge of the channel bandwidth.

Table 6.6.3.3.5.4-1: Additional requirements (network signalled value "NS_09")

Frequency band (MHz)	Channel bandwidth / Spectrum emission limit (dBm)			Measurement bandwidth
	5MHz	10MHz	15MHz	
$1475.9 \leq f \leq 1510.9$	-35	-35	-35	1 MHz

NOTE 1 (only for testing requirements in Table 6.6.3.3.5.4-1): For measurement conditions at the edge of each frequency range, the lowest frequency of the measurement position in each frequency range should be set at the lowest boundary of the frequency range plus MBW/2. The highest frequency of the measurement position in each frequency range should be set at the highest boundary of the frequency range minus MBW/2. MBW denotes the measurement bandwidth (1 MHz).

NOTE 2: To improve measurement accuracy, A-MPR values for NS_09 specified in Table 6.2.4.3-1 in sub-clause 6.2.4 are derived based on both the above NOTE 1 and 100 kHz RBW.

6.6.3.3.5.5 Test requirement (network signalled value "NS_12")

When "NS 12" is indicated in the cell:

- the measured UE mean power in the channel bandwidth, derived in step 3, shall fulfil requirements in Table 6.2.4.5-12 as appropriate,

and

- the power of any UE emission shall not exceed the levels specified in Table 6.6.3.3.5-1. This requirement also applies for the frequency ranges that are less than Δf_{OoB} (MHz) in Table 6.6.3.1.3-1 from the edge of the channel bandwidth.

Table 6.6.3.3.5.5-1: Additional requirements

Frequency band (MHz)	Channel bandwidth / Spectrum emission limit (dBm)	Measurement bandwidth	Note
	1.4, 3, 5 MHz		
$806 \leq f \leq 813.5$	-42	6.25 kHz	1
NOTE 1: The emission limit applies at an offset of 0.7 MHz below any block of E-UTRA carriers			

6.6.3.3.5.6 Test requirement (network signalled value "NS_13")

When "NS 13" is indicated in the cell:

- the measured UE mean power in the channel bandwidth, derived in step 3, shall fulfil requirements in Table 6.2.4.5-13 as appropriate,

and

- the power of any UE emission shall not exceed the levels specified in Table 6.6.3.3.5.6-1. This requirement also applies for the frequency ranges that are less than Δf_{OOB} (MHz) in Table 6.6.3.1.3-1 from the edge of the channel bandwidth.

Table 6.6.3.3.5.6-1: Additional requirements

Frequency band (MHz)	Channel bandwidth / Spectrum emission limit (dBm)	Measurement bandwidth	Note
	5 MHz		
$806 \leq f \leq 816$	-42	6.25 kHz	1
NOTE 1: The emission limit applies at an offset of 3 MHz below any block of E-UTRA carriers			

6.6.3.3.5.7 Test requirement (network signalled value "NS_14")

When "NS 14" is indicated in the cell:

- the measured UE mean power in the channel bandwidth, derived in step 3, shall fulfil requirements in Table 6.2.4.5-14 as appropriate,

and

- the power of any UE emission shall not exceed the levels specified in Table 6.6.3.3.5.7-1. This requirement also applies for the frequency ranges that are less than Δf_{OOB} (MHz) in Table 6.6.3.1.3-1 from the edge of the channel bandwidth.

Table 6.6.3.3.5.7-1: Additional requirements

Frequency band (MHz)	Channel bandwidth / Spectrum emission limit (dBm)	Measurement bandwidth	Note
	10, 15 MHz		
$806 \leq f \leq 816$	-42	6.25 kHz	1
NOTE 1: The emission limit applies at an offset of 8 MHz below any block of E-UTRA carriers			

6.6.3.3.5.8 Test requirement (network signalled value "NS_15")

When "NS 15" is indicated in the cell:

the measured UE mean power in the channel bandwidth, derived in step 3, shall fulfil requirements in Table 6.2.4.5-15 as appropriate,

and

- the power of any UE emission shall not exceed the levels specified in Table 6.6.3.3.5.8-1. This requirement also applies for the frequency ranges that are less than Δf_{OOB} (MHz) in Table 6.6.3.1.3-1 from the edge of the channel bandwidth.

Table 6.6.3.3.5.8-1: Additional requirements

Frequency band (MHz)	Channel bandwidth / Spectrum emission limit (dBm)	Measurement bandwidth	Note
	1.4, 3, 5, 10, 15 MHz		
$851 \leq f \leq 859$	-53	6.25 kHz	
$852 \leq f \leq 859$	-32	1 MHz	

6.6.3.3.5.9 Test requirement (network signalled value "NS_16")

When "NS 16" is indicated in the cell:

the measured UE mean power in the channel bandwidth, derived in step 3, shall fulfil requirements in Table 6.2.4.5-16 as appropriate,

and

- the power of any UE emission shall not exceed the levels specified in Table 6.6.3.3.5.9-1. This requirement also applies for the frequency ranges that are less than Δf_{OOB} (MHz) in Table 6.6.3.1.3-1 from the edge of the channel bandwidth.

Table 6.6.3.3.5.9-1: Additional requirements

Frequency band (MHz)	Channel bandwidth / Spectrum emission limit (dBm)	Measurement bandwidth	Note
	1.4, 3, 5, 10 MHz		
$790 \leq f \leq 803$	-32	1 MHz	

6.6.3.3.5.10 Test requirement (network signalled value "NS_17")

When "NS 17" is indicated in the cell:

the measured UE mean power in the channel bandwidth, derived in step 3, shall fulfil requirements in Table 6.2.4.5-17 as appropriate,

and

- the power of any UE emission shall not exceed the levels specified in Table 6.6.3.3.5.10-1. This requirement also applies for the frequency ranges that are less than Δf_{OOB} (MHz) in Table 6.6.3.1.3-1 from the edge of the channel bandwidth.

Table 6.6.3.3.5.10-1: Additional requirements

Frequency band (MHz)	Channel bandwidth / Spectrum emission limit (dBm)	Measurement bandwidth	Note
	5, 10 MHz		
$470 \leq f \leq 710$	-26.2	6 MHz	1
NOTE 1: Applicable when the assigned E-UTRA carrier is confined within 718 MHz and 748 MHz and when the channel bandwidth used is 5 or 10 MHz.			

6.6.3.3.5.11 Test requirement (network signalled value "NS_18")

When "NS 18" is indicated in the cell:

the measured UE mean power in the channel bandwidth, derived in step 3, shall fulfil requirements in Table 6.2.4.5-18 as appropriate,

and

- the power of any UE emission shall not exceed the levels specified in Table 6.6.3.3.5.11-1. This requirement also applies for the frequency ranges that are less than Δf_{OoB} (MHz) in Table 6.6.3.1.3-1 from the edge of the channel bandwidth.

Table 6.6.3.3.5.11-1: Additional requirements

Frequency band (MHz)	Channel bandwidth / Spectrum emission limit (dBm)	Measurement bandwidth	Note
	5, 10, 15, 20 MHz		
692-698	-26.2	6 MHz	

6.6.3.3A Additional spurious emissions for CA

6.6.3.3A.1 Additional spurious emissions for CA (intra-band contiguous DL CA and UL CA)

6.6.3.3A.1.1 Test purpose

To verify that UE transmitter does not cause unacceptable interference to other channels or other systems in terms of transmitter spurious emissions in intra-band contiguous carrier aggregation under the deployment scenarios where additional requirements are specified.

6.6.3.3A.1.2 Test applicability

This test case applies to all types of E-UTRA UE release 10 and forward that support intra-band contiguous DL CA and UL CA.

6.6.3.3A.1.3 Minimum conformance requirements

6.6.3.3A.1.3.1 Minimum conformance requirements for CA_1C (network signalled value "CA_NS_01")

When "CA_NS_01" is indicated in the cell, the power of any UE emission shall not exceed the levels specified in Table 6.6.3.3A.1.3.1-1. This requirement also applies for the frequency ranges that are less than Δf_{OoB} (MHz) in Table 6.6.3.1A.3-1 from the edge of the channel bandwidth.

Table 6.6.3.3A.1.3.1-1: Additional requirements (PHS) for CA

Protected band	Frequency range (MHz)			Maximum Level (dBm)	MBW (MHz)	Note
E-UTRA band 34	$F_{\text{DL_low}}$	-	$F_{\text{DL_high}}$	-50	1	
Frequency range	1884.5	-	1915.7	-41	0.3	1
NOTE 1: Applicable when the aggregated channel bandwidth is confined within frequency range 1940 – 1980 MHz						

NOTE 1: For measurement conditions at the edge of each frequency range, the lowest frequency of the measurement position in each frequency range should be set at the lowest boundary of the frequency range plus MBW/2. The highest frequency of the measurement position in each frequency range should be set at the highest boundary of the frequency range minus MBW/2. MBW denotes the measurement bandwidth (300 kHz).

The normative reference for this requirement is TS 36.101[2] subclause 6.6.3.3A.1.

6.6.3.3A.1.3.2 Minimum conformance requirements for CA_1C (network signalled value "CA_NS_02")

When "CA_NS_02" is indicated in the cell, the power of any UE emission shall not exceed the levels specified in Table 6.6.3.3A.1.3.2-1. These requirements also apply for the frequency ranges that are less than Δf_{OoB} (MHz) in Table 6.6.3.1A.3-1 from the edge of the channel bandwidth.

Table 6.6.3.3A.1.3.2-1: Additional requirements for CA

Protected band	Frequency range (MHz)			Maximum Level (dBm)	MBW (MHz)
E-UTRA band 34	F_{DL_low}	-	F_{DL_high}	-50	1
Frequency range	1900	-	1915	-15.5	5
Frequency range	1915	-	1920	+1.6	5

The normative reference for this requirement is TS 36.101[2] subclause 6.6.3.3A.2.

6.6.3.3A.1.3.3 Minimum requirement for CA_1C (network signalled value "CA_NS_03")

When "CA_NS_03" is indicated in the cell, the power of any UE emission shall not exceed the levels specified in Table 6.6.3.3A.1.3.3-1. This requirement also applies for the frequency ranges that are less than Δf_{OOB} (MHz) in Table 6.6.3.1A.3-1 from the edge of the channel bandwidth.

Table 6.6.3.3A.1.3.3-1: Additional requirement for CA

Protected band	Frequency range (MHz)			Maximum Level (dBm)	MBW (MHz)
E-UTRA band 34	F_{DL_low}	-	F_{DL_high}	-50	1
Frequency range	1880	-	1895	-40	1
Frequency range	1895	-	1915	-15.5	5
Frequency range	1915	-	1920	+1.6	5

6.6.3.3A.1.3.4 Minimum requirement for CA_38C (network signalled value "CA_NS_05")

When "CA_NS_05" is indicated in the cell, the power of any UE emission shall not exceed the levels specified in Table 6.6.3.3A.1.3.4-1. This requirement also applies for the frequency ranges that are less than F_{OOB} (MHz) in Table 6.6.3.1A.3-1 from the edge of the aggregated channel bandwidth.

Table 6.6.3.3A.1.3.4-1: Additional requirements

Protected band	Frequency range (MHz)			Maximum Level (dBm)	MBW (MHz)
Frequency range	2620	-	2645	-15.5	5
Frequency range	2645	-	2690	-40	1

6.6.3.3A.1.3.5 Minimum requirement for CA_7C (network signalled value "CA_NS_06")

When "CA_NS_06" is indicated in the cell, the power of any UE emission shall not exceed the levels specified in Table 6.6.3.3A.1.3.5-1. This requirement also applies for the frequency ranges that are less than F_{OOB} (MHz) in Table 6.6.3.1A.3-1 from the edge of the aggregated channel bandwidth.

Table 6.6.3.3A.1.3.5-1: Additional requirements

Protected band	Frequency range (MHz)			Maximum Level (dBm)	MBW (MHz)
Frequency range	2570	-	2575	+1.6	5
Frequency range	2575	-	2595	-15.5	5
Frequency range	2595	-	2620	-40	1

The normative reference for this requirement is TS 36.101[2] subclause 6.6.3.3A.3.

6.6.3.3A.1.4 Test description

6.6.3.3A.1.4.1 Initial conditions

Initial conditions are a set of test configurations the UE needs to be tested in and the steps for the SS to take with the UE to reach the correct measurement state.

The initial test configurations consist of environmental conditions, test frequencies, and CC combinations based on E-UTRA CA configurations specified in table 5.4.2A.1-1. All of these configurations shall be tested with applicable test parameters for each CA Configuration, and are shown in tables' 6.6.3.3A.1.4.1-1 to 6.6.3.3A.1.4.1-3. The details of the uplink reference measurement channels (RMCs) are specified in Annexes A.2. Configurations of PDSCH and PDCCH before measurement are specified in Annex C.2.

Table 6.6.3.3A.1.4.1-1: Test Configuration Table for CA (network signalled value "CA_NS_01")

Initial Conditions									
Test Environment as specified in TS 36.508[7] subclause 4.1					NC				
Test Frequencies as specified in TS36.508 [7] subclause 4.3.1 for different CA bandwidth classes.					C: Low and High range				
Test CC Combination setting (N _{RB_agg}) as specified in subclause 5.4.2A.1 for the CA Configuration					Lowest N _{RB_agg} Highest N _{RB_agg}				
Test Parameters for CA Configurations									
ID	CA Configuration / N _{RB_agg}		DL Allocation (PDCCH on PCC)	CC MOD	UL Allocation				
	PCC N _{RB}	SCCs N _{RB}			PCC & SCC RB allocation	N _{RB_alloc}	PCC & SCC RB allocations (L _{CRB} @ RB _{start})		
1	75	75	N/A	QPSK			1	P_1@0	S_0@0
2	75	75		QPSK	150	P_75@0	S_75@0		
3	75	75		QPSK	45	P_45@7	S_0@0		
4	75	75		QPSK	8	P_0@0	S_8@67		
5	75	75		QPSK	128	P_75@0	S_53@0		
6	75	75		QPSK	2	P_1@0	S_1@74		
7	75	75		QPSK	30	P_10@0	P_5@50	S_5@25	S_10@65
8	75	75		QPSK	105	P_35@0	P_20@55	S_15@0	S_35@40
9	100	100		QPSK	200	P_100@0	S_100@0		
10	100	100		QPSK	1	P_1@0	S_0@0		
11	100	100		QPSK	175	P_75@25	S_100@0		
12	100	100		QPSK	25	P_0@0	S_25@75		
13	100	100		QPSK	64	P_64@24	S_0@0		
14	100	100		QPSK	2	P_1@0	S_1@99		
15	100	100		QPSK	40	P_10@0	P_10@65	S_10@35	S_10@90
16	100	100		QPSK	150	P_40@0	P_35@65	S_35@0	S_40@60
Note 1: CA Configuration Test CC Combination settings are checked separately for each CA Configuration which applicable aggregated channel bandwidths are specified in Table 5.4.2A.1-1									

Table 6.6.3.3A.1.4.1-2: Test Configuration Table for CA (network signalled value "CA_NS_02")

Initial Conditions								
Test Environment as specified in TS 36.508[7] subclause 4.1					NC			
Test Frequencies as specified in TS36.508 [7] subclause 4.3.1 for different CA bandwidth classes.					C: Low and High range			
Test CC Combination setting (N _{RB_agg}) as specified in subclause 5.4.2A.1 for the CA Configuration					Lowest N _{RB_agg} Highest N _{RB_agg}			
Test Parameters for CA Configurations								
ID	CA Configuration / N _{RB_agg}		DL Allocation (PDCCH on PCC)	CC MOD	UL Allocation			
	PCC N _{RB}	SCCs N _{RB}			PCC & SCC RB allocation	N _{RB_allo} c	PCC & SCC RB allocations (L _{CRB} @ RB _{start})	

1	75	75	N/A	QPSK	1	P_1@0	S_0@0		
2	75	75		QPSK	75	P_75@0	S_0@0		
3	75	75		QPSK	128	P_75@0	S_53@0		
4	75	75		QPSK	128	P_53@22	S_75@0		
5	75	75		QPSK	1	P_0@0	S_1@74		
6	75	75		QPSK	1	P_0@0	S_1@54		
7	75	75		QPSK	TBD	TBD	TBD		
8	75	75		QPSK	TBD	TBD	TBD		
9	100	100		QPSK	1	P_1@0	S_0@0		
10	100	100		QPSK	1	P_1@21	S_0@0		
11	100	100		QPSK	90	P_90@0	S_0@0		
12	100	100		QPSK	180	P_100@0	S_80@0		
13	100	100		QPSK	1	P_0@0	S_1@99		
14	100	100		QPSK	1	P_0@0	S_1@83		
15	100	100		QPSK	TBD	TBD	TBD		
16	100	100		QPSK	TBD	TBD	TBD		

Note 1: CA Configuration Test CC Combination settings are checked separately for each CA Configuration which applicable aggregated channel bandwidths are specified in Table 5.4.2A.1-1

Table 6.6.3.3A.1.4.1-3: Test Configuration Table for CA (network signalled value “CA_NS_03”)

Initial Conditions								
Test Environment as specified in TS 36.508[7] subclause 4.1					NC			
Test Frequencies as specified in TS36.508 [7] subclause 4.3.1 for different CA bandwidth classes.					C: Low and High range			
Test CC Combination setting (N _{RB_agg}) as specified in subclause 5.4.2A.1 for the CA Configuration					Lowest N _{RB_agg} Highest N _{RB_agg}			
Test Parameters for CA Configurations								
ID	CA Configuration / N _{RB_agg}		DL Allocation (PDCCH on PCC)	CC MOD	UL Allocation			
	PCC N _{RB}	SCCs N _{RB}			PCC & SCC RB allocation	N _{RB_allo} _c	PCC & SCC RB allocations (L _{CRB} @ RB _{start})	
1	75	75	N/A	QPSK			1	P_1@0
2	75	75		QPSK	1	P_1@21	S_0@0	
3	75	75		QPSK	75	P_75@0	S_0@0	
4	75	75		QPSK	90	P_75@0	S_15@0	
5	75	75		QPSK	150	P_75@0	S_75@0	
6	75	75		QPSK	1	P_0@0	S_1@74	
7	75	75		QPSK	1	P_0@0	S_1@44	
8	75	75		QPSK	TBD	TBD	TBD	
9	100	100		QPSK	1	P_1@0	S_0@0	
10	100	100		QPSK	60	P_60@0	S_0@0	
11	100	100		QPSK	1	P_1@63	S_0@0	
12	100	100		QPSK	90	P_90@0	S_0@0	
13	100	100		QPSK	162	P_100@0	S_62@0	
14	100	100		QPSK	1	P_0@0	S_1@99	
15	100	100		QPSK	1	P_0@0	S_1@70	
16	100	100		QPSK	TBD	TBD	TBD	

Note 1: CA Configuration Test CC Combination settings are checked separately for each CA Configuration which applicable aggregated channel bandwidths are specified in Table 5.4.2A.1-1

1. Connect the SS to the UE to the UE antenna connectors as shown in Figure TS 36.508 [7] Annex A, Figure group A.33 as appropriate.
2. The parameter settings for the cell are set up according to TS 36.508 [7] subclause 4.4.3.
3. Downlink signals for PCC are initially set up according to Annex C.0, C.1 and C.3.0, and uplink signals according to Annex H.1 and H.3.0.
4. The UL Reference Measurement channels are set according to Table 6.6.3.3A.1.4.1-1, Table 6.6.3.3A.1.4.1-2 or Table 6.6.3.3A.1.4.1-3 depending on network signal value.

5. Propagation conditions are set according to Annex B.0.
6. Ensure the UE is in State 3A-RF according to TS 36.508 [7] clause 5.2A.2. Message contents are defined in clause 6.6.3.3A.1.4.3.

6.6.3.3A.1.4.2 Test procedure

1. Configure SCC according to Annex C.0, C.1 and Annex C.3.0 for all downlink physical channels except PHICH.
2. The SS shall configure SCC as per TS 36.508 [7] clause 5.2A.4. Message contents are defined in clause 6.6.2.3A.1.4.3
3. SS activates SCC by sending the activation MAC-CE (Refer TS 36.321 [13], clauses 5.13, 6.1.3.8). Wait for at least 2 seconds (Refer TS 36.133, clauses 8.3.3.2).
4. SS sends uplink scheduling information for each UL HARQ process via PDCCH DCI format 0 for C_RNTI to schedule the UL RMC according to Table 6.6.3.3A.1.4.1-1 on both PCC and SCC. Since the UE has no payload and no loopback data to send the UE sends uplink MAC padding bits on the UL RMC.
5. Send continuously uplink power control “up” commands in every uplink scheduling information to the UE until the UE transmits at P_{UMAX} level.
3. Measure the mean power of the UE in the channel bandwidth of the radio access mode according to the test configuration, which shall meet the requirements described in Tables 6.2.4A.1.5-1 to 6.2.4A.1.5-3 as appropriate. The period of the measurement shall be at least one sub-frame (1ms).
4. Measure the power of the transmitted signal with a measurement filter of bandwidths according to Table 6.6.3.3A.1.5.1-1, 6.6.3.3A.1.5.2-1 and 6.6.3.3A.1.5.3-1 as appropriate. The centre frequency of the filter shall be stepped in contiguous steps according to the same table. The measured power shall be verified for each step. The measurement period shall capture the active time slots.

6.6.3.3A.1.4.3 Message contents

Message contents are according to TS 36.508 [7] subclause 4.6, with the following exceptions for each network signalled value.

6.6.3.3A.1.4.3.1 Message contents (network signalled value "CA_NS_01")

1. Information element `additionalSpectrumEmissionSCell-r10` is set to `CA_NS_01`. This can be set in the *RadioResourceConfigCommonSCell-r10-DEFAULT* as part of the common RRC messages. This exception indicates that the UE shall meet the additional spurious emission requirement for a specific deployment scenario.

Table 6.6.3.3A.1.4.3.1-1: *RadioResourceConfigCommonSCell-r10-DEFAULT*: Additional spectrum emission test requirement for “CA_NS_01”

Derivation Path: TS 36.508 [7] clause 4.6.3, Table 4.6.3-13A			
Information Element	Value/remark	Comment	Condition
<code>additionalSpectrumEmissionSCell-r10</code>	1 (CA_NS_01)		

6.6.3.3A.1.4.3.2 Message contents exceptions (network signalled value "CA_NS_02")

1. Information element `additionalSpectrumEmissionSCell-r10` is set to `CA_NS_02`. This can be set in the *RadioResourceConfigCommonSCell-r10-DEFAULT* as part of the common RRC messages. This exception indicates that the UE shall meet the additional spurious emission requirement for a specific deployment scenario.

Table 6.6.3.3A.1.4.3.2-1: *RadioResourceConfigCommonSCell-r10-DEFAULT*: Additional spectrum emission test requirement for “CA_NS_02”

Derivation Path: TS 36.508 [7] clause 4.6.3, Table 4.6.3-13A			
Information Element	Value/remark	Comment	Condition
<code>additionalSpectrumEmissionSCell-r10</code>	2 (CA_NS_02)		

6.6.3.3A.1.4.3.3 Message contents exceptions (network signalled value "CA_NS_03")

- Information element `additionalSpectrumEmission` is set to NS_08. This can be set in the *RadioResourceConfigCommonSCell-r10-DEFAULT* as part of the common RRC messages. This exception indicates that the UE shall meet the additional spurious emission requirement for a specific deployment scenario.

Table 6.6.3.3A.1.4.3.3-1: *RadioResourceConfigCommonSCell-r10-DEFAULT*: Additional spectrum emission test requirement for "CA_NS_03"

Derivation Path: TS 36.508 [7] clause 4.6.3, Table 4.6.3-13A			
Information Element	Value/remark	Comment	Condition
<code>additionalSpectrumEmissionSCell-r10</code>	3 (CA_NS_03)		

6.6.3.3A.1.5 Test requirement

6.6.3.3A.1.5.1 Test requirement for CA (network signalled value "CA_NS_01")

When "CA_NS_01" is indicated in the cell:

- the measured UE mean power in the channel bandwidth, derived in step 3, shall fulfil requirements in Table 6.2.4A.1.5-1 as appropriate,

and

the measured average power of spurious emission, derived in step 2, shall not exceed the described value in Table 6.6.3.3A.1.5.1-1. This requirement also applies for the frequency ranges that are less than Δf_{OoB} (MHz) in Table 6.6.3.1A.1.3-1 from the edge of the channel bandwidth.

Table 6.6.3.3A.1.5.1-1: Additional requirements (PHS) for CA

Protected band	Frequency range (MHz)			Maximum Level (dBm)	MBW (MHz)	Note
E-UTRA band 34	$F_{\text{DL_low}}$	-	$F_{\text{DL_high}}$	-50	1	
Frequency range	1884.5	-	1915.7	-41	0.3	1
NOTE 1: Applicable when the aggregated channel bandwidth is confined within frequency range 1940 – 1980 MHz						

NOTE 1: For measurement conditions at the edge of each frequency range, the lowest frequency of the measurement position in each frequency range should be set at the lowest boundary of the frequency range plus MBW/2. The highest frequency of the measurement position in each frequency range should be set at the highest boundary of the frequency range minus MBW/2. MBW denotes the measurement bandwidth (300 kHz).

6.6.3.3A.1.5.2 Test requirement for CA (network signalled value "CA_NS_02")

When "CA_NS_02" is indicated in the cell:

- the measured UE mean power in the channel bandwidth, derived in step 3, shall fulfil requirements in Table 6.2.4A.1.5-2 as appropriate,

and

the measured average power of spurious emission, derived in step 2, shall not exceed the described value in Table 6.6.3.3A.1.5.2-1. This requirement also applies for the frequency ranges that are less than Δf_{OoB} (MHz) in Table 6.6.3.1A.1.3-1 from the edge of the channel bandwidth.

Table 6.6.3.3A.1.5.2-1: Additional requirements for CA

Protected band	Frequency range (MHz)			Maximum Level (dBm)	MBW (MHz)
	F_{DL_low}	-	F_{DL_high}		
E-UTRA band 34	F_{DL_low}	-	F_{DL_high}	-50	1
Frequency range	1900	-	1915	-15.5	5
Frequency range	1915	-	1920	+1.6	5

6.6.3.3A.1.5.3 Test requirement for CA (network signalled value "CA_NS_03")

When "CA_NS_03" is indicated in the cell:

- the measured UE mean power in the channel bandwidth, derived in step 3, shall fulfil requirements in Table 6.2.4A.1.5-3 as appropriate,

and

the measured average power of spurious emission, derived in step 2, shall not exceed the described value in Table 6.6.3.3A.1.5.3-1. This requirement also applies for the frequency ranges that are less than Δf_{OOB} (MHz) in Table 6.6.3.1A.1.3-1 from the edge of the channel bandwidth.

Table 6.6.3.3A.1.5.3-1: Additional requirement for CA

Protected band	Frequency range (MHz)			Maximum Level (dBm)	MBW (MHz)
	F_{DL_low}	-	F_{DL_high}		
E-UTRA band 34	F_{DL_low}	-	F_{DL_high}	-50	1
Frequency range	1880	-	1895	-40	1
Frequency range	1895	-	1915	-15.5	5
Frequency range	1915	-	1920	+1.6	5

6.6.3B Spurious emission for UL-MIMO

For UE supporting UL-MIMO, the requirements for Spurious emissions which are caused by unwanted transmitter effects such as harmonics emission, parasitic emissions, intermodulation products and frequency conversion products are specified at each transmit antenna connector.

For UEs with two transmit antenna connectors in closed-loop spatial multiplexing scheme, the requirements in subclause 6.6.3 apply to each transmit antenna connector. The requirements shall be met with the UL-MIMO configurations specified in Table 6.2.2B-1.

For single-antenna port scheme, the general requirements in subclause 6.6.2 apply.

6.6.3B.1 Transmitter Spurious emissions for UL-MIMO

6.6.3B.1.1 Test purpose

To verify that UE transmitter with a UL-MIMO does not cause unacceptable interference to other channels or other systems in terms of transmitter spurious emissions.

6.6.3B.1.2 Test applicability

This test case applies to all types of E-UTRA UE release 10 and forward that support UL-MIMO.

6.6.3B.1.3 Minimum conformance requirements

For UE with multiple transmit antenna connectors, the requirements for Spurious emissions which are caused by unwanted transmitter effects such as harmonics emission, parasitic emissions, intermodulation products and frequency conversion products are specified at each transmit antenna connector.

For UEs with two transmit antenna connectors, the requirements in clause 6.6.3 apply to each transmit antenna with the UL-MIMO configurations specified in Table 6.2.2B-1 for closed-loop spatial multiplexing scheme.

The normative reference for this requirement is TS 36.101 [2] clause 6.6.3B.

6.6.3B.1.4 Test description

6.6.3B.1.4.1 Initial conditions

Initial conditions are a set of test configurations the UE needs to be tested in and the steps for the SS to take with the UE to reach the correct measurement state.

The initial test configurations consist of environmental conditions, test frequencies, and channel bandwidths based on E-UTRA bands specified in Table 5.4.2.1-1. All of these configurations shall be tested with applicable test parameters for each channel bandwidth, and are shown in Table 6.6.3B.1.4.1-1. The details of the uplink reference measurement channels (RMCs) are specified in Annex A.2. Configurations of PDSCH and PDCCH before measurement are specified in Annex C.2.

Table 6.6.3B.1.4.1-1: Test Configuration Table

Initial Conditions								
Test Environment (as specified in TS 36.508 [7] clause 4.1)			NC					
Test Frequencies (as specified in TS 36.508 [7] clause 4.3.1)			Low range, Mid range, High range					
Test Channel Bandwidths (as specified in TS 36.508 [7] clause 4.3.1)			Lowest, 5MHz, Highest					
Test Parameters for Channel Bandwidths								
Ch BW	Downlink Configuration			Uplink Configuration				
	Mod'n	RB allocation		Mod'n	RB allocation			
		FDD	TDD		FDD	TDD		
1.4MHz	N/A for Spurious Emissions testing			QPSK	6	6		
1.4MHz				QPSK	1	1		
3MHz				QPSK	15	15		
3MHz				QPSK	1	1		
5MHz				QPSK	25	25		
5MHz				QPSK	1	1		
10MHz				QPSK	50	50		
10MHz				QPSK	1	1		
15MHz				QPSK	75	75		
15MHz				QPSK	1	1		
20MHz				QPSK	100	100		
20MHz				QPSK	1	1		
Note 1: Test Channel Bandwidths are checked separately for each E-UTRA band, which applicable channel bandwidths are specified in Table 5.4.2.1-1.								
Note 2: The 1 RB allocation shall be tested at both RB #0 and RB #max.								

1. Connect the SS to the UE antenna connectors as shown in Figure TS 36.508 [7] Annex A, Figure A.38.
2. The parameter settings for the cell are set up according to TS 36.508 [7] clause 4.4.3.
3. Downlink signals are initially set up according to Annex C0, C.1 and C.3.0, and uplink signals according to Annex H.1 and H.3.0.
4. The UL Reference Measurement channels are set according to Table 6.6.3B.1.4.1-1.

5. Propagation conditions are set according to Annex B.0.
6. Ensure the UE is in State 3A-RF according to TS 36.508 [7] clause 5.2A.2. Message contents are defined in clause 6.6.3B.1.4.3.

6.6.3B.1.4.2 Test procedure

1. SS sends uplink scheduling information for each UL HARQ process via PDCCH DCI format 4 for C_RNTI to schedule the UL RMC according to Table 6.6.3B.1.4.1-1. Since the UE has no payload data to send, the UE transmits uplink MAC padding bits on the UL RMC.
2. Send continuously uplink power control "up" commands in the uplink scheduling information to the UE until the UE transmits at PUMAX level.
3. Measure the power of the transmitted signal at each UE antenna connector with a measurement filter of bandwidths according to table 6.6.3B.1.5-1. The centre frequency of the filter shall be stepped in contiguous steps according to table 6.6.3B.1.5-1. The measured power shall be verified for each step. The measurement period shall capture the active time slots.

6.6.3B.1.4.3 Message contents

Message contents are according to TS 36.508 [7] subclause 4.6.

6.6.3B.1.5 Test requirement

The measured average power of spurious emission, derived in step 3, shall not exceed the described value in table 6.6.3B.1.5-1.

The spurious emission limits apply for the frequency ranges that are more than Δf_{OOB} (MHz) from the edge of the channel bandwidth shown in Table 6.6.3.1.3-1.

Table 6.6.3B.1.5-1: General spurious emissions test requirements

Frequency Range	Maximum Level	Measurement Bandwidth	Notes
$9 \text{ kHz} \leq f < 150 \text{ kHz}$	-36 dBm	1 kHz	
$150 \text{ kHz} \leq f < 30 \text{ MHz}$	-36 dBm	10 kHz	
$30 \text{ MHz} \leq f < 1000 \text{ MHz}$	-36 dBm	100 kHz	
$1 \text{ GHz} \leq f < 12.75 \text{ GHz}$	-30 dBm	1 MHz	
$12.75 \text{ GHz} \leq f < 5\text{th}$ harmonic of the upper frequency edge of the UL operating band in GHz	-30 dBm	1 MHz	Note 1
Note 1: Applies for Band 22, Band 42 and Band 43.			

NOTE: In order that the measurement of spurious emissions falls within the frequency ranges that are more than Δf_{OOB} (MHz) from the edge of the channel bandwidth, the minimum offset of the measurement frequency from each edge of the channel should be $\Delta f_{OOB} + MBW/2$. MBW denotes the measurement bandwidth defined in Table 6.6.3B.1.5-1.

6.6.3B.2 Spurious emission band UE co-existence for UL-MIMO

Editor's note: This test case contains different requirements for different UE releases

6.6.3B.2.1 Test purpose

To verify that UE transmitter with a UL-MIMO does not cause unacceptable interference to co-existing systems for the specified bands which has specific requirements in terms of transmitter spurious emissions.

6.6.3B.2.2 Test applicability

This test case applies to all types of E-UTRA UE release 10 and forward that support UL-MIMO.

6.6.3B.2.3 Minimum conformance requirements

For UE with multiple transmit antenna connectors, the requirements for Spurious emissions which are caused by unwanted transmitter effects such as harmonics emission, parasitic emissions, intermodulation products and frequency conversion products are specified at each transmit antenna connector.

For UEs with two transmit antenna connectors, the requirements in clause 6.6.3 apply to each transmit antenna with the UL-MIMO configurations specified in Table 6.2.2B-1 for closed-loop spatial multiplexing scheme.

The normative reference for this requirement is TS 36.101 [2] clause 6.6.3B.

This test use minimum requirements from many releases of TS 36.101 [2] due to release independence defined in TS 36.307 [16].

6.6.3B.2.4 Test description

6.6.3B.2.4.1 Initial conditions

Initial conditions are a set of test configurations the UE needs to be tested in and the steps for the SS to take with the UE to reach the correct measurement state.

The initial test configurations consist of environmental conditions, test frequencies, and channel bandwidths based on E-UTRA bands specified in Table 5.4.2.1-1. All of these configurations shall be tested with applicable test parameters for each channel bandwidth, and are shown in Table 6.6.3B.2.4.1-1. The details of the uplink reference measurement channels (RMCs) are specified in Annexe A.2. Configurations of PDSCH and PDCCH before measurement are specified in Annex C.2.

Table 6.6.3B.2.4.1-1: Test Configuration Table

Initial Conditions									
Test Environment (as specified in TS 36.508 [7] clause 4.1)				NC					
Test Frequencies (as specified in TS 36.508 [7] clause 4.3.1) (Note 3)				Low range, Mid range, High range (Note 3, Note 4)					
Test Channel Bandwidths (as specified in TS 36.508 [7] clause 4.3.1)				Lowest, 5MHz, Highest					
Test Parameters for Channel Bandwidths									
Ch BW	Downlink Configuration			Uplink Configuration					
	Mod'n	RB allocation		Mod'n	RB allocation				
		FDD	TDD		FDD	TDD			
1.4MHz	N/A for Spurious Emissions testing			QPSK	6	6			
1.4MHz				QPSK	1	1			
3MHz				QPSK	15	15			
3MHz				QPSK	1	1			
5MHz				QPSK	25	25 ⁵			
5MHz				QPSK	1	1 ⁵			
10MHz				QPSK	50	50			
10MHz				QPSK	1	1			
15MHz				QPSK	75	75			
15MHz				QPSK	1	1			
20MHz				QPSK	100	100			
20MHz				QPSK	1	1			
Note 1: Test Channel Bandwidths are checked separately for each E-UTRA band, which applicable channel bandwidths are specified in Table 5.4.2.1-1. Note 2: The 1 RB allocation shall be tested at both RB #0 and RB #max. Note 3: Do not apply for requirements under Note 13 in Tables 6.6.3.2.3-1B to 6.6.3.2.3-1D . Test frequencies for these requirements are defined in Table 6.6.3B.2.4.1-2. Note 4: For E-UTRA band 28, when the test frequency is low range of upper duplexer (as shown in TS 36.508[7] Table 4.3.1.1.28-2) and CBW is 5MHz and 10MHz, the test shall be conducted under NS_17 in [Table 6.2.4B.3-1]. Note 5: For requirements under note 22 in Table 6.6.3B.2.5-1, the message exception in Table 6.6.3B.2.4.3-1 is used to test with the high channel.									

Table 6.6.3B.2.4.1-2: Test frequencies for E-UTRA channel bandwidth for operating band 3 with Note 13 (in Tables 6.6.3.2.3-1B to 6.6.3.2.3-1D)

Bandwidth [MHz]	N_{UL}	Frequency of Uplink [MHz]	N_{DL}	Frequency of Downlink [MHz]
5	19924	1782.4	1924	1877.4
10	19899	1779.9	1899	1874.9
15	19874	1777.4	1874	1872.4
20	19849	1774.9	1849	1869.9

1. Connect the SS to the UE antenna connectors as shown in Figure TS 36.508 [7] Annex A, Figure A.38.
2. The parameter settings for the cell are set up according to TS 36.508 [7] clause 4.4.3.
3. Downlink signals are initially set up according to Annex C0, C.1 and C.3.0, and uplink signals according to Annex H.1 and H.3.0.
4. The UL Reference Measurement channels are set according to Table 6.6.3B.2.4.1-1.
5. Propagation conditions are set according to Annex B.0.
6. Ensure the UE is in State 3A-RF according to TS 36.508 [7] clause 5.2A.2. Message contents are defined in clause 6.6.3B.2.4.3.

6.6.3B.2.4.2 Test procedure

1. SS sends uplink scheduling information for each UL HARQ process via PDCCH DCI format 4 for C_RNTI to schedule the UL RMC according to Table 6.6.3B.2.4.1-1. Since the UE has no payload data to send, the UE transmits uplink MAC padding bits on the UL RMC.
2. Send continuously uplink power control "up" commands in the uplink scheduling information to the UE until the UE transmits at P_{UMAX} level.
3. Measure the power of the transmitted signal at each UE antenna connector with a measurement filter of bandwidths according to table 6.6.3B.2.5-1. For band 14 measurements made in a bandwidth of 6.25kHz, measurement parameter settings defined in table 6.6.3B.2.4.2-1 shall be used. The centre frequency of the filter shall be stepped in contiguous steps according to table 6.6.3B.2.5-1. The measured power shall be verified for each step. The measurement period shall capture the active time slots.

Table 6.6.3B.2.4.2-1: Measurement setup for band 14

	Option 1: Measurement with No RMS VBW available	Option2 Measurement with VBW Filtering on Power scale
VBW	>=62.5 kHz (10 times or more the RBW)	<=43Hz
RBW	<=6.25kHz	<=6.25kHz
Detector type	Averages signal envelope during each measurement point, such as "RMS detector"	Peak
Averaging mode (Trace averaging)	Power (RMS voltage)	Power (RMS voltage), as controlled by "Average Type"
Average Type (applies to detector)	Power (RMS voltage) (automatically occurs with "RMS detector")	Not applicable
Average Type (applies to VBW filter)	Not applicable	Power (RMS voltage)
Number of averages	30, to reduce variance as required, or use an even longer sweep time	1 or use an even narrower VBW filter, thus a longer sweep time
Sweep time	[Don't specify]	Sweep rate (span divided by sweep time) <= 0.8 * RBW*VBW

6.6.3B.2.4.3 Message contents

Message contents are according to TS 36.508 [7] subclause 4.6 with the following exceptions:

Table 6.6.3B.2.4.3-1: SystemInformationBlockType1 with Note 22 in table 6.6.3B.2.5-1

Derivation Path: TS 36.508 [7] clause 4.4.3.2, Table 4.4.3.2-3 SystemInformationBlockType1			
Information Element	Value/remark	Comment	Condition
p-Max	20		

6.6.3B.2.5 Test requirement

Test requirements for Spurious Emissions UE Co-existence for UL-MIMO are the same as the minimum requirements and are not repeated in this section.

The measured average power of spurious emission, derived in step 3, shall not exceed the described value in tables 6.6.3.2.3-1B to 6.6.3.2.3-1D according to the following rule:

The requirements for the UE are release specific and can be found in Tables 6.6.3.2.3-1B to 6.6.3.2.3-1D. If the UE support a band, which is not defined in the table corresponding UE's release, the requirements for this band are taken from the table of earliest release where requirements for this band are defined. This has been described in following Table 6.6.3B.2.5-1.

The spurious emission limits apply for the frequency ranges that are more than Δf_{OOB} (MHz) from the edge of the channel bandwidth shown in Table 6.6.3.1.3-1.

Table 6.6.3B.2.5-1: UE Requirements according to UE E-UTRA release and supported E-UTRA band

Band	UE Requirements per release				
	Rel-10	Rel-11	Rel-12		
1	Table 6.6.3.2.3-1B	Table 6.6.3.2.3-1C	Table 6.6.3.2.3-1D		
2	Table 6.6.3.2.3-1B	Table 6.6.3.2.3-1C	Table 6.6.3.2.3-1D		
3	Table 6.6.3.2.3-1B	Table 6.6.3.2.3-1C	Table 6.6.3.2.3-1D		
4	Table 6.6.3.2.3-1B	Table 6.6.3.2.3-1C	Table 6.6.3.2.3-1D		
5	Table 6.6.3.2.3-1B	Table 6.6.3.2.3-1C	Table 6.6.3.2.3-1D		
6	Table 6.6.3.2.3-1B	Table 6.6.3.2.3-1C	Table 6.6.3.2.3-1D		
7	Table 6.6.3.2.3-1B	Table 6.6.3.2.3-1C	Table 6.6.3.2.3-1D		
8	Table 6.6.3.2.3-1B	Table 6.6.3.2.3-1C	Table 6.6.3.2.3-1D		
9	Table 6.6.3.2.3-1B	Table 6.6.3.2.3-1C	Table 6.6.3.2.3-1D		
10	Table 6.6.3.2.3-1B	Table 6.6.3.2.3-1C	Table 6.6.3.2.3-1D		
11	Table 6.6.3.2.3-1B	Table 6.6.3.2.3-1C	Table 6.6.3.2.3-1D		
12	Table 6.6.3.2.3-1B	Table 6.6.3.2.3-1C	Table 6.6.3.2.3-1D		
13	Table 6.6.3.2.3-1B	Table 6.6.3.2.3-1C	Table 6.6.3.2.3-1D		
14	Table 6.6.3.2.3-1B	Table 6.6.3.2.3-1C	Table 6.6.3.2.3-1D		
...					
17	Table 6.6.3.2.3-1B	Table 6.6.3.2.3-1C	Table 6.6.3.2.3-1D		
18	Table 6.6.3.2.3-1B	Table 6.6.3.2.3-1C	Table 6.6.3.2.3-1D		
19	Table 6.6.3.2.3-1B	Table 6.6.3.2.3-1C	Table 6.6.3.2.3-1D		
20	Table 6.6.3.2.3-1B	Table 6.6.3.2.3-1C	Table 6.6.3.2.3-1D		
21	Table 6.6.3.2.3-1B	Table 6.6.3.2.3-1C	Table 6.6.3.2.3-1D		
22	Table 6.6.3.2.3-1B	Table 6.6.3.2.3-1C	Table 6.6.3.2.3-1D		

23	Table 6.6.3.2.3- 1B	Table 6.6.3.2.3- 1C	Table 6.6.3.2.3- 1D		
24	Table 6.6.3.2.3- 1B	Table 6.6.3.2.3- 1C	Table 6.6.3.2.3- 1D		
25	Table 6.6.3.2.3- 1B	Table 6.6.3.2.3- 1C	Table 6.6.3.2.3- 1D		
26	Table 6.6.3.2.3- 1C	Table 6.6.3.2.3- 1C	Table 6.6.3.2.3- 1D		
27	Table 6.6.3.2.3- 1C	Table 6.6.3.2.3- 1C	Table 6.6.3.2.3- 1D		
28	Table 6.6.3.2.3- 1C	Table 6.6.3.2.3- 1C	Table 6.6.3.2.3- 1D		
31	Table 6.6.3.2.3- 1D	Table 6.6.3.2.3- 1D	Table 6.6.3.2.3- 1D		
...					
33	Table 6.6.3.2.3- 1B	Table 6.6.3.2.3- 1C	Table 6.6.3.2.3- 1D		
34	Table 6.6.3.2.3- 1B	Table 6.6.3.2.3- 1C	Table 6.6.3.2.3- 1D		
35					
36					
37					
38	Table 6.6.3.2.3- 1B	Table 6.6.3.2.3- 1C	Table 6.6.3.2.3- 1D		
39	Table 6.6.3.2.3- 1B	Table 6.6.3.2.3- 1C	Table 6.6.3.2.3- 1D		
40	Table 6.6.3.2.3- 1B	Table 6.6.3.2.3- 1C	Table 6.6.3.2.3- 1D		
41	Table 6.6.3.2.3- 1B	Table 6.6.3.2.3- 1C	Table 6.6.3.2.3- 1D		
42	Table 6.6.3.2.3- 1B	Table 6.6.3.2.3- 1C	Table 6.6.3.2.3- 1D		
43	Table 6.6.3.2.3- 1B	Table 6.6.3.2.3- 1C	Table 6.6.3.2.3- 1D		
44	Table 6.6.3.2.3- 1C	Table 6.6.3.2.3- 1C	Table 6.6.3.2.3- 1D		

NOTE: The frequency range applicable with network signalled values of NS_05, NS_08, and NS_09 are covered in 6.6.3B.3 Additional Spurious Emissions for UL-MIMO.

6.6.3B.3 Additional spurious emissions for UL-MIMO

Editor's note: This clause is incomplete. for Rel-10 as it is also testing Rel-11 minimum requirements.

6.6.3B.3.1 Test purpose

To verify that UE transmitter with a UL-MIMO does not cause unacceptable interference to other channels or other systems in terms of transmitter spurious emissions under the deployment scenarios where additional requirements are specified.

6.6.3B.3.2 Test applicability

This test case applies to all types of E-UTRA UE release 10 and forward that support UL-MIMO.

6.6.3B.3.3 Minimum conformance requirements

For UE with multiple transmit antenna connectors, the requirements for Spurious emissions which are caused by unwanted transmitter effects such as harmonics emission, parasitic emissions, intermodulation products and frequency conversion products are specified at each transmit antenna connector.

For UEs with two transmit antenna connectors, the requirements in clause 6.6.3 apply to each transmit antenna with the UL-MIMO configurations specified in Table 6.2.2B-1 for closed-loop spatial multiplexing scheme.

The normative reference for this requirement is TS 36.101 [2] clause 6.6.3B.

6.6.3B.3.4 Test description

6.6.3B.3.4.1 Initial conditions

Initial conditions are a set of test configurations the UE needs to be tested in and the steps for the SS to take with the UE to reach the correct measurement state.

The initial test configurations consist of environmental conditions, test frequencies, and channel bandwidths based on E-UTRA operating bands specified in table 5.4.2.1-1. All of these configurations shall be tested with applicable test parameters for each channel bandwidth, and are shown in tables 6.6.3B.3.4.1-1 through table, 6.6.3B.3.4.1-12. The details of the uplink reference measurement channels (RMCs) are specified in Annexes A.2. Configurations of PDSCH and PDCCH before measurement are specified in Annex C.2.

Table 6.6.3B.3.4.1-1: Test Configuration Table (network signalled value "NS_05")

Initial Conditions						
Test Environment as specified in TS 36.508 [7] clause 4.1			Normal			
Test Frequencies as specified in TS 36.508 [7] clause 4.3.1			Low range, Mid range In case of Low range: <ul style="list-style-type: none"> - For 5MHz Channel Bandwidth: 1927.2MHz ($N_{UL} = 18072$) - For 10MHz Channel Bandwidth: 1934.7MHz ($N_{UL} = 18147$) - For 15MHz Channel Bandwidth: 1932.5MHz ($N_{UL} = 18125$) - For 20MHz Channel Bandwidth: 1930MHz ($N_{UL} = 18100$) 			
Test Channel Bandwidths as specified in TS 36.508 [7] clause 4.3.1			5MHz, 10MHz, 15MHz, 20MHz			
Test Parameters for Channel Bandwidths						
Ch BW	Downlink Configuration			Uplink Configuration		
	Mod'n	RB allocation		Mod'n	RB allocation	
		FDD	TDD		FDD	TDD
5MHz	N/A for Additional Spurious Emissions testing			QPSK	1	N/A
5MHz				QPSK	25	
10MHz				QPSK	1	
10MHz				QPSK	12	
10MHz				QPSK	48	
10MHz				QPSK	50	
10MHz				16QAM	50 (Note 3)	
15MHz				QPSK	1	
15MHz				QPSK	16	
15MHz				QPSK	30 (Note 4)	
15MHz			QPSK	48 (Note 5)		
15MHz			QPSK	75 (Note 5)		
15MHz			16QAM	75 (Note 3, 5)		
20MHz			QPSK	1		
20MHz			QPSK	18		
20MHz			QPSK	24 (Note 4)		
20MHz			QPSK	48 (Note 5)		
20MHz			QPSK	100 (Note 5)		
20MHz			16QAM	100 (Note 3, 5)		
Note 1: The 1 RB allocation shall be tested at both RB #0 and RB #max except for 15MHz and 20MHz of Low Range. For 15MHz of Low Range, the 1 RB allocation shall be tested at both RB#8 and RB#66. For 20MHz of Low Range, the 1 RB allocation shall be tested at both RB#24 and RB#75. Note 2: The RB _{start} of partial RB allocation shall be RB# 0 and RB# (max +1 - RB allocation) of the channel bandwidth except for 15MHz and 20MHz of Low Range. For 15MHz of Low Range, the RB _{start} shall be RB#8 and RB# (67 - RB allocation). For 20MHz of Low Range, the RB _{start} shall be RB#24 and RB# (76 - RB allocation). Note 3: Applies only for UE-Categories ≥ 2 . Note 4: Required for Low Range only. Note 5: Not available for Low Range.						

Table 6.6.3B.3.4.1-2: Test Configuration Table (network signalled value "NS_07")

Initial Conditions						
Test Environment as specified in TS 36.508 [7] clause 4.1				NC		
Test Frequencies as specified in TS 36.508 [7] clause 4.3.1				Mid range		
Test Channel Bandwidths as specified in TS 36.508 [7] clause 4.3.1				10MHz		
Test Parameters for Channel Bandwidths						
Test Number	Ch BW	Downlink Configuration		Uplink Configuration		
		Mod'n	RB allocation	Mod'n	RB allocation	TDD
1	10MHz	N/A for Additional Spurious Emissions testing.		QPSK	1	0
2	10MHz			QPSK	8	0
3	10MHz			QPSK	6	13
4	10MHz			QPSK	20	13
5	10MHz			QPSK	12	13
6	10MHz			16QAM	36 (Note 1)	13
7	10MHz			QPSK	16	19
8	10MHz			QPSK	12	19
9	10MHz			16QAM	16	19
10	10MHz			QPSK	30	19
11	10MHz			16QAM	30 (Note 1)	19
12	10MHz			QPSK	6	43
13	10MHz			QPSK	2	48
14	10MHz			QPSK	50	0
15	10MHz			QPSK	12	0
16	10MHz			16QAM	50 (Note 1)	0

Note 1: Applies only for UE-Categories ≥ 2 .

Table 6.6.3B.3.4.1-3: Test Configuration Table (network signalled value "NS_08")

Initial Conditions								
Test Environment as specified in TS 36.508 [7] clause 4.1				Normal				
Test Frequencies as specified in TS 36.508 [7] clause 4.3.1				High range				
Test Channel Bandwidths as specified in TS 36.508 [7] clause 4.3.1				5MHz, 10MHz, 15MHz				
Test Parameters for Channel Bandwidths								
Ch BW	Downlink Configuration			Uplink Configuration				
	Mod'n	RB allocation		Mod'n	RB allocation			
		FDD	TDD		FDD	TDD		
5MHz	N/A for Additional Spurious Emissions testing			QPSK	1	N/A		
5MHz				QPSK	8			
5MHz				QPSK	25			
10MHz				QPSK	1			
10MHz				QPSK	12			
10MHz				QPSK	40			
10MHz				QPSK	50			
10MHz				16QAM	50 (Note 3)			
15MHz				QPSK	1			
15MHz				QPSK	16			
15MHz				QPSK	40			
15MHz				QPSK	75			
15MHz				16QAM	75 (Note 3)			
<p>Note 1: The 1 RB allocation shall be tested at both RB #0 and RB #max.</p> <p>Note 2: The RBstart of partial RB allocation shall be RB#0 and RB# (max + 1 - RB allocation) of the channel bandwidth.</p> <p>Note 3: Applies only for UE-Categories ≥ 2.</p>								

Table 6.6.3B.3.4.1-4: Test Configuration Table (network signalled value "NS_09")

Initial Conditions						
Test Environment as specified in TS 36.508 [7] clause 4.1				Normal		
Test Frequencies as specified in TS 36.508 [7] clause 4.3.1				High range		
Test Channel Bandwidths as specified in TS 36.508 [7] clause 4.3.1				5MHz, 10MHz, 15MHz		
Test Parameters for Channel Bandwidths						
Ch BW	Downlink Configuration			Uplink Configuration		
	Mod'n	RB allocation		Mod'n	RB allocation	
		FDD	TDD		FDD	TDD
5MHz	N/A for Additional Spurious Emissions testing			QPSK	1	N/A
5MHz				QPSK	8	
5MHz				QPSK	25	
10MHz				QPSK	1	
10MHz				QPSK	12	
10MHz				QPSK	40	
10MHz				QPSK	50	
10MHz				16QAM	50 (Note 3)	
15MHz				QPSK	1	
15MHz				QPSK	16	
15MHz				QPSK	40	
15MHz				QPSK	54	
15MHz				QPSK	75	
15MHz				16QAM	75 (Note 3)	
Note 1: The 1 RB allocation shall be tested at both RB #0 and RB #max. Note 2: The RBstart of partial RB allocation shall be RB#0 and RB# (max + 1 - RB allocation) of the channel bandwidth. Note 3: Applies only for UE-Categories ≥2.						

Table 6.6.3B.3.4.1-5: Test Configuration Table (network signalled value "NS_12")

Initial Conditions						
Test Environment (as specified in TS 36.508 [7] clause 4.1)				NC		
Test Frequencies (as specified in TS 36.508 [7] clause 4.3.1)				Mid range		
Test Channel Bandwidths (as specified in TS 36.508 [7] clause 4.3.1)				1.4 MHz, 3 MHz and 5 MHz		
Test Parameters for Channel Bandwidths						
Test Number	Ch BW	Downlink Configuration		Uplink Configuration		
		Mod'n	RB allocation	Mod'n	RB allocation FDD	RB _{start} FDD
1	1.4 MHz	N/A for Additional Spurious Emissions testing		QPSK	1	0
2	1.4 MHz			QPSK	6	0
3	1.4 MHz			QPSK	1	1
4	1.4 MHz			QPSK	5	1
5	1.4 MHz			16QAM	6	0
6	3 MHz			QPSK	4	0
7	3 MHz			QPSK	10	0
8	3 MHz			QPSK	4	4
9	3 MHz			QPSK	10	4
10	3 MHz			16QAM	15	0
11	5 MHz			QPSK	8	0
12	5 MHz			QPSK	15	0
13	5 MHz			QPSK	8	7
14	5 MHz			QPSK	15	7
15	5 MHz			16QAM	25	0

Table 6.6.3B.3.4.1-6: Test Configuration Table (network signalled value "NS_13")

Initial Conditions						
Test Environment (as specified in TS 36.508 [7] clause 4.1)			NC			
Test Frequencies (as specified in TS 36.508 [7] clause 4.3.1)			Mid range			
Test Channel Bandwidths (as specified in TS 36.508 [7] clause 4.3.1)			5 MHz			
Test Parameters for Channel Bandwidths						
Test Number	Ch BW	Downlink Configuration		Uplink Configuration		
		Mod'n	RB allocation	Mod'n	RB allocation FDD	RB _{start} FDD
1	5 MHz	N/A for Additional Spurious Emissions testing		QPSK	1	0
2	5 MHz			QPSK	25	0
3	5 MHz			QPSK	15	0
4	5 MHz			QPSK	15	7
5	5 MHz			16QAM	25	0

Table 6.6.3B.3.4.1-7: Test Configuration Table (network signalled value "NS_14")

Initial Conditions						
Test Environment (as specified in TS 36.508 [7] clause 4.1)			NC			
Test Frequencies (as specified in TS 36.508 [7] clause 4.3.1)			Mid range			
Test Channel Bandwidths (as specified in TS 36.508 [7] clause 4.3.1)			10 MHz, 15 MHz			
Test Parameters for Channel Bandwidths						
Test Number	Ch BW	Downlink Configuration		Uplink Configuration		
		Mod'n	RB allocation	Mod'n	RB allocation FDD	RB _{start} FDD
1	10 MHz	N/A for Additional Spurious Emissions testing		QPSK	1	0
2	10 MHz			QPSK	25	0
3	10 MHz			QPSK	50	0
4	10 MHz			QPSK	25	1
5	10 MHz			16QAM	50	0
(Note 1)						
6	15 MHz			QPSK	8	0
7	15 MHz			QPSK	25	0
8	15 MHz			QPSK	75	0
9	15 MHz			QPSK	50	15
10	15 MHz	16QAM	75	0		
(Note 1)						
Note 1: Applies only for UE-Categories ≥2.						

Table 6.6.3B.3.4.1-8: Test Configuration Table (network signalled value "NS_15")

Initial Conditions						
Test Environment (as specified in TS 36.508 [7] subclause 4.1)		NC				
Test Frequencies (as specified in TS36.508 [7] subclause 4.3.1)		For 1.4 MHz Channel Bandwidth: High range For 3 MHz Channel Bandwidth: 843.5 MHz (N _{UL} = 26985) or High range For 5 MHz Channel Bandwidth: 842.5 MHz (N _{UL} = 26975) or High range For 10 MHz Channel Bandwidth: 840 MHz (NUL = 26950) or High range For 15 MHz Channel Bandwidth: 837.5 MHz (NUL = 26925) or High range				
Test Channel Bandwidths (as specified in TS 36.508 [7] subclause 4.3.1)		1.4 MHz, 3 MHz, 5 MHz, 10 MHz, 15 MHz				
Test Parameters for Channel Bandwidths						
Configuration ID	Ch BW	Downlink Configuration		Uplink Configuration		
		Mod'n	RB allocation	Mod'n	RB allocation FDD	RBstart FDD
1 (note 3)	1.4 MHz	N/A for A-MPR testing.		QPSK	4	0
2 (note 3)	1.4 MHz			16QAM	6	0
3 (note 3)	3 MHz			QPSK	6	7
4 (note 3)	3 MHz			QPSK	12	1
5 (note 3)	3 MHz			16QAM	15	0
6 (note 2)	3 MHz			QPSK	15	0
7 (note 3)	5 MHz			QPSK	6	14
8 (note 3)	5 MHz			QPSK	20	0
9 (note 3)	5 MHz			16QAM	25	0
10 (note 2)	5 MHz			QPSK	16	9
11 (note 2)	5 MHz			QPSK	25	0
12 (note 3)	10 MHz			QPSK	1	49
13 (note 3)	10 MHz			QPSK	1	0
14 (note 3)	10 MHz			QPSK	3	0
15 (note 3)	10 MHz			QPSK	20	3
16 (note 3)	10 MHz			QPSK	36	1
17 (note 3)	10 MHz			QPSK	50	0
18 (note 3)	10 MHz			16QAM	50	0
19 (note 2)	10 MHz			QPSK	20	25
20 (note 2)	10 MHz			QPSK	45	0
21 (note 3)	15 MHz			QPSK	18	36
22 (note 3)	15 MHz			QPSK	25	1
23 (note 3)	15 MHz			QPSK	54	0
24 (note 3)	15 MHz			16QAM	75	0
25 (note 2)	15 MHz			QPSK	18	44

26 (note 2)	15 MHz		QPSK	60	2
Note 1: Applies only for UE-Categories ≥ 2 .					
Note 2: Applicable only test frequency < high range					
Note 3: Applicable only to high range frequency testing					

Table 6.6.3B.3.4.1-9: Test Configuration Table (network signalled value "NS_16")

Initial Conditions						
Test Environment (as specified in TS 36.508 [7] subclause 4.1)				NC		
Test Frequencies (as specified in TS36.508 [7] subclause 4.3.1)				For 1.4 MHz Channel Bandwidth: Low range For 3 MHz Channel Bandwidth: Low range, 810 MHz ($N_{UL}= 27070$) For 5 MHz Channel Bandwidth: Low range, 811 MHz ($N_{UL}= 27080$) , 814.5 MHz ($N_{UL}= 27115$) For 10 MHz Channel Bandwidth: Low range, 813.5 MHz ($N_{UL}= 27105$), 817 MHz ($N_{UL}= 27140$)		
Test Channel Bandwidths (as specified in TS 36.508 [7] subclause 4.3.1)				1.4 MHz, 3 MHz, 5 MHz, 10 MHz		
Test Parameters for Channel Bandwidths						
Configuration ID	Ch BW	Downlink Configuration		Uplink Configuration		
		Mod'n	RB allocation	Mod'n	RB allocation FDD	RBstart FDD
1	1.4 MHz	N/A for Additional Spurious Emissions A-MPR testing.		QPSK	1	0
2	1.4 MHz			QPSK	6	0
3 (Note 1)	1.4 MHz			16QAM	6	0
4	3 MHz			QPSK	1	0
5	3 MHz			QPSK	12	1
6	3 MHz			QPSK	15	0
7 (Note 1)	3 MHz			16QAM	15	0
8	5 MHz			QPSK	1	0
9	5 MHz			QPSK	12	2
10	5 MHz			QPSK	18	2
11	5 MHz			QPSK	20	0
12	5 MHz			QPSK	20	2
13	5 MHz			QPSK	25	0
14 (Note 1)	5 MHz			16QAM	25	0
15	10 MHz			QPSK	1	0
16 (Note 2)	10 MHz			QPSK	1	10

17 (Note 2)	10 MHz	QPSK	20	0
18 (Note 2)	10 MHz	QPSK	27	15
19 (Note 2)	10 MHz	QPSK	32	15
20	10 MHz	QPSK	32	0
21	10 MHz	QPSK	50	0
22 (Note 1)	10 MHz	16QAM	50	0
23 (Note 3)	10 MHz	QPSK	40	0
24 Note 3)	10 MHz	QPSK	40	1
Note 1: Applies only for UE-Categories ≥ 2 . Note 2: Applies only for 10 MHz channel for Low Range, and 813.5 MHz Note 3: Applies only for 10 MHz channel for 817 MHz range				

Table 6.6.3B.3.4.1-10: Test Configuration Table (network signalled value "NS_17")

Initial Conditions					
Test Environment (as specified in TS 36.508[7] subclause 4.1)				Normal	
Test Frequencies (as specified in TS 36.508 [7] subclause 4.3.1)				Low range	
Test Channel Bandwidths (as specified in TS 36.508 [7] subclause 4.3.1)				5MHz, 10MHz	
Test Parameters for Channel Bandwidths					
Configuration ID	Ch BW	Downlink Configuration		Uplink Configuration	
		Mod'n	RB allocation FDD	Mod'n	RB allocation FDD
1	5MHz	N/A for Additional Spurious Emissions testing		QPSK	1
2	5MHz			QPSK	8
3	5MHz			QPSK	25
4	5MHz			16QAM	25 (Note 3)
5	10MHz			QPSK	1
6	10MHz			QPSK	12
7	10MHz			QPSK	50
8	10MHz			16QAM	50 (Note 3)
Note 1: The 1 RB allocation shall be tested at both RB #0 and RB #max. Note 2: The RBstart of partial RB allocation shall be RB# 0 and RB# (max +1 - RB allocation) of the channel bandwidth. Note 3: Applies only for UE-Categories ≥ 2 .					

Table 6.6.3B.3.4.1-11: Test Configuration Table (network signalled value "NS_18")

Initial Conditions

Test Environment (as specified in TS 36.508[7] subclause 4.1)				Normal	
Test Frequencies (as specified in TS 36.508 [7] subclause 4.3.1)				Low range	
Test Channel Bandwidths (as specified in TS 36.508 [7] subclause 4.3.1)				5MHz, 10MHz, 15MHz, 20MHz	
Test Parameters for Channel Bandwidths					
Configuration ID	Ch BW	Downlink Configuration		Uplink Configuration	
		Mod'n	RB allocation FDD	Mod'n	RB allocation FDD
1	5MHz	N/A for Additional Spurious Emissions testing		QPSK	1
2	5MHz			QPSK	8
3	5MHz			QPSK	25
4	5MHz			16QAM	25 (Note 3)
5	10MHz			QPSK	1
6	10MHz			QPSK	12
7	10MHz			QPSK	50
8	10MHz			16QAM	50 (Note 3)
9	15MHz			QPSK	1
10	15MHz			QPSK	16
11	15MHz			QPSK	75
12	15MHz			16QAM	75 (Note 3)
13	20MHz			QPSK	1
14	20MHz			QPSK	18
15	20MHz			QPSK	100
16	20MHz			16QAM	100 (Note 3)
<p>Note 1: The 1 RB allocation shall be tested at both RB #0 and RB #max.</p> <p>Note 2: The RBstart of partial RB allocation shall be RB# 0 and RB# (max +1 - RB allocation) of the channel bandwidth.</p> <p>Note 3: Applies only for UE-Categories ≥ 2.</p>					

Table 6.6.3B.3.4.1-12: Test Configuration Table (network signalled value "NS_19")

FFS

Editor's note: The following lines belong at the end of section 6.2.4.4.1. As new tables are added to this section, these lines should always follow the tables.

1. Connect the SS to the UE antenna connectors as shown in Figure TS 36.508 [7] Annex A, Figure A.38.
2. The parameter settings for the cell are set up according to TS 36.508 [7] clause 4.4.3.
3. Downlink signals are initially set up according to Annex C0, C.1 and C.3.0, and uplink signals according to Annex H.1 and H.3.0.
4. The UL Reference Measurement channels are set according to Tables 6.6.3B.3.4.1-1 through Table, 6.6.3B.3.4.1-8 depending on network signal value.
5. Propagation conditions are set according to Annex B.0.

6. Ensure the UE is in State 3A-RF according to TS 36.508 [7] clause 5.2A.2. Message contents are defined in clause 6.6.3B.3.4.3.

6.6.3B.3.4.2 Test procedure

1. SS sends uplink scheduling information for each UL HARQ process via PDCCH DCI format 4 for C_RNTI to schedule the UL RMC according to Tables 6.6.3B.3.4.1-1 through table, 6.6.3B.3.4.1-8. Since the UE has no payload and no loopback data to send the UE sends uplink MAC padding bits on the UL RMC.
2. Send continuously uplink power control "up" commands in the uplink scheduling information to the UE until the UE transmits at P_{UMAX} level.
3. Measure the mean power of the UE in the channel bandwidth of the radio access mode according to the test configuration, which shall meet the requirements described in Tables 6.2.4B.5-1 to 6.2.4B.5-9 as appropriate. The period of the measurement shall be at least one sub-frame (1ms).
4. Measure the power of the transmitted signal at each UE antenna connector with a measurement filter of bandwidths according to Tables 6.6.3B.3.5.1-1 through table, 6.6.3B.3.5.1-8 as appropriate. The centre frequency of the filter shall be stepped in contiguous steps according to the same table. For NS_07 measurements made in a bandwidth of 6.25kHz, measurement parameter settings defined in table 6.6.3B.3.4.2-1 shall be used. The measured power shall be verified for each step. The measurement period shall capture the active time slots.

Table 6.6.3B.3.4.2-1: Measurement setup for NS_07

	Option 1: Measurement with No RMS VBW available	Option 2: Measurement with VBW Filtering on Power scale
VBW	≥ 62.5 kHz (10 times or more the RBW)	≤ 43 Hz
RBW	≤ 6.25 kHz	≤ 6.25 kHz
Detector type	Averages signal envelope during each measurement point, such as "RMS detector"	Peak
Averaging mode (Trace averaging)	Power (RMS voltage)	Power (RMS voltage), as controlled by "Average Type"
Average Type (applies to detector)	Power (RMS voltage) (automatically occurs with "RMS detector")	Not applicable
Average Type (applies to VBW filter)	Not applicable	Power (RMS voltage)
Number of averages	30, to reduce variance as required, or use an even longer sweep time	1 or use an even narrower VBW filter, thus a longer sweep time
Sweep time	[Don't specify]	Sweep rate (span divided by sweep time) $\leq 0.8 * RBW * VBW$

6.6.3B.3.4.3 Message contents

6.6.3B.3.4.3.1 Message contents (network signalled value "NS_05")

Message contents are according to TS 36.508 [7] subclause 4.6, with the following exceptions:

1. Information element `additionalSpectrumEmission` is set to NS_05. This can be set in the `SystemInformationBlockType2` as part of the cell broadcast message. This exception indicates that the UE shall meet the additional spurious emission requirement for a specific deployment scenario.

Table 6.6.3B.3.4.3.1-1: SystemInformationBlockType2 :Additional spurious emissions requirement

Derivation Path: TS 36.508 [7] clause 4.4.3.3, Table 4.4.3.3-1			
Information Element	Value/remark	Comment	Condition
additionalSpectrumEmission	5 (NS_05)		

6.6.3B.3.4.3.2 Message contents (network signalled value "NS_07")

Message contents are according to TS 36.508 [7] subclause 4.6, with the following exceptions:

1. Information element additionalSpectrumEmission is set to NS_07. This can be set in the *SystemInformationblockType2* as part of the cell broadcast message. This exception indicates that the UE shall meet the additional spurious emission requirement for a specific deployment scenario.

Table 6.6.3B.3.4.3.2-1: SystemInformationBlockType2 :Additional spurious emissions requirement

Derivation Path: TS 36.508 [7] clause 4.4.3.3, Table 4.4.3.3-1			
Information Element	Value/remark	Comment	Condition
additionalSpectrumEmission	7 (NS_07)		

6.6.3B.3.4.3.3 Message contents (network signalled value "NS_08")

Message contents are according to TS 36.508 [7] subclause 4.6, with the following exceptions:

1. Information element additionalSpectrumEmission is set to NS_08. This can be set in the *SystemInformationblockType2* as part of the cell broadcast message. This exception indicates that the UE shall meet the additional spurious emission requirement for a specific deployment scenario.

Table 6.6.3B.3.4.3.3-1: SystemInformationBlockType2 :Additional spurious emissions requirement

Derivation Path: TS 36.508 [7] clause 4.4.3.3, Table 4.4.3.3-1			
Information Element	Value/remark	Comment	Condition
additionalSpectrumEmission	8 (NS_08)		

6.6.3B.3.4.3.4 Message contents (network signalled value "NS_09")

Message contents are according to TS 36.508 [7] subclause 4.6, with the following exceptions:

1. Information element additionalSpectrumEmission is set to NS_09. This can be set in the *SystemInformationblockType2* as part of the cell broadcast message. This exception indicates that the UE shall meet the additional spurious emission requirement for a specific deployment scenario.

Table 6.6.3B.3.4.3.4-1: SystemInformationBlockType2 :Additional spurious emissions requirement

Derivation Path: TS 36.508 [7] clause 4.4.3.3, Table 4.4.3.3-1			
Information Element	Value/remark	Comment	Condition
additionalSpectrumEmission	9 (NS_09)		

6.6.3B.3.4.3.5 Message contents exceptions (network signalled value "NS_12")

1. Information element additionalSpectrumEmission is set to NS_12. This can be set in the *SystemInformationblockType2* as part of the cell broadcast message. This exception indicates that the UE shall meet the additional spurious emission requirement for a specific deployment scenario.

Table 6.6.3B.3.4.3.5-1: SystemInformationBlockType2 :Additional spurious emissions test requirement for "NS_12"

Derivation Path: TS 36.508 [7] clause 4.4.3.3, Table 4.4.3.3-1			
Information Element	Value/remark	Comment	Condition
additionalSpectrumEmission	12 (NS_12)		

6.6.3B.3.4.3.6 Message contents exceptions (network signalled value "NS_13")

- Information element additionalSpectrumEmission is set to NS_13. This can be set in the *SystemInformationblockType2* as part of the cell broadcast message. This exception indicates that the UE shall meet the additional spurious emission requirement for a specific deployment scenario.

Table 6.6.3B.3.4.3.6-1: SystemInformationBlockType2 :Additional spurious emissions test requirement for "NS_13"

Derivation Path: TS 36.508 [7] clause 4.4.3.3, Table 4.4.3.3-1			
Information Element	Value/remark	Comment	Condition
additionalSpectrumEmission	13 (NS_13)		

6.6.3B.3.4.3.7 Message contents exceptions (network signalled value "NS_14")

- Information element additionalSpectrumEmission is set to NS_14. This can be set in the *SystemInformationblockType2* as part of the cell broadcast message. This exception indicates that the UE shall meet the additional spurious emission requirement for a specific deployment scenario.

Table 6.6.3B.3.4.3.7-1: SystemInformationBlockType2 :Additional spurious emissions test requirement for "NS_14"

Derivation Path: TS 36.508 [7] clause 4.4.3.3, Table 4.4.3.3-1			
Information Element	Value/remark	Comment	Condition
additionalSpectrumEmission	14 (NS_14)		

6.6.3B.3.4.3.8 Message contents exceptions (network signalled value "NS_15")

- Information element additionalSpectrumEmission is set to NS_15. This can be set in the *SystemInformationblockType2* as part of the cell broadcast message. This exception indicates that the UE shall meet the additional spurious emission requirement for a specific deployment scenario.

Table 6.6.3B.3.4.3.8-1: SystemInformationBlockType2 :Additional spurious emissions test requirement for "NS_15"

Derivation Path: TS 36.508 [7] clause 4.4.3.3, Table 4.4.3.3-1			
Information Element	Value/remark	Comment	Condition
additionalSpectrumEmission	15 (NS_15)		

6.6.3B.3.4.3.9 Message contents exceptions (network signalled value "NS_16")

- Information element additionalSpectrumEmission is set to NS_16. This can be set in the *SystemInformationblockType2* as part of the cell broadcast message. This exception indicates that the UE shall meet the additional spurious emission requirement for a specific deployment scenario.

Table 6.6.3B.3.4.3.9-1: SystemInformationBlockType2 :Additional spurious emissions test requirement for "NS_16"

Derivation Path: TS 36.508 [7] clause 4.4.3.3, Table 4.4.3.3-1			
Information Element	Value/remark	Comment	Condition
additionalSpectrumEmission	16 (NS_16)		

6.6.3B.3.4.3.10 Message contents exceptions (network signalled value "NS_17")

1. Information element `additionalSpectrumEmission` is set to NS_17. This can be set in the *SystemInformationBlockType2* as part of the cell broadcast message. This exception indicates that the UE shall meet the additional spurious emission requirement for a specific deployment scenario.

Table 6.6.3B.3.4.3.10-1: SystemInformationBlockType2 :Additional spurious emissions test requirement for "NS_17"

Derivation Path: TS 36.508 [7] clause 4.4.3.3, Table 4.4.3.3-1			
Information Element	Value/remark	Comment	Condition
<code>additionalSpectrumEmission</code>	17 (NS_17)		

6.6.3B.3.4.3.11 Message contents exceptions (network signalled value "NS_18")

1. Information element `additionalSpectrumEmission` is set to NS_18. This can be set in the *SystemInformationBlockType2* as part of the cell broadcast message. This exception indicates that the UE shall meet the additional spurious emission requirement for a specific deployment scenario.

Table 6.6.3B.3.4.3.11-1: SystemInformationBlockType2 :Additional spurious emissions test requirement for "NS_18"

Derivation Path: TS 36.508 [7] clause 4.4.3.3, Table 4.4.3.3-1			
Information Element	Value/remark	Comment	Condition
<code>additionalSpectrumEmission</code>	18 (NS_18)		

6.6.3B.3.4.3.12 Message contents exceptions (network signalled value "NS_19")

1. Information element `additionalSpectrumEmission` is set to NS_19. This can be set in the *SystemInformationBlockType2* as part of the cell broadcast message. This exception indicates that the UE shall meet the additional spurious emission requirement for a specific deployment scenario.

Table 6.6.3B.3.4.3.12-1: SystemInformationBlockType2: Additional spurious emissions test requirement for "NS_19"

Derivation Path: TS 36.508 [7] clause 4.4.3.3, Table 4.4.3.3-1			
Information Element	Value/remark	Comment	Condition
<code>additionalSpectrumEmission</code>	19 (NS_19)		

6.6.3B.3.5 Test requirement

6.6.3B.3.5.1 Test requirement (network signalled value "NS_05")

When "NS_05" is indicated in the cell:

- the measured UE mean power in the channel bandwidth, derived in step 3, shall fulfil requirements in Table 6.2.4B.5-4 as appropriate,
- and
- the measured average power of spurious emission, derived in step 2, shall not exceed the described value in Table 6.6.3B.3.5.1-1. This requirement also applies for the frequency ranges that are less than Δf_{OOB} (MHz) in Table 6.6.3.1.3-1 from the edge of the channel bandwidth.

Table 6.6.3B.3.5.1-1: Additional requirements (PHS) test requirements

Frequency band (MHz)	Channel bandwidth / Spectrum emission limit (dBm)				Measurement bandwidth
	5 MHz	10 MHz	15 MHz	20 MHz	
$1884.5 \leq f \leq 1915.7^*1$	-41	-41	-41	-41	300 KHz
Note 1: Applicable when the lower edge of the assigned E-UTRA UL channel bandwidth frequency is larger than or equal to the upper edge of PHS band (1915.7 MHz) + 4 MHz + the Channel BW assigned, where Channel BW is as defined in clause 5.4.2. Additional restrictions apply for operations below this point.					

The requirements in Table 6.6.3B.3.5.1-1 apply with the additional restrictions specified in Table 6.6.3B.3.5.1-2 when the lower edge of the assigned E-UTRA UL channel bandwidth frequency is less than the upper edge of PHS band (1915.7 MHz) + 4 MHz + the channel BW assigned.

Table 6.6.3B.3.5.1-2: RB restrictions for additional requirement (PHS)

15 MHz channel bandwidth with $f_c = 1932.5$ MHz			
RB _{start}	0-7	8-66	67-74
LCRB	N/A	$\leq \text{MIN}(30, 67 - \text{RB}_{\text{start}})$	N/A
20 MHz channel bandwidth with $f_c = 1930$ MHz			
RB _{start}	0-23	24-75	76-99
LCRB	N/A	$\leq \text{MIN}(24, 76 - \text{RB}_{\text{start}})$	N/A

NOTE: (only for testing requirements in Table 6.6.3B.3.5.1-1):
 For measurement conditions at the edge of each frequency range, the lowest frequency of the measurement position in each frequency range should be set at the lowest boundary of the frequency range plus MBW/2. The highest frequency of the measurement position in each frequency range should be set at the highest boundary of the frequency range minus MBW/2. MBW denotes the measurement bandwidth (300 kHz).

6.6.3B.3.5.2 Test requirement (network signalled value "NS_07")

When "NS_07" is indicated in the cell:

- the measured UE mean power in the channel bandwidth, derived in step 3, shall fulfil requirements in Table 6.2.4B.5-7 as appropriate,
- and
- the measured average power of spurious emission, derived in step 4, shall not exceed the described value in Table 6.6.3B.3.5.2-1. These requirements also apply for the frequency ranges that are less than Δf_{OOB} (MHz) in Table 6.6.3.1.3-1 from the edge of the channel bandwidth.

Table 6.6.3B.3.5.2-1: Additional requirements (network signalled value "NS_07")

Frequency band (MHz)	Channel bandwidth / Spectrum emission limit (dBm)	Measurement bandwidth
	10 MHz	
$769 \leq f \leq 775$	-55.5	6.25 kHz
Note: The emissions measurement shall be sufficiently power averaged to ensure a standard deviation < 0.5 dB.		

NOTE: (only for testing requirements in Table 6.6.3B.3.5.2-1):
 For measurement conditions at the edge of each frequency range, the lowest frequency of the measurement position in each frequency range should be set at the lowest boundary of the frequency range plus MBW/2. The highest frequency of the measurement position in each frequency range should be set at the highest boundary of the frequency range minus MBW/2. MBW denotes the measurement bandwidth (6.25 kHz).

6.6.3B.3.5.3 Test requirement (network signalled value "NS_08")

When "NS_08" is indicated in the cell:

- the measured UE mean power in the channel bandwidth, derived in step 3, shall fulfil requirements in Table 6.2.4B.5-8 as appropriate,
- and
- the measured average power of spurious emission, derived in step 4, shall not exceed the described value in Table 6.6.3B.3.5.3-1. This requirement also applies for the frequency ranges that are less than Δf_{OOB} (MHz) in Table 6.6.3.1.3-1 from the edge of the channel bandwidth.

Table 6.6.3B.3.5.3-1: Additional requirements (network signalled value "NS_08")

Frequency band (MHz)	Channel bandwidth / Spectrum emission limit (dBm)			Measurement bandwidth
	5MHz	10MHz	15MHz	
$860 \leq f \leq 890$	-40	-40	-40	1 MHz

NOTE: (only for testing requirements in Table 6.6.3B.3.5.3-1):

For measurement conditions at the edge of each frequency range, the lowest frequency of the measurement position in each frequency range should be set at the lowest boundary of the frequency range plus MBW/2. The highest frequency of the measurement position in each frequency range should be set at the highest boundary of the frequency range minus MBW/2. MBW denotes the measurement bandwidth (1 MHz).

6.6.3B.3.5.4 Test requirement (network signalled value "NS_09")

When "NS_09" is indicated in the cell:

- the measured UE mean power in the channel bandwidth, derived in step 3, shall fulfil requirements in Table 6.2.4B.5-9 as appropriate,
- and
- the measured average power of spurious emission, derived in step 4, shall not exceed the described value in table 6.6.3B.3.5.4-1. This requirement also applies for the frequency ranges that are less than Δf_{OOB} (MHz) in Table 6.6.3.1.3-1 from the edge of the channel bandwidth.

Table 6.6.3B.3.5.4-1: Additional requirements (network signalled value "NS_09")

Frequency band (MHz)	Channel bandwidth / Spectrum emission limit (dBm)			Measurement bandwidth
	5MHz	10MHz	15MHz	
$1475.9 \leq f \leq 1510.9$	-35	-35	-35	1 MHz

NOTE 1: (only for testing requirements in Table 6.6.3B.3.5.4-1):

For measurement conditions at the edge of each frequency range, the lowest frequency of the measurement position in each frequency range should be set at the lowest boundary of the frequency range plus MBW/2. The highest frequency of the measurement position in each frequency range should be set at the highest boundary of the frequency range minus MBW/2. MBW denotes the measurement bandwidth (1 MHz).

NOTE 2: To improve measurement accuracy, A-MPR values for NS_09 specified in Table 6.2.4B.3-1 in clause 6.2.4B are derived based on both the above NOTE 1 and 100 kHz RBW.

6.6.3B.3.5.5 Test requirement (network signalled value "NS_12")

When "NS 12" is indicated in the cell:

- the measured UE mean power in the channel bandwidth, derived in step 3, shall fulfil requirements in Table 6.2.4B.5-12 as appropriate,
- and

- the power of any UE emission shall not exceed the levels specified in Table 6.6.3B.3.5-1. This requirement also applies for the frequency ranges that are less than Δf_{OOB} (MHz) in Table 6.6.3.1.3-1 from the edge of the channel bandwidth.

Table 6.6.3B.3.5.5-1: Additional requirements

Frequency band (MHz)	Channel bandwidth / Spectrum emission limit (dBm)	Measurement bandwidth	Note
	1.4, 3, 5 MHz		
$806 \leq f \leq 813.5$	-42	6.25 kHz	1
NOTE 1: The emission limit applies at an offset of 0.7 MHz below any block of E-UTRA carriers.			

6.6.3B.3.5.6 Test requirement (network signalled value "NS_13")

When "NS 13" is indicated in the cell:

- the measured UE mean power in the channel bandwidth, derived in step 3, shall fulfil requirements in Table 6.2.4B.5-13 as appropriate,
- and
- the power of any UE emission shall not exceed the levels specified in Table 6.6.3B.3.5.6-1. This requirement also applies for the frequency ranges that are less than Δf_{OOB} (MHz) in Table 6.6.3.1.3-1 from the edge of the channel bandwidth.

Table 6.6.3B.3.5.6-1: Additional requirements

Frequency band (MHz)	Channel bandwidth / Spectrum emission limit (dBm)	Measurement bandwidth	Note
	5 MHz		
$806 \leq f \leq 816$	-42	6.25 kHz	1
NOTE 1: The emission limit applies at an offset of 3 MHz below any block of E-UTRA carriers.			

6.6.3B.3.5.7 Test requirement (network signalled value "NS_14")

When "NS 14" is indicated in the cell:

- the measured UE mean power in the channel bandwidth, derived in step 3, shall fulfil requirements in Table 6.2.4B.5-14 as appropriate,
- and
- the power of any UE emission shall not exceed the levels specified in Table 6.6.3B.3.5.7-1. This requirement also applies for the frequency ranges that are less than Δf_{OOB} (MHz) in Table 6.6.3.1.3-1 from the edge of the channel bandwidth.

Table 6.6.3B.3.5.7-1: Additional requirements

Frequency band (MHz)	Channel bandwidth / Spectrum emission limit (dBm)	Measurement bandwidth	Note
	10, 15 MHz		
$806 \leq f \leq 816$	-42	6.25 kHz	1
NOTE 1: The emission limit applies at an offset of 8 MHz below any block of E-UTRA carriers.			

6.6.3B.3.5.8 Test requirement (network signalled value "NS_15")

When "NS 15" is indicated in the cell:

- the measured UE mean power in the channel bandwidth, derived in step 3, shall fulfil requirements in Table 6.2.4B.5-15 as appropriate,

and

- the power of any UE emission shall not exceed the levels specified in Table 6.6.3B.3.5.8-1. This requirement also applies for the frequency ranges that are less than Δf_{OOB} (MHz) in Table 6.6.3.1.3-1 from the edge of the channel bandwidth.

Table 6.6.3B.3.5.8-1: Additional requirements

Frequency band (MHz)	Channel bandwidth / Spectrum emission limit (dBm)	Measurement bandwidth	Note
	1.4, 3, 5, 10, 15 MHz		
$851 \leq f \leq 859$	-53	6.25 kHz	
NOTE: The emissions measurement shall be sufficiently power averaged to ensure standard deviation < 0.5 dB.			

6.6.3B.3.5.9 Test requirement (network signalled value "NS_16")

When "NS 16" is indicated in the cell:

- the measured UE mean power in the channel bandwidth, derived in step 3, shall fulfil requirements in Table 6.2.4B.5-16 as appropriate,

and

- the power of any UE emission shall not exceed the levels specified in Table 6.6.3B.3.5.9-1. This requirement also applies for the frequency ranges that are less than Δf_{OOB} (MHz) in Table 6.6.3.1.3-1 from the edge of the channel bandwidth.

Table 6.6.3B.3.5.9-1: Additional requirements

Frequency band (MHz)	Channel bandwidth / Spectrum emission limit (dBm)	Measurement bandwidth	Note
	1.4, 3, 5, 10 MHz		
$790 \leq f \leq 803$	-32	1 MHz	

6.6.3B.3.5.10 Test requirement (network signalled value "NS_17")

When "NS 17" is indicated in the cell:

the measured UE mean power in the channel bandwidth, derived in step 3, shall fulfil requirements in Table 6.2.4B.5-17 as appropriate,

and

- the power of any UE emission shall not exceed the levels specified in Table 6.6.3B.3.5.10-1. This requirement also applies for the frequency ranges that are less than Δf_{OOB} (MHz) in Table 6.6.3.1.3-1 from the edge of the channel bandwidth.

Table 6.6.3B.3.5.10-1: Additional requirements

Frequency band (MHz)	Channel bandwidth / Spectrum emission limit (dBm)	Measurement bandwidth	Note
	5, 10 MHz		
$470 \leq f \leq 710$	-26.2	6 MHz	1
NOTE 1: Applicable when the assigned E-UTRA carrier is confined within 718 MHz and 748 MHz and when the channel bandwidth used is 5 or 10 MHz.			

6.6.3B.3.5.11 Test requirement (network signalled value "NS_18")

When "NS 18" is indicated in the cell:

the measured UE mean power in the channel bandwidth, derived in step 3, shall fulfil requirements in Table 6.2.4B.5-18 as appropriate,

and

- the power of any UE emission shall not exceed the levels specified in Table 6.6.3B.3.5.11-1. This requirement also applies for the frequency ranges that are less than Δf_{OOB} (MHz) in Table 6.6.3.1.3-1 from the edge of the channel bandwidth.

Table 6.6.3B.3.5.11-1: Additional requirements

Frequency band (MHz)	Channel bandwidth / Spectrum emission limit (dBm)	Measurement bandwidth	Note
	5, 10, 15, 20 MHz		
692-698	-26.2	6 MHz	

6.6.3B.3.5.12 Test requirement (network signalled value "NS_19")

When "NS_19" is indicated in the cell:

- the measured UE mean power in the channel bandwidth, derived in step 3, shall fulfil requirements in Table 6.2.4B.5-18 as appropriate,

and

- the power of any UE emission shall not exceed the levels specified in Table 6.6.3B.3.5.12-1. This requirement also applies for the frequency ranges that are less than F_{OOB} (MHz) in Table 6.6.3.1.3-1 from the edge of the channel bandwidth.

Table 6.6.3B.3.5.12-1: Additional requirements

Frequency band (MHz)	Channel bandwidth / Spectrum emission limit (dBm)	Measurement bandwidth	Note
	3, 5, 10, 15, 20 MHz		
$662 \leq f \leq 694$	-25	8 MHz	

6.7 Transmit intermodulation

6.7.1 Test purpose

To verify that the UE transmit intermodulation does not exceed the described value in the test requirement.

The transmit intermodulation performance is a measure of the capability of the transmitter to inhibit the generation of signals in its non linear elements caused by presence of the wanted signal and an interfering signal reaching the transmitter via the antenna.

6.7.2 Test applicability

This test applies to all types of E-UTRA UE release 8 and forward.

6.7.3 Minimum conformance requirements

User Equipment(s) transmitting in close vicinity of each other can produce intermodulation products, which can fall into the UE, or eNode B receive band as an unwanted interfering signal. The UE intermodulation attenuation is defined by

the ratio of the mean power of the wanted signal to the mean power of the intermodulation product when an interfering CW signal is added at a level below the wanted signal at each of the transmitter antenna port with the other antenna port(s) if any is terminated. Both the wanted signal power and the intermodulation product power are measured through E-UTRA rectangular filter with measurement bandwidth shown in Table 6.7.3-1.

The requirement of transmitting intermodulation is prescribed in Table 6.7.3-1.

Table 6.7.3-1: Transmit Intermodulation

BWChannel (UL)	5MHz		10MHz		15MHz		20MHz	
Interference Signal Frequency Offset	5MHz	10MHz	10MHz	20MHz	15MHz	30MHz	20MHz	40MHz
Interference CW Signal Level	-40dBc							
Intermodulation Product	-29dBc	-35dBc	-29dBc	-35dBc	-29dBc	-35dBc	-29dBc	-35dBc
Measurement bandwidth	4.5MHz	4.5MHz	9.0MHz	9.0MHz	13.5MHz	13.5MHz	18MHz	18MHz

The normative reference for this requirement is TS 36.101 [2] clause 6.7.1.

6.7.4 Test description

6.7.4.1 Initial conditions

Initial conditions are a set of test configurations the UE needs to be tested in and the steps for the SS to take with the UE to reach the correct measurement state.

The initial test configurations consist of environmental conditions, test frequencies, and channel bandwidths based on E-UTRA operating bands specified in table 5.4.2.1-1. All of these configurations shall be tested with applicable test parameters for each channel bandwidth, and are shown in table 6.7.4.1-1. The details of the uplink reference measurement channels (RMCs) are specified in Annexes A.2. Configurations of PDSCH and PDCCH before measurement are specified in Annex C.2.

Table 6.7.4.1-1: Test Configuration Table

Initial Conditions					
Test Environment as specified in TS 36.508[7] subclause 4.1		Normal			
Test Frequencies as specified in TS36.508 [7] subclause 4.3.1		Mid range			
Test Channel Bandwidths as specified in TS 36.508 [7] subclause 4.3.1		5MHz and Highest			
Test Parameters for Channel Bandwidths					
Ch BW	Downlink Configuration		Uplink Configuration		
	N/A for Transmit Intermodulation		Mod'n	RB allocation	
			FDD	TDD	
5MHz			QPSK	8	8
10MHz			QPSK	12	12
15MHz			QPSK	16	16
20MHz			QPSK	18	18
Note 1: Test Channel Bandwidths are checked separately for each E-UTRA band, the applicable channel bandwidths are specified in Table 5.4.2.1-1.					

1. Connect the SS to the UE antenna connectors as shown in TS 36.508 [7] Annex A, Figure A.2.
2. The parameter settings for the cell are set up according to TS 36.508 [7] subclause 4.4.3.
3. Downlink signals are initially set up according to Annex C.0, C.1, and C.3.0, and uplink signals according to Annex H.1 and H.3.0.

4. The UL Reference Measurement channels are set according to Table 6.7.4.1-1.
5. Propagation conditions are set according to Annex B.0.
6. Ensure the UE is in State 3A-RF according to TS 36.508 [7] clause 5.2A.2. Message contents are defined in clause 6.7.4.3.

6.7.4.3 Test procedure

1. SS sends uplink scheduling information for each UL HARQ process via PDCCH DCI format 0 for C_RNTI to schedule the UL RMC according to Table 6.7.4.1-1. Since the UE has no payload and no loopback data to send the UE sends uplink MAC padding bits on the UL RMC.
2. Send continuously uplink power control "up" commands to the UE until the UE transmits at its P_{UMAX} level.
3. Measure the rectangular filtered mean power of the UE. For TDD slots with transient periods are not under test for the wanted signal and for the intermodulation product.
4. Set the interference signal frequency below the UL carrier frequency using the first offset in table 6.7.5-1.
5. Set the interference CW signal level according to table 6.7.5-1.
6. Search the intermodulation product signals below and above the UL carrier frequency, then measure the rectangular filtered mean power of transmitting intermodulation for both signals, and calculate the ratios with the power measured in step 3.
7. Set the interference signal frequency above the UL carrier frequency using the first offset in table 6.7.5-1.
8. Search the intermodulation product signals below and above the UL carrier frequency, then measure the rectangular filtered mean power of transmitting intermodulation for both signals, and calculate the ratios with the power measured in step 3.

Repeat the measurement using the second offset in table 6.7.5-1.

6.7.4.3 Message contents

Message contents are according to TS 36.508 [7] subclause 4.6.

6.7.5 Test requirement

The ratio derived in step 5 and 7, shall not exceed the described value in table 6.7.5-1

Table 6.7.5-1: Transmit Intermodulation

BWChannel (UL)	5MHz		10MHz		15MHz		20MHz	
Interference Signal Frequency Offset	5MHz	10MHz	10MHz	20MHz	15MHz	30MHz	20MHz	40MHz (Note 1)
Interference CW Signal Level	-40dBc							
Intermodulation Product	-29dBc	-35dBc	-29dBc	-35dBc	-29dBc	-35dBc	-29dBc	-35dBc
Measurement bandwidth	4.5MHz	4.5MHz	9.0MHz	9.0MHz	13.5MHz	13.5MHz	18MHz	18MHz
Note 1: For Band 20, only applicable for interference signal frequency above the UL carrier frequency.								

6.7A Transmit intermodulation for CA

6.7A.1 Transmit intermodulation for CA (intra-band contiguous DL CA and UL CA)

Editor's notes:

The following items are missing or incomplete:

- Test tolerances

6.7A.1.1 Test purpose

To verify that the UE transmit intermodulation does not exceed the described value in the test requirement.

The transmit intermodulation performance is a measure of the capability of the transmitter to inhibit the generation of signals in its non linear elements caused by presence of the wanted signal and an interfering signal reaching the transmitter via the antenna.

6.7A.1.2 Test applicability

This test applies to all types of E-UTRA UE release 10 and forward that supports intra-band contiguous DL CA and UL CA.

6.7A.1.3 Minimum conformance requirements

User Equipment(s) transmitting in close vicinity of each other can produce intermodulation products, which can fall into the UE, or eNode B receive band as an unwanted interfering signal. The UE intermodulation attenuation is defined by the ratio of the mean power of the wanted signal to the mean power of the intermodulation product on both component carriers when an interfering CW signal is added at a level below the wanted signal at each of the transmitter antenna port with the other antenna port(s) if any is terminated. Both the wanted signal power and the intermodulation product power are measured through rectangular filter with measurement bandwidth shown in Table 6.7A.1-1.

For intra-band contiguous carrier aggregation the requirement of transmitting intermodulation is specified in Table 6.7.1A-1.

Table 6.7A.1-1: Transmit Intermodulation

CA bandwidth class(UL)	C	
Interference Signal Frequency Offset	$BW_{\text{Channel_CA}}$	$2 \cdot BW_{\text{Channel_CA}}$
Interference CW Signal Level	-40dBc	
Intermodulation Product	[-29dBc]	[-35dBc]
Measurement bandwidth	$BW_{\text{Channel_CA}} - 2 \cdot BW_{\text{GB}}$	

The normative reference for this requirement is TS 36.101 [2] clause 6.7.1A.

6.7A.1.4 Test description

6.7A.1.4.1 Initial conditions

Initial conditions are a set of test configurations the UE needs to be tested in and the steps for the SS to take with the UE to reach the correct measurement state.

The initial test configurations consist of environmental conditions, test frequencies, and channel bandwidths based on E-UTRA operating bands specified in table 5.4.2.1-1. All of these configurations shall be tested with applicable test

parameters for each channel bandwidth, and are shown in table 6.7A.1.4.1-1. The details of the uplink reference measurement channels (RMCs) are specified in Annexes A.2. Configurations of PDSCH and PDCCH before measurement are specified in Annex C.2.

Table 6.7A.1.4.1-1: Test Configuration Table

Initial Conditions									
Test Environment as specified in TS 36.508[7] subclause 4.1					Normal				
Test Frequencies as specified in TS36.508 [7] subclause 4.3.1 for different CA bandwidth classes.					C: Mid range				
Test CC Combination setting (N_{RB_agg}) as specified in subclause 5.4.2A.1 for the CA Configuration					Lowest N_{RB_agg} Highest N_{RB_agg}				
Test Parameters for CA Configurations									
CA Configuration / N_{RB_agg}		DL Allocation		CC MOD	UL Allocation				
PCC N_{RB}	SCCs N_{RB}	PCC & SCC RB allocation			N_{RB_alloc}	PCC & SCC RB allocations (L_{CRB} @ RB_{start})			
75	75	N/A		QPSK	16	P_16@0	S_0@0	-	-
100	50			QPSK	12	P_12@0	S_0@0	-	-
100	100			QPSK	18	P_18@0	S_0@0	-	-
Note 1: CA Configuration Test CC Combination settings are checked separately for each CA Configuration, which applicable aggregated channel bandwidths are specified in Table 5.4.2A.1-1									

1. Connect the SS to the UE antenna connectors as shown in TS 36.508 [7] Annex A, Figure group A.37 as appropriate.
2. The parameter settings for the cell are set up according to TS 36.508 [7] subclause 4.4.3.
3. Downlink signals for PCC are initially set up according to Annex C.0, C.1, and C.3.0, and uplink signals according to Annex H.1 and H.3.0.
4. Propagation conditions are set according to Annex B.0.
5. Ensure the UE is in State 3A-RF according to TS 36.508 [7] clause 5.2A.2. Message contents are defined in clause 6.7A.1.4.3.

6.7A.1.4.2 Test procedure

1. Configure SCC according to Annex C.0, C.1 and Annex C.3.0 for all downlink physical channels except PHICH.
2. The SS shall configure SCC as per TS 36.508 [7] clause 5.2A.4. Message contents are defined in clause 6.7A.1.4.3
3. SS activates SCC by sending the activation MAC-CE (Refer TS 36.321 [13], clauses 5.13, 6.1.3.8). Wait for at least 2 seconds (Refer TS 36.133, clauses 8.3.3.2).
4. SS sends uplink scheduling information for each UL HARQ process via PDCCH DCI format 0 for C_RNTI to schedule the UL RMC according to Table 6.7A.1.4.1-1. Since the UE has no payload and no loopback data to send the UE sends uplink MAC padding bits on the UL RMC.
5. Send continuously uplink power control "up" commands on PCC and SCC to the UE until the UE transmits at its P_{UMAX} level; allow at least 200ms for the UE to reach P_{UMAX} level.

6. Measure the rectangular filtered mean power of the UE. For TDD slots with transient periods are not under test for the wanted signal and for the intermodulation product.
7. Set the interference signal frequency below F_{CA_low} using the first offset in table 6.7A.1-1.
8. Set the interference CW signal level according to table 6.7A.1-1.
9. Search the intermodulation product signals below and above the aggregated UL carrier, then measure the rectangular filtered mean power of transmitting intermodulation for both signals, and calculate the ratios with the power measured in step 6.
10. Set the interference signal frequency above F_{CA_high} using the first offset in table 6.7A.1-1.
11. Search the intermodulation product signals below and above the aggregated UL carrier, then measure the rectangular filtered mean power of transmitting intermodulation for both signals, and calculate the ratios with the power measured in step 6.
12. Repeat the measurement using the second offset in table 6.7A.1-1.

6.7A.1.4.3 Message contents

Message contents are according to TS 36.508 [7] subclause 4.6. In test procedure step 2, for SCC configuration there are no additional message contents.

6.7A.1.5 Test requirement

The ratio derived in step 9 and 11, shall not exceed the described value in table 6.7A.1.5-1

Table 6.7A.1.5-1: Transmit Intermodulation

CA bandwidth class(UL)	C	
Interference Signal Frequency Offset	$BW_{Channel_CA}$	$2 * BW_{Channel_CA}$
Interference CW Signal Level	-40dBc	
Intermodulation Product	[-29dBc]	[-35dBc]
Measurement bandwidth	$BW_{Channel_CA} - 2 * BW_{GB}$	

6.7B Transmit intermodulation for UL-MIMO

6.7B.1 Test purpose

To verify that the UE transmit intermodulation at each transmit antenna does not exceed the described value in the test requirement.

The transmit intermodulation performance is a measure of the capability of the transmitter to inhibit the generation of signals in its non linear elements caused by presence of the wanted signal and an interfering signal reaching the transmitter via the antenna.

6.7B.2 Test applicability

This test applies to all types of E-UTRA UE release 10 and forward that support UL-MIMO.

6.7B.3 Minimum conformance requirements

For UE with multiple antenna transmit connectors, the transmit intermodulation requirements are specified at each transmit antenna connector and the wanted signal is defined as the sum of output power at each transmit antenna connector.

For UEs with two transmit antenna connectors supporting dual-layer transmission, the requirements in subclause 6.7.3-1 apply to each transmit antenna connector with the UL-MIMO configurations specified in Table 6.2.2B.3-2.

The normative reference for this requirement is TS 36.101 [2] clause 6.7.1B.

6.7B.4 Test description

6.7B.4.1 Initial conditions

Initial conditions are a set of test configurations the UE needs to be tested in and the steps for the SS to take with the UE to reach the correct measurement state.

The initial test configurations consist of environmental conditions, test frequencies, and channel bandwidths based on E-UTRA operating bands specified in table 5.4.2.1-1. All of these configurations shall be tested with applicable test parameters for each channel bandwidth, and are shown in table 6.7B.4.1-1. The details of the uplink reference measurement channels (RMCs) are specified in Annexes A.2. Configurations of PDSCH and PDCCH before measurement are specified in Annex C.2.

Table 6.7B.4.1-1: Test Configuration Table

Initial Conditions				
Test Environment as specified in TS 36.508[7] subclause 4.1	Normal			
Test Frequencies as specified in TS36.508 [7] subclause 4.3.1	Mid range			
Test Channel Bandwidths as specified in TS 36.508 [7] subclause 4.3.1	5MHz and Highest			
Test Parameters for Channel Bandwidths				
Ch BW	Downlink Configuration	Uplink Configuration		
	N/A for Transmit Intermodulation	Mod'n	RB allocation	
		FDD	TDD	
5MHz		QPSK	8	8
10MHz		QPSK	12	12
15MHz		QPSK	16	16
20MHz		QPSK	18	18
Note 1: Test Channel Bandwidths are checked separately for each E-UTRA band, the applicable channel bandwidths are specified in Table 5.4.2.1-1.				

1. Connect the SS to the UE antenna connectors as shown in TS 36.508 [7] Annex A, Figure A.39.
2. The parameter settings for the cell are set up according to TS 36.508 [7] subclause 4.4.3.
3. Downlink signals are initially set up according to Annex C.0, C.1, and C.3.0, and uplink signals according to Annex H.1 and H.3.0.
4. The UL Reference Measurement channels are set according to Table 6.7B.4.1-1.
5. Propagation conditions are set according to Annex B.0.
6. Ensure the UE is in State 3A-RF according to TS 36.508 [7] clause 5.2A.2. Message contents are defined in clause 6.7B.4.3.

6.7B.4.2 Test procedure

1. SS sends uplink scheduling information for each UL HARQ process via PDCCH DCI format 4 for C_RNTI to schedule the UL RMC according to Table 6.7B.4.1-1. Since the UE has no payload and no loopback data to send the UE sends uplink MAC padding bits on the UL RMC.
2. Send continuously uplink power control "up" commands to the UE until the UE transmits at its P_{UMAX} level.
3. Measure the rectangular filtered mean power of the UE. For TDD slots with transient periods are not under test for the wanted signal and for the intermodulation product.
4. Set the interference signal frequency below the UL carrier frequency using the first offset in table 6.7B.5-1.
5. Set the interference CW signal level according to table 6.7B.5-1.
6. Search the intermodulation product signals below and above the UL carrier frequency, then measure the rectangular filtered mean power of transmitting intermodulation for both signals, and calculate the ratios with the power measured in step 3.
7. Set the interference signal frequency above the UL carrier frequency using the first offset in table 6.7B.5-1.
8. Search the intermodulation product signals below and above the UL carrier frequency, then measure the rectangular filtered mean power of transmitting intermodulation for both signals, and calculate the ratios with the power measured in step 3.
9. Repeat the measurement using the second offset in table 6.7B.5-1.
10. Repeat step 3) until 9) for each of transmit antenna of the UE.

6.7B.4.3 Message contents

Message contents are according to TS 36.508 [7] clause 4.6.6.7B.5 Test requirement

The ratio derived in step 5 and 7 at each transmit antenna of UE shall not exceed the described value in table 6.7B.5-1.

Table 6.7B.5-1: Transmit Intermodulation

BWChannel (UL)	5MHz		10MHz		15MHz		20MHz	
Interference Signal Frequency Offset	5MHz	10MHz	10MHz	20MHz	15MHz	30MHz	20MHz	40MHz (Note 1)
Interference CW Signal Level	-40dBc							
Intermodulation Product	-29dBc	-35dBc	-29dBc	-35dBc	-29dBc	-35dBc	-29dBc	-35dBc
Measurement bandwidth	4.5MHz	4.5MHz	9.0MHz	9.0MHz	13.5MHz	13.5MHz	18MHz	18MHz
Note 1: For Band 20, only applicable for interference signal frequency above the UL carrier frequency.								

6.8 Time alignment

FFS.

6.8.1 Void

6.8A Void

6.8B Time alignment error for UL-MIMO

6.8B.1 Test purpose

To verify that the error of time alignment in UL MIMO does not exceed the range prescribed by the specified UL MIMO Time Alignment Error (TAE) and tolerance.

An excess time alignment error has the possibility to interfere to other channels or other systems and decrease UL MIMO performance because of the timing unsynchronization.

6.8B.2 Test applicability

This test case applies to all types of E-UTRA UE release 10 and forward that support UL MIMO.

6.8B.3 Minimum conformance requirements

For UE(s) with multiple transmit antenna connectors, the Time Alignment Error (TAE) shall not exceed 130 ns.

Table 6.8B.3-1: UL-MIMO configuration in closed-loop spatial multiplexing scheme

Transmission mode	DCI format	Codebook Index
Mode 2	DCI format 4	Codebook index 0

The normative reference for this requirement is TS 36.101 [2] clause 6.8B.

6.8B.4 Test description

6.8B.4.1 Initial condition

Initial conditions are a set of test configurations the UE needs to be tested in and the steps for the SS to take with the UE to reach the correct measurement state.

The initial test configurations consist of environmental conditions, test frequencies, and channel bandwidths based on E-UTRA operating bands specified in table 5.4.2.1-1. All of these configurations shall be tested with applicable test parameters for each channel bandwidth, and are shown in table 6.8B.4.1-1. The details of the uplink reference measurement channels (RMCs) are specified in Annex A.2. Configurations of PDSCH and PDCCH before measurement are specified in Annex C.2.

Table 6.8B.4.1-1: Test Configuration Table

Initial Conditions				
Test Environment as specified in TS 36.508[7] clause 4.1		Normal		
Test Frequencies as specified in TS36.508 [7] clause 4.3.1		Mid range		
Test Channel Bandwidths as specified in TS 36.508 [7] clause 4.3.1		Lowest, 5MHz, Highest		
Test Parameters for Channel Bandwidths				
Ch BW	Downlink Configuration	Uplink Configuration		
		Mod'n	RB allocation	
	N/A		FDD	TDD
1.4MHz		QPSK	6	6
3MHz		QPSK	15	15
5MHz		QPSK	25	25
10MHz		QPSK	50	50
15MHz		QPSK	75	75
20MHz		QPSK	100	100
Note 1: Test Channel Bandwidths are checked separately for each E-UTRA band, the applicable channel bandwidths are specified in Table 5.4.2.1-1.				

1. Connect the SS to the UE antenna connectors as shown in TS 36.508[7] Annex A Figure A.28.
2. The parameter settings for the cell are set up according to TS 36.508 [7] clause 4.4.3.
3. Downlink signals are initially set up according to Annex C.0, C.1, and C.3.0, and uplink signals according to Annex H.1 and H.3.0.
4. The UL Reference Measurement channel is set according to Table 6.8B.4.1-1.
5. Propagation conditions are set according to Annex B.0.
6. Ensure the UE is in State 3A-RF according to TS 36.508 [7] clause 5.2A.2. Message contents are defined in clause 6.8B.4.3.

6.8B.4.2 Test procedure

1. SS sends uplink scheduling information for each UL HARQ process via PDCCH DCI format 4 for C_RNTI to schedule the UL RMC according to Table 6.8B.4.1-1. Since the UE has no payload and no loopback data to send the UE sends uplink MAC padding bits on the UL RMC.
2. Send continuously uplink power control "up" commands in every uplink scheduling information to the UE; allow at least 200ms for the UE to reach PUMAX level for UE.
3. Measure the timing of one sub-frame at each antenna connector.

6.8B.4.3 Message contents

Message contents are according to TS 36.508 [7] clause 4.6.

6.8B.5 Test requirements

For UE(s) with multiple transmit antenna connectors, the Time Alignment Error (TAE) shall not exceed 155 ns.

7 Receiver Characteristics

7.1 General

Unless otherwise stated the receiver characteristics are specified at the antenna connector(s) of the UE. For UE(s) with an integral antenna only, a reference antenna(s) with a gain of 0 dBi is assumed for each antenna port(s). UE with an

integral antenna(s) may be taken into account by converting these power levels into field strength requirements, assuming a 0 dBi gain antenna. For UEs with more than one receiver antenna connector, identical interfering signals shall be applied to each receiver antenna port if more than one of these is used (diversity).

Unless otherwise stated, the test signal levels are defined at each antenna port, and specified in the respective sections below. Any specific test conditions are defined in the paragraph for each test. Unless stated otherwise, power control of the Downlink is OFF.

In general, the UE is set into the correct state in the "Initial conditions" part of the test, using normal SS signalling procedures over the air interface under easy radio conditions to ensure reliable message exchange. In the "Test procedure" part of the test, specific radio conditions are applied according to the test requirement and the desired measurement is made or the desired response is tested.

The ACS, blocking, spurious emissions and intermodulation requirements in sections 7.5, 7.6, 7.7 and 7.8 are defined for full band width signals i.e. for signals where all resource blocks are allocated for a specific user.

With the exception of Clause 7.3, the requirements shall be verified with the network signalling value NS_01 configured (Table 6.2.4.3-1).

All the parameters in clause 7 are defined using the UL reference measurement channels specified in Annexes A.2.2 and A.2.3, the DL reference measurement channels specified in Annex A.3.2 and using the set-up specified in Annex C.3.1.

For CA tests, Cell ID = 0 applies to P-Cell, and Cell ID = 1 is used for S-Cell.

Parameters given in table 7.1-1 are used throughout this section for CA, unless otherwise stated by the test case.

Table 7.1-1: Common Test Parameters

Parameter	Value	Comments
Cross carrier scheduling	Not configured	

7.2 Diversity characteristics

The requirements in Section 7 assume that the receiver is equipped with two Rx port as a baseline. Requirements for 4 ports are FFS. With the exception of clause 7.9, All requirements shall be verified by using both (all) antenna ports simultaneously.

7.3 Reference sensitivity level

Editor's note: FDD/TDD aspects missing or not yet determined:

- **The Maximum Sensitivity Degradation figures for large transmission configurations are not finalised in the core specification.**

7.3.1 Test purpose

To verify the UE's ability to receive data with a given average throughput for a specified reference measurement channel, under conditions of low signal level, ideal propagation and no added noise.

A UE unable to meet the throughput requirement under these conditions will decrease the effective coverage area of an e-NodeB.

7.3.2 Test applicability

This test applies to all types of E-UTRA UE release 8 and forward.

7.3.3 Minimum conformance requirements

The throughput shall be $\geq 95\%$ of the maximum throughput of the reference measurement channels as specified in Annexes A.2.2, A.2.3 and A.3.2 (with one sided dynamic OCNG Pattern OP.1 FDD/TDD for the DL-signal as described in Annex A.5.1.1/A.5.2.1) with parameters specified in Table 7.3.3-1, Table 7.3.3-2 and Table 7.3.3-3.

Table 7.3.3-1: Reference sensitivity QPSK P_{REFSENS}

E-UTRA Band	Channel bandwidth						Duplex Mode
	1.4 MHz (dBm)	3 MHz (dBm)	5 MHz (dBm)	10 MHz (dBm)	15 MHz (dBm)	20 MHz (dBm)	
1	-	-	-100	-97	-95.2	-94	FDD
2	-102.7	-99.7	-98	-95	-93.2	-92	FDD
3	-101.7	-98.7	-97	-94	-92.2	-91	FDD
4	-104.7	-101.7	-100	-97	-95.2	-94	FDD
5	-103.2	-100.2	-98	-95			FDD
6	-	-	-100	-97			FDD
7	-	-	-98	-95	-93.2	-92	FDD
8	-102.2	-99.2	-97	-94			FDD
9	-	-	-99	-96	-94.2	-93	FDD
10	-	-	-100	-97	-95.2	-94	FDD
11	-	-	-100	-97			FDD
12	-101.7	-98.7	-97	-94			FDD
13			-97	-94			FDD
14		-	-97	-94			FDD
...							
17	-	-	-97	-94			FDD
18	-	-	-100 ⁷	-97 ⁷	-95.2 ⁷	-	FDD
19	-	-	-100	-97	-95.2	-	FDD
20			-97	-94	-91.2	-90	FDD
21			-100	-97	-95.2		FDD
22			-97	-94	-92.2	-91	FDD
23	-104.7	-101.7	-100	-97	-95.2	-94	FDD
24			-100	-97			FDD
25	-101.2	-98.2	-96.5	-93.5	-91.7	-90.5	FDD
26	-102.7	-99.7	-97.5 ⁶	-94.5 ⁶	-92.7 ⁶		FDD
27	-103.2	-100.2	-98	-95			FDD
28		-100.2	-98.5	-95.5	-93.7	-91	FDD
31	-99.0	-95.7	-93.5				FDD
...							
33	-	-	-100	-97	-95.2	-94	TDD
34	-	-	-100	-97	-95.2	-	TDD
35	-106.2	-102.2	-100	-97	-95.2	-94	TDD
36	-106.2	-102.2	-100	-97	-95.2	-94	TDD
37	-	-	-100	-97	-95.2	-94	TDD
38	-	-	-100	-97	-95.2	-94	TDD
39	-	-	-100	-97	-95.2	-94	TDD
40	-	-	-100	-97	-95.2	-94	TDD
41	-	-	-98	-95	-93.2	-92	TDD
42	-	-	-99	-96	-94.2	-93	TDD
43	-	-	-99	-96	-94.2	-93	TDD
44		[-100.2]	[-98]	[-95]	[-93.2]	[-92]	TDD
Note 1:	The transmitter shall be set to P_{UMAX} as defined in clause 6.2.5						
Note 2:	The reference measurement channel is specified in A.3.2 with one sided dynamic OCNG Pattern OP.1 FDD/TDD as described in Annex A.5.1.1/A.5.2.1						
Note 3:	The signal power is specified per port						
Note 4:	For the UE which supports both Band 3 and Band 9 the reference sensitivity level is FFS.						
Note 5:	For the UE which supports both Band 11 and Band 21 the reference sensitivity level is FFS.						
Note 6:	⁶ indicates that the requirement is modified by -0.5 dB when the carrier frequency of the assigned E-UTRA channel bandwidth is within 865-894 MHz.						
Note 7:	For a UE that support both Band 18 and Band 26, the reference sensitivity level						

for Band 26 applies for the applicable channel bandwidths.

The reference receive sensitivity (REFSENS) requirement specified in Table 7.3.3-1 shall be met for an uplink transmission bandwidth less than or equal to that specified in Table 7.3.3-2.

NOTE: Table 7.3.3-2 does not necessarily reflect the operational conditions of the network, where the number of uplink and downlink allocated resource blocks will be practically constrained by other factors.

Table 7.3.3-2: Uplink configuration for reference sensitivity

E-UTRA Band	E-UTRA Band / Channel bandwidth / N_{RB} / Duplex mode						Duplex Mode
	1.4 MHz	3 MHz	5 MHz	10 MHz	15 MHz	20 MHz	
1	-	-	25	50	75	100	FDD
2	6	15	25	50	50 ¹	50 ¹	FDD
3	6	15	25	50	50 ¹	50 ¹	FDD
4	6	15	25	50	75	100	FDD
5	6	15	25	25 ¹	-	-	FDD
6	-	-	25	25 ¹	-	-	FDD
7	-	-	25	50	75	75 ¹	FDD
8	6	15	25	25 ¹	-	-	FDD
9	-	-	25	50	50 ¹	50 ¹	FDD
10	-	-	25	50	75	100	FDD
11	-	-	25	25 ¹			FDD
12	6	15	20 ¹	20 ¹			FDD
13			20 ¹	20 ¹			FDD
14		-	15 ¹	15 ¹			FDD
...							
17	-	-	20 ¹	20 ¹			FDD
18	-	-	25	25 ¹	25 ¹	-	FDD
19	-	-	25	25 ¹	25 ¹	-	FDD
20			25	20 ¹	20 ³	20 ³	FDD
21			25	25 ¹	25 ¹		FDD
22			25	50	50 ¹	50 ¹	FDD
23	6	15	25	50	75	100	FDD
24			25	50			FDD
25	6	15	25	50	50 ¹	50 ¹	FDD
26	6	15	25	25 ¹	25 ¹		FDD
27	6	15	25	25 ¹			FDD
28		15	25	25 ¹	25 ¹	25 ¹	FDD
31	6	5 ⁴	5 ⁴				FDD
...							
33	-	-	25	50	75	100	TDD
34	-	-	25	50	75	-	TDD
35	6	15	25	50	75	100	TDD
36	6	15	25	50	75	100	TDD
37	-	-	25	50	75	100	TDD
38	-	-	25	50	75	100	TDD
39			25	50	75	100	TDD
40			25	50	75	100	TDD
41			25	50	75	100	TDD
42			25	50	75	100	TDD
43			25	50	75	100	TDD
44		15	25	50	75	100	TDD
Note 1:	The UL resource blocks shall be located as close as possible to the downlink operating band but confined within the transmission bandwidth configuration for the channel bandwidth (Table 5.4.2-1).						
Note 2:	For the UE which supports both Band 11 and Band 21 the uplink configuration for reference sensitivity is FFS.						
Note 3:	For Band 20; in the case of 15MHz channel bandwidth, the UL resource blocks shall be located at $RB_{start}=11$ and in the case of 20MHz channel bandwidth, the UL resource blocks shall be located at $RB_{start}=16$.						
Note 4:	⁴ refers to Band 31; in the case of 3 MHz channel bandwidth, the UL resource blocks shall be located at RB_{start} 9 and in the case of 5 MHz						

channel bandwidth, the UL resource blocks shall be located at RB_{start} 10.

Unless given by Table 7.3.3-3, the minimum requirements specified in Tables 7.3.3-1 and 7.3.3-2 shall be verified with the network signalling value NS_01 (Table 6.2.4.3-1) configured.

Table 7.3.3-3: Network Signalling Value for reference sensitivity

E-UTRA Band	Network Signalling value
2	NS_03
4	NS_03
10	NS_03
12	NS_06
13	NS_06
14	NS_06
17	NS_06
19	NS_08
21	NS_09
23	NS_03

The normative reference for this requirement is TS 36.101 [2] clause 7.3.1.

7.3.4 Test description

7.3.4.1 Initial conditions

Initial conditions are a set of test configurations the UE needs to be tested in and the steps for the SS to take with the UE to reach the correct measurement state.

The initial test configurations consist of environmental conditions, test frequencies, and channel bandwidths based on E-UTRA bands specified in table 5.4.2.1-1. All of these configurations shall be tested with applicable test parameters for each channel bandwidth, and are shown in table 7.3.4.1-1. The details of the downlink and uplink reference measurement channels (RMCs) are specified in Annexes A.2 and A.3. The details of the OCNG patterns used are specified in Annex A.5. Configurations of PDSCH and PDCCH before measurement are specified in Annex C.2.

Table 7.3.4.1-1: Test Configuration Table

Initial Conditions						
Test Environment as specified in TS 36.508[7] subclause 4.1			NC, TL/VL, TL/VH, TH/VL, TH/VH			
Test Frequencies as specified in TS36.508 [7] subclause 4.3.1			Low range, Mid range, High range			
Test Channel Bandwidths as specified in TS 36.508 [7] subclause 4.3.1			Lowest, 5MHz, Highest			
Test Parameters for Channel Bandwidths						
Ch BW	Downlink Configuration			Uplink Configuration		
	Mod'n	RB allocation		Mod'n	RB allocation	
		FDD	TDD		FDD	TDD
1.4MHz	QPSK	6	6	QPSK	6	6
3MHz	QPSK	15	15	QPSK	15	15
5MHz	QPSK	25	25	QPSK	25	25
5MHz	QPSK	25	N/A	QPSK	20	N/A
5MHz	QPSK	25	N/A	QPSK	15	N/A
10MHz	QPSK	50	50	QPSK	50	50
10MHz	QPSK	50	N/A	QPSK	25	N/A
10MHz	QPSK	50	N/A	QPSK	20	N/A
10MHz	QPSK	50	N/A	QPSK	15	N/A
15MHz	QPSK	75	75	QPSK	75	75
15MHz	QPSK	75	N/A	QPSK	50	N/A
15MHz	QPSK	75	N/A	QPSK	25	N/A
15MHz	QPSK	75	N/A	QPSK	20	N/A
20MHz	QPSK	100	100	QPSK	100	100
20MHz	QPSK	100	N/A	QPSK	75	N/A
20MHz	QPSK	100	N/A	QPSK	50	N/A
20MHz	QPSK	100	N/A	QPSK	25	N/A
20MHz	QPSK	100	N/A	QPSK	20	N/A
Note 1: Test Channel Bandwidths are checked separately for each E-UTRA band, which applicable channel bandwidths are specified in Table 5.4.2.1-1. Note 2: Depending on E-UTRA band, only the appropriate Uplink RB allocation value according to table 7.3.3-2 is tested per Test Channel Bandwidth. The allocation shall be located as close as possible to the downlink operating band but confined within the transmission bandwidth configuration for the channel bandwidth (Table 5.4.2-1). Note 3: For the DL signal one sided dynamic OCNG Pattern OP.1 FDD/TDD is used.						

1. Connect the SS to the UE antenna connectors as shown in TS 36.508 [7] Annex A, Figure A.3.
2. The parameter settings for the cell are set up according to TS 36.508 [7] subclause 4.4.3.
3. Downlink signals are initially set up according to Annex C0, C.1 and C.3.1, and uplink signals according to Annex H.1 and H.3.1.
4. The UL and DL Reference Measurement channels are set according to Table 7.3.4.1-1.
5. Propagation conditions are set according to Annex B.0.
6. Ensure the UE is in State 3A-RF according to TS 36.508 [7] clause 5.2A.2. Message contents are defined in clause 7.3.4.3.

7.3.4.2 Test procedure

1. SS transmits PDSCH via PDCCH DCI format 1A for C_RNTI to transmit the DL RMC according to Table 7.3.4.1-1. The SS sends downlink MAC padding bits on the DL RMC.
2. SS sends uplink scheduling information for each UL HARQ process via PDCCH DCI format 0 for C_RNTI to schedule the UL RMC according to Table 7.3.4.1-1. Since the UE has no payload data to send, the UE transmits uplink MAC padding bits on the UL RMC.
3. Set the Downlink signal level to the appropriate REFSENS value defined in Table 7.3.5-1. Send continuously uplink power control "up" commands in the uplink scheduling information to the UE to ensure the UE transmits P_{UMAX} level for at least the duration of the Throughput measurement.

4. Measure the average throughput for a duration sufficient to achieve statistical significance according to Annex G.2.

7.3.4.3 Message contents

Message contents are according to TS 36.508 [7] subclause 4.6 with the following exceptions.

7.3.4.3.1 Message contents exceptions (network signalled value "NS_01")

Message contents according to TS 36.508 [7] subclause 4.6 can be used without exceptions.

7.3.4.3.2 Message contents exceptions (network signalled value "NS_03")

1. Information element `additionalSpectrumEmission` is set to NS_03. This can be set in the *SystemInformationBlockType2* as part of the cell broadcast message. This exception indicates that the UE shall meet the additional spurious emission requirement for a specific deployment scenario.

Table 7.3.4.3.2-1: *SystemInformationBlockType2*: Additional spurious emissions test requirement for "NS_03"

Derivation Path: TS 36.508 [7] clause 4.4.3.3, Table 4.4.3.3-1			
Information Element	Value/remark	Comment	Condition
<code>additionalSpectrumEmission</code>	3 (NS_03)		

7.3.4.3.3 Message contents exceptions (network signalled value "NS_06")

1. Information element `additionalSpectrumEmission` is set to NS_06. This can be set in the *SystemInformationBlockType2* as part of the cell broadcast message. This exception indicates that the UE shall meet the additional spurious emission requirement for a specific deployment scenario.

Table 7.3.4.3.3-1: *SystemInformationBlockType2*: Additional spurious emissions test requirement for "NS_06"

Derivation Path: TS 36.508 [7] clause 4.4.3.3, Table 4.4.3.3-1			
Information Element	Value/remark	Comment	Condition
<code>additionalSpectrumEmission</code>	6 (NS_06)		

7.3.4.3.4 Message contents exceptions (network signalled value "NS_[09]")

1. Information element `additionalSpectrumEmission` is set to NS_[09]. This can be set in the *SystemInformationBlockType2* as part of the cell broadcast message. This exception indicates that the UE shall meet the additional spurious emission requirement for a specific deployment scenario.

Table 7.3.4.3.4-1: *SystemInformationBlockType2*: Additional spurious emissions test requirement for "NS_[09]"

Derivation Path: TS 36.508 [7] clause 4.4.3.3, Table 4.4.3.3-1			
Information Element	Value/remark	Comment	Condition
<code>additionalSpectrumEmission</code>	TBD		

7.3.5 Test requirement

The throughput shall be $\geq 95\%$ of the maximum throughput of the reference measurement channels as specified in Annex A.3.2 with parameters specified in Tables 7.3.5-1 and Table 7.3.5-2.

Table 7.3.5-1: Reference sensitivity QPSK P_{REFSENS}

E-UTRA Band	Channel bandwidth						Duplex Mode
	1.4 MHz (dBm)	3 MHz (dBm)	5 MHz (dBm)	10 MHz (dBm)	15 MHz (dBm)	20 MHz (dBm)	
1	-	-	-99.3	-96.3	-94.5	-93.3	FDD
2	-102.0	-99.0	-97.3	-94.3	-92.5	-91.3	FDD
3	-101.0	-98.0	-96.3	-93.3	-91.5	-90.3	FDD
4	-104.0	-101	-99.3	-96.3	-94.5	-93.3	FDD
5	-102.5	-99.5	-97.3	-94.3			FDD
6	-	-	-99.3	-96.3			FDD
7	-	-	-97.3	-94.3	-92.5	-91.3	FDD
8	-101.5	-98.5	-96.3	-93.3			FDD
9	-	-	-98.3	-95.3	-93.5	-92.3	FDD
10	-	-	-99.3	-96.3	-94.5	-93.3	FDD
11	-	-	-99.3	-96.3			FDD
12	-101.0	-98.0	-96.3	-93.3			FDD
13			-96.3	-93.3			FDD
14		-	-96.3	-93.3			FDD
...							
17	-	-	-96.3	-93.3			FDD
18	-	-	-99.3 ⁷	-96.3 ⁷	-94.5 ⁷	-	FDD
19	-	-	-99.3	-96.3	-94.5	-	FDD
20			-96.3	-93.3	-90.5	-89.3	FDD
21			-99.3	-96.3	-94.5		FDD
22			-96.0	-93.0	-91.2	-90.0	FDD
23	-104.0	-101	-99.3	-96.3	-94.5	-93.3	FDD
24			-99.3	-96.3			FDD
25	-100.5	-97.5	-95.8	-92.8	-91.0	-89.8	FDD
26	-102	-99	-96.8 ⁶	-93.8 ⁶	-92 ⁶		FDD
27	-102.5	-99.5	-97.3	-94.3			FDD
28		-99.5	-97.8	-94.8	-93.0	-90.3	FDD
31	-98.3	-95.0	-92.8				FDD
...							
33	-	-	-99.3	-96.3	-94.5	-93.3	TDD
34	-	-	-99.3	-96.3	-94.5	-	TDD
35	-105.5	-101.5	-99.3	-96.3	-94.5	-93.3	TDD
36	-105.5	-101.5	-99.3	-96.3	-94.5	-93.3	TDD
37	-	-	-99.3	-96.3	-94.5	-93.3	TDD
38	-	-	-99.3	-96.3	-94.5	-93.3	TDD
39	-	-	-99.3	-96.3	-94.5	-93.3	TDD
40	-	-	-99.3	-96.3	-94.5	-93.3	TDD
41	-	-	-97.3	-94.3	-92.5	-91.3	TDD
42	-	-	-98.0	-95.0	-93.2	-92.0	TDD
43	-	-	-98.0	-95.0	-93.2	-92.0	TDD
44		[-99.5]	[-97.3]	[-94.3]	[-92.5]	[-91.3]	TDD
Note 1:	The transmitter shall be set to maximum output power level (Table 7.3.5-2)						
Note 2:	The reference measurement channel is specified in A.3.2 with one sided dynamic OCNG Pattern OP.1 FDD/TDD as described in Annex A.5.1.1/A.5.2.1						
Note 3:	The signal power is specified per port						
Note 4:	For the UE which supports both Band 3 and Band 9 the reference sensitivity level is FFS.						
Note 5:	For the UE which supports both Band 11 and Band 21 the reference sensitivity level is FFS.						
Note 6:	⁶ indicates that the requirement is modified by -0.5 dB when the carrier frequency of the assigned E-UTRA channel bandwidth is within 865-894 MHz.						
Note 7:	For a UE that support both Band 18 and Band 26, the reference sensitivity level						

for Band 26 applies for the applicable channel bandwidths.

NOTE 1: The relation to the received PSD is $\langle \text{REF} \hat{I}_{or} \rangle = P_{\text{REFSENS}} (N_{sc}^{RB} N_{RB} \Delta f)^{-1}$ with N_{RB} is the transmission bandwidth configuration according to Table 5.4.2-1.

The reference receive sensitivity (REFSENS) requirement specified in Table 7.3.5-1 shall be met for an uplink transmission bandwidth less than or equal to that specified in Table 7.3.5-2.

NOTE 2: Table 7.3.5-2 does not necessarily reflect the operational conditions of the network, where the number of uplink and downlink allocated resource blocks will be practically constrained by other factors.

Table 7.3.5-2: Uplink configuration for reference sensitivity

E-UTRA Band	E-UTRA Band / Channel bandwidth / N_{RB} / Duplex mode						Duplex Mode
	1.4 MHz	3 MHz	5 MHz	10 MHz	15 MHz	20 MHz	
1	-	-	25	50	75	100	FDD
2	6	15	25	50	50 ¹	50 ¹	FDD
3	6	15	25	50	50 ¹	50 ¹	FDD
4	6	15	25	50	75	100	FDD
5	6	15	25	25 ¹	-	-	FDD
6	-	-	25	25 ¹	-	-	FDD
7	-	-	25	50	75	75 ¹	FDD
8	6	15	25	25 ¹	-	-	FDD
9	-	-	25	50	50 ¹	50 ¹	FDD
10	-	-	25	50	75	100	FDD
11	-	-	25	25 ¹			FDD
12	6	15	20 ¹	20 ¹			FDD
13			20 ¹	20 ¹			FDD
14		-	15 ¹	15 ¹			FDD
...							
17	-	-	20 ¹	20 ¹			FDD
18	-	-	25	25 ¹	25 ¹	-	FDD
19	-	-	25	25 ¹	25 ¹	-	FDD
20			25	20 ¹	20 ³	20 ³	FDD
21			25	25 ¹	25 ¹		FDD
22			25	50	50 ¹	50 ¹	FDD
23	6	15	25	50	75	100	FDD
24			25	50			FDD
25	6	15	25	50	50 ¹	50 ¹	FDD
26	6	15	25	25 ¹	25 ¹		FDD
27	6	15	25	25 ¹			FDD
28		15	25	25 ¹	25 ¹	25 ¹	FDD
31	6	5 ⁴	5 ⁴				FDD
...							
33	-	-	25	50	75	100	TDD
34	-	-	25	50	75	-	TDD
35	6	15	25	50	75	100	TDD
36	6	15	25	50	75	100	TDD
37	-	-	25	50	75	100	TDD
38	-	-	25	50	75	100	TDD
39			25	50	75	100	TDD
40			25	50	75	100	TDD
41			25	50	75	100	TDD
42			25	50	75	100	TDD
43			25	50	75	100	TDD
44		15	25	50	75	100	TDD
Note 1:	The UL resource blocks shall be located as close as possible to the downlink operating band but confined within the transmission bandwidth configuration for the channel bandwidth (Table 5.4.2-1).						
Note 2:	For the UE which supports both Band 11 and Band 21 the uplink configuration for reference sensitivity is FFS.						
Note 3:	For Band 20; in the case of 15MHz channel bandwidth, the UL resource blocks shall be located at $RB_{start}=11$ and in the case of 20MHz channel bandwidth, the UL resource blocks shall be located at $RB_{start}=16$						
Note 4:	⁴ refers to Band 31; in the case of 3 MHz channel bandwidth, the UL resource blocks shall be located at RB_{start} 9 and in the case of 5 MHz						

channel bandwidth, the UL resource blocks shall be located at RB_{start} 10.

7.3A Reference sensitivity level for CA

7.3A.1 Reference sensitivity level for CA (intra-band contiguous DL CA and UL CA)

7.3A.1.1 Test purpose

To verify the ability of UE that support CA to receive data with a given average throughput for a specified reference measurement channel, under conditions of low signal level, ideal propagation and no added noise.

A UE unable to meet the throughput requirement under these conditions will decrease the effective coverage area of an e-NodeB.

7.3A.1.2 Test applicability

This test case applies to all types of E-UTRA UE release 10 and forward that support intra-band contiguous DL CA and UL CA.

7.3A.1.3 Minimum conformance requirements

For inter-band carrier aggregation with uplink assigned to one E-UTRA band the throughput shall be $\geq 95\%$ of the maximum throughput of the reference measurement channels as specified in Annexes A.2.2, A.2.3 and A.3.2 (with one sided dynamic OCNG Pattern OP.1 FDD/TDD for the DL-signal as described in Annex A.5.1.1/A.5.2.1) with parameters specified in Table 7.3.3-1 and Table 7.3.3-2. The reference sensitivity is defined to be met with both downlink component carriers active and either of the uplink component carriers active. The UE shall meet the requirements specified in clause 7.3.1 with the following exceptions.

For the UE which supports inter-band carrier aggregation configuration in Table 7.3A.1.3-0 with uplink in one E-UTRA band, the minimum requirement for reference sensitivity in Table 7.3.1-1 shall be increased by the amount given in $\Delta R_{IB,c}$ in Table 7.3A.1.3-0 for the applicable E-UTRA bands.

Table 7.3A.1.3-0: $\Delta R_{IB,c}$

Inter-band CA Configuration	E-UTRA Band	$\Delta R_{IB,c}$ [dB]
CA_1A-5A	1	0
	5	0
CA_1A-18A	1	0
	18	0
CA_1A-19A	1	0
	19	0
CA_1A-21A	1	0
	21	0
CA_2A-17A	2	0
	17	0.5
CA_3A-5A	3	0
	5	0
CA_3A-7A	3	0
	7	0
CA_3A-8A	3	0
	8	0
CA_3A-20A	3	0
	20	0
CA_4A-5A	4	0
	5	0
CA_4A-7A	4	0.5
	7	0.5

Inter-band CA Configuration	E-UTRA Band	$\Delta R_{IB,c}$ [dB]
CA_4A-12A	4	0
	12	0.5
CA_4A-13A	4	0
	13	0
CA_4A-17A	4	0
	17	0.5
CA_5A-12A	5	0.5
	12	0.3
CA_5A-17A	5	0.5
	17	0.3
CA_7A-20A	7	0
	20	0
CA_8A-20A	8	0
	20	0
CA_11A-18A	11	0
	18	0
<p>NOTE 1: The above additional tolerances are only applicable for the E-UTRA operating bands that belong to the supported inter-band carrier aggregation configurations</p> <p>NOTE 2: The above additional tolerances also apply in non-aggregated operation for the supported E-UTRA operating bands that belong to the supported inter-band carrier aggregation configurations</p> <p>NOTE 3: In case the UE supports more than one of the above inter-band carrier aggregation configurations and a E-UTRA operating band belongs to more than one inter-band carrier aggregation configurations then:</p> <ul style="list-style-type: none"> - When the E-UTRA operating band frequency range is ≤ 1GHz, the applicable additional tolerance shall be the average of the tolerances in Table 7.3A.1.3-0, truncated to one decimal place that would apply for that operating band among the supported CA configurations. In case there is a harmonic relation between low band UL and high band DL, then the maximum tolerance among the different supported carrier aggregation configurations involving such band shall be applied - When the E-UTRA operating band frequency range is >1GHz, the applicable additional tolerance shall be the maximum tolerance in Table 7.3A.1.3-0 that would apply for that operating band among the supported CA configurations 		

NOTE: The above additional tolerances do not apply to supported UTRA operating bands with frequency range below 1 GHz that correspond to the E-UTRA operating bands that belong to the supported inter-band carrier aggregation configurations when such bands are belonging only to band combination(s) where one band is <1 GHz and another band is >1.7 GHz and there is no harmonic relationship between the low band UL and high band DL. Otherwise the above additional tolerances also apply to supported UTRA operating bands that correspond to the E-UTRA operating bands that belong to the supported inter-band carrier aggregation configurations.

For the UE that supports any of the E-UTRA CA configurations given in Table 7.3A.1.3-0a, exceptions are allowed when the uplink active in the lower-frequency operating band is within a specified frequency range as noted in Table 7.3A.1.3-0a. For these exceptions, the UE shall meet the requirements specified in Table 7.3A.1.3-0a, Table 7.3A.1.3-0b and Table 7.3A.1.3-0c.

Table 7.3A.1.3-0a: Reference sensitivity for carrier aggregation QPSK PREFSENS, CA

Channel bandwidth								
EUTRA CA Configuration	EUTRA band	1.4 MHz (dBm)	3 MHz (dBm)	5 MHz (dBm)	10 MHz (dBm)	15 MHz (dBm)	20 MHz (dBm)	Duplex mode
CA_3A-8A ⁴	3				N/A	N/A	N/A	FDD
	8			N/A	N/A			
CA_4A-12A ⁵	4	[-89.2]	[-89.2]	[-90]	[-89.5]			FDD
	12			-96.5	-93.5			
CA_4A-17A ⁵	4			[-90]	[-89.5]			FDD
	17			-96.5	-93.5			

NOTE 1: The transmitter shall be set to P_{UMAX} as defined in subclause 6.2.5A.
NOTE 2: Reference measurement channel is A.3.2 with one sided dynamic OCNG Pattern OP.1 FDD/TDD as described in Annex A.5.1.1/A.5.2.1
NOTE 3: The signal power is specified per port
NOTE 4: No requirements apply when there is at least one individual RE within the transmission bandwidth of the low band for which the 2nd harmonic is within the transmission bandwidth of the high band. The reference sensitivity is only verified when this is not the case (the requirements specified in clause 7.3.3 apply).
NOTE 5: These requirements apply when there is at least one individual RE within the transmission bandwidth of the low band for which the 3rd harmonic is within transmission bandwidth of the high band. The requirements should be verified for UL EARFCN of the low band (superscript LB) such that $f_{UL}^{LB} = \lfloor f_{DL}^{HB} / 0.3 \rfloor 0.1$ in MHz and $F_{UL_low}^{LB} + BW_{Channel}^{LB} / 2 < f_{UL}^{LB} < F_{UL_high}^{LB} - BW_{Channel}^{LB} / 2$ with f_{DL}^{HB} the carrier frequency of the high band in MHz and $BW_{Channel}^{LB}$ the channel bandwidth configured in the low band.

Table 7.3A.1.3-0b: Uplink configuration for the low band

E-UTRA Band / Channel bandwidth of the high band / NRB / Duplex mode								
EUTRA CA Configuration	UL band	1.4 MHz (dBm)	3 MHz (dBm)	5 MHz (dBm)	10 MHz (dBm)	15 MHz (dBm)	20 MHz (dBm)	Duplex mode
CA_4A-12A	12	2	5	8	16			FDD
CA_4A-17A	17			8	16			FDD

NOTE 1: refers to the UL resource blocks, which shall be centred within the transmission bandwidth configuration for the channel bandwidth
NOTE 2: the UL configuration applies regardless of the channel bandwidth of the low band unless the UL resource blocks exceed that specified in Table 7.3.3-2 for the uplink bandwidth in which case the allocation according to Table 7.3.3-2 applies

Unless given by Table 7.3A.1.3-0c, the minimum requirements specified in Tables 7.3A.1.3-0a and 7.3A.1.3-0b shall be verified with the network signalling value NS_01 (Table 6.2.4.3-1) configured.

Table 7.3A.1.3-0c: Network signalling value for reference sensitivity

E-UTRA CA Configuration	Uplink Band	Network Signalling value
CA_4A-12A	12	NS_06
CA_4A-17A	17	NS_06

For band combinations including operating bands without uplink band (as noted in Table 5.2-1), the requirements are specified in Table 7.3A.1-3-0d, Table 7.3A.1.3-0e and Table 7.3A.1.3-0f.

Table 7.3A.1.3-0d: Reference sensitivity QPSK P_{REFSENS}

Channel bandwidth								
EUTRA CA Configuration	EUTRA band	1.4 MHz (dBm)	3 MHz (dBm)	5 MHz (dBm)	10 MHz (dBm)	15 MHz (dBm)	20 MHz (dBm)	Duplex mode
CA_2A-29A	2			-98	-95			FDD
	29		-98.7	-97	-94			
NOTE 1: The transmitter shall be set to P_{UMAX} as defined in subclause 6.2.5A.								
NOTE 2: Reference measurement channel is A.3.2 with one sided dynamic OCNG Pattern OP.1 FDD/TDD as described in Annex A.5.1.1/A.5.2.1								
NOTE 3: The signal power is specified per port								

Table 7.3A.1.3-0e: Uplink configuration for reference sensitivity

E-UTRA Band / Channel bandwidth / NRB / Duplex mode								
E-UTRA CA Configuration	EUTRA band	1.4 MHz (dBm)	3 MHz (dBm)	5 MHz (dBm)	10 MHz (dBm)	15 MHz (dBm)	20 MHz (dBm)	Duplex mode
CA_2A-29A	2			25	50			FDD
	29		N/A	N/A	N/A			

Unless given by Table 7.3A.1.3-0f, the minimum requirements specified in Tables 7.3A.1.3-0d and 7.3A.1.3-0e shall be verified with the network signalling value NS_01 (Table 6.2.4.3-1) configured.

Table 7.3A.1.3-0f: Network signalling value for reference sensitivity

EUTRA CA Configuration	Uplink Band	Network Signalling value
CA_2A-29A	2	NS_03

For intra-band contiguous carrier aggregation the throughput of each component carrier shall be $\geq 95\%$ of the maximum throughput of the reference measurement channels as specified in as specified in Annexes A.2.2, A.2.3 and A.3.2 (with one sided dynamic OCNG Pattern OP.1 FDD/TDD for the DL-signal as described in Annex A.5.1.1/A.5.2.1) with parameters specified in Table 7.3.3-1 and table 7.3A.1.3-1. Table 7.3A.1.3-1 specifies the maximum number of allocated uplink resource blocks for which the intra-band contiguous carrier aggregation reference sensitivity requirement shall be met. The PCC and SCC allocations follow Table 7.3.3-2 and form a contiguous allocation where TX–RX frequency separations are as defined in Table 5.3-1. For UE(s) supporting one uplink carrier, the uplink configuration of the PCC shall be in accordance with Table 7.3.3-2.

Table 7.3A.1.3-1: Intra-band CA uplink configuration for reference sensitivity

CA configuration / CC combination / N _{RB_agg} / Duplex mode									
CA configuration	100RB+50RB		75RB+75RB		100RB+75RB		100RB+100RB		Duplex Mode
	PCC	SCC	PCC	SCC	PCC	SCC	PCC	SCC	
CA_1C	n/a	n/a	75	55	n/a	n/a	100	30	FDD
CA_7C	n/a	n/a	75	0	n/a	n/a	75	0	FDD
CA_38C			75	75			100	100	TDD
CA_40C	100	50	75	75	n/a	n/a	100	100	TDD
CA_41C	100	50	75	75	100	75	100	100	TDD

NOTE 1: The carrier centre frequency of SCC in the UL operating band is configured closer to the DL operating band.
NOTE 2: The transmitted power over both PCC and SCC shall be set to P_{UMAX} as defined in subclause 6.2.5A.
NOTE 3: The UL resource blocks in both PCC and SCC shall be confined within the transmission bandwidth configuration for the channel bandwidth (Table 5.4.2-1).
NOTE 4: The UL resource blocks in PCC shall be located as close as possible to the downlink operating band, while the UL resource blocks in SCC shall be located as far as possible from the downlink operating band.

For intra-band non-contiguous carrier aggregation with one uplink carrier on the PCC, the throughput of each downlink component carrier shall be $\geq 95\%$ of the maximum throughput of the reference measurement channels as specified in Annexes A.2.2, A.2.3 and A.3.2 (with one sided dynamic OCNG Pattern OP.1 FDD/TDD for the DL-signal as described in Annex A.5.1.1/A.5.2.1) with parameters specified in Table 7.3.3-1. The reference sensitivity is defined to be met with both downlink component carriers active and one uplink carrier active. For reference sensitivity measured on the downlink PCC, the parameters in Table 7.3.3-2 apply. For reference sensitivity measured on the downlink SCC, the parameters in Table 7.3A.1.3-2 apply. The minimum requirement for reference sensitivity in Table 7.3.3-1 shall be increased by the amount given in DR_{IBNC} in Table 7.3A.1.3-2 for the downlink SCC.

Table 7.3A.1.3-2: Intra-band non-contiguous CA uplink configuration for reference sensitivity

CA configuration	Aggregated channel bandwidth (PCC+SCC)	$W_{\text{gap}} / [\text{MHz}]$	UL PCC allocation	$\Delta R_{\text{IBNC}} (\text{dB})$	Duplex mode
CA_25A-25A	25RB+25RB	$30.0 < W_{\text{gap}} \leq 55.0$	10^1	5.0	FDD
		$0.0 < W_{\text{gap}} \leq 30.0$	25^1	0.0	
	25RB+50RB	$25.0 < W_{\text{gap}} \leq 50.0$	10^1	4.5	
		$0.0 < W_{\text{gap}} \leq 25.0$	25^1	0.0	
	50RB+25RB	$15.0 < W_{\text{gap}} \leq 50.0$	10^4	5.5	
		$0.0 < W_{\text{gap}} \leq 15.0$	32^1	0.0	
50RB+50RB	$10.0 < W_{\text{gap}} \leq 45.0$	10^4	5.0		
	$0.0 < W_{\text{gap}} \leq 10.0$	32^1	0.0		
CA_41A-41A ⁵	NOTE 6	NOTE 7	NOTE 8	0.0	TDD
<p>NOTE 1: ¹ refers to the UL resource blocks shall be located as close as possible to the downlink operating band but confined within the transmission.</p> <p>NOTE 2: W_{gap} is the sub-block gap between the two sub-blocks.</p> <p>NOTE 3: The carrier centre frequency of PCC in the UL operating band is configured closer to the DL operating band.</p> <p>NOTE 4: ⁴ refers to the UL resource blocks shall be located at $\text{RB}_{\text{start}}=33$.</p> <p>NOTE 5: For the TDD intra-band non-contiguous CA configurations, the minimum requirements apply only in synchronized operation between all component carriers.</p> <p>NOTE 6: All combinations of channel bandwidths defined in Table [5.2A-3].</p> <p>NOTE 7: All applicable sub-block gap sizes.</p> <p>NOTE 8: The PCC allocation is same as Transmission bandwidth configuration N_{RB} as defined in Table 5.4.2-1.</p>					

The normative reference for this requirement is TS 36.101[2] clause 7.3.1 and 7.3.1A.

7.3A.1.4 Test description

7.3A.1.4.1 Initial conditions

Initial conditions are a set of test configurations the UE needs to be tested in and the steps for the SS to take with the UE to reach the correct measurement state.

The initial test configurations consist of environmental conditions, test frequencies, and channel bandwidths based on E-UTRA CA configurations specified in table 5.4.2A.1-1. All of these configurations shall be tested with applicable test parameters for each channel bandwidth, and are shown in table 7.3A.1.4.1-1. The details of the uplink reference measurement channels (RMCs) are specified in Annex A.2. Configurations of PDSCH and PDCCH before measurement are specified in Annex C.2.

Table 7.3A.1.4.1-1: Test Configuration Table

Initial Conditions									
Test Environment as specified in TS 36.508[7] subclause 4.1					NC, TL/VL, TL/VH, TH/VL, TH/VH				
Test Frequencies as specified in TS36.508 [7] subclause 4.3.1 for different CA bandwidth classes.					C: Low range, High range				
Test CC Combination setting (N_{RB_agg}) as specified in subclause 5.4.2A.1 for the CA Configuration across bandwidth combination sets supported by the UE.					Lowest N_{RB_agg} , Highest N_{RB_agg}				
Test Parameters for CA Configurations									
CA Configuration / N_{RB_agg}		DL Allocation			UL Allocation				
PCC N_{RB}	SCCs N_{RB}	CC MOD	PCC & SCC RB allocation	CC MOD	N_{RB_alloc}	PCC & SCC RB allocations (L _{CRB} @ RB _{start})			
75	75	QPSK	75+75	QPSK	75	P_75@0	S_0@0	-	-
75	75	QPSK	75+75	QPSK	50	P_50@25	S_0@0	-	-
75	75	QPSK	75+75	QPSK	25	P_25@50	S_0@0	-	-
75	75	QPSK	75+75	QPSK	20	P_20@55	S_0@0	-	-
75	75	QPSK	75+75	QPSK	130	P_75@0	S_55@0	-	-
75	75	QPSK	75+75	QPSK	150	P_75@0	S_75@0	-	-
100	50	QPSK	100+50	QPSK	100	P_100@0	S_0@0	-	-
100	50	QPSK	100+50	QPSK	75	P_75@25	S_0@0	-	-
100	50	QPSK	100+50	QPSK	50	P_50@50	S_0@0	-	-
100	50	QPSK	100+50	QPSK	25	P_25@75	S_0@0	-	-
100	50	QPSK	100+50	QPSK	20	P_20@80	S_0@0	-	-
100	50	QPSK	100+50	QPSK	150	P_100@0	S_50@0	-	-
100	100	QPSK	100+100	QPSK	100	P_100@0	S_0@0	-	-
100	100	QPSK	100+100	QPSK	75	P_75@25	S_0@0	-	-
100	100	QPSK	100+100	QPSK	50	P_50@50	S_0@0	-	-
100	100	QPSK	100+100	QPSK	25	P_25@75	S_0@0	-	-
100	100	QPSK	100+100	QPSK	20	P_20@80	S_0@0	-	-
100	100	QPSK	100+100	QPSK	130	P_100@0	S_30@0	-	-
100	100	QPSK	100+100	QPSK	200	P_100@0	S_100@0	-	-
Note 1: CA Configuration Test CC Combination settings are checked separately for each CA Configuration, which applicable aggregated channel bandwidths are specified in Table 5.4.2A.1-1 and Table 5.4.2A.1-2.									
Note 2: Depending on CA configurations, only the appropriate Uplink RB allocation value according to table 7.3A.1.3-1 for UE supporting two uplink carriers is tested per Test CA configuration.									

1. Connect the SS to the UE antenna connectors as shown in TS 36.508[7] Annex A Figure group A.32 as appropriate .
2. The parameter settings for the cell are set up according to TS 36.508 [7] subclause 4.4.3.
3. Downlink signals for PCC are initially set up according to Annex C.0, C.1, and C.3.1, and uplink signals according to Annex H.1 and H.3.0.
4. The UL and DL Reference Measurement channel is set according to Table 7.3A. 1.4.1-1.
5. Propagation conditions are set according to Annex B.0.
6. Ensure the UE is in State 3A-RF according to TS 36.508 [7] clause 5.2A.2. Message contents are defined in clause 7.3A. 1.4.3.

7.3A.1.4.2 Test procedure

1. Configure SCC according to Annex C.0, C.1 and Annex C.3.1 for all downlink physical channels except PHICH.
2. The SS shall configure SCC as per TS 36.508 [7] clause 5.2A.4. Message contents are defined in clause 7.3A.1.4.3
3. SS activates SCC by sending the activation MAC-CE (Refer TS 36.321 [13], clauses 5.13, 6.1.3.8). Wait for at least 2 seconds (Refer TS 36.133, clauses 8.3.3.2).

4. SS transmits PDSCH via PDCCH DCI format 1A for C_RNTI to transmit the DL RMC according to Tables 7.3A.1.4.1-1 on both PCC and SCC. The SS sends downlink MAC padding bits on the DL RMC.
5. SS sends uplink scheduling information for each UL HARQ process via PDCCH DCI format 0 for C_RNTI to schedule the UL RMC according to Table 7.3A.1.4.1-1 on both PCC and SCC. Since the UE has no payload and no loopback data to send the UE sends uplink MAC padding bits on the UL RMC.
6. Set the Downlink signal level for PCC and SCC to the appropriate REFSSENS value defined in Table 7.3A.1.5-1. Send continuously uplink power control "up" commands in every uplink scheduling information to the UE to ensure the UE transmits P_{UMAX} level for at least the duration of the Throughput measurement.
7. Measure the average throughput for each component carrier for a duration sufficient to achieve statistical significance according to Annex G.2A.

7.3A.1.4.3 Message contents

Message contents are according to TS 36.508 [7] subclause 4.6. In test procedure step 2, for SCC configuration there are no additional message contents.

7.3A.1.5 Test requirement

For intra-band contiguous carrier aggregation the throughput of each component carrier shall be $\geq 95\%$ of the maximum throughput of the reference measurement channels as specified in as specified in Annexes A.2.2, A.2.3 and A.3.2 (with one sided dynamic OCNG Pattern OP.1 FDD/TDD for the DL-signal as described in Annex A.5.1.1/A.5.2.1) with parameters specified in Table 7.3A.1.5-1 and table 7.3A.1.5-2.

Table 7.3A.1.5-1: Reference sensitivity QPSK $P_{REFSENS}$ for intra-band

CA Configuration	CA Band / Aggregated channel bandwidth / NRB / Duplex mode								Duplex Mode
	100RB+50RB		75RB+75RB		100RB+75RB		100RB+100RB		
	100RB	50RB	75RB	75RB	100RB	75RB	100RB	100RB	
CA_1C	-	-	-94.5	-94.5	-	-	-93.3	-93.3	FDD
CA_7C	-	-	-92.5	-92.5	-	-	-91.3	-91.3	FDD
CA_38C	-	-	-94.5	-94.5	-	-	-93.3	-93.3	TDD
CA_40C	-93.3	-96.3	-94.5	-94.5	-	-	-93.3	-93.3	TDD
CA_41C	-91.3	-94.3	-92.5	-92.5	-91.3	-92.5	-91.3	-91.3	TDD
	Note 1: The transmitter shall be set to P_{UMAX} as defined in clause 6.2.5A Note 2: The reference measurement channel is specified in A.3.2 with one sided dynamic OCNG Pattern OP.1 FDD/TDD as described in Annex A.5.1.1/A.5.2.1 Note 3: The signal power is specified per port								

The reference receive sensitivity (REFSENS) requirement for intra-band specified in Table 7.3A.1.5-1 shall be met for each uplink CA configurations less than or equal to that specified in Table 7.3A.1.5-2.

NOTE: Table 7.3A.1.5-2 does not necessarily reflect the operational conditions of the network, where the number of uplink and downlink allocated resource blocks will be practically constrained by other factors.

Table 7.3A.1.5-2: Intra-band CA uplink configuration for reference sensitivity

CA configuration / CC combination / NRB_agg / Duplex mode									
CA configuration	100RB+50RB		75RB+75RB		100RB+75RB		100RB+100RB		Duplex Mode
	PCC	SCC	PCC	SCC	PCC	SCC	PCC	SCC	
CA_1C	n/a	n/a	75	55	<u>n/a</u>	<u>n/a</u>	100	30	FDD
CA_7C	n/a	n/a	75	0	n/a	n/a	75	0	FDD
CA_38C	n/a	n/a	75	75	n/a	n/a	100	100	TDD
CA_40C	100	50	75	75	<u>n/a</u>	<u>n/a</u>	100	100	TDD
CA_41C	100	50	75	75	100	75	100	100	TDD

NOTE 1: The carrier centre frequency of SCC in the UL operating band is configured closer to the DL operating band.
NOTE 2: The transmitted power over both PCC and SCC shall be set to P_{UMAX} as defined in subclause 6.2.5A.
NOTE 3: The UL resource blocks in both PCC and SCC shall be confined within the transmission bandwidth configuration for the channel bandwidth (Table 5.4.2A-1).
NOTE 4: The UL resource blocks in PCC shall be located as close as possible to the downlink operating band, while the UL resource blocks in SCC shall be located as far as possible from the downlink operating band.

7.3A.2 Reference sensitivity level for CA (intra-band contiguous DL CA without UL CA)

7.3A.2.1 Test purpose

Same as in clause 7.3A.1.1.

7.3A.2.2 Test applicability

This test case applies to all types of E-UTRA UE release 10 and forward that support intra-band contiguous DL CA and but no UL CA.

7.3A.2.3 Minimum conformance requirements

Same as in clause 7.3A.1.3.

7.3A.2.4 Test description

7.3A.2.4.1 Initial conditions

Same as in clause 7.3A.1.4.1 with the following exceptions:

- Instead of Table 7.3A.1.4.1-1 → use Table 7.3A.2.4.1-1.

Table 7.3A.2.4.1-1: Test Configuration Table

Initial Conditions									
Test Environment as specified in TS 36.508[7] subclause 4.1					NC, TL/VL, TL/VH, TH/VL, TH/VH				
Test Frequencies as specified in TS36.508 [7] subclause 4.3.1 for different CA bandwidth classes.					C: Low range, High range				
Test CC Combination setting (N_{RB_agg}) as specified in subclause 5.4.2A.1 for the CA Configuration across bandwidth combination sets supported by the UE.					Lowest N_{RB_agg} , Highest N_{RB_agg}				
Test Parameters for CA Configurations									
CA Configuration / N_{RB_agg}		DL Allocation			UL Allocation				
PCC N_{RB}	SCCs N_{RB}	CC MOD	PCC & SCC RB allocation	CC MOD	N_{RB_alloc}	PCC & SCC RB allocations (L_{CRB} @ RB_{start})			
75	75	QPSK	75+75	QPSK	75	P_75@0	-	-	-
75	75	QPSK	75+75	QPSK	50	P_50@0	-	-	-
75	75	QPSK	75+75	QPSK	25	P_25@0	-	-	-
75	75	QPSK	75+75	QPSK	20	P_20@0	-	-	-
100	50	QPSK	100+50	QPSK	100	P_100@0	-	-	-
100	50	QPSK	100+50	QPSK	75	P_75@0	-	-	-
100	50	QPSK	100+50	QPSK	50	P_50@0	-	-	-
100	50	QPSK	100+50	QPSK	25	P_25@0	-	-	-
100	50	QPSK	100+50	QPSK	20	P_20@0	-	-	-
100	100	QPSK	100+100	QPSK	100	P_100@0	-	-	-
100	100	QPSK	100+100	QPSK	75	P_75@0	-	-	-
100	100	QPSK	100+100	QPSK	50	P_50@0	-	-	-
100	100	QPSK	100+100	QPSK	25	P_25@0	-	-	-
100	100	QPSK	100+100	QPSK	20	P_20@0	-	-	-
Note 1: CA Configuration Test CC Combination settings are checked separately for each CA Configuration, which applicable aggregated channel bandwidths are specified in Table 5.4.2A.1-1 and Table 5.4.2A.1-2.									
Note 2: Depending on CA configurations, only the appropriate Uplink RB allocation value according to table 7.3.3-2 for UE supporting one uplink carrier is tested per Test CA configuration.									

7.3A.2.4.2 Test procedure

1. Configure SCC according to Annex C.0, C.1 and Annex C.3.1 for all downlink physical channels except PHICH.
2. The SS shall configure SCC as per TS 36.508 [7] clause 5.2A.4. Message contents are defined in clause 7.3A.1.4.3
3. SS activates SCC by sending the activation MAC-CE (Refer TS 36.321 [13], clauses 5.13, 6.1.3.8). Wait for at least 2 seconds (Refer TS 36.133, clauses 8.3.3.2).
4. SS transmits PDSCH via PDCCH DCI format 1A for C_RNTI to transmit the DL RMC according to Tables 7.3A.2.4.1-1 on both PCC and SCC. The SS sends downlink MAC padding bits on the DL RMC.
5. SS sends uplink scheduling information for each UL HARQ process via PDCCH DCI format 0 for C_RNTI to schedule the UL RMC according to Table 7.3A.2.4.1-1 on PCC. Since the UE has no payload and no loopback data to send the UE sends uplink MAC padding bits on the UL RMC.
6. Set the Downlink signal level for PCC and SCC to the appropriate REFSENS value defined in Table 7.3A.1.5-1. Send continuously uplink power control "up" commands in every uplink scheduling information to the UE to ensure the UE transmits P_{UMAX} level for at least the duration of the Throughput measurement.
7. Measure the average throughput for each component carrier for a duration sufficient to achieve statistical significance according to Annex G.2A.

7.3A.2.4.3 Message contents

Same as in clause 7.3A.1.4.3.

7.3A.2.5 Test requirement

Same as in clause 7.3A.1.5.

7.3A.3 Reference sensitivity level for CA (inter-band DL CA without UL CA)

7.3A.3.1 Test purpose

Same as in clause 7.3A.1.1.

7.3A.3.2 Test applicability

This test case applies to all types of E-UTRA UE release 10 and forward that support inter-band DL CA but no UL CA.

7.3A.3.3 Minimum conformance requirements

Same as in clause 7.3A.1.3.

7.3A.3.4 Test description

7.3A.3.4.1 Initial conditions

Same as in clause 7.3A.1.4.1 with the following exceptions:

- Instead of Table 7.3A.1.4.1-1 → use Table 7.3A.3.4.1-1.
- Instead of clause 7.3A.1.4.3 use clause 7.3A.3.4.3.

Table 7.3A.3.4.1-1: Test Configuration Table

Initial Conditions						
Test Environment as specified in TS 36.508[7] subclause 4.1				NC, TL/VL, TL/VH, TH/VL, TH/VH		
Test Frequencies as specified in TS36.508 [7] subclause 4.3.1 for different CA bandwidth classes.				A: Mid range for PCC and SCC, unless otherwise specified in the Tables 7.3A.3.4.1-2 to 7.3A.3.4.1-9		
Test CC Combination setting (N_{RB_agg}) as specified in subclause 5.4.2A.1 for the CA Configuration across bandwidth combination sets supported by the UE.				Highest N_{RB_agg} , unless otherwise specified in the Tables 7.3A.3.4.1-2 to 7.3A.3.4.1-9		
Network signalling value				NS_01 Unless given by Table 7.3A.3.4.1-1a		
Test Parameters for CA Configurations						
CA Configuration / N_{RB_agg}		DL Allocation			UL Allocation	
PCC NRB	SCCs N_{RB}	CC MOD	PCC & SCC RB allocation		CC MOD	PCC N_{RB_alloc}
50	50	QPSK	50	50	QPSK	50
50	50	QPSK	50	50	QPSK	25
50	50	QPSK	50	50	QPSK	20
50	50	QPSK	50	50	QPSK	16
50	75	QPSK	50	75	QPSK	50
50	75	QPSK	50	75	QPSK	25
50	75	QPSK	50	75	QPSK	20
50	100	QPSK	50	100	QPSK	50
50	100	QPSK	50	100	QPSK	25
50	100	QPSK	50	100	QPSK	20
75	50	QPSK	75	50	QPSK	75
75	50	QPSK	75	50	QPSK	75
75	50	QPSK	75	50	QPSK	50
75	50	QPSK	75	50	QPSK	25
75	50	QPSK	75	50	QPSK	20
75	75	QPSK	75	75	QPSK	75
75	75	QPSK	75	75	QPSK	50
75	75	QPSK	75	75	QPSK	25
75	75	QPSK	75	75	QPSK	20
75	100	QPSK	75	100	QPSK	75
75	100	QPSK	75	100	QPSK	50
75	100	QPSK	75	100	QPSK	25
75	100	QPSK	75	100	QPSK	20
100	50	QPSK	100	50	QPSK	100
100	50	QPSK	100	50	QPSK	75
100	50	QPSK	100	50	QPSK	50

100	50	QPSK	100	50	QPSK	25
100	50	QPSK	100	50	QPSK	20
100	75	QPSK	100	75	QPSK	100
100	75	QPSK	100	75	QPSK	75
100	75	QPSK	100	75	QPSK	50
100	75	QPSK	100	75	QPSK	25
100	75	QPSK	100	75	QPSK	20
<p>Note 1: CA Configuration Test CC Combination settings are checked separately for each CA Configuration, which applicable aggregated channel bandwidths are specified in Table 5.4.2A.1-2.</p> <p>Note 2: Depending on CA configurations, only the appropriate Uplink RB allocation value according to table 7.3.3-2 for UE supporting one uplink carrier is tested per Test CA configuration.</p> <p>Note 3: The UL resource blocks shall be located as close as possible to the downlink SCC but confined within the transmission bandwidth configuration for the channel bandwidth (Table 5.4.2-1).</p> <p>Note 4: The frequencies of PCC and SCC shall be switched and tested in each configuration (given UL is supported in PCC band as per Table 5.2-1).</p>						

Table 7.3A.3.4.1-1a: Network signalling value for reference sensitivity

E-UTRA CA Configuration	Uplink Band	Network Signalling value
CA_4A-12A	12	NS_06
CA_4A-17A	17	NS_06

Table 7.3A.3.4.1-2: Test frequencies and Test CC combinations for CA_1A-18A

CBW			Band 18	
			10MHz	15MHz
			Low range	Mid range
Band 1	10MHz	Low range	X	
	15MHz		X	
	20MHz		X	X

Table 7.3A.3.4.1-3: Test frequencies and Test CC combinations for CA_1A-19A

CBW			Band 19	
			10MHz	15MHz
			High range	Mid range
Band 1	10MHz	Mid range		X
	15MHz		X	
	20MHz			X

Table 7.3A.3.4.1-4: Test frequencies and Test CC combinations for CA_1A-21A

CBW			Band 21	
			15MHz	
			High range	Mid range
Band 1	15MHz	Mid range	X	X
	20MHz		-	X

Table 7.3A.3.4.1-5: Test frequencies and Test CC combinations for CA_3A-8A

CBW			Band 8	
			5 MHz	10 MHz
			High range	
Band 3	10MHz	Mid range	-	X
	15MHz		X	-
	20MHz		X	X

Table 7.3A.3.4.1-6: Test frequencies and Test CC combinations for CA_4A-5A

CBW			Band 5		
			10 MHz		
			Low range	Mid range	High range
Band 4	10MHz	Mid range	X	X	X

Table 7.3A.3.4.1-7: Test frequencies and Test CC combinations for CA_4A-13A

CBW			Band 13
			10MHz
			Mid range
Band 4	10MHz	Low range	X
	15 MHz	Mid range	X
	20 MHz	High range	X

Table 7.3A.3.4.1-8: Test frequencies and Test CC combinations for CA_4A-17A

CBW			Band 17		
			10MHz		
			Low range	Mid range	High range
Band 4 as PCC	10 MHz	Mid range	X	-	X
Band 4 as SCC (Note 1)	10MHz	Low range	X ²	-	-
		Mid range	-	X ³	-
		High range	-	-	X ⁴
Note 1: For Band 4 as SCC the exceptions described in Table 7.3A.1.3-0 are tested. For this purpose the test frequencies are selected to fulfil the equation in Table 7.3A.1.3-0 Note 5.					
Note 2: Band 17: $f_{UL} = 709.1$ MHz ($N_{UL} = 23781$), $f_{DL} = 739.1$ MHz ($N_{DL} = 5781$) Band 4: $f_{DL} = 2127.3$ MHz ($N_{DL} = 2123$)					
Note 3: Band 17: $f_{UL} = 710$ MHz ($N_{UL} = 23790$), $f_{DL} = 740$ MHz ($N_{DL} = 5790$) Band 4: $f_{DL} = 2130$ MHz ($N_{DL} = 2150$)					
Note 4: Band 17: $f_{UL} = 710.9$ MHz ($N_{UL} = 23799$), $f_{DL} = 740.9$ MHz ($N_{DL} = 5799$) Band 4: $f_{DL} = 2132.7$ MHz ($N_{DL} = 2177$)					

Table 7.3A.3.4.1-9: Test frequencies and Test CC combinations for CA_11A-18A

CBW			Band 18	
			10MHz	15MHz
			Low range	Mid range
Band 11	10MHz	High range	X	X

7.3A.3.4.2 Test procedure

1. Configure SCC according to Annex C.0, C.1 and Annex C.3.1 for all downlink physical channels except PHICH.
2. The SS shall configure SCC as per TS 36.508 [7] clause 5.2A.4. Message contents are defined in clause 7.3A3.4.3
3. SS activates SCC by sending the activation MAC-CE (Refer TS 36.321 [13], clauses 5.13, 6.1.3.8). Wait for at least 2 seconds (Refer TS 36.133, clauses 8.3.3.2).
4. SS transmits PDSCH via PDCCH DCI format 1A for C_RNTI to transmit the DL RMC according to Tables 7.3A.3.4.1-1 on both PCC and SCC. The SS sends downlink MAC padding bits on the DL RMC.
5. SS sends uplink scheduling information for each UL HARQ process via PDCCH DCI format 0 for C_RNTI to schedule the UL RMC according to Table 7.3A.3.4.1-1 on PCC. Since the UE has no payload and no loopback data to send the UE sends uplink MAC padding bits on the UL RMC.
6. Set the Downlink signal level for PCC and SCC to the appropriate REFSSENS value defined in Table 7.3A.3.5-1. Send continuously uplink power control "up" commands in the uplink scheduling information to the UE to ensure the UE transmits P_{UMAX} level for at least the duration of the Throughput measurement.
7. Measure the average throughput for each component carrier for a duration sufficient to achieve statistical significance according to Annex G.2A.

7.3A3.4.3 Message contents

Message contents are according to TS 36.508 [7] subclause 4.6. In test procedure step 2, for SCC configuration there are no additional message contents.

7.3A.3.5 Test requirement

For inter-band carrier aggregation with uplink assigned to one E-UTRA band the throughput shall be $\geq 95\%$ of the maximum throughput of the reference measurement channels as specified in Annex A.3.2 with parameters specified in Tables 7.3A.3.5-1 and Table 7.3A.3.5-2. The test requirement tables are originated from Table 7.3.5-1 and Table 7.3.5-2.

Table 7.3A.3.5-1: Reference sensitivity QPSK P_{REFSENS} for inter-band

CA Configuration	E-UTRA Band	Channel bandwidth						Duplex Mode
		1.4 MHz (dBm)	3 MHz (dBm)	5 MHz (dBm)	10 MHz (dBm)	15 MHz (dBm)	20 MHz (dBm)	
CA_1A-5A	1	-	-	-	-96.3	-	-	FDD
	5	-	-	-	-94.3	-	-	
CA_1A-18A	1	-	-	-99.3	-96.3	-94.5	-93.3	FDD
	18	-	-	-99.3	-96.3	-94.5	-	
CA_1A-19A	1	-	-	-99.3	-96.3	-94.5	-93.3	FDD
	19	-	-	-99.3	-96.3	-94.5	-	
CA_1A-21A	1	-	-	-99.3	-96.3	-94.5	-93.3	FDD
	21	-	-	-99.3	-96.3	-94.5	-	
CA_2A-17A	2	-	-	-97.3	-94.3	-	-	FDD
	17	-	-	-95.8	-92.8	-	-	
CA_3A-7A	3	-	-	-96.3	-93.3	-91.5	-90.3	FDD
	7	-	-	-	-94.3	-92.5	-91.3	
CA_3A-8A	3	-	-	-	-93.3	-91.5	-90.3	FDD
	8	-	-	-96.3	-93.3	-	-	
CA_4A-5A	4	-	-	-99.3	-96.3	-	-	FDD
	5	-	-	-97.3	-94.3	-	-	
CA_4A-12A	4	-104	-101	-99.3	-96.3	-	-	FDD
	4 (Note 4)	[-88.5]	[-88.5]	[-89.3]	[-88.8]	-	-	
	12	-	-	-95.8	-92.8	-	-	
CA_4A-13A	4	-	-	-99.3	-96.3	-94.5	-93.3	FDD
	13	-	-	-	-93.3	-	-	
CA_4A-17A	4	-	-	-99.3	-96.3	-	-	FDD
	4 (Note 4)	-	-	[-89.3]	[-88.8]	-	-	
	17	-	-	-95.8	-92.8	-	-	
CA_4A-29A	4	-	-	-99.3	-96.3	-	-	FDD
	29	-	-98	-96.3	-93.3	-	-	
CA_5A-12A	5	-	-	-96.8	-93.8	-	-	FDD
	12	-	-	-96.0	-93.0	-	-	
CA_7A-20A	7	-	-	-	-94.3	-92.5	-91.3	FDD
	20	-	-	-96.3	-93.3	-	-	
CA_11A-18A	11	-	-	-99.3	-96.3	-	-	FDD
	18	-	-	-99.3	-96.3	-94.5	-	
CA_2A-29A	2	-	-	-97.3	-94.3	-	-	FDD
	29	-	-98	-96.3	-93.3	-	-	

Note 1: The transmitter shall be set to maximum output power level (Table 7.3A.3.5-2)
Note 2: The reference measurement channel is specified in A.3.2 with one sided dynamic OCN Pattern OP.1 FDD/TDD as described in Annex A.5.1.1/A.5.2.1
Note 3: The signal power is specified per port
Note 4: Reference sensitivity for the high band for which the 3rd harmonic of the low band is within transmission bandwidth, as specified in Table 7.3A.1.3-0a.

The reference receive sensitivity (REFSENS) requirement for inter-band specified in Table 7.3A.3.5-1 shall be met for an uplink CA configurations than or equal to that specified in Table 7.3A.3.5-2.

NOTE: Table 7.3A.3.5-2 does not necessarily reflect the operational conditions of the network, where the number of uplink and downlink allocated resource blocks will be practically constrained by other factors.

Table 7.3A.3.5-2: Inter-band CA uplink configuration for reference sensitivity

CA Configuration	Channel bandwidth							Duplex Mode
	E-UTRA Band	1.4 MHz	3 MHz	5 MHz	10 MHz	15 MHz	20 MHz	
CA_1A-5A	1	-	-	-	50	-	-	FDD
	5	-	-	-	25 ¹	-	-	
CA_1A-18A	1	-	-	25	50	75	100	FDD
	18	-	-	25	25 ¹	25 ¹	-	
CA_1A-19A	1	-	-	25	50	75	100	FDD
	19	-	-	25	25 ¹	25 ¹	-	
CA_1A-21A	1	-	-	25	50	75	100	FDD
	21	-	-	25	25 ¹	25 ¹	-	
CA_2A-17A	2	-	-	25	50	-	-	FDD
	17	-	-	20 ¹	20 ¹	-	-	
CA_3A-7A	3	-	-	25	50	50 ¹	50 ¹	FDD
	7	-	-	-	50	75 ¹	75 ¹	
CA_3A-8A	3	-	-	25	50	50 ¹	50 ¹	FDD
	8	-	-	25	25 ¹	-	-	
CA_4A-5A	4	-	-	25	50	-	-	FDD
	5	-	-	25	25 ¹	-	-	
CA_4A-12A	4	6	15	25	50	-	-	FDD
	12	-	-	20 ¹	20 ¹	-	-	
CA_4A-13A	4	-	-	25	50	75	100	FDD
	13	-	-	-	20 ¹	-	-	
CA_4A-17A	4	-	-	25	50	-	-	FDD
	17	-	-	8 ^{2,3}	16 ^{2,3}	-	-	
CA_4A-29A	4	-	-	25	50	-	-	FDD
	29	-	-	-	-	-	-	
CA_5A-12A	5	-	-	25	25 ¹	-	-	FDD
	12	-	-	20 ¹	20 ¹	-	-	
CA_7A-20A	7	-	-	-	50	75 ¹	75 ¹	FDD
	20	-	-	25	20 ¹	-	-	
CA_11A-18A	11	-	-	25	25 ¹	-	-	FDD
	18	-	-	25	25 ¹	25 ¹	-	
CA_2A-29A	2	-	-	25	50	-	-	FDD
	29	-	-	-	-	-	-	

Note 1: The UL resource blocks shall be located as close as possible to the downlink SCC but confined within the transmission bandwidth configurations (Table 5.4.2-1).

Note 2: Configuration for the low band for which the 3rd harmonic is within transmission bandwidth of the high band, as specified in Table 7.3A.1.3-0b.

Note 3: In the case of 5MHz channel bandwidth, the UL resource blocks shall be located at RB_{start}=9 and in the case of 10MHz channel bandwidth, the UL resource blocks shall be located at RB_{start}=17 according to Note 1 in Table 7.3A.1.3-0b

7.3A.4 Reference sensitivity level for CA (intra-band non-contiguous DL CA without UL CA)

Editor's notes: The following items are missing or incomplete:

- Initial conditions
- Test procedure
- Message contents
- Test requirement
- Test Tolerance

7.3A.4.1 Test purpose

Same as in clause 7.3A.1.1.

7.3A.4.2 Test applicability

This test case applies to all types of E-UTRA UE release 11 and forward that support intra-band non-contiguous DL CA but no UL CA.

7.3A.4.3 Minimum conformance requirements

Same as in clause 7.3A.1.3.

7.3A.4.4 Test description

7.3A.4.4.1 Initial conditions

FFS

7.3A.4.4.2 Test procedure

FFS

7.3A.4.4.3 Message contents

FFS

7.3A.4.5 Test requirement

FFS

7.3B Reference sensitivity level for UL-MIMO

7.3B.1 Test purpose

To verify the ability of UE that support UL-MIMO to receive data with a given average throughput for a specified reference measurement channel, under conditions of low signal level, ideal propagation and no added noise.

A UE unable to meet the throughput requirement under these conditions will decrease the effective coverage area of an e-NodeB.

7.3B.2 Test applicability

This test applies to all types of E-UTRA UE release 10 and forward that support UL-MIMO.

7.3B.3 Minimum conformance requirements

For UE with two transmitter antenna connectors in closed-loop spatial multiplexing scheme, the minimum requirements in Clause 7.3.3 shall be met with the UL-MIMO configurations specified in Table 6.2.2B.3-2. For UL-MIMO, the parameter P_{UMAX} is the total transmitter power over the two transmit antenna connectors.

The normative reference for this requirement is TS 36.101 [2] clause 7.3.1B.

7.3B.4 Test description

7.3B.4.1 Initial conditions

Initial conditions are a set of test configurations the UE needs to be tested in and the steps for the SS to take with the UE to reach the correct measurement state.

The initial test configurations consist of environmental conditions, test frequencies, and channel bandwidths based on E-UTRA bands specified in table 5.4.2.1-1. All of these configurations shall be tested with applicable test parameters for each channel bandwidth, and are shown in table 7.3B.4.1-1. The details of the downlink and uplink reference measurement channels (RMCs) are specified in Annexes A.2 and A.3. The details of the OCNG patterns used are specified in Annex A.5. Configurations of PDSCH and PDCCH before measurement are specified in Annex C.2.

Table 7.3B.4.1-1: Test Configuration Table

Initial Conditions						
Test Environment as specified in TS 36.508[7] subclause 4.1			NC, TL/VL, TL/VH, TH/VL, TH/VH			
Test Frequencies as specified in TS36.508 [7] subclause 4.3.1			Low range, Mid range, High range			
Test Channel Bandwidths as specified in TS 36.508 [7] subclause 4.3.1			Lowest, 5MHz, Highest			
Test Parameters for Channel Bandwidths						
Ch BW	Downlink Configuration			Uplink Configuration		
	Mod'n	RB allocation		Mod'n	RB allocation	
		FDD	TDD		FDD	TDD
1.4MHz	QPSK	6	6	QPSK	6	6
3MHz	QPSK	15	15	QPSK	15	15
5MHz	QPSK	25	25	QPSK	25	25
5MHz	QPSK	25	N/A	QPSK	20	N/A
5MHz	QPSK	25	N/A	QPSK	15	N/A
10MHz	QPSK	50	50	QPSK	50	50
10MHz	QPSK	50	N/A	QPSK	25	N/A
10MHz	QPSK	50	N/A	QPSK	20	N/A
10MHz	QPSK	50	N/A	QPSK	15	N/A
15MHz	QPSK	75	75	QPSK	75	75
15MHz	QPSK	75	N/A	QPSK	50	N/A
15MHz	QPSK	75	N/A	QPSK	25	N/A
15MHz	QPSK	75	N/A	QPSK	20	N/A
20MHz	QPSK	100	100	QPSK	100	100
20MHz	QPSK	100	N/A	QPSK	75	N/A
20MHz	QPSK	100	N/A	QPSK	50	N/A
20MHz	QPSK	100	N/A	QPSK	25	N/A
20MHz	QPSK	100	N/A	QPSK	20	N/A
Note 1: Test Channel Bandwidths are checked separately for each E-UTRA band, which applicable channel bandwidths are specified in Table 5.4.2.1-1. Note 2: Depending on E-UTRA band, only the appropriate Uplink RB allocation value according to table 7.3.3-2 is tested per Test Channel Bandwidth. Note 3: For the DL signal one sided dynamic OCNG Pattern OP.1 FDD/TDD is used.						

1. Connect the SS to the UE antenna connectors as shown in TS 36.508 [7] Annex A, Figure A.28.
2. The parameter settings for the cell are set up according to TS 36.508 [7] subclause 4.4.3.
3. Downlink signals are initially set up according to Annex C0, C.1 and C.3.1, and uplink signals according to Annex H.1 and H.3.1.
4. The UL and DL Reference Measurement channels are set according to Table 7.3B.4.1-1.
5. Propagation conditions are set according to Annex B.0.

6. Ensure the UE is in State 3A-RF according to TS 36.508 [7] clause 5.2A.2. Message contents are defined in clause 7.3B.4.3.

7.3B.4.2 Test procedure

1. SS transmits PDSCH via PDCCH DCI format 1A for C_RNTI to transmit the DL RMC according to Table 7.3B.4.1-1. The SS sends downlink MAC padding bits on the DL RMC.
2. SS sends uplink scheduling information for each UL HARQ process via PDCCH DCI format 4 for C_RNTI to schedule the UL RMC according to Table 7.3B.4.1-1. Since the UE has no payload data to send, the UE transmits uplink MAC padding bits on the UL RMC.
3. Set the Downlink signal level to the appropriate REFSENS value defined in Table 7.3B.5-1. Send continuously uplink power control "up" commands in the uplink scheduling information to the UE to ensure the UE transmits P_{UMAX} level for at least the duration of the throughput measurement.
4. Measure the average throughput for a duration sufficient to achieve statistical significance according to Annex G.2.

7.3B.4.3 Message contents

Message contents are according to TS 36.508 [7] clause 4.6 with the following exceptions.

7.3B.4.3.1 Message contents exceptions (network signalled value "NS_01")

Message contents according to TS 36.508 [7] clause 4.6 can be used without exceptions.

7.3B.4.3.2 Message contents exceptions (network signalled value "NS_03")

1. Information element additionalSpectrumEmission is set to NS_03. This can be set in the SystemInformationblockType2 as part of the cell broadcast message. This exception indicates that the UE shall meet the additional spurious emission requirement for a specific deployment scenario.

Table 7.3B.4.3.2-1: SystemInformationBlockType2: Additional spurious emissions test requirement for "NS_03"

Derivation Path: TS 36.508 [7] clause 4.4.3.3, Table 4.4.3.3-1			
Information Element	Value/remark	Comment	Condition
additionalSpectrumEmission	3 (NS_03)		

7.3B.4.3.3 Message contents exceptions (network signalled value "NS_06")

1. Information element additionalSpectrumEmission is set to NS_06. This can be set in the SystemInformationblockType2 as part of the cell broadcast message. This exception indicates that the UE shall meet the additional spurious emission requirement for a specific deployment scenario.

Table 7.3B.4.3.3-1: SystemInformationBlockType2: Additional spurious emissions test requirement for "NS_06"

Derivation Path: TS 36.508 [7] clause 4.4.3.3, Table 4.4.3.3-1			
Information Element	Value/remark	Comment	Condition
additionalSpectrumEmission	6 (NS_06)		

7.3B.4.3.4 Message contents exceptions (network signalled value "NS_[09]")

1. Information element additionalSpectrumEmission is set to NS_[09]. This can be set in the SystemInformationblockType2 as part of the cell broadcast message. This exception indicates that the UE shall meet the additional spurious emission requirement for a specific deployment scenario.

Table 7.3B.4.3.4-1: SystemInformationBlockType2: Additional spurious emissions test requirement for "NS_[09]"

Derivation Path: TS 36.508 [7] clause 4.4.3.3, Table 4.4.3.3-1			
Information Element	Value/remark	Comment	Condition
additionalSpectrumEmission	TBD		

7.3B.5 Test requirement

The throughput shall be $\geq 95\%$ of the maximum throughput of the reference measurement channels as specified in Annex A.3.2 with parameters specified in Tables 7.3B.5-1 and Table 7.3B.5-2.

Table 7.3B.5-1: Reference sensitivity QPSK P_{REFSENS}

E-UTRA Band	Channel bandwidth						Duplex Mode
	1.4 MHz (dBm)	3 MHz (dBm)	5 MHz (dBm)	10 MHz (dBm)	15 MHz (dBm)	20 MHz (dBm)	
1	-	-	-99.3	-96.3	-94.5	-93.3	FDD
2	-102.0	-99.0	-97.3	-94.3	-92.5	-91.3	FDD
3	-101.0	-98.0	-96.3	-93.3	-91.5	-90.3	FDD
4	-104.0	-101.0	-99.3	-96.3	-94.5	-93.3	FDD
5	-102.5	-99.5	-97.3	-94.3			FDD
6	-	-	-99.3	-96.3			FDD
7	-	-	-97.3	-94.3	-92.5	-91.3	FDD
8	-101.5	-98.5	-96.3	-93.3			FDD
9	-	-	-98.3	-95.3	-93.5	-92.3	FDD
10	-	-	-99.3	-96.3	-94.5	-93.3	FDD
11	-	-	-99.3	-96.3			FDD
12	-101.0	-98.0	-96.3	-93.3			FDD
13			-96.3	-93.3			FDD
14		-	-96.3	-93.3			FDD
...							
17	-	-	-96.3	-93.3			FDD
18	-	-	-99.3	-96.3	-94.5	-	FDD
19	-	-	-99.3	-96.3	-94.5	-	FDD
20			-96.3	-93.3	-90.5	-89.3	FDD
21			-99.3	-96.3	-94.5		FDD
22			-96.0	-93.0	-91.2	-90.0	FDD
23	-104.0	-101.0	-99.3	-96.3	-94.5	-93.3	FDD
24			-99.3	-96.3			FDD
25	-100.5	-97.5	-95.8	-92.8	-91.0	-89.8	FDD
26	-102	-99	-96.8 ⁶	-93.8 ⁶	-92 ⁶		FDD
27	-102.5	-99.5	-97.3	-94.3			FDD
28		-99.5	-97.8	-94.8	-93.0	-90.3	FDD
31	-98.3	-95.0	-92.8				FDD
...							
33	-	-	-99.3	-96.3	-94.5	-93.3	TDD
34	-	-	-99.3	-96.3	-94.5	-	TDD
35	-105.5	-101.5	-99.3	-96.3	-94.5	-93.3	TDD
36	-105.5	-101.5	-99.3	-96.3	-94.5	-93.3	TDD
37	-	-	-99.3	-96.3	-94.5	-93.3	TDD
38	-	-	-99.3	-96.3	-94.5	-93.3	TDD
39	-	-	-99.3	-96.3	-94.5	-93.3	TDD
40	-	-	-99.3	-96.3	-94.5	-93.3	TDD
41	-	-	-97.3	-94.3	-92.5	-91.3	TDD
42	-	-	-98.0	-95.0	-93.2	-92.0	TDD
43	-	-	-98.0	-95.0	-93.2	-92.0	TDD
Note 1:	The transmitter shall be set to P_{UMAX} as defined in clause 6.2.5						
Note 2:	The reference measurement channel is specified in A.3.2 with one sided dynamic OCNG Pattern OP.1 FDD/TDD as described in Annex A.5.1.1/A.5.2.1						
Note 3:	The signal power is specified per port						
Note 4:	For the UE which supports both Band 3 and Band 9 the reference sensitivity level is FFS.						
Note 5:	For the UE which supports both Band 11 and Band 21 the reference sensitivity level is FFS.						
Note 6:	⁶ indicates that the requirement is modified by -0.5 dB when the carrier frequency of the assigned E-UTRA channel bandwidth is within 865-894 MHz.						

NOTE: The relation to the received PSD is $\langle \text{REF} \hat{I}_{or} \rangle = P_{\text{REFSENS}} (N_{sc}^{RB} N_{RB} \Delta f)^{-1}$ with N_{RB} is the transmission bandwidth configuration according to Table 5.4.2-1.

The reference receive sensitivity (REFSENS) requirement specified in Table 7.3B.5-1 shall be met for an uplink transmission bandwidth less than or equal to that specified in Table 7.3B.5-2.

NOTE: Table 7.3B.5-2 does not necessarily reflect the operational conditions of the network, where the number of uplink and downlink allocated resource blocks will be practically constrained by other factors.

Table 7.3B.5-2: Uplink configuration for reference sensitivity

E-UTRA Band / Channel bandwidth / N_{RB} / Duplex mode							
E-UTRA Band	1.4 MHz	3 MHz	5 MHz	10 MHz	15 MHz	20 MHz	Duplex Mode
1	-	-	25	50	75	100	FDD
2	6	15	25	50	50 ¹	50 ¹	FDD
3	6	15	25	50	50 ¹	50 ¹	FDD
4	6	15	25	50	75	100	FDD
5	6	15	25	25 ¹	-	-	FDD
6	-	-	25	25 ¹	-	-	FDD
7	-	-	25	50	75 ¹	75 ¹	FDD
8	6	15	25	25 ¹	-	-	FDD
9	-	-	25	50	50 ¹	50 ¹	FDD
10	-	-	25	50	75	100	FDD
11	-	-	25	25 ¹			FDD
12	6	15	20 ¹	20 ¹			FDD
13			20 ¹	20 ¹			FDD
14		-	15 ¹	15 ¹			FDD
...							
17	-	-	20 ¹	20 ¹			FDD
18	-	-	25	25 ¹	25 ¹	-	FDD
19	-	-	25	25 ¹	25 ¹	-	FDD
20			25	20 ¹	20 ³	20 ³	FDD
21			25	25 ¹	25 ¹		FDD
22			25	50	50 ¹	50 ¹	FDD
23	6	15	25	50	75 ¹	100 ¹	FDD
24			25	50			FDD
25	6	15	25	50	50 ¹	50 ¹	FDD
26	6	15	25	25 ¹	25 ¹		FDD
27	6	15	25	25 ¹	-	-	FDD
28		15	25	25 ¹	25 ¹	25 ¹	FDD
31	6	5 ⁴	5 ⁴				FDD
...							
33	-	-	25	50	75	100	TDD
34	-	-	25	50	75	-	TDD
35	6	15	25	50	75	100	TDD
36	6	15	25	50	75	100	TDD
37	-	-	25	50	75	100	TDD
38	-	-	25	50	75	100	TDD
39			25	50	75	100	TDD
40			25	50	75	100	TDD
41			25	50	75	100	TDD
42			25	50	75	100	TDD
43			25	50	75	100	TDD
Note 1:	The UL resource blocks shall be located as close as possible to the downlink operating band but confined within the transmission bandwidth configuration for the channel bandwidth (Table 5.4.2-1).						
Note 2:	For the UE which supports both Band 11 and Band 21 the uplink configuration for reference sensitivity is FFS.						
Note 3:	For Band 20; in the case of 15MHz channel bandwidth, the UL resource blocks shall be located at $RB_{start}=11$ and in the case of 20MHz channel bandwidth, the UL resource blocks shall be located at $RB_{start}=16$.						
Note 4:	⁴ refers to Band 31; in the case of 3 MHz channel bandwidth, the UL resource blocks shall be located at $RB_{start} 9$ and in the case of 5 MHz channel bandwidth, the UL resource blocks shall be located at RB_{start}						

7.4 Maximum input level

7.4.1 Test purpose

Maximum input level tests the UE's ability to receive data with a given average throughput for a specified reference measurement channel, under conditions of high signal level, ideal propagation and no added noise.

A UE unable to meet the throughput requirement under these conditions will decrease the coverage area near to an e-NodeB.

7.4.2 Test applicability

This test applies to all types of E-UTRA UE release 8 and forward.

7.4.3 Minimum conformance requirements

Maximum input level is defined as the maximum mean power received at the UE antenna port, at which the specified relative throughput shall meet or exceed the minimum requirements for the specified reference measurement channel.

The throughput shall be $\geq 95\%$ of the maximum throughput of the reference measurement channels as specified in Annexes A.2.2, A.2.3 and A.3.2 (with one sided dynamic OCNG Pattern OP.1 FDD/TDD as described in Annex A.5.1.1/A.5.2.1) with parameters specified in Table 7.4.3-1.

Table 7.4.3-1: Maximum input level

Rx Parameter	Units	Channel bandwidth					
		1.4 MHz	3 MHz	5 MHz	10 MHz	15 MHz	20 MHz
Power in Transmission Bandwidth Configuration	dBm	-25					
Note 1:	The transmitter shall be set to 4dB below $P_{\text{CMAX,L}}$ at the minimum uplink configuration specified in Table 7.3.3-2 with $P_{\text{CMAX,L}}$ as defined in clause 6.2.5.						
Note 2:	Reference measurement channel is Annex A.3.2 64QAM R=3/4 variant with one sided dynamic OCNG Pattern OP.1 FDD/TDD as described in Annex A.5.1.1/A.5.2.1.						

The normative reference for this requirement is TS 36.101 [2] clause 7.4.1.

7.4.4 Test description

7.4.4.1 Initial conditions

Initial conditions are a set of test configurations the UE needs to be tested in and the steps for the SS to take with the UE to reach the correct measurement state.

The initial test configurations consist of environmental conditions, test frequencies, and channel bandwidths based on E-UTRA bands specified in table 5.4.2.1-1. All of these configurations shall be tested with applicable test parameters for each channel bandwidth, and are shown in table 7.4.4.1-1. The details of the uplink and downlink reference measurement channels (RMCs) are specified in Annexes A.2 and A.3 respectively. The details of the OCNG patterns used are specified in Annex A.5. Configurations of PDSCH and PDCCH before measurement are specified in Annex C.2.

Table 7.4.4.1-1: Test Configuration Table

Initial Conditions							
Test Environment as specified in TS 36.508[7] clause 4.1				NC			
Test Frequencies as specified in TS36.508 [7] clause 4.3.1				Mid range			
Test Channel Bandwidths as specified in TS 36.508 [7] clause 4.3.1				Lowest, 5MHz, Highest			
Test Parameters for Channel Bandwidths							
Ch BW	Downlink Configuration			Uplink Configuration			UE Category
	Mod'n	RB allocation		Mod'n	RB allocation		
		FDD	TDD		FDD	TDD	
1.4MHz	64-QAM	6	6	QPSK	6	6	1-5
3MHz	64-QAM	15	15	QPSK	15	15	1-5
5MHz	64-QAM	25	25	QPSK	25	25	2-5
5MHz	64-QAM	25	N/A	QPSK	20	N/A	2-5
5MHz	64-QAM	25	N/A	QPSK	15	N/A	2-5
5MHz	64-QAM	18	18	QPSK	25	25	1
5MHz	64-QAM	18	18	QPSK	20	20	1
5MHz	64-QAM	18	18	QPSK	15	15	1
10MHz	64-QAM	50	50	QPSK	50	50	2-5
10MHz	64-QAM	50	N/A	QPSK	25	N/A	2-5
10MHz	64-QAM	50	N/A	QPSK	20	N/A	2-5
10MHz	64-QAM	50	N/A	QPSK	15	N/A	2-5
10MHz	64-QAM	17	17	QPSK	50	50	1
10MHz	64-QAM	17	N/A	QPSK	25	N/A	1
10MHz	64-QAM	17	N/A	QPSK	20	N/A	1
10MHz	64-QAM	17	N/A	QPSK	15	N/A	1
15MHz	64-QAM	75	75	QPSK	75	75	2-5
15MHz	64-QAM	75	N/A	QPSK	50	N/A	2-5
15MHz	64-QAM	75	N/A	QPSK	25	N/A	2-5
15MHz	64-QAM	75	N/A	QPSK	20	N/A	2-5
15MHz	64-QAM	17	17	QPSK	75	75	1
15MHz	64-QAM	17	N/A	QPSK	50	N/A	1
15MHz	64-QAM	17	N/A	QPSK	25	N/A	1
15MHz	64-QAM	17	N/A	QPSK	20	N/A	1
20MHz	64-QAM	100	100	QPSK	100	100	3-5
20MHz	64-QAM	100	N/A	QPSK	75	N/A	3-5
20MHz	64-QAM	100	N/A	QPSK	50	N/A	3-5
20MHz	64-QAM	100	N/A	QPSK	25	N/A	3-5
20MHz	64-QAM	100	N/A	QPSK	20	N/A	3-5
20MHz	64-QAM	83	83	QPSK	100	100	2
20MHz	64-QAM	83	N/A	QPSK	75	N/A	2
20MHz	64-QAM	83	N/A	QPSK	50	N/A	2
20MHz	64-QAM	83	N/A	QPSK	25	N/A	2
20MHz	64-QAM	83	N/A	QPSK	20	N/A	2
20MHz	64-QAM	17	17	QPSK	100	100	1
20MHz	64-QAM	17	N/A	QPSK	75	N/A	1
20MHz	64-QAM	17	N/A	QPSK	50	N/A	1
20MHz	64-QAM	17	N/A	QPSK	25	N/A	1
20MHz	64-QAM	17	N/A	QPSK	20	N/A	1

Note 1: Test Channel Bandwidths are checked separately for each E-UTRA band. The applicable channel bandwidths are specified in Table 5.4.2.1-1.

Note 2: Depending on E-UTRA band, only the appropriate Uplink RB allocation value according to table 7.3.3-2 is tested per Test Channel Bandwidth. The allocation shall be located as close as possible to the downlink operating band but confined within the transmission bandwidth configuration for the channel bandwidth (Table 5.4.2-1).

Note 3: For the DL signal one sided dynamic OCNG Pattern OP.1 FDD/TDD is used.

1. Connect the SS to the UE antenna connectors as shown in TS 36.508 [7] Figure A.3.
2. The parameter settings for the cell are set up according to TS 36.508 [7] subclause 4.4.3.
3. Downlink signals are initially set up according to Annex C0, C.1 and C.3.1, and uplink signals according to Annex H.1 and H.3.1.

4. The UL and DL Reference Measurement channels are set according to Table 7.4.4.1-1.
5. Propagation conditions are set according to Annex B.0.
6. Ensure the UE is in State 3A-RF according to TS 36.508 [7] clause 5.2A.2. Message contents are defined in clause 7.4.4.3.

7.4.4.2 Test procedure

SS transmits PDSCH via PDCCH DCI format 1A for C_RNTI to transmit the DL RMC according to Table 7.4.4.1-1. The SS sends downlink MAC padding bits on the DL RMC.

SS sends uplink scheduling information for each UL HARQ process via PDCCH DCI format 0 for C_RNTI to schedule the UL RMC according to Table 7.4.4.1-1. Since the UE has no payload data to send, the UE transmits uplink MAC padding bits on the UL RMC.

Set the Downlink signal level to the value defined in Table 7.4.5-1. Send Uplink power control commands to the UE (less or equal to 1dB step size should be used), to ensure that the UE output power is within +0, - 3.4 dB of the target level in Table 7.4.5-1 for carrier frequency $f \leq 3.0\text{GHz}$ or within +0, -4.0 dB of the target level for carrier frequency $3.0\text{GHz} < f \leq 4.2\text{GHz}$, for at least the duration of the Throughput measurement.

Measure the average throughput for a duration sufficient to achieve statistical significance according to Annex G.2.

7.4.4.3 Message contents

Message contents are according to TS 36.508 [7] subclause 4.6 with the following exception.

Table 7.4.4.3-1: UplinkPowerControlDedicated

Derivation Path: 36.331 clause 6.3.2			
Information Element	Value/remark	Comment	Condition
UplinkPowerControlDedicated-DEFAULT ::= SEQUENCE {			
p0-UePUSCH	0		
deltaMCS-Enabled	en0		
accumulationEnabled	TRUE		
p0-uePUCCH	0		
pSRS-Offset	3 (-6 dB)		
filterCoefficient	fc8	larger filter length is used to reduce the RSRP measurement variation	
}			

7.4.5 Test requirement

The throughput shall be $\geq 95\%$ of the maximum throughput of the reference measurement channels as specified in Annex A.3.2 with parameters specified in Table 7.4.5-1.

Table 7.4.5-1: Maximum input level

Rx Parameter	Units	Channel bandwidth					
		1.4 MHz	3 MHz	5 MHz	10 MHz	15 MHz	20 MHz
Power in Transmission Bandwidth Configuration	dBm	For carrier frequency $f \leq 3.0\text{GHz}$: -25.7 For carrier frequency $3.0\text{GHz} < f \leq 4.2\text{GHz}$: -26.0					
Note 1:	The transmitter shall be set to 4dB below $P_{\text{CMAX_L}}$ with $P_{\text{CMAX_L}}$ as defined in clause 6.2.5.						
Note 2:	Reference measurement channel is Annex A.3.2 64QAM R=3/4variant with one sided dynamic OCNG Pattern OP.1 FDD/TDD as described in Annex A.5.1.1/A.5.2.1.						

7.4A Maximum input level for CA

7.4A.1 Maximum input level for CA (intra-band contiguous DL CA and UL CA)

7.4A.1.1 Test purpose

Maximum input level for CA test verifies the UE's ability to receive data with a given average throughput for a specified reference measurement channel, under conditions of high signal level, ideal propagation and no added noise.

A UE unable to meet the throughput requirement under these conditions will decrease the coverage area near to an e-NodeB.

7.4A.1.2 Test applicability

This test applies to all types of E-UTRA UE release 10 and forward that support intra-band contiguous DL CA and UL CA.

7.4A.1.3 Minimum conformance requirements

For inter-band carrier aggregation with uplink assigned to one E-UTRA band the maximum input level is defined with the uplink active on the band other than the band whose downlink is being tested. The UE shall meet the requirements specified in subclause 7.4.1 for each component carrier while both downlink carriers are active.

For intra-band contiguous carrier aggregation UE maximum input level is defined as a mean power received at the UE antenna port over the aggregated channel bandwidth, at which the specified relative throughput shall meet or exceed the minimum requirements for the specified reference measurement channel over each component carrier. The downlink SCC shall be configured at nominal channel spacing to the PCC with the PCC configured closest to the uplink band. Downlink PCC and SCC are both activated. The uplink output power shall be set as specified in Table 7.4A.1.3-1 with the uplink configuration set according to Table 7.3A.1.3-1 for the applicable carrier aggregation configuration. For UE(s) supporting one uplink carrier, the uplink configuration of the PCC shall be in accordance with Table 7.3.3-2.

The throughput shall be $\geq 95\%$ of the maximum throughput of the reference measurement channels over each component carrier as specified in Annexes A.2.2, A.2.3 and A.3.2 (with one sided dynamic OCNG Pattern OP.1 FDD/TDD as described in Annex A.5.1.1/A.5.2.1) with parameters specified in Table 7.4A.1.3-1.

Table 7.4A.1.3-1: Maximum input level for intra-band contiguous CA

Rx Parameter	Units	CA Bandwidth Class					
		A	B	C	D	E	F
Power in Transmission Aggregated Bandwidth Configuration	dBm			-22			
Note 1: The transmitter shall be set to 4dB below $P_{\text{CMAX_L}}$ or $P_{\text{CMAX_L_CA}}$ as defined in clause 6.2.5A. Note 2: Reference measurement channel is Annex A.3.2: 64QAM, R=3/4 variant with one sided dynamic OCNG Pattern OP.1 FDD/TDD as described in Annex A.5.1.1/A.5.2.1.							

The normative reference for this requirement is TS 36.101 [2] clause 7.4.1A.

7.4A.1.4 Test description

7.4A.1.4.1 Initial conditions

Initial conditions are a set of test configurations the UE needs to be tested in and the steps for the SS to take with the UE to reach the correct measurement state.

The initial test configurations consist of environmental conditions, test frequencies, and channel bandwidths based on E-UTRA CA configurations specified in table 5.4.2A.1-1. All of these configurations shall be tested with applicable test parameters for each CA Configuration, and are shown in table 7.4A.1.4.1-1. The details of the uplink and downlink reference measurement channels (RMCs) are specified in Annexes A.2 and A.3 respectively. The details of the OCN patterns used are specified in Annex A.5. Configurations of PDSCH and PDCCH before measurement are specified in Annex C.2.

Table 7.4A.1.4.1-1: Test Configuration Table

Initial Conditions							
Test Environment as specified in TS 36.508[7] clause 4.1				NC			
Test Frequencies as specified in TS36.508 [7] clause 4.3.1 for different CA bandwidth classes.				C: Mid range			
Test CC Combination setting (N_{RB_agg}) as specified in clause 5.4.2A.1 for the CA Configuration across bandwidth combination sets supported by the UE.				Lowest N_{RB_agg} Highest N_{RB_agg}			
Test Parameters for CA Configurations							
CA Configuration / N_{RB_agg}		DL Allocation			UL Allocation		
PCC N_{RB}	SCC N_{RB}	CC MOD	PCC & SCC RB allocation	CC MOD	N_{RB_alloc}	PCC & SCC RB allocations (L_{CRB} @ RB_{start})	
75	75	QPSK	75+75	QPSK	75	P_75@0	S_0@0
75	75	QPSK	75+75	QPSK	130	P_75@0	S_55@0
75	75	QPSK	75+75	QPSK	150	P_75@0	S_75@0
100	50	QPSK	100+50	QPSK	150	P_100@0	S_50@0
100	100	QPSK	100+100	QPSK	75	P_75@25	S_0@0
100	100	QPSK	100+100	QPSK	130	P_100@0	S_30@0
100	100	QPSK	100+100	QPSK	200	P_100@0	S_100@0
Note 1: CA Configuration Test CC Combination settings are checked separately for each CA Configuration, which applicable aggregated channel bandwidths are specified in Table 5.4.2A.1-1.							
Note 2: Depending on CA Configuration only the appropriate Uplink RB allocation value according to table 7.3A.1.3 1 is tested per CA Configuration Test CC combination.							

- 1 Connect the SS to the UE antenna connectors as shown in TS 36.508 [7] Annex A, Figure group A.32 as appropriate
- 2 The parameter settings for the cell are set up according to TS 36.508 [7] clause 4.4.3.
- 3 Downlink signals for PCC are initially set up according to Annex C0, C.1 and C.3.1, and uplink signals according to Annex H.1 and H.3.1
- 4 The UL and DL Reference Measurement channels are set according to Table 7.4A.1.4.1-1.
- 5 Propagation conditions are set according to Annex B.0.
- 6 Ensure the UE is in State 3A-RF according to TS 36.508 [7] clause 5.2A.2. Message contents are defined in clause 7.4A.1.4.3.

7.4A.1.4.2 Test procedure

1. Configure SCC according to Annex C0, C.1 and Annex C.3.2 for all downlink physical channels except PHICH.
2. The SS shall configure SCC as per TS 36.508 [7] clause 5.2A.4. Message contents are defined in clause 7.4A.1.4.3
3. SS activates SCC by sending the activation MAC-CE (Refer TS 36.321 [13], clauses 5.13, 6.1.3.8). Wait for at least 2 seconds (Refer TS 36.133, clauses 8.3.3.2).

4. SS transmits PDSCH via PDCCH DCI format 1A for C_RNTI to transmit the DL RMC according to Table 7.4A.1.4.1-1. The SS sends downlink MAC padding bits on the DL RMC.
5. SS sends uplink scheduling information for each UL HARQ process via PDCCH DCI format 0 for C_RNTI to schedule the UL RMC according to Table 7.4A.1.4.1-1. Since the UE has no payload data to send, the UE transmits uplink MAC padding bits on the UL RMC.
6. Set the Downlink signal level to the value defined in Table 7.4A.1.5-1. Send Uplink power control commands to the UE (less or equal to 1dB step size should be used), to ensure that the UE output power is within +0, - 3.4 dB of the target level in Table 7.4A.1.5-1 for carrier frequency $f \leq 3.0\text{GHz}$ or within +0, -4.0 dB of the target level for carrier frequency $3.0\text{GHz} < f \leq 4.2\text{GHz}$, for at least the duration of the Throughput measurement.
7. Measure the average throughput for each component carrier for duration sufficient to achieve statistical significance according to Annex G.2A.

7.4A.1.4.3 Message contents

Message contents are according to TS 36.508 [7] clause subclause 4.6. In test procedure step 2, for SCC configuration there are no additional message contents.

7.4A.1.5 Test requirement

The throughput measurement of each carrier derived in test procedure shall be $\geq 95\%$ of the maximum throughput of the reference measurement channels as specified in Annex A.3.2 with parameters specified in Table 7.4A.1.5-1.

Table 7.4A.1.5-1: Maximum input level for intra-band contiguous CA

Rx Parameter	Units	CA Bandwidth Class					
		A	B	C	D	E	F
Power in Transmission Aggregated Bandwidth Configuration	dBm			For carrier frequency $f \leq 3.0\text{GHz}$: -22.7 For carrier frequency $3.0\text{GHz} < f \leq 4.2\text{GHz}$: -23.0			
Note 1: The transmitter shall be set to 4dB below PCMAX_L or PCMAX_L_CA as defined in clause 6.2.5A. Note 2: Reference measurement channel is Annex A.3.2: 64QAM, R=3/4 variant with one sided dynamic OCNG Pattern OP.1 FDD/TDD as described in Annex A.5.1.1/A.5.2.1.							

7.4A.2 Maximum input level for CA (intra-band contiguous DL CA without UL CA)

7.4A.2.1 Test purpose

Same test purpose as in clause 7.4A.1.1

7.4A.2.2 Test applicability

This test applies to all types of E-UTRA UE release 10 and forward that support intra-band contiguous DL CA but no UL CA.

7.4A.2.3 Minimum conformance requirements

Same minimum conformance requirements as in clause 7.4A.1.3

7.4A.2.4 Test description

7.4A.2.4.1 Initial conditions

Same initial conditions as in clause 7.4A.1.4.1 with the following exceptions:

- Instead of Table 7.4A.1.4.1-1 → use Table 7.4A.2.4.1-1

Table 7.4A.2.4.1-1: Test Configuration Table

Initial Conditions							
Test Environment as specified in TS 36.508[7] clause 4.1					NC		
Test Frequencies as specified in TS36.508 [7] clause 4.3.1 for different CA bandwidth classes.					C: Mid range		
Test CC Combination setting (N_{RB_agg}) as specified in clause 5.4.2A.1 for the CA Configuration across bandwidth combination sets supported by the UE.					Lowest N_{RB_agg} Highest N_{RB_agg}		
Test Parameters for CA Configurations							
CA Configuration / N_{RB_agg}		DL Allocation			UL Allocation		
PCC N_{RB}	SCC N_{RB}	CC MOD	PCC & SCC RB allocation	CC MOD	N_{RB_alloc}	PCC & SCC RB allocations (L_{CRB} @ RB_{start})	
75	75	QPSK	75+75	QPSK	75	P_75@0	NA
75	75	QPSK	75+75	QPSK	50	P_50@0	NA
75	75	QPSK	75+75	QPSK	25	P_25@0	NA
75	75	QPSK	75+75	QPSK	20	P_20@0	NA
100	50	QPSK	100+50	QPSK	100	P_100@0	NA
100	50	QPSK	100+50	QPSK	75	P_75@0	NA
100	50	QPSK	100+50	QPSK	50	P_50@0	NA
100	50	QPSK	100+50	QPSK	25	P_25@0	NA
100	50	QPSK	100+50	QPSK	20	P_20@0	NA
100	100	QPSK	100+100	QPSK	100	P_100@0	NA
100	100	QPSK	100+100	QPSK	75	P_75@0	NA
100	100	QPSK	100+100	QPSK	50	P_50@0	NA
100	100	QPSK	100+100	QPSK	25	P_25@0	NA
100	100	QPSK	100+100	QPSK	20	P_20@0	NA

Note 1: CA Configuration Test CC Combination settings are checked separately for each CA Configuration, which applicable aggregated channel bandwidths are specified in Table 5.4.2A.1-1.

Note 2: Depending on CA Configuration only the appropriate Uplink RB allocation value according to table 7.3.3-2 is tested per CA Configuration Test CC combination.

7.4A.2.4.2 Test procedure

Same test procedure as in clause 7.4A.1.4.2 with the following exceptions:

- Instead of Table 7.4A.1.4.1-1 → use Table 7.4A.2.4.1-1

7.4A.2.4.3 Message contents

Same message contents as in clause 7.4A.1.4.3

7.4A.2.5 Test requirement

Same test requirements as in clause 7.4A.1.5.

7.4A.3 Maximum input level for CA (inter-band DL CA without UL CA)

7.4A.3.1 Test purpose

Same test purpose as in clause 7.4A.1.1

7.4A.3.2 Test applicability

This test applies to all types of E-UTRA UE release 10 and forward that support inter-band DL CA but no UL CA.

7.4A.3.3 Minimum conformance requirements

Same minimum conformance requirements as in clause 7.4A.1.3

7.4A.3.4 Test description

7.4A.3.4.1 Initial conditions

Same initial conditions as in clause 7.4A.1.4.1 with the following exceptions:

- Instead of Table 7.4A.1.4.1-1 → use Table 7.4A.3.4.1-1

Table 7.4A.3.4.1-1: Test Configuration Table

Initial Conditions						
Test Environment as specified in TS 36.508[7] subclause 4.1			NC			
Test Frequencies as specified in TS36.508 [7] subclause 4.3.1 for different CA bandwidth classes.			A: Mid range for PCC and SCC			
Test CC Combination setting (N_{RB_agg}) as specified in subclause 5.4.2A.1 for the CA Configuration across bandwidth combination sets supported by the UE.			Highest N_{RB_agg} for PCC and SCC			
Test Parameters for CA Configurations						
CA Configuration / N_{RB_agg}		DL Allocation			UL Allocation	
PCC N_{RB}	SCCs N_{RB}	CC MOD	PCC & SCC RB allocation		CC MOD	PCC N_{RB_alloc}
50	50	QPSK	50	50	QPSK	50
50	50	QPSK	50	50	QPSK	25
50	50	QPSK	50	50	QPSK	20
50	50	QPSK	50	50	QPSK	16
50	75	QPSK	50	75	QPSK	25
50	100	QPSK	50	100	QPSK	50
50	100	QPSK	50	100	QPSK	25
50	100	QPSK	50	100	QPSK	20
75	50	QPSK	75	50	QPSK	25
75	100	QPSK	75	100	QPSK	25
100	50	QPSK	100	50	QPSK	100
100	50	QPSK	100	50	QPSK	75
100	50	QPSK	100	50	QPSK	50
100	75	QPSK	100	75	QPSK	100
100	100	QPSK	100	100	QPSK	75
100	100	QPSK	100	100	QPSK	50
<p>Note 1: CA Configuration Test CC Combination settings are checked separately for each CA Configuration, which applicable aggregated channel bandwidths are specified in Table 5.4.2A.1-2.</p> <p>Note 2: Depending on CA configurations, only the appropriate Uplink RB allocation value according to table 7.3.3-2 for UE supporting one uplink carrier is tested per Test CA configuration, unless otherwise stated in table 7.3A.1.3-0b.</p> <p>Note 3: The UL resource blocks shall be located as close as possible to the downlink SCC but confined within the transmission bandwidth configuration for the channel bandwidth (Table 5.4.2-1).</p> <p>Note 4: The frequencies of PCC and SCC shall be switched and tested in each configuration (given UL is supported in PCC band as per Table 5.2-1).</p>						

7.4A.3.4.2 Test procedure

1. Configure SCC according to Annex C.0, C.1 and Annex C.3.1 for all downlink physical channels except PHICH.
2. The SS shall configure SCC as per TS 36.508 [7] clause 5.2A.4. Message contents are defined in clause 7.4A.3.4.3.
3. SS activates SCC by sending the activation MAC-CE (Refer TS 36.321 [13], clauses 5.13, 6.1.3.8). Wait for at least 2 seconds (Refer TS 36.133, clauses 8.3.3.2).

4. SS transmits PDSCH via PDCCH DCI format 1A for C_RNTI to transmit the DL RMC according to Tables 7.4A.3.4.1-1 on both PCC and SCC. The SS sends downlink MAC padding bits on the DL RMC.
5. SS sends uplink scheduling information for each UL HARQ process via PDCCH DCI format 0 for C_RNTI to schedule the UL RMC according to Table 7.4A.3.4.1-1 on PCC. Since the UE has no payload and no loopback data to send the UE sends uplink MAC padding bits on the UL RMC.
6. Set the Downlink signal level to the value as defined in Table 7.4A.3.5-1. Send Uplink power control commands to the UE (less or equal to 1dB step size should be used), to ensure that the UE output power is within +0, - 3.4 dB of the target level in Table 7.4A.3.5-1 for carrier frequency $f \leq 3.0\text{GHz}$ or within +0, -4.0 dB of the target level for carrier frequency $3.0\text{GHz} < f \leq 4.2\text{GHz}$, for at least the duration of the Throughput measurement.
7. Measure the average throughput of SCC for a duration sufficient to achieve statistical significance according to Annex G.2.

7.4A.3.4.3 Message contents

Same message contents as in clause 7.4A.1.4.3

7.4A.3.5 Test requirement

For inter-band carrier aggregation with uplink assigned to one E-UTRA band the maximum input level is defined with the uplink active on the band other than the band whose downlink is being tested, i.e. the requirements are tested only for the SCell downlink. The throughput for each component carrier, when operated as S-Cell, shall be $\geq 95\%$ of the maximum throughput of the reference measurement channels as specified in Annex A.3.2 with parameters specified in Table 7.4A.3.5-1. The parameters are related to both carriers in this table. The test requirement tables are originated from Table 7.4.5-1.

Table 7.4A.3.5-1: Maximum input level for inter-band DL CA without UL CA

Rx Parameter	Units	Channel bandwidth				
		1.4 MHz	3 MHz	5 MHz	10 MHz	15 MHz
Power in Transmission Bandwidth Configuration	dBm	For carrier frequency $f \leq 3.0\text{GHz}$: -25.7 For carrier frequency $3.0\text{GHz} < f \leq 4.2\text{GHz}$: -26.0				
Note 1:	The transmitter shall be set to 4dB below $P_{\text{CMAX,L}}$ with $P_{\text{CMAX,L}}$ as defined in clause 6.2.5.					
Note 2:	Reference measurement channel is Annex A.3.2 64QAM R=3/4 variant with one sided dynamic OCNG Pattern OP.1 FDD/TDD as described in Annex A.5.1.1/A.5.2.1.					

7.4B Maximum input level for UL-MIMO

7.4B.1 Test purpose

Maximum input level tests the ability of UE that support UL- MIMO to receive data with a given average throughput for a specified reference measurement channel, under conditions of high signal level, ideal propagation and no added noise.

A UE unable to meet the throughput requirement under these conditions will decrease the coverage area near to an e-NodeB.

7.4B.2 Test applicability

This test applies to all types of E-UTRA UE release 10 and forward that support UL- MIMO.

7.4B.3 Minimum conformance requirements

For UE with two transmitter antenna connectors in closed-loop spatial multiplexing, the minimum requirements in Clause 7.4.3 shall be met with the UL-MIMO configurations specified in Table 6.2.2B.3-2. For UL-MIMO, the parameter P_{CMAX_L} is defined as the total transmitter power over the two transmit antenna connectors.

The normative reference for this requirement is TS 36.101 [2] clause 7.4.1B.

7.4B.4 Test description

7.4B.4.1 Initial conditions

Initial conditions are a set of test configurations the UE needs to be tested in and the steps for the SS to take with the UE to reach the correct measurement state.

The initial test configurations consist of environmental conditions, test frequencies, and channel bandwidths based on E-UTRA bands specified in table 5.4.2.1-1. All of these configurations shall be tested with applicable test parameters for each channel bandwidth, and are shown in table 7.4B.4.1-1. The details of the uplink and downlink reference measurement channels (RMCs) are specified in Annexes A.2 and A.3 respectively. The details of the OCNG patterns used are specified in Annex A.5. Configurations of PDSCH and PDCCH before measurement are specified in Annex C.2.

Table 7.4B.4.1-1: Test Configuration Table

Initial Conditions							
Test Environment as specified in TS 36.508[7] subclause 4.1				NC			
Test Frequencies as specified in TS36.508 [7] subclause 4.3.1				Mid range			
Test Channel Bandwidths as specified in TS 36.508 [7] subclause 4.3.1				Lowest, 5MHz, Highest			
Test Parameters for Channel Bandwidths							
Ch BW	Downlink Configuration			Uplink Configuration			UE Category
	Mod'n	RB allocation		Mod'n	RB allocation		
		FDD	TDD		FDD	TDD	
1.4MHz	64-QAM	6	6	QPSK	5	5	1-5
3MHz	64-QAM	15	15	QPSK	4	4	1-5
5MHz	64-QAM	25	25	QPSK	8	8	2-5
5MHz	64-QAM	18	18	QPSK	8	8	1
10MHz	64-QAM	50	50	QPSK	12	12	2-5
10MHz	64-QAM	17	17	QPSK	12	12	1
15MHz	64-QAM	75	75	QPSK	16	16	2-5
15MHz	64-QAM	17	17	QPSK	16	16	1
20MHz	64-QAM	100	100	QPSK	18	18	3-5
20MHz	64-QAM	83	83	QPSK	18	18	2
20MHz	64-QAM	17	17	QPSK	18	18	1
Note 1: Test Channel Bandwidths are checked separately for each E-UTRA band. The applicable channel bandwidths are specified in Table 7.3.3-2.							
Note 2: For the DL signal one sided dynamic OCNG Pattern OP.1 FDD/TDD is used							

1. Connect the SS to the UE antenna connectors as shown in TS 36.508 [7] Figure A.28.
2. The parameter settings for the cell are set up according to TS 36.508 [7] subclause 4.4.3.
3. Downlink signals are initially set up according to Annex C0, C.1 and C.3.1, and uplink signals according to Annex H.1 and H.3.1.
4. The UL and DL Reference Measurement channels are set according to Table 7.4B.4.1-1.
5. Propagation conditions are set according to Annex B.0.
6. Ensure the UE is in State 3A-RF according to TS 36.508 [7] clause 5.2A.2. Message contents are defined in clause 7.4B.4.3.

7.4B.4.2 Test procedure

1. SS transmits PDSCH via PDCCH DCI format 1A for C_RNTI to transmit the DL RMC according to Table 7.4B.4.1-1. The SS sends downlink MAC padding bits on the DL RMC.
2. SS sends uplink scheduling information for each UL HARQ process via PDCCH DCI format 4 for C_RNTI to schedule the UL RMC according to Table 7.4B.4.1-1. Since the UE has no payload data to send, the UE transmits uplink MAC padding bits on the UL RMC.
3. Set the Downlink signal level to the value defined in Table 7.4B.5-1. Send Uplink power control commands to the UE (less or equal to 1dB step size should be used), to ensure that the UE output power is within +0, - 3.4 dB of the target level in Table 7.4B.5-1 for carrier frequency $f \leq 3.0\text{GHz}$ or within +0, -4.0 dB of the target level for carrier frequency $3.0\text{GHz} < f \leq 4.2\text{GHz}$, for at least the duration of the throughput measurement.
4. Measure the average throughput for a duration sufficient to achieve statistical significance according to Annex G.2.

7.4B.4.3 Message contents

Message contents are according to TS 36.508 [7] clause 4.6 with the following exception.

Table 7.4B.4.3-1: UplinkPowerControlDedicated

Derivation Path: 36.331 clause 6.3.2			
Information Element	Value/remark	Comment	Condition
UplinkPowerControlDedicated-DEFAULT ::= SEQUENCE {			
p0-UePUSCH	0		
deltaMCS-Enabled	en0		
accumulationEnabled	TRUE		
p0-uePUCCH	0		
pSRS-Offset	3 (-6 dB)		
filterCoefficient	fc8	larger filter length is used to reduce the RSRP measurement variation	
}			

7.4B.5 Test requirement

The throughput shall be $\geq 95\%$ of the maximum throughput of the reference measurement channels as specified in Annex A.3.2 with parameters specified in Table 7.4B.5-1.

Table 7.4B.5-1: Maximum input level

Rx Parameter	Units	Channel bandwidth					
		1.4 MHz	3MHz	5MHz	10 MHz	15 MHz	20 MHz
Power in Transmission Bandwidth Configuration	dBm	For carrier frequency $f \leq 3.0\text{GHz}$: -25.7 For carrier frequency $3.0\text{GHz} < f \leq 4.2\text{GHz}$: -26.0					
Note 1:	The transmitter shall be set to 4dB below $P_{\text{CMAX_L}}$ at the minimum uplink configuration specified in Table 7.3.1-2 with $P_{\text{CMAX_L}}$ as defined in clause 6.2.5.						
Note 2:	Reference measurement channel is Annex A.3.2: 64QAM, R=3/4 variant with one sided dynamic OCNG Pattern OP.1 FDD/TDD as described in Annex A.5.1.1/A.5.2.1.						

7.5 Adjacent Channel Selectivity (ACS)

7.5.1 Test purpose

Adjacent channel selectivity tests the UE's ability to receive data with a given average throughput for a specified reference measurement channel, in the presence of an adjacent channel signal at a given frequency offset from the centre frequency of the assigned channel, under conditions of ideal propagation and no added noise.

A UE unable to meet the throughput requirement under these conditions will decrease the coverage area when other e-NodeB transmitters exist in the adjacent channel.

7.5.2 Test applicability

This test applies to all types of E-UTRA UE release 8 and forward.

7.5.3 Minimum conformance requirements

Adjacent Channel Selectivity (ACS) is a measure of a receiver's ability to receive an E-UTRA signal at its assigned channel frequency in the presence of an adjacent channel signal at a given frequency offset from the centre frequency of the assigned channel. ACS is the ratio of the receive filter attenuation on the assigned channel frequency to the receive filter attenuation on the adjacent channel(s).

The UE shall fulfil the minimum requirement specified in Table 7.5.3-1 for all values of an adjacent channel interferer up to -25 dBm. However it is not possible to directly measure the ACS, instead the lower and upper range of test parameters are chosen in Table 7.5.3-2 and Table 7.5.3-3 where the throughput R_{av} shall be $\geq 95\%$ of the maximum throughput of the reference measurement channels as specified in Annexes A.2.2, A.2.3 and A.3.2 (with one sided dynamic OCNG Pattern OP.1 FDD/TDD for the DL-signal as described in Annex A.5.1.1/A.5.2.1).

Table 7.5.3-1: Adjacent channel selectivity

Rx Parameter	Units	Channel bandwidth					
		1.4 MHz	3 MHz	5 MHz	10 MHz	15 MHz	20 MHz
ACS	dB	33.0	33.0	33.0	33.0	30	27

Table 7.5.3-2: Test parameters for Adjacent channel selectivity, Case 1

Rx Parameter	Units	Channel bandwidth					
		1.4 MHz	3 MHz	5 MHz	10 MHz	15 MHz	20 MHz
Power in Transmission Bandwidth Configuration	dBm	REFSENS + 14 dB					
$P_{\text{Interferer}}$	dBm	REFSENS +45.5dB	REFSENS +45.5dB	REFSENS +45.5dB	REFSENS +45.5dB	REFSENS +42.5dB	REFSENS +39.5dB
$BW_{\text{Interferer}}$	MHz	1.4	3	5	5	5	5
$F_{\text{Interferer}}$ (offset)	MHz	1.4+0.0025 / -1.4-0.0025	3+0.0075 / -3-0.0075	5+0.0025 / -5-0.0025	7.5+0.0075 / -7.5-0.0075	10+0.0125 / -10-0.0125	12.5+0.0025 / -12.5-0.0025
Note 1:	The transmitter shall be set to 4dB below $P_{\text{CMAX_L}}$ at the minimum uplink configuration specified in Table 7.3.3-2 with $P_{\text{CMAX_L}}$ as defined in clause 6.2.5.						
Note 2:	The interferer consists of the Reference measurement channel specified in Annex A.3.2 with one sided dynamic OCNG Pattern OP.1 FDD/TDD as described in Annex A.5.1.1/A.5.2.1 and set-up according to Annex C.3.1.						

Table 7.5.3-3: Test parameters for Adjacent channel selectivity, Case 2

Rx Parameter	Units	Channel bandwidth					
		1.4 MHz	3 MHz	5 MHz	10 MHz	15 MHz	20 MHz
Power in Transmission Bandwidth Configuration	dBm	-56.5	-56.5	-56.5	-56.5	-53.5	-50.5
$P_{\text{Interferer}}$	dBm	-25					
$BW_{\text{Interferer}}$	MHz	1.4	3	5	5	5	5
$F_{\text{Interferer}}$ (offset)	MHz	$1.4+0.0025$ / -1.4- 0.0025	$3+0.0075$ / -3-0.0075	$5+0.0025$ / -5-0.0025	$7.5+0.0075$ / -7.5- 0.0075	$10+0.0125$ / -10-0.0125	$12.5+0.0025$ / 5 / -12.5- 0.0025
Note 1:	The transmitter shall be set to 24dB below $P_{\text{CMAX_L}}$ at the minimum uplink configuration specified in Table 7.3.3-2 with $P_{\text{CMAX_L}}$ as defined in clause 6.2.5.						
Note 2:	The interferer consists of the Reference measurement channel specified in Annex A.3.2 with one sided dynamic OCNG Pattern OP.1 FDD/TDD as described in Annex A.5.1.1/A.5.2.1 and set-up according to Annex C.3.1.						

The normative reference for this requirement is TS 36.101 [2] clause 7.5.1.

7.5.4 Test description

7.5.4.1 Initial conditions

Initial conditions are a set of test configurations the UE needs to be tested in and the steps for the SS to take with the UE to reach the correct measurement state.

The initial test configurations consist of environmental conditions, test frequencies, and channel bandwidths based on E-UTRA bands specified in table 5.4.2.1-1. All of these configurations shall be tested with applicable test parameters for each channel bandwidth, and are shown in table 7.5.4.1-1. The details of the uplink and downlink reference measurement channels (RMCs) are specified in Annexes A.2 and A.3 respectively. The details of the OCNG patterns used are specified in Annex A.5. Configurations of PDSCH and PDCCH before measurement are specified in Annex C.2.

Table 7.5.4.1-1: Test Configuration Table

Initial Conditions						
Test Environment as specified in TS 36.508[7] clause 4.1			NC			
Test Frequencies as specified in TS36.508 [7] clause 4.3.1			Mid range			
Test Channel Bandwidths as specified in TS 36.508 [7] clause 4.3.			Lowest, 5MHz, Highest			
Test Parameters for Channel Bandwidths						
Ch BW	Downlink Configuration			Uplink Configuration		
	Mod'n	RB allocation		Mod'n	RB allocation	
		FDD	TDD		FDD	TDD
1.4MHz	QPSK	6	6	QPSK	6	6
3MHz	QPSK	15	15	QPSK	15	15
5MHz	QPSK	25	25	QPSK	25	25
5MHz	QPSK	25	N/A	QPSK	20	N/A
5MHz	QPSK	25	N/A	QPSK	15	N/A
10MHz	QPSK	50	50	QPSK	50	50
10MHz	QPSK	50	N/A	QPSK	25	N/A
10MHz	QPSK	50	N/A	QPSK	20	N/A
10MHz	QPSK	50	N/A	QPSK	15	N/A
15MHz	QPSK	75	75	QPSK	75	75
15MHz	QPSK	75	N/A	QPSK	50	N/A
15MHz	QPSK	75	N/A	QPSK	25	N/A
15MHz	QPSK	75	N/A	QPSK	20	N/A
20MHz	QPSK	100	100	QPSK	100	100
20MHz	QPSK	100	N/A	QPSK	75	N/A
20MHz	QPSK	100	N/A	QPSK	50	N/A
20MHz	QPSK	100	N/A	QPSK	25	N/A
20MHz	QPSK	100	N/A	QPSK	20	N/A
Note 1: Test Channel Bandwidths are checked separately for each E-UTRA band, which applicable channel bandwidths are specified in Table 5.4.2.1-1. Note 2: Depending on E-UTRA band, only the appropriate Uplink RB allocation value according to table 7.3.3-2 is tested per Test Channel Bandwidth. The allocation shall be located as close as possible to the downlink operating band but confined within the transmission bandwidth configuration for the channel bandwidth (Table 5.4.2-1). Note 3: For the DL signal one sided dynamic OCNG Pattern OP.1 FDD/TDD is used.						

1. Connect the SS and interfering source to the UE antenna connectors as shown in TS 36.508 [7] Figure A.4.
2. The parameter settings for the cell are set up according to TS 36.508 [7] subclause 4.4.3.
3. Downlink signals are initially set up according to Annex C0, C.1 and C.3.1, and uplink signals according to Annex H.1 and H.3.1.
4. The UL and DL Reference Measurement channels are set according to Table 7.5.4.1-1.
5. Propagation conditions are set according to Annex B.0.
6. Ensure the UE is in State 3A-RF according to TS 36.508 [7] clause 5.2A.2. Message contents are defined in clause 7.5.4.3.

7.5.4.2 Test procedure

1. SS transmits PDSCH via PDCCH DCI format 1A for C_RNTI to transmit the DL RMC according to Table 7.5.4.1-1. The SS sends downlink MAC padding bits on the DL RMC.
2. SS sends uplink scheduling information for each UL HARQ process via PDCCH DCI format 0 for C_RNTI to schedule the UL RMC according to Table 7.5.4.1-1. Since the UE has no payload data to send, the UE transmits uplink MAC padding bits on the UL RMC.
3. Set the Downlink signal level to the value as defined in Table 7.5.5-2 (Case 1). Send Uplink power control commands to the UE (less or equal to 1dB step size should be used), to ensure that the UE output power is within +0, - 3.4 dB of the target level in Table 7.5.5-2 (Case 1) for carrier frequency $f \leq 3.0\text{GHz}$ or within +0, -4.0 dB

of the target level for carrier frequency $3.0\text{GHz} < f \leq 4.2\text{GHz}$, for at least the duration of the Throughput measurement.

4. Set the Interferer signal level to the value as defined in Table 7.5.5-2 (Case 1) and frequency below the wanted signal, using a modulated interferer bandwidth as defined in Annex D of the present document.
5. Measure the average throughput for a duration sufficient to achieve statistical significance according to Annex G.2.
6. Repeat steps from 3 to 5, using an interfering signal above the wanted signal in Case 1 at step 4.
7. Set the Downlink signal level to the value as defined in Table 7.5.5-3 (Case 2). Send Uplink power control commands to the UE (less or equal to 1dB step size should be used), to ensure that the UE output power is within +0, - 3.4 dB of the target level in Table 7.5.5-3 (Case 2) for carrier frequency $f \leq 3.0\text{GHz}$ or within +0, -4.0 dB of the target level for carrier frequency $3.0\text{GHz} < f \leq 4.2\text{GHz}$, for at least the duration of the Throughput measurement.
8. Set the Interferer signal level to the value as defined in Table 7.5.5-3 (Case 2) and frequency below the wanted signal, using a modulated interferer bandwidth as defined in Annex D of the present document.
9. Measure the average throughput for a duration sufficient to achieve statistical significance according to Annex G.2.
10. Repeat steps from 7 to 9, using an interfering signal above the wanted signal in Case 2 at step 8.
11. Repeat for applicable channel bandwidths and operating band combinations in both Case 1 and Case 2.

7.5.4.3 Message contents

Message contents are according to TS 36.508 [7] subclause 4.6 with the following exception

Table 7.5.4.3-1: UplinkPowerControlDedicated

Derivation Path: 36.331 clause 6.3.2			
Information Element	Value/remark	Comment	Condition
UplinkPowerControlDedicated-DEFAULT ::= SEQUENCE {			
p0-UePUSCH	0		
deltaMCS-Enabled	en0		
accumulationEnabled	TRUE		
p0-uePUCCH	0		
pSRS-Offset	3 (-6 dB)		
filterCoefficient	fc8	larger filter length is used to reduce the RSRP measurement variation	
}			

7.5.5 Test requirement

The throughput R_{av} shall be $\geq 95\%$ of the maximum throughput of the reference measurement channels as specified in Annex A.3.2 under the conditions specified in table 7.5.5-2, and also under the conditions specified in table 7.5.5-3.

Table 7.5.5-1: Adjacent channel selectivity

Rx Parameter	Units	Channel bandwidth					
		1.4 MHz	3 MHz	5 MHz	10 MHz	15 MHz	20 MHz
ACS	dB	33.0	33.0	33.0	33.0	30	27

Table 7.5.5-2: Test parameters for Adjacent channel selectivity, Case 1

Rx Parameter	Units	Channel bandwidth					
		1.4MHz	3 MHz	5 MHz	10 MHz	15 MHz	20 MHz
Power in Transmission Bandwidth Configuration	dBm	REFSENS + 14 dB					
$P_{\text{Interferer}}$	dBm	REFSENS +45.5dB	REFSENS +45.5dB	REFSENS +45.5dB	REFSENS +45.5dB	REFSENS +42.5dB	REFSENS +39.5dB
$BW_{\text{Interferer}}$	MHz	1.4	3	5	5	5	5
$F_{\text{Interferer}}$ (offset)	MHz	1.4+0.0025/ -1.4-0.0025	3+0.0075 / -3-0.0075	5+0.0025 / -5-0.0025	7.5+0.0075 / -7.5-0.0075	10+0.0125 / -10-0.0125	12.5+0.0025 5 / -12.5-0.0025
Note 1: The transmitter shall be set to 4dB below $P_{\text{CMAX_L}}$ with $P_{\text{CMAX_L}}$ as defined in clause 6.2.5.							
Note 2: The interferer consists of the Reference measurement channel specified in Annex A.3.2 with one sided dynamic OCNG Pattern OP.1 FDD/TDD as described in Annex A.5.1.1/A.5.2.1 and set-up according to Annex C.3.1.							

Table 7.5.5-3: Test parameters for Adjacent channel selectivity, Case 2

Rx Parameter	Units	Channel bandwidth					
		1.4 MHz	3 MHz	5 MHz	10 MHz	15 MHz	20 MHz
Power in Transmission Bandwidth Configuration	dBm	-56.5	-56.5	-56.5	-56.5	-53.5	-50.5
$P_{\text{Interferer}}$	dBm	-25					
$BW_{\text{Interferer}}$	MHz	1.4	3	5	5	5	5
$F_{\text{Interferer}}$ (offset)	MHz	1.4+0.0025 / -1.4-0.0025	3+0.0075 / -3-0.0075	5+0.0025 / -5-0.0025	7.5+0.0075 / -7.5-0.0075	10+0.0125 / -10-0.0125	12.5+0.0025 5 / -12.5-0.0025
Note 1: The transmitter shall be set to 24dB below $P_{\text{CMAX_L}}$ with $P_{\text{CMAX_L}}$ as defined in clause 6.2.5.							
Note 2: The interferer consists of the Reference measurement channel specified in Annex A.3.2 with one sided dynamic OCNG Pattern OP.1 FDD/TDD as described in Annex A.5.1.1/A.5.2.1 and set-up according to Annex C.3.1.							

7.5A Adjacent Channel Selectivity (ACS) for CA

7.5A.1 Adjacent Channel Selectivity (ACS) for CA (intra-band contiguous DL CA and UL CA)

Editor's note: This test case is incomplete. The following aspects are either missing or not yet determined:

- The test is still under discussion for the value for within how much the total power in each of the assigned carriers should be equal to each other

7.5A.1.1 Test purpose

Adjacent channel selectivity for CA test verifies the UE's ability to receive data with a given average throughput for a specified reference measurement channel, in the presence of an adjacent channel signal at a given frequency offset from the centre frequency of the assigned channel, under conditions of ideal propagation and no added noise.

A UE unable to meet the throughput requirement under these conditions will decrease the coverage area when other e-NodeB transmitters exist in the adjacent channel.

7.5A.1.2 Test applicability

This test applies to all types of E-UTRA UE release 10 and forward that support intra-band contiguous DL CA and UL CA.

7.5A.1.3 Minimum conformance requirements

For inter-band carrier aggregation with uplink assigned to one E-UTRA band, the adjacent channel requirements are defined with the uplink active on the band other than the band whose downlink is being tested. The UE shall meet the requirements specified in subclause 7.5.1 for each component carrier while both downlink carriers are active. For E-UTRA CA configurations including an operating band without uplink band (as noted in Table 5.2-1), the requirements for both downlinks shall be met with the uplink active in the band capable of UL operation. For E-UTRA CA configurations listed in Table 7.3A.1.3-0a under conditions for which reference sensitivity for the operating band being tested is N/A, the adjacent channel requirements of subclause 7.5A.1.3 do not apply.

For intra-band contiguous carrier aggregation the downlink SCC shall be configured at nominal channel spacing to the PCC with the PCC configured closest to the uplink band. Downlink PCC and SCC are both activated. The uplink output power shall be set as specified in Tables 7.5A.1.3-2 or 7.5A.1.3-3 with the uplink configuration set according to Table 7.3A.1.3-1 for the applicable carrier aggregation configuration. For UE(s) supporting one uplink carrier, the uplink configuration of the PCC shall be in accordance with Table 7.3.5-2. The UE shall fulfil the minimum requirement specified in Table 7.5A.1.3-1 for an adjacent channel interferer on either side of the aggregated downlink signal at a specified frequency offset and for an interferer power up to -25 dBm. The throughput of each carrier shall be $\geq 95\%$ of the maximum throughput of the reference measurement channels as specified in Annexes A.2.2, A.2.3 and A.3.2 (with one sided dynamic OCNG Pattern OP.1 FDD/TDD for the DL-signal as described in Annex A.5.1.1/A.5.2.1) with parameters specified in Tables 7.5A.1.3-2 and 7.5A.1.3-3.

Table 7.5A.1.3-1: Adjacent channel selectivity

Rx Parameter	Units	CA Bandwidth Class				
		B	C	D	E	F
ACS	dB		24			

Table 7.5A.1.3-2: Test parameters for Adjacent channel selectivity, Case 1

Rx Parameter	Units	CA Bandwidth Class				
		B	C	D	E	F
Power per CC in Aggregated Transmission Bandwidth Configuration			REFSENS + 14 dB			
$P_{\text{Interferer}}$	dBm		Aggregated power + 22.5 dB			
$BW_{\text{Interferer}}$	MHz		5			
$F_{\text{Interferer}}$ (offset)	MHz		2.5 + Foffset / -2.5 - Foffset			
NOTE 1: The transmitter shall be set to 4dB below $P_{\text{CMAX_L}}$ or $P_{\text{CMAX_L_CA}}$ as defined in subclause 6.2.5A.						
NOTE 2: The interferer consists of the Reference measurement channel specified in Annex A.3.2 with one sided dynamic OCNG Pattern OP.1 FDD/TDD as described in Annex A.5.1.1/A.5.2.1 and set-up according to Annex C.3.1						
NOTE 3: The $F_{\text{interferer}}$ (offset) is relative to the centre frequency of the adjacent CC being tested and shall be further adjusted to $\lfloor F_{\text{interferer}} / 0.015 + 0.5 \rfloor 0.015 + 0.0075$ MHz to be offset from the sub-carrier raster.						

Table 7.5A.1.3-3: Test parameters for Adjacent channel selectivity, Case 2

Rx Parameter	Units	CA Bandwidth Class				
		B	C	D	E	F

Power per CC in Aggregated Transmission Bandwidth Configuration	dBm		-50.5			
$P_{\text{Interferer}}$	dBm	-25				
$BW_{\text{Interferer}}$	MHz		5			
$F_{\text{Interferer}}$ (offset)	MHz		$2.5 + F_{\text{offset}}$ / $-2.5 - F_{\text{offset}}$			
<p>NOTE 1: The transmitter shall be set to 24dB below $P_{\text{CMAX_L}}$ or $P_{\text{CMAX_L_CA}}$ as defined in subclause 6.2.5A.</p> <p>NOTE 2: The interferer consists of the Reference measurement channel specified in Annex 3.2 with one sided dynamic OCNG Pattern OP.1 FDD/TDD as described in Annex A.5.1.1/A.5.2.1 and set-up according to Annex C.3.1</p> <p>NOTE 3: The $F_{\text{Interferer}}$ (offset) is relative to the centre frequency of the adjacent CC being tested and shall be further adjusted to $\lfloor F_{\text{Interferer}} / 0.015 + 0.5 \rfloor 0.015 + 0.0075$ MHz to be offset from the sub-carrier raster.</p>						

The normative reference for this requirement is TS 36.101 [2] clause 7.5.1A.

7.5A.1.4 Test description

7.5A.1.4.1 Initial conditions

Initial conditions are a set of test configurations the UE needs to be tested in and the steps for the SS to take with the UE to reach the correct measurement state.

The initial test configurations consist of environmental conditions, test frequencies, and channel bandwidths based on E-UTRA CA configurations specified in table 5.4.2A.1-1. All of these configurations shall be tested with applicable test parameters for each channel bandwidth, and are shown in table 7.5A.1.4.1-1. The details of the uplink and downlink reference measurement channels (RMCs) are specified in Annexes A.2 and A.3 respectively. The details of the OCNG patterns used are specified in Annex A.5. Configurations of PDSCH and PDCCH before measurement are specified in Annex C.2.

Table 7.5A.1.4.1-1: Test Configuration Table

Initial Conditions									
Test Environment as specified in TS 36.508[7] clause 4.1					NC				
Test Frequencies as specified in TS36.508 [7] clause 4.3.1 for different CA bandwidth classes.					C: Mid range				
Test CC Combination setting (NRB_agg) as specified in clause 5.4.2A.1 for the CA Configuration across bandwidth combination sets supported by the UE.					Lowest N _{RB_agg} Highest N _{RB_agg}				
Test Parameters for CA Configurations									
CA Configuration / N _{RB_agg}		DL Allocation			UL Allocation				
PCC N _{RB}	SCC N _{RB}	CC MOD	PCC & SCC RB allocation	CC MOD	N _{RB_allo} c	PCC & SCC RB allocations (L _{CRB} @ RB _{start})			
75	75	QPSK	75+75	QPSK	75	P_75@0	S_0@0	-	-
75	75	QPSK	75+75	QPSK	130	P_75@0	S_55@0	-	-
75	75	QPSK	75+75	QPSK	150	P_75@0	S_75@0	-	-
100	50	QPSK	100+50	QPSK	150	P_100@0	S_50@0	-	-
100	100	QPSK	100+100	QPSK	75	P_75@25	S_0@0	-	-
100	100	QPSK	100+100	QPSK	130	P_100@0	S_30@0	-	-
100	100	QPSK	100+100	QPSK	200	P_100@0	S_100@0	-	-
NOTE 1: CA Configuration Test CC Combination settings are checked separately for each CA Configuration, which applicable aggregated channel bandwidths are specified in Table 5.4.2A.1-1 and Table 5.4.2A.1-2.									
NOTE 2: Depending on CA configurations, only the appropriate Uplink RB allocation value according to table 7.3.3-2 for UE supporting one uplink carrier and to table 7.3A.1.3-1 for UE supporting two uplink carriers are tested per Test CA configuration.									

1. Connect the SS and interfering source to the UE antenna connectors as shown in TS 36.508 [7] Annex A, Figure group A.34 as appropriate.
2. The parameter settings for the cell are set up according to TS 36.508 [7] clause 4.4.3.
3. Downlink signals for PCC are initially set up according to Annex C.0, C.1 and C.3.0, and uplink signals according to Annex H.1 and H.3.0.
4. The UL and DL Reference Measurement channels are set according to Table 7.5A.1.4.1-1.
5. Propagation conditions are set according to Annex B.0.
6. Ensure the UE is in State 3A-RF according to TS 36.508 [7] clause 5.2A.2. Message contents are defined in clause 7.5A.1.4.3.

7.5A.1.4.2 Test procedure

1. Configure SCC according to Annex C.0, C.1 and Annex C.3.1 for all downlink physical channels except PHICH.
2. The SS shall configure SCC as per TS 36.508 [7] clause 5.2A.4. Message contents are defined in clause 7.5A.1.4.3.
3. SS activates SCC by sending the activation MAC-CE (Refer TS 36.321 [13], clauses 5.13, 6.1.3.8). Wait for at least 2 seconds (Refer TS 36.133, clauses 8.3.3.2).
4. SS transmits PDSCH via PDCCH DCI format 1A for C_RNTI to transmit the DL RMC according to Tables 7.5A.1.4.1-1 on both PCC and SCC. The SS sends downlink MAC padding bits on the DL RMC.

5. SS sends uplink scheduling information for each UL HARQ process via PDCCH DCI format 0 for C_RNTI to schedule the UL RMC according to Table 7.5A.1.4.1-1 on both PCC and SCC. Since the UE has no payload and no loopback data to send the UE sends uplink MAC padding bits on the UL RMC.
6. Set the Downlink signal level for PCC and SCC to the value as defined in Table 7.5A.1.5-2 (Case 1). Send Uplink power control commands to the UE (less or equal to 1dB step size should be used), to ensure that the UE output power is within +0, - 3.4 dB of the target level in Table 7.5A.1.5-2 (Case 1) for carrier frequency $f \leq 3.0\text{GHz}$ or within +0, -4.0 dB of the target level for carrier frequency $3.0\text{GHz} < f \leq 4.2\text{GHz}$, for at least the duration of the Throughput measurement. Suitable uplink power control commands should be sent to ensure the total power in each of the assigned carriers to be equal to each other within +/-[2] dB.
7. Set the Interferer signal level to the value as defined in Table 7.5A.1.5-2 (Case 1) and frequency below the wanted signal, using a modulated interferer bandwidth as defined in Annex D of the present document.
8. Measure the average throughput for each component carrier for a duration sufficient to achieve statistical significance according to Annex G.2A.
9. Repeat steps from 6 to 8, using an interfering signal above the wanted signal in Case 1 at step 7.
10. Set the Downlink signal level for PCC and SCC to the value as defined in Table 7.5A.1.5-3 (Case 2). Send Uplink power control commands to the UE (less or equal to 1dB step size should be used), to ensure that the UE output power is within +0, - 3.4 dB of the target level in Table 7.5A.1.5-3 (Case 2) for carrier frequency $f \leq 3.0\text{GHz}$ or within +0, -4.0 dB of the target level for carrier frequency $3.0\text{GHz} < f \leq 4.2\text{GHz}$, for at least the duration of the Throughput measurement. Suitable uplink power control commands should be sent to ensure the total power in each of the assigned carriers to be equal to each other within +/-[2] dB.
11. Set the Interferer signal level to the value as defined in Table 7.5A.1.5-3 (Case 2) and frequency below the wanted signal, using a modulated interferer bandwidth as defined in Annex D of the present document.
12. Measure the average throughput for each component carrier for a duration sufficient to achieve statistical significance according to Annex G.2A.
13. Repeat steps from 10 to 12, using an interfering signal above the wanted signal in Case 2 at step 11.

7.5A.1.4.3 Message contents

Message contents are according to TS 36.508 [7] subclause 4.6 with the following exception.

Table 7.5A.1.4.3-1: UplinkPowerControlDedicatedSCell-r10

Derivation Path: 36.508 clause 4.6.3			
Information Element	Value/remark	Comment	Condition
UplinkPowerControlDedicated-DEFAULT ::= SEQUENCE {			
p0-UE-PUSCH-r10	0		
deltaMCS-Enabled-r10	en0		
accumulationEnabled-r10	TRUE		
pSRS-Offset	7 (0 dB)	The actual parameter value is $-10.5 + 1.5 \cdot \text{pSRS-Offset}$ value; 0 is the actual value in dB ($-10.5 + 1.5 \cdot 7$ dB).	
pSRS-OffsetAp-r10	7 (0 dB)	The actual parameter value is $-10.5 + 1.5 \cdot \text{pSRS-Offset}$ value; 0 is the actual value in dB ($-10.5 + 1.5 \cdot 7$ dB).	
filterCoefficient-r10	fc8	larger filter length is used to reduce the RSRP measurement variation	
pathlossReferenceLinking-r10	sCell		
}			

7.5A.1.5 Test Requirements

The throughput of each carrier shall be $\geq 95\%$ of the maximum throughput of the reference measurement channels as specified in Annex A.3.2 under the conditions specified in table 7.5A.1.5-2, and also under the conditions specified in table 7.5A.1.5-3.

Table 7.5A.1.5-1: Adjacent channel selectivity

Rx Parameter	Units	CA Bandwidth Class				
		B	C	D	E	F
ACS	dB		24			

Table 7.5A.1.5-2: Test parameters for Adjacent channel selectivity, Case 1

Rx Parameter	Units	CA Bandwidth Class				
		B	C	D	E	F
Power per CC in Aggregated Transmission Bandwidth Configuration			REFSENS + 14 dB			
$P_{\text{Interferer}}$	dBm		Aggregated power + 22.5 dB			
$BW_{\text{Interferer}}$	MHz		5			
$F_{\text{Interferer}}$ (offset)	MHz		$2.5 + F_{\text{offset}}$ / $-2.5 - F_{\text{offset}}$			
NOTE 1: The transmitter shall be set to 4dB below $P_{\text{CMAX_L}}$ or $P_{\text{CMAX_L_CA}}$ as defined in subclause 6.2.5A. NOTE 2: The interferer consists of the Reference measurement channel specified in Annex A.3.2 with one sided dynamic OCNNG Pattern OP.1 FDD/TDD as described in Annex A.5.1.1/A.5.2.1 and set-up according to Annex C.3.1 NOTE 3: The $F_{\text{interferer}}$ (offset) is relative to the centre frequency of the adjacent CC being tested and shall be further adjusted to $\lfloor F_{\text{interferer}} / 0.015 + 0.5 \rfloor 0.015 + 0.0075$ MHz to be offset from the sub-carrier raster.						

Table 7.5A.1.5-3: Test parameters for Adjacent channel selectivity, Case 2

Rx Parameter	Units	CA Bandwidth Class				
		B	C	D	E	F
Power per CC in Aggregated Transmission Bandwidth Configuration	dBm		-50.5			
$P_{\text{Interferer}}$	dBm			-25		
$BW_{\text{Interferer}}$	MHz		5			
$F_{\text{Interferer}}$ (offset)	MHz		$2.5 + F_{\text{offset}}$ / $-2.5 - F_{\text{offset}}$			
NOTE 1: The transmitter shall be set to 24dB below $P_{\text{CMAX_L}}$ or $P_{\text{CMAX_L_CA}}$ as defined in subclause 6.2.5A. NOTE 2: The interferer consists of the Reference measurement channel specified in Annex 3.2 with one sided dynamic OCNNG Pattern OP.1 FDD/TDD as described in Annex A.5.1.1/A.5.2.1 and set-up according to Annex C.3.1 NOTE 3: The $F_{\text{interferer}}$ (offset) is relative to the centre frequency of the adjacent CC being tested and shall be further adjusted to $\lfloor F_{\text{interferer}} / 0.015 + 0.5 \rfloor 0.015 + 0.0075$ MHz to be offset from the sub-carrier raster.						

7.5A.2 Adjacent Channel Selectivity (ACS) for CA (intra-band contiguous DL CA without UL CA)

7.5A.2.1 Test purpose

The test purpose is the same as in clause 7.5A.1.1.

7.5A.2.2 Test applicability

This test applies to all types of E-UTRA UE release 10 and forward that support intra-band contiguous DL CA without UL CA.

7.5A.2.3 Minimum conformance requirements

Minimum conformance requirements for intra-band contiguous carrier aggregation with one uplink carrier support as in clause 7.5A.1.3.

7.5A.2.4 Test description

7.5A.2.4.1 Initial conditions

Same as in clause 7.5A.1.4.1 with the following exceptions:

- Instead of Table 7.5A.1.4.1-1 → use Table 7.5A.2.4.1-1.

Table 7.5A.2.4.1-1: Test Configuration Table

Initial Conditions									
Test Environment as specified in TS 36.508[7] clause 4.1					NC				
Test Frequencies as specified in TS36.508 [7] clause 4.3.1 for different CA bandwidth classes.					C: Mid range				
Test CC Combination setting (NRB_agg) as specified in clause 5.4.2A.1 for the CA Configuration across bandwidth combination sets supported by the UE.					Lowest N _{RB_agg} Highest N _{RB_agg}				
Test Parameters for CA Configurations									
CA Configuration / N _{RB_agg}		DL Allocation			UL Allocation				
PCC N _{RB}	SCC N _{RB}	CC MOD	PCC & SCC RB allocation	CC MOD	N _{RB_alloc}	PCC & SCC RB allocations (L _{CRB} @ RB _{start})			
75	75	QPSK	75+75	QPSK	75	P_75@0	-	-	-
75	75	QPSK	75+75	QPSK	50	P_50@0	-	-	-
75	75	QPSK	75+75	QPSK	25	P_25@0	-	-	-
75	75	QPSK	75+75	QPSK	20	P_20@0	-	-	-
100	50	QPSK	100+50	QPSK	100	P_100@ 0	-	-	-
100	50	QPSK	100+50	QPSK	75	P_75@0	-	-	-
100	50	QPSK	100+50	QPSK	50	P_50@0	-	-	-
100	50	QPSK	100+50	QPSK	25	P_25@0	-	-	-
100	50	QPSK	100+50	QPSK	20	P_20@0	-	-	-
100	100	QPSK	100+100	QPSK	100	P_100@ 0	-	-	-
100	100	QPSK	100+100	QPSK	75	P_75@0	-	-	-
100	100	QPSK	100+100	QPSK	50	P_50@0	-	-	-
100	100	QPSK	100+100	QPSK	25	P_25@0	-	-	-
100	100	QPSK	100+100	QPSK	20	P_20@0	-	-	-
NOTE 1: CA Configuration Test CC Combination settings are checked separately for each CA Configuration, which applicable aggregated channel bandwidths are specified in Table 5.4.2A.1-1 and Table 5.4.2A.1-2.									
NOTE 2: Depending on CA configurations, only the appropriate Uplink RB allocation value according to table 7.3.3-2 for UE supporting one uplink carrier and to table 7.3A.1.3-1 for UE supporting two uplink carriers are tested per Test CA configuration.									

7.5A.2.4.2 Test procedure

1. Configure SCC according to Annex C.0, C.1 and Annex C.3.1 for all downlink physical channels except PHICH.
2. The SS shall configure SCC as per TS 36.508 [7] clause 5.2A.4. Message contents are defined in clause 7.5A.1.4.3.
3. SS activates SCC by sending the activation MAC-CE (Refer TS 36.321 [13], clauses 5.13, 6.1.3.8). Wait for at least 2 seconds (Refer TS 36.133, clauses 8.3.3.2).

4. SS transmits PDSCH via PDCCH DCI format 1A for C_RNTI to transmit the DL RMC according to Tables 7.5A.1.4.1-1 on both PCC and SCC. The SS sends downlink MAC padding bits on the DL RMC.
5. SS sends uplink scheduling information for each UL HARQ process via PDCCH DCI format 0 for C_RNTI to schedule the UL RMC according to Table 7.5A.2.4.1-1 on PCC. Since the UE has no payload and no loopback data to send the UE sends uplink MAC padding bits on the UL RMC.
6. Set the Downlink signal level for PCC and SCC to the value as defined in Table 7.5A.1.5-2 (Case 1). Send Uplink power control commands to the UE (less or equal to 1dB step size should be used), to ensure that the UE output power is within +0, - 3.4 dB of the target level in Table 7.5A.1.5-2 (Case 1) for carrier frequency $f \leq 3.0\text{GHz}$ or within +0, -4.0 dB of the target level for carrier frequency $3.0\text{GHz} < f \leq 4.2\text{GHz}$, for at least the duration of the Throughput measurement.
7. Set the Interferer signal level to the value as defined in Table 7.5A.1.5-2 (Case 1) and frequency below the wanted signal, using a modulated interferer bandwidth as defined in Annex D of the present document.
8. Measure the average throughput for each component carrier for a duration sufficient to achieve statistical significance according to Annex G.2A.
9. Repeat steps from 6 to 8, using an interfering signal above the wanted signal in Case 1 at step 7.
10. Set the Downlink signal level for PCC and SCC to the value as defined in Table 7.5A.1.5-3 (Case 2). Send Uplink power control commands to the UE (less or equal to 1dB step size should be used), to ensure that the UE output power is within +0, - 3.4 dB of the target level in Table 7.5A.1.5-3 (Case 2) for carrier frequency $f \leq 3.0\text{GHz}$ or within +0, -4.0 dB of the target level for carrier frequency $3.0\text{GHz} < f \leq 4.2\text{GHz}$, for at least the duration of the Throughput measurement.
11. Set the Interferer signal level to the value as defined in Table 7.5A.1.5-3 (Case 2) and frequency below the wanted signal, using a modulated interferer bandwidth as defined in Annex D of the present document.
12. Measure the average throughput for each component carrier for a duration sufficient to achieve statistical significance according to Annex G.2A.
13. Repeat steps from 10 to 12, using an interfering signal above the wanted signal in Case 2 at step 11.

7.5A.2.4.3 Message contents

The message contents are the same as in clause 7.5A.1.4.3.

7.5A.2.5 Test Requirements

The test requirements are the same as in clause 7.5A.1.5.

7.5A.3 Adjacent Channel Selectivity (ACS) for CA (inter-band DL CA without UL CA)

Editor's note: This test case is incomplete. The following aspects are either missing or not yet determined:

- The test is still under discussion for Inter-band

7.5A.3.1 Test purpose

The test purpose is the same as in clause 7.5A.1.1.

7.5A.3.2 Test applicability

This test applies to all types of E-UTRA UE release 10 and forward that support inter-band DL CA without UL CA.

7.5A.3.3 Minimum conformance requirements

Minimum conformance requirements for inter-band carrier aggregation with one uplink carrier support as in clause 7.5A.1.3.

7.5A.3.4 Test description

7.5A.3.4.1 Initial conditions

Same as in clause 7.5A.1.4.1 with the following exceptions:

- Instead of Table 7.5A.1.4.1-1 → use Table 7.5A.3.4.1-1.

Table 7.5A.3.4.1-1: Test Configuration Table

Initial Conditions						
Test Environment as specified in TS 36.508[7] subclause 4.1			NC			
Test Frequencies as specified in TS36.508 [7] subclause 4.3.1 for different CA bandwidth classes.			A: Mid range for PCC and SCC			
Test CC Combination setting (N_{RB_agg}) as specified in subclause 5.4.2A.1 for the CA Configuration across bandwidth combination sets supported by the UE.			Highest N_{RB_agg} for PCC and SCC			
Test Parameters for CA Configurations						
CA Configuration / N_{RB_agg}		DL Allocation			UL Allocation	
PCC N_{RB}	SCCs N_{RB}	CC MOD	PCC & SCC RB allocation		CC MOD	PCC N_{RB_alloc}
50	50	QPSK	50	50	QPSK	50
50	50	QPSK	50	50	QPSK	25
50	50	QPSK	50	50	QPSK	20
50	50	QPSK	50	50	QPSK	16
50	75	QPSK	50	75	QPSK	25
50	100	QPSK	50	100	QPSK	50
50	100	QPSK	50	100	QPSK	25
50	100	QPSK	50	100	QPSK	20
75	50	QPSK	75	50	QPSK	25
75	100	QPSK	75	100	QPSK	25
100	50	QPSK	100	50	QPSK	100
100	50	QPSK	100	50	QPSK	75
100	50	QPSK	100	50	QPSK	50
100	75	QPSK	100	75	QPSK	100
100	100	QPSK	100	100	QPSK	75
100	100	QPSK	100	100	QPSK	50
Note 1: CA Configuration Test CC Combination settings are checked separately for each CA Configuration, which applicable aggregated channel bandwidths are specified in Table 5.4.2A.1-2. Note 2: Depending on CA configurations, only the appropriate Uplink RB allocation value according to table 7.3.3-2 for UE supporting one uplink carrier is tested per Test CA configuration, unless otherwise stated in table 7.3A.1.3-0b. Note 3: The UL resource blocks shall be located as close as possible to the downlink SCC but confined within the transmission bandwidth configuration for the channel bandwidth (Table 5.4.2-1). Note 4: The frequencies of PCC and SCC shall be switched and tested in each configuration (given UL is supported in PCC band as per Table 5.2-1).						

7.5A.3.4.2 Test procedure

1. Configure SCC according to Annex C.0, C.1 and Annex C.3.1 for all downlink physical channels except PHICH.
2. The SS shall configure SCC as per TS 36.508 [7] clause 5.2A.4. Message contents are defined in clause 7.5A.1.4.3.

3. SS activates SCC by sending the activation MAC-CE (Refer TS 36.321 [13], clauses 5.13, 6.1.3.8). Wait for at least 2 seconds (Refer TS 36.133, clauses 8.3.3.2).
4. SS transmits PDSCH via PDCCH DCI format 1A for C_RNTI to transmit the DL RMC according to Tables 7.5A.1.4.1-1 on both PCC and SCC. The SS sends downlink MAC padding bits on the DL RMC.
5. SS sends uplink scheduling information for each UL HARQ process via PDCCH DCI format 0 for C_RNTI to schedule the UL RMC according to Table 7.5A.3.4.1-1 on PCC. Since the UE has no payload and no loopback data to send the UE sends uplink MAC padding bits on the UL RMC.
6. Set the Downlink signal level for PCC and SCC to the value as defined in Table 7.5A.3.5-2 (Case 1). Send Uplink power control commands to the UE (less or equal to 1dB step size should be used), to ensure that the UE output power is within +0, - 3.4 dB of the target level in Table 7.5A. 3.5-2 (Case 1) for carrier frequency $f \leq 3.0\text{GHz}$ or within +0, -4.0 dB of the target level for carrier frequency $3.0\text{GHz} < f \leq 4.2\text{GHz}$, for at least the duration of the Throughput measurement.
7. Set the Interferer signal level to the value as defined in Table 7.5A. 3.5-2 (Case 1) and frequency below the wanted signal, using a modulated interferer bandwidth as defined in Annex D of the present document.
8. Measure the average throughput of SCC for a duration sufficient to achieve statistical significance according to Annex G.2A.
9. Repeat steps from 6 to 8, using an interfering signal above the wanted signal in Case 1 at step 7.
10. Set the Downlink signal level for PCC and SCC to the value as defined in Table 7.5A.3.5-3 (Case 2). Send Uplink power control commands to the UE (less or equal to 1dB step size should be used), to ensure that the UE output power is within +0, - 3.4 dB of the target level in Table 7.5A.3.5-3 (Case 2) for carrier frequency $f \leq 3.0\text{GHz}$ or within +0, -4.0 dB of the target level for carrier frequency $3.0\text{GHz} < f \leq 4.2\text{GHz}$, for at least the duration of the Throughput measurement.
11. Set the Interferer signal level to the value as defined in Table 7.5A.3.5-3 (Case 2) and frequency below the wanted signal, using a modulated interferer bandwidth as defined in Annex D of the present document.
12. Measure the average throughput of SCC for a duration sufficient to achieve statistical significance according to Annex G.2A.
13. Repeat steps from 10 to 12, using an interfering signal above the wanted signal in Case 2 at step 11.

7.5A.3.4.3 Message contents

The message contents are the same as in clause 7.5A.1.4.3.

7.5A.3.5 Test Requirements

For inter-band carrier aggregation with uplink assigned to one E-UTRA band, the adjacent channel requirements are defined with the uplink active on the band other than the band whose downlink is being tested i.e. the requirements are tested only for the SCell downlink. The UE shall meet the requirements specified in Table 7.5A.3.5-2 and Table 7.5A.3.5-3 for each component carrier, when operated as SCell, while both downlink carriers are active. The requirements for each component carrier are the same as single carrier requirements in Table 7.5.5-2 and Table 7.5.5-3. The parameters in these tables are related to the carrier operated as SCell.

Table 7.5A.3.5-1: Adjacent channel selectivity

Rx Parameter	Units	Channel bandwidth					
		1.4 MHz	3 MHz	5 MHz	10 MHz	15 MHz	20 MHz
ACS	dB	33.0	33.0	33.0	33.0	30	27

Table 7.5A.3.5-2: Test parameters for Adjacent channel selectivity, Case 1

Rx Parameter	Units	Channel bandwidth					
		1.4 MHz	3 MHz	5 MHz	10 MHz	15 MHz	20 MHz

Power in Transmission Bandwidth Configuration	dBm	REFSENS + 14 dB					
$P_{\text{Interferer}}$	dBm	REFSENS +45.5dB	REFSENS +45.5dB	REFSENS +45.5dB	REFSENS +45.5dB	REFSENS +42.5dB	REFSENS +39.5dB
$BW_{\text{Interferer}}$	MHz	1.4	3	5	5	5	5
$F_{\text{Interferer}}$ (offset)	MHz	1.4+0.0025 / -1.4-0.0025	3+0.0075 / -3-0.0075	5+0.0025 / -5-0.0025	7.5+0.0075 / -7.5-0.0075	10+0.0125 / -10-0.0125	12.5+0.0025 / -12.5-0.0025
Note 1: The transmitter shall be set to 4dB below $P_{\text{CMAX,L}}$ at the minimum uplink configuration specified in Table 7.3.3-2 with $P_{\text{CMAX,L}}$ as defined in clause 6.2.5.							
Note 2: The interferer consists of the Reference measurement channel specified in Annex A.3.2 with one sided dynamic OCNG Pattern OP.1 FDD/TDD as described in Annex A.5.1.1/A.5.2.1 and set-up according to Annex C.3.1.							

Table 7.5A.3.5-3: Test parameters for Adjacent channel selectivity, Case 2

Rx Parameter	Units	Channel bandwidth					
		1.4 MHz	3 MHz	5 MHz	10 MHz	15 MHz	20 MHz
Power in Transmission Bandwidth Configuration	dBm	-56.5	-56.5	-56.5	-56.5	-53.5	-50.5
$P_{\text{Interferer}}$	dBm	-25					
$BW_{\text{Interferer}}$	MHz	1.4	3	5	5	5	5
$F_{\text{Interferer}}$ (offset)	MHz	1.4+0.0025 / -1.4-0.0025	3+0.0075 / -3-0.0075	5+0.0025 / -5-0.0025	7.5+0.0075 / -7.5-0.0075	10+0.0125 / -10-0.0125	12.5+0.0025 / -12.5-0.0025
Note 1: The transmitter shall be set to 24dB below $P_{\text{CMAX,L}}$ at the minimum uplink configuration specified in Table 7.3.3-2 with $P_{\text{CMAX,L}}$ as defined in clause 6.2.5.							
Note 2: The interferer consists of the Reference measurement channel specified in Annex A.3.2 with one sided dynamic OCNG Pattern OP.1 FDD/TDD as described in Annex A.5.1.1/A.5.2.1 and set-up according to Annex C.3.1.							

7.5B Adjacent Channel Selectivity (ACS) for UL-MIMO

7.5B.1 Test purpose

Adjacent channel selectivity tests the ability of UE that support UL-MIMO to receive data with a given average throughput for a specified reference measurement channel, in the presence of an adjacent channel signal at a given frequency offset from the centre frequency of the assigned channel, under conditions of ideal propagation and no added noise.

A UE unable to meet the throughput requirement under these conditions will decrease the coverage area when other e-NodeB transmitters exist in the adjacent channel.

7.5B.2 Test applicability

This test applies to all types of E-UTRA UE release 10 and forward that support UL-MIMO.

7.5B.3 Minimum conformance requirements

For UE(s) with two transmitter antenna connectors in closed-loop spatial multiplexing scheme, the minimum requirements in Clause 7.5.3 shall be met with the UL-MIMO configurations specified in Table 6.2.2B.3-2. For UL-MIMO, the parameter $P_{\text{CMAX,L}}$ is defined as the total transmitter power over the two transmit antenna connectors.

The normative reference for this requirement is TS 36.101 [2] clause 7.5.1B.

7.5B.4 Test description

7.5B.4.1 Initial conditions

Initial conditions are a set of test configurations the UE needs to be tested in and the steps for the SS to take with the UE to reach the correct measurement state.

The initial test configurations consist of environmental conditions, test frequencies, and channel bandwidths based on E-UTRA bands specified in table 5.4.2.1-1. All of these configurations shall be tested with applicable test parameters for each channel bandwidth, and are shown in table 7.5B.4.1-1. The details of the uplink and downlink reference measurement channels (RMCs) are specified in Annexes A.2 and A.3 respectively. The details of the OCNG patterns used are specified in Annex A.5. Configurations of PDSCH and PDCCH before measurement are specified in Annex C.2.

Table 7.5B.4.1-1: Test Configuration Table

Initial Conditions						
Test Environment as specified in TS 36.508[7] subclause 4.1			NC			
Test Frequencies as specified in TS36.508 [7] subclause 4.3.1			Mid range			
Test Channel Bandwidths as specified in TS 36.508 [7] subclause 4.3.1			Lowest, 5MHz, Highest			
Test Parameters for Channel Bandwidths						
Ch BW	Downlink Configuration			Uplink Configuration		
	Mod'n	RB allocation		Mod'n	RB allocation	
		FDD	TDD		FDD	TDD
1.4MHz	QPSK	Full	Full	QPSK	5	5
3MHz	QPSK	Full	Full	QPSK	4	4
5MHz	QPSK	Full	Full	QPSK	8	8
10MHz	QPSK	Full	Full	QPSK	12	12
15MHz	QPSK	Full	Full	QPSK	16	16
20MHz	QPSK	Full	Full	QPSK	18	18
Note 1: Test Channel Bandwidths are checked separately for each E-UTRA band. The applicable channel bandwidths are specified in Table 7.3.3-2.						
Note 2: For the DL signal one sided dynamic OCNG Pattern OP.1 FDD/TDD is used.						

1. Connect the SS and interfering source to the UE antenna connectors as shown in TS 36.508 [7] Figure A.29.
2. The parameter settings for the cell are set up according to TS 36.508 [7] subclause 4.4.3.
3. Downlink signals are initially set up according to Annex C0, C.1 and C.3.1, and uplink signals according to Annex H.1 and H.3.1.
4. The UL and DL Reference Measurement channels are set according to Table 7.5B.4.1-1.
5. Propagation conditions are set according to Annex B.0.
6. Ensure the UE is in State 3A-RF according to TS 36.508 [7] clause 5.2A.2. Message contents are defined in clause 7.5B.4.3.

7.5B.4.2 Test procedure

1. SS transmits PDSCH via PDCCH DCI format 1A for C_RNTI to transmit the DL RMC according to Table 7.5B.4.1-1. The SS sends downlink MAC padding bits on the DL RMC.
2. SS sends uplink scheduling information for each UL HARQ process via PDCCH DCI format 4 for C_RNTI to schedule the UL RMC according to Table 7.5B.4.1-1. Since the UE has no payload data to send, the UE transmits uplink MAC padding bits on the UL RMC.
3. Set the Downlink signal level to the value as defined in Table 7.5B.5-2 (Case 1). Send Uplink power control commands to the UE (less or equal to 1dB step size should be used), to ensure that the UE output power is within

+0, - 3.4 dB of the target level in Table 7.5B.5-2 (Case 1) for carrier frequency $f \leq 3.0\text{GHz}$ or within +0, -4.0 dB of the target level for carrier frequency $3.0\text{GHz} < f \leq 4.2\text{GHz}$, for at least the duration of the Throughput measurement.

4. Set the Interferer signal level to the value as defined in Table 7.5B.5-2 (Case 1) and frequency below the wanted signal, using a modulated interferer bandwidth as defined in Annex D of the present document.
5. Measure the average throughput for a duration sufficient to achieve statistical significance according to Annex G.2.
6. Repeat steps from 3 to 5, using an interfering signal above the wanted signal in Case 1 at step 4.
7. Set the Downlink signal level to the value as defined in Table 7.5B.5-3 (Case 2). Send Uplink power control commands to the UE (less or equal to 1dB step size should be used), to ensure that the UE output power is within +0, - 3.4 dB of the target level in Table 7.5B.5-3 (Case 2) for carrier frequency $f \leq 3.0\text{GHz}$ or within +0, -4.0 dB of the target level for carrier frequency $3.0\text{GHz} < f \leq 4.2\text{GHz}$, for at least the duration of the throughput measurement.
8. Set the Interferer signal level to the value as defined in Table 7.5B.5-3 (Case 2) and frequency below the wanted signal, using a modulated interferer bandwidth as defined in Annex D of the present document.
9. Measure the average throughput for a duration sufficient to achieve statistical significance according to Annex G.2.
10. Repeat steps from 7 to 9, using an interfering signal above the wanted signal in Case 2 at step 8.
11. Repeat for applicable channel bandwidths and operating band combinations in both Case 1 and Case 2.

7.5B.4.3 Message contents

Message contents are according to TS 36.508 [7] clause 4.6 with the following exception

Table 7.5B.4.3-1: UplinkPowerControlDedicated

Derivation Path: 36.331 clause 6.3.2			
Information Element	Value/remark	Comment	Condition
UplinkPowerControlDedicated-DEFAULT ::= SEQUENCE {			
p0-UePUSCH	0		
deltaMCS-Enabled	en0		
accumulationEnabled	TRUE		
p0-uePUCCH	0		
pSRS-Offset	3 (-6 dB)		
filterCoefficient	fc8	larger filter length is used to reduce the RSRP measurement variation	
}			

7.5B.5 Test requirement

The throughput R_m shall be $\geq 95\%$ of the maximum throughput of the reference measurement channels as specified in Annex A.3.2 under the conditions specified in table 7.5B.5-2, and also under the conditions specified in table 7.5B.5-3.

Table 7.5B.5-1: Adjacent channel selectivity

Rx Parameter	Units	Channel bandwidth					
		1.4 MHz	3 MHz	5 MHz	10 MHz	15 MHz	20 MHz
ACS	dB	33.0	33.0	33.0	33.0	30	27

Table 7.5B.5-2: Test parameters for Adjacent channel selectivity, Case 1

Rx Parameter	Units	Channel bandwidth					
		1.4 MHz	3 MHz	5 MHz	10 MHz	15 MHz	20 MHz
Power in Transmission Bandwidth Configuration	dBm	REFSENS + 14 dB					
$P_{\text{Interferer}}$	dBm	REFSENS +45.5dB	REFSENS +45.5dB	REFSENS +45.5dB*	REFSENS +45.5dB	REFSENS +42.5dB	REFSENS +39.5dB
$BW_{\text{Interferer}}$	MHz	1.4	3	5	5	5	5
$F_{\text{Interferer}}$ (offset)	MHz	1.4+0.0025	3+0.0075	5+0.0025	7.5+0.0075	10+0.0125	12.5+0.0025
Note 1:	The transmitter shall be set to 4dB below $P_{\text{CMAX,L}}$ at the minimum uplink configuration specified in Table 7.3.3-2 with $P_{\text{CMAX,L}}$ as defined in clause 6.2.5.						
Note 2:	The interferer consists of the Reference measurement channel specified in Annex A.3.2 with one sided dynamic OCNG Pattern OP.1 FDD/TDD as described in Annex A.5.1.1/A.5.2.1 and set-up according to Annex C.3.1.						

Table 7.5B.5-3: Test parameters for Adjacent channel selectivity, Case 2

Rx Parameter	Units	Channel bandwidth					
		1.4 MHz	3 MHz	5 MHz	10 MHz	15 MHz	20 MHz
Power in Transmission Bandwidth Configuration	dBm	-56.5	-56.5	-56.5	-56.5	-53.5	-50.5
$P_{\text{Interferer}}$	dBm	-25					
$BW_{\text{Interferer}}$	MHz	1.4	3	5	5	5	5
$F_{\text{Interferer}}$ (offset)	MHz	1.4+0.0025	3+0.0075	5+0.0025	7.5+0.0075	10+0.0125	12.5+0.0025
Note 1:	The transmitter shall be set to 24dB below $P_{\text{CMAX,L}}$ at the minimum uplink configuration specified in Table 7.3.3-2 with $P_{\text{CMAX,L}}$ as defined in clause 6.2.5.						
Note 2:	The interferer consists of the Reference measurement channel specified in Annex A.3.2 with one sided dynamic OCNG Pattern OP.1 FDD/TDD as described in Annex A.5.1.1/A.5.2.1 and set-up according to Annex C.3.1.						

7.6 Blocking characteristics

The blocking characteristic is a measure of the receiver's ability to receive a wanted signal at its assigned channel frequency in the presence of an unwanted interferer on frequencies other than those of the spurious response or the adjacent channels, without this unwanted input signal causing a degradation of the performance of the receiver beyond a specified limit. The blocking performance shall apply at all frequencies except those at which a spurious response occur.

7.6.1 In-band blocking

7.6.1.1 Test Purpose

In-band blocking is defined for an unwanted interfering signal falling into the range from 15MHz below to 15MHz above the UE receive band, at which the relative throughput shall meet or exceed the requirement for the specified measurement channels.

The lack of in-band blocking ability will decrease the coverage area when other e-NodeB transmitters exist (except in the adjacent channels and spurious response).

7.6.1.2 Test Applicability

This test applies to all types of E-UTRA UE release 8 and forward..

7.6.1.3 Minimum Conformance Requirements

The throughput shall be $\geq 95\%$ of the maximum throughput of the reference measurement channels as specified in Annexes A.2.2, A.2.3 and A.3.2 (with one sided dynamic OCNB Pattern OP.1 FDD/TDD for the DL-signal as described in Annex A.5.1.1/A.5.2.1) with parameters specified in Tables 7.6.1.3-1 and 7.6.1.3-2.

Table 7.6.1.3-1: In band blocking parameters

Rx Parameter	Units	Channel bandwidth					
		1.4 MHz	3 MHz	5 MHz	10 MHz	15 MHz	20 MHz
Power in Transmission Bandwidth Configuration	dBm	REFSENS + channel bandwidth specific value below					
		6	6	6	6	7	9
BW _{Interferer}	MHz	1.4	3	5	5	5	5
F _{offset, case 1}	MHz	2.1+0.0125	4.5+0.0075	7.5+0.0125	7.5+0.0025	7.5+0.0075	7.5+0.0125
F _{offset, case 2}	MHz	3.5+0.0075	7.5+0.0075	12.5+0.0075	12.5+0.012	12.5+0.002	12.5+0.007
					5	5	5
Note 1: The transmitter shall be set to 4dB below P _{CMAX,L} at the minimum uplink configuration specified in Table 7.3.3-2 with P _{CMAX,L} as defined in clause 6.2.5. Note 2: The interferer consists of the Reference measurement channel specified in Annex A.3.2 with one sided dynamic OCNB Pattern OP.1 FDD/TDD as described in Annex A.5.1.1/A.5.2.1 and set-up according to Annex C.3.1.							

Table 7.6.1.3-2: In-band blocking

E-UTRA band	Parameter	Unit	Case 1	Case 2	Case 3	Case 4
	P _{Interferer}	dBm	-56	-44	-30	[-30]
	F _{Interferer (offset)}	MHz	$=-BW/2 - F_{\text{offset, case 1}}$ & $=+BW/2 + F_{\text{offset, case 1}}$	$\leq -BW/2 - F_{\text{offset, case 2}}$ & $\geq +BW/2 + F_{\text{offset, case 2}}$	$-BW/2 - 15$ & $-BW/2 - 9$	$-BW/2 - 10$
1, 2, 3, 4, 5, 6, 7, 8, 9, 10, 11, 13, 14, 18, 19, 20, 21, 22, 23, 25, 26, 27, 28, 31, 33, 34, 35, 36, 37, 38, 39, 40, 41, 42, 43, 44	F _{Interferer}	MHz	(Note 2)	F _{DL_low} - 15 to F _{DL_high} + 15		
12	F _{Interferer}	MHz	(Note 2)	F _{DL_low} - 10 to F _{DL_high} + 15		F _{DL_low} - 10
17	F _{Interferer}	MHz	(Note 2)	F _{DL_low} - 9 to F _{DL_high} + 15	F _{DL_low} - 15 and F _{DL_low} - 9	
Note 1: For certain bands, the unwanted modulated interfering signal may not fall inside the UE receive band, but within the first 15 MHz below or above the UE receive band Note 2: For each carrier frequency the requirement is valid for two frequencies: a. the carrier frequency $-BW/2 - F_{\text{offset, case 1}}$ and b. the carrier frequency $+BW/2 + F_{\text{offset, case 1}}$ Note 3: F _{Interferer} range values for unwanted modulated interfering signal are interferer centre frequencies Note 4: Case 3 and Case 4 only apply to assigned UE channel bandwidth of 5 MHz						

The normative reference for this requirement is TS 36.101 [2] clause 7.6.1.

7.6.1.4 Test Description

7.6.1.4.1 Initial Conditions

Initial conditions are a set of test configurations the UE needs to be tested in and the steps for the SS to take with the UE to reach the correct measurement state.

The initial test configurations consist of environmental conditions, test frequencies, and channel bandwidths based on E-UTRA bands specified in table 5.4.2.1-1. All of these configurations shall be tested with applicable test parameters for each channel bandwidth, and are shown in table 7.6.1.4.1-1. The details of the uplink and downlink reference measurement channels (RMCs) are specified in Annexes A.2 and A.3 respectively. The details of the OCNG patterns used are specified in Annex A.5. Configurations of PDSCH and PDCCH before measurement are specified in Annex C.2.

Table 7.6.1.4.1-1: Test Configuration Table

Initial Conditions						
Test Environment as specified in TS 36.508[7] subclause 4.1			NC			
Test Frequencies as specified in TS36.508 [7] subclause 4.3.1			Mid range			
Test Channel Bandwidths as specified in TS 36.508 [7] subclause 4.3.1			Lowest, 5MHz, Highest			
Test Parameters for Channel Bandwidths						
Ch BW	Downlink Configuration			Uplink Configuration		
	Mod'n	RB allocation		Mod'n	RB allocation	
		FDD	TDD		FDD	TDD
1.4MHz	QPSK	6	6	QPSK	6	6
3MHz	QPSK	15	15	QPSK	15	15
5MHz	QPSK	25	25	QPSK	25	25
5MHz	QPSK	25	N/A	QPSK	20	N/A
5MHz	QPSK	25	N/A	QPSK	15	N/A
10MHz	QPSK	50	50	QPSK	50	50
10MHz	QPSK	50	N/A	QPSK	25	N/A
10MHz	QPSK	50	N/A	QPSK	20	N/A
10MHz	QPSK	50	N/A	QPSK	15	N/A
15MHz	QPSK	75	75	QPSK	75	75
15MHz	QPSK	75	N/A	QPSK	50	N/A
15MHz	QPSK	75	N/A	QPSK	25	N/A
15MHz	QPSK	75	N/A	QPSK	20	N/A
20MHz	QPSK	100	100	QPSK	100	100
20MHz	QPSK	100	N/A	QPSK	75	N/A
20MHz	QPSK	100	N/A	QPSK	50	N/A
20MHz	QPSK	100	N/A	QPSK	25	N/A
20MHz	QPSK	100	N/A	QPSK	20	N/A
Note 1: Test Channel Bandwidths are checked separately for each E-UTRA band, which applicable channel bandwidths are specified in Table 5.4.2.1-1. Note 2: Depending on E-UTRA band, only the appropriate Uplink RB allocation value according to table 7.3.3-2 is tested per Test Channel Bandwidth. The allocation shall be located as close as possible to the downlink operating band but confined within the transmission bandwidth configuration for the channel bandwidth (Table 5.4.2-1). Note 3: For the DL signal one sided dynamic OCNG Pattern OP.1 FDD/TDD is used.						

1. Connect the SS to the UE antenna connectors as shown in TS 36.508 [7] Annex A, in Figure A.4.
2. The parameter settings for the cell are set up according to TS 36.508 [7] subclause 4.4.3.
3. Downlink signals are initially set up according to Annex C0, C.1 and C.3.1, and uplink signals according to Annex H.1 and H.3.1.
4. The UL and DL Reference Measurement channels are set according to in Table 7.6.1.4.1-1.
5. Propagation conditions are set according to Annex B.0.
6. Ensure the UE is in State 3A-RF according to TS 36.508 [7] clause 5.2A.2. Message contents are defined in clause 7.6.1.4.3.

7.6.1.4.2 Test Procedure

1. SS transmits PDSCH via PDCCH DCI format 1A for C_RNTI to transmit the DL RMC according to Table 7.6.1.4.1-1. The SS sends downlink MAC padding bits on the DL RMC.
2. SS sends uplink scheduling information for each UL HARQ process via PDCCH DCI format 0 for C_RNTI to schedule the UL RMC according to Table 7.6.1.4.1-1. Since the UE has no payload data to send, the UE transmits uplink MAC padding bits on the UL RMC.
3. Set the parameters of the signal generator for an interfering signal below the wanted signal in Case 1 according to Tables 7.6.1.5-1 and 7.6.1.5-2.
4. Set the downlink signal level according to the table 7.6.1.5-1. Send uplink power control commands to the UE (less or equal to 1dB step size should be used), to ensure that the UE output power is within +0, - 3.4 dB of the target level in table 7.6.1.5-1 for carrier frequency $f \leq 3.0\text{GHz}$ or within +0, -4.0 dB of the target level for carrier frequency $3.0\text{GHz} < f \leq 4.2\text{GHz}$, for at least the duration of the throughput measurement.
5. Measure the average throughput for a duration sufficient to achieve statistical significance according to Annex G.2.
6. Repeat steps from 3 to 5, using an interfering signal above the wanted signal in Case 1 at step 3.
7. Repeat steps from 3 to 6, using interfering signals in Case 2 at step 3 and 6. The ranges of case 2 are covered in steps equal to the interferer bandwidth. The test frequencies are chosen in analogy to table 7.6.1.4.2-1.
8. Repeat steps from 3 to 5, using successively all interfering signals in Case 3 and Case 4 at step 3.

Table 7.6.1.4.2-1: Example for interferer frequencies

	Lower frequency	Upper frequency
Band 1 DL	2110 MHz	2170 MHz
Band 1 Midrange	2140 MHz	
Receive band wanted signal (BW 5MHz)	2137.5 MHz	2142.5 MHz
Interferer case 1	2129.9875 MHz	2150.0125 MHz
Interferer case 2 (inner frequency)	2124.9925 MHz	2155.0075 MHz
Interferer case 2 (outer frequency)	2099.9925 MHz	2180.0075 MHz
Outer limit for in band blocking	2095MHz	2185MHz
Number of test frequencies case 2	6	6
Number of test frequencies for Band 17(asymmetric!), BW 5MHz, case 2	0	2

7.6.1.4.3 Message Contents

Message contents are according to TS 36.508 [7] subclause 4.6 with the following exception

Table 7.6.1.4.3-1: UplinkPowerControlDedicated

Derivation Path: 36.331 clause 6.3.2			
Information Element	Value/remark	Comment	Condition
UplinkPowerControlDedicated-DEFAULT ::= SEQUENCE {			
p0-UePUSCH	0		
deltaMCS-Enabled	en0		
accumulationEnabled	TRUE		
p0-uePUCCH	0		
pSRS-Offset	3 (-6 dB)		
filterCoefficient	fc8	larger filter length is used to reduce the RSRP measurement variation	
}			

7.6.1.5 Test Requirement

The throughput measurement derived in test procedure shall be $\geq 95\%$ of the maximum throughput of the reference measurement channels as specified in Annex A.3.2 with parameters specified in Tables 7.6.1.5-1 and 7.6.1.5-2.

Table 7.6.1.5-1: In band blocking parameters

Rx Parameter	Units	Channel bandwidth					
		1.4 MHz	3 MHz	5 MHz	10 MHz	15 MHz	20 MHz
Power in Transmission Bandwidth Configuration	dBm	REFSENS + channel bandwidth specific value below					
		6	6	6	6	7	9
$BW_{\text{Interferer}}$	MHz	1.4	3	5	5	5	5
$F_{\text{offset, case 1}}$	MHz	2.1+0.0125	4.5+0.0075	7.5+0.0125	7.5+0.0025	7.5+0.0075	7.5+0.0125
$F_{\text{offset, case 2}}$	MHz	3.5+0.0075	7.5+0.0075	12.5+0.0075	12.5+0.012	12.5+0.002	12.5+0.007
					5	5	5
Note 1: The transmitter shall be set to 4dB below $P_{\text{CMAX,L}}$ with $P_{\text{CMAX,L}}$ as defined in clause 6.2.5.							
Note 2: The interferer consists of the Reference measurement channel specified in Annex A.3.2 with one sided dynamic OCNG Pattern OP.1 FDD/TDD as described in Annex A.5.1.1/A.5.2.1 and set-up according to Annex C.3.1.							

Table 7.6.1.5-2: In-band blocking

E-UTRA band	Parameter	Unit	Case 1	Case 2	Case 3	Case 4
	$P_{\text{Interferer}}$	dBm	-56	-44	-30	[-30]
	$F_{\text{Interferer}}$ (offset)	MHz	$=-BW/2 - F_{\text{offset, case 1}}$ & $=+BW/2 + F_{\text{offset, case 1}}$	$\leq -BW/2 - F_{\text{offset, case 2}}$ & $\geq +BW/2 + F_{\text{offset, case 2}}$	$-BW/2 - 15$ & $-BW/2 - 9$	$-BW/2 - 10$

1, 2, 3, 4, 5, 6, 7, 8, 9, 10, 11, 13, 14, 18, 19, 20, 21, 22, 23, 25, 26, 27, 28, 31, 33, 34, 35, 36, 37, 38, 39, 40, 41, 42, 43, 44	$F_{\text{Interferer}}$	MHz	(Note 2)	$F_{\text{DL_low}} - 15$ to $F_{\text{DL_high}} + 15$		
12	$F_{\text{Interferer}}$	MHz	(Note 2)	$F_{\text{DL_low}} - 10$ to $F_{\text{DL_high}} + 15$		$F_{\text{DL_low}} - 10$
17	$F_{\text{Interferer}}$	MHz	(Note 2)	$F_{\text{DL_low}} - 9$ to $F_{\text{DL_high}} + 15$	$F_{\text{DL_low}} - 15$ and $F_{\text{DL_low}} - 9$	
<p>Note 1: For certain bands, the unwanted modulated interfering signal may not fall inside the UE receive band, but within the first 15 MHz below or above the UE receive band</p> <p>Note 2: For each carrier frequency the requirement is valid for two frequencies: a. the carrier frequency $-BW/2 - F_{\text{offset, case 1}}$ and b. the carrier frequency $+BW/2 + F_{\text{offset, case 1}}$</p> <p>Note 3: $F_{\text{Interferer}}$ range values for unwanted modulated interfering signal are interferer centre frequencies</p> <p>Note 4: Case 3 and Case 4 only apply to assigned UE channel bandwidth of 5 MHz</p>						

7.6.1A In-band blocking for CA

7.6.1A.1 In-band blocking for CA (intra-band contiguous DL CA and UL CA)

7.6.1A.1.1 Test Purpose

In-band blocking is defined for an unwanted interfering signal falling into the range from 15MHz below to 15MHz above the UE receive band, at which the relative throughput shall meet or exceed the requirement for the specified measurement channels.

The lack of in-band blocking ability will decrease the coverage area when other e-NodeB transmitters exist (except in the adjacent channels and spurious response).

7.6.1A.1.2 Test Applicability

This test applies to all types of E-UTRA UE release 10 and forward that support intra-band contiguous DL CA and UL CA.

7.6.1A.1.3 Minimum Conformance Requirements

For inter-band carrier aggregation with uplink assigned to one E-UTRA band the in-band blocking requirements are defined with the uplink active on the band other than the band whose downlink is being tested. The UE shall meet the requirements specified in subclause 7.6.1 for each component carrier while both downlink carriers are active. For the UE which supports inter band CA configuration in Table 7.3A.3-0, $P_{\text{Interferer}}$ power defined in Table 7.6.1.3-2 is increased by the amount given by $\Delta R_{\text{IB,c}}$ in Table 7.3A.3-0. For E-UTRA CA configurations including an operating band without uplink band (as noted in Table 5.2-1), the requirements for both downlinks shall be met with the uplink in the band capable of UL operation.. The requirements for the component carrier configured in the operating band without uplink band are specified in Table 7.6.1.3-1 and Table 7.6.1A.1.3-0.

Table 7.6.1A.1.3-0: In-band blocking for additional operating bands for carrier aggregation

E-UTRA band	Parameter	Unit	Case 1	Case 2
		$P_{\text{Interferer}}$	dBm	-56
	$F_{\text{Interferer}}$ (offset)	MHz	$=-BW/2 - F_{\text{offset,case 1}}$ & $=+BW/2 + F_{\text{offset,case 1}}$	$\leq -BW/2 - F_{\text{offset,case 2}}$ & $\geq +BW/2 + F_{\text{offset,case 2}}$
29	$F_{\text{Interferer}}$	MHz	(Note 2)	$F_{\text{DL_low}} - 15$ to $F_{\text{DL_high}} + 15$
<p>NOTE 1: For certain bands, the unwanted modulated interfering signal may not fall inside the UE receive band, but within the first 15 MHz below or above the UE receive band.</p> <p>NOTE 2: For each carrier frequency the requirement is valid for two frequencies: a. the carrier frequency $-BW/2 - F_{\text{offset, case 1}}$ and b. the carrier frequency $+BW/2 + F_{\text{offset, case 1}}$</p> <p>NOTE 3: $F_{\text{Interferer}}$ range values for unwanted modulated interfering signal are interferer centre frequencies.</p>				

For E-UTRA CA configurations listed in Table 7.3A.1.3-0a under conditions for which reference sensitivity for the operating band being tested is N/A, the in-band blocking requirements of subclause 7.6.1A.1.3 do not apply.

For intra-band contiguous carrier aggregation the downlink SCC shall be configured at nominal channel spacing to the PCC with the PCC configured closest to the uplink band. Downlink PCC and SCC are both activated. The uplink output power shall be set as specified in Table 7.6.1A.1.3-1 with the uplink configuration set according to Table 7.3A.3-1 for the applicable carrier aggregation configuration. For UE(s) supporting one uplink carrier, the uplink configuration of the PCC shall be in accordance with Table 7.3.3-2. The UE shall fulfil the minimum requirement in presence of an interfering signal specified in Tables 7.6.1A.3-1 and Tables 7.6.1A.1.3-2 being on either side of the aggregated signal. The throughput of each carrier shall be $\geq 95\%$ of the maximum throughput of the reference measurement channels as specified in Annexes A.2.2, A.2.3 and A.3.2 (with one sided dynamic OCN Pattern OP.1 FDD/TDD for the DL-signal as described in Annex A.5.1.1/A.5.2.1) with parameters specified in Tables 7.6.1A.1.3-1 and 7.6.1A.1.3-2.

Table 7.6.1A.1.3-1: In band blocking parameters

Rx Parameter	Units	CA Bandwidth Class				
		B	C	D	E	F
Power per CC in Aggregated Transmission Bandwidth Configuration	dBm	REFSENS + CA Bandwidth Class specific value below				
			12			
$BW_{\text{Interferer}}$	MHz		5			
$F_{\text{offset, case 1}}$	MHz		7.5			
$F_{\text{offset, case 2}}$	MHz		12.5			
<p>Note 1: The transmitter shall be set to 4dB below $P_{\text{CMAX_L}}$ or $P_{\text{CMAX_L_CA}}$ as defined in subclause 6.2.5A</p> <p>Note 2: The interferer consists of the Reference measurement channel specified in Annex A.3.2 with one sided dynamic OCN Pattern OP.1 FDD/TDD as described in Annex A.5.1.1/A.5.2.1 and set-up according to Annex C.3.1</p>						

Table 7.6.1A.1.3-2: In-band blocking

CA configuration	Parameter	Unit	Case 1	Case 2
		$P_{\text{Interferer}}$	dBm	-56
	$F_{\text{Interferer}}$	MHz	$=-F_{\text{offset}} - F_{\text{offset,case 1}}$ & $=+F_{\text{offset}} + F_{\text{offset,case 1}}$	$\leq -F_{\text{offset}} - F_{\text{offset,case 2}}$ & $\geq +F_{\text{offset}} + F_{\text{offset,case 2}}$

CA_1C, CA_7C, CA_38C, CA_40C, CA_41C	$F_{\text{Interferer}}$ (Range)	MHz	(Note 2)	$F_{\text{DL_low}} - 15$ to $F_{\text{DL_high}} + 15$
<p>Note 1: For certain bands, the unwanted modulated interfering signal may not fall inside the UE receive band, but within the first 15 MHz below or above the UE receive band</p> <p>Note 2: For each carrier frequency the requirement is valid for two frequencies: a. the carrier frequency $-F_{\text{offset}} - F_{\text{offset, case 1}}$ and b. the carrier frequency $+F_{\text{offset}} + F_{\text{offset, case 1}}$</p> <p>Note 3: F_{offset} is the frequency offset from the centre frequency of the adjacent CC being tested to the edge of aggregated channel bandwidth.</p> <p>Note 4: The $F_{\text{interferer}}$ (offset) is relative to the centre frequency of the adjacent CC being tested and shall be further adjusted to $\lfloor F_{\text{interferer}} / 0.015 + 0.5 \rfloor 0.015 + 0.0075$ MHz to be offset from the sub-carrier raster.</p>				

The normative reference for this requirement is TS 36.101 [2] clause 7.6.1.1A.

7.6.1A.1.4 Test Description

7.6.1A.1.4.1 Initial Conditions

Initial conditions are a set of test configurations the UE needs to be tested in and the steps for the SS to take with the UE to reach the correct measurement state.

The initial test configurations consist of environmental conditions, test frequencies, and CC combinations based on E-UTRA CA configurations specified in table 5.4.2A.1-1. All of these configurations shall be tested with applicable test parameters for each CA Configuration, and are shown in table 7.6.1A.1.4.1-1. The details of the OCN patterns used are specified in Annex A.5. Configurations of PDSCH and PDCCH before measurement are specified in Annex C.2.

Table 7.6.1A.1.4.1-1: Test Configuration Table

Initial Conditions							
Test Environment as specified in TS 36.508[7] subclause 4.1				NC			
Test Frequencies as specified in TS36.508 [7] subclause 4.3.1 for different CA bandwidth classes.				C: Mid range			
Test CC Combination setting ($N_{\text{RB_agg}}$) as specified in subclause 5.4.2A.1 for the CA Configuration across bandwidth combination sets supported by the UE.				Lowest $N_{\text{RB_agg}}$ Highest $N_{\text{RB_agg}}$			
Test Parameters for CA Configurations							
CA Configuration / $N_{\text{RB_agg}}$		DL Allocation			UL Allocation		
PCC N_{RB}	SCC N_{RB}	CC MOD	PCC & SCC RB allocation	CC MOD	$N_{\text{RB_alloc}}$	PCC & SCC RB allocations ($L_{\text{CRB}} @ \text{RB}_{\text{start}}$)	
75	75	QPSK	75+75	QPSK	75	P_75@0	S_0@0
75	75	QPSK	75+75	QPSK	130	P_75@0	S_55@0
75	75	QPSK	75+75	QPSK	150	P_75@0	S_75@0
100	50	QPSK	100+50	QPSK	150	P_100@0	S_50@0
100	100	QPSK	100+100	QPSK	75	P_75@25	S_0@0
100	100	QPSK	100+100	QPSK	130	P_100@0	S_30@0
100	100	QPSK	100+100	QPSK	200	P_100@0	S_100@0
<p>Note 1: CA Configuration Test CC Combination settings are checked separately for each CA Configuration, which applicable aggregated channel bandwidths are specified in Table 5.4.2A.1-1.</p> <p>Note 2: Depending on CA Configuration only the appropriate Uplink RB allocation value according to table 7.3A.1.3-1 is tested per CA Configuration Test CC combination.</p>							

1. Connect the SS to the UE antenna connectors as shown in TS 36.508 [7] Annex A, Figure group A.34 as appropriate. .
2. The parameter settings for the cell are set up according to TS 36.508 [7] subclause 4.4.3.
3. Downlink signals are initially set up according to Annex C0, C.1 and C.3.1, and uplink signals according to Annex H.1 and H.3.1.
4. The UL and DL Reference Measurement channels are set according to Table 7.6.1A.1.4.1-1.
5. Propagation conditions are set according to Annex B.0.
6. Ensure the UE is in State 3A-RF according to TS 36.508 [7] clause 5.2A.2. Message contents are defined in clause 7.6.1A.1.4.3.

7.6.1A.1.4.2 Test Procedure

1. Configure SCC according to Annex C.0, C.1 and Annex C.3.2 for all downlink physical channels except PHICH.
2. The SS shall configure SCC as per TS 36.508 [7] clause 5.2A.4. Message contents are defined in clause 7.6.1A.1.4.3.
3. SS activates SCC by sending the activation MAC-CE (Refer TS 36.321 [13], clauses 5.13, 6.1.3.8). Wait for at least 2 seconds (Refer TS 36.133, clauses 8.3.3.2).
4. SS transmits PDSCH via PDCCH DCI format 1A for C_RNTI to transmit the DL RMC according to Table 7.6.1A.1.4.1-1 on both PCC and SCC. The SS sends downlink MAC padding bits on the DL RMC.
5. SS sends uplink scheduling information for each UL HARQ process via PDCCH DCI format 0 for C_RNTI to schedule the UL RMC according to Table 7.6.1A.1.4.1-1 on both PCC and SCC. Since the UE has no payload data to send, the UE transmits uplink MAC padding bits on the UL RMC.
6. Set the parameters of the signal generator for an interfering signal below the wanted aggregated signal in Case 1 according to Tables 7.6.1A.1.5-1 and 7.6.1A.1.5-2.
7. Set the downlink signal level according to the table 7.6.1A.1.5-1. Send uplink power control commands to the UE (less or equal to 1dB step size should be used), to ensure that the UE output power is within +0, - 3.4 dB of the target level in table 7.6.1A.1.5-1 for carrier frequency $f \leq 3.0\text{GHz}$ or within +0, -4.0 dB of the target level for carrier frequency $3.0\text{GHz} < f \leq 4.2\text{GHz}$, for at least the duration of the throughput measurement. Suitable uplink power control commands should be sent to ensure the total power in each of the assigned carriers to be equal to each other within +/-[2] dB.
8. Measure the average throughput for each component carrier for duration sufficient to achieve statistical significance according to Annex G.2A.
9. Repeat steps from 6 to 8, using an interfering signal above the wanted aggregated signal in Case 1 at step 6.
10. Repeat steps from 6 to 9, using interfering signals in Case 2 at step 6 and 9. The ranges of case 2 are covered in steps equal to the interferer bandwidth. The test frequencies are chosen in analogy to table 7.6.1A.1.4.2-1.

Table 7.6.1A.1.4.2-1: Example for interferer frequencies

	Lower frequency	Upper frequency
Band 1 DL	2110 MHz	2170 MHz
Band 1 Midrange	PCC: 2132.5 MHz SCC: 2147.5 MHz	
Receive band wanted signal (CC Configuration / $N_{RB_agg} 75 + 75$)	PCC: 2125 MHz SCC: 2140 MHz	2140 MHz 2155 MHz
Interferer case 1	2117.5125 MHz	2162.5125 MHz
Interferer case 2 (inner frequency)	2112.5025 MHz	2167.5075 MHz
Interferer case 2 (outer frequency)	2097.5025 MHz	2177.5075 MHz
Outer limit for in band blocking	2095MHz	2185MHz
Number of test frequencies case 2	4	3

7.6.1A.1.4.3 Message Contents

Message contents are according to TS 36.508 [7] subclause 4.6. In test procedure step 2, for SCC configuration there are no additional message contents.

7.6.1A.1.5 Test Requirement

The throughput measurement of each carrier derived in test procedure shall be $\geq 95\%$ of the maximum throughput of the reference measurement channels as specified in Annex A.3.2 with parameters specified in Table 7.6.1A.1.5-1 and 7.6.1A.1.5-2.

Table 7.6.1A.1.5-1: In band blocking parameter

Rx Parameter	Units	CA Bandwidth Class				
		B	C	D	E	F
Power per CC in Aggregated Transmission Bandwidth Configuration	dBm	REFSENS + CA Bandwidth Class specific value below				
			12			
BW _{Interferer}	MHz		5			
F _{offset, case 1}	MHz		7.5			
F _{offset, case 2}	MHz		12.5			
Note 1:	The transmitter shall be set to 4dB below P _{CMAX,L} or P _{CMAX,L,CA} as defined in subclause 6.2.5A					
Note 2:	The interferer consists of the Reference measurement channel specified in Annex A.3.2 with one sided dynamic OCNG Pattern OP.1 FDD/TDD as described in Annex A.5.1.1/A.5.2.1 and set-up according to Annex C.3.1					

Table 7.6.1A.1.5-2: In-band blocking

CA configuration	Parameter	Unit	Case 1	Case 2
		P _{Interferer}	dBm	-56
	F _{Interferer}	MHz	$= -F_{\text{offset}} - F_{\text{offset, case 1}}$ & $= +F_{\text{offset}} + F_{\text{offset, case 1}}$	$\leq -F_{\text{offset}} - F_{\text{offset, case 2}}$ & $\geq +F_{\text{offset}} + F_{\text{offset, case 2}}$
CA_1C, CA_7C, CA_38C, CA_40C, CA_41C	F _{Interferer} (Range)	MHz	(Note 2)	F _{DL_low} - 15 to F _{DL_high} + 15
Note 1:	For certain bands, the unwanted modulated interfering signal may not fall inside the UE receive band, but within the first 15 MHz below or above the UE receive band			
Note 2:	For each carrier frequency the requirement is valid for two frequencies: a. the carrier frequency $-F_{\text{offset}} - F_{\text{offset, case 1}}$ and b. the carrier frequency $+F_{\text{offset}} + F_{\text{offset, case 1}}$			
Note 3:	F _{offset} is the frequency offset from the centre frequency of the adjacent CC being tested to the edge of aggregated channel bandwidth.			
Note 4:	The F _{interferer} (offset) is relative to the centre frequency of the adjacent CC being tested and shall be further adjusted to $\lfloor F_{\text{interferer}} / 0.015 + 0.5 \rfloor \cdot 0.015 + 0.0075$ MHz to be offset from the sub-carrier raster.			

7.6.1A.2 In-band blocking for CA (intra-band contiguous DL CA without UL CA)

7.6.1A.2.1 Test Purpose

Same test purpose as in clause 7.6.1A.1.

7.6.1A.2.2 Test Applicability

This test applies to all types of E-UTRA UE release 10 and forward that support intra-band contiguous DL CA without UL CA.

7.6.1A.2.3 Minimum Conformance Requirements

Minimum conformance requirements for intra-band contiguous carrier aggregation with one uplink carrier support as in clause 7.6.1A.1.

7.6.1A.2.4 Test Description

7.6.1A.2.4.1 Initial Conditions

Same initial conditions as in clause 7.6.1A.1.4.1 with the following exceptions:

- Instead of Table 7.6.1A.1.4.1-1 → use Table 7.6.1A.2.4.1-1

Table 7.6.1A.2.4.1-1: Test Configuration Table

Initial Conditions							
Test Environment as specified in TS 36.508[7] subclause 4.1					NC		
Test Frequencies as specified in TS36.508 [7] subclause 4.3.1 for different CA bandwidth classes.					C: Mid range		
Test CC Combination setting (N_{RB_agg}) as specified in subclause 5.4.2A.1 for the CA Configuration across bandwidth combination sets supported by the UE.					Lowest N_{RB_agg} Highest N_{RB_agg}		
Test Parameters for CA Configurations							
CA Configuration / N_{RB_agg}		DL Allocation			UL Allocation		
PCC N_{RB}	SCC N_{RB}	CC MOD	PCC & SCC RB allocation	CC MOD	N_{RB_alloc}	PCC & SCC RB allocations (L-CRB @ RB _{start})	
75	75	QPSK	75+75	QPSK	75	P_75@0	-
75	75	QPSK	75+75	QPSK	50	P_50@0	-
75	75	QPSK	75+75	QPSK	25	P_25@0	-
75	75	QPSK	75+75	QPSK	20	P_20@0	-
100	50	QPSK	100+50	QPSK	100	P_100@0	-
100	50	QPSK	100+50	QPSK	75	P_75@0	-
100	50	QPSK	100+50	QPSK	50	P_50@0	-
100	50	QPSK	100+50	QPSK	25	P_25@0	-
100	50	QPSK	100+50	QPSK	20	P_20@0	-
100	100	QPSK	100+100	QPSK	100	P_100@0	-
100	100	QPSK	100+100	QPSK	75	P_75@0	-
100	100	QPSK	100+100	QPSK	50	P_50@0	-
100	100	QPSK	100+100	QPSK	25	P_25@0	-
100	100	QPSK	100+100	QPSK	20	P_20@0	-

Note 1: CA Configuration Test CC Combination settings are checked separately for each CA Configuration, which applicable aggregated channel bandwidths are specified in Table 5.4.2A.1-1.

Note 2: Depending on CA Configuration only the appropriate Uplink RB allocation value according to table 7.3.3-2 is tested per CA Configuration Test CC combination.

7.6.1A.2.4.2 Test Procedure

Same test procedure as in clause 7.6.1A.1.4.2 with the following exceptions:

- Instead of Table 7.6.1A.1.4.1-1 → use Table 7.6.1A.2.4.1-1

7.6.1A.2.4.3 Message Contents

Message contents are according to TS 36.508 [7] subclause 4.6. In test procedure step 2, for SCC configuration there are no additional message contents.

7.6.1A.2.5 Test Requirement

Same test requirement as in clause 7.6.1A.1.5.

7.6.1A.3 In-band blocking for CA (inter-band DL CA without UL CA)

7.6.1A.3.1 Test Purpose

Same test purpose as in clause 7.6.1A.1.

7.6.1A.3.2 Test Applicability

This test applies to all types of E-UTRA UE release 10 and forward that support inter-band DL CA without UL CA.

7.6.1A.3.3 Minimum Conformance Requirements

Minimum conformance requirements for inter-band carrier aggregation with one uplink carrier support as in clause 7.6.1A.1.

7.6.1A.3.4 Test Description

7.6.1A.3.4.1 Initial Conditions

Same initial conditions as in clause 7.6.1A.1.4.1 with the following exceptions:

- Instead of Table 7.6.1A.1.4.1-1 → use Table 7.6.1A.3.4.1-1

Table 7.6.1A.3.4.1-1: Test Configuration Table

Initial Conditions						
Test Environment as specified in TS 36.508[7] subclause 4.1			NC			
Test Frequencies as specified in TS36.508 [7] subclause 4.3.1 for different CA bandwidth classes.			A: Mid range for PCC and SCC			
Test CC Combination setting (N_{RB_agg}) as specified in subclause 5.4.2A.1 for the CA Configuration across bandwidth combination sets supported by the UE.			Highest N_{RB_agg} for PCC and SCC			
Test Parameters for CA Configurations						
CA Configuration / N_{RB_agg}		DL Allocation			UL Allocation	
PCC N_{RB}	SCCs N_{RB}	CC MOD	PCC & SCC RB allocation		CC MOD	PCC N_{RB_alloc}
50	50	QPSK	50	50	QPSK	50
50	50	QPSK	50	50	QPSK	25
50	50	QPSK	50	50	QPSK	20
50	50	QPSK	50	50	QPSK	16
50	75	QPSK	50	75	QPSK	25
50	100	QPSK	50	100	QPSK	50
50	100	QPSK	50	100	QPSK	25
50	100	QPSK	50	100	QPSK	20
75	50	QPSK	75	50	QPSK	25
75	100	QPSK	75	100	QPSK	25
100	50	QPSK	100	50	QPSK	100
100	50	QPSK	100	50	QPSK	75
100	50	QPSK	100	50	QPSK	50
100	75	QPSK	100	75	QPSK	100
100	100	QPSK	100	100	QPSK	75
100	100	QPSK	100	100	QPSK	50
Note 1: CA Configuration Test CC Combination settings are checked separately for each CA Configuration, which applicable aggregated channel bandwidths are specified in Table 5.4.2A.1-2. Note 2: Depending on CA configurations, only the appropriate Uplink RB allocation value according to table 7.3.3-2 for UE supporting one uplink carrier is tested per Test CA configuration, unless otherwise stated in table 7.3A.1.3-0b. Note 3: The UL resource blocks shall be located as close as possible to the downlink SCC but confined within the transmission bandwidth configuration for the channel bandwidth (Table 5.4.2-1). Note 4: The frequencies of PCC and SCC shall be switched and tested in each configuration (given UL is supported in PCC band as per Table 5.2-1).						

7.6.1A.3.4.2 Test Procedure

1. Configure SCC according to Annex C0, C.1 and Annex C.3.2 for all downlink physical channels except PHICH.
2. The SS shall configure SCC as per TS 36.508 [7] clause 5.2A.4. Message contents are defined in clause 7.6.1A.3.4.3.
3. SS activates SCC by sending the activation MAC-CE (Refer TS 36.321 [13], clauses 5.13, 6.1.3.8). Wait for at least 2 seconds (Refer TS 36.133, clauses 8.3.3.2).
4. SS transmits PDSCH via PDCCH DCI format 1A for C_RNTI to transmit the DL RMC according to Table 7.6.1A.3.4.1-1 on both PCC and SCC. The SS sends downlink MAC padding bits on the DL RMC.

5. SS sends uplink scheduling information for each UL HARQ process via PDCCH DCI format 0 for C_RNTI to schedule the UL RMC according to Table 7.6.1A.3.4.1-1 on PCC. Since the UE has no payload data to send, the UE transmits uplink MAC padding bits on the UL RMC.
6. Set the parameters of the signal generator for an interfering signal below the SCC's wanted signal in Case 1 according to Tables 7.6.1.5-1 and 7.6.1.5-2, or 7.6.1.5-1 and 7.6.1A.3.5-0 for operating bands without uplink band (as noted in Table 5.2-1).
7. Set the downlink signal level according to the table 7.6.1.5-1. Send uplink power control commands to the UE (less or equal to 1dB step size should be used), to ensure that the UE output power is within +0, - 3.4 dB of the target level in table 7.6.1.5-1 for carrier frequency $f \leq 3.0\text{GHz}$ or within +0, -4.0 dB of the target level for carrier frequency $3.0\text{GHz} < f \leq 4.2\text{GHz}$, for at least the duration of the throughput measurement.
8. Measure the average throughput of SCC for duration sufficient to achieve statistical significance according to Annex G.2A.
9. Repeat steps from 6 to 8, using an interfering signal above the SCC's wanted signal in Case 1 at step 6.
10. Repeat steps from 6 to 9, using interfering signals in Case 2 at step 6 and 9. The ranges of case 2 are covered in steps equal to the interferer bandwidth. The test frequencies are chosen in analogy to table 7.6.1.4.2-1.

7.6.1A.3.4.3 Message Contents

Message contents are according to TS 36.508 [7] subclause 4.6. In test procedure step 2, for SCC configuration there are no additional message contents.

7.6.1A.3.5 Test Requirement

For inter-band carrier aggregation with uplink assigned to one E-UTRA band the in-band blocking requirements are defined with the uplink active on the band other than the band whose downlink is being tested i.e. the requirements are tested only for the S-Cell downlink. The UE shall meet the requirements specified in Tables 7.6.1A.3.5-1 and 7.6.1A.3.5-2 for each component carrier, when operated as S-Cell, while both downlink carriers are active. The requirements for each component carrier are the same as single carrier requirements in Tables 7.6.1.5-1 and 7.6.1.5-2.

For band combinations including an operating band without uplink band (as noted in Table 5.2-1), the requirements for both downlinks shall be met with the uplink in the band capable of UL operation.. The requirements for the component carrier configured in the operating band without uplink band are specified in Table 7.6.1.5-1 and Table 7.6.1A.3.5-0.

The throughput measurement derived in test procedure shall be $\geq 95\%$ of the maximum throughput of the reference measurement channels as specified in Annex A.3.2 with parameters specified in Tables 7.6.1A.3.5-1 and 7.6.1A.3.5-2. The parameters in these tables are related to the carrier operated as S-Cell.

Table 7.6.1A.3.5-0: In-band blocking for additional operating bands for carrier aggregation

E-UTRA band	Parameter	Unit	Case 1	Case 2
		$P_{\text{Interferer}}$	dBm	-56
	$F_{\text{Interferer}}$ (offset)	MHz	$=-BW/2 - F_{\text{offset,case 1}}$ & $=+BW/2 + F_{\text{offset,case 1}}$	$\leq -BW/2 - F_{\text{offset,case 2}}$ & $\geq +BW/2 + F_{\text{offset,case 2}}$
29	$F_{\text{Interferer}}$	MHz	(Note 2)	$F_{\text{DL_low}} - 10$ to $F_{\text{DL_high}} + 15$
NOTE 1: For certain bands, the unwanted modulated interfering signal may not fall inside the UE receive band, but within the first 15 MHz below or above the UE receive band.				
NOTE 2: For each carrier frequency the requirement is valid for two frequencies: a. the carrier frequency $-BW/2 - F_{\text{offset, case 1}}$ and b. the carrier frequency $+BW/2 + F_{\text{offset, case 1}}$				
NOTE 3: $F_{\text{Interferer}}$ range values for unwanted modulated interfering signal are interferer centre frequencies.				
NOTE 4: Case 3 only apply to assigned UE channel bandwidth of 5 MHz.				

Table 7.6.1A.3.5-1: In band blocking parameters

Rx Parameter	Units	Channel bandwidth					
		1.4 MHz	3 MHz	5 MHz	10 MHz	15 MHz	20 MHz
Power in Transmission Bandwidth Configuration	dBm	REFSENS + channel bandwidth specific value below					
		6	6	6	6	7	9
$BW_{\text{Interferer}}$	MHz	1.4	3	5	5	5	5
$F_{\text{offset, case 1}}$	MHz	2.1+0.0125	4.5+0.0075	7.5+0.0125	7.5+0.0025	7.5+0.0075	7.5+0.0125
$F_{\text{offset, case 2}}$	MHz	3.5+0.0075	7.5+0.0075	12.5+0.0075	12.5+0.012	12.5+0.002	12.5+0.007
					5	5	5
Note 1:	The transmitter shall be set to 4dB below P_{CMAX_L} with P_{CMAX_L} as defined in clause 6.2.5.						
Note 2:	The interferer consists of the Reference measurement channel specified in Annex A.3.2 with one sided dynamic OCNG Pattern OP.1 FDD/TDD as described in Annex A.5.1.1/A.5.2.1 and set-up according to Annex C.3.1.						

Table 7.6.1A.3.5-2: In-band blocking

E-UTRA band	Parameter	Unit	Case 1	Case 2	Case 3	Case 4
		$P_{\text{Interferer}}$	dBm	-56	-44	-30
	$F_{\text{Interferer}}$ (offset)	MHz	$=-BW/2 - F_{\text{offset, case 1}}$ & $=+BW/2 + F_{\text{offset, case 1}}$	$\leq -BW/2 - F_{\text{offset, case 2}}$ & $\geq +BW/2 + F_{\text{offset, case 2}}$	$-BW/2 - 15$ & $-BW/2 - 9$	$-BW/2 - 10$
1, 2, 3, 4, 5, 6, 7, 8, 9, 10, 11, 13, 14, 18, 19, 20, 21, 22, 23, 25, 26, 33, 34, 35, 36, 37, 38, 39, 40, 41	$F_{\text{Interferer}}$	MHz	(Note 2)	$F_{\text{DL_low}} - 15$ to $F_{\text{DL_high}} + 15$		
12	$F_{\text{Interferer}}$	MHz	(Note 2)	$F_{\text{DL_low}} - 10$ to $F_{\text{DL_high}} + 15$		$F_{\text{DL_low}} - 10$
17	$F_{\text{Interferer}}$	MHz	(Note 2)	$F_{\text{DL_low}} - 9$ to $F_{\text{DL_high}} + 15$	$F_{\text{DL_low}} - 15$ and $F_{\text{DL_low}} - 9$	
Note 1:	For certain bands, the unwanted modulated interfering signal may not fall inside the UE receive band, but within the first 15 MHz below or above the UE receive band					
Note 2:	For each carrier frequency the requirement is valid for two frequencies: a. the carrier frequency $-BW/2 - F_{\text{offset, case 1}}$ and b. the carrier frequency $+BW/2 + F_{\text{offset, case 1}}$					
Note 3:	$F_{\text{Interferer}}$ range values for unwanted modulated interfering signal are interferer centre frequencies					
Note 4:	Case 3 and Case 4 only apply to assigned UE channel bandwidth of 5 MHz					

7.6.1B In-band blocking for UL-MIMO

7.6.1B.1 Test Purpose

In-band blocking for UL- MIMO is defined for an unwanted interfering signal falling into the range from 15MHz below to 15MHz above the UE that support UL-MIMO receive band, at which the relative throughput shall meet or exceed the requirement for the specified measurement channels.

The lack of in-band blocking ability will decrease the coverage area when other e-NodeB transmitters exist (except in the adjacent channels and spurious response).

7.6.1B.2 Test Applicability

This test applies to all types of E-UTRA UE release 10 and forward that support UL-MIMO.

7.6.1B.3 Minimum Conformance Requirements

For UE with two transmitter antenna connectors in closed-loop spatial multiplexing scheme, the minimum requirements in subclause 7.6 shall be met with the UL-MIMO configurations specified in Table 6.2.2B.3-2. For UL-MIMO, the parameter $P_{\text{CMAX,L}}$ is defined as the total transmitter power over the two transmit antenna connectors.

The normative reference for this requirement is TS 36.101 [2] clause 7.6B.

7.6.1B.4 Test Description

7.6.1B.4.1 Initial Conditions

Initial conditions are a set of test configurations the UE needs to be tested in and the steps for the SS to take with the UE to reach the correct measurement state.

The initial test configurations consist of environmental conditions, test frequencies, and channel bandwidths based on E-UTRA bands specified in table 5.4.2.1-1. All of these configurations shall be tested with applicable test parameters for each channel bandwidth, and are shown in table 7.6.1B.4.1-1. The details of the uplink and downlink reference measurement channels (RMCs) are specified in Annexes A.2 and A.3 respectively. The details of the OCNG patterns used are specified in Annex A.5. Configurations of PDSCH and PDCCH before measurement are specified in Annex C.2.

Table 7.6.1B.4.1-1: Test Configuration Table

Initial Conditions						
Test Environment as specified in TS 36.508[7] subclause 4.1				NC		
Test Frequencies as specified in TS36.508 [7] subclause 4.3.1				Mid range		
Test Channel Bandwidths as specified in TS 36.508 [7] subclause 4.3.1				Lowest, 5MHz, Highest		
Test Parameters for Channel Bandwidths						
Ch BW	Downlink Configuration			Uplink Configuration		
	Mod'n	RB allocation		Mod'n	RB allocation	
		FDD	TDD		FDD	TDD
1.4MHz	QPSK	6	6	QPSK	6	6
3MHz	QPSK	15	15	QPSK	15	15
5MHz	QPSK	25	25	QPSK	25	25
5MHz	QPSK	25	N/A	QPSK	20	N/A
5MHz	QPSK	25	N/A	QPSK	15	N/A
10MHz	QPSK	50	50	QPSK	50	50
10MHz	QPSK	50	N/A	QPSK	25	N/A
10MHz	QPSK	50	N/A	QPSK	20	N/A
10MHz	QPSK	50	N/A	QPSK	15	N/A
15MHz	QPSK	75	75	QPSK	75	75
15MHz	QPSK	75	N/A	QPSK	50	N/A
15MHz	QPSK	75	N/A	QPSK	25	N/A
15MHz	QPSK	75	N/A	QPSK	20	N/A
20MHz	QPSK	100	100	QPSK	100	100
20MHz	QPSK	100	N/A	QPSK	75	N/A
20MHz	QPSK	100	N/A	QPSK	50	N/A
20MHz	QPSK	100	N/A	QPSK	25	N/A
20MHz	QPSK	100	N/A	QPSK	20	N/A
Note 1: Test Channel Bandwidths are checked separately for each E-UTRA band, which applicable channel bandwidths are specified in Table 5.4.2.1-1. Note 2: Depending on E-UTRA band, only the appropriate Uplink RB allocation value according to table 7.3.3-2 is tested per Test Channel Bandwidth. Note 3: For the DL signal one sided dynamic OCNG Pattern OP.1 FDD/TDD is used.						

1. Connect the SS to the UE antenna connectors as shown in TS 36.508 [7] Annex A, in Figure A.29.
2. The parameter settings for the cell are set up according to TS 36.508 [7] subclause 4.4.3.

3. Downlink signals are initially set up according to Annex C0, C.1 and C.3.1, and uplink signals according to Annex H.1 and H.3.1.
4. The UL and DL Reference Measurement channels are set according to in Table 7.6.1B.4.1-1.
5. Propagation conditions are set according to Annex B.0.
6. Ensure the UE is in State 3A-RF according to TS 36.508 [7] clause 5.2A.2. Message contents are defined in clause 7.6.1B.4.3.

7.6.1B.4.2 Test Procedure

1. SS transmits PDSCH via PDCCH DCI format 1A for C_RNTI to transmit the DL RMC according to Table 7.6.1B.4.1-1. The SS sends downlink MAC padding bits on the DL RMC.
2. SS sends uplink scheduling information for each UL HARQ process via PDCCH DCI format 4 for C_RNTI to schedule the UL RMC according to Table 7.6.1B.4.1-1. Since the UE has no payload data to send, the UE transmits uplink MAC padding bits on the UL RMC.
3. Set the parameters of the signal generator for an interfering signal below the wanted signal in Case 1 according to Tables 7.6.1B.5-1 and 7.6.1B.5-2.
4. Set the downlink signal level according to the table 7.6.1B.5-1. Send uplink power control commands to the UE (less or equal to 1dB step size should be used), to ensure that the UE output power is within +0, - 3.4 dB of the target level in table 7.6.1B.5-1 for carrier frequency $f \leq 3.0\text{GHz}$ or within +0, -4.0 dB of the target level for carrier frequency $3.0\text{GHz} < f \leq 4.2\text{GHz}$, for at least the duration of the throughput measurement.
5. Measure the average throughput for a duration sufficient to achieve statistical significance according to Annex G.2.
6. Repeat steps from 3 to 5, using an interfering signal above the wanted signal in Case 1 at step 3.
7. Repeat steps from 3 to 6, using interfering signals in Case 2 at step 3 and 6. The ranges of case 2 are covered in steps equal to the interferer bandwidth. The test frequencies are chosen in analogy to table 7.6.1B.4.2-1.
8. Repeat steps from 3 to 5, using successively all interfering signals in Case 3 and Case 4 at step 3.

Table 7.6.1B.4.2-1: Example for interferer frequencies

	Lower frequency	Upper frequency
Band 1 DL	2110 MHz	2170 MHz
Band 1 Midrange	2140 MHz	
Receive band wanted signal (BW 5MHz)	2137.5 MHz	2142.5 MHz
Interferer case 1	2129.9875 MHz	2150.0125 MHz
Interferer case 2 (inner frequency)	2124.9925 MHz	2155.0075 MHz
Interferer case 2 (outer frequency)	2099.9925 MHz	2180.0075 MHz
Outer limit for in band blocking	2095MHz	2185MHz
Number of test frequencies case 2	6	6
Number of test frequencies for Band 17(asymmetric!), BW 5MHz, case 2	0	2

7.6.1B.4.3 Message Contents

Message contents are according to TS 36.508 [7] clause 4.6 with the following exception:

Table 7.6.1B.4.3-1: UplinkPowerControlDedicated

Derivation Path: 36.331 clause 6.3.2			
Information Element	Value/remark	Comment	Condition
UplinkPowerControlDedicated-DEFAULT ::= SEQUENCE {			
p0-UePUSCH	0		
deltaMCS-Enabled	en0		
accumulationEnabled	TRUE		
p0-uePUCCH	0		
pSRS-Offset	3 (-6 dB)		
filterCoefficient	fc8	larger filter length is used to reduce the RSRP measurement variation	
}			

7.6.1B.5 Test Requirement

The throughput measurement derived in test procedure shall be $\geq 95\%$ of the maximum throughput of the reference measurement channels as specified in Annex A.3.2 with parameters specified in Tables 7.6.1B.5-1 and 7.6.1B.5-2.

Table 7.6.1B.5-1: In band blocking parameters

Rx Parameter	Units	Channel bandwidth					
		1.4 MHz	3 MHz	5 MHz	10 MHz	15 MHz	20 MHz
Power in Transmission Bandwidth Configuration	dBm	REFSENS + channel bandwidth specific value below					
		6	6	6	6	7	9
$BW_{\text{Interferer}}$	MHz	1.4	3	5	5	5	5
$F_{\text{offset, case 1}}$	MHz	2.1+0.0125	4.5+0.0075	7.5+0.0125	7.5+0.0025	7.5+0.0075	7.5+0.0125
$F_{\text{offset, case 2}}$	MHz	3.5+0.0075	7.5+0.0075	12.5+0.0075	12.5+0.012	12.5+0.002	12.5+0.007
					5	5	5
Note 1: The transmitter shall be set to 4dB below $P_{\text{CMAX,L}}$ with $P_{\text{CMAX,L}}$ as defined in clause 6.2.5. Note 2: The interferer consists of the Reference measurement channel specified in Annex A.3.2 with one sided dynamic OCNG Pattern OP.1 FDD/TDD as described in Annex A.5.1.1/A.5.2.1 and set-up according to Annex C.3.1.							

Table 7.6.1B.5-2: In-band blocking

E-UTRA band	Parameter	Unit	Case 1	Case 2	Case 3	Case 4
	$P_{\text{Interferer}}$	dBm	-56	-44	-30	[-30]
	$F_{\text{Interferer}}$ (offset)	MHz	$=-BW/2 - F_{\text{offset,case 1}}$ & $=+BW/2 + F_{\text{offset,case 1}}$	$\leq -BW/2 - F_{\text{offset,case 2}}$ & $\geq +BW/2 + F_{\text{offset,case 2}}$	$-BW/2 - 15$ & $-BW/2 - 9$	$-BW/2 - 10$

1, 2, 3, 4, 5, 6, 7, 8, 9, 10, 11, 13, 14, 18, 19, 20, 21, 22, 23, 25, 26, 27, 28, 31, 33, 34, 35, 36, 37, 38,39, 40, 41,42,43,44	$F_{\text{Interferer}}$	MHz	(Note 2)	$F_{\text{DL_low}} - 15$ to $F_{\text{DL_high}} + 15$		
12	$F_{\text{Interferer}}$	MHz	(Note 2)	$F_{\text{DL_low}} - 10$ to $F_{\text{DL_high}} + 15$		$F_{\text{DL_low}} - 10$
17	$F_{\text{Interferer}}$	MHz	(Note 2)	$F_{\text{DL_low}} - 9$ to $F_{\text{DL_high}} + 15$	$F_{\text{DL_low}} - 15$ and $F_{\text{DL_low}} - 9$	
<p>Note 1: For certain bands, the unwanted modulated interfering signal may not fall inside the UE receive band, but within the first 15 MHz below or above the UE receive band</p> <p>Note 2: For each carrier frequency the requirement is valid for two frequencies: a. the carrier frequency $-BW/2 - F_{\text{offset, case 1}}$ and b. the carrier frequency $+BW/2 + F_{\text{offset, case 1}}$</p> <p>Note 3: $F_{\text{Interferer}}$ range values for unwanted modulated interfering signal are interferer centre frequencies</p> <p>Note 4: Case 3 and Case 4 only apply to assigned UE channel bandwidth of 5 MHz</p>						

7.6.2 Out-of-band blocking

7.6.2.1 Test Purpose

Out-of-band band blocking is defined for an unwanted CW interfering signal falling more than 15 MHz below or above the UE receive band, at which a given average throughput shall meet or exceed the requirement for the specified measurement channels.

For the first 15 MHz below or above the UE receive band the appropriate in-band blocking or adjacent channel selectivity in sub-clause 7.5.1 and sub-clause 7.6.1 shall be applied.

The lack of out-of-band blocking ability will decrease the coverage area when other e-NodeB transmitters exist (except in the adjacent channels and spurious response).

7.6.2.2 Test Applicability

This test applies to all types of E-UTRA UE release 8 and forward.

7.6.2.3 Minimum Conformance Requirements

The throughput shall be $\geq 95\%$ of the maximum throughput of the reference measurement channels as specified in Annexes A.2.2, A.2.3 and A.3.2 (with one sided dynamic OCNG Pattern OP.1 FDD/TDD for the DL-signal as described in Annex A.5.1.1/A.5.2.1) with parameters specified in Tables 7.6.2.3-1 and 7.6.2.3-2.

For Table 7.6.2.3-2 in frequency range 1, 2 and 3, up to $\max(24, 6 \cdot \lceil N_{RB} / 6 \rceil)$ exceptions are allowed for spurious response frequencies in each assigned frequency channel when measured using a 1MHz step size, where N_{RB} is the number of resource blocks in the downlink transmission bandwidth configuration (see Figure 5.4.2-1). For these exceptions the requirements of clause 7.7 Spurious Response are applicable.

For Table 7.6.2.3-2 in frequency range 4, up to $\max(8, \lceil (N_{RB} + 2 \cdot L_{CRBs}) / 8 \rceil)$ exceptions are allowed for spurious response frequencies in each assigned frequency channel when measured using a 1MHz step size, where N_{RB} is the number of resource blocks in the downlink transmission bandwidth configurations (see Figure 5.4.2-1) and L_{CRBs} is the number of resource blocks allocated in the uplink. For these exceptions the requirements of clause 7.7 Spurious Response are applicable.

Table 7.6.2.3-1: Out-of-band blocking parameters

Rx Parameter	Units	Channel bandwidth					
		1.4 MHz	3 MHz	5 MHz	10 MHz	15 MHz	20 MHz
Power in Transmission Bandwidth Configuration	dBm	REFSENS + channel bandwidth specific value below					
		6	6	6	6	7	9
Note 1: The transmitter shall be set to 4dB below $P_{\text{CMAX_L}}$ at the minimum uplink configuration specified in Table 7.3.3-2 with $P_{\text{CMAX_L}}$ as defined in clause 6.2.5.							
Note 2: The reference measurement channel is specified in Annex A.3.2 with one sided dynamic OCN Pattern OP.1 FDD/TDD as described in Annex A.5.1.1/A.5.2.1.							

Table 7.6.2.3-2: Out of band blocking

E-UTRA band	Parameter	Units	Frequency			
			range 1	range 2	range 3	range 4
	$P_{\text{Interferer}}$	dBm	-44	-30	-15	-15
1, 2, 3, 4, 5, 6, 7, 8, 9, 10, 11, 12, 13, 14, 17, 18, 19, 20, 21, 22, 23, 24, 25, 26, 27, 28, 31, 33, 34, 35, 36, 37, 38, 39, 40, 41, 42, 43, 44	$F_{\text{Interferer}}$ (CW)	MHz	$F_{\text{DL_low}} -15$ to $F_{\text{DL_low}} -60$	$F_{\text{DL_low}} -60$ to $F_{\text{DL_low}} -85$	$F_{\text{DL_low}} -85$ to 1 MHz	-
			$F_{\text{DL_high}} +15$ to $F_{\text{DL_high}} +60$	$F_{\text{DL_high}} +60$ to $F_{\text{DL_high}} +85$	$F_{\text{DL_high}} +85$ to +12750 MHz	-
2, 5, 12, 17	$F_{\text{Interferer}}$	MHz	-	-	-	$F_{\text{UL_low}} - F_{\text{UL_high}}$
Note: For the UE which supports both Band 11 and Band 21 the out of blocking is FFS.						

The normative reference for this requirement is TS 36.101 [2] clause 7.6.2.

7.6.2.4 Test Description

7.6.2.4.1 Initial Conditions

Initial conditions are a set of test configurations the UE needs to be tested in and the steps for the SS to take with the UE to reach the correct measurement state.

The initial test configurations consist of environmental conditions, test frequencies, and channel bandwidths based on E-UTRA bands specified in table 5.4.2.1-1. All of these configurations shall be tested with applicable test parameters for each channel bandwidth, and are shown in table 7.6.2.4.1-1. The details of the uplink and downlink reference measurement channels (RMCs) are specified in Annexes A.2 and A.3 respectively. The details of the OCN patterns used are specified in Annex A.5. Configurations of PDSCH and PDCCH before measurement are specified in Annex C.2.

Table 7.6.2.4.1-1: Test Configuration Table

Initial Conditions	
Test Environment as specified in TS 36.508[7] subclause 4.1	NC
Test Frequencies as specified in TS36.508 [7] subclause 4.3.1	One frequency chosen arbitrarily from low or high range
Test Channel Bandwidths as specified in TS 36.508 [7] subclause 4.3.1	Lowest, 5MHz, Highest
Test Parameters for Channel Bandwidths	
Downlink Configuration	Uplink Configuration

Ch BW	Mod'n	RB allocation		Mod'n	RB allocation	
		FDD	TDD		FDD	TDD
1.4MHz	QPSK	6	6	QPSK	6	6
3MHz	QPSK	15	15	QPSK	15	15
5MHz	QPSK	25	25	QPSK	25	25
5MHz	QPSK	25	N/A	QPSK	20	N/A
5MHz	QPSK	25	N/A	QPSK	15	N/A
10MHz	QPSK	50	50	QPSK	50	50
10MHz	QPSK	50	N/A	QPSK	25	N/A
10MHz	QPSK	50	N/A	QPSK	20	N/A
10MHz	QPSK	50	N/A	QPSK	15	N/A
15MHz	QPSK	75	75	QPSK	75	75
15MHz	QPSK	75	N/A	QPSK	50	N/A
15MHz	QPSK	75	N/A	QPSK	25	N/A
15MHz	QPSK	75	N/A	QPSK	20	N/A
20MHz	QPSK	100	100	QPSK	100	100
20MHz	QPSK	100	N/A	QPSK	75	N/A
20MHz	QPSK	100	N/A	QPSK	50	N/A
20MHz	QPSK	100	N/A	QPSK	25	N/A
20MHz	QPSK	100	N/A	QPSK	20	N/A

Note 1: Test Channel Bandwidths are checked separately for each E-UTRA band, which applicable channel bandwidths are specified in Table 5.4.2.1-1.

Note 2: Depending on E-UTRA band, only the appropriate Uplink RB allocation value according to table 7.3.3-2 is tested per Test Channel Bandwidth. The allocation shall be located as close as possible to the downlink operating band but confined within the transmission bandwidth configuration for the channel bandwidth (Table 5.4.2-1).

Note 3: For the DL signal one sided dynamic OCN Pattern OP.1 FDD/TDD is used.

1. Connect the SS to the UE antenna connectors as shown in TS 36.508 [7] Annex A, in Figure A.5.
2. The parameter settings for the cell are set up according to TS 36.508 [7] subclause 4.4.3.
3. Downlink signals are initially set up according to Annex C0, C.1 and C.3.1, and uplink signals according to Annex H.1 and H.3.1.
4. The UL and DL Reference Measurement channels are set according to Table 7.6.2.4.1-1.
5. Propagation conditions are set according to Annex B.0.
6. Ensure the UE is in State 3A-RF according to TS 36.508 [7] clause 5.2A.2. Message contents are defined in clause 7.6.2.4.3.

7.6.2.4.2 Test Procedure

1. SS transmits PDSCH via PDCCH DCI format 1A for C_RNTI to transmit the DL RMC according to Table 7.6.2.4.1-1. The SS sends downlink MAC padding bits on the DL RMC.
2. SS sends uplink scheduling information for each UL HARQ process via PDCCH DCI format 0 for C_RNTI to schedule the UL RMC according to Table 7.6.2.4.1-1. Since the UE has no payload data to send, the UE transmits uplink MAC padding bits on the UL RMC.
3. Set the parameters of the CW signal generator for an interfering signal below the wanted signal according to Table 7.6.2.5-2. The frequency step size is 1MHz.
4. Set the downlink signal level according to the table 7.6.2.5-1. Send uplink power control commands to the UE (less or equal to 1dB step size should be used), to ensure that the UE output power is within +0, - 3.4 dB of the target level in table 7.6.2.5-1 for carrier frequency $f \leq 3.0\text{GHz}$ or within +0, -4.0 dB of the target level for carrier frequency $3.0\text{GHz} < f \leq 4.2\text{GHz}$, for at least the duration of the throughput measurement.
5. Measure the average throughput for a duration sufficient to achieve statistical significance according to Annex G.2.
6. Record the frequencies for which the throughput doesn't meet the requirements.
7. Repeat steps from 3 to 6, using an interfering signal above the wanted signal at step 3.

7.6.2.4.3 Message Contents

Message contents are according to TS 36.508 [7] subclause 4.6 with the following exception.

Table 7.6.2.4.3-1: UplinkPowerControlDedicated

Derivation Path: 36.331 clause 6.3.2			
Information Element	Value/remark	Comment	Condition
UplinkPowerControlDedicated-DEFAULT ::= SEQUENCE {			
p0-UePUSCH	0		
deltaMCS-Enabled	en0		
accumulationEnabled	TRUE		
p0-uePUCCH	0		
pSRS-Offset	3 (-6 dB)		
filterCoefficient	fc8	larger filter length is used to reduce the RSRP measurement variation	
}			

7.6.2.5 Test Requirement

Except for the spurious response frequencies recorded at the final step of test procedure, the throughput measurement derived in test procedure shall be $\geq 95\%$ of the maximum throughput of the reference measurement channels as specified in Annex A.3.2 with parameters specified in Tables 7.6.2.5-1 and 7.6.2.5-2.

For frequency range 1, 2, and 3, the number of spurious response frequencies recorded in the final step of test procedure shall not exceed $\max(24, 6 \cdot \lceil N_{RB} / 6 \rceil)$ in each assigned frequency channel when measured using a 1MHz step size. For these exceptions the requirements of clause 7.7 Spurious Response are applicable.

For frequency range 4, the number of spurious response frequencies recorded in the final step of test procedure shall not exceed $\max(8, \lceil (N_{RB} + 2 \cdot L_{CRBS}) / 8 \rceil)$ in each assigned frequency channel when measured using a 1MHz step size. For these exceptions the requirements of clause 7.7 Spurious Response are applicable.

Table 7.6.2.5-1: Out-of-band blocking parameters

Rx Parameter	Units	Channel bandwidth					
		1.4 MHz	3 MHz	5 MHz	10 MHz	15 MHz	20 MHz
Power in Transmission Bandwidth Configuration	dBm	REFSENS + channel bandwidth specific value below					
		6	6	6	6	7	9
Note 1: The transmitter shall be set to 4dB below P_{CMAX_L} with P_{CMAX_L} as defined in clause 6.2.5.							
Note 2: The reference measurement channel is specified in Annex A.3.2 with one sided dynamic OCN Pattern OP.1 FDD/TDD as described in Annex A.5.1.1/A.5.2.1.							

Table 7.6.2.5-2: Out of band blocking

E-UTRA band	Parameter	Units	Frequency			
			range 1	range 2	range 3	range 4
	$P_{Interferer}$	dBm	-44	-30	-15	-15

1, 2, 3, 4, 5, 6, 7, 8, 9, 10, 11, 12, 13, 14, 17, 18, 19, 20, 21, 22, 23, 24, 25, 26, 27, 28, 31, 33, 34, 35, 36, 37, 38, 39, 40, 41, 42, 43, 44	$F_{\text{Interferer}}$ (CW)	MHz	$F_{\text{DL_low}} -15$ to $F_{\text{DL_low}} -60$	$F_{\text{DL_low}} -60$ to $F_{\text{DL_low}} -85$	$F_{\text{DL_low}} -85$ to 1 MHz	-
			$F_{\text{DL_high}} +15$ to $F_{\text{DL_high}} +60$	$F_{\text{DL_high}} +60$ to $F_{\text{DL_high}} +85$	$F_{\text{DL_high}} +85$ to +12750 MHz	-
2, 5, 12, 17	$F_{\text{Interferer}}$	MHz	-	-	-	$F_{\text{UL_low}} - F_{\text{UL_high}}$
Note 1: Range 3 shall be tested only with the highest channel bandwidth.						
Note 2: For the UE which supports both Band 11 and Band 21 the out of blocking is FFS.						

7.6.2A Out-of-band blocking for CA

7.6.2A.1 Out-of-band blocking for CA (intra-band contiguous DL CA and UL CA)

7.6.2A.1.1 Test Purpose

Out-of-band blocking for CA is defined for an unwanted CW interfering signal falling more than 15 MHz below or above the UE receive band, at which a given average throughput shall meet or exceed the requirement for the specified measurement channels in aggregated signals.

For the first 15 MHz below or above the UE receive band the appropriate in-band blocking or adjacent channel selectivity in sub-clause 7.5A and sub-clause 7.6.1A shall be applied.

The lack of out-of-band blocking ability will decrease the coverage area when other e-NodeB transmitters exist (except in the adjacent channels and spurious response).

7.6.2A.1.2 Test Applicability

This test applies to all types of E-UTRA UE release 10 and forward that support intra-band contiguous DL CA and UL CA.

7.6.2A.1.3 Minimum Conformance Requirements

For inter-band carrier aggregation with the uplink assigned to one E-UTRA band, the out-of-band blocking requirements are defined with the uplink active on the band other than the band whose downlink is being tested. The throughput in the downlink measured shall be $\geq 95\%$ of the maximum throughput of the reference measurement channels as specified in Annexes A.2.2, A.2.3 and A.3.2 (with one sided dynamic OCNG Pattern OP.1 FDD/TDD for the DL-signal as described in Annex A.5.1.1/A.5.2.1) with parameters specified in Tables 7.6.2.3-1 and 7.6.2A.1.3-0. The UE shall meet these requirements for each component carrier while both downlink carriers are active.

For E-UTRA CA configurations listed in Table 7.3A.1.3-0a under conditions for which reference sensitivity for the operating band being tested is N/A, the out-of-band blocking requirements of subclause 7.6.2A.1.3 do not apply.

For Table 7.6.2A.1.3-0 in frequency ranges 1, 2 and 3, up to $\max(24, 6 \cdot \lceil N_{RB} \cdot / 6 \rceil)$ exceptions per downlink are allowed for spurious response frequencies when measured using a step size of 1 MHz. For these exceptions the requirements in clause 7.7A.1.3 apply.

For intra-band contiguous carrier aggregations the downlink SCC shall be configured at nominal channel spacing to the PCC with the PCC configured closest to the uplink band. Downlink PCC and SCC are both activated. The uplink output power shall be set as specified in Table 7.6.2A.1.3-1 with the uplink configuration set according to Table 7.3A.1.3-1 for the applicable carrier aggregation configuration. For UE(s) supporting one uplink carrier, the uplink configuration of the PCC shall be in accordance with Table 7.3.3-2.

The UE shall fulfil the minimum requirement in presence of an interfering signal specified in Tables 7.6.2A.1.3-1 and Tables 7.6.2A.1.3-2 being on either side of the aggregated signal. The throughput of each carrier shall be $\geq 95\%$ of the maximum throughput of the reference measurement channels as specified in Annexes A.2.2, A.2.3 and A.3.2 (with one sided dynamic OCNG Pattern OP.1 FDD/TDD for the DL-signal as described in Annex A.5.1.1/A.5.2.1) with parameters specified in Tables 7.6.2A.1.3-1 and 7.6.2A.1.3-2.

For Table 7.6.2A.1.3-2 in frequency range 1, 2 and 3, up to $\max(24, 6 \cdot \lceil N_{RB,agg} / 6 \rceil)$ exceptions are allowed for spurious response frequencies in each assigned frequency channel when measured using a 1MHz step size, where $N_{RB,agg}$ is the number of aggregated resource blocks in the downlink transmission bandwidth configuration. For these exceptions the requirements of subclause 7.7A Spurious response for CA are applicable.

For Table 7.6.2A.1.3-2 in frequency range 4, up to $\max(8, \lceil (N_{RB,agg} + 2 \cdot L_{CRBs}) / 8 \rceil)$ exceptions are allowed for spurious response frequencies in each assigned frequency channel when measured using a 1MHz step size, where $N_{RB,agg}$ is the number of aggregated resource blocks in the downlink transmission bandwidth configurations and L_{CRBs} is the number of resource blocks allocated in the uplink. For these exceptions the requirements of subclause 7.7A spurious response for CA are applicable.

Table 7.6.2A.1.3-0: Out-of-band blocking for inter-band carrier aggregation with one active uplink

Parameter	Unit	Range 1	Range 2	Range 3
P_{wanted}	dBm	Table 7.6.2.3-1 for both component carriers		
$P_{interferer}$	dBm	$-44 + \Delta R_{IB,c}$	$-30 + \Delta R_{IB,c}$	$-15 + \Delta R_{IB,c}$
$F_{interferer}$ (CW)	MHz	$-60 < f - F_{DL_Low(1)} < -15$ or $-60 < f - F_{DL_Low(2)} < -15$ or $15 < f - F_{DL_High(1)} < 60$ or $15 < f - F_{DL_High(2)} < 60$	$-85 < f - F_{DL_Low(1)} \leq -60$ or $-85 < f - F_{DL_Low(2)} \leq -60$ or $60 \leq f - F_{DL_High(1)} < 85$ or $60 \leq f - F_{DL_High(2)} < 85$	$1 \leq f \leq F_{DL_Low(1)} - 85$ or $F_{DL_High(1)} + 85 \leq f \leq F_{DL_Low(2)} - 85$ or $F_{DL_High(2)} + 85 \leq f \leq 12750$
Note 1: $F_{DL_Low(1)}$ and $F_{DL_High(1)}$ denote the respective lower and upper frequency limits of the lower operating band, $F_{DL_Low(2)}$ and $F_{DL_High(2)}$ the respective lower and upper frequency limits of the upper operating band. Note 2: For $F_{DL_Low(2)} - F_{DL_High(1)} < 145$ MHz and $F_{interferer}$ in $F_{DL_High(1)} < f < F_{DL_Low(2)}$, $F_{interferer}$ can be in both Range 1 and Range 2. Then the lower of the $P_{interferer}$ applies. Note 3: For $F_{DL_Low(1)} - 15$ MHz $\leq f \leq F_{DL_High(1)} + 15$ MHz and $F_{DL_Low(2)} - 15$ MHz $\leq f \leq F_{DL_High(2)} + 15$ MHz the appropriate adjacent channel selectivity and in-band blocking in the respective subclauses 7.5A.1.3 and 7.6.1A.3 shall be applied. Note 4: $\Delta R_{IB,c}$ according to Table 7.3A.1.3-0 applies when serving cell c is measured.				

Table 7.6.2A.1.3-1: Out-of-band blocking parameters

Rx Parameter	Units	CA Bandwidth Class				
		B	C	D	E	F
Power per CC in Aggregated Transmission Bandwidth Configuration	dBm	REFSENS + CA Bandwidth Class specific value below				
			9			
Note 1: The transmitter shall be set to 4dB below P_{CMAX_L} or $P_{CMAX_L_CA}$ as defined in subclause 6.2.5A. Note 2: Reference measurement channel is specified in Annex A.3.2 with one sided dynamic OCNG Pattern OP.1 FDD/TDD as described in Annex A.5.1.1/A.5.2.						

Table 7.6.2A.1.3-2: Out of band blocking

CA configuration	Parameter	Units	Frequency		
			range 1	range 2	range 3
	$P_{interferer}$	dBm	-44	-30	-15
CA_1C, CA_7C, CA_38C, CA_40C, CA_41C	$F_{interferer}$ (CW)	MHz	$F_{DL_low} -15$ to $F_{DL_low} -60$ $F_{DL_high} +15$ to $F_{DL_high} +60$	$F_{DL_low} -60$ to $F_{DL_low} -85$ $F_{DL_high} +60$ to $F_{DL_high} +85$	$F_{DL_low} -85$ to 1 MHz $F_{DL_high} +85$ to +12750 MHz

The normative reference for this requirement is TS 36.101 [2] clause 7.6.2.1A.

7.6.2A.1.4 Test Description

7.6.2A.1.4.1 Initial Conditions

Initial conditions are a set of test configurations the UE needs to be tested in and the steps for the SS to take with the UE to reach the correct measurement state.

The initial test configurations consist of environmental conditions, test frequencies, and CC combinations based on E-UTRA CA configurations specified in table 5.4.2A.1-1. All of these configurations shall be tested with applicable test parameters for each CA Configuration, and are shown in table 7.6.2A.1.4.1-1. The details of the OCNG patterns used are specified in Annex A.5. Configurations of PDSCH and PDCCH before measurement are specified in Annex C.2.

Table 7.6.2A.1.4.1-1: Test Configuration Table

Initial Conditions							
Test Environment as specified in TS 36.508[7] subclause 4.1					NC		
Test Frequencies as specified in TS36.508 [7] subclause 4.3.1 for different CA bandwidth classes.					C: Mid range		
Test CC Combination setting (N_{RB_agg}) as specified in subclause 5.4.2A.1 for the CA Configuration across bandwidth combination sets supported by the UE.					Highest N_{RB_agg}		
Test Parameters for CA Configurations							
CA Configuration / N_{RB_agg}		DL Allocation			UL Allocation		
PCC N_{RB}	SCC N_{RB}	CC MOD	PCC & SCC RB allocation	CC MOD	N_{RB_alloc}	PCC & SCC RB allocations (LCRB @ RB_{start})	
75	75	QPSK	75+75	QPSK	75	P_75@0	S_0@0
75	75	QPSK	75+75	QPSK	130	P_75@0	S_55@0
75	75	QPSK	75+75	QPSK	150	P_75@0	S_75@0
100	50	QPSK	100+50	QPSK	150	P_100@0	S_50@0
100	100	QPSK	100+100	QPSK	75	P_75@25	S_0@0
100	100	QPSK	100+100	QPSK	130	P_100@0	S_30@0
100	100	QPSK	100+100	QPSK	200	P_100@0	S_100@0
Note 1: CA Configuration Test CC Combination settings are checked separately for each CA Configuration, which applicable aggregated channel bandwidths are specified in Table 5.4.2A.1-1.							
Note 2: Depending on CA Configuration only the appropriate Uplink RB allocation value according to table 7.3A.1.3-1 is tested per CA Configuration Test CC combination.							

1. Connect the SS to the UE antenna connectors as shown in TS 36.508 [7] Annex A, Figure group A.34 as appropriate.
2. The parameter settings for the cell are set up according to TS 36.508 [7] subclause 4.4.3.
3. Downlink signals are initially set up according to Annex C0, C.1 and C.3.1, and uplink signals according to Annex H.1 and H.3.1
4. The UL and DL Reference Measurement channels are set according to Table 7.6.2A.1.4.1-1.
5. Propagation conditions are set according to Annex B.0.
6. Ensure the UE is in State 3A-RF according to TS 36.508 [7] clause 5.2A.2. Message contents are defined in clause 7.6.2A.1.4.3.

7.6.2A.1.4.2 Test Procedure

1. Configure SCC according to Annex C.0, C.1 and Annex C.3.1 for all downlink physical channels except PHICH.
2. The SS shall configure SCC as per TS 36.508 [7] clause 5.2A.4. Message contents are defined in clause 7.6.2A.1.4.3.
3. SS activates SCC by sending the activation MAC-CE (Refer TS 36.321 [13], clauses 5.13, 6.1.3.8). Wait for at least 2 seconds (Refer TS 36.133, clauses 8.3.3.2).
4. SS transmits PDSCH via PDCCH DCI format 1A for C_RNTI to transmit the DL RMC according to Table 7.6.2A.1.4.1-1 on both PCC and SCC. The SS sends downlink MAC padding bits on the DL RMC.
5. SS sends uplink scheduling information for each UL HARQ process via PDCCH DCI format 0 for C_RNTI to schedule the UL RMC according to Table 7.6.2A.1.4.1-1 on both PCC and SCC. Since the UE has no payload data to send, the UE transmits uplink MAC padding bits on the UL RMC.
6. Set the parameters of the CW signal generator for an interfering signal below the wanted aggregated signal according to Table 7.6.2A.1.5-2. The frequency step size is 1MHz.
7. Set the downlink signal level according to the table 7.6.2A.1.5-1 for both carriers. Send uplink power control commands to the UE (less or equal to 1dB step size should be used), to ensure that the UE output power is within +0, - 3.4 dB of the target level in table 7.6.2A.1.5-1 for carrier frequency $f \leq 3.0\text{GHz}$ or within +0, -4.0 dB of the target level for carrier frequency $3.0\text{GHz} < f \leq 4.2\text{GHz}$, for at least the duration of the throughput measurement. Suitable uplink power control commands should be sent to ensure the total power in each of the assigned carriers to be equal to each other within +/-[2] dB.
8. Measure the average throughput for each component carrier for duration sufficient to achieve statistical significance according to Annex G.2A.
9. Record the frequencies for which the throughput doesn't meet the requirements.
10. Repeat steps from 6 to 9, using an interfering signal above the wanted aggregated signal at step 5.

7.6.2A.1.4.3 Message Contents

Message contents are according to TS 36.508 [7] subclause 4.6. In test procedure step 2, for SCC configuration there are no additional message contents.

7.6.2A.1.5 Test Requirement

Except for the spurious response frequencies recorded at the final step of test procedure, the throughput measurement of each carrier derived in test procedure shall be $\geq 95\%$ of the maximum throughput of the reference measurement channels as specified in Annex A.3.2 with parameters specified in Table 7.6.2A.1.5-1 and 7.6.2A.1.5-2.

For Table 7.6.2A.1.5-2 in frequency range 1, 2 and 3, up to $\max(24, 6 \cdot \lceil N_{RB,agg} / 6 \rceil)$ exceptions are allowed for spurious response frequencies in each assigned frequency channel when measured using a 1MHz step size, where $N_{RB,agg}$ is the number of aggregated resource blocks in the downlink transmission bandwidth configuration. For these exceptions the requirements of subclause 7.7A Spurious response for CA are applicable.

For Table 7.6.2A.1.5-2 in frequency range 4, up to $\max(8, \lceil (N_{RB,agg} + 2 \cdot L_{CRBs}) / 8 \rceil)$ exceptions are allowed for spurious response frequencies in each assigned frequency channel when measured using a 1MHz step size, where $N_{RB,agg}$ is the number of aggregated resource blocks in the downlink transmission bandwidth configurations and L_{CRBs} is the number of resource blocks allocated in the uplink. For these exceptions the requirements of subclause 7.7A Spurious response for CA are applicable.

Table 7.6.2A.1.5-1: Out-of-band blocking parameters

Rx Parameter	Units	CA Bandwidth Class				
		B	C	D	E	F

Power per CC in Aggregated Transmission Bandwidth Configuration	dBm	REFSENS + CA Bandwidth Class specific value below			
			9		
Note 1: The transmitter shall be set to 4dB below $P_{\text{CMAX_L}}$ or $P_{\text{CMAX_L_CA}}$ as defined in subclause 6.2.5A.					
Note 2: Reference measurement channel is specified in Annex A.3.2 with one sided dynamic OCNG Pattern OP.1 FDD/TDD as described in Annex A.5.1.1/A.5.2.					

Table 7.6.2A.1.5-2: Out of band blocking

CA configuration	Parameter	Units	Frequency		
			range 1	range 2	range 3
	$P_{\text{Interferer}}$	dBm	-44	-30	-15
CA_1C, CA_7C, CA_38C, CA_40C,CA_41C	$F_{\text{Interferer}}$ (CW)	MHz	$F_{\text{DL_low}} -15$ to $F_{\text{DL_low}} -60$	$F_{\text{DL_low}} -60$ to $F_{\text{DL_low}} -85$	$F_{\text{DL_low}} -85$ to 1 MHz
			$F_{\text{DL_high}} +15$ to $F_{\text{DL_high}} + 60$	$F_{\text{DL_high}} +60$ to $F_{\text{DL_high}} +85$	$F_{\text{DL_high}} +85$ to +12750 MHz

7.6.2A.2 Out-of-band blocking for CA (intra-band contiguous DL CA without UL CA)

7.6.2A.2.1 Test Purpose

Same test purpose as 7.6.2A.1.

7.6.2A.2.2 Test Applicability

This test applies to all types of E-UTRA UE release 10 and forward that support intra-band contiguous DL CA without UL CA.

7.6.2A.2.3 Minimum Conformance Requirements

Minimum conformance requirements for intra-band contiguous carrier aggregation with one uplink carrier support as in clause 7.6.2A.1.

7.6.2A.2.4 Test Description

7.6.2A.2.4.1 Initial Conditions

Same initial conditions as in clause 7.6.2A.1.4.1 with the following exceptions:

- Instead of Table 7.6.2A.1.4.1-1 → use Table 7.6.2A.2.4.1-1

Table 7.6.2A.2.4.1-1: Test Configuration Table

Initial Conditions							
Test Environment as specified in TS 36.508[7] subclause 4.1					NC		
Test Frequencies as specified in TS36.508 [7] subclause 4.3.1 for different CA bandwidth classes.					C: Mid range		
Test CC Combination setting (N_{RB_agg}) as specified in subclause 5.4.2A.1 for the CA Configuration across bandwidth combination sets supported by the UE.					Highest N_{RB_agg}		
Test Parameters for CA Configurations							
CA Configuration / N_{RB_agg}		DL Allocation		UL Allocation			
PCC N_{RB}	SCC N_{RB}	CC MOD	PCC & SCC RB allocation	CC MOD	N_{RB_alloc}	PCC & SCC RB allocations (L_{CRB} @ RB_{start})	
75	75	QPSK	75+75	QPSK	75	P_75@0	-
75	75	QPSK	75+75	QPSK	50	P_50@0	-
75	75	QPSK	75+75	QPSK	25	P_25@0	-
75	75	QPSK	75+75	QPSK	20	P_20@0	-
100	50	QPSK	100+50	QPSK	100	P_100@0	-
100	50	QPSK	100+50	QPSK	75	P_75@0	-
100	50	QPSK	100+50	QPSK	50	P_50@0	-
100	50	QPSK	100+50	QPSK	25	P_25@0	-
100	50	QPSK	100+50	QPSK	20	P_20@0	-
100	100	QPSK	100+100	QPSK	100	P_100@0	-
100	100	QPSK	100+100	QPSK	75	P_75@0	-
100	100	QPSK	100+100	QPSK	50	P_50@0	-
100	100	QPSK	100+100	QPSK	25	P_25@0	-
100	100	QPSK	100+100	QPSK	20	P_20@0	-
Note 1: CA Configuration Test CC Combination settings are checked separately for each CA Configuration, which applicable aggregated channel bandwidths are specified in Table 5.4.2A.1-1.							
Note 2: Depending on CA Configuration only the appropriate Uplink RB allocation value according to table 7.3.3-2 is tested per CA Configuration Test CC combination.							

7.6.2A.2.4.2 Test Procedure

Same test procedure as in clause 7.6.2A.1.4.2 with the following exceptions:

- Instead of Table 7.6.2A.1.4.1-1 → use Table 7.6.2A.2.4.1-1

7.6.2A.2.4.3 Message Contents

Message contents are according to TS 36.508 [7] subclause 4.6. In test procedure step 2, for SCC configuration there are no additional message contents.

7.6.2A.2.5 Test Requirement

Same test requirement as in clause 7.6.2A.1.5.

7.6.2A.3 Out-of-band blocking for CA (inter-band DL CA without UL CA)

7.6.2A.3.1 Test Purpose

Same test purpose as 7.6.2A.1.

7.6.2A.3.2 Test Applicability

This test applies to all types of E-UTRA UE release 10 and forward that support inter-band DL CA without UL CA.

7.6.2A.3.3 Minimum Conformance Requirements

Minimum conformance requirements for inter-band carrier aggregation with one uplink carrier support as in clause 7.6.2A.1.

7.6.2A.3.4 Test Description

7.6.2A.3.4.1 Initial Conditions

Same initial conditions as in clause 7.6.2A.1.4.1 with the following exceptions:

- Instead of Table 7.6.2A.1.4.1-1 → use Table 7.6.2A.3.4.1-1

Table 7.6.2A.3.4.1-1: Test Configuration Table

Initial Conditions						
Test Environment as specified in TS 36.508[7] subclause 4.1			NC			
Test Frequencies as specified in TS36.508 [7] subclause 4.3.1 for different CA bandwidth classes.			A: Mid range for PCC and SCC			
Test CC Combination setting $b(N_{RB_agg})$ as specified in subclause 5.4.2A.1 for the CA Configuration across bandwidth combination sets supported by the UE.			Highest N_{RB_agg} for PCC and SCC			
Test Parameters for CA Configurations						
CA Configuration / N_{RB_agg}		DL Allocation			UL Allocation	
PCC N_{RB}	SCCs N_{RB}	CC MOD	PCC & SCC RB allocation		CC MOD	PCC N_{RB_alloc}
50	50	QPSK	50	50	QPSK	50
50	50	QPSK	50	50	QPSK	25
50	50	QPSK	50	50	QPSK	20
50	50	QPSK	50	50	QPSK	16
50	75	QPSK	50	75	QPSK	25
50	100	QPSK	50	100	QPSK	50
50	100	QPSK	50	100	QPSK	25
50	100	QPSK	50	100	QPSK	20
75	50	QPSK	75	50	QPSK	25
75	100	QPSK	75	100	QPSK	25
100	50	QPSK	100	50	QPSK	100
100	50	QPSK	100	50	QPSK	75
100	50	QPSK	100	50	QPSK	50
100	75	QPSK	100	75	QPSK	100
100	100	QPSK	100	100	QPSK	75
100	100	QPSK	100	100	QPSK	50
Note 1: CA Configuration Test CC Combination settings are checked separately for each CA Configuration, which applicable aggregated channel bandwidths are specified in Table 5.4.2A.1-2. Note 2: Depending on CA configurations, only the appropriate Uplink RB allocation value according to table 7.3.3-2 for UE supporting one uplink carrier is tested per Test CA configuration, unless otherwise stated in table 7.3A.1.3-0b. Note 3: The UL resource blocks shall be located as close as possible to the downlink SCC but confined within the transmission bandwidth configuration for the channel bandwidth (Table 5.4.2-1). Note 4: The frequencies of PCC and SCC shall be switched and tested in each configuration (given UL is supported in PCC band as per Table 5.2-1).						

7.6.2A.3.4.2 Test Procedure

1. Configure SCC according to Annex C0, C.1 and Annex C.3.2 for all downlink physical channels except PHICH.
2. The SS shall configure SCC as per TS 36.508 [7] clause 5.2A.4. Message contents are defined in clause 7.6.2A.3.4.3.

3. SS activates SCC by sending the activation MAC-CE (Refer TS 36.321 [13], clauses 5.13, 6.1.3.8). Wait for at least 2 seconds (Refer TS 36.133, clauses 8.3.3.2).
4. SS transmits PDSCH via PDCCH DCI format 1A for C_RNTI to transmit the DL RMC according to Table 7.6.2A.3.4.1-1 on both PCC and SCC. The SS sends downlink MAC padding bits on the DL RMC.
5. SS sends uplink scheduling information for each UL HARQ process via PDCCH DCI format 0 for C_RNTI to schedule the UL RMC according to Table 7.6.2A.3.4.1-1 on PCC. Since the UE has no payload data to send, the UE transmits uplink MAC padding bits on the UL RMC.
6. Set the parameters of the signal generator for an interfering signal below the SCC's wanted signal according to Table 7.6.2.5-2. The frequency step size is 1 MHz.
7. Set the downlink signal level according to the table 7.6.2.5-1 for both carriers. Send uplink power control commands to the UE (less or equal to 1dB step size should be used), to ensure that the UE output power is within +0, - 3.4 dB of the target level in table 7.6.1.5-1 for carrier frequency $f \leq 3.0\text{GHz}$ or within +0, -4.0 dB of the target level for carrier frequency $3.0\text{GHz} < f \leq 4.2\text{GHz}$, for at least the duration of the throughput measurement.
8. Measure the average throughput of SCC for duration sufficient to achieve statistical significance according to Annex G.2A.
9. Record the frequencies for which the throughput doesn't meet the requirements.
10. Repeat steps from 6 to 9, using an interfering signal above the SCC's wanted signal at step 6.
11. Switch the SCell into PCell and repeat steps 1 to 10, except for operating bands without uplink band (as noted in Table 5.2-1).

7.6.2A.3.4.3 Message Contents

Message contents are according to TS 36.508 [7] subclause 4.6. In test procedure step 2, for SCC configuration there are no additional message contents.

7.6.2A.3.5 Test Requirement

For inter-band carrier aggregation with uplink assigned to one E-UTRA band the out-of-band blocking requirements are defined with the uplink active on the band other than the band whose downlink is being tested i.e. the requirements are tested only for the S-Cell downlink. The out-of-band blocking parameters in table 7.6.2A.3.5-1 for each component carrier are the same as single carrier requirements in Table 7.6.2.5-1. Out-of-band blocking for inter-band carrier aggregation with one active uplink requirements are found in table 7.6.2A.1.3-0.

Except for the spurious response frequencies recorded at step 9, the throughput measurement in the downlink derived in the test procedure shall be $\geq 95\%$ of the maximum throughput of the reference measurement channels as specified in Annexes A.2.2, A.2.3 and A.3.2 (with one sided dynamic OCNG Pattern OP.1 FDD/TDD for the DL-signal as described in Annex A.5.1.1/A.5.2.1) with parameters specified in Tables 7.6.2A.3.5-1 and 7.6.2A.3.5-2. The parameters in these tables are related to the carrier operated as S-Cell.

For frequency range 1, 2, and 3, the number of spurious response frequencies recorded in the step 9 of the test procedure shall not exceed $\max(24, 6 \cdot \lceil N_{RB} / 6 \rceil)$ exceptions per downlink in each assigned frequency channel when measured using a 1MHz step size. For these exceptions the requirements of clause 7.7A.3 Spurious Response are applicable.

Table 7.6.2A.3.5-1: Out-of-band blocking parameters

Rx Parameter	Units	Channel bandwidth					
		1.4 MHz	3 MHz	5 MHz	10 MHz	15 MHz	20 MHz
Power in Transmission Bandwidth Configuration	dBm	REFSENS + channel bandwidth specific value below					
		6	6	6	6	7	9

Note 1:	The transmitter shall be set to 4dB below $P_{\text{CMAX,L}}$ with $P_{\text{CMAX,L}}$ as defined in clause 6.2.5.
Note 2:	The reference measurement channel is specified in Annex A.3.2 with one sided dynamic OCNG Pattern OP.1 FDD/TDD as described in Annex A.5.1.1/A.5.2.1.

Table 7.6.2A.3.5-2: Out-of-band blocking for inter-band carrier aggregation with one uplink carrier

Parameter	Unit	Range 1	Range 2	Range 3
P_{wanted}	dBm	Table 7.6.2.5-1 for both component carriers		
$P_{\text{interferer}}$	dBm	$-44 + \Delta R_{\text{IB,c}}$	$-30 + \Delta R_{\text{IB,c}}$	$-15 + \Delta R_{\text{IB,c}}$
$F_{\text{interferer}}$ (CW)	MHz	$-60 < f - F_{\text{DL_Low}(1)} < -15$ or $-60 < f - F_{\text{DL_Low}(2)} < -15$ or $15 < f - F_{\text{DL_High}(1)} < 60$ or $15 < f - F_{\text{DL_High}(2)} < 60$	$-85 < f - F_{\text{DL_Low}(1)} \leq -60$ or $-85 < f - F_{\text{DL_Low}(2)} \leq -60$ or $60 \leq f - F_{\text{DL_High}(1)} < 85$ or $60 \leq f - F_{\text{DL_High}(2)} < 85$	$1 \leq f \leq F_{\text{DL_Low}(1)} - 85$ or $F_{\text{DL_High}(1)} + 85 \leq f \leq F_{\text{DL_Low}(2)} - 85$ or $F_{\text{DL_High}(2)} + 85 \leq f \leq 12750$
Note 1:	$F_{\text{DL_Low}(1)}$ and $F_{\text{DL_High}(1)}$ denote the respective lower and upper frequency limits of the lower operating band, $F_{\text{DL_Low}(2)}$ and $F_{\text{DL_High}(2)}$ the respective lower and upper frequency limits of the upper operating band.			
Note 2:	For $F_{\text{DL_Low}(2)} - F_{\text{DL_High}(1)} < 145$ MHz and $F_{\text{interferer}}$ in $F_{\text{DL_High}(1)} < f < F_{\text{DL_Low}(2)}$, $F_{\text{interferer}}$ can be in both Range 1 and Range 2. Then the lower of the $P_{\text{interferer}}$ applies.			
Note 3:	For $F_{\text{DL_Low}(1)} - 15 \text{ MHz} \leq f \leq F_{\text{DL_High}(1)} + 15 \text{ MHz}$ and $F_{\text{DL_Low}(2)} - 15 \text{ MHz} \leq f \leq F_{\text{DL_High}(2)} + 15 \text{ MHz}$ the appropriate adjacent channel selectivity and in-band blocking in the respective subclauses 7.5A.1.5 and 7.6.1A.5 shall be applied.			
Note 4:	$\Delta R_{\text{IB,c}}$ according to Table 7.3A.1.3-0 applies when serving cell c is measured.			

7.6.2B Out-of-band blocking for UL-MIMO

7.6.2B.1 Test Purpose

Out-of-band band blocking for UL-MIMO is defined for an unwanted CW interfering signal falling more than 15 MHz below or above the UE that support UL-MIMO receive band, at which a given average throughput shall meet or exceed the requirement for the specified measurement channels.

For the first 15 MHz below or above the UE that support UL-MIMO receive band the appropriate in-band blocking for UL-MIMO or adjacent channel selectivity for UL-MIMO in sub-clause 7.5.3 and sub-clause 7.6.1.3 shall be applied.

The lack of out-of-band blocking ability will decrease the coverage area when other e-NodeB transmitters exist (except in the adjacent channels and spurious response).

7.6.2B.2 Test Applicability

This test applies to all types of E-UTRA UE release 10 and forward that support UL-MIMO.

7.6.2B.3 Minimum Conformance Requirements

For UE with two transmitter antenna connectors in closed-loop spatial multiplexing scheme, the minimum requirements in subclause 7.6 shall be met with the UL-MIMO configurations specified in Table 6.2.2B.3-2. For UL-MIMO, the parameter $P_{\text{CMAX,L}}$ is defined as the total transmitter power over the two transmit antenna connectors.

The normative reference for this requirement is TS 36.101 [2] clause 7.6B.

7.6.2B.4 Test Description

7.6.2B.4.1 Initial Conditions

Initial conditions are a set of test configurations the UE needs to be tested in and the steps for the SS to take with the UE to reach the correct measurement state.

The initial test configurations consist of environmental conditions, test frequencies, and channel bandwidths based on E-UTRA bands specified in table 5.4.2.1-1. All of these configurations shall be tested with applicable test parameters for each channel bandwidth, and are shown in table 7.6.2B.4.1-1. The details of the uplink and downlink reference measurement channels (RMCs) are specified in Annexes A.2 and A.3 respectively. The details of the OCN patterns used are specified in Annex A.5. Configurations of PDSCH and PDCCH before measurement are specified in Annex C.2.

Table 7.6.2B.4.1-1: Test Configuration Table

Initial Conditions						
Test Environment as specified in TS 36.508[7] subclause 4.1			NC			
Test Frequencies as specified in TS36.508 [7] subclause 4.3.1			One frequency chosen arbitrarily from low or high range			
Test Channel Bandwidths as specified in TS 36.508 [7] subclause 4.3.1			Lowest, 5MHz, Highest			
Test Parameters for Channel Bandwidths						
Ch BW	Downlink Configuration			Uplink Configuration		
	Mod'n	RB allocation		Mod'n	RB allocation	
		FDD	TDD		FDD	TDD
1.4MHz	QPSK	6	6	QPSK	6	6
3MHz	QPSK	15	15	QPSK	15	15
5MHz	QPSK	25	25	QPSK	25	25
5MHz	QPSK	25	N/A	QPSK	20	N/A
5MHz	QPSK	25	N/A	QPSK	15	N/A
10MHz	QPSK	50	50	QPSK	50	50
10MHz	QPSK	50	N/A	QPSK	25	N/A
10MHz	QPSK	50	N/A	QPSK	20	N/A
10MHz	QPSK	50	N/A	QPSK	15	N/A
15MHz	QPSK	75	75	QPSK	75	75
15MHz	QPSK	75	N/A	QPSK	50	N/A
15MHz	QPSK	75	N/A	QPSK	25	N/A
15MHz	QPSK	75	N/A	QPSK	20	N/A
20MHz	QPSK	100	100	QPSK	100	100
20MHz	QPSK	100	N/A	QPSK	75	N/A
20MHz	QPSK	100	N/A	QPSK	50	N/A
20MHz	QPSK	100	N/A	QPSK	25	N/A
20MHz	QPSK	100	N/A	QPSK	20	N/A
Note 1: Test Channel Bandwidths are checked separately for each E-UTRA band, which applicable channel bandwidths are specified in Table 5.4.2.1-1.						
Note 2: Depending on E-UTRA band, only the appropriate Uplink RB allocation value according to table 7.3.3-2 is tested per Test Channel Bandwidth.						
Note 3: For the DL signal one sided dynamic OCN Pattern OP.1 FDD/TDD is used.						

1. Connect the SS to the UE antenna connectors as shown in TS 36.508 [7] Annex A, in Figure A.30.
2. The parameter settings for the cell are set up according to TS 36.508 [7] subclause 4.4.3.
3. Downlink signals are initially set up according to Annex C0, C.1 and C.3.1, and uplink signals according to Annex H.1 and H.3.1.
4. The UL and DL Reference Measurement channels are set according to Table 7.6.2B.4.1-1.
5. Propagation conditions are set according to Annex B.0.
6. Ensure the UE is in State 3A-RF according to TS 36.508 [7] clause 5.2A.2. Message contents are defined in clause 7.6.2B.4.3.

7.6.2B.4.2 Test Procedure

1. SS transmits PDSCH via PDCCH DCI format 1A for C_RNTI to transmit the DL RMC according to Table 7.6.2B.4.1-1. The SS sends downlink MAC padding bits on the DL RMC.

2. SS sends uplink scheduling information for each UL HARQ process via PDCCH DCI format 4 for C_RNTI to schedule the UL RMC according to Table 7.6.2B.4.1-1. Since the UE has no payload data to send, the UE transmits uplink MAC padding bits on the UL RMC.
3. Set the parameters of the CW signal generator for an interfering signal below the wanted signal according to Table 7.6.2B.5-2. The frequency step size is 1MHz.
4. Set the downlink signal level according to the table 7.6.2B.5-1. Send uplink power control commands to the UE (less or equal to 1dB step size should be used), to ensure that the UE output power is within +0, - 3.4 dB of the target level in table 7.6.2B.5-1 for carrier frequency $f \leq 3.0\text{GHz}$ or within +0, -4.0 dB of the target level for carrier frequency $3.0\text{GHz} < f \leq 4.2\text{GHz}$, for at least the duration of the throughput measurement.
5. Measure the average throughput for a duration sufficient to achieve statistical significance according to Annex G.2.
6. Record the frequencies for which the throughput doesn't meet the requirements.
7. Repeat steps from 3 to 6, using an interfering signal above the wanted signal at step 3.

7.6.2B.4.3 Message Contents

Message contents are according to TS 36.508 [7] clause 4.6 with the following exception.

Table 7.6.2B.4.3-1: UplinkPowerControlDedicated

Derivation Path: 36.331 clause 6.3.2			
Information Element	Value/remark	Comment	Condition
UplinkPowerControlDedicated-DEFAULT ::= SEQUENCE {			
p0-UePUSCH	0		
deltaMCS-Enabled	en0		
accumulationEnabled	TRUE		
p0-uePUCCH	0		
pSRS-Offset	3 (-6 dB)		
filterCoefficient	fc8	larger filter length is used to reduce the RSRP measurement variation	
}			

7.6.2B.5 Test Requirement

Except for the spurious response frequencies recorded at the final step of test procedure, the throughput measurement derived in test procedure shall be $\geq 95\%$ of the maximum throughput of the reference measurement channels as specified in Annex A.3.2 with parameters specified in Tables 7.6.2B.5-1 and 7.6.2B.5-2.

For frequency range 1, 2, and 3, the number of spurious response frequencies recorded in the final step of test procedure shall not exceed $\max(24, 6 \cdot \lceil N_{RB} / 6 \rceil)$ in each assigned frequency channel when measured using a 1MHz step size. For these exceptions the requirements of clause 7.7 Spurious Response are applicable.

For frequency range 4, the number of spurious response frequencies recorded in the final step of test procedure shall not exceed $\max(8, \lceil (N_{RB} + 2 \cdot L_{CRBs}) / 8 \rceil)$ in each assigned frequency channel when measured using a 1MHz step size. For these exceptions the requirements of clause 7.7 Spurious Response are applicable.

Table 7.6.2B.5-1: Out-of-band blocking parameters

Rx Parameter	Units	Channel bandwidth					
		1.4 MHz	3 MHz	5 MHz	10 MHz	15 MHz	20 MHz
Power in Transmission	dBm	REFSENS + channel bandwidth specific value below					
		6	6	6	6	7	9

Bandwidth Configuration						
Note 1:	The transmitter shall be set to 4dB below P_{CMAX_L} with P_{CMAX_L} as defined in clause 6.2.5.					
Note 2:	The reference measurement channel is specified in Annex A.3.2 with one sided dynamic OCNG Pattern OP.1 FDD/TDD as described in Annex A.5.1.1/A.5.2.1.					

Table 7.6.2B.5-2: Out of band blocking

E-UTRA band	Parameter	Units	Frequency			
			range 1	range 2	range 3	range 4
	$P_{Interferer}$	dBm	-44	-30	-15	-15
1, 2, 3, 4, 5, 6, 7, 8, 9, 10, 11, 12, 13, 14, 17, 18, 19, 20, 21, 22, 23, 24, 25, 26, 27, 28, 31, 33, 34, 35, 36, 37, 38, 39, 40, 41, 42, 43, 44	$F_{Interferer}$ (CW)	MHz	$F_{DL_low} -15$ to $F_{DL_low} -60$	$F_{DL_low} -60$ to $F_{DL_low} -85$	$F_{DL_low} -85$ to 1 MHz	-
			$F_{DL_high} +15$ to $F_{DL_high} +60$	$F_{DL_high} +60$ to $F_{DL_high} +85$	$F_{DL_high} +85$ to +12750 MHz	-
2, 5, 12, 17	$F_{Interferer}$	MHz	-	-	-	$F_{UL_low} - F_{UL_high}$
Note 1: Range 3 shall be tested only with the highest channel bandwidth.						
Note 2: For the UE which supports both Band 11 and Band 21 the out of blocking is FFS.						

7.6.3 Narrow band blocking

7.6.3.1 Test Purpose

Verifies a receiver's ability to receive an E-UTRA signal at its assigned channel frequency in the presence of an unwanted narrow band CW interferer at a frequency, which is less than the nominal channel spacing.

The lack of narrow-band blocking ability will decrease the coverage area when other e-NodeB transmitters exist (except in the adjacent channels and spurious response).

7.6.3.2 Test Applicability

This test applies to all types of E-UTRA UE release 8 and forward.

7.6.3.3 Minimum Conformance Requirements

The relative throughput shall be $\geq 95\%$ of the maximum throughput of the reference measurement channels as specified in Annexes A.2.2, A.2.3 and A.3.2 (with one sided dynamic OCNG Pattern OP.1 FDD/TDD for the DL-signal as described in Annex A.5.1.1/A.5.2.1) with parameters specified in Table 7.6.3.3-1.

Table 7.6.3.3-1: Narrow-band blocking

Parameter	Unit	Channel Bandwidth					
		1.4 MHz	3 MHz	5 MHz	10 MHz	15 MHz	20 MHz
P_w	dBm	$P_{REFSENS}$ + channel-bandwidth specific value below					
		22	18	16	13	14	16
P_{uw} (CW)	dBm	-55	-55	-55	-55	-55	-55
F_{uw} (offset for $\Delta f = 15$ kHz)	MHz	0.9075	1.7025	2.7075	5.2125	7.7025	10.2075
F_{uw} (offset for $\Delta f = 7.5$ kHz)	MHz						
Note 1: The transmitter shall be set a 4 dB below P_{CMAX_L} at the minimum uplink configuration specified in Table 7.3.3-2 with P_{CMAX_L} as defined in clause 6.2.5.							
Note 2: The reference measurement channel is specified in Annex A.3.2 with one sided dynamic OCNG Pattern OP.1 FDD/TDD as described in Annex A.5.1.1/A.5.2.1.							

The normative reference for this requirement is TS 36.101 [2] clause 7.6.3.

7.6.3.4 Test Description

7.6.3.4.1 Initial Conditions

Initial conditions are a set of test configurations the UE needs to be tested in and the steps for the SS to take with the UE to reach the correct measurement state.

The initial test configurations consist of environmental conditions, test frequencies, and channel bandwidths based on E-UTRA bands specified in table 5.4.2.1-1. All of these configurations shall be tested with applicable test parameters for each channel bandwidth, and are shown in table 7.6.3.4.1-1. The details of the uplink and downlink reference measurement channels (RMCs) are specified in Annexes A.2 and A.3 respectively. The details of the OCNG patterns used are specified in Annex A.5. Configurations of PDSCH and PDCCH before measurement are specified in Annex C.2.

Table 7.6.3.4.1-1: Test Configuration Table

Initial Conditions						
Test Environment as specified in TS 36.508 [7] subclause 4.1			NC			
Test Frequencies as specified in TS 36.508 [7] subclause 4.3.1			Mid range			
Test Channel Bandwidths as specified in TS 36.508 [7] subclause 4.3.1			Lowest, 5MHz, Highest			
Test Parameters for Channel Bandwidths						
Ch BW	Downlink Configuration			Uplink Configuration		
	Mod'n	RB allocation		Mod'n	RB allocation	
		FDD	TDD		FDD	TDD
1.4MHz	QPSK	6	6	QPSK	6	6
3MHz	QPSK	15	15	QPSK	15	15
5MHz	QPSK	25	25	QPSK	25	25
5MHz	QPSK	25	N/A	QPSK	20	N/A
5MHz	QPSK	25	N/A	QPSK	15	N/A
10MHz	QPSK	50	50	QPSK	50	50
10MHz	QPSK	50	N/A	QPSK	25	N/A
10MHz	QPSK	50	N/A	QPSK	20	N/A
10MHz	QPSK	50	N/A	QPSK	15	N/A
15MHz	QPSK	75	75	QPSK	75	75
15MHz	QPSK	75	N/A	QPSK	50	N/A
15MHz	QPSK	75	N/A	QPSK	25	N/A
15MHz	QPSK	75	N/A	QPSK	20	N/A
20MHz	QPSK	100	100	QPSK	100	100
20MHz	QPSK	100	N/A	QPSK	75	N/A
20MHz	QPSK	100	N/A	QPSK	50	N/A
20MHz	QPSK	100	N/A	QPSK	25	N/A
20MHz	QPSK	100	N/A	QPSK	20	N/A
Note 1: Test Channel Bandwidths are checked separately for each E-UTRA band, which applicable channel bandwidths are specified in Table 5.4.2.1-1. Note 2: Depending on E-UTRA band, only the appropriate Uplink RB allocation value according to table 7.3.3-2 is tested per Test Channel Bandwidth. The allocation shall be located as close as possible to the downlink operating band but confined within the transmission bandwidth configuration for the channel bandwidth (Table 5.4.2-1). Note 3: For the DL signal one sided dynamic OCNG Pattern OP.1 FDD/TDD is used.						

1. Connect the SS to the UE antenna connectors as shown in TS 36.508 [7] Annex A, Figure A.5.
2. The parameter settings for the cell are set up according to TS 36.508 [7] subclause 4.4.3.
3. Downlink signals are initially set up according to Annex C0, C.1 and C.3.1, and uplink signals according to Annex H.1 and H.3.1
4. The UL and DL Reference Measurement channels are set according to Table 7.6.3.4.1-1.

5. Propagation conditions are set according to Annex B.0.
6. Ensure the UE is in State 3A-RF according to TS 36.508 [7] clause 5.2A.2. Message contents are defined in clause 7.6.3.4.3.

7.6.3.4.2 Test Procedure

1. SS transmits PDSCH via PDCCH DCI format 1A for C_RNTI to transmit the DL RMC according to Table 7.6.3.4.1-1. The SS sends downlink MAC padding bits on the DL RMC.
2. SS sends uplink scheduling information for each UL HARQ process via PDCCH DCI format 0 for C_RNTI to schedule the UL RMC according to Table 7.6.3.4.1-1. Since the UE has no payload data to send, the UE transmits uplink MAC padding bits on the UL RMC.
3. Set the parameters of the CW signal generator for an interfering signal below the wanted signal according to Table 7.6.3.5-1.
4. Set the downlink signal level according to the table 7.6.3.5-1. Send uplink power control commands to the UE (less or equal to 1dB step size should be used), to ensure that the UE output power is within +0, - 3.4 dB of the target level in table 7.6.3.5-1 for carrier frequency $f \leq 3.0\text{GHz}$ or within +0, -4.0 dB of the target level for carrier frequency $3.0\text{GHz} < f \leq 4.2\text{GHz}$, for at least the duration of the throughput measurement.
5. Measure the average throughput for a duration sufficient to achieve statistical significance according to Annex G.2.
6. Repeat steps from 3 to 5, using an interfering signal above the wanted signal at step 3.

7.6.3.4.3 Message Contents

Message contents are according to TS 36.508 [7] subclause 4.6 with the following exception.

Table 7.6.3.4.3-1: UplinkPowerControlDedicated

Derivation Path: 36.331 clause 6.3.2			
Information Element	Value/remark	Comment	Condition
UplinkPowerControlDedicated-DEFAULT ::= SEQUENCE {			
p0-UePUSCH	0		
deltaMCS-Enabled	en0		
accumulationEnabled	TRUE		
p0-uePUCCH	0		
pSRS-Offset	3 (-6 dB)		
filterCoefficient	fc8	larger filter length is used to reduce the RSRP measurement variation	
}			

7.6.3.5 Test Requirement

The throughput measurement derived in test procedure shall be $\geq 95\%$ of the maximum throughput of the reference measurement channels as specified in Annex A.3.2 with parameters specified in Table 7.6.3.5-1.

Table 7.6.3.5-1: Narrow-band blocking

Parameter	Unit	Channel Bandwidth					
		1.4 MHz	3 MHz	5 MHz	10 MHz	15 MHz	20 MHz
P_w	dBm	P_{REFSENS} + channel-bandwidth specific value below					
		22	18	16	13	14	16
P_{UW} (CW)	dBm	-55	-55	-55	-55	-55	-55
F_{UW} (offset for $\Delta f = 15$ kHz)	MHz	0.9075	1.7025	2.7075	5.2125	7.7025	10.2075
F_{UW} (offset for $\Delta f = 7.5$ kHz)	MHz						
Note 1: The transmitter shall be set a 4 dB below $P_{\text{CMAX,L}}$ with $P_{\text{CMAX,L}}$ as defined in clause 6.2.5.							
Note 2: The reference measurement channel is specified in Annex A.3.2 with one sided dynamic OCNG Pattern OP.1 FDD/TDD as described in Annex A.5.1.1/A.5.2.1.							

7.6.3A Narrow band blocking for CA

7.6.3A.1 Narrow band blocking for CA (intra-band contiguous DL CA and UL CA)

7.6.3A.1.1 Test Purpose

Verifies a receiver's ability to receive an E-UTRA signal at its assigned CA channel frequencies in the presence of an unwanted narrow band CW interferer at a frequency, which is less than the nominal channel spacing.

The lack of narrow-band blocking ability will decrease the coverage area when other e-NodeB transmitters exist (except in the adjacent channels and spurious response).

7.6.3A.1.2 Test Applicability

This test applies to all types of E-UTRA UE release 10 and forward that support intra-band contiguous DL CA and UL CA.

7.6.3A.1.3 Minimum Conformance Requirements

For inter-band carrier aggregation with uplink assigned to one E-UTRA band the narrow-band blocking requirements are defined with the uplink active on the band other than the band whose downlink is being tested. The UE shall meet the requirements specified in subclause 7.6.3 for each component carrier while both downlink carriers are active. For E-UTRA CA configurations including an operating band without uplink band (as noted in Table 5.2-1), the requirements for both downlinks shall be met with the uplink active in the band capable of UL operation. For E-UTRA CA configurations listed in Table 7.3A.1.3-0a under conditions for which reference sensitivity for the operating band being tested is N/A, the narrow-band blocking requirements of subclause 7.6.3A.1.3 do not apply.

For intra-band contiguous carrier aggregation the downlink SCC shall be configured at nominal channel spacing to the PCC with the PCC configured closest to the uplink band. Downlink PCC and SCC are both activated. The uplink output power shall be set as specified in Table 7.6.3A.1.3-1 with the uplink configuration set according to Table 7.3A.1.3-1 for the applicable carrier aggregation configuration. For UE(s) supporting one uplink, the uplink configuration of the PCC shall be in accordance with Table 7.3.3-2.

The UE shall fulfil the minimum requirement in presence of an interfering signal specified in Table 7.6.3A.1.3-1 being on either side of the aggregated signal. The throughput of each carrier shall be $\geq 95\%$ of the maximum throughput of the reference measurement channels as specified in Annexes A.2.2, A.2.3 and A.3.2 (with one sided dynamic OCNG Pattern OP.1 FDD/TDD for the DL-signal as described in Annex A.5.1.1/A.5.2.1) with parameters specified in Table 7.6.3A.1.3-1.

Table 7.6.3A.1.3-1: Narrow-band blocking

Parameter	Unit	CA Bandwidth Class				
		B	C	D	E	F

Power per CC in Aggregated Transmission Bandwidth Configuration	dBm	REFSENS + CA Bandwidth Class specific value below			
P_{UW} (CW)	dBm		16		
F_{UW} (offset for $\Delta f = 15$ kHz)	MHz		- $F_{offset} - 0.2$ / $+ F_{offset} + 0.2$		
F_{UW} (offset for $\Delta f = 7.5$ kHz)	MHz				
<p>Note 1: The transmitter shall be set to 4dB below $P_{C_{MAX_L}}$ or $P_{C_{MAX_L_CA}}$ as defined in subclause 6.2.5A.</p> <p>Note 2: Reference measurement channel is specified in Annex A.3.2 with one sided dynamic OCNG Pattern OP.1 FDD/TDD as described in Annex A.5.1.1/A.5.2.1.</p> <p>Note 3: The $F_{interferer}$ (offset) is relative to the centre frequency of the adjacent CC being tested and shall be further adjusted to $\lfloor F_{interferer} / 0.015 + 0.5 \rfloor 0.015 + 0.0075$ MHz to be offset from the sub-carrier raster.</p>					

The normative reference for this requirement is TS 36.101 [2] clause 7.6.3.1A.

7.6.3A.1.4 Test Description

7.6.3A.1.4.1 Initial Conditions

Initial conditions are a set of test configurations the UE needs to be tested in and the steps for the SS to take with the UE to reach the correct measurement state.

The initial test configurations consist of environmental conditions, test frequencies, and CC combinations based on E-UTRA CA configurations specified in table 5.4.2A.1-1. All of these configurations shall be tested with applicable test parameters for each CA Configuration, and are shown in table 7.6.3A.1.4.1-1. The details of the OCNG patterns used are specified in Annex A.5. Configurations of PDSCH and PDCCH before measurement are specified in Annex C.2.

Table 7.6.3A.1.4.1-1: Test Configuration Table

Initial Conditions							
Test Environment as specified in TS 36.508[7] subclause 4.1				NC			
Test Frequencies as specified in TS36.508 [7] subclause 4.3.1 for different CA bandwidth classes.				C: Mid range			
Test CC Combination setting (N_{RB_agg}) as specified in subclause 5.4.2A.1 for the CA Configuration across bandwidth combination sets supported by the UE.				Lowest N_{RB_agg} Highest N_{RB_agg}			
Test Parameters for CA Configurations							
CA Configuration / N_{RB_agg}		DL Allocation			UL Allocation		
PCC N_{RB}	SCC N_{RB}	CC MOD	PCC & SCC RB allocation	CC MOD	N_{RB_alloc}	PCC & SCC RB allocations (L_{CRB} @ RB_{start})	
75	75	QPSK	75+75	QPSK	75	P_75@0	S_0@0
75	75	QPSK	75+75	QPSK	130	P_75@0	S_55@0
75	75	QPSK	75+75	QPSK	150	P_75@0	S_75@0
100	50	QPSK	100+50	QPSK	150	P_100@0	S_50@0
100	100	QPSK	100+100	QPSK	75	P_75@25	S_0@0
100	100	QPSK	100+100	QPSK	130	P_100@0	S_30@0
100	100	QPSK	100+100	QPSK	200	P_100@0	S_100@0
<p>Note 1: CA Configuration Test CC Combination settings are checked separately for each CA Configuration, which applicable aggregated channel bandwidths are specified in Table 5.4.2A.1-1.</p> <p>Note 2: Depending on CA Configuration only the appropriate Uplink RB allocation value according to table 7.3A.1.3-1 is tested per CA Configuration Test CC combination.</p>							

1. Connect the SS to the UE antenna connectors as shown in TS 36.508 [7] Annex A, Figure group A.34 as appropriate.
2. The parameter settings for the cell are set up according to TS 36.508 [7] subclause 4.4.3.
3. Downlink signals are initially set up according to Annex C0, C.1 and C.3.1, and uplink signals according to Annex H.1 and H.3.1.
4. The UL and DL Reference Measurement channels are set according to Table 7.6.3A.1.4.1-1.
5. Propagation conditions are set according to Annex B.0.
6. Ensure the UE is in State 3A-RF-CA according to TS 36.508 [7] clause 5.2A.2. Message contents are defined in clause 7.6.3A.1.4.3.

7.6.3A.1.4.2 Test Procedure

1. Configure SCC according to Annex C0, C.1 and Annex C.3.1 for all downlink physical channels except PHICH.
2. The SS shall configure SCC as per TS 36.508 [7] clause 5.2A.4. Message contents are defined in clause 7.6.3A.1.4.3.
3. SS activates SCC by sending the activation MAC-CE (Refer TS 36.321 [13], clauses 5.13, 6.1.3.8). Wait for at least 2 seconds (Refer TS 36.133, clauses 8.3.3.2).
4. SS transmits PDSCH via PDCCH DCI format 1A for C_RNTI to transmit the DL RMC according to Table 7.6.3A.1.4.1-1 on both PCC and SCC. The SS sends downlink MAC padding bits on the DL RMC.
5. SS sends uplink scheduling information for each UL HARQ process via PDCCH DCI format 0 for C_RNTI to schedule the UL RMC according to Table 7.6.3A.1.4.1-1 on both PCC and SCC. Since the UE has no payload data to send, the UE transmits uplink MAC padding bits on the UL RMC.
6. Set the parameters of the CW signal generator for an interfering signal below the wanted signal according to Table 7.6.3A.1.5-1.
7. Set the downlink signal level according to the table 7.6.3A.1.5-1. Send uplink power control commands to the UE (less or equal to 1dB step size should be used), to ensure that the UE output power is within +0, - 3.4 dB of the target level in table 7.6.3A.1.5-1 for carrier frequency $f \leq 3.0\text{GHz}$ or within +0, -4.0 dB of the target level for carrier frequency $3.0\text{GHz} < f \leq 4.2\text{GHz}$, for at least the duration of the throughput measurement. Suitable uplink power control commands should be sent to ensure the total power in each of the assigned carriers to be equal to each other within +/-[2] dB.
8. Measure the average throughput for each component carrier for duration sufficient to achieve statistical significance according to Annex G.2A.
9. Repeat steps from 6 to 8, using an interfering signal above the wanted signal at step 6.

7.6.3A.1.4.3 Message Contents

Message contents are according to TS 36.508 [7] subclause 4.6. In test procedure step 2, for SCC configuration there are no additional message contents.

7.6.3A.1.5 Test Requirement

The throughput measurement of each carrier derived in test procedure shall be $\geq 95\%$ of the maximum throughput of the reference measurement channels as specified in Annex A.3.2 with parameters specified in Table 7.6.3A.5-1.

Table 7.6.3A.1.5-1: Narrow-band blocking

Parameter	Unit	CA Bandwidth Class				
		B	C	D	E	F

Power per CC in Aggregated Transmission Bandwidth Configuration	dBm	REFSENS + CA Bandwidth Class specific value below			
		16			
P_{UW} (CW)	dBm		-55		
F_{UW} (offset for $\Delta f = 15$ kHz)	MHz		$- F_{offset} - 0.2$ / $+ F_{offset} + 0.2$		
F_{UW} (offset for $\Delta f = 7.5$ kHz)	MHz				
<p>Note 1: The transmitter shall be set to 4dB below $P_{C_{MAX_L}}$ or $P_{C_{MAX_L_CA}}$ as defined in subclause 6.2.5A.</p> <p>Note 2: Reference measurement channel is specified in Annex A.3.2 with one sided dynamic OCNG Pattern OP.1 FDD/TDD as described in Annex A.5.1.1/A.5.2.1.</p> <p>Note 3: The $F_{interferer}$ (offset) is relative to the centre frequency of the adjacent CC being tested and shall be further adjusted to $\lfloor F_{interferer} / 0.015 + 0.5 \rfloor 0.015 + 0.0075$ MHz to be offset from the sub-carrier raster.</p>					

7.6.3A.2 Narrow band blocking for CA (intra-band contiguous DL CA without UL CA)

7.6.3A.2.1 Test Purpose

Same test purpose as 7.6.3A.1.

7.6.3A.2.2 Test Applicability

This test applies to all types of E-UTRA UE release 10 and forward that support intra-band contiguous DL CA without UL CA.

7.6.3A.2.3 Minimum Conformance Requirements

Minimum conformance requirements for intra-band contiguous carrier aggregation with one uplink carrier support as in clause 7.6.3A.1.

7.6.3A.2.4 Test Description

7.6.3A.2.4.1 Initial Conditions

Same initial conditions as in clause 7.6.3A.1.4.1 with the following exceptions:

- instead of Table 7.6.3A.1.4.1-1 → use Table 7.6.3A.2.4.1-1

Table 7.6.3A.2.4.1-1: Test Configuration Table

Initial Conditions							
Test Environment as specified in TS 36.508[7] subclause 4.1					NC		
Test Frequencies as specified in TS36.508 [7] subclause 4.3.1 for different CA bandwidth classes.					C: Mid range		
Test CC Combination setting (N_{RB_agg}) as specified in subclause 5.4.2A.1 for the CA Configuration across bandwidth combination sets supported by the UE.					Lowest N_{RB_agg} Highest N_{RB_agg}		
Test Parameters for CA Configurations							
CA Configuration / N_{RB_agg}		DL Allocation			UL Allocation		
PCC N_{RB}	SCC N_{RB}	CC MOD	PCC & SCC RB allocation	CC MOD	N_{RB_alloc}	PCC & SCC RB allocations (L_{CRB} @ RB_{start})	
75	75	QPSK	75+75	QPSK	75	P_75@0	-
75	75	QPSK	75+75	QPSK	50	P_50@0	-
75	75	QPSK	75+75	QPSK	25	P_25@0	-
75	75	QPSK	75+75	QPSK	20	P_20@0	-
100	50	QPSK	100+50	QPSK	100	P_100@0	-
100	50	QPSK	100+50	QPSK	75	P_75@0	-
100	50	QPSK	100+50	QPSK	50	P_50@0	-
100	50	QPSK	100+50	QPSK	25	P_25@0	-
100	50	QPSK	100+50	QPSK	20	P_20@0	-
100	100	QPSK	100+100	QPSK	100	P_100@0	-
100	100	QPSK	100+100	QPSK	75	P_75@0	-
100	100	QPSK	100+100	QPSK	50	P_50@0	-
100	100	QPSK	100+100	QPSK	25	P_25@0	-
100	100	QPSK	100+100	QPSK	20	P_20@0	-
Note 1: CA Configuration Test CC Combination settings are checked separately for each CA Configuration, which applicable aggregated channel bandwidths are specified in Table 5.4.2A.1-1.							
Note 2: Depending on CA Configuration only the appropriate Uplink RB allocation value according to table 7.3.3-2 is tested per CA Configuration Test CC combination.							

7.6.3A.2.4.2 Test Procedure

Same test procedure as in clause 7.6.3A.1.4.2 with the following exceptions:

- Instead of Table 7.6.3A.1.4.1-1 → use Table 7.6.3A.2.4.1-1

7.6.3A.2.4.3 Message Contents

Message contents are according to TS 36.508 [7] subclause 4.6. In test procedure step 2, for SCC configuration there are no additional message contents.

7.6.3A.2.5 Test Requirement

Same test requirement as in clause 7.6.3A.1.5.

7.6.3A.3 Narrow band blocking for CA (inter-band DL CA without UL CA)

7.6.3A.3.1 Test Purpose

Same test purpose as 7.6.3A.1.

7.6.3A.3.2 Test Applicability

This test applies to all types of E-UTRA UE release 10 and forward that support inter-band DL CA without UL CA.

7.6.3A.3.3 Minimum Conformance Requirements

Minimum conformance requirements for inter-band carrier aggregation with one uplink carrier support as in clause 7.6.3A.1.

7.6.3A.3.4 Test Description

7.6.3A.3.4.1 Initial Conditions

Same initial conditions as in clause 7.6.3A.1.4.1 with the following exceptions:

- instead of Table 7.6.3A.1.4.1-1 → use Table 7.6.3A.3.4.1-1

Table 7.6.3A.3.4.1-1: Test Configuration Table

Initial Conditions						
Test Environment as specified in TS 36.508[7] subclause 4.1		NC				
Test Frequencies as specified in TS36.508 [7] subclause 4.3.1 for different CA bandwidth classes.		A: Mid range for PCC and SCC				
Test CC Combination setting (N_{RB_agg}) as specified in subclause 5.4.2A.1 for the CA Configuration across bandwidth combination sets supported by the UE.		Highest N_{RB_agg} for PCC and SCC				
Test Parameters for CA Configurations						
CA Configuration / N_{RB_agg}		DL Allocation			UL Allocation	
PCC N_{RB}	SCCs N_{RB}	CC MOD	PCC & SCC RB allocation		CC MOD	PCC N_{RB_alloc}
50	50	QPSK	50	50	QPSK	50
50	50	QPSK	50	50	QPSK	25
50	50	QPSK	50	50	QPSK	20
50	50	QPSK	50	50	QPSK	16
50	75	QPSK	50	75	QPSK	25
50	100	QPSK	50	100	QPSK	50
50	100	QPSK	50	100	QPSK	25
50	100	QPSK	50	100	QPSK	20
75	50	QPSK	75	50	QPSK	25
75	100	QPSK	75	100	QPSK	25
100	50	QPSK	100	50	QPSK	100
100	50	QPSK	100	50	QPSK	75
100	50	QPSK	100	50	QPSK	50
100	75	QPSK	100	75	QPSK	100
100	100	QPSK	100	100	QPSK	75
100	100	QPSK	100	100	QPSK	50
Note 1: CA Configuration Test CC Combination settings are checked separately for each CA Configuration, which applicable aggregated channel bandwidths are specified in Table 5.4.2A.1-2. Note 2: Depending on CA configurations, only the appropriate Uplink RB allocation value according to table 7.3.3-2 for UE supporting one uplink carrier is tested per Test CA configuration, unless otherwise stated in table 7.3A.1.3-0b. Note 3: The UL resource blocks shall be located as close as possible to the downlink SCC but confined within the transmission bandwidth configuration for the channel bandwidth (Table 5.4.2-1). Note 4: The frequencies of PCC and SCC shall be switched and tested in each configuration (given UL is supported in PCC band as per Table 5.2-1).						

7.6.3A.3.4.2 Test Procedure

1. Configure SCC according to Annex C0, C.1 and Annex C.3.1 for all downlink physical channels except PHICH.
2. The SS shall configure SCC as per TS 36.508 [7] clause 5.2A.4. Message contents are defined in clause 7.6.3A.3.4.3.
3. SS activates SCC by sending the activation MAC-CE (Refer TS 36.321 [13], clauses 5.13, 6.1.3.8). Wait for at least 2 seconds (Refer TS 36.133, clauses 8.3.3.2).

4. SS transmits PDSCH via PDCCH DCI format 1A for C_RNTI to transmit the DL RMC according to Table 7.6.3A.3.4.1-1 on both PCC and SCC. The SS sends downlink MAC padding bits on the DL RMC.
5. SS sends uplink scheduling information for each UL HARQ process via PDCCH DCI format 0 for C_RNTI to schedule the UL RMC according to Table 7.6.3A.3.4.1-1 on PCC. Since the UE has no payload data to send, the UE transmits uplink MAC padding bits on the UL RMC.
6. Set the parameters of the CW signal generator for an interfering signal below the wanted signal according to Table 7.6.3A.1.5-1.
7. Set the downlink signal level according to the table 7.6.3A.1.5-1. Send uplink power control commands to the UE (less or equal to 1dB step size should be used), to ensure that the UE output power is within +0, - 3.4 dB of the target level in table 7.6.3A.1.5-1 for carrier frequency $f \leq 3.0\text{GHz}$ or within +0, -4.0 dB of the target level for carrier frequency $3.0\text{GHz} < f \leq 4.2\text{GHz}$, for at least the duration of the throughput measurement.
8. Measure the average throughput of SCC for duration sufficient to achieve statistical significance according to Annex G.2A.
9. Repeat steps from 6 to 8, using an interfering signal above the wanted signal at step 6.

7.6.3A.3.4.3 Message Contents

Message contents are according to TS 36.508 [7] subclause 4.6. In test procedure step 2, for SCC configuration there are no additional message contents.

7.6.3A.3.5 Test Requirement

For inter-band carrier aggregation with uplink assigned to one E-UTRA band the narrow-band blocking requirements are defined with the uplink active on the band other than the band whose downlink is being tested, i.e., the requirements are tested only for the S-Cell downlink. The UE shall meet the requirements specified in Table 7.6.3A.3.5-1 for each component carrier, when operated as S-Cell, while both downlink carriers are active. The requirements for each component carrier are the same as single carrier requirements in Table 7.6.3.5-1.

The throughput measurement derived in test procedure shall be $\geq 95\%$ of the maximum throughput of the reference measurement channels as specified in Annex A.3.2 with parameters specified in Table 7.6.3A.3.5-1. The parameters in these tables are related to the carrier operated as S-Cell.

Table 7.6.3A.3.5-1: Narrow-band blocking

Parameter	Unit	Channel Bandwidth					
		1.4 MHz	3 MHz	5 MHz	10 MHz	15 MHz	20 MHz
P_w	dBm	P_{REFSENS} + channel-bandwidth specific value below					
		22	18	16	13	14	16
P_{uw} (CW)	dBm	-55	-55	-55	-55	-55	-55
F_{uw} (offset for $\Delta f = 15$ kHz)	MHz	0.9075	1.7025	2.7075	5.2125	7.7025	10.2075
F_{uw} (offset for $\Delta f = 7.5$ kHz)	MHz						
Note 1: The transmitter shall be set a 4 dB below $P_{\text{CMAX,L}}$ with $P_{\text{CMAX,L}}$ as defined in clause 6.2.5.							
Note 2: The reference measurement channel is specified in Annex A.3.2 with one sided dynamic OCNG Pattern OP.1 FDD/TDD as described in Annex A.5.1.1/A.5.2.1.							

7.6.3B Narrow band blocking for UL-MIMO

7.6.3B.1 Test Purpose

Narrow band blocking for UL-MIMO is defined for an unwanted CW interfering signal falling near the UE that supports UL-MIMO receive band, at which a given average throughput shall meet or exceed the requirement for the specified measurement channels,

The lack of narrow-band blocking ability will decrease the coverage area when other e-NodeB transmitters exist (except in the adjacent channels and spurious response).

7.6.3B.2 Test Applicability

This test applies to all types of E-UTRA UE release 10 and forward that support UL-MIMO.

7.6.3B.3 Minimum Conformance Requirements

For UE with two transmitter antenna connectors in closed-loop spatial multiplexing scheme, the minimum requirements in clause 7.6 shall be met with the UL-MIMO configurations specified in Table 6.2.2B-2. For UL-MIMO, the parameter $P_{\text{CMAX,L}}$ is defined as the total transmitter power over the two transmit antenna connectors.

7.6.3B.4 Test Description

7.6.3B.4.1 Initial Conditions

Initial conditions are a set of test configurations the UE needs to be tested in and the steps for the SS to take with the UE to reach the correct measurement state.

The initial test configurations consist of environmental conditions, test frequencies, and channel bandwidths based on E-UTRA bands specified in table 5.4.2.1-1. All of these configurations shall be tested with applicable test parameters for each channel bandwidth, and are shown in table 7.6.3B.4.1-1. The details of the uplink and downlink reference measurement channels (RMCs) are specified in Annexes A.2 and A.3 respectively. The details of the OCNB patterns used are specified in Annex A.5. Configurations of PDSCH and PDCCH before measurement are specified in Annex C.2.

Table 7.6.3B.4.1-1: Test Configuration Table

Initial Conditions						
Test Environment as specified in TS 36.508 [7] clause 4.1			NC			
Test Frequencies as specified in TS 36.508 [7] clause 4.3.1			Mid range			
Test Channel Bandwidths as specified in TS 36.508 [7] clause 4.3.1			Lowest, 5MHz, Highest			
Test Parameters for Channel Bandwidths						
Ch BW	Downlink Configuration			Uplink Configuration		
	Mod'n	RB allocation		Mod'n	RB allocation	
		FDD	TDD		FDD	TDD
1.4MHz	QPSK	6	6	QPSK	6	6
3MHz	QPSK	15	15	QPSK	15	15
5MHz	QPSK	25	25	QPSK	25	25
5MHz	QPSK	25	N/A	QPSK	20	N/A
5MHz	QPSK	25	N/A	QPSK	15	N/A
10MHz	QPSK	50	50	QPSK	50	50
10MHz	QPSK	50	N/A	QPSK	25	N/A
10MHz	QPSK	50	N/A	QPSK	20	N/A
10MHz	QPSK	50	N/A	QPSK	15	N/A
15MHz	QPSK	75	75	QPSK	75	75
15MHz	QPSK	75	N/A	QPSK	50	N/A
15MHz	QPSK	75	N/A	QPSK	25	N/A
15MHz	QPSK	75	N/A	QPSK	20	N/A
20MHz	QPSK	100	100	QPSK	100	100
20MHz	QPSK	100	N/A	QPSK	75	N/A
20MHz	QPSK	100	N/A	QPSK	50	N/A
20MHz	QPSK	100	N/A	QPSK	25	N/A
20MHz	QPSK	100	N/A	QPSK	20	N/A
Note 1: Test Channel Bandwidths are checked separately for each E-UTRA band, which applicable channel bandwidths are specified in Table 5.4.2.1-1.						
Note 2: Depending on E-UTRA band, only the appropriate Uplink RB allocation value according to table 7.3.3-2 is tested per Test Channel Bandwidth.						
Note 3: For the DL signal one sided dynamic OCNB Pattern OP.1 FDD/TDD is used.						

1. Connect the SS to the UE antenna connectors as shown in TS 36.508 [7] Annex A, Figure A.30.

2. The parameter settings for the cell are set up according to TS 36.508 [7] clause 4.4.3.
3. Downlink signals are initially set up according to Annex C0, C.1 and C.3.1, and uplink signals according to Annex H.1 and H.3.1
4. The UL and DL Reference Measurement channels are set according to Table 7.6.3B.4.1-1.
5. Propagation conditions are set according to Annex B.0.
6. Ensure the UE is in State 3A-RF according to TS 36.508 [7] clause 5.2A.2. Message contents are defined in clause 7.6.3B.4.3.

7.6.3B.4.2 Test Procedure

1. SS transmits PDSCH via PDCCH DCI format 1A for C_RNTI to transmit the DL RMC according to Table 7.6.3B.4.1-1. The SS sends downlink MAC padding bits on the DL RMC.
2. SS sends uplink scheduling information for each UL HARQ process via PDCCH DCI format 4 for C_RNTI to schedule the UL RMC according to Table 7.6.3B.4.1-1. Since the UE has no payload data to send, the UE transmits uplink MAC padding bits on the UL RMC.
3. Set the parameters of the CW signal generator for an interfering signal below the wanted signal according to Table 7.6.3B.5-1.
4. Set the downlink signal level according to the table 7.6.3B.5-1. Send uplink power control commands to the UE (less or equal to 1dB step size should be used), to ensure that the UE output power is within +0, - 3.4 dB of the target level in table 7.6.3B.5-1 for carrier frequency $f \leq 3.0\text{GHz}$ or within +0, -4.0 dB of the target level for carrier frequency $3.0\text{GHz} < f \leq 4.2\text{GHz}$, for at least the duration of the throughput measurement and the UE output power is mean sum power of each antenna connector for UE.
5. Measure the average throughput for a duration sufficient to achieve statistical significance according to Annex G.2.
6. Repeat steps from 3 to 5, using an interfering signal above the wanted signal at step 3.

7.6.3B.4.3 Message Contents

Message contents are according to TS 36.508 [7] clause 4.6 with the following exception.

Table 7.6.3B.4.3-1: UplinkPowerControlDedicated

Derivation Path: 36.331 clause 6.3.2			
Information Element	Value/remark	Comment	Condition
UplinkPowerControlDedicated-DEFAULT ::= SEQUENCE {			
p0-UePUSCH	0		
deltaMCS-Enabled	en0		
accumulationEnabled	TRUE		
p0-uePUCCH	0		
pSRS-Offset	3 (-6 dB)		
filterCoefficient	fc8	larger filter length is used to reduce the RSRP measurement variation	
}			

7.6.3B.5 Test Requirement

The throughput measurement derived in test procedure shall be $\geq 95\%$ of the maximum throughput of the reference measurement channels as specified in Annex A.3.2 with parameters specified in Table 7.6.3B.5-1.

Table 7.6.3B.5-1: Narrow-band blocking

Parameter	Unit	Channel Bandwidth					
		1.4 MHz	3 MHz	5 MHz	10 MHz	15 MHz	20 MHz
P_w	dBm	P_{REFSENS} + channel-bandwidth specific value below					
		22	18	16	13	14	16
$P_{\text{UW}}(\text{CW})$	dBm	-55	-55	-55	-55	-55	-55
F_{UW} (offset for $\Delta f = 15$ kHz)	MHz	0.9075	1.7025	2.7075	5.2125	7.7025	10.2075
F_{UW} (offset for $\Delta f = 7.5$ kHz)	MHz						
Note 1: The transmitter shall be set a 4 dB below P_{CMAX_L} with P_{CMAX_L} as defined in clause 6.2.5.							
Note 2: The reference measurement channel is specified in Annex A.3.2 with one sided dynamic OCNG Pattern OP.1 FDD/TDD as described in Annex A.5.1.1/A.5.2.1.							

7.7 Spurious response

7.7.1 Test Purpose

Spurious response verifies the receiver's ability to receive a wanted signal on its assigned channel frequency without exceeding a given degradation due to the presence of an unwanted CW interfering signal at any other frequency at which a response is obtained i.e. for which the out of band blocking limit as specified in sub-clause 7.6.2 is not met.

The lack of the spurious response ability decreases the coverage area when other unwanted interfering signal exists at any other frequency.

7.7.2 Test Applicability

This test applies to all types of E-UTRA UE release 8 and forward.

7.7.3 Minimum Conformance Requirements

The throughput shall be $\geq 95\%$ of the maximum throughput of the reference measurement channels as specified in Annexes A.2.2, A.2.3 and A.3.2 (with one sided dynamic OCNG Pattern OP.1 FDD/TDD for the DL-signal as described in Annex A.5.1.1/A.5.2.1) with parameters specified in Tables 7.7.3-1 and 7.7.3-2.

Table 7.7.3-1: Spurious response parameters

Rx Parameter	Units	Channel bandwidth					
		1.4 MHz	3 MHz	5 MHz	10 MHz	15 MHz	20 MHz
Power in Transmission Bandwidth Configuration	dBm	$\text{REFSENS} + \text{channel bandwidth specific value below}$					
		6	6	6	6	7	9
Note 1: The transmitter shall be set to 4dB below P_{CMAX_L} at the minimum uplink configuration specified in Table 7.3.3-2 with P_{CMAX_L} as defined in clause 6.2.5.							
Note 2: The reference measurement channel is specified in Annex A.3.2 with one sided dynamic OCNG Pattern OP.1 FDD/TDD as described in Annex A.5.1.1/A.5.2.1.							

Table 7.7.3-2: Spurious Response

Parameter	Unit	Level
$P_{\text{Interferer}}(\text{CW})$	dBm	-44
$F_{\text{Interferer}}$	MHz	Spurious response frequencies

The normative reference for this requirement is TS 36.101 [2] clause 7.7.

7.7.4 Test Description

7.7.4.1 Initial Conditions

The initial conditions shall be the same as in clause 7.6.2.4.1 in order to test spurious responses obtained in clause 7.6.2 under the same conditions.

7.7.4.2 Test Procedure

1. SS transmits PDSCH via PDCCH DCI format 1A for C_RNTI to transmit the DL RMC according to Table 7.6.2.4.1-1. The SS sends downlink MAC padding bits on the DL RMC.
2. SS sends uplink scheduling information for each UL HARQ process via PDCCH DCI format 0 for C_RNTI to schedule the UL RMC according to Table 7.6.2.4.1-1. Since the UE has no payload data to send, the UE transmits uplink MAC padding bits on the UL RMC.
3. Set the parameters of the CW signal generator for an interfering signal according to Table 7.7.5-2. The spurious frequencies are taken from records in the final step of test procedures in clause 7.6.2.4.2.
4. Set the downlink signal level according to the table 7.7.5-1. Send uplink power control commands to the UE (less or equal to 1dB step size should be used), to ensure that the UE output power is within +0, - 3.4 dB of the target level in table 7.7.5-1 for carrier frequency $f \leq 3.0\text{GHz}$ or within +0, -4.0 dB of the target level for carrier frequency $3.0\text{GHz} < f \leq 4.2\text{GHz}$, for at least the duration of the throughput measurement.
5. For the spurious frequency, measure the average throughput for a duration sufficient to achieve statistical significance according to Annex G.2.

7.7.4.3 Message Contents

Message contents are according to TS 36.508 [7] subclause 4.6 with the following exception.

Table 7.7.4.3-1: UplinkPowerControlDedicated

Derivation Path: 36.331 clause 6.3.2			
Information Element	Value/remark	Comment	Condition
UplinkPowerControlDedicated-DEFAULT ::= SEQUENCE {			
p0-UePUSCH	0		
deltaMCS-Enabled	en0		
accumulationEnabled	TRUE		
p0-uePUCCH	0		
pSRS-Offset	3 (-6 dB)		
filterCoefficient	fc8	larger filter length is used to reduce the RSRP measurement variation	
}			

7.7.5 Test Requirement

The throughput measurement derived in test procedure shall be $\geq 95\%$ of the maximum throughput of the reference measurement channels as specified in Annex A.3.2 with parameters specified in Tables 7.7.5-1 and 7.7.5-2.

Table 7.7.5-1: Spurious response parameters

Rx Parameter	Units	Channel bandwidth					
		1.4 MHz	3 MHz	5 MHz	10 MHz	15 MHz	20 MHz
Power in Transmission Bandwidth Configuration	dBm	REFSENS + channel bandwidth specific value below					
		6	6	6	6	7	9

Note 1:	The transmitter shall be set to 4dB below $P_{\text{CMAX_L}}$ with $P_{\text{CMAX_L}}$ as defined in clause 6.2.5.
Note 2:	The reference measurement channel is specified in Annex A.3.2 with one sided dynamic OCNG Pattern OP.1 FDD/TDD as described in Annex A.5.1.1/A.5.2.1.

Table 7.7.5-2: Spurious Response

Parameter	Unit	Level
$P_{\text{Interferer}}$ (CW)	dBm	-44
$F_{\text{Interferer}}$	MHz	Spurious response frequencies

7.7A Spurious response for CA

7.7A.1 Spurious response for CA (intra-band contiguous DL CA and UL CA)

7.7A.1.1 Test Purpose

Spurious response for CA verifies the receiver's ability to receive a wanted aggregated signal on its assigned channel frequency without exceeding a given degradation due to the presence of an unwanted CW interfering signal at any other frequency at which a response is obtained i.e. for which the out of band blocking limit as specified in sub-clause 7.6.2A is not met.

The lack of the spurious response ability decreases the coverage area when other unwanted interfering signal exists at any other frequency.

7.7A.1.2 Test Applicability

This test applies to all types of E-UTRA UE release 10 and forward that support intra-band contiguous DL CA and UL CA.

7.7A.1.3 Minimum Conformance Requirements

For inter-band carrier aggregation with uplink assigned to one E-UTRA band the spurious response requirements are defined with the uplink active on the band other than the band whose downlink is being tested. The throughput measured in each downlink with $F_{\text{interferer}}$ in Table 7.6.2A.1.3-0 at spurious response frequencies shall be $\geq 95\%$ of the maximum throughput of the reference measurement channels as specified in Annexes A.2.2, A.2.3 and A.3.2 (with one sided dynamic OCNG Pattern OP.1 FDD/TDD for the DL-signal as described in Annex A.5.1.1/A.5.2.1) with parameters specified in Tables 7.7.3-1 and 7.7.3-2. The UE shall meet these requirements for each component carrier while both downlink carriers are active.

For E-UTRA CA configurations including an operating band without uplink band (as noted in Table 5.2-1), the requirements for both downlinks shall be met with the uplink active in the band capable of UL operation. For E-UTRA CA configurations listed in Table 7.3A.1.3-0a under conditions for which reference sensitivity for the operating band being tested is N/A, the spurious response requirements of subclause 7.7A.1.3 do not apply.

For intra-band contiguous carrier aggregation the downlink SCC shall be configured at nominal channel spacing to the PCC with the PCC configured closest to the uplink band. Downlink PCC and SCC are both activated. The uplink output power shall be set as specified in Table 7.7A.1.3-1 with the uplink configuration set according to Table 7.3A.1A.3-1 for the applicable carrier aggregation configuration. For UE(s) supporting one uplink carrier, the uplink configuration of the PCC shall be in accordance with Table 7.3.3-2. The throughput shall be $\geq 95\%$ of the maximum throughput of the reference measurement channels as specified in Annexes A.2.2, A.2.3 and A.3.2 (with one sided dynamic OCNG Pattern OP.1 FDD/TDD for the DL-signal as described in Annex A.5.1.1/A.5.2.1) with parameters specified in Tables 7.7A.1.3-1 and 7.7A.1.3-2.

Table 7.7A.1.3-1: Spurious response parameters

Rx Parameter	Units	CA Bandwidth Class				
		B	C	D	E	F
Power per CC in Aggregated Transmission Bandwidth Configuration	dBm	REFSENS + CA Bandwidth Class specific value below				
			9			
Note 1: The transmitter shall be set to 4dB below $P_{\text{CMAX_L}}$ or $P_{\text{CMAX_L_CA}}$ as defined in subclause 6.2.5A.						
Note 2: Reference measurement channel is specified in Annex A.3.2 with one sided dynamic OCNG Pattern OP.1 FDD/TDD as described in Annex A.5.1.1/A.5.2.1.						

Table 7.7A.1.3-2: Spurious response

Parameter	Unit	Level
$P_{\text{Interferer (CW)}}$	dBm	-44
$F_{\text{Interferer}}$	MHz	Spurious response frequencies

The normative reference for this requirement is TS 36.101 [2] clause 7.7.1A.

7.7A.1.4 Test Description

7.7A.1.4.1 Initial Conditions

The initial conditions shall be the same as in clause 7.6.2A.1.4.1 in order to test spurious responses obtained in clause 7.6.2A.1 under the same conditions.

7.7A.1.4.2 Test Procedure

1. Configure SCC according to Annex C0, C.1 and Annex C.3.1 for all downlink physical channels except PHICH.
2. The SS shall configure SCC as per TS 36.508 [7] clause 5.2A.4. Message contents are defined in clause 7.7A.1.4.3.
3. SS activates SCC by sending the activation MAC-CE (Refer TS 36.321 [13], clauses 5.13, 6.1.3.8). Wait for at least 2 seconds (Refer TS 36.133, clauses 8.3.3.2).
4. SS transmits PDSCH via PDCCH DCI format 1A for C_{RNTI} to transmit the DL RMC according to Table 7.6.2A.1.4.1-1 on both PCC and SCC. The SS sends downlink MAC padding bits on the DL RMC.
5. SS sends uplink scheduling information for each UL HARQ process via PDCCH DCI format 0 for C_{RNTI} to schedule the UL RMC according to Table 7.6.2A.1.4.1-1 on both PCC and SCC. Since the UE has no payload data to send, the UE transmits uplink MAC padding bits on the UL RMC.
6. Set the parameters of the CW signal generator for an interfering signal below the wanted aggregated signal according to Table 7.7A.1.5-2. The spurious frequencies are taken from records in the final step of test procedures in clause 7.6.2A.1.4.2.
7. Set the downlink signal level according to the table 7.7A.1.5-1 for both carriers. Send uplink power control commands to the UE (less or equal to 1dB step size should be used), to ensure that the UE output power is within +0, - 3.4 dB of the target level in table 7.7A.1.5-1 for carrier frequency $f \leq 3.0\text{GHz}$ or within +0, -4.0 dB of the target level for carrier frequency $3.0\text{GHz} < f \leq 4.2\text{GHz}$, for at least the duration of the throughput measurement. Suitable uplink power control commands should be sent to ensure the total power in each of the assigned carriers to be equal to each other within +/-[2] dB.
8. For each spurious frequency, measure the average throughput for each component carrier for duration sufficient to achieve statistical significance according to Annex G.2A.

7.7A.1.4.3 Message Contents

Message contents are according to TS 36.508 [7] subclause 4.6. In test procedure step 2, for SCC configuration there are no additional message contents.

7.7A.1.5 Test Requirement

The throughput measurement of each carrier derived in test procedure shall be $\geq 95\%$ of the maximum throughput of the reference measurement channels as specified in Annex A.3.2 with parameters specified in Table 7.7A.1.5-1 and 7.7A.1.5-2.

Table 7.7A.1.5-1: Spurious response parameters

Rx Parameter	Units	CA Bandwidth Class				
		B	C	D	E	F
Power per CC in Aggregated Transmission Bandwidth Configuration	dBm	REFSENS + CA Bandwidth Class specific value below				
			9			
Note 1: The transmitter shall be set to 4dB below $P_{\text{CMAX_L}}$ or $P_{\text{CMAX_L_CA}}$ as defined in subclause 6.2.5A.						
Note 2: Reference measurement channel is specified in Annex A.3.2 with one sided dynamic OCNG Pattern OP.1 FDD/TDD as described in Annex A.5.1.1/A.5.2.1.						

Table 7.7A.1.5-2: Spurious response

Parameter	Unit	Level
$P_{\text{Interferer}}$ (CW)	dBm	-44
$F_{\text{Interferer}}$	MHz	Spurious response frequencies

7.7A.2 Spurious response for CA (intra-band contiguous DL CA without UL CA)

7.7A.2.1 Test Purpose

Same test purpose as in clause 7.7A.1.

7.7A.2.2 Test Applicability

This test applies to all types of E-UTRA UE release 10 and forward that support intra-band contiguous DL CA without UL CA.

7.7A.2.3 Minimum Conformance Requirements

Minimum conformance requirements for intra-band contiguous carrier aggregation with one uplink carrier support as in clause 7.7A.1.

7.7A.2.4 Test Description

7.7A.2.4.1 Initial Conditions

The initial conditions shall be the same as in clause 7.6.2A.2.4.1 in order to test spurious responses obtained in clause 7.6.2A.2 under the same conditions.

7.7A.2.4.2 Test Procedure

Same test procedure as in clause 7.7A.1.4.2 with the following exceptions:

- In step 6, the spurious frequencies are taken from records in the final step of test procedures in clause 7.6.2A.2.4.2.

7.7A.2.4.3 Message Contents

Message contents are according to TS 36.508 [7] subclause 4.6. In test procedure step 2, for SCC configuration there are no additional message contents.

7.7A.2.5 Test Requirement

Same test requirement as in clause 7.7A.1.5.

7.7A.3 Spurious response for CA (inter-band DL CA without UL CA)

7.7A.3.1 Test Purpose

Same test purpose as in clause 7.7A.1.

7.7A.3.2 Test Applicability

This test applies to all types of E-UTRA UE release 10 and forward that support inter-band DL CA without UL CA.

7.7A.3.3 Minimum Conformance Requirements

Minimum conformance requirements for inter-band carrier aggregation with one uplink carrier support as in clause 7.7A.1.

7.7A.3.4 Test Description

7.7A.3.4.1 Initial Conditions

The initial conditions shall be the same as in clause 7.6.2A.3.4.1 in order to test spurious responses obtained in clause 7.6.2A.3 under the same conditions.

7.7A.3.4.2 Test Procedure

1. Configure SCC according to Annex C0, C.1 and Annex C.3.1 for all downlink physical channels except PHICH.
2. The SS shall configure SCC as per TS 36.508 [7] clause 5.2A.4. Message contents are defined in clause 7.7A.3.4.3.
3. SS activates SCC by sending the activation MAC-CE (Refer TS 36.321 [13], clauses 5.13, 6.1.3.8). Wait for at least 2 seconds (Refer TS 36.133, clauses 8.3.3.2).
4. SS transmits PDSCH via PDCCH DCI format 1A for C_RNTI to transmit the DL RMC according to Table 7.6.2A.3.4.1-1 on both PCC and SCC. The SS sends downlink MAC padding bits on the DL RMC.
5. SS sends uplink scheduling information for each UL HARQ process via PDCCH DCI format 0 for C_RNTI to schedule the UL RMC according to Table 7.6.2A.3.4.1-1 on PCC. Since the UE has no payload data to send, the UE transmits uplink MAC padding bits on the UL RMC.
6. Set the parameters of the CW signal generator for an interfering signal below or above the wanted aggregated signal according to Table 7.7A.3.5-2. The spurious frequencies are taken from records in the step 9 of test procedures in clause 7.6.2A.3.4.2.
7. Set the downlink signal level according to the table 7.7A.3.5-1 for both carriers. Send uplink power control commands to the UE (less or equal to 1dB step size should be used), to ensure that the UE output power is within +0, - 3.4 dB of the target level in table 7.7A.3.5-1 for carrier frequency $f \leq 3.0\text{GHz}$ or within +0, -4.0 dB of the target level for carrier frequency $3.0\text{GHz} < f \leq 4.2\text{GHz}$, for at least the duration of the throughput measurement. Suitable uplink power control commands should be sent to ensure the total power in each of the assigned carriers to be equal to each other within +/-[2] dB.
8. For each spurious frequency, measure the average throughput of SCC for duration sufficient to achieve statistical significance according to Annex G.2A.

7.7A.3.4.3 Message Contents

Message contents are according to TS 36.508 [7] subclause 4.6.

7.7A.3.5 Test Requirement

For inter-band carrier aggregation with uplink assigned to one E-UTRA band the out-of-band blocking requirements are defined with the uplink active on the band other than the band whose downlink is being tested i.e. the requirements are tested only for the S-Cell downlink. The requirements for each component carrier are the same as single carrier requirements in Tables 7.7.5-1 and 7.7.5-2.

The throughput measurement derived in the test procedure for each downlink shall be $\geq 95\%$ of the maximum throughput of the reference measurement channels as specified in Annexes A.2.2, A.2.3 and A.3.2 (with one sided dynamic OCNG Pattern OP.1 FDD/TDD for the DL-signal as described in Annex A.5.1.1/A.5.2.1) with parameters specified in Tables 7.7A.3.5-1 and 7.7A.3.5-2. The parameters in these tables are related to the carrier operated as S-Cell.

Table 7.7A.3.5-1: Spurious response parameters

Rx Parameter	Units	Channel bandwidth					
		1.4 MHz	3 MHz	5 MHz	10 MHz	15 MHz	20 MHz
Power in Transmission Bandwidth Configuration	dBm	REFSENS + channel bandwidth specific value below					
		6	6	6	6	7	9
Note 1: The transmitter shall be set to 4dB below $P_{\text{CMAX_L}}$ with $P_{\text{CMAX_L}}$ as defined in clause 6.2.5.							
Note 2: The reference measurement channel is specified in Annex A.3.2 with one sided dynamic OCNG Pattern OP.1 FDD/TDD as described in Annex A.5.1.1/A.5.2.1.							

Table 7.7A.3.5-2: Spurious Response

Parameter	Unit	Level
$P_{\text{Interferer}}$ (CW)	dBm	-44
$F_{\text{Interferer}}$	MHz	Spurious response frequencies

7.7B Spurious response for UL-MIMO

7.7B.1 Test Purpose

Spurious response verifies the ability of the UE that support UL-MIMO to receive a wanted signal on its assigned channel frequency without exceeding a given degradation due to the presence of an unwanted CW interfering signal at any other frequency at which a response is obtained i.e. for which the out of band blocking limit as specified in sub-clause 7.6B.2 is not met.

The lack of the spurious response ability decreases the coverage area when other unwanted interfering signal exists at any other frequency.

7.7B.2 Test Applicability

This test applies to all types of E-UTRA UE release 10 and forward that support UL-MIMO.

7.7B.3 Minimum Conformance Requirements

For UE with two transmitter antenna connectors in closed-loop spatial multiplexing scheme, the minimum requirements in Clause 7.7.3 shall be met with the UL-MIMO configurations specified in Table 6.2.2B.3-2. For UL-MIMO, the parameter $P_{\text{CMAX_L}}$ is defined as the total transmitter power over the two transmit antenna connectors.

The normative reference for this requirement is TS 36.101 [2] clause 7.7.1B.

7.7B.4 Test Description

7.7B.4.1 Initial Conditions

The initial conditions shall be the same as in clause 7.6B.2.4.1 in order to test spurious responses obtained in clause 7.6B.2 under the same conditions.

7.7B.4.2 Test Procedure

1. SS transmits PDSCH via PDCCH DCI format 1A for C_RNTI to transmit the DL RMC according to Table 7.6.2B.4.1-1. The SS sends downlink MAC padding bits on the DL RMC.
2. SS sends uplink scheduling information for each UL HARQ process via PDCCH DCI format 4 for C_RNTI to schedule the UL RMC according to Table 7.6B.2.4.1-1. Since the UE has no payload data to send, the UE transmits uplink MAC padding bits on the UL RMC.
3. Set the parameters of the CW signal generator for an interfering signal according to Table 7.7B.5-2. The spurious frequencies are taken from records in the final step of test procedures in clause 7.6B.2.4.2.
4. Set the downlink signal level according to the table 7.7B.5-1. Send uplink power control commands to the UE (less or equal to 1dB step size should be used), to ensure that the UE output power is within +0, - 3.4 dB of the target level in table 7.7B.5-1 for carrier frequency $f \leq 3.0\text{GHz}$ or within +0, -4.0 dB of the target level for carrier frequency $3.0\text{GHz} < f \leq 4.2\text{GHz}$, for at least the duration of the throughput measurement.
5. For the spurious frequency, measure the average throughput for a duration sufficient to achieve statistical significance according to Annex G.2.

7.7B.4.3 Message Contents

Message contents are according to TS 36.508 [7] clause 4.6 with the following exception.

Table 7.7B.4.3-1: UplinkPowerControlDedicated

Derivation Path: 36.331 clause 6.3.2			
Information Element	Value/remark	Comment	Condition
UplinkPowerControlDedicated-DEFAULT ::= SEQUENCE {			
p0-UePUSCH	0		
deltaMCS-Enabled	en0		
accumulationEnabled	TRUE		
p0-uePUCCH	0		
pSRS-Offset	3 (-6 dB)		
filterCoefficient	fc8	larger filter length is used to reduce the RSRP measurement variation	
}			

7.7B.5 Test Requirement

The throughput measurement derived in test procedure shall be $\geq 95\%$ of the maximum throughput of the reference measurement channels as specified in Annex A.3.2 with parameters specified in Tables 7.7B.5-1 and 7.7B.5-2.

Table 7.7B.5-1: Spurious response parameters

Rx Parameter	Units	Channel bandwidth					
		1.4 MHz	3 MHz	5 MHz	10 MHz	15 MHz	20 MHz
Power in Transmission	dBm	REFSENS + channel bandwidth specific value below					
		6	6	6	6	7	9

Bandwidth Configuration							
Note 1:	The transmitter shall be set to 4dB below P_{CMAX_L} with P_{CMAX_L} as defined in clause 6.2.5.						
Note 2:	The reference measurement channel is specified in Annex A.3.2 with one sided dynamic OCNG Pattern OP.1 FDD/TDD as described in Annex A.5.1.1/A.5.2.1.						

Table 7.7B.5-2: Spurious Response

Parameter	Unit	Level
$P_{Interferer}$ (CW)	dBm	-44
$F_{Interferer}$	MHz	Spurious response frequencies

7.8 Intermodulation characteristics

7.8.1 Wide band Intermodulation

7.8.1.1 Test purpose

Intermodulation response tests the UE's ability to receive data with a given average throughput for a specified reference measurement channel, in the presence of two or more interfering signals which have a specific frequency relationship to the wanted signal, under conditions of ideal propagation and no added noise.

A UE unable to meet the throughput requirement under these conditions will decrease the coverage area when two or more interfering signals exist which have a specific frequency relationship to the wanted signal.

7.8.1.2 Test applicability

This test applies to all types of E-UTRA UE release 8 and forward.

7.8.1.3 Minimum conformance requirements

Intermodulation response rejection is a measure of the capability of the receiver to receive a wanted signal on its assigned channel frequency in the presence of two or more interfering signals which have a specific frequency relationship to the wanted signal.

The throughput shall be $\geq 95\%$ of the maximum throughput of the reference measurement channels as specified in Annexes A.2.2, A.2.3 and A.3.2 (with one sided dynamic OCNG Pattern OP.1 FDD/TDD for the DL-signal as described in Annex A.5.1.1/A.5.2.1) with parameters specified in Table 7.8.1.3-1 for the specified wanted signal mean power in the presence of two interfering signals.

Table 7.8.1.3-1: Wide band intermodulation

Rx Parameter	Units	Channel bandwidth					
		1.4 MHz	3 MHz	5 MHz	10 MHz	15 MHz	20 MHz
Power in Transmission Bandwidth Configuration	dBm	REFSENS + channel bandwidth specific value below					
		12	8	6	6	7	9

$P_{\text{Interferer 1}}$ (CW)	dBm	-46		
$P_{\text{Interferer 2}}$ (Modulated)	dBm	-46		
$BW_{\text{Interferer 2}}$		1.4	3	5
$F_{\text{Interferer 1}}$ (Offset)	MHz	$-BW/2 - 2.1$ / $+BW/2 + 2.1$	$-BW/2 - 4.5$ / $+BW/2 + 4.5$	$-BW/2 - 7.5$ / $+BW/2 + 7.5$
$F_{\text{Interferer 2}}$ (Offset)	MHz	$2 * F_{\text{Interferer 1}}$		
Note 1:	The transmitter shall be set to 4dB below $P_{\text{CMAX_L}}$ at the minimum uplink configuration specified in Table 7.3.3-2 with $P_{\text{CMAX_L}}$ as defined in clause 6.2.5.			
Note 2:	The reference measurement channel is specified in Annex A.3.2 with one sided dynamic OCNG Pattern OP.1 FDD/TDD as described in Annex A.5.1.1/A.5.2.1.			
Note 3:	The modulated interferer consists of the Reference measurement channel specified in Annex A.3.2 with one sided dynamic OCNG Pattern OP.1 FDD/TDD as described in Annex A.5.1.1/A.5.2.1 with set-up according to Annex C.3.1. The interfering modulated signal is 5MHz E-UTRA signal as described in Annex D for channel bandwidth $\geq 5\text{MHz}$			

For the UE which supports inter band CA configuration in Table 7.3.1A-2, $P_{\text{interferer1}}$ and $P_{\text{interferer2}}$ powers defined in Table 7.8.1.1-1 are increased by the amount given by ΔR_{IB} in Table 7.3.1A-2.

The normative reference for this requirement is TS 36.101 [2] clause 7.8.1 and TS 36.101 [2] Annexes A and D.

[FFS: Although it is not explicitly stated in TS 36.101 [2] whether the modulated interferer defined in 36.101 Annex D applies to wanted channel bandwidths of less than 5MHz, this test specification has assumed that the modulated interferer definition applies to all channel bandwidths. The content of TS 36.101 [2] Annex D.2 has been copied into Annex FFS of the present document]

7.8.1.4 Test description

7.8.1.4.1 Initial condition

Initial conditions are a set of test configurations the UE needs to be tested in and the steps for the SS to take with the UE to reach the correct measurement state.

The initial test configurations consist of environmental conditions, test frequencies, and channel bandwidths based on E-UTRA bands specified in table 5.4.2.1-1. All of these configurations shall be tested with applicable test parameters for each channel bandwidth, and are shown in table 7.8.1.4.1-1. The details of the uplink and downlink reference measurement channels (RMCs) are specified in Annexes A.2 and A.3 respectively. The details of the OCNG patterns used are specified in Annex A.5. Configurations of PDSCH and PDCCH before measurement are specified in Annex C.2.

Table 7.8.1.4.1-1: Test Configuration Table

Initial Conditions					
Test Environment as specified in TS 36.508[7] subclause 4.1	NC				
Test Frequencies as specified in TS36.508 [7] subclause 4.3.1	Mid range				
Test Channel Bandwidths as specified in TS 36.508 [7] subclause 4.3.1	Lowest, 5MHz, Highest				
Test Parameters for Channel Bandwidths					
	<table border="1"> <thead> <tr> <th>Downlink Configuration</th> <th>Uplink Configuration</th> </tr> </thead> <tbody> <tr> <td></td> <td></td> </tr> </tbody> </table>	Downlink Configuration	Uplink Configuration		
Downlink Configuration	Uplink Configuration				

Ch BW	Mod'n	RB allocation		Mod'n	RB allocation	
		FDD	TDD		FDD	TDD
1.4MHz	QPSK	6	6	QPSK	6	6
3MHz	QPSK	15	15	QPSK	15	15
5MHz	QPSK	25	25	QPSK	25	25
5MHz	QPSK	25	N/A	QPSK	20	N/A
5MHz	QPSK	25	N/A	QPSK	15	N/A
10MHz	QPSK	50	50	QPSK	50	50
10MHz	QPSK	50	N/A	QPSK	25	N/A
10MHz	QPSK	50	N/A	QPSK	20	N/A
10MHz	QPSK	50	N/A	QPSK	15	N/A
15MHz	QPSK	75	75	QPSK	75	75
15MHz	QPSK	75	N/A	QPSK	50	N/A
15MHz	QPSK	75	N/A	QPSK	25	N/A
15MHz	QPSK	75	N/A	QPSK	20	N/A
20MHz	QPSK	100	100	QPSK	100	100
20MHz	QPSK	100	N/A	QPSK	75	N/A
20MHz	QPSK	100	N/A	QPSK	50	N/A
20MHz	QPSK	100	N/A	QPSK	25	N/A
20MHz	QPSK	100	N/A	QPSK	20	N/A

Note 1: Test Channel Bandwidths are checked separately for each E-UTRA band, which applicable channel bandwidths are specified in Table 5.4.2.1-1.

Note 2: Depending on E-UTRA band, only the appropriate Uplink RB allocation value according to table 7.3.3-2 is tested per Test Channel Bandwidth. The allocation shall be located as close as possible to the downlink operating band but confined within the transmission bandwidth configuration for the channel bandwidth (Table 5.4.2-1).

Note 3: For the DL signal one sided dynamic OCN Pattern OP.1 FDD/TDD is used.

1. Connect the SS and interfering sources to the UE antenna connectors as shown in TS 36.508 [7] Figure A.6.
2. The parameter settings for the cell are set up according to TS 36.508 [7] subclause 4.4.3.
3. Downlink signals are initially set up according to Annex C.0, C.1 and C.3.1, and uplink signals according to Annex H.1 and H.3.1.
4. The UL and DL Reference Measurement channels are set according to Table 7.8.1.4.1-1.
5. Propagation conditions are set according to Annex B.0.
6. Ensure the UE is in State 3A-RF according to TS 36.508 [7] clause 5.2A.2. Message contents are defined in clause 7.8.1.4.3.

7.8.1.4.2 Test procedure

1. SS transmits PDSCH via PDCCH DCI format 1A for C_RNTI to transmit the DL RMC according to Table 7.8.1.4.1-1. The SS sends downlink MAC padding bits on the DL RMC.
2. SS sends uplink scheduling information for each UL HARQ process via PDCCH DCI format 0 for C_RNTI to schedule the UL RMC according to Table 7.8.1.4.1-1. Since the UE has no payload data to send, the UE transmits uplink MAC padding bits on the UL RMC.
3. Set the Downlink signal level to the value as defined in Table 7.8.1.5-1. Send Uplink power control commands to the UE (less or equal to 1dB step size should be used), to ensure that the UE output power is within +0, - 3.4 dB of the target level in Table 7.8.1.5-1 for carrier frequency $f \leq 3.0\text{GHz}$ or within +0, -4.0 dB of the target level for carrier frequency $3.0\text{GHz} < f \leq 4.2\text{GHz}$, for at least the duration of the Throughput measurement.
4. Set the Interfering signal levels to the values as defined in Table 7.8.1.5-1 and frequency below the wanted signal, using a modulated interferer bandwidth as defined in Annex D of the present document.
5. Measure the average throughput for a duration sufficient to achieve statistical significance according to Annex G.2.
6. Repeat steps from 3 to 5, using an interfering signal above the wanted signal at step 4.

7.8.1.4.3 Message contents

Message contents are according to TS 36.508 [7] subclause 4.6 with the following exception.

Table 7.8.1.4.3-1: UplinkPowerControlDedicated

Derivation Path: 36.331 clause 6.3.2			
Information Element	Value/remark	Comment	Condition
UplinkPowerControlDedicated-DEFAULT ::= SEQUENCE {			
p0-UePUSCH	0		
deltaMCS-Enabled	en0		
accumulationEnabled	TRUE		
p0-uePUCCH	0		
pSRS-Offset	3 (-6 dB)		
filterCoefficient	fc8	larger filter length is used to reduce the RSRP measurement variation	
}			

7.8.1.5 Test requirements

The throughput shall be $\geq 95\%$ of the maximum throughput of the reference measurement channels as specified in Annex A.3.2 with parameters specified in Table 7.8.1.5-1 for the specified wanted signal mean power in the presence of two interfering signals.

Table 7.8.1.5-1: Test parameters for Wide band intermodulation

Rx Parameter	Units	Channel bandwidth					
		1.4 MHz	3 MHz	5 MHz	10 MHz	15 MHz	20 MHz
Power in Transmission Bandwidth Configuration	dBm	REFSENS + channel bandwidth specific value below					
		12	8	6	6	7	9
$P_{\text{Interferer 1 (CW)}}$	dBm	-46					
$P_{\text{Interferer 2 (Modulated)}}$	dBm	-46					
$BW_{\text{Interferer 2}}$		1.4	3	5			
$F_{\text{Interferer 1 (Offset)}}$	MHz	-BW/2 -2.1 / +BW/2+ 2.1	-BW/2 -4.5 / +BW/2 + 4.5	-BW/2 - 7.5 / +BW/2 + 7.5			
$F_{\text{Interferer 2 (Offset)}}$	MHz	$2 * F_{\text{Interferer 1}}$					
Note 1:	The transmitter shall be set to 4dB below $P_{\text{CMAX_L}}$ with $P_{\text{CMAX_L}}$ as defined in clause 6.2.5.						
Note 2:	The reference measurement channel is specified in Annex A.3.2 with one sided dynamic OCNG Pattern OP.1 FDD/TDD as described in Annex A.5.1.1/A.5.2.1.						
Note 3:	The modulated interferer consists of the Reference measurement channel specified in Annex A.3.2 with one sided dynamic OCNG Pattern OP.1 FDD/TDD as described in Annex A.5.1.1/A.5.2.1 and set-up according to Annex C.3.1. The interfering modulated signal is 5MHz E-UTRA signal as described in Annex D for channel bandwidth $\geq 5\text{MHz}$						
Note 4:	For the UE which supports inter band CA configuration in Table 7.3A.3-0, $P_{\text{Interferer1}}$ and $P_{\text{Interferer2}}$ powers are increased by the amount given by ΔR_{IB} in Table 7.3A.3-0						

7.8.1A Wide band Intermodulation for CA

7.8.1A.1 Wideband intermodulation for CA (intra-band contiguous DL CA and UL CA)

7.8.1A.1.1 Test purpose

Intermodulation response tests the UE's ability to receive data with a given average throughput for a specified reference measurement channel, in the presence of two or more interfering signals which have a specific frequency relationship to the wanted signal, under conditions of ideal propagation and no added noise.

A UE unable to meet the throughput requirement under these conditions will decrease the coverage area when two or more interfering signals exist which have a specific frequency relationship to the wanted signal.

7.8.1A.1.2 Test applicability

This test applies to all types of E-UTRA UE release 10 and forward that supports intra-band contiguous DL CA and UL CA.

7.8.1A.1.3 Minimum conformance requirements

For inter-band carrier aggregation with uplink assigned to one E-UTRA band the wide band intermodulation requirements are defined with the uplink active on the band other than the band whose downlink is being tested. The UE shall meet the requirements specified in subclause 7.8.1.3 for each component carrier while both downlink carriers are active. For E-UTRA CA configurations including an operating band without uplink band (as noted in Table 5.2-1), the requirements for both downlinks shall be met with the uplink active in the band capable of UL operation. For E-UTRA CA configurations listed in Table 7.3A.1.3-0a under conditions for which reference sensitivity for the operating band being tested is N/A, the wideband intermodulation requirements of subclause 7.8.1A.1.3 do not apply.

For intra-band contiguous carrier aggregation the downlink SCC shall be configured at nominal channel spacing to the PCC with the PCC configured closest to the uplink band. Downlink PCC and SCC are both activated. The uplink output power shall be set as specified in Table 7.8.1A.1.3-1 with the uplink configuration set according to Table 7.3A.1.3-1 for the applicable carrier aggregation configuration. For UE(s) supporting one uplink carrier, the uplink configuration of the PCC shall be in accordance with Table 7.3.3-2. The UE shall fulfil the minimum requirement in presence of an interfering signal specified in Table 7.8.1A.1.3-1 being on either side of the aggregated signal. The throughput of each carrier shall be $\geq 95\%$ of the maximum throughput of the reference measurement channels as specified in Annexes A.2.2, A.2.3 and A.3.2 (with one sided dynamic OCNG Pattern OP.1 FDD/TDD for the DL-signal as described in Annex A.5.1.1/A.5.2.1) with parameters specified in Table 7.8.1A.1.3-1

Table 7.8.1A.1.3-1: Wide band intermodulation

Rx parameter	Units	CA Bandwidth Class				
		B	C	D	E	F
Power per CC in Aggregated Transmission Bandwidth Configuration	dBm	REFSENS + CA Bandwidth Class specific value below				
			12			

$P_{\text{Interferer 1}}$ (CW)	dBm	-46				
$P_{\text{Interferer 2}}$ (Modulated)	dBm	-46				
$BW_{\text{Interferer 2}}$	MHz	5				
$F_{\text{Interferer 1}}$ (Offset)	MHz	$\begin{matrix} -F_{\text{offset}}-7.5 \\ / \\ + F_{\text{offset}}+7.5 \end{matrix}$				
$F_{\text{Interferer 2}}$ (Offset)	MHz	$2 * F_{\text{Interferer 1}}$				
NOTE 1: The transmitter shall be set to 4dB below $P_{\text{CMAX_L}}$ or $P_{\text{CMAX_L_CA}}$ as defined in subclause 6.2.5A.						
NOTE 2: Reference measurement channel is specified in Annex A.3.2 with one sided dynamic OCNG Pattern OP.1 FDD/TDD as described in Annex A.5.1.1/A.5.2.1.						
NOTE 3: The modulated interferer consists of the Reference measurement channel specified in Annex A.3.2 with one sided dynamic OCNG Pattern OP.1 FDD/TDD as described in Annex A.5.1.1/A.5.2.1 with set-up according to Annex C.3.1.						
NOTE 4: The interfering modulated signal is 5MHz E-UTRA signal as described in Annex D for channel bandwidth $\geq 5\text{MHz}$						

The normative reference for this requirement is TS 36.101 [2] clause 7.8.1A and TS 36.101 [2] Annexes A and D.

7.8.1A.1.4 Test description

7.8.1A.1.4.1 Initial condition

Initial conditions are a set of test configurations the UE needs to be tested in and the steps for the SS to take with the UE to reach the correct measurement state.

The initial test configurations consist of environmental conditions, test frequencies, and channel bandwidths based on E-UTRA bands specified in table 5.4.2.1-1. All of these configurations shall be tested with applicable test parameters for each channel bandwidth, and are shown in table 7.8.1A.1.4.1-1. The details of the uplink and downlink reference measurement channels (RMCs) are specified in Annexes A.2 and A.3 respectively. The details of the OCNG patterns used are specified in Annex A.5. Configurations of PDSCH and PDCCH before measurement are specified in Annex C.2.

Table 7.8.1A.1.4.1-1: Test Configuration Table

Initial Conditions								
Test Environment as specified in TS 36.508[7] subclause 4.1					Normal			
Test Frequencies as specified in TS36.508 [7] subclause 4.3.1 for different CA bandwidth classes.					C: Mid range			
Test CC Combination setting ($N_{\text{RB_agg}}$) as specified in subclause 5.4.2A.1 for the CA Configuration across bandwidth combination sets supported by the UE.					Lowest $N_{\text{RB_agg}}$, Highest $N_{\text{RB_agg}}$			
Test Parameters for CA Configurations								
CA Configuration / $N_{\text{RB_agg}}$			DL Allocation		UL Allocation			
PCC N_{RB}	SCCs N_{RB}	CC MOD	PCC & SCC RB allocation		CC MOD	$N_{\text{RB_alloc}}$	PCC & SCC RB allocations (L_{CRB} @ RB_{start})	
75	75	QPSK	75+75		QPSK	75	P_75@0	S_0@0
75	75	QPSK	75+75		QPSK	130	P_75@0	S_55@0
75	75	QPSK	75+75		QPSK	150	P_75@0	S_75@0
100	50	QPSK	100+50		QPSK	150	P_100@0	S_50@0
100	100	QPSK	100+100		QPSK	75	P_75@25	S_0@0
100	100	QPSK	100+100		QPSK	130	P_100@0	S_30@0
100	100	QPSK	100+100		QPSK	200	P_100@0	S_100@0
Note 1: CA Configuration Test CC Combination settings are checked separately for each CA Configuration, which applicable ag channel bandwidths are specified in Table 5.4.2A.1-1.								
Note 2: Depending on CA configurations, only the appropriate Uplink RB allocation value according to table 7.3A.3-1 is tested p configuration.								
Note 3: PCC and SCC should be ordered so that PCC is configured closest to the uplink band.								

1. Connect the SS and interfering sources to the UE antenna connectors as shown in TS 36.508 [7] Figure group A.34 as appropriate.
2. The parameter settings for the cell are set up according to TS 36.508 [7] subclause 4.4.3.
3. Downlink signals for PCC are initially set up according to Annex C.0, C.1 and C.3.1, and uplink signals according to Annex H.1 and H.3.1.
4. Propagation conditions are set according to Annex B.0.
5. Ensure the UE is in State 3A-RF according to TS 36.508 [7] clause 5.2A.2. Message contents are defined in clause 7.8.1A.4.3.

7.8.1A.1.4.2 Test procedure

1. Configure SCC according to Annex C.0, C.1 and Annex C.3.1 for all downlink physical channels except PHICH.
2. The SS shall configure SCC as per TS 36.508 [7] clause 5.2A.4. Message contents are defined in clause 7.8.1A.1.4.3
3. SS activates SCC by sending the activation MAC-CE (Refer TS 36.321 [13], clauses 5.13, 6.1.3.8). Wait for at least 2 seconds (Refer TS 36.133, clauses 8.3.3.2).
4. SS transmits PDSCH via PDCCH DCI format 2A for C_RNTI to transmit the DL RMC according to Table 7.8.1A.1.4.1-1 on both PCC and SCC. The SS sends downlink MAC padding bits on the DL RMC.
5. SS sends uplink scheduling information for each UL HARQ process via PDCCH DCI format 0 for C_RNTI to schedule the UL RMC according to Table 7.8.1A.1.4.1-1. Since the UE has no payload data to send, the UE transmits uplink MAC padding bits on the UL RMC.
6. Set the Downlink signal level to the value as defined in Table 7.8.1A.1.5-1. Send Uplink power control commands to the UE (less or equal to 1dB step size should be used), to ensure that the UE output power is within +0, - 3.4 dB of the target level in Table 7.8.1A.5-1 for carrier frequency $f \leq 3.0\text{GHz}$ or within +0, -4.0 dB of the target level for carrier frequency $3.0\text{GHz} < f \leq 4.2\text{GHz}$, for at least the duration of the Throughput measurement. Suitable uplink power control commands should be sent to ensure the total power in each of the assigned carriers to be equal to each other within +/-[2] dB.
7. Set the Interfering signal levels to the values as defined in Table 7.8.1A.1.5-1 and frequency below the wanted signal, using a modulated interferer bandwidth as defined in Annex D of the present document.
8. Measure the average throughput for each component carrier for a duration sufficient to achieve statistical significance according to Annex G.2.
9. Repeat steps from 6 to 8, using an interfering signal above the wanted signal at step 7.

7.8.1A.1.4.3 Message contents

Message contents are according to TS 36.508 [7] subclause 4.6. In test procedure step 2, for SCC configuration there are no additional message contents.

7.8.1A.1.5 Test requirements

The throughput of each carrier shall be $\geq 95\%$ of the maximum throughput of the reference measurement channels as specified in Annex A.3.2 with parameters specified in Table 7.8.1A.1.5-1 for the specified wanted signal mean power in the presence of two interfering signals.

Table 7.8.1A.1.5-1: Test parameters for Wide band intermodulation

Rx parameter	Units	CA Bandwidth Class				
		B	C	D	E	F
Power per CC in Aggregated Transmission Bandwidth Configuration	dBm	REFSENS + CA Bandwidth Class specific value below				
			12			

$P_{\text{Interferer 1}}$ (CW)	dBm	-46				
$P_{\text{Interferer 2}}$ (Modulated)	dBm	-46				
$BW_{\text{Interferer 2}}$	MHz	5				
$F_{\text{Interferer 1}}$ (Offset)	MHz	$\begin{array}{c} -F_{\text{offset}}-7.5 \\ / \\ + F_{\text{offset}}+7.5 \end{array}$				
$F_{\text{Interferer 2}}$ (Offset)	MHz	$2 * F_{\text{Interferer 1}}$				
NOTE 1: The transmitter shall be set to 4dB below $P_{\text{CMAX_L}}$ or $P_{\text{CMAX_L_CA}}$ as defined in subclause 6.2.5A.						
NOTE 2: Reference measurement channel is specified in Annex A.3.2 with one sided dynamic OCNG Pattern OP.1 FDD/TDD as described in Annex A.5.1.1/A.5.2.1.						
NOTE 3: The modulated interferer consists of the Reference measurement channel specified in Annex A.3.2 with one sided dynamic OCNG Pattern OP.1 FDD/TDD as described in Annex A.5.1.1/A.5.2.1 with set-up according to Annex C.3.1.						
NOTE 4: The interfering modulated signal is 5MHz E-UTRA signal as described in Annex D for channel bandwidth $\geq 5\text{MHz}$						

7.8.1A.2 Wideband intermodulation for CA (intra-band contiguous DL CA without UL CA)

7.8.1A.2.1 Test purpose

Same as 7.8.1A.1

7.8.1A.2.2 Test applicability

This test applies to all types of E-UTRA UE release 10 and forward that supports intra-band contiguous DL CA but not UL CA.

7.8.1A.2.3 Minimum conformance requirements

Same as 7.8.1A.1

7.8.1A.2.4 Test description

7.8.1A.2.4.1 Initial condition

Initial conditions are a set of test configurations the UE needs to be tested in and the steps for the SS to take with the UE to reach the correct measurement state.

The initial test configurations consist of environmental conditions, test frequencies, and channel bandwidths based on E-UTRA bands specified in table 5.4.2.1-1. All of these configurations shall be tested with applicable test parameters for each channel bandwidth, and are shown in table 7.8.1A.2.4.1-1. The details of the uplink and downlink reference measurement channels (RMCs) are specified in Annexes A.2 and A.3 respectively. The details of the OCNG patterns used are specified in Annex A.5. Configurations of PDSCH and PDCCH before measurement are specified in Annex C.2.

Table 7.8.1A.2.4.1-1: Test Configuration Table

Initial Conditions									
Test Environment as specified in TS 36.508[7] subclause 4.1					Normal				
Test Frequencies as specified in TS36.508 [7] subclause 4.3.1 for different CA bandwidth classes.					C: Mid range				
Test CC Combination setting (N_{RB_agg}) as specified in subclause 5.4.2A.1 for the CA Configuration across bandwidth combination sets supported by the UE.					Lowest N_{RB_agg} , Highest N_{RB_agg}				
Test Parameters for CA Configurations									
CA Configuration / N_{RB_agg}		DL Allocation			UL Allocation				
PCC N_{RB}	SCCs NRB	CC MOD	PCC & SCC RB allocation	CC MOD	N_{RB_alloc}	PCC & SCC RB allocations (L_{CRB} @ RB_{start})			
75	75	QPSK	75+75	QPSK	75	P_75@0			
75	75	QPSK	75+75	QPSK	50	P_50@0			
75	75	QPSK	75+75	QPSK	25	P_25@0			
75	75	QPSK	75+75	QPSK	20	P_20@0			
100	50	QPSK	100+50	QPSK	100	P_100@0			
100	50	QPSK	100+50	QPSK	75	P_75@0			
100	50	QPSK	100+50	QPSK	50	P_50@0			
100	50	QPSK	100+50	QPSK	25	P_25@0			
100	50	QPSK	100+50	QPSK	20	P_20@0			
100	100	QPSK	100+100	QPSK	100	P_100@0			
100	100	QPSK	100+100	QPSK	75	P_75@0			
100	100	QPSK	100+100	QPSK	50	P_50@0			
100	100	QPSK	100+100	QPSK	25	P_25@0			
100	100	QPSK	100+100	QPSK	20	P_20@0			
Note 1: CA Configuration Test CC Combination settings are checked separately for each CA Configuration, which applicable aggregated channel bandwidths are specified in Table 5.4.2A.1-1. Note 2: Depending on CA configurations, only the appropriate Uplink RB allocation value according to table 7.3.3-2 is tested per Test CA configuration. Note 3: PCC and SCC should be ordered so that PCC is configured closest to the uplink band.									

1. Connect the SS and interfering sources to the UE antenna connectors as shown in TS 36.508 [7] Figure group A.34 as appropriate.
2. The parameter settings for the cell are set up according to TS 36.508 [7] subclause 4.4.3.
3. Downlink signals for PCC are initially set up according to Annex C.0, C.1 and C.3.1, and uplink signals according to Annex H.1 and H.3.1.
4. Propagation conditions are set according to Annex B.0.
5. Ensure the UE is in State 3A-RF according to TS 36.508 [7] clause 5.2A.2. Message contents are defined in clause 7.8.1A.4.3.

7.8.1A.2.4.2 Test procedure

1. Configure SCC according to Annex C.0, C.1 and Annex C.3.1 for all downlink physical channels except PHICH.
2. The SS shall configure SCC as per TS 36.508 [7] clause 5.2A.4. Message contents are defined in clause 7.8.1A.2.4.3
3. SS activates SCC by sending the activation MAC-CE (Refer TS 36.321 [13], clauses 5.13, 6.1.3.8). Wait for at least 2 seconds (Refer TS 36.133, clauses 8.3.3.2).
4. SS transmits PDSCH via PDCCH DCI format 2A for C_RNTI to transmit the DL RMC according to Table 7.8.1A.2.4.1-1 on both PCC and SCC. The SS sends downlink MAC padding bits on the DL RMC.

5. SS sends uplink scheduling information for each UL HARQ process via PDCCH DCI format 0 for C_RNTI to schedule the UL RMC according to Table 7.8.1A.2.4.1-1. Since the UE has no payload data to send, the UE transmits uplink MAC padding bits on the UL RMC.
6. Set the Downlink signal level to the value as defined in Table 7.8.1A.2.5-1. Send Uplink power control commands to the UE (less or equal to 1dB step size should be used), to ensure that the UE output power is within +0, - 3.4 dB of the target level in Table 7.8.1A.2.5-1 for carrier frequency $f \leq 3.0\text{GHz}$ or within +0, -4.0 dB of the target level for carrier frequency $3.0\text{GHz} < f \leq 4.2\text{GHz}$, for at least the duration of the Throughput measurement.
7. Set the Interfering signal levels to the values as defined in subclause 7.8.1A.2.5 and frequency below the wanted signal, using a modulated interferer bandwidth as defined in Annex D of the present document.
8. Measure the average throughput for each component carrier for a duration sufficient to achieve statistical significance according to Annex G.2.
9. Repeat steps from 6 to 8, using an interfering signal above the wanted signal at step 7.

7.8.1A.2.4.3 Message contents

Message contents are according to TS 36.508 [7] subclause 4.6. In test procedure step 2, for SCC configuration there are no additional message contents.

7.8.1A.2.5 Test requirements

Same as 7.8.1A.1

7.8.1A.3 Wideband intermodulation for CA (inter-band DL CA without UL CA)

7.8.1A.3.1 Test purpose

Intermodulation response tests the UE's ability to receive data with a given average throughput for a specified reference measurement channel, in the presence of two or more interfering signals which have a specific frequency relationship to the wanted signal, under conditions of ideal propagation and no added noise.

A UE unable to meet the throughput requirement under these conditions will decrease the coverage area when two or more interfering signals exist which have a specific frequency relationship to the wanted signal.

7.8.1A.3.2 Test applicability

This test applies to all types of E-UTRA UE release 10 and forward that supports inter-band contiguous DL CA but not UL CA.

7.8.1A.3.3 Minimum conformance requirements

Same as 7.8.1A.1

7.8.1A.3.4 Test description

7.8.1A.3.4.1 Initial condition

Initial conditions are a set of test configurations the UE needs to be tested in and the steps for the SS to take with the UE to reach the correct measurement state.

The initial test configurations consist of environmental conditions, test frequencies, and channel bandwidths based on E-UTRA bands specified in table 5.4.2.1-1. All of these configurations shall be tested with applicable test parameters for each channel bandwidth, and are shown in table 7.8.1A.3.4.1-1. The details of the uplink and downlink reference measurement channels (RMCs) are specified in Annexes A.2 and A.3 respectively. The details of the OCNG patterns used are specified in Annex A.5. Configurations of PDSCH and PDCCH before measurement are specified in Annex C.2.

Table 7.8.1A.3.4.1-1: Test Configuration Table

Initial Conditions						
Test Environment as specified in TS 36.508[7] subclause 4.1			NC			
Test Frequencies as specified in TS36.508 [7] subclause 4.3.1 for different CA bandwidth classes.			A: Mid range for PCC and SCC			
Test CC Combination setting (N_{RB_agg}) as specified in subclause 5.4.2A.1 for the CA Configuration across bandwidth combination sets supported by the UE.			Highest N_{RB_agg} for PCC and SCC			
Test Parameters for CA Configurations						
CA Configuration / N_{RB_agg}		DL Allocation			UL Allocation	
PCC N_{RB}	SCCs N_{RB}	CC MOD	PCC & SCC RB allocation		CC MOD	PCC N_{RB_alloc}
50	50	QPSK	50	50	QPSK	50
50	50	QPSK	50	50	QPSK	25
50	50	QPSK	50	50	QPSK	20
50	50	QPSK	50	50	QPSK	16
50	75	QPSK	50	75	QPSK	25
50	100	QPSK	50	100	QPSK	50
50	100	QPSK	50	100	QPSK	25
50	100	QPSK	50	100	QPSK	20
75	50	QPSK	75	50	QPSK	25
75	100	QPSK	75	100	QPSK	25
100	50	QPSK	100	50	QPSK	100
100	50	QPSK	100	50	QPSK	75
100	50	QPSK	100	50	QPSK	50
100	75	QPSK	100	75	QPSK	100
100	100	QPSK	100	100	QPSK	75
100	100	QPSK	100	100	QPSK	50
<p>Note 1: CA Configuration Test CC Combination settings are checked separately for each CA Configuration, which applicable aggregated channel bandwidths are specified in Table 5.4.2A.1-2.</p> <p>Note 2: Depending on CA configurations, only the appropriate Uplink RB allocation value according to table 7.3.3-2 for UE supporting one uplink carrier is tested per Test CA configuration, unless otherwise stated in table 7.3A.1.3-0b.</p> <p>Note 3: The UL resource blocks shall be located as close as possible to the downlink SCC but confined within the transmission bandwidth configuration for the channel bandwidth (Table 5.4.2-1).</p> <p>Note 4: The frequencies of PCC and SCC shall be switched and tested in each configuration (given UL is supported in PCC band as per Table 5.2-1).</p>						

1. Connect the SS and interfering sources to the UE antenna connectors as shown in TS 36.508 [7] Figure group A.34 as appropriate.
2. The parameter settings for the cell are set up according to TS 36.508 [7] subclause 4.4.3.
3. Downlink signals for PCC are initially set up according to Annex C.0, C.1 and C.3.1, and uplink signals according to Annex H.1 and H.3.1.
4. Propagation conditions are set according to Annex B.0.

5. Ensure the UE is in State 3A-RF according to TS 36.508 [7] clause 5.2A.2. Message contents are defined in clause 7.8.1A.4.3.

7.8.1A.3.4.2 Test procedure

1. Configure SCC according to Annex C.0, C.1 and Annex C.3.1 for all downlink physical channels except PHICH.
2. The SS shall configure SCC as per TS 36.508 [7] clause 5.2A.4. Message contents are defined in clause 7.8.1A.3.4.3
3. SS activates SCC by sending the activation MAC-CE (Refer TS 36.321 [13], clauses 5.13, 6.1.3.8). Wait for at least 2 seconds (Refer TS 36.133, clauses 8.3.3.2).
4. SS transmits PDSCH via PDCCH DCI format 2A for C_RNTI to transmit the DL RMC according to Table 7.8.1A.3.4.1-1 on both PCC and SCC. The SS sends downlink MAC padding bits on the DL RMC.
5. SS sends uplink scheduling information for each UL HARQ process via PDCCH DCI format 0 for C_RNTI to schedule the UL RMC according to Table 7.8.1A.3.4.1-1. Since the UE has no payload data to send, the UE transmits uplink MAC padding bits on the UL RMC.
6. Set the Downlink signal level to the value as defined in Table 7.8.1A.5-1. Send Uplink power control commands to the UE (less or equal to 1dB step size should be used), to ensure that the UE output power is within +0, - 3.4 dB of the target level in Table 7.8.1A.3.5-1 for carrier frequency $f \leq 3.0\text{GHz}$ or within +0, -4.0 dB of the target level for carrier frequency $3.0\text{GHz} < f \leq 4.2\text{GHz}$, for at least the duration of the Throughput measurement.
7. Set the Interfering signal levels to the values as defined in Table 7.8.1A.3.5-1 and frequency below the wanted signal, using a modulated interferer bandwidth as defined in Annex D of the present document.
8. Measure the average throughput of SCC for a duration sufficient to achieve statistical significance according to Annex G.2.
9. Repeat steps from 6 to 8, using an interfering signal above the wanted signal at step 4.

7.8.1A.3.4.3 Message contents

Message contents are according to TS 36.508 [7] subclause 4.6. In test procedure step 2, for SCC configuration there are no additional message contents.

7.8.1A.3.5 Test requirements

For inter-band carrier aggregation with uplink assigned to one E-UTRA band the in-band blocking requirements are defined with the uplink active on the band other than the band whose downlink is being tested, i.e., the requirements are tested only for the S-Cell downlink. The UE shall meet the requirements specified in Table 7.8.1A.3.5-1 for each component carrier, when operated as S-Cell, while both downlink carriers are active. The requirements for each component carrier are the same as single carrier requirements in Table 7.8.1.5-1. The parameters in these tables are related to the carrier operated as S-Cell.

Table 7.8.1A.3.5-1: Test parameters for Wide band intermodulation

Rx Parameter	Units	Channel bandwidth					
		1.4 MHz	3 MHz	5 MHz	10 MHz	15 MHz	20 MHz
Power in Transmission Bandwidth Configuration	dBm	REFSENS + channel bandwidth specific value below					
		12	8	6	6	7	9

$P_{\text{Interferer 1}}$ (CW)	dBm	-46		
$P_{\text{Interferer 2}}$ (Modulated)	dBm	-46		
$BW_{\text{Interferer 2}}$		1.4	3	5
$F_{\text{Interferer 1}}$ (Offset)	MHz	-BW/2 -2.1 / +BW/2+ 2.1	-BW/2 -4.5 / +BW/2 + 4.5	-BW/2 - 7.5 / +BW/2 + 7.5
$F_{\text{Interferer 2}}$ (Offset)	MHz	$2 \cdot F_{\text{Interferer 1}}$		
Note 1:	The transmitter shall be set to 4dB below $P_{\text{CMAX,L}}$ with $P_{\text{CMAX,L}}$ as defined in clause 6.2.5.			
Note 2:	The reference measurement channel is specified in Annex A.3.2 with one sided dynamic OCNG Pattern OP.1 FDD/TDD as described in Annex A.5.1.1/A.5.2.1.			
Note 3:	The modulated interferer consists of the Reference measurement channel specified in Annex A.3.2 with one sided dynamic OCNG Pattern OP.1 FDD/TDD as described in Annex A.5.1.1/A.5.2.1 and set-up according to Annex C.3.1. The interfering modulated signal is 5MHz E-UTRA signal as described in Annex D for channel bandwidth $\geq 5\text{MHz}$			
Note 4:	For the UE which supports inter band CA configuration in Table 7.3A.3-0, $P_{\text{Interferer1}}$ and $P_{\text{Interferer2}}$ powers are increased by the amount given by ΔR_{IB} in Table 7.3A.3-0			

7.8.1B Wide band Intermodulation for UL-MIMO

7.8.1B.1 Test purpose

Intermodulation response tests the ability of UE that support UL-MIMO to receive data with a given average throughput for a specified reference measurement channel, in the presence of two or more interfering signals which have a specific frequency relationship to the wanted signal, under conditions of ideal propagation and no added noise.

A UE unable to meet the throughput requirement under these conditions will decrease the coverage area when two or more interfering signals exist which have a specific frequency relationship to the wanted signal.

7.8.1B.2 Test applicability

This test applies to all types of E-UTRA UE release 10 and forward that support UL-MIMO.

7.8.1B.3 Minimum conformance requirements

For UE(s) with two transmitter antenna connectors in closed-loop spatial multiplexing scheme, the minimum requirements in subclause 7.8.1B.3 shall be met with the UL-MIMO configurations specified in Table 6.2.2B.3-2. For UL-MIMO, the parameter $P_{\text{CMAX,L}}$ is defined as the total transmitter power over the two transmit antenna connectors.

The normative reference for this requirement is TS 36.101 [2] clause 7.8.1B and TS 36.101 [2] Annexes A and D.

7.8.1B.4 Test description

7.8.1B.4.1 Initial condition

Initial conditions are a set of test configurations the UE needs to be tested in and the steps for the SS to take with the UE to reach the correct measurement state.

The initial test configurations consist of environmental conditions, test frequencies, and channel bandwidths based on E-UTRA bands specified in table 5.4.2.1-1. All of these configurations shall be tested with applicable test parameters for each channel bandwidth, and are shown in table 7.8.1B.4.1-1. The details of the uplink and downlink reference measurement channels (RMCs) are specified in Annexes A.2 and A.3 respectively. The details of the OCNG patterns used are specified in Annex A.5. Configurations of PDSCH and PDCCH before measurement are specified in Annex C.2.

Table 7.8.1B.4.1-1: Test Configuration Table

Initial Conditions						
Test Environment as specified in TS 36.508[7] subclause 4.1			NC			
Test Frequencies as specified in TS36.508 [7] subclause 4.3.1			Mid range			
Test Channel Bandwidths as specified in TS 36.508 [7] subclause 4.3.1			Lowest, 5MHz, Highest			
Test Parameters for Channel Bandwidths						
Ch BW	Downlink Configuration			Uplink Configuration		
	Mod'n	RB allocation		Mod'n	RB allocation	
		FDD	TDD		FDD	TDD
1.4MHz	QPSK	6	6	QPSK	6	6
3MHz	QPSK	15	15	QPSK	15	15
5MHz	QPSK	25	25	QPSK	25	25
5MHz	QPSK	25	N/A	QPSK	20	N/A
5MHz	QPSK	25	N/A	QPSK	15	N/A
10MHz	QPSK	50	50	QPSK	50	50
10MHz	QPSK	50	N/A	QPSK	25	N/A
10MHz	QPSK	50	N/A	QPSK	20	N/A
10MHz	QPSK	50	N/A	QPSK	15	N/A
15MHz	QPSK	75	75	QPSK	75	75
15MHz	QPSK	75	N/A	QPSK	50	N/A
15MHz	QPSK	75	N/A	QPSK	25	N/A
15MHz	QPSK	75	N/A	QPSK	20	N/A
20MHz	QPSK	100	100	QPSK	100	100
20MHz	QPSK	100	N/A	QPSK	75	N/A
20MHz	QPSK	100	N/A	QPSK	50	N/A
20MHz	QPSK	100	N/A	QPSK	25	N/A
20MHz	QPSK	100	N/A	QPSK	20	N/A
Note 1: Test Channel Bandwidths are checked separately for each E-UTRA band, which applicable channel bandwidths are specified in Table 5.4.2.1-1. Note 2: Depending on E-UTRA band, only the appropriate Uplink RB allocation value according to table 7.3.3-2 is tested per Test Channel Bandwidth. Note 3: For the DL signal one sided dynamic OCNG Pattern OP.1 FDD/TDD is used.						

1. Connect the SS and interfering sources to the UE antenna connectors as shown in TS 36.508 [7] Figure A.31.
2. The parameter settings for the cell are set up according to TS 36.508 [7] subclause 4.4.3.
3. Downlink signals are initially set up according to Annex C0, C.1 and C.3.1, and uplink signals according to Annex H.1 and H.3.1.
4. The UL and DL Reference Measurement channels are set according to Table 7.8.1B.4.1-1.
5. Propagation conditions are set according to Annex B.0.
6. Ensure the UE is in State 3A-RF according to TS 36.508 [7] clause 5.2A.2. Message contents are defined in clause 7.8.1B.4.3.

7.8.1B.4.2 Test procedure

1. SS transmits PDSCH via PDCCH DCI format 1A for C_RNTI to transmit the DL RMC according to Table 7.8.1B.4.1-1. The SS sends downlink MAC padding bits on the DL RMC.
2. SS sends uplink scheduling information for each UL HARQ process via PDCCH DCI format 4 for C_RNTI to schedule the UL RMC according to Table 7.8.1B.4.1-1. Since the UE has no payload data to send, the UE transmits uplink MAC padding bits on the UL RMC.
3. Set the Downlink signal level to the value as defined in Table 7.8.1B.5-1. Send Uplink power control commands to the UE (less or equal to 1dB step size should be used), to ensure that the UE output power is within +0, - 3.4 dB of the target level in Table 7.8.1B.5-1 for carrier frequency $f \leq 3.0\text{GHz}$ or within +0, -4.0 dB of the target level for carrier frequency $3.0\text{GHz} < f \leq 4.2\text{GHz}$, for at least the duration of the throughput measurement.

4. Set the Interfering signal levels to the values as defined in Table 7.8.1B.5-1 and frequency below the wanted signal, using a modulated interferer bandwidth as defined in Annex D of the present document.
5. Measure the average throughput for a duration sufficient to achieve statistical significance according to Annex G.2.
6. Repeat steps from 3 to 5, using an interfering signal above the wanted signal at step 4.

7.8.1B.4.3 Message contents

Message contents are according to TS 36.508 [7] clause 4.6 with the following exception.

Table 7.8.1B.4.3-1: UplinkPowerControlDedicated

Derivation Path: 36.331 clause 6.3.2			
Information Element	Value/remark	Comment	Condition
UplinkPowerControlDedicated-DEFAULT ::= SEQUENCE {			
p0-UePUSCH	0		
deltaMCS-Enabled	en0		
accumulationEnabled	TRUE		
p0-uePUCCH	0		
pSRS-Offset	3 (-6 dB)		
filterCoefficient	fc8	larger filter length is used to reduce the RSRP measurement variation	
}			

7.8.1B.5 Test requirements

The throughput shall be $\geq 95\%$ of the maximum throughput of the reference measurement channels as specified in Annex A.3.2 with parameters specified in Table 7.8.1B.5-1 for the specified wanted signal mean power in the presence of two interfering signals.

Table 7.8.1B.5-1: Test parameters for Wide band intermodulation

Rx Parameter	Units	Channel bandwidth					
		1.4 MHz	3 MHz	5 MHz	10 MHz	15 MHz	20 MHz
Power in Transmission Bandwidth Configuration	dBm	REFSENS + channel bandwidth specific value below					
		12	8	6	6	7	9
$P_{\text{Interferer 1}}$ (CW)	dBm	-46					
$P_{\text{Interferer 2}}$ (Modulated)		-46					
$BW_{\text{Interferer 2}}$		1.4	3	5			
$F_{\text{Interferer 1}}$ (Offset)	MHz	-BW/2 -2.1 / +BW/2+ 2.1	-BW/2 -4.5 / +BW/2 + 4.5	-BW/2 - 7.5 / +BW/2 + 7.5			
$F_{\text{Interferer 2}}$ (Offset)		MHz	$2 * F_{\text{Interferer 1}}$				
Note 1:	The transmitter shall be set to 4dB below $P_{\text{CMAX_L}}$ with $P_{\text{CMAX_L}}$ as defined in clause 6.2.5.						
Note 2:	The reference measurement channel is specified in Annex A.3.2 with one sided dynamic OCNG Pattern OP.1 FDD/TDD as described in Annex A.5.1.1/A.5.2.1.						
Note 3:	The modulated interferer consists of the Reference measurement channel specified in Annex A.3.2 with one sided dynamic OCNG Pattern OP.1 FDD/TDD as described in Annex A.5.1.1/A.5.2.1 and set-up according to Annex C.3.1. The interfering modulated signal is 5MHz E-UTRA signal as described in Annex D for channel bandwidth ≥ 5 MHz.						

7.8.2 Void

7.9 Spurious emissions

The spurious emissions power is the power of emissions generated or amplified in a receiver that appear at the UE antenna connector.

7.9.1 Test Purpose

Test verifies the UE's spurious emissions meet the requirements described in clause 7.9.3.

Excess spurious emissions increase the interference to other systems.

7.9.2 Test Applicability

This test applies to all types of E-UTRA UE release 8 and forward.

7.9.3 Minimum Conformance Requirements

The power of any narrow band CW spurious emission shall not exceed the maximum level specified in Table 7.9.3-1

Table 7.9.3-1: General receiver spurious emission requirements

Frequency Band	Measurement Bandwidth	Maximum level	Note
$30\text{MHz} \leq f < 1\text{GHz}$	100 kHz	-57 dBm	
$1\text{GHz} \leq f \leq 12.75\text{ GHz}$	1 MHz	-47 dBm	
$12.75\text{ GHz} \leq f \leq 5^{\text{th}}$ harmonic of the upper frequency edge of the DL operating band in GHz	1 MHz	-47 dBm	Note 1
Note 1: Applies only for Band 22, Band 42 and Band 43.			
Note 2: Unused PDCCH resources are padded with resource element groups with power level given by PDCCH_RA/RB as defined in Annex C.3.1.			

The normative reference for this requirement is TS 36.101 [2] clause 7.9.

7.9.4 Test Description

7.9.4.1 Initial Conditions

Initial conditions are a set of test configurations the UE needs to be tested in and the steps for the SS to take with the UE to reach the correct measurement state.

The initial test configurations consist of environmental conditions, test frequencies, and channel bandwidths based on E-UTRA bands specified in table 5.4.2.1-1. All of these configurations shall be tested with applicable test parameters for each channel bandwidth, and are shown in table 7.9.4.1-1. The details of the downlink and uplink reference measurement channels (RMCs) are specified in Annexes A.3 and A.2 respectively.

Table 7.9.4.1-1: Test Configuration Table

Initial Conditions						
Test Environment as specified in TS 36.508[7] subclause 4.1			NC			
Test Frequencies as specified in TS36.508 [7] subclause 4.3.1			Low range, Mid range, High range			
Test Channel Bandwidths as specified in TS 36.508 [7] subclause 4.3.1			Highest			
Test Parameters for Channel Bandwidths						
Ch BW	Downlink Configuration			Uplink Configuration		
	Mod'n	RB allocation		Mod'n	RB allocation	
		FDD	TDD		FDD	TDD
1.4MHz	QPSK	0	0	QPSK	0	0
3MHz	QPSK	0	0	QPSK	0	0
5MHz	QPSK	0	0	QPSK	0	0
10MHz	QPSK	0	0	QPSK	0	0
15MHz	QPSK	0	0	QPSK	0	0
20MHz	QPSK	0	0	QPSK	0	0
Note 1: Test Channel Bandwidths are checked separately for each E-UTRA band. The applicable channel bandwidths are specified in Table 7.3.3-2.						

1. Connect a spectrum analyzer (or other suitable test equipment) to the UE antenna connectors as shown in TS 36.508 [7] Annex A, Figure A.8.
2. The parameter settings for the cell are set up according to TS 36.508 [7] subclause 4.4.3.
3. Downlink signals are initially set up according to Annex C0, C.1 and C.3.1.
4. The DL Reference Measurement channels are set according to Table 7.9.4.1-1.
5. Propagation conditions are set according to Annex B.0.
6. Ensure the UE is in State 3A-RF according to TS 36.508 [7] clause 5.2A.2. Message contents are defined in clause 7.9.4.3.

7.9.4.2 Test Procedure

1. Sweep the spectrum analyzer (or equivalent equipment) over a frequency range and measure the average power of spurious emission.
2. Repeat step 1 for all E-UTRA Rx antennas of the UE.

7.9.4.3 Message Contents

Message contents are according to TS 36.508 [7] subclause 4.6.

7.9.5 Test Requirement

The measured spurious emissions derived in step 1), shall not exceed the maximum level specified in Table 7.9.5-1

Table 7.9.5-1: General receiver spurious emission requirements

Frequency Band	Measurement Bandwidth	Maximum level	Note
$30\text{MHz} \leq f < 1\text{GHz}$	100 kHz	-57 dBm	
$1\text{GHz} \leq f \leq 12.75\text{ GHz}$	1 MHz	-47 dBm	
$12.75\text{ GHz} \leq f \leq 5^{\text{th}}$ harmonic of the upper frequency edge of the DL operating band in GHz	1 MHz	-47 dBm	Note 1
Note 1: Applies only for Band 22, Band 42 and Band 43.			
Note 2: Unused PDCCH resources are padded with resource element groups with power level given by PDCCH_RA/RB as defined in Annex C.3.1.			

7.10 Void

7.10A Receiver image for CA

TS 36.101 [2] clause 7.10.1A specifies minimum requirements for receiver image for CA but recommends that these requirements do not need to be tested.

8 Performance Requirement

8.1 General

The performance requirements for the physical channels specified in TS 36.211 [8] clause 6 (for downlink physical channels) shall be as defined in the respective sections below.

The requirements for the UE in this clause are specified for the downlink reference measurement channels specified in Annex A, the propagation conditions specified in Annex B and the downlink physical channels specified in Annex C.

Unless otherwise stated the throughput measurements in clause 8 shall be performed according to the general rules for statistical testing in Annex G clause G.3.

The requirement for a UE that support E-UTRA in downlink shall be tested according to the declared UE PDSCH category and CA capabilities.

The fading of the signals and the AWGN signals applied to each receiver antenna connector shall be uncorrelated. The levels of the test signal applied to each of the antenna connectors shall be as defined in the respective test cases.

The UE performance in this section is considered to be operating band independent. Therefore, the required performance in the respective test cases can be verified in one of the operating bands supported by the UE under test. All the test points supported by the bands of the multiband UE (based on channel bandwidth, DL and UL configuration) need to be tested.

8.1.1 Dual-antenna receiver capability

The performance requirements are based on UE(s) that utilize a dual-antenna receiver.

For all test cases, the SNR is defined as:

$$SNR = \frac{\hat{E}_s^{(1)} + \hat{E}_s^{(2)}}{N_{oc}^{(1)} + N_{oc}^{(2)}}$$

where the superscript indicates the receiver antenna connector. The above SNR definition assumes that the REs are not precoded. The SNR definition does not account for any gain which can be associated to the precoding operation. The relative power of physical channels transmitted is defined in Table C.3.2-1. The SNR requirement applies for the UE categories given for each test.

For enhanced performance requirements type A, the SINR is defined as

$$SINR = \frac{\hat{E}_s^{(1)} + \hat{E}_s^{(2)}}{N_{oc}^{(1)'} + N_{oc}^{(2)'}}$$

where the superscript indicates the receiver antenna connector. The above SINR definition assumes that the REs are not precoded. The SINR definition does not account for any gain which can be associated to the precoding operation. The relative power of physical channels transmitted is defined in Table C.3.2-1. The SINR requirement applies for the UE categories given for each test.

The applicability of the requirements with respect to CA capabilities is given as in Table 8.1.1-1. In case the CA capability is omitted, the requirement is applicable to a UE regardless of its CA capability.

Table 8.1.1-1: Applicability of the requirement with respect to the CA capability

CA Capability	CA Capability Description
CL_X	The requirement is applicable to a UE that indicates a CA bandwidth class X on at least one E-UTRA band.
CL_X-Y	The requirement is applicable to a UE that indicates CA bandwidth classes X and Y on at least one E-UTRA band combination.
Note: The CA bandwidth classes are defined in Table 5.4.2A-1	

For test cases with more than one component carrier, "Fraction of Maximum Throughput" in the performance requirement refers to the ratio of the sum of throughput values of all component carriers to the sum of the nominal maximum throughput values of all component carriers. The normative reference for this requirement is TS 36.101 [2] clause 8.1.1.

8.1.1.1 Simultaneous unicast and MBMS operations

8.1.1.2 Dual-antenna receiver capability in idle mode

8.2 Demodulation of PDSCH (Cell-Specific Reference Symbols)

8.2.1 FDD (Fixed Reference Channel)

The parameters specified in Table 8.2.1-1 are valid for all FDD tests unless otherwise stated.

Table 8.2.1-1: Common Test Parameters (FDD)

Parameter	Unit	Value	Comments
Inter-TTI Distance		1	
Number of HARQ processes	Processes	8	For FDD, 8 HARQ processes in the DL, as specified in TS 36.213 [10] clause 7. All 8 HARQ processes are used.
Scheduling of retransmissions			1. Retransmissions use the same Transport Block Size (TBS) as the initial transmission. 2. HARQ processes are scheduled consecutively, independent of the fact, whether retransmissions (for negatively acknowledged HARQ processes) or new transmissions (for positively acknowledged HARQ processes) occur.
Maximum number of HARQ transmission		4	It is always 4 for FDD, as specified in TS 36.213 [10] clause 8
Redundancy version coding sequence		{0,1,2,3} for QPSK and 16QAM {0,0,1,2} for 64QAM	
Number of OFDM symbols for PDCCH	OFDM symbols	4 for 1.4 MHz bandwidth, 3 for 3 MHz and 5 MHz bandwidths, 2 for 10 MHz, 15 MHz and 20 MHz bandwidths	The PCFICH carries information about the number of OFDM symbols used for transmission of PDCCHs in a subframe, as specified in TS 36.211 [8] clause 6.7
Cyclic Prefix		Normal	CP consist of the following physical resource blocks (RBs) parameters: 12 consecutive subcarriers at a 15 kHz spacing and 7 OFDM symbols, as specified in TS 36.211 [8] clause 6.2.3
Cell ID		0 (Note 1)	The Cell ID is uniquely defined by a number in the range of 0 to 503, representing the physical-layer cell identity, as specified in TS 36.211 [8] clause 6.11.
Cross carrier scheduling		Not configured	
Note 1: For CA tests, Cell ID = 0 applies only to P-Cell. For S-Cell, Cell ID = 1 is used.			

The normative reference for this requirement is TS 36.101 [2] clause 8.2.1.

8.2.1.1 FDD PDSCH Single Antenna Port Performance (Cell-Specific Reference Symbols)

8.2.1.1.1 FDD PDSCH Single Antenna Port Performance

8.2.1.1.1.1 Test purpose

To verify the UE's ability to receive a predefined test signal, representing a multi-path fading channel that is determined by the SNR with a percentage of the information bit throughput for a specified downlink Reference Measurement Channel (RMC) not falling below a specified value for transmission on a single-antenna port with different channel models and MCS.

8.2.1.1.1.2 Test applicability

This test applies to all types of E-UTRA FDD UE release 8 and forward.

8.2.1.1.1.3 Minimum conformance requirements

The requirements are specified in terms of the percentage of information bit throughput for the downlink reference measurement channels specified in Annex A clause A.3.3.1, with the addition of the relevant parameters in Tables 8.2.1-1, 8.2.1.1.1.3-1 and the downlink physical channel setup according to Table C.3.2-1 in Annex C.

Using this configuration the fraction of maximum throughput percentage shall meet or exceed the minimum requirements specified in Table 8.2.1.1.1.3-2 for the specified SNR. For QPSK and 64QAM performance the bandwidths specified in Table 5.4.2.1-1 are verified.

Table 8.2.1.1.1.3-1: Test Parameters for Testing

Parameter		Unit	Test 1- 5	Test 6- 8	Test 9- 15	Test 16- 18
Downlink power allocation	ρ_A	dB	0	0	0	0
	ρ_B	dB	0 (Note 1)	0 (Note 1)	0 (Note 1)	0 (Note 1)
	σ	dB	0	0	0	0
N_{oc} at antenna port		dBm/15kHz	-98	-98	-98	-98
Symbols for unused PRBs			OCNG (Note 2)	OCNG (Note 2)	OCNG (Note 2)	OCNG (Note 2)
Modulation			QPSK	16QAM	64QAM	16QAM
PDSCH transmission mode			1	1	1	1
Note 1: $P_B = 0$						
Note 2: These physical resource blocks are assigned to an arbitrary number of virtual UE's with one PDSCH per virtual UE; the data transmitted over the OCNG PDSCHs shall be uncorrelated pseudo random data, which is QPSK modulated.						

Table 8.2.1.1.1.3-2: Minimum performance (FRC)

Test number	Bandwidth	Reference Channel	OCNG Pattern	Propagation Condition	Correlation Matrix and Antenna Configuration	Reference value		UE Category
						Fraction of Maximum Throughput (%)	SNR (dB)	
1	10 MHz	R.2 FDD	OP.1 FDD	EVA5	1x2 Low	70	-1.0	1-5
2	10 MHz	R.2 FDD	OP.1 FDD	ETU70	1x2 Low	70	-0.4	1-5
3	10 MHz	R.2 FDD	OP.1 FDD	ETU300	1x2 Low	70	0.0	1-5
4	10 MHz	R.2 FDD	OP.1 FDD	HST	1x2 Low	70	-2.4	1-5
5	1.4 MHz	R.4 FDD	OP.1 FDD	EVA5	1x2 Low	70	0.0	1-5
6	10 MHz	R.3 FDD	OP.1 FDD	EVA5	1x2 Low	70	6.7	2-5
7	10 MHz	R.3 FDD	OP.1 FDD	ETU70	1x2 Low	30	1.4	2-5
8	10 MHz	R.3 FDD	OP.1 FDD	ETU300	1x2 High	70	9.4	2-5
9	3 MHz	R.5 FDD	OP.1 FDD	EVA5	1x2 Low	70	17.6	1-5
10	5 MHz	R.6 FDD	OP.1 FDD	EVA5	1x2 Low	70	17.4	2-5
11	10 MHz	R.7 FDD	OP.1 FDD	EVA5	1x2 Low	70	17.7	2-5
12	10 MHz	R.7 FDD	OP.1 FDD	ETU70	1x2 Low	70	19.0	2-5
13	10 MHz	R.7 FDD	OP.1 FDD	EVA5	1x2 High	70	19.1	2-5
14	15 MHz	R.8 FDD	OP.1 FDD	EVA5	1x2 Low	70	17.7	2-5
15	20 MHz	R.9 FDD	OP.1 FDD	EVA5	1x2 Low	70	17.6	3-5
16	3 MHz	R.0 FDD	OP.1 FDD	ETU70	1x2 Low	30	1.9	1-5
17	10 MHz	R.1 FDD	OP.1 FDD	ETU70	1x2 Low	30	1.9	1-5
18	20 MHz	R.1 FDD	OP.1 FDD	ETU70	1x2 Low	30	1.9	1-5

The normative reference for this requirement is TS 36.101 [2] clause 8.2.1.1.

8.2.1.1.1.4 Test description

8.2.1.1.1.4.1 Initial conditions

Initial conditions are a set of test configurations the UE needs to be tested in and the steps for the SS to take with the UE to reach the correct measurement state.

Configurations of PDSCH and PDCCH before measurement are specified in Annex C.2.

Test Environment: Normal, as defined in TS 36.508 [7] clause 4.1.

Frequencies to be tested: Mid Range, as defined in TS 36.508 [7] clause 4.3.1.1.

Frequencies to be tested for 1PRB allocation: Low Range, as defined in TS 36.508 [7] clause 4.3.1.1.

Channel Bandwidths to be tested: As specified per test number in Table 8.2.1.1.1.3-2 as defined in TS 36.508 [7] clause 4.3.1.1

1. Connect the SS, the faders and AWGN noise source to the UE antenna connectors as shown in TS 36.508 [7] Annex A, Figure A.9.

2. The parameter settings for the cell are set up according to Table 8.2.1-1 and 8.2.1.1.3-1 as appropriate.
3. Downlink signals are initially set up according to Annex C0, C.1 and Annex C.3.2 and uplink signals according to Annex H.1 and H.3.2.
4. Propagation conditions are set according to Annex B.0.
5. Ensure the UE is in State 3A-RF according to TS 36.508 [7] clause 5.2A.2. Message contents are defined in clause 8.2.1.1.4.3.

8.2.1.1.1.4.2 Test procedure

1. SS transmits PDSCH via PDCCH DCI format 1A for C_RNTI to transmit the DL RMC according to Tables 8.2.1.1.3-1 and 8.2.1.1.3-2. The SS sends downlink MAC padding bits on the DL RMC.
2. Set the parameters of the bandwidth, MCS, reference channel, the propagation condition, the correlation matrix and the SNR according to Tables 8.2.1.1.5-1 as appropriate.
3. Measure the average throughput for a duration sufficient to achieve statistical significance according to Annex G clause G.3. Count the number of NACKs, ACKs and statDTXs on the UL during each subtest and decide pass or fail according to Tables G.3.5 and G.3.6 in Annex G clause G.3.
4. Repeat steps from 1 to 3 for each subtest in Table 8.2.1.1.5-1 as appropriate.

8.2.1.1.1.4.3 Message contents

Message contents are according to TS 36.508 [7] clause 4.6.

8.2.1.1.1.5 Test requirement

Table 8.2.1.1.3-1 defines the primary level settings.

The fraction of maximum throughput percentage for the downlink reference measurement channels specified in Annex A clause A.3.3.1 for each throughput test shall meet or exceed the specified value in Table 8.2.1.1.5-1 for the specified SNR including test tolerances for all throughput tests.

Table 8.2.1.1.1.5-1: Test requirement (FRC)

Test number	Bandwidth	Reference Channel	OCNG Pattern	Propagation Condition	Correlation Matrix and Antenna Configuration	Reference value		UE Category
						Fraction of Maximum Throughput (%)	SNR (dB)	
1	10 MHz	R.2 FDD	OP.1 FDD	EVA5	1x2 Low	70	-0.2	1-5
2	10 MHz	R.2 FDD	OP.1 FDD	ETU70	1x2 Low	70	+0.4	1-5
3	10 MHz	R.2 FDD	OP.1 FDD	ETU300	1x2 Low	70	+0.8	1-5
4	10 MHz	R.2 FDD	OP.1 FDD	HST	1x2 Low	70	-1.8	1-5
5	1.4 MHz	R.4 FDD	OP.1 FDD	EVA5	1x2 Low	70	+0.8	1-5
6	10 MHz	R.3 FDD	OP.1 FDD	EVA5	1x2 Low	70	+7.5	2-5
7	10 MHz	R.3 FDD	OP.1 FDD	ETU70	1x2 Low	30	+2.2	2-5
8	10 MHz	R.3 FDD	OP.1 FDD	ETU300	1x2 High	70	+10.2	2-5
9	3 MHz	R.5 FDD	OP.1 FDD	EVA5	1x2 Low	70	+18.4	1-5
10	5 MHz	R.6 FDD	OP.1 FDD	EVA5	1x2 Low	70	+18.2	2-5
11	10 MHz	R.7 FDD	OP.1 FDD	EVA5	1x2 Low	70	+18.5	2-5
12	10 MHz	R.7 FDD	OP.1 FDD	ETU70	1x2 Low	70	+19.8	2-5
13	10 MHz	R.7 FDD	OP.1 FDD	EVA5	1x2 High	70	+19.9	2-5
14	15 MHz	R.8 FDD	OP.1 FDD	EVA5	1x2 Low	70	+18.5	2-5
15	20 MHz	R.9 FDD	OP.1 FDD	EVA5	1x2 Low	70	+18.4	3-5
16	3 MHz	R.0 FDD	OP.1 FDD	ETU70	1x2 Low	30	+2.7	1-5
17	10 MHz	R.1 FDD	OP.1 FDD	ETU70	1x2 Low	30	+2.7	1-5
18	20 MHz	R.1 FDD	OP.1 FDD	ETU70	1x2 Low	30	+2.7	1-5

8.2.1.1.1_1 FDD PDSCH Single Antenna Port Performance (Release 9 and forward)

8.2.1.1.1_1.1 Test purpose

Same test purpose as in clause 8.2.1.1.1.1.

8.2.1.1.1_1.2 Test applicability

This test applies to all types of E-UTRA FDD UE release 9 and forward of UE category 1 and 2.

8.2.1.1.1_1.3 Minimum conformance requirements

Same minimum conformance requirements as in clause 8.2.1.1.1.3 with the following exceptions:

- Instead of Table 8.2.1.1.1.3-1 → use Table 8.2.1.1.1_1.3-1.
- Instead of Table 8.2.1.1.1.3-2 → use Table 8.2.1.1.1_1.3-2.

Table 8.2.1.1.1_1.3-1: Test Parameters for Testing

Parameter		Unit	Test 1- 5	Test 6- 8	Test 9- 15	Test 16- 18
Downlink power allocation	ρ_A	dB	0	0	0	0
	ρ_B	dB	0 (Note 1)	0 (Note 1)	0 (Note 1)	0 (Note 1)
	σ	dB	0	0	0	0
N_{oc} at antenna port		dBm/15kHz	-98	-98	-98	-98
Symbols for unused PRBs			OCNG (Note 2)	OCNG (Note 2)	OCNG (Note 2)	OCNG (Note 2)
Modulation			QPSK	16QAM	64QAM	16QAM
PDSCH transmission mode			1	1	1	1
Note 1: $P_B = 0$						
Note 2: These physical resource blocks are assigned to an arbitrary number of virtual UEs with one PDSCH per virtual UE; the data transmitted over the OCNG PDSCHs shall be uncorrelated pseudo random data, which is QPSK modulated.						

Table 8.2.1.1.1_1.3-2: Minimum performance (FRC)

Test number	Bandwidth	Reference Channel	OCNG Pattern	Propagation Condition	Correlation Matrix and Antenna Configuration	Reference value		UE Category
						Fraction of Maximum Throughput (%)	SNR (dB)	
1	N/A							
2	N/A							
3	N/A							
4	N/A							
5	N/A							
6	5 MHz	R.3-1 FDD	OP.1 FDD	EVA5	1x2 Low	70	6.7	1
7	5 MHz	R.3-1 FDD	OP.1 FDD	ETU70	1x2 Low	30	1.4	1
8	5 MHz	R.3-1 FDD	OP.1 FDD	ETU300	1x2 High	70	9.4	1
9	N/A							
10	5 MHz	R.6-1 FDD	OP.1 FDD	EVA5	1x2 Low	70	17.5	1
11	10 MHz	R.7-1 FDD	OP.1 FDD	EVA5	1x2 Low	70	16.7	1
12	10 MHz	R.7-1 FDD	OP.1 FDD	ETU70	1x2 Low	70	18.1	1
13	10 MHz	R.7-1 FDD	OP.1 FDD	EVA5	1x2 High	70	17.8	1
14	15 MHz	R.8-1 FDD	OP.1 FDD	EVA5	1x2 Low	70	16.8	1
15	20 MHz	R.9-2 FDD	OP.1 FDD	EVA5	1x2 Low	70	17.3	2
	20 MHz	R.9-1 FDD	OP.1 FDD	EVA5	1x2 Low	70	16.7	1
16	N/A							
17	N/A							
18	N/A							

The normative reference for this requirement is TS 36.101 [2] clause 8.2.1.1.

8.2.1.1.1_1.4 Test description

Same test description as in clause 8.2.1.1.1.4 with the following exceptions:

- Instead of Table 8.2.1.1.1.3-1 → use Table 8.2.1.1.1_1.3-1.
- Instead of Table 8.2.1.1.1.3-2 → use Table 8.2.1.1.1_1.3-2.

- Instead of Table 8.2.1.1.1.5-1 → use Table 8.2.1.1.1_1.5-1.

8.2.1.1.1_1.5 Test requirement

Same test requirements as in clause 8.2.1.1.1.5 with the following exceptions:

- Instead of Table 8.2.1.1.1.3-1 → use Table 8.2.1.1.1_1.3-1.
- Instead of Table 8.2.1.1.1.5-1 → use Table 8.2.1.1.1_1.5-1.

Table 8.2.1.1.1_1.5-1: Test requirement (FRC)

Test number	Bandwidth	Reference Channel	OCNG Pattern	Propagation Condition	Correlation Matrix and Antenna Configuration	Reference value		UE Category
						Fraction of Maximum Throughput (%)	SNR (dB)	
1	N/A							
2	N/A							
3	N/A							
4	N/A							
5	N/A							
6	5 MHz	R.3-1 FDD	OP.1 FDD	EVA5	1x2 Low	70	+7.5	1
7	5 MHz	R.3-1 FDD	OP.1 FDD	ETU70	1x2 Low	30	+2.2	1
8	5 MHz	R.3-1 FDD	OP.1 FDD	ETU300	1x2 High	70	+10.2	1
9	N/A							
10	5 MHz	R.6-1 FDD	OP.1 FDD	EVA5	1x2 Low	70	+18.3	1
11	10 MHz	R.7-1 FDD	OP.1 FDD	EVA5	1x2 Low	70	+17.5	1
12	10 MHz	R.7-1 FDD	OP.1 FDD	ETU70	1x2 Low	70	+18.9	1
13	10 MHz	R.7-1 FDD	OP.1 FDD	EVA5	1x2 High	70	+18.6	1
14	15 MHz	R.8-1 FDD	OP.1 FDD	EVA5	1x2 Low	70	+17.6	1
15	20 MHz	R.9-2 FDD	OP.1 FDD	EVA5	1x2 Low	70	+18.1	2
	20 MHz	R.9-1 FDD	OP.1 FDD	EVA5	1x2 Low	70	+17.5	1
16	N/A							
17	N/A							
18	N/A							

8.2.1.1.1_A FDD PDSCH Single Antenna Port Performance for CA

8.2.1.1.1_A.1 FDD PDSCH Single Antenna Port Performance for CA (intra-band contiguous DL CA)

8.2.1.1.1_A.1.1 Test purpose

To verify the UE's ability to receive a predefined test signal, representing a multi-path fading channel that is determined by the SNR with a percentage of the information bit throughput for a specified downlink Reference Measurement Channel (RMC) not falling below a specified value for transmission on a single-antenna port with different channel models and MCS.

8.2.1.1.1_A.1.2 Test applicability

This test applies to all types of E-UTRA FDD UE release 10 and forward that support intra-band contiguous DL CA.

8.2.1.1.1_A.1.3 Minimum conformance requirements

The requirements are specified in terms of the percentage of information bit throughput for the downlink reference measurement channels specified in Annex A clause A.3.3.1, with the addition of the relevant parameters in Tables 8.2.1-1, 8.2.1.1.1_A.1.3-1 and the downlink physical channel setup according to Table C.3.2-1 in Annex C.

Using this configuration the fraction of maximum throughput percentage shall meet or exceed the minimum requirements specified in Table 8.2.1.1.1_A.1.3-2 for the specified SNR. For QPSK and 64QAM performance the bandwidths specified in Table 5.4.2.1-1 are verified.

Table 8.2.1.1.1_A.1.3-1: Test Parameters for Testing

Parameter	Unit	Test 1	Test 2	
Downlink power allocation	ρ_A	dB	0	0
	ρ_B	dB	0 (Note 1)	0 (Note 1)
	σ	dB	0	0
N_{oc} at antenna port	dBm/15kHz	-98	-98	
Symbols for unused PRBs		OCNG (Note 2)	OCNG (Note 2)	
Modulation		QPSK	QPSK	
PDSCH transmission mode		1	1	
Note 1: $P_B = 0$				
Note 2: These physical resource blocks are assigned to an arbitrary number of virtual UEs with one PDSCH per virtual UE; the data transmitted over the OCNG PDSCHs shall be uncorrelated pseudo random data, which is QPSK modulated.				
Note 3: For CA test cases, PUCCH format 1b with channel selection is used to feedback ACK/NACK.				
Note 4: For CA test cases, the same PDSCH transmission mode is applied to each component carrier.				

Table 8.2.1.1.1_A.1.3-2: Minimum performance (FRC)

Test num.	Bandwidth	Reference channel	OCNG pattern	Propagation condition	Correlation matrix and antenna config.	Reference value		UE category	CA capability
						Fraction of maximum throughput (%)	SNR (dB)		
1	2x10 MHz	R.2 FDD	OP.1 FDD (Note 1)	EVA5	1x2 Low	70	-1.1	3-8	CL_A-A (Note 2)
2	2x20 MHz	R.42 FDD	OP.1 FDD (Note 1)	EVA5	1x2 Low	70	-1.3	5-8	CL_C
Note 1: For CA capable UE, the OCNG pattern applies for each CC.									
Note 2: 30usec timing difference between two CCs is applied in inter-band CA case.									

The normative reference for this requirement is TS 36.101 [2] clause 8.2.1.1.

8.2.1.1.1_A.1.4 Test description

8.2.1.1.1_A.1.4.1 Initial conditions

Initial conditions are a set of test configurations the UE needs to be tested in and the steps for the SS to take with the UE to reach the correct measurement state.

Configurations of PDSCH and PDCCH before measurement are specified in Annex C.2.

Test Environment: Normal, as defined in TS 36.508 [7] clause 4.1.

Frequencies to be tested for full allocation: Mid Range, as defined in TS 36.508 [7] clause 4.3.1.

Channel Bandwidths to be tested: As specified per test number in Table 8.2.1.1.1_A.1.3-2 as defined in TS 36.508 [7] clause 4.3.1.

1. Connect the SS, the faders and AWGN noise source to the UE antenna connectors as shown in TS 36.508 [7] Annex A, Figure group A.35 as appropriate
2. The parameter settings for the cell are set up according to Table 8.2.1-1 and 8.2.1.1.1_A.3-1 as appropriate.
3. Downlink signals for PCC are initially set up according to Annex C0, C.1 and Annex C.3.2 and uplink signals according to Annex H.1 and H.3.2.
4. Propagation conditions are set according to Annex B.0.
5. Ensure the UE is in State 3A-RF according to TS 36.508 [7] clause 5.2A. 2. Message contents are defined in clause 8.2.1.1.1_A.1.4.3.

8.2.1.1.1_A.1.4.2 Test procedure

1. Configure SCC according to Annex C0, C.1 and Annex C.3.2 for all downlink physical channels except PHICH.
2. The SS shall configure SCC as per TS 36.508 [7] clause 5.2A.4. Message contents are defined in clause 8.2.1.1.1_A.1.4.3
3. SS activates SCC by sending the activation MAC-CE (Refer TS 36.321 [13], clauses 5.13, 6.1.3.8). Wait for at least 2 seconds (Refer TS 36.133, clauses 8.3.3.2).
4. SS transmits PDSCH via PDCCH DCI format 1A for C_RNTI to transmit the DL RMC according to Tables 8.2.1.1.1_A.1.3-1 and 8.2.1.1.1_A.1.3-2 on both PCC and SCC. The SS sends downlink MAC padding bits on the DL RMC.
5. Set the parameters of the bandwidth, MCS, reference channel, the propagation condition, the correlation matrix and the SNR on each of the component carriers according to Tables 8.2.1.1.1_A.1.5-1 as appropriate.
6. Measure the average throughput per component carrier for a duration sufficient to achieve statistical significance according to Annex G clause G.3A, Table G.3A.5-1 on both PCC and SCC. Count the number of NACKs, ACKs and statDTXs on the UL during each subtest on both component carriers.
7. Repeat steps from 1 to 6 for each subtest in Table 8.2.1.1.1_A.1.5-1 depending on UE CA capability as defined in Table 8.1.1-1 and as appropriate.

8.2.1.1.1_A.1.4.3 Message contents

Message contents are according to TS 36.508 [7] subclause 4.6. In test procedure step 2, for SCC configuration there are no additional message contents.

8.2.1.1.1_A.1.5 Test requirement

Table 8.2.1.1.1_A.1.3-1 defines the primary level settings.

The fraction of maximum throughput percentage for the downlink reference measurement channels specified in Annex A clause A.3.3.1 for the throughput test shall meet or exceed the specified value in Table 8.2.1.1.1_A. 1.5-1 for the specified SNR including test tolerances for all throughput tests.

Table 8.2.1.1.1_A.5-1: Test requirement (FRC)

Test num.	Band-width	Reference channel	OCNG pattern	Propa-gation condi-tion	Correlation matrix and antenna config.	Reference value		UE cate-gory	CA capa-bility
						Fraction of maximum throughput (%)	SNR (dB)		
1	NA								
2	2x20 MHz	R.42 FDD	OP.1 FDD (Note 1)	EVA5	1x2 Low	70	-0.5	5-8	CL_C

Note 1: For CA capable UE, the OCNG pattern applies for each CC.

Decide pass or fail for each subtest according to Annex G.3A.4. Decide the entire test pass or fail according to Annex G.3A.6.

8.2.1.1.1_A.2 FDD PDSCH Single Antenna Port Performance for CA (inter-band DL CA)

8.2.1.1.1_A.2.1 Test purpose

Same test purpose as in clause 8.2.1.1.1_A.1.1

8.2.1.1.1_A.2.2 Test applicability

This test applies to all types of E-UTRA FDD UE release 10 and forward that support inter-band DL CA.

8.2.1.1.1_A.2.3 Minimum conformance requirements

Same minimum conformance requirements as in clause 8.2.1.1.1_A.1.3

8.2.1.1.1_A.2.4 Test description

8.2.1.1.1_A.2.4.1 Initial conditions

Same initial conditions as in clause 8.2.1.1.1_A.1.4.1 with the following exceptions:

- Instead of clause 8.2.1.1.1_A.1.4.3 → use 8.2.1.1.1_A.2.4.3

8.2.1.1.1_A.2.4.2 Test procedure

1. Configure SCC according to Annex C0, C.1 and Annex C.3.2 for all downlink physical channels except PHICH and with the timing offsets according to Table 8.2.1.1.1_A.2.5-1.
2. The SS shall configure SCC as per TS 36.508 [7] clause 5.2A.4. Message contents are defined in clause 8.2.1.1.1_A.2.4.3
3. SS activates SCC by sending the activation MAC-CE (Refer TS 36.321 [13], clauses 5.13, 6.1.3.8). Wait for at least 2 seconds (Refer TS 36.133, clauses 8.3.3.2).
4. SS transmits PDSCH via PDCCH DCI format 1A for C_RNTI to transmit the DL RMC according to Tables 8.2.1.1.1_A.2.3-1 and 8.2.1.1.1_A.2.3-2 on both PCC and SCC. The SS sends downlink MAC padding bits on the DL RMC.
5. Set the parameters of the bandwidth, MCS, reference channel, the propagation condition, the correlation matrix and the SNR on each of the component carriers according to Tables 8.2.1.1.1_A.2.5-1 as appropriate.
6. Measure the average throughput per component carrier for a duration sufficient to achieve statistical significance according to Annex G clause G.3A, Table G.3A.5-2 on both PCC and SCC. Count the number of NACKs, ACKs and statDTXs on the UL during each subtest on both component carriers.
7. Repeat steps from 1 to 6 for each subtest in Table 8.2.1.1.1_A.2.5-1 depending on UE CA capability as defined in Table 8.1.1-1 and as appropriate.

8.2.1.1.1_A.2.4.3 Message contents

Message contents are according to TS 36.508 [7] subclause 4.6. In test procedure step 2, for SCC configuration there are no additional message contents.

8.2.1.1.1_A.2.5 Test requirement

Table 8.2.1.1.1_A.2.3-1 defines the primary level settings.

The fraction of maximum throughput percentage for the downlink reference measurement channels specified in Annex A clause A.3.3.1 for the throughput test shall meet or exceed the specified value in Table 8.2.1.1.1_A.2.5-1 for the specified SNR including test tolerances for all throughput tests.

Table 8.2.1.1.1_A.2.5-1: Test requirement (FRC)

Test num.	Band-width	Reference channel	OCNG pattern	Propa-gation condition	Correlation matrix and antenna config.	Reference value		UE cate-gory	CA capa-bility
						Fraction of maximum throughput (%)	SNR (dB)		
1	2x10 MHz	R.2 FDD	OP.1 FDD (Note 1)	EVA5	1x2 Low	70	-0.3	3-8	CL_A-A (Note 2)
2	NA								
Note 1: For CA capable UE, the OCNG pattern applies for each CC.									
Note 2: 30usec or 922*Ts timing difference between two CCs is applied in inter-band CA case.									

Decide pass or fail for each subtest according to Annex G.3A.4. Decide the entire test pass or fail according to Annex G.3A.6.

8.2.1.1.2 FDD PDSCH Single Antenna Port Performance with 1 PRB in presence of MBSFN

8.2.1.1.2.1 Test purpose

To verify the UE's ability to receive a predefined test signal, representing a multi-path fading channel that is determined by the SNR with a percentage of the information bit throughput for a specified downlink Reference Measurement Channel (RMC) not falling below a specified value for transmission on a single-antenna port with different channel models and MCS for 1 PRB allocation in presence of MBSFN.

8.2.1.1.2.2 Test applicability

This test applies to all types of E-UTRA FDD UE release 8 and forward.

8.2.1.1.2.3 Minimum conformance requirements

The requirements are specified in terms of the percentage of information bit throughput for the downlink reference measurement channels specified in Annex A clause A.3.3.1, with the addition of the relevant parameters in Tables 8.2.1-1, 8.2.1.1.2.3-1, and the downlink physical channel setup according to Table C.3.2-1 in Annex C.

Using this configuration the fraction of maximum throughput percentage shall meet or exceed the minimum requirements specified in Tables 8.2.1.1.2.3-2, for the specified SNR.

Table 8.2.1.1.2.3-1: Test Parameters for Testing 1 PRB allocation

Parameter	Unit	Test 1	
Downlink power allocation	ρ_A	dB	0
	ρ_B	dB	0 (Note 1)
	σ	dB	0
N_{oc} at antenna port	dBm/15kHz	-98	
Symbols for MBSFN portion of MBSFN subframes (Note 2)		OCNG (Note 3)	
PDSCH transmission mode		1	
Note 1: $P_B = 0$ Note 2: The MBSFN portion of an MBSFN subframe comprises the whole MBSFN subframe except the first two symbols in the first slot. Note 3: The MBSFN portion of the MBSFN subframes shall contain QPSK modulated data. Cell-specific reference signals are not inserted in the MBSFN portion of the MBSFN subframes, QPSK modulated MBSFN data is used instead.			

Table 8.2.1.1.2.3-2: Minimum performance 1 PRB allocation (FRC)

Test number	Bandwidth	Reference Channel	OCNG Pattern	Propagation Condition	Correlation Matrix and Antenna Configuration	Reference value		UE Category
						Fraction of Maximum Throughput (%)	SNR (dB)	
1	10 MHz	R.29 FDD	OP.3 FDD	ETU70	1x2 Low	30	2.0	1-5

The normative reference for this requirement is TS 36.101 [2] clause 8.2.1.1.

8.2.1.1.2.4 Test description

8.2.1.1.2.4.1 Initial conditions

Initial conditions are a set of test configurations the UE needs to be tested in and the steps for the SS to take with the UE to reach the correct measurement state.

Configurations of PDSCH and PDCCH before measurement are specified in Annex C.2.

Test Environment: Normal, as defined in TS 36.508 [7] clause 4.1.

Frequencies to be tested: Low Range, as defined in TS 36.508 [7] clause 4.3.1.1.

Channel Bandwidths to be tested: As specified per test number in Tables 8.2.1.1.2.3-2as defined in TS 36.508 [7] clause 4.3.1.1

1. Connect the SS, the faders and AWGN noise source to the UE antenna connectors as shown in TS 36.508 [7] Annex A, Figure A.9.
2. The parameter settings for the cell are set up according to Tables 8.2.1-1, 8.2.1.1.2.3-1as appropriate.
3. Downlink signals are initially set up according to Annex C.1 and Annex C.3.2 and uplink signals according to Annex H.1 and H.3.2.
4. Propagation conditions are set according to Annex B.0.
5. Ensure the UE is in State 3A-RF according to TS 36.508 [7] clause 5.2A.2. Message contents are defined in clause 8.2.1.1.2.4.3.

8.2.1.1.2.4.2 Test procedure

1. SS transmits PDSCH via PDCCH DCI format 1A for C_RNTI to transmit the DL RMC according to Tables 8.2.1.1.2.3-1 and 8.2.1.1.2.3-2. The SS sends downlink MAC padding bits on the DL RMC.
2. Set the parameters of the bandwidth, MCS, reference channel, the propagation condition, the correlation matrix and the SNR according to Table 8.2.1.1.2.5-1as appropriate.
3. Measure the average throughput for a duration sufficient to achieve statistical significance according to Annex G clause G.3. Count the number of NACKs, ACKs and statDTXs on the UL during each subtest and decide pass or fail according to Tables G.3.5 and G.3.6 in Annex G clause G.3.

8.2.1.1.2.4.3 Message contents

Message contents are according to TS 36.508 [7] clause 4.6 with the following exceptions:

Table 8.2.1.1.2.4.3-1: SystemInformationBlockType2: Additional FDD PDSCH Single Antenna Port Performance for 1 PRB allocation with MBSFN subframes test point 1 requirement

Derivation Path: TS 36.508 [7] clause 4.4.3.3, Table 4.4.3.3-1 SystemInformationBlockType2			
Information Element	Value/remark	Comment	Condition
SystemInformationBlockType2 ::= SEQUENCE {			
mbsfn-SubframeConfig ::= SEQUENCE {			
radioframeAllocationPeriod	n1	Every radio frame is with MBSFN subframe	
radioframeAllocationOffset	0		
subframeAllocation CHOICE {			
oneFrame	111111	Subframe 1, 2, 3, 6, 7, 8 is used for MBSFN	FDD
}			
}			
}			

8.2.1.1.2.5 Test requirement

Table 8.2.1.1.2.3-1 defines the primary level settings.

The fraction of maximum throughput percentage for the downlink reference measurement channels specified in Annex A clause A.3.3.1 for each throughput test shall meet or exceed the specified value in Tables 8.2.1.1.2.5-1 for the specified SNR including test tolerances for all throughput tests.

Table 8.2.1.1.2.5-1: Test requirement 1 PRB allocation with MBSFN subframes (FRC)

Test number	Bandwidth	Reference Channel	OCNG Pattern	Propagation Condition	Correlation Matrix and Antenna Configuration	Reference value		UE Category
						Fraction of Maximum Throughput (%)	SNR (dB)	
1	10 MHz	R.29 FDD	OP.3 FDD	ETU70	1x2 Low	30	+2.8	1-5

8.2.1.2 FDD PDSCH Transmit Diversity Performance (Cell-Specific Reference Symbols)

8.2.1.2.1 FDD PDSCH Transmit Diversity 2x2

8.2.1.2.1.1 Test purpose

To verify the UE's ability to receive a predefined test signal, representing a multi-path fading channel that is determined by the SNR with a percentage of the information bit throughput for a specified downlink Reference Measurement Channel (RMC) not falling below a specified value for transmission on two antenna ports using transmit diversity (SFBC).

8.2.1.2.1.2 Test applicability

This test applies to all types of E-UTRA FDD UE release 8 and forward.

8.2.1.2.1.3 Minimum conformance requirements

The requirements are specified in terms of the percentage of information bit throughput for the downlink reference measurement channels specified in Annex A clause A.3.3.2, with the addition of the relevant parameters in Tables 8.2.1-1 and 8.2.1.2.1.3-1 and the downlink physical channel setup according to Table C.3.2-1 in Annex C.3.2.

Using this configuration the fraction of maximum throughput percentage shall meet or exceed the minimum requirements specified in Table 8.2.1.2.1.3-2 for the specified SNR. For transmit diversity (SFBC) performance with 2 transmitter antennas as specified.

Table 8.2.1.2.1.3-1: Test Parameters for Testing Transmit Diversity Performance

Parameter		Unit	Test 1-2
Downlink power allocation	ρ_A	dB	-3
	ρ_B	dB	-3 (Note 1)
	σ	dB	0
N_{oc} at antenna port		dBm/15kHz	-98
PDSCH transmission mode			2
Note 1: $P_B = 1$			

Table 8.2.1.2.1.3-2: Minimum performance Transmit Diversity (FRC)

Test number	Band-width	Reference Channel	OCNG Pattern	Propagation Condition	Correlation Matrix and Antenna Configuration	Reference value		UE Category
						Fraction of Maximum Throughput (%)	SNR (dB)	
1	10 MHz	R.11 FDD	OP.1 FDD	EVA5	2x2 Medium	70	6.8	2-5
2	10 MHz	R.10 FDD	OP.1 FDD	HST	2x2 Low	70	-2.3	1-5

The normative reference for this requirement is TS 36.101 [2] clause 8.2.1.2.

8.2.1.2.1.4 Test description

8.2.1.2.1.4.1 Initial conditions

Initial conditions are a set of test configurations the UE needs to be tested in and the steps for the SS to take with the UE to reach the correct measurement state.

Configurations of PDSCH and PDCCH before measurement are specified in Annex C.2.

Test Environment: Normal, as defined in TS 36.508 [7] clause 4.1.

Frequencies to be tested: Mid Range, as defined in TS 36.508 [7] clause 4.3.1.1.

Channel Bandwidths to be tested: As specified per test number in Table 8.2.1.2.1.3-2 as defined in TS 36.508 [7] clause 4.3.1.1.

1. Connect the SS, the faders and AWGN noise sources to the UE antenna connectors as shown in TS 36.508 [7] Annex A, Figure A.10 for antenna configuration 2x2.
2. The parameter settings for the cell are set up according to Tables 8.2.1-1 and 8.2.1.2.1.3-1 as appropriate.
3. Downlink signals are initially set up according to Annex C0, C.1 and Annex C.3.2 and uplink signals according to Annex H.1 and H.3.2.

4. Propagation conditions are set according to Annex B.0.
5. Ensure the UE is in State 3A-RF according to TS 36.508 [7] clause 5.2A.2. Message contents are defined in clause 8.2.1.2.1.4.3.

8.2.1.2.1.4.2 Test procedure

1. SS transmits PDSCH via PDCCH DCI format 1A for C_RNTI to transmit the DL RMC according to Tables 8.2.1.2.1.3-1 and 8.2.1.2.1.3-2. The SS sends downlink MAC padding bits on the DL RMC.
2. Set the parameters of the bandwidth, MCS, reference channel, the propagation condition, the correlation matrix, antenna configuration and the SNR according to Tables 8.2.1.2.1.5-1 as appropriate.
3. Measure the average throughput for a duration sufficient to achieve statistical significance according to Annex G clause G.3. Count the number of NACKs, ACKs and statDTXs on the UL during the test interval and decide pass or fail according to Tables G.3.5 and G.3.6 in Annex G clause G.3.
4. Repeat steps from 1 to 3 for each test interval in Table 8.2.1.2.1.5-1 as appropriate.

8.2.1.2.1.4.3 Message contents

Message contents are according to TS 36.508 [7] clause 4.6.

8.2.1.2.1.5 Test requirement

Table 8.2.1.2.1.3-1 defines the primary level settings.

The fraction of maximum throughput percentage for the downlink reference measurement channels specified in Annex A clause A.3.3.2 for each throughput test shall meet or exceed the specified value in Table 8.2.1.2.1.5-1 for the specified SNR including test tolerances for all throughput tests.

Table 8.2.1.2.1.5-1: Test requirement Transmit Diversity (FRC)

Test number	Band-width	Reference Channel	OCNG Pattern	Propagation Condition	Correlation Matrix and Antenna Configuration	Reference value		UE Category
						Fraction of Maximum Throughput (%)	SNR (dB)	
1	10 MHz	R.11 FDD	OP.1 FDD	EVA5	2x2 Medium	70	7.7	2-5
2	10 MHz	R.10 FDD	OP.1 FDD	HST	2x2 Low	70	-1.7	1-5

8.2.1.2.1_1 FDD PDSCH Transmit Diversity 2x2 (Release 9 and forward)

8.2.1.2.1_1.1 Test purpose

Same test purpose as in clause 8.2.1.2.1.1.

8.2.1.2.1_1.2 Test applicability

This test applies to all types of E-UTRA FDD UE release 9 and forward of UE category 1.

8.2.1.2.1_1.3 Minimum conformance requirements

Same minimum conformance requirements as in clause 8.2.1.2.1.3 with the following exceptions:

- Instead of Table 8.2.1.2.1.3-1 → use Table 8.2.1.2.1_1.3-1.
- Instead of Table 8.2.1.2.1.3-2 → use Table 8.2.1.2.1_1.3-2.

Table 8.2.1.2.1_1.3-1: Test Parameters for Testing Transmit Diversity Performance

Parameter		Unit	Test 1
Downlink power allocation	ρ_A	dB	-3
	ρ_B	dB	-3 (Note 1)
	σ	dB	0
N_{oc} at antenna port		dBm/15kHz	-98
PDSCH transmission mode			2
Note 1: $P_B = 1$			

Table 8.2.1.2.1_1.3-2: Minimum performance Transmit Diversity (FRC)

Test number	Band-width	Reference Channel	OCNG Pattern	Propagation Condition	Correlation Matrix and Antenna Configuration	Reference value		UE Category
						Fraction of Maximum Throughput (%)	SNR (dB)	
1	5 MHz	R.11-2 FDD	OP.1 FDD	EVA5	2x2 Medium	70	5.9	1

The normative reference for this requirement is TS 36.101 [2] clause 8.2.1.2.

8.2.1.2.1_1.4 Test description

Same test description as in clause 8.2.1.2.1.4 with the following exceptions:

- Instead of Table 8.2.1.2.1.3-1 → use Table 8.2.1.2.1_1.3-1.
- Instead of Table 8.2.1.2.1.3-2 → use Table 8.2.1.2.1_1.3-2.
- Instead of Table 8.2.1.2.1.5-1 → use Table 8.2.1.2.1_1.5-1.

8.2.1.2.1_1.5 Test requirement

Same test requirements as in clause 8.2.1.2.1.5 with the following exceptions:

- Instead of Table 8.2.1.2.1.3-1 → use Table 8.2.1.2.1_1.3-1.
- Instead of Table 8.2.1.2.1.5-1 → use Table 8.2.1.2.1_1.5-1.

Table 8.2.1.2.1_1.5-1: Test requirement Transmit Diversity (FRC)

Test number	Band-width	Reference Channel	OCNG Pattern	Propagation Condition	Correlation Matrix and Antenna Configuration	Reference value		UE Category
						Fraction of Maximum Throughput (%)	SNR (dB)	
1	5 MHz	R.11-2 FDD	OP.1 FDD	EVA5	2x2 Medium	70	+6.8	1

8.2.1.2.2 FDD PDSCH Transmit Diversity 4x2

8.2.1.2.2.1 Test purpose

To verify the UE's ability to receive a predefined test signal, representing a multi-path fading channel that is determined by the SNR with a percentage of the information bit throughput for a specified downlink Reference Measurement Channel (RMC) not falling below a specified value for transmission on two antenna ports using transmit diversity (SFBC-FSTD).

8.2.1.2.2.2 Test applicability

This test applies to all types of E-UTRA FDD UE release 8 and forward.

8.2.1.2.2.3 Minimum conformance requirements

The requirements are specified in terms of the percentage of information bit throughput for the downlink reference measurement channels specified in Annex A clause A.3.3.2, with the addition of the relevant parameters in Tables 8.2.1-1 and 8.2.1.2.2.3-1 and the downlink physical channel setup according to Table C.3.2-1 in Annex C.3.2.

Using this configuration the fraction of maximum throughput percentage shall meet or exceed the minimum requirements specified in Table 8.2.1.2.2.3-2 for the specified SNR. For transmit diversity (SFBC) performance with 4 transmitter antennas as specified.

Table 8.2.1.2.2.3-1: Test Parameters for Testing Transmit Diversity Performance

Parameter		Unit	Test 1
Downlink power allocation	ρ_A	dB	-3
	ρ_B	dB	-3 (Note 1)
	σ	dB	0
N_{oc} at antenna port		dBm/15kHz	-98
PDSCH transmission mode			2
Note 1: $P_B = 1$			

Table 8.2.1.2.2.3-2: Minimum performance Transmit Diversity (FRC)

Test number	Band-width	Reference Channel	OCNG Pattern	Propagation Condition	Correlation Matrix and Antenna Configuration	Reference value		UE Category
						Fraction of Maximum Throughput (%)	SNR (dB)	
1	1.4 MHz	R.12 FDD	OP.1 FDD	EPA5	4x2 Medium	70	0.6	1-5

The normative reference for this requirement is TS 36.101 [2] clause 8.2.1.2.

8.2.1.2.2.4 Test description

8.2.1.2.2.4.1 Initial conditions

Initial conditions are a set of test configurations the UE needs to be tested in and the steps for the SS to take with the UE to reach the correct measurement state.

Configurations of PDSCH and PDCCH before measurement are specified in Annex C.2.

Test Environment: Normal, as defined in TS 36.508 [7] clause 4.1.

Frequencies to be tested: Mid Range, as defined in TS 36.508 [7] clause 4.3.1.1.

Channel Bandwidths to be tested: As specified per test number in Table 8.2.1.2.2.3-2 as defined in TS 36.508 [7] clause 4.3.1.1.

1. Connect the SS, the faders and AWGN noise sources to the UE antenna connectors as shown in TS 36.508 [7] Annex A, Figure A.11 for antenna configuration 4x2.
2. The parameter settings for the cell are set up according to Tables 8.2.1-1 and 8.2.1.2.2.3-1 as appropriate.
3. Downlink signals are initially set up according to Annex C.1 and Annex C.3.2 and uplink signals according to Annex H.1 and H.3.2.
4. Propagation conditions are set according to Annex B.0.

5. Ensure the UE is in State 3A-RF according to TS 36.508 [7] clause 5.2A.2. Message contents are defined in clause 8.2.1.2.2.4.3.

8.2.1.2.2.4.2 Test procedure

1. SS transmits PDSCH via PDCCH DCI format 1A for C_RNTI to transmit the DL RMC according to Tables 8.2.1.2.2.3-1 and 8.2.1.2.2.3-2. The SS sends downlink MAC padding bits on the DL RMC.
2. Set the parameters of the bandwidth, MCS, reference channel, the propagation condition, the correlation matrix, antenna configuration and the SNR according to Tables 8.2.1.2.2.5-1 as appropriate.
3. Measure the average throughput for a duration sufficient to achieve statistical significance according to Annex G clause G.3. Count the number of NACKs, ACKs and statDTXs on the UL during the test interval and decide pass or fail according to Tables G.3.5 and G.3.6 in Annex G clause G.3.

8.2.1.2.2.4.3 Message contents

Message contents are according to TS 36.508 [7] clause 4.6 with the following exceptions:

Table 8.2.1.2.2.4.3-1: PDSCH-ConfigDedicated-DEFAULT: Additional FDD PDSCH transmit diversity performance downlink power allocation test point 1 requirement

Derivation Path: 36.331 clause 6.3.2			
Information Element	Value/remark	Comment	Condition
PDSCH-ConfigDedicated-DEFAULT ::= SEQUENCE {			
p-a	dB-3		
}			

8.2.1.2.2.5 Test requirement

Table 8.2.1.2.2.3-1 defines the primary level settings.

The fraction of maximum throughput percentage for the downlink reference measurement channels specified in Annex A clause A.3.3.2 for each throughput test shall meet or exceed the specified value in Table 8.2.1.2.2.5-1 for the specified SNR including test tolerances for all throughput tests.

Table 8.2.1.2.2.5-1: Test requirement Transmit Diversity (FRC)

Test number	Band-width	Reference Channel	OCNG Pattern	Propagation Condition	Correlation Matrix and Antenna Configuration	Reference value		UE Category
						Fraction of Maximum Throughput (%)	SNR (dB)	
1	1.4 MHz	R.12 FDD	OP.1 FDD	EPA5	4x2 Medium	70	1.5	1-5

8.2.1.2.2_1 FDD PDSCH Transmit Diversity 4x2 (Release 9 and forward)

8.2.1.2.2_1.1 Test purpose

Same test purpose as in clause 8.2.1.2.2.1.

8.2.1.2.2_1.2 Test applicability

This test applies to all types of E-UTRA FDD UE release 9 and forward.

8.2.1.2.2_1.3 Minimum conformance requirements

Same minimum conformance requirements as in clause 8.2.1.2.2.3 with the following exceptions:

- Instead of Table 8.2.1.2.2.3-1 → use Table 8.2.1.2.2_1.3-1.

- Instead of Table 8.2.1.2.2.3-2 → use Table 8.2.1.2.2_1.3-2.

Table 8.2.1.2.2_1.3-1: Test Parameters for Testing Transmit Diversity Performance

Parameter		Unit	Test 1
Downlink power allocation	ρ_A	dB	-3
	ρ_B	dB	-3 (Note 1)
	σ	dB	0
N_{oc} at antenna port		dBm/15kHz	-98
PDSCH transmission mode			2
Note 1: $P_B = 1$			

Table 8.2.1.2.2_1.3-2: Minimum performance Transmit Diversity (FRC)

Test number	Band-width	Reference Channel	OCNG Pattern	Propagation Condition	Correlation Matrix and Antenna Configuration	Reference value		UE Category
						Fraction of Maximum Throughput (%)	SNR (dB)	
1	10 MHz	R.13 FDD	OP.1 FDD	ETU70	4x2 Low	70	-0.9	1-5

The normative reference for this requirement is TS 36.101 [2] clause 8.2.1.2.

8.2.1.2.2_1.4 Test description

Same test description as in clause 8.2.1.2.2.4 with the following exceptions:

- Instead of Table 8.2.1.2.2.3-1 → use Table 8.2.1.2.2_1.3-1.
- Instead of Table 8.2.1.2.2.3-2 → use Table 8.2.1.2.2_1.3-2.
- Instead of Table 8.2.1.2.2.5-1 → use Table 8.2.1.2.2_1.5-1.

8.2.1.2.2_1.5 Test requirement

Same test requirements as in clause 8.2.1.2.2.5 with the following exceptions:

- Instead of Table 8.2.1.2.2.3-1 → use Table 8.2.1.2.2_1.3-1.
- Instead of Table 8.2.1.2.2.5-1 → use Table 8.2.1.2.2_1.5-1.

Table 8.2.1.2.2_1.5-1: Test requirement Transmit Diversity (FRC)

Test number	Band-width	Reference Channel	OCNG Pattern	Propagation Condition	Correlation Matrix and Antenna Configuration	Reference value		UE Category
						Fraction of Maximum Throughput (%)	SNR (dB)	
1	10 MHz	R.13 FDD	OP.1 FDD	ETU70	4x2 Low	70	0	1-5

8.2.1.2.3_C FDD PDSCH Transmit diversity 2x2 for eICIC

8.2.1.2.3_C.1 FDD PDSCH Transmit diversity 2x2 for eICIC (non-MBFSN ABS)

Editor's notes: This test case is incomplete. The following items are missing or incomplete:

- Connection diagram in Annex A of TS 36.508 is TBD
- Tests requirements are TBD

- Test tolerances are incomplete

8.2.1.2.3_C.1.1 Test purpose

To verify the UE's performance of transmit diversity (SFBC) with 2 transmit antennas if the PDSCH transmission in the serving cell takes place in subframes that overlap with ABS of the aggressor cell.

8.2.1.2.3_C.1.2 Test applicability

This test applies to all types of E-UTRA FDD UE release 10 and forward. Applicability requires support for FGI bit 115.

8.2.1.2.3_C.1.3 Minimum conformance requirements

The requirements are specified in terms of the percentage of information bit throughput for the downlink reference measurement channels specified in Annex A clause A.3.3.2, with the addition of the relevant parameters in Tables 8.2.1-1 and 8.2.1.2.3_C.1.3-1.

In Table 8.2.1.2.3_C.1.3-1, Cell 1 is the serving cell, and Cell 2 is the aggressor cell. The downlink physical channel setup for Cell 1 is according to Table C.3.2-1 in Annex C.3.2 and for Cell 2 is according to Table C.3.3-1 in Annex C.3.3, respectively.

Using this configuration the fraction of maximum throughput percentage shall meet or exceed the minimum requirements specified in Table 8.2.1.2.3_C.1.3-2 for the specified SNR.

Table 8.2.1.2.3_C.1.3-1: Test Parameters for Transmit diversity Performance (FRC)

Parameter		Unit	Cell 1	Cell 2
Downlink power allocation	ρ_A	dB	-3	-3
	ρ_B	dB	-3 (Note 1)	-3
	σ	dB	0	N/A
N_{oc} at antenna port	N_{oc1}	dBm/15kHz	-102 (Note 2)	N/A
	N_{oc2}	dBm/15kHz	-98 (Note 3)	N/A
	N_{oc3}	dBm/15kHz	-94.8 (Note 4)	N/A

\hat{E}_s / N_{oc2}		dB	Reference Value in Table 8.2.1.2.3_C.1.3-2	6
BW _{Channel}		MHz	10	10
Subframe Configuration			Non-MBSFN	Non-MBSFN
Time Offset between Cells		µs	2.5 (synchronous cells)	
Cell Id			0	1
ABS pattern (Note 5)			N/A	11000100 11000000 11000000 11000000 11000000
RLM/RRM Measurement Subframe Pattern (Note 6)			10000000 10000000 10000000 10000000 10000000	N/A
CSI Subframe Sets (Note7)	C _{CSI,0}		11000100 11000000 11000000 11000000 11000000	N/A
	C _{CSI,1}		00111011 00111111 00111111 00111111 00111111	N/A
Number of control OFDM symbols			2	
PDSCH transmission mode			2	N/A
Cyclic prefix			Normal	Normal
<p>Note 1: $P_b = 1$.</p> <p>Note 2: This noise is applied in OFDM symbols #1, #2, #3, #5, #6, #8, #9, #10, #12, #13 of a subframe overlapping with the aggressor ABS.</p> <p>Note 3: This noise is applied in OFDM symbols #0, #4, #7, #11 of a subframe overlapping with the aggressor ABS.</p> <p>Note 4: This noise is applied in all OFDM symbols of a subframe overlapping with aggressor non-ABS</p> <p>Note 5: ABS pattern as defined in [14]. PDSCH other than SIB1/paging and its associated PDCCH/PCFICH are transmitted in the serving cell subframe when the subframe is overlapped with the ABS subframe of aggressor cell and the subframe is available in the definition of the reference channel.</p> <p>Note 6: Time-domain measurement resource restriction pattern for PCell measurements as defined in [5]</p> <p>Note 7: As configured according to the time-domain measurement resource restriction pattern for CSI measurements defined in [5].</p> <p>Note 8: Cell 1 is the serving cell. Cell 2 is the aggressor cell. The number of the CRS ports in Cell1 and Cell2 is the same.</p> <p>Note 9: SIB-1 will not be transmitted in Cell2 in this test.</p>				

Table 8.2.1.2.3_C.1.3-2: Minimum Performance Transmit Diversity (FRC)

Test Number	Reference Channel	OCNG Pattern		Propagation Conditions (Note 1)		Correlation Matrix and Antenna Configuration	Reference Value		UE Category
		Cell 1	Cell 2	Cell 1	Cell 2		Fraction of Maximum Throughput (%)	SNR (dB) (Note 2)	
1	R.11-4 FDD	OP.1 FDD	OP.1 FDD	EVA5	EVA 5	2x2 Medium	70	3.4	2-8
<p>Note 1: The propagation conditions for Cell 1 and Cell2 are statistically independent.</p> <p>Note 2: SNR corresponds to \hat{E}_s / N_{oc2} of cell 1.</p>									

The normative reference for this requirement is TS 36.101 [2] clause 8.2.1.2.3.

8.2.1.2.3_C.1.4 Test description

8.2.1.2.3_C.1.4.1 Initial conditions

Initial conditions are a set of test configurations the UE needs to be tested in and the steps for the SS to take with the UE to reach the correct measurement state.

Configurations of PDSCH and PDCCH before measurement are specified in Annex C.2.

Test Environment: Normal, as defined in TS 36.508 [7] clause 4.1.

Frequencies to be tested: Mid Range, as defined in TS 36.508 [7] clause 4.3.1.1.

Channel Bandwidths to be tested: As specified per test number in Table 8.2.1.2.3_C.1.3-2 as defined in TS 36.508 [7] clause 4.3.1.1.

1. Connect the SS, the faders and AWGN noise sources to the UE antenna connectors as shown in TS 36.508 [7] Annex A, Figure [TBD] for antenna configuration 2x2.
2. The parameter settings for the cell1 are set up according to Tables 8.2.1-1 and 8.2.1.2.3_C.1.3-1 as appropriate.
3. Downlink signals are initially set up for Cell1 according to Annex C.1 and Annex C.3.2 and uplink signals according to Annex H.1 and H.3.2.
4. Propagation conditions are set according to Annex B.0.
5. Ensure the UE is in State 3A-RF according to TS 36.508 [7] clause 5.2A.2. Message contents are defined in clause 8.2.1.2.3_C.1.4.3.

8.2.1.2.3_C.1.4.2 Test procedure

1. SS transmits PDSCH via PDCCH DCI format 1A for C_RNTI to transmit the DL RMC according to Tables 8.2.1.2.3_C.1.3-1 and 8.2.1.2.3_C.1.3-2. The SS sends downlink MAC padding bits on the DL RMC.
2. Set the parameters of the bandwidth, MCS, reference channel, the propagation condition, the correlation matrix, antenna configuration and the SNR according to Tables 8.2.1.2.3_C.1.5-1 as appropriate.
3. Set the Cell2 –aggressor cell- as defined in Tables 8.2.1.2.3_C.1.3-1, 8.2.1.2.3_C.1.5-1 and according to Annex C3.3.
4. Measure the average throughput for a duration sufficient to achieve statistical significance according to Annex G clause G.3. Count the number of NACKs, ACKs and statDTXs on the UL during the test interval and decide pass or fail according to Tables G.3.5 and G.3.6 in Annex G clause G.3.

8.2.1.2.3_C.1.4.3 Message contents

Message contents are according to TS 36.508 [7] clause 4.6 with the following exceptions:

Table 8.2.1.2.3_C.1.4.3-1: RadioResourceConfigDedicated-SRB2-DRB(n, m): Additional FDD PDSCH transmit diversity performance downlink power allocation

Derivation Path: TS 36.508 [7] clause 4.6.3, Table 4.6.3-16 RadioResourceConfigDedicated-SRB2-DRB(n,m)			
Information Element	Value/remark	Comment	Condition
RadioResourceConfigDedicated-SRB2-DRB(n, m) ::= SEQUENCE {			
MeasSubframePatternPCell-r10 CHOICE {			
setup SEQUENCE {			
subframePatternFDD-r10	'10000000100000001000 00001000000010000000'	BIT STRING (SIZE (40))	
}			
}			
}			

Table 8.2.1.2.3_C.1.4.3-2: CQI-ReportConfig-r10-DEFAULT: Additional FDD PDSCH transmit diversity performance downlink power allocation

Derivation Path: 36.508 [7] clause 4.6.3, Table 4.6.3-2AA CQI-ReportConfig-r10-DEFAULT_			
Information Element	Value/remark	Comment	Condition
CQI-ReportConfig-r10-DEFAULT ::= SEQUENCE {			
cqi-ReportAperiodic-r10	Not present		
nomPDSCH-RS-EPRE-Offset	0		
cqi-ReportPeriodic-r10	Not present		
pmi-RI-Report-r9	Not present		
csi-SubframePatternConfig-r10 CHOICE {			
setup SEQUENCE {			
csi-MeasSubframeSet1-r10 CHOICE {			
subframePatternFDD-r10	'11000100110000001100 00001100000011000000'	BIT STRING (SIZE (40))	
}			
csi-MeasSubframeSet2-r10 CHOICE {			
subframePatternFDD-r10	'00111011001111110011 11110011111100111111'	BIT STRING (SIZE (40))	
}			
}			
}			
}			

8.2.1.2.3_C.1.5 Test requirement

Table 8.2.1.2.3_C.1.3-1 defines the primary level settings.

The fraction of maximum throughput percentage for the downlink reference measurement channels specified in Annex A clause A.3.3.2 for each throughput test shall meet or exceed the specified value in Table 8.2.1.2.3_C.1.5-1 for the specified SNR including test tolerances for all throughput tests.

Table 8.2.1.2.3_C.1.5-1: Test requirement Transmit Diversity (FRC)

Test Number	Reference Channel	OCNG Pattern		Propagation Conditions (Note 1)		Correlation Matrix and Antenna Configuration	Reference Value		UE Category
		Cell 1	Cell 2	Cell 1	Cell 2		Fraction of Maximum Throughput (%)	SNR (dB) (Note 2)	
1	R.11-4 FDD	OP.1 FDD	OP.1 FDD	EVA5	EVA 5	2x2 Medium	70	[TBD]	2-8

Note 1: The propagation conditions for Cell 1 and Cell2 are statistically independent.
 Note 2: SNR corresponds to \hat{E}_s / N_{oc2} of cell 1.

8.2.1.3 FDD PDSCH Open Loop Spatial Multiplexing Performance (Cell-Specific Reference Symbols)

8.2.1.3.1 FDD PDSCH Open Loop Spatial Multiplexing 2x2

8.2.1.3.1.1 Test purpose

To verify the UE's ability to receive a predefined test signal, representing a multi-path fading channel that is determined by the SNR with a percentage of the information bit throughput for a specified downlink Reference Measurement Channel (RMC) not falling below a specified value for transmission on two antenna ports using large delay CDD.

8.2.1.3.1.2 Test applicability

This test applies to all types of E-UTRA FDD UE release 8 and forward.

8.2.1.3.1.3 Minimum conformance requirements

The requirements are specified in terms of the percentage of information bit throughput for the downlink reference measurement channels specified in Annex A clause A.3.3.2, with the addition of the relevant parameters in Tables 8.2.1-1 and 8.2.1.3.1.3-1 and the downlink physical channel setup according to Table C.3.2-1 in Annex C.

Using this configuration the fraction of maximum throughput percentage shall meet or exceed the minimum requirements specified in Table 8.2.1.3.1.3-1 for the specified SNR. For open-loop spatial multiplexing performance with large delay CDD is specified.

Table 8.2.1.3.1.3-1: Test Parameters for Large Delay CDD (FRC)

Parameter		Unit	Test 1
Downlink power allocation	ρ_A	dB	-3
	ρ_B	dB	-3 (Note 1)
	σ	dB	0
N_{oc} at antenna port		dBm/15kHz	-98
PDSCH transmission mode			3
Note 1: $P_B = 1$			

Table 8.2.1.3.1.3-2: Minimum performance Large Delay CDD (FRC)

Test number	Band-width	Reference Channel	OCNG Pattern	Propagation Condition	Correlation Matrix and Antenna Configuration	Reference value		UE Category
						Fraction of Maximum Throughput (%)	SNR (dB)	
1	10 MHz	R.11 FDD	OP.1 FDD	EVA70	2x2 Low	70	13.0	2-5

The normative reference for this requirement is TS 36.101 [2] clause 8.2.1.3.

8.2.1.3.1.4 Test description

8.2.1.3.1.4.1 Initial conditions

Initial conditions are a set of test configurations the UE needs to be tested in and the steps for the SS to take with the UE to reach the correct measurement state.

Configurations of PDSCH and PDCCH before measurement are specified in Annex C.2.

Test Environment: Normal, as defined in TS 36.508 [7] clause 4.1.

Frequencies to be tested: Mid Range, as defined in TS 36.508 [7] clause 4.3.1.1.

Channel Bandwidths to be tested: As specified per test number in Table 8.2.1.3.1.3-2, as defined in TS 36.508 [7] clause 4.3.1.1

1. Connect the SS, the faders and AWGN noise sources to the UE antenna connectors as shown in TS 36.508 [7] Annex A, Figure A.10 for antenna configuration 2x2.
2. The parameter settings for the cell are set up according to Tables 8.2.1-1 and 8.2.1.3.1.3-1 as appropriate.
3. Downlink signals are initially set up according to Annex C0, C.1 and Annex C.3.2 and uplink signals according to Annex H.1 and H.3.2.
4. Propagation conditions are set according to Annex B.0.
5. Ensure the UE is in State 3A-RF according to TS 36.508 [7] clause 5.2A.2. Message contents are defined in clause 8.2.1.3.1.4.3.

8.2.1.3.1.4.2 Test procedure

1. SS transmits PDSCH via PDCCH DCI format 2A for C_RNTI to transmit the DL RMC according to Tables 8.2.1.3.1.3-1 and 8.2.1.3.1.3-2. The SS sends downlink MAC padding bits on the DL RMC.
2. Set the parameters of the reference channel, the propagation condition, the correlation matrix and the SNR according to Table 8.2.1.3.1.5-1 as appropriate.
3. Measure the average throughput for a duration sufficient to achieve statistical significance according to Annex G clause G.3. Count the number of NACKs, ACKs and statDTXs on the UL during the test interval and decide pass or fail according to Tables G.3.5 and G.3.6 in Annex G clause G.3.

8.2.1.3.1.4.3 Message contents

Message contents are according to TS 36.508 [7] clause 4.6 with the following exceptions:

Table 8.2.1.3.1.4.3-1: PhysicalConfigDedicated-DEFAULT: Additional FDD PDSCH open loop spatial multiplexing performance downlink power allocation for Test number 1

Derivation Path: 36.331 clause 6.3.2			
Information Element	Value/remark	Comment	Condition
PhysicalConfigDedicated-DEFAULT ::= SEQUENCE {			
antennaInfo CHOICE {			
antennaInfoDedicated ::= SEQUENCE {			
transmissionMode	tm3		
codebookSubsetRestriction CHOICE {			
n2TxAntenna-tm3	11		
}			
ue-TransmitAntennaSelection CHOICE {			
release	NULL		
}			
}			
}			

8.2.1.3.1.5 Test requirement

Table 8.2.1.3.1.3-1 defines the primary level settings.

The fraction of maximum throughput percentage for the downlink reference measurement channels specified in Annex A clause A.3.3.2 for each throughput test shall meet or exceed the specified value in Tables 8.2.1.3.1.5-1 for the specified SNR including test tolerances for all throughput tests.

Table 8.2.1.3.1.5-1: Test Requirement Large Delay CDD (FRC)

Test number	Band-width	Reference Channel	OCNG Pattern	Propagation Condition	Correlation Matrix and Antenna Configuration	Reference value		UE Category
						Fraction of Maximum Throughput (%)	SNR (dB)	
1	10 MHz	R.11 FDD	OP.1 FDD	EVA70	2x2 Low	70	13.9	2-5

8.2.1.3.1_A FDD PDSCH Open Loop Spatial Multiplexing 2x2 for CA

8.2.1.3.1_A.1 FDD PDSCH Open Loop Spatial Multiplexing 2x2 for CA (intra-band contiguous DL CA)

8.2.1.3.1_A.1.1 Test purpose

To verify the UE's ability to receive a predefined test signal, representing a multi-path fading channel that is determined by the SNR with a percentage of the information bit throughput for a specified downlink Reference Measurement Channel (RMC) not falling below a specified value for transmission on two antenna ports using large delay CDD.

8.2.1.3.1_A.1.2 Test applicability

This test applies to all types of E-UTRA FDD UE release 10 and forward that support intra-band contiguous DL CA.

8.2.1.3.1_A.1.3 Minimum conformance requirements

The requirements are specified in terms of the percentage of information bit throughput for the downlink reference measurement channels specified in Annex A clause A.3.3.2, with the addition of the relevant parameters in Tables 8.2.1-1 and 8.2.1.3.1_A.1.3-1 and the downlink physical channel setup according to Table C.3.2-1 in Annex C.

Using this configuration the fraction of maximum throughput percentage shall meet or exceed the minimum requirements specified in Table 8.2.1.3.1_A.1.3-1 for the specified SNR. For open-loop spatial multiplexing performance with large delay CDD is specified.

Table 8.2.1.3.1_A.1.3-1: Test Parameters for Large Delay CDD (FRC)

Parameter	Unit	Test 1 -2	
Downlink power allocation	ρ_A	dB	-3
	ρ_B	dB	-3 (Note 1)
	σ		
dB N_{oc} 0at antenna port	dBm/15kHz	-98	
PDSCH Transmission mode		3	
Note 1: $P_B = 1$			
Note 2: For CA test cases, PUCCH format 1b with channel selection is used to feedback ACK/NACK.			
Note 3: For CA test cases, the same PDSCH transmission mode is applied to each component carrier.			

Table 8.2.1.3.1_A.1.3-2: Minimum performance Large Delay CDD (FRC)

Test num.	Bandwidth	Reference channel	OCNG pattern	Propagation condition	Correlation matrix and antenna config.	Reference value		UE category	CA capability
						Fraction of maximum throughput (%)	SNR (dB)		
1	2x10 MHz	R.11 FDD	OP.1 FDD (Note 1)	EVA70	2x2 Low	70	13.7	3-8	CL_A-A
2	2x20 MHz	R.30 FDD	OP.1 FDD (Note 1)	EVA70	2x2 Low	70	13.2	3,5-8	CL_A-A (Note 3), CL_C
3	2x20 MHz	R.35-1 FDD	OP.1 FDD (Note 1)	EVA5	2x2 Low	70	15.8	4	CL_A-A, CL_C
4	15MHz + 10 MHz	R.35-2 FDD for 15MHz CC	OP.1 FDD (Note 1)	[EVA5]	2x2 Low	70	TBD	3	CL_A-A
		R.35-3 FDD for 10MHz CC	OP.1 FDD (Note 1)			TBD	TBD		
5	20MHz + X MHz	R.30 FDD for 20MHz CC	OP.1 FDD (Note 1)	EVA70	2x2 Low	70	[13.2]	3	CL_A-A
		As defined in Note 4	OP.1 FDD (Note 1)			TBD	TBD		
6	20MHz + X MHz	R.35-1 FDD for 20MHz CC	OP.1 FDD (Note 1)	EVA5	2x2 Low	70	[15.8]	4	CL_A-A
		As defined in Note 5	OP.1 FDD (Note 1)			TBD	TBD		
<p>Note 1: For CA capable UE, the OCNG pattern applies for each CC.</p> <p>Note 3: For UE category 5-8 test CA capability is CL_C; for UE category 3 test CA capability is CL_A-A and CL_C.</p> <p>Note 4: For UE category 3 test, 20MHz+X is the maximum aggregated bandwidth supported for the UE under test, where X is 10MHz or 15MHz. The reference channel is R.11 FDD without scheduling subframe #0 when X is 10MHz and R.30-1 FDD when X is 15MHz.</p> <p>Note 5: For UE category 4 test, 20MHz+X is the maximum aggregated bandwidth supported for the UE under test, where X is 10MHz or 15MHz. The reference channel is R.35-3 FDD when X is 10MHz and R.35-2 FDD when X is 15MHz.</p>									

The normative reference for this requirement is TS 36.101 [2] clause 8.2.1.3.

8.2.1.3.1_A.1.4 Test description

8.2.1.3.1_A.1.4.1 Initial conditions

Initial conditions are a set of test configurations the UE needs to be tested in and the steps for the SS to take with the UE to reach the correct measurement state.

Configurations of PDSCH and PDCCH before measurement are specified in Annex C.2.

Test Environment: Normal, as defined in TS 36.508 [7] clause 4.1.

Frequencies to be tested: Mid Range, as defined in TS 36.508 [7] clause 4.3.1.

Channel Bandwidths to be tested: As specified per test number in Table 8.2.1.3.1_A.1.3-1, as defined in TS 36.508 [7] clause 4.3.1.1.

1. Connect the SS, the faders and AWGN noise sources to the UE antenna connectors as shown in TS 36.508 [7] Annex A, Figure group A.36 as appropriate.
2. The parameter settings for the cell are set up according to Tables 8.2.1-1 and 8.2.1.3.1_A.1.3-1 as appropriate.
3. Downlink signals for PCC are initially set up according to Annex C0, C.1 and Annex C.3.2 and uplink signals according to Annex H.1 and H.3.2.

- 4. Propagation conditions are set according to Annex B.0.
- 5. Ensure the UE is in State 3A-RF according to TS 36.508 [7] clause 5.2A.2. Message contents are defined in clause 8.2.1.3.1_A.1.4.3.

8.2.1.3.1_A.1.4.2 Test procedure

- 1. Configure SCC according to Annex C0, C.1 and Annex C.3.2 for all downlink physical channels except PHICH.
- 2. The SS shall configure SCC as per TS 36.508 [7] clause 5.2A.4. Message contents for PhysicalConfigDedicated-DEFAULT is defined in Table 8.2.1.3.1_A.1.4.3-1, PhysicalConfigDedicatedSCell-r10-DEFAULT is defined in Table 8.2.1.3.1_A.1.4.3-1A.
- 3. SS activates SCC by sending the activation MAC-CE (Refer TS 36.321 [13], clauses 5.13, 6.1.3.8). Wait for at least 2 seconds (Refer TS 36.133, clauses 8.3.3.2).
- 4. SS transmits PDSCH via PDCCH DCI format 2A for C_RNTI to transmit the DL RMC according to Tables 8.2.1.3.1_A.1.3-1 and 8.2.1.3.1_A.1.3-2 on both PCC and SCC. The SS sends downlink MAC padding bits on the DL RMC.5. Set the parameters of the reference channel, the propagation condition, the correlation matrix and the SNR on each of the component carrier according to Table 8.2.1.3.1_A.1.5-1 as appropriate.
- 6. Measure the average throughput per component carrier for a duration sufficient to achieve statistical significance according to Annex G clause G.3A, table G.3A.5-3. Count the number of NACKs, ACKs and statDTXs on the UL during the test interval on both the component carrier.
- 7. Repeat steps from 1 to 6 for each subtest in Table 8.2.1.3.1_A.1.5-1 depending on UE CA capability as defined in Table 8.1.1-1 and as appropriate.

8.2.1.3.1_A.1.4.3 Message contents

Message contents are according to TS 36.508 [7] clause 4.6 with the following exceptions

Table 8.2.1.3.1_A.1.4.3-1: PhysicalConfigDedicated-DEFAULT: Additional FDD PDSCH open loop spatial multiplexing performance downlink power allocation

Derivation Path: 36.331 clause 6.3.2			
Information Element	Value/remark	Comment	Condition
PhysicalConfigDedicated-DEFAULT ::= SEQUENCE {			
antennaInfo CHOICE {			
antennaInfoDedicated ::= SEQUENCE {			
transmissionMode	tm3		
codebookSubsetRestriction CHOICE {			
n2TxAntenna-tm3	11		
}			
ue-TransmitAntennaSelection CHOICE {			
release	NULL		
}			
}			
}			

Table 8.2.1.3.1_A.1.4.3-1A: PhysicalConfigDedicatedSCell-r10-DEFAULT: Additional FDD PDSCH open loop spatial multiplexing performance downlink power allocation

Derivation Path: 36.508 clause 4.6.3 Table 4.6.3-6A			
Information Element	Value/remark	Comment	Condition
PhysicalConfigDedicated SCell-r10-DEFAULT ::= SEQUENCE {			
nonUL-Configuration-r10 SEQUENCE {			
antennaInfo-r10 CHOICE {			
antennaInfoDedicated-r10 ::= SEQUENCE {			
transmissionMode	tm3		
codebookSubsetRestriction CHOICE {			
n2TxAntenna-tm3	11		
}			
ue-TransmitAntennaSelection CHOICE {			
release	NULL		
}			
}			
}			
}			

8.2.1.3.1_A.1.5 Test requirement

Table 8.2.1.3.1_A.1.3-1 defines the primary level settings.

The fraction of maximum throughput percentage for the downlink reference measurement channels specified in Annex A clause A.3.3.2 for the throughput test shall meet or exceed the specified value in Tables 8.2.1.3.1_A.1.5-1 for the specified SNR including test tolerances for all throughput tests.

Table 8.2.1.3.1_A.1.5-1: Test Requirement Large Delay CDD (FRC)

Test num.	Band-width	Reference channel	OCNG pattern	Propagation condition	Correlation matrix and antenna config.	Reference value		UE category	CA capability
						Fraction of maximum throughput (%)	SNR (dB)		
1	NA								
2	2x20 MHz	R.30 FDD	OP.1 FDD (Note 1)	EVA70	2x2 Low	70	14.1	3, 5-8	CL_C
3	2x20 MHz	R.35-1 FDD	OP.1 FDD (Note 1)	EVA5	2x2 Low	70	16.7	4	CL_C

Note 1: For CA capable UE, the OCNG pattern applies for each CC.

Decide pass or fail for each subtest according to Annex G.3A.4. Decide the entire test pass or fail according to Annex G.3A.6.

8.2.1.3.1_A.2 FDD PDSCH Open Loop Spatial Multiplexing 2x2 for CA (inter-band DL CA)

Editor’s notes: This test case is incomplete. The following item is missing or incomplete:

-Test tolerances are incomplete

8.2.1.3.1_A.2.1 Test purpose

Same test purpose as in clause 8.2.1.3.1_A.1.1

8.2.1.3.1_A.2.2 Test applicability

This test applies to all types of E-UTRA FDD UE release 10 that support inter-band DL CA.

8.2.1.3.1_A.2.3 Minimum conformance requirements

Same minimum conformance requirements as in clause 8.2.1.3.1_A.1.3.

8.2.1.3.1_A.2.4 Test description

8.2.1.3.1_A.2.4.1 Initial conditions

Same initial conditions as in clause 8.2.1.3.1_A.1.4.1.

8.2.1.3.1_A.2.4.2 Test procedure

1. Configure SCC according to Annex C0, C.1 and Annex C.3.2 for all downlink physical channels except PHICH.
2. The SS shall configure SCC as per TS 36.508 [7] clause 5.2A.4. Message contents for PhysicalConfigDedicated-DEFAULT is defined in Table 8.2.1.3.1_A.2.4.3-1, PhysicalConfigDedicatedSCell-r10-DEFAULT is defined in Table 8.2.1.3.1_A.2.4.3-1A
3. SS activates SCC by sending the activation MAC-CE (Refer TS 36.321 [13], clauses 5.13, 6.1.3.8). Wait for at least 2 seconds (Refer TS 36.133, clauses 8.3.3.2).
4. SS transmits PDSCH via PDCCH DCI format 2A for C_RNTI to transmit the DL RMC according to Tables 8.2.1.3.1_A.2.3-1 and 8.2.1.3.1_A.2.3-2 on both PCC and SCC. The SS sends downlink MAC padding bits on the DL RMC.
5. Set the parameters of the reference channel, the propagation condition, the correlation matrix and the SNR on each of the component carrier according to Table 8.2.1.3.1_A.2.5-1 as appropriate.
6. Measure the average throughput per component carrier for a duration sufficient to achieve statistical significance according to Annex G clause G.3A, table G.3A.5-4. Count the number of NACKs, ACKs and statDTXs on the UL during the test interval on both the component carrier.
7. Repeat steps from 1 to 6 for each subtest in Table 8.2.1.3.1_A.2.5-1 depending on UE CA capability as defined in Table 8.1.1-1 and as appropriate.

8.2.1.3.1_A.2.4.3 Message contents

Message contents are according to TS 36.508 [7] clause 4.6 with the following exceptions

Table 8.2.1.3.1_A.2.4.3-1: PhysicalConfigDedicated-DEFAULT: Additional FDD PDSCH open loop spatial multiplexing performance downlink power allocation

Derivation Path: 36.331 clause 6.3.2			
Information Element	Value/remark	Comment	Condition
PhysicalConfigDedicated-DEFAULT ::= SEQUENCE {			
antennaInfo CHOICE {			
antennaInfoDedicated ::= SEQUENCE {			
transmissionMode	tm3		
codebookSubsetRestriction CHOICE {			
n2TxAntenna-tm3	11		
}			
ue-TransmitAntennaSelection CHOICE {			
release	NULL		
}			
}			
}			

Table 8.2.1.3.1_A.2.4.3-1A: PhysicalConfigDedicatedSCell-r10-DEFAULT: Additional FDD PDSCH open loop spatial multiplexing performance downlink power allocation

Derivation Path: 36.508 clause 4.6.3 Table 4.6.3-6A			
Information Element	Value/remark	Comment	Condition
PhysicalConfigDedicated SCell-r10-DEFAULT ::= SEQUENCE {			
nonUL-Configuration-r10 SEQUENCE {			
antennaInfo-r10 CHOICE {			
antennaInfoDedicated-r10 ::= SEQUENCE {			
transmissionMode	tm3		
codebookSubsetRestriction CHOICE {			
n2TxAntenna-tm3	11		
}			
ue-TransmitAntennaSelection CHOICE {			
release	NULL		
}			
}			
}			
}			

8.2.1.3.1_A.2.5 Test requirement

Table 8.2.1.3.1_A.2.3-1 defines the primary level settings.

The fraction of maximum throughput percentage for the downlink reference measurement channels specified in Annex A clause A.3.3.2 for the throughput test shall meet or exceed the specified value in Tables 8.2.1.3.1_A.2.5-1 for the specified SNR including test tolerances for all throughput tests.

Table 8.2.1.3.1_A.2.5-1: Test Requirement Large Delay CDD (FRC)

Test num.	Band-width	Reference channel	OCNG pattern	Propagation condition	Correlation matrix and antenna config.	Reference value		UE category	CA capability
						Fraction of maximum throughput (%)	SNR (dB)		
1	2x10 MHz	R.11 FDD	OP.1 FDD (Note 1)	EVA70	2x2 Low	70	13.7+ TT	3-8	CL_A-A
2	NA								
3	NA								

Note 1: For CA capable UE, the OCNG pattern applies for each CC.

Decide pass or fail for each subtest according to Annex G.3A.4. Decide the entire test pass or fail according to Annex G.3A.6.

8.2.1.3.1_A.2_1 FDD PDSCH Open Loop Spatial Multiplexing 2x2 for CA (inter-band DL CA) (Release 11 and forward)

Editor’s notes: This test case is incomplete. The following item is missing or incomplete:

-Test tolerances are incomplete

8.2.1.3.1_A.2_1.1 Test purpose

Same test purpose as in clause 8.2.1.3.1_A.1.1

8.2.1.3.1_A.2_1.2 Test applicability

This test applies to all types of E-UTRA FDD UE release 11 and forward that support inter-band DL CA.

8.2.1.3.1_A.2_1.3 Minimum conformance requirements

Same minimum conformance requirements as in clause 8.2.1.3.1_A.1.3

8.2.1.3.1_A.2_1.4 Test description

8.2.1.3.1_A.2_1.4.1 Initial conditions

Same initial conditions as in clause 8.2.1.3.1_A.1.4.1.

8.2.1.3.1_A.2_1.4.2 Test procedure

1. Configure SCC according to Annex C0, C.1 and Annex C.3.2 for all downlink physical channels except PHICH.
2. The SS shall configure SCC as per TS 36.508 [7] clause 5.2A.4. Message contents for PhysicalConfigDedicated-DEFAULT is defined in Table 8.2.1.3.1_A.2_1.4.3-1, PhysicalConfigDedicatedSCell-r10-DEFAULT is defined in Table 8.2.1.3.1_A.2_1.4.3-1A
3. SS activates SCC by sending the activation MAC-CE (Refer TS 36.321 [13], clauses 5.13, 6.1.3.8). Wait for at least 2 seconds (Refer TS 36.133, clauses 8.3.3.2).
4. SS transmits PDSCH via PDCCH DCI format 2A for C_RNTI to transmit the DL RMC according to Tables 8.2.1.3.1_A.2_1.3-1 and 8.2.1.3.1_A.2_1.3-2 on both PCC and SCC. The SS sends downlink MAC padding bits on the DL RMC.
5. Set the parameters of the reference channel, the propagation condition, the correlation matrix and the SNR on each of the component carrier according to Table 8.2.1.3.1_A_1.2.5-1 as appropriate.
6. Measure the average throughput per component carrier for a duration sufficient to achieve statistical significance according to Annex G clause G.3A, table G.3A.5-4. Count the number of NACKs, ACKs and statDTXs on the UL during the test interval on both the component carrier.
7. Repeat steps from 1 to 6 for each subtest in Table 8.2.1.3.1_A.2_1.5-1 depending on UE CA capability as defined in Table 8.1.1-1 and as appropriate.

8.2.1.3.1_A.2_1.4.3 Message contents

Message contents are according to TS 36.508 [7] clause 4.6 with the following exceptions

Table 8.2.1.3.1_A.2_1.4.3-1: PhysicalConfigDedicated-DEFAULT: Additional FDD PDSCH open loop spatial multiplexing performance downlink power allocation

Derivation Path: 36.331 clause 6.3.2			
Information Element	Value/remark	Comment	Condition
PhysicalConfigDedicated-DEFAULT ::= SEQUENCE {			
antennaInfo CHOICE {			
antennaInfoDedicated ::= SEQUENCE {			
transmissionMode	tm3		
codebookSubsetRestriction CHOICE {			
n2TxAntenna-tm3	11		
}			
ue-TransmitAntennaSelection CHOICE {			
release	NULL		
}			
}			
}			

Table 8.2.1.3.1_A.2_1.4.3-1A: *PhysicalConfigDedicatedSCell-r10-DEFAULT*: Additional FDD PDSCH open loop spatial multiplexing performance downlink power allocation

Derivation Path: 36.508 clause 4.6.3 Table 4.6.3-6A			
Information Element	Value/remark	Comment	Condition
PhysicalConfigDedicated SCell-r10-DEFAULT ::= SEQUENCE {			
nonUL-Configuration-r10 SEQUENCE {			
antennaInfo-r10 CHOICE {			
antennaInfoDedicated-r10 ::= SEQUENCE {			
transmissionMode	tm3		
codebookSubsetRestriction CHOICE {			
n2TxAntenna-tm3	11		
}			
ue-TransmitAntennaSelection CHOICE {			
release	NULL		
}			
}			
}			
}			

8.2.1.3.1_A.2_1.5 Test requirement

Table 8.2.1.3.1_A.2_1.3-1 defines the primary level settings.

The fraction of maximum throughput percentage for the downlink reference measurement channels specified in Annex A clause A.3.3.2 for the throughput test shall meet or exceed the specified value in Tables 8.2.1.3.1_A.2_1.5-1 for the specified SNR including test tolerances for all throughput tests. Test points selection for different UE Categories should refer to Tables 8.2.1.3.1_A.2_1.5-2.

Table 8.2.1.3.1_A.2_1.5-1: Test Requirement Large Delay CDD (FRC)

Test num.	Bandwidth	Reference channel	OCNG pattern	Propagation condition	Correlation matrix and antenna config.	Reference value		UE category	CA capability
						Fraction of maximum throughput (%)	SNR (dB)		
1	2x10 MHz	R.11 FDD	OP.1 FDD (Note 1)	EVA70	2x2 Low	70	14.6	3-8	CL_A-A
2	2x20 MHz	R.30 FDD	OP.1 FDD (Note 1)	EVA70	2x2 Low	70	14.1	3	CL_A-A
3	2x20 MHz	R.35-1 FDD	OP.1 FDD (Note 1)	EVA5	2x2 Low	70	15.8+TT	4	CL_A-A
4	15MHz + 10 MHz	R.35-2 FDD for 15MHz CC	OP.1 FDD (Note 1)	[EVA5]	2x2 Low	70	TBD	3	CL_A-A
		R.35-3 FDD for 10MHz CC	OP.1 FDD (Note 1)			TBD	TBD		
5	20MHz + X MHz	R.30 FDD for 20MHz CC	OP.1 FDD (Note 1)	EVA70	2x2 Low	70	[13.2]+TT	3	CL_A-A
		As defined in Note 4	OP.1 FDD (Note 1)			TBD	TBD		
6	20MHz + X MHz	R.35-1 FDD for 20MHz CC	OP.1 FDD (Note 1)	EVA5	2x2 Low	70	[15.8]+TT	4	CL_A-A
		As defined in Note 5	OP.1 FDD (Note 1)			TBD	TBD		
Note 1: For CA capable UE, the OCNG pattern applies for each CC. Note 4: For UE category 3 test, 20MHz+X is the maximum aggregated bandwidth supported for the UE under test, where X is 10MHz or 15MHz. The reference channel is R.11 FDD without scheduling subframe #0 when X is 10MHz and R.30-1 FDD when X is 15MHz. Note 5: For UE category 4 test, 20MHz+X is the maximum aggregated bandwidth supported for the UE under test, where X is 10MHz or 15MHz. The reference channel is R.35-3 FDD when X is 10MHz and R.35-2 FDD when X is 15MHz.									

Table 8.2.1.3.1_A.2_1.5-2: Test Points Selection for UE Category

Maximum aggregated bandwidth [MHz] (Note 1)	Applicable test points		
	Category 3	Category 4	Category 5-8
20	1	1	1
25	1, 4	1	1
30	1, 5	1, 6	1
35	1, 5	1, 6	1
40	1, 2	1, 3	1
Note 1: Maximum over all supported CA configurations and bandwidth combination sets according to Table 5.4.2A.1-2 for UE category 3 and 4. Note 2: If a specific maximum aggregated bandwidth is supported in multiple CA configurations, the test can be run in any of them			

Decide pass or fail for each subtest according to Annex G.3A.4. Decide the entire test pass or fail according to Annex G.3A.6.

8.2.1.3.2 FDD PDSCH Open Loop Spatial Multiplexing 4x2

8.2.1.3.2.1 Test purpose

To verify the UE's ability to receive a predefined test signal, representing a multi-path fading channel that is determined by the SNR with a percentage of the information bit throughput for a specified downlink Reference Measurement Channel (RMC) not falling below a specified value for transmission on two antenna ports using large delay CDD.

8.2.1.3.2.2 Test applicability

This test applies to all types of E-UTRA FDD UE release 8 and forward.

8.2.1.3.2.3 Minimum conformance requirements

The requirements are specified in terms of the percentage of information bit throughput for the downlink reference measurement channels specified in Annex A clause A.3.3.2, with the addition of the relevant parameters in Tables 8.2.1-1 and 8.2.1.3.2.3-1 and the downlink physical channel setup according to Table C.3.2-1 in Annex C.

Using this configuration the fraction of maximum throughput percentage shall meet or exceed the minimum requirements specified in Table 8.2.1.3.2.3-1 for the specified SNR. For open-loop spatial multiplexing performance with large delay CDD is specified.

Table 8.2.1.3.2.3-1: Test Parameters for Large Delay CDD (FRC)

Parameter	Unit	Test 1
Downlink power allocation	ρ_A	dB
	ρ_B	dB
	σ	dB
N_{oc} at antenna port	dBm/15kHz	-98
PDSCH transmission mode		3
Note 1: $P_B = 1$		

Table 8.2.1.3.2.3-2: Minimum performance Large Delay CDD (FRC)

Test number	Band-width	Reference Channel	OCNG Pattern	Propagation Condition	Correlation Matrix and Antenna Configuration	Reference value		UE Category
						Fraction of Maximum Throughput (%)	SNR (dB)	
1	10 MHz	R.14 FDD	OP.1 FDD	EVA70	4x2 Low	70	14.3	2-5

The normative reference for this requirement is TS 36.101 [2] clause 8.2.1.3.

8.2.1.3.2.4 Test description

8.2.1.3.2.4.1 Initial conditions

Initial conditions are a set of test configurations the UE needs to be tested in and the steps for the SS to take with the UE to reach the correct measurement state.

Configurations of PDSCH and PDCCH before measurement are specified in Annex C.2.

Test Environment: Normal, as defined in TS 36.508 [7] clause 4.1.

Frequencies to be tested: Mid Range, as defined in TS 36.508 [7] clause 4.3.1.1.

Channel Bandwidths to be tested: As specified per test number in Table 8.2.1.3.2.3-2, as defined in TS 36.508 [7] clause 4.3.1.1

1. Connect the SS, the faders and AWGN noise sources to the UE antenna connectors as shown in TS 36.508 [7] Annex A, Figure A.11 for antenna configuration 4x2.
2. The parameter settings for the cell are set up according to Tables 8.2.1-1 and 8.2.1.3.2.3-1 as appropriate.
3. Downlink signals are initially set up according to Annex C.1 and Annex C.3.2 and uplink signals according to Annex H.1 and H.3.2.
4. Propagation conditions are set according to Annex B.0.
5. Ensure the UE is in State 3A-RF according to TS 36.508 [7] clause 5.2A.2. Message contents are defined in clause 8.2.1.3.2.4.3.

8.2.1.3.2.4.2 Test procedure

1. SS transmits PDSCH via PDCCH DCI format 2A for C_RNTI to transmit the DL RMC according to Tables 8.2.1.3.2.3-1 and 8.2.1.3.2.3-2. The SS sends downlink MAC padding bits on the DL RMC.
2. Set the parameters of the reference channel, the propagation condition, the correlation matrix and the SNR according to Table 8.2.1.3.2.5-1 as appropriate.
3. Measure the average throughput for a duration sufficient to achieve statistical significance according to Annex G clause G.3. Count the number of NACKs, ACKs and statDTXs on the UL during the test interval and decide pass or fail according to Tables G.3.5 and G.3.6 in Annex G clause G.3.

8.2.1.3.2.4.3 Message contents

Message contents are according to TS 36.508 [7] clause 4.6 with the following exceptions:

Table 8.2.1.3.2.4.3-1: PDSCH-ConfigDedicated-DEFAULT: Additional FDD PDSCH open loop spatial multiplexing performance downlink power allocation for Test number 1

Derivation Path: 36.331 clause 6.3.2			
Information Element	Value/remark	Comment	Condition
PDSCH-ConfigDedicated-DEFAULT ::= SEQUENCE {			
p-a	dB-6		
}			

Table 8.2.1.3.2.4.3-2: PhysicalConfigDedicated-DEFAULT: Additional FDD PDSCH open loop spatial multiplexing performance downlink power allocation for Test number 1

Derivation Path: 36.331 clause 6.3.2			
Information Element	Value/remark	Comment	Condition
PhysicalConfigDedicated-DEFAULT ::= SEQUENCE {			
antennaInfo CHOICE {			
antennaInfoDedicated ::= SEQUENCE {			
transmissionMode	tm3		
codebookSubsetRestriction CHOICE {			
n4TxAntenna-tm3	1111		
}			
ue-TransmitAntennaSelection CHOICE {			
release	NULL		
}			
}			
}			

8.2.1.3.2.5 Test requirement

Table 8.2.1.3.2.3-1 defines the primary level settings.

The fraction of maximum throughput percentage for the downlink reference measurement channels specified in Annex A clause A.3.3.2 for each throughput test shall meet or exceed the specified value in Tables 8.2.1.3.2.5-1 for the specified SNR including test tolerances for all throughput tests.

Table 8.2.1.3.2.5-1: Test Requirement Large Delay CDD (FRC)

Test number	Band-width	Reference Channel	OCNG Pattern	Propagation Condition	Correlation Matrix and Antenna Configuration	Reference value		UE Category
						Fraction of Maximum Throughput (%)	SNR (dB)	
1	10 MHz	R.14 FDD	OP.1 FDD	EVA70	4x2 Low	70	15.2	2-5

8.2.1.3.3_C FDD FDD PDSCH Open Loop Spatial Multiplexing 2x2 for eICIC

8.2.1.3.3_C.1 FDD PDSCH Open Loop Spatial Multiplexing 2x2 for eICIC (non-MBSFN ABS)

Editor's notes: This test case is incomplete. The following items are missing or incomplete:

- Step of test procedure may be confirmed or updated.
- Test requirement table needs to be corrected or updated.
- Connection diagram in Annex A of TS 36.508 is TBD
- Test tolerances are incomplete

8.2.1.3.3_C.1.1 Test purpose

To verify the UE's ability to receive a predefined test signal, representing a multi-path fading channel that is determined by the SNR with a percentage of the information bit throughput for a specified downlink Reference Measurement Channel (RMC) not falling below a specified value for transmission on two antenna ports using large delay CDD.

8.2.1.3.3_C.1.2 Test applicability

This test applies to all types of E-UTRA FDD UE release 10 and forward. Applicability requires support for FGI bit 115.

8.2.1.3.3_C.1.3 Minimum conformance requirements

The requirements are specified in terms of the percentage of information bit throughput for the downlink reference measurement channels specified in Annex A clause A.3.3.2, with the addition of the relevant parameters in Tables 8.2.1-1 and 8.2.1.3.3_C.1.3-1 and the downlink physical channel setup according to Table C.3.2-1 in Annex C.

Using this configuration the fraction of maximum throughput percentage shall meet or exceed the minimum requirements specified in Table 8.2.1.3.3_C.1.3-1 for the specified SNR. For open-loop spatial multiplexing performance with large delay CDD is specified.

Table 8.2.1.3.3_C.1.3-1: Test Parameters for Large Delay CDD (FRC) no MBSFN ABS

Parameter		Unit	Cell 1	Cell 2
Downlink power allocation	ρ_A	dB	-3	-3
	ρ_B	dB	-3 (Note 1)	-3
N_{oc} at antenna port	N_{oc1}	dBm/15kHz	-102 (Note 2)	N/A
	N_{oc2}	dBm/15kHz	-98 (Note 3)	N/A
	N_{oc3}	dBm/15kHz	-94.8 (Note 4)	N/A

\hat{E}_s / N_{oc2}		dB	Reference Value in Table 8.2.1.3.3_C.1.3-2	[6]
BW _{Channel}		MHz	10	10
Subframe Configuration			Non-MBSFN	Non-MBSFN
Cell Id			0	1
Time Offset between Cells		[µs]	2.5 (synchronous cells)	
ABS pattern (Note 5)			N/A	11000100, 11000000, 11000000, 11000000, 11000000
RLM/RRM Measurement Subframe Pattern(Note 6)			10000000 10000000 10000000 10000000 10000000	N/A
CSI Subframe Sets (Note 7)	C _{CSI,0}		11000100 11000000 11000000 11000000 11000000	N/A
	C _{CSI,1}		00111011 00111111 00111111 00111111 00111111	N/A
Number of control OFDM symbols			2	
PDSCH transmission mode			3	N/A
Cyclic prefix			Normal	Normal
<p>Note 1: $P_B = 1$</p> <p>Note 2: This noise is applied in OFDM symbols #1, #2, #3, #5, #6, #8, #9, #10,#12, #13 of a subframe overlapping with the aggressor ABS</p> <p>Note 3: This noise is applied in OFDM symbols #0, #4, #7, #11 of a subframe overlapping with the aggressor ABS</p> <p>Note 4: This noise is applied in all OFDM symbols of a subframe overlapping with aggressor non-ABS</p> <p>Note 5: ABS pattern as defined in [14]. PDSCH other than SIB1/paging and its associated PDCCH/PCFICH are transmitted in the serving cell subframe when the subframe is overlapped with the ABS subframe of aggressor cell and the subframe is available in the definition of the reference channel.</p> <p>Note 6: Time-domain measurement resource restriction pattern for PCell measurements as defined in [5]</p> <p>Note 7: As configured according to the time-domain measurement resource restriction pattern for CSI measurements defined in [5]</p> <p>Note 8: Cell 1 is the serving cell. Cell 2 is the aggressor cell. The number of the CRS ports in Cell1 and Cell2 is the same.</p> <p>Note 9: SIB-1 will not be transmitted in Cell2 in this test.</p>				

Table 8.2.1.3.3_C.1.3-2: Minimum performance Large Delay CDD (FRC) no MBSFN ABS

Test Number	Reference Channel	OCNG Pattern		Propagation Conditions (Note 1)		Correlation Matrix and Antenna Configuration	Reference Value		UE Category
		Cell 1	Cell 2	Cell 1	Cell 2		Fraction of Maximum Throughput (%)	SNR (dB) (Note 2)	
1	R.11 FDD	OP.1 FDD	OP.1 FDD	EVA 5	EVA 5	2x2 Low	[70]	[13.3]	2-8
<p>Note 1: The propagation conditions for Cell 1 and Cell2 are statistically independent.</p> <p>Note 2: SNR corresponds to \hat{E}_s / N_{oc2} of cell 1.</p>									

The normative reference for this requirement is TS 36.101 [2] clause 8.2.1.3.3.

8.2.1.3.3_C.1.4 Test description

8.2.1.3.3_C.1.4.1 Initial conditions

Initial conditions are a set of test configurations the UE needs to be tested in and the steps for the SS to take with the UE to reach the correct measurement state.

Configurations of PDSCH and PDCCH before measurement are specified in Annex C.2.

Test Environment: Normal, as defined in TS 36.508 [7] clause 4.1.

Frequencies to be tested: Mid Range, as defined in TS 36.508 [7] clause 4.3.1.1.

Channel Bandwidths to be tested: As specified per test number in Table 8.2.1.3.3_C.1.3-2, as defined in TS 36.508 [7] clause 4.3.1.1

1. Connect the SS, the faders and AWGN noise sources to the UE antenna connectors as shown in TS 36.508 [7] Annex A, Figure TBD for antenna configuration 2x2.
2. The parameter settings for the cell 1 are set up according to Tables 8.2.1-1 and 8.2.1.3.3_C.1.3-1 as appropriate.
3. Downlink signals are initially set up according to Annex C0, C.1 and Annex C.3.2 and uplink signals according to Annex H.1 and H.3.2.
4. Propagation conditions are set according to Annex B.0.
5. Ensure the UE is in State 3A-RF according to TS 36.508 [7] clause 5.2A.2. Message contents are defined in clause 8.2.1.3.3_C.1.4.3.

8.2.1.3.3_C.1.4.2 Test procedure

1. SS transmits PDSCH via PDCCH DCI format 2A for C_RNTI to transmit the DL RMC according to Tables 8.2.1.3.3_C.1.3-1 and 8.2.1.3.3_C.1.3-2. The SS sends downlink MAC padding bits on the DL RMC.
2. Set the parameters of the reference channel, the propagation condition, the correlation matrix and the SNR according to Table 8.2.1.3.3_C.1.5-1 as appropriate.
3. Set the Cell2 –aggressor cell- as defined in Tables 8.2.1.3.3_C.1.3-2, 8.2.1.3.3_C.1.5-1 and according to Annex C3.3 for non-MBSFN ABS.
4. Measure the average throughput for a duration sufficient to achieve statistical significance according to Annex G clause G.3. Count the number of NACKs, ACKs and statDTXs on the UL during the test interval and decide pass or fail according to Tables G.3.5 and G.3.6 in Annex G clause G.3.

8.2.1.3.3_C.1.4.3 Message contents

Message contents are according to TS 36.508 [7] clause 4.6 with the following exceptions:

Table 8.2.1.3.3_C.1.4.3-1: *PhysicalConfigDedicated-DEFAULT*: Additional FDD PDSCH open loop spatial multiplexing performance downlink power allocation

Derivation Path: 36.331 clause 6.3.2			
Information Element	Value/remark	Comment	Condition
PhysicalConfigDedicated-DEFAULT ::= SEQUENCE {			
antennaInfo CHOICE {			
antennaInfoDedicated ::= SEQUENCE {			
transmissionMode	tm3		
codebookSubsetRestriction CHOICE {			
n2TxAntenna-tm3	11		
}			
ue-TransmitAntennaSelection CHOICE {			
release	NULL		
}			
}			
}			

Table 8.2.1.3.3_C.1.4.3-2: *RadioResourceConfigDedicated-SRB2-DRB(n, m)*: Additional FDD PDSCH open loop spatial multiplexing performance downlink power allocation

Derivation Path: TS 36.508 [7] clause 4.6.3, Table 4.6.3-16 RadioResourceConfigDedicated-SRB2-DRB(n,m)			
Information Element	Value/remark	Comment	Condition
RadioResourceConfigDedicated-SRB2-DRB(n, m) ::= SEQUENCE {			
MeasSubframePatternPCell-r10 CHOICE {			
setup SEQUENCE {			
subframePatternFDD-r10	'10000000100000001000 00001000000010000000'	BIT STRING (SIZE (40))	
}			
}			
}			

Table 8.2.1.3.3_C.1.4.3-3: *CQI-ReportConfig-r10-DEFAULT*: Additional FDD PDSCH open loop spatial multiplexing performance downlink power allocation

Derivation Path: 36.508 [7] clause 4.6.3, Table 4.6.3-2AA CQI-ReportConfig-r10-DEFAULT_			
Information Element	Value/remark	Comment	Condition
CQI-ReportConfig-r10-DEFAULT ::= SEQUENCE {			
cqi-ReportAperiodic-r10	Not present		
nomPDSCH-RS-EPRE-Offset	0		
cqi-ReportPeriodic-r10	Not present		
pmi-RI-Report-r9	Not present		
csi-SubframePatternConfig-r10 CHOICE {			
setup SEQUENCE {			
csi-MeasSubframeSet1-r10 CHOICE {			
subframePatternFDD-r10	'11000100110000001100 00001100000011000000'	BIT STRING (SIZE (40))	
}			
csi-MeasSubframeSet2-r10 CHOICE {			
subframePatternFDD-r10	'00111011001111110011 11110011111100111111'	BIT STRING (SIZE (40))	
}			
}			
}			
}			

8.2.1.3.3.5 Test requirement

Table 8.2.1.3.3_C.1.3-1 defines the primary level settings.

The fraction of maximum throughput percentage for the downlink reference measurement channels specified in Annex A clause A.3.3.2 for each throughput test shall meet or exceed the specified value in Tables 8.2.1.3.3_C.1.5-1 for the specified SNR including test tolerances for all throughput tests.

Table 8.2.1.3.3_C.1.5-1: Test Requirement Large Delay CDD (FRC)

Test Number	Reference Channel	OCNG Pattern		Propagation Conditions (Note 1)		Correlation Matrix and Antenna Configuration	Reference Value		UE Category
		Cell 1	Cell 2	Cell 1	Cell 2		Fraction of Maximum Throughput (%)	SNR (dB) (Note 2)	
1	R.11 FDD	OP.1 FDD	OP.1 FDD	EVA 5	EVA 5	2x2 Low	[70]	[13.3 +TT]	2-8

Note 1: The propagation conditions for Cell 1 and Cell2 are statistically independent.
Note 2: SNR corresponds to \hat{E}_s / N_{oc2} of cell 1.

8.2.1.3.3_C.2 FDD PDSCH Open Loop Spatial Multiplexing 2x2 for eICIC (MBSFN ABS)

Editor's notes: This test case is incomplete. The following items are missing or incomplete:

- Step of test procedure may be confirmed or updated.
- Test requirement table needs to be corrected or updated.
- Connection diagram in Annex A of TS 36.508 is TBD
- Test tolerances are incomplete

8.2.1.3.3_C.2.1 Test purpose

To verify the UE's ability to receive a predefined test signal, representing a multi-path fading channel that is determined by the SNR with a percentage of the information bit throughput for a specified downlink Reference Measurement Channel (RMC) not falling below a specified value for transmission on two antenna ports using large delay CDD.

8.2.1.3.3_C.2.2 Test applicability

This test applies to all types of E-UTRA FDD UE release 10 and forward. Applicability requires support for FGI bit 115.

8.2.1.3.3_C.2.3 Minimum conformance requirements

The requirements are specified in terms of the percentage of information bit throughput for the downlink reference measurement channels specified in Annex A clause A.3.3.2, with the addition of the relevant parameters in Tables 8.2.1-1 and 8.2.1.3.3_C.2.3-1 and the downlink physical channel setup according to Table C.3.2-1 in Annex C.

Using this configuration the fraction of maximum throughput percentage shall meet or exceed the minimum requirements specified in Table 8.2.1.3.3_C.2.3-1 for the specified SNR. For open-loop spatial multiplexing performance with large delay CDD is specified.

Table 8.2.1.3.3_C.2.3-1: Test Parameters for Large Delay CDD (FRC) MBSFN ABS

Parameter		Unit	Cell 1	Cell 2
Downlink power allocation	ρ_A	dB	-3	-3
	ρ_B	dB	-3 (Note 1)	-3
	σ	dB	0	N/A
N_{oc} at antenna port	N_{oc1}	dBm/15kHz	-102 (Note 2)	N/A
	N_{oc2}	dBm/15kHz	-98 (Note 3)	N/A
	N_{oc3}	dBm/15kHz	-94.8 (Note 4)	N/A
\widehat{E}_s / N_{oc2}		dB	Reference Value in Table 8.2.1.3.3_C.2.3-2	6
BW _{Channel}		MHz	10	10
Subframe Configuration			Non-MBSFN	MBSFN
Cell Id			0	126
Time Offset between Cells		μ s	2.5 (synchronous cells)	
ABS pattern (Note 5)			N/A	0001000000 0100000010 0000001000 0000000000
RLM/RRM Measurement Subframe Pattern (Note 6)			0001000000 0100000010 0000001000 0000000000	N/A
CSI Subframe Sets (Note 7)	$C_{CSI,0}$		0001000000 0100000010 0000001000 0000000000	N/A
	$C_{CSI,1}$		1110111111 1011111101 1111110111 1111111111	N/A
MBSFN Subframe Allocation (Note 10)			N/A	001000 100001 000100 000000
Number of control OFDM symbols			2	
PDSCH transmission mode			3	N/A
Cyclic prefix			Normal	Normal
<p>Note 1: $P_B = 1$.</p> <p>Note 2: This noise is applied in OFDM symbols #1, #2, #3, #4, #5, #6, #7, #8, #9, #10, #11, #12, #13 of a subframe overlapping with the aggressor ABS.</p> <p>Note 3: This noise is applied in OFDM symbol #0 of a subframe overlapping with the aggressor ABS.</p> <p>Note 4: This noise is applied in all OFDM symbols of a subframe overlapping with aggressor non-ABS.</p> <p>Note 5: ABS pattern as defined in [14]. The 4th, 12th, 19th and 27th subframes indicated by ABS pattern are MBSFN ABS subframes. PDSCH other than SIB1/paging and its associated PDCCH/PCFICH are transmitted in the serving cell subframe when the subframe is overlapped with the ABS subframe of aggressor cell and the subframe is available in the definition of the reference channel.</p> <p>Note 6: Time-domain measurement resource restriction pattern for PCell measurements as defined in [5].</p> <p>Note 7: As configured according to the time-domain measurement resource restriction pattern for CSI measurements defined in [5].</p> <p>Note 8: Cell 1 is the serving cell. Cell 2 is the aggressor cell. The number of the CRS ports in Cell1 and Cell2 is the same.</p> <p>Note 9: SIB-1 will not be transmitted in Cell2 in this test.</p> <p>Note 10: MBSFN Subframe Allocation as defined in [5], four frames with 24 bits is chosen for MBSFN subframe allocation.</p> <p>Note 11: The maximum number of uplink HARQ transmission is limited to 2 so that each PHICH channel transmission is in a subframe protected by MBSFN ABS in this test.</p>				

Table 8.2.1.3.3_C.2.3-2: Minimum performance Large Delay CDD (FRC) MBSFN ABS

Test Number	Reference Channel	OCNG Pattern		Propagation Conditions (Note 1)		Correlation Matrix and Antenna Configuration	Reference Value		UE Category
		Cell 1	Cell 2	Cell 1	Cell 2		Fraction of Maximum Throughput (%)	SNR (dB) (Note 2)	
1	R.11 FDD	OP.1 FDD	OP.1 FDD	EVA 5	EVA 5	2x2 Low	70	12.0	2-8
Note 1: The propagation conditions for Cell 1 and Cell2 are statistically independent.									
Note 2: SNR corresponds to \hat{E}_s/N_{oc2} of cell 1.									

The normative reference for this requirement is TS 36.101 [2] clause 8.2.1.3.3.

8.2.1.3.3_C.2.4 Test description

8.2.1.3.3_C.2.4.1 Initial conditions

Initial conditions are a set of test configurations the UE needs to be tested in and the steps for the SS to take with the UE to reach the correct measurement state.

Configurations of PDSCH and PDCCH before measurement are specified in Annex C.2.

Test Environment: Normal, as defined in TS 36.508 [7] clause 4.1.

Frequencies to be tested: Mid Range, as defined in TS 36.508 [7] clause 4.3.1.1.

Channel Bandwidths to be tested: As specified per test number in Table 8.2.1.3.3_C.2.3-2, as defined in TS 36.508 [7] clause 4.3.1.1

1. Connect the SS, the faders and AWGN noise sources to the UE antenna connectors as shown in TS 36.508 [7] Annex A, Figure TBD for antenna configuration 2x2.
2. The parameter settings for the cell 1 are set up according to Tables 8.2.1-1 and 8.2.1.3.3_C.2.3-1 as appropriate.
3. Downlink signals are initially set up according to Annex C0, C.1 and Annex C.3.2 and uplink signals according to Annex H.1 and H.3.2.
4. Propagation conditions are set according to Annex B.0.
5. Ensure the UE is in State 3A-RF according to TS 36.508 [7] clause 5.2A.2. Message contents are defined in clause 8.2.1.3.3_C.2.4.3.

8.2.1.3.3_C.2.4.2 Test procedure

1. SS transmits PDSCH via PDCCH DCI format 2A for C_RNTI to transmit the DL RMC according to Tables 8.2.1.3.3_C.2.3-1 and 8.2.1.3.3_C.2.3-2. The SS sends downlink MAC padding bits on the DL RMC.
2. Set the parameters of the reference channel, the propagation condition, the correlation matrix and the SNR according to Table 8.2.1.3.3_C.2.5-1 as appropriate.
3. Set the Cell2 –aggressor cell- as defined in Tables 8.2.1.3.3_C.2.3-2, 8.2.1.3.3_C.2.5-1 and according to Annex C3.3 for MBSFN ABS.
4. Measure the average throughput for a duration sufficient to achieve statistical significance according to Annex G clause G.3. Count the number of NACKs, ACKs and statDTXs on the UL during the test interval and decide pass or fail according to Tables G.3.5 and G.3.6 in Annex G clause G.3.

8.2.1.3.3_C.2.4.3 Message contents

Message contents are according to TS 36.508 [7] clause 4.6 with the following exceptions:

Table 8.2.1.3.3_C.2.4.3-1: PhysicalConfigDedicated-DEFAULT: Additional FDD PDSCH open loop spatial multiplexing performance downlink power allocation

Derivation Path: 36.331 clause 6.3.2			
Information Element	Value/remark	Comment	Condition
PhysicalConfigDedicated-DEFAULT ::= SEQUENCE {			
antennaInfo CHOICE {			
antennaInfoDedicated ::= SEQUENCE {			
transmissionMode	tm3		
codebookSubsetRestriction CHOICE {			
n2TxAntenna-tm3	11		
}			
ue-TransmitAntennaSelection CHOICE {			
release	NULL		
}			
}			
}			

Table 8.2.1.3.3_C.2.4.3-2: RadioResourceConfigDedicated-SRB2-DRB(n, m): Additional FDD PDSCH open loop spatial multiplexing performance downlink power allocation

Derivation Path: TS 36.508 [7] clause 4.6.3, Table 4.6.3-16 RadioResourceConfigDedicated-SRB2-DRB(n,m)			
Information Element	Value/remark	Comment	Condition
RadioResourceConfigDedicated-SRB2-DRB(n, m) ::= SEQUENCE {			
MeasSubframePatternPCell-r10 CHOICE {			
setup SEQUENCE {			
subframePatternFDD-r10	'00010000000100000010 00000010000000000000'	BIT STRING (SIZE (40))	
}			
}			
}			

Table 8.2.1.3.3_C.2.4.3-3: CQI-ReportConfig-r10-DEFAULT: Additional FDD PDSCH open loop spatial multiplexing performance downlink power allocation

Derivation Path: 36.508 [7] clause 4.6.3, Table 4.6.3-2AA CQI-ReportConfig-r10-DEFAULT_			
Information Element	Value/remark	Comment	Condition
CQI-ReportConfig-r10-DEFAULT ::= SEQUENCE {			
cqi-ReportAperiodic-r10	Not present		
nomPDSCH-RS-EPRE-Offset	0		
cqi-ReportPeriodic-r10	Not present		
pmi-RI-Report-r9	Not present		
csi-SubframePatternConfig-r10 CHOICE {			
setup SEQUENCE {			
csi-MeasSubframeSet1-r10 CHOICE {			
subframePatternFDD-r10	'00010000000100000010 00000010000000000000'	BIT STRING (SIZE (40))	
}			
csi-MeasSubframeSet2-r10 CHOICE {			
subframePatternFDD-r10	'1110111111011111101 111110111111111111'	BIT STRING (SIZE (40))	
}			
}			
}			
}			

8.2.1.3.3_C.2.5 Test requirement

Table 8.2.1.3.3_C.2.3-1 defines the primary level settings.

The fraction of maximum throughput percentage for the downlink reference measurement channels specified in Annex A clause A.3.3.2 for each throughput test shall meet or exceed the specified value in Tables 8.2.1.3.3_C.2.5-1 for the specified SNR including test tolerances for all throughput tests.

Table 8.2.1.3.3_C.2.5-1: Test Requirement Large Delay CDD (FRC)

Test Number	Reference Channel	OCNG Pattern		Propagation Conditions (Note 1)		Correlation Matrix and Antenna Configuration	Reference Value		UE Category
		Cell 1	Cell 2	Cell 1	Cell 2		Fraction of Maximum Throughput (%)	SNR (dB) (Note 2)	
1	R.11 FDD	OP.1 FDD	OP.1 FDD	EVA 5	EVA 5	2x2 Low	70	12.0+ TT	2-8
Note 1: The propagation conditions for Cell 1 and Cell2 are statistically independent.									
Note 2: SNR corresponds to \hat{E}_s / N_{oc2} of cell 1.									

8.2.1.4 FDD PDSCH Closed Loop Spatial Multiplexing Performance (Cell-Specific Reference Symbols)

8.2.1.4.1 FDD PDSCH Closed Loop Single/Multi Layer Spatial Multiplexing 2x2

8.2.1.4.1.1 Test purpose

To verify the UE's ability to receive a predefined test signal, representing a multi-path fading channel that is determined by the SNR with a percentage of the information bit throughput for a specified downlink Reference Measurement Channel (RMC) not falling below a specified value for transmission on two antenna ports using closed-loop spatial multiplexing.

8.2.1.4.1.2 Test applicability

This test applies to all types of E-UTRA FDD UE release 8.

8.2.1.4.1.3 Minimum conformance requirements

The requirements are specified in terms of the percentage of information bit throughput for the downlink reference measurement channels specified in Annex A clause A.3.3.2, with the addition of the relevant parameters in Tables 8.2.1-1, 8.2.1.4.1.3-1 and 8.2.1.4.1.3-3 and the downlink physical channel setup according to Table C.3.2-1 in Annex C.

Using this configuration the fraction of maximum throughput percentage shall meet or exceed the minimum requirements specified in Tables 8.2.1.4.1.3-2 and 8.2.1.4.1.3-4 for the specified SNR. For single-layer spatial multiplexing closed loop rank-one performance with wideband and frequency selective precoding is specified. For multi-layer spatial multiplexing closed loop rank-two performance with wideband and frequency selective precoding is specified.

Table 8.2.1.4.1.3-1: Test Parameters for Testing Single-Layer Spatial Multiplexing (FRC)

Parameter		Unit	Test 1	Test 2
Downlink power allocation	ρ_A	dB	-3	-3
	ρ_B	dB	-3 (Note 1)	-3 (Note 1)
	σ	dB	0	0
N_{oc} at antenna port		dBm/15kHz	-98	-98
Precoding granularity		PRB	6	50
PMI delay (Note 2)		ms	8	8
Reporting interval		ms	1	1
Reporting mode			PUSCH 1-2	PUSCH 3-1
CodeBookSubsetRestriction bitmap			001111	001111
PDSCH transmission mode			4	4
Note 1: $P_B = 1$				
Note 2: If the UE reports in an available uplink reporting instance at subframe SF#n based on PMI estimation at a downlink SF not later than SF#(n-4), this reported PMI cannot be applied at the eNB downlink before SF#(n+4)				
If the UE reports in an available uplink reporting instance at subframe SF#n based on PMI estimation at a downlink SF not later than SF#(n-4), this reported PMI cannot be applied at the eNB downlink before SF#(n+4)				
If the UE reports in an available uplink reporting instance at subframe SF#n based on PMI estimation at a downlink SF not later than SF#(n-4), this reported PMI cannot be applied at the eNB downlink before SF#(n+4)				

Table 8.2.1.4.1.3-2: Minimum performance Single-Layer Spatial Multiplexing (FRC)

Test number	Band-width	Reference Channel	OCNG Pattern	Propagation Condition	Correlation Matrix and Antenna Configuration	Reference value		UE Category
						Fraction of Maximum Throughput (%)	SNR (dB)	
1	10 MHz	R.10 FDD	OP.1 FDD	EVA5	2x2 Low	70	-2.5	1-5
2	10 MHz	R.10 FDD	OP.1 FDD	EPA5	2x2 High	70	-2.3	1-5

Table 8.2.1.4.1.3-3: Test Parameters for Testing Multi-Layer Spatial Multiplexing

Parameter		Unit	Test 3	Test 4
Downlink power allocation	ρ_A	dB	-3	-3
	ρ_B	dB	-3 (Note 1)	-3 (Note 1)
	σ	dB	0	0
N_{oc} at antenna port		dBm/15kHz	-98	-98
Precoding granularity		PRB	50	50
PMI delay (Note 2)		ms	8	8
Reporting interval		ms	1	1
Reporting mode			PUSCH 3-1	PUSCH 3-1
CodeBookSubsetRestriction bitmap			110000	110000
PDSCH transmission mode			4	4
Note 1: $P_B = 1$				
Note 2: If the UE reports in an available uplink reporting instance at subframe SF#n based on PMI estimation at a downlink SF not later than SF#(n-4), this reported PMI cannot be applied at the eNB downlink before SF#(n+4)				

Table 8.2.1.4.1.3-4: Minimum performance Multi-Layer Spatial Multiplexing (FRC)

Test number	Band-width	Reference Channel	OCNG Pattern	Propagation Condition	Correlation Matrix and Antenna Configuration	Reference value		UE Category
						Fraction of Maximum Throughput (%)	SNR (dB)	
3	10 MHz	R.11 FDD	OP.1 FDD	EVA5	2x2 Low	70	12.9	2-5
4	10 MHz	R.11 FDD	OP.1 FDD	ETU70	2x2 Low	70	14.3	2-5

The normative reference for this requirement is TS 36.101 [2] clause 8.2.1.4.

8.2.1.4.1.4 Test description

8.2.1.4.1.4.1 Initial conditions

Initial conditions are a set of test configurations the UE needs to be tested in and the steps for the SS to take with the UE to reach the correct measurement state.

Configurations of PDSCH and PDCCH before measurement are specified in Annex C.2.

Test Environment: Normal, as defined in TS 36.508 [7] clause 4.1.

Frequencies to be tested: Mid Range, as defined in TS 36.508 [7] clause 4.3.1.1.

Channel Bandwidths to be tested: As specified per test number in Tables 8.2.1.4.1.3-2 and 8.2.1.4.1.3-4 as defined in TS 36.508 [7] clause 4.3.1.1.

1. Connect the SS, the faders and AWGN noise sources to the UE antenna connectors as shown in TS 36.508 [7] Annex A, Figure A.10 for antenna configuration 2x2.
2. The parameter settings for the cell are set up according to Tables 8.2.1-1, 8.2.1.4.1.3-1 and 8.2.1.4.1.3-3 as appropriate.
3. Downlink signals are initially set up according to Annex C0, C.1 and Annex C.3.2 and uplink signals according to Annex H.1 and H.3.2.
4. Propagation conditions are set according to Annex B.0.
5. Ensure the UE is in State 3A-RF according to TS 36.508 [7] clause 5.2A.2. Message contents are defined in clause 8.2.1.4.1.4.3.

8.2.1.4.1.4.2 Test procedure

1. For single-layer spatial multiplexing, SS transmits PDSCH via PDCCH DCI format 2 for C_RNTI to transmit the DL RMC according to Tables 8.2.1.4.1.3-1 and 8.2.1.4.1.3-2. For multi-layer spatial multiplexing, SS transmits PDSCH via PDCCH DCI format 2 for C_RNTI to transmit the DL RMC according to Tables 8.2.1.4.1.3-3 and 8.2.1.4.1.3-4. The SS sends downlink MAC padding bits on the DL RMC.
2. SS schedules the UL transmission to carry the PUSCH CQI feedback via PDCCH DCI format 0 with CQI request bit set to 1 and I_MCS=29 and N_PRB allocated to be less or equal to 4.
3. Set the parameters of the bandwidth, MCS, reference channel, the propagation condition, the correlation matrix, antenna configuration and the SNR according to Tables 8.2.1.4.1.5-1 and 8.2.1.4.1.5-2 as appropriate.
4. Measure the average throughput for a duration sufficient to achieve statistical significance according to Annex G clause G.3. Count the number of NACKs, ACKs and statDTXs on the UL during the test interval and decide pass or fail according to Tables G.3.5 and G.3.6 in Annex G clause G.3.
5. Repeat steps from 1 to 4 for each test interval in Tables 8.2.1.4.1.5-1 and 8.2.1.4.1.5-2 as appropriate.

8.2.1.4.1.4.3 Message contents

Message contents are according to TS 36.508 [7] clause 4.6 with the following exceptions:

Table 8.2.1.4.1.4.3-1: *PhysicalConfigDedicated-DEFAULT*: Additional FDD PDSCH closed loop single-layer spatial multiplexing performance downlink power allocation for Test number 1, 2

Derivation Path: 36.331 clause 6.3.2			
Information Element	Value/remark	Comment	Condition
PhysicalConfigDedicated-DEFAULT ::= SEQUENCE {			
antennaInfo CHOICE {			
antennaInfoDedicated ::= SEQUENCE {			
transmissionMode	tm4		
codebookSubsetRestriction CHOICE {			
n2TxAntenna-tm4	001111		
}			
ue-TransmitAntennaSelection CHOICE {			
release	NULL		
}			
}			
}			

Table 8.2.1.4.1.4.3-2: *PhysicalConfigDedicated-DEFAULT*: Additional FDD PDSCH closed loop multi-layer spatial multiplexing performance downlink power allocation for Test number 3, 4

Derivation Path: 36.331 clause 6.3.2			
Information Element	Value/remark	Comment	Condition
PhysicalConfigDedicated-DEFAULT ::= SEQUENCE {			
antennaInfo CHOICE {			
antennaInfoDedicated ::= SEQUENCE {			
transmissionMode	tm4		
codebookSubsetRestriction CHOICE {			
n2TxAntenna-tm4	110000		
}			
ue-TransmitAntennaSelection CHOICE {			
release	NULL		
}			
}			
}			

Table 8.2.1.4.1.4.3-3: *CQI-ReportConfig-DEFAULT*: Additional FDD PDSCH closed loop single-layer spatial multiplexing performance downlink power allocation for Test number 1

Derivation Path: 36.331 clause 6.3.2			
Information Element	Value/remark	Comment	Condition
CQI-ReportConfig-DEFAULT ::= SEQUENCE {			
cqi-ReportModeAperiodic	rm12		
nomPDSCH-RS-EPRE-Offset	0		
cqi-ReportPeriodic	Not present		
}			

Table 8.2.1.4.1.4.3-4: *CQI-ReportConfig-DEFAULT*: Additional FDD PDSCH closed loop single/multi-layer spatial multiplexing performance downlink power allocation for Test number 2, 3, 4

Derivation Path: 36.331 clause 6.3.2			
Information Element	Value/remark	Comment	Condition
CQI-ReportConfig-DEFAULT ::= SEQUENCE {			
cqi-ReportModeAperiodic	rm31		
nomPDSCH-RS-EPRE-Offset	0		
cqi-ReportPeriodic	Not present		
}			

8.2.1.4.1.5 Test requirement

Tables 8.2.1.4.3-1 and 8.2.1.4.3-3 define the primary level settings.

The fraction of maximum throughput percentage for the downlink reference measurement channels specified in Annex A clause A.3.3.2 for each throughput test shall meet or exceed the specified value in Tables 8.2.1.4.1.5-1 and 8.2.1.4.1.5-2 for the specified SNR including test tolerances for all throughput tests.

Table 8.2.1.4.1.5-1: Test requirement Single-Layer Spatial Multiplexing (FRC)

Test number	Band-width	Reference Channel	OCNG Pattern	Propagation Condition	Correlation Matrix and Antenna Configuration	Reference value		UE Category
						Fraction of Maximum Throughput (%)	SNR (dB)	
1	10 MHz	R.10 FDD	OP.1 FDD	EVA5	2x2 Low	70	-1.6	1-5
2	10 MHz	R.10 FDD	OP.1 FDD	EPA5	2x2 High	70	-1.4	1-5

Table 8.2.1.4.1.5-2: Test requirement Multi-Layer Spatial Multiplexing (FRC)

Test number	Band-width	Reference Channel	OCNG Pattern	Propagation Condition	Correlation Matrix and Antenna Configuration	Reference value		UE Category
						Fraction of Maximum Throughput (%)	SNR (dB)	
3	10 MHz	R.11 FDD	OP.1 FDD	EVA5	2x2 Low	70	13.8	2-5
4	10 MHz	R.11 FDD	OP.1 FDD	ETU70	2x2 Low	70	15.2	2-5

8.2.1.4.1_1 FDD PDSCH Closed Loop Single/Multi Layer Spatial Multiplexing 2x2 (Release 9 and forward)

8.2.1.4.1_1.1 Test purpose

Same test purpose as in clause 8.2.1.4.1.1

8.2.1.4.1_1.2 Test applicability

This test applies to all types of E-UTRA FDD UE release 9 and forward.

8.2.1.4.1_1.3 Minimum conformance requirements

Same minimum conformance requirements as in clause 8.2.1.4.1.3 with the following exceptions:

- Instead of Table 8.2.1.4.1.3-3 → use Table 8.2.1.4.1_1.3-1.
- Instead of Table 8.2.1.4.1.3-4 → use Table 8.2.1.4.1_1.3-2.

Table 8.2.1.4.1_1.3-1: Test Parameters for Testing Multi-Layer Spatial Multiplexing

Parameter	Unit	Test 3-4	
Downlink power allocation	ρ_A	dB	-3
	ρ_B	dB	-3 (Note 1)
	σ	dB	0
N_{oc} at antenna port	dBm/15kHz	-98	
Precoding granularity	PRB	50	
PMI delay (Note 2)	ms	8	
Reporting interval	ms	1	
Reporting mode		PUSCH 3-1	
PDSCH transmission mode		4	
CodeBookSubsetRestriction bitmap		110000	
Note 1: $P_B = 1$			
Note 2: If the UE reports in an available uplink reporting instance at subframe SF#n based on PMI estimation at a downlink SF not later than SF#(n-4), this reported PMI cannot be applied at the eNB downlink before SF#(n+4)			

Table 8.2.1.4.1_1.3-2: Minimum performance Multi-Layer Spatial Multiplexing (FRC)

Test number	Band-width	Reference Channel	OCNG Pattern	Propagation Condition	Correlation Matrix and Antenna Configuration	Reference value		UE Category
						Fraction of Maximum Throughput (%)	SNR (dB)	
3	10 MHz	R.35 FDD	OP.1 FDD	EPA5	2x2 Low	70	18.9	2-5
4	10 MHz	R.11 FDD	OP.1 FDD	ETU70	2x2 Low	70	14.3	2-5

The normative reference for this requirement is TS 36.101 [2] clause 8.2.1.4.

8.2.1.4.1_1.4 Test description

Same test description as in clause 8.2.1.4.1.4 with the following exceptions:

- Instead of Table 8.2.1.4.1.3-3 → use Table 8.2.1.4.1_1.3-1.
- Instead of Table 8.2.1.4.1.3-4 → use Table 8.2.1.4.1_1.3-2.
- Instead of Table 8.2.1.4.1.5-2 → use Table 8.2.1.4.1_1.5-1.

8.2.1.4.1_1.5 Test requirement

Same test requirement as in clause 8.3.2.1.1.5 with the following exceptions:

- Instead of Table 8.2.1.4.1.3-3 → use Table 8.2.1.4.1_1.3-1.
- Instead of Table 8.2.1.4.1.5-2 → use Table 8.2.1.4.1_1.5-1.

Table 8.2.1.4.1_1.5-1: Test requirement Multi-Layer Spatial Multiplexing (FRC)

Test number	Band-width	Reference Channel	OCNG Pattern	Propagation Condition	Correlation Matrix and Antenna Configuration	Reference value		UE Category
						Fraction of Maximum Throughput (%)	SNR (dB)	
3	10 MHz	R.35 FDD	OP.1 FDD	EPA5	2x2 Low	70	+19.8	2-5
4	10 MHz	R.11 FDD	OP.1 FDD	ETU70	2x2 Low	70	+15.2	2-5

8.2.1.4.2 FDD PDSCH Closed Loop Single/Multi Layer Spatial Multiplexing 4x2

8.2.1.4.2.1 Test purpose

To verify the UE's ability to receive a predefined test signal, representing a multi-path fading channel that is determined by the SNR with a percentage of the information bit throughput for a specified downlink Reference Measurement Channel (RMC) not falling below a specified value for transmission on two antenna ports using closed-loop spatial multiplexing.

8.2.1.4.2.2 Test applicability

This test applies to all types of E-UTRA FDD UE release 8.

8.2.1.4.2.3 Minimum conformance requirements

The requirements are specified in terms of the percentage of information bit throughput for the downlink reference measurement channels specified in Annex A clause A.3.3.2, with the addition of the relevant parameters in Tables 8.2.1-1, 8.2.1.4.2.3-1 and 8.2.1.4.2.3-3 and the downlink physical channel setup according to Table C.3.2-1 in Annex C.

Using this configuration the fraction of maximum throughput percentage shall meet or exceed the minimum requirements specified in Tables 8.2.1.4.2.3-2 and 8.2.1.4.2.3-4 for the specified SNR. For single-layer spatial multiplexing closed loop rank-one performance with wideband and frequency selective precoding is specified. For multi-layer spatial multiplexing closed loop rank-two performance with wideband and frequency selective precoding is specified.

Table 8.2.1.4.2.3-1: Test Parameters for Testing Single-Layer Spatial Multiplexing

Parameter	Unit	Test 1	
Downlink power allocation	ρ_A	dB	-6
	ρ_B	dB	-6 (Note 1)
	σ	dB	3
N_{oc} at antenna port	dBm/15kHz	-98	
Precoding granularity	PRB	6	
PMI delay (Note 2)	ms	8	
Reporting interval	ms	1	
Reporting mode		PUSCH 1-2	
CodeBookSubsetRestriction bitmap		00000000000000 00000000000000 00000000000000 00000011111111 11111111	
PDSCH transmission mode		4	
Note 1: $P_B = 1$			
Note 2:			

Table 8.2.1.4.2.3-2: Minimum performance Single-Layer Spatial Multiplexing (FRC)

Test number	Band-width	Reference Channel	OCNG Pattern	Propagation Condition	Correlation Matrix and Antenna Configuration	Reference value		UE Category
						Fraction of Maximum Throughput (%)	SNR (dB)	
1	10 MHz	R.13 FDD	OP.1 FDD	EVA5	4x2 Low	70	-3.2	1-5

Table 8.2.1.4.2.3-3: Test Parameters for Testing Multi-Layer Spatial Multiplexing

Parameter	Unit	Test 2	
Downlink power allocation	ρ_A	dB	-6
	ρ_B	dB	-6 (Note 1)
	σ	dB	3
N_{oc} at antenna port	dBm/15kHz	-98	
Precoding granularity	PRB	6	
PMI delay (Note 2)	ms	8	
Reporting interval	ms	1	
Reporting mode		PUSCH 1-2	
CodeBookSubsetRestriction bitmap		00000000000000 00000000000000 00001111111111 11111100000000 00000000	
PDSCH transmission mode		4	
Note 1: $P_B = 1$			
Note 2: If the UE reports in an available uplink reporting instance at subframe SF#n based on PMI estimation at a downlink SF not later than SF#(n-4), this reported PMI cannot be applied at the eNB downlink before SF#(n+4)			

Table 8.2.1.4.2.3-4: Minimum performance Multi-Layer Spatial Multiplexing (FRC)

Test number	Band-width	Reference Channel	OCNG Pattern	Propagation Condition	Correlation Matrix and Antenna Configuration	Reference value		UE Category
						Fraction of Maximum Throughput (%)	SNR (dB)	
2	10 MHz	R.14 FDD	OP.1 FDD	EVA5	4x2 Low	70	10.5	2-5

The normative reference for this requirement is TS 36.101 [2] clause 8.2.1.4.

8.2.1.4.2.4 Test description

8.2.1.4.2.4.1 Initial conditions

Initial conditions are a set of test configurations the UE needs to be tested in and the steps for the SS to take with the UE to reach the correct measurement state.

Configurations of PDSCH and PDCCH before measurement are specified in Annex C.2.

Test Environment: Normal, as defined in TS 36.508 [7] clause 4.1.

Frequencies to be tested: Mid Range, as defined in TS 36.508 [7] clause 4.3.1.1.

Channel Bandwidths to be tested: As specified per test number in Tables 8.2.1.4.2.3-2 and 8.2.1.4.2.3-4 as defined in TS 36.508 [7] clause 4.3.1.1.

1. Connect the SS, the faders and AWGN noise sources to the UE antenna connectors as shown in TS 36.508 [7] Annex A, Figure A.11 for antenna configuration 4x2.
2. The parameter settings for the cell are set up according to Tables 8.2.1-1, 8.2.1.4.2.3-1 and 8.2.1.4.2.3-3 as appropriate.
3. Downlink signals are initially set up according to Annex C.1 and Annex C.3.2 and uplink signals according to Annex H.1 and H.3.2.
4. Propagation conditions are set according to Annex B.0.
5. Ensure the UE is in State 3A-RF according to TS 36.508 [7] clause 5.2A.2. Message contents are defined in clause 8.2.1.4.2.4.3.

8.2.1.4.2.4.2 Test procedure

1. For single-layer spatial multiplexing, SS transmits PDSCH via PDCCH DCI format 2 for C_RNTI to transmit the DL RMC according to Tables 8.2.1.4.2.3-1 and 8.2.1.4.2.3-2. For multi-layer spatial multiplexing, SS transmits PDSCH via PDCCH DCI format 2 for C_RNTI to transmit the DL RMC according to Tables 8.2.1.4.2.3-3 and 8.2.1.4.2.3-4. The SS sends downlink MAC padding bits on the DL RMC.
2. SS schedules the UL transmission to carry the PUSCH CQI feedback via PDCCH DCI format 0 with CQI request bit set to 1 and I_MCS=29 and N_PRB allocated to be less or equal to 4.
3. Set the parameters of the bandwidth, MCS, reference channel, the propagation condition, the correlation matrix, antenna configuration and the SNR according to Tables 8.2.1.4.2.5-1 and 8.2.1.4.2.5-2 as appropriate.
4. Measure the average throughput for a duration sufficient to achieve statistical significance according to Annex G clause G.3. Count the number of NACKs, ACKs and statDTXs on the UL during the test interval and decide pass or fail according to Tables G.3.5 and G.3.6 in Annex G clause G.3.
5. Repeat steps from 1 to 4 for each test interval in Tables 8.2.1.4.2.5-1 and 8.2.1.4.2.5-2 as appropriate.

8.2.1.4.2.4.3 Message contents

Message contents are according to TS 36.508 [7] clause 4.6 with the following exceptions:

Table 8.2.1.4.2.4.3-1: PDSCH-ConfigDedicated-DEFAULT: Additional FDD PDSCH closed loop spatial multiplexing performance downlink power allocation for Test numbers 1, 2

Derivation Path: TS 36.508 [7] clause 4.6.3, Table 4.6.3-6 PDSCH-ConfigDedicated-DEFAULT			
Information Element	Value/remark	Comment	Condition
PDSCH-ConfigDedicated-DEFAULT ::= SEQUENCE {			
p-a	dB-6		
}			

Table 8.2.1.4.2.4.3-2: PhysicalConfigDedicated-DEFAULT: Additional FDD PDSCH closed loop single-layer spatial multiplexing performance downlink power for Test number 1

Derivation Path: 36.331 clause 6.3.2			
Information Element	Value/remark	Comment	Condition
PhysicalConfigDedicated-DEFAULT ::= SEQUENCE {			
antennaInfo CHOICE {			
antennaInfoDedicated ::= SEQUENCE {			
transmissionMode	tm4		
codebookSubsetRestriction CHOICE {			
n4TxAntenna-tm4	00000000000000000000 00000000000000000000 00000000111111111111 1111		
}			
ue-TransmitAntennaSelection CHOICE {			
release	NULL		
}			
}			
}			

Table 8.2.1.4.2.4.3-3: PhysicalConfigDedicated-DEFAULT: Additional FDD PDSCH closed loop multi-layer spatial multiplexing performance downlink power allocation Test number 2

Derivation Path: 36.331 clause 6.3.2			
Information Element	Value/remark	Comment	Condition
PhysicalConfigDedicated-DEFAULT ::= SEQUENCE {			
antennaInfo CHOICE {			
antennaInfoDedicated ::= SEQUENCE {			
transmissionMode	tm4		
codebookSubsetRestriction CHOICE {			
n4TxAntenna-tm4	00000000000000000000 00000000000011111111 11111111000000000000 0000		
}			
ue-TransmitAntennaSelection CHOICE {			
release	NULL		
}			
}			

Table 8.2.1.4.2.4.3-4: CQI-ReportConfig-DEFAULT: Additional FDD PDSCH closed loop single/multi-layer spatial multiplexing performance downlink power allocation Test number 1, 2

Derivation Path: 36.331 clause 6.3.2			
Information Element	Value/remark	Comment	Condition
CQI-ReportConfig-DEFAULT ::= SEQUENCE {			
cqi-ReportModeAperiodic	rm12		
nomPDSCH-RS-EPRE-Offset	0		
cqi-ReportPeriodic	Not present		
}			

8.2.1.4.2.5 Test requirement

Tables 8.2.1.4.2.3-1 and 8.2.1.4.2.3-3 define the primary level settings.

The fraction of maximum throughput percentage for the downlink reference measurement channels specified in Annex A clause A.3.3.2 for each throughput test shall meet or exceed the specified value in Tables 8.2.1.4.25-1 and 8.2.1.4.2.5-2 for the specified SNR including test tolerances for all throughput tests.

Table 8.2.1.4.2.5-1: Test requirement Single-Layer Spatial Multiplexing (FRC)

Test number	Band-width	Reference Channel	OCNG Pattern	Propagation Condition	Correlation Matrix and Antenna Configuration	Reference value		UE Category
						Fraction of Maximum Throughput (%)	SNR (dB)	
1	10 MHz	R.13 FDD	OP.1 FDD	EVA5	4x2 Low	70	-2.3	1-5

Table 8.2.1.4.2.5-2: Test requirement Multi-Layer Spatial Multiplexing (FRC)

Test number	Band-width	Reference Channel	OCNG Pattern	Propagation Condition	Correlation Matrix and Antenna Configuration	Reference value		UE Category
						Fraction of Maximum Throughput (%)	SNR (dB)	
2	10 MHz	R.14 FDD	OP.1 FDD	EVA5	4x2 Low	70	11.4	2-5

8.2.1.4.2_1 FDD PDSCH Closed Loop Single/Multi Layer Spatial Multiplexing 4x2 (Release 9 and forward)

8.2.1.4.2_1.1 Test purpose

Same test purpose as in clause 8.2.1.4.2.1

8.2.1.4.2_1.2 Test applicability

This test applies to all types of E-UTRA FDD UE release 9 and forward.

8.2.1.4.2_1.3 Minimum conformance requirements

Same minimum conformance requirements as in clause 8.2.1.4.2.3 with the following exceptions:

- Instead of Table 8.2.1.4.2.3-3 → use Table 8.2.1.4.2_1.3-1.
- Instead of Table 8.2.1.4.2.3-4 → use Table 8.2.1.4.2_1.3-2.

Table 8.2.1.4.2_1.3-1: Test Parameters for Testing Multi-Layer Spatial Multiplexing

Parameter	Unit	Test 2
Downlink power allocation	ρ_A	dB
	ρ_B	dB
	σ	dB
N_{oc} at antenna port	dBm/15kHz	-98
Precoding granularity	PRB	6
PMI delay (Note 2)	ms	8
Reporting interval	ms	1
Reporting mode		PUSCH 1-2
CodeBookSubsetRestriction bitmap		000000000000 000000000000 000000111111 111111111000 000000000000
PDSCH transmission mode		4
Note 1: $P_B = 1$ Note 2: If the UE reports in an available uplink reporting instance at subframe SF#n based on PMI estimation at a downlink SF not later than SF#(n-4), this reported PMI cannot be applied at the eNB downlink before SF#(n+4)		

Table 8.2.1.4.2_1.3-2: Minimum performance Multi-Layer Spatial Multiplexing (FRC)

Test number	Band-width	Reference Channel	OCNG Pattern	Propagation Condition	Correlation Matrix and Antenna Configuration	Reference value		UE Category
						Fraction of Maximum Throughput (%)	SNR (dB)	
2	10 MHz	R.36 FDD	OP.1 FDD	EPA5	4x2 Low	70	14.7	2-5

The normative reference for this requirement is TS 36.101 [2] clause 8.2.1.4.

8.2.1.4.2_1.4 Test description

Same test description as in clause 8.2.1.4.2.4 with the following exceptions:

- Instead of Table 8.2.1.4.2.3-3 → use Table 8.2.1.4.2_1.3-1.
- Instead of Table 8.2.1.4.2.3-4 → use Table 8.2.1.4.2_1.3-2.
- Instead of Table 8.2.1.4.2.5-2 → use Table 8.2.1.4.2_1.5-1.

8.2.1.4.2_1.5 Test requirement

Same test requirement as in clause 8.3.2.1.2.5 with the following exceptions:

- Instead of Table 8.2.1.4.2.3-3 → use Table 8.2.1.4.2_1.3-1.
- Instead of Table 8.2.1.4.2.5-2 → use Table 8.2.1.4.2_1.5-1.

Table 8.2.1.4.2_1.5-1: Test requirement Multi-Layer Spatial Multiplexing (FRC)

Test number	Band-width	Reference Channel	OCNG Pattern	Propagation Condition	Correlation Matrix and Antenna Configuration	Reference value		UE Category
						Fraction of Maximum Throughput (%)	SNR (dB)	
2	10 MHz	R.36 FDD	OP.1 FDD	EPA5	4x2 Low	70	+15.6	2-5

8.2.1.4.2_A FDD PDSCH Closed Loop Multi Layer Spatial Multiplexing 4x2 for CA

8.2.1.4.2_A.1 FDD PDSCH Closed Loop Multi Layer Spatial Multiplexing 4x2 for CA (intra-band contiguous DL CA)

Editor's note: This clause is incomplete. The following aspects are either missing or not yet determined:

- Connection diagram is FFS.
- Test tolerance is undefined
- Test frequencies are FFS
- Statistical significance related parameters in Annex G.3A are FFS

8.2.1.4.2_A.1.1 Test purpose

To verify the UE's ability to receive a predefined test signal, representing a multi-path fading channel that is determined by the SNR with a percentage of the information bit throughput for a specified downlink Reference Measurement Channel (RMC) not falling below a specified value for transmission on two antenna ports using closed-loop spatial multiplexing.

8.2.1.4.2_A.1.2 Test applicability

This test applies to all types of E-UTRA FDD UE release10 and forward which supports intra-band contiguous DL CA.

8.2.1.4.2_A.1.3 Minimum conformance requirements

The requirements are specified in terms of the percentage of information bit throughput for the downlink reference measurement channels specified in Annex A clause A.3.3.2, with the addition of the relevant parameters in Tables 8.2.1-1, 8.2.1.4.2_A.1.3-1 and the downlink physical channel setup according to Table C.3.2-1 in Annex C.

Using this configuration the fraction of maximum throughput percentage shall meet or exceed the minimum requirements specified in Tables 8.2.1.4.2_A.1.3-2 for the specified SNR. For multi-layer spatial multiplexing closed loop rank-two performance with wideband and frequency selective precoding is specified.

Table 8.2.1.4.2_A.1.3-1: Test Parameters for Testing Multi-Layer Spatial Multiplexing

Parameter		Unit	Test 1
Downlink power allocation	ρ_A	dB	-6
	ρ_B	dB	-6 (Note 1)
N_{oc} at antenna port		dBm/15kHz	-98
Precoding granularity		PRB	6
PMI delay (Note 2)		ms	8
Reporting interval		ms	1
Reporting mode			PUSCH 1-2
CodeBookSubsetRestriction bitmap			000000000000 000000000000 000001111111 111111110000 000000000000
CSI request field (Note 3)			'10'
Note 1: $P_B = 1$ Note 2: If the UE reports in an available uplink reporting instance at subframe SF#n based on PMI estimation at a downlink SF not later than SF#(n-4), this reported PMI cannot be applied at the eNB downlink before SF#(n+4) Note 3: CSI request field applies for CA demodulation requirement only. Multiple CC-s under test are configured as the 1 st set of serving cells by higher layers. Note 4: For CA test cases, ACK/NACK bits are transmitted using PUSCH with PUCCH format 1b with channel selection configured.			

Table 8.2.1.4.2_A.1.3-2: Minimum performance Multi-Layer Spatial Multiplexing (FRC)

Test num.	Band-width	Reference channel	OCNG pattern	Propagation condition	Correlation matrix and antenna config.	Reference value		UE category	CA capability
						Fraction of maximum throughput (%)	SNR (dB)		
1	2x10 MHz	R.14 FDD	OP.1 FDD (Note 1)	EVA5	4x2 Low	70	10.8	3-8	CL_A-A
2	2x20 MHz	R.14-3 FDD	OP.1 FDD (Note 1)	EVA5	4x2 Low	70	[10.9]	5-8	CL_C

Note 1: For CA capable UE, the OCNG pattern applies for each CC.

The normative reference for this requirement is TS 36.101 [2] clause 8.2.1.4.

8.2.1.4.2_A.1.4 Test description

8.2.1.4.2_A.1.4.1 Initial conditions

Initial conditions are a set of test configurations the UE needs to be tested in and the steps for the SS to take with the UE to reach the correct measurement state.

Configurations of PDSCH and PDCCH before measurement are specified in Annex C.2.

Test Environment: Normal, as defined in TS 36.508 [7] clause 4.1.

Frequencies to be tested: Mid Range, as defined in TS 36.508 [7] clause FFS.

Channel Bandwidths to be tested: As specified per test number in Tables 8.2.1.4.2_A.1.3-2 as defined in TS 36.508 [7] clause 4.3.1.1.

1. Connect the SS, the faders and AWGN noise sources to the UE antenna connectors as shown in TS 36.508 [7] Annex A, Figure FFS for antenna configuration 4x2.

2. The parameter settings for the cell are set up according to Tables 8.2.1-1, 8.2.1.4.2_A.1.3-1 as appropriate.
3. Downlink signals for PCC are initially set up according to Annex C.1 and Annex C.3.2 and uplink signals according to Annex H.1 and H.3.2.
4. Propagation conditions are set according to Annex B.0.
5. Ensure the UE is in State 3A-RF according to TS 36.508 [7] clause 5.2A.2. Message contents are defined in clause 8.2.1.4.2_A.1.4.3.

8.2.1.4.2_A.1.4.2 Test procedure

1. Configure SCC according to Annex C.0, C.1 and Annex C.3.2 for all downlink physical channels except PHICH.
2. The SS shall configure SCC as per TS 36.508 [7] clause 5.2A.4. Message contents for *PDSCH-ConfigDedicated-DEFAULT* is defined in Table 8.2.1.4.2_A.1.4.3-1, *PhysicalConfigDedicated-DEFAULT* is defined in Table 8.2.1.4.2_A.1.4.3-2, *PhysicalConfigDedicatedSCell-r10-DEFAULT* is defined in Table 8.2.1.4.2_A.1.4.3-2A, *CQI-ReportConfig-DEFAULT* is defined in Table 8.2.1.4.2_A.1.4.3-3, *CQI-ReportConfig-r10-DEFAULT* is defined in Table 8.2.1.4.2_A.1.4.3-4, *CQI-ReportAperiodic-r10-DEFAULT* is defined in Table 8.2.1.4.2_A.1.4.3-5.
3. SS activates SCC by sending the activation MAC-CE (Refer TS 36.321 [13], clauses 5.13, 6.1.3.8). Wait for at least 2 seconds (Refer TS 36.133, clauses 8.3.3.2).
4. For multi-layer spatial multiplexing, SS transmits PDSCH via PDCCH DCI format 2 for C_RNTI to transmit the DL RMC according to Tables 8.2.1.4.2_A.1.3-1 and 8.2.1.4.2_A.1.3-3. The SS sends downlink MAC padding bits on the DL RMC.
5. SS schedules the UL transmission to carry the PUSCH CSI feedback via PDCCH DCI format 0 with CSI request bit set to '10' and I_MCS=29 and N_PRB allocated to be less or equal to 20.
6. Set the parameters of the bandwidth, MCS, reference channel, the propagation condition, the correlation matrix, antenna configuration and the SNR according to Tables 8.2.1.4.2_A.1.5-1 as appropriate.
7. Measure the average throughput for a duration sufficient to achieve statistical significance according to Annex G clause G.3. Count the number of NACKs, ACKs and statDTXs on the UL during the test interval and decide pass or fail according to Tables G.3.5 and G.3.6 in Annex G clause G.3.

8.2.1.4.2_A.1.4.3 Message contents

Message contents are according to TS 36.508 [7] clause 4.6 with the following exceptions:

Table 8.2.1.4.2_A.1.4.3-1: *PDSCH-ConfigDedicated-DEFAULT*: Additional FDD PDSCH closed loop spatial multiplexing performance downlink power allocation

Derivation Path: TS 36.508 [7] clause 4.6.3, Table 4.6.3-6 <i>PDSCH-ConfigDedicated-DEFAULT</i>			
Information Element	Value/remark	Comment	Condition
<i>PDSCH-ConfigDedicated-DEFAULT</i> ::= SEQUENCE {			
p-a	dB-6		
}			

Table 8.2.1.4.2_A.1.4.3-2: PhysicalConfigDedicated-DEFAULT: Additional FDD PDSCH closed loop multi-layer spatial multiplexing performance downlink power allocation Test number 1

Derivation Path: 36.331 clause 6.3.2			
Information Element	Value/remark	Comment	Condition
PhysicalConfigDedicated-DEFAULT ::= SEQUENCE {			
antennaInfo CHOICE {			
antennaInfoDedicated ::= SEQUENCE {			
transmissionMode	tm4		
codebookSubsetRestriction CHOICE {			
n4TxAntenna-tm4	00000000000000000000 00000000000011111111 11111111000000000000 0000		
}			
ue-TransmitAntennaSelection CHOICE {			
release	NULL		
}			
}			
}			

Table 8.2.1.4.2_A.1.4.3-2A: PhysicalConfigDedicatedSCell-r10-DEFAULT: Additional FDD PDSCH closed loop multi-layer spatial multiplexing performance downlink power allocation

Derivation Path: 36.508 clause 4.6.3 Table 4.6.3-6A			
Information Element	Value/remark	Comment	Condition
PhysicalConfigDedicated SCell-r10-DEFAULT ::= SEQUENCE {			
nonUL-Configuration-r10 SEQUENCE {			
antennaInfo-r10 CHOICE {			
antennaInfoDedicated-r10 ::= SEQUENCE {			
transmissionMode	tm4		
codebookSubsetRestriction CHOICE {			
n4TxAntenna-tm4	00000000000000000000 00000000000011111111 11111111000000000000 0000		
}			
ue-TransmitAntennaSelection CHOICE {			
release	NULL		
}			
}			
}			
}			

Table 8.2.1.4.2_A.1.4.3-3: CQI-ReportConfig-DEFAULT: Additional FDD PDSCH closed loop multi-layer spatial multiplexing performance downlink power allocation

Derivation Path: 36.331 clause 6.3.2			
Information Element	Value/remark	Comment	Condition
CQI-ReportConfig-DEFAULT ::= SEQUENCE {			
cqi-ReportModeAperiodic	rm12		
nomPDSCH-RS-EPRE-Offset	0		
cqi-ReportPeriodic	Not present		
}			

Table 8.2.1.4.2_A.1.4.3-4: CQI-ReportConfig-r10-DEFAULT: Additional FDD PDSCH closed loop multi-layer spatial multiplexing performance downlink power allocation

Derivation Path: 36.508 clause 4.6.3 Table 4.6.3-2AA			
Information Element	Value/remark	Comment	Condition
CQI-ReportConfig-r10 ::= SEQUENCE {			
cqi-ReportAperiodic-r10	CQI-ReportAperiodic-r10-DEFAULT		
nomPDSCH-RS-EPRE-Offset	0		
cqi-ReportPeriodic-r10	Not present		
pmi-RI-Report-r9	Not present		
csi-SubframePatternConfig-r10	Not present		
}			

Table 8.2.1.4.2_A.1.4.3-5: CQI-ReportAperiodic-r10-DEFAULT: Additional FDD PDSCH closed loop multi-layer spatial multiplexing performance downlink power allocation

Derivation Path: 36.508 clause 4.6.3 Table 4.6.3-1A			
Information Element	Value/remark	Comment	Condition
CQI-ReportAperiodic-r10 ::= CHOICE {			
setup SEQUENCE {			
cqi-ReportModeAperiodic-r10	rm12		
aperiodicCSI-Trigger-r10 ::= SEQUENCE {			
trigger1-r10	11000000	P-Cell, S-Cell report	
trigger2-r10	00000000	No report	
}			
}			
}			

8.2.1.4.2_A.1.5 Test requirement

Tables 8.2.1.4.2_A.1.3-1 define the primary level settings.

The fraction of maximum throughput percentage for the downlink reference measurement channels specified in Annex A clause A.3.4.2 for each throughput test shall meet or exceed the specified value in Tables 8.2.1.4.2_A.1.5-1 for the specified SNR including test tolerances for all throughput tests.

Table 8.2.1.4.2_A.1.5-1: Test requirement Multi-Layer Spatial Multiplexing (FRC)

Test num.	Band-width	Reference channel	OCNG pattern	Propagation condition	Correlation matrix and antenna config.	Reference value		UE category	CA capability
						Fraction of maximum throughput (%)	SNR (dB)		
1	NA								
2	2x20 MHz	R.14-3 FDD	OP.1 FDD (Note 1)	EVA5	4x2 Low	70	[10.9] +TT	5-8	CL_C

Note 1: For CA capable UE, the OCNG pattern applies for each CC.

Decide pass or fail for each subtest according to Annex G.3A.4. Decide the entire test pass or fail according to Annex G.3A.6.

8.2.1.4.2_A.2 FDD PDSCH Closed Loop Multi Layer Spatial Multiplexing 4x2 for CA (inter-band DL CA)

Editor's note: This clause is incomplete. The following aspects are either missing or not yet determined

- Connection diagram is FFS.
- Test tolerance is undefined

- Test frequencies are FFS
- Statistical significance related parameters in Annex G.3A are FFS

8.2.1.4.2_A.2.1 Test purpose

Same test purpose as in clause 8.2.1.4.2_A.1.1.

8.2.1.4.2_A.2.2 Test applicability

This test applies to all types of E-UTRA FDD UE release10 and forward which supports inter-band DL CA.

8.2.1.4.2_A.2.3 Minimum conformance requirements

Same minimum conformance requirements as in clause 8.2.1.4.2_A.1.3.

8.2.1.4.2_A.2.4 Test description

8.2.1.4.2_A.2.4.1 Initial conditions

Same initial conditions as in clause 8.2.1.4.2_A.1.4.1.

8.2.1.4.2_A.2.4.2 Test procedure

1. Configure SCC according to Annex C.0, C.1 and Annex C.3.2 for all downlink physical channels except PHICH.
2. The SS shall configure SCC as per TS 36.508 [7] clause 5.2A.4. Message contents for *PDSCH-ConfigDedicated-DEFAULT* is defined in Table 8.2.1.4.2_A.2.4.3-1, *PhysicalConfigDedicated-DEFAULT* is defined in Table 8.2.1.4.2_A.2.4.3-2, *PhysicalConfigDedicatedSCell-r10-DEFAULT* is defined in Table 8.2.1.4.2_A.2.4.3-2A, *CQI-ReportConfig-DEFAULT* is defined in Table 8.2.1.4.2_A.2.4.3-3, *CQI-ReportConfig-r10-DEFAULT* is defined in Table 8.2.1.4.2_A.2.4.3-4, *CQI-ReportAperiodic-r10-DEFAULT* is defined in Table 8.2.1.4.2_A.2.4.3-5.
3. SS activates SCC by sending the activation MAC-CE (Refer TS 36.321 [13], clauses 5.13, 6.1.3.8). Wait for at least 2 seconds (Refer TS 36.133, clauses 8.3.3.2).
4. For multi-layer spatial multiplexing, SS transmits PDSCH via PDCCH DCI format 2 for C_RNTI to transmit the DL RMC according to Tables 8.2.1.4.2_A.2.3-1 and 8.2.1.4.2_A.2.3-3. The SS sends downlink MAC padding bits on the DL RMC.
5. SS schedules the UL transmission to carry the PUSCH CSI feedback via PDCCH DCI format 0 with CSI request bit set to '10' and I_MCS=29 and N_PRB allocated to be less or equal to 20.
6. Set the parameters of the bandwidth, MCS, reference channel, the propagation condition, the correlation matrix, antenna configuration and the SNR according to Tables 8.2.1.4.2_A.2.5-1 as appropriate.
7. Measure the average throughput for a duration sufficient to achieve statistical significance according to Annex G clause G.3. Count the number of NACKs, ACKs and statDTXs on the UL during the test interval and decide pass or fail according to Tables G.3.5 and G.3.6 in Annex G clause G.3.

8.2.1.4.2_A.2.4.3 Message contents

Message contents are according to TS 36.508 [7] clause 4.6 with the following exceptions:

Table 8.2.1.4.2_A.2.4.3-1: PDSCH-ConfigDedicated-DEFAULT: Additional FDD PDSCH closed loop spatial multiplexing performance downlink power allocation

Derivation Path: TS 36.508 [7] clause 4.6.3, Table 4.6.3-6 PDSCH-ConfigDedicated-DEFAULT			
Information Element	Value/remark	Comment	Condition
PDSCH-ConfigDedicated-DEFAULT ::= SEQUENCE {			
p-a	dB-6		
}			

Table 8.2.1.4.2_A.2.4.3-2: PhysicalConfigDedicated-DEFAULT: Additional FDD PDSCH closed loop multi-layer spatial multiplexing performance downlink power allocation Test number 1

Derivation Path: 36.331 clause 6.3.2			
Information Element	Value/remark	Comment	Condition
PhysicalConfigDedicated-DEFAULT ::= SEQUENCE {			
antennaInfo CHOICE {			
antennaInfoDedicated ::= SEQUENCE {			
transmissionMode	tm4		
codebookSubsetRestriction CHOICE {			
n4TxAntenna-tm4	00000000000000000000 00000000000011111111 11111111000000000000 0000		
}			
ue-TransmitAntennaSelection CHOICE {			
release	NULL		
}			
}			
}			

Table 8.2.1.4.2_A.2.4.3-2A: PhysicalConfigDedicatedSCell-r10-DEFAULT: Additional FDD PDSCH closed loop multi-layer spatial multiplexing performance downlink power allocation

Derivation Path: 36.508 clause 4.6.3 Table 4.6.3-6A			
Information Element	Value/remark	Comment	Condition
PhysicalConfigDedicated SCell-r10-DEFAULT ::= SEQUENCE {			
nonUL-Configuration-r10 SEQUENCE {			
antennaInfo-r10 CHOICE {			
antennaInfoDedicated-r10 ::= SEQUENCE {			
transmissionMode	tm4		
codebookSubsetRestriction CHOICE {			
n4TxAntenna-tm4	00000000000000000000 00000000000011111111 11111111000000000000 0000		
}			
ue-TransmitAntennaSelection CHOICE {			
release	NULL		
}			
}			
}			
}			

Table 8.2.1.4.2_A.2.4.3-3: CQI-ReportConfig-DEFAULT: Additional FDD PDSCH closed loop multi-layer spatial multiplexing performance downlink power allocation

Derivation Path: 36.331 clause 6.3.2			
Information Element	Value/remark	Comment	Condition
CQI-ReportConfig-DEFAULT ::= SEQUENCE {			
cqi-ReportModeAperiodic	rm12		
nomPDSCH-RS-EPRE-Offset	0		
cqi-ReportPeriodic	Not present		
}			

Table 8.2.1.4.2_A.2.4.3-4: CQI-ReportConfig-r10-DEFAULT: Additional FDD PDSCH closed loop multi-layer spatial multiplexing performance downlink power allocation

Derivation Path: 36.508 clause 4.6.3 Table 4.6.3-2AA			
Information Element	Value/remark	Comment	Condition
CQI-ReportConfig-r10 ::= SEQUENCE {			
cqi-ReportAperiodic-r10	CQI-ReportAperiodic-r10-DEFAULT		
nomPDSCH-RS-EPRE-Offset	0		
cqi-ReportPeriodic-r10	Not present		
pmi-RI-Report-r9	Not present		
csi-SubframePatternConfig-r10	Not present		
}			

Table 8.2.1.4.2_A.2.4.3-5: CQI-ReportAperiodic-r10-DEFAULT: Additional FDD PDSCH closed loop multi-layer spatial multiplexing performance downlink power allocation

Derivation Path: 36.508 clause 4.6.3 Table 4.6.3-1A			
Information Element	Value/remark	Comment	Condition
CQI-ReportAperiodic-r10 ::= CHOICE {			
setup SEQUENCE {			
cqi-ReportModeAperiodic-r10	rm12		
aperiodicCSI-Trigger-r10 ::= SEQUENCE {			
trigger1-r10	11000000	P-Cell, S-Cell report	
trigger2-r10	00000000	No report	
}			
}			
}			

8.2.1.4.2_A.2.5 Test requirement

Table 8.2.1.4.2_A.2.3-1 defines the primary level settings.

The fraction of maximum throughput percentage for the downlink reference measurement channels specified in Annex A clause A.3.4.2 for each throughput test shall meet or exceed the specified value in Tables 8.2.1.4.2_A.2.5-1 for the specified SNR including test tolerances for all throughput tests.

Table 8.2.1.4.2_A.2.5-1: Test requirement Multi-Layer Spatial Multiplexing (FRC)

Test num.	Band-width	Reference channel	OCNG pattern	Propagation condition	Correlation matrix and antenna config.	Reference value		UE category	CA capability
						Fraction of maximum throughput (%)	SNR (dB)		
1	2x10 MHz	R.14 FDD	OP.1 FDD (Note 1)	EVA5	4x2 Low	70	10.8+TT	3-8	CL_A-A
2					NA				

Note 1: For CA capable UE, the OCNG pattern applies for each CC.

Decide pass or fail for each subtest according to Annex G.3A.4. Decide the entire test pass or fail according to Annex G.3A.6.

8.2.2 TDD (Fixed Reference Channel)

The parameters specified in Table 8.2.2-1 are valid for all TDD tests unless otherwise stated.

Table 8.2.2-1: Common Test Parameters (TDD)

Parameter	Unit	Value	Comments
Uplink downlink configuration (Note 1)		1	
Special subframe configuration (Note 2)		4	
Inter-TTI Distance		1	
Number of HARQ processes	Processes	7	For TDD, 7 HARQ processes in the DL, as specified in TS 36.213 [10] clause 7. All 7 HARQ processes are used.
Scheduling of retransmissions			1. Retransmissions use the same Transport Block Size (TBS) as the initial transmission. 2. HARQ processes are scheduled consecutively, independent of the fact, whether retransmissions (for negatively acknowledged HARQ processes) or new transmissions (for positively acknowledged HARQ processes) occur. 3. In case when the initial transmission and the retransmissions are scheduled in subframes with a different N_{PRB} (in terms of TS 36.213 [10] subclause 7.1.7) $29 \leq I_{MCS} \leq 31$ according to TS 36.213 [10] subclause 7.1.7.2 and the appropriate modulation is used.
Maximum number of HARQ transmission		4	It is always 4 for TDD, as specified in TS 36.213 [10] clause 8
Redundancy version coding sequence		{0,1,2,3} for QPSK and 16QAM {0,0,1,2} for 64QAM	
Number of OFDM symbols for PDCCH	OFDM symbols	4 for 1.4 MHz bandwidth, 3 for 3 MHz and 5 MHz bandwidths, 2 for 10 MHz, 15 MHz and 20 MHz bandwidths	The PCFICH carries information about the number of OFDM symbols used for transmission of PDCCHs in a subframe, as specified in TS 36.211 [8] clause 6.7
Cyclic Prefix		Normal	CP consist of the following physical resource blocks (RBs) parameters: 12 consecutive subcarriers at a 15 kHz spacing and 7 OFDM symbols, as specified in TS 36.211 [8] clause 6.2.3
Cell ID		0 (Note 3)	The Cell ID is uniquely defined by a number in the range of 0 to 503, representing the physical-layer cell identity, as specified in TS 36.211 [8] clause 6.11.
Cross carrier scheduling		Not configured	
Note 1: as specified in Table 4.2-2 in TS 36.211 [8] Note 2: as specified in Table 4.2-1 in TS 36.211 [8] Note 3: For CA tests, Cell ID = 0 applies only to P-Cell. For S-Cell, Cell ID = 1 is used.			

The normative reference for this requirement is TS 36.101 [2] clause 8.2.2.

8.2.2.1 TDD PDSCH Single Antenna Port Performance (Cell-Specific Reference Symbols)

8.2.2.1.1 TDD PDSCH Single Antenna Port Performance

8.2.2.1.1.1 Test purpose

To verify the UE's ability to receive a predefined test signal, representing a multi-path fading channel that is determined by the SNR with a percentage of the information bit throughput for a specified downlink Reference Measurement Channel (RMC) not falling below a specified value for transmission on a single-antenna port with different channel models and MCS and also for the transmission on a single-antenna port with full RB allocation.

8.2.2.1.1.2 Test applicability

This test applies to all types of E-UTRA TDD UE release 8 and forward.

8.2.2.1.1.3 Minimum conformance requirements

The requirements are specified in terms of the percentage of information bit throughput for the downlink reference measurement channels specified in Annex A clause A.3.4.1, with the addition of the relevant parameters in Tables 8.2.2-1, 8.2.2.1.1.3-1 and the downlink physical channel setup according to table C.3.2-1 in Annex C.

Using this configuration the fraction of maximum throughput percentage shall meet or exceed the minimum requirements specified in Tables 8.2.2.1.1.3-2 for the specified SNR.

Table 8.2.2.1.1.3-1: Test Parameters

Parameter		Unit	Test 1- 5	Test 6- 8	Test 9- 15	Test 16- 18
Downlink power allocation	ρ_A	dB	0	0	0	0
	ρ_B	dB	0 (Note 1)	0 (Note 1)	0 (Note 1)	0 (Note 1)
N_{oc} at antenna port		dBm/15kHz	-98	-98	-98	-98
Symbols for unused PRBs			OCNG (Note 2)	OCNG (Note 2)	OCNG (Note 2)	OCNG (Note 2)
Modulation			QPSK	16QAM	64QAM	16QAM
ACK/NACK feedback mode			Multiplexing	Multiplexing	Multiplexing	Multiplexing
Note 1: $P_B = 0$ Note 2: These physical resource blocks are assigned to an arbitrary number of virtual UEs with one PDSCH per virtual UE; the data transmitted over the OCNG PDSCHs shall be uncorrelated pseudo random data, which is QPSK modulated.						

Table 8.2.2.1.1.3-2: Minimum performance (FRC)

Test number	Bandwidth	Reference Channel	OCNG Pattern	Propagation Condition	Correlation Matrix and Antenna Configuration	Reference value		UE Category
						Fraction of Maximum Throughput (%)	SNR (dB)	
1	10 MHz	R.2 TDD	OP.1 TDD	EVA5	1x2 Low	70	-1.2	1-5
2	10 MHz	R.2 TDD	OP.1 TDD	ETU70	1x2 Low	70	-0.6	1-5
3	10 MHz	R.2 TDD	OP.1 TDD	ETU300	1x2 Low	70	-0.2	1-5
4	10 MHz	R.2 TDD	OP.1 TDD	HST	1x2 Low	70	-2.6	1-5
5	1.4 MHz	R.4 TDD	OP.1 TDD	EVA5	1x2 Low	70	0.0	1-5
6	10 MHz	R.3 TDD	OP.1 TDD	EVA5	1x2 Low	70	6.7	2-5
7	10 MHz	R.3 TDD	OP.1 TDD	ETU70	1x2 Low	30	1.4	2-5
8	10 MHz	R.3 TDD	OP.1 TDD	ETU300	1x2 High	70	9.3	2-5
9	3 MHz	R.5 TDD	OP.1 TDD	EVA5	1x2 Low	70	17.6	1-5
10	5 MHz	R.6 TDD	OP.1 TDD	EVA5	1x2 Low	70	17.6	2-5
11	10 MHz	R.7 TDD	OP.1 TDD	EVA5	1x2 Low	70	17.6	2-5
12	10 MHz	R.7 TDD	OP.1 TDD	ETU70	1x2 Low	70	19.1	2-5
13	10 MHz	R.7 TDD	OP.1 TDD	EVA5	1x2 High	70	19.1	2-5
14	15 MHz	R.8 TDD	OP.1 TDD	EVA5	1x2 Low	70	17.8	2-5
15	20 MHz	R.9 TDD	OP.1 TDD	EVA5	1x2 Low	70	17.7	3-5
16	3 MHz	R.0 TDD	OP.1 TDD	ETU70	1x2 Low	30	2.1	1-5
17	10 MHz	R.1 TDD	OP.1 TDD	ETU70	1x2 Low	30	2.0	1-5
18	20 MHz	R.1 TDD	OP.1 TDD	ETU70	1x2 Low	30	2.1	1-5

The normative reference for this requirement is TS 36.101 [2] clause 8.2.2.

8.2.2.1.1.4 Test description

8.2.2.1.1.4.1 Initial conditions

Initial conditions are a set of test configurations the UE needs to be tested in and the steps for the SS to take with the UE to reach the correct measurement state.

Configurations of PDSCH and PDCCH before measurement are specified in Annex C.2.

Test Environment: Normal, as defined in TS 36.508 [7] clause 4.1.

Frequencies to be tested: Mid Range, as defined in TS 36.508 [7] clause 4.3.1.2.

Frequencies to be tested for 1PRB allocation: Low Range, as defined in TS 36.508 [7] clause 4.3.1.1.

Bandwidths to be tested: As specified per test number in Tables 8.2.2.1.1.3-2 as defined in TS 36.508 [7] clause 4.3.1.2.

1. Connect the SS, the faders and AWGN noise sources to the UE antenna connectors as shown in TS 36.508 [7] Annex A, Figure A.9.

2. The parameter settings for the cell are set up according to Tables 8.2.2-1, 8.2.2.1.1.3-1 as appropriate.
3. Downlink signals are initially set up according to Annex C.0, C.1 and Annex C.3.2 and uplink signals according to Annex H.1 and H.3.2.
4. Propagation conditions are set according to Annex B.0.
5. Ensure the UE is in State 3A-RF according to TS 36.508 [7] clause 5.2A.2. Message contents are defined in clause 8.2.2.1.1.4.3.

8.2.2.1.1.4.2 Test procedure

1. SS transmits PDSCH via PDCCH DCI format 1A for C_RNTI to transmit the DL RMC according to Tables 8.2.2.1.1.3-1 and 8.2.2.1.1.3-2. The SS sends downlink MAC padding bits on the DL RMC.
2. Set the parameters of the reference channel, MCS, reference channel, the propagation condition, the correlation matrix and the SNR according to Tables 8.2.2.1.1.5-1 as appropriate.
3. Measure the average throughput for a duration sufficient to achieve statistical significance according to Annex G clause G.3. Count the number of NACKs, ACKs and statDTXs on the UL during each subtest interval and decide pass or fail according to Tables G.3.5 and G.3.6 in Annex G clause G.3.
4. Repeat steps from 1 to 3 for each subtest in Tables 8.2.2.1.1.5-1 as appropriate.

8.2.2.1.1.4.3 Message contents

Message contents are according to TS 36.508 [7] clause 4.6.

8.2.2.1.1.5 Test requirement

Table 8.2.2.1.1.3-1 defines the primary level settings including test tolerances for all throughput tests.

The fraction of maximum throughput percentage for the downlink reference measurement channels specified in Annex A for each throughput test shall meet or exceed the specified value in Tables 8.2.2.1.1.5-1 for the specified SNR including test tolerances for all throughput tests.

Table 8.2.2.1.1.5-1: Test Requirement (FRC)

Test number	Bandwidth	Reference Channel	OCNG Pattern	Propagation Condition	Correlation Matrix and Antenna Configuration	Reference value		UE Category
						Fraction of Maximum Throughput (%)	SNR (dB)	
1	10 MHz	R.2 TDD	OP.1 TDD	EVA5	1x2 Low	70	-0.4	1-5
2	10 MHz	R.2 TDD	OP.1 TDD	ETU70	1x2 Low	70	0.2	1-5
3	10 MHz	R.2 TDD	OP.1 TDD	ETU300	1x2 Low	70	0.6	1-5
4	10 MHz	R.2 TDD	OP.1 TDD	HST	1x2 Low	70	-2.0	1-5
5	1.4 MHz	R.4 TDD	OP.1 TDD	EVA5	1x2 Low	70	0.8	1-5
6	10 MHz	R.3 TDD	OP.1 TDD	EVA5	1x2 Low	70	7.5	2-5
7	10 MHz	R.3 TDD	OP.1 TDD	ETU70	1x2 Low	30	2.2	2-5
8	10 MHz	R.3 TDD	OP.1 TDD	ETU300	1x2 High	70	10.1	2-5
9	3 MHz	R.5 TDD	OP.1 TDD	EVA5	1x2 Low	70	18.4	1-5
10	5 MHz	R.6 TDD	OP.1 TDD	EVA5	1x2 Low	70	18.4	2-5
11	10 MHz	R.7 TDD	OP.1 TDD	EVA5	1x2 Low	70	18.4	2-5
12	10 MHz	R.7 TDD	OP.1 TDD	ETU70	1x2 Low	70	19.9	2-5
13	10 MHz	R.7 TDD	OP.1 TDD	EVA5	1x2 High	70	19.9	2-5
14	15 MHz	R.8 TDD	OP.1 TDD	EVA5	1x2 Low	70	18.6	2-5
15	20 MHz	R.9 TDD	OP.1 TDD	EVA5	1x2 Low	70	18.5	3-5
16	3 MHz	R.0 TDD	OP.1 TDD	ETU70	1x2 Low	30	2.9	1-5
17	10 MHz	R.1 TDD	OP.1 TDD	ETU70	1x2 Low	30	2.8	1-5
18	20 MHz	R.1 TDD	OP.1 TDD	ETU70	1x2 Low	30	2.9	1-5

8.2.2.1.1_1 TDD PDSCH Single Antenna Port Performance (Release 9 and forward)

8.2.2.1.1_1.1 Test purpose

Same test purpose as in clause 8.2.2.1.1.1.

8.2.2.1.1_1.2 Test applicability

This test applies to all types of E-UTRA TDD UE release 9 and forward.

8.2.2.1.1_1.3 Minimum conformance requirements

Same minimum conformance requirements as in clause 8.2.2.1.1.3 with the following exceptions:

- Instead of Table 8.2.2.1.1.3-1 → use Table 8.2.2.1.1_1.3-1.
- Instead of Table 8.2.2.1.1.3-2 → use Table 8.2.2.1.1_1.3-2.

Table 8.2.2.1.1_1.3-1: Test Parameters

Parameter		Unit	Test 1- 5	Test 6- 8	Test 9- 15	Test 16- 18
Downlink power allocation	ρ_A	dB	0	0	0	0
	ρ_B	dB	0 (Note 1)	0 (Note 1)	0 (Note 1)	0 (Note 1)
N_{oc} at antenna port		dBm/15kHz	-98	-98	-98	-98
Symbols for unused PRBs			OCNG (Note 2)	OCNG (Note 2)	OCNG (Note 2)	OCNG (Note 2)
Modulation			QPSK	16QAM	64QAM	16QAM
ACK/NACK feedback mode			Multiplexing	Multiplexing	Multiplexing	Multiplexing
Note 1: $P_B = 0$						
Note 2: These physical resource blocks are assigned to an arbitrary number of virtual UEs with one PDSCH per virtual UE; the data transmitted over the OCNG PDSCHs shall be uncorrelated pseudo random data, which is QPSK modulated.						

Table 8.2.2.1.1_1.3-2: Minimum performance (FRC)

Test number	Bandwidth	Reference Channel	OCNG Pattern	Propagation Condition	Correlation Matrix and Antenna Configuration	Reference value		UE Category
						Fraction of Maximum Throughput (%)	SNR (dB)	
1								
2								
3								
4								
5								
6	5 MHz	R.3-1 TDD	OP.1 TDD	EVA5	1x2 Low	70	6.7	1
7	5 MHz	R.3-1 TDD	OP.1 TDD	ETU70	1x2 Low	30	1.4	1
8	5 MHz	R.3-1 TDD	OP.1 TDD	ETU300	1x2 High	70	9.3	1
9								
10	5 MHz	R.6-1 TDD	OP.1 TDD	EVA5	1x2 Low	70	17.6	1
11	10 MHz	R.7-1 TDD	OP.1 TDD	EVA5	1x2 Low	70	17.6	1
12	10 MHz	R.7-1 TDD	OP.1 TDD	ETU70	1x2 Low	70	19.1	1
13	10 MHz	R.7-1 TDD	OP.1 TDD	EVA5	1x2 High	70	19.1	1
14	15 MHz	R.8-1 TDD	OP.1 TDD	EVA5	1x2 Low	70	17.8	1
15	20 MHz	R.9-2 TDD	OP.1 TDD	EVA5	1x2 Low	70	17.7	2
	20 MHz	R.9-1 TDD	OP.1 TDD	EVA5	1x2 Low	70	17.7	1
16								
17								
18								

The normative reference for this requirement is TS 36.101 [2] clause 8.2.2.

8.2.2.1.1_1.4 Test description

Same test description as in clause 8.2.2.1.1.4 with the following exceptions:

- Instead of Table 8.2.2.1.1.3-1 → use Table 8.2.2.1.1_1.3-1.
- Instead of Table 8.2.2.1.1.3-2 → use Table 8.2.2.1.1_1.3-2.

- Instead of Table 8.2.2.1.1.5-1 → use Table 8.2.2.1.1_1.5-1.

8.2.2.1.1_1.5 Test requirement

Same test requirements as in clause 8.2.2.1.1.5 with the following exceptions:

- Instead of Table 8.2.2.1.1.3-1 → use Table 8.2.2.1.1_1.3-1.
- Instead of Table 8.2.2.1.1.5-1 → use Table 8.2.2.1.1_1.5-1.

Table 8.2.2.1.1_1.5-1: Test Requirement (FRC)

Test number	Bandwidth	Reference Channel	OCNG Pattern	Propagation Condition	Correlation Matrix and Antenna Configuration	Reference value		UE Category
						Fraction of Maximum Throughput (%)	SNR (dB)	
1								
2								
3								
4								
5								
6	5 MHz	R.3-1 TDD	OP.1 TDD	EVA5	1x2 Low	70	7.5	1
7	5 MHz	R.3-1 TDD	OP.1 TDD	ETU70	1x2 Low	30	2.2	1
8	5 MHz	R.3-1 TDD	OP.1 TDD	ETU300	1x2 High	70	10.1	1
9								
10	5 MHz	R.6-1 TDD	OP.1 TDD	EVA5	1x2 Low	70	+18.4	1
11	10 MHz	R.7-1 TDD	OP.1 TDD	EVA5	1x2 Low	70	+18.4	1
12	10 MHz	R.7-1 TDD	OP.1 TDD	ETU70	1x2 Low	70	+19.9	1
13	10 MHz	R.7-1 TDD	OP.1 TDD	EVA5	1x2 High	70	+19.9	1
14	15 MHz	R.8-1 TDD	OP.1 TDD	EVA5	1x2 Low	70	+18.6	1
15	20 MHz	R.9-2 TDD	OP.1 TDD	EVA5	1x2 Low	70	+18.5	2
	20 MHz	R.9-1 TDD	OP.1 TDD	EVA5	1x2 Low	70	+18.5	1
16								
17								
18								

8.2.2.1.1_A TDD PDSCH Single Antenna Port Performance for CA

8.2.2.1.1_A.1 TDD PDSCH Single Antenna Port Performance for CA (intra-band contiguous DL CA)

Editor's note: This clause is incomplete. The following aspects are either missing or not yet determined

- Test tolerance are FFS
- Statistical significance related parameters in Annex G.3A are FFS

8.2.2.1.1_A.1.1 Test purpose

Same test purpose as 8.2.2.1.1.1.

8.2.2.1.1_A.1.2 Test applicability

This test applies to all types of E-UTRA TDD UE release 10 and forward which support intra-band contiguous DL CA.

8.2.2.1.1_A.1.3 Minimum conformance requirements

The requirements are specified in terms of the percentage of information bit throughput for the downlink reference measurement channels specified in Annex A clause A.3.4.1, with the addition of the relevant parameters in Tables 8.2.2-1, 8.2.2.1.1_A.1.3-1 and the downlink physical channel setup according to table C.3.2-1 in Annex C.

Using this configuration the fraction of maximum throughput percentage shall meet or exceed the minimum requirements specified in Tables 8.2.2.1.1_A.1.3-2 for the specified SNR. For QPSK and 64QAM performance the bandwidths specified in Table 5.4.2.1-1 are verified.

Table 8.2.2.1.1_A.1.3-1: Test Parameters

Parameter	Unit	Test 1
Downlink power allocation	ρ_A	dB
	ρ_B	dB
N_{oc} at antenna port	dBm/15kHz	-98
Symbols for unused PRBs		OCNG (Note 2)
Modulation		QPSK
ACK/NACK feedback mode		Multiplexing
Note 1: $P_B = 0$ Note 2: These physical resource blocks are assigned to an arbitrary number of virtual UEs with one PDSCH per virtual UE; the data transmitted over the OCNG PDSCHs shall be uncorrelated pseudo random data, which is QPSK modulated.		

Table 8.2.2.1.1_A.1.3-2: Minimum performance (FRC)

Test number	Bandwidth	Reference Channel	OCNG Pattern	Propagation Condition	Correlation Matrix and Antenna Configuration	Reference value		UE Category	CA Applicability
						Fraction of Maximum Throughput (%)	SNR (dB)		
1	2x20 MHz	R.42 TDD	OP.1 TDD (Note1)	EVA5	1x2 Low	70	-1.2	5-8	CL_C

Note 1: For CA capable UE, the OCNG pattern applies for each CC.

The normative reference for this requirement is TS 36.101 [2] clause 8.2.2.

8.2.2.1.1_A.1.4 Test description

8.2.2.1.1_A.1.4.1 Initial conditions

Initial conditions are a set of test configurations the UE needs to be tested in and the steps for the SS to take with the UE to reach the correct measurement state.

Configurations of PDSCH and PDCCH before measurement are specified in Annex C.2.

Test Environment: Normal, as defined in TS 36.508 [7] clause 4.1.

Frequencies to be tested: Mid Range, as defined in TS 36.508 [7] clause 4.3.1.2.

Bandwidths to be tested: As specified per test number in Tables 8.2.2.1.1_A.1.3-2 as defined in TS 36.508 [7] clause 4.3.1.2.

1. Connect the SS, the faders and AWGN noise sources to the UE antenna connectors as shown in TS 36.508 [7] Annex A, Figure group A.35 as appropriate.
2. The parameter settings for the cell are set up according to Tables 8.2.2-1, 8.2.2.1.1_A.1.3-1 as appropriate.
3. Downlink signals for PCC are initially set up according to Annex C.0, C.1 and Annex C.3.2 and uplink signals according to Annex H.1 and H.3.2.
4. Propagation conditions are set according to Annex B.0.
5. Ensure the UE is in State 3A-RF according to TS 36.508 [7] clause 5.2A.2. Message contents are defined in clause 8.2.2.1.1_A.1.4.3.

8.2.2.1.1_A.1.4.2 Test procedure

1. Configure SCC according to Annex C0, C.1 and Annex C.3.2 for all downlink physical channels except PHICH.
2. The SS shall configure SCC as per TS 36.508 [7] clause 5.2A.4. Message contents are defined in clause 8.2.2.1.1_A.1.4.3.
3. SS activates SCC by sending the activation MAC-CE (Refer TS 36.321 [13], clauses 5.13, 6.1.3.8). Wait for at least 2 seconds (Refer TS 36.133, clauses 8.3.3.2).
4. SS transmits PDSCH via PDCCH DCI format 1A for C_RNTI to transmit the DL RMC according to Tables 8.2.2.1.1_A.1.3-1 and 8.2.2.1.1_A.1.3-2 on both PCC and SCC. The SS sends downlink MAC padding bits on the DL RMC.
5. Set the parameters of the reference channel, MCS, reference channel, the propagation condition, the correlation matrix and the SNR according to Tables 8.2.2.1.1_A.1.5-1 as appropriate.
6. Measure the average throughput per component carrier for a duration sufficient to achieve statistical significance according to Annex G clause G.3A, Table G.3A.5-6 on both PCC and SCC. Count the number of NACKs, ACKs and statDTXs on the UL during each subtest on both component carriers.
7. Repeat steps from 1 to 6 for each subtest in Tables 8.2.2.1.1_A.1.5-1 as appropriate

8.2.2.1.1_A.1.4.3 Message contents

Message contents are according to TS 36.508 [7] clause 4.6.

In test procedure step 2, for SCC configuration there are no additional message contents.

8.2.2.1.1_A.1.5 Test requirement

Table 8.2.2.1.1_A.1.3-1 defines the primary level settings including test tolerances for all throughput tests.

The fraction of maximum throughput percentage for the downlink reference measurement channels specified in Annex A clause 3.3.1 for the throughput test shall meet or exceed the specified value in Tables 8.2.2.1.1_A. 1.5-1 for the specified SNR including test tolerances for all throughput tests.

Table 8.2.2.1.1_A.1.5-1: Test Requirement (FRC)

Test number	Bandwidth	Reference Channel	OCNG Pattern	Propagation Condition	Correlation Matrix and Antenna Configuration	Reference value		UE Category	CA Applicability
						Fraction of Maximum Throughput (%)	SNR (dB)		
1	2x20 MHz	R.42 TDD	OP.1 TDD (Note1)	EVA5	1x2 Low	70	-1.2+TT	5-8	CL_C

Note 1: For CA capable UE, the OCNG pattern applies for each CC.

Decide pass or fail for each subtest according to Annex G.3A.4. Decide the entire test pass or fail according to Annex G.3A.6.

8.2.2.1.2 TDD PDSCH Single Antenna Port Performance with 1 PRB in the presence of MBSFN

8.2.2.1.2.1 Test purpose

To verify the UE's ability to receive a predefined test signal, representing a multi-path fading channel that is determined by the SNR with a percentage of the information bit throughput for a specified downlink Reference Measurement Channel (RMC) not falling below a specified value for transmission on a single-antenna port with different channel models and MCS and also for the transmission on a single-antenna port with single RB allocation in the presence of MBSFN.

8.2.2.1.2.2 Test applicability

This test applies to all types of E-UTRA TDD UE release 8 and forward.

8.2.2.1.2.3 Minimum conformance requirements

The requirements are specified in terms of the percentage of information bit throughput for the downlink reference measurement channels specified in Annex A clause A.3.4.1, with the addition of the relevant parameters in Tables 8.2.2-1, 8.2.2.1.2.3-1 and the downlink physical channel setup according to table C.3.2-1 in Annex C.

Using this configuration the fraction of maximum throughput percentage shall meet or exceed the minimum requirements specified in Tables 8.2.2.1.2.3-2 for the specified SNR.

Table 8.2.2.1.2.3-1: Test Parameters for Testing 1 PRB allocation

Parameter		Unit	Test 1
Downlink power allocation	ρ_A	dB	0
	ρ_B	dB	0 (Note 1)
N_{oc} at antenna port		dBm/15kHz	-98
Symbols for MBSFN portion of MBSFN subframes (Note 2)			OCNG (Note 3)
ACK/NACK feedback mode			Multiplexing
Note 1: $P_B = 0$ Note 2: The MBSFN portion of an MBSFN subframe comprises the whole MBSFN subframe except the first two symbols in the first slot. Note 3: The MBSFN portion of the MBSFN subframes shall contain QPSK modulated data. Cell-specific reference signals are not inserted in the MBSFN portion of the MBSFN subframes, QPSK modulated MBSFN data is used instead.			

Table 8.2.2.1.2.3-2: Minimum performance 1 PRB allocation (FRC)

Test number	Bandwidth	Reference Channel	OCNG Pattern	Propagation Condition	Correlation Matrix and Antenna Configuration	Reference value		UE Category
						Fraction of Maximum Throughput (%)	SNR (dB)	
1	10 MHz	R.29 TDD	OP.3 TDD	ETU70	1x2 Low	30	2.0	1-5

The normative reference for this requirement is TS 36.101 [2] clause 8.2.2.

8.2.2.1.2.4 Test description

8.2.2.1.2.4.1 Initial conditions

Initial conditions are a set of test configurations the UE needs to be tested in and the steps for the SS to take with the UE to reach the correct measurement state.

Configurations of PDSCH and PDCCH before measurement are specified in Annex C.2.

Test Environment: Normal, as defined in TS 36.508 [7] clause 4.1.

Frequencies to be tested: Low Range, as defined in TS 36.508 [7] clause 4.3.1.1.

Bandwidths to be tested: As specified per test number in Tables 8.2.2.1.2.3-2 as defined in TS 36.508 [7] clause 4.3.1.2.

1. Connect the SS, the faders and AWGN noise sources to the UE antenna connectors as shown in TS 36.508 [7] Annex A, Figure A.9.
2. The parameter settings for the cell are set up according to Tables 8.2.2-1, 8.2.2.1.2.3-1 as appropriate.
3. Downlink signals are initially set up according to Annex C.0, C.1 and Annex C.3.2 and uplink signals according to Annex H.1 and H.3.2.
4. Propagation conditions are set according to Annex B.0.
5. Ensure the UE is in State 3A-RF according to TS 36.508 [7] clause 5.2A.2. Message contents are defined in clause 8.2.2.1.2.4.3.

8.2.2.1.2.4.2 Test procedure

1. SS transmits PDSCH via PDCCH DCI format 1A for C_RNTI to transmit the DL RMC according to Tables 8.2.2.1.2.3-1 and 8.2.2.1.2.3-2. The SS sends downlink MAC padding bits on the DL RMC.
2. Set the parameters of the reference channel, MCS, reference channel, the propagation condition, the correlation matrix and the SNR according to Tables 8.2.2.1.1.2.5-1 as appropriate.
3. Measure the average throughput for a duration sufficient to achieve statistical significance according to Annex G clause G.3. Count the number of NACKs, ACKs and statDTXs on the UL during each subtest interval and decide pass or fail according to Tables G.3.5 and G.3.6 in Annex G clause G.3.

8.2.2.1.2.4.3 Message contents

Message contents are according to TS 36.508 [7] clause 4.6 with the following exceptions.

Table 8.2.2.1.2.4.3-1: SystemInformationBlockType2: Additional TDD PDSCH Single Antenna Port Performance for 1 PRB allocation with MBSFN subframes test point 1 requirement

Derivation Path: TS 36.508 [7] clause 4.4.3.3, Table 4.4.3.3-1 SystemInformationBlockType2			
Information Element	Value/remark	Comment	Condition
SystemInformationBlockType2 ::= SEQUENCE {			
mbsfn-SubframeConfig ::= SEQUENCE {			
radioframeAllocationPeriod	n1	Every radio frame is with MBSFN subframe	
radioframeAllocationOffset	0		
subframeAllocation CHOICE {			
oneFrame	01001x	subframe 4 and 9 is used for MBSFN.	TDD
}			
}			
}			

8.2.2.1.2.5 Test requirement

Table 8.2.2.1.2.3-1 defines the primary level settings including test tolerances for all throughput tests.

The fraction of maximum throughput percentage for the downlink reference measurement channels specified in Annex A for each throughput test shall meet or exceed the specified value in Tables 8.2.2.1.2.5-1 for the specified SNR including test tolerances for all throughput tests.

Table 8.2.2.1.2.5-1: Test Requirement 1PRB with MBSFN subframes (FRC)

Test number	Bandwidth	Reference Channel	OCNG Pattern	Propagation Condition	Correlation Matrix and Antenna Configuration	Reference value		UE Category
						Fraction of Maximum Throughput (%)	SNR (dB)	
1	10 MHz	R.29 TDD	OP.3 TDD	ETU70	1x2 Low	30	2.8	1-5

8.2.2.2 TDD PDSCH Transmit Diversity Performance (Cell-Specific Reference Symbols)

8.2.2.2.1 TDD PDSCH Transmit Diversity 2x2

8.2.2.2.1.1 Test purpose

To verify the UE's ability to receive a predefined test signal, representing a multi-path fading channel that is determined by the SNR with a percentage of the information bit throughput for a specified downlink Reference Measurement Channel (RMC) not falling below a specified value for transmission on two antenna ports using transmit diversity (SFBC).

8.2.2.2.1.2 Test applicability

This test applies to all types of E-UTRA TDD UE release 8 and forward.

8.2.2.2.1.3 Minimum conformance requirements

The requirements are specified in terms of the percentage of information bit throughput for the downlink reference measurement channels specified in Annex A clause A.3.4.2, with the addition of the relevant parameters in Tables 8.2.2-1 and 8.2.2.2.1.3-1 and the downlink physical channel setup according to Table C.3.2-1 in Annex C.3.2.

Using this configuration the fraction of maximum throughput percentage shall meet or exceed the minimum requirements specified in Table 8.2.2.2.1.3-2 for the specified SNR. For transmit diversity (SFBC) performance with 2 and 4 transmitter antennas as specified.

Table 8.2.2.2.1.3-1: Test Parameters for Testing Transmit Diversity Performance (FRC)

Parameter	Unit	Test 1-2
Downlink power allocation	ρ_A	dB
	ρ_B	dB
N_{oc} at antenna port	dBm/15kHz	-98
ACK/NACK feedback mode		Multiplexing
Note 1: $P_B = 1$		

Table 8.2.2.1.3-2: Minimum performance Transmit Diversity (FRC)

Test number	Bandwidth	Reference Channel	OCNG Pattern	Propagation Condition	Correlation Matrix and Antenna Configuration	Reference value		UE Category
						Fraction of Maximum Throughput (%)	SNR (dB)	
1	10 MHz	R.11 TDD	OP.1 TDD	EVA5	2x2 Medium	70	6.8	2-5
2	10 MHz	R.10 TDD	OP.1 TDD	HST	2x2 Low	70	-2.3	1-5

The normative reference for this requirement is TS 36.101 [2] clause 8.2.2.2.

8.2.2.2.1.4 Test description

8.2.2.2.1.4.1 Initial conditions

Initial conditions are a set of test configurations the UE needs to be tested in and the steps for the SS to take with the UE to reach the correct measurement state.

Configurations of PDSCH and PDCCH before measurement are specified in Annex C.2.

Test Environment: Normal, as defined in TS 36.508 [7] clause 4.1.

Frequencies to be tested: Mid Range, as defined in TS 36.508 [7] clause 4.3.1.2.

Bandwidths to be tested: As specified per test number in Table 8.2.2.1.3-2 as defined in TS 36.508 [7] clause 4.3.1.2

1. Connect the SS, the faders and AWGN noise sources to the UE antenna connectors as shown in TS 36.508 [7] Annex A, Figure A.10 for antenna configuration 2x2.
2. The parameter settings for the cell are set up according to Tables 8.2.2-1 and 8.2.2.2.1.3-1 as appropriate.
3. Downlink signals are initially set up according to Annex C.0, C.1 and Annex C.3.2 and uplink signals according to Annex H.1 and H.3.2.
4. Propagation conditions are set according to Annex B.0.
5. Ensure the UE is in State 3A-RF according to TS 36.508 [7] clause 5.2A.2. Message contents are defined in clause 8.2.2.2.1.4.3.

8.2.2.2.1.4.2 Test procedure

1. SS transmits PDSCH via PDCCH DCI format 1A for C_RNTI to transmit the DL RMC according to Tables 8.2.2.2.1.3-1 and 8.2.2.2.1.3-2. The SS sends downlink MAC padding bits on the DL RMC.
2. Set the parameters of the bandwidth, MCS, reference channel, the propagation condition, the correlation matrix, antenna configuration and the SNR according to Table 8.2.2.2.1.5-1 as appropriate.
3. Measure the average throughput for a duration sufficient to achieve statistical significance according to Annex G clause G.3. Count the number of NACKs, ACKs and statDTXs on the UL during each test interval and decide pass or fail according to Tables G.3.5 and G.3.6 in Annex G clause G.3.
4. Repeat steps from 1 to 3 for each test interval in Table 8.2.2.2.1.5-1 as appropriate.

8.2.2.2.1.4.3 Message contents

Message contents are according to TS 36.508 [7] clause 4.6.

8.2.2.2.1.5 Test requirement

Table 8.2.2.2.1.3-1 defines the primary level settings.

The fraction of maximum throughput percentage for the downlink reference measurement channels specified in Annex A clause A.3.4.2, for each throughput test shall meet or exceed the specified value in Table 8.2.2.2.1.5-1 for the specified SNR including test tolerances for all throughput tests.

Table 8.2.2.1.5-1: Test requirement Transmit Diversity (FRC)

Test number	Bandwidth	Reference Channel	OCNG Pattern	Propagation Condition	Correlation Matrix and Antenna Configuration	Reference value		UE Category
						Fraction of Maximum Throughput (%)	SNR (dB)	
1	10 MHz	R.11 TDD	OP.1 TDD	EVA5	2x2 Medium	70	7.7	2-5
2	10 MHz	R.10 TDD	OP.1 TDD	HST	2x2 Low	70	-1.7	1-5

8.2.2.2.1_1 TDD PDSCH Transmit Diversity 2x2 (Release 9 and forward)**8.2.2.2.1_1.1 Test purpose**

Same test purpose as in clause 8.2.2.2.1.1

8.2.2.2.1_1.2 Test applicability

This test applies to all types of E-UTRA TDD UE release 9 and forward.

8.2.2.2.1_1.3 Minimum conformance requirements

Same minimum conformance requirements as in clause 8.2.2.2.1.3 with the following exceptions:

- Instead of Table 8.2.2.2.1.3-1 → use Table 8.2.2.2.1_1.3-1.
- Instead of Table 8.2.2.2.1.3-2 → use Table 8.2.2.2.1_1.3-2.

Table 8.2.2.2.1_1.3-1: Test Parameters for Testing Transmit Diversity Performance (FRC)

Parameter		Unit	Test 1
Downlink power allocation	ρ_A	dB	-3
	ρ_B	dB	-3 (Note 1)
N_{oc} at antenna port		dBm/15kHz	-98
ACK/NACK feedback mode			Multiplexing
Note 1: $P_B = 1$			

Table 8.2.2.2.1_1.3-2: Minimum performance Transmit Diversity (FRC)

Test number	Bandwidth	Reference Channel	OCNG Pattern	Propagation Condition	Correlation Matrix and Antenna Configuration	Reference value		UE Category
						Fraction of Maximum Throughput (%)	SNR (dB)	
1	5 MHz	R.11-2 TDD	OP.1 TDD	EVA5	2x2 Medium	70	6.8	1

The normative reference for this requirement is TS 36.101 [2] clause 8.2.2.2.

8.2.2.2.1_1.4 Test description

Same test description as in clause 8.2.2.2.1.4 with the following exceptions:

- Instead of Table 8.2.2.2.1.3-1 → use Table 8.2.2.2.1_1.3-1.
- Instead of Table 8.2.2.2.1.3-2 → use Table 8.2.2.2.1_1.3-2.
- Instead of Table 8.2.2.2.1.5-1 → use Table 8.2.2.2.1_1.5-1.

8.2.2.2.1_1.5 Test requirement

Same test requirements as in clause 8.2.1.2.1.5 with the following exceptions:

- Instead of Table 8.2.1.2.1.3-1 → use Table 8.2.1.2.1_1.3-1.
- Instead of Table 8.2.1.2.1.5-1 → use Table 8.2.1.2.1_1.5-1.

Table 8.2.2.2.1_1.5-1: Test requirement Transmit Diversity (FRC)

Test number	Bandwidth	Reference Channel	OCNG Pattern	Propagation Condition	Correlation Matrix and Antenna Configuration	Reference value		UE Category
						Fraction of Maximum Throughput (%)	SNR (dB)	
1	5 MHz	R.11-2 TDD	OP.1 TDD	EVA5	2x2 Medium	70	+7.7	1

8.2.2.2.2 TDD PDSCH Transmit Diversity 4x2

8.2.2.2.2.1 Test purpose

To verify the UE's ability to receive a predefined test signal, representing a multi-path fading channel that is determined by the SNR with a percentage of the information bit throughput for a specified downlink Reference Measurement Channel (RMC) not falling below a specified value for transmission on four antenna ports using transmit diversity (SFBC-FSTD).

8.2.2.2.2.2 Test applicability

This test applies to all types of E-UTRA TDD UE release 8 and forward.

8.2.2.2.2.3 Minimum conformance requirements

The requirements are specified in terms of the percentage of information bit throughput for the downlink reference measurement channels specified in Annex A clause A.3.4.2, with the addition of the relevant parameters in Tables 8.2.2-1 and 8.2.2.2.2.3-1 and the downlink physical channel setup according to Table C.3.2-1 in Annex C.3.2.

Using this configuration the fraction of maximum throughput percentage shall meet or exceed the minimum requirements specified in Table 8.2.2.2.3-2 for the specified SNR. For transmit diversity (SFBC) performance with 2 and 4 transmitter antennas as specified.

Table 8.2.2.2.3-1: Test Parameters for Testing Transmit Diversity Performance (FRC)

Parameter		Unit	Test 1
Downlink power allocation	ρ_A	dB	-3
	ρ_B	dB	-3 (Note 1)
N_{oc} at antenna port		dBm/15kHz	-98
ACK/NACK feedback mode			Multiplexing
Note 1: $P_B = 1$			

Table 8.2.2.2.3-2: Minimum performance Transmit Diversity (FRC)

Test number	Bandwidth	Reference Channel	OCNG Pattern	Propagation Condition	Correlation Matrix and Antenna Configuration	Reference value		UE Category
						Fraction of Maximum Throughput (%)	SNR (dB)	
1	1.4 MHz	R.12 TDD	OP.1 TDD	EPA5	4x2 Medium	70	0.2	1-5

The normative reference for this requirement is TS 36.101 [2] clause 8.2.2.2.

8.2.2.2.2.4 Test description

8.2.2.2.2.4.1 Initial conditions

Initial conditions are a set of test configurations the UE needs to be tested in and the steps for the SS to take with the UE to reach the correct measurement state.

Configurations of PDSCH and PDCCH before measurement are specified in Annex C.2.

Test Environment: Normal, as defined in TS 36.508 [7] clause 4.1.

Frequencies to be tested: Mid Range, as defined in TS 36.508 [7] clause 4.3.1.2.

Bandwidths to be tested: As specified per test number in Table 8.2.2.2.3-2 as defined in TS 36.508 [7] clause 4.3.1.2

1. Connect the SS, the faders and AWGN noise sources to the UE antenna connectors as shown in TS 36.508 [7] Annex A, Figure A.11 for antenna configuration 4x2.
2. The parameter settings for the cell are set up according to Tables 8.2.2-1 and 8.2.2.2.3-1 as appropriate.
3. Downlink signals are initially set up according to Annex C.0, C.1 and Annex C.3.2 and uplink signals according to Annex H.1 and H.3.2.
4. Propagation conditions are set according to Annex B.0.
5. Ensure the UE is in State 3A-RF according to TS 36.508 [7] clause 5.2A.2. Message contents are defined in clause 8.2.2.2.4.3.

8.2.2.2.2.4.2 Test procedure

1. SS transmits PDSCH via PDCCH DCI format 1A for C_RNTI to transmit the DL RMC according to Tables 8.2.2.2.3-1 and 8.2.2.2.3-2. The SS sends downlink MAC padding bits on the DL RMC.
2. Set the parameters of the bandwidth, MCS, reference channel, the propagation condition, the correlation matrix, antenna configuration and the SNR according to Table 8.2.2.2.5-1 as appropriate.
3. Measure the average throughput for a duration sufficient to achieve statistical significance according to Annex G clause G.3. Count the number of NACKs, ACKs and statDTXs on the UL during each test interval and decide pass or fail according to Tables G.3.5 and G.3.6 in Annex G clause G.3.

8.2.2.2.2.4.3 Message contents

Message contents are according to TS 36.508 [7] clause 4.6 with the following exceptions.

Table 8.2.2.2.4.3-1: PDSCH-ConfigDedicated-DEFAULT: Additional TDD PDSCH transmit diversity performance downlink power allocation test point 1 requirement

Derivation Path: 36.508 clause 4.6.3			
Information Element	Value/remark	Comment	Condition
PDSCH-ConfigDedicated-DEFAULT ::= SEQUENCE {			
p-a	dB-3		
}			

8.2.2.2.2.5 Test requirement

Table 8.2.2.2.3-1 defines the primary level settings.

The fraction of maximum throughput percentage for the downlink reference measurement channels specified in Annex A clause A.3.4.2, for each throughput test shall meet or exceed the specified value in Table 8.2.2.2.5-1 for the specified SNR including test tolerances for all throughput tests.

Table 8.2.2.2.5-1: Test requirement Transmit Diversity (FRC)

Test number	Bandwidth	Reference Channel	OCNG Pattern	Propagation Condition	Correlation Matrix and Antenna Configuration	Reference value		UE Category
						Fraction of Maximum Throughput (%)	SNR (dB)	
1	1.4 MHz	R.12 TDD	OP.1 TDD	EPA5	4x2 Medium	70	1.1	1-5

8.2.2.2.2_1 TDD PDSCH Transmit Diversity 4x2 (Release 9 and forward)**8.2.2.2.2_1.1 Test purpose**

Same test purpose as in clause 8.2.2.2.1.

8.2.2.2.2_1.2 Test applicability

This test applies to all types of E-UTRA TDD UE release 9 and forward.

8.2.2.2.2_1.3 Minimum conformance requirements

Same minimum conformance requirements as in clause 8.2.1.2.2.3 with the following exceptions:

- Instead of Table 8.2.2.2.3-1 → use Table 8.2.2.2.2_1.3-1.
- Instead of Table 8.2.2.2.3-2 → use Table 8.2.2.2.2_1.3-2.

Table 8.2.2.2_1.3-1: Test Parameters for Testing Transmit Diversity Performance (FRC)

Parameter		Unit	Test 1
Downlink power allocation	ρ_A	dB	-3
	ρ_B	dB	-3 (Note 1)
N_{oc} at antenna port		dBm/15kHz	-98
ACK/NACK feedback mode			Multiplexing
Note 1: $P_B = 1$			

Table 8.2.2.2_1.3-2: Minimum performance Transmit Diversity (FRC)

Test number	Bandwidth	Reference Channel	OCNG Pattern	Propagation Condition	Correlation Matrix and Antenna Configuration	Reference value		UE Category
						Fraction of Maximum Throughput (%)	SNR (dB)	
1	10 MHz	R.13 TDD	OP.1 TDD	ETU70	4x2 Low	70	-0.5	1-5

The normative reference for this requirement is TS 36.101 [2] clause 8.2.2.2.

8.2.2.2.2_1.4 Test description

Same test description as in clause 8.2.2.2.4 with the following exceptions:

- Instead of Table 8.2.2.2.3-1 → use Table 8.2.2.2.2_1.3-1.
- Instead of Table 8.2.2.2.3-2 → use Table 8.2.2.2.2_1.3-2.
- Instead of Table 8.2.2.2.5-1 → use Table 8.2.2.2.2_1.5-1.

8.2.2.2.2_1.5 Test requirement

Same test requirements as in clause 8.2.2.2.2.5 with the following exceptions:

- Instead of Table 8.2.2.2.2.3-1 → use Table 8.2.2.2.2_1.3-1.
- Instead of Table 8.2.2.2.2.5-1 → use Table 8.2.2.2.2_1.5-1.

Table 8.2.2.2.2_1.5-1: Test requirement Transmit Diversity (FRC)

Test number	Bandwidth	Reference Channel	OCNG Pattern	Propagation Condition	Correlation Matrix and Antenna Configuration	Reference value		UE Category
						Fraction of Maximum Throughput (%)	SNR (dB)	
1	10 MHz	R.13 TDD	OP.1 TDD	ETU70	4x2 Low	70	+0.4	1-5

8.2.2.2.3_C TDD PDSCH Transmit diversity 2x2 for eICIC

8.2.2.2.3_C.1 TDD PDSCH Transmit diversity 2x2 for eICIC (non-MBFSN ABS)

Editor's notes: This test case is incomplete. The following items are missing or incomplete:

- Connection diagram in Annex A of TS 36.508 is TBD
- Test tolerances are incomplete

8.2.2.2.3_C.1.1 Test purpose

To verify the UE's performance of transmit diversity (SFBC) with 2 transmit antennas if the PDSCH transmission in the serving cell takes place in subframes that overlap with ABS of the aggressor cell.

8.2.2.2.3_C.1.2 Test applicability

This test applies to all types of E-UTRA TDD UE release 10 and forward. Applicability requires support for FGI bit 115.

8.2.2.2.3_C.1.3 Minimum conformance requirements

The requirements are specified in terms of the percentage of information bit throughput for the downlink reference measurement channels specified in Annex A clause A.3.4.2, with the addition of the relevant parameters in Tables 8.2.2-1 and 8.2.2.2.3_C.1.3-1.

In Table 8.2.2.2.3_C.1.3-1, Cell 1 is the serving cell, and Cell 2 is the aggressor cell. The downlink physical channel setup for Cell 1 is according to Table C.3.2-1 in Annex C.3.2 and for Cell 2 is according to Table C.3.3-1 in Annex C.3.3, respectively.

Using this configuration the fraction of maximum throughput percentage shall meet or exceed the minimum requirements specified in Table 8.2.2.2.3_C.1.3-2 for the specified SNR.

Table 8.2.2.2.3_C.1.3-1: Test Parameters for Transmit diversity Performance (FRC)

Parameter		Unit	Cell 1	Cell 2
Uplink downlink configuration			1	1
Special subframe configuration			4	4
Downlink power allocation	ρ_A	dB	-3	-3
	ρ_B	dB	-3 (Note 1)	-3 (Note 1)
	σ	dB	0	N/A
N_{oc} at antenna port	N_{oc1}	dBm/15kHz	-102 (Note 2)	N/A
	N_{oc2}	dBm/15kHz	-98 (Note 3)	N/A
	N_{oc3}	dBm/15kHz	-94.8 (Note 4)	N/A
\hat{E}_s / N_{oc2}		dB	Reference Value in Table 8.2.2.2.3_C.1.3-2	6
BW_{Channel}		MHz	10	10
Subframe Configuration			Non-MBSFN	Non-MBSFN
Time Offset between Cells		μs	2.5 (synchronous cells)	
Cell Id			0	1
ABS pattern (Note 5)			N/A	0000010001 0000000001
RLM/RRM Measurement Subframe Pattern (Note 6)			0000000001 0000000001	N/A
CSI Subframe Sets (Note 7)	$C_{\text{CSI},0}$		0000010001 0000000001	N/A
	$C_{\text{CSI},1}$		1100101000 1100111000	N/A
Number of control OFDM symbols			2	
ACK/NACK feedback mode			Multiplexing	
PDSCH transmission mode			2	N/A
Cyclic prefix			Normal	Normal
<p>Note 1: $P_B = 1$.</p> <p>Note 2: This noise is applied in OFDM symbols #1, #2, #3, #5, #6, #8, #9, #10, #12, #13 of a subframe overlapping with the aggressor ABS.</p> <p>Note 3: This noise is applied in OFDM symbols #0, #4, #7, #11 of a subframe overlapping with the aggressor ABS.</p> <p>Note 4: This noise is applied in all OFDM symbols of a subframe overlapping with aggressor non-ABS.</p> <p>Note 5: ABS pattern as defined in [14]. PDSCH other than SIB1/paging and its associated PDCCH/PCFICH are transmitted in the serving cell subframe when the subframe is overlapped with the ABS subframe of aggressor cell and the subframe is available in the definition of the reference channel.</p> <p>Note 6: Time-domain measurement resource restriction pattern for PCell measurements as defined in [5].</p> <p>Note 7: As configured according to the time-domain measurement resource restriction pattern for CSI measurements defined in [5].</p> <p>Note 8: Cell 1 is the serving cell. Cell 2 is the aggressor cell. The number of the CRS ports in Cell1 and Cell2 is the same.</p> <p>Note 9: SIB-1 will not be transmitted in Cell2 in this test.</p>				

Table 8.2.2.2.3_C.1.3-2: Minimum Performance Transmit Diversity (FRC)

Test Number	Reference Channel	OCNG Pattern		Propagation Conditions (Note 1)		Correlation Matrix and Antenna Configuration	Reference Value		UE Category
		Cell 1	Cell 2	Cell 1	Cell 2		Fraction of Maximum Throughput (%)	SNR (dB) (Note 2)	
1	R.11-4 TDD	OP.1 TDD	OP.1 TDD	EVA5	EVA5	2x2 Medium	70	3.8	2-8
Note 1: The propagation conditions for Cell 1 and Cell2 are statistically independent. Note 2: SNR corresponds to \hat{E}_s / N_{oc2} of cell 1. Note 3: The correlation matrix and antenna configuration apply for Cell 1 and Cell 2.									

The normative reference for this requirement is TS 36.101 [2] clause 8.2.2.2.3.

8.2.2.2.3_C.1.4 Test description

8.2.2.2.3_C.1.4.1 Initial conditions

Initial conditions are a set of test configurations the UE needs to be tested in and the steps for the SS to take with the UE to reach the correct measurement state.

Configurations of PDSCH and PDCCH before measurement are specified in Annex C.2.

Test Environment: Normal, as defined in TS 36.508 [7] clause 4.1.

Frequencies to be tested: Mid Range, as defined in TS 36.508 [7] clause 4.3.1.2.

Channel Bandwidths to be tested: As specified per test number in Table 8.2.2.2.3_C.1.3-2 as defined in TS 36.508 [7] clause 4.3.1.2.

1. Connect the SS, the faders and AWGN noise sources to the UE antenna connectors as shown in TS 36.508 [7] Annex A, Figure [TBD] for antenna configuration 2x2.
2. The parameter settings for the cell1 are set up according to Tables 8.2.2-1 and 8.2.2.2.3_C.1.3-1 as appropriate.
3. Downlink signals are initially set up for Cell1 according to Annex C.0, C.1 and Annex C.3.2 and uplink signals according to Annex H.1 and H.3.2.
4. Propagation conditions are set according to Annex B.0.
5. Ensure the UE is in State 3A-RF according to TS 36.508 [7] clause 5.2A.2. Message contents are defined in clause 8.2.2.2.3_C.1.4.3.

8.2.2.2.3_C.1.4.2 Test procedure

1. SS transmits PDSCH via PDCCH DCI format 1A for C_RNTI to transmit the DL RMC according to Tables 8.2.2.2.3_C.1.3-1 and 8.2.2.2.3_C.1.3-2. The SS sends downlink MAC padding bits on the DL RMC.
2. Set the parameters of the reference channel, the propagation condition, the correlation matrix, antenna configuration and the SNR according to Tables 8.2.2.2.3_C.1.5-1 as appropriate.
3. Set the Cell2 –aggressor cell- as defined in Tables 8.2.2.2.3_C.1.3-1, 8.2.2.2.3_C.1.5-1 and according to Annex C3.3.
4. Measure the average throughput for a duration sufficient to achieve statistical significance according to Annex G clause G.3. Count the number of NACKs, ACKs and statDTXs on the UL during the test interval and decide pass or fail according to Tables G.3.5 and G.3.6 in Annex G clause G.3.

8.2.2.2.3_C.1.4.3 Message contents

Message contents are according to TS 36.508 [7] clause 4.6 with the following exceptions:

Table 8.2.2.2.3_C.1.4.3-1: *RadioResourceConfigDedicated-SRB2-DRB(n, m)*: Additional TDD PDSCH transmit diversity performance downlink power allocation

Derivation Path: TS 36.508 [7] clause 4.6.3, Table 4.6.3-16 RadioResourceConfigDedicated-SRB2-DRB(n,m)			
Information Element	Value/remark	Comment	Condition
RadioResourceConfigDedicated-SRB2-DRB(n, m) ::= SEQUENCE {			
MeasSubframePatternPCell-r10 CHOICE {			
setup SEQUENCE {			
subframePatternTDD-r10 CHOICE {			
subframeConfig1-5-r10	'00000000010000000001'	BIT STRING (SIZE (20))	
}			
}			
}			
}			

Table 8.2.2.2.3_C.1.4.3-2: *CQI-ReportConfig-r10-DEFAULT*: Additional FDD PDSCH transmit diversity performance downlink power allocation

Derivation Path: 36.508 [7] clause 4.6.3, Table 4.6.3-2AA CQI-ReportConfig-r10-DEFAULT_			
Information Element	Value/remark	Comment	Condition
CQI-ReportConfig-r10-DEFAULT ::= SEQUENCE {			
cqi-ReportAperiodic-r10	Not present		
nomPDSCH-RS-EPRE-Offset	0		
cqi-ReportPeriodic-r10	Not present		
pmi-RI-Report-r9	Not present		
csi-SubframePatternConfig-r10 CHOICE {			
setup SEQUENCE {			
csi-MeasSubframeSet1-r10 CHOICE {			
subframePatternTDD-r10 CHOICE {			
subframeConfig1-5-r10	'00000100010000000001'	BIT STRING (SIZE (20))	
}			
}			
csi-MeasSubframeSet2-r10 CHOICE {			
subframePatternTDD-r10 CHOICE {			
subframeConfig1-5-r10	'11001010001100111000'	BIT STRING (SIZE (20))	
}			
}			
}			
}			

8.2.2.2.3_C.1.5 Test requirement

Table 8.2.2.2.3_C.1.3-1 defines the primary level settings.

The fraction of maximum throughput percentage for the downlink reference measurement channels specified in Annex A clause A.3.4.2 for each throughput test shall meet or exceed the specified value in Table 8.2.2.2.3_C.1.5-1 for the specified SNR including test tolerances for all throughput tests.

Table 8.2.2.3_C.1.5-1: Test requirement Transmit Diversity (FRC)

Test Number	Reference Channel	OCNG Pattern		Propagation Conditions (Note 1)		Correlation Matrix and Antenna Configuration	Reference Value		UE Category
		Cell 1	Cell 2	Cell 1	Cell 2		Fraction of Maximum Throughput (%)	SNR (dB) (Note 2)	
1	R.11-4 TDD	OP.1 TDD	OP.1 TDD	EVA5	EVA5	2x2 Medium	70	3.8 + TT	2-8
Note 1: The propagation conditions for Cell 1 and Cell2 are statistically independent.									
Note 2: SNR corresponds to \hat{E}_s / N_{oc2} of cell 1.									

8.2.2.3 TDD PDSCH Open Loop Spatial Multiplexing Performance (Cell-Specific Reference Symbols)

8.2.2.3.1 TDD PDSCH Open Loop Spatial Multiplexing 2x2

8.2.2.3.1.1 Test purpose

To verify the UE's ability to receive a predefined test signal, representing a multi-path fading channel that is determined by the SNR with a percentage of the information bit throughput for a specified downlink Reference Measurement Channel (RMC) not falling below a specified value for transmission on two antenna ports using large delay CDD.

8.2.2.3.1.2 Test applicability

This test applies to all types of E-UTRA TDD UE release 8 and forward.

8.2.2.3.1.3 Minimum conformance requirements

The requirements are specified in terms of the percentage of information bit throughput for the downlink reference measurement channels specified in Annex A clause A.3.4.2, with the addition of the relevant parameters in Tables 8.2.2-1 and 8.2.2.3.1.3-1 and the downlink physical channel setup according to Table C.3.2-1 in Annex C.

Using this configuration the fraction of maximum throughput percentage shall meet or exceed the minimum requirements specified in Tables 8.2.2.3.1.3-2 for the specified SNR. For open-loop spatial multiplexing performance with large delay CDD is specified.

Table 8.2.2.3.1.3-1: Test Parameters for Large Delay CDD (FRC)

Parameter	Unit	Test 1
Downlink power allocation	ρ_A	-3
	ρ_B	-3 (Note 1)
N_{oc} at antenna port	dBm/15kHz	-98
ACK/NACK feedback mode		Bundling
Note 1: $P_B = 1$		

Table 8.2.2.3.1.3-2: Minimum performance Large Delay CDD (FRC)

Test number	Bandwidth	Reference Channel	OCNG Pattern	Propagation Condition	Correlation Matrix and Antenna Configuration	Reference value		UE Category
						Fraction of Maximum Throughput (%)	SNR (dB)	
1	10 MHz	R.11-1 TDD	OP.1 TDD	EVA70	2x2 Low	70	13.1	2-5

The normative reference for this requirement is TS 36.101 [2] clause 8.2.2.3.

8.2.2.3.1.4 Test description

8.2.2.3.1.4.1 Initial conditions

Initial conditions are a set of test configurations the UE needs to be tested in and the steps for the SS to take with the UE to reach the correct measurement state.

Configurations of PDSCH and PDCCH before measurement are specified in Annex C.2.

Test Environment: Normal, as defined in TS 36.508 [7] clause 4.1.

Frequencies to be tested: Mid Range, as defined in TS 36.508 [7] clause 4.3.1.2.

Bandwidths to be tested: As specified per test number in Table 8.2.2.3.1.3-2 as defined in TS 36.508 [7] clause 4.3.1.2.

1. Connect the SS, the faders and AWGN noise sources to the UE antenna connectors as shown in TS 36.508 [7] Annex A, Figure A.10 for antenna configuration 2x2.
2. The parameter settings for the cell are set up according to Tables 8.2.2-1 and 8.2.2.3.1.3-1 as appropriate.
3. Downlink signals are initially set up according to Annex C.0, C.1 and Annex C.3.2 and uplink signals according to Annex H.1 and H.3.2.
4. Propagation conditions are set according to Annex B.0.
5. Ensure the UE is in State 3A-RF according to TS 36.508 [7] clause 5.2A.2. Message contents are defined in clause 8.2.2.3.1.4.3.

8.2.2.3.1.4.2 Test procedure

1. SS transmits PDSCH via PDCCH DCI format 2A for C_RNTI to transmit the DL RMC according to Tables 8.2.2.3.1.3-1 and 8.2.2.3.1.3-2. The SS sends downlink MAC padding bits on the DL RMC.
2. Set the parameters of the bandwidth, MCS, reference channel, the propagation condition, the correlation matrix, antenna configuration and the SNR according to Table 8.2.2.3.1.5-1 as appropriate.
3. Measure the average throughput for a duration sufficient to achieve statistical significance according to Annex G clause G.3. Count the number of NACKs, ACKs and statDTXs on the UL during each test interval and decide pass or fail according to Tables G.3.5 and G.3.6 in Annex G clause G.3.

8.2.2.3.1.4.3 Message contents

Message contents are according to TS 36.508 [7] clause 4.6 with the following exceptions.

Table 8.2.2.3.1.4.3-1: PhysicalConfigDedicated-DEFAULT: Additional TDD PDSCH open loop spatial multiplexing performance downlink power allocation for Test number 1

Derivation Path: 36.331 clause 6.3.2			
Information Element	Value/remark	Comment	Condition
PhysicalConfigDedicated-DEFAULT ::= SEQUENCE {			
antennaInfo CHOICE {			
antennaInfoDedicated ::= SEQUENCE {			
transmissionMode	tm3		
codebookSubsetRestriction CHOICE {			
n2TxAntenna-tm3	11		
}			
ue-TransmitAntennaSelection CHOICE {			
release	NULL		
}			
}			
}			

8.2.2.3.1.5 Test requirement

Table 8.2.2.3.1.3-1 defines the primary level settings.

The fraction of maximum throughput percentage for the downlink reference measurement channels specified in Annex A clause A.3.4.2, for each throughput test shall meet or exceed the specified value in Tables 8.2.2.3.1.5-1 for the specified SNR including test tolerances for all throughput tests.

Table 8.2.2.3.5-1: Test requirement Large Delay CDD (FRC)

Test number	Bandwidth	Reference Channel	OCNG Pattern	Propagation Condition	Correlation Matrix and Antenna Configuration	Reference value		UE Category
						Fraction of Maximum Throughput (%)	SNR (dB)	
1	10 MHz	R.11-1 TDD	OP.1 TDD	EVA70	2x2 Low	70	14.0	2-5

8.2.2.3.1_A TDD PDSCH Open Loop Spatial Multiplexing 2x2 for CA

8.2.2.3.1_A.1 TDD PDSCH Open Loop Spatial Multiplexing 2x2 for CA (intra-band contiguous DL CA)

Editor's note: This clause is incomplete. The following aspects are either missing or not yet determined:

- Connection diagram is FFS.
- Test tolerance is undefined
- Test frequencies are FFS
- Statistical significance related parameters in Annex G.3A are FFS

8.2.2.3.1_A.1.1 Test purpose

Same test purpose as 8.2.2.3.1.1.

8.2.2.3.1_A.1.2 Test applicability

This test applies to all types of E-UTRA TDD UE release 10 and forward which support intra-band contiguous DL CA.

8.2.2.3.1_A.1.3 Minimum conformance requirements

The requirements are specified in terms of the percentage of information bit throughput for the downlink reference measurement channels specified in Annex A clause A.3.4.2, with the addition of the relevant parameters in Tables 8.2.2-1 and 8.2.2.3.1_A.1.3-1 and the downlink physical channel setup according to Table C.3.2-1 in Annex C.

Using this configuration the fraction of maximum throughput percentage shall meet or exceed the minimum requirements specified in Tables 8.2.2.3.1_A.1.3-2 for the specified SNR. For open-loop spatial multiplexing performance with large delay CDD is specified.

Table 8.2.2.3.1_A.1.3-1: Test Parameters for Large Delay CDD (FRC)

Parameter	Unit	Test 1
Downlink power allocation	ρ_A	dB
	ρ_B	dB
N_{oc} at antenna port	dBm/15kHz	-98
ACK/NACK feedback mode		Bundling
Note 1: $P_B = 1$		

Table 8.2.2.3.1_A.1.3-2: Minimum performance Large Delay CDD (FRC)

Test number	Bandwidth	Reference Channel	OCNG Pattern	Propagation Condition	Correlation Matrix and Antenna Configuration	Reference value		UE Category	CA Applicability
						Fraction of Maximum Throughput (%)	SNR (dB)		
1	2x20 MHz	R.30-1 TDD	OP.1 TDD (Note 1)	EVA70	2x2 Low	70	13.7	5-8	CL_C
2	2x20 MHz	R.30-2 TDD	OP.1 TDD (Note 1)	[EVA70]	2x2 Low	70	[TBD]	3	CL_C
3	2x20 MHz	R.35-1 TDD	OP.1 TDD (Note 1)	EVA5	2x2 Low	70	[TBD]	4	CL_C

Note 1: For CA capable UE, the OCNG pattern applies for each CC

The normative reference for this requirement is TS 36.101 [2] clause 8.2.2.3.

8.2.2.3.1_A.1.4 Test description

8.2.2.3.1_A.1.4.1 Initial conditions

Initial conditions are a set of test configurations the UE needs to be tested in and the steps for the SS to take with the UE to reach the correct measurement state.

Configurations of PDSCH and PDCCH before measurement are specified in Annex C.2.

Test Environment: Normal, as defined in TS 36.508 [7] clause 4.1.

Frequencies to be tested: Mid Range, as defined in TS 36.508 [7] clause FFS.

Bandwidths to be tested: As specified per test number in Table 8.2.2.3.1_A.1.3-2 as defined in TS 36.508 [7] clause 4.3.1.2.

1. Connect the SS, the faders and AWGN noise sources to the UE antenna connectors as shown in TS 36.508 [7] Annex A, Figure group A.36 as appropriate.
2. The parameter settings for the cell are set up according to Tables 8.2.2-1 and 8.2.2.3.1_A.3-1 as appropriate.
3. Downlink signals for PCC are initially set up according to Annex C.0, C.1 and Annex C.3.2 and uplink signals according to Annex H.1 and H.3.2.
4. Propagation conditions are set according to Annex B.0.
5. Ensure the UE is in State 3A-RF according to TS 36.508 [7] clause 5.2A.2. Message contents are defined in clause 8.2.2.3.1_A.1.4.3.

8.2.2.3.1_A.1.4.2 Test procedure

1. Configure SCC according to Annex C.0, C.1 and Annex C.3.2 for all downlink physical channels except PHICH.
2. The SS shall configure SCC as per TS 36.508 [7] clause 5.2A.4. Message contents for *PhysicalConfigDedicated-DEFAULT* is defined in Table 8.2.2.3.1_A.1.4.3-1. *PhysicalConfigDedicatedSCell-r10-DEFAULT* is defined in Table 8.2.2.3.1_A.1.4.3-1A.
3. SS activates SCC by sending the activation MAC-CE (Refer TS 36.321 [13], clauses 5.13, 6.1.3.8). Wait for at least 2 seconds (Refer TS 36.133, clauses 8.3.3.2).

4. SS transmits PDSCH via PDCCH DCI format 2A for C_RNTI to transmit the DL RMC according to Tables 8.2.2.3.1_A.1.3-1 and 8.2.2.3.1_A.1.3-2 on both PCC and SCC. The SS sends downlink MAC padding bits on the DL RMC.
5. Set the parameters of the bandwidth, MCS, reference channel, the propagation condition, the correlation matrix, antenna configuration and the SNR according to Table 8.2.2.3.1_A. 1.5-1 as appropriate.
6. Measure the average throughput per component carrier for a duration sufficient to achieve statistical significance according to Annex G clause G.3A, Table G.3A.5-7 on both PCC and SCC. Count the number of NACKs, ACKs and statDTXs on the UL during each subtest on both component carriers
7. Repeat steps from 1 to 6 for each subtest in Tables 8.2.2.3.1_A. 1. 5-1 as appropriate

8.2.2.3.1_A.1.4.3 Message contents

Message contents are according to TS 36.508 [7] clause 4.6 with the following exceptions.

Table 8.2.2.3.1_A.1.4.3-1: PhysicalConfigDedicated-DEFAULT: Additional TDD PDSCH open loop spatial multiplexing performance downlink power allocation for Test number 1

Derivation Path: 36.331 clause 6.3.2			
Information Element	Value/remark	Comment	Condition
PhysicalConfigDedicated-DEFAULT ::= SEQUENCE {			
antennaInfo CHOICE {			
antennaInfoDedicated ::= SEQUENCE {			
transmissionMode	tm3		
codebookSubsetRestriction CHOICE {			
n2TxAntenna-tm3	11		
}			
ue-TransmitAntennaSelection CHOICE {			
release	NULL		
}			
}			
}			

Table 8.2.2.3.1_A.1.4.3-1A: PhysicalConfigDedicatedSCell-r10-DEFAULT: Additional FDD PDSCH open loop spatial multiplexing performance downlink power allocation

Derivation Path: 36.508 clause 4.6.3 Table 4.6.3-6A			
Information Element	Value/remark	Comment	Condition
PhysicalConfigDedicated SCell-r10-DEFAULT ::= SEQUENCE {			
nonUL-Configuration-r10 SEQUENCE {			
antennaInfo-r10 CHOICE {			
antennaInfoDedicated-r10 ::= SEQUENCE {			
transmissionMode	tm3		
codebookSubsetRestriction CHOICE {			
n2TxAntenna-tm3	11		
}			
ue-TransmitAntennaSelection CHOICE {			
release	NULL		
}			
}			
}			
}			

8.2.2.3.1_A.1.5 Test requirement

Table 8.2.2.3.1_A.1.3-1 defines the primary level settings.

The fraction of maximum throughput percentage for the downlink reference measurement channels specified in Annex A clause A.3.4.2, for the throughput test shall meet or exceed the specified value in Tables 8.2.2.3.1_A.1.5-1 for the specified SNR including test tolerances for all throughput tests.

Table 8.2.2.3.1_A.1.5-1: Test requirement Large Delay CDD (FRC)

Test number	Bandwidth	Reference Channel	OCNG Pattern	Propagation Condition	Correlation Matrix and Antenna Configuration	Reference value		UE Category	CA Applicability
						Fraction of Maximum Throughput (%)	SNR (dB)		
1	2x20 MHz	R.30-1 TDD	OP.1 TDD (Note 1)	EVA70	2x2 Low	70	13.7+ TT	5-8	CL_C
2	2x20 MHz	R.30-2 TDD	OP.1 TDD (Note 1)	[EVA70]	2x2 Low	70	[TBD]	3	CL_C
3	2x20 MHz	R.35-1 TDD	OP.1 TDD (Note 1)	EVA5	2x2 Low	70	[TBD]	4	CL_C

Note1: For CA capable UE, the OCNG pattern applies for each CC

Decide pass or fail for each subtest according to Annex G.3A.4. Decide the entire test pass or fail according to Annex G.3A.6.

8.2.2.3.2 TDD PDSCH Open Loop Spatial Multiplexing 4x2

8.2.2.3.2.1 Test purpose

To verify the UE's ability to receive a predefined test signal, representing a multi-path fading channel that is determined by the SNR with a percentage of the information bit throughput for a specified downlink Reference Measurement Channel (RMC) not falling below a specified value for transmission on four antenna ports using large delay CDD.

8.2.2.3.2.2 Test applicability

This test applies to all types of E-UTRA TDD UE release 8 and forward.

8.2.2.3.2.3 Minimum conformance requirements

The requirements are specified in terms of the percentage of information bit throughput for the downlink reference measurement channels specified in Annex A clause A.3.4.2, with the addition of the relevant parameters in Tables 8.2.2-1 and 8.2.2.3.2.3-1 and the downlink physical channel setup according to Table C.3.2-1 in Annex C.

Using this configuration the fraction of maximum throughput percentage shall meet or exceed the minimum requirements specified in Tables 8.2.2.3.2.3-2 for the specified SNR. For open-loop spatial multiplexing performance with large delay CDD is specified.

Table 8.2.2.3.2.3-1: Test Parameters for Large Delay CDD (FRC)

Parameter	Unit	Test 1
Downlink power allocation	ρ_A	-6
	ρ_B	-6 (Note 1)
N_{oc} at antenna port	dBm/15kHz	-98
ACK/NACK feedback mode		Bundling
Note 1: $P_B = 1$		

Table 8.2.3.2.3-2: Minimum performance Large Delay CDD (FRC)

Test number	Bandwidth	Reference Channel	OCNG Pattern	Propagation Condition	Correlation Matrix and Antenna Configuration	Reference value		UE Category
						Fraction of Maximum Throughput (%)	SNR (dB)	
1	10 MHz	R.14 TDD	OP.1 TDD	EVA70	4x2 Low	70	14.2	2-5

The normative reference for this requirement is TS 36.101 [2] clause 8.2.2.3.

8.2.2.3.2.4 Test description

8.2.2.3.2.4.1 Initial conditions

Initial conditions are a set of test configurations the UE needs to be tested in and the steps for the SS to take with the UE to reach the correct measurement state.

Configurations of PDSCH and PDCCH before measurement are specified in Annex C.2.

Test Environment: Normal, as defined in TS 36.508 [7] clause 4.1.

Frequencies to be tested: Mid Range, as defined in TS 36.508 [7] clause 4.3.1.2.

Bandwidths to be tested: As specified per test number in Table 8.2.2.3.2.3-2 as defined in TS 36.508 [7] clause 4.3.1.2.

1. Connect the SS, the faders and AWGN noise sources to the UE antenna connectors as shown in TS 36.508 [7] Annex A, Figure A.11 for antenna configuration 4x2.
2. The parameter settings for the cell are set up according to Tables 8.2.2-1 and 8.2.2.3.2.3-1 as appropriate.
3. Downlink signals are initially set up according to Annex C.0, C.1 and Annex C.3.2 and uplink signals according to Annex H.1 and H.3.2.
4. Propagation conditions are set according to Annex B.0.
5. Ensure the UE is in State 3A-RF according to TS 36.508 [7] clause 5.2A.2. Message contents are defined in clause 8.2.2.3.2.4.3.

8.2.2.3.2.4.2 Test procedure

1. SS transmits PDSCH via PDCCH DCI format 2A for C_RNTI to transmit the DL RMC according to Tables 8.2.2.3.2.3-1 and 8.2.2.3.2.3-2. The SS sends downlink MAC padding bits on the DL RMC.
2. Set the parameters of the bandwidth, MCS, reference channel, the propagation condition, the correlation matrix, antenna configuration and the SNR according to Table 8.2.2.3.2.5-1 as appropriate.
3. Measure the average throughput for a duration sufficient to achieve statistical significance according to Annex G clause G.3. Count the number of NACKs, ACKs and statDTXs on the UL during each test interval and decide pass or fail according to Tables G.3.5 and G.3.6 in Annex G clause G.3.

8.2.2.3.2.4.3 Message contents

Message contents are according to TS 36.508 [7] clause 4.6 with the following exceptions.

Table 8.2.2.3.2.4.3-1: PDSCH-ConfigDedicated-DEFAULT: Additional TDD PDSCH open loop spatial multiplexing performance downlink power allocation for Test number 1

Derivation Path: 36.508 clause 4.6.3			
Information Element	Value/remark	Comment	Condition
PDSCH-ConfigDedicated-DEFAULT ::= SEQUENCE {			
p-a	dB-6		
}			

Table 8.2.2.3.2.4.3-2: PhysicalConfigDedicated-DEFAULT: Additional TDD PDSCH open loop spatial multiplexing performance downlink power for Test number 1

Derivation Path: 36.331 clause 6.3.2			
Information Element	Value/remark	Comment	Condition
PhysicalConfigDedicated-DEFAULT ::= SEQUENCE {			
antennaInfo CHOICE {			
antennaInfoDedicated ::= SEQUENCE {			
transmissionMode	tm3		
codebookSubsetRestriction CHOICE {			
n4TxAntenna-tm3	1111		
}			
ue-TransmitAntennaSelection CHOICE {			
release	NULL		
}			
}			
}			

8.2.2.3.2.5 Test requirement

Table 8.2.2.3.2.3-1 defines the primary level settings.

The fraction of maximum throughput percentage for the downlink reference measurement channels specified in Annex A clause A.3.4.2, for each throughput test shall meet or exceed the specified value in Tables 8.2.2.3.2.5-1 for the specified SNR including test tolerances for all throughput tests.

Table 8.2.2.3.2.5-1: Test requirement Large Delay CDD (FRC)

Test number	Bandwidth	Reference Channel	OCNG Pattern	Propagation Condition	Correlation Matrix and Antenna Configuration	Reference value		UE Category
						Fraction of Maximum Throughput (%)	SNR (dB)	
1	10 MHz	R.14 TDD	OP.1 TDD	EVA70	4x2 Low	70	15.1	2-5

8.2.2.3.3_C TDD PDSCH Open Loop Spatial Multiplexing 2x2 for eICIC

8.2.2.3.3_C.1 TDD PDSCH Open Loop Spatial Multiplexing 2x2 for eICIC (non-MBSFN ABS)

Editor’s notes: This test case is incomplete. The following items are missing or incomplete:

- Step of test procedure may be confirmed or updated.
- Test Tolerance is undefined.
- Connection diagram in Annex A of TS 36.508 is TBD

8.2.2.3.3_C.1.1 Test purpose

To verify the UE's ability to receive a predefined test signal, representing a multi-path fading channel that is determined by the SNR with a percentage of the information bit throughput for a specified downlink Reference Measurement Channel (RMC) not falling below a specified value for transmission on two antenna ports using large delay CDD.

8.2.2.3.3_C.1.2 Test applicability

This test applies to all types of E-UTRA TDD UE release 10 and forward. Applicability requires support for FGI bit 115.

8.2.2.3.3_C.1.3 Minimum conformance requirements

The requirements are specified in terms of the percentage of information bit throughput for the downlink reference measurement channels specified in Annex A clause A.3.4.2, with the addition of the relevant parameters in Tables 8.2.2-1 and 8.2.2.3.3_C.1.3-1, and the downlink physical channel setup according to Table C.3.2-1 in Annex C.

The requirements for non-MBSFN ABS are specified in Table 8.2.2.3.3_C.1.3-2, with the addition of parameters in Table 8.2.2.3.3_C.1.3-1 and the downlink physical channel setup according to Annex C.3.2 and Annex C.3.3.

Using this configuration the fraction of maximum throughput percentage shall meet or exceed the minimum requirements specified in Tables 8.2.2.3.3_C.1.3-2 for the specified SNR. For open-loop spatial multiplexing performance with large delay CDD is specified.

Table 8.2.2.3.3_C.1.3-1: Test Parameters for Large Delay CDD (FRC) – no MBSFN ABS

Parameter		Unit	Cell 1	Cell 2
Uplink downlink configuration			1	1
Special subframe configuration			4	4
Downlink power allocation	ρ_A	dB	-3	-3
	ρ_B	dB	-3 (Note 1)	-3 (Note 1)
	σ	dB	0	N/A
N_{oc} at antenna port	N_{oc1}	dBm/15kHz	-102 (Note 2)	N/A
	N_{oc2}	dBm/15kHz	-98 (Note 3)	N/A
	N_{oc3}	dBm/15kHz	-94.8 (Note 4)	N/A
\hat{E}_s / N_{oc2}		dB	Reference Value in Table 8.2.2.3.3_C.1.3-2	6
BW _{Channel}		MHz	10	10
Subframe Configuration			Non-MBSFN	Non-MBSFN
Cell Id			0	1
Time Offset between Cells		μ s	2.5 (synchronous cells)	
ABS pattern (Note 5)			N/A	0000010001, 0000000001
RLM/RRM Measurement Subframe Pattern (Note 6)			0000000001, 0000000001	N/A
CSI Subframe Sets (Note 7)	$C_{CSI,0}$		0000010001, 0000000001	N/A
	$C_{CSI,1}$		1100101000 1100111000	N/A
Number of control OFDM symbols			2	
ACK/NACK feedback mode			Multiplexing	
PDSCH transmission mode			3	N/A
Cyclic prefix			Normal	Normal
<p>Note 1: $P_B = 1$.</p> <p>Note 2: This noise is applied in OFDM symbols #1, #2, #3, #5, #6, #8, #9, #10, #12, #13 of a subframe overlapping with the aggressor ABS.</p> <p>Note 3: This noise is applied in OFDM symbols #0, #4, #7, #11 of a subframe overlapping with the aggressor ABS.</p> <p>Note 4: This noise is applied in all OFDM symbols of a subframe overlapping with aggressor non-ABS.</p> <p>Note 5: ABS pattern as defined in [14]. PDSCH other than SIB1/paging and its associated PDCCH/PCFICH are transmitted in the serving cell subframe when the subframe is overlapped with the ABS subframe of aggressor cell and the subframe is available in the definition of the reference channel.</p> <p>Note 6: Time-domain measurement resource restriction pattern for PCell measurements as defined in [5].</p> <p>Note 7: As configured according to the time-domain measurement resource restriction pattern for CSI measurements defined in [5].</p> <p>Note 8: Cell 1 is the serving cell. Cell 2 is the aggressor cell. The number of the CRS ports in Cell1 and Cell2 is the same.</p> <p>Note 9: SIB-1 will not be transmitted in Cell2 in this test.</p>				

Table 8.2.2.3.3_C.1.3-2: Minimum performance Large Delay CDD (FRC) – no MBSFN ABS

Test Number	Reference Channel	OCNG Pattern		Propagation Conditions (Note 1)		Correlation Matrix and Antenna Configuration	Reference Value		UE Category
		Cell 1	Cell 2	Cell 1	Cell 2		Fraction of Maximum Throughput (%)	SNR (dB) (Note 2)	
1	R.11 TDD	OP.1 TDD	OP.1 TDD	EVA 5	EVA 5	2x2 Low	70	14.0	2-8
Note 1: The propagation conditions for Cell 1 and Cell2 are statistically independent.									
Note 2: SNR corresponds to \hat{E}_s / N_{oc2} of cell 1.									
Note 3: The correlation matrix and antenna configuration apply for Cell 1 and Cell 2.									

The normative reference for this requirement is TS 36.101 [2] clause 8.2.2.3.3.

8.2.2.3.3_C.1.4 Test description

8.2.2.3.3_C.1.4.1 Initial conditions

Initial conditions are a set of test configurations the UE needs to be tested in and the steps for the SS to take with the UE to reach the correct measurement state.

Configurations of PDSCH and PDCCH before measurement are specified in Annex C.2.

Test Environment: Normal, as defined in TS 36.508 [7] clause 4.1.

Frequencies to be tested: Mid Range, as defined in TS 36.508 [7] clause 4.3.1.2.

Channel Bandwidths to be tested: As specified per test number in Table 8.2.2.3.3_C.1.3-2, as defined in TS 36.508 [7] clause 4.3.1.2

1. Connect the SS, the faders and AWGN noise sources to the UE antenna connectors as shown in TS 36.508 [7] Annex A, Figure TBD for antenna configuration 2x2.
2. The parameter settings for the cell 1 are set up according to Tables 8.2.2-1 and 8.2.2.3.3_C.1.3-1 as appropriate.
3. Downlink signals are initially set up according to Annex C0, C.1 and Annex C.3.2 and uplink signals according to Annex H.1 and H.3.2.
4. Propagation conditions are set according to Annex B.0.
5. Ensure the UE is in State 3A-RF according to TS 36.508 [7] clause 5.2A.2. Message contents are defined in clause 8.2.2.3.3_C.1.4.3.

8.2.2.3.3_C.1.4.2 Test procedure

1. SS transmits PDSCH via PDCCH DCI format 2A for C_RNTI to transmit the DL RMC according to Tables 8.2.2.3.3_C.1.3-1 and 8.2.2.3.3_C.1.3-2. The SS sends downlink MAC padding bits on the DL RMC.
2. Set the parameters of the reference channel, the propagation condition, the correlation matrix and the SNR according to Table 8.2.2.3.3_C.1.5-1 as appropriate.
3. Set the Cell2 –aggressor cell- as defined in Tables 8.2.2.3.3_C.1.3-1, 8.2.2.3.3_C.1.5-1 and according to Annex C3.3
4. Measure the average throughput for a duration sufficient to achieve statistical significance according to Annex G clause G.3. Count the number of NACKs, ACKs and statDTXs on the UL during the test interval and decide pass or fail according to Tables G.3.5 and G.3.6 in Annex G clause G.3.

8.2.2.3.3_C.1.4.3 Message contents

Message contents are according to TS 36.508 [7] clause 4.6 with the following exceptions:

Table 8.2.2.3.3_C.1.4.3-1: *PhysicalConfigDedicated-DEFAULT*: Additional TDD PDSCH open loop spatial multiplexing performance downlink power allocation

Derivation Path: 36.331 clause 6.3.2			
Information Element	Value/remark	Comment	Condition
PhysicalConfigDedicated-DEFAULT ::= SEQUENCE {			
antennaInfo CHOICE {			
antennaInfoDedicated ::= SEQUENCE {			
transmissionMode	tm3		
codebookSubsetRestriction CHOICE {			
n2TxAntenna-tm3	11		
}			
ue-TransmitAntennaSelection CHOICE {			
release	NULL		
}			
}			
}			

Table 8.2.2.3.3_C.1.4.3-2: *RadioResourceConfigDedicated-SRB2-DRB(n, m)*: Additional FDD PDSCH open loop spatial multiplexing performance downlink power allocation

Derivation Path: TS 36.508 [7] clause 4.6.3, Table 4.6.3-16 RadioResourceConfigDedicated-SRB2-DRB(n,m)			
Information Element	Value/remark	Comment	Condition
RadioResourceConfigDedicated-SRB2-DRB(n, m) ::= SEQUENCE {			
MeasSubframePatternPCell-r10 CHOICE {			
setup SEQUENCE {			
subframePatternTDD-r10 CHOICE {			
subframeConfig1-5-r10	'00000000010000000001'	BIT STRING (SIZE (20))	
}			
}			
}			
}			

Table 8.2.2.3.3_C.1.4.3-3: CQI-ReportConfig-r10-DEFAULT: Additional FDD PDSCH open loop spatial multiplexing performance downlink power allocation

Derivation Path: 36.508 [7] clause 4.6.3, Table 4.6.3-2AA CQI-ReportConfig-r10-DEFAULT_			
Information Element	Value/remark	Comment	Condition
CQI-ReportConfig-r10-DEFAULT ::= SEQUENCE {			
cqi-ReportAperiodic-r10	Not present		
nomPDSCH-RS-EPRE-Offset	0		
cqi-ReportPeriodic-r10	Not present		
pmi-RI-Report-r9	Not present		
csi-SubframePatternConfig-r10 CHOICE {			
setup SEQUENCE {			
csi-MeasSubframeSet1-r10 CHOICE {			
subframePatternTDD-r10 CHOICE {			
subframeConfig1-5-r10	'00000100010000000001'	BIT STRING (SIZE (20))	
}			
}			
csi-MeasSubframeSet2-r10 CHOICE {			
subframePatternTDD-r10 CHOICE {			
subframeConfig1-5-r10	'11001010001100111000'	BIT STRING (SIZE (20))	
}			
}			
}			
}			
}			

8.2.2.3.3_C.1.5 Test requirement

Table 8.2.2.3.3_C.1.3-1 defines the primary level settings.

The fraction of maximum throughput percentage for the downlink reference measurement channels specified in Annex A clause A.3.4.2 for each throughput test shall meet or exceed the specified value in Tables 8.2.2.3.3_C.1.5-1 for the specified SNR including test tolerances for all throughput tests.

Table 8.2.2.3.3_C.1.5-1: Test Requirement Large Delay CDD (FRC)

Test Number	Reference Channel	OCNG Pattern		Propagation Conditions (Note 1)		Correlation Matrix and Antenna Configuration	Reference Value		UE Category
		Cell 1	Cell 2	Cell 1	Cell 2		Fraction of Maximum Throughput (%)	SNR (dB) (Note 2)	
1	R.11 TDD	OP.1 TDD	OP.1 TDD	EVA 5	EVA 5	2x2 Low	70	14.0+TT	2-8
Note 1: The propagation conditions for Cell 1 and Cell2 are statistically independent.									
Note 2: SNR corresponds to \hat{E}_s / N_{oc2} of cell 1.									

8.2.2.3.3_C.2 TDD PDSCH Open Loop Spatial Multiplexing 2x2 for eICIC (MBSFN ABS)

Editor's notes: This test case is incomplete. The following items are missing or incomplete:

- Step of test procedure may be confirmed or updated.
- Test Tolerance is undefined.
- Connection diagram in Annex A of TS 36.508 is TBD

8.2.2.3.3_C.2.1 Test purpose

To verify the UE's ability to receive a predefined test signal, representing a multi-path fading channel that is determined by the SNR with a percentage of the information bit throughput for a specified downlink Reference Measurement Channel (RMC) not falling below a specified value for transmission on two antenna ports using large delay CDD.

8.2.2.3.3_C.2.2 Test applicability

This test applies to all types of E-UTRA TDD UE release 10 and forward. Applicability requires support for FGI bit 115.

8.2.2.3.3_C.2.3 Minimum conformance requirements

The requirements are specified in terms of the percentage of information bit throughput for the downlink reference measurement channels specified in Annex A clause A.3.4.2, with the addition of the relevant parameters in Tables 8.2.2-1 and 8.2.2.3.3_C.2.3-1 and the downlink physical channel setup according to Table C.3.2-1 in Annex C.

The requirements for MBSFN ABS are specified in Table 8.2.2.3.3_C.2.3-2, with the addition of parameters in Table 8.2.2.3.3_C.2.3-1 and the downlink physical channel setup according to Annex C.3.2 and Annex C.3.3.

Using this configuration the fraction of maximum throughput percentage shall meet or exceed the minimum requirements specified in Tables 8.2.2.3.3_C.2.3-2 for the specified SNR. For open-loop spatial multiplexing performance with large delay CDD is specified.

Table 8.2.2.3.3_C.2.3-1: Test Parameters for Large Delay CDD (FRC) – MBSFN ABS

Parameter		Unit	Cell 1	Cell 2
Uplink downlink configuration			1	1
Special subframe configuration			4	4
Downlink power allocation	ρ_A	dB	-3	-3
	ρ_B	dB	-3 (Note 1)	-3 (Note 1)
	σ	dB	0	N/A
N_{oc} at antenna port	N_{oc1}	dBm/15kHz	-102 (Note 2)	N/A
	N_{oc2}	dBm/15kHz	-98 (Note 3)	N/A
	N_{oc3}	dBm/15kHz	-94.8 (Note 4)	N/A
\hat{E}_s / N_{oc2}		dB	Reference Value in Table 8.2.2.3.3_C.2.3-2	6
BW _{Channel}		MHz	10	10
Subframe Configuration			Non-MBSFN	MBSFN
Cell Id			0	126
Time Offset between Cells		μ s	2.5 (synchronous cells)	
ABS pattern (Note 5)			N/A	000000001 000000001
RLM/RRM Measurement Subframe Pattern (Note 6)			000000001 000000001	N/A
CSI Subframe Sets (Note 7)	$C_{CSI,0}$		000000001 000000001	N/A
	$C_{CSI,1}$		1100111000 1100111000	N/A
MBSFN Subframe Allocation (Note 10)			N/A	000010
Number of control OFDM symbols			2	
ACK/NACK feedback mode			Multiplexing	
PDSCH transmission mode			3	N/A
Cyclic prefix			Normal	Normal
<p>Note 1: $P_B = 1$.</p> <p>Note 2: This noise is applied in OFDM symbols #1, #2, #3, #4, #5, #6, #7, #8, #9, #10, #11, #12, #13 of a subframe overlapping with the aggressor ABS.</p> <p>Note 3: This noise is applied in OFDM symbol #0 of a subframe overlapping with the aggressor ABS.</p> <p>Note 4: This noise is applied in all OFDM symbols of a subframe overlapping with aggressor non-ABS.</p> <p>Note 5: ABS pattern as defined in [14]. The 10th and 20th subframes indicated by ABS pattern are MBSFN ABS subframes. PDSCH other than SIB1/paging and its associated PDCCH/PCFICH are transmitted in the serving cell subframe when the subframe is overlapped with the ABS subframe of aggressor cell and the subframe is available in the definition of the reference channel.</p> <p>Note 6: Time-domain measurement resource restriction pattern for PCell measurements as defined in [5]</p> <p>Note 7: As configured according to the time-domain measurement resource restriction pattern for CSI measurements defined in [5].</p> <p>Note 8: Cell 1 is the serving cell. Cell 2 is the aggressor cell. The number of the CRS ports in Cell1 and Cell2 is the same.</p> <p>Note 9: SIB-1 will not be transmitted in Cell2 in this test.</p> <p>Note 10: MBSFN Subframe Allocation as defined in [5], one frame with 6 bits is chosen for MBSFN subframe allocation.</p>				

Table 8.2.2.3.3_C.2.3-2: Minimum performance Large Delay CDD (FRC) – MBSFN ABS

Test Number	Reference Channel	OCNG Pattern		Propagation Conditions (Note 1)		Correlation Matrix and Antenna Configuration	Reference Value		UE Category
		Cell 1	Cell 2	Cell 1	Cell 2		Fraction of Maximum Throughput (%)	SNR (dB) (Note 2)	
1	R.11 TDD	OP.1 TDD	OP.1 TDD	EVA 5	EVA 5	2x2 Low	70	12.2	2-8
Note 1: The propagation conditions for Cell 1 and Cell2 are statistically independent.									
Note 2: SNR corresponds to \hat{E}_s / N_{oc2} of cell 1.									
Note 3: The correlation matrix and antenna configuration apply for Cell 1 and Cell 2.									

The normative reference for this requirement is TS 36.101 [2] clause 8.2.2.3.3.

8.2.2.3.3_C.2.4 Test description

8.2.2.3.3_C.2.4.1 Initial conditions

Initial conditions are a set of test configurations the UE needs to be tested in and the steps for the SS to take with the UE to reach the correct measurement state.

Configurations of PDSCH and PDCCH before measurement are specified in Annex C.2.

Test Environment: Normal, as defined in TS 36.508 [7] clause 4.1.

Frequencies to be tested: Mid Range, as defined in TS 36.508 [7] clause 4.3.1.2.

Channel Bandwidths to be tested: As specified per test number in Table 8.2.2.3.3_C.2.3-2, as defined in TS 36.508 [7] clause 4.3.1.2

1. Connect the SS, the faders and AWGN noise sources to the UE antenna connectors as shown in TS 36.508 [7] Annex A, Figure TBD for antenna configuration 2x2.
2. The parameter settings for the cell 1 are set up according to Tables 8.2.2-1 and 8.2.2.3.3_C.2.3-1 as appropriate.
3. Downlink signals are initially set up according to Annex C0, C.1 and Annex C.3.2 and uplink signals according to Annex H.1 and H.3.2.
4. Propagation conditions are set according to Annex B.0.
5. Ensure the UE is in State 3A-RF according to TS 36.508 [7] clause 5.2A.2. Message contents are defined in clause 8.2.2.3.3_C.2.4.3.

8.2.2.3.3_C.2.4.2 Test procedure

1. SS transmits PDSCH via PDCCH DCI format 2A for C_RNTI to transmit the DL RMC according to Tables 8.2.2.3.3_C.2.3-1 and 8.2.2.3.3_C.2.3-2. The SS sends downlink MAC padding bits on the DL RMC.
2. Set the parameters of the reference channel, the propagation condition, the correlation matrix and the SNR according to Table 8.2.2.3.3_C.2.5-1 as appropriate.
3. Set the Cell2 –aggressor cell- as defined in Tables 8.2.2.3.3_C.2.3-1, 8.2.2.3.3_C.2.5-1 and according to Annex C3.3
4. Measure the average throughput for a duration sufficient to achieve statistical significance according to Annex G clause G.3. Count the number of NACKs, ACKs and statDTXs on the UL during the test interval and decide pass or fail according to Tables G.3.5 and G.3.6 in Annex G clause G.3.

8.2.2.3.3_C.2.4.3 Message contents

Message contents are according to TS 36.508 [7] clause 4.6 with the following exceptions:

Table 8.2.2.3.3_C.2.4.3-1: *PhysicalConfigDedicated-DEFAULT*: Additional TDD PDSCH open loop spatial multiplexing performance downlink power allocation

Derivation Path: 36.331 clause 6.3.2			
Information Element	Value/remark	Comment	Condition
PhysicalConfigDedicated-DEFAULT ::= SEQUENCE {			
antennaInfo CHOICE {			
antennaInfoDedicated ::= SEQUENCE {			
transmissionMode	tm3		
codebookSubsetRestriction CHOICE {			
n2TxAntenna-tm3	11		
}			
ue-TransmitAntennaSelection CHOICE {			
release	NULL		
}			
}			
}			

Table 8.2.2.3.3_C.2.4.3-2: *RadioResourceConfigDedicated-SRB2-DRB(n, m)*: Additional FDD PDSCH open loop spatial multiplexing performance downlink power allocation

Derivation Path: TS 36.508 [7] clause 4.6.3, Table 4.6.3-16 RadioResourceConfigDedicated-SRB2-DRB(n,m)			
Information Element	Value/remark	Comment	Condition
RadioResourceConfigDedicated-SRB2-DRB(n, m) ::= SEQUENCE {			
MeasSubframePatternPCell-r10 CHOICE {			
setup SEQUENCE {			
subframePatternTDD-r10			
subframeConfig1-5-r10	'00000000010000000001'	BIT STRING (SIZE (20))	
}			
}			
}			

Table 8.2.2.3.3_C.2.4.3-3: CQI-ReportConfig-r10-DEFAULT: Additional FDD PDSCH open loop spatial multiplexing performance downlink power allocation

Derivation Path: 36.508 [7] clause 4.6.3, Table 4.6.3-2AA CQI-ReportConfig-r10-DEFAULT_			
Information Element	Value/remark	Comment	Condition
CQI-ReportConfig-r10-DEFAULT ::= SEQUENCE {			
cqi-ReportAperiodic-r10	Not present		
nomPDSCH-RS-EPRE-Offset	0		
cqi-ReportPeriodic-r10	Not present		
pmi-RI-Report-r9	Not present		
csi-SubframePatternConfig-r10 CHOICE {			
setup SEQUENCE {			
csi-MeasSubframeSet1-r10 CHOICE {			
subframePatternTDD-r10 CHOICE {			
subframeConfig1-5-r10	'00000000010000000001'	BIT STRING (SIZE (20))	
}			
}			
csi-MeasSubframeSet2-r10 CHOICE {			
subframePatternTDD-r10 CHOICE {			
subframeConfig1-5-r10	'11001110001100111000'	BIT STRING (SIZE (20))	
}			
}			
}			
}			
}			

8.2.2.3.3_C.2.5 Test requirement

Table 8.2.2.3.3_C.2.3-1 defines the primary level settings.

The fraction of maximum throughput percentage for the downlink reference measurement channels specified in Annex A clause A.3.4.2 for each throughput test shall meet or exceed the specified value in Tables 8.2.2.3.3_C.2.5-1 for the specified SNR including test tolerances for all throughput tests.

Table 8.2.2.3.3_C.2.5-1: Test Requirement Large Delay CDD (FRC)

Test Number	Reference Channel	OCNG Pattern		Propagation Conditions (Note 1)		Correlation Matrix and Antenna Configuration	Reference Value		UE Category
		Cell 1	Cell 2	Cell 1	Cell 2		Fraction of Maximum Throughput (%)	SNR (dB) (Note 2)	
1	R.11 TDD	OP.1 TDD	OP.1 TDD	EVA 5	EVA 5	2x2 Low	70	12.2+TT	2-8
Note 1: The propagation conditions for Cell 1 and Cell2 are statistically independent.									
Note 2: SNR corresponds to of cell 1.									

8.2.2.4 TDD PDSCH Closed Loop Spatial Multiplexing Performance (Cell-Specific Reference Symbols)

8.2.2.4.1 TDD PDSCH Closed Loop Single/Multi Layer Spatial Multiplexing 2x2

8.2.2.4.1.1 Test purpose

To verify the UE's ability to receive a predefined test signal, representing a multi-path fading channel that is determined by the SNR with a percentage of the information bit throughput for a specified downlink Reference Measurement Channel (RMC) not falling below a specified value for transmission on two antenna ports using closed loop spatial multiplexing with wideband and frequency selective precoding.

8.2.2.4.1.2 Test applicability

This test applies to all types of E-UTRA TDD UE release 8.

8.2.2.4.1.3 Minimum conformance requirements

The requirements are specified in terms of the percentage of information bit throughput for the downlink reference measurement channels specified in Annex A clause A.3.4.2, with the addition of the relevant parameters in Tables 8.2.2-1, 8.2.2.4.1.3-1 and 8.2.2.4.1.3-3 and the downlink physical channel setup according to Table C.3.2-1 in Annex C.

Using this configuration the fraction of maximum throughput percentage shall meet or exceed the minimum requirements specified in Tables 8.2.2.4.1.3-2 and 8.2.2.4.1.3-4 for the specified SNR. For single-layer spatial multiplexing closed loop rank-one performance with wideband and frequency selective precoding is specified. For multi-layer spatial multiplexing closed loop rank-two performance with wideband and frequency selective precoding is specified.

Table 8.2.2.4.1.3-1: Test Parameters for Testing Single-Layer Spatial Multiplexing (FRC)

Parameter		Unit	Test 1	Test 2
Downlink power allocation	ρ_A	dB	-3	-3
	ρ_B	dB	-3 (Note 1)	-3 (Note 1)
N_{oc} at antenna port		dBm/15kHz	-98	-98
Precoding granularity		PRB	6	50
PMI delay (Note 2)		ms	10 or 11	10 or 11
Reporting interval		ms	1 or 4 (Note 3)	1 or 4 (Note 3)
Reporting mode			PUSCH 1-2	PUSCH 3-1
CodeBookSubsetRestriction bitmap			001111	001111
ACK/NACK feedback mode			Multiplexing	Multiplexing
Note 1: $P_B = 1$				
Note 2: If the UE reports in an available uplink reporting instance at SF#n based on PMI estimation at a downlink SF not later than SF#(n-4), this reported PMI cannot be applied at the eNB downlink before SF#(n+4)				
Note 3: For Uplink - downlink configuration 1 the reporting interval will alternate between 1ms and 4ms				

Table 8.2.2.4.1.3-2: Minimum performance Single-Layer Spatial Multiplexing (FRC)

Test number	Bandwidth	Reference Channel	OCNG Pattern	Propagation Condition	Correlation Matrix and Antenna Configuration	Reference value		UE Category
						Fraction of Maximum Throughput (%)	SNR (dB)	
1	10 MHz	R.10 TDD	OP.1 TDD	EVA5	2x2 Low	70	-3.1	1-5
2	10 MHz	R.10 TDD	OP.1 TDD	EPA5	2x2 High	70	-2.8	1-5

Table 8.2.2.4.1.3-3: Test Parameters for Testing Multi-Layer Spatial Multiplexing

Parameter		Unit	Test 3	Test 4
Downlink power allocation	ρ_A	dB	-3	-3
	ρ_B	dB	-3 (Note 1)	-3 (Note 1)
N_{oc} at antenna port		dBm/15kHz	-98	-98
Precoding granularity		PRB	50	50
PMI delay (Note 2)		ms	10 or 11	10 or 11
Reporting interval		ms	1 or 4 (Note 3)	1 or 4 (Note 3)
Reporting mode			PUSCH 3-1	PUSCH 3-1
ACK/NACK feedback mode			Bundling	Bundling
CodeBookSubsetRestriction bitmap			110000	110000
Note 1: $P_B = 1$				
Note 2: If the UE reports in an available uplink reporting instance at subframe SF#n based on PMI estimation at a downlink SF not later than SF#(n-4), this reported PMI cannot be applied at the eNB downlink before SF#(n+4)				
Note 3: For Uplink - downlink configuration 1 the reporting interval will alternate between 1ms and 4ms				

Table 8.2.2.4.1.3-4: Minimum performance Multi-Layer Spatial Multiplexing (FRC)

Test number	Bandwidth	Reference Channel	OCNG Pattern	Propagation Condition	Correlation Matrix and Antenna Configuration	Reference value		UE Category
						Fraction of Maximum Throughput (%)	SNR (dB)	
3	10 MHz	R.11-1 TDD	OP.1 TDD	EVA5	2x2 Low	70	12.8	2-5
4	10 MHz	R.11-1 TDD	OP.1 TDD	ETU70	2x2 Low	70	13.9	2-5

The normative reference for this requirement is TS 36.101 [2] clause 8.2.2.4.

8.2.2.4.1.4 Test description

8.2.2.4.1.4.1 Initial conditions

Initial conditions are a set of test configurations the UE needs to be tested in and the steps for the SS to take with the UE to reach the correct measurement state.

Configurations of PDSCH and PDCCH before measurement are specified in Annex C.2.

Test Environment: Normal, as defined in TS 36.508 [7] clause 4.1.

Frequencies to be tested: Mid Range, as defined in TS 36.508 [7] clause 4.3.1.2.

Bandwidths to be tested: As specified per test number in Tables 8.2.2.4.1.3-2 and 8.2.2.4.1.3-4 as defined in TS 36.508 [7] clause 4.3.1.2.

1. Connect the SS, the faders and AWGN noise sources to the UE antenna connectors as shown in TS 36.508 [7] Annex A, Figure A.10 for antenna configuration 2x2.
2. The parameter settings for the cell are set up according to Tables 8.2.2-1, 8.2.2.4.1.3-1 and 8.2.2.4.1.3-3 as appropriate.
3. Downlink signals are initially set up according to Annex C.0, C.1 and Annex C.3.2 and uplink signals according to Annex H.1 and H.3.2.
4. Propagation conditions are set according to Annex B.0.
5. Ensure the UE is in State 3A-RF according to TS 36.508 [7] clause 5.2A.2. Message contents are defined in clause 8.2.2.4.1.4.3.

8.2.2.4.1.4.2 Test procedure

1. For single-layer spatial multiplexing, SS transmits PDSCH via PDCCH DCI format 2 for C_RNTI to transmit the DL RMC according to Tables 8.2.2.4.1.3-1 and 8.2.2.4.1.3-2. For multi-layer spatial multiplexing, SS transmits PDSCH via PDCCH DCI format 2 for C_RNTI to transmit the DL RMC according to Tables 8.2.2.4.1.3-3 and 8.2.2.4.1.3-4. The SS sends downlink MAC padding bits on the DL RMC.
2. SS schedules the UL transmission to carry the PUSCH CQI feedback via PDCCH DCI format 0 with CQI request bit set to 1 and I_MCS=29 and N_PRB allocated to be less or equal to 4.
3. Set the parameters of the bandwidth, MCS, reference channel, the propagation condition, the correlation matrix, antenna configuration and the SNR according to Tables 8.2.2.4.1.5-1 and 8.2.2.4.1.5-2 as appropriate.
4. Measure the average throughput for a duration sufficient to achieve statistical significance according to Annex G clause G.3. Count the number of NACKs, ACKs and statDTXs on the UL during each test interval and decide pass or fail according to Tables G.3.5 and G.3.6 in Annex G clause G.3.
5. Repeat steps from 1 to 4 for each test interval in Tables 8.2.2.4.1.5-1 and 8.2.2.4.1.5-2 as appropriate.

8.2.2.4.1.4.3 Message contents

Message contents are according to TS 36.508 [7] clause 4.6 with the following exceptions.

Table 8.2.2.4.1.4.3-1: PhysicalConfigDedicated-DEFAULT: Additional TDD PDSCH closed loop single-layer spatial multiplexing performance downlink power allocation for Test number 1,2

Derivation Path: 36.331 clause 6.3.2			
Information Element	Value/remark	Comment	Condition
PhysicalConfigDedicated-DEFAULT ::= SEQUENCE {			
antennaInfo CHOICE {			
antennaInfoDedicated ::= SEQUENCE {			
transmissionMode	tm4		
codebookSubsetRestriction CHOICE {			
n2TxAntenna-tm4	001111		
}			
ue-TransmitAntennaSelection CHOICE {			
release	NULL		
}			
}			
}			

Table 8.2.2.4.1.4.3-2: PhysicalConfigDedicated-DEFAULT: Additional TDD PDSCH closed loop multi-layer spatial multiplexing performance downlink power allocation for Test number 3,4

Derivation Path: 36.331 clause 6.3.2			
Information Element	Value/remark	Comment	Condition
PhysicalConfigDedicated-DEFAULT ::= SEQUENCE {			
antennaInfo CHOICE {			
antennaInfoDedicated ::= SEQUENCE {			
transmissionMode	tm4		
codebookSubsetRestriction CHOICE {			
n2TxAntenna-tm4	110000		
}			
ue-TransmitAntennaSelection CHOICE {			
release	NULL		
}			
}			
}			

Table 8.2.2.4.1.4.3-3: CQI-ReportConfig-DEFAULT: Additional TDD PDSCH closed loop single -layer spatial multiplexing performance downlink power allocation for Test number 1

Derivation Path: 36.331 clause 6.3.2			
Information Element	Value/remark	Comment	Condition
CQI-ReportConfig-DEFAULT ::= SEQUENCE {			
cqi-ReportModeAperiodic	rm12		
nomPDSCH-RS-EPRE-Offset	0		
cqi-ReportPeriodic	Not present		
}			

Table 8.2.2.4.1.4.3-4: CQI-ReportConfig-DEFAULT: Additional TDD PDSCH closed loop single/multi-layer spatial multiplexing performance downlink power allocation for Test number 2, 3, 4

Derivation Path: 36.331 clause 6.3.2			
Information Element	Value/remark	Comment	Condition
CQI-ReportConfig-DEFAULT ::= SEQUENCE {			
cqi-ReportModeAperiodic	rm31		
nomPDSCH-RS-EPRE-Offset	0		
cqi-ReportPeriodic	Not present		
}			

8.2.2.4.1.5 Test requirement

Tables 8.2.2.4.1.3-1 and 8.2.2.4.1.3-3 defines the primary level settings.

The fraction of maximum throughput percentage for the downlink reference measurement channels specified in Annex A clause A.3.4.2, for each throughput test shall meet or exceed the specified value in Tables 8.2.2.4.1.5-1 and 8.2.2.4.1.5-2 for the specified SNR including test tolerances for all throughput tests.

Table 8.2.2.4.1.5-1: Test requirement Single-Layer Spatial Multiplexing (FRC)

Test number	Bandwidth	Reference Channel	OCNG Pattern	Propagation Condition	Correlation Matrix and Antenna Configuration	Reference value		UE Category
						Fraction of Maximum Throughput (%)	SNR (dB)	
1	10 MHz	R.10 TDD	OP.1 TDD	EVA5	2x2 Low	70	-2.2	1-5
2	10 MHz	R.10 TDD	OP.1 TDD	EPA5	2x2 High	70	-2.0	1-5

Table 8.2.2.4.1.5-2: Test requirement Multi-Layer Spatial Multiplexing (FRC)

Test number	Bandwidth	Reference Channel	OCNG Pattern	Propagation Condition	Correlation Matrix and Antenna Configuration	Reference value		UE Category
						Fraction of Maximum Throughput (%)	SNR (dB)	
3	10 MHz	R.11-1 TDD	OP.1 TDD	EVA5	2x2 Low	70	13.7	2-5
4	10 MHz	R.11-1 TDD	OP.1 TDD	ETU70	2x2 Low	70	14.8	2-5

8.2.2.4.1_1 TDD PDSCH Closed Loop Single/Multi Layer Spatial Multiplexing 2x2 (Release 9 and forward)

8.2.2.4.1_1.1 Test purpose

Same test purpose as in clause 8.2.2.4.1.1.

8.2.2.4.1_1.2 Test applicability

This test applies to all types of E-UTRA TDD UE release 9 and forward.

8.2.2.4.1_1.3 Minimum conformance requirements

Same minimum conformance requirements as in clause 8.2.2.4.1.3 with the following exceptions:

- Instead of Table 8.2.2.4.1.3-3 → use Table 8.2.2.4.1_1.3-1.
- Instead of Table 8.2.2.4.1.3-4 → use Table 8.2.2.4.1_1.3-2.

Table 8.2.2.4.1_1.3-1: Test Parameters for Testing Multi-Layer Spatial Multiplexing

Parameter		Unit	Test 3-4
Downlink power allocation	ρ_A	dB	-3
	ρ_B	dB	-3 (Note 1)
N_{oc} at antenna port		dBm/15kHz	-98
Precoding granularity		PRB	50
PMI delay (Note 2)		ms	10 or 11
Reporting interval		ms	1 or 4 (Note 3)
Reporting mode			PUSCH 3-1
ACK/NACK feedback mode			Bundling
CodeBookSubsetRestriction bitmap			110000
Note 1: $P_B = 1$ Note 2: If the UE reports in an available uplink reporting instance at subframe SF#n based on PMI estimation at a downlink SF not later than SF#(n-4), this reported PMI cannot be applied at the eNB downlink before SF#(n+4) Note 3: For Uplink - downlink configuration 1 the reporting interval will alternate between 1ms and 4ms			

Table 8.2.2.4.1_1.3-2: Minimum performance Multi-Layer Spatial Multiplexing (FRC)

Test number	Bandwidth	Reference Channel	OCNG Pattern	Propagation Condition	Correlation Matrix and Antenna Configuration	Reference value		UE Category
						Fraction of Maximum Throughput (%)	SNR (dB)	
3	10 MHz	R.35 TDD	OP.1 TDD	EPA5	2x2 Low	70	19.5	2-5
4	10 MHz	R.11-1 TDD	OP.1 TDD	ETU70	2x2 Low	70	13.9	2-5

The normative reference for this requirement is TS 36.101 [2] clause 8.2.2.4.

8.2.2.4.1_1.4 Test description

Same test description as in clause 8.2.2.4.1.4 with the following exceptions:

- Instead of Table 8.2.2.4.1.3-3 → use Table 8.2.2.4.1_1.3-1.
- Instead of Table 8.2.2.4.1.3-4 → use Table 8.2.2.4.1_1.3-2.
- Instead of Table 8.2.2.4.1.5-2 → use Table 8.2.2.4.1_1.5-1.

8.2.2.4.1_1.5 Test requirement

Same test requirements as in clause 8.2.2.4.1.5 with the following exceptions:

- Instead of Table 8.2.2.4.1.3-3 → use Table 8.2.2.4.1_1.3-1.

- Instead of Table 8.2.2.4.1.5-2 → use Table 8.2.2.4.1_1.5-1.

Table 8.2.2.4.1_1.5-1: Test requirement Multi-Layer Spatial Multiplexing (FRC)

Test number	Bandwidth	Reference Channel	OCNG Pattern	Propagation Condition	Correlation Matrix and Antenna Configuration	Reference value		UE Category
						Fraction of Maximum Throughput (%)	SNR (dB)	
3	10 MHz	R.35 TDD	OP.1 TDD	EPA5	2x2 Low	70	+20.4	2-5
4	10 MHz	R.11-1 TDD	OP.1 TDD	ETU70	2x2 Low	70	+14.8	2-5

8.2.2.4.2 TDD PDSCH Closed Loop Single/Multi Layer Spatial Multiplexing 4x2

8.2.2.4.2.1 Test purpose

To verify the UE's ability to receive a predefined test signal, representing a multi-path fading channel that is determined by the SNR with a percentage of the information bit throughput for a specified downlink Reference Measurement Channel (RMC) not falling below a specified value for transmission on four antenna ports using closed loop spatial multiplexing with wideband and frequency selective precoding.

8.2.2.4.2.2 Test applicability

This test applies to all types of E-UTRA TDD UE release 8.

8.2.2.4.2.3 Minimum conformance requirements

The requirements are specified in terms of the percentage of information bit throughput for the downlink reference measurement channels specified in Annex A clause A.3.4.2, with the addition of the relevant parameters in Tables 8.2.2-1, 8.2.2.4.2.3-1 and 8.2.2.4.2.3-3 and the downlink physical channel setup according to Table C.3.2-1 in Annex C.

Using this configuration the fraction of maximum throughput percentage shall meet or exceed the minimum requirements specified in Tables 8.2.2.4.3-2 and 8.2.2.4.3-4 for the specified SNR. For single-layer spatial multiplexing closed loop rank-one performance with wideband and frequency selective precoding is specified. For multi-layer spatial multiplexing closed loop rank-two performance with wideband and frequency selective precoding is specified.

Table 8.2.2.4.2.3-1: Test Parameters for Testing Single-Layer Spatial Multiplexing (FRC)

Parameter		Unit	Test 1
Downlink power allocation	ρ_A	dB	-6
	ρ_B	dB	-6 (Note 1)
N_{oc} at antenna port		dBm/15kHz	-98
Precoding granularity		PRB	6
PMI delay (Note 2)		ms	10 or 11
Reporting interval		ms	1 or 4 (Note 3)
Reporting mode			PUSCH 1-2
CodeBookSubsetRestriction bitmap			000000000000 000000000000 000000000000 000000001111 111111111111
ACK/NACK feedback mode			Multiplexing
Note 1: $P_B = 1$ Note 2: If the UE reports in an available uplink reporting instance at subframe SF#n based on PMI estimation at a downlink SF not later than SF#(n-4), this reported PMI cannot be applied at the eNB downlink before SF#(n+4) Note 3: For Uplink - downlink configuration 1 the reporting interval will alternate between 1ms and 4ms			

Table 8.2.2.4.2.3-2: Minimum performance Single-Layer Spatial Multiplexing (FRC)

Test number	Bandwidth	Reference Channel	OCNG Pattern	Propagation Condition	Correlation Matrix and Antenna Configuration	Reference value		UE Category
						Fraction of Maximum Throughput (%)	SNR (dB)	
1	10 MHz	R.13 TDD	OP.1 TDD	EVA5	4x2 Low	70	-3.5	1-5

Table 8.2.2.4.2.3-3: Test Parameters for Testing Multi-Layer Spatial Multiplexing

Parameter		Unit	Test 2
Downlink power allocation	ρ_A	dB	-6
	ρ_B	dB	-6 (Note 1)
N_{oc} at antenna port		dBm/15kHz	-98
Precoding granularity		PRB	6
PMI delay (Note 2)		ms	10 or 11
Reporting interval		ms	1 or 4 (Note 3)
Reporting mode			PUSCH 1-2
ACK/NACK feedback mode			Bundling
CodeBookSubsetRestriction bitmap			000000000000 000000000000 000001111111 111111111000 000000000000
Note 1: $P_B = 1$ Note 2: If the UE reports in an available uplink reporting instance at subframe SF#n based on PMI estimation at a downlink SF not later than SF#(n-4), this reported PMI cannot be applied at the eNB downlink before SF#(n+4) Note 3: For Uplink - downlink configuration 1 the reporting interval will alternate between 1ms and 4ms			

Table 8.2.2.4.2.3-4: Minimum performance Multi-Layer Spatial Multiplexing (FRC)

Test number	Bandwidth	Reference Channel	OCNG Pattern	Propagation Condition	Correlation Matrix and Antenna Configuration	Reference value		UE Category
						Fraction of Maximum Throughput (%)	SNR (dB)	
2	10 MHz	R.14 TDD	OP.1 TDD	EVA5	4x2 Low	70	10.7	2-5

The normative reference for this requirement is TS 36.101 [2] clause 8.2.2.4.

8.2.2.4.2.4 Test description

8.2.2.4.2.4.1 Initial conditions

Initial conditions are a set of test configurations the UE needs to be tested in and the steps for the SS to take with the UE to reach the correct measurement state.

Configurations of PDSCH and PDCCH before measurement are specified in Annex C.2.

Test Environment: Normal, as defined in TS 36.508 [7] clause 4.1.

Frequencies to be tested: Mid Range, as defined in TS 36.508 [7] clause 4.3.1.2.

Bandwidths to be tested: As specified per test number in Tables 8.2.2.4.2.3-2 and 8.2.2.4.2.3-4 as defined in TS 36.508 [7] clause 4.3.1.2.

1. Connect the SS, the faders and AWGN noise sources to the UE antenna connectors as shown in TS 36.508 [7] Annex A, Figure A.10 Figure A.11 for antenna configuration 4x2.
2. The parameter settings for the cell are set up according to Tables 8.2.2-1, 8.2.2.4.2.3-1 and 8.2.2.4.2.3-3 as appropriate.
3. Downlink signals are initially set up according to Annex C.0, C.1 and Annex C.3.2 and uplink signals according to Annex H.1 and H.3.2.
4. Propagation conditions are set according to Annex B.0.
5. Ensure the UE is in State 3A-RF according to TS 36.508 [7] clause 5.2A.2. Message contents are defined in clause 8.2.2.4.2.4.3.

8.2.2.4.2.4.2 Test procedure

1. For single-layer spatial multiplexing, SS transmits PDSCH via PDCCH DCI format 2 for C_RNTI to transmit the DL RMC according to Tables 8.2.2.4.2.3-1 and 8.2.2.4.2.3-2. For multi-layer spatial multiplexing, SS transmits PDSCH via PDCCH DCI format 2 for C_RNTI to transmit the DL RMC according to Tables 8.2.2.4.2.3-3 and 8.2.2.4.2.3-4. The SS sends downlink MAC padding bits on the DL RMC.
2. SS schedules the UL transmission to carry the PUSCH CQI feedback via PDCCH DCI format 0 with CQI request bit set to 1 and I_MCS=29 and N_PRB allocated to be less or equal to 4.
3. Set the parameters of the bandwidth, MCS, reference channel, the propagation condition, the correlation matrix, antenna configuration and the SNR according to Tables 8.2.2.4.2.5-1 and 8.2.2.4.2.5-2 as appropriate.
4. Measure the average throughput for a duration sufficient to achieve statistical significance according to Annex G clause G.3. Count the number of NACKs, ACKs and statDTXs on the UL during each test interval and decide pass or fail according to Tables G.3.5 and G.3.6 in Annex G clause G.3.
5. Repeat steps from 1 to 4 for each test interval in Tables 8.2.2.4.2.5-1 and 8.2.2.4.2.5-2 as appropriate.

8.2.2.4.2.4.3 Message contents

Message contents are according to TS 36.508 [7] clause 4.6 with the following exceptions.

Table 8.2.2.4.2.4.3-1: PDSCH-ConfigDedicated-DEFAULT: Additional TDD PDSCH closed loop spatial multiplexing performance downlink power allocation for Test numbers 1,2

Derivation Path: 36.508 clause 4.6.3			
Information Element	Value/remark	Comment	Condition
PDSCH-ConfigDedicated-DEFAULT ::= SEQUENCE {			
p-a	dB-6		
}			

Table 8.2.2.4.2.4.3-2: PhysicalConfigDedicated-DEFAULT: Additional TDD PDSCH closed loop single-layer spatial multiplexing performance downlink power allocation for Test number 1

Derivation Path: 36.331 clause 6.3.2			
Information Element	Value/remark	Comment	Condition
PhysicalConfigDedicated-DEFAULT ::= SEQUENCE {			
antennaInfo CHOICE {			
antennaInfoDedicated ::= SEQUENCE {			
transmissionMode	tm4		
codebookSubsetRestriction CHOICE {			
n4TxAntenna-tm4	00000000000000000000 00000000000000000000 00000000111111111111 1111		
}			
ue-TransmitAntennaSelection CHOICE {			
release	NULL		
}			
}			
}			

Table 8.2.2.4.2.4.3-3: PhysicalConfigDedicated-DEFAULT: Additional TDD PDSCH closed loop multi-layer spatial multiplexing performance downlink power allocation for Test number 2

Derivation Path: 36.331 clause 6.3.2			
Information Element	Value/remark	Comment	Condition
PhysicalConfigDedicated-DEFAULT ::= SEQUENCE {			
antennaInfo CHOICE {			
antennaInfoDedicated ::= SEQUENCE {			
transmissionMode	tm4		
codebookSubsetRestriction CHOICE {			
n4TxAntenna-tm4	00000000000000000000 00000000000011111111 11111111000000000000 0000		
}			
ue-TransmitAntennaSelection CHOICE {			
release	NULL		
}			
}			
}			

Table 8.2.2.4.2.3-4: CQI-ReportConfig-DEFAULT: Additional TDD PDSCH closed loop single/multi-layer spatial multiplexing performance downlink power allocation for Test number 1, 2

Derivation Path: 36.331 clause 6.3.2			
Information Element	Value/remark	Comment	Condition
CQI-ReportConfig-DEFAULT ::= SEQUENCE {			
cqi-ReportModeAperiodic	rm12		
nomPDSCH-RS-EPRE-Offset	0		
cqi-ReportPeriodic	Not present		
}			

8.2.2.4.2.5 Test requirement

Tables 8.2.2.4.2.3-1 and 8.2.2.4.2.3-3 defines the primary level settings.

The fraction of maximum throughput percentage for the downlink reference measurement channels specified in Annex A clause A.3.4.2, for each throughput test shall meet or exceed the specified value in Tables 8.2.2.4.2.5-1 and 8.2.2.4.2.5-2 for the specified SNR including test tolerances for all throughput tests.

Table 8.2.2.4.2.5-1: Test requirement Single-Layer Spatial Multiplexing (FRC)

Test number	Bandwidth	Reference Channel	OCNG Pattern	Propagation Condition	Correlation Matrix and Antenna Configuration	Reference value		UE Category
						Fraction of Maximum Throughput (%)	SNR (dB)	
1	10 MHz	R.13 TDD	OP.1 TDD	EVA5	4x2 Low	70	-2.6	1-5

Table 8.2.2.4.2.5-2: Test requirement Multi-Layer Spatial Multiplexing (FRC)

Test number	Bandwidth	Reference Channel	OCNG Pattern	Propagation Condition	Correlation Matrix and Antenna Configuration	Reference value		UE Category
						Fraction of Maximum Throughput (%)	SNR (dB)	
2	10 MHz	R.14 TDD	OP.1 TDD	EVA5	4x2 Low	70	11.6	2-5

8.2.2.4.2_1 TDD PDSCH Closed Loop Multi Layer Spatial Multiplexing 4x2 (Release 9 and forward)

8.2.2.4.2_1.1 Test purpose

Same test purpose as in clause 8.2.2.4.2.1.

8.2.2.4.2_1.2 Test applicability

This test applies to all types of E-UTRA TDD UE release 9 and forward.

8.2.2.4.2_1.3 Minimum conformance requirements

Same minimum conformance requirements as in clause 8.2.2.4.2.3 with the following exceptions:

- Instead of Table 8.2.2.4.2.3-3 → use Table 8.2.2.4.2_1.3-1.
- Instead of Table 8.2.2.4.2.3-4 → use Table 8.2.2.4.2_1.3-2.

Table 8.2.2.4.2_1.3-1: Test Parameters for Testing Multi-Layer Spatial Multiplexing

Parameter	Unit	Test 2
Downlink power allocation	ρ_A	dB
	ρ_B	dB
		-6 (Note 1)

N_{oc} at antenna port	dBm/15kHz	-98
Precoding granularity	PRB	6
PMI delay (Note 2)	ms	10 or 11
Reporting interval	ms	1 or 4 (Note 3)
Reporting mode		PUSCH 1-2
ACK/NACK feedback mode		Bundling
CodeBookSubsetRestriction bitmap		000000000000 000000000000 000000111111 111111111000 000000000000
<p>Note 1: $P_b = 1$</p> <p>Note 2: If the UE reports in an available uplink reporting instance at subframe SF#n based on PMI estimation at a downlink SF not later than SF#(n-4), this reported PMI cannot be applied at the eNB downlink before SF#(n+4)</p> <p>Note 3: For Uplink - downlink configuration 1 the reporting interval will alternate between 1ms and 4ms</p>		

Table 8.2.2.4.2_1.3-2: Minimum performance Multi-Layer Spatial Multiplexing (FRC)

Test number	Bandwidth	Reference Channel	OCNG Pattern	Propagation Condition	Correlation Matrix and Antenna Configuration	Reference value		UE Category
						Fraction of Maximum Throughput (%)	SNR (dB)	
2	10 MHz	R.36 TDD	OP.1 TDD	EPA5	4x2 Low	70	15.7	2-5

The normative reference for this requirement is TS 36.101 [2] clause 8.2.2.4.

8.2.2.4.2_1.4 Test description

Same test description as in clause 8.2.2.4.2.4 with the following exceptions:

- Instead of Table 8.2.2.4.2.3-3 → use Table 8.2.2.4.2_1.3-1.
- Instead of Table 8.2.2.4.2.3-4 → use Table 8.2.2.4.2_1.3-2.
- Instead of Table 8.2.2.4.2.5-2 → use Table 8.2.2.4.2_1.5-1.

8.2.2.4.2_1.5 Test requirement

Same test requirements as in clause 8.2.2.4.2.5 with the following exceptions:

- Instead of Table 8.2.2.4.2.3-3 → use Table 8.2.2.4.2_1.3-1.
- Instead of Table 8.2.2.4.2.5-2 → use Table 8.2.2.4.2_1.5-1.

Table 8.2.2.4.2_1.5-1: Test requirement Multi-Layer Spatial Multiplexing (FRC)

Test number	Bandwidth	Reference Channel	OCNG Pattern	Propagation Condition	Correlation Matrix and Antenna Configuration	Reference value		UE Category
						Fraction of Maximum Throughput (%)	SNR (dB)	
2	10 MHz	R.36 TDD	OP.1 TDD	EPA5	4x2 Low	70	+16.6	2-5

8.2.2.4.2_A TDD PDSCH Closed Loop Multi Layer Spatial Multiplexing 4x2 for CA

8.2.2.4.2_A.1 TDD PDSCH Closed Loop Multi Layer Spatial Multiplexing 4x2 for CA (intra-band contiguous DL CA)

Editor's note: This clause is incomplete. The following aspects are either missing or not yet determined:

- Connection diagram is FFS.
- Test tolerance is undefined
- Test frequencies are FFS
- Statistical significance related parameters in Annex G.3A are FFS

8.2.2.4.2_A.1.1 Test purpose

To verify the UE's ability to receive a predefined test signal, representing a multi-path fading channel that is determined by the SNR with a percentage of the information bit throughput for a specified downlink Reference Measurement Channel (RMC) not falling below a specified value for transmission on two antenna ports using closed-loop spatial multiplexing.

8.2.2.4.2_A.1.2 Test applicability

This test applies to all types of E-UTRA TDD UE release10 and forward which supports Intra-band contiguous DL CA.

8.2.2.4.2_A.1.3 Minimum conformance requirements

The requirements are specified in terms of the percentage of information bit throughput for the downlink reference measurement channels specified in Annex A clause A.3.3.2, with the addition of the relevant parameters in Tables 8.2.1-1, 8.2.2.4.2_A.1.3-1 and the downlink physical channel setup according to Table C.3.2-1 in Annex C.

Using this configuration the fraction of maximum throughput percentage shall meet or exceed the minimum requirements specified in Tables 8.2.2.4.2_A.1.3-2 for the specified SNR. For multi-layer spatial multiplexing closed loop rank-two performance with wideband and frequency selective precoding is specified.

Table 8.2.2.4.2_A.1.3-1: Test Parameters for Testing Multi-Layer Spatial Multiplexing

Parameter		Unit	Test 1
Downlink power allocation	ρ_A	dB	-6
	ρ_B	dB	-6 (Note 1)
N_{oc} at antenna port		dBm/15kHz	-98
Precoding granularity		PRB	8
PMI delay (Note 2)		ms	10 or 11
Reporting interval		ms	1 or 4 (Note 2)
Reporting mode			PUSCH 1-2
ACK/NACK feedback mode			- (Note 5)
CodeBookSubsetRestriction bitmap			000000000000 000000000000 000000111111 111111111000 000000000000
CSI request field (Note 3)			'10'
Note 1: $P_B = 1$ Note 2: If the UE reports in an available uplink reporting instance at subframe SF#n based on PMI estimation at a downlink SF not later than SF#(n-4), this reported PMI cannot be applied at the eNB downlink before SF#(n+4) Note 3: For Uplink - downlink configuration 1 the reporting interval will alternate between 1ms and 4ms Note 4: CSI request field applies for CA demodulation requirement only. Multiple CC-s under test are configured as the 1 st set of serving cells by high layers. Note 5: ACK/NACK bits are transmitted using PUSCH with PUCCH format 1b with channel selection configured.			

Table 8.2.2.4.2_A.1.3-2: Minimum performance Multi-Layer Spatial Multiplexing (FRC)

Test number	Bandwidth	Reference Channel	OCNG Pattern	Propagation Condition	Correlation Matrix and Antenna Configuration	Reference value		UE Category	CA capability
						Fraction of Maximum Throughput (%)	SNR (dB)		
1	2x20 MHz	R.43 TDD	OP.1 TDD (Note 1)	EVA5	4x2 Low	70	11.1	5-8	CL_C
Note 1: For CA capable UE, the OCNG pattern applies for each CC.									

The normative reference for this requirement is TS 36.101 [2] clause 8.2.2.4.

8.2.2.4.2_A.1.4 Test description

8.2.2.4.2_A.1.4.1 Initial conditions

Initial conditions are a set of test configurations the UE needs to be tested in and the steps for the SS to take with the UE to reach the correct measurement state.

Configurations of PDSCH and PDCCH before measurement are specified in Annex C.2.

Test Environment: Normal, as defined in TS 36.508 [7] clause 4.1.

Frequencies to be tested: Mid Range, as defined in TS 36.508 [7] clause FFS.

Channel Bandwidths to be tested: As specified per test number in Tables 8.2.2.4.2_A.1.3-2 as defined in TS 36.508 [7] clause 4.3.1.2.

1. Connect the SS, the faders and AWGN noise sources to the UE antenna connectors as shown in TS 36.508 [7] Annex A, Figure FFS for antenna configuration 4x2.
2. The parameter settings for the cell are set up according to Tables 8.2.1-1, 8.2.2.4.2_A.1.3-1 as appropriate.
3. Downlink signals for PCC are initially set up according to Annex C.1 and Annex C.3.2 and uplink signals according to Annex H.1 and H.3.2.
4. Propagation conditions are set according to Annex B.0.
5. Ensure the UE is in State 3A-RF according to TS 36.508 [7] clause 5.2A.2. Message contents are defined in clause 8.2.2.4.2_A.1.4.3.

8.2.2.4.2_A.1.4.2 Test procedure

1. Configure SCC according to Annex C.0, C.1 and Annex C.3.2 for all downlink physical channels except PHICH.
2. The SS shall configure SCC as per TS 36.508 [7] clause 5.2A.4. Message contents for *PDSCH-ConfigDedicated-DEFAULT* is defined in Table 8.2.2.4.2_A.1.4.3-1, *PhysicalConfigDedicatedSCell-r10-DEFAULT* is defined in Table 8.2.2.4.2_A.1.4.3-2A, *PhysicalConfigDedicated-DEFAULT* is defined in Table 8.2.2.4.2_A.1.4.3-2, *CQI-ReportConfig-DEFAULT* is defined in Table 8.2.2.4.2_A.1.4.3-3, *CQI-ReportConfigSCell-DEFAULT* is defined in Table 8.2.2.4.2_A.1.4.3-4, *CQI-ReportAperiodic-r10-DEFAULT* is defined in Table 8.2.2.4.2_A.1.4.3-5.
3. SS activates SCC by sending the activation MAC-CE (Refer TS 36.321 [13], clauses 5.13, 6.1.3.8). Wait for at least 2 seconds (Refer TS 36.133, clauses 8.3.3.2).
4. For multi-layer spatial multiplexing, SS transmits PDSCH via PDCCH DCI format 2 for C_RNTI to transmit the DL RMC according to Tables 8.2.2.4.2_A.1.3-1 and 8.2.2.4.2_A.1.3-3. The SS sends downlink MAC padding bits on the DL RMC.
5. SS schedules the UL transmission to carry the PUSCH CSI feedback via PDCCH DCI format 0 with CSI request bit set to '10' and I_MCS=29 and N_PRB allocated to be less or equal to 20.
6. Set the parameters of the bandwidth, MCS, reference channel, the propagation condition, the correlation matrix, antenna configuration and the SNR according to Tables 8.2.2.4.2_A.1.5-1 as appropriate.
7. Measure the average throughput for a duration sufficient to achieve statistical significance according to Annex G clause G.3. Count the number of NACKs, ACKs and statDTXs on the UL during the test interval and decide pass or fail according to Tables G.3.5 and G.3.6 in Annex G clause G.3.

8.2.2.4.2_A.1.4.3 Message contents

Message contents are according to TS 36.508 [7] clause 4.6 with the following exceptions:

Table 8.2.2.4.2_A.1.4.3-1: PDSCH-ConfigDedicated-DEFAULT: Additional TDD PDSCH closed loop spatial multiplexing performance downlink power allocation

Derivation Path: TS 36.508 [7] clause 4.6.3, Table 4.6.3-6 PDSCH-ConfigDedicated-DEFAULT			
Information Element	Value/remark	Comment	Condition
PDSCH-ConfigDedicated-DEFAULT ::= SEQUENCE {			
p-a	dB-6		
}			

Table 8.2.2.4.2_A.1.4.3-2: PhysicalConfigDedicated-DEFAULT: Additional TDD PDSCH closed loop multi-layer spatial multiplexing performance downlink power allocation Test number 1

Derivation Path: 36.331 clause 6.3.2			
Information Element	Value/remark	Comment	Condition
PhysicalConfigDedicated-DEFAULT ::= SEQUENCE {			
antennaInfo CHOICE {			
antennaInfoDedicated ::= SEQUENCE {			
transmissionMode	tm4		
codebookSubsetRestriction CHOICE {			
n4TxAntenna-tm4	00000000000000000000 00000000000011111111 11111111000000000000 0000		
}			
ue-TransmitAntennaSelection CHOICE {			
release	NULL		
}			
}			
}			

Table 8.2.2.4.2_A.1.4.3-2A: PhysicalConfigDedicatedSCell-r10-DEFAULT: Additional FDD PDSCH closed loop multi-layer spatial multiplexing performance downlink power allocation

Derivation Path: 36.508 clause 4.6.3 Table 4.6.3-6A			
Information Element	Value/remark	Comment	Condition
PhysicalConfigDedicated SCell-r10-DEFAULT ::= SEQUENCE {			
nonUL-Configuration-r10 SEQUENCE {			
antennaInfo-r10 CHOICE {			
antennaInfoDedicated-r10 ::= SEQUENCE {			
transmissionMode	tm4		
codebookSubsetRestriction CHOICE {			
n4TxAntenna-tm4	00000000000000000000 00000000000011111111 11111111000000000000 0000		
}			
ue-TransmitAntennaSelection CHOICE {			
release	NULL		
}			
}			
}			
}			

Table 8.2.2.4.2_A.1.4.3-3: CQI-ReportConfig-DEFAULT: Additional TDD PDSCH closed loop multi-layer spatial multiplexing performance downlink power allocation

Derivation Path: 36.331 clause 6.3.2			
Information Element	Value/remark	Comment	Condition
CQI-ReportConfig-DEFAULT ::= SEQUENCE {			
cqi-ReportModeAperiodic	rm12		
nomPDSCH-RS-EPRE-Offset	0		
cqi-ReportPeriodic	Not present		
}			

Table 8.2.2.4.2_A.1.4.3-4: CQI-ReportConfig-r10-DEFAULT: Additional TDD PDSCH closed loop multi-layer spatial multiplexing performance downlink power allocation

Derivation Path: 36.508 clause 4.6.3 Table 4.6.3-2AA			
Information Element	Value/remark	Comment	Condition
CQI-ReportConfig-r10 ::= SEQUENCE {			
cqi-ReportAperiodic-r10	CQI-ReportAperiodic-r10-DEFAULT		
nomPDSCH-RS-EPRE-Offset	0		
cqi-ReportPeriodic-r10	Not present		
pmi-RI-Report-r9	Not present		
csi-SubframePatternConfig-r10	Not present		
}			

Table 8.2.2.4.2_A.1.4.3-5: CQI-ReportAperiodic-r10-DEFAULT: Additional TDD PDSCH closed loop multi-layer spatial multiplexing performance downlink power allocation

Derivation Path: 36.508 clause 4.6.3 Table 4.6.3-1A			
Information Element	Value/remark	Comment	Condition
CQI-ReportAperiodic-r10 ::= CHOICE {			
setup SEQUENCE {			
cqi-ReportModeAperiodic-r10	rm12		
aperiodicCSI-Trigger-r10 ::= SEQUENCE {			
trigger1-r10	11000000	P-Cell, S-Cell report	
trigger2-r10	00000000	No report	
}			
}			
}			

8.2.2.4.2_A.1.5 Test requirement

Tables 8.2.2.4.2_A.1.3-1 define the primary level settings.

The fraction of maximum throughput percentage for the downlink reference measurement channels specified in Annex A clause A.3.4.2 for each throughput test shall meet or exceed the specified value in Tables 8.2.2.4.2_A.1.5-1 for the specified SNR including test tolerances for all throughput tests.

Table 8.2.2.4.2_A.1.5-1: Test requirement Multi-Layer Spatial Multiplexing (FRC)

Test number	Bandwidth	Reference Channel	OCNG Pattern	Propagation Condition	Correlation Matrix and Antenna Configuration	Reference value		UE Category	CA capability
						Fraction of Maximum Throughput (%)	SNR (dB)		
1	2x20 MHz	R.43 TDD	OP.1 TDD (Note 1)	EVA5	4x2 Low	70	11.1 + TT	5-8	CL_C

Note 1: For CA capable UE, the OCNG pattern applies for each CC.

Decide pass or fail for each subtest according to Annex G.3A.4. Decide the entire test pass or fail according to Annex G.3A.6.

8.3 Demodulation of PDSCH (User-Specific Reference Symbols)

8.3.1 FDD

The parameters specified in Table 8.3.1-1 are valid for FDD unless otherwise stated.

Table 8.3.1-1: Common Test Parameters for User-specific Reference Symbols

Parameter	Unit	Value
Cyclic prefix		Normal
Cell ID		0
Inter-TTI Distance		1
Number of HARQ processes	Processes	8
Maximum number of HARQ transmission		4
Redundancy version coding sequence		{0,1,2,3} for QPSK and 16QAM {0,0,1,2} for 64QAM
Number of OFDM symbols for PDCCH	OFDM symbols	2
Precoder update granularity		Frequency domain: 1 PRG for Transmission mode 9 Time domain: 1 ms
Note 1: as specified in Table 4.2-2 in TS 36.211 [8].		
Note 2: as specified in Table 4.2-1 in TS 36.211 [8].		

8.3.1.1 FDD PDSCH Single-layer Spatial Multiplexing Performance (UE-Specific Reference Symbols)

8.3.1.1.1_D FDD PDSCH Single-layer Spatial Multiplexing on antenna ports 7 or 8 without a simultaneous transmission for eDL-MIMO

8.3.1.1.1_D.1 Test purpose

To verify the UE's ability to receive a predefined test signal, representing a multi-path fading channel that is determined by the SNR with a percentage of the information bit throughput for a specified downlink Reference Measurement Channel (RMC) not falling below a specified value for single-layer transmission on antenna ports 7 or 8 without a simultaneous transmission on the other antenna port and multiple CSI reference symbols configurations with non-zero and zero transmission power.

8.3.1.1.1_D.2 Test applicability

This test applies to all types of E-UTRA FDD UE release 10 and forward that support eDL-MIMO. Applicability requires support for FGI bit 103.

8.3.1.1.1_D.3 Minimum conformance requirements

The requirements are specified in terms of the percentage of information bit throughput for the downlink reference measurement channels specified in Annex A clause A.3.3.3, with the addition of the relevant parameters in Tables 8.3.1-1, 8.3.1.1.1_D.3-1, and the downlink physical channel setup according to Table C.3.2-1 in Annex C.3.2.

Using this configuration the fraction of maximum throughput percentage shall meet or exceed the minimum requirements specified in Table 8.3.1.1.1_D.3-2 for the specified SNR.

Table 8.3.1.1.1_D.3-1: Test Parameters for Testing CDM-multiplexed DM RS (single layer) with multiple CSI-RS configurations

parameter	Unit	Test 1	Test 2
Downlink power allocation	ρ_A	dB	0
	ρ_B	dB	0 (Note 1)
	σ	dB	-3
Cell-specific reference signals		Antenna ports 0,1	
CSI reference signals		Antenna ports 15,...,18	Antenna ports 15,...,18
Beamforming model		Annex B.4.1	Annex B.4.1
CSI-RS periodicity and subframe offset $T_{\text{CSI-RS}} / \Delta_{\text{CSI-RS}}$	Subframes	5 / 2	5 / 2
CSI reference signal configuration		0	3
Zero-power CSI-RS configuration $I_{\text{CSI-RS}} / \text{ZeroPowerCSI-RS}$ bitmap	Subframes / bitmap	3 / 0001000000000000	3 / 0001000000000000
N_{oc} at antenna port	dBm/15kHz	-98	-98
Symbols for unused PRBs		OCNG (Note 4)	OCNG (Note 4)
Number of allocated resource blocks (Note 2)	PRB	50	50
Simultaneous transmission		No	Yes (Note 3, 5)
PDSCH transmission mode		9	9
<p>Note 1: $P_B = 1$.</p> <p>Note 2: The modulation symbols of the signal under test are mapped onto antenna port 7 or 8.</p> <p>Note 3: Modulation symbols of an interference signal is mapped onto the antenna port (7 or 8) not used for the input signal under test.</p> <p>Note 4: These physical resource blocks are assigned to an arbitrary number of virtual UEs with one PDSCH per virtual UE; the data transmitted over the OCNG PDSCHs shall be uncorrelated pseudo random data, which is QPSK modulated.</p> <p>Note 5: The two UEs' scrambling identities n_{SCID} are set to 0 for CDM-multiplexed DM RS with interfering simultaneous transmission test cases.</p>			

Table 8.3.1.1.1_D.3-2: Minimum performance for CDM-multiplexed DM RS without simultaneous transmission (FRC) with multiple CSI-RS configurations

Test number	Bandwidth and MCS	Reference Channel	OCNG Pattern	Propagation Condition	Correlation Matrix and Antenna Configuration	Reference value		UE Category
						Fraction of Maximum Throughput (%)	SNR (dB)	
1	10 MHz QPSK 1/3	R.43 FDD	OP.1 FDD	EVA5	2x2 Low	70	-1	1-8

The normative reference for this requirement is TS 36.101 [2] clause 8.3.1.1.

8.3.1.1.1_D.4 Test description

8.3.1.1.1_D.4.1 Initial conditions

Initial conditions are a set of test configurations the UE needs to be tested in and the steps for the SS to take with the UE to reach the correct measurement state.

Configurations of PDSCH and PDCCH before measurement are specified in Annex C.2.

Test Environment: Normal, as defined in TS 36.508 [7] clause 4.1.

Frequencies to be tested: Mid Range, as defined in TS 36.508 [7] clause 4.3.1.1.

Bandwidths to be tested: 10MHz, as defined in TS 36.508 [7] clause 4.3.1.1.

1. Connect the SS, the faders and AWGN noise sources to the UE antenna connectors as shown in TS 36.508 [7] Annex A, Figure A.10.
2. The parameter settings for the cell are set up according to Tables 8.3.1-1 and 8.3.1.1.1_D.3-1 as appropriate.
3. Downlink signals are initially set up according to Annex C0, C.1 and Annex C.3.2 and uplink signals according to Annex H.1 and H.3.2.
4. Propagation conditions are set according to Annex B.0.
5. Ensure the UE is in State 3A-RF according to TS 36.508 [7] clause 5.2A.2. Message contents are defined in clause 8.3.1.1.1_D.4.3.

8.3.1.1.1_D.4.2 Test procedure

1. SS transmits PDSCH via PDCCH DCI format 2C for C_RNTI to transmit the DL RMC according to Tables 8.3.1.1.1_D.3-1, 8.3.1.1.1_D.3-2. The SS sends downlink MAC padding bits on the DL RMC.
2. Set the parameters of the bandwidth, MCS, reference channel, the propagation condition, the correlation matrix and the SNR according to Table 8.3.1.1.1_D.5-1 as appropriate.
BCH/CRS/PDCCH/PCFICH are sent on antenna ports 0 and 1 using two Tx antennas, while DRS/PDSCH for the test UE are sent on antenna port 7 (or 8) using two Tx antennas with beam-forming model as specified in Annex B.4.1 and precoder update granularity specified in Table 8.3.1-1. CSI-RS are sent on antenna ports 15-18 using two Tx antennas with mapping according to beam-forming model as specified in Annex B.4.1.
3. Measure the average throughput for a duration sufficient to achieve statistical significance according to Annex G clause G.3. Count the number of NACKs, ACKs and statDTXs on the UL during each test interval and decide pass or fail according to Tables G.3.5 and G.3.6 in Annex G clause G.3.

8.3.1.1.1_D.4.3 Message contents

Message contents are according to TS 36.508 [7] clause 4.6 with the following exceptions:

Table 8.3.1.1.1_D.4.3-1: PDSCH-ConfigDedicated-DEFAULT

Derivation Path: 36.331 clause 6.3.2			
Information Element	Value/remark	Comment	Condition
PDSCH-ConfigDedicated-DEFAULT ::= SEQUENCE {			
p-a	dB0		
}			

Table 8.3.1.1.1_D.4.3-2: *AntennaInfoDedicated-r10*

Derivation Path: 36.331 clause 6.3.2			
Information Element	Value/remark	Comment	Condition
AntennaInfoDedicated-r10 ::= SEQUENCE {			
transmissionMode-r10	tm9-v1020		
codebookSubsetRestriction-r10	Not present	If the UE is configured with <i>transmissionMode</i> tm9, E-UTRAN only configures the field <i>codebookSubsetRestriction</i> if PMI/RI reporting is configured	
}			
ue-TransmitAntennaSelection CHOICE {			
release	NULL		
}			

Table 8.3.1.1.1_D.4.3-3: *CSI-RS-Config*

Derivation Path: 36.331 clause 6.3.2			
Information Element	Value/remark	Comment	Condition
CSI-RS-Config-r10 ::= SEQUENCE {			
csi-RS-r10 CHOICE{			
release			
setup SEQUENCE {			
antennaPortsCount-r10	an4	Parameter represents the number of antenna ports used for transmission of CSI reference signals	
resourceConfig-r10	0 for Test 1 3 for Test 2	Parameter: CSI reference signal configuration	
subframeConfig-r10	2	$\Delta_{\text{CSI-RS}} = I_{\text{CSI-RS}}$ when CSI-RS SubframeConfig is from 0-4; Parameter: $I_{\text{CSI-RS}}$	
p-C-r10	-3 dB	Parameter: P_c which is the assumed ratio of PDSCH EPRE to CSI-RS EPRE when UE derives CSI feedback	
}			
}			
zeroTxPowerCSI-RS-r10 CHOICE{			
release	NULL		
setup SEQUENCE {			
zeroTxPowerResourceConfigList-r10	3	Parameter: <i>ZeroPowerCSI-RS</i>	
zeroTxPowerSubframeConfig-r10	2	Parameter: $I_{\text{CSI-RS}}$	
}			
}			
}			

8.3.1.1.1_D.5 Test requirement

Table 8.3.1.1.1_D.3-1 defines the primary level settings.

The fraction of maximum throughput percentage for the downlink reference measurement channels specified in Annex A clause A.3.3.2 for the throughput test shall meet or exceed the specified value in Table 8.3.1.1.1_D.5-1 for the specified SNR including test tolerances for the throughput test.

Table 8.3.1.1.1_D.5-1: Test requirement for CDM-multiplexed DM RS without simultaneous transmission (FRC) with multiple CSI-RS configurations

Test number	Bandwidth and MCS	Reference Channel	OCNG Pattern	Propagation Condition	Correlation Matrix and Antenna Configuration	Reference value		UE Category
						Fraction of Maximum Throughput (%)	SNR (dB)	
1	10 MHz QPSK 1/3	R.43 FDD	OP.1 FDD	EVA5	2x2 Low	70	-.01	1-8

8.3.1.1.2_D FDD PDSCH Single-layer Spatial Multiplexing on antenna ports 7 or 8 with a simultaneous transmission for eDL-MIMO

8.3.1.1.2_D.1 Test purpose

To verify the UE's ability to receive a predefined test signal, representing a multi-path fading channel that is determined by the SNR with a percentage of the information bit throughput for a specified downlink Reference Measurement Channel (RMC) not falling below a specified value for single-layer transmission on antenna ports 7 or 8 with a simultaneous transmission on the other antenna port and multiple CSI reference symbols configurations with non-zero and zero transmission power.

8.3.1.1.2_D.2 Test applicability

This test applies to all types of E-UTRA FDD UE release 10 and forward that support eDL-MIMO. Applicability requires support for FGI bit 103.

8.3.1.1.2_D.3 Minimum conformance requirements

The requirements are specified in terms of the percentage of information bit throughput for the downlink reference measurement channels specified in Annex A clause A.3.3.3, with the addition of the relevant parameters in Tables 8.3.1-1, 8.3.1.1.2_D.3-1, and the downlink physical channel setup according to Table C.3.2-1 in Annex C.3.2.

Using this configuration the fraction of maximum throughput percentage shall meet or exceed the minimum requirements specified in Table 8.3.1.1.2_D.3-2 for the specified SNR.

Table 8.3.1.1.2_D.3-1: Test Parameters for Testing CDM-multiplexed DM RS (single layer) with multiple CSI-RS configurations

parameter	Unit	Test 1	Test 2
Downlink power allocation	ρ_A	dB	0
	ρ_B	dB	0 (Note 1)
	σ	dB	-3
Cell-specific reference signals		Antenna ports 0,1	
CSI reference signals		Antenna ports 15,...,18	Antenna ports 15,...,18
Beamforming model		Annex B.4.1	Annex B.4.1
CSI-RS periodicity and subframe offset $T_{\text{CSI-RS}} / \Delta_{\text{CSI-RS}}$	Subframes	5 / 2	5 / 2
CSI reference signal configuration		0	3
Zero-power CSI-RS configuration $I_{\text{CSI-RS}} / \text{ZeroPowerCSI-RS}$ bitmap	Subframes / bitmap	3 / 0001000000000000	3 / 0001000000000000
N_{oc} at antenna port	dBm/15kHz	-98	-98
Symbols for unused PRBs		OCNG (Note 4)	OCNG (Note 4)
Number of allocated resource blocks (Note 2)	PRB	50	50
Simultaneous transmission		No	Yes (Note 3, 5)
PDSCH transmission mode		9	9
Note 1: $P_B = 1$. Note 2: The modulation symbols of the signal under test are mapped onto antenna port 7 or 8. Note 3: Modulation symbols of an interference signal is mapped onto the antenna port (7 or 8) not used for the input signal under test. Note 4: These physical resource blocks are assigned to an arbitrary number of virtual UEs with one PDSCH per virtual UE; the data transmitted over the OCNG PDSCHs shall be uncorrelated pseudo random data, which is QPSK modulated. Note 5: The two UEs' scrambling identities n_{SCID} are set to 0 for CDM-multiplexed DM RS with interfering simultaneous transmission test cases.			

Table 8.3.1.1.2_D.3-2: Minimum performance for CDM-multiplexed DM RS with interfering simultaneous transmission (FRC) with multiple CSI-RS configurations

Test number	Bandwidth and MCS	Reference Channel	OCNG Pattern	Propagation Condition	Correlation Matrix and Antenna Configuration	Reference value		UE Category
						Fraction of Maximum Throughput (%)	SNR (dB)	
2	10 MHz 64QAM 1/2	R.50 FDD	OP.1 FDD	EPA5	2x2 Low	70	21.9	2-8
Note 1: The reference channel applies to both the input signal under test and the interfering signal.								

The normative reference for this requirement is TS 36.101 [2] clause 8.3.1.1.

8.3.1.1.2_D.4 Test description

8.3.1.1.2_D.4.1 Initial conditions

Initial conditions are a set of test configurations the UE needs to be tested in and the steps for the SS to take with the UE to reach the correct measurement state.

Configurations of PDSCH and PDCCH before measurement are specified in Annex C.2.

Test Environment: Normal, as defined in TS 36.508 [7] clause 4.1.

Frequencies to be tested: Mid Range, as defined in TS 36.508 [7] clause 4.3.1.1.

Bandwidths to be tested: 10MHz, as defined in TS 36.508 [7] clause 4.3.1.1.

1. Connect the SS, the faders and AWGN noise sources to the UE antenna connectors as shown in TS 36.508 [7] Annex A, Figure A.10.
2. The parameter settings for the cell are set up according to Tables 8.3.1-1 and 8.3.1.1.2_D.3-1 as appropriate.
3. Downlink signals are initially set up according to Annex C0, C.1 and Annex C.3.2 and uplink signals according to Annex H.1 and H.3.2.
4. Propagation conditions are set according to Annex B.0.
5. Ensure the UE is in State 3A-RF according to TS 36.508 [7] clause 5.2A.2. Message contents are defined in clause 8.3.1.1.2_D.4.3.

8.3.1.1.2_D.4.2 Test procedure

1. SS transmits PDSCH via PDCCH DCI format 2C for C_RNTI to transmit the DL RMC according to Tables 8.3.1.1.2_D.3-1, 8.3.1.1.2_D.3-2. The SS sends downlink MAC padding bits on the DL RMC.
2. Set the parameters of the bandwidth, MCS, reference channel, the propagation condition, the correlation matrix and the SNR according to Table 8.3.1.1.2_D.5-1 as appropriate.
BCH/CRS/PDCCH/PCFICH are sent on antenna ports 0 and 1 using two Tx antennas, while DRS/PDSCH for the test UE are sent on antenna port 7 (or 8) and another simultaneous transmission of DRS/PDSCH not for the test UE are sent on antenna port 8 (or 7). The DRS/PDSCH transmissions use two Tx antennas with beam-forming model as specified in Annex B.4.1 and precoder update granularity specified in Table 8.3.1-1. CSI-RS are sent on antenna ports 15-18 using two Tx antennas with mapping according to beam-forming model as specified in Annex B.4.1.
3. Measure the average throughput for a duration sufficient to achieve statistical significance according to Annex G clause G.3. Count the number of NACKs, ACKs and statDTXs on the UL during each test interval and decide pass or fail according to Tables G.3.5 and G.3.6 in Annex G clause G.3.

8.3.1.1.2_D.4.3 Message contents

Message contents are according to TS 36.508 [7] clause 4.6 with the following exceptions:

Table 8.3.1.1.2_D.4.3-1: PDSCH-ConfigDedicated-DEFAULT

Derivation Path: 36.331 clause 6.3.2			
Information Element	Value/remark	Comment	Condition
PDSCH-ConfigDedicated-DEFAULT ::= SEQUENCE {			
p-a	dB0		
}			

Table 8.3.1.1.2_D.4.3-2: *AntennaInfoDedicated-r10*

Derivation Path: 36.331 clause 6.3.2			
Information Element	Value/remark	Comment	Condition
AntennaInfoDedicated-r10 ::= SEQUENCE {			
transmissionMode-r10	tm9-v1020		
codebookSubsetRestriction-r10	Not present	If the UE is configured with <i>transmissionMode</i> tm9, E-UTRAN only configures the field <i>codebookSubsetRestriction</i> if PMI/RI reporting is configured	
}			
ue-TransmitAntennaSelection CHOICE {			
release	NULL		
}			

Table 8.3.1.1.2_D.4.3-3: *CSI-RS-Config*

Derivation Path: 36.331 clause 6.3.2			
Information Element	Value/remark	Comment	Condition
CSI-RS-Config-r10 ::= SEQUENCE {			
csi-RS-r10 CHOICE{			
release			
setup SEQUENCE {			
antennaPortsCount-r10	an4	Parameter represents the number of antenna ports used for transmission of CSI reference signals	
resourceConfig-r10	0 for Test 1 3 for Test 2	Parameter: CSI reference signal configuration	
subframeConfig-r10	2	$\Delta_{\text{CSI-RS}} = I_{\text{CSI-RS}}$ when CSI-RS SubframeConfig is from 0-4; Parameter: $I_{\text{CSI-RS}}$	
p-C-r10	-3 dB	Parameter: P_c which is the assumed ratio of PDSCH EPRE to CSI-RS EPRE when UE derives CSI feedback	
}			
}			
zeroTxPowerCSI-RS-r10 CHOICE{			
release	NULL		
setup SEQUENCE {			
zeroTxPowerResourceConfigList-r10	3	Parameter: <i>ZeroPowerCSI-RS</i>	
zeroTxPowerSubframeConfig-r10	2	Parameter: $I_{\text{CSI-RS}}$	
}			
}			
}			

8.3.1.1.2_D.5 Test requirement

Table 8.3.1.1.2_D.3-1 defines the primary level settings.

The fraction of maximum throughput percentage for the downlink reference measurement channels specified in Annex A clause A.3.3.3.2 for the throughput test shall meet or exceed the specified value in Table 8.3.1.1.2_D.5-1 for the specified SNR including test tolerances for the throughput test.

Table 8.3.1.1.2_D.5-1: Test requirement for CDM-multiplexed DM RS with interfering simultaneous transmission (FRC) with multiple CSI-RS configurations

Test number	Bandwidth and MCS	Reference Channel	OCNG Pattern	Propagation Condition	Correlation Matrix and Antenna Configuration	Reference value		UE Category
						Fraction of Maximum Throughput (%)	SNR (dB)	
2	10 MHz 64QAM 1/2	R.50 FDD	OP.1 FDD	EPA5	2x2 Low	70	22.8	2-8

Note 1: The reference channel applies to both the input signal under test and the interfering signal.

8.3.1.1.3 FDD PDSCH Single-layer Spatial Multiplexing on antenna ports 7 or 8 with TM9 Interference Model - Enhanced Performance Requirement Type A

Editor's notes: This test case is incomplete. The following item is missing or incomplete:

-Test tolerances are incomplete

-Connection diagram is TBD

8.3.1.1.3.1 Test purpose

To verify the UE's ability to receive a predefined test signal, representing a multi-path fading channel that is determined by the SNR with a percentage of the information bit throughput for a specified downlink Reference Measurement Channel (RMC) not falling below a specified value for single-layer transmission on antenna ports 7 or 8 without a simultaneous transmission on the other antenna port in the serving cell when the PDSCH transmission in the serving cell is interfered by PDSCH of one dominant interfering cell applying transmission mode 9 interference model defined in clause B.5.4.

8.3.1.1.3.2 Test applicability

This test applies to all types of E-UTRA FDD UE release 11 and forward that support enhanced receiver Type A.

8.3.1.1.3.3 Minimum conformance requirements

The requirements are specified in terms of the percentage of information bit throughput for the downlink reference measurement channels specified in Annex A clause A.3.3.3, with the addition of the relevant parameters in Tables 8.3.1-1, 8.3.1.1.3.3-1, and the downlink physical channel setup according to Table C.3.2-1 in Annex C.3.2.

Using this configuration the fraction of maximum throughput percentage shall meet or exceed the minimum requirements specified in Table 8.3.1.1.3.3-2 for the specified SNR.

Table 8.3.1.1.3.3-1: Test Parameters for Testing CDM-multiplexed DM RS (single layer) with TM9 interference model

parameter		Unit	Cell 1	Cell 2
Downlink power allocation	ρ_A	dB	0	0
	ρ_B	dB	0 (Note 1)	0
	σ	dB	-3	-3
Cell-specific reference signals			Antenna ports 0,1	Antenna ports 0,1
CSI reference signals			Antenna ports 15,...,18	N/A
CSI-RS periodicity and subframe offset $T_{\text{CSI-RS}} / \Delta_{\text{CSI-RS}}$		Subframes	5 / 2	N/A
CSI reference signal configuration			0	N/A
N_{oc} at antenna port		dBm/15kHz	-98	N/A
DIP (Note 2)		dB	N/A	-1.73
BW_{Channel}		MHz	10	10
Cyclic Prefix			Normal	Normal
Cell Id			0	126
Number of control OFDM symbols			2	2
PDSCH transmission mode			9	N/A
Beamforming model			As specified in clause B.4.3 (Note 4, 5)	N/A
Interference model			N/A	As specified in clause B.5.4
Probability of occurrence of transmission rank in interfering cells	Rank 1		N/A	70
	Rank 2		N/A	30
Precoder update granularity		PRB	50	6
PMI delay (Note 5)		Ms	8	N/A
Reporting interval		Ms	5	N/A
Reporting mode			PUCCH 1-1	N/A
CodeBookSubsetRestriction bitmap			0000000000000000 0000000000000000 0000000000000000 1111111111111111	N/A
Symbols for unused PRBs			OCNG (Note 6)	N/A
Simultaneous transmission			No simultaneous transmission on the other antenna port in (7 or 8) not used for the input signal under test	N/A
Note 1: $P_B = 1$				
Note 2: The respective received power spectral density of each interfering cell relative to N_{oc} is defined by its associated DIP value as specified in clause B.5.1.				
Note 3: The modulation symbols of the signal under test in Cell 1 are mapped onto antenna port 7 or 8.				
Note 4: The precoder in clause B.4.3 follows UE recommended PMI.				
Note 5: If the UE reports in an available uplink reporting instance at subframe SF#n based on PMI estimation at a downlink SF not later than SF#(n-4), this reported PMI				

Note 6:	cannot be applied at the eNB downlink before SF#(n+4). These physical resource blocks are assigned to an arbitrary number of virtual UEs with one PDSCH per virtual UE; the data transmitted over the OCNG PDSCHs shall be uncorrelated pseudo random data, which is QPSK modulated.
Note 7:	All cells are time-synchronous.

Table 8.3.1.1.3.3-2: Enhanced Performance Requirement Type A, CDM-multiplexed DM RS with TM9 interference model

Test Number	Reference Channel	OCNG Pattern		Propagation Conditions		Correlation Matrix and Antenna Configuration (Note 3)	Reference Value		UE Category
		Cell 1	Cell 2	Cell 1	Cell 2		Fraction of Maximum Throughput (%)	SINR (dB) (Note 2)	
1	R.48 FDD	OP.1 FDD	N/A	EVA5	EVA5	4x2 Low	70	-1.1	1-8
Note 1: The propagation conditions for Cell 1 and Cell 2 are statistically independent.									
Note 2: SINR corresponds to \hat{E}_s / N_{oc} of Cell 1 as defined in clause 8.1.1.									
Note 3: Correlation matrix and antenna configuration parameters apply for each of Cell 1 and Cell 2.									

The normative reference for this requirement is TS 36.101 [2] clause 8.3.1.1A.

8.3.1.1.3.4 Test description

8.3.1.1.3.4.1 Initial conditions

Initial conditions are a set of test configurations the UE needs to be tested in and the steps for the SS to take with the UE to reach the correct measurement state.

Configurations of PDSCH and PDCCH before measurement are specified in Annex C.2.

Test Environment: Normal, as defined in TS 36.508 [7] clause 4.1.

Frequencies to be tested: Mid Range, as defined in TS 36.508 [7] clause 4.3.1.1.

Bandwidths to be tested: 10MHz, as defined in TS 36.508 [7] clause 4.3.1.1.

1. Connect the SS, the faders and AWGN noise sources to the UE antenna connectors as shown in TS 36.508 [7] Annex A, TBD.
2. The parameter settings for the cell are set up according to Tables 8.3.1-1 and 8.3.1.1.3.3-1 as appropriate.
3. Downlink signals are initially set up according to Annex C0, C.1 and Annex C.3.2 and uplink signals according to Annex H.1 and H.3.2.
4. Propagation conditions are set according to Annex B.0.
5. Ensure the UE is in State 3A-RF according to TS 36.508 [7] clause 5.2A.2. Message contents are defined in clause 8.3.1.1.3.4.3.

8.3.1.1.3.4.2 Test procedure

1. SS transmits PDSCH via PDCCH DCI format 2C for C_RNTI to transmit the DL RMC according to Tables 8.3.1.1.3.3-1, 8.3.1.1.3.3-2. The SS sends downlink MAC padding bits on the DL RMC.
2. Set the parameters of the bandwidth, MCS, reference channel, the propagation condition, the correlation matrix and the SNR according to Table 8.3.1.1.3.5-1 as appropriate.
BCH/CRS/PDCCH/PCFICH are sent on antenna ports 0 and 1 using two Tx antennas, while DRS/PDSCH for the test UE are sent on antenna port 7 (or 8) using four Tx antennas with beam-forming model as specified in

Annex B.4.1 and precoder update granularity specified in Table 8.3.1.1.3.3-1. CSI-RS are sent on antenna ports 15-18 using four Tx antennas with mapping according to beam-forming model as specified in Annex B.4.1.

3. Set the Cell2 –aggressor cell- as defined in Tables 8.3.1.1.3.3-1, 8.3.1.1.3.3-2 and according to Annex B.4.3.
4. Measure the average throughput for a duration sufficient to achieve statistical significance according to Annex G clause G.3. Count the number of NACKs, ACKs and statDTXs on the UL during each test interval and decide pass or fail according to Tables G.3.5 and G.3.6 in Annex G clause G.3.

8.3.1.1.3.4.3 Message contents

Message contents are according to TS 36.508 [7] clause 4.6 with the following exceptions:

Table 8.3.1.1.3.4.3-1: PDSCH-ConfigDedicated-DEFAULT

Derivation Path: TS 36.508 [7] clause 4.6.3, Table 4.6.3-6 PDSCH-ConfigDedicated-DEFAULT			
Information Element	Value/remark	Comment	Condition
PDSCH-ConfigDedicated-DEFAULT ::= SEQUENCE {			
p-a	dB0		
}			

Table 8.3.1.1.3.4.3-2: AntennaInfoDedicated-r10

Derivation Path: 36.331 clause 6.3.2			
Information Element	Value/remark	Comment	Condition
AntennaInfoDedicated-r10 ::= SEQUENCE {			
transmissionMode-r10	tm9-v1020		
codebookSubsetRestriction-r10	000000000000000000 000000000000000000 000000000000111111 1111111111		
}			
ue-TransmitAntennaSelection CHOICE {			
release	NULL		
}			

Table 8.3.1.1.3.4.3-3: CSI-RS-Config-r10

Derivation Path: 36.331 clause 6.3.2			
Information Element	Value/remark	Comment	Condition
CSI-RS-Config-r10 ::= SEQUENCE {			
csi-RS-r10 CHOICE{			
release			
setup SEQUENCE {			
antennaPortsCount-r10	an4	Parameter represents the number of antenna ports used for transmission of CSI reference signals	
resourceConfig-r10	0	Parameter: CSI reference signal configuration	
subframeConfig-r10	2	$\Delta_{\text{CSI-RS}} = I_{\text{CSI-RS}}$ when CSI-RS SubframeConfig is from 0-4; Parameter: $I_{\text{CSI-RS}}$	
p-C-r10	-3 dB	Parameter: P_c which is the assumed ratio of PDSCH EPRE to CSI-RS EPRE when UE derives CSI feedback	
}			
}			
zeroTxPowerCSI-RS-r10 CHOICE{			
release	NULL		
setup SEQUENCE {			
zeroTxPowerResourceConfigList-r10	NULL	Parameter: $ZeroPowerCSI-RS$	
zeroTxPowerSubframeConfig-r10	NULL	Parameter: $I_{\text{CSI-RS}}$	
}			
}			
}			

Table 8.3.1.1.3.4.3-4: CQI-ReportPeriodic-r10

Derivation Path: TS 36.508 [7] clause 4.6.3, Table 4.6.3-2AC CQI-ReportPeriodic-r10-DEFAULT			
Information Element	Value/remark	Comment	Condition
CQI-ReportPeriodic-r10 ::= CHOICE {			
setup SEQUENCE {			
cqi-PUCCH-ResourceIndex-r10	0		
cqi-PUCCH-ResourceIndexP1-r10	Not present		
cqi-pmi-ConfigIndex	25	FDD	
cqi-FormatIndicatorPeriodic-r10 CHOICE {			
widebandCQI-r10 SEQUENCE {			
csi-ReportMode-r10	Not present		
}			
}			
ri-ConfigIndex	483	FDD	
simultaneousAckNackAndCQI	FALSE		
cqi-Mask-r9	Not present		
csi-ConfigIndex-r10	Not present		
}			
}			

8.3.1.1.3.5 Test requirement

Table 8.3.1.1.3.3-1 defines the primary level settings.

The fraction of maximum throughput percentage for the downlink reference measurement channels specified in Annex A clause A.3.3.3.2 for the throughput test shall meet or exceed the specified value in Table 8.3.1.1.3.5-1 for the specified SNR including test tolerances for the throughput test.

Table 8.3.1.1.3.5-1: Enhanced Performance Requirement Type A, CDM-multiplexed DM RS with TM9 interference model

Test Number	Reference Channel	OCNG Pattern		Propagation Conditions		Correlation Matrix and Antenna Configuration (Note 3)	Reference Value		UE Category
		Cell 1	Cell 2	Cell 1	Cell 2		Fraction of Maximum Throughput (%)	SINR (dB) (Note 2)	
1	R.48 FDD	OP.1 FDD	N/A	EVA5	EVA5	4x2 Low	70	- 1.1+TT	1-8
Note 1: The propagation conditions for Cell 1 and Cell 2 are statistically independent. Note 2: SINR corresponds to \hat{E}_s / N_{oc} of Cell 1 as defined in clause 8.1.1. Note 3: Correlation matrix and antenna configuration parameters apply for each of Cell 1 and Cell 2.									

8.3.1.2 FDD PDSCH Dual-layer Spatial Multiplexing Performance (UE-Specific Reference Symbols)

8.3.1.2.1_D FDD PDSCH Dual-layer Spatial Multiplexing for eDL-MIMO

8.3.1.2.1_D.1 Test purpose

To verify the UE's rank-2 performance and ability to receive a predefined test signal, representing a multi-path fading channel that is determined by the SNR with a percentage of the information bit throughput for a specified downlink Reference Measurement Channel (RMC) not falling below a specified value for dual-layer transmission on antenna ports 7 and 8 using DM-RS with full RB allocation with multiple CSI reference symbol configurations with non-zero and zero transmission power.

8.3.1.2.1_D.2 Test applicability

This test applies to all types of E-UTRA FDD UE release 10 and forward that support eDL-MIMO. Applicability requires support for FGI bit 103.

8.3.1.2.1_D.3 Minimum conformance requirements

The requirements are specified in terms of the percentage of information bit throughput for the downlink reference measurement channels specified in Annex A clause A.3.3.3, with the addition of the relevant parameters in Tables 8.3.1-1, 8.3.1.2.1_D.3-1, and the downlink physical channel setup according to Table C.3.2-1 in Annex C.3.2.

Using this configuration the fraction of maximum throughput percentage shall meet or exceed the minimum requirements specified in Table 8.3.1.2.1_D.3-2 for the specified SNR.

Table 8.3.1.2.1_D.3-1: Test Parameters for Testing CDM-multiplexed DM RS (dual layer) with multiple CSI-RS configurations

parameter		Unit	Test 1
Downlink power allocation	ρ_A	dB	0
	ρ_B	dB	0 (Note 1)
	σ	dB	-3
Cell-specific reference signals			Antenna ports 0 and 1
CSI reference signals			Antenna ports 15,16
Beamforming model			Annex B.4.2
CSI-RS periodicity and subframe offset $T_{\text{CSI-RS}} / \Delta_{\text{CSI-RS}}$		Subframes	5 / 2
CSI reference signal configuration			8
Zero-power CSI-RS configuration $I_{\text{CSI-RS}} / \text{ZeroPowerCSI-RS}$ bitmap		Subframes / bitmap	3 / 0010000000000000
N_{oc} at antenna port		dBm/15kHz	-98
Symbols for unused PRBs			OCNG (Note 2)
Number of allocated resource blocks (Note 2)		PRB	50
Simultaneous transmission			No
PDSCH transmission mode			9
Note 1: $P_B = 1$.			
Note 2: These physical resource blocks are assigned to an arbitrary number of virtual UEs with one PDSCH per virtual UE; the data transmitted over the OCNG PDSCHs shall be uncorrelated pseudo random data, which is QPSK modulated.			

Table 8.3.1.2.1_D.3-2: Minimum performance for CDM-multiplexed DM RS (FRC) with multiple CSI-RS configurations

Test number	Bandwidth and MCS	Reference Channel	OCNG Pattern	Propagation Condition	Correlation Matrix and Antenna Configuration	Reference value		UE Category
						Fraction of Maximum Throughput (%)	SNR (dB)	
1	10 MHz 16QAM 1/2	R.51 FDD	OP.1 FDD	EPA5	2x2 Low	70	13.3	2-8

The normative reference for this requirement is TS 36.101 [2] clause 8.3.1.2.

8.3.1.2.1_D.4 Test description

8.3.1.2.1_D.4.1 Initial conditions

Initial conditions are a set of test configurations the UE needs to be tested in and the steps for the SS to take with the UE to reach the correct measurement state.

Configurations of PDSCH and PDCCH before measurement are specified in Annex C.2.

Test Environment: Normal, as defined in TS 36.508 [7] clause 4.1.

Frequencies to be tested: Mid Range, as defined in TS 36.508 [7] clause 4.3.1.1.

Bandwidths to be tested: 10MHz, as defined in TS 36.508 [7] clause 4.3.1.1.

1. Connect the SS, the faders and AWGN noise sources to the UE antenna connectors as shown in TS 36.508 [7] Annex A, Figure A. 10.
2. The parameter settings for the cell are set up according to Tables 8.3.1-1 and 8.3.1.2.1_D.3-1 as appropriate.
3. Downlink signals are initially set up according to Annex C0, C.1 and Annex C.3.2 and uplink signals according to Annex H.1 and H.3.2.
4. Propagation conditions are set according to Annex B.0.
5. Ensure the UE is in State 3A-RF according to TS 36.508 [7] clause 5.2A.2. Message contents are defined in clause 8.3.1.2.1_D.4.3.

8.3.1.2.1_D.4.2 Test procedure

1. SS transmits PDSCH via PDCCH DCI format 2C for C_RNTI to transmit the DL RMC according to Tables 8.3.1.2.1_D.3-1, 8.3.1.2.1_D.3-2. The SS sends downlink MAC padding bits on the DL RMC.
2. Set the parameters of the bandwidth, MCS, reference channel, the propagation condition, the correlation matrix and the SNR according to Table 8.3.1.2.1_D.5-1 as appropriate.
BCH/CRS/PDCCH/PCFICH are sent on antenna ports 0 and 1 using two Tx antennas, while DRS/ PDSCH for the test UE are sent on antenna ports 7 and 8 using two Tx antennas with beam-forming model as specified in Annex B.4.2 and precoder update granularity specified in Table 8.3.1-1. CSI-RS are sent on antenna ports 15 and 16 using two Tx antennas with mapping according to beam-forming model as specified in Annex B.4.2.
3. Measure the average throughput for a duration sufficient to achieve statistical significance according to Annex G clause G.3. Count the number of NACKs, ACKs and statDTXs on the UL during each test interval and decide pass or fail according to Tables G.3.5 and G.3.6 in Annex G clause G.3.

8.3.1.2.1_D.4.3 Message contents

Message contents are according to TS 36.508 [7] clause 4.6 with the following exceptions:

Table 8.3.1.2.1_D.4.3-1: PDSCH-ConfigDedicated-DEFAULT

Derivation Path: 36.331 clause 6.3.2			
Information Element	Value/remark	Comment	Condition
PDSCH-ConfigDedicated-DEFAULT ::= SEQUENCE {			
p-a	dB0		
}			

Table 8.3.1.2.1_D.4.3-2: *AntennaInfoDedicated-r10*

Derivation Path: 36.331 clause 6.3.2			
Information Element	Value/remark	Comment	Condition
AntennaInfoDedicated-r10 ::= SEQUENCE {			
transmissionMode-r10	tm9-v1020		
codebookSubsetRestriction-r10	Not present	If the UE is configured with <i>transmissionMode</i> tm9, E-UTRAN only configures the field <i>codebookSubsetRestriction</i> if PMI/RI reporting is configured	
}			
ue-TransmitAntennaSelection CHOICE {			
release	NULL		
}			

Table 8.3.1.2.1_D.4.3-3: *CSI-RS-Config*

Derivation Path: 36.331 clause 6.3.2			
Information Element	Value/remark	Comment	Condition
CSI-RS-Config-r10 ::= SEQUENCE {			
csi-RS-r10 CHOICE{			
release			
setup SEQUENCE {			
antennaPortsCount-r10	an2	Parameter represents the number of antenna ports used for transmission of CSI reference signals	
resourceConfig-r10	8	Parameter: CSI reference signal configuration	
subframeConfig-r10	2	$\Delta_{\text{CSI-RS}} = I_{\text{CSI-RS}}$ when CSI-RS SubframeConfig is from 0-4; Parameter: $I_{\text{CSI-RS}}$	
p-C-r10	0	Parameter: P_c which is the assumed ratio of PDSCH EPRE to CSI-RS EPRE when UE derives CSI feedback	
}			
}			
zeroTxPowerCSI-RS-r10 CHOICE{			
release	NULL		
setup SEQUENCE {			
zeroTxPowerResourceConfigList-r10	3	Parameter: <i>ZeroPowerCSI-RS</i>	
zeroTxPowerSubframeConfig-r10	2	Parameter: $I_{\text{CSI-RS}}$	
}			
}			
}			

8.3.1.2.1_D.5 Test requirement

Table 8.3.1.2.1_D.3-1 defines the primary level settings.

The fraction of maximum throughput percentage for the downlink reference measurement channels specified in Annex A clause A.3.3.3.1 for the throughput test shall meet or exceed the specified value in Table 8.3.1.2.1_D.5-1 for the specified SNR including test tolerances for the throughput test.

Table 8.3.1.2.1_D.5-1: Test requirement for CDM-multiplexed DM RS (FRC) with multiple CSI-RS configurations

Test number	Bandwidth and MCS	Reference Channel	OCNG Pattern	Propagation Condition	Correlation Matrix and Antenna Configuration	Reference value		UE Category
						Fraction of Maximum Throughput (%)	SNR (dB)	
1	10 MHz 16QAM 1/2	R.51 FDD	OP.1 FDD	EPA5	2x2 Low	70	14.2	2-8

8.3.2 TDD

The parameters specified in Table 8.3.2-1 are valid for TDD unless otherwise stated.

Table 8.3.2-1: Common Test Parameters for User-specific Reference Symbols

Parameter	Unit	Value
Uplink downlink configuration (Note 1)		1
Special subframe configuration (Note 2)		4
Cyclic prefix		Normal
Cell ID		0
Inter-TTI Distance		1
Number of HARQ processes. All these HARQ processes are used.	Processes	7
Maximum number of HARQ transmission		4
Redundancy version coding sequence		{0,1,2,3} for QPSK and 16QAM {0,0,1,2} for 64QAM
Number of OFDM symbols for PDCCH	OFDM symbols	2
Precoder update granularity		Frequency domain: 1 PRB for Transmission mode 7 & 8, 1 PRG for Transmission mode 9 Time domain: 1 ms
ACK/NACK feedback mode		Multiplexing
Note 1: as specified in Table 4.2-2 in TS 36.211 [8].		
Note 2: as specified in Table 4.2-1 in TS 36.211 [8].		

For all test cases, the SNR is defined as:

$$SNR = \frac{\hat{E}_s^{(1)} + \hat{E}_s^{(2)}}{N_{oc}^{(1)} + N_{oc}^{(2)}}$$

where the superscript indicates the receiver antenna connector. The SNR requirement applies for the UE categories given for each test.

The normative reference for this requirement is TS 36.101 [2] clause 8.3.2.

8.3.2.1 TDD PDSCH Single-layer Spatial Multiplexing Performance (UE-Specific Reference Symbols)

8.3.2.1.1 TDD PDSCH Single-layer Spatial Multiplexing on antenna port 5 (Release 8 and forward)

8.3.2.1.1.1 Test purpose

To verify the UE's ability to receive a predefined test signal, representing a multi-path fading channel that is determined by the SNR with a percentage of the information bit throughput for a specified downlink Reference Measurement Channel (RMC) not falling below a specified value for single-layer transmission on antenna port 5 using user-specific reference signals with full RB or single RB allocation.

8.3.2.1.1.2 Test applicability

This test applies to all types of E-UTRA TDD UE release 8 and forward.

8.3.2.1.1.3 Minimum conformance requirements

The requirements are specified in terms of the percentage of information bit throughput for the downlink reference measurement channels specified in Annex A clause A.3.4.3.1, with the addition of the relevant parameters in Tables 8.3.2-1, 8.3.2.1.1.3-1, and the downlink physical channel setup according to Table C.3.2-1 in Annex C.

Using this configuration the fraction of maximum throughput percentage shall meet or exceed the minimum requirements specified in Tables 8.3.2.1.1.3-2 for the specified SNR.

Table 8.3.2.1.1.3-1: Test Parameters for Testing DRS

parameter	Unit	Test 1	Test 2	Test 3	Test 4	
Downlink power allocation	ρ_A	dB	0	0	0	0
	ρ_B	dB	0 (Note 1)	0 (Note 1)	0 (Note 1)	0 (Note 1)
	σ	dB	0	0	0	0
Cell-specific reference signals	Antenna port 0					
Beamforming model	Annex B.4.1					
N_{oc} at antenna port	dBm/15kHz	-98	-98	-98	-98	
Symbols for unused PRBs		OCNG (Note 2)	OCNG (Note 2)	OCNG (Note 2)	OCNG (Note 2)	
PDSCH transmission mode		7	7	7	7	
Note 1: $P_B = 0$						
Note 2: These physical resource blocks are assigned to an arbitrary number of virtual UEs with one PDSCH per virtual UE; the data transmitted over the OCNG PDSCHs shall be uncorrelated pseudo random data, which is QPSK modulated.						

Table 8.3.2.1.1.3-2: Minimum performance DRS (FRC)

Test number	Bandwidth and MCS	Reference Channel	OCNG Pattern	Propagation Condition	Correlation Matrix and Antenna Configuration	Reference value		UE Category
						Fraction of Maximum Throughput (%)	SNR (dB)	
1	10 MHz QPSK 1/3	R.25 TDD	OP.1 TDD	EPA5	2x2 Low	70	-0.8	1-5
2	10 MHz 16QAM 1/2	R.26 TDD	OP.1 TDD	EPA5	2x2 Low	70	7.0	2-5
3	10 MHz 64QAM 3/4	R.27 TDD	OP.1 TDD	EPA5	2x2 Low	70	17.0	2-5
4	10 MHz 16QAM 1/2	R.28 TDD	OP.1 TDD	EPA5	2x2 Low	30	1.7	1-5

The normative reference for this requirement is TS 36.101 [2] clause 8.3.2.

8.3.2.1.1.4 Test description

8.3.2.1.1.4.1 Initial conditions

Initial conditions are a set of test configurations the UE needs to be tested in and the steps for the SS to take with the UE to reach the correct measurement state.

Configurations of PDSCH and PDCCH before measurement are specified in Annex C.2.

Test Environment: Normal, as defined in TS 36.508 [7] clause 4.1.

Frequencies to be tested: Mid Range, as defined in TS 36.508 [7] clause 4.3.1.2.

Bandwidths to be tested: 10MHz, as defined in TS 36.508 [7] clause 4.3.1.2.

1. Connect the SS, the faders and AWGN noise sources to the UE antenna connectors as shown in TS 36.508 [7] Annex A, Figure A.10 for antenna configuration 2x2.
2. The parameter settings for the cell are set up according to Tables 8.3.2-1 and 8.3.2.1.1.3-1 as appropriate.
3. Downlink signals are initially set up according to Annex C0, C.1 and Annex C.3.2 and uplink signals according to Annex H.1 and H.3.2.
4. Propagation conditions are set according to Annex B.0.
5. Ensure the UE is in State 3A-RF according to TS 36.508 [7] clause 5.2A.2. Message contents are defined in clause 8.3.2.1.1.4.3.

8.3.2.1.1.4.2 Test procedure

1. SS transmits PDSCH via PDCCH DCI format 1 for C_RNTI to transmit the DL RMC according to Tables 8.3.2.1.1.3-1, 8.3.2.1.1.3-2. The SS sends downlink MAC padding bits on the DL RMC.
2. Set the parameters of the bandwidth, MCS, reference channel, the propagation condition, the correlation matrix and the SNR according to Table 8.3.2.1.1.5-1 as appropriate.

BCH/CRS/PDCCH/PCFICH are sent on antenna port 0 using one Tx antenna, while DRS/Dedicated data for the test UE are sent on antenna port 5 using two Tx antennas with beam-forming model as specified in Annex B.4.1 and precoder update granularity specified in Table 8.3.2-1.
3. Measure the average throughput for a duration sufficient to achieve statistical significance according to Annex G clause G.3. Count the number of NACKs, ACKs and statDTXs on the UL during each test interval and decide pass or fail according to Tables G.3.5 and G.3.6 in Annex G clause G.3.
4. Repeat steps from 1 to 3 for each test interval in Tables 8.3.2.1.1.5-1 as appropriate.

8.3.2.1.1.4.3 Message contents

Message contents are according to TS 36.508 [7] clause 4.6 with the following exceptions.

Table 8.3.2.1.1.4.3-1: PhysicalConfigDedicated-DEFAULT: Additional TDD PDSCH DRS performance downlink power allocation test point 1 requirement for Test number 1 - 4

Derivation Path: 36.331 clause 6.3.2			
Information Element	Value/remark	Comment	Condition
PhysicalConfigDedicated-DEFAULT ::= SEQUENCE {			
antennaInfo CHOICE {			
antennaInfoDedicated ::= SEQUENCE {			
transmissionMode	tm7		
ue-TransmitAntennaSelection CHOICE {			
Release	NULL		
}			
}			
}			

8.3.2.1.1.5 Test requirement

Table 8.3.2.1.1.3-1 defines the primary level settings.

The fraction of maximum throughput percentage for the downlink reference measurement channels specified in Annex A clause A.3.4.3.1 for each throughput test shall meet or exceed the specified value in Table 8.3.2.1.1.5-1 for the specified SNR including test tolerances for all throughput tests.

Table 8.3.2.1.1.5-1: Test requirement DRS

Test number	Bandwidth and MCS	Reference Channel	OCNG Pattern	Propagation Condition	Correlation Matrix and Antenna Configuration	Reference value		UE Category
						Fraction of Maximum Throughput (%)	SNR (dB)	
1	10 MHz QPSK 1/3	R.25 TDD	OP.1 TDD	EPA5	2x2 Low	70	0.1	1-5
2	10 MHz 16QAM 1/2	R.26 TDD	OP.1 TDD	EPA5	2x2 Low	70	7.9	2-5
3	10 MHz 64QAM 3/4	R.27 TDD	OP.1 TDD	EPA5	2x2 Low	70	17.9	2-5
4	10 MHz 16QAM 1/2	R.28 TDD	OP.1 TDD	EPA5	2x2 Low	30	2.6	1-5

8.3.2.1.1_1 TDD PDSCH Single-layer Spatial Multiplexing on antenna port 5 (Release 9 and forward)

8.3.2.1.1_1.1 Test purpose

Same test purpose as in clause 8.3.2.1.1.1.

8.3.2.1.1_1.2 Test applicability

This test applies to all types of E-UTRA TDD UE release 9 and forward of UE category 1.

8.3.2.1.1_1.3 Minimum conformance requirements

Same minimum conformance requirements as in clause 8.3.2.1.1.3 with the following exceptions:

- Instead of Table 8.3.2.1.1.3-1 -> use Table 8.3.2.1.1_1.3-1.
- Instead of Table 8.3.2.1.1.3-2 -> use Table 8.3.2.1.1_1.3-2.

Table 8.3.2.1.1_1.3-1: Test Parameters for Testing DRS (Antenna port 5)

Parameter		Unit	Test 1 (Note 4)	Test 2	Test 3	Test 4 (Note 4)
Downlink power allocation	ρ_A	dB	N/A	0	0	NA
	ρ_B	dB		0 (Note 1)	0 (Note 1)	
	σ	dB		0	0	
Cell-specific reference signals		Antenna port 0				
Beamforming model		Annex B.4.1				
N_{oc} at antenna port		dBm/15kHz	N/A	-98	-98	NA
Symbols for unused PRBs			N/A	OCNG (Note 2)	OCNG (Note 2)	N/A
PDSCH transmission mode			N/A	7	7	N/A
Note 1: $P_B = 0$						
Note 2: These physical resource blocks are assigned to an arbitrary number of virtual UEs with one PDSCH per virtual UE; the data transmitted over the OCNG PDSCHs shall be uncorrelated pseudo random data, which is QPSK modulated.						
Note 3: The modulation symbols of the signal under test are mapped onto antenna port 5.						
Note 4: This tests are covered in subclause 8.3.2.1.1						

Table 8.3.2.1.1_1.3-2: Minimum performance DRS (FRC) (Antenna port 5)

Test number	Bandwidth and MCS	Reference Channel	OCNG Pattern	Propagation Condition	Correlation Matrix and Antenna Configuration	Reference value		UE Category
						Fraction of Maximum Throughput (%)	SNR (dB)	
1 (Note 1)	N/A							
2	5MHz 16QAM 1/2	R.26-1 TDD	OP.1 TDD	EPA5	2x2 Low	70	7.0	1
3	10 MHz 64QAM 3/4	R.27-1 TDD	OP.1 TDD	EPA5	2x2 Low	70	17.0	1
4 (Note 1)	N/A							
Note 1: These tests are covered in subclause 8.3.2.1.1								

The normative reference for this requirement is TS 36.101 [2] clause 8.3.2.

8.3.2.1.1_1.4 Test description

Same test description as in clause 8.3.2.1.1.4 with the following exceptions:

- Instead of Table 8.3.2.1.1.3-1 -> use Table 8.3.2.1.1_1.3-1.
- Instead of Table 8.3.2.1.1.3-2 -> use Table 8.3.2.1.1_1.3-2.
- Instead of Table 8.3.2.1.1.5-1 -> use Table 8.3.2.1.1_1.5-1.

8.3.2.1.1_1.5 Test requirement

Same test requirement as in clause 8.3.2.1.1.5 with the following exceptions:

- Instead of Table 8.3.2.1.1.3-1 -> use Table 8.3.2.1.1_1.3-1.
- Instead of Table 8.3.2.1.1.5-1 -> use Table 8.3.2.1.1_1.5-1.

Table 8.3.2.1.1_1.5-1: Test requirement DRS (FRC) (Antenna port 5)

Test number	Bandwidth and MCS	Reference Channel	OCNG Pattern	Propagation Condition	Correlation Matrix and Antenna Configuration	Reference value		UE Category
						Fraction of Maximum Throughput (%)	SNR (dB)	
1 (Note 1)	N/A							
2	5MHz 16QAM 1/2	R.26-1 TDD	OP.1 TDD	EPA5	2x2 Low	70	7.9	1
3	10 MHz 64QAM 3/4	R.27-1 TDD	OP.1 TDD	EPA5	2x2 Low	70	17.9	1
4 (Note 1)	N/A							
Note 1:	These tests are covered in subclause 8.3.2.1.1							

8.3.2.1.2 TDD PDSCH Single-layer Spatial Multiplexing on antenna port 7 or 8 without a simultaneous transmission

8.3.2.1.2.1 Test purpose

To verify the UE's ability to receive a predefined test signal, representing a multi-path fading channel that is determined by the SNR with a percentage of the information bit throughput for a specified downlink Reference Measurement Channel (RMC) not falling below a specified value for single-layer transmission on antenna port 7 or 8 without a simultaneous transmission on the other antenna port using DM-RS with full RB allocation.

8.3.2.1.2.2 Test applicability

This test applies to Release 9 UEs that support enhanced Dual Layer TDD (TM8) and all types of E-UTRATDD UE release 10 and forward.

8.3.2.1.2.3 Minimum conformance requirements

The requirements are specified in terms of the percentage of information bit throughput for the downlink reference measurement channels specified in Annex A clause A.3.4.3.2, with the addition of the relevant parameters in Tables 8.3.2-1, 8.3.2.1.2.3-1, and the downlink physical channel setup according to Table C.3.2-1 in Annex C.

Using this configuration the fraction of maximum throughput percentage shall meet or exceed the minimum requirements specified in Tables 8.3.2.1.2.3-2 for the specified SNR.

Table 8.3.2.1.2.3-1: Test Parameters for Testing CDM-multiplexed DM RS (single layer)

parameter		Unit	Test 1	Test 2	Test 3	Test 4 (Note 3)	Test 5 (Note 3)
Downlink power allocation	ρ_A	dB	0	0	0	N/A	N/A
	ρ_B	dB	0 (Note 1)	0 (Note 1)	0 (Note 1)	N/A	N/A
	σ	dB	-3	-3	-3		
Cell-specific reference signals			Antenna port 0 and antenna port 1				
N_{oc} at antenna port		dBm/15kHz	-98	-98	-98	N/A	N/A
Symbols for unused PRBs			OCNG (Note 4)	OCNG (Note 4)	OCNG (Note 4)	N/A	N/A
Simultaneous transmission			No	No	No	N/A	N/A
Note 1: $P_B = 1$ Note 2: The modulation symbols of the signal under test are mapped onto antenna port 7 or 8. Note 3: Test 4 and Test 5 are covered in subclause 8.3.2.1.3. Note 4: These physical resource blocks are assigned to an arbitrary number of virtual UEs with one PDSCH per virtual UE; the data transmitted over the OCNG PDSCHs shall be uncorrelated pseudo random data, which is QPSK modulated.							

Table 8.3.2.1.2.3-2: Minimum performance for CDM-multiplexed DM RS without simultaneous transmission (FRC)

Test number	Bandwidth and MCS	Reference Channel	OCNG Pattern	Propagation Condition	Correlation Matrix and Antenna Configuration	Reference value		UE Category
						Fraction of Maximum Throughput (%)	SNR (dB)	
1	10 MHz QPSK 1/3	R.31 TDD	OP.1 TDD	EVA5	2x2 Low	70	-1.0	1-5
2	10 MHz 16QAM 1/2	R.32 TDD	OP.1 TDD	EPA5	2x2 Medium	70	7.7	2-5
	5MHz 16QAM 1/2	R.32-1 TDD	OP.1 TDD	EPA5	2x2 Medium	70	7.7	1
3	10 MHz 64QAM 3/4	R.33 TDD	OP.1 TDD	EPA5	2x2 Low	70	17.7	2-5
	10 MHz 64QAM 3/4	R.33-1 TDD	OP.1 TDD	EPA5	2x2 Low	70	17.7	1

The normative reference for this requirement is TS 36.101 [2] clause 8.3.2.

8.3.2.1.2.4 Test description

8.3.2.1.2.4.1 Initial conditions

Initial conditions are a set of test configurations the UE needs to be tested in and the steps for the SS to take with the UE to reach the correct measurement state.

Configurations of PDSCH and PDCCH before measurement are specified in Annex C.2.

Test Environment: Normal, as defined in TS 36.508 [7] clause 4.1.

Frequencies to be tested: Mid Range, as defined in TS 36.508 [7] clause 4.3.1.2.

Bandwidths to be tested: 10MHz, as defined in TS 36.508 [7] clause 4.3.1.2.

1. Connect the SS, the faders and AWGN noise sources to the UE antenna connectors as shown in TS 36.508 [7] Annex A, Figure A.10.
2. The parameter settings for the cell are set up according to Tables 8.3.2-1 and 8.3.2.1.2.3-1 as appropriate.
3. Downlink signals are initially set up according to Annex C0, C.1 and Annex C.3.2 and uplink signals according to Annex H.1 and H.3.2.

4. Propagation conditions are set according to Annex B.0.
5. Ensure the UE is in State 3A-RF according to TS 36.508 [7] clause 5.2A.2. Message contents are defined in clause 8.3.2.1.2.4.3.

8.3.2.1.2.4.2 Test procedure

1. SS transmits PDSCH via PDCCH DCI format 2B for C_RNTI to transmit the DL RMC according to Tables 8.3.2.1.2.3-1, 8.3.2.1.2.3-2. The SS sends downlink MAC padding bits on the DL RMC.
2. Set the parameters of the bandwidth, MCS, reference channel, the propagation condition, the correlation matrix and the SNR according to Table 8.3.2.1.2.5-1 as appropriate.
BCH/CRS/PDCCH/PCFICH are sent on antenna ports 0 and 1 using two Tx antennas, while DRS/Dedicated data for the test UE are sent on antenna port 7 (or 8) using two Tx antennas with beam-forming model as specified in Annex B.4.1 and precoder update granularity specified in Table 8.3.2-1.
3. Measure the average throughput for a duration sufficient to achieve statistical significance according to Annex G clause G.3. Count the number of NACKs, ACKs and statDTXs on the UL during each test interval and decide pass or fail according to Tables G.3.5 and G.3.6 in Annex G clause G.3.
4. Repeat steps from 1 to 3 for each test interval in Tables 8.3.2.1.2.5-1 as appropriate.

8.3.2.1.2.4.3 Message contents

Message contents are according to TS 36.508 [7] clause 4.6 with the following exceptions.

Table 8.3.2.1.2.4.3-1: PhysicalConfigDedicated-DEFAULT

Derivation Path: 36.331 clause 6.3.2			
Information Element	Value/remark	Comment	Condition
PhysicalConfigDedicated-DEFAULT ::= SEQUENCE {			
antennaInfo CHOICE {			
antennaInfoDedicated ::= SEQUENCE {			
transmissionMode	tm8-v920		
}			
}			
Extension ::= SEQUENCE {			
antennaInfo-v920 ::= SEQUENCE {			
codebookSubsetRestriction-v920 CHOICE {			
n2TxAntenna-tm8-r9	111111		
}			
}			
}			
}			

8.3.2.1.2.5 Test requirement

Table 8.3.2.1.2.3-1 defines the primary level settings.

The fraction of maximum throughput percentage for the downlink reference measurement channels specified in Annex A clause A.3.4.3.2 for each throughput test shall meet or exceed the specified value in Table 8.3.2.1.2.5-1 for the specified SNR including test tolerances for all throughput tests.

Table 8.3.2.1.2.5-1: Test requirement for CDM-multiplexed DM RS without simultaneous transmission (FRC)

Test number	Bandwidth and MCS	Reference Channel	OCNG Pattern	Propagation Condition	Correlation Matrix and Antenna Configuration	Reference value		UE Category
						Fraction of Maximum Throughput (%)	SNR (dB)	
1	10 MHz QPSK 1/3	R.31 TDD	OP.1 TDD	EVA5	2x2 Low	70	-0.1	1-5
2	10 MHz 16QAM 1/2	R.32 TDD	OP.1 TDD	EPA5	2x2 Medium	70	8.6	2-5
	5 MHz 16QAM 1/2	R.32-1 TDD	OP.1 TDD	EPA5	2x2 Medium	70	8.6	1
3	10 MHz 64QAM 3/4	R.33 TDD	OP.1 TDD	EPA5	2x2 Low	70	18.6	2-5
	10 MHz 64QAM 3/4	R.33-1 TDD	OP.1 TDD	EPA5	2x2 Low	70	18.6	1

8.3.2.1.2_D TDD PDSCH Single-layer Spatial Multiplexing on antenna ports 7 or 8 without a simultaneous transmission for eDL-MIMO

8.3.2.1.2_D.1 Test purpose

To verify the UE's ability to receive a predefined test signal, representing a multi-path fading channel that is determined by the SNR with a percentage of the information bit throughput for a specified downlink Reference Measurement Channel (RMC) not falling below a specified value for single-layer transmission on antenna ports 7 or 8 without a simultaneous transmission on the other antenna port and multiple CSI reference symbol configurations with non-zero and zero transmission power.

8.3.2.1.2_D.2 Test applicability

This test applies to all types of E-UTRA TDD UE release 10 and forward that support eDL-MIMO. Applicability requires support for FGI bit 104.

8.3.2.1.2_D.3 Minimum conformance requirements

The requirements are specified in terms of the percentage of information bit throughput for the downlink reference measurement channels specified in Annex A clause A.3.4.3.5, with the addition of the relevant parameters in Tables 8.3.2-1, 8.3.2.1.2_D.3-1, and the downlink physical channel setup according to Table C.3.2-1 in Annex C.3.2.

Using this configuration the fraction of maximum throughput percentage shall meet or exceed the minimum requirements specified in Table 8.3.2.1.2_D.3-2 for the specified SNR.

Table 8.3.2.1.2_D.3-1: Test Parameters for Testing CDM-multiplexed DM RS (single layer) with multiple CSI-RS configurations

Table 8.3.2.1.2_D.3-2: Minimum performance for CDM-multiplexed DM RS without simultaneous transmission (FRC) with multiple CSI-RS configurations

The normative reference for this requirement is TS 36.101 [2] clause 8.3.2.1A.

8.3.2.1.2_D.4 Test description

Parameter	Unit	Test 1	Test 2				
Downlink power allocation	ρ_A	0	0				
	ρ_B	0 (Note 1)	0 (Note 1)				
	σ	-3	-3				
Cell-specific reference signals		Antenna ports 0,1					
CSI reference signals		Antenna ports 15,...,22	Antenna ports 15,...,18				
Beamforming model		Annex B.4.1	Annex B.4.1				
CSI-RS periodicity and subframe offset	Subframes	5 / 4	5 / 4				
$T_{CSI-RS} / \Delta_{CSI-RS}$							
CSI reference signal configuration		1	3				
Zero-power CSI-RS configuration	Subframes / bitmap	4 / 0010000100000000	4 / 0010000000000000				
Test Bandwidth	Reference Channel	OCNG Pattern	Propagation Condition	Correlation Matrix and Antenna Configuration	Reference value	SNR	UE Category
Zero-power CSI-RS bitmap	OCNG	OCNG (Note 4)	OCNG (Note 4)	OCNG (Note 4)	Fraction of Maximum Throughput (%)	(dB)	
N_{oc} at antenna port	dBm/15kHz	-98	-98	2x2 Low	70	-0.6	1-8
Symbols for unused PRBs	10 MHz	R.50 TDD	OP.1 TDD	EVA5	50		
Number of allocated resource blocks (Note 2)	QPSK 1/3			50			
Simultaneous transmission		No		Yes			
PDSCH transmission mode		9		9			

Note 1: $P_B = 1$.

Note 2: The modulation symbols of the signal under test are mapped onto antenna port 7 or 8.

Note 3: Modulation symbols of an interference signal is mapped onto the antenna port (7 or 8) not used for the input signal under test.

Note 4: These physical resource blocks are assigned to an arbitrary number of virtual UEs with one PDSCH per virtual UE; the data transmitted over the OCNG PDSCHs shall be uncorrelated pseudo random data, which is QPSK modulated.

Note 5: The two UEs' scrambling identities n_{SCID} are set to 0 for CDM-multiplexed DM RS with interfering simultaneous transmission test cases.

8.3.2.1.2_D.4.1 Initial conditions

Initial conditions are a set of test configurations the UE needs to be tested in and the steps for the SS to take with the UE to reach the correct measurement state.

Configurations of PDSCH and PDCCH before measurement are specified in Annex C.2.

Test Environment: Normal, as defined in TS 36.508 [7] clause 4.1.

Frequencies to be tested: Mid Range, as defined in TS 36.508 [7] clause 4.3.1.2.

Bandwidths to be tested: 10MHz, as defined in TS 36.508 [7] clause 4.3.1.2.

1. Connect the SS, the faders and AWGN noise sources to the UE antenna connectors as shown in TS 36.508 [7] Annex A, Figure A. 10.
2. The parameter settings for the cell are set up according to Tables 8.3.2-1 and 8.3.2.1.2_D.3-1 as appropriate.
3. Downlink signals are initially set up according to Annex C0, C.1 and Annex C.3.2 and uplink signals according to Annex H.1 and H.3.2.
4. Propagation conditions are set according to Annex B.0.
5. Ensure the UE is in State 3A-RF according to TS 36.508 [7] clause 5.2A.2. Message contents are defined in clause 8.3.2.1.2_D.4.3.

8.3.2.1.2_D.4.2 Test procedure

1. SS transmits PDSCH via PDCCH DCI format 2C for C_RNTI to transmit the DL RMC according to Tables 8.3.2.1.2_D.3-1, 8.3.2.1.2_D.3-2. The SS sends downlink MAC padding bits on the DL RMC.
2. Set the parameters of the bandwidth, MCS, reference channel, the propagation condition, the correlation matrix and the SNR according to Table 8.3.2.1.2_D.5-1 as appropriate.
BCH/CRS/PDCCH/PCFICH are sent on antenna ports 0 and 1 using two Tx antennas, while DRS/ PDSCH for the test UE are sent on antenna port 7 (or 8) using two Tx antennas with beam-forming model as specified in Annex B.4.1 and precoder update granularity specified in Table 8.3.2-1. CSI-RS are sent on antenna ports 15-22 using two Tx antennas with mapping according to beam-forming model as specified in Annex B.4.1.
3. Measure the average throughput for a duration sufficient to achieve statistical significance according to Annex G clause G.3. Count the number of NACKs, ACKs and statDTXs on the UL during each test interval and decide pass or fail according to Tables G.3.5 and G.3.6 in Annex G clause G.3.

8.3.2.1.2_D.4.3 Message contents

Message contents are according to TS 36.508 [7] clause 4.6 with the following exceptions:

Table 8.3.2.1.2_D.4.3-1: PDSCH-ConfigDedicated-DEFAULT

Derivation Path: 36.331 clause 6.3.2			
Information Element	Value/remark	Comment	Condition
PDSCH-ConfigDedicated-DEFAULT ::= SEQUENCE {			
p-a	dB0		
}			

Table 8.3.2.1.2_D.4.3-2: AntennaInfoDedicated-r10

Derivation Path: 36.331 clause 6.3.2			
Information Element	Value/remark	Comment	Condition
AntennaInfoDedicated-r10 ::= SEQUENCE {			
transmissionMode-r10	tm9-v1020		
codebookSubsetRestriction-r10	Not present	If the UE is configured with <i>transmissionMode</i> tm9, E-UTRAN only configures the field <i>codebookSubsetRestriction</i> if PMI/RI reporting is configured	
}			
ue-TransmitAntennaSelection CHOICE {			
release	NULL		
}			

Table 8.3.2.1.2_D.4.3-3: CSI-RS-Config

Derivation Path: 36.331 clause 6.3.2			
Information Element	Value/remark	Comment	Condition
CSI-RS-Config-r10 ::= SEQUENCE {			
csi-RS-r10 CHOICE{			
release			
setup SEQUENCE {			
antennaPortsCount-r10	an8 for Test 1 an4 for Test 2	Parameter represents the number of antenna ports used for transmission of CSI reference signals	
resourceConfig-r10	1 for Test 1 3 for Test 2	Parameter: CSI reference signal configuration	
subframeConfig-r10	4	$\Delta_{\text{CSI-RS}} = I_{\text{CSI-RS}}$ when CSI-RS SubframeConfig is from 0-4; Parameter: $I_{\text{CSI-RS}}$	
p-C-r10	-6 dB for Test 1 -3 dB for Test 2	Parameter: P_c which is the assumed ratio of PDSCH EPRE to CSI-RS EPRE when UE derives CSI feedback	
}			
}			
zeroTxPowerCSI-RS-r10 CHOICE{			
release	NULL		
setup SEQUENCE {			
zeroTxPowerResourceConfigList-r10	4	Parameter: <i>ZeroPowerCSI-RS</i>	
zeroTxPowerSubframeConfig-r10	4	Parameter: $I_{\text{CSI-RS}}$	
}			
}			
}			

8.3.2.1.2_D.5 Test requirement

Table 8.3.2.1.2_D.3-1 defines the primary level settings.

The fraction of maximum throughput percentage for the downlink reference measurement channels specified in Annex A clause A.3.4.3.5 for the throughput test shall meet or exceed the specified value in Table 8.3.2.1.2_D.5-1 for the specified SNR including test tolerances for the throughput test.

Table 8.3.2.1.2_D.5-1: Test requirement for CDM-multiplexed DM RS without simultaneous transmission (FRC) with multiple CSI-RS configurations

Test number	Bandwidth and MCS	Reference Channel	OCNG Pattern	Propagation Condition	Correlation Matrix and Antenna Configuration	Reference value		UE Category
						Fraction of Maximum Throughput (%)	SNR (dB)	
1	10 MHz QPSK 1/3	R.50 TDD	OP.1 TDD	EVA5	2x2 Low	70	0.3	1-8

8.3.2.1.3 TDD PDSCH Single-layer Spatial Multiplexing on antenna port 7 or 8 with a simultaneous transmission

8.3.2.1.3.1 Test purpose

To verify the UE's ability to receive a predefined test signal, representing a multi-path fading channel that is determined by the SNR with a percentage of the information bit throughput for a specified downlink Reference Measurement Channel (RMC) not falling below a specified value for single-layer transmission on antenna port 7 or 8 with a simultaneous transmission on the other antenna port using DM-RS with full RB allocation.

8.3.2.1.3.2 Test applicability

This test applies to Release9 UEs that support enhanced Dual Layer TDD (TM8) and all types of E-UTRA TDD UE release 10 and forward.

8.3.2.1.3.3 Minimum conformance requirements

The requirements are specified in terms of the percentage of information bit throughput for the downlink reference measurement channels specified in Annex A clause A.3.4.3.2, with the addition of the relevant parameters in Tables 8.3.2-1, 8.3.2.1.3.3-1, and the downlink physical channel setup according to Table C.3.2-1 in Annex C.

Using this configuration the fraction of maximum throughput percentage shall meet or exceed the minimum requirements specified in Tables 8.3.2.1.3.3-2 for the specified SNR.

Table 8.3.2.1.3.3-1: Test Parameters for Testing CDM-multiplexed DM RS (single layer)

parameter	Unit	Test 1 (Note 6)	Test 2 (Note 6)	Test 3 (Note 6)	Test 4	Test 5	
Downlink power allocation	ρ_A	dB	N/A	N/A	N/A	0	0
	ρ_B	dB	N/A	N/A	N/A	0 (Note 1)	0 (Note 1)
	σ	dB	N/A	N/A	N/A	-3	-3
Cell-specific reference signals		Antenna port 0 and antenna port 1					
Beamforming model		Annex B.4.1					
N_{oc} at antenna port	dBm/15kHz	N/A	N/A	N/A	-98	-98	
Symbols for unused PRBs		N/A	N/A	N/A	OCNG (Note 4)	OCNG (Note 4)	
Simultaneous transmission		N/A	N/A	N/A	Yes (Note 3, 5)	Yes (Note 3, 5)	
PDSCH transmission mode		N/A	N/A	N/A	8	8	
Note 1: $P_B = 1$ Note 2: The modulation symbols of the signal under test are mapped onto antenna port 7 or 8. Note 3: Modulation symbols of an interference signal is mapped onto the antenna port (7 or 8) not used for the input signal under test. Note 4: These physical resource blocks are assigned to an arbitrary number of virtual UEs with one PDSCH per virtual UE; the data transmitted over the OCNG PDSCHs shall be uncorrelated pseudo random data, which is QPSK modulated. Note 5: The two UEs' scrambling identities n_{SCID} are set to 0 for CDM-multiplexed DM RS with interfering simultaneous transmission test cases. Note 6: Test 1, Test 2 and Test 3 are covered in subclause 8.3.2.1.2.							

Table 8.3.2.1.3.3-2: Minimum performance for CDM-multiplexed DM RS with interfering simultaneous transmission (FRC)

Test number	Bandwidth and MCS	Reference Channel	OCNG Pattern	Propagation Condition	Correlation Matrix and Antenna Configuration	Reference value		UE Category
						Fraction of Maximum Throughput (%)	SNR (dB)	
4	10 MHz 16QAM 1/2	R.32 TDD (Note 1)	OP.1 TDD	EPA5	2x2 Medium	70	21.9	2-5
5	10 MHz 64QAM 1/2	R.34 TDD (Note 1)	OP.1 TDD	EPA5	2x2 Low	70	22.0	2-5

Note 1: The reference channel applies to both the input signal under test and the interfering signal.

The normative reference for this requirement is TS 36.101 [2] clause 8.3.2.

8.3.2.1.3.4 Test description

8.3.2.1.3.4.1 Initial conditions

Initial conditions are a set of test configurations the UE needs to be tested in and the steps for the SS to take with the UE to reach the correct measurement state.

Configurations of PDSCH and PDCCH before measurement are specified in Annex C.2.

Test Environment: Normal, as defined in TS 36.508 [7] clause 4.1.

Frequencies to be tested: Mid Range, as defined in TS 36.508 [7] clause 4.3.1.2.

Bandwidths to be tested: 10MHz, as defined in TS 36.508 [7] clause 4.3.1.2.

1. Connect the SS, the faders and AWGN noise sources to the UE antenna connectors as shown in TS 36.508 [7] Annex A, Figure A.10.
2. The parameter settings for the cell are set up according to Tables 8.3.2-1 and 8.3.2.1.3.3-1 as appropriate.
3. Downlink signals are initially set up according to Annex C0, C.1 and Annex C.3.2 and uplink signals according to Annex H.1 and H.3.2.
4. Propagation conditions are set according to Annex B.0.
5. Ensure the UE is in State 3A-RF according to TS 36.508 [7] clause 5.2A.2. Message contents are defined in clause 8.3.2.1.3.4.3.

8.3.2.1.3.4.2 Test procedure

1. SS transmits PDSCH via PDCCH DCI format 2B for C_RNTI to transmit the DL RMC according to Tables 8.3.2.1.3.3-1, 8.3.2.1.3.3-2. The SS sends downlink MAC padding bits on the DL RMC.
2. Set the parameters of the bandwidth, MCS, reference channel, the propagation condition, the correlation matrix and the SNR according to Table 8.3.2.1.3.5-1 as appropriate.
BCH/CRS/PDCCH/PCFICH are sent on antenna ports 0 and 1 using two Tx antennas, while DRS/Dedicated data for the test UE are sent on antenna port 7 (or 8) and another simultaneous transmission of DRS/Dedicated data not for the test UE is sent on antenna port 8 (or 7). The DRS/Dedicated data transmissions use two Tx antennas with different beam-forming model as specified in Annex B.4.1 and precoder update granularity specified in Table 8.3.2-1.
3. Measure the average throughput for a duration sufficient to achieve statistical significance according to Annex G clause G.3. Count the number of NACKs, ACKs and statDTXs on the UL during each test interval and decide pass or fail according to Tables G.3.5 and G.3.6 in Annex G clause G.3.
4. Repeat steps from 1 to 3 for each test interval in Tables 8.3.2.1.3.5-1 as appropriate.

8.3.2.1.3.4.3 Message contents

Message contents are according to TS 36.508 [7] clause 4.6 with the following exceptions.

Table 8.3.2.1.3.4.3-1: PhysicalConfigDedicated-DEFAULT

Derivation Path: 36.331 clause 6.3.2			
Information Element	Value/remark	Comment	Condition
PhysicalConfigDedicated-DEFAULT ::= SEQUENCE {			
antennaInfo CHOICE {			
antennaInfoDedicated ::= SEQUENCE {			
transmissionMode	tm8-v920		
}			
}			
Extension ::= SEQUENCE {			
antennaInfo-v920 ::= SEQUENCE{			
codebookSubsetRestriction-v920 CHOICE {			
n2TxAntenna-tm8-r9	111111		
}			
}			
}			
}			

8.3.2.1.3.5 Test requirement

Table 8.3.2.1.3.3-1 defines the primary level settings.

The fraction of maximum throughput percentage for the downlink reference measurement channels specified in Annex A clause A.3.4.3.2 for each throughput test shall meet or exceed the specified value in Table 8.3.2.1.3.5-1 for the specified SNR including test tolerances for all throughput tests.

Table 8.3.2.1.3.5-1: Test requirement for CDM-multiplexed DM RS with interfering simultaneous transmission (FRC)

Test number	Bandwidth and MCS	Reference Channel	OCNG Pattern	Propagation Condition	Correlation Matrix and Antenna Configuration	Reference value		UE Category
						Fraction of Maximum Throughput (%)	SNR (dB)	
4	10 MHz 16QAM 1/2	R.32 TDD (Note 1)	OP.1 TDD	EPA5	2x2 Medium	70	22.8	2-5
5	10 MHz 64QAM 1/2	R.34 TDD (Note 1)	OP.1 TDD	EPA5	2x2 Low	70	22.9	2-5

Note 1: The reference channel applies to both the input signal under test and the interfering signal.

8.3.2.1.3_D TDD PDSCH Single-layer Spatial Multiplexing on antenna ports 7 or 8 with a simultaneous transmission for eDL-MIMO

8.3.2.1.3_D.1 Test purpose

To verify the UE's ability to receive a predefined test signal, representing a multi-path fading channel that is determined by the SNR with a percentage of the information bit throughput for a specified downlink Reference Measurement Channel (RMC) not falling below a specified value for single-layer transmission on antenna ports 7 or 8 with a simultaneous transmission on the other antenna port and multiple CSI reference symbol configurations with non-zero and zero transmission power.

8.3.2.1.3_D.2 Test applicability

This test applies to all types of E-UTRA TDD UE release 10 and forward that support eDL-MIMO. Applicability requires support for FGI bit 103.

8.3.2.1.3_D.3 Minimum conformance requirements

The requirements are specified in terms of the percentage of information bit throughput for the downlink reference measurement channels specified in Annex A clause A.3.4.3.5, with the addition of the relevant parameters in Tables 8.3.2-1, 8.3.2.1.3_D.3-1, and the downlink physical channel setup according to Table C.3.2-1 in Annex C.3.2.

Using this configuration the fraction of maximum throughput percentage shall meet or exceed the minimum requirements specified in Table 8.3.2.1.3_D.3-2 for the specified SNR.

Parameter	Unit	Test 1	Test 2	Reference value	UE Category
Downlink power allocation	ρ_A dB	0	0		
	ρ_B dB	0 (Note 1)	0 (Note 1)		
	σ dB	-3	-3		
Cell-specific reference signals		Antenna ports 0,1			
CSI reference signals		Antenna ports 15,...,22	Antenna ports 15,...,18		
Beamforming model		Annex B.4.1	Annex B.4.1		
CSI-RS periodicity and subframe offset	Subframes	5 / 4	5 / 4		
CSI reference signal configuration		1	3		
Zero-power CSI-RS	Subframes	4 /	4 /		
Test configuration and MCS	Reference Channel	OCNG 001000000000	OCNG 000000000000		
Zero-power CSI-RS bitmap	OCNG	001000000000	000000000000		
N_{oc} at antenna port	dBm/15kHz	-98	-98		
Symbols for unused PRBs	R.44 TDD	OP.1 TDD	OCNG (Note 4)	OCNG (Note 4)	
Number of allocated resource blocks (Note 2)	PRB	50	50		
Simultaneous transmission		No	Yes		
PDSCH transmission mode		9	9		

Note 1: $P_B = 1$.

Note 2: The modulation symbols of the signal under test are mapped onto antenna port 7 or 8.

Note 3: Modulation symbols of an interference signal is mapped onto the antenna port (7 or 8) not used for the input signal under test.

Note 4: These physical resource blocks are assigned to an arbitrary number of virtual UEs with one PDSCH per virtual UE; the data transmitted over the OCNG PDSCHs shall be uncorrelated pseudo random data, which is QPSK modulated.

Note 5: The two UEs' scrambling identities n_{SCID} are set to 0 for CDM-multiplexed DM RS with interfering simultaneous transmission test cases.

Table 8.3.2.1.3_D.3-1: Test Parameters for Testing CDM-multiplexed DM RS (single layer) with multiple CSI-RS configurations

Table 8.3.2.1.3_D.3-2: Minimum performance for CDM-multiplexed DM RS with interfering simultaneous transmission (FRC) with multiple CSI-RS configurations

The normative reference for this requirement is TS 36.101 [2] clause 8.3.2.1A.

8.3.2.1.3_D.4 Test description

8.3.2.1.3_D.4.1 Initial conditions

Initial conditions are a set of test configurations the UE needs to be tested in and the steps for the SS to take with the UE to reach the correct measurement state.

Configurations of PDSCH and PDCCH before measurement are specified in Annex C.2.

Test Environment: Normal, as defined in TS 36.508 [7] clause 4.1.

Frequencies to be tested: Mid Range, as defined in TS 36.508 [7] clause 4.3.1.2.

Bandwidths to be tested: 10MHz, as defined in TS 36.508 [7] clause 4.3.1.2.

1. Connect the SS, the faders and AWGN noise sources to the UE antenna connectors as shown in TS 36.508 [7] Annex A, Figure A. 10.
2. The parameter settings for the cell are set up according to Tables 8.3.2-1 and 8.3.2.1.3_D.3-1 as appropriate.
3. Downlink signals are initially set up according to Annex C0, C.1 and Annex C.3.2 and uplink signals according to Annex H.1 and H.3.2.
4. Propagation conditions are set according to Annex B.0.
5. Ensure the UE is in State 3A-RF according to TS 36.508 [7] clause 5.2A.2. Message contents are defined in clause 8.3.2.1.3_D.4.3.

8.3.2.1.3_D.4.2 Test procedure

1. SS transmits PDSCH via PDCCH DCI format 2C for C_RNTI to transmit the DL RMC according to Tables 8.3.2.1.3_D.3-1, 8.3.2.1.3_D.3-2. The SS sends downlink MAC padding bits on the DL RMC.
2. Set the parameters of the bandwidth, MCS, reference channel, the propagation condition, the correlation matrix and the SNR according to Table 8.3.2.1.3_D.5-1 as appropriate.
BCH/CRS/PDCCH/PCFICH are sent on antenna ports 0 and 1 using two Tx antennas, while DRS/ PDSCH for the test UE are sent on antenna port 7 (or 8) and another simultaneous transmission of DRS/PDSCH not for the test UE are sent on antenna port 8 (or 7). The DRS/PDSCH transmissions use two Tx antennas with beam-forming model as specified in Annex B.4.1 and precoder update granularity specified in Table 8.3.2-1. CSI-RS are sent on antenna ports 15-18 using two Tx antennas with mapping according to beam-forming model as specified in Annex B.4.1.
3. Measure the average throughput for a duration sufficient to achieve statistical significance according to Annex G clause G.3. Count the number of NACKs, ACKs and statDTXs on the UL during each test interval and decide pass or fail according to Tables G.3.5 and G.3.6 in Annex G clause G.3.

8.3.2.1.3_D.4.3 Message contents

Message contents are according to TS 36.508 [7] clause 4.6 with the following exceptions:

Table 8.3.2.1.3_D.4.3-1: PDSCH-ConfigDedicated-DEFAULT

Derivation Path: 36.331 clause 6.3.2			
Information Element	Value/remark	Comment	Condition
PDSCH-ConfigDedicated-DEFAULT ::= SEQUENCE {			
p-a	dB0		
}			

Table 8.3.2.1.3_D.4.3-2: *AntennaInfoDedicated-r10*

Derivation Path: 36.331 clause 6.3.2			
Information Element	Value/remark	Comment	Condition
AntennaInfoDedicated-r10 ::= SEQUENCE {			
transmissionMode-r10	tm9-v1020		
codebookSubsetRestriction-r10	Not present	If the UE is configured with <i>transmissionMode</i> tm9, E-UTRAN only configures the field <i>codebookSubsetRestriction</i> if PMI/RI reporting is configured	
}			
ue-TransmitAntennaSelection CHOICE {			
release	NULL		
}			

Table 8.3.2.1.3_D.4.3-3: *CSI-RS-Config*

Derivation Path: 36.331 clause 6.3.2			
Information Element	Value/remark	Comment	Condition
CSI-RS-Config-r10 ::= SEQUENCE {			
csi-RS-r10 CHOICE{			
release			
setup SEQUENCE {			
antennaPortsCount-r10	an8 for Test 1 an4 for Test 2	Parameter represents the number of antenna ports used for transmission of CSI reference signals	
resourceConfig-r10	1 for Test 1 3 for Test 2	Parameter: CSI reference signal configuration	
subframeConfig-r10	4	$\Delta_{\text{CSI-RS}} = I_{\text{CSI-RS}}$ when CSI-RS SubframeConfig is from 0-4; Parameter: $I_{\text{CSI-RS}}$	
p-C-r10	-6 dB for Test 1 -3 dB for Test 2	Parameter: P_c which is the assumed ratio of PDSCH EPRE to CSI-RS EPRE when UE derives CSI feedback	
}			
}			
zeroTxPowerCSI-RS-r10 CHOICE{			
release	NULL		
setup SEQUENCE {			
zeroTxPowerResourceConfigList-r10	4	Parameter: <i>ZeroPowerCSI-RS</i>	
zeroTxPowerSubframeConfig-r10	4	Parameter: $I_{\text{CSI-RS}}$	
}			
}			
}			

8.3.2.1.3_D.5 Test requirement

Table 8.3.2.1.3_D.3-1 defines the primary level settings.

The fraction of maximum throughput percentage for the downlink reference measurement channels specified in Annex A clause A.3.4.3.4 for the throughput test shall meet or exceed the specified value in Table 8.3.2.1.3_D.5-1 for the specified SNR including test tolerances for the throughput test.

Table 8.3.2.1.3_D.5-1: Test requirement for CDM-multiplexed DM RS with interfering simultaneous transmission (FRC) with multiple CSI-RS configurations

Test number	Bandwidth and MCS	Reference Channel	OCNG Pattern	Propagation Condition	Correlation Matrix and Antenna Configuration	Reference value		UE Category
						Fraction of Maximum Throughput (%)	SNR (dB)	
2	10 MHz 64QAM 1/2	R.44 TDD	OP.1 TDD	EPA5	2x2 Low	70	23	2-8

Note 1: The reference channel applies to both the input signal under test and the interfering signal.

8.3.2.1.4 TDD PDSCH Single-layer Spatial Multiplexing on antenna ports 7 or 8 with TM9 Interference Model - Enhanced Performance Requirement Type A

Editor's notes: This test case is incomplete. The following item is missing or incomplete:

-Test tolerances are incomplete

-Connection diagram is TBD

8.3.2.1.4.1 Test purpose

To verify the UE's ability to receive a predefined test signal, representing a multi-path fading channel that is determined by the SNR with a percentage of the information bit throughput for a specified downlink Reference Measurement Channel (RMC) not falling below a specified value for single-layer transmission on antenna ports 7 or 8 without a simultaneous transmission on the other antenna port in the serving cell when the PDSCH transmission in the serving cell is interfered by PDSCH of one dominant interfering cell applying transmission mode 9 interference model defined in clause B.5.4.

8.3.2.1.4.2 Test applicability

This test applies to all types of E-UTRA FDD UE release 11 and forward that support enhanced receiver Type A.

8.3.2.1.4.3 Minimum conformance requirements

The requirements are specified in terms of the percentage of information bit throughput for the downlink reference measurement channels specified in Annex A clause A.3.4.3, with the addition of the relevant parameters in Tables 8.3.2-1, 8.3.2.1.4.3-1, and the downlink physical channel setup according to Table C.3.2-1 in Annex C.3.2.

Using this configuration the fraction of maximum throughput percentage shall meet or exceed the minimum requirements specified in Table 8.3.2.1.4.3-2 for the specified SNR.

Table 8.3.2.1.4.3-1: Test Parameters for Testing CDM-multiplexed DM RS (single layer) with TM9 interference model

parameter		Unit	Cell 1	Cell 2
Downlink power allocation	ρ_A	dB	0	0
	ρ_B	dB	0 (Note 1)	0
	σ	dB	-3	-3
Cell-specific reference signals			Antenna ports 0,1	Antenna ports 0,1
CSI reference signals			Antenna ports 15,...,18	N/A
CSI-RS periodicity and subframe offset $T_{\text{CSI-RS}} / \Delta_{\text{CSI-RS}}$		Subframes	5 / 4	N/A
CSI reference signal configuration			0	N/A
N_{oc} at antenna port		dBm/15kHz z	-98	N/A
DIP (Note 2)		dB	N/A	-1.73
BW_{Channel}		MHz	10	10
Cyclic Prefix			Normal	Normal
Cell Id			0	126
Number of control OFDM symbols			2	2
PDSCH transmission mode			9	N/A
Beamforming model			As specified in clause B.4.3 (Note 4, 5)	N/A
Interference model			N/A	As specified in clause B.5.4
Probability of occurrence of transmission rank in interfering cells	Rank 1		N/A	70
	Rank 2		N/A	30
Precoder update granularity		PRB	50	6
PMI delay (Note 5)		ms	10 or 11	N/A
Reporting interval		ms	5	N/A
Reporting mode			PUCCH 1-1	N/A
CodeBookSubsetRestriction bitmap			0000000000000000 0000000000000000 0000000000000000 1111111111111111	N/A
Symbols for unused PRBs			OCNG (Note 6)	N/A
Simultaneous transmission			No simultaneous transmission on the other antenna port in (7 or 8) not used for the input signal under test	N/A
Note 1: $P_B = 1$				
Note 2: The respective received power spectral density of each interfering cell relative to N_{oc} is defined by its associated DIP value as specified in clause B.5.1.				
Note 3: The modulation symbols of the signal under test in Cell 1 are mapped onto antenna port 7 or 8.				
Note 4: The precoder in clause B.4.3 follows UE recommended PMI.				
Note 5: If the UE reports in an available uplink reporting instance at subframe SF#n based on PMI estimation at a downlink SF not later than SF#(n-4), this reported PMI				

<p>Note 6: cannot be applied at the eNB downlink before SF#(n+4). These physical resource blocks are assigned to an arbitrary number of virtual UEs with one PDSCH per virtual UE; the data transmitted over the OCNG PDSCHs shall be uncorrelated pseudo random data, which is QPSK modulated.</p> <p>Note 7: All cells are time-synchronous.</p>
--

Table 8.3.2.1.4.3-2: Enhanced Performance Requirement Type A, CDM-multiplexed DM RS with TM9 interference model

Test Number	Reference Channel	OCNG Pattern		Propagation Conditions		Correlation Matrix and Antenna Configuration (Note 3)	Reference Value		UE Category
		Cell 1	Cell 2	Cell 1	Cell 2		Fraction of Maximum Throughput (%)	SINR (dB) (Note 2)	
1	R.48 TDD	OP.1 TDD	N/A	EVA5	EVA5	4x2 Low	70	-1.0	1-8
<p>Note 1: The propagation conditions for Cell 1 and Cell 2 are statistically independent.</p> <p>Note 2: SINR corresponds to \hat{E}_s / N_{oc} of Cell 1 as defined in clause 8.1.1.</p> <p>Note 3: Correlation matrix and antenna configuration parameters apply for each of Cell 1 and Cell 2.</p>									

The normative reference for this requirement is TS 36.101 [2] clause 8.3.2.1B.

8.3.2.1.4.4 Test description

8.3.2.1.4.4.1 Initial conditions

Initial conditions are a set of test configurations the UE needs to be tested in and the steps for the SS to take with the UE to reach the correct measurement state.

Configurations of PDSCH and PDCCH before measurement are specified in Annex C.2.

Test Environment: Normal, as defined in TS 36.508 [7] clause 4.1.

Frequencies to be tested: Mid Range, as defined in TS 36.508 [7] clause 4.3.1.2.

Bandwidths to be tested: 10MHz, as defined in TS 36.508 [7] clause 4.3.1.2.

1. Connect the SS, the faders and AWGN noise sources to the UE antenna connectors as shown in TS 36.508 [7] Annex A, TBD.
2. The parameter settings for the cell are set up according to Tables 8.3.2-1 and 8.3.2.1.4.3-1 as appropriate.
3. Downlink signals are initially set up according to Annex C0, C.1 and Annex C.3.2 and uplink signals according to Annex H.1 and H.3.2.
4. Propagation conditions are set according to Annex B.0.
5. Ensure the UE is in State 3A-RF according to TS 36.508 [7] clause 5.2A.2. Message contents are defined in clause 8.3.2.1.4.4.3.

8.3.2.1.4.4.2 Test procedure

1. SS transmits PDSCH via PDCCH DCI format 2C for C_RNTI to transmit the DL RMC according to Tables 8.3.2.1.4.3-1, 8.3.2.1.4.3-2. The SS sends downlink MAC padding bits on the DL RMC.
2. Set the parameters of the bandwidth, MCS, reference channel, the propagation condition, the correlation matrix and the SNR according to Table 8.3.2.1.4.5-1 as appropriate.
BCH/CRS/PDCCH/PCFICH are sent on antenna ports 0 and 1 using two Tx antennas, while DRS/PDSCH for the test UE are sent on antenna port 7 (or 8) using four Tx antennas with beam-forming model as specified in

Annex B.4.1 and precoder update granularity specified in Table 8.3.2.1.4.3-1. CSI-RS are sent on antenna ports 15-18 using four Tx antennas with mapping according to beam-forming model as specified in Annex B.4.1.

3. Set the Cell2 –aggressor cell- as defined in Tables 8.3.2.1.4.3-1, 8.3.2.1.4.3-2 and according to Annex B.4.3.
4. Measure the average throughput for a duration sufficient to achieve statistical significance according to Annex G clause G.3. Count the number of NACKs, ACKs and statDTXs on the UL during each test interval and decide pass or fail according to Tables G.3.5 and G.3.6 in Annex G clause G.3.

8.3.2.1.4.4.3 Message contents

Message contents are according to TS 36.508 [7] clause 4.6 with the following exceptions:

Table 8.3.2.1.4.4.3-1: PDSCH-ConfigDedicated-DEFAULT

Derivation Path: TS 36.508 [7] clause 4.6.3, Table 4.6.3-6 PDSCH-ConfigDedicated-DEFAULT			
Information Element	Value/remark	Comment	Condition
PDSCH-ConfigDedicated-DEFAULT ::= SEQUENCE {			
p-a	dB0		
}			

Table 8.3.2.1.4.4.3-2: AntennaInfoDedicated-r10

Derivation Path: 36.331 clause 6.3.2			
Information Element	Value/remark	Comment	Condition
AntennaInfoDedicated-r10 ::= SEQUENCE {			
transmissionMode-r10	tm9-v1020		
codebookSubsetRestriction-r10	000000000000000000 000000000000000000 000000000000111111 1111111111		
}			
ue-TransmitAntennaSelection CHOICE {			
release	NULL		
}			

Table 8.3.2.1.4.4.3-3: CSI-RS-Config-r10

Derivation Path: 36.331 clause 6.3.2			
Information Element	Value/remark	Comment	Condition
CSI-RS-Config-r10 ::= SEQUENCE {			
csi-RS-r10 CHOICE{			
release			
setup SEQUENCE {			
antennaPortsCount-r10	an4	Parameter represents the number of antenna ports used for transmission of CSI reference signals	
resourceConfig-r10	0	Parameter: CSI reference signal configuration	
subframeConfig-r10	4	$\Delta_{\text{CSI-RS}} = I_{\text{CSI-RS}}$ when CSI-RS SubframeConfig is from 0-4; Parameter: $I_{\text{CSI-RS}}$	
p-C-r10	-3 dB	Parameter: P_c which is the assumed ratio of PDSCH EPRE to CSI-RS EPRE when UE derives CSI feedback	
}			
}			
zeroTxPowerCSI-RS-r10 CHOICE{			
release	NULL		
setup SEQUENCE {			
zeroTxPowerResourceConfigList-r10	NULL	Parameter: $ZeroPowerCSI-RS$	
zeroTxPowerSubframeConfig-r10	NULL	Parameter: $I_{\text{CSI-RS}}$	
}			
}			
}			

Table 8.3.2.1.4.4.3-4: CQI-ReportPeriodic-r10

Derivation Path: TS 36.508 [7] clause 4.6.3, Table 4.6.3-2AC CQI-ReportPeriodic-r10-DEFAULT			
Information Element	Value/remark	Comment	Condition
CQI-ReportPeriodic-r10 ::= CHOICE {			
setup SEQUENCE {			
cqi-PUCCH-ResourceIndex-r10	0		
cqi-PUCCH-ResourceIndexP1-r10	Not present		
cqi-pmi-ConfigIndex	24	TDD	
cqi-FormatIndicatorPeriodic-r10 CHOICE {			
widebandCQI-r10 SEQUENCE {			
csi-ReportMode-r10	Not present		
}			
}			
ri-ConfigIndex	484	TDD	
simultaneousAckNackAndCQI	FALSE		
cqi-Mask-r9	Not present		
csi-ConfigIndex-r10	Not present		
}			
}			

8.3.2.1.4.5 Test requirement

Table 8.3.2.1.4.3-1 defines the primary level settings.

The fraction of maximum throughput percentage for the downlink reference measurement channels specified in Annex A clause A.3.4.3.4 for the throughput test shall meet or exceed the specified value in Table 8.3.2.1.4.5-1 for the specified SNR including test tolerances for the throughput test.

Table 8.3.2.1.4.5-1: Enhanced Performance Requirement Type A, CDM-multiplexed DM RS with TM9 interference model

Test Number	Reference Channel	OCNG Pattern		Propagation Conditions		Correlation Matrix and Antenna Configuration (Note 3)	Reference Value		UE Category
		Cell 1	Cell 2	Cell 1	Cell 2		Fraction of Maximum Throughput (%)	SINR (dB) (Note 2)	
1	R.48 TDD	OP.1 TDD	N/A	EVA5	EVA5	4x2 Low	70	-1.0+TT	1-8
Note 1: The propagation conditions for Cell 1 and Cell 2 are statistically independent. Note 2: SINR corresponds to \hat{E}_s / N_{oc} of Cell 1 as defined in clause 8.1.1. Note 3: Correlation matrix and antenna configuration parameters apply for each of Cell 1 and Cell 2.									

8.3.2.2 TDD PDSCH Dual-layer Spatial Multiplexing Performance (UE-Specific Reference Symbols)

8.3.2.2.1 TDD PDSCH Dual-layer Spatial Multiplexing

8.3.2.2.1.1 Test purpose

To verify the UE's rank-2 performance and ability to receive a predefined test signal, representing a multi-path fading channel that is determined by the SNR with a percentage of the information bit throughput for a specified downlink Reference Measurement Channel (RMC) not falling below a specified value for dual-layer transmission on antenna ports 7 and 8 using DM-RS with full RB allocation.

8.3.2.2.1.2 Test applicability

This test applies to Release 9 UEs that support enhanced Dual Layer TDD (TM8) and all types of E-UTRA TDD UE release 10 and forward.

8.3.2.2.1.3 Minimum conformance requirements

The requirements are specified in terms of the percentage of information bit throughput for the downlink reference measurement channels specified in Annex A clause A.3.4.3.2, with the addition of the relevant parameters in Tables 8.3.2-1, 8.3.2.2.1.3-1, and the downlink physical channel setup according to Table C.3.2-1 in Annex C.

Using this configuration the fraction of maximum throughput percentage shall meet or exceed the minimum requirements specified in Tables 8.3.2.2.1.3-2 for the specified SNR.

Table 8.3.2.2.1.3-1: Test Parameters for Testing CDM-multiplexed DM RS (dual layer)

Parameter		Unit	Test 1	Test 2
Downlink power allocation	ρ_A	dB	0	0
	ρ_B	dB	0 (Note 1)	0 (Note 1)
	σ	dB	-3	-3
Cell-specific reference symbols			Antenna port 0 and antenna port 1	
Beamforming model			Annex B.4.2	
N_{oc} at antenna port		dBm/15kHz	-98	-98
Symbols for unused PRBs			OCNG (Note 2)	OCNG (Note 2)
Number of allocated resource blocks		PRB	50	50
PDSCH transmission mode			8	8
Note 1: $P_B = 1$ Note 2: These physical resource blocks are assigned to an arbitrary number of virtual UEs with one PDSCH per virtual UE; the data transmitted over the OCNG PDSCHs shall be uncorrelated pseudo random data, which is QPSK modulated.				

Table 8.3.2.2.1.3-2: Minimum performance for CDM-multiplexed DM RS (FRC)

Test number	Bandwidth and MCS	Reference Channel	OCNG Pattern	Propagation Condition	Correlation Matrix and Antenna Configuration	Reference value		UE Category
						Fraction of Maximum Throughput (%)	SNR (dB)	
1	10 MHz QPSK 1/3	R.31 TDD	OP.1 TDD	EVA5	2x2 Low	70	4.5	2-5
2	10 MHz 16QAM 1/2	R.32 TDD	OP.1 TDD	EPA5	2x2 Medium	70	21.7	2-5

The normative reference for this requirement is TS 36.101 [2] clause 8.3.2.

8.3.2.2.1.4 Test description

8.3.2.2.1.4.1 Initial conditions

Initial conditions are a set of test configurations the UE needs to be tested in and the steps for the SS to take with the UE to reach the correct measurement state.

Configurations of PDSCH and PDCCH before measurement are specified in Annex C.2.

Test Environment: Normal, as defined in TS 36.508 [7] clause 4.1.

Frequencies to be tested: Mid Range, as defined in TS 36.508 [7] clause 4.3.1.2.

Bandwidths to be tested: 10MHz, as defined in TS 36.508 [7] clause 4.3.1.2.

1. Connect the SS, the faders and AWGN noise sources to the UE antenna connectors as shown in TS 36.508 [7] Annex A, Figure A.10.
2. The parameter settings for the cell are set up according to Tables 8.3.2-1 and 8.3.2.2.1.3-1 as appropriate.
3. Downlink signals are initially set up according to Annex C0, C.1 and Annex C.3.2 and uplink signals according to Annex H.1 and H.3.2.

4. Propagation conditions are set according to Annex B.0.
5. Ensure the UE is in State 3A-RF according to TS 36.508 [7] clause 5.2A.2. Message contents are defined in clause 8.3.2.2.1.4.3.

8.3.2.2.1.4.2 Test procedure

1. SS transmits PDSCH via PDCCH DCI format 2B for C_RNTI to transmit the DL RMC according to Tables 8.3.2.2.1.3-1, 8.3.2.2.1.3-2. The SS sends downlink MAC padding bits on the DL RMC.
2. Set the parameters of the bandwidth, MCS, reference channel, the propagation condition, the correlation matrix and the SNR according to Table 8.3.2.2.1.5-1 as appropriate.
BCH/CRS/PDCCH/PCFICH are sent on antenna ports 0 and 1 using two Tx antennas, while DRS/Dedicated data for test UE are sent on antenna ports 7 and 8 using two Tx antennas with beam-forming model as specified in Annex B.4.2 and precoder update granularity specified in Table 8.3.2-1.
3. Measure the average throughput for a duration sufficient to achieve statistical significance according to Annex G clause G.3. Count the number of NACKs, ACKs and statDTXs on the UL during each test interval and decide pass or fail according to Tables G.3.5 and G.3.6 in Annex G clause G.3.
4. Repeat steps from 1 to 3 for each test interval in Tables 8.3.2.2.1.5-1 as appropriate.

8.3.2.1.2.4.3 Message contents

Message contents are according to TS 36.508 [7] clause 4.6 with the following exceptions .

Table 8.3.2.2.1.4.3-1: PhysicalConfigDedicated-DEFAULT

Derivation Path: 36.331 clause 6.3.2			
Information Element	Value/remark	Comment	Condition
PhysicalConfigDedicated-DEFAULT ::= SEQUENCE {			
antennaInfo CHOICE {			
antennaInfoDedicated ::= SEQUENCE {			
transmissionMode	tm8-v920		
}			
}			
Extension ::= SEQUENCE {			
antennaInfo-v920 ::= SEQUENCE {			
codebookSubsetRestriction-v920 CHOICE {			
n2TxAntenna-tm8-r9	111111		
}			
}			
}			
}			

8.3.2.2.1.5 Test requirement

Table 8.3.2.2.1.3-1 defines the primary level settings.

The fraction of maximum throughput percentage for the downlink reference measurement channels specified in Annex A clause A.3.4.3.2 for each throughput test shall meet or exceed the specified value in Table 8.3.2.2.1.5-1 for the specified SNR including test tolerances for all throughput tests.

Table 8.3.2.2.1.5-1: Test requirement for CDM-multiplexed DM RS (FRC)

Test number	Bandwidth and MCS	Reference Channel	OCNG Pattern	Propagation Condition	Correlation Matrix and Antenna Configuration	Reference value		UE Category
						Fraction of Maximum Throughput (%)	SNR (dB)	
1	10 MHz QPSK 1/3	R.31 TDD	OP.1 TDD	EVA5	2x2 Low	70	5.4	2-5
2	10 MHz 16QAM 1/2	R.32 TDD	OP.1 TDD	EPA5	2x2 Medium	70	22.6	2-5

8.3.2.2.1_D TDD PDSCH Dual-layer Spatial Multiplexing for eDL-MIMO

8.3.2.2.1_D.1 Test purpose

To verify the UE's rank-2 performance and ability to receive a predefined test signal, representing a multi-path fading channel that is determined by the SNR with a percentage of the information bit throughput for a specified downlink Reference Measurement Channel (RMC) not falling below a specified value for dual-layer transmission on antenna ports 7 and 8 using DM-RS with full RB allocation with multiple CSI reference symbol configurations with non-zero and zero transmission power.

8.3.2.2.1_D.2 Test applicability

This test applies to all types of E-UTRA TDD UE release 10 and forward that support eDL-MIMO. Applicability requires support for FGI bit 103.

8.3.2.2.1_D.3 Minimum conformance requirements

The requirements are specified in terms of the percentage of information bit throughput for the downlink reference measurement channels specified in Annex A clause A.3.4.2, with the addition of the relevant parameters in Tables 8.3.2-1, 8.3.2.2.1_D.3-1, and the downlink physical channel setup according to Table C.3.2-1 in Annex C.3.2.

Using this configuration the fraction of maximum throughput percentage shall meet or exceed the minimum requirements specified in Table 8.3.2.2.1_D.3-2 for the specified SNR.

Table 8.3.2.2.1_D.3-1: Test Parameters for Testing CDM-multiplexed DM RS (dual layer) with multiple CSI-RS configurations

parameter		Unit	Test 1
Downlink power allocation	ρ_A	dB	0
	ρ_B	dB	0 (Note 1)
	σ	dB	-3
Cell-specific reference signals			Antenna ports 0 and 1
CSI reference signals			Antenna ports 15,16
Beamforming model			Annex B.4.2
CSI-RS periodicity and subframe offset $T_{\text{CSI-RS}} / \Delta_{\text{CSI-RS}}$		Subframes	5 / 4
CSI reference signal configuration			8
Zero-power CSI-RS configuration $I_{\text{CSI-RS}} / \text{ZeroPowerCSI-RS}$ bitmap		Subframes / bitmap	4 / 0010000000000000
N_{oc} at antenna port		dBm/15kHz	-98
Symbols for unused PRBs			OCNG (Note 2)
Number of allocated resource blocks (Note 2)		PRB	50
Simultaneous transmission			No
PDSCH transmission mode			9
Note 1: $P_B = 1$. Note 2: These physical resource blocks are assigned to an arbitrary number of virtual UEs with one PDSCH per virtual UE; the data transmitted over the OCNG PDSCHs shall be uncorrelated pseudo random data, which is QPSK modulated.			

Table 8.3.2.2.1_D.3-2: Minimum performance for CDM-multiplexed DM RS (FRC) with multiple CSI-RS configurations

Test number	Bandwidth and MCS	Reference Channel	OCNG Pattern	Propagation Condition	Correlation Matrix and Antenna Configuration	Reference value		UE Category
						Fraction of Maximum Throughput (%)	SNR (dB)	
1	10 MHz 16QAM 1/2	R.51 TDD	OP.1 TDD	EPA5	2x2 Low	70	14.5	2-8

The normative reference for this requirement is TS 36.101 [2] clause 8.3.2.3.

8.3.2.2.1_D.4 Test description

8.3.2.2.1_D.4.1 Initial conditions

Initial conditions are a set of test configurations the UE needs to be tested in and the steps for the SS to take with the UE to reach the correct measurement state.

Configurations of PDSCH and PDCCH before measurement are specified in Annex C.2.

Test Environment: Normal, as defined in TS 36.508 [7] clause 4.1.

Frequencies to be tested: Mid Range, as defined in TS 36.508 [7] clause 4.3.1.2.

Bandwidths to be tested: 10MHz, as defined in TS 36.508 [7] clause 4.3.1.2.

1. Connect the SS, the faders and AWGN noise sources to the UE antenna connectors as shown in TS 36.508 [7] Annex A, Figure A. 10 .
2. The parameter settings for the cell are set up according to Tables 8.3.2-1 and 8.3.2.2.1_D.3-1 as appropriate.
3. Downlink signals are initially set up according to Annex C0, C.1 and Annex C.3.2 and uplink signals according to Annex H.1 and H.3.2.
4. Propagation conditions are set according to Annex B.0.
5. Ensure the UE is in State 3A-RF according to TS 36.508 [7] clause 5.2A.2. Message contents are defined in clause 8.3.2.2.1_D.4.3.

8.3.2.2.1_D.4.2 Test procedure

1. SS transmits PDSCH via PDCCH DCI format 2C for C_RNTI to transmit the DL RMC according to Tables 8.3.2.2.1_D.3-1, 8.3.2.2.1_D.3-2. The SS sends downlink MAC padding bits on the DL RMC.
2. Set the parameters of the bandwidth, MCS, reference channel, the propagation condition, the correlation matrix and the SNR according to Table 8.3.2.2.1_D.5-1 as appropriate.
BCH/CRS/PDCCH/PCFICH are sent on antenna ports 0 and 1 using two Tx antennas, while DRS/ PDSCH for the test UE are sent on antenna port 7 and 8 using two Tx antennas with beam-forming model as specified in Annex B.4.2 and precoder update granularity specified in Table 8.3.2-1. CSI-RS are sent on antenna ports 15 and 16 using two Tx antennas with mapping according to beam-forming model as specified in Annex B.4.2.
3. Measure the average throughput for a duration sufficient to achieve statistical significance according to Annex G clause G.3. Count the number of NACKs, ACKs and statDTXs on the UL during each test interval and decide pass or fail according to Tables G.3.5 and G.3.6 in Annex G clause G.3.

8.3.2.2.1_D.4.3 Message contents

Message contents are according to TS 36.508 [7] clause 4.6 with the following exceptions:

Table 8.3.2.2.1_D.4.3-1: PDSCH-ConfigDedicated-DEFAULT

Derivation Path: 36.331 clause 6.3.2			
Information Element	Value/remark	Comment	Condition
PDSCH-ConfigDedicated-DEFAULT ::= SEQUENCE {			
p-a	dB0		
}			

Table 8.3.2.2.1_D.4.3-2: *AntennaInfoDedicated-r10*

Derivation Path: 36.331 clause 6.3.2			
Information Element	Value/remark	Comment	Condition
AntennaInfoDedicated-r10 ::= SEQUENCE {			
transmissionMode-r10	tm9-v1020		
codebookSubsetRestriction-r10	Not present	If the UE is configured with <i>transmissionMode</i> tm9, E-UTRAN only configures the field <i>codebookSubsetRestriction</i> if PMI/RI reporting is configured	
}			
ue-TransmitAntennaSelection CHOICE {			
release	NULL		
}			

Table 8.3.2.2.1_D.4.3-3: *CSI-RS-Config*

Derivation Path: 36.331 clause 6.3.2			
Information Element	Value/remark	Comment	Condition
CSI-RS-Config-r10 ::= SEQUENCE {			
csi-RS-r10 CHOICE{			
release			
setup SEQUENCE {			
antennaPortsCount-r10	an2	Parameter represents the number of antenna ports used for transmission of CSI reference signals	
resourceConfig-r10	8	Parameter: CSI reference signal configuration	
subframeConfig-r10	4	$\Delta_{\text{CSI-RS}} = I_{\text{CSI-RS}}$ when CSI-RS SubframeConfig is from 0-4; Parameter: $I_{\text{CSI-RS}}$	
p-C-r10	0	Parameter: P_c which is the assumed ratio of PDSCH EPRE to CSI-RS EPRE when UE derives CSI feedback	
}			
}			
zeroTxPowerCSI-RS-r10 CHOICE{			
release	NULL		
setup SEQUENCE {			
zeroTxPowerResourceConfigList-r10	4	Parameter: <i>ZeroPowerCSI-RS</i>	
zeroTxPowerSubframeConfig-r10	4	Parameter: $I_{\text{CSI-RS}}$	
}			
}			
}			

8.3.2.2.1_D.5 Test requirement

Table 8.3.2.2.1_D.3-1 defines the primary level settings.

The fraction of maximum throughput percentage for the downlink reference measurement channels specified in Annex A clause A.3.4.3.3 for the throughput test shall meet or exceed the specified value in Table 8.3.2.2.1_D.5-1 for the specified SNR including test tolerances for the throughput test.

Table 8.3.2.2.1_D.5-1: Test requirement for CDM-multiplexed DM RS (FRC) with multiple CSI-RS configurations

Test number	Bandwidth and MCS	Reference Channel	OCNG Pattern	Propagation Condition	Correlation Matrix and Antenna Configuration	Reference value		UE Category
						Fraction of Maximum Throughput (%)	SNR (dB)	
1	10 MHz 16QAM 1/2	R.51 TDD	OP.1 TDD	EPA5	2x2 Low	70	15.4	2-8

8.4 Demodulation of PCFICH/PDCCH

8.4.1 FDD

8.4.1.1 FDD PCFICH/PDCCH Single-antenna Port Performance

8.4.1.1.1 Test purpose

This test verifies the demodulation performance of PCFICH/PDCCH for a single-antenna port with a given SNR for which the average probability of miss-detection of the Downlink Scheduling Grant, tested jointly on PDCCH and PCFICH of the specified reference measurement channels in A.3.5.1 remains below a given reference value.

8.4.1.1.2 Test applicability

This test applies to all types of E-UTRA FDD UE release 8 and forward.

8.4.1.1.3 Minimum conformance requirements

The receiver characteristics of the PDCCH/PCFICH are determined by the probability of miss-detection of the Downlink Scheduling Grant (P_{m-dsg}). PDCCH and PCFICH are tested jointly, i.e. a miss detection of PCFICH implies a miss detection of PDCCH.

Table 8.4.1.1.3-1: Test Parameters for PDCCH/PCFICH

Parameter		Unit	Single antenna port
Number of PDCCH symbols		symbols	2
Number of PHICH groups (N_g)			1
PHICH duration			Normal
Unused RE-s and PRB-s			OCNG
Cell ID			0
Downlink power allocation	PCFICH_RA PDCCH_RA PHICH_RA OCNG_RA	dB	0
	PCFICH_RB PDCCH_RB PHICH_RB OCNG_RB	dB	0
N_{oc} at antenna port		dBm/15kHz	-98
Cyclic prefix			Normal
Note: PHICH power setting refer to PHICH group power, i.e. the total power of all active PHICH sequences within a PHICH group.			

For the parameters specified in Table 8.4.1.1.3-1 the average probability of a missed downlink scheduling grant (P_{m-dsg}) shall be below the specified value in Table 8.4.1.1.3-2.

Table 8.4.1.1.3-2: Minimum performance PDCCH/PCFICH

Test number	Bandwidth	Aggregation level	Reference Channel	OCNG Pattern	Propagation Condition	Antenna configuration and Correlation Matrix	Reference value	
							P_{m-dsg} (%)	SNR (dB)
1	10 MHz	8 CCE	R.15 FDD	OP.1 FDD	ETU70	1x2 Low	1	-1.7

The normative reference for this requirement is TS 36.101 [2] clause 8.4.1.

8.4.1.1.4 Test description

8.4.1.1.4.1 Initial conditions

Initial conditions are a set of test configurations the UE needs to be tested in and the steps for the SS to take with the UE to reach the correct measurement state.

Configurations of PDSCH and PDCCH before measurement are specified in Annex C.2.

Test Environment: Normal, as defined in TS 36.508 [7] clause 4.1.

Frequencies to be tested: Mid Range, as defined in TS 36.508 [7] clause 4.3.1.1.

Channel Bandwidths to be tested: 10MHz, as defined in TS 36.508 [7] clause 4.3.1.1

1. Connect the SS, the faders and AWGN noise source to the UE antenna connector (s) as shown in TS 36.508 [7] Annex A, Figure A.9.
2. The parameter settings for the cell are set up according to Table 8.4.1.1.3-1.
3. The downlink signals are initially set up according to Annex C.1 and Annex C.3.2 and uplink signals according to Annex H.1 and H.3.2.
4. Propagation conditions are set according to Annex B clause B.0.

5. Ensure the UE is in State 3A-RF according to TS 36.508 [7] clause 5.2A.2. Message contents are defined in clause 8.4.1.1.4.3.

8.4.1.1.4.2 Test procedure

1. SS transmits PDSCH via PDCCH DCI format 1 for C_RNTI to transmit the DL RMC according to Table 8.4.1.1.3-2. The details of PDCCH and PDSCH are specified in Table A.3.5.1-1 and Table A.3.5.1-2 respectively. The SS sends downlink MAC padding bits on the DL RMC.
2. Set the parameters of the propagation condition, antenna configuration, the correlation matrix and the SNR according to Table 8.4.1.1.5-1 as appropriate.
3. Measure the Pm-dsg for a duration sufficient to achieve statistical significance according to Annex G clause G.4. Count the number of NACKs, ACKs and statDTXs on the UL PUCCH during each subtest interval. Pm-dsg is the ratio (statDTX)/(NACK+ACK+statDTX). If Pm-dsg is less than the value specified in table 8.4.1.1.5-1, pass the UE. Otherwise fail the UE.

8.4.1.1.4.3 Message contents

Message contents are according to TS 36.508 [7] clause 4.6.

8.4.1.1.5 Test requirement

For the parameters specified in Table 8.4.1.1.3-1 the average probability of a missed downlink scheduling grant (Pm-dsg) shall be below the specified value in Table 8.4.1.1.5-1.

Table 8.4.1.1.5-1: Test requirement PDCCH/PCFICH

Test number	Bandwidth	Aggregation level	Reference Channel	OCNG Pattern	Propagation Condition	Antenna configuration and correlation Matrix	Reference value	
							Pm-dsg (%)	SNR (dB)
1	10 MHz	8 CCE	R.15 FDD	OP.1 FDD	ETU70	1x2 Low	1	-0.9

8.4.1.2 FDD PCFICH/PDCCH Transmit Diversity Performance

8.4.1.2.1 FDD PCFICH/PDCCH Transmit Diversity 2x2

8.4.1.2.1.1 Test purpose

This test verifies the demodulation performance of PCFICH/PDCCH for transmit diversity with a given SNR for which the average probability of miss-detection of the Downlink Scheduling Grant, tested jointly on PDCCH and PCFICH of the specified reference measurement channels in A.3.5.1 remains below a given reference value.

8.4.1.2.1.2 Test applicability

This test applies to all types of E-UTRA FDD UE release 8.

8.4.1.2.1.3 Minimum conformance requirements

The receiver characteristics of the PDCCH/PCFICH are determined by the probability of miss-detection of the Downlink Scheduling Grant (Pm-dsg). PDCCH and PCFICH are tested jointly, i.e. a miss detection of PCFICH implies a miss detection of PDCCH.

Table 8.4.1.2.1.3-1: Test Parameters for PDCCH/PCFICH

Parameter		Unit	Transmit diversity
Number of PDCCH symbols		symbols	2
Number of PHICH groups (N_g)			1
PHICH duration			Normal
Unused RE-s and PRB-s			OCNG
Cell ID			0
Downlink power allocation	PCFICH_RA PDCCH_RA PHICH_RA OCNG_RA	dB	-3
	PCFICH_RB PDCCH_RB PHICH_RB OCNG_RB	dB	-3
N_{oc} at antenna port		dBm/15kHz	-98
Cyclic prefix			Normal
Note: PHICH power setting refer to PHICH group power, i.e. the total power of all active PHICH sequences within a PHICH group.			

For the parameters specified in Table 8.4.1.2.1.3-1 the average probability of a missed downlink scheduling grant (Pm-dsg) shall be below the specified value in Table 8.4.1.2.1.3-2.

Table 8.4.1.2.1.3-2: Minimum performance PDCCH/PCFICH 2 Tx Antenna Port

Test number	Bandwidth	Aggregation level	Reference Channel	OCNG Pattern	Propagation Condition	Antenna configuration and correlation Matrix	Reference value	
							Pm-dsg (%)	SNR (dB)
1	1.4 MHz	2 CCE	R.16 FDD	OP.1 FDD	EPA5	2 x 2 Low	1	4.3

The normative reference for this requirement is TS 36.101 [2] clause 8.4.1.

8.4.1.2.1.4 Test description

8.4.1.2.1.4.1 Initial conditions

Initial conditions are a set of test configurations the UE needs to be tested in and the steps for the SS to take with the UE to reach the correct measurement state.

Configurations of PDSCH and PDCCH before measurement are specified in Annex C.2.

Test Environment: Normal, as defined in TS 36.508 [7] clause 4.1.

Frequencies to be tested: Mid Range, as defined in TS 36.508 [7] clause 4.3.1.1.

Channel Bandwidths to be tested: 1.4MHz, as defined in TS 36.508 [7] clause 4.3.1.1

1. Connect the SS, the faders and AWGN noise sources to the UE antenna connector (s) as shown in TS 36.508 [7] Annex A, Figure A.10.
2. The parameter settings for the cell are set up according to Table 8.4.1.2.1.3-1.
3. The downlink signals are initially set up according to Annex C.1 and C.3.2 and uplink signals according to Annex H.1 and H.3.2.
4. Propagation conditions are set according to Annex B clauses B.0.
5. Ensure the UE is in State 3A-RF according to TS 36.508 [7] clause 5.2A.2. Message contents are defined in clause 8.4.1.2.1.4.3.

8.4.1.2.1.4.2 Test procedure

1. SS transmits PDSCH via PDCCH DCI format 2 for C_RNTI to transmit the DL RMC according to Table 8.4.1.2.1.3-2. The details of PDCCH and PDSCH are specified in Table A.3.5.1-1 and Table A.3.5.1-2 respectively. The SS sends downlink MAC padding bits on the DL RMC. Transmission scheme for the PDSCH shall be transmit diversity.
2. Set the parameters of the propagation condition, antenna configuration, the correlation matrix and the SNR according to Table 8.4.1.2.1.5-1.
3. Measure the Pm-dsg for a duration sufficient to achieve statistical significance according to Annex G clause G.4. Count the number of NACKs, ACKs and statDTXs on the UL PUCCH during each subtest interval. Pm-dsg is the ratio (statDTX)/(NACK+ACK+statDTX).

If Pm-dsg is less than the value specified in table 8.4.1.2.1.5-1, pass the UE. Otherwise fail the UE.

8.4.1.2.1.4.3 Message contents

Message contents are according to TS 36.508 [7] clause 4.6 with the following exceptions:

Table 8.4.1.2.1.4.3-1: PhysicalConfigDedicated-DEFAULT

Derivation Path: 36.331 clause 6.3.2			
Information Element	Value/remark	Comment	Condition
PhysicalConfigDedicated-DEFAULT ::= SEQUENCE {			
antennaInfo CHOICE {			
antennaInfoDedicated ::= SEQUENCE {			
transmissionMode	tm4		
codebookSubsetRestriction CHOICE {			
n2TxAntenna-tm4	111111		
}			
ue-TransmitAntennaSelection CHOICE {			
release	NULL		
}			
}			
}			

8.4.1.2.1.5 Test requirement

For the parameters specified in Table 8.4.1.2.1.3-1 the average probability of a missed downlink scheduling grant (Pm-dsg) shall be below the specified value in Table 8.4.1.2.1.5-1.

Table 8.4.1.2.1.5-1: Test requirement PDCCH/PCFICH 2 Tx Antenna Port

Test number	Bandwidth	Aggregation level	Reference Channel	OCNG Pattern	Propagation Condition	Antenna configuration and correlation Matrix	Reference value	
							Pm-dsg (%)	SNR (dB)
1	1.4 MHz	2 CCE	R.16 FDD	OP.1 FDD	EPA5	2 x 2 Low	1	5.3

8.4.1.2.1_1 FDD PCFICH/PDCCH Transmit Diversity 2x2 (Release 9 and forward)

8.4.1.2.1_1.1 Test purpose

This test verifies the demodulation performance of PCFICH/PDCCH for transmit diversity with a given SNR for which the average probability of miss-detection of the Downlink Scheduling Grant, tested jointly on PDCCH and PCFICH of the specified reference measurement channels in A.3.5.1 remains below a given reference value.

8.4.1.2.1_1.2 Test applicability

This test applies to all types of E-UTRA FDD UE release 9 and forward.

8.4.1.2.1_1.3 Minimum conformance requirements

The receiver characteristics of the PDCCH/PCFICH are determined by the probability of miss-detection of the Downlink Scheduling Grant (Pm-dsg). PDCCH and PCFICH are tested jointly, i.e. a miss detection of PCFICH implies a miss detection of PDCCH.

Table 8.4.1.2.1_1.3-1: Test Parameters for PDCCH/PCFICH

Parameter		Unit	Transmit diversity
Number of PDCCH symbols		symbols	2
Number of PHICH groups (Ng)			1
PHICH duration			Normal
Unused RE-s and PRB-s			OCNG
Cell ID			0
Downlink power allocation	PCFICH_RA PDCCH_RA PHICH_RA OCNG_RA	dB	-3
	PCFICH_RB PDCCH_RB PHICH_RB OCNG_RB	dB	-3
N_{oc} at antenna port		dBm/15kHz	-98
Cyclic prefix			Normal
Note: PHICH power setting refer to PHICH group power, i.e. the total power of all active PHICH sequences within a PHICH group.			

For the parameters specified in Table 8.4.1.2.1_1.3-1 the average probability of a missed downlink scheduling grant (Pm-dsg) shall be below the specified value in Table 8.4.1.2.1_1.3-2.

Table 8.4.1.2.1_1.3-2: Minimum performance PDCCH/PCFICH 2 Tx Antenna Port

Test number	Bandwidth	Aggregation level	Reference Channel	OCNG Pattern	Propagation Condition	Antenna configuration and correlation Matrix	Reference value	
							Pm-dsg (%)	SNR (dB)
1	10 MHz	4 CCE	R.16_1 FDD	OP.1 FDD	EVA70	2 x 2 Low	1	-0.6

The normative reference for this requirement is TS 36.101 [2] clause 8.4.1

8.4.1.2.1_1.4 Test description

8.4.1.2.1_1.4.1 Initial conditions

Initial conditions are a set of test configurations the UE needs to be tested in and the steps for the SS to take with the UE to reach the correct measurement state.

Configurations of PDSCH and PDCCH before measurement are specified in Annex C.2.

Test Environment: Normal, as defined in TS 36.508 [7] clause 4.1.

Frequencies to be tested: Mid Range, as defined in TS 36.508 [7] clause 4.3.1.1.

Channel Bandwidths to be tested: 10MHz, as defined in TS 36.508 [7] clause 4.3.1.1

1. Connect the SS, the faders and AWGN noise sources to the UE antenna connector (s) as shown in TS 36.508 [7] Annex A, Figure A.10.
2. The parameter settings for the cell are set up according to Table 8.4.1.2.1_1.3-1.
3. The downlink signals are initially set up according to Annex C.1 and C.3.2 and uplink signals according to Annex H.1 and H.3.2.
4. Propagation conditions are set according to Annex B clauses B.0.
5. Ensure the UE is in State 3A-RF according to TS 36.508 [7] clause 5.2A.2. Message contents are defined in clause 8.4.1.2.1_1.4.3.

8.4.1.2.1_1.4.2 Test procedure

1. SS transmits PDSCH via PDCCH DCI format 2 for C_RNTI to transmit the DL RMC according to Table 8.4.1.2.1_1.3-2. The details of PDCCH and PDSCH are specified in Table A.3.5.1-1 and Table A.3.5.1-2 respectively. The SS sends downlink MAC padding bits on the DL RMC. Transmission scheme for the PDSCH shall be transmit diversity.
2. Set the parameters of the propagation condition, antenna configuration, the correlation matrix and the SNR according to Table 8.4.1.2.1_1.5-1.
3. Measure the Pm-dsg for a duration sufficient to achieve statistical significance according to Annex G clause G.4. Count the number of NACKs, ACKs and statDTXs on the UL PUCCH during each subtest interval. Pm-dsg is the ratio (statDTX)/(NACK+ACK+statDTX).

If Pm-dsg is less than the value specified in table 8.4.1.2.1_1.5-1, pass the UE. Otherwise fail the UE.

8.4.1.2.1_1.4.3 Message contents

Message contents are according to TS 36.508 [7] clause 4.6 with the following exceptions:

Table 8.4.1.2.1_1.4.3-1: PhysicalConfigDedicated-DEFAULT

Derivation Path: 36.331 clause 6.3.2			
Information Element	Value/remark	Comment	Condition
PhysicalConfigDedicated-DEFAULT ::= SEQUENCE {			
antennaInfo CHOICE {			
antennaInfoDedicated ::= SEQUENCE {			
transmissionMode	tm4		
codebookSubsetRestriction CHOICE {			
n2TxAntenna-tm4	111111		
}			
ue-TransmitAntennaSelection CHOICE {			
release	NULL		
}			
}			
}			

8.4.1.2.1_1.5 Test requirement

For the parameters specified in Table 8.4.1.2.1_1.3-1 the average probability of a missed downlink scheduling grant (Pm-dsg) shall be below the specified value in Table 8.4.1.2.1_1.5-1.

Table 8.4.1.2.1_1.5-1: Test requirement PDCCH/PCFICH 2 Tx Antenna Port

Test number	Bandwidth	Aggregation level	Reference Channel	OCNG Pattern	Propagation Condition	Antenna configuration and correlation Matrix	Reference value	
							Pm-dsg (%)	SNR (dB)
1	10 MHz	4 CCE	R.16_1 FDD	OP.1 FDD	EVA70	2 x 2 Low	1	+0.4

8.4.1.2.2 FDD PCFICH/PDCCH Transmit Diversity 4x2

8.4.1.2.2.1 Test purpose

This test verifies the demodulation performance of PCFICH/PDCCH for transmit diversity with a given SNR for which the average probability of miss-detection of the Downlink Scheduling Grant, tested jointly on PDCCH and PCFICH of the specified reference measurement channels in A.3.5.1 remains below a given reference value.

8.4.1.2.2.2 Test applicability

This test applies to all types of E-UTRA FDD UE release 8.

8.4.1.2.2.3 Minimum conformance requirements

The receiver characteristics of the PDCCH/PCFICH are determined by the probability of miss-detection of the Downlink Scheduling Grant (Pm-dsg). PDCCH and PCFICH are tested jointly, i.e. a miss detection of PCFICH implies a miss detection of PDCCH.

Table 8.4.1.2.2.3-1: Test Parameters for PDCCH/PCFICH

Parameter		Unit	Transmit diversity
Number of PDCCH symbols		symbols	2
Number of PHICH groups (N_g)			1
PHICH duration			Normal
Unused RE-s and PRB-s			OCNG
Cell ID			0
Downlink power allocation	PCFICH_RA PDCCH_RA PHICH_RA OCNG_RA	dB	-3
	PCFICH_RB PDCCH_RB PHICH_RB OCNG_RB	dB	-3
N_{oc} at antenna port		dBm/15kHz	-98
Cyclic prefix			Normal
Note:	PHICH power setting refer to PHICH group power, i.e. the total power of all active PHICH sequences within a PHICH group.		

For the parameters specified in Table 8.4.1.2.2.3-1 the average probability of a missed downlink scheduling grant (Pm-dsg) shall be below the specified value in Table 8.4.1.2.2.3-2.

Table 8.4.1.2.2.3-2: Minimum performance PDCCH/PCFICH 4 Tx Antenna Port

Test number	Bandwidth	Aggregation level	Reference Channel	OCNG Pattern	Propagation Condition	Antenna configuration and correlation Matrix	Reference value	
							Pm-dsg (%)	SNR (dB)
1	10 MHz	4 CCE	R.17 FDD	OP.1 FDD	EVA5	4 x 2 Medium	1	0.9

The normative reference for this requirement is TS 36.101 [2] clause 8.4.1.

8.4.1.2.2.4 Test description

8.4.1.2.2.4.1 Initial conditions

Initial conditions are a set of test configurations the UE needs to be tested in and the steps for the SS to take with the UE to reach the correct measurement state.

Configurations of PDSCH and PDCCH before measurement are specified in Annex C.2.

Test Environment: Normal, as defined in TS 36.508 [7] clause 4.1.

Frequencies to be tested: Mid Range, as defined in TS 36.508 [7] clause 4.3.1.1.

Channel Bandwidths to be tested: 10MHz, as defined in TS 36.508 [7] clause 4.3.1.1

1. Connect the SS, the faders and AWGN noise sources to the UE antenna connector (s) as shown in TS 36.508 [7] Annex A, Figure A.11.
2. The parameter settings for the cell are set up according to Table 8.4.1.2.2.3-1.
3. The downlink signals are initially set up according to Annex C.1 and C.3.2 and uplink signals according to Annex H.1 and H.3.2.
4. Propagation conditions are set according to Annex B clauses B.0.
5. Ensure the UE is in State 3A-RF according to TS 36.508 [7] clause 5.2A.2. Message contents are defined in clause 8.4.1.2.2.4.3.

8.4.1.2.2.4.2 Test procedure

1. SS transmits PDSCH via PDCCH DCI format 2 for C_RNTI to transmit the DL RMC according to Table 8.4.1.2.2.3-2. The details of PDCCH and PDSCH are specified in Table A.3.5.1-1 and Table A.3.5.1-2 respectively. The SS sends downlink MAC padding bits on the DL RMC. Transmission scheme for the PDSCH shall be transmit diversity.
2. Set the parameters of the propagation condition, antenna configuration, the correlation matrix and the SNR according to Table 8.4.1.2.2.5-1.
3. Measure the Pm-dsg for a duration sufficient to achieve statistical significance according to Annex G clause G.4. Count the number of NACKs, ACKs and statDTXs on the UL PUCCH during each subtest interval. Pm-dsg is the ratio (statDTX)/(NACK+ACK+statDTX). If Pm-dsg is less than the value specified in table 8.4.1.2.2.5-1, pass the UE. Otherwise fail the UE.

8.4.1.2.2.4.3 Message contents

Message contents are according to TS 36.508 [7] clause 4.6 with the following exceptions:

Table 8.4.1.2.2.4.3-1: PhysicalConfigDedicated-DEFAULT

Derivation Path: 36.331 clause 6.3.2			
Information Element	Value/remark	Comment	Condition
PhysicalConfigDedicated-DEFAULT ::= SEQUENCE {			
antennaInfo CHOICE {			
antennaInfoDedicated ::= SEQUENCE {			
transmissionMode	tm4		
codebookSubsetRestriction CHOICE {			
n4TxAntenna-tm4	11111111111111111111 11111111111111111111 11111111111111111111 1111		
}			
ue-TransmitAntennaSelection CHOICE {			
release	NULL		
}			
}			
}			

8.4.1.2.2.5 Test requirement

For the parameters specified in Table 8.4.1.2.2.3-1 the average probability of a missed downlink scheduling grant (Pm-dsg) shall be below the specified value in Table 8.4.1.2.2.5-1.

Table 8.4.1.2.2.5-1: Test requirement PDCCH/PCFICH 4 Tx Antenna Port

Test number	Bandwidth	Aggregation level	Reference Channel	OCNG Pattern	Propagation Condition	Antenna configuration and correlation Matrix	Reference value	
							Pm-dsg (%)	SNR (dB)
1	10 MHz	4 CCE	R.17 FDD	OP.1 FDD	EVA5	4 x 2 Medium	1	1.9

8.4.1.2.2_1 FDD PCFICH/PDCCH Transmit Diversity 4x2 (Release 9 and forward)

8.4.1.2.2_1.1 Test purpose

This test verifies the demodulation performance of PCFICH/PDCCH for transmit diversity with a given SNR for which the average probability of miss-detection of the Downlink Scheduling Grant, tested jointly on PDCCH and PCFICH of the specified reference measurement channels in A.3.5.1 remains below a given reference value.

8.4.1.2.2_1.2 Test applicability

This test applies to all types of E-UTRA FDD UE release 9 and forward.

8.4.1.2.2_1.3 Minimum conformance requirements

The receiver characteristics of the PDCCH/PCFICH are determined by the probability of miss-detection of the Downlink Scheduling Grant (Pm-dsg). PDCCH and PCFICH are tested jointly, i.e. a miss detection of PCFICH implies a miss detection of PDCCH.

Table 8.4.1.2.2_1.3-1: Test Parameters for PDCCH/PCFICH

Parameter		Unit	Transmit diversity
Number of PDCCH symbols		symbols	2
Number of PHICH groups (N_g)			1
PHICH duration			Normal
Unused RE-s and PRB-s			OCNG
Cell ID			0
Downlink power allocation	PCFICH_RA PDCCH_RA PHICH_RA OCNG_RA	dB	-3
	PCFICH_RB PDCCH_RB PHICH_RB OCNG_RB	dB	-3
N_{oc} at antenna port		dBm/15kHz	-98
Cyclic prefix			Normal
Note: PHICH power setting refer to PHICH group power, i.e. the total power of all active PHICH sequences within a PHICH group.			

For the parameters specified in Table 8.4.1.2.2_1.3-1 the average probability of a missed downlink scheduling grant (P_m -dsg) shall be below the specified value in Table 8.4.1.2.2_1.3-2.

Table 8.4.1.2.2_1.3-2: Minimum performance PDCCH/PCFICH 4 Tx Antenna Port

Test number	Bandwidth	Aggregation level	Reference Channel	OCNG Pattern	Propagation Condition	Antenna configuration and correlation Matrix	Reference value	
							Pm-dsg (%)	SNR (dB)
1	5 MHz	2 CCE	R.17_1 FDD	OP.1 FDD	EPA5	4 x 2 Medium	1	6.3

The normative reference for this requirement is TS 36.101 [2] clause 8.4.1.

8.4.1.2.2_1.4 Test description

8.4.1.2.2_1.4.1 Initial conditions

Initial conditions are a set of test configurations the UE needs to be tested in and the steps for the SS to take with the UE to reach the correct measurement state.

Configurations of PDSCH and PDCCH before measurement are specified in Annex C.2.

Test Environment: Normal, as defined in TS 36.508 [7] clause 4.1.

Frequencies to be tested: Mid Range, as defined in TS 36.508 [7] clause 4.3.1.1.

Channel Bandwidths to be tested: 5MHz, as defined in TS 36.508 [7] clause 4.3.1.1

1. Connect the SS, the faders and AWGN noise sources to the UE antenna connector (s) as shown in TS 36.508 [7] Annex A, Figure A.11.
2. The parameter settings for the cell are set up according to Table 8.4.1.2.2_1.3-1.
3. The downlink signals are initially set up according to Annex C.1 and C.3.2 and uplink signals according to Annex H.1 and H.3.2.
4. Propagation conditions are set according to Annex B clauses B.0.

5. Ensure the UE is in State 3A-RF according to TS 36.508 [7] clause 5.2A.2. Message contents are defined in clause 8.4.1.2.2_1.4.3.

8.4.1.2.2_1.4.2 Test procedure

1. SS transmits PDSCH via PDCCH DCI format 2 for C_RNTI to transmit the DL RMC according to Table 8.4.1.2.2_1.3-2. The details of PDCCH and PDSCH are specified in Table A.3.5.1-1 and Table A.3.5.1-2 respectively. The SS sends downlink MAC padding bits on the DL RMC. Transmission scheme for the PDSCH shall be transmit diversity.
2. Set the parameters of the propagation condition, antenna configuration, the correlation matrix and the SNR according to Table 8.4.1.2.2_1.5-1.
3. Measure the Pm-dsg for a duration sufficient to achieve statistical significance according to Annex G clause G.4. Count the number of NACKs, ACKs and statDTXs on the UL PUCCH during each subtest interval. Pm-dsg is the ratio (statDTX)/(NACK+ACK+statDTX). If Pm-dsg is less than the value specified in table 8.4.1.2.2_1.5-1, pass the UE. Otherwise fail the UE.

8.4.1.2.2_1.4.3 Message contents

Message contents are according to TS 36.508 [7] clause 4.6 with the following exceptions:

Table 8.4.1.2.2_1.4.3-1: PhysicalConfigDedicated-DEFAULT

Derivation Path: 36.331 clause 6.3.2			
Information Element	Value/remark	Comment	Condition
PhysicalConfigDedicated-DEFAULT ::= SEQUENCE {			
antennaInfo CHOICE {			
antennaInfoDedicated ::= SEQUENCE {			
transmissionMode	tm4		
codebookSubsetRestriction CHOICE {			
n4TxAntenna-tm4	11111111111111111111111111111111 11111111111111111111111111111111 11111111111111111111111111111111 1111		
}			
ue-TransmitAntennaSelection CHOICE {			
release	NULL		
}			
}			
}			

8.4.1.2.2_1.5 Test requirement

For the parameters specified in Table 8.4.1.2.2_1.3-1 the average probability of a missed downlink scheduling grant (Pm-dsg) shall be below the specified value in Table 8.4.1.2.2_1.5-1.

Table 8.4.1.2.2_1.5-1: Test requirement PDCCH/PCFICH 4 Tx Antenna Port

Test number	Bandwidth	Aggregation level	Reference Channel	OCNG Pattern	Propagation Condition	Antenna configuration and correlation Matrix	Reference value	
							Pm-dsg (%)	SNR (dB)
1	5 MHz	2 CCE	R.17_1 FDD	OP.1 FDD	EPA5	4 x 2 Medium	1	+7.3

8.4.1.2.3_C FDD PCFICH/PDCCH Transmit Diversity 2x2 for eICIC

8.4.1.2.3_C.1 FDD PCFICH/PDCCH Transmit Diversity 2x2 for eICIC (non-MBSFN ABS)

Editor's notes: This test case is incomplete. The following items are missing or incomplete:

- Connection diagram in Annex A of TS 36.508 is TBD
- Tests requirements are TBD
- Test tolerances are incomplete

8.4.1.2.3_C.1.1 Test purpose

To verify the UE's performance of transmit diversity (SFBC) with 2 transmit antennas if the PCFICH/PDCCH transmission in the serving cell takes place in subframes that overlap with ABS of the aggressor cell.

8.4.1.2.3_C.1.2 Test applicability

This test applies to all types of E-UTRA FDD UE release 10 and forward. Applicability requires support for FGI bit 115.

8.4.1.2.3_C.1.3 Minimum conformance requirements

The receiver characteristics of the PDCCH/PCFICH are determined by the probability of miss-detection of the Downlink Scheduling Grant (Pm-dsg). PDCCH and PCFICH are tested jointly, i.e. a miss detection of PCFICH implies a miss detection of PDCCH.

Table 8.4.1.2.3_C.1.3-1: Test Parameters for PDCCH/PCFICH

Parameter		Unit	Transmit diversity
Number of PDCCH symbols		symbols	2
Number of PHICH groups (Ng)			1
PHICH duration			Normal
Unused RE-s and PRB-s			OCNG
Cell ID			0
Downlink power allocation	PCFICH_RA PDCCH_RA PHICH_RA OCNG_RA	dB	-3
	PCFICH_RB PDCCH_RB PHICH_RB OCNG_RB	dB	-3
N_{oc} at antenna port		dBm/15kHz	-98
Cyclic prefix			Normal
Note:	PHICH power setting refer to PHICH group power, i.e. the total power of all active PHICH sequences within a PHICH group.		

For the parameters for non-MBSFN ABS specified in Table 8.4.1.2.3_C.1.3-1 and Table 8.4.1.2.3_C.1.3-2, the average probability of a missed downlink scheduling grant (Pm-dsg) shall be below the specified value in Table 8.4.1.2.3_C.1-3. The downlink physical setup is in accordance with Annex C.3.2 and Annex C.3.3. In Table 8.4.1.2.3_C.1.3-2, Cell 1 is the serving cell, and Cell 2 is the aggressor cell. The downlink physical channel setup for Cell 1 is according to Annex C.3.2 and for Cell 2 is according to Annex C.3.3, respectively.

Table 8.4.1.2.3_C.1.3-2: Test Parameters for PDCCH/PCFICH – Non-MBSFN ABS

Parameter		Unit	Cell 1	Cell 2
Downlink power allocation	PDCCH_RA PHICH_RA OCNG_RA	dB	-3	-3
	PCFICH_RB PDCCH_RB PHICH_RB OCNG_RB	dB	-3	-3
N_{oc} at antenna port	N_{oc1}	dBm/15kHz	-100.5 (Note 1)	N/A
	N_{oc2}	dBm/15kHz	-98 (Note 2)	N/A
	N_{oc3}	dBm/15kHz	-95.3 (Note 3)	N/A
\hat{E}_s/N_{oc2}		dB	Reference Value in Table 8.4.1.2.3_C.1.3-3	1.5
BW _{Channel}		MHz	10	10
Subframe Configuration			Non-MBSFN	Non-MBSFN
Time Offset between Cells		μs	2.5 (synchronous cells)	
Cell Id			0	1
ABS pattern (Note 4)			N/A	00000100 00000100 00000100 01000100 00000100
RLM/RRM Measurement Subframe Pattern (Note 5)			00000100 00000100 00000100 00000100	N/A
CSI Subframe Sets (Note 6)	$C_{CSI,0}$		00000100 00000100 00000100 01000100 00000100	N/A
	$C_{CSI,1}$		11111011 11111011 11111011 10111011 11111011	N/A
Number of control OFDM symbols			3	
Number of PHICH groups (N_g)			1	
PHICH duration			Extended	
Unused RE-s and PRB-s			OCNG	
Cyclic prefix			Normal	Normal
<p>Note 1: This noise is applied in OFDM symbols #1, #2, #3, #5, #6, #8, #9, #10, #12, #13 of a subframe overlapping with the aggressor ABS.</p> <p>Note 2: This noise is applied in OFDM symbols #0, #4, #7, #11 of a subframe overlapping with the aggressor ABS.</p> <p>Note 3: This noise is applied in all OFDM symbols of a subframe overlapping with aggressor non-ABS</p> <p>Note 4: ABS pattern as defined in [14]. PDCCH/PCFICH other than that associated with SIB1/Paging are transmitted in the serving cell subframe when the subframe is overlapped with the ABS subframe of aggressor cell.</p> <p>Note 5: Time-domain measurement resource restriction pattern for PCell measurements as defined in [5];</p> <p>Note 6: As configured according to the time-domain measurement resource restriction pattern for CSI measurements defined in [5];</p> <p>Note 7: Cell 1 is the serving cell. Cell 2 is the aggressor cell. The number of the CRS ports in Cell1 and Cell2 is the same.</p> <p>Note 8: SIB-1 will not be transmitted in Cell2 in the test.</p>				

Table 8.4.1.2.3_C.1.3-3: Minimum performance PDCCH/PCFICH – Non-MBSFN ABS

Test Number	Aggregation Level	Reference Channel	OCNG Pattern		Propagation Conditions (Note 1)		Correlation Matrix and Antenna Configuration	Reference Value	
			Cell 1	Cell 2	Cell 1	Cell 2		Pm-dsg (%)	SNR (dB) (Note 2)
1	8 CCE	R15-1 FDD	OP.1 FDD	OP.1 FDD	EVA5	EVA5	2x2 Low	1	-3.9
Note 1: The propagation conditions for Cell 1 and Cell 2 are statistically independent. Note 2: SNR corresponds to \hat{E}_s / N_{oc2} of cell 1 Note 3: The correlation matrix and antenna configuration apply for Cell 1 and Cell 2.									

The normative reference for this requirement is TS 36.101 [2] clause 8.4.1.2.3

8.4.1.2.3_C.1.4 Test description

8.4.1.2.3_C.1.4.1 Initial conditions

Initial conditions are a set of test configurations the UE needs to be tested in and the steps for the SS to take with the UE to reach the correct measurement state.

Configurations of PDSCH and PDCCH before measurement are specified in Annex C.2.

Test Environment: Normal, as defined in TS 36.508 [7] clause 4.1.

Frequencies to be tested: Mid Range, as defined in TS 36.508 [7] clause 4.3.1.1.

Channel Bandwidths to be tested: 10MHz, as defined in TS 36.508 [7] clause 4.3.1.1

1. Connect the SS, the faders and AWGN noise sources to the UE antenna connector (s) as shown in TS 36.508 [7] Annex A, Figure [TBD] for antenna configuration 2x2.
2. The parameter settings for the cell1 are set up according to Tables 8.4.1.2.3_C.1.3-1 and 8.4.1.2.3_C.1.3-2.
3. The downlink signals are initially set up according to Annex C.1 and C.3.2 and uplink signals according to Annex H.1 and H.3.2.
4. Propagation conditions are set according to Annex B clauses B.0.
5. Ensure the UE is in State 3A-RF according to TS 36.508 [7] clause 5.2A.2. Message contents are defined in clause 8.4.1.2.3_C.1.4.3.

8.4.1.2.3_C.1.4.2 Test procedure

1. SS transmits PDSCH via PDCCH DCI format 2 for C_RNTI to transmit the DL RMC according to Table 8.4.1.2.3_C.1.3-3. The details of PDCCH and PDSCH are specified in Table A.3.5.1-1 and Table A.3.5.1-2 respectively. The SS sends downlink MAC padding bits on the DL RMC. Transmission scheme for the PDSCH shall be transmit diversity.
2. Set the parameters of the propagation condition, antenna configuration, the correlation matrix and the SNR according to Table 8.4.1.2.3_C.1.5-1
3. Set the Cell2 –aggressor cell- as defined in Tables 8.4.1.2.3_C.1.3-2, 8.4.1.2.3_C.1.5-1 and according to Annex C3.3.
4. Measure the Pm-dsg for a duration sufficient to achieve statistical significance according to Annex G clause G.4. Count the number of NACKs, ACKs and statDTXs on the UL PUCCH during each subtest interval. Pm-dsg is the ratio (statDTX)/(NACK+ACK+statDTX).

If Pm-dsg is less than the value specified in table 8.4.1.2.3_C.1.5-1, pass the UE. Otherwise fail the UE.

8.4.1.2.3_C.1.4.3 Message contents

Message contents are according to TS 36.508 [7] clause 4.6 with the following exceptions:

Table 8.4.1.2.3_C.1.4.3-1: PhysicalConfigDedicated-DEFAULT

Derivation Path: 36.331 clause 6.3.2			
Information Element	Value/remark	Comment	Condition
PhysicalConfigDedicated-DEFAULT ::= SEQUENCE {			
antennaInfo CHOICE {			
antennaInfoDedicated ::= SEQUENCE {			
transmissionMode	tm4		
codebookSubsetRestriction CHOICE {			
n2TxAntenna-tm4	111111		
}			
ue-TransmitAntennaSelection CHOICE {			
release	NULL		
}			
}			
}			

Table 8.4.1.2.3_C.1.4.3-2: RadioResourceConfigDedicated-SRB2-DRB(n, m)

Derivation Path: TS 36.508 [7] clause 4.6.3, Table 4.6.3-16 RadioResourceConfigDedicated-SRB2-DRB(n,m)			
Information Element	Value/remark	Comment	Condition
RadioResourceConfigDedicated-SRB2-DRB(n, m) ::= SEQUENCE {			
MeasSubframePatternPCell-r10 CHOICE {			
setup SEQUENCE {			
subframePatternFDD-r10	'00000100000001000000 0100000001000000100'	BIT STRING (SIZE (40))	
}			
}			
}			

Table 8.4.1.2.3_C.1.4.3-3: CQI-ReportConfig-r10-DEFAULT

Derivation Path: 36.508 [7] clause 4.6.3, Table 4.6.3-2AA CQI-ReportConfig-r10-DEFAULT_			
Information Element	Value/remark	Comment	Condition
CQI-ReportConfig-r10-DEFAULT ::= SEQUENCE {			
csi-SubframePatternConfig-r10 CHOICE {			
setup SEQUENCE {			
csi-MeasSubframeSet1-r10 CHOICE {			
subframePatternFDD-r10	'00000100000001000000 0100010001000000100'	BIT STRING (SIZE (40))	
}			
csi-MeasSubframeSet2-r10 CHOICE {			
subframePatternFDD-r10	'11111011111110111111 10111011110111111011'	BIT STRING (SIZE (40))	
}			
}			
}			
}			

8.4.1.2.3_C.1.5 Test requirement

For the parameters specified in Table 8.4.1.2.3_C.1.3-2, the average probability of a missed downlink scheduling grant (Pm-dsg) shall be below the specified value in Table 8.4.1.2.3_C.1.5-1.

Table 8.4.1.2.3_C.1.5-1: Test Requirement PDCCH/PCFICH – Non-MBSFN ABS

Test Number	Aggregation Level	Reference Channel	OCNG Pattern		Propagation Conditions (Note 1)		Correlation Matrix and Antenna Configuration	Reference Value	
			Cell 1	Cell 2	Cell 1	Cell 2		Pm-dsg (%)	SNR (dB) (Note 2)
1	8 CCE	R15-1 FDD	OP.1 FDD	OP.1 FDD	EVA5	EVA5	2x2 Low	1	[TBD]
Note 1: The propagation conditions for Cell 1 and Cell 2 are statistically independent.									
Note 2: SNR corresponds to \hat{E}_s / N_{oc2} of cell 1									

8.4.1.2.3_C.2 FDD PCFICH/PDCCH Transmit Diversity 2x2 for eICIC (MBSFN ABS)

Editor's notes: This test case is incomplete. The following items are missing or incomplete:

- Connection diagram in Annex A of TS 36.508 is TBD
- Tests requirements are TBD
- Test tolerances are incomplete

8.4.1.2.3_C.2.1 Test purpose

To verify the UE's performance of transmit diversity (SFBC) with 2 transmit antennas if the PCFICH/PDCCH transmission in the serving cell takes place in subframes that overlap with ABS of the aggressor cell.

8.4.1.2.3_C.2.2 Test applicability

This test applies to all types of E-UTRA FDD UE release 10 and forward. Applicability requires support for FGI bit 115.

8.4.1.2.3_C.2.3 Minimum conformance requirements

The receiver characteristics of the PDCCH/PCFICH are determined by the probability of miss-detection of the Downlink Scheduling Grant (Pm-dsg). PDCCH and PCFICH are tested jointly, i.e. a miss detection of PCFICH implies a miss detection of PDCCH.

Table 8.4.1.2.3_C.2.3-1: Test Parameters for PDCCH/PCFICH

Parameter	Unit	Transmit diversity	
Number of PDCCH symbols	symbols	2	
Number of PHICH groups (Ng)		1	
PHICH duration		Normal	
Unused RE-s and PRB-s		OCNG	
Cell ID		0	
Downlink power allocation	PCFICH_RA PDCCH_RA PHICH_RA OCNG_RA	dB	-3
	PCFICH_RB PDCCH_RB PHICH_RB OCNG_RB	dB	-3
N_{oc} at antenna port	dBm/15kHz	-98	
Cyclic prefix		Normal	
Note:	PHICH power setting refer to PHICH group power, i.e. the total power of all active PHICH sequences within a PHICH group.		

For the parameters for MBSFN ABS specified in Table 8.4.1.2.3_C.2.3-1 and Table 8.4.1.2.3_C.2.3-2, the average probability of a missed downlink scheduling grant (P_{m-dsg}) shall be below the specified value in Table 8.4.1.2.3_C.2-5. The downlink physical setup is in accordance with Annex C.3.2 and Annex C.3.3. In Table 8.4.1.2.3_C.2.3-2, Cell 1 is the serving cell, and Cell 2 is the aggressor cell. The downlink physical channel setup for Cell 1 is according to Annex C.3.2 and for Cell 2 is according to Annex C.3.3, respectively.

Table 8.4.1.2.3_C.2.3-2: Test Parameters for PDCCH/PCFICH – MBSFN ABS

Parameter		Unit	Cell 1	Cell 2
Downlink power allocation	PCFICH_RA PDCCH_RA PHICH_RA OCNG_RA	dB	-3	-3
	PCFICH_RB PDCCH_RB PHICH_RB OCNG_RB	dB	-3	-3
N_{oc} at antenna port	N_{oc1}	dBm/15kHz	-100.5 (Note 1)	N/A
	N_{oc2}	dBm/15kHz	-98 (Note 2)	N/A
	N_{oc3}	dBm/15kHz	-95.3 (Note 3)	N/A
\hat{E}_s / N_{oc2}		dB	Reference Value in Table 8.4.1.2.3_C.2.3-3	1.5
$BW_{Channel}$		MHz	10	10
Subframe Configuration			Non-MBSFN	MBSFN
Time Offset between Cells		μ s	2.5 (synchronous cells)	
Cell Id			0	126
ABS pattern (Note 4)			N/A	0001000000 0100000010 0000001000 0000000000
RLM/RRM Measurement Subframe Pattern (Note 5)			0001000000 0100000010 0000001000 0000000000	N/A
CSI Subframe Sets (Note 6)	$C_{CSI,0}$		0001000000 0100000010 0000001000 0000000000	N/A
	$C_{CSI,1}$		1110111111 1011111101 1111110111 1111111111	N/A
MBSFN Subframe Allocation (Note 9)			N/A	001000 100001 000100 000000
Number of control OFDM symbols			3	
Number of PHICH groups (N_g)			1	
PHICH duration			extended	
Unused RE-s and PRB-s			OCNG	
Cyclic prefix			Normal	Normal

Note 1:	This noise is applied in OFDM symbols #1, #2, #3, #4, #5, #6, #7, #8, #9, #10, #11, #12, #13 of a subframe overlapping with the aggressor ABS.
Note 2:	This noise is applied in OFDM symbols #0 of a subframe overlapping with the aggressor ABS.
Note 3:	This noise is applied in all OFDM symbols of a subframe overlapping with aggressor non-ABS
Note 4:	ABS pattern as defined in [14]. The 4 th , 12 th , 19 th and 27 th subframes indicated by ABS pattern are MBSFN ABS subframes. PDSCH other than SIB1/paging and its associated PDCCH/PCFICH are transmitted in the serving cell subframe when the subframe is overlapped with the MBSFN ABS subframe of aggressor cell and the subframe is available in the definition of the reference channel.
Note 5:	Time-domain measurement resource restriction pattern for PCell measurements as defined in [5].
Note 6:	As configured according to the time-domain measurement resource restriction pattern for CSI measurements defined in [5].
Note 7:	Cell 1 is the serving cell. Cell 2 is the aggressor cell. The number of the CRS ports in Cell1 and Cell2 is the same.
Note 8:	SIB-1 will not be transmitted in Cell2 in this test.
Note 9:	MBSFN Subframe Allocation as defined in [5], four frames with 24 bits is chosen for MBSFN subframe allocation.
Note 10:	The maximum number of uplink HARQ transmission is limited to 2 so that each PHICH channel transmission is in a subframe protected by MBSFN ABS in this test.

Table 8.4.1.2.3_C.2.3-3: Minimum performance PDCCH/PCHICH – MBSFN ABS

Test Number	Aggregation Level	Reference Channel	OCNG Pattern		Propagation Conditions (Note 1)		Correlation Matrix and Antenna Configuration	Reference Value	
			Cell 1	Cell 2	Cell 1	Cell 2		Pm-dsg (%)	SNR (dB) (Note 2)
1	8 CCE	R15-1 FDD	OP.1 FDD	OP.1 FDD	EVA5	EVA5	2x2 Low	1	-4.2
Note 1: The propagation conditions for Cell 1 and Cell2 are statistically independent.									
Note 2: SNR corresponds to \hat{E}_s / N_{oc2} of cell 1.									
Note 3: The correlation matrix and antenna configuration apply for Cell 1 and Cell 2.									

The normative reference for this requirement is TS 36.101 [2] clause 8.4.1.2.3

8.4.1.2.3_C.2.4 Test description

8.4.1.2.3_C.2.4.1 Initial conditions

Initial conditions are a set of test configurations the UE needs to be tested in and the steps for the SS to take with the UE to reach the correct measurement state.

Configurations of PDSCH and PDCCH before measurement are specified in Annex C.2.

Test Environment: Normal, as defined in TS 36.508 [7] clause 4.1.

Frequencies to be tested: Mid Range, as defined in TS 36.508 [7] clause 4.3.1.1.

Channel Bandwidths to be tested: 10MHz, as defined in TS 36.508 [7] clause 4.3.1.1

1. Connect the SS, the faders and AWGN noise sources to the UE antenna connector (s) as shown in TS 36.508 [7] Annex A, Figure [TBD] for antenna configuration 2x2.
2. The parameter settings for the cell1 are set up according to Tables 8.4.1.2.3_C.2.3-1 and 8.4.1.2.3_C.2.3-2.
3. The downlink signals are initially set up according to Annex C.1 and C.3.2 and uplink signals according to Annex H.1 and H.3.2.
4. Propagation conditions are set according to Annex B clauses B.0.
5. Ensure the UE is in State 3A-RF according to TS 36.508 [7] clause 5.2A.2. Message contents are defined in clause 8.4.1.2.3_C.2.4.3.

8.4.1.2.3_C.2.4.2 Test procedure

1. SS transmits PDSCH via PDCCH DCI format 2 for C_RNTI to transmit the DL RMC according to Table 8.4.1.2.3_C.2.3-3. The details of PDCCH and PDSCH are specified in Table A.3.5.1-1 and Table A.3.5.1-2 respectively. The SS sends downlink MAC padding bits on the DL RMC. Transmission scheme for the PDSCH shall be transmit diversity.
2. Set the parameters of the propagation condition, antenna configuration, the correlation matrix and the SNR according to Table 8.4.1.2.3_C.2.5-1.
3. Set the Cell2 –aggressor cell- as defined in Tables 8.4.1.2.3_C.2.3-2, 8.4.1.2.3_C.2.5-1 and according to Annex C3.3
4. Measure the Pm-dsg for a duration sufficient to achieve statistical significance according to Annex G clause G.4. Count the number of NACKs, ACKs and statDTXs on the UL PUCCH during each subtest interval. Pm-dsg is the ratio (statDTX)/(NACK+ACK+statDTX).

If Pm-dsg is less than the value specified in table 8.4.1.2.3_C.2.5-1, pass the UE. Otherwise fail the UE.

8.4.1.2.3_C.2.4.3 Message contents

Message contents are according to TS 36.508 [7] clause 4.6 with the following exceptions:

Table 8.4.1.2.3_C.2.4.3-1: PhysicalConfigDedicated-DEFAULT

Derivation Path: 36.331 clause 6.3.2			
Information Element	Value/remark	Comment	Condition
PhysicalConfigDedicated-DEFAULT ::= SEQUENCE {			
antennaInfo CHOICE {			
antennaInfoDedicated ::= SEQUENCE {			
transmissionMode	tm4		
codebookSubsetRestriction CHOICE {			
n2TxAntenna-tm4	111111		
}			
ue-TransmitAntennaSelection CHOICE {			
release	NULL		
}			
}			
}			

Table 8.4.1.2.3_C.2.4.3-2: RadioResourceConfigDedicated-SRB2-DRB(n, m)

Derivation Path: TS 36.508 [7] clause 4.6.3, Table 4.6.3-16 RadioResourceConfigDedicated-SRB2-DRB(n,m)			
Information Element	Value/remark	Comment	Condition
RadioResourceConfigDedicated-SRB2-DRB(n, m) ::= SEQUENCE {			
MeasSubframePatternPCell-r10 CHOICE {			
setup SEQUENCE {			
subframePatternFDD-r10	'00010000000100000010 00000010000000000000'	BIT STRING (SIZE (40))	
}			
}			
}			

Table 8.4.1.2.3_C.2.4.3-3: CQI-ReportConfig-r10-DEFAULT

Derivation Path: 36.508 [7] clause 4.6.3, Table 4.6.3-2AA CQI-ReportConfig-r10-DEFAULT_			
Information Element	Value/remark	Comment	Condition
CQI-ReportConfig-r10-DEFAULT ::= SEQUENCE {			
csi-SubframePatternConfig-r10 CHOICE {			
setup SEQUENCE {			
csi-MeasSubframeSet1-r10 CHOICE {			
subframePatternFDD-r10	'00010000000100000010 00000010000000000000'	BIT STRING (SIZE (40))	
}			
csi-MeasSubframeSet2-r10 CHOICE {			
subframePatternFDD-r10	'11101111111011111101 11111101111111111111'	BIT STRING (SIZE (40))	
}			
}			
}			
}			

8.4.1.2.3_C.2.5 Test requirement

For the parameters specified in Table 8.4.1.2.3_C.2.3-2, the average probability of a missed downlink scheduling grant (Pm-dsg) shall be below the specified value in Table 8.4.1.2.3_C.2.5-1.

Table 8.4.1.2.3_C.2.5-1: Test Requirement PDCCH/PCHICH – MBSFN ABS

Test Number	Aggregation Level	Reference Channel	OCNG Pattern		Propagation Conditions (Note 1)		Correlation Matrix and Antenna Configuration	Reference Value	
			Cell 1	Cell 2	Cell 1	Cell 2		Pm-dsg (%)	SNR (dB) (Note 2)
1	8 CCE	R15-1 FDD	OP.1 FDD	OP.1 FDD	EVA5	EVA5	2x2 Low	1	[TBD]
Note 1: The propagation conditions for Cell 1 and Cell2 are statistically independent.									
Note 2: SNR corresponds to \hat{E}_s / N_{oc2} of cell 1									

8.4.2 TDD

8.4.2.1 TDD PCFICH/PDCCH Single-antenna Port Performance

8.4.2.1.1 Test purpose

This test verifies the demodulation performance of PCFICH/PDCCH for a single-antenna port with a given SNR for which the average probability of miss-detection of the Downlink Scheduling Grant, tested jointly on PDCCH and PCFICH of the specified reference measurement channels in A.3.5.2 remains below a given reference value.

8.4.2.1.2 Test applicability

This test applies to all types of E-UTRA TDD UE release 8 and forward.

8.4.2.1.3 Minimum conformance requirements

The receiver characteristics of the PDCCH/PCFICH are determined by the probability of miss-detection of the Downlink Scheduling Grant (Pm-dsg). PDCCH and PCFICH are tested jointly, i.e. a miss detection of PCFICH implies a miss detection of PDCCH.

Table 8.4.2.1.3-1: Test Parameters for PDCCH/PCFICH

Parameter		Unit	Single antenna port
Uplink downlink configuration (Note 1)			0
Special subframe configuration (Note 2)			4
Number of PDCCH symbols		symbols	2
Number of PHICH groups (N_g)			1
PHICH duration			Normal
Unused RE-s and PRB-s			OCNG
Cell ID			0
Downlink power allocation	PCFICH_RA PDCCH_RA PHICH_RA OCNG_RA	dB	0
	PCFICH_RB PDCCH_RB PHICH_R B OCNG_RB	dB	0
N_{oc} at antenna port		dBm/15kHz	-98
Cyclic prefix			Normal
ACK/NACK feedback mode			Multiplexing
Note 1: as specified in Table 4.2-2 in TS 36.211 [8] Note 2: as specified in Table 4.2-1 in TS 36.211 [8] Note 3: PHICH power setting refer to PHICH group power, i.e. the total power of all active PHICH sequences within a PHICH group.			

For the parameters specified in Table 8.4.2.1.3-1 the average probability of a missed downlink scheduling grant (P_{m-dsg}) shall be below the specified value in Table 8.4.2.1.3-2.

Table 8.4.2.1.3-2: Minimum performance PDCCH/PCFICH

Test number	Bandwidth	Aggregation level	Reference Channel	OCNG Pattern	Propagation Condition	Antenna configuration and correlation Matrix	Reference value	
							P_{m-dsg} (%)	SNR (dB)
1	10 MHz	8 CCE	R.15 TDD	OP.1 TDD	ETU70	1x2Low	1	-1.6

The normative reference for this requirement is TS 36.101 [2] clause 8.4.2.

8.4.2.1.4 Test description

8.4.2.1.4.1 Initial conditions

Initial conditions are a set of test configurations the UE needs to be tested in and the steps for the SS to take with the UE to reach the correct measurement state.

Configurations of PDSCH and PDCCH before measurement are specified in Annex C.2.

Test Environment: Normal, as defined in TS 36.508 [7] clause 4.1.

Frequencies to be tested: Mid Range, as defined in TS 36.508 [7] clause 4.3.1.2.

Channel Bandwidths to be tested: 10MHz, as defined in TS 36.508 [7] clause 4.3.1.2.

1. Connect the SS, the faders and AWGN noise source to the UE antenna connector (s) as shown in TS 36.508 [7] Annex A, Figure A.9.
2. The parameter settings for the cell are set up according to 8.4.2.1.3-1.
3. Downlink signals are initially set up according to Annex C0, C.1 and Annex C.3.2 and uplink signals according to Annex H.1 and H.3.2.
4. Propagation conditions are set according to Annex B.0.
5. Ensure the UE is in State 3A-RF according to TS 36.508 [7] clause 5.2A.2. Message contents are defined in clause 8.4.2.1.4.3.

8.4.2.1.4.2 Test procedure

1. SS transmits PDSCH via PDCCH DCI format 1 for C_RNTI to transmit the DL RMC according to Table 8.4.2.1.3-2. The details of PDCCH and PDSCH are specified in Table A.3.5.2-1 and Table A.3.5.2-2 respectively. The SS sends downlink MAC padding bits on the DL RMC.
2. Set the parameters of the propagation condition, the correlation matrix, antenna configuration and the SNR according to Tables 8.4.2.1.5-1 as appropriate.
3. Measure the Pm-dsg for a duration sufficient to achieve statistical significance according to Annex G clause G.4. Count the number of NACKs, ACKs and statDTXs on the UL PUCCH during each subtest interval. Pm-dsg is the ratio (statDTX)/(NACK + ACK + statDTX). If Pm-dsg is less than the value specified in table 8.4.2.1.5-1, pass the UE. Otherwise fail the UE.

8.4.2.1.4.3 Message contents

Message contents are according to TS 36.508 [7] clause 4.6 with the following exception:

Table 8.4.2.1.4.3-1: TDD-Configuration-DEFAULT

Derivation Path: 36.508 clause 4.6.4			
Information Element	Value/remark	Comment	Condition
TDD-Configuration-DEFAULT ::= SEQUENCE {			
subframeAssignment	sa0		
specialSubframePatterns	Ssp4		
}			

8.4.2.1.5 Test requirement

For the parameters specified in Table 8.4.2.1.3-1 the average probability of a missed downlink scheduling grant (Pm-dsg) shall be below the specified value in Table 8.4.2.1.5-1.

Table 8.4.2.1.5-1: Test requirement PDCCH/PCFICH

Test number	Bandwidth	Aggregation level	Reference Channel	OCNG Pattern	Propagation Condition	Antenna configuration and correlation Matrix	Reference value	
							Pm-dsg (%)	SNR (dB)
1	10 MHz	8 CCE	R.15 TDD	OP.1 TDD	ETU70	1x2Low	1	-0.8

8.4.2.2 TDD PCFICH/PDCCH Transmit Diversity Performance

8.4.2.2.1 TDD PCFICH/PDCCH Transmit Diversity 2x2

8.4.2.2.1.1 Test purpose

This test verifies the demodulation performance of PCFICH/PDCCH for transmit diversity with a given SNR for which the average probability of miss-detection of the Downlink Scheduling Grant, tested jointly on PDCCH and PCFICH of the specified reference measurement channels in A.3.5.2 remains below a given reference value.

8.4.2.2.1.2 Test applicability

This test applies to all types of E-UTRA TDD UE release 8.

8.4.2.2.1.3 Minimum conformance requirements

The receiver characteristics of the PDCCH/PCFICH are determined by the probability of miss-detection of the Downlink Scheduling Grant (Pm-dsg). PDCCH and PCFICH are tested jointly, i.e. a miss detection of PCFICH implies a miss detection of PDCCH.

Table 8.4.2.2.1.3-1: Test Parameters for PDCCH/PCFICH

Parameter		Unit	Transmit diversity
Uplink downlink configuration (Note 1)			0
Special subframe configuration (Note 2)			4
Number of PDCCH symbols		symbols	2
Number of PHICH groups (N_g)			1
PHICH duration			Normal
Unused RE-s and PRB-s			OCNG
Cell ID			0
Downlink power allocation	PCFICH_RA PDCCH_RA PHICH_RA OCNG_RA	dB	-3
	PCFICH_RB PDCCH_RB PHICH_RB OCNG_RB	dB	-3
N_{oc} at antenna port		dBm/15kHz	-98
Cyclic prefix			Normal
ACK/NACK feedback mode			Multiplexing
Note 1: as specified in Table 4.2-2 in TS 36.211 [8] Note 2: as specified in Table 4.2-1 in TS 36.211 [8] Note 3: PHICH power setting refer to PHICH group power, i.e. the total power of all active PHICH sequences within a PHICH group			

For the parameters specified in Table 8.4.2.2.1.3-1 the average probability of a missed downlink scheduling grant (Pm-dsg) shall be below the specified value in Table 8.4.2.2.1.3-2.

Table 8.4.2.2.1.3-2: Minimum performance PDCCH/PCFICH 2 Tx Antenna Port

Test number	Bandwidth	Aggregation level	Reference Channel	OCNG Pattern	Propagation Condition	Antenna configuration and correlation Matrix	Reference value	
							Pm-dsg (%)	SNR (dB)
1	1.4 MHz	2 CCE	R.16 TDD	OP.1 TDD	EPA5	2 x 2 Low	1	4.2

The normative reference for this requirement is TS 36.101 [2] clause 8.4.2.

8.4.2.2.1.4 Test description

8.4.2.2.1.4.1 Initial conditions

Initial conditions are a set of test configurations the UE needs to be tested in and the steps for the SS to take with the UE to reach the correct measurement state.

Configurations of PDSCH and PDCCH before measurement are specified in Annex C.2.

Test Environment: Normal, as defined in TS 36.508 [7] clause 4.1.

Frequencies to be tested: Mid Range, as defined in TS 36.508 [7] clause 4.3.1.1.

Channel Bandwidths to be tested: 1.4MHz, as defined in TS 36.508 [7] clause 4.3.1.1

1. Connect the SS, the faders and AWGN noise sources to the UE antenna connectors as shown in TS 36.508 [7] Annex A, Figure A.10.
2. The parameter settings for the cell are set up according to 8.4.2.2.1.3-1.
3. Downlink signals are initially set up according to Annex C0, C.1 and C.3.2 and uplink signals according to Annex H.1 and H.3.2.
4. Propagation conditions are set according to Annex B.0.
5. Ensure the UE is in State 3A-RF according to TS 36.508 [7] clause 5.2A.2. Message contents are defined in clause 8.4.2.2.1.4.3.

8.4.2.2.1.4.2 Test procedure

1. SS transmits PDSCH via PDCCH DCI format 2 for C_RNTI to transmit the DL RMC according to Table 8.4.2.2.1.3-2. The details of PDCCH and PDSCH are specified in Table A.3.5.2-1 and Table A.3.5.2-2 respectively. The SS sends downlink MAC padding bits on the DL RMC. Transmission scheme for the PDSCH shall be transmit diversity.
2. Set the parameters of the propagation condition, the correlation matrix, antenna configuration and the SNR according to Tables 8.4.2.2.1.5-1 as appropriate.
3. Measure the Pm-dsg for a duration sufficient to achieve statistical significance according to Annex G clause G.4. Count the number of NACKs, ACKs and statDTXs on the UL PUCCH during each subtest interval. Pm-dsg is the ratio (statDTX)/(NACK + ACK + statDTX). If Pm-dsg is less than the value specified in table 8.4.2.2.1.5-1, pass the UE. Otherwise fail the UE

8.4.2.2.1.4.3 Message contents

Message contents are according to TS 36.508 [7] clause 4.6 with the following exception:.

Table 8.4.2.2.1.4.3-1: TDD-Configuration-DEFAULT

Derivation Path: 36.508 clause 4.6.4			
Information Element	Value/remark	Comment	Condition
TDD-Configuration-DEFAULT ::= SEQUENCE {			
subframeAssignment	Sa0		
specialSubframePatterns	Ssp4		
}			

Table 8.4.2.2.1.4.3-2: PhysicalConfigDedicated-DEFAULT

Derivation Path: 36.331 clause 6.3.2			
Information Element	Value/remark	Comment	Condition
PhysicalConfigDedicated-DEFAULT ::= SEQUENCE {			
antennaInfo CHOICE {			
antennaInfoDedicated ::= SEQUENCE {			
transmissionMode	tm4		
codebookSubsetRestriction CHOICE {			
n2TxAntenna-tm4	111111		
}			
ue-TransmitAntennaSelection CHOICE {			
release	NULL		
}			
}			
}			

8.4.2.2.1.5 Test requirement

For the parameters specified in Table 8.4.2.2.1.3-1 the average probability of a missed downlink scheduling grant (Pm-dsg) shall be below the specified value in Table 8.4.2.2.1.5-1.

Table 8.4.2.2.1.5-1: Test requirement PDCCH/PCFICH 2 Tx Antenna Port

Test number	Bandwidth	Aggregation level	Reference Channel	OCNG Pattern	Propagation Condition	Antenna configuration and correlation Matrix	Reference value	
							Pm-dsg (%)	SNR (dB)
1	1.4 MHz	2 CCE	[R.16 TDD]	OP.1 TDD	EPA5	2 x 2 Low	1	5.2

8.4.2.2.1_1 TDD PCFICH/PDCCH Transmit Diversity 2x2 (Release 9 and forward)

8.4.2.2.1_1.1 Test purpose

This test verifies the demodulation performance of PCFICH/PDCCH for transmit diversity with a given SNR for which the average probability of miss-detection of the Downlink Scheduling Grant, tested jointly on PDCCH and PCFICH of the specified reference measurement channels in A.3.5.2 remains below a given reference value.

8.4.2.2.1_1.2 Test applicability

This test applies to all types of E-UTRA TDD UE release 9 and forward.

8.4.2.2.1_1.3 Minimum conformance requirements

The receiver characteristics of the PDCCH/PCFICH are determined by the probability of miss-detection of the Downlink Scheduling Grant (Pm-dsg). PDCCH and PCFICH are tested jointly, i.e. a miss detection of PCFICH implies a miss detection of PDCCH.

Table 8.4.2.2.1_1.3-1: Test Parameters for PDCCH/PCFICH

Parameter		Unit	Transmit diversity
Uplink downlink configuration (Note 1)			0
Special subframe configuration (Note 2)			4
Number of PDCCH symbols		symbols	2
Number of PHICH groups (N_g)			1
PHICH duration			Normal
Unused RE-s and PRB-s			OCNG
Cell ID			0
Downlink power allocation	PCFICH_RA PDCCH_RA PHICH_RA OCNG_RA	dB	-3
	PCFICH_RB PDCCH_RB PHICH_RB OCNG_RB	dB	-3
N_{oc} at antenna port		dBm/15kHz	-98
Cyclic prefix			Normal
ACK/NACK feedback mode			Multiplexing
Note 1: as specified in Table 4.2-2 in TS 36.211 [8] Note 2: as specified in Table 4.2-1 in TS 36.211 [8] Note 3: PHICH power setting refer to PHICH group power, i.e. the total power of all active PHICH sequences within a PHICH group			

For the parameters specified in Table 8.4.2.2.1_1.3-1 the average probability of a missed downlink scheduling grant (Pm-dsg) shall be below the specified value in Table 8.4.2.2.1_1.3-2.

Table 8.4.2.2.1_1.3-2: Minimum performance PDCCH/PCFICH 2 Tx Antenna Port

Test number	Bandwidth	Aggregation level	Reference Channel	OCNG Pattern	Propagation Condition	Antenna configuration and correlation Matrix	Reference value	
							Pm-dsg (%)	SNR (dB)
1	10 MHz	4 CCE	R.16_1 TDD	OP.1 TDD	EVA70	2 x 2 Low	1	0.1

The normative reference for this requirement is TS 36.101 [2] clause 8.4.2.

8.4.2.2.1_1.4 Test description

8.4.2.2.1_1.4.1 Initial conditions

Initial conditions are a set of test configurations the UE needs to be tested in and the steps for the SS to take with the UE to reach the correct measurement state.

Configurations of PDSCH and PDCCH before measurement are specified in Annex C.2.

Test Environment: Normal, as defined in TS 36.508 [7] clause 4.1.

Frequencies to be tested: Mid Range, as defined in TS 36.508 [7] clause 4.3.1.1.

Channel Bandwidths to be tested: 10MHz, as defined in TS 36.508 [7] clause 4.3.1.1

1. Connect the SS, the faders and AWGN noise sources to the UE antenna connectors as shown in TS 36.508 [7] Annex A, Figure A.10.
2. The parameter settings for the cell are set up according to 8.4.2.2.1_1.3-1.
3. Downlink signals are initially set up according to Annex C0, C.1 and C.3.2 and uplink signals according to Annex H.1 and H.3.2.
4. Propagation conditions are set according to Annex B.0.
5. Ensure the UE is in State 3A-RF according to TS 36.508 [7] clause 5.2A.2. Message contents are defined in clause 8.4.2.2.1_1.4.3.

8.4.2.2.1_1.4.2 Test procedure

1. SS transmits PDSCH via PDCCH DCI format 2 for C_RNTI to transmit the DL RMC according to Table 8.4.2.2.1_1.3-2. The details of PDCCH and PDSCH are specified in Table A.3.5.2-1 and Table A.3.5.2-2 respectively. The SS sends downlink MAC padding bits on the DL RMC. Transmission scheme for the PDSCH shall be transmit diversity.
2. Set the parameters of the propagation condition, the correlation matrix, antenna configuration and the SNR according to Tables 8.4.2.2.1_1.5-1 as appropriate.
3. Measure the Pm-dsg for a duration sufficient to achieve statistical significance according to Annex G clause G.4. Count the number of NACKs, ACKs and statDTXs on the UL PUCCH during each subtest interval. Pm-dsg is the radio (statDTX)/(NACK +ACK+statDTX). If Pm-dsg is less than the value specified in table 8.4.2.2.1_1.5-1, pass the UE. Otherwise fail the UE

8.4.2.2.1_1.4.3 Message contents

Message contents are according to TS 36.508 [7] clause 4.6 with the following exception:

Table 8.4.2.2.1_1.4.3-1: TDD-Configuration-DEFAULT

Derivation Path: 36.508 clause 4.6.4			
Information Element	Value/remark	Comment	Condition
TDD-Configuration-DEFAULT ::= SEQUENCE {			
subframeAssignment	Sa0		
specialSubframePatterns	Ssp4		
}			

Table 8.4.2.2.1_1.4.3-2: PhysicalConfigDedicated-DEFAULT

Derivation Path: 36.331 clause 6.3.2			
Information Element	Value/remark	Comment	Condition
PhysicalConfigDedicated-DEFAULT ::= SEQUENCE {			
antennaInfo CHOICE {			
antennaInfoDedicated ::= SEQUENCE {			
transmissionMode	tm4		
codebookSubsetRestriction CHOICE {			
n2TxAntenna-tm4	111111		
}			
ue-TransmitAntennaSelection CHOICE {			
release	NULL		
}			
}			
}			

8.4.2.2.1_1.5 Test requirement

For the parameters specified in Table 8.4.2.2.1_1.3-1 the average probability of a missed downlink scheduling grant (Pm-dsg) shall be below the specified value in Table 8.4.2.2.1_1.5-1.

Table 8.4.2.2.1_1.5-1: Test requirement PDCCH/PCFICH 2 Tx Antenna Port

Test number	Bandwidth	Aggregation level	Reference Channel	OCNG Pattern	Propagation Condition	Antenna configuration and correlation Matrix	Reference value	
							Pm-dsg (%)	SNR (dB)
1	10 MHz	4 CCE	R.16_1 TDD	OP.1 TDD	EVA70	2 x 2 Low	1	+1.0

8.4.2.2.2 TDD PCFICH/PDCCH Transmit Diversity 4x2

8.4.2.2.2.1 Test purpose

This test verifies the demodulation performance of PCFICH/PDCCH for transmit diversity with a given SNR for which the average probability of miss-detection of the Downlink Scheduling Grant, tested jointly on PDCCH and PCFICH of the specified reference measurement channels in A.3.5.2 remains below a given reference value.

8.4.2.2.2.2 Test applicability

This test applies to all types of E-UTRA TDD UE release 8.

8.4.2.2.2.3 Minimum conformance requirements

The receiver characteristics of the PDCCH/PCFICH are determined by the probability of miss-detection of the Downlink Scheduling Grant (Pm-dsg). PDCCH and PCFICH are tested jointly, i.e. a miss detection of PCFICH implies a miss detection of PDCCH.

Table 8.4.2.2.3-1: Test Parameters for PDCCH/PCFICH

Parameter		Unit	Transmit diversity
Uplink downlink configuration (Note 1)			0
Special subframe configuration (Note 2)			4
Number of PDCCH symbols		symbols	2
Number of PHICH groups (N_g)			1
PHICH duration			Normal
Unused RE-s and PRB-s			OCNG
Cell ID			0
Downlink power allocation	PCFICH_RA PDCCH_RA PHICH_RA OCNG_RA	dB	-3
	PCFICH_RB PDCCH_RB PHICH_RB OCNG_RB	dB	-3
N_{oc} at antenna port		dBm/15kHz	-98
Cyclic prefix			Normal
ACK/NACK feedback mode			Multiplexing
Note 1: as specified in Table 4.2-2 in TS 36.211 [8] Note 2: as specified in Table 4.2-1 in TS 36.211 [8] Note 3: PHICH power setting refer to PHICH group power, i.e. the total power of all active PHICH sequences within a PHICH group.			

For the parameters specified in Table 8.4.2.2.3-1 the average probability of a missed downlink scheduling grant (Pm-dsg) shall be below the specified value in Table 8.4.2.2.3-2.

Table 8.4.2.2.3-2: Minimum performance PDCCH/PCFICH 2 Tx Antenna Port

Test number	Bandwidth	Aggregation level	Reference Channel	OCNG Pattern	Propagation Condition	Antenna configuration and correlation Matrix	Reference value	
							Pm-dsg (%)	SNR (dB)
1	10 MHz	4 CCE	R.17 TDD	OP.1 TDD	EVA5	4 x 2 Medium	1	1.2

The normative reference for this requirement is TS 36.101 [2] clause 8.4.2.

8.4.2.2.2.4 Test description

8.4.2.2.2.4.1 Initial conditions

Initial conditions are a set of test configurations the UE needs to be tested in and the steps for the SS to take with the UE to reach the correct measurement state.

Configurations of PDSCH and PDCCH before measurement are specified in Annex C.2.

Test Environment: Normal, as defined in TS 36.508 [7] clause 4.1.

Frequencies to be tested: Mid Range, as defined in TS 36.508 [7] clause 4.3.1.1.

Channel Bandwidths to be tested: 10 MHz, as defined in TS 36.508 [7] clause 4.3.1.1

1. Connect the SS, the faders and AWGN noise sources to the UE antenna connectors as shown in TS 36.508 [7] Annex A, Figure A.11.
2. The parameter settings for the cell are set up according to 8.4.2.2.3-1.
3. Downlink signals are initially set up according to Annex C0, C.1 and C.3.2 and uplink signals according to Annex H.1 and H.3.2.
4. Propagation conditions are set according to Annex B.0.
5. Ensure the UE is in State 3A-RF according to TS 36.508 [7] clause 5.2A.2. Message contents are defined in clause 8.4.2.2.4.3.

8.4.2.2.4.2 Test procedure

1. SS transmits PDSCH via PDCCH DCI format 2 for C_RNTI to transmit the DL RMC according to Table 8.4.2.2.3-2. The details of PDCCH and PDSCH are specified in Table A.3.5.2-1 and Table A.3.5.2-2 respectively. The SS sends downlink MAC padding bits on the DL RMC. Transmission scheme for the PDSCH shall be transmit diversity.
2. Set the parameters of the propagation condition, the correlation matrix, antenna configuration and the SNR according to Tables 8.4.2.2.5-1 as appropriate.
3. Measure the Pm-dsg for a duration sufficient to achieve statistical significance according to Annex G clause G.4. Count the number of NACKs, ACKs and statDTXs on the UL PUCCH during each subtest interval. Pm-dsg is the radio (statDTX)/(NACK +ACK+statDTX). If Pm-dsg is less than the value specified in table 8.4.2.2.5-1, pass the UE. Otherwise fail the UE

8.4.2.2.4.3 Message contents

Message contents are according to TS 36.508 [7] clause 4.6 with the following exception:

Table 8.4.2.2.4.3-1: TDD-Configuration-DEFAULT

Derivation Path: 36.508 clause 4.6.4			
Information Element	Value/remark	Comment	Condition
TDD-Configuration-DEFAULT ::= SEQUENCE {			
subframeAssignment	Sa0		
specialSubframePatterns	Ssp4		
}			

Table 8.4.2.2.4.3-2: PhysicalConfigDedicated-DEFAULT

Derivation Path: 36.331 clause 6.3.2			
Information Element	Value/remark	Comment	Condition
PhysicalConfigDedicated-DEFAULT ::= SEQUENCE {			
antennaInfo CHOICE {			
antennaInfoDedicated ::= SEQUENCE {			
transmissionMode	tm4		
codebookSubsetRestriction CHOICE {			
n4TxAntenna-tm4	11111111111111111111 11111111111111111111 11111111111111111111 1111		
}			
ue-TransmitAntennaSelection CHOICE {			
release	NULL		
}			
}			

8.4.2.2.2.5 Test requirement

For the parameters specified in Table 8.4.2.2.2.3-1 the average probability of a missed downlink scheduling grant (Pm-dsg) shall be below the specified value in Table 8.4.2.2.2.5-1.

Table 8.4.2.2.2.5-1: Test requirement PDCCH/PCFICH 2 Tx Antenna Port

Test number	Bandwidth	Aggregation level	Reference Channel	OCNG Pattern	Propagation Condition	Antenna configuration and correlation Matrix	Reference value	
							Pm-dsg (%)	SNR (dB)
1	10 MHz	4 CCE	R.17 TDD	OP.1 TDD	EVA5	4 x 2 Medium	1	2.2

8.4.2.2.2_1 TDD PCFICH/PDCCH Transmit Diversity 4x2 (Release 9 and forward)

8.4.2.2.2_1.1 Test purpose

This test verifies the demodulation performance of PCFICH/PDCCH for transmit diversity with a given SNR for which the average probability of miss-detection of the Downlink Scheduling Grant, tested jointly on PDCCH and PCFICH of the specified reference measurement channels in A.3.5.2 remains below a given reference value.

8.4.2.2.2_1.2 Test applicability

This test applies to all types of E-UTRA TDD UE release 9 and forward.

8.4.2.2.2_1.3 Minimum conformance requirements

The receiver characteristics of the PDCCH/PCFICH are determined by the probability of miss-detection of the Downlink Scheduling Grant (Pm-dsg). PDCCH and PCFICH are tested jointly, i.e. a miss detection of PCFICH implies a miss detection of PDCCH.

Table 8.4.2.2.2_1.3-1: Test Parameters for PDCCH/PCFICH

Parameter	Unit	Transmit diversity	
Uplink downlink configuration (Note 1)		0	
Special subframe configuration (Note 2)		4	
Number of PDCCH symbols	symbols	2	
Number of PHICH groups (Ng)		1	
PHICH duration		Normal	
Unused RE-s and PRB-s		OCNG	
Cell ID		0	
Downlink power allocation	PCFICH_RA PDCCH_RA PHICH_RA OCNG_RA	dB	-3
	PCFICH_RB PDCCH_RB PHICH_RB OCNG_RB	dB	-3
N_{oc} at antenna port	dBm/15kHz	-98	
Cyclic prefix		Normal	
ACK/NACK feedback mode		Multiplexing	
Note 1: as specified in Table 4.2-2 in TS 36.211 [8] Note 2: as specified in Table 4.2-1 in TS 36.211 [8] Note 3: PHICH power setting refer to PHICH group power, i.e. the total power of all active PHICH sequences within a PHICH group.			

For the parameters specified in Table 8.4.2.2.2_1.3-1 the average probability of a missed downlink scheduling grant (Pm-dsg) shall be below the specified value in Table 8.4.2.2.2_1.3-2.

Table 8.4.2.2.2_1.3-2: Minimum performance PDCCH/PCFICH 2 Tx Antenna Port

Test number	Bandwidth	Aggregation level	Reference Channel	OCNG Pattern	Propagation Condition	Antenna configuration and correlation Matrix	Reference value	
							Pm-dsg (%)	SNR (dB)
1	5 MHz	2 CCE	R.17_1 TDD	OP.1 TDD	EPA5	4 x 2 Medium	1	6.5

The normative reference for this requirement is TS 36.101 [2] clause 8.4.2.

8.4.2.2.2_1.4 Test description

8.4.2.2.2_1.4.1 Initial conditions

Initial conditions are a set of test configurations the UE needs to be tested in and the steps for the SS to take with the UE to reach the correct measurement state.

Configurations of PDSCH and PDCCH before measurement are specified in Annex C.2.

Test Environment: Normal, as defined in TS 36.508 [7] clause 4.1.

Frequencies to be tested: Mid Range, as defined in TS 36.508 [7] clause 4.3.1.1.

Channel Bandwidths to be tested: 5 MHz, as defined in TS 36.508 [7] clause 4.3.1.1

1. Connect the SS, the faders and AWGN noise sources to the UE antenna connectors as shown in TS 36.508 [7] Annex A, Figure A.11.
2. The parameter settings for the cell are set up according to 8.4.2.2.2_1.3-1.
3. Downlink signals are initially set up according to Annex C0, C.1 and C.3.2 and uplink signals according to Annex H.1 and H.3.2.
4. Propagation conditions are set according to Annex B.0.
5. Ensure the UE is in State 3A-RF according to TS 36.508 [7] clause 5.2A.2. Message contents are defined in clause 8.4.2.2.2_1.4.3.

8.4.2.2.2_1.4.2 Test procedure

1. SS transmits PDSCH via PDCCH DCI format 2 for C_RNTI to transmit the DL RMC according to Table 8.4.2.2.2_1.3-2. The details of PDCCH and PDSCH are specified in Table A.3.5.2-1 and Table A.3.5.2-2 respectively. The SS sends downlink MAC padding bits on the DL RMC. Transmission scheme for the PDSCH shall be transmit diversity.
2. Set the parameters of the propagation condition, the correlation matrix, antenna configuration and the SNR according to Tables 8.4.2.2.2_1.5-1 as appropriate.
3. Measure the Pm-dsg for a duration sufficient to achieve statistical significance according to Annex G clause G.4. Count the number of NACKs, ACKs and statDTXs on the UL PUCCH during each subtest interval. Pm-dsg is the ratio (statDTX)/(NACK + ACK + statDTX). If Pm-dsg is less than the value specified in table 8.4.2.2.2_1.5-1, pass the UE. Otherwise fail the UE

8.4.2.2.2_1.4.3 Message contents

Message contents are according to TS 36.508 [7] clause 4.6 with the following exception:

Table 8.4.2.2.2_1.4.3-1: TDD-Configuration-DEFAULT

Derivation Path: 36.508 clause 4.6.4			
Information Element	Value/remark	Comment	Condition
TDD-Configuration-DEFAULT ::= SEQUENCE {			
subframeAssignment	Sa0		
specialSubframePatterns	Ssp4		
}			

Table 8.4.2.2.2_1.4.3-2: PhysicalConfigDedicated-DEFAULT

Derivation Path: 36.331 clause 6.3.2			
Information Element	Value/remark	Comment	Condition
PhysicalConfigDedicated-DEFAULT ::= SEQUENCE {			
antennaInfo CHOICE {			
antennaInfoDedicated ::= SEQUENCE {			
transmissionMode	tm4		
codebookSubsetRestriction CHOICE {			
n4TxAntenna-tm4	11111111111111111111 11111111111111111111 11111111111111111111 1111		
}			
ue-TransmitAntennaSelection CHOICE {			
release	NULL		
}			
}			
}			
}			

8.4.2.2.2_1.5 Test requirement

For the parameters specified in Table 8.4.2.2.2.3-1 the average probability of a missed downlink scheduling grant (Pm-dsg) shall be below the specified value in Table 8.4.2.2.2_1.5-1.

Table 8.4.2.2.2_1.5-1: Test requirement PDCCH/PCFICH 2 Tx Antenna Port

Test number	Bandwidth	Aggregation level	Reference Channel	OCNG Pattern	Propagation Condition	Antenna configuration and correlation Matrix	Reference value	
							Pm-dsg (%)	SNR (dB)
1	5 MHz	2 CCE	R.17_1 TDD	OP.1 TDD	EPA5	4 x 2 Medium	1	+7.5

8.4.2.2.3_C TDD PCFICH/PDCCH Transmit Diversity 2x2 for eICIC

8.4.2.2.3_C.1 TDD PCFICH/PDCCH Transmit Diversity 2x2 for eICIC (non-MBSFN ABS)

Editor's notes: This test case is incomplete. The following items are missing or incomplete:

- Connection diagram in Annex A of TS 36.508 is TBD
- Test tolerances are incomplete

8.4.2.2.3_C.1.1 Test purpose

To verify the UE's performance of transmit diversity (SFBC) with 2 transmit antennas if the PCFICH/PDCCH transmission in the serving cell takes place in subframes that overlap with ABS of the aggressor cell.

8.4.2.2.3_C.1.2 Test applicability

This test applies to all types of E-UTRA TDD UE release 10 and forward. Applicability requires support for FGI bit 115.

8.4.2.2.3_C.1.3 Minimum conformance requirements

The receiver characteristics of the PDCCH/PCFICH are determined by the probability of miss-detection of the Downlink Scheduling Grant (Pm-dsg). PDCCH and PCFICH are tested jointly, i.e. a miss detection of PCFICH implies a miss detection of PDCCH.

Table 8.4.2.2.3_C.1.3-1: Test Parameters for PDCCH/PCFICH

Parameter		Unit	Transmit diversity
Uplink downlink configuration (Note 1)			0
Special subframe configuration (Note 2)			4
Number of PDCCH symbols		symbols	2
Number of PHICH groups (N_g)			1
PHICH duration			Normal
Unused RE-s and PRB-s			OCNG
Cell ID			0
Downlink power allocation	PCFICH_RA PDCCH_RA PHICH_RA OCNG_RA	dB	-3
	PCFICH_RB PDCCH_RB PHICH_RB OCNG_RB	dB	-3
N_{oc} at antenna port		dBm/15kHz	-98
Cyclic prefix			Normal
ACK/NACK feedback mode			Multiplexing
Note 1: as specified in Table 4.2-2 in TS 36.211 [8] Note 2: as specified in Table 4.2-1 in TS 36.211 [8] Note 3: PHICH power setting refer to PHICH group power, i.e. the total power of all active PHICH sequences within a PHICH group			

For the parameters for non-MBSFN ABS specified in Table 8.4.2.2.3_C.1.3-1 and Table 8.4.2.2.3_C.1.3-2, the average probability of a missed downlink scheduling grant (Pm-dsg) shall be below the specified value in Table 8.4.2.2.3_C.1.3-3. The downlink physical setup is in accordance with Annex C.3.2 and Annex C.3.3. In Table 8.4.2.2.3_C.1.3-2, Cell 1 is the serving cell, and Cell 2 is the aggressor cell. The downlink physical channel setup for Cell 1 is according to Annex C.3.2 and for Cell 2 is according to Annex C.3.3, respectively.

Table 8.4.2.2.3_C.1.3-2: Test Parameters for PDCCH/PCFICH – Non-MBSFN ABS

Parameter		Unit	Cell 1	Cell 2
Uplink downlink configuration			1	1
Special subframe configuration			4	4
Downlink power allocation	PDCCH_RA PHICH_RA OCNG_RA	dB	-3	-3
	PCFICH_RB PDCCH_RB PHICH_RB OCNG_RB	dB	-3	-3
N_{oc} at antenna port	N_{oc1}	dBm/15kHz	-100.5 (Note 1)	N/A
	N_{oc2}	dBm/15kHz	-98 (Note 2)	N/A
	N_{oc3}	dBm/15kHz	-95.3 (Note 3)	N/A
\hat{E}_s / N_{oc2}		dB	Reference Value in Table 8.4.2.2.3_C.1.3-3	1.5
$BW_{Channel}$		MHz	10	10
Subframe Configuration			Non-MBSFN	Non-MBSFN
Time Offset between Cells		μ s	2.5 (synchronous cells)	
Cell Id			0	1
ABS pattern (Note 4)			N/A	0000010001 0000000001
RLM/RRM Measurement Subframe Pattern(Note 5)			0000000001 0000000001	
CSI Subframe Sets(Note 6)	$C_{CSI,0}$		0000010001 0000000001	N/A
	$C_{CSI,1}$		1100101000 1100111000	N/A
Number of control OFDM symbols			3	
ACK/NACK feedback mode			Multiplexing	
Number of PHICH groups (N_q)			1	
PHICH duration			extended	
Unused RE-s and PRB-s			OCNG	
Cyclic prefix			Normal	Normal
<p>Note 1: This noise is applied in OFDM symbols #1, #2, #3, #5, #6, #8, #9, #10,#12, #13 of a subframe overlapping with the aggressor ABS.</p> <p>Note 2: This noise is applied in OFDM symbols #0, #4, #7, #11 of a subframe overlapping with the aggressor ABS.</p> <p>Note 3: This noise is applied in OFDM symbols of a subframe overlapping with aggressor non-ABS</p> <p>Note 4: ABS pattern as defined in [14]. PDCCH/PCFICH other than that associated with SIB1/Paging are transmitted in the serving cell subframe when the subframe is overlapped with the ABS subframe of aggressor cell.</p> <p>Note 5: Time-domain measurement resource restriction pattern for PCell measurements as defined in [5].</p> <p>Note 6: As configured according to the time-domain measurement resource restriction pattern for CSI measurements defined in [5].</p> <p>Note 7: Cell 1 is the serving cell. Cell 2 is the aggressor cell. The number of the CRS ports in Cell1 and Cell2 is the same.</p> <p>Note 8: SIB-1 will not be transmitted in Cell2 in the test.</p>				

Table 8.4.2.2.3_C.1.3-3: Minimum performance PDCCH/PCFICH – Non-MBSFN ABS

Test Number	Aggregation Level	Reference Channel	OCNG Pattern		Propagation Conditions (Note 1)		Correlation Matrix and Antenna Configuration	Reference Value	
			Cell 1	Cell 2	Cell 1	Cell 2		Pm-dsg (%)	SNR (dB) (Note 2)
1	8 CCE	R15-1 TDD	OP.1 TDD	OP.1 TDD	EVA5	EVA5	2x2 Low	1	-3.9
Note 1: The propagation conditions for Cell 1 and Cell 2 are statistically independent. Note 2: SNR corresponds to \hat{E}_s/N_{oc2} of cell 1. Note 3: The correlation matrix and antenna configuration apply for Cell 1 and Cell 2.									

The normative reference for this requirement is TS 36.101 [2] clause 8.4.2.2.3

8.4.2.2.3_C.1.4 Test description

8.4.2.2.3_C.1.4.1 Initial conditions

Initial conditions are a set of test configurations the UE needs to be tested in and the steps for the SS to take with the UE to reach the correct measurement state.

Configurations of PDSCH and PDCCH before measurement are specified in Annex C.2.

Test Environment: Normal, as defined in TS 36.508 [7] clause 4.1.

Frequencies to be tested: Mid Range, as defined in TS 36.508 [7] clause 4.3.1.2.

Channel Bandwidths to be tested: 10MHz, as defined in TS 36.508 [7] clause 4.3.1.2

1. Connect the SS, the faders and AWGN noise sources to the UE antenna connector (s) as shown in TS 36.508 [7] Annex A, Figure [TBD] for antenna configuration 2x2.
2. The parameter settings for the cell1 are set up according to Tables 8.4.2.2.3_C.1.3-1 and 8.4.2.2.3_C.1.3-2.
3. The downlink signals are initially set up according to Annex C0, C.1 and C.3.2 and uplink signals according to Annex H.1 and H.3.2.
4. Propagation conditions are set according to Annex B clauses B.0.
5. Ensure the UE is in State 3A-RF according to TS 36.508 [7] clause 5.2A.2. Message contents are defined in clause 8.4.2.2.3_C.1.4.3.

8.4.2.2.3_C.1.4.2 Test procedure

1. SS transmits PDSCH via PDCCH DCI format 2 for C_RNTI to transmit the DL RMC according to Table 8.4.2.2.3_C.1.3-3. The details of PDCCH and PDSCH are specified in Table A.3.5.2-1 and Table A.3.5.2-2 respectively. The SS sends downlink MAC padding bits on the DL RMC. Transmission scheme for the PDSCH shall be transmit diversity.
2. Set the parameters of the propagation condition, antenna configuration, the correlation matrix and the SNR according to Table 8.4.2.2.3_C.1.5-1
3. Set the Cell2 –aggressor cell- as defined in Tables 8.4.2.2.3_C.1.3-2, 8.4.2.2.3_C.1.5-1 and according to Annex C3.3.
4. Measure the Pm-dsg for a duration sufficient to achieve statistical significance according to Annex G clause G.4. Count the number of NACKs, ACKs and statDTXs on the UL PUCCH during each subtest interval. Pm-dsg is the ratio (statDTX)/(NACK+ACK+statDTX).

If Pm-dsg is less than the value specified in table 8.4.2.2.3_C.1.5-1, pass the UE. Otherwise fail the UE.

8.4.2.2.3_C.1.4.3 Message contents

Message contents are according to TS 36.508 [7] clause 4.6 with the following exceptions:

Table 8.4.2.2.3_C.1.4.3-1: PhysicalConfigDedicated-DEFAULT

Derivation Path: 36.331 clause 6.3.2			
Information Element	Value/remark	Comment	Condition
PhysicalConfigDedicated-DEFAULT ::= SEQUENCE {			
antennaInfo CHOICE {			
antennaInfoDedicated ::= SEQUENCE {			
transmissionMode	tm4		
codebookSubsetRestriction CHOICE {			
n2TxAntenna-tm4	111111		
}			
ue-TransmitAntennaSelection CHOICE {			
release	NULL		
}			
}			
}			

Table 8.4.2.2.3_C.1.4.3-2: RadioResourceConfigDedicated-SRB2-DRB(n, m)

Derivation Path: TS 36.508 [7] clause 4.6.3, Table 4.6.3-16 RadioResourceConfigDedicated-SRB2-DRB(n,m)			
Information Element	Value/remark	Comment	Condition
RadioResourceConfigDedicated-SRB2-DRB(n, m) ::= SEQUENCE {			
MeasSubframePatternPCell-r10 CHOICE {			
setup SEQUENCE {			
subframePatternTDD-r10 CHOICE {			
subframeConfig1-5-r10	'00000000010000000001'	BIT STRING (SIZE (20))	
}			
}			
}			
}			

Table 8.4.2.2.3_C.1.4.3-3: CQI-ReportConfig-r10-DEFAULT

Derivation Path: 36.508 [7] clause 4.6.3, Table 4.6.3-2AA CQI-ReportConfig-r10-DEFAULT			
Information Element	Value/remark	Comment	Condition
CQI-ReportConfig-r10-DEFAULT ::= SEQUENCE {			
csi-SubframePatternConfig-r10 CHOICE {			
setup SEQUENCE {			
csi-MeasSubframeSet1-r10 CHOICE {			
subframePatternTDD-r10 CHOICE {			
subframeConfig1-5-r10	'00000100010000000001'	BIT STRING (SIZE (20))	
}			
}			
csi-MeasSubframeSet2-r10 CHOICE {			
subframePatternTDD-r10 CHOICE {			
subframeConfig1-5-r10	'11001010001100111000'	BIT STRING (SIZE (20))	
}			
}			
}			

8.4.2.2.3_C.1.5 Test requirement

For the parameters specified in Table 8.4.2.2.3_C.1.3-2, the average probability of a missed downlink scheduling grant (Pm-dsg) shall be below the specified value in Table 8.4.2.2.3_C.1.5-1.

Table 8.4.2.2.3_C.1.5-1: Test Requirement PDCCH/PCFICH – Non-MBSFN ABS

Test Number	Aggregation Level	Reference Channel	OCNG Pattern		Propagation Conditions (Note 1)		Correlation Matrix and Antenna Configuration	Reference Value	
			Cell 1	Cell 2	Cell 1	Cell 2		Pm-dsg (%)	SNR (dB) (Note 2)
1	8 CCE	R15-1 TDD	OP.1 TDD	OP.1 TDD	EVA5	EVA5	2x2 Low	1	-3.9 + [TT]
Note 1: The propagation conditions for Cell 1 and Cell 2 are statistically independent.									
Note 2: SNR corresponds to \hat{E}_s / N_{oc2} of cell 1.									

8.4.2.2.3_C.2 TDD PCFICH/PDCCH Transmit Diversity 2x2 for eICIC (MBSFN ABS)

Editor's notes: This test case is incomplete. The following items are missing or incomplete:

- Connection diagram in Annex A of TS 36.508 is TBD
- Test tolerances are incomplete

8.4.2.2.3_C.2.1 Test purpose

To verify the UE's performance of transmit diversity (SFBC) with 2 transmit antennas if the PCFICH/PDCCH transmission in the serving cell takes place in subframes that overlap with ABS of the aggressor cell.

8.4.2.2.3_C.2.2 Test applicability

This test applies to all types of E-UTRA TDD UE release 10 and forward. Applicability requires support for FGI bit 115.

8.4.2.2.3_C.2.3 Minimum conformance requirements

The receiver characteristics of the PDCCH/PCFICH are determined by the probability of miss-detection of the Downlink Scheduling Grant (Pm-dsg). PDCCH and PCFICH are tested jointly, i.e. a miss detection of PCFICH implies a miss detection of PDCCH.

Table 8.4.2.2.3_C.2.3-1: Test Parameters for PDCCH/PCFICH - MBSFN ABS

Parameter		Unit	Transmit diversity
Uplink downlink configuration (Note 1)			0
Special subframe configuration (Note 2)			4
Number of PDCCH symbols		symbols	2
Number of PHICH groups (N_g)			1
PHICH duration			Normal
Unused RE-s and PRB-s			OCNG
Cell ID			0
Downlink power allocation	PCFICH_RA PDCCH_RA PHICH_RA OCNG_RA	dB	-3
	PCFICH_RB PDCCH_RB PHICH_RB OCNG_RB	dB	-3
N_{oc} at antenna port		dBm/15kHz	-98
Cyclic prefix			Normal
ACK/NACK feedback mode			Multiplexing
Note 1: as specified in Table 4.2-2 in TS 36.211 [8]			
Note 2: as specified in Table 4.2-1 in TS 36.211 [8]			
Note 3: PHICH power setting refer to PHICH group power, i.e. the total power of all active PHICH sequences within a PHICH group			

For the parameters for MBSFN ABS specified in Table 8.4.2.2.3_C.2.3-1 and Table 8.4.2.2.3_C.2.3-2, the average probability of a missed downlink scheduling grant (P_{m-dsg}) shall be below the specified value in Table 8.4.2.2.3_C.2-5.

The downlink physical setup is in accordance with Annex C.3.2 and Annex C.3.3. In Table 8.4.2.2.3_C.2.3-2, Cell 1 is the serving cell, and Cell 2 is the aggressor cell. The downlink physical channel setup for Cell 1 is according to Annex C.3.2 and for Cell 2 is according to Annex C.3.3, respectively.

Table 8.4.2.2.3_C.2.3-2: Minimum performance PDCCH/PCHICH – MBSFN ABS

Parameter		Unit	Cell 1	Cell 2
Uplink downlink configuration			1	1
Special subframe configuration			4	4
Downlink power allocation	PCFICH_RA PDCCH_RA PHICH_RA OCNG_RA	dB	-3	-3
	PCFICH_RB PDCCH_RB PHICH_RB OCNG_RB	dB	-3	-3
N_{oc} at antenna port	N_{oc1}	dBm/15kHz	-100.5 (Note 1)	N/A
	N_{oc2}	dBm/15kHz	-98 (Note 2)	N/A
	N_{oc3}	dBm/15kHz	-95.3 (Note 3)	N/A
\hat{E}_s/N_{oc2}		dB	Reference Value in Table 8.4.2.2.3_C.2.3-3	1.5
$BW_{Channel}$		MHz	10	10
Subframe Configuration			Non-MBSFN	MBSFN
Time Offset between Cells		μ s	2.5 (synchronous cells)	
Cell Id			0	126
ABS pattern (Note 4)			N/A	000000001 000000001
RLM/RRM Measurement Subframe Pattern(Note 5)			000000001 000000001	
CSI Subframe Sets(Note 6)	$C_{CSI,0}$		000000001 000000001	N/A
	$C_{CSI,1}$		1100111000 1100111000	N/A
MBSFN Subframe Allocation (Note 9)			N/A	000010
Number of control OFDM symbols			3	
ACK/NACK feedback mode			Multiplexing	
Number of PHICH groups (N_g)			1	
PHICH duration			extended	
Unused RE-s and PRB-s			OCNG	
Cyclic prefix			Normal	Normal
<p>Note 1: This noise is applied in OFDM symbols #1, #2, #3, #4, #5, #6, #7, #8, #9, #10, #11, #12, #13 of a subframe overlapping with the aggressor ABS.</p> <p>Note 2: This noise is applied in OFDM symbols #0 of a subframe overlapping with the aggressor ABS.</p> <p>Note 3: This noise is applied in OFDM symbols of a subframe overlapping with aggressor non-ABS</p> <p>Note 4: ABS pattern as defined in [14]. The 10th and 20th subframes indicated by ABS pattern are MBSFN ABS subframes. PDSCH other than SIB1/paging and its associated PDCCH/PCFICH are transmitted in the serving cell subframe when the subframe is overlapped with the MBSFN ABS subframe of aggressor cell and the subframe is available in the definition of the reference channel.</p> <p>Note 5: Time-domain measurement resource restriction pattern for PCell measurements as defined in [5].</p> <p>Note 6: As configured according to the time-domain measurement resource restriction pattern for CSI measurements defined in [5].</p> <p>Note 7: Cell 1 is the serving cell. Cell 2 is the aggressor cell. The number of the CRS ports in Cell1 and Cell2 is the same.</p> <p>Note 8: SIB-1 will not be transmitted in Cell2 in this test.</p> <p>Note 9: MBSFN Subframe Allocation as defined in [5], one frame with 6 bits is chosen for MBSFN subframe allocation.</p>				

Table 8.4.2.2.3_C.2.3-3: Minimum performance PDCCH/PCHICH – MBSFN ABS

Test Number	Aggregation Level	Reference Channel	OCNG Pattern		Propagation Conditions(Note 1)		Correlation Matrix and Antenna Configuration	Reference Value	
			Cell 1	Cell 2	Cell 1	Cell 2		Pm-dsg (%)	SNR (dB) (Note 2)
1	8 CCE	R15-1 TDD	OP.1 TDD	OP.1 TDD	EVA5	EVA5	2x2 Low	1	-4.1
Note 1: The propagation conditions for Cell 1 and Cell2 are statistically independent. Note 2: SNR corresponds to \hat{E}_s/N_{oc2} of cell 1. Note 3: The correlation matrix and antenna configuration apply for Cell 1 and Cell 2.									

The normative reference for this requirement is TS 36.101 [2] clause 8.4.2.2.3

8.4.2.2.3_C.2.4 Test description

8.4.2.2.3_C.2.4.1 Initial conditions

Initial conditions are a set of test configurations the UE needs to be tested in and the steps for the SS to take with the UE to reach the correct measurement state.

Configurations of PDSCH and PDCCH before measurement are specified in Annex C.2.

Test Environment: Normal, as defined in TS 36.508 [7] clause 4.1.

Frequencies to be tested: Mid Range, as defined in TS 36.508 [7] clause 4.3.1.2.

Channel Bandwidths to be tested: 10MHz, as defined in TS 36.508 [7] clause 4.3.1.2

1. Connect the SS, the faders and AWGN noise sources to the UE antenna connector (s) as shown in TS 36.508 [7] Annex A, Figure [TBD] for antenna configuration 2x2.
2. The parameter settings for the cell1 are set up according to Tables 8.4.2.2.3_C.2.3-1 and 8.4.2.2.3_C.2.3-2.
3. The downlink signals are initially set up according to Annex C0, C.1 and C.3.2 and uplink signals according to Annex H.1 and H.3.2.
4. Propagation conditions are set according to Annex B clauses B.0.
5. Ensure the UE is in State 3A-RF according to TS 36.508 [7] clause 5.2A.2. Message contents are defined in clause 8.4.2.2.3_C.2.4.3.

8.4.2.2.3_C.2.4.2 Test procedure

1. SS transmits PDSCH via PDCCH DCI format 2 for C_RNTI to transmit the DL RMC according to Table 8.4.2.2.3_C.2.3-3. The details of PDCCH and PDSCH are specified in Table A.3.5.2-1 and Table A.3.5.2-2 respectively. The SS sends downlink MAC padding bits on the DL RMC. Transmission scheme for the PDSCH shall be transmit diversity.
2. Set the parameters of the propagation condition, antenna configuration, the correlation matrix and the SNR according to Table 8.4.2.2.3_C.2.5-1.
3. Set the Cell2 –aggressor cell- as defined in Tables 8.4.2.2.3_C.2.3-2, 8.4.2.2.3_C.2.5-1 and according to Annex C3.3
4. Measure the Pm-dsg for a duration sufficient to achieve statistical significance according to Annex G clause G.4. Count the number of NACKs, ACKs and statDTXs on the UL PUCCH during each subtest interval. Pm-dsg is the ratio (statDTX)/(NACK+ACK+statDTX).

If Pm-dsg is less than the value specified in table 8.4.2.2.3_C.2.5-1, pass the UE. Otherwise fail the UE.

8.4.2.2.3_C.2.4.3 Message contents

Message contents are according to TS 36.508 [7] clause 4.6 with the following exceptions:

Table 8.4.2.2.3_C.2.4.3-1: PhysicalConfigDedicated-DEFAULT

Derivation Path: 36.331 clause 6.3.2			
Information Element	Value/remark	Comment	Condition
PhysicalConfigDedicated-DEFAULT ::= SEQUENCE {			
antennaInfo CHOICE {			
antennaInfoDedicated ::= SEQUENCE {			
transmissionMode	tm4		
codebookSubsetRestriction CHOICE {			
n2TxAntenna-tm4	111111		
}			
ue-TransmitAntennaSelection CHOICE {			
release	NULL		
}			
}			
}			

Table 8.4.2.2.3_C.1.4.3-2: RadioResourceConfigDedicated-SRB2-DRB(n, m)

Derivation Path: TS 36.508 [7] clause 4.6.3, Table 4.6.3-16 RadioResourceConfigDedicated-SRB2-DRB(n,m)			
Information Element	Value/remark	Comment	Condition
RadioResourceConfigDedicated-SRB2-DRB(n, m) ::= SEQUENCE {			
MeasSubframePatternPCell-r10 CHOICE {			
setup SEQUENCE {			
subframePatternTDD-r10 CHOICE {			
subframeConfig1-5-r10	'00000000010000000001'	BIT STRING (SIZE (20))	
}			
}			
}			
}			

Table 8.4.2.2.3_C.1.4.3-3: CQI-ReportConfig-r10-DEFAULT

Derivation Path: 36.508 [7] clause 4.6.3, Table 4.6.3-2AA CQI-ReportConfig-r10-DEFAULT			
Information Element	Value/remark	Comment	Condition
CQI-ReportConfig-r10-DEFAULT ::= SEQUENCE {			
csi-SubframePatternConfig-r10 CHOICE {			
setup SEQUENCE {			
csi-MeasSubframeSet1-r10 CHOICE {			
subframePatternTDD-r10 CHOICE {			
subframeConfig1-5-r10	'00000000010000000001'	BIT STRING (SIZE (20))	
}			
}			
csi-MeasSubframeSet2-r10 CHOICE {			
subframePatternTDD-r10 CHOICE {			
subframeConfig1-5-r10	'11001110001100111000'	BIT STRING (SIZE (20))	
}			
}			
}			

8.4.2.2.3_C.2.5 Test requirement

For the parameters specified in Table 8.4.2.2.3_C.2.3-2, the average probability of a missed downlink scheduling grant (Pm-dsg) shall be below the specified value in Table 8.4.2.2.3_C.2.5-1.

Table 8.4.1.2.3_C.2.5-1: Test Requirement PDCCH/PCHICH – MBSFN ABS

Test Number	Aggregation Level	Reference Channel	OCNG Pattern		Propagation Conditions(Note 1)		Correlation Matrix and Antenna Configuration	Reference Value	
			Cell 1	Cell 2	Cell 1	Cell 2		Pm-dsg (%)	SNR (dB) (Note 2)
1	8 CCE	R15-1 TDD	OP.1 TDD	OP.1 TDD	EVA5	EVA5	2x2 Low	1	-4.1 + [TT]
Note 1: The propagation conditions for Cell 1 and Cell2 are statistically independent. Note 2: SNR corresponds to \widehat{E}_s/N_{oc2} of cell 1.									

8.5 Demodulation of PHICH

8.5.1 FDD

8.5.1.1 FDD PHICH Single-antenna Port Performance

8.5.1.1.1 Test purpose

This test verifies the demodulation performance of PHICH for a single antenna port with a given SNR for which the average probability of miss detection of Hybrid Indicator ("ACK to NACK") of the specified reference measurement channels remains below a specified value.

8.5.1.1.2 Test applicability

This test applies to all types of E-UTRA FDD UE release 8 and forward.

8.5.1.1.3 Minimum conformance requirements

The receiver characteristics of the PHICH are determined by the probability of miss-detecting an ACK for a NACK (Pm-an). It is assumed that there is no bias applied to the detection of ACK and NACK (zero-threshold detection).

Table 8.5.1.1.3-1: Test Parameters for PHICH

Parameter		Unit	Single antenna port
Downlink power allocation	PCFICH_RA PDCCH_RA PHICH_RA OCNG_RA	dB	0
	PCFICH_RB PDCCH_RB PHICH_RB OCNG_RB	dB	0
PHICH duration			Normal
Number of PHICH groups (Note 1)			$N_g = 1$
PDCCH Content		UL Grant should be included with the proper information aligned with A.3.6.	
Unused RE-s and PRB-s			OCNG
Cell ID			0
N_{oc} at antenna port		dBm/15kHz	-98
Cyclic prefix			Normal
Note 1: according to Clause 6.9 in TS 36.211 [8]			
Note 2: PHICH power settings refer to PHICH group power, i.e. the total power of all active PHICH sequences within a PHICH group.			

For the parameters specified in Table 8.5.1.1.3-1 the average probability of a miss-detecting an ACK for a NACK (P_{m-an}) shall be below the specified value in Table 8.5.1.1.3-2.

Table 8.5.1.1.3-2: Minimum performance PHICH

Test number	Bandwidth	Reference Channel	OCNG Pattern	Propagation Condition	Antenna configuration and correlation Matrix	Reference value	
						P_{m-an} (%)	SNR (dB)
1	10 MHz	R.18	OP.1 FDD	ETU70	1 x 2 Low	0.1	5.5
2	10 MHz	R.24	OP.1 FDD	ETU70	1 x 2 Low	0.1	0.6

The normative reference for this requirement is TS 36.101 [2] clause 8.5.

8.5.1.1.4 Test description

8.5.1.1.4.1 Initial conditions

Initial conditions are a set of test configurations the UE needs to be tested in and the steps for the SS to take with the UE to reach the correct measurement state.

Configurations of PDSCH and PDCCH before measurement are specified in Annex C.2.

Test Environment: Normal as defined in TS 36.508 [7] clause 4.1.

Frequencies to be tested: Mid Range as defined in TS 36.508 [7] clause 4.3.1.1.

Channel Bandwidths to be tested: 10 MHz, as defined in TS 36.508 [7] clause 4.3.1.1

1. Connect the SS, the faders and AWGN noise sources to the UE antenna connector (s) as shown in TS 36.508 [7] Annex A, Figure A.9.

2. The parameter settings for the cell are set up according to Table 8.5.1.1.3-1.
3. Downlink signals are initially set up according to Annex C0, C.1 and Annex C.3.2 and uplink signals according to Annex H.1 and H.3.2.
4. Propagation conditions are set according to Annex B.0.
5. Ensure the UE is in State 3A-RF according to TS 36.508 [7] clause 5.2A.2. Message contents are defined in clause 8.5.1.1.4.3.

8.5.1.1.4.2 Test procedure

1. Set the parameters of bandwidth, reference Channel, the propagation condition, antenna configuration, the correlation matrix and the SNR according to Table 8.5.1.1.5-1 Test 1 as appropriate.
2. SS shall schedule PUSCH transmissions according to Annex A.2.2.1.1 Table A.2.2.1.1-1 to happen during 8 consecutive uplink TTIs via PDCCH DCI format 0 with new data indicator set to true. Since the UE has no payload, the UE shall send uplink MAC padding bits in PUSCH. SS upon receiving the PUSCH transmissions will transmit the associated ACKs. PHICH is set according to Annex 3.6 Table A.3.6-1. SS will only transmit PDCCH to schedule PUSCH transmission in the appropriate sub-frames. Table 8.5.1.1.4.2-1 indicates the transmissions for one cycle.

Table 8.5.1.1.4.2-1: PHICH test pattern

TTI	1-4	5-8	9-12	13-16	17-20	21-24
PDCCH	S	S	-	-	S	S
PHICH	-	-	A	A	-	-
PUSCH		T	T	R	R	T
UL HARQ Process	1-4	5-8	1-4	5-8	1-4	5-8
Note 1:	This table gives an example test pattern for HARQ process for FDD PHICH test					
Note 2:	Following notation is used:					
	S: represents sending PDCCH DCI format 0 to schedule a future PUSCH transmission					
	A: represents the ACK transmission on PHICH					
	T: represents a scheduled PUSCH transmission					
	R: represents a potential PUSCH re-transmission due to a missed ACK					

3. SS will only monitor for uplink retransmissions due to ACK missed-detections. Such re-transmissions (if they occur) will potentially happen in TTI 13 to 20. DTXs on TTI 13 to 20 are counted as successful ACK receptions while any transmission on these TTIs is counted as NACKs.
4. Repeat steps 1 – 3 for a duration sufficient to achieve statistical significance according to Annex G clause G.4 and measure P_{m-an} . P_{m-an} is $(NACK) / (ACK + NACK)$.
If P_{m-an} is less than the value specified in table 8.5.1.1.5-1, pass the UE. Otherwise fail the UE.
5. Repeat the same procedure (steps 1 to 3) with test conditions according to the Table 8.5.1.1.5-1 for Test 2.

8.5.1.1.4.3 Message contents

Message contents are according to TS 36.508 [7] clause 4.6, with the following exceptions

Table 8.5.1.1.4.3-1: MAC-MainConfig-RBC

Derivation Path: TS 36.508 [7] clause 4.8.2.1.5, Table 4.8.2.1.5-1			
Information Element	Value/remark	Comment	Condition
MAC-MainConfig-RBC ::= SEQUENCE {			
dl-SCH-Config SEQUENCE {	Not present		
ul-SCH-Config SEQUENCE {			
maxHARQ-Tx	n2	Only one retransmission per UL HARQ	

8.5.1.1.5 Test requirement

For the parameters specified in Table 8.5.1.1.3-1 the average probability of a miss-detecting ACK for NACK (P_{m-dsg}) shall be below the specified value in Table 8.5.1.1.5-1.

Table 8.5.1.1.5-1: Test requirement PHICH

Test number	Bandwidth	Reference Channel	OCNG Pattern	Propagation Condition	Antenna configuration and correlation Matrix	Reference value	
						P_{m-an} (%)	SNR (dB)
1	10 MHz	R.18	OP.1 FDD	ETU70	1 x 2 Low	0.1	6.4
2	10 MHz	R.24	OP.1 FDD	ETU70	1 x 2 Low	0.1	1.5

8.5.1.2 FDD PHICH Transmit Diversity Performance

8.5.1.2.1 FDD PHICH Transmit Diversity 2x2

8.5.1.2.1.1 Test purpose

This test verifies the demodulation performance of PHICH for transmit diversity with a given SNR for which the average probability of miss detection of Hybrid Indicator ("ACK to NACK") of the specified reference measurement channels remains below a specified value.

8.5.1.2.1.2 Test applicability

This test applies to all types of E-UTRA FDD UE release 8.

8.5.1.2.1.3 Minimum conformance requirements

The receiver characteristics of the PHICH are determined by the probability of miss-detecting an ACK for a NACK (P_{m-an}). It is assumed that there is no bias applied to the detection of ACK and NACK (zero-threshold detection).

Table 8.5.1.2.1.3-1: Test Parameters for PHICH

Parameter		Unit	Transmit diversity
Downlink power allocation	PCFICH_RA PDCCH_RA PHICH_RA OCNG_RA	dB	-3
	PCFICH_RB PDCCH_RB PHICH_RB OCNG_RB	dB	-3
PHICH duration			Normal
Number of PHICH groups (Note 1)			$N_g = 1$
PDCCH Content		UL Grant should be included with the proper information aligned with A.3.6.	
Unused RE-s and PRB-s			OCNG
Cell ID			0
N_{oc} at antenna port		dBm/15kHz	-98
Cyclic prefix			Normal
Note 1: according to Clause 6.9 in TS 36.211 [8]			
Note 2: PHICH power settings refer to PHICH group power, i.e. the total power of all active PHICH sequences within a PHICH group.			

For the parameters specified in Table 8.5.1.2.1.3-1 the average probability of a miss-detecting an ACK for a NACK (P_{m-an}) shall be below the specified value in Table 8.5.1.2.1.3-2

Table 8.5.1.2.1.3-2: Minimum performance PHICH 2 Tx Antenna Port

Test number	Bandwidth	Reference Channel	OCNG Pattern	Propagation Condition	Antenna configuration and correlation Matrix	Reference value	
						P_{m-an} (%)	SNR (dB)
1	1.4 MHz	R.19	OP.1 FDD	EPA5	2 x 2 Low	0.1	5.6

The normative reference for this requirement is TS 36.101 [2] clause 8.5.1.

8.5.1.2.1.4 Test description

8.5.1.2.1.4.1 Initial conditions

Test Environment: Normal as defined in TS 36.508 [7] clause 4.1.

Frequencies to be tested: Mid Range as defined in TS 36.508 [7] clause 4.3.1.1.

Channel Bandwidths to be tested: 1.4 MHz, as defined in TS 36.508 [7] clause 4.3.1.1

1. Connect the SS, the faders and AWGN noise sources to the UE antenna connector (s) as shown in TS 36.508 [7] Annex A, Figure A.10.
2. The parameter settings for the cell are set up according to Table 8.5.1.2.1.3-1.
3. Downlink signals are initially set up according to Annex C.1 and C.3.2 and uplink signals according to Annex H.1 and H.3.2.

4. Propagation conditions are set according to Annex B clauses B.0.
5. Ensure the UE is in State 3A-RF according to TS 36.508 [7] clause 5.2A.2. Message contents are defined in clause 8.5.1.2.1.4.3.

8.5.1.2.1.4.2 Test procedure

1. Set the parameters of bandwidth, reference Channel, the propagation condition, antenna configuration, the correlation matrix and the SNR according to Table 8.5.1.2.1.5-1.
2. SS shall schedule PUSCH transmissions according to Annex A.2.2.1.1 Table A.2.2.1.1-1 to happen during 8 consecutive uplink TTIs via PDCCH DCI format 0 with new data indicator set to true. Since the UE has no payload, the UE shall send uplink MAC padding bits in PUSCH. SS upon receiving the PUSCH transmissions will transmit the associated ACKs. PHICH is set according to Annex 3.6 Table A.3.6-1. SS will only transmit PDCCH to schedule PUSCH transmission in the appropriate sub-frames. Table 8.5.1.2.1.4.2-1 indicates the transmissions for one cycle.

Table 8.5.1.2.1.4.2-1: PHICH test pattern

TTI	1-4	5-8	9-12	13-16	17-20	21-24
PDCCH	S	S	-	-	S	S
PHICH	-	-	A	A	-	-
PUSCH		T	T	R	R	T
UL HARQ Process	1-4	5-8	1-4	5-8	1-4	5-8
Note 1: This table gives an example test pattern for HARQ process for FDD PHICH test Note 2: Following notation is used: S: represents sending PDCCH DCI format 0 to schedule a future PUSCH transmission A: represents the ACK transmission on PHICH T: represents a scheduled PUSCH transmission R: represents a potential PUSCH re-transmission due to a missed ACK						

3. SS will only monitor for uplink retransmissions due to ACK missed-detections. Such re-transmissions (if they occur) will potentially happen in TTI 13 to 20. DTxs on TTI 13 to 20 are counted as successful ACK receptions while any transmission on these TTIs is counted as NACKs.
4. Repeat steps 1 – 3 for a duration sufficient to achieve statistical significance according to Annex G clause G.4 and measure Pm-an. Pm-an is (NACK) / (ACK + NACK).
If Pm-an is less than the value specified in table 8.5.1.2.1.5-1, pass the UE. Otherwise fail the UE.

8.5.1.2.1.4.3 Message contents

Message contents are according to TS 36.508 [7] clause 4.6 with the following exceptions

Table 8.5.1.2.1.4.3-1: MAC-MainConfig-RBC

Derivation Path: TS 36.508 [7] clause 4.8.2.1.5, Table 4.8.2.1.5-1			
Information Element	Value/remark	Comment	Condition
MAC-MainConfig-RBC ::= SEQUENCE {			
dl-SCH-Config SEQUENCE {	Not present		
ul-SCH-Config SEQUENCE {			
maxHARQ-Tx	n2	Only one retransmission per UL HARQ	

8.5.1.2.1.5 Test requirement

For the parameters specified in Table 8.5.1.2.1.3-1 the average probability of a miss-detecting ACK for NACK (Pm-dsg) shall be below the specified value in Table 8.5.1.2.1.5-1.

Table 8.5.1.2.1.5-1: Test requirement PHICH 2 Tx Antenna Port

Test number	Bandwidth	Reference Channel	OCNG Pattern	Propagation Condition	Antenna configuration and correlation Matrix	Reference value	
						Pm-an (%)	SNR (dB)
1	1.4 MHz	R.19	OP.1 FDD	EPA5	2 x 2 Low	0.1	6.7

8.5.1.2.1_1 FDD PHICH Transmit Diversity 2x2 (Release 9 and forward)

8.5.1.2.1_1.1 Test purpose

This test verifies the demodulation performance of PHICH for transmit diversity with a given SNR for which the average probability of miss detection of Hybrid Indicator ("ACK to NACK") of the specified reference measurement channels remains below a specified value.

8.5.1.2.1_1.2 Test applicability

This test applies to all types of E-UTRA FDD UE release 9 and forward.

8.5.1.2.1_1.3 Minimum conformance requirements

The receiver characteristics of the PHICH are determined by the probability of miss-detecting an ACK for a NACK (Pm-an). It is assumed that there is no bias applied to the detection of ACK and NACK (zero-threshold detection).

Table 8.5.1.2.1_1.3-1: Test Parameters for PHICH

Parameter		Unit	Transmit diversity
Downlink power allocation	PCFICH_RA PDCCH_RA PHICH_RA OCNG_RA	dB	-3
	PCFICH_RB PDCCH_RB PHICH_RB OCNG_RB	dB	-3
PHICH duration			Normal
Number of PHICH groups (Note 1)			Ng = 1
PDCCH Content		UL Grant should be included with the proper information aligned with A.3.6.	
Unused RE-s and PRB-s		OCNG	
Cell ID			0
N_{oc} at antenna port		dBm/15kHz	-98
Cyclic prefix			Normal
Note 1: according to Clause 6.9 in TS 36.211 [8] Note 2: PHICH power settings refer to PHICH group power, i.e. the total power of all active PHICH sequences within a PHICH group.			

For the parameters specified in Table 8.5.1.2.1_1.3-1 the average probability of a miss-detecting an ACK for a NACK (Pm-an) shall be below the specified value in Table 8.5.1.2.1_1.3-2

Table 8.5.1.2.1_1.3-2: Minimum performance PHICH 2 Tx Antenna Port

Test number	Bandwidth	Reference Channel	OCNG Pattern	Propagation Condition	Antenna configuration and correlation Matrix	Reference value	
						Pm-an (%)	SNR (dB)
1	10 MHz	R.19_1	OP.1 FDD	EVA70	2 x 2 Low	0.1	4.4

The normative reference for this requirement is TS 36.101 [2] clause 8.5.1.

8.5.1.2.1_1.4 Test description

8.5.1.2.1_1.4.1 Initial conditions

Test Environment: Normal as defined in TS 36.508 [7] clause 4.1.

Frequencies to be tested: Mid Range as defined in TS 36.508 [7] clause 4.3.1.1.

Channel Bandwidths to be tested: 10 MHz, as defined in TS 36.508 [7] clause 4.3.1.1

1. Connect the SS, the faders and AWGN noise sources to the UE antenna connector (s) as shown in TS 36.508 [7] Annex A, Figure A.10.
2. The parameter settings for the cell are set up according to Table 8.5.1.2.1_1.3-1.
3. Downlink signals are initially set up according to Annex C.1 and C.3.2 and uplink signals according to Annex H.1 and H.3.2.
4. Propagation conditions are set according to Annex B clauses B.0.
5. Ensure the UE is in State 3A-RF according to TS 36.508 [7] clause 5.2A.2. Message contents are defined in clause 8.5.1.2.1_1.4.3.

8.5.1.2.1_1.4.2 Test procedure

1. Set the parameters of bandwidth, reference Channel, the propagation condition, antenna configuration, the correlation matrix and the SNR according to Table 8.5.1.2.1_1.5-1.
2. SS shall schedule PUSCH transmissions according to Annex A.2.2.1.1 Table A.2.2.1.1-1 to happen during 8 consecutive uplink TTIs via PDCCH DCI format 0 with new data indicator set to true. Since the UE has no payload, the UE shall send uplink MAC padding bits in PUSCH. SS upon receiving the PUSCH transmissions will transmit the associated ACKs. PHICH is set according to Annex 3.6 Table A.3.6-1. SS will only transmit PDCCH to schedule PUSCH transmission in the appropriate sub-frames. Table 8.5.1.2.1_1.4.2-1 indicates the transmissions for one cycle.

Table 8.5.1.2.1_1.4.2-1: PHICH test pattern

TTI	1-4	5-8	9-12	13-16	17-20	21-24
PDCCH	S	S	-	-	S	S
PHICH	-	-	A	A	-	-
PUSCH		T	T	R	R	T
UL HARQ Process	1-4	5-8	1-4	5-8	1-4	5-8
Note 1:	This table gives an example test pattern for HARQ process for FDD PHICH test					
Note 2:	Following notation is used: S: represents sending PDCCH DCI format 0 to schedule a future PUSCH transmission A: represents the ACK transmission on PHICH T: represents a scheduled PUSCH transmission R: represents a potential PUSCH re-transmission due to a missed ACK					

3. SS will only monitor for uplink retransmissions due to ACK missed-detections. Such re-transmissions (if they occur) will potentially happen in TTI 13 to 20. DTXs on TTI 13 to 20 are counted as successful ACK receptions while any transmission on these TTIs is counted as NACKs.

4. Repeat steps 1 – 3 for a duration sufficient to achieve statistical significance according to Annex G clause G.4 and measure Pm-an. Pm-an is (NACK) / (ACK + NACK).
If Pm-an is less than the value specified in table 8.5.1.2.1_1.5-1, pass the UE. Otherwise fail the UE.

8.5.1.2.1_1.4.3 Message contents

Message contents are according to TS 36.508 [7] clause 4.6 with the following exceptions

Table 8.5.1.2.1_1.4.3-1: MAC-MainConfig-RBC

Derivation Path: TS 36.508 [7] clause 4.8.2.1.5, Table 4.8.2.1.5-1			
Information Element	Value/remark	Comment	Condition
MAC-MainConfig-RBC ::= SEQUENCE {			
dl-SCH-Config SEQUENCE {}	Not present		
ul-SCH-Config SEQUENCE {			
maxHARQ-Tx	n2	Only one retransmission per UL HARQ	

8.5.1.2.1_1.5 Test requirement

For the parameters specified in Table 8.5.1.2.1_1.3-1 the average probability of a miss-detecting ACK for NACK (Pm-dsg) shall be below the specified value in Table 8.5.1.2.1_1.5-1.

Table 8.5.1.2.1_1.5-1: Test requirement PHICH 2 Tx Antenna Port

Test number	Bandwidth	Reference Channel	OCNG Pattern	Propagation Condition	Antenna configuration and correlation Matrix	Reference value	
						Pm-an (%)	SNR (dB)
1	10 MHz	R.19_1	OP.1 FDD	EVA70	2 x 2 Low	0.1	+5.5

8.5.1.2.2 FDD PHICH Transmit Diversity 4x2

8.5.1.2.2.1 Test purpose

This test verifies the demodulation performance of PHICH for transmit diversity with a given SNR for which the average probability of miss detection of Hybrid Indicator ("ACK to NACK") of the specified reference measurement channels remains below a specified value.

8.5.1.2.2.2 Test applicability

This test applies to all types of E-UTRA FDD UE release 8.

8.5.1.2.2.3 Minimum conformance requirements

The receiver characteristics of the PHICH are determined by the probability of miss-detecting an ACK for a NACK (Pm-an). It is assumed that there is no bias applied to the detection of ACK and NACK (zero-threshold detection).

Table 8.5.1.2.2.3-1: Test Parameters for PHICH

Parameter		Unit	Transmit diversity
Downlink power allocation	PCFICH_RA PDCCH_RA PHICH_RA OCNG_RA	dB	-3
	PCFICH_RB PDCCH_RB PHICH_RB OCNG_RB	dB	-3
PHICH duration			Normal
Number of PHICH groups (Note 1)			Ng = 1
PDCCH Content		UL Grant should be included with the proper information aligned with A.3.6.	
Unused RE-s and PRB-s			OCNG
Cell ID			0
N_{oc} at antenna port		dBm/15kHz	-98
Cyclic prefix			Normal
Note 1: according to Clause 6.9 in TS 36.211 [8]			
Note 2: PHICH power settings refer to PHICH group power, i.e. the total power of all active PHICH sequences within a PHICH group.			

For the parameters specified in Table 8.5.1.2.2.3-1 the average probability of a miss-detecting an ACK for a NACK (P_{m-an}) shall be below the specified value in Table 8.5.1.2.2.3-2.

Table 8.5.1.2.2.3-2: Minimum performance PHICH 4 Tx Antenna Port

Test number	Bandwidth	Reference Channel	OCNG Pattern	Propagation Condition	Antenna configuration and correlation Matrix	Reference value	
						P_{m-an} (%)	SNR (dB)
1	10 MHz	R.20	OP.1 FDD	EVA5	4 x 2 Medium	0.1	6.0

The normative reference for this requirement is TS 36.101 [2] clause 8.5.1.

8.5.1.2.2.4 Test description

8.5.1.2.2.4.1 Initial conditions

Test Environment: Normal as defined in TS 36.508 [7] clause 4.1.

Frequencies to be tested: Mid Range as defined in TS 36.508 [7] clause 4.3.1.1.

Channel Bandwidths to be tested: 10 MHz, as defined in TS 36.508 [7] clause 4.3.1.1

1. Connect the SS, the faders and AWGN noise sources to the UE antenna connector (s) as shown in TS 36.508 [7] Annex A, Figure A.11.
2. The parameter settings for the cell are set up according to Table 8.5.1.2.2.3-1.
3. Downlink signals are initially set up according to Annex C.1 and C.3.2 and uplink signals according to Annex H.1 and H.3.2.
4. Propagation conditions are set according to Annex B clauses B.0.
5. Ensure the UE is in State 3A-RF according to TS 36.508 [7] clause 5.2A.2. Message contents are defined in clause 8.5.1.2.2.4.3.

8.5.1.2.2.4.2 Test procedure

1. Set the parameters of bandwidth, reference Channel, the propagation condition, antenna configuration, the correlation matrix and the SNR according to Table 8.5.1.2.2.5-1.
2. SS shall schedule PUSCH transmissions according to Annex A.2.2.1.1 Table A.2.2.1.1-1 to happen during 8 consecutive uplink TTIs via PDCCH DCI format 0 with new data indicator set to true. Since the UE has no payload, the UE shall send uplink MAC padding bits in PUSCH. SS upon receiving the PUSCH transmissions will transmit the associated ACKs. PHICH is set according to Annex 3.6 Table A.3.6-1. SS will only transmit PDCCH to schedule PUSCH transmission in the appropriate sub-frames. Table 8.5.1.2.2.4.2-1 indicates the transmissions for one cycle.

Table 8.5.1.2.2.4.2-1: PHICH test pattern

TTI	1-4	5-8	9-12	13-16	17-20	21-24
PDCCH	S	S	-	-	S	S
PHICH	-	-	A	A	-	-
PUSCH		T	T	R	R	T
UL HARQ Process	1-4	5-8	1-4	5-8	1-4	5-8
Note 1:	This table gives an example test pattern for HARQ process for FDD PHICH test					
Note 2:	Following notation is used: S: represents sending PDCCH DCI format 0 to schedule a future PUSCH transmission A: represents the ACK transmission on PHICH T: represents a scheduled PUSCH transmission R: represents a potential PUSCH re-transmission due to a missed ACK					

3. SS will only monitor for uplink retransmissions due to ACK missed-detections. Such re-transmissions (if they occur) will potentially happen in TTI 13 to 20. DTXs on TTI 13 to 20 are counted as successful ACK receptions while any transmission on these TTIs is counted as NACKs.
4. Repeat steps 1 – 3 for a duration sufficient to achieve statistical significance according to Annex G clause G.4 and measure Pm-an. Pm-an is (NACK) / (ACK + NACK). If Pm-an is less than the value specified in table 8.5.1.2.2.5-1, pass the UE. Otherwise fail the UE.

8.5.1.2.2.4.3 Message contents

Message contents are according to TS 36.508 [7] clause 4.6 with the following exceptions

Table 8.5.1.2.2.4.3-1: MAC-MainConfig-RBC

Derivation Path: TS 36.508 [7] clause 4.8.2.1.5, Table 4.8.2.1.5-1			
Information Element	Value/remark	Comment	Condition
MAC-MainConfig-RBC ::= SEQUENCE {			
dl-SCH-Config SEQUENCE {	Not present		
ul-SCH-Config SEQUENCE {			
maxHARQ-Tx	n2	Only one retransmission per UL HARQ	

8.5.1.2.2.5 Test requirement

For the parameters specified in Table 8.5.1.2.2.3-1 the average probability of a miss-detecting ACK for NACK (Pm-dsg) shall be below the specified value in Table 8.5.1.2.2.5-1.

Table 8.5.1.2.2.5-1: Test requirement PHICH 4 Tx Antenna Port

Test number	Bandwidth	Reference Channel	OCNG Pattern	Propagation Condition	Antenna configuration and correlation Matrix	Reference value	
						Pm-an (%)	SNR (dB)
1	10 MHz	R.20	OP.1 FDD	EVA5	4 x 2 Medium	0.1	7.0

8.5.1.2.2_1 FDD PHICH Transmit Diversity 4x2 (Release 9 and forward)

8.5.1.2.2_1.1 Test purpose

This test verifies the demodulation performance of PHICH for transmit diversity with a given SNR for which the average probability of miss detection of Hybrid Indicator ("ACK to NACK") of the specified reference measurement channels remains below a specified value.

8.5.1.2.2_1.2 Test applicability

This test applies to all types of E-UTRA FDD UE release 9 and forward.

8.5.1.2.2_1.3 Minimum conformance requirements

The receiver characteristics of the PHICH are determined by the probability of miss-detecting an ACK for a NACK (Pm-an). It is assumed that there is no bias applied to the detection of ACK and NACK (zero-threshold detection).

Table 8.5.1.2.2_1.3-1: Test Parameters for PHICH

Parameter		Unit	Transmit diversity
Downlink power allocation	PCFICH_RA PDCCH_RA PHICH_RA OCNG_RA	dB	-3
	PCFICH_RB PDCCH_RB PHICH_RB OCNG_RB	dB	-3
PHICH duration			Normal
Number of PHICH groups (Note 1)			Ng = 1
PDCCH Content		UL Grant should be included with the proper information aligned with A.3.6.	
Unused RE-s and PRB-s		OCNG	
Cell ID			0
N_{oc} at antenna port		dBm/15kHz	-98
Cyclic prefix			Normal
Note 1: according to Clause 6.9 in TS 36.211 [8] Note 2: PHICH power settings refer to PHICH group power, i.e. the total power of all active PHICH sequences within a PHICH group.			

For the parameters specified in Table 8.5.1.2.2_1.3-1 the average probability of a miss-detecting an ACK for a NACK (Pm-an) shall be below the specified value in Table 8.5.1.2.2_1.3-2.

Table 8.5.1.2.2_1.3-2: Minimum performance PHICH 4 Tx Antenna Port

Test number	Bandwidth	Reference Channel	OCNG Pattern	Propagation Condition	Antenna configuration and correlation Matrix	Reference value	
						Pm-an (%)	SNR (dB)
1	5 MHz	R.20_1	OP.1 FDD	EPA5	4 x 2 Medium	0.1	6.1

The normative reference for this requirement is TS 36.101 [2] clause 8.5.1.

8.5.1.2.2_1.4 Test description

8.5.1.2.2_1.4.1 Initial conditions

Test Environment: Normal as defined in TS 36.508 [7] clause 4.1.

Frequencies to be tested: Mid Range as defined in TS 36.508 [7] clause 4.3.1.1.

Channel Bandwidths to be tested: 5 MHz, as defined in TS 36.508 [7] clause 4.3.1.1

1. Connect the SS, the faders and AWGN noise sources to the UE antenna connector (s) as shown in TS 36.508 [7] Annex A, Figure A.11.
2. The parameter settings for the cell are set up according to Table 8.5.1.2.2_1.3-1.
3. Downlink signals are initially set up according to Annex C.1 and C.3.2 and uplink signals according to Annex H.1 and H.3.2.
4. Propagation conditions are set according to Annex B clauses B.0.
5. Ensure the UE is in State 3A-RF according to TS 36.508 [7] clause 5.2A.2. Message contents are defined in clause 8.5.1.2.2_1.4.3.

8.5.1.2.2_1.4.2 Test procedure

1. Set the parameters of bandwidth, reference Channel, the propagation condition, antenna configuration, the correlation matrix and the SNR according to Table 8.5.1.2.2_1.5-1.
2. SS shall schedule PUSCH transmissions according to Annex A.2.2.1.1 Table A.2.2.1.1-1 to happen during 8 consecutive uplink TTIs via PDCCH DCI format 0 with new data indicator set to true. Since the UE has no payload, the UE shall send uplink MAC padding bits in PUSCH. SS upon receiving the PUSCH transmissions will transmit the associated ACKs. PHICH is set according to Annex 3.6 Table A.3.6-1. SS will only transmit PDCCH to schedule PUSCH transmission in the appropriate sub-frames. Table 8.5.1.2.2_1.4.2-1 indicates the transmissions for one cycle.

Table 8.5.1.2.2_1.4.2-1: PHICH test pattern

TTI	1-4	5-8	9-12	13-16	17-20	21-24
PDCCH	S	S	-	-	S	S
PHICH	-	-	A	A	-	-
PUSCH		T	T	R	R	T
UL HARQ Process	1-4	5-8	1-4	5-8	1-4	5-8
Note 1: This table gives an example test pattern for HARQ process for FDD PHICH test Note 2: Following notation is used: S: represents sending PDCCH DCI format 0 to schedule a future PUSCH transmission A: represents the ACK transmission on PHICH T: represents a scheduled PUSCH transmission R: represents a potential PUSCH re-transmission due to a missed ACK						

3. SS will only monitor for uplink retransmissions due to ACK missed-detections. Such re-transmissions (if they occur) will potentially happen in TTI 13 to 20. DTXs on TTI 13 to 20 are counted as successful ACK receptions while any transmission on these TTIs is counted as NACKs.
4. Repeat steps 1 – 3 for a duration sufficient to achieve statistical significance according to Annex G clause G.4 and measure Pm-an. Pm-an is (NACK) / (ACK + NACK). If Pm-an is less than the value specified in table 8.5.1.2.2_1.5-1, pass the UE. Otherwise fail the UE.

8.5.1.2.2_1.4.3 Message contents

Message contents are according to TS 36.508 [7] clause 4.6 with the following exceptions

Table 8.5.1.2.2_1.4.3-1: MAC-MainConfig-RBC

Derivation Path: TS 36.508 [7] clause 4.8.2.1.5, Table 4.8.2.1.5-1			
Information Element	Value/remark	Comment	Condition
MAC-MainConfig-RBC ::= SEQUENCE {			
dl-SCH-Config SEQUENCE {}	Not present		
ul-SCH-Config SEQUENCE {			
maxHARQ-Tx	n2	Only one retransmission per UL HARQ	

8.5.1.2.2_1.5 Test requirement

For the parameters specified in Table 8.5.1.2.2_1.3-1 the average probability of a miss-detecting ACK for NACK (Pm-dsg) shall be below the specified value in Table 8.5.1.2.2_1.5-1.

Table 8.5.1.2.2_1.5-1: Test requirement PHICH 4 Tx Antenna Port

Test number	Bandwidth	Reference Channel	OCNG Pattern	Propagation Condition	Antenna configuration and correlation Matrix	Reference value	
						Pm-an (%)	SNR (dB)
1	5 MHz	R.20_1	OP.1 FDD	EPA5	4 x 2 Medium	0.1	+7.1

8.5.1.2.3_C FDD PHICH Transmit Diversity 2x2 for eICIC

8.5.1.2.3_C.1 FDD PHICH Transmit Diversity 2x2 for eICIC (non-MBSFN ABS)

Editor's notes: This test case is incomplete. The following items are missing or incomplete:

- Connection diagram in Annex A of TS 36.508 is TBD
- Tests requirements are TBD
- Test tolerances are incomplete

8.5.1.2.3_C.1.1 Test purpose

This test verifies the demodulation performance of PHICH for transmit diversity with a given SNR for which the average probability of miss detection of Hybrid Indicator ("ACK to NACK") of the specified reference measurement channels remains below a specified value.

8.5.1.2.3_C.1.2 Test applicability

This test applies to all types of E-UTRA FDD UE release 10 and forward. Applicability requires support for FGI bit 115.

8.5.1.2.3_C.1.3 Minimum conformance requirements

The receiver characteristics of the PHICH are determined by the probability of miss-detecting an ACK for a NACK (Pm-an). It is assumed that there is no bias applied to the detection of ACK and NACK (zero-threshold detection).

Table 8.5.1.2.3_C.1.3-1: Test Parameters for PHICH

Parameter	Unit	Cell 1	Cell 2	
Downlink power allocation	PDCCH_RA PHICH_RA OCNG_RA	dB	-3	-3
	PCFICH_RB PDCCH_RB PHICH_RB OCNG_RB	dB	-3	-3
N_{oc} at antenna port	N_{oc1}	dBm/15kHz	-100.5 (Note 1)	N/A
	N_{oc2}	dBm/15kHz	-98 (Note 2)	N/A
	N_{oc3}	dBm/15kHz	-95.3 (Note 3)	N/A
\hat{E}_s / N_{oc2}		dB	Reference Value in Table 8.5.1.2.3_C.1.3-2	1.5
$BW_{Channel}$		MHz	10	10
Subframe Configuration			Non-MBSFN	Non-MBSFN
Time Offset between Cells		μs	2.5 (synchronous cells)	
Cell Id			0	1
ABS pattern (Note 4)			N/A	00000100 00000100 00000100 01000100 00000100
RLM/RRM Measurement Subframe Pattern (Note 5)			00000100 00000100 00000100 00000100 00000100	N/A
CSI Subframe Sets (Note 6)	$C_{CSI,0}$		00000100 00000100 00000100 01000100 00000100	N/A
	$C_{CSI,1}$		11111011 11111011 11111011 10111011 11111011	N/A
Number of control OFDM symbols			3	
Number of PHICH groups (N_g)			1	
PHICH duration			extended	
Unused RE-s and PRB-s			OCNG	OCNG
Cyclic prefix			Normal	Normal
Note 1:	This noise is applied in OFDM symbols #1, #2, #3, #5, #6, #8, #9, #10, #12, #13 of a subframe overlapping with the aggressor ABS			
Note 2:	This noise is applied in OFDM symbols #0, #4, #7, #11 of a subframe overlapping with the aggressor ABS			
Note 3:	This noise is applied in OFDM symbols of a subframe overlapping with aggressor non-ABS			
Note 4:	ABS pattern as defined in [14]. PHICH is transmitted in the serving cell subframe when the subframe is overlapped with the ABS subframe of aggressor cell but not in the 26 th subframe indicated by the ABS pattern.			
Note 5:	Time-domain measurement resource restriction pattern for PCell measurements as defined in [5]			
Note 6:	As configured according to the time-domain measurement resource restriction pattern for CSI measurements defined in [5]			
Note 7:	Cell 1 is the serving cell. Cell 2 is the aggressor cell. The number of the CRS ports in Cell1 and Cell2 is the same.			
Note 8:	SIB-1 will not be transmitted in Cell2 in the test.			

For the parameters specified in Table 8.5.1.2.3_C.1.3-1, the average probability of a miss-detecting an ACK for a NACK (Pm-an) shall be below the specified value in Table 8.5.1.2.3_C.1.3-2. . In Table 8.5.1.2.3_C.1.3-1, Cell 1 is the serving cell, and Cell 2 is the aggressor cell. The downlink physical channel setup for Cell 1 is according to Annex C.3.2 and for Cell 2 is according to Annex C.3.3, respectively.

Table 8.5.1.2.3_C.1.3-2: Minimum performance PHICH

Test Number	Reference Channel	OCNG Pattern		Propagation Conditions (Note 1)		Antenna Configuration and Correlation Matrix	Reference Value	
		Cell 1	Cell 2	Cell 1	Cell 2		Pm-an (%)	SNR (dB) (Note 2)
1	R.19_1	OP.1 FDD	OP.1 FDD	EPA5	EPA5	2x2 Low	0.1	4.6
Note 1: The propagation conditions for Cell 1 and Cell 2 are statistically independent.								
Note 2: SNR corresponds to \hat{E}_s / N_{oc2} of cell 1.								
Note 3: The correlation matrix and antenna configuration apply for Cell 1 and Cell 2.								

The normative reference for this requirement is TS 36.101 [2] clause 8.5.1.2.3.

8.5.1.2.3_C.1.4 Test description

8.5.1.2.3_C.1.4.1 Initial conditions

Initial conditions are a set of test configurations the UE needs to be tested in and the steps for the SS to take with the UE to reach the correct measurement state.

Test Environment: Normal as defined in TS 36.508 [7] clause 4.1.

Frequencies to be tested: Mid Range as defined in TS 36.508 [7] clause 4.3.1.1.

Channel Bandwidths to be tested: 10 MHz, as defined in TS 36.508 [7] clause 4.3.1.1

1. Connect the SS, the faders and AWGN noise sources to the UE antenna connector (s) as shown in TS 36.508 [7] Annex A, Figure [TBD] for antenna transmit diversity 2x2 configuration.
2. The parameter settings for the cell are set up according to Table 8.5.1.2.3_C.1.3-1 and 8.5.1.2.3_C.1.3-2.
3. Downlink signals are initially set up according to Annex C.1, C.3.2 and C.3.3 and uplink signals according to Annex H.1 and H.3.2.
4. Propagation conditions are set according to Annex B clauses B.0.
5. Ensure the UE is in State 3A-RF according to TS 36.508 [7] clause 5.2A.2. Message contents are defined in clause 8.5.1.2.3_C.1.4.3.

8.5.1.2.3_C.1.4.2 Test procedure

1. Set the parameters of bandwidth, reference Channel, the propagation condition, antenna configuration, the correlation matrix and the SNR according to Table 8.5.1.2.3_C.1.5-1.
2. SS shall schedule PUSCH transmissions according to Annex A.2.2.1.1 Table A.2.2.1.1-1 to happen during 8 consecutive uplink TTIs via PDCCH DCI format 0 with new data indicator set to true. Since the UE has no payload, the UE shall send uplink MAC padding bits in PUSCH. SS upon receiving the PUSCH transmissions will transmit the associated ACKs. PHICH is set according to Annex 3.6 Table A.3.6-1. SS will only transmit PDCCH to schedule PUSCH transmission in the appropriate sub-frames. Table 8.5.1.2.3_C.1.4.2-1 indicates the transmissions for one cycle.

Table 8.5.1.2.3_C.1.4.2-1: PHICH test pattern

TTI	1-4	5-8	9-12	13-16	17-20	21-24
PDCCH	S	S	-	-	S	S
PHICH	-	-	A	A	-	-
PUSCH		T	T	R	R	T
UL HARQ Process	1-4	5-8	1-4	5-8	1-4	5-8
Note 1:	This table gives an example test pattern for HARQ process for FDD PHICH test					
Note 2:	Following notation is used: S: represents sending PDCCH DCI format 0 to schedule a future PUSCH transmission A: represents the ACK transmission on PHICH T: represents a scheduled PUSCH transmission R: represents a potential PUSCH re-transmission due to a missed ACK					

- SS will only monitor for uplink retransmissions due to ACK missed-detections. Such re-transmissions (if they occur) will potentially happen in TTI 13 to 20. DTXs on TTI 13 to 20 are counted as successful ACK receptions while any transmission on these TTIs is counted as NACKs.
- Repeat steps 1 – 3 for a duration sufficient to achieve statistical significance according to Annex G clause G.4 and measure P_{m-an}. P_{m-an} is (NACK) / (ACK + NACK).
If P_{m-an} is less than the value specified in table 8.5.1.2.3_C.1.5-1, pass the UE. Otherwise fail the UE.

8.5.1.2.3_C.1.4.3 Message contents

Message contents are according to TS 36.508 [7] clause 4.6 with the following exceptions

Table 8.5.1.2.3_C.1.4.3-1: MAC-MainConfig-RBC

Derivation Path: TS 36.508 [7] clause 4.8.2.1.5, Table 4.8.2.1.5-1			
Information Element	Value/remark	Comment	Condition
MAC-MainConfig-RBC ::= SEQUENCE {			
dl-SCH-Config SEQUENCE {	Not present		
ul-SCH-Config SEQUENCE {			
maxHARQ-Tx	n2	Only one retransmission per UL HARQ	

Table 8.5.1.2.3_C.1.4.3-2: RadioResourceConfigDedicated-SRB2-DRB(n, m)

Derivation Path: TS 36.508 [7] clause 4.6.3, Table 4.6.3-16 RadioResourceConfigDedicated-SRB2-DRB(n,m)			
Information Element	Value/remark	Comment	Condition
RadioResourceConfigDedicated-SRB2-DRB(n, m) ::= SEQUENCE {			
MeasSubframePatternPCell-r10 CHOICE {			
setup SEQUENCE {			
subframePatternFDD-r10	'00000100000001000000 0100000001000000100'	BIT STRING (SIZE (40))	
}			
}			
}			

Table 8.5.1.2.3_C.1.4.3-3: CQI-ReportConfig-r10-DEFAULT

Derivation Path: 36.508 [7] clause 4.6.3, Table 4.6.3-2AA CQI-ReportConfig-r10-DEFAULT_			
Information Element	Value/remark	Comment	Condition
CQI-ReportConfig-r10-DEFAULT ::= SEQUENCE {			
csi-SubframePatternConfig-r10 CHOICE {			
setup SEQUENCE {			
csi-MeasSubframeSet1-r10 CHOICE {			
subframePatternFDD-r10	'00000100000001000000 01000100010000000100'	BIT STRING (SIZE (40))	
}			
csi-MeasSubframeSet2-r10 CHOICE {			
subframePatternFDD-r10	'11111011111110111111 10111011101111111011'	BIT STRING (SIZE (40))	
}			
}			
}			
}			

8.5.1.2.3_C.1.5 Test requirement

For the parameters specified in Table 8.5.1.2.3_C.1.3-1 and 8.5.1.2.3_C.1.3-2 the average probability of a miss-detecting ACK for NACK (Pm-dsg) shall be below the specified value in Table 8.5.1.2.3_C.1.5-1.

Table 8.5.1.2.3_C.1.5-1: Test requirement FDD PHICH Transmit Diversity 2x2 for eICIC (non-MBSFN ABS)

Test Number	Reference Channel	OCNG Pattern		Propagation Conditions (Note 1)		Antenna Configuration and Correlation Matrix	Reference Value	
		Cell 1	Cell 2	Cell 1	Cell 2		Pm-an (%)	SNR (dB) (Note 2)
1	R.19_1	OP.1 FDD	OP.1 FDD	EPA5	EPA5	2x2 Low	0.1	[TBD]
Note 1: The propagation conditions for Cell 1 and Cell 2 are statistically independent.								
Note 2: SNR corresponds to \hat{E}_s / N_{oc2} of cell 1.								
Note 3: The correlation matrix and antenna configuration apply for Cell 1 and Cell 2.								

8.5.2 TDD

8.5.2.1 TDD PHICH Single-antenna Port Performance

8.5.2.1.1 Test purpose

This test verifies the demodulation performance of PHICH for a single antenna port with a given SNR for which a certain Hybrid Indicator detection error rate (i.e. missed detection of "NACK to ACK" and "ACK to NACK") of the specified reference measurement channels is achieved.

8.5.2.1.2 Test applicability

This test applies to all types of E-UTRA TDD UE release 8 and forward.

8.5.2.1.3 Minimum conformance requirements

The receiver characteristics of the PHICH are determined by the probability of miss-detecting an ACK for a NACK (Pm-an). It is assumed that there is no bias applied to the detection of ACK and NACK (zero-threshold detection).

Table 8.5.2.1.3-1: Test Parameters for PHICH

Parameter		Unit	Single antenna port
Uplink downlink configuration (Note 1)			1
Special subframe configuration (Note 2)			4
Downlink power allocation	PCFICH_RA PDCCH_RA PHICH_RA OCNG_RA	dB	0
	PCFICH_RB PDCCH_RB PHICH_RB OCNG_RB	dB	0
PHICH duration			Normal
Number of PHICH groups (Note 3)			$N_g = 1$
Cell ID			0
PDCCH Content		UL Grant should be included with the proper information aligned with A.3.6.	
Unused RE-s and PRB-s			OCNG
N_{oc} at antenna port		dBm/15kHz	-98
Cyclic prefix			Normal
ACK/NACK feedback mode			Multiplexing
Note 1: as specified in Table 4.2-2 in TS 36.211 [8] Note 2: as specified in Table 4.2-1 in TS 36.211 [8] Note 3: according to Clause 6.9 in TS 36.211 [8] Note 4: PHICH power settings refer to PHICH group power, i.e. the total power of all active PHICH sequences within a PHICH group.			

For the parameters specified in Table 8.5.2.1.3-1 the average probability of a miss-detecting ACK for NACK (P_{m-an}) shall be below the specified value in Table 8.5.2.1.3-2.

Table 8.5.2.1.3-2: Minimum performance of PHICH

Test number	Bandwidth	Reference Channel	OCNG Pattern	Propagation Condition	Antenna configuration and correlation Matrix	Reference value	
						P_{m-an} (%)	SNR (dB)
1	10 MHz	R.18	OP.1 TDD	ETU70	1 x 2 Low	0.1	5.8
2	10 MHz	R.24	OP.1 TDD	ETU70	1 x 2 Low	0.1	1.3

The normative reference for this requirement is TS 36.101 [2] clause 8.5.2.

8.5.2.1.4 Test description

8.5.2.1.4.1 Initial conditions

Initial conditions are a set of test configurations the UE needs to be tested in and the steps for the SS to take with the UE to reach the correct measurement state.

Configurations of PDSCH and PDCCH before measurement are specified in Annex C.2.

Test Environment: Normal, as defined in TS 36.508 [7] clause 4.1

Frequencies to be tested: Mid Range, as defined in TS 36.508 [7] clause 4.3.1.1

Bandwidths to be tested: As specified per test number in Tables 8.5.2.1.3-2 as defined in TS 36.508 [7] clause 4.3.1.2.

1. Connect the SS, the faders and AWGN noise source to the UE antenna connector (s) as shown in TS 36.508 [7] Annex a, Figure A.9.
2. The parameter settings for the cell are set up according to 8.5.2.1.3-1.
3. Downlink signals are initially set up according to Annex C0, C.1 and Annex C.3.2 and uplink signals according to Annex H.1 and H.3.2.
4. Propagation conditions are set according to Annex B.0.
5. Ensure the UE is in State 3A-RF according to TS 36.508 [7] clause 5.2A.2. Message contents are defined in clause 8.5.2.1.4.3.

8.5.2.1.4.2 Test procedure

1. Set the parameters of bandwidth, reference Channel, the propagation condition, antenna configuration, the correlation matrix and the SNR according to Table 8.5.2.1.5-1 Test 1 as appropriate.
2. In Each HARQ process (4 HARQ processes for UL/DL configuration 1); SS shall schedule PUSCH transmissions according to Annex A.2.3.1.1 Table A.2.3.1.1-1 via PDCCH DCI format 0 with new data indicator set to true. Since the UE has no payload, the UE shall send uplink MAC padding bits in PUSCH. SS upon receiving the PUSCH transmissions shall transmit the associated ACKs. PHICH is set according to Annex 3.6 Table A.3.6-1. SS will only transmit PDCCH to schedule PUSCH transmission in the appropriate sub-frames. Table 8.5.2.1.4.2-1 indicates the transmissions for one cycle.
3. SS will only monitor for uplink retransmissions due to ACK missed-detections. DTX from the UE side is counted as successful ACK reception, while any transmission on these subframes is counted as NACKs.

Table 8.5.2.1.4.2-1: PHICH test pattern

Subframe Index	0	1	2	3	4	5	6	7	8	9	0	1	2	3	4	5	6	7	8	9
PDCCH		S			S		S			S										
PHICH												A			A		A			A
PUSCH			R?	R?				T	T				T	T					R?	R?
HARQ process		1	3	4	2		3	1	2	4		1	3	4	2		3	1	2	4
Note 1:	This table gives an example test pattern for HARQ process for TDD PHICH test																			
Note 2:	Following notation is used: S: represents sending PDCCH DCI format 0 to schedule a future PUSCH transmission A: represents the ACK transmission on PHICH T: represents a scheduled PUSCH transmission R: represents a potential PUSCH re-transmission due to a missed ACK																			
Note 3:	TDD UL/DL configuration 1 is used here, special subframe is denoted as blue																			

4. Repeat steps 1 – 3 for a duration sufficient to achieve statistical significance according to Annex G clause G.4 and measure Pm-an. Pm-an is (NACK) / (ACK + NACK).

If Pm-an is less than the value specified in table 8.5.2.1.5-1, pass the UE. Otherwise fail the UE.
5. Repeat the same procedure (steps 1 to 4) with test conditions according to the Table 8.5.2.1.5-1 for Test 2.

8.5.2.1.4.3 Message contents

Message contents are according to TS 36.508 [7] clause 4.6, with the following exceptions

Table 8.5.1.1.4.3-1: MAC-MainConfig-RBC

Derivation Path: TS 36.508 [7] clause 4.8.2.1.5, Table 4.8.2.1.5-1			
Information Element	Value/remark	Comment	Condition
MAC-MainConfig-RBC ::= SEQUENCE {			
dl-SCH-Config SEQUENCE {}	Not present		
ul-SCH-Config SEQUENCE {			
maxHARQ-Tx	n2	Only one retransmission per UL HARQ	

8.5.2.1.5 Test requirement

For the parameters specified in Table 8.5.2.1.3-1 the average probability of a miss-detecting ACK for NACK (P_{m-an}) shall be below the specified value in Table 8.5.2.1.5-1.

Table 8.5.2.1.5-1: Test requirement of PHICH

Test number	Bandwidth	Reference Channel	OCNG Pattern	Propagation Condition	Antenna configuration and correlation Matrix	Reference value	
						P_{m-an} (%)	SNR (dB)
1	10 MHz	R.18	OP.1 TDD	ETU70	1 x 2 Low	0.1	6.7
2	10 MHz	R.24	OP.1 TDD	ETU70	1 x 2 Low	0.1	2.2

8.5.2.2 TDD PHICH Transmit Diversity Performance

8.5.2.2.1 TDD PHICH Transmit Diversity 2x2

8.5.2.2.1.1 Test purpose

This test verifies the demodulation performance of PHICH for transmit diversity with a given SNR for which a certain Hybrid Indicator detection error rate (i.e. missed detection of "NACK to ACK" and "ACK to NACK") of the specified reference measurement channels is achieved.

8.5.2.2.1.2 Test applicability

This test applies to all types of E-UTRA TDD UE release 8.

8.5.2.2.1.3 Minimum conformance requirements

The receiver characteristics of the PHICH are determined by the probability of miss-detecting an ACK for a NACK (P_{m-an}). It is assumed that there is no bias applied to the detection of ACK and NACK (zero-threshold detection).

Table 8.5.2.2.1.3-1: Test Parameters for PHICH

Parameter		Unit	Transmit diversity
Uplink downlink configuration (Note 1)			1
Special subframe configuration (Note 2)			4
Downlink power allocation	PCFICH_RA PDCCH_RA PHICH_RA OCNG_RA	dB	-3
	PCFICH_RB PDCCH_RB PHICH_RB OCNG_RB	dB	-3
PHICH duration			Normal
Number of PHICH groups (Note 3)			$N_g = 1$
Cell ID			0
PDCCH Content		UL Grant should be included with the proper information aligned with A.3.6.	
Unused RE-s and PRB-s			OCNG
N_{oc} at antenna port		dBm/15kHz	-98
Cyclic prefix			Normal
ACK/NACK feedback mode			Multiplexing
Note 1:		as specified in Table 4.2-2 in TS 36.211 [8]	
Note 2:		as specified in Table 4.2-1 in TS 36.211 [8]	
Note 3:		according to Clause 6.9 in TS 36.211 [8]	
Note 4:		PHICH power settings refer to PHICH group power, i.e. the total power of all active PHICH sequences within a PHICH group.	

For the parameters specified in Table 8.5.2.2.1.3-1 the average probability of a miss-detecting ACK for NACK (P_{m-an}) shall be below the specified value in Table 8.5.2.2.1.3-2.

Table 8.5.2.2.1.3-2: Minimum performance of PHICH 2 Tx Antenna Port

Test number	Bandwidth	Reference Channel	OCNG Pattern	Propagation Condition	Antenna configuration and correlation Matrix	Reference value	
						P_{m-an} (%)	SNR (dB)
1	1.4 MHz	R.19	OP.1 TDD	EPA5	2 x 2 Low	0.1	5.3

The normative reference for this requirement is TS 36.101 [2] clause 8.5.2.

8.5.2.2.1.4 Test description

8.5.2.2.1.4.1 Initial conditions

Test Environment: Normal, as defined in TS 36.508 [7] clause 4.1

Frequencies to be tested: Mid Range, as defined in TS 36.508 [7] clause 4.3.1.2

Bandwidths to be tested: 1.4 MHz, as defined in TS 36.508 [7] clause 4.3.1.2.

1. Connect the SS, the faders and AWGN noise sources to the UE antenna connector (s) as shown in TS 36.508 [7] Annex A Figure A.10.
2. The parameter settings for the cell are set up according to Table 8.5.2.2.1.3-1.

3. Downlink signals are initially set up according to Annex C.1 and Annex C.3.2 and uplink signals according to Annex H.1 and H.3.2.
4. Propagation conditions are set according to Annex B clause B.0.
5. Ensure the UE is in State 3A-RF according to TS 36.508 [7] clause 5.2A.2. Message contents are defined in clause 8.5.2.2.1.4.3.

8.5.2.2.1.4.2 Test procedure

1. Set the parameters of bandwidth, reference Channel, the propagation condition, antenna configuration, the correlation matrix and the SNR according to Table 8.5.2.2.1.5-1.
2. In Each HARQ process (4 HARQ processes for UL/DL configuration 1), SS shall schedule PUSCH transmissions according to Annex A.2.3.1.1 Table A.2.3.1.1-1 via PDCCH DCI format 0 with new data indicator set to true. Since the UE has no payload, the UE shall send uplink MAC padding bits in PUSCH. SS upon receiving the PUSCH transmissions shall transmit the associated ACKs. PHICH is set according to Annex 3.6 Table A.3.6-1. SS will only transmit PDCCH to schedule PUSCH transmission in the appropriate sub-frames. Table 8.5.2.2.1.4.2-1 indicates the transmissions for one cycle.
3. SS will only monitor for uplink retransmissions due to ACK missed-detections. DTX from the UE side is counted as successful ACK reception, while any transmission on these subframes is counted as NACKs.
4. Repeat steps 1 – 3 for a duration sufficient to achieve statistical significance according to Annex G clause G.4 and measure Pm-an. Pm-an is (NACK) / (ACK + NACK).

If Pm-an is less than the value specified in table 8.5.2.2.1.5-1, pass the UE. Otherwise fail the UE.

Table 8.5.2.2.1.4.2-1: PHICH test pattern

Subframe Index	0	1	2	3	4	5	6	7	8	9	0	1	2	3	4	5	6	7	8	9
PDCCH		S			S		S			S										
PHICH												A			A		A			A
PUSCH			R?	R?				T	T				T	T					R?	R?
HARQ process		1	3	4	2		3	1	2	4		1	3	4	2		3	1	2	4

Note 1: This table gives an example test pattern for HARQ process for TDD PHICH test
 Note 2: Following notation is used:
 S: represents sending PDCCH DCI format 0 to schedule a future PUSCH transmission
 A: represents the ACK transmission on PHICH
 T: represents a scheduled PUSCH transmission
 R: represents a potential PUSCH re-transmission due to a missed ACK
 Note 3: TDD UL/DL configuration 1 is used here, special subframe is denoted as blue

8.5.2.2.1.4.3 Message contents

Message contents are according to TS 36.508 [7] clause 4.6, with the following exceptions:

Table 8.5.2.2.1.4.3-1: MAC-MainConfig-RBC

Derivation Path: TS 36.508 [7] clause 4.8.2.1.5, Table 4.8.2.1.5-1			
Information Element	Value/remark	Comment	Condition
MAC-MainConfig-RBC ::= SEQUENCE {			
dl-SCH-Config SEQUENCE {	Not present		
ul-SCH-Config SEQUENCE {			
maxHARQ-Tx	n2	Only one retransmission per UL HARQ	
...			

8.5.2.2.1.5 Test requirement

For the parameters specified in Table 8.5.2.2.1.3-1 the average probability of a miss-detecting ACK for NACK (P_{m-an}) shall be below the specified value in Table 8.5.2.2.1.5-1.

Table 8.5.2.2.1.5-1: Test requirement of PHICH 2 Tx Antenna Port

Test number	Bandwidth	Reference Channel	OCNG Pattern	Propagation Condition	Antenna configuration and correlation Matrix	Reference value	
						P_{m-an} (%)	SNR (dB)
1	1.4 MHz	R.19	OP.1 TDD	EPA5	2 x 2 Low	0.1	6.4

8.5.2.2.1_1 TDD PHICH Transmit Diversity 2x2 (Release 9 and forward)

8.5.2.2.1_1.1 Test purpose

This test verifies the demodulation performance of PHICH for transmit diversity with a given SNR for which a certain Hybrid Indicator detection error rate (i.e. missed detection of "NACK to ACK" and "ACK to NACK") of the specified reference measurement channels is achieved.

8.5.2.2.1_1.2 Test applicability

This test applies to all types of E-UTRA TDD UE release 9 and forward.

8.5.2.2.1_1.3 Minimum conformance requirements

The receiver characteristics of the PHICH are determined by the probability of miss-detecting an ACK for a NACK (P_{m-an}). It is assumed that there is no bias applied to the detection of ACK and NACK (zero-threshold detection).

Table 8.5.2.2.1_1.3-1: Test Parameters for PHICH

Parameter		Unit	Transmit diversity
Uplink downlink configuration (Note 1)			1
Special subframe configuration (Note 2)			4
Downlink power allocation	PCFICH_RA PDCCH_RA PHICH_RA OCNG_RA	dB	-3
	PCFICH_RB PDCCH_RB PHICH_RB OCNG_RB	dB	-3
PHICH duration			Normal
Number of PHICH groups (Note 3)			$N_g = 1$
Cell ID			0
PDCCH Content		UL Grant should be included with the proper information aligned with A.3.6.	
Unused RE-s and PRB-s		OCNG	
N_{oc} at antenna port		dBm/15kHz	-98
Cyclic prefix			Normal
ACK/NACK feedback mode			Multiplexing
Note 1: as specified in Table 4.2-2 in TS 36.211 [8] Note 2: as specified in Table 4.2-1 in TS 36.211 [8] Note 3: according to Clause 6.9 in TS 36.211 [8] Note 4: PHICH power settings refer to PHICH group power, i.e. the total power of all active PHICH sequences within a PHICH group.			

For the parameters specified in Table 8.5.2.2.1_1.3-1 the average probability of a miss-detecting ACK for NACK (P_{m-an}) shall be below the specified value in Table 8.5.2.2.1_1.3-2.

Table 8.5.2.2.1_1.3-2: Minimum performance of PHICH 2 Tx Antenna Port

Test number	Bandwidth	Reference Channel	OCNG Pattern	Propagation Condition	Antenna configuration and correlation Matrix	Reference value	
						P_{m-an} (%)	SNR (dB)
1	10 MHz	R.19_1	OP.1 TDD	EVA70	2 x 2 Low	0.1	4.2

The normative reference for this requirement is TS 36.101 [2] clause 8.5.2.

8.5.2.2.1_1.4 Test description

8.5.2.2.1_1.4.1 Initial conditions

Test Environment: Normal, as defined in TS 36.508 [7] clause 4.1

Frequencies to be tested: Mid Range, as defined in TS 36.508 [7] clause 4.3.1.2

Bandwidths to be tested: 10 MHz, as defined in TS 36.508 [7] clause 4.3.1.2.

1. Connect the SS, the faders and AWGN noise sources to the UE antenna connector (s) as shown in TS 36.508 [7] Annex A Figure A.10.
2. The parameter settings for the cell are set up according to Table 8.5.2.2.1_1.3-1.
3. Downlink signals are initially set up according to Annex C.1 and Annex C.3.2 and uplink signals according to Annex H.1 and H.3.2.

4. Propagation conditions are set according to Annex B clause B.0.
5. Ensure the UE is in State 3A-RF according to TS 36.508 [7] clause 5.2A.2. Message contents are defined in clause 8.5.2.2.1_1.4.3.

8.5.2.2.1_1.4.2 Test procedure

1. Set the parameters of bandwidth, reference Channel, the propagation condition, antenna configuration, the correlation matrix and the SNR according to Table 8.5.2.2.1_1.5-1.
2. In Each HARQ process (4 HARQ processes for UL/DL configuration 1), SS shall schedule PUSCH transmissions according to Annex A.2.3.1.1 Table A.2.3.1.1-1 via PDCCH DCI format 0 with new data indicator set to true. Since the UE has no payload, the UE shall send uplink MAC padding bits in PUSCH. SS upon receiving the PUSCH transmissions shall transmit the associated ACKs. PHICH is set according to Annex 3.6 Table A.3.6-1. SS will only transmit PDCCH to schedule PUSCH transmission in the appropriate sub-frames. Table 8.5.2.2.1_1.4.2-1 indicates the transmissions for one cycle.
3. SS will only monitor for uplink retransmissions due to ACK missed-detections. DTX from the UE side is counted as successful ACK reception, while any transmission on these subframes is counted as NACKs.
4. Repeat steps 1 – 3 for a duration sufficient to achieve statistical significance according to Annex G clause G.4 and measure Pm-an. Pm-an is (NACK) / (ACK + NACK).

If Pm-an is less than the value specified in table 8.5.2.2.1_1.5-1, pass the UE. Otherwise fail the UE.

Table 8.5.2.2.1_1.4.2-1: PHICH test pattern

Subframe Index	0	1	2	3	4	5	6	7	8	9	0	1	2	3	4	5	6	7	8	9
PDCCH		S			S		S			S										
PHICH												A			A		A			A
PUSCH			R?	R?				T	T				T	T					R?	R?
HARQ process		1	3	4	2		3	1	2	4		1	3	4	2		3	1	2	4

Note 1: This table gives an example test pattern for HARQ process for TDD PHICH test
 Note 2: Following notation is used:
 S: represents sending PDCCH DCI format 0 to schedule a future PUSCH transmission
 A: represents the ACK transmission on PHICH
 T: represents a scheduled PUSCH transmission
 R: represents a potential PUSCH re-transmission due to a missed ACK
 Note 3: TDD UL/DL configuration 1 is used here, special subframe is denoted as blue

8.5.2.2.1_1.4.3 Message contents

Message contents are according to TS 36.508 [7] clause 4.6, with the following exceptions:

Table 8.5.2.2.1_1.4.3-1: MAC-MainConfig-RBC

Derivation Path: TS 36.508 [7] clause 4.8.2.1.5, Table 4.8.2.1.5-1			
Information Element	Value/remark	Comment	Condition
MAC-MainConfig-RBC ::= SEQUENCE {			
dl-SCH-Config SEQUENCE {	Not present		
ul-SCH-Config SEQUENCE {			
maxHARQ-Tx	n2	Only one retransmission per UL HARQ	

8.5.2.2.1_1.5 Test requirement

For the parameters specified in Table 8.5.2.2.1_1.3-1 the average probability of a miss-detecting ACK for NACK (Pm-an) shall be below the specified value in Table 8.5.2.2.1_1.5-1.

Table 8.5.2.2.1_1.5-1: Test requirement of PHICH 2 Tx Antenna Port

Test number	Bandwidth	Reference Channel	OCNG Pattern	Propagation Condition	Antenna configuration and correlation Matrix	Reference value	
						Pm-an (%)	SNR (dB)
1	10 MHz	R.19_1	OP.1 TDD	EVA70	2 x 2 Low	0.1	+5.3

8.5.2.2.2 TDD PHICH Transmit Diversity 4x2

8.5.2.2.2.1 Test purpose

This test verifies the demodulation performance of PHICH for transmit diversity with a given SNR for which a certain Hybrid Indicator detection error rate (i.e. missed detection of "NACK to ACK" and "ACK to NACK") of the specified reference measurement channels is achieved.

8.5.2.2.2.2 Test applicability

This test applies to all types of E-UTRA TDD UE release 8.

8.5.2.2.2.3 Minimum conformance requirements

The receiver characteristics of the PHICH are determined by the probability of miss-detecting an ACK for a NACK (Pm-an). It is assumed that there is no bias applied to the detection of ACK and NACK (zero-threshold detection).

Table 8.5.2.2.3-1: Test Parameters for PHICH

Parameter	Unit	Transmit diversity	
Uplink downlink configuration (Note 1)		1	
Special subframe configuration (Note 2)		4	
Downlink power allocation	PCFICH_RA PDCCH_RA PHICH_RA OCNG_RA	dB	-3
	PCFICH_RB PDCCH_RB PHICH_RB OCNG_RB	dB	-3
PHICH duration		Normal	
Number of PHICH groups (Note 3)		Ng = 1	
Cell ID		0	
PDCCH Content	UL Grant should be included with the proper information aligned with A.3.6.		
Unused RE-s and PRB-s		OCNG	
N_{oc} at antenna port	dBm/15kHz	-98	
Cyclic prefix		Normal	
ACK/NACK feedback mode		Multiplexing	
Note 1:	as specified in Table 4.2-2 in TS 36.211 [8]		
Note 2:	as specified in Table 4.2-1 in TS 36.211 [8]		
Note 3:	according to Clause 6.9 in TS 36.211 [8]		
Note 4:	PHICH power settings refer to PHICH group power, i.e. the total power of all active PHICH sequences within a PHICH group.		

For the parameters specified in Table 8.5.2.2.3-1 the average probability of a miss-detecting ACK for NACK (Pm-an) shall be below the specified value in Table 8.5.2.2.3-2.

Table 8.5.2.2.3-2: Minimum performance of PHICH 4 Tx Antenna port

Test number	Bandwidth	Reference Channel	OCNG Pattern	Propagation Condition	Antenna configuration and correlation Matrix	Reference value	
						Pm-an (%)	SNR (dB)
1	10 MHz	R.20	OP.1 TDD	EVA5	4 x 2 Medium	0.1	6.1

The normative reference for this requirement is TS 36.101 [2] clause 8.5.2.

8.5.2.2.2.4 Test description

8.5.2.2.2.4.1 Initial conditions

Test Environment: Normal, as defined in TS 36.508 [7] clause 4.1

Frequencies to be tested: Mid Range, as defined in TS 36.508 [7] clause 4.3.1.2

Channel Bandwidths to be tested: 10 MHz, as defined in TS 36.508 [7] clause 4.3.1.2.

1. Connect the SS, the faders and AWGN noise sources to the UE antenna connector (s) as shown in TS 36.508 [7] Annex A, Figure A.11.
2. The parameter settings for the cell are set up according to Table 8.5.2.2.3-1.
3. Downlink signals are initially set up according to Annex C.1 and Annex C.3.2 and uplink signals according to Annex H.1 and H.3.2.
4. Propagation conditions are set according to Annex B clause B.0.
5. Ensure the UE is in State 3A-RF according to TS 36.508 [7] clause 5.2A.2. Message contents are defined in clause 8.5.2.2.4.3.

8.5.2.2.2.4.2 Test procedure

1. Set the parameters of bandwidth, reference Channel, the propagation condition, antenna configuration, the correlation matrix and the SNR according to Table 8.5.2.2.5-1.
2. In Each HARQ process (4 HARQ processes for UL/DL configuration 1), SS shall schedule PUSCH transmissions according to Annex A.2.3.1.1 Table A.2.3.1.1-1 via PDCCH DCI format 0 with new data indicator set to true. Since the UE has no payload, the UE shall send uplink MAC padding bits in PUSCH. SS upon receiving the PUSCH transmissions shall transmit the associated ACKs. PHICH is set according to Annex 3.6 Table A.3.6-1. SS will only transmit PDCCH to schedule PUSCH transmission in the appropriate sub-frames. Table 8.5.2.2.4.2-1 indicates the transmissions for one cycle.
3. SS will only monitor for uplink retransmissions due to ACK missed-detections. DTX from the UE side is counted as successful ACK reception, while any transmission on these subframes is counted as NACKs.
4. Repeat steps 1 – 3 for a duration sufficient to achieve statistical significance according to Annex G clause G.4 and measure Pm-an. Pm-an is (NACK) / (ACK + NACK).

If Pm-an is less than the value specified in table 8.5.2.2.5-1, pass the UE. Otherwise fail the UE.

Table 8.5.2.2.4.2-1: PHICH test pattern

Subframe Index	0	1	2	3	4	5	6	7	8	9	0	1	2	3	4	5	6	7	8	9
PDCCH		S			S		S			S										
PHICH												A			A		A			A
PUSCH			R?	R?				T	T				T	T					R?	R?
HARQ process		1	3	4	2		3	1	2	4		1	3	4	2		3	1	2	4
<p>Note 1: This table gives an example test pattern for HARQ process for TDD PHICH test</p> <p>Note 2: Following notation is used: S: represents sending PDCCH DCI format 0 to schedule a future PUSCH transmission A: represents the ACK transmission on PHICH T: represents a scheduled PUSCH transmission R: represents a potential PUSCH re-transmission due to a missed ACK</p> <p>Note 3: TDD UL/DL configuration 1 is used here, special subframe is denoted as blue</p>																				

8.5.2.2.4.3 Message contents

Message contents are according to TS 36.508 [7] clause 4.6, with the following exceptions:

Table 8.5.2.2.4.3-1: MAC-MainConfig-RBC

Derivation Path: TS 36.508 [7] clause 4.8.2.1.5, Table 4.8.2.1.5-1			
Information Element	Value/remark	Comment	Condition
MAC-MainConfig-RBC ::= SEQUENCE {			
dl-SCH-Config SEQUENCE {	Not present		
ul-SCH-Config SEQUENCE {			
maxHARQ-Tx	n2	Only one retransmission per UL HARQ	
...			

8.5.2.2.5 Test requirement

For the parameters specified in Table 8.5.2.2.3-1 the average probability of a miss-detecting ACK for NACK (Pm-an) shall be below the specified value in Table 8.5.2.2.5-1.

Table 8.5.2.2.5-1: Test requirement of PHICH 4 Tx Antenna Port

Test number	Bandwidth	Reference Channel	OCNG Pattern	Propagation Condition	Antenna configuration and correlation Matrix	Reference value	
						Pm-an (%)	SNR (dB)
1	10 MHz	R.20	OP.1 TDD	EVA5	4 x 2 Medium	0.1	7.1

8.5.2.2.2_1 TDD PHICH Transmit Diversity 4x2 (Release 9 and forward)

8.5.2.2.2_1.1 Test purpose

This test verifies the demodulation performance of PHICH for transmit diversity with a given SNR for which a certain Hybrid Indicator detection error rate (i.e. missed detection of "NACK to ACK" and "ACK to NACK") of the specified reference measurement channels is achieved.

8.5.2.2.2_1.2 Test applicability

This test applies to all types of E-UTRA TDD UE release 9 and forward.

8.5.2.2.2_1.3 Minimum conformance requirements

The receiver characteristics of the PHICH are determined by the probability of miss-detecting an ACK for a NACK (Pm-an). It is assumed that there is no bias applied to the detection of ACK and NACK (zero-threshold detection).

Table 8.5.2.2.2_1.3-1: Test Parameters for PHICH

Parameter		Unit	Transmit diversity
Uplink downlink configuration (Note 1)			1
Special subframe configuration (Note 2)			4
Downlink power allocation	PCFICH_RA PDCCH_RA PHICH_RA OCNG_RA	dB	-3
	PCFICH_RB PDCCH_RB PHICH_RB OCNG_RB	dB	-3
PHICH duration			Normal
Number of PHICH groups (Note 3)			$N_g = 1$
Cell ID			0
PDCCH Content		UL Grant should be included with the proper information aligned with A.3.6, other PDCCH resource shall be occupied by non-zero data.	
Unused RE-s and PRB-s		OCNG	
N_{oc} at antenna port		dBm/15kHz	-98
Cyclic prefix			Normal
ACK/NACK feedback mode			Multiplexing
Note 1: as specified in Table 4.2-2 in TS 36.211 [8] Note 2: as specified in Table 4.2-1 in TS 36.211 [8] Note 3: according to Clause 6.9 in TS 36.211 [8] Note 4: PHICH power settings refer to PHICH group power, i.e. the total power of all active PHICH sequences within a PHICH group.			

For the parameters specified in Table 8.5.2.2.2_1.3-1 the average probability of a miss-detecting ACK for NACK (P_{m-an}) shall be below the specified value in Table 8.5.2.2.2_1.3-2.

Table 8.5.2.2.2_1.3-2: Minimum performance of PHICH 4 Tx Antenna port

Test number	Bandwidth	Reference Channel	OCNG Pattern	Propagation Condition	Antenna configuration and correlation Matrix	Reference value	
						P_{m-an} (%)	SNR (dB)
1	5 MHz	R.20_1	OP.1 TDD	EPA5	4 x 2 Medium	0.1	6.2

The normative reference for this requirement is TS 36.101 [2] clause 8.5.2.

8.5.2.2.2_1.4 Test description

8.5.2.2.2_1.4.1 Initial conditions

Test Environment: Normal, as defined in TS 36.508 [7] clause 4.1

Frequencies to be tested: Mid Range, as defined in TS 36.508 [7] clause 4.3.1.2

Channel Bandwidths to be tested: 5 MHz, as defined in TS 36.508 [7] clause 4.3.1.2.

1. Connect the SS, the faders and AWGN noise sources to the UE antenna connector (s) as shown in TS 36.508 [7] Annex A, Figure A.11.
2. The parameter settings for the cell are set up according to Table 8.5.2.2.2_1.3-1.

3. Downlink signals are initially set up according to Annex C.1 and Annex C.3.2 and uplink signals according to Annex H.1 and H.3.2.
4. Propagation conditions are set according to Annex B clause B.0.
5. Ensure the UE is in State 3A-RF according to TS 36.508 [7] clause 5.2A.2. Message contents are defined in clause 8.5.2.2.2_1.4.3.

8.5.2.2.2_1.4.2 Test procedure

1. Set the parameters of bandwidth, reference Channel, the propagation condition, antenna configuration, the correlation matrix and the SNR according to Table 8.5.2.2.2_1.5-1.
2. In Each HARQ process (4 HARQ processes for UL/DL configuration 1), SS shall schedule PUSCH transmissions according to Annex A.2.3.1.1 Table A.2.3.1.1-1 via PDCCH DCI format 0 with new data indicator set to true. Since the UE has no payload, the UE shall send uplink MAC padding bits in PUSCH. SS upon receiving the PUSCH transmissions shall transmit the associated ACKs. PHICH is set according to Annex 3.6 Table A.3.6-1. SS will only transmit PDCCH to schedule PUSCH transmission in the appropriate sub-frames. Table 8.5.2.2.2_1.4.2-1 indicates the transmissions for one cycle.
3. SS will only monitor for uplink retransmissions due to ACK missed-detections. DTX from the UE side is counted as successful ACK reception, while any transmission on these subframes is counted as NACKs.
4. Repeat steps 1 – 3 for a duration sufficient to achieve statistical significance according to Annex G clause G.4 and measure Pm-an. Pm-an is (NACK) / (ACK + NACK).

If Pm-an is less than the value specified in table 8.5.2.2.2_1.5-1, pass the UE. Otherwise fail the UE.

Table 8.5.2.2.2_1.4.2-1: PHICH test pattern

Subframe Index	0	1	2	3	4	5	6	7	8	9	0	1	2	3	4	5	6	7	8	9
PDCCH		S			S		S			S										
PHICH												A			A		A			A
PUSCH			R?	R?				T	T				T	T					R?	R?
HARQ process		1	3	4	2		3	1	2	4		1	3	4	2		3	1	2	4

Note 1: This table gives an example test pattern for HARQ process for TDD PHICH test
 Note 2: Following notation is used:
 S: represents sending PDCCH DCI format 0 to schedule a future PUSCH transmission
 A: represents the ACK transmission on PHICH
 T: represents a scheduled PUSCH transmission
 R: represents a potential PUSCH re-transmission due to a missed ACK
 Note 3: TDD UL/DL configuration 1 is used here, special subframe is denoted as blue

8.5.2.2.2_1.4.3 Message contents

Message contents are according to TS 36.508 [7] clause 4.6, with the following exceptions:

Table 8.5.2.2.2_1.4.3-1: MAC-MainConfig-RBC

Derivation Path: TS 36.508 [7] clause 4.8.2.1.5, Table 4.8.2.1.5-1			
Information Element	Value/remark	Comment	Condition
MAC-MainConfig-RBC ::= SEQUENCE {			
dl-SCH-Config SEQUENCE {	Not present		
ul-SCH-Config SEQUENCE {			
maxHARQ-Tx	n2	Only one retransmission per UL HARQ	
...			

8.5.2.2.2_1.5 Test requirement

For the parameters specified in Table 8.5.2.2.2_1.3-1 the average probability of a miss-detecting ACK for NACK (P_{m-an}) shall be below the specified value in Table 8.5.2.2.2_1.5-1.

Table 8.5.2.2.2_1.5-1: Test requirement of PHICH 4 Tx Antenna Port

Test number	Bandwidth	Reference Channel	OCNG Pattern	Propagation Condition	Antenna configuration and correlation Matrix	Reference value	
						P_{m-an} (%)	SNR (dB)
1	5 MHz	R.20_1	OP.1 TDD	EPA5	4 x 2 Medium	0.1	+7.2

8.5.2.2.3_C TDD PHICH Transmit Diversity 2x2 for eICIC

8.5.2.2.3_C.1 TDD PHICH Transmit Diversity 2x2 for eICIC (non-MBSFN ABS)

Editor's notes: This test case is incomplete. The following items are missing or incomplete:

- Step of test procedure may be confirmed or updated.
- Test requirement table needs to be corrected.

8.5.2.2.3_C.1.1 Test purpose

This test verifies the demodulation performance of PHICH for transmit diversity with a given SNR for which a certain Hybrid Indicator detection error rate (i.e. missed detection of "NACK to ACK" and "ACK to NACK") of the specified reference measurement channels is achieved.

8.5.2.2.3_C.1.2 Test applicability

This test applies to all types of E-UTRA TDD UE release 10 and forward. Applicability requires support for FGI bit 115.

8.5.2.2.3_C.1.3 Minimum conformance requirements

The receiver characteristics of the PHICH are determined by the probability of miss-detecting an ACK for a NACK (P_{m-an}). It is assumed that there is no bias applied to the detection of ACK and NACK (zero-threshold detection).

Table 8.5.2.2.3_C.1.3-1: Test Parameters for PHICH

Parameter		Unit	Cell 1	Cell 2
Uplink downlink configuration			1	1
Special subframe configuration			4	4
Downlink power allocation	PDCCH_RA PHICH_RA OCNG_RA	dB	-3	-3
	PCFICH_RB PDCCH_RB PHICH_RB OCNG_RB	dB	-3	-3
N_{oc} at antenna port	N_{oc1}	dBm/15kHz	-100.5 (Note 1)	N/A
	N_{oc2}	dBm/15kHz	-98 (Note 2)	N/A
	N_{oc3}	dBm/15kHz	-95.3 (Note 3)	N/A
\hat{E}_s / N_{oc2}		dB	Reference Value in Table 8.5.2.2.3_C.1.3-2	1.5
$BW_{Channel}$		MHz	10	10
Subframe Configuration			Non-MBSFN	Non-MBSFN
Time Offset between Cells		μ s	2.5 (synchronous cells)	
Cell Id			0	1
ABS pattern (Note 4)			N/A	0000010001 0000000001
RLM/RRM Measurement Subframe Pattern (Note 5)			0000000001 0000000001	N/A
CSI Subframe Sets (Note 6)	$C_{CSI,0}$		0000010001 0000000001	N/A
	$C_{CSI,1}$		1100101000 1100111000	N/A
Number of control OFDM symbols			3	
ACK/NACK feedback mode			Multiplexing	
Number of PHICH groups (N_g)			1	
PHICH duration			extended	
Unused RE-s and PRB-s			OCNG	OCNG
Cyclic prefix			Normal	Normal
<p>Note 1: This noise is applied in OFDM symbols #1, #2, #3, #5, #6, #8, #9, #10, #12, #13 of a subframe overlapping with the aggressor ABS</p> <p>Note 2: This noise is applied in OFDM symbols #0, #4, #7, #11 of a subframe overlapping with the aggressor ABS</p> <p>Note 3: This noise is applied in OFDM symbols of a subframe overlapping with aggressor non-ABS</p> <p>Note 4: ABS pattern as defined in [14]. PHICH is transmitted in the serving cell subframe when the subframe is overlapped with the ABS subframe of aggressor cell but not in subframe 5</p> <p>Note 5: Time-domain measurement resource restriction pattern for PCell measurements as defined in [5]</p> <p>Note 6: As configured according to the time-domain measurement resource restriction pattern for CSI measurements defined in [5]</p> <p>Note 7: Cell 1 is the serving cell. Cell 2 is the aggressor cell. The number of the CRS ports in Cell1 and Cell2 is the same.</p> <p>Note 8: SIB-1 will not be transmitted in Cell2 in the test.</p>				

For the parameters specified in Table 8.5.2.2.3_C.1.3-1 the average probability of a miss-detecting ACK for NACK (P_{m-an}) shall be below the specified value in Table 8.5.2.2.3_C.1.3-2. The downlink physical setup is in accordance with Annex C.3.2 and Annex C.3.3, In Table 8.5.2.2.3_C.1.3-1, Cell 1 is the serving cell, and Cell 2 is the aggressor cell. The downlink physical channel setup for Cell 1 is according to Annex C.3.2 and for Cell 2 is according to Annex C.3.3, respectively.

Table 8.5.2.2.3_C.1.3-2: Minimum performance of PHICH 2 Tx Antenna Port

Test Number	Reference Channel	OCNG Pattern		Propagation Conditions (Note 1)		Antenna Configuration and Correlation Matrix	Reference Value	
		Cell 1	Cell 2	Cell 1	Cell 2		Pm-an (%)	SNR (dB) (Note 2)
1	R.19	OP.1 TDD	OP.1 TDD	EPA5	EPA5	2x2 Low	0.1	4.6
Note 1: The propagation conditions for Cell 1 and Cell 2 are statistically independent.								
Note 2: SNR corresponds to \hat{E}_s / N_{oc2} of cell 1.								
Note 3: The correlation matrix and antenna configuration apply for Cell 1 and Cell 2.								

The normative reference for this requirement is TS 36.101 [2] clause 8.5.2.2.3.

8.5.2.2.3_C.1.4 Test description

8.5.2.2.3_C.1.4.1 Initial conditions

Test Environment: Normal, as defined in TS 36.508 [7] clause 4.1

Frequencies to be tested: Mid Range, as defined in TS 36.508 [7] clause 4.3.1.2

Bandwidths to be tested: 10 MHz, as defined in TS 36.508 [7] clause 4.3.1.2.

1. Connect the SS, the faders and AWGN noise sources to the UE antenna connector (s) as shown in TS 36.508 [7] Annex A Figure A.10.
2. The parameter settings for the cell are set up according to Table 8.5.2.2.3_C.1.3-1.
3. Downlink signals are initially set up according to Annex C.1 and Annex C.3.2 and uplink signals according to Annex H.1 and H.3.2.
4. Propagation conditions are set according to Annex B clause B.0.
5. Ensure the UE is in State 3A-RF according to TS 36.508 [7] clause 5.2A.2. Message contents are defined in clause 8.5.2.2.3_C.1.4.3.

8.5.2.2.3_C.1.4.2 Test procedure

1. Set the parameters of bandwidth, reference Channel, the propagation condition, antenna configuration, the correlation matrix and the SNR according to Table 8.5.2.2.3_C.1.5-1.
2. In Each HARQ process (4 HARQ processes for UL/DL configuration 1), SS shall schedule PUSCH transmissions according to Annex A.2.3.1.1 Table A.2.3.1.1-1 via PDCCH DCI format 0 with new data indicator set to true. Since the UE has no payload, the UE shall send uplink MAC padding bits in PUSCH. SS upon receiving the PUSCH transmissions shall transmit the associated ACKs. PHICH is set according to Annex 3.6 Table A.3.6-1. SS will only transmit PDCCH to schedule PUSCH transmission in the appropriate sub-frames. Table 8.5.2.2.3_C.1.4.2-1 indicates the transmissions for one cycle.
3. SS will only monitor for uplink retransmissions due to ACK missed-detections. DTX from the UE side is counted as successful ACK reception, while any transmission on these subframes is counted as NACKs.
4. Repeat steps 1 – 3 for a duration sufficient to achieve statistical significance according to Annex G clause G.4 and measure Pm-an. Pm-an is (NACK) / (ACK + NACK).

If Pm-an is less than the value specified in table 8.5.2.2.3_C.1.5-1, pass the UE. Otherwise fail the UE.

Table 8.5.2.2.3_C.1.4.2-1: PHICH test pattern

Subframe Index	0	1	2	3	4	5	6	7	8	9	0	1	2	3	4	5	6	7	8	9
PDCCH		S			S		S			S										
PHICH												A			A		A			A
PUSCH			R?	R?				T	T				T	T					R?	R?
HARQ process		1	3	4	2		3	1	2	4		1	3	4	2		3	1	2	4

Note 1: This table gives an example test pattern for HARQ process for TDD PHICH test
 Note 2: Following notation is used:
 S: represents sending PDCCH DCI format 0 to schedule a future PUSCH transmission
 A: represents the ACK transmission on PHICH
 T: represents a scheduled PUSCH transmission
 R: represents a potential PUSCH re-transmission due to a missed ACK
 Note 3: TDD UL/DL configuration 1 is used here, special subframe is denoted as blue

8.5.2.2.3_C.1.4.3 Message contents

Message contents are according to TS 36.508 [7] clause 4.6, with the following exceptions:

Table 8.5.2.2.3_C.1.4.3-1: MAC-MainConfig-RBC

Derivation Path: TS 36.508 [7] clause 4.8.2.1.5, Table 4.8.2.1.5-1			
Information Element	Value/remark	Comment	Condition
MAC-MainConfig-RBC ::= SEQUENCE {			
dl-SCH-Config SEQUENCE {	Not present		
ul-SCH-Config SEQUENCE {			
maxHARQ-Tx	n2	Only one retransmission per UL HARQ	
...			

Table 8.5.2.2.3_C.1.4.3-2: RadioResourceConfigDedicated-SRB2-DRB(n, m)

Derivation Path: TS 36.508 [7] clause 4.6.3, Table 4.6.3-16 RadioResourceConfigDedicated-SRB2-DRB(n,m)			
Information Element	Value/remark	Comment	Condition
RadioResourceConfigDedicated-SRB2-DRB(n, m) ::= SEQUENCE {			
MeasSubframePatternPCell-r10 CHOICE {			
setup SEQUENCE {			
subframePatternTDD-r10 CHOICE {			
subframeConfig1-5-r10	'00000000010000000001'	BIT STRING (SIZE (20))	
}			
}			
}			
}			

Table 8.5.2.2.3_C.1.4.3-3: CQI-ReportConfig-r10-DEFAULT

Derivation Path: 36.508 [7] clause 4.6.3, Table 4.6.3-2AA CQI-ReportConfig-r10-DEFAULT_			
Information Element	Value/remark	Comment	Condition
CQI-ReportConfig-r10-DEFAULT ::= SEQUENCE {			
csi-SubframePatternConfig-r10 CHOICE {			
setup SEQUENCE {			
csi-MeasSubframeSet1-r10 CHOICE {			
subframePatternTDD-r10 CHOICE {			
subframeConfig1-5-r10	'00000100010000000001'	BIT STRING (SIZE (20))	
}			
}			
csi-MeasSubframeSet2-r10 CHOICE {			
subframePatternTDD-r10 CHOICE {			
subframeConfig1-5-r10	'11001010001100111000'	BIT STRING (SIZE (20))	
}			
}			
}			
}			

8.5.2.2.3_C.1.5 Test requirement

For the parameters specified in Table 8.5.2.2.3_C.1.3-1 the average probability of a miss-detecting ACK for NACK (Pm-an) shall be below the specified value in Table 8.5.2.2.3_C.1.5-1.

Table 8.5.2.2. 3_C.1.5-1: Test requirement of PHICH 2 Tx Antenna Port

Test number	Bandwidth	Reference Channel	OCNG Pattern	Propagation Condition	Antenna configuration and correlation Matrix	Reference value	
						Pm-an (%)	SNR (dB)
1	10 MHz	R.19	OP.1 TDD	EPA5	2 x 2 Low	0.1	TBD

8.6 Demodulation of PBCH

RAN4 will specify the PBCH performance requirements and has recommended that these requirements do not need to be tested.

8.7 Sustained downlink data rate provided by lower layers

8.7.1 FDD

8.7.1.1 FDD sustained data rate performance

8.7.1.1.1 Test purpose

The purpose of the test is to verify that the Layer 1 and Layer 2 correctly process in a sustained manner the received packets corresponding to the maximum number of DL-SCH transport block bits received within a TTI for the UE category indicated. The sustained downlink data rate shall be verified in terms of the success rate of delivered PDCP SDU(s) by Layer 2. The test case below specifies the RF conditions and the required success rate of delivered TB by Layer 1 to meet the sustained data rate requirement. The size of the TB per TTI corresponds to the largest possible DL-SCH transport block for each UE category using the maximum number of layers for spatial multiplexing. Transmission modes 1 and 3 are used with radio conditions resembling a scenario where sustained maximum data rates are available.

8.7.1.1.2 Test applicability

This test applies to all types of E-UTRA FDD UE Release 9 and forward.

8.7.1.1.3 Minimum requirements

The parameters specified in Table 8.7.1.1.3-1 are valid for all FDD tests unless otherwise stated.

Table 8.7.1.1.3-1: Common Test Parameters (FDD)

Parameter	Unit	Value
Cyclic prefix		Normal
Cell ID		0
Inter-TTI Distance		1
Number of HARQ processes	Processes	Downlink: 8 Uplink: 8
Maximum number of HARQ transmission		Downlink: 4 Uplink: 1
Scheduling of retransmissions		1. Retransmissions use the same Transport Block Size (TBS) as the initial transmission. 2. HARQ processes are scheduled consecutively, independent of the fact, whether retransmissions (for negatively acknowledged HARQ processes) or new transmissions (for positively acknowledged HARQ processes) occur. 3. Despite of 1) and 2) the number of RB-s to be allocated in each SF remains firm as specified in the RMC. Thus in case of RMC-s with SF dependent allocation, for retransmissions the TBS and the modulation scheme (MCS) are indicated implicitly ($29 \leq I_{MCS} \leq 31$) according to TS 36.213 [10] subclause 7.1.7.2.
Redundancy version coding sequence		{0,0,1,2} for 64QAM
Number of OFDM symbols for PDCCH	OFDM symbols	1
Cross carrier scheduling		Not configured

The requirements are specified in Table 8.7.1.1.3-3, with the addition of the parameters in Table 8.7.1.1.3-2 and the downlink physical channel setup according to Annex C.3.2. The PDCP SDU success rate shall be sustained during at least 300 frames.

Table 8.7.1.1.3-2: Test Parameters for sustained downlink data rate (FDD)

Parameter		Unit	Test 1	Test 2	Test 3,4	Test 3A
Bandwidth		MHz	10	10	20	10
Transmission mode			1	3	3	3
Antenna configuration			1 x 2	2 x 2	2 x 2	2 x 2
Propagation condition			Static propagation condition (Note 1)			
CodeBookSubsetRestriction bitmap			n/a	10	10	10
Downlink power allocation	ρ_A	dB	0	-3	-3	-3
	ρ_B	dB	0	-3	-3	-3
\hat{E}_s at antenna port		dBm/15kHz	-85	-85	-85	-85
Symbols for unused PRBs			OP.6 FDD	OP.1 FDD	OP.1 FDD	OP.1 FDD

Note 1: No external noise sources are applied

Table 8.7.1.1.3-3: Minimum Requirement (FDD)

Test	UE Category	Number of bits of a DL-SCH transport block received within a TTI	Measurement channel	Reference value TB success rate [%]
1	Category 1	10296	R31-1 FDD	95
2	Category 2	25456	R31-2 FDD	95
3	Category 3 (Note 1)	51024	R31-3 FDD	95
3A	Category 3 (Note 2)	36696 (Note 4)	R31-3A FDD	85
4	Category 4	75376 (Note 5)	R31-4 FDD	85

Note 1: If the operating band under test does not support 20 MHz channel bandwidth, then test is executed according to Test 3A.
Note 2: Applicable to operating bands supporting up to 10 MHz channel bandwidths.
Note 3: For 2 layer transmissions, 2 transport blocks are received within a TTI
Note 4: 35160 bits for sub-frame 5
Note 5: 71112 bits for sub-frame 5
Note 6: The TB success rate is defined as TB success rate = $100\% \cdot N_{DL_correct_rx} / (N_{DL_newtx} + N_{DL_retx})$, where N_{DL_newtx} is the number of newly transmitted DL transport blocks, N_{DL_retx} is the number of retransmitted DL transport blocks, and $N_{DL_correct_rx}$ is the number of correctly received DL transport blocks.

The normative reference for this requirement is TS 36.101[2] clause 8.7.1

8.7.1.1.4 Test description

8.7.1.1.4.1 Initial conditions

Table 8.7.1.1.4.1-1: Applicable test and Transport Block Size for different UE categories

UE Category	Applicable test	DL Measurement channel	UL Measurement channel	TB _{size} per Codeword	Number of PDCP SDU per Codeword	PDCP SDU size [bits] Note 3
1	Test 1	R31-1 FDD	R.1-1 FDD	10296	1	$8 * \text{FLOOR}((\text{TB}_{\text{size}} - 96)/8)$
2	Test 2	R31-2 FDD	R.1-2 FDD	25456	3	$8 * \text{FLOOR}((\text{TB}_{\text{size}} - 152)/24)$
3	Test 3 (Note 1)	R31-3 FDD	R.1-3 FDD	51024	5	$8 * \text{FLOOR}((\text{TB}_{\text{size}} - 208)/40)$
3	Test 3A (Note 2)	R31-3A FDD	R.1-3A FDD	36696 (Note 5)	4	$8 * \text{FLOOR}((\text{TB}_{\text{size}} - 184)/32)$
4	Test 4 (Note 2)	R31-4 FDD	R.1-4 FDD	75376 (Note 6)	7	$8 * \text{FLOOR}((\text{TB}_{\text{size}} - 264)/56)$

Note 1: If the operating band under test does not support 20 MHz channel bandwidth, then test is executed according to Test 3A.

Note 2: Applicable to operating bands supporting up to 10 MHz channel bandwidths.

Note 3: Transport block size under test according to applicable Fixed Reference Channel for sustained data-rate test in annex A.3.9. In case of varying TBS across SFs of the RMC, only the maximum TBS is used for PDCP SDU size calculation.

Note 4: Each PDCP SDU is limited to 1500 octets (to keep below maximum SDU size of ESM as specified in TS 24.301 clause 9.9.4.12).

The PDCP SDU size of each PDCP SDU is:

$$\text{PDCP SDU size} = (\text{TB}_{\text{size}} - N * \text{PDCP header size} - \text{AMD PDU header size} - \text{MAC header size} - \text{Size of RLC STATUS PDU}) / N,$$

where PDCP header size is 16 bits for the RLC AM and 12-bit SN case; AMD PDU header size is $\text{CEIL}[(16 + (N-1) * 12)/8]$ bytes which includes 16 bit standard AM header and (N-1) Length indicators; and MAC header size = R/R/E/LCID/F/L MAC subheader (24 bits for MAC SDU for RLC STATUS PDU with 15 bit LI) + R/R/E/LCID MAC subheader (8 bits for MAC SDU for RLC Data PDU) = 32 bits. The size of RLC STATUS PDU including one ACK_SN field and one NACK_SN field is 32 bits (if no STATUS PDU is sent or if the size of the STATUS PDU is less than 32 bits then padding will be used to fill the 32 bits). This gives: PDCP SDU size = $8 * \text{FLOOR}((\text{TB}_{\text{size}} - N * 16 - 8 * \text{CEIL}[(16 + (N-1) * 12)/8] - 64)/(8 * N))$ bits.

The calculation of PDCP SDU sizes does not consider timing advance MAC CE as timing advance is not transmitted by SS for RF test cases, and the header sizes are informative and may vary during the test.

Note 5: 35160 bits for sub-frame 5

Note 6: 71112 bits for sub-frame 5

Initial conditions are a set of test configurations the UE needs to be tested in and the steps for the SS to take with the UE to reach the correct measurement state.

Configurations of PDSCH and PDCCH before measurement are specified in Annex C.2.

Test Environment: Normal as defined in TS 36.508 [7] clause 4.1.

Frequencies to be tested: Mid Range as defined in TS 36.508 [7] clause 4.3.1.1.

Channel Bandwidths to be tested: According to table 8.7.1.1.3-2.

1. Connect the SS to the UE antenna connector(s) as shown in TS 36.508 [7] Annex A, Figure A.3 for test 1 and Figure A.10 for tests 2-5 (without using faders and AWGN generators).
2. The parameter settings for the cell are set up according to Table 8.7.1.1.5-1 and Table 8.7.1.1.5-2.
3. Downlink signals are initially set up according to Annex C0, C.1 and Annex C.3.2 and uplink signals according to Annex H.1 and H.3.2.
4. Propagation conditions are set according to Annex B.0.

5. Ensure the UE is in State 4 (Loopback activated) according to TS 36.508 [7] clause 4.5.4. Message contents are defined in clause 8.7.1.1.4.3.

8.7.1.1.4.2 Test procedure

1. The SS looks up TB_{size} in table 8.7.1.1.4.1-1 according to the UE category under test.
2. SS sets the counters N_{DL_newtx} , N_{DL_retx} , N_{UL_PDCP} , and N_{DL_PDCP} to 0.
3. For each new DL HARQ transmission the SS generates sufficient PDCP SDUs to fill up the TB in accordance with Table 8.7.1.1.4.1-1 (Note 1). The SS ciphers the PDCP SDUs, concatenates the resultant PDCP PDUs to form an RLC PDU and then a MAC PDU. The SS transmits the MAC PDU. The SS increments then N_{DL_newtx} by one and N_{DL_PDCP} by the number of new PDCP SDUs (Note 1) included in the sent MAC PDU.
4. If PHY requests a DL HARQ retransmission, the SS performs a HARQ retransmission and increments N_{DL_retx} by one.
5. Steps 3 to 4 are repeated at every TTI for at least 300 frames and the SS waits for 300ms to let any HARQ retransmissions and RLC retransmissions to finish.
6. For each PDCP SDU received at the SS, if the content of the data matches that of the truncated version of the original PDCP SDU generated at the SS, the SS increments N_{UL_PDCP} by one
7. The SS calculates the TB success rate as $A = 100\% * N_{DL_newtx} / (N_{DL_newtx} + N_{DL_retx})$
8. The SS calculates the PDCP SDU loss as $B = N_{DL_PDCP} - N_{UL_PDCP}$
9. The UE passes the test if $A \geq$ "corresponding TB success rates according to Table 8.7.1.1.3-3" and $B = 0$.

NOTE 1: In case of RLC PDU retransmission, the number of new required PDCP SDUs is as many as to fill the rest of TB.

8.7.1.1.4.3 Message contents

Message contents are according to TS 36.508 [7] clause 4.6 and 4.7A, with the following exceptions:

Table 8.7.1.1.4.3-1: CLOSE UE TEST LOOP (in the preamble)

Derivation Path: 36.509 clause 6.1			
Information Element	Value/remark	Comment	Condition
Protocol discriminator	1 1 1 1		
Skip indicator	0 0 0 0		
Message type	1 0 0 0 0 0 0 0		
UE test loop mode	0 0 0 0 0 0 0 0	UE test loop mode A	
UE test loop mode A LB setup			
Length of UE test loop mode A LB setup list in bytes	0 0 0 0 0 0 1 1	Length of one LB setup DRB (3 bytes)	
LB setup DRB	0 0 0 0 0 0 0 0, 0 0 1 0 1 0 0 0, 0 0 0 Q4 Q3 Q2 Q1 Q0	UL PDCP SDU size = 40 bits (5 bytes) Q4..Q0 = Data Radio Bearer identity number for the default radio bearer. See 36.509 clause 6.1	
UE test loop mode B LB setup	Not present		

Table 8.7.1.1.4.3-2: SecurityModeCommand (in the preamble)

Derivation Path: TS36.508 clause 4.6.1 table 4.6.1-19			
Information Element	Value/remark	Comment	Condition
SecurityModeCommand ::= SEQUENCE {			
criticalExtensions CHOICE {			
c1 CHOICE{			
securityModeCommand-r8 SEQUENCE {			
securityConfiguration SEQUENCE {			
cipheringAlgorithm	eea2		
nextHopChainingCount	Not present		
}			
nonCriticalExtension SEQUENCE {}	Not present		
}			
}			
}			

8.7.1.1.5 Test requirement

The requirements are specified in Table 8.7.1.1.5-1. The PDCP SDU success rate shall be sustained during at least 300 frames.

Table 8.7.1.1.5-1: Test requirements for sustained downlink data rate (FDD)

Test	UE Category	Number of bits of a DL-SCH transport block received within a TTI per Codeword	Measurement channel	Number of PDCP SDU per Codeword	PDCP SDU size [Octets]	Reference value
						TB success rate [%]
1	Category 1	10296	R31-1 FDD	1	1275	95
2	Category 2	25456	R31-2 FDD	3	1054	95
3	Category 3 (Note 1)	51024	R31-3 FDD	5	1270	95
3A	Category 3 (Note 2)	36696 (Note4)	R31-3A FDD	4	1141	85
4	Category 4	75376 (Note5)	R31-4 FDD	7	1341	85
Note 1: If the operating band under test does not support 20 MHz channel bandwidth, then test is executed according to Test 3A. Note 2: Applicable to operating bands supporting up to 10 MHz channel bandwidths Note 3: For 2 layer transmissions, 2 transport blocks are received within a TTI Note 4: 35160 bits for sub-frame 5 Note 5: 71112 bits for sub-frame 5 Note 6: The TB success rate is defined as $TB\ success\ rate = 100\% * N_{DL_correct_rx} / (N_{DL_newtx} + N_{DL_retx})$, where N_{DL_newtx} is the number of newly transmitted DL transport blocks, N_{DL_retx} is the number of retransmitted DL transport blocks, and $N_{DL_correct_rx}$ is the number of correctly received DL transport blocks.						

Table 8.7.1.1.5-2: Test Parameters for sustained downlink data rate (FDD)

Parameter	Unit	Test 1	Test 2	Test 3,4	Test 3A	
Bandwidth	MHz	10	10	20	10	
Transmission mode		1	3	3	3	
Antenna configuration		1 x 2	2 x 2	2 x 2	2 x 2	
Propagation condition		Static propagation condition (Note 1)				
CodeBookSubsetRestriction bitmap		n/a	10	10	10	
Downlink power allocation	ρ_A	dB	0	-3	-3	-3
	ρ_B	dB	0	-3	-3	-3
\hat{E}_s at antenna port	dBm/15kHz	-85	-85	-85	-85	
Symbols for unused PRBs		OP.6 FDD	OP.1 FDD	OP.1 FDD	OP.1 FDD	
Note 1: No external noise sources are applied						

8.7.1.1_A FDD sustained data rate performance for CA

8.7.1.1_A.1 FDD Sustained data rate performance for CA (intra-band contiguous DL CA)

Editor's note: UL RMC is TBD

8.7.1.1_A.1.1 Test purpose

Same test purpose as 8.7.1.1

8.7.1.1_A.1.2 Test applicability

This test applies to all types of E-UTRA FDD UE release 10 and forward which support intra-band contiguous DL CA.

8.7.1.1_A.1.3 Minimum requirements

The parameters specified in Table 8.7.1.1_A.1.3-1 are valid for all FDD tests unless otherwise stated.

Table 8.7.1.1_A.1.3-1: Common Test Parameters (FDD)

Parameter	Unit	Value
Cyclic prefix		Normal
Cell ID		0
Inter-TTI Distance		1
Number of HARQ processes per component carrier	Processes	Downlink: 8
Maximum number of HARQ transmission		Downlink: 4 Uplink: 1
Scheduling of retransmissions per component carrier		1. Retransmissions use the same Transport Block Size (TBS) as the initial transmission. 2. HARQ processes are scheduled consecutively, independent of the fact, whether retransmissions (for negatively acknowledged HARQ processes) or new transmissions (for positively acknowledged HARQ processes) occur. 3. Despite of 1) and 2) the number of RB-s to be allocated in each SF remains firm as specified in the RMC. Thus in case of RMC-s with SF dependent allocation, for retransmissions the TBS and the modulation scheme (MCS) are indicated implicitly ($29 \leq I_{MCS} \leq 31$) according to TS 36.213 [10] subclause 7.1.7.2.
Redundancy version coding sequence		{0,0,1,2} for 64QAM
Number of OFDM symbols for PDCCH per component carrier	OFDM symbols	1
Cross carrier scheduling		Not configured

The requirements are specified in Table 8.7.1.1_A.1.3-3, with the addition of the parameters in Table 8.7.1.1_A.1.3-2 and the downlink physical channel setup according to Annex C.3.2. The PDCP SDU success rate shall be sustained during at least 300 frames.

Table 8.7.1.1_A.1.3-2: Test Parameters for sustained downlink data rate (FDD)

Parameter	Unit	Test 3B	Test 4A	Test 6A	Test 6B	Test 6C	Test 6D
Bandwidth	MHz	2x10	2x10	2x20	10+15	10+20	15+20
Transmission mode		3	3	3	3	3	3
Antenna configuration		2x2	2x2	2 x 2	2x2	2x2	2x2
Propagation condition		Static propagation condition (Note 1)					
CodeBookSubsetRestriction bitmap		10	10	10	10	10	10
Downlink power allocation	ρ_A	dB	-3	-3	-3	-3	-3
	ρ_B	dB	-3	-3	-3	-3	-3
	σ	dB	0	0	0	0	0
\hat{E}_s at antenna port	dBm/15kHz	-85	-85	-85	-85	-85	-85
Symbols for unused PRBs		OP.1 FDD	OP.1 FDD	OP.1 FDD	OP.1 FDD	OP.1 FDD	OP.1 FDD
Note 1: No external noise sources are applied							
Note 2: For CA test cases, PUCCH format 1b with channel selection is used to feedback ACK/NACK.							

Table 8.7.1.1_A.1.3-3: Minimum requirement (FDD)

Test	UE Category	CA capability	Number of bits of a DL-SCH transport block received within a TTI	Measurement channel	Reference value
					TB success rate [%]
3B	Category 3	CL_A-A	25456	R.31-2 FDD	[95]
4A	Category 4	CL_A-A	36696 (Note 4)	R.31-3A FDD	[85]
6A	Category 6, 7	CL_A-A CL_C	75376 (Note 2)	R.31-4 FDD	85
6B	Category 6, 7	CL_A-A	36696 (Note 4) for 10MHz CC 55056 for 15MHz CC	R.31-3A FDD for 10MHz carrier CC R.31-5 FDD for 15MHz CC	[85]
6C	Category 6, 7	CL_A-A	36696 (Note 4) for 10MHz CC 75376 (Note 5) for 20MHz CC	R.31-3A FDD for 10MHz CC R.31-4 FDD for 20MHz CC	[85]
6D	Category 6, 7	CL_A-A	55056 for 15MHz CC 75376 (Note 5) for 20MHz CC	R.31-5 FDD for 15MHz CC R.31-4 FDD for 20MHz CC	[85]
Note 1: For 2 layer transmissions, 2 transport blocks are received within a TTI					
Note 2: 71112 bits for sub-frame 5					
Note 3: The TB success rate is defined as TB success rate = 100% * $N_{DL_correct_rx} / (N_{DL_newtx} + N_{DL_retx})$, where N_{DL_newtx} is the number of newly transmitted DL transport blocks, N_{DL_retx} is the number of retransmitted DL transport blocks, and $N_{DL_correct_rx}$ is the number of correctly received DL transport blocks.					
Note 4: 35160 bits for sub-frame 5.					
Note 5: The TB success rate is defined as TB success rate = 100% * $N_{DL_correct_rx} / (N_{DL_newtx} + N_{DL_retx})$, where N_{DL_newtx} is the number of newly transmitted DL transport blocks, N_{DL_retx} is the number of retransmitted DL transport blocks, and $N_{DL_correct_rx}$ is the number of correctly received DL transport blocks.					
Note 6: Test 6 may not be executed for UE-s for which Test 6A is applicable.					

The normative reference for this requirement is TS 36.101[2] clause 8.7.1

8.7.1.1_A.1.4 Test description

8.7.1.1_A.1.4.1 Initial conditions

Table 8.7.1.1_A.1.4.1-1: Applicable test and Transport Block Size for different UE categories

UE Category	Applicable test	DL Measurement channel	UL Measurement channel	TB _{size} per Codeword per Component Carrier	Number of PDCP SDU per Codeword	PDCP SDU size [bits] Note 3
6,7	6A	R.31-4 FDD	TBD	75376 (Note 4)	7	$8 * \text{FLOOR}((\text{TB}_{\text{size}} - 264) / 56)$
<p>Note 1: Transport block size under test according to applicable Fixed Reference Channel for sustained data-rate test in annex A.3.9. In case of varying TBS across SFs of the RMC, only the maximum TBS is used for PDCP SDU size calculation.</p> <p>Note 2: Each PDCP SDU is limited to 1500 octets (to keep below maximum SDU size of ESM as specified in TS 24.301 clause 9.9.4.12).</p> <p>The PDCP SDU size of each PDCP SDU is:</p> $\text{PDCP SDU size} = (\text{TB}_{\text{size}} - N * \text{PDCP header size} - \text{AMD PDU header size} - \text{MAC header size} - \text{Size of RLC STATUS PDU}) / N,$ <p>where PDCP header size is 16 bits for the RLC AM and 12-bit SN case; AMD PDU header size is $\text{CEIL}[(16 + (N-1) * 12) / 8]$ bytes which includes 16 bit standard AM header and (N-1) Length indicators; and MAC header size = R/R/E/LCID/F/L MAC subheader (24 bits for MAC SDU for RLC STATUS PDU with 15 bit LI) + R/R/E/LCID MAC subheader (8 bits for MAC SDU for RLC Data PDU) = 32 bits. The size of RLC STATUS PDU including one ACK_SN field and one NACK_SN field is 32 bits (if no STATUS PDU is sent or if the size of the STATUS PDU is less than 32 bits then padding will be used to fill the 32 bits). This gives: PDCP SDU size = $8 * \text{FLOOR}((\text{TB}_{\text{size}} - N * 16 - 8 * \text{CEIL}[(16 + (N-1) * 12) / 8] - 64) / (8 * N))$ bits.</p> <p>The calculation of PDCP SDU sizes does not consider timing advance MAC CE as timing advance is not transmitted by SS for RF test cases, and the header sizes are informative and may vary during the test.</p> <p>Note 3: Transport block size under test according to applicable Fixed Reference Channel for sustained data-rate test in annex A.3.9. In case of varying TBS across SFs of the RMC, only the maximum TBS is used for PDCP SDU size calculation.</p> <p>Note 4: 71112 bits for sub-frame 5</p>						

Initial conditions are a set of test configurations the UE needs to be tested in and the steps for the SS to take with the UE to reach the correct measurement state.

Configurations of PDSCH and PDCCH before measurement are specified in Annex C.2.

Test Environment: Normal as defined in TS 36.508 [7] clause 4.1.

Frequencies to be tested: Mid Range as defined in TS 36.508 [7] clause 4.3.1.1.

Channel Bandwidths to be tested: According to table 8.7.1.1_A.1.3-2.

1. Connect the SS to the UE antenna connector(s) as shown in TS 36.508 [7] Annex A, Figure group A.36 (without using faders and AWGN generators).
2. The parameter settings for the cell are set up according to Table 8.7.1.1_A.1.3-1 and Table 8.7.1.1_A.1.5-1.
3. Downlink signals for PCC are initially set up according to Annex C0, C.1 and Annex C.3.2 and uplink signals according to Annex H.1 and H.3.2.
4. Propagation conditions are set according to Annex B.0.
5. Ensure the UE is in State 4 (Loopback activated) according to TS 36.508 [7] clause 4.5.4.5. Message contents are defined in clause 8.7.1.1_A.1.4.3.

8.7.1.1_A.1.4.2 Test procedure

1. Configure SCC according to Annex C.0, C.1 and Annex C.3.2 for all downlink physical channels except PHICH.
 2. The SS shall configure SCC as per TS 36.508 [7] clause 5.2A.4. Message contents for PhysicalConfigDedicated-DEFAULT is defined in Table 8.2.2.3.1_A.1.4.3-1
 3. SS activates SCC by sending the activation MAC-CE (Refer TS 36.321 [13], clauses 5.13, 6.1.3.8). Wait for at least 2 seconds (Refer TS 36.133, clauses 8.3.3.2).
 4. The SS looks up TB_{size} in table 8.7.1.1_A.1.4.1-1 according to the UE category under test.
 5. SS sets the counters $N_{DL_{newtx}}$, $N_{DL_{retx}}$, N_{UL_PDCP} , and N_{DL_PDCP} to 0.
 6. For each new DL HARQ transmission the SS generates sufficient PDCP SDUs to fill up the TB in accordance with Table 8.7.1.1_A.1.4.1-1 (Note 1). The SS ciphers the PDCP SDUs, concatenates the resultant PDCP PDUs to form an RLC PDU and then a MAC PDU. The SS transmits the MAC PDU. The SS increments then $N_{DL_{newtx}}$ by one and N_{DL_PDCP} by the number of new PDCP SDUs (Note 1) included in the sent MAC PDU.
 7. If PHY requests a DL HARQ retransmission, the SS performs a HARQ retransmission and increments $N_{DL_{retx}}$ by one.
 8. Steps 3 to 4 are repeated at every TTI for at least 300 frames and the SS waits for 300ms to let any HARQ retransmissions and RLC retransmissions to finish.
 9. For each PDCP SDU received at the SS, if the content of the data matches that of the truncated version of the original PDCP SDU generated at the SS, the SS increments N_{UL_PDCP} by one
 10. The SS calculates the TB success rate as $A = 100\% * N_{DL_{newtx}} / (N_{DL_{newtx}} + N_{DL_{retx}})$
 11. The SS calculates the PDCP SDU loss as $B = N_{DL_PDCP} - N_{UL_PDCP}$
 12. The UE passes the test if $A \geq$ "corresponding TB success rate according to Table 8.7.1.1_A.1.3-3" and $B = 0$.
- NOTE 1: In case of RLC PDU retransmission, the number of new required PDCP SDUs is as many as to fill the rest of TB.

8.7.1.1_A.1.4.3 Message contents

Message contents are according to TS 36.508 [7] clause 4.6 and 4.7A, with the following exceptions:

Table 8.7.1.1_A.1.4.3-1: CLOSE UE TEST LOOP (in the preamble)

Derivation Path: 36.509 clause 6.1			
Information Element	Value/remark	Comment	Condition
Protocol discriminator	1 1 1 1		
Skip indicator	0 0 0 0		
Message type	1 0 0 0 0 0 0 0		
UE test loop mode	0 0 0 0 0 0 0 0	UE test loop mode A	
UE test loop mode A LB setup			
Length of UE test loop mode A LB setup list in bytes	0 0 0 0 0 0 1 1	Length of one LB setup DRB (3 bytes)	
LB setup DRB	0 0 0 0 0 0 0 0, 0 0 1 0 1 0 0 0, 0 0 0 Q4 Q3 Q2 Q1 Q0	UL PDCP SDU size = 40 bits (5 bytes) Q4..Q0 = Data Radio Bearer identity number for the default radio bearer. See 36.509 clause 6.1	
UE test loop mode B LB setup	Not present		

Table 8.7.1.1_A.1.4.3-2: SecurityModeCommand (in the preamble)

Derivation Path: TS36.508 clause 4.6.1 table 4.6.1-19			
Information Element	Value/remark	Comment	Condition
SecurityModeCommand ::= SEQUENCE {			
criticalExtensions CHOICE {			
c1 CHOICE{			
securityModeCommand-r8 SEQUENCE {			
securityConfiguration SEQUENCE {			
cipheringAlgorithm	eea2		
nextHopChainingCount	Not present		
}			
nonCriticalExtension SEQUENCE {}	Not present		
}			
}			
}			

8.7.1.1_A.1.5 Test requirement

The requirements are specified in Table 8.7.1.1_A.1.5-1. The PDCP SDU success rate shall be sustained during at least 300 frames.

Table 8.7.1.1_A.1.5-1: Test requirements for sustained downlink data rate (FDD)

Test	UE Category	Number of bits of a DL-SCH transport block received within a TTI per Codeword	Measurement channel	Number of PDCP SDU per Codeword	PDCP SDU size [Octets]	Reference value
						TB success rate [%]
3B			NA			
4A			NA			
6A	Category 6,7	75376 (Note 2)	R.31-4 FDD	7	1341	85
6B			NA			
6C			NA			
6D			NA			
Note 1:	For 2 layer transmissions, 2 transport blocks are received within a TTI per component carrier.					
Note 2:	71112 bits for sub-frame 5					
Note 3:	The TB success rate is defined as $TB\ success\ rate = 100\% * N_{DL_correct_rx} / (N_{DL_newtx} + N_{DL_retx})$, where N_{DL_newtx} is the number of newly transmitted DL transport blocks, N_{DL_retx} is the number of retransmitted DL transport blocks, and $N_{DL_correct_rx}$ is the number of correctly received DL transport blocks.					

8.7.1.1_A.2 FDD Sustained data rate performance for CA (inter-band DL CA)

Editor's note: UL RMC is TBD

8.7.1.1_A.2.1 Test purpose

Same test purpose as 8.7.1.1

8.7.1.1_A.2.2 Test applicability

This test applies to all types of E-UTRA FDD UE release 10 which support inter-band DL CA.

8.7.1.1_A.2.3 Minimum requirements

The parameters specified in Table 8.7.1.1_A.2.3-1 are valid for all FDD tests unless otherwise stated.

Table 8.7.1.1_A.2.3-1: Common Test Parameters (FDD)

Parameter	Unit	Value
Cyclic prefix		Normal
Cell ID		0
Inter-TTI Distance		1
Number of HARQ processes per component carrier	Processes	8
Maximum number of HARQ transmission		4
Redundancy version coding sequence		{0,0,1,2} for 64QAM
Number of OFDM symbols for PDCCH per component carrier	OFDM symbols	1
Cross carrier scheduling		Not configured

The requirements are specified in Table 8.7.1.1_A.2.3-3, with the addition of the parameters in Table 8.7.1.1_A.2.3-2 and the downlink physical channel setup according to Annex C.3.2. The TB success rate shall be sustained during at least 300 frames.

Table 8.7.1.1_A.2.3-2: test parameters for sustained downlink data rate (FDD)

Parameter	Unit	Test 1	Test 2	Test 3,4,6	Test 3A	Test 3B	Test 4A	Test 6A
Bandwidth	MHz	10	10	20	10	2x10	2x10	2x20
Transmission mode		1	3	3	3	3	3	3
Antenna configuration		1 x 2	2 x 2	2 x 2	2 x 2	2x2	2x2	2 x 2
Propagation condition		Static propagation condition (Note 1)						
CodeBookSubsetRestriction bitmap		n/a	10	10	10	10	10	10
Downlink power allocation	ρ_A	dB	0	-3	-3	-3	-3	-3
	ρ_B	dB	0	-3	-3	-3	-3	-3
	σ	dB	0	0	0	0	0	0
\hat{E}_s at antenna port	dBm/15kHz	-85	-85	-85	-85	-85	-85	-85
Symbols for unused PRBs		OP.6 FDD	OP.1 FDD	OP.1 FDD	OP.1 FDD	OP.1 FDD	OP.1 FDD	OP.1 FDD
Note 1: No external noise sources are applied.								
Note 2: For CA test cases, PUCCH format 1b with channel selection is used to feedback ACK/NACK.								

Table 8.7.1.1_A.2.3-3: Minimum requirement (FDD)

Test	UE Category	CA capability	Number of bits of a DL-SCH transport block received within a TTI	Measurement channel	Reference value
					TB success rate [%]
3B	Category 3	CL_A-A	25456	R.31-2 FDD	[95]
4A	Category 4	CL_A-A	36696 (Note 4)	R.31-3A FDD	[85]
6A	Category 6, 7	CL_A-A, CL_C	75376 (Note 5)	R.31-4 FDD	85
Note 1: NA. Note 2: NA. Note 3: For 2 layer transmissions, 2 transport blocks are received within a TTI. Note 4: 35160 bits for sub-frame 5. Note 5: 71112 bits for sub-frame 5. Note 6: The TB success rate is defined as TB success rate = $100\% \cdot N_{DL_correct_rx} / (N_{DL_newtx} + N_{DL_retx})$, where N_{DL_newtx} is the number of newly transmitted DL transport blocks, N_{DL_retx} is the number of retransmitted DL transport blocks, and $N_{DL_correct_rx}$ is the number of correctly received DL transport blocks.					

8.7.1.1_A.2.4 Test description

8.7.1.1_A.2.4.1 Initial conditions

Table 8.7.1.1_A.2.4.1-1: Applicable test and Transport Block Size for different UE categories

UE Category	Applicable test	DL Measurement channel	UL Measurement channel	TB _{size} per Codeword per Component Carrier	Number of PDCP SDU per Codeword	PDCP SDU size [bits] Note 3
3	3B	R.31-2 FDD	TBD	25456	7	$8 \cdot \text{FLOOR}((\text{TB}_{\text{size}} - 264)/56)$
4	4A	R.31-3A FDD	TBD	36696 (Note 4)	7	$8 \cdot \text{FLOOR}((\text{TB}_{\text{size}} - 264)/56)$
6,7	6A	R.31-4 FDD	TBD	75376 (Note 4)	7	$8 \cdot \text{FLOOR}((\text{TB}_{\text{size}} - 264)/56)$
Note 1: Transport block size under test according to applicable Fixed Reference Channel for sustained data-rate test in annex A.3.9. In case of varying TBS across SFs of the RMC, only the maximum TBS is used for PDCP SDU size calculation. Note 2: Each PDCP SDU is limited to 1500 octets (to keep below maximum SDU size of ESM as specified in TS 24.301 clause 9.9.4.12). The PDCP SDU size of each PDCP SDU is: $\text{PDCP SDU size} = (\text{TB}_{\text{size}} - N \cdot \text{PDCP header size} - \text{AMD PDU header size} - \text{MAC header size} - \text{Size of RLC STATUS PDU}) / N,$ where PDCP header size is 16 bits for the RLC AM and 12-bit SN case; AMD PDU header size is $\text{CEIL}[(16+(N-1) \cdot 12)/8]$ bytes which includes 16 bit standard AM header and (N-1) Length indicators; and MAC header size = R/R/E/LCID/F/L MAC subheader (24 bits for MAC SDU for RLC STATUS PDU with 15 bit LI) + R/R/E/LCID MAC subheader (8 bits for MAC SDU for RLC Data PDU) = 32 bits. The size of RLC STATUS PDU including one ACK_SN field and one NACK_SN field is 32 bits (if no STATUS PDU is sent or if the size of the STATUS PDU is less than 32 bits then padding will be used to fill the 32 bits). This gives: PDCP SDU size = $8 \cdot \text{FLOOR}((\text{TB}_{\text{size}} - N \cdot 16 - 8 \cdot \text{CEIL}[(16+(N-1) \cdot 12)/8] - 64)/(8 \cdot N))$ bits. The calculation of PDCP SDU sizes does not consider timing advance MAC CE as timing advance is not transmitted by SS for RF test cases. Note 3: Transport block size under test according to applicable Fixed Reference Channel for sustained data-rate test in annex A.3.9. In case of varying TBS across SFs of the RMC, only the maximum TBS is used for PDCP SDU size calculation. Note 4: 71112 bits for sub-frame 5						

Initial conditions are a set of test configurations the UE needs to be tested in and the steps for the SS to take with the UE to reach the correct measurement state.

Configurations of PDSCH and PDCCH before measurement are specified in Annex C.2.

Test Environment: Normal as defined in TS 36.508 [7] clause 4.1.

Frequencies to be tested: Mid Range as defined in TS 36.508 [7] clause 4.3.1.1.

Channel Bandwidths to be tested: According to table 8.7.1.1_A.2.3-2.

1. Connect the SS to the UE antenna connector(s) as shown in TS 36.508 [7] Annex A, Figure group A.36 (without using faders and AWGN generators).
2. The parameter settings for the cell are set up according to Table 8.7.1.1_A.2.3-1 and Table 8.7.1.1_A.2.5-1.
3. Downlink signals for PCC are initially set up according to Annex C0, C.1 and Annex C.3.2 and uplink signals according to Annex H.1 and H.3.2.
4. Propagation conditions are set according to Annex B.0.
5. Ensure the UE is in State 4 (Loopback activated) according to TS 36.508 [7] clause 4.5.4.5. Message contents are defined in clause 8.7.1.1_A.2.4.3.

8.7.1.1_A.2.4.2 Test procedure

1. Configure SCC according to Annex C.0, C.1 and Annex C.3.2 for all downlink physical channels except PHICH.
2. The SS shall configure SCC as per TS 36.508 [7] clause 5.2A.4. Message contents for PhysicalConfigDedicated-DEFAULT is defined in Table 8.2.2.3.1_A.2.4.3-1
3. SS activates SCC by sending the activation MAC-CE (Refer TS 36.321 [13], clauses 5.13, 6.1.3.8). Wait for at least 2 seconds (Refer TS 36.133, clauses 8.3.3.2).
4. The SS looks up TB_{size} in table 8.7.1.1_A.2.4.1-1 according to the UE category under test.
5. SS sets the counters N_{DL_newtx} , N_{DL_retx} , N_{UL_PDCP} , and N_{DL_PDCP} to 0.
6. For each new DL HARQ transmission the SS generates sufficient PDCP SDUs to fill up the TB in accordance with Table 8.7.1.1_A.2.4.1-1 (Note 1). The SS ciphers the PDCP SDUs, concatenates the resultant PDCP PDUs to form an RLC PDU and then a MAC PDU. The SS transmits the MAC PDU. The SS increments then N_{DL_newtx} by one and N_{DL_PDCP} by the number of new PDCP SDUs (Note 1) included in the sent MAC PDU.
7. If PHY requests a DL HARQ retransmission, the SS performs a HARQ retransmission and increments N_{DL_retx} by one.
8. Steps 3 to 4 are repeated at every TTI for at least 300 frames and the SS waits for 300ms to let any HARQ retransmissions and RLC retransmissions to finish.
9. For each PDCP SDU received at the SS, if the content of the data matches that of the truncated version of the original PDCP SDU generated at the SS, the SS increments N_{UL_PDCP} by one
10. The SS calculates the TB success rate as $A = 100\% * N_{DL_newtx} / (N_{DL_newtx} + N_{DL_retx})$
11. The SS calculates the PDCP SDU loss as $B = N_{DL_PDCP} - N_{UL_PDCP}$
12. The UE passes the test if $A \geq$ "corresponding TB success rate according to Table 8.7.1.1_A.1.3-3" and $B = 0$.

NOTE 1: In case of RLC PDU retransmission, the number of new required PDCP SDUs is as many as to fill the rest of TB.

8.7.1.1_A.2.4.3 Message contents

Message contents are according to TS 36.508 [7] clause 4.6 and 4.7A, with the following exceptions:

Table 8.7.1.1_A.2.4.3-1: CLOSE UE TEST LOOP (in the preamble)

Derivation Path: 36.509 clause 6.1			
Information Element	Value/remark	Comment	Condition
Protocol discriminator	1 1 1 1		
Skip indicator	0 0 0 0		
Message type	1 0 0 0 0 0 0 0		
UE test loop mode	0 0 0 0 0 0 0 0	UE test loop mode A	
UE test loop mode A LB setup			
Length of UE test loop mode A LB setup list in bytes	0 0 0 0 0 0 1 1	Length of one LB setup DRB (3 bytes)	
LB setup DRB	0 0 0 0 0 0 0 0, 0 0 1 0 1 0 0 0, 0 0 0 Q4 Q3 Q2 Q1 Q0	UL PDCP SDU size = 40 bits (5 bytes) Q4..Q0 = Data Radio Bearer identity number for the default radio bearer. See 36.509 clause 6.1	
UE test loop mode B LB setup	Not present		

Table 8.7.1.1_A.2.4.3-2: SecurityModeCommand (in the preamble)

Derivation Path: TS36.508 clause 4.6.1 table 4.6.1-19			
Information Element	Value/remark	Comment	Condition
SecurityModeCommand ::= SEQUENCE {			
criticalExtensions CHOICE {			
c1 CHOICE{			
securityModeCommand-r8 SEQUENCE {			
securityConfiguration SEQUENCE {			
cipheringAlgorithm	eea2		
nextHopChainingCount	Not present		
}			
nonCriticalExtension SEQUENCE {}	Not present		
}			
}			
}			
}			

8.7.1.1_A.2.5 Test requirement

The requirements are specified in Table 8.7.1.1_A.2.5-1. The PDCP SDU success rate shall be sustained during at least 300 frames.

Table 8.7.1.1_A.2.5-1: Test requirements for sustained downlink data rate (FDD)

Test	UE Category	Number of bits of a DL-SCH transport block received within a TTI per Codeword	Measurement channel	Number of PDCP SDU per Codeword	PDCP SDU size [Octets]	Reference value
						TB success rate [%]
3B	Category 3	25456	R.31-2 FDD	7	TBD	[95]
4A	Category 4	36696 (Note 2)	R.31-3A FDD	7	TBD	[85]
6A	Category 6, 7	75376 (Note 3)	R.31-4 FDD	7	TBD	85
Note 1:	For 2 layer transmissions, 2 transport blocks are received within a TTI per component carrier.					
Note 2:	35160 bits for sub-frame 5.					
Note 3:	71112 bits for sub-frame 5.					
Note 4:	The TB success rate is defined as $TB\ success\ rate = 100\% * N_{DL_correct_rx} / (N_{DL_newtx} + N_{DL_retx})$, where N_{DL_newtx} is the number of newly transmitted DL transport blocks, N_{DL_retx} is the number of retransmitted DL transport blocks, and $N_{DL_correct_rx}$ is the number of correctly received DL transport blocks.					
Note 5:	For category 6 and 7 UE, select one CA configuration among CA configurations corresponding to largest aggregated CA bandwidth signalled by UE.					

8.7.1.1_A.2_1 FDD Sustained data rate performance for CA (inter-band DL CA) (Release 11 and forward)

Editor's note: UL RMC is TBD

8.7.1.1_A.2_1.1 Test purpose

Same test purpose as 8.7.1.1

8.7.1.1_A.2_1.2 Test applicability

This test applies to all types of E-UTRA FDD UE release 11 and forward which support inter-band DL CA.

8.7.1.1_A.2_1.3 Minimum requirements

Same minimum conformance requirements as in clause 8.7.1.1_A.1.3.

8.7.1.1_A.2_1.4 Test description

8.7.1.1_A.2_1.4.1 Initial conditions

Table 8.7.1.1_A.2_1.4.1-1: Applicable test and Transport Block Size for different UE categories

UE Category	Applicable test	DL Measurement channel	UL Measurement channel	T _{Bsize} per Codeword per Component Carrier	Number of PDCP SDU per Codeword	PDCP SDU size [bits] Note 3
3	3B	R.31-2 FDD	TBD	25456	7	$8 * \text{FLOOR}((T_{Bsize} - 264) / 56)$
4	4A	R.31-3A FDD	TBD	36696 (Note 4)	7	$8 * \text{FLOOR}((T_{Bsize} - 264) / 56)$
6,7	6A	R.31-4 FDD	TBD	75376 (Note 4)	7	$8 * \text{FLOOR}((T_{Bsize} - 264) / 56)$
6,7	6B	R.31-3A FDD for 10MHz carrier CC R.31-5 FDD for 15MHz CC	TBD	36696 (Note 4) for 10MHz CC 55056 for 15MHz CC	7	$8 * \text{FLOOR}((T_{Bsize} - 264) / 56)$
6,7	6C	R.31-3A FDD for 10MHz CC R.31-4 FDD for 20MHz CC	TBD	36696 (Note 4) for 10MHz CC 75376 (Note 5) for 20MHz CC	7	$8 * \text{FLOOR}((T_{Bsize} - 264) / 56)$
6,7	6D	R.31-5 FDD for 15MHz CC R.31-4 FDD for 20MHz CC	TBD	55056 for 15MHz CC 75376 (Note 5) for 20MHz CC	7	$8 * \text{FLOOR}((T_{Bsize} - 264) / 56)$
<p>Note 1: Transport block size under test according to applicable Fixed Reference Channel for sustained data-rate test in annex A.3.9. In case of varying TBS across SFs of the RMC, only the maximum TBS is used for PDCP SDU size calculation.</p> <p>Note 2: Each PDCP SDU is limited to 1500 octets (to keep below maximum SDU size of ESM as specified in TS 24.301 clause 9.9.4.12).</p> <p>The PDCP SDU size of each PDCP SDU is:</p> $\text{PDCP SDU size} = (T_{Bsize} - N * \text{PDCP header size} - \text{AMD PDU header size} - \text{MAC header size} - \text{Size of RLC STATUS PDU}) / N,$ <p>where PDCP header size is 16 bits for the RLC AM and 12-bit SN case; AMD PDU header size is $\text{CEIL}[(16 + (N-1) * 12) / 8]$ bytes which includes 16 bit standard AM header and (N-1) Length indicators; and MAC header size = R/R/E/LCID/F/L MAC subheader (24 bits for MAC SDU for RLC STATUS PDU with 15 bit LI) + R/R/E/LCID MAC subheader (8 bits for MAC SDU for RLC Data PDU) = 32 bits. The size of RLC STATUS PDU including one ACK_SN field and one NACK_SN field is 32 bits (if no STATUS PDU is sent or if the size of the STATUS PDU is less than 32 bits then padding will be used to fill the 32 bits). This gives: PDCP SDU size = $8 * \text{FLOOR}((T_{Bsize} - N * 16 - 8 * \text{CEIL}[(16 + (N-1) * 12) / 8] - 64) / (8 * N))$ bits.</p> <p>The calculation of PDCP SDU sizes does not consider timing advance MAC CE as timing advance is not transmitted by SS for RF test cases, and the header sizes are informative and may vary during the test.</p> <p>Note 3: Transport block size under test according to applicable Fixed Reference Channel for sustained data-rate test in annex A.3.9. In case of varying TBS across SFs of the RMC, only the maximum TBS is used for PDCP SDU size calculation.</p> <p>Note 4: 35160 bits for sub-frame 5.</p> <p>Note 5: 71112 bits for sub-frame 5.</p>						

Initial conditions are a set of test configurations the UE needs to be tested in and the steps for the SS to take with the UE to reach the correct measurement state.

Configurations of PDSCH and PDCCH before measurement are specified in Annex C.2.

Test Environment: Normal as defined in TS 36.508 [7] clause 4.1.

Frequencies to be tested: Mid Range as defined in TS 36.508 [7] clause 4.3.1.1.

Channel Bandwidths to be tested: According to table 8.7.1.1_A.2_1.3-2.

1. Connect the SS to the UE antenna connector(s) as shown in TS 36.508 [7] Annex A, Figure group A.36 (without using faders and AWGN generators).
2. The parameter settings for the cell are set up according to Table 8.7.1.1_A.2_1.3-1 and Table 8.7.1.1_A.2_1.5-1.
3. Downlink signals for PCC are initially set up according to Annex C0, C.1 and Annex C.3.2 and uplink signals according to Annex H.1 and H.3.2.
4. Propagation conditions are set according to Annex B.0.
5. Ensure the UE is in State 4 (Loopback activated) according to TS 36.508 [7] clause 4.5.4.5. Message contents are defined in clause 8.7.1.1_A.2_1.4.3.

8.7.1.1_A.2_1.4.2 Test procedure

1. Configure SCC according to Annex C.0, C.1 and Annex C.3.2 for all downlink physical channels except PHICH.
2. The SS shall configure SCC as per TS 36.508 [7] clause 5.2A.4. Message contents for PhysicalConfigDedicated-DEFAULT is defined in Table 8.2.2.3.1_A.2_1.4.3-1
3. SS activates SCC by sending the activation MAC-CE (Refer TS 36.321 [13], clauses 5.13, 6.1.3.8). Wait for at least 2 seconds (Refer TS 36.133, clauses 8.3.3.2).
4. The SS looks up TB_{size} in table 8.7.1.1_A.2_1.4.1-1 according to the UE category under test.
5. SS sets the counters N_{DL_newtx} , N_{DL_retrx} , N_{UL_PDCP} , and N_{DL_PDCP} to 0.
6. For each new DL HARQ transmission the SS generates sufficient PDCP SDUs to fill up the TB in accordance with Table 8.7.1.1_A.2_1.4.1-1 (Note 1). The SS ciphers the PDCP SDUs, concatenates the resultant PDCP PDUs to form an RLC PDU and then a MAC PDU. The SS transmits the MAC PDU. The SS increments then N_{DL_newtx} by one and N_{DL_PDCP} by the number of new PDCP SDUs (Note 1) included in the sent MAC PDU.
7. If PHY requests a DL HARQ retransmission, the SS performs a HARQ retransmission and increments N_{DL_retrx} by one.
8. Steps 3 to 4 are repeated at every TTI for at least 300 frames and the SS waits for 300ms to let any HARQ retransmissions and RLC retransmissions to finish.
9. For each PDCP SDU received at the SS, if the content of the data matches that of the truncated version of the original PDCP SDU generated at the SS, the SS increments N_{UL_PDCP} by one
10. The SS calculates the TB success rate as $A = 100\% * N_{DL_newtx} / (N_{DL_newtx} + N_{DL_retrx})$
11. The SS calculates the PDCP SDU loss as $B = N_{DL_PDCP} - N_{UL_PDCP}$
12. The UE passes the test if $A \geq$ "corresponding TB success rate according to Table 8.7.1.1_A.1.3-3" and $B = 0$.

NOTE 1: In case of RLC PDU retransmission, the number of new required PDCP SDUs is as many as to fill the rest of TB.

8.7.1.1_A.2_1.4.3 Message contents

Message contents are according to TS 36.508 [7] clause 4.6 and 4.7A, with the following exceptions:

Table 8.7.1.1_A.2_1.4.3-1: CLOSE UE TEST LOOP (in the preamble)

Derivation Path: 36.509 clause 6.1			
Information Element	Value/remark	Comment	Condition
Protocol discriminator	1 1 1 1		
Skip indicator	0 0 0 0		
Message type	1 0 0 0 0 0 0 0		
UE test loop mode	0 0 0 0 0 0 0 0	UE test loop mode A	
UE test loop mode A LB setup			
Length of UE test loop mode A LB setup list in bytes	0 0 0 0 0 0 1 1	Length of one LB setup DRB (3 bytes)	
LB setup DRB	0 0 0 0 0 0 0 0, 0 0 1 0 1 0 0 0, 0 0 0 Q4 Q3 Q2 Q1 Q0	UL PDCP SDU size = 40 bits (5 bytes) Q4..Q0 = Data Radio Bearer identity number for the default radio bearer. See 36.509 clause 6.1	
UE test loop mode B LB setup	Not present		

Table 8.7.1.1_A.2_1.4.3-2: SecurityModeCommand (in the preamble)

Derivation Path: TS36.508 clause 4.6.1 table 4.6.1-19			
Information Element	Value/remark	Comment	Condition
SecurityModeCommand ::= SEQUENCE {			
criticalExtensions CHOICE {			
c1 CHOICE{			
securityModeCommand-r8 SEQUENCE {			
securityConfiguration SEQUENCE {			
cipheringAlgorithm	eea2		
nextHopChainingCount	Not present		
}			
nonCriticalExtension SEQUENCE {}	Not present		
}			
}			
}			
}			

8.7.1.1_A.2_1.5 Test requirement

The requirements are specified in Table 8.7.1.1_A.2_1.5-1. The PDCP SDU success rate shall be sustained during at least 300 frames.

Table 8.7.1.1_A.2_1.5-1: Test requirements for sustained downlink data rate (FDD)

Test	UE Category	Number of bits of a DL-SCH transport block received within a TTI per Codeword	Measurement channel	Number of PDCP SDU per Codeword	PDCP SDU size [Octets]	Reference value
						TB success rate [%]
3B	Category 3	25456	R.31-2 FDD	7	TBD	[95]
4A	Category 4	36696 (Note 4)	R.31-3A FDD	7	TBD	[85]
6A	Category 6,7	75376 (Note 2)	R.31-4 FDD	7	1431	85
6B	Category 6, 7	36696 (Note 4) for 10MHz CC 55056 for 15MHz CC	R.31-3A FDD for 10MHz carrier CC R.31-5 FDD for 15MHz CC	7	TBD	[85]
6C	Category 6, 7	36696 (Note 4) for 10MHz CC 75376 (Note 2) for 20MHz CC	R.31-3A FDD for 10MHz CC R.31-4 FDD for 20MHz CC	7	TBD	[85]
6D	Category 6, 7	55056 for 15MHz CC 75376 (Note 2) for 20MHz CC	R.31-5 FDD for 15MHz CC R.31-4 FDD for 20MHz CC	7	TBD	[85]
Note 1:	For 2 layer transmissions, 2 transport blocks are received within a TTI per component carrier.					
Note 2:	71112 bits for sub-frame 5					
Note 3:	The TB success rate is defined as $TB\ success\ rate = 100\% * N_{DL_correct_rx} / (N_{DL_newtx} + N_{DL_retx})$, where N_{DL_newtx} is the number of newly transmitted DL transport blocks, N_{DL_retx} is the number of retransmitted DL transport blocks, and $N_{DL_correct_rx}$ is the number of correctly received DL transport blocks.					
Note 4:	35160 bits for sub-frame 5.					

Table 8.7.1.1_A.2_1.5-2: Test Points Selection for UE Category

Maximum aggregated bandwidth [MHz] (Note 1)	Applicable test points		
	Category 3	Category 4	Category 6, 7
20	3B	4A	-
25	3B	4A	6B
30	3B	4A	6C
35	3B	4A	6D
40	3B	4A	6A
Note 1:	Maximum over all supported CA configurations and bandwidth combination sets according to Table 5.4.2A.1-2.		
Note 2:	If a specific maximum aggregated bandwidth is supported in multiple CA configurations, the test can be run in any of them		

8.7.2 TDD

8.7.2.1 TDD sustained data rate performance

8.7.2.1.1 Test purpose

The purpose of the test is to verify that the Layer 1 and Layer 2 correctly process in a sustained manner the received packets corresponding to the maximum number of DL-SCH transport block bits received within a TTI for the UE category indicated. The sustained downlink data rate shall be verified in terms of the success rate of delivered PDCP SDU(s) by Layer 2. The test case below specifies the RF conditions and the required success rate of delivered TB by Layer 1 to meet the sustained data rate requirement. The size of the TB per TTI corresponds to the largest possible DL-SCH transport block for each UE category using the maximum number of layers for spatial multiplexing. Transmission modes 1 and 3 are used with radio conditions resembling a scenario where sustained maximum data rates are available.

8.7.2.1.2 Test applicability

This test applies to all types of E-UTRA TDD UE release 9 and forward.

8.7.2.1.3 Minimum requirements

The parameters specified in Table 8.7.2.1.3-1 are valid for all TDD tests unless otherwise stated.

Table 8.7.2.1.3-1: Common Test Parameters (TDD)

Parameter	Unit	Value
Special subframe configuration (Note 1)		4
Cyclic prefix		Normal
Cell ID		0
Inter-TTI Distance		1
Maximum number of HARQ transmission		Downlink: 4 Uplink: 1
Redundancy version coding sequence		{0,0,1,2} for 64QAM
Scheduling of retransmissions		<ol style="list-style-type: none"> 1. Retransmissions use the same Transport Block Size (TBS) as the initial transmission. 2. HARQ processes are scheduled consecutively, independent of the fact, whether retransmissions (for negatively acknowledged HARQ processes) or new transmissions (for positively acknowledged HARQ processes) occur. 3. Despite of 1) and 2) the number of RB-s to be allocated in each SF remains firm as specified in the RMC. Thus in case of RMC-s with SF dependent allocation, for retransmissions the TBS and the modulation scheme (MCS) are indicated implicitly ($29 \leq I_{MCS} \leq 31$) according to TS 36.213 [10] subclause 7.1.7.2.
Number of OFDM symbols for PDCCH	OFDM symbols	1
Cross carrier scheduling		Not configured
Note 1: as specified in Table 4.2-1 in TS 36.211 [4]		

The requirements are specified in Table 8.7.2.1.3-3, with the addition of the parameters in Table 8.7.2.1.3-2 and the downlink physical channel setup according to Annex C.3.2. The PDCP SDU success rate shall be sustained during at least 300 frames.

Table 8.7.2.1.3-2: test parameters for sustained downlink data rate (TDD)

Parameter		Unit	Test 1	Test 2	Test 3	Test 3B	Test 4	
Bandwidth		MHz	10	10	20	15	20	
Transmission mode			1	3	3	3	3	
Antenna configuration			1 x 2	2 x 2	2 x 2	2 x 2	2x2	
Propagation condition			Static propagation condition (Note 1)					
CodeBookSubsetRestriction bitmap			n/a	10	10	10	10	
Downlink power allocation	ρ_A	dB	0	-3	-3	-3	-3	
	ρ_B	dB	0	-3	-3	-3	-3	
\hat{E}_s at antenna port		dBm/15kHz	-85	-85	-85	-85	-85	
Symbols for unused PRBs			OP.6 TDD	OP.1 TDD	OP.1 TDD	OP.2 TDD	OP.1 TDD	
ACK/NACK feedback mode			Bundling	Bundling	Bundling	Multiplexing	Multiplexing	
Note 1: No external noise sources are applied								

Table 8.7.2.1.3-3: Minimum requirement (TDD)

Test	UE Category	Number of bits of a DL-SCH transport block received within a TTI for normal/special sub-frame	Measurement channel	Reference value
				TB success rate [%]
1	Category 1	10296/0	R31-1 TDD	95
2	Category 2	25456/0	R31-2 TDD	95
3	Category 3 (Note 1)	51024/0	R31-3 TDD	95
3B	Category 3 (Note 2)	51024/0	R31-3B TDD	85
4	Category 4	75376/0 (Note 4)	R31-4 TDD	85
Note 1: If the operating band under test does not support 20 MHz channel bandwidth, then test is executed according to Test 3B. Note 2: Applicable to operating bands supporting up to 15 MHz channel bandwidths. Note 3: For 2 layer transmissions, 2 transport blocks are received within a TTI Note 4: 71112 bits for sub-frame 5 Note 5: The TB success rate is defined as TB success rate = $100\% \cdot N_{DL_correct_rx} / (N_{DL_newtx} + N_{DL_retx})$, where N_{DL_newtx} is the number of newly transmitted DL transport blocks, N_{DL_retx} is the number of retransmitted DL transport blocks, and $N_{DL_correct_rx}$ is the number of correctly received DL transport blocks.				

The normative reference for this requirement is TS 36.101[2] clause 8.7.2

8.7.2.1.4 Test description

8.7.2.1.4.1 Initial conditions

Table 8.7.2.1.4.1-1: Applicable test and Transport Block Size for different UE categories

UE Category	Applicable test	DL Measurement channel	UL Measurement Channel	TB _{size} per Codeword	Number of PDCP SDU per Codeword for normal/special sub-frame	PDCP SDU size [bits] Note 3
1	Test 1	R.31-1 TDD	R.1-1 TDD	10296	1/0	$8 * \text{FLOOR}((\text{TB}_{\text{size}} - 96)/8)$
2	Test 2	R.31-2 TDD	R.1-2 TDD	25456	3/0	$8 * \text{FLOOR}((\text{TB}_{\text{size}} - 152)/24)$
3	Test 3 (Note 1)	R.31-3 TDD	R.1-3 TDD	51024	5/0	$8 * \text{FLOOR}((\text{TB}_{\text{size}} - 208)/40)$
3	Test 3B (Note 2)	R.31-3B TDD	R.1-3B TDD	51024	4/0	$8 * \text{FLOOR}((\text{TB}_{\text{size}} - 184)/32)$ "
4	Test 4	R.31-4 TDD	R.1-4 TDD	75376 (Note 5)	7/0	$8 * \text{FLOOR}((\text{TB}_{\text{size}} - 264)/56)$
<p>Note 1: If the operating band under test does not support 20 MHz channel bandwidth, then test is executed according to Test 3B.</p> <p>Note 2: Applicable to operating bands supporting up to 15 MHz channel bandwidths</p> <p>Note 3: Transport block size under test according to applicable Fixed Reference Channel for sustained data-rate test in annex A.3.9. In case of varying TBS across SFs of the RMC, only the maximum TBS is used for PDCP SDU size calculation.</p> <p>Note 4: Each PDCP SDU is limited to 1500 octets (to keep below maximum SDU size of ESM as specified in TS 24.301 clause 9.9.4.12).</p> <p>The PDCP SDU size of each PDCP SDU is:</p> $\text{PDCP SDU size} = (\text{TB}_{\text{size}} - N * \text{PDCP header size} - \text{AMD PDU header size} - \text{MAC header size} - \text{Size of Timing Advance} - \text{Size of RLC STATUS PDU}) / N,$ <p>where PDCP header size is 16 bits for the RLC AM and 12-bit SN case; AMD PDU header size is $\text{CEIL}[(16 + (N-1) * 12)/8]$ bytes which includes 16 bit standard AM header and (N-1) Length indicators; and MAC header size = R/R/E/LCID/F/L MAC subheader (24 bits for MAC SDU for RLC STATUS PDU with 15 bit LI) + R/R/E/LCID MAC subheader (8 bits for MAC SDU for RLC data PDU) = 32 bits. The size of RLC STATUS PDU including one ACK_SN field and one NACK_SN field is 32 bits (if no STATUS PDU is sent or if the size of the STATUS PDU is less than 32 bits then padding will be used to fill the 32 bits). This gives: $\text{PDCP SDU size} = 8 * \text{FLOOR}((\text{TB}_{\text{size}} - N * 16 - 8 * \text{CEIL}((16 + (N-1) * 12)/8) - 64)/(8 * N))$ bits.</p> <p>The calculation of PDCP SDU sizes does not consider timing advance MAC CE as timing advance is not transmitted by SS for RF test cases, and the header sizes are informative and may vary during the test.</p> <p>Note 5: 71112 bits for sub-frame 5</p>						

Initial conditions are a set of test configurations the UE needs to be tested in and the steps for the SS to take with the UE to reach the correct measurement state.

Configurations of PDSCH and PDCCH before measurement are specified in Annex C.2.

Test Environment: Normal as defined in TS 36.508 [7] clause 4.1.

Frequencies to be tested: Mid Range as defined in TS 36.508 [7] clause 4.3.1.1.

Channel Bandwidths to be tested: According to table 8.7.2.1.3-2.

1. Connect the SS, to the UE antenna connector(s) as shown in TS 36.508 [7] Annex A, Figure A.3 for test 1 and Figure A.10 for tests 2-5 (without using faders and AWGN generators).
2. The parameter settings for the cell are set up according to Table 8.7.2.1.5-1 and Table 8.7.2.1.5-2.
3. Downlink signals are initially set up according to Annex C0, C.1 and Annex C.3.2 and uplink signals according to Annex H.1 and H.3.2.

4. Propagation conditions are set according to Annex B.0.
5. Ensure the UE is in State 4 (Loopback activated) according to TS 36.508 [7] clause 4.5.4. Message contents are defined in clause 8.7.2.1.4.3.

8.7.2.1.4.2 Test procedure

1. The SS looks up TB_{size} in table 8.7.2.1.4.1-1 according to the UE category under test.
2. SS sets the counters N_{DL_newtx} , N_{DL_retx} , N_{UL_PDCP} , and N_{DL_PDCP} to 0.
3. For each new DL HARQ transmission the SS generates sufficient PDCP SDUs to fill up the TB in accordance with Table 8.7.2.1.4.1-1 (Note 1). The SS ciphers the PDCP SDUs, concatenates the resultant PDCP PDUs to form an RLC PDU and then a MAC PDU. The SS transmits the MAC PDU. The SS increments then N_{DL_newtx} by one and N_{DL_PDCP} by the number of new PDCP SDUs (Note 1) included in the sent MAC PDU.
4. If PHY requests a DL HARQ retransmission, the SS performs a HARQ retransmission and increments N_{DL_retx} by one.
5. Steps 3 to 4 are repeated at every TTI for at least 300 frames and the SS waits for 300ms to let any HARQ retransmissions and RLC retransmissions to finish.
6. For each PDCP SDU received at the SS, if the content of the data matches that of the truncated version of the original PDCP SDU generated at the SS, the SS increments N_{UL_PDCP} by one.
7. The SS calculates the TB success rate as $A = 100\% * N_{DL_newtx} / (N_{DL_newtx} + N_{DL_retx})$
8. The SS calculates the PDCP SDU loss as $B = N_{DL_PDCP} - N_{UL_PDCP}$
9. The UE passes the test if $A \geq$ "corresponding TB success rates according to Table 8.7.2.1.3-3" and $B = 0$.

NOTE 1 In case of RLC PDU retransmission, the number of new required PDCP SDUs is as many as to fill the rest of TB.

8.7.2.1.4.3 Message contents

Message contents are according to TS 36.508 [7] clause 4.6 and 4.7A, with the following exceptions:

Table 8.7.2.1.4.3-1: CLOSE UE TEST LOOP (in the preamble)

Derivation Path: 36.509 clause 6.1			
Information Element	Value/remark	Comment	Condition
Protocol discriminator	1 1 1 1		
Skip indicator	0 0 0 0		
Message type	1 0 0 0 0 0 0 0		
UE test loop mode	0 0 0 0 0 0 0 0	UE test loop mode A	
UE test loop mode A LB setup			
Length of UE test loop mode A LB setup list in bytes	0 0 0 0 0 0 1 1	Length of one LB setup DRB (3 bytes)	
LB setup DRB	0 0 0 0 0 0 0 0, 0 0 101 0 0 0, 0 0 0 Q4 Q3 Q2 Q1 Q0	UL PDCP SDU size = 40 bits (5 bytes) Q4..Q0 = Data Radio Bearer identity number for the default radio bearer. See 36.509 clause 6.1.	
UE test loop mode B LB setup	Not present		

Table 8.7.2.1.4.3-2: SecurityModeCommand (in the preamble)

Derivation Path: TS36.508 clause 4.6.1 table 4.6.1-19			
Information Element	Value/remark	Comment	Condition
SecurityModeCommand ::= SEQUENCE {			
criticalExtensions CHOICE {			
c1 CHOICE{			
securityModeCommand-r8 SEQUENCE {			
securityConfiguration SEQUENCE {			
cipheringAlgorithm	eea2		
nextHopChainingCount	Not present		
}			
nonCriticalExtension SEQUENCE {}	Not present		
}			
}			
}			

8.7.2.1.5 Test requirement

The requirements are specified in Table 8.7.2.1.5-1. The PDCP SDU success rate shall be sustained during at least 300 frames.

Table 8.7.2.1.5-1: Test requirements for sustained downlink data rate (TDD)

Test	UE Category	Number of bits of a DL-SCH transport block received within a TTI per codeword for normal/special sub-frame	Measurement channel	Number of PDCP SDU per TTI per codeword for normal/special sub-frame	PDCP SDU size for normal/special sub-frame [Octets]	Reference value
						TB success rate [%]
1	Category 1	10296/0	R31-1 TDD	1/0	1275/0	95
2	Category 2	25456/0	R31-2 TDD	3/0	1054/0	95
3	Category 3 (Note 1)	51024/0	R31-3 TDD	5/0	1270/0	95
3B	Category 3 (Note 2)	51024	R31-3B TDD	4/0	1588	85
4	Category 4	75376/0	R31-4 TDD	7/0	1341/0	85
Note 1: If the operating band under test does not support 20 MHz channel bandwidth, then test is executed according to Test 3B. Note 2: Applicable to operating bands supporting up to 15 MHz channel bandwidths. Note 3: For 2 layer transmissions, 2 transport blocks are received within a TTI Note 4: 71112 bits for sub-frame 5 Note 5: The TB success rate is defined as $TB\ success\ rate = 100\% * N_{DL_correct_rx} / (N_{DL_newtx} + N_{DL_retx})$, where N_{DL_newtx} is the number of newly transmitted DL transport blocks, N_{DL_retx} is the number of retransmitted DL transport blocks, and $N_{DL_correct_rx}$ is the number of correctly received DL transport blocks.						

Table 8.7.2.1.5-2: test parameters for sustained downlink data rate (TDD)

Parameter		Unit	Test 1	Test 2	Test 3	Test 3B	Test 4	
Bandwidth		MHz	10	10	20	15	20	
Transmission mode			1	3	3	3	3	
Antenna configuration			1 x 2	2 x 2	2 x 2	2 x 2	2x2	
Propagation condition			Static propagation condition (Note 1)					
CodeBookSubsetRestriction bitmap			n/a	10	10	10	10	
Downlink power allocation	ρ_A	dB	0	-3	-3	-3	-3	
	ρ_B	dB	0	-3	-3	-3	-3	
\hat{E}_s at antenna port		dBm/15kHz	-85	-85	-85	-85	-85	
Symbols for unused PRBs			OP.6 TDD	OP.1 TDD	OP.1 TDD	OP.2 TDD	OP.1 TDD	
ACK/NACK feedback mode			Bundling	Bundling	Bundling	Multiplexing	Multiplexing	
Note 1: No external noise sources are applied								

8.7.2.1_1 TDD sustained data rate performance (Rel-10 and forward)

Editor's Note: This clause is incomplete. The following aspects are either missing or not yet determined:

- OCNG pattern needs to be confirmed.

8.7.2.1_1.1 Test purpose

Same test purpose as in clause 8.7.2.1.

8.7.2.1_1.2 Test applicability

This test case applies to E-UTRA TDD UE release 10 and forward of UE category 6 and 7.

8.7.2.1_1.3 Minimum requirements

Same minimum conformance requirements as in clause 8.7.2.1.3 with the following exceptions:

- Instead of Table 8.7.2.1.3-1 -> use Table 8.7.2.1_1.3-1.
- Instead of Table 8.7.2.1.3-2 -> use Table 8.7.2.1_1.3-2.
- Instead of Table 8.7.2.1.3-3 -> use Table 8.7.2.1_1.3-3.

Table 8.7.2.1_1.3-1: Common Test Parameters (TDD)

Parameter	Unit	Value
Special subframe configuration (Note 1)		4
Cyclic prefix		Normal
Cell ID		0
Inter-TTI Distance		1
Maximum number of HARQ transmission		4
Redundancy version coding sequence		{0,0,1,2} for 64QAM
Number of OFDM symbols for PDCCH per component carrier	OFDM symbols	1
Cross carrier scheduling		Not configured
Note 1: As specified in Table 4.2-1 in TS 36.211 [4].		

Table 8.7.2.1_1.3-2: test parameters for sustained downlink data rate (TDD)

Parameter		Unit	Test 1-5	Test 6	Test 6A
Bandwidth		MHz	N/A	20	N/A
Transmission mode				3	
Antenna configuration				2 x 2	
Propagation condition				Static propagation condition (Note 1)	
CodeBookSubsetRestriction bitmap				10	
Downlink power allocation	ρ_A	dB		-3	
	ρ_B	dB		-3	
\hat{E}_s at antenna port		dBm/15kHz		-85	
Symbols for unused PRBs				[OCNG]	
ACK/NACK feedback mode				Multiplexing	

Note 1: No external noise sources are applied.

Table 8.7.2.1_1.3-3: Minimum requirement (TDD)

Test	Number of bits of a DL-SCH transport block received within a TTI for normal/special sub-frame	Measurement channel	Reference value
			TB success rate [%]
1-5	N/A		
6	75376/0 (Note 2)	R.31-4 TDD	85
6A	N/A		
Note 1: For 2 layer transmissions, 2 transport blocks are received within a TTI. Note 2: 71112 bits for sub-frame 5. Note 3: The TB success rate is defined as TB success rate = $100\% * N_{DL_correct_rx} / (N_{DL_newtx} + N_{DL_retx})$, where N_{DL_newtx} is the number of newly transmitted DL transport blocks, N_{DL_retx} is the number of retransmitted DL transport blocks, and $N_{DL_correct_rx}$ is the number of correctly received DL transport blocks.			

The normative reference for this requirement is TS 36.101[2] clause 8.7.2.

8.7.2.1_1.4 Test description

Same test description as in clause 8.7.2.1.4 with the following exceptions:

- Instead of Table 8.7.2.1.3-2 -> use Table 8.7.2.1_1.3-2.
- Instead of Table 8.7.2.1.3-3 -> use Table 8.7.2.1_1.3-3.
- Instead of Table 8.7.2.1.4.1-1 -> use Table 8.7.2.1_1.4-1.
- Instead of Table 8.7.2.1.5-1 -> use Table 8.7.2.1_1.5-1.

Table 8.7.2.1_1.4-1: Applicable test and Transport Block Size for different UE categories

UE Category	Applicable test	DL Measurement channel	UL Measurement Channel	TB _{size} per Codeword	Number of PDCP SDU per Codeword for normal/special sub-frame	PDCP SDU size [bits] Note 2
6,7	Test 6	R31-4 TDD	R.1-4 TDD	75376 (Note 3)	7/0	$8 * \text{FLOOR}((\text{TB}_{\text{size}} - 264) / 56)$
<p>Note 1: Each PDCP SDU is limited to 1500 octets (to keep below maximum SDU size of ESM as specified in TS 24.301 clause 9.9.4.12).</p> <p>The PDCP SDU size of each PDCP SDU is:</p> <p>PDCP SDU size = (TB_{size} – N*PDCP header size - AMD PDU header size - MAC header size – Size of Timing Advance - Size of RLC STATUS PDU) / N,</p> <p>where PDCP header size is 16 bits for the RLC AM and 12-bit SN case; AMD PDU header size is $\text{CEIL}[(16+(N-1)*12)/8]$ bytes which includes 16 bit standard AM header and (N-1) Length indicators; and MAC header size = R/R/E/LCID/F/L MAC subheader (24 bits for MAC SDU for RLC STATUS PDU with 15 bit LI) + R/R/E/LCID MAC subheader (8 bits for MAC SDU for RLC data PDU) = 32 bits. The size of RLC STATUS PDU including one ACK_SN field and one NACK_SN field is 32 bits (if no STATUS PDU is sent or if the size of the STATUS PDU is less than 32 bits then padding will be used to fill the 32 bits). This gives: PDCP SDU size = $8 * \text{FLOOR}((\text{TB}_{\text{size}} - N * 16 - 8 * \text{CEIL}[(16+(N-1)*12)/8] - 64) / (8 * N))$ bits.</p> <p>The calculation of PDCP SDU sizes does not consider timing advance MAC CE as timing advance is not transmitted by SS for RF test cases, and the header sizes are informative and may vary during the test.</p> <p>Note 2: Transport block size under test according to applicable Fixed Reference Channel for sustained data-rate test in annex A.3.9. In case of varying TBS across SFs of the RMC, only the maximum TBS is used for PDCP SDU size calculation.</p> <p>Note 3: 71112 bits for sub-frame 5</p>						

8.7.2.1_1.5 Test requirement

Same test requirement as in clause 8.7.2.1.5 with the following exceptions:

- Instead of Table 8.7.2.1.5-1 -> use Table 8.7.2.1_1.5-1.

Table 8.7.2.1_1.5-1: Test requirements for sustained downlink data rate (TDD)

Test	Number of bits of a DL-SCH transport block received within a TTI per codeword for normal/special sub-frame	Measurement channel	Number of PDCP SDU per TTI per codeword for normal/special sub-frame	PDCP SDU size for normal/special sub-frame [Octets]	Reference value
					TB success rate [%]
6	75376/0 (Note 2)	R.31-4 TDD	7/0	1341/0	85
<p>Note 1: For 2 layer transmissions, 2 transport blocks are received within a TTI.</p> <p>Note 2: 71112 bits for sub-frame 5.</p> <p>Note 3: The TB success rate is defined as $\text{TB success rate} = 100\% * N_{\text{DL_correct_rx}} / (N_{\text{DL_newtx}} + N_{\text{DL_retx}})$, where $N_{\text{DL_newtx}}$ is the number of newly transmitted DL transport blocks, $N_{\text{DL_retx}}$ is the number of retransmitted DL transport blocks, and $N_{\text{DL_correct_rx}}$ is the number of correctly received DL transport blocks.</p>					

8.7.2.1_A TDD sustained data rate performance for CA

8.7.2.1_A.1 TDD sustained data rate performance for CA (intra-band contiguous DL CA)

Editor's Note: This clause is incomplete. The following aspects are either missing or not yet determined

- Message Contents for this test are undefined
- Number of PDCP SDU per TTI per codeword for normal/special sub-frame is FFS

- PDCP SDU size for normal/special sub-frame [Octets] is FFS
- Test procedure to consider SCC aspects is FFS
- UL RMC is TBD
- OCNG pattern needs to be confirmed
- The statistical rules specified for TB success rate in Annex G.y is TBD

8.7.2.1_A.1.1 Test purpose

Same test purpose as in clause 8.7.2.1.

8.7.2.1_A.1.2 Test applicability

This test case applies to all types of E-UTRA UE release 10 and forward that support intra-band contiguous CA.

8.7.2.1_A.1.3 Minimum requirements

Same minimum conformance requirements as in clause 8.7.2.1.3 with the following exceptions:

- Instead of Table 8.7.2.1.3-1 -> use Table 8.7.2.1_A.1.3-1.
- Instead of Table 8.7.2.1.3-2 -> use Table 8.7.2.1_A.1.3-2.
- Instead of Table 8.7.2.1.3-3 -> use Table 8.7.2.1_A.1.3-3.

Table 8.7.2.1_A.1.3-1: Common Test Parameters (TDD)

Parameter	Unit	Value
Special subframe configuration (Note 1)		4
Cyclic prefix		Normal
Cell ID		0
Inter-TTI Distance		1
Maximum number of HARQ transmission		4
Redundancy version coding sequence		{0,0,1,2} for 64QAM
Number of OFDM symbols for PDCCH per component carrier	OFDM symbols	1
Cross carrier scheduling		Not configured
Note 1: as specified in Table 4.2-1 in TS 36.211 [4]		

Table 8.7.2.1_A.1.3-2: test parameters for sustained downlink data rate for CA (TDD)

Parameter		Unit	Test 6	Test 6A
Bandwidth		MHz	N/A	2x20
Transmission mode				3
Antenna configuration				2 x 2
Propagation condition				Static propagation condition (Note 1)
CodeBookSubsetRestriction bitmap				10
Downlink power allocation	ρ_A	dB		-3
	ρ_B	dB		-3
	σ	dB		0
\hat{E}_s at antenna port		dBm/15kHz		-85
Symbols for unused PRBs				OP.1 TDD
ACK/NACK feedback mode				- (Note 2)
Note 1: No external noise sources are applied.				
Note 2: PUCCH format 1b with channel selection is used to feedback ACK/NACK.				

Table 8.7.2.1_A.1.3-3: Minimum requirement (TDD)

Test	UE Category	CA Capability	Number of bits of a DL-SCH transport block received within a TTI for normal/special sub-frame	Measurement channel	Reference value
					TB success rate [%]
1-6	N/A				
6A	Category 6,7	CL_C	75376/0 (Note 2)	R.31-4 TDD	85
Note 1: For 2 layer transmissions, 2 transport blocks are received within a TTI.					
Note 2: 71112 bits for sub-frame 5.					
Note 3: The TB success rate is defined as TB success rate = 100% * $N_{DL_correct_rx} / (N_{DL_newtx} + N_{DL_retx})$, where N_{DL_newtx} is the number of newly transmitted DL transport blocks, N_{DL_retx} is the number of retransmitted DL transport blocks, and $N_{DL_correct_rx}$ is the number of correctly received DL transport blocks.					

The normative reference for this requirement is TS 36.101[2] clause 8.7.2

8.7.2.1_A.1.4 Test description

8.7.2.1_A.1.4.1 Initial conditions

Table 8.7.2.1_A.1.4.1-1: Applicable test and Transport Block Size for different UE categories

UE Category	Applicable test	DL Measurement channel	UL Measurement channel	TB _{size} per Codeword per Component Carrier	Number of PDCP SDU per Codeword	PDCP SDU size [bits] Note 2
6,7	6A	R.31-4 TDD	TBD	75376 (Note 3)	TBD	$8 \cdot \text{FLOOR}((\text{TB}_{\text{size}} - 264)/56)$
<p>Note 1: Each PDCP SDU is limited to 1500 octets (to keep below maximum SDU size of ESM as specified in TS 24.301 clause 9.9.4.12).</p> <p>The PDCP SDU size of each PDCP SDU is:</p> <p>$\text{PDCP SDU size} = (\text{TB}_{\text{size}} - N \cdot \text{PDCP header size} - \text{AMD PDU header size} - \text{MAC header size} - \text{Size of RLC STATUS PDU}) / N$,</p> <p>where PDCP header size is 16 bits for the RLC AM and 12-bit SN case; AMD PDU header size is $\text{CEIL}[(16+(N-1) \cdot 12)/8]$ bytes which includes 16 bit standard AM header and (N-1) Length indicators; and MAC header size = R/R/E/LCID/F/L MAC subheader (24 bits for MAC SDU for RLC STATUS PDU with 15 bit LI) + R/R/E/LCID MAC subheader (8 bits for MAC SDU for RLC Data PDU) = 32 bits. The size of RLC STATUS PDU including one ACK_SN field and one NACK_SN field is 32 bits (if no STATUS PDU is sent or if the size of the STATUS PDU is less than 32 bits then padding will be used to fill the 32 bits). This gives: PDCP SDU size = $8 \cdot \text{FLOOR}((\text{TB}_{\text{size}} - N \cdot 16 - 8 \cdot \text{CEIL}[(16+(N-1) \cdot 12)/8] - 64)/(8 \cdot N))$ bits.</p> <p>The calculation of PDCP SDU sizes does not consider timing advance MAC CE as timing advance is not transmitted by SS for RF test cases, and the header sizes are informative and may vary during the test.</p> <p>Note 2: Transport block size under test according to applicable Fixed Reference Channel for sustained data-rate test in annex A.3.9. In case of varying TBS across SFs of the RMC, only the maximum TBS is used for PDCP SDU size calculation.</p> <p>Note 3: 71112 bits for sub-frame 5</p>						

Initial conditions are a set of test configurations the UE needs to be tested in and the steps for the SS to take with the UE to reach the correct measurement state.

Configurations of PDSCH and PDCCH before measurement are specified in Annex C.2.

Test Environment: Normal as defined in TS 36.508 [7] clause 4.1.

Frequencies to be tested: Mid Range as defined in TS 36.508 [7] clause 4.3.1.2.

Channel Bandwidths to be tested: According to table 8.7.2.1_A.1.3-2.

1. Connect the SS to the UE antenna connector(s) as shown in TS 36.508 [7] Annex A, FFS.
2. The parameter settings for the cell are set up according to Table 8.7.2.1_A.1.3-1, Table 8.7.2.1_A.1.3-2 and Table 8.7.2.1_A.1.5-1.
3. Downlink signals for PCC are initially set up according to Annex C0, C.1 and Annex C.3.2 and uplink signals according to Annex H.1 and H.3.2.
4. Propagation conditions are set according to Annex B.0.
5. Ensure the UE is in State 4 (Loopback activated) according to TS 36.508 [7] clause FFS. Message contents are defined in clause 8.7.2.1_A.1.4.3.

8.7.2.1_A.1.4.2 Test procedure

1. Configure SCC according to Annex C.0, C.1 and Annex C.3.2 for all downlink physical channels except PHICH.

2. The SS shall configure SCC as per TS 36.508 [7] clause 5.2A.4. Message contents for PhysicalConfigDedicated-DEFAULT is defined in Table 8.2.2.3.1_A.1.4.3-1
3. SS activates SCC by sending the activation MAC-CE (Refer TS 36.321 [13], clauses 5.13, 6.1.3.8). Wait for at least 2 seconds (Refer TS 36.133, clauses 8.3.3.2).
4. The SS looks up TB_{size} in table 8.7.2.1_A.1.4.1-1 according to the UE category under test.
5. SS sets the counters N_{DL_newtx}, N_{DL_retx}, N_{UL_PDCP}, and ND_{DL_PDCP} to 0.
6. For each new DL HARQ transmission the SS generates sufficient PDCP SDUs to fill up the TB in accordance with Table 8.7.2.1_A.1.4.1-1 (Note 1). The SS ciphers the PDCP SDUs, concatenates the resultant PDCP PDUs to form an RLC PDU and then a MAC PDU. The SS transmits the MAC PDU. The SS increments then N_{DL_newtx} by one and N_{DL_PDCP} by the number of new PDCP SDUs (Note 1) included in the sent MAC PDU.
7. If PHY requests a DL HARQ retransmission, the SS performs a HARQ retransmission and increments N_{DL_retx} by one.
8. Steps 3 to 4 are repeated at every TTI for at least 300 frames or until statistical significance is fulfilled according to [Annex G FFS] and the SS waits for 300ms to let any HARQ retransmissions and RLC retransmissions to finish.
9. For each PDCP SDU received at the SS, if the content of the data matches that of the truncated version of the original PDCP SDU generated at the SS, the SS increments N_{UL_PDCP} by one
10. The SS calculates the TB success rate as $A = 100\% * N_{DL_newtx} / (N_{DL_newtx} + N_{DL_retx})$
11. The SS calculates the PDCP SDU loss as $B = N_{DL_PDCP} - N_{UL_PDCP}$
12. The UE passes the test if $A \geq$ "corresponding TB success rate according to Table 8.7.2.1_A.1.3-3" and $B = 0$.

NOTE 1: In case of RLC PDU retransmission, the number of new required PDCP SDUs is as many as to fill the rest of TB.

8.7.2.1_A.1.4.3 Message contents

Same message contents as in clause 8.7.2.1.4.3.

8.7.2.1_A.1.5 Test requirement

Same test requirement as in clause 8.7.2.1.5 with the following exceptions:

- Instead of Table 8.7.2.1.5-1 -> use Table 8.7.2.1_A.1.5-1.

Table 8.7.2.1_A.1.5-1: Test requirements for sustained downlink data rate for CA (TDD)

Test	UE Category	CA Capability	Number of bits of a DL-SCH transport block received within a TTI per codeword for normal/special sub-frame	Measurement channel	Number of PDCP SDU per TTI per codeword for normal/special sub-frame	PDCP SDU size for normal/special sub-frame [Octets]	Reference value
							TB success rate [%]
6A	Category 6,7	CL_C	75376/0 (Note 2)	R.31-4 TDD	FFS	FFS	85
Note 1: For 2 layer transmissions, 2 transport blocks are received within a TTI. Note 2: 71112 bits for sub-frame 5. Note 3: The TB success rate is defined as $TB \text{ success rate} = 100\% * N_{DL_correct_rx} / (N_{DL_newtx} + N_{DL_retx})$, where N _{DL_newtx} is the number of newly transmitted DL transport blocks, N _{DL_retx} is the number of retransmitted DL transport blocks, and N _{DL_correct_rx} is the number of correctly received DL transport blocks.							

9 Reporting of Channel State Information

9.1 General

For the cases in this clause it is expected that the UE will not always detect the PDCCH, resulting in a statDTX for the uplink ACK/NACK transmission. The downlink configuration for evaluating CQI performance does not use retransmission. Therefore any BLER and Throughput calculations must exclude any packets where the UE may have attempted to combine data from more than one transmission due to missed new data indicators from lost PDCCH transmissions. Thus in all test cases in which there are not retransmission (Max number of HARQ transmissions = 1), if the number of consecutive discarded statDTX for any one process is an odd number including one, also discard the next response for that HARQ process regardless whether it is an ACK or NACK. In the calculation of Throughput the discarded ACK / NACK is considered as a statDTX.

This section includes requirements for the reporting of channel state information (CSI). For all test cases in this section,

the definition of SNR is in accordance with the one given in clause 8.1.1, where $SNR = \frac{\sum \hat{I}_{or}^{(j)}}{\sum N_{oc}^{(j)}}$.

The fading of the signals and the AWGN signals applied to each receiver antenna connector shall be uncorrelated. The levels of the test signal applied to each of the antenna connectors shall be as defined in the respective test cases.

The UE performance in this section is considered to be operating band independent. Therefore, the required performance in the respective test cases can be verified in one of the operating bands supported by the UE under test. All the test points supported by the bands of the multiband UE (based on channel bandwidth, DL and UL configuration) need to be tested.

9.2 CQI Reporting under AWGN conditions

The reporting accuracy of the channel quality indicator (CQI) under frequency non-selective conditions is determined by the reporting variance and the BLER performance using the transport format indicated by the reported CQI median. The purpose is to verify that the reported CQI values are in accordance with the CQI definition given in TS 36.213 [10] clause 7.2. To account for sensitivity of the input SNR the reporting definition is considered to be verified if the reporting accuracy is met for at least one of two SNR levels separated by an offset of 1 dB.

9.2.1 CQI Reporting under AWGN conditions - PUCCH 1-0 (Cell-Specific Reference Symbols)

9.2.1.1 FDD CQI Reporting under AWGN conditions – PUCCH 1-0

9.2.1.1.1 Test purpose

To verify the variance of the wideband CQI reports is within the limits defined and a PDSCH BLER of 10% falls between the transport format based median CQI-1 and median CQI or the transport format based median CQI and median CQI +1.

9.2.1.1.2 Test applicability

This test applies to E-UTRA FDD UE release 8 and forward.

9.2.1.1.3 Minimum conformance requirements

For the parameters specified in Table 9.2.1.1.3-1, and using the downlink physical channels specified in tables C.3.2-1 and C.3.2-2, the reported CQI value according to Table A.4-1 shall be in the range of ± 1 of the reported median more than 90% of the time. If the PDSCH BLER using the transport format indicated by median CQI is less than or equal to 0.1, the BLER using the transport format indicated by the (median CQI +1) shall be greater than 0.1. If the PDSCH

BLER using the transport format indicated by the median CQI is greater than 0.1, the BLER using transport format indicated by (median CQI –1) shall be less than or equal to 0.1

Table 9.2.1.1.3-1: PUCCH 1-0 static test

Parameter		Unit	Test 1		Test 2	
Bandwidth		MHz	10			
PDSCH transmission mode			1			
Downlink power allocation	ρ_A	dB	0			
	ρ_B	dB	0			
	σ	dB	0			
Propagation condition and antenna configuration			AWGN (1 x 2)			
SNR (Note 2)		dB	0	1	6	7
$\hat{I}_{or}^{(j)}$		dB[mW/15kHz]	-98	-97	-92	-91
$N_{oc}^{(j)}$		dB[mW/15kHz]	-98		-98	
Max number of HARQ transmissions			1			
Physical channel for CQI reporting			PUCCH Format 2			
PUCCH Report Type			4			
Reporting periodicity		ms	$N_p = 5$			
<i>cqi-pmi-ConfigurationIndex</i>			6			
Note 1: Reference measurement channel according to Table A.4-1 with one sided dynamic OCNG Pattern OP.1 FDD as described in Annex A.5.1.1.						
Note 2: For each test, the minimum requirements shall be fulfilled for at least one of the two SNR(s) and the respective wanted signal input level.						

The normative reference for this requirement is TS 36.101 [2] clause 9.2.1.1.

9.2.1.1.4 Test description

9.2.1.1.4.1 Initial conditions

Initial conditions are a set of test configurations the UE needs to be tested in and the steps for the SS to take with the UE to reach the correct measurement state.

Configurations of PDSCH and PDCCH before measurement are specified in Annex C.2.

Test Environment: Normal as defined in TS 36.508 [7] clause 4.1.

Frequencies to be tested: Mid Range as defined in TS 36.508 [7] clause 4.3.1.1.

Channel Bandwidths to be tested: 10MHz, as defined in TS 36.508 [7] clause 4.3.1.1

1. Connect the SS, faders and AWGN noise source to the UE antenna connector (s) as shown in TS 36.508 [7] Annex A, Figure A.9.
2. The parameter settings for the cell are set up according to Table 9.2.1.1.3-1.
3. Downlink signals are initially set up according to Annex C0, C.1 and Annex C.3.2 and uplink signals according to Annex H.1 and H.3.2.
4. Propagation conditions are set according to Annex B.0.
5. Ensure the UE is in State 3A-RF according to TS 36.508 [7] clause 5.2A.2. Message contents are defined in clause 9.2.1.1.4.3.

9.2.1.1.4.2 Test procedure

1. Set the parameters of bandwidth, reference Channel, the propagation condition, antenna configuration and the SNR according to Table 9.2.1.1.3-1 as appropriate.
2. The SS shall transmit PDSCH via PDCCH DCI format 1A for C_RNTI to transmit the DL RMC (Table A.4-1) according to CQI value 8 of Annex A.4 Table A.4-3 and keep it regardless of the wideband CQI value sent by the UE. The SS sends downlink MAC padding bits on the DL RMC. Continue transmission of the PDSCH until 2000 wideband CQI reports have been gathered. In this process the SS collects wideband CQI reports every 5 ms and also cases where UE transmits nothing in its CQI timing are also counted as wideband CQI reports.
3. Set up a relative frequency distribution for the reported wideband CQI-values, Calculate the median value (wideband Median CQI is the wideband CQI that is at or crosses 50% distribution from the lower wideband CQI side). This CQI-value is declared as wideband Median CQI value.
4. If Median CQI is not equal to 1 or 15 and 1800 or more of the wideband CQI values are in the range (Median CQI - 1) ≤ Median CQI ≤ (Median CQI + 1) then continue with step 5, otherwise go to step 8.
5. The SS shall transmit PDSCH via PDCCH DCI format 1A for C_RNTI to transmit the DL RMC (Table A.4-1) according to the wideband median-CQI value and shall not react to the UE's wideband CQI reports. The SS sends downlink MAC padding bits on the DL RMC. For any PDSCH transmitted by the SS, record the associated ACK, NACK and statDTX responses. The responses are then filtered as follows: for the sequence of responses for each HARQ process, discard all the statDTX responses. Continue to gather data until the number of filtered ACK+NACK responses reaches 1000.

For the filtered ACK and NACK responses if the ratio (NACK / ACK + NACK) ≤ 0.1 then go to step 6, otherwise go to step 7.

6. The SS shall transmit PDSCH via PDCCH DCI format 1A for C_RNTI to transmit the DL RMC (Table A.4-1) according to the wideband median-CQI+1 value and shall not react to the UE's wideband CQI reports. The SS sends downlink MAC padding bits on the DL RMC. For any PDSCH, transmitted by the SS, record and filter the ACK, NACK and statDTX responses as in step 5 until 1000 filtered ACK+NACK responses are gathered.

If the ratio (NACK /ACK + NACK) > 0.1

then pass the UE for this test and go to step 9, otherwise go to step 8.

7. The SS shall transmit PDSCH via PDCCH DCI format 1A for C_RNTI to transmit the DL RMC (Table A.4-1) according to the wideband median-CQI-1 value and shall not react to the UE's wideband CQI reports. The SS sends downlink MAC padding bits on the DL RMC. For any PDSCH, transmitted by the SS, record and filter the ACK, NACK and statDTX responses as in step 5 until 1000 filtered ACK+NACK responses are gathered.

If the ratio (NACK /ACK + NACK) ≤ 0.1

then pass the UE for this test and go to step 9, otherwise go to step 8.

8. If both SNR points of the test have not been tested, then repeat the same procedure (steps 1 to 7) for the other SNR point as appropriate. Otherwise fail the UE.
9. If both tests have not been done, then repeat the same procedure (steps 1 to 8) with test conditions according to the table 9.2.1.1.3-1 for the other Test as appropriate. Otherwise pass the UE.

9.2.1.1.4.3 Message contents

Message contents are according to TS 36.508 [7] clause 4.6 with the following exceptions:

Table 9.2.1.1.4.3-1: PhysicalConfigDedicated-DEFAULT

Derivation Path: 36.508 clause 5.5.1.2			
Information Element	Value/remark	Comment	Condition
PhysicalConfigDedicated-DEFAULT ::= SEQUENCE {			
cqi-ReportConfig	<i>CQI-ReportConfig-DEFAULT</i>		
}			

Table 9.2.1.1.4.3-2: CQI-ReportConfig-DEFAULT

Derivation Path: 36.508 clause 4.6.3			
Information Element	Value/remark	Comment	Condition
CQI-ReportConfig-DEFAULT ::= SEQUENCE {			
cqi-ReportModeAperiodic	Not present		
nomPDSCH-RS-EPRE-Offset	0		
cqi-ReportPeriodic CHOICE {			
setup SEQUENCE {			
cqi-PUCCH-ResourceIndex	0		
cqi-pmi-ConfigIndex	6	(see Table 7.2.2-1A in TS 36.213)	
cqi-FormatIndicatorPeriodic CHOICE {			
widebandCQI	NULL		
}			
ri-ConfigIndex	NULL	(see Table 7.2.2-1B in TS 36.213)	
simultaneousAckNackAndCQI	FALSE		
}			
}			

9.2.1.1.5 Test requirement

The pass fail decision is as specified in the test procedure in clause 9.2.1.1.4.2.

There are no parameters in the test setup or measurement process whose variation impacts the results so there are no applicable test tolerances for this test.

9.2.1.2 TDD CQI Reporting under AWGN conditions – PUCCH 1-0

9.2.1.2.1 Test purpose

To verify the variance of the wideband CQI reports is within the limits defined and a PDSCH BLER of 10% falls between the transport format based on wideband median CQI-1 and wideband median CQI or the transport format based on wideband median CQI and wideband median CQI +1.

9.2.1.2.2 Test applicability

This test applies to E-UTRA TDD UE release 8 and forward.

9.2.1.2.3 Minimum conformance requirements

For the parameters specified in Table 9.2.1.2.3-1, and using the downlink physical channels specified in tables C.3.2-1 and C.3.2-2, the reported CQI value according to Table A.4-2 shall be in the range of ± 1 of the reported median more than 90% of the time. If the PDSCH BLER using the transport format indicated by median CQI is less than or equal to 0.1, the BLER using the transport format indicated by the (median CQI +1) shall be greater than 0.1. If the PDSCH BLER using the transport format indicated by the median CQI is greater than 0.1, the BLER using transport format indicated by (median CQI -1) shall be less than or equal to 0.1.

Table 9.2.1.2.3-1: PUCCH 1-0 static test (TDD)

Parameter		Unit	Test 1		Test 2	
Bandwidth		MHz			10	
PDSCH transmission mode					1	
Uplink downlink configuration					2	
Special subframe configuration					4	
Downlink power allocation	ρ_A	dB			0	
	ρ_B	dB			0	
	σ	dB			0	
Propagation condition and antenna configuration			AWGN (1 x 2)			
SNR (Note 2)		dB	0	1	6	7
$\hat{I}_{or}^{(j)}$		dB[mW/15kHz]	-98	-97	-92	-91
$N_{oc}^{(j)}$		dB[mW/15kHz]	-98		-98	
Maximum number of HARQ transmissions			1			
Physical channel for CQI reporting			PUSCH (Note 3)			
PUCCH Report Type			4			
Reporting periodicity		ms	$N_p = 5$			
<i>cqi-pmi-ConfigurationIndex</i>			3			
ACK/NACK feedback mode			Multiplexing			
Note 1:		Reference measurement channel according to clause A.4-2 with one sided dynamic OCNB Pattern OP.1 TDD as described in Annex A.5.2.1				
Note 2:		For each test, the minimum requirements shall be fulfilled for at least one of the two SNR(s) and the respective wanted signal input level.				
Note 3:		To avoid collisions between CQI reports and HARQ-ACK it is necessary to report both on PUSCH instead of PUCCH. PDCCH DCI format 0 shall be transmitted in downlink SF#3 and #8 to allow periodic CQI to multiplex with the HARQ-ACK on PUSCH in uplink subframe SF#7 and #2.				

The normative reference for this requirement is TS 36.101 [2] clause 9.2.1.2.

9.2.1.2.4 Test description

9.2.1.2.4.1 Initial conditions

Initial conditions are a set of test configurations the UE needs to be tested in and the steps for the SS to take with the UE to reach the correct measurement state.

Configurations of PDSCH and PDCCH before measurement are specified in Annex C.2.

Test Environment: Normal as defined in TS 36.508 [7] clause 4.1.

Frequencies to be tested: Mid Range as defined in TS 36.508 [7] clause 4.3.1.2.

Channel Bandwidths to be tested: 10MHz, as defined in TS 36.508 [7] clause 4.3.1.2

1. Connect the SS, faders and AWGN noise source to the UE antenna connector (s) as shown in TS 36.508 [7] Annex A, Figure A.9.
2. The parameter settings for the cell are set up according to Table 9.2.1.2.3-1.
3. Downlink signals are initially set up according to Annex C0, C.1 and Annex C.3.2 and uplink signals according to Annex H.1 and H.3.2.
4. Propagation conditions are set according to Annex B.0
5. Ensure the UE is in State 3A-RF according to TS 36.508 [7] clause 5.2A.2. Message contents are defined in clause 9.2.1.2.4.3.

9.2.1.2.4.2 Test procedure

1. Set the parameters of bandwidth, reference Channel, the propagation condition, antenna configuration and the SNR according to Table 9.2.1.2.3-1 as appropriate.
2. The SS shall transmit PDSCH via PDCCH DCI format 1A for C_RNTI to transmit the DL RMC (Table A.4-2) according to CQI value 8 of Annex A.4 Table A.4-3 and keep it regardless of the wideband CQI value sent by the UE. The SS sends downlink MAC padding bits on the DL RMC. The SS sends uplink scheduling information via PDCCH DCI format 0 with CQI request bit set to 0 to schedule UL RMC in subframe #2 and subframe #7 (Table A.4-2). The UE will send ACK/NACK and periodic CQI report using PUSCH. Continue transmission of the PDSCH until 2000 wideband CQI reports have been gathered. In this process the SS collects wideband CQI reports every 5 ms and also cases where UE transmits nothing in its CQI timing are counted as wideband CQI reports.
3. Set up a relative frequency distribution for the reported wideband CQI-values, Calculate the median value (wideband Median CQI is the CQI that is at or crosses 50% distribution from the lower wideband CQI side). This CQI-value is declared as wideband Median CQI value.
4. If Median CQI is not equal to 1 or 15 and 1800 or more of the wideband CQI values are in the range $(\text{Median CQI} - 1) \leq \text{Median CQI} \leq (\text{Median CQI} + 1)$ then continue with step 5, otherwise go to step 8.
5. The SS shall transmit PDSCH via PDCCH DCI format 1A for C_RNTI to transmit the DL RMC (Table A.4-2) according to the wideband median-CQI value and shall not react to the UE's wideband CQI reports. The SS sends downlink MAC padding bits on the DL RMC. The SS sends uplink scheduling information via PDCCH DCI format 0 with CQI request bit set to 0 to schedule UL RMC in subframe #2 and subframe #7 (Table A.4-2). The UE will send ACK/NACK and periodic CQI report using PUSCH. For any PDSCH transmitted by the SS, record the associated ACK, NACK and statDTX responses. *In case statDTX can not be differentiated from NACK due to multiplexing effect, evaluate the feedback as a NACK* The responses are then filtered as follows: for the sequence of responses for each HARQ process, discard all the statDTX responses. Continue to gather data until the number of filtered ACK+NACK responses reaches 1000.

For the filtered ACK and NACK responses if the ratio $(\text{NACK} / \text{ACK} + \text{NACK}) \leq 0.1$ then go to step 6, otherwise go to step 7.

6. The SS shall transmit PDSCH via PDCCH DCI format 1A for C_RNTI to transmit the DL RMC (Table A.4-2) according to the wideband median-CQI+1 value and shall not react to the UE's wideband CQI reports. The SS sends downlink MAC padding bits on the DL RMC. The SS sends uplink scheduling information via PDCCH DCI format 0 with CQI request bit set to 0 to schedule UL RMC in subframe #2 and subframe #7 (Table A.4-2). The UE will send ACK/NACK and periodic CQI report using PUSCH. For any PDSCH, transmitted by the SS, record and filter the ACK, NACK and statDTX responses as in step 5 until 1000 filtered ACK+NACK responses are gathered. *In case statDTX can not be differentiated from NACK due to multiplexing effect, evaluate the feedback as a NACK*

If the ratio $(\text{NACK} / \text{ACK} + \text{NACK}) > 0.1$

then pass the UE for this test and go to step 9, otherwise go to step 8.

7. The SS shall transmit PDSCH via PDCCH DCI format 1A for C_RNTI to transmit the DL RMC (Table A.4-2) according to the wideband median-CQI-1 value and shall not react to the UE's wideband CQI reports. The SS sends downlink MAC padding bits on the DL RMC. The SS sends uplink scheduling information via PDCCH DCI format 0 with CQI request bit set to 0 to schedule UL RMC in subframe #2 and subframe #7 (Table A.4-2). The UE will send ACK/NACK and periodic CQI report using PUSCH. For any PDSCH, transmitted by the SS, record and filter the ACK, NACK and statDTX responses as in step 5 until 1000 filtered ACK+NACK responses are gathered. *In case statDTX can not be differentiated from NACK due to multiplexing effect, evaluate the feedback as a NACK*

If the ratio $(\text{NACK} / \text{ACK} + \text{NACK}) \leq 0.1$

then pass the UE for this test and go to step 9, otherwise go to step 8.

8. If both SNR points of the test have not been tested, then repeat the same procedure (steps 1 to 7) for the other SNR point as appropriate. Otherwise fail the UE.
9. If both tests have not been done, then repeat the same procedure (steps 1 to 8) with test conditions according to the table 9.2.1.2.3-1 for the other Test as appropriate. Otherwise pass the UE.

9.2.1.2.4.3 Message contents

Message contents are according to TS 36.508 [7] clause 4.6 with the following exceptions:

Table 9.2.1.2.4.3-1: PhysicalConfigDedicated-DEFAULT

Derivation Path: 36.508 clause 5.5.1.2			
Information Element	Value/remark	Comment	Condition
PhysicalConfigDedicated-DEFAULT ::= SEQUENCE {			
cqi-ReportConfig	<i>CQI-ReportConfig-DEFAULT</i>		
}			

Table 9.2.1.2.4.3-2: CQI-ReportConfig-DEFAULT

Derivation Path: 36.508 clause 4.6.3			
Information Element	Value/remark	Comment	Condition
CQI-ReportConfig-DEFAULT ::= SEQUENCE {			
cqi-ReportModeAperiodic	Not present		
nomPDSCH-RS-EPRE-Offset	0		
cqi-ReportPeriodic CHOICE {			
setup SEQUENCE {			
cqi-PUCCH-ResourceIndex	0		
cqi-pmi-ConfigIndex	3		
cqi-FormatIndicatorPeriodic CHOICE {			
widebandCQI	NULL		
}			
ri-ConfigIndex	NULL		
simultaneousAckNackAndCQI	FALSE		
}			
}			

Table 9.2.1.2.4.3-3: TDD-Config-DEFAULT

Derivation Path: 36.508 clause 4.6.3			
Information Element	Value/remark	Comment	Condition
TDD-Config-DEFAULT ::= SEQUENCE {			
subframeAssignment	sa2		
specialSubframePatterns	ssp4		
}			

9.2.1.2.5 Test requirement

The pass fail decision is as specified in the test procedure in clause 9.2.1.2.4.2.

There are no parameters in the test setup or measurement process whose variation impacts the results so there are no applicable test tolerances for this test.

9.2.1.3

9.2.1.3_C FDD CQI Reporting under AWGN conditions – PUCCH 1-0 for eICIC

9.2.1.3_C.1 FDD CQI Reporting under AWGN conditions – PUCCH 1-0 for eICIC (non-MBSFN ABS)

Editor's notes: This test case is incomplete. The following item is missing or incomplete:

- Connection diagram in Annex A of TS 36.508 is TBD

9.2.1.3_C.1.1 Test purpose

To verify the variance of the wideband CQI reports - in subframes overlapping with aggressor cell ABS and non-ABS subframes - is within the limits defined and a PDSCH BLER of 10% falls between the transport format based median CQI-1 and median CQI or the transport format based median CQI and median CQI +1.

9.2.1.3_C.1.2 Test applicability

This test applies to E-UTRA FDD UE - Category 2-8 - release 10 and forward. Applicability requires support for FGI bit 115.

9.2.1.3_C.1.3 Minimum conformance requirements

For the parameters specified in Table 9.2.1.3_C.1.3-1, and using the downlink physical channels specified in tables C.3.2-1 for Cell 1, C.3.3-1 for Cell 2 and C.3.2-2, the reported CQI value according to Table A.4-1 in subframes overlapping with aggressor cell ABS and non-ABS subframes shall be in the range of ± 1 of the reported median more than 90% of the time. If the PDSCH BLER in non-ABS subframes using the transport format indicated by median CQI obtained by reports in CSI subframe sets $C_{CSI,1}$ is less than or equal to 0.1, the BLER in non-ABS subframes using the transport format indicated by the (median CQI + 1) shall be greater than 0.1. If the PDSCH BLER in non-ABS subframes using the transport format indicated by the median CQI is greater than 0.1, the BLER in non-ABS subframes using transport format indicated by (median CQI - 1) shall be less than or equal to 0.1. The value of the median CQI obtained by reports in CSI subframe sets $C_{CSI,0}$ minus the median CQI obtained by reports in CSI subframe sets $C_{CSI,1}$ shall be larger than or equal to 2 and less than or equal to 5 in Test 1 and shall be larger than or equal to 0 and less than or equal to 1 in Test 2.

Table 9.2.1.3_C.1.3-1: PUCCH 1-0 static test (FDD)

Parameter		Unit	Test 1			Test 2		
			Cell 1	Cell 2		Cell 1	Cell 2	
Bandwidth		MHz	10			10		
PDSCH transmission mode			2	Note 10		2	Note 10	
Downlink power allocation	ρ_A	dB	-3			-3		
	ρ_B	dB	-3			-3		
	σ	dB	0			0		
Propagation condition and antenna configuration			Clause B.1 (2x2)			Clause B.1 (2x2)		
\hat{E}_s / N_{oc2} (Note 1)		dB	4	5	6	4	5	-12
$N_{oc}^{(j)}$ at antenna port	$N_{oc1}^{(j)}$	dBm/15kHz	-102 (Note 7)		N/A	-98(Note 7)		N/A
	$N_{oc2}^{(j)}$	dBm/15kHz	-98 (Note 8)		N/A	-98(Note 8)		N/A
	$N_{oc3}^{(j)}$	dBm/15kHz	-94.8 (Note 9)		N/A	-98(Note 9)		N/A
$\hat{I}_{or}^{(j)}$		dB[mW/15kHz]	-94	-93	-92	-94	-93	-110
Subframe Configuration			Non-MBSFN		Non-MBSFN	Non-MBSFN		Non-MBSFN
Cell Id			0		1	0		1
Time Offset between Cells		μ s	2.5 (synchronous cells)			2.5 (synchronous cells)		
ABS pattern (Note 2)			N/A		01010101 01010101 01010101 01010101 01010101	N/A		01010101 01010101 01010101 01010101 01010101
RLM/RRM Measurement Subframe Pattern (Note 4)			00000100 00000100 00000100 00000100 00000100		N/A	00000100 00000100 00000100 00000100 00000100		N/A
CSI Subframe Sets (Note 3)	$C_{CSI,0}$		01010101 01010101 01010101 01010101 01010101		N/A	01010101 01010101 01010101 01010101 01010101		N/A
	$C_{CSI,1}$		10101010 10101010 10101010 10101010 10101010		N/A	10101010 10101010 10101010 10101010 10101010		N/A
Number of control OFDM symbols			3			3		
Max number of HARQ transmissions			1			1		
Physical channel for $C_{CSI,0}$ CQI reporting			PUCCH Format 2			PUCCH Format 2		
Physical channel for $C_{CSI,1}$ CQI reporting			PUSCH (Note 12)			PUSCH (Note 12)		
PUCCH Report Type			4			4		
Reporting periodicity		Ms	$N_{pd} = 5$			$N_{pd} = 5$		
$cqi-pmi-ConfigurationIndex_{C_{CSI,0}}$ (Note 13)			6	N/A		6	N/A	
$cqi-pmi-ConfigurationIndex2_{C_{CSI,1}}$ (Note 14)			5	N/A		5	N/A	

Note 1:	For each test, the minimum requirements shall be fulfilled for at least one of the two SNR(s) and the respective wanted signal input level.
Note 2:	ABS pattern as defined in [14].
Note 3:	Time-domain measurement resource restriction pattern for PCell measurements as defined in [5]
Note 4:	As configured according to the time-domain measurement resource restriction pattern for CSI measurements defined in [5]
Note 5:	Time-domain measurement resource restriction pattern for PCell measurements as defined in [5]
Note 6:	Cell 1 is the serving cell. Cell 2 is the aggressor cell.
Note 7:	This noise is applied in OFDM symbols #1, #2, #3, #5, #6, #8, #9, #10, #12, #13 of a subframe overlapping with the aggressor ABS.
Note 8:	This noise is applied in OFDM symbols #0, #4, #7, #11 of a subframe overlapping with the aggressor ABS.
Note 9:	This noise is applied in all OFDM symbols of a subframe overlapping with aggressor non-ABS.
Note 10:	Downlink physical channel setup in Cell 2 in accordance with Annex C.3.3 applying OCNG pattern as defined in Annex A.5.1.5
Note 11:	Reference measurement channel in Cell 1 according to Table A.4-1 with one sided dynamic OCNG Pattern OP.1 FDD as described in Annex A.5.1.1.
Note 12:	To avoid collisions between HARQ-ACK and wideband CQI it is necessary to report both on PUSCH instead of PUCCH. PDCCH DCI format 0 shall be transmitted in downlink SF#4 and #9 to allow periodic CQI to multiplex with the HARQ-ACK on PUSCH in uplink subframe SF#8 and #3.
Note 13:	<i>cqi-pmi-ConfigurationIndex</i> is applied for $C_{CSI,0}$.
Note 14:	<i>cqi-pmi-ConfigurationIndex2</i> is applied for $C_{CSI,1}$.

The normative reference for this requirement is TS 36.101 [2] clause 9.2.1.3.

9.2.1.3_C.1.4 Test description

9.2.1.3_C.1.4.1 Initial conditions

Initial conditions are a set of test configurations the UE needs to be tested in and the steps for the SS to take with the UE to reach the correct measurement state.

Configurations of PDSCH and PDCCH before measurement are specified in Annex C.2.

Test Environment: Normal as defined in TS 36.508 [7] clause 4.1.

Frequencies to be tested: Mid Range as defined in TS 36.508 [7] clause 4.3.1.1.

Channel Bandwidths to be tested: 10MHz, as defined in TS 36.508 [7] clause 4.3.1.1

1. Connect the SS, faders and AWGN noise source to the UE antenna connector (s) as shown in TS 36.508 [7] Annex A, Figure [TBD].
2. The parameter settings for the cell are set up according to Table 9.2.1.3_C.1.3-1.
3. Downlink signals are initially set up according to Annex C0, C.1 and Annex C.3.2 and uplink signals according to Annex H.1 and H.3.2.
4. Propagation conditions are set according to Annex B.0.
5. Ensure the UE is in State 3A-RF according to TS 36.508 [7] clause 5.2A.2. Message contents are defined in clause 9.2.1.3_C.1.4.3.

9.2.1.3_C.1.4.2 Test procedure

1. Set the parameters of bandwidth, reference Channel, the propagation condition, antenna configuration and the SNR according to Table 9.2.1.3_C.1.3-1 as appropriate.
2. The SS shall transmit PDSCH via PDCCH DCI format 1A for C_{RNTI} to transmit the DL RMC (Table A.4-1) according to CQI value 8 of Annex A.4 Table A.4-3 and keep it regardless of the wideband CQI value sent by the UE. The SS sends downlink MAC padding bits on the DL RMC. Continue transmission of the PDSCH until 2000 wideband CQI reports have been gathered. In this process the SS collects wideband CQI reports every 5 ms and also cases where UE transmits nothing in its CQI timing are also counted as wideband CQI reports.

3. Set up a relative frequency distribution for the reported wideband CQI-values, Calculate the median value (wideband Median CQI is the wideband CQI that is at or crosses 50% distribution from the lower wideband CQI side). This CQI-value is declared as wideband Median CQI value.
4. If Median CQI is not equal to 1 or 15 and 1800 or more of the wideband CQI values are in the range (Median CQI - 1) ≤ Median CQI ≤ (Median CQI + 1) AND the value of the median CQI obtained by reports in CSI subframe sets C_{CSI,0} minus the median CQI obtained by reports in CSI subframe sets C_{CSI,1} is larger than or equal to 2 and less than or equal to 5 in Test 1 and is larger than or equal to 0 and less than or equal to 1 in Test 2, then continue with step 5, otherwise go to step 8.
5. The SS shall transmit PDSCH via PDCCH DCI format 1A for C_{RNTI} to transmit the DL RMC (Table A.4-1) according to the wideband median-CQI value and shall not react to the UE's wideband CQI reports. The SS sends downlink MAC padding bits on the DL RMC. For any PDSCH transmitted by the SS, record the associated ACK, NACK and statDTX responses. The responses are then filtered as follows: for the sequence of responses for each HARQ process, discard all the statDTX responses. Continue to gather data until the number of filtered ACK+NACK responses reaches 1000.

For the filtered ACK and NACK responses if the ratio (NACK / ACK + NACK) ≤ 0.1 then go to step 6, otherwise go to step 7.

6. The SS shall transmit PDSCH via PDCCH DCI format 1A for C_{RNTI} to transmit the DL RMC (Table A.4-1) according to the wideband median-CQI+1 value and shall not react to the UE's wideband CQI reports. The SS sends downlink MAC padding bits on the DL RMC. For any PDSCH, transmitted by the SS, record and filter the ACK, NACK and statDTX responses as in step 5 until 1000 filtered ACK+NACK responses are gathered.

If the ratio (NACK /ACK + NACK) > 0.1

then pass the UE for this test and go to step 9, otherwise go to step 8.

7. The SS shall transmit PDSCH via PDCCH DCI format 1A for C_{RNTI} to transmit the DL RMC (Table A.4-1) according to the wideband median-CQI-1 value and shall not react to the UE's wideband CQI reports. The SS sends downlink MAC padding bits on the DL RMC. For any PDSCH, transmitted by the SS, record and filter the ACK, NACK and statDTX responses as in step 5 until 1000 filtered ACK+NACK responses are gathered.

If the ratio (NACK /ACK + NACK) ≤ 0.1

then pass the UE for this test and go to step 9, otherwise go to step 8.

8. If both SNR points of the test have not been tested, then repeat the same procedure (steps 1 to 7) for the other SNR point as appropriate. Otherwise fail the UE.
9. If both tests have not been done, then repeat the same procedure (steps 1 to 8) with test conditions according to the table 9.2.1.3_C.1.3-1 for the other Test as appropriate. Otherwise pass the UE.

9.2.1.3_C.1.4.3 Message contents

Message contents are according to TS 36.508 [7] clause 4.6 with the following exceptions:

Table 9.2.1.3_C.1.4.3-1: PhysicalConfigDedicated-DEFAULT

Derivation Path: 36.508 clause 5.5.1.2			
Information Element	Value/remark	Comment	Condition
PhysicalConfigDedicated-DEFAULT ::= SEQUENCE {			
cqi-ReportConfig	<i>CQI-ReportConfig-DEFAULT</i>		
}			

Table 9.2.1.3_C.1.4.3-2: CQI-ReportConfig-DEFAULT

Derivation Path: 36.508 clause 4.6.3			
Information Element	Value/remark	Comment	Condition
CQI-ReportConfig-DEFAULT ::= SEQUENCE {			
cqi-ReportModeAperiodic	Not present		
nomPDSCH-RS-EPRE-Offset	0		
cqi-ReportPeriodic CHOICE {			
setup SEQUENCE {			
cqi-PUCCH-ResourceIndex	0		
cqi-pmi-ConfigIndex	6	(see Table 7.2.2-1A in TS 36.213)	
cqi-FormatIndicatorPeriodic CHOICE {			
widebandCQI	NULL		
}			
ri-ConfigIndex	NULL	(see Table 7.2.2-1B in TS 36.213)	
simultaneousAckNackAndCQI	FALSE		
}			
}			
}			

9.2.1.3_C.1.5 Test requirement

The pass fail decision is as specified in the test procedure in clause 9.2.1.3_C.1.4.2.

There are no parameters in the test setup or measurement process whose variation impacts the results so there are no applicable test tolerances for this test.

9.2.1.4

9.2.1.4_C TDD CQI Reporting under AWGN conditions – PUCCH 1-0 for eICIC

9.2.1.4_C.1 TDD CQI Reporting under AWGN conditions – PUCCH 1-0 for eICIC (non-MBSFN ABS)

Editor's notes: This test case is incomplete. The following items are missing or incomplete:

- Minimum conformance requirements table needs to be confirmed or updated.
- Step 2, 5, 6, 7 of test procedure need to be confirmed.
- Table TDD-config-DEFAULT needs to be confirmed

9.2.1.4_C.1.1 Test purpose

To verify the variance of the wideband CQI reports is within the limits defined and a PDSCH BLER of 10% falls between the transport format based median CQI-1 and median CQI or the transport format based median CQI and median CQI +1.

9.2.1.4_C.1.2 Test applicability

This test applies to E-UTRA TDD UE release 10 and forward. Applicability requires support for FGI bit115.

9.2.1.4_C.1.3 Minimum conformance requirements

For the parameters specified in Table 9.2.1.4_C.1.3-1, and using the downlink physical channels specified in tables C.3.2-1 and C.3.2-2, the reported CQI value according to Table A.4-1 shall be in the range of ± 1 of the reported median more than 90% of the time. If the PDSCH BLER using the transport format indicated by median CQI is less than or equal to 0.1, the BLER using the transport format indicated by the (median CQI +1) shall be greater than 0.1. If the

PDSCH BLER using the transport format indicated by the median CQI is greater than 0.1, the BLER using transport format indicated by (median CQI –1) shall be less than or equal to 0.1

Table 9.2.1.4_C.1.3-1: PUCCH 1-0 static test

Parameter	Unit	Test 1			Test 2		
		Cell 1	Cell 2		Cell 1	Cell 2	
Bandwidth	MHz	10			10		
PDSCH transmission mode		2	Note 10		2	Note 10	
Uplink downlink configuration		[1]			[1]		
Special subframe configuration		4			4		
Downlink power allocation	ρ_A	dB			-3		
	ρ_B	dB			-3		
Propagation condition and antenna configuration		Clause B.1 (2x2)			Clause B.1 (2x2)		
\hat{E}_s/N_{oc2} (Note 1)	dB	[4]	[5]	[6]	[4]	[5]	[-12]
$N_{oc}^{(j)}$ at antenna port	$N_{oc1}^{(j)}$	dBm/15kHz		-102(Note 7)	N/A	[-98](Note 7)	
	$N_{oc2}^{(j)}$	dBm/15kHz		-98(Note 8)	N/A	[-98](Note 8)	
	$N_{oc3}^{(j)}$	dBm/15kHz		-94.8(Note 9)	N/A	[-98](Note 9)	
$\hat{I}_{or}^{(j)}$	dB[mW/15k Hz]	[-94]	[-93]	[-92]	[-94]	[-93]	TBD
Subframe Configuration		Non-MBSFN	Non-MBSFN	Non-MBSFN	Non-MBSFN	Non-MBSFN	Non-MBSFN
Cell Id		0	1	0	1	0	1
Time Offset between Cells	[μ s]	2.5 (synchronous cells)			2.5 (synchronous cells)		
ABS pattern (Note 2)		N/A	[01000100 01 01000100 01]	N/A	[01000100 01 01000100 01]	N/A	[01000100 01 01000100 01]
RLM/RRM Measurement Subframe Pattern (Note 4)		[00000000 01 00000000 1]	N/A	[00000000 01 00000000 01]	N/A	[00000000 01 00000000 01]	N/A
CSI Subframe Sets (Note 3)	$C_{CSI,0}$	[01000100 01 01000100 1]	N/A	[01000100 01 01000100 01]	N/A	[01000100 01 01000100 01]	N/A
	$C_{CSI,1}$	[10001010 00 10001010 0]	N/A	[10001010 00 10001010 00]	N/A	[10001010 00 10001010 00]	N/A
Number of control OFDM symbols		3			3		
Max number of HARQ transmissions		1			1		
Physical channel for $C_{CSI,0}$ CQI reporting		PUCCH Format 2			PUCCH Format 2		
Physical channel for $C_{CSI,1}$ CQI reporting		PUSCH (Note 12)			PUSCH (Note 12)		
PUCCH Report Type		4			4		
Reporting periodicity	ms	[$N_{pd} = 5$]			[$N_{pd} = 5$]		
$cqi-pmi$ -ConfigurationIndex	$C_{CSI,0}$	[3]	N/A	[3]	N/A	[3]	N/A
	$C_{CSI,1}$	[4]	N/A	[4]	N/A	[4]	N/A

ACK/NACK feedback mode		[Multiplexing]	[Multiplexing]
Note 1:	For each test, the minimum requirements shall be fulfilled for at least one of the two SNR(s) and the respective wanted signal input level.		
Note 2:	ABS pattern as defined in [9].		
Note 3:	Time-domain measurement resource restriction pattern for PCell measurements as defined in [7]		
Note 4:	As configured according to the time-domain measurement resource restriction pattern for CSI measurements defined in [7]		
Note 5:	Time-domain measurement resource restriction pattern for PCell measurements as defined in [7]		
Note 6:	Cell 1 is the serving cell. Cell 2 is the aggressor cell.		
Note 7:	This noise is applied in OFDM symbols #1, #2, #3, #5, #6, #8, #9, #10, #12, #13 of a subframe overlapping with the aggressor ABS.		
Note 8:	This noise is applied in OFDM symbols #0, #4, #7, #11 of a subframe overlapping with the aggressor ABS		
Note 9:	This noise is applied in all OFDM symbols of a subframe overlapping with aggressor non-ABS.		
Note 10:	Downlink physical channel setup in Cell 2 in accordance with Annex C.3.3 applying OCNG pattern as defined in Annex A5.2.5		
Note 11:	Reference measurement channel in Cell 1 according to Table A.4-2 with one sided dynamic OCNG Pattern OP.1 TDD as described in Annex A.5.2.1.		
Note 12:	To avoid collisions between HARQ-ACK and wideband CQI it is necessary to report both on PUSCH instead of PUCCH. PDCCH DCI format 0 shall be transmitted in downlink SF#4 and #9 to allow periodic CQI to multiplex with the HARQ-ACK on PUSCH in uplink subframe SF#8 and #3.		

The normative reference for this requirement is TS 36.101 [2] clause 9.2.1.4.

9.2.1.4_C.1.4 Test description

9.2.1.4_C.14.1 Initial conditions

Initial conditions are a set of test configurations the UE needs to be tested in and the steps for the SS to take with the UE to reach the correct measurement state.

Configurations of PDSCH and PDCCH before measurement are specified in Annex C.2.

Test Environment: Normal as defined in TS 36.508 [7] clause 4.1.

Frequencies to be tested: Mid Range as defined in TS 36.508 [7] clause 4.3.1.2.

Channel Bandwidths to be tested: 10MHz, as defined in TS 36.508 [7] clause 4.3.1.2

1. Connect the SS, faders and AWGN noise source to the UE antenna connector (s) as shown in TS 36.508 [7] Annex A, Figure A.9.
2. The parameter settings for the cell are set up according to Table 9.2.1.4_C.1.3-1.
3. Downlink signals are initially set up according to Annex C0, C.1 and Annex C.3.2 and uplink signals according to Annex H.1 and H.3.2.
4. Propagation conditions are set according to Annex B.0
5. Ensure the UE is in State 3A-RF according to TS 36.508 [7] clause 5.2A.2. Message contents are defined in clause 9.2.1.4_C.1.4.3.

9.2.1.4_C.1.4.2 Test procedure

1. Set the parameters of bandwidth, reference Channel, the propagation condition, antenna configuration and the SNR according to Table 9.2.1.4_C.1.3-1 as appropriate.
2. The SS shall transmit PDSCH via PDCCH DCI format 1A for C_RNTI to transmit the DL RMC (Table A.4-2) according to CQI value 8 of Annex A.4 Table A.4-3 and keep it regardless of the wideband CQI value sent by the UE. The SS sends downlink MAC padding bits on the DL RMC. The SS sends uplink scheduling

information via PDCCH DCI format 0 with CQI request bit set to 0 to schedule UL RMC in subframe #2 and subframe #7 (Table A.4-2). The UE will send ACK/NACK and periodic CQI report using PUSCH. Continue transmission of the PDSCH until 2000 wideband CQI reports have been gathered. In this process the SS collects wideband CQI reports every 5 ms and also cases where UE transmits nothing in its CQI timing are counted as wideband CQI reports.

3. Set up a relative frequency distribution for the reported wideband CQI-values, Calculate the median value (wideband Median CQI is the CQI that is at or crosses 50% distribution from the lower wideband CQI side). This CQI-value is declared as wideband Median CQI value.
4. If Median CQI is not equal to 1 or 15 and 1800 or more of the wideband CQI values are in the range $(\text{Median CQI} - 1) \leq \text{Median CQI} \leq (\text{Median CQI} + 1)$ then continue with step 5, otherwise go to step 8.
5. The SS shall transmit PDSCH via PDCCH DCI format 1A for C_RNTI to transmit the DL RMC (Table A.4-2) according to the wideband median-CQI value and shall not react to the UE's wideband CQI reports. The SS sends downlink MAC padding bits on the DL RMC. The SS sends uplink scheduling information via PDCCH DCI format 0 with CQI request bit set to 0 to schedule UL RMC in subframe #2 and subframe #7 (Table A.4-2). The UE will send ACK/NACK and periodic CQI report using PUSCH. For any PDSCH transmitted by the SS, record the associated ACK, NACK and statDTX responses. *In case statDTX can not be differentiated from NACK due to multiplexing effect, evaluate the feedback as a NACK* The responses are then filtered as follows: for the sequence of responses for each HARQ process, discard all the statDTX responses. Continue to gather data until the number of filtered ACK+NACK responses reaches 1000.

For the filtered ACK and NACK responses if the ratio $(\text{NACK} / \text{ACK} + \text{NACK}) \leq 0.1$ then go to step 6, otherwise go to step 7.

6. The SS shall transmit PDSCH via PDCCH DCI format 1A for C_RNTI to transmit the DL RMC (Table A.4-2) according to the wideband median-CQI+1 value and shall not react to the UE's wideband CQI reports. The SS sends downlink MAC padding bits on the DL RMC. The SS sends uplink scheduling information via PDCCH DCI format 0 with CQI request bit set to 0 to schedule UL RMC in subframe #2 and subframe #7 (Table A.4-2). The UE will send ACK/NACK and periodic CQI report using PUSCH. For any PDSCH, transmitted by the SS, record and filter the ACK, NACK and statDTX responses as in step 5 until 1000 filtered ACK+NACK responses are gathered. *In case statDTX can not be differentiated from NACK due to multiplexing effect, evaluate the feedback as a NACK*

If the ratio $(\text{NACK} / \text{ACK} + \text{NACK}) > 0.1$

then pass the UE for this test and go to step 9, otherwise go to step 8.

7. The SS shall transmit PDSCH via PDCCH DCI format 1A for C_RNTI to transmit the DL RMC (Table A.4-2) according to the wideband median-CQI-1 value and shall not react to the UE's wideband CQI reports. The SS sends downlink MAC padding bits on the DL RMC. The SS sends uplink scheduling information via PDCCH DCI format 0 with CQI request bit set to 0 to schedule UL RMC in subframe #2 and subframe #7 (Table A.4-2). The UE will send ACK/NACK and periodic CQI report using PUSCH. For any PDSCH, transmitted by the SS, record and filter the ACK, NACK and statDTX responses as in step 5 until 1000 filtered ACK+NACK responses are gathered. *In case statDTX can not be differentiated from NACK due to multiplexing effect, evaluate the feedback as a NACK*

If the ratio $(\text{NACK} / \text{ACK} + \text{NACK}) \leq 0.1$

then pass the UE for this test and go to step 9, otherwise go to step 8.

8. If both SNR points of the test have not been tested, then repeat the same procedure (steps 1 to 7) for the other SNR point as appropriate. Otherwise fail the UE.
9. If both tests have not been done, then repeat the same procedure (steps 1 to 8) with test conditions according to the table 9.2.1.4_C.1.3-1 for the other Test as appropriate. Otherwise pass the UE.

9.2.1.4_C.1.4.3 Message contents

Message contents are according to TS 36.508 [7] clause 4.6 with the following exceptions:

Table 9.2.1.4_C.1.4.3-1: PhysicalConfigDedicated-DEFAULT

Derivation Path: 36.508 clause 5.5.1.2			
Information Element	Value/remark	Comment	Condition
PhysicalConfigDedicated-DEFAULT ::= SEQUENCE {			
cqi-ReportConfig	CQI-ReportConfig-DEFAULT		
}			

Table 9.2.1.4_C.1.4.3-2: CQI-ReportConfig-DEFAULT

Derivation Path: 36.508 clause 4.6.3			
Information Element	Value/remark	Comment	Condition
CQI-ReportConfig-DEFAULT ::= SEQUENCE {			
cqi-ReportModeAperiodic	Not present		
nomPDSCH-RS-EPRE-Offset	0		
cqi-ReportPeriodic CHOICE {			
setup SEQUENCE {			
cqi-PUCCH-ResourceIndex	0		
cqi-pmi-ConfigIndex	3		
cqi-FormatIndicatorPeriodic CHOICE {			
widebandCQI	NULL		
}			
ri-ConfigIndex	NULL		
simultaneousAckNackAndCQI	FALSE		
}			
}			

Table 9.2.1.4_C.1.4.3-3: TDD-Config-DEFAULT

Derivation Path: 36.508 clause 4.6.3			
Information Element	Value/remark	Comment	Condition
TDD-Config-DEFAULT ::= SEQUENCE {			
subframeAssignment	sa1		
specialSubframePatterns	ssp4		
}			

9.2.1.4_C.1.5 Test requirement

The pass fail decision is as specified in the test procedure in clause 9.2.1.4_C.1.4.2.

There are no parameters in the test setup or measurement process whose variation impacts the results so there are no applicable test tolerances for this test.

9.2.2 CQI Reporting under AWGN conditions - PUCCH 1-1 (Cell-Specific Reference Symbols)

9.2.2.1 FDD CQI Reporting under AWGN conditions – PUCCH 1-1

9.2.2.1.1 Test purpose

To verify the variance of the wideband spatial differential CQI between codeword #0 and codeword #1 are within the limits defined and for both codeword #0 and codeword #1, the PDSCH BLER using the transport format indicated by the respective median $CQI_0 - 1$ and median $CQI_1 - 1$ shall be less than or equal to 0.1 and the PDSCH BLER using the transport format indicated by the respective median $CQI_0 + 1$ and median $CQI_1 + 1$ shall be greater than or equal to 0.1.

9.2.2.1.2 Test applicability

This test applies to E-UTRA FDD UE release 8 and forward of.

9.2.2.1.3 Minimum conformance requirements

The minimum requirements for dual codeword transmission are defined in terms of a reporting spread of the wideband CQI value for codeword #1, and their BLER performance using the transport format indicated by the reported CQI median of codeword #0 and codeword #1. The precoding used at the transmitter is a fixed precoding matrix specified by the bitmap parameter *codebookSubsetRestriction*. The propagation condition assumed for the minimum performance requirement is defined in subclause B.1.

For the parameters specified in table 9.2.2.1.3-1, and using the downlink physical channels specified in tables C.3.2-1 and C.3.2-2, the reported offset level of the wideband spatial differential CQI for codeword #1 (Table 7.2.2 in TS 36.213 [10]) shall be used to determine the wideband CQI index for codeword #1 as

$$\text{wideband CQI}_1 = \text{wideband CQI}_0 - \text{Codeword 1 offset level}$$

The wideband CQI₁ shall be within the set {median CQI₁ -1, median CQI₁ +1} for more than 90% of the time, where the resulting wideband values CQI₁ shall be used to determine the median CQI values for codeword #1. For both codewords #0 and #1, the PDSCH BLER using the transport format indicated by the respective median CQI₀ - 1 and median CQI₁ - 1 shall be less than or equal to 0.1. Furthermore, for both codewords #0 and #1, the PDSCH BLER using the transport format indicated by the respective median CQI₀ + 1 and median CQI₁ + 1 shall be greater than or equal to 0.1.

Table 9.2.2.1.3-1: PUCCH 1-1 static test (FDD)

Parameter	Unit	Test 1		Test 2	
Bandwidth	MHz	10			
PDSCH transmission mode		4			
Downlink power allocation	ρ_A	dB	-3		
	ρ_B	dB	-3		
	σ	dB	0		
Propagation condition and antenna configuration		Clause B.1 (2 x 2)			
CodeBookSubsetRestriction bitmap		010000			
SNR (Note 2)	dB	10	11	16	17
$\hat{I}_{or}^{(j)}$	dB[mW/15kHz]	-88	-87	-82	-81
$N_{oc}^{(j)}$	dB[mW/15kHz]	-98		-98	
Max number of HARQ transmissions		1			
Physical channel for CQI/PMI reporting		PUCCH Format 2			
PUCCH Report Type for CQI/PMI		2			
PUCCH Report Type for RI		3			
Reporting periodicity	ms	$N_P = 5$			
<i>cqi-pmi-ConfigurationIndex</i>		6			
<i>ri-ConfigIndex</i>		1 (Note 3)			
Note 1:	Reference measurement channel according to Table A.4-1 with one sided dynamic OCNG Pattern OP.1 FDD as described in Annex A.5.1.1				
Note 2:	For each test, the minimum requirements shall be fulfilled for at least one of the two SNR(s) and the respective wanted signal input level.				
Note 3:	It is intended to have UL collisions between RI reports and HARQ-ACK, since the RI reports shall not be used by the eNB in this test.				

The normative reference for this requirement is TS 36.101 [2] clause 9.2.2.1.

9.2.2.1.4 Test description

9.2.2.1.4.1 Initial conditions

Initial conditions are a set of test configurations the UE needs to be tested in and the steps for the SS to take with the UE to reach the correct measurement state.

Configurations of PDSCH and PDCCH before measurement are specified in Annex C.2.

Test Environment: Normal as defined in TS 36.508 [7] clause 4.1.

Frequencies to be tested: Mid Range as defined in TS 36.508 [7] clause 4.3.1.1.

Channel Bandwidths to be tested: 10MHz, as defined in TS 36.508 [7] clause 4.3.1.1

1. Connect the SS, faders and AWGN noise source to the UE antenna connector (s) as shown in TS 36.508 [7] Annex A, Figure A.10.
2. The parameter settings for the cell are set up according to Table 9.2.2.1.3-1.
3. Downlink signals are initially set up according to Annex C0, C.1 and Annex C.3.2 and uplink signals according to Annex H.1 and H.3.2.
4. Propagation conditions are set according to Annex B.0.
5. Ensure the UE is in State 3A-RF according to TS 36.508 [7] clause 5.2A.2. Message contents are defined in clause 9.2.2.1.4.3.

9.2.2.1.4.2 Test procedure

1. Set the parameters of bandwidth, reference Channel, the propagation condition, antenna configuration and the SNR according to Table 9.2.2.1.3-1 as appropriate.
2. The SS shall transmit PDSCH via PDCCH DCI format 2 for C_RNTI to transmit the DL RMC (Table A.4-1) including two codewords with spatial multiplexing both using the transport format according to CQI value 8 of Annex A.4 Table A.4-3a and keep them regardless of the wideband CQI value sent by the UE. The SS sends downlink MAC padding bits on the DL RMC. The SS shall use a fixed precoding matrix specified by the bitmap parameter *codebookSubsetRestriction*. Continue transmission of the PDSCH until 2000 wideband and wideband spatial differential CQI reports have been gathered. In this process the SS collects wideband and wideband spatial differential CQI reports every 5 ms and also cases where UE transmits nothing in its CQI timing are also counted as wideband and wideband spatial differential CQI reports respectively.
3. From each wideband CQI report, wideband CQI₀ is defined as Wideband CQI of codeword #0 and wideband CQI₁ is calculated according to clause 9.2.2.1.3. Codeword 1 offset level is selected from {0,1,2,3,-4,-3,-2,-1}. Set up a relative frequency distribution for the wideband CQI-values, reported. Calculate the median value (wideband Median CQI is the CQI that is at or crosses 50% distribution from the lower wideband CQI side) for each codewords. Wideband Median CQI₀ is based on the wideband CQI₀ and wideband median CQI₁ is based on the wideband CQI₁.
4. If Median CQI is not equal to 1 or 15 and 1800 or more of the wideband CQI₁ values are in the range (Median CQI₁ - 1) ≤ Median CQI ≤ (Median CQI₁ + 1) then continue with step 5, otherwise go to step 7.
5. The SS shall transmit PDSCH via PDCCH DCI format 2 for C_RNTI to transmit the DL RMC (Table A.4-1) including two codewords with spatial multiplexing where the transport format of codeword #0 is according to the wideband median- CQI₀- 1 and the transport format of codeword #1 is according to the wideband median CQI₁- 1. The SS sends downlink MAC padding bits on the DL RMC. The SS shall not react to the any wideband CQI reports from UE and shall use a fixed precoding matrix specified by the bitmap parameter *codebookSubsetRestriction*. For any PDSCH transmitted by the SS, record the associated ACK, NACK and statDTX responses for each codewords respectively. The responses are then filtered as follows: for the sequence of responses for each HARQ process, discard all the statDTX responses. Continue to gather data until the number of filtered ACK+NACK responses for each codewords reaches 1000.

If the ratio (NACK /ACK + NACK) ≤ 0.1 for both codeword #0 and codeword #1

then and go to step 6, otherwise go to step 7.

6. The SS shall transmit PDSCH via PDCCH DCI format 2 for C_RNTI to transmit the DL RMC (Table A.4-1) including two codewords with spatial multiplexing where the transport format of codeword #0 is according to the wideband median-CQI₀ + 1 and the transport format of codeword #1 is according to the wideband median-CQI₁ + 1. The SS sends downlink MAC padding bits on the DL RMC. The SS shall not react to the any wideband CQI reports from UE and shall use a fixed precoding matrix specified by the bitmap parameter *codebookSubsetRestriction*. For any PDSCH transmitted by the SS, record the associated ACK, NACK and statDTX responses for each codewords respectively. The responses are then filtered as follows: for the sequence of responses for each HARQ process, discard all the statDTX responses. Continue to gather data until the number of filtered ACK+NACK responses for each codewords reaches 1000.

If the ratio $(NACK / (ACK + NACK)) \geq 0.1$ for both codeword #0 and codeword #1

then pass the UE for this test and go to step 8, otherwise go to step 7.

7. If both SNR points of the test have not been tested, then repeat the same procedure (steps 1 to 6) for the other SNR point as appropriate. Otherwise fail the UE.
8. If both tests have not been done, then repeat the same procedure (steps 1 to 7) with test conditions according to the table 9.2.2.1.3-1 for the other Test as appropriate. Otherwise pass the UE.

9.2.2.1.4.3 Message contents

Message contents are according to TS 36.508 [7] clause 4.6 with the following exceptions:

Table 9.2.2.1.4.3-1: PhysicalConfigDedicated-DEFAULT

Derivation Path: 36.508 clause 5.5.1.2			
Information Element	Value/remark	Comment	Condition
PhysicalConfigDedicated-DEFAULT ::= SEQUENCE {			
cqi-ReportConfig	<i>CQI-ReportConfig-DEFAULT</i>		
antennaInfo CHOICE {			
antennaInfoDedicated ::= SEQUENCE {			
transmissionMode	tm4		
}			
codebookSubsetRestriction CHOICE {			
n2TxAntenna-tm4	010000		
ue-TransmitAntennaSelection CHOICE {			
release	NULL		
}			
}			

Table 9.2.2.1.4.3-2: PDSCH-ConfigDedicated-DEFAULT

Derivation Path: 36.508 clause 4.6.3			
Information Element	Value/remark	Comment	Condition
PDSCH-ConfigDedicated-DEFAULT ::= SEQUENCE {			
p-a	dB-3		
}			

Table 9.2.2.1.4.3-3: CQI-ReportConfig-DEFAULT

Derivation Path: 36.508 clause 4.6.3			
Information Element	Value/remark	Comment	Condition
CQI-ReportConfig-DEFAULT ::= SEQUENCE {			
cqi-ReportModeAperiodic	Not present		
nomPDSCH-RS-EPRE-Offset	0		
cqi-ReportPeriodic CHOICE {			
setup SEQUENCE {			
cqi-PUCCH-ResourceIndex	0		
cqi-pmi-ConfigIndex	6	(see Table 7.2.2-1A in TS 36.213)	
cqi-FormatIndicatorPeriodic CHOICE {			
widebandCQI	NULL		
}			
ri-ConfigIndex	1	(see Table 7.2.2-1B in TS 36.213)	
simultaneousAckNackAndCQI	FALSE		
}			
}			
}			

9.2.2.1.5 Test requirement

The pass fail decision is as specified in the test procedure in clause 9.2.2.1.4.2.

There are no parameters in the test setup or measurement process whose variation impacts the results so there are no applicable test tolerances for this test.

9.2.2.1_D.5 Test requirement

The pass fail decision is as specified in the test procedure in clause 9.2.2.1_D.4.2.

[TT TBD]

9.2.2.2 TDD CQI Reporting under AWGN conditions – PUCCH 1-1

9.2.2.2.1 Test purpose

To verify the variance of the wideband spatial differential CQI between codeword #0 and codeword #1 are within the limits defined and for both codeword #0 and codeword #1, the PDSCH BLER using the transport format indicated by the respective wideband median $CQI_0 - 1$ and wideband median $CQI_1 - 1$ shall be less than or equal to 0.1 and the PDSCH BLER using the transport format indicated by the respective wideband median $CQI_0 + 1$ and wideband median $CQI_1 + 1$ shall be greater than or equal to 0.1.

9.2.2.2.2 Test applicability

This test applies to E-UTRA TDD UE release 8 and forward.

9.2.2.2.3 Minimum conformance requirements

For the parameters specified in table 9.2.2.2.3-1, and using the downlink physical channels specified in tables C.3.2-1 and C.3.2-2, the reported offset level of the wideband spatial differential CQI for codeword #1 (Table 7.2.2 in TS 36.213 [10]) shall be used to determine the wideband CQI index for codeword #1 as:

$$\text{wideband } CQI_1 = \text{wideband } CQI_0 - \text{Codeword 1 offset level}$$

The wideband CQI_1 shall be within the set {median $CQI_1 - 1$, median $CQI_1 + 1$ } for more than 90% of the time, where the resulting wideband values CQI_1 shall be used to determine the median CQI values for codeword #1. For both codewords #0 and #1, the PDSCH BLER using the transport format indicated by the respective median $CQI_0 - 1$ and

median $CQI_1 - 1$ shall be less than or equal to 0.1. Furthermore, for both codewords #0 and #1, the PDSCH BLER using the transport format indicated by the respective median $CQI_0 + 1$ and median $CQI_1 + 1$ shall be greater than or equal to 0.1.

Table 9.2.2.3-1: PUCCH 1-1 static test (TDD)

Parameter		Unit	Test 1		Test 2	
Bandwidth		MHz	10			
PDSCH transmission mode			4			
Uplink downlink configuration			2			
Special subframe configuration			4			
Downlink power allocation	ρ_A	dB	-3			
	ρ_B	dB	-3			
	σ	dB	0			
Propagation condition and antenna configuration			Clause B.1 (2 x 2)			
CodeBookSubsetRestriction bitmap			010000			
SNR (Note 2)		dB	10	11	16	17
$\hat{I}_{or}^{(j)}$		dB[mW/15kHz]	-88	-87	-82	-81
$N_{oc}^{(j)}$		dB[mW/15kHz]	-98		-98	
Maximum number of HARQ transmissions			1			
Physical channel for CQI/PMI reporting			PUSCH (Note 3)			
PUCCH Report Type			2			
Reporting periodicity		ms	$N_p = 5$			
<i>cqi-pmi-ConfigurationIndex</i>			3			
<i>ri-ConfigIndex</i>			805 (Note 4)			
ACK/NACK feedback mode			Multiplexing			
<p>Note 1: Reference measurement channel according to Table A.4-2 with one sided dynamic OCNG Pattern OP.1 TDD as described in Annex A.5.2.1</p> <p>Note 2: For each test, the minimum requirements shall be fulfilled for at least one of the two SNR(s) and the respective wanted signal input level.</p> <p>Note 3: To avoid collisions between CQI/PMI reports and HARQ-ACK it is necessary to report both on PUSCH instead of PUCCH. PDCCH DCI format 0 shall be transmitted in downlink SF#3 and #8 to allow periodic CQI/PMI to multiplex with the HARQ-ACK on PUSCH in uplink subframe SF#7 and #2.</p> <p>Note 4: RI reporting interval is set to the maximum allowable length of 160ms to minimise collisions between RI, CQI/PMI and HARQ-ACK reports. In the case when all three reports collide, it is expected that CQI/PMI reports will be dropped, while RI and HARQ-ACK will be multiplexed. At eNB, CQI report collection shall be skipped every 160ms during performance verification.</p>						

The normative reference for this requirement is TS 36.101 [2] clause 9.2.2.2.

9.2.2.2.4 Test description

9.2.2.2.4.1 Initial conditions

Initial conditions are a set of test configurations the UE needs to be tested in and the steps for the SS to take with the UE to reach the correct measurement state.

Configurations of PDSCH and PDCCH before measurement are specified in Annex C.2.

Test Environment: Normal as defined in TS 36.508 [7] clause 4.1.

Frequencies to be tested: Mid Range as defined in TS 36.508 [7] clause 4.3.1.2.

Channel Bandwidths to be tested: 10MHz, as defined in TS 36.508 [7] clause 4.3.1.2

1. Connect the SS, faders and AWGN noise source to the UE antenna connector (s) as shown in TS 36.508 [7] Annex A, Figure A.10.
2. The parameter settings for the cell are set up according to Table 9.2.2.2.3-1.
3. Downlink signals are initially set up according to Annex C0, C.1 and Annex C.3.2 and uplink signals according to Annex H1 and H.3.2.
4. Propagation conditions are set according to Annex B.0.
5. Ensure the UE is in State 3A-RF according to TS 36.508 [7] clause 5.2A.2. Message contents are defined in clause 9.2.2.2.4.3.

9.2.2.2.4.2 Test procedure

1. Set the parameters of bandwidth, reference Channel, the propagation condition, antenna configuration and the SNR according to Table 9.2.2.2.3-1 as appropriate.
2. The SS shall transmit PDSCH via PDCCH DCI format 2 for C_RNTI to transmit the DL RMC (Table A.4-2) including two codewords with spatial multiplexing both using the transport format according to CQI value 8 of Annex A.4 Table A.4-3a and keep them regardless of the wideband CQI value sent by the UE. The SS sends downlink MAC padding bits on the DL RMC. The SS shall use a fixed precoding matrix specified by the bitmap parameter *codebookSubsetRestriction*. The SS sends uplink scheduling information via PDCCH DCI format 0 with CQI request bit set to 0 to schedule UL RMC in subframe #2 and subframe #7 (Table A.4-2). The UE will send ACK/NACK and periodic CQI report using PUSCH. Continue transmission of the PDSCH until 2000 wideband and wideband spatial differential CQI reports have been gathered. In this process the SS collects wideband and wideband spatial differential CQI reports every 5 ms and also cases where UE transmits nothing in its CQI timing are counted as wideband and wideband spatial differential CQI reports respectively.
3. From each wideband CQI report, wideband CQI₀ is defined as Wideband CQI of codeword #0 and wideband CQI₁ is calculated according to clause 9.2.2.2.3. Codeword 1 offset level is selected from {0,1,2,3,-4,-3,-2,-1}. Set up a relative frequency distribution for the wideband CQI-values, reported. Calculate the median value (wideband Median CQI is the CQI that is at or crosses 50% distribution from the lower wideband CQI side) for each codewords. Wideband Median CQI₀ is based on the wideband CQI₀ and wideband median CQI₁ is based on the wideband CQI₁.
4. If Median CQI is not equal to 1 or 15 and 1800 or more of the wideband CQI₁ values are in the range (Median CQI₁ - 1) ≤ Median CQI ≤ (Median CQI₁ + 1) then continue with step 5, otherwise go to step 7.
5. The SS shall transmit PDSCH via PDCCH DCI format 2 for C_RNTI to transmit the DL RMC (Table A.4-2) including two codewords with spatial multiplexing where the transport format of codeword #0 is according to the wideband median-CQI₀- 1 and the transport format of codeword #1 is according to the wideband median CQI₁- 1. The SS sends downlink MAC padding bits on the DL RMC. The SS shall not react to the any wideband CQI reports from UE and shall use a fixed precoding matrix specified by the bitmap parameter *codebookSubsetRestriction*. The SS sends uplink scheduling information via PDCCH DCI format 0 with CQI request bit set to 0 to schedule UL RMC in subframe #2 and subframe #7 (Table A.4-2). The UE will send ACK/NACK and periodic CQI report using PUSCH. For any PDSCH transmitted by the SS, record the associated ACK, NACK and statDTX responses for each codewords respectively. *In case statDTX can not be differentiated from NACK due to multiplexing effect, evaluate the feedback as a NACK* The responses are then filtered as follows: for the sequence of responses for each HARQ process, discard all the statDTX responses. Continue to gather data until the number of filtered ACK+NACK responses for each codewords reaches 1000.

If the ratio $(\text{NACK} / \text{ACK} + \text{NACK}) \leq 0.1$

then, and go to step 6, otherwise go to step 7.

6. The SS shall transmit PDSCH via PDCCH DCI format 2 for C_RNTI to transmit the DL RMC (Table A.4-2) including two codewords with spatial multiplexing where the transport format of codeword #0 is according to the wideband median-CQI₀ + 1 and the transport format of codeword #1 is according to the wideband median-CQI₁ + 1. The SS sends downlink MAC padding bits on the DL RMC. The SS shall not react to the any wideband CQI reports from UE and shall use a fixed precoding matrix specified by the bitmap parameter *codebookSubsetRestriction*. The SS sends uplink scheduling information via PDCCH DCI format 0 with CQI request bit set to 0 to schedule UL RMC in subframe #2 and subframe #7 (Table A.4-2). The UE will send ACK/NACK and periodic CQI report using PUSCH. For any PDSCH transmitted by the SS, record the

associated ACK, NACK and statDTX responses for each codewords respectively. *In case statDTX can not be differentiated from NACK due to multiplexing effect, evaluate the feedback as a NACK* The responses are then filtered as follows: for the sequence of responses for each HARQ process, discard all the statDTX responses. Continue to gather data until the number of filtered ACK+NACK responses for each codewords reaches 1000.

If the ratio $(NACK / (ACK + NACK)) \geq 0.1$

then pass the UE for this test and go to step 8, otherwise go to step 7.

7. If both SNR points of the test have not been tested, then repeat the same procedure (steps 1 to 6) for the other SNR point as appropriate. Otherwise fail the UE.
8. If both tests have not been done, then repeat the same procedure (steps 1 to 7) with test conditions according to the table 9.2.2.2.3-1 for the other Test as appropriate. Otherwise pass the UE.

9.2.2.2.4.3 Message contents

Message contents are according to TS 36.508 [7] clause 4.6 with the following exceptions:

Table 9.2.2.2.4.3-1: PhysicalConfigDedicated-DEFAULT

Derivation Path: 36.508 clause 5.5.1.2			
Information Element	Value/remark	Comment	Condition
PhysicalConfigDedicated-DEFAULT ::= SEQUENCE {			
cqi-ReportConfig	<i>CQI-ReportConfig-DEFAULT</i>		
antennaInfo CHOICE {			
antennaInfoDedicated ::= SEQUENCE {			
transmissionMode	tm4		
}			
codebookSubsetRestriction CHOICE {			
n2TxAntenna-tm4	010000		
ue-TransmitAntennaSelection CHOICE {			
release	NULL		
}			
}			
}			

Table 9.2.2.2.4.3-2: PDSCH-ConfigDedicated-DEFAULT

Derivation Path: TS 36.508 [7] clause 4.6.3, Table 4.6.3-6 PDSCH-ConfigDedicated-DEFAULT			
Information Element	Value/remark	Comment	Condition
PDSCH-ConfigDedicated-DEFAULT ::= SEQUENCE {			
p-a	dB-3		
}			

Table 9.2.2.2.4.3-3: CQI-ReportConfig-DEFAULT

Derivation Path: 36.508 clause 4.6.3			
Information Element	Value/remark	Comment	Condition
CQI-ReportConfig-DEFAULT ::= SEQUENCE {			
cqi-ReportModeAperiodic	Not present		
nomPDSCH-RS-EPRE-Offset	0		
cqi-ReportPeriodic CHOICE {			
setup SEQUENCE {			
cqi-PUCCH-ResourceIndex	0		
cqi-pmi-ConfigIndex	3		
cqi-FormatIndicatorPeriodic CHOICE {			
widebandCQI	NULL		
}			
ri-ConfigIndex	805		
simultaneousAckNackAndCQI	FALSE		
}			
}			

Table 9.2.2.2.4.3-4: TDD-Config-DEFAULT

Derivation Path: 36.508 clause 4.6.3			
Information Element	Value/remark	Comment	Condition
TDD-Config-DEFAULT ::= SEQUENCE {			
subframeAssignment	Sa2		
specialSubframePatterns	Ssp4		
}			

9.2.2.2.5 Test requirement

The pass fail decision is as specified in the test procedure in clause 9.2.2.2.4.2.

There are no parameters in the test setup or measurement process whose variation impacts the results so there are no applicable test tolerances for this test.

9.2.3 CQI Reporting under AWGN conditions - PUCCH 1-1 (CSI Reference Symbols)9.2.3.1_D FDD CQI Reporting under AWGN conditions – PUCCH 1-1 for eDL-MIMO

9.2.3.1_D.1 Test purpose

To verify the variance of the wideband spatial differential CQI between codeword #0 and codeword #1 are within the limits defined and for both codeword #0 and codeword #1, the PDSCH BLER using the transport format indicated by the respective median $CQI_0 - 1$ and median $CQI_1 - 1$ shall be less than or equal to 0.1 and the PDSCH BLER using the transport format indicated by the respective median $CQI_0 + 1$ and median $CQI_1 + 1$ shall be greater than or equal to 0.1.

9.2.3.1_D.2 Test applicability

This test applies to all types of E-UTRA FDD UE release 10 and forward that support eDL-MIMO. Applicability requires support for FGI bit 103.

9.2.3.1_D.3 Minimum conformance requirements

The minimum requirements for dual codeword transmission are defined in terms of a reporting spread of the wideband CQI value for codeword #1, and their BLER performance using the transport format indicated by the reported CQI median of codeword #0 and codeword #1. The precoding used at the transmitter is a fixed precoding matrix specified by the bitmap parameter *codebookSubsetRestriction*. The propagation condition assumed for the minimum performance requirement is defined in subclause B.1.

For the parameters specified in table 9.2.3.1_D.3-1, and using the downlink physical channels specified in tables C.3.2-1 and C.3.2-2, the reported offset level of the wideband spatial differential CQI for codeword #1 (Table 7.2 -2 in TS 36.213 [10]) shall be used to determine the wideband CQI index for codeword #1 as:

$$\text{wideband CQI}_1 = \text{wideband CQI}_0 - \text{Codeword 1 offset level}$$

The wideband CQI₁ shall be within the set {median CQI₁ -1, median CQI₁ +1} for more than 90% of the time, where the resulting wideband values CQI₁ shall be used to determine the median CQI values for codeword #1. For both codewords #0 and #1, the PDSCH BLER using the transport format indicated by the respective median CQI₀ - 1 and median CQI₁ - 1 shall be less than or equal to 0.1. Furthermore, for both codewords #0 and #1, the PDSCH BLER using the transport format indicated by the respective median CQI₀ + 1 and median CQI₁ + 1 shall be greater than or equal to 0.1.

Table 9.2.3.1_D.3-1: PUCCH 1-1 static test (FDD)

Parameter	Unit	Test 1		Test 2	
Bandwidth	MHz	10			
PDSCH transmission mode		9			
Downlink power allocation	ρ_A	dB	0		
	ρ_B	dB	0		
	P_c	dB	-3		
	σ	dB	0		
Cell-specific reference signals		Antenna ports 0, 1			
CSI reference signals		Antenna ports 15,...,18			
Beamforming model		As specified in Annex B.4.3			
CSI-RS periodicity and subframe offset $T_{\text{CSI-RS}} / \Delta_{\text{CSI-RS}}$		5/1			
CSI reference signal configuration		0			
Propagation condition and antenna configuration		Clause B.1 (4 x 2)			
CodeBookSubsetRestriction bitmap		0x0000 0000 0100 0000			
SNR (Note 2)	dB	7	8	13	14
$\hat{I}_{or}^{(j)}$	dB[mW/15kHz]	-91	-90	-85	-84
$N_{oc}^{(j)}$	dB[mW/15kHz]	-98		-98	
Max number of HARQ transmissions		1			
Physical channel for CQI/PMI reporting		PUSCH (Note3)			
PUCCH Report Type for CQI/PMI		2			
Physical channel for RI reporting		PUCCH Format 2			
PUCCH Report Type for RI		3			
Reporting periodicity	ms	$N_{pd} = 5$			
CQI delay	ms	8			
<i>cqi-pmi-ConfigurationIndex</i>		2			
<i>ri-ConfigIndex</i>		1			
Note 1:	Reference measurement channel according to Table A.4-1a with one sided dynamic OCNG Pattern OP.1 FDD as described in Annex A.5.1.1.				
Note 2:	For each test, the minimum requirements shall be fulfilled for at least one of the two SNR(s) and the respective wanted signal input level.				
Note 3:	To avoid collisions between CQI/PMI reports and HARQ-ACK it is necessary to report both on PUSCH instead of PUCCH. PDCCH DCI format 0 shall be transmitted in downlink SF#1 and #6 to allow periodic CQI/PMI to multiplex with the HARQ-ACK on PUSCH in uplink SF#0 and #5.				

The normative reference for this requirement is TS 36.101 [2] clause 9.2.3.1.

9.2.3.1_D.4 Test description

9.2.3.1_D.4.1 Initial conditions

Initial conditions are a set of test configurations the UE needs to be tested in and the steps for the SS to take with the UE to reach the correct measurement state.

Configurations of PDSCH and PDCCH before measurement are specified in Annex C.2.

Test Environment: Normal as defined in TS 36.508 [7] clause 4.1.

Frequencies to be tested: Mid Range as defined in TS 36.508 [7] clause 4.3.1.1.

Channel Bandwidths to be tested: 10MHz, as defined in TS 36.508 [7] clause 4.3.1.1

1. Connect the SS, faders and AWGN noise source to the UE antenna connector (s) as shown in TS 36.508 [7] Annex A, Figure A.11.
2. The parameter settings for the cell are set up according to Table 9.2.3.1_D.3-1.
3. Downlink signals are initially set up according to Annex C.0, C.1 and Annex C.3.2 and uplink signals according to Annex H.1 and H.3.2.
4. Propagation conditions are set according to Annex B.0.
5. Ensure the UE is in State 3A-RF according to TS 36.508 [7] clause 5.2A.2. Message contents are defined in clause 9.2.3.1_D.4.3.

9.2.3.1_D.4.2 Test procedure

1. Set the parameters of bandwidth, reference channel, the propagation condition, antenna configuration and the SNR according to Table 9.2.3.1_D.3-1 as appropriate.
2. The SS shall transmit PDSCH via PDCCH DCI format 2C for C_RNTI to transmit the DL RMC (Table A.4-1a) including two codewords with spatial multiplexing both using the transport format according to CQI value 8 of Annex A.4 Table A.4-3c and keep them regardless of the wideband CQI value sent by the UE. The SS sends downlink MAC padding bits on the DL RMC. The SS shall use a fixed precoding matrix specified by the bitmap parameter *codebookSubsetRestriction*. The SS sends uplink scheduling information via PDCCH DCI format 0 with CQI request bit set to 0 to schedule UL RMC in subframe #0 and subframe #5 (Table A.4-1a). The UE will send ACK/NACK and periodic CQI report using PUSCH. Continue transmission of the PDSCH until 2000 wideband and wideband spatial differential CQI reports have been gathered. In this process the SS collects wideband and wideband spatial differential CQI reports every 5 ms and also cases where UE transmits nothing in its CQI timing are also counted as wideband and wideband spatial differential CQI reports respectively.
3. From each wideband CQI report, wideband CQI₀ is defined as Wideband CQI of codeword #0 and wideband CQI₁ is calculated according to clause 9.2.2.1_D.3. Codeword 1 offset level is selected from {0,1,2,3,-4,-3,-2,-1}. Set up a relative frequency distribution for the wideband CQI-values, reported. Calculate the median value (wideband Median CQI is the CQI that is at or crosses 50% distribution from the lower wideband CQI side) for each codewords. Wideband Median CQI₀ is based on the wideband CQI₀ and wideband median CQI₁ is based on the wideband CQI₁.
4. If Median CQI is not equal to 1 or 15 and 1800 or more of the wideband CQI₁ values are in the range (Median CQI₁ - 1) ≤ Median CQI ≤ (Median CQI₁ + 1) then continue with step 5, otherwise go to step 7.
5. The SS shall transmit PDSCH via PDCCH DCI format 2C for C_RNTI to transmit the DL RMC (Table A.4-1a) including two codewords with spatial multiplexing where the transport format of codeword #0 is according to the wideband median- CQI₀- 1 and the transport format of codeword #1 is according to the wideband median CQI₁- 1. The SS sends downlink MAC padding bits on the DL RMC. The SS shall not react to the any wideband CQI reports from UE and shall use a fixed precoding matrix specified by the bitmap parameter *codebookSubsetRestriction*. The SS sends uplink scheduling information via PDCCH DCI format 0 with CQI request bit set to 0 to schedule UL RMC in subframe #0 and subframe #5 (Table A.4-1a). The UE will send ACK/NACK and periodic CQI report using PUSCH. For any PDSCH transmitted by the SS, record the associated ACK, NACK and statDTX responses for each codewords respectively. The responses are then filtered as follows: for the sequence of responses for each HARQ process, discard all the statDTX responses. Continue to gather data until the number of filtered ACK+NACK responses for each codewords reaches 1000.

If the ratio (NACK /ACK + NACK) ≤ 0.1 for both codeword #0 and codeword #1

then and go to step 6, otherwise go to step 7.

6. The SS shall transmit PDSCH via PDCCH DCI format 2C for C_RNTI to transmit the DL RMC (Table A.4-1a) including two codewords with spatial multiplexing where the transport format of codeword #0 is according to

the wideband median-CQI₀ + 1 and the transport format of codeword #1 is according to the wideband median-CQI₁ + 1. The SS sends downlink MAC padding bits on the DL RMC. The SS shall not react to the any wideband CQI reports from UE and shall use a fixed precoding matrix specified by the bitmap parameter *codebookSubsetRestriction*. The SS sends uplink scheduling information via PDCCH DCI format 0 with CQI request bit set to 0 to schedule UL RMC in subframe #0 and subframe #5 (Table A.4-1a). The UE will send ACK/NACK and periodic CQI report using PUSCH. For any PDSCH transmitted by the SS, record the associated ACK, NACK and statDTX responses for each codewords respectively. The responses are then filtered as follows: for the sequence of responses for each HARQ process, discard all the statDTX responses. Continue to gather data until the number of filtered ACK+NACK responses for each codewords reaches 1000.

If the ratio (NACK /ACK + NACK) ≥ 0.1 for both codeword #0 and codeword #1

then pass the UE for this test and go to step 8, otherwise go to step 7.

7. If both SNR points of the test have not been tested, then repeat the same procedure (steps 1 to 6) for the other SNR point as appropriate. Otherwise fail the UE.
8. If both tests have not been done, then repeat the same procedure (steps 1 to 7) with test conditions according to the table 9.2.3.1_D.3-1 for the other Test as appropriate. Otherwise pass the UE.

9.2.3.1_D.4.3 Message contents

Message contents are according to TS 36.508 [7] clause 4.6 with the following exceptions:

Table 9.2.3.1_D.4.3-1: PhysicalConfigDedicated-DEFAULT

Derivation Path: 36.508 clause 4.6.3			
Information Element	Value/remark	Comment	Condition
RadioResourceConfigDedicated-SRB2-DRB(n, m) ::= SEQUENCE {			
physicalConfigDedicated	<i>CQI-ReportConfig-r10-DEFAULT</i> using condition RBC		
antennaInfo CHOICE {			
explicitValue	AntennaInfoDedicated		
}			
}			

Table 9.2.3.1_D.4.3-2: PDSCH-ConfigDedicated-DEFAULT

Derivation Path: 36.331 clause 6.3.2			
Information Element	Value/remark	Comment	Condition
PDSCH-ConfigDedicated-DEFAULT ::= SEQUENCE {			
p-a	dB0		
}			

Table 9.2.3.1_D.4.3-3: AntennaInfoDedicated-r10

Derivation Path: 36.331 clause 6.3.2			
Information Element	Value/remark	Comment	Condition
AntennaInfoDedicated-r10 ::= SEQUENCE {			
transmissionMode-r10	tm9-v1020		
codebookSubsetRestriction-r10	0x0000 0000 0100 0000		
}			
ue-TransmitAntennaSelection CHOICE {			
release	NULL		
}			

Table 9.2.3.1_D.4.3-4: CQI-ReportConfig-r10-DEFAULT

Derivation Path: 36.508 clause 4.6.3			
Information Element	Value/remark	Comment	Condition
CQI-ReportConfig-r10 ::= SEQUENCE {			
cqi-ReportModeAperiodic-r10	Not Present		
nomPDSCH-RS-EPRE-Offset	0		
cqi-ReportPeriodic-r10	CQI-ReportPeriodic-r10-DEFAULT		
}			

Table 9.2.3.1_D.4.3-5: CQI-ReportPeriodic-r10-DEFAULT

Derivation Path: 36.508 clause 4.6.3			
Information Element	Value/remark	Comment	Condition
CQI-ReportPeriodic-r10 ::= CHOICE {			
setup SEQUENCE {			
cqi-PUCCH-ResourceIndex-r10	0		
cqi-PUCCH-ResourceIndexP1-r10	Not present		
cqi-pmi-ConfigIndex	2	(see Table 7.2.2-1A in TS 36.213)	
cqi-FormatIndicatorPeriodic-r10 CHOICE {			
widebandCQI-r10 SEQUENCE {			
csi-ReportMode-r10	Not present		
}			
ri-ConfigIndex	1	(see Table 7.2.2-1B in TS 36.213)	
simultaneousAckNackAndCQI	FALSE		
}			
}			

Table 9.2.3.1_D.4.3-6: CSI-RS-Config

Derivation Path: 36.331 clause 6.3.2			
Information Element	Value/remark	Comment	Condition
CSI-RS-Config-r10 ::= SEQUENCE {			
csi-RS-r10 CHOICE {			
release	NULL		
setup SEQUENCE {			
antennaPortsCount-r10	an4	Parameter represents the number of antenna ports used for transmission of CSI reference signals	
resourceConfig-r10	0	Parameter: CSI reference signal configuration	
subframeConfig-r10	1	$\Delta_{\text{CSI-RS}} = I_{\text{CSI-RS}}$ when CSI-RS SubframeConfig is from 0-4; Parameter: $I_{\text{CSI-RS}}$	
p-C-r10	-3	Parameter: P_c which is the assumed ratio of PDSCH EPRE to CSI-RS EPRE when UE derives CSI feedback	
}			
}			
}			

9.2.3.1_D.5 Test requirement

The pass fail decision is as specified in the test procedure in clause 9.2.3.1_D.4.2.

There are no parameters in the test setup or measurement process whose variation impacts the results so there are no applicable test tolerances for this test.

9.2.3.2_D TDD CQI Reporting under AWGN conditions – PUCCH 1-1 for eDL-MIMO

Editor's note: SS vendors have not decided on the 8x2 antenna configuration due to test system complexity and cost

9.2.3.2_D.1 Test purpose

To verify the variance of the wideband spatial differential CQI between codeword #0 and codeword #1 are within the limits defined and for both codeword #0 and codeword #1, the PDSCH BLER using the transport format indicated by the respective median $\text{CQI}_0 - 1$ and median $\text{CQI}_1 - 1$ shall be less than or equal to 0.1 and the PDSCH BLER using the transport format indicated by the respective median $\text{CQI}_0 + 1$ and median $\text{CQI}_1 + 1$ shall be greater than or equal to 0.1.

9.2.3.2_D.2 Test applicability

This test applies to all types of E-UTRA TDD UE release 10 and forward that support eDL-MIMO. Applicability requires support for FGI bit 104.

9.2.3.2_D.3 Minimum conformance requirements

The minimum requirements for dual codeword transmission are defined in terms of a reporting spread of the wideband CQI value for codeword #1, and their BLER performance using the transport format indicated by the reported CQI median of codeword #0 and codeword #1. The precoding used at the transmitter is a fixed precoding matrix specified by the bitmap parameter *codebookSubsetRestriction*. The propagation condition assumed for the minimum performance requirement is defined in subclause B.1.

For the parameters specified in table 9.2.3.2_D.3-1, and using the downlink physical channels specified in tables C.3.2-1 and C.3.2-2, the reported offset level of the wideband spatial differential CQI for codeword #1 (Table 7.2 -2 in TS 36.213 [10]) shall be used to determine the wideband CQI index for codeword #1 as

$$\text{wideband CQI}_1 = \text{wideband CQI}_0 - \text{Codeword 1 offset level}$$

The wideband CQI₁ shall be within the set {median CQI₁ -1, median CQI₁ +1} for more than 90% of the time, where the resulting wideband values CQI₁ shall be used to determine the median CQI values for codeword #1. For both codewords #0 and #1, the PDSCH BLER using the transport format indicated by the respective median CQI₀ - 1 and median CQI₁ - 1 shall be less than or equal to 0.1. Furthermore, for both codewords #0 and #1, the PDSCH BLER using the transport format indicated by the respective median CQI₀ + 1 and median CQI₁ + 1 shall be greater than or equal to 0.1.

Table 9.2.3.2_D.3-1: PUCCH 1-1 static test (TDD)

Parameter		Unit	Test 1		Test 2	
Bandwidth		MHz	10			
PDSCH transmission mode			9			
Uplink downlink configuration			2			
Special subframe configuration			4			
Downlink power allocation	ρ_A	dB	0			
	ρ_B	dB	0			
	P_c	dB	-6			
	σ	dB	0			
CRS reference signals			Antenna ports 0, 1			
CSI reference signals			Antenna ports 15,...,22			
Beamforming model			As specified in Annex B.4.3			
CSI-RS periodicity and subframe offset $T_{\text{CSI-RS}} / \Delta_{\text{CSI-RS}}$			5/3			
CSI reference signal configuration			0			
Propagation condition and antenna configuration			Clause B.1 (8 x 2)			
CodeBookSubsetRestriction bitmap			0x0000 0000 0020 0000 0000 0001 0000			
SNR (Note 2)		dB	4	5	10	11
$\hat{I}_{or}^{(j)}$		dB[mW/15kHz]	-94	-93	-88	-87
$N_{oc}^{(j)}$		dB[mW/15kHz]	-98		-98	
Max number of HARQ transmissions			1			
Physical channel for CQI/PMI reporting			PUSCH (Note 3)			
PUCCH Report Type for CQI/second PMI			2b			
Physical channel for RI reporting			PUSCH			
PUCCH Report Type for RI/ first PMI			5			
Reporting periodicity		ms	$N_{pd} = 5$			
CQI delay		ms	10 or 11			
<i>cqi-pmi-ConfigurationIndex</i>			3			
<i>ri-ConfigIndex</i>			805 (Note 4)			
ACK/NACK feedback mode			Multiplexing			
<p>Note 1: Reference measurement channel according to Table A.4-2a with one sided dynamic OCNG Pattern OP.1 TDD as described in Annex A.5.2.1.</p> <p>Note 2: For each test, the minimum requirements shall be fulfilled for at least one of the two SNR(s) and the respective wanted signal input level.</p> <p>Note 3: To avoid collisions between CQI/PMI reports and HARQ-ACK it is necessary to report both on PUSCH instead of PUCCH. PDCCH DCI format 0 shall be transmitted in downlink SF#3 and #8 to allow periodic CQI/PMI to multiplex with the HARQ-ACK on PUSCH in uplink SF#7 and #2.</p> <p>Note 4: RI reporting interval is set to the maximum allowable length of 160ms to minimise collisions between RI, CQI/PMI and HARQ-ACK reports. In the case when all three reports collide, it is expected that CQI/PMI reports will be dropped, while RI and HARQ-ACK will be multiplexed. At eNB, CQI report collection shall be skipped every 160ms during performance verification.</p>						

The normative reference for this requirement is TS 36.101 [2] clause 9.2.3.2.

9.2.3.2_D.4 Test description

9.2.3.2_D.4.1 Initial conditions

Initial conditions are a set of test configurations the UE needs to be tested in and the steps for the SS to take with the UE to reach the correct measurement state.

Configurations of PDSCH and PDCCH before measurement are specified in Annex C.2.

Test Environment: Normal as defined in TS 36.508 [7] clause 4.1.

Frequencies to be tested: Mid Range as defined in TS 36.508 [7] clause 4.3.1.2.

Channel Bandwidths to be tested: 10MHz, as defined in TS 36.508 [7] clause 4.3.1.2

1. Connect the SS, faders and AWGN noise source to the UE antenna connector (s) as shown in TS 36.508 [7] Annex A, Figure [TBD].
2. The parameter settings for the cell are set up according to Table 9.2.3.2_D.3-1.
3. Downlink signals are initially set up according to Annex C.0, C.1 and Annex C.3.2 and uplink signals according to Annex H.1 and H.3.2.
4. Propagation conditions are set according to Annex B.0.
5. Ensure the UE is in State 3A-RF according to TS 36.508 [7] clause 5.2A.2. Message contents are defined in clause 9.2.3.2_D.4.3.

9.2.3.2_D.4.2 Test procedure

1. Set the parameters of bandwidth, reference channel, the propagation condition, antenna configuration and the SNR according to Table 9.2.3.2_D.3-1 as appropriate.
2. The SS shall transmit PDSCH via PDCCH DCI format 2C for C_RNTI to transmit the DL RMC (Table A.4-2a) including two codewords with spatial multiplexing both using the transport format according to CQI value 8 of Annex A.4 Table A.4-3d and keep them regardless of the wideband CQI value sent by the UE. The SS sends downlink MAC padding bits on the DL RMC. The SS shall use a fixed precoding matrix specified by the bitmap parameter *codebookSubsetRestriction*. The SS sends uplink scheduling information via PDCCH DCI format 0 with CQI request bit set to 0 to schedule UL RMC in subframe #2 and subframe #7 (Table A.4-2a). The UE will send ACK/NACK and periodic CQI report using PUSCH. Continue transmission of the PDSCH until 2000 wideband and wideband spatial differential CQI reports have been gathered. In this process the SS collects wideband and wideband spatial differential CQI reports every 5 ms and also cases where UE transmits nothing in its CQI timing are counted as wideband and wideband spatial differential CQI reports respectively.
3. From each wideband CQI report, wideband CQI₀ is defined as Wideband CQI of codeword #0 and wideband CQI₁ is calculated according to clause 9.2.3.2_D.3. Codeword 1 offset level is selected from {0,1,2,3,-4,-3,-2,-1}. Set up a relative frequency distribution for the wideband CQI-values, reported. Calculate the median value (wideband Median CQI is the CQI that is at or crosses 50% distribution from the lower wideband CQI side) for each codewords. Wideband Median CQI₀ is based on the wideband CQI₀ and wideband median CQI₁ is based on the wideband CQI₁.
4. If Median CQI is not equal to 1 or 15 and 1800 or more of the wideband CQI₁ values are in the range (Median CQI₁ - 1) ≤ Median CQI ≤ (Median CQI₁ + 1) then continue with step 5, otherwise go to step 7.
5. The SS shall transmit PDSCH via PDCCH DCI format 2C for C_RNTI to transmit the DL RMC (Table A.4-2a) including two codewords with spatial multiplexing where the transport format of codeword #0 is according to the wideband median- CQI₀- 1 and the transport format of codeword #1 is according to the wideband median CQI₁- 1. The SS sends downlink MAC padding bits on the DL RMC. The SS shall not react to the any wideband CQI reports from UE and shall use a fixed precoding matrix specified by the bitmap parameter *codebookSubsetRestriction*. The SS sends uplink scheduling information via PDCCH DCI format 0 with CQI request bit set to 0 to schedule UL RMC in subframe #2 and subframe #7 (Table A.4-2a). The UE will send ACK/NACK and periodic CQI report using PUSCH. For any PDSCH transmitted by the SS, record the associated ACK, NACK and statDTX responses for each codewords respectively. *In case statDTX can not be differentiated from NACK due to multiplexing effect, evaluate the feedback as a NACK* The responses are then

filtered as follows: for the sequence of responses for each HARQ process, discard all the statDTX responses. Continue to gather data until the number of filtered ACK+NACK responses for each codewords reaches 1000.

If the ratio $(\text{NACK} / \text{ACK} + \text{NACK}) \leq 0.1$

then, and go to step 6, otherwise go to step 7.

6. The SS shall transmit PDSCH via PDCCH DCI format 2C for C_RNTI to transmit the DL RMC (Table A.4-2a) including two codewords with spatial multiplexing where the transport format of codeword #0 is according to the wideband median-CQI₀ + 1 and the transport format of codeword #1 is according to the wideband median-CQI₁ + 1. The SS sends downlink MAC padding bits on the DL RMC. The SS shall not react to the any wideband CQI reports from UE and shall use a fixed precoding matrix specified by the bitmap parameter *codebookSubsetRestriction*. The SS sends uplink scheduling information via PDCCH DCI format 0 with CQI request bit set to 0 to schedule UL RMC in subframe #2 and subframe #7 (Table A.4-2a). The UE will send ACK/NACK and periodic CQI report using PUSCH. For any PDSCH transmitted by the SS, record the associated ACK, NACK and statDTX responses for each codewords respectively. *In case statDTX can not be differentiated from NACK due to multiplexing effect, evaluate the feedback as a NACK*. The responses are then filtered as follows: for the sequence of responses for each HARQ process, discard all the statDTX responses. Continue to gather data until the number of filtered ACK+NACK responses for each codewords reaches 1000.

If the ratio $(\text{NACK} / \text{ACK} + \text{NACK}) \geq 0.1$

then pass the UE for this test and go to step 8, otherwise go to step 7.

7. If both SNR points of the test have not been tested, then repeat the same procedure (steps 1 to 6) for the other SNR point as appropriate. Otherwise fail the UE.
8. If both tests have not been done, then repeat the same procedure (steps 1 to 7) with test conditions according to the table 9.2.3.2_D.3-1 for the other Test as appropriate. Otherwise pass the UE.

9.2.3.2_D.4.3 Message contents

Message contents are according to TS 36.508 [7] clause 4.6 with the following exceptions:

Table 9.2.3.2_D.4.3-1: PhysicalConfigDedicated-DEFAULT

Derivation Path: 36.508 clause 4.6.3			
Information Element	Value/remark	Comment	Condition
RadioResourceConfigDedicated-SRB2-DRB(n, m) ::= SEQUENCE {			
physicalConfigDedicated	CQI-ReportConfig-r10-DEFAULT using condition RBC		
antennaInfo CHOICE {			
explicitValue	AntennaInfoDedicated		
}			
}			

Table 9.2.3.2_D.4.3-2: PDSCH-ConfigDedicated-DEFAULT

Derivation Path: TS 36.508 [7] clause 4.6.3, Table 4.6.3-6 PDSCH-ConfigDedicated-DEFAULT			
Information Element	Value/remark	Comment	Condition
PDSCH-ConfigDedicated-DEFAULT ::= SEQUENCE {			
p-a	dB0		
}			

Table 9.2.3.2_D.4.3-3: *AntennaInfoDedicated-r10*

Derivation Path: 36.331 clause 6.3.2			
Information Element	Value/remark	Comment	Condition
AntennaInfoDedicated-r10 ::= SEQUENCE {			
transmissionMode-r10	tm9-v1020		
codebookSubsetRestriction-r10	0x0000 0000 0020 0000 0000 0001 0000		
}			
ue-TransmitAntennaSelection CHOICE {			
release	NULL		
}			

Table 9.2.3.2_D.4.3-4: *CQI-ReportConfig-r10-DEFAULT*

Derivation Path: 36.508 clause 4.6.3			
Information Element	Value/remark	Comment	Condition
CQI-ReportConfig-r10 ::= SEQUENCE {			
cqi-ReportModeAperiodic-r10	Not Present		
nomPDSCH-RS-EPRE-Offset	0		
cqi-ReportPeriodic-r10	CQI-ReportPeriodic-r10- DEFAULT		
}			

Table 9.2.3.2_D.4.3-5: *CQI-ReportPeriodic-r10-DEFAULT*

Derivation Path: 36.508 clause 4.6.3			
Information Element	Value/remark	Comment	Condition
CQI-ReportPeriodic-r10 ::= CHOICE {			
setup SEQUENCE {			
cqi-PUCCH-ResourceIndex-r10	0		
cqi-PUCCH-ResourceIndexP1-r10	Not present		
cqi-pmi-ConfigIndex	3	(see Table 7.2.2- 1A in TS 36.213)	
cqi-FormatIndicatorPeriodic-r10 CHOICE {			
widebandCQI-r10 SEQUENCE {			
csi-ReportMode-r10	Not present		
}			
ri-ConfigIndex	805	(see Table 7.2.2- 1B in TS 36.213)	
simultaneousAckNackAndCQI	FALSE		
}			
}			

Table 9.2.3.2_D.4.3-6: *TDD-Config-DEFAULT*

Derivation Path: 36.508 clause 4.6.3			
Information Element	Value/remark	Comment	Condition
TDD-Config-DEFAULT ::= SEQUENCE {			
subframeAssignment	sa2		
specialSubframePatterns	ssp4		
}			

Table 9.2.3.2_D.4.3-7: PUCCH-ConfigDedicated-DEFAULT

Derivation Path: 36.331 clause 6.3.2			
Information Element	Value/remark	Comment	Condition
PUCCH-ConfigDedicated-DEFAULT ::= SEQUENCE {			
ackNackRepetition CHOICE {			
release	NULL		
}			
tddAckNackFeedbackMode	Multiplexing	Multiplexing is selected as default to align with RAN4's assumptions in RF tests.	TDD
}			

Table 9.2.3.2_D.4.3-8: CSI-RS-Config

Derivation Path: 36.331 clause 6.3.2			
Information Element	Value/remark	Comment	Condition
CSI-RS-Config-r10 ::= SEQUENCE {			
csi-RS-r10 CHOICE {			
release	NULL		
setup SEQUENCE {			
antennaPortsCount-r10	an8	Parameter represents the number of antenna ports used for transmission of CSI reference signals	
resourceConfig-r10	0	Parameter: CSI reference signal configuration	
subframeConfig-r10	3	$\Delta_{\text{CSI-RS}} = I_{\text{CSI-RS}}$ when CSI-RS SubframeConfig is from 0-4; Parameter: $I_{\text{CSI-RS}}$	
p-C-r10	-6	Parameter: P_c which is the assumed ratio of PDSCH EPRE to CSI-RS EPRE when UE derives CSI feedback	
}			
}			
}			

9.2.3.2_D.5 Test requirement

The pass fail decision is as specified in the test procedure in clause 9.2.3.2_D.4.2.

There are no parameters in the test setup or measurement process whose variation impacts the results so there are no applicable test tolerances for this test.

9.3 CQI Reporting under fading conditions

9.3.1 Frequency-selective scheduling mode

The accuracy of sub-band channel quality indicator (CQI) reporting under frequency selective fading conditions is determined by a double-sided percentile of the reported differential CQI offset level 0 per sub-band, and the relative increase of the throughput obtained when transmitting on any one of the sub-bands with the highest reported differential CQI offset level the corresponding transport format compared to the case for which a fixed format is transmitted on any sub-band in set of TS 36.213 [10]. To account for sensitivity of the input SNR the sub-band CQI reporting under frequency selective fading conditions is considered to be verified if the reporting accuracy is met for at least one of two SNR levels separated by an offset of 1 dB.

9.3.1.1 CQI Reporting under fading conditions – PUSCH 3-0 (Cell-Specific Reference Symbols)

9.3.1.1.1 FDD CQI Reporting under fading conditions – PUSCH 3-0

9.3.1.1.1.1 Test purpose

To verify that preferred sub-bands can be used for frequently-selective scheduling.

9.3.1.1.1.2 Test applicability

This test applies to all types of E-UTRA FDD UE release 8 and forward.

9.3.1.1.1.3 Minimum conformance requirements

For the parameters specified in Table 9.3.1.1.1.3-1, and using the downlink physical channels specified in Annex C, the minimum requirements are specified in Table 9.3.1.1.1.3-2 and by the following

- a) a sub-band differential CQI offset level of 0 shall be reported at least α % of the time but less than β % for each sub-band;
- b) the ratio of the throughput obtained when transmitting a randomly selected sub-band among the sub-bands with the highest differential CQI offset level the corresponding TBS and that obtained when transmitting the TBS indicated by the reported wideband CQI median on a randomly selected sub-band in set S shall be $\geq \gamma$;
- c) when transmitting a randomly selected sub-band among the sub-bands with the highest differential CQI offset level the corresponding TBS, the average BLER for the indicated transport formats shall be greater or equal to 0.05.

The requirements only apply for sub-bands of full size and the random scheduling across the sub-bands is done by selecting a new sub-band in each TTI. The transport block size TBS(wideband CQI median) is that resulting from the code rate which is closest to that indicated by the wideband CQI median and the N_{PRB} entry in Table 7.1.7.2.1-1 of TS 36.213 [10] that corresponds to the sub-band size.

Table 9.3.1.1.1.3-1: Sub-band test for single antenna transmission (FDD)

Parameter		Unit	Test 1		Test 2	
Bandwidth		MHz	10 MHz			
Transmission mode			1 (port 0)			
Downlink power allocation	ρ_A	dB	0			
	ρ_B	dB	0			
	σ	dB	0			
SNR (Note 3)		dB	9	10	14	15
$\hat{I}_{or}^{(j)}$		dB[mW/15kHz]	-89	-88	-84	-83
$N_{oc}^{(j)}$		dB[mW/15kHz]	-98		-98	
Propagation channel			Clause B.2.4 with $\tau_d = 0.45 \mu s$, $a = 1$, $f_D = 5$ Hz			
Antenna configuration			1x2			
Reporting interval		ms	5			
CQI delay		ms	8			
Reporting mode			PUSCH 3-0			
Sub-band size		RB	6 (full size)			
Max number of HARQ transmissions			1			
<p>Note 1: If the UE reports in an available uplink reporting instance at subframe SF#n based on CQI estimation at a downlink subframe not later than SF#(n-4), this reported subband or wideband CQI cannot be applied at the eNB downlink before SF#(n+4).</p> <p>Note 2: Reference measurement channel according to Table A.4-4 with one/two sided dynamic OCNG Pattern OP.1/2 FDD as described in Annex A.5.1.1/2.</p> <p>Note 3: For each test, the minimum requirements shall be fulfilled for at least one of the two SNR(s) and the respective wanted signal input level.</p>						

Table 9.3.1.1.1.3-2: Minimum requirement (FDD)

Parameter	Test 1	Test 2
α [%]	2	2
β [%]	55	55
γ	1.1	1.1
UE Category	1-8	1-8

The normative reference for this requirement is TS 36.101 [2] clause 9.3.1.1.1.

9.3.1.1.1.4 Test description

9.3.1.1.1.4.1 Initial conditions

Initial conditions are a set of test configurations the UE needs to be tested in and the steps for the SS to take with the UE to reach the correct measurement state.

Configurations of PDSCH and PDCCH before measurement are specified in Annex C.2.

Test Environment: Normal as defined in TS 36.508 [7] clause 4.1.

Frequencies to be tested: Mid Range as defined in TS 36.508 [7] clause 4.3.1.1.

Channel Bandwidths to be tested: 10MHz, as defined in TS 36.508 [7] clause 4.3.1.1

1. Connect the SS, faders and AWGN noise source to the UE antenna connector (s) as shown in TS 36.508 [7] Annex A, Figure A.9.
2. The parameter settings for the cell are set up according to Table 9.3.1.1.1.3-1.

3. Downlink signals are initially set up according to Annex C0, C.1 and Annex C.3.2, and uplink signals according to Annex H.1 and H.3.2.
4. Propagation conditions are set according to Annex B.0.
5. Ensure the UE is in State 3A-RF according to TS 36.508 [7] clause 5.2A.2. Message contents are defined in clause 9.3.1.1.4.3.

9.3.1.1.4.2 Test procedure

1. Set the parameters of bandwidth, reference Channel, the propagation condition, antenna configuration and the SNR according to Table 9.3.1.1.3-1 as appropriate.
2. The SS shall transmit PDSCH via PDCCH DCI format 1A for C_RNTI to transmit the DL RMC (Table A.4-4) according to CQI value 8 of Annex A.4 Table A.4-3 and keep it regardless of the wideband and subband CQI value sent by the UE. Continue transmission of the PDSCH until 2000 wideband CQI reports and full-size subband CQI reports for each full-size subband have been gathered. The SS sends downlink MAC padding bits on the DL RMC. SS schedules the UL transmission every 5 ms to carry the PUSCH CQI feedback via PDCCH DCI format 0 with CQI request bit set to 1 and I_MCS=29 and N_PRB allocated to be less or equal to 4. In this process the SS collects wideband CQI reports every 5 ms and also cases where UE transmits nothing in its CQI timing are counted as wideband CQI and full-size subband CQI reports.
3. Set up a relative frequency distribution for the reported wideband CQI-values, Calculate the median value (wideband Median CQI is the CQI that is at or crosses 50% distribution from the lower wideband CQI side). This CQI-value is declared as wideband Median CQI value.
4. Check if “ $2000 \cdot \alpha \% / 100 \leq \text{number of CQI reports with index } 0 \text{ for each full-size subband} \leq 2000 \cdot \beta \% / 100$ ”. (2000= No of full-size subband reports, 100 because of %) If yes, continue with step5, otherwise goto step 7.
5. The SS shall transmit PDSCH via PDCCH DCI format 1A for C_RNTI to transmit the DL RMC (Table A.4-4) according to the wideband median-CQI value in an each TTI randomly selected full-size subband regardless of UE wideband and full-size subband CQI report. Note that each full-size subband is selected in equal probability. The SS sends downlink MAC padding bits on the DL RMC. The transport format to be used is defined in Annex A.4 Table A.4-6. SS schedules the UL transmission every 5 ms to carry the PUSCH CQI feedback via PDCCH DCI format 0 with CQI request bit set to 1 and I_MCS=29 and N_PRB allocated to be less or equal to 4. Measure the average throughput according to Annex G.5.3. Declare the throughput as t_{median} .
6. The SS shall transmit PDSCH via PDCCH DCI format 1A for C_RNTI to transmit the DL RMC (Table A.4-4) according to the highest UE reported full-size subband CQI value in one full-size subband selected among the subbands in which UE reports the highest full-size subband CQI. Subband differential CQI offset level is selected from {0, 1, 2, -1}. Note that the SS shall send PDSCH in the same full-size subband until next UE report is available. In case when same full-size subbands are reported subsequently as subbands with highest full-size subband CQI, the SS shall select for transmission a different subband with respect to the last selection. The SS sends downlink MAC padding bits on the DL RMC. The transport format to be used is defined in Annex A.4 Table A.4-6. SS schedules the UL transmission every 5 ms to carry the PUSCH CQI feedback via PDCCH DCI format 0 with CQI request bit set to 1 and I_MCS=29 and N_PRB allocated to be less or equal to 4. Measure the average throughput and (NACK / (ACK + NACK)) according to Annex G.5.3. Declare the throughput as $t_{subband}$. If the ratio $(t_{subband} / t_{median}) \geq \gamma$ and (NACK / (ACK + NACK)) ≥ 0.05 , pass the UE for this test and go to step 8. Otherwise, go to step 7.
7. If both SNR points of the test have not been tested, then repeat the same procedure (steps 1 to 6) for the other SNR point as appropriate. Otherwise fail the UE.
8. If both tests have not been done, then repeat the same procedure (steps 1 to 7) with test conditions according to the table 9.3.1.1.3-1 for the other Test as appropriate. Otherwise pass the UE.

9.3.1.1.4.3 Message contents

Message contents are according to TS 36.508 [7] clause 4.6 with the following exceptions:

Table 9.3.1.1.4.3-1: PhysicalConfigDedicated-DEFAULT

Derivation Path: 36.508 clause 5.5.1.2			
Information Element	Value/remark	Comment	Condition
PhysicalConfigDedicated-DEFAULT ::= SEQUENCE {			
cqi-ReportConfig	<i>CQI-ReportConfig-DEFAULT</i>		
}			

Table 9.3.1.1.4.3-2: CQI-ReportConfig-DEFAULT

Derivation Path: 36.508 clause 4.6.3			
Information Element	Value/remark	Comment	Condition
CQI-ReportConfig-DEFAULT ::= SEQUENCE {			
cqi-ReportModeAperiodic	rm30		
nomPDSCH-RS-EPRE-Offset	0		
cqi-ReportPeriodic	Not present		
}			

9.3.1.1.1.5 Test requirement

Table 9.3.1.1.5-1: Test requirement (FDD)

Parameter	Test 1	Test 2
α [%]	2	2
β [%]	55	55
γ	1.09	1.09
BLER	0.05	0.05

To pass the test, α and β and γ and BLER must be fulfilled.

To pass the test, Test 1 and Test 2 must be passed.

To pass the test, one **or** the other SNR point within one test must be fulfilled.

9.3.1.1.2 TDD CQI Reporting under fading conditions – PUSCH 3-0

9.3.1.1.2.1 Test purpose

To verify that preferred sub-bands can be used for frequently-selective scheduling.

9.3.1.1.2.2 Test applicability

This test applies to all types of E-UTRA TDD UE release 8 and forward.

9.3.1.1.2.3 Minimum conformance requirements

For the parameters specified in Table 9.3.1.1.2.3-1, and using the downlink physical channels specified in Annex C, the minimum requirements are specified in Table 9.3.1.1.2.3-2 and by the following

- a sub-band differential CQI offset level of 0 shall be reported at least α % of the time but less than β % for each sub-band;
- the ratio of the throughput obtained when transmitting on a randomly selected sub-band among the sub-bands with the highest differential CQI offset level the corresponding TBS and that obtained when transmitting the TBS indicated by the reported wideband CQI median on a randomly selected sub-band in set S shall be $\geq \gamma$;

- c) when transmitting on a randomly selected sub-band among the sub-bands with the highest differential CQI offset level the corresponding TBS, the average BLER for the indicated transport formats shall be greater or equal to 0.05.

The requirements only apply for sub-bands of full size and the random scheduling across the sub-bands is done by selecting a new sub-band in each available downlink transmission instance]. The transport block size TBS(wideband CQI median) is that resulting from the code rate which is closest to that indicated by the wideband CQI median and the N_{PRB} entry in Table 7.1.7.2.1-1 of TS 36.213 [10] that corresponds to the sub-band size.

Table 9.3.1.1.2.3-1: Sub-band test for single antenna transmission (TDD)

Parameter		Unit	Test 1		Test 2	
Bandwidth		MHz	10 MHz			
Transmission mode			1 (port 0)			
Downlink power allocation	ρ_A	dB	0			
	ρ_B	dB	0			
	σ	dB	0			
Uplink downlink configuration			2			
Special subframe configuration			4			
SNR		dB	9	10	14	15
$N_{oc}^{(j)}$		dB[mW/15kHz]	-98		-98	
$\hat{I}_{or}^{(j)}$		dB[mW/15kHz]	-89	-88	-84	-83
Propagation channel			Clause B.2.4 with $\tau_d = 0.45 \mu s$ $a = 1, f_D = 5 \text{ Hz}$			
Antenna configuration			1 x 2			
Reporting interval		ms	5			
Minimum CQI delay		ms	10 or 11			
Reporting mode			PUSCH 3-0			
Sub-band size		RB	6 (full size)			
Max number of HARQ transmissions			1			
ACK/NACK feedback mode			Multiplexing			
<p>Note 1: If the UE reports in an available uplink reporting instance at subframe SF#n based on CQI estimation at a downlink subframe not later than SF#(n-4), this reported subband or wideband CQI cannot be applied at the eNB downlink before SF#(n+4)</p> <p>Note 2: Reference measurement channel according to Table A.4-5 with one/two sided dynamic OCNG Pattern OP.1/2 TDD as described in Annex A.5.2.1/2.</p> <p>Note 3: For each test, the minimum requirements shall be fulfilled for at least one of the two SNR(s) and the respective wanted signal input level.</p>						

Table 9.3.1.1.2.3-2: Minimum requirement (TDD)

Parameter	Test 1	Test 2
α [%]	2	2
β [%]	55	55
γ	1.1	1.1
UE Category	1-8	1-8

The normative reference for this requirement is TS 36.101 [2] clause 9.2.1.1.

9.3.1.1.2.4 Test description

9.3.1.1.2.4.1 Initial conditions

Initial conditions are a set of test configurations the UE needs to be tested in and the steps for the SS to take with the UE to reach the correct measurement state.

Configurations of PDSCH and PDCCH before measurement are specified in Annex C.2.

Test Environment: Normal as defined in TS 36.508 [7] clause 4.1.

Frequencies to be tested: Mid Range as defined in TS 36.508 [7] clause 4.3.1.2.

Channel Bandwidths to be tested: 10MHz, as defined in TS 36.508 [7] clause 4.3.1.2

1. Connect the SS to the UE antenna connector (s) as shown in TS 36.508 [7] Annex A, Figure A.9.
2. The parameter settings for the cell are set up according to Table 9.3.1.1.2.3-1.
3. Downlink signals are initially set up according to Annex C0, C.1 and Annex C.3.2, and uplink signals according to Annex H.1 and H.3.2.
4. Propagation conditions are set according to Annex B.0
5. Ensure the UE is in State 3A-RF according to TS 36.508 [7] clause 5.2A.2. Message contents are defined in clause 9.3.1.1.2.4.3.

9.3.1.1.2.4.2 Test procedure

1. Set the parameters of bandwidth, reference Channel, the propagation condition, antenna configuration and the SNR according to Table 9.3.1.1.2.3-1 as appropriate.
2. The SS shall transmit PDSCH via PDCCH DCI format 1A for C_RNTI to transmit the DL RMC (Table A.4-5) according to CQI value 8 of Annex A.4 Table A.4-3 and keep it regardless of the wideband and full-size subband CQI value sent by the UE. Continue transmission of the PDSCH until 2000 wideband CQI reports and full-size subband CQI report for each full-size subband have been gathered. The SS sends downlink MAC padding bits on the DL RMC. SS schedules the UL transmission in subframe #2 and subframe #7 to carry the PUSCH CQI feedback via PDCCH DCI format 0 with CQI request bit set to 1 and I_MCS=29 and N_PRB allocated to be less or equal to 4. In this process the SS collects wideband CQI reports every 5 ms and also cases where UE transmits nothing in its CQI timing are counted as wideband CQI and full-size subband CQI reports.
3. Set up a relative frequency distribution for the reported wideband CQI-values, Calculate the median value (wideband Median CQI is the CQI that is at or crosses 50% distribution from the lower wideband CQI side). This CQI-value is declared as wideband Median CQI value.
4. For each subband, if subband CQI of index 0 is reported, at least α % but less than β % of 2000 full-size subband CQI report, then continue to step 5, otherwise, go to step 7.
5. The SS shall send PDSCH via PDCCH DCI format 1A for C_RNTI to transmit the DL RMC (Table A.4-5) according to the wideband median-CQI value in an each available downlink transmission instance randomly selected full-size subband regardless of UE wideband and subband CQI report. Note that each full-size subband is selected in equal probability. The SS sends downlink MAC padding bits on the DL RMC. The transport format to be used is defined in Annex A.4 Table A.4-6. SS schedules the UL transmission in subframe #2 and subframe #7 to carry the PUSCH CQI feedback via PDCCH DCI format 0 with CQI request bit set to 1 and I_MCS=29 and N_PRB allocated to be less or equal to 4. Measure the average throughput according to Annex G.5.3 Declare the throughput as t_{median} .
6. The SS shall transmit PDSCH via PDCCH DCI format 1A for C_RNTI to transmit the DL RMC (Table A.4-5) according to the highest UE reported full-size subband CQI value in one full-size subband selected among the sub-bands in which UE report the highest full-size subband CQI. Subband differential CQI offset level is selected from {0, 1, 2, -1}. Note that the SS shall send PDSCH in the same full-size subband until next UE report is available. In case when same full-size subbands are reported subsequently as subbands with highest full-size subband CQI, the SS shall select for transmission a different subband with respect to the last selection. The SS sends downlink MAC padding bits on the DL RMC. The transport format to be used is defined in Annex

A.4 Table A.4-6. SS schedules the UL transmission in subframe #2 and subframe #7 to carry the PUSCH CQI feedback via PDCCH DCI format 0 with CQI request bit set to 1 and I_MCS=29 and N_PRB allocated to be less or equal to 4. Measure the average throughput and (NACK / (ACK + NACK)) according to Annex G.5.3.

Declare the throughput as $t_{subband}$. If the ratio $(t_{subband} / t_{median}) \geq \gamma$ and (NACK / (ACK + NACK)) \geq 0.05, pass the UE and go to step 8. Otherwise, go to step 7.

7. If both SNR points of the test have not been tested, then repeat the same procedure (steps 1 to 6) for the other SNR point as appropriate. Otherwise fail the UE.
8. If both tests have not been done, then repeat the same procedure (steps 1 to 7) with test conditions according to the table 9.3.1.1.2.3-1 for the other test as appropriate.

9.3.1.1.2.4.3 Message contents

Message contents are according to TS 36.508 [7] clause 4.6 with the following exceptions:

Table 9.3.1.1.2.4.3-1: PhysicalConfigDedicated-DEFAULT

Derivation Path: 36.508 clause 5.5.1.2			
Information Element	Value/remark	Comment	Condition
PhysicalConfigDedicated-DEFAULT ::= SEQUENCE {			
cqi-ReportConfig	CQI-ReportConfig-DEFAULT		
}			

Table 9.3.1.1.2.4.3-2: CQI-ReportConfig-DEFAULT

Derivation Path: 36.508 clause 4.6.3			
Information Element	Value/remark	Comment	Condition
CQI-ReportConfig-DEFAULT ::= SEQUENCE {			
cqi-ReportModeAperiodic	rm30		
nomPDSCH-RS-EPRE-Offset	0		
cqi-ReportPeriodic	Not present		
}			

Table 9.3.1.1.2.4.3-3: TDD-Config-DEFAULT

Derivation Path: 36.508 clause 4.6.3			
Information Element	Value/remark	Comment	Condition
TDD-Config-DEFAULT ::= SEQUENCE {			
subframeAssignment	Sa2		
specialSubframePatterns	Ssp4		
}			

9.3.1.1.2.5 Test requirement

Table 9.3.1.1.2.5-1: Test requirement (TDD)

Parameter	Test 1	Test 2
α [%]	2	2
β [%]	55	55
γ	1.09	1.09
BLER	0.05	0.05

To pass the test, α and β and γ and BLER must be fulfilled.

To pass the test, Test 1 and Test 2 must be passed.

To pass the test, one **or** the other SNR point within one test must be fulfilled.

9.3.1.2 CQI Reporting under fading conditions – PUSCH 3-1 (CSI Reference Symbols)

9.3.1.2.1_D FDD CQI Reporting under fading conditions – PUSCH 3-1 for eDL MIMO

9.3.1.2.1_D.1 Test purpose

To verify that preferred sub-bands can be used for frequently-selective scheduling.

9.3.1.2.1_D.2 Test applicability

This test applies to all types of E-UTRA FDD UE release 10 and forward that supports eDL MIMO. Applicability requires support for FGI bit 103.

9.3.1.2.1_D.3 Minimum conformance requirements

For the parameters specified in Table 9.3.1.2.1_D.3-1, and using the downlink physical channels specified in Annex C.3.2, the minimum requirements are specified in Table 9.3.1.2.1_D.3-2 and by the following:

- a) a sub-band differential CQI offset level of 0 shall be reported at least $\alpha\%$ of the time but less than $\beta\%$ for each sub-band;
- b) the ratio of the throughput obtained when transmitting a randomly selected sub-band among the sub-bands with the highest differential CQI offset level the corresponding TBS and that obtained when transmitting the TBS indicated by the reported wideband CQI median on a randomly selected sub-band in set S shall be $\geq \gamma$;
- c) when transmitting a randomly selected sub-band among the sub-bands with the highest differential CQI offset level the corresponding TBS, the average BLER for the indicated transport formats shall be greater or equal to 0.05.

The requirements only apply for sub-bands of full size and the random scheduling across the sub-bands is done by selecting a new sub-band in each TTI. The transport block size TBS(wideband CQI median) is that resulting from the code rate which is closest to that indicated by the wideband CQI median and subband CQI are selected according to Table A.4-6a or Table A.4-6b.

Table 9.3.1.2.1_D.3-1: Sub-band test for FDD

Parameter		Unit	Test 1		Test 2	
Bandwidth		MHz	10 MHz			
Transmission mode			9			
Downlink power allocation	ρ_A	dB	0			
	ρ_B	dB	0			
	P_c	dB	0			
	σ	dB	0			
SNR (Note 3)		dB	4	5	11	12
$\hat{I}_{or}^{(j)}$		dB[mW/15kHz]	-94	-93	-87	86
$N_{oc}^{(j)}$		dB[mW/15kHz]	-98		-98	
Propagation channel			Clause B.2.4 with $\tau_d = 0.45 \mu s, a = 1, f_D = 5 \text{ Hz}$			
Antenna configuration			2x2			
CRS reference signals			Antenna port 0			
CSI reference signals			Antenna ports 15, 16			
Beamforming model			Annex B.4.3			
CSI-RS periodicity and subframe offset $T_{\text{CSI-RS}} / \Delta_{\text{CSI-RS}}$			5/ 1			
CSI-RS reference signal configuration			4			
CodeBookSubsetRestriction bitmap			000001			
Reporting interval (Note 4)		Ms	5			
CQI delay		Ms	8			
Reporting mode			PUSCH 3-1			
Sub-band size		RB	6 (full size)			
Max number of HARQ transmissions			1			
<p>Note 1: If the UE reports in an available uplink reporting instance at subframe SF#n based on CQI estimation at a downlink subframe not later than SF#(n-4), this reported subband or wideband CQI cannot be applied at the eNB downlink before SF#(n+4)</p> <p>Note 2: Reference measurement channel according to Table A.4-4a with one/two sided dynamic OCN Pattern OP.1/2 FDD as described in Annex A.5.1.1/2.</p> <p>Note 3: For each test, the minimum requirements shall be fulfilled for at least one of the two SNR(s) and the respective wanted signal input level.</p> <p>Note 4: PDCCH DCI format 0 with a trigger for aperiodic CQI shall be transmitted in downlink SF#1 and #6 to allow aperiodic CQI/PMI/RI to be transmitted in uplink SF#0 and #5.</p>						

Table 9.3.1.2.1_D.3-2: Minimum requirement (FDD)

Parameter	Test 1	Test 2
α [%]	2	2
β [%]	40	40
γ	1.1	1.1
UE Category	1-8	1-8

The normative reference for this requirement is TS 36.101 [2] clause 9.3.1.2.1.

9.3.1.2.1_D.4 Test description

9.3.1.2.1_D.4.1 Initial conditions

Initial conditions are a set of test configurations the UE needs to be tested in and the steps for the SS to take with the UE to reach the correct measurement state.

Configurations of PDSCH and PDCCH before measurement are specified in Annex C.2.

Test Environment: Normal as defined in TS 36.508 [7] clause 4.1.

Frequencies to be tested: Mid Range as defined in TS 36.508 [7] clause 4.3.1.1.

Channel Bandwidths to be tested: 10MHz, as defined in TS 36.508 [7] clause 4.3.1.1

1. Connect the SS, faders and AWGN noise source to the UE antenna connector (s) as shown in TS 36.508 [7] Annex A, Figure A.10.
2. The parameter settings for the cell are set up according to Table 9.3.1.2.1_D.3-1.
3. Downlink signals are initially set up according to Annex C0, C.1 and Annex C.3.2, and uplink signals according to Annex H.1 and H.3.2.
4. Propagation conditions are set according to Annex B.0.
5. Ensure the UE is in State 3A-RF according to TS 36.508 [7] clause 5.2A.2. Message contents are defined in clause 9.3.1.2.1_D.4.3.

9.3.1.2.1_D.4.2 Test procedure

1. Set the parameters of bandwidth, reference Channel, the propagation condition, antenna configuration and the SNR according to Table 9.3.1.2.1_D.3-1 as appropriate.
2. The SS shall transmit PDSCH via PDCCH DCI format 2C for C_RNTI to transmit the DL RMC (Table A.4-4a) according to CQI value 8 of Annex A.4 Table A.4-3f and keep it regardless of the wideband and subband CQI value sent by the UE. Continue transmission of the PDSCH until 2000 wideband CQI reports and full-size subband CQI reports for each full-size subband have been gathered. The SS sends downlink MAC padding bits on the DL RMC. SS schedules the UL transmission in subframe #0 and subframe #5 to carry the PUSCH CQI feedback via PDCCH DCI format 0 with CQI request bit set to 1 and I_MCS=29 and N_PRB allocated to be less or equal to 4. In this process the SS collects wideband CQI reports every 5 ms and also cases where UE transmits nothing in its CQI timing are counted as wideband CQI and full-size subband CQI reports.
3. Set up a relative frequency distribution for the reported wideband CQI-values, Calculate the median value (wideband Median CQI is the CQI that is at or crosses 50% distribution from the lower wideband CQI side). This CQI-value is declared as wideband Median CQI value.
4. Check if “ $2000 * \alpha \% / 100 \leq \text{number of CQI reports with index } 0 \text{ for each full-size subband} \leq 2000 * \beta \% / 100$ ”. (2000= No of full-size subband reports, 100 because of %) If yes, continue with step5, otherwise goto step 7.
5. The SS shall transmit PDSCH via PDCCH DCI format 2C for C_RNTI to transmit the DL RMC (Table A.4-4a) according to the wideband median-CQI value in an each TTI randomly selected full-size subband regardless of UE wideband and full-size subband CQI report. Note that each full-size subband is selected in equal probability. The SS sends downlink MAC padding bits on the DL RMC. The transport format to be used is defined in Annex A.4 Table A.4-6b. SS schedules the UL transmission in subframe #0 and subframe #5 to carry the PUSCH CQI feedback via PDCCH DCI format 0 with CQI request bit set to 1 and I_MCS=29 and N_PRB allocated to be less or equal to 4. Measure the average throughput according to Annex G.5.3. Declare the throughput as t_{median} .
6. The SS shall transmit PDSCH via PDCCH DCI format 2C for C_RNTI to transmit the DL RMC (Table A.4-4a) according to the highest UE reported full-size subband CQI value in one full-size subband selected among the subbands in which UE reports the highest full-size subband CQI. Subband differential CQI offset level is selected from {0, 1, 2, -1}. Note that the SS shall send PDSCH in the same full-size subband until next UE report is available. In case when same full-size subbands are reported subsequently as subbands with highest full-size subband CQI, the SS shall select for transmission a different subband with respect to the last selection. The SS sends downlink MAC padding bits on the DL RMC. The transport format to be used is defined in Annex A.4 Table A.4-6b SS schedules the UL transmission in subframe #0 and subframe #5 to carry the PUSCH CQI feedback via PDCCH DCI format 0 with CQI request bit set to 1 and I_MCS=29 and N_PRB allocated to be less or equal to 4. Measure the average throughput and (NACK / (ACK + NACK)) according to Annex G.5.3. Declare the throughput as $t_{subband}$. If the ratio $(t_{subband} / t_{median}) \geq \gamma$ and (NACK / (ACK + NACK)) ≥ 0.05 , pass the UE for this test and go to step 8. Otherwise, go to step 7.
7. If both SNR points of the test have not been tested, then repeat the same procedure (steps 1 to 6) for the other SNR point as appropriate. Otherwise fail the UE.
8. If both tests have not been done, then repeat the same procedure (steps 1 to 7) with test conditions according to the table 9.3.1.2.1_D.3-1 for the other Test as appropriate. Otherwise pass the UE.

9.3.1.2.1_D.4.3 Message contents

Message contents are according to TS 36.508 [7] clause 4.6 and TS 36.331 clause 6.3.2 with the following exceptions:

Table 9.3.1.2.1_D.4.3-1: PhysicalConfigDedicated-DEFAULT

Derivation Path: 36.508 clause 4.6.3			
Information Element	Value/remark	Comment	Condition
RadioResourceConfigDedicated-SRB2-DRB(n, m) ::= SEQUENCE {			
physicalConfigDedicated	<i>CQI-ReportConfig-r10-DEFAULT</i> using condition RBC		
antennaInfo CHOICE {			
explicitValue	AntennaInfoDedicated		
}			
}			

Table 9.3.1.2.1_D.4.3-2: PDSCH-ConfigDedicated-DEFAULT

Derivation Path: 36.331 clause 6.3.2			
Information Element	Value/remark	Comment	Condition
PDSCH-ConfigDedicated-DEFAULT ::= SEQUENCE {			
p-a	dB0		
}			

Table 9.3.1.2.1_D.4.3-3: AntennaInfoDedicated-r10

Derivation Path: 36.331 clause 6.3.2			
Information Element	Value/remark	Comment	Condition
AntennaInfoDedicated-r10 ::= SEQUENCE {			
transmissionMode-r10	tm9-v1020		
codebookSubsetRestriction-r10	0x0000 0000 0000 0001		
}			
ue-TransmitAntennaSelection CHOICE {			
release	NULL		
}			

Table 9.3.1.2.1_D.4.3-4: CQI-ReportConfig-DEFAULT

Derivation Path: 36.508 clause 4.6.3			
Information Element	Value/remark	Comment	Condition
CQI-ReportConfig-r10 ::= SEQUENCE {			
cqi-ReportAperiodic-r10	rm31		
nomPDSCH-RS-EPRE-Offset	0		
cqi-ReportPeriodic-r10	Not present		
}			

Table 9.3.1.2.1_D.4.3-5: CSI-RS-Config

Derivation Path: 36.331 clause 6.3.2			
Information Element	Value/remark	Comment	Condition
CSI-RS-Config-r10 ::= SEQUENCE {			
csi-RS-r10 CHOICE{			
release	NULL		
setup SEQUENCE {			
antennaPortsCount-r10	an2	Parameter represents the number of antenna ports used for transmission of CSI reference signals	
resourceConfig-r10	4	Parameter: CSI reference signal configuration	
subframeConfig-r10	1	$\Delta_{\text{CSI-RS}} = I_{\text{CSI-RS}}$ when CSI-RS SubframeConfig is from 0-4; Parameter: $I_{\text{CSI-RS}}$	
p-C-r10	0	Parameter: P_c which is the assumed ratio of PDSCH EPRE to CSI-RS EPRE when UE derives CSI feedback	
}			
}			
}			

9.3.1.2.1_D.5 Test requirement

Table 9.3.1.1.5-1: Test requirement (FDD)

Parameter	Test 1	Test 2
α [%]	2	2
β [%]	40	40
γ	1.09	1.09
UE Category	1-8	1-8

To pass the test, α and β and γ and BLER must be fulfilled.

To pass the test, Test 1 and Test 2 must be passed.

To pass the test, one **or** the other SNR point within one test must be fulfilled.

9.3.1.2.2_D TDD CQI Reporting under fading conditions – PUSCH 3-1 for eDL MIMO

9.3.1.2.2_D.1 Test purpose

To verify that preferred sub-bands can be used for frequently-selective scheduling.

9.3.1.2.2_D.2 Test applicability

This test applies to all types of E-UTRA TDD UE release 10 and forward that supports eDL MIMO. Applicability requires support for FGI bit 103.

9.3.1.2.2_D.3 Minimum conformance requirements

For the parameters specified in Table 9.3.1.2.2_D.3-1, and using the downlink physical channels specified in Annex C.3.2, the minimum requirements are specified in Table 9.3.1.2.2_D.3-2 and by the following:

- a sub-band differential CQI offset level of 0 shall be reported at least $\alpha\%$ of the time but less than $\beta\%$ for each sub-band;
- the ratio of the throughput obtained when transmitting a randomly selected sub-band among the sub-bands with the highest differential CQI offset level the corresponding TBS and that obtained when transmitting the TBS indicated by the reported wideband CQI median on a randomly selected sub-band in set S shall be $\geq \gamma$;
- when transmitting a randomly selected sub-band among the sub-bands with the highest differential CQI offset level the corresponding TBS, the average BLER for the indicated transport formats shall be greater or equal to 0.05.

The requirements only apply for sub-bands of full size and the random scheduling across the sub-bands is done by selecting a new sub-band in each TTI. The transport block size TBS(wideband CQI median) is that resulting from the code rate which is closest to that indicated by the wideband CQI median and subband CQI are selected according to Table A.4-6a or Table A.4-6b.

Table 9.3.1.2.2_D.3-1: Sub-band test for TDD

Parameter		Unit	Test 1		Test 2	
Bandwidth		MHz	10 MHz			
Transmission mode			9			
Uplink downlink configuration			2			
Special subframe configuration			4			
Downlink power allocation	ρ_A	dB	0			
	ρ_B	dB	0			
	P_c	dB	0			
	σ	dB	0			
SNR (Note 3)		dB	4	5	11	12
$\hat{I}_{or}^{(j)}$		dB[mW/15kHz]	-94	-93	-87	-86
$N_{oc}^{(j)}$		dB[mW/15kHz]	-98		-98	
Propagation channel			Clause B.2.4 with $\tau_d = 0.45 \mu s, a = 1, f_D = 5 \text{ Hz}$			
Antenna configuration			2x2			
CRS reference signals			Antenna port 0			
CSI reference signals			Antenna ports 15,16			
Beamforming model			Annex B.4.3			
CSI-RS periodicity and subframe offset $T_{\text{CSI-RS}} / \Delta_{\text{CSI-RS}}$			5/3			
CSI-RS reference signal configuration			4			
CodeBookSubsetRestriction bitmap			000001			
Reporting interval (Note 4)		ms	5			
CQI delay		ms	10			
Reporting mode			PUSCH 3-1			
Sub-band size		RB	6 (full size)			
Max number of HARQ transmissions			1			
ACK/NACK feedback mode			Multiplexing			
Note 1: If the UE reports in an available uplink reporting instance at subframe SF#n based on CQI estimation at a downlink subframe not later than SF#(n-4), this reported subband or wideband CQI cannot be applied at the eNB downlink before SF#(n+4)						
Note 2: Reference measurement channel according to Table A.4-5a with one/two sided dynamic OCN Pattern OP.1/2 TDD as described in Annex A.5.2.1/2.						
Note 3: For each test, the minimum requirements shall be fulfilled for at least one of the two SNR(s) and the respective wanted signal input level.						
Note 4: PDCCH DCI format 0 with a trigger for aperiodic CQI shall be transmitted in downlink SF#3 and #8 to allow aperiodic CQI/PMI/RI to be transmitted on uplink SF#2 and #7.						

Table 9.3.1.2.2_D.3-2: Minimum requirement (TDD)

Parameter	Test 1	Test 2
α [%]	2	2
β [%]	40	40
γ	1.1	1.1
UE Category	1-8	1-8

The normative reference for this requirement is TS 36.101 [2] clause 9.3.1.2.2.

9.3.1.2.2_D.4 Test description

9.3.1.2.2_D.4.1 Initial conditions

Initial conditions are a set of test configurations the UE needs to be tested in and the steps for the SS to take with the UE to reach the correct measurement state.

Configurations of PDSCH and PDCCH before measurement are specified in Annex C.2.

Test Environment: Normal as defined in TS 36.508 [7] clause 4.1.

Frequencies to be tested: Mid Range as defined in TS 36.508 [7] clause 4.3.1.2.

Channel Bandwidths to be tested: 10MHz, as defined in TS 36.508 [7] clause 4.3.1.2

1. Connect the SS, faders and AWGN noise source to the UE antenna connector (s) as shown in TS 36.508 [7] Annex A, Figure A.10.
2. The parameter settings for the cell are set up according to Table 9.3.1.2.2_D.3-1.
3. Downlink signals are initially set up according to Annex C0, C.1 and Annex C.3.2, and uplink signals according to Annex H.1 and H.3.2.
4. Propagation conditions are set according to Annex B.0.
5. Ensure the UE is in State 3A-RF according to TS 36.508 [7] clause 5.2A.2. Message contents are defined in clause 9.3.1.2.2_D.4.3.

9.3.1.2.2_D.4.2 Test procedure

1. Set the parameters of bandwidth, reference Channel, the propagation condition, antenna configuration and the SNR according to Table 9.3.1.2.2_D.3-1 as appropriate.
2. The SS shall transmit PDSCH via PDCCH DCI format 2C for C_RNTI to transmit the DL RMC (Table A.4-5a) according to CQI value 10 of Annex A.4 Table A.4-3f and keep it regardless of the wideband and full-size subband CQI value sent by the UE. Continue transmission of the PDSCH until 2000 wideband CQI reports and full-size subband CQI report for each full-size subband have been gathered. The SS sends downlink MAC padding bits on the DL RMC. SS schedules the UL transmission in subframe #2 and subframe #7 to carry the PUSCH CQI feedback via PDCCH DCI format 0 with CQI request bit set to 1 and I_MCS=29 and N_PRB allocated to be less or equal to 4. In this process the SS collects wideband CQI reports every 5 ms and also cases where UE transmits nothing in its CQI timing are counted as wideband CQI and full-size subband CQI reports.
3. Set up a relative frequency distribution for the reported wideband CQI-values, Calculate the median value (wideband Median CQI is the CQI that is at or crosses 50% distribution from the lower wideband CQI side). This CQI-value is declared as wideband Median CQI value.
4. For each subband, if subband CQI of index 0 is reported, at least α % but less than β % of 2000 full-size subband CQI report, then continue to step 5, otherwise, go to step 7.
5. The SS shall send PDSCH via PDCCH DCI format 2C for C_RNTI to transmit the DL RMC (Table A.4-5a) according to the wideband median-CQI value in an each available downlink transmission instance randomly selected full-size subband regardless of UE wideband and subband CQI report. Note that each full-size subband is selected in equal probability. The SS sends downlink MAC padding bits on the DL RMC. The transport

format to be used is defined in Annex A.4 Table A.4-6b. SS schedules the UL transmission in subframe #2 and subframe #7 to carry the PUSCH CQI feedback via PDCCH DCI format 0 with CQI request bit set to 1 and I_MCS=29 and N_PRB allocated to be less or equal to 4. Measure the average throughput according to Annex G.5.3 Declare the throughput as t_{median} .

6. The SS shall transmit PDSCH via PDCCH DCI format 2C for C_RNTI to transmit the DL RMC (Table A.4-5a) according to the highest UE reported full-size subband CQI value in one full-size subband selected among the sub-bands in which UE report the highest full-size subband CQI. Subband differential CQI offset level is selected from {0, 1, 2, -1}. Note that the SS shall send PDSCH in the same full-size subband until next UE report is available. In case when same full-size subbands are reported subsequently as subbands with highest full-size subband CQI, the SS shall select for transmission a different subband with respect to the last selection. The SS sends downlink MAC padding bits on the DL RMC. The transport format to be used is defined in Annex A.4 Table A.4-6b. SS schedules the UL transmission in subframe #2 and subframe #7 to carry the PUSCH CQI feedback via PDCCH DCI format 0 with CQI request bit set to 1 and I_MCS=29 and N_PRB allocated to be less or equal to 4. Measure the average throughput and (NACK / (ACK + NACK)) according to Annex G.5.3. Declare the throughput as $t_{subband}$. If the ratio $(t_{subband} / t_{median}) \geq \gamma$ and (NACK / (ACK + NACK)) ≥ 0.05 , pass the UE and go to step 8. Otherwise, go to step 7.
7. If both SNR points of the test have not been tested, then repeat the same procedure (steps 1 to 6) for the other SNR point as appropriate. Otherwise fail the UE.
8. If both tests have not been done, then repeat the same procedure (steps 1 to 7) with test conditions according to the table 9.3.1.2.2_D.3-1 for the other test as appropriate.

9.3.1.2.2_D.4.3 Message contents

Message contents are according to TS 36.508 [7] clause 4.6 and TS 36.331 clause 6.3.2 with the following exceptions:

Table 9.3.1.2.2_D.4.3-1: PhysicalConfigDedicated-DEFAULT

Derivation Path: 36.508 clause 4.6.3			
Information Element	Value/remark	Comment	Condition
RadioResourceConfigDedicated-SRB2-DRB(n, m) ::= SEQUENCE {			
physicalConfigDedicated	CQI-ReportConfig-r10-DEFAULT using condition RBC		
antennaInfo CHOICE {			
explicitValue	AntennaInfoDedicated		
}			
}			

Table 9.3.1.2.2_D.4.3-2: PDSCH-ConfigDedicated-DEFAULT

Derivation Path: 36.331 clause 6.3.2			
Information Element	Value/remark	Comment	Condition
PDSCH-ConfigDedicated-DEFAULT ::= SEQUENCE {			
p-a	dB0		
}			

Table 9.3.1.2.2_D.4.3-3: *AntennaInfoDedicated-r10*

Derivation Path: 36.331 clause 6.3.2			
Information Element	Value/remark	Comment	Condition
AntennaInfoDedicated-r10 ::= SEQUENCE {			
transmissionMode-r10	tm9-v1020		
codebookSubsetRestriction-r10	0x0000 0000 0000 0001		
}			
ue-TransmitAntennaSelection CHOICE {			
release	NULL		
}			

Table 9.3.1.2.2_D.4.3-4: *CQI-ReportConfig-DEFAULT*

Derivation Path: 36.508 clause 4.6.3			
Information Element	Value/remark	Comment	Condition
CQI-ReportConfig-r10 ::= SEQUENCE {			
cqi-ReportAperiodic-r10	rm31		
nomPDSCH-RS-EPRE-Offset	0		
cqi-ReportPeriodic-r10	Not present		
}			

Table 9.3.1.2.2_D.4.3-5: *TDD-Config-DEFAULT*

Derivation Path: 36.508 clause 4.6.3			
Information Element	Value/remark	Comment	Condition
TDD-Config-DEFAULT ::= SEQUENCE {			
subframeAssignment	sa2		
specialSubframePatterns	ssp4		
}			

Table 9.3.1.2.2_D.4.3-6: *PUSCH-ConfigDedicated-DEFAULT*

Derivation Path: 36.331 clause 6.3.2			
Information Element	Value/remark	Comment	Condition
PUSCH-ConfigDedicated-DEFAULT ::= SEQUENCE {			
ackNackRepetition CHOICE {			
release	NULL		
}			
tddAckNackFeedbackMode	Multiplexing	Multiplexing is selected as default to align with RAN4's assumptions in RF tests.	TDD
}			

Table 9.3.1.2.2_D.4.3-7: CSI-RS-Config

Derivation Path: 36.331 clause 6.3.2			
Information Element	Value/remark	Comment	Condition
CSI-RS-Config-r10 ::= SEQUENCE {			
csi-RS-r10 CHOICE{			
release	NULL		
setup SEQUENCE {			
antennaPortsCount-r10	an2	Parameter represents the number of antenna ports used for transmission of CSI reference signals	
resourceConfig-r10	4	Parameter: CSI reference signal configuration	
subframeConfig-r10	3	$\Delta_{\text{CSI-RS}} = I_{\text{CSI-RS}}$ when CSI-RS SubframeConfig is from 0-4; Parameter: $I_{\text{CSI-RS}}$	
p-C-r10	0	Parameter: P_c which is the assumed ratio of PDSCH EPRE to CSI-RS EPRE when UE derives CSI feedback	
}			
}			
}			

9.3.1.2.2_D.5 Test requirement

Table 9.3.1.1.5-1: Test requirement (TDD)

Parameter	Test 1	Test 2
α [%]	2	2
β [%]	40	40
γ	1.09	1.09
UE Category	1-8	1-8

To pass the test, α and β and γ and BLER must be fulfilled.

To pass the test, Test 1 and Test 2 must be passed.

To pass the test, one **or** the other SNR point within one test must be fulfilled.

9.3.2 Frequency non-selective scheduling mode

The reporting accuracy of the channel quality indicator (CQI) under frequency non-selective fading conditions is determined by the reporting variance, and the relative increase of the throughput obtained when the transport format transmitted is that indicated by the reported CQI compared to the case for which a fixed transport format configured according to the reported median CQI is transmitted. In addition, the reporting accuracy is determined by a minimum BLER using the transport formats indicated by the reported CQI. To account for sensitivity of the input SNR the CQI reporting under frequency non-selective fading conditions is considered to be verified if the reporting accuracy is met for at least one of two SNR levels separated by an offset of 1 dB.

9.3.2.1 CQI Reporting under fading conditions – PUCCH 1-0 (Cell-Specific Reference Symbols)

9.3.2.1.1 FDD CQI Reporting under fading conditions – PUCCH 1-0

9.3.2.1.1.1 Test purpose

To verify that the UE is tracking the channel variations and selecting the largest transport format possible according to the prevailing channel state for frequently non-selective scheduling

9.3.2.1.1.2 Test applicability

This test applies to E-UTRA FDD UE release 8 and forward of UE category ≥ 2 .

9.3.2.1.1.3 Minimum conformance requirements

For the parameters specified in Table 9.3.2.1.1.3-1, and using the downlink physical channels specified in Annex C, the minimum requirements are specified in Table 9.3.2.1.1.3-2 and by the following

- a) CQI index not in the set {median CQI -1, median CQI +1} shall be reported at least α % of the time;
- b) the ratio of the throughput obtained when transmitting the transport format indicated by each reported wideband CQI index and that obtained when transmitting a fixed transport format configured according to the wideband CQI median shall be $\geq \gamma$;
- c) when transmitting the transport format indicated by each reported wideband CQI index, the average BLER for the indicated transport formats shall be greater or equal to 0.02

The transport block sizes TBS for wideband CQI median and reported wideband CQI are selected according to Table A.4-3 (for Category 2-8) or Table A.4-9 (for Category 1).

Table 9.3.2.1.1.3-1 Fading test for single antenna (FDD)

Parameter		Unit	Test 1		Test 2	
Bandwidth		MHz	10 MHz			
Transmission mode			1 (port 0)			
Downlink power allocation	ρ_A	dB	0			
	ρ_B	dB	0			
	σ	dB	0			
SNR (Note 3)		dB	6	7	12	13
$\hat{I}_{or}^{(j)}$		dB[mW/15kHz]	-92	-91	-86	-85
$N_{oc}^{(j)}$		dB[mW/15kHz]	-98		-98	
Propagation channel			EPA5			
Correlation and antenna configuration			High (1 x 2)			
Reporting mode			PUCCH 1-0			
Reporting periodicity		ms	$N_P = 2$			
CQI delay		ms	8			
Physical channel for CQI reporting			PUSCH (Note 4)			
PUCCH Report Type			4			
<i>cqi-pmi-ConfigurationIndex</i>			1			
Max number of HARQ transmissions			1			
<p>Note 1: If the UE reports in an available uplink reporting instance at subframe SF#n based on CQI estimation at a downlink SF not later than SF#(n-4), this reported wideband CQI cannot be applied at the eNB downlink before SF#(n+4)</p> <p>Note 2: Reference measurement channel according to Table A.4-1 for Category 2-8 with one sided dynamic OCNG Pattern OP.1 FDD as described in Annex A.5.1.1 and Table A.4-7 for Category 1 with one/two sided dynamic OCNG Pattern OP.1/2 FDD as described in Annex A.5.1.1/2.</p> <p>Note 3: For each test, the minimum requirements shall be fulfilled for at least one of the two SNR(s) and the respective wanted signal input level.</p> <p>Note 4: To avoid collisions between CQI reports and HARQ-ACK it is necessary to report both on PUSCH instead of PUCCH. PDCCH DCI format 0 shall be transmitted in downlink SF#1, #3, #7 and #9 to allow periodic CQI to multiplex with the HARQ-ACK on PUSCH in uplink subframe SF#5, #7, #1 and #3.</p>						

Table 9.3.2.1.1.3-2 Minimum requirement (FDD)

Parameter	Test 1	Test 2
α [%]	20	20
γ	1.05	1.05
UE Category	1-8	1-8

The normative reference for this requirement is TS 36.101 [2] clause 9.3.2.1.1.

9.3.2.1.1.4 Test description

9.3.2.1.1.4.1 Initial conditions

Initial conditions are a set of test configurations the UE needs to be tested in and the steps for the SS to take with the UE to reach the correct measurement state.

Configurations of PDSCH and PDCCH before measurement are specified in Annex C.2.

Test Environment: Normal as defined in TS 36.508 [7] clause 4.1.

Frequencies to be tested: Mid Range as defined in TS 36.508 [7] clause 4.3.1.1.

Channel Bandwidths to be tested: 10MHz, as defined in TS 36.508 [7] clause 4.3.1.1

1. Connect the SS, faders and AWGN noise source to the UE antenna connector (s) as shown in TS 36.508 [7] Annex A, Figure A.9.
2. The parameter settings for the cell are set up according to Table 9.3.2.1.1.3-1.
3. Downlink signals are initially set up according to Annex C0, C.1 and Annex C.3.2, and uplink signals according to Annex H.3.2.
4. Propagation conditions are set according to Annex B.0.
5. Ensure the UE is in State 3A-RF according to TS 36.508 [7] clause 5.2A.2. Message contents are defined in clause 9.3.2.1.1.4.3.

9.3.2.1.1.4.2 Test procedure

1. Set the parameters of bandwidth, the propagation condition, antenna configuration and measurement channel according to Table 9.3.2.1.1.3-1 as appropriate.
2. The SS shall transmit PDSCH via PDCCH DCI format 1A for C_RNTI to transmit the DL RMC (Table A.4-1) according to CQI value 8 of Annex A.4 Table A.4-3 and keep it regardless of the wideband CQI value sent by the UE. The SS sends downlink MAC padding bits on the DL RMC. The SS sends uplink scheduling information via PDCCH DCI format 0 with CQI request bit set to 0 to schedule UL RMC in subframe #1,#3,#5 and subframe #7 (Table A.4.1-1). The UE will send ACK/NACK and periodic CQI report using PUSCH. Continue transmission of the PDSCH until 100000 wideband CQI reports have been gathered. In this process the SS collects wideband CQI reports every 2 ms and also cases where UE transmits nothing in its CQI timing are counted as wideband CQI reports.
3. Set up a relative frequency distribution for the reported wideband CQI-values, reported. Calculate the median value (wideband Median CQI is the wideband CQI that is at or crosses 50% distribution from the lower wideband CQI side). This CQI-value is declared as wideband Median CQI value.
4. If less than $(100-\alpha)/100 \cdot 100000$ of the wideband CQI values are in the range $(\text{Median CQI} - 1) \leq \text{Median CQI} \leq (\text{Median CQI} + 1)$ then continue with step 5, otherwise go to step 7.
5. The SS shall transmit PDSCH via PDCCH DCI format 1A for C_RNTI to transmit the DL RMC (Table A.4-1) according to the wideband median-CQI value regardless of UE wideband CQI report. The SS sends downlink MAC padding bits on the DL RMC. The SS sends uplink scheduling information via PDCCH DCI format 0 with CQI request bit set to 0 to schedule UL RMC in subframe #1,#3,#5 and subframe #7 (Table A.4.1-1). The UE will send ACK/NACK and periodic CQI report using PUSCH. Measure the average throughput according to Annex G.5.3. Declare the throughput as t_{median} .
6. The SS shall transmit PDSCH via PDCCH DCI format 1A for C_RNTI to transmit the DL RMC (Table A.4-1) according to the wideband CQI value reported from UE. The SS sends downlink MAC padding bits on the DL RMC. The SS sends uplink scheduling information via PDCCH DCI format 0 with CQI request bit set to 0 to schedule UL RMC in subframe #1,#3,#5 and subframe #7 (Table A.4.1-1). The UE will send ACK/NACK and periodic CQI report using PUSCH. Measure the average throughput according to Annex G.5.3. Declare the throughput as $t_{wideband}$. For any PDSCH transmitted by the SS, record the associated ACK, NACK and statDTX responses. The responses are then filtered as follows: for the sequence of responses for each HARQ process, discard all the statDTX responses.
If the ratio $(t_{wideband} / t_{median}) \geq \gamma$ and ratio $(\text{NACK} / (\text{ACK} + \text{NACK}))$ is greater or equal to 0.02, then pass the UE for this test and go to step 8. Otherwise go to step 7.
7. If both SNR points of the test have not been tested, then repeat the same procedure (steps 1 to 6) for the other SNR point as appropriate. Otherwise fail the UE.
8. If both tests have not been done, then repeat the same procedure (steps 1 to 7) with test conditions according to the table 9.3.2.1.1.3-1 for the other Test as appropriate. Otherwise pass the UE.

9.3.2.1.1.4.3 Message contents

Message contents are according to TS 36.508 [7] clause 4.6 with the following exceptions:

Table 9.3.2.1.1.4.3-1: PhysicalConfigDedicated-DEFAULT

Derivation Path: 36.508 clause 5.5.1.2			
Information Element	Value/remark	Comment	Condition
PhysicalConfigDedicated-DEFAULT ::= SEQUENCE {			
cqi-ReportConfig	<i>CQI-ReportConfig-DEFAULT</i>		
}			

Table 9.3.2.1.1.4.3-2: CQI-ReportConfig-DEFAULT

Derivation Path: 36.508 clause 4.6.3			
Information Element	Value/remark	Comment	Condition
CQI-ReportConfig-DEFAULT ::= SEQUENCE {			
cqi-ReportModeAperiodic	Not present		
nomPDSCH-RS-EPRE-Offset	0		
cqi-ReportPeriodic CHOICE {			
setup SEQUENCE {			
cqi-PUCCH-ResourceIndex	0		
cqi-pmi-ConfigIndex	1	(see Table 7.2.2-1A in TS 36.213)	
cqi-FormatIndicatorPeriodic CHOICE {			
widebandCQI	NULL		
}			
ri-ConfigIndex	NULL	(see Table 7.2.2-1B in TS 36.213)	
simultaneousAckNackAndCQI	FALSE		
}			
}			

9.3.2.1.1.5 Test requirement

Table 9.3.2.1.1.5-1: Test requirement (FDD)

Parameter	Test 1	Test 2
α [%]	20	20
γ	1.04	1.04
BLER	0.02	0.02
UE category	2-8	2-8

To pass the test, α and γ and BLER must be fulfilled.

To pass the test, Test 1 and Test 2 must be passed.

To pass the test, one **or** the other SNR point within one test must be fulfilled.

9.3.2.1.1_1 FDD CQI Reporting under fading conditions - PUCCH 1-0 (Release 9 and forward)

9.3.2.1.1_1.1 Test purpose

Same test purpose as in clause 9.3.2.1.1.1.

9.3.2.1.1_1.2 Test applicability

This test applies to E-UTRA FDD UE release 9 and forward of UE category 1.

9.3.2.1.1_1.3 Minimum conformance requirements

Same minimum conformance requirements as in clause 9.3.2.1.1.3.

9.3.2.1.1_1.4 Test description

9.3.2.1.1_1.4.1 Initial conditions

Same initial conditions as in clause 9.3.2.1.1.4.1.

9.3.2.1.1_1.4.2 Test procedure

Same test procedure as in clause 9.3.2.1.1.4.2 with the following exceptions:

- In steps 2, 5 and 6: Instead of table A.4-1-> use table A.4-7.
- In step 2: Instead of table A.4-3 -> use Table A.4-9.

9.3.2.1.1_1.4.3 Message contents

Same message contents as in clause 9.3.2.1.1.4.3.

9.3.2.1.1_1.5 Test requirement

Same test requirements as in clause 9.3.2.1.1.5 with the following exceptions:

Instead of table 9.3.2.1.1.5.1-> use table 9.3.2.1.1_1.5-1 below:

Table 9.3.2.1.1_1.5-1: Test requirement (FDD)

Parameter	Test 1	Test 2
α [%]	20	20
γ	1.04	1.04
BLER	0.02	0.02
UE category	1	1

9.3.2.1.2 TDD CQI Reporting under fading conditions – PUCCH 1-0

9.3.2.1.2.1 Test purpose

To verify that the UE is tracking the channel variations and selecting the transport format according to the prevailing channel state for frequently non-selective scheduling

9.3.2.1.2.2 Test applicability

This test applies to E-UTRA TDD UE release 8 and forward of UE category ≥ 2 .

9.3.2.1.2.3 Minimum conformance requirements

For the parameters specified in Table 9.3.2.1.2.3-1, and using the downlink physical channels specified in Annex C, the minimum requirements are specified in Table 9.3.2.1.2.3-2 and by the following

- a) a CQI index not in the set {median CQI -1, median CQI +1} shall be reported at least α % of the time;
- b) the ratio of the throughput obtained when transmitting the transport format indicated by each reported wideband CQI index and that obtained when transmitting a fixed transport format configured according to the wideband CQI median shall be $\geq \gamma$;
- c) when transmitting the transport format indicated by each reported wideband CQI index, the average BLER for the indicated transport formats shall be greater or equal to 0.02

The transport block sizes TBS for wideband CQI median and reported wideband CQI are selected according to Table A.4-3 (for Category 2-8) or Table A.4-9 (for Category 1).

Table 9.3.2.1.2.3-1: Fading test for single antenna (TDD)

Parameter		Unit	Test 1		Test 2	
Bandwidth		MHz	10 MHz			
Transmission mode			1 (port 0)			
Downlink power allocation	ρ_A	dB	0			
	ρ_B	dB	0			
	σ	dB	0			
Uplink downlink configuration			2			
Special subframe configuration			4			
SNR		dB	6	7	12	13
$N_{oc}^{(j)}$		dB[mW/15kHz]	-98		-98	
$\hat{I}_{or}^{(j)}$		dB[mW/15kHz]	-92	-91	-86	-85
Propagation channel			EPA5			
Correlation and antenna configuration			High (1 x 2)			
Reporting mode			PUCCH 1-0			
Reporting periodicity		ms	$N_P = 5$			
CQI delay		ms	10 or 11			
Physical channel for CQI reporting			PUSCH (Note 4)			
PUCCH Report Type			4			
<i>cqi-pmi-ConfigurationIndex</i>			3			
Max number of HARQ transmissions			1			
ACK/NACK feedback mode			Multiplexing			
<p>Note 1: If the UE reports in an available uplink reporting instance at subframe SF#n based on CQI estimation at a downlink SF not later than SF#(n-4), this reported wideband CQI cannot be applied at the eNB downlink before SF#(n+4)</p> <p>Note 2: Reference measurement channel according to Table A.4-2 for Category 2-8 with one sided dynamic OCNG Pattern OP.1 TDD as described in Annex A.5.2.1 and Table A.4-8 for Category 1 with one/two sided dynamic OCNG Pattern OP.1/2 TDD as described in Annex A.5.2.1/2.</p> <p>Note 3: For each test, the minimum requirements shall be fulfilled for at least one of the two SNR(s) and the respective wanted signal input level.</p> <p>Note 4: To avoid collisions between CQI reports and HARQ-ACK it is necessary to report both on PUSCH instead of PUCCH. PDCCH DCI format 0 shall be transmitted in downlink SF#3 and #8 to allow periodic CQI to multiplex with the HARQ-ACK on PUSCH in uplink subframe SF#7 and #2.</p>						

Table 9.3.2.1.2.3-2: Minimum requirement (TDD)

Parameter	Test 1	Test 2
α [%]	20	20
γ	1.05	1.05
UE Category	1-8	1-8

The normative reference for this requirement is TS 36.101 [2] clause 9.3.2.1.2.

9.3.2.1.2.4 Test description

9.3.2.1.2.4.1 Initial conditions

Initial conditions are a set of test configurations the UE needs to be tested in and the steps for the SS to take with the UE to reach the correct measurement state.

Configurations of PDSCH and PDCCH before measurement are specified in Annex C.2.

Test Environment: Normal as defined in TS 36.508 [7] clause 4.1.

Frequencies to be tested: Mid Range as defined in TS 36.508 [7] clause 4.3.1.2.

Channel Bandwidths to be tested: 10MHz, as defined in TS 36.508 [7] clause 4.3.1.2

1. Connect the SS to the UE antenna connector (s) as shown in TS 36.508 [7] Annex A, Figure A.9.
2. The parameter settings for the cell are set up according to Table 9.3.2.1.2.3-1.
3. Downlink signals are initially set up according to Annex C0, C.1 and Annex C.3.2, and uplink signals according to Annex H.3.2.
4. Propagation conditions are set according to Annex B.0.
5. Ensure the UE is in State 3A-RF according to TS 36.508 [7] clause 5.2A.2. Message contents are defined in clause 9.3.2.1.2.4.3.

9.3.2.1.2.4.2 Test procedure

1. Set the parameters of bandwidth, the propagation condition, antenna configuration and measurement channel according to Table 9.3.2.1.2.3-1 as appropriate.
2. The SS shall transmit PDSCH via PDCCH DCI format 1A for C_RNTI to transmit the DL RMC (Table A.4-2) according to CQI value 8 of Annex A.4 Table A.4-3 and keep it regardless of the wideband CQI value sent by the UE. The SS sends downlink MAC padding bits on the DL RMC. The SS sends uplink scheduling information via PDCCH DCI format 0 with CQI request bit set to 0 to schedule UL RMC in subframe #2 and subframe #7 (Table A.4.1-2). The UE will send ACK/NACK and periodic CQI report using PUSCH Continue transmission of the PDSCH until 100000 wideband CQI reports have been gathered. In this process the SS collects wideband CQI reports every 5 ms and also cases where UE transmits nothing in its CQI timing are counted as wideband CQI reports.
3. Set up a relative frequency distribution for the reported wideband CQI-values, reported. Calculate the median value (wideband Median CQI is the wideband CQI that is at or crosses 50% distribution from the lower wideband CQI side). This CQI-value is declared as wideband Median CQI value.
4. If less than $(100-\alpha)/100 \cdot 100000$ of the wideband CQI values are in the range $(\text{Median CQI} - 1) \leq \text{Median CQI} \leq (\text{Median CQI} + 1)$ then continue with step 5, otherwise go to step 7.
5. The SS shall transmit PDSCH via PDCCH DCI format 1A for C_RNTI to transmit the DL RMC (Table A.4-2) according to the wideband median-CQI value regardless of UE wideband CQI report. The SS sends downlink MAC padding bits on the DL RMC. The SS sends uplink scheduling information via PDCCH DCI format 0 with CQI request bit set to 0 to schedule UL RMC in subframe #2 and subframe #7 (Table A.4.1-2). The UE will send ACK/NACK and periodic CQI report using PUSCH. Measure the average throughput for a duration sufficient to achieve statistical significance according to Annex G clause G.3. Declare the throughput as t_{median} .
6. The SS shall transmit PDSCH via PDCCH DCI format 1A for C_RNTI to transmit the DL RMC (Table A.4-2) according to the wideband CQI value reported from UE. The SS sends downlink MAC padding bits on the DL RMC. The SS sends uplink scheduling information via PDCCH DCI format 0 with CQI request bit set to 0 to schedule UL RMC in subframe #2 and subframe #7 (Table A.4.1-2). The UE will send ACK/NACK and periodic CQI report using PUSCH Measure the average throughput for a duration sufficient to achieve statistical significance according to Annex G clause G.3. Declare the throughput as $t_{wideband}$. For any PDSCH transmitted by the SS, record the associated ACK, NACK and statDTX responses. The responses are then filtered as follows: for the sequence of responses for each HARQ process, discard all the statDTX responses.

If the ratio $(t_{wideband} / t_{median}) \geq \gamma$ and ratio $(NACK / (ACK + NACK))$ is greater or equal to 0.02, then pass the UE and go to step 8. Otherwise go to step 7.

7. If both SNR points of the test have not been tested, then repeat the same procedure (steps 1 to 6) for the other SNR point as appropriate. Otherwise fail the UE.
8. If both tests have not been done, repeat the same procedure (steps 1 to 7) with test conditions according to the table 9.3.2.1.2.3-1 for the other test as appropriate.

9.3.2.1.2.4.3 Message contents

Message contents are according to TS 36.508 [7] clause 4.6 with the following exceptions:

Table 9.3.2.1.2.4.3-1: PhysicalConfigDedicated-DEFAULT

Derivation Path: 36.508 clause 5.5.1.2			
Information Element	Value/remark	Comment	Condition
PhysicalConfigDedicated-DEFAULT ::= SEQUENCE {			
cqi-ReportConfig	<i>CQI-ReportConfig-DEFAULT</i>		
}			

Table 9.3.2.1.2.4.3-2: CQI-ReportConfig-DEFAULT

Derivation Path: 36.508 clause 4.6.3			
Information Element	Value/remark	Comment	Condition
CQI-ReportConfig-DEFAULT ::= SEQUENCE {			
cqi-ReportModeAperiodic	Not present		
nomPDSCH-RS-EPRE-Offset	0		
cqi-ReportPeriodic CHOICE {			
setup SEQUENCE {			
cqi-PUCCH-ResourceIndex	0		
cqi-pmi-ConfigIndex	3	(see Table 7.2.2-1C in TS 36.213)	
cqi-FormatIndicatorPeriodic CHOICE {			
widebandCQI	NULL		
}			
ri-ConfigIndex	NULL	(see Table 7.2.2-1B in TS 36.213)	
simultaneousAckNackAndCQI	FALSE		
}			
}			

Table 9.3.2.1.2.4.3-3: TDD-Config-DEFAULT

Derivation Path: 36.508 clause 4.6.3			
Information Element	Value/remark	Comment	Condition
TDD-Config-DEFAULT ::= SEQUENCE {			
subframeAssignment	Sa2		
specialSubframePatterns	Ssp4		
}			

9.3.2.1.2.5 Test requirement

Table 9.3.2.1.2.5-1: Test requirement (TDD)

Parameter	Test 1	Test 2
α [%]	20	20
γ	1.04	1.04
BLER	0.02	0.02
UE category	2-8	2-8

To pass the test, α and γ and BLER must be fulfilled.

To pass the test, Test 1 and Test 2 must be passed.

To pass the test, one **or** the other SNR point within one test must be fulfilled.

9.3.2.1.2_1 TDD CQI Reporting under fading conditions - PUCCH 1-0 (Release 9 and forward)

9.3.2.1.2_2.1 Test purpose

Same test purpose as in clause 9.3.2.1.2.1.

9.3.2.1.2_1.2 Test applicability

This test applies to E-UTRA TDD UE release 9 and forward of UE category 1.

9.3.2.1.2_1.3 Minimum conformance requirements

Same minimum conformance requirements as in clause 9.3.2.1.2.3.

9.3.2.1.2_1.4 Test description

9.3.2.1.2_1.4.1 Initial conditions

Same initial conditions as in clause 9.3.2.1.2.4.1.

9.3.2.1.2_1.4.2 Test procedure

Same test procedure as in clause 9.3.2.1.2.4.2 with the following exceptions:

- In steps 2, 5 and 6: Instead of table A.4-2 -> use table A.4-8.
- In step 2: Instead of using table A.4-3 -> use Table A.4-9.

9.3.2.1.2_1.4.3 Message contents

Same message contents as in clause 9.3.2.1.2.4.3.

9.3.2.1.2_1.5 Test requirement

Same test requirements as in clause 9.3.2.1.2.5 with the following exceptions:

Instead of table 9.3.2.1.2.5-1 -> use table 9.3.2.1.2_1.5-1 below:

Table 9.3.2.1.2_1.5-1: Test requirement (TDD)

Parameter	Test 1	Test 2
α [%]	20	20
γ	1.04	1.04
BLER	0.02	0.02
UE category	1	1

9.3.2.2 CQI Reporting under fading conditions – PUCCH 1-1 (CSI Reference Symbols)

9.3.2.2.1_D FDD CQI Reporting under fading conditions – PUCCH 1-1 for eDL-MIMO

9.3.2.2.1_D.1 Test purpose

To verify that the UE is tracking the channel variations and selecting the largest transport format possible according to the prevailing channel state for frequently non-selective scheduling.

9.3.2.2.1_D.2 Test applicability

This test applies to all types of E-UTRA FDD UE release 10 and forward that support eDL-MIMO. Applicability requires support for FGI bit 103.

9.3.2.2.1_D.3 Minimum conformance requirements

For the parameters specified in Table 9.3.2.2.1_D.3-1, and using the downlink physical channels specified in Annex C.3.2, the minimum requirements are specified in Table 9.3.2.2.1_D.3-2 and by the following:

- a) CQI index not in the set {median CQI -1, median CQI +1} shall be reported at least α % of the time;
- b) The ratio of the throughput obtained when transmitting the transport format indicated by each reported wideband CQI index and that obtained when transmitting a fixed transport format configured according to the wideband CQI median shall be $\geq \gamma$;
- c) When transmitting the transport format indicated by each reported wideband CQI index, the average BLER for the indicated transport formats shall be greater or equal to 0.02.

The transport block sizes TBS for wideband CQI median and reported wideband CQI are selected according to Table A.4-3b or A.4-3c.

Table 9.3.2.2.1_D.3-1: Fading test for FDD

Parameter	Unit	Test 1		Test 2	
Bandwidth	MHz	10 MHz			
Transmission mode		9			
Downlink power allocation	ρ_A	dB		0	
	ρ_B	dB		0	
	P_C	dB		-3	
	σ	dB		-3	
SNR (Note 3)	dB	2	3	7	8
$\hat{I}_{or}^{(j)}$	dB[mW/15kHz]	-96	-95	-91	-90
$N_{oc}^{(j)}$	dB[mW/15kHz]	-98		-98	
Propagation channel		EPA5			
Correlation and antenna configuration		ULA High (4 x 2)			
Cell-specific reference signals		Antenna ports 0,1			
CSI reference signals		Antenna ports 15,...,18			
Beamforming model		As specified in Annex B.4.3			
CSI-RS periodicity and subframe offset $T_{\text{CSI-RS}} / \Delta_{\text{CSI-RS}}$		5/1			
CSI-RS reference signal configuration		2			
CodeBookSubsetRestriction bitmap		0x0000 0000 0000 0001			
Reporting mode		PUCCH 1-1			
Reporting periodicity	ms	$N_{pd} = 5$			
CQI delay	ms	8			
Physical channel for CQI/ PMI reporting		PUSCH (Note 4)			
PUCCH Report Type for CQI/PMI		2			
PUCCH channel for RI reporting		PUCCH Format 2			
PUCCH report type for RI		3			
<i>cqi-pmi-ConfigurationIndex</i>		2			
<i>ri-ConfigIndex</i>		1			
Max number of HARQ transmissions		1			
Note 1:	If the UE reports in an available uplink reporting instance at subframe SF#n based on CQI estimation at a downlink SF not later than SF#(n-4), this reported wideband CQI cannot be applied at the eNB downlink before SF#(n+4).				
Note 2:	Reference measurement channel according to Table A.4-1a with one sided dynamic OCN Pattern OP.1 FDD as described in Annex A.5.1.1.				
Note 3:	For each test, the minimum requirements shall be fulfilled for at least one of the two SNR(s) and the respective wanted signal input level.				
Note 4:	To avoid collisions between CQI/ PMI reports and HARQ-ACK it is necessary to report both on PUSCH instead of PUCCH. PDCCH DCI format 0 shall be transmitted in downlink SF#1 and #6 to allow periodic CQI/ PMI to multiplex with the HARQ-ACK on PUSCH in uplink subframe SF#0 and #5.				

Table 9.3.2.2.1_D.3-2: Minimum requirement (FDD)

	Test 1	Test 2
α [%]	20	20
γ	1.05	1.05
UE Category	1-8	1-8

The normative reference for this requirement is TS 36.101 [2] clause 9.3.2.2.1.

9.3.2.2.1_D.4 Test description

9.3.2.2.1_D.4.1 Initial conditions

Initial conditions are a set of test configurations the UE needs to be tested in and the steps for the SS to take with the UE to reach the correct measurement state.

Configurations of PDSCH and PDCCH before measurement are specified in Annex C.2.

Test Environment: Normal as defined in TS 36.508 [7] clause 4.1.

Frequencies to be tested: Mid Range as defined in TS 36.508 [7] clause 4.3.1.1.

Channel Bandwidths to be tested: 10MHz, as defined in TS 36.508 [7] clause 4.3.1.1

1. Connect the SS, faders and AWGN noise source to the UE antenna connector (s) as shown in TS 36.508 [7] Annex A, Figure A.11.
2. The parameter settings for the cell are set up according to Table 9.3.2.2.1_D.3-1.
3. Downlink signals are initially set up according to Annex C0, C.1 and Annex C.3.2, and uplink signals according to Annex H.3.2.
4. Propagation conditions are set according to Annex B.0.
5. Ensure the UE is in State 3A-RF according to TS 36.508 [7] clause 5.2A.2. Message contents are defined in clause 9.3.2.2.1_D.4.3.

9.3.2.2.1_D.4.2 Test procedure

1. Set the parameters of bandwidth, the propagation condition, antenna configuration and measurement channel according to Table 9.3.2.2.1_D.3-1 as appropriate.
2. The SS shall transmit PDSCH via PDCCH DCI format 2C for C_RNTI to transmit the DL RMC (Table A.4-1a) according to CQI value 8 of Annex A.4 Table A.4-3c and keep it regardless of the wideband CQI value sent by the UE. The SS sends downlink MAC padding bits on the DL RMC. The SS sends uplink scheduling information via PDCCH DCI format 0 with CQI request bit set to 0 to schedule UL RMC in subframe #0 and subframe #5 (Table A.4-1a). The UE will send ACK/NACK and periodic CQI report using PUSCH. The UE will send ACK/NACK and periodic CQI report using PUSCH. Continue transmission of the PDSCH until 2000 wideband CQI reports have been gathered. In this process the SS collects wideband CQI reports every 2 ms and also cases where UE transmits nothing in its CQI timing are counted as wideband CQI reports.
3. Set up a relative frequency distribution for the reported wideband CQI-values, reported. Calculate the median value (wideband Median CQI is the wideband CQI that is at or crosses 50% distribution from the lower wideband CQI side). This CQI-value is declared as wideband Median CQI value.
4. If less than $(100-\alpha)/100 \cdot 2000$ of the wideband CQI values are in the range $(\text{Median CQI} - 1) \leq \text{Median CQI} \leq (\text{Median CQI} + 1)$ then continue with step 5, otherwise go to step 7.
5. The SS shall transmit PDSCH via PDCCH DCI format 2C for C_RNTI to transmit the DL RMC (Table A.4-1a) according to the wideband median-CQI value regardless of UE wideband CQI report. The SS sends downlink MAC padding bits on the DL RMC. The SS sends uplink scheduling information via PDCCH DCI format 0 with CQI request bit set to 0 to schedule UL RMC in subframe #0 and subframe #5 (Table A.4-1a). The UE will send ACK/NACK and periodic CQI report using PUSCH. The UE will send ACK/NACK and periodic CQI report using PUSCH. Measure the average throughput according to Annex G.5.3. Declare the throughput as t_{median} .
6. The SS shall transmit PDSCH via PDCCH DCI format 2C for C_RNTI to transmit the DL RMC (Table A.4-1a) according to the wideband CQI value reported from UE. The SS sends downlink MAC padding bits on the DL RMC. The SS sends uplink scheduling information via PDCCH DCI format 0 with CQI request bit set to 0 to schedule UL RMC in subframe #0 and subframe #5 (Table A.4-1a). The UE will send ACK/NACK and periodic CQI report using PUSCH. The UE will send ACK/NACK and periodic CQI report using PUSCH. Measure the average throughput according to Annex G.5.3. Declare the throughput as $t_{wideband}$. For any PDSCH transmitted by the SS, record the associated ACK, NACK and statDTX responses. The responses are then filtered as follows: for the sequence of responses for each HARQ process, discard all the statDTX responses. If the ratio $(t_{wideband} / t_{median}) \geq \gamma$ and ratio $(\text{NACK} / (\text{ACK} + \text{NACK}))$ is greater or equal to 0.02, then pass the UE for this test and go to step 8. Otherwise go to step 7.
7. If both SNR points of the test have not been tested, then repeat the same procedure (steps 1 to 6) for the other SNR point as appropriate. Otherwise fail the UE.

8. If both tests have not been done, repeat the same procedure (steps 1 to 7) with test conditions according to the table 9.3.2.2.1_D.3-1 for the other test as appropriate.

9.3.2.2.1_D.4.3 Message contents

Message contents are according to TS 36.508 [7] clause 4.6 with the following exceptions:

Table 9.3.2.2.1_D.4.3-1: PhysicalConfigDedicated-DEFAULT

Derivation Path: 36.508 clause 4.6.3			
Information Element	Value/remark	Comment	Condition
RadioResourceConfigDedicated-SRB2-DRB(n, m) ::= SEQUENCE {			
physicalConfigDedicated	<i>CQI-ReportConfig-r10-DEFAULT</i> using condition RBC		
antennaInfo CHOICE {			
explicitValue	AntennaInfoDedicated		
}			
}			

Table 9.3.2.2.1_D.4.3-2: PDSCH-ConfigDedicated-DEFAULT

Derivation Path: 36.331 clause 6.3.2			
Information Element	Value/remark	Comment	Condition
PDSCH-ConfigDedicated-DEFAULT ::= SEQUENCE {			
p-a	dB0		
}			

Table 9.3.2.2.1_D.4.3-3: AntennaInfoDedicated-r10

Derivation Path: 36.331 clause 6.3.2			
Information Element	Value/remark	Comment	Condition
AntennaInfoDedicated-r10 ::= SEQUENCE {			
transmissionMode-r10	tm9-v1020		
codebookSubsetRestriction-r10	0x0000 0000 0000 0001		
}			
ue-TransmitAntennaSelection CHOICE {			
release	NULL		
}			

Table 9.3.2.2.1_D.4.3-4: CQI-ReportConfig-r10-DEFAULT

Derivation Path: 36.508 clause 4.6.3			
Information Element	Value/remark	Comment	Condition
CQI-ReportConfig-r10 ::= SEQUENCE {			
cqi-ReportModeAperiodic-r10	Not Present		
nomPDSCH-RS-EPRE-Offset	0		
cqi-ReportPeriodic-r10	<i>CQI-ReportPeriodic-r10-DEFAULT</i>		
}			

Table 9.3.2.2.1_D.4.3-5: CQI-ReportPeriodic-r10-DEFAULT

Derivation Path: 36.508 clause 4.6.3			
Information Element	Value/remark	Comment	Condition
CQI-ReportPeriodic-r10 ::= CHOICE {			
setup SEQUENCE {			
cqi-PUCCH-ResourceIndex-r10	0		
cqi-PUCCH-ResourceIndexP1-r10	Not present		
cqi-pmi-ConfigIndex	2	(see Table 7.2.2-1A in TS 36.213)	
cqi-FormatIndicatorPeriodic-r10 CHOICE {			
widebandCQI-r10 SEQUENCE {			
csi-ReportMode-r10	Not present		
}			
ri-ConfigIndex	1	(see Table 7.2.2-1B in TS 36.213)	
simultaneousAckNackAndCQI	FALSE		
}			
}			

Table 9.3.2.2.1_D.4.3-6: CSI-RS-Config

Derivation Path: 36.331 clause 6.3.2			
Information Element	Value/remark	Comment	Condition
CSI-RS-Config-r10 ::= SEQUENCE {			
csi-RS-r10 CHOICE{			
release	NULL		
setup SEQUENCE {			
antennaPortsCount-r10	an4	Parameter represents the number of antenna ports used for transmission of CSI reference signals	
resourceConfig-r10	2	Parameter: CSI reference signal configuration	
subframeConfig-r10	1	$\Delta_{CSI-RS} = I_{CSI-RS}$ when CSI-RS SubframeConfig is from 0-4; Parameter: I_{CSI-RS}	
p-C-r10	-3	Parameter: P_c which is the assumed ratio of PDSCH EPRE to CSI-RS EPRE when UE derives CSI feedback	
}			
}			
}			

9.3.2.2.1_D.5 Test requirement

Table 9.3.2.2.1_D.3-2: Test requirement (FDD)

	Test 1	Test 2
α [%]	20	20
γ	1.04	1.04
UE Category	1-8	1-8

To pass the test, α and γ and BLER must be fulfilled.

To pass the test, Test 1 and Test 2 must be passed.

To pass the test, one **or** the other SNR point within one test must be fulfilled.

9.3.2.2.2_D TDD CQI Reporting under fading conditions – PUCCH 1-1 for eDL-MIMO

Editor's note: SS vendors have not decided on the 8x2 antenna configuration due to test system complexity and cost

9.3.2.2.2_D.1 Test purpose

To verify that the UE is tracking the channel variations and selecting the largest transport format possible according to the prevailing channel state for frequently non-selective scheduling.

9.3.2.2.2_D.2 Test applicability

This test applies to all types of E-UTRA TDD UE release 10 and forward that support eDL-MIMO. Applicability requires support for FGI bits 104 and 110.

9.3.2.2.2_D.3 Minimum conformance requirements

For the parameters specified in Table 9.3.2.2.2_D.3-1, and using the downlink physical channels specified in Annex C.3.2, the minimum requirements are specified in Table 9.3.2.2.2_D.3-2 and by the following:

- a) CQI index not in the set {median CQI -1, median CQI +1} shall be reported at least α % of the time;
- b) The ratio of the throughput obtained when transmitting the transport format indicated by each reported wideband CQI index and that obtained when transmitting a fixed transport format configured according to the wideband CQI median shall be $\geq \gamma$;
- c) When transmitting the transport format indicated by each reported wideband CQI index, the average BLER for the indicated transport formats shall be greater or equal to 0.02.

The transport block sizes TBS for wideband CQI median and reported wideband CQI are selected according to Table A.4-3b or A.4-3d.

Table 9.3.2.2.2_D.3-1: Fading test for TDD

Parameter		Unit	Test 1		Test 2	
Bandwidth		MHz	10 MHz			
Transmission mode			9			
Uplink downlink configuration			2			
Special subframe configuration			4			
Downlink power allocation	ρ_A	dB	0			
	ρ_B	dB	0			
	P_C	dB	-6			
	σ	dB	-3			
SNR (Note 3)		dB	1	2	7	8
$\hat{I}_{or}^{(j)}$		dB[mW/15kHz]	-97	-96	-91	-90
$N_{oc}^{(j)}$		dB[mW/15kHz]	-98		-98	
Propagation channel			EPA5			
Correlation and antenna configuration			XP High (8 x 2)			
CRS reference signals			Antenna ports 0, 1			
CSI reference signals			Antenna ports 15,...,22			
Beamforming model			As specified in Annex B.4.3			
CSI-RS periodicity and subframe offset $T_{CSI-RS} / \Delta_{CSI-RS}$			5/ 3			
CSI-RS reference signal configuration			2			
CodeBookSubsetRestriction bitmap			0x0000 0000 0000 0020 0000 0000 0001			
Reporting mode			PUCCH 1-1 (Sub-mode: 2)			
Reporting periodicity		ms	$N_{pd} = 5$			
CQI delay		ms	10			
Physical channel for CQI/ PMI reporting			PUSCH (Note 4)			
PUCCH Report Type for CQI/ PMI			2c			
Physical channel for RI reporting			PUCCH Format 2			
PUCCH report type for RI			3			
<i>cqi-pmi-ConfigurationIndex</i>			3			
<i>ri-ConfigIndex</i>			805 (Note 5)			
Max number of HARQ transmissions			1			
ACK/NACK feedback mode			Multiplexing			
<p>Note 1: If the UE reports in an available uplink reporting instance at subframe SF#n based on CQI estimation at a downlink SF not later than SF#(n-4), this reported wideband CQI cannot be applied at the eNB downlink before SF#(n+4)</p> <p>Note 2: Reference measurement channel according to Table A.4-2a with one sided dynamic OCNG Pattern OP.1 TDD as described in Annex A.5.2.1.</p> <p>Note 3: For each test, the minimum requirements shall be fulfilled for at least one of the two SNR(s) and the respective wanted signal input level.</p> <p>Note 4: To avoid collisions between CQI/ PMI reports and HARQ-ACK it is necessary to report both on PUSCH instead of PUCCH. PDCCH DCI format 0 shall be transmitted in downlink SF#3 and #8 to allow periodic CQI/ PMI to multiplex with the HARQ-ACK on PUSCH in uplink subframe SF#2 and #7.</p> <p>Note 5: RI reporting interval is set to the maximum allowable length of 160ms to minimise collisions between RI, CQI/PMI and HARQ-ACK reports. In the case when all three reports collide, it is expected that CQI/PMI reports will be dropped, while RI and HARQ-ACK will be multiplexed. At eNB, CQI report collection shall be skipped every 160ms during performance verification and the reported CQI in subframe SF#7 of the previous frame is applied in downlink subframes until a new CQI (after CQI/PMI dropping) is available.</p>						

Table 9.3.2.2.2_D.3-2: Minimum requirement (TDD)

	Test 1	Test 2
α [%]	20	20
γ	1.05	1.05
UE Category	1-8	1-8

The normative reference for this requirement is TS 36.101 [2] clause 9.3.2.2.2.

9.3.2.2.2_D.4 Test description

9.3.2.2.2_D.4.1 Initial conditions

Initial conditions are a set of test configurations the UE needs to be tested in and the steps for the SS to take with the UE to reach the correct measurement state.

Configurations of PDSCH and PDCCH before measurement are specified in Annex C.2.

Test Environment: Normal as defined in TS 36.508 [7] clause 4.1.

Frequencies to be tested: Mid Range as defined in TS 36.508 [7] clause 4.3.1.2.

Channel Bandwidths to be tested: 10MHz, as defined in TS 36.508 [7] clause 4.3.1.2.

1. Connect the SS to the UE antenna connector (s) as shown in TS 36.508 [7] Annex A, Figure [TBD].
2. The parameter settings for the cell are set up according to Table 9.3.2.2.2_D.3-1.
3. Downlink signals are initially set up according to Annex C0, C.1 and Annex C.3.2, and uplink signals according to Annex H.3.2.
4. Propagation conditions are set according to Annex B.0.
5. Ensure the UE is in State 3A-RF according to TS 36.508 [7] clause 5.2A.2. Message contents are defined in clause 9.3.2.2.2_D.4.3.

9.3.2.2.2_D.4.2 Test procedure

1. Set the parameters of bandwidth, the propagation condition, antenna configuration and measurement channel according to Table 9.3.2.2.2_D.3-1 as appropriate.
2. The SS shall transmit PDSCH via PDCCH DCI format 1A for C_RNTI to transmit the DL RMC (Table A.4-2a) according to CQI value 8 of Annex A.4 Table A.4-3d and keep it regardless of the wideband CQI value sent by the UE. The SS sends downlink MAC padding bits on the DL RMC. The SS sends uplink scheduling information via PDCCH DCI format 0 with CQI request bit set to 0 to schedule UL RMC in subframe #2 and subframe #7 (Table A.4.1-2). The UE will send ACK/NACK and periodic CQI report using PUSCH Continue transmission of the PDSCH until 2000 wideband CQI reports have been gathered. In this process the SS collects wideband CQI reports every 5 ms and also cases where UE transmits nothing in its CQI timing are counted as wideband CQI reports.
3. Set up a relative frequency distribution for the reported wideband CQI-values, reported. Calculate the median value (wideband Median CQI is the wideband CQI that is at or crosses 50% distribution from the lower wideband CQI side). This CQI-value is declared as wideband Median CQI value.
4. If less than $(100-\alpha)/100 \cdot 2000$ of the wideband CQI values are in the range $(\text{Median CQI} - 1) \leq \text{Median CQI} \leq (\text{Median CQI} + 1)$ then continue with step 5, otherwise go to step 7.
5. The SS shall transmit PDSCH via PDCCH DCI format 2C for C_RNTI to transmit the DL RMC (Table A.4-2a) according to the wideband median-CQI value regardless of UE wideband CQI report. The SS sends downlink MAC padding bits on the DL RMC. The SS sends uplink scheduling information via PDCCH DCI format 0 with CQI request bit set to 0 to schedule UL RMC in subframe #2 and subframe #7 (Table A.4.1-2). The UE will send ACK/NACK and periodic CQI report using PUSCH. Measure the average throughput for a duration sufficient to achieve statistical significance according to Annex G clause G.3. Declare the throughput as t_{median} .
6. The SS shall transmit PDSCH via PDCCH DCI format 2C for C_RNTI to transmit the DL RMC (Table A.4-2a) according to the wideband CQI value reported from UE. The SS sends downlink MAC padding bits on the DL RMC. The SS sends uplink scheduling information via PDCCH DCI format 0 with CQI request bit set to 0 to schedule UL RMC in subframe #2 and subframe #7 (Table A.4.1-2). The UE will send ACK/NACK and periodic CQI report using PUSCH Measure the average throughput for a duration sufficient to achieve statistical significance according to Annex G clause G.3. Declare the throughput as $t_{wideband}$. For any PDSCH transmitted

by the SS, record the associated ACK, NACK and statDTX responses. The responses are then filtered as follows: for the sequence of responses for each HARQ process, discard all the statDTX responses.

If the ratio $(t_{wideband} / t_{median}) \geq \gamma$ and ratio $(NACK / (ACK + NACK))$ is greater or equal to 0.02, then pass the UE and go to step 8. Otherwise go to step 7.

7. If both SNR points of the test have not been tested, then repeat the same procedure (steps 1 to 6) for the other SNR point as appropriate. Otherwise fail the UE.
8. If both tests have not been done, repeat the same procedure (steps 1 to 7) with test conditions according to the table 9.3.2.2.2_D.3-1 for the other test as appropriate.

9.3.2.2.2_D.4.3 Message contents

Message contents are according to TS 36.508 [7] clause 4.6 with the following exceptions:

Table 9.3.2.2.2_D.4.3-1: PhysicalConfigDedicated-DEFAULT

Derivation Path: 36.508 clause 4.6.3			
Information Element	Value/remark	Comment	Condition
RadioResourceConfigDedicated-SRB2-DRB(n, m) ::= SEQUENCE {			
physicalConfigDedicated	<i>CQI-ReportConfig-r10-DEFAULT</i> using condition RBC		
antennaInfo CHOICE {			
explicitValue	AntennaInfoDedicated		
}			
}			

Table 9.3.2.2.2_D.4.3-2: PDSCH-ConfigDedicated-DEFAULT

Derivation Path: TS 36.508 [7] clause 4.6.3, Table 4.6.3-6 PDSCH-ConfigDedicated-DEFAULT			
Information Element	Value/remark	Comment	Condition
PDSCH-ConfigDedicated-DEFAULT ::= SEQUENCE {			
p-a	dB0		
}			

Table 9.3.2.2.2_D.4.3-3: AntennaInfoDedicated-r10

Derivation Path: 36.331 clause 6.3.2			
Information Element	Value/remark	Comment	Condition
AntennaInfoDedicated-r10 ::= SEQUENCE {			
transmissionMode-r10	tm9-v1020		
codebookSubsetRestriction-r10	0x0000 0000 0000 0020 0000 0000 0001		
}			
ue-TransmitAntennaSelection CHOICE {			
release	NULL		
}			

Table 9.3.2.2.2_D.4.3-4: CQI-ReportConfig-r10-DEFAULT

Derivation Path: 36.508 clause 4.6.3			
Information Element	Value/remark	Comment	Condition
CQI-ReportConfig-r10 ::= SEQUENCE {			
cqi-ReportModeAperiodic-r10	Not Present		
nomPDSCH-RS-EPRE-Offset	0		
cqi-ReportPeriodic-r10	CQI-ReportPeriodic-r10-DEFAULT		
}			

Table 9.3.2.2.2_D.4.3-5: CQI-ReportPeriodic-r10-DEFAULT

Derivation Path: 36.508 clause 4.6.3			
Information Element	Value/remark	Comment	Condition
CQI-ReportPeriodic-r10 ::= CHOICE {			
setup SEQUENCE {			
cqi-PUCCH-ResourceIndex-r10	0		
cqi-PUCCH-ResourceIndexP1-r10	Not present		
cqi-pmi-ConfigIndex	3	(see Table 7.2.2-1A in TS 36.213)	
cqi-FormatIndicatorPeriodic-r10 CHOICE {			
widebandCQI-r10 SEQUENCE {			
csi-ReportMode-r10	Not present		
}			
ri-ConfigIndex	805	(see Table 7.2.2-1B in TS 36.213)	
simultaneousAckNackAndCQI	FALSE		
}			
}			

Table 9.3.2.2.2_D.4.3-6: TDD-Config-DEFAULT

Derivation Path: 36.508 clause 4.6.3			
Information Element	Value/remark	Comment	Condition
TDD-Config-DEFAULT ::= SEQUENCE {			
subframeAssignment	sa2		
specialSubframePatterns	ssp4		
}			

Table 9.3.2.2.2_D.4.3-7: PUCCH-ConfigDedicated-DEFAULT

Derivation Path: 36.331 clause 6.3.2			
Information Element	Value/remark	Comment	Condition
PUCCH-ConfigDedicated-DEFAULT ::= SEQUENCE {			
ackNackRepetition CHOICE {			
release	NULL		
}			
tddAckNackFeedbackMode	Multiplexing	Multiplexing is selected as default to align with RAN4's assumptions in RF tests.	TDD
}			

Table 9.3.2.2.2_D.4.3-8: CSI-RS-Config

Derivation Path: 36.331 clause 6.3.2			
Information Element	Value/remark	Comment	Condition
CSI-RS-Config-r10 ::= SEQUENCE {			
csi-RS-r10 CHOICE{			
release	NULL		
setup SEQUENCE {			
antennaPortsCount-r10	an8	Parameter represents the number of antenna ports used for transmission of CSI reference signals	
resourceConfig-r10	2	Parameter: CSI reference signal configuration	
subframeConfig-r10	3	$\Delta_{\text{CSI-RS}} = I_{\text{CSI-RS}}$ when CSI-RS SubframeConfig is from 0-4; Parameter: $I_{\text{CSI-RS}}$	
p-C-r10	-6	Parameter: P_c which is the assumed ratio of PDSCH EPRE to CSI-RS EPRE when UE derives CSI feedback	
}			
}			
}			

9.3.2.2.2_D.5 Test requirement

Table 9.3.2.2.2_D.5-1: Test requirement (TDD)

	Test 1	Test 2
α [%]	20	20
γ	1.04	1.04
UE Category	1-8	1-8

To pass the test, α and γ and BLER must be fulfilled.

To pass the test, Test 1 and Test 2 must be passed.

To pass the test, one **or** the other SNR point within one test must be fulfilled.

9.3.3 Frequency-selective interference

The accuracy of sub-band channel quality indicator (CQI) reporting under frequency selective interference conditions is determined by a double-sided percentile of the reported differential CQI offset level +2 for a preferred sub-band, and the relative increase of the throughput obtained when transmitting on any one of the sub-bands with the highest reported differential CQI offset level the corresponding transport format compared to the case for which a fixed format is transmitted on any sub-band in set of TS 36.213 [10]. The purpose is to verify that preferred sub-bands are used for frequently-selective scheduling under frequency-selective interference conditions.

9.3.3.1 CQI Reporting under fading conditions and frequency-selective interference – PUSCH 3-0 (Cell-Specific Reference Symbols)

9.3.3.1.1 FDD CQI Reporting under fading conditions and frequency-selective interference – PUSCH 3-0

9.3.3.1.1.1 Test purpose

To verify that preferred sub-bands can be used for frequently-selective scheduling with frequency-selective interference situation.

9.3.3.1.1.2 Test applicability

This test applies to all types of E-UTRA FDD UE release 8 and forward.

9.3.3.1.1.3 Minimum conformance requirements

For the parameters specified in Table 9.3.3.1.1.3-1, and using the downlink physical channels specified in Annex C, the minimum requirements are specified in Table 9.3.3.1.1.3-2 and by the following:

- a) a sub-band differential CQI offset level of +2 shall be reported at least α % for at least one of the sub-bands of full size at the channel edges;
- b) the ratio of the throughput obtained when transmitting on a randomly selected sub-band among the sub-bands with the highest differential CQI offset level the corresponding TBS and that obtained when transmitting the TBS indicated by the reported wideband CQI median on a randomly selected sub-band in set S shall be $\geq \gamma$;

The requirements only apply for sub-bands of full size and the random scheduling across the sub-bands is done by selecting a new sub-band in each TTI for FDD, each available downlink transmission instance for TDD. Sub-bands of a size smaller than full size are excluded from the test. The transport block size TBS(wideband CQI median) is that resulting from the code rate which is closest to that indicated by the wideband CQI median and the N_{PRB} entry in Table 7.1.7.2.1-1 of TS 36.213 [10] that corresponds to the sub-band size.

Table 9.3.3.1.1.3-1 Sub-band test for single antenna transmission (FDD)

Parameter	Unit	Test 1	Test 2
Bandwidth	MHz	10 MHz	10 MHz
Transmission mode		1 (port 0)	1 (port 0)
Downlink power allocation	ρ_A	dB	0
	ρ_B	dB	0
	σ	dB	0
$I_{ot}^{(j)}$ for RB 0...5 Note 3	dB[mW/15kHz]	-102	-93
$I_{ot}^{(j)}$ for RB 6...41 Note 3	dB[mW/15kHz]	-93	-93
$I_{ot}^{(j)}$ for RB 42...49 Note 3	dB[mW/15kHz]	-93	-102
$\hat{I}_{or}^{(j)}$	dB[mW/15kHz]	-94	-94
Max number of HARQ transmissions		1	
Propagation channel		Clause B.2.4 with $\tau_d = 0.45 \mu s$, $a = 1$, $f_D = 5$ Hz	
Reporting interval	ms	5	
Antenna configuration		1 x 2	
CQI delay	ms	8	
Reporting mode		PUSCH 3-0	
Sub-band size	RB	6 (full size)	
<p>Note 1: If the UE reports in an available uplink reporting instance at subframe SF#n based on CQI estimation at a downlink subframe not later than SF#(n-4), this reported subband or wideband CQI cannot be applied at the eNB downlink before SF#(n+4)</p> <p>Note 2: Reference measurement channel according to Table A.4-4.with one/two sided dynamic OCNG Pattern OP.1/2 FDD as described in Annex A.5.1.1/2</p> <p>Note 3: lot shall be modelled as connecting Gaussian distributed uncorrelated interference source for each UE receive antenna port. The received power spectral density of the interfering signal as measured at the UE antenna connector is to be scaled accordingly for different RB groups.</p>			

Table 9.3.3.1.1.3-2: Minimum requirement (FDD)

Parameter	Test 1	Test 2
α [%]	60	60
γ	1.6	1.6
UE Category	1-8	1-8

The normative reference for this requirement is TS 36.101 [2] clause 9.3.3.1.1.

9.3.3.1.1.4 Test description

9.3.3.1.1.4.1 Initial conditions

Initial conditions are a set of test configurations the UE needs to be tested in and the steps for the SS to take with the UE to reach the correct measurement state.

Configurations of PDSCH and PDCCH before measurement are specified in Annex C.2.

Test Environment: Normal as defined in TS 36.508 [7] clause 4.1.

Frequencies to be tested: Mid Range as defined in TS 36.508 [7] clause 4.3.1.1.

Channel Bandwidths to be tested: 10MHz, as defined in TS 36.508 [7] clause 4.3.1.1

1. Connect the SS, interfering source and faders to the UE antenna connector (s) as shown in TS 36.508 [7] Annex A, Figure A.21.
2. The parameter settings for the cell are set up according to Table 9.3.3.1.1.3-1.
3. Downlink signals are initially set up according to Annex C.1 and Annex C.3.2, and uplink signals according to Annex H.1 and H.3.2.
4. Propagation conditions are set according to Annex B.0.
5. Ensure the UE is in State 3A-RF according to TS 36.508 [7] clause 5.2A.2. Message contents are defined in clause 9.3.3.1.1.4.3.

9.3.3.1.1.4.2 Test procedure

1. Set the parameters of bandwidth, the propagation condition, antenna configuration and measurement channel according to Table 9.3.3.1.1.3-1 as appropriate.
2. The SS shall transmit PDSCH via PDCCH DCI format 1A for C_RNTI to transmit the DL RMC (Table A.4-4) according to CQI value 8 of Annex A.4 Table A.4-3 and keep it regardless of the wideband and subband CQI value sent by the UE. Continue transmission of the PDSCH until 2000 wideband CQI reports and full-size subband CQI reports for each full-size subband have been gathered. The SS sends downlink MAC padding bits on the DL RMC. SS schedules the UL transmission every 5 ms to carry the PUSCH CQI feedback via PDCCH DCI format 0 with CQI request bit set to 1 and I_MCS=29 and N_PRB allocated to be less or equal to 4. In this process the SS collects wideband CQI reports every 5 ms and also cases where UE transmits nothing in its CQI timing are counted as wideband CQI and full-size subband CQI reports.
3. Set up a relative frequency distribution for the reported wideband CQI-values, Calculate the median value (wideband Median CQI is the CQI that is at or crosses 50% distribution from the lower wideband CQI side). This CQI-value is declared as wideband Median CQI value.
4. If for at least one of the full-size subbands at the channel edges, a subband differential CQI offset level of +2 is reported in α % or more of 2000 reports, then continue with step 5, otherwise fail the UE.
5. The SS shall transmit PDSCH via PDCCH DCI format 1A for C_RNTI to transmit the DL RMC (Table A.4-4) on an each TTI randomly selected full-size subband using the transport format according to the wideband median-CQI value regardless of UE wideband or subband CQI report. Note that each full-size subband shall be selected in the equal probability The SS sends downlink MAC padding bits on the DL RMC. The transport format to be used is defined in Annex A.4 Table A.4-6. SS schedules the UL transmission every 5 ms to carry the PUSCH CQI feedback via PDCCH DCI format 0 with CQI request bit set to 1 and I_MCS=29 and N_PRB allocated to be less or equal to 4. Measure the average throughput according to Annex G.5.3. Declare the throughput as t_{median} .
6. The SS shall transmit PDSCH via PDCCH DCI format 1A for C_RNTI to transmit the DL RMC (Table A.4-4) according to the highest UE reported full-size subband CQI value in one full-size subband selected among the sub-bands in which UE reports the highest full-size subband CQI. Subband differential CQI offset level is selected from {0, 1, 2, -1}. Note that the SS shall send PDSCH in the same full-size subband until next UE report is available. In case when same full-size subbands are reported subsequently as subbands with highest full-size subband CQI, the SS shall select for transmission a different subband with respect to the last selection. The SS sends downlink MAC padding bits on the DL RMC. The transport format to be used is defined in Annex A.4 Table A.4-6. SS schedules the UL transmission every 5 ms to carry the PUSCH CQI feedback via PDCCH DCI format 0 with CQI request bit set to 1 and I_MCS=29 and N_PRB allocated to be less or equal to 4. Measure the average throughput according to Annex G.5.3. Declare the throughput as $t_{subband}$. Count the number of NACKs, ACKs and statDTXs on the UL during the test interval.
If $t_{subband} / t_{median} \geq \gamma$, then pass the UE for this test and go to step 7. Otherwise fail the UE.
7. If both tests have not been done, then repeat the same procedure (steps 1 to 6) with test conditions according to the table 9.3.3.1.1.3-1 for the other Test as appropriate. Otherwise pass the UE.

9.3.3.1.1.4.3 Message contents

Table 9.3.3.1.1.4.3-1: PhysicalConfigDedicated-DEFAULT

Derivation Path: 36.508 clause 5.5.1.2			
Information Element	Value/remark	Comment	Condition
PhysicalConfigDedicated-DEFAULT ::= SEQUENCE {			
cqi-ReportConfig	<i>CQI-ReportConfig-DEFAULT</i>		
}			

Table 9.3.3.1.1.4.3-2: CQI-ReportConfig-DEFAULT

Derivation Path: 36.508 clause 4.6.3			
Information Element	Value/remark	Comment	Condition
CQI-ReportConfig-DEFAULT ::= SEQUENCE {			
cqi-ReportModeAperiodic	rm30		
nomPDSCH-RS-EPRE-Offset	0		
cqi-ReportPeriodic CHOICE {	Not present		
}			
}			

9.3.3.1.1.5 Test requirement

Table 9.3.3.1.1.5-1: Test requirement (FDD)

Parameter	Test 1	Test 2
α [%]	40	40
γ	1.50	1.50

9.3.3.1.2 TDD CQI Reporting under fading conditions and frequency-selective interference – PUSCH 3-0

9.3.3.1.2.1 Test purpose

To verify that preferred sub-bands can be used for frequently-selective scheduling with frequency-selective interference situation.

9.3.3.1.2.2 Test applicability

This test applies to all types of E-UTRA TDD UE release 8 and forward.

9.3.3.1.2.3 Minimum conformance requirements

For the parameters specified in Table 9.3.3.1.2.3-1, and using the downlink physical channels specified in Annex C, the minimum requirements are specified in Table 9.3.3.1.2.3-2 and by the following:

- a sub-band differential CQI offset level of +2 shall be reported at least α % for at least one of the sub-bands of full size at the channel edges;
- the ratio of the throughput obtained when transmitting on any one of the sub-bands with the highest differential CQI offset level the corresponding TBS and that obtained when transmitting the TBS indicated by the reported wideband CQI median on a randomly selected sub-band in set S shall be $\geq \gamma$;

The requirements only apply for sub-bands of full size and the random scheduling across the sub-bands is done by selecting a new sub-band in each TTI for FDD, each available downlink transmission instance for TDD. Sub-bands of a size smaller than full size are excluded from the test. The transport block size TBS(wideband CQI median) is that resulting from the code rate which is closest to that indicated by the wideband CQI median and the N_{PRB} entry in Table 7.1.7.2.1-1 of TS 36.213 [10] that corresponds to the sub-band size.

Table 9.3.3.1.2.3-1: Sub-band test for single antenna transmission (TDD)

Parameter	Unit	Test 1	Test 2
Bandwidth	MHz	10 MHz	10 MHz
Transmission mode		1 (port 0)	1 (port 0)
Downlink power allocation	ρ_A	dB	0
	ρ_B	dB	0
	σ	dB	0
Uplink downlink configuration		2	
Special subframe configuration		4	
$I_{ot}^{(j)}$ for RB 0...[5] Note 3	dB[mW/15kHz]	-102	-93
$I_{ot}^{(j)}$ for RB 6...[41] Note 3	dB[mW/15kHz]	-93	-93
$I_{ot}^{(j)}$ for RB [42]...49 Note 3	dB[mW/15kHz]	-93	-102
$\hat{I}_{or}^{(j)}$	dB[mW/15kHz]	-94	-94
Max number of HARQ transmissions		1	
Propagation channel		Clause B.2.4 with $\tau_d = 0.45 \mu s$, $a = 1$, $f_D = 5$ Hz	
Antenna configuration		1 x 2	
Reporting interval	ms	5	
CQI delay	ms	10 or 11	
Reporting mode		PUSCH 3-0	
Sub-band size	RB	6 (full size)	
ACK/NACK feedback mode		Multiplexing	
Note 1:	If the UE reports in an available uplink reporting instance at subframe SF#n based on CQI estimation at a downlink subframe not later than SF#(n-4), this reported subband or wideband CQI cannot be applied at the eNB downlink before SF#(n+4)		
Note 2:	Reference measurement channel according to table A.4-5 with one/two sided dynamic OCNG Pattern OP.1/2 TDD as described in Annex A.5.2.1/2.		
Note 3:	lot shall be modelled as connecting Gaussian distributed uncorrelated interference source for each UE receive antenna port. The received power spectral density of the interfering signal as measured at the UE antenna connector is to be scaled accordingly for different RB groups.		

Table 9.3.3.1.2.3-2: Minimum requirement (TDD)

Parameter	Test 1	Test 2
α [%]	60	60
γ	1.6	1.6
UE Category	1-8	1-8

The normative reference for this requirement is TS 36.101 [2] clause 9.3.3.1.2.

9.3.3.1.2.4 Test description

9.3.3.1.2.4.1 Initial conditions

Initial conditions are a set of test configurations the UE needs to be tested in and the steps for the SS to take with the UE to reach the correct measurement state.

Configurations of PDSCH and PDCCH before measurement are specified in Annex C.2.

Test Environment: Normal as defined in TS 36.508 [7] clause 4.1.

Frequencies to be tested: Mid Range as defined in TS 36.508 [7] clause 4.3.1.1.

Channel Bandwidths to be tested: 10MHz, as defined in TS 36.508 [7] clause 4.3.1.1

1. Connect the SS, faders and interfering source to the UE antenna connector (s) as shown in TS 36.508 [7] Annex A, Figure A.21.
2. The parameter settings for the cell are set up according to Table 9.3.3.1.2.3-1.
3. Downlink signals are initially set up according to Annex C.1 and Annex C.3.2, and uplink signals according to Annex H.1 and H.3.2.
4. Propagation conditions are set according to Annex B.0.
5. Ensure the UE is in State 3A-RF according to TS 36.508 [7] clause 5.2A.2. Message contents are defined in clause 9.3.3.1.2.4.3.

9.3.3.1.2.4.2 Test procedure

1. Set the parameters of bandwidth, the propagation condition, antenna configuration and measurement channel according to Table 9.3.3.1.2.3-1 as appropriate.
2. The SS shall transmit PDSCH via PDCCH DCI format 1A for C_RNTI to transmit the DL RMC (Table A.4-5) according to CQI value 8 of Annex A.4 Table A.4-3 and keep it regardless of the wideband and subband CQI value sent by the UE. Continue transmission of the PDSCH until 2000 wideband CQI reports and full-size subband CQI reports for each full-size subband have been gathered. The SS sends downlink MAC padding bits on the DL RMC. SS schedules the UL transmission in subframe #2 and subframe #7 to carry the PUSCH CQI feedback via PDCCH DCI format 0 with CQI request bit set to 1 and I_MCS=29 and N_PRB allocated to be less or equal to 4. In this process the SS collects wideband CQI reports every 5 ms and also cases where UE transmits nothing in its CQI timing are counted as wideband CQI and full-size subband CQI reports.
3. Set up a relative frequency distribution for the reported wideband CQI-values, Calculate the median value (wideband Median CQI is the CQI that is at or crosses 50% distribution from the lower wideband CQI side). This CQI-value is declared as wideband Median CQI value.
4. If for at least one of the full-size subbands at the channel edges, a subband differential CQI offset level of +2 is reported in α % or more of 2000 reports, then continue with step 5, otherwise fail the UE.
5. The SS shall transmit PDSCH via PDCCH DCI format 1A for C_RNTI to transmit the DL RMC (Table A.4-5) in an each available downlink transmission instance randomly selected full-size subband using the transport format according to the wideband median-CQI value regardless of UE wideband or subband CQI report. Note that each full-size subband shall be selected in the equal probability. The SS sends downlink MAC padding bits on the DL RMC. SS schedules the UL transmission in subframe #2 and subframe #7 to carry the PUSCH CQI feedback via PDCCH DCI format 0 with CQI request bit set to 1 and I_MCS=29 and N_PRB allocated to be less or equal to 4. Measure the average throughput according to Annex G.5.3. Declare the throughput as t_{median} .
6. The SS shall transmit PDSCH via PDCCH DCI format 1A for C_RNTI to transmit the DL RMC (Table A.4-5) according to the highest UE reported full-size subband CQI value in one full-size subband selected among the sub-bands in which UE reports the highest full-size subband CQI. Subband differential CQI offset level is selected from {0, 1, 2, -1}. Note that the SS shall send PDSCH in the same full-size subband until next UE report is available. In case when same full-size subbands are reported subsequently as subbands with highest full-size subband CQI, the SS shall select for transmission a different subband with respect to the last selection. The SS sends downlink MAC padding bits on the DL RMC. The transport format to be used is defined in Annex A.4 Table A.4-6. SS schedules the UL transmission in subframe #2 and subframe #7 to carry the PUSCH CQI feedback via PDCCH DCI format 0 with CQI request bit set to 1 and I_MCS=29 and N_PRB allocated to be less or equal to 4. Measure the average throughput according to Annex G.5.3. Declare the throughput as $t_{subband}$. Count the number of NACKs, ACKs and statDTXs on the UL during the test interval.
If $t_{subband} / t_{median} \geq \gamma$, then pass the UE for this test and go to step 7. Otherwise fail the UE.

7. If both tests have not been done, then repeat the same procedure (steps 1 to 6) with test conditions according to the table 9.3.3.1.2.3-1 for the other Test as appropriate. Otherwise pass the UE.

9.3.3.1.2.4.3 Message contents

Message contents are according to TS 36.508 [7] clause 4.6 with the following exceptions:

Table 9.3.3.1.2.4.3-1: PhysicalConfigDedicated-DEFAULT

Derivation Path: 36.508 clause 5.5.1.2			
Information Element	Value/remark	Comment	Condition
PhysicalConfigDedicated-DEFAULT ::= SEQUENCE {			
cqi-ReportConfig	<i>CQI-ReportConfig-DEFAULT</i>		
}			

Table 9.3.3.1.2.4.3-2: CQI-ReportConfig-DEFAULT

Derivation Path: 36.508 clause 4.6.3			
Information Element	Value/remark	Comment	Condition
CQI-ReportConfig-DEFAULT ::= SEQUENCE {			
cqi-ReportModeAperiodic	rm30		
nomPDSCH-RS-EPRE-Offset	0		
cqi-ReportPeriodic CHOICE {	Not present		
}			
}			

Table 9.3.3.1.2.4.3-3: TDD-Config-DEFAULT

Derivation Path: 36.508 clause 4.6.3			
Information Element	Value/remark	Comment	Condition
TDD-Config-DEFAULT ::= SEQUENCE {			
subframeAssignment	Sa2		
specialSubframePatterns	Ssp4		
}			

9.3.3.1.2.5 Test requirement

Table 9.3.3.1.2.5-1: Test requirement (TDD)

Parameter	Test 1	Test 2
α [%]	40	40
γ	1.50	1.50

9.3.4 UE-selected subband CQI

The accuracy of UE-selected subband channel quality indicator (CQI) reporting under frequency-selective fading conditions is determined by the relative increase of the throughput obtained when transmitting on the UE-selected subbands with the corresponding transport format compared to the case for which a fixed format is transmitted on any subband in set S of TS 36.213 [10]. The purpose is to verify that correct subbands are accurately reported for frequency-selective scheduling. To account for sensitivity of the input SNR the subband CQI reporting under frequency-selective fading conditions is considered to be verified if the reporting accuracy is met for at least one of two SNR levels separated by an offset of 1 dB.

9.3.4.1 CQI Reporting under fading conditions – PUSCH 2-0 (Cell-Specific Reference Symbols)

9.3.4.1.1 FDD CQI Reporting under fading conditions – PUSCH 2-0

9.3.4.1.1.1 Test purpose

To verify that UE-selected sub-bands can be used for frequently-selective scheduling.

9.3.4.1.1.2 Test applicability

This test applies to all types of E-UTRA FDD UE release 9 and forward. Applicability requires support for FGI bit 1.

9.3.4.1.1.3 Minimum conformance requirements

For the parameters specified in Table 9.3.4.1.1.3-1, and using the downlink physical channels specified in Annex C, the minimum requirements are specified in Table 9.3.4.1.1.3-2 and by the following:

- a) the ratio of the throughput obtained when transmitting on a randomly selected subband among the best M subbands reported by the UE the corresponding TBS and that obtained when transmitting the TBS indicated by the reported wideband CQI median on a randomly selected subband in set S shall be $\geq \gamma$;

The requirements only apply for subbands of full size and the random scheduling across the subbands is done by selecting a new subband in each TTI for FDD. The transport block size TBS (wideband CQI median) is that resulting from the code rate which is closest to that indicated by the wideband CQI median and the N_{PRB} entry in Table 7.1.7.2.1-1 of TS 36.213 [10] that corresponds to the subband size.

Table 9.3.4.1.1.3-1: Subband test for single antenna transmission (FDD)

Parameter		Unit	Test 1		Test 2	
Bandwidth		MHz	10 MHz			
Transmission mode			1 (port 0)			
Downlink power allocation	ρ_A	dB	0			
	ρ_B	dB	0			
	σ	dB	0			
SNR (Note 3)		dB	9	10	14	15
$\hat{I}_{or}^{(j)}$		dB[mW/15kHz]	-89	-88	-84	-83
$N_{oc}^{(j)}$		dB[mW/15kHz]	-98		-98	
Propagation channel			Clause B.2.4 with $\tau_d = 0.45 \mu s$, $a = 1$, $f_D = 5$ Hz			
Reporting interval		ms	5			
CQI delay		ms	8			
Reporting mode			PUSCH 2-0			
Max number of HARQ transmissions			1			
Subband size (k)		RBs	3 (full size)			
Number of preferred subbands (M)			5			
<p>Note 1: If the UE reports in an available uplink reporting instance at subframe SF#n based on CQI estimation at a downlink subframe not later than SF#$(n-4)$, this reported subband or wideband CQI cannot be applied at the eNB downlink before SF#$(n+4)$</p> <p>Note 2: Reference measurement channel according to Table A.4-10 with one/two sided dynamic OCNG Pattern OP.1/2 FDD as described in Annex A.5.1.1/2.</p> <p>Note 3: For each test, the minimum requirements shall be fulfilled for at least one of the two SNR(s) and the respective wanted signal input level.</p>						

Table 9.3.4.1.1.3-2: Minimum requirement (FDD)

	Test 1	Test 2
γ	1.2	1.2
UE Category	1-8	1-8

The normative reference for this requirement is TS 36.101 [2] clause 9.3.4.1.1.

9.3.4.1.1.4 Test description

9.3.4.1.1.4.1 Initial conditions

Initial conditions are a set of test configurations the UE needs to be tested in and the steps for the SS to take with the UE to reach the correct measurement state.

Configurations of PDSCH and PDCCH before measurement are specified in Annex C.2.

Test Environment: Normal as defined in TS 36.508 [7] clause 4.1.

Frequencies to be tested: Mid Range as defined in TS 36.508 [7] clause 4.3.1.1.

Channel Bandwidths to be tested: 10MHz, as defined in TS 36.508 [7] clause 4.3.1.1

1. Connect the SS and faders to the UE antenna connector (s) as shown in TS 36.508 [7] Annex A, Figure A.9.
2. The parameter settings for the cell are set up according to Table 9.3.4.1.1.3-1.
3. Downlink signals are initially set up according to Annex C.1 and Annex C.3.2, and uplink signals according to Annex H.1 and H.3.2.
4. Propagation conditions are set according to Annex B.0.
5. Ensure the UE is in State 3A-RF according to TS 36.508 [7] clause 5.2A.2. Message contents are defined in clause 9.3.4.1.1.4.3.

9.3.4.1.1.4.2 Test procedure

1. Set the parameters of bandwidth, the propagation condition, antenna configuration and measurement channel according to Table 9.3.4.1.1.3-1 as appropriate.
2. The SS shall transmit PDSCH via PDCCH DCI format 1A for C_RNTI to transmit the DL RMC (Table A.4-10) according to CQI value 8 of Annex A.4 Table A.4-3 and keep it regardless of the wideband and subband CQI value sent by the UE. Continue transmission of the PDSCH until 2000 wideband CQI reports and full-size subband CQI reports for each full-size subband have been gathered. The SS sends downlink MAC padding bits on the DL RMC. SS schedules the UL transmission every 5 ms to carry the PUSCH CQI feedback via PDCCH DCI format 0 with CQI request bit set to 1 and I_MCS=29 and N_PRB allocated to be less or equal to 4. In this process the SS collects wideband CQI reports every 5 ms and also cases where UE transmits nothing in its CQI timing are counted as wideband CQI and full-size subband CQI reports.
3. Set up a relative frequency distribution for the reported wideband CQI-values, Calculate the median value (wideband Median CQI is the CQI that is at or crosses 50% distribution from the lower wideband CQI side). This CQI-value is declared as wideband Median CQI value.
4. The SS shall transmit PDSCH via PDCCH DCI format 1A for C_RNTI to transmit the DL RMC (Table A.4-10) on a randomly selected full-size subband using the transport format according to the wideband median-CQI value regardless of UE wideband or subband CQI report. Note that each full-size subband shall be selected in the equal probability The SS sends downlink MAC padding bits on the DL RMC. SS schedules the UL transmission every 5 ms to carry the PUSCH CQI feedback via PDCCH DCI format 0 with CQI request bit set to 1 and I_MCS=29 and N_PRB allocated to be less or equal to 4. Measure the average throughput according to Annex G.5.3. Declare the throughput as t_{median} .
5. The SS shall transmit PDSCH via PDCCH DCI format 1A for C_RNTI to transmit the DL RMC (Table A.4-10) in one full-size subband selected among the M subbands reported by the UE and with the corresponding TBS. Differential CQI offset level is selected from {1, 2, 3, 4}. Note that the SS shall send PDSCH in the same full-

size subband until next UE report is available. In case when same full-size subbands are reported subsequently, the SS shall select for transmission a different subband with respect to the last selection. The SS sends downlink MAC padding bits on the DL RMC. SS schedules the UL transmission every 5 ms to carry the PUSCH CQI feedback via PDCCH DCI format 0 with CQI request bit set to 1 and I_MCS=29 and N_PRB allocated to be less or equal to 4. Measure the average throughput according to Annex G.5.3. Declare the throughput as $t_{subband}$. Count the number of NACKs, ACKs and statDTXs on the UL during the test interval.

If $t_{subband} / t_{median} \geq \gamma$, then pass the UE for this test and go to step 7. Otherwise go to step 6.

6. If both SNR points of the test have not been tested, then repeat the same procedure (steps 1 to 5) for the other SNR point as appropriate. Otherwise fail the UE.
7. If both tests have not been done, then repeat the same procedure (steps 1 to 5) with test conditions according to the table 9.3.4.1.1.3-1 for the other Test as appropriate. Otherwise pass the UE.

9.3.4.1.1.4.3 Message contents

Table 9.3.4.1.1.4.3-1: PhysicalConfigDedicated-DEFAULT

Derivation Path: 36.508 clause 5.5.1.2			
Information Element	Value/remark	Comment	Condition
PhysicalConfigDedicated-DEFAULT ::= SEQUENCE {			
cqi-ReportConfig	CQI-ReportConfig-DEFAULT		
}			

Table 9.3.4.1.1.4.3-2: CQI-ReportConfig-DEFAULT

Derivation Path: 36.508 clause 4.6.3			
Information Element	Value/remark	Comment	Condition
CQI-ReportConfig-DEFAULT ::= SEQUENCE {			
cqi-ReportModeAperiodic	rm20		
nomPDSCH-RS-EPRE-Offset	0		
cqi-ReportPeriodic CHOICE {	Not present		
}			
}			

9.3.4.1.1.5 Test requirement

Table 9.3.4.1.1.5-1: Test requirement (FDD)

	Test 1	Test 2
γ	1.19	1.19
UE Category	1-8	1-8

9.3.4.1.2 TDD CQI Reporting under fading conditions – PUSCH 2-0

9.3.4.1.2.1 Test purpose

To verify that UE-selected sub-bands can be used for frequently-selective scheduling.

9.3.4.1.2.2 Test applicability

This test applies to all types of E-UTRA TDD UE release 9 and forward. Applicability requires support for FGI bit 1.

9.3.4.1.2.3 Minimum conformance requirements

For the parameters specified in Table 9.3.4.1.2.3-1, and using the downlink physical channels specified in Annex C, the minimum requirements are specified in Table 9.3.4.1.2.3-2 and by the following:

- a) the ratio of the throughput obtained when transmitting on a randomly selected subband among the best M subbands reported by the UE the corresponding TBS and that obtained when transmitting the TBS indicated by the reported wideband CQI median on a randomly selected subband in set S shall be $\geq \gamma$;

The requirements only apply for subbands of full size and the random scheduling across the subbands is done by selecting a new subband in each available downlink transmission instance for TDD. The transport block size TBS (wideband CQI median) is that resulting from the code rate which is closest to that indicated by the wideband CQI median and the N_{PRB} entry in Table 7.1.7.2.1-1 of TS 36.213 [10] that corresponds to the subband size.

Table 9.3.4.1.2.3-1: Sub-band test for single antenna transmission (TDD)

Parameter		Unit	Test 1		Test 2	
Bandwidth		MHz	10 MHz			
Transmission mode			1 (port 0)			
Downlink power allocation	ρ_A	dB	0			
	ρ_B	dB	0			
	σ	dB	0			
Uplink downlink configuration			2			
Special subframe configuration			4			
SNR (Note 3)		dB	9	10	14	15
$\hat{I}_{or}^{(j)}$		dB[mW/15kHz]	-89	-88	-84	-83
$N_{oc}^{(j)}$		dB[mW/15kHz]	-98		-98	
Propagation channel			Clause B.2.4 with $\tau_d = 0.45 \mu s$, $a = 1$, $f_D = 5$ Hz			
Reporting interval		ms	5			
CQI delay		ms	10 or 11			
Reporting mode			PUSCH 2-0			
Max number of HARQ transmissions			1			
Subband size (k)		RBs	3 (full size)			
Number of preferred subbands (M)			5			
ACK/NACK feedback mode			Multiplexing			
<p>Note 1: If the UE reports in an available uplink reporting instance at subframe SF#n based on CQI estimation at a downlink subframe not later than SF#($n-4$), this reported subband or wideband CQI cannot be applied at the eNB downlink before SF#($n+4$)</p> <p>Note 2: Reference measurement channel according to Table A.4-11 with one/two sided dynamic OCNG Pattern OP.1/2 TDD as described in Annex A.5.2.1/2.</p> <p>Note 3: For each test, the minimum requirements shall be fulfilled for at least one of the two SNR(s) and the respective wanted signal input level.</p>						

Table 9.3.4.1.2.3-2: Minimum requirement (TDD)

	Test 1	Test 2
γ	1.2	1.2
UE Category	1-8	1-8

The normative reference for this requirement is TS 36.101 [2] clause 9.3.4.1.2.

9.3.4.1.2.4 Test description

9.3.4.1.2.4.1 Initial conditions

Initial conditions are a set of test configurations the UE needs to be tested in and the steps for the SS to take with the UE to reach the correct measurement state.

Configurations of PDSCH and PDCCH before measurement are specified in Annex C.2.

Test Environment: Normal as defined in TS 36.508 [7] clause 4.1.

Frequencies to be tested: Mid Range as defined in TS 36.508 [7] clause 4.3.1.1.

Channel Bandwidths to be tested: 10MHz, as defined in TS 36.508 [7] clause 4.3.1.1

1. Connect the SS, faders and AWGN noise source to the UE antenna connector (s) as shown in TS 36.508 [7] Annex A, Figure A.9.
2. The parameter settings for the cell are set up according to Table 9.3.4.1.2.3-1.
3. Downlink signals are initially set up according to Annex C.1 and Annex C.3.2, and uplink signals according to Annex H.1 and H.3.2.
4. Propagation conditions are set according to Annex B.0.
5. Ensure the UE is in State 3A-RF according to TS 36.508 [7] clause 5.2A.2. Message contents are defined in clause 9.3.4.1.2.4.3.

9.3.4.1.2.4.2 Test procedure

1. Set the parameters of bandwidth, the propagation condition, antenna configuration and measurement channel according to Table 9.3.4.1.2.3-1 as appropriate.
2. The SS shall transmit PDSCH via PDCCH DCI format 1A for C_RNTI to transmit the DL RMC (Table A.4-11) according to CQI value 8 of Annex A.4 Table A.4-3 and keep it regardless of the wideband and subband CQI value sent by the UE. Continue transmission of the PDSCH until 2000 wideband CQI reports and full-size subband CQI reports for each full-size subband have been gathered. The SS sends downlink MAC padding bits on the DL RMC. SS schedules the UL transmission in subframe #2 and subframe #7 to carry the PUSCH CQI feedback via PDCCH DCI format 0 with CQI request bit set to 1 and I_MCS=29 and N_PRB allocated to be less or equal to 4. In this process the SS collects wideband CQI reports every 5 ms and also cases where UE transmits nothing in its CQI timing are counted as wideband CQI and full-size subband CQI reports.
3. Set up a relative frequency distribution for the reported wideband CQI-values, Calculate the median value (wideband Median CQI is the CQI that is at or crosses 50% distribution from the lower wideband CQI side). This CQI-value is declared as wideband Median CQI value.
4. The SS shall transmit PDSCH via PDCCH DCI format 1A for C_RNTI to transmit the DL RMC (Table A.4-11) on a randomly selected full-size subband using the transport format according to the wideband median-CQI value regardless of UE wideband or subband CQI report. Note that each full-size subband shall be selected in the equal probability. The SS sends downlink MAC padding bits on the DL RMC. SS schedules the UL transmission in subframe #2 and subframe #7 to carry the PUSCH CQI feedback via PDCCH DCI format 0 with CQI request bit set to 1 and I_MCS=29 and N_PRB allocated to be less or equal to 4. Measure the average throughput according to Annex G.5.3. Declare the throughput as f_{median} .
5. The SS shall transmit PDSCH via PDCCH DCI format 1A for C_RNTI to transmit the DL RMC (Table A.4-11) in one full-size subband selected among the M subbands reported by the UE and with the corresponding TBS. Differential CQI offset level is selected from {1, 2, 3, 4}. Note that the SS shall send PDSCH in the same full-size until next UE report is available. In case when same full-size subbands are reported subsequently, the SS shall select for transmission a different subband with respect to the last selection. The SS sends downlink MAC padding bits on the DL RMC. SS schedules the UL transmission in subframe #2 and subframe #7 to carry the PUSCH CQI feedback via PDCCH DCI format 0 with CQI request bit set to 1 and I_MCS=29 and N_PRB allocated to be less or equal to 4. Measure the average throughput according to Annex G.5.3. Declare the

throughput as $t_{subband} \cdot \text{Count the number of NACKs, ACKs and statDTXs on the UL during the test interval.}$

If $t_{subband} / t_{median} \geq \gamma$, then pass the UE for this test and go to step 7. Otherwise go to step 6.

6. If both SNR points of the test have not been tested, then repeat the same procedure (steps 1 to 5) for the other SNR point as appropriate. Otherwise fail the UE.
7. If both tests have not been done, then repeat the same procedure (steps 1 to 6) with test conditions according to the table 9.3.4.1.2.3-1 for the other Test as appropriate. Otherwise pass the UE.

9.3.4.1.2.4.3 Message contents

Message contents are according to TS 36.508 [7] clause 4.6 with the following exceptions:

Table 9.3.4.1.2.4.3-1: PhysicalConfigDedicated-DEFAULT

Derivation Path: 36.508 clause 5.5.1.2			
Information Element	Value/remark	Comment	Condition
PhysicalConfigDedicated-DEFAULT ::= SEQUENCE {			
cqi-ReportConfig	<i>CQI-ReportConfig-DEFAULT</i>		
}			

Table 9.3.4.1.2.4.3-2: CQI-ReportConfig-DEFAULT

Derivation Path: 36.508 clause 4.6.3			
Information Element	Value/remark	Comment	Condition
CQI-ReportConfig-DEFAULT ::= SEQUENCE {			
cqi-ReportModeAperiodic	rm20		
nomPDSCH-RS-EPRE-Offset	0		
cqi-ReportPeriodic CHOICE {	Not present		
}			
}			

Table 9.3.4.1.2.4.3-3: TDD-Config-DEFAULT

Derivation Path: 36.508 clause 4.6.3			
Information Element	Value/remark	Comment	Condition
TDD-Config-DEFAULT ::= SEQUENCE {			
subframeAssignment	Sa2		
specialSubframePatterns	Ssp4		
}			

9.3.4.1.2.5 Test requirement

Table 9.3.4.1.2.5-1: Test requirement (TDD)

	Test 1	Test 2
γ	1.19	1.19
UE Category	1-8	1-8

9.3.4.2 CQI Reporting under fading conditions – PUCCH 2-0 (Cell-Specific Reference Symbols)

9.3.4.2.1 FDD CQI Reporting under fading conditions – PUCCH 2-0

9.3.4.2.1.1 Test purpose

To verify that UE-selected sub-bands can be used for frequently-selective scheduling.

9.3.4.2.1.2 Test applicability

This test applies to all types of E-UTRA FDD UE release 9 and forward. Applicability requires support for FGI bit 2.

9.3.4.2.1.3 Minimum conformance requirements

For the parameters specified in Table 9.3.4.2.1.3-1, and using the downlink physical channels specified in Annex C, the minimum requirements are specified in Table 9.3.4.2.1.3-2 and by the following

- a) the ratio of the throughput obtained when transmitting on subbands reported by the UE the corresponding TBS and that obtained when transmitting the TBS indicated by the reported wideband CQI median on a randomly selected subband in set S shall be $\geq \gamma$;

The requirements only apply for subbands of full size and the random scheduling across the subbands is done by selecting a new subband in each TTI for FDD. The transport block size TBS (wideband CQI median) is that resulting from the code rate which is closest to that indicated by the wideband CQI median and the N_{PRB} entry in Table 7.1.7.2.1-1 of TS 36.213 [10] that corresponds to the subband size.

Table 9.3.4.2.1.3-1: Subband test for single antenna transmission (FDD)

Parameter	Unit	Test 1		Test 2	
Bandwidth	MHz	10 MHz			
Transmission mode		1 (port 0)			
Downlink power allocation	ρ_A	dB			
	ρ_B	dB			
	σ	dB			
SNR (Note 3)	dB	8	9	13	14
$\hat{I}_{or}^{(j)}$	dB[mW/15kHz]	-90	-89	-85	-84
$N_{oc}^{(j)}$	dB[mW/15kHz]	-98		-98	
Propagation channel		Clause B.2.4 with $\tau_d = 0.45 \mu s$, $a = 1$, $f_D = 5$ Hz			
Reporting periodicity	ms	$N_p = 2$			
CQI delay	ms	8			
Physical channel for CQI reporting		PUSCH (Note 4)			
PUCCH Report Type for wideband CQI		4			
PUCCH Report Type for subband CQI		1			
Max number of HARQ transmissions		1			
Subband size (k)	RBs	6 (full size)			
Number of bandwidth parts (J)		3			
K		1			
<i>cqi-pmi-ConfigIndex</i>		1			
Note 1:	If the UE reports in an available uplink reporting instance at subframe SF# n based on CQI estimation at a downlink subframe not later than SF#($n-4$), this reported subband or wideband CQI cannot be applied at the eNB downlink before SF#($n+4$)				
Note 2:	Reference measurement channel according to Table A.4-4 with one/two sided dynamic OCNG Pattern OP.1/2 FDD as described in Annex A.5.1.1/2.				
Note 3:	For each test, the minimum requirements shall be fulfilled for at least one of the two SNR(s) and the respective wanted signal input level.				
Note 4:	To avoid collisions between CQI reports and HARQ-ACK it is necessary to report both on PUSCH instead of PUCCH. PDCCH DCI format 0 shall be transmitted in downlink SF#1, #3, #7 and #9 to allow periodic CQI to multiplex with the HARQ-ACK on PUSCH in uplink subframe SF#5, #7, #1 and #3.				
Note 5:	CQI reports for the short subband (having 2RBs in the last bandwidth part) are to be disregarded and data scheduling according to the most recent subband CQI report for bandwidth part with $j=1$.				
Note 6:	In the case where wideband CQI is reported, data is to be scheduled according to the most recently used subband CQI report.				

Table 9.3.4.2.1.3-2: Minimum requirement (FDD)

	Test 1	Test 2
γ	1.15	1.15
UE Category	1-8	1-8

The normative reference for this requirement is TS 36.101 [2] clause 9.3.4.2.1.

9.3.4.2.1.4 Test description

9.3.4.2.1.4.1 Initial conditions

Initial conditions are a set of test configurations the UE needs to be tested in and the steps for the SS to take with the UE to reach the correct measurement state.

Configurations of PDSCH and PDCCH before measurement are specified in Annex C.2.

Test Environment: Normal as defined in TS 36.508 [7] clause 4.1.

Frequencies to be tested: Mid Range as defined in TS 36.508 [7] clause 4.3.1.1.

Channel Bandwidths to be tested: 10MHz, as defined in TS 36.508 [7] clause 4.3.1.1

1. Connect the SS and faders to the UE antenna connector (s) as shown in TS 36.508 [7] Annex A, Figure A.9.
2. The parameter settings for the cell are set up according to Table 9.3.4.2.1.3-1.
3. Downlink signals are initially set up according to Annex C.1 and Annex C.3.2, and uplink signals according to Annex H.1 and H.3.2.
4. Propagation conditions are set according to Annex B.0.
5. Ensure the UE is in State 3A-RF according to TS 36.508 [7] clause 5.2A.2. Message contents are defined in clause 9.3.4.2.1.4.3.

9.3.4.2.1.4.2 Test procedure

1. Set the parameters of bandwidth, the propagation condition, antenna configuration and measurement channel according to Table 9.3.4.2.1.3-1 as appropriate.
2. The SS shall transmit PDSCH via PDCCH DCI format 1A for C_RNTI to transmit the DL RMC (Table A.4-4) according to CQI value 8 of Annex A.4 Table A.4-3 and keep it regardless of the wideband and subband CQI value sent by the UE. Continue transmission of the PDSCH until 2000 wideband CQI reports and full-size subband CQI reports for each full-size subband have been gathered. The SS sends downlink MAC padding bits on the DL RMC. The SS sends uplink scheduling information via PDCCH DCI format 0 with CQI request bit set to 0 to schedule UL RMC in subframe #1, #3, #5 and subframe #7 (Table A.4.1-1). The UE will send ACK/NACK and periodic CQI report using PUSCH. In this process the SS collects wideband CQI reports and also cases where UE transmits nothing in its wideband CQI timing are counted as wideband CQI reports.
3. Set up a relative frequency distribution for the reported wideband CQI-values, Calculate the median value (wideband Median CQI is the CQI that is at or crosses 50% distribution from the lower wideband CQI side). This CQI-value is declared as wideband Median CQI value.
4. The SS shall transmit PDSCH via PDCCH DCI format 1A for C_RNTI to transmit the DL RMC (Table A.4-4) on a randomly selected full-size subband using the transport format according to the wideband median-CQI value regardless of UE wideband or subband CQI report. Note that each full-size subband shall be selected in the equal probability The SS sends downlink MAC padding bits on the DL RMC.. The SS sends uplink scheduling information via PDCCH DCI format 0 with CQI request bit set to 0 to schedule UL RMC in subframe #1, #3, #5 and subframe #7 (Table A.4.1-1). The UE will send ACK/NACK and periodic CQI report using PUSCH. Measure the average throughput according to Annex G.5.3. Declare the throughput as t_{median} .
5. The SS shall transmit PDSCH via PDCCH DCI format 1A for C_RNTI to transmit the DL RMC (Table A.4-4) in the full-size subband reported by the UE and with the corresponding TBS. When the UE reports a non-full-size SB, the SS schedules the recent reported SB for bandwidth part with $j=1$ and with the corresponding TBS. Note that the SS shall send PDSCH in the same full-size subband until next subband UE report is available. The SS sends downlink MAC padding bits on the DL RMC. The SS sends uplink scheduling information via PDCCH DCI format 0 with CQI request bit set to 0 to schedule UL RMC in subframe #1, #3, #5 and subframe #7 (Table A.4.1-1). The UE will send ACK/NACK and periodic CQI report using PUSCH. Measure the average throughput according to Annex G.5.3. Declare the throughput as $t_{subband}$. Count the number of NACKs, ACKs and statDTXs on the UL during the test interval.
If $t_{subband} / t_{median} \geq \gamma$, then pass the UE for this test and go to step 7. Otherwise go to step 6.

6. If both SNR points of the test have not been tested, then repeat the same procedure (steps 1 to 5) for the other SNR point as appropriate. Otherwise fail the UE.
7. If both tests have not been done, then repeat the same procedure (steps 1 to 6) with test conditions according to the table 9.3.4.2.1.3-1 for the other Test as appropriate. Otherwise pass the UE.

9.3.4.1.1.4.3 Message contents

Table 9.3.4.2.1.4.3-1: PhysicalConfigDedicated-DEFAULT

Derivation Path: 36.508 clause 5.5.1.2			
Information Element	Value/remark	Comment	Condition
PhysicalConfigDedicated-DEFAULT ::= SEQUENCE {			
cqi-ReportConfig	<i>CQI-ReportConfig-DEFAULT</i>		
}			

Table 9.3.4.2.1.4.3-2: CQI-ReportConfig-DEFAULT

Derivation Path: 36.508 clause 4.6.3			
Information Element	Value/remark	Comment	Condition
CQI-ReportConfig-DEFAULT ::= SEQUENCE {			
cqi-ReportModeAperiodic	Not present		
nomPDSCH-RS-EPRE-Offset	0		
cqi-ReportPeriodic CHOICE {			
setup SEQUENCE {			
cqi-PUCCH-ResourceIndex	0		
cqi-pmi-ConfigIndex	1	(see Table 7.2.2-1A in TS 36.213)	
cqi-FormatIndicatorPeriodic CHOICE {			
subbandCQI	1		
}			
ri-ConfigIndex	483	(see Table 7.2.2-1B in TS 36.213)	
simultaneousAckNackAndCQI	FALSE		
}			
}			

9.3.4.2.1.5 Test requirement

Table 9.3.4.2.1.5-1: Test requirement (FDD)

	Test 1	Test 2
γ	1.14	1.14
UE Category	1-8	1-8

9.3.4.2.2 TDD CQI Reporting under fading conditions – PUCCH 2-0

9.3.4.2.2.1 Test purpose

To verify that UE-selected sub-bands can be used for frequently-selective scheduling.

9.3.4.2.2.2 Test applicability

This test applies to all types of E-UTRA TDD UE release 9 and forward. Applicability requires support for FGI bit 2.

9.3.4.2.2.3 Minimum conformance requirements

For the parameters specified in Table 9.3.4.2.2.3-1, and using the downlink physical channels specified in Annex C, the minimum requirements are specified in Table 9.3.4.2.2.3-2 and by the following:

- a) the ratio of the throughput obtained when transmitting on subbands reported by the UE the corresponding TBS and that obtained when transmitting the TBS indicated by the reported wideband CQI median on a randomly selected subband in set S shall be $\geq \gamma$;

The requirements only apply for subbands of full size and the random scheduling across the subbands is done by selecting a new subband in each available downlink transmission instance for TDD. The transport block size TBS (wideband CQI median) is that resulting from the code rate which is closest to that indicated by the wideband CQI median and the N_{PRB} entry in Table 7.1.7.2.1-1 of TS 36.213 [10] that corresponds to the subband size.

Table 9.3.4.2.2.3-1: Sub-band test for single antenna transmission (TDD)

Parameter		Unit	Test 1		Test 2	
Bandwidth		MHz	10 MHz			
Transmission mode			1 (port 0)			
Downlink power allocation	ρ_A	dB	0			
	ρ_B	dB	0			
	σ	dB	0			
Uplink downlink configuration			2			
Special subframe configuration			4			
SNR (Note 3)		dB	8	9	13	14
$\hat{I}_{or}^{(j)}$		dB[mW/15kHz]	-90	-89	-85	-84
$N_{oc}^{(j)}$		dB[mW/15kHz]	-98		-98	
Propagation channel			Clause B.2.4 with $\tau_d = 0.45 \mu s$, $a = 1$, $f_D = 5$ Hz			
Reporting periodicity		ms	$N_p = 5$			
CQI delay		ms	10 or 11			
Physical channel for CQI reporting			PUSCH (Note 4)			
PUCCH Report Type for wideband CQI			4			
PUCCH Report Type for subband CQI			1			
Max number of HARQ transmissions			1			
Subband size (k)		RBs	6 (full size)			
Number of bandwidth parts (J)			3			
K			1			
$cqi-pmi-ConfigIndex$			3			
ACK/NACK feedback mode			Multiplexing			
<p>Note 1: If the UE reports in an available uplink reporting instance at subframe SF#n based on CQI estimation at a downlink subframe not later than SF#(n-4), this reported subband or wideband CQI cannot be applied at the eNB downlink before SF#(n+4)</p> <p>Note 2: Reference measurement channel according to Table A.4-5 with one/two sided dynamic OCNG Pattern OP.1/2 TDD as described in Annex A.5.2.1/2.</p> <p>Note 3: For each test, the minimum requirements shall be fulfilled for at least one of the two SNR(s) and the respective wanted signal input level.</p> <p>Note 4: To avoid collisions between CQI reports and HARQ-ACK it is necessary to report both on PUSCH instead of PUCCH. PDCCH DCI format 0 shall be transmitted in downlink SF#3 and #8 to allow periodic CQI to multiplex with the HARQ-ACK on PUSCH in uplink subframe SF#7 and #2.</p> <p>Note 5: CQI reports for the short subband (having 2RBs in the last bandwidth part) are to be disregarded and data scheduling according to the most recent subband CQI report for bandwidth part with $j=1$.</p> <p>Note 6: In the case where wideband CQI is reported, data is to be scheduled according to the most recently used subband CQI report.</p>						

Table 9.3.4.2.2.3-2: Minimum requirement (TDD)

	Test 1	Test 2
γ	1.15	1.15
UE Category	1-8	1-8

The normative reference for this requirement is TS 36.101 [2] clause 9.3.4.2.2.

9.3.4.2.2.4 Test description

9.3.4.2.2.4.1 Initial conditions

Initial conditions are a set of test configurations the UE needs to be tested in and the steps for the SS to take with the UE to reach the correct measurement state.

Configurations of PDSCH and PDCCH before measurement are specified in Annex C.2.

Test Environment: Normal as defined in TS 36.508 [7] clause 4.1.

Frequencies to be tested: Mid Range as defined in TS 36.508 [7] clause 4.3.1.1.

Channel Bandwidths to be tested: 10MHz, as defined in TS 36.508 [7] clause 4.3.1.1

1. Connect the SS, faders and AWGN noise source to the UE antenna connector (s) as shown in TS 36.508 [7] Annex A, Figure A.9.
2. The parameter settings for the cell are set up according to Table 9.3.4.2.2.3-1.
3. Downlink signals are initially set up according to Annex C.1 and Annex C.3.2, and uplink signals according to Annex H.1 and H.3.2.
4. Propagation conditions are set according to Annex B.0.
5. Ensure the UE is in State 3A-RF according to TS 36.508 [7] clause 5.2A.2. Message contents are defined in clause 9.3.4.2.2.4.3.

9.3.4.2.2.4.2 Test procedure

1. Set the parameters of bandwidth, the propagation condition, antenna configuration and measurement channel according to Table 9.3.4.2.2.3-1 as appropriate.
2. The SS shall transmit PDSCH via PDCCH DCI format 1A for C_RNTI to transmit the DL RMC (Table A.4-5) according to CQI value 8 of Annex A.4 Table A.4-3 and keep it regardless of the wideband and subband CQI value sent by the UE. Continue transmission of the PDSCH until 2000 wideband CQI reports and full-size subband CQI reports for each full-size subband have been gathered. The SS sends downlink MAC padding bits on the DL RMC. The SS sends uplink scheduling information via PDCCH DCI format 0 with CQI request bit set to 0 to schedule UL RMC in subframe #2 and subframe #7 (Table A.4.1-2). The UE will send ACK/NACK and periodic CQI report using PUSCH. In this process the SS collects wideband CQI reports and also cases where UE transmits nothing in its wideband CQI timing are counted as wideband CQI reports.
3. Set up a relative frequency distribution for the reported wideband CQI-values, Calculate the median value (wideband Median CQI is the CQI that is at or crosses 50% distribution from the lower wideband CQI side). This CQI-value is declared as wideband Median CQI value.
4. The SS shall transmit PDSCH via PDCCH DCI format 1A for C_RNTI to transmit the DL RMC (Table A.4-5) on a randomly selected full-size subband using the transport format according to the wideband median-CQI value regardless of UE wideband or subband CQI report. Note that each full-size subband shall be selected in the equal probability. The SS sends downlink MAC padding bits on the DL RMC. The SS sends uplink scheduling information via PDCCH DCI format 0 with CQI request bit set to 0 to schedule UL RMC in subframe #2 and subframe #7 (Table A.4.1-2). The UE will send ACK/NACK and periodic CQI report using PUSCH. Measure the average throughput according to Annex G.5.3. Declare the throughput as t_{median} .
5. The SS shall transmit PDSCH via PDCCH DCI format 1A for C_RNTI to transmit the DL RMC (Table A.4-5) in the full-size subband reported by the UE and with the corresponding TBS. When the UE reports a non-full-size SB, the SS schedules the recent reported SB for bandwidth part with $j=1$ and with the corresponding TBS. Note that the SS shall send PDSCH in the same full-size subband until next subband UE report is available. The SS sends downlink MAC padding bits on the DL RMC. The SS sends uplink scheduling information via PDCCH DCI format 0 with CQI request bit set to 0 to schedule UL RMC in subframe #2 and subframe #7 (Table A.4.1-2). The UE will send ACK/NACK and periodic CQI report using PUSCH. Measure the average throughput according to Annex G.5.3. Declare the throughput as $t_{subband}$. Count the number of NACKs, ACKs

and statDTXs on the UL during the test interval.

If $t_{subband} / t_{median} \geq \gamma$, then pass the UE for this test and go to step 7. Otherwise go to step 6.

6. If both SNR points of the test have not been tested, then repeat the same procedure (steps 1 to 5) for the other SNR point as appropriate. Otherwise fail the UE.
7. If both tests have not been done, then repeat the same procedure (steps 1 to 6) with test conditions according to the table 9.3.4.2.2.3-1 for the other Test as appropriate. Otherwise pass the UE.

9.3.4.2.2.4.3 Message contents

Message contents are according to TS 36.508 [7] clause 4.6 with the following exceptions:

Table 9.3.4.2.2.4.3-1: PhysicalConfigDedicated-DEFAULT

Derivation Path: 36.508 clause 5.5.1.2			
Information Element	Value/remark	Comment	Condition
PhysicalConfigDedicated-DEFAULT ::= SEQUENCE {			
cqi-ReportConfig	<i>CQI-ReportConfig-DEFAULT</i>		
}			

Table 9.3.4.2.2.4.3-2: CQI-ReportConfig-DEFAULT

Derivation Path: 36.508 clause 4.6.3			
Information Element	Value/remark	Comment	Condition
CQI-ReportConfig-DEFAULT ::= SEQUENCE {			
cqi-ReportModeAperiodic	Not present		
nomPDSCH-RS-EPRE-Offset	0		
cqi-ReportPeriodic CHOICE {			
setup SEQUENCE {			
cqi-PUCCH-ResourceIndex	0		
cqi-pmi-ConfigIndex	3	(see Table 7.2.2-1A in TS 36.213)	
cqi-FormatIndicatorPeriodic CHOICE {			
subbandCQI	1		
}			
ri-ConfigIndex	484	(see Table 7.2.2-1B in TS 36.213)	
simultaneousAckNackAndCQI	FALSE		
}			
}			

Table 9.3.4.2.2.4.3-3: TDD-Config-DEFAULT

Derivation Path: 36.508 clause 4.6.3			
Information Element	Value/remark	Comment	Condition
TDD-Config-DEFAULT ::= SEQUENCE {			
subframeAssignment	Sa2		
specialSubframePatterns	Ssp4		
}			

9.3.4.2.2.5 Test requirement

Table 9.3.4.2.2.5-1: Test requirement (TDD)

	Test 1	Test 2
γ	1.14	1.14
UE Category	1-8	1-8

9.3.5 Additional requirements for enhanced receiver Type A

9.3.5.1 PUCCH 1-0 (Cell-Specific Reference Symbol)

9.3.5.1.1 FDD CQI Reporting under fading conditions - PUCCH 1-0 - Enhanced Performance Requirement Type A

Editor's notes: This test case is incomplete. The following items are missing or are incomplete:

- Connection diagram in Annex A of TS 36.508 is TBD
- Test tolerances are undefined
- Corresponding test case needs to be added into TS 36.521-2.

9.3.5.1.1.1 Test purpose

The purpose of the test is to verify that the reporting of the channel quality is based on the receiver of the enhanced Type A. Performance requirements are specified in terms of the relative increase of the throughput obtained when the transport format is that indicated by the reported CQI subject to an interference model compared to the case with a white Gaussian noise model, and a requirement on the minimum BLER of the transmitted transport formats indicated by the reported CQI subject to an interference model.

9.3.5.1.1.2 Test applicability

This test applies to all types of E-UTRA FDD UE release 11 and forward that support enhanced receiver Type A.

9.3.5.1.1.3 Minimum conformance requirements

For the parameters specified in Table 9.3.5.1.1.3-1, and using the downlink physical channels specified in Annex C, the minimum requirements are specified in Table 9.3.5.1.1.3-2 and by the following

- a) the ratio of the throughput obtained when transmitting the transport format indicated by each reported wideband CQI index subject to an interference source with specified DIP and that obtained when transmitting the transport format indicated by each reported wideband CQI index subject to a white Gaussian noise source shall be $\geq \gamma$;
- b) when transmitting the transport format indicated by each reported wideband CQI index subject to an interference source with specified DIP, the average BLER for the indicated transport formats shall be greater than or equal to 2%.

The transport block sizes indicated by the reported wideband CQI are selected according to Table A.4-3 (for Category 2-8) or Table A.4-9 (for Category 1).

Table 9.3.5.1.1.3-1 Fading test for single antenna (FDD)

Parameter	Unit	Cell 1	Cell 2
Bandwidth	MHz	10 MHz	
Transmission mode		1 (port 0)	
Cyclic Prefix		Normal	Normal
Cell ID		0	1
SINR (Note 8)	dB	-2	N/A
$N_{oc}^{(j)}$	dB[mW/15kHz]	-98	N/A
Propagation channel		EPA5	Static (Note 7)
Correlation and antenna configuration		Low (1 x 2)	(1 x 2)
DIP (Note 4)	dB	N/A	-0.41
Reference measurement channel		Note 2	R.2 FDD
Reporting mode		PUCCH 1-0	N/A
Reporting periodicity	ms	$N_{pd} = 2$	N/A
CQI delay	ms	8	N/A
Physical channel for CQI reporting		PUSCH (Note 3)	N/A
PUCCH Report Type		4	N/A
<i>cqi-pmi-ConfigurationIndex</i>		1	N/A
Max number of HARQ transmissions		1	N/A
<p>Note 1: If the UE reports in an available uplink reporting instance at subframe SF#n based on CQI estimation at a downlink SF not later than SF#(n-4), this reported wideband CQI cannot be applied at the eNB downlink before SF#(n+4)</p> <p>Note 2: Reference measurement channel according to Table A.4-1 for Category 2-8 with one sided dynamic OCNG Pattern OP.1 FDD as described in Annex A.5.1.1 and Table A.4-7 for Category 1 with one/two sided dynamic OCNG Pattern OP.1/2 FDD as described in Annex A.5.1.1/2.</p> <p>Note 3: To avoid collisions between CQI reports and HARQ-ACK it is necessary to report both on PUSCH instead of PUCCH. PDCCH DCI format 0 shall be transmitted in downlink SF#1, #3, #7 and #9 to allow periodic CQI to multiplex with the HARQ-ACK on PUSCH in uplink subframe SF#5, #7, #1 and #3.</p> <p>Note 4: The respective received power spectral density of each interfering cell relative to N_{oc} is defined by its associated DIP value as specified in clause B.5.1.</p> <p>Note 5: Two cells are considered in which Cell 1 is the serving cell and Cell 2 is the interfering cell. The number of the CRS ports in both cells is the same. Interfering cell is fully loaded.</p> <p>Note 6: Both cells are time-synchronous.</p> <p>Note 7: Static channel is used for the interference model. In case for white Gaussian noise model Cell 2 is not present.</p> <p>Note 8: SINR corresponds to \hat{E}_s / N_{oc} of Cell 1 as defined in clause 8.1.1.</p>			

Table 9.3.5.1.1.3-2 Minimum requirement (FDD)

γ	1.8
UE Category	1-8

The normative reference for this requirement is TS 36.101 [2] clause 9.3.5.1.1.

9.3.5.1.1.4 Test description

9.3.5.1.1.4.1 Initial conditions

Initial conditions are a set of test configurations the UE needs to be tested in and the steps for the SS to take with the UE to reach the correct measurement state.

Configurations of PDSCH and PDCCH before measurement are specified in Annex C.2.

Test Environment: Normal as defined in TS 36.508 [7] clause 4.1.

Frequencies to be tested: Mid Range as defined in TS 36.508 [7] clause 4.3.1.1.

Channel Bandwidths to be tested: 10MHz, as defined in TS 36.508 [7] clause 4.3.1.1

1. Connect the SS and faders to the UE antenna connector (s) as shown in TS 36.508 [7] Annex A, Figure TBD.
2. The parameter settings for the cell 1 are set up according to Table 9.3.5.1.1.3-1.
3. Downlink signals are initially set up according to Annex C.1 and Annex C.3.2, and uplink signals according to Annex H.1 and H.3.2.
4. Propagation conditions are set according to Annex B.0.
5. Ensure the UE is in State 3A-RF according to TS 36.508 [7] clause 5.2A.2. Message contents are defined in clause 9.3.5.1.1.4.3.

9.3.5.1.1.4.2 Test procedure

1. Set the cell 1 and 2 parameters of bandwidth, the propagation condition, antenna configuration and measurement channel according to Table 9.3.5.1.1.3-1 as appropriate.
2. The SS shall transmit PDSCH via PDCCH DCI format 1A for C_RNTI to transmit the DL RMC (Table A.4-1) according to the wideband CQI value reported from UE. The SS sends downlink MAC padding bits on the DL RMC. The SS sends uplink scheduling information via PDCCH DCI format 0 with CQI request bit set to 0 to schedule UL RMC in subframe #1,#3,#5 and subframe #7 (Table A.4.1-1). The UE will send ACK/NACK and periodic CQI report using PUSCH. Measure the average throughput according to Annex G.5.3. Declare the throughput as $t_{\text{wideband_interference}}$. The responses are then filtered as follows: for the sequence of responses for each HARQ process, discard all the statDTX responses.
3. Deactivate i.e., stop transmitting anything from the cell 2 and set the cell 1 parameters of bandwidth, the propagation condition, antenna configuration and measurement channel according to Table 9.3.5.1.1.3-1 as appropriate.
4. The SS shall transmit PDSCH via PDCCH DCI format 1A for C_RNTI to transmit the DL RMC (Table A.4-1) according to the wideband CQI value reported from UE. The SS sends downlink MAC padding bits on the DL RMC. The SS sends uplink scheduling information via PDCCH DCI format 0 with CQI request bit set to 0 to schedule UL RMC in subframe #1,#3,#5 and subframe #7 (Table A.4.1-1). The UE will send ACK/NACK and periodic CQI report using PUSCH. Measure the average throughput according to Annex G.5.3. Declare the throughput as $t_{\text{wideband_gaussian_noise}}$.
5. If the ratio $(t_{\text{wideband_interference}} / t_{\text{wideband_gaussian_noise}}) \geq \gamma$ and ratio (NACK / (ACK + NACK)) calculated in step 2 is greater or equal to 0.02, then pass the UE for this test. Otherwise fail the UE.

9.3.5.1.1.4.3 Message contents

Message contents are according to TS 36.508 [7] clause 4.6 with the following exceptions:

Table 9.3.5.1.1.4.3-1: PhysicalConfigDedicated-DEFAULT

Derivation Path: 36.508 clause 5.5.1.2			
Information Element	Value/remark	Comment	Condition
PhysicalConfigDedicated-DEFAULT ::= SEQUENCE {			
cqi-ReportConfig	CQI-ReportConfig-DEFAULT		
}			

Table 9.3.5.1.1.4.3-2: CQI-ReportConfig-DEFAULT

Derivation Path: 36.508 clause 4.6.3			
Information Element	Value/remark	Comment	Condition
CQI-ReportConfig-DEFAULT ::= SEQUENCE {			
cqi-ReportModeAperiodic	Not present		
nomPDSCH-RS-EPRE-Offset	0		
cqi-ReportPeriodic CHOICE {			
setup SEQUENCE {			
cqi-PUCCH-ResourceIndex	0		
cqi-pmi-ConfigIndex	1	(see Table 7.2.2-1A in TS 36.213)	
cqi-FormatIndicatorPeriodic CHOICE {			
widebandCQI	NULL		
}			
ri-ConfigIndex	NULL	(see Table 7.2.2-1B in TS 36.213)	
simultaneousAckNackAndCQI	FALSE		
}			
}			

9.3.5.1.1.5 Test requirement

Table 9.3.5.1.1.5-1 Minimum requirement (FDD)

γ	1.8 + TT
UE Category	1-8

9.4 Reporting of Precoding Matrix Indicator (PMI)

The minimum performance requirements of PMI reporting are defined based on the precoding gain, expressed as the relative increase in throughput when the transmitter is configured according to the UE reports compared to the case when the transmitter is using random precoding. When the transmitter uses random precoding, for each PDSCH allocation a precoder is randomly generated and applied to the PDSCH. A fixed transport format (FRC) configured.

The requirements for transmission mode 6 and transmission mode 9 with 4 TX are specified in terms of the ratio

$$\gamma = \frac{t_{ue}}{t_{rnd}}$$

In the definition of γ , for PUSCH 3-1 single PMI and PUSCH 1-2 multiple PMI requirements, t_{rnd} is 60% of the maximum throughput obtained at SNR_{rnd} using random precoding, and t_{ue} the throughput measured at SNR_{rnd} with precoders configured according to the UE reports.

For the PUCCH 2-1 single PMI requirement, t_{rnd} is 60% of the maximum throughput obtained at SNR_{rnd} using random precoding on a randomly selected full-size subband in set S subbands, and t_{ue} the throughput measured at SNR_{rnd} with both the precoder and the preferred full-size subband applied according to the UE reports;

For PUSCH 2-2 multiple PMI requirements, t_{rd} is 60% of the maximum throughput obtained at SNR_{rd} using random precoding on a randomly selected full-size subband in set S subbands, and t_{ue} the throughput measured at SNR_{rd} with both the subband precoder and a randomly selected full-size subband (within the preferred subbands) applied according to the UE reports.

The requirements for transmission mode 9 with 8 TX are specified in terms of the ratio

$$\gamma = \frac{t_{ue, follow1, follow2}}{t_{rd1, rd2}}$$

In the definition of γ , for PUSCH 3-1 single PMI and PUSCH 1-2 multiple PMI requirements, $t_{follow1, follow2}$ is 70% of the maximum throughput obtained at $SNR_{follow1, follow2}$ using the precoders configured according to the UE reports, and $t_{rd1, rd2}$ is the throughput measured at $SNR_{follow1, follow2}$ with random precoding .

9.4.1 Single PMI

9.4.1.1 PMI Reporting – PUSCH 3-1 (Single PMI) (Cell-Specific Reference Symbols)

9.4.1.1.1 FDD PMI Reporting – PUSCH 3-1 (Single PMI)

9.4.1.1.1.1 Test purpose

To test the accuracy of the Precoding Matrix Indicator (PMI) reporting such that the system throughput is maximized based on the precoders configured according to the UE reports.

9.4.1.1.1.2 Test applicability

This test applies to all types of E-UTRA FDD UE release 8 and forward.

9.4.1.1.1.3 Minimum conformance requirements

For the parameters specified in Table 9.4.1.1.1.3-1, and using the downlink physical channels specified in Annex C, the minimum requirements are specified in Table 9.4.1.1.1.3-2.

Table 9.4.1.1.1.3-1: PMI test for single-layer (FDD)

Parameter		Unit	Test 1
Bandwidth		MHz	10
Transmission mode			6
Propagation channel			EVA5
Precoding granularity		PRB	50
Correlation and antenna configuration			Low 2 x 2
Downlink power allocation	ρ_A	dB	-3
	ρ_B	dB	-3
	σ	dB	0
$N_{oc}^{(j)}$		dB[mW/15kHz]	-98
Reporting mode			PUSCH 3-1
Reporting interval		ms	1
PMI delay (Note 2)		ms	8
Measurement channel			R.10 FDD
OCNG Pattern			OP.1 FDD
Max number of HARQ transmissions			4
Redundancy version coding sequence			{0,1,2,3}
Note 1: For random precoder selection, the precoder shall be updated in each TTI (1 ms granularity) Note 2: If the UE reports in an available uplink reporting instance at subframe SF#n based on PMI estimation at a downlink SF not later than SF#(n-4), this reported PMI cannot be applied at the eNB downlink before SF#(n+4).			

Table 9.4.1.1.1.3-2: Minimum requirement (FDD)

Parameter	Test 1
γ	1.1
UE Category	1-8

The normative reference for this requirement is TS 36.101 [2] clause 9.4.1.1.1.

9.4.1.1.1.4 Test description

9.4.1.1.1.4.1 Initial conditions

Initial conditions are a set of test configurations the UE needs to be tested in and the steps for the SS to take with the UE to reach the correct measurement state.

Configurations of PDSCH and PDCCH before measurement are specified in Annex C.2.

Test Environment: Normal as defined in TS 36.508 [7] clause 4.1.

Frequencies to be tested: Mid Range as defined in TS 36.508 [7] clause 4.3.1.1.

Channel Bandwidths to be tested: 10MHz, as defined in TS 36.508 [7] clause 4.3.1.1

1. Connect the SS to the UE antenna connector (s) as shown in TS 36.508 [7] Annex A, Figure A.10.
2. The parameter settings for the cell are set up according to Table 9.4.1.1.1.3-1.
3. Downlink signals are initially set up according to Annex C.1 and Annex C.3.2, and uplink signals according to Annex H.1 and H.3.2.
4. Propagation conditions are set according to Annex B clause B.0

5. Ensure the UE is in State 3A-RF according to TS 36.508 [7] clause 5.2A.2. Message contents are defined in clause 9.4.1.1.1.4.3.

9.4.1.1.1.4.2 Test procedure

1. Set the parameters of bandwidth, the propagation condition, antenna configuration and measurement channel according to Table 9.4.1.1.1.3-1 as appropriate.
2. The SS shall transmit PDSCH via PDCCH DCI format 1B for C_RNTI to transmit the DL RMC with randomly selected precoding matrix from codebook (Table 6.3.4.2.3-1 in TS 36.211 [8]) every subframe regardless of PMI reports from the UE. Note that each precoding matrix shall be selected in equal probabilities. The SS sends downlink MAC padding bits on the DL RMC. SS schedules the UL transmission to carry the PUSCH CQI feedback via PDCCH DCI format 0 with CQI request bit set to 1 and I_MCS=29 and N_PRB allocated to be less or equal to 4. Establish t_{rnd} and SNR_{rnd} according to annex G.5.2
3. Set SNR to SNR_{rnd} . The SS shall transmit PDSCH with precoding matrix according to PMI report from the UE. The SS sends downlink MAC padding bits on the DL RMC. SS schedules the UL transmission to carry the PUSCH CQI feedback via PDCCH DCI format 0 with CQI request bit set to 1 and I_MCS=29 and N_PRB allocated to be less or equal to 4 every subframe. Measure t_{ue} according to Annex G.5.3
4. Calculate $\gamma = \frac{t_{ue}}{t_{rnd}}$. If the ratio (throughput / t_{rnd}) $\geq \gamma$ which is specified in table 9.4.1.1.1.5-1, then the test is pass. Otherwise, the test is fail.

9.4.1.1.1.4.3 Message contents

Message contents are according to TS 36.508 [7] clause 4.6 with the following exceptions:

Table 9.4.1.1.1.4.3-1: PhysicalConfigDedicated-DEFAULT

Derivation Path: 36.508 clause 5.5.1.2			
Information Element	Value/remark	Comment	Condition
PhysicalConfigDedicated-DEFAULT ::= SEQUENCE {			
cqi-ReportConfig	CQI-ReportConfig-DEFAULT		
antennaInfo CHOICE {			
explicitValue	AntennaInfoDedicated		
}			
}			

Table 9.4.1.1.1.4.3-2: AntennaInfoDedicated

Derivation Path: 36.331 clause 6.3.2			
Information Element	Value/remark	Comment	Condition
AntennaInfoDedicated ::= SEQUENCE {			
transmissionMode	tm6		
codebookSubsetRestriction CHOICE{			
n2TxAntenna-tm6	1111		
}			
ue-TransmitAntennaSelection CHOICE{			
release	NULL		
}			

Table 9.4.1.1.1.4.3-3: CQI-ReportConfig-DEFAULT

Derivation Path: 36.508 clause 4.6.3			
Information Element	Value/remark	Comment	Condition
CQI-ReportConfig-DEFAULT ::= SEQUENCE {			
cqi-ReportModeAperiodic	rm31		
nomPDSCH-RS-EPRE-Offset	0		
cqi-ReportPeriodic	Not present		
}			

9.4.1.1.1.5 Test requirement

Table 9.4.1.1.1.5-1: Test requirement (FDD)

Parameter	Test 1
γ	1.09

The ratio of throughput using precoding matrix of PMI reports from the UE to using random precoding matrix shall equal or exceed the value specified in table 9.4.1.1.1.5.

9.4.1.1.2 TDD PMI Reporting – PUSCH 3-1 (Single PMI)

9.4.1.1.2.1 Test purpose

To test the accuracy of the Precoding Matrix Indicator (PMI) reporting such that the system throughput is maximized based on the precoders configured according to the UE reports.

9.4.1.1.2.2 Test applicability

This test applies to all types of E-UTRA TDD UE release 8 and forward.

9.4.1.1.2.3 Minimum conformance requirements

For the parameters specified in Table 9.4.1.1.2.3-1, and using the downlink physical channels specified in Annex C, the minimum requirements are specified in 9.4.1.1.2.3-2.

Table 9.4.1.1.2.3-1: PMI test for single-layer (TDD)

Parameter	Unit	Test 1	
Bandwidth	MHz	10	
Transmission mode		6	
Uplink downlink configuration		1	
Special subframe configuration		4	
Propagation channel		EVA5	
Precoding granularity	PRB	50	
Correlation and antenna configuration		Low 2 x 2	
Downlink power allocation	ρ_A	dB	-3
	ρ_B	dB	-3
	σ	dB	0
$N_{oc}^{(j)}$	dB[mW/15kHz]	-98	
Reporting mode		PUSCH 3-1	
Reporting interval	ms	1	
Minimum PMI delay (Node-2)	ms	10 or 11	
Measurement channel		R.10 TDD	
OCNG Pattern		OP.1 TDD	
Max number of HARQ transmissions		4	
Redundancy version coding sequence		{0,1,2,3}	
ACK/NACK feedback mode		Multiplexing	
Note 1: For random precoder selection, the precoder shall be updated in each available downlink transmission instance Note 2: If the UE reports in an available uplink reporting instance at subframe SF#n based on PMI estimation at a downlink SF not later than SF#(n-4), this reported PMI cannot be applied at the eNB downlink before SF#(n+4)			

Table 9.4.1.1.2.3-2: Minimum requirement (TDD)

Parameter	Test 1
γ	1.1
UE Category	1-8

The normative reference for this requirement is TS 36.101 [2] clause 9.4.1.1.2.

9.4.1.1.2.4 Test description

9.4.1.1.2.4.1 Initial conditions

Initial conditions are a set of test configurations the UE needs to be tested in and the steps for the SS to take with the UE to reach the correct measurement state.

Configurations of PDSCH and PDCCH before measurement are specified in Annex C.2.

Test Environment: Normal as defined in TS 36.508 [7] clause 4.1.

Frequencies to be tested: Mid Range as defined in TS 36.508 [7] clause 4.3.1.2.

Channel Bandwidths to be tested: 10MHz, as defined in TS 36.508 [7] clause 4.3.1.2

1. Connect the SS to the UE antenna connector (s) as shown in TS 36.508 [7] Annex A, Figure A.10.
2. The parameter settings for the cell are set up according to Table 9.4.1.1.2.3-1.
3. Downlink signals are initially set up according to Annex C.1 and Annex C.3.2, and uplink signals according to Annex H.1 and H.3.2.
4. Propagation conditions are set according to Annex B clause B.0
5. Ensure the UE is in State 3A-RF according to TS 36.508 [7] clause 5.2A.2. Message contents are defined in clause 9.4.1.1.2.4.3.

9.4.1.1.2.4.2 Test procedure

1. Set the bandwidth, propagation condition, antenna configuration and measurement channel parameters according to Table 9.4.1.1.2.3-1 as appropriate.
2. The SS shall transmit PDSCH via PDCCH DCI format 1B for C_RNTI to transmit the DL RMC with randomly selected precoding matrix from codebook (Table 6.3.4.2.3-1 in TS 36.211 [8]) every subframe regardless of PMI reports from the UE. Note that each precoding matrix shall be selected in equal probabilities. The SS sends downlink MAC padding bits on the DL RMC. SS schedules the UL transmission to carry the PUSCH CQI feedback via PDCCH DCI format 0 with CQI request bit set to 1 and I_MCS=29 and N_PRB allocated to be less or equal to 4. Establish t_{md} and SNR_{md} according to annex G.5.2.
3. Set SNR to SNR_{md} . The SS shall transmit PDSCH with precoding matrix according to PMI report from the UE. The SS sends downlink MAC padding bits on the DL RMC. SS schedules the UL transmission to carry the PUSCH CQI feedback via PDCCH DCI format 0 with CQI request bit set to 1 and I_MCS=29 and N_PRB allocated to be less or equal to 4. Measure t_{ue} according to Annex G.5.3

4. Calculate $\gamma = \frac{t_{ue}}{t_{md}}$

9.4.1.1.2.4.3 Message contents

Message contents are according to TS 36.508 [7] clause 4.6 with the following exceptions:

Table 9.4.1.1.2.4.3-1: PhysicalConfigDedicated-DEFAULT

Derivation Path: 36.508 clause 5.5.1.2			
Information Element	Value/remark	Comment	Condition
PhysicalConfigDedicated-DEFAULT ::= SEQUENCE {			
cqi-ReportConfig	CQI-ReportConfig-DEFAULT		
antennaInfo CHOICE {			
explicitValue	AntennaInfoDedicated		
}			
}			

Table 9.4.1.1.2.4.3-2: AntennaInfoDedicated

Derivation Path: 36.331 clause 6.3.2			
Information Element	Value/remark	Comment	Condition
AntennaInfoDedicated ::= SEQUENCE {			
transmissionMode	tm6		
codebookSubsetRestriction CHOICE{			
n2TxAntenna-tm6	1111		
}			
ue-TransmitAntennaSelection CHOICE{			
release	NULL		
}			

Table 9.4.1.1.2.4.3-3: CQI-ReportConfig-DEFAULT

Derivation Path: 36.508 clause 4.6.3			
Information Element	Value/remark	Comment	Condition
CQI-ReportConfig-DEFAULT ::= SEQUENCE {			
cqi-ReportModeAperiodic	rm31		
nomPDSCH-RS-EPRE-Offset	0		
cqi-ReportPeriodic	Not present		
}			

9.4.1.1.2.5 Test requirement

Table 9.4.1.1.2.5-1: Test requirement (TDD)

Parameter	Test 1
γ	1.09

9.4.1.2 PMI Reporting – PUCCH 2-1 (Single PMI) (Cell-Specific Reference Symbols)

9.4.1.2.1 FDD PMI Reporting – PUCCH 2-1 (Single PMI)

9.4.1.2.1.1 Test purpose

To test the accuracy of the Precoding Matrix Indicator (PMI) reporting such that the system throughput is maximized based on the precoders configured according to the UE reports.

9.4.1.2.1.2 Test applicability

This test applies to all types of E-UTRA FDD UE release 9 and forward. Applicability requires support for FGI bit 2.

9.4.1.2.1.3 Minimum conformance requirements

For the parameters specified in Table 9.4.1.2.1.3-1, and using the downlink physical channels specified in Annex C, the minimum requirements are specified in Table 9.4.1.2.1.3-2.

Table 9.4.1.2.1.3-1: PMI test for single-layer (FDD)

Parameter		Unit	Test 1
Bandwidth		MHz	10
Transmission mode			6
Propagation channel			EVA5
Correlation and antenna configuration			Low 4 x 2
Downlink power allocation	ρ_A	dB	-6
	ρ_B	dB	-6
	σ	dB	3
$N_{oc}^{(j)}$		dB[mW/15kHz]	-98
PMI delay		ms	8 or 9
Reporting mode			PUCCH 2-1 (Note 6)
Reporting periodicity		ms	$N_p = 2$
Physical channel for CQI reporting			PUSCH (Note 3)
PUCCH Report Type for wideband CQI/PMI			2
PUCCH Report Type for subband CQI			1
Measurement channel			R.14-1 FDD
OCNG Pattern			OP. 1/2 FDD
Precoding granularity		PRB	6 (full size)
Number of bandwidth parts (J)			3
K			1
<i>cqi-pmi-ConfigIndex</i>			1
Max number of HARQ transmissions			4
Redundancy version coding sequence			{0,1,2,3}
<p>Note 1: For random precoder selection, the precoder shall be updated every two TTI (2 ms granularity)</p> <p>Note 2: If the UE reports in an available uplink reporting instance at subframe SF#n based on PMI estimation at a downlink SF not later than SF#(n-4), this reported PMI cannot be applied at the eNB downlink before SF#(n+4).</p> <p>Note 3: To avoid collisions between HARQ-ACK and wideband CQI/PMI or subband CQI, it is necessary to report both on PUSCH instead of PUCCH. PDCCH DCI format 0 shall be transmitted in downlink SF#1, #3, #7 and #9 to allow periodic CQI to multiplex with the HARQ-ACK on PUSCH in uplink subframe SF#5, #7, #1 and #3.</p> <p>Note 4: Reports for the short subband (having 2RBs in the last bandwidth part) are to be disregarded and instead data is to be transmitted on the most recently used subband for bandwidth part with $j=1$.</p> <p>Note 5: In the case where wideband PMI is reported, data is to be transmitted on the most recently used subband.</p> <p>Note 6: The bit field for PMI confirmation in DCI format 1B shall be mapped to "0" and TPMI information shall indicate the codebook index used in Table 6.3.4.2.3-2 of TS36.211 [4] according to the latest PMI report on PUCCH.</p>			

Table 9.4.1.2.1.3-2: Minimum requirement (FDD)

	Test 1
γ	1.2
UE Category	1-8

The normative reference for this requirement is TS 36.101 [2] clause 9.4.1.2.1.

9.4.1.2.1.4 Test description

9.4.1.2.1.4.1 Initial conditions

Initial conditions are a set of test configurations the UE needs to be tested in and the steps for the SS to take with the UE to reach the correct measurement state.

Configurations of PDSCH and PDCCH before measurement are specified in Annex C.2.

Test Environment: Normal as defined in TS 36.508 [7] clause 4.1.

Frequencies to be tested: Mid Range as defined in TS 36.508 [7] clause 4.3.1.1.

Channel Bandwidths to be tested: 10MHz, as defined in TS 36.508 [7] clause 4.3.1.1

1. Connect the SS to the UE antenna connector (s) as shown in TS 36.508 [7] Annex A, Figure A.11.
2. The parameter settings for the cell are set up according to Table 9.4.1.2.1.3-1.
3. Downlink signals are initially set up according to Annex C.1 and Annex C.3.2, and uplink signals according to Annex H.1 and H.3.2.
4. Propagation conditions are set according to Annex B clause B.0
5. Ensure the UE is in State 3A-RF according to TS 36.508 [7] clause 5.2A.2. Message contents are defined in clause 9.4.1.2.1.4.3.

9.4.1.2.1.4.2 Test procedure

1. Set the parameters of bandwidth, the propagation condition, antenna configuration and measurement channel according to Table 9.4.1.2.1.3-1 as appropriate.
2. The SS shall transmit every subframe PDSCH via PDCCH DCI format 1B for C_RNTI to transmit the DL RMC (R.14-1 FDD) on a randomly selected full-size subband with a randomly selected precoding matrix from the codebook (Table 6.3.4.2.3-2 in TS 36.211 [8]), regardless of the SB and PMI reports from the UE. Note that each full-size subband and each precoding matrix shall be selected in equal probability. The SS sends downlink MAC padding bits on the DL RMC. The SS shall transmit PDCCH DCI format 0 in downlink SF#1, #3, #7 and #9 to schedule UL transmission in uplink subframes #5, #7, #1 and #3 (Table A.4.1-1). The UE will send ACK/NACK and periodic CSI reports using PUSCH. Establish t_{md} and SNR_{md} according to annex G.5.2.
3. Set SNR to SNR_{md} . The SS shall transmit every subframe PDSCH via PDCCH DCI format 1B for C_RNTI to transmit the DL RMC (R.14-1 FDD) on the full-size subband and with the latest precoding matrix reported by the UE. When the UE reports a non-full-size subband, the SS schedules the recent reported subband for bandwidth part with $j=1$ with the latest reported precoding matrix. Note that the SS shall send PDSCH in the same full-size subband and with the latest reported precoding matrix until next UE subband report is available. The SS sends downlink MAC padding bits on the DL RMC. The SS shall transmit PDCCH DCI format 0 in downlink SF#1, #3, #7 and #9 to schedule UL transmission in uplink subframes #5, #7, #1 and #3 (Table A.4.1-1). The UE will send ACK/NACK and periodic CSI reports using PUSCH. Measure t_{ue} according to Annex G.5.3.
4. Calculate $\gamma = \frac{t_{ue}}{t_{md}}$. If the ratio (throughput / t_{md}) $\geq \gamma$ which is specified in table 9.4.1.2.2.5-1, then the test is pass. Otherwise, the test is fail.

9.4.1.2.1.4.3 Message contents

Message contents are according to TS 36.508 [7] clause 4.6 with the following exceptions:

Table 9.4.1.2.1.4.3-1: PhysicalConfigDedicated-DEFAULT

Derivation Path: 36.508 clause 5.5.1.2			
Information Element	Value/remark	Comment	Condition
PhysicalConfigDedicated-DEFAULT ::= SEQUENCE {			
cqi-ReportConfig	CQI-ReportConfig-DEFAULT		
antennaInfo CHOICE {			
explicitValue	AntennaInfoDedicated		
}			
}			

Table 9.4.1.2.1.4.3-2: AntennaInfoDedicated

Derivation Path: 36.331 clause 6.3.2			
Information Element	Value/remark	Comment	Condition
AntennaInfoDedicated ::= SEQUENCE {			
transmissionMode	tm6		
codebookSubsetRestriction CHOICE{			
n4TxAntenna-tm6	1111111111111111		
}			
ue-TransmitAntennaSelection CHOICE{			
release	NULL		
}			
}			

Table 9.4.1.2.1.4.3-3: CQI-ReportConfig-DEFAULT

Derivation Path: 36.508 clause 4.6.3			
Information Element	Value/remark	Comment	Condition
CQI-ReportConfig-DEFAULT ::= SEQUENCE {			
cqi-ReportModeAperiodic	Not present		
nomPDSCH-RS-EPRE-Offset	0		
cqi-ReportPeriodic CHOICE {			
setup SEQUENCE {			
cqi-PUCCH-ResourceIndex	0		
cqi-pmi-ConfigIndex	1	(see Table 7.2.2-1A in TS 36.213)	
cqi-FormatIndicatorPeriodic CHOICE {			
subbandCQI	1		
}			
ri-ConfigIndex	483	(see Table 7.2.2-1B in TS 36.213)	
simultaneousAckNackAndCQI	FALSE		
}			
}			

9.4.1.2.1.5 Test requirement

Table 9.4.1.2.1.5-1: Test requirement (FDD)

	Test 1
γ	1.19
UE Category	1-8

The ratio of throughput using precoding matrix of PMI reports from the UE to using random precoding matrix shall equal or exceed the value specified in table 9.4.1.2.1.5.

9.4.1.2.2 TDD PMI Reporting – PUCCH 2-1 (Single PMI)

9.4.1.2.2.1 Test purpose

To test the accuracy of the Precoding Matrix Indicator (PMI) reporting such that the system throughput is maximized based on the precoders configured according to the UE reports.

9.4.1.2.2.2 Test applicability

This test applies to all types of E-UTRA TDD UE release 9 and forward. Applicability requires support for FGI bit 2.

9.4.1.2.2.3 Minimum conformance requirements

For the parameters specified in Table 9.4.1.2.2.3-1, and using the downlink physical channels specified in Annex C, the minimum requirements are specified in 9.4.1.2.2.3-2.

Table 9.4.1.2.2.3-1: PMI test for single-layer (TDD)

Parameter	Unit	Test 1	
Bandwidth	MHz	10	
Transmission mode		6	
Uplink downlink configuration		1	
Special subframe configuration		4	
Propagation channel		EVA5	
Correlation and antenna configuration		Low 4 x 2	
Downlink power allocation	ρ_A	dB	-6
	ρ_B	dB	-6
	σ	dB	3
$N_{oc}^{(j)}$	dB[mW/15kHz]	-98	
PMI delay	ms	10	
Reporting mode		PUCCH 2-1 (Note 6)	
Reporting periodicity	ms	$N_p = 5$	
Physical channel for CQI reporting		PUSCH (Note 3)	
PUCCH Report Type for wideband CQI/PMI		2	
PUCCH Report Type for subband CQI		1	
Measurement channel		R.14-1 TDD	
OCNG Pattern		OP.1/2 TDD	
Precoding granularity	PRB	6 (full size)	
Number of bandwidth parts (J)		3	
K		1	
$cqi-pmi-ConfigIndex$		4	
Max number of HARQ transmissions		4	
Redundancy version coding sequence		{0,1,2,3}	
ACK/NACK feedback mode		Multiplexing	
<p>Note 1: For random precoder selection, the precoder shall be updated in each available downlink transmission instance</p> <p>Note 2: If the UE reports in an available uplink reporting instance at subframe SF#n based on PMI estimation at a downlink SF not later than SF#(n-4), this reported PMI cannot be applied at the eNB downlink before SF#(n+4)</p> <p>Note 3: To avoid collisions between HARQ-ACK and wideband CQI/PMI or subband CQI it is necessary to report both on PUSCH instead of PUCCH. PDCCH DCI format 0 shall be transmitted in downlink SF#4 and #9 to allow periodic CQI to multiplex with the HARQ-ACK on PUSCH in uplink subframe SF#8 and #3.</p> <p>Note 4: Reports for the short subband (having 2RBs in the last bandwidth part) are to be disregarded and instead data is to be transmitted on the most recently used subband for bandwidth part with j=1.</p> <p>Note 5: In the case where wideband PMI is reported, data is to be transmitted on the most recently used subband.</p> <p>Note 6: The bit field for PMI confirmation in DCI format 1B shall be mapped to "0" and TPMI information shall indicate the codebook index used in Table 6.3.4.2.3-2 of TS36.211 [4] according to the latest PMI report on PUCCH.</p>			

Table 9.4.1.2.2.3-2: Minimum requirement (TDD)

Parameter	Test 1
γ	1.2
UE Category	1-8

The normative reference for this requirement is TS 36.101 [2] clause 9.4.1.2.2.

9.4.1.2.2.4 Test description

9.4.1.2.2.4.1 Initial conditions

Initial conditions are a set of test configurations the UE needs to be tested in and the steps for the SS to take with the UE to reach the correct measurement state.

Configurations of PDSCH and PDCCH before measurement are specified in Annex C.2.

Test Environment: Normal as defined in TS 36.508 [7] clause 4.1.

Frequencies to be tested: Mid Range as defined in TS 36.508 [7] clause 4.3.1.2.

Channel Bandwidths to be tested: 10MHz, as defined in TS 36.508 [7] clause 4.3.1.2

1. Connect the SS to the UE antenna connector (s) as shown in TS 36.508 [7] Annex A, Figure A.11.
2. The parameter settings for the cell are set up according to Table 9.4.1.2.2.3-1.
3. Downlink signals are initially set up according to Annex C.1 and Annex C.3.2, and uplink signals according to Annex H.1 and H.3.2.
4. Propagation conditions are set according to Annex B clause B.0
5. Ensure the UE is in State 3A-RF according to TS 36.508 [7] clause 5.2A.2. Message contents are defined in clause 9.4.1.2.2.4.3.

9.4.1.2.2.4.2 Test procedure

1. Set the bandwidth, propagation condition, antenna configuration and measurement channel parameters according to Table 9.4.1.2.2.3-1 as appropriate.
2. The SS shall transmit every subframe PDSCH via PDCCH DCI format 1B for C_RNTI to transmit the DL RMC (R.14-1 TDD) on a randomly selected full-size subband with a randomly selected precoding matrix from the codebook (Table 6.3.4.2.3-2 in TS 36.211 [8]), regardless of the SB and PMI reports from the UE. Note that each full-size subband and each precoding matrix shall be selected in equal probability. The SS sends downlink MAC padding bits on the DL RMC.
The SS shall transmit PDCCH DCI format 0 in downlink SF#4 and #9 to schedule UL transmission in uplink subframes #8 and #3 (Table A.4.1-2). The UE will send ACK/NACK and periodic CSI reports using PUSCH. Establish t_{md} and SNR_{md} according to annex G.5.2.
3. Set SNR to SNR_{md} . The SS shall transmit every subframe PDSCH via PDCCH DCI format 1B for C_RNTI to transmit the DL RMC (R.14-1 TDD) on the full-size subband and with the latest precoding matrix reported by the UE. When the UE reports a non-full-size subband, the SS schedules the recent reported subband for bandwidth part with $j=1$ with the latest reported precoding matrix. Note that the SS shall send PDSCH in the same full-size subband and with the latest reported precoding matrix until next UE subband report is available. The SS sends downlink MAC padding bits on the DL RMC.
The SS shall transmit PDCCH DCI format 0 in downlink SF#4 and #9 to schedule UL transmission in uplink subframes #8 and #3 (Table A.4.1-2). The UE will send ACK/NACK and periodic CSI reports using PUSCH. Measure t_{ue} according to Annex G.5.3.
4. Calculate $\gamma = \frac{t_{ue}}{t_{md}}$. If the ratio (throughput / t_{md}) $\geq \gamma$ which is specified in table 9.4.1.2.2.5-1, then the test is pass. Otherwise, the test is fail.

9.4.1.2.2.4.3 Message contents

Message contents are according to TS 36.508 [7] clause 4.6 with the following exceptions:

Table 9.4.1.2.2.4.3-1: *PhysicalConfigDedicated-DEFAULT*

Derivation Path: 36.508 clause 5.5.1.2			
Information Element	Value/remark	Comment	Condition
PhysicalConfigDedicated-DEFAULT ::= SEQUENCE {			
cqi-ReportConfig	<i>CQI-ReportConfig-DEFAULT</i>		
antennaInfo CHOICE {			
explicitValue	AntennaInfoDedicated		
}			
}			

Table 9.4.1.2.2.4.3-2: *AntennaInfoDedicated*

Derivation Path: 36.331 clause 6.3.2			
Information Element	Value/remark	Comment	Condition
AntennaInfoDedicated ::= SEQUENCE {			
transmissionMode	tm6		
codebookSubsetRestriction CHOICE{			
n4TxAntenna-tm6	1111111111111111		
}			
ue-TransmitAntennaSelection CHOICE{			
release	NULL		
}			
}			

Table 9.4.1.2.2.4.3-3: *CQI-ReportConfig-DEFAULT*

Derivation Path: 36.508 clause 4.6.3			
Information Element	Value/remark	Comment	Condition
CQI-ReportConfig-DEFAULT ::= SEQUENCE {			
cqi-ReportModeAperiodic	Not present		
nomPDSCH-RS-EPRE-Offset	0		
cqi-ReportPeriodic CHOICE {			
setup SEQUENCE {			
cqi-PUCCH-ResourceIndex	0		
cqi-pmi-ConfigIndex	4	(see Table 7.2.2-1A in TS 36.213)	
cqi-FormatIndicatorPeriodic CHOICE {			
subbandCQI	1		
}			
ri-ConfigIndex	484	(see Table 7.2.2-1B in TS 36.213)	
simultaneousAckNackAndCQI	FALSE		
}			
}			

9.4.1.2.2.5

Test requirement

Table 9.4.1.2.2.5-1: Test requirement (TDD)

Parameter	Test 1
γ	1.19
UE Category	1-8

9.4.1.3 PMI Reporting – PUSCH 3-1 (Single PMI) (CSI Reference Symbols)

9.4.1.3.1

9.4.1.3.1_D FDD Reporting of PMI – PUSCH 3-1 (Single PMI) for eDL MIMO

9.4.1.3.1_D.1 Test purpose

To test the accuracy of the Precoding Matrix Indicator (PMI) reporting such that the system throughput is maximized based on the precoders configured according to the UE reports.

9.4.1.3.1_D.2 Test applicability

This test applies to all types of E-UTRA FDD UE release 10 and forward that support eDL-MIMO. Applicability requires support for FGI bit 103.

9.4.1.3.1_D.3 Minimum conformance requirements

For the parameters specified in Table 9.4.1.3.1_D.3-1, and using the downlink physical channels specified in Annex C.3.2, the minimum requirements are specified in Table 9.4.1.3.1_D.3-2.

Table 9.4.1.3.1_D.3-1: PMI test for single-layer (FDD)

Parameter	Unit	Test 1	
Bandwidth	MHz	10	
Transmission mode		9	
Propagation channel		EPA5	
Precoding granularity	PRB	50	
Correlation and antenna configuration		Low ULA 4 x 2	
Cell-specific reference signals		Antenna ports 0,1	
CSI reference signals		Antenna ports 15,...,18	
Beamforming model		Annex B.4.3	
CSI-RS periodicity and subframe offset $T_{\text{CSI-RS}} / \Delta_{\text{CSI-RS}}$		5/ 1	
CSI-RS reference signal configuration		6	
CodeBookSubsetRestriction bitmap		0x0000 0000 0000 FFFF	
Downlink power allocation	ρ_A	dB	0
	ρ_B	dB	0
	P_c	dB	-3
	σ	dB	-3
$N_{oc}^{(j)}$	dB[mW/15kHz]	-98	
Reporting mode		PUSCH 3-1	
Reporting interval	ms	5	
PMI delay (Note 2)	ms	8	
Measurement channel		R.44 FDD	
OCNG Pattern		OP.1 FDD	
Max number of HARQ transmissions		4	
Redundancy version coding sequence		{0,1,2,3}	
<p>Note 1: For random precoder selection, the precoder shall be updated in each TTI (1 ms granularity).</p> <p>Note 2: If the UE reports in an available uplink reporting instance at subframe SF#n based on PMI estimation at a downlink SF not later than SF#(n-4), this reported PMI cannot be applied at the eNB downlink before SF#(n+4).</p> <p>Note 3: PDSCH_RA= 0 dB, PDSCH_RB= 0 dB in order to have the same PDSCH and OCNG power per subcarrier at the receiver.</p>			

Table 9.4.1.3.1_D.3-2: Minimum requirement (FDD)

Parameter	Test 1
γ	1.2
UE Category	1-8

The normative reference for this requirement is TS 36.101 [2] clause 9.4.1.3.1.

9.4.1.3.1_D.4 Test description

9.4.1.3.1_D.4.1 Initial conditions

Initial conditions are a set of test configurations the UE needs to be tested in and the steps for the SS to take with the UE to reach the correct measurement state.

Configurations of PDSCH and PDCCH before measurement are specified in Annex C.2.

Test Environment: Normal as defined in TS 36.508 [7] clause 4.1.

Frequencies to be tested: Mid Range as defined in TS 36.508 [7] clause 4.3.1.1.

Channel Bandwidths to be tested: 10MHz, as defined in TS 36.508 [7] clause 4.3.1.1

1. Connect the SS to the UE antenna connector (s) as shown in TS 36.508 [7] Annex A, Figure A.11.
2. The parameter settings for the cell are set up according to Table 9.4.1.3.1_D.3-1.
3. Downlink signals are initially set up according to Annex C.1 and Annex C.3.2, and uplink signals according to Annex H.1 and H.3.2.
4. Propagation conditions are set according to Annex B clause B.0
5. Ensure the UE is in State 3A-RF according to TS 36.508 [7] clause 5.2A.2. Message contents are defined in clause 9.4.1.3.1_D.4.3.

9.4.1.3.1_D.4.2 Test procedure

1. Set the parameters of bandwidth, the propagation condition, antenna configuration and measurement channel according to Table 9.4.1.3.1_D.3-1 as appropriate.
2. The SS shall transmit PDSCH via PDCCH DCI format 2C for C_RNTI to transmit the DL RMC with randomly selected precoding matrix from codebook (Table 6.3.4.2.3-2 in TS 36.211 [8]) every subframe regardless of PMI reports from the UE. Note that each precoding matrix shall be selected in equal probabilities. The SS sends downlink MAC padding bits on the DL RMC. SS schedules the UL transmission to carry the PUSCH CQI feedback via PDCCH DCI format 0 with CQI request bit set to 1 and I_MCS=29 and N_PRB allocated to be less or equal to 4. Establish t_{rnd} and SNR_{rnd} according to annex G.5.2
3. Set SNR to SNR_{rnd} . The SS shall transmit PDSCH with precoding matrix according to PMI report from the UE. The SS sends downlink MAC padding bits on the DL RMC. SS schedules the UL transmission to carry the PUSCH CQI feedback via PDCCH DCI format 0 with CQI request bit set to 1 and I_MCS=29 and N_PRB allocated to be less or equal to 4 every subframe. Measure t_{ue} according to Annex G.5.3
4. Calculate $\gamma = \frac{t_{ue}}{t_{rnd}}$. If the ratio (throughput / t_{rnd}) $\geq \gamma$ which is specified in table 9.4.1.3.1_D.5-1, then the test is pass. Otherwise, the test is fail.

9.4.1.3.1_D.4.3 Message contents

Message contents are according to TS 36.508 [7] clause 4.6 with the following exceptions:

Table 9.4.1.3.1_D.4.3-1: PhysicalConfigDedicated-DEFAULT

Derivation Path: 36.508 clause 5.5.1.2			
Information Element	Value/remark	Comment	Condition
PhysicalConfigDedicated-DEFAULT ::= SEQUENCE {			
cqi-ReportConfig	CQI-ReportConfig-r10-DEFAULT		
antennaInfo CHOICE {			
explicitValue	AntennaInfoDedicated		
}			
}			

Table 9.4.1.3.1_D.4.3-2: PDSCH-ConfigDedicated-DEFAULT

Derivation Path: 36.331 clause 6.3.2			
Information Element	Value/remark	Comment	Condition
PDSCH-ConfigDedicated-DEFAULT ::= SEQUENCE {			
p-a	dB0		
}			

Table 9.4.1.3.1_D.4.3-3: AntennaInfoDedicated-r10

Derivation Path: 36.331 clause 6.3.2			
Information Element	Value/remark	Comment	Condition
AntennaInfoDedicated-r10 ::= SEQUENCE {			
transmissionMode-r10	tm9-v1020		
codebookSubsetRestriction-r10	0x0000 0000 0000 FFFF		
}			
ue-TransmitAntennaSelection CHOICE{			
release	NULL		
}			
AntennaInfoDedicated-r10 ::= SEQUENCE {			

Table 9.4.1.3.1_D.4.3-4: CQI-ReportConfig-r10-DEFAULT

Derivation Path: 36.508 clause 4.6.3			
Information Element	Value/remark	Comment	Condition
CQI-ReportConfig-DEFAULT ::= SEQUENCE {			
cqi-ReportModeAperiodic	rm31		
nomPDSCH-RS-EPRE-Offset	0		
cqi-ReportPeriodic	Not present		
}			

Table 9.4.1.3.1_D.4.3-5: CSI-RS-Config

Derivation Path: 36.331 clause 6.3.2			
Information Element	Value/remark	Comment	Condition
CSI-RS-Config-r10 ::= SEQUENCE {			
csi-RS-r10 CHOICE{			
release	NULL		
setup SEQUENCE {			
antennaPortsCount-r10	an4	Parameter represents the number of antenna ports used for transmission of CSI reference signals	
resourceConfig-r10	6	Parameter: CSI reference signal configuration	
subframeConfig-r10	1	$\Delta_{\text{CSI-RS}} = I_{\text{CSI-RS}}$ when CSI-RS SubframeConfig is from 0-4; Parameter: $I_{\text{CSI-RS}}$	
p-C-r10	-3	Parameter: P_c which is the assumed ratio of PDSCH EPRE to CSI-RS EPRE when UE derives CSI feedback	
}			
}			
}			

9.4.1.3.1_D.5 Test requirement

Table 9.4.1.3.1_D.5-1: Test requirement (FDD)

Parameter	Test 1
γ	1.19

The ratio of throughput using precoding matrix of PMI reports from the UE to using random precoding matrix shall equal or exceed the value specified in table 9.4.1.1.1_D.5.

9.4.1.3.2_D TDD Reporting of PMI – PUSCH 3-1 (Single PMI) for eDL-MIMO

Editor's note: SS vendors have not decided on the 8x2 antenna configuration due to test system complexity and cost

9.4.1.3.2_D.1 Test purpose

To test the accuracy of the Precoding Matrix Indicator (PMI) reporting such that the system throughput is maximized based on the precoders configured according to the UE reports.

9.4.1.3.2_D.2 Test applicability

This test applies to all types of E-UTRA TDD UE release 10 and forward that support eDL-MIMO. Applicability requires support for FGI bit 104.

9.4.1.3.2_D.3 Minimum conformance requirements

For the parameters specified in Table 9.4.1.3.2_D.3-1, and using the downlink physical channels specified in Annex C.3.2, the minimum requirements are specified in Table 9.4.1.3.2_D.3-2.

Table 9.4.1.3.2_D.3-1: PMI test for single-layer (TDD)

Parameter	Unit	Test 1	
Bandwidth	MHz	10	
Transmission mode		9	
Uplink downlink configuration		1	
Special subframe configuration		4	
Propagation channel		EVA5	
Precoding granularity	PRB	50	
Antenna configuration		8 x 2	
Correlation modelling		High, Cross polarized	
Cell-specific reference signals		Antenna ports 0,1	
CSI reference signals		Antenna ports 15,...,22	
Beamforming model		Annex B.4.3	
CSI-RS periodicity and subframe offset $T_{\text{CSI-RS}} / \Delta_{\text{CSI-RS}}$		5/ 4	
CSI-RS reference signal configuration		0	
CodeBookSubsetRestriction bitmap		0x0000 0000 001F FFE0 0000 0000 FFFF	
Downlink power allocation	ρ_A	dB	0
	ρ_B	dB	0
	P_c	dB	-6
	σ	dB	-3
$N_{oc}^{(j)}$	dB[mW/15kHz]	-98	
Reporting mode		PUSCH 3-1	
Reporting interval	ms	5	
PMI delay (Note 2)	ms	10	
Measurement channel		R.45-1 TDD for UE Category 1, R.45 TDD for UE Category 2-8	
OCNG Pattern		OP.1 TDD	
Max number of HARQ transmissions		4	
Redundancy version coding sequence		{0,1,2,3}	
ACK/NACK feedback mode		Multiplexing	
Note 1:	For random precoder selection, the precoder shall be updated in each TTI (1 ms granularity).		
Note 2:	If the UE reports in an available uplink reporting instance at subframe SF#n based on PMI estimation at a downlink SF not later than SF#(n-4), this reported PMI cannot be applied at the eNB downlink before SF#(n+4).		
Note 3:	PDCCH DCI format 0 with a trigger for aperiodic CQI shall be transmitted in downlink SF#4 and #9 to allow aperiodic CQI/PMI/RI to be transmitted on uplink SF#3 and #8.		
Note 4:	Randomization of the principle beam direction shall be used as specified in B.2.3A.4		

Table 9.4.1.3.2_D.3-2: Minimum requirement (TDD)

Parameter	Test 1
γ	3
UE Category	1-8

The normative reference for this requirement is TS 36.101 [2] clause 9.4.1.3.2.

9.4.1.3.2_D.4 Test description

9.4.1.3.2_D.4.1 Initial conditions

Initial conditions are a set of test configurations the UE needs to be tested in and the steps for the SS to take with the UE to reach the correct measurement state.

Configurations of PDSCH and PDCCH before measurement are specified in Annex C.2.

Test Environment: Normal as defined in TS 36.508 [7] clause 4.1.

Frequencies to be tested: Mid Range as defined in TS 36.508 [7] clause 4.3.1.2.

Channel Bandwidths to be tested: 10MHz, as defined in TS 36.508 [7] clause 4.3.1.2

1. Connect the SS to the UE antenna connector (s) as shown in TS 36.508 [7] Annex A, Figure TBD.
2. The parameter settings for the cell are set up according to Table 9.4.1.3.2_D.3-1.
3. Downlink signals are initially set up according to Annex C.1 and Annex C.3.2, and uplink signals according to Annex H.1 and H.3.2.
4. Propagation conditions are set according to Annex B clause B.0
5. Ensure the UE is in State 3A-RF according to TS 36.508 [7] clause 5.2A.2. Message contents are defined in clause 9.4.1.3.2_D.4.3.

9.4.1.3.2_D.4.2 Test procedure

1. Set the bandwidth, propagation condition, antenna configuration and measurement channel parameters according to Table 9.4.1.3.2_D.3-1 as appropriate.
2. The SS shall transmit PDSCH via PDCCH DCI format 2C for C_RNTI to transmit the DL RMC with randomly selected precoding matrix from codebook (Table 6.3.4.2.3-2 in TS 36.211 [8]) every subframe regardless of PMI reports from the UE. Note that each precoding matrix shall be selected in equal probabilities. The SS sends downlink MAC padding bits on the DL RMC. SS schedules the UL transmission to carry the PUSCH CQI feedback via PDCCH DCI format 0 with CQI request bit set to 1 and I_MCS=29 and N_PRB allocated to be less or equal to 4. Establish t_{rnd} and SNR_{rnd} according to annex G.5.2.
3. Set SNR to SNR_{rnd} . The SS shall transmit PDSCH with precoding matrix according to PMI report from the UE. The SS sends downlink MAC padding bits on the DL RMC. SS schedules the UL transmission to carry the PUSCH CQI feedback via PDCCH DCI format 0 with CQI request bit set to 1 and I_MCS=29 and N_PRB allocated to be less or equal to 4. Measure t_{ue} according to Annex G.5.3

4. Calculate $\gamma = \frac{t_{ue}}{t_{rnd}}$

9.4.1.3.2_D.4.3 Message contents

Message contents are according to TS 36.508 [7] clause 4.6 with the following exceptions:

Table 9.4.1.3.2_D.4.3-1: PhysicalConfigDedicated-DEFAULT

Derivation Path: 36.508 clause 5.5.1.2			
Information Element	Value/remark	Comment	Condition
PhysicalConfigDedicated-DEFAULT ::= SEQUENCE {			
cqi-ReportConfig	CQI-ReportConfig-r10-DEFAULT		
antennaInfo CHOICE {			
explicitValue	AntennaInfoDedicated		
}			
}			

Table 9.4.1.3.2_D.4.3-2: PDSCH-ConfigDedicated-DEFAULT

Derivation Path: 36.331 clause 6.3.2			
Information Element	Value/remark	Comment	Condition
PDSCH-ConfigDedicated-DEFAULT ::= SEQUENCE {			
p-a	dB0		
}			

Table 9.4.1.3.2_D.4.3-3: AntennaInfoDedicated-r10

Derivation Path: 36.331 clause 6.3.2			
Information Element	Value/remark	Comment	Condition
AntennaInfoDedicated-r10 ::= SEQUENCE {			
transmissionMode-r10	tm9-v1020		
codebookSubsetRestriction-r10	0x0000 0000 001F FFE0 0000 0000 FFFF		
}			
ue-TransmitAntennaSelection CHOICE{			
release	NULL		
}			
AntennaInfoDedicated-r10 ::= SEQUENCE {			

Table 9.4.1.3.2_D.4.3-4: CQI-ReportConfig-r10-DEFAULT

Derivation Path: 36.508 clause 4.6.3			
Information Element	Value/remark	Comment	Condition
CQI-ReportConfig-DEFAULT ::= SEQUENCE {			
cqi-ReportModeAperiodic	rm31		
nomPDSCH-RS-EPRE-Offset	0		
cqi-ReportPeriodic	Not present		
}			

Table 9.4.1.3.2_D.4.3-5: TDD-Config-DEFAULT

Derivation Path: 36.508 clause 4.6.3			
Information Element	Value/remark	Comment	Condition
TDD-Config-DEFAULT ::= SEQUENCE {			
subframeAssignment	sa2		
specialSubframePatterns	ssp4		
}			

Table 9.4.1.3.2_D.4.3-6: PUSCH-ConfigDedicated-DEFAULT

Derivation Path: 36.331 clause 6.3.2			
Information Element	Value/remark	Comment	Condition
PUSCH-ConfigDedicated-DEFAULT ::= SEQUENCE {			
ackNackRepetition CHOICE {			
release	NULL		
}			
tddAckNackFeedbackMode	Multiplexing	Multiplexing is selected as default to align with RAN4's assumptions in RF tests.	TDD
}			

Table 9.4.1.3.2_D.4.3-7: CSI-RS-Config

Derivation Path: 36.331 clause 6.3.2			
Information Element	Value/remark	Comment	Condition
CSI-RS-Config-r10 ::= SEQUENCE {			
csi-RS-r10 CHOICE {			
release	NULL		
setup SEQUENCE {			
antennaPortsCount-r10	an8	Parameter represents the number of antenna ports used for transmission of CSI reference signals	
resourceConfig-r10	0	Parameter: CSI reference signal configuration	
subframeConfig-r10	4	$\Delta_{\text{CSI-RS}} = I_{\text{CSI-RS}}$ when CSI-RS SubframeConfig is from 0-4; Parameter: $I_{\text{CSI-RS}}$	
p-C-r10	-6	Parameter: P_c which is the assumed ratio of PDSCH EPRE to CSI-RS EPRE when UE derives CSI feedback	
}			
}			
}			

9.4.1.3.2_D.5 Test requirement

Table 9.4.1.3.2_D.5-1: Test requirement (TDD)

Parameter	Test 1
γ	3.49

The ratio of throughput using precoding matrix of PMI reports from the UE to using random precoding matrix shall equal or exceed the value specified in table 9.4.1.3.2_D.5.

9.4.2 Multiple PMI

9.4.2.1 PMI Reporting – PUSCH 1-2 (Multiple PMI) (Cell-Specific Reference Symbols)

9.4.2.1.1 FDD PMI Reporting – PUSCH 1-2 (Multiple PMI)

9.4.2.1.1.1 Test purpose

To test the accuracy of the Precoding Matrix Indicator (PMI) reporting such that the system throughput is maximized based on the precoders configured according to the UE reports.

9.4.2.1.1.2 Test applicability

This test applies to E-UTRA FDD UE release 8 of UE category 2-5.

9.4.2.1.1.3 Minimum conformance requirements

For the parameters specified in Table 9.4.2.1.1.3-1, and using the downlink physical channels specified in Annex C, the minimum requirements are specified in Table 9.4.2.1.1.3-2.

Table 9.4.2.1.1.3-1 PMI test for single-layer (FDD)

Parameter	Unit	Test 1	
Bandwidth	MHz	20	
Transmission mode		6	
Propagation channel		EPA5	
Precoding granularity (only for reporting and following PMI)	PRB	8	
Correlation and antenna configuration		Low 2 x 2	
Downlink power allocation	ρ_A	dB	-3
	ρ_B	dB	-3
	σ	dB	0
$N_{oc}^{(j)}$	dB[mW/15kHz]	-98	
Reporting mode		PUSCH 1-2	
Reporting interval	ms	1	
PMI delay	ms	8	
Measurement channel		R.30 FDD	
OCNG Pattern		OP.1 FDD	
Max number of HARQ transmissions		4	
Redundancy version coding sequence		{0,1,2,3}	
Note 1:	For random precoder selection, the precoders shall be updated in each TTI (1 ms granularity)		
Note 2:	If the UE reports in an available uplink reporting instance at subframe SF#n based on PMI estimation at a downlink SF not later than SF#(n-4), this reported PMI cannot be applied at the eNB downlink before SF#(n+4)		

Table 9.4.2.1.1.3-2: Minimum requirement (FDD)

Parameter	Test 1
γ	1.2
UE Category	2-5

The normative reference for this requirement is TS 36.101 [2] clause 9.4.2.1.1.

9.4.2.1.1.4 Test description

9.4.2.1.1.4.1 Initial conditions

Initial conditions are a set of test configurations the UE needs to be tested in and the steps for the SS to take with the UE to reach the correct measurement state.

Configurations of PDSCH and PDCCH before measurement are specified in Annex C.2.

Test Environment: Normal as defined in TS 36.508 [7] clause 4.1.

Frequencies to be tested: Mid Range as defined in TS 36.508 [7] clause 4.3.1.1.

Channel Bandwidths to be tested: 20MHz, as defined in TS 36.508 [7] clause 4.3.1.1

1. Connect the SS to the UE antenna connector (s) as shown in TS 36.508 [7] Annex A, Figure A.10.
2. The parameter settings for the cell are set up according to Table 9.4.2.1.1.3-1.
3. Downlink signals are initially set up according to Annex C.1 and Annex C.3.2, and uplink signals according to Annex H.1 and H.3.2.
4. Propagation conditions are set according to Annex B clause B.0
5. Ensure the UE is in State 3A-RF according to TS 36.508 [7] clause 5.2A.2. Message contents are defined in clause 9.4.2.1.1.4.3.

9.4.2.1.1.4.2 Test procedure

1. Set the parameters of bandwidth, the propagation condition, antenna configuration and measurement channel according to Table 9.4.2.1.1.3-1 as appropriate.
2. The SS shall transmit PDSCH via PDCCH DCI format 1B for C_RNTI to transmit the DL RMC with randomly selected precoding matrix from codebook (Table 6.3.4.2.3-1 in TS 36.211 [8]) every subframe regardless of PMI reports from the UE. Note that each precoding matrix shall be selected in equal probabilities. The SS sends downlink MAC padding bits on the DL RMC SS schedules the UL transmission to carry the PUSCH CQI feedback via PDCCH DCI format 0 with CQI request bit set to 1 and I_MCS=29 and N_PRB allocated to be less or equal to 4. Establish t_{rnd} and SNR_{rnd} according to annex G.5.2
3. Set SNR to SNR_{rnd} . The SS shall transmit PDSCH with precoding matrix according to PMI report from the UE. The SS sends downlink MAC padding bits on the DL RMC SS schedules the UL transmission to carry the PUSCH CQI feedback via PDCCH DCI format 0 with CQI request bit set to 1 and I_MCS=29 and N_PRB allocated to be less or equal to 4 every subframe. Measure the average throughput. Measure t_{ue} according to Annex G.5.3
4. Calculate $\gamma = \frac{t_{ue}}{t_{rnd}}$

9.4.2.1.1.4.3 Message contents

Message contents are according to TS 36.508 [7] clause 4.6 with the following exceptions:

Table 9.4.2.1.1.4.3-1: PhysicalConfigDedicated-DEFAULT

Derivation Path: 36.508 clause 5.5.1.2			
Information Element	Value/remark	Comment	Condition
PhysicalConfigDedicated-DEFAULT ::= SEQUENCE {			
cqi-ReportConfig	CQI-ReportConfig-DEFAULT		
antennaInfo CHOICE {			
explicitValue	AntennaInfoDedicated		
}			
}			

Table 9.4.2.1.1.4.3-2: AntennaInfoDedicated

Derivation Path: 36.331 clause 6.3.2			
Information Element	Value/remark	Comment	Condition
AntennaInfoDedicated ::= SEQUENCE {			
transmissionMode	tm6		
codebookSubsetRestriction CHOICE{			
n2TxAntenna-tm6	1111		
}			
ue-TransmitAntennaSelection CHOICE{			
release	NULL		
}			
}			

Table 9.4.2.1.1.4.3-3: CQI-ReportConfig-DEFAULT

Derivation Path: 36.508 clause 4.6.3			
Information Element	Value/remark	Comment	Condition
CQI-ReportConfig-DEFAULT ::= SEQUENCE {			
cqi-ReportModeAperiodic	rm12		
nomPDSCH-RS-EPRE-Offset	0		
cqi-ReportPeriodic	Not present		
}			

9.4.2.1.1.5 Test requirement

Table 9.4.2.1.1.5-1: Test requirement (FDD)

Parameter	Test 1
γ	1.19
UE Category	2-5

9.4.2.1.1_1 FDD PMI Reporting – PUSCH 1-2 (Multiple PMI) (Release 9 and forward)

9.4.2.1.1_1.1 Test purpose

To test the accuracy of the Precoding Matrix Indicator (PMI) reporting such that the system throughput is maximized based on the precoders configured according to the UE reports.

9.4.2.1.1_1.2 Test applicability

This test applies to all types of E-UTRA FDD UE release 9 and forward.

9.4.2.1.1_1.3 Minimum conformance requirements

For the parameters specified in Table 9.4.2.1.1_1.3-1, and using the downlink physical channels specified in Annex C, the minimum requirements are specified in Table 9.4.2.1.1_1.3-2.

Table 9.4.2.1.1_1.3-1: PMI test for single-layer (FDD)

Parameter		Unit	Test 1
Bandwidth		MHz	10
Transmission mode			6
Propagation channel			EPA5
Precoding granularity (only for reporting and following PMI)		PRB	6
Correlation and antenna configuration			Low 2 x 2
Downlink power allocation	ρ_A	dB	-3
	ρ_B	dB	-3
	σ	dB	0
$N_{oc}^{(j)}$		dB[mW/15kHz]	-98
Reporting mode			PUSCH 1-2
Reporting interval		ms	1
PMI delay		ms	8
Measurement channel			R.11-3 FDD for UE Category 1, R.11 FDD for UE Category 2-8
OCNG Pattern			OP.1 FDD
Max number of HARQ transmissions			4
Redundancy version coding sequence			{0,1,2,3}
Note 1: For random precoder selection, the precoders shall be updated in each TTI (1 ms granularity) Note 2: If the UE reports in an available uplink reporting instance at subframe SF#n based on PMI estimation at a downlink SF not later than SF#(n-4), this reported PMI cannot be applied at the eNB downlink before SF#(n+4) Note 3: One/two sided dynamic OCNG Pattern OP.1/2 FDD as described in Annex A.5.1.1/2 shall be used.			

Table 9.4.2.1.1_1.3-2: Minimum requirement (FDD)

Parameter	Test 1
γ	1.2
UE Category	1-8

The normative reference for this requirement is TS 36.101 [2] clause 9.4.2.1.1.

9.4.2.1.1_1.4 Test description

9.4.2.1.1_1.4.1 Initial conditions

Initial conditions are a set of test configurations the UE needs to be tested in and the steps for the SS to take with the UE to reach the correct measurement state.

Configurations of PDSCH and PDCCH before measurement are specified in Annex C.2.

Test Environment: Normal as defined in TS 36.508 [7] clause 4.1.

Frequencies to be tested: Mid Range as defined in TS 36.508 [7] clause 4.3.1.1.

Channel Bandwidths to be tested: 10MHz, as defined in TS 36.508 [7] clause 4.3.1.1

1. Connect the SS to the UE antenna connector (s) as shown in TS 36.508 [7] Annex A, Figure A.10.
2. The parameter settings for the cell are set up according to Table 9.4.2.1.1_1.3-1.
3. Downlink signals are initially set up according to Annex C.1 and Annex C.3.2, and uplink signals according to Annex H.1 and H.3.2.
4. Propagation conditions are set according to Annex B clause B.0
5. Ensure the UE is in State 3A-RF according to TS 36.508 [7] clause 5.2A.2. Message contents are defined in clause 9.4.2.1.1_1.4.3.

9.4.2.1.1_1.4.2 Test procedure

1. Set the parameters of bandwidth, the propagation condition, antenna configuration and measurement channel according to Table 9.4.2.1.1_1.3-1 as appropriate.
2. The SS shall transmit PDSCH via PDCCH DCI format 1B for C_RNTI to transmit the DL RMC (R.11-3 FDD for UE Category 1 with allocation centred within the transmission bandwidth configuration or R.11 FDD for UE Category 2-8) with randomly selected precoding matrix from codebook (Table 6.3.4.2.3-1 in TS 36.211 [8]) every subframe regardless of PMI reports from the UE. Note that each precoding matrix shall be selected in equal probabilities. The SS sends downlink MAC padding bits on the DL RMC SS schedules the UL transmission to carry the PUSCH CQI feedback via PDCCH DCI format 0 with CQI request bit set to 1 and I_MCS=29 and N_PRB allocated to be less or equal to 4. Establish t_{rd} and SNR_{rd} according to annex G.5.2
3. Set SNR to SNR_{rd} . The SS shall transmit PDSCH via PDCCH DCI format 1B for C-RNTI to transmit the DL RMC (R.11-3 FDD for UE Category 1 with allocation centred within the transmission bandwidth configuration or R.11 FDD for UE Category 2-8) with precoding matrix according to PMI report from the UE. The SS sends downlink MAC padding bits on the DL RMC SS schedules the UL transmission to carry the PUSCH CQI feedback via PDCCH DCI format 0 with CQI request bit set to 1 and I_MCS=29 and N_PRB allocated to be less or equal to 4 every subframe. Measure the average throughput.
Measure t_{ue} according to Annex G.5.3
4. Calculate $\gamma = \frac{t_{ue}}{t_{rd}}$

9.4.2.1.1_1.4.3 Message contents

Message contents are according to TS 36.508 [7] clause 4.6 with the following exceptions:

Table 9.4.2.1.1_1.4.3-1: PhysicalConfigDedicated-DEFAULT

Derivation Path: 36.508 clause 5.5.1.2			
Information Element	Value/remark	Comment	Condition
PhysicalConfigDedicated-DEFAULT ::= SEQUENCE {			
cqi-ReportConfig	CQI-ReportConfig-DEFAULT		
antennaInfo CHOICE {			
explicitValue	AntennaInfoDedicated		
}			
}			

Table 9.4.2.1.1_1.4.3-2: AntennaInfoDedicated

Derivation Path: 36.331 clause 6.3.2			
Information Element	Value/remark	Comment	Condition
AntennaInfoDedicated ::= SEQUENCE {			
transmissionMode	tm6		
codebookSubsetRestriction CHOICE{			
n2TxAntenna-tm6	1111		
}			
ue-TransmitAntennaSelection CHOICE{			
release	NULL		
}			
}			

Table 9.4.2.1.1_1.4.3-3: CQI-ReportConfig-DEFAULT

Derivation Path: 36.508 clause 4.6.3			
Information Element	Value/remark	Comment	Condition
CQI-ReportConfig-DEFAULT ::= SEQUENCE {			
cqi-ReportModeAperiodic	rm12		
nomPDSCH-RS-EPRE-Offset	0		
cqi-ReportPeriodic	Not present		
}			

9.4.2.1.1_1.5 Test requirement

Table 9.4.2.1.1_1.5-1: Test requirement (FDD)

Parameter	Test 1
γ	1.19
UE Category	1-8

9.4.2.1.2 TDD PMI Reporting – PUSCH 1-2 (Multiple PMI)

9.4.2.1.2.1 Test purpose

To test the accuracy of the Precoding Matrix Indicator (PMI) reporting such that the system throughput is maximized based on the precoders configured according to the UE reports.

9.4.2.1.2.2 Test applicability

This test applies to E-UTRA TDD UE release 8 of UE category 2-5.

9.4.2.1.2.3 Minimum conformance requirements

For the parameters specified in Table 9.4.2.1.2.3-1, and using the downlink physical channels specified in Annex C, the minimum requirements are specified in Table 9.4.2.1.2.3-2.

Table 9.4.2.1.2.3-1: PMI test for single-layer (TDD)

Parameter		Unit	Test 1
Bandwidth		MHz	20
Transmission mode			6
Uplink downlink configuration			1
Special subframe configuration			4
Propagation channel			EPA5
Precoding granularity (only for reporting and following PMI)		PRB	8
Correlation and antenna configuration			Low 2 x 2
Downlink power allocation	ρ_A	dB	-3
	ρ_B	dB	-3
	σ	dB	0
$N_{oc}^{(j)}$		dB[mW/15kHz]	-98
Reporting mode			PUSCH 1-2
Reporting interval		ms	1
Minimum PMI delay		ms	10 or 11
Measurement channel			R.30 TDD
OCNG Pattern			OP.1 TDD
Max number of HARQ transmissions			4
Redundancy version coding sequence			{0,1,2,3}
ACK/NACK feedback mode			Multiplexing
Note 1: For random precoder selection, the precoders shall be updated in each available downlink transmission instance Note 2: If the UE reports in an available uplink reporting instance at subframe SF#n based on PMI estimation at a downlink SF not later than SF#(n-4), this reported PMI cannot be applied at the eNB downlink before SF#(n+4)			

Table 9.4.2.1.2.3-2: Minimum requirement (TDD)

Parameter	Test 1
γ	1.2
UE Category	2-5

The normative reference for this requirement is TS 36.101 [2] clause 9.4.2.1.2.

9.4.2.1.2.4 Test description

9.4.2.1.2.4.1 Initial conditions

Initial conditions are a set of test configurations the UE needs to be tested in and the steps for the SS to take with the UE to reach the correct measurement state.

Configurations of PDSCH and PDCCH before measurement are specified in Annex C.2.

Test Environment: Normal as defined in TS 36.508 [7] clause 4.1.

Frequencies to be tested: Mid Range as defined in TS 36.508 [7] clause 4.3.1.2.

Channel Bandwidths to be tested: 20MHz, as defined in TS 36.508 [7] clause 4.3.1.2

1. Connect the SS to the UE antenna connector (s) as shown in TS 36.508 [7] Annex A, Figure A.10.

2. The parameter settings for the cell are set up according to Table 9.4.2.1.2.3-1.
3. Downlink signals are initially set up according to Annex C.1 and Annex C.3.2, and uplink signals according to Annex H.1 and H.3.2.
4. Propagation conditions are set according to Annex B clause B.0
5. Ensure the UE is in State 3A-RF according to TS 36.508 [7] clause 5.2A.2. Message contents are defined in clause 9.4.2.1.2.4.3.

9.4.2.1.2.4.2 Test procedure

1. Set the bandwidth, propagation condition, antenna configuration and measurement channel parameters according to Table 9.4.2.1.2.3-1 as appropriate.
2. The SS shall transmit PDSCH via PDCCH DCI format 1B for C_RNTI to transmit the DL RMC with randomly selected precoding matrix from codebook (Table 6.3.4.2.3-1 in TS 36.211 [8]) every subframe regardless of PMI reports from the UE. Note that each precoding matrix shall be selected in equal probabilities. The SS sends downlink MAC padding bits on the DL RMC. SS schedules the UL transmission to carry the PUSCH CQI feedback via PDCCH DCI format 0 with CQI request bit set to 1 and I_MCS=29 and N_PRB allocated to be less or equal to 4. Establish t_{md} and SNR_{md} according to annex G.5.2
3. Set SNR to SNR_{md} . The SS shall transmit PDSCH with precoding matrix according to PMI report from the UE. The SS sends downlink MAC padding bits on the DL RMC. SS schedules the UL transmission to carry the PUSCH CQI feedback via PDCCH DCI format 0 with CQI request bit set to 1 and I_MCS=29 and N_PRB allocated to be less or equal to 4. Measure t_{ue} according to Annex G.5.3
4. Calculate $\gamma = \frac{t_{ue}}{t_{md}}$

9.4.2.1.2.4.3 Message contents

Message contents are according to TS 36.508 [7] clause 4.6 with the following exceptions:

Table 9.4.2.1.2.4.3-1: PhysicalConfigDedicated-DEFAULT

Derivation Path: 36.508 clause 5.5.1.2			
Information Element	Value/remark	Comment	Condition
PhysicalConfigDedicated-DEFAULT ::= SEQUENCE {			
cqi-ReportConfig	CQI-ReportConfig-DEFAULT		
antennaInfo CHOICE {			
explicitValue	AntennaInfoDedicated		
}			
}			

Table 9.4.2.1.2.4.3-2: AntennaInfoDedicated

Derivation Path: 36.331 clause 6.3.2			
Information Element	Value/remark	Comment	Condition
AntennaInfoDedicated ::= SEQUENCE {			
transmissionMode	tm6		
codebookSubsetRestriction CHOICE{			
n2TxAntenna-tm6	1111		
}			
ue-TransmitAntennaSelection CHOICE{			
release	NULL		
}			

Table 9.4.2.1.2.4.3-3: CQI-ReportConfig-DEFAULT

Derivation Path: 36.508 clause 4.6.3			
Information Element	Value/remark	Comment	Condition
CQI-ReportConfig-DEFAULT ::= SEQUENCE {			
cqi-ReportModeAperiodic	rm12		
nomPDSCH-RS-EPRE-Offset	0		
cqi-ReportPeriodic	Not present		
}			

9.4.2.1.2.5 Test requirement

Table 9.4.2.1.2.5-1: Test requirement (TDD)

Parameter	Test 1
γ	1.19
UE Category	2-5

9.4.2.1.2_1 TDD PMI Reporting – PUSCH 1-2 (Multiple PMI) (Release 9 and forward)

9.4.2.1.2_1.1 Test purpose

To test the accuracy of the Precoding Matrix Indicator (PMI) reporting such that the system throughput is maximized based on the precoders configured according to the UE reports.

9.4.2.1.2_1.2 Test applicability

This test applies to all types of E-UTRA TDD UE release 9 and forward.

9.4.2.1.2_1.3 Minimum conformance requirements

For the parameters specified in Table 9.4.2.1.2_1.3-1, and using the downlink physical channels specified in Annex C, the minimum requirements are specified in Table 9.4.2.1.2_1.3-2.

Table 9.4.2.1.2_1.3-1: PMI test for single-layer (TDD)

Parameter		Unit	Test 1
Bandwidth		MHz	10
Transmission mode			6
Uplink downlink configuration			1
Special subframe configuration			4
Propagation channel			EPA5
Precoding granularity (only for reporting and following PMI)		PRB	6
Correlation and antenna configuration			Low 2 x 2
Downlink power allocation	ρ_A	dB	-3
	ρ_B	dB	-3
	σ	dB	0
$N_{oc}^{(j)}$		dB[mW/15kHz]	-98
Reporting mode			PUSCH 1-2
Reporting interval		ms	1
PMI delay		ms	10 or 11
Measurement channel			R.11-3 TDD for UE Category 1 R.11 TDD for UE Category 2-8
OCNG Pattern			OP.1 TDD
Max number of HARQ transmissions			4
Redundancy version coding sequence			{0,1,2,3}
ACK/NACK feedback mode			Multiplexing
<p>Note 1: For random precoder selection, the precoders shall be updated in each available downlink transmission instance</p> <p>Note 2: If the UE reports in an available uplink reporting instance at subframe SF#n based on PMI estimation at a downlink SF not later than SF#(n-4), this reported PMI cannot be applied at the eNB downlink before SF#(n+4)</p> <p>Note 3: One/two sided dynamic OCNG Pattern OP.1/2 TDD as described in Annex A.5.2.1/2 shall be used.</p>			

Table 9.4.2.1.2_1.3-2: Minimum requirement (TDD)

Parameter	Test 1
γ	1.2
UE Category	1-8

The normative reference for this requirement is TS 36.101 [2] clause 9.4.2.1.2.

9.4.2.1.2_1.4 Test description

9.4.2.1.2_1.4.1 Initial conditions

Initial conditions are a set of test configurations the UE needs to be tested in and the steps for the SS to take with the UE to reach the correct measurement state.

Configurations of PDSCH and PDCCH before measurement are specified in Annex C.2.

Test Environment: Normal as defined in TS 36.508 [7] clause 4.1.

Frequencies to be tested: Mid Range as defined in TS 36.508 [7] clause 4.3.1.2.

Channel Bandwidths to be tested: 10MHz, as defined in TS 36.508 [7] clause 4.3.1.2

1. Connect the SS to the UE antenna connector (s) as shown in TS 36.508 [7] Annex A, Figure A.10.
2. The parameter settings for the cell are set up according to Table 9.4.2.1.2_1.3-1.
3. Downlink signals are initially set up according to Annex C.1 and Annex C.3.2, and uplink signals according to Annex H.1 and H.3.2.
4. Propagation conditions are set according to Annex B clause B.0
5. Ensure the UE is in State 3A-RF according to TS 36.508 [7] clause 5.2A.2. Message contents are defined in clause 9.4.2.1.2_1.4.3.

9.4.2.1.2_1.4.2 Test procedure

1. Set the bandwidth, propagation condition, antenna configuration and measurement channel parameters according to Table 9.4.2.1.2_1.3-1 as appropriate.
2. The SS shall transmit PDSCH via PDCCH DCI format 1B for C_RNTI to transmit the DL RMC (R.11-3 TDD for UE Category 1 with allocation centred within the transmission bandwidth configuration or R.11 TDD for UE Category 2-8) with randomly selected precoding matrix from codebook (Table 6.3.4.2.3-1 in TS 36.211 [8]) every subframe regardless of PMI reports from the UE. Note that each precoding matrix shall be selected in equal probabilities. The SS sends downlink MAC padding bits on the DL RMC. SS schedules the UL transmission to carry the PUSCH CQI feedback via PDCCH DCI format 0 with CQI request bit set to 1 and I_MCS=29 and N_PRB allocated to be less or equal to 4. Establish t_{rnd} and SNR_{rnd} according to annex G.5.2
3. Set SNR to SNR_{rnd} . The SS shall transmit PDSCH via PDCCH DCI format 1B for C-RNTI to transmit the DL RMC (R.11-3 TDD for UE Category 1 with allocation centred within the transmission bandwidth configuration or R.11 TDD for UE Category 2-8) with precoding matrix according to PMI report from the UE. The SS sends downlink MAC padding bits on the DL RMC. SS schedules the UL transmission to carry the PUSCH CQI feedback via PDCCH DCI format 0 with CQI request bit set to 1 and I_MCS=29 and N_PRB allocated to be less or equal to 4. Measure t_{ue} according to Annex G.5.3

4. Calculate $\gamma = \frac{t_{ue}}{t_{rnd}}$

9.4.2.1.2_1.4.3 Message contents

Message contents are according to TS 36.508 [7] clause 4.6 with the following exceptions:

Table 9.4.2.1.2_1.4.3-1: PhysicalConfigDedicated-DEFAULT

Derivation Path: 36.508 clause 5.5.1.2			
Information Element	Value/remark	Comment	Condition
PhysicalConfigDedicated-DEFAULT ::= SEQUENCE {			
cqi-ReportConfig	CQI-ReportConfig-DEFAULT		
antennaInfo CHOICE {			
explicitValue	AntennaInfoDedicated		
}			
}			

Table 9.4.2.1.2_1.4.3-2: AntennaInfoDedicated

Derivation Path: 36.331 clause 6.3.2			
Information Element	Value/remark	Comment	Condition
AntennaInfoDedicated ::= SEQUENCE {			
transmissionMode	tm6		
codebookSubsetRestriction CHOICE{			
n2TxAntenna-tm6	1111		
}			
ue-TransmitAntennaSelection CHOICE{			
release	NULL		
}			
}			

Table 9.4.2.1.2_1.4.3-3: CQI-ReportConfig-DEFAULT

Derivation Path: 36.508 clause 4.6.3			
Information Element	Value/remark	Comment	Condition
CQI-ReportConfig-DEFAULT ::= SEQUENCE {			
cqi-ReportModeAperiodic	rm12		
nomPDSCH-RS-EPRE-Offset	0		
cqi-ReportPeriodic	Not present		
}			

9.4.2.1.2_1.5 Test requirement

Table 9.4.2.1.2_1.5-1: Test requirement (TDD)

Parameter	Test 1
γ	1.19
UE Category	1-8

9.4.2.2 PMI Reporting – PUSCH 2-2 (Multiple PMI) (Cell-Specific Reference Symbols)

9.4.2.2.1 FDD PMI Reporting – PUSCH 2-2 (Multiple PMI)

9.4.2.2.1.1 Test purpose

To test the accuracy of the Precoding Matrix Indicator (PMI) reporting such that the system throughput is maximized based on the precoders configured according to the UE reports.

9.4.2.2.1.2 Test applicability

This test applies to all types of E-UTRA FDD UE release 9 and forward. Applicability requires support of FGI bit 1.

9.4.2.2.1.3 Minimum conformance requirements

For the parameters specified in Table 9.4.2.2.1.3-1, and using the downlink physical channels specified in Annex C, the minimum requirements are specified in Table 9.4.2.2.1.3-2.

Table 9.4.2.2.1.3-1: PMI test for single-layer (FDD)

Parameter		Unit	Test 1
Bandwidth		MHz	10
Transmission mode			6
Propagation channel			EVA5
Correlation and antenna configuration			Low 4 x 2
Downlink power allocation	ρ_A	dB	-6
	ρ_B	dB	-6
	σ	dB	3
$N_{oc}^{(j)}$		dB[mW/15kHz]	-98
PMI delay		ms	8
Reporting mode			PUSCH 2-2
Reporting interval		ms	1
Measurement channel			R.14-2 FDD
OCNG Pattern			OP. 1/2 FDD
Subband size (k)		RBs	3 (full size)
Number of preferred subbands (M)			5
Max number of HARQ transmissions			4
Redundancy version coding sequence			{0,1,2,3}
Note 1: For random precoder selection, the precoder shall be updated in each TTI (1 ms granularity)			
Note 2: If the UE reports in an available uplink reporting instance at subframe SF#n based on PMI estimation at a downlink SF not later than SF#(n-4), this reported PMI cannot be applied at the eNB downlink before SF#(n+4)			

Table 9.4.2.2.1.3-2: Minimum requirement (FDD)

	Test 1
γ	1.2
UE Category	1-8

The normative reference for this requirement is TS 36.101 [2] clause 9.4.2.2.1.

9.4.2.2.1.4 Test description

9.4.2.2.1.4.1 Initial conditions

Initial conditions are a set of test configurations the UE needs to be tested in and the steps for the SS to take with the UE to reach the correct measurement state.

Configurations of PDSCH and PDCCH before measurement are specified in Annex C.2.

Test Environment: Normal as defined in TS 36.508 [7] clause 4.1.

Frequencies to be tested: Mid Range as defined in TS 36.508 [7] clause 4.3.1.1.

Channel Bandwidths to be tested: 10MHz, as defined in TS 36.508 [7] clause 4.3.1.1

1. Connect the SS to the UE antenna connector (s) as shown in TS 36.508 [7] Annex A, Figure A.11.
2. The parameter settings for the cell are set up according to Table 9.4.2.2.1.3-1.
3. Downlink signals are initially set up according to Annex C.1 and Annex C.3.2, and uplink signals according to Annex H.1 and H.3.2.
4. Propagation conditions are set according to Annex B clause B.0

5. Ensure the UE is in State 3A-RF according to TS 36.508 [7] clause 5.2A.2. Message contents are defined in clause 9.4.2.2.1.4.3.

9.4.2.2.1.4.2 Test procedure

1. Set the parameters of bandwidth, the propagation condition, antenna configuration and measurement channel according to Table 9.4.2.2.1.3-1 as appropriate.
2. The SS shall transmit every subframe PDSCH via PDCCH DCI format 1B for C_RNTI to transmit the DL RMC (R.14-2 FDD) on a randomly selected full-size subband with a randomly selected precoding matrix from the codebook (Table 6.3.4.2.3-2 in TS 36.211 [8]), regardless of the SB and PMI reports from the UE. Note that each full-size subband and each precoding matrix shall be selected in equal probability. The SS sends downlink MAC padding bits on the DL RMC.
The SS shall transmit PDCCH DCI format 0 with CQI request bit set to 1 and I_MCS=29 and N_PRB allocated to be less or equal to 4. The UE will send aperiodic CSI report on PUSCH.
Establish t_{md} and SNR_{md} according to annex G.5.2.
3. Set SNR to SNR_{md} . The SS shall transmit every subframe PDSCH via PDCCH DCI format 1B for C_RNTI to transmit the DL RMC (R.14-2 FDD) on one full-size subband selected among the M preferred subbands and the corresponding subband precoding matrix reported by the UE. Note that the SS shall send PDSCH in the same full-size subband until next UE report is available. In case when same M preferred subbands are reported subsequently, the SS shall select for transmission a different subband with respect to the last selection. The SS sends downlink MAC padding bits on the DL RMC.
The SS shall transmit PDCCH DCI format 0 with CQI request bit set to 1 and I_MCS=29 and N_PRB allocated to be less or equal to 4. The UE will send aperiodic CSI report on PUSCH.
Measure t_{ue} according to Annex G.5.3.

4. Calculate $\gamma = \frac{t_{ue}}{t_{md}}$

9.4.2.2.1.4.3 Message contents

Message contents are according to TS 36.508 [7] clause 4.6 with the following exceptions:

Table 9.4.2.2.1.4.3-1: PhysicalConfigDedicated-DEFAULT

Derivation Path: 36.508 clause 5.5.1.2			
Information Element	Value/remark	Comment	Condition
PhysicalConfigDedicated-DEFAULT ::= SEQUENCE {			
cqi-ReportConfig	CQI-ReportConfig-DEFAULT		
antennaInfo CHOICE {			
explicitValue	AntennaInfoDedicated		
}			
}			

Table 9.4.2.2.1.4.3-2: AntennaInfoDedicated

Derivation Path: 36.331 clause 6.3.2			
Information Element	Value/remark	Comment	Condition
AntennaInfoDedicated ::= SEQUENCE {			
transmissionMode	tm6		
codebookSubsetRestriction CHOICE{			
n4TxAntenna-tm6	1111111111111111		
}			
ue-TransmitAntennaSelection CHOICE{			
release	NULL		
}			
}			

Table 9.4.2.2.1.4.3-3: CQI-ReportConfig-DEFAULT

Derivation Path: 36.508 clause 4.6.3			
Information Element	Value/remark	Comment	Condition
CQI-ReportConfig-DEFAULT ::= SEQUENCE {			
cqi-ReportModeAperiodic	rm22		
nomPDSCH-RS-EPRE-Offset	0		
cqi-ReportPeriodic	Not present		
}			

9.4.2.2.1.5 Test requirement

Table 9.4.2.2.1.5-1: Test requirement (FDD)

	Test 1
γ	1.19
UE Category	1-8

9.4.2.2.2 TDD PMI Reporting – PUSCH 2-2 (Multiple PMI)

9.4.2.2.2.1 Test purpose

To test the accuracy of the Precoding Matrix Indicator (PMI) reporting such that the system throughput is maximized based on the precoders configured according to the UE reports.

9.4.2.2.2.2 Test applicability

This test applies to all types of E-UTRA TDD UE release 9 and forward. Applicability requires support of FGI bit 1.

9.4.2.2.2.3 Minimum conformance requirements

For the parameters specified in Table 9.4.2.2.2.3-1, and using the downlink physical channels specified in Annex C, the minimum requirements are specified in Table 9.4.2.2.2.3-2.

Table 9.4.2.2.3-1: PMI test for single-layer (TDD)

Parameter	Unit	Test 1	
Bandwidth	MHz	10	
Transmission mode		6	
Uplink downlink configuration		1	
Special subframe configuration		4	
Propagation channel		EVA5	
Correlation and antenna configuration		Low 4 x 2	
Downlink power allocation	ρ_A	dB	-6
	ρ_B	dB	-6
	σ	dB	3
$N_{oc}^{(j)}$	dB[mW/15kHz]	-98	
PMI delay	ms	10	
Reporting mode		PUSCH 2-2	
Reporting interval	ms	1	
Measurement channel		R.14-2 TDD	
OCNG Pattern		OP. 1/2 FDD	
Subband size (k)	RBs	3 (full size)	
Number of preferred subbands (M)		5	
Max number of HARQ transmissions		4	
Redundancy version coding sequence		{0,1,2,3}	
ACK/NACK feedback mode		Multiplexing	
Note 1: For random precoder selection, the precoders shall be updated in each available downlink transmission instance			
Note 2: If the UE reports in an available uplink reporting instance at subframe SF# n based on PMI estimation at a downlink SF not later than SF#(n-4), this reported PMI cannot be applied at the eNB downlink before SF#(n+4)			

Table 9.4.2.2.3-2: Minimum requirement (TDD)

	Test 1
γ	1.15
UE Category	1-8

The normative reference for this requirement is TS 36.101 [2] clause 9.4.2.2.2.

9.4.2.2.2.4 Test description

9.4.2.2.2.4.1 Initial conditions

Initial conditions are a set of test configurations the UE needs to be tested in and the steps for the SS to take with the UE to reach the correct measurement state.

Configurations of PDSCH and PDCCH before measurement are specified in Annex C.2.

Test Environment: Normal as defined in TS 36.508 [7] clause 4.1.

Frequencies to be tested: Mid Range as defined in TS 36.508 [7] clause 4.3.1.2.

Channel Bandwidths to be tested: 10MHz, as defined in TS 36.508 [7] clause 4.3.1.2

1. Connect the SS to the UE antenna connector (s) as shown in TS 36.508 [7] Annex A, Figure A.11.

2. The parameter settings for the cell are set up according to Table 9.4.2.2.2.3-1.
3. Downlink signals are initially set up according to Annex C.1 and Annex C.3.2, and uplink signals according to Annex H.1 and H.3.2.
4. Propagation conditions are set according to Annex B clause B.0
5. Ensure the UE is in State 3A-RF according to TS 36.508 [7] clause 5.2A.2. Message contents are defined in clause 9.4.2.2.2.4.3.

9.4.2.2.2.4.2 Test procedure

1. Set the bandwidth, propagation condition, antenna configuration and measurement channel parameters according to Table 9.4.2.2.2.3-1 as appropriate.
2. The SS shall transmit every subframe PDSCH via PDCCH DCI format 1B for C_RNTI to transmit the DL RMC (R.14-2 TDD) on a randomly selected full-size subband with a randomly selected precoding matrix from the codebook (Table 6.3.4.2.3-2 in TS 36.211 [8]), regardless of the SB and PMI reports from the UE. Note that each full-size subband and each precoding matrix shall be selected in equal probability. The SS sends downlink MAC padding bits on the DL RMC.
The SS shall transmit PDCCH DCI format 0 with CQI request bit set to 1 and I_MCS=29 and N_PRB allocated to be less or equal to 4. The UE will send aperiodic CSI report on PUSCH.
Establish t_{md} and SNR_{md} according to annex G.5.2.
3. Set SNR to SNR_{md} . The SS shall transmit every subframe PDSCH via PDCCH DCI format 1B for C_RNTI to transmit the DL RMC (R.14-2 TDD) on one full-size subband selected among the M preferred subbands and the corresponding subband precoding matrix reported by the UE. Note that the SS shall send PDSCH in the same full-size subband until next UE report is available. In case when same M preferred subbands are reported subsequently, the SS shall select for transmission a different subband with respect to the last selection. The SS sends downlink MAC padding bits on the DL RMC.
The SS shall transmit PDCCH DCI format 0 with CQI request bit set to 1 and I_MCS=29 and N_PRB allocated to be less or equal to 4. The UE will send aperiodic CSI report on PUSCH.
Measure t_{ue} according to Annex G.5.3.

4. Calculate $\gamma = \frac{t_{ue}}{t_{md}}$

9.4.2.2.2.4.3 Message contents

Message contents are according to TS 36.508 [7] clause 4.6 with the following exceptions:

Table 9.4.2.2.2.4.3-1: PhysicalConfigDedicated-DEFAULT

Derivation Path: 36.508 clause 5.5.1.2			
Information Element	Value/remark	Comment	Condition
PhysicalConfigDedicated-DEFAULT ::= SEQUENCE {			
cqi-ReportConfig	CQI-ReportConfig-DEFAULT		
antennaInfo CHOICE {			
explicitValue	AntennaInfoDedicated		
}			
}			

Table 9.4.2.2.2.4.3-2: AntennaInfoDedicated

Derivation Path: 36.331 clause 6.3.2			
Information Element	Value/remark	Comment	Condition
AntennaInfoDedicated ::= SEQUENCE {			
transmissionMode	tm6		
codebookSubsetRestriction CHOICE{			
n4TxAntenna-tm6	1111111111111111		
}			
ue-TransmitAntennaSelection CHOICE{			
release	NULL		
}			
}			

Table 9.4.2.2.2.4.3-3: CQI-ReportConfig-DEFAULT

Derivation Path: 36.508 clause 4.6.3			
Information Element	Value/remark	Comment	Condition
CQI-ReportConfig-DEFAULT ::= SEQUENCE {			
cqi-ReportModeAperiodic	rm22		
nomPDSCH-RS-EPRE-Offset	0		
cqi-ReportPeriodic	Not present		
}			

9.4.2.2.2.5 Test requirement

Table 9.4.2.2.2.5-1: Test requirement (TDD)

	Test 1
γ	1.14
UE Category	1-8

9.4.2.3 PMI Reporting – PUSCH 1-2 (Multiple PMI) (CSI Reference Symbols)

9.4.2.3.1

9.4.2.3.1_D FDD PMI Reporting - PUSCH 1-2 (Multiple PMI) for eDL-MIMO

9.4.2.3.1_D.1 Test purpose

To test the accuracy of the Precoding Matrix Indicator (PMI) reporting such that the system throughput is maximized based on the precoders configured according to the UE reports.

9.4.2.3.1_D.2 Test applicability

This test applies to all types of E-UTRA FDD UE release 10 and forward that support eDL-MIMO. Applicability requires support for FGI bit 103.

9.4.2.3.1_D.3 Minimum conformance requirements

For the parameters specified in Table 9.4.2.3.1_D.3-1, and using the downlink physical channels specified in Annex C.3.2, the minimum requirements are specified in Table 9.4.2.3.1_D.3-2.

Table 9.4.2.3.1_D.3-1: PMI test for single-layer (FDD) for eDL-MIMO

Parameter		Unit	Test 1
Bandwidth		MHz	10
Transmission mode			9
Propagation channel			EVA5
Precoding granularity (only for reporting and following PMI)		PRB	6
Correlation and antenna configuration			Low ULA 4 x 2
Cell-specific reference signals			Antenna ports 0,1
CSI reference signals			Antenna ports 15,...,18
Beamforming model			Annex B.4.3
CSI-RS periodicity and subframe offset $T_{\text{CSI-RS}} / \Delta_{\text{CSI-RS}}$			5/ 1
CSI-RS reference signal configuration			8
CodeBookSubsetRestriction bitmap			0x0000 0000 0000 FFFF
Downlink power allocation	ρ_A	dB	0
	ρ_B	dB	0
	P_c	dB	-3
	σ	dB	-3
$N_{oc}^{(j)}$		dB[mW/15kHz]	-98
Reporting mode			PUSCH 1-2
Reporting interval		ms	5
PMI delay		ms	8
Measurement channel			R.45-1 FDD for UE Category 1, R.45 FDD for UE Category 2-8
OCNG Pattern			OP.1 FDD
Max number of HARQ transmissions			4
Redundancy version coding sequence			{0,1,2,3}
<p>Note 1: For random precoder selection, the precoders shall be updated in each TTI (1 ms granularity).</p> <p>Note 2: If the UE reports in an available uplink reporting instance at subframe SF#n based on PMI estimation at a downlink SF not later than SF#(n-4), this reported PMI cannot be applied at the eNB downlink before SF#(n+4).</p> <p>Note 3: One/two sided dynamic OCNG Pattern OP.1/2 FDD as described in Annex A.5.1.1/2 shall be used.</p> <p>Note 4: PDSCH_RA= 0 dB, PDSCH_RB= 0 dB in order to have the same PDSCH and OCNG power per subcarrier at the receiver.</p>			

Table 9.4.2.3.1_D.3-2: Minimum requirement (FDD) for eDL-MIMO

Parameter	Test 1
γ	1.3
UE Category	1-8

The normative reference for this requirement is TS 36.101 [2] clause 9.4.2.3.1.

9.4.2.3.1_D.4 Test description

9.4.2.3.1_D.4.1 Initial conditions

Initial conditions are a set of test configurations the UE needs to be tested in and the steps for the SS to take with the UE to reach the correct measurement state.

Configurations of PDSCH and PDCCH before measurement are specified in Annex C.2.

Test Environment: Normal as defined in TS 36.508 [7] clause 4.1.

Frequencies to be tested: Mid Range as defined in TS 36.508 [7] clause 4.3.1.1.

Channel Bandwidths to be tested: 10MHz, as defined in TS 36.508 [7] clause 4.3.1.1

1. Connect the SS to the UE antenna connector (s) as shown in TS 36.508 [7] Annex A, Figure A.11.
2. The parameter settings for the cell are set up according to Table 9.4.2.3.1_D.3-1.
3. Downlink signals are initially set up according to Annex C.1 and Annex C.3.2, and uplink signals according to Annex H.1 and H.3.2.
4. Propagation conditions are set according to Annex B clause B.0
5. Ensure the UE is in State 3A-RF according to TS 36.508 [7] clause 5.2A.2. Message contents are defined in clause 9.4.2.3.1_D.4.3.

9.4.2.3.1_D.4.2 Test procedure

1. Set the parameters of bandwidth, the propagation condition, antenna configuration and measurement channel according to Table 9.4.2.3.1_D.3-1 as appropriate.
2. The SS shall transmit PDSCH via PDCCH DCI format 2C for C_RNTI to transmit the DL RMC with randomly selected precoding matrix from codebook (Table 6.3.4.2.3-2 in TS 36.211 [8]) every subframe regardless of PMI reports from the UE. Note that each precoding matrix shall be selected in equal probabilities. The SS sends downlink MAC padding bits on the DL RMC SS schedules the UL transmission to carry the PUSCH CQI feedback via PDCCH DCI format 0 with CQI request bit set to 1 and I_MCS=29 and N_PRB allocated to be less or equal to 4. Establish t_{md} and SNR_{md} according to annex G.5.2
3. Set SNR to SNR_{md} . The SS shall transmit PDSCH with precoding matrix according to PMI report from the UE. The SS sends downlink MAC padding bits on the DL RMC SS schedules the UL transmission to carry the PUSCH CQI feedback via PDCCH DCI format 0 with CQI request bit set to 1 and I_MCS=29 and N_PRB allocated to be less or equal to 4 every subframe. Measure the average throughput. Measure t_{ue} according to Annex G.5.3
4. Calculate $\gamma = \frac{t_{ue}}{t_{md}}$

9.4.2.3.1_D.4.3 Message contents

Message contents are according to TS 36.508 [7] clause 4.6 with the following exceptions:

Table 9.4.2.3.1_D.4.3-1: PhysicalConfigDedicated-DEFAULT

Derivation Path: 36.508 clause 5.5.1.2			
Information Element	Value/remark	Comment	Condition
PhysicalConfigDedicated-DEFAULT ::= SEQUENCE {			
cqi-ReportConfig	CQI-ReportConfig-r10-DEFAULT		
antennaInfo CHOICE {			
explicitValue	AntennaInfoDedicated		
}			
}			

Table 9.4.2.3.1_D.4.3-2: PDSCH-ConfigDedicated-DEFAULT

Derivation Path: 36.331 clause 6.3.2			
Information Element	Value/remark	Comment	Condition
PDSCH-ConfigDedicated-DEFAULT ::= SEQUENCE {			
p-a	dB0		
}			

Table 9.4.2.3.1_D.4.3-3: AntennaInfoDedicated-r10

Derivation Path: 36.331 clause 6.3.2			
Information Element	Value/remark	Comment	Condition
AntennaInfoDedicated-r10 ::= SEQUENCE {			
transmissionMode-r10	tm9-v1020		
codebookSubsetRestriction-r10	0x0000 0000 0000 FFFF		
}			
ue-TransmitAntennaSelection CHOICE{			
release	NULL		
}			

Table 9.4.2.3.1_D.4.3-4: CQI-ReportConfig-r10-DEFAULT

Derivation Path: 36.508 clause 4.6.3			
Information Element	Value/remark	Comment	Condition
CQI-ReportConfig-r10 ::= SEQUENCE {			
cqi-ReportModeAperiodic-r10	rm12		
nomPDSCH-RS-EPRE-Offset	0		
cqi-ReportPeriodic-r10	Not present		
}			

Table 9.4.2.3.1_D.4.3-5: CSI-RS-Config

Derivation Path: 36.331 clause 6.3.2			
Information Element	Value/remark	Comment	Condition
CSI-RS-Config-r10 ::= SEQUENCE {			
csi-RS-r10 CHOICE{			
release	NULL		
setup SEQUENCE {			
antennaPortsCount-r10	an4	Parameter represents the number of antenna ports used for transmission of CSI reference signals	
resourceConfig-r10	8	Parameter: CSI reference signal configuration	
subframeConfig-r10	1	$\Delta_{\text{CSI-RS}} = I_{\text{CSI-RS}}$ when CSI-RS SubframeConfig is from 0-4; Parameter: $I_{\text{CSI-RS}}$	
p-C-r10	-3	Parameter: P_c which is the assumed ratio of PDSCH EPRE to CSI-RS EPRE when UE derives CSI feedback	
}			
}			
}			

9.4.2.3.1_D.5 Test requirement

Table 9.4.2.3.1_D.5-1: Test requirement (FDD) for eDL-MIMO

Parameter	Test 1
γ	1.29
UE Category	1-8

9.4.2.3.2_D TDD PMI Reporting - PUSCH 1-2 (Multiple PMI) for eDL-MIMO

Editor's note: SS vendors have not decided on the 8x2 antenna configuration due to test system complexity and cost

9.4.2.3.2_D.1 Test purpose

To test the accuracy of the Precoding Matrix Indicator (PMI) reporting such that the system throughput is maximized based on the precoders configured according to the UE reports.

9.4.2.3.2_D.2 Test applicability

This test applies to all types of E-UTRA TDD UE release 10 and forward that support eDL-MIMO. Applicability requires support for FGI bit 104.

9.4.2.3.2_D.3 Minimum conformance requirements

For the parameters specified in Table 9.4.2.3.2_D.3-1, and using the downlink physical channels specified in Annex C.3.2, the minimum requirements are specified in Table 9.4.2.3.2_D.3-2.

Table 9.4.2.3.2_D.3-1: PMI test for single-layer (TDD) for eDL-MIMO

Parameter		Unit	Test 1
Bandwidth		MHz	10
Transmission mode			9
Uplink downlink configuration			1
Special subframe configuration			4
Propagation channel			EVA5
Precoding granularity (only for reporting and following PMI)		PRB	6
Antenna configuration			8 x 2
Correlation modelling			High, Cross polarized
Cell-specific reference signals			Antenna ports 0,1
CSI reference signals			Antenna ports 15,...,22
Beamforming model			Annex B.4.3
CSI-RS periodicity and subframe offset $T_{\text{CSI-RS}} / \Delta_{\text{CSI-RS}}$			5/ 4
CSI-RS reference signal configuration			4
CodeBookSubsetRestriction bitmap			0x0000 0000 001F FFE0 0000 0000 FFFF
Downlink power allocation	ρ_A	dB	0
	ρ_B	dB	0
	P_c	dB	-6
	σ	dB	-3
$N_{oc}^{(j)}$		dB[mW/15kHz]	-98
Reporting mode			PUSCH 1-2
Reporting interval		ms	5 (Note 4)
PMI delay		ms	8
Measurement channel			R.45-1 TDD for UE Category 1, R.45 TDD for UE Category 2-8
OCNG Pattern			OP.1 TDD
Max number of HARQ transmissions			4
Redundancy version coding sequence			{0,1,2,3}
ACK/NACK feedback mode			Multiplexing
<p>Note 1: For random precoder selection, the precoders shall be updated in each TTI (1 ms granularity) .</p> <p>Note 2: If the UE reports in an available uplink reporting instance at subframe SF#n based on PMI estimation at a downlink SF not later than SF#(n-4), this reported PMI cannot be applied at the eNB downlink before SF#(n+4) .</p> <p>Note 3: One/two sided dynamic OCNG Pattern OP.1/2 TDD as described in Annex A.5.2.1/2 shall be used.</p> <p>Note 4: PDCCH DCI format 0 with a trigger for aperiodic CQI shall be transmitted in downlink SF#4 and #9 to allow aperiodic CQI/PMI/RI to be transmitted</p>			

Note 5:	on uplink SF#3 and #8. Randomization of the principle beam direction shall be used as specified in B.2.3A.4
---------	--

Table 9.4.2.3.2_D.3-2: Minimum requirement (TDD) for eDL-MIMO

Parameter	Test 1
γ	3.5
UE Category	1-8

The normative reference for this requirement is TS 36.101 [2] clause 9.4.2.3.2.

9.4.2.3.2_D.4 Test description

9.4.2.3.2_D.4.1 Initial conditions

Initial conditions are a set of test configurations the UE needs to be tested in and the steps for the SS to take with the UE to reach the correct measurement state.

Configurations of PDSCH and PDCCH before measurement are specified in Annex C.2.

Test Environment: Normal as defined in TS 36.508 [7] clause 4.1.

Frequencies to be tested: Mid Range as defined in TS 36.508 [7] clause 4.3.1.1.

Channel Bandwidths to be tested: 10MHz, as defined in TS 36.508 [7] clause 4.3.1.1

1. Connect the SS to the UE antenna connector (s) as shown in TS 36.508 [7] Annex A, Figure [TBD].
2. The parameter settings for the cell are set up according to Table 9.4.2.3.2_D.3-1.
3. Downlink signals are initially set up according to Annex C.1 and Annex C.3.2, and uplink signals according to Annex H.1 and H.3.2.
4. Propagation conditions are set according to Annex B clause B.0
5. Ensure the UE is in State 3A-RF according to TS 36.508 [7] clause 5.2A.2. Message contents are defined in clause 9.4.2.3.2_D.4.3.

9.4.2.3.2_D.4.2 Test procedure

1. Set the bandwidth, propagation condition, antenna configuration and measurement channel parameters according to Table 9.4.2.3.2_D.3-1 as appropriate.
2. The SS shall transmit PDSCH via PDCCH DCI format 2C for C_RNTI to transmit the DL RMC with randomly selected precoding matrix from codebook (Table 7.2.4-1 in TS 36.213 [10]) every subframe regardless of PMI reports from the UE. Note that each precoding matrix shall be selected in equal probabilities. The SS sends downlink MAC padding bits on the DL RMC. SS schedules the UL transmission to carry the PUSCH CQI feedback via PDCCH DCI format 0 with CQI request bit set to 1 and I_MCS=29 and N_PRB allocated to be less or equal to 4. Establish t_{md} and SNR_{md} according to annex G.5.2
3. Set SNR to SNR_{md} . The SS shall transmit PDSCH with precoding matrix according to PMI report from the UE. The SS sends downlink MAC padding bits on the DL RMC. SS schedules the UL transmission to carry the PUSCH CQI feedback via PDCCH DCI format 0 with CQI request bit set to 1 and I_MCS=29 and N_PRB allocated to be less or equal to 4. Measure t_{ue} according to Annex G.5.3
4. Calculate $\gamma = \frac{t_{ue}}{t_{md}}$

9.4.2.3.2_D.4.3 Message contents

Message contents are according to TS 36.508 [7] clause 4.6 with the following exceptions:

Table 9.4.2.3.2_D.4.3-1: PhysicalConfigDedicated-DEFAULT

Derivation Path: 36.508 clause 5.5.1.2			
Information Element	Value/remark	Comment	Condition
PhysicalConfigDedicated-DEFAULT ::= SEQUENCE {			
cqi-ReportConfig	<i>CQI-ReportConfig-r10-DEFAULT</i>		
antennaInfo CHOICE {			
explicitValue	AntennaInfoDedicated		
}			
}			

Table 9.4.2.3.2_D.4.3-2: PDSCH-ConfigDedicated-DEFAULT

Derivation Path: 36.331 clause 6.3.2			
Information Element	Value/remark	Comment	Condition
PDSCH-ConfigDedicated-DEFAULT ::= SEQUENCE {			
p-a	dB0		
}			

Table 9.4.2.3.2_D.4.3-3: AntennaInfoDedicated-r10

Derivation Path: 36.331 clause 6.3.2			
Information Element	Value/remark	Comment	Condition
AntennaInfoDedicated-r10 ::= SEQUENCE {			
transmissionMode-r10	tm9-v1020		
codebookSubsetRestriction-r10	0x0000 0000 001F FFE0 0000 0000 FFFF		
}			
ue-TransmitAntennaSelection CHOICE{			
Release	NULL		
}			

Table 9.4.2.3.2_D.4.3-4: CQI-ReportConfig-r10-DEFAULT

Derivation Path: 36.508 clause 4.6.3			
Information Element	Value/remark	Comment	Condition
CQI-ReportConfig-r10 ::= SEQUENCE {			
cqi-ReportModeAperiodic-r10	rm12		
nomPDSCH-RS-EPRE-Offset	0		
cqi-ReportPeriodic-r10	Not present		
}			

Table 9.4.2.3.2_D.4.3-5: PUCCH-ConfigDedicated-DEFAULT

Derivation Path: 36.331 clause 6.3.2			
Information Element	Value/remark	Comment	Condition
PUCCH-ConfigDedicated-DEFAULT ::= SEQUENCE {			
ackNackRepetition CHOICE {			
Release	NULL		
}			
tddAckNackFeedbackMode	Multiplexing	Multiplexing is selected as default to align with RAN4's assumptions in RF tests.	TDD
}			

Table 9.4.2.3.2_D.4.3-6: TDD-Config-DEFAULT

Derivation Path: 36.508 clause 4.6.3			
Information Element	Value/remark	Comment	Condition
TDD-Config-DEFAULT ::= SEQUENCE {			
subframeAssignment	sa1		
specialSubframePatterns	ssp4		
}			

Table 9.4.2.3.2_D.4.3-7: CSI-RS-Config

Derivation Path: 36.331 clause 6.3.2			
Information Element	Value/remark	Comment	Condition
CSI-RS-Config-r10 ::= SEQUENCE {			
csi-RS-r10 CHOICE {			
Release	NULL		
setup SEQUENCE {			
antennaPortsCount-r10	an8	Parameter represents the number of antenna ports used for transmission of CSI reference signals	
resourceConfig-r10	4	Parameter: CSI reference signal configuration	
subframeConfig-r10	4	$\Delta_{\text{CSI-RS}} = I_{\text{CSI-RS}}$ when CSI-RS SubframeConfig is from 0-4; Parameter: $I_{\text{CSI-RS}}$	
p-C-r10	-6	Parameter: P_c which is the assumed ratio of PDSCH EPRE to CSI-RS EPRE when UE derives CSI feedback	
}			
}			
}			

9.4.2.3.2_D.5 Test requirement

Table 9.4.2.3.2_D.5-1: Test requirement (TDD) for eDL-MIMO

Parameter	Test 1
γ	3.49
UE Category	1-8

9.5 Reporting of Rank Indicator (RI)

The purpose of this test is to verify that the reported rank indicator accurately represents the channel rank. The accuracy of RI (CQI) reporting is determined by the relative increase of the throughput obtained when transmitting based on the reported rank compared to the case for which a fixed rank is used for transmission. Transmission mode 4 is used with the specified CodebookSubSetRestriction.

For fixed rank 1 transmission, the RI and PMI reporting is restricted to two single-layer precoders, For fixed rank 2 transmission, the RI and PMI reporting is restricted to one two-layer precoder, For follow RI transmission, the RI and PMI reporting is restricted to select the union of these precoders. Channels with low and high correlation are used to ensure that RI reporting reflects the channel condition.

9.5.1 RI Reporting (Cell-Specific Reference Symbols)

9.5.1.1 FDD RI Reporting– PUCCH 1-1

9.5.1.1.1 Test purpose

To verify that the reported rank indicator accurately represents the channel rank.

9.5.1.1.2 Test applicability

This test applies to E-UTRA FDD UE release 8 and 9 of UE category ≥ 2 .

9.5.1.1.3 Minimum conformance requirements

The minimum performance requirement in Table 9.5.1.1.3-2 is defined as

- The ratio of the throughput obtained when transmitting based on UE reported RI and that obtained when transmitting with fixed rank 1 shall be $\geq \gamma_1$;
- The ratio of the throughput obtained when transmitting based on UE reported RI and that obtained when transmitting with fixed rank 2 shall be $\geq \gamma_2$;

TBS selection is based on the UE wideband CQI feedback. The transport block size TBS for wideband CQI is selected according to Table A.4-3a.

For the parameters specified in Table 9.5.1.1.3-1, and using the downlink physical channels specified in Annex C, the minimum requirements are specified in Table 9.5.1.1.3-2.

Table 9.5.1.1.3-1: RI Test (FDD)

Parameter	Unit	Test 1	Test 2	Test 3
Bandwidth	MHz		10	
PDSCH transmission mode			4	
Downlink power allocation	ρ_A	dB	-3	
	ρ_B	dB	-3	
	σ	dB	0	
CodeBookSubsetRestriction bitmap		000011 for fixed RI = 1 010000 for fixed RI = 2 010011 for UE reported RI		
Propagation condition and antenna configuration		2 x 2 EPA5		
Antenna correlation		Low	Low	High
RI configuration		Fixed RI=2 and follow RI	Fixed RI=1 and follow RI	Fixed RI=2 and follow RI
SNR	dB	0	20	20
$N_{oc}^{(j)}$	dB[mW/15kHz]	-98	-98	-98
$\hat{I}_{or}^{(j)}$	dB[mW/15kHz]	-98	-78	-78
Maximum number of HARQ transmissions		1		
Reporting mode		PUCCH 1-1 (Note 4)		
Physical channel for CQI/PMI reporting		PUCCH Format 2		
PUCCH Report Type for CQI/PMI		2		
Physical channel for RI reporting		PUSCH (Note 3)		
PUCCH Report Type for RI		3		
Reporting periodicity	ms	$N_p = 5$		
PMI and CQI delay	ms	8		
<i>cqi-pmi-ConfigurationIndex</i>		6		
<i>ri-ConfigurationInd</i>		1 (Note 5)		
Note 1:	If the UE reports in an available uplink reporting instance at subframe SF#n based on PMI and CQI estimation at a downlink subframe not later than SF#(n-4), this reported PMI and wideband CQI cannot be applied at the eNB downlink before SF#(n+4).			
Note 2:	Reference measurement channel according to Table A.4-1 with one sided dynamic OCNG Pattern OP.1 FDD as described in Annex A.5.1.1.			
Note 3:	To avoid collisions between RI reports and HARQ-ACK it is necessary to report both on PUSCH instead of PUCCH. PDCCH DCI format 0 shall be transmitted in downlink SF#4 and #9 to allow periodic RI to multiplex with the HARQ-ACK on PUSCH in uplink subframe SF#8 and #3.			
Note 4:	The bit field for precoding information in DCI format 2 shall be mapped as: - For reported RI = 1 and PMI = 0 >> precoding information bit field index = 1 - For reported RI = 1 and PMI = 1 >> precoding information bit field index = 2 - For reported RI = 2 and PMI = 0 >> precoding information bit field index = 0			
Note 5:	To avoid the ambiguity of SS behaviour when applying CQI and PMI during rank switching, RI reports are to be applied at the SS with one subframe delay in addition to Note 1 to align with CQI and PMI reports.			

Table 9.5.1.1.3-2: Minimum requirement (FDD)

Parameter	Test 1	Test 2	Test 3
γ_1	N/A	1.05	N/A
γ_2	1	N/A	1.1
UE Category	2-8	2-8	2-8

The normative reference for this requirement is TS 36.101 [2] clause 9.5.1.1.

9.5.1.1.4 Test description

9.5.1.1.4.1 Initial conditions

Initial conditions are a set of test configurations the UE needs to be tested in and the steps for the SS to take with the UE to reach the correct measurement state.

Configurations of PDSCH and PDCCH before measurement are specified in Annex C.2.

Test Environment: Normal as defined in TS 36.508 [7] clause 4.1.

Frequencies to be tested: Mid Range as defined in TS 36.508 [7] clause 4.3.1.1.

Channel Bandwidths to be tested: 10MHz, as defined in TS 36.508 [7] clause 4.3.1.1

1. Connect the SS, faders and AWGN noise source to the UE antenna connector (s) as shown in TS 36.508 [7] Annex A, Figure A.10.
2. The parameter settings for the cell are set up according to Table 9.5.1.1.3-1.
3. Downlink signals are initially set up according to Annex C.1 and Annex C.3.2, and uplink signals according to Annex H.1 and H.3.2.
4. Propagation conditions are set according to Annex B.0.
5. Ensure the UE is in State 3A-RF according to TS 36.508 [7] clause 5.2A.2. Message contents are defined in clause 9.5.1.1.4.3.

9.5.1.1.4.2 Test procedure

1. Set the parameters of bandwidth, reference Channel, the propagation condition, antenna configuration, antenna correlation, CodeBookSubsetRestriction for fixed Rank and the SNR according to Table 9.5.1.1.3-1 as appropriate.
2. The SS shall send PDSCH via PDCCH DCI format 2 for C_RNTI to transmit the DL RMC according to the UE reported CQI, PMI and RI. In case of CQI reports for two codewords (codeword #0 and #1), the CQI offset level for codeword #1 is selected from {0,1,2,3,-4,-3,-2,-1}. The SS sends downlink MAC padding bits on the DL RMC. The transport format to be used is defined in Annex A.4 Table A.4-3a. The SS sends uplink scheduling information via PDCCH DCI format 0 with CQI request bit set to 0 to schedule UL RMC in subframe #3 and #8 according to Annex A.4-10. Measure the t_{fix} according to annex G.5.3.
3. Propagation conditions are set according to Annex B.1.
4. The SS sends uplink scheduling information via PDCCH DCI format 0 to schedule UL RMC in every subframe according to Annex A.4-10.
5. The SS shall transmit an RRC Connection Reconfiguration message to set codebookSubsetRestriction as for UE reported RI according to Table 9.5.1.1.3-1.
6. The UE shall transmit RRC Connection Reconfiguration Complete message.
7. Propagation conditions are set according to Table 9.5.1.1.3-1.
8. The SS shall send PDSCH via PDCCH DCI format 2 for C_RNTI to transmit the DL RMC according to the UE reported CQI, PMI and RI. In case of CQI reports for two codewords (codeword #0 and #1), the CQI offset level for codeword #1 is selected from {0,1,2,3,-4,-3,-2,-1}. The SS sends downlink MAC padding bits on the DL RMC. The transport format to be used is defined in Annex A.4 Table A.4-3a. The SS sends uplink scheduling information via PDCCH DCI format 0 with CQI request bit set to 0 to schedule UL RMC in subframe #3 and #8 according to Annex A.4-10. Measure $t_{reported}$ according to Annex G.5.3
If the ratio ($t_{reported} / t_{fix}$) satisfies the requirement in Table 9.5.1.1.5-1, then pass the UE for this test and go to step 9. Otherwise, fail the UE.
9. If all tests have not been done, then repeat the same procedure (steps 1 to 8) with test conditions according to the Table 9.5.1.1.3-2 for the other Tests as appropriate. Otherwise pass the UE.

9.5.1.1.4.3 Message contents

Message contents are according to TS 36.508 [7] clause 4.6 with the following exceptions:

Table 9.5.1.1.4.3-1: PhysicalConfigDedicated-DEFAULT

Derivation Path: 36.508 clause 4.6.3			
Information Element	Value/remark	Comment	Condition
RadioResourceConfigDedicated-SRB2-DRB(n, m) ::= SEQUENCE {			
physicalConfigDedicated	PhysicalConfigDedicated - DEFAULT using condition RBC		
}			

Table 9.5.1.1.4.3-2: PhysicalConfigDedicated-DEFAULT

Derivation Path: 36.508 clause 5.5.1.2			
Information Element	Value/remark	Comment	Condition
PhysicalConfigDedicated-DEFAULT ::= SEQUENCE {			
cqi-ReportConfig	<i>CQI-ReportConfig-DEFAULT</i>		RBC
antennaInfo CHOICE {			
antennaInfoDedicated ::= SEQUENCE {			
transmissionMode	tm4		
}			
codebookSubsetRestriction CHOICE {			
N2TxAntenna-tm4	According to each test		
ue-TransmitAntennaSelection CHOICE {			
release	NULL		
}			
}			

Table 9.5.1.1.4.3-3: PDSCH-ConfigDedicated-DEFAULT

Derivation Path: 36.331 clause 6.3.2			
Information Element	Value/remark	Comment	Condition
PDSCH-ConfigDedicated-DEFAULT ::= SEQUENCE {			
p-a	dB-3		
}			

Table 9.5.1.1.4.3-4: CQI-ReportConfig-DEFAULT

Derivation Path: 36.508 clause 4.6.3			
Information Element	Value/remark	Comment	Condition
CQI-ReportConfig-DEFAULT ::= SEQUENCE {			
cqi-ReportModeAperiodic	Not present		
nomPDSCH-RS-EPRE-Offset	0		
cqi-ReportPeriodic CHOICE {			
setup SEQUENCE {			
cqi-PUCCH-ResourceIndex	0		
cqi-pmi-ConfigIndex	6	(see Table 7.2.2-1A in TS 36.213)	
cqi-FormatIndicatorPeriodic CHOICE {			
widebandCQI	NULL		
}			
ri-ConfigIndex	1	(see Table 7.2.2-1B in TS 36.213)	
simultaneousAckNackAndCQI	FALSE		
}			
}			
}			

9.5.1.1.5 Test requirement

Table 9.5.1.1.5-1: Test requirement (FDD)

Parameter	Test 1	Test 2	Test 3
γ_1	N/A	1.04	N/A
γ_2	0.99	N/A	1.09
UE Category	2-8	2-8	2-8

9.5.1.1.1_1 FDD RI Reporting– PUCCH 1-1 (Release 10)

9.5.1.1.1.1 Test purpose

Same test purpose as in clause 9.5.1.1.1.

9.5.1.1.1.2 Test applicability

This test applies to E-UTRA FDD UE release 10 of UE category ≥ 2 .

9.5.1.1.1.3 Minimum conformance requirements

Same minimum conformance requirements as in clause 9.5.1.1.3 with the following exceptions:

- Instead of Table 9.5.1.1.3-1 → use Table 9.5.1.1.1.3-1.
- Instead of Table 9.5.1.1.3-2 → use Table 9.5.1.1.1.3-2.

Table 9.5.1.1_1.3-1: RI Test (FDD)

Parameter		Unit	Test 1	Test 2	Test 3	
Bandwidth		MHz			10	
PDSCH transmission mode					4	
Downlink power allocation	ρ_A	dB			-3	
	ρ_B	dB			-3	
	σ	dB			0	
CodeBookSubsetRestriction bitmap			000011 for fixed RI = 1 010000 for fixed RI = 2 010011 for UE reported RI			
Propagation condition and antenna configuration			2 x 2 EPA5			
Antenna correlation			Low	Low	High	
RI configuration			Fixed RI=2 and follow RI	Fixed RI=1 and follow RI	Fixed RI=1 and follow RI	Fixed RI=2 and follow RI
SNR		dB	0	20	20	20
$N_{oc}^{(j)}$		dB[mW/15kHz]	-98	-98	-98	-98
$\hat{I}_{or}^{(j)}$		dB[mW/15kHz]	-98	-78	-78	-78
Maximum number of HARQ transmissions			1			
Reporting mode			PUCCH 1-1 (Note 4)			
Physical channel for CQI/PMI reporting			PUCCH Format 2			
PUCCH Report Type for CQI/PMI			2			
Physical channel for RI reporting			PUSCH (Note 3)			
PUCCH Report Type for RI			3			
Reporting periodicity		ms	$N_P = 5$			
PMI and CQI delay		ms	8			
<i>cqi-pmi-ConfigurationIndex</i>			6			
<i>ri-ConfigurationInd</i>			1 (Note 5)			
<p>Note 1: If the UE reports in an available uplink reporting instance at subframe SF#n based on PMI and CQI estimation at a downlink subframe not later than SF#(n-4), this reported PMI and wideband CQI cannot be applied at the eNB downlink before SF#(n+4).</p> <p>Note 2: Reference measurement channel according to Table A.4-1 with one sided dynamic OCNG Pattern OP.1 FDD as described in Annex A.5.1.1.</p> <p>Note 3: To avoid collisions between RI reports and HARQ-ACK it is necessary to report both on PUSCH instead of PUCCH. PDCCH DCI format 0 shall be transmitted in downlink SF#4 and #9 to allow periodic RI to multiplex with the HARQ-ACK on PUSCH in uplink subframe SF#8 and #3.</p> <p>Note 4: The bit field for precoding information in DCI format 2 shall be mapped as: - For reported RI = 1 and PMI = 0 >> precoding information bit field index = 1 - For reported RI = 1 and PMI = 1 >> precoding information bit field index = 2 - For reported RI = 2 and PMI = 0 >> precoding information bit field index = 0</p> <p>Note 5: To avoid the ambiguity of SS behaviour when applying CQI and PMI during rank switching, RI reports are to be applied at the SS with one subframe delay in addition to Note 1 to align with CQI and PMI reports.</p>						

Table 9.5.1.1_1.3-2: Minimum requirement (FDD)

Parameter	Test 1	Test 2	Test 3
γ_1	N/A	1.05	0.9 (Note 1)
γ_2	1	N/A	1.1 (Note 1)
UE Category	2-8	2-8	2-8
Note 1: For Test 3, the minimum requirements shall be fulfilled for at least one of γ_1 or γ_2 .			

9.5.1.1_1.4 Test description

Same test description as in clause 9.5.1.1.4 with the following exceptions:

- Instead of Table 9.5.1.1.3-1 → use Table 9.5.1.1_1.3-1.
- Instead of Table 9.5.1.1.3-2 → use Table 9.5.1.1_1.3-2.
- Instead of Table 9.5.1.1.5-1 → use Table 9.5.1.1_1.5-1.

9.5.1.1_1.4.1 Initial conditions

Same initial conditions as in clause 9.5.1.1.4.1.

9.5.1.1_1.4.2 Test procedure

1. Set the parameters of bandwidth, reference Channel, the propagation condition, antenna configuration, antenna correlation, CodeBookSubsetRestriction for fixed Rank and the SNR according to Table 9.5.1.1_1.3-1 as appropriate.
2. The SS shall send PDSCH via PDCCH DCI format 2 for C_RNTI to transmit the DL RMC according to the UE reported CQI, PMI and RI. In case of CQI reports for two codewords (codeword #0 and #1), the CQI offset level for codeword #1 is selected from {0,1,2,3,-4,-3,-2,-1}. The SS sends downlink MAC padding bits on the DL RMC. The transport format to be used is defined in Annex A.4 Table A.4-3a. The SS sends uplink scheduling information via PDCCH DCI format 0 with CQI request bit set to 0 to schedule UL RMC in subframe #3 and #8 according to Annex A.4-10. Measure the t_{fix} according to annex G.5.3.
3. Propagation conditions are set according to Annex B.1.
4. For Test 3 the SS repeats steps 1 to 3 to get two values for t_{fix} , one value for fixed Rank 1 case and the other value for fixed Rank 2 case.
5. The SS sends uplink scheduling information via PDCCH DCI format 0 to schedule UL RMC in every subframe according to Annex A.4-10.
6. The SS shall transmit an RRC Connection Reconfiguration message to set codebookSubsetRestriction as for UE reported RI according to Table 9.5.1.1_1.3-1.
7. The UE shall transmit RRC Connection Reconfiguration Complete message.
8. Propagation conditions are set according to Table 9.5.1.1_1.3-1.
9. The SS shall send PDSCH via PDCCH DCI format 2 for C_RNTI to transmit the DL RMC according to the UE reported CQI, PMI and RI. In case of CQI reports for two codewords (codeword #0 and #1), the CQI offset level for codeword #1 is selected from {0,1,2,3,-4,-3,-2,-1}. The SS sends downlink MAC padding bits on the DL RMC. The transport format to be used is defined in Annex A.4 Table A.4-3a. The SS sends uplink scheduling information via PDCCH DCI format 0 with CQI request bit set to 0 to schedule UL RMC in subframe #3 and #8 according to Annex A.4-10. Measure $t_{reported}$ according to Annex G.5.3
10. For Test 1 and Test 2 if the ratio ($t_{reported} / t_{fix}$) satisfies the requirement in Table 9.5.1.1_1.5-1, then pass the UE for Test 1 and Test 2.
11. For Test 3 if the ratio ($t_{reported} / t_{fix}$) satisfies at least one of the γ_1 or γ_2 requirements in Table 9.5.1.1_1.5-1, then pass the UE for Test 3.
12. For a complete test case to pass the UE has to pass all test cases 1, 2 and 3. Otherwise, fail the UE.
13. If all tests have not been done, then repeat the same procedure (steps 1 to 12) with test conditions according to the Table 9.5.1.1_1.3-2 for the other Tests as appropriate.

9.5.1.1_1.4.3 Message contents

Same message contents as in clause 9.5.1.1.4.3.

9.5.1.1_1.5 Test requirement

Same test requirements as in clause 9.5.1.1.5 with the following exceptions:

- Instead of Table 9.5.1.1.5-1 → use Table 9.5.1.1_1.5-1

Table 9.5.1.1_1.5-1: Test requirement (FDD)

Parameter	Test 1	Test 2	Test 3
γ_1	N/A	1.04	0.89 (Note 1)
γ_2	0.99	N/A	1.09 (Note 1)
UE Category	2-8	2-8	2-8
Note 1: For Test 3, the minimum requirements shall be fulfilled for at least one of γ_1 or γ_2 .			

9.5.1.1_2 FDD RI Reporting– PUCCH 1-1 (Release 11)

9.5.1.1_2.1 Test purpose

Same test purpose as in clause 9.5.1.1.1.

9.5.1.1_2.2 Test applicability

This test applies to E-UTRA FDD UE release 11 and forward of UE category ≥ 2 .

9.5.1.1_2.3 Minimum conformance requirements

Same minimum conformance requirements as in clause 9.5.1.1.3 with the following exceptions:

- Instead of Table 9.5.1.1.3-1 → use Table 9.5.1.1_2.3-1.
- Instead of Table 9.5.1.1.3-2 → use Table 9.5.1.1_2.3-2.

Table 9.5.1.1_2.3-1: RI Test (FDD)

Parameter	Unit	Test 1	Test 2	Test 3
Bandwidth	MHz		10	
PDSCH transmission mode			4	
Downlink power allocation	ρ_A	dB	-3	
	ρ_B	dB	-3	
	σ	dB	0	
Propagation condition and antenna configuration		2 x 2 EPA5		
CodeBookSubsetRestriction bitmap		000011 for fixed RI = 1 010000 for fixed RI = 2 010011 for UE reported RI		
Antenna correlation		Low	Low	High
RI configuration		Fixed RI=2 and follow RI	Fixed RI=1 and follow RI	Fixed RI=1 and follow RI
SNR	dB	0	20	20
$N_{oc}^{(j)}$	dB[mW/15kHz]	-98	-98	-98
$\hat{I}_{or}^{(j)}$	dB[mW/15kHz]	-98	-78	-78
Maximum number of HARQ transmissions		1		
Reporting mode		PUCCH 1-1 (Note 4)		
Physical channel for CQI/PMI reporting		PUCCH Format 2		
PUCCH Report Type for CQI/PMI		2		
Physical channel for RI reporting		PUSCH (Note 3)		
PUCCH Report Type for RI		3		
Reporting periodicity	ms	$N_{pd}=5$		
PMI and CQI delay	ms	8		
<i>cqi-pmi-ConfigurationIndex</i>		6		
<i>ri-ConfigurationInd</i>		1 (Note 5)		
<p>Note 1: If the UE reports in an available uplink reporting instance at subframe SF#n based on PMI and CQI estimation at a downlink subframe not later than SF#(n-4), this reported PMI and wideband CQI cannot be applied at the eNB downlink before SF#(n+4).</p> <p>Note 2: Reference measurement channel according to Table A.4-1 with one sided dynamic OCNG Pattern OP.1 FDD as described in Annex A.5.1.1.</p> <p>Note 3: To avoid collisions between RI reports and HARQ-ACK it is necessary to report both on PUSCH instead of PUCCH. PDCCH DCI format 0 shall be transmitted in downlink SF#4 and #9 to allow periodic RI to multiplex with the HARQ-ACK on PUSCH in uplink subframe SF#8 and #3.</p> <p>Note 4: The bit field for precoding information in DCI format 2 shall be mapped as: - For reported RI = 1 and PMI = 0 >> precoding information bit field index = 1 - For reported RI = 1 and PMI = 1 >> precoding information bit field index = 2 - For reported RI = 2 and PMI = 0 >> precoding information bit field index = 0</p> <p>Note 5: To avoid the ambiguity of TE behaviour when applying CQI and PMI during rank switching, RI reports are to be applied at the TE with one subframe delay in addition to Note 1 to align with CQI and PMI reports.</p>				

Table 9.5.1.1_2.3-2: Minimum requirement (FDD)

Parameter	Test 1	Test 2	Test 3
γ_1	N/A	1.05	0.9
γ_2	1	N/A	N/A
UE Category	2-8	2-8	2-8

9.5.1.1_2.4 Test description

Same test description as in clause 9.5.1.1.4 with the following exceptions:

- Instead of Table 9.5.1.1.3-1 → use Table 9.5.1.1_2.3-1.
- Instead of Table 9.5.1.1.3-2 → use Table 9.5.1.1_2.3-2.
- Instead of Table 9.5.1.1.5-1 → use Table 9.5.1.1_2.5-1.

9.5.1.1_2.5 Test requirement

Same test requirements as in clause 9.5.1.1.5 with the following exceptions:

- Instead of Table 9.5.1.1.5-1 → use Table 9.5.1.1_2.5-1

Table 9.5.1.1_2.5-1: Test requirement (FDD)

Parameter	Test 1	Test 2	Test 3
γ_1	N/A	1.04	0.89
γ_2	0.99	N/A	N/A
UE Category	2-8	2-8	2-8

9.5.1.2 TDD RI Reporting – PUSCH 3-1

9.5.1.2.1 Test purpose

To verify that the reported rank indicator accurately represents the channel rank.

9.5.1.2.2 Test applicability

This test applies to E-UTRA TDD UE release 8 and 9, which support UE Category ≥ 2 .

9.5.1.2.3 Minimum conformance requirements

The minimum performance requirement in Table 9.5.1.2.3-2 is defined as

- a) The ratio of the throughput obtained when transmitting based on UE reported RI and that obtained when transmitting with fixed rank 1 shall be $\geq \gamma_1$;
- b) The ratio of the throughput obtained when transmitting based on UE reported RI and that obtained when transmitting with fixed rank 2 shall be $\geq \gamma_2$;

TBS selection is based on the UE wideband CQI feedback. The transport block size TBS is that resulting from the code rate which is closest to that indicated by $M = \text{wideband CQI}$ and the N_{PRB} entry in Table 7.1.7.2.1-1 of TS36.213 [10] that corresponds to the transmission bandwidth configuration in Table 5.6-1 of TS36.101 [2].

For the parameters specified in Table 9.5.1.2.3-1, and using the downlink physical channels specified in Annex C, the minimum requirements are specified in Table 9.5.1.2.3-2.

Table 9.5.1.2.3-1: RI Test (TDD)

Parameter	Unit	Test 1	Test 2	Test 3
Bandwidth	MHz		10	
PDSCH transmission mode			4	
Downlink power allocation	ρ_A	dB	-3	
	ρ_B	dB	-3	
	σ	dB	0	
Uplink downlink configuration			2	
Special subframe configuration			4	
Propagation condition and antenna configuration			2 x 2 EPA5	
CodeBookSubsetRestriction bitmap			000011 for fixed RI = 1 010000 for fixed RI = 2 010011 for UE reported RI	
Antenna correlation		Low	Low	High
RI configuration		Fixed RI=2 and follow RI	Fixed RI=1 and follow RI	Fixed RI=2 and follow RI
SNR	dB	0	20	20
$N_{oc}^{(j)}$	dB[mW/15kHz]	-98	-98	-98
$\hat{I}_{or}^{(j)}$	dB[mW/15kHz]	-98	-78	-78
Maximum number of HARQ transmissions		1		
Reporting mode		PUSCH 3-1 (Note 3)		
Reporting interval	ms	5		
PMI and CQI delay	ms	10 or 11		
ACK/NACK feedback mode		Bundling		
Note 1:	If the UE reports in an available uplink reporting instance at subframe SF#n based on PMI and CQI estimation at a downlink subframe not later than SF#(n-4), this reported PMI and wideband CQI cannot be applied at the eNB downlink before SF#(n+4).			
Note 2:	Reference measurement channel according to Table A.4-2 with one sided dynamic OCNG Pattern OP.1 TDD as described in Annex A.5.2.1.			
Note 3:	Reported wideband CQI and PMI are used and sub-band CQI is discarded.			

Table 9.5.1.2.3-2: Minimum requirement (TDD)

Parameter	Test 1	Test 2	Test 3
γ_1	N/A	1.05	N/A
γ_2	1	N/A	1.1
UE Category	2-8	2-8	2-8

The normative reference for this requirement is TS 36.101 [2] clause 9.5.1.2.

9.5.1.2.4 Test description

9.5.1.2.4.1 Initial conditions

Initial conditions are a set of test configurations the UE needs to be tested in and the steps for the SS to take with the UE to reach the correct measurement state.

Configurations of PDSCH and PDCCH before measurement are specified in Annex C.2.

Test Environment: Normal as defined in TS 36.508 [7] clause 4.1.

Frequencies to be tested: Mid Range as defined in TS 36.508 [7] clause 4.3.1.2.

Channel Bandwidths to be tested: 10MHz, as defined in TS 36.508 [7] clause 4.3.1.2

1. Connect the SS, faders and AWGN noise source to the UE antenna connector (s) as shown in TS 36.508 [7] Annex A, Figure A.10.

2. The parameter settings for the cell are set up according to Table 9.5.1.2.3-1.
3. Downlink signals are initially set up according to Annex C.1 and Annex C.3.2, and uplink signals according to Annex H.1 and H.3.2.
4. Propagation conditions are set according to Annex B.0.
5. Ensure the UE is in State 3A-RF according to TS 36.508 [7] clause 5.2A.2. Message contents are defined in clause 9.5.1.2.4.3.

9.5.1.2.4.2 Test procedure

1. Set the parameters of bandwidth, reference Channel, the propagation condition, antenna configuration, antenna correlation, CodeBookSubsetRestriction for fixed Rank and the SNR according to Table 9.5.1.2.3-1 as appropriate.
2. The SS shall send PDSCH via PDCCH DCI format 2 for C_RNTI to transmit the DL RMC according to the UE reported CQI (wideband CQI), PMI and RI. The SS sends downlink MAC padding bits on the DL RMC. The transport format to be used is defined in Annex A.4 Table A.4-3a. The SS schedules the UL transmission to carry the PUSCH CQI feedback via PDCCH DCI format 0 with CQI request bit set to 1 and I_MCS=29 and N_PRB allocated to be less or equal to 4. Measure the t_{fix} according to annex G.5.3
3. Propagation conditions are set according to Annex B.1.
4. The SS sends uplink scheduling information via PDCCH DCI format 0 with CQI request bit to 0 to schedule UL RMC in subframe#2 and #7 according to Annex A.4-11.
5. The SS shall transmit an RRC Connection Reconfiguration message to set codebookSubsetRestriction as for UE reported RI according to Table 9.5.1.2.3-1.
6. The UE shall transmit RRC Connection Reconfiguration Complete message.
7. Propagation conditions are set according to Table 9.5.1.2.3-1.
8. The SS shall send PDSCH via PDCCH DCI format 2 for C_RNTI to transmit the DL RMC according to the UE reported CQI (wideband CQI), PMI and RI. The SS sends downlink MAC padding bits on the DL RMC. The transport format to be used is defined in Annex A.4 Table A.4-3a. The SS schedules the UL transmission to carry the PUSCH CQI feedback via PDCCH DCI format 0 with CQI request bit set to 1 and I_MCS=29 and N_PRB allocated to be less or equal to 4. Measure $t_{reported}$ according to Annex G.5.3
If the ratio ($t_{reported} / t_{fix}$) satisfies the requirement in Table 9.5.1.2.5-1, then pass the UE for this test and go to step 9. Otherwise, fail the UE.
9. If all tests have not been done, then repeat the same procedure (steps 1 to 8) with test conditions according to the Table 9.5.1.2.3-2 for the other Tests as appropriate. Otherwise pass the UE.

9.5.1.2.4.3 Message contents

Message contents are according to TS 36.508 [7] clause 4.6 with the following exceptions:

Table 9.5.1.2.4.3-1: *PhysicalConfigDedicated-DEFAULT*

Derivation Path: 36.508 clause 5.5.1.2			
Information Element	Value/remark	Comment	Condition
PhysicalConfigDedicated-DEFAULT ::= SEQUENCE {			
cqi-ReportConfig	<i>CQI-ReportConfig-DEFAULT</i>		
antennaInfo CHOICE {			
antennaInfoDedicated ::= SEQUENCE {			
transmissionMode	tm4		
}			
codebookSubsetRestriction CHOICE {			
N2TxAntenna-tm4	According to each test		
ue-TransmitAntennaSelection CHOICE {			
release	NULL		
}			
}			

Table 9.5.1.2.4.3-2: *PDSCH-ConfigDedicated-DEFAULT*

Derivation Path: 36.331 clause 6.3.2			
Information Element	Value/remark	Comment	Condition
PDSCH-ConfigDedicated-DEFAULT ::= SEQUENCE {			
p-a	dB-3		
}			

Table 9.5.1.2.4.3-3: *CQI-ReportConfig-DEFAULT*

Derivation Path: 36.508 clause 4.6.3			
Information Element	Value/remark	Comment	Condition
CQI-ReportConfig-DEFAULT ::= SEQUENCE {			
cqi-ReportModeAperiodic	rm31		
nomPDSCH-RS-EPRE-Offset	0		
cqi-ReportPeriodic CHOICE {	Not Present		
}			
}			

Table 9.5.1.2.4.3-4: *PUCCH-ConfigDedicated-DEFAULT*

Derivation Path: 36.331 clause 6.3.2			
Information Element	Value/remark	Comment	Condition
PUCCH-ConfigDedicated-DEFAULT ::= SEQUENCE {			
ackNackRepetition CHOICE {			
release	NULL		
}			
tddAckNackFeedbackMode	Bundling	Multiplexing is selected as default to align with RAN4's assumptions in RF tests.	TDD
}			

9.5.1.2.5 Test requirement

Table 9.5.1.2.5-1: Test requirement (TDD)

Parameter	Test 1	Test 2	Test 3
γ_1	N/A	1.04	N/A
γ_2	0.99	N/A	1.09
UE Category	2-8	2-8	2-8

9.5.1.2_1 TDD RI Reporting – PUSCH 3-1 (Release 10)

9.5.1.2_1.1 Test purpose

Same test purpose as in clause 9.5.1.2.1.

9.5.1.2_1.2 Test applicability

This test applies to E-UTRA TDD UE release 10, which supports UE Category ≥ 2 .

9.5.1.2_1.3 Minimum conformance requirements

Same minimum conformance requirements as in clause 9.5.1.2.3 with the following exceptions:

- Instead of Table 9.5.1.2.3-1 → use Table 9.5.1.2_1.3-1.
- Instead of Table 9.5.1.2.3-2 → use Table 9.5.1.2_1.3-2.

Table 9.5.1.2_1.3-1: RI Test (TDD)

Parameter	Unit	Test 1	Test 2	Test 3	
Bandwidth	MHz			10	
PDSCH transmission mode				4	
Downlink power allocation	ρ_A	dB		-3	
	ρ_B	dB		-3	
	σ	dB		0	
Uplink downlink configuration				2	
Special subframe configuration				4	
Propagation condition and antenna configuration				2 x 2 EPA5	
CodeBookSubsetRestriction bitmap				000011 for fixed RI = 1 010000 for fixed RI = 2 010011 for UE reported RI	
Antenna correlation		Low	Low	High	High
RI configuration		Fixed RI=2 and follow RI	Fixed RI=1 and follow RI	Fixed RI=1 and follow RI	Fixed RI=2 and follow RI
SNR	dB	0	20	20	20
$N_{oc}^{(j)}$	dB[mW/15kHz]	-98	-98	-98	-98
$\hat{I}_{or}^{(j)}$	dB[mW/15kHz]	-98	-78	-78	-78
Maximum number of HARQ transmissions		1			
Reporting mode		PUSCH 3-1 (Note 3)			
Reporting interval	ms	5			
PMI and CQI delay	ms	10 or 11			
ACK/NACK feedback mode		Bundling			
Note 1:	If the UE reports in an available uplink reporting instance at subframe SF#n based on PMI and CQI estimation at a downlink subframe not later than SF#(n-4), this reported PMI and wideband CQI cannot be applied at the eNB downlink before SF#(n+4).				
Note 2:	Reference measurement channel according to Table A.4-2 with one sided dynamic OCNG Pattern OP.1 TDD as described in Annex A.5.2.1.				
Note 3:	Reported wideband CQI and PMI are used and sub-band CQI is discarded.				

Table 9.5.1.2_1.3-2: Minimum requirement (TDD)

Parameter	Test 1	Test 2	Test 3
γ_1	N/A	1.05	0.9 (Note 1)
γ_2	1	N/A	1.1 (Note 1)
UE Category	2-8	2-8	2-8
Note 1:	For Test 3, the minimum requirements shall be fulfilled for at least one of γ_1 or γ_2 .		

9.5.1.2_1.4 Test description

9.5.1.2_1.4.1 Initial conditions

Same initial conditions as in clause 9.5.1.2.4.1.

9.5.1.2_1.4.2 Test procedure

1. Set the parameters of bandwidth, reference Channel, the propagation condition, antenna configuration, antenna correlation, CodeBookSubsetRestriction for fixed Rank and the SNR according to Table 9.5.1.2_1.3-1 as appropriate.
2. The SS shall send PDSCH via PDCCH DCI format 2 for C_RNTI to transmit the DL RMC according to the UE reported CQI (wideband CQI), PMI and RI. The SS sends downlink MAC padding bits on the DL RMC. The transport format to be used is defined in Annex A.4 Table A.4-3a. The SS schedules the UL transmission to

carry the PUSCH CQI feedback via PDCCH DCI format 0 with CQI request bit set to 1 and I_MCS=29 and N_PRB allocated to be less or equal to 4. Measure the t_{fix} according to annex G.5.3

3. Propagation conditions are set according to Annex B.1.
4. For Test 3 the SS repeats steps 1 to 3 to get two values for t_{fix} , one value for fixed Rank 1 case and the other value for fixed Rank 2 case.
5. The SS sends uplink scheduling information via PDCCH DCI format 0 with CQI request bit to 0 to schedule UL RMC in subframe#2 and #7 according to Annex A.4-11.
6. The SS shall transmit an RRC Connection Reconfiguration message to set codebookSubsetRestriction as for UE reported RI according to Table 9.5.1.2_1.3-1.
6. The UE shall transmit RRC Connection Reconfiguration Complete message.
7. Propagation conditions are set according to Table 9.5.1.2_1.3-1.
8. The SS shall send PDSCH via PDCCH DCI format 2 for C_RNTI to transmit the DL RMC according to the UE reported CQI (wideband CQI), PMI and RI. The SS sends downlink MAC padding bits on the DL RMC. The transport format to be used is defined in Annex A.4 Table A.4-3a. The SS schedules the UL transmission to carry the PUSCH CQI feedback via PDCCH DCI format 0 with CQI request bit set to 1 and I_MCS=29 and N_PRB allocated to be less or equal to 4. Measure $t_{reported}$ according to Annex G.5.3
10. For Test 1 and Test 2 if the ratio ($t_{reported} / t_{fix}$) satisfies the requirement in Table 9.5.1.2_1.5-1, then pass the UE for Test 1 and Test 2.
11. For Test 3 if the ratio ($t_{reported} / t_{fix}$) satisfies at least one of the γ_1 or γ_2 requirements in Table 9.5.1.2_1.5-1, then pass the UE for Test 3.
12. For a complete test case to pass the UE has to pass all test cases 1, 2 and 3. Otherwise, fail the UE
13. If all tests have not been done, then repeat the same procedure (steps 1 to 12) with test conditions according to the Table 9.5.1.2_1.3-2 for the other Tests as appropriate.

9.5.1.2_1.4.3 Message contents

Same message contents as in clause 9.5.1.2.4.3.

9.5.1.2_1.5 Test requirement

Same test requirements as in clause 9.5.1.2.5 with the following exceptions:

- Instead of Table 9.5.1.2.5-1 → use Table 9.5.1.2_1.5-1

Table 9.5.1.2_1.5-1: Test requirement (TDD)

Parameter	Test 1	Test 2	Test 3
γ_1	N/A	1.04	0.89 (Note 1)
γ_2	0.99	N/A	1.09 (Note 1)
UE Category	2-8	2-8	2-8
Note 1: For Test 3, the minimum requirements shall be fulfilled for at least one of γ_1 or γ_2 .			

9.5.1.2_2 TDD RI Reporting – PUSCH 3-1 (Release 11)

9.5.1.2_2.1 Test purpose

Same test purpose as in clause 9.5.1.2.1.

9.5.1.2_2.2 Test applicability

This test applies to E-UTRA TDD UE release 11 and forward, which supports UE Category ≥ 2 .

9.5.1.2_2.3 Minimum conformance requirements

Same minimum conformance requirements as in clause 9.5.1.2.3 with the following exceptions:

- Instead of Table 9.5.1.2.3-1 → use Table 9.5.1.2_2.3-1.
- Instead of Table 9.5.1.2.3-2 → use Table 9.5.1.2_2.3-2.

Table 9.5.1.2_2.3-1: RI Test (TDD)

Parameter	Unit	Test 1	Test 2	Test 3
Bandwidth	MHz	10		
PDSCH transmission mode		4		
Downlink power allocation	ρ_A	dB	-3	
	ρ_B	dB	-3	
	σ	dB	0	
Uplink downlink configuration		2		
Special subframe configuration		4		
Propagation condition and antenna configuration		2 x 2 EPA5		
CodeBookSubsetRestriction bitmap		000011 for fixed RI = 1 010000 for fixed RI = 2 010011 for UE reported RI		
Antenna correlation		Low	Low	High
RI configuration		Fixed RI=2 and follow RI	Fixed RI=1 and follow RI	Fixed RI=1 and follow RI
SNR	dB	0	20	20
$N_{oc}^{(j)}$	dB[mW/15kHz]	-98	-98	-98
$\hat{I}_{or}^{(j)}$	dB[mW/15kHz]	-98	-78	-78
Maximum number of HARQ transmissions		1		
Reporting mode		PUSCH 3-1 (Note 3)		
Reporting interval	ms	5		
PMI and CQI delay	ms	10 or 11		
ACK/NACK feedback mode		Bundling		
Note 1:	If the UE reports in an available uplink reporting instance at subframe SF#n based on PMI and CQI estimation at a downlink subframe not later than SF#(n-4), this reported PMI and wideband CQI cannot be applied at the eNB downlink before SF#(n+4).			
Note 2:	Reference measurement channel according to Table A.4-2 with one sided dynamic OCNG Pattern OP.1 TDD as described in Annex A.5.2.1.			
Note 3:	Reported wideband CQI and PMI are used and sub-band CQI is discarded.			

Table 9.5.1.2_2.3-2: Minimum requirement (TDD)

Parameter	Test 1	Test 2	Test 3
γ_1	N/A	1.05	0.9
γ_2	1	N/A	N/A
UE Category	2-8	2-8	2-8

9.5.1.2_2.4 Test description

Same test description as in clause 9.5.1.2.4 with the following exceptions:

- Instead of Table 9.5.1.2.3-1 → use Table 9.5.1.2_2.3-1.

- Instead of Table 9.5.1.2.3-2 → use Table 9.5.1.2_2.3-2.
- Instead of Table 9.5.1.2.5-1 → use Table 9.5.1.2_2.5-1.

9.5.1.2_2.5 Test requirement

Same test requirements as in clause 9.5.1.2.5 with the following exceptions:

- Instead of Table 9.5.1.2.5-1 → use Table 9.5.1.2_2.5-1

Table 9.5.1.2_2.5-1: Test requirement (TDD)

Parameter	Test 1	Test 2	Test 3
γ_1	N/A	1.04	0.89
γ_2	0.99	N/A	N/A
UE Category	2-8	2-8	2-8

9.5.2 RI Reporting (CSI Reference Symbols)

9.5.2.1

9.5.2.1_D FDD RI Reporting- PUCCH 1-1 for eDL-MIMO

9.5.2.1_D.1 Test purpose

To verify that the reported rank indicator accurately represents the channel rank.

9.5.2.1_D.2 Test applicability

This test applies to E-UTRA FDD UE release 10 and forward that support eDL-MIMO. Applicability requires support for FGI bit 103.

9.5.2.1_D.3 Minimum conformance requirements

The minimum performance requirement in Table 9.5.2.1_D.3-2 is defined as

- a) The ratio of the throughput obtained when transmitting based on UE reported RI and that obtained when transmitting with fixed rank 1 shall be $\geq \gamma_1$;
- b) The ratio of the throughput obtained when transmitting based on UE reported RI and that obtained when transmitting with fixed rank 2 shall be $\geq \gamma_2$;

TBS selection is based on the UE wideband CQI feedback. The transport block size TBS for wideband CQI is selected according to Table A.4-3e or Table A.4-3f.

For the parameters specified in Table 9.5.2.1_D.3-1, and using the downlink physical channels specified in Annex C.3.2, the minimum requirements are specified in Table 9.5.2.1_D.3-2.

Table 9.5.2.1_D.3-1: RI Test (FDD) for eDL-MIMO

Parameter		Unit	Test 1	Test 2	Test 3
Bandwidth		MHz		10	
PDSCH transmission mode				9	
Downlink power allocation	ρ_A	dB		0	
	ρ_B	dB		0	
	P_C	dB		0	
	σ	dB		0	
Propagation condition and antenna configuration			2 x 2 EPA5		
Cell-specific reference signals			Antenna ports 0		
CSI reference signals			Antenna ports 15, 16		
Beamforming model			As specified in Annex B.4.3		
CSI-RS periodicity and subframe offset $T_{\text{CSI-RS}} / \Delta_{\text{CSI-RS}}$			5/1		
CSI reference signal configuration			6		
CodeBookSubsetRestriction bitmap			000011 for fixed RI = 1 010000 for fixed RI = 2 010011 for UE reported RI		
Antenna correlation			Low	Low	High
RI configuration			Fixed RI=2 and follow RI	Fixed RI=1 and follow RI	Fixed RI=2 and follow RI
SNR		dB	0	20	20
$N_{oc}^{(j)}$		dB[mW/15kHz]	-98	-98	-98
$\hat{I}_{or}^{(j)}$		dB[mW/15kHz]	-98	-78	-78
Maximum number of HARQ transmissions			1		
Reporting mode			PUCCH 1-1		
Physical channel for CQI/PMI reporting			PUSCH (Note 3)		
PUCCH Report Type for CQI/PMI			2		
Physical channel for RI reporting			PUCCH Format 2		
PUCCH Report Type for RI			3		
Reporting periodicity		ms	$N_{pd} = 5$		
PMI and CQI delay		ms	8		
<i>cqi-pmi-ConfigurationIndex</i>			6		
<i>ri-ConfigurationInd</i>			1 (Note 4)		
<p>Note 1: If the UE reports in an available uplink reporting instance at subframe SF#n based on PMI and CQI estimation at a downlink subframe not later than SF#(n-4), this reported PMI and wideband CQI cannot be applied at the eNB downlink before SF#(n+4).</p> <p>Note 2: Reference measurement channel according to Table A.4-1b with one sided dynamic OCNG Pattern OP.1 FDD as described in Annex A.5.1.1.</p> <p>Note 3: To avoid collisions between CQI/ PMI reports and HARQ-ACK it is necessary to report both on PUSCH instead of PUCCH. PDCCH DCI format 0 shall be transmitted in downlink SF#1 and #6 to allow periodic CQI/ PMI to multiplex with the HARQ-ACK on PUSCH in uplink SF#0 and #5.</p> <p>Note 4: To avoid the ambiguity of TE behaviour when applying CQI and PMI during rank switching, RI reports are to be applied at the TE with one subframe delay in addition to Note 1 to align with CQI and PMI reports.</p>					

Table 9.5.2.1_D.3-2: Minimum requirement (FDD) for eDL-MIMO

Parameter	Test 1	Test 2	Test 3
γ_1	N/A	1.05	0.9
γ_2	1	N/A	N/A
UE Category	2-8	2-8	2-8

The normative reference for this requirement is TS 36.101 [2] clause 9.5.2.1.

9.5.2.1_D.4 Test description

9.5.2.1_D.4.1 Initial conditions

Initial conditions are a set of test configurations the UE needs to be tested in and the steps for the SS to take with the UE to reach the correct measurement state.

Configurations of PDSCH and PDCCH before measurement are specified in Annex C.2.

Test Environment: Normal as defined in TS 36.508 [7] clause 4.1.

Frequencies to be tested: Mid Range as defined in TS 36.508 [7] clause 4.3.1.1.

Channel Bandwidths to be tested: 10MHz, as defined in TS 36.508 [7] clause 4.3.1.1

1. Connect the SS, faders and AWGN noise source to the UE antenna connector (s) as shown in TS 36.508 [7] Annex A, Figure A.10.
2. The parameter settings for the cell are set up according to Table 9.5.2.1_D.3-1.
3. Downlink signals are initially set up according to Annex C.1 and Annex C.3.2, and uplink signals according to Annex H.1 and H.3.2.
4. Propagation conditions are set according to Annex B.0.
5. Ensure the UE is in State 3A-RF according to TS 36.508 [7] clause 5.2A.2. Message contents are defined in clause 9.5.2.1_D.4.3.

9.5.2.1_D.4.2 Test procedure

1. Set the parameters of bandwidth, reference channel, the propagation condition, antenna configuration, antenna correlation, CodeBookSubsetRestriction for fixed Rank and the SNR according to Table 9.5.2.1_D.3-1 as appropriate.
2. The SS shall send PDSCH via PDCCH DCI format 2C for C_RNTI to transmit the DL RMC according to the UE reported CQI, PMI and RI. In case of CQI reports for two codewords (codeword #0 and #1), the CQI offset level for codeword #1 is selected from {0,1,2,3,-4,-3,-2,-1}. The SS sends downlink MAC padding bits on the DL RMC. The transport format to be used is defined in Annex A.4 Table A.4-3f. The SS sends uplink scheduling information via PDCCH DCI format 0 with CQI request bit set to 0 to schedule UL RMC in subframe #0 and #5 (Table A.4-1b). Measure the t_{fix} according to annex G.5.3.
3. Propagation conditions are set according to Annex B.1.
4. The SS sends uplink scheduling information via PDCCH DCI format 0 to schedule UL RMC in every subframe according to Table A.4-1b.
5. The SS shall transmit an RRC Connection Reconfiguration message to set codebookSubsetRestriction as for UE reported RI according to Table 9.5.2.1_D.3-1.
6. The UE shall transmit RRC Connection Reconfiguration Complete message.
7. Propagation conditions are set according to Table 9.5.2.1_D.3-1.
8. The SS shall send PDSCH via PDCCH DCI format 2 for C_RNTI to transmit the DL RMC according to the UE reported CQI, PMI and RI. In case of CQI reports for two codewords (codeword #0 and #1), the CQI offset level for codeword #1 is selected from {0,1,2,3,-4,-3,-2,-1}. The SS sends downlink MAC padding bits on the DL RMC. The transport format to be used is defined in Annex A.4 Table A.4-3f. The SS sends uplink scheduling information via PDCCH DCI format 0 with CQI request bit set to 0 to schedule UL RMC in subframe #0 and #5 (Table A.4-1b). Measure $t_{reported}$ according to Annex G.5.3

If the ratio ($t_{reported} / t_{fix}$) satisfies the requirement in Table 9.5.2. 1_D.5-1, then pass the UE for this test and go to step 9. Otherwise, fail the UE.

9. If all tests have not been done, then repeat the same procedure (steps 1 to 8) with test conditions according to the Table 9.5.2.1_D.3-2 for the other Tests as appropriate. Otherwise pass the UE.

9.5.2.1_D.4.3 Message contents

Message contents are according to TS 36.508 [7] clause 4.6 with the following exceptions:

Table 9.5.2.1_D.4.3-1: PhysicalConfigDedicated-DEFAULT

Derivation Path: 36.508 clause 4.6.3			
Information Element	Value/remark	Comment	Condition
RadioResourceConfigDedicated-SRB2-DRB(n, m) ::= SEQUENCE {			
physicalConfigDedicated	<i>CQI-ReportConfig-r10-DEFAULT</i> using condition RBC		
antennaInfo CHOICE {			
explicitValue	AntennaInfoDedicated		
}			
}			

Table 9.5.2.1_D.4.3-2: PDSCH-ConfigDedicated-DEFAULT

Derivation Path: 36.331 clause 6.3.2			
Information Element	Value/remark	Comment	Condition
PDSCH-ConfigDedicated-DEFAULT ::= SEQUENCE {			
p-a	dB0		
}			

Table 9.5.2.1_D.4.3-3: AntennaInfoDedicated-r10

Derivation Path: 36.331 clause 6.3.2			
Information Element	Value/remark	Comment	Condition
AntennaInfoDedicated-r10 ::= SEQUENCE {			
transmissionMode-r10	tm9-v1020		
codebookSubsetRestriction-r10	According to each test	000011 for fixed RI = 1 010000 for fixed RI = 2 010011 for UE reported RI	
}			
ue-TransmitAntennaSelection CHOICE {			
release	NULL		
}			

Table 9.5.2.1_D.4.3-4: CQI-ReportConfig-r10-DEFAULT

Derivation Path: 36.508 clause 4.6.3			
Information Element	Value/remark	Comment	Condition
CQI-ReportConfig-r10 ::= SEQUENCE {			
cqi-ReportModeAperiodic-r10	Not Present		
nomPDSCH-RS-EPRE-Offset	0		
cqi-ReportPeriodic-r10	CQI-ReportPeriodic-r10-DEFAULT		
}			

Table 9.5.2.1_D.4.3-5: CQI-ReportPeriodic-r10-DEFAULT

Derivation Path: 36.508 clause 4.6.3			
Information Element	Value/remark	Comment	Condition
CQI-ReportPeriodic-r10 ::= CHOICE {			
setup SEQUENCE {			
cqi-PUCCH-ResourceIndex-r10	0		
cqi-PUCCH-ResourceIndexP1-r10	Not present		
cqi-pmi-ConfigIndex	6	(see Table 7.2.2-1A in TS 36.213)	
cqi-FormatIndicatorPeriodic-r10 CHOICE {			
widebandCQI-r10 SEQUENCE {			
csi-ReportMode-r10	Not present		
}			
ri-ConfigIndex	1	(see Table 7.2.2-1B in TS 36.213)	
simultaneousAckNackAndCQI	FALSE		
}			
}			

Table 9.5.2.1_D.4.3-6: CSI-RS-Config

Derivation Path: 36.331 clause 6.3.2			
Information Element	Value/remark	Comment	Condition
CSI-RS-Config-r10 ::= SEQUENCE {			
csi-RS-r10 CHOICE{			
release	NULL		
setup SEQUENCE {			
antennaPortsCount-r10	an2	Parameter represents the number of antenna ports used for transmission of CSI reference signals	
resourceConfig-r10	6	Parameter: CSI reference signal configuration	
subframeConfig-r10	1	$\Delta_{CSI-RS} = I_{CSI-RS}$ when CSI-RS SubframeConfig is from 0-4; Parameter: I_{CSI-RS}	
p-C-r10	0	Parameter: P_c which is the assumed ratio of PDSCH EPRE to CSI-RS EPRE when UE derives CSI feedback	
}			
}			
}			

9.5.2.1_D.5 Test requirement

Table 9.5.2.1_D.5-1: Test requirement (FDD) for eDL-MIMO

Parameter	Test 1	Test 2	Test 3
γ_1	N/A	1.04	0.89
γ_2	0.99	N/A	N/A
UE Category	2-8	2-8	2-8

9.5.2.2_D TDD RI Reporting- PUCCH 1-1 for eDL-MIMO

9.5.2.2_D.1 Test purpose

To verify that the reported rank indicator accurately represents the channel rank.

9.5.2.2_D.2 Test applicability

This test applies to E-UTRA TDD UE Release 10 and forward that support eDL-MIMO. Applicability requires support for FGI bit 103.

9.5.2.2_D.3 Minimum conformance requirements

The minimum performance requirement in Table 9.5.2.2_D.3-2 is defined as:

- a) The ratio of the throughput obtained when transmitting based on UE reported RI and that obtained when transmitting with fixed rank 1 shall be $\geq \gamma_1$;
- b) The ratio of the throughput obtained when transmitting based on UE reported RI and that obtained when transmitting with fixed rank 2 shall be $\geq \gamma_2$;

TBS selection is based on the UE wideband CQI feedback. The transport block size TBS for wideband CQI is selected according to Table A.4-3e or Table A.4-3f.

For the parameters specified in Table 9.5.2.2_D.3-1, and using the downlink physical channels specified in Annex C.3.2, the minimum requirements are specified in Table 9.5.2.2_D.3-2.

Table 9.5.2.2_D.3-1: RI Test (TDD) for eDL-MIMO

Parameter	Unit	Test 1	Test 2	Test 3
Bandwidth	MHz		10	
PDSCH transmission mode			9	
Downlink power allocation	ρ_A	dB	0	
	ρ_B	dB	0	
	P_c	dB	0	
	σ	dB	0	
Uplink downlink configuration			1	
Special subframe configuration			4	
Propagation condition and antenna configuration			2 x 2 EPA5	
Cell-specific reference signals			Antenna ports 0	
CSI reference signals			Antenna ports 15, 16	
CSI reference signal configuration			4	
Beamforming model			As specified in Annex B.4.3	
CSI-RS periodicity and subframe offset $T_{\text{CSI-RS}} / \Delta_{\text{CSI-RS}}$			5/4	
CodeBookSubsetRestriction bitmap			000011 for fixed RI = 1 010000 for fixed RI = 2 010011 for UE reported RI	
Antenna correlation		Low	Low	High
RI configuration		Fixed RI=2 and follow RI	Fixed RI=1 and follow RI	Fixed RI=2 and follow RI
SNR	dB	0	20	20
$N_{oc}^{(j)}$	dB[mW/15kHz]	-98	-98	-98
$\hat{I}_{or}^{(j)}$	dB[mW/15kHz]	-98	-78	-78
Maximum number of HARQ transmissions			1	
Reporting mode			PUCCH 1-1	
Physical channel for CQI/ PMI reporting			PUSCH (Note 3)	
PUCCH report type for CQI/ PMI			2	
Physical channel for RI reporting			PUCCH Format 2	
Reporting periodicity	ms		$N_{pd} = 5$	
PMI and CQI delay	ms		10	
ACK/NACK feedback mode			Bundling	
<i>cqi-pmi-ConfigurationIndex</i>			4	
<i>ri-ConfigurationInd</i>			1	
Note 1:	If the UE reports in an available uplink reporting instance at subframe SF#n based on PMI and CQI estimation at a downlink subframe not later than SF#(n-4), this reported PMI and wideband CQI cannot be applied at the eNB downlink before SF#(n+4).			
Note 2:	Reference measurement channel according to Table A.4-2b with one sided dynamic OCNB Pattern OP.1 TDD as described in Annex A.5.2.1.			
Note 3:	To avoid collisions between CQI/PMI reports and HARQ-ACK it is necessary to report both on PUSCH instead of PUCCH. PDCCH DCI format 0 shall be transmitted in downlink SF#4 and #9 to allow periodic CQI/PMI to multiplex with the HARQ-ACK on PUSCH in uplink SF#3 and #8.			

Table 9.5.2.2_D.3-2: Minimum requirement (TDD) for eDL-MIMO

Parameter	Test 1	Test 2	Test 3
γ_1	N/A	1.05	0.9
γ_2	1	N/A	N/A
UE Category	2-8	2-8	2-8

The normative reference for this requirement is TS 36.101 [2] clause 9.5.2.2.

9.5.2.2_D.4 Test description

9.5.2.2_D.4.1 Initial conditions

Initial conditions are a set of test configurations the UE needs to be tested in and the steps for the SS to take with the UE to reach the correct measurement state.

Configurations of PDSCH and PDCCH before measurement are specified in Annex C.2.

Test Environment: Normal as defined in TS 36.508 [7] clause 4.1.

Frequencies to be tested: Mid Range as defined in TS 36.508 [7] clause 4.3.1.1.

Channel Bandwidths to be tested: 10MHz, as defined in TS 36.508 [7] clause 4.3.1.1

1. Connect the SS, faders and AWGN noise source to the UE antenna connector (s) as shown in TS 36.508 [7] Annex A, Figure A.10.
2. The parameter settings for the cell are set up according to Table 9.5.2.2_D.3-1.
3. Downlink signals are initially set up according to Annex C.1 and Annex C.3.2, and uplink signals according to Annex H.1 and H.3.2.
4. Propagation conditions are set according to Annex B.0.
5. Ensure the UE is in State 3A-RF according to TS 36.508 [7] clause 5.2A.2. Message contents are defined in clause 9.5.2.2_D.4.3.

9.5.1.2_D.4.2 Test procedure

1. Set the parameters of bandwidth, reference channel, the propagation condition, antenna configuration, antenna correlation, CodeBookSubsetRestriction for fixed Rank and the SNR according to Table 9.5.2.2_D.3-1 as appropriate.
2. The SS shall send PDSCH via PDCCH DCI format 2C for C_RNTI to transmit the DL RMC according to the UE reported CQI (wideband CQI), PMI and RI. The SS sends downlink MAC padding bits on the DL RMC. The transport format to be used is defined in Annex A.4 Table A.4-3f. The SS sends uplink scheduling information via PDCCH DCI format 0 with CQI request bit set to 0 to schedule UL RMC in subframe #3 and #8 (Table A.4-2b). Measure the t_{fix} according to annex G.5.3
3. Propagation conditions are set according to Annex B.1.
4. The SS sends uplink scheduling information via PDCCH DCI format 0 with CQI request bit to 0 to schedule UL RMC in subframe#3 and #8 according to Table A.4-2b.
5. The SS shall transmit an RRC Connection Reconfiguration message to set codebookSubsetRestriction as for UE reported RI according to Table 9.5.2.2_D.3-1.
6. The UE shall transmit RRC Connection Reconfiguration Complete message.
7. Propagation conditions are set according to Table 9.5.2.2_D.3-1.
8. The SS shall send PDSCH via PDCCH DCI format 2C for C_RNTI to transmit the DL RMC according to the UE reported CQI (wideband CQI), PMI and RI. The SS sends downlink MAC padding bits on the DL RMC. The transport format to be used is defined in Annex A.4 Table A.4-3f. The SS sends uplink scheduling information via PDCCH DCI format 0 with CQI request bit set to 0 to schedule UL RMC in subframe #3 and subframe #8 (Table A.4-2b). Measure $t_{reported}$ according to Annex G.5.3

If the ratio ($t_{reported} / t_{fix}$) satisfies the requirement in Table 9.5.2.2_D.5-1, then pass the UE for this test and go to step 9. Otherwise, fail the UE.

9. If all tests have not been done, then repeat the same procedure (steps 1 to 8) with test conditions according to the Table 9.5.2.2_D.3-2 for the other Tests as appropriate. Otherwise pass the UE.

9.5.2.2_D.4.3 Message contents

Message contents are according to TS 36.508 [7] clause 4.6 with the following exceptions:

Table 9.5.2.2_D.4.3-1: PhysicalConfigDedicated-DEFAULT

Derivation Path: 36.508 clause 4.6.3			
Information Element	Value/remark	Comment	Condition
RadioResourceConfigDedicated-SRB2-DRB(n, m) ::= SEQUENCE {			
physicalConfigDedicated	CQI-ReportConfig-r10-DEFAULT using condition RBC		
antennaInfo CHOICE {			
explicitValue	AntennaInfoDedicated		
}			
}			

Table 9.5.2.2_D.4.3-2: PDSCH-ConfigDedicated-DEFAULT

Derivation Path: 36.331 clause 6.3.2			
Information Element	Value/remark	Comment	Condition
PDSCH-ConfigDedicated-DEFAULT ::= SEQUENCE {			
p-a	dB0		
}			

Table 9.5.2.2_D.4.3-3: AntennaInfoDedicated-r10

Derivation Path: 36.331 clause 6.3.2			
Information Element	Value/remark	Comment	Condition
AntennaInfoDedicated-r10 ::= SEQUENCE {			
transmissionMode-r10	tm9-v1020		
codebookSubsetRestriction-r10	According to each test	000011 for fixed RI = 1 010000 for fixed RI = 2 010011 for UE reported RI	
}			
ue-TransmitAntennaSelection CHOICE {			
release	NULL		
}			

Table 9.5.2.2_D.4.3-4: CQI-ReportConfig-r10-DEFAULT

Derivation Path: 36.508 clause 4.6.3			
Information Element	Value/remark	Comment	Condition
CQI-ReportConfig-r10 ::= SEQUENCE {			
cqi-ReportModeAperiodic-r10	Not Present		
nomPDSCH-RS-EPRE-Offset	0		
cqi-ReportPeriodic-r10	CQI-ReportPeriodic-r10-DEFAULT		
}			

Table 9.5.2.2_D.4.3-5: CQI-ReportPeriodic-r10-DEFAULT

Derivation Path: 36.508 clause 4.6.3			
Information Element	Value/remark	Comment	Condition
CQI-ReportPeriodic-r10 ::= CHOICE {			
setup SEQUENCE {			
cqi-PUCCH-ResourceIndex-r10	0		
cqi-PUCCH-ResourceIndexP1-r10	Not present		
cqi-pmi-ConfigIndex	4	(see Table 7.2.2-1A in TS 36.213)	
cqi-FormatIndicatorPeriodic-r10 CHOICE {			
widebandCQI-r10 SEQUENCE {			
csi-ReportMode-r10	Not present		
}			
ri-ConfigIndex	1	(see Table 7.2.2-1B in TS 36.213)	
simultaneousAckNackAndCQI	FALSE		
}			
}			

Table 9.5.2.2_D.4.3-6: PUCCH-ConfigDedicated-DEFAULT

Derivation Path: 36.331 clause 6.3.2			
Information Element	Value/remark	Comment	Condition
PUCCH-ConfigDedicated-DEFAULT ::= SEQUENCE {			
ackNackRepetition CHOICE {			
release	NULL		
}			
tddAckNackFeedbackMode	Bundling	Multiplexing is selected as default to align with RAN4's assumptions in RF tests.	TDD
}			

Table 9.5.2.2_D.4.3-7: TDD-Config-DEFAULT

Derivation Path: 36.508 clause 4.6.3			
Information Element	Value/remark	Comment	Condition
TDD-Config-DEFAULT ::= SEQUENCE {			
subframeAssignment	sa1		
specialSubframePatterns	ssp4		
}			

Table 9.5.2.2_D.4.3-8: CSI-RS-Config

Derivation Path: 36.331 clause 6.3.2			
Information Element	Value/remark	Comment	Condition
CSI-RS-Config-r10 ::= SEQUENCE {			
csi-RS-r10 CHOICE{			
release	NULL		
setup SEQUENCE {			
antennaPortsCount-r10	an2	Parameter represents the number of antenna ports used for transmission of CSI reference signals	
resourceConfig-r10	4	Parameter: CSI reference signal configuration	
subframeConfig-r10	4	$\Delta_{\text{CSI-RS}} = I_{\text{CSI-RS}}$ when CSI-RS SubframeConfig is from 0-4; Parameter: $I_{\text{CSI-RS}}$	
p-C-r10	0	Parameter: P_c which is the assumed ratio of PDSCH EPRE to CSI-RS EPRE when UE derives CSI feedback	
}			
}			
}			

9.5.2.2_D.5 Test requirement

Table 9.5.2.2_D.5-1: Test requirement (TDD) for eDL-MIMO

Parameter	Test 1	Test 2	Test 3
γ_1	N/A	1.04	0.89
γ_2	0.99	N/A	N/A
UE Category	2-8	2-8	2-8

9.5.3 RI Reporting (Cell-Specific Reference Symbols)

9.5.3.1_C FDD RI Reporting – PUCCH 1-0 for eICIC

9.5.3.1_C.1 FDD RI Reporting – PUCCH 1-0 for eICIC (non-MBSFN ABS)

Editor's notes: This test case is incomplete. The following item is missing or incomplete:

- Some test parameters are still in square brackets.
- Message contents are FFS.
- Test tolerances are TBD.

9.5.3.1_C.1.1 Test purpose

To verify that the reported rank indicator accurately represents the channel rank under time domain resource restriction i.e. in case two CSI subframe sets are configured.

9.5.3.1_C.1.2 Test applicability

This test applies to all types of E-UTRA FDD UE release 10 and forward. Applicability requires support for FGI bit 115.

9.5.3.1_C.1.3 Minimum conformance requirements

The minimum performance requirement in Table 9.5.3.1_C.1.3-2 is defined as

- a) The ratio of the throughput obtained when transmitting based on UE reported RI and that obtained when transmitting with fixed rank 1 shall be $\geq \gamma_1$

TBS selection is based on the UE wideband CQI feedback. The transport block size TBS for wideband is selected according to Table A.4.3-a.

For the parameters specified in Table 9.5.3.1_C.1.3-1, and using the downlink physical channels specified in Annex C.3.2, the minimum requirements are specified in Table 9.5.3.1_C.1.3-2.

Table 9.5.3.1_C.1.3-1: RI Test (FDD)

Parameter	Unit	Test 1		Test 2		
		Cell 1	Cell 2	Cell 1	Cell 2	
Bandwidth	MHz	10		10		
PDSCH transmission mode		3	Note 10	3	Note 10	
Downlink power allocation	ρ_A	-3		-3		
	ρ_B	-3		-3		
	σ	0		0		
Propagation condition and antenna configuration		2 x 2 EPA5		2 x 2 EPA5		
CodeBookSubsetRestriction bitmap		01 for fixed RI = 1 10 for fixed RI = 2 11 for UE reported RI	N/A	01 for fixed RI = 1 10 for fixed RI = 2 11 for UE reported RI	N/A	
Antenna correlation		Low		Low		
RI configuration		Fixed RI=1 and follow RI	N/A	Fixed RI=1 and follow RI	N/A	
\hat{E}_s / N_{oc2}	dB	0	-12	20	6	
$N_{oc}^{(j)}$	$N_{oc1}^{(j)}$	dBmW/15kHz z	[-98] (Note 3)	N/A	-102 (Note 3)	N/A
	$N_{oc2}^{(j)}$		[-98] (Note 4)	N/A	-98 (Note 4)	N/A
	$N_{oc3}^{(j)}$		[-98] (Note 5)	N/A	-94.8 (Note 5)	N/A
$\hat{I}_{or}^{(j)}$	dB[mW/15k Hz]	-98	-110	-78	-92	
Subframe Configuration		Non-MBSFN	Non-MBSFN	Non-MBSFN	Non-MBSFN	
Cell Id		0	1	0	1	
Time Offset between Cells	μs	2.5 (synchronous cells)		2.5 (synchronous cells)		
ABS Pattern (Note 6)		N/A	10000000 10000000 10000000 10000000 10000000	N/A	10000000 10000000 10000000 10000000 10000000	
RLM/RRM Measurement Subframe Pattern (Note 7)		10000000 10000000 10000000 10000000 10000000	N/A	10000000 10000000 10000000 10000000 10000000	N/A	
CSI Subframe Sets (Note 8)	$C_{CSI,0}$	10000000 10000000 10000000 10000000 10000000	N/A	10000000 10000000 10000000 10000000 10000000	N/A	
	$C_{CSI,1}$	01111111 01111111 01111111 01111111 01111111		01111111 01111111 01111111 01111111 01111111		
Number of control OFDM Symbols		3	3	3	3	
Maximum number of HARQ transmissions		1		1		
Reporting mode		PUCCH 1-0		PUCCH 1-0		
Physical channel for CQI reporting		PUCCH Format 2		PUCCH Format 2		
PUCCH Report Type for CQI		4		4		

Physical channel for RI reporting		PUCCH Format 2		PUCCH Format 2	
PUCCH Report Type for RI		3		3	
Reporting periodicity	ms	$N_{pd}=10$		$N_{pd}=10$	
<i>cqi-pmi-ConfigurationIndex</i>		11		11	
<i>ri-ConfigurationInd</i>		5		5	
<i>cqi-pmi-ConfigurationIndex2</i>		10		10	
<i>ri-ConfigurationInd2</i>		2		2	
Cyclic prefix		Normal	Normal	Normal	Normal
Note 1:	If the UE reports in an available uplink reporting instance at subframe SF#n based on CQI estimation at a downlink subframe not later than SF#(n-4), this reported wideband CQI cannot be applied at the eNB downlink before SF#(n+4).				
Note 2:	Reference measurement channel in Cell 1 according to Table A.4-1 with one sided dynamic OCNG Pattern OP.1 FDD as described in Annex A.5.1.1.				
Note 3:	This noise is applied in OFDM symbols #1, #2, #3, #5, #6, #8, #9, #10,#12, #13 of a subframe overlapping with the aggressor ABS.				
Note 4:	This noise is applied in OFDM symbols #0, #4, #7, #11 of a subframe overlapping with the aggressor ABS.				
Note 5:	This noise is applied in all OFDM symbols of a subframe overlapping with aggressor non-ABS.				
Note 6:	ABS pattern as defined in TS 36.423 [14].				
Note 7:	Time-domain measurement resource restriction pattern for PCell measurements as defined in TS 36.331 [5].				
Note 8:	As configured according to the time-domain measurement resource restriction pattern for CSI measurements defined in TS 36.331 [5].				
Note 9:	Cell 1 is the serving cell. Cell 2 is the aggressor cell.				
Note 10:	Downlink physical channel setup in Cell 2 in accordance with Annex C.3.3 applying OCNG pattern OP.5 FDD as defined in Annex A.5.1.5.				

Table 9.5.3.1_C.1.3-2: Minimum requirement (FDD)

	Test 1	Test 2
γ	0.9	1.05
UE Category	2-8	2-8

The normative reference for this requirement is TS 36.101 [2] clause 9.5.3.1.

9.5.3.1_C.1.4 Test description

9.5.3.1_C.1.4.1 Initial conditions

Initial conditions are a set of test configurations the UE needs to be tested in and the steps for the SS to take with the UE to reach the correct measurement state.

Configurations of PDSCH and PDCCH before measurement are specified in Annex C.2.

Test Environment: Normal as defined in TS 36.508 [7] clause 4.1.

Frequencies to be tested: Mid Range as defined in TS 36.508 [7] clause 4.3.1.1.

Channel Bandwidths to be tested: 10MHz, as defined in TS 36.508 [7] clause 4.3.1.1

1. Connect the SS, faders and AWGN noise source to the UE antenna connector (s) as shown in TS 36.508 [7] Annex A, Figure [TBD].
2. The parameter settings for the cell are set up according to Table 9.5.3.1_C.1.3-1.
3. Downlink signals are initially set up according to Annex C.1 and Annex C.3.2, and uplink signals according to Annex H.1 and H.3.2.
4. Propagation conditions are set according to Annex B.0.
5. Ensure the UE is in State 3A-RF (in Cell 1) according to TS 36.508 [7] clause 5.2A.2. Message contents are defined in clause 9.5.3.1_C.1.4.3.

9.5.3.1_C.1.4.2 Test procedure

1. Set the parameters of bandwidth, reference channel, propagation condition, antenna configuration, antenna correlation, CodeBookSubsetRestriction for fixed Rank and the SNR according to Table 9.5.3.1_C.1.3-1 as appropriate.
2. Set the Cell2 –aggressor cell- as defined in Table 9.5.3.1_C.1.3-1 and according to Annex C3.3.
3. The SS shall send PDSCH via PDCCH DCI format 2A for C_RNTI to transmit the DL RMC according to the UE reported CQI and RI. In case of CQI reports for two codewords (codeword #0 and #1), the CQI offset level for codeword #1 is selected from {0,1,2,3,-4,-3,-2,-1}. The SS sends downlink MAC padding bits on the DL RMC. The transport format to be used is defined in Annex A.4 Table A.4-3a.
4. Measure the t_{fix} according to annex G.5.3.
5. Propagation conditions are set according to Annex B.1.
6. The SS sends uplink scheduling information via PDCCH DCI format 0 to schedule UL RMC in every subframe according to Table A.4.1-1.
7. The SS shall transmit an RRC Connection Reconfiguration message to set codebookSubsetRestriction as for UE reported RI according to Table 9.5.3.1_C.1.3-1.
8. The UE shall transmit RRC Connection Reconfiguration Complete message.
9. Propagation conditions are set according to Table 9.5.3.1_C.1.3-1.
10. The SS shall send PDSCH via PDCCH DCI format 2A for C_RNTI to transmit the DL RMC according to the UE reported CQI and RI. In case of CQI reports for two codewords (codeword #0 and #1), the CQI offset level for codeword #1 is selected from {0,1,2,3,-4,-3,-2,-1}. The SS sends downlink MAC padding bits on the DL RMC. The transport format to be used is defined in Annex A.4 Table A.4-3a.
11. Measure $t_{reported}$ according to Annex G.5.3
If the ratio ($t_{reported} / t_{fix}$) satisfies the requirement in Table 9.5.3.1_C.1.5-1, then pass the UE for this test and go to step 12. Otherwise, fail the UE.
12. If all tests have not been done, then repeat the same procedure (steps 1 to 11) with test conditions according to the Table 9.5.3.1_C.1.3-1 for the other Tests as appropriate. Otherwise pass the UE.

9.5.3.1_C.1.4.3 Message contents

[FFS]

9.5.3.1_C.1.5 Test requirement

Table 9.5.3.1_C.1.5-1: Minimum requirement (FDD)

	Test 1	Test 2
γ	0.9+TT	1.05+TT
UE Category	2-8	2-8

9.5.3.2_C TDD RI Reporting – PUCCH 1-0 for eICIC

9.5.3.2_C.1 TDD RI Reporting – PUCCH 1-0 for eICIC (non-MBSFN ABS)

Editor's notes: This test case is incomplete. The following item is missing or incomplete:

- Some test parameters are still in square brackets.
- Message contents are FFS.

- Test tolerances are TBD.

9.5.3.2_C.1.1 Test purpose

To verify that the reported rank indicator accurately represents the channel rank under time domain resource restriction i.e. in case two CSI subframe sets are configured.

9.5.3.2_C.1.2 Test applicability

This test applies to all types of E-UTRA TDD UE release 10 and forward. Applicability requires support for FGI bit 115.

9.5.3.2_C.1.3 Minimum conformance requirements

The minimum performance requirement in Table 9.5.3.2_C.1.3-2 is defined as:

- a) The ratio of the throughput obtained when transmitting based on UE reported RI and that obtained when transmitting with fixed rank 1 shall be $\geq \gamma_1$.

TBS selection is based on the UE wideband CQI feedback. The transport block size TBS for wideband is selected according to Table A.4.3-a.

For the parameters specified in Table 9.5.3.2_C.1.3-1, and using the downlink physical channels specified in Annex C.3.2, the minimum requirements are specified in Table 9.5.3.2_C.1.3-2.

Table 9.5.3.2_C.1.3-1: RI Test (TDD)

Parameter		Unit	Test1		Test2	
			Cell 1	Cell 2	Cell 1	Cell 2
Bandwidth		MHz	10		10	
PDSCH transmission mode			3	Note 11	3	Note 11
Uplink downlink configuration			1			
Special subframe configuration			[4]		4	
Downlink power allocation	ρ_A	dB	[-3]		-3	
	ρ_B	dB	[-3]		-3	
	σ	dB	0		0	
Propagation condition and antenna configuration			[2 x 2 EPA5]		2 x 2 EPA5	
CodeBookSubsetRestriction bitmap			01 for fixed RI = 1 10 for fixed RI = 2 11 for UE reported RI	N/A	01 for fixed RI = 1 10 for fixed RI = 2 11 for UE reported RI	N/A
Antenna correlation			Low		Low	
RI configuration			Fixed RI=1 and follow RI	N/A	Fixed RI=1 and follow RI	N/A
\hat{E}_s / N_{oc2}		dB	[0]	-12	20	6
$N_{oc}^{(j)}$	$N_{oc1}^{(j)}$	dB[mW/15k Hz]	-98 (Note 4)	N/A	-102 (Note 4)	N/A
	$N_{oc2}^{(j)}$		-98 (Note 5)	N/A	-98 (Note 5)	N/A
	$N_{oc3}^{(j)}$		-98 (Note 6)	N/A	-94.8 (Note 6)	N/A
$\hat{I}_{or}^{(j)}$		dB[mW/15k Hz]	-98	-110	-78	-92
Subframe Configuration			Non-MBSFN	Non-MBSFN	Non-MBSFN	Non-MBSFN
Cell Id			0	1	0	1
Time Offset between Cells		μs	2.5 (synchronous cells)		2.5 (synchronous cells)	
ABS Pattern (Note 7)			N/A	0000000 001 0000000 001	N/A	000000001 000000001
RLM/RRM Measurement Subframe Pattern (Note 8)			00000000 01 00000000 01	N/A	000000001 000000001	N/A
CSI Subframe Sets (Note 9)	$C_{CSI,0}$		00000000 01 00000000 01	N/A	000000001 000000001	N/A
	$C_{CSI,1}$		11001110 00 11001110 00		1100111000 1100111000	
Number of control OFDM Symbols			3	3	3	3
Maximum number of HARQ transmissions			1		1	
Reporting mode			PUCCH 1-0		PUCCH 1-0	
Physical channel for $C_{CSI,0}$ CQI and RI reporting			PUCCH Format 2		PUCCH Format 2	
PUCCH Report Type for CQI			4		4	

Physical channel for C _{CSI,1} CQI and RI reporting		PUSCH (Note 3)		PUSCH (Note 3)	
PUCCH Report Type for RI		3		3	
Reporting periodicity	ms	N _{pd} = 10		N _{pd} = 10	
ACK/NACK feedback mode		Multiplexing		Multiplexing	
<i>cqi-pmi-ConfigurationIndex</i>		8		8	
<i>ri-ConfigurationInd</i>		5		5	
<i>cqi-pmi-ConfigurationIndex2</i>		9		9	
<i>ri-ConfigurationInd2</i>		0		0	
Cyclic prefix		Normal	Normal	Normal	Normal
Note 1:	If the UE reports in an available uplink reporting instance at subframe SF#n based on CQI estimation at a downlink subframe not later than SF#(n-4), this reported wideband CQI cannot be applied at the eNB downlink before SF#(n+4).				
Note 2:	Reference measurement channel in Cell 1 according to Table A.4-2 with one sided dynamic OCNG Pattern OP.1 TDD as described in Annex A.5.2.1.				
Note 3:	To avoid collisions between RI/CQI reports and HARQ-ACK it is necessary to report them on PUSCH instead of PUCCH. PDCCH DCI format 0 shall be transmitted in downlink SF#4 and #9 to allow periodic RI/CQI to multiplex with the HARQ-ACK on PUSCH in uplink subframe SF#8 and #3.				
Note 4:	This noise is applied in OFDM symbols #1, #2, #3, #5, #6, #8, #9, #10,#12, #13 of a subframe overlapping with the aggressor ABS				
Note 5:	This noise is applied in OFDM symbols #0, #4, #7, #11 of a subframe overlapping with the aggressor ABS.				
Note 6:	This noise is applied in all OFDM symbols of a subframe overlapping with aggressor non-ABS.				
Note 7:	ABS pattern as defined in TS 36.423 [14].				
Note 8:	Time-domain measurement resource restriction pattern for PCell measurements as defined in TS 36.331 [5].				
Note 9:	As configured according to the time-domain measurement resource restriction pattern for CSI measurements defined in TS 36.331 [5].				
Note 10:	Cell 1 is the serving cell. Cell 2 is the aggressor cell.				
Note 11:	Downlink physical channel setup in Cell 2 in accordance with Annex C.3.3 applying OCNG pattern OP.5 TDD as defined in Annex A.5.2.5.				

Table 9.5.3.2_C.1.3-2: Minimum requirement (TDD)

	Test 1	Test 2
γ	0.9	1.05
UE Category	2-8	2-8

The normative reference for this requirement is TS 36.101 [2] clause 9.5.3.2.

9.5.3.2_C.1.4 Test description

9.5.3.2_C.1.4.1 Initial conditions

Initial conditions are a set of test configurations the UE needs to be tested in and the steps for the SS to take with the UE to reach the correct measurement state.

Configurations of PDSCH and PDCCH before measurement are specified in Annex C.2.

Test Environment: Normal as defined in TS 36.508 [7] clause 4.1.

Frequencies to be tested: Mid Range as defined in TS 36.508 [7] clause 4.3.1.1.

Channel Bandwidths to be tested: 10MHz, as defined in TS 36.508 [7] clause 4.3.1.1

1. Connect the SS, faders and AWGN noise source to the UE antenna connector (s) as shown in TS 36.508 [7] Annex A, Figure [TBD].
2. The parameter settings for the cell are set up according to Table 9.5.3.1_C.1.3-1.
3. Downlink signals are initially set up according to Annex C.1 and Annex C.3.2, and uplink signals according to Annex H.1 and H.3.2.

4. Propagation conditions are set according to Annex B.0.
5. Ensure the UE is in State 3A-RF according to TS 36.508 [7] clause 5.2A.2. Message contents are defined in clause 9.5.3.1_C.1.4.3.

9.5.3.2_C.1.4.2 Test procedure

1. Set the parameters of bandwidth, reference channel, propagation condition, antenna configuration, antenna correlation, CodeBookSubsetRestriction for fixed Rank and the SNR according to Table 9.5.3.2_C.1.3-1 as appropriate.
2. Set the Cell2 –aggressor cell- as defined in Tables 9.5.3.2_C.1.3-1 and according to Annex C3.3
3. The SS shall send PDSCH in via PDCCH DCI format 2A for C_RNTI to transmit the DL RMC according to the UE reported CQI and RI. In case of CQI reports for two codewords (codeword #0 and #1), the CQI offset level for codeword #1 is selected from {0,1,2,3,-4,-3,-2,-1}. The SS sends downlink MAC padding bits on the DL RMC. The transport format to be used is defined in Annex A.4 Table A.4-3a.
The SS sends uplink scheduling information via PDCCH DCI format 0 in subframe #4 and #9 with CQI request bit set to 0 to schedule UL RMC in subframe #8 and #3 according to Annex A.4.1 Table A.4.1-2.
4. Measure the t_{fix} according to annex G.5.3.
5. Propagation conditions are set according to Annex B.1.
6. The SS sends uplink scheduling information via PDCCH DCI format 0 to schedule UL RMC in subframe #3 and #8 according to Annex A.4.1 Table A.4.1-2.
7. The SS shall transmit an RRC Connection Reconfiguration message to set codebookSubsetRestriction as for UE reported RI according to Table 9.5.3.2_C.1.3-1.
8. The UE shall transmit RRC Connection Reconfiguration Complete message.
9. Propagation conditions are set according to Table 9.5.3.2_C.1.3-1.
10. The SS shall send PDSCH via PDCCH DCI format 2A for C_RNTI to transmit the DL RMC according to the UE reported CQI and RI. In case of CQI reports for two codewords (codeword #0 and #1), the CQI offset level for codeword #1 is selected from {0,1,2,3,-4,-3,-2,-1}. The SS sends downlink MAC padding bits on the DL RMC. The transport format to be used is defined in Annex A.4 Table A.4-3a.
The SS sends uplink scheduling information via PDCCH DCI format 0 in subframe #4 and #9 with CQI request bit set to 0 to schedule UL RMC in subframe #8 and #3 according to Annex A.4.1 Table A.4.1-2.
11. Measure $t_{reported}$ according to Annex G.5.3
If the ratio ($t_{reported} / t_{fix}$) satisfies the requirement in Table 9.5.3.2_C.1.5-1, then pass the UE for this test and go to step 12. Otherwise, fail the UE.
12. If all tests have not been done, then repeat the same procedure (steps 1 to 11) with test conditions according to the Table 9.5.3.2_C.1.3-1 for the other Tests as appropriate. Otherwise pass the UE.

9.5.3.2_C.1.4.3 Message contents

[FFS]

9.5.3.2_C.1.5 Test requirement

Table 9.5.3.2_C.1.5-1: Minimum requirement (TDD)

	Test 1	Test 2
γ	0.9+TT	1.05+TT
UE Category	2-8	2-8

9.6 Additional requirements for carrier aggregation

This clause includes requirements for the reporting of channel state information (CSI) with the UE configured for carrier aggregation. The purpose is to verify that the channel state for each cell is correctly reported with multiple cells configured for periodic reporting.

9.6.1 Periodic reporting on multiple cells (Cell-Specific Reference Symbols)

9.6.1.1_A FDD CQI Reporting under AWGN conditions – PUCCH 1-0 for CA

9.6.1.1_A.1 FDD CQI Reporting under AWGN conditions – PUCCH 1-0 for CA (intra band contiguous DL CA)

FFS

9.6.1.1_A.2 FDD CQI Reporting under AWGN conditions – PUCCH 1-0 for CA (inter band DL CA)

Editor's notes: This test case is incomplete. The following item is missing or incomplete:

- Some test parameters are still in square brackets.
- Message contents are FFS.

9.6.1.1_A.2.1 Test purpose

9.6.1.1_A.2.2 Test applicability

This test applies to all types of E-UTRA FDD UE release 10 and forward that support inter-band DL CA.

9.6.1.1_A.2.3 Minimum conformance requirements

The following requirements apply to UE Category 3-8. For the parameters specified in Table 9.6.1.1_A.2.3-1, and using the downlink physical channels specified in tables C.3.2-1 and C.3.2-2 on each cell, the difference between the wideband CQI indices of Pcell and Scell reported according to Table A.4-3 shall be such that

$$\text{wideband CQI}_{\text{Pcell}} - \text{wideband CQI}_{\text{Scell}} \geq 2$$

for more than 90% of the time.

Table 9.6.1.1_A.2.3-1: PUCCH 1-0 static test on multiple cells (FDD)

Parameter		Unit	Pcell	Scell
Bandwidth		MHz	[10 MHz for both cells]	
PDSCH transmission mode			1	
Downlink power allocation	ρ_A	dB	0	
	ρ_B	dB	0	
Propagation condition and antenna configuration			AWGN (1 x 2)	
SNR		dB	[10]	[4]
$\hat{I}_{or}^{(j)}$		dB[mW/15kHz]	[-88]	[-94]
$N_{oc}^{(j)}$		dB[mW/15kHz]	-98	-98
Physical channel for CQI reporting			PUCCH	
PUCCH Report Type			PUCCH Format 2	
Reporting periodicity		ms	$N_{pd} = 10$	
<i>cqi-pmi-ConfigurationIndex</i>			11	16 [shift of 5 ms relative to Pcell]
Note 1: Reference measurement channel according to Table A.4-1 with one sided dynamic OCNG Pattern OP.1 FDD as described in Annex A.5.1.1.				

The normative reference for this requirement is TS 36.101 [2] clause 9.6.1.1.

9.6.1.1_A.2.4 Test description

9.6.1.1_A.2.4.1 Initial conditions

Initial conditions are a set of test configurations the UE needs to be tested in and the steps for the SS to take with the UE to reach the correct measurement state.

Configurations of PDSCH and PDCCH before measurement are specified in Annex C.2.

Test Environment: Normal as defined in TS 36.508 [7] clause 4.1.

Frequencies to be tested: Mid Range as defined in TS 36.508 [7] clause 4.3.1.

Channel Bandwidths to be tested: 10MHz for both carriers, as defined in TS 36.508 [7] clause 4.3.1

1. Connect the SS and AWGN noise source to the UE antenna connector (s) as shown in TS 36.508 [7] Annex A, Figure group [TBD] as appropriate.
2. The parameter settings for the cell are set up according to Table 9.6.1.1_A.2.3-1.
3. Downlink signals are initially set up according to Annex C0, C.1 and Annex C.3.2 and uplink signals according to Annex H.1 and H.3.2.
4. Propagation conditions are set according to Annex B.0.
5. Ensure the UE is in State 3A-RF according to TS 36.508 [7] clause 5.2A.2. Message contents are defined in clause 9.6.1.1_A.2.4.3.

9.6.1.1_A.2.4.2 Test procedure

1. Set the parameters of bandwidth, reference channel, propagation condition, antenna configuration and the SNR according to Table 9.6.1.1_A.2.3-1 as appropriate.
2. The SS shall transmit PDSCH via PDCCH DCI format 1A for C_RNTI to transmit the DL RMC (Table A.4-1) according to CQI value 8 of Annex A.4 Table A.4-3 in both P-Cell and S-Cell and keep it regardless of the wideband CQI value sent by the UE. The SS sends downlink MAC padding bits on the DL RMC.

3. Continue transmission of the PDSCH until [2000] wideband CQI reports have been gathered for each P-Cell and S-Cell. For each CSI report calculate the respective difference $CQI_{P,S} = \text{wideband } CQI_{Pcell} - \text{wideband } CQI_{Scell}$.
4. If more than [1800] values of $CQI_{P,S}$ are ≥ 2 pass the UE. Otherwise fail the UE.

9.6.1.1_A.2.4.3 Message contents

FFS

9.6.1.1_A.2.5 Test requirement

The pass fail decision is as specified in the test procedure in clause 9.6.1.1_A.2.4.2.

There are no parameters in the test setup or measurement process whose variation impacts the results so there are no applicable test tolerances for this test.

9.6.1.2_A TDD CQI Reporting under AWGN conditions – PUCCH 1-0 for CA

9.6.1.2_A.1 TDD CQI Reporting under AWGN conditions – PUCCH 1-0 for CA (intra band contiguous DL CA)

Editor's notes: This test case is incomplete. The following item is missing or incomplete:

- Some test parameters are still in square brackets.
- Message contents are FFS.

9.6.1.2_A.1.1 Test purpose

9.6.1.2_A.1.2 Test applicability

This test applies to all types of E-UTRA TDD UE release 10 and forward that support intra-band contiguous DL CA.

9.6.1.2_A.1.3 Minimum conformance requirements

The following requirements apply to UE Category 3-8. For the parameters specified in Table 9.6.1.2_A.1.3-1, and using the downlink physical channels specified in tables C.3.2-1 and C.3.2-2 on each cell, the difference between the wideband CQI indices of Pcell and Scell reported according to Table A.4-3 shall be such that

$$\text{wideband } CQI_{Pcell} - \text{wideband } CQI_{Scell} \geq 2$$

for more than 90% of the time.

Table 9.6.1.2_A.1.3-1: PUCCH 1-0 static test on multiple cells (TDD)

Parameter		Unit	Pcell	Scell
Bandwidth		MHz	[20 MHz for both cells]	
PDSCH transmission mode			1	
Uplink downlink configuration			2	
Special subframe configuration			4	
Downlink power allocation	ρ_A	dB	0	
	ρ_B	dB	0	
Propagation condition and antenna configuration			AWGN (1 x 2)	
SNR		dB	[10]	[4]
$\hat{I}_{or}^{(j)}$		dB[mW/15kHz]	[-88]	[-94]
$N_{oc}^{(j)}$		dB[mW/15kHz]	-98	-98
Physical channel for CQI reporting			PUCCH	
PUCCH Report Type			4	
Reporting periodicity		ms	$N_{pd} = 10$	
<i>cqi-pmi-ConfigurationIndex</i>			8	13 [shift of 5 ms relative to Pcell]
Note 1: Reference measurement channel according to Table A.4-2 with one sided dynamic OCNG Pattern OP.1 TDD as described in Annex A.5.2.1.				

The normative reference for this requirement is TS 36.101 [2] clause 9.6.1.2.

9.6.1.2_A.1.4 Test description

9.6.1.2_A.1.4.1 Initial conditions

Initial conditions are a set of test configurations the UE needs to be tested in and the steps for the SS to take with the UE to reach the correct measurement state.

Configurations of PDSCH and PDCCH before measurement are specified in Annex C.2.

Test Environment: Normal as defined in TS 36.508 [7] clause 4.1.

Frequencies to be tested: Mid Range as defined in TS 36.508 [7] clause 4.3.1.

Channel Bandwidths to be tested: 10MHz for both carriers, as defined in TS 36.508 [7] clause 4.3.1

1. Connect the SS and AWGN noise source to the UE antenna connector (s) as shown in TS 36.508 [7] Annex A, Figure group [TBD] as appropriate.
2. The parameter settings for the cell are set up according to Table 9.6.1.2_A.2.3-1.
3. Downlink signals are initially set up according to Annex C0, C.1 and Annex C.3.2 and uplink signals according to Annex H.1 and H.3.2.
4. Propagation conditions are set according to Annex B.0.
5. Ensure the UE is in State 3A-RF according to TS 36.508 [7] clause 5.2A.2. Message contents are defined in clause 9.6.1.2_A.2.4.3.

9.6.1.2_A.1.4.2 Test procedure

1. Set the parameters of bandwidth, reference channel, propagation condition, antenna configuration and the SNR according to Table 9.6.1.2_A.2.3-1 as appropriate.

2. The SS shall transmit PDSCH via PDCCH DCI format 1A for C_RNTI to transmit the DL RMC (Table A.4-1) according to CQI value 8 of Annex A.4 Table A.4-3 in both P-Cell and S-Cell and keep it regardless of the wideband CQI value sent by the UE. The SS sends downlink MAC padding bits on the DL RMC.
3. Continue transmission of the PDSCH until [2000] wideband CQI reports have been gathered for each P-Cell and S-Cell. For each CSI report calculate the respective difference $CQI_{P,S} = \text{wideband } CQI_{Pcell} - \text{wideband } CQI_{Scell}$.
4. If more than [1800] values of $CQI_{P,S}$ are ≥ 2 pass the UE. Otherwise fail the UE.

9.6.1.2_A.1.4.3 Message contents

FFS

9.6.1.2_A.1.5 Test requirement

The pass fail decision is as specified in the test procedure in clause 9.6.1.2_A.1.4.2.

There are no parameters in the test setup or measurement process whose variation impacts the results so there are no applicable test tolerances for this test.

9.6.1.2_A.2 TDD CQI Reporting under AWGN conditions – PUCCH 1-0 for CA (inter band DL CA)

FFS

10 MBMS Performance

10.1 FDD MBMS performance (Fixed Reference Channel)

10.1.1 Test purpose

This test verifies the performance of FDD MBMS with a given SNR for which the average BLER remains below a given reference value.

10.1.2 Test applicability

This test applies to all types of E-UTRA FDD UE supporting MBMS release 9 and forward.

10.1.3 Minimum conformance requirements

The parameters specified in Table 10.1.3-1 are valid for all FDD tests unless otherwise stated. For the requirements defined in this section, the difference between CRS EPRE and the MBSFN RS EPRE should be set to 0 dB as the UE demodulation performance might be different when this condition is not met (e.g. in scenarios where power offsets are present, such as scenarios when reserved cells are present).

Table 10.1.3-1: Common Test Parameters (FDD)

Parameter	Unit	Value
Number of HARQ processes	Processes	None
Subcarrier spacing	kHz	15 kHz
Allocated subframes per Radio Frame (Note 1)		6 subframes
Number of OFDM symbols for PDCCH (Note 2)		2 symbols in the case of 3 PHICH symbols or 4 RS Ports; 1 or 2 symbols for other scenarios.
Cyclic Prefix		Extended
Note1: For FDD mode, up to 6 subframes (#1/2/3/6/7/8) are available for MBMS, in line with TS 36.331.		
Note2: 2 OFDM symbols are reserved for PDCCH in this subclause.		

The receive characteristic of MBMS is determined by the BLER. The requirement is valid for all RRC states for which the UE has capabilities for MBMS.

For the parameters specified in Table 10.1.3-1 and Table 10.1.3-2 and Annex A.3.8.1, the average downlink SNR shall be below the specified value for the BLER shown in Table 10.1.3-3.

Table 10.1.3-2: Test Parameters for Testing

Parameter	Unit	Test 1-4	
Downlink power allocation	ρ_A	dB	0
	ρ_B	dB	0 (Note 1)
N_{oc} at antenna port	dBm/15kHz	-98	
Note 1: $P_B = 0$			

Table 10.1.3-3: Minimum performance

Test number	Bandwidth	Reference Channel	OCNG Pattern	Propagation condition	Correlation Matrix and antenna	Reference value		MBMS UE Category
						BLER (%)	SNR(dB)	
1	10 MHz	R.37 FDD	OP.4 FDD	MBSFN channel model (Table B.2.6-1)	1x2 low	1	4.1	1-5
2	10 MHz	R.38 FDD	OP.4 FDD				11.0	1-5
3	10 MHz	R.39 FDD	OP.4 FDD				20.1	2-5
	5.0MHz	R.39-1 FDD	OP.4 FDD				20.5	1
4	1.4 MHz	R.40 FDD	OP.4 FDD			6.6	1-5	

The normative reference for this requirement is TS 36.101 [2] clause 10.1.

10.1.4 Test description

10.1.4.1 Initial conditions

Test Environment: Normal, as defined in TS 36.508 [7] clause 4.1.

Frequencies to be tested: Mid Range, as defined in TS 36.508 [7] clause 4.3.1.

Channel Bandwidths to be tested: As specified per test number in Table 10.1.3-3 as defined in TS 36.508 [7] clause 4.3.1.

1. Connect the SS, the faders and AWGN noise source to the UE antenna connector (s) as shown in TS 36.508 [7] Annex A, Figure A.9.
2. The parameter settings for the cell are set up according to Table 10.1.3-1.
3. The downlink signals are initially set up according to Annex C.1 and Annex C.3.2 and uplink signals according to Annex H.1 and H.3.2.
4. Propagation conditions are set according to Annex B clause B.0.
5. Ensure the UE is in State 2A according to TS 36.508 [7] clause 4.5.2A. Message contents are defined in clause 10.1.4.3.
6. SS transmits *MBSFNAreaConfiguration* message. Message content is defined in clause 10.1.4.3.
7. Wait for a period equal to the MCCH modification period to make sure the UE has received the *MBSFNAreaConfiguration* message.
8. SS continues with the generic procedures described in TS 36.508 [7] clause 4.5.3A.3 and 4.5.4.3 and ensures the UE is in State 4 according to TS 36.508 [7] clause 4.5.4 and the UE test loop Mode C is activated. Message contents are defined in clause 10.1.4.3.
9. SS is configured to include 10 MBMS packets in one TB.

10.1.4.2 Test procedure

1. Initialise the variables M_{tot} and M_{ok} as 0. Set the parameters of bandwidth, reference channel, the propagation condition, antenna configuration and the SNR according to Table 10.1.5-1 as appropriate.
2. SS shall send MBMS Packets on the MTCH radio bearer for the test time specified in Table G.6.4-1 . SS stores the number of the transmitted MBMS Packets on the MTCH in the current test iteration in the variable M_{tot} .
3. SS shall send a “UE TEST LOOP MODE C MBMS PACKET COUNTER REQUEST” message and wait for the UE to respond with a “UE TEST LOOP MODE C MBMS PACKET COUNTER RESPONSE” reporting the received MBMS Packet counter value. Message contents are defined in clause 10.1.4.3. SS calculates the variable M_{ok} as (current counter value - counter value at last test iteration).
4. SS shall compute the BLER as the following:

$$\text{The BLER} = (M_{tot} - M_{ok}) / M_{tot}$$

5. Repeat steps from 1 to 4 for each subtest in Table 10.1.5-1 as appropriate.

10.1.4.3 Message contents

Message contents are according to TS 36.508 [7] clauses 4.6 and 4.7A with following exceptions:

Table 10.1.4.3-1: SystemInformationBlockType2: Additional FDD MBMS performance (Fixed Reference Channel)

Derivation Path: 36.508 table 4.4.3.3-1			
Information Element	Value/remark	Comment	Condition
SystemInformationBlockType2 ::= SEQUENCE {			
mbsfn-SubframeConfig SEQUENCE {			
radioframeAllocationPeriod	n1		
radioframeAllocationOffset	0		
subframeAllocation CHOICE{			
oneFrame	'111111'		
}			
}			
}			

Table 10.1.4.3-2: MBSFNAreaConfiguration message: Additional FDD MBMS performance (Fixed Reference Channel)

Derivation Path: 36.508, Table 4.6.1-4A			
Information Element	Value/remark	Comment	Condition
MBSFNAreaConfiguration-r9 ::= SEQUENCE {			
commonSF-Alloc-r9 SEQUENCE (SIZE (1..maxMBSFN-Allocations)) OF SEQUENCE {			
radioframeAllocationPeriod	n1		
radioframeAllocationOffset	0		
subframeAllocation CHOICE {			
oneFrame	'111111'		
}			
}			
commonSF-AllocPeriod-r9	rf8		
pmch-InfoList-r9 SEQUENCE (SIZE (0..maxPMCH-PerMBSFN)) OF SEQUENCE {			
pmch-Config-r9 SEQUENCE {			
sf-AllocEnd-r9	47	48 active subframes in 8 Radio-frames	
dataMCS-r9	4	Test number 1 and 4	R.37 FDD R.40 FDD
	12	Test number 2	R.38 FDD
	20	Test number 3	R.39 FDD R.39-1 FDD
mch-SchedulingPeriod-r9	rf8		
}			
...			
}			

Table 10.1.4.3-3: ACTIVATE TEST MODE: Additional FDD MBMS performance (Fixed Reference Channel)

Derivation Path: 36.508, Table 4.7A-1, condition UE TEST LOOP MODE C
--

Table 10.1.4.3-4: CLOSE UE TEST LOOP: Additional FDD MBMS performance (Fixed Reference Channel)

Derivation Path: 36.508, Table 4.7A-3, condition UE TEST LOOP MODE C
--

Table 10.1.4.3-5: SystemInformationBlockType13: Additional FDD MBMS performance (Fixed Reference Channel)

Derivation Path: 36.508 table 4.4.3.3-13			
Information Element	Value/remark	Comment	Condition
SystemInformationBlockType13 ::= SEQUENCE {			
MBSFN-AreaInfo-r9 SEQUENCE (SIZE(1..maxMBSFN-Area)) OF SEQUENCE {			
mch-Config-r9 SEQUENCE {			
signallingMCS-r9	n7	Test number 1 and 4	QPSK
	n13	Test number 2	16QAM
	n19	Test number 3	64QAM
}			
}			
}			

10.1.5 Test requirement

For the parameters specified in Table 10.1.3-1, Table 10.1.3-2, Annex A.3.8.1, and SNR in Table 10.1.5-1, the value for the BLER in step 4 shall be below the test limit in Annex G.6.3 for all subtests shown in Table 10.1.5-1.

Table 10.1.5-1: Test requirement

Test number	Bandwidth	Reference Channel	OCNG Pattern	Propagation condition	Correlation Matrix and antenna	Reference value		MBMS UE Category
						BLER (%)	SNR(dB)	
1	10 MHz	R.37 FDD	OP.4 FDD	MBSFN channel model (Table B.2.6-1)	1x2 low	1	5	1-5
2	10 MHz	R.38 FDD	OP.4 FDD				11.9	1-5
3	10 MHz	R.39 FDD	OP.4 FDD				21.0	2-5
	5.0MHz	R.39-1 FDD	OP.4 FDD				21.4	1
4	1.4 MHz	R.40 FDD	OP.4 FDD				7.5	1-5

10.2 TDD MBMS performance (Fixed Reference Channel)

10.2.1 Test purpose

This test verifies the performance of TDD MBMS with a given SNR for which the average BLER remains below a given reference value.

10.2.2 Test applicability

This test applies to all types of E-UTRA TDD UE supporting MBMS release 9 and forward.

10.2.3 Minimum conformance requirements

The parameters specified in Table 10.2.3-1 are valid for all TDD tests unless otherwise stated. For the requirements defined in this section, the difference between CRS EPRE and the MBSFN RS EPRE should be set to 0 dB as the UE demodulation performance might be different when this condition is not met (e.g. in scenarios where power offsets are present, such as scenarios when reserved cells are present).

Table 10.2.3-1: Common Test Parameters (TDD)

Parameter	Unit	Value
Number of HARQ processes	Processes	None
Subcarrier spacing	kHz	15 kHz
Allocated subframes per Radio Frame (Note 1)		5 subframes
Number of OFDM symbols for PDCCH (Note 2)		2 symbols in the case of 3 PHICH symbols or 4 RS Ports; 1 or 2 symbols for other scenarios.
Cyclic Prefix		Extended
Note1:	For TDD mode, in line with TS 36.331, Uplink-Downlink Configuration 5 is proposed, up to 5 subframes (#3/4/7/8/9) are available for MBMS.	
Note2:	2 OFDM symbols are reserved for PDCCH in this subclause.	

The receive characteristic of MBMS is determined by the BLER. The requirement is valid for all RRC states for which the UE has capabilities for MBMS.

For the parameters specified in Table 10.2.3-1 and Table 10.2.3-2 and Annex A.3.8.2, the average downlink SNR shall be below the specified value for the BLER shown in Table 10.2.3-3.

Table 10.2.3-2: Test Parameters for Testing

Parameter		Unit	Test 1-4
Downlink power allocation	ρ_A	dB	0
	ρ_B	dB	0 (Note 1)
N_{oc} at antenna port		dBm/15kHz	-98
Note 1: $P_B = 0$			

Table 10.2.3-3: Minimum performance

Test number	Bandwidth	Reference Channel	OCNG Pattern	Propagation condition	Correlation Matrix and antenna	Reference value		MBMS UE Category
						BLER (%)	SNR(dB)	
1	10 MHz	R.37 TDD	OP.4 TDD	MBSFN channel model (Table B.2.6-1)	1x2 low	1	3.4	1-5
2	10 MHz	R.38 TDD	OP.4 TDD				11.1	1-5
3	10 MHz	R.39 TDD	OP.4 TDD				20.1	2-5
	5MHz	R.39-1 TDD	OP.4 TDD				20.5	1
4	1.4 MHz	R.40 TDD	OP.4 TDD				5.8	1-5

The normative reference for this requirement is TS 36.101 [2] clause 10.2.

10.2.4 Test description

10.2.4.1 Initial conditions

Test Environment: Normal, as defined in TS 36.508 [7] clause 4.1.

Frequencies to be tested: Mid Range, as defined in TS 36.508 [7] clause 4.3.1.

Channel Bandwidths to be tested: As specified per test number in Table 10.2.3-3 as defined in TS 36.508 [7] clause 4.3.1.

1. Connect the SS, the faders and AWGN noise source to the UE antenna connector (s) as shown in TS 36.508 [7] Annex A, Figure A.9.
2. The parameter settings for the cell are set up according to Table 10.2.3-1.
3. The downlink signals are initially set up according to Annex C.1 and Annex C.3.2 and uplink signals according to Annex H.1 and H.3.2.
4. Propagation conditions are set according to Annex B clause B.0.
5. Ensure the UE is in State 2A according to TS 36.508 [7] clause 4.5.2A. Message contents are defined in clause 10.1.4.3.
6. SS transmits *MBSFNAreaConfiguration* message. Message content is defined in clause 10.2.4.3.
7. Wait for a period equal to the MCCH modification period to make sure the UE has received the *MBSFNAreaConfiguration* message.
8. SS continues with the generic procedures described in TS 36.508 [7] clause 4.5.3A.3 and 4.5.4.3 and ensures the UE is in State 4 according to TS 36.508 [7] clause 4.5.4 and the UE test loop Mode C is activated. Message contents are defined in clause 10.2.4.3.

9. SS is configured to include 10 MBMS packets in one TB.

10.2.4.2 Test procedure

1. Initialise the variables M_{tot} and M_{ok} as 0. Set the parameters of bandwidth, reference channel, the propagation condition, antenna configuration and the SNR according to Table 10.2.5-1 as appropriate.
2. SS shall send MBMS Packets on the MTCH radio bearer for the test time specified in Table G.6.4-1. SS stores the number of the transmitted MBMS Packets on the MTCH in the current test iteration in the variable M_{tot} .
3. SS shall send a "UE TEST LOOP MODE C MBMS PACKET COUNTER REQUEST" message and wait for the UE to respond with a "UE TEST LOOP MODE C MBMS PACKET COUNTER RESPONSE" reporting the received MBMS Packet counter value. Message contents are defined in clause 10.2.4.3. SS calculates the variable M_{ok} as (current counter value - counter value at last test iteration).
4. SS shall compute the BLER as the following:

$$\text{The BLER} = (M_{tot} - M_{ok}) / M_{tot}$$

5. Repeat steps from 1 to 4 for each subtest in Table 10.2.5-1 as appropriate.

10.2.4.3 Message contents

Message contents are according to TS 36.508 [7] clauses 4.6 and 4.7A with following exceptions:

Table 10.2.4.3-1: SystemInformationBlockType2: Additional TDD MBMS performance (Fixed Reference Channel)

Derivation Path: 36.508 table 4.4.3.3-1			
Information Element	Value/remark	Comment	Condition
SystemInformationBlockType2 ::= SEQUENCE {			
mbsfn-SubframeConfig SEQUENCE {			
radioframeAllocationPeriod	n1		
radioframeAllocationOffset	0		
subframeAllocation CHOICE{			
oneFrame	'111110'	The last bit is not used	
}			
}			
}			

Table 10.2.4.3-2: MBSFNAreaConfiguration message: Additional TDD MBMS performance (Fixed Reference Channel)

Derivation Path: 36.508, Table 4.6.1-4A			
Information Element	Value/remark	Comment	Condition
MBSFNAreaConfiguration-r9 ::= SEQUENCE {			
commonSF-Alloc-r9 SEQUENCE (SIZE (1..maxMBSFN-Allocations)) OF SEQUENCE {			
radioframeAllocationPeriod	n1		
radioframeAllocationOffset	0		
subframeAllocation CHOICE {			
oneFrame	'111110'	The last bit is not used	
}			
}			
commonSF-AllocPeriod-r9	rf8		
pmch-InfoList-r9 SEQUENCE (SIZE (0..maxPMCH-PerMBSFN)) OF SEQUENCE {			
pmch-Config-r9 SEQUENCE {			
sf-AllocEnd-r9	39	40 active subframes in 8 Radio-frames	
dataMCS-r9	4	Test number 1 and 4	R.37 TDD R.40 TDD
	12	Test number 2	R.38 TDD
	20	Test number 3	R.39 TDD R.39-1 TDD
mch-SchedulingPeriod-r9	rf8		
}			
...			
}			

Table 10.2.4.3-3: ACTIVATE TEST MODE: Additional TDD MBMS performance (Fixed Reference Channel)

Derivation Path: 36.508, Table 4.7A-1, condition UE TEST LOOP MODE C

Table 10.2.4.3-4: CLOSE UE TEST LOOP: Additional TDD MBMS performance (Fixed Reference Channel)

Derivation Path: 36.508, Table 4.7A-3, condition UE TEST LOOP MODE C

Table 10.2.4.3-5: SystemInformationBlockType13: Additional TDD MBMS performance (Fixed Reference Channel)

Derivation Path: 36.508 table 4.4.3.3-13			
Information Element	Value/remark	Comment	Condition
SystemInformationBlockType13 ::= SEQUENCE {			
MBSFN-AreaInfo-r9 SEQUENCE (SIZE(1..maxMBSFN-Area)) OF SEQUENCE {			
mcch-Config-r9 SEQUENCE {			
signallingMCS-r9	n7	Test number 1 and 4	QPSK
	n13	Test number 2	16QAM
	n19	Test number 3	64QAM
}			
}			
}			

10.2.5 Test requirement

For the parameters specified in Table 10.2.3-1, Table 10.2.3-2, Annex A.3.8. 2, and SNR in Table 10.2.5-1, the value for the BLER in step 4 shall be below the test limit in Annex G.6.3 for all subtests shown in Table 10.2.5-1.

Table 10.2.5-1: Test

Test number	Bandwidth	Reference Channel	OCNG Pattern	Propagation condition	Correlation Matrix and antenna	Reference value		MBMS UE Category
						BLER (%)	SNR(dB)	
1	10 MHz	R.37 TDD	OP.4 TDD	MBSFN channel model (Table B.2.6-1)	1x2 low	1	4.3	1-5
2	10 MHz	R.38 TDD	OP.4 TDD				12	1-5
3	10 MHz	R.39 TDD	OP.4 TDD				21.0	2-5
	5MHz	R.39-1 TDD	OP.4 TDD				21.4	1
4	1.4 MHz	R.40 TDD	OP.4 TDD				6.7	1-5

Annex A (normative): Measurement Channels

A.1 General

A schematic overview of the encoding process for the reference measurement channels is provided in Figure A-1.

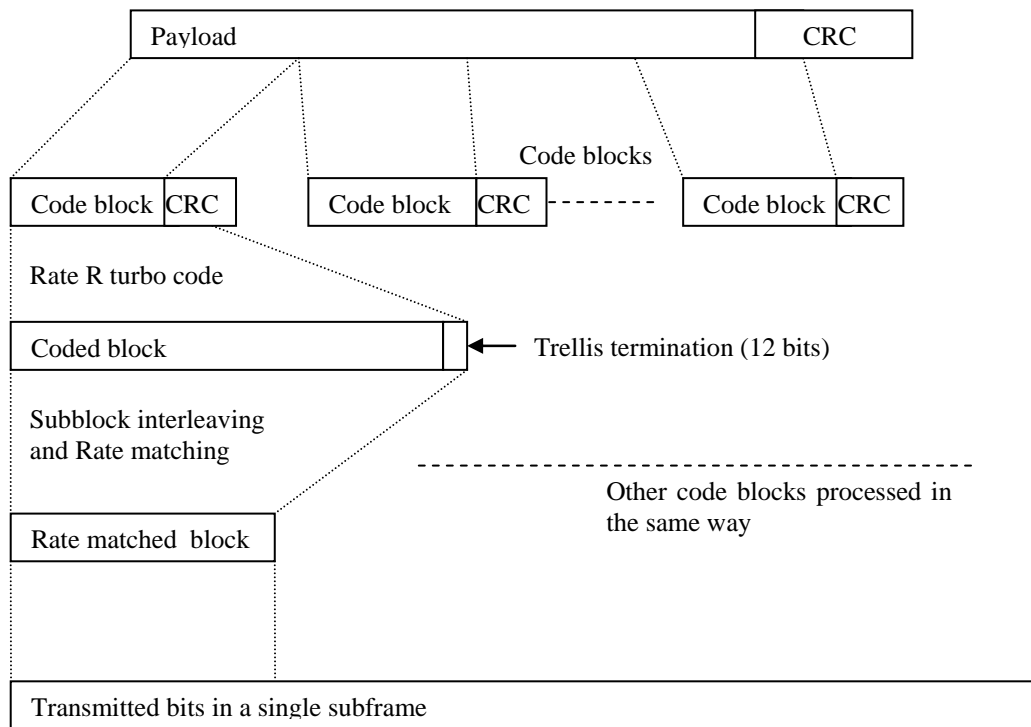

Figure A-1: Schematic overview of the encoding process

The throughput values defined in the measurement channels specified in Annex A, are calculated and are valid per data stream (codeword). For multi-stream (more than one codeword) transmissions, the throughput referenced in the minimum requirements is the sum of throughputs of all data streams (codewords).

The UE category entry in the definition of the reference measurement channels in Annex A is only informative and reveals the UE categories, which can support the corresponding measurement channel. Whether the measurement channel is used for testing a certain UE category or not is specified in the individual test cases.

Rate matching process in Figure A-1 is dependent on the parameter “Total number of Soft Channel bits” which has been defined for each UE category in TS 36.306 [15] clause 4.1. The SS shall use the Soft Channel bits size according to the UE category.

A.2 UL reference measurement channels

A.2.1 General

A.2.1.1 Applicability and common parameters

The following sections define the UL signal applicable to the Transmitter Characteristics (clause 6) and for the Receiver Characteristics (clause 7) where the UL signal is relevant.

The Reference channels in this section assume transmission of PUSCH and Demodulation Reference signal only. The following conditions apply:

- 1 HARQ transmission
- Cyclic Prefix normal
- PUSCH hopping off
- Link adaptation off
- Demodulation Reference signal as per TS 36.211 [8] clause 5.5.2.1.2.

Where ACK/NACK is transmitted, it is assumed to be multiplexed on PUSCH as per TS 36.212 [9] subclause 5.2.2.6.

- ACK/NACK 1 bit
- ACK/NACK mapping adjacent to Demodulation Reference symbol
- ACK/NACK resources punctured into data
- Max number of resources for ACK/NACK: 4 SC-FDMA symbols per subframe
- No CQI transmitted, no RI transmitted

A.2.1.2 Determination of payload size

The algorithm for determining the payload size A is as follows; given a desired coding rate R and radio block allocation N_{RB} :

1. Calculate the number of channel bits N_{ch} that can be transmitted during the first transmission of a given sub-frame.
2. Find A such that the resulting coding rate is as close to R as possible, that is,

$$\min \left| R - (A + 24) / N_{ch} \right|,$$

subject to

- a) A is a valid TB size according to clause 7.1.7 of TS 36.213 [10] assuming an allocation of N_{RB} resource blocks.
 - b) Segmentation is not included in this formula, but should be considered in the TBS calculation.
 - c) For RMC-s, which at the nominal target coding rate do not cover all the possible UE categories for the given modulation, reduce the target coding rate gradually (within the same modulation), until the maximal possible number of UE categories is covered.
3. If there is more than one A that minimises the equation above, then the larger value is chosen per default.

A.2.1.3 Overview of UL reference measurement channels

In Table A.2.1.3-1 are listed the UL reference measurement channels specified in annexes A.2.2 and A.2.3 of this release of TS 36.521-1. This table is informative and serves only to a better overview. The reference for the concrete reference measurement channels and corresponding implementation's parameters as to be used for testing are annexes A.2.2 and A.2.3 as appropriate.

Table A.2.1.3-1: Overview of UL reference measurement channels

Duplex	Table	Name	B W	Mod	TCR	RB	RB Off set	UE Cat eg	Notes
FDD, Full RB allocation, QPSK									
FDD	Table A.2.2.1.1-1		1.4	QPSK	1/3	6		≥ 1	
FDD	Table A.2.2.1.1-1		3	QPSK	1/3	15		≥ 1	
FDD	Table A.2.2.1.1-1		5	QPSK	1/3	25		≥ 1	
FDD	Table A.2.2.1.1-1		10	QPSK	1/3	50		≥ 1	
FDD	Table A.2.2.1.1-1		15	QPSK	1/5	75		≥ 1	
FDD	Table A.2.2.1.1-1		20	QPSK	1/6	100		≥ 1	
FDD, Full RB allocation, 16-QAM									
FDD	Table A.2.2.1.2-1		1.4	16QAM	3/4	6		≥ 1	
FDD	Table A.2.2.1.2-1		3	16QAM	1/2	15		≥ 1	
FDD	Table A.2.2.1.2-1		5	16QAM	1/3	25		≥ 1	
FDD	Table A.2.2.1.2-1		10	16QAM	3/4	50		≥ 2	
FDD	Table A.2.2.1.2-1		15	16QAM	1/2	75		≥ 2	
FDD	Table A.2.2.1.2-1		20	16QAM	1/3	100		≥ 2	
FDD, Partial RB allocation, QPSK, 1.4 MHz									
FDD	Table A.2.2.2.1-1		1.4	QPSK	1/3	1		≥ 1	
FDD	Table A.2.2.2.1-1		1.4	QPSK	1/3	2		≥ 1	Not yet used in tests
FDD	Table A.2.2.2.1-1		1.4	QPSK	1/3	3		≥ 1	Not yet used in tests
FDD	Table A.2.2.2.1-1		1.4	QPSK	1/3	4		≥ 1	Not yet used in tests
FDD	Table A.2.2.2.1-1		1.4	QPSK	1/3	5		≥ 1	
FDD, Partial RB allocation, QPSK, 3 MHz									
FDD	Table A.2.2.2.1-2		3	QPSK	1/3	1		≥ 1	
FDD	Table A.2.2.2.1-2		3	QPSK	1/3	2		≥ 1	Not yet used in tests
FDD	Table A.2.2.2.1-2		3	QPSK	1/3	3		≥ 1	Not yet used in tests
FDD	Table A.2.2.2.1-2		3	QPSK	1/3	4		≥ 1	
FDD	Table A.2.2.2.1-2		3	QPSK	1/3	5		≥ 1	Not yet used in tests
FDD	Table A.2.2.2.1-2		3	QPSK	1/3	6		≥ 1	Not yet used in tests
FDD	Table A.2.2.2.1-2		3	QPSK	1/3	10		≥ 1	Not yet used in tests
FDD, Partial RB allocation, QPSK, 5 MHz									
FDD	Table A.2.2.2.1-3		5	QPSK	1/3	1		≥ 1	
FDD	Table A.2.2.2.1-3		5	QPSK	1/3	2		≥ 1	Not yet used in tests
FDD	Table A.2.2.2.1-3		5	QPSK	1/3	5		≥ 1	Not yet used in tests
FDD	Table A.2.2.2.1-3		5	QPSK	1/3	6		≥ 1	
FDD	Table A.2.2.2.1-3		5	QPSK	1/3	8		≥ 1	
FDD	Table A.2.2.2.1-3a		5	QPSK	1/3	10		≥ 1	Not yet used in tests
FDD	Table A.2.2.2.1-3a		5	QPSK	1/3	15		≥ 1	
FDD	Table A.2.2.2.1-3a		5	QPSK	1/3	18		≥ 1	Not yet used in tests
FDD	Table A.2.2.2.1-3a		5	QPSK	1/3	20		≥ 1	
FDD	Table A.2.2.2.1-3a		5	QPSK	1/3	24		≥ 1	Not yet used in tests
FDD, Partial RB allocation, QPSK, 10 MHz									
FDD	Table A.2.2.2.1-4		10	QPSK	1/3	1		≥ 1	
FDD	Table A.2.2.2.1-4		10	QPSK	1/3	2		≥ 1	
FDD	Table A.2.2.2.1-4		10	QPSK	1/3	5		≥ 1	Not yet used in tests
FDD	Table A.2.2.2.1-4		10	QPSK	1/3	6		≥ 1	
FDD	Table A.2.2.2.1-4		10	QPSK	1/3	8		≥ 1	

FDD	Table A.2.2.2.1-4		10	QPSK	1/3	10		≥ 1	Not yet used in tests
FDD	Table A.2.2.2.1-4a		10	QPSK	1/3	12		≥ 1	
FDD	Table A.2.2.2.1-4a		10	QPSK	1/3	15		≥ 1	
FDD	Table A.2.2.2.1-4a		10	QPSK	1/3	16		≥ 1	
FDD	Table A.2.2.2.1-4a		10	QPSK	1/3	18		≥ 1	Not yet used in tests
FDD	Table A.2.2.2.1-4a		10	QPSK	1/3	20		≥ 1	
FDD	Table A.2.2.2.1-4a		10	QPSK	1/3	24		≥ 1	Not yet used in tests
FDD	Table A.2.2.2.1-4a		10	QPSK	1/3	25		≥ 1	
FDD	Table A.2.2.2.1-4b		10	QPSK	1/3	27		≥ 1	Not yet used in tests
FDD	Table A.2.2.2.1-4b		10	QPSK	1/3	30		≥ 1	
FDD	Table A.2.2.2.1-4b		10	QPSK	1/3	32		≥ 1	
FDD	Table A.2.2.2.1-4b		10	QPSK	1/3	36		≥ 1	Not yet used in tests
FDD	Table A.2.2.2.1-4b		10	QPSK	1/3	40		≥ 1	
FDD	Table A.2.2.2.1-4b		10	QPSK	1/3	45		≥ 1	

FDD	Table A.2.2.2.1-4b		10	QPSK	1/3	48		≥ 1	
FDD, Partial RB allocation, QPSK, 15 MHz									
FDD	Table A.2.2.2.1-5		15	QPSK	1/3	1		≥ 1	
FDD	Table A.2.2.2.1-5		15	QPSK	1/3	2		≥ 1	Not yet used in tests
FDD	Table A.2.2.2.1-5		15	QPSK	1/3	5		≥ 1	Not yet used in tests
FDD	Table A.2.2.2.1-5		15	QPSK	1/3	6		≥ 1	Not yet used in tests
FDD	Table A.2.2.2.1-5		15	QPSK	1/3	8		≥ 1	
FDD	Table A.2.2.2.1-5		15	QPSK	1/3	9		≥ 1	Not yet used in tests
FDD	Table A.2.2.2.1-5a		15	QPSK	1/3	10		≥ 1	Not yet used in tests
FDD	Table A.2.2.2.1-5a		15	QPSK	1/3	16		≥ 1	
FDD	Table A.2.2.2.1-5a		15	QPSK	1/3	18		≥ 1	Not yet used in tests
FDD	Table A.2.2.2.1-5a		15	QPSK	1/3	20		≥ 1	
FDD	Table A.2.2.2.1-5a		15	QPSK	1/3	24		≥ 1	Not yet used in tests
FDD	Table A.2.2.2.1-5a		15	QPSK	1/3	25		≥ 1	
FDD	Table A.2.2.2.1-5b		15	QPSK	1/3	27		≥ 1	Not yet used in tests
FDD	Table A.2.2.2.1-5b		15	QPSK	1/3	36		≥ 1	Not yet used in tests
FDD	Table A.2.2.2.1-5b		15	QPSK	1/3	40		≥ 1	
FDD	Table A.2.2.2.1-5b		15	QPSK	1/3	48		≥ 1	
FDD	Table A.2.2.2.1-5b		15	QPSK	1/3	50		≥ 1	
FDD	Table A.2.2.2.1-5b		15	QPSK	1/3	54		≥ 1	
FDD	Table A.2.2.2.1-5b		15	QPSK	1/3	60		≥ 1	
FDD, Partial RB allocation, QPSK, 20 MHz									
FDD	Table A.2.2.2.1-6		20	QPSK	1/3	1		≥ 1	
FDD	Table A.2.2.2.1-6		20	QPSK	1/3	2		≥ 1	Not yet used in tests
FDD	Table A.2.2.2.1-6		20	QPSK	1/3	5		≥ 1	Not yet used in tests
FDD	Table A.2.2.2.1-6		20	QPSK	1/3	6		≥ 1	Not yet used in tests
FDD	Table A.2.2.2.1-6		20	QPSK	1/3	8		≥ 1	Not yet used in tests
FDD	Table A.2.2.2.1-6		20	QPSK	1/3	10		≥ 1	
FDD	Table A.2.2.2.1-6a		20	QPSK	1/3	16		≥ 1	Not yet used in tests
FDD	Table A.2.2.2.1-6a		20	QPSK	1/3	18		≥ 1	
FDD	Table A.2.2.2.1-6a		20	QPSK	1/3	20		≥ 1	
FDD	Table A.2.2.2.1-6a		20	QPSK	1/3	24		≥ 1	Not yet used in tests
FDD	Table A.2.2.2.1-6a		20	QPSK	1/3	25		≥ 1	
FDD	Table A.2.2.2.1-6a		20	QPSK	1/3	48		≥ 1	
FDD	Table A.2.2.2.1-6b		20	QPSK	1/3	50		≥ 1	
FDD	Table A.2.2.2.1-6b		20	QPSK	1/3	54		≥ 1	
FDD	Table A.2.2.2.1-6b		20	QPSK	1/5	75		≥ 1	
FDD, Partial RB allocation, 16-QAM, 1.4 MHz									
FDD	Table A.2.2.2.2-1		1.4	16QAM	3/4	1		≥ 1	
FDD	Table A.2.2.2.2-1		1.4	16QAM	3/4	5		≥ 1	
FDD, Partial RB allocation, 16-QAM, 3 MHz									
FDD	Table A.2.2.2.2-2		3	16QAM	3/4	1		≥ 1	Not yet used in tests
FDD	Table A.2.2.2.2-2		3	16QAM	3/4	4		≥ 1	
FDD	Table A.2.2.2.2-2		3	16QAM	3/4	6		≥ 1	
FDD, Partial RB allocation, 16-QAM, 5 MHz									
FDD	Table A.2.2.2.2-3		5	16QAM	3/4	1		≥ 1	Not yet used in tests
FDD	Table A.2.2.2.2-3		5	16QAM	3/4	8		≥ 1	
FDD, Partial RB allocation, 16-QAM, 10 MHz									

FDD	Table A.2.2.2.2-4		10	16QAM	3/4	1		≥ 1	
FDD	Table A.2.2.2.2-4		10	16QAM	3/4	12		≥ 1	
FDD	Table A.2.2.2.2-4		10	16QAM	1/2	16		≥ 1	
FDD	Table A.2.2.2.2-4		10	16QAM	3/4	30		≥ 2	
FDD	Table A.2.2.2.2-4		10	16QAM	3/4	36		≥ 2	
FDD, Partial RB allocation, 16-QAM, 15 MHz									
FDD	Table A.2.2.2.2-5		15	16QAM	3/4	1		≥ 1	Not yet used in tests
FDD	Table A.2.2.2.2-5		15	16QAM	3/4	6		≥ 1	Not yet used in tests
FDD	Table A.2.2.2.2-5		15	16QAM	3/4	8		≥ 1	Not yet used in tests
FDD	Table A.2.2.2.2-5		15	16QAM	3/4	9		≥ 1	Not yet used in tests
FDD	Table A.2.2.2.2-5		15	16QAM	1/2	16		≥ 1	
FDD	Table A.2.2.2.2-5		15	16QAM	1/2	18		≥ 1	Not yet used in tests
FDD	Table A.2.2.2.2-5a		15	16QAM	1/3	20		≥ 1	Not yet used in tests
FDD	Table A.2.2.2.2-5a		15	16QAM	1/3	24		≥ 1	Not yet used in tests
FDD, Partial RB allocation, 16-QAM, 20 MHz									
FDD	Table A.2.2.2.2-6		20	16QAM	3/4	1		≥ 1	Not yet used in tests
FDD	Table A.2.2.2.2-6		20	16QAM	3/4	2		≥ 1	Not yet used in tests
FDD	Table A.2.2.2.2-6		20	16QAM	1/2	16		≥ 1	Not yet used in tests
FDD	Table A.2.2.2.2-6		20	16QAM	1/2	18		≥ 1	
FDD	Table A.2.2.2.2-6		20	16QAM	1/3	20		≥ 1	Not yet used in tests
FDD	Table A.2.2.2.2-6		20	16QAM	1/3	24		≥ 1	Not yet used in tests
FDD	Table A.2.2.2.2-6		20	16QAM	1/2	75		≥ 2	Not yet used in tests
FDD, Sustained data rate									
FDD	Table A.2.2.3-1	R.1-1 FDD	10	QPSK	0.31	40		≥ 1	
FDD	Table A.2.2.3-1	R.1-2 FDD	10	QPSK	0.31	40		≥ 1	
FDD	Table A.2.2.3-1	R.1-3 FDD	20	QPSK	0.31	90		≥ 2	
FDD	Table A.2.2.3-1	R.1-3A FDD	10	QPSK	0.31	40		≥ 1	
FDD	Table A.2.2.3-1	R.1-4 FDD	20	QPSK	0.31	40		≥ 2	
TDD, Full RB allocation, QPSK									
TDD	Table A.2.3.1.1-1		1.4	QPSK	1/3	6		≥ 1	
TDD	Table A.2.3.1.1-1		3	QPSK	1/3	15		≥ 1	
TDD	Table A.2.3.1.1-1		5	QPSK	1/3	25		≥ 1	
TDD	Table A.2.3.1.1-1		10	QPSK	1/3	50		≥ 1	
TDD	Table A.2.3.1.1-1		15	QPSK	1/5	75		≥ 1	
TDD	Table A.2.3.1.1-1		20	QPSK	1/6	100		≥ 1	
TDD, Full RB allocation, 16-QAM									
TDD	Table A.2.3.1.2-1		1.4	16QAM	3/4	6		≥ 1	
TDD	Table A.2.3.1.2-1		3	16QAM	1/2	15		≥ 1	
TDD	Table A.2.3.1.2-1		5	16QAM	1/3	25		≥ 1	
TDD	Table A.2.3.1.2-1		10	16QAM	3/4	50		≥ 2	
TDD	Table A.2.3.1.2-1		15	16QAM	1/2	75		≥ 2	
TDD	Table A.2.3.1.2-1		20	16QAM	1/3	100		≥ 2	
TDD, Partial RB allocation, QPSK, 1.4 MHz									
TDD	Table A.2.3.2.1-1		1.4	QPSK	1/3	1		≥ 1	
TDD	Table A.2.3.2.1-1		1.4	QPSK	1/3	2		≥ 1	Not yet used in tests
TDD	Table A.2.3.2.1-1		1.4	QPSK	1/3	3		≥ 1	Not yet used in tests
TDD	Table A.2.3.2.1-1		1.4	QPSK	1/3	4		≥ 1	Not yet used in tests
TDD	Table A.2.3.2.1-1		1.4	QPSK	1/3	5		≥ 1	

TDD, Partial RB allocation, QPSK, 3 MHz									
TDD	Table A.2.3.2.1-2		3	QPSK	1/3	1		≥ 1	
TDD	Table A.2.3.2.1-2		3	QPSK	1/3	2		≥ 1	Not yet used in tests
TDD	Table A.2.3.2.1-2		3	QPSK	1/3	3		≥ 1	Not yet used in tests
TDD	Table A.2.3.2.1-2		3	QPSK	1/3	4		≥ 1	
TDD	Table A.2.3.2.1-2		3	QPSK	1/3	5		≥ 1	Not yet used in tests
TDD	Table A.2.3.2.1-2		3	QPSK	1/3	6		≥ 1	Not yet used in tests
TDD	Table A.2.3.2.1-2		3	QPSK	1/3	10		≥ 1	Not yet used in tests
TDD, Partial RB allocation, QPSK, 5 MHz									
TDD	Table A.2.3.2.1-3		5	QPSK	1/3	1		≥ 1	
TDD	Table A.2.3.2.1-3		5	QPSK	1/3	2		≥ 1	Not yet used in tests
TDD	Table A.2.3.2.1-3		5	QPSK	1/3	5		≥ 1	Not yet used in tests
TDD	Table A.2.3.2.1-3		5	QPSK	1/3	6		≥ 1	
TDD	Table A.2.3.2.1-3		5	QPSK	1/3	8		≥ 1	
TDD	Table A.2.3.2.1-3a		5	QPSK	1/3	10		≥ 1	Not yet used in tests
TDD	Table A.2.3.2.1-3a		5	QPSK	1/3	15		≥ 1	Not yet used in tests
TDD	Table A.2.3.2.1-3a		5	QPSK	1/3	18		≥ 1	Not yet used in tests
TDD	Table A.2.3.2.1-3a		5	QPSK	1/3	20		≥ 1	
TDD	Table A.2.3.2.1-3a		5	QPSK	1/3	24		≥ 1	Not yet used in tests
TDD, Partial RB allocation, QPSK, 10 MHz									
TDD	Table A.2.3.2.1-4		10	QPSK	1/3	1		≥ 1	
TDD	Table A.2.3.2.1-4		10	QPSK	1/3	2		≥ 1	Not yet used in tests
TDD	Table A.2.3.2.1-4		10	QPSK	1/3	5		≥ 1	Not yet used in tests
TDD	Table A.2.3.2.1-4		10	QPSK	1/3	6		≥ 1	
TDD	Table A.2.3.2.1-4		10	QPSK	1/3	8		≥ 1	Not yet used in tests
TDD	Table A.2.3.2.1-4		10	QPSK	1/3	10		≥ 1	Not yet used in tests
TDD	Table A.2.3.2.1-4a		10	QPSK	1/3	12		≥ 1	
TDD	Table A.2.3.2.1-4a		10	QPSK	1/3	16		≥ 1	Not yet used in tests
TDD	Table A.2.3.2.1-4a		10	QPSK	1/3	18		≥ 1	Not yet used in tests
TDD	Table A.2.3.2.1-4a		10	QPSK	1/3	20		≥ 1	Not yet used in tests
TDD	Table A.2.3.2.1-4a		10	QPSK	1/3	24		≥ 1	
TDD	Table A.2.3.2.1-4a		10	QPSK	1/3	25		≥ 1	
TDD	Table A.2.3.2.1-4b		10	QPSK	1/3	27		≥ 1	Not yet used in tests
TDD	Table A.2.3.2.1-4b		10	QPSK	1/3	30		≥ 1	Not yet used in tests
TDD	Table A.2.3.2.1-4b		10	QPSK	1/3	36		≥ 1	
TDD	Table A.2.3.2.1-4b		10	QPSK	1/3	40		≥ 1	Not yet used in tests
TDD	Table A.2.3.2.1-4b		10	QPSK	1/3	48		≥ 1	
TDD, Partial RB allocation, QPSK, 15 MHz									
TDD	Table A.2.3.2.1-5		15	QPSK	1/3	1		≥ 1	
TDD	Table A.2.3.2.1-5		15	QPSK	1/3	2		≥ 1	Not yet used in tests
TDD	Table A.2.3.2.1-5		15	QPSK	1/3	5		≥ 1	Not yet used in tests
TDD	Table A.2.3.2.1-5		15	QPSK	1/3	6		≥ 1	Not yet used in tests
TDD	Table A.2.3.2.1-5		15	QPSK	1/3	8		≥ 1	
TDD	Table A.2.3.2.1-5		15	QPSK	1/3	10		≥ 1	Not yet used in tests
TDD	Table A.2.3.2.1-5a		15	QPSK	1/3	16		≥ 1	
TDD	Table A.2.3.2.1-5a		15	QPSK	1/3	18		≥ 1	
TDD	Table A.2.3.2.1-5a		15	QPSK	1/3	20		≥ 1	Not yet used in tests
TDD	Table A.2.3.2.1-5a		15	QPSK	1/3	24		≥ 1	Not yet used in tests

TDD	Table A.2.3.2.1-5a		15	QPSK	1/3	25		≥ 1	Not yet used in tests
TDD	Table A.2.3.2.1-5a		15	QPSK	1/3	27		≥ 1	Not yet used in tests
TDD	Table A.2.3.2.1-5b		15	QPSK	1/3	36		≥ 1	
TDD	Table A.2.3.2.1-5b		15	QPSK	1/3	40		≥ 1	Not yet used in tests
TDD	Table A.2.3.2.1-5b		15	QPSK	1/3	48		≥ 1	Not yet used in tests
TDD	Table A.2.3.2.1-5b		15	QPSK	1/3	50		≥ 1	
TDD	Table A.2.3.2.1-5b		15	QPSK	1/3	54		≥ 1	
TDD, Partial RB allocation, QPSK, 20 MHz									
TDD	Table A.2.3.2.1-6		20	QPSK	1/3	1		≥ 1	
TDD	Table A.2.3.2.1-6		20	QPSK	1/3	2		≥ 1	Not yet used in tests
TDD	Table A.2.3.2.1-6		20	QPSK	1/3	5		≥ 1	Not yet used in tests
TDD	Table A.2.3.2.1-6		20	QPSK	1/3	6		≥ 1	Not yet used in tests
TDD	Table A.2.3.2.1-6		20	QPSK	1/3	8		≥ 1	Not yet used in tests
TDD	Table A.2.3.2.1-6		20	QPSK	1/5	10		≥ 1	
TDD	Table A.2.3.2.1-6a		20	QPSK	1/5	18		≥ 1	
TDD	Table A.2.3.2.1-6a		20	QPSK	1/3	20		≥ 1	Not yet used in tests
TDD	Table A.2.3.2.1-6a		20	QPSK	1/3	24		≥ 1	Not yet used in tests
TDD	Table A.2.3.2.1-6a		20	QPSK	1/3	25		≥ 1	
TDD	Table A.2.3.2.1-6a		20	QPSK	1/3	48		≥ 1	Not yet used in tests
TDD	Table A.2.3.2.1-6a		20	QPSK	1/3	50		≥ 1	
TDD	Table A.2.3.2.1-6b		20	QPSK	1/3	54		≥ 1	
TDD	Table A.2.3.2.1-6b		20	QPSK	1/5	75		≥ 1	
TDD, Partial RB allocation, 16-QAM, 1.4 MHz									
TDD	Table A.2.3.2.2-1		1.4	16QAM	3/4	1		≥ 1	
TDD	Table A.2.3.2.2-1		1.4	16QAM	3/4	5		≥ 1	
TDD, Partial RB allocation, 16-QAM, 3 MHz									
TDD	Table A.2.3.2.2-2		3	16QAM	3/4	1		≥ 1	Not yet used in tests
TDD	Table A.2.3.2.2-2		3	16QAM	3/4	4		≥ 1	
TDD, Partial RB allocation, 16-QAM, 5 MHz									
TDD	Table A.2.3.2.2-3		5	16QAM	3/4	1		≥ 1	Not yet used in tests
TDD	Table A.2.3.2.2-3		5	16QAM	3/4	8		≥ 1	
TDD, Partial RB allocation, 16-QAM, 10 MHz									
TDD	Table A.2.3.2.2-4		10	16QAM	3/4	1		≥ 1	
TDD	Table A.2.3.2.2-4		10	16QAM	3/4	12		≥ 1	
TDD	Table A.2.3.2.2-4		10	16QAM	1/2	16		≥ 1	Not yet used in tests
TDD	Table A.2.3.2.2-4		10	16QAM	1/3	24		≥ 1	
TDD	Table A.2.3.2.2-4		10	16QAM	3/4	30		≥ 2	Not yet used in tests
TDD	Table A.2.3.2.2-4		10	16QAM	3/4	36		≥ 2	Not yet used in tests
TDD, Partial RB allocation, 16-QAM, 15 MHz									
TDD	Table A.2.3.2.2-5		15	16QAM	3/4	1		≥ 1	Not yet used in tests
TDD	Table A.2.3.2.2-5		15	16QAM	1/2	16		≥ 1	
TDD	Table A.2.3.2.2-5		15	16QAM	3/4	36		≥ 2	
TDD, Partial RB allocation, 16-QAM, 20 MHz									
TDD	Table A.2.3.2.2-6		20	16QAM	3/4	1		≥ 1	Not yet used in tests
TDD	Table A.2.3.2.2-6		20	16QAM	1/2	18		≥ 1	
TDD	Table A.2.3.2.2-6		20	16QAM	3/4	50		≥ 2	
TDD	Table A.2.3.2.2-6		20	16QAM	1/2	75		≥ 2	Not yet used in tests
TDD, Sustained data rate									

TDD	Table A.2.3.3-1	R.1-1 TDD	10	QPSK	0.43	40		≥ 1	
TDD	Table A.2.3.3-1	R.1-2 TDD	10	QPSK	0.61	40		≥ 2	
TDD	Table A.2.3.3-1	R.1-3 TDD	20	QPSK	0.49	90		≥ 2	
TDD	Table A.2.3.3-1	R.1-3B TDD	15	QPSK	0.42	60		≥ 2	
TDD	Table A.2.3.3-1	R.1-4 TDD	20	QPSK	0.49	90		≥ 2	

A.2.2 Reference measurement channels for FDD

A.2.2.1 Full RB allocation

A.2.2.1.1 QPSK

Table A.2.2.1.1-1: Reference Channels for QPSK with full RB allocation

Parameter	Unit	Value					
		1.4	3	5	10	15	20
Channel bandwidth	MHz	1.4	3	5	10	15	20
Allocated resource blocks		6	15	25	50	75	100
DFT-OFDM Symbols per Sub-Frame		12	12	12	12	12	12
Modulation		QPSK	QPSK	QPSK	QPSK	QPSK	QPSK
Target Coding rate		1/3	1/3	1/3	1/3	1/5	1/6
Payload size	Bits	600	1544	2216	5160	4392	4584
Transport block CRC	Bits	24	24	24	24	24	24
Number of code blocks per Sub-Frame (Note 1)		1	1	1	1	1	1
Total number of bits per Sub-Frame (Note 1)	Bits	1728	4320	7200	14400	21600	28800
Total symbols per Sub-Frame		864	2160	3600	7200	10800	14400
UE Category		≥ 1	≥ 1	≥ 1	≥ 1	≥ 1	≥ 1

Note 1: If more than one Code Block is present, an additional CRC sequence of L = 24 Bits is attached to each Code Block (otherwise L = 0 Bit)

A.2.2.1.2 16-QAM

Table A.2.2.1.2-1: Reference Channels for 16-QAM with full RB allocation

Parameter	Unit	Value					
		1.4	3	5	10	15	20
Channel bandwidth	MHz	1.4	3	5	10	15	20
Allocated resource blocks		6	15	25	50	75	100
DFT-OFDM Symbols per Sub-Frame		12	12	12	12	12	12
Modulation		16QAM	16QAM	16QAM	16QAM	16QAM	16QAM
Target Coding rate		3/4	1/2	1/3	3/4	1/2	1/3
Payload size	Bits	2600	4264	4968	21384	21384	19848
Transport block CRC	Bits	24	24	24	24	24	24
Number of code blocks per Sub-Frame (Note 1)		1	1	1	4	4	4
Total number of bits per Sub-Frame	Bits	3456	8640	14400	28800	43200	57600
Total symbols per Sub-Frame		864	2160	3600	7200	10800	14400
UE Category		≥ 1	≥ 1	≥ 1	≥ 2	≥ 2	≥ 2

Note 1: If more than one Code Block is present, an additional CRC sequence of L = 24 Bits is attached to each Code Block (otherwise L = 0 Bit)

A.2.2.2 Partial RB allocation

For each channel bandwidth, various partial RB allocations are specified. The number of allocated RBs is chosen according to values specified in the Tx and Rx requirements. The single allocated RB case is included.

The allocated RBs are contiguous and start from one end of the channel bandwidth. A single allocated RB is at one end of the channel bandwidth.

A.2.2.2.1 QPSK

Table A.2.2.2.1-1: Reference Channels for 1.4MHz QPSK with partial RB allocation

Parameter	Unit	Value	Value	Value	Value	Value
Channel bandwidth	MHz	1.4	1.4	1.4	1.4	1.4
Allocated resource blocks		1	2	3	4	5
DFT-OFDM Symbols per Sub-Frame		12	12	12	12	12
Modulation		QPSK	QPSK	QPSK	QPSK	QPSK
Target Coding rate		1/3	1/3	1/3	1/3	1/3
Payload size	Bits	72	176	256	392	424
Transport block CRC	Bits	24	24	24	24	24
Number of code blocks per Sub-Frame (Note 1)		1	1	1	1	1
Total number of bits per Sub-Frame	Bits	288	576	864	1152	1440
Total symbols per Sub-Frame		144	288	432	576	720
UE Category		≥ 1	≥ 1	≥ 1	≥ 1	≥ 1

Note 1: If more than one Code Block is present, an additional CRC sequence of L = 24 Bits is attached to each Code Block (otherwise L = 0 Bit)

Table A.2.2.2.1-2: Reference Channels for 3MHz QPSK with partial RB allocation

Parameter	Unit	Value	Value	Value	Value	Value	Value	Value
Channel bandwidth	MHz	3	3	3	3	3	3	3
Allocated resource blocks		1	2	3	4	5	6	10
DFT-OFDM Symbols per Sub-Frame		12	12	12	12	12	12	12
Modulation		QPSK	QPSK	QPSK	QPSK	QPSK	QPSK	QPSK
Target Coding rate		1/3	1/3	1/3	1/3	1/3	1/3	1/3
Payload size	Bits	72	176	256	392	424	600	872
Transport block CRC	Bits	24	24	24	24	24	24	24
Number of code blocks per Sub-Frame (Note 1)		1	1	1	1	1	1	1
Total number of bits per Sub-Frame	Bits	288	576	864	1152	1440	1728	2880
Total symbols per Sub-Frame		144	288	432	576	720	864	1440
UE Category		≥ 1	≥ 1	≥ 1	≥ 1	≥ 1	≥ 1	≥ 1

Note 1: If more than one Code Block is present, an additional CRC sequence of L = 24 Bits is attached to each Code Block (otherwise L = 0 Bit)

Table A.2.2.2.1-3: Reference Channels for 5MHz QPSK with partial RB allocation

Parameter	Unit	Value	Value	Value	Value	Value
Channel bandwidth	MHz	5	5	5	5	5
Allocated resource blocks		1	2	5	6	8
DFT-OFDM Symbols per Sub-Frame		12	12	12	12	12
Modulation		QPSK	QPSK	QPSK	QPSK	QPSK
Target Coding rate		1/3	1/3	1/3	1/3	1/3
Payload size	Bits	72	176	424	600	808
Transport block CRC	Bits	24	24	24	24	24
Number of code blocks per Sub-Frame (Note 1)		1	1	1	1	1
Total number of bits per Sub-Frame	Bits	288	576	1440	1728	2304
Total symbols per Sub-Frame		144	288	720	864	1152
UE Category		≥ 1	≥ 1	≥ 1	≥ 1	≥ 1

Note 1: If more than one Code Block is present, an additional CRC sequence of L = 24 Bits is attached to each Code Block (otherwise L = 0 Bit)

Table A.2.2.2.1-3a: Reference Channels for 5MHz QPSK with partial RB allocation

Parameter	Unit	Value	Value	Value	Value	Value
Channel bandwidth	MHz	5	5	5	5	5
Allocated resource blocks		10	15	18	20	24
DFT-OFDM Symbols per Sub-Frame		12	12	12	12	12
Modulation		QPSK	QPSK	QPSK	QPSK	QPSK
Target Coding rate		1/3	1/3	1/3	1/3	1/3
Payload size	Bits	872	1320	1864	1736	2472
Transport block CRC	Bits	24	24	24	24	24
Number of code blocks per Sub-Frame (Note 1)		1	1	1	1	1
Total number of bits per Sub-Frame	Bits	2880	4320	5184	5760	6912
Total symbols per Sub-Frame		1440	2160	2592	2880	3456
UE Category		≥ 1	≥ 1	≥ 1	≥ 1	≥ 1

Note 1: If more than one Code Block is present, an additional CRC sequence of L = 24 Bits is attached to each Code Block (otherwise L = 0 Bit)

Table A.2.2.2.1-4: Reference Channels for 10MHz QPSK with partial RB allocation

Parameter	Unit	Value	Value	Value	Value	Value	Value
Channel bandwidth	MHz	10	10	10	10	10	10
Allocated resource blocks		1	2	5	6	8	10
DFT-OFDM Symbols per Sub-Frame		12	12	12	12	12	12
Modulation		QPSK	QPSK	QPSK	QPSK	QPSK	QPSK
Target Coding rate		1/3	1/3	1/3	1/3	1/3	1/3
Payload size	Bits	72	176	424	600	808	872
Transport block CRC	Bits	24	24	24	24	24	24
Number of code blocks per Sub-Frame (Note 1)		1	1	1	1	1	1
Total number of bits per Sub-Frame	Bits	288	576	1440	1728	2304	2880
Total symbols per Sub-Frame		144	288	720	864	1152	1440
UE Category		≥ 1	≥ 1	≥ 1	≥ 1	≥ 1	≥ 1

Note 1: If more than one Code Block is present, an additional CRC sequence of L = 24 Bits is attached to each Code Block (otherwise L = 0 Bit)

Table A.2.2.2.1-4a: Reference Channels for 10MHz QPSK with partial RB allocation

Parameter	Unit	Value	Value	Value	Value	Value	Value	Value
Channel bandwidth	MHz	10	10	10	10	10	10	10
Allocated resource blocks		12	15	16	18	20	24	25
DFT-OFDM Symbols per Sub-Frame		12	12	12	12	12	12	12
Modulation		QPSK	QPSK	QPSK	QPSK	QPSK	QPSK	QPSK
Target Coding rate		1/3	1/3	1/3	1/3	1/3	1/3	1/3
Payload size	Bits	1224	1320	1384	1864	1736	2472	2216
Transport block CRC	Bits	24	24	24	24	24	24	24
Number of code blocks per Sub-Frame (Note 1)		1	1	1	1	1	1	1
Total number of bits per Sub-Frame	Bits	3456	4320	4608	5184	5760	6912	7200
Total symbols per Sub-Frame		1728	2160	2304	2592	2880	3456	3600
UE Category		≥ 1	≥ 1	≥ 1	≥ 1	≥ 1	≥ 1	≥ 1

Note 1: If more than one Code Block is present, an additional CRC sequence of L = 24 Bits is attached to each Code Block (otherwise L = 0 Bit)

Table A.2.2.1-4b: Reference Channels for 10MHz QPSK with partial RB allocation

Parameter	Unit	Value	Value	Value	Value	Value	Value	Value
Channel bandwidth	MHz	10	10	10	10	10	10	10
Allocated resource blocks		27	30	32	36	40	45	48
DFT-OFDM Symbols per Sub-Frame		12	12	12	12	12	12	12
Modulation		QPSK	QPSK	QPSK	QPSK	QPSK	QPSK	QPSK
Target Coding rate		1/3	1/3	1/3	1/3	1/3	1/3	1/3
Payload size	Bits	2792	2664	2792	3752	4136	4008	4264
Transport block CRC	Bits	24	24	24	24	24	24	24
Number of code blocks per Sub-Frame (Note 1)		1	1	1	1	1	1	1
Total number of bits per Sub-Frame	Bits	7776	8640	9216	10368	11520	12960	13824
Total symbols per Sub-Frame		3888	4320	4608	5184	5760	6480	6912
UE Category		≥ 1	≥ 1	≥ 1	≥ 1	≥ 1	≥ 1	≥ 1
Note 1: If more than one Code Block is present, an additional CRC sequence of L = 24 Bits is attached to each Code Block (otherwise L = 0 Bit)								

Table A.2.2.1-5: Reference Channels for 15MHz QPSK with partial RB allocation

Parameter	Unit	Value	Value	Value	Value	Value	Value
Channel bandwidth	MHz	15	15	15	15	15	15
Allocated resource blocks		1	2	5	6	8	9
DFT-OFDM Symbols per Sub-Frame		12	12	12	12	12	12
Modulation		QPSK	QPSK	QPSK	QPSK	QPSK	QPSK
Target Coding rate		1/3	1/3	1/3	1/3	1/3	1/3
Payload size	Bits	72	176	424	600	808	776
Transport block CRC	Bits	24	24	24	24	24	24
Number of code blocks per Sub-Frame (Note 1)		1	1	1	1	1	1
Total number of bits per Sub-Frame	Bits	288	576	1440	1728	2304	2592
Total symbols per Sub-Frame		144	288	720	864	1152	1296
UE Category		≥ 1	≥ 1	≥ 1	≥ 1	≥ 1	≥ 1
Note 1: If more than one Code Block is present, an additional CRC sequence of L = 24 Bits is attached to each Code Block (otherwise L = 0 Bit)							

Table A.2.2.1-5a: Reference Channels for 15MHz QPSK with partial RB allocation

Parameter	Unit	Value	Value	Value	Value	Value	Value
Channel bandwidth	MHz	15	15	15	15	15	15
Allocated resource blocks		10	16	18	20	24	25
DFT-OFDM Symbols per Sub-Frame		12	12	12	12	12	12
Modulation		QPSK	QPSK	QPSK	QPSK	QPSK	QPSK
Target Coding rate		1/3	1/3	1/3	1/3	1/3	1/3
Payload size	Bits	872	1384	1864	1736	2472	2216
Transport block CRC	Bits	24	24	24	24	24	24
Number of code blocks per Sub-Frame (Note 1)		1	1	1	1	1	1
Total number of bits per Sub-Frame	Bits	2880	4608	5184	5760	6912	7200
Total symbols per Sub-Frame		1440	2304	2592	2880	3456	3600
UE Category		≥ 1	≥ 1	≥ 1	≥ 1	≥ 1	≥ 1
Note 1: If more than one Code Block is present, an additional CRC sequence of L = 24 Bits is attached to each Code Block (otherwise L = 0 Bit)							

Table A.2.2.1-5b: Reference Channels for 15MHz QPSK with partial RB allocation

Parameter	Unit	Value	Value	Value	Value	Value	Value	Value
Channel bandwidth	MHz	15	15	15	15	15	15	15
Allocated resource blocks		27	36	40	48	50	54	60
DFT-OFDM Symbols per Sub-Frame		12	12	12	12	12	12	12
Modulation		QPSK	QPSK	QPSK	QPSK	QPSK	QPSK	QPSK
Target Coding rate		1/3	1/3	1/3	1/3	1/3	1/3	1/3
Payload size	Bits	2792	3752	4136	4264	5160	4776	4264
Transport block CRC	Bits	24	24	24	24	24	24	24
Number of code blocks per Sub-Frame (Note 1)		1	1	1	1	1	1	1
Total number of bits per Sub-Frame	Bits	7776	10368	11520	13824	14400	15552	17280
Total symbols per Sub-Frame		3888	5184	5760	6912	7200	7776	8640
UE Category		≥ 1	≥ 1	≥ 1	≥ 1	≥ 1	≥ 1	≥ 1

Note 1: If more than one Code Block is present, an additional CRC sequence of L = 24 Bits is attached to each Code Block (otherwise L = 0 Bit)

Table A.2.2.1-6: Reference Channels for 20MHz QPSK with partial RB allocation

Parameter	Unit	Value	Value	Value	Value	Value	Value
Channel bandwidth	MHz	20	20	20	20	20	20
Allocated resource blocks		1	2	5	6	8	10
DFT-OFDM Symbols per Sub-Frame		12	12	12	12	12	12
Modulation		QPSK	QPSK	QPSK	QPSK	QPSK	QPSK
Target Coding rate		1/3	1/3	1/3	1/3	1/3	1/3
Payload size	Bits	72	176	424	600	808	872
Transport block CRC	Bits	24	24	24	24	24	24
Number of code blocks per Sub-Frame (Note 1)		1	1	1	1	1	1
Total number of bits per Sub-Frame	Bits	288	576	1440	1728	2304	2880
Total symbols per Sub-Frame		144	288	720	864	1152	1440
UE Category		≥ 1	≥ 1	≥ 1	≥ 1	≥ 1	≥ 1

Note 1: If more than one Code Block is present, an additional CRC sequence of L = 24 Bits is attached to each Code Block (otherwise L = 0 Bit)

Table A.2.2.1-6a: Reference Channels for 20MHz QPSK with partial RB allocation

Parameter	Unit	Value	Value	Value	Value	Value	Value
Channel bandwidth	MHz	20	20	20	20	20	20
Allocated resource blocks		16	18	20	24	25	48
DFT-OFDM Symbols per Sub-Frame		12	12	12	12	12	12
Modulation		QPSK	QPSK	QPSK	QPSK	QPSK	QPSK
Target Coding rate		1/3	1/3	1/3	1/3	1/3	1/3
Payload size	Bits	1384	1864	1736	2472	2216	4264
Transport block CRC	Bits	24	24	24	24	24	24
Number of code blocks per Sub-Frame (Note 1)		1	1	1	1	1	1
Total number of bits per Sub-Frame	Bits	4608	5184	5760	6912	7200	13824
Total symbols per Sub-Frame		2304	2592	2880	3456	3600	6912
UE Category		≥ 1	≥ 1	≥ 1	≥ 1	≥ 1	≥ 1

Note 1: If more than one Code Block is present, an additional CRC sequence of L = 24 Bits is attached to each Code Block (otherwise L = 0 Bit)

Table A.2.2.2.1-6b: Reference Channels for 20MHz QPSK with partial RB allocation

Parameter	Unit	Value	Value	Value
Channel bandwidth	MHz	20	20	20
Allocated resource blocks		50	54	75
DFT-OFDM Symbols per Sub-Frame		12	12	12
Modulation		QPSK	QPSK	QPSK
Target Coding rate		1/3	1/3	1/5
Payload size	Bits	5160	4776	4392
Transport block CRC	Bits	24	24	24
Number of code blocks per Sub-Frame (Note 1)		1	1	1
Total number of bits per Sub-Frame	Bits	14400	15552	21600
Total symbols per Sub-Frame		7200	7776	10800
UE Category		≥ 1	≥ 1	≥ 1
Note 1: If more than one Code Block is present, an additional CRC sequence of L = 24 Bits is attached to each Code Block (otherwise L = 0 Bit)				

A.2.2.2.2 16-QAM**Table A.2.2.2.2-1: Reference Channels for 1.4MHz 16-QAM with partial RB allocation**

Parameter	Unit	Value	Value
Channel bandwidth	MHz	1.4	1.4
Allocated resource blocks		1	5
DFT-OFDM Symbols per Sub-Frame		12	12
Modulation		16QAM	16QAM
Target Coding rate		3/4	3/4
Payload size	Bits	408	2152
Transport block CRC	Bits	24	24
Number of code blocks per Sub-Frame (Note 1)		1	1
Total number of bits per Sub-Frame	Bits	576	2880
Total symbols per Sub-Frame		144	720
UE Category		≥ 1	≥ 1
Note 1: If more than one Code Block is present, an additional CRC sequence of L = 24 Bits is attached to each Code Block (otherwise L = 0 Bit)			

Table A.2.2.2.2-2: Reference Channels for 3MHz 16-QAM with partial RB allocation

Parameter	Unit	Value	Value	Value
Channel bandwidth	MHz	3	3	3
Allocated resource blocks		1	4	6
DFT-OFDM Symbols per Sub-Frame		12	12	12
Modulation		16QAM	16QAM	16QAM
Target Coding rate		3/4	3/4	3/4
Payload size	Bits	408	1736	2600
Transport block CRC	Bits	24	24	24
Number of code blocks per Sub-Frame (Note 1)		1	1	1
Total number of bits per Sub-Frame	Bits	576	2304	3456
Total symbols per Sub-Frame		144	576	864
UE Category		≥ 1	≥ 1	≥ 1
Note 1: If more than one Code Block is present, an additional CRC sequence of L = 24 Bits is attached to each Code Block (otherwise L = 0 Bit)				

Table A.2.2.2-3: Reference Channels for 5MHz 16-QAM with partial RB allocation

Parameter	Unit	Value	Value
Channel bandwidth	MHz	5	5
Allocated resource blocks		1	8
DFT-OFDM Symbols per Sub-Frame		12	12
Modulation		16QAM	16QAM
Target Coding rate		3/4	3/4
Payload size	Bits	408	3496
Transport block CRC	Bits	24	24
Number of code blocks per Sub-Frame (Note 1)		1	1
Total number of bits per Sub-Frame	Bits	576	4608
Total symbols per Sub-Frame		144	1152
UE Category		≥ 1	≥ 1
Note 1: If more than one Code Block is present, an additional CRC sequence of L = 24 Bits is attached to each Code Block (otherwise L = 0 Bit)			

Table A.2.2.2-4: Reference Channels for 10MHz 16-QAM with partial RB allocation

Parameter	Unit	Value	Value	Value	Value	Value
Channel bandwidth	MHz	10	10	10	10	10
Allocated resource blocks		1	12	16	30	36
DFT-OFDM Symbols per Sub-Frame		12	12	12	12	12
Modulation		16QAM	16QAM	16QAM	16QAM	16QAM
Target Coding rate		3/4	3/4	1/2	3/4	3/4
Payload size	Bits	408	5160	4584	12960	15264
Transport block CRC	Bits	24	24	24	24	24
Number of code blocks per Sub-Frame (Note 1)		1	1	1	3	3
Total number of bits per Sub-Frame	Bits	576	6912	9216	17280	20736
Total symbols per Sub-Frame		144	1728	2304	4320	5184
UE Category		≥ 1	≥ 1	≥ 1	≥ 2	≥ 2
Note 1: If more than one Code Block is present, an additional CRC sequence of L = 24 Bits is attached to each Code Block (otherwise L = 0 Bit)						

Table A.2.2.2-5: Reference Channels for 15MHz 16-QAM with partial RB allocation

Parameter	Unit	Value	Value	Value	Value	Value	Value
Channel bandwidth	MHz	15	15	15	15	15	15
Allocated resource blocks		1	6	8	9	16	18
DFT-OFDM Symbols per Sub-Frame		12	12	12	12	12	12
Modulation		16QAM	16QAM	16QAM	16QAM	16QAM	16QAM
Target Coding rate		3/4	3/4	3/4	3/4	1/2	1/2
Payload size	Bits	408	2600	3496	3880	4584	5160
Transport block CRC	Bits	24	24	24	24	24	24
Number of code blocks per Sub-Frame (Note 1)		1	1	1	1	1	1
Total number of bits per Sub-Frame	Bits	576	3456	4608	5184	9216	10368
Total symbols per Sub-Frame		144	864	1152	1296	2304	2592
UE Category		≥ 1	≥ 1	≥ 1	≥ 1	≥ 1	≥ 1
Note 1: If more than one Code Block is present, an additional CRC sequence of L = 24 Bits is attached to each Code Block (otherwise L = 0 Bit)							

Table A.2.2.2-5a: Reference Channels for 15MHz 16-QAM with partial RB allocation

Parameter	Unit	Value	Value
Channel bandwidth	MHz	15	15
Allocated resource blocks		20	24
DFT-OFDM Symbols per Sub-Frame		12	12
Modulation		16QAM	16QAM
Target Coding rate		1/3	1/3
Payload size	Bits	4008	4776
Transport block CRC	Bits	24	24
Number of code blocks per Sub-Frame (Note 1)		1	1
Total number of bits per Sub-Frame	Bits	11520	13824
Total symbols per Sub-Frame		2880	3456
UE Category		≥ 1	≥ 1
Note 1: If more than one Code Block is present, an additional CRC sequence of L = 24 Bits is attached to each Code Block (otherwise L = 0 Bit)			

Table A.2.2.2-6: Reference Channels for 20MHz 16-QAM with partial RB allocation

Parameter	Unit	Value	Value	Value	Value	Value	Value	Value
Channel bandwidth	MHz	20	20	20	20	20	20	20
Allocated resource blocks		1	2	16	18	20	24	75
DFT-OFDM Symbols per Sub-Frame		12	12	12	12	12	12	12
Modulation		16QAM	16QAM	16QAM	16QAM	16QAM	16QAM	16QAM
Target Coding rate		3/4	3/4	1/2	1/2	1/3	1/3	1/2
Payload size	Bits	408	840	4584	5160	4008	4776	21384
Transport block CRC	Bits	24	24	24	24	24	24	24
Number of code blocks per Sub-Frame (Note 1)		1	1	1	1	1	1	4
Total number of bits per Sub-Frame	Bits	576	1152	9216	10368	11520	13824	43200
Total symbols per Sub-Frame		144	288	2304	2592	2880	3456	10800
UE Category		≥ 1	≥ 1	≥ 1	≥ 1	≥ 1	≥ 1	≥ 2
Note 1: If more than one Code Block is present, an additional CRC sequence of L = 24 Bits is attached to each Code Block (otherwise L = 0 Bit)								

A.2.2.3 Reference measurement channels for sustained downlink data rate provided by lower layers

Table A.2.2.3-1: Uplink Reference Channels for sustained data-rate test (FDD)

Parameter	Unit	Value					
		R.1-1 FDD	R.1-2 FDD	R.1-3 FDD	R.1-3A FDD	R.1-4 FDD	FFS
Reference Channel							
Channel Bandwidth	MHz	10	10	20	10	20	
Allocated Resource Blocks		40 (Note 2)	40 (Note 2)	90 (Note 3)	40(Note 2)	90 (Note 3)	
Allocated Sub-Frames per Radio-Frame		10	10	10	10	10	
DFT-OFDM Symbols per Sub-Frame		12	12	12	12	12	
Modulation		QPSK	QPSK	QPSK	QPSK	QPSK	
Coding Rate		0.31	0.31	0.31	0.31	0.31	
Information Bit Payload per Sub-Frame	Bits	3496	3496	7992	3496	7992	
Number of Code Blocks per Sub-Frame (Note 1)		1	1	2	1	2	
Modulation Symbols per Sub-Frame		5760	5760	12960	5760	12960	
Binary Channel Bits per Sub-Frame		11520	11520	25920	11520	25920	
Max Throughput over 1 Radio-Frame	Mbps	3.496	3.496	7.992	3.496	7.992	
UE Category		≥ 1	≥ 1	≥ 2	≥ 1	≥ 2	
Note 1:	If more than one Code Block is present, an additional CRC sequence of L = 24 Bits is attached to each Code Block (otherwise L = 0 Bit)						
Note 2:	RB-s 5-44 allocated with PUSCH.						
Note 3:	RB-s 5-94 allocated with PUSCH.						

A.2.3 Reference measurement channels for TDD

For TDD the measurement channel is based on DL/UL configuration ratio of 2DL:2UL.

A.2.3.1 Full RB allocation

A.2.3.1.1 QPSK

Table A.2.3.1.1-1: Reference Channels for QPSK with full RB allocation

Parameter	Unit	Value					
		1,4	3	5	10	15	20
Channel bandwidth	MHz						
Allocated resource blocks		6	15	25	50	75	100
Uplink-Downlink Configuration (Note 2)		1	1	1	1	1	1
DFT-OFDM Symbols per Sub-Frame		12	12	12	12	12	12
Modulation		QPSK	QPSK	QPSK	QPSK	QPSK	QPSK
Target Coding rate		1/3	1/3	1/3	1/3	1/5	1/6
Payload size							
For Sub-Frame 2,3,7,8	Bits	600	1544	2216	5160	4392	4584
Transport block CRC	Bits	24	24	24	24	24	24
Number of code blocks per Sub-Frame (Note 1)		1	1	1	1	1	1
Total number of bits per Sub-Frame							
For Sub-Frame 2,3,7,8	Bits	1728	4320	7200	14400	21600	28800
Total symbols per Sub-Frame							
For Sub-Frame 2,3,7,8		864	2160	3600	7200	10800	14400
UE Category		≥ 1	≥ 1	≥ 1	≥ 1	≥ 1	≥ 1
Note 1:	If more than one Code Block is present, an additional CRC sequence of L = 24 Bits is attached to each Code Block (otherwise L = 0 Bit)						
Note 2:	As per Table 4.2-2 in TS 36.211 [8]						

A.2.3.1.2 16-QAM

Table A.2.3.1.2-1: Reference Channels for 16-QAM with full RB allocation

Parameter	Unit	Value					
		1.4	3	5	10	15	20
Channel bandwidth	MHz	1.4	3	5	10	15	20
Allocated resource blocks		6	15	25	50	75	100
Uplink-Downlink Configuration (Note 2)		1	1	1	1	1	1
DFT-OFDM Symbols per Sub-Frame		12	12	12	12	12	12
Modulation		16QAM	16QAM	16QAM	16QAM	16QAM	16QAM
Target Coding rate		3/4	1/2	1/3	3/4	1/2	1/3
Payload size							
For Sub-Frame 2,3,7,8	Bits	2600	4264	4968	21384	21384	19848
Transport block CRC	Bits	24	24	24	24	24	24
Number of code blocks - C		1	1	1	4	4	4
Total number of bits per Sub-Frame							
For Sub-Frame 2,3,7,8	Bits	3456	8640	14400	28800	43200	57600
Total symbols per Sub-Frame							
For Sub-Frame 2,3,7,8		864	2160	3600	7200	10800	14400
UE Category		≥ 1	≥ 1	≥ 1	≥ 2	≥ 2	≥ 2
Note 1: If more than one Code Block is present, an additional CRC sequence of L = 24 Bits is attached to each Code Block (otherwise L = 0 Bit)							
Note 2: As per Table 4.2-2 in TS 36.211 [8]							

A.2.3.2 Partial RB allocation

For each channel bandwidth, various partial RB allocations are specified. The number of allocated RBs is chosen according to values specified in the Tx and Rx requirements. The single allocated RB case is included.

The allocated RBs are contiguous and start from one end of the channel bandwidth. A single allocated RB is at one end of the channel bandwidth.

A.2.3.2.1 QPSK

Table A.2.3.2.1-1: Reference Channels for 1.4MHz QPSK with partial RB allocation

Parameter	Unit	Value	Value	Value	Value	Value
Channel bandwidth	MHz	1.4	1.4	1.4	1.4	1.4
Allocated resource blocks		1	2	3	4	5
Uplink-Downlink Configuration (Note 2)		1	1	1	1	1
DFT-OFDM Symbols per Sub-Frame		12	12	12	12	12
Modulation		QPSK	QPSK	QPSK	QPSK	QPSK
Target Coding rate		1/3	1/3	1/3	1/3	1/3
Payload size						
For Sub-Frame 2,3,7,8	Bits	72	176	256	392	424
Transport block CRC	Bits	24	24	24	24	24
Number of code blocks per Sub-Frame (Note 1)		1	1	1	1	1
Total number of bits per Sub-Frame						
For Sub-Frame 2,3,7,8	Bits	288	576	864	1152	1440
Total symbols per Sub-Frame						
For Sub-Frame 2,3,7,8		144	288	432	576	720
UE Category		≥ 1	≥ 1	≥ 1	≥ 1	≥ 1
Note 1: If more than one Code Block is present, an additional CRC sequence of L = 24 Bits is attached to each Code Block (otherwise L = 0 Bit)						
Note 2: As per Table 4.2-2 in TS 36.211 [8]						

Table A.2.3.2.1-2: Reference Channels for 3MHz QPSK with partial RB allocation

Parameter	Unit	Value	Value	Value	Value	Value	Value	Value
Channel bandwidth	MHz	3	3	3	3	3	3	3
Allocated resource blocks		1	2	3	4	5	6	10
Uplink-Downlink Configuration (Note 2)		1	1	1	1	1	1	1
DFT-OFDM Symbols per Sub-Frame		12	12	12	12	12	12	12
Modulation		QPSK	QPSK	QPSK	QPSK	QPSK	QPSK	QPSK
Target Coding rate		1/3	1/3	1/3	1/3	1/3	1/3	1/3
Payload size								
For Sub-Frame 2,3,7,8	Bits	72	176	256	392	424	600	872
Transport block CRC	Bits	24	24	24	24	24	24	24
Number of code blocks per Sub-Frame (Note 1)		1	1	1	1	1	1	1
Total number of bits per Sub-Frame								
For Sub-Frame 2,3,7,8	Bits	288	576	864	1152	1440	1728	2880
Total symbols per Sub-Frame								
For Sub-Frame 2,3,7,8		144	288	432	576	720	864	1440
UE Category		≥ 1	≥ 1	≥ 1	≥ 1	≥ 1	≥ 1	≥ 1
Note 1:	If more than one Code Block is present, an additional CRC sequence of L = 24 Bits is attached to each Code Block (otherwise L = 0 Bit)							
Note 2:	As per Table 4.2-2 in TS 36.211 [8]							

Table A.2.3.2.1-3: Reference Channels for 5MHz QPSK with partial RB allocation

Parameter	Unit	Value	Value	Value	Value	Value
Channel bandwidth	MHz	5	5	5	5	5
Allocated resource blocks		1	2	5	6	8
Uplink-Downlink Configuration (Note 2)		1	1	1	1	1
DFT-OFDM Symbols per Sub-Frame		12	12	12	12	12
Modulation		QPSK	QPSK	QPSK	QPSK	QPSK
Target Coding rate		1/3	1/3	1/3	1/3	1/3
Payload size						
For Sub-Frame 2,3,7,8	Bits	72	176	424	600	808
Transport block CRC	Bits	24	24	24	24	24
Number of code blocks per Sub-Frame (Note 1)		1	1	1	1	1
Total number of bits per Sub-Frame	Bits					
For Sub-Frame 2,3,7,8		288	576	1440	1728	2304
Total symbols per Sub-Frame						
For Sub-Frame 2,3,7,8		144	288	720	864	1152
UE Category		≥ 1	≥ 1	≥ 1	≥ 1	≥ 1
Note 1:	If more than one Code Block is present, an additional CRC sequence of L = 24 Bits is attached to each Code Block (otherwise L = 0 Bit)					
Note 2:	As per Table 4.2-2 in TS 36.211 [8]					

Table A.2.3.2.1-3a: Reference Channels for 5MHz QPSK with partial RB allocation

Parameter	Unit	Value	Value	Value	Value	Value
Channel bandwidth	MHz	5	5	5	5	5
Allocated resource blocks		10	15	18	20	24
Uplink-Downlink Configuration (Note 2)		1	1	1	1	1
DFT-OFDM Symbols per Sub-Frame		12	12	12	12	12
Modulation		QPSK	QPSK	QPSK	QPSK	QPSK
Target Coding rate		1/3	1/3	1/3	1/3	1/3
Payload size						
For Sub-Frame 2,3,7,8	Bits	872	1320	1864	1736	2472
Transport block CRC	Bits	24	24	24	24	24
Number of code blocks per Sub-Frame (Note 1)		1	1	1	1	1
Total number of bits per Sub-Frame	Bits					
For Sub-Frame 2,3,7,8		2880	4320	5184	5760	6912
Total symbols per Sub-Frame						
For Sub-Frame 2,3,7,8		1440	2160	2592	2880	3456
UE Category		≥ 1	≥ 1	≥ 1	≥ 1	≥ 1
Note 1: If more than one Code Block is present, an additional CRC sequence of L = 24 Bits is attached to each Code Block (otherwise L = 0 Bit)						
Note 2: As per Table 4.2-2 in TS 36.211 [8]						

Table A.2.3.2.1-4: Reference Channels for 10MHz QPSK with partial RB allocation

Parameter	Unit	Value	Value	Value	Value	Value	Value
Channel bandwidth	MHz	10	10	10	10	10	10
Allocated resource blocks		1	2	5	6	8	10
Uplink-Downlink Configuration		1	1	1	1	1	1
DFT-OFDM Symbols per Sub-Frame		12	12	12	12	12	12
Modulation		QPSK	QPSK	QPSK	QPSK	QPSK	QPSK
Target Coding rate		1/3	1/3	1/3	1/3	1/3	1/3
Payload size							
For Sub-Frame 2,3,7,8	Bits	72	176	424	600	808	872
Transport block CRC	Bits	24	24	24	24	24	24
Number of code blocks per Sub-Frame (Note 1)		1	1	1	1	1	1
Total number of bits per Sub-Frame							
For Sub-Frame 2,3,7,8	Bits	288	576	1440	1728	2304	2880
Total symbols per Sub-Frame							
For Sub-Frame 2,3,7,8		144	288	720	864	1152	1440
UE Category		≥ 1	≥ 1	≥ 1	≥ 1	≥ 1	≥ 1
Note 1: If more than one Code Block is present, an additional CRC sequence of L = 24 Bits is attached to each Code Block (otherwise L = 0 Bit)							
Note 2: As per Table 4.2-2 in TS 36.211 [8]							

Table A.2.3.2.1-4a: Reference Channels for 10MHz QPSK with partial RB allocation

Parameter	Unit	Value	Value	Value	Value	Value	Value
Channel bandwidth	MHz	10	10	10	10	10	10
Allocated resource blocks		12	16	18	20	24	25
Uplink-Downlink Configuration		1	1	1	1	1	1
DFT-OFDM Symbols per Sub-Frame		12	12	12	12	12	12
Modulation		QPSK	QPSK	QPSK	QPSK	QPSK	QPSK
Target Coding rate		1/3	1/3	1/3	1/3	1/3	1/3
Payload size							
For Sub-Frame 2,3,7,8	Bits	1224	1384	1864	1736	2472	2216
Transport block CRC	Bits	24	24	24	24	24	24
Number of code blocks per Sub-Frame (Note 1)		1	1	1	1	1	1
Total number of bits per Sub-Frame							
For Sub-Frame 2,3,7,8	Bits	3456	4608	5184	5760	6912	7200
Total symbols per Sub-Frame							
For Sub-Frame 2,3,7,8		1728	2304	2592	2880	3456	3600
UE Category		≥ 1	≥ 1	≥ 1	≥ 1	≥ 1	≥ 1
Note 1: If more than one Code Block is present, an additional CRC sequence of L = 24 Bits is attached to each Code Block (otherwise L = 0 Bit)							
Note 2: As per Table 4.2-2 in TS 36.211 [8]							

Table A.2.3.2.1-4b: Reference Channels for 10MHz QPSK with partial RB allocation

Parameter	Unit	Value	Value	Value	Value	Value
Channel bandwidth	MHz	10	10	10	10	10
Allocated resource blocks		27	30	36	40	48
Uplink-Downlink Configuration		1	1	1	1	1
DFT-OFDM Symbols per Sub-Frame		12	12	12	12	12
Modulation		QPSK	QPSK	QPSK	QPSK	QPSK
Target Coding rate		1/3	1/3	1/3	1/3	1/3
Payload size						
For Sub-Frame 2,3,7,8	Bits	2792	2664	3752	4136	4264
Transport block CRC	Bits	24	24	24	24	24
Number of code blocks per Sub-Frame (Note 1)		1	1	1	1	1
Total number of bits per Sub-Frame						
For Sub-Frame 2,3,7,8	Bits	7776	8640	10368	11520	13824
Total symbols per Sub-Frame						
For Sub-Frame 2,3,7,8		3888	4320	5184	5760	6912
UE Category		≥ 1	≥ 1	≥ 1	≥ 1	≥ 1
Note 1: If more than one Code Block is present, an additional CRC sequence of L = 24 Bits is attached to each Code Block (otherwise L = 0 Bit)						
Note 2: As per Table 4.2-2 in TS 36.211 [8]						

Table A.2.3.2.1-5: Reference Channels for 15MHz QPSK with partial RB allocation

Parameter	Unit	Value	Value	Value	Value	Value	Value
Channel bandwidth	MHz	15	15	15	15	15	15
Allocated resource blocks		1	2	5	6	8	10
Uplink-Downlink Configuration		1	1	1	1	1	1
DFT-OFDM Symbols per Sub-Frame		12	12	12	12	12	12
Modulation		QPSK	QPSK	QPSK	QPSK	QPSK	QPSK
Target Coding rate		1/3	1/3	1/3	1/3	1/3	1/3
Payload size							
For Sub-Frame 2,3,7,8	Bits	72	176	424	600	808	872
Transport block CRC	Bits	24	24	24	24	24	24
Number of code blocks per Sub-Frame (Note 1)		1	1	1	1	1	1
Total number of bits per Sub-Frame							
For Sub-Frame 2,3,7,8	Bits	288	576	1440	1728	2304	2880
Total symbols per Sub-Frame							
For Sub-Frame 2,3,7,8		144	288	720	864	1152	1440
UE Category		≥ 1	≥ 1	≥ 1	≥ 1	≥ 1	≥ 1
Note 1: If more than one Code Block is present, an additional CRC sequence of L = 24 Bits is attached to each Code Block (otherwise L = 0 Bit)							
Note 2: As per Table 4.2-2 in TS 36.211 [8]							

Table A.2.3.2.1-5a: Reference Channels for 15MHz QPSK with partial RB allocation

Parameter	Unit	Value	Value	Value	Value	Value	Value
Channel bandwidth	MHz	15	15	15	15	15	15
Allocated resource blocks		16	18	20	24	25	27
Uplink-Downlink Configuration		1	1	1	1	1	1
DFT-OFDM Symbols per Sub-Frame		12	12	12	12	12	12
Modulation		QPSK	QPSK	QPSK	QPSK	QPSK	QPSK
Target Coding rate		1/3	1/3	1/3	1/3	1/3	1/3
Payload size							
For Sub-Frame 2,3,7,8	Bits	1384	1864	1736	2472	2216	2792
Transport block CRC	Bits	24	24	24	24	24	24
Number of code blocks per Sub-Frame (Note 1)		1	1	1	1	1	1
Total number of bits per Sub-Frame							
For Sub-Frame 2,3,7,8	Bits	4608	5184	5760	6912	7200	7776
Total symbols per Sub-Frame							
For Sub-Frame 2,3,7,8		2304	2592	2880	3456	3600	3888
UE Category		≥ 1	≥ 1	≥ 1	≥ 1	≥ 1	≥ 1
Note 1: If more than one Code Block is present, an additional CRC sequence of L = 24 Bits is attached to each Code Block (otherwise L = 0 Bit)							
Note 2: As per Table 4.2-2 in TS 36.211 [8]							

Table A.2.3.2.1-5b: Reference Channels for 15MHz QPSK with partial RB allocation

Parameter	Unit	Value	Value	Value	Value	Value
Channel bandwidth	MHz	15	15	15	15	15
Allocated resource blocks		36	40	48	50	54
Uplink-Downlink Configuration		1	1	1	1	1
DFT-OFDM Symbols per Sub-Frame		12	12	12	12	12
Modulation		QPSK	QPSK	QPSK	QPSK	QPSK
Target Coding rate		1/3	1/3	1/3	1/3	1/3
Payload size						
For Sub-Frame 2,3,7,8	Bits	3752	4136	4264	5160	4776
Transport block CRC	Bits	24	24	24	24	24
Number of code blocks per Sub-Frame (Note 1)		1	1	1	1	1
Total number of bits per Sub-Frame						
For Sub-Frame 2,3,7,8	Bits	10368	11520	13824	14400	15552
Total symbols per Sub-Frame						
For Sub-Frame 2,3,7,8		5184	5760	6912	7200	7776
UE Category		≥ 1	≥ 1	≥ 1	≥ 1	≥ 1
Note 1: If more than one Code Block is present, an additional CRC sequence of L = 24 Bits is attached to each Code Block (otherwise L = 0 Bit)						
Note 2: As per Table 4.2-2 in TS 36.211 [8]						

Table A.2.3.2.1-6: Reference Channels for 20MHz QPSK with partial RB allocation

Parameter	Unit	Value	Value	Value	Value	Value	Value
Channel bandwidth	MHz	20	20	20	20	20	20
Allocated resource blocks		1	2	5	6	8	10
Uplink-Downlink Configuration (Note 2)		1	1	1	1	1	1
DFT-OFDM Symbols per Sub-Frame		12	12	12	12	12	12
Modulation		QPSK	QPSK	QPSK	QPSK	QPSK	QPSK
Target Coding rate		1/3	1/3	1/3	1/3	1/3	1/3
Payload size							
For Sub-Frame 2,3,7,8	Bits	72	176	424	600	808	872
Transport block CRC	Bits	24	24	24	24	24	24
Number of code blocks per Sub-Frame (Note 1)		1	1	1	1	1	1
Total number of bits per Sub-Frame							
For Sub-Frame 2,3,7,8	Bits	288	576	1440	1728	2304	2880
Total symbols per Sub-Frame							
For Sub-Frame 2,3,7,8		144	288	720	864	1152	1440
UE Category		≥ 1	≥ 1	≥ 1	≥ 1	≥ 1	≥ 1
Note 1: If more than one Code Block is present, an additional CRC sequence of L = 24 Bits is attached to each Code Block (otherwise L = 0 Bit)							
Note 2: As per Table 4.2-2 in TS 36.211 [8]							

Table A.2.3.2.1-6a: Reference Channels for 20MHz QPSK with partial RB allocation

Parameter	Unit	Value	Value	Value	Value	Value	Value
Channel bandwidth	MHz	20	20	20	20	20	20
Allocated resource blocks		18	20	24	25	48	50
Uplink-Downlink Configuration (Note 2)		1	1	1	1	1	1
DFT-OFDM Symbols per Sub-Frame		12	12	12	12	12	12
Modulation		QPSK	QPSK	QPSK	QPSK	QPSK	QPSK
Target Coding rate		1/3	1/3	1/3	1/3	1/3	1/3
Payload size							
For Sub-Frame 2,3,7,8	Bits	1864	1736	2472	2216	4264	5160
Transport block CRC	Bits	24	24	24	24	24	24
Number of code blocks per Sub-Frame (Note 1)		1	1	1	1	1	1
Total number of bits per Sub-Frame							
For Sub-Frame 2,3,7,8	Bits	5184	5760	6912	7200	13824	14400
Total symbols per Sub-Frame							
For Sub-Frame 2,3,7,8		2592	2880	3456	3600	6912	7200
UE Category		≥ 1	≥ 1	≥ 1	≥ 1	≥ 1	≥ 1
Note 1: If more than one Code Block is present, an additional CRC sequence of L = 24 Bits is attached to each Code Block (otherwise L = 0 Bit)							
Note 2: As per Table 4.2-2 in TS 36.211 [8]							

Table A.2.3.2.1-6b: Reference Channels for 20MHz QPSK with partial RB allocation

Parameter	Unit	Value	Value
Channel bandwidth	MHz	20	20
Allocated resource blocks		54	75
Uplink-Downlink Configuration (Note 2)		1	1
DFT-OFDM Symbols per Sub-Frame		12	12
Modulation		QPSK	QPSK
Target Coding rate		1/3	1/5
Payload size			
For Sub-Frame 2,3,7,8	Bits	4776	4392
Transport block CRC	Bits	24	24
Number of code blocks per Sub-Frame (Note 1)		1	1
Total number of bits per Sub-Frame			
For Sub-Frame 2,3,7,8	Bits	15552	21600
Total symbols per Sub-Frame			
For Sub-Frame 2,3,7,8		7776	10800
UE Category		≥ 1	≥ 1
Note 1: If more than one Code Block is present, an additional CRC sequence of L = 24 Bits is attached to each Code Block (otherwise L = 0 Bit)			
Note 2: As per Table 4.2-2 in TS 36.211 [8]			

A.2.3.2.2 16-QAM

Table A.2.3.2.2-1: Reference Channels for 1.4MHz 16-QAM with partial RB allocation

Parameter	Unit	Value	Value
Channel bandwidth	MHz	1.4	1.4
Allocated resource blocks		1	5
Uplink-Downlink Configuration (Note 2)		1	1
DFT-OFDM Symbols per Sub-Frame		12	12
Modulation		16QAM	16QAM
Target Coding rate		3/4	3/4
Payload size			
For Sub-Frame 2,3,7,8	Bits	408	2152
Transport block CRC	Bits	24	24
Number of code blocks per Sub-Frame (Note 1)		1	1
Total number of bits per Sub-Frame			
For Sub-Frame 2,3,7,8	Bits	576	2880
Total symbols per Sub-Frame			
For Sub-Frame 2,3,7,8		144	720
UE Category		≥ 1	≥ 1
Note 1: If more than one Code Block is present, an additional CRC sequence of L = 24 Bits is attached to each Code Block (otherwise L = 0 Bit)			
Note 2: As per Table 4.2-2 in TS 36.211 [8]			

Table A.2.3.2.2-2: Reference Channels for 3MHz 16-QAM with partial RB allocation

Parameter	Unit	Value	Value
Channel bandwidth	MHz	3	3
Allocated resource blocks		1	4
Uplink-Downlink Configuration (Note 2)		1	1
DFT-OFDM Symbols per Sub-Frame		12	12
Modulation		16QAM	16QAM
Target Coding rate		3/4	3/4
Payload size			
For Sub-Frame 2,3,7,8	Bits	408	1736
Transport block CRC	Bits	24	24
Number of code blocks per Sub-Frame (Note 1)		1	1
Total number of bits per Sub-Frame			
For Sub-Frame 2,3,7,8	Bits	576	2304
Total symbols per Sub-Frame			
For Sub-Frame 2,3,7,8		144	576
UE Category		≥ 1	≥ 1
Note 1: If more than one Code Block is present, an additional CRC sequence of L = 24 Bits is attached to each Code Block (otherwise L = 0 Bit)			
Note 2: As per Table 4.2-2 in TS 36.211 [8]			

Table A.2.3.2.2-3: Reference Channels for 5MHz 16-QAM with partial RB allocation

Parameter	Unit	Value	Value
Channel bandwidth	MHz	5	5
Allocated resource blocks		1	8
Uplink-Downlink Configuration (Note 2)		1	1
DFT-OFDM Symbols per Sub-Frame		12	12
Modulation		16QAM	16QAM
Target Coding rate		3/4	3/4
Payload size			
For Sub-Frame 2,3,7,8	Bits	408	3496
Transport block CRC	Bits	24	24
Number of code blocks per Sub-Frame (Note 1)		1	1
Total number of bits per Sub-Frame			
For Sub-Frame 2,3,7,8	Bits	576	4608
Total symbols per Sub-Frame			
For Sub-Frame 2,3,7,8		144	1152
UE Category		≥ 1	≥ 1
Note 1: If more than one Code Block is present, an additional CRC sequence of L = 24 Bits is attached to each Code Block (otherwise L = 0 Bit)			
Note 2: As per Table 4.2-2 in TS 36.211 [8]			

Table A.2.3.2.2-4: Reference Channels for 10MHz 16-QAM with partial RB allocation

Parameter	Unit	Value	Value	Value	Value	Value	Value
Channel bandwidth	MHz	10	10	10	10	10	10
Allocated resource blocks		1	12	16	24	30	36
Uplink-Downlink Configuration (Note 2)		1	1	1	1	1	1
DFT-OFDM Symbols per Sub-Frame		12	12	12	12	12	12
Modulation		16QAM	16QAM	16QAM	16QAM	16QAM	16QAM
Target Coding rate		3/4	3/4	1/2	1/3	3/4	3/4
Payload size							
For Sub-Frame 2,3,7,8	Bits	408	5160	4584	4776	12960	15264
Transport block CRC	Bits	24	24	24	24	24	24
Number of code blocks per Sub-Frame (Note 1)		1	1	1	1	3	3
Total number of bits per Sub-Frame							
For Sub-Frame 2,3,7,8	Bits	576	6912	9216	13824	17280	20736
Total symbols per Sub-Frame							
For Sub-Frame 2,3,7,8		144	1728	2304	3456	4320	5184
UE Category		≥ 1	≥ 1	≥ 1	≥ 1	≥ 2	≥ 2
Note 1: If more than one Code Block is present, an additional CRC sequence of L = 24 Bits is attached to each Code Block (otherwise L = 0 Bit)							
Note 2: As per Table 4.2-2 in TS 36.211 [8]							

Table A.2.3.2.2-5: Reference Channels for 15MHz 16-QAM with partial RB allocation

Parameter	Unit	Value	Value	Value
Channel bandwidth	MHz	15	15	15
Allocated resource blocks		1	16	36
Uplink-Downlink Configuration(Note 2)		1	1	1
DFT-OFDM Symbols per Sub-Frame		12	12	12
Modulation		16QAM	16QAM	16QAM
Target Coding rate		3/4	1/2	3/4
Payload size				
For Sub-Frame 2,3,7,8	Bits	408	4584	15264
Transport block CRC	Bits	24	24	24
Number of code blocks per Sub-Frame (Note 1)		1	1	3
Total number of bits per Sub-Frame				
For Sub-Frame 2,3,7,8	Bits	576	9216	20736
Total symbols per Sub-Frame				
For Sub-Frame 2,3,7,8		144	2304	5184
UE Category		≥ 1	≥ 1	≥ 2
Note 1: If more than one Code Block is present, an additional CRC sequence of L = 24 Bits is attached to each Code Block (otherwise L = 0 Bit)				
Note 2: As per Table 4.2-2 in TS 36.211 [8]				

Table A.2.3.2.2-6: Reference Channels for 20MHz 16-QAM with partial RB allocation

Parameter	Unit	Value	Value	Value	Value
Channel bandwidth	MHz	20	20	20	20
Allocated resource blocks		1	18	50	75
Uplink-Downlink Configuration (Note 2)		1	1	1	1
DFT-OFDM Symbols per Sub-Frame		12	12	12	12
Modulation		16QAM	16QAM	16QAM	16QAM
Target Coding rate		3/4	1/2	3/4	1/2
Payload size					
For Sub-Frame 2,3,7,8	Bits	408	5160	21384	21384
Transport block CRC	Bits	24	24	24	24
Number of code blocks per Sub-Frame (Note 1)		1	1	4	4
Total number of bits per Sub-Frame					
For Sub-Frame 2,3,7,8	Bits	576	10368	28800	43200
Total symbols per Sub-Frame					
For Sub-Frame 2,3,7,8		144	2592	7200	10800
UE Category		≥ 1	≥ 1	≥ 2	≥ 2
Note 1: If more than one Code Block is present, an additional CRC sequence of L = 24 Bits is attached to each Code Block (otherwise L = 0 Bit)					
Note 2: As per Table 4.2-2 in TS 36.211 [8]					

A.2.3.3 Reference measurement channels for sustained downlink data rate provided by lower layers

Table A.2.3.3-1: Uplink Reference Channels for sustained data-rate test (TDD)

Parameter	Unit	Value				
		R.1-1 TDD	R.1-2 TDD	R.1-3 TDD	R.1-3B TDD	R.1-4 TDD
Reference Channel						
Channel Bandwidth	MHz	10	10	20	15	20
Uplink-Downlink Configuration (Note 2)		5	5	5	1	1
Allocated Resource Blocks		40 (Note 3)	40 (Note 3)	90 (Note 5)	60 (Note 4)	90 (Note 5)
Allocated Sub-Frames per Radio-Frame		1	1	1	1	1
DFT-OFDM Symbols per Sub-Frame		12	12	12	12	12
Modulation		QPSK	QPSK	QPSK	QPSK	QPSK
Coding Rate						
For Sub-Frame 2		0.43	0.61	0.49	0.42	0.49
For Sub-Frame 3,7,8		n/a	n/a	n/a	0.42	0.49
Information Bit Payload per Sub-Frame	Bits					
For Sub-Frame 2		4968	6968	12576	7224	12576
For Sub-Frame 3,7,8		0	0	0	7224	12576
Number of Code Blocks per Sub-Frame (Note 1)						
For Sub-Frame 2		1	2	3	2	3
For Sub-Frame 3,7,8		0	0	0	2	3
Modulation Symbols per Sub-Frame						
For Sub-Frame 2		5760	5760	12960	8640	10240
For Sub-Frame 3,7,8		0	0	0	8640	10240
Binary Channel Bits per Sub-Frame						
For Sub-Frame 2		11520	11520	25920	17280	25920
For Sub-Frame 3,7,8		n/a	n/a	n/a	17280	25920
Max Throughput over 1 Radio-Frame	Mbps	0.4968	0.6968	1.2576	2.8896	5.0304
UE Category		≥ 1	≥ 2	≥ 2	≥ 2	≥ 2
Note 1: If more than one Code Block is present, an additional CRC sequence of L = 24 Bits is attached to each Code Block (otherwise L = 0 Bit)						
Note 2: As per Table 4.2-2 in TS 36.211 [8]						
Note 3: RB-s 5-44 allocated with PUSCH.						
Note 4: RB-s 7-66 allocated with PUSCH.						
Note 5: RB-s 5-94 allocated with PUSCH.						

A.3 DL reference measurement channels

A.3.1 General

The number of available channel bits varies across the sub-frames due to PBCH and PSS/SSS overhead. The payload size per sub-frame is varied in order to keep the code rate constant throughout a frame.

No user data is scheduled on subframes #5 in order to facilitate the transmission of system information blocks (SIB).

The algorithm for determining the payload size A is as follows; given a desired coding rate R and radio block allocation N_{RB}

1. Calculate the number of channel bits N_{ch} that can be transmitted during the first transmission of a given sub-frame.
2. Find A such that the resulting coding rate is as close to R as possible, that is,

$$\min |R - (A + 24) / N_{ch}|,$$

subject to

- a) A is a valid TB size (according to TS 36.213 [10] clause 7.1.7) assuming an allocation of N_{RB} resource blocks
 - b) Segmentation is not included in this formula, but should be considered in the TBS calculation
3. If there is more than one A that minimizes the equation above, then the larger value is chosen per default.
 4. For TDD, the measurement channel is based on DL/UL configuration ratio of 2DL+DwPTS (12 OFDM symbol); 2UL.

A.3.1.1 Overview of DL reference measurement channels

In Table A.3.1.1-1 are listed the DL reference measurement channels specified in annexes A.3.2 to A.3.9 of this release of TS 36.521-1. This table is informative and serves only to a better overview. The reference for the concrete reference measurement channels and corresponding implementation's parameters as to be used for testing are annexes A.3.2 to A.3.9 as appropriate.

Table A.3.1.1-1: Overview of DL reference measurement channels

Duple x	Table	Name	B W	Mod	TCR	RB	RB Off set	UE Cat eg	Notes
FDD, Receiver requirements									
FDD	Table A.3.2-1		1.4	QPSK	1/3	6		≥ 1	
FDD	Table A.3.2-1		3	QPSK	1/3	15		≥ 1	
FDD	Table A.3.2-1		5	QPSK	1/3	25		≥ 1	
FDD	Table A.3.2-1		10	QPSK	1/3	50		≥ 1	
FDD	Table A.3.2-1		15	QPSK	1/3	75		≥ 1	
FDD	Table A.3.2-1		20	QPSK	1/3	100		≥ 1	
TDD, Receiver requirements									
TDD	Table A.3.2-2		1.4	QPSK	1/3	6		≥ 1	
TDD	Table A.3.2-2		3	QPSK	1/3	15		≥ 1	
TDD	Table A.3.2-2		5	QPSK	1/3	25		≥ 1	
TDD	Table A.3.2-2		10	QPSK	1/3	50		≥ 1	
TDD	Table A.3.2-2		15	QPSK	1/3	75		≥ 1	
TDD	Table A.3.2-2		20	QPSK	1/3	100		≥ 1	
FDD, Receiver requirements, Maximum input level for UE Categories 3-5									
FDD	Table A.3.2-3		1.4	64QAM	3/4	6		-	
FDD	Table A.3.2-3		3	64QAM	3/4	15		-	
FDD	Table A.3.2-3		5	64QAM	3/4	25		-	
FDD	Table A.3.2-3		10	64QAM	3/4	50		-	
FDD	Table A.3.2-3		15	64QAM	3/4	75		-	
FDD	Table A.3.2-3		20	64QAM	3/4	100		-	
FDD, Receiver requirements, Maximum input level for UE Categories 1									
FDD	Table A.3.2-3a		1.4	64QAM	3/4	6		-	
FDD	Table A.3.2-3a		3	64QAM	3/4	15		-	
FDD	Table A.3.2-3a		5	64QAM	3/4	18		-	
FDD	Table A.3.2-3a		10	64QAM	3/4	17		-	
FDD	Table A.3.2-3a		15	64QAM	3/4	17		-	
FDD	Table A.3.2-3a		20	64QAM	3/4	17		-	
FDD, Receiver requirements, Maximum input level for UE Categories 2									
FDD	Table A.3.2-3b		1.4	64QAM	3/4	6		-	
FDD	Table A.3.2-3b		3	64QAM	3/4	15		-	
FDD	Table A.3.2-3b		5	64QAM	3/4	25		-	
FDD	Table A.3.2-3b		10	64QAM	3/4	50		-	
FDD	Table A.3.2-3b		15	64QAM	3/4	75		-	
FDD	Table A.3.2-3b		20	64QAM	3/4	83		-	
TDD, Receiver requirements, Maximum input level for UE Categories 3-5									
TDD	Table A.3.2-4		1.4	64QAM	3/4	6		-	
TDD	Table A.3.2-4		3	64QAM	3/4	15		-	
TDD	Table A.3.2-4		5	64QAM	3/4	25		-	
TDD	Table A.3.2-4		10	64QAM	3/4	50		-	
TDD	Table A.3.2-4		15	64QAM	3/4	75		-	
TDD	Table A.3.2-4		20	64QAM	3/4	100		-	
TDD, Receiver requirements, Maximum input level for UE Categories 1									
TDD	Table A.3.2-4a		1.4	64QAM	3/4	6		-	
TDD	Table A.3.2-4a		3	64QAM	3/4	15		-	

TDD	Table A.3.2-4a		5	64QAM	3/4	18		-	
TDD	Table A.3.2-4a		10	64QAM	3/4	17		-	
TDD	Table A.3.2-4a		15	64QAM	3/4	17		-	
TDD	Table A.3.2-4a		20	64QAM	3/4	17		-	
TDD, Receiver requirements, Maximum input level for UE Categories 2									
TDD	Table A.3.2-4b		1.4	64QAM	3/4	6		-	
TDD	Table A.3.2-4b		3	64QAM	3/4	15		-	
TDD	Table A.3.2-4b		5	64QAM	3/4	25		-	
TDD	Table A.3.2-4b		10	64QAM	3/4	50		-	
TDD	Table A.3.2-4b		15	64QAM	3/4	75		-	
TDD	Table A.3.2-4b		20	64QAM	3/4	83		-	
FDD, Transmitter requirements									
FDD	Table A.3.2A-1		1.4	QPSK	1/8-1/3	3		≥ 1	
FDD	Table A.3.2A-1		3	QPSK	1/3	4		≥ 1	
FDD	Table A.3.2A-1		5	QPSK	1/3	8		≥ 1	
FDD	Table A.3.2A-1		10	QPSK	1/3	16		≥ 1	
FDD	Table A.3.2A-1		15	QPSK	1/3	25		≥ 1	
FDD	Table A.3.2A-1		20	QPSK	1/3	30		≥ 1	
TDD, Transmitter requirements									
TDD	Table A.3.2A-2		1.4	QPSK	1/8-1/3	3		≥ 1	
TDD	Table A.3.2A-2		3	QPSK	1/3	4		≥ 1	
TDD	Table A.3.2A-2		5	QPSK	1/3	8		≥ 1	
TDD	Table A.3.2A-2		10	QPSK	1/3	16		≥ 1	
TDD	Table A.3.2A-2		15	QPSK	1/3	25		≥ 1	
TDD	Table A.3.2A-2		20	QPSK	1/3	30		≥ 1	
FDD, PDSCH Performance, Single-antenna transmission (CRS)									
FDD	Table A.3.3.1-1	R.4 FDD	1.4	QPSK	1/3	6		≥ 1	
FDD	Table A.3.3.1-1	R.42 FDD	20	QPSK	1/3	100		≥ 1	
FDD	Table A.3.3.1-1	R.2 FDD	10	QPSK	1/3	50		≥ 1	
FDD	Table A.3.3.1-2	R.3-1 FDD	5	16QAM	1/2	25		≥ 1	
FDD	Table A.3.3.1-2	R.3 FDD	10	16QAM	1/2	50		≥ 2	
FDD	Table A.3.3.1-3	R.5 FDD	3	64QAM	3/4	15		≥ 1	
FDD	Table A.3.3.1-3	R.6 FDD	5	64QAM	3/4	25		≥ 2	
FDD	Table A.3.3.1-3	R.7 FDD	10	64QAM	3/4	50		≥ 2	
FDD	Table A.3.3.1-3	R.8 FDD	15	64QAM	3/4	75		≥ 2	
FDD	Table A.3.3.1-3	R.9 FDD	20	64QAM	3/4	100		≥ 3	
FDD	Table A.3.3.1-3a	R.6-1 FDD	5	64QAM	3/4	18		≥ 1	
FDD	Table A.3.3.1-3a	R.7-1 FDD	10	64QAM	3/4	17		≥ 1	
FDD	Table A.3.3.1-3a	R.8-1 FDD	15	64QAM	3/4	17		≥ 1	
FDD	Table A.3.3.1-3a	R.9-1 FDD	20	64QAM	3/4	17		≥ 1	
FDD	Table A.3.3.1-3a	R.9-2 FDD	20	64QAM	3/4	83		≥ 2	
FDD, PDSCH Performance, Single-antenna transmission (CRS), Single PRB (Channel edge)									
FDD	Table A.3.3.1-4	R.0 FDD	3	16QAM	1/2	1		≥ 1	
FDD	Table A.3.3.1-4	R.1 FDD	10 / 20	16QAM	1/2	1		≥ 1	
FDD, PDSCH Performance, Single-antenna transmission (CRS), Single PRB (MBSFN Configuration)									
FDD	Table A.3.3.1-5	R.29 FDD	10	16QAM	1/2	1		≥ 1	
FDD, PDSCH Performance, Multi-antenna transmission (CRS), Two antenna ports									

FDD	Table A.3.3.2.1-1	R.10 FDD	10	QPSK	1/3	50		≥ 1	
FDD	Table A.3.3.2.1-1	R.11 FDD	10	16QAM	1/2	50		≥ 2	
FDD	Table A.3.3.2.1-1	R.11-2 FDD	5	16QAM	1/2	25		≥ 1	
FDD	Table A.3.3.2.1-1	R.11-3 FDD	10	16QAM	1/2	40		≥ 1	
FDD	Table A.3.3.2.1-1	R.11-4 FDD	10	QPSK	1/2	50		≥ 1	
FDD	Table A.3.3.2.1-1	R.30 FDD	20	16QAM	1/2	100		≥ 2	
FDD	Table A.3.3.2.1-1	R.35 FDD	10	64QAM	1/2	50		≥ 2	
FDD	Table A.3.3.2.1-2	R.46 FDD	10	QPSK		50		≥ 1	
FDD	Table A.3.3.2.1-2	R.47 FDD	10	16QAM		50		≥ 1	
FDD, PDSCH Performance, Multi-antenna transmission (CRS), Four antenna ports									
FDD	Table A.3.3.2.2-1	R.12 FDD	1.4	QPSK	1/3	6		≥ 1	
FDD	Table A.3.3.2.2-1	R.13 FDD	10	QPSK	1/3	50		≥ 1	
FDD	Table A.3.3.2.2-1	R.14 FDD	10	16QAM	1/2	50		≥ 2	
FDD	Table A.3.3.2.2-1	R.14-1 FDD	10	16QAM	1/2	6		≥ 1	
FDD	Table A.3.3.2.2-1	R.14-2 FDD	10	16QAM	1/2	3		≥ 1	
FDD	Table A.3.3.2.2-1	R.14-3 FDD	20	16QAM	1/2	100		≥ 1	
FDD	Table A.3.3.2.2-1	R.36 FDD	10	64QAM	1/2	50		≥ 2	
FDD, PDSCH Performance (UE specific RS) Two antenna ports (CSI-RS)									
FDD	Table A.3.3.3.1-1	R.51 FDD	10	16QAM	1/2	50		≥ 2	
FDD, PDSCH Performance (UE specific RS) Four antenna ports (CSI-RS)									
FDD	Table A.3.3.3.2-1	R.43 FDD	10	QPSK	1/3	50		≥ 1	
FDD	Table A.3.3.3.2-1	R.50 FDD	10	64QAM	1/2	50		≥ 2	
FDD	Table A.3.3.3.2-2	R.44 FDD	10	QPSK	1/3	50		≥ 1	
FDD	Table A.3.3.3.2-2	R.45 FDD	10	16QAM	1/2	50		≥ 2	
FDD	Table A.3.3.3.2-2	R.45-1 FDD	10	16QAM	1/2	39		≥ 1	
FDD	Table A.3.3.3.2-1	R.48 FDD	10	QPSK		50		≥ 1	
TDD, PDSCH Performance, Single-antenna transmission (CRS)									
TDD	Table A.3.4.1-1	R.4 TDD	1.4	QPSK	1/3	6		≥ 1	
TDD	Table A.3.4.1-1	R.42 TDD	20	QPSK	1/3	100		≥ 1	
TDD	Table A.3.4.1-1	R.2 TDD	10	QPSK	1/3	50		≥ 1	
TDD	Table A.3.4.1-2	R.3-1 TDD	5	16QAM	1/2	25		≥ 1	
TDD	Table A.3.4.1-2	R.3 TDD	10	16QAM	1/2	50		≥ 2	
TDD	Table A.3.4.1-3	R.5 TDD	3	64QAM	3/4	15		≥ 1	
TDD	Table A.3.4.1-3	R.6 TDD	5	64QAM	3/4	25		≥ 2	
TDD	Table A.3.4.1-3	R.7 TDD	10	64QAM	3/4	50		≥ 2	
TDD	Table A.3.4.1-3	R.8 TDD	15	64QAM	3/4	75		≥ 2	
TDD	Table A.3.4.1-3	R.9 TDD	20	64QAM	3/4	100		≥ 3	
TDD	Table A.3.4.1-3a	R.6-1 TDD	5	64QAM	3/4	18		≥ 1	
TDD	Table A.3.4.1-3a	R.7-1 TDD	10	64QAM	3/4	17		≥ 1	
TDD	Table A.3.4.1-3a	R.8-1 TDD	15	64QAM	3/4	17		≥ 1	
TDD	Table A.3.4.1-3a	R.9-1 TDD	20	64QAM	3/4	17		≥ 1	
TDD	Table A.3.4.1-3a	R.9-2 TDD	20	64QAM	3/4	83		≥ 2	
TDD, PDSCH Performance, Single-antenna transmission (CRS), Single PRB (Channel edge)									
TDD	Table A.3.4.1-4	R.0 TDD	3	16QAM	1/2	1		≥ 1	
TDD	Table A.3.4.1-4	R.1 TDD	10 / 20	16QAM	1/2	1		≥ 1	
TDD, PDSCH Performance, Single-antenna transmission (CRS), Single PRB (MBSFN Configuration)									
TDD	Table A.3.4.1-5	R.29 TDD	10	16QAM	1/2	1		≥ 1	

TDD, PDSCH Performance, Multi-antenna transmission (CRS), Two antenna ports									
TDD	Table A.3.4.2.1-1	R.10 TDD	10	QPSK	1/3	50		≥ 1	
TDD	Table A.3.4.2.1-1	R.11 TDD	10	16QAM	1/2	50		≥ 2	
TDD	Table A.3.4.2.1-1	R.11-1 TDD	10	16QAM	1/2	50		≥ 2	
TDD	Table A.3.4.2.1-1	R.11-2 TDD	5	16QAM	1/2	25		≥ 1	
TDD	Table A.3.4.2.1-1	R.11-3 TDD	10	16QAM	1/2	40		≥ 1	
TDD	Table A.3.4.2.1-1	R.11-4 TDD	10	QPSK	1/2	20		≥ 1	
TDD	Table A.3.4.2.1-1	R.30 TDD	20	16QAM	1/2	100		≥ 2	
TDD	Table A.3.4.2.1-1	R.30-1 TDD	20	16QAM	1/2	100		≥ 2	
TDD	Table A.3.4.2.1-1	R.30-2 TDD	20	16QAM	1/2	100		≥ 2	
TDD	Table A.3.4.2.1-1	R.35 TDD	10	64QAM	1/2	50		≥ 2	
TDD	Table A.3.4.2.1-2	R.46 TDD	10	QPSK		50		≥ 1	
TDD	Table A.3.4.2.1-2	R.47 TDD	10	16QAM		50		≥ 1	
TDD	Table A.3.4.2.1-1	R.35-1 TDD	20	64QAM	0.39	100		≥ 2	
TDD, PDSCH Performance, Multi-antenna transmission (CRS), Four antenna ports									
TDD	Table A.3.4.2.2-1	R.12 TDD	1.4	QPSK	1/3	6		≥ 1	
TDD	Table A.3.4.2.2-1	R.13 TDD	10	QPSK	1/3	50		≥ 1	
TDD	Table A.3.4.2.2-1	R.14 TDD	10	16QAM	1/2	50		≥ 2	
TDD	Table A.3.4.2.2-1	R.14-1 TDD	10	16QAM	1/2	6		≥ 1	
TDD	Table A.3.4.2.2-1	R.14-2 TDD	10	16QAM	1/2	3		≥ 1	
TDD	Table A.3.4.2.2-1	R.43 TDD	20	16QAM	1/2	100		≥ 2	
TDD	Table A.3.4.2.2-1	R.36 TDD	10	64QAM	1/2	50		≥ 2	
TDD, PDSCH Performance, Single antenna port (DRS)									
TDD	Table A.3.4.3.1-1	R.25 TDD	10	QPSK	1/3	50		≥ 1	
TDD	Table A.3.4.3.1-1	R.26 TDD	10	16QAM	1/2	50		≥ 2	
TDD	Table A.3.4.3.1-1	R.26-1 TDD	5	16QAM	1/2	25		≥ 1	
TDD	Table A.3.4.3.1-1	R.27 TDD	10	64QAM	3/4	50		≥ 2	
TDD	Table A.3.4.3.1-1	R.27-1 TDD	10	64QAM	3/4	18		≥ 1	
TDD	Table A.3.4.3.1-1	R.28 TDD	10	16QAM	1/2	1		≥ 1	
TDD, PDSCH Performance, Two antenna ports (DRS)									
TDD	Table A.3.4.3.2-1	R.31 TDD	10	QPSK	1/3	50		≥ 1	
TDD	Table A.3.4.3.2-1	R.32 TDD	10	16QAM	1/2	50		≥ 2	
TDD	Table A.3.4.3.2-1	R.32-1 TDD	5	16QAM	1/2	[25]		≥ 1	
TDD	Table A.3.4.3.2-1	R.33 TDD	10	64QAM	3/4	50		≥ 2	
TDD	Table A.3.4.3.2-1	R.33-1 TDD	10	64QAM	3/4	[18]		≥ 1	
TDD	Table A.3.4.3.2-1	R.34 TDD	10	64QAM	1/2	50		≥ 2	
TDD, PDSCH Performance (UE specific RS) Two antenna ports (CSI-RS)									
TDD	Table A.3.4.3.3-1	R.51 TDD	10	16QAM	1/2	50		≥ 2	
TDD, PDSCH Performance (UE specific RS) Four antenna ports (CSI-RS)									
TDD	Table A.3.4.3.4-1	R.44 TDD	10	64QAM	1/2	50		≥ 2	
TDD	Table A.3.4.3.4-1	R.48 TDD	10	QPSK		50		≥ 1	
TDD, PDSCH Performance (UE specific RS) Eight antenna ports (CSI-RS)									
TDD	Table A.3.4.3.5-1	R.51 TDD	10	QPSK	1/3	50		≥ 1	
TDD	Table A.3.4.3.5-2	R.45 TDD	10	16QAM	1/2	50		≥ 2	
TDD	Table A.3.4.3.5-2	R.45-1 TDD	10	16QAM	1/2	39		≥ 1	
FDD, PDCCH / PCFICH Performance									
FDD	Table A.3.5.1-1	R.15 FDD	10	PDCCH					
FDD	Table A.3.5.1-1	R.15-1 FDD	10	PDCCH					

FDD	Table A.3.5.1-1	R.15-2 FDD	10	PDCCH					
FDD	Table A.3.5.1-1	R.15-2 FDD	10	PDCCH					
FDD	Table A.3.5.1-1	R.16 FDD	1.4	PDCCH					
FDD	Table A.3.5.1-1	R.17 FDD	10	PDCCH					
FDD	Table A.3.5.1-1A	R.16_1 FDD	10	PDCCH					
FDD	Table A.3.5.1-1A	R.17_1 FDD	5	PDCCH					
FDD	Table A.3.5.1-2		10	QPSK	1/3	50		≥ 1	
FDD	Table A.3.5.1-2		1.4	QPSK	1/3	6		≥ 1	
FDD	Table A.3.5.1-2		10	QPSK	1/3	50		≥ 1	
FDD	Table A.3.5.1-2		10	QPSK	1/3	50		≥ 1	
FDD	Table A.3.5.1-2		5	QPSK	1/3	25		≥ 1	
TDD, PDCCH / PCFICH Performance									
TDD	Table A.3.5.2-1	R.15 TDD	10	PDCCH					
TDD	Table A.3.5.2-1	R.15-1 TDD	10	PDCCH					
TDD	Table A.3.5.2-1	R.15-2 TDD	10	PDCCH					
TDD	Table A.3.5.2-1	R.15-2 TDD	10	PDCCH					
TDD	Table A.3.5.2-1	R.16 TDD	1.4	PDCCH					
TDD	Table A.3.5.2-1	R.17 TDD	10	PDCCH					
TDD	Table A.3.5.2-1A	R.16_1 TDD	10	PDCCH					
TDD	Table A.3.5.2-1A	R.17_1 TDD	5	PDCCH					
TDD	Table A.3.5.2-2		10	QPSK	1/3	50		≥ 1	
TDD	Table A.3.5.2-2		1.4	QPSK	1/3	6		≥ 1	
TDD	Table A.3.5.2-2		10	QPSK	1/3	50		≥ 1	
TDD	Table A.3.5.2-2		10	QPSK	1/3	50		≥ 1	
TDD	Table A.3.5.2-2		5	QPSK	1/3	25		≥ 1	
FDD / TDD, PHICH Performance									
FDD / TDD	Table A.3.6-1	R.18	10	PHICH					
FDD / TDD	Table A.3.6-1	R.19	1.4	PHICH					
FDD / TDD	Table A.3.6-1	R.20	10	PHICH					
FDD / TDD	Table A.3.6-1	R.24	10	PHICH					
FDD / TDD	Table A.3.6-1A	R.19_1	10	PHICH					
FDD / TDD	Table A.3.6-1A	R.20_1	5	PHICH					
FDD, PMCH Performance									
FDD	Table A.3.8.1-1	R.40 FDD	1.4	QPSK	1/3	6		≥ 1	
FDD	Table A.3.8.1-1	R.37 FDD	10	QPSK	1/3	50		≥ 1	
FDD	Table A.3.8.1-2	R.38 FDD	10	16QAM	1/2	50		≥ 1	
FDD	Table A.3.8.1-3	R.39-1 FDD	5	64QAM	2/3	25		≥ 1	
FDD	Table A.3.8.1-3	R.39 FDD	10	64QAM	2/3	50		≥ 2	
TDD, PMCH Performance									
TDD	Table A.3.8.2-1	R.40 TDD	1.4	QPSK	1/3	6		≥ 1	
TDD	Table A.3.8.2-1	R.37 TDD	10	QPSK	1/3	50		≥ 1	
TDD	Table A.3.8.2-2	R.38 TDD	10	16QAM	1/2	50		≥ 1	
TDD	Table A.3.8.2-3	R.39-1 TDD	5	64QAM	2/3	25		≥ 1	
TDD	Table A.3.8.2-3	R.39 TDD	10	64QAM	2/3	50		≥ 2	
FDD, Sustained data rate (CRS)									
FDD	Table A.3.9.1-1	R.31-1 FDD	10	64QAM	0.40			≥ 1	

FDD	Table A.3.9.1-1	R.31-2 FDD	10	64QAM	0.59-0.64			≥ 2	
FDD	Table A.3.9.1-1	R.31-3 FDD	20	64QAM	0.59-0.62			≥ 2	
FDD	Table A.3.9.1-1	R.31-3A FDD	10	64QAM	0.85-0.90			≥ 2	
FDD	Table A.3.9.1-1	R.31-4 FDD	20	64QAM	0.87-0.90			≥ 3	
TDD, Sustained data rate (CRS)									
TDD	Table A.3.9.2-1	R.31-1 TDD	10	64QAM	0.40			≥ 1	
TDD	Table A.3.9.2-1	R.31-2 TDD	10	64QAM	0.59-0.64			≥ 2	
TDD	Table A.3.9.2-1	R.31-3 TDD	20	64QAM	0.59-0.62			≥ 2	
TDD	Table A.3.9.2-1	R.31-3B TDD	15	64QAM	0.87-0.90			≥ 2	
TDD	Table A.3.9.2-1	R.31-4 TDD	20	64QAM	0.87-0.90			≥ 3	

A.3.2 Reference measurement channel for receiver characteristics

Tables A.3.2-1 and A.3.2-2 are applicable for measurements on the Receiver Characteristics (clause 7) with the exception of sub-clause 7.4 (Maximum input level).

Tables A.3.2-3, A.3.2-3a, A.3.2-3b, A.3.2-4, A.3.2-4a and A.3.2-4b are applicable for sub-clause 7.4 (Maximum input level).

Tables A.3.2-1 and A.3.2-2 also apply for the modulated interferer used in Clauses 7.5, 7.6 and 7.8 with test specific bandwidths.

Table A.3.2-1: Fixed Reference Channel for Receiver Requirements (FDD)

Parameter	Unit	Value					
		1.4	3	5	10	15	20
Channel bandwidth	MHz	1.4	3	5	10	15	20
Allocated resource blocks		6	15	25	50	75	100
Subcarriers per resource block		12	12	12	12	12	12
Allocated subframes per Radio Frame		9	9	9	9	9	9
Modulation		QPSK	QPSK	QPSK	QPSK	QPSK	QPSK
Target Coding Rate		1/3	1/3	1/3	1/3	1/3	1/3
Number of HARQ Processes	Processes	8	8	8	8	8	8
Maximum number of HARQ transmissions		1	1	1	1	1	1
Information Bit Payload per Sub-Frame							
For Sub-Frames 1,2,3,4,6,7,8,9	Bits	408	1320	2216	4392	6712	8760
For Sub-Frame 5	Bits	n/a	n/a	n/a	n/a	n/a	n/a
For Sub-Frame 0	Bits	152	872	1800	4392	6712	8760
Transport block CRC	Bits	24	24	24	24	24	24
Number of Code Blocks per Sub-Frame (Note 3)							
For Sub-Frames 1,2,3,4,6,7,8,9	Bits	1	1	1	1	2	2
For Sub-Frame 5	Bits	n/a	n/a	n/a	n/a	n/a	n/a
For Sub-Frame 0	Bits	1	1	1	1	2	2
Binary Channel Bits Per Sub-Frame							
For Sub-Frames 1,2,3,4,6,7,8,9	Bits	1368	3780	6300	13800	20700	27600
For Sub-Frame 5	Bits	n/a	n/a	n/a	n/a	n/a	n/a
For Sub-Frame 0	Bits	528	2940	5460	12960	19860	26760
Max. Throughput averaged over 1 frame	kbps	341.6	1143.2	1952.8	3952.8	6040.8	7884
UE Category		≥ 1	≥ 1	≥ 1	≥ 1	≥ 1	≥ 1
Note 1:	2 symbols allocated to PDCCH for 20 MHz, 15 MHz and 10MHz channel BW. 3 symbols allocated to PDCCH for 5 MHz and 3 MHz. 4 symbols allocated to PDCCH for 1.4 MHz						
Note 2:	Reference signal, Synchronization signals and PBCH allocated as per TS 36.211 [8]						
Note 3:	If more than one Code Block is present, an additional CRC sequence of L = 24 Bits is attached to each Code Block (otherwise L = 0 Bit)						

Table A.3.2-2: Fixed Reference Channel for Receiver Requirements (TDD)

Parameter	Unit	Value					
		1.4	3	5	10	15	20
Channel Bandwidth	MHz	1.4	3	5	10	15	20
Allocated resource blocks		6	15	25	50	75	100
Uplink-Downlink Configuration (Note 6)		1	1	1	1	1	1
Allocated subframes per Radio Frame (D+S)		3	3+2	3+2	3+2	3+2	3+2
Number of HARQ Processes	Processes	7	7	7	7	7	7
Maximum number of HARQ transmission		1	1	1	1	1	1
Modulation		QPSK	QPSK	QPSK	QPSK	QPSK	QPSK
Target coding rate		1/3	1/3	1/3	1/3	1/3	1/3
Information Bit Payload per Sub-Frame	Bits						
For Sub-Frame 4, 9		408	1320	2216	4392	6712	8760
For Sub-Frame 1, 6		n/a	968	1544	3240	4968	6712
For Sub-Frame 5		n/a	n/a	n/a	n/a	n/a	n/a
For Sub-Frame 0		208	1064	1800	4392	6712	8760
Transport block CRC	Bits	24	24	24	24	24	24
Number of Code Blocks per Sub-Frame (Note 4)							
For Sub-Frame 4, 9		1	1	1	1	2	2
For Sub-Frame 1, 6		n/a	1	1	1	1	2
For Sub-Frame 5		n/a	n/a	n/a	n/a	n/a	n/a
For Sub-Frame 0		1	1	1	1	2	2
Binary Channel Bits Per Sub-Frame	Bits						
For Sub-Frame 4, 9		1368	3780	6300	13800	20700	27600
For Sub-Frame 1, 6		n/a	3276	5556	11256	16956	22656
For Sub-Frame 5		n/a	n/a	n/a	n/a	n/a	n/a
For Sub-Frame 0		672	3084	5604	13104	20004	26904
Max. Throughput averaged over 1 frame	kbps	102.4	564	932	1965.6	3007.2	3970.4
UE Category		≥ 1	≥ 1	≥ 1	≥ 1	≥ 1	≥ 1
Note 1:	For normal subframes(0,4,5,9), 2 symbols allocated to PDCCH for 20 MHz, 15 MHz and 10 MHz channel BW; 3 symbols allocated to PDCCH for 5 MHz and 3 MHz; 4 symbols allocated to PDCCH for 1.4 MHz. For special subframe (1&6), only 2 OFDM symbols are allocated to PDCCH for all BWs.						
Note 2:	For 1.4MHz, no data shall be scheduled on special subframes (1&6) to avoid problems with insufficient PDCCH performance						
Note 3:	Reference signal, Synchronization signals and PBCH allocated as per TS 36.211 [8]						
Note 4:	If more than one Code Block is present, an additional CRC sequence of L = 24 Bits is attached to each Code Block (otherwise L = 0 Bit).						
Note 5:	As per Table 4.2-2 in TS 36.211 [8]						

Table A.3.2-3: Fixed Reference Channel for Maximum input level for UE Categories 3-5 (FDD)

Parameter	Unit	Value					
		1.4	3	5	10	15	20
Channel bandwidth	MHz	1.4	3	5	10	15	20
Allocated resource blocks		6	15	25	50	75	100
Subcarriers per resource block		12	12	12	12	12	12
Allocated subframes per Radio Frame		8	9	9	9	9	9
Modulation		64QAM	64QAM	64QAM	64QAM	64QAM	64QAM
Target Coding Rate		3/4	3/4	3/4	3/4	3/4	3/4
Number of HARQ Processes	Processes	8	8	8	8	8	8
Maximum number of HARQ transmissions		1	1	1	1	1	1
Information Bit Payload per Sub-Frame							
For Sub-Frames 1,2,3,4,6,7,8,9	Bits	2984	8504	14112	30576	46888	61664
For Sub-Frame 5	Bits	n/a	n/a	n/a	n/a	n/a	n/a
For Sub-Frame 0	Bits	n/a	6456	12576	28336	45352	61664
Transport block CRC	Bits	24	24	24	24	24	24
Number of Code Blocks per Sub-Frame (Note 3)							
For Sub-Frames 1,2,3,4,6,7,8,9		1	2	3	5	8	11
For Sub-Frame 5		n/a	n/a	n/a	n/a	n/a	n/a
For Sub-Frame 0		n/a	2	3	5	8	11
Binary Channel Bits Per Sub-Frame							
For Sub-Frames 1,2,3,4,6,7,8,9	Bits	4104	11340	18900	41400	62100	82800
For Sub-Frame 5	Bits	n/a	n/a	n/a	n/a	n/a	n/a
For Sub-Frame 0	Bits	n/a	8820	16380	38880	59580	80280
Max. Throughput averaged over 1 frame	kbps	2387.2	7448.8	12547	27294	42046	55498
Note 1:	2 symbols allocated to PDCCH for 20 MHz, 15 MHz and 10 MHz channel BW. 3 symbols allocated to PDCCH for 5 MHz and 3 MHz. 4 symbols allocated to PDCCH for 1.4 MHz						
Note 2:	Reference signal, Synchronization signals and PBCH allocated as per TS 36.211 [8]						
Note 3:	If more than one Code Block is present, an additional CRC sequence of L = 24 Bits is attached to each Code Block (otherwise L = 0 Bit)						

Table A.3.2-3a: Fixed Reference Channel for Maximum input level for UE Category 1 (FDD)

Parameter	Unit	Value					
		1.4	3	5	10	15	20
Channel bandwidth	MHz	1.4	3	5	10	15	20
Allocated resource blocks		6	15	18	17	17	17
Subcarriers per resource block		12	12	12	12	12	12
Allocated subframes per Radio Frame		8	9	9	9	9	9
Modulation		64QAM	64QAM	64QAM	64QAM	64QAM	64QAM
Target Coding Rate		3/4	3/4	3/4	3/4	3/4	3/4
Number of HARQ Processes	Processes	8	8	8	8	8	8
Maximum number of HARQ transmissions		1	1	1	1	1	1
Information Bit Payload							
For Sub-Frames 1,2,3,4,6,7,8,9	Bits	2984	8504	10296	10296	10296	10296
For Sub-Frame 5	Bits	n/a	n/a	n/a	n/a	n/a	n/a
For Sub-Frame 0	Bits	n/a	6456	8248	10296	10296	10296
Transport block CRC	Bits	24	24	24	24	24	24
Number of Code Blocks per Sub-Frame (Note 3)							
For Sub-Frames 1,2,3,4,6,7,8,9		1	2	2	2	2	2
For Sub-Frame 5		n/a	n/a	n/a	n/a	n/a	n/a
For Sub-Frame 0		n/a	2	2	2	2	2
Binary Channel Bits Per Sub-Frame							
For Sub-Frames 1,2,3,4,6,7,8,9	Bits	4104	11340	13608	14076	14076	14076
For Sub-Frame 5	Bits	n/a	n/a	n/a	n/a	n/a	n/a
For Sub-Frame 0	Bits	n/a	8820	11088	14076	14076	14076
Max. Throughput averaged over 1 frame	kbps	2387.2	7448.8	9079.6	9266.4	9266.4	9266.4
Note 1:	2 symbols allocated to PDCCH for 20 MHz, 15 MHz and 10 MHz channel BW. 3 symbols allocated to PDCCH for 5 MHz and 3 MHz. 4 symbols allocated to PDCCH for 1.4 MHz						
Note 2:	Reference signal, Synchronization signals and PBCH allocated as per TS 36.211 [8]						
Note 3:	If more than one Code Block is present, an additional CRC sequence of L = 24 Bits is attached to each Code Block (otherwise L = 0 Bit)						

Table A.3.2-3b: Fixed Reference Channel for Maximum input level for UE Category 2 (FDD)

Parameter	Unit	Value					
		1.4	3	5	10	15	20
Channel bandwidth	MHz	1.4	3	5	10	15	20
Allocated resource blocks		6	15	25	50	75	83
Subcarriers per resource block		12	12	12	12	12	12
Allocated subframes per Radio Frame		8	9	9	9	9	9
Modulation		64QAM	64QAM	64QAM	64QAM	64QAM	64QAM
Target Coding Rate		3/4	3/4	3/4	3/4	3/4	3/4
Number of HARQ Processes	Processes	8	8	8	8	8	8
Maximum number of HARQ transmissions		1	1	1	1	1	1
Information Bit Payload							
For Sub-Frames 1,2,3,4,6,7,8,9	Bits	2984	8504	14112	30576	46888	51024
For Sub-Frame 5	Bits	n/a	n/a	n/a	n/a	n/a	n/a
For Sub-Frame 0	Bits	n/a	6456	12576	28336	45352	51024
Transport block CRC	Bits	24	24	24	24	24	24
Number of Code Blocks per Sub-Frame (Note 3)							
For Sub-Frames 1,2,3,4,6,7,8,9		1	2	3	5	8	9
For Sub-Frame 5		n/a	n/a	n/a	n/a	n/a	n/a
For Sub-Frame 0		n/a	2	3	5	8	9
Binary Channel Bits Per Sub-Frame							
For Sub-Frames 1,2,3,4,6,7,8,9	Bits	4104	11340	18900	41400	62100	68724
For Sub-Frame 5	Bits	n/a	n/a	n/a	n/a	n/a	n/a
For Sub-Frame 0	Bits	n/a	8820	16380	38880	59580	66204
Max. Throughput averaged over 1 frame	kbps	2387.2	7448.8	12547	27294	42046	45922
Note 1:	2 symbols allocated to PDCCH for 20 MHz, 15 MHz and 10 MHz channel BW. 3 symbols allocated to PDCCH for 5 MHz and 3 MHz. 4 symbols allocated to PDCCH for 1.4 MHz						
Note 2:	Reference signal, Synchronization signals and PBCH allocated as per TS 36.211 [8]						
Note 3:	If more than one Code Block is present, an additional CRC sequence of L = 24 Bits is attached to each Code Block (otherwise L = 0 Bit)						

Table A.3.2-4: Fixed Reference Channel for Maximum input level for UE Categories 3-5 (TDD)

Parameter	Unit	Value					
		1.4	3	5	10	15	20
Channel bandwidth	MHz	1.4	3	5	10	15	20
Allocated resource blocks		6	15	25	50	75	100
Subcarriers per resource block		12	12	12	12	12	12
Uplink-Downlink Configuration (Note 6)		1	1	1	1	1	1
Allocated subframes per Radio Frame		2	3+2	3+2	3+2	3+2	3+2
Modulation		64QAM	64QAM	64QAM	64QAM	64QAM	64QAM
Target Coding Rate		3/4	3/4	3/4	3/4	3/4	3/4
Number of HARQ Processes	Processes	7	7	7	7	7	7
Maximum number of HARQ transmissions		1	1	1	1	1	1
Information Bit Payload per Sub-Frame							
For Sub-Frames 4,9	Bits	2984	8504	14112	30576	46888	61664
For Sub-Frames 1,6	Bits	n/a	6968	11448	23688	35160	46888
For Sub-Frame 5	Bits	n/a	n/a	n/a	n/a	n/a	n/a
For Sub-Frame 0	Bits	n/a	6968	12576	30576	45352	61664
Transport block CRC	Bits	24	24	24	24	24	24
Number of Code Blocks per Sub-Frame (Note 4)							
For Sub-Frames 4,9		1	2	3	5	8	11
For Sub-Frames 1,6		n/a	2	2	4	6	8
For Sub-Frame 5		n/a	n/a	n/a	n/a	n/a	n/a
For Sub-Frame 0		n/a	2	3	5	8	11
Binary Channel Bits per Sub-Frame							
For Sub-Frames 4,9	Bits	4104	11340	18900	41400	62100	82800
For Sub-Frames 1,6		n/a	9828	16668	33768	50868	67968
For Sub-Frame 5	Bits	n/a	n/a	n/a	n/a	n/a	n/a
For Sub-Frame 0	Bits	n/a	9252	16812	39312	60012	80712
Max. Throughput averaged over 1 frame	kbps	596.8	3791.2	6369.6	13910	20945	27877
Note 1:	For normal subframes(0,4,5,9), 2 symbols allocated to PDCCH for 20 MHz, 15 MHz and 10 MHz channel BW; 3 symbols allocated to PDCCH for 5 MHz and 3 MHz; 4 symbols allocated to PDCCH for 1.4 MHz. For special subframe (1&6), only 2 OFDM symbols are allocated to PDCCH for all BWs.						
Note 2:	For 1.4MHz, no data shall be scheduled on special subframes(1&6) to avoid problems with insufficient PDCCH performance						
Note 3:	Reference signal, Synchronization signals and PBCH allocated as per TS 36.211 [8]						
Note 4:	If more than one Code Block is present, an additional CRC sequence of L = 24 Bits is attached to each Code Block (otherwise L = 0 Bit).						
Note 5:	As per Table 4.2-2 in TS 36.211 [8]						

Table A.3.2-4a: Fixed Reference Channel for Maximum input level for UE Category 1 (TDD)

Parameter	Unit	Value					
		1.4	3	5	10	15	20
Channel bandwidth	MHz	1.4	3	5	10	15	20
Allocated resource blocks		6	15	18	17	17	17
Subcarriers per resource block		12	12	12	12	12	12
Uplink-Downlink Configuration (Note 5)		1	1	1	1	1	1
Allocated subframes per Radio Frame		2	3+2	3+2	3+2	3+2	3+2
Modulation		64QAM	64QAM	64QAM	64QAM	64QAM	64QAM
Target Coding Rate		3/4	3/4	3/4	3/4	3/4	3/4
Number of HARQ Processes	Processes	7	7	7	7	7	7
Maximum number of HARQ transmissions		1	1	1	1	1	1
Information Bit Payload per Sub-Frame							
For Sub-Frames 4,9	Bits	2984	8504	10296	10296	10296	10296
For Sub-Frames 1,6	Bits	n/a	6968	8248	7480	7480	7480
For Sub-Frame 5	Bits	n/a	n/a	n/a	n/a	n/a	n/a
For Sub-Frame 0	Bits	n/a	6968	8248	10296	10296	10296
Transport block CRC	Bits	24	24	24	24	24	24
Number of Code Blocks per Sub-Frame (Note 4)							
For Sub-Frames 4,9		1	2	2	2	2	2
For Sub-Frames 1,6		n/a	2	2	2	2	2
For Sub-Frame 5		n/a	n/a	n/a	n/a	n/a	n/a
For Sub-Frame 0		n/a	2	2	2	2	2
Binary Channel Bits per Sub-Frame							
For Sub-Frames 4,9	Bits	4104	11340	13608	14076	14076	14076
For Sub-Frames 1,6		n/a	9828	11880	11628	11628	11628
For Sub-Frame 5	Bits	n/a	n/a	n/a	n/a	n/a	n/a
For Sub-Frame 0	Bits	n/a	9252	11520	14076	14076	14076
Max. Throughput averaged over 1 frame	kbps	596.8	3791.2	4533.6	4584.8	4584.8	4584.8
Note 1:	For normal subframes(0,4,5,9), 2 symbols allocated to PDCCH for 20 MHz, 15 MHz and 10 MHz channel BW; 3 symbols allocated to PDCCH for 5 MHz and 3 MHz; 4 symbols allocated to PDCCH for 1.4 MHz. For special subframe (1&6), only 2 OFDM symbols are allocated to PDCCH for all BWs.						
Note 2:	For 1.4MHz, no data shall be scheduled on special subframes(1&6) to avoid problems with insufficient PDCCH performance						
Note 3:	Reference signal, Synchronization signals and PBCH allocated as per TS 36.211 [8]						
Note 4:	If more than one Code Block is present, an additional CRC sequence of L = 24 Bits is attached to each Code Block (otherwise L = 0 Bit)						
Note 5:	As per Table 4.2-2 in TS 36.211 [8]						

Table A.3.2-4b: Fixed Reference Channel for Maximum input level for UE Category 2 (TDD)

Parameter	Unit	Value					
		1.4	3	5	10	15	20
Channel bandwidth	MHz	1.4	3	5	10	15	20
Allocated resource blocks		6	15	25	50	75	83
Subcarriers per resource block		12	12	12	12	12	12
Uplink-Downlink Configuration (Note 5)		1	1	1	1	1	1
Allocated subframes per Radio Frame		2	3+2	3+2	3+2	3+2	3+2
Modulation		64QAM	64QAM	64QAM	64QAM	64QAM	64QAM
Target Coding Rate		3/4	3/4	3/4	3/4	3/4	3/4
Number of HARQ Processes	Processes	7	7	7	7	7	7
Maximum number of HARQ transmissions		1	1	1	1	1	1
Information Bit Payload per Sub-Frame							
For Sub-Frames 4,9	Bits	2984	8504	14112	30576	46888	51024
For Sub-Frames 1,6	Bits	n/a	6968	11448	23688	35160	39232
For Sub-Frame 5	Bits	n/a	n/a	n/a	n/a	n/a	n/a
For Sub-Frame 0	Bits	n/a	6968	12576	30576	45352	51024
Transport block CRC	Bits	24	24	24	24	24	24
Number of Code Blocks per Sub-Frame (Note 4)							
For Sub-Frames 4,9		1	2	3	5	8	9
For Sub-Frames 1,6		n/a	2	3	5	7	7
For Sub-Frame 5		n/a	n/a	n/a	n/a	n/a	n/a
For Sub-Frame 0		n/a	2	3	5	8	9
Binary Channel Bits per Sub-Frame							
For Sub-Frames 4,9	Bits	4104	11340	18900	41400	62100	68724
For Sub-Frames 1,6		n/a	9828	16668	33768	50868	56340
For Sub-Frame 5	Bits	n/a	n/a	n/a	n/a	n/a	n/a
For Sub-Frame 0	Bits	n/a	9252	16380	39312	60012	66636
Max. Throughput averaged over 1 frame	kbps	596.8	3791.2	6369.6	13910	20945	23154
Note 1:	For normal subframes(0,4,5,9), 2 symbols allocated to PDCCH for 20 MHz, 15 MHz and 10 MHz channel BW; 3 symbols allocated to PDCCH for 5 MHz and 3 MHz; 4 symbols allocated to PDCCH for 1.4 MHz. For special subframe (1&6), only 2 OFDM symbols are allocated to PDCCH for all BWs.						
Note 2:	For 1.4MHz, no data shall be scheduled on special subframes(1&6) to avoid problems with insufficient PDCCH performance						
Note 3:	Reference signal, Synchronization signals and PBCH allocated as per TS 36.211 [8]						
Note 4:	If more than one Code Block is present, an additional CRC sequence of L = 24 Bits is attached to each Code Block (otherwise L = 0 Bit)						
Note 5:	As per Table 4.2-2 in TS 36.211 [8]						

A.3.2A Downlink Reference measurement channel for TX characteristics

Tables A.3.2A-1 and A.3.2A-2 describes the reference measurement channels to be used on the downlink during Transmitter Characteristics (clause 6) for FDD and TDD respectively. The number of allocated resource blocks have been defined (partial allocation) to allow the transmission of PBCH, PSS/SSS and system information mapped on PDSCH.

Table A.3.2A-1: Fixed DL PDSCH Dedicated Reference Channel for TX Requirements (FDD)

Parameter	Unit	Value					
		1.4	3	5	10	15	20
Channel bandwidth	MHz	1.4	3	5	10	15	20
Allocated resource blocks		3	4	8	16	25	30
Subcarriers per resource block		12	12	12	12	12	12
Allocated subframes per Radio Frame		10	10	10	10	10	10
Modulation		QPSK	QPSK	QPSK	QPSK	QPSK	QPSK
Target Coding Rate		(Note 4)	1/3	1/3	1/3	1/3	1/3
Number of HARQ Processes	Processes	8	8	8	8	8	8
Maximum number of HARQ transmissions		1	1	1	1	1	1
Information Bit Payload							
For Sub-Frames 0, 1, 2, 3, 4, 5, 6, 7, 8, 9	Bits	88	328	680	1384	2216	2664
Transport block CRC	Bits	24	24	24	24	24	24
Number of Code Blocks per Sub-Frame		1	1	1	1	1	1
Code block CRC size	Bits	0	0	0	0	0	0
Binary Channel Bits Per Sub-Frame							
For Sub-Frames 1, 2, 3, 4, 6, 7, 8, 9	Bits	684	1008	2016	4416	6900	8280
For Sub-Frames 5		540	1008	2016	4416	6900	8280
For Sub-Frames 0		264	1008	2016	4416	6900	8280
Max. Throughput averaged over 1 frame	kbps	88	328	680	1384	2216	2664
UE-Category		≥ 1	≥ 1	≥ 1	≥ 1	≥ 1	≥ 1
Note 1:	2 symbols allocated to PDCCH for 20 MHz, 15 MHz and 10MHz channel BW. 3 symbols allocated to PDCCH for 5 MHz and 3 MHz. 4 symbols allocated to PDCCH for 1.4 MHz						
Note 2:	Reference signal, Synchronization signals and PBCH allocated as per TS 36.211 [8]						
Note 3:	The PDSCH shall be assigned to the UE under test with a set of allocated localized virtual resource blocks starting from one end of the channel.						
Note 4:	To ensure constant transport block size in 1.4MHz, the code rate for subframes varies approx. within {1/8-1/3}						

Table A.3.2A-2: Fixed DL PDSCH Dedicated Reference Channel for TX Requirements (TDD)

Parameter	Unit	Value					
		1.4	3	5	10	15	20
Channel Bandwidth	MHz	1.4	3	5	10	15	20
Allocated resource blocks		3	4	8	16	25	30
Uplink-Downlink Configuration (Note 6)		1	1	1	1	1	1
Allocated subframes per Radio Frame (D+S)		4	4	4	4	4	4
Number of HARQ Processes	Processes	7	7	7	7	7	7
Maximum number of HARQ transmission		1	1	1	1	1	1
Modulation		QPSK	QPSK	QPSK	QPSK	QPSK	QPSK
Target coding rate		(Note 5)	1/3	1/3	1/3	1/3	1/3
Information Bit Payload per Sub-Frame	Bits						
For Sub-Frame 1, 6		n/a	n/a	n/a	n/a	n/a	n/a
For Sub-Frame 0, 4, 5, 9		88	328	680	1384	2216	2664
Transport block CRC	Bits	24	24	24	24	24	24
Number of Code Blocks		1	1	1	1	1	1
Code block CRC size		0	0	0	0	0	0
Binary Channel Bits Per Sub-Frame	Bits						
For Sub-Frame 1, 6		n/a	n/a	n/a	n/a	n/a	n/a
For Sub-Frame 4, 9		684	1008	2016	4416	6900	8280
For Sub-Frame 0		336	1008	2016	4416	6900	8280
For Sub-Frame 5		612	1008	2016	4416	6900	8280
Max. Throughput averaged over one frame	kbps	35.2	131.2	272	553.6	886.4	1065.6
UE-Category		≥ 1	≥ 1	≥ 1	≥ 1	≥ 1	≥ 1
Note 1:	For normal subframes (0,4,5,9), 2 symbols allocated to PDCCH for 20 MHz, 15 MHz and 10 MHz channel BW; 3 symbols allocated to PDCCH for 5 MHz and 3 MHz; 4 symbols allocated to PDCCH for 1.4 MHz. For special subframe (1&6), only 2 OFDM symbols are allocated to PDCCH for all BWs.						
Note 2:	For simplicity, no data shall be scheduled on special subframes (1&6).						
Note 3:	Reference signal, Synchronization signals and PBCH allocated as per TS 36.211 [8]						
Note 4:	The PDSCH shall be assigned to the UE under test with a set of allocated localized virtual resource blocks starting from one end of the channel.						
Note 5:	To ensure constant transport block size in 1.4MHz, the code rate for subframes varies approx. within {1/8-1/3}.						
Note 6:	As per Table 4.2-2 in TS 36.211 [8]						

A.3.3 Reference measurement channel for PDSCH performance requirements (FDD)

A.3.3.1 Single-antenna transmission (Common Reference Symbols)

Table A.3.3.1-1: Fixed Reference Channel QPSK R=1/3

Parameter	Unit	Value					
		R.4 FDD	R.42 FDD		R.2 FDD		
Reference channel							
Channel bandwidth	MHz	1.4	20	5	10	15	20
Allocated resource blocks (Note 4)		6	100		50		
Allocated subframes per Radio Frame		9	9		9		
Modulation		QPSK	QPSK		QPSK		
Target Coding Rate		1/3	1/3		1/3		
Information Bit Payload (Note 4)							
For Sub-Frames 1,2,3,4,6,7,8,9	Bits	408	8760		4392		
For Sub-Frame 5	Bits	n/a	n/a		n/a		
For Sub-Frame 0	Bits	152	8760		4392		
Number of Code Blocks (Notes 3 and 4)							
For Sub-Frames 1,2,3,4,6,7,8,9		1	2		1		
For Sub-Frame 5		n/a	n/a		n/a		
For Sub-Frame 0		1	2		1		
Binary Channel Bits (Note 4)							
For Sub-Frames 1,2,3,4,6,7,8,9	Bits	1368	27600		13800		
For Sub-Frame 5	Bits	n/a	n/a		n/a		
For Sub-Frame 0	Bits	528	26760		12960		
Max. Throughput averaged over 1 frame (Note 4)	Mbps	0.342	7.884		3.953		
UE Category		≥ 1	≥ 1		≥ 1		
Note 1: 2 symbols allocated to PDCCH for 20 MHz, 15 MHz and 10 MHz channel BW; 3 symbols allocated to PDCCH for 5 MHz and 3 MHz; 4 symbols allocated to PDCCH for 1.4 MHz Note 2: Reference signal, synchronization signals and PBCH allocated as per TS 36.211 [8] Note 3: If more than one Code Block is present, an additional CRC sequence of L = 24 Bits is attached to each Code Block (otherwise L = 0 Bit) Note 4: Given per component carrier per codeword							

Table A.3.3.1-2: Fixed Reference Channel 16QAM R=1/2

Parameter	Unit	Value					
				R.3-1 FDD	R.3 FDD		
Reference channel							
Channel bandwidth	MHz	1.4	3	5	10	15	20
Allocated resource blocks				25	50		
Allocated subframes per Radio Frame				9	9		
Modulation				16QAM	16QAM		
Target Coding Rate				1/2	1/2		
Information Bit Payload							
For Sub-Frames 1,2,3,4,6,7,8,9	Bits			6456	14112		
For Sub-Frame 5	Bits			n/a	n/a		
For Sub-Frame 0	Bits			5736	12960		
Number of Code Blocks per Sub-Frame (see Note 3)							
For Sub-Frames 1,2,3,4,6,7,8,9				2	3		
For Sub-Frame 5				n/a	n/a		
For Sub-Frame 0				1	3		
Binary Channel Bits Per Sub-Frame							
For Sub-Frames 1,2,3,4,6,7,8,9	Bits			12600	27600		
For Sub-Frame 5	Bits			n/a	n/a		
For Sub-Frame 0	Bits			10920	25920		
Max. Throughput averaged over 1 frame	Mbps			5.738	12.586		
UE Category				≥ 1	≥ 2		
Note 1:	2 symbols allocated to PDCCH for 20 MHz, 15 MHz and 10 MHz channel BW; 3 symbols allocated to PDCCH for 5 MHz and 3 MHz; 4 symbols allocated to PDCCH for 1.4 MHz						
Note 2:	Reference signal, synchronization signals and PBCH allocated as per TS 36.211 [8]						
Note 3:	If more than one Code Block is present, an additional CRC sequence of L = 24 Bits is attached to each Code Block (otherwise L = 0 Bit)						

Table A.3.3.1-3: Fixed Reference Channel 64QAM R=3/4

Parameter	Unit	Value					
			R.5 FDD	R.6 FDD	R.7 FDD	R.8 FDD	R.9 FDD
Reference channel							
Channel bandwidth	MHz	1.4	3	5	10	15	20
Allocated resource blocks			15	25	50	75	100
Allocated subframes per Radio Frame			9	9	9	9	9
Modulation		64QAM	64QAM	64QAM	64QAM	64QAM	64QAM
Target Coding Rate		3/4	3/4	3/4	3/4	3/4	3/4
Information Bit Payload							
For Sub-Frames 1,2,3,4,6,7,8,9	Bits		8504	14112	30576	46888	61664
For Sub-Frame 5	Bits		n/a	n/a	n/a	n/a	n/a
For Sub-Frame 0	Bits		6456	12576	28336	45352	61664
Number of Code Blocks per Sub-Frame (see Note 3)			2	3	5	8	11
Binary Channel Bits Per Sub-Frame							
For Sub-Frames 1,2,3,4,6,7,8,9	Bits		11340	18900	41400	62100	82800
For Sub-Frame 5	Bits		n/a	n/a	n/a	n/a	n/a
For Sub-Frame 0	Bits		8820	16380	38880	59580	80280
Max. Throughput averaged over 1 frame	Mbps		7.449	12.547	27.294	42.046	55.498
UE Category			≥ 1	≥ 2	≥ 2	≥ 2	≥ 3
Note 1:	2 symbols allocated to PDCCH for 20 MHz, 15 MHz and 10 MHz channel BW; 3 symbols allocated to PDCCH for 5 MHz and 3 MHz; 4 symbols allocated to PDCCH for 1.4 MHz						
Note 2:	Reference signal, synchronization signals and PBCH allocated as per TS 36.211 [8]						
Note 3:	If more than one Code Block is present, an additional CRC sequence of L = 24 Bits is attached to each Code Block (otherwise L = 0 Bit)						

Table A.3.3.1-3a: Fixed Reference Channel 64QAM R=3/4

Parameter	Unit	Value				
		R.6-1 FDD	R.7-1 FDD	R.8-1 FDD	R.9-1 FDD	R.9-2 FDD
Reference channel						
Channel bandwidth	MHz	5	10	15	20	20
Allocated resource blocks (Note 3)		18	17	17	17	83
Allocated subframes per Radio Frame		9	9	9	9	9
Modulation		64QAM	64QAM	64QAM	64QAM	64QAM
Target Coding Rate		3/4	3/4	3/4	3/4	3/4
Information Bit Payload						
For Sub-Frames 1,2,3,4,6,7,8,9	Bits	10296	10296	10296	10296	51024
For Sub-Frame 5	Bits	n/a	n/a	n/a	n/a	n/a
For Sub-Frame 0	Bits	8248	10296	10296	10296	51024
Number of Code Blocks per Sub-Frame (Note 4)						
For Sub-Frames 1,2,3,4,6,7,8,9		2	2	2	2	9
For Sub-Frame 5		n/a	n/a	n/a	n/a	n/a
For Sub-Frame 0		2	2	2	2	9
Binary Channel Bits Per Sub-Frame						
For Sub-Frames 1,2,3,4,6,7,8,9	Bits	13608	14076	14076	14076	68724
For Sub-Frame 5	Bits	n/a	n/a	n/a	n/a	n/a
For Sub-Frame 0	Bits	11088	14076	14076	14076	66204
Max. Throughput averaged over 1 frame	Mbps		9.266	9.266	9.266	45.922
UE Category			≥ 1	≥ 1	≥ 1	≥ 2
Note 1:	2 symbols allocated to PDCCH for 20 MHz, 15 MHz and 10 MHz channel BW; 3 symbols allocated to PDCCH for 5 MHz and 3 MHz; 4 symbols allocated to PDCCH for 1.4 MHz					
Note 2:	Reference signal, synchronization signals and PBCH allocated as per TS 36.211 [8]					
Note 3:	Localized allocation started from RB #0 is applied.					
Note 4:	If more than one Code Block is present, an additional CRC sequence of L = 24 Bits is attached to each Code Block (otherwise L = 0 Bit)					

Table A.3.3.1-4: Fixed Reference Channel Single PRB (Channel Edge)

Parameter	Unit	Value					
		R.0 FDD		R.1 FDD			
Reference channel							
Channel bandwidth	MHz	1.4	3	5	10/20	15	20
Allocated resource blocks			1		1		
Allocated subframes per Radio Frame			9		9		
Modulation			16QAM		16QAM		
Target Coding Rate			1/2		1/2		
Information Bit Payload							
For Sub-Frames 1,2,3,4,6,7,8,9	Bits		224		256		
For Sub-Frame 5	Bits		n/a		n/a		
For Sub-Frame 0	Bits		224		256		
Number of Code Blocks per Sub-Frame (see Note 3)			1		1		
Binary Channel Bits Per Sub-Frame							
For Sub-Frames 1,2,3,4,6,7,8,9	Bits		504		552		
For Sub-Frame 5	Bits		n/a		n/a		
For Sub-Frame 0	Bits		504		552		
Max. Throughput averaged over 1 frame	Mbps		0.202		0.230		
UE Category			≥ 1		≥ 1		
Note 1:	2 symbols allocated to PDCCH for 20 MHz, 15 MHz and 10 MHz channel BW; 3 symbols allocated to PDCCH for 5 MHz and 3 MHz; 4 symbols allocated to PDCCH for 1.4 MHz						
Note 2:	Reference signal, synchronization signals and PBCH allocated as per TS 36.211 [8]						
Note 3:	If more than one Code Block is present, an additional CRC sequence of L = 24 Bits is attached to each Code Block (otherwise L = 0 Bit)						

Table A.3.3.1-5: Fixed Reference Channel Single PRB (MBSFN Configuration)

Parameter	Unit	Value
Reference channel		R.29 FDD (MBSFN)
Channel bandwidth	MHz	10
Allocated resource blocks		1
MBSFN Configuration		TBD
Allocated subframes per Radio Frame		3
Modulation		16QAM
Target Coding Rate		1/2
Information Bit Payload		
For Sub-Frames 4,9	Bits	256
For Sub-Frame 5	Bits	n/a
For Sub-Frame 0	Bits	256
For Sub-Frame 1,2,3,6,7,8	Bits	0 (MBSFN)
Number of Code Blocks per Sub-Frame (see Note 3)		1
For Sub-Frames 4,9		1
For Sub-Frame 5		n/a
For Sub-Frame 0		1
For Sub-Frame 1,2,3,6,7,8		0 (MBSFN)
Binary Channel Bits Per Sub-Frame		
For Sub-Frames 4,9	Bits	552
For Sub-Frame 5	Bits	n/a
For Sub-Frame 0	Bits	552
For Sub-Frame 1,2,3,6,7,8	Bits	0 (MBSFN)
Max. Throughput averaged over 1 frame	kbps	76.8
UE Category		≥ 1
Note 1:	2 symbols allocated to PDCCH	
Note 2:	Reference signal, synchronization signals and PBCH allocated as per TS 36.211 [8]	
Note 3:	If more than one Code Block is present, an additional CRC sequence of L = 24 Bits is attached to each Code Block (otherwise L = 0 Bit)	

A.3.3.2 Multi-antenna transmission (Common Reference Symbols)

A.3.3.2.1 Two antenna ports

Table A.3.3.2.1-1: Fixed Reference Channel two antenna ports

Parameter	Unit	Value						
		R.10 FDD	R.11 FDD	R.11-2 FDD	R.11-3 FDD (Note 5)	R.11-4 FDD	R.30 FDD	R.35 FDD
Reference channel								
Channel bandwidth	MHz	10	10	5	10	10	20	10
Allocated resource blocks		50	50	25	40	50	100	50
Allocated subframes per Radio Frame		9	9	9	9	9	9	9
Modulation		QPSK	16QAM	16QAM	16QAM	QPSK	16QAM	64QAM
Target Coding Rate		1/3	1/2	1/2	1/2	1/2	1/2	1/2
Information Bit Payload								
For Sub-Frames 1,2,3,4,6,7,8,9	Bits	4392	12960	5736	10296	6968	25456	19848
For Sub-Frame 5	Bits	n/a	n/a	n/a	n/a	N/A	n/a	n/a
For Sub-Frame 0	Bits	4392	12960	4968	10296	6968	25456	18336
Number of Code Blocks per Sub-Frame (Note 3)								
For Sub-Frames 1,2,3,4,6,7,8,9	Bits	1	3	1	2	2	5	4
For Sub-Frame 5	Bits	n/a	n/a	n/a	n/a	N/A	n/a	n/a
For Sub-Frame 0	Bits	1	3	1	2	2	5	3
Binary Channel Bits Per Sub-Frame								
For Sub-Frames 1,2,3,4,6,7,8,9	Bits	13200	26400	12000	21120	13200	52800	39600
For Sub-Frame 5	Bits	n/a	n/a	n/a	n/a	N/A	n/a	n/a
For Sub-Frame 0	Bits	12384	24768	10368	19488	12384	51168	37152
Max. Throughput averaged over 1 frame	Mbps	3.953	11.664	5.086	9.266	6.271	22.910	17.712
UE Category		≥ 1	≥ 2	≥ 1	≥ 1	≥ 1	≥ 2	≥ 2
Note 1:	2 symbols allocated to PDCCH for 20 MHz, 15 MHz and 10 MHz channel BW; 3 symbols allocated to PDCCH for 5 MHz and 3 MHz; 4 symbols allocated to PDCCH for 1.4 MHz.							
Note 2:	Reference signal, synchronization signals and PBCH allocated as per TS 36.211 [8].							
Note 3:	If more than one Code Block is present, an additional CRC sequence of L = 24 Bits is attached to each Code Block (otherwise L = 0 Bit).							
Note 4:	Given per component carrier per codeword.							
Note 5:	For R.11-3 resource blocks of RB6–RB45 are allocated.							

Table A.3.3.2.1-2: Fixed Reference Channel two antenna ports

Parameter	Unit	Value							
		R.46 FDD	R.47 FDD						
Reference channel									
Channel bandwidth	MHz	10	10						
Allocated resource blocks (Note 4)		50	50						
Allocated subframes per Radio Frame		9	9						
Modulation		QPSK	16QAM						
Target Coding Rate									
Information Bit Payload (Note 4)									
For Sub-Frames 1,2,3,4,6,7,8,9	Bits	5160	8760						
For Sub-Frame 5	Bits	n/a	n/a						
For Sub-Frame 0	Bits	5160	8760						
Number of Code Blocks (Notes 3 and 4)									
For Sub-Frames 1,2,3,4,6,7,8,9	Bits	1	2						
For Sub-Frame 5	Bits	n/a	n/a						
For Sub-Frame 0	Bits	1	2						
Binary Channel Bits (Note 4)									
For Sub-Frames 1,2,3,4,6,7,8,9	Bits	13200	26400						
For Sub-Frame 5	Bits	n/a	n/a						
For Sub-Frame 0	Bits	12384	24768						
Max. Throughput averaged over 1 frame (Note 4)	Mbps	4.644	7.884						
UE Category		≥ 1	≥ 1						
Note 1:	2 symbols allocated to PDCCH for 20 MHz, 15 MHz and 10 MHz channel BW; 3 symbols allocated to PDCCH for 5 MHz and 3 MHz; 4 symbols allocated to PDCCH for 1.4 MHz								
Note 2:	Reference signal, synchronization signals and PBCH allocated as per TS 36.211 [4]								
Note 3:	If more than one Code Block is present, an additional CRC sequence of L = 24 Bits is attached to each Code Block (otherwise L = 0 Bit)								
Note 4:	Given per component carrier per codeword.								

A.3.3.2.2 Four antenna ports

Table A.3.3.2.2-1: Fixed Reference Channel four antenna ports

Parameter	Unit	Value						
		R.12 FDD	R.13 FDD	R.14 FDD	R.14-1 FDD	R.14-2 FDD	R.14-3 FDD	R.36 FDD
Reference channel								
Channel bandwidth	MHz	1.4	10	10	10	10	20	10
Allocated resource blocks		6	50	50	6	3	100	50
Allocated subframes per Radio Frame		9	9	9	8	8	9	9
Modulation		QPSK	QPSK	16QAM	16QAM	16QAM	16QAM	64QAM
Target Coding Rate		1/3	1/3	1/2	1/2	1/2	1/2	1/2
Information Bit Payload								
For Sub-Frames 1,2,3,4,6,7,8,9	Bits	408	4392	12960	1544	744	[25456]	18336
For Sub-Frame 5	Bits	n/a	n/a	n/a	n/a	n/a	n/a	n/a
For Sub-Frame 0	Bits	152	3624	11448	n/a	n/a	[22920]	18336
Number of Code Blocks per Sub-Frame (see Note 3)								
For Sub-Frames 1,2,3,4,6,7,8,9		1	1	3	1	1	5	3
For Sub-Frame 5		n/a	n/a	n/a	n/a	n/a	n/a	n/a
For Sub-Frame 0		1	1	2	n/a	n/a	4	3
Binary Channel Bits Per Sub-Frame								
For Sub-Frames 1,2,3,4,6,7,8,9	Bits	1248	12800	25600	3072	1536	51200	38400
For Sub-Frame 5	Bits	n/a	n/a	n/a	n/a	n/a	n/a	n/a
For Sub-Frame 0	Bits	480	12032	24064	n/a	n/a	49664	36096
Max. Throughput averaged over 1 frame	Mbps	0.342	3.876	11.513	1.235	0.595	[22.65 6]	16.502
UE Category		≥ 1	≥ 1	≥ 2	≥ 1	≥ 1	≥ 2	≥ 2
Note 1:	2 symbols allocated to PDCCH for 20 MHz, 15 MHz and 10 MHz channel BW; 3 symbols allocated to PDCCH for 5 MHz and 3 MHz; 4 symbols allocated to PDCCH for 1.4 MHz							
Note 2:	Reference signal, synchronization signals and PBCH allocated as per TS 36.211 [8]							
Note 3:	If more than one Code Block is present, an additional CRC sequence of L = 24 Bits is attached to each Code Block (otherwise L = 0 Bit)							

A.3.3.3 Reference Measurement Channel for UE-Specific Reference Symbols

A.3.3.3.1 Two antenna port (CSI-RS)

The reference measurement channels in Table A.3.3.3.1-1 apply for verifying demodulation performance for UE-specific reference symbols with two cell-specific antenna ports and two CSI-RS antenna ports.

Table A.3.3.3.1-1: Fixed Reference Channel for CDM-multiplexed DM RS with two CSI-RS antenna ports

Parameter	Unit	Value
Reference channel		R.51 FDD
Channel bandwidth	MHz	10
Allocated resource blocks		50 (Note 3)
Allocated subframes per Radio Frame		9
Modulation		16QAM
Target Coding Rate		1/2
Information Bit Payload		
For Sub-Frames 1,4,6,9	Bits	11448
For Sub-Frames 2,3,7,8	Bits	11448
For Sub-Frame 5	Bits	n/a
For Sub-Frame 0	Bits	9528
Number of Code Blocks (Note 4)		
For Sub-Frames 1,4,6,9	Code blocks	2
For Sub-Frames 2,3,7,8	Code blocks	2
For Sub-Frame 5	Bits	n/a
For Sub-Frame 0	Bits	2
Binary Channel Bits		
For Sub-Frames 1,4,6,9	Bits	24000
For Sub-Frames 2,7		23600
For Sub-Frames 3,8		23200
For Sub-Frame 5	Bits	n/a
For Sub-Frame 0	Bits	19680
Max. Throughput averaged over 1 frame	Mbps	10.1112
UE Category		≥ 2
Note 1:	2 symbols allocated to PDCCH.	
Note 2:	Reference signal, synchronization signals and PBCH allocated as per TS 36.211 [8].	
Note 3:	50 resource blocks are allocated in sub-frames 1, 2, 3, 4, 6, 7, 8, 9 and 41 resource blocks (RB0–RB20 and RB30–RB49) are allocated in sub-frame 0.	
Note 4:	If more than one Code Block is present, an additional CRC sequence of L = 24 Bits is attached to each Code Block (otherwise L = 0 Bit).	

A.3.3.3.2 Four antenna ports (CSI-RS)

The reference measurement channels in Table A.3.3.3.2-1 apply for verifying demodulation performance for UE-specific reference symbols with two cell-specific antenna ports and four CSI-RS antenna ports.

Table A.3.3.3.2-1: Fixed Reference Channel for CDM-multiplexed DM RS with four CSI-RS antenna ports

Parameter	Unit	Value		
		R.43 FDD	R.48 FDD	R.50 FDD
Reference channel		R.43 FDD	R.48 FDD	R.50 FDD
Channel bandwidth	MHz	10	10	10
Allocated resource blocks		50 (Note 3)	50 (Note 3)	50 (Note 3)
Allocated subframes per Radio Frame		9	9	9
Modulation		QPSK	QPSK	64QAM
Target Coding Rate		1/3		1/2
Information Bit Payload				
For Sub-Frames 1,4,6,9	Bits	3624	6200	18336
For Sub-Frames 2,3,7,8	Bits	3624	6200	16416
For Sub-Frame 5	Bits	n/a	n/a	n/a
For Sub-Frame 0	Bits	2984	4968	14688
Number of Code Blocks (Note 4)				
For Sub-Frames 1,4,6,9	Code blocks	1	2	3
For Sub-Frames 2,3,7,8	Code blocks	1	2	3
For Sub-Frame 5	Bits	n/a	n/a	n/a
For Sub-Frame 0	Bits	1	1	3
Binary Channel Bits				
For Sub-Frames 1,4,6,9	Bits	12000	12000	36000
For Sub-Frames 2,7		11600	11600	34800
For Sub-Frames 3,8		11600	12000	34800
For Sub-Frame 5	Bits	n/a	n/a	n/a
For Sub-Frame 0	Bits	9840	9840	29520
Max. Throughput averaged over 1 frame	Mbps	3.1976	5.4568	15.3696
UE Category		≥ 1	≥ 1	≥ 2
Note 1:	2 symbols allocated to PDCCH.			
Note 2:	Reference signal, synchronization signals and PBCH allocated as per TS 36.211 [8].			
Note 3:	50 resource blocks are allocated in sub-frames 1, 2, 3, 4, 6, 7, 8, 9 and 41 resource blocks (RB0–RB20 and RB30–RB49) are allocated in sub-frame 0.			
Note 4:	If more than one Code Block is present, an additional CRC sequence of L = 24 Bits is attached to each Code Block (otherwise L = 0 Bit).			

The reference measurement channels in Table A.3.3.3.2-2 apply for verifying FDD PMI accuracy measurement with two CRS antenna ports and four CSI-RS antenna ports.

Table A.3.3.2-2: Fixed Reference Channel for four antenna ports (CSI-RS)

Parameter	Unit	Value		
		R.44 FDD	R.45 FDD	R.45-1 FDD
Reference channel		R.44 FDD	R.45 FDD	R.45-1 FDD
Channel bandwidth	MHz	10	10	10
Allocated resource blocks		50 ³	50 ³	39
Allocated subframes per Radio Frame		10	10	10
Modulation		QPSK	16QAM	16QAM
Target Coding Rate		1/3	1/2	1/2
Information Bit Payload				
For Sub-Frames (Non CSI-RS subframe)	Bits	3624	11448	8760
For Sub-Frames (CSI-RS subframe)	Bits	3624	11448	8760
For Sub-Frames (ZeroPowerCSI-RS subframe)	Bits	n/a	n/a	n/a
For Sub-Frame 5	Bits	n/a	n/a	n/a
For Sub-Frame 0	Bits	2984	9528	8760
Number of Code Blocks per Sub-Frame (Note 4)				
For Sub-Frames (Non CSI-RS subframe)		1	2	2
For Sub-Frames (CSI-RS subframe)		1	2	2
For Sub-Frames (ZeroPowerCSI-RS subframe)	Bits	n/a	n/a	n/a
For Sub-Frame 5		n/a	n/a	n/a
For Sub-Frame 0		1	2	2
Binary Channel Bits Per Sub-Frame				
For Sub-Frames (Non CSI-RS subframe)	Bits	12000	24000	18720
For Sub-Frames (CSI-RS subframe)	Bits	11600	23200	18096
For Sub-Frames (ZeroPowerCSI-RS subframe)	Bits	n/a	n/a	n/a
For Sub-Frame 5	Bits	n/a	n/a	n/a
For Sub-Frame 0	Bits	9840	19680	18720
Max. Throughput averaged over 1 frame	Mbps	3.1976	10.1112	7.884
UE Category		≥ 1	≥ 2	≥ 1
Note 1:	2 symbols allocated to PDCCH for 20 MHz, 15 MHz and 10 MHz channel BW; 3 symbols allocated to PDCCH for 5 MHz and 3 MHz; 4 symbols allocated to PDCCH for 1.4 MHz.			
Note 2:	Reference signal, synchronization signals and PBCH allocated as per TS 36.211 [8].			
Note 3:	For R.44 and R.45, 50 resource blocks are allocated in sub-frames 1, 2, 3, 4, 6, 7, 8, 9 and 41 resource blocks (RB0-RB20 and RB30-RB49) are allocated in sub-frame 0.			
Note 4:	If more than one Code Block is present, an additional CRC sequence of L = 24 Bits is attached to each Code Block (otherwise L = 0 Bit).			

A.3.4 Reference measurement channel for PDSCH performance requirements (TDD)

A.3.4.1 Single-antenna transmission (Common Reference Symbols)

Table A.3.4.1-1: Fixed Reference Channel QPSK R=1/3

Parameter	Unit	Value			
		R.4 TDD	R.42 TDD	R.2 TDD	
Reference channel					
Channel bandwidth	MHz	1.4	20	10	
Allocated resource blocks (Note 6)		6	100	50	
Uplink-Downlink Configuration (Note 4)		1	1	1	
Allocated subframes per Radio Frame (D+S)		3	3+2	3+2	
Modulation		QPSK	QPSK	QPSK	
Target Coding Rate		1/3	1/3	1/3	
Information Bit Payload (Note 6)					
For Sub-Frames 4,9	Bits	408	8760	4392	
For Sub-Frames 1,6	Bits	n/a	7736	3240	
For Sub-Frame 5	Bits	n/a	n/a	n/a	
For Sub-Frame 0	Bits	208	8760	4392	
Number of Code Blocks per Sub-Frame (Note 5 and 6)					
For Sub-Frames 4,9		1	2	1	
For Sub-Frames 1,6		n/a	2	1	
For Sub-Frame 5		n/a	n/a	n/a	
For Sub-Frame 0		1	2	1	
Binary Channel Bits Per Sub-Frame (Note 6)					
For Sub-Frames 4,9	Bits	1368	27600	13800	
For Sub-Frames 1,6	Bits	n/a	22656	11256	
For Sub-Frame 5	Bits	n/a	n/a	n/a	
For Sub-Frame 0	Bits	672	26904	13104	
Max. Throughput averaged over 1 frame (Note 6)	Mbps	0.102	4.175	1.966	
UE Category		≥ 1	≥ 1	≥ 1	
Note 1:	2 symbols allocated to PDCCH for 20 MHz, 15 MHz and 10 MHz channel BW; 3 symbols allocated to PDCCH for 5 MHz and 3 MHz; 4 symbols allocated to PDCCH for 1.4 MHz. For subframe 1&6, only 2 OFDM symbols are allocated to PDCCH.				
Note 2:	For BW=1.4 MHz, the information bit payloads of special subframes are set to zero (no scheduling) to avoid problems with insufficient PDCCH performance at the test point.				
Note 3:	Reference signal, synchronization signals and PBCH allocated as per TS 36.211 [8]				
Note 4:	As per Table 4.2-2 in TS 36.211 [8]				
Note 5:	If more than one Code Block is present, an additional CRC sequence of L = 24 Bits is attached to each Code Block (otherwise L = 0 Bit)				
Note 6:	Given per component carrier per codeword				

Table A.3.4.1-2: Fixed Reference Channel 16QAM R=1/2

Parameter	Unit	Value					
				R.3-1 TDD	R.3 TDD		
Reference channel							
Channel bandwidth	MHz	1.4	3	5	10	15	20
Allocated resource blocks				25	50		
Uplink-Downlink Configuration (Note 3)				1	1		
Allocated subframes per Radio Frame (D+S)				3+2	3+2		
Modulation				16QAM	16QAM		
Target Coding Rate				1/2	1/2		
Information Bit Payload							
For Sub-Frames 4,9	Bits			6456	14112		
For Sub-Frames 1,6	Bits			5160	11448		
For Sub-Frame 5	Bits			n/a	n/a		
For Sub-Frame 0	Bits			5736	12960		
Number of Code Blocks per Sub-Frame (see Note 4)							
For Sub-Frames 4,9				2	3		
For Sub-Frames 1,6				1	2		
For Sub-Frame 5				n/a	n/a		
For Sub-Frame 0				1	3		
Binary Channel Bits Per Sub-Frame							
For Sub-Frames 4,9	Bits			12600	27600		
For Sub-Frames 1,6	Bits			11112	22512		
For Sub-Frame 5	Bits			n/a	n/a		
For Sub-Frame 0	Bits			11208	26208		
Max. Throughput averaged over 1 frame	Mbps			2.897	6.408		
UE Category				≥ 1	≥ 2		
Note 1:	2 symbols allocated to PDCCH for 20 MHz, 15 MHz and 10 MHz channel BW; 3 symbols allocated to PDCCH for 5 MHz and 3 MHz; 4 symbols allocated to PDCCH for 1.4 MHz. For subframe 1&6, only 2 OFDM symbols are allocated to PDCCH.						
Note 2:	Reference signal, synchronization signals and PBCH allocated as per TS 36.211 [8]						
Note 3:	As per Table 4.2-2 in TS 36.211 [8]						
Note 4:	If more than one Code Block is present, an additional CRC sequence of L = 24 Bits is attached to each Code Block (otherwise L = 0 Bit)						

Table A.3.4.1-3: Fixed Reference Channel 64QAM R=3/4

Parameter	Unit	Value					
			R.5 TDD	R.6 TDD	R.7 TDD	R.8 TDD	R.9 TDD
Reference channel							
Channel bandwidth	MHz	1.4	3	5	10	15	20
Allocated resource blocks			15	25	50	75	100
Uplink-Downlink Configuration (Note 3)			1	1	1	1	1
Allocated subframes per Radio Frame (D+S)			3+2	3+2	3+2	3+2	3+2
Modulation		64QAM	64QAM	64QAM	64QAM	64QAM	64QAM
Target Coding Rate			3/4	3/4	3/4	3/4	3/4
Information Bit Payload							
For Sub-Frames 4,9	Bits		8504	14112	30576	46888	61664
For Sub-Frames 1,6	Bits		6968	11448	23688	35160	46888
For Sub-Frame 5	Bits		n/a	n/a	n/a	n/a	n/a
For Sub-Frame 0	Bits		6968	12576	30576	45352	61664
Number of Code Blocks per Sub-Frame (see Note 4)							
For Sub-Frames 4,9			2	3	5	8	11
For Sub-Frames 1,6			2	2	4	6	8
For Sub-Frame 5			n/a	n/a	n/a	n/a	n/a
For Sub-Frame 0			2	3	5	8	11
Binary Channel Bits Per Sub-Frame							
For Sub-Frames 4,9	Bits		11340	18900	41400	62100	82800
For Sub-Frames 1,6	Bits		9828	16668	33768	50868	67968
For Sub-Frame 5	Bits		n/a	n/a	n/a	n/a	n/a
For Sub-Frame 0	Bits		9252	16812	39312	60012	80712
Max. Throughput averaged over 1 frame	Mbps		3.791	6.370	13.910	20.945	27.877
UE Category			≥ 1	≥ 2	≥ 2	≥ 2	≥ 3
Note 1:	2 symbols allocated to PDCCH for 20 MHz, 15 MHz and 10 MHz channel BW; 3 symbols allocated to PDCCH for 5 MHz and 3 MHz; 4 symbols allocated to PDCCH for 1.4 MHz. For subframe 1&6, only 2 OFDM symbols are allocated to PDCCH.						
Note 2:	Reference signal, synchronization signals and PBCH allocated as per TS 36.211 [8]						
Note 3:	As per Table 4.2-2 TS 36.211 [8]						
Note 4:	If more than one Code Block is present, an additional CRC sequence of L = 24 Bits is attached to each Code Block (otherwise L = 0 Bit)						

Table A.3.4.1-3a: Fixed Reference Channel 64QAM R=3/4

Parameter	Unit	Value				
		R.6-1 TDD	R.7-1 TDD	R.8-1 TDD	R.9-1 TDD	R.9-2 TDD
Reference channel						
Channel bandwidth	MHz	5	10	15	20	20
Allocated resource blocks (Note 3)		18	17	17	17	83
Uplink-Downlink Configuration (Note 4)		1	1	1	1	1
Allocated subframes per Radio Frame (D+S)		3+2	3+2	3+2	3+2	3+2
Modulation		64QAM	64QAM	64QAM	64QAM	64QAM
Target Coding Rate		3/4	3/4	3/4	3/4	3/4
Information Bit Payload						
For Sub-Frames 4,9	Bits	10296	10296	10296	10296	51024
For Sub-Frames 1,6	Bits	8248	7480	7480	7480	39232
For Sub-Frame 5	Bits	n/a	n/a	n/a	n/a	n/a
For Sub-Frame 0	Bits	8248	10296	10296	10296	51024
Number of Code Blocks per Sub-Frame (Note 5)						
For Sub-Frames 4,9		2	2	2	2	9
For Sub-Frames 1,6		2	2	2	2	7
For Sub-Frame 5		n/a	n/a	n/a	n/a	n/a
For Sub-Frame 0		2	2	2	2	9
Binary Channel Bits Per Sub-Frame						
For Sub-Frames 4,9	Bits	13608	14076	14076	14076	68724
For Sub-Frames 1,6	Bits	11880	11628	11628	11628	56340
For Sub-Frame 5	Bits	n/a	n/a	n/a	n/a	n/a
For Sub-Frame 0	Bits	11520	14076	14076	14076	66636
Max. Throughput averaged over 1 frame	Mbps	4.534	4.585	4.585	4.585	23.154
UE Category		≥ 1	≥ 1	≥ 1	≥ 1	≥ 2
Note 1:	2 symbols allocated to PDCCH for 20 MHz, 15 MHz and 10 MHz channel BW; 3 symbols allocated to PDCCH for 5 MHz and 3 MHz; 4 symbols allocated to PDCCH for 1.4 MHz. For subframe 1&6, only 2 OFDM symbols are allocated to PDCCH.					
Note 2:	Reference signal, synchronization signals and PBCH allocated as per TS 36.211 [8]					
Note 3:	Localized allocation started from RB #0 is applied.					
Note 4:	As per Table 4.2-2 TS 36.211 [8]					
Note 5:	If more than one Code Block is present, an additional CRC sequence of L = 24 Bits is attached to each Code Block (otherwise L = 0 Bit)					

Table A.3.4.1-4: Fixed Reference Channel Single PRB

Parameter	Unit	Value					
			R.0 TDD		R.1 TDD		
Reference channel							
Channel bandwidth	MHz	1.4	3	5	10/20	15	20
Allocated resource blocks			1		1		
Uplink-Downlink Configuration (Note 3)			1		1		
Allocated subframes per Radio Frame (D+S)			3+2		3+2		
Modulation			16QAM		16QAM		
Target Coding Rate			1/2		1/2		
Information Bit Payload							
For Sub-Frames 4,9	Bits		224		256		
For Sub-Frames 1,6	Bits		208		208		
For Sub-Frame 5	Bits		n/a		n/a		
For Sub-Frame 0	Bits		224		256		
Number of Code Blocks per Sub-Frame (Note 4)							
For Sub-Frames 4,9			1		1		
For Sub-Frames 1,6			1		1		
For Sub-Frame 5			n/a		n/a		
For Sub-Frame 0			1		1		
Binary Channel Bits Per Sub-Frame							
For Sub-Frames 4,9	Bits		504		552		
For Sub-Frames 1,6	Bits		456		456		
For Sub-Frame 5	Bits		n/a		n/a		
For Sub-Frame 0	Bits		504		552		
Max. Throughput averaged over 1 frame	Mbps		0.109		0.118		
UE Category			≥ 1		≥ 1		
Note 1:	2 symbols allocated to PDCCH for 20 MHz, 15 MHz and 10 MHz channel BW; 3 symbols allocated to PDCCH for 5 MHz and 3 MHz; 4 symbols allocated to PDCCH for 1.4 MHz. For subframe 1&6, only 2 OFDM symbols are allocated to PDCCH.						
Note 2:	Reference signal, synchronization signals and PBCH allocated as per TS 36.211 [8]						
Note 3:	As per Table 4.2-2 in TS 36.211 [8]						
Note 4:	If more than one Code Block is present, an additional CRC sequence of L = 24 Bits is attached to each Code Block (otherwise L = 0 Bit)						

Table A.3.4.1-5: Fixed Reference Channel Single PRB (MBSFN Configuration)

Parameter	Unit	Value
Reference channel		R.29 TDD (MBSFN)
Channel bandwidth	MHz	10
Allocated resource blocks		1
MBSFN Configuration		[TBD]
Uplink-Downlink Configuration (Note 3)		1
Allocated subframes per Radio Frame (D+S)		1+2
Modulation		16QAM
Target Coding Rate		1/2
Information Bit Payload		
For Sub-Frames 4,9	Bits	0 (MBSFN)
For Sub-Frames 1,6	Bits	208
For Sub-Frame 5	Bits	n/a
For Sub-Frame 0	Bits	256
Number of Code Blocks per Sub-Frame (Note 4)		
For Sub-Frames 4,9	Bits	0 (MBSFN)
For Sub-Frames 1,6	Bits	1
For Sub-Frame 5	Bits	n/a
Binary Channel Bits Per Sub-Frame		
For Sub-Frames 4,9	Bits	0 (MBSFN)
For Sub-Frames 1,6	Bits	456
For Sub-Frame 5	Bits	n/a
For Sub-Frame 0	Bits	552
Max. Throughput averaged over 1 frame	kbps	67.2
UE Category		≥ 1
Note 1:	2 symbols allocated to PDCCH	
Note 2:	Reference signal, synchronization signals and PBCH allocated as per TS 36.211 [8]	
Note 3:	as per Table 4.2-2 in TS 36.211 [8]	
Note 4:	If more than one Code Block is present, an additional CRC sequence of L = 24 Bits is attached to each Code Block (otherwise L = 0 Bit)	

A.3.4.2 Multi-antenna transmission (Common Reference Symbols)

A.3.4.2.1 Two antenna ports

Table A.3.4.2.1-1: Fixed Reference Channel two antenna ports

Parameter	Unit	Value										
		R.10 TDD	R.11 TDD	R.11-1 TDD	R.11-2 TDD	R.11-3 TDD (Note 6)	R.11-4 TDD	R.30 TDD	R.30-1 TDD	R.30-2 TDD	R.35 TDD	R.35-1 TDD
Reference channel												
Channel bandwidth	MHz	10	10	10	5	10	10	20	20	20	10	20
Allocated resource blocks		50	50	50	25	40	50	100	100	100	50	100
Uplink-Downlink Configuration (Note 3)		1	1	1	1	1	1	1	1	1	1	1
Allocated subframes per Radio Frame (D+S)		3+2	3+2	2+2	3+2	3+2	2	3+2	+2	2	2+2	2
Modulation		QPSK	16QA M	16QA M	16QA M	16QA M	QPSK	16QA M	16QA M	16QA M	64QA M	64QA M
Target Coding Rate		1/3	1/2	1/2	1/2	1/2	1/2	1/2	1/2	1/2	1/2	0.39
Information Bit Payload (Note 5)												
For Sub-Frames 4,9	Bits	4392	12960	12960	5736	10296	6968	25456	25456	25456	19848	30576
For Sub-Frames 1,6		3240	9528	9528	5160	9144	n/a	22920	21384	n/a	15840	n/a
For Sub-Frame 5	Bits	n/a	n/a	n/a	n/a	n/a	n/a	n/a	n/a	n/a	n/a	n/a
For Sub-Frame 0	Bits	4392	12960	n/a	4968	10296	n/a	25456	n/a	n/a	n/a	n/a
Number of Code Blocks per Sub-Frame (Note 4 and 5)												
For Sub-Frames 4,9		1	3	3	1	2	2	5	5	5	4	5
For Sub-Frames 1,6		1	2	2	1	2	n/a	4	4	n/a	3	n/a
For Sub-Frame 5		n/a	n/a	n/a	n/a	n/a	n/a	n/a	n/a	n/a	n/a	n/a
For Sub-Frame 0		1	3	n/a	1	2	n/a	5	n/a	n/a	n/a	n/a
Binary Channel Bits Per Sub-Frame (Note 5)												
For Sub-Frames 4,9	Bits	13200	26400	26400	12000	21120	13200	52800	52800	52800	39600	79200
For Sub-Frames 1,6		10656	21312	21312	10512	16992	10656	42912	42912	n/a	31968	n/a
For Sub-Frame 5	Bits	n/a	n/a	n/a	n/a	n/a	n/a	n/a	n/a	n/a	n/a	n/a
For Sub-Frame 0	Bits	12528	25056	n/a	10656	19776	12528	51456	n/a	n/a	n/a	n/a
Max. Throughput averaged over 1 frame (Note 5)	Mbps	1.966	5.794	4.498	2.676	4.918	1.39	12.22 1	9.368	5.091	7.138	6.115
UE Category		≥ 1	≥ 2	≥ 2	≥ 1	≥ 1	≥ 1	≥ 2	≥ 2	≥ 2	≥ 2	≥ 2
Note 1:	2 symbols allocated to PDCCH for 20 MHz, 15 MHz and 10 MHz channel BW; 3 symbols allocated to PDCCH for 5 MHz and 3 MHz; 4 symbols allocated to PDCCH for 1.4 MHz. For subframe 1&6, only 2 OFDM symbols are allocated to PDCCH.											
Note 2:	Reference signal, synchronization signals and PBCH allocated as per TS 36.211 [8].											
Note 3:	As per Table 4.2-2 in TS 36.211 [8].											
Note 4:	If more than one Code Block is present, an additional CRC sequence of L = 24 Bits is attached to each Code Block (otherwise L = 0 Bit).											
Note 5:	Given per component carrier per codeword.											
Note 6:	For R.11-3 resource blocks of RB6–RB45 are allocated.											

Table A.3.4.2.1-2: Fixed Reference Channel two antenna ports

Parameter	Unit	Value			
		R.46 TDD	R.47 TDD		
Reference channel					
Channel bandwidth	MHz	10	10		
Allocated resource blocks (Note 5)		50	50		
Uplink-Downlink Configuration (Note 3)		1	1		
Allocated subframes per Radio Frame (D+S)		3+2	3+2		
Modulation		QPSK	16QAM		
Target Coding Rate					
Information Bit Payload (Note 5)					
For Sub-Frames 4,9	Bits	5160	8760		
For Sub-Frames 1,6		3880	7480		
For Sub-Frame 5	Bits	n/a	n/a		
For Sub-Frame 0	Bits	5160	8760		
Number of Code Blocks (Notes 4 and 5)					
For Sub-Frames 4,9		1	2		
For Sub-Frames 1,6		1	2		
For Sub-Frame 5		n/a	n/a		
For Sub-Frame 0		1	2		
Binary Channel Bits (Note 5)					
For Sub-Frames 4,9	Bits	13200	26400		
For Sub-Frames 1,6		10656	21312		
For Sub-Frame 5	Bits	n/a	n/a		
For Sub-Frame 0	Bits	12528	25056		
Max. Throughput averaged over 1 frame (Note 5)	Mbps	2.324	4.124		
UE Category		≥ 1	≥ 1		
<p>Note 1: 2 symbols allocated to PDCCH for 20 MHz, 15 MHz and 10 MHz channel BW; 3 symbols allocated to PDCCH for 5 MHz and 3 MHz; 4 symbols allocated to PDCCH for 1.4 MHz. For subframe 1&6, only 2 OFDM symbols are allocated to PDCCH.</p> <p>Note 2: Reference signal, synchronization signals and PBCH allocated as per TS 36.211 [4].</p> <p>Note 3: As per Table 4.2-2 in TS 36.211 [4].</p> <p>Note 4: If more than one Code Block is present, an additional CRC sequence of L = 24 Bits is attached to each Code Block (otherwise L = 0 Bit).</p> <p>Note 5: Given per component carrier per codeword</p>					

A.3.4.2.2 Four antenna ports

Table A.3.4.2.2-1: Fixed Reference Channel four antenna ports

Parameter	Unit	Value						
		R.12 TDD	R.13 TDD	R.14 TDD	R.14-1 TDD	R.14-2 TDD	R.43 TDD	R.36 TDD
Reference channel								
Channel bandwidth	MHz	1.4	10	10	10	10	20	10
Allocated resource blocks		6	50	50	6	3	100	50
Uplink-Downlink Configuration (Note 4)		1	1	1	1	1	1	1
Allocated subframes per Radio Frame (D+S)		3	3+2	2+2	2	2	2+2	2+2
Modulation		QPSK	QPSK	16QAM	16QAM	16QAM	16QAM	64QAM
Target Coding Rate		1/3	1/3	1/2	1/2	1/2	1/2	1/2
Information Bit Payload								
For Sub-Frames 4,9	Bits	408	4392	12960	1544	744	25456	18336
For Sub-Frames 1,6	Bits	n/a	3240	9528	n/a	n/a	21384	15840
For Sub-Frame 5	Bits	n/a	n/a	n/a	n/a	n/a	n/a	n/a
For Sub-Frame 0	Bits	208	4392	n/a	n/a	n/a	n/a	n/a
Number of Code Blocks per Sub-Frame (Note 5)								
For Sub-Frames 4,9		1	1	3	1	1	5	3
For Sub-Frames 1,6		n/a	1	2	n/a	n/a	4	3
For Sub-Frame 5		n/a	n/a	n/a	n/a	n/a	n/a	n/a
For Sub-Frame 0		1	1	n/a	n/a	n/a	n/a	n/a
Binary Channel Bits Per Sub-Frame								
For Sub-Frames 4,9	Bits	1248	12800	25600	3072	1536	51200	38400
For Sub-Frames 1,6		n/a	10256	20512	n/a	n/a	41312	30768
For Sub-Frame 5	Bits	n/a	n/a	n/a	n/a	n/a	n/a	n/a
For Sub-Frame 0	Bits	624	12176	n/a	n/a	n/a	n/a	n/a
Max. Throughput averaged over 1 frame	Mbps	0.102	1.966	4.498	0.309	0.149	9.368	6.835
UE Category		≥ 1	≥ 1	≥ 2	≥ 1	≥ 1	≥ 2	≥ 2
Note 1:	2 symbols allocated to PDCCH for 20 MHz, 15 MHz and 10 MHz channel BW; 3 symbols allocated to PDCCH for 5 MHz and 3 MHz; 4 symbols allocated to PDCCH for 1.4 MHz. For subframe 1&6, only 2 OFDM symbols are allocated to PDCCH.							
Note 2:	For BW=1.4 MHz, the information bit payloads of special subframes are set to zero (no scheduling) to avoid problems with insufficient PDCCH performance at the test point.							
Note 3:	Reference signal, synchronization signals and PBCH allocated as per TS 36.211 [8]							
Note 4:	As per Table 4.2-2 in TS 36.211 [8]							
Note 5:	If more than one Code Block is present, an additional CRC sequence of L = 24 Bits is attached to each Code Block (otherwise L = 0 Bit).							
Note 6:	Given per component carrier per codeword.							

A.3.4.3 Reference Measurement Channels for UE-Specific Reference Symbols

A.3.4.3.1 Single antenna port (Cell Specific)

The reference measurement channels in Table A.3.4.3.1-1 apply for verifying demodulation performance for UE-specific reference symbols with one cell-specific antenna port.

Table A.3.4.3.1-1: Fixed Reference Channel for DRS

Parameter	Unit	Value					
		R.25 TDD	R.26 TDD	R.26-1 TDD	R.27 TDD	R.27-1 TDD	R.28 TDD
Reference channel							
Channel bandwidth	MHz	10	10	5	10	10	10
Allocated resource blocks		50 ⁴	50 ⁴	25 ⁴	50 ⁴	18 ⁶	1
Uplink-Downlink Configuration (Note 3)		1	1	1	1	1	1
Allocated subframes per Radio Frame (D+S)		3+2	3+2	3+2	3+2	3+2	3+2
Modulation		QPSK	16QAM	16QAM	64QAM	64QAM	16QAM
Target Coding Rate		1/3	1/2	1/2	3/4	3/4	1/2
Information Bit Payload							
For Sub-Frames 4,9	Bits	4392	12960	5736	28336	10296	224
For Sub-Frames 1,6	Bits	3240	9528	4584	22920	8248	176
For Sub-Frame 5	Bits	n/a	n/a	n/a	n/a	n/a	n/a
For Sub-Frame 0	Bits	2984	9528	3880	22152	10296	224
Number of Code Blocks per Sub-Frame (see Note 5)							
For Sub-Frames 4,9		1	3	1	5	2	1
For Sub-Frames 1,6		1	2	1	4	2	1
For Sub-Frame 5		n/a	n/a	n/a	n/a	n/a	n/a
For Sub-Frame 0		1	2	1	4	2	1
Binary Channel Bits Per Sub-Frame							
For Sub-Frames 4,9	Bits	12600	25200	11400	37800	13608	504
For Sub-Frames 1,6	Bits	10356	20712	10212	31068	11340	420
For Sub-Frame 5	Bits	n/a	n/a	n/a	n/a	n/a	n/a
For Sub-Frame 0	Bits	10332	20664	7752	30996	13608	504
Max. Throughput averaged over 1 frame	Mbps	1.825	5.450	2.452	12.466	4.738	0.102
UE Category		≥ 1	≥ 2	≥ 1	≥ 2	≥ 1	≥ 1
Note 1:	2 symbols allocated to PDCCH for 20 MHz, 15 MHz and 10 MHz channel BW; 3 symbols allocated to PDCCH for 5 MHz and 3 MHz; 4 symbols allocated to PDCCH for 1.4 MHz. For subframe 1&6, only 2 OFDM symbols are allocated to PDCCH.						
Note 2:	Reference signal, synchronization signals and PBCH allocated as per TS 36.211 [8].						
Note 3:	as per Table 4.2-2 in TS 36.211 [8].						
Note 4:	For R.25, R.26 and R.27, 50 resource blocks are allocated in sub-frames 1, 4, 6, 9 and 41 resource blocks (RB0–RB20 and RB30–RB49) are allocated in sub-frame 0. For R.26-1, 25 resource blocks are allocated in sub-frames 1, 4, 6, 9 and 17 resource blocks (RB0–RB7 and RB16–RB24) are allocated in sub-frame 0.						
Note 5:	If more than one Code Block is present, an additional CRC sequence of L = 24 Bits is attached to each Code Block (otherwise L = 0 Bit).						
Note 6:	Localized allocation started from RB #0 is applied.						

A.3.4.3.2 Two antenna ports (Cell Specific)

The reference measurement channels in Table A.3.4.3.2-1 apply for verifying demodulation performance for CDM-multiplexed UE specific reference symbols with two cell-specific antenna ports.

Table A.3.4.3.2-1: Fixed Reference Channel for CDM-multiplexed DM RS

Parameter	Unit	Value					
		R.31 TDD	R.32 TDD	R.32-1 TDD	R.33 TDD	R.33-1 TDD	R.34 TDD
Reference channel							
Channel bandwidth	MHz	10	10	5	10	10	10
Allocated resource blocks		50 ^a	50 ^a	25 ^a	50 ^a	18 ^b	50 ^a
Uplink-Downlink Configuration (Note 3)		1	1	1	1	1	1
Allocated subframes per Radio Frame (D+S)		3+2	3+2	3+2	3+2	3+2	3+2
Modulation		QPSK	16QAM	16QAM	64QAM	64QAM	64QAM
Target Coding Rate		1/3	1/2	1/2	3/4	3/4	1/2
Information Bit Payload							
For Sub-Frames 4,9	Bits	3624	11448	5736	27376	9528	18336
For Sub-Frames 1,6		2664	7736	3112	16992	7480	11832
For Sub-Frame 5	Bits	n/a	n/a	n/a	n/a	n/a	n/a
For Sub-Frame 0	Bits	2984	9528	3496	22152	9528	14688
Number of Code Blocks per Sub-Frame (Note 5)							
For Sub-Frames 4,9		1	2	1	5	2	3
For Sub-Frames 1,6		1	2	1	3	2	2
For Sub-Frame 5		n/a	n/a	n/a	n/a	n/a	n/a
For Sub-Frame 0		1	2	1	4	2	3
Binary Channel Bits Per Sub-Frame							
For Sub-Frames 4,9	Bits	12000	24000	10800	36000	12960	36000
For Sub-Frames 1,6		7872	15744	6528	23616	10368	23616
For Sub-Frame 5	Bits	n/a	n/a	n/a	n/a	n/a	n/a
For Sub-Frame 0	Bits	9840	19680	7344	29520	12960	29520
Max. Throughput averaged over 1 frame	Mbps	1.556	4.79	2.119	11.089	4.354	7.502
UE Category		≥ 1	≥ 2	≥ 1	≥ 2	≥ 1	≥ 2
Note 1:	2 symbols allocated to PDCCH for 20 MHz, 15 MHz and 10 MHz channel BW; 3 symbols allocated to PDCCH for 5 MHz and 3 MHz; 4 symbols allocated to PDCCH for 1.4 MHz. For subframe 1&6, only 2 OFDM symbols are allocated to PDCCH.						
Note 2:	Reference signal, synchronization signals and PBCH allocated as per TS 36.211 [8].						
Note 3:	as per Table 4.2-2 in TS 36.211 [8].						
Note 4:	For R.31, R.32, R.33 and R.34, 50 resource blocks are allocated in sub-frames 4, 9 and 41 resource blocks (RB0–RB20 and RB30–RB49) are allocated in sub-frame 0 and the DwPTS portion of sub-frames 1, 6. For R.32-1, 25 resource blocks are allocated in sub-frames 4, 9 and 17 resource blocks (RB0–RB7 and RB16–RB24) are allocated in sub-frame 0 and the DwPTS portion of sub-frames 1, 6.						
Note 5:	If more than one Code Block is present, an additional CRC sequence of L = 24 Bits is attached to each Code Block (otherwise L = 0 Bit).						
Note 6:	Localized allocation started from RB#0 is applied.						

A.3.4.3.3 Two antenna ports (CSI-RS)

The reference measurement channels in Table A.3.4.3.3-1 apply for verifying demodulation performance for CDM-multiplexed UE specific reference symbols with two cell-specific antenna ports and two CSI-RS antenna ports.

Table A.3.4.3.3-1: Fixed Reference Channel for CDM-multiplexed DM RS with two CSI-RS antenna ports

Parameter	Unit	Value
Reference channel		R.51 TDD
Channel bandwidth	MHz	10
Allocated resource blocks		50 (Note 5)
Uplink-Downlink Configuration (Note 3)		1
Allocated subframes per Radio Frame (D+S)		3+2
Modulation		16QAM
Target Coding Rate		1/2
Information Bit Payload		
For Sub-Frames 4,9 (non CSI-RS subframe)	Bits	11448
For Sub-Frame 4,9	Bits	11448
For Sub-Frames 1,6	Bits	7736
For Sub-Frame 5	Bits	n/a
For Sub-Frame 0	Bits	9528
Number of Code Blocks (Note 4)		
For Sub-Frames 4, 9 (non CSI-RS subframe)	Code blocks	2
For Sub-Frames 4,9	Code blocks	2
For Sub-Frames 1,6	Code blocks	2
For Sub-Frame 5		n/a
For Sub-Frame 0	Code blocks	2
Binary Channel Bits		
For Sub-Frames 4, 9 (non CSI-RS subframe)	Bits	24000
For Sub-Frames 4,9		22800
For Sub-Frames 1,6		15744
For Sub-Frame 5	Bits	n/a
For Sub-Frame 0	Bits	19680
Max. Throughput averaged over 1 frame	Mbps	4.7896
UE Category		≥ 2
Note 1:	2 symbols allocated to PDCCH.	
Note 2:	Reference signal, synchronization signals and PBCH allocated as per TS 36.211 [8].	
Note 3:	as per Table 4.2-2 in TS 36.211 [8].	
Note 4:	If more than one Code Block is present, an additional CRC sequence of L = 24 Bits is attached to each Code Block (otherwise L = 0 Bit).	
Note 5:	50 resource blocks are allocated in sub-frames 4, 9 and 41 resource blocks (RB0–RB20 and RB30–RB49) are allocated in sub-frame 0 and the DwPTS portion of sub-frames 1, 6.	

A.3.4.3.4 Four antenna ports (CSI-RS)

The reference measurement channels in Table A.3.4.3.4-1 apply for verifying demodulation performance for CDM-multiplexed UE specific reference symbols with two cell-specific antenna ports and four CSI-RS antenna ports.

Table A.3.4.3.4-1: Fixed Reference Channel for CDM-multiplexed DM RS with four CSI-RS antenna ports

Parameter	Unit	Value	
Reference channel		R.44 TDD	R.48 TDD
Channel bandwidth	MHz	10	10
Allocated resource blocks		50 (Note 4)	50 (Note 4)
Uplink-Downlink Configuration (Note 3)		1	1
Allocated subframes per Radio Frame (D+S)		3+2	3+2
Modulation		64QAM	QPSK
Target Coding Rate		1/2	
Information Bit Payload			
For Sub-Frames 4,9 (non CSI-RS subframe)	Bits	18336	n/a
For Sub-Frames 4,9 (CSI-RS subframe)	Bits	16416	6200
For Sub-Frames 1,6		11832	4264
For Sub-Frame 5	Bits	n/a	n/a
For Sub-Frame 0	Bits	14688	4968
Number of Code Blocks per Sub-Frame (Note 5)			
For Sub-Frames 4,9 (non CSI-RS subframe)		3	2
For Sub-Frames 4,9 (CSI-RS subframe)		3	2
For Sub-Frames 1,6		2	1
For Sub-Frame 5		n/a	n/a
For Sub-Frame 0		3	1
Binary Channel Bits Per Sub-Frame			
For Sub-Frames 4,9 (non CSI-RS subframe)	Bits	36000	12000
For Sub-Frames 4,9 (CSI-RS subframe)	Bits	33600	11600
For Sub-Frames 1,6		23616	7872
For Sub-Frame 5	Bits	n/a	n/a
For Sub-Frame 0	Bits	29520	9840
Max. Throughput averaged over 1 frame	Mbps	7.1184	2.5896
UE Category		≥ 2	≥ 1
Note 1:	2 symbols allocated to PDCCH		
Note 2:	Reference signal, synchronization signals and PBCH allocated as per TS 36.211 [8].		
Note 3:	as per Table 4.2-2 in TS 36.211 [8].		
Note 4:	50 resource blocks are allocated in sub-frames 4, 9 and 41 resource blocks (RB0–RB20 and RB30–RB49) are allocated in sub-frame 0 and the DwPTS portion of sub-frames 1, 6.		
Note 5:	If more than one Code Block is present, an additional CRC sequence of L = 24 Bits is attached to each Code Block (otherwise L = 0 Bit).		

A.3.4.3.5 Eight antenna ports (CSI-RS)

The reference measurement channels in Table A.3.4.3.5-1 apply for verifying demodulation performance for CDM-multiplexed UE specific reference symbols with two cell-specific antenna ports and eight CSI-RS antenna ports.

Table A.3.4.3.5-1: Fixed Reference Channel for CDM-multiplexed DM RS with eight CSI-RS antenna ports

Parameter	Unit	Value
Reference channel		R.50 TDD
Channel bandwidth	MHz	10
Allocated resource blocks		50 (Note 4)
Uplink-Downlink Configuration (Note 3)		1
Allocated subframes per Radio Frame (D+S)		3+2
Modulation		QPSK
Target Coding Rate		1/3
Information Bit Payload		
For Sub-Frames 4,9 (non CSI-RS subframe)	Bits	3624
For Sub-Frames 4,9 (CSI-RS subframe)	Bits	3624
For Sub-Frames 1,6		2664
For Sub-Frame 5	Bits	n/a
For Sub-Frame 0	Bits	2984
Number of Code Blocks per Sub-Frame (Note 5)		
For Sub-Frames 4,9 (non CSI-RS subframe)		1
For Sub-Frames 4,9 (CSI-RS subframe)		1
For Sub-Frames 1,6		1
For Sub-Frame 5		n/a
For Sub-Frame 0		1
Binary Channel Bits Per Sub-Frame		
For Sub-Frames 4,9 (non CSI-RS subframe)	Bits	12000
For Sub-Frames 4,9 (CSI-RS subframe)	Bits	10400
For Sub-Frames 1,6		7872
For Sub-Frame 5	Bits	n/a
For Sub-Frame 0	Bits	9840
Max. Throughput averaged over 1 frame	Mbps	1.556
UE Category		≥ 1
Note 1: 2 symbols allocated to PDCCH. Note 2: Reference signal, synchronization signals and PBCH allocated as per TS 36.211 [8]. Note 3: as per Table 4.2-2 in TS 36.211 [8]. Note 4: 50 resource blocks are allocated in sub-frames 4, 9 and 41 resource blocks (RB0–RB20 and RB30–RB49) are allocated in sub-frame 0 and the DwPTS portion of sub-frames 1, 6. Note 5: If more than one Code Block is present, an additional CRC sequence of L = 24 Bits is attached to each Code Block (otherwise L = 0 Bit).		

The reference measurement channels in Table A.3.4.3.5-2 apply for verifying TDD PMI accuracy measurement with two CRS antenna ports and eight CSI-RS antenna ports.

Table A.3.4.3.5-2: Fixed Reference Channel for eight antenna ports (CSI-RS)

Parameter	Unit	Value	
		R.45 TDD	R.45-1 TDD
Reference channel			
Channel bandwidth	MHz	10	10
Allocated resource blocks		50 ⁴	39
Uplink-Downlink Configuration (Note 3)		1	1
Allocated subframes per Radio Frame (D+S)		4+2	4+2
Allocated subframes per Radio Frame		10	10
Modulation		16QAM	16QAM
Target Coding Rate		1/2	1/2
Information Bit Payload			
For Sub-Frames 4 and 9 (Non CSI-RS subframe)	Bits	n/a	n/a
For Sub-Frames 4 and 9 (CSI-RS subframe)	Bits	11448	8760
For Sub-Frames 1,6	Bits	7736	7480
For Sub-Frame 5	Bits	n/a	n/a
For Sub-Frame 0	Bits	9528	8760
Number of Code Blocks per Sub-Frame (Note 5)			
For Sub-Frames 4 and 9 (Non CSI-RS subframe)		n/a	n/a
For Sub-Frames 4 and 9 (CSI-RS subframe)		2	2
For Sub-Frames 1,6		2	2
For Sub-Frame 5		n/a	n/a
For Sub-Frame 0		2	2
Binary Channel Bits Per Sub-Frame			
For Sub-Frames 4 and 9 (Non CSI-RS subframe)	Bits	n/a	n/a
For Sub-Frames 4 and 9 (CSI-RS subframe)	Bits	22400	17472
For Sub-Frames 1,6	Bits	15744	14976
For Sub-Frame 5	Bits	n/a	n/a
For Sub-Frame 0	Bits	19680	18720
Max. Throughput averaged over 1 frame	Mbps	4.7896	4.1240
UE Category		≥ 2	≥ 1
Note 1:	2 symbols allocated to PDCCH for 20 MHz, 15 MHz and 10 MHz channel BW; 3 symbols allocated to PDCCH for 5 MHz and 3 MHz; 4 symbols allocated to PDCCH for 1.4 MHz. For subframe 1&6, only 2 OFDM symbols are allocated to PDCCH.		
Note 2:	Reference signal, synchronization signals and PBCH allocated as per TS 36.211 [8].		
Note 3:	As per Table 4.2-2 in TS 36.211 [8].		
Note 4:	For R.45, 50 resource blocks are allocated in sub-frames 4, 9 and 41 resource blocks (RB0-RB20 and RB30-RB49) are allocated in sub-frame 0 and the DwPTS portion of sub-frames 1, 6.		
Note 5:	If more than one Code Block is present, an additional CRC sequence of L = 24 Bits is attached to each Code Block (otherwise L = 0 Bit).		
Note 6:	Localized allocation started from RB #0 is applied.		

A.3.5 Reference measurement channels for PDCCH/PCFICH performance requirements

A.3.5.1 FDD

Table A.3.5.1-1: Reference Channel FDD

Parameter	Unit	Value				
		R.15 FDD	R.15-1 FDD	R.15-2 FDD	R.16 FDD	R.17 FDD
Reference channel						
Number of transmitter antennas		1	2	2	2	4
Channel bandwidth	MHz	10	10	10	1.4	10
Number of OFDM symbols for PDCCH	symbols	2	3	2	2	2
Aggregation level	CCE	8	8	8	2	4
DCI Format		Format 1	Format 1	Format 1	Format 2	Format 2
Cell ID		0	0	0	0	0
Payload (without CRC)	Bits	31	31	31	31	46

Table A.3.5.1-1A: Reference Channel FDD

Parameter	Unit	Value	
		R.16_1 FDD	R.17_1 FDD
Reference channel			
Number of transmitter antennas		2	4
Channel bandwidth	MHz	10	5
Number of OFDM symbols for PDCCH	symbols	2	2
Aggregation level	CCE	4	2
DCI Format		Format 2	Format 2
Cell ID		0	0
Payload (without CRC)	Bits	43	42

Table A.3.5.1-2: Additional PDSCH Reference Channel FDD

Parameter	Unit	Value				
Number of transmitter antennas		1	2	2	4	4
Channel bandwidth	MHz	10	1.4	10	10	5
Allocated Resource Blocks		50	6	50	50	25
Modulation		QPSK	QPSK	QPSK	QPSK	QPSK
Target Coding Rate		1/3	1/3	1/3	1/3	1/3
Information Bit Payload						
For Sub-Frames 1,2,3,4,6,7,8,9	Bits	4392	504	4392	4392	2216
For Sub-Frame 5		n/a	n/a	n/a	n/a	n/a
For Sub-Frame 0	Bits	4392	256	4392	3624	1800
Number of Code Blocks per Sub-Frame						
For Sub-Frames 1,2,3,4,6,7,8,9		1	1	1	1	1
For Sub-Frame 5		n/a	n/a	n/a	n/a	n/a
For Sub-Frame 0		1	1	1	1	1
Binary Channel Bits Per Sub-Frame						
For Sub-Frames 1,2,3,4,6,7,8,9	Bits	13800	1584	13200	12800	6400
For Sub-Frame 5	Bits	n/a	n/a	n/a	n/a	n/a
For Sub-Frame 0		12960	768	12384	12032	5632
Max. Throughput averaged over 1 frame	Mbps	3.953	0.429	3.953	3.876	1.953
UE Category		≥ 1	≥ 1	≥ 1	≥ 1	≥ 1

Note 1: 2 symbols allocated to PDCCH for all BW.

A.3.5.2 TDD

Table A.3.5.2-1: Reference Channel TDD

Parameter	Unit	Value				
		R.15 TDD	R.15-1 TDD	R.15-2 TDD	R.16 TDD	R.17 TDD
Reference channel						
Number of transmitter antennas		1	2	2	2	4
Channel bandwidth	MHz	10	10	10	1.4	10
Number of OFDM symbols for PDCCH	symbols	2	3	2	2	2
Aggregation level	CCE	8	8	8	2	4
DCI Format		Format 1	Format 1	Format 1	Format 2	Format 2
Cell ID		0	0	0	0	0
Payload (without CRC)	Bits	34	34	34	34	49

Table A.3.5.2-1A: Reference Channel TDD

Parameter	Unit	Value	
		R.16_1 TDD	R.17_1 TDD
Reference channel			
Number of transmitter antennas		2	4
Channel bandwidth	MHz	10	5
Number of OFDM symbols for PDCCH	symbols	2	2
Aggregation level	CCE	4	2
DCI Format		Format 2	Format 2
Cell ID		0	0
Payload (without CRC)	Bits	46	45

Table A.3.5.2-2: Additional PDSCH Reference Channel TDD

Parameter	Unit	Value				
Number of transmitter antennas		1	2	2	4	4
Channel bandwidth	MHz	10	1.4	10	10	5
Uplink-Downlink Configuration (Note 2)		0	0	0	0	0
Allocated Resource Blocks		50	6	50	50	25
Modulation		QPSK	QPSK	QPSK	QPSK	QPSK
Target Coding Rate		1/3	1/3	1/3	1/3	1/3
Information Bit Payload						
For Sub-Frame 1,6	Bits	3240	328	3240	3240	1544
For Sub-Frame 5	Bits	n/a	n/a	n/a	n/a	n/a
For Sub-Frame 0	Bits	4392	256	4392	4392	1800
Number of Code Blocks per Sub-Frame						
For Sub-Frame 1,6		1	1	1	1	1
For Sub-Frame 5	Bits	n/a	n/a	n/a	n/a	n/a
For Sub-Frame 0		1	1	1	1	1
Binary Channel Bits Per Sub-Frame						
For Sub-Frame 1,6	Bits	11256	1152	10656	10256	5056
For Sub-Frame 5	Bits	n/a	n/a	n/a	n/a	n/a
For Sub-Frame 0	Bits	13104	936	12528	12176	5776
Max. Throughput averaged over 1 frame	Mbps	1.087	0.091	1.087	1.164	0.489
UE Category		≥ 1	≥ 1	≥ 1	≥ 1	≥ 1

Note 1: 2 symbols allocated to PDCCH for all BW.

Note 2: As per Table 4.2-2 in TS 36.211 [8].

A.3.6 Reference measurement channels for PHICH performance requirements

Table A.3.6-1: Reference Channel FDD/TDD

Parameter	Unit	Value			
		R.18	R.19	R.20	R.24
Reference channel		R.18	R.19	R.20	R.24
Number of transmitter antennas		1	2	4	1
Channel bandwidth	MHz	10	1.4	10	10
User roles (Note 1)		[W I1 I2]	[W I1 I2]	[W I1 I2]	[W I1]
Resource allocation (Note 2)		[(0,0) (0,1) (0,4)]	[(0,0) (0,1) (0,4)]	[(0,0) (0,1) (0,4)]	[(0,0) (0,1)]
Power offsets (Note 3)	dB	[-4 0 -3]	[-4 0 -3]	[-4 0 -3]	[+3 0]
Payload (Note 4)		[A R R]	[A R R]	[A R R]	[A R]
Note 1: W=wanted user, I1=interfering user 1, I2=interfering user 2. Note 2: The resource allocation per user is given as (N_group_PHICH, N_seq_PHICH). Note 3: The power offsets (per user) represent the difference of the power of BPSK modulated symbol per PHICH relative to the first interfering user. Note 4: A=fixed ACK, R=random ACK/NACK.					

Table A.3.6-1A: Reference Channel FDD/TDD

Parameter	Unit	Value	
		R.19_1	R.20_1
Reference channel		R.19_1	R.20_1
Number of transmitter antennas		2	4
Channel bandwidth	MHz	10	5
User roles (Note 1)		[W I1 I2]	[W I1 I2]
Resource allocation (Note 2)		[(0,0) (0,1) (0,4)]	[(0,0) (0,1) (0,4)]
Power offsets (Note 3)	dB	[-4 0 -3]	[-4 0 -3]
Payload (Note 4)		[A R R]	[A R R]
Note 1: W=wanted user, I1=interfering user 1, I2=interfering user 2. Note 2: The resource allocation per user is given as (N_group_PHICH, N_seq_PHICH). Note 3: The power offsets (per user) represent the difference of the power of BPSK modulated symbol per PHICH relative to the first interfering user. Note 4: A=fixed ACK, R=random ACK/NACK.			

A.3.7 [FFS]

A.3.8 Reference measurement channels for MBMS performance requirements

A.3.8.1 FDD

Table A.3.8.1-1: Fixed Reference Channel QPSK R=1/3

Parameter	PMCH						
	Unit	Value					
Reference channel		R.40 FDD			R.37 FDD		
Channel bandwidth	MHz	1.4	3	5	10	15	20
Allocated resource blocks		6			50		
Allocated subframes per Radio Frame (Note 1)		6			6		
Modulation		QPSK			QPSK		
Target Coding Rate		1/3			1/3		
Information Bit Payload (Note 2)							
For Sub-Frames 1,2,3,6,7,8	Bits	408			3624		
For Sub-Frames 0,4,5,9	Bits	n/a			n/a		
Number of Code Blocks per Subframe (Note 3)		1			1		
Binary Channel Bits Per Subframe							
For Sub-Frames 1,2,3,6,7,8	Bits	1224			10200		
For Sub-Frames 0,4,5,9	Bits	n/a			n/a		
MBMS UE Category		≥ 1			≥ 1		
Note 1: For FDD mode, up to 6 subframes (#1/2/3/6/7/8) are available for MBMS, in line with TS 36.331. Note 2: 2 OFDM symbols are reserved for PDCCH; and reference signal allocated as per TS 36.211. Note 3: If more than one Code Block is present, an additional CRC sequence of L = 24 Bits is attached to each Code Block (otherwise L = 0 Bit).							

Table A.3.8.1-2: Fixed Reference Channel 16QAM R=1/2

Parameter	PMCH						
	Unit	Value					
Reference channel					R.38 FDD		
Channel bandwidth	MHz	1.4	3	5	10	15	20
Allocated resource blocks					50		
Allocated subframes per Radio Frame (Note 1)					6		
Modulation					16QAM		
Target Coding Rate					1/2		
Information Bit Payload (Note 2)							
For Sub-Frames 1,2,3,6,7,8	Bits				9912		
For Sub-Frames 0,4,5,9	Bits				n/a		
Number of Code Blocks per Subframe (Note 3)					2		
Binary Channel Bits Per Subframe							
For Sub-Frames 1,2,3,6,7,8	Bits				20400		
For Sub-Frames 0,4,5,9	Bits				n/a		
MBMS UE Category					≥ 1		
Note 1: For FDD mode, up to 6 subframes (#1/2/3/6/7/8) are available for MBMS, in line with TS 36.331. Note 2: 2 OFDM symbols are reserved for PDCCH; and reference signal allocated as per TS 36.211. Note 3: If more than one Code Block is present, an additional CRC sequence of L = 24 Bits is attached to each Code Block (otherwise L = 0 Bit).							

Table A.3.8.1-3: Fixed Reference Channel 64QAM R=2/3

Parameter	PMCH						
	Unit	Value					
Reference channel				R.39-1 FDD	R.39 FDD		
Channel bandwidth	MHz	1.4	3	5	10	15	20
Allocated resource blocks				25	50		
Allocated subframes per Radio Frame(Note1)				6	6		
Modulation				64QAM	64QAM		
Target Coding Rate				2/3	2/3		
Information Bit Payload (Note 2)							
For Sub-Frames 1,2,3,6,7,8	Bits			9912	19848		
For Sub-Frames 0,4,5,9	Bits			n/a	n/a		
Number of Code Blocks per Sub-Frame (Note 3)				2	4		
Binary Channel Bits Per Subframe							
For Sub-Frames 1,2,3,6,7,8	Bits			15300	30600		
For Sub-Frames 0,4,5,9	Bits			n/a	n/a		
MBMS UE Category				≥ 1	≥ 2		
Note 1: For FDD mode, up to 6 subframes (#1/2/3/6/7/8) are available for MBMS, in line with TS 36.331. Note 2: 2 OFDM symbols are reserved for PDCCH; and reference signal allocated as per TS 36.211. Note 3: If more than one Code Block is present, an additional CRC sequence of L = 24 Bits is attached to each Code Block (otherwise L = 0 Bit).							

A.3.8.2 TDD

Table A.3.8.2-1: Fixed Reference Channel QPSK R=1/3

Parameter	PMCH						
	Unit	Value					
Reference channel		R.40 TDD			R.37 TDD		
Channel bandwidth	MHz	1.4	3	5	10	15	20
Allocated resource blocks		6			50		
Uplink-Downlink Configuration(Note 1)		5			5		
Allocated subframes per Radio Frame		5			5		
Modulation		QPSK			QPSK		
Target Coding Rate		1/3			1/3		
Information Bit Payload (Note 2)							
For Sub-Frames 3,4,7,8,9	Bits	408			3624		
For Sub-Frames 0,1,2,5,6	Bits	n/a			n/a		
Number of Code Blocks per Subframe (Note 3)		1			1		
Binary Channel Bits Per Subframe							
For Sub-Frames 3,4,7,8,9	Bits	1224			10200		
For Sub-Frames 0,1,2,5,6	Bits	n/a			n/a		
MBMS UE Category					≥ 1		
Note 1: For TDD mode, in line with TS 36.331, Uplink-Downlink Configuration 5 is proposed, up to 5 subframes (#3/4/7/8/9) are available for MBMS. Note 2: 2 OFDM symbols are reserved for PDCCH; reference signal allocated as per TS 36.211. Note 3: If more than one Code Block is present, an additional CRC sequence of L = 24 Bits is attached to each Code Block (otherwise L = 0 Bit).							

Table A.3.8.2-2: Fixed Reference Channel 16QAM R=1/2

Parameter	PMCH						
	Unit	Value					
Reference channel					R.38 TDD		
Channel bandwidth	MHz	1.4	3	5	10	15	20
Allocated resource blocks					50		
Uplink-Downlink Configuration(Note 1)					5		
Allocated subframes per Radio Frame					5		
Modulation					16QAM		
Target Coding Rate					1/2		
Information Bit Payload (Note 2)							
For Sub-Frames 3,4,7,8,9	Bits				9912		
For Sub-Frames 0,1,2,5,6	Bits				n/a		
Number of Code Blocks per Subframe (Note 3)					2		
Binary Channel Bits Per Subframe							
For Sub-Frames 3,4,7,8,9	Bits				20400		
For Sub-Frames 0,1,2,5,6	Bits				n/a		
MBMS UE Category					≥ 1		
Note 1: For TDD mode, in line with TS 36.331, Uplink-Downlink Configuration 5 is proposed, up to 5 subframes (#3/4/7/8/9) are available for MBMS.							
Note 2: 2 OFDM symbols are reserved for PDCCH; reference signal allocated as per TS 36.211.							
Note 3: If more than one Code Block is present, an additional CRC sequence of L = 24 Bits is attached to each Code Block (otherwise L = 0 Bit).							

Table A.3.8.2-3: Fixed Reference Channel 64QAM R=2/3

Parameter	PMCH						
	Unit	Value					
Reference channel				R.39-1 TDD	R.39 TDD		
Channel bandwidth	MHz	1.4	3	5	10	15	20
Allocated resource blocks				25	50		
Uplink-Downlink Configuration(Note 1)				5	5		
Allocated subframes per Radio Frame				5	5		
Modulation				64QAM	64QAM		
Target Coding Rate				2/3	2/3		
Information Bit Payload (Note 2)							
For Sub-Frames 3,4,7,8,9	Bits			9912	19848		
For Sub-Frames 0,1,2,5,6	Bits			n/a	n/a		
Number of Code Blocks per Sub-Frame (Note 3)				2	4		
Binary Channel Bits Per Subframe							
For Sub-Frames 3,4,7,8,9	Bits			15300	30600		
For Sub-Frames 0,1,2,5,6	Bits			n/a	n/a		
MBMS UE Category				≥ 1	≥ 2		
Note 1: For TDD mode, in line with TS 36.331, Uplink-Downlink Configuration 5 is proposed, up to 5 subframes (#3/4/7/8/9) are available for MBMS.							
Note 2: 2 OFDM symbols are reserved for PDCCH; reference signal allocated as per TS 36.211.							
Note 3: If more than one Code Block is present, an additional CRC sequence of L = 24 Bits is attached to each Code Block (otherwise L = 0 Bit).							

A.3.9 Reference measurement channels for sustained downlink data rate provided by lower layers

A.3.9.1 FDD

Table A.3.9.1-1: Fixed Reference Channel for sustained data-rate test (FDD)

Parameter	Unit	Value				
		R.31-1 FDD	R.31-2 FDD	R.31-3 FDD	R.31-3A FDD	R.31-4 FDD
Reference channel						
Channel bandwidth	MHz	10	10	20	10	20
Allocated resource blocks		Note 5	Note 6	Note 7	Note 6	Note 7
Allocated subframes per Radio Frame		10	10	10	10	10
Modulation		64QAM	64QAM	64QAM	64QAM	64QAM
Coding Rate						
For Sub-Frame 1,2,3,4,6,7,8,9,		0.40	0.59	0.59	0.85	0.88
For Sub-Frame 5		0.40	0.64	0.62	0.89	0.87
For Sub-Frame 0		0.40	0.63	0.61	0.90	0.90
Information Bit Payload						
For Sub-Frames 1,2,3,4,6,7,8,9	Bits	10296	25456	51024	36696	75376
For Sub-Frame 5	Bits	10296	25456	51024	35160	71112
For Sub-Frame 0	Bits	10296	25456	51024	36696	75376
Number of Code Blocks per Sub-Frame (Note 3)						
For Sub-Frames 1,2,3,4,6,7,8,9	Bits	2	5	9	6	13
For Sub-Frame 5		2	5	9	6	12
For Sub-Frame 0	Bits	2	5	9	6	13
Binary Channel Bits Per Sub-Frame						
For Sub-Frames 1,2,3,4,6,7,8,9	Bits	26100	43200	86400	43200	86400
For Sub-Frame 5		26100	39744	82080	39744	82080
For Sub-Frame 0	Bits	26100	40752	83952	40752	83952
Number of layers		1	2	2	2	2
Max. Throughput averaged over 1 frame	Mbps	10.296	25.456	51.024	36.542	74.950
UE Category		≥ 1	≥ 2	≥ 2	≥ 2	≥ 3
Note 1:	1 symbol allocated to PDCCH for all tests					
Note 2:	Reference signal, synchronization signals and PBCH allocated as per TS 36.211 [8]					
Note 3:	If more than one Code Block is present, an additional CRC sequence of L = 24 Bits is attached to each Code Block (otherwise L = 0 Bit)					
Note 4:	Resource blocks $n_{PRB} = 0..2$ are allocated for SIB transmissions in sub-frame 5 for all bandwidths					
Note 5:	Resource blocks $n_{PRB} = 6..14,30..49$ are allocated for the user data in all sub-frames					
Note 6:	Resource blocks $n_{PRB} = 3..49$ are allocated for the user data in sub-frame 5, and resource blocks $n_{PRB} = 0..49$ in sub-frames 0,1,2,3,4,6,7,8,9					
Note 7:	Resource blocks $n_{PRB} = 4..99$ are allocated for the user data in sub-frame 5, and resource blocks $n_{PRB} = 0..99$ in sub-frames 0,1,2,3,4,6,7,8,9					

A.3.9.2 TDD

Table A.3.9.2-1: Fixed Reference Channel for sustained data-rate test (TDD)

Parameter	Unit	Value				
		R.31-1 TDD	R.31-2 TDD	R.31-3 TDD	R.31-3B TDD	R.31-4 TDD
Reference channel						
Channel bandwidth	MHz	10	10	20	15	20
Allocated resource blocks		Note 6	Note 7	Note 8	Note 9	Note 8
Uplink-Downlink Configuration (Note 3)		5	5	5	1	1
Number of HARQ Processes per component carrier	Processes	15	15	15	7	7
Allocated subframes per Radio Frame (D+S)		8+1	8+1	8+1	4+2	4+2
Modulation		64QAM	64QAM	64QAM	64QAM	64QAM
Coding Rate						
For Sub-Frames 4,9		0.40	0.59	0.59	0.87	0.88
For Sub-Frames 3,7,8		0.40	0.59	0.59	n/a	n/a
For Sub-Frame 1		n/a	n/a	n/a	n/a	n/a
For Sub-Frame 5		0.40	0.64	0.62	0.88	0.87
For Sub-Frame 6		0.40	0.60	0.60	n/a	n/a
For Sub-Frame 0		0.40	0.62	0.61	0.90	0.90
Information Bit Payload						
For Sub-Frames 4,9	Bits	10296	25456	51024	51024	75376
For Sub-Frames 3,7,8	Bits	10296	25456	51024	0	0
For Sub-Frame 1	Bits	0	0	0	0	0
For Sub-Frame 5	Bits	10296	25456	51024	51024	71112
For Sub-Frame 6	Bits	10296	25456	51024	0	0
For Sub-Frame 0	Bits	10296	25456	51024	51024	75376
Number of Code Blocks per Sub-Frame (Note 4)						
For Sub-Frames 4,9		2	5	9	9	13
For Sub-Frames 3,7,8		2	5	9	n/a	n/a
For Sub-Frame 1		n/a	n/a	n/a	n/a	n/a
For Sub-Frame 5		2	5	9	9	12
For Sub-Frame 6		2	5	9	n/a	n/a
For Sub-Frame 0		2	5	9	9	13
Binary Channel Bits Per Sub-Frame						
For Sub-Frames 4,9	Bits	26100	43200	86400	58752	86400
For Sub-Frames 3,7,8	Bits	26100	43200	86400	n/a	n/a
For Sub-Frame 1	Bits	n/a	n/a	n/a	n/a	n/a
For Sub-Frame 5	Bits	26100	40176	82512	58320	82512
For Sub-Frame 6	Bits	26100	42768	85968	n/a	n/a
For Sub-Frame 0	Bits	26100	41184	84384	56736	84384
Number of layers		1	2	2	2	2
Max. Throughput averaged over 1 frame	Mbps	8.237	20.365	40.819	20.409	29.724
UE Category		≥ 1	≥ 2	≥ 2	≥ 2	≥ 3
Note 1:	1 symbol allocated to PDCCH for all tests					
Note 2:	Reference signal, synchronization signals and PBCH allocated as per TS 36.211 [8]					
Note 3:	As per Table 4.2-2 in TS 36.211 [8]					
Note 4:	If more than one Code Block is present, an additional CRC sequence of L = 24 Bits is attached to each Code Block (otherwise L = 0 Bit)					
Note 5:	Resource blocks $n_{PRB} = 0..2$ are allocated for SIB transmissions in sub-frame 5 for all bandwidths					
Note 6:	Resource blocks $n_{PRB} = 6..14,30..49$ are allocated for the user data in all subframes					
Note 7:	Resource blocks $n_{PRB} = 3..49$ are allocated for the user data in sub-frame 5, and resource blocks $n_{PRB} = 0..49$ in sub-frames 0,3,4,6,7,8,9					
Note 8:	Resource blocks $n_{PRB} = 4..99$ are allocated for the user data in sub-frame 5, and resource blocks $n_{PRB} = 0..99$ in sub-frames 0,3,4,6,7,8,9					
Note 9:	Resource blocks $n_{PRB} = 4..71$ are allocated for the user data in all sub-frames					

A.4 CQI reference measurement channels

This section defines the DL signal applicable to the reporting of channel quality information (Clause 9.2 and 9.3).

In Table A.4-0 are listed the UL/DL reference measurement channels specified in annex A.4 of this release of TS 36.521-1. This table is informative and serves only to a better overview. The reference for the concrete reference measurement channels and corresponding implementation's parameters as to be used for testing are the other tables of this annex as appropriate.

Table A.4-0: Overview of CSI reference measurement channels

Duple x	Table	Name	B W	Mod	TCR	RB	RB Off set	UE Cat eg	Notes
CSI Performance, PDSCH, Full allocation (CRS)									
FDD	Table A.4-1		10	CQI	CQI	50			
TDD	Table A.4-2		10	CQI	CQI	50			
CSI Performance, PDSCH, Full allocation (CSI-RS): 2 CRS ports									
FDD	Table A.4-1a		10	CQI	CQI	50			
TDD	Table A.4-2a		10	CQI	CQI	50			
CSI Performance, PDSCH, Full allocation (CSI-RS): 1 CRS port									
FDD	Table A.4-1b		10	CQI	CQI	50			
TDD	Table A.4-2b		10	CQI	CQI	50			
CSI Performance, PDSCH, Partial allocation (CRS) (6 RB-s)									
FDD	Table A.4-4		10	CQI	CQI	6			
TDD	Table A.4-5		10	CQI	CQI	6			
CSI Performance, PDSCH, Partial allocation (CSI-RS) (6 RB-s)									
FDD	Table A.4-4a		10	CQI	CQI	6			
TDD	Table A.4-5a		10	CQI	CQI	6			
CSI Performance, PDSCH, Partial allocation (CRS) (15 RB-s)									
FDD	Table A.4-7		10	CQI	CQI	15			
TDD	Table A.4-8		10	CQI	CQI	15			
CSI Performance, PDSCH, Partial allocation (CRS) (3 RB-s)									
FDD	Table A.4-10		10	CQI	CQI	3			
TDD	Table A.4-11		10	CQI	CQI	3			
CSI Performance, PUSCH for PUCCH reporting mode									
FDD	Table A.4.1-1		10	QPSK	1/3	6		≥ 1	Allocated Sub-Frames 1, 3, 5, 7
FDD	Table A.4.1-1		10	QPSK	1/3	6		≥ 1	Allocated Sub-Frames 3, 8
FDD	Table A.4.1-1		10	QPSK	1/3	6		≥ 1	Allocated Sub-Frames 0 - 9
TDD	Table A.4.1-2		10	QPSK	1/3	6		≥ 1	Allocated Sub-Frames 2, 7
TDD	Table A.4.1-2		10	QPSK	1/3	6		≥ 1	Allocated Sub-Frames 3, 8

The reference channels in Table A.4-1, A.4-2, A.4-4 and A.4-5 comply with the CQI definition specified in Sec. 7.2.3 of TS 36.213 [10]. Table A.4-3 and A.4-6 specify the transport format corresponding to each CQI for single antenna transmission. Table A.4-3a specifies the transport format corresponding to each CQI for dual antenna transmission.

Table A.4-1: Reference channel for CQI requirements (FDD) full PRB allocation

Parameter	Unit	Value					
		1.4	3	5	10	15	20
Channel bandwidth	MHz	1.4	3	5	10	15	20
Allocated resource blocks		6	15	25	50	75	100
Subcarriers per resource block		12	12	12	12	12	12
Allocated subframes per Radio Frame		8	8	8	8	8	8
Modulation					Table A.4-3	Table A.4-3a	
Target coding rate					Table A.4-3	Table A.4-3a	
Number of HARQ Processes	Processes	8	8	8	8	8	8
Maximum number of HARQ transmissions		1	1	1	1	1	1
Note 1: 3 symbols allocated to PDCCH							
Note 2: Only subframes 1,2,3,4,6,7,8, and 9 are allocated to avoid PBCH and synchronization signal overhead							

Table A.4-1a: Reference channel for CQI requirements (FDD) full PRB allocation (CSI-RS): 2 CRS ports

Parameter	Unit	Value					
		1.4	3	5	10	15	20
Channel bandwidth	MHz	1.4	3	5	10	15	20
Allocated resource blocks		6	15	25	50	75	100
Subcarriers per resource block		12	12	12	12	12	12
Allocated subframes per Radio Frame		8	8	8	8	8	8
Modulation					Table A.4-3b	Table A.4-3c	
Target coding rate					Table A.4-3b	Table A.4-3c	
Number of HARQ Processes	Processes	8	8	8	8	8	8
Maximum number of HARQ transmissions		1	1	1	1	1	1
Note 1: 3 symbols allocated to PDCCH							
Note 2: Only subframes 1,2,3,4,6,7,8, and 9 are allocated to avoid PBCH and synchronization signal overhead							

Table A.4-1b: Reference channel for CQI requirements (FDD) full PRB allocation (CSI-RS): 1 CRS port

Parameter	Unit	Value					
		1.4	3	5	10	15	20
Channel bandwidth	MHz	1.4	3	5	10	15	20
Allocated resource blocks		6	15	25	50	75	100
Subcarriers per resource block		12	12	12	12	12	12
Allocated subframes per Radio Frame		8	8	8	8	8	8
Modulation					Table A.4-3e	Table A.4-3f	
Target coding rate					Table A.4-3e	Table A.4-3f	
Number of HARQ Processes	Processes	8	8	8	8	8	8
Maximum number of HARQ transmissions		1	1	1	1	1	1
Note 1: 3 symbols allocated to PDCCH							
Note 2: Only subframes 1,2,3,4,6,7,8, and 9 are allocated to avoid PBCH and synchronization signal overhead							

Table A.4-2: Reference channel for CQI requirements (TDD) full PRB allocation

Parameter	Unit	Value					
		1.4	3	5	10	15	20
Channel bandwidth	MHz	1.4	3	5	10	15	20
Allocated resource blocks		6	15	25	50	75	100
Subcarriers per resource block		12	12	12	12	12	12
Allocated subframes per Radio Frame		4	4	4	4	4	4
Modulation					Table A.4-3	Table A.4-3a	
Target coding rate					Table A.4-3	Table A.4-3a	
Number of HARQ Processes	Processes	10	10	10	10	10	10
Maximum number of HARQ transmissions		1	1	1	1	1	1
Note 1: 3 symbols allocated to PDCCH							
Note 2: UL-DL configuration 2 is used and only subframes 3, 4, 8, and 9 are allocated to avoid PBCH and synchronization signal overhead							

Table A.4-2a: Reference channel for CQI requirements (TDD) full PRB allocation (CSI-RS): 2 CRS ports

Parameter	Unit	Value					
		1.4	3	5	10	15	20
Channel bandwidth	MHz	1.4	3	5	10	15	20
Allocated resource blocks		6	15	25	50	75	100
Subcarriers per resource block		12	12	12	12	12	12
Allocated subframes per Radio Frame		4	4	4	4	4	4
Modulation					Table A.4-3b	Table A.4-3d	
Target coding rate					Table A.4-3b	Table A.4-3d	
Number of HARQ Processes	Processes	10	10	10	10	10	10
Maximum number of HARQ transmissions		1	1	1	1	1	1
Note 1: 3 symbols allocated to PDCCH							
Note 2: UL-DL configuration 2 is used and only subframes 3, 4, 8, and 9 are allocated to avoid PBCH and synchronization signal overhead							

Table A.4-2b: Reference channel for CQI requirements (TDD) full PRB allocation (CSI-RS): 1 CRS port

Parameter	Unit	Value					
		1.4	3	5	10	15	20
Channel bandwidth	MHz	1.4	3	5	10	15	20
Allocated resource blocks		6	15	25	50	75	100
Subcarriers per resource block		12	12	12	12	12	12
Allocated subframes per Radio Frame		2	2	2	2	2	2
Modulation					Table A.4-3e	Table A.4-3f	
Target coding rate					Table A.4-3e	Table A.4-3f	
Number of HARQ Processes	Processes	10	10	10	10	10	10
Maximum number of HARQ transmissions		1	1	1	1	1	1
Note 1: 3 symbols allocated to PDCCH							
Note 2: UL-DL configuration 2 is used and only subframes 4 and 9 are allocated to avoid PBCH and synchronization signal overhead							

Table A.4-3: Transport format corresponding to each CQI index for 50 PRB allocation single antenna transmission

CQI index	Modulation	Target code rate	Imcs	Information Bit Payload (Subframes 1,2,3,4,6,7,8,9)	Binary Channel Bits Per Sub-Frame (Subframes 1,2,3,4,6,7,8,9)	Actual Code rate
0	out of range	out of range	DTX	-	-	-
1	QPSK	0.0762	0	1384	12600	0.1117
2	QPSK	0.1172	0	1384	12600	0.1117
3	QPSK	0.1885	2	2216	12600	0.1778
4	QPSK	0.3008	4	3624	12600	0.2895
5	QPSK	0.4385	6	5160	12600	0.4114
6	QPSK	0.5879	8	6968	12600	0.5549
7	16QAM	0.3691	11	8760	25200	0.3486
8	16QAM	0.4785	13	11448	25200	0.4552
9	16QAM	0.6016	16	15264	25200	0.6067
10	64QAM	0.4551	18	16416	37800	0.4349
11	64QAM	0.5537	21	21384	37800	0.5663
12	64QAM	0.6504	23	25456	37800	0.6741
13	64QAM	0.7539	25	28336	37800	0.7503
14	64QAM	0.8525	27	31704	37800	0.8394
15	64QAM	0.9258	27	31704	37800	0.8394

Note1: Sub-frame#0 and #5 are not used for the corresponding requirement.

Table A.4-3a: Transport format corresponding to each CQI index for 50 PRB allocation dual antenna transmission

CQI index	Modulation	Target code rate	Imcs	Information Bit Payload (Subframes 1,2,3,4,6,7,8,9)	Binary Channel Bits Per Sub-Frame (Subframes 1,2,3,4,6,7,8,9)	Actual Code rate
0	out of range	out of range	DTX	-	-	-
1	QPSK	0.0762	0	1384	12000	0.1173
2	QPSK	0.1172	0	1384	12000	0.1173
3	QPSK	0.1885	2	2216	12000	0.1867
4	QPSK	0.3008	4	3624	12000	0.3040
5	QPSK	0.4385	6	5160	12000	0.4320
6	QPSK	0.5879	8	6968	12000	0.5827
7	16QAM	0.3691	11	8760	24000	0.3660
8	16QAM	0.4785	13	11448	24000	0.4780
9	16QAM	0.6016	15	14112	24000	0.5890
10	64QAM	0.4551	18	16416	36000	0.4567
11	64QAM	0.5537	20	19848	36000	0.5520
12	64QAM	0.6504	22	22920	36000	0.6373
13	64QAM	0.7539	24	27376	36000	0.7611
14	64QAM	0.8525	26	30576	36000	0.8500
15	64QAM	0.9258	27	31704	36000	0.8813

Note1: Sub-frame#0 and #5 are not used for the corresponding requirement. The next subframe (i.e. sub-frame#1 or #6) shall be used for the retransmission.

Table A.4-3b: Transport format corresponding to each CQI index for 50 PRB allocation (CSI-RS): 2 CRS ports, Non CSI-RS subframe

CQI index	Modulation	Target code rate	lmcs	Information Bit Payload	Binary Channel Bits Per Sub-Frame
0	out of range	out of range	DTX	-	-
1	QPSK	0.0762	0	1384	10800
2	QPSK	0.1172	0	1384	10800
3	QPSK	0.1885	2	2216	10800
4	QPSK	0.3008	∅	[3624]	10800
5	QPSK	0.4385	5	4392	10800
6	QPSK	0.5879	7	6200	10800
7	16QAM	0.3691	10	7992	21600
8	16QAM	0.4785	12	9912	21600
9	16QAM	0.6016	14	12960	21600
10	64QAM	0.4551	17	15264	32400
11	64QAM	0.5537	19	18336	32400
12	64QAM	0.6504	21	21384	32400
13	64QAM	0.7539	23	25456	32400
14	64QAM	0.8525	24	27376	32400
15	64QAM	0.9258	25	28336	32400
Note 1: Sub-frame#0 and #5 are not used for the corresponding requirement. The next subframe (i.e. sub-frame#1 or #6) shall be used for the retransmission.					

Table A.4-3c: Transport format corresponding to each CQI index for 50 PRB allocation (CSI-RS): 2 CRS ports, 4 CSI-RS ports, CSI-RS Subframe

CQI index	Modulation	Target code rate	lmcs	Information Bit Payload	Binary Channel Bits Per Sub-Frame
0	out of range	out of range	DTX	-	-
1	QPSK	0.0762	0	1384	10400
2	QPSK	0.1172	0	1384	10400
3	QPSK	0.1885	1	1800	10400
4	QPSK	0.3008	3	2856	10400
5	QPSK	0.4385	5	4392	10400
6	QPSK	0.5879	7	6200	10400
7	16QAM	0.3691	10	7992	20800
8	16QAM	0.4785	12	9912	20800
9	16QAM	0.6016	14	12960	20800
10	64QAM	0.4551	17	15264	31200
11	64QAM	0.5537	18	16416	31200
12	64QAM	0.6504	20	19848	31200
13	64QAM	0.7539	22	22920	31200
14	64QAM	0.8525	24	27376	31200
15	64QAM	0.9258	25	28336	31200
Note 1: Sub-frame#0 and #5 are not used for the corresponding requirement. The next subframe (i.e. sub-frame#1 or #6) shall be used for the retransmission.					

Table A.4-3d: Transport format corresponding to each CQI index for 50 PRB allocation (CSI-RS): 2 CRS ports, 8 CSI-RS ports, CSI-RS Subframe

CQI index	Modulation	Target code rate	lmcs	Information Bit Payload	Binary Channel Bits Per Sub-Frame
0	out of range	out of range	DTX	-	-
1	QPSK	0.0762	0	1384	10000
2	QPSK	0.1172	0	1384	10000
3	QPSK	0.1885	1	1800	10000
4	QPSK	0.3008	3	2856	10000
5	QPSK	0.4385	5	4392	10000
6	QPSK	0.5879	7	6200	10000
7	16QAM	0.3691	10	7992	20000
8	16QAM	0.4785	12	9912	20000
9	16QAM	0.6016	13	11448	20000
10	64QAM	0.4551	17	15264	30000
11	64QAM	0.5537	18	16416	30000
12	64QAM	0.6504	20	19848	30000
13	64QAM	0.7539	22	22920	30000
14	64QAM	0.8525	23	25456	30000
15	64QAM	0.9258	24	27376	30000

Note 1: Sub-frame#0 and #5 are not used for the corresponding requirement. The next subframe (i.e. sub-frame#1 or #6) shall be used for the retransmission.

Table A.4-3e: Transport format corresponding to each CQI index for 50 PRB allocation (CSI-RS): 1 CRS port, Non CSI-RS subframe

CQI index	Modulation	Target code rate	lmcs	Information Bit Payload	Binary Channel Bits Per Sub-Frame
0	out of range	out of range	DTX	-	-
1	QPSK	0.0762	0	1384	11400
2	QPSK	0.1172	0	1384	11400
3	QPSK	0.1885	2	2216	11400
4	QPSK	0.3008	4	3624	11400
5	QPSK	0.4385	6	5160	11400
6	QPSK	0.5879	8	6968	11400
7	16QAM	0.3691	10	7992	22800
8	16QAM	0.4785	13	11448	22800
9	16QAM	0.6016	15	14112	22800
10	64QAM	0.4551	17	15264	34200
11	64QAM	0.5537	19	18336	34200
12	64QAM	0.6504	21	21384	34200
13	64QAM	0.7539	23	25456	34200
14	64QAM	0.8525	25	28336	34200
15	64QAM	0.9258	26	30576	34200

Note 1: Sub-frame#0 and #5 are not used for the corresponding requirement. The next subframe (i.e. sub-frame#1 or #6) shall be used for the retransmission.

Table A.4-3f: Transport format corresponding to each CQI index for 50 PRB allocation (CSI-RS): 1 CRS port, 2 CSI-RS ports, CSI-RS Subframe

CQI index	Modulation	Target code rate	lmcs	Information Bit Payload	Binary Channel Bits Per Sub-Frame
0	out of range	out of range	DTX	-	-
1	QPSK	0.0762	0	1384	11200
2	QPSK	0.1172	0	1384	11200
3	QPSK	0.1885	2	2216	11200
4	QPSK	0.3008	4	3624	11200
5	QPSK	0.4385	6	5160	11200
6	QPSK	0.5879	7	6200	11200
7	16QAM	0.3691	10	7992	22400
8	16QAM	0.4785	12	9912	22400
9	16QAM	0.6016	14	12960	22400
10	64QAM	0.4551	17	15264	33600
11	64QAM	0.5537	19	18336	33600
12	64QAM	0.6504	21	21384	33600
13	64QAM	0.7539	23	25456	33600
14	64QAM	0.8525	25	28336	33600
15	64QAM	0.9258	26	30576	33600

Note 1: Sub-frame#0 and #5 are not used for the corresponding requirement. The next subframe (i.e. sub-frame#1 or #6) shall be used for the retransmission.

Table A.4-4: Reference channel for CQI requirements (FDD) 6 PRB allocation (CRS)

Parameter	Unit	Value					
		1.4	3	5	10	15	20
Channel bandwidth	MHz	1.4	3	5	10	15	20
Allocated resource blocks		6	6	6	6	6	6
Subcarriers per resource block		12	12	12	12	12	12
Allocated subframes per Radio Frame		8	8	8	8	8	8
Modulation					Table A.4-6		
Target coding rate					Table A.4-6		
Number of HARQ Processes	Processes	8	8	8	8	8	8
Maximum number of HARQ transmissions		1	1	1	1	1	1

Note 1: 3 symbols allocated to PDCCH
 Note 2: Only subframes 1,2,3,4,6,7,8, and 9 are allocated to avoid PBCH and synchronization signal overhead

Table A.4-4a: Reference channel for CQI requirements (FDD) 6 PRB allocation (CSI-RS)

Parameter	Unit	Value					
		1.4	3	5	10	15	20
Channel bandwidth	MHz	1.4	3	5	10	15	20
Allocated resource blocks		6	6	6	6	6	6
Subcarriers per resource block		12	12	12	12	12	12
Allocated subframes per Radio Frame		8	8	8	8	8	8
Modulation					Table A.4-6a	Table A.4-6b	
Target coding rate					Table A.4-6a	Table A.4-6b	
Number of HARQ Processes	Processes	8	8	8	8	8	8
Maximum number of HARQ transmissions		1	1	1	1	1	1

Note 1: 3 symbols allocated to PDCCH.
 Note 2: Only subframes 1,2,3,4,6,7,8, and 9 are allocated to avoid PBCH and synchronization signal overhead.

Table A.4-5: Reference channel for CQI requirements (TDD) 6 PRB allocation (CRS)

Parameter	Unit	Value					
		1.4	3	5	10	15	20
Channel bandwidth	MHz	1.4	3	5	10	15	20
Allocated resource blocks		6	6	6	6	6	6
Subcarriers per resource block		12	12	12	12	12	12
Allocated subframes per Radio Frame		4	4	4	4	4	4
Modulation					Table A.4-6		
Target coding rate					Table A.4-6		
Number of HARQ Processes	Processes	10	10	10	10	10	10
Maximum number of HARQ transmissions		1	1	1	1	1	1
Note 1: 3 symbols allocated to PDCCH							
Note 2: UL-DL configuration 2 is used and only subframes 3, 4, 8, and 9 are allocated to avoid PBCH and synchronization signal overhead							

Table A.4-5a: Reference channel for CQI requirements (TDD) 6 PRB allocation (CSI-RS)

Parameter	Unit	Value					
		1.4	3	5	10	15	20
Channel bandwidth	MHz	1.4	3	5	10	15	20
Allocated resource blocks		6	6	6	6	6	6
Subcarriers per resource block		12	12	12	12	12	12
Allocated subframes per Radio Frame		4	4	4	4	4	4
Modulation					Table A.4-6a	Table A.4-6b	
Target coding rate					Table A.4-6a	Table A.4-6b	
Number of HARQ Processes	Processes	10	10	10	10	10	10
Maximum number of HARQ transmissions		1	1	1	1	1	1
Note 1: 3 symbols allocated to PDCCH.							
Note 2: UL-DL configuration 2 is used and only subframes 3, 4, 8, and 9 are allocated to avoid PBCH and synchronization signal overhead.							

Table A.4-6: Transport format corresponding to each CQI index for 6 PRB allocation (CRS)

CQI index	Modulation	Target code rate	Imcs	Information Bit Payload (Subframes 1,2,3,4,6,7,8,9)	Binary Channel Bits Per Sub-Frame (Subframes 1,2,3,4,6,7,8,9)	Actual Code rate
0	out of range	out of range	DTX	-	-	-
1	QPSK	0.0762	0	152	1512	0.1005
2	QPSK	0.1172	0	152	1512	0.1005
3	QPSK	0.1885	2	256	1512	0.1693
4	QPSK	0.3008	4	408	1512	0.2698
5	QPSK	0.4385	6	600	1512	0.3968
6	QPSK	0.5879	8	808	1512	0.5344
7	16QAM	0.3691	11	1032	3024	0.3413
8	16QAM	0.4785	13	1352	3024	0.4471
9	16QAM	0.6016	16	1800	3024	0.5952
10	64QAM	0.4551	19	2152	4536	0.4744
11	64QAM	0.5537	21	2600	4536	0.5732
12	64QAM	0.6504	23	2984	4536	0.6578
13	64QAM	0.7539	25	3496	4536	0.7707
14	64QAM	0.8525	27	3752	4536	0.8272
15	64QAM	0.9258	27	3752	4536	0.8272
Note1: Sub-frame#0 and #5 are not used for the corresponding requirement.						

Table A.4-6a: Transport format corresponding to each CQI index for 6 PRB allocation (CSI-RS): 1 CRS port, Non CSI-RS subframe

CQI index	Modulation	Target code rate	lmcs	Information Bit Payload	Binary Channel Bits Per Sub-Frame
0	out of range	out of range	DTX	-	-
1	QPSK	0.0762	0	152	1368
2	QPSK	0.1172	0	152	1368
3	QPSK	0.1885	2	256	1368
4	QPSK	0.3008	4	408	1368
5	QPSK	0.4385	6	600	1368
6	QPSK	0.5879	8	808	1368
7	16QAM	0.3691	11	1032	2736
8	16QAM	0.4785	13	1352	2736
9	16QAM	0.6016	14	1544	2736
10	64QAM	0.4551	17	1800	4104
11	64QAM	0.5537	20	2344	4104
12	64QAM	0.6504	21	2600	4104
13	64QAM	0.7539	23	2984	4104
14	64QAM	0.8525	25	3496	4104
15	64QAM	0.9258	27	3752	4104

Note 1: Sub-frame#0 and #5 are not used for the corresponding requirement.

Table A.4-6b: Transport format corresponding to each CQI index for 6 PRB allocation (CSI-RS): 1 CRS port, 2 CSI-RS ports, CSI-RS Subframe

CQI index	Modulation	Target code rate	lmcs	Information Bit Payload	Binary Channel Bits Per Sub-Frame
0	out of range	out of range	DTX	-	-
1	QPSK	0.0762	0	152	1344
2	QPSK	0.1172	0	152	1344
3	QPSK	0.1885	1	208	1344
4	QPSK	0.3008	4	408	1344
5	QPSK	0.4385	6	600	1344
6	QPSK	0.5879	8	808	1344
7	16QAM	0.3691	10	936	2688
8	16QAM	0.4785	12	1192	2688
9	16QAM	0.6016	14	1544	2688
10	64QAM	0.4551	17	1800	4032
11	64QAM	0.5537	19	2152	4032
12	64QAM	0.6504	21	2600	4032
13	64QAM	0.7539	23	2984	4032
14	64QAM	0.8525	25	3496	4032
15	64QAM	0.9258	26	3624	4032

Note 1: Sub-frame#0 and #5 are not used for the corresponding requirement.

Table A.4-7: Reference channel for CQI requirements (FDD) partial PRB allocation (CRS)

Parameter	Unit	Value				
		3	5	10	15	20
Channel bandwidth	MHz	3	5	10	15	20
Allocated resource blocks				15 (Note 3)		
Subcarriers per resource block				12		
Allocated subframes per Radio Frame				8		
Modulation		Table A.4-9				
Target coding rate		Table A.4-9				
Number of HARQ processes				8		
Maximum number of HARQ transmissions				1		
Note 1: 3 symbols allocated to PDCCH						
Note 2: Only subframes 1,2,3,4,6,7,8, and 9 are allocated to avoid PBCH and synchronization signal overhead						
Note 3: Centred within the Transmission Bandwidth Configuration (Figure 5.4.2-1)						

Table A.4-8: Reference channel for CQI requirements (TDD) partial PRB allocation (CRS)

Parameter	Unit	Value				
		3	5	10	15	20
Channel bandwidth	MHz	3	5	10	15	20
Allocated resource blocks				15 (Note 3)		
Subcarriers per resource block				12		
Allocated subframes per Radio Frame				4		
Modulation		Table A.4-9				
Target coding rate		Table A.4-9				
Number of HARQ processes				10		
Maximum number of HARQ transmissions				1		
Note 1: 3 symbols allocated to PDCCH						
Note 2: UL-DL configuration 2 is used and only subframes 3, 4, 8, and 9 are allocated to avoid PBCH and synchronization signal overhead						
Note 3: Centred within the Transmission Bandwidth Configuration (Figure 5.4.2-1)						

Table A.4-9: Transport format corresponding to each CQI index for 15 PRB allocation (CRS)

CQI index	Modulation	Target code rate	Imcs	Information Bit Payload (Subframes 1,2,3,4,6,7,8,9)	Binary Channel Bits Per Sub-Frame (Subframes 1,2,3,4,6,7,8,9)	Actual Code rate
0	out of range	out of range	DTX	-	-	-
1	QPSK	0.0762	0	392	3780	0.1037
2	QPSK	0.1172	0	392	3780	0.1037
3	QPSK	0.1885	2	648	3780	0.1714
4	QPSK	0.3008	4	1064	3780	0.2815
5	QPSK	0.4385	6	1544	3780	0.4085
6	QPSK	0.5879	8	2088	3780	0.5524
7	16QAM	0.3691	11	2664	7560	0.3524
8	16QAM	0.4785	13	3368	7560	0.4455
9	16QAM	0.6016	16	4584	7560	0.6063
10	64QAM	0.4551	18	4968	11340	0.4381
11	64QAM	0.5537	21	6456	11340	0.5693
12	64QAM	0.6504	23	7480	11340	0.6596
13	64QAM	0.7539	25	8504	11340	0.7499
14	64QAM	0.8525	27	9528	11340	0.8402
15	64QAM	0.9258	27	9528	11340	0.8402

Note1: Sub-frame#0 and #5 are not used for the corresponding requirement.

Table A.4-10: Reference channel for CQI requirements (FDD) 3 PRB allocation (CRS)

Parameter	Unit	Value					
		1.4	3	5	10	15	20
Channel bandwidth	MHz	1.4	3	5	10	15	20
Allocated resource blocks		3	3	3	3	3	3
Subcarriers per resource block		12	12	12	12	12	12
Allocated subframes per Radio Frame		8	8	8	8	8	8
Modulation					Table A.4-12		
Target coding rate					Table A.4-12		
Number of HARQ Processes	Processes	8	8	8	8	8	8
Maximum number of HARQ transmissions		1	1	1	1	1	1
Note 1: 3 symbols allocated to PDCCH							
Note 2: Only subframes 1,2,3,4,6,7,8, and 9 are allocated to avoid PBCH and synchronization signal overhead							

Table A.4-11: Reference channel for CQI requirements (TDD) 3 PRB allocation (CRS)

Parameter	Unit	Value					
		1.4	3	5	10	15	20
Channel bandwidth	MHz	1.4	3	5	10	15	20
Allocated resource blocks		3	3	3	3	3	3
Subcarriers per resource block		12	12	12	12	12	12
Allocated subframes per Radio Frame		4	4	4	4	4	4
Modulation					Table A.4-12		
Target coding rate					Table A.4-12		
Number of HARQ Processes	Processes	10	10	10	10	10	10
Maximum number of HARQ transmissions		1	1	1	1	1	1
Note 1: 3 symbols allocated to PDCCH.							
Note 2: UL-DL configuration 2 is used and only subframes 3, 4, 8, and 9 are allocated to avoid PBCH and synchronization signal overhead.							

Table A.4-12: Transport format corresponding to each CQI index for 3 PRB allocation (CRS)

CQI index	Modulation	Target code rate	Imcs	Information Bit Payload (Subframes 1,2,3,4,6,7,8,9)	Binary Channel Bits Per Sub-Frame (Subframes 1,2,3,4,6,7,8,9)	Actual Code rate
0	out of range	out of range	DTX	-	-	-
1	QPSK	0.0762	0	56	756	0.0741
2	QPSK	0.1172	1	88	756	0.1164
3	QPSK	0.1885	2	144	756	0.1905
4	QPSK	0.3008	5	224	756	0.2963
5	QPSK	0.4385	7	328	756	0.4339
6	QPSK	0.5879	9	456	756	0.6032
7	16QAM	0.3691	12	584	1512	0.3862
8	16QAM	0.4785	13	744	1512	0.4921
9	16QAM	0.6016	16	904	1512	0.5979
10	64QAM	0.4551	19	1064	2268	0.4691
11	64QAM	0.5537	21	1288	2268	0.5679
12	64QAM	0.6504	23	1480	2268	0.6526
13	64QAM	0.7539	25	1736	2268	0.7654
14	64QAM	0.8525	27	1864	2268	0.8219
15	64QAM	0.9258	27	1864	2268	0.8219
Note1: Sub-frame#0 and #5 are not used for the corresponding requirement.						

A.4.1 Additional CSI reference measurement channels

This sections defines additional reference measurement channels for CSI testing, required to run the test properly according to the test parameters.

Table A.4.1-1: Uplink reference channels for transmitting CSI reports on PUSCH, when being in a PUCCH reporting mode (FDD)

Parameter	Unit	Value				
Channel bandwidth	MHz	10	10	10		
Allocated resource blocks		6	6	6		
DFT-OFDM Symbols per Sub-Frame		12	12	12		
Modulation		QPSK	QPSK	QPSK		
Target Coding rate		1/3	1/3	1/3		
Allocated Sub-Frames (Note 1)		1, 3, 5, 7	3, 8	0, 1, 2, 3, 4, 5, 6, 7, 8, 9		
Payload size	Bits	600	600	600		
Transport block CRC	Bits	24	24	24		
Number of code blocks per Sub-Frame (Note 2)		1	1	1		
Total number of bits per Sub-Frame	Bits	1728	1728	1728		
Total symbols per Sub-Frame		864	864	864		
UE Category		≥ 1	≥ 1	≥ 1		
Note 1: The remaining subframes are not allocated with data. All the allocation details specified in the reference channel are valid only for the allocated subframes.						
Note 2: If more than one Code Block is present, an additional CRC sequence of L = 24 Bits is attached to each Code Block (otherwise L = 0 Bit)						

Table A.4.1-2: Uplink reference channels for transmitting CSI reports on PUSCH, when being in a PUCCH reporting mode (TDD)

Parameter	Unit	Value				
Channel bandwidth	MHz	10	10			
Allocated resource blocks		6	6			
Uplink-Downlink Configuration (Note 1)		2	1			
DFT-OFDM Symbols per Sub-Frame		12	12			
Modulation		QPSK	QPSK			
Target Coding rate		1/3	1/3			
Allocated Sub-Frames (Note 2)		2, 7	3, 8			
Payload size	Bits	600	600			
Transport block CRC	Bits	24	24			
Number of code blocks per Sub-Frame (Note 3)		1	1			
Total number of bits per Sub-Frame	Bits	1728	1728			
Total symbols per Sub-Frame		864	864			
UE Category		≥ 1	≥ 1			
Note 1: As per Table 4.2-2 in TS 36.211 [4]						
Note 2: The remaining subframes are not allocated with data. All the allocation details specified in the reference channel are valid only for the allocated subframes.						
Note 3: If more than one Code Block is present, an additional CRC sequence of L = 24 Bits is attached to each Code Block (otherwise L = 0 Bit)						

A.5 OFDMA Channel Noise Generator (OCNG)

A.5.1 OCNG Patterns for FDD

The following OCNG patterns are used for modelling allocations to virtual UEs (which are not under test). The OCNG pattern for each sub frame specifies the allocations that shall be filled with OCNG, and furthermore, the relative power level of each such allocation.

In each test case the OCNG is expressed by parameters OCNG_RA and OCNG_RB which together with a relative power level (γ) specifies the PDSCH EPRE-to-RS EPRE ratios in OFDM symbols with and without reference symbols, respectively. The relative power, which is used for modelling boosting per virtual UE allocation, is expressed by:

$$\gamma_i = PDSCH_i_RA / OCNG_RA = PDSCH_i_RB / OCNG_RB,$$

where γ_i denotes the relative power level of the i :th virtual UE. The parameter settings of OCNG_RA, OCNG_RB, and the set of relative power levels γ are chosen such that when also taking allocations to the UE under test into account, as given by a PDSCH reference channel, a transmitted power spectral density that is constant on an OFDM symbol basis is targeted.

Moreover the OCNG pattern is accompanied by a PCFICH/PDCCH/PHICH reference channel which specifies the control region. For any aggregation and PHICH allocation, the PDCCH and any unused PHICH groups are padded with resource element groups with a power level given respectively by PDCCH_RA/RB and PHICH_RA/RB as specified in the test case such that a total power spectral density in the control region that is constant on an OFDM symbol basis is targeted.

A.5.1.1 OCNG FDD pattern 1: One sided dynamic OCNG FDD pattern

This OCNG Pattern fills with OCNG all empty PRB-s (PRB-s with no allocation of data or system information) of the DL sub-frames, when the unallocated area is continuous in frequency domain (one sided).

Table A.5.1.1-1: OP.1 FDD: One sided dynamic OCNG FDD Pattern

Relative power level γ_{PRB} [dB]			PDSCH Data
Subframe			
0	5	1 – 4, 6 – 9	
Allocation			
First unallocated PRB – Last unallocated PRB	First unallocated PRB – Last unallocated PRB	First unallocated PRB – Last unallocated PRB	
0	0	0	Note 1
<p>Note 1: These physical resource blocks are assigned to an arbitrary number of virtual UEs with one PDSCH per virtual UE; the data transmitted over the OCNG PDSCHs shall be uncorrelated pseudo random data, which is QPSK modulated. The parameter γ_{PRB} is used to scale the power of PDSCH.</p> <p>Note 2: If two or more transmit antennas with CRS are used in the test, the OCNG shall be transmitted to the virtual users by all the transmit antennas with CRS according to transmission mode 2. The parameter γ_{PRB} applies to each antenna port separately, so the transmit power is equal between all the transmit antennas with CRS used in the test. The antenna transmission modes are specified in section 7.1 in 3GPP TS 36.213.</p>			

A.5.1.2 OCNG FDD pattern 2: Two sided dynamic OCNG FDD pattern

This OCNG Pattern fills with OCNG all empty PRB-s (PRB-s with no allocation of data or system information) of the DL sub-frames, when the unallocated area is discontinuous in frequency domain (divided in two parts by the allocated area – two sided), starts with PRB 0 and ends with PRB $N_{RB} - 1$.

Table A.5.1.2-1: OP.2 FDD: Two sided dynamic OCNG FDD Pattern

Relative power level γ_{PRB} [dB]			PDSCH Data
Subframe			
0	5	1 – 4, 6 – 9	
Allocation			
0 – (First allocated PRB-1) and (Last allocated PRB+1) – ($N_{RB} - 1$)	0 – (First allocated PRB-1) and (Last allocated PRB+1) – ($N_{RB} - 1$)	0 – (First allocated PRB-1) and (Last allocated PRB+1) – ($N_{RB} - 1$)	
0	0	0	Note 1
<p>Note 1: These physical resource blocks are assigned to an arbitrary number of virtual UEs with one PDSCH per virtual UE; the data transmitted over the OCNG PDSCHs shall be uncorrelated pseudo random data, which is QPSK modulated. The parameter γ_{PRB} is used to scale the power of PDSCH.</p> <p>Note 2: If two or more transmit antennas with CRS are used in the test, the OCNG shall be transmitted to the virtual users by all the transmit antennas with CRS according to transmission mode 2. The parameter γ_{PRB} applies to each antenna port separately, so the transmit power is equal between all the transmit antennas with CRS used in the test. The antenna transmission modes are specified in section 7.1 in 3GPP TS 36.213.</p>			

A.5.1.3 OCNG FDD pattern 3: 49 RB OCNG allocation with MBSFN in 10 MHz

Table A.5.1.3-1: OP.3 FDD: OCNG FDD Pattern 3

Allocation n_{PRB}	Relative power level γ_{PRB} [dB]				PDSCH Data	PMCH Data
	Subframe					
	0	5	4, 9	1 – 3, 6 – 8		
1 – 49	0	0 (Allocation: all empty PRB-s)	0	N/A	Note 1	N/A
0 – 49	N/A	N/A	N/A	0	N/A	Note 2
<p>Note 1: These physical resource blocks are assigned to an arbitrary number of virtual UEs with one PDSCH per virtual UE; the data transmitted over the OCNG PDSCHs shall be uncorrelated pseudo random data, which is QPSK modulated. The parameter γ_{PRB} is used to scale the power of PDSCH.</p> <p>Note 2: Each physical resource block (PRB) is assigned to MBSFN transmission. The data in each PRB shall be uncorrelated with data in other PRBs over the period of any measurement. The MBSFN data shall be QPSK modulated. PMCH subframes shall contain cell-specific Reference Signals only in the first symbol of the first time slot. The parameter γ_{PRB} is used to scale the power of PMCH.</p> <p>Note 3: If two or more transmit antennas are used in the test, the OCNG shall be transmitted to the virtual users by all the transmit antennas according to transmission mode 2. The transmit power shall be equally split between all the transmit antennas used in the test. The antenna transmission modes are specified in section 7.1 in 3GPP TS 36.213.</p>						
N/A: Not Applicable						

A.5.1.4 OCNG FDD pattern 4: One sided dynamic OCNG FDD pattern for MBMS transmission

This OCNG Pattern fills with OCNG all empty PRB-s (PRB-s with no allocation of data or system information) of the DL sub-frames, when the unallocated area is continuous in frequency domain (one sided) and MBMS performance is tested.

Table A.5.1.4-1: OP.4 FDD: One sided dynamic OCNG FDD Pattern for MBMS transmission

Allocation n_{PRB}	Relative power level γ_{PRB} [dB]			PDSCH Data	PMCH Data
	Subframe				
	0, 4, 9	5	1 – 3, 6 – 8		
First unallocated PRB – Last unallocated PRB	0	0 (Allocation: all empty PRB-s)	N/A	Note 1	N/A
First unallocated PRB – Last unallocated PRB	N/A	N/A	N/A	N/A	Note 2
<p>Note 1: These physical resource blocks are assigned to an arbitrary number of virtual UEs with one PDSCH per virtual UE; the data transmitted over the OCNG PDSCHs shall be uncorrelated pseudo random data, which is QPSK modulated. The parameter γ_{PRB} is used to scale the power of PDSCH.</p> <p>Note 2: Each physical resource block (PRB) is assigned to MBSFN transmission. The data in each PRB shall be uncorrelated with data in other PRBs over the period of any measurement. The MBSFN data shall be QPSK modulated. PMCH subframes shall contain cell-specific Reference Signals only in the first symbol of the first time slot. The parameter γ_{PRB} is used to scale the power of PMCH.</p> <p>Note 3: If two or more transmit antennas are used in the test, the OCNG shall be transmitted to the virtual users by all the transmit antennas according to transmission mode 2. The transmit power shall be equally split between all the transmit antennas used in the test. The antenna transmission modes are specified in section 7.1 in 3GPP TS 36.213.</p> <p>N/A: Not Applicable</p>					

A.5.1.5 OCNG FDD pattern 5: One sided dynamic 16QAM modulated OCNG FDD pattern

This OCNG Pattern fills with OCNG all empty PRB-s (PRB-s with no allocation of data or system information) of DL sub-frames, when the unallocated area is continuous in the frequency domain (one sided).

Table A.5.1.5-1: OP.5 FDD: One sided dynamic 16QAM modulated OCNG FDD Pattern

Relative power level γ_{PRB} [dB]			PDSCH Data
Subframe			
0	5	1 – 4, 6 – 9	
Allocation			
First unallocated PRB – Last unallocated PRB	First unallocated PRB – Last unallocated PRB	First unallocated PRB – Last unallocated PRB	
0	0	0	Note 1
<p>Note 1: These physical resource blocks are assigned to an arbitrary number of virtual UEs with one PDSCH per virtual UE; the data transmitted over the OCNG PDSCHs shall be uncorrelated pseudo random data, which is 16QAM modulated. The parameter γ_{PRB} is used to scale the power of PDSCH.</p> <p>Note 2: If two or more transmit antennas with CRS are used in the test, the OCNG shall be transmitted to the virtual users by all the transmit antennas with CRS according to transmission mode 3 (Large Delay CDD). The parameter γ_{PRB} applies to each antenna port separately, so the transmit power is equal between all the transmit antennas with CRS used in the test. The antenna transmission modes are specified in section 7.1 in 3GPP TS 36.213.</p>			

A.5.1.6 OCNG FDD pattern 6: dynamic OCNG FDD pattern when user data is in 2 non-contiguous blocks

This OCNG Pattern fills with OCNG all empty PRB-s (PRB-s with no allocation of data or system information) of the DL sub-frames, when the unallocated area is discontinuous in frequency domain (divided in two parts by the first allocated block). The second allocated block ends with PRB $N_{RB} - 1$.

Table A.5.1.6-1: OP.6 FDD: OCNG FDD Pattern when user data is in 2 non-contiguous blocks

Relative power level γ_{PRB} [dB]			PDSCH Data
Subframe			
0	5	1 – 4, 6 – 9	
Allocation			
0 – (First allocated PRB of first block -1) and (Last allocated PRB of first block +1) – (First allocated PRB of second block -1)	0 – (First allocated PRB of first block -1) and (Last allocated PRB of first block +1) – (First allocated PRB of second block -1)	0 – (First allocated PRB of first block -1) and (Last allocated PRB of first block +1) – (First allocated PRB of second block -1)	
0	0	0	Note 1
<p>Note 1: These physical resource blocks are assigned to an arbitrary number of virtual UEs with one PDSCH per virtual UE; the data transmitted over the OCNG PDSCHs shall be uncorrelated pseudo random data, which is QPSK modulated. The parameter γ_{PRB} is used to scale the power of PDSCH.</p> <p>Note 2: If two or more transmit antennas with CRS are used in the test, the OCNG shall be transmitted to the virtual users by all the transmit antennas with CRS according to transmission mode 2. The parameter γ_{PRB} applies to each antenna port separately, so the transmit power is equal between all the transmit antennas with CRS used in the test. The antenna transmission modes are specified in section 7.1 in 3GPP TS 36.213.</p>			

A.5.2 OCNG Patterns for TDD

The following OCNG patterns are used for modelling allocations to virtual UEs (which are not under test). The OCNG pattern for each sub frame specifies the allocations that shall be filled with OCNG, and furthermore, the relative power level of each such allocation.

In each test case the OCNG is expressed by parameters OCNG_RA and OCNG_RB which together with a relative power level (γ) specifies the PDSCH EPRE-to-RS EPRE ratios in OFDM symbols with and without reference symbols, respectively. The relative power, which is used for modelling boosting per virtual UE allocation, is expressed by:

$$\gamma_i = PDSCH_i_RA / OCNG_RA = PDSCH_i_RB / OCNG_RB,$$

where γ_i denotes the relative power level of the i :th virtual UE. The parameter settings of OCNG_RA, OCNG_RB, and the set of relative power levels γ are chosen such that when also taking allocations to the UE under test into account, as given by a PDSCH reference channel, a transmitted power spectral density that is constant on an OFDM symbol basis is targeted.

Moreover the OCNG pattern is accompanied by a PCFICH/PDCCH/PHICH reference channel which specifies the control region. For any aggregation and PHICH allocation, the PDCCH and any unused PHICH groups are padded with resource element groups with a power level given respectively by PDCCH_RA/RB and PHICH_RA/RB as specified in the test case such that a total power spectral density in the control region that is constant on an OFDM symbol basis is targeted.

A.5.2.1 OCNG TDD pattern 1: One sided dynamic OCNG TDD pattern

This OCNG Pattern fills with OCNG all empty PRB-s (PRB-s with no allocation of data or system information) of the subframes available for DL transmission (depending on TDD UL/DL configuration), when the unallocated area is continuous in frequency domain (one sided).

Table A.5.2.1-1: OP.1 TDD: One sided dynamic OCNG TDD Pattern

Relative power level γ_{PRB} [dB]				PDSCH Data
Subframe (only if available for DL)				
0	5	3, 4, 7, 8, 9 and 6 (as normal subframe) ^{Note 2}	1 and 6 (as special subframe) ^{Note 2}	
Allocation				
First unallocated PRB –	First unallocated PRB –	First unallocated PRB –	First unallocated PRB –	
Last unallocated PRB	Last unallocated PRB	Last unallocated PRB	Last unallocated PRB	
0	0	0	0	Note 1
<p>Note 1: These physical resource blocks are assigned to an arbitrary number of virtual UEs with one PDSCH per virtual UE; the data transmitted over the OCNG PDSCHs shall be uncorrelated pseudo random data, which is QPSK modulated. The parameter γ_{PRB} is used to scale the power of PDSCH.</p> <p>Note 2: Subframes available for DL transmission depends on the Uplink-Downlink configuration in Table 4.2-2 in 3GPP TS 36.211.</p> <p>Note 3: If two or more transmit antennas with CRS are used in the test, the OCNG shall be transmitted to the virtual users by all the transmit antennas with CRS according to transmission mode 2. The parameter γ_{PRB} applies to each antenna port separately, so the transmit power is equal between all the transmit antennas with CRS used in the test. The antenna transmission modes are specified in section 7.1 in 3GPP TS 36.213.</p>				

A.5.2.2 OCNG TDD pattern 2: Two sided dynamic OCNG TDD pattern

This OCNG Pattern fills with OCNG all empty PRB-s (PRB-s with no allocation of data or system information) of the subframes available for DL transmission (depending on TDD UL/DL configuration), when the unallocated area is

discontinuous in frequency domain (divided in two parts by the allocated area – two sided), starts with PRB 0 and ends with PRB $N_{RB} - 1$.

Table A.5.2.2-1: OP.2 TDD: Two sided dynamic OCNG TDD Pattern

Relative power level γ_{PRB} [dB]				PDSCH Data
Subframe (only if available for DL)				
0	5	3, 4, 6, 7, 8, 9 (6 as normal subframe) ^{Note 2}	1, 6 (6 as special subframe) ^{Note 2}	
Allocation				
0 – (First allocated PRB-1) and (Last allocated PRB+1) – ($N_{RB} - 1$)	0 – (First allocated PRB-1) and (Last allocated PRB+1) – ($N_{RB} - 1$)	0 – (First allocated PRB-1) and (Last allocated PRB+1) – ($N_{RB} - 1$)	0 – (First allocated PRB-1) and (Last allocated PRB+1) – ($N_{RB} - 1$)	
0	0	0	0	Note 1
<p>Note 1: These physical resource blocks are assigned to an arbitrary number of virtual UEs with one PDSCH per virtual UE; the data transmitted over the OCNG PDSCHs shall be uncorrelated pseudo random data, which is QPSK modulated. The parameter γ_{PRB} is used to scale the power of PDSCH.</p> <p>Note 2: Subframes available for DL transmission depends on the Uplink-Downlink configuration in Table 4.2-2 in 3GPP TS 36.211.</p> <p>Note 3: If two or more transmit antennas with CRS are used in the test, the OCNG shall be transmitted to the virtual users by all the transmit antennas with CRS according to transmission mode 2. The parameter γ_{PRB} applies to each antenna port separately, so the transmit power is equal between all the transmit antennas with CRS used in the test. The antenna transmission modes are specified in section 7.1 in 3GPP TS 36.213.</p>				

A.5.2.3 OCNG TDD pattern 3: 49 RB OCNG allocation with MBSFN in 10 MHz

Table A.5.2. 3-1: OP.3 TDD: OCNG TDD Pattern 3 for 5ms downlink-to-uplink switch-point periodicity

Allocation n_{PRB}	Relative power level γ_{PRB} [dB]				PDSCH Data	PMCH Data
	Subframe					
	0	5	4, 9 ^{Note 2}	1, 6		

1 – 49	0	0 (Allocation: all empty PRB-s)	N/A	0	Note 1	N/A
0 – 49	N/A	N/A	0	N/A	N/A	Note 3
<p>Note 1: These physical resource blocks are assigned to an arbitrary number of virtual UEs with one PDSCH per virtual UE; the data transmitted over the OCNG PDSCHs shall be uncorrelated pseudo random data, which is QPSK modulated. The parameter γ_{PRB} is used to scale the power of PDSCH.</p> <p>Note 2: Subframes available for DL transmission depends on the Uplink-Downlink configuration in Table 4.2-2 in 3GPP TS 36.211.</p> <p>Note 3: Each physical resource block (PRB) is assigned to MBSFN transmission. The data in each PRB shall be uncorrelated with data in other PRBs over the period of any measurement. The MBSFN data shall be QPSK modulated. PMCH symbols shall not contain cell-specific Reference Signals</p> <p>Note 4: If two or more transmit antennas are used in the test, the OCNG shall be transmitted to the virtual users by all the transmit antennas according to transmission mode 2. The transmit power shall be equally split between all the transmit antennas used in the test. The antenna transmission modes are specified in section 7.1 in 3GPP TS 36.213.</p> <p>N/A: Not Applicable</p>						

A.5.2.4 OCNG TDD pattern 4: One sided dynamic OCNG TDD pattern for MBMS transmission

This OCNG Pattern fills with OCNG all empty PRB-s (PRB-s with no allocation of data or system information) of the DL sub-frames, when the unallocated area is continuous in frequency domain (one sided) and MBMS performance is tested.

Table A.5.2.4-1: OP.4 TDD: One sided dynamic OCNG TDD Pattern for MBMS transmission

Allocation n_{PRB}	Relative power level γ_{PRB} [dB]				PDSCH Data	PMCH Data
	Subframe (only for DL)					
	0 and 6 (as normal subframe)	1 (as special subframe)	5	3, 4, 7 – 9		
First unallocated PRB – Last unallocated PRB	0	0 (Allocation: all empty PRB-s of DwPTS)	0 (Allocation: all empty PRB-s)	N/A	Note 1	N/A
First unallocated PRB – Last unallocated PRB	N/A	N/A	N/A	N/A	N/A	Note2
<p>Note 1: These physical resource blocks are assigned to an arbitrary number of virtual UEs with one PDSCH per virtual UE; the data transmitted over the OCNG PDSCHs shall be uncorrelated pseudo random data, which is QPSK modulated. The parameter γ_{PRB} is used to scale the power of PDSCH.</p> <p>Note 2: Each physical resource block (PRB) is assigned to MBSFN transmission. The data in each PRB shall be uncorrelated with data in other PRBs over the period of any measurement. The MBSFN data shall be QPSK modulated. PMCH symbols shall not contain cell-specific Reference Signals.</p> <p>Note 3: If two or more transmit antennas are used in the test, the OCNG shall be transmitted to the virtual users by all the transmit antennas according to transmission mode 2. The transmit power shall be equally split between all the transmit antennas used in the test. The antenna transmission modes are specified in section 7.1 in 3GPP TS 36.213.</p> <p>N/A: Not Applicable</p>						

A.5.2.5 OCNG TDD pattern 5: One sided dynamic 16QAM modulated OCNG TDD pattern

This OCNG Pattern fills with OCNG all empty PRB-s (PRB-s with no allocation of data or system information) of the sub-frames available for DL transmission (depending on TDD UL/DL configuration), when the unallocated area is continuous in frequency domain (one sided).

Table A.5.2.5-1: OP.5 TDD: One sided dynamic 16QAM modulated OCNG TDD Pattern

Relative power level γ_{PRB} [dB]				PDSCH Data
Subframe (only if available for DL)				
0	5	3, 4, 7, 8, 9 and 6 (as normal subframe) ^{Note 2}	1 and 6 (as special subframe) ^{Note 2}	
Allocation				
First unallocated PRB – Last unallocated PRB	First unallocated PRB – Last unallocated PRB	First unallocated PRB – Last unallocated PRB	First unallocated PRB – Last unallocated PRB	
0	0	0	0	Note 1
Note 1: These physical resource blocks are assigned to an arbitrary number of virtual UEs with one PDSCH per virtual UE; the data transmitted over the OCNG PDSCHs shall be uncorrelated pseudo random data, which is 16QAM modulated. The parameter γ_{PRB} is used to scale the power of PDSCH.				
Note 2: Subframes available for DL transmission depends on the Uplink-Downlink configuration in Table 4.2-2 in 3GPP TS 36.211				
Note 3: If two or more transmit antennas with CRS are used in the test, the OCNG shall be transmitted to the virtual users by all the transmit antennas with CRS according to transmission mode 3 (Large Delay CDD). The parameter γ_{PRB} applies to each antenna port separately, so the transmit power is equal between all the transmit antennas with CRS used in the test. The antenna transmission modes are specified in section 7.1 in 3GPP TS 36.213.				

A.5.2.6 OCNG TDD pattern 6: dynamic OCNG TDD pattern when user data is in 2 non-contiguous blocks

This OCNG Pattern fills with OCNG all empty PRB-s (PRB-s with no allocation of data or system information) of the subframes available for DL transmission (depending on TDD UL/DL configuration), when the unallocated area is discontinuous in frequency domain (divided in two parts by the first allocated block). The second allocated block ends with PRB $N_{RB} - 1$.

Table A.5.2.6-1: OP.6 TDD: OCNG TDD Pattern when user data is in 2 non-contiguous blocks

Relative power level γ_{PRB} [dB]				PDSCH Data
Subframe (only if available for DL)				
0	5	3, 4, 6, 7, 8, 9 (6 as normal subframe) <small>Note 2</small>	1,6 (6 as special subframe) <small>Note 2</small>	
Allocation				
0 – (First allocated PRB of first block -1) and (Last allocated PRB of first block +1) – (First allocated PRB of second block -1)	0 – (First allocated PRB of first block -1) and (Last allocated PRB of first block +1) – (First allocated PRB of second block -1)	0 – (First allocated PRB of first block -1) and (Last allocated PRB of first block +1) – (First allocated PRB of second block -1)	0 – (First allocated PRB of first block -1) and (Last allocated PRB of first block +1) – (First allocated PRB of second block -1)	
0	0	0	0	Note 1
<p>Note 1: These physical resource blocks are assigned to an arbitrary number of virtual UEs with one PDSCH per virtual UE; the data transmitted over the OCNG PDSCHs shall be uncorrelated pseudo random data, which is QPSK modulated. The parameter γ_{PRB} is used to scale the power of PDSCH.</p> <p>Note 2: Subframes available for DL transmission depends on the Uplink-Downlink configuration in Table 4.2-2 in 3GPP TS 36.211</p> <p>Note 3: If two or more transmit antennas with CRS are used in the test, the OCNG shall be transmitted to the virtual users by all the transmit antennas with CRS according to transmission mode 2. The parameter γ_{PRB} applies to each antenna port separately, so the transmit power is equal between all the transmit antennas with CRS used in the test. The antenna transmission modes are specified in section 7.1 in 3GPP TS 36.213.</p>				

Annex B (normative): Propagation Conditions

The propagation conditions and channel models for various environments are specified. For each environment a propagation model is used to evaluate the propagation pathloss due to the distance. Channel models are formed by combining delay profiles with a Doppler spectrum, with the addition of correlation properties in the case of a multi-antenna scenario.

B.0 No interference

The downlink connection between the System Simulator and the UE is without Additive White Gaussian Noise, and has no fading or multipath effects.

B.1 Static propagation condition

The downlink connection between the System Simulator and the UE is an Additive White Gaussian Noise (AWGN) environment with no fading or multipath effects.

For 2 port transmission the channel matrix is defined in the frequency domain by

$$\mathbf{H} = \begin{pmatrix} 1 & j \\ 1 & -j \end{pmatrix}$$

For 4 port transmission the channel matrix is defined in the frequency domain by

$$\mathbf{H} = \begin{bmatrix} 1 & 1 & j & j \\ 1 & 1 & -j & -j \end{bmatrix}$$

For 8 port transmission the channel matrix is defined in the frequency domain by

$$\mathbf{H} = \begin{bmatrix} 1 & 1 & 1 & 1 & j & j & j & j \\ 1 & 1 & 1 & 1 & -j & -j & -j & -j \end{bmatrix}$$

B.1.1 Definition of Additive White Gaussian Noise (AWGN) Interferer

Note that the AWGN interferer can be used in static propagation conditions, or in conjunction with multi-path fading.

The acceptable uncertainties of the AWGN interferer are defined in Annex F.

B.2 Multi-path fading Propagation Conditions

The multipath propagation conditions consist of several parts:

- A delay profile in the form of a "tapped delay-line", characterized by a number of taps at fixed positions on a sampling grid. The profile can be further characterized by the r.m.s. delay spread and the maximum delay spanned by the taps.

- A combination of channel model parameters that include the Delay profile and the Doppler spectrum, that is characterized by a classical spectrum shape and a maximum Doppler frequency
- A set of correlation matrices defining the correlation between the UE and eNodeB antennas in case of multi-antenna systems.

B.2.1 Delay profiles

The delay profiles are selected to be representative of low, medium and high delay spread environments. The resulting model parameters are defined in Table B.2.1-1 and the tapped delay line models are defined in Tables B.2.1-2, B.2.1-3 and B.2.1-4.

Table B.2.1-1: Delay profiles for E-UTRA channel models

Model	Number of channel taps	Delay spread (r.m.s.)	Maximum excess tap delay (span)
Extended Pedestrian A (EPA)	7	45 ns	410 ns
Extended Vehicular A model (EVA)	9	357 ns	2510 ns
Extended Typical Urban model (ETU)	9	991 ns	5000 ns

Table B.2.1-2: Extended Pedestrian A model (EPA)

Excess tap delay [ns]	Relative power [dB]
0	0.0
30	-1.0
70	-2.0
90	-3.0
110	-8.0
190	-17.2
410	-20.8

Table B.2.1-3: Extended Vehicular A model (EVA)

Excess tap delay [ns]	Relative power [dB]
0	0.0
30	-1.5
150	-1.4
310	-3.6
370	-0.6
710	-9.1
1090	-7.0
1730	-12.0
2510	-16.9

Table B.2.1-4: Extended Typical Urban model (ETU)

Excess tap delay [ns]	Relative power [dB]
0	-1.0
50	-1.0
120	-1.0
200	0.0
230	0.0
500	0.0
1600	-3.0
2300	-5.0
5000	-7.0

B.2.2 Combinations of channel model parameters

Table B.2.2-1 shows propagation conditions that are used for the performance measurements in multi-path fading environment for low, medium and high Doppler frequencies.

Table B.2.2-1: Channel model parameters

Model	Maximum Doppler frequency
EPA 5Hz	5 Hz
EVA 5Hz	5 Hz
EVA 70Hz	70 Hz
ETU 30Hz	30 Hz
ETU 70Hz	70 Hz
ETU 300Hz	300 Hz

B.2.3 MIMO Channel Correlation Matrices

The MIMO channel correlation matrices defined in B.2.3 apply for the antenna configuration using uniform linear arrays at both eNodeB and UE.

B.2.3.1 Definition of MIMO Correlation Matrices

Table B.2.3.1-1 defines the correlation matrix for the eNodeB

Table B.2.3.1-1: eNodeB correlation matrix

	One antenna	Two antennas	Four antennas
eNode B Correlation	$R_{eNB} = 1$	$R_{eNB} = \begin{pmatrix} 1 & \alpha \\ \alpha^* & \mathbf{1} \end{pmatrix}$	$R_{eNB} = \begin{pmatrix} 1 & \alpha^{1/9} & \alpha^{4/9} & \alpha \\ \alpha^{1/9*} & 1 & \alpha^{1/9} & \alpha^{4/9} \\ \alpha^{4/9*} & \alpha^{1/9*} & 1 & \alpha^{1/9} \\ \alpha^* & \alpha^{4/9*} & \alpha^{1/9*} & 1 \end{pmatrix}$

Table B.2.3.1-2 defines the correlation matrix for the UE:

Table B.2.3.1-2: UE correlation matrix

	One antenna	Two antennas	Four antennas
UE Correlation	$R_{UE} = 1$	$R_{UE} = \begin{pmatrix} 1 & \beta \\ \beta^* & \mathbf{1} \end{pmatrix}$	$R_{UE} = \begin{pmatrix} 1 & \beta^{1/9} & \beta^{4/9} & \beta \\ \beta^{1/9*} & 1 & \beta^{1/9} & \beta^{4/9} \\ \beta^{4/9*} & \beta^{1/9*} & 1 & \beta^{1/9} \\ \beta^* & \beta^{4/9*} & \beta^{1/9*} & 1 \end{pmatrix}$

Table B.2.3.1-3 defines the channel spatial correlation matrix R_{spat} . The parameters, α and β in Table B.2.3.1-3 defines the spatial correlation between the antennas at the eNodeB and UE.

Table B.2.3.1-3: R_{spat} correlation matrices

1x2 case	$R_{spat} = R_{UE} = \begin{bmatrix} 1 & \beta \\ \beta^* & 1 \end{bmatrix}$
2x2 case	$R_{spat} = R_{eNB} \otimes R_{UE} = \begin{bmatrix} 1 & \alpha \\ \alpha^* & 1 \end{bmatrix} \otimes \begin{bmatrix} 1 & \beta \\ \beta^* & 1 \end{bmatrix} = \begin{bmatrix} 1 & \beta & \alpha & \alpha\beta \\ \beta^* & 1 & \alpha\beta^* & \alpha \\ \alpha^* & \alpha^*\beta & 1 & \beta \\ \alpha^*\beta^* & \alpha^*\beta^* & \beta^* & 1 \end{bmatrix}$
4x2 case	$R_{spat} = R_{eNB} \otimes R_{UE} = \begin{bmatrix} 1 & \alpha^{1/9} & \alpha^{4/9} & \alpha \\ \alpha^{1/9*} & 1 & \alpha^{1/9} & \alpha^{4/9} \\ \alpha^{4/9*} & \alpha^{1/9*} & 1 & \alpha^{1/9} \\ \alpha^* & \alpha^{4/9*} & \alpha^{1/9*} & 1 \end{bmatrix} \otimes \begin{bmatrix} 1 & \beta \\ \beta^* & 1 \end{bmatrix}$
4x4 case	$R_{spat} = R_{eNB} \otimes R_{UE} = \begin{bmatrix} 1 & \alpha^{1/9} & \alpha^{4/9} & \alpha \\ \alpha^{1/9*} & 1 & \alpha^{1/9} & \alpha^{4/9} \\ \alpha^{4/9*} & \alpha^{1/9*} & 1 & \alpha^{1/9} \\ \alpha^* & \alpha^{4/9*} & \alpha^{1/9*} & 1 \end{bmatrix} \otimes \begin{bmatrix} 1 & \beta^{1/9} & \beta^{4/9} & \beta \\ \beta^{1/9*} & 1 & \beta^{1/9} & \beta^{4/9} \\ \beta^{4/9*} & \beta^{1/9*} & 1 & \beta^{1/9} \\ \beta^* & \beta^{4/9*} & \beta^{1/9*} & 1 \end{bmatrix}$

For cases with more antennas at either eNodeB or UE or both, the channel spatial correlation matrix can still be expressed as the Kronecker product of R_{eNB} and R_{UE} according to $R_{spat} = R_{eNB} \otimes R_{UE}$.

B.2.3.2 MIMO Correlation Matrices at High, Medium and Low Level

The α and β for different correlation types are given in Table B.2.3.2-1.

Table B.2.3.2-1

Low correlation		Medium Correlation		High Correlation	
α	β	α	β	α	β
0	0	0.3	0.9	0.9	0.9

The correlation matrices for high, medium and low correlation are defined in Table B.2.3.2-2, B.2.3.2-3 and B.2.3.2-4, as below.

The values in the Table B.2.3.2-2 table have been adjusted for the 4x2 and 4x4 high correlation cases to insure the correlation matrix is positive semi-definite after round-off to 4 digit precision. This is done using the equation:

$$\mathbf{R}_{high} = [\mathbf{R}_{spatial} + a\mathbf{I}_n] / (1 + a)$$

Where the value “a” is a scaling factor such that the smallest value is used to obtain a positive semi-definite result. For the 4x2 high correlation case, a=0.00010. For the 4x4 high correlation case, a=0.00012.

The same method is used to adjust the 4x4 medium correlation matrix in Table B.2.3.2-3 to insure the correlation matrix is positive semi-definite after round-off to 4 digit precision with a = 0.00012.

Table B.2.3.2-2: MIMO correlation matrices for high correlation

1x2 case	$R_{high} = \begin{pmatrix} 1 & 0.9 \\ 0.9 & 1 \end{pmatrix}$																																																																																																																																																																																																																																																																	
2x2 case	$R_{high} = \begin{pmatrix} 1 & 0.9 & 0.9 & 0.81 \\ 0.9 & 1 & 0.81 & 0.9 \\ 0.9 & 0.81 & 1 & 0.9 \\ 0.81 & 0.9 & 0.9 & 1 \end{pmatrix}$																																																																																																																																																																																																																																																																	
4x2 case	$R_{high} =$	<table border="1" style="border-collapse: collapse; width: 100%; text-align: center;"> <tr><td>1.0000</td><td>0.8999</td><td>0.9883</td><td>0.8894</td><td>0.9542</td><td>0.8587</td><td>0.8999</td><td>0.8099</td></tr> <tr><td>0.8999</td><td>1.0000</td><td>0.8894</td><td>0.9883</td><td>0.8587</td><td>0.9542</td><td>0.8099</td><td>0.8999</td></tr> <tr><td>0.9883</td><td>0.8894</td><td>1.0000</td><td>0.8999</td><td>0.9883</td><td>0.8894</td><td>0.9542</td><td>0.8587</td></tr> <tr><td>0.8894</td><td>0.9883</td><td>0.8999</td><td>1.0000</td><td>0.8894</td><td>0.9883</td><td>0.8587</td><td>0.9542</td></tr> <tr><td>0.9542</td><td>0.8587</td><td>0.9883</td><td>0.8894</td><td>1.0000</td><td>0.8999</td><td>0.9883</td><td>0.8894</td></tr> <tr><td>0.8587</td><td>0.9542</td><td>0.8894</td><td>0.9883</td><td>0.8999</td><td>1.0000</td><td>0.8894</td><td>0.9883</td></tr> <tr><td>0.8999</td><td>0.8099</td><td>0.9542</td><td>0.8587</td><td>0.9883</td><td>0.8894</td><td>1.0000</td><td>0.8999</td></tr> <tr><td>0.8099</td><td>0.8999</td><td>0.8587</td><td>0.9542</td><td>0.8894</td><td>0.9883</td><td>0.8999</td><td>1.0000</td></tr> </table>	1.0000	0.8999	0.9883	0.8894	0.9542	0.8587	0.8999	0.8099	0.8999	1.0000	0.8894	0.9883	0.8587	0.9542	0.8099	0.8999	0.9883	0.8894	1.0000	0.8999	0.9883	0.8894	0.9542	0.8587	0.8894	0.9883	0.8999	1.0000	0.8894	0.9883	0.8587	0.9542	0.9542	0.8587	0.9883	0.8894	1.0000	0.8999	0.9883	0.8894	0.8587	0.9542	0.8894	0.9883	0.8999	1.0000	0.8894	0.9883	0.8999	0.8099	0.9542	0.8587	0.9883	0.8894	1.0000	0.8999	0.8099	0.8999	0.8587	0.9542	0.8894	0.9883	0.8999	1.0000																																																																																																																																																																																																
1.0000	0.8999	0.9883	0.8894	0.9542	0.8587	0.8999	0.8099																																																																																																																																																																																																																																																											
0.8999	1.0000	0.8894	0.9883	0.8587	0.9542	0.8099	0.8999																																																																																																																																																																																																																																																											
0.9883	0.8894	1.0000	0.8999	0.9883	0.8894	0.9542	0.8587																																																																																																																																																																																																																																																											
0.8894	0.9883	0.8999	1.0000	0.8894	0.9883	0.8587	0.9542																																																																																																																																																																																																																																																											
0.9542	0.8587	0.9883	0.8894	1.0000	0.8999	0.9883	0.8894																																																																																																																																																																																																																																																											
0.8587	0.9542	0.8894	0.9883	0.8999	1.0000	0.8894	0.9883																																																																																																																																																																																																																																																											
0.8999	0.8099	0.9542	0.8587	0.9883	0.8894	1.0000	0.8999																																																																																																																																																																																																																																																											
0.8099	0.8999	0.8587	0.9542	0.8894	0.9883	0.8999	1.0000																																																																																																																																																																																																																																																											
4x4 case	$R_{high} =$	<table border="1" style="border-collapse: collapse; width: 100%; text-align: center;"> <tr><td>1.0000</td><td>0.9882</td><td>0.9541</td><td>0.8999</td><td>0.9882</td><td>0.9767</td><td>0.9430</td><td>0.8894</td><td>0.9541</td><td>0.9430</td><td>0.9105</td><td>0.8587</td><td>0.8999</td><td>0.8894</td><td>0.8587</td><td>0.8099</td></tr> <tr><td>0.9882</td><td>1.0000</td><td>0.9882</td><td>0.9541</td><td>0.9767</td><td>0.9882</td><td>0.9767</td><td>0.9430</td><td>0.9430</td><td>0.9541</td><td>0.9430</td><td>0.9105</td><td>0.8894</td><td>0.8999</td><td>0.8894</td><td>0.8587</td></tr> <tr><td>0.9541</td><td>0.9882</td><td>1.0000</td><td>0.9882</td><td>0.9430</td><td>0.9767</td><td>0.9882</td><td>0.9767</td><td>0.9105</td><td>0.9430</td><td>0.9541</td><td>0.9430</td><td>0.8587</td><td>0.8894</td><td>0.8999</td><td>0.8894</td></tr> <tr><td>0.8999</td><td>0.9541</td><td>0.9882</td><td>1.0000</td><td>0.8894</td><td>0.9430</td><td>0.9767</td><td>0.9882</td><td>0.8587</td><td>0.9105</td><td>0.9430</td><td>0.9541</td><td>0.8099</td><td>0.8587</td><td>0.8894</td><td>0.8999</td></tr> <tr><td>0.9882</td><td>0.9767</td><td>0.9430</td><td>0.8894</td><td>1.0000</td><td>0.9882</td><td>0.9541</td><td>0.8999</td><td>0.9882</td><td>0.9767</td><td>0.9430</td><td>0.8894</td><td>0.9541</td><td>0.9430</td><td>0.9105</td><td>0.8587</td></tr> <tr><td>0.9767</td><td>0.9882</td><td>0.9767</td><td>0.9430</td><td>0.9882</td><td>1.0000</td><td>0.9882</td><td>0.9541</td><td>0.9767</td><td>0.9882</td><td>0.9767</td><td>0.9430</td><td>0.9430</td><td>0.9541</td><td>0.9430</td><td>0.9105</td></tr> <tr><td>0.9430</td><td>0.9767</td><td>0.9882</td><td>0.9767</td><td>0.9541</td><td>0.9882</td><td>1.0000</td><td>0.9882</td><td>0.9430</td><td>0.9767</td><td>0.9882</td><td>0.9767</td><td>0.9105</td><td>0.9430</td><td>0.9541</td><td>0.9430</td></tr> <tr><td>0.8894</td><td>0.9430</td><td>0.9767</td><td>0.9882</td><td>0.8999</td><td>0.9541</td><td>0.9882</td><td>1.0000</td><td>0.8894</td><td>0.9430</td><td>0.9767</td><td>0.9882</td><td>0.8587</td><td>0.9105</td><td>0.9430</td><td>0.9541</td></tr> <tr><td>0.9541</td><td>0.9430</td><td>0.9105</td><td>0.8587</td><td>0.9882</td><td>0.9767</td><td>0.9430</td><td>0.8894</td><td>1.0000</td><td>0.9882</td><td>0.9541</td><td>0.8999</td><td>0.9882</td><td>0.9767</td><td>0.9430</td><td>0.8894</td></tr> <tr><td>0.9430</td><td>0.9541</td><td>0.9430</td><td>0.9105</td><td>0.9767</td><td>0.9882</td><td>0.9767</td><td>0.9430</td><td>0.9882</td><td>1.0000</td><td>0.9882</td><td>0.9541</td><td>0.9767</td><td>0.9882</td><td>0.9767</td><td>0.9430</td></tr> <tr><td>0.9105</td><td>0.9430</td><td>0.9541</td><td>0.9430</td><td>0.9430</td><td>0.9767</td><td>0.9882</td><td>0.9767</td><td>0.9541</td><td>0.9882</td><td>1.0000</td><td>0.9882</td><td>0.9430</td><td>0.9767</td><td>0.9882</td><td>0.9767</td></tr> <tr><td>0.8587</td><td>0.9105</td><td>0.9430</td><td>0.9541</td><td>0.8894</td><td>0.9430</td><td>0.9767</td><td>0.9882</td><td>0.8999</td><td>0.9541</td><td>0.9882</td><td>1.0000</td><td>0.8894</td><td>0.9430</td><td>0.9767</td><td>0.9882</td></tr> <tr><td>0.8999</td><td>0.8894</td><td>0.8587</td><td>0.8099</td><td>0.9541</td><td>0.9430</td><td>0.9105</td><td>0.8587</td><td>0.9882</td><td>0.9767</td><td>0.9430</td><td>0.8894</td><td>1.0000</td><td>0.9882</td><td>0.9541</td><td>0.8999</td></tr> <tr><td>0.8894</td><td>0.8999</td><td>0.8894</td><td>0.8587</td><td>0.9430</td><td>0.9541</td><td>0.9430</td><td>0.9105</td><td>0.9767</td><td>0.9882</td><td>0.9767</td><td>0.9430</td><td>0.9882</td><td>1.0000</td><td>0.9882</td><td>0.9541</td></tr> <tr><td>0.8587</td><td>0.8894</td><td>0.8999</td><td>0.8894</td><td>0.9105</td><td>0.9430</td><td>0.9541</td><td>0.9430</td><td>0.9430</td><td>0.9767</td><td>0.9882</td><td>0.9767</td><td>0.9541</td><td>0.9882</td><td>1.0000</td><td>0.9882</td></tr> <tr><td>0.8099</td><td>0.8587</td><td>0.8894</td><td>0.8999</td><td>0.8587</td><td>0.9105</td><td>0.9430</td><td>0.9541</td><td>0.8894</td><td>0.9430</td><td>0.9767</td><td>0.9882</td><td>0.8999</td><td>0.9541</td><td>0.9882</td><td>1.0000</td></tr> </table>	1.0000	0.9882	0.9541	0.8999	0.9882	0.9767	0.9430	0.8894	0.9541	0.9430	0.9105	0.8587	0.8999	0.8894	0.8587	0.8099	0.9882	1.0000	0.9882	0.9541	0.9767	0.9882	0.9767	0.9430	0.9430	0.9541	0.9430	0.9105	0.8894	0.8999	0.8894	0.8587	0.9541	0.9882	1.0000	0.9882	0.9430	0.9767	0.9882	0.9767	0.9105	0.9430	0.9541	0.9430	0.8587	0.8894	0.8999	0.8894	0.8999	0.9541	0.9882	1.0000	0.8894	0.9430	0.9767	0.9882	0.8587	0.9105	0.9430	0.9541	0.8099	0.8587	0.8894	0.8999	0.9882	0.9767	0.9430	0.8894	1.0000	0.9882	0.9541	0.8999	0.9882	0.9767	0.9430	0.8894	0.9541	0.9430	0.9105	0.8587	0.9767	0.9882	0.9767	0.9430	0.9882	1.0000	0.9882	0.9541	0.9767	0.9882	0.9767	0.9430	0.9430	0.9541	0.9430	0.9105	0.9430	0.9767	0.9882	0.9767	0.9541	0.9882	1.0000	0.9882	0.9430	0.9767	0.9882	0.9767	0.9105	0.9430	0.9541	0.9430	0.8894	0.9430	0.9767	0.9882	0.8999	0.9541	0.9882	1.0000	0.8894	0.9430	0.9767	0.9882	0.8587	0.9105	0.9430	0.9541	0.9541	0.9430	0.9105	0.8587	0.9882	0.9767	0.9430	0.8894	1.0000	0.9882	0.9541	0.8999	0.9882	0.9767	0.9430	0.8894	0.9430	0.9541	0.9430	0.9105	0.9767	0.9882	0.9767	0.9430	0.9882	1.0000	0.9882	0.9541	0.9767	0.9882	0.9767	0.9430	0.9105	0.9430	0.9541	0.9430	0.9430	0.9767	0.9882	0.9767	0.9541	0.9882	1.0000	0.9882	0.9430	0.9767	0.9882	0.9767	0.8587	0.9105	0.9430	0.9541	0.8894	0.9430	0.9767	0.9882	0.8999	0.9541	0.9882	1.0000	0.8894	0.9430	0.9767	0.9882	0.8999	0.8894	0.8587	0.8099	0.9541	0.9430	0.9105	0.8587	0.9882	0.9767	0.9430	0.8894	1.0000	0.9882	0.9541	0.8999	0.8894	0.8999	0.8894	0.8587	0.9430	0.9541	0.9430	0.9105	0.9767	0.9882	0.9767	0.9430	0.9882	1.0000	0.9882	0.9541	0.8587	0.8894	0.8999	0.8894	0.9105	0.9430	0.9541	0.9430	0.9430	0.9767	0.9882	0.9767	0.9541	0.9882	1.0000	0.9882	0.8099	0.8587	0.8894	0.8999	0.8587	0.9105	0.9430	0.9541	0.8894	0.9430	0.9767	0.9882	0.8999	0.9541	0.9882	1.0000
1.0000	0.9882	0.9541	0.8999	0.9882	0.9767	0.9430	0.8894	0.9541	0.9430	0.9105	0.8587	0.8999	0.8894	0.8587	0.8099																																																																																																																																																																																																																																																			
0.9882	1.0000	0.9882	0.9541	0.9767	0.9882	0.9767	0.9430	0.9430	0.9541	0.9430	0.9105	0.8894	0.8999	0.8894	0.8587																																																																																																																																																																																																																																																			
0.9541	0.9882	1.0000	0.9882	0.9430	0.9767	0.9882	0.9767	0.9105	0.9430	0.9541	0.9430	0.8587	0.8894	0.8999	0.8894																																																																																																																																																																																																																																																			
0.8999	0.9541	0.9882	1.0000	0.8894	0.9430	0.9767	0.9882	0.8587	0.9105	0.9430	0.9541	0.8099	0.8587	0.8894	0.8999																																																																																																																																																																																																																																																			
0.9882	0.9767	0.9430	0.8894	1.0000	0.9882	0.9541	0.8999	0.9882	0.9767	0.9430	0.8894	0.9541	0.9430	0.9105	0.8587																																																																																																																																																																																																																																																			
0.9767	0.9882	0.9767	0.9430	0.9882	1.0000	0.9882	0.9541	0.9767	0.9882	0.9767	0.9430	0.9430	0.9541	0.9430	0.9105																																																																																																																																																																																																																																																			
0.9430	0.9767	0.9882	0.9767	0.9541	0.9882	1.0000	0.9882	0.9430	0.9767	0.9882	0.9767	0.9105	0.9430	0.9541	0.9430																																																																																																																																																																																																																																																			
0.8894	0.9430	0.9767	0.9882	0.8999	0.9541	0.9882	1.0000	0.8894	0.9430	0.9767	0.9882	0.8587	0.9105	0.9430	0.9541																																																																																																																																																																																																																																																			
0.9541	0.9430	0.9105	0.8587	0.9882	0.9767	0.9430	0.8894	1.0000	0.9882	0.9541	0.8999	0.9882	0.9767	0.9430	0.8894																																																																																																																																																																																																																																																			
0.9430	0.9541	0.9430	0.9105	0.9767	0.9882	0.9767	0.9430	0.9882	1.0000	0.9882	0.9541	0.9767	0.9882	0.9767	0.9430																																																																																																																																																																																																																																																			
0.9105	0.9430	0.9541	0.9430	0.9430	0.9767	0.9882	0.9767	0.9541	0.9882	1.0000	0.9882	0.9430	0.9767	0.9882	0.9767																																																																																																																																																																																																																																																			
0.8587	0.9105	0.9430	0.9541	0.8894	0.9430	0.9767	0.9882	0.8999	0.9541	0.9882	1.0000	0.8894	0.9430	0.9767	0.9882																																																																																																																																																																																																																																																			
0.8999	0.8894	0.8587	0.8099	0.9541	0.9430	0.9105	0.8587	0.9882	0.9767	0.9430	0.8894	1.0000	0.9882	0.9541	0.8999																																																																																																																																																																																																																																																			
0.8894	0.8999	0.8894	0.8587	0.9430	0.9541	0.9430	0.9105	0.9767	0.9882	0.9767	0.9430	0.9882	1.0000	0.9882	0.9541																																																																																																																																																																																																																																																			
0.8587	0.8894	0.8999	0.8894	0.9105	0.9430	0.9541	0.9430	0.9430	0.9767	0.9882	0.9767	0.9541	0.9882	1.0000	0.9882																																																																																																																																																																																																																																																			
0.8099	0.8587	0.8894	0.8999	0.8587	0.9105	0.9430	0.9541	0.8894	0.9430	0.9767	0.9882	0.8999	0.9541	0.9882	1.0000																																																																																																																																																																																																																																																			

Table B.2.3.2-3: MIMO correlation matrices for medium correlation

1x2 case	N/A
2x2 case	$R_{medium} = \begin{pmatrix} 1 & 0.9 & 0.3 & 0.27 \\ 0.9 & 1 & 0.27 & 0.3 \\ 0.3 & 0.27 & 1 & 0.9 \\ 0.27 & 0.3 & 0.9 & 1 \end{pmatrix}$
4x2 case	$R_{medium} = \begin{pmatrix} 1.0000 & 0.9000 & 0.8748 & 0.7873 & 0.5856 & 0.5271 & 0.3000 & 0.2700 \\ 0.9000 & 1.0000 & 0.7873 & 0.8748 & 0.5271 & 0.5856 & 0.2700 & 0.3000 \\ 0.8748 & 0.7873 & 1.0000 & 0.9000 & 0.8748 & 0.7873 & 0.5856 & 0.5271 \\ 0.7873 & 0.8748 & 0.9000 & 1.0000 & 0.7873 & 0.8748 & 0.5271 & 0.5856 \\ 0.5856 & 0.5271 & 0.8748 & 0.7873 & 1.0000 & 0.9000 & 0.8748 & 0.7873 \\ 0.5271 & 0.5856 & 0.7873 & 0.8748 & 0.9000 & 1.0000 & 0.7873 & 0.8748 \\ 0.3000 & 0.2700 & 0.5856 & 0.5271 & 0.8748 & 0.7873 & 1.0000 & 0.9000 \\ 0.2700 & 0.3000 & 0.5271 & 0.5856 & 0.7873 & 0.8748 & 0.9000 & 1.0000 \end{pmatrix}$
4x4 case	$R_{medium} = \begin{pmatrix} 1.0000 & 0.9882 & 0.9541 & 0.8999 & 0.8747 & 0.8645 & 0.8347 & 0.7872 & 0.5855 & 0.5787 & 0.5588 & 0.5270 & 0.3000 & 0.2965 & 0.2862 & 0.2700 \\ 0.9882 & 1.0000 & 0.9882 & 0.9541 & 0.8645 & 0.8747 & 0.8645 & 0.8347 & 0.5787 & 0.5855 & 0.5787 & 0.5588 & 0.2965 & 0.3000 & 0.2965 & 0.2862 \\ 0.9541 & 0.9882 & 1.0000 & 0.9882 & 0.8347 & 0.8645 & 0.8747 & 0.8645 & 0.5588 & 0.5787 & 0.5855 & 0.5787 & 0.2862 & 0.2965 & 0.3000 & 0.2965 \\ 0.8999 & 0.9541 & 0.9882 & 1.0000 & 0.7872 & 0.8347 & 0.8645 & 0.8747 & 0.5270 & 0.5588 & 0.5787 & 0.5855 & 0.2700 & 0.2862 & 0.2965 & 0.3000 \\ 0.8747 & 0.8645 & 0.8347 & 0.7872 & 1.0000 & 0.9882 & 0.9541 & 0.8999 & 0.8747 & 0.8645 & 0.8347 & 0.7872 & 0.5855 & 0.5787 & 0.5588 & 0.5270 \\ 0.8645 & 0.8747 & 0.8645 & 0.8347 & 0.9882 & 1.0000 & 0.9882 & 0.9541 & 0.8645 & 0.8747 & 0.8645 & 0.8347 & 0.5787 & 0.5855 & 0.5787 & 0.5588 \\ 0.8347 & 0.8645 & 0.8747 & 0.8645 & 0.9541 & 0.9882 & 1.0000 & 0.9882 & 0.8347 & 0.8645 & 0.8747 & 0.8645 & 0.5588 & 0.5787 & 0.5855 & 0.5787 \\ 0.7872 & 0.8347 & 0.8645 & 0.8747 & 0.8999 & 0.9541 & 0.9882 & 1.0000 & 0.7872 & 0.8347 & 0.8645 & 0.8747 & 0.5270 & 0.5588 & 0.5787 & 0.5855 \\ 0.5855 & 0.5787 & 0.5588 & 0.5270 & 0.8747 & 0.8645 & 0.8347 & 0.7872 & 1.0000 & 0.9882 & 0.9541 & 0.8999 & 0.8747 & 0.8645 & 0.8347 & 0.7872 \\ 0.5787 & 0.5855 & 0.5787 & 0.5588 & 0.8645 & 0.8747 & 0.8645 & 0.8347 & 0.9882 & 1.0000 & 0.9882 & 0.9541 & 0.8645 & 0.8747 & 0.8645 & 0.8347 \\ 0.5588 & 0.5787 & 0.5855 & 0.5787 & 0.8347 & 0.8645 & 0.8747 & 0.8645 & 0.9541 & 0.9882 & 1.0000 & 0.9882 & 0.8347 & 0.8645 & 0.8747 & 0.8645 \\ 0.5270 & 0.5588 & 0.5787 & 0.5855 & 0.7872 & 0.8347 & 0.8645 & 0.8747 & 0.8999 & 0.9541 & 0.9882 & 1.0000 & 0.7872 & 0.8347 & 0.8645 & 0.8747 \\ 0.3000 & 0.2965 & 0.2862 & 0.2700 & 0.5855 & 0.5787 & 0.5588 & 0.5270 & 0.8747 & 0.8645 & 0.8347 & 0.7872 & 1.0000 & 0.9882 & 0.9541 & 0.8999 \\ 0.2965 & 0.3000 & 0.2965 & 0.2862 & 0.5787 & 0.5855 & 0.5787 & 0.5588 & 0.8645 & 0.8747 & 0.8645 & 0.8347 & 0.9882 & 1.0000 & 0.9882 & 0.9541 \\ 0.2862 & 0.2965 & 0.3000 & 0.2965 & 0.5588 & 0.5787 & 0.5855 & 0.5787 & 0.8347 & 0.8645 & 0.8747 & 0.8645 & 0.9541 & 0.9882 & 1.0000 & 0.9882 \\ 0.2700 & 0.2862 & 0.2965 & 0.3000 & 0.5270 & 0.5588 & 0.5787 & 0.5855 & 0.7872 & 0.8347 & 0.8645 & 0.8747 & 0.8999 & 0.9541 & 0.9882 & 1.0000 \end{pmatrix}$

Table B.2.3.2-4: MIMO correlation matrices for low correlation

1x2 case	$R_{low} = \mathbf{I}_2$
2x2 case	$R_{low} = \mathbf{I}_4$
4x2 case	$R_{low} = \mathbf{I}_8$
4x4 case	$R_{low} = \mathbf{I}_{16}$

In Table B.2.3.2-4, \mathbf{I}_d is the $d \times d$ identity matrix.

B.2.3A MIMO Channel Correlation Matrices using cross polarized antennas

The MIMO channel correlation matrices defined in B.2.3A apply for the antenna configuration using cross polarized antennas at both eNodeB and UE. The cross-polarized antenna elements with +/-45 degrees polarization slant angles are deployed at eNB and cross-polarized antenna elements with +90/0 degrees polarization slant angles are deployed at UE.

For the cross-polarized antennas, the N antennas are labelled such that antennas for one polarization are listed from 1 to N/2 and antennas for the other polarization are listed from N/2+1 to N, where N is the number of transmit or receive antennas.

B.2.3A.1 Definition of MIMO Correlation Matrices using cross polarized antennas

For the channel spatial correlation matrix, the following is used:

$$R_{spat} = P(R_{eNB} \otimes \Gamma \otimes R_{UE})P^T$$

Where

- R_{UE} is the spatial correlation matrix at the UE with same polarization,
- R_{eNB} is the spatial correlation matrix at the eNB with same polarization,
- Γ is a polarization correlation matrix, and
- $(\bullet)^T$ denotes transpose.

The matrix Γ is defined as

$$\Gamma = \begin{bmatrix} 1 & 0 & -\gamma & 0 \\ 0 & 1 & 0 & \gamma \\ -\gamma & 0 & 1 & 0 \\ 0 & \gamma & 0 & 1 \end{bmatrix}$$

A permutation matrix P elements defined as:

$$P(a,b) = \begin{cases} 1 & \text{for } a = (j-1)Nr + i \text{ and } b = 2(j-1)Nr + i, \quad i = 1, \dots, Nr, j = 1, \dots, Nt/2 \\ 1 & \text{for } a = (j-1)Nr + i \text{ and } b = 2(j - Nt/2)Nr - Nr + i, \quad i = 1, \dots, Nr, j = Nt/2 + 1, \dots, Nt \\ 0 & \text{otherwise} \end{cases}$$

Where N_t and N_r is the number of transmitter and receiver respectively. This is used to map the spatial correlation coefficients in accordance with the antenna element labelling system described in B.2.3A.

B.2.3A.2 Spatial Correlation Matrices using cross polarized antennas at eNB and UE sides

B.2.3A.2.1 Spatial Correlation Matrices at eNB side

For 2-antenna transmitter using one pair of cross-polarized antenna elements, $R_{eNB} = 1$.

For 4-antenna transmitter using two pairs of cross-polarized antenna elements, $R_{eNB} = \begin{pmatrix} 1 & \alpha \\ \alpha^* & 1 \end{pmatrix}$.

For 8-antenna transmitter using four pairs of cross-polarized antenna elements, $R_{eNB} = \begin{pmatrix} 1 & \alpha^{1/9} & \alpha^{4/9} & \alpha \\ \alpha^{1/9*} & 1 & \alpha^{1/9} & \alpha^{4/9} \\ \alpha^{4/9*} & \alpha^{1/9*} & 1 & \alpha^{1/9} \\ \alpha^* & \alpha^{4/9*} & \alpha^{1/9*} & 1 \end{pmatrix}$.

B.2.3A.2.2 Spatial Correlation Matrices at UE side

For 2-antenna transmitter using one pair of cross-polarized antenna elements, $R_{UE} = 1$.

For 4-antenna transmitter using two pairs of cross-polarized antenna elements, $R_{UE} = \begin{pmatrix} 1 & \beta \\ \beta^* & 1 \end{pmatrix}$.

B.2.3A.3 MIMO Correlation Matrices using cross polarized antennas

The values for parameters α , β and γ for low correlation and high spatial correlation are given in Table B.2.3A.3-1.

Table B.2.3A.3-1

High spatial correlation		
α	β	γ
0.9	0.9	0.3
Note 1: Value of α applies when more than one pair of cross-polarized antenna elements at eNB side.		
Note 2: Value of β applies when more than one pair of cross-polarized antenna elements at UE side.		

The correlation matrices for high spatial and low correlation are defined in Table B.2.3A.3-2 as below.

The values in Table B.2.3A.3-2 have been adjusted to insure the correlation matrix is positive semi-definite after round-off to 4 digit precision. This is done using the equation:

$$\mathbf{R}_{high} = [\mathbf{R}_{spat} + a\mathbf{I}_n] / (1 + a)$$

Where the value "a" is a scaling factor such that the smallest value is used to obtain a positive semi-definite result. For the 8x2 high spatial correlation case, a=0.00010.

Table B.2.3A.3-2: MIMO correlation matrices for high spatial correlation

8x2 case	R_{high}
	1.0000 0.0000 0.9883 0.0000 0.9542 0.0000 0.8999 0.0000 -0.3000 0.0000 -0.2965 0.0000 -0.2862 0.0000 -0.2700 0.0000
	0.0000 1.0000 0.0000 0.9883 0.0000 0.9542 0.0000 0.8999 0.0000 0.3000 0.0000 0.2965 0.0000 0.2862 0.0000 0.2700
	0.9883 0.0000 1.0000 0.0000 0.9883 0.0000 0.9542 0.0000 -0.2965 0.0000 -0.3000 0.0000 -0.2965 0.0000 -0.2862 0.0000
	0.0000 0.9883 0.0000 1.0000 0.0000 0.9883 0.0000 0.9542 0.0000 0.2965 0.0000 0.3000 0.0000 0.2965 0.0000 0.2862
	0.9542 0.0000 0.9883 0.0000 1.0000 0.0000 0.9883 0.0000 -0.2862 0.0000 -0.2965 0.0000 -0.3000 0.0000 -0.2965 0.0000
	0.0000 0.9542 0.0000 0.9883 0.0000 1.0000 0.0000 0.9883 0.0000 0.2862 0.0000 0.2965 0.0000 0.3000 0.0000 0.2965
	0.8999 0.0000 0.9542 0.0000 0.9883 0.0000 1.0000 0.0000 -0.2700 0.0000 -0.2862 0.0000 -0.2965 0.0000 -0.3000 0.0000
	0.0000 0.8999 0.0000 0.9542 0.0000 0.9883 0.0000 1.0000 0.0000 0.2700 0.0000 0.2862 0.0000 0.2965 0.0000 0.3000
	-0.3000 0.0000 -0.2965 0.0000 -0.2862 0.0000 -0.2700 0.0000 1.0000 0.0000 0.9883 0.0000 0.9542 0.0000 0.8999 0.0000
	0.0000 0.3000 0.0000 0.2965 0.0000 0.2862 0.0000 0.2700 0.0000 1.0000 0.0000 0.9883 0.0000 0.9542 0.0000 0.8999
	-0.2965 0.0000 -0.3000 0.0000 -0.2965 0.0000 -0.2862 0.0000 0.9883 0.0000 1.0000 0.0000 0.9883 0.0000 0.9542 0.0000
	0.0000 0.2965 0.0000 0.3000 0.0000 0.2965 0.0000 0.2862 0.0000 0.9883 0.0000 1.0000 0.0000 0.9883 0.0000 0.9542
	-0.2862 0.0000 -0.2965 0.0000 -0.3000 0.0000 -0.2965 0.0000 0.9542 0.0000 0.9883 0.0000 1.0000 0.0000 0.9883 0.0000
	0.0000 0.2862 0.0000 0.2965 0.0000 0.3000 0.0000 0.2965 0.0000 0.9542 0.0000 0.9883 0.0000 1.0000 0.0000 0.9883
	-0.2700 0.0000 -0.2862 0.0000 -0.2965 0.0000 -0.3000 0.0000 0.8999 0.0000 0.9542 0.0000 0.9883 0.0000 1.0000 0.0000
	0.0000 0.2700 0.0000 0.2862 0.0000 0.2965 0.0000 0.3000 0.0000 0.8999 0.0000 0.9542 0.0000 0.9883 0.0000 1.0000

B.2.3A.4 Beam steering approach

Given the channel spatial correlation matrix in B.2.3A.1, the corresponding random channel matrix \mathbf{H} can be calculated. The signal model for the k-th subframe is denoted as:

$$y = \mathbf{H}D_{\theta_k} Wx + n$$

Where

- \mathbf{H} is the N-r xNt channel matrix per subcarrier.

- D_{θ_k} is the steering matrix, which is $D_{\theta_k} = \begin{bmatrix} 1 & 0 \\ 0 & 1 \end{bmatrix} \otimes \begin{bmatrix} 1 & 0 & 0 & 0 \\ 0 & e^{j\theta_k} & 0 & 0 \\ 0 & 0 & e^{j2\theta_k} & 0 \\ 0 & 0 & 0 & e^{j3\theta_k} \end{bmatrix}$,

- θ_k controls the phase variation, and the phase for k-th subframe is denoted by $\theta_k = \theta_0 + \Delta\theta \cdot k$, where θ_0 is the random start value with the uniform distribution, i.e. $\theta_0 \in [0, 2\pi]$, $\Delta\theta$ is the step of phase variation, which is defined in Table B.2.3A.4-1, and k is the linear increment of 1 for every subframe throughout the simulation,

- W is the precoding matrix for 8 transmission antennas,
- y is the received signal, x is the transmitted signal, and n is AWGN.

Table B.2.3A.4-1: The step of phase variation

Variation Step	Value (rad/subframe)
$\Delta\theta$	1.2566×10^{-3}

B.2.4 Propagation conditions for CQI tests

[For Channel Quality Indication (CQI) tests, the following additional multi-path profile is used:

$$h(t, \tau) = \delta(\tau) + a \exp(-i2\pi f_D t) \delta(\tau - \tau_d)$$

in continuous time (t, τ) representation, with τ_d the delay, a a constant and f_D the Doppler frequency.]

B.2.5 FFS

B.2.6 MBSFN Propagation Channel Profile

Table B.2.6-1 shows propagation conditions that are used for the MBSFN performance requirements in multi-path fading environment in an extended delay spread environment.

Table B.2.6-1: Propagation Conditions for Multi-Path Fading Environments for MBSFN Performance Requirements in an extended delay spread environment

Extended Delay Spread	
Maximum Doppler frequency [5Hz]	
Relative Delay [ns]	Relative Mean Power [dB]
0	0
30	-1.5
150	-1.4
310	-3.6
370	-0.6
1090	-7.0
12490	-10
12520	-11.5
12640	-11.4
12800	-13.6
12860	-10.6
13580	-17.0
27490	-20
27520	-21.5
27640	-21.4
27800	-23.6
27860	-20.6
28580	-27.0

B.3 High speed train scenario

The high speed train condition for the test of the baseband performance is a non fading propagation channel with one tap. Doppler shift is given by

$$f_s(t) = f_d \cos \theta(t) \quad (\text{B.3.1})$$

where $f_s(t)$ is the Doppler shift and f_d is the maximum Doppler frequency. The cosine of angle $\theta(t)$ is given by

$$\cos \theta(t) = \frac{D_s/2 - vt}{\sqrt{D_{\min}^2 + (D_s/2 - vt)^2}}, \quad 0 \leq t \leq D_s/v \quad (\text{B.3.2})$$

$$\cos \theta(t) = \frac{-1.5D_s + vt}{\sqrt{D_{\min}^2 + (-1.5D_s + vt)^2}}, \quad D_s/v < t \leq 2D_s/v \quad (\text{B.3.3})$$

$$\cos \theta(t) = \cos \theta(t \bmod (2D_s/v)), \quad t > 2D_s/v \quad (\text{B.3.4})$$

where $D_s/2$ is the initial distance of the train from eNodeB, and D_{\min} is eNodeB Railway track distance, both in meters; v is the velocity of the train in m/s, t is time in seconds.

Doppler shift and cosine angle are given by equation B.3.1 and B.3.2-B.3.4 respectively, where the required input parameters listed in table B.3-1 and the resulting Doppler shift is shown in Figure B.3-1 are applied for all frequency bands.

Table B.3-1: High speed train scenario

Parameter	Value
D_s	300 m
D_{\min}	2 m
v	300 km/h
f_d	750 Hz

NOTE 1: Parameters for HST conditions in table B.3-1 including f_d and Doppler shift trajectories presented on figure B.3-1 were derived for Band7.

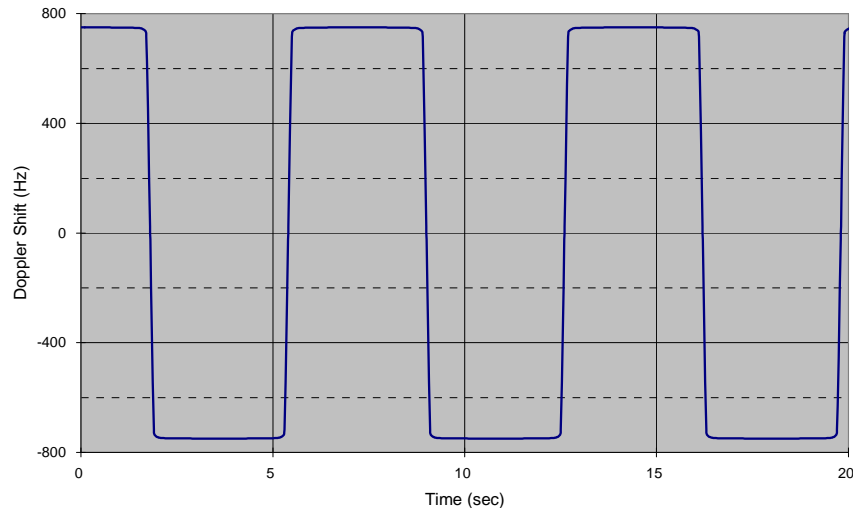

Figure B.3-1: Doppler shift trajectory

B.4 Beamforming Model

B.4.1 Single-layer random beamforming (Antenna port 5, 7 or 8)

Single-layer transmission on antenna port 5 or on antenna port 7 or 8 without a simultaneous transmission on the other antenna port, is defined by using a precoder vector $W(i)$ of size 2×1 randomly selected with the number of layers $\nu = 1$ from Table 6.3.4.2.3-1 in TS 36.211 [8] as beamforming weights. This precoder takes as an input the signal $y^{(p)}(i)$, $i = 0, 1, \dots, M_{\text{symb}}^{\text{ap}} - 1$, for antenna port $p \in \{5, 7, 8\}$, with $M_{\text{symb}}^{\text{ap}}$ the number of modulation symbols including the user-specific reference symbols (DRS), and generates a block of signals $y_{\text{bf}}(i) = [y_{\text{bf}}(i) \ \tilde{y}_{\text{bf}}(i)]^T$ the elements of which are to be mapped onto the same physical RE but transmitted on different antenna elements:

$$\begin{bmatrix} y_{\text{bf}}(i) \\ \tilde{y}_{\text{bf}}(i) \end{bmatrix} = W(i)y^{(p)}(i)$$

Single-layer transmission on antenna port 7 or 8 with a simultaneous transmission on the other antenna port, is defined by using a pair of precoder vectors $W_1(i)$ and $W_2(i)$ each of size 2×1 , which are not identical and randomly selected with the number of layers $\nu = 1$ from Table 6.3.4.2.3-1 in TS 36.211 [8], as beamforming weights, and normalizing the transmit power as follows:

$$\begin{bmatrix} y_{\text{bf}}(i) \\ \tilde{y}_{\text{bf}}(i) \end{bmatrix} = \frac{1}{\sqrt{2}} (W_1(i)y^{(7)}(i) + W_2(i)y^{(8)}(i))$$

The precoder update granularity is specific to a test case.

The CSI reference symbols $a_{k,l}^{(p)}$ satisfying $p \bmod 2 = 1$, $p \in \{15, 16, \dots, 22\}$, are transmitted on the same physical antenna element as the modulation symbols $y_{\text{bf}}(i)$. The CSI reference symbols $a_{k,l}^{(p)}$ satisfying $p \bmod 2 = 0$, $p \in \{15, 16, \dots, 22\}$, are transmitted on the same physical antenna element as the modulation symbols $\tilde{y}_{\text{bf}}(i)$.

B.4.2 Dual-layer random beamforming (antenna ports 7 and 8)

Dual-layer transmission on antenna ports 7 and 8 is defined by using a precoder matrix $W(i)$ of size 2×2 randomly selected with the number of layers $\nu = 2$ from Table 6.3.4.2.3-1 in TS 36.211 [8] as beamforming weights. This precoder takes as an input a block of signals for antenna ports 7 and 8, $y(i) = [y^{(7)}(i) \ y^{(8)}(i)]^T$, $i = 0, 1, \dots, M_{\text{symp}}^{\text{ap}} - 1$, with $M_{\text{symp}}^{\text{ap}}$ being the number of modulation symbols per antenna port including the user-specific reference symbols, and generates a block of signals $y_{\text{bf}}(i) = [y_{\text{bf}}(i) \ \tilde{y}_{\text{bf}}(i)]^T$ the elements of which are to be mapped onto the same physical RE but transmitted on different antenna elements:

$$\begin{bmatrix} y_{\text{bf}}(i) \\ \tilde{y}_{\text{bf}}(i) \end{bmatrix} = W(i) \begin{bmatrix} y^{(7)}(i) \\ y^{(8)}(i) \end{bmatrix},$$

The precoder update granularity is specific to a test case.

The CSI reference symbols $a_{k,l}^{(p)}$ satisfying $p \bmod 2 = 1$, $p \in \{15, 16, \dots, 22\}$, are transmitted on the same physical antenna element as the modulation symbols $y_{\text{bf}}(i)$. The CSI reference symbols $a_{k,l}^{(p)}$ satisfying $p \bmod 2 = 0$, $p \in \{15, 16, \dots, 22\}$, are transmitted on the same physical antenna element as the modulation symbols $\tilde{y}_{\text{bf}}(i)$.

B.4.3 Generic beamforming model (antenna ports 7-14)

The transmission on antenna port(s) $p = 7, 8, \dots, \nu + 6$ is defined by using a precoder matrix $W(i)$ of size $N_{\text{CSI}} \times \nu$, where N_{CSI} is the number of CSI reference signals configured per test and ν is the number of spatial layers. This precoder takes as an input a block of signals for antenna port(s) $p = 7, 8, \dots, \nu + 6$, $y^{(p)}(i) = [y^{(7)}(i) \ y^{(8)}(i) \ \dots \ y^{(6+\nu)}(i)]$, $i = 0, 1, \dots, M_{\text{symp}}^{\text{ap}} - 1$, with $M_{\text{symp}}^{\text{ap}}$ being the number of modulation symbols per antenna port including the user-specific reference symbols (DM-RS), and generates a block of signals $y_{\text{bf}}^{(q)}(i) = [y_{\text{bf}}^{(0)}(i) \ y_{\text{bf}}^{(1)}(i) \ \dots \ y_{\text{bf}}^{(N_{\text{CSI}}-1)}(i)]^T$ the elements of which are to be mapped onto the same time-frequency index pair (k, l) but transmitted on different physical antenna elements:

$$\begin{bmatrix} y_{\text{bf}}^{(0)}(i) \\ y_{\text{bf}}^{(1)}(i) \\ \vdots \\ y_{\text{bf}}^{(N_{\text{CSI}}-1)}(i) \end{bmatrix} = W(i) \begin{bmatrix} y^{(7)}(i) \\ y^{(8)}(i) \\ \vdots \\ y^{(6+\nu)}(i) \end{bmatrix}$$

The precoder matrix $W(i)$ is specific to a test case.

The physical antenna elements are identified by indices $j = 0, 1, \dots, N_{\text{ANT}} - 1$, where $N_{\text{ANT}} = N_{\text{CSI}}$ is the number of physical antenna elements configured per test.

Modulation symbols $y_{\text{bf}}^{(q)}(i)$ with (i.e. beamformed PDSCH and DM-RS) are mapped to the physical antenna index .

Modulation symbols with $p \in \{0, 1, \dots, P - 1\}$ (i.e. PBCH, PDCCH, PHICH, PCFICH) are mapped to the physical antenna index $j = p$, where P is the number of cell-specific reference signals configured per test.

Modulation symbols $a_{k,l}^{(p)}$ with $p \in \{0, 1, \dots, P - 1\}$ (i.e. CRS) are mapped to the physical antenna index $j = p$, where P is the number of cell-specific reference signals configured per test.

Modulation symbols $a_{k,l}^{(p)}$ with $p \in \{15, 16, \dots, 14 + N_{CSI}\}$ (i.e. CSI-RS) are mapped to the physical antenna index $j = p - 15$, where N_{CSI} is the number of CSI reference signals configured per test.

B.5 Interference models for enhanced performance requirements Type-A

This clause provides a description for the modelling of interfering cell transmissions for enhanced performance requirements Type-A including: definition of dominant interferer proportion, transmission mode 3, 4 and 9 type of interference modelling.

B.5.1 Dominant interferer proportion

Each interfering cell involved in enhanced performance requirements Type-A is characterized by its associated dominant interferer proportion (DIP) value:

$$DIP_i = \frac{\hat{I}_{or(i+1)}}{N_{oc}'}$$

where $\hat{I}_{or(i+1)}$ is the average received power spectral density from the i -th strongest interfering cell involved in the requirement scenario ($\hat{I}_{or(1)}$ is assumed to be the power spectral density associated with the serving cell) and

$N_{oc}' = \sum_{j=2}^N \hat{I}_{or(j)} + N_{oc}$ where N_{oc} is the average power spectral density of a white noise source consistent with the

definition provided in subclause 3.2 and N is the total number of cells involved in a given requirement scenario.

B.5.2 Transmission mode 3 interference model

This subclause provides transmission mode 3 interference modelling for each explicitly modelled interfering cell in the requirement scenario. In each subframe, each interfering cell shall transmit randomly modulated data over the entire PDSCH region and the full transmission bandwidth. Transmitted physical channels shall include PSS, SSS and PBCH.

For each subframe and each CQI subband as defined in subclause 7.2 of [10], a transmission rank shall be randomly determined independently from other CQI subbands as well as other interfering cells. Probabilities of occurrence of each possible transmission rank are as specified in the requirement scenario.

For rank-1 transmission over a subband, precoding for transmit diversity for the number of antenna ports in the requirement scenario shall be applied to 16QAM randomly modulated layer symbols, as specified in subclause 6.3.4.3 of [8].

For rank-2 transmission over a subband, precoding for spatial multiplexing with large delay CDD over two layers for the number of antenna ports in the requirement scenario shall be applied to 16QAM randomly modulated layer symbols, as specified in subclause 6.3.4.2.2 of [8].

For unallocated REs in the control region, precoding for transmit diversity for the number of antenna ports in the requirement scenario shall be applied to QPSK randomly modulated layer symbols, as specified in subclause 6.3.4.3 of [8]. The EPRE ratio for these REs shall be as defined for PDCCH in Annex C.3.2.

B.5.3 Transmission mode 4 interference model

This subclause provides transmission mode 4 interference modelling for each explicitly modelled interfering cell in the requirement scenario. In each subframe, each interfering cell shall transmit randomly modulated data over the entire PDSCH region and the full transmission bandwidth. Transmitted physical channels shall include PSS, SSS and PBCH.

For each subframe and each CQI subband as defined in subclause 7.2 of [10], a transmission rank shall be randomly determined independently from other CQI subbands as well as other interfering cells. Probabilities of occurrence of each possible transmission rank are as specified in the requirement scenario.

For each subframe and CQI subband, a precoding matrix for the number of layers ν associated to the selected rank shall be selected randomly from Table 6.3.4.2.3-1 of [8]. Note that codebook index 0 shall be excluded from random precoder selection when the number of layers is $\nu = 2$.

Precoding for spatial multiplexing with cell-specific reference signals for the number of antenna ports in the requirement scenario shall be applied to 16QAM randomly modulated layer symbols, as specified in subclause 6.3.4.2.1 of [8] with the selected precoding matrices for each subframe and each CQI subband.

For unallocated REs in the control region, precoding for transmit diversity for the number of antenna ports in the requirement scenario shall be applied to QPSK randomly modulated layer symbols, as specified in subclause 6.3.4.3 of [8]. The EPRE ratio for these REs shall be as defined for PDCCH in Annex C.3.2.

B.5.4 Transmission mode 9 interference model

This subclause provides transmission mode 9 interference modelling for each explicitly modelled interfering cell in the requirement scenario. In each subframe, each interfering cell shall transmit randomly modulated data over the entire PDSCH region and the full transmission bandwidth. Transmitted physical channels shall include PSS, SSS and PBCH.

For each subframe and each CQI subband as defined in subclause 7.2 of [10], a transmission rank shall be randomly determined independently from other CQI subbands as well as other interfering cells. Probabilities of occurrence of each possible transmission rank are as specified in the requirement scenario.

For each subframe and each CQI subband, a precoding matrix for the number of layers ν associated to the selected rank shall be selected randomly from Table 6.3.4.2.3-2 of [8].

The generic beamforming model in subclause B.4.3 shall be applied assuming cell-specific reference signals and CSI reference signals as specified in the requirement scenario. Random precoding with selected rank and precoding matrices for each subframe and each CQI subband shall be applied to 16QAM randomly modulated layer symbols including the user-specific reference symbols over antenna port 7 when the rank is one and antenna ports 7, 8 when the rank is two.

For unallocated REs in the control region, precoding for transmit diversity for the number of antenna ports in the requirement scenario shall be applied to QPSK randomly modulated layer symbols, as specified in subclause 6.3.4.3 of [8]. The EPRE ratio for these REs shall be as defined for PDCCH in Annex C.3.2.

Annex C (normative): Downlink Physical Channels

This annex specifies the downlink physical channels that are needed for setting a connection and channels that are needed during a connection.

C.0 Downlink signal levels

The downlink power settings in Table C.0-1 are used unless otherwise specified in a test case.

If the UE has two Rx antennas, the downlink signal is applied to each one. Both UE Rx antennas shall be connected.

If the UE has one Rx antenna, the downlink signal is applied to it.

Table C.0-1: Default Downlink power levels

	Unit	Channel bandwidth					
		1.4 MHz	3 MHz	5 MHz	10 MHz	15 MHz	20 MHz
Number of RBs		6	15	25	50	75	100
Channel BW Power	dBm	-66	-62	-60	-57	-55	-54
RS EPRE	dBm/15kHz	-85	-85	-85	-85	-85	-85
Note 1: The channel bandwidth powers and RB allocations are informative, based on -85dBm/15kHz RS_EPRES, then scaled according to the number of RBs and rounded to the nearest integer dBm value. Full RE allocation with no boost or deboost is assumed in this calculation, but allocation may vary during setup.							
Note 2: The power level is specified at each UE Rx antenna.							

The default signal level uncertainty is +/-3dB at each test port, for any level specified. If the uncertainty value is critical for the test purpose, a tighter uncertainty is specified for the related test case in Annex F.

C.1 General

Table C.1-1 describes the mapping of downlink physical channels and signals to physical resources for FDD.

Table C.1-2 describes the mapping of downlink physical channels and signals to physical resources for TDD.

Table C.1-1: Mapping of downlink physical channels and signals to physical resources for FDD

Physical channel	Time Domain Location	Frequency Domain Location	Note
RS	Symbols 0, 4 of each subframe for antenna port 0 & 1 Symbol 1 of each subframe for antenna port 2 & 3	Downlink system bandwidth dependent.	Mapping rule is specified in TS36.211 6.10.1.2 - CELL_ID = 0
PBCH	Symbols 0 to 3 of slot 1 of subframe 0 of each radio frame	Occupies 72 subcarriers centred on the DC subcarrier	Mapping rule is specified in TS36.211 Section 6.6.4 (Note 2)
PSS	Symbol 6 of slot 0 and 10 of each radio frame	Occupies 62 subcarriers centred on the DC subcarrier. Additional 10 subcarriers (5 on each side) adjacent to the centred 62 subcarriers are reserved.	Mapping rule is specified in TS36.211 Section 6.11.1.2
SSS	Symbol 5 of slots 0 and 10 of each radio frame	Occupies 62 subcarriers centred on the DC subcarrier. Additional 10 subcarriers (5 on each side) adjacent to the centred 62 subcarriers are reserved.	Mapping rule is specified in TS36.211 Section 6.11.2.2
PCFICH	Symbol 0 of each subframe	Downlink system bandwidth dependent. Maps into 4 REGs uniformly spread in the frequency domain over the whole system bandwidth.	Mapping rule is specified in TS36.211 Section 6.7.4 (Note 1) - CELL_ID = 0
PHICH	Symbol 0 of each subframe	Downlink system bandwidth dependent. Each PHICH group maps into 3 REGs in the frequency domain on the REGs not assigned to PCFICH over the whole system bandwidth,	Mapping rule is specified in TS36.211 Section 6.9.3 (Note 1) - CELL_ID = 0 - Ng = 1 - Normal PHICH duration - Number of PHICH groups = 1(BW=1.4MHz)/2(BW=3MHz)/4(BW=5MHz)/7(BW=10MHz)/10(BW=15MHz)/13(BW=20MHz)
PDCCH	Symbols 0, 1, 2, 3 of each subframe for 1.4 MHz Symbols 0, 1, 2, of each subframe for 3 and 5 MHz Symbols 0, 1 of each subframe for 10, 15 and 20 MHz	The remaining REGs not allocated to both PCFICH and PHICH are used for PDCCH	Mapping rule is specified in TS36.211 Section 6.8.5 (Note 1)
PDSCH	All remaining OFDM symbols of each subframe not allocated to PDCCH	For Subframe 0, REs not allocated to RS, PSS, SSS and PBCH, is allocated to PDSCH For Subframe 5, REs not allocated to RS, PSS and SSS, is allocated to PDSCH For other subframes, REs not allocated to RS, is allocated to PDSCH	Note that there are reserved REs that are not used for transmission of any physical channels (Note 3) & (Note 4) which need to be taken into account when allocating REs to PDSCH

Note 1: In case a single cell-specific RS is configured, cell-specific RS shall be assumed to be present on antenna ports 0 and 1 for the purpose of mapping a symbol-quadruplet to a REG (resource-element group). (See TS 36.211 Section 6.2.4).

Note 2: PBCH is mapped into RE assuming RS from 4 antennas are used at the eNB transmitter, irrespective of the actual number of Tx antenna. Resource elements assumed to be reserved for RS but not used for transmission of RS shall not be used for transmission of any physical channel. (See TS 36.211 Section 6.6.4).

Note 3: In slot 0 and slot 10 of each radio frame, there are reserved REs for PSS and SSS that are not used for transmission of any physical channels. (See TS 36.211 Section 6.11.1.2 & 6.11.2.2).

Note 4: REs used for RS transmission on any of the antenna ports in a slot shall not be used for any transmission on any other antenna port in the same slot and set to zero. (See TS 36.211 Section 6.10.1.2).

Table C.1-2: Mapping of downlink physical channels and signals to physical resources for TDD

Physical channel	Time Domain Location	Frequency Domain Location	Note
RS	Symbols 0, 4 of each subframe for antenna port 0 & 1 Symbol 1 of each subframe for antenna port 2 & 3	Downlink system bandwidth dependent.	Mapping rule is specified in TS36.211[8] 6.10.1.2 - CELL_ID = 0
PBCH	Symbols 0 to 3 of slot 1 of subframe 0 of each radio frame	Occupies 72 subcarriers centred on the DC subcarrier	Mapping rule is specified in TS36.211[8] Section 6.6.4 (Note 3)
PSS	Symbol 2 of slot 2 and 12 of each radio frame	Occupies 62 subcarriers centred on the DC subcarrier. Additional 10 subcarriers (5 on each side) adjacent to the centred 62 subcarriers are reserved.	Mapping rule is specified in TS36.211[8] Section 6.11.1.2
SSS	Symbol 6 of slots 1 and 11 of each radio frame	Occupies 62 subcarriers centred on the DC subcarrier. Additional 10 subcarriers (5 on each side) adjacent to the centred 62 subcarriers are reserved.	Mapping rule is specified in TS36.211[8] Section 6.11.2.2
PCFICH	Symbol 0 of each subframe and special subframe	Downlink system bandwidth dependent. Maps into 4 REGs uniformly spread in the frequency domain over the whole system bandwidth.	Mapping rule is specified in TS36.211[8] Section 6.7.4 (Note 2) - CELL_ID = 0
PHICH	Symbol 0 of each subframe and special subframe	Downlink system bandwidth dependent. Each PHICH group maps into 3 REGs in the frequency domain on the REGs not assigned to PCFICH over the whole system bandwidth,	Mapping rule is specified in TS36.211[8] Section 6.9.3 (Note 2) - CELL_ID = 0 - Ng = 1 - Normal PHICH duration - Number of PHICH groups = 1(BW=1.4MHz)/2(BW=3MHz)/4(BW=5MHz)/7(BW=10MHz)/10(BW=15MHz)/13(BW=20MHz)
PDCCH	For normal subframes(0,4,5,9) Symbols 0, 1, 2, 3 of each subframe for 1.4 MHz Symbols 0, 1, 2, of each subframe for 3 and 5 MHz Symbols 0, 1 of each subframe for 10, 15 and 20 MHz For special subframe (1&6) Symbols 0, 1 of each subframe for all BWs	The remaining REGs not allocated to both PCFICH and PHICH are used for PDCCH	Mapping rule is specified in TS36.211[8] Section 6.8.5 (Note 2)
PDSCH	,All remaining OFDM symbols of each subframe not allocated to PDCCH with the following exception: For 1.4MHz,no data shall be scheduled on special subframes (1&6) to avoid problems with insufficient PDCCH performance	For Subframe 0, REs not allocated to RS, SSS and PBCH, is allocated to PDSCH For Subframe 5, REs not allocated to RS and SSS, is allocated to PDSCH For Subframe 1 and 6, REs not allocated to RS, PSS, GP and UpPTS is allocated to PDSCH For other downlink subframes, REs not allocated to RS is allocated to PDSCH	Note that there are reserved REs that are not used for transmission of any physical channels (Note 4) & (Note 5) which need to be taken into account when allocating REs to PDSCH
Note 1: The mapping is based on the default TDD configuration for subframe assignment and special subframe patterns (see 36.508 [7]subclause 4.6.3)			
Note 2: In case a single cell-specific RS is configured, cell-specific RS shall be assume to be present on antenna ports 0 and 1 for the purpose of mapping a symbol-quadruplet to a REG (resource-element group). (See TS			

36.211[8] Section 6.2.4).

Note 3: PBCH is mapped into RE assuming RS from 4 antennas are used at the eNB transmitter, irrespective of the actual number of Tx antenna. Resource elements assumed to be reserved for RS but not used for transmission of RS shall not be used for transmission of any physical channel. (See TS 36.211[8] Section 6.6.4).

Note 4: In slot 1,2,11 and 12 of each radio frame, there are reserved REs for PSS and SSS that are not used for transmission of any physical channels. (See TS 36.211[8] Section 6.11.1.2 & 6.11.2.2).

Note 5: REs used for RS transmission on any of the antenna ports in a slot shall not be used for any transmission on any other antenna port in the same slot and set to zero. (See TS 36.211[8] Section 6.10.1.2).

C.2 Set-up

Table C.2-1 describes the downlink Physical Channels that are required for connection set up.

Table C.2-1: Downlink Physical Channels required for connection set-up

Physical Channel	EPRE Ratio	Note
PBCH	PBCH_RA = 0 dB	
	PBCH_RB = 0 dB	
PSS	PSS_RA = 0 dB	
SSS	SSS_RA = 0 dB	
PCFICH	PCFICH_RB = 0 dB	
PDCCH	PDCCH_RA = 0 dB	
	PDCCH_RB = 0 dB	
PDSCH	PDSCH_RA = 0 dB	
	PDSCH_RB = 0 dB	
PHICH	PHICH_RA = 0 dB	Note 2
	PHICH_RB = 0 dB	
Note 1: No boosting is applied.		
Note 2: PHICH group power, i.e. the total power of all active PHICH sequences within a PHICH group.		

Table C.2-2 describes the configuration of PDSCH and PDCCH before measurement for FDD and Table C.2-3 for TDD.

Table C.2-2: PDSCH and PDCCH configuration for FDD

Parameter	Unit	Value	Comments
Allocated resource blocks		6	
MCS Index		-	TB Size with transmitting message in 1TTI
Number of HARQ processes	Processes	8	
Maximum number of HARQ transmission		5	
Aggregation level	CCE	2	Note 4
DCI Format for PDSCH		Format 1A	
DCI Format for PUSCH		Format 0	
Note 1: 2 symbols allocated to PDCCH for 20 MHz, 15 MHz and 10 MHz channel BW. 3 symbols allocated to PDCCH for 5 MHz and 3 MHz. 4 symbols allocated to PDCCH for 1.4 MHz.			
Note 2: Reference signal, Synchronization signals and PBCH allocated as per TS 36.211 [8].			
Note 3: The PDSCH shall be occupied 6 resource blocks centred on the DC subcarrier.			
Note 4: For PDCCH using SI-RNTI, Aggregation level: a) Tables C.3.0-3, C.3.1-3, and C.3.2-3 for RF tests b) Table A.2.1-1 of 36.521-3 for RRM tests.			

Table C.2-3: PDSCH and PDCCH configuration for TDD

Parameter	Unit	Value	Comments
Allocated resource blocks		6	
MCS Index		0	TB Size with transmitting message in 1TTI
Number of HARQ processes (Note 1)	Processes	7	
Maximum number of HARQ transmission		4	
Aggregation level	CCE	2	Note 5
DCI Format for PDSCH		Format 1A	
DCI Format for PUSCH		Format 0	
Note 1:	Number of HARQ processes shall be determined by UL/DL configuration, for configuration other than 1, the process number shall be set per TS 36.213 [10] Table 8-1.		
Note 2:	For normal downlink subframes, 2 symbols allocated to PDCCH for 20 MHz, 15 MHz and 10 MHz channel BW. 3 symbols allocated to PDCCH for 5 MHz and 3 MHz. 4 symbols allocated to PDCCH for 1.4 MHz. For special subframe (1&6), only 2 OFDM symbols are allocated to PDCCH for all BWs.		
Note 3:	Reference signal, Synchronization signals and PBCH allocated as per TS 36.211 [8].		
Note 4:	The PDSCH shall be occupied 6 resource blocks centred on the DC subcarrier.		
Note 5:	For PDCCH using SI-RNTI, Aggregation level: a) Tables C.3.0-3, C.3.1-3, and C.3.2-3 for RF tests b) Table A.2.2-1 of 36.521-3 for RRM tests		

C.3 Connection

The following clauses describes the downlink Physical Channels that are transmitted during a connection i.e., when measurements are done.

C.3.0 Measurement of Transmitter Characteristics

Table C.3.0-1 is applicable for measurements on the Transmitter Characteristics (clause 6).

Table C.3.0-1: Downlink Physical Channels transmitted during a connection (FDD and TDD)

Physical Channel	EPRE Ratio	Note
PBCH	PBCH_RA = 0 dB	
	PBCH_RB = 0 dB	
PSS	PSS_RA = 0 dB	
SSS	SSS_RA = 0 dB	
PCFICH	PCFICH_RB = 0 dB	
PDCCH	PDCCH_RA = 0 dB	
	PDCCH_RB = 0 dB	
PDSCH	PDSCH_RA = 0 dB	
	PDSCH_RB = 0 dB	
PHICH	PHICH_RB = 0 dB	Note 1
Note 1: PHICH group power, i.e. the total power of all active PHICH sequences within a PHICH group.		

NOTE 1: No boosting is applied.

Table C.3.0-2: Power allocation for OFDM symbols and reference signals

Parameter	Unit	Value	Note
Transmitted power spectral density I_{or}	dBm/15 kHz	Test specific	1. I_{or} shall be kept constant throughout all OFDM symbols
Cell-specific reference signal power ratio E_{RS} / I_{or}		0 dB	

Table C.3.0-3: PDCCH Aggregation Level (in CCE-s)

Bandwidth	DCI for DL (SI-RNTI)	DCI for DL (C-RNTI)	DCI for UL (C-RNTI)	Notes
1.4 MHz	4	1	1	Note 1
3 MHz	4	4	4	Note 1
5 MHz	4	4	4	Note 1
10 MHz	8	8	8	Note 1
15 MHz	8	8	8	Note 1
20 MHz	8	8	8	Note 1

Note 1: No DL data allocated on TDD special subframes

C.3.1 Measurement of Receiver Characteristics

Table C.3.1-1 is applicable for measurements on the Receiver Characteristics (clause 7).

Table C.3.1-1: Downlink Physical Channels transmitted during a connection (FDD and TDD)

Physical Channel	EPRE Ratio	Note
PBCH	PBCH_RA = 0 dB	
	PBCH_RB = 0 dB	
PSS	PSS_RA = 0 dB	
SSS	SSS_RA = 0 dB	
PCFICH	PCFICH_RB = 0 dB	
PDCCH	PDCCH_RA = 0 dB	
	PDCCH_RB = 0 dB	
PDSCH	PDSCH_RA = 0 dB	
	PDSCH_RB = 0 dB	
PHICH	PHICH_RB = 0 dB	Note 1
OCNG	OCNG_RA = 0 dB	
	OCNG_RB = 0 dB	

Note 1: PHICH group power, i.e. the total power of all active PHICH sequences within a PHICH group.

NOTE 1: No boosting is applied.

Table C.3.1-2: Power allocation for OFDM symbols and reference signals

Parameter	Unit	Value	Note
Transmitted power spectral density I_{or}	dBm/15 kHz	Test specific	1. I_{or} shall be kept constant throughout all OFDM symbols
Cell-specific reference signal power ratio E_{RS} / I_{or}		0 dB	

Table C.3.1-3: PDCCH Aggregation Level (in CCE-s)

Bandwidth	DCI for DL (SI-RNTI)	DCI for DL (C-RNTI)	DCI for UL (C-RNTI)	Notes
1.4 MHz	4	4	2	Note 1, 2
3 MHz	4	4	2	Note 2
5 MHz	8	8	4	Note 2
10 MHz	8	8	8	Note 2
15 MHz	8	8	8	Note 2
20 MHz	8	8	8	Note 2

Note 1: No DL data allocated on TDD special subframes
Note 2: No DL data allocated on subframe 5

C.3.2 Measurement of Performance requirements

Table C.3.2-1 is applicable for measurements in which uniform RS-to-EPRE boosting for all downlink physical channels.

Table C.3.2-1: Downlink Physical Channels transmitted during a connection (FDD and TDD)

Physical Channel	EPRE Ratio	Note
PBCH	PBCH_RA = $\rho_A + \sigma$	
	PBCH_RB = $\rho_B + \sigma$	
PSS	PSS_RA = 0 (Note 4)	
SSS	SSS_RA = 0 (Note 4)	
PCFICH	PCFICH_RB = $\rho_B + \sigma$	
PDCCH	PDCCH_RA = $\rho_A + \sigma$	
	PDCCH_RB = $\rho_B + \sigma$	
PDSCH	PDSCH_RA = ρ_A	
	PDSCH_RB = ρ_B	
PMCH	PMCH_RA = ρ_A	
	PMCH_RB = ρ_B	
MBSFN RS	MBSFN_RS_RA = ρ_A	
	MBSFN_RS_RB = ρ_B	
PHICH	PHICH_RB = $\rho_B + \sigma$	Note 1
OCNG	OCNG_RA = $\rho_A + \sigma$	
	OCNG_RB = $\rho_B + \sigma$	
Note 1: PHICH group power, i.e. the total power of all active PHICH sequences within a PHICH group.		

NOTE 1: ρ_A denotes the ratio of PDSCH EPRE to cell-specific RS EPRE among PDSCH REs in all the OFDM symbols not containing cell-specific RS. ρ_B denotes the ratio of PDSCH EPRE to cell-specific RS EPRE among PDSCH REs in all the OFDM symbols containing cell-specific RS.

NOTE 2: $\rho_A = \rho_B = 0$ dB means no RS boosting.

NOTE 3: MBSFN RS and OCNG are not defined downlink physical channels in [8].

NOTE 4: Assuming PSS and SSS transmitted on a single antenna port.

NOTE 5: ρ_A , ρ_B , and σ are test specific, $\sigma = 0$ dB otherwise.

NOTE 6: For TM8 and TM9 ρ_A and ρ_B are used for the purpose of the test set up only.

Table C.3.2-2: Power allocation for OFDM symbols and reference signals

Parameter	Unit	Value	Note
Total transmitted power spectral density I_{or}	dBm/15 kHz	Test specific	1. I_{or} shall be kept constant throughout all OFDM symbols
Cell-specific reference signal power ratio E_{RS} / I_{or}		Test specific	1. Applies for antenna port p
Energy per resource element EPRE		Test specific	1. The complex-valued symbols $y^{(p)}(i)$ and $a_{k,l}^{(p)}$ defined in [8] shall conform to the given EPRE value. 2. For TM8 and TM9 the reference point for EPRE is before the precoder in Annex B.4.

Table C.3.2-3: PDCCH Aggregation Level (in CCE-s) for PDSCH demodulation and PMI performance tests

Bandwidth	DCI for DL (SI-RNTI)	DCI for DL (C-RNTI)	DCI for UL (C-RNTI)	Notes
1.4 MHz	4	4	2	Note 1, 2
3 MHz	4	4	2	Note 2
5 MHz	8	8	4	Note 2
10 MHz	8	8	8	Note 2
15 MHz	8	8	8	Note 2
20 MHz	8	8	8	Note 2
Note 1: No DL data allocated on TDD special subframes				
Note 2: No DL data allocated on subframe 5				

Table C.3.2-4: PDCCH Aggregation Level for CQI and RI performance tests (in CCE-s)

Bandwidth	DCI for DL (SI-RNTI)	DCI for DL (C-RNTI)	DCI for UL (C-RNTI)	Notes
1.4 MHz				
3 MHz				
5 MHz				
10 MHz	8	8	8	Note 1,2
15 MHz				
20 MHz				
Note 1: 3 symbols allocated to PDCCH				
Note 2: No DL data allocated on subframes 0 and 5 for FDD and 0, 1, 5 and 6 for TDD				

Table C.3.2-5: PDCCH Aggregation Level for sustained downlink data rate performance tests (in CCE-s)

Bandwidth	DCI for DL (SI-RNTI)	DCI for DL (C-RNTI)	DCI for UL (C-RNTI)	Notes
1.4 MHz				
3 MHz				
5 MHz				
10 MHz	4	4	4	Note 1,2,4
15 MHz	4	8	4	Note 1,3,4
20 MHz	8	8	8	Note 1,3,4
Note 1: 1 symbol allocated to PDCCH				
Note 2: On subframe 5 Aggregation level 2 is used to transmit DCI for DL(C-RNTI) and UL(C-RNTI).				
Note 3: On subframe 5, Aggregation level 4 is used to transmit DCI for DL(C-RNTI) and UL(C-RNTI).				
Note 4: No DL data allocated on subframes 1 for TDD.				

C.3.3 Aggressor cell power allocation for Measurement of Performance Requirements when ABS is Configured

For the performance requirements and channel state information reporting when ABS is configured, the power allocation for the physical channels of the aggressor cell in non-ABS and ABS is listed in Table C.3.3-1.

Table C.3.3-1: Downlink physical channels transmitted in aggressor cell when ABS is configured in this cell

Physical Channel	Parameters	Unit	EPRE Ratio	
			Non-ABS	ABS
PBCH	PBCH_RA	dB	ρ_A	Note 1
	PBCH_RB	dB	ρ_B	Note 1
PSS	PSS_RA	dB	ρ_A	Note 1
SSS	SSS_RA	dB	ρ_A	Note 1
PCFICH	PCFICH_RB	dB	ρ_B	Note 1
PHICH	PHICH_RA	dB	ρ_A	Note 1
	PHICH_RB	dB	ρ_B	Note 1
PDCCH	PDCCH_RA	dB	ρ_A	Note 1
	PDCCH_RB	dB	ρ_B	Note 1
PDSCH	PDSCH_RA	dB	N/A	Note 1
	PDSCH_RB	dB	N/A	Note 1
OCNG	OCNG_RA	dB	ρ_A	Note 1
	OCNG_RB	dB	ρ_B	Note 1

Note 1: $-\infty$ dB is allocated for this channel in this test.

Table C.3.3-2: Downlink physical channels transmitted in aggressor cell when ABS is configured in this cell when the CRS assistance information is provided

Physical Channel	Parameters	Unit	EPRE Ratio	
			Non-ABS	ABS
PBCH	PBCH_RA	dB	ρ_A	ρ_A
	PBCH_RB	dB	ρ_B	ρ_B
PSS	PSS_RA	dB	ρ_A	ρ_A
SSS	SSS_RA	dB	ρ_A	ρ_A
PCFICH	PCFICH_RB	dB	ρ_B	Note 1
PHICH	PHICH_RA	dB	ρ_A	Note 1
	PHICH_RB	dB	ρ_B	Note 1
PDCCH	PDCCH_RA	dB	ρ_A	Note 1
	PDCCH_RB	dB	ρ_B	Note 1
PDSCH	PDSCH_RA	dB	N/A	Note 1
	PDSCH_RB	dB	N/A	Note 1
OCNG	OCNG_RA	dB	ρ_A	Note 1
	OCNG_RB	dB	ρ_B	Note 1

Note 1: $-\infty$ dB is allocated for this channel in this test.

Annex D (normative): Characteristics of the Interfering Signal

D.1 General

Some RF performance requirements for the E-UTRA UE receiver are defined with interfering signals present in addition to the wanted signal. When the wanted channel band width is wider than or equal to 5MHz, a modulated 5MHz full band width E-UTRA down link signal, and in some cases an additional CW signal, are used. For wanted channel band widths below 5MHz, the band width of the modulated interferer should be equal to the channel band width of the wanted signal.

D.2 Interference signals

Table D.2-1 describes the modulated interferer for different channel band width options.

Table D.2-1: Description of modulated E-UTRA interferer

	Channel bandwidth					
	1.4 MHz	3 MHz	5 MHz	10 MHz	15 MHz	20 MHz
RB	6	15	25	25	25	25
BW _{Interferer}	1.4 MHz	3 MHz	5 MHz	5 MHz	5 MHz	5 MHz

Annex E (normative): Global In-Channel TX-Test

Note: Clauses E.2.2 to E.5.9.3 are descriptions, which assume no power ramping adjacent to the measurement period. *Power ramping adjacent to the measurement period requires exclusion periods, described in clause E.7*

E.1 General

The global in-channel TX test enables the measurement of all relevant parameters that describe the in-channel quality of the output signal of the TX under test in a single measurement process.

The parameters describing the in-channel quality of a transmitter, however, are not necessarily independent. The algorithm chosen for description inside this annex places particular emphasis on the exclusion of all interdependencies among the parameters.

E.2 Signals and results

E.2.1 Basic principle

The process is based on the comparison of the actual **output signal of the TX under test**, received by an ideal receiver, with a **reference signal**, that is generated by the measuring equipment and represents an ideal error free received signal. All signals are represented as equivalent (generally complex) baseband signals.

The description below uses numbers as examples. These numbers are taken from frame structure 1 with normal CP length and 20 MHz bandwidth. The application of the text below, however, is not restricted to this frame structure and bandwidth.

E.2.2 Output signal of the TX under test

The output signal of the TX under test is acquired by the measuring equipment and stored for further processing. It is sampled at a sampling rate of 30.72 Msps. In the time domain it comprises at least 10 uplink subframes. The measurement period is derived by concatenating the correct number of individual uplink slots until the correct measurement period is reached. The output signal is named $z(v)$. Each slot is modelled as a signal with the following parameters: demodulated data content, carrier frequency, amplitude and phase for each subcarrier, timing, carrier leakage.

NOTE 1: TDD

For frame structure type 2, subframes with special fields (UpPTS) do not undergo any evaluation. Since the uplink subframes are not continuous, the 20 slots should be extracted from more than 1 continuous radio frame:

Figure E.2.2-1 is an example for uplink-downlink configuration 1 (DSUUDDSUUD) as specified in TS 36.211 [8] Table 4.2-2, assuming all uplink subframes are active.

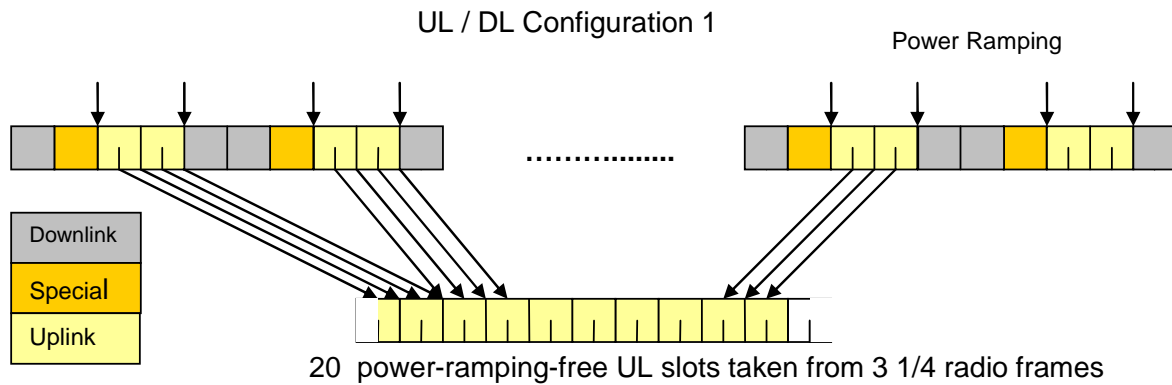

Figure E.2.2-1: Example of uplink – downlink configuration 1

E.2.3 Reference signal

Two types of reference signal are defined:

The reference signal $i_1(v)$ is constructed by the measuring equipment according to the relevant TX specifications, using the following parameters: demodulated data content, nominal carrier frequency, nominal amplitude and phase for each subcarrier, nominal timing, no carrier leakage. It is represented as a sequence of samples at a sampling rate of 30.72 Msps in the time domain.

The reference signal $i_2(v)$ is constructed by the measuring equipment according to the relevant TX specifications, using the following parameters: restricted data content: nominal reference symbols, (all modulation symbols for user data symbols are set to 0V), nominal carrier frequency, nominal amplitude and phase for each applicable subcarrier, nominal timing, no carrier leakage. It is represented as a sequence of samples at a sampling rate of 30.72 Msps in the time domain.

NOTE: The PUCCH is off during the time under test.

E.2.4 Measurement results

The measurement results, achieved by the global in channel TX test are the following:

- Carrier Frequency error
- EVM (Error Vector Magnitude)
- Carrier leakage
- Unwanted emissions, falling into non allocated resource blocks.
- EVM equalizer spectrum flatness

E.2.5 Measurement points

The unwanted emission falling into non-allocated RB(s) is calculated directly after the FFT as described below. In contrast to this, the EVM for the allocated RB(s) is calculated after the IDFT. The samples after the TX-RX chain equalizer are used to calculate EVM equalizer spectrum flatness. Carrier frequency error and carrier leakage is calculated in the block “RF correction”.

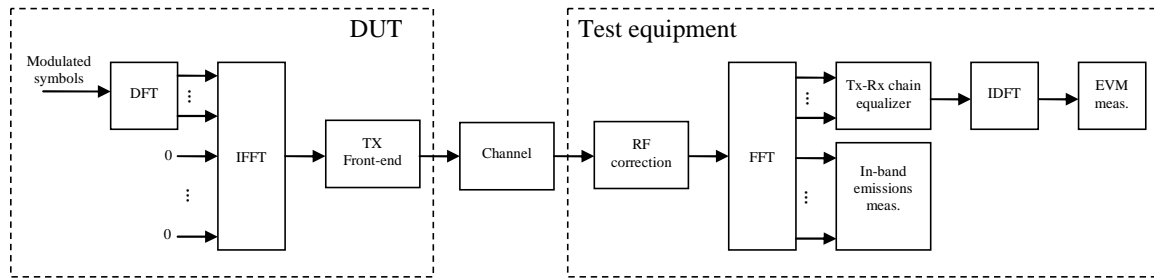

Figure E.2.5-1: EVM measurement points

E.3 Signal processing

E.3.1 Pre FFT minimization process

Before applying the pre-FFT minimization process, $z(v)$ and $i(v)$ are portioned into 20 pieces, comprising one slot each. Each slot is processed separately. Sample timing, Carrier frequency and baseband-I/Q offset (corresponding carrier leakage in RF) in $z(v)$ are jointly varied in order to minimise the difference between $z(v)$ and $i(v)$. Best fit (minimum difference) is achieved when the RMS difference value between $z(v)$ and $i(v)$ is an absolute minimum.

The carrier frequency variation and the IQ variation are the measurement results: Carrier Frequency Error and Carrier leakage.

From the acquired samples 20 carrier frequencies and 20 carrier leakages can be derived.

NOTE 1: The minimisation process, to derive carrier leakage and RF error can be supported by Post FFT operations. However the minimisation process defined in the pre FFT domain comprises all acquired samples (i.e. it does not exclude the samples in between the FFT widths and it does not exclude the bandwidth outside the transmission bandwidth configuration)

NOTE 2: The algorithm would allow to derive Carrier Frequency error and Sample Frequency error of the TX under test separately. However there are no requirements for Sample Frequency error. Hence the algorithm models the RF and the sample frequency commonly (not independently). It returns one error and does not distinguish between both.

After this process the samples $z(v)$ are called $z^0(v)$.

E.3.2 Timing of the FFT window

The FFT window length is 2048 samples per OFDM symbol. 7 FFTs (14336 samples) cover less than the acquired number of samples (15360 samples) The position in time for FFT must be determined.

In an ideal signal, the FFT may start at any instant within the cyclic prefix without causing an error. The TX filter, however, reduces the window. The EVM requirements shall be met within a window $W < CP$. There are three different instants for FFT:

Centre of the reduced window, called $\Delta\tilde{c}$, $\Delta\tilde{c} - W/2$ and $\Delta\tilde{c} + W/2$.

The timing of the measured signal is determined in the pre FFT domain as follows, using $z^0(v)$ and $i_2(v)$:

1. The measured signal is delay spread by the TX filter. Hence the distinct borders between the OFDM symbols and between Data and CP are also spread and the timing is not obvious.
2. In the Reference Signal $i_2(v)$ the timing is known.
3. Correlation between (1.) and (2.) will result in a correlation peak. The meaning of the correlation peak is approx. the “impulse response” of the TX filter. The meaning of “impulse response” assumes that the autocorrelation of the reference signal $i_2(v)$ is a Dirac peak and that the correlation between the reference signal $i_2(v)$ and the data

in the measured signal is 0. The correlation peak, (the highest, or in case of more than one, the earliest) indicates the timing in the measured signal.

From the acquired samples 20 timings can be derived.

For all calculations, except EVM, the number of samples in $z^0(v)$ is reduced to 7 blocks of samples, comprising 2048 samples (FFT width) and starting with $\Delta\tilde{c}$ in each OFDM symbol including the demodulation reference signal.

For the EVM calculation the output signal under test is reduced to 14 blocks of samples, comprising 2048 samples (FFT width) and starting with $\Delta\tilde{c} -W/2$ and $\Delta\tilde{c} +W/2$ in each OFDM symbol including the demodulation reference signal.

The number of samples, used for FFT is reduced compared to $z^0(v)$. This subset of samples is called $z'(v)$.

The timing of the centre $\Delta\tilde{c}$ with respect to the different CP length in a slot is as follows: (Frame structure 1, normal CP length)

$\Delta\tilde{c}$ is on $T_{f=72}$ within the CP of length 144 (in OFDM symbol 1 to 6)

$\Delta\tilde{c}$ is on $T_{f=88}$ (=160-72) within the CP of length 160 (in OFDM symbol 0)

E.3.3 Post FFT equalisation

Perform 7 FFTs on $z'(v)$, one for each OFDM symbol in a slot using the timing $\Delta\tilde{c}$, including the demodulation reference symbol. The result is an array of samples, 7 in the time axis t times 2048 in the frequency axis f . The samples represent the DFT coded data symbols (in OFDM-symbol 0,1,2,4,5 and 6 in each slot) and demodulation reference symbols (OFDM symbol 3 in each slot) in the allocated RBs and inband emissions in the non allocated RBs within the transmission BW.

Only the allocated resource blocks in the frequency domain are used for equalisation.

The nominal demodulation reference symbols and nominal DFT coded data symbols are used to equalize the measured data symbols. (Location for equalization see Figure E.2.5-1)

NOTE: The nomenclature inside this note is local and not valid outside.

The nominal DFT coded data symbols are created by a demodulation process. The location to gain the demodulated data symbols is "EVM" in Figure E.2.5-1. A demodulation process as follows is recommended:

1. Equalize the measured DFT coded data symbols using the reference symbols for equalisation. Result: Equalized DFT coded data symbols
2. iDFT transform the equalized DFT coded data symbols: Result: Equalized data symbols
3. Decide for the nearest constellation point: Result: Nominal data symbols
4. DFT transform the nominal data symbols: Result: Nominal DFT coded data symbols

At this stage we have an array of Measured DFT coded data-Symbols and reference-Symbols ($MS(f,t)$)

versus an array of Nominal DFT coded data-Symbols and reference Symbols ($NS(f,t)$)

(complex, the arrays comprise 6 DFT coded data symbols and 1 demodulation reference symbol in the time axis and the number of allocated subcarriers in the frequency axis.)

$MS(f,t)$ and $NS(f,t)$ are processed with a least square (LS) estimator, to derive one equalizer coefficient per time slot and per allocated subcarrier. $EC(f)$

$$EC(f) = \frac{\sum_{t=0}^6 NS(f,t)^* NS(f,t)}{\sum_{t=0}^6 NS(f,t)^* MS(f,t)}$$

With $*$ denoting complex conjugation.

$EC(f)$ are used to equalize the DFT-coded data symbols. The measured DFT-coded data and the references symbols are equalized by:

$$Z'(f,t) = MS(f,t) \cdot EC(f)$$

With \cdot denoting multiplication.

$Z'(f,t)$, restricted to the data symbol (excluding $t=3$) is used to calculate EVM, as described in E.4.1.

$EC(f)$ is used in E.4.4 to calculate EVM equalizer spectral flatness.

NOTE: although an exclusion period for EVM may be applicable in E.7, the post FFT minimisation process is done over 7 symbols (6 DFT-coded data symbols and 1 reference symbol).

The samples of the non allocated resource blocks within the transmission bandwidth configuration in the post FFT domain are called $Y(f,t)$ (f covering the non allocated subcarriers within the transmission bandwidth configuration, t covering the OFDM symbols during 1 slot).

E.4 Derivation of the results

E.4.1 EVM

For EVM create two sets of $Z'(f,t)$, according to the timing " $\Delta\tilde{c} = -W/2$ " and " $\Delta\tilde{c} = +W/2$ " using the equalizer coefficients from E.3.3.

Perform the iDFTs on $Z'(f,t)$. The IDFT-decoding preserves the meaning of t but transforms the variable f (representing the allocated sub carriers) into an another variable g , covering the same count and representing the demodulated symbols. The samples in the post IDFT domain are called $iZ'(g, t)$. The equivalent ideal samples are called $iI(g,t)$. Those samples of $Z'(f,t)$, carrying the reference symbols (=symbol 3) are not iDFT processed.

The EVM is the difference between the ideal waveform and the measured and equalized waveform for the allocated RB(s)

$$EVM = \sqrt{\frac{\sum_{t \in T} \sum_{g \in G} |iZ'(g, t) - iI(g, t)|^2}{|G| \cdot |T| \cdot P_0}},$$

where

t covers the count of demodulated symbols with the considered modulation scheme being active within the measurement period, (i.e. symbol 0,1,2,4,5 and 6 in each slot, $\Rightarrow |T|=6$)

g covers the count of demodulated symbols with the considered modulation scheme being active within the allocated bandwidth. ($|G|=12 * L_{CRBs}$ (with L_{CRBs} : number of allocated resource blocks)).

$iZ'(g, t)$ are the samples of the signal evaluated for the EVM.

$iI(g, t)$ is the ideal signal reconstructed by the measurement equipment, and

P_0 is the average power of the ideal signal. For normalized modulation symbols P_0 is equal to 1.

From the acquired samples 40 EVM value can be derived, 20 values for the timing " $\Delta\tilde{c} = -W/2$ " and 20 values for the timing " $\Delta\tilde{c} = +W/2$ "

E.4.2 Averaged EVM

EVM is averaged over all basic EVM measurements.

The averaging comprises 20 UL slots (for frame structure 2: excluding special fields(UpPTS))

$$\overline{EVM} = \sqrt{\frac{1}{20} \sum_{i=1}^{20} EVM_i^2}$$

The averaging is done separately for timing! $\Delta\tilde{c} -W/2$ and $\Delta\tilde{c} +W/2$ leading to \overline{EVM}_l and \overline{EVM}_h

$EVM_{\text{final}} = \max(\overline{EVM}_l, \overline{EVM}_h)$ is compared against the test requirements.

E.4.3 In-band emissions measurement

The in-band emissions are a measure of the interference falling into the non-allocated resources blocks.

Explanatory Note:

The inband emission measurement is only meaningful with allocated RBs next to non allocated RB. The allocated RBs are necessary but not under test. The non allocated RBs are under test. The RB allocation for this test is as follows: The allocated RBs are at one end of the channel BW, leaving the other end unallocated. The number of allocated RBs is smaller than half of the number of RBs, available in the channel BW. This means that the vicinity of the carrier in the centre is unallocated.

There are 3 types of inband emissions:

1. General
2. IQ image
3. Carrier leakage

Carrier leakage are inband emissions next to the carrier.

IQ image are inband emissions symmetrically (with respect to the carrier) on the other side of the allocated RBs.

General are applied to all unallocated RBs.

For each evaluated RB, the minimum requirement is calculated as the higher of $P_{RB} - 30$ dB and the power sum of all limit values (General, IQ Image or Carrier leakage) that apply.

In specific the following combinations:

- Power (General)
- Power (General + Carrier leakage)
- Power (General + IQ Image)

1 and 2 is expressed in terms of power in one non allocated RB under test, normalized to the average power of an allocated RB (unit dB).

3 is expressed in terms of power in one non allocated RB, normalized to the power of all allocated RBs. (unit dBc).

This is the reason for two formulas *Emissions relative*.

Create one set of $Y(t,f)$ per slot according to the timing “ $\Delta\tilde{c}$ ”

For the non-allocated RBs below the in-band emissions are calculated as follows

$$Emissions_{absolute}(\Delta_{RB}) = \begin{cases} \frac{1}{|T_s|} \sum_{t \in T_s} \sum_{c_l + (12 \cdot \Delta_{RB} + 1) \cdot \Delta f}^{c_l + (12 \cdot \Delta_{RB} + 11) \cdot \Delta f} |Y(t, f)|^2, \Delta_{RB} < 0 \\ \frac{1}{|T_s|} \sum_{t \in T_s} \sum_{c_h + (12 \cdot \Delta_{RB} - 11) \cdot \Delta f}^{\min(f_{\max}, (c_h + 12 \cdot \Delta_{RB} \cdot \Delta f))} |Y(t, f)|^2, \Delta_{RB} > 0 \end{cases}$$

where

the upper formula represents the in band emissions below the allocated frequency block and the lower one the in band emissions above the allocated frequency block.

T_s is a set of $|T_s|$ SC-FDMA symbols with the considered modulation scheme being active within the measurement period,

Δ_{RB} is the starting frequency offset between the allocated RB and the measured non-allocated RB (e.g. $\Delta_{RB} = 1$ for the first upper or $\Delta_{RB} = -1$ for the first lower adjacent RB),

f_{\min} and f_{\max} are the lower and upper edge of the UL transmission BW configuration,

c_l and c_h are the lower and upper edge of the allocated BW,

Δf is 15kHz, and

$Y(t, f)$ is the frequency domain signal evaluated for in-band emissions as defined in the subsection E.3.3

The allocated RB power per RB and the total allocated RB power are given by:

$$P_{RB} = \frac{1}{|T_s| \cdot L_{CRBs}} \sum_{t \in T_s} \sum_{c_1}^{c_1 + (12 \cdot L_{CRBs} - 1) \cdot \Delta f} |MS(t, f)|^2 \text{ [dBm/180 kHz]}$$

$$P_{All-RBs} = \frac{1}{|T_s|} \sum_{t \in T_s} \sum_{c_1}^{c_1 + (12 \cdot L_{CRBs} - 1) \cdot \Delta f} |MS(t, f)|^2 \text{ [dBm]}$$

The relative in-band emissions, applicable for General and IQ image, are given by:

$$Emissions_{relative}(\Delta_{RB}) = 10 \cdot \log_{10} \left(\frac{Emissions_{absolute}(\Delta_{RB})}{\frac{1}{|T_s| \cdot L_{CRBs}} \sum_{t \in T_s} \sum_{c_1}^{c_1 + (12 \cdot L_{CRBs} - 1) \cdot \Delta f} |MS(t, f)|^2} \right) \text{ [dB]}$$

$$= Emissions_{absolute}(\Delta_{RB}) \text{ [dBm/180 kHz]} - P_{RB} \text{ [dBm/180 kHz]}$$

where

L_{CRBs} is the number of allocated resource blocks,

and

$MS(t, f)$ is the frequency domain samples for the allocated bandwidth, as defined in the subsection E.3.3.

The relative in-band emissions, applicable for carrier leakage, is given by:

$$\begin{aligned}
Emissions_{relative} &= 10 \cdot \log_{10} \left(\frac{Emissions_{absolute}(RB_{nextDC})}{\frac{1}{|T_s|} \sum_{t \in T_s} \sum_{c_1}^{c_1 + (12 \cdot L_{CRBS} - 1) \cdot \Delta f} |MS(t, f)|^2} \right) [\text{dBc}] \\
&= Emissions_{absolute}(RB_{nextDC}) [\text{dBm}/180\text{kHz}] - P_{All-RBs} [\text{dBm}]
\end{aligned}$$

where RBnextDC means: Resource Block next to the carrier.

This is one RB, namely the central one in case of an odd number of RBs in the channel BW.

This is one pair of RBs, namely the immediately adjacent RBs to the carrier in case of an even number of RBs in the channel BW.

Although an exclusion period may be applicable in the time domain, when evaluating EVM (clause E.7), the inband emissions measurement interval is defined over one complete slot in the time domain.

From the acquired samples 20 functions for general in band emissions and IQ image inband emissions can be derived. 20 values or 20 pairs of carrier leakage inband emissions can be derived. They are compared against different limits.

E.4.4 EVM equalizer spectrum flatness

For EVM equalizer spectrum flatness use EC(f) as defined in E.3.3. Note, EC(f) represents equalizer coefficient

$f \in F$, f is the allocated subcarriers within the transmission bandwidth ($|F|=12 \cdot L_{CRBS}$)

From the acquired samples 20 functions EC(f) can be derived.

EC(f) is broken down to 2 functions:

$$EC_1(f), f \in \text{Range } 1$$

$$EC_2(f), f \in \text{Range } 2$$

Where Range 1 and Range 2 are as defined in Table 6.5.2.4.5-1 for normal condition and Table 6.5.2.4.5-2 for extreme condition

The following peak to peak ripple is calculated:

$$RP_1 = 20 * \log (\max (| EC_1 (f) |) / \min (| EC_1 (f) |)) , \text{ which denote the maximum ripple in Range 1}$$

$$RP_2 = 20 * \log (\max (| EC_2 (f) |) / \min (| EC_2 (f) |)) , \text{ which denote the maximum ripple in Range 2}$$

$$RP_{12} = 20 * \log (\max (| EC_1 (f) |) / \min (| EC_2 (f) |)) , \text{ which denote the maximum ripple between the upper side of Range 1 and lower side of Range 2}$$

$$RP_{21} = 20 * \log (\max (| EC_2 (f) |) / \min (| EC_1 (f) |)) , \text{ which denote the maximum ripple between the upper side of Range 2 and lower side of Range 1}$$

E.4.5 Frequency error and Carrier leakage

See E.3.1.

E.4.6 EVM of Demodulation reference symbols (EVM_{DMRS})

For the purpose of EVM_{DMRS}, the steps E.2.2 to E.4.2 are repeated 6 times, constituting 6 EVM_{DMRS} sub-periods. The only purpose of the repetition is to cover the longer gross measurement period of EVM_{DMRS} (120 time slots) and to derive the FFT window timing per sub-period.

The bigger of the EVM results in one 20 TS period corresponding to the timing! $\Delta\tilde{c} - W/2$ or $\Delta\tilde{c} + W/2$ is compared against the limit. (Clause E.4.2) This timing is re-used for EVM_{DMRS} in the equivalent EVM_{DMRS} sub-period.

For EVM the demodulation reference symbols are excluded, while the data symbols are used. For EVM_{DMRS} the data symbols are excluded, while the demodulation references symbols are used. This is illustrated in figure E.4.6-1

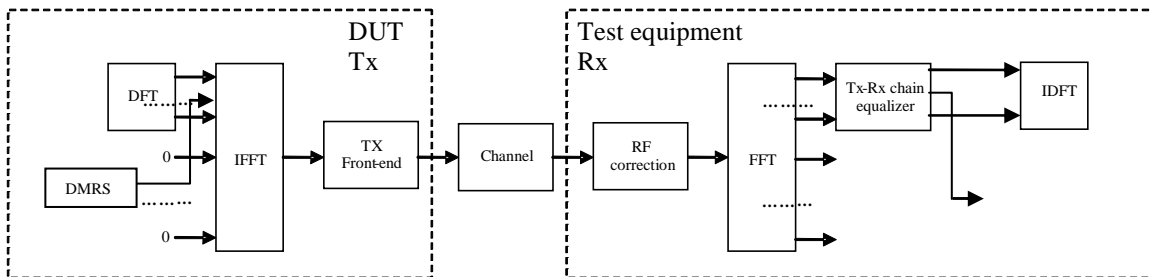

Figure E.4.6-1: EVM_{DMRS} measurement points

Re-use the following formula from E.3.3:

$$Z'(f,t) = MS(f,t) \cdot EC(f)$$

To calculate EVM_{DMRS}, the data symbol (t=0,1,2,4,5,6) in Z'(f,t) are excluded and only the reference symbol (t=3) is used.

The EVM_{DMRS} is the difference between the ideal waveform and the measured and equalized waveform for the allocated RB(s)

$$EVM_{DMRS} = \sqrt{\frac{\sum_{t \in T} \sum_{f \in F} |Z'(f,t) - I(f,t)|^2}{|T| \cdot |P_0| \cdot |F|}}$$

where

t covers the count of demodulation reference symbols (i.e. only symbol 3 in each slot, so count =1)

f covers the count of demodulation reference symbols within the allocated bandwidth. (|F|=12* L_{CRBs} (with L_{CRBs} : number of allocated resource blocks)).

$Z'(f,t)$ are the samples of the signal evaluated for the EVM_{DMRS}

$I(f,t)$ is the ideal signal reconstructed by the measurement equipment, and

P_0 is the average power of the ideal signal. For normalized modulation symbols P_0 is equal to 1.

20 such results are generated per measurement sub-period.

E.4.6.1 1st average for EVM_{DMRS}

EVM_{DMRS} is averaged over all basic EVM_{DMRS} measurements in one sub-period

The averaging comprises 20 UL slots (for frame structure 2: excluding special fields(UpPTS))

$$1stEVM_{DMRS} = \sqrt{\frac{1}{20} \sum_{i=1}^{20} EVM_{DMRS_i}^2}$$

The timing is taken from the EVM for the data. 6 of those results are achieved from the samples. In general the timing is not the same for each result.

E.4.6.2 Final average for EVM_{DMRS}

$$finalEVM_{DMRS} = \sqrt{\frac{1}{6} \sum_{i=1}^6 1stEVM_{DMRS_i}^2}$$

E.5 EVM and inband emissions for PUCCH

For the purpose of worst case testing, the PUCCH shall be located on the edges of the Transmission Bandwidth Configuration (6,15,25,50,75,100 RBs).

The EVM for PUCCH (EVM_{PUCCH}) is averaged over 20 slots. At least 20 TSs shall be transmitted by the UE without power change. SRS multiplexing shall be avoided during this period. The following transition periods are applicable: One OFDM symbol on each side of the slot border (instant of band edge alternation).

The description below is generic in the sense that all 6 PUCCH formats are covered. Although the number of OFDM symbols in one slot is 6 or 7 (depending on the cyclic prefix length), the text below uses 7 without excluding 6.

E.5.1 Basic principle

The basis principle is the same as described in E.2.1

E.5.2 Output signal of the TX under test

The output signal of the TX under test is processed same as described in E.2.2

E.5.3 Reference signal

The reference signal is defined same as in E.2.3. Same as in E.2.3, $i_1(v)$ is the ideal reference for EVM_{PUCCH} and $i_2(v)$ is used to estimate the FFT window timing.

Note PUSCH is off during the PUCCH measurement period.

E.5.4 Measurement results

The measurement results are:

- EVM_{PUCCH}
- Inband emissions with the sub-results: General in-band emission, IQ image (according to: 36.101. Annex F.4, Clause starting with: "At this stage the")

E.5.5 Measurement points

The measurement points are illustrated in the figure below:

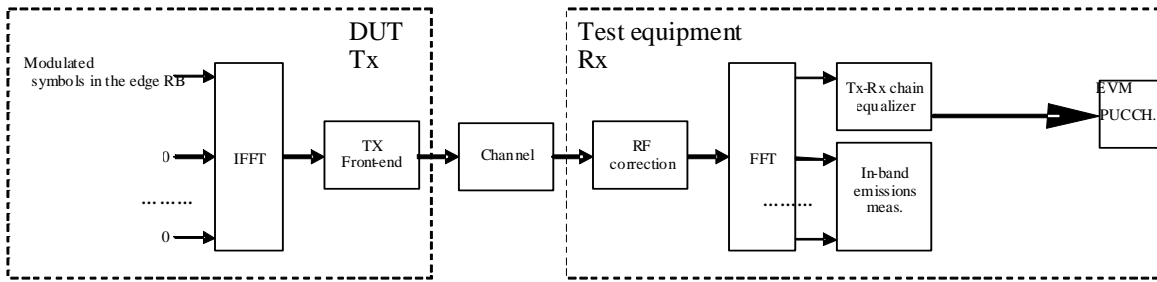

Figure E.5.5-1

E.5.6 Pre FFT minimization process

The pre FFT minimisation process is the same as describes in clause E.3.1.

NOTE: although an exclusion period for EVM_{PUCCH} is applicable in E.5.9.1, the pre FFT minimisation process is done over the complete slot.

RF error, and carrier leakage are necessary for best fit of the measured signal towards the ideal signal in the pre FFT domain. However they are not used to compare them against the limits.

E.5.7 Timing of the FFT window

Timing of the FFT window is estimated with the same method as described in E.3.2.

E.5.8 Post FFT equalisation

The post FFT equalisation is described separately without reference to E.3.3:

Perform 7 FFTs on $z'(v)$, one for each OFDM symbol in a slot using the timing $\Delta\tilde{c}$, including the demodulation reference symbol. The result is an array of samples, 7 in the time axis t times 2048 in the frequency axis f . The samples represent the OFDM symbols (data and reference symbols) in the allocated RBs and inband emissions in the non allocated RBs within the transmission BW.

Only the allocated resource blocks in the frequency domain are used for equalisation.

The nominal reference symbols and **nominal** OFDM data symbols are used to equalize the measured data symbols.

Note: (The nomenclature inside this note is local and not valid outside)

The nominal OFDM data symbols are created by a demodulation process. A demodulation process as follows is recommended:

1. Equalize the measured OFDM data symbols using the reference symbols for equalisation. Result: Equalized OFDM data symbols
2. Decide for the nearest constellation point, however not independent for each subcarrier in the RB. 12 constellation points are decided dependent, using the applicable CAZAC sequence. Result: Nominal OFDM data symbols

At this stage we have an array of Measured data-Symbols and reference-Symbols ($MS(f,t)$)

versus an array of Nominal data-Symbols and reference Symbols ($NS(f,t)$)

The arrays comprise in sum 7 data and reference symbols, depending on the PUCCH format, in the time axis and the number of allocated sub-carriers in the frequency axis.

$MS(f,t)$ and $NS(f,t)$ are processed with a least square (LS) estimator, to derive one equalizer coefficient per time slot and per allocated subcarrier. $EC(f)$

$$EC(f) = \frac{\sum_{t=0}^6 NS(f,t)^* NS(f,t)}{\sum_{t=0}^6 MS(f,t)^* NS(f,t)}$$

With * denoting complex conjugation.

EC(f) are used to equalize the OFDM data together with the demodulation reference symbols by:

$$Z'(f,t) = MS(f,t) \cdot EC(f)$$

With · denoting multiplication.

Z'(f,t) is used to calculate EVM_{PUCCH}, as described in E.5.9.1

NOTE: although an exclusion period for EVM_{PUCCH} is applicable in E.5.9.1, the post FFT minimisation process is done over 7 OFDM symbols.

The samples of the non allocated resource blocks within the transmission bandwidth configuration in the post FFT domain are called Y(f,t) (f covering the non allocated subcarriers within the transmission bandwidth configuration, t covering the OFDM symbols during 1 slot).

E.5.9 Derivation of the results

E.5.9.1 EVM_{PUCCH}

For EVM_{PUCCH} create two sets of Z'(f,t), according to the timing "Δc̃ -W/2 and Δc̃ +W/2" using the equalizer coefficients from E.5.8

The EVM_{PUCCH} is the difference between the ideal waveform and the measured and equalized waveform for the allocated RB(s)

$$EVM_{PUCCH} = \sqrt{\frac{\sum_{t \in T} \sum_{f \in F} |Z'(f,t) - I(f,t)|^2}{|T| \cdot P_0 \cdot |F|}},$$

where

the OFDM symbols next to slot borders (instant of band edge alternation) are excluded:

t covers less than the count of demodulated symbols in the slot (|T|= 5)

f covers the count of subcarriers within the allocated bandwidth. (|F|=12)

Z'(f,t) are the samples of the signal evaluated for the EVM_{PUCCH}

I(f,t) is the ideal signal reconstructed by the measurement equipment, and

P₀ is the average power of the ideal signal. For normalized modulation symbols P₀ is equal to 1.

From the acquired samples 40 EVM_{PUCCH} value can be derived, 20 values for the timing Δc̃ -W/2 and 20 values for the timing Δc̃ +W/2

E.5.9.2 Averaged EVM_{PUCCH}

EVM_{PUCCH} is averaged over all basic EVM_{PUCCH} measurements

The averaging comprises 20 UL slots (for frame structure 2: excluding special fields(UpPTS))

$$\overline{EVM}_{PUCCH} = \sqrt{\frac{1}{20} \sum_{i=1}^{20} EVM_{PUCCH,i}^2}$$

The averaging is done separately for timing! $\Delta\tilde{c} - W/2$ and $\Delta\tilde{c} + W/2$ leading to $\overline{EVM}_{PUCCH,low}$ and $\overline{EVM}_{PUCCH,high}$

$EVM_{PUCCH,final} = \max(\overline{EVM}_{PUCCH,low}, \overline{EVM}_{PUCCH,high})$ is compared against the test requirements.

E.5.9.3 In-band emissions measurement

The in-band emissions are a measure of the interference falling into the non-allocated resources blocks

Create one set of $Y(t,f)$ per slot according to the timing “ $\Delta\tilde{c}$ ”

For the non-allocated RBs the in-band emissions are calculated as follows

$$Emissions_{absolute}(\Delta_{RB}) = \begin{cases} \frac{1}{|T_s|} \sum_{t \in T_s} \sum_{c_l + (12 \cdot \Delta_{RB} + 11) \cdot \Delta f}^{c_l + (12 \cdot \Delta_{RB} + 11) \cdot \Delta f} |Y(t, f)|^2, \Delta_{RB} < 0 \\ \frac{1}{|T_s|} \sum_{t \in T_s} \sum_{c_h + (12 \cdot \Delta_{RB} - 11) \cdot \Delta f}^{\min(f_{max}, (c_h + 12 \cdot \Delta_{RB} \cdot \Delta f))} |Y(t, f)|^2, \Delta_{RB} > 0 \end{cases},$$

where

the upper formula represents the inband emissions below the allocated frequency block and the lower one the inband emissions above the allocated frequency block.

T_s is a set of $|T_s|$ OFDM symbols in the measurement period,

Δ_{RB} is the starting frequency offset between the allocated RB and the measured non-allocated RB (e.g. $\Delta_{RB} = 1$ for the first upper or $\Delta_{RB} = -1$ for the first lower adjacent RB),

f_{min} and f_{max} are the lower and upper edge of the UL system BW,

c_l and c_h are the lower and upper edge of the allocated BW,

Δf is 15kHz, and

$Y(t, f)$ is the frequency domain signal evaluated for in-band emissions as defined in the subsection E.5.8

The relative in-band emissions are, given by

$$Emissions_{relative}(\Delta_{RB}) = 10 * \log_{10} \frac{Emissions_{absolute}(\Delta_{RB})}{\frac{1}{|T_s|} \cdot L_{CRBs} \sum_{t \in T_s} \sum_{c_1}^{c_1 + (12 \cdot L_{CRBs} - 1) \cdot \Delta f} |MS(t, f)|^2} [dB]$$

where

L_{CRBs} is the number of allocated RBs, which is always 1 in case of PUCCH

and $MS(t, f)$ is the frequency domain samples for the allocated bandwidth, as defined in the subsection E.5.8

Although an exclusion period for EVM is applicable in E.5.9.1, the inband emissions measurement interval is defined over one complete slot in the time domain.

From the acquired samples 20 functions for inband emissions can be derived.

Since the PUCCH allocation is always on the upper or lower band-edge, the opposite to the allocated one represents the IQ image, and the remaining inner RBs represent the general inband emissions. They are compared against different limits.

E.6 EVM for PRACH

The description below is generic in the sense that all 5 PRACH formats are covered. The numbers, used in the text below are taken from PRACH format#0 without excluding the other formats. The sampling rate for the PUSCH, 30.72 Msps in the time domain, is re-used for the PRACH. The carrier spacing of the PUSCH is 12 (format 0 to 3) and 2 (format 4) times of the PRACH. This results in an oversampling factor of 12 (format 0 to 3) and 2 (format 4), when acquiring the time samples for the PRACH. The pre-FFT algorithms (clauses E.6.6 and E.6.7) use all time samples, although oversampled. For the FFT the time samples are decimated by the factor of 12 (format 0 to 3) and 2 (format 4), resulting in the same FFT size as for the other transmit modulation tests (2048). Decimation requires a decision, which samples are used and which ones are rejected. The algorithm in E.6.6, Timing of the FFT window, can also be used to decide about the used samples.

E.6.1 Basic principle

The basic principle is the same as described in E.2.1

E.6.2 Output signal of the TX under test

The output signal of the TX under test is processed same as described in E.2.2

The measurement period is different:

- 2 PRACH preambles are recorded for format 0 and 1,
- 1 PRACH preamble is recorded for format 2 and 3, each containing 1 CP and 2 preamble sequences
- 10 RPRACH preambles are recorded for format 4.

E.6.3 Reference signal

The test description in 6.5.2.1.4.1A is based on non contention based access:

- PRACH configuration index (responsible for Preamble format, System frame number and subframe number)
- Preamble ID
- Preamble power

signalled to the UE, defines the reference signal unambiguously, such that no demodulation process is necessary to gain the reference signal.

The reference signal $i(v)$ is constructed by the measuring equipment according to the relevant TX specifications, using the following parameters: the applicable Zadoff Chu sequence, nominal carrier frequency, nominal amplitude and phase for each subcarrier, nominal timing, no carrier leakage. It is represented as a sequence of samples at a sampling rate of 30.72 Msps in the time domain.

E.6.4 Measurement results

The measurement result is:

- EVMPRACH

E.6.5 Measurement points

The measurement points are illustrated in the figure below:

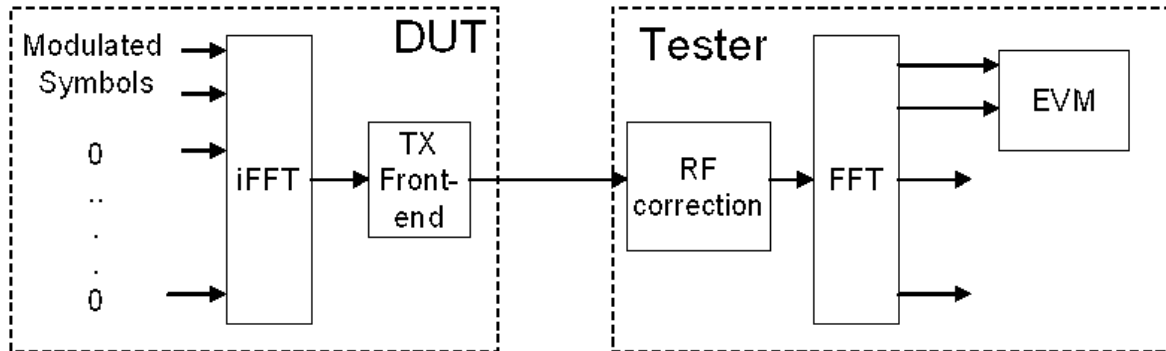

Figure E.6.5-1

E.6.6 Pre FFT minimization process

The pre-FFT minimization process is applied to each PRACH preamble separately. The time period for the pre-FFT minimisation process includes the complete CP and Zadoff-Chu sequence (in other words, the power transition period is per definition outside of this time period) Sample timing, Carrier frequency and I/Q offset in $z(v)$ are jointly varied in order to minimise the difference between $z(v)$ and $i(v)$. Best fit (minimum difference) is achieved when the RMS difference value between $z(v)$ and $i(v)$ is an absolute minimum.

After this process the samples $z(v)$ are called $z^0(v)$.

RF error, and carrier leakage are necessary for best fit of the measured signal towards the ideal signal in the pre FFT domain. However they are not used to compare them against the limits.

E.6.7 Timing of the FFT window

The FFT window length is 24576 samples for preamble format 0, however in the measurement period is at least 27744 samples are taken. The position in time for FFT must be determined.

In an ideal signal, the FFT may start at any instant within the cyclic prefix without causing an error. The TX filter, however, reduces the window. The EVM requirements shall be met within a window $W < CP$.

The reference instant for the FFT start is the centre of the reduced window, called $\Delta\tilde{c}$,

EVM is measured at the following two instants: $\Delta\tilde{c} - W/2$ and $\Delta\tilde{c} + W/2$.

The timing of the measured signal $z^0(v)$ with respect to the ideal signal $i(v)$ is determined in the pre FFT domain as follows:

Correlation between $z^0(v)$ and $i(v)$ will result in a correlation peak. The meaning of the correlation peak is approx. the “impulse response” of the TX filter. The correlation peak, (the highest, or in case of more than one, the earliest) indicates the timing in the measured signal with respect to the ideal signal.

W is different for different preamble formats and shown in Table E.6.7-1.

Table E.6.7-1EVM window length for PRACH

Preamble format	Cyclic prefix length ¹ N_{cp}	Nominal FFT size ²	EVM window length W in FFT samples	Ratio of W to CP ³
0	3168	24576	3072	96.7%
1	21024	24576	20928	99.5%
2	6240	49152	6144	98.5%
3	21024	49152	20928	99.5%
4	448	4096	432	96.4%
Note 1: The unit is number of samples, sampling rate of 30.72MHz is assumed				
Note 2: Decimation of time samples by 12(format 0 to 3) and factor 2 (format 4) is assumed, leading to a uniform FFT size of 2048 for all formats.				
Note 3: These percentages are informative				

The number of samples, used for FFT is reduced compared to $z^0(v)$. This subset of samples is called $z'(v)$.

The sample frequency 30.72 MHz is oversampled with respect to the PRACH-subcarrier spacing of 1.25kHz (format 0 to 3) and 7.5kHz (format 4). EVM is based on 2048 samples per PRACH preamble and requires decimation of the time samples by the factor of 12 (format 0 to 3) and factor 2 (format 4). The final number of samples per PRACH preamble, used for FFT is reduced compared to $z'(v)$ by the factor of 12 (format 0 to 3) and factor 2 (format 4). This subset of samples is called $z''(v)$.

E.6.8 Post FFT equalisation

Equalisation is not applicable for the PRACH.

E.6.9 Derivation of the results

E.6.9.1 EVM_{PRACH}

Perform FFT on $z'(v)$ and $i(v)$ using the FFT timing $\Delta\tilde{c} - W/2$ and $\Delta\tilde{c} + W/2$.

For format 2 and 3 the first and the repeated preamble sequence are FFT-converted separately. using the standard FFT length of 2048

The EVM_{PRACH} is the difference between the ideal waveform and the measured and equalized waveform for the allocated RB(s).

$$EVM_{PRACH} = \sqrt{\frac{\sum_{f \in F} |Z'(f) - I(f)|^2}{N_{ZC} \cdot P_0}}$$

where

f covers the count of demodulated symbols within the allocated bandwidth.

$Z'(f)$ are the samples of the signal evaluated for the EVM_{PRACH}

$I(f)$ is the ideal signal reconstructed by the measurement equipment, and

P_0 is the average power of the ideal signal. For normalized modulation symbols P_0 is equal to 1.

N_{ZC} is random access preamble sequence length.

From the acquired samples 4 EVM_{PRACH} value can be derived, 2 values for the timing $\Delta\tilde{c} -W/2$ and 2 values for the timing $\Delta\tilde{c} +W/2$ (4 and 2 applies for format 0,1,2,3. 20 and 10 applies for format 4).

E.6.9.2 Averaged EVM_{PRACH}

EVM_{PRACH} is averaged over all basic EVM_{PRACH} measurements

$$\overline{EVM}_{PRACH} = \sqrt{\frac{1}{2} \sum_{i=1}^2 EVM_{PRACH_i}^2}$$

(i= 2 applies for format 0,1,2,3. i= 10 applies for format 4)

The averaging is done separately for timing! $\Delta\tilde{c} -W/2$ and $\Delta\tilde{c} +W/2$ leading to $\overline{EVM}_{PRACH,low}$ and $\overline{EVM}_{PRACH,high}$

$EVM_{PRACH,final} = \max(\overline{EVM}_{PRACH,low}, \overline{EVM}_{PRACH,high})$ is compared against the test requirements.

E.7 EVM with exclusion period

E.7.1 General

EVM with exclusion periods is defined in clause 6.5.2.1.1, third paragraph. For PUCCH entire symbols are excluded, if applicable. For PUSCH fractions of symbols are excluded, if applicable. The exclusion period for PUSCH is defined at the air interface, leading to exclusion periods in the EVM domain. The necessary mapping is described in this clause.

E.7.2 The model

The exclusion period in the time domain has corresponding periods in the quasi time domains (Table E.7.2). The mapping of corresponding periods needs only scaling and cyclic shifting.

The algorithm below uses a sampling frequency 30.72 MHz and FFT-width 2048 for all bandwidths. Bandwidth-adapted sampling frequencies and FFT-widths are not excluded. Only normal cyclic prefix is mentioned in the model without excluding the extended CP.

Table. E.7.2: Model for mapping exclusion period in the time domain

Operation	TX			Channel	EVM meter				
		DFT	IFFT			FFT		iDFT	
Meaning	Modulation symbols		Precoded symbols		BB samples	BB samples		Precoded symbols	demodulated symbols
No of samples	allocated Sub Carriers		allocated subcarriers + unallocated subcarriers = 2048		allocated subcarriers + unallocated subcarriers + CP samples	2048, position depending on EVM window		allocated subcarriers	allocated subcarriers
Domain	Quasi time domain		Frequency domain		Time domain	Time domain		Frequency domain	Quasi time domain
text below		1	2	3	4	7	7	8	9 11

1. A sequence of complex valued modulation symbols are Transform-Precoded (DFT) according to 36.211 clause 5.3.3. The size of this transformation is the number of allocated subcarriers.

2. The outcome of (1) is supplemented by 0 for the non allocated subcarriers. In sum 2048 subcarriers.
3. The baseband time signal (without CP) is then calculated by a iFFT according to 36.211 clause 5.6
4. (3) is then supplemented by a cyclic prefix (144 or 160 samples) leading to 2192 or 2208 samples. (144 CP samples = 144 tail samples from the data field)
5. (4) is transmitted over the channel and sampled by the EVM meter.
6. In case of an exclusion period those samples of (5) are marked, where the exclusion applies. The exclusion period is an unbroken leading or lagging exclusion period next to a subframe or timeslot boarder.
7. Depending on early or late EVM-window a subset of 2048 samples (out of 2192 or 2208 samples) are the input for the subsequent FFT . These samples may or may not comprise marked samples. The result are 2048 frequency domain samples.
8. The non allocated subcarriers are removed from the 2048 samples.
9. (8) is then iDFT transformed. The result are demodulated complex valued symbols in the same domain as (1)
10. Step 7, 8 and 9 are modified by an equalizer algorithm.
For the purpose of this clause, the equalizer partly re-does step 4 (CP insertion):
The equalizer algorithm cuts that subset of CP samples, covered by the FFT, from the head and copies it to the tail of the data field.
11. The result of (10) is: complex valued symbols in the same sequence as in (1) They are compared with (1) symbol by symbol for EVM. Due to exclusion in the time domain (6) we have marked corresponding symbols, which are disregarded for EVM.
12. From step 1 to 4 the number of samples is expanded. A subset of expanded samples is marked as excluded.
Form step 6 to step 9 the number of samples is compressed, leading to a non integer number of samples, marked as excluded. The number of marked samples in this domain is rounded up at the expense of the EVM samples

E.7.3 Illustration

The figures below illustrate the cyclic shift due to the equalizer and scaling.

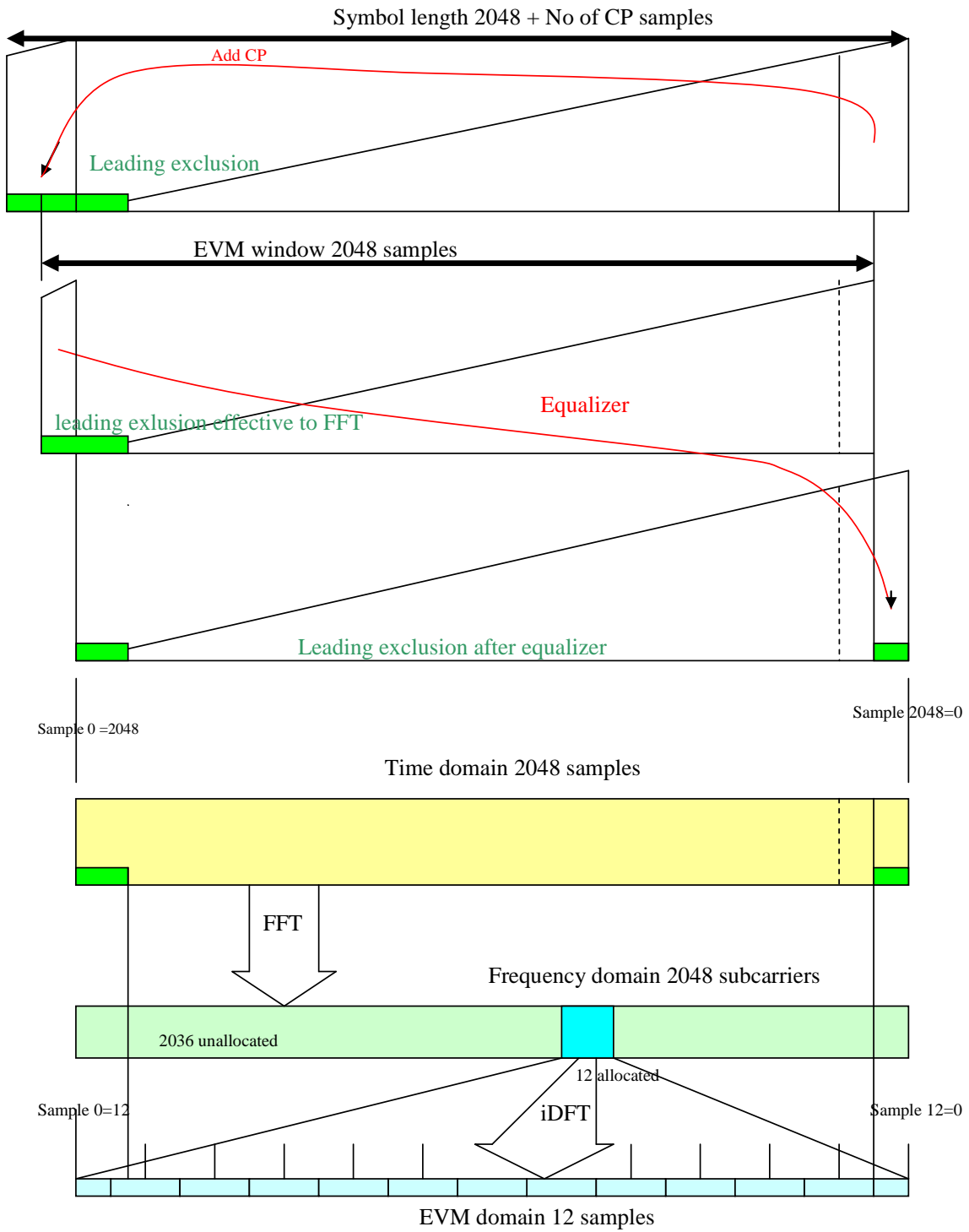

Figure E.7.3-1: leading exclusion period (when number of RBs=1)

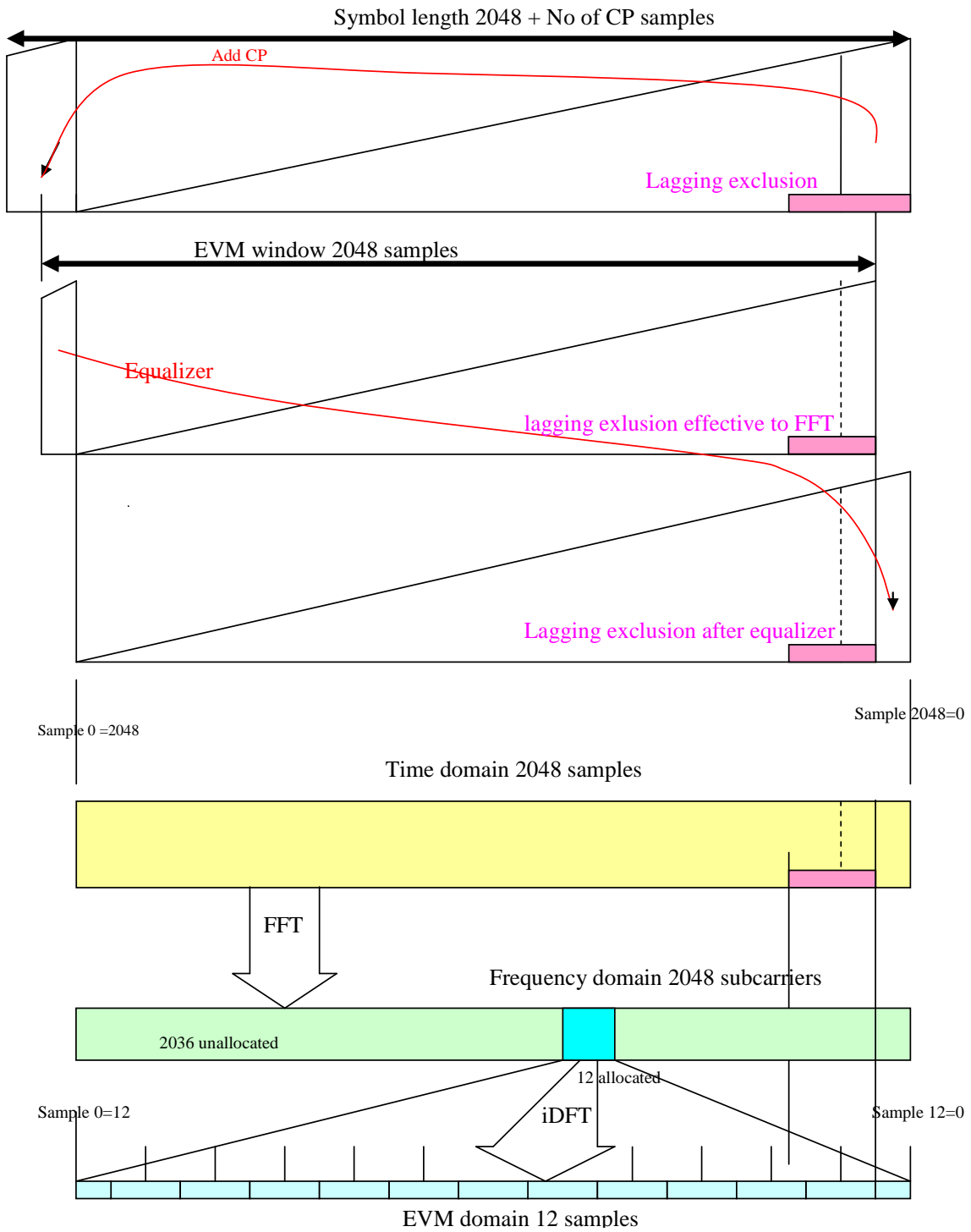

Figure E.7.3-2: lagging exclusion period (when number of RBs=1)

Legend to figure E.7.3-1

The figure contains 6 related subfigures.

The upper 3 triangles illustrate the cyclic shift due to EVM windowing and equalizer.

The lower 3 boxes illustrate the mapping from the time domain, where the exclusion period is defined, into the EVM domain, where EVM samples are actually excluded.

Cyclic shift

The leading exclusion period covers the entire CP and a part of the data field. The EVM window masks a part of the exclusion period. For the purpose of this annex, the equalizer re-arranges the time domain samples into the original order, splitting the exclusion period into two parts.

Mapping

The split exclusion period (after cyclic shift) is copied from above. The frequency domain is derived by Fast Fourier Transformation from the time domain and represent the frequency domain with 2048 subcarriers, 12 of them are allocated, the rest is unallocated. The 12 allocated subcarriers are iDFT transformed into the EVM domain comprising 12 samples. Note that all 3 domains are displayed cyclically: the leftmost sample is identical to the rightmost sample.

The two transformations map the time domain into the EVM domain, carrying out a compression of samples 12/2048. In spite of the compression, there is a correspondence of ranges in the time domain and in the EVM domain. One sample in the EVM domain comprises a range, which is influenced from (and only from) the equivalent samples in the time domain vertically above. Note that this correspondence holds irrespective of the position of the 12 allocated samples in the frequency domain.

Example leading exclusion (figure E.7.3-1)

Sample No in the EVM domain	Influence(exclusion) from the time domain	EVM exclusion
12=0	full	excluded
1	partly	excluded
2 to 11	none	counted

Example lagging exclusion example (figure E.7.3-2)

Sample No in the EVM domain	Influence(exclusion) from the time domain	EVM exclusion
12=0	none	counted
1 to 9	none	counted
10	partly	excluded
11	full	excluded

E.7.4 Formula

The exclusion period is defined in μs at the air interface.

Convert the μs 's into No of samples in the time domain.

No of exclusion samples (before EVM windowing and equalizer) is calculated from:

No of exclusion sample = $\text{ceil}(30.72 * \text{Exclusion } \mu\text{s})$

then, EVM windowing and equalizer is applied by 2048 samples based cyclic shift process.

(the upper 3 triangles illustrate in fig. E.7.3-1 and -2.)

Determine the indices k , to be excluded in the time domain, according to fig. E.7.3-1 and -2

(after application of EVM windowing and equaliser, original sample order,

\mathbf{k} = subset from the set (0 to 2047))

The indices \mathbf{l} in the EVM domain, to be excluded, are:

$$\mathbf{l} = [\text{round} (\mathbf{k} * 12 * L_{\text{CRBs}} / 2048)] \text{mod} (12 * L_{\text{CRBs}})$$

with L_{CRBs} number of allocated resource blocks

Annex F (normative): Measurement uncertainties and Test Tolerances

F.1 Acceptable uncertainty of Test System (normative)

The maximum acceptable uncertainty of the Test System is specified below for each test, where appropriate. The Test System shall enable the stimulus signals in the test case to be adjusted to within the specified range, and the equipment under test to be measured with an uncertainty not exceeding the specified values. All ranges and uncertainties are absolute values, and are valid for a confidence level of 95 %, unless otherwise stated.

A confidence level of 95 % is the measurement uncertainty tolerance interval for a specific measurement that contains 95 % of the performance of a population of test equipment.

For RF tests it should be noted that the uncertainties in clause F.1 apply to the Test System operating into a nominal 50 ohm load and do not include system effects due to mismatch between the DUT and the Test System.

The downlink signal uncertainties apply at each receiver antenna connector.

F.1.1 Measurement of test environments

The measurement accuracy of the UE test environments defined in TS 36.508 subclause 4.1, Test environments shall be.

- Pressure ± 5 kPa.
- Temperature ± 2 degrees.
- Relative Humidity ± 5 %.
- DC Voltage $\pm 1,0$ %.
- AC Voltage $\pm 1,5$ %.
- Vibration 10 %.
- Vibration frequency 0,1 Hz.

The above values shall apply unless the test environment is otherwise controlled and the specification for the control of the test environment specifies the uncertainty for the parameter.

F.1.2 Measurement of transmitter

Table F.1.2-1: Maximum Test System Uncertainty for transmitter tests

Subclause	Maximum Test System Uncertainty	Derivation of Test System Uncertainty
6.2.2 UE Maximum Output Power	± 0.7 dB, $f \leq 3.0$ GHz ± 1.0 dB, 3.0 GHz $< f \leq 4.2$ GHz	
6.2.2_1 Maximum Output Power for HPUE	± 0.7 dB, $f \leq 3.0$ GHz	
6.2.2A.1 UE Maximum Output Power for CA (intra-band contiguous DL CA and UL CA)	Same as 6.2.2 for each CC	
6.2.2B UE Maximum Output Power for UL-MIMO	Same as 6.2.2 for each antenna	
6.2.3 Maximum Power Reduction	± 0.7 dB, $f \leq 3.0$ GHz ± 1.0 dB, 3.0 GHz $< f \leq 4.2$ GHz	
6.2.3_1 Maximum Power Reduction (MPR) for HPUE	± 0.7 dB, $f \leq 3.0$ GHz	
6.2.3A.1 Maximum Power Reduction (MPR) for CA (intra-band contiguous DL CA and UL CA)	Same as 6.2.3 for each CC	
6.2.3B Maximum Power Reduction (MPR) for UL-MIMO	Same as 6.2.3 for each antenna	
6.2.4 UE Maximum Output Power with additional requirements	± 0.7 dB, $f \leq 3.0$ GHz ± 1.0 dB, 3.0 GHz $< f \leq 4.2$ GHz	
6.2.4_1 Additional Maximum Power Reduction (A-MPR) for HPUE	± 0.7 dB, $f \leq 3.0$ GHz	
6.2.4A.1 Additional Maximum Power Reduction (A-MPR) for CA (intra-band contiguous DL CA and UL CA)	Same as 6.2.4 for each CC	
6.2.4B Additional Maximum Power Reduction (A-MPR) for UL-MIMO	Same as 6.2.4 for each antenna	
6.2.5 Configured UE transmitted Output Power	± 0.7 dB, $f \leq 3.0$ GHz ± 1.0 dB, 3.0 GHz $< f \leq 4.2$ GHz	
6.2.5_1 Configured UE transmitted Output Power for HPUE	± 0.7 dB, $f \leq 3.0$ GHz	
6.2.5A.1 Configured UE transmitted Output Power for CA (intra-band contiguous DL CA and UL CA)	Same as 6.2.5 for each CC	
6.2.5A.2 Configured UE transmitted Output Power for CA (inter-band DL CA without UL CA)	TBD	
6.2.5B Configured UE transmitted output power for UL-MIMO	Same as 6.2.5 for each antenna	
6.3.2 Minimum Output Power	± 1.0 dB, $f \leq 3.0$ GHz ± 1.3 dB, 3.0 GHz $< f \leq 4.2$ GHz	
6.3.2A.1 Minimum Output Power for CA (intra-band contiguous DL CA and UL CA)	Same as 6.3.2 for each CC	
6.3.2B Minimum Output Power for UL-MIMO	Same as 6.3.2 for each antenna	

6.3.3 Transmission ON/OFF Power	Transmission OFF Power: ± 1.5 dB, $f \leq 3.0$ GHz ± 1.8 dB, 3.0 GHz $< f \leq 4.2$ GHz	
6.3.3A.1 UE Transmit OFF power for CA (intra-band contiguous DL CA and UL CA)	Same as 6.3.3 for each CC	
6.3.3B UE Transmit OFF power for UL-MIMO	Same as 6.3.3 for each antenna	
6.3.4.1 General ON/OFF time mask	Transmission ON/OFF Power: ± 1.5 dB, $f \leq 3.0$ GHz ± 1.8 dB, 3.0 GHz $< f \leq 4.2$ GHz	
6.3.4.2 PRACH and SRS time mask	Transmission ON/OFF Power: ± 1.5 dB, $f \leq 3.0$ GHz ± 1.8 dB, 3.0 GHz $< f \leq 4.2$ GHz	
6.3.4A.1.1 General ON/OFF time mask for CA (intra-band contiguous DL CA and UL CA)	Same as 6.3.4.1 for each CC	
6.3.4B.1 General ON/OFF time mask for UL-MIMO	Same as 6.3.4.1 for each antenna	
6.3.5.1 Power Control Absolute power tolerance	± 1.0 dB, $f \leq 3.0$ GHz ± 1.4 dB, 3.0 GHz $< f \leq 4.2$ GHz	Overall system uncertainty comprises two quantities: 1. Downlink signal level uncertainty 2. Uplink level measurement uncertainty Items 1 and 2 are assumed to be uncorrelated so can be root sum squared. Test System uncertainty = [SQRT (DL level uncert ² + UL measurement uncert ²)] $f \leq 3.0$ GHz DL signal level uncert ± 0.7 dB UL meas't uncert ± 0.7 dB 3.0 GHz $< f \leq 4.2$ GHz DL signal level uncert ± 1.0 dB UL meas't uncert ± 1.0 dB
6.3.5.2 Power Control Relative power tolerance	± 0.7 dB	
6.3.5_1.1 Power Control Absolute power tolerance for HPUE	± 1.0 dB, $f \leq 3.0$ GHz	
6.3.5_1.2 Power Control Relative power tolerance for HPUE	± 0.7 dB	
6.3.5A.1.1 Power Control Absolute power tolerance for CA (intra-band contiguous DL CA and UL CA)	Same as 6.3.5.1 for each CC	
6.3.5A.2.1 Power Control Relative power tolerance for CA (intra-band contiguous DL CA and UL CA)	Same as 6.3.5.2 for each CC	
6.3.5B.1 Power Control Absolute Power Tolerance for UL- MIMO	Same as 6.3.5.1 for each antenna	
6.3.5B.2 Power Control Relative power tolerance for UL-MIMO	Same as 6.3.5.2 for each antenna	
6.3.5.3 Aggregate power control tolerance	± 0.7 dB	
6.3.5_1.3 Aggregate power control tolerance for HPUE	± 0.7 dB	
6.3.5A.3.1 Aggregate power control tolerance for CA (intra-band contiguous DL CA and UL CA)	Same as 6.3.5.3 for each CC	

6.3.5B.3 Aggregate power control tolerance for UL-MIMO	Same as 6.3.5.3 for each antenna	
6.5.1 Frequency Error	± 15 Hz DL Signal level: ± 0.7 dB, $f \leq 3.0$ GHz DL Signal level: ± 1.0 dB, 3.0 GHz $< f \leq 4.2$ GHz	
6.5.1A.1 Frequency error for CA (intra-band contiguous DL CA and UL CA)	TBD	
6.5.1B Frequency Error for UL-MIMO	Same as 6.5.1 for each antenna DL signal level same as 6.5.1	
6.5.2.1 Error Vector Magnitude	PUSCH: $\pm 2.5\%$ PUCCH: $\pm 2.5\%$ PRACH: $\pm 2.5\%$	
6.5.2A.1.1 Error Vector Magnitude (EVM) for CA (intra-band contiguous DL CA and UL CA)	Same as 6.5.2.1	
6.5.2B.1 Error Vector Magnitude (EVM) for UL-MIMO	Same as 6.5.2.1 for each antenna	
6.5.2.1A PUSCH-EVM with exclusion period	PUSCH : $\pm 2.5\%$	

6.5.2.2 Carrier leakage	± 0.8 dB	
6.5.2A.2.1 Carrier leakage for CA (intra-band contiguous DL CA and UL CA)	TBD	
6.5.2.3 In-band emissions for non allocated RB	± 0.8 dB	
6.5.2.4 EVM equalizer Spectrum flatness	± 1.4 dB	
6.5.2A.3.1 In-band emissions for non allocated RB for CA (intra-band contiguous DL CA and UL CA)	TBD	
6.5.2B.1 Error vector magnitude (EVM) for UL-MIMO	TBD	
6.5.2B.2 Carrier leakage for UL-MIMO	Same as 6.5.2.2 for each antenna	
6.5.2B.3 In-band emissions for non allocated RB for UL-MIMO	Same as 6.5.2.3 for each antenna	
6.5.2B.4 EVM equalizer spectrum flatness for UL-MIMO	Same as 6.5.2.4 for each antenna	
6.6.1 Occupied bandwidth	1.4MHz, 3MHz: 30kHz 5MHz, 10MHz: 100kHz 15MHz, 20MHz: 300kHz	
6.6.1A.1 Occupied bandwidth for CA (intra-band contiguous DL CA and UL CA)	1.4MHz, 3MHz: 30kHz 5MHz, 10MHz: 100kHz 15MHz, 20MHz: 300kHz 20MHz < f ≤ 40MHz: 500kHz	
6.6.1B Occupied bandwidth for UL-MIMO	Same as 6.6.1 for each antenna	
6.6.2.1 Spectrum Emission Mask	± 1.5 dB, $f \leq 3.0$ GHz ± 1.8 dB, 3.0 GHz < $f \leq 4.2$ GHz	
6.6.2.1A.1 Spectrum emission mask for CA (intra-band contiguous DL CA and UL CA)	Same as 6.6.2.1	
6.6.2.1B Spectrum Emission Mask for UL-MIMO	Same as 6.6.2.1 for each antenna	
6.6.2.2 Additional Spectrum Emission Mask	± 1.5 dB, $f \leq 3.0$ GHz ± 1.8 dB, 3.0 GHz < $f \leq 4.2$ GHz	
6.6.2.3 Adjacent Channel Leakage power Ratio	± 0.8 dB	
6.6.2.3.1 Adjacent Channel Leakage power Ratio for HPUE	± 0.8 dB	
6.6.2.3A.1 Adjacent Channel Leakage power Ratio for CA	± 0.8 dB	
6.6.2.3B Adjacent Channel Leakage power Ratio for UL-MIMO	Same as 6.6.2.3 for each antenna	
6.6.2.4 Additional ACLR requirements	± 0.8 dB	
6.6.3.1 Transmitter Spurious emissions	9kHz < f ≤ 4 GHz: ± 2.0 dB 4 GHz < f ≤ 19 GHz: ± 4.0 dB	
6.6.3.1A.1 Transmitter Spurious emissions for CA (intra-band contiguous DL CA and UL CA)	Same as 6.6.3.1	
6.6.3B.1 Transmitter Spurious emissions for UL-MIMO	Same as 6.6.3.1, at each antenna used for transmission	The overall UL power is the linear sum of the output powers over all Tx antenna connectors

6.6.3.2 Spurious emission band UE co-existence	± 2.0 dB for results > -60 dBm, $f \leq 3.0$ GHz ± 2.5 dB, 3.0 GHz $< f \leq 4.2$ GHz ± 3.0 dB for results ≤ -60 dBm, $f \leq 3.0$ GHz ± 3.6 dB, 3.0 GHz $< f \leq 4.2$ GHz	
6.6.3.2A.1 Spurious emission band UE co-existence for CA (intra-band contiguous DL CA and UL CA)	TBD	
6.6.3.3 Additional spurious emissions	9 kHz $< f \leq 4$ GHz: ± 2.0 dB NS-07 $769 \leq f \leq 775$ MHz: ± 1.5 dB	
6.6.3.3A.1 Additional spurious emissions for CA (intra-band contiguous DL CA and UL CA)	9 kHz $< f \leq 4$ GHz: ± 2.0 dB	
6.6.3B.2 Spurious emission band UE co-existence for UL-MIMO	Same as 6.6.3.2 at each antenna used for transmission	
6.6.3B.3 Additional spurious emissions for UL-MIMO	Same as 6.6.3.3, at each antenna used for transmission	
6.7 Transmit intermodulation	± 2.6 dB, $f \leq 3.0$ GHz ± 3.6 dB, 3.0 GHz $< f \leq 4.2$ GHz	<p>Overall system uncertainty comprises four quantities:</p> <ol style="list-style-type: none"> 1. Wanted signal setting error 2. CW Interferer level error 3. Wanted signal meas. error 4. Intermodulation product measurement error <p>The relative level of the wanted signal and the CW interferer has 2 x effect on the intermodulation product.</p> <p>Items 1, 2, 3 and 4 are assumed to be uncorrelated so can be root sum squared to provide the combined effect.</p> <p>Test System uncertainty = $\text{SQRT} [(2 \times \text{SQRT} (\text{Wanted setting_error}^2 + \text{CW_level_error}^2))^2 + \text{Wanted_level_meas error}^2 + \text{Intermodulation product measurement error}^2]$</p> <p>$f \leq 3.0$GHz Wanted signal setting ± 0.7dB CW Interferer level ± 1.0dB Wanted signal meas ± 0.7dB Intermodulation product measurement error ± 0.7dB</p> <p>3.0GHz $< f \leq 4.2$GHz Wanted signal setting ± 1.0dB CW Interferer level ± 1.3dB Wanted signal meas ± 1.0dB Intermodulation product measurement error ± 1.0dB</p>
6.7A.1 Transmit intermodulation	TBD	
6.8B Time alignment error for UL-MIMO	± 25 ns	

F.1.3 Measurement of receiver

Table F.1.3-1: Maximum Test System Uncertainty for receiver tests

Subclause	Maximum Test System Uncertainty ¹	Derivation of Test System Uncertainty
7.3 Reference sensitivity power level	Downlink power ± 0.7 dB, $f \leq 3.0$ GHz ± 1.0 dB, 3.0 GHz $< f \leq 4.2$ GHz	
7.3A.1 Reference sensitivity level for CA (intra-band contiguous DL CA and UL CA)	Same as 7.3 for each CC	
7.3A.2 Reference sensitivity level for CA (intra-band contiguous DL CA without UL CA)	Same as 7.3A.1	
7.3A.3 Reference sensitivity level for CA (inter-band DL CA without UL CA)	Same as 7.3A.1	
7.3B Reference Sensitivity Level for UL-MIMO	Same as 7.3	
7.4 Maximum input level	Downlink power ± 0.7 dB, $f \leq 3.0$ GHz ± 1.0 dB, 3.0 GHz $< f \leq 4.2$ GHz Uplink power measurement ± 0.7 dB, $f \leq 3.0$ GHz ± 1.0 dB, 3.0 GHz $< f \leq 4.2$ GHz	
7.4A.1 Maximum input level for CA (intra band contiguous DL CA and UL CA)	Downlink power same as 7.4 Uplink power measurement TBD	Uncertainties apply for each CC or group of CCs, at the antenna port where received
7.4A.2 Maximum input level for CA (intra band contiguous DL CA without UL CA)	Downlink power same as 7.4 Uplink power measurement same as 7.4	Uncertainties apply for each CC or group of CCs, at the antenna port where received
7.4A.3 Maximum input level for CA (inter-band DL CA without UL CA)	Downlink power same as 7.4 Uplink power measurement same as 7.4	Uncertainties apply for each CC or group of CCs, at the antenna port where received
7.4B Maximum Input Level for UL-MIMO	Downlink power same as 7.4 Uplink power measurement same as 7.4, at each antenna connector used for transmission	The overall UL power is the linear sum of the output powers over all Tx antenna connectors

7.5 Adjacent Channel Selectivity (ACS)	ACS value ± 1.1 dB, $f \leq 3.0$ GHz ± 1.5 dB, 3.0 GHz $< f \leq 4.2$ GHz Uplink power measurement ± 0.7 dB, $f \leq 3.0$ GHz ± 1.0 dB, 3.0 GHz $< f \leq 4.2$ GHz	Overall ACS uncertainty comprises three quantities: 1. Wanted signal level error 2. Interferer signal level error 3. Additional impact of interferer ACLR Items 1 and 2 are assumed to be uncorrelated so can be root sum squared to provide the ratio error of the two signals. The interferer ACLR effect is systematic, and is added arithmetically. Test System uncertainty = [SQRT (wanted_level_error ² + interferer_level_error ²)] + ACLR effect. $f \leq 3.0$ GHz Wanted signal level ± 0.7 dB Interferer signal level ± 0.7 dB 3.0 GHz $< f \leq 4.2$ GHz Wanted signal level ± 1.0 dB Interferer signal level ± 1.0 dB $f \leq 4.2$ GHz Impact of interferer ACLR 0.1dB
7.5A.1 Adjacent Channel Selectivity (ACS) for CA (intra band contiguous DL CA and UL CA)	Same as 7.5 for each CC	Same as 7.5 The wanted signal level uncertainty applies for each CC. Overall ACS uncertainty calculation includes the uncertainty for wanted level error only once, as the uncertainty of other CCs is not expected to have any significant effect.
7.5A.2 Adjacent Channel Selectivity (ACS) for CA (intra band contiguous DL CA without UL CA)	Same as 7.5A.1	
7.5A.3 Adjacent Channel Selectivity (ACS) for CA (inter band DL CA without UL CA)	Same as 7.5A.1	
7.5B Adjacent Channel Selectivity (ACS) for UL-MIMO	ACS value same as 7.5 Uplink power measurement same as 7.5, at each antenna connector used for transmission	The overall UL power is the linear sum of the output powers over all Tx antenna connectors

7.6.1 In-band blocking	<p>Blocking ± 1.4 dB, $f \leq 3.0$GHz ± 1.8 dB, 3.0GHz $< f \leq 4.2$GHz Uplink power measurement ± 0.7 dB, $f \leq 3.0$GHz ± 1.0 dB, 3.0GHz $< f \leq 4.2$GHz</p>	<p>Overall blocking uncertainty can have these contributions:</p> <ol style="list-style-type: none"> 1. Wanted signal level error 2. Interferer signal level error 3. Interferer ACLR 4. Interferer broadband noise <p>Items 1 and 2 are assumed to be uncorrelated so can be root sum squared to provide the ratio error of the two signals. The Interferer ACLR or Broadband noise effect is systematic, and is added arithmetically.</p> <p>Test System uncertainty = [SQRT (wanted_level_error² + interferer_level_error²)] + ACLR effect + Broadband noise effect.</p> <p><u>In-band blocking, using modulated interferer:</u> $f \leq 3.0$GHz Wanted signal level ± 0.7dB Interferer signal level: ± 0.7dB 3.0GHz $< f \leq 4.2$GHz Wanted signal level ± 1.0dB Interferer signal level ± 1.0dB</p> <p>$f \leq 4.2$GHz Interferer ACLR 0.4dB Broadband noise not applicable</p>
7.6.1A.1 In-band blocking for CA (intra band contiguous DL CA and UL CA)	Same as 7.6.1 for each CC	<p><u>Same as 7.6.1</u></p> <p><u>The wanted signal level uncertainty applies for each CC.</u></p> <p><u>Overall blocking uncertainty calculation includes the uncertainty for wanted level error only once, as the uncertainty of other CCs is not expected to have any significant effect.</u></p>
7.6.1A.2 In-band blocking for CA (intra band contiguous DL CA without UL CA)	Same as 7.6.1A.1	<u>Same as 7.6.1A.1</u>
7.6.1A.3 In-band blocking for CA (inter band DL CA without UL CA)	Same as 7.6.1A.1	<u>Same as 7.6.1A.1</u>
7.6.1B In-band blocking for UL-MIMO	<p>Blocking same as 7.6.1</p> <p>Uplink power measurement same as 7.6.1, at each antenna connector used for transmission</p>	The overall UL power is the linear sum of the output powers over all Tx antenna connectors

7.6.2 Out-of-band blocking	<p>Wanted signal $f \leq 3.0\text{GHz}$ Blocking, $1\text{MHz} < f_{\text{interferer}} \leq 3\text{GHz}$: $\pm 1.3\text{ dB}$ Blocking, $3\text{GHz} < f_{\text{interferer}} \leq 12.75\text{GHz}$: $\pm 3.2\text{ dB}$ Uplink power measurement $\pm 0.7\text{ dB}$</p> <p>Wanted signal $3.0\text{GHz} < f \leq 4.2\text{GHz}$ Blocking, $1\text{MHz} < f_{\text{interferer}} \leq 3\text{GHz}$: $\pm 1.5\text{ dB}$ Blocking, $3\text{GHz} < f_{\text{interferer}} \leq 12.75\text{GHz}$: $\pm 3.3\text{ dB}$ Uplink power measurement $\pm 1.0\text{ dB}$</p>	<p><u>Out of band blocking, using CW interferer:</u> $f \leq 3.0\text{GHz}$ Wanted signal level $\pm 0.7\text{dB}$ $3.0\text{GHz} < f \leq 4.2\text{GHz}$ Wanted signal level $\pm 1.0\text{dB}$ Interferer signal level: $\pm 1.0\text{dB}$ up to 3GHz $\pm 3.0\text{dB}$ up to 12.75GHz Interferer ACLR not applicable Impact of interferer Broadband noise 0.1dB</p> <p>Figures are combined to give Test System uncertainty, using formula given for 7.6.1</p>
7.6.2A.1 Out-of-band blocking for CA (intra band contiguous DL CA and UL CA)	Same as 7.6.2 for each CC	<p>Same as 7.6.2</p> <p><u>The wanted signal level uncertainty applies for each CC.</u></p> <p><u>Overall blocking uncertainty calculation includes the uncertainty for wanted level error only once, as the uncertainty of other CCs is not expected to have any significant effect.</u></p>
7.6.2A.2 Out-of-band blocking for CA (intra band contiguous DL CA without UL CA)	Same as 7.6.2A.1	Same as 7.6.2A.1
7.6.2A.3 Out-of-band blocking for CA (inter band DL CA without UL CA)	Same as 7.6.2A.1	Same as 7.6.2A.1
7.6.2B Out-of-band blocking for UL-MIMO	<p>Blocking same as 7.6.2</p> <p>Uplink power measurement same as 7.6.2, at each antenna connector used for transmission</p>	The overall UL power is the linear sum of the output powers over all Tx antenna connectors
7.6.3 Narrow band blocking	<p>Blocking $\pm 1.3\text{ dB}$, $f \leq 3.0\text{GHz}$ $\pm 1.8\text{ dB}$, $3.0\text{GHz} < f \leq 4.2\text{GHz}$ Uplink power measurement $\pm 0.7\text{ dB}$, $f \leq 3.0\text{GHz}$ $\pm 1.0\text{ dB}$, $3.0\text{GHz} < f \leq 4.2\text{GHz}$</p>	<p><u>Narrow band blocking, using CW interferer:</u> Wanted signal level $\pm 0.7\text{dB}$ Interferer signal level: $\pm 1.0\text{dB}$ Interferer ACLR not applicable Impact of interferer Broadband noise 0.1dB</p> <p>Figures are combined to give Test System uncertainty, using formula given for 7.6.1</p>
7.6.3A.1 Narrow band blocking for CA (intra band contiguous DL CA and UL CA)	Same as 7.6.3 for each CC	<p>Same as 7.6.3</p> <p><u>The wanted signal level uncertainty applies for each CC.</u></p> <p><u>Overall blocking uncertainty calculation includes the uncertainty for wanted level error only once, as the uncertainty of other CCs is not expected to have any significant effect.</u></p>
7.6.3A.2 Narrow band blocking for CA (intra band contiguous DL CA without UL CA)	Same as 7.6.3A.1	Same as 7.6.3A.1
7.6.3A.3 Narrow band blocking for CA (inter band DL CA without UL CA)	Same as 7.6.3A.1	Same as 7.6.3A.1

7.6.3B Narrow band blocking for UL-MIMO	Blocking same as 7.6.3 Uplink power measurement same as 7.6.3, at each antenna connector used for transmission	The overall UL power is the linear sum of the output powers over all Tx antenna connectors
7.7 Spurious response	Same as 7.6.2	Same as 7.6.2.
7.7A.1 Spurious response for CA (intra band contiguous DL CA and UL CA)	Same as 7.6.2A.1	Same as 7.6.2A.1
7.7A.2 Spurious response for CA (intra band contiguous DL CA without UL CA)	Same as 7.6.2A.1	Same as 7.6.2A.1
7.7A.3 Spurious response for CA (inter band DL CA without UL CA)	Same as 7.6.2A.1	Same as 7.6.2A.1
7.7B Spurious response for UL-MIMO	Same as 7.7 Uplink power measurement same as 7.6.2, at each antenna connector used for transmission	The overall UL power is the linear sum of the output powers over all Tx antenna connectors
7.8.1 Wide band intermodulation	Intermodulation ± 1.4 dB, $f \leq 3.0$ GHz ± 2.6 dB, 3.0 GHz $< f \leq 4.2$ GHz Uplink power measurement ± 0.7 dB, $f \leq 3.0$ GHz ± 1.0 dB, 3.0 GHz $< f \leq 4.2$ GHz	Overall intermodulation uncertainty comprises three quantities: 1. Wanted signal level error 2. CW Interferer level error 3. Modulated Interferer level error Effect of interferer ACLR has not been included as modulated interferer has larger frequency offset The effect of the closer CW signal has twice the effect. Items 1, 2 and 3 are assumed to be uncorrelated so can be root sum squared to provide the combined effect of the three signals. Test System uncertainty = SQRT $[(2 \times \text{CW_level_error})^2 + (\text{mod interferer_level_error})^2 + (\text{wanted signal_level_error})^2]$ $f \leq 3.0$ GHz Wanted signal level ± 0.7 dB CW Interferer level ± 0.5 dB Mod Interferer level ± 0.7 dB 3.0 GHz $< f \leq 4.2$ GHz Wanted signal level ± 1.0 dB CW Interferer level ± 0.8 dB Mod Interferer level ± 1.0 dB
7.8.1A.1 Wideband intermodulation for CA (intra band contiguous DL CA and UL CA)	Same as 7.8.1 for each CC	Same as 7.8.1 The wanted signal level uncertainty applies for each CC. Overall intermodulation uncertainty calculation includes the uncertainty for wanted level error only once, as the uncertainty of other CCs is not expected to have any significant effect.
7.8.1A.2 Wideband intermodulation for CA (intra band contiguous DL CA without UL CA)	Same as 7.8.1A.1	Same as 7.8.1A.1

7.8.1A.3 Wideband intermodulation for CA (inter band DL CA without UL CA)	Same as 7.8.1A.1	Same as 7.8.1A.1
7.8.1B Wide band intermodulation for UL-MIMO	Intermodulation same as 7.8.1 Uplink power measurement same as 7.8.1, at each antenna connector used for transmission	The overall UL power is the linear sum of the output powers over all Tx antenna connectors
7.9 Spurious emissions	30MHz ≤ f ≤ 4.0GHz: ± 2.0 dB 4 GHz < f ≤ 19 GHz: ± 4.0 dB	
Note 1: Unless otherwise noted, only the Test System stimulus error is considered here. The effect of errors in the throughput measurements due to finite test duration is not considered.		

F.1.4 Measurement of performance requirements

Table F.1.4-1: Maximum Test System Uncertainty for Performance Requirements

Subclause	Maximum Test System Uncertainty ¹	Derivation of Test System Uncertainty
8.2.1.1.1 Multiple PRBs - Propagation Condition EVA5 - Propagation Condition ETU70 - Propagation Condition ETU300	± 0.8 dB	Overall system uncertainty for fading conditions comprises three quantities: 1. Signal-to-noise ratio uncertainty 2. Fading profile power uncertainty 3. Effect of AWGN flatness and signal flatness Items 1, 2 and 3 are assumed to be uncorrelated so can be root sum squared: AWGN flatness and signal flatness has x 0.25 effect on the required SNR, so use sensitivity factor of x 0.25 for the uncertainty contribution. Test System uncertainty = $\text{SQRT}(\text{Signal-to-noise ratio uncertainty}^2 + \text{Fading profile power uncertainty}^2 + (0.25 \times \text{AWGN flatness and signal flatness})^2)$ Signal-to-noise ratio uncertainty ±0.3 dB Fading profile power uncertainty ±0.5 dB for single Tx AWGN flatness and signal flatness ±2.0 dB
8.2.1.1.1 Multiple PRBs - Propagation Condition HST	± 0.6 dB	Overall system uncertainty for HST condition comprises two quantities: 1. Signal-to-noise ratio uncertainty 2. Effect of AWGN flatness and signal flatness Items 1 and 2 are assumed to be uncorrelated so can be root sum squared: AWGN flatness and signal flatness has x 0.25 effect on the required SNR, so use sensitivity factor of x 0.25 for the uncertainty contribution. Test System uncertainty = $\text{SQRT}(\text{Signal-to-noise ratio uncertainty}^2 + (0.25 \times \text{AWGN flatness and signal flatness})^2)$ Signal-to-noise ratio uncertainty ±0.3 dB AWGN flatness and signal flatness ±2.0 dB
8.2.1.1.1 Single PRB - Propagation Condition ETU70	± 0.8 dB	Overall system uncertainty for fading condition comprises three quantities: 1. Average Signal-to-noise ratio uncertainty 2. Signal-to noise ratio variation for single PRB 3. Fading profile power uncertainty Items 1, 2 and 3 are assumed to be uncorrelated so can be root sum squared: Test System uncertainty = $\text{SQRT}(\text{Average signal-to-noise ratio uncertainty}^2 + \text{Signal-to-noise ratio variation}^2 + \text{Fading profile power uncertainty}^2)$ Signal-to-noise ratio uncertainty ±0.3 dB Signal-to-noise ratio variation ±0.5 dB Fading profile power uncertainty ±0.5 dB for single Tx
8.2.1.1.1_A.1	Same as 8.2.1.1.1 Multiple PRBs, for each CC	Same as 8.2.1.1.1 Multiple PRBs Calculation applies for each CC
8.2.1.1.1_A.2	Same as 8.2.1.1.1 Multiple PRBs, for each CC	Same as 8.2.1.1.1 Multiple PRBs Calculation applies for each CC
8.2.1.1.1_1 Multiple PRBs - Propagation Condition EVA5 - Propagation Condition ETU70 - Propagation Condition ETU300	Same as 8.2.1.1.1 Multiple PRBs Propagation EVA5, ETU70, ETU300	
8.2.1.1.2 Single PRB	± 0.8 dB	Same as 8.2.1.1.1 Single PRB

8.2.1.2.1 - Propagation Condition EVA5	± 0.9 dB	Overall system uncertainty for fading conditions comprises three quantities: 1. Signal-to-noise ratio uncertainty 2. Fading profile power uncertainty 3. Effect of AWGN flatness and signal flatness Items 1, 2 and 3 are assumed to be uncorrelated so can be root sum squared: AWGN flatness and signal flatness has x 0.25 effect on the required SNR, so use sensitivity factor of x 0.25 for the uncertainty contribution. Test System uncertainty = $\text{SQRT}(\text{Signal-to-noise ratio uncertainty}^2 + \text{Fading profile power uncertainty}^2 + (0.25 \times \text{AWGN flatness and signal flatness})^2)$ Signal-to-noise ratio uncertainty ±0.3 dB Fading profile power uncertainty ±0.7 dB for Tx Diversity AWGN flatness and signal flatness ±2.0 dB
8.2.1.2.1 - Propagation Condition HST	± 0.6 dB	Overall system uncertainty for HST condition comprises two quantities: 1. Signal-to-noise ratio uncertainty 2. Effect of AWGN flatness and signal flatness Items 1 and 2 are assumed to be uncorrelated so can be root sum squared: AWGN flatness and signal flatness has x 0.25 effect on the required SNR, so use sensitivity factor of x 0.25 for the uncertainty contribution. Test System uncertainty = $\text{SQRT}(\text{Signal-to-noise ratio uncertainty}^2 + (0.25 \times \text{AWGN flatness and signal flatness})^2)$ Signal-to-noise ratio uncertainty ±0.3 dB AWGN flatness and signal flatness ±2.0 dB
8.2.1.2.1_1 - Propagation Condition EVA5	Same as 8.2.1.2.1 Propagation EVA5	
8.2.1.2.2	± 0.9 dB	Same as 8.2.1.2.1 Propagation Condition EVA5
8.2.1.2.2_1	Same as 8.2.1.2.2	
8.2.1.2.3_C.1 - Propagation Condition EVA5	[TBD]	[TBD]
8.2.1.3.1	± 0.9 dB	Overall system uncertainty for fading conditions comprises three quantities: 1. Signal-to-noise ratio uncertainty 2. Fading profile power uncertainty 3. Effect of AWGN flatness and signal flatness Items 1, 2 and 3 are assumed to be uncorrelated so can be root sum squared: AWGN flatness and signal flatness has x 0.25 effect on the required SNR, so use sensitivity factor of x 0.25 for the uncertainty contribution. Test System uncertainty = $\text{SQRT}(\text{Signal-to-noise ratio uncertainty}^2 + \text{Fading profile power uncertainty}^2 + (0.25 \times \text{AWGN flatness and signal flatness})^2)$ Signal-to-noise ratio uncertainty ±0.3 dB Fading profile power uncertainty ±0.7 dB for MIMO AWGN flatness and signal flatness ±2.0 dB
8.2.1.3.1_A.1 FDD PDSCH Open Loop Spatial Multiplexing 2x2 (intra band contiguous DL CA)	Same as 8.2.1.3.1 for each CC	Same as 8.2.1.3.1 Calculation applies for each CC
8.2.1.3.1_A.2 FDD PDSCH Open Loop Spatial Multiplexing 2x2 (inter band DL CA)	Same as 8.2.1.3.1 for each CC	Same as 8.2.1.3.1 Calculation applies for each CC
8.2.1.3.2	± 0.9 dB	Same as 8.2.1.3.1
8.2.1.4.1	± 0.9 dB	Same as 8.2.1.3.1

8.2.1.4.1_1	Same as 8.2.1.4.1	
8.2.1.4.2	± 0.9 dB	Same as 8.2.1.3.1
8.2.1.4.2_1	Same as 8.2.1.4.2	
8.2.1.4.2_A.1	TBD	TBD
8.2.1.7.1_A.1	TBD	TBD
8.2.2.1.1 Multiple PRBs - Propagation Condition EVA5 - Propagation Condition ETU70 - Propagation Condition ETU300	± 0.8 dB	Overall system uncertainty for fading conditions comprises three quantities: 1. Signal-to-noise ratio uncertainty 2. Fading profile power uncertainty 3. Effect of AWGN flatness and signal flatness Items 1, 2 and 3 are assumed to be uncorrelated so can be root sum squared: AWGN flatness and signal flatness has x 0.25 effect on the required SNR, so use sensitivity factor of x 0.25 for the uncertainty contribution. Test System uncertainty = SQRT (Signal-to-noise ratio uncertainty ² + Fading profile power uncertainty ² + (0.25 x AWGN flatness and signal flatness) ²) Signal-to-noise ratio uncertainty ±0.3 dB Fading profile power uncertainty ±0.5 dB for single Tx AWGN flatness and signal flatness ±2.0 dB
8.2.2.1.1 Multiple PRBs - Propagation Condition HST	± 0.6 dB	Overall system uncertainty for HST condition comprises two quantities: 1. Signal-to-noise ratio uncertainty 2. Effect of AWGN flatness and signal flatness Items 1 and 2 are assumed to be uncorrelated so can be root sum squared: AWGN flatness and signal flatness has x 0.25 effect on the required SNR, so use sensitivity factor of x 0.25 for the uncertainty contribution. Test System uncertainty = SQRT (Signal-to-noise ratio uncertainty ² + (0.25 x AWGN flatness and signal flatness) ²) Signal-to-noise ratio uncertainty ±0.3 dB AWGN flatness and signal flatness ±2.0 dB
8.2.2.1.1 Single PRB - Propagation Condition ETU70	± 0.8 dB	Overall system uncertainty for fading condition comprises three quantities: 1. Average Signal-to-noise ratio uncertainty 2. Signal-to noise ratio variation for single PRB 3. Fading profile power uncertainty Items 1, 2 and 3 are assumed to be uncorrelated so can be root sum squared: Test System uncertainty = SQRT (Average signal-to-noise ratio uncertainty ² + Signal-to-noise ratio variation ² + Fading profile power uncertainty ²) Signal-to-noise ratio uncertainty ±0.3 dB Signal-to-noise ratio variation ±0.5 dB Fading profile power uncertainty ±0.5 dB for single Tx
8.2.2.1.1_1 Multiple PRBs - Propagation Condition EVA5 - Propagation Condition ETU70 - Propagation Condition ETU300	Same as 8.2.2.1.1 Multiple PRBs Propagation EVA5, ETU70, ETU300	
8.2.2.1.1_A.1	Same as 8.2.2.1.1 Multiple PRBs for each CC	Same as 8.2.2.1.1 Multiple PRBs Calculation applies for each CC
8.2.2.1.2 Single PRB	± 0.8 dB	Same as 8.2.2.1.1 Single PRB

8.2.2.2.1 - Propagation Condition EVA5	± 0.9 dB	Overall system uncertainty for fading conditions comprises three quantities: 1. Signal-to-noise ratio uncertainty 2. Fading profile power uncertainty 3. Effect of AWGN flatness and signal flatness Items 1, 2 and 3 are assumed to be uncorrelated so can be root sum squared: AWGN flatness and signal flatness has x 0.25 effect on the required SNR, so use sensitivity factor of x 0.25 for the uncertainty contribution. Test System uncertainty = $\text{SQRT}(\text{Signal-to-noise ratio uncertainty}^2 + \text{Fading profile power uncertainty}^2 + (0.25 \times \text{AWGN flatness and signal flatness})^2)$ Signal-to-noise ratio uncertainty ±0.3 dB Fading profile power uncertainty ±0.7 dB for Tx Diversity AWGN flatness and signal flatness ±2.0 dB
8.2.2.2.1 - Propagation Condition HST	± 0.6 dB	Overall system uncertainty for HST condition comprises two quantities: 1. Signal-to-noise ratio uncertainty 2. Effect of AWGN flatness and signal flatness Items 1 and 2 are assumed to be uncorrelated so can be root sum squared: AWGN flatness and signal flatness has x 0.25 effect on the required SNR, so use sensitivity factor of x 0.25 for the uncertainty contribution. Test System uncertainty = $\text{SQRT}(\text{Signal-to-noise ratio uncertainty}^2 + (0.25 \times \text{AWGN flatness and signal flatness})^2)$ Signal-to-noise ratio uncertainty ±0.3 dB AWGN flatness and signal flatness ±2.0 dB
8.2.2.2.1_1 - Propagation Condition EVA5	Same as 8.2.2.2.1 Propagation EVA5	
8.2.2.2.2	± 0.9 dB	Same as 8.2.2.2.1 Propagation Condition EVA5
8.2.2.2.2_1	Same as 8.2.2.2.2	
8.2.2.3.1	± 0.9 dB	Overall system uncertainty for fading conditions comprises three quantities: 1. Signal-to-noise ratio uncertainty 2. Fading profile power uncertainty 3. Effect of AWGN flatness and signal flatness Items 1, 2 and 3 are assumed to be uncorrelated so can be root sum squared: AWGN flatness and signal flatness has x 0.25 effect on the required SNR, so use sensitivity factor of x 0.25 for the uncertainty contribution. Test System uncertainty = $\text{SQRT}(\text{Signal-to-noise ratio uncertainty}^2 + \text{Fading profile power uncertainty}^2 + (0.25 \times \text{AWGN flatness and signal flatness})^2)$ Signal-to-noise ratio uncertainty ±0.3 dB Fading profile power uncertainty ±0.7 dB for MIMO AWGN flatness and signal flatness ±2.0 dB
8.2.2.3.1_A.1	Same as 8.2.2.3.1 for each CC	Same as 8.2.2.3.1 Calculation applies for each CC
8.2.2.3.2	± 0.9 dB	Same as 8.2.2.3.1
8.2.2.4.1	± 0.9 dB	Same as 8.2.2.3.1
8.2.2.4.1_1	Same as 8.2.2.4.1	
8.2.2.4.2	± 0.9 dB	Same as 8.2.2.3.1
8.2.2.4.2_1	Same as 8.2.2.4.2	
8.2.2.4.2_A.1	TBD	TBD
8.2.2.7.1_A.1	TBD	TBD

8.3.1.1.1_D	± 0.9 dB	<p>Overall system uncertainty for fading conditions comprises three quantities:</p> <ol style="list-style-type: none"> 1. Signal-to-noise ratio uncertainty 2. Fading profile power uncertainty 3. Effect of AWGN flatness and signal flatness <p>Items 1, 2 and 3 are assumed to be uncorrelated so can be root sum squared: AWGN flatness and signal flatness has x 0.25 effect on the required SNR, so use sensitivity factor of x 0.25 for the uncertainty contribution. Test System uncertainty = SQRT (Signal-to-noise ratio uncertainty² + Fading profile power uncertainty² + (0.25 x AWGN flatness and signal flatness)²)</p> <p>Signal-to-noise ratio uncertainty ±0.3 dB Fading profile power uncertainty ±0.7 dB for MIMO AWGN flatness and signal flatness ±2.0 dB</p>
8.3.1.1.2_D	± 0.9 dB	Same as 8.3.1.1.1_D
8.3.1.2.1_D	± 0.9 dB	Same as 8.3.1.1.1_D
8.3.2.1.1	± 0.9 dB	<p>Overall system uncertainty for fading conditions comprises three quantities:</p> <ol style="list-style-type: none"> 1. Signal-to-noise ratio uncertainty 2. Fading profile power uncertainty 3. Effect of AWGN flatness and signal flatness <p>Items 1, 2 and 3 are assumed to be uncorrelated so can be root sum squared: AWGN flatness and signal flatness has x 0.25 effect on the required SNR, so use sensitivity factor of x 0.25 for the uncertainty contribution. Test System uncertainty = SQRT (Signal-to-noise ratio uncertainty² + Fading profile power uncertainty² + (0.25 x AWGN flatness and signal flatness)²)</p> <p>Signal-to-noise ratio uncertainty ±0.3 dB Fading profile power uncertainty ±0.7 dB for Tx Diversity AWGN flatness and signal flatness ±2.0 dB</p>
8.3.2.1.1_1	± 0.9 dB	Same as 8.3.2.1.1
8.3.2.1.2	± 0.9 dB	Same as 8.2.2.3.1
8.3.2.1.2_D	± 0.9 dB	Same as 8.2.2.3.1
8.3.2.1.3	± 0.9 dB	Same as 8.2.2.3.1
8.3.2.1.3_D	± 0.9 dB	Same as 8.2.2.3.1
8.3.2.2.1	± 0.9 dB	Same as 8.2.2.3.1
8.3.2.2.1_D	± 0.9 dB	Same as 8.2.2.3.1

8.4.1.1	± 0.8 dB	<p>Overall system uncertainty for fading conditions comprises four quantities:</p> <ol style="list-style-type: none"> 1. Signal-to-noise ratio uncertainty 2. Fading profile power uncertainty 3. Effect of AWGN flatness and signal flatness 4. Result variation due to finite test time <p>Items 1, 2, 3 and 4 are assumed to be uncorrelated so can be root sum squared: AWGN flatness and signal flatness has x 0.25 effect on the required SNR, so use sensitivity factor of x 0.25 for the uncertainty contribution. Test System uncertainty = $\text{SQRT}(\text{Signal-to-noise ratio uncertainty}^2 + \text{Fading profile power uncertainty}^2 + (0.25 \times \text{AWGN flatness and signal flatness})^2 + \text{variation due to finite test time}^2)$</p> <p>Signal-to-noise ratio uncertainty ±0.3 dB Fading profile power uncertainty ±0.5 dB for single Tx AWGN flatness and signal flatness ±2.0 dB Result variation due to finite test time ±0.2 dB</p>
8.4.1.2.1	± 1.0 dB	<p>Overall system uncertainty for fading conditions comprises four quantities:</p> <ol style="list-style-type: none"> 1. Signal-to-noise ratio uncertainty 2. Fading profile power uncertainty 3. Effect of AWGN flatness and signal flatness 4. Result variation due to finite test time <p>Items 1, 2, 3 and 4 are assumed to be uncorrelated so can be root sum squared: AWGN flatness and signal flatness has x 0.25 effect on the required SNR, so use sensitivity factor of x 0.25 for the uncertainty contribution. Test System uncertainty = $\text{SQRT}(\text{Signal-to-noise ratio uncertainty}^2 + \text{Fading profile power uncertainty}^2 + (0.25 \times \text{AWGN flatness and signal flatness})^2 + \text{variation due to finite test time}^2)$</p> <p>Signal-to-noise ratio uncertainty ±0.3 dB Fading profile power uncertainty ±0.7 dB for Tx Diversity AWGN flatness and signal flatness ±2.0 dB Result variation due to finite test time ±0.4 dB</p>
8.4.1.2.1_1	Same as 8.4.1.2.1	
8.4.1.2.2	± 1.0 dB	<p>Overall system uncertainty for fading conditions comprises four quantities:</p> <ol style="list-style-type: none"> 1. Signal-to-noise ratio uncertainty 2. Fading profile power uncertainty 3. Effect of AWGN flatness and signal flatness 4. Result variation due to finite test time <p>Items 1, 2, 3 and 4 are assumed to be uncorrelated so can be root sum squared: AWGN flatness and signal flatness has x 0.25 effect on the required SNR, so use sensitivity factor of x 0.25 for the uncertainty contribution. Test System uncertainty = $\text{SQRT}(\text{Signal-to-noise ratio uncertainty}^2 + \text{Fading profile power uncertainty}^2 + (0.25 \times \text{AWGN flatness and signal flatness})^2 + \text{variation due to finite test time}^2)$</p> <p>Signal-to-noise ratio uncertainty ±0.3 dB Fading profile power uncertainty ±0.7 dB for MIMO AWGN flatness and signal flatness ±2.0 dB Result variation due to finite test time ±0.4 dB</p>
8.4.1.2.2_1	Same as 8.4.1.2.2	

8.4.1.2.3_C.1	[TBD]	[TBD]
8.4.1.2.3_C.2	[TBD]	[TBD]
8.4.2.1	± 0.8 dB	<p>Overall system uncertainty for fading conditions comprises four quantities:</p> <ol style="list-style-type: none"> 1. Signal-to-noise ratio uncertainty 2. Fading profile power uncertainty 3. Effect of AWGN flatness and signal flatness 4. Result variation due to finite test time <p>Items 1, 2, 3 and 4 are assumed to be uncorrelated so can be root sum squared: AWGN flatness and signal flatness has x 0.25 effect on the required SNR, so use sensitivity factor of x 0.25 for the uncertainty contribution. Test System uncertainty = SQRT (Signal-to-noise ratio uncertainty² + Fading profile power uncertainty² + (0.25 x AWGN flatness and signal flatness)² + variation due to finite test time²)</p> <p>Signal-to-noise ratio uncertainty ±0.3 dB Fading profile power uncertainty ±0.5 dB for single Tx AWGN flatness and signal flatness ±2.0 dB Result variation due to finite test time ±0.2 dB</p>
8.4.2.2.1	± 1.0 dB	<p>Overall system uncertainty for fading conditions comprises four quantities:</p> <ol style="list-style-type: none"> 1. Signal-to-noise ratio uncertainty 2. Fading profile power uncertainty 3. Effect of AWGN flatness and signal flatness 4. Result variation due to finite test time <p>Items 1, 2, 3 and 4 are assumed to be uncorrelated so can be root sum squared: AWGN flatness and signal flatness has x 0.25 effect on the required SNR, so use sensitivity factor of x 0.25 for the uncertainty contribution. Test System uncertainty = SQRT (Signal-to-noise ratio uncertainty² + Fading profile power uncertainty² + (0.25 x AWGN flatness and signal flatness)² + variation due to finite test time²)</p> <p>Signal-to-noise ratio uncertainty ±0.3 dB Fading profile power uncertainty ±0.7 dB for Tx Diversity AWGN flatness and signal flatness ±2.0 dB Result variation due to finite test time ±0.4 dB</p>
8.4.2.2.1_1	Same as 8.4.2.2.1	

8.4.2.2.2	± 1.0 dB	<p>Overall system uncertainty for fading conditions comprises four quantities:</p> <ol style="list-style-type: none"> 1. Signal-to-noise ratio uncertainty 2. Fading profile power uncertainty 3. Effect of AWGN flatness and signal flatness 4. Result variation due to finite test time <p>Items 1, 2, 3 and 4 are assumed to be uncorrelated so can be root sum squared: AWGN flatness and signal flatness has x 0.25 effect on the required SNR, so use sensitivity factor of x 0.25 for the uncertainty contribution. Test System uncertainty = $\text{SQRT}(\text{Signal-to-noise ratio uncertainty}^2 + \text{Fading profile power uncertainty}^2 + (0.25 \times \text{AWGN flatness and signal flatness})^2 + \text{variation due to finite test time}^2)$</p> <p>Signal-to-noise ratio uncertainty ±0.3 dB Fading profile power uncertainty ±0.7 dB for MIMO AWGN flatness and signal flatness ±2.0 dB Result variation due to finite test time ±0.4 dB</p>
8.4.2.2.2_1	Same as 8.4.2.2.2	
8.5.1.1	± 0.9 dB	<p>Overall system uncertainty for fading conditions comprises four quantities:</p> <ol style="list-style-type: none"> 1. Signal-to-noise ratio uncertainty 2. Fading profile power uncertainty 3. Effect of AWGN flatness and signal flatness 4. Result variation due to finite test time <p>Items 1, 2, 3 and 4 are assumed to be uncorrelated so can be root sum squared: AWGN flatness and signal flatness has x 0.25 effect on the required SNR, so use sensitivity factor of x 0.25 for the uncertainty contribution. Test System uncertainty = $\text{SQRT}(\text{Signal-to-noise ratio uncertainty}^2 + \text{Fading profile power uncertainty}^2 + (0.25 \times \text{AWGN flatness and signal flatness})^2 + \text{variation due to finite test time}^2)$</p> <p>Signal-to-noise ratio uncertainty ±0.3 dB Fading profile power uncertainty ±0.5 dB for single Tx AWGN flatness and signal flatness ±2.0 dB Result variation due to finite test time ±0.4 dB</p>
8.5.1.2.1	± 1.1 dB	<p>Overall system uncertainty for fading conditions comprises four quantities:</p> <ol style="list-style-type: none"> 1. Signal-to-noise ratio uncertainty 2. Fading profile power uncertainty 3. Effect of AWGN flatness and signal flatness 4. Result variation due to finite test time <p>Items 1, 2, 3 and 4 are assumed to be uncorrelated so can be root sum squared: AWGN flatness and signal flatness has x 0.25 effect on the required SNR, so use sensitivity factor of x 0.25 for the uncertainty contribution. Test System uncertainty = $\text{SQRT}(\text{Signal-to-noise ratio uncertainty}^2 + \text{Fading profile power uncertainty}^2 + (0.25 \times \text{AWGN flatness and signal flatness})^2 + \text{variation due to finite test time}^2)$</p> <p>Signal-to-noise ratio uncertainty ±0.3 dB Fading profile power uncertainty ±0.7 dB for Tx Diversity AWGN flatness and signal flatness ±2.0 dB Result variation due to finite test time ±0.6 dB</p>
8.5.1.2.1_1	Same as 8.5.1.2.1	

8.5.1.2.2	± 1.0 dB	<p>Overall system uncertainty for fading conditions comprises four quantities:</p> <ol style="list-style-type: none"> 1. Signal-to-noise ratio uncertainty 2. Fading profile power uncertainty 3. Effect of AWGN flatness and signal flatness 4. Result variation due to finite test time <p>Items 1, 2, 3 and 4 are assumed to be uncorrelated so can be root sum squared: AWGN flatness and signal flatness has x 0.25 effect on the required SNR, so use sensitivity factor of x 0.25 for the uncertainty contribution. Test System uncertainty = SQRT (Signal-to-noise ratio uncertainty² + Fading profile power uncertainty² + (0.25 x AWGN flatness and signal flatness)² + variation due to finite test time²)</p> <p>Signal-to-noise ratio uncertainty ±0.3 dB Fading profile power uncertainty ±0.7 dB for MIMO AWGN flatness and signal flatness ±2.0 dB Result variation due to finite test time ±0.4 dB</p>
8.5.1.2.2_1	Same as 8.5.1.2.2	
8.5.1.2.3_C.1	[TBD]	[TBD]
8.5.2.1	± 0.9 dB	<p>Overall system uncertainty for fading conditions comprises four quantities:</p> <ol style="list-style-type: none"> 1. Signal-to-noise ratio uncertainty 2. Fading profile power uncertainty 3. Effect of AWGN flatness and signal flatness 4. Result variation due to finite test time <p>Items 1, 2, 3 and 4 are assumed to be uncorrelated so can be root sum squared: AWGN flatness and signal flatness has x 0.25 effect on the required SNR, so use sensitivity factor of x 0.25 for the uncertainty contribution. Test System uncertainty = SQRT (Signal-to-noise ratio uncertainty² + Fading profile power uncertainty² + (0.25 x AWGN flatness and signal flatness)² + variation due to finite test time²)</p> <p>Signal-to-noise ratio uncertainty ±0.3 dB Fading profile power uncertainty ±0.5 dB for single Tx AWGN flatness and signal flatness ±2.0 dB Result variation due to finite test time ±0.4 dB</p>
8.5.2.2.1	± 1.1 dB	<p>Overall system uncertainty for fading conditions comprises four quantities:</p> <ol style="list-style-type: none"> 1. Signal-to-noise ratio uncertainty 2. Fading profile power uncertainty 3. Effect of AWGN flatness and signal flatness 4. Result variation due to finite test time <p>Items 1, 2, 3 and 4 are assumed to be uncorrelated so can be root sum squared: AWGN flatness and signal flatness has x 0.25 effect on the required SNR, so use sensitivity factor of x 0.25 for the uncertainty contribution. Test System uncertainty = SQRT (Signal-to-noise ratio uncertainty² + Fading profile power uncertainty² + (0.25 x AWGN flatness and signal flatness)² + variation due to finite test time²)</p> <p>Signal-to-noise ratio uncertainty ±0.3 dB Fading profile power uncertainty ±0.7 dB for Tx Diversity AWGN flatness and signal flatness ±2.0 dB Result variation due to finite test time ±0.6 dB</p>

8.5.1.2.2_1	Same as 8.5.2.2.1	
8.5.2.2.2	± 1.0 dB	Overall system uncertainty for fading conditions comprises four quantities: 1. Signal-to-noise ratio uncertainty 2. Fading profile power uncertainty 3. Effect of AWGN flatness and signal flatness 4. Result variation due to finite test time Items 1, 2, 3 and 4 are assumed to be uncorrelated so can be root sum squared: AWGN flatness and signal flatness has x 0.25 effect on the required SNR, so use sensitivity factor of x 0.25 for the uncertainty contribution. Test System uncertainty = SQRT (Signal-to-noise ratio uncertainty ² + Fading profile power uncertainty ² + (0.25 x AWGN flatness and signal flatness) ² + variation due to finite test time ²) Signal-to-noise ratio uncertainty ±0.3 dB Fading profile power uncertainty ±0.7 dB for MIMO AWGN flatness and signal flatness ±2.0 dB Result variation due to finite test time ±0.4 dB
8.5.2.2.2_1	Same as 8.5.2.2.2	
8.7.1.1 FDD sustained data rate performance	Downlink absolute power uncertainty, averaged over BW_{Config} ±1.0 dB Downlink EVM ≤ 3%	3% EVM is equivalent to a Test system downlink SNR of 30.5dB. The noise from the Test system is then sufficiently below that required for the UE to demodulate the signal with the required % success rate. Under these conditions the UE throughput is limited by the Reference measurement channel and the UE capability, and not by the Test system EVM.
8.7.1.1_1	Same as 8.7.1.1	Same as 8.7.1.1
8.7.1.1_A.1	Same as 8.7.1.1 for each CC	Same as 8.7.1.1 Calculation applies for each CC
8.7.1.1_A.2	Same as 8.7.1.1A.1	Same as 8.7.1.1A.1
8.7.2.1 TDD sustained data rate performance	Same as 8.7.1.1	Same as 8.7.1.1
8.7.2.1_1	Same as 8.7.2.1	Same as 8.7.2.1
8.7.2.1_A.1	Same as 8.7.2.1 for each CC	Same as 8.7.2.1 Calculation applies for each CC
8.7.2.1_A.2	Same as 8.7.2.1A.1	Same as 8.7.2.1A.1
10.1	± 0.9 dB	Overall system uncertainty for fading conditions comprises three quantities: 1. Signal-to-noise ratio uncertainty 2. Fading profile power uncertainty 3. Effect of AWGN flatness and signal flatness Items 1, 2 and 3 are assumed to be uncorrelated so can be root sum squared: AWGN flatness and signal flatness has x 0.25 effect on the required SNR, so use sensitivity factor of x 0.25 for the uncertainty contribution. Test System uncertainty = SQRT (Signal-to-noise ratio uncertainty ² + Fading profile power uncertainty ² + (0.25 x AWGN flatness and signal flatness) ²) Signal-to-noise ratio uncertainty ±0.3 dB Fading profile power uncertainty ±0.7 dB for Tx Diversity AWGN flatness and signal flatness ±2.0 dB
10.2	± 0.9 dB	Same as 10.1
[Other tests FFS]		
In addition, the following Test System uncertainties and related constraints apply:		
AWGN Bandwidth		≥ 1.08MHz, 2.7MHz, 4.5MHz, 9MHz, 13.5MHz, 18MHz; $N_{RB} \times 180\text{kHz}$ according to BW_{Config}
AWGN absolute power uncertainty, averaged over BW_{Config}		±3 dB

AWGN flatness and signal flatness, max deviation for any Resource Block, relative to average over BW_{Config}	± 2 dB
AWGN peak to average ratio	≥ 10 dB @0.001%
Signal-to noise ratio uncertainty, averaged over downlink transmission Bandwidth	± 0.3 dB (includes uncertainty in precoding applied by the test system, where applicable)
Signal-to noise ratio variation for any resource block, relative to average over downlink transmission Bandwidth	± 0.5 dB
Fading profile power uncertainty	Test-specific
Fading profile delay uncertainty, relative to frame timing	± 5 ns (excludes absolute errors related to baseband timing)
CA performance requirements only: Relative frequency error between carriers	30Hz, measured over a 1ms period, and maximum carrier spacing 80MHz
Note 1:	Only the overall stimulus error is considered here. The effect of errors in the throughput measurements due to finite test duration is not considered.
Note 2:	The AWGN parameters apply to all test cases except 8.7.1 and 8.7.2. The fading parameters apply to test cases using fading
Note 3:	In CA test cases using multiple component carriers (CCs), the uncertainties and related constraints apply for each CC.

F.1.5 Measurement of Channel State Information reporting

Table F.1.5-1: Maximum Test System Uncertainty for Channel State Information reporting

Subclause	Maximum Test System Uncertainty ¹	Derivation of Test System Uncertainty
9.2.1.1 FDD CQI Reporting under AWGN conditions – PUCCH 1-0	± 0.3 dB	Signal-to-noise ratio uncertainty ±0.3 dB <i>AWGN flatness and signal flatness ±2.0 dB not expected to have any significant effect</i> <i>AWGN absolute power uncertainty ±3.0 dB not expected to have any significant effect</i>
9.2.1.2 TDD CQI Reporting under AWGN conditions – PUCCH 1-0	± 0.3 dB	Same as 9.2.1.1
9.2.1.3_C.1 FDD CQI Reporting under AWGN conditions – PUCCH 1-0 for eICIC (non-MBSFN ABS)	± 0.3 dB	Same as 9.2.1.1
9.2.1.4_C.1 TDD CQI Reporting under AWGN conditions – PUCCH 1-0 for eICIC (non-MBSFN ABS)	FFS	FFS
9.2.2.1 FDD CQI Reporting under AWGN conditions – PUCCH 1-1	± 0.3 dB	Signal-to-noise ratio uncertainty ±0.3 dB <i>AWGN flatness and signal flatness ±2.0 dB not expected to have any significant effect</i> <i>AWGN absolute power uncertainty ±3.0 dB not expected to have any significant effect</i>
9.2.2.2 TDD CQI Reporting under AWGN conditions – PUCCH 1-1	± 0.3 dB	Same as 9.2.1.1
9.2.3.1_D FDD CQI Reporting under AWGN conditions – PUCCH 1-1 for eDL-MIMO	± 0.3 dB	Same as 9.2.2.1
9.2.3.2_D TDD CQI Reporting under AWGN conditions – PUCCH 1-1 for eDL-MIMO	± 0.3 dB	Same as 9.2.2.1
9.3.1.1.1 FDD CQI Reporting under fading conditions – PUSCH 3-0	± 0.6 dB	Overall system uncertainty for fading conditions comprises two quantities: 1. Signal-to-noise ratio uncertainty ±0.3 dB 2. Fading profile power uncertainty ±0.5 dB Items 1 and 2 are assumed to be uncorrelated so can be root sum squared: Test System uncertainty = SQRT (Signal-to-noise ratio uncertainty ² + Fading profile power uncertainty ²) <i>AWGN flatness and signal flatness ±2.0 dB not expected to have any significant effect</i> <i>AWGN absolute power uncertainty ±3.0 dB not expected to have any significant effect</i>
9.3.1.1.2 TDD CQI Reporting under fading conditions – PUSCH 3-0	± 0.6 dB	Same as 9.3.1.1.1
9.3.1.2.1_D FDD CQI Reporting under fading conditions – PUSCH 3-1 for eDL-MIMO	± 0.6 dB	Same as 9.3.1.1.1
9.3.1.2.2_D TDD CQI Reporting under fading conditions – PUSCH 3-1 for eDL-MIMO	± 0.6 dB	Same as 9.3.1.1.1

9.3.2.1.1 FDD CQI Reporting under fading conditions – PUCCH 1-0	± 0.6 dB	<p>Overall system uncertainty for fading conditions comprises two quantities:</p> <ol style="list-style-type: none"> 1. Signal-to-noise ratio uncertainty ±0.3 dB 2. Fading profile power uncertainty ±0.5 dB <p>Items 1 and 2 are assumed to be uncorrelated so can be root sum squared:</p> <p>Test System uncertainty = SQRT (Signal-to-noise ratio uncertainty² + Fading profile power uncertainty²)</p> <p><i>AWGN flatness and signal flatness ±2.0 dB not expected to have any significant effect</i></p> <p><i>AWGN absolute power uncertainty ±3.0 dB not expected to have any significant effect</i></p>
9.3.2.1.1_1 FDD CQI Reporting under fading conditions – PUCCH 1-0	± 0.6 dB	Same as 9.3.2.1.1
9.3.2.1.2 TDD CQI Reporting under fading conditions – PUCCH 1-0	± 0.6 dB	Same as 9.3.2.1.1
9.3.2.1.2_1 TDD CQI Reporting under fading conditions – PUCCH 1-0	± 0.6 dB	Same as 9.3.2.1.1
9.3.2.2.1_D FDD CQI Reporting under fading conditions – PUCCH 1-1 for eDL-MIMO	± 0.6 dB	Same as 9.3.2.1.1
9.3.2.2.2_D TDD CQI Reporting under fading conditions – PUCCH 1-1 for eDL-MIMO	± 0.6 dB	Same as 9.3.2.1.1
9.3.3.1.1 FDD CQI Reporting under fading conditions and frequency-selective interference – PUSCH 3-0	± 1.2 dB	<p>Overall system uncertainty for fading conditions comprises two quantities:</p> <ol style="list-style-type: none"> 1. Ior/lot ratio uncertainty ±1.0 dB 2. Fading profile power uncertainty ±0.5 dB <p>Items 1 and 2 are assumed to be uncorrelated so can be root sum squared:</p> <p>Test System uncertainty = SQRT (Ior/lot ratio uncertainty² + Fading profile power uncertainty²)</p> <p><i>Ior absolute power uncertainty ±3.0 dB not expected to have any significant effect</i></p>
9.3.3.1.2 TDD CQI Reporting under fading conditions and frequency-selective interference – PUSCH 3-0	± 1.2 dB	Same as 9.3.3.1.1
9.3.4.1.1 FDD CQI Reporting under fading conditions – PUSCH 2-0	± 0.6 dB	<p>Overall system uncertainty for fading conditions comprises two quantities:</p> <ol style="list-style-type: none"> 1. Signal-to-noise ratio uncertainty ±0.3 dB 2. Fading profile power uncertainty ±0.5 dB <p>Items 1 and 2 are assumed to be uncorrelated so can be root sum squared:</p> <p>Test System uncertainty = SQRT (Signal-to-noise ratio uncertainty² + Fading profile power uncertainty²)</p> <p><i>AWGN flatness and signal flatness ±2.0 dB not expected to have any significant effect</i></p> <p><i>AWGN absolute power uncertainty ±3.0 dB not expected to have any significant effect</i></p>
9.3.4.1.2 TDD CQI Reporting under fading conditions – PUSCH 2-0	± 0.6 dB	Same as 9.3.4.1.1
9.3.4.2.1 FDD CQI Reporting under fading conditions – PUCCH 2-0	± 0.6 dB	Same as 9.3.4.1.1
9.3.4.2.2 TDD CQI Reporting under fading conditions – PUCCH 2-0	± 0.6 dB	Same as 9.3.4.1.1

9.4.1.1.1 FDD PMI Reporting – PUSCH 3-1 (Single PMI)	± 0.6 dB	<p>Overall system uncertainty for fading conditions comprises two quantities:</p> <ol style="list-style-type: none"> 1. Signal-to-noise ratio uncertainty ±0.3 dB 2. Fading profile power uncertainty ±0.5 dB <p>Items 1 and 2 are assumed to be uncorrelated so can be root sum squared:</p> <p>Test System uncertainty = SQRT (Signal-to-noise ratio uncertainty² + Fading profile power uncertainty²)</p> <p><i>AWGN flatness and signal flatness ±2.0 dB not expected to have any significant effect</i></p> <p><i>AWGN absolute power uncertainty ±3.0 dB not expected to have any significant effect</i></p>
9.4.1.1.2 TDD PMI Reporting – PUSCH 3-1 (Single PMI)	± 0.6 dB	Same as 9.4.1.1.1
9.4.1.2.1 FDD PMI Reporting – PUCCH 2-1 (Single PMI)	± 0.6 dB	<p>Overall system uncertainty for fading conditions comprises two quantities:</p> <ol style="list-style-type: none"> 1. Signal-to-noise ratio uncertainty ±0.3 dB 2. Fading profile power uncertainty ±0.5 dB <p>Items 1 and 2 are assumed to be uncorrelated so can be root sum squared:</p> <p>Test System uncertainty = SQRT (Signal-to-noise ratio uncertainty² + Fading profile power uncertainty²)</p> <p><i>AWGN flatness and signal flatness ±2.0 dB not expected to have any significant effect</i></p> <p><i>AWGN absolute power uncertainty ±3.0 dB not expected to have any significant effect</i></p>
9.4.1.2.2 TDD PMI Reporting – PUCCH 2-1 (Single PMI)	± 0.6 dB	Same as 9.4.1.2.1
9.4.1.3.1_D FDD Reporting of PMI – PUSCH 3-1 (Single PMI) for eDL-MIMO	± 0.6 dB	Same as 9.4.1.1.1
9.4.1.3.2_D TDD Reporting of PMI – PUSCH 3-1 (Single PMI) for eDL-MIMO	± 0.6 dB	Same as 9.4.1.1.1
9.4.2.1.1 FDD PMI Reporting – PUSCH 1-2 (Multiple PMI)	± 0.6 dB	<p>Overall system uncertainty for fading conditions comprises two quantities:</p> <ol style="list-style-type: none"> 1. Signal-to-noise ratio uncertainty ±0.3 dB 2. Fading profile power uncertainty ±0.5 dB <p>Items 1 and 2 are assumed to be uncorrelated so can be root sum squared:</p> <p>Test System uncertainty = SQRT (Signal-to-noise ratio uncertainty² + Fading profile power uncertainty²)</p> <p><i>AWGN flatness and signal flatness ±2.0 dB not expected to have any significant effect</i></p> <p><i>AWGN absolute power uncertainty ±3.0 dB not expected to have any significant effect</i></p>
9.4.2.1.1_1 FDD PMI Reporting – PUSCH 1-2 (Multiple PMI)	± 0.6 dB	Same as 9.4.2.1.1
9.4.2.1.2 TDD PMI Reporting – PUSCH 1-2 (Multiple PMI)	± 0.6 dB	Same as 9.4.2.1.1
9.4.2.1.2_1 TDD PMI Reporting – PUSCH 1-2 (Multiple PMI)	± 0.6 dB	Same as 9.4.2.1.1
9.4.2.2.1 FDD PMI Reporting – PUSCH 2-2 (Multiple PMI)	± 0.6 dB	Same as 9.4.2.1.1
9.4.2.2.2 TDD PMI Reporting – PUSCH 2-2 (Multiple PMI)	± 0.6 dB	Same as 9.4.2.1.1

9.4.2.3.1_D FDD PMI Reporting – PUSCH 1-2 (Multiple PMI) for eDL-MIMO	± 0.6 dB	Same as 9.4.2.1.1
9.4.2.3.2_D TDD PMI Reporting – PUSCH 1-2 (Multiple PMI) for eDL-MIMO	± 0.6 dB	Same as 9.4.2.1.1
9.5.1.1 FDD RI Reporting– PUCCH 1-1	± 0.6 dB	Overall system uncertainty for fading conditions comprises two quantities: 1. Signal-to-noise ratio uncertainty ±0.3 dB 2. Fading profile power uncertainty ±0.5 dB Items 1 and 2 are assumed to be uncorrelated so can be root sum squared: Test System uncertainty = SQRT (Signal-to-noise ratio uncertainty ² + Fading profile power uncertainty ²) <i>AWGN flatness and signal flatness ±2.0 dB not expected to have any significant effect</i> <i>AWGN absolute power uncertainty ±3.0 dB not expected to have any significant effect</i>
9.5.1.1_1 FDD RI Reporting– PUCCH 1-1 (Release 10)	± 0.6 dB	Same as 9.5.1.1
9.5.1.1_2 FDD RI Reporting– PUCCH 1-1 (Release 11)	± 0.6 dB	Same as 9.5.1.1
9.5.1.2 TDD RI Reporting– PUSCH 3-1	± 0.6 dB	Same as 9.5.1.1
9.5.1.2_1 TDD RI Reporting– PUSCH 3-1 (Release 10)	± 0.6 dB	Same as 9.5.1.1
9.5.1.2_2 TDD RI Reporting– PUSCH 3-1 (Release 11)	± 0.6 dB	Same as 9.5.1.1
9.5.2.1_D FDD RI Reporting – PUCCH 1-1 for eDL-MIMO	± 0.6 dB	Same as 9.5.1.1
9.5.2.2_D TDD RI Reporting – PUCCH 1-1 for eDL-MIMO	± 0.6 dB	Same as 9.5.1.1
In addition, the following Test System uncertainties and related constraints apply:		
AWGN Bandwidth		≥ 1.08MHz, 2.7MHz, 4.5MHz, 9MHz, 13.5MHz, 18MHz; N _{RB} x 180kHz according to BW _{Config}
AWGN absolute power uncertainty, averaged over BW _{Config}		±3 dB
AWGN flatness and signal flatness, max deviation for any Resource Block, relative to average over BW _{Config}		±2 dB
AWGN peak to average ratio		≥10 dB @0.001%
Signal-to noise ratio uncertainty, averaged over downlink transmission Bandwidth		±0.3 dB (includes uncertainty in precoding applied by the test system, where applicable)
Signal-to noise ratio variation for any resource block, relative to average over downlink transmission Bandwidth		±0.5 dB
Fading profile power uncertainty		Test-specific
Fading profile delay uncertainty, relative to frame timing		±5 ns (excludes absolute errors related to baseband timing)
Downlink channel matrix uncertainties:		
Tx phase error, as shown in Figure F.1.5-1		$\Theta_{Tx} = \begin{bmatrix} e^{j\theta_1} & 0 & \dots & 0 \\ 0 & e^{j\theta_2} & \ddots & 0 \\ \vdots & \ddots & \ddots & \vdots \\ 0 & 0 & \dots & e^{j\theta_{N_{Tx}}} \end{bmatrix}$ <p>θ_n is defined for each Tx antenna up to N_{Tx} $\theta_n \in (-\theta_{MAX}, \theta_{MAX})$ $\theta_{MAX} \leq 10^\circ$ θ_n is constant for the duration of the test</p>

<p>Rx phase error, as shown in Figure F.1.5-1</p>	$\Theta_{Rx} = \begin{bmatrix} e^{j\theta_1} & 0 & \dots & 0 \\ 0 & e^{j\theta_2} & \ddots & 0 \\ \vdots & \ddots & \ddots & \vdots \\ 0 & 0 & \dots & e^{j\theta_{N_{Rx}}} \end{bmatrix}$ <p>θ_n is defined for each Rx antenna up to N_{Rx} There is no constraint on the value of θ_n except that it is constant for the duration of the test</p>
---	---

- Note 1: Only the overall stimulus error is considered. The effect of errors in the throughput measurements due to finite test duration is not considered.
- Note 2: The AWGN parameters apply to all test cases except 9.3.3.1.1 and 9.3.3.1.2. The fading parameters apply to test cases using fading
- Note 3: Downlink channel matrix uncertainties apply to eDL-MIMO CSI test cases

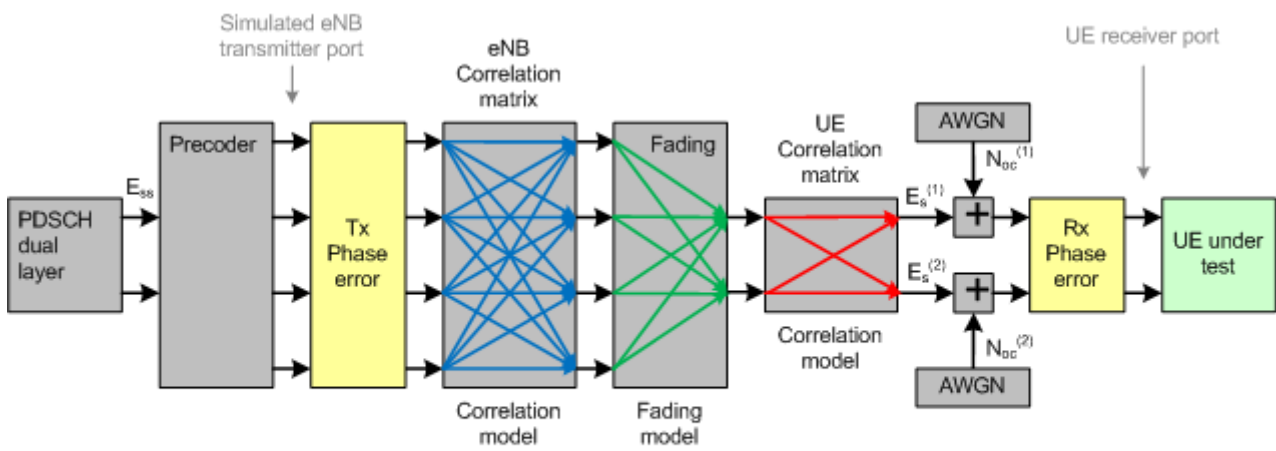

Example for dual layer PDSCH, 4Tx antennas x 2Rx antennas, fading propagation, with correlation and AWGN

Figure F.1.5-1: Location of Tx Phase error and Rx Phase error for eDL-MIMO (Informative)

F.2 Interpretation of measurement results (normative)

The measurement results returned by the Test System are compared – without any modification – against the Test Requirements as defined by the shared risk principle.

The Shared Risk principle is defined in ETR 273-1-2 clause 6.5.

The actual measurement uncertainty of the Test System for the measurement of each parameter shall be included in the test report.

The recorded value for the Test System uncertainty shall be, for each measurement, equal to or lower than the appropriate figure in clause F.1 of the present document.

If the Test System for a test is known to have a measurement uncertainty greater than that specified in clause F.1, it is still permitted to use this apparatus provided that an adjustment is made value as follows:

Any additional uncertainty in the Test System over and above that specified in clause F.1 shall be used to tighten the Test Requirement, making the test harder to pass. For some tests, for example receiver tests, this may require modification of stimulus signals. This procedure will ensure that a Test System not compliant with clause F.1 does not

increase the chance of passing a device under test where that device would otherwise have failed the test if a Test System compliant with clause F.1 had been used.

F.3 Test Tolerance and Derivation of Test Requirements (informative)

The Test Requirements in the present document have been calculated by relaxing the Minimum Requirements of the core specification using the Test Tolerances defined in this clause. When the Test Tolerance is zero, the Test Requirement will be the same as the Minimum Requirement. When the Test Tolerance is non-zero, the Test Requirements will differ from the Minimum Requirements, and the formula used for the relaxation is given in this clause.

The Test Tolerances are derived from Test System uncertainties, regulatory requirements and criticality to system performance. As a result, the Test Tolerances may sometimes be set to zero.

The test tolerances should not be modified for any reason e.g. to take account of commonly known test system errors (such as mismatch, cable loss, etc.).

The downlink Test Tolerances apply at each receiver antenna connector.

F.3.1 Measurement of test environments

The UE test environments are set to the values defined in TS 36.508 subclause 4.1, without any relaxation. The applied Test Tolerance is therefore zero.

F.3.2 Measurement of transmitter

Table F.3.2-1: Derivation of Test Requirements (Transmitter tests)

Test	Minimum Requirement in TS 36.101	Test Tolerance (TT)	Test Requirement in TS 36.521-1
6.2.2 UE Maximum Output Power	<p>$f \leq 3.0\text{GHz}$ Power class 1: [FFS] Power class 2: [FFS] Power class 3: 23dBm ± 2 dB Power class 4: [FFS]</p> <p>$3.0\text{GHz} < f \leq 4.2\text{GHz}$ Power class 3: 23dBm +2/-3 dB</p>	<p>0.7 dB 0.7 dB 0.7 dB 0.7 dB</p> <p>1.0 dB</p>	<p>Formula: Upper limit + TT, Lower limit - TT</p> <p>Power class 1: [FFS] Power class 2: [FFS] Power class 3: 23dBm ± 2.7 dB Power class 4: [FFS]</p> <p>Power class 3: 23dBm +3.0/-4.0 dB</p>
6.2.2_1 UE Maximum Output Power for HPUE	<p>$f \leq 3.0\text{GHz}$ Power class 1: 31dBm +2/-3dB</p>	0.7dB	<p>Formula: Upper limit + TT, Lower limit - TT</p> <p>Power class 1: 31dBm +2.7/-3.7dB</p>
6.2.2A.1 UE Maximum Output Power for CA (intra-band contiguous DL CA and UL CA)	Same as 6.2.2	Same as 6.2.2	Same as 6.2.2
6.2.2B UE Maximum Output Power for UL-MIMO	<p>$f \leq 3.0\text{GHz}$ Power class 1: [FFS] Power class 2: [FFS] Power class 3: 23dBm +2/-3 dB Power class 4: [FFS]</p> <p>$3.0\text{GHz} < f \leq 4.2\text{GHz}$ Power class 3: 23dBm +2/-4 dB</p>	Same as 6.2.2	<p>Formula: Upper limit +TT, Lower limit - TT</p> <p>Power class 1: [FFS] Power class 2: [FFS] Power class 3: 23dBm +2.7/-3.7 dB Power class 4: [FFS]</p> <p>Power class 3: 23dBm +3.0/-5.0 dB</p> <p>Uplink power measurement applies to overall UL power, which is the linear sum of the output powers over all Tx antenna connectors</p>
6.2.3 Maximum Power Reduction	<p>Power class 3</p> <p>$f \leq 3.0\text{GHz}$ QPSK: MPR ≤ 1dB 16QAM: MPR ≤ 1dB 16QAM: MPR ≤ 2dB</p> <p>$3.0\text{GHz} < f \leq 4.2\text{GHz}$ QPSK: MPR ≤ 1dB 16QAM: MPR ≤ 1dB 16QAM: MPR ≤ 2dB</p>	<p>0.7 dB 0.7 dB 0.7 dB</p> <p>1.0 dB 1.0 dB 1.0 dB</p>	<p>Formula: Upper limit + TT, Lower limit – MPR – TT Power class 3:</p> <p>QPSK: 23dBm +2.7 / - 3.7dB 16QAM: 23dBm +2.7 / - 3.7dB 16QAM: 23dBm +2.7 / - 4.7dB</p> <p>QPSK: 23dBm +3.0 / - 5.0dB 16QAM: 23dBm +3.0 / - 5.0dB 16QAM: 23dBm +3.0 / - 6.0dB</p>
6.2.3_1 Maximum Power Reduction for HPUE	<p>Power class 1</p> <p>$f \leq 3.0\text{GHz}$ QPSK: MPR ≤ 1dB 16QAM: MPR ≤ 1dB 16QAM: MPR ≤ 2dB</p>	<p>0.7 dB 0.7 dB 0.7 dB</p>	<p>Formula: Upper limit + TT, Lower limit – MPR – TT Power class 1:</p> <p>QPSK: 31dBm +2.7 / - 4.7dB 16QAM: 31dBm +2.7 / - 4.7dB 16QAM: 31dBm +2.7 / - 5.7dB</p>
6.2.3A.1 Maximum Power Reduction (MPR) for CA (intra-band contiguous DL CA and UL CA)	TBD	TBD	TBD
6.2.3B Maximum Power Reduction (MPR) for UL-MIMO	Same as 6.2.3	Same as 6.2.3	<p>Same as 6.2.3</p> <p>Uplink power measurement applies to</p>

			<p>overall UL power, which is the linear sum of the output powers over all Tx antenna connectors</p>
<p>6.2.4 UE Maximum Output Power with additional requirements</p>	<p>For the UE maximum output power modified by MPR and A-MPR, the power limits specified in TS 36.101 [2] clause 6.2.5 apply.</p> <p>For transmission bandwidths (Figure 5.4.2-1) confined within FUL_low and FUL_low + 4 MHz or FUL_high – 4 MHz and FUL_high, the power requirement is relaxed by reducing the lower tolerance limit by 1.5 dB.</p> <p>Power class 3:</p> <p>QPSK: $MPR \leq 1\text{dB}$</p> <p>16QAM: Depending on the number RB allocated: 16QAM: $MPR \leq 1\text{dB}$ 16QAM: $MPR \leq 2\text{dB}$</p> <p>For network signalled value NS_03 , NS_04 (5MHz only), NS_05, to NS_06: A-MPR $\leq 1\text{dB}$</p> <p>For network signalled value NS-04; Depending on the RB_start and RB allocation (10MHz, 15MHz and 20MHz):</p> <p>For 10MHz Region A with RB_start=0 – 12: A-MPR $\leq 3\text{dB}$.</p> <p>Region B with RB_start=13 – 36 : A-MPR $\leq 2\text{dB}$.</p> <p>Region C with RB_start=37 – 49 : A-MPR $\leq 3\text{dB}$.</p> <p>For 15MHz</p> <p>Region A with RB_start=0 – 18: A-MPR $\leq 3\text{dB}$.</p> <p>Region B with RB_start=19 – 55 : A-MPR $\leq 2\text{dB}$.</p> <p>Region C with RB_start=56 – 74 : A-MPR $\leq 3\text{dB}$.</p> <p>For 20MHz Region A with RB_start=0 – 24: A-MPR $\leq 3\text{dB}$.</p> <p>Region B with RB_start=25 – 74 : A-MPR $\leq 2\text{dB}$.</p>	<p>0.7 dB</p>	<p>Formula: Upper limit + TT, A: Lower limit – TT, B: (UE Maximum Output Power from 6.2.2) - T(P_{C_{MAX}}) – MPR – TT, C: (UE Maximum Output Power from 6.2.2) - T(P_{C_{MAX}}) – A-MPR – TT, D: (UE Maximum Output Power from 6.2.2) - T(P_{C_{MAX}}) – A-MPR – MPR – TT</p> <p>Power class 3:</p> <p>Test Requirement Configuration ID versus Formula Above</p> <p>Network signalled value NS_03:</p> <p>[A]:2, 5, 10, 15, 20, 25 [B]:1, 3, 7 [C]:9, 14, 19, 24 [D]:4, 6, 8, 11, 12, 13, 16, 17, 18, 21, 22, 23, 26, 27</p> <p>Network signalled value NS_04 (5, 10, 15, 20MHz):</p> <p>[A] 3 [B] 10, 11, 19, 20, 28, 29 [C] 2, 6, 7, 13, 14, 15, 16, 23, 24, 25, 32 [D] 1, 4, 5, 8, 9, 12, 17, 18, 21, 22, 26, 27, 30, 31</p> <p>Network signalled value NS_05:</p> <p>[A] 1, 3, 4, 8, 9, 14, 15, [B] 2, 5, 10, 11, 16, 17 [C] None [D] 6, 7, 12, 13, 18, 19</p> <p>Network signalled value NS_06:</p> <p>[A]:2, 5, 8, 11, 14, 17 [B]:1, 3, 4, 6, 7, 9, 10, 12, 13, 15, 16, 18 [C]:None [D]:None</p> <p>Network signalled value NS_07:</p> <p>[A]:3, 8, 12 [B]:7, 9 [C]:1, 2, 5, 13, 15 [D]:4, 6, 10, 11, 14, 16</p>

	<p>Region C with RB_start=75 – 99 : A-MPR \leq 3dB.</p> <p>For network signalled value NS-11; Depending on the RB_start and RB allocation (15MHz and 20MHz):</p> <p>For 15MHz $F_c < 2012.5$ Region A with RB_start=0 – 4: A-MPR \leq 15dB.</p> <p>Region B with RB_start=5 – 21: A-MPR \leq 7dB ($L_{CRB}=7-50$) or \leq 10dB ($L_{CRB}=0-6$ & ≥ 50).</p> <p>Region C with RB_start=22 – 56: A-MPR \leq 0dB ($L_{CRB}=\leq 25$) or \leq 6dB ($L_{CRB}>25$).</p> <p>Region D with RB_start=57 – 74: A-MPR \leq 15dB.</p> <p>For 15MHz $F_c = 2012.5$ Region A with RB_start=0 – 12: A-MPR \leq 10dB.</p> <p>Region B with RB_start=13 – 39: A-MPR \leq 6dB ($L_{CRB}=\geq 30$) or \leq 0dB ($L_{CRB}< 30$).</p> <p>Region C with RB_start=40 – 65: A-MPR \leq 2dB.</p> <p>Region D with RB_start=66 – 74: A-MPR \leq 6.5dB.</p> <p>For 20MHz Region A with RB_start=0 – 12: A-MPR \leq 15dB.</p> <p>Region B with RB_start=13 – 29: A-MPR \leq 7dB ($L_{CRB}=10-60$) or \leq 10dB ($L_{CRB}=1-9$ & > 60).</p> <p>Region C with RB_start=30 – 68: A-MPR \leq 0dB ($L_{CRB}=1-24$) or \leq 7dB ($L_{CRB}=\geq 25$).</p> <p>Region D with RB_start=69 – 99: A-MPR \leq 15dB.</p> <p>For network signalled value NS-20; Depending on the RB_start and RB allocation (5MHz, 10MHz, 15MHz and 20MHz):</p> <p>For 5MHz Region A with RB_start=≤ 24: A-MPR \leq 17dB.</p> <p>Region B with RB_start=0 – 3: A-MPR \leq 1dB ($L_{CRB}=15-19$) or \leq 4dB ($L_{CRB}=\geq 20$).</p> <p>Region C with RB_start=4 – 6:</p>		<p>Network signalled value NS_08:</p> <p>[A]:1, 2, 4, 5, 12 [B]:3, 6, 11, 13 [C]:None [D]:7, 8, 9, 10, 14, 15, 16, 17</p> <p>Network signalled value NS_11:</p> <p>[A]: 5c, 6b, 10c, 11c, 25 [B]:8b, 12c, 13c, 14c, 17a, 17b, 21a, 21b, 28 [C]:5a, 5b, 6a, 6c, 10a, 10b, 11, 11b, 15a, 15b, 16a, 16b, 24 [D]: 1a, 1b, 2a, 2b, 3a, 3b, 4a, 4b, 7a,7b,7c, 8a, 8c, 9a, 9b,9c, 12a, 12b, 13a, 13b, 14a, 14b, 18a, 18b, 19a, 19b, 20a, 20b, 22a, 22b, 23a, 23b, 26, 27, 29, 30</p> <p>Network signalled value NS_12:</p> <p>[A]: 3, 8, 13 [B]: None [C]: 1, 4, 6, 11 [D]: 2, 5, 7, 9, 10, 12, 14, 15</p> <p>Network signalled value NS_13:</p> <p>[A]: None [B]: 3, 4 [C]: 1 [D]: 2, 5</p> <p>Network signalled value NS_14:</p> <p>[A]: None [B]: 2, 4, 7, 9 [C]: 1, 6 [D]: 3, 5, 8, 10</p> <p>Network signalled value NS_15:</p> <p>[A]: 8 [B]: 27 [C]: 1, 2, 3, 4, 15, 19, 21, 26, 31 [D]: 5, 6, 7, 9, 10, 11, 12, 13, 14, 16, 17, 18, 20, 22, 23, 24, 25, 28, 29, 30, 32, 33, 34, 35</p> <p>Network signalled value NS_20:</p> <p>[A]: 1b, 1c, 1d, 6b, 7b [B]: 2d, 3d, 4d, 5d, 9b [C]: 1a, 6a, 7a, 11, 18, 19 [D]: 2a, 2b, 2c, 3a, 3b, 3c, 4a, 4b, 4c, 5a, 5b, 5c, 8a, 8b, 9a, 10a, 11b, 12, 13, 14, 15, 16, 17, 20, 21, 22, 23, 24, 25, 26</p>
--	---	--	--

	<p>A-MPR \leq 2dB.</p> <p>Region D with RB_start=\leq24: A-MPR \leq 0dB.</p> <p>For 10MHz Fc = 2005 Region A with RB_start=0 – 25: A-MPR \leq 16dB.</p> <p>Region B with RB_start=26 – 34: A-MPR \leq 2dB (L_{CRB}=8-15) or \leq 5dB (L_{CRB} > 15).</p> <p>Region C with RB_start=35 – 49: A-MPR \leq 6dB.</p> <p>For 10MHz Fc = 2015 Region A with RB_start=0 – 5: A-MPR \leq 4dB.</p> <p>Region B with RB_start=6 – 10: A-MPR \leq 2dB.</p> <p>For 15MHz Region A with RB_start=0 – 14: A-MPR \leq 11dB (L_{CRB}=1-9 & 40-5) or \leq 6dB (L_{CRB}= 10-39).</p> <p>Region B with RB_start=15 – 24: A-MPR \leq 1dB (L_{CRB}=24-29) or \leq 7dB ($L_{CRB}$$\geq$30).</p> <p>Region C with RB_start=25 – 39: A-MPR \leq 5dB.</p> <p>Region D with RB_start=61 – 74: A-MPR \leq 6dB.</p> <p>For 20MHz Region A with RB_start=0 – 21: A-MPR \leq 17dB.</p> <p>Region B with RB_start=22 – 31: A-MPR \leq 12dB (L_{CRB}=1-9 & 31-75) or \leq 6dB (L_{CRB}=10-30).</p> <p>Region C with RB_start=32 – 38: A-MPR \leq 9dB.</p> <p>Region D with RB_start=39 – 49: A-MPR \leq 7dB.</p> <p>Region E with RB_start=50 – 69: A-MPR \leq 5dB.</p> <p>Region F with RB_start=70 – 99: A-MPR \leq 16dB.</p>		
<p>6.2.4_1 Additional Maximum Power Reduction (A-MPR) for HPUE</p>	<p>For the UE maximum output power modified by MPR and A-MPR, the power limits specified in TS 36.101 [2] clause 6.2.5 apply.</p> <p>For transmission bandwidths (Figure 5.4.2-1) confined within FUL_low and FUL_low + 4 MHz or FUL_high – 4 MHz and</p>	<p>0.7dB</p>	<p>Formula: Upper limit + TT, (UE Maximum Output Power from 6.2.2) - T(P_CMAX) – A-MPR – MPR – TT</p>

	<p>FUL_high, the power requirement is relaxed by reducing the lower tolerance limit by 1.5 dB.</p> <p>Power class 1:</p> <p>QPSK: $\text{MPR} \leq 1\text{dB}$</p> <p>16QAM: Depending on the number RB allocated: 16QAM: $\text{MPR} \leq 1\text{dB}$ 16QAM: $\text{MPR} \leq 2\text{dB}$</p> <p>Power class 1: For network signalled value NS_06: A-MPR 0dB</p>		
6.2.4A.1 Additional Maximum Power Reduction (A-MPR) for CA (intra-band contiguous DL CA and UL CA)	<p>Power class 3:</p> <p>For network signalled value CA_NS_01: [TBC]</p> <p>For network signalled value CA_NS_02: [TBD]</p> <p>For network signalled value CA_NS_03: [TBD]</p>	Same as 6.2.4	TBD
6.2.4B Additional Maximum Power Reduction (A-MPR) for UL-MIMO	Same as 6.2.4	Same as 6.2.4	Same as 6.2.4 Uplink power measurement applies to overall UL power, which is the linear sum of the output powers over all Tx antenna connectors
6.2.5 Configured UE transmitted Output Power	<p>$f \leq 3.0\text{GHz}$ $13 \leq \text{PCMAX} < 18 \pm 5.0$ $8 \leq \text{PCMAX} < 13 \pm 6.0$ $-40 \leq \text{PCMAX} < 8 \pm 7.0$</p> <p>$3.0\text{GHz} < f \leq 4.2\text{GHz}$ $13 \leq \text{PCMAX} < 18 \pm 5.0$ $8 \leq \text{PCMAX} < 13 \pm 6.0$ $-40 \leq \text{PCMAX} < 8 \pm 7.0$</p>	<p>0.7 dB 0.7 dB 0.7 dB</p> <p>1.0 dB 1.0 dB 1.0 dB</p>	<p>Formula: Upper limit + TT, Lower limit – TT</p> <p>$13 \leq \text{PCMAX} < 18 \pm 5.7$ $8 \leq \text{PCMAX} < 13 \pm 6.7$ $-40 \leq \text{PCMAX} < 8 \pm 7.7$</p> <p>$13 \leq \text{PCMAX} < 18 \pm 6.0$ $8 \leq \text{PCMAX} < 13 \pm 7.0$ $-40 \leq \text{PCMAX} < 8 \pm 8.0$</p>
6.2.5_1 Configured UE transmitted Output Power for HPUE	<p>$f \leq 3.0\text{GHz}$ $23 \leq \text{PCMAX} < 33 \pm 2.0$ $13 \leq \text{PCMAX} < 18 \pm 5.0$ $8 \leq \text{PCMAX} < 13 \pm 6.0$ $-40 \leq \text{PCMAX} < 8 \pm 7.0$</p>	<p>0.7 dB 0.7 dB 0.7 dB 0.7 dB</p>	<p>Formula: Upper limit + TT, Lower limit – TT</p> <p>$23 \leq \text{PCMAX} < 33 \pm 2.7$ $13 \leq \text{PCMAX} < 18 \pm 5.7$ $8 \leq \text{PCMAX} < 13 \pm 6.7$ $-40 \leq \text{PCMAX} < 8 \pm 7.7$</p>
6.2.5A.1 Configured UE transmitted Output Power for CA (intra-band contiguous DL CA and UL CA)	<p>$f \leq 3.0\text{GHz}$ $13 \leq \text{PCMAX} < 18 \pm 5.0$ $8 \leq \text{PCMAX} < 13 \pm 6.0$ $-40 \leq \text{PCMAX} < 8 \pm 7.0$</p> <p>$3.0\text{GHz} < f \leq 4.2\text{GHz}$ $13 \leq \text{PCMAX} < 18 \pm 5.0$ $8 \leq \text{PCMAX} < 13 \pm 6.0$ $-40 \leq \text{PCMAX} < 8 \pm 7.0$</p>	<p>0.7 dB 0.7 dB 0.7 dB</p> <p>1.0 dB 1.0 dB 1.0 dB</p>	<p>Formula: Upper limit + TT, Lower limit – TT</p> <p>$13 \leq \text{PCMAX} < 18 \pm 5.7$ $8 \leq \text{PCMAX} < 13 \pm 6.7$ $-40 \leq \text{PCMAX} < 8 \pm 7.7$</p> <p>$13 \leq \text{PCMAX} < 18 \pm 6.0$ $8 \leq \text{PCMAX} < 13 \pm 7.0$ $-40 \leq \text{PCMAX} < 8 \pm 8.0$</p>
6.2.5A.2 Configured UE transmitted Output Power for CA (inter-band DL CA without UL CA)	TBD	TBD	TBD

6.2.5B Configured UE transmitted output power for UL-MIMO	$f \leq 3.0\text{GHz}$ $[16] \leq \text{PCMAX} < [20] \pm [5.0]$ $[11] \leq \text{PCMAX} < [16] \pm [6.0]$ $[-40] \leq \text{PCMAX} < [11] \pm [7.0]$ $3.0\text{GHz} < f \leq 4.2\text{GHz}$ $[16] \leq \text{PCMAX} < [20] \pm [5.0]$ $[11] \leq \text{PCMAX} < [16] \pm [6.0]$ $[-40] \leq \text{PCMAX} < [11] \pm [7.0]$	Same as 6.2.5	Formula: Upper limit + TT, Lower limit – TT $[16] \leq \text{PCMAX} < [20] \pm [5.7]$ $[11] \leq \text{PCMAX} < [16] \pm [6.7]$ $[-40] \leq \text{PCMAX} < [11] \pm [7.7]$ $[16] \leq \text{PCMAX} < [20] \pm [6.0]$ $[11] \leq \text{PCMAX} < [16] \pm [7.0]$ $[-40] \leq \text{PCMAX} < [11] \pm [8.0]$ Uplink power measurement applies to overall UL power, which is the linear sum of the output powers over all Tx antenna connectors
6.3.2 Minimum Output Power	$f \leq 3.0\text{GHz}$ -40 dBm $3.0\text{GHz} < f \leq 4.2\text{GHz}$ -40 dBm	1.0 dB	Formula: Minimum Requirement + TT UE min. output power = -39 dBm
6.3.2A.1 Minimum Output Power for CA (intra-band contiguous DL CA and UL CA)	Same as 6.3.2	Same as 6.3.2	UE min. output power = -38.7 dBm [Same as 6.3.2]
6.3.2B Minimum Output Power for UL-MIMO	Same as 6.3.2	Same as 6.3.2	Same as 6.3.2 Uplink power measurement applies to overall UL power, which is the linear sum of the output powers over all Tx antenna connectors
6.3.3 Transmission ON/OFF Power	$f \leq 3.0\text{GHz}$ $\leq -50 \text{ dBm}$ $3.0\text{GHz} < f \leq 4.2\text{GHz}$ $\leq -50 \text{ dBm}$	1.5 dB	Formula: Minimum Requirement + TT UE OFF Power $\leq -48.5 \text{ dBm}$
6.3.3A.1 UE Transmit OFF power for CA (intra-band contiguous DL CA and UL CA)	Same as 6.3.3	Same as 6.3.3	UE OFF Power $\leq -48.2 \text{ dBm}$ Same as 6.3.3
6.3.3B UE Transmit OFF power for UL-MIMO	Same as 6.3.3	Same as 6.3.3	Same as 6.3.3 Uplink power measurement applies to each Tx antenna connector
6.3.4.1 General ON/OFF time mask	$f \leq 3.0\text{GHz}$ OFF Power $\leq -50 \text{ dBm}$ ON Power BW dependent $3.0\text{GHz} < f \leq 4.2\text{GHz}$ OFF Power $\leq -50 \text{ dBm}$ ON Power BW dependent Transmission ON Power value depends on the test parameters. In the particular test case parameters the ON power measurement has minimum requirements of $\pm 6.0 \text{ dB}$	1.5 dB 1.5 dB 1.8 dB 1.8 dB	Formulae: OFF Power Minimum Req't + TT ON Power Upper limit + TT, Lower limit – TT UE OFF Power $\leq -48.5 \text{ dBm}$ UE ON Power: Test value $\pm 7.5 \text{ dB}$ UE OFF Power $\leq -48.2 \text{ dBm}$ UE ON Power: Test value $\pm 7.8 \text{ dB}$
6.3.4A.1.1 General ON/OFF time mask for CA (intra-band contiguous DL CA and UL CA)	TBD	Same as 6.3.4.1	TBD

6.3.4B.1 General ON/OFF time mask for UL-MIMO	Same as 6.3.4.1	Same as 6.3.4.1	Same as 6.3.4.1 Uplink OFF power measurement applies to each Tx antenna connector Uplink ON power measurement applies to [FFS]
6.3.4.2 PRACH and SRS time mask	$f \leq 3.0\text{GHz}$ OFF Power ≤ -50 dBm ON Power BW dependent $3.0\text{GHz} < f \leq 4.2\text{GHz}$ OFF Power ≤ -50 dBm ON Power BW dependent Transmission ON Power value depends on the test parameters. In the particular test case parameters the ON power measurement has minimum requirements of ± 6.0 dB	1.5 dB 1.5 dB 1.8 dB 1.8 dB	Formulae: OFF Power Minimum Req't + TT ON Power Upper limit + TT, Lower limit - TT UE OFF Power ≤ -48.5 dBm UE ON Power: Test value ± 7.5 dB UE OFF Power ≤ -48.2 dBm UE ON Power: Test value ± 7.8 dB
6.3.5.1 Power Control Absolute power tolerance	$f \leq 3.0\text{GHz}$ Normal conditions ± 9.0 dB Extreme conditions ± 12.0 dB $3.0\text{GHz} < f \leq 4.2\text{GHz}$ Normal conditions ± 9.0 dB Extreme conditions ± 12.0 dB	1.0 dB 1.0 dB 1.4 dB 1.4 dB	Formula: Upper limit + TT, Lower limit - TT Normal conditions ± 10.0 dB Extreme conditions ± 13.0 dB Normal conditions ± 10.4 dB Extreme conditions ± 13.4 dB
6.3.5_1.1 Power Control Absolute power tolerance for HPUE	$f \leq 3.0\text{GHz}$ Normal conditions ± 9.0 dB Extreme conditions ± 12.0 dB	1.0 dB 1.0 dB	Formula: Upper limit + TT, Lower limit - TT Normal conditions ± 10.0 dB Extreme conditions ± 13.0 dB
6.3.5_1.2 Power Control Relative power tolerance for HPUE	Same as 6.3.5.2	Same as 6.3.5.2	Same as 6.3.5.2
6.3.5_1.3 Aggregate power control tolerance for HPUE	Same as 6.3.5.3	Same as 6.3.5.3	Same as 6.3.5.3
6.3.5A.1.1 Power Control Absolute power tolerance for CA (intra-band contiguous DL CA and UL CA)	TBD	Same as 6.3.5.1	TBD
6.3.5B.1 Power Control Absolute Power Tolerance for UL- MIMO	Same as 6.3.5.1	Same as 6.3.5.1	Same as 6.3.5.1 Uplink power measurement applies to overall UL power, which is the linear sum of the output powers over all Tx antenna connectors
6.3.5.2 Power Control Relative power tolerance	TS 36.101 [2] clause 6.3.5.1 All combinations of PUSCH and PUCCH transitions: $\Delta P < 2$; ± 2.5 dB $2 \leq \Delta P < 3$; ± 3.0 dB $3 \leq \Delta P < 4$; ± 3.5 dB $4 \leq \Delta P \leq 10$; ± 4.0 dB $10 \leq \Delta P < 15$; ± 5.0 dB $15 \leq \Delta P$; ± 6.0 dB	0.7 dB	Formula: Upper limit + TT, Lower limit - TT All combinations of PUSCH and PUCCH transitions: $\Delta P < 2$; ± 3.2 dB $2 \leq \Delta P < 3$; ± 3.7 dB $3 \leq \Delta P < 4$; ± 4.2 dB $4 \leq \Delta P < 10$; ± 4.7 dB $10 \leq \Delta P < 15$; ± 5.7 dB $15 \leq \Delta P$; ± 6.7 dB
6.3.5.3 Aggregate power control tolerance	Aggregate power control tolerance within 21 ms:	0.7 dB	Formula: Upper limit + TT, Lower limit - TT

	PUCCH = ± 2.5 dB PUSCH = ± 3.5 dB		PUCCH = ± 3.2 dB PUSCH = ± 4.2 dB
6.3.5A.2.1 Power Control Relative power tolerance for CA (intra-band contiguous DL CA and UL CA)	TBD	Same as 6.3.5.2	TBD
6.3.5B.2 Power Control Relative power tolerance for UL-MIMO	Same as 6.3.5.2	Same as 6.3.5.2	Same as 6.3.5.2 Uplink power measurement applies to overall UL power, which is the linear sum of the output powers over all Tx antenna connectors
6.3.5A.3.1 Aggregate power control tolerance for CA (intra-band contiguous DL CA and UL CA)	Same as 6.3.5.3	Same as 6.3.5.3	Same as 6.3.5.3
6.3.5B.3 Aggregate power control tolerance for UL-MIMO	Same as 6.3.5.3	Same as 6.3.5.3	Same as 6.3.5.3 Uplink power measurement applies to overall UL power, which is the linear sum of the output powers over all Tx antenna connectors
6.5.1 Frequency Error	Modulated carrier, $f \leq 4.2$ GHz Within ± 0.1 ppm compared to the received carrier frequency $f \leq 3.0$ GHz DL power: Refsens 3.0 GHz $< f \leq 4.2$ GHz DL power: Refsens	15 Hz 0.7 dB 1.0 dB	Formulae: Modulated carrier frequency: Upper limit + TT, Lower limit – TT DL power: Refsens + TT Modulated carrier frequency error = $\pm(0.1 \text{ ppm} + 15 \text{ Hz})$ Refsens +0.7dB Refsens +1.0dB
6.5.1A.1 Frequency error for CA (intra-band contiguous DL CA and UL CA)	TBD	TBD	TBD
6.5.1B Frequency Error for UL-MIMO	Same as 6.5.1	Same as 6.5.1	Same as 6.5.1
6.5.2.1 Error Vector Magnitude	EVM limit: BPSK :17.5 % QPSK: 17.5 % 16QAM: 12.5 %	0%	Formula: Minimum Requirement + TT
6.5.2.1A PUSCH-EVM with exclusion period	EVM limit: QPSK: 17.5 % 16QAM: 12.5 %	0%	Formula: Minimum Requirement + TT
6.5.2A.1.1 Error Vector Magnitude (EVM) for CA (intra-band contiguous DL CA and UL CA)	Same as 6.5.2.1	Same as 6.5.2.1	Same as 6.5.2.1
6.5.2B.1 Error Vector Magnitude (EVM) for UL-MIMO	Same as 6.5.2.1	Same as 6.5.2.1	Same as 6.5.2.1 Uplink power measurement window applies to overall UL power, which is the linear sum of the output powers over all Tx antenna connectors
6.5.2.2 Carrier leakage	For Output power > 0 dBm -25dBc For -30 dBm \leq Output power ≤ 0 dBm -20dBc For -40 dBm \leq Output power $<$	0.8dB	Formula: Minimum Requirement + TT

	-30 dBm -10dBc		
6.5.2.3 In-band emissions for non allocated RB	<p>For general emissions: $\max \left\{ -25 - 10 \cdot \log_{10} (N_{RB} / L_{CRF}) \right.$ $20 \cdot \log_{10} EVM - 3 - 5 \cdot (\Delta_{RB} - 1)$ $\left. - 57 \text{ dBm} / 180 \text{ kHz} - P_{RB} \right\}$</p> <p>For IQ image: -25dB</p> <p>For Carrier leakage: Output power >0 dBm -25dBc</p> <p>-30 dBm ≤ Output power ≤ 0 dBm -20dBc</p> <p>-40 dBm ≤ Output power < -30 dBm -10dBc</p> <p>For each evaluated RB, the test requirement is calculated as the higher of $P_{RB} - 30$ dB and the power sum of all limit values (General, IQ Image or Carrier leakage)</p>	0.8dB	Formula: Minimum Requirement + TT
6.5.2.4 EVM equalizer Spectrum flatness	<p>Normal conditions.</p> <p>If (F-FUL_low ≥ [3MHz]) & (FUL_high-F ≥ [3MHz]) 4 dB else 8 dB</p> <p>maximum coefficient in Range 1 - the minimum coefficient in Range 2 5 dB the maximum coefficient in Range 2 - the minimum coefficient in Range 7 dB</p> <p>Extreme conditions:</p> <p>If (F-FUL_low ≥ [5MHz]) & (FUL_high-F ≥ [5MHz]) 4 dB else 12 dB</p> <p>maximum coefficient in Range 1 - the minimum coefficient in Range 2 6 dB the maximum coefficient in Range 2 - the minimum coefficient in Range 10 dB</p>	1.4dB	Formula: Minimum Requirement + TT
6.5.2A.2.1 Carrier leakage for CA (intra-band contiguous DL CA and UL CA)	TBD	TBD	TBD
6.5.2A.3.1 In-band emissions for non allocated RB for CA (intra-band contiguous DL CA and UL CA)	TBD	TBD	TBD

6.5.2B.1 Error vector magnitude (EVM) for UL-MIMO	TBD	TBD	TBD
6.5.2B.2 Carrier leakage for UL-MIMO	Same as 6.5.2.2	Same as 6.5.2.2	Same as 6.5.2.2 Uplink power measurement window applies to overall UL power, which is the linear sum of the output powers over all Tx antenna connectors
6.5.2B.3 In-band emissions for non allocated RB for UL-MIMO	Same as 6.5.2.3	Same as 6.5.2.3	Same as 6.5.2.3 Uplink power measurement window applies to overall UL power, which is the linear sum of the output powers over all Tx antenna connectors
6.5.2B.4 EVM equalizer spectrum flatness for UL-MIMO	Same as 6.5.2.4	Same as 6.5.2.4	Same as 6.5.2.4
6.6.1 Occupied bandwidth	For 1.4 MHz channel bandwidth: Occupied channel bandwidth = 1.4 MHz For 3.0 MHz channel bandwidth: Occupied channel bandwidth = 3.0 MHz For 5 MHz channel bandwidth: Occupied channel bandwidth = 5 MHz For 10 MHz channel bandwidth: Occupied channel bandwidth = 10 MHz For 15 MHz channel bandwidth: Occupied channel bandwidth = 15 MHz For 20 MHz channel bandwidth: Occupied channel bandwidth = 20 MHz	0kHz	Formula: Minimum Requirement + TT
6.6.1A.1 Occupied bandwidth for CA (intra-band contiguous DL CA and UL CA)	TBD	Same as 6.6.1	Same as 6.6.1
6.6.1B Occupied bandwidth for UL-MIMO	Same as 6.6.1	Same as 6.6.1	Same as 6.6.1
6.6.2.1 Spectrum Emission Mask	For 1.4 MHz BW: -10 dBm / 30kHz -25dBm to -10dBm / 1MHz For 3 MHz BW: -13 dBm / 30kHz -25dBm to -10dBm / 1MHz For 5 MHz BW: -15dBm / 30kHz -25dBm to -10dBm / 1MHz For 10 MHz BW: -18dBm / 30kHz -25dBm to -10dBm / 1MHz For 15 MHz BW: -20dBm / 30kHz -25dBm to -10dBm / 1MHz For 20 MHz BW: -21dBm / 30kHz -25dBm to -10dBm / 1MHz	All cases: $f \leq 3.0\text{GHz}$ 1.5dB $3.0\text{GHz} < f \leq 4.2\text{GHz}$ 1.8dB	Formula: Minimum Requirement + TT Note: The Test Tolerance would be 0dB for $\Delta f_{\text{OOB}} \geq 2 \times \text{Channel Bandwidth}$, but taking into account the filter position, the Test requirements specified all have $\Delta f_{\text{OOB}} < 2 \times \text{Channel Bandwidth}$
6.6.2.1A.1 Spectrum emission mask for CA (intra-band contiguous DL	For 29.9 MHz BW: -22.5 dBm / 30kHz -25dBm to -10dBm / 1MHz	Same as 6.6.2.1	Same as 6.6.2.1

CA and UL CA)	For 30 MHz BW: -22.5 dBm / 30kHz -25dBm to -10dBm / 1MHz For 34.85 MHz BW: -23.5dBm / 30kHz -25dBm to -10dBm / 1MHz For 39.8 MHz BW: -24dBm / 30kHz -25dBm to -10dBm / 1MHz		
6.6.2.1B Spectrum Emission Mask for UL-MIMO	Same as 6.6.2.1	Same as 6.6.2.1	Same as 6.6.2.1
6.6.2.2 Additional Spectrum Emission Mask	For 1.4 MHz BW: NS_03, NS_04 -10 dBm / 30 kHz -25 dBm to -13 dBm / 1MHz NS_06 or NS_07 -13 dBm / 30 kHz -13 dBm / 100 kHz -25 dBm to -13 dBm / 1MHz For 3 MHz BW: NS_03, NS_04 -13 dBm / 30 kHz -25 dBm to -13 dBm / 1 MHz NS_06 or NS_07 -13 dBm / 30 kHz -13 dBm / 100kHz -25 dBm to -13 dBm / 1 MHz For 5 MHz BW: NS_03, NS_04 -15 dBm / 30 kHz -25 dBm to -13 dBm / 1 MHz NS_06 or NS_07 -15 dBm / 30 kHz -13 dBm / 100 kHz -25 dBm to -13 dBm / 1 MHz For 10 MHz BW: NS_03, NS_04, -18 dBm / 30 kHz -25 dBm to -13dBm / 1 MHz NS_06 or NS_07 -18 dBm / 30 kHz -13 dBm / 100 kHz -25 dBm to -13dBm / 1 MHz For 15 MHz BW: NS_03, NS_04 -20 dBm / 30kHz -25 dBm to -13 dBm / 1 MHz For 20 MHz BW: NS_03, NS_04 -21 dBm / 30 kHz -25 dBm to -13 dBm / 1 MHz	All cases: <u>$f \leq 3.0\text{GHz}$</u> 1.5dB <u>$3.0\text{GHz} < f \leq 4.2\text{GHz}$</u> 1.8dB	Formula: Minimum Requirement + TT Note: The Test Tolerance would be 0dB for $\Delta f_{\text{OoB}} \geq 2 \times \text{Channel Bandwidth}$, but taking into account the filter position, the Test requirements specified all have $\Delta f_{\text{OoB}} < 2 \times \text{Channel Bandwidth}$
6.6.2.2B Additional Spectrum Emission Mask for UL-MIMO	Same as 6.6.2.2	Same as 6.6.2.2	Same as 6.6.2.2
6.6.2.3 Adjacent Channel Leakage power Ratio	If the adjacent channel power is greater than -50 dBm then the ACLR shall be higher than the values specified below.	0 dB	Formula: ACLR Minimum Requirement + TT Formula:

	E-UTRA ACLR: 30 dB	0.8 dB	ACLR Minimum Requirement - TT E-UTRA ACLR: 29.2 dB
	UTRA ACLR: 33 dB for UTRA ACLR 1 36 dB for UTRA ACLR 2	0.8 dB 0.8 dB	UTRA ACLR: 32.2 dB for UTRA ACLR 1 35.2 dB for UTRA ACLR 2
6.6.2.3_1 Adjacent Channel Leakage power Ratio for HPUE	If the adjacent channel power is greater than -50 dBm then the ACLR shall be higher than the values specified below. E-UTRA ACLR: 37 dB	0dB 0.8dB	Formula: ACLR Minimum Requirement + TT Formula: ACLR Minimum Requirement - TT E-UTRA ACLR: 36.2 dB
6.6.2.3A.1 Adjacent Channel Leakage power Ratio for CA	If the adjacent channel power is greater than -50 dBm then the ACLR shall be higher than the values specified below. UTRA ACLR: 33 dB for UTRA ACLR 1 36 dB for UTRA ACLR 2 E-UTRA ACLR: 30 dB	0 dB 0.8 dB 0.8 dB 0.8 dB	Formula: ACLR Minimum Requirement + TT Formula: ACLR Minimum Requirement - TT UTRA ACLR: 32.2 dB for UTRA ACLR 1 35.2 dB for UTRA ACLR 2 E-UTRA ACLR: 29.2 dB
6.6.2.3B Adjacent Channel Leakage power Ratio for UL-MIMO	Same as 6.6.2.3	Same as 6.6.2.3	Same as 6.6.2.3
6.6.2.4 Additional ACLR requirements	If the adjacent channel power is greater than -50 dBm then the ACLR shall be higher than the values specified below. E-UTRA ACLR: 43 dB for UTRA ACLR 2	0 dB 0.8 dB	Formula: ACLR Minimum Requirement + TT Formula: ACLR Minimum Requirement - TT E-UTRA ACLR: 42.2 dB for UTRA ACLR 2
6.6.3.1 Transmitter Spurious emissions	9 kHz $\leq f < 150$ kHz: -36dBm / 1kHz 150 kHz $\leq f < 30$ MHz: -36dBm / 10kHz 30 MHz $\leq f < 1$ GHz: -36dBm / 100kHz 1 GHz $\leq f < 12.75$ GHz: -30dBm / 1MHz 12.75 GHz $\leq f < 19$ GHz: -30dBm / 1MHz	0 dB	Formula: Minimum Requirement + TT
6.6.3.1A.1 Transmitter Spurious emissions for CA (intra-band contiguous DL CA and UL CA)	TBD	Same as 6.6.3.1	TBD
6.6.3B.1 Transmitter Spurious emissions for UL-MIMO	Same as 6.6.3.1	Same as 6.6.3.1	Formula: Minimum Requirement + TT
6.6.3.2 Spurious emission band UE co-existence	-35 dBm / 6.25kHz -36 dBm / 100kHz -41 dBm / 300kHz -37 dBm / 1MHz -40 dBm / 1MHz -50 dBm / 1MHz Frequencies as detailed in core	0 dB	Formula: Minimum Requirement + TT

	requirement		
6.6.3.2A.1 Spurious emission band UE co-existence for CA (intra-band contiguous DL CA and UL CA)	TBD	TBD	TBD
6.6.3.3 Additional spurious emissions	NS_05 $1884.5\text{MHz} \leq f \leq 1915.7\text{MHz}$: -41dBm / 300kHz NS_07 $769\text{MHz} \leq f \leq 775\text{MHz}$ -57dBm / 6.25kHz NS_08 $860\text{MHz} \leq f \leq 895\text{MHz}$ -40dBm / 1MHz NS_09 $1475.9\text{MHz} \leq f \leq 1510.9\text{MHz}$ -35dBm / 1MHz	0 dB 1.5dB 0 dB 0 dB	Formula: Minimum Requirement + TT -41dBm / 300kHz -55.5 dBm / 6.25kHz -40dBm / 1MHz -35dBm / 1MHz
6.6.3.3A.1 Additional spurious emissions for CA (intra-band contiguous DL CA and UL CA)	CA_NS_01 E-UTRA band 34: -50dBm / 1MHz $1884.5\text{MHz} \leq f \leq 1915.7\text{MHz}$: -41dBm / 300kHz CA_NS_02 E-UTRA band 33: -50dBm / 1MHz E-UTRA band 34: -50dBm / 1MHz CA_NS_03 E-UTRA band 34: -50dBm / 1MHz E-UTRA band 39: -50dBm / 1MHz	0 dB 0 dB 0 dB 0 dB 0 dB 0 dB	Formula: Minimum Requirement + TT -50 MHz / 1MHz -41 dBm / 300kHz -50 MHz / 1MHz -50 MHz / 1MHz -50 MHz / 1MHz
6.6.3B.2 Spurious emission band UE co-existence for UL-MIMO	Same as 6.6.3.2	Same as 6.6.3.2	Formula: Minimum Requirement + TT
6.6.3B.3 Additional spurious emissions for UL-MIMO	Same as 6.6.3.3	Same as 6.6.3.3	Formula: Minimum Requirement + TT
6.7 Transmit intermodulation	Intermodulation Product 5MHz -29 dBc 10MHz -35 dBc CW Interferer level = -40 dBc	0 dB	Formula: CW interferer Minimum Requirement– TT Intermod Products limits remain unchanged. CW interferer level = -40 dBc
6.7A.1 Transmit intermodulation	TBD	TBD	TBD
6.7B Transmit intermodulation for UL-MIMO	Same as 6.7	Same as 6.7	Same as 6.7
6.8B Time alignment error for UL-MIMO	The Time Alignment Error (TAE) shall not exceed 130 ns	25 ns	Formula: Minimum Requirement+ TT

F.3.3 Measurement of receiver

Table F.3.3-1: Derivation of Test Requirements (Receiver tests)

Test	Minimum Requirement in TS 36.101	Test Tolerance (TT)	Test Requirement in TS 36.521-1
7.3 Reference sensitivity power level	<p>Reference sensitivity power level:</p> <p>For 1.4MHz -102.2dBm -103.2dBm -105.2dBm -106.2dBm</p> <p>For 3MHz -99.2dBm -100.2dBm -102.2dBm</p> <p>For 5MHz -97dBm -98dBm -98.5dBm -99dBm -100dBm -96.5dBm Band 9 with Multi band</p> <p>For 10MHz -94dBm -95dBm -95.5dBm -96dBm -97dBm -93.5dBm Band 9 with Multi band</p> <p>For 15MHz -92.2dBm -93.2dBm -93.7dBm -94.2dBm -95.2dBm -91.7dBm Band 9 with Multi band</p> <p>For 20MHz -91dBm -92dBm -93dBm -94dBm -90.5dBm Band 9 with Multi band</p> <p>T-put limit = 95% of maximum for the Ref Meas channel</p>	<p>All cases:</p> <p>$f \leq 3.0\text{GHz}$ 0.7dB</p> <p>$3.0\text{GHz} < f \leq 4.2\text{GHz}$ 1.0 dB</p>	<p>Formula: Reference sensitivity power level + TT</p> <p>T-put limit unchanged</p>
7.3A.1 Reference sensitivity level for CA (intra-band contiguous DL CA and UL CA)	TBD	Same as 7.3	TBD
7.3A.2 Reference sensitivity level for CA (intra-band contiguous DL CA without UL CA)	TBD	Same as 7.3A.1	TBD

7.3A.3 Reference sensitivity level for CA (inter-band DL CA without UL CA)	TBD	Same as 7.3A.1	TBD
7.3B Reference Sensitivity Level for UL-MIMO	Same as 7.3	Same as 7.3	Same as 7.3
7.4 Maximum input level	<p>Signal level -25dBm</p> <p>T-put limit = 95% of maximum for the Ref Meas channel</p> <p>Uplink power</p>	<p>$f \leq 3.0\text{GHz}$ 0.7 dB</p> <p>$3.0\text{GHz} < f \leq 4.2\text{GHz}$ 1.0 dB</p> <p>$f \leq 3.0\text{GHz}$ 0dB, -3.4dB</p> <p>$3.0\text{GHz} < f \leq 4.2\text{GHz}$ 0dB, -4.0dB</p>	<p>Formula: Maximum input level - TT</p> <p>Signal level: $f \leq 3.0\text{GHz}$: -25.7 dBm $3.0\text{GHz} < f \leq 4.2\text{GHz}$: -26.0 dBm</p> <p>T-put limit unchanged</p> <p>Uplink power measurement window comprises four quantities:</p> <ol style="list-style-type: none"> 1. UE power step size 1dB 2. UE Power step tolerance $\pm 1\text{dB}$ 3. Test system power measurement at top of window: $f \leq 3.0\text{GHz} \pm 0.7\text{ dB}$ $3.0\text{GHz} < f \leq 4.2\text{GHz} \pm 1.0\text{ dB}$. 4. Test system power measurement at bottom of window: $f \leq 3.0\text{GHz} \pm 0.7\text{ dB}$ $3.0\text{GHz} < f \leq 4.2\text{GHz} \pm 1.0\text{ dB}$. <p>Items 1 to 4 are added arithmetically: Overall UL power window size: $f \leq 3.0\text{GHz}$: $(1\text{dB}+1\text{dB}+0.7\text{dB}+0.7\text{dB}) = 3.4\text{dB}$ $3.0\text{GHz} < f \leq 4.2\text{GHz}$: $(1\text{dB}+1\text{dB}+1\text{dB}+1\text{dB}) = 4\text{dB}$</p> <p>Top of window is aligned to UL power requirement, hence +0dB, -3.4dB or +0dB, -4.0dB according to frequency</p>
7.4A.1 Maximum input level for CA (intra band contiguous DL CA and UL CA)	<p>Signal level -22dBm</p> <p>T-put limit = 95% of maximum for the Ref Meas channel</p> <p>Uplink power</p>	<p>$f \leq 3.0\text{GHz}$ 0.7 dB</p> <p>$3.0\text{GHz} < f \leq 4.2\text{GHz}$ 1.0 dB</p> <p>Uplink power TBD</p>	<p>Formula: Maximum input level - TT</p> <p>Signal level: $f \leq 3.0\text{GHz}$: -22.7 dBm $3.0\text{GHz} < f \leq 4.2\text{GHz}$: -23.0 dBm</p> <p>T-put limit unchanged</p> <p>Uplink power TBD</p>
7.4A.2 Maximum input level for CA (intra band contiguous DL CA without UL CA)	<p>Signal level -22dBm</p> <p>T-put limit = 95% of maximum for the Ref Meas channel</p> <p>Uplink power</p>	<p>$f \leq 3.0\text{GHz}$ 0.7 dB</p> <p>$3.0\text{GHz} < f \leq 4.2\text{GHz}$ 1.0 dB</p> <p>$f \leq 3.0\text{GHz}$ 0dB, -3.4dB</p> <p>$3.0\text{GHz} < f \leq 4.2\text{GHz}$ 0dB, -4.0dB</p>	<p>Formula: Maximum input level - TT</p> <p>Signal level: $f \leq 3.0\text{GHz}$: -22.7 dBm $3.0\text{GHz} < f \leq 4.2\text{GHz}$: -23.0 dBm</p> <p>T-put limit unchanged</p> <p>Uplink power measurement window same as 7.4</p>
7.4A.3 Maximum input level for CA (inter-band DL CA without UL CA)	<p>Signal level -25dBm</p> <p>T-put limit = 95% of maximum for the Ref Meas channel</p> <p>Uplink power</p>	<p>$f \leq 3.0\text{GHz}$ 0.7 dB</p> <p>$3.0\text{GHz} < f \leq 4.2\text{GHz}$ 1.0 dB</p> <p>$f \leq 3.0\text{GHz}$ 0dB, -3.4dB</p> <p>$3.0\text{GHz} < f$</p>	<p>Formula: Maximum input level - TT</p> <p>Signal level: $f \leq 3.0\text{GHz}$: -25.7 dBm $3.0\text{GHz} < f \leq 4.2\text{GHz}$: -26.0 dBm</p> <p>T-put limit unchanged</p> <p>Uplink power measurement window same as 7.4</p>

		$\leq 4.2\text{GHz}$ 0dB, -4.0dB	
--	--	-------------------------------------	--

7.4B Maximum Input Level for UL-MIMO	Same as 7.4	Same as 7.4	Same as 7.4 Uplink power measurement window applies to overall UL power, which is the linear sum of the output powers over all Tx antenna connectors
7.5 Adjacent Channel Selectivity (ACS)	<p><u>Case 1:</u> Wanted signal power, all BWs: (REFSENS + 14 dB)</p> <p>Interferer signal power For 1.4 MHz, 3 MHz, 5 MHz, 10 MHz BW: (REFSENS + 45.5 dB) For 15 MHz BW: (REFSENS + 42.5 dB) For 20 MHz BW: (REFSENS + 39.5 dB)</p> <p><u>Case 2:</u> Wanted signal power For 1.4 MHz, 3 MHz, 5 MHz, 10 MHz BW: -56.5 dBm For 15 MHz BW: -53.5 dBm For 20 MHz BW: -50.5 dBm</p> <p>Interferer signal power, all BWs: -25 dBm</p> <p>T-put limit = 95% of maximum for the Ref Meas channel</p> <p>Uplink power</p>	<p>0 dB</p> <p>$f \leq 3.0\text{GHz}$ 0dB, -3.4dB</p> <p>$3.0\text{GHz} < f \leq 4.2\text{GHz}$ 0dB, -4.0dB</p>	<p>Formula: Wanted signal power + TT</p> <p>Interferer signal power unchanged</p> <p>T-put limit unchanged</p> <p>Uplink power measurement window same as 7.4</p>
7.5.1A.1 Adjacent Channel Selectivity (ACS) for CA (intra-band contiguous DL CA and UL CA)	<p><u>Case 1:</u> Wanted signal power: (REFSENS + 14 dB)</p> <p>Interferer signal power For CA BW Class C: (Aggregated power + 22.5 dB)</p> <p><u>Case 2:</u> Wanted signal power: -50.5 dBm</p> <p>Interferer signal power For CA BW Class C: -25 dBm</p> <p>T-put limit = 95% of maximum for the Ref Meas channel</p> <p>Uplink power</p>	<p>0 dB</p> <p>$f \leq 3.0\text{GHz}$ 0dB, -3.4dB</p> <p>$3.0\text{GHz} < f \leq 4.2\text{GHz}$ 0dB, -4.0dB</p>	<p>Formula: Wanted signal power + TT</p> <p>Interferer signal power unchanged</p> <p>T-put limit unchanged</p> <p>Uplink power measurement window same as 7.4</p>
7.5.1A.2 Adjacent Channel Selectivity (ACS) for CA (intra band contiguous DL CA without UL CA)	Same as 7.5A.1	Same as 7.5A.1	Same as 7.5A.1
7.5.1A.3 Adjacent Channel	Same as 7.5 for each CC	Same as	Same as 7.5 for each CC

Selectivity (ACS) for CA (inter band DL CA without UL CA)		7.5	
7.5B Adjacent Channel Selectivity (ACS) for UL-MIMO	Same as 7.5	Same as 7.5	Same as 7.5 Uplink power measurement window applies to overall UL power, which is the linear sum of the output powers over all Tx antenna connectors
7.6.1 In-band blocking	Wanted signal power: (REFSENS + BW dependent value) Interferer signal power: -56dBm or -44dBm T-put limit = 95% of maximum for the Ref Meas channel Uplink power	0 dB $f \leq 3.0\text{GHz}$ 0dB, -3.4dB $3.0\text{GHz} < f \leq 4.2\text{GHz}$ 0dB, -4.0dB	Formula: Wanted signal power + TT Interferer signal power unchanged T-put limit unchanged Uplink power measurement window same as 7.4
7.6.1A.1 In-band blocking for CA (intra band contiguous DL CA and UL CA)	Wanted signal power: (REFSENS + CA BW Class specific value) Interferer signal power: -56dBm or -44dBm T-put limit = 95% of maximum for the Ref Meas channel Uplink power	Same as 7.6.1	Formula: Wanted signal power + TT Interferer signal power unchanged T-put limit unchanged Uplink power measurement window same as 7.4A
7.6.1A.2 In-band blocking for CA (intra band contiguous DL CA without UL CA)	Same as 7.6.1A.1	Same as 7.6.1A.1	Same as 7.6.1A.1
7.6.1A.3 In-band blocking for CA (inter band DL CA without UL CA)	Same as 7.6.1A.1	Same as 7.6.1A.1	Same as 7.6.1A.1
7.6.1B In-band blocking for UL-MIMO	Same as 7.6.1	Same as 7.6.1	Same as 7.6.1 Uplink power measurement window applies to overall UL power, which is the linear sum of the output powers over all Tx antenna connectors
7.6.2 Out of-band blocking	Wanted signal power: (REFSENS + BW dependent value) Interferer signal power: -44dBm, -30dBm or -15dBm T-put limit = 95% of maximum for the Ref Meas channel Uplink power	0 dB $f \leq 3.0\text{GHz}$ 0dB, -3.4dB $3.0\text{GHz} < f \leq 4.2\text{GHz}$ 0dB, -4.0dB	Formula: Wanted signal power + TT Interferer signal power unchanged T-put limit unchanged Uplink power measurement window same as 7.4
7.6.2A.1 Out-of-band blocking for CA (intra band contiguous DL CA and UL CA)	Wanted signal power: (REFSENS + CA BW Class specific value) Interferer signal power: -44dBm, -30dBm or -15dBm T-put limit = 95% of maximum for	Same as 7.6.2	Formula: Wanted signal power + TT Interferer signal power unchanged T-put limit unchanged

	the Ref Meas channel Uplink power		Uplink power measurement window same as 7.4A
7.6.2A.2 Out-of-band blocking for CA (intra band contiguous DL CA without UL CA)	Same as 7.6.2A.1	Same as 7.6.2A.1	Same as 7.6.2A.1
7.6.2A.3 Out-of-band blocking for CA (inter band DL CA without UL CA)	TBD	TBD	TBD
7.6.2B Out-of-band blocking for UL-MIMO	Same as 7.6.2	Same as 7.6.2	Same as 7.6.2 Uplink power measurement window applies to overall UL power, which is the linear sum of the output powers over all Tx antenna connectors
7.6.3 Narrow band blocking	Wanted signal power, : (REFSENS + BW dependent value) Interferer signal power: -55dBm T-put limit = 95% of maximum for the Ref Meas channel Uplink power	0 dB $f \leq 3.0\text{GHz}$ 0dB, -3.4dB $3.0\text{GHz} < f \leq 4.2\text{GHz}$ 0dB, -4.0dB	Formula: Wanted signal power + TT Interferer signal power unchanged T-put limit unchanged Uplink power measurement window same as 7.4
7.6.3A.1 Narrow band blocking for CA (intra band contiguous DL CA and UL CA)	Wanted signal power: (REFSENS + CA BW Class specific value) Interferer signal power: -55dBm T-put limit = 95% of maximum for the Ref Meas channel Uplink power	Same as 7.6.3	Formula: Wanted signal power + TT Interferer signal power unchanged T-put limit unchanged Uplink power measurement window same as 7.4A
7.6.3A.2 Narrow band blocking for CA (intra band contiguous DL CA without UL CA)	Same as 7.6.3A.1	Same as 7.6.3A.1	Same as 7.6.3A.1
7.6.3A.3 Narrow band blocking for CA (inter band DL CA without UL CA)	Same as 7.6.3A.1	Same as 7.6.3A.1	Same as 7.6.3A.1
7.6.3B Narrow band blocking for UL-MIMO	Same as 7.6.3	Same as 7.6.3	Same as 7.6.3 Uplink power measurement window applies to overall UL power, which is the linear sum of the output powers over all Tx antenna connectors
7.7 Spurious response	Wanted signal power: (REFSENS + BW dependent value) Interferer signal power: -44dBm T-put limit = 95% of maximum for the Ref Meas channel Uplink power	0 dB $f \leq 3.0\text{GHz}$ 0dB, -3.4dB $3.0\text{GHz} < f \leq 4.2\text{GHz}$	Formula: Wanted signal power + TT Interferer signal power unchanged T-put limit unchanged Uplink power measurement window same as 7.4

		$3.0\text{GHz} < f \leq 4.2\text{GHz}$ 0dB, -4.0dB	
7.8.1A.2 Wideband intermodulation for CA (intra band contiguous DL CA without UL CA)	Same as 7.8.1A.1	Same as 7.8.1A.1	Same as 7.8.1A.1
7.8.1A.3 Wideband intermodulation for CA (inter band DL CA without UL CA)	Same as 7.8.1A.1	Same as 7.8.1A.1	Same as 7.8.1A.1
7.8.1B Wide band intermodulation for UL-MIMO	Same as 7.8.1	Same as 7.8.1	Same as 7.8.1 Uplink power measurement window applies to overall UL power, which is the linear sum of the output powers over all Tx antenna connectors
7.9 Spurious emissions	$30\text{MHz} \leq f < 1\text{GHz}$: -57dBm / 100kHz $1\text{GHz} \leq f \leq 12.75\text{GHz}$: -47dBm / 1MHz $12.75\text{GHz} \leq f \leq 19\text{GHz}$: -47dBm / 1MHz	0 dB	Formula: Minimum Requirement + TT

F.3.4 Measurement of performance requirements

Table F.3.4-1: Derivation of Test Requirements (performance tests)

Test	Minimum Requirement in TS 36.133	Test Tolerance (TT)	Test Requirement in TS 36.521-1
8.2.1.1.1 Multiple PRBs - Prop'n Condition EVA5 - Prop'n Condition ETU70 - Prop'n Condition ETU300	SNRs as specified	0.8dB	Formula: SNR + TT T-put limit unchanged
8.2.1.1.1 Multiple PRBs - Prop'n Condition HST	SNR as specified	0.6dB	Formula: SNR + TT T-put limit unchanged
8.2.1.1.1 Single PRB - Prop'n Condition ETU70	SNRs as specified	0.8dB	Formula: SNR + TT T-put limit unchanged
8.2.1.1.1_1 Multiple PRBs - Prop'n Condition EVA5 - Prop'n Condition ETU70 - Prop'n Condition ETU300	SNRs as specified	Same as 8.2.1.1.1 Multiple PRBs Propagation EVA5, ETU70, ETU300	Formula: SNR + TT T-put limit unchanged
8.2.1.1.1_A.1	TBD	TBD	TBD
8.2.1.1.1_A.2	TBD	TBD	TBD
8.2.1.1.2 Single PRB	SNR as specified	0.8dB	Formula: SNR + TT T-put limit unchanged
8.2.1.2.1 - Prop'n Condition EVA5	SNR as specified	0.9 dB	Formula: SNR + TT T-put limit unchanged
8.2.1.2.1 - Prop'n Condition HST	SNR as specified	0.6 dB	Formula: SNR + TT T-put limit unchanged
8.2.1.2.1_1 - Prop'n Condition EVA5	SNR as specified	Same as 8.2.1.2.1	Formula: SNR + TT T-put limit unchanged
8.2.1.2.2	SNR as specified	0.9 dB	Formula: SNR + TT T-put limit unchanged
8.2.1.2.2_1	SNR as specified	Same as 8.2.1.2.2	Formula: SNR + TT T-put limit unchanged
8.2.1.2.3_C.1 - Prop'n Condition EVA5	[TBD]	[TBD]	[TBD]
8.2.1.3.1	SNR as specified	0.9 dB	Formula: SNR + TT T-put limit unchanged
8.2.1.3.1_A.1	TBD	TBD	TBD
8.2.1.3.1_A.2	TBD	TBD	TBD
8.2.1.3.2	SNR as specified	0.9 dB	Formula: SNR + TT T-put limit unchanged
8.2.1.4.1	SNRs as specified	0.9 dB	Formula: SNR + TT T-put limit unchanged
8.2.1.4.1_1	SNR as specified	Same as 8.2.1.4.1	Formula: SNR + TT T-put limit unchanged
8.2.1.4.2	SNRs as specified	0.9 dB	Formula: SNR + TT T-put limit unchanged
8.2.1.4.2_1	SNR as specified	Same as 8.2.1.4.2	Formula: SNR + TT T-put limit unchanged
8.2.1.4.2_A.1	TBD	TBD	TBD
8.2.1.7.1_A.1	TBD	TBD	TBD
8.2.2.1.1 Multiple PRBs - Prop'n Condition EVA5 - Prop'n Condition ETU70 - Prop'n Condition ETU300	SNRs as specified	0.8dB	Formula: SNR + TT T-put limit unchanged
8.2.2.1.1 Multiple PRBs - Prop'n Condition HST	SNR as specified	0.6dB	Formula: SNR + TT T-put limit unchanged
8.2.2.1.1 Single PRB - Prop'n Condition ETU70	SNRs as specified	0.8dB	Formula: SNR + TT T-put limit unchanged

8.2.2.1.1_1 Multiple PRBs - Prop'n Condition EVA5 - Prop'n Condition ETU70 - Prop'n Condition ETU300	SNRs as specified	Same as 8.2.2.1.1 Multiple PRBs Propagation EVA5, ETU70, ETU300	Formula: SNR + TT T-put limit unchanged
8.2.2.1.1_A.1	TBD	TBD	TBD
8.2.2.1.2 Single PRB	SNR as specified	0.8dB	Formula: SNR + TT T-put limit unchanged
8.2.2.2.1 - Prop'n Condition EVA5	SNR as specified	0.9 dB	Formula: SNR + TT T-put limit unchanged
8.2.2.2.1 - Prop'n Condition HST	SNR as specified	0.6 dB	Formula: SNR + TT T-put limit unchanged
8.2.2.2.1_1 - Prop'n Condition EVA5	SNR as specified	Same as 8.2.2.2.1	Formula: SNR + TT T-put limit unchanged
8.2.2.2.2	SNR as specified	0.9 dB	Formula: SNR + TT T-put limit unchanged
8.2.2.2.2_1	SNR as specified	Same as 8.2.2.2.2	Formula: SNR + TT T-put limit unchanged
8.2.2.3.1	SNR as specified	0.9 dB	Formula: SNR + TT T-put limit unchanged
8.2.2.3.1_A.1	TBD	TBD	TBD
8.2.2.3.2	SNR as specified	0.9 dB	Formula: SNR + TT T-put limit unchanged
8.2.2.4.1	SNRs as specified	0.9 dB	Formula: SNR + TT T-put limit unchanged
8.2.2.4.1_1	SNR as specified	Same as 8.2.2.4.1	Formula: SNR + TT T-put limit unchanged
8.2.2.4.2	SNRs as specified	0.9 dB	Formula: SNR + TT T-put limit unchanged
8.2.2.4.2_1	SNR as specified	Same as 8.2.2.4.2	Formula: SNR + TT T-put limit unchanged
8.3.1.2.1_D	TBD		
8.2.2.4.2_A.1	TBD	TBD	TBD
8.2.2.7.1_A.1	TBD	TBD	TBD
8.3.1.1.1_D	SNR as specified	0.9 dB	Formula: SNR + TT T-put limit unchanged
8.3.1.1.2_D	SNR as specified	0.9 dB	Formula: SNR + TT T-put limit unchanged
8.3.1.2.1_D	SNR as specified	0.9 dB	Formula: SNR + TT T-put limit unchanged
8.3.2.1.1	SNRs as specified	0.9 dB	Formula: SNR + TT T-put limit unchanged
8.3.2.1.1_1	SNRs as specified	0.9 dB	Formula: SNR + TT T-put limit unchanged
8.3.2.1.2	SNRs as specified	0.9 dB	Formula: SNR + TT T-put limit unchanged
8.3.2.1.2_D	SNR as specified	0.9 dB	Formula: SNR + TT T-put limit unchanged
8.3.2.1.3	SNRs as specified	0.9 dB	Formula: SNR + TT T-put limit unchanged
8.3.2.1.3_D	SNR as specified	0.9 dB	Formula: SNR + TT T-put limit unchanged
8.3.2.2.1	SNRs as specified	0.9 dB	Formula: SNR + TT T-put limit unchanged
8.3.2.2.1_D	SNR as specified	0.9 dB	Formula: SNR + TT T-put limit unchanged
8.4.1.1	SNR as specified	0.8 dB	Formula: SNR + TT T-put limit unchanged
8.4.1.2.1	SNR as specified	1.0 dB	Formula: SNR + TT T-put limit unchanged
8.4.1.2.1_1	SNR as specified	Same as 8.4.1.2.1	Formula: SNR + TT T-put limit unchanged
8.4.1.2.2	SNR as specified	1.0 dB	Formula: SNR + TT T-put limit unchanged

8.4.1.2.2_1	SNR as specified	Same as 8.4.1.2.2	Formula: SNR + TT T-put limit unchanged
8.4.1.2.3_C.1	[TBD]	[TBD]	[TBD]
8.4.1.2.3_C.2	[TBD]	[TBD]	[TBD]
8.4.2.1	SNR as specified	0.8 dB	Formula: SNR + TT T-put limit unchanged
8.4.2.2.1	SNR as specified	1.0 dB	Formula: SNR + TT T-put limit unchanged
8.4.2.2.1_1	SNR as specified	Same as 8.4.2.2.1	Formula: SNR + TT T-put limit unchanged
8.4.2.2.2	SNR as specified	1.0 dB	Formula: SNR + TT T-put limit unchanged
8.4.2.2.2_1	SNR as specified	Same as 8.4.2.2.2	Formula: SNR + TT T-put limit unchanged
8.5.1.1	SNRs as specified	0.9 dB	Formula: SNR + TT T-put limit unchanged
8.5.1.2.1	SNR as specified	1.1 dB	Formula: SNR + TT T-put limit unchanged
8.5.1.2.1_1	SNR as specified	Same as 8.5.1.2.1	Formula: SNR + TT T-put limit unchanged
8.5.1.2.2	SNR as specified	1.0 dB	Formula: SNR + TT T-put limit unchanged
8.5.1.2.3_C.1	[TBD]	[TBD]	[TBD]
8.5.1.2.2_1	SNR as specified	Same as 8.5.1.2.2	Formula: SNR + TT T-put limit unchanged
8.5.2.1	SNRs as specified	0.9 dB	Formula: SNR + TT T-put limit unchanged
8.5.2.2.1	SNR as specified	1.1 dB	Formula: SNR + TT T-put limit unchanged
8.5.2.2.1_1	SNR as specified	Same as 8.5.2.2.1	Formula: SNR + TT T-put limit unchanged
8.5.2.2.2	SNR as specified	1.0 dB	Formula: SNR + TT T-put limit unchanged
8.5.2.2.2_1	SNR as specified	Same as 8.5.2.2.2	Formula: SNR + TT T-put limit unchanged
8.7.1.1 FDD sustained data rate performance	Downlink power -85dBm/15kHz	0 dB	Formula: Downlink power + TT T-put limit unchanged
8.7.1.1_1	Same as 8.7.1.1	Same as 8.7.1.1	Formula: Downlink power + TT T-put limit unchanged
8.7.1.1_A.1	TBD	TBD	TBD
8.7.1.1_A.2	TBD	TBD	TBD
8.7.2.1 TDD sustained data rate performance	Same as 8.7.1.1	Same as 8.7.1.1	Same as 8.7.1.1
8.7.2.1_1	Same as 8.7.2.1	Same as 8.7.2.1	Formula: Downlink power + TT T-put limit unchanged
8.7.2.1_A.1	TBD	TBD	TBD
8.7.2.1_A.2	TBD	TBD	TBD
10.1	SNR as specified	0.9dB	Formula: SNR + TT T-put limit unchanged
10.2	SNR as specified	0.9dB	Formula: SNR + TT T-put limit unchanged
[Other tests FFS]			

F.3.5 Measurement of Channel State Information reporting

Table F.3.5-1: Derivation of Test Requirements (Channel State Information reporting tests)

Test	Minimum Requirement in TS 36.101	Test Tolerance (TT)	Test Requirement in TS 36.521-1
9.2.1.1 FDD CQI Reporting under AWGN conditions – PUCCH 1-0	SNRs as specified Limits as in the Test Procedure	No test tolerances applied	SNR and limits unchanged
9.2.1.2 TDD CQI Reporting under AWGN conditions – PUCCH 1-0	SNRs as specified Limits as in the Test Procedure	No test tolerances applied	SNR and limits unchanged
9.2.1.3_C.1 FDD CQI Reporting under AWGN conditions – PUCCH 1-0 for eICIC (non-MBSFN ABS)	SNRs as specified Limits as in the Test Procedure	No test tolerances applied	SNR and limits unchanged
9.2.1.4_C.1 TDD CQI Reporting under AWGN conditions – PUCCH 1-0 for eICIC (non-MBSFN ABS)	FFS	FFS	FFS
9.2.2.1 FDD CQI Reporting under AWGN conditions – PUCCH 1-1	SNRs as specified Limits as in the Test Procedure	No test tolerances applied	SNR and limits unchanged
9.2.2.2 TDD CQI Reporting under AWGN conditions – PUCCH 1-1	SNRs as specified Limits as in the Test Procedure	No test tolerances applied	SNR and limits unchanged
9.2.3.1_D FDD CQI Reporting under AWGN conditions – PUCCH 1-1 for eDL-MIMO	SNRs as specified Limits as in the Test Procedure	No test tolerances applied	SNR and limits unchanged
9.2.3.2_D TDD CQI Reporting under AWGN conditions – PUCCH 1-1 for eDL-MIMO	SNRs as specified Limits as in the Test Procedure	No test tolerances applied	SNR and limits unchanged
9.3.1.1.1 FDD CQI Reporting under fading conditions – PUSCH 3-0	SNRs as specified α 2% β 55% γ 1.10 BLER 0.05	SNR 0dB α 0% β 0% γ 0.01 BLER 0	SNR unchanged α limit unchanged β limit unchanged γ 1.09 as per Table G.5.4-1 BLER limit unchanged
9.3.1.1.2 TDD CQI Reporting under fading conditions – PUSCH 3-0	Same as 9.3.1.1.1	Same as 9.3.1.1.1	Same as 9.3.1.1.1
9.3.1.2.1_D FDD CQI Reporting under fading conditions – PUSCH 3-1 for eDL-MIMO	Same as 9.3.1.1.1	Same as 9.3.1.1.1	Same as 9.3.1.1.1
9.3.1.2.2_D TDD CQI Reporting under fading conditions – PUSCH 3-1 for eDL-MIMO	Same as 9.3.1.1.1	Same as 9.3.1.1.1	Same as 9.3.1.1.1
9.3.2.1.1 FDD CQI Reporting under fading conditions – PUCCH 1-0	SNRs as specified α 20% γ 1.05 BLER 0.02	SNR 0dB α 0% γ 0.01 BLER 0	SNR and α , BLER limits unchanged α limit unchanged γ 1.04 as per Table G.5.4-1 BLER limit unchanged
9.3.2.1.1_1 FDD CQI Reporting under fading conditions – PUCCH 1-0	Same as 9.3.2.1.1	Same as 9.3.2.1.1	Same as 9.3.2.1.1

9.3.2.1.2 TDD CQI Reporting under fading conditions – PUCCH 1-0	Same as 9.3.2.1.1	Same as 9.3.2.1.1	Same as 9.3.2.1.1
9.3.2.1.2_1 TDD CQI Reporting under fading conditions – PUCCH 1-0	Same as 9.3.2.1.1	Same as 9.3.2.1.1	Same as 9.3.2.1.1
9.3.2.2.1_D FDD CQI Reporting under fading conditions – PUCCH 1-1 for eDL-MIMO	Same as 9.3.2.1.1	Same as 9.3.2.1.1	Same as 9.3.2.1.1
9.3.2.2.2_D TDD CQI Reporting under fading conditions – PUCCH 1-1 for eDL-MIMO	Same as 9.3.2.1.1	Same as 9.3.2.1.1	Same as 9.3.2.1.1
9.3.3.1.1 FDD CQI Reporting under fading conditions and frequency-selective interference – PUSCH 3-0	lor and lot as specified α 60% γ 1.60	lor, lot 0dB α 20% γ 0.10	lor and lot unchanged α 40%, Formula: Min Req't – Test Tol γ 1.50, Formula: Min Req't – Test Tol The effect of AWGN flatness and signal flatness on the α requirement was derived by simulation. AWGN flatness / signal flatness and the statistical effect of a finite test time both affect the T-put result. The Test Tolerance comprises two quantities: 1. Effect of AWGN flatness and signal flatness, derived by simulation 2. Statistical effect as per Table G.5.4-1 Items 1 and 2 are assumed to be uncorrelated so can be root sum squared T-put requirement Test Tol = SQRT (AWGN flatness and signal flatness effect ² + Statistical effect ²) AWGN flatness and signal flatness effect 0.1, Statistical effect 0.01, giving overall effect 0.10
9.3.3.1.2 TDD CQI Reporting under fading conditions and frequency-selective interference – PUSCH 3-0	Same as 9.3.3.1.1	Same as 9.3.3.1.1	Same as 9.3.3.1.1
9.3.4.1.1 FDD CQI Reporting under fading conditions – PUSCH 2-0	SNRs as specified Limits as in the Test Procedure γ 1.2	γ 0.01	SNR unchanged γ 1.19 as per Table G.5.4-1
9.3.4.1.2 TDD CQI Reporting under fading conditions – PUSCH 2-0	Same as 9.3.4.1.1	Same as 9.3.4.1.1	Same as 9.3.4.1.1
9.3.4.2.1 FDD CQI Reporting under fading conditions – PUCCH 2-0	SNRs as specified Limits as in the Test Procedure γ 1.15	γ 0.01	SNR unchanged γ 1.14 as per Table G.5.4-1
9.3.4.2.2 TDD CQI Reporting under fading conditions – PUCCH 2-0	Same as 9.3.4.2.1	Same as 9.3.4.2.1	Same as 9.3.4.2.1
9.4.1.1.1 FDD PMI Reporting – PUSCH 3-1 (Single PMI)	γ 1.10	γ 0.01	γ 1.09 as per Table G.5.4-1

9.4.1.1.2 TDD PMI Reporting – PUSCH 3-1 (Single PMI)	Same as 9.4.1.1.1	Same as 9.4.1.1.1	Same as 9.4.1.1.1
9.4.1.2.1 FDD PMI Reporting – PUCCH 2-1 (Single PMI)	N_{oc} as specified in test procedure γ 1.2	 γ 0.01	N_{oc} unchanged $lor/ N_{oc}=SNR_{rmd}$ is a result of an approach according to G.5.2 and is reused unchanged as setting in procedure step 3. γ 1.19 as per Table G.5.4-1
9.4.1.2.2 TDD PMI Reporting – PUCCH 2-1 (Single PMI)	Same as 9.4.1.2.1	Same as 9.4.1.2.1	Same as 9.4.1.2.1
9.4.1.3.1_D FDD Reporting of PMI – PUSCH 3-1 (Single PMI) for eDL-MIMO	Same as 9.4.1.2.1	Same as 9.4.1.2.1	Same as 9.4.1.2.1
9.4.1.3.2_D TDD Reporting of PMI – PUSCH 3-1 (Single PMI) for eDL-MIMO	Same as 9.4.1.2.1	Same as 9.4.1.2.1	Same as 9.4.1.2.1
9.4.2.1.1 FDD PMI Reporting – PUSCH 1-2 (Multiple PMI)	N_{oc} as specified in test procedure γ 1.20	γ 0.01	N_{oc} unchanged $lor/ N_{oc}=SNR_{rmd}$ is a result of an approach according to G.5.2 and is reused unchanged as setting in procedure step 3. γ 1.19 as per Table G.5.4-1
9.4.2.1.1_1 FDD PMI Reporting – PUSCH 1-2 (Multiple PMI)	Same as 9.4.2.1.1	Same as 9.4.2.1.1	Same as 9.4.2.1.1
9.4.2.1.2 TDD PMI Reporting – PUSCH 1-2 (Multiple PMI)	Same as 9.4.2.1.1	Same as 9.4.2.1.1	Same as 9.4.2.1.1
9.4.2.1.2_1 TDD PMI Reporting – PUSCH 1-2 (Multiple PMI)	Same as in 9.4.2.1.1	Same as in 9.4.2.1.1	Same as in 9.4.2.1.1
9.4.2.2.1 FDD PMI Reporting – PUSCH 2-2 (Multiple PMI)	Same as in 9.4.2.1.1	Same as in 9.4.2.1.1	Same as in 9.4.2.1.1
9.4.2.2.2 TDD PMI Reporting – PUSCH 2-2 (Multiple PMI)	N_{oc} as specified in test procedure γ 1.15	 γ 0.01	N_{oc} unchanged $lor/ N_{oc}=SNR_{rmd}$ is a result of an approach according to G.5.2 and is reused unchanged as setting in procedure step 3. γ 1.14 as per Table G.5.4-1
9.4.2.3.1_D FDD PMI Reporting – PUSCH 1-2 (Multiple PMI) for eDL-MIMO	N_{oc} as specified in test procedure γ 1.30	γ 0.01	N_{oc} unchanged $lor/ N_{oc}=SNR_{rmd}$ is a result of an approach according to G.5.2 and is reused unchanged as setting in procedure step 3. γ 1.29 as per Table G.5.4-1
9.4.2.3.2_D TDD PMI Reporting – PUSCH 1-2 (Multiple PMI) for eDL-MIMO	N_{oc} as specified in test procedure γ 3.50	γ 0.01	N_{oc} unchanged $lor/ N_{oc}=SNR_{rmd}$ is a result of an approach according to G.5.2 and is reused unchanged as setting in procedure step 3. γ 3.49 as per Table G.5.4-1
9.5.1.1 FDD RI Reporting– PUCCH 1-1	SNRs as specified Test 1: γ_2 1.00 Test 2: γ_1 1.05 Test 3: γ_2 1.10	SNR 0dB γ_2 0.01 γ_1 0.01 γ_2 0.01	SNR unchanged γ_2 0.99 as per Table G.5.4-1 γ_1 1.04 as per Table G.5.4-1 γ_2 1.09 as per Table G.5.4-1
9.5.1.1_1 FDD RI Reporting– PUCCH 1-1 (Release 10)	SNRs as specified Test 1: γ_2 1.00 Test 2: γ_1 1.05 Test 3: γ_1 0.90, γ_2 1.10	SNR 0dB γ_2 0.01 γ_1 0.01 γ_2 0.01	SNR unchanged γ_2 0.99 as per Table G.5.4-1 γ_1 1.04 as per Table G.5.4-1 γ_1 0.89, γ_2 1.09 as per Table G.5.4-1

9.5.1.1_2 FDD RI Reporting– PUCCH 1-1 (Release 11)	SNRs as specified Test 1: γ_2 1.00 Test 2: γ_1 1.05 Test 3: γ_1 0.90	SNR 0dB γ_2 0.01 γ_1 0.01 γ_1 0.01	SNR unchanged γ_2 0.99 as per Table G.5.4-1 γ_1 1.04 as per Table G.5.4-1 γ_1 0.89 as per Table G.5.4-1
9.5.1.2 TDD RI Reporting– PUSCH 3-1	Same as 9.5.1.1	Same as 9.5.1.1	Same as 9.5.1.1
9.5.1.2_1 TDD RI Reporting– PUSCH 3-1 (Release 10)	Same as 9.5.1.1_1	Same as 9.5.1.1_1	Same as 9.5.1.1_1
9.5.1.2_2 TDD RI Reporting– PUSCH 3-1 (Release 11)	Same as 9.5.1.1_2	Same as 9.5.1.1_2	Same as 9.5.1.1_2
9.5.2.1_D FDD RI Reporting – PUCCH 1-1 for eDL-MIMO	SNR as specified Test 1: γ_2 1.00 Test 2: γ_1 1.05 Test 3: γ_1 0.9	SNR 0dB γ_2 0.01 γ_1 0.01 γ_2 0.01	SNR unchanged γ_2 0.99 as per Table G.5.4-1 γ_1 1.04 as per Table G.5.4-1 γ_1 0.89 as per Table G.5.4-1
9.5.2.2_D TDD RI Reporting – PUCCH 1-1 for eDL-MIMO	SNR as specified Test 1: γ_2 1.00 Test 2: γ_1 1.05 Test 3: γ_1 0.9	SNR 0dB γ_2 0.01 γ_1 0.01 γ_2 0.01	SNR unchanged γ_2 0.99 as per Table G.5.4-1 γ_1 1.04 as per Table G.5.4-1 γ_1 0.89 as per Table G.5.4-1

Annex G (normative): Statistical Testing

G.1 General

FFS.

G.2 Statistical testing of receiver characteristics

G.2.1 General

The test of receiver characteristics is two fold.

1. A signal or a combination of signals is offered to the RX port(s) of the receiver.
2. The ability of the receiver to demodulate /decode this signal is verified by measuring the throughput.

In (2) is the statistical aspect of the test and is treated here.

The minimum requirement for all receiver tests is >95% of the maximum throughput.

All receiver tests are performed in static propagation conditions. No fading conditions are applied.

G.2.2 Mapping throughput to error ratio

- a) The measured information bit throughput R is defined as the sum (in kilobits) of the information bit payloads successfully received during the test interval, divided by the duration of the test interval (in seconds).
- b) In measurement practice the UE indicates successfully received information bit payload by signalling an ACK to the SS.
If payload is received, but damaged and cannot be decoded, the UE signals a NACK.
- c) Only the ACK and NACK signals, not the data bits received, are accessible to the SS.
The number of bits is known in the SS from knowledge of what payload was sent.
- d) For the reference measurement channel, applied for testing, the number of bits is different in different subframes, however in a radio frame it is fixed during one test.
- e) The time in the measurement interval is composed of successfully received subframes (ACK), unsuccessfully received subframes (NACK) and no reception at all (DTX-subframes).
- f) DTX-subframes may occur regularly according the applicable reference measurement channel (regDTX).
In real live networks this is the time when other UEs are served. In TDD these are the UL and special subframes. regDTX vary from test to test but are fixed within the test.
- g) Additional DTX-subframes occur statistically when the UE is not responding ACK or NACK where it should. (statDTX)
This may happen when the UE was not expecting data or decided that the data were not intended for it.

The pass / fail decision is done by observing the:

- number of NACKs
- number of ACKs and
- number of statDTXs (regDTX is implicitly known to the SS)

The ratio $(NACK + statDTX) / (NACK + statDTX + ACK)$ is the Error Ratio (ER). Taking into account the time consumed by the ACK, NACK, and DTX-TTIs (regular and statistical), ER can be mapped unambiguously to throughput for any single reference measurement channel test.

G.2.3 Design of the test

The test is defined by the following design principles (see clause G.x, Theory....):

1. The early decision concept is applied.
2. A second limit is introduced: Bad DUT factor $M > 1$
3. To decide the test pass:

Supplier risk is applied based on the Bad DUT quality

To decide the test fail

Customer Risk is applied based on the specified DUT quality

The test is defined by the following parameters:

1. Limit ER = 0.05 (Throughput limit = 95%)
2. Bad DUT factor $M = 1.5$ (selectivity)
3. Confidence level CL = 95% (for specified DUT and Bad DUT-quality)

G.2.4 Numerical definition of the pass fail limits

Table G.2.4-1: pass fail limits

ne	ns _p	ns _f	ne	ns _p	ns _f	ne	ns _p	ns _f	ne	ns _p	ns _f
0	67	NA	39	763	500	78	1366	1148	117	1951	1828
1	95	NA	40	778	516	79	1381	1166	118	1965	1845
2	119	2	41	794	532	80	1396	1183	119	1980	1863
3	141	7	42	810	548	81	1412	1200	120	1995	1881
4	162	14	43	826	564	82	1427	1217	121	2010	1899
5	183	22	44	842	580	83	1442	1234	122	2025	1916
6	202	32	45	858	596	84	1457	1252	123	2039	1934
7	222	42	46	873	612	85	1472	1269	124	2054	1952
8	241	53	47	889	629	86	1487	1286	125	2069	1969
9	259	64	48	905	645	87	1502	1303	126	2084	1987
10	278	76	49	920	661	88	1517	1321	127	2099	2005
11	296	88	50	936	678	89	1532	1338	128	2113	2023
12	314	100	51	952	694	90	1547	1355	129	2128	2040
13	332	113	52	967	711	91	1562	1373	130	2143	2058
14	349	126	53	983	727	92	1577	1390	131	2158	2076
15	367	140	54	998	744	93	1592	1407	132	2172	2094
16	384	153	55	1014	760	94	1607	1425	133	2187	2111
17	401	167	56	1029	777	95	1623	1442	134	2202	2129
18	418	181	57	1045	793	96	1637	1459	135	2217	2147
19	435	195	58	1060	810	97	1652	1477	136	2231	2165
20	452	209	59	1076	827	98	1667	1494	137	2246	2183
21	469	224	60	1091	844	99	1682	1512	138	2261	2201
22	486	238	61	1106	860	100	1697	1529	139	2275	2218
23	503	253	62	1122	877	101	1712	1547	140	2290	2236
24	519	268	63	1137	894	102	1727	1564	141	2305	2254

25	536	283	64	1153	911	103	1742	1582	142	2320	2272
26	552	298	65	1168	928	104	1757	1599	143	2334	2290
27	569	313	66	1183	944	105	1772	1617	144	2349	2308
28	585	328	67	1199	961	106	1787	1634	145	2364	2326
29	602	343	68	1214	978	107	1802	1652	146	2378	2344
30	618	359	69	1229	995	108	1817	1669	147	2393	2361
31	634	374	70	1244	1012	109	1832	1687	148	2408	2379
32	650	389	71	1260	1029	110	1847	1704	149	2422	2397
33	667	405	72	1275	1046	111	1861	1722	150	2437	2415
34	683	421	73	1290	1063	112	1876	1740	151	2452	2433
35	699	436	74	1305	1080	113	1891	1757	152	2466	2451
36	715	452	75	1321	1097	114	1906	1775	153*)	NA	2469
37	731	468	76	1336	1114	115	1921	1793			
38	747	484	77	1351	1131	116	1936	1810	*) note 2 in G.2.5		

NOTE 1: The first column is the number of errors (ne = number of NACK + statDTX)

NOTE 2: The second column is the number of samples for the pass limit (ns_p, ns=Number of Samples= number of NACK + statDTX + ACK)

NOTE 3: The third column is the number of samples for the fail limit (ns_f)

G.2.5 Pass fail decision rules

The pass fail decision rules apply for a single test, comprising one component in the test vector. The over all Pass /Fail conditions are defined in clause G.2.1.5.

Having observed 0 errors, pass the test at 67+ samples, otherwise continue

Having observed 1 error, pass the test at 95+ otherwise continue

Having observed 2 errors, pass the test at 119+ samples, fail the test at 2- samples, otherwise continue

Etc. etc.

Having observed 151 errors, pass the test at 2452+ samples, fail the test at 2433- samples, otherwise continue

Having observed 152 errors, pass the test at 2466+ samples, fail the test at 2451- samples.

Where x+ means: x or more, x- means x or less

NOTE 1: an ideal DUT passes after 67 samples. The maximum test time is 2466 samples.

NOTE 2: It is allowed to deviate from the early decision concept by postponing the decision (pass/fail or continue). Postponing the decision to or beyond the end of Table G.2.4-1 requires a pass fail decision against the test limit: pass the DUT for ER<0.0618, otherwise fail.

G.2.6 Test conditions for receiver tests

Table G.2.6-1: Test conditions for receiver tests

Test	Statistical independence	Number of components in the test vector, as specified in the test requirements and initial conditions of the applicable test	Over all Pass/Fail condition
7.3 Reference sensitivity level	Yes: the inherent receiver noise is assumed to be AWGN	tbd	To pass 7.3 each component in the test vector must pass
7.4 Maximum input level	Unclear: in case, clipping causes errors, errors are data dependent. Statistical independence is assumed.	tbd	To pass 7.4 each component in the test vector must pass
7.5 Adjacent Channel Selectivity (ACS)	Unclear: errors are data dependent on the interferers data. Statistical independence is assumed.	tbd	To pass 7.5 each component in the test vector must pass
7.6.1 In-band blocking	Unclear: errors are data dependent on the interferers data. Statistical independence is assumed.	tbd	To pass 7.6.1 each component in the test vector must pass
7.6.2 Out of-band blocking	yes: it is assumed that the CW interferer causes errors, which are independent and time invariant.	tbd	To pass 7.6.2, all except [tbd] components in the test vector must pass
7.6.3 Narrow band blocking	yes: it is assumed that the CW interferer causes errors, which are independent and time invariant.	tbd	To pass 7.6.3 each component in the test vector must pass
7.7 Spurious response	yes: it is assumed that the CW interferer causes errors, which are independent and time invariant.	tbd	To pass 7.7 each component in the test vector must pass
7.8.1 Wide band Intermodulation	Unclear: errors are dependent on the data content of the interferer. Statistical independence is assumed.	tbd	To pass 7.8.1 each component in the test vector must pass

G.2A Statistical testing of receiver characteristics with CA

G.2A.1 General

G.2.1 applies.

G.2A.2 Mapping throughput to error ratio

The test is defined by the following design principles (see clause G.x, Theory...):

1. The standard concept is applied. (not the early decision concept).
2. A second limit is introduced, defining the Bad DUT.

3. To decide the test pass:
 - Supplier risk is applied based on the Bad DUT quality.
 - To decide the test fail.
 - Customer Risk is applied based on the specified DUT quality.

The test is defined by the following parameters:

- 1) Limit Error Ratio = 0.05 (95% throughput is tested).
- 2) Bad DUT factor $M=1.5$ (selectivity).
- 3) Confidence level $CL = 95\%$ (for specified DUT and Bad DUT-quality).

G.2A.4 Pass fail limits

Apply 1003 samples to the DUT per CC.

Decide pass per CC in case of ≤ 62 errors, otherwise fail.

NOTE 1: The pass fail decision is done individually for each CC. The pass fail decision for one component in the test vector is as follows: pass if all CCs or SCC only according to the test cases pass, otherwise fail. The overall pass fail decision is according to clause G.2A.6

NOTE 2: It is allowed to apply more samples to the DUT, common for all CCs, (e.g. up to an integer number of frames). Use the ratio (62/1003) for the pass fail decision.

NOTE 3: $62/1003 = 0.0618$, the same test limit is used at the end of Table G.2.4-1

G.2A.5 void

G.2A.6 Test conditions for receiver tests with CA

Table G.2A.6-1: Test conditions for receiver tests with CA

Test	Statistical independence	Number of components in the test vector, as specified in the test requirements and initial conditions of the applicable test Note 1	Over all Pass/Fail condition Note 1
7.3A Reference sensitivity level for CA	Yes: the inherent receiver noise is assumed to be AWGN	tbd	To pass 7.3A each component in the test vector must pass
7.4A Maximum input level for CA	Unclear: in case, clipping causes errors, errors are data dependent. Statistical independence is assumed.	tbd	To pass 7.4A each component in the test vector must pass
7.5A Adjacent Channel Selectivity (ACS) for CA	Unclear: errors are data dependent on the interferers data. Statistical independence is assumed.	tbd	To pass 7.5A each component in the test vector must pass
7.6.1A In-band blocking for CA	Unclear: errors are data dependent on the interferers data. Statistical independence is assumed.	tbd	To pass 7.6.1A each component in the test vector must pass
7.6.2.A Out-of-band blocking for CA	yes: it is assumed that the CW interferer causes errors, which are independent and time invariant.	tbd	To pass 7.6.2A, all except [tbd] components in the test vector must pass
7.6.3A Narrow band blocking for CA	yes: it is assumed that the CW interferer causes errors, which are independent and time invariant.	tbd	To pass 7.6.3A each component in the test vector must pass
7.7A Spurious response for CA	yes: it is assumed that the CW interferer causes errors, which are independent and time invariant.	tbd	To pass 7.7A each component in the test vector must pass
[place holder] 7.8.1A Wide band Intermodulation			
Note 1: A DUT with marginal performance on one component in the test vector passes this component with a confidence level of 95%, which is a false fail probability of 5%. All components in the test vector shall pass, to pass the test, For more than 1 component, performing marginal, there is an increased probability of a false fail for the test.			

G.3 Statistical testing of Performance Requirements with throughput

G.3.1 General

The test of receiver performance characteristics is two fold.

1. A signal or a combination of signals is offered to the RX port(s) of the receiver.
2. The ability of the receiver to demodulate /decode this signal is verified by measuring the throughput.

In (2) is the statistical aspect of the test and is treated here.

The minimum requirement for all receiver performance tests is either 70% or 30% of the maximum throughput.

All receiver performance tests are performed in fading conditions. In addition to the statistical considerations, this requires the definition of a minimum test time.

G.3.2 Mapping throughput to error ratio

G.2.2 applies

G.3.3 Design of the test

The test is defined by the following design principles (see clause G.x, Theory...):

1. The standard concept is applied. (not the early decision concept)
2. A second limit is introduced: The second limit is different, whether 30% or 70% throughput is tested.
3. To decide the test pass:
 - Supplier risk is applied based on the Bad DUT quality
 - To decide the test fail:
 - Customer Risk is applied based on the specified DUT quality

The test is defined by the following parameters:

- 1a) Limit Error Ratio = 0.3 (in case 70% Throughput is tested) or
- 1b) Limit Throughput = 0.3 (in case 30% Throughput is tested)
- 2a) Bad DUT factor $M=1.378$ (selectivity)
- 2b) Bad DUT factor $m=0.692$ (selectivity)
 - justification see: TS 34.121 Clause F.6.3.3
- 3) Confidence level $CL = 95\%$ (for specified DUT and Bad DUT-quality)

G.3.4 Pass Fail limit

Testing Throughput = 30%, then the test limit is

Number of successes (ACK) / number of samples $\geq 59 / 233$

Testing Throughput = 70% then the test limit is

Number of fails (NACK and statDTX) / number of samples $\leq 66 / 184$

We have to distinguish 3 cases:

- a) The duration for the number of samples (233 or 184) is greater than the minimum test time:

Then the number of samples (233 or 184) is predefined and the decision is done according to the number of events (59 successes or 66 fails)

- b) Since subframe 0 and 5 contain less bits than the remaining subframes, it is allowed to predefine a number of samples contained in an integer number of frames. In this case test-limit-ratio applies.

- c) The minimum test time is greater than the duration for the number of samples:

The minimum test time is predefined and the decision is done comparing the measured ratio at that instant against the test-limit-ratio.

NOTE: The test time for most of the tests is governed by the Minimum Test Time

G.3.5 Minimum Test time

If a pass fail decision in G.3.4 can be achieved earlier than the minimum test time, then the test shall not be decided, but continued until the minimum test time is elapsed.

The tables below contain the minimum number of subframes for FDD and TDD.

By simulations the minimum number of active subframes (carrying DL payload) was derived (MNAS),

then adding inactive subframes to the active ones (e.g. subframe 5 contains no DL payload. For TDD additional subframes contain no DL payload)

then rounding up to full thousand and

then adding a bias of 1000 (BMNSF).

Simulation method to derive minimum test time:

With a level, corresponding a throughput at the test limit (here 30% or 70% of the max. throughput) the preliminary throughput versus time converges towards the final throughput. The allowance of ± 0.2 dB around the above mentioned level is predefined by RAN5 to find the minimum test time. The allowance of ± 0.2 dB maps through the function “final throughput versus level” into a throughput corridor. The minimum test time is achieved when the preliminary throughput escapes the corridor the last time. The two functions “final throughput versus level” and “preliminary throughput versus time” are simulation results, which are done individual for each demodulation scenario. HST-scenarios and scenarios with $MNAS \geq 50000$ are derived differently.

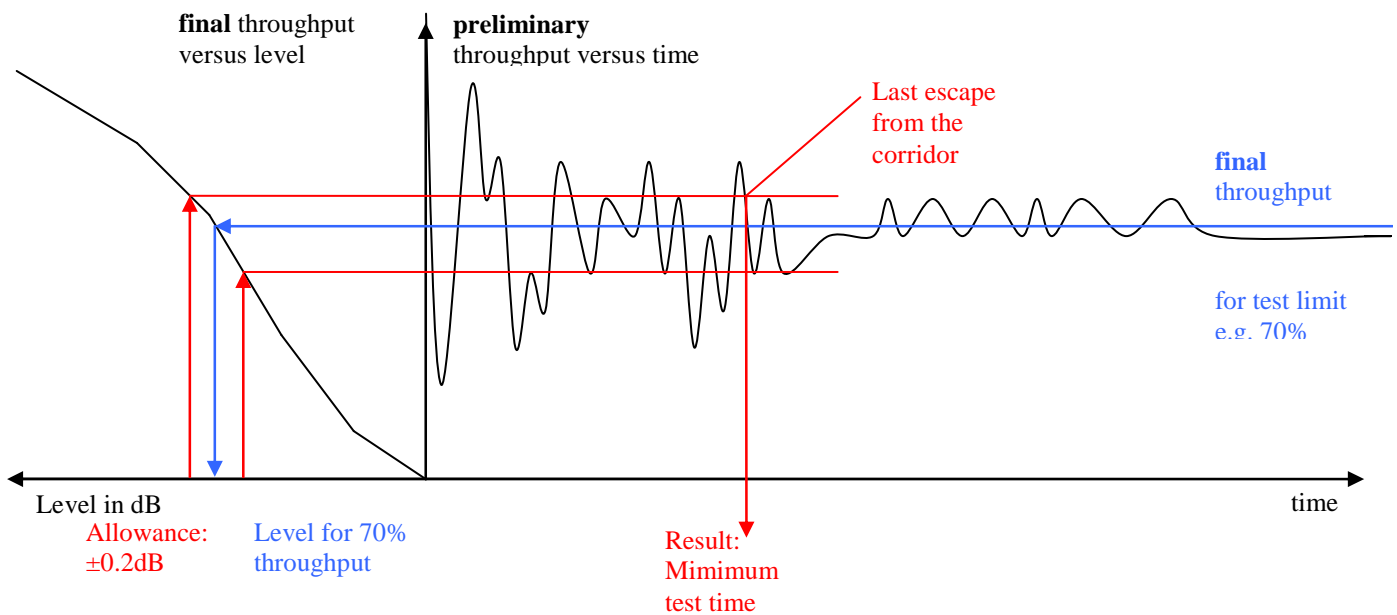

Fig. G.3.5-1: Simulation method to derive minimum test time

Table G.3.5-1: Minimum Test time for PDSCH Single Antenna Port Performance

Test No	Demod. scenario	Demodulation scenario plain text: RMC (Bandwidth, allocated RBs, modulation, coding) Antenna (configuration, correlation) Propagation condition, Doppler [additional parameters, if applicable] (info only)	Minimum Number of Active Subframes (MNAS) to reach the corridor (Simulation, info only)	Minimum Number of Subframes (MNS) to reach the corridor (MNS = active and inactive subframes) (Calculation, info only)		Biased Minimum Number of SubFrames (BMNSF) $BMNSF = 1000 * \left\lceil \frac{MNS}{1000} \right\rceil + 1000$ (mandatory)	
				FDD	TDD	FDD	TDD
				1	[1.1]	R.2 (10 MHz, full, QPSK, 1/3) (1x2 Low) EVA,5	38 764
2	[1.2]	R.2 (10 MHz, full, QPSK, 1/3) (1x2 Low) ETU,70	2 764	3 072	5 528	5 000	7 000
3	[1.3]	R.2 (10 MHz, full, QPSK, 1/3) (1x2 Low) ETU,300	1 424	1 583	2 848	3 000	4 000
4	[1.4]	R.2 (10 MHz, full, QPSK, 1/3) (1x2 Low) HST	28 800	NA	NA	28 800	57 600
5	[2.1]	R.4 (1.4 MHz, full, QPSK, 1/3) (1x2 Low) EVA,5	44 354	49 283	147 847	51 000	149 000
6	[1.5]	R.3 (10 MHz, full, 16QAM, ½) (1x2 Low) EVA,5	39 020	43 356	78 040	45 000	80 000
6 Rel-9		R.3-1 (5MHz, full, 16QAM, ½) (1x2 Low) EVA5	39 020 (MNAS is not simulated, but estimated based on similar scenario in Table G.3.5-1 Test6)	43 356	78 040	45 000	80 000
7	[1.6]	R.3 (10 MHz, full, 16QAM, ½) (1x2 Low) ETU,70	1 366	1 518	2 732	3 000	4 000
7 Rel-9		R.3-1 (5MHz, full, 16QAM, ½) (1x2 Low) ETU70	1 366 (MNAS is not simulated, but estimated based on similar scenario in Table G.3.5-1 Test7)	1 518	2 732	3 000	4 000
8	[1.7]	R.3 (10 MHz, full, 16QAM, ½)	3 189	3 544	6 378	5 000	8 000

		(1x2 High) ETU,300					
8 Rel-9		R.3-1 (5MHz, full, 16QAM, 1/2) (1x2 High) ETU300	3 189 (MNAS is not simulated, but estimated based on similar scenario in Table G.3.5-1 Test8)	3 544	6 378	5 000	8 000
9	[2.2]	R.5 (3 MHz, full, 64QAM, 3/4) (1x2 Low) EVA,5	50 000	55 556	100 000	57 000	101 000
10	[2.3]	R.6 (5 MHz, full, 64QAM, 3/4) (1x2 Low) EVA,5	48 847	54 275	97 694	56 000	99 000
10 Rel-9		R.6-1 (5MHz, partial, 64QAM, 3/4) (1x2 Low) EVA5	48 847 (MNAS is not simulated, but estimated based on similar scenario in Table G.3.5-1 Test10)	54 275	97 694	56 000	99 000
11	[1.8]	R.7 (10 MHz, full, 64QAM, 3/4) (1x2 Low) EVA,5	46 524	51 694	93 048	53 000	95 000
11 Rel-9		R.7-1 (10MHz, partial, 64QAM, 3/4) (1x2 Low) EVA5	46 524 (MNAS is not simulated, but estimated based on similar scenario in Table G.3.5-1 Test11)	51 694	93 048	53 000	95 000
12	[1.9]	R.7 (10 MHz, full, 64QAM, 3/4) (1x2 Low) ETU,70	4 722	5 247	9 444	7 000	11 000
12 Rel-9		R.7-1 (10MHz, partial, 64QAM, 3/4) (1x2 Low) ETU70	4 722 (MNAS is not simulated, but estimated based on similar scenario in Table G.3.5-1 Test12)	5 247	9 444	7 000	11 000
13	[1.10]	R.7 (10 MHz, full, 64 QAM, 3/4) (1x2High) EVA,5	100 000	111 112	200 000	113 000	201 000
13 Rel-		R.7-1 (10MHz, partial, 64QAM,	100 000 (MNAS is	111 112	200 000	113 000	201 000

9		$\frac{3}{4}$ (1x2 High) EVA5	not simulated, but estimated based on similar scenario in Table G.3.5-1 Test13)				
14	[2.4]	R.8 (15 MHz, full, 64QAM, $\frac{3}{4}$) (1x2 Low) EVA,5	48 434	53 816	96 868	55 000	98 000
14 Rel-9		R.8-1 (15MHz, partial, 64QAM, $\frac{3}{4}$) (1x2 Low) EVA5	48 434 (MNAS is not simulated, but estimated based on similar scenario in Table G.3.5-1 Test14)	53 816	96 868	55 000	98 000
15	[2.5]	R.9 (20 MHz, full, 64QAM,3/4) (1x2 Low) EVA,5	100 000	111 112	200 000	113 000	201 000
15 Rel-9		R.9-1 (20MHz, partial, 64QAM, $\frac{3}{4}$) (1x2 Low) EVA5	100 000 (MNAS is not simulated, but estimated based on similar scenario in Table G.3.5-1 Test15)	111 112	200 000	113 000	201 000
15 Rel-9		R.9-2 (20MHz, partial, 64QAM, $\frac{3}{4}$) (1x2 Low) EVA5	100 000 (MNAS is not simulated, but estimated based on similar scenario in Table G.3.5-1 Test15)	111 112	200 000	113 000	201 000
16	[3.1]	R.0 (3 MHz, 1PRB,16QAM, $\frac{1}{2}$) (1x2 Low) ETU,70	5 710	6 345	11 420	8 000	13 000
17	[3.2]	R.1 (10MHz,1PRB,16QAM, $\frac{1}{2}$) (1x2 Low) ETU,70	9 234	10 260	18 468	12 000	20 000
18	[3.3]	R.1 (20MHz,1PRB,16QAM, $\frac{1}{2}$) (1x2 Low) ETU,70	13 373	14 859	26 746	16 000	28 000

Table G.3.5-2: Minimum Test time for PDSCH Single Antenna Port Performance with 1 PRB

Test No	Demod. scenario	Demodulation scenario (info only)	MNAS (Simulation)	MNS (Calculation)		MNSF (Min No Sub Frames, mandatory)	
				FDD	TDD	FDD	TDD
1	[3.4]	R.29 (10MHz, 1PRB, 16QAM, 1/2) (1x2 Low) ETU, 70 [MBFSN]	5 246	17 487	17 487	19 000	19 000

Table G.3.5-3: Minimum Test time for PDSCH Transmit diversity 2x2

Test No	Demod. scenario	Demodulation scenario (info only)	MNAS (Simulation)	MNS (Calculation)		MNSF (Min No Sub Frames, mandatory)	
				FDD	TDD	FDD	TDD
1	[7.1]	R11 (10MHz, full, 16QAM, 1/2) (2x2 Med) EVA,5 [SFBC, Space Frequency Block Code]	50 000	55 556	100 000	57 000	101 000
1 Rel-9		R.11-2 (5MHz, full, 16QAM, 1/2) (2x2 Med) EVA5 [SFBC]	50 000 (MNAS is not simulated, but estimated based on similar scenario in Table G.3.5-2 Test1)	55 556	100 000	57 000	101 000
2	[7.2]	R.10 (10MHz, Full, QPSK, 1/3) (2x2 low) HST [SFBC]	28 800	NA	NA	28 800	57 600

Table G.3.5-4: Minimum Test time for PDSCH Transmit diversity 4x2

Test No	Demod. scenario	Demodulation scenario (info only)	MNAS (Simulation)	MNS (Calculation)		MNSF (Min No Sub Frames, mandatory)	
				FDD	TDD	FDD	TDD
1	[7.3]	R.12 (1.4MHz, full, QPSK, 1/3) (4x2 med) EPA,5 [SFBC-FSTD, SFBC-Frequency Shifted Transmit Diversity]	150 000	166 667	300 000	168 000	301 000
1 Rel-9		R.13 (10 MHz, full, QPSK, 1/3) (4x2 Low) ETU70 [SFBC-FSTD]	10 000 (MNAS is not simulated, but estimated based on similar scenarios in Table G.3.5-4 Test1)	11 112	20 000	13 000	21 000

Table G.3.5-5: Minimum Test time for PDSCH Open Loop Spatial Multiplexing 2x2

Test No	Demod. scenario	Demodulation scenario (info only)	MNAS (Simulation)	MNS (Calculation)		MNSF (Min No Sub Frames, mandatory)	
				FDD	TDD	FDD	TDD
1	[6.1]	R.11 (10MHz, Full, 16QAM, ½) (2x2 Low) EVA,70 [LD-CDD, Large Delay-Cyclic Delay Diversity]	7 600	8 445	19 000	10 000	20 000

Table G.3.5-6: Minimum Test time for PDSCH Open Loop Spatial Multiplexing 4x2

Test No	Demod. scenario	Demodulation scenario (info only)	MNAS (Simulation)	MNS (Calculation)		MNSF (Min No Sub Frames, mandatory)	
				FDD	TDD	FDD	TDD
1	[6.2]	R.14 (10MHz, full, 16 QAM, ½) (4x2 low) EVA,70 [LD-CDD]	4 860	5 400	12 150	7 000	14 000

Table G.3.5-7: Minimum Test time for PDSCH Closed Loop Single/Multilayer Spatial Multiplexing 2x2

Test No	Demod. scenario	Demodulation scenario (info only)	MNAS (Simulation)	MNS (Calculation)		MNSF (Min No Sub Frames, mandatory)	
				FDD	TDD	FDD	TDD
1	[4.1]	R.10 (10MHz, Full, QPSK, 1/3) (2x2 Low) EVA,5 [SCW, Single CodeWord]	49 140	54 600	98 280	56 000	100 000
2	[4.2]	R.10 (10MHz, Full, QPSK, 1/3) (2x2 High) EPA,5 [SCW]	50 000	55 556	100 000	57 000	101 000
3 FDD	[5.1]	R.11 (10MHz, full, 16QAM, 1/2) (2x2Low) EVA,5 [MCW, Multiple Code Word]	34 266	38 074	-	40 000	-
3 TDD	[5.1]	R.11-1 (10MHz, full, 16QAM, 1/2) (2x2Low) EVA,5 [MCW, Multiple Code Word]	34 266	-	85 665	-	87 000
3 Rel-9		R.35 (10MHz, full, 64QAM, 1/2) (2x2 Low) EPA5 [MCW]	48 000 (MNAS is not simulated, but estimated based on similar scenarios in Table G.3.5-12 Test5)	53 333	120 000	55 000	121 000
4 FDD	[5.2]	R.11 (10MHz, full, 16QAM, 1/2) (2x2Low) ETU,70 [MCW]	2 736	3 040	-	5 000	-
4 TDD	[5.2]	R.11-1 (10MHz, full, 16QAM, 1/2) (2x2Low) ETU,70 [MCW]	2 736	-	6840	-	8000

Table G.3.5-8: Minimum Test time for PDSCH Closed Loop Single/Multilayer Spatial Multiplexing 4x2

Test No	Demod. scenario	Demodulation scenario (info only)	MNAS (Simulation)	MNS (Calculation)		MNSF (Min No Sub Frames, mandatory)	
				FDD	TDD	FDD	TDD
1	[4.3]	R.13 (10 MHz, Full, QPSK, 1/3) (4x2 Low) EVA,5 [SCW]	26 528	29 476	53 056	31 000	55 000
2	[5.3]	R.14 (10MHz, Full, 16QAM, ½) (4x2low) EVA5 [MCW]	26 066	28 963	65 165	30 000	67 000
2 Rel-9		R.36 (10MHz, full, 64QAM 1/2) (4x2 Low) EPA5 [MCW]	30 000 (MNAS is not simulated, but estimated based on similar scenarios in Table G.3.5-4 Test1)	33 333	75 000	35 000	76 000

Table G.3.5-9: Minimum Test time for PDSCH Single-layer Spatial Multiplexing on antenna port 5 (Release 8 and forward)

Test No	Demod. scenario	Demodulation scenario (info only)	MNAS (Simulation)	MNS (Calculation)		MNSF (Min No Sub Frames, mandatory)	
				FDD	TDD	FDD	TDD
1	[11.1]	R.25 (10 MHz, full, QPSK, 1/3) (1x2 Low) EPA,5	38 879	43 199	77 758	45 000	79 000
2	[11.2]	R.26 (10MHz, full, 16QAM, ½) (1x2 Low) EPA5	47 781	53 090	95 562	55 000	97 000
3	[11.3]	R.27 (10MHz, full, 64QAM, 3/4) (1x2 Low) EPA,5	48 685	54 095	97 370	56 000	99 000
4	[11.4]	R.28 (10MHz, 1PRB, 16QAM, ½) (1x2 Low) EPA,5	100 000	111 112	200 000	113 000	201 000

Table G.3.5-10: Minimum Test time for PDSCH Single-layer Spatial Multiplexing on antenna port 5 (Release 9 and forward)

Test No	Demod. scenario	Demodulation scenario (info only)	MNAS (Simulation)	MNSF (Min No Sub Frames, mandatory)	
				FDD	TDD
1 NA					
2	[]	R.26 (5MHz, full, 16QAM ½) (2x2 Low) EPA5	Note: MNAS is not simulated. Because of same demodulation scenario except for antenna configuration, MNSF is reused from Table G.3.5-9, Test 2	55 000	97 000
3	[]	R.27 (10MHz, part, 64QAM ¾) (2x2 Low) EPA,5	Note: MNAS is not simulated. Because of same demodulation scenario except for antenna configuration, MNSF is reused from Table G.3.5-9, Test 3	56 000	99 000
4 NA					

Table G.3.5-11: Minimum Test time for PDSCH Single-layer Spatial Multiplexing on antenna port 7 or 8 without simultaneous transmission

Test No	Demod. scenario	Demodulation scenario (info only)	MNAS (Simulation)	MNSF (Min No Sub Frames, mandatory)	
				FDD	TDD
1	[]	R.31 (10 MHz, full, QPSK, 1/3) (2x2 Low) EVA,5	Note: MNAS is not simulated. Because of same demodulation scenario except for RMC, antenna configuration, MNSF is reused from Table G.3.5-9, Test 1	45 000	79 000
2	[]	R.32 (10MHz, full, 16QAM, ½) (2x2 Medium) EPA5	Note: MNAS is not simulated. Because of same demodulation scenario except for RMC, antenna configuration, MNSF is reused from Table G.3.5-9, Test 2	55 000	97 000
		R.32-1 (5MHz, full, 16QAM, ½) (2x2 Medium) EPA5	Note: MNAS is not simulated. Because of same demodulation scenario except for RMC, channel BW, antenna configuration, MNSF is reused from Table G.3.5-9, Test 2		
3	[]	R.33 (10MHz, full, 64QAM, ¾) (2x2 Low) EPA,5	Note: MNAS is not simulated. Because of same demodulation scenario except for RMC, antenna configuration, MNSF is reused from Table G.3.5-9, Test 3	56 000	99 000
		R.33-1 (10MHz, part, 64QAM, ¾) (2x2 Low) EPA5	Note: MNAS is not simulated. Because of same demodulation scenario except for RMC, allocation, antenna configuration, MNSF is reused from Table G.3.5-9, Test 3		

Table G.3.5-12: Minimum Test time for PDSCH Single-layer Spatial Multiplexing on antenna port 7 or 8 with a simultaneous transmission

Test No	Demod. scenario	Demodulation scenario (info only)	MNAS (Simulation)	MNSF (Min No Sub Frames, mandatory)	
				FDD	TDD
4	[]	R.32 (10MHz, full, 16QAM, 1/2) (2x2 Medium) EPA,5	Note: MNAS is not simulated. Because of same demodulation scenario except for RMC number, antenna configuration, MNSF is reused from Table G.3.5-9, Test 2	55 000	97 000
5	[]	R.34 (10MHz, full, 64QAM, 1/2) (2x2 Low) EPA,5	Note: MNAS is not simulated. Because of same demodulation scenario except for RMC number, target coding rate, antenna configuration, MNSF is reused from Table G.3.5-9, Test 3	56 000	99 000

Table G.3.5-12a: Minimum Test time for PDSCH Single-layer Spatial Multiplexing on antenna port 7 or 8 without simultaneous transmission for eDL-MIMO

Test No	Demod. scenario	Demodulation scenario (info only)	MNAS (Simulation)	MNSF (Min No Sub Frames, mandatory)	
				FDD	TDD
1	[]	R.43 FDD, R50 TDD (10 MHz, full, QSPK, 1/3) (2x2 Low) EVA,5	Note: MNAS is not simulated. Because of same demodulation scenario except for RMC, antenna configuration, propagation condition, MNSF is reused from Table G.3.5-9, Test 1	45 000	79 000

Table G.3.5-12b: Minimum Test time for PDSCH Single-layer Spatial Multiplexing on antenna port 7 or 8 with a simultaneous transmission for eDL-MIMO

Test No	Demod. scenario	Demodulation scenario (info only)	MNAS (Simulation)	MNSF (Min No Sub Frames, mandatory)	
				FDD	TDD
2	[]	R.50 FDD, R.44 TDD (10MHz, full, 64QAM, 1/2) (2x2 Low) EPA,5	Note: MNAS is not simulated. Because of same demodulation scenario except for RMC, target coding rate, antenna configuration, MNSF is reused from Table G.3.5-9, Test 3	56 000	99 000

Table G.3.5-13: Minimum Test time for PDSCH Dual-layer Spatial Multiplexing

Test No	Demod. scenario	Demodulation scenario (info only)	MNAS (Simulation)	MNSF (Min No Sub Frames, mandatory)	
				FDD	TDD
1	[]	R.31 (10 MHz, full, QPSK, 1/3) (2x2 Low) EVA,5	Note: MNAS is not simulated. Because of same demodulation scenario except for RMC, antenna configuration, MNSF is reused from Table G.3.5-9, Test 1	[45 000]	[79 000]
2	[]	R.32 (10MHz, full, 16QAM, ½) (2x2 Medium) EPA5	Note: MNAS is not simulated. Because of same demodulation scenario except for RMC, antenna configuration, MNSF is reused from Table G.3.5-9, Test 2	[55 000]	[97 000]

Table G.3.5-13a: Minimum Test time for PDSCH Dual-layer Spatial Multiplexing for eDL-MIMO

Test No	Demod. scenario	Demodulation scenario (info only)	MNAS (Simulation)	MNSF (Min No Sub Frames, mandatory)	
				FDD	TDD
1	[]	R.51 (10MHz, full, 16QAM, 1/2) (2x2 Low) EPA5	Note: MNAS is not simulated. Because of same demodulation scenario except for RMC, antenna configuration, MNSF is reused from Table G.3.5-9, Test 2	55 000	97 000

G.3.6 Test conditions for receiver performance tests

Table G.3.6: Test conditions for receiver performance tests

Table G.3.6-1: Single Antenna Port Performance (Cell-specific Reference Symbols) for test case 8.2.1.1 and 8.2.2.1 demodulation of PDSCH

Test	Statistical independence	Number of components in the test vector, as specified in the test requirements and initial conditions of the applicable test				Over all Pass/Fail condition
8.2.1.1 FDD PDSCH Single Antenna Port Performance (Cell- Specific Reference Symbols)	subframes are independent	CAT	1	2	3-5	To pass 8.2.1.1 and 8.2.2.1 each component in the test vector must pass For UEs, supporting multiple E_UTRA-bands (number of bands =B), the number of repetitions must be multiplied by B.
		QPSK	5	5	5	
		16QAM	0	3	3	
8.2.1.2 TDD PDSCH Single Antenna Port Performance (Cell- Specific Reference Symbols)	subframes are independent	64 QAM	1	6	7	If a test is defined over a BW>(BW of the E_UTRA band), the test is not applicable and reduces the number of repetitions. If a test is defined over a BW, which is not supported in the E_UTRAN band, the test is not applicable and reduces the number of repetitions.
		1PRB	4	4	4	
		Σ	10	18	19	

Table G.3.6-2: Transmit Diversity Performance (Cell-specific Reference Symbols) for test case 8.2.1.2 and 8.2.2.2 demodulation of PDSCH

Test	Statistical independence	Number of components in the test vector, as specified in the test requirements and initial conditions of the applicable test				Over all Pass/Fail condition
8.2.1.2 FDD PDSCH Transmit Diversity Performance (Cell-Specific Reference Symbols)	subframes are independent	CAT	1	2	3-5	To pass 8.2.1.2 and 8.2.2.2 each component in the test vector must pass For UEs, supporting multiple E_UTRA-bands (number of bands =B), the number of repetitions must be multiplied by B.
		QPSK	2	2	2	
8.2.2.2 TDD PDSCH Transmit Diversity Performance (Cell-Specific Reference Symbols)	subframes are independent	16QAM	0	1	1	If a test is defined over a BW, which is not supported in the E_UTRAN band, the test is not applicable and reduces the number of repetitions.
		Σ	2	3	3	

Table G.3.6-3: Open Loop Spatial Multiplexing Performance (Cell-specific Reference Symbols) for test case 8.2.1.3 and 8.2.2.3 demodulation of PDSCH

Test	Statistical independence	Number of components in the test vector, as specified in the test requirements and initial conditions of the applicable test				Over all Pass/Fail condition
8.2.1.3 FDD PDSCH Open Loop Spatial Multiplexing Performance (Cell-Specific Reference Symbols)	subframes are independent	CAT	1	2	3-5	To pass 8.2.1.3 and 8.2.2.3 each component in the test vector must pass
		16QAM	0	2	2	
8.2.2.3 TDD PDSCH Open Loop Spatial Multiplexing Performance (Cell-Specific Reference Symbols)	subframes are independent	Σ	0	2	2	

Table G.3.6-4: Closed Loop Spatial Multiplexing Performance (Cell-specific Reference Symbols) for test case 8.2.1.4 and 8.2.2.4 demodulation of PDSCH

Test	Statistical independence	Number of components in the test vector, as specified in the test requirements and initial conditions of the applicable test				Over all Pass/Fail condition
8.2.1.4 FDD PDSCH Closed Loop Spatial Multiplexing Performance (Cell- Specific Reference Symbols)	subframes are independent	CAT	1	2	3-5	To pass 8.2.1.4 and 8.2.2.4 each component in the test vector must pass
		Single layer QPSK	3	3	3	
8.2.2.4 TDD PDSCH Closed Loop Spatial Multiplexing Performance (Cell- Specific Reference Symbols)	subframes are independent	Multi layer 16QAM	0	3	3	
		Σ	3	6	6	

Table G.3.6-5: TDD PDSCH Single-layer Spatial Multiplexing on antenna port 5 (Release 8 and forward)

Test	Statistical independence	Number of components in the test vector, as specified in the test requirements and initial conditions of the applicable test				Over all Pass/Fail condition
8.3.2.1.1 TDD PDSCH Single-layer Spatial Multiplexing on antenna port 5 (Release 8 and forward)	subframes are independent	CAT	1	2	3-5	To pass 8.3.2.1 each component in the test vector must pass
		QPSK	1	1	1	
		16QAM	1	2	2	
		64 QAM	0	1	1	
		Σ	2	4	4	

Table G.3.6-6: TDD PDSCH Single-layer Spatial Multiplexing on antenna port 5 (Release 9 and forward)

Test	Statistical independence	Number of components in the test vector, as specified in the test requirements and initial conditions of the applicable test				Over all Pass/Fail condition
		CAT	1	2	3-5	
8.3.2.1.1_1 TDD PDSCH Single-layer Spatial Multiplexing on antenna port 5 (Release 9 and forward)	subframes are independent	16QAM	1	0	0	To pass 8.3.2.1.1_1 each component in the test vector must pass
		64 QAM	1	0	0	
		Σ	2	0	0	

Table G.3.6-7: TDD PDSCH Single-layer Spatial Multiplexing on antenna port 7 or 8 without a simultaneous transmission

Test	Statistical independence	Number of components in the test vector, as specified in the test requirements and initial conditions of the applicable test				Over all Pass/Fail condition
		CAT	1	2-5		
8.3.2.1.2 TDD PDSCH Single-layer Spatial Multiplexing on antenna port 7 or 8 without a simultaneous transmission	subframes are independent	QPSK	1	1		To pass 8.3.2.1.2 each component in the test vector must pass
		16QAM	1	1		
		64 QAM	1	1		
		Σ	3	3		

Table G.3.6-8: TDD PDSCH Single-layer Spatial Multiplexing on antenna port 7 or 8 with a simultaneous transmission

Test	Statistical independence	Number of components in the test vector, as specified in the test requirements and initial conditions of the applicable test				Over all Pass/Fail condition
		CAT	1	2-5		
8.3.2.1.3 TDD PDSCH Single-layer Spatial Multiplexing on antenna port 7 or 8 with a simultaneous transmission	subframes are independent	16QAM	0	1		To pass 8.3.2.1.3 each component in the test vector must pass
		64 QAM	0	1		
		Σ	0	2		

Table G.3.6-8a: TDD PDSCH Single-layer Spatial Multiplexing on antenna port 7 or 8 without a simultaneous transmission for eDL-MIMO

Test	Statistical independence	Number of components in the test vector, as specified in the test requirements and initial conditions of the applicable test				Over all Pass/Fail condition
8.3.1.1.1_D FDD PDSCH Single-layer Spatial Multiplexing on antenna port 7 or 8 without a simultaneous transmission	subframes are independent	CAT	1-8			To pass 8.3.1.1.1_D and 8.3.2.1.2_D each component in the test vector must pass
		QPSK	1			
8.3.2.1.2_D TDD PDSCH Single-layer Spatial Multiplexing on antenna port 7 or 8 without a simultaneous transmission	subframes are independent	QPSK	1			
		Σ	2			

Table G.3.6-8b: TDD PDSCH Single-layer Spatial Multiplexing on antenna port 7 or 8 with a simultaneous transmission for eDL-MIMO

Test	Statistical independence	Number of components in the test vector, as specified in the test requirements and initial conditions of the applicable test				Over all Pass/Fail condition
8.3.1.1.2_D FDD PDSCH Single-layer Spatial Multiplexing on antenna port 7 or 8 with a simultaneous transmission for eDL- MIMO	subframes are independent	CAT	1	2-8		To pass 8.3.1.1.2_D and 8.3.2.1.3_D each component in the test vector must pass
		64QAM	0	1		
8.3.2.1.3_D TDD PDSCH Single-layer Spatial Multiplexing on antenna port 7 or 8 with a simultaneous transmission for eDL- MIMO	subframes are independent	64QAM	0	1		
		Σ	0	2		

Table G.3.6-9: TDD PDSCH Dual-layer Spatial Multiplexing

Test	Statistical independence	Number of components in the test vector, as specified in the test requirements and initial conditions of the applicable test				Over all Pass/Fail condition
		CAT	1	2	3-5	
8.3.2.2.1 TDD PDSCH Dual-layer Spatial Multiplexing	subframes are independent	QPSK	1	1	1	To pass 8.3.2.2.1 each component in the test vector must pass
		16QAM	1	2	2	
		64 QAM	0	1	1	
		Σ	2	4	4	

Table G.3.6-9a: PDSCH Dual-layer Spatial Multiplexing for eDL-MIMO

Test	Statistical independence	Number of components in the test vector, as specified in the test requirements and initial conditions of the applicable test				Over all Pass/Fail condition
		CAT	1	2-8		
8.3.1.2.1_D FDD PDSCH Dual-layer Spatial Multiplexing for eDL- MIMO	subframes are independent	CAT	1	2-8		To pass 8.3.1.2.1_D and 8.3.2.2.1_D each component in the test vector must pass
		16QAM	0	1		
8.3.2.2.1_D TDD PDSCH Dual-layer Spatial Multiplexing for eDL- MIMO	subframes are independent	16QAM	0	1		
		Σ	0	2		

G.3A Statistical testing of Performance Requirements with throughput for CA

G.3A.1 General

The minimum requirements for performance tests in fading conditions in clause 8 with respect to CA are 70% of the maximum throughput. The minimum requirements in static conditions in clause 8 with respect to CA are [TBD]. Statistical tests in static propagation conditions lead to a statistically justified number of samples (testtime) and a test limit. The fading conditions require a minimum test time, overriding the statistically justified test time. It can be found in Tables G.3A.5. The statistically justified test limit is also used for the tests under fading conditions. The throughput is measured on both carriers in parallel (unless otherwise stated). The test for both carriers need the same time. The sum of the CC's throughput is compared against the limit, where the limit is the sum of the individual carrier's limit.

G.3A.2 Mapping throughput to error ratio

G.2.2 applies separate for each CC

G.3A.3 Design of the test

The test is defined by the following design principles (see clause G.x, Theory....):

1. The standard concept is applied (not the early decision concept).
2. A second limit is introduced, defining the Bad DUT.
3. To decide the test pass:
 - Supplier risk is applied based on the Bad DUT quality.
 - To decide the test fails.
 - Customer Risk is applied based on the specified DUT quality.

The test is defined by the following parameters:

- 1) Limit Error Ratio = 0.3.
(in case 70% throughput is tested , otherwise [TBD]).
- 2) Bad DUT factor $M = 1.378$ (selectivity) justification see: TS 34.121 Clause F.6.3.3.
($M = 1.378$ is tied to 70% throughput, otherwise M is [TBD].)
- 3) Confidence level $CL = 95\%$ (for specified DUT and Bad DUT-quality).

G.3A.4 Pass Fail limit

Testing with the parameters from G.3A.3 (70% throughput, $M = 1.378$, $CL95\%$): Apply 184 samples to the DUT per CC and count the errors for each CC. The test limit to pass for one CC is ≤ 66 errors, however this is not individually applicable for CA.

Pass fail decision for one test point in CA: The sum of the CC's errors is compared against the test limit, where the test limit is the sum of the individual carrier's test limit.

It is allowed to apply more samples, in parallel for all CCs, to the DUT (e.g. up to an integer number of frames).

In fading conditions it is necessary to apply more samples, in parallel for all CCs, to the DUT, as in fading conditions the minimum test time overrides the statistically justified test time.

When more samples are applied, decide against the ratio $66/184 = 0.3587$.

Testing with parameters from G.3A.3 ([TBD]% throughput, $M = [TBD]$, $CL = 95\%$) is [TBD].

G.3A.5 Minimum test time

In contrast to G.3.5, where the minimum test time is derived from simulations, the test time here is selected without simulation utilising test time information from similar demodulation scenarios in non-CA test cases and while maintaining the reasonable testing time.

Note MNAS values in this clause may need to be changed in future if current MNAS values turn out to be too short for giving stable CA throughput results.

Table G.3A.5-1: Minimum Test time FDD PDSCH Single Antenna Port Performance (intra-band contiguous DL CA)

Clause 8.2.1.1.1_A.1 Test No	Demodulation scenario plain text: RMC (Bandwidth, allocated RBs, modulation, coding) Antenna (configuration, correlation) Propagation condition, Doppler [additional parameters, if applicable] (info only)	Minimum Number of Active Subframes in each CC	Minimum Number of Subframes (MNS) in each CC (MNS = active and inactive subframes)
			FDD
1	R.42FDD (2x20 MHz, full, QPSK, 1/3) (1x2 Low) EVA5	50 000	55 556

Table G.3A.5-2: Minimum Test time FDD PDSCH Single Antenna Port Performance (inter-band DL CA)

Clause 8.2.1.1.1_A.2 Test No	Demodulation scenario plain text: RMC (Bandwidth, allocated RBs, modulation, coding) Antenna (configuration, correlation) Propagation condition, Doppler [additional parameters, if applicable] (info only)	Minimum Number of Active Subframes in each CC	Minimum Number of Subframes (MNS) in each CC (MNS = active and inactive subframes)
			FDD
1	R.2FDD (2x10 MHz, full, QPSK, 1/3) (1x2 Low) EVA5	50 000	55 556
2	R.42FDD (2x20 MHz, full, QPSK, 1/3) (1x2 Low) EVA5	50 000	55 556

Table G.3A.5-3: Minimum Test time FDD PDSCH Open Loop Spatial Multiplexing 2x2 (intra band contiguous DL CA)

Clause 8.2.1.3.1_A.1 Test No	Demodulation scenario plain text: RMC (Bandwidth, allocated RBs, modulation, coding) Antenna (configuration, correlation) Propagation condition, Doppler [additional parameters, if applicable] (info only)	Minimum Number of Active Subframes in each CC	Minimum Number of Subframes (MNS) in each CC (MNS = active and inactive subframes)
			FDD
1	R.30FDD (2x20 MHz, full, 16QAM, 1/2) (2x2 Low) EVA70	10 000	11 112

Table G.3A.5-4: Minimum Test time FDD PDSCH Open Loop Spatial Multiplexing 2x2 (inter band DL CA)

Clause 8.2.1.3.1_A.2 Test No	Demodulation scenario plain text: RMC (Bandwidth, allocated RBs, modulation, coding) Antenna (configuration, correlation) Propagation condition, Doppler [additional parameters, if applicable] (info only)	Minimum Number of Active Subframes in each CC	Minimum Number of Subframes (MNS) in each CC (MNS = active and inactive subframes)
			FDD
1	R.11FDD (2x10 MHz, full, 16QAM, 1/2) (2x2 Low) EVA 70	10 000	11 112
2	R.30FDD (2x20 MHz, full, 16QAM, 1/2) (2x2 Low) EVA70	10 000	11 112

Table G.3A.5-4A: Minimum Test time FDD PDSCH Closed Loop Multi Layer Spatial Multiplexing 4x2 (intra band contiguous DL CA)

Clause 8.2.1.4.2_A.1 Test No	Demodulation scenario plain text: RMC (Bandwidth, allocated RBs, modulation, coding) Antenna (configuration, correlation) Propagation condition, Doppler [additional parameters, if applicable] (info only)	Minimum Number of Active Subframes in each CC	Minimum Number of Subframes (MNS) in each CC (MNS = active and inactive subframes)
			FDD
1	R.14-3 FDD (2x20 MHz, full, 16QAM, 1/2) (4x2 Low) EVA5	50 000	55 556

Table G.3A.5-5: Minimum Test time FDD PDSCH Closed Loop Multi Layer Spatial Multiplexing 4x2 (inter band DL CA)

Clause 8.2.1.4.2_A.2 Test No	Demodulation scenario plain text: RMC (Bandwidth, allocated RBs, modulation, coding) Antenna (configuration, correlation) Propagation condition, Doppler [additional parameters, if applicable] (info only)	Minimum Number of Active Subframes in each CC	Minimum Number of Subframes (MNS) in each CC (MNS = active and inactive subframes)
			FDD
1	R.14FDD (2x10 MHz,full,16QAM, 1/2) (4x2 Low) EVA 5	10 000	11 112

Table G.3A.5-6: Minimum Test time TDD PDSCH Single Antenna Port Performance (intra-band contiguous DL CA)

Clause 8.2.2.1.1_A.1 Test No	Demodulation scenario plain text: RMC (Bandwidth, allocated RBs, modulation, coding) Antenna (configuration, correlation) Propagation condition, Doppler [additional parameters, if applicable] (info only)	Minimum Number of Active Subframes in each CC	Minimum Number of Subframes (MNS) in each CC (MNS = active and inactive subframes)
			TDD
1	R.42TDD (2x20 MHz,full,QPSK,1/3) (1x2 Low) EVA5	50 000	100 000

Table G.3A.5-7: Minimum Test time TDD PDSCH Open Loop Spatial Multiplexing 2x2 (intra band contiguous DL CA)

Clause 8.2.2.3.1_A.1 Test No	Demodulation scenario plain text: RMC (Bandwidth, allocated RBs, modulation, coding) Antenna (configuration, correlation) Propagation condition, Doppler [additional parameters, if applicable] (info only)	Minimum Number of Active Subframes in each CC	Minimum Number of Subframes (MNS) in each CC (MNS = active and inactive subframes)
			TDD
1	R.30-1 TDD (2x20 MHz, full, 16QAM, 1/2) (2x2 Low) EVA70	10 000	20 000

**Table G.3A.5-8: Minimum Test time TDD PDSCH Closed Loop Multi Layer Spatial Multiplexing 4x2
(intra band contiguous DL CA)**

Clause 8.2.2.4.2_A.1 Test No	Demodulation scenario plain text: RMC (Bandwidth, allocated RBs, modulation, coding) Antenna (configuration, correlation) Propagation condition, Doppler [additional parameters, if applicable] (info only)	Minimum Number of Active Subframes in each CC	Minimum Number of Subframes (MNS) in each CC (MNS = active and inactive subframes)
			TDD
1	R.43TDD (2x20 MHz,full,16QAM, 1/2) (4x2 Low) EVA 5	50 000	100 000

G.3A.6 Test conditions

Table G.3A.6-1: Test conditions for CA performance tests

Test	Statistical independence	Number of components in the test vector, as specified in the test requirements and initial conditions of the applicable test	Over all Pass/Fail condition
8.2.1.1.1_A.1 FDD PDSCH Single Antenna Port Performance for CA (intra-band contiguous DL CA)	subframes are independent	1	To pass the test case each component in the test vector must pass
8.2.1.1.1_A.2 FDD PDSCH Single Antenna Port Performance for CA (inter-band DL CA)	subframes are independent	2	To pass the test case each component in the test vector must pass
8.2.1.3.1_A.1 FDD PDSCH Open Loop Spatial Multiplexing 2x2 for CA (intra-band contiguous DL CA)	subframes are independent	1	To pass the test case each component in the test vector must pass
8.2.1.3.1_A.2 FDD PDSCH Open Loop Spatial Multiplexing 2x2 for CA (inter-band DL CA)	subframes are independent	2	To pass the test case each component in the test vector must pass
8.2.1.4.2_A.1 FDD PDSCH Closed Loop Multi Layer Spatial Multiplexing 4 x 2 for CA (intra-band contiguous DL CA)	subframes are independent	1	To pass the test case each component in the test vector must pass
8.2.1.4.2_A.2 FDD PDSCH Closed Loop Multi Layer Spatial Multiplexing 4 x 2 for CA (inter-band DL CA)	subframes are independent	1	To pass the test case each component in the test vector must pass
8.2.2.1.1_A.1 TDD PDSCH Single Antenna Port Performance for CA (intra-band contiguous DL CA)	subframes are independent	1	To pass the test case each component in the test vector must pass
8.2.2.3.1_A.1 TDD PDSCH Open Loop Spatial Multiplexing 2x2 for CA (intra-band contiguous DL CA)	subframes are independent	1	To pass the test case each component in the test vector must pass
8.2.2.4.2_A.1 TDD PDSCH Closed Loop Multi Layer Spatial Multiplexing 4x2 for CA (intra-band contiguous DL CA)	subframes are independent	1	To pass the test case each component in the test vector must pass

G.4 Statistical testing of Performance Requirements with probability of misdetection

G.4.1 General

The test of receiver performance characteristics is two fold.

1. A signal or a combination of signals is offered to the RX port(s) of the receiver.
2. The ability of the receiver to demodulate /decode this signal is verified by analyzing the reaction of the UE to this signal.

In (2) is the statistical aspect of the test and is treated here.

The minimum requirement for those receiver performance tests are 1% or 0.1% misdetection probability

All receiver performance tests are performed in fading conditions. In addition to the statistical considerations, this requires the definition of a minimum test time.

NOTE: All demodulation performance tests (state from version 9.5.0) require a minimum test time, which exceeds the maximum test time in tables G.4.4. Under this circumstances only the test limit at the end of tables G.4.4.-1 resp. G.4.4.-2 is applicable.

G.4.2 Mapping the UE reaction to error ratio

The UE can not indicate the detection or misdetection of the physical channel under test directly. Indirect methods are described in the procedure of the applicable test.

G.4.3 Design of the test

G.2.3 applies, exception:

Limit ER = 0.01 and ER = 0.001

G.4.4 Numerical definition of the pass fail limits

Table G.4.4-1 pass fail limits for ER = 0.01

ne	ns _p	ns _f	ne	ns _p	ns _f	ne	ns _p	ns _f	ne	ns _p	ns _f
0	344	NA	40	3929	2553	80	7033	5874	120	10036	9354
1	485	NA	41	4009	2632	81	7109	5960	121	10110	9442
2	607	10	42	4089	2712	82	7185	6046	122	10184	9530
3	719	33	43	4168	2792	83	7261	6131	123	10259	9619
4	826	66	44	4247	2873	84	7336	6217	124	10333	9707
5	929	107	45	4327	2953	85	7412	6303	125	10407	9796
6	1029	152	46	4406	3034	86	7488	6389	126	10481	9884
7	1127	202	47	4484	3115	87	7564	6475	127	10555	9972
8	1223	255	48	4563	3196	88	7639	6561	128	10629	10061
9	1317	311	49	4642	3278	89	7715	6648	129	10703	10150
10	1409	370	50	4720	3359	90	7790	6734	130	10777	10238
11	1501	430	51	4799	3441	91	7866	6820	131	10851	10327
12	1592	492	52	4877	3523	92	7941	6907	132	10925	10416
13	1681	555	53	4955	3605	93	8017	6993	133	10999	10504
14	1770	620	54	5033	3688	94	8092	7080	134	11073	10593
15	1858	686	55	5111	3770	95	8167	7167	135	11147	10682
16	1946	754	56	5189	3853	96	8242	7253	136	11221	10771
17	2032	822	57	5267	3935	97	8317	7340	137	11295	10860
18	2119	891	58	5344	4018	98	8393	7427	138	11369	10949
19	2204	961	59	5422	4101	99	8468	7514	139	11442	11038
20	2290	1032	60	5499	4185	100	8543	7601	140	11516	11127
21	2374	1103	61	5577	4268	101	8618	7688	141	11590	11216
22	2459	1175	62	5654	4352	102	8693	7775	142	11664	11305
23	2543	1248	63	5731	4435	103	8768	7863	143	11737	11394
24	2627	1321	64	5809	4519	104	8843	7950	144	11811	11483
25	2710	1395	65	5886	4603	105	8917	8037	145	11885	11573
26	2793	1470	66	5963	4687	106	8992	8125	146	11958	11662
27	2876	1544	67	6039	4771	107	9067	8212	147	12032	11751
28	2958	1620	68	6116	4855	108	9142	8300	148	12105	11840
29	3040	1696	69	6193	4940	109	9216	8387	149	12179	11930
30	3122	1772	70	6270	5024	110	9291	8475	150	12252	12019
31	3204	1848	71	6346	5109	111	9366	8562	151	12326	12109
32	3285	1925	72	6423	5193	112	9440	8650	152	12399	12198
33	3366	2003	73	6499	5278	113	9515	8738	153	12473	12288
34	3447	2080	74	6576	5363	114	9589	8826	154	12546	12377
35	3528	2158	75	6652	5448	115	9664	8914	155	12620	12467
36	3609	2237	76	6728	5533	116	9738	9002	156	12693	12556
37	3689	2315	77	6805	5618	117	9813	9090	157	12767	12646
38	3769	2394	78	6881	5704	118	9887	9178	158	12840	12736
39	3850	2473	79	6957	5789	119	9962	9266	159	12913	12826
									160	NA	12915
									Test limit = 1.2352E-2		

Table G.4.4-2 pass fail limits for ER = 0.001

ne	ns _p	ns _f	ne	ns _p	ns _f	ne	ns _p	ns _f	ne	ns _p	ns _f
0	3463	NA	41	40174	26265	82	71961	60368	123	102723	96075
1	4874	4	42	40971	27063	83	72720	61225	124	103465	96958
2	6096	99	43	41766	27863	84	73479	62083	125	104208	97842
3	7226	329	44	42559	28666	85	74237	62941	126	104949	98726
4	8298	658	45	43352	29471	86	74995	63801	127	105691	99610
5	9330	1059	46	44142	30279	87	75752	64661	128	106432	100495
6	10332	1513	47	44932	31088	88	76509	65522	129	107173	101380
7	11310	2009	48	45720	31899	89	77265	66383	130	107914	102266
8	12269	2539	49	46507	32713	90	78020	67246	131	108655	103152
9	13212	3096	50	47293	33528	91	78776	68109	132	109395	104039
10	14141	3677	51	48078	34345	92	79530	68973	133	110135	104926
11	15058	4278	52	48861	35164	93	80285	69838	134	110875	105813
12	15965	4896	53	49644	35984	94	81038	70704	135	111614	106701
13	16863	5530	54	50425	36807	95	81792	71570	136	112353	107589
14	17753	6177	55	51205	37631	96	82544	72437	137	113092	108478
15	18635	6836	56	51985	38456	97	83297	73305	138	113830	109367
16	19511	7507	57	52763	39283	98	84049	74173	139	114569	110257
17	20380	8188	58	53541	40112	99	84800	75042	140	115307	111146
18	21244	8878	59	54317	40942	100	85551	75911	141	116045	112037
19	22103	9576	60	55092	41773	101	86302	76782	142	116782	112927
20	22957	10282	61	55867	42606	102	87052	77653	143	117520	113818
21	23806	10995	62	56641	43440	103	87802	78524	144	118257	114710
22	24652	11715	63	57414	44276	104	88552	79396	145	118994	115602
23	25493	12441	64	58186	45113	105	89301	80269	146	119730	116494
24	26331	13173	65	58957	45951	106	90050	81143	147	120466	117386
25	27166	13911	66	59728	46790	107	90798	82017	148	121203	118279
26	27997	14654	67	60497	47631	108	91546	82891	149	121939	119173
27	28826	15401	68	61266	48472	109	92293	83766	150	122674	120066
28	29651	16154	69	62035	49315	110	93041	84642	151	123410	120960
29	30474	16910	70	62802	50159	111	93787	85518	152	124145	121855
30	31294	17671	71	63569	51004	112	94534	86395	153	124880	122749
31	32111	18436	72	64335	51851	113	95280	87273	154	125615	123644
32	32927	19204	73	65100	52698	114	96026	88151	155	126349	124540
33	33740	19976	74	65865	53546	115	96771	89029	156	127083	125435
34	34551	20752	75	66629	54396	116	97516	89908	157	127818	126332
35	35360	21531	76	67393	55246	117	98261	90788	158	128551	127228
36	36166	22312	77	68156	56097	118	99005	91668	159	129285	128125
37	36971	23097	78	68918	56950	119	99750	92548	160	130019	129022
38	37775	23885	79	69679	57803	120	100493	93429	161	130752	129919
39	38576	24676	80	70440	58657	121	101237	94311	162	NA	130817
40	39376	25469	81	71201	59512	122	101980	95193	Test limit = 1.2345E-3		

NOTE 1: The first column is the number of errors (ne = number of misdetections)

NOTE 2: The second column is the number of samples for the pass limit (ns_p, ns=Number of Samples= number misdetections + number of detections)

NOTE 3: The third column is the number of samples for the fail limit (ns_f)

NOTE 4: The test limit at the end of the table is applicable, when the minimum test time in clause 3.5 governs the test. Pass the test for ER ≤ Test limit, otherwise fail.

G.4.5 Pass fail decision rules

G.2.5 applies

NOTE: For ER=0.01 an ideal DUT passes after 344 samples. The maximum test time is 12913 samples. For ER=0.001 an ideal DUT passes after 3463 samples. The maximum test time is 130752 samples.

G.4.6 Minimum Test time

Table G.4.6-1: Minimum Test time for Demodulation of PCFICH/PDCCH

Test No	Demod. Scenario	Demodulation scenario (info only)	MNAS (Simulation)	MNS (Calculation)		MNSF (Min No Sub Frames, mandatory)	
				FDD	TDD	FDD	TDD
1	[8.1]	R.15 (10 MHz, 8CCE, full, QPSK 1/3) (1x2 Low) ETU70	200 000	222 222	400 000	224 000	401 000
1	[8.2]	R.16 (1.4MHz, 2CCE, full, QPSK 1/3) (2x2 Low) EPA5	200 000	222 222	400 000	224 000	401 000
1 Rel-9 ...	[]	R.16_1 (10MHz, 4CCE, full, QPSK 1/3) (2x2 Low) EVA70	200 000	222 222	400 000	224 000	401 000
1	[8.3]	R.17 (10MHz, 4CCE, full, QPSK 1/3) (4x2 Medium) EVA5	200 000	222 222	400 000	224 000	401 000
1 Rel-9 ...	[]	R.17_1 (5MHz, 2CCE, full, QPSK 1/3) (4x2 Medium) EPA5	200 000	222 222	400 000	224 000	401 000
Note: Simulation method to derive MNAS is based on finite test time and its effect on test system uncertainty specified in clause F.1.4.							

Table G.4.6-2: Minimum Test time for Demodulation of PHICH

Test No	Demod. scenario	Demodulation scenario (info only)	MNAS (Simulation)	MNS (Calculation)		MNSF (Min No Sub Frames, mandatory)	
				FDD	TDD	FDD	TDD
1	[9.1]	R.18 (10 MHz, full, QPSK 1/3) (1x2 Low) ETU70	200 000	200 000	500 000	200 000	500 000
2	[9.4]	R.24 (10MHz, full, 16QAM 1/2) (1x2 Low) ETU70	200 000	200 000	500 000	200 000	500 000
1	[9.2]	R.19 (1.4MHz, full, 64QAM 3/4) (2x2 Low) EPA5	200 000	200 000	500 000	200 000	500 000
1 Rel- 9...	[]	R.19_1 (10MHz, full, 64QAM 3/4) (2x2 Low) EVA70	200 000	200 000	500 000	200 000	500 000
1	[9.3]	R.20 (10MHz, 1PRB, 16QAM 1/2) (4x2 Medium) EVA5	200 000	200 000	500 000	200 000	500 000
1 Rel- 9...	[]	R.20_1 (5MHz, 1PRB, 16QAM 1/2) (4x2 Medium) EPA5	200 000 R.20 has 5MHz BW Scenario 9.3. has EVA5	200 000	500 000	200 000	500 000
Note: Simulation method to derive MNAS is based on finite test time and its effect on test system uncertainty specified in clause F.1.4.							

G.4.7 Test conditions for receiver performance tests

Table G.4.7: Test conditions for receiver performance tests

Test	Statistical independence	Number of components in the test vector, as specified in the test requirements and initial conditions of the applicable test	Over all Pass/Fail condition Restrictions and extensions see Table G.3.6-1
8.4.1.1 FDD PCFICH/PDCCH Single-antenna Port Performance	A misdetection is an independent event	1	NA
8.4.1.2 FDD PCFICH/PDCCH Transmit Diversity Performance	A misdetection is an independent event	2	To pass 8.4.1.2 each component in the test vector must pass
8.4.2.1 TDD PCFICH/PDCCH Single-antenna Port Performance	A misdetection is an independent event	1	NA
8.4.2.2 TDD PCFICH/PDCCH Transmit Diversity Performance	A misdetection is an independent event	2	To pass 8.4.2.2 each component in the test vector must pass
8.5.1.1 FDD PHICH Single-antenna Port Performance	A misdetection is an independent event	2	To pass 8.5.1.1 each component in the test vector must pass
8.5.1.2 FDD PHICH Transmit Diversity Performance	A misdetection is an independent event	2	To pass 8.5.1.2 each component in the test vector must pass
8.5.2.1 TDD PHICH Single- antenna Port Performance	A misdetection is an independent event	2	To pass 8.5.2.1 each component in the test vector must pass
8.5.2.2 TDD PHICH Transmit Diversity Performance	A misdetection is an independent event	2	To pass 8.5.2.2 each component in the test vector must pass

G.5 Measuring throughput ratio

G.5.1 General

Annex G.5 is applicable for clauses 9.3, 9.4 and 9.5. Common to those clauses is, that a throughput ratio γ is measured. These clauses are tested exclusively with “slow” multipath fading profiles. Hence the test time is governed by test time due to fading, and number of samples due to statistical significance is not applicable.

The test requirements in clause 9.4 are a ratio of 2 throughput tests according to $\gamma = \frac{t_{ue}}{t_{rnd}}$. The denominator must be established by an approach, resulting in the denominator throughput t_{rnd} and the reference SNR_{rnd} , the latter is reused to measure the nominator throughput.

The test requirements in clauses 9.3 and 9.5 are a ratio of 2 throughput tests according to $\gamma = \frac{t_{subband}}{t_{median}}$, $\gamma = \frac{t_{reported}}{t_{fix}}$ etc. Nominator and denominator are ordinary throughput tests

t_{ue} , t_{rnd} , $t_{reported}$, t_{fix} , $t_{subband}$, t_{median} , $t_{wideband}$ are throughputs, derived under different conditions and are defined in clauses 9.3, 9.4 and 9.5.

SNR_{rnd} is the signal noise ratio, derived together with t_{rnd} and is defined in clause 9.4.

G.5.2 Establishing t_{rnd}

Adjust SNR such that the measured throughput is $58\% \leq t_{rnd} \leq 62\%$.

The resulting SNR is declared SNR_{rnd}

To achieve statistical significance the final throughput measurement must be done with MNS samples, given table G.5.4-1

The approach, leading to t_{rnd} and SNR_{rnd} is not specified.

G.5.3 Measuring T-put

To achieve statistical significance the final throughput measurement must be done with MNS samples, given in table.G.5.4 -1. Number of samples due to statistical significance is not applicable.

For measuring $t_{subband}$, $t_{wideband}$, $t_{reported}$ and t_{fix} , the SS collects ACK, NACK and statDTX from the UE and records the time, elapsed from the beginning of the test. The payload size, received by the UE and acknowledged towards the SS, may vary within a test versus time (e.g. due to subband changes upon a UE report) Throughput is calculated in the SS by summing up the payload, associated to each ACK, from the start of the test and dividing the accumulated payload in kilobits by the time in seconds, elapsed from the beginning of the test. This is similar but not same as in G.2.2. (Main difference in bullet d, where the payload size is constant).

For measuring t_{median} , t_{ue} , and t_{rnd} , the SS collects ACK, NACK and statDTX from the UE and records the time, elapsed from the beginning of the test. The payload size, received by the UE and acknowledged towards the SS, is constant. Throughput can be calculated in the SS by multiplying the payload size with the number of ACKs and dividing the accumulated payload in kilobits by the time in seconds, elapsed from the beginning of the test, being associated to the following ratio: $ACK / (ACK + NACK + DTX)$.

G.5.4 Number of samples for throughput ratios

TT for γ and MNS are based on theoretical estimations.

Table G.5.4-1: Test time for testing throughput ratios

Test	Demodulation scenario: RMC (Bandwidth, allocated RBs, modulation, coding) [Antenna configuration, correlation] Propagation condition, Doppler	Γ	Minimum Number of Subframes (MNS)		Γ including TT	BLER
			FDD	TDD		
9.3.1.1.1 9.3.1.1.2	(10 MHz, 6, variable modulation and coding) [1x2, full] Special propagation according to clause B. 2. 4, 5Hz	1.1	100000 For denominator- and nominator-measurement each	170000 For denominator- and nominator-measurement each	$\gamma = 1.09$	BLER=0.05, no TT No of samples: subset of ACKs and NACKs in the MNS for throughput.
9.3.1.2.1 _D	(10 MHz, 6, variable modulation and coding) [2x2, full] Special propagation according to clause B.2.4, 5Hz	1.1	100000 For denominator- and nominator-measurement each	170000 For denominator- and nominator-measurement each	$\gamma = 1.09$	BLER=0.05, no TT No of samples: subset of ACKs and NACKs in the MNS for throughput.
9.3.1.2.2 _D	(10 MHz, 6, variable modulation and coding) [2x2, full] Special propagation according to clause B.2.4, 5Hz	1.1	100000 For denominator- and nominator-measurement each	170000 For denominator- and nominator-measurement each	$\gamma = 1.09$	BLER=0.05, no TT No of samples: subset of ACKs and NACKs in the MNS for throughput.
9.3.2.1.1 9.3.2.1.2	(10 MHz, full, variable modulation and coding) [1x2, high] EPA5	1.05	100000 For denominator- and nominator-measurement each	170000 For denominator- and nominator-measurement each	$\gamma = 1.04$	BLER=0.02, no TT No of samples for FDD: subset of ACKs and NACKs in the MNS for throughput. No of samples for TDD: subset of <i>filtered</i> ACKs and NACKs in the MNS for throughput.
9.3.2.1.1 _1 9.3.2.1.2 _1	(10 MHz, partial, variable modulation and coding) [1x2, high] EPA5	1.05	100000 For denominator- and nominator-measurement each	170000 For denominator- and nominator-measurement each	$\gamma = 1.04$	BLER=0.02, no TT No of samples for FDD: subset of ACKs and NACKs in the MNS for throughput. No of samples for TDD: subset of <i>filtered</i> ACKs and NACKs in the MNS for throughput.
9.3.2.2.1 _D	(10 MHz, full, variable modulation and coding) [4x2, high] EPA5	1.05	100000 For denominator- and nominator-measurement each	170000 For denominator- and nominator-measurement each	$\gamma = 1.04$	BLER=0.02, no TT No of samples for FDD: subset of ACKs and NACKs in the MNS for throughput.

9.3.2.2.2 _D	(10 MHz, full, variable modulation and coding) [8x2, high] EPA5	1.05	100000 For denominator- and nominator-measurement each	170000 For denominator- and nominator-measurement each	$\gamma = 1.04$	BLER=0.02, no TT No of samples for TDD: subset of <i>filtered</i> ACKs and NACKs in the MNS for throughput.
9.3.3.1.1 9.3.3.1.2	10 MHz, full(however unequal SNR), variable modulation and coding) [1x2, full] Special: propagation according to clause B.2.4, 5Hz	1.6	100000 For denominator- and nominator-measurement each	170000 For denominator- and nominator-measurement each	1.50	
9.3.4.1.1 9.3.4.1.2	Same as 9.3.3	1.2	100000	170000	1.19	
9.3.4.2.1 9.3.4.2.2	Same as 9.3.3	1.15	100000	170000	1.14	
9.4.1.1.1 9.4.1.1.2	R. 10 (10 MHz, full, QPSK, 1/3) (2x2 Low) EVA5	1.1	100000	170000	$\gamma = 1.09$	
9.4.1.2.1 9.4.1.2.2	R.14-1 (10 MHz, partial, QPSK, 1/3) (4x2 Low) EVA,5	1.2	100000	170000	1.19	
9.4.2.1.1 9.4.2.1.2	R.30 (20 MHz, full, 16QAM, 1/2) (2x2 Low) EPA5	1.2	100000	170000	$\gamma = 1.19$	
9.4.2.1.1 _1 9.4.2.1.2 _1	R.11-3 or R.11 (10 MHz, partial or full, 16QAM, 1/2) (2x2 Low) EPA5	1.2	100000	170000	$\gamma = 1.19$	
9.4.2.2.1	R.14-2 FDD (10MHz, 3, 16 QAM, 1/2, 4x2low, EVA5)	1.2	100000	170000	1.19	
9.4.2.2.2	R.14-2 TDD (10MHz, 3, 16QAM, 1/2, 4x2low, EVA5)	1.15	100000	170000	1.14	
9.4.1.3.1 _D	R.44 (10 MHz, partial, QPSK, 1/3) (4x2 Low) EPA5	1.2	100000	170000	$\gamma = 1.19$	
9.4.1.3.2 _D	R.45-1 or R.45 (10 MHz, partial or full, 16QAM, 1/2) (8x2 High) EVA5	1.2	100000	170000	$\gamma = 1.19$	

9.4.2.3.1_D	R.45-1 or R.45 (10 MHz, partial or full, 16QAM, 1/2) (4x2 Low) EVA5	1.3	100000	170000	$\gamma = 1.29$	
9.4.2.3.2_D	R.45-1 or R.45 (10 MHz, partial or full, 16QAM, 1/2) (8x2 High) EVA5	3.5	100000	170000	$\gamma = 3.49$	
9.5.1.1 9.5.1.2	(10MHz, full, variable modulation and coding) (2x2, low or high according to test) (2x2, EPA5)	Test 2 $\gamma_1=1.05$ Test 1 $\gamma_2=1$ Test 3 $\gamma_2=1.1$	100000	170000	Test2 $\gamma_1=1.04$ Test1 $\gamma_2=0.99$ Test3 $\gamma_2=1.09$	
9.5.1.1_1 9.5.1.2_1	(10MHz, full, variable modulation and coding) (2x2, low or high according to test) (2x2, EPA5)	Test 2 $\gamma_1=1.05$ Test 1 $\gamma_2=1$ Test 3: $\gamma_1=0.90$ $\gamma_2=1.10$	100000	170000	Test2 $\gamma_1=1.04$ Test1 $\gamma_2=0.99$ Test3: $\gamma_1=0.89$ $\gamma_2=1.09$	
9.5.1.1_2 9.5.1.2_2	(10MHz, full, variable modulation and coding) (2x2, low or high according to test) (2x2, EPA5)	Test 2 $\gamma_1=1.05$ Test 1 $\gamma_2=1$ Test 3: $\gamma_1=0.90$	100000	170000	Test2 $\gamma_1=1.04$ Test1 $\gamma_2=0.99$ Test3: $\gamma_1=0.89$	
9.5.2.1_D 9.5.2.2_D	(10MHz, full, variable modulation and coding) (2x2, low or high according to test) (2x2, EPA5)	Test 2 $\gamma_1=1.05$ Test 3 $\gamma_1=0.9$ Test 1 $\gamma_2=1.0$	100000	170000	Test2 $\gamma_1=1.04$ Test3 $\gamma_1=0.89$ Test1 $\gamma_2=0.99$	

G.6 Statistical testing of MBMS Performance

G.6.1 General

The system simulator sends MBMS packets to the UE under test. The number of packets, the SS sends, is predefined by the test time in G.6.4. The UE under tests demodulates the MBMS packets and counts the successfully received number of MBMS packets into the UE internal MBMS packet counter. The SS reads out the counter and issues a pass fail decision.

G.6.2 Mapping of MBMS Packet ratio to BLER

The minimum requirements are designed in terms of BLER = 1%. 10 MBMS packets are included in one Transport block, constant throughout the test. The ratio of correct received MBMS packets (M_{ok}) to transmitted packets (M_{tot}) is assumed to be equal to the ratio of correct received transport blocks to transmitted transport blocks. This assumption ignores the unlikely case that payload and CRC for a transport block are consistent but wrong.

G.6.3 Design of the test

The minimum requirement for all MBMS tests is BLER = 1%. All MBMS tests are performed under a fading scenario: MBSFN channel model (Table B.2.6-1). It is obvious, that this fading scenario requires a minimum test time, greater than the time, required for statistical significance. In addition the test design with the MBMS packet counter in the UE suggest a fixed test time. Without simulation the test time is set to [200 000] active subframes (Transport blocks), leading to [333 333] subframes (333sec) for FDD and [400 000] subframes (400sec) for TDD. In order to avoid the fail of a good DUT due to statistical uncertainty the minimum requirement of BLER = 1% leads to a

Test limit = 1.2352 %. (refer Table G.4.4-1)

This means a DUT actually on the limit (1%) is measured and passed with a confidence level of greater than 95%.

G.6.4 Test time for MBMS performance tests

Table G.6.4-1: Minimum Test time for MBMS

Test No	Demodulation scenario (info only)	Min No of Sub Frames	
		FDD (6 of 10 subframes are active)	TDD (5 of 10 subframes are active)
1	R.37 (10 MHz, full, QPSK 1/3) (1x2 Low) MBSFN channel model	[333 333]	[400 000]
2	R.38 (10MHz, full, 16QAM 1/2) (1x2 Low) MBSFN channel model	[333 333]	[400 000]
3	R.39 (10 MHz, full, 64QAM 2/3) (1x2 Low) MBSFN channel model	[333 333]	[400 000]
3	R.39-1 (5 MHz, full, 64QAM 2/3) (1x2 Low) MBSFN channel model	[333 333]	[400 000]
4	R.40 (1.4 MHz, full, QPSK 1/3) (1x2 Medium) MBSFN channel model	[333 333]	[400 000]

G.X Theory to derive the numbers in Table G.2.4-1 (Informative)

Editor's note: This clause of the Annex G is for information only and it described the background theory and information to derive the entries in the table G.2.4-1.

G.X.1 Error Ratio (ER)

The Error Ratio (ER) is defined as the ratio of number of errors (ne) to all results, number of samples (ns).

(1-ER is the success ratio).

G.X.2 Test Design

A statistical test is characterised by:

Test-time, Selectivity and Confidence level.

G.X.3 Confidence level

The outcome of a statistical test is a decision. This decision may be correct or in-correct. The Confidence Level CL describes the probability that the decision is a correct one. The complement is the wrong decision probability (risk) $D = 1 - CL$

G.X.4 Introduction: Supplier Risk versus Customer Risk

There are two targets of decision:

- (a) A measurement on the pass-limit shows, that the DUT has the specified quality or is better with probability CL (CL e.g.95%) This shall lead to a "pass decision"

The pass-limit is on the good side of the specified DUT-quality. A more stringent CL (CL e.g.99%) shifts the pass-limit farther into the good direction. Given the quality of the DUTs is distributed, a greater CL passes less and better DUTs.

A measurement on the bad side of the pass-limit is simply "not pass" (undecided or artificial fail).

- (aa) Complementary:

A measurement on the fail-limit shows, that the DUT is worse than the specified quality with probability CL.

The fail-limit is on the bad side of the specified DUT-quality. A more stringent CL shifts the fail-limit farther into the bad direction. Given the quality of the DUTs is distributed, a greater CL fails less and worse DUTs.

A measurement on the good side of the fail-limit is simply "not fail".

- (b) A DUT, known to have the specified quality, shall be measured and decided pass with probability CL. This leads to the test limit.

For CL e.g. 95%, the test limit is on the bad side of the specified DUT-quality. CL e.g.99% shifts the pass-limit farther into the bad direction. Given the DUT-quality is distributed, a greater CL passes more and worse DUTs.

- (bb) A DUT, known to be an ($\epsilon \rightarrow 0$) beyond the specified quality, shall be measured and decided fail with probability CL.

For CL e.g.95%, the test limit is on the good side of the specified DUT-quality.

NOTE 1: The different sense for CL in (a), (aa) versus (b), (bb).

NOTE 2: For constant CL in all 4 bullets (a) is equivalent to (bb) and (aa) is equivalent to (b).

G.X.5 Supplier Risk versus Customer Risk

The table below summarizes the different targets of decision.

Table G.X.5-1 Equivalent statements

	Equivalent statements, using different cause-to-effect-directions, and assuming CL = constant >1/2	
cause-to-effect-directions	Known measurement result → estimation of the DUT's quality	Known DUT's quality → estimation of the measurement's outcome
Supplier Risk	A measurement on the pass-limit shows, that the DUT has the specified quality or is better (a)	A DUT, known to have an ($\epsilon \rightarrow 0$) beyond the specified DUT-quality, shall be measured and decided fail (bb)
Customer Risk	A measurement on the fail-limit shall shows, that the DUT is worse than the specified quality (aa)	A DUT, known to have the specified quality, shall be measured and decided pass (b)

The shaded area shown the direct interpretation of Supplier Risk and Customer Risk.

The same statements can be based on other DUT-quality-definitions.

G.X.6 Introduction: Standard test versus early decision concept

In standard statistical tests, a certain number of results (ns) is predefined in advance to the test. After ns results the number of bad results (ne) is counted and the error ratio (ER) is calculated by ne/ns.

Applying statistical theory, a decision limit can be designed, against which the calculated ER is compared to derive the decision. Such a limit is one decision point and is characterised by:

- D: the wrong decision probability (a predefined parameter)
- ns: the number of results (a fixed predefined parameter)
- ne: the number of bad results (the limit based on just ns)

In the formula for the limit, D and ns can be understood as variable parameter and variable. However the standard test execution requires fixed ns and D. The property of such a test is: It discriminate between two states only, depending on the test design:

- pass (with CL) / undecided (undecided in the sense: finally undecided)
- fail (with CL) / undecided (undecided in the sense: finally undecided)
- pass(with CL) / fail (with CL) (however against two limits).

In contrast to the standard statistical tests, the early decision concept predefines a set of (ne,ns) co-ordinates, representing the limit-curve for decision. After each result a preliminary ER is calculated and compared against the limit-curve. After each result one may make the decision or not (undecided for later decision) The parameters and variables in the limit-curve for the early decision concept have a similar but not equal meaning:

- D: the wrong decision probability (a predefined parameter)
- ns: the number of results (a variable parameter)
- ne: the number of bad results (the limit. It varies together with ns)

To avoid a "final undecided" in the standard test, a second limit must be introduced and the single decision co-ordinate (ne,ns) needs a high ne, leading to a fixed (high) test time. In the early decision concept, having the same selectivity and

the same confidence level an “undecided” need not to be avoided, as it can be decided later. A perfect DUT will hit the decision coordinate (ne,ns) with ne=0. This test time is short.

G.X.7 Standard test versus early decision concept

For Supplier Risk:

The wrong decision probability D in the standard test is the probability, to decide a DUT in-correct in the single decision point. In the early decision concept there is a probability of in-correct decisions d at each point of the limit-curve. The sum of all those wrong decision probabilities accumulate to D. Hence $d < D$

For Customer Risk:

The correct decision probability CL in the standard test is the probability, to decide a DUT correct in the single decision point. In the early decision concept there is a probability of correct decisions cl at each point of the limit-curve. The sum of all those correct decision probabilities accumulate to CL. Hence $cl < CL$ or $d > D$

G.X.8 Selectivity

There is no statistical test which can discriminate between a limit DUT and a DUT which is an $(\epsilon \rightarrow 0)$ apart from the limit in finite time and high confidence level CL. Either the test discriminates against one limit with the results pass (with CL)/undecided or fail (with CL)/undecided, or the test ends in a result pass (with CL)/fail (with CL) but this requires a second limit.

For $CL > 1/2$, a (measurement-result = specified-DUT-quality), generates undecided in test “supplier risk against pass limit” (a, from above) and also in the test “customer risk against the fail limit” (aa)

For $CL > 1/2$, a DUT, known to be on the limit, will be decided pass for the test “customer risk against pass limit” (b) and also “supplier risk against fail limit” (bb).

This overlap or undecided area is not a fault or a contradiction, however it can be avoided by introducing a Bad or a Good DUT quality according to:

- Bad DUT quality: specified DUT-quality * M ($M > 1$)
- Good DUT quality: specified DUT-quality * m ($m < 1$)

Using e.g. $M > 1$ and $CL = 95\%$ the test for different DUT qualities yield different pass probabilities:

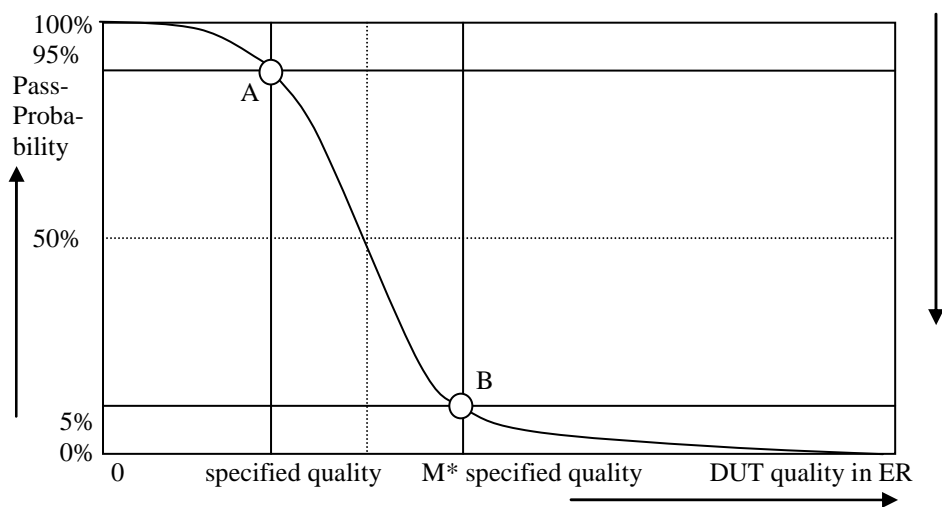

Figure G.X.8-1: Pass probability versus DUT quality

G.X.9 Design of the test

The receiver characteristic test are defined by the following design principles:

1. The early decision concept is applied.
2. A second limit is introduced: Bad DUT factor $M > 1$
3. To decide the test pass:
 - Supplier risk is applied based on the Bad DUT quality
 - To decide the test fail
 - Customer Risk is applied based on the specified DUT quality

The receiver characteristic test are defined by the following parameters:

1. Limit $ER = 0.05$
2. Bad DUT factor $M = 1.5$ (selectivity)
3. Confidence level $CL = 95\%$ (for specified DUT and Bad DUT-quality)

This has the following consequences:

1. A measurement on the fail limit is connected with 2 equivalent statements:

A measurement on the fail-limit shows, that the DUT is worse than the specified DUT-quality	A DUT, known have the specified quality, shall be measured and decided pass
---	---

2. A measurement on the pass limit is connected with the complementary statements:

A measurement on the pass limit shows, that the DUT is better than the Bad DUT-quality.	A DUT, known to have the Bad DUT quality, shall be measured and decided fail
---	--

The left column is used to decide the measurement.

The right column is used to verify the design of the test by simulation.

The simulation is based on the two fulcrums A and B only in Figure G.x.8-1

3. Test time
 - The minimum and maximum test time is fixed.
 - The average test time is a function of the DUT's quality.
 - The individual test time is not predictable.
4. The number of decision co-ordinates (n_e, n_s) in the early decision concept is responsible for the selectivity of the test and the maximum test time. Having fixed the number of decision co-ordinates there is still freedom to select the individual decision co-ordinates in many combinations, all leading to the same confidence level.

G.X.10 Simulation to derive the pass fail limits in Table G.2.4-1

There is freedom to design the decision co-ordinates (n_e, n_s).

The binomial distribution and its inverse is used to design the pass and fail limits. Note that this method is not unique and that other methods exist.

$$\text{fail}(ne, d_f) := \frac{ne}{(ne + \text{qnbinom}(d_f, ne, ER))}$$

$$\text{pass}(ne, cl_p, M) := \frac{ne}{(ne + \text{qnbinom}(cl_p, ne, ER \cdot M))}$$

Where

- fail(..) is the error ratio for the fail limit
- pass(..) is the error ratio for the pass limit
- ER is the specified error ratio 0.05
- ne is the number of bad results. This is the variable in both equations
- M is the Bad DUT factor M=1.5
- d_f is the wrong decision probability of a single (ne,ns) co-ordinate for the fail limit.
It is found by simulation to be $d_f = 0.004$
- cl_p is the confidence level of a single (ne,ns) co-ordinate for the pass limit.
It is found by simulation to be $cl_p = 0.9975$
- $\text{qnbinom}(\cdot)$: The inverse cumulative function of the negative binomial distribution

The simulation works as follows:

- A large population of limit DUTs with true ER = 0.05 is decided against the pass and fail limits.
- cl_p and d_f are tuned such that CL (95%) of the population passes and D (5%) of the population fails.
- A population of Bad DUTs with true ER = M*0.05 is decided against the same pass and fail limits.
- cl_p and d_f are tuned such that CL (95%) of the population fails and D (5%) of the population passes.
- This procedure and the relationship to the measurement is justified in clause G.x.9. The number of DUTs decrease during the simulation, as the decided DUTs leave the population. That number decreases with an approximately exponential characteristics. After 169 bad results all DUTs of the population are decided.

NOTE: The exponential decrease of the population is an optimal design goal for the decision co-ordinates (ne,ns), which can be achieved with other formulas or methods as well.

Annex H (normative): Uplink Physical Channels

H.0 Uplink Signal Levels

Uplink signal power is a UE figure, which is configured by the Test System by means of:

RRC messages (IE-s), such as:

- UplinkPowerControlCommon (-v1020, SCell-r10),
- UplinkPowerControlDedicated (-v1020, SCell-r10),
- Other IE-s affecting directly or indirectly the uplink power,

and L1/2 Power control commands (TPC).

The uplink power settings are specified in the test case.

Otherwise, the uplink power settings result from the default RRC messages described in 3GPP TS 36.508 [7], and appropriate TPC-s, which are sent to the UE to transmit with an UL power level necessary for maintaining the call during the test.

H.1 General

This annex specifies the uplink physical channels that are needed for setting a connection and channels that are needed during a connection. Table H.1-1 describes the mapping of uplink physical channels and signals to physical resources for FDD. Table H.1-2 describes the mapping of uplink physical channels and signals to physical resources for TDD.

Table H.1-1: Mapping of uplink physical channels and signals to physical resources for FDD

Physical channel	Time Domain Location	Frequency Domain Location	Note
PRACH	Allowed for the parameter <i>prach-Configuration Index</i> provided by higher layers	Allowed for the parameter <i>prach-FrequencyOffset</i> provided by higher layers	Mapping rule is specified in TS36.211 [8] Section 5.7.1
DMRS	For PUCCH: Symbols 2 to 4 of each slot (PUCCH format: 1, 1a, 1b) Symbol 1 and 5 of each slot (PUCCH format: 2, 2a, 2b) For PUSCH: Symbol 3 of each slot	Uplink system bandwidth dependent.	Mapping rule of DMRS for PUCCH is specified in TS36.211 [8] 5.5.2.2.2 Mapping rule of DMRS for PUSCH is specified in TS36.211 [8] 5.5.2.1.2
PUCCH	Slot 0 and 1 of each subframe	Each 12 subcarriers of both ends of the bandwidth	Mapping rule is specified in TS36.211 [8] Section 5.4.3
PUSCH	All remaining SC-FDMA symbols of each subframe not allocated to DMRS	RBs allocated according to Reference Measurement channel in Annex A.2	Mapping rule is specified in TS36.211 [8] Section 5.4.2
SRS	Allowed for the cell-specific parameter <i>srs-BandwidthConfig</i> and the UE-specific parameter <i>srs-Bandwidth</i> provided by higher layers	Allowed for the cell-specific parameter <i>srsMaxUpPt</i> and the UE-specific parameter <i>transmissionComb</i> or <i>transmissionComb-ap</i> provided by higher layers	Mapping rule is specified in TS36.211 [8] Section 5.5.3.2

Table H.1-2: Mapping of uplink physical channels and signals to physical resources for TDD

Physical channel	Time Domain Location	Frequency Domain Location	Note
PRACH	Allowed for the parameters $(t_{RA}^0, t_{RA}^1, t_{RA}^2)$ in <i>prach-Configuration Index</i> provided by higher layers	For format 0-3, the frequency location allowed is by <i>prach-FrequencyOffset</i> and (f_{RA}) in <i>prach-Configuration Index</i> provided by higher layers. Preamble format 4 is mapped only on UpPTS, where the frequency location allowed is only by (f_{RA}) in <i>prach-Configuration Index</i> provided by higher layers.	Mapping rule is specified in TS36.211 [8] Section 5.7.1
DMRS	For PUCCH: Symbols 2 to 4 of each slot (PUCCH format: 1, 1a, 1b) Symbol 1 and 5 of each slot (PUCCH format: 2, 2a, 2b) For PUSCH: Symbol 3 of each slot	Uplink system bandwidth dependent.	Mapping rule of DMRS for PUCCH is specified in TS36.211 [8] 5.5.2.2.2 Mapping rule of DMRS for PUSCH is specified in TS36.211 [8] 5.5.2.1.2
PUCCH	Slot 0 and 1 of each subframe	Each 12 subcarriers of both ends of the bandwidth	Mapping rule is specified in TS36.211 [8] Section 5.4.3
PUSCH	All remaining SC-FDMA symbols of each subframe not allocated to DMRS	RBs allocated according to Reference Measurement channel in Annex A.2	Mapping rule is specified in TS36.211 [8] Section 5.4.2
SRS	Allowed for the cell-specific parameter <i>srs-BandwidthConfig</i> and the UE-specific parameter <i>srs-Bandwidth</i> provided by higher layers	Allowed for the cell-specific parameter <i>srsMaxUpPt</i> and the UE-specific parameter <i>transmissionComb</i> or <i>transmissionComb-ap</i> provided by higher layers	Mapping rule is specified in TS36.211 [8] Section 5.5.3.2

NOTE: PUSCH, PUCCH, DMRS are not present in UpPTS for TDD.

H.2 Set-up

Table H.2-1 describes the uplink physical channels that are required for connection set up.

Table H.2-1: Uplink Physical Channels required for connection set-up

Physical Channel
PRACH
DMRS
PUCCH
PUSCH

H.3 Connection

The following clauses describes the uplink physical channels that are transmitted during a connection i.e., when measurements are done.

H.3.0 Measurement of Transmitter Characteristics

As specified in the test case. Otherwise:

- PUSCH + DMRS for PUSCH (and DMRS) measurements.

- PUCCH + DMRS for PUCCH (and DMRS) measurements.
- PRACH for PRACH measurements.

SRS for SRS measurements.

H.3.1 Measurement of Receiver Characteristics

As specified in the test case. Otherwise:

- PUSCH + DMRS for measurements with uplink interference configured.
- PUCCH + DMRS for measurements without uplink interference configured.

H.3.2 Measurement of Performance Requirements

As specified in the test case. Otherwise:

- PUCCH + DMRS for measurements without CSI feedback, or with CSI feedback in PUCCH mode.
- PUSCH + DMRS for measurements with CSI feedback in PUSCH mode.

Annex I (informative): Handling requirements and tests for different releases and UE capabilities

This annex gives guidance on how minimum requirements in different releases of 3GPP TS 36.101 [2] and different UE capabilities are handled in the specification 3GPP TS 36.521-1.

I.1 General considerations

Conformance tests in TS 36.521-1 are derived and specified by RAN WG5 based on minimum requirements in TS 36.101 [2] defined by RAN WG4. The actual practice of RAN WG5 is to specify conformance tests only in a single release of TS 36.521-1, capturing requirements defined by RAN WG4 in all releases of TS 36.101 [2].

- 1) In general the structure of TS 36.521-1 follows the structure of TS 36.101 [2].
- 2) In general for minimum requirements specified in a single clause in TS 36.101 [2], a corresponding conformance test is specified in a single clause in TS 36.521-1.
- 3) Exceptions to rule 2) occur in the following cases:
 - a) Coverage of minimum requirements is too wide, in term of different test environments required for verifying all of them.
 - b) Coverage of minimum requirements is too wide, in term of different features which need to be tested for verifying all of them.
 - c) Coverage of minimum requirements is too wide, in term of different UE capabilities required for verifying all of them.

A set of conformance tests is generated in TS 36.521-1 based on the same clause with minimum requirements in TS 36.101 [2]. This "test group" consists in several "individual tests".

- 4) Exceptions to rule 2) occur also in the case when minimum requirements (including test conditions, test points etc.) are not the same in different releases of TS 36.101 [2]. More in details the differences may consist in:
 - a) Different requirement values / test conditions for the same test points.
 - b) Exclusion / Replacement / Addition of test points without introduction of new features
 - c) Addition of test points introducing new features.

A set of conformance tests is generated in TS 36.521-1 based on the same clause with minimum requirements in TS 36.101 [2]. This set consists in one "original test" and one or several "additional tests".

- 5) The clause-number and the title of the "test group" / "original test" is derived based on the number and title of the corresponding minimum requirements in TS 36.101 [2], while the clause-numbers and titles of the "individual tests" / "additional tests" are derived based on those of the "test group" / "original test". In any case it should be avoided to have in TS 36.521-1 specification tests with the same title, even though they have different clause-numbers.
- 6) In case of high similarity between "individual tests", or between "additional tests" and "original test", in order to reduce the standardization and maintenance work the content of clauses for "individual tests" / "additional tests" may be reduced to a minimum by referencing to the analogue clauses of other "individual tests" / the "original test" and specifying the exceptions (requirement-tables, test parameter tables etc). This method should be applied very carefully considering differences in core functionalities of different E-UTRAN releases.

Details how to apply the above principles to concrete scenarios are defined in Annex I.2.

1.2 Concrete scenarios

1.2.1 Tests for minimum requirements varying between releases, without introduction of new features

Different minimum requirement between different releases of 3GPP TS 36.101 [2] without introduction of new features represent scenarios according to Annex I.1 bullets 4) a) and b).

In TS 36.521-1 are specified one "original test" and several "additional tests" respectively applicable to the appropriate releases. This is shown graphically in Figure I.2.1-1.

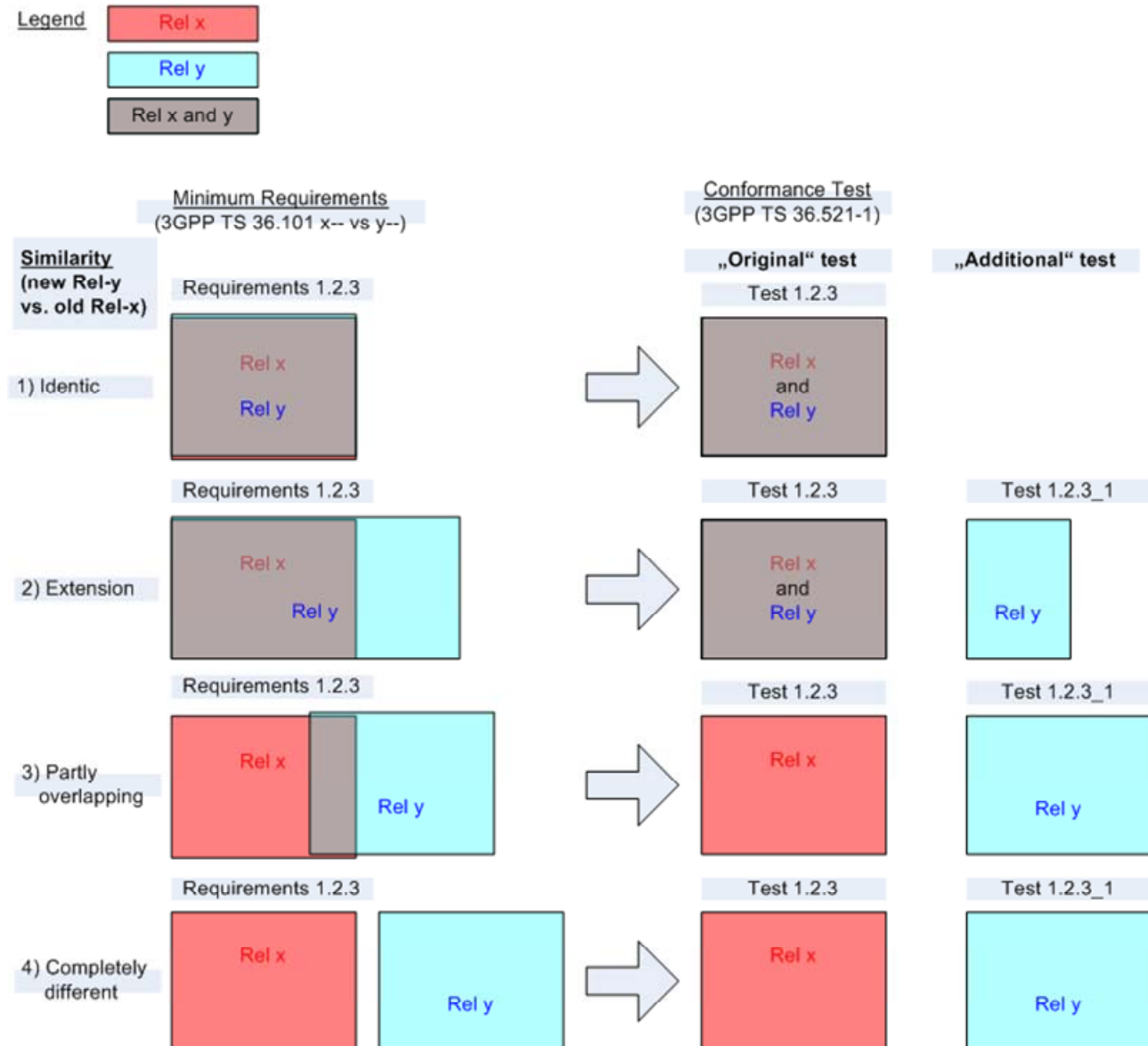

Figure I.2.1-1: Mapping of minimum requirements to conformance tests, when minimum requirements are specified in multiple releases

Rule:

Following tests and clauses are specified in TS 36.521-1:

Original tests:

<x.x.x> <Test>

Additional tests:

<x.x.x>_<y> <Test> (<Release> <UE capability>)

where:

<x.x.x> = number of the original test

<y> = incrementing clause number (Arabic numeral)

<Test> = title of the original test

<Release> = optional identifier showing the release applicability of the test. To be included only when there is already a test with the same title for earlier releases.

<UE capability> = optional identifier showing the UE capability, which leads to additional test. To be included only when there is already a test with the same title for the same release.

Examples:

1.2.3 Virtual test

1.2.3_1 Virtual test (Rel-9 and forward)

1.2.3_2 Virtual test (Rel-10 and forward)

1.2.2 Tests for CA (Carrier aggregation)

1.2.2.1 CA Tx tests (Chapter 6)

CA Transmitter minimum requirements in 3GPP TS 36.101 [2] are already specified in separate clauses from the legacy requirements, bearing the suffix "A" in the number and "for CA" in the title. However minimum requirements have a wide coverage in terms of Annex I.1 bullet 3).

In TS 36.521-1 are specified several separate "individual tests" for different CA scenarios and UE capabilities.

Rule:

Following tests and clauses are specified in TS 36.521-1:

Test group clause:

<x.x.x>A <Test> for CA

Individual tests:

<x.x.x>A.<y> <Test> for CA (<CA type> <DL/UL support> <BW Class> <Release>)

where:

<x.x.x> = number of the corresponding legacy test (if available), or number derived from TS 36.101 without potential suffix "A" (if no legacy test available)

<y> = incrementing clause number (Arabic numeral)

<Test> = title of the corresponding legacy test (if available), or title derived from TS 36.101 without potential suffix "for CA" (if no legacy test available)

<CA type> = mandatory identifier {intra-band contiguous; intra-band non-contiguous; inter-band}

<DL/UL support>= mandatory identifier {DL CA without UL CA; DL CA and UL CA}

<BW Class> = optional identifier showing UE CA Bandwidth class {Class B; Class C}. To be included only for intra-band contiguous scenarios, if there is already a test with the same title.

<Release> = optional identifier showing the release applicability of the test. To be included only when there is already a test with the same title for earlier releases.

Examples:

1.2.3 Virtual test
 1.2.3A Virtual test for CA
 1.2.3A.1 Virtual test for CA (intra-band contiguous DL CA and UL CA)
 1.2.3A.2 Virtual test for CA (inter-band DL CA without UL CA)
 1.2.3A.3 Virtual test for CA (intra-band contiguous DL CA and UL CA Class B)

1.2.2.2 CA Rx tests (Chapter 7)

Same as for Transmitter tests (Chapter 6) in Annex I.2.2.1.

1.2.2.3 CA Performance tests (Chapter 8)

CA Performance minimum requirements in 3GPP TS 36.101 [2] are specified mostly in the same clause with the legacy requirements, as additional test points marked with CA capability identifiers. CA introduces a new feature in terms of Annex I.1 bullet 4) c). Furthermore the set of CA test points has a wide coverage in terms of Annex I.1 bullet 3).

In TS 36.521-1 are specified several separate "individual tests" for different CA scenarios and UE capabilities.

Rule:

Following tests and clauses are specified in TS 36.521-1:

Test group clause:

<x.x.x>_A <Test> for CA

Individual tests:

<x.x.x>_A.<y> <Test> for CA (<CA type > <DL/UL support> <Release>)

where:

<x.x.x> = number of the corresponding legacy test (if available), or number derived from TS 36.101 without potential suffix "A" (if no legacy test available)

<y> = incrementing clause number (Arabic numeral)

<Test> = title of the corresponding legacy test (if available), or title derived from TS 36.101 without potential "for CA" (if no legacy test available)

<CA type> = mandatory identifier {intra-band contiguous; intra-band non-contiguous; inter-band}

<DL/UL support> = mandatory identifier {DL CA}

<Release> = optional identifier showing the release applicability of the test. To be included only when there is already a test with the same title for earlier releases.

Examples:

1.2.3	Virtual test
1.2.3_A	Virtual test for CA
1.2.3_A.1	Virtual test for CA (intra-band contiguous DL CA)
1.2.3_A.2	Virtual test for CA (inter-band DL CA)
1.2.3_A.3	Virtual test for CA (intra-band non-contiguous)
1.2.3_A.4	Virtual test for CA (intra-band contiguous DL CA Rel-11 and forward)

1.2.3 Tests for UL-MIMO (Uplink Multiple Antenna Transmission)

1.2.3.1 UL-MIMO Tx tests (Chapter 6)

UL-MIMO Transmitter minimum requirements in 3GPP TS 36.101 [2] are already specified in separate clauses from the legacy requirements, bearing the suffix "B" in the number and "for UL-MIMO" in the title.

Rule:

Following tests and clauses are specified in TS 36.521-1:

Test group clause:

<x.x.x>B <Test> for UL-MIMO

Individual tests:

<x.x.x>B.<y> <Test> for UL-MIMO (<Release>)

where:

<x.x.x> = number of the corresponding legacy test (if available), or number derived from TS 36.101 without potential suffix "B" (if no legacy test available)

<y> = incrementing clause number (Arabic numeral)

<Test> = title of the corresponding legacy test (if available), or title derived from TS 36.101 without potential suffix "for UL-MIMO" (if no legacy test available)

<Release> = optional identifier showing the release applicability of the test. To be included only when there is already a test with the same title for earlier releases.

Examples:

1.2.3	Virtual test
1.2.3B	Virtual test for UL-MIMO

1.2.3.2 UL-MIMO Rx tests (Chapter 7)

Same as for Transmitter tests (Chapter 6) in Annex I.2.3.1.

1.2.4 Tests for eDL-MIMO (Enhanced Downlink Multiple Antenna Transmission)

1.2.4.1 eDL MIMO Performance tests (Chapter 8)

eDL MIMO Performance minimum requirements in 3GPP TS 36.101 [2] are specified in separate clauses from the legacy requirements. In some cases the minimum requirements have a wide coverage in terms of Annex I.1 bullet 3) a) with respect of the presence of a simultaneous interfering transmission a) with respect of the presence of a simultaneous interfering transmission.

In TS 36.521-1 are specified several separate "individual tests" for eDL-MIMO.

Rule:

Following tests and clauses are specified in TS 36.521-1:

Test group clause:

<x.x.x>_D <Test> for eDL-MIMO

Individual tests:

<x.x.x>_D.<y> <Test> for eDL-MIMO (<Release>)

where:

<x.x.x> = number of the corresponding legacy test (if available), or number derived from TS 36.101 without potential suffix (if no legacy test available).

<y> = optional incrementing clause number (Arabic numeral) (if many individual tests).

<Test> = title of the corresponding legacy test (if available), or title derived from TS 36.101 without potential suffix (if no legacy test available).

<Release> = optional identifier showing the release applicability of the test. To be included only when there is already a test with the same title for earlier releases.

Examples:

1.2.4 Virtual test

1.2.4_D Virtual test for eDL-MIMO

1.2.4.2 eDL MIMO CSI tests (Chapter 9)

eDL MIMO CSI minimum requirements in 3GPP TS 36.101 [2] are specified in separate clauses from legacy requirements.

Rule:

Following tests and clauses are specified in TS 36.521-1:

Test group clause:

<x.x.x>_D <Test> for eDL-MIMO

Individual tests:

<x.x.x>_D.<y> <Test> for eDL-MIMO (<Release>)

where:

<x.x.x> = number of the corresponding legacy test (if available), or number derived from TS 36.101 without potential suffix (if no legacy test available).

- <y> = optional incrementing clause number (Arabic numeral) (if many individual tests).
- <Test> = title of the corresponding legacy test (if available), or title derived from TS 36.101 without potential suffix (if no legacy test available).
- <Release> = optional identifier showing the release applicability of the test. To be included only when there is already a test with the same title for earlier releases.

Examples:

- 1.2.4 Virtual test
- 1.2.4_D Virtual test for eDL-MIMO

1.2.5 Tests for eICIC (Enhanced Inter-carrier Interference Cancellation / Coordination)

1.2.5.1 eICIC Performance tests (Chapter 8)

eICIC Performance minimum requirements in 3GPP TS 36.101 [2] are specified in separate clauses from the legacy requirements. The set of eICIC test points have a wide coverage in terms of Annex I.1 bullet 3)a) with respect of the ABS type (Non-MBSFN / MBSFN). In TS 36.521-1 are specified several separate "individual tests" for eICIC.

Rule:

Following tests and clauses are specified in TS 36.521-1:

Test group clause:

- <x.x.x>_C <Test> for eICIC

Individual tests:

- <x.x.x>_C.<y> <Test> for eICIC (<ABS-type> <Release>)

where:

- <x.x.x> = number of the corresponding legacy test (if available), or number derived from TS 36.101 without potential suffix (if no legacy test available).
- <y> = optional incrementing clause number (Arabic numeral) (if many individual tests).
- <Test> = title of the corresponding legacy test (if available), or title derived from TS 36.101 without potential suffix (if no legacy test available).
- <ABS-Type> = mandatory identifier {non-MBSFN ABS, MBSFN ABS}
- <Release> = optional identifier showing the release applicability of the test. To be included only when there is already a test with the same title for earlier releases.

Examples:

- 1.2.4 Virtual test
- 1.2.4_C Virtual test for eICIC
- 1.2.4_C.1 Virtual test for eICIC (non-MBSFN ABS)
- 1.2.4_C.2 Virtual test for eICIC (MBSFN ABS)

1.2.5.2 eICIC CSI tests (Chapter 9)

Same as for Performance tests (Chapter 8) in Annex I.2.5.1.

Annex J (informative): Change history

Change history								
Date	TSG #	TSG Doc.	CR	R ev	Subject/Comment	Old	New	
2007-08	RAN5 #36	R5-072185			Skeleton proposed for RAN5#36Athens		0.0.1	
2007-08	RAN5 #36	R5-072419			Update the skeleton base on R4-071234_TR36.803.0.4.0.doc	0.0.1	0.0.2	
2007-08	RAN5 #36	R5-072424			Update with editorial changes	0.0.2	0.0.3	
2007-11	RAN5 #37	R5-073043			Update document with some info as following: Section 5: Frequency band information Section 6.2: Maximum output power Section 6.5: Output RF spectrum emissions Section 6.5.1: Occupied bandwidth Section 6.5.2: Out of band emission Section 6.5.3: Spurious emissions	0.0.3	0.0.4	
2007-11	RAN5 #37	R5-073360			Editorial change to split MOP and UE Power classes	0.0.4	0.0.5	
2008-03	RAN5 #38	R5-080069			Editorial changes to sync up with 36.101 v1.0.0 as much as feasible for the moment: Update definitions, symbols and abbreviations Update frequency bands, channel bandwidth, channel numbers information. Restructure document to move "frequency error" sub-section inside Transmit signal quality. Add "additional spectrum Emission Mask" sub-test (mask A,B,C) section to address the regulatory requirements that are not met with the general mask (OOB and spurious emission). Add "Additional ACLR requirements" to address additional requirements that the network might indicate to the UE via signalling for a specific deployment scenario (in terms of additional requirements for UTRA/ACLR2 Restructure "Spurious Emission" to indicate we need to have 3 test cases to address: "E-UTRA Spurious Emission" requirements, "Spurious Emission band UE co-existence" requirements, and "Additional spurious emissions" requirements Separate wide band and narrow band intermodulation in the intermodulation characteristics	0.0.5	0.0.6	
2008-03	RAN5 #38	R5-080408			LTE Reference Sensitivity test Text proposal		0.0.7	
2008-03	RAN5 #38	R5-080409			LTE Maximum Rx input level test Text proposal		0.0.7	
2008-03	RAN5 #38	R5-080410			LTE Adjacent Channel Selectivity test Text proposal		0.0.7	
2008-03	RAN5 #38	R5-080064			LTE RF Receiver tests, General section Text proposal		0.0.7	
2008-03	RAN5 #38	R5-080412			LTE RF: transmission modulation initial EVM test proposal		0.0.7	
2008-03	RAN5 Workshop-UE LTE Test (9-11 April)	R5w0800027			Modify styles and formats of tables and others according to drafting rules. Add some definitions and abbreviations Modified section 6.2 structure to be aligned with 36.101 v8.1.0 Modify tables of requirements to remove 1.6 MHz and 3.2MHz channel bandwidth according to new requirements 36.101 v8.1.0		0.0.9	
2008-03	RAN5 Workshop-UE LTE Test (9-11 April)	R5w0800028			Following TPs have been included: R5w080013r1 R5w080014r1 R5w080008r2 R5w080009r2 R5w080040r1 R5w080015r1 R5w080016r1 R5w080017r1 R5w080018r2	0.0.9	0.1.0	
2008-05	RAN5#39	R5-081046			36-521-1 alignment of measurement state for test cases	0.1.0	0.1.1	

2008-05	RAN5#39	R5-081042		<p>Following approved TPs have been included:</p> <p>R5-081040 36.521-1 after April LTE-RF workshop</p> <p>R5-081415 36-521-1 alignment of measurement state for test cases – also the measurement state for each test cases has been updated according to R5-081404</p> <p>R5-081416 Cover for LTE E-UTRAN RRC_IDLE State Mobility text proposal</p> <p>R5-081417 Cover for LTE E-UTRAN RRC_CONNECTED State Mobility text proposal</p> <p>R5-081404 LTE Rx Intermodulation test case text proposal</p> <p>R5-081409 Annex structure for Measurement uncertainty & Test Tools</p> <p>R5-081405 Text Proposal for TS36.521-1 TC7.6 Blocking Characteristics</p> <p>R5-081406 Text Proposal for TS36.521-1 TC7.7 Spurious Response</p> <p>R5-081403 Text Proposal for TS36.521-1 TC7.9 Spurious Emissions</p> <p>R5-081410 Uncertainties and Test Tools for subset of UE tests</p> <p>R5-081331 Clarification of diversity characteristics section for multiple UE antennas</p> <p>R5-081335 36-521-1 update of nominal and additional channel bandwidths</p>	0.1.1	0.2.0
2008-06	RAN5 #39bis	R5-082029		<p>Following approved TPs have been included:</p> <p>R5-082129: Restructure of TS 36.521-1 and RRM proposal (Split of RRM from 36.521-1 v0.2.0 in its own specification 36.521-3.)</p> <p>R5-082166: Text Proposal for Annex C Downlink Physical Channels</p> <p>R5-082130: Text Proposal for Chan bandwidths in TS 36.521-1</p> <p>R5-082155: Text Proposal for LTE Tx Minimum Output Power</p> <p>R5-082027: Text Proposal for Occupied bandwidth in TS 36.521-1</p> <p>R5-082171: Text Proposal for LTE Adjacent Channel Leakage power Ratio</p> <p>R5-082134: Text Proposal for LTE Tx Spurious Emissions</p> <p>R5-082135: Text Proposal for LTE UE Maximum Output Power</p> <p>R5-082136: Text Proposal for LTE Spectrum Emission Mask</p> <p>R5-082138: UE Spurious Emissions Measurement uncertainty & Test Tolerances</p> <p>R5-082169: LTE Spectrum Emission Mask test uncertainties and TTs</p> <p>R5-082151: LTE UE Max Power and ACLR tests uncertainties and TTs</p> <p>R5-082152: Text proposal for LTE Transmit OFF Power</p> <p>R5-082153: LTE UE Max Rx Input and ACS test cases update</p> <p>R5-082082: LTE Rx Intermodulation test case uncertainties and TTs</p> <p>R5-082093: Text Proposal for TS36.521-1 TC7.6 Blocking Characteristics</p> <p>R5-082154: Text Proposal for TS36.521-1 TC7.7 Spurious Response</p> <p>R5-082167: OBW Measurement uncertainty & Test Tolerances</p> <p>R5-082158: Cover for LTE Performance Requirement text proposal</p> <p>R5-082159: Text Proposal for LTE Demodulation of PCFICH/PDCCH and PHICH</p> <p>R5-082156: Text proposal for LTE Tx Minimum Output Power Uncertainty</p> <p>R5-082157: Text proposal for LTE Tx Minimum Output Power Tolerance</p> <p>R5-082164: Statistical testing of receiver characteristics</p> <p>R5-082170: Cover for LTE Propagation Conditions Text Proposal</p> <p>Editorial changes to align tables and figures numbering with R5-082025</p>	0.2.0	0.3.0

2008-08	RAN5 #40	R5-083163		<p>Following approved TPs have been included:</p> <p>R5-083804: LTE Demodulation Performance text proposal</p> <p>R5-083159: LTE-RF Occupied bandwidth test case / measurement uncertainty and TT text proposal</p> <p>R5-083160: Transmission OFF power: TP, measurement uncertainty and test tolerances proposal</p> <p>R5-083805: Frequency Error test case / measurement uncertainty and TT test proposal</p> <p>R5-083162: Propagation conditions correction text proposal</p> <p>R5-083220: Text Proposal for LTE Tx Minimum Output Power</p> <p>R5-083806: TP of section 8 for E-UTRAN TDD in 36.521-1</p> <p>R5-083344: Test Tolerance and System uncertainty for OBW test</p> <p>R5-083848: Test Tolerance and System uncertainty for Reference sensitivity test</p> <p>R5-083840: Test Tolerances for Spectrum Emission Mask</p> <p>R5-083808: Reference Measurement Channel for LTE UE Receiver tests</p> <p>R5-083350: Test Tolerance and System uncertainty for Blocking and Spurious response</p> <p>R5-083366: Text Proposal for LTE Reporting of CQI/PMI</p> <p>R5-083810: LTE PBCH Demodulation Performance Requirements</p> <p>R5-083482: LTE-RF TP for Test Case 7.6 Blocking Characteristics</p> <p>R5-083809: LTE-RF TP for Test Case 7.7 Spurious Response</p> <p>R5-083484: LTE-RF TP for Test Case 7.9 Spurious Emissions</p> <p>R5-083811: Annex E Global In-Channel TX-Test</p> <p>R5-083163: TS 36.521-1 after RAN5#40</p>	0.3.0	1.0.0
2008-10	RAN5 #40Bis	R5-084072		<p>Following approved TPs have been included:</p> <p>R5-084072 TS 36.521-1 after RAN5#40Bis</p> <p>R5-084300 LTE-RF TP for Definitions Symbols and Abbreviations</p> <p>R5-084304 LTE-RF-TP for general section</p> <p>R5-084036 Test Tolerances for additional SEM</p> <p>R5-084303 LTE-RF TP for Channel bandwidths and frequency range</p> <p>R5-084305 LTE-RF TP for new Absolute Power Tolerance test case</p> <p>R5-084067 LTE-RF TP for Transmission OFF test case</p> <p>R5-084318 LTE-RF TP for Transmission Modulation test cases</p> <p>R5-084069 LTE-RF Investigation of E-UTRA-TDD Frequency Error test case applicability</p> <p>R5-084319 LTE-RF TP for Frequency Error test case</p> <p>R5-084309 Text Proposal for LTE Tx Spurious Emissions</p> <p>R5-084111 Text Proposal for LTE Adjacent Channel Leakage power Ratio</p> <p>R5-084320 Text Proposal for LTE Additional Spectrum Emission Mask</p> <p>R5-084310 Test Tolerances for additional spurious emission</p> <p>R5-084311 Text Proposal for Occupied bandwidth</p> <p>R5-084321 Text Proposal for LTE Spectrum Emission Mask</p> <p>R5-084060 Modification to section 7.2 Diversity characteristics</p> <p>R5-084312 References in 36.521-1 tests initial conditions</p> <p>R5-084148 Update of Reference Measurement Channel for LTE UE Rx tests</p> <p>R5-084167 LTE-RF TP for TC7.9 Spurious Emissions</p> <p>R5-084075 LTE DL Reference Measurement Channel for PDSCH (FDD) text proposal</p> <p>R5-084077 LTE Measurement of Performance Requirements text proposal</p> <p>R5-084313 LTE Demodulation of PDSCH Test Requirements text proposal</p> <p>R5-084147 Specification of DL propagation conditions for LTE UE tests</p> <p>R5-084315 Text Proposal for LTE Demodulation of PCFICH/PDCCH</p> <p>R5-084323 Text Proposal for Annex E Global In-Channel</p>	1.0.0	1.1.0
2008-12	RAN#42	RP-080863		Approval of version 2.0.0 at RAN#42, then put to version 8.0.0.	2.0.0	8.0.0
2008-01				Editorial corrections.	8.0.0	8.0.1
2009-03	RAN#43	R5-086011	0001	- TP for In-band emissions	8.0.1	8.1.0
2009-03	RAN#43	R5-086012	0002	- TP for Spectrum flatness	8.0.1	8.1.0
2009-03	RAN#43	R5-086013	0003	- TP for IQ-component	8.0.1	8.1.0
2009-03	RAN#43	R5-086064	0004	- LTE-RF: UE max output power	8.0.1	8.1.0

2009-03	RAN#43	R5-086093	0005	-	Clarification of measurement period in minimum output power test procedure	8.0.1	8.1.0
2009-03	RAN#43	R5-086094	0006	-	Clarification of measurement period in transmit OFF power test procedure	8.0.1	8.1.0
2009-03	RAN#43	R5-086120	0007	-	Update of Max.input level test	8.0.1	8.1.0
2009-03	RAN#43	R5-086125	0008	-	Addition of UL Reference Measurement Channels in Annex A2	8.0.1	8.1.0
2009-03	RAN#43	R5-086160	0009	-	correction for Maximum Power Reduction (MPR)	8.0.1	8.1.0
2009-03	RAN#43	R5-086167	0010	-	LTE-RF: TDD applicability and CR for Blocking Characteristics and Spurious Response	8.0.1	8.1.0
2009-03	RAN#43	R5-086168	0011	-	LTE-RF: TDD applicability and CR for Spurious Emissions	8.0.1	8.1.0
2009-03	RAN#43	R5-086239	0012	-	Update of Symbols	8.0.1	8.1.0
2009-03	RAN#43	R5-086401	0013	-	LTE-RF: TX-RX channel freq separation	8.0.1	8.1.0
2009-03	RAN#43	R5-086405	0014	-	Update of 6.7 Transmit intermodulation test	8.0.1	8.1.0
2009-03	RAN#43	R5-086406	0015	-	Update of initial conditions for Tx and Rx test cases	8.0.1	8.1.0
2009-03	RAN#43	R5-086408	0016	-	Update of Adjacent Channel Leakage power Ratio	8.0.1	8.1.0
2009-03	RAN#43	R5-086409	0017	-	Removal of [] from Clause 7 Receiver Characteristics	8.0.1	8.1.0
2009-03	RAN#43	R5-086413	0018	-	Updates to Demodulation of PCFICH/PDCCH test case	8.0.1	8.1.0
2009-03	RAN#43	R5-086414	0019	-	Text proposal for Reporting of Channel State Information	8.0.1	8.1.0
2009-03	RAN#43	R5-086415	0020	-	Correction of RS_EPRE powers for default DL signal levels	8.0.1	8.1.0
2009-03	RAN#43	R5-086416	0021	-	Update of DL Reference Measurement Channels in Annex A3	8.0.1	8.1.0
2009-03	RAN#43	R5-086417	0022	-	Update to Annex E	8.0.1	8.1.0
2009-03	RAN#43	R5-086425	0023	-	Update of General text in clause 6	8.0.1	8.1.0
2009-03	RAN#43	R5-086426	0024	-	Clarification of measurement bandwidth in spectrum emission mask test	8.0.1	8.1.0
2009-03	RAN#43	R5-086428	0025	-	Demodulation of TDD PHICH test requirements text proposal	8.0.1	8.1.0
2009-03	RAN#43	R5-086429	0026	-	Demodulation of TDD PCFICH/PDCCH test requirements text proposal	8.0.1	8.1.0
2009-03	RAN#43	R5-090306	0027	-	New Annex H for Uplink Physical Channels	8.0.1	8.1.0
2009-03	RAN#43	R5-090308	0028	-	Text proposal for Reporting of Channel State Information	8.0.1	8.1.0
2009-03	RAN#43	R5-090403	0029	-	CR to 36.521-1: Update of Spurious Emissions test cases	8.0.1	8.1.0
2009-03	RAN#43	R5-090404	0030	-	CR to 36.521-1: Update of ACLR test case	8.0.1	8.1.0
2009-03	RAN#43	R5-090443	0031	-	LTE-RF: Correction to 36.521-1 Frequency error test case	8.0.1	8.1.0
2009-03	RAN#43	R5-090488	0032	-	LTE TDD applicability for Transmit intermodulation test case	8.0.1	8.1.0
2009-03	RAN#43	R5-091002	0033	-	LTE Demodulation of PDSCH Test Requirements text proposal	8.0.1	8.1.0
2009-03	RAN#43	R5-091004	0034	-	LTE-RF: CR for UE max power test case	8.0.1	8.1.0
2009-03	RAN#43	R5-091007	0035	-	LTE-RF: TDD Applicability and CR for Spectrum Emission Mask and Additional Spectrum Emission Mask	8.0.1	8.1.0
2009-03	RAN#43	R5-091008	0036	-	LTE-RF Investigation of E-UTRA-TDD for Occupied bandwidth test case applicability	8.0.1	8.1.0
2009-03	RAN#43	R5-091009	0037	-	LTE-RF: Investigation of E-UTRA-TDD for Adjacent Channel Leakage power Ratio test case applicability	8.0.1	8.1.0
2009-03	RAN#43	R5-091011	0038	-	LTE-RF: TDD applicability and CR for Maximum Input Level	8.0.1	8.1.0
2009-03	RAN#43	R5-091012	0039	-	LTE-RF: TDD applicability and CR for Adjacent Channel Selectivity (ACS)	8.0.1	8.1.0
2009-03	RAN#43	R5-091017	0040	-	Removal of Rx Narrowband Intermod 7.8.2	8.0.1	8.1.0
2009-03	RAN#43	R5-091019	0041	-	Relocation of 36.521-1 Annex C DL mapping	8.0.1	8.1.0
2009-03	RAN#43	R5-091020	0042	-	Removal of "Out-of-synchronization handling of output power" heading	8.0.1	8.1.0
2009-03	RAN#43	R5-091023	0043	-	Test requirements of TDD PDSCH demodulation performance with user-specific reference symbols	8.0.1	8.1.0
2009-03	RAN#43	R5-091024	0044	-	CR to 36.521-1: Update of Annex F.3.2 Measurement of transmitter	8.0.1	8.1.0
2009-03	RAN#43	R5-091025	0045	-	CR to 36.521-1: Update of SEM and Additional SEM test cases	8.0.1	8.1.0
2009-03	RAN#43	R5-091077	0046	-	CR to 36.521-1: Addition of test combinations for test cases with MPR application	8.0.1	8.1.0
2009-03	RAN#43	R5-091082	0047	-	Spurious emission requirements on PHS band including the future plan in Japan	8.0.1	8.1.0
2009-03	RAN#43	R5-091101	0048	-	LTE-RF: CR for MPR test case	8.0.1	8.1.0
2009-03	RAN#43	R5-091106	0049	-	Update of Reference sensitivity test in 7.3	8.0.1	8.1.0
2009-03	RAN#43	R5-091111	0050	1	Update of initial conditions for Rx tests	8.0.1	8.1.0
2009-05	RAN#44	R5-092144	0051	-	LTE-RF: Resubmission of R5-086424 UE output power dynamics 36.521-1 v8.1.0 (re-submit no changes)	8.1.0	8.2.0
2009-05	RAN#44	R5-092146	0052	-	LTE-RF: CR for UE configured UE transmitted output power test case (re-submit no changes)	8.1.0	8.2.0
2009-05	RAN#44	R5-092147	0053	-	LTE-RF: CR for UE minimum output power test case (re-submit no change)	8.1.0	8.2.0
2009-05	RAN#44	R5-092149	0054	-	LTE-RF: CR for Power Control Absolute power tolerance test case (re-submit no changes)	8.1.0	8.2.0
2009-05	RAN#44	R5-092150	0055	-	LTE-RF: CR for Power Control Relative power tolerance test case (re-submit no changes)	8.1.0	8.2.0

2009-05	RAN#44	R5-092151	0056	-	LTE-RF: New test case for Aggregate power control tolerance (re-submit no changes)	8.1.0	8.2.0
2009-05	RAN#44	R5-092263	0057	-	Text proposal for Reporting of Channel State Information	8.1.0	8.2.0
2009-05	RAN#44	R5-092264	0058	-	Propagation conditions for CQI tests	8.1.0	8.2.0
2009-05	RAN#44	R5-092265	0059	-	Correction to Demodulation of PDCCH/PCFICH test cases	8.1.0	8.2.0
2009-05	RAN#44	R5-092273	0060	-	Mapping of downlink physical channels for TDD	8.1.0	8.2.0
2009-05	RAN#44	R5-092277	0061	-	Annex A RMC updates	8.1.0	8.2.0
2009-05	RAN#44	R5-092369	0062	-	Update of A.3.4.3 for RMC with UE-specific RS	8.1.0	8.2.0
2009-05	RAN#44	R5-092372	0063	-	Maintenance on Initial configurations for Perf TCs	8.1.0	8.2.0
2009-05	RAN#44	R5-092436	0064	-	CR to 36.521-1: Update of ACLR test case	8.1.0	8.2.0
2009-05	RAN#44	R5-092442	0065	-	CR to 36.521-1: Update of Spurious Emissions test case	8.1.0	8.2.0
2009-05	RAN#44	R5-092467	0066	-	LTE-RF: Transmit OFF Power update	8.1.0	8.2.0
2009-05	RAN#44	R5-092473	0067	-	LTE_RF - Update on TC 7.7 Spurious Response (re-submit with no changes)	8.1.0	8.2.0
2009-05	RAN#44	R5-092474	0068	-	LTE_RF - Update on TC 7.9 Spurious Emissions (re-submit with no changes)	8.1.0	8.2.0
2009-05	RAN#44	R5-092527	0069	-	Update of TDD PDSCH test cases	8.1.0	8.2.0
2009-05	RAN#44	R5-092602	0070	-	LTE-RF: CR for Maximum Power Reduction test case (re-submit no changes)	8.1.0	8.2.0
2009-05	RAN#44	R5-092603	0071	-	TP for Demodulation of TDD PDCCH/PCFICH	8.1.0	8.2.0
2009-05	RAN#44	R5-092605	0072	-	Mapping of uplink physical channels for FDD	8.1.0	8.2.0
2009-05	RAN#44	R5-092606	0073	-	Update of Annex C	8.1.0	8.2.0
2009-05	RAN#44	R5-092607	0074	-	CR to 36.521-1: Update of test parameters for Demodulation of PDSCH (FDD) tests	8.1.0	8.2.0
2009-05	RAN#44	R5-092614	0075	-	Update of SEM test case	8.1.0	8.2.0
2009-05	RAN#44	R5-092642	0076	-	Update of transmit quality test cases	8.1.0	8.2.0
2009-05	RAN#44	R5-092643	0077	-	Text proposal for TDD part of CQI Reporting under Fading conditions	8.1.0	8.2.0
2009-05	RAN#44	R5-092644	0078	-	Text proposal for TDD part of CQI Reporting under AWGN conditions	8.1.0	8.2.0
2009-05	RAN#44	R5-092645	0079	-	LTE-RF: Update of Additional Spectrum Emission mask Test case with TDD Uplink Test configuration	8.1.0	8.2.0
2009-05	RAN#44	R5-092649	0080	-	LTE-RF: CR for TDD DL RMC to be used in TX test cases	8.1.0	8.2.0
2009-05	RAN#44	R5-092653	0081	-	LTE-RF: CR for Additional Maximum Power Reduction test case	8.1.0	8.2.0
2009-05	RAN#44	R5-092661	0082	-	RMC update for PDCCH/PCFICH performance requirement	8.1.0	8.2.0
2009-05	RAN#44	RP-090444	1161	-	Test frequencies for Additional Spurious Emission test case	8.6.0	8.7.0
2009-05	RAN#44	R5-092366	0084	-	Update of 7.3.1	8.1.0	8.2.0
2009-05	RAN#44	R5-092440	0085	-	LTE-RF: CR for UE max output power test case	8.1.0	8.2.0
2009-05	RAN#44	R5-092472	0086	-	LTE_RF - Update on TC 7.6 Blocking Characteristics (re-submit with changes)	8.1.0	8.2.0
2009-05	RAN#44	R5-092636	0087	-	CR to 36.521-1 Addition of frequencies for band 18 and band 19	8.1.0	8.2.0
2009-05	RAN#44	R5-092652	0088	2	Improved stability of TC 7.8.5 Power Control in the DL fro F-DPCH to HSPA TC 5.2D and 5.13.2B	8.1.0	8.2.0
-	-	-	-	-	Editorial corrections	8.2.0	8.2.1
2009-09	RAN#45	R5-094032	0089	-	Correction CR to 36.521-1: Update of Requirements for Demodulation of PDSCH (FDD) tests	8.2.1	8.3.0
2009-09	RAN#45	R5-094034	0090	-	Correction CR to 36.521-1: Update of General Requirements for Demodulation tests	8.2.1	8.3.0
2009-09	RAN#45	R5-094214	0091	-	Update of In-band emissions	8.2.1	8.3.0
2009-09	RAN#45	R5-094215	0092	-	TDD Initial downlink channel setting	8.2.1	8.3.0
2009-09	RAN#45	R5-094216	0093	-	Correction to Annex B	8.2.1	8.3.0
2009-09	RAN#45	R5-094248	0094	-	CR to 36.521-1: Update to ACLR test case	8.2.1	8.3.0
2009-09	RAN#45	R5-094250	0095	-	CR to 36.521-1: Update to UE max output power test case	8.2.1	8.3.0
2009-09	RAN#45	R5-094281	0096	-	Mapping of uplink physical channels for TDD	8.2.1	8.3.0
2009-09	RAN#45	R5-094282	0097	-	LTE-RF: CR for notes in TDD DL RMC to be used in TX test cases	8.2.1	8.3.0
2009-09	RAN#45	R5-094283	0098	-	LTE-RF: message update to keep Tx power constant for some Rx test cases	8.2.1	8.3.0
2009-09	RAN#45	R5-094313	0099	-	LTE-RF: CR to test case for Aggregate power control tolerance	8.2.1	8.3.0
2009-09	RAN#45	R5-094317	0100	-	LTE-RF: CR for UE minimum output power test case for TDD	8.2.1	8.3.0
2009-09	RAN#45	R5-094318	0101	-	LTE-RF: CR for Power Control Relative power tolerance test case	8.2.1	8.3.0
2009-09	RAN#45	R5-094319	0102	-	In band emission for non-allocated RB	8.2.1	8.3.0
2009-09	RAN#45	R5-094320	0103	-	LTE RF: correction for subclause 6.6.2.2.5 (A-SEM) supported band list	8.2.1	8.3.0
2009-09	RAN#45	R5-094362	0104	-	Correction of RMCs (36.521 Annex A)	8.2.1	8.3.0
2009-09	RAN#45	R5-094363	0105	-	Usage of the Global In-Channels TX-Test across different Signal Quality tests.	8.2.1	8.3.0
2009-09	RAN#45	R5-094365	0106	-	LTE TX: 1to2 RX antenna	8.2.1	8.3.0
2009-09	RAN#45	R5-094367	0107	-	Correction to 6.6.2.2 Additional Spectrum Emission Mask	8.2.1	8.3.0

2009-09	RAN#45	R5-094370	0108	-	Correction to 6.6.2.3 ACLR	8.2.1	8.3.0
2009-09	RAN#45	R5-094371	0109	-	Correction to 6.7 TX Intermodulation	8.2.1	8.3.0
2009-09	RAN#45	R5-094374	0110	-	Correction to 7.6.1 In-Band Blocking	8.2.1	8.3.0
2009-09	RAN#45	R5-094375	0111	-	UE category (36.521 clause 8)	8.2.1	8.3.0
2009-09	RAN#45	R5-094378	0112	-	Completion of Global in-Channel TX-Test (36.521 Annex E)	8.2.1	8.3.0
2009-09	RAN#45	R5-094379	0113	-	Completion of Global in-Channel TX-Test with PRACH (36.521 Annex E)	8.2.1	8.3.0
2009-09	RAN#45	R5-094380	0114	-	Completion of Statistical testing (36.521 Annex G)	8.2.1	8.3.0
2009-09	RAN#45	R5-094385	0115	-	Correction to Annex D.2 Interference signals	8.2.1	8.3.0
2009-09	RAN#45	R5-094439	0116	-	Update for ACS	8.2.1	8.3.0
2009-09	RAN#45	R5-094661	0117	-	LTE RF - Core update on TC7.6.2 Out-of-band Blocking	8.2.1	8.3.0
2009-09	RAN#45	R5-094663	0118	-	LTE RF - Symbols Update on UL transmission configurations	8.2.1	8.3.0
2009-09	RAN#45	R5-094665	0119	-	LTE RF - Clarification for Test Configurations in General Section	8.2.1	8.3.0
2009-09	RAN#45	R5-094668	0120	-	LTE RF - Applicability of 6.2.3 MPR	8.2.1	8.3.0
2009-09	RAN#45	R5-094671	0121	-	LTE RF - Verification of UE Output Power in Out of Band Emission tests	8.2.1	8.3.0
2009-09	RAN#45	R5-094684	0122	-	CR to 36.521-1: Update to UE max output power test case	8.2.1	8.3.0
2009-09	RAN#45	R5-094686	0123	-	LTE-RF CR to 36.521-1: Update the E-UTRA channel numbers	8.2.1	8.3.0
2009-09	RAN#45	R5-094687	0124	-	LTE-RF: CR for UE maximum power reduction(MPR) test case	8.2.1	8.3.0
2009-09	RAN#45	R5-094699	0125	-	Update to SEM and spurious emissions TC	8.2.1	8.3.0
2009-09	RAN#45	R5-094706	0126	-	Resubmission-Update to the Requirements for frequency-selective fading test	8.2.1	8.3.0
2009-09	RAN#45	R5-094717	0127	-	Update of SEM	8.2.1	8.3.0
2009-09	RAN#45	R5-094718	0128	-	Update of initial conditions with Annex references	8.2.1	8.3.0
2009-09	RAN#45	R5-094721	0129	-	Update of 6.7 Tx Inter Mod	8.2.1	8.3.0
2009-09	RAN#45	R5-094725	0130	-	Correction to E-UTRA channel numbers for Band 2	8.2.1	8.3.0
2009-09	RAN#45	R5-094726	0131	-	Correction to Tx spurious emissions	8.2.1	8.3.0
2009-09	RAN#45	R5-094757	0132	-	Update of TDD PHICH test cases	8.2.1	8.3.0
2009-09	RAN#45	R5-094874	0133	-	Correction to Demodulation of PDCCH/PCFICH test cases	8.2.1	8.3.0
2009-09	RAN#45	R5-094902	0134	-	Addition of 15 MHz and 20 MHz bandwidths and corresponding sensitivity requirements into band 38	8.2.1	8.3.0
2009-09	RAN#45	R5-094903	0135	-	Correction CR to 36.521-1: Update of Transmitter tests network signalled parameter value	8.2.1	8.3.0
2009-09	RAN#45	R5-094905	0136	-	Update of TDD PDSCH test cases	8.2.1	8.3.0
2009-09	RAN#45	R5-094908	0137	-	LTE-RF: CR for Power Control Absolute power tolerance test case	8.2.1	8.3.0
2009-09	RAN#45	R5-094909	0138	-	Update to Output Power dynamics test cases	8.2.1	8.3.0
2009-09	RAN#45	R5-094913	0139	-	Clarification for downlink signal setting in RX tests	8.2.1	8.3.0
2009-09	RAN#45	R5-094914	0140	-	UL RB allocation for receiver tests	8.2.1	8.3.0
2009-09	RAN#45	R5-094915	0141	-	Update of TDD PCFICH/PDCCH test cases	8.2.1	8.3.0
2009-09	RAN#45	R5-094921	0142	-	Correction to CQI performance test case	8.2.1	8.3.0
2009-09	RAN#45	R5-094922	0143	-	Test description for CQI test cases under AWGN conditions	8.2.1	8.3.0
2009-09	RAN#45	R5-094923	0144	-	Resubmission - Requirements for PMI reporting (Single and Multiple PMI)	8.2.1	8.3.0
2009-09	RAN#45	R5-094966	0145	-	CR to 36.521-1: Addition of A-MPR for band 19	8.2.1	8.3.0
2009-09	RAN#45	R5-094976	0146	-	Without loop back: 6.2.2 UE maximum output power	8.2.1	8.3.0
2009-09	RAN#45	R5-094977	0147	-	Without loop back: 6.3.2 Minimum output power	8.2.1	8.3.0
2009-09	RAN#45	R5-094979	0148	-	LTE-RF: CR for UE configured UE transmitted output power test case	8.2.1	8.3.0
2009-09	RAN#45	R5-094980	0149	-	CR to 36.521-1: Definition of Maximum Power state in TX/RX test cases	8.2.1	8.3.0
2009-09	RAN#45	R5-094982	0150	1	Correction of Tx general description	8.2.1	8.3.0
2009-09	RAN#45	R5-094986	0151	-	Update of 6.6.1OBW	8.2.1	8.3.0
2009-09	RAN#45	R5-094989	0152	-	Correction to 1PRB tests in Demodulation of PDSCH	8.2.1	8.3.0
2009-09	RAN#45	R5-094995	0153	-	Correction CR to 36.521-1: Update of Requirements for Additional Maximum Power Reduction (A-MPR) test	8.2.1	8.3.0
2009-09	RAN#45	R5-094996	0154	-	Correction to Demodulation of PHICH test cases	8.2.1	8.3.0
2009-09	RAN#45	R5-094997	0155	-	EVM TC update	8.2.1	8.3.0
2009-09	RAN#45	R5-095300	0156	-	LTE-RF: test description update	8.2.1	8.3.0
2009-09	RAN#45	R5-095301	0157	-	Correction CR to 36.521-1: Addition of measurement uncertainty and test tolerances for A-MPR	8.2.1	8.3.0
2009-09	RAN#45	R5-095304	0158	-	Sorting out Demodulation of PDSCH for FDD	8.2.1	8.3.0
2009-09	-	-	-	-	TOC update and Annexes' titles formatings	8.3.0	8.3.1
2009-12	RAN#46	R5-095515	0159	-	Correction CR to 36.521-1: Additional Spectrum Emission Mask test need to be updated to include the network signalled value "NS_07o message contents exceptions	8.3.1	8.4.0
2009-12	RAN#46	R5-095589	0160	-	Update for test period description in the general section	8.3.1	8.4.0
2009-12	RAN#46	R5-095657	0161	-	LTE-RF: CR for Power Control Absolute power tolerance test case	8.3.1	8.4.0
2009-12	RAN#46	R5-095661	0162	-	LTE-RF: CR for UE minimum output power test case	8.3.1	8.4.0

2009-12	RAN#46	R5-095735	0163	-	Corrections to Annex A.4	8.3.1	8.4.0
2009-12	RAN#46	R5-095766	0164	-	LTE-RF: CR for In band emission for non-allocated RB	8.3.1	8.4.0
2009-12	RAN#46	R5-095790	0165	-	Completion of Statistical testing (36.521 Annex G)	8.3.1	8.4.0
2009-12	RAN#46	R5-095791	0166	-	Corrections to Annex E	8.3.1	8.4.0
2009-12	RAN#46	R5-096058	0167	-	Removal of [] from 7.6.1, 7.8.1, and 7.5 of Annex F3.3	8.3.1	8.4.0
2009-12	RAN#46	R5-096096	0168	-	Update on 8.2.1	8.3.1	8.4.0
2009-12	RAN#46	R5-096105	0169	-	LTE RF: Symbols Update on Configured UE Transmitted Power	8.3.1	8.4.0
2009-12	RAN#46	R5-096204	0170	-	LTE-RF: CR to Transmission signal quality	8.3.1	8.4.0
2009-12	RAN#46	R5-096208	0171	-	LTE-RF: CR for Power Control Relative power tolerance test case	8.3.1	8.4.0
2009-12	RAN#46	R5-096210	0172	-	LTE-RF: CR to ON/OFF Time mask test cases	8.3.1	8.4.0
2009-12	RAN#46	R5-096211	0173	-	Measurement period for TX-Tests	8.3.1	8.4.0
2009-12	RAN#46	R5-096213	0174	-	CR to 36.521-1: Update to Spurious Emissions test cases	8.3.1	8.4.0
2009-12	RAN#46	R5-096214	0175	-	CR to 36.521-1: Update to ACLR test case	8.3.1	8.4.0
2009-12	RAN#46	R5-096219	0176	-	LTE-RF: CR for UE configured UE transmitted output power test case	8.3.1	8.4.0
2009-12	RAN#46	R5-096222	0177	-	Test description for CQI test cases under AWGN conditions	8.3.1	8.4.0
2009-12	RAN#46	R5-096223	0178	-	LTE RF: Blocking Characteristics update	8.3.1	8.4.0
2009-12	RAN#46	R5-096224	0179	-	LTE RF: Spurious Response Update	8.3.1	8.4.0
2009-12	RAN#46	R5-096228	0180	-	LTE-RF: CR for MPR test case	8.3.1	8.4.0
2009-12	RAN#46	R5-096229	0204	2	CR to 36.521-1: Update to A-MPR test case	8.3.1	8.4.0
2009-12	RAN#46	R5-096230	0181	-	LTE RF: Applicability of 6.2.4 A-MPR	8.3.1	8.4.0
2009-12	RAN#46	R5-096231	0182	-	Correction to Demodulation of PHICH test cases	8.3.1	8.4.0
2009-12	RAN#46	R5-096235	0183	-	Introduction of CQI reporting test with frequency-selective interference	8.3.1	8.4.0
2009-12	RAN#46	R5-096239	0184	-	Update to the test procedure and message contents of TDD PMI reporting test cases	8.3.1	8.4.0
2009-12	RAN#46	R5-096240	0205	-	CR to 36.521-1: Update to Derivation of Test Requirements for A-MPR	8.3.1	8.4.0
2009-12	RAN#46	R5-096241	0185	-	Measurement uncertainties and Test Tolerances for transmit quality test cases	8.3.1	8.4.0
2009-12	RAN#46	R5-096242	0186	-	Update for 36.521-1 Annex A	8.3.1	8.4.0
2009-12	RAN#46	R5-096289	0187	-	CR on 36.521-1, 'Introduction of clause 8.2.1.1 test case uncertainties and Test Tolerances'	8.3.1	8.4.0
2009-12	RAN#46	R5-096306	0188	-	Update to the test procedure of SEM test cases of 36.521-1	8.3.1	8.4.0
2009-12	RAN#46	R5-096311	0189	-	Update of 6.6.1 OBW	8.3.1	8.4.0
2009-12	RAN#46	R5-096312	0190	-	Correction to SEM	8.3.1	8.4.0
2009-12	RAN#46	R5-096313	0191	-	Update of 6.7 Transmit intermodulation	8.3.1	8.4.0
2009-12	RAN#46	R5-096315	0192	-	CR to 36.521-1: Update to UE max output power test case	8.3.1	8.4.0
2009-12	RAN#46	R5-096316	0193	-	CR to 36.521-1: Update to Additional Spurious Emissions test case	8.3.1	8.4.0
2009-12	RAN#46	R5-096317	0194	-	CR to TDD PHICH demodulation test cases	8.3.1	8.4.0
2009-12	RAN#46	R5-096318	0195	-	Correction to FDD PMI reporting test cases	8.3.1	8.4.0
2009-12	RAN#46	R5-096320	0196	-	Tx power range and core update for Receiver tests	8.3.1	8.4.0
2009-12	RAN#46	R5-096322	0197	-	Update on 7.4, 7.5, and 7.8.1	8.3.1	8.4.0
2009-12	RAN#46	R5-096323	0198	-	Introduction of RI reporting test	8.3.1	8.4.0
2009-12	RAN#46	R5-096333	0199	-	Update to 6.5 Transmit signal quality test cases	8.3.1	8.4.0
2009-12	RAN#46	R5-096334	0200	-	LTE-RF: CR for Aggregate power control tolerance test case	8.3.1	8.4.0
2009-12	RAN#46	R5-096335	0201	-	Correction CR to 36.521-1: Update for Demodulation of PDSCH (FDD) tests to correct CR merges results from RAN5#44	8.3.1	8.4.0
2009-12	RAN#46	R5-096336	0206	1	Update TDD PDSCH test cases	8.3.1	8.4.0
2009-12	RAN#46	R5-096338	0202	-	Number of used HARQ processes in DL Performance tests	8.3.1	8.4.0
2009-12	RAN#46	R5-096342	0207	2	Minimum test time for performance tests	8.3.1	8.4.0
2009-12	RAN#46	R5-096718	0203	-	LTE RF: A-SEM update and A-MPR verification	8.3.1	8.4.0
2010-03	RAN#47	R5-100353	0208	-	LTE-RF CR to 36.521-1: TIME MASK test case updated	8.4.0	8.5.0
2010-03	RAN#47	R5-100354	0209	-	LTE-RF: CR for A-MPR notation in NS_07	8.4.0	8.5.0
2010-03	RAN#47	R5-100403	0210	-	LTE-RF: CR for Tx Intermodulation test case	8.4.0	8.5.0
2010-03	RAN#47	R5-100404	0211	-	LTE-RF: CR for OBW measurement period alignment	8.4.0	8.5.0
2010-03	RAN#47	R5-100408	0212	-	Reporting mode, Reporting Interval and Editorial corrections for demodulation	8.4.0	8.5.0
2010-03	RAN#47	R5-100456	0213	-	Misc update on MAC padding in Rx and performance sections	8.4.0	8.5.0
2010-03	RAN#47	R5-100566	0214	-	Missing Test limits in 36.521-1 Annex G	8.4.0	8.5.0
2010-03	RAN#47	R5-100567	0215	-	Wrong references from 36.521-1 clauses 8.4 and 8.5 into Annex G	8.4.0	8.5.0
2010-03	RAN#47	R5-100569	0216	-	Typos in 36.521-1, Annex E	8.4.0	8.5.0
2010-03	RAN#47	R5-100571	0217	-	Minimum test time for performance tests	8.4.0	8.5.0
2010-03	RAN#47	R5-100572	0218	-	Correction to 6.6.3.3 Additional spurious emissions	8.4.0	8.5.0
2010-03	RAN#47	R5-100790	0219	-	DL-RMC-s for transmitter tests: Corrections	8.4.0	8.5.0
2010-03	RAN#47	R5-100800	0220	-	Update of Test environment for RF test	8.4.0	8.5.0
2010-03	RAN#47	R5-100803	0221	-	Spectrum emission mask: Correction to uplink configuration	8.4.0	8.5.0

2010-03	RAN#47	R5-100807	0222	-	Performance tests: Scheduling of retransmissions	8.4.0	8.5.0
2010-03	RAN#47	R5-100810	0223	-	UL-RMC-s: Corrections and completion	8.4.0	8.5.0
2010-03	RAN#47	R5-100814	0224	-	Corrections to CI 5.4.2.1 of TS 36.521-1	8.4.0	8.5.0
2010-03	RAN#47	R5-100815	0225	-	LTE-RF: CR for UE configured UE transmitted output power test case	8.4.0	8.5.0
2010-03	RAN#47	R5-100816	0226	-	LTE-RF: CR for Power Control Relative power tolerance test case	8.4.0	8.5.0
2010-03	RAN#47	R5-100822	0227	-	CR to 36.521-1: Update to Maximum output power	8.4.0	8.5.0
2010-03	RAN#47	R5-100823	0228	-	CR to 36.521-1: Update to ACLR test case	8.4.0	8.5.0
2010-03	RAN#47	R5-100825	0229	-	CR to 36.521-1: Update to Additional Tx spurious emissions test case	8.4.0	8.5.0
2010-03	RAN#47	R5-100826	0230	-	RMC-s and OCNG patterns: Update according 36.101 8.8.0	8.4.0	8.5.0
2010-03	RAN#47	R5-100827	0231	-	Receiver and performance tests: Update use of OCNG according 36.101 8.8.0	8.4.0	8.5.0
2010-03	RAN#47	R5-100828	0232	-	Update of PDSCH Demodulation Tests	8.4.0	8.5.0
2010-03	RAN#47	R5-100831	0233	-	Introduction of clause 8.2.1.2, 8.2.1.3, 8.2.1.4 test case uncertainties and Test Tolerances	8.4.0	8.5.0
2010-03	RAN#47	R5-100832	0234	-	Clarifications on DRS performance test case	8.4.0	8.5.0
2010-03	RAN#47	R5-100833	0235	-	Misc update on MAC padding in PDCCH, CSI test	8.4.0	8.5.0
2010-03	RAN#47	R5-100834	0236	-	Updates to the TDD portion of CQI reporting test cases under AWGN	8.4.0	8.5.0
2010-03	RAN#47	R5-100838	0237	-	Editorial Correction to 8.2.1.3	8.4.0	8.5.0
2010-03	RAN#47	R5-100839	0238	-	Update on Annex C for 36.521-1	8.4.0	8.5.0
2010-03	RAN#47	R5-100840	0239	-	Update on MAC padding in TDD PMI test case 9.4 of 36.521-1.	8.4.0	8.5.0
2010-03	RAN#47	R5-100841	0240	-	Correction to CQI test cases under AWGN conditions	8.4.0	8.5.0
2010-03	RAN#47	R5-100842	0241	-	Correction to CQI test cases under fading conditions	8.4.0	8.5.0
2010-03	RAN#47	R5-100843	0242	-	Correction to PMI reporting test cases	8.4.0	8.5.0
2010-03	RAN#47	R5-100845	0243	-	CSI: Corrections to tests titles and RI clause structure	8.4.0	8.5.0
2010-03	RAN#47	R5-100848	0244	-	CR to 36.521-1: Update LTE RF test cases with test requirements for extended LTE1500MHz	8.4.0	8.5.0
2010-03	RAN#47	R5-100886	0245	-	Transmitter characteristics: UE Categories and other corrections	8.4.0	8.5.0
2010-03	RAN#47	R5-100887	0246	-	CR to 36.521-1: Update to Tx spurious emissions and Spurious emission band UE co-existence	8.4.0	8.5.0
2010-03	RAN#47	R5-100888	0247	-	Clarification on notes in Max Power	8.4.0	8.5.0
2010-03	RAN#47	R5-100889	0248	-	Maximum input level: Corrections w.r.t. UE categories	8.4.0	8.5.0
2010-03	RAN#47	R5-100891	0249	-	Correction to PDCCH demodulation test cases	8.4.0	8.5.0
2010-03	RAN#47	R5-100892	0250	-	Correction to PHICH demodulation test cases	8.4.0	8.5.0
2010-03	RAN#47	R5-100907	0251	-	Update of RI reporting test case	8.4.0	8.5.0
2010-03	RAN#47	R5-100909	0252	-	Correction to set UL power in Rx TCs	8.4.0	8.5.0
2010-03	RAN#47	-	-	-	Moved to v9.0.0 with no change	8.5.0	9.0.0
2010-06	RAN#48	R5-103102	0253	-	CR to 36.521-1: Update of EARFCN for band 21	9.0.0	9.1.0
2010-06	RAN#48	R5-103103	0254	-	CR to 36.521-1: Update of A-MPR test case with band 21	9.0.0	9.1.0
2010-06	RAN#48	R5-103104	0255	-	CR to 36.521-1: Update of Additional Spurious test case with band 21	9.0.0	9.1.0
2010-06	RAN#48	R5-103106	0256	-	CR to 36.521-1: Update to ACLR test case	9.0.0	9.1.0
2010-06	RAN#48	R5-103108	0257	-	CR to 36.521-1: Update of Reference sensitivity level test case	9.0.0	9.1.0
2010-06	RAN#48	R5-103226	0258	-	CR to 36.521-1: Update of UE RF requirements for LTE, Band 20	9.0.0	9.1.0
2010-06	RAN#48	R5-103263	0259	-	LTE-RF: Updates of PDCCH demodulation test cases (FDD and TDD)	9.0.0	9.1.0
2010-06	RAN#48	R5-103265	0260	-	LTE-RF:CR for TDD ACK/NACK feedback mode in CQI BLER test cases	9.0.0	9.1.0
2010-06	RAN#48	R5-103288	0261	-	PDCCH Aggregation level for RF tests	9.0.0	9.1.0
2010-06	RAN#48	R5-103291	0262	-	Update and correction to UE maximum output power requirements	9.0.0	9.1.0
2010-06	RAN#48	R5-103293	0263	-	Editorial correction in In-band blocking test	9.0.0	9.1.0
2010-06	RAN#48	R5-103296	0264	-	Correction to additional spectrum emission mask test configuration	9.0.0	9.1.0
2010-06	RAN#48	R5-103300	0265	-	Corrections to Uplink RMC-s	9.0.0	9.1.0
2010-06	RAN#48	R5-103450	0266	-	LTE-RF: editorial CR for TC 7.6.2 and 7.7	9.0.0	9.1.0
2010-06	RAN#48	R5-103471	0267	-	Minimum test time for performance tests	9.0.0	9.1.0
2010-06	RAN#48	R5-103476	0268	-	EVM with exclusion period (annex)	9.0.0	9.1.0
2010-06	RAN#48	R5-103521	0269	-	CR on 36.521-1 for updating the "Reporting of Channel State Information"	9.0.0	9.1.0
2010-06	RAN#48	R5-103525	0270	-	CR on 36.521-1 for corrections in UE RF requirements	9.0.0	9.1.0
2010-06	RAN#48	R5-103598	0271	-	Correction to notes in Max Power	9.0.0	9.1.0
2010-06	RAN#48	R5-103602	0272	-	Clarification of measurement conditions for Rx spurious emission	9.0.0	9.1.0
2010-06	RAN#48	R5-103726	0273	-	CR to 36.521-1: Update of Spurious emission band UE co-existence test case	9.0.0	9.1.0
2010-06	RAN#48	R5-103727	0274	-	LTE-RF: CR for Prach time mask test case	9.0.0	9.1.0

2010-06	RAN#48	R5-103728	0275	-	LTE-RF: CR for General ON/OFF time mask test case	9.0.0	9.1.0
2010-06	RAN#48	R5-103729	0276	-	LTE-RF: Update to spectrum flatness test case and relevant annexes	9.0.0	9.1.0
2010-06	RAN#48	R5-103730	0277	-	LTE-RF:CR for test case of In-band emissions	9.0.0	9.1.0
2010-06	RAN#48	R5-103731	0278	-	EVM with exclusion period (test)	9.0.0	9.1.0
2010-06	RAN#48	R5-103732	0279	-	CR to 36.521-1 on Correction to Demodulation Requirements for PDSCH	9.0.0	9.1.0
2010-06	RAN#48	R5-103733	0280	-	CR to 36.521-1: Update PDCCH DCI Formats for Open Loop and Closed Loop Spatial Multiplexing Test Cases	9.0.0	9.1.0
2010-06	RAN#48	R5-103751	0281	-	Misc update in CSI tests	9.0.0	9.1.0
2010-06	RAN#48	R5-103752	0282	-	Correction of the statistical part in PMI and RI tests	9.0.0	9.1.0
2010-06	RAN#48	R5-103753	0283	-	LTE-RF:CR to downlink RMCs for TX characteristics	9.0.0	9.1.0
2010-06	RAN#48	R5-103754	0284	-	LTE-RF: Update of annex C	9.0.0	9.1.0
2010-06	RAN#48	R5-103756	0285	-	Measuring throughput ratios (Annex G)	9.0.0	9.1.0
2010-06	RAN#48	R5-103763	0286	-	LTE-RF: CR for Minimum output power test case	9.0.0	9.1.0
2010-06	RAN#48	R5-103764	0287	-	Performance, CSI reporting and uncertainties for UEs with multiple Rx antennas	9.0.0	9.1.0
2010-06	RAN#48	R5-103771	0288	-	Introduction of clause 8.4.1 and 8.5.1 test case uncertainties and Test Tolerances	9.0.0	9.1.0
2010-06	RAN#48	R5-103778	0291	-	Uplink power for receiver tests	9.0.0	9.1.0
2010-06	RAN#48	R5-103780	0292	1	Addition of the exceptional message for In-band emissions	9.0.0	9.1.0
2010-06	RAN#48	R5-103781	0289	-	Correction to 6.5.2.1 EVM	9.0.0	9.1.0
2010-06	RAN#48	R5-103782	0290	-	Correction to CQI reporting	9.0.0	9.1.0
2010-09	RAN#49	R5-104090	0294	-	Corrections to Spectrum emission mask test regarding UE category	9.1.0	9.2.0
2010-09	RAN#49	R5-104091	0295	-	Missing note in Additional spurious emission test with NS_07	9.1.0	9.2.0
2010-09	RAN#49	R5-104095	0296	-	PDCCH Aggregation level for CSI tests	9.1.0	9.2.0
2010-09	RAN#49	R5-104096	0297	-	Default initial and connection Uplink power for RF tests	9.1.0	9.2.0
2010-09	RAN#49	R5-104212	0298	-	Limits on Uplink power for Receiver tests	9.1.0	9.2.0
2010-09	RAN#49	R5-104244	0299	-	Correction to Demodulation Requirements	9.1.0	9.2.0
2010-09	RAN#49	R5-104461	0300	-	CR to 36.521-1: Editorial Corrections for Closed Loop Spatial Multiplexing Test Cases	9.1.0	9.2.0
2010-09	RAN#49	R5-104478	0301	-	Correction to Test requirements in 6.5.2.2	9.1.0	9.2.0
2010-09	RAN#49	R5-104482	0302	-	Correction to 8.2.1.1	9.1.0	9.2.0
2010-09	RAN#49	R5-104520	0303	-	36521-1 General update of sections 00 to 08: missing Introduction references formatting	9.1.0	9.2.0
2010-09	RAN#49	R5-104583	0304	-	No necessity to apply - consecutive time slots for EVM	9.1.0	9.2.0
2010-09	RAN#49	R5-104584	0305	-	Correction to E.4.4 EVM equalizer spectrum flatness	9.1.0	9.2.0
2010-09	RAN#49	R5-104630	0306	-	Correction of table reference in In-band emissions test	9.1.0	9.2.0
2010-09	RAN#49	R5-104808	0307	-	CR to 36.521-1: Update to Additional Spectrum Emission Mask test case	9.1.0	9.2.0
2010-09	RAN#49	R5-104809	0308	-	CR to 36.521-1: Update to Spurious emission band UE co-existence test case	9.1.0	9.2.0
2010-09	RAN#49	R5-104810	0309	-	LTE-RF: CR for Max Output Power	9.1.0	9.2.0
2010-09	RAN#49	R5-104811	0310	-	LTE-RF: CR for Freq Error	9.1.0	9.2.0
2010-09	RAN#49	R5-104812	0311	-	Introduction of exclusion period for PUCCH-EVM test in clause 6.5.3	9.1.0	9.2.0
2010-09	RAN#49	R5-104813	0312	-	Correction to Demodulation UE-Specific Reference Symbols	9.1.0	9.2.0
2010-09	RAN#49	R5-104814	0313	-	Uncertainties and Test Tolerances for CSI Test cases 9.2.1.1 and 9.2.1.2	9.1.0	9.2.0
2010-09	RAN#49	R5-104815	0314	-	Uncertainties and Test Tolerances for CSI Test cases 9.2.2.1 and 9.2.2.2	9.1.0	9.2.0
2010-09	RAN#49	R5-104816	0315	-	UE applicability for CSI test cases	9.1.0	9.2.0
2010-09	RAN#49	R5-104817	0316	-	Update of CQI reporting TCs under fading conditions	9.1.0	9.2.0
2010-09	RAN#49	R5-104818	0317	-	Update of Reporting of Precoding Matrix Indicator TCs	9.1.0	9.2.0
2010-09	RAN#49	R5-104819	0318	-	Correction of the statistical part 9.3.1.1.1 (CQI Reporting under fading conditions)	9.1.0	9.2.0
2010-09	RAN#49	R5-104820	0319	-	Correction of the statistical part 9.3.3.1.1 (CQI Reporting under fading conditions)	9.1.0	9.2.0
2010-09	RAN#49	R5-104821	0320	-	Correction of the statistical part 9.3.2.1.1 (CQI Reporting under fading conditions)	9.1.0	9.2.0
2010-09	RAN#49	R5-104822	0321	-	Update and new RMC-s for CQI tests	9.1.0	9.2.0
2010-09	RAN#49	R5-104823	0322	-	Correction of EVM calculation in annex	9.1.0	9.2.0
2010-09	RAN#49	R5-104824	0323	-	Introduction of exclusion period for PUCCH-EVM test in Annex E	9.1.0	9.2.0
2010-09	RAN#49	R5-104844	0324	-	Pcmax changes to Configured UE Transmitted Output Power	9.1.0	9.2.0
2010-09	RAN#49	R5-104845	0325	-	Clarification on the frequency range with net work signal in 6.6.3.2	9.1.0	9.2.0
2010-09	RAN#49	R5-104846	0326	-	Update of editor's notes	9.1.0	9.2.0
2010-09	RAN#49	R5-104847	0327	-	Removal of Extreme Conditions in 6.2.3	9.1.0	9.2.0
2010-09	RAN#49	R5-104850	0328	-	Corrections to Test procedure loop in CSI tests	9.1.0	9.2.0
2010-09	RAN#49	R5-104851	0329	-	Introduction of TDD CQI Reporting under fading conditions and frequency-selective interference test case	9.1.0	9.2.0

2010-09	RAN#49	R5-104852	0330	-	Introduction of TDD RI Reporting test case	9.1.0	9.2.0
2010-09	RAN#49	R5-104853	0331	-	Update of CQI reporting TCs under AWGN conditions	9.1.0	9.2.0
2010-09	RAN#49	R5-104854	0332	-	Update of FDD RI Reporting TC	9.1.0	9.2.0
2010-09	RAN#49	R5-104857	0333	-	CR to 36.521-1 LTE UE Tx_RX test cases band 20	9.1.0	9.2.0
2010-09	RAN#49	R5-104861	0334	-	Corrections to Test requirements for MPR test	9.1.0	9.2.0
2010-09	RAN#49	R5-104863	0335	-	Clarification on notes in Max Power	9.1.0	9.2.0
2010-09	RAN#49	R5-104872	0336	-	Correction to 6.3.5.2	9.1.0	9.2.0
2010-09	RAN#49	R5-104873	0337	-	Numbering and alignment of TDD PHICH demod test cases	9.1.0	9.2.0
2010-09	RAN#49	R5-104874	0338	-	Correction to test numbering for exceptional messages in 8.2.x.x	9.1.0	9.2.0
2010-09	RAN#49	R5-104875	0339	-	Correction to 9.2.2	9.1.0	9.2.0
2010-09	RAN#49	R5-104876	0340	-	Correction to the test procedures of 9.3.x	9.1.0	9.2.0
2010-09	RAN#49	R5-104877	0341	-	Correction to 9.4.x	9.1.0	9.2.0
2010-09	RAN#49	R5-104878	0342	-	The new reference of connection diagram for 9.3.3	9.1.0	9.2.0
2010-09	RAN#49	R5-104879	0343	-	Correction to 6.3.4.1 and 6.3.5.1	9.1.0	9.2.0
2010-09	RAN#49	R5-104888	0344	-	Update of Annex C.2 for AG level	9.1.0	9.2.0
2010-09	RAN#49	R5-105055	0345	-	Introduction of a new RF test case (8.7) to verify downlink sustained data rate performance	9.1.0	9.2.0
2010-09	RAN#49	R5-105061	0347	-	CR to 36.521-1: Modification to Additional Maximum Power Reduction Test Case	9.1.0	9.2.0
2010-09	RAN#49	R5-105062	0348	-	Modification to Additional Spectrum Emission Mask	9.1.0	9.2.0
2010-09	RAN#49	R5-105063	0349	-	Modification to Additional Spurious Emissions	9.1.0	9.2.0
2010-09	RAN#49	R5-105064	0350	-	Modification to Maximum Power Reduction	9.1.0	9.2.0
2010-09	RAN#49	R5-105065	0351	-	Modification to Adjacent Channel Leakage Power Ratio	9.1.0	9.2.0
2010-09	RAN#49	RP-100987	0352	-	Correction of status for RF performance test case	9.1.0	9.2.0
2010-12	RAN#50	R5-106073	0353	-	Corrections to receiver spurious emissions test	9.2.0	9.3.0
2010-12	RAN#50	R5-106074	0354	-	Update of downlink power for receiver tests	9.2.0	9.3.0
2010-12	RAN#50	R5-106076	0355	-	CQI: Side condition when CQI median equals min or max CQI-values	9.2.0	9.3.0
2010-12	RAN#50	R5-106077	0356	-	Update of the throughput-definition for multi-data stream transmission	9.2.0	9.3.0
2010-12	RAN#50	R5-106078	0357	-	Update of RF OCNG patterns	9.2.0	9.3.0
2010-12	RAN#50	R5-106092	0358	-	Correction of DCI format used in PDSCH performance test 8.2.1.4.2	9.2.0	9.3.0
2010-12	RAN#50	R5-106249	0359	-	CR to 36.521-1: Correction to Spurious emission band UE co-existence test case	9.2.0	9.3.0
2010-12	RAN#50	R5-106250	0360	-	CR to 36.521-1: Correction to Additional Tx spurious emissions test case	9.2.0	9.3.0
2010-12	RAN#50	R5-106374	0361	-	Correction of FDD CQI reporting test under AWGN - PUCCH 1-1	9.2.0	9.3.0
2010-12	RAN#50	R5-106394	0362	-	Correction of clause 9.3.1 and 9.3.3	9.2.0	9.3.0
2010-12	RAN#50	R5-106399	0363	-	"Correction of G.2.5 Pass fail decision rules"	9.2.0	9.3.0
2010-12	RAN#50	R5-106420	0364	-	Introduction of test uncertainties and tolerances for TDD PDSCH DRS test cases	9.2.0	9.3.0
2010-12	RAN#50	R5-106440	0365	-	Correction to unsigned numbers in Annex F.1.2	9.2.0	9.3.0
2010-12	RAN#50	R5-106443	0366	-	Correction to the exceptional messages in 9.4 Reporting of PMI TCs	9.2.0	9.3.0
2010-12	RAN#50	R5-106491	0367	-	CR to 36.521-1: Correction to Table Numbering Error in TDD PDSCH Closed Loop Single/Multi Layer Spatial Multiplexing 2x2	9.2.0	9.3.0
2010-12	RAN#50	R5-106512	0368	-	Transport format table clarification in CSI test cases	9.2.0	9.3.0
2010-12	RAN#50	R5-106801	0369	-	HARQ scheduling in TDD performance tests using special subframes	9.2.0	9.3.0
2010-12	RAN#50	R5-106803	0370	-	Correction to Fading Profiles in TCs 8.4 and 8.5	9.2.0	9.3.0
2010-12	RAN#50	R5-106816	0372	-	CR to 36.521-1: Modification to Spectrum Emissions Mask	9.2.0	9.3.0
2010-12	RAN#50	R5-106817	0373	-	Introduction of test uncertainties and tolerances for TDD PCFICH/PDCCH and PHICH test cases	9.2.0	9.3.0
2010-12	RAN#50	R5-106818	0374	-	Update of TDD PDSCH CRS Demodulation test cases	9.2.0	9.3.0
2010-12	RAN#50	R5-106821	0375	-	PUSCH-EVM with exclusion period	9.2.0	9.3.0
2010-12	RAN#50	R5-106822	0376	-	Maintenance of Band 20 for receiver tests	9.2.0	9.3.0
2010-12	RAN#50	R5-106823	0377	-	Completion of clause 9.3.1 and 9.3.2	9.2.0	9.3.0
2010-12	RAN#50	R5-106824	0378	-	Update of FDD RI Reporting TC	9.2.0	9.3.0
2010-12	RAN#50	R5-106825	0379	-	Correction to 9.2.2 CQI TCs	9.2.0	9.3.0
2010-12	RAN#50	R5-106826	0380	-	G.3.5 on PDCCH&PHICH Minimum Test Times	9.2.0	9.3.0
2010-12	RAN#50	R5-106827	0381	-	Completion of test time and $\frac{TT}{T}$ -TT for clauses 9.3 to 9.5	9.2.0	9.3.0
2010-12	RAN#50	R5-106828	0382	-	EVM window length for PRACH	9.2.0	9.3.0
2010-12	RAN#50	R5-106842	0383	-	Modification of TC 8.3.2.1 - TDD PDSCH Single-layer SM Performance (UE-Specific Reference Symbols)	9.2.0	9.3.0
2010-12	RAN#50	R5-106843	0384	-	Power control relative power tolerance: Missing band edge relaxation	9.2.0	9.3.0
2010-12	RAN#50	R5-106844	0385	-	SRS time mask test procedure update	9.2.0	9.3.0
2010-12	RAN#50	R5-106845	0386	-	Correction of TC General ON/OFF time mask	9.2.0	9.3.0

2010-12	RAN#50	R5-106846	0387	-	Update of TDD CQI reporting test under frequency selective interference conditions	9.2.0	9.3.0
2010-12	RAN#50	R5-106847	0388	-	Update of TDD RI reporting test	9.2.0	9.3.0
2010-12	RAN#50	R5-106848	0389	-	lot setting in CQI test clarification	9.2.0	9.3.0
2010-12	RAN#50	R5-106850	0390	-	Correction of Test Uncertainties and Test Tolerances for Reference Sensitivity-Band 4	9.2.0	9.3.0
2010-12	RAN#50	R5-106855	0391	-	Correction to DL and UL RMC configurations in 6.5.1 Frequency Error	9.2.0	9.3.0
2010-12	RAN#50	R5-106858	0392	-	CR to 36.521-1: Update LTE RF test cases with test requirements for EUTRA TDD LTE band 41.	9.2.0	9.3.0
2011-03	RAN#51	R5-110138	0393	-	Spurious emission band co-existence test: Remaining old test requirement table	9.3.0	9.4.0
2011-03	RAN#51	R5-110139	0394	-	Transmit intermodulation test: Interferer offset for Band 20, Bandwidth 20 MHz	9.3.0	9.4.0
2011-03	RAN#51	R5-110141	0395	-	PMI Performance tests: Corrections to test settings	9.3.0	9.4.0
2011-03	RAN#51	R5-110143	0396	-	PDCCH Performance test: Correction to TDD DL RMC-s	9.3.0	9.4.0
2011-03	RAN#51	R5-110144	0397	-	OCNG for RF tests: Updates	9.3.0	9.4.0
2011-03	RAN#51	R5-110158	0398	-	CQI Performance tests: Clarification on subbands used in the test	9.3.0	9.4.0
2011-03	RAN#51	R5-110302	0399	-	LTE RF: PCFICH/PDCCH Transmit Diversity Performance	9.3.0	9.4.0
2011-03	RAN#51	R5-110349	0401	-	Correction of OFF power measurements in 6.3.4 ON/OFF time mask	9.3.0	9.4.0
2011-03	RAN#51	R5-110354	0402	-	Correction of Annex E (Global In-Channel TX-Test)	9.3.0	9.4.0
2011-03	RAN#51	R5-110506	0403	-	Addition of 3500 MHz TDD bands into chapter 5 of 36.521-1	9.3.0	9.4.0
2011-03	RAN#51	R5-110747	0404	-	Updates to section 8.7 DL sustained data rate test case	9.3.0	9.4.0
2011-03	RAN#51	R5-110850	0405	-	Sustained data rate: Definition of UL RMC-s	9.3.0	9.4.0
2011-03	RAN#51	R5-110860	0400	-	Update measurement period from test procedure of 6.2.2	9.3.0	9.4.0
2011-03	RAN#51	R5-110861	0428	-	A-MPR Test requirement update	9.3.0	9.4.0
2011-03	RAN#51	R5-110862	0437	-	Measuring throughput with different payload size.	9.3.0	9.4.0
2011-03	RAN#51	R5-110900	0406	-	Correction to SNR reference in FDD PCFICH/PDCCH Single Antenna Port Performance Test	9.3.0	9.4.0
2011-03	RAN#51	R5-110901	0407	-	CR to 36.521-1: Correction of Additional Maximum Power Reduction (A-MPR) test case	9.3.0	9.4.0
2011-03	RAN#51	R5-110915	0408	-	Uncertainties and Test Tolerances for CSI Test cases 9.3.1.1.x and 9.3.2.1.x	9.3.0	9.4.0
2011-03	RAN#51	R5-110916	0409	-	Uncertainties and Test Tolerances for CSI Test cases 9.3.3.1.x	9.3.0	9.4.0
2011-03	RAN#51	R5-110917	0410	-	Uncertainties and Test Tolerances for CSI Test cases 9.4.1.1.x and 9.4.2.1.x	9.3.0	9.4.0
2011-03	RAN#51	R5-110918	0411	-	Uncertainties and Test Tolerances for CSI Test cases 9.5.1.x	9.3.0	9.4.0
2011-03	RAN#51	R5-110919	0412	-	Editorial errors in CSI test cases 9.2.1.x Test procedure	9.3.0	9.4.0
2011-03	RAN#51	R5-110933	0413	-	Handling of different releases in RAN5 LTE RF specification	9.3.0	9.4.0
2011-03	RAN#51	R5-110938	0414	-	PRACH Time mask and EVM tests: TDD Special subframe configuration	9.3.0	9.4.0
2011-03	RAN#51	R5-110939	0415	-	Update on PRACH time mask for TDD	9.3.0	9.4.0
2011-03	RAN#51	R5-110940	0416	-	Correction of the connection diagram reference in the initial conditions for Transmitter Characteristics	9.3.0	9.4.0
2011-03	RAN#51	R5-110941	0417	-	Update of the reference sensitivity requirement for the 1.4MHz and 3MHz bandwidths and note correction for Band 3 and Band 9	9.3.0	9.4.0
2011-03	RAN#51	R5-110942	0418	-	CR Removing brackets of band 41 reference sensitivity in 36.521-1	9.3.0	9.4.0
2011-03	RAN#51	R5-110949	0419	-	PDCCH and PHICH performance tests: Updates and corrections	9.3.0	9.4.0
2011-03	RAN#51	R5-110950	0420	-	Addition of CodeBookSubsetRestriction bitmap for Multi-Layer Spatial Multiplexing	9.3.0	9.4.0
2011-03	RAN#51	R5-110951	0421	-	Addition of exceptional message in 8.4.1.2.2	9.3.0	9.4.0
2011-03	RAN#51	R5-110952	0422	-	CQI test 9.2.2.2: Update acc TS 36.101	9.3.0	9.4.0
2011-03	RAN#51	R5-110953	0423	-	Maximum input level test: Correction to DL-RMC	9.3.0	9.4.0
2011-03	RAN#51	R5-110954	0424	-	Correction of E.7, EVM with exclusion period	9.3.0	9.4.0
2011-03	RAN#51	R5-110967	0425	-	Updates to Additional Spurious emissions and Spurious emission band UE co-existence test	9.3.0	9.4.0
2011-03	RAN#51	R5-110970	0426	-	LTE RF: references to state 3A in 36.521-1	9.3.0	9.4.0
2011-03	RAN#51	R5-110973	0429	-	RI Performance tests: Corrections	9.3.0	9.4.0
2011-03	RAN#51	R5-110975	0430	-	Completion of annex G.3.5 (Minimum test time, performance tests)	9.3.0	9.4.0
2011-03	RAN#51	R5-110978	0431	-	Correction to Band 12 frequency range	9.3.0	9.4.0
2011-03	RAN#51	R5-110979	0432	-	Additional in-band blocking requirement for Band 12	9.3.0	9.4.0
2011-03	RAN#51	R5-110989	0433	-	Completion of annex G.3.6 (test conditions, performance tests)	9.3.0	9.4.0
2011-03	RAN#51	R5-110990	0434	-	Addition of test cases of TDD PDSCH Single-layer and Dual-layer Spatial Multiplexing Performance	9.3.0	9.4.0
2011-03	RAN#51	R5-110991	0435	-	Correction to Times Mask and Power Control tests	9.3.0	9.4.0

2011-03	RAN#51	R5-110992	0436	-	Add requirement of QPSK with partial RB allocation into test requirement of 6.2.3	9.3.0	9.4.0
2011-04	-	-	-	-	Added approved R5-110967 which was missing.	9.4.0	9.4.1
2011-06	RAN#52	R5-112148	0438	-	ON/OFF time mask for PRACH: PRACH configuration index	9.4.1	9.5.0
2011-06	RAN#52	R5-112149	0439	-	CQI tests with frequency selective scheduling mode: Random selection of Sub-Bands	9.4.1	9.5.0
2011-06	RAN#52	R5-112150	0440	-	DL-RMC for receiver tests: Obsolete editors note	9.4.1	9.5.0
2011-06	RAN#52	R5-112211	0441	-	Adding Band 24 to TS 36.521-1	9.4.1	9.5.0
2011-06	RAN#52	R5-112311	0442	-	Correction to the sustained data rate tests	9.4.1	9.5.0
2011-06	RAN#52	R5-112312	0443	-	Correction to the multi-antenna transmission tests	9.4.1	9.5.0
2011-06	RAN#52	R5-112349	0444	-	Update Annex G.3.6 for spatial multiplexing test cases	9.4.1	9.5.0
2011-06	RAN#52	R5-112412	0445	-	Correction to DL RMC for Max input for UE category 2	9.4.1	9.5.0
2011-06	RAN#52	R5-112459	0446	-	EVM window length for PRACH	9.4.1	9.5.0
2011-06	RAN#52	R5-112460	0447	-	Removal of square brackets in Annex G.5.4	9.4.1	9.5.0
2011-06	RAN#52	R5-112462	0448	-	Test tolerances for EVM with exclusion period	9.4.1	9.5.0
2011-06	RAN#52	R5-112808	0449	-	LTE RF - UEs Demodulation and CSI Band applicability	9.4.1	9.5.0
2011-06	RAN#52	R5-112810	0450	-	Correction on test requirement of test case 6.5.2.3	9.4.1	9.5.0
2011-06	RAN#52	R5-112811	0451	-	LTE RF - TC6.3.5.2 Change in Minimum Requirements	9.4.1	9.5.0
2011-06	RAN#52	R5-112812	0452	-	Removal of NS values for TDD	9.4.1	9.5.0
2011-06	RAN#52	R5-112813	0453	-	Correction on initial condition for test cases of 9.3.3	9.4.1	9.5.0
2011-06	RAN#52	R5-112814	0454	-	Correction to 9.4 PMI test cases	9.4.1	9.5.0
2011-06	RAN#52	R5-112816	0455	-	Test procedure change on Tx spurious emissions test cases	9.4.1	9.5.0
2011-06	RAN#52	R5-112850	0456	-	Update of Initial conditions according to table 7.3.3-2 for the 5MHz and 10MHz bandwidths	9.4.1	9.5.0
2011-06	RAN#52	R5-112851	0457	-	lot modelling in frequency-selective interference CQI tests	9.4.1	9.5.0
2011-06	RAN#52	R5-112852	0458	-	Correction to test procedure in 9.5.1	9.4.1	9.5.0
2011-06	RAN#52	R5-112859	0459	-	Introduction of additional PDCCH test cases for Rel-9	9.4.1	9.5.0
2011-06	RAN#52	R5-112860	0460	-	Introduction of additional PHICH test cases for Rel-9	9.4.1	9.5.0
2011-06	RAN#52	R5-112861	0461	-	Introducing UE-selected subband CQI tests for Rel-9	9.4.1	9.5.0
2011-06	RAN#52	R5-112862	0462	-	Introduction of new PMI test cases for UE-selected sub-band reporting for Rel-9	9.4.1	9.5.0
2011-06	RAN#52	R5-112863	0463	-	Addition of a new TC for FDD MBMS performance	9.4.1	9.5.0
2011-06	RAN#52	R5-112864	0464	-	Addition of a new TC for TDD MBMS performance	9.4.1	9.5.0
2011-06	RAN#52	R5-112866	0465	-	Addition of UE category 1 coverage for single-layer spatial multiplexing transmission on antenna port 7 or 8	9.4.1	9.5.0
2011-06	RAN#52	R5-112870	0466	-	Removal of square brackets in annex G.3.5 (Minimum test time, performance tests)	9.4.1	9.5.0
2011-06	RAN#52	R5-112871	0467	-	Update minimum requirements and test requirements for spatial multiplexing test cases	9.4.1	9.5.0
2011-06	RAN#52	R5-112873	0468	-	Test procedure change on few Rx test cases	9.4.1	9.5.0
2011-09	RAN#53	R5-113178	0506	-	RF TC 8.7.2: Correction of the ACK/NACK feedback mode	9.5.0	9.6.0
2011-09	RAN#53	R5-113179	0469	-	RF TC-s 9.3.4: Updates to minimum requirements and corrections to test procedures	9.5.0	9.6.0
2011-09	RAN#53	R5-113180	0470	-	RF: New UL RMC for 10 MHz 15RB-s	9.5.0	9.6.0
2011-09	RAN#53	R5-113181	0471	-	RF: Use of State 3A-RF	9.5.0	9.6.0
2011-09	RAN#53	R5-113233	0472	-	LTE RF: EVM Annex E correction	9.5.0	9.6.0
2011-09	RAN#53	R5-113238	0473	-	RF TC 6.3.4.2.2: Correction to SRS configuration	9.5.0	9.6.0
2011-09	RAN#53	R5-113368	0474	-	Correction in test cases of 8.2.2.1.2 and 8.5.1	9.5.0	9.6.0
2011-09	RAN#53	R5-113369	0475	-	Correction in test cases of 9.5	9.5.0	9.6.0
2011-09	RAN#53	R5-113380	0476	-	Update of minimum test time for PCFICH/PDCCH and PHICH tests	9.5.0	9.6.0
2011-09	RAN#53	R5-113383	0477	-	Correction of Table G.3.5-1 (minimum test time)	9.5.0	9.6.0
2011-09	RAN#53	R5-113419	0478	-	Correction for spurious emission band UE co-existence limits of Band 3	9.5.0	9.6.0
2011-09	RAN#53	R5-113454	0479	-	Correction to test procedure in 6.5.1	9.5.0	9.6.0
2011-09	RAN#53	R5-113455	0480	-	Correction to Minimum requirement in 6.6.2.2	9.5.0	9.6.0
2011-09	RAN#53	R5-113456	0481	-	Correction to RMC for PDCCH/PCFICH performance requirements	9.5.0	9.6.0
2011-09	RAN#53	R5-113458	0482	-	Correction to CSI TCs	9.5.0	9.6.0
2011-09	RAN#53	R5-113541	0483	-	Introduction of Expanded 1900MHz Band (Band 25) into section 5 of 36.521-1	9.5.0	9.6.0
2011-09	RAN#53	R5-113596	0506	-	Abbreviation update and Editorial corrections in TS36.521-1	9.5.0	9.6.0
2011-09	RAN#53	R5-114000	0484	-	Correction in 6.3.5.2 Power Control Relative power tolerance	9.5.0	9.6.0
2011-09	RAN#53	R5-114001	0485	-	Correction in 6.3.4.2.2 SRS time mask	9.5.0	9.6.0
2011-09	RAN#53	R5-114002	0486	-	Addition of PDSCH TDD performance tests for Low UE categories	9.5.0	9.6.0
2011-09	RAN#53	R5-114003	0487	-	Additional FDD scenarios	9.5.0	9.6.0
2011-09	RAN#53	R5-114004	0488	-	Addition of RMC-s for PDSCH performance tests for low UE categories	9.5.0	9.6.0
2011-09	RAN#53	R5-114032	0489	-	Introduction of Expanded 1900MHz Band (Band 25) into section 6 of 36.521-1	9.5.0	9.6.0

2011-09	RAN#53	R5-114033	0490	-	Correction on TDD MBMS performance requirements for 64QAM mode	9.5.0	9.6.0
2011-09	RAN#53	R5-114034	0491	-	Correction on FDD MDMS performance requirements for 64QAM mode	9.5.0	9.6.0
2011-09	RAN#53	R5-114038	0492	-	RF TC 6.3.5.2: Consideration of band edge relaxation in test requirements	9.5.0	9.6.0
2011-09	RAN#53	R5-114039	0493	-	Band 19 A-MPR refinement	9.5.0	9.6.0
2011-09	RAN#53	R5-114040	0494	-	Test system uncertainty and TT for 6.6.3.3 additional spurious emissions NS_07	9.5.0	9.6.0
2011-09	RAN#53	R5-114041	0495	-	Correction to Additional Maximum Power Reduction	9.5.0	9.6.0
2011-09	RAN#53	R5-114042	0496	-	Correction to 6.3.4.2.1 PRACH time mask	9.5.0	9.6.0
2011-09	RAN#53	R5-114043	0497	-	Correction to Receiver Characteristics Minimum Requirements	9.5.0	9.6.0
2011-09	RAN#53	R5-114044	0498	-	Addition of PDSCH FDD performance tests for Low UE categories	9.5.0	9.6.0
2011-09	RAN#53	R5-114045	0499	-	Additional Rel-9 TDD scenarios	9.5.0	9.6.0
2011-09	RAN#53	R5-114046	0500	-	Update of CQI/PMI test cases	9.5.0	9.6.0
2011-09	RAN#53	R5-114047	0501	-	Update of RI test cases	9.5.0	9.6.0
2011-09	RAN#53	R5-114048	0502	-	Release dependent RMCs in PCFICH/PDCCH and PHICH tests	9.5.0	9.6.0
2011-09	RAN#53	R5-114049	0503	-	Addition of tests scenarios in Annex	9.5.0	9.6.0
2011-09	RAN#53	R5-114073	0504	-	Introduction of Expanded 1900MHz Band (Band 25) into section 7 of 36.521-1	9.5.0	9.6.0
2011-09	RAN#53	R5-114091	0505	-	Correction to test cases 10.1 and 10.2	9.5.0	9.6.0
2011-12	RAN#54	R5-115112	0507	-	RF: Coverage of MPR and A-MPR requirements in emissions tests	9.6.0	9.7.0
2011-12	RAN#54	R5-115113	0508	-	RF: Update to names of some RMC-s used in different releases	9.6.0	9.7.0
2011-12	RAN#54	R5-115114	0509	-	RF TC 6.2.4, 6.6.2.2, 6.6.3.3: Corrections to A-MPR related tests	9.6.0	9.7.0
2011-12	RAN#54	R5-115115	0510	-	RF TC-s 9: Corrections to UL allocation for some CQI tests	9.6.0	9.7.0
2011-12	RAN#54	R5-115116	0511	-	RF TC 6.3.5.2: Missing extreme conditions in test requirements	9.6.0	9.7.0
2011-12	RAN#54	R5-115117	0512	-	RF TC 6.2.3: Missing test requirements for band 25	9.6.0	9.7.0
2011-12	RAN#54	R5-115118	0513	-	RF TC 6.5.2.1: Redundant conflicting IE-s in message contents	9.6.0	9.7.0
2011-12	RAN#54	R5-115119	0514	-	RF TC 6.6.3.1: Correction of reference to the connection diagram	9.6.0	9.7.0
2011-12	RAN#54	R5-115324	0517	-	LTE RF: CSI test case update	9.6.0	9.7.0
2011-12	RAN#54	R5-115472	0518	-	Corrections to the dual-layer beamforming demodulation requirements	9.6.0	9.7.0
2011-12	RAN#54	R5-115475	0519	-	Correction to Code Block Numbers	9.6.0	9.7.0
2011-12	RAN#54	R5-115800	0522	-	Delete note in PUSCH-EVM	9.6.0	9.7.0
2011-12	RAN#54	R5-115812	0526	-	RF: Corrections to tests with release dependent requirements	9.6.0	9.7.0
2011-12	RAN#54	R5-115815	0527	-	Test Frequency for Relative Power Tolerance	9.6.0	9.7.0
2011-12	RAN#54	R5-115821	0531	-	RF: General review of the reference measurement channels	9.6.0	9.7.0
2011-12	RAN#54	R5-115822	0532	-	Correction for codebook subset restriction in single-layer closed loop spatial multiplexing test	9.6.0	9.7.0
2011-12	RAN#54	R5-115830	0533	-	Uncertainties and Test Tolerances for 3000MHz to 4200MHz, Tx Test cases	9.6.0	9.7.0
2011-12	RAN#54	R5-115831	0534	-	Uncertainties and Test Tolerances for 3000MHz to 4200MHz, Rx Test cases	9.6.0	9.7.0
2011-12	RAN#54	R5-115832	0535	-	Support for band 22, 42 and 43	9.6.0	9.7.0
2011-12	RAN#54	R5-115837	0536	-	Update LTE RF test cases with test requirements for FDD LTE Band 23 in 36.521-1	9.6.0	9.7.0
2011-12	RAN#54	R5-115875	0537	-	Correction on FDD and TDD MBMS conformance requirements	9.6.0	9.7.0
2011-12	RAN#54	R5-115877	0538	-	Introduction of test system uncertainties and TT to new TCs in clauses 9.3.4 to 9.4.2.2.2	9.6.0	9.7.0
2011-12	RAN#54	R5-115879	0539	-	Uncertainties and Test Tolerances for Sustained data rate test cases	9.6.0	9.7.0
2011-12	RAN#54	R5-115891	0540	-	Requirement change in UE spurious emissions for Band 7 and 38 co-existence (Rel-8 only)	9.6.0	9.7.0
2011-12	RAN#54	R5-115162	0515	-	Definitions, symbols and abbreviations for CA RF	9.7.0	10.0.0
2011-12	RAN#54	R5-115565	0520	-	In-band blocking for CA (New)	9.7.0	10.0.0
2011-12	RAN#54	R5-115568	0521	-	Spurious Response for CA (New)	9.7.0	10.0.0
2011-12	RAN#54	R5-115801	0523	-	Out-of-Band blocking for CA (new)	9.7.0	10.0.0
2011-12	RAN#54	R5-115802	0524	-	Narrow band blocking for CA (new)	9.7.0	10.0.0
2011-12	RAN#54	R5-115803	0525	-	Addition of new RMCs for CA feature related Chapter8 test cases	9.7.0	10.0.0
2011-12	RAN#54	R5-115816	0528	-	General Section for CA RF	9.7.0	10.0.0
2011-12	RAN#54	R5-115817	0529	-	Frequency Band and Channel Assignments for CA RF	9.7.0	10.0.0
2011-12	RAN#54	R5-115818	0530	-	UE Maximum Output Power for intra-band contiguous CA (new)	9.7.0	10.0.0

2012-03	RAN#55	R5-120080	0587	-	Removal of technical content in 36.521-1 v9.7.0 and substitution with pointer to the next Release	10.0.0	10.1.0
2012-03	RAN#55	R5-120134	0541	-	RF: General clarification on the count of ACK / NACKs in throughput calculation in CQI tests	10.0.0	10.1.0
2012-03	RAN#55	R5-120137	0542	-	RF: Corrections to message contents in some MIMO demodulation performance tests	10.0.0	10.1.0
2012-03	RAN#55	R5-120138	0543	-	RF: Updates to handling requirements and tests for different releases	10.0.0	10.1.0
2012-03	RAN#55	R5-120140	0544	-	RF: Coverage of MPR and A-MPR requirements in Tx emissions tests	10.0.0	10.1.0
2012-03	RAN#55	R5-120243	0545	-	Tx Test cases Uplink power limit window for 3000MHz to 4200MHz	10.0.0	10.1.0
2012-03	RAN#55	R5-120244	0546	-	Rx Test cases Uplink power limit window for 3000MHz to 4200MHz	10.0.0	10.1.0
2012-03	RAN#55	R5-120252	0547	-	Global in-channel TX-test, delete note	10.0.0	10.1.0
2012-03	RAN#55	R5-120288	0548	-	LTE RF - Update of abbreviations and addition of RBstart	10.0.0	10.1.0
2012-03	RAN#55	R5-120314	0549	-	Clarification for the starting point of RB in 6.3.5.2 Relative Power test	10.0.0	10.1.0
2012-03	RAN#55	R5-120338	0550	-	Correction to MCS value in Table A.4-3	10.0.0	10.1.0
2012-03	RAN#55	R5-120343	0551	-	Introduction of new maximum input level test case for CA	10.0.0	10.1.0
2012-03	RAN#55	R5-120351	0552	-	CA RF - Changes in aggregated CC configurations	10.0.0	10.1.0
2012-03	RAN#55	R5-120355	0553	-	CA RF - updates to 7.7A Spurious response for CA	10.0.0	10.1.0
2012-03	RAN#55	R5-120370	0554	-	Test Tolerance for 6.6.3.3 additional spurious emissions NS_07	10.0.0	10.1.0
2012-03	RAN#55	R5-120426	0555	-	Correction to Frequency Range for Spurious Emission Requirements	10.0.0	10.1.0
2012-03	RAN#55	R5-120521	0556	-	Introduction to Maximum Power Reduction for CA	10.0.0	10.1.0
2012-03	RAN#55	R5-120524	0557	-	Introduction to Maximum Power Reduction for CA in Annex	10.0.0	10.1.0
2012-03	RAN#55	R5-120526	0558	-	Introduction to Adjacent Channel Leakage power Ratio (ACLR) for CA in Annex	10.0.0	10.1.0
2012-03	RAN#55	R5-120801	0559	-	Correction of TC 6.5.2.1 Error Vector Magnitude (EVM) for Test requirement	10.0.0	10.1.0
2012-03	RAN#55	R5-120802	0560	-	Correction of TC 8.2.1.3.1 FDD PDSCH Open Loop Spatial Multiplexing 2x2 for 8.2.1.3.1.4.1 Initial conditions	10.0.0	10.1.0
2012-03	RAN#55	R5-120803	0561	-	Correction of TC8.2.1.3.2 FDD PDSCH Open Loop Spatial Multiplexing 4x2 for 8.2.1.3.2.4.1 Initial conditions	10.0.0	10.1.0
2012-03	RAN#55	R5-120804	0562	-	Correction of TC 8.2.2.3.1 TDD PDSCH Open Loop Spatial Multiplexing 2x2 for 8.2.2.3.1.4.1 Initial conditions	10.0.0	10.1.0
2012-03	RAN#55	R5-120805	0563	-	Correction of TC 8.2.2.3.2 TDD PDSCH Open Loop Spatial Multiplexing 4x2 for 8.2.2.3.2.4.1 Initial conditions	10.0.0	10.1.0
2012-03	RAN#55	R5-120816	0564	-	Addition of frequency band and channel assignments for UL MIMO	10.0.0	10.1.0
2012-03	RAN#55	R5-120825	0565	-	Introduction of Chapter8 Single antenna port and Open loop spatial Multiplexing test cases for CA capable UE's.	10.0.0	10.1.0
2012-03	RAN#55	R5-120828	0566	-	LTE RF - UE Co-ex test point clarification for bands 7 and 38	10.0.0	10.1.0
2012-03	RAN#55	R5-120833	0567	-	Addition of receiver image section 7.10	10.0.0	10.1.0
2012-03	RAN#55	R5-120835	0568	-	Correction to Reporting of Rank Indicator (RI) FDD Test	10.0.0	10.1.0
2012-03	RAN#55	R5-120837	0569	-	Introduction to Adjacent Channel Leakage power Ratio (ACLR) for CA	10.0.0	10.1.0
2012-03	RAN#55	R5-120839	0570	-	Addition of a new TC 6.2.2B for UE Maximum Output Power for UL-MIMO	10.0.0	10.1.0
2012-03	RAN#55	R5-120842	0571	-	Harmonic exceptions in LTE UE to UE co-existence tests	10.0.0	10.1.0
2012-03	RAN#55	R5-120843	0572	-	Clarification for upper and lower interferers in 7.6.3 Narrow Band Blocking	10.0.0	10.1.0
2012-03	RAN#55	R5-120844	0573	-	RF: Correction of frequency range for out of band blocking test	10.0.0	10.1.0
2012-03	RAN#55	R5-120845	0574	-	Correction and completion to clause 10 MBMS performance	10.0.0	10.1.0
2012-03	RAN#55	R5-120874	0575	-	RF: New RMC-s and updates to the RMC-s overview tables	10.0.0	10.1.0
2012-03	RAN#55	R5-120875	0576	-	RF: Test frequencies for UE co-existence emissions under Note 13	10.0.0	10.1.0
2012-03	RAN#55	R5-120877	0577	-	UE Transmit OFF power for CA	10.0.0	10.1.0
2012-03	RAN#55	R5-120878	0578	-	Frequency error for Intra-band CA	10.0.0	10.1.0
2012-03	RAN#55	R5-120879	0579	-	Occupied bandwidth for intra-band contiguous CA	10.0.0	10.1.0
2012-03	RAN#55	R5-120880	0580	-	Transmitter Spurious emissions for CA	10.0.0	10.1.0
2012-03	RAN#55	R5-120881	0581	-	Reference sensitivity level for CA	10.0.0	10.1.0
2012-03	RAN#55	R5-120882	0582	-	CA RF - Addition of test description to 6.2.2A MOP for intra-band CA	10.0.0	10.1.0
2012-03	RAN#55	R5-120884	0583	-	CA RF - updates to 7.6.2A OOB blocking for CA	10.0.0	10.1.0
2012-03	RAN#55	R5-120885	0584	-	CA RF - updates to 7.6.3A Narrow-band blocking for CA	10.0.0	10.1.0
2012-03	RAN#55	R5-120899	0585	-	CA RF - updates to 7.6.1A In-band Blocking for CA	10.0.0	10.1.0
2012-03	RAN#55	R5-120900	0586	-	Correction to UE Spurious Emissions	10.0.0	10.1.0
2012-06	RAN#56	R5-121138	0588	-	Correction of TC 6.3.5.2 Power Control Relative power tolerance	10.1.0	10.2.0
2012-06	RAN#56	R5-121155	0589	-	Correction in test configuration table of sections 7.4 and 7.5	10.1.0	10.2.0

2012-06	RAN#56	R5-121206	0590	-	Correction of test procedure for intermodulation	10.1.0	10.2.0
2012-06	RAN#56	R5-121208	0591	-	Correction of test procedure for out-of-band blocking	10.1.0	10.2.0
2012-06	RAN#56	R5-121221	0592	-	Relative frequency error for CA performance tests	10.1.0	10.2.0
2012-06	RAN#56	R5-121241	0593	-	RF: Corrections to derivation of test requirements for some test points of TC 6.2.4	10.1.0	10.2.0
2012-06	RAN#56	R5-121242	0594	-	RF: Updates to Annex I (Handling of different releases)	10.1.0	10.2.0
2012-06	RAN#56	R5-121253	0595	-	RF: Clarification of test frequencies for UE co-existence emissions under Note 13	10.1.0	10.2.0
2012-06	RAN#56	R5-121254	0596	-	RF: Minor correction to RMC reference in minimum test time annex for TC 8.3.2.1.3	10.1.0	10.2.0
2012-06	RAN#56	R5-121305	0597	-	Removal of test description from Transmit off power for CA and introducing ON/OFF time mask for CA	10.1.0	10.2.0
2012-06	RAN#56	R5-121322	0598	-	Update of 6.3.4.2.2	10.1.0	10.2.0
2012-06	RAN#56	R5-121337	0599	-	Clarifications to Maximum Power Reduction for CA	10.1.0	10.2.0
2012-06	RAN#56	R5-121438	0600	-	Modification to Configured UE transmitted Output Power	10.1.0	10.2.0
2012-06	RAN#56	R5-121451	0601	-	Correction of the Band 23 for UE coexistence requirements	10.1.0	10.2.0
2012-06	RAN#56	R5-121459	0602	-	Correction of RF Test case: 8.7.2.1 TDD sustained data rate performance	10.1.0	10.2.0
2012-06	RAN#56	R5-121463	0603	-	Introduction of Adjacent Channel Selectivity (ACS) for CA	10.1.0	10.2.0
2012-06	RAN#56	R5-121475	0604	-	LTE CA general updates to sections 3 - 5	10.1.0	10.2.0
2012-06	RAN#56	R5-121479	0605	-	CA RF - TC 6.2.2A MOP updates	10.1.0	10.2.0
2012-06	RAN#56	R5-121482	0606	-	CA RF - 7.6.1A In-band blocking updates	10.1.0	10.2.0
2012-06	RAN#56	R5-121483	0607	-	CA RF - 7.6.2A Out-of-band blocking updates	10.1.0	10.2.0
2012-06	RAN#56	R5-121484	0608	-	CA RF - 7.6.3A Narrow-band blocking updates	10.1.0	10.2.0
2012-06	RAN#56	R5-121485	0609	-	CA RF - 7.7A Spurious response updates	10.1.0	10.2.0
2012-06	RAN#56	R5-121488	0610	-	LTE RF - TC 6.6.3.2 UE co-existence requirements correction	10.1.0	10.2.0
2012-06	RAN#56	R5-121523	0611	-	Correction to downlink RB allocation in 7.5.4	10.1.0	10.2.0
2012-06	RAN#56	R5-121525	0612	-	Correction to test requirement in 9.2.2.2	10.1.0	10.2.0
2012-06	RAN#56	R5-121678	0613	-	TS 36.521-1: Spurious emission band UE co-existence alignment	10.1.0	10.2.0
2012-06	RAN#56	R5-121680	0614	-	TS 36.521-1: Applicability correction for 9.3.2.1.1 and 9.3.2.1.2	10.1.0	10.2.0
2012-06	RAN#56	R5-121700	0615	-	Suffix definition of Clause 5 for CA, UL-MIMO, and DL-MIMO for 36.521-1 R-10	10.1.0	10.2.0
2012-06	RAN#56	R5-121903	0616	-	Update of Band 41 RF requirements to align with recent core specification changes	10.1.0	10.2.0
2012-06	RAN#56	R5-121906	0617	-	TS 36.521-1: Introduction of Band 26/XXVI in section 5	10.1.0	10.2.0
2012-06	RAN#56	R5-121907	0618	-	TS 36.521-1: Band 26 Test points for A-MPR test	10.1.0	10.2.0
2012-06	RAN#56	R5-121909	0619	-	CA RF - Adding contents to TC 6.2.4A A-MPR for CA	10.1.0	10.2.0
2012-06	RAN#56	R5-121918	0620	-	TS 36.521-1: Introduction of Band 26/XXVI in section 6	10.1.0	10.2.0
2012-06	RAN#56	R5-121920	0621	-	Corrections of test parameters and test procedure for ACS	10.1.0	10.2.0
2012-06	RAN#56	R5-121921	0622	-	TS 36.521-1: Introduction of Band 26/XXVI in section 7	10.1.0	10.2.0
2012-06	RAN#56	R5-121925	0623	-	CA RF - addition of test case 8.7.2.1A TDD sustained data rate performance for CA	10.1.0	10.2.0
2012-06	RAN#56	R5-121937	0624	-	A-MPR: Band 20, NS_10 not tested	10.1.0	10.2.0
2012-06	RAN#56	R5-121938	0625	-	RF: Several corrections to sustained data rate TC-s 8.7.1 and 8.7.2	10.1.0	10.2.0
2012-06	RAN#56	R5-121939	0626	-	RF: Corrections to CSI tests	10.1.0	10.2.0
2012-06	RAN#56	R5-121944	0627	-	Addition of a new TC 6.3.3B	10.1.0	10.2.0
2012-06	RAN#56	R5-121945	0628	-	Addition of a new TC 6.3.2B for Minimum Output Power for UL-MIMO	10.1.0	10.2.0
2012-06	RAN#56	R5-121946	0629	-	Addition of a new TC 6.3.4B	10.1.0	10.2.0
2012-06	RAN#56	R5-121947	0630	-	Addition of a new TC 6.5.1B for Frequency Error for UL-MIMO	10.1.0	10.2.0
2012-06	RAN#56	R5-121948	0631	-	Addition of a new TC 6.6.1B	10.1.0	10.2.0
2012-06	RAN#56	R5-121949	0632	-	Addition of a new TC 6.7B	10.1.0	10.2.0
2012-06	RAN#56	R5-121950	0633	-	Addition of a new TC for Configured transmitted power for UL-MIMO	10.1.0	10.2.0
2012-06	RAN#56	R5-121951	0634	-	Addition of a new TC for Power Control Absolute Power Tolerance for UL-MIMO	10.1.0	10.2.0
2012-06	RAN#56	R5-121955	0635	-	SEM for CA	10.1.0	10.2.0
2012-06	RAN#56	R5-121956	0636	-	Addition of a new TC for Carrier leakage for UL-MIMO	10.1.0	10.2.0
2012-06	RAN#56	R5-121957	0637	-	Addition of a new TC for In-band emissions for non allocated RB for UL-MIMO	10.1.0	10.2.0
2012-06	RAN#56	R5-121958	0638	-	Addition of a new TC for EVM equalizer spectrum flatness for UL-MIMO	10.1.0	10.2.0
2012-06	RAN#56	R5-121959	0639	-	Addition of a new TC for Reference sensitivity level for UL-MIMO	10.1.0	10.2.0
2012-06	RAN#56	R5-121960	0640	-	Addition of a new TC for Maximum input level for UL-MIMO	10.1.0	10.2.0
2012-06	RAN#56	R5-121961	0641	-	Addition of a new TC for Adjacent Channel Selectivity (ACS) for UL-MIMO	10.1.0	10.2.0
2012-06	RAN#56	R5-121962	0642	-	Addition of a new TC for In-band blocking for UL-MIMO	10.1.0	10.2.0
2012-06	RAN#56	R5-121963	0643	-	Addition of a new TC for Narrow band blocking for UL-MIMO	10.1.0	10.2.0
2012-06	RAN#56	R5-121964	0644	-	Addition of a new TC for Wide band Intermodulation for UL-MIMO	10.1.0	10.2.0

2012-06	RAN#56	R5-121983	0645	-	Introduction of Chapter8 Single antenna port and Open loop spatial Multiplexing TDD test cases for CA capable UEs	10.1.0	10.2.0
2012-06	RAN#56	R5-121984	0646	-	EVM and Global In-Channel TX-Test for intra band CA	10.1.0	10.2.0
2012-06	RAN#56	R5-121985	0647	-	RF: Corrections to applicability of some CA tests	10.1.0	10.2.0
2012-06	RAN#56	R5-121986	0648	-	Addition of test description to Occupied bandwidth for CA	10.1.0	10.2.0
2012-06	RAN#56	R5-121987	0649	-	Addition of test description to ACLR for CA	10.1.0	10.2.0
2012-06	RAN#56	R5-121988	0650	-	Addition of test description to Transmitter Spurious emissions for CA	10.1.0	10.2.0
2012-06	RAN#56	R5-121989	0651	-	Addition of test description to Reference sensitivity level for CA	10.1.0	10.2.0
2012-06	RAN#56	R5-121994	0652	-	Addition of Codebook Subset Restriction in 8.3.2.x	10.1.0	10.2.0
2012-06	RAN#56	R5-121995	0653	-	Update of 6.3.5.2	10.1.0	10.2.0
2012-06	RAN#56	R5-121996	0654	-	TS 36.521-1: 9.4.1.2.1 and 9.4.1.2.2.1 test procedure correction	10.1.0	10.2.0
2012-06	RAN#56	R5-121997	0655	-	TS 36.521-1: Minimum conformance requirements alignments for section 9	10.1.0	10.2.0
2012-06	RAN#56	R5-122003	0656	-	Addition of a new TC for Out-of-band blocking for UL-MIMO	10.1.0	10.2.0
2012-06	RAN#56	R5-122004	0657	-	Addition of a new TC for Spurious response for UL-MIMO	10.1.0	10.2.0
2012-06	RAN#56	R5-122006	0658	-	Addition of a new TC for Error Vector Magnitude for UL-MIMO	10.1.0	10.2.0
2012-09	RAN#57	R5-123136	0659	-	Correction of TC 6.3.5.2	10.2.0	10.3.0
2012-09	RAN#57	R5-123146	0660	-	Corrections to Transmitter Characteristics Requirements	10.2.0	10.3.0
2012-09	RAN#57	R5-123148	0661	-	Correction to SNR definition	10.2.0	10.3.0
2012-09	RAN#57	R5-123150	0662	-	RF: Several editorial corrections	10.2.0	10.3.0
2012-09	RAN#57	R5-123161	0663	-	RF: PDCCH Padding in Rx spurious emissions test	10.2.0	10.3.0
2012-09	RAN#57	R5-123179	0664	-	Introduction of eDL-MIMO to Propagation Conditions	10.2.0	10.3.0
2012-09	RAN#57	R5-123209	0665	-	RF: Alignment of RMC references in test procedure of CSI tests	10.2.0	10.3.0
2012-09	RAN#57	R5-123234	0666	-	LTE RF - Correction to 7.4 and 7.5 UL allocations	10.2.0	10.3.0
2012-09	RAN#57	R5-123239	0667	-	Addition of test description to CA Maximum input level test case	10.2.0	10.3.0
2012-09	RAN#57	R5-123267	0668	-	Correction to Occupied bandwidth for CA	10.2.0	10.3.0
2012-09	RAN#57	R5-123268	0669	-	Correction to Reference sensitivity level for CA	10.2.0	10.3.0
2012-09	RAN#57	R5-123324	0670	-	New Annex for: Statistical testing of receiver performance with throughput for CA	10.2.0	10.3.0
2012-09	RAN#57	R5-123330	0671	-	Correction to test parameters in 6.6.3.2	10.2.0	10.3.0
2012-09	RAN#57	R5-123332	0672	-	Update of section 8 uncertainties and Test Tolerances for Rel-9 Tests	10.2.0	10.3.0
2012-09	RAN#57	R5-123333	0673	-	Clarification of RB allocation for DRS demodulation tests	10.2.0	10.3.0
2012-09	RAN#57	R5-123334	0674	-	Correction to uplink reference measurement channel	10.2.0	10.3.0
2012-09	RAN#57	R5-123386	0675	-	Addition of a new TC for power control relative power tolerance for UL-MIMO	10.2.0	10.3.0
2012-09	RAN#57	R5-123387	0676	-	Addition of a new TC for aggregate power control tolerance for UL-MIMO	10.2.0	10.3.0
2012-09	RAN#57	R5-123392	0677	-	Update carrier frequency and EARFCN	10.2.0	10.3.0
2012-09	RAN#57	R5-123394	0678	-	Update test case of UE maximum output power for UL-MIMO	10.2.0	10.3.0
2012-09	RAN#57	R5-123395	0679	-	Update test case of configured UE transmitted output power for UL-MIMO	10.2.0	10.3.0
2012-09	RAN#57	R5-123397	0680	-	Update test case of power control absolute power tolerance for UL- MIMO	10.2.0	10.3.0
2012-09	RAN#57	R5-123507	0681	-	Editorial corrections to blocking characteristics for CA	10.2.0	10.3.0
2012-09	RAN#57	R5-123510	0682	-	ACLR for UL-MIMO	10.2.0	10.3.0
2012-09	RAN#57	R5-123521	0683	-	TS 36.521-1: A-MPR and additional spurious corrections	10.2.0	10.3.0
2012-09	RAN#57	R5-123522	0684	-	TS 36.521-1: UL allocation clarification in PUSCH-EVM with exclusion period test	10.2.0	10.3.0
2012-09	RAN#57	R5-123523	0685	-	TS 36.521-1: Section 9 applicability revision (UE categories)	10.2.0	10.3.0
2012-09	RAN#57	R5-123534	0687	-	TS 36.521-1:A-MPR Test tolerances update for NS_12, NS_13, NS_14, NS_15	10.2.0	10.3.0
2012-09	RAN#57	R5-123547	0688	-	Correction to the content of reference table number for TC 7.8.1	10.2.0	10.3.0
2012-09	RAN#57	R5-123783	0689	-	Corrections to EVM and global in channel test for Intra-Band CA	10.2.0	10.3.0
2012-09	RAN#57	R5-123850	0690	-	Correction to ONOFF time mask for CA	10.2.0	10.3.0
2012-09	RAN#57	R5-123851	0691	-	Correction to Transmitter Spurious emissions for CA	10.2.0	10.3.0
2012-09	RAN#57	R5-123852	0692	-	New Annex for: Statistical testing of receiver characteristics with CA	10.2.0	10.3.0
2012-09	RAN#57	R5-123853	0693	-	Introduction of eDL-MIMO to measurement of performance requirements	10.2.0	10.3.0
2012-09	RAN#57	R5-123854	0694	-	Addition of a new TC for additional maximum power reduction (A-MPR) for UL-MIMO	10.2.0	10.3.0
2012-09	RAN#57	R5-123855	0695	-	Additional texts for Note2 in Spurious emission test	10.2.0	10.3.0
2012-09	RAN#57	R5-123857	0696	-	Additions to test requirements for Maximum Power Reduction for CA	10.2.0	10.3.0
2012-09	RAN#57	R5-123859	0697	-	Addition of a new TC for time alignment between transmitter branches for UL-MIMO	10.2.0	10.3.0

2012-09	RAN#57	R5-123900	0698	-	Changes associated with PHS band operation change for LTE	10.2.0	10.3.0
2012-09	RAN#57	R5-123901	0699	-	TS 36.521-1: PDSCH RMC for Rel-9 PCFICH test cases	10.2.0	10.3.0
2012-09	RAN#57	R5-123902	0700	-	TS 36.521-1: Adding missing UL RMCs for test 9.4.1.2.2	10.2.0	10.3.0
2012-09	RAN#57	R5-123910	0701	-	MPR for UL-MIMO	10.2.0	10.3.0
2012-09	RAN#57	R5-123911	0702	-	SEM for UL-MIMO	10.2.0	10.3.0
2012-09	RAN#57	R5-123912	0703	-	ADDITIONAL SEM for UL-MIMO	10.2.0	10.3.0
2012-09	RAN#57	R5-123915	0704	-	RF: Update of Annex I	10.2.0	10.3.0
2012-09	RAN#57	R5-123917	0705	-	Correction of test procedure for 36.521-1 chapter 8 CA test cases	10.2.0	10.3.0
2012-09	RAN#57	R5-123919	0706	-	TS 36.521-1: New test cases for CQI reporting under fading conditions - PUCCH 1-0	10.2.0	10.3.0
2012-09	RAN#57	R5-123932	0707	-	RF: Updates to transmission mode 8 test cases	10.2.0	10.3.0
2012-09	RAN#57	R5-123933	0708	-	RF: Several corrections to MBMS performance tests	10.2.0	10.3.0
2012-09	RAN#57	R5-123934	0709	-	Addition of RF Test case: 8.7.2.1_1 TDD sustained data rate performance (Rel-10 and forward)	10.2.0	10.3.0
2012-09	RAN#57	R5-123943	0710	-	Introduction of FDD PMI Reporting - PUSCH 1-2 (Multiple PMI) for eDL-MIMO	10.2.0	10.3.0
2012-09	RAN#57	R5-123944	0711	-	Introduction of TDD PMI Reporting - PUSCH 1-2 (Multiple PMI) for eDL-MIMO	10.2.0	10.3.0
2012-09	RAN#57	R5-123945	0712	-	FDD RI Reporting for eDL-MIMO	10.2.0	10.3.0
2012-09	RAN#57	R5-123946	0713	-	TDD RI Reporting for eDL-MIMO	10.2.0	10.3.0
2012-09	RAN#57	R5-123947	0714	-	Introduction of eDL-MIMO to CSI Reference Measurement Channels	10.2.0	10.3.0
2012-09	RAN#57	R5-123948	0715	-	Introduction of eDL-MIMO to structure of subclauses	10.2.0	10.3.0
2012-09	RAN#57	R5-123950	0716	-	RF-CA: Introduction of new specification structure for Tx tests for CA	10.2.0	10.3.0
2012-09	RAN#57	R5-123951	0717	-	CA RF - TC 6.2.2A update	10.2.0	10.3.0
2012-09	RAN#57	R5-123952	0718	-	CA RF - Updates to Blocking Test Cases	10.2.0	10.3.0
2012-09	RAN#57	R5-123953	0719	-	CA RF - TC 7.7A Spurious Response update	10.2.0	10.3.0
2012-09	RAN#57	R5-123954	0720	-	New RF TC for 36.521-1 _ 6.3.5A.1 Power Control Absolute power tolerance for CA	10.2.0	10.3.0
2012-09	RAN#57	R5-123955	0721	-	New RF TC for 36.521-1 _ 6.3.5A.2 Power Control Relative power tolerance for CA	10.2.0	10.3.0
2012-09	RAN#57	R5-123956	0722	-	Correction to Transmit OFF power for CA	10.2.0	10.3.0
2012-09	RAN#57	R5-123957	0723	-	Adjusting test procedure and test requirements to new Annex G.3A	10.2.0	10.3.0
2012-09	RAN#57	R5-123958	0724	-	Update of Test case 8.7.2.1A TDD sustained data rate performance for CA	10.2.0	10.3.0
2012-09	RAN#57	R5-123961	0725	-	Corrections to A-MPR for CA	10.2.0	10.3.0
2012-09	RAN#57	R5-123962	0726	-	Additions to test description for Adjacent Channel Selectivity (ACS) for CA	10.2.0	10.3.0
2012-09	RAN#57	R5-123963	0727	-	Introduction to UE configured transmitted output power for CA	10.2.0	10.3.0
2012-09	RAN#57	R5-123964	0728	-	Introduction of ACS and UE configured Tx output power for CA in Annex	10.2.0	10.3.0
2012-09	RAN#57	R5-123969	0729	-	Introduction Single-Layer Spatial Multiplexing for eDL-MIMO	10.2.0	10.3.0
2012-09	RAN#57	R5-123970	0730	-	updates to 6.6.2.1A SEM for CA	10.2.0	10.3.0
2012-09	RAN#57	R5-123977	0731	-	Addition of a new TC6.6.3B.1 for Transmitter Spurious emissions for UL-MIMO	10.2.0	10.3.0
2012-09	RAN#57	R5-123978	0732	-	Addition of a new TC6.6.3B.2 for Spurious emission band UE co-existence for UL-MIMO	10.2.0	10.3.0
2012-09	RAN#57	R5-123979	0733	-	Addition of a new TC6.6.3B.3 for Additional spurious emissions for UL-MIMO	10.2.0	10.3.0
2012-09	RAN#57	R5-123980	0734	-	Addition of a new TC for narrow band blocking for UL-MIMO	10.2.0	10.3.0
2012-09	RAN#57	R5-123981	0735	-	Update test case of general ON OFF time mask for UL-MIMO	10.2.0	10.3.0
2012-09	RAN#57	R5-123982	0736	-	Update test case of frequency error for UL-MIMO	10.2.0	10.3.0
2012-09	RAN#57	R5-123983	0737	-	Update test case of Error Vector Magnitude (EVM) for UL-MIMO	10.2.0	10.3.0
2012-09	RAN#57	R5-123984	0738	-	Update test case of carrier leakage for UL-MIMO	10.2.0	10.3.0
2012-09	RAN#57	R5-123985	0739	-	Update test case of in-band emissions for non allocated RB for UL-MIMO	10.2.0	10.3.0
2012-09	RAN#57	R5-123986	0740	-	Update test case of EVM equalizer spectrum flatness for UL-MIMO	10.2.0	10.3.0
2012-09	RAN#57	R5-123987	0741	-	Update test case of reference sensitivity level for UL-MIMO	10.2.0	10.3.0
2012-09	RAN#57	R5-123988	0742	-	Update test case of maximum input level for UL-MIMO	10.2.0	10.3.0
2012-09	RAN#57	R5-123989	0743	-	Update test case of in-band blocking for UL-MIMO	10.2.0	10.3.0
2012-09	RAN#57	R5-123990	0744	-	Update test case of out-of-band blocking for UL-MIMO	10.2.0	10.3.0
2012-09	RAN#57	R5-123991	0745	-	Update test case of spurious response for UL-MIMO	10.2.0	10.3.0
2012-09	RAN#57	R5-123992	0746	-	Update test case of wide band Intermodulation for UL-MIMO	10.2.0	10.3.0
2012-09	RAN#57	R5-123994	0747	-	Update test case of Adjacent Channel Selectivity (ACS) for UL-MIMO	10.2.0	10.3.0
2012-12	RAN#58	R5-125109	0749	-	Update of TC6.6.3B.2 for Spurious emissions band UE co-existence for UL-MIMO	10.3.0	10.4.0

2012-12	RAN#58	R5-125110	0750	-	Update of TC6.6.3B.3 for Additional spurious emissions for UL-MIMO	10.3.0	10.4.0
2012-12	RAN#58	R5-125146	0751	-	Corrections to Test Procedure of TC 6.6.2.3 ACLR	10.3.0	10.4.0
2012-12	RAN#58	R5-125147	0752	-	Updates for TC 6.2.3B MPR for UL-MIMO	10.3.0	10.4.0
2012-12	RAN#58	R5-125148	0753	-	Updates for TC 6.6.2.1B SEM for UL-MIMO	10.3.0	10.4.0
2012-12	RAN#58	R5-125149	0754	-	Updates for TC 6.6.2.2B A-SEM for UL-MIMO	10.3.0	10.4.0
2012-12	RAN#58	R5-125150	0755	-	Updates for TC 6.6.2.3B ACLR for UL-MIMO	10.3.0	10.4.0
2012-12	RAN#58	R5-125215	0756	-	Correction of TC 6.6.2.1	10.3.0	10.4.0
2012-12	RAN#58	R5-125252	0757	-	Adding normative reference for core requirements in TC 6.2.4	10.3.0	10.4.0
2012-12	RAN#58	R5-125253	0758	-	Adding normative reference for core requirements for many section 9 tests	10.3.0	10.4.0
2012-12	RAN#58	R5-125254	0759	-	Correction of table references in sub clause G.X	10.3.0	10.4.0
2012-12	RAN#58	R5-125260	0760	-	CR to TC 7.4A: Splitting the CA Maximum input level test case	10.3.0	10.4.0
2012-12	RAN#58	R5-125263	0761	-	RF CI G.3A: General corrections and completion of Annex G.3A with TDD tests	10.3.0	10.4.0
2012-12	RAN#58	R5-125304	0762	-	Updates for Minimum requirements of 6.2.5 Configured UE transmitted Output Power	10.3.0	10.4.0
2012-12	RAN#58	R5-125309	0763	-	Addition of Band 28 definition to Chap.5	10.3.0	10.4.0
2012-12	RAN#58	R5-125311	0764	-	Addition of Band 28 to 6.2.2 MOP	10.3.0	10.4.0
2012-12	RAN#58	R5-125314	0765	-	Addition of Band 28 to 7.3 Refsens	10.3.0	10.4.0
2012-12	RAN#58	R5-125321	0766	-	Updates for TC6.6.1A: Occupied bandwidth for CA	10.3.0	10.4.0
2012-12	RAN#58	R5-125322	0767	-	Updates for TC6.6.2.3A: ACLR for CA	10.3.0	10.4.0
2012-12	RAN#58	R5-125323	0768	-	Updates for TC6.6.3.1A: Transmitter Spurious emissions for CA	10.3.0	10.4.0
2012-12	RAN#58	R5-125346	0769	-	TC 6.2.4A.1 A-MPR for CA updates	10.3.0	10.4.0
2012-12	RAN#58	R5-125351	0770	-	Correction to LTE Rx TCs UL allocation location	10.3.0	10.4.0
2012-12	RAN#58	R5-125365	0771	-	Uncertainties and Test Tolerances for Rel-9 CQI Reporting under fading conditions, PUCCH 1-0 Tests	10.3.0	10.4.0
2012-12	RAN#58	R5-125374	0772	-	Clean up of Tx tests	10.3.0	10.4.0
2012-12	RAN#58	R5-125405	0773	-	Addition of 15MHz and 20MHz Bandwidths for Band 23	10.3.0	10.4.0
2012-12	RAN#58	R5-125407	0774	-	RF TC 6.6.3.2: Clarification and corrections	10.3.0	10.4.0
2012-12	RAN#58	R5-125417	0775	-	Additions to test description for TC 7.5A.1 Adjacent Channel Selectivity (ACS) for CA (intra-band contiguous DL CA and UL CA)	10.3.0	10.4.0
2012-12	RAN#58	R5-125422	0776	-	Introduction to CA_1 & CA_40 TC 7.5A.2 Adjacent Channel Selectivity (ACS) for CA (intra-band contiguous DL CA without UL CA)	10.3.0	10.4.0
2012-12	RAN#58	R5-125443	0777	-	Corrections of RMC for receiver characteristics	10.3.0	10.4.0
2012-12	RAN#58	R5-125445	0778	-	Corrections of FRC subframe allocations for performance requirements	10.3.0	10.4.0
2012-12	RAN#58	R5-125450	0779	-	Introduction of TC 9.2.2.1_D FDD CQI Reporting under AWGN conditions - PUCCH 1-1 for eDL-MIMO	10.3.0	10.4.0
2012-12	RAN#58	R5-125451	0780	-	Introduction of TC 9.2.2.2_D TDD CQI Reporting under AWGN conditions - PUCCH 1-1 for eDL-MIMO	10.3.0	10.4.0

2012-12	RAN#58	R5-125452	0781	-	Introduction of TC 9.3.2.2.1_D FDD CQI Reporting under fading conditions - PUCCH 1-1 for eDL-MIMO	10.3.0	10.4.0
2012-12	RAN#58	R5-125453	0782	-	Introduction of TC 9.3.2.2.2_D TDD CQI Reporting under fading conditions - PUCCH 1-1 for eDL-MIMO	10.3.0	10.4.0
2012-12	RAN#58	R5-125454	0783	-	Additions of eDL-MIMO to Annex A	10.3.0	10.4.0
2012-12	RAN#58	R5-125455	0784	-	Additions of eDL-MIMO to Annex B Propagation Conditions for eDL-MIMO	10.3.0	10.4.0
2012-12	RAN#58	R5-125456	0785	-	Additions of eDL-MIMO to Annex F	10.3.0	10.4.0
2012-12	RAN#58	R5-125463	0786	-	Additions to TC 9.4.2.1.1_D FDD PMI Reporting - PUSCH 1-2 (Multiple PMI) for eDL-MIMO	10.3.0	10.4.0
2012-12	RAN#58	R5-125464	0787	-	Additions to TC 9.4.2.1.2_D TDD PMI Reporting - PUSCH 1-2 (Multiple PMI) for eDL-MIMO	10.3.0	10.4.0
2012-12	RAN#58	R5-125465	0788	-	Additions to TC 9.5.1.1_D FDD RI Reporting for eDL-MIMO	10.3.0	10.4.0
2012-12	RAN#58	R5-125466	0789	-	Additions to TC 9.5.1.2_D TDD RI Reporting for eDL-MIMO	10.3.0	10.4.0
2012-12	RAN#58	R5-125593	0790	-	RF TC 6.2.4: Minor correction to test points for NS_15	10.3.0	10.4.0
2012-12	RAN#58	R5-125594	0791	-	RF TC 6.2.4B: Minor correction to test points for NS_15	10.3.0	10.4.0
2012-12	RAN#58	R5-125610	0792	-	TS 36-521-1: MPR correction for band 26	10.3.0	10.4.0
2012-12	RAN#58	R5-125801	0793	-	Updates of 6.3.3A UE Transmit OFF power for CA	10.3.0	10.4.0
2012-12	RAN#58	R5-125802	0794	-	Update of Annex F in 36.521-1	10.3.0	10.4.0
2012-12	RAN#58	R5-125803	0795	-	Updates for 6.3.4A ON/OFF time mask for CA	10.3.0	10.4.0
2012-12	RAN#58	R5-125804	0796	-	Addition of Transmitter test case - Transmit intermodulation for CA	10.3.0	10.4.0
2012-12	RAN#58	R5-125835	0797	-	Update of TC6.6.3B.1 for Transmitter Spurious emissions for UL-MIMO	10.3.0	10.4.0
2012-12	RAN#58	R5-125851	0798	-	Introduction of TC 8.3.1.2.1_D FDD PDSCH Dual-layer Spatial Multiplexing for eDL-MIMO	10.3.0	10.4.0
2012-12	RAN#58	R5-125852	0799	-	Introduction of TC 8.3.2.2.1_D TDD PDSCH Dual-layer Spatial Multiplexing for eDL-MIMO	10.3.0	10.4.0
2012-12	RAN#58	R5-125853	0800	-	Additions to Annex G for eDL-MIMO	10.3.0	10.4.0
2012-12	RAN#58	R5-125854	0801	-	Corrections to Annex H for eDL-MIMO	10.3.0	10.4.0
2012-12	RAN#58	R5-125855	0802	-	Additions to TC 8.3.2.1.2_D TDD Single-Layer Spatial Multiplexing on antenna ports without a simultaneous transmission for eDL-MIMO	10.3.0	10.4.0
2012-12	RAN#58	R5-125856	0803	-	Additions to TC 8.3.2.1.3_D TDD Single-Layer Spatial Multiplexing on antenna ports with a simultaneous transmission for eDL-MIMO	10.3.0	10.4.0
2012-12	RAN#58	R5-125857	0804	-	Introduction of Band 27 to TS 36.521-1	10.3.0	10.4.0
2012-12	RAN#58	R5-125858	0805	-	Updates to TC 8.2.2.3.1_A.1 for CA	10.3.0	10.4.0
2012-12	RAN#58	R5-125859	0806	-	Addition of new test case 8.2.1.4.2_A.1 for CA	10.3.0	10.4.0
2012-12	RAN#58	R5-125860	0807	-	Addition of new test case 8.2.2.4.2_A.1 for CA	10.3.0	10.4.0
2012-12	RAN#58	R5-125861	0808	-	Addition of sustained downlink data rate TC 8.7.1.1_A.1 for CA	10.3.0	10.4.0
2012-12	RAN#58	R5-125862	0809	-	Addition of sustained downlink data rate TC 8.7.1.1_A.2 for CA	10.3.0	10.4.0
2012-12	RAN#58	R5-125866	0810	-	Update of RF TC for 36.521-1 _ 6.3.5A.2.1 Power Control Relative power tolerance for CA	10.3.0	10.4.0

2012-12	RAN#58	R5-125867	0811	-	Update TC 6.6.3.2_1 Spurious emission band UE co-existence(Release 9 and forward)	10.3.0	10.4.0
2012-12	RAN#58	R5-125868	0812	-	Correction to test applicability in 6.2.4 A-MPR test case	10.3.0	10.4.0
2012-12	RAN#58	R5-125869	0813	-	Correction to test parameter in Perf 8.2.1 of 36.521-1	10.3.0	10.4.0
2012-12	RAN#58	R5-125870	0814	-	Clarification of AG level for 8.7 sustained data rate test of 36.521-1	10.3.0	10.4.0
2012-12	RAN#58	R5-125871	0815	-	Correction to SNR test points in test procedure	10.3.0	10.4.0
2012-12	RAN#58	R5-125872	0816	-	Clarification of random precoding granularity	10.3.0	10.4.0
2012-12	RAN#58	R5-125873	0817	-	Update of General sections for CA	10.3.0	10.4.0
2012-12	RAN#58	R5-125874	0818	-	Introduction to CA_1-5 TC 7.5A.3 Adjacent Channel Selectivity (ACS) for CA (inter-band DL CA without UL CA)	10.3.0	10.4.0
2012-12	RAN#58	R5-125875	0819	-	Addition of a new TC 6.3.5A.3.1 Aggregate power control tolerance for CA(intra-band contiguous DL CA and UL CA)	10.3.0	10.4.0
2012-12	RAN#58	R5-125876	0820	-	Addition of a new TC 6.6.3.2A.1 Spurious emission band UE co-existence for CA(intra-band contiguous DL CA and UL CA)	10.3.0	10.4.0
2012-12	RAN#58	R5-125890	0821	-	Addition of Band 28 to 6.6.3.2 Spurious emission band UE co-existence	10.3.0	10.4.0
2012-12	RAN#58	R5-125891	0822	-	Addition of Band 28 to 6.6.3.3 Additional spurious emissions	10.3.0	10.4.0
2012-12	RAN#58	R5-125892	0823	-	UE output power definition for UL-MIMO	10.3.0	10.4.0
2012-12	RAN#58	R5-125893	0824	-	Update TC 6.2.4B Additional maximum power reduction (A-MPR) for UL-MIMO	10.3.0	10.4.0
2012-12	RAN#58	R5-125894	0825	-	Update TC 6.5.2B.1 Error vector magnitude (EVM) for UL-MIMO	10.3.0	10.4.0
2012-12	RAN#58	R5-125895	0826	-	Update TC 6.2.5B Configured transmitted output power for UL-MIMO	10.3.0	10.4.0
2012-12	RAN#58	R5-125896	0827	-	Update TC 7.3B Reference sensitivity level for UL-MIMO	10.3.0	10.4.0
2012-12	RAN#58	R5-125897	0828	-	Update TC 7.4B Maximum input level for UL-MIMO	10.3.0	10.4.0
2012-12	RAN#58	R5-125898	0829	-	Update TC 7.5B Adjacent Channel Selectivity (ACS) for UL-MIMO	10.3.0	10.4.0
2012-12	RAN#58	R5-125899	0830	-	Update TC 7.6.1B In-band blocking for UL-MIMO	10.3.0	10.4.0
2012-12	RAN#58	R5-125900	0831	-	Update TC 7.6.2B Out-of-band blocking for UL-MIMO	10.3.0	10.4.0
2012-12	RAN#58	R5-125901	0832	-	Update TC 7.6.3B Narrow band blocking for UL-MIMO	10.3.0	10.4.0
2012-12	RAN#58	R5-125902	0833	-	Update TC 7.7B Spurious response for UL-MIMO	10.3.0	10.4.0
2012-12	RAN#58	R5-125903	0834	-	Update TC 7.8.1B Wide band intermodulation for UL-MIMO	10.3.0	10.4.0
2012-12	RAN#58	R5-125906	0835	-	New RF TC for 36.521-1_8.2.1.2.3_Enhanced ICIC for LTE	10.3.0	10.4.0
2012-12	RAN#58	R5-125907	0836	-	New RF TC for 36.521-1_8.4.1.2.3_Enhanced ICIC for LTE	10.3.0	10.4.0
2012-12	RAN#58	R5-125908	0837	-	TDD CQI Reporting under AWGN conditions-PUCCH 1-0-Demod subframe overlaps with aggressor cell ABS (eICIC)	10.3.0	10.4.0
2012-12	RAN#58	R5-125909	0838	-	TDD PHICH Transmit Diversity 2x2-Demod subframe overlaps with aggressor cell ABS (eICIC)	10.3.0	10.4.0
2012-12	RAN#58	R5-125910	0839	-	TDD PDSCH Open Loop Spatial Multiplexing 2x2 Demod subframe overlaps with aggressor cell ABS (eICIC)	10.3.0	10.4.0
2012-12	RAN#58	R5-125924	0841	-	CR to 8.2.1.1.1_A: Correction to an average throughput measurement	10.3.0	10.4.0

2012-12	RAN#58	R5-125925	0842	-	CR to 8.2.1.3.1_A: Correction to an average throughput measurement	10.3.0	10.4.0
2012-12	RAN#58	R5-125931	0844	-	Additions to test description TC 6.2.5A.1 and 6.2.5A.2 including CA_1A-19A and CA_1A-21A updates	10.3.0	10.4.0
2012-12	RAN#58	R5-125932	0845	-	Updates for TC7.3A: Reference sensitivity level for CA including CA_41C, CA_1-19 and CA_1-21	10.3.0	10.4.0
2012-12	RAN#58	R5-125934	0846	-	Update of RF TC for 36.521-1_6.3.5A.1.1 Power Control Absolute power tolerance for CA	10.3.0	10.4.0
2012-12	RAN#58	R5-125935	0847	-	Updates for TC6.5.1A: Frequency error for CA	10.3.0	10.4.0
2012-12	RAN#58	R5-126043	0849	-	Updates for 5.2A operating bands for CA_7, CA_38, CA_41, CA_1-18, CA_1-19, CA_1-21, CA_2-17, CA_3-5, CA_3-7, CA_3-8, CA_3-20, CA_4-12, CA_4-13, CA_4-17, CA_4-20	10.3.0	10.4.0
2012-12	RAN#58	R5-126044	0850	-	Updates for 5.4.2A channel bandwidth for CA_7, CA_38, CA_41, CA_1-18, CA_1-19, CA_1-21, CA_2-17, CA_3-5, CA_3-7, CA_3-8, CA_3-20, CA_4-12, CA_4-13, CA_4-17, CA_4-20	10.3.0	10.4.0
2012-12	RAN#58	R5-126063	0840	-	Update of Perf 8.7.1.1 and 8.7.2.1 of 36.521-1	10.3.0	10.4.0
2012-12	RAN#58	R5-126065	0843	-	Clarification of RB position in 9.4.1 and 9.4.2	10.3.0	10.4.0
2012-12	RAN#58	R5-126066	0848	-	Update of minimum test time in Annex G.3.5	10.3.0	10.4.0
2012-12	RAN#58	R5-124010	0851	-	RF CI 8.1.1: Update of the CA capability table	10.3.0	10.4.0
2012-12	RAN#58	R5-124013	0852	-	RF CI 8.7.2.1A: Update of test structure according to the work plan	10.3.0	10.4.0
2012-12	RAN#58	R5-124082	0853	-	Correction to TC 7.5.1 Adjacent Channel Selectivity (ACS)	10.3.0	10.4.0
2012-12	RAN#58	R5-124116	0854	-	Addition to test description for SEM for CA	10.3.0	10.4.0
2012-12	RAN#58	R5-124123	0855	-	Addition to minimum requirement for TC 6.5.2A.3.1 in-band emissions for non allocated RB for CA	10.3.0	10.4.0
2012-12	RAN#58	R5-124125	0856	-	TC 6.2.2A.1 UE MOP for CA updates	10.3.0	10.4.0
2012-12	RAN#58	R5-124126	0857	-	CR to Annex G.3A.5: Minimum number of samples for CA performance tests	10.3.0	10.4.0
2012-12	RAN#58	R5-124131	0858	-	Additions to test case for TC 6.2.3A.1 Maximum Power Reduction (MPR) for CA (intra-band contiguous DL CA and UL CA)	10.3.0	10.4.0
2012-12	RAN#58	R5-124133	0859	-	Introduction to TC 6.6.3.3A.1 Additional spurious emissions for CA (intra-band contiguous DL CA and UL CA)	10.3.0	10.4.0
2012-12	RAN#58	R5-124139	0860	-	TC 6.3.2A.1 Minimum Output Power for CA introduction	10.3.0	10.4.0
2012-12	RAN#58	R5-124149	0861	-	RF TC 8.2.2.1.1_A: Adjusting test procedure and requirements to completed Annex G.3A	10.3.0	10.4.0
2012-12	RAN#58	R5-124160	0862	-	TC 7.6.1A.x In-band blocking for CA introduction	10.3.0	10.4.0
2012-12	RAN#58	R5-124163	0863	-	TC 7.6.2A.x Out-of-band blocking for CA introduction	10.3.0	10.4.0
2012-12	RAN#58	R5-124164	0864	-	TC 7.6.3A.x Narrow-band blocking for CA introduction	10.3.0	10.4.0
2012-12	RAN#58	R5-124165	0865	-	TC 7.7A.x Spurious response for CA introduction	10.3.0	10.4.0
2012-12	RAN#58	R5-124166	0866	-	Addition of Receiver test case - Wideband intermodulation for CA	10.3.0	10.4.0
2012-12	RAN#58	R5-124186	0867	-	RF: Addition of references to connection diagrams in CA tests	10.3.0	10.4.0
2013-03	RAN#59	R5-130092	0851	-	Updates of 6.6.3.3 - Addition of Low-channel Band 1 coexistence with PHS condition	10.4.0	10.5.0

2013-03	RAN#59	R5-130105	0854	-	Update of TC6.6.3B.2 for Spurious emissions band UE co-existence for UL-MIMO	10.4.0	10.5.0
2013-03	RAN#59	R5-130125	0856	-	Update of TC6.6.3B.3 for Additional spurious emissions for UL-MIMO	10.4.0	10.5.0
2013-03	RAN#59	R5-130128	0857	-	Update TC 6.2.4B Additional Maximum Power Reduction (AMPR) for UL-MIMO	10.4.0	10.5.0
2013-03	RAN#59	R5-130129	0858	-	Update TC 6.3.5B.1 Power control absolute power tolerance for UL-MIMO	10.4.0	10.5.0
2013-03	RAN#59	R5-130130	0859	-	Update TC 6.3.5B.2 Power Control Relative power tolerance for UL-MIMO	10.4.0	10.5.0
2013-03	RAN#59	R5-130131	0860	-	Update TC 6.3.5B.3 Aggregate power control tolerance for UL-MIMO	10.4.0	10.5.0
2013-03	RAN#59	R5-130132	0861	-	Update TC 6.5.2B.2 Carrier leakage for UL-MIMO	10.4.0	10.5.0
2013-03	RAN#59	R5-130133	0862	-	Update TC 6.3.2B Minimum Output Power for UL-MIMO	10.4.0	10.5.0
2013-03	RAN#59	R5-130134	0863	-	Update TC 6.6.1B Occupied bandwidth for UL-MIMO	10.4.0	10.5.0
2013-03	RAN#59	R5-130135	0864	-	Update TC 6.7B Transmit intermodulation for UL-MIMO	10.4.0	10.5.0
2013-03	RAN#59	R5-130176	0869	-	Introduction of new rel-10 Reporting of RI test cases into annexes	10.4.0	10.5.0
2013-03	RAN#59	R5-130182	0870	-	CA RF: Correction to Annex I	10.4.0	10.5.0
2013-03	RAN#59	R5-130183	0871	-	UL-MIMO RF: Correction to Annex I	10.4.0	10.5.0
2013-03	RAN#59	R5-130184	0872	-	eICIC RF: Correction to Annex I	10.4.0	10.5.0
2013-03	RAN#59	R5-130185	0873	-	eDL-MIMO RF: Correction to Annex I	10.4.0	10.5.0
2013-03	RAN#59	R5-130188	0874	-	RF: Correction to TC 8.2.1.1.1 - Frequency range for partial allocation	10.4.0	10.5.0
2013-03	RAN#59	R5-130245	0877	-	Additions to TC 6.6.2.3A.1 Adjacent Channel Leakage power Ratio for CA (intra-band contiguous DL CA and UL CA)	10.4.0	10.5.0
2013-03	RAN#59	R5-130273	0880	-	Corrections to Annex A DL Reference Measurement and PMI Accuracy Measurements	10.4.0	10.5.0
2013-03	RAN#59	R5-130285	0881	-	Correction to TC 8.3.2.1.3 TDD PDSCH Single-layer Spatial Multiplexing on antenna port 7 or 8 with a simultaneous transmission	10.4.0	10.5.0
2013-03	RAN#59	R5-130288	0882	-	Addition to TC 9.2.2.2_D TDD CQI Reporting under AWGN conditions - PUCCH 1-1 for eDL-MIMO	10.4.0	10.5.0
2013-03	RAN#59	R5-130291	0883	-	Addition to TC 9.3.2.2.2_D TDD CQI Reporting under fading conditions " PUCCH 1-1 for eDL-MIMO	10.4.0	10.5.0
2013-03	RAN#59	R5-130292	0884	-	Additions to TC 9.4.2.1.1_D FDD PMI Reporting - PUSCH 1-2 (Multiple PMI) for eDL-MIMO	10.4.0	10.5.0
2013-03	RAN#59	R5-130293	0885	-	Additions to TC 9.4.2.1.2_D TDD PMI Reporting - PUSCH 1-2 (Multiple PMI) for eDL-MIMO	10.4.0	10.5.0
2013-03	RAN#59	R5-130298	0886	-	CA RF: Correction to TC 7.6.1A	10.4.0	10.5.0
2013-03	RAN#59	R5-130299	0887	-	Uncertainties and Test Tolerances for Test case 7.4A	10.4.0	10.5.0
2013-03	RAN#59	R5-130308	0888	-	Corrections to test procedure of TC 6.2.2 UE Maximum Output Power	10.4.0	10.5.0
2013-03	RAN#59	R5-130309	0889	-	Corrections to test purpose of TC 6.2.3 Maximum Power Reduction (MPR)	10.4.0	10.5.0
2013-03	RAN#59	R5-130310	0890	-	Correction to test procedure of TC 6.7A.1 Transmit Intermodulation for CA	10.4.0	10.5.0

2013-03	RAN#59	R5-130407	0894	-	Correction to test requirement of 6.2.4A	10.4.0	10.5.0
2013-03	RAN#59	R5-130408	0895	-	Correction to test procedure in 6.3.5A.1	10.4.0	10.5.0
2013-03	RAN#59	R5-130411	0896	-	Correction to test procedure in 6.6.2.3A	10.4.0	10.5.0
2013-03	RAN#59	R5-130413	0897	-	Correction to 7.6.3A.3 test procedure	10.4.0	10.5.0
2013-03	RAN#59	R5-130415	0898	-	Correction to 6.6.3.2A and 6.6.3.3A	10.4.0	10.5.0
2013-03	RAN#59	R5-130416	0899	-	Correction to 6.6.3B.2 and 6.6.3B.3	10.4.0	10.5.0
2013-03	RAN#59	R5-130419	0900	-	Correction to 9.3.4 UE-selected subband CQI	10.4.0	10.5.0
2013-03	RAN#59	R5-130421	0901	-	Correction to wideband CQI-samples	10.4.0	10.5.0
2013-03	RAN#59	R5-130427	0902	-	Update of minimum test time in Annex G.5.4	10.4.0	10.5.0
2013-03	RAN#59	R5-130471	0905	-	Update of spurious emission test cases for introduction of Japanese Regulatory Requirements for LTE Band 8	10.4.0	10.5.0
2013-03	RAN#59	R5-130779	0875	1	CA RF: Clarification on Cell ID	10.4.0	10.5.0
2013-03	RAN#59	R5-130780	0903	1	Correction to 941 and 942	10.4.0	10.5.0
2013-03	RAN#59	R5-130801	0908	-	Additions of CA RF test cases to Annex F	10.4.0	10.5.0
2013-03	RAN#59	R5-130804	0909	-	Correction to 6.6.3.2 and 6.6.3.3	10.4.0	10.5.0
2013-03	RAN#59	R5-130806	0911	-	Update TC 6.6.3.2 Spurious emission band UE co-existence	10.4.0	10.5.0
2013-03	RAN#59	R5-130808	0912	-	CA RF - SCC configuration references	10.4.0	10.5.0
2013-03	RAN#59	R5-130809	0913	-	CA RF Rx - Update of blocking characteristics	10.4.0	10.5.0
2013-03	RAN#59	R5-130811	0915	-	LTE RF - Correction to LTE Rx TCs UL allocation location	10.4.0	10.5.0
2013-03	RAN#59	R5-130901	0916	-	Update of TC 8.7.2.1_A.1 TDD sustained data rate performance for CA (intra-band contiguous DL CA)	10.4.0	10.5.0
2013-03	RAN#59	R5-130902	0917	-	Editorial correction for ON/OFF time mask for CA	10.4.0	10.5.0
2013-03	RAN#59	R5-130903	0918	-	Correction to Band 12 frequency for CA_4-12	10.4.0	10.5.0
2013-03	RAN#59	R5-130908	0920	-	Additions of eDL-MIMO to Annex A.4 CQI Reference Measurement Channels	10.4.0	10.5.0
2013-03	RAN#59	R5-130909	0921	-	Introduction of TC 8.3.1.1.1_D FDD Single-Layer Spatial Multiplexing on antenna ports without a simultaneous transmission for eDL-MIMO	10.4.0	10.5.0
2013-03	RAN#59	R5-130910	0922	-	Introduction of FDD TC 8.3.1.1.2_D FDD Single-Layer Spatial Multiplexing on antenna ports with a simultaneous transmission for eDL-MIMO	10.4.0	10.5.0
2013-03	RAN#59	R5-130911	0923	-	Additions to TC 8.3.1.2.1_D FDD PDSCH Dual-layer Spatial Multiplexing for eDL-MIMO	10.4.0	10.5.0
2013-03	RAN#59	R5-130912	0924	-	Additions to TC 8.3.2.1.1_D TDD PDSCH Dual-layer Spatial Multiplexing for eDL-MIMO	10.4.0	10.5.0
2013-03	RAN#59	R5-130913	0925	-	Additions to TC 8.3.2.1.2_D TDD Single-Layer Spatial Multiplexing on antenna ports without a simultaneous transmission for eDL-MIMO	10.4.0	10.5.0
2013-03	RAN#59	R5-130914	0926	-	Additions to TC 8.3.2.1.3_D TDD Single-Layer Spatial Multiplexing on antenna ports with a simultaneous transmission for eDL-MIMO	10.4.0	10.5.0
2013-03	RAN#59	R5-130924	0934	-	Update RF TC for 36.521-1_8.2.1.2.3_C FDD PDSCH Transmit div 2x2 Enhanced ICIC for LTE	10.4.0	10.5.0
2013-03	RAN#59	R5-130925	0935	-	Update RF TC for 36.521-1_8.4.1.2.3_C FDD PCFICH PDCCH Transmit div 2x2 Enhanced ICIC for LTE	10.4.0	10.5.0

2013-03	RAN#59	R5-130935	0937	-	SNR uncertainty	10.4.0	10.5.0
2013-03	RAN#59	R5-130936	0938	-	Introduction of new rel-10 Reporting of RI test cases	10.4.0	10.5.0
2013-03	RAN#59	R5-130937	0939	-	RF: Corrections to Annex H - Default uplink settings	10.4.0	10.5.0
2013-03	RAN#59	R5-130938	0940	-	Update of TC 8.7.2.1_1 TDD sustained data rate performance (Rel-10 and forward)	10.4.0	10.5.0
2013-03	RAN#59	R5-130939	0941	-	Clarification to Soft Channel Bit size used by SS and UE	10.4.0	10.5.0
2013-03	RAN#59	R5-130940	0942	-	Correction to sustained data rate performance test	10.4.0	10.5.0
2013-03	RAN#59	R5-130941	0943	-	Clean up on performance tests	10.4.0	10.5.0
2013-03	RAN#59	R5-130944	0944	-	Update TC 6.3.5A.3.1 Aggregate power control tolerance for CA (intra-band contiguous DL CA and UL CA)	10.4.0	10.5.0
2013-03	RAN#59	R5-130945	0945	-	Update TC 6.6.3.2A.1 Spurious emission band UE co-existence for CA (intra-band contiguous DL CA and UL CA)	10.4.0	10.5.0
2013-03	RAN#59	R5-130946	0946	-	Additions to TC 6.2.5A.1 Configured UE transmitted Power for CA (intra-band contiguous DL CA and UL CA)	10.4.0	10.5.0
2013-03	RAN#59	R5-130947	0947	-	Additions to TC 6.6.3.3A.1 Additional spurious emissions for CA (intra-band contiguous DL CA and UL CA)	10.4.0	10.5.0
2013-03	RAN#59	R5-130948	0948	-	Additions to TC 7.5A.1 Adjacent Channel Selectivity (ACS) for CA (intra-band contiguous DL CA and UL CA)	10.4.0	10.5.0
2013-03	RAN#59	R5-130949	0949	-	Additions to TC 7.5A.2 Adjacent Channel Selectivity (ACS) for CA (intra-band contiguous DL CA without UL CA)	10.4.0	10.5.0
2013-03	RAN#59	R5-130950	0950	-	Additions to TC 7.5A.3 Adjacent Channel Selectivity (ACS) for CA (inter-band contiguous DL CA without UL CA)	10.4.0	10.5.0
2013-03	RAN#59	R5-130951	0951	-	Correction to test point of Frequency Error for CA and addition of TC for intra-band contiguous DL CA without UL CA	10.4.0	10.5.0
2013-03	RAN#59	R5-130961	0955	-	Channel matrix impairments for eDL-MIMO CSI tests	10.4.0	10.5.0
2013-03	RAN#59	R5-130965	0957	-	TC 9.4.1.1.1_D FDD Reporting of PMI - PUSCH 3-1 (Single PMI) for eDL-MIMO	10.4.0	10.5.0
2013-03	RAN#59	R5-130966	0958	-	TC 9.4.1.1.2_D TDD Reporting of PMI -PUSCH 3-1 (Single PMI) for eDL-MIMO	10.4.0	10.5.0
2013-03	RAN#59	R5-130967	0959	-	Additions of eDL-MIMO to Annex C Measurement of Performance Requirements	10.4.0	10.5.0
2013-03	RAN#59	R5-130968	0960	-	Additions of eDL-MIMO test cases to Annex F	10.4.0	10.5.0
2013-03	RAN#59	R5-130969	0961	-	Additions to Annex G for eDL-MIMO	10.4.0	10.5.0
2013-03	RAN#59	R5-130970	0962	-	Addition to TC 9.2.2.1_D FDD CQI Reporting under AWGN conditions - PUCCH 1-1 for eDL-MIMO	10.4.0	10.5.0
2013-03	RAN#59	R5-130971	0963	-	Addition to TC 9.3.2.2.1_D FDD CQI Reporting under fading conditions - PUCCH 1-1 for eDL-MIMO	10.4.0	10.5.0
2013-03	RAN#59	R5-130972	0964	-	Additions to TC 9.5.1.1_D FDD RI Reporting for eDL-MIMO	10.4.0	10.5.0
2013-03	RAN#59	R5-130973	0965	-	Additions to TC 9.5.1.2_D TDD RI Reporting for eDL-MIMO	10.4.0	10.5.0
2013-03	RAN#59	R5-130978	0966	-	Correcting TS 36.521-1 to reflect changes in 36.101	10.4.0	10.5.0
2013-03	RAN#59	R5-130979	0967	-	Correction of RF conformance Test case: 8.2.1.3.3	10.4.0	10.5.0
2013-03	RAN#59	R5-130980	0968	-	Addition new TC 8.2.2.3.3 TDD PDSCH Open Loop Spatial Multiplexing 2x2-Demod subframe overlaps with aggressor cell ABS (eICIC)	10.4.0	10.5.0
2013-03	RAN#59	R5-130994	0969	-	Corrections to 7.8.1A Wideband intermodulation for CA	10.4.0	10.5.0

2013-03	RAN#59	R5-130998	0970	-	TC 9.3.1.2.1_D FDD CQI Reporting under fading conditions - PUSCH 3-1 for eDL-MIMO	10.4.0	10.5.0
2013-03	RAN#59	R5-130999	0971	-	TC 9.3.1.2.2_D TDD CQI Reporting under fading conditions - PUSCH 3-1 for eDL-MIMO	10.4.0	10.5.0
2013-03	RAN#59	R5-130093	0852	-	Updates of 5.2A Operating bands for CA_11-18	10.5.0	11.0.0
2013-03	RAN#59	R5-130094	0853	-	Updates of 5.4.2A Channel bandwidth combination for CA_11-18	10.5.0	11.0.0
2013-03	RAN#59	R5-130124	0855	-	Additions to the inter-band relaxation term for CA 3A-8A in Table 6.2.5A.1.3-3	10.5.0	11.0.0
2013-03	RAN#59	R5-130140	0865	-	Update TC 7.3A.3 Reference sensitivity level for CA_3-7 and CA_7-20 (inter-band DL CA without UL CA)	10.5.0	11.0.0
2013-03	RAN#59	R5-130141	0866	-	Update TC 7.6.2A.1 Out-of-band blocking for CA_38 (intra-band contiguous DL CA and UL CA)	10.5.0	11.0.0
2013-03	RAN#59	R5-130142	0867	-	Update TC 6.2.2A.1 UE Maximum Output Power for CA_38 (intra-band contiguous DL CA and UL CA)	10.5.0	11.0.0
2013-03	RAN#59	R5-130144	0868	-	Update TC 6.2.4A.1 Additional Maximum Power Reduction (A-MPR) for CA_38 (intra-band contiguous DL CA and UL CA)	10.5.0	11.0.0
2013-03	RAN#59	R5-130239	0876	-	Updates of 6.2.5A - inter-band relaxation term for CA_1A-18A and CA_11A-18A	10.5.0	11.0.0
2013-03	RAN#59	R5-130257	0878	-	Addition of TDD operating band 44 in receiver characteristic test cases	10.5.0	11.0.0
2013-03	RAN#59	R5-130258	0879	-	Addition of TDD operating band 44 in transmitter characteristic test cases	10.5.0	11.0.0
2013-03	RAN#59	R5-130329	0891	-	Updates for 7.6.1A.1 in-band blocking for CA_7 and CA_41	10.5.0	11.0.0
2013-03	RAN#59	R5-130330	0892	-	Updates for 7.6.2A.1 Out-of-band blocking for CA_7 and CA_41	10.5.0	11.0.0
2013-03	RAN#59	R5-130348	0972	-	Correction to Spurious emission band UE co-existence and Additional spurious emissions for Band 28	10.5.0	11.0.0
2013-03	RAN#59	R5-130349	0893	-	Addition of Band 28 to MPR and A-MPR	10.5.0	11.0.0
2013-03	RAN#59	R5-130769	0907	-	Updates of Refsens for inter-band CA test points for CA_1A-19A and CA_1A-21A	10.5.0	11.0.0
2013-03	RAN#59	R5-130783	0906	-	Update TC 6.2.3A.1 Maximum Power Reduction (MPR) for CA_38 (intra-band contiguous DL CA and UL CA)	10.5.0	11.0.0
2013-03	RAN#59	R5-130805	0910	-	Update TC 7.3A.1 Reference sensitivity level for CA_38, CA_3-7 and CA_7-20 (intra-band contiguous DL CA and UL CA)	10.5.0	11.0.0
2013-03	RAN#59	R5-130810	0914	-	CA_2-17 and CA_4-17 addition to 36.521-1 Rx characteristics	10.5.0	11.0.0
2013-03	RAN#59	R5-130905	0919	-	Addition of TDD operating band 44 in chapter 5	10.5.0	11.0.0
2013-03	RAN#59	R5-130915	0927	-	Addition of band 38 and band 41 in intra-band contiguous CA transmitter test cases	10.5.0	11.0.0
2013-03	RAN#59	R5-130916	0928	-	Update TC 7.6.1A.1 In-band blocking for CA_38 (intra-band contiguous DL CA and UL CA)	10.5.0	11.0.0
2013-03	RAN#59	R5-130917	0929	-	Addition of Inter Band CA combo CA_2A-29A	10.5.0	11.0.0
2013-03	RAN#59	R5-130918	0930	-	Update of 6.2.5A Configured transmitted power for CA	10.5.0	11.0.0
2013-03	RAN#59	R5-130919	0931	-	CA_2-17 and CA_4-17 addition to 36.521-1 Tx characteristics	10.5.0	11.0.0
2013-03	RAN#59	R5-130920	0932	-	Adding transmit power relaxation value for inter-band CA configurations CA_4A-5A and CA_4A-13A	10.5.0	11.0.0

2013-03	RAN#59	R5-130921	0933	-	Adding refsens relaxation value for inter-band CA configurations CA_4A-5A and CA_4A-13A	10.5.0	11.0.0
2013-03	RAN#59	R5-130926	0936	-	Updates for 6.6.2.1A Spectrum emission mask for CA for CA_7 and CA_41	10.5.0	11.0.0
2013-03	RAN#59	R5-130956	0952	-	Updates for 7.3A.1 Reference sensitivity level for CA_7C	10.5.0	11.0.0
2013-03	RAN#59	R5-130957	0953	-	Updates for 6.2.2A UE Maximum Output Power for CA_7 and CA_41	10.5.0	11.0.0
2013-03	RAN#59	R5-130958	0954	-	Updates of 7.3A - Reference sensitivity level for CA_11A-18A	10.5.0	11.0.0
2013-03	RAN#59	R5-130964	0956	-	Adding Band 27 to TS 36.521-1	10.5.0	11.0.0
2013-03	RAN#59	-	-	-	Correction of missing small changes of R5-130806 in Table 6.6.3.2.3-1, 6.6.3.2.5-1, 6.6.3.2_1.3-1 and 6.6.3.2_1.5-1.	11.0.0	11.0.1
2013-06	RAN#60	R5-131085	0973	-	Removal of technical content in 36.521-1 v10.5.0 and substitution with pointer to the next Release	11.0.1	11.1.0
2013-06	RAN#60	R5-131147	0974	-	Updates to Chapter7 for Inter Band CA combo CA_2A-29A	11.0.1	11.1.0
2013-06	RAN#60	R5-131149	0975	-	New chap8 TDD TC 8.2.2.2.3_C for eICIC	11.0.1	11.1.0
2013-06	RAN#60	R5-131150	0976	-	New chap 8 TDD TC 8.4.2.2.3_C for eICIC	11.0.1	11.1.0
2013-06	RAN#60	R5-131153	0977	-	Introduction of new rel-11 Reporting of RI test cases	11.0.1	11.1.0
2013-06	RAN#60	R5-131154	0978	-	Introduction of new rel-11 Reporting of RI test cases into annexes	11.0.1	11.1.0
2013-06	RAN#60	R5-131156	0979	-	Correction to TC 8.4.1.1 test procedure	11.0.1	11.1.0
2013-06	RAN#60	R5-131158	0980	-	Introduction of Maximum Input Level test case for CA (inter-band DL CA without UL CA) into annexes	11.0.1	11.1.0
2013-06	RAN#60	R5-131210	0981	-	Correction of test applicability for TC 8.2.1.1.1_1: TC 8.2.1.2.1_1 and TC 8.3.2.1.1_1 in 36.521-1	11.0.1	11.1.0
2013-06	RAN#60	R5-131222	0982	-	Update of TC6.6.3B.1 for Transmitter Spurious emissions for UL-MIMO	11.0.1	11.1.0
2013-06	RAN#60	R5-131226	0983	-	Clarification to test procedure on applying timing offset between CCs for Chap8 inter-band CA test cases	11.0.1	11.1.0
2013-06	RAN#60	R5-131238	0984	-	Update TC 6.2.4A.1 Additional Maximum Power Reduction (A-MPR) for CA_38C (intra-band contiguous DL CA and UL CA)	11.0.1	11.1.0
2013-06	RAN#60	R5-131241	0985	-	Update TC 7.3A.1 Reference sensitivity level for CA_4A-12A (intra-band contiguous DL CA and UL CA)	11.0.1	11.1.0
2013-06	RAN#60	R5-131242	0986	-	Update TC 7.3A.3 Reference sensitivity level for CA_4A-12A (inter-band DL CA without UL CA)	11.0.1	11.1.0
2013-06	RAN#60	R5-131245	0987	-	Update TT of 6.3.5A.3.1 Aggregate power control tolerance for CA (intra-band contiguous DL CA and UL CA)	11.0.1	11.1.0
2013-06	RAN#60	R5-131289	0988	-	Uncertainties and Test Tolerances for CA spectrum emission mask	11.0.1	11.1.0
2013-06	RAN#60	R5-131358	0989	-	RF: Corrections to RMC-s for sustained data rate test	11.0.1	11.1.0
2013-06	RAN#60	R5-131379	0990	-	CA RF - Corrections to 6.2.4A.1 requirements	11.0.1	11.1.0
2013-06	RAN#60	R5-131381	0991	-	LTE RF - Editorial correction to 8.2.2.4.2_1	11.0.1	11.1.0
2013-06	RAN#60	R5-131415	0992	-	Updates for 6.6.1A Occupied bandwidth for CA_41C	11.0.1	11.1.0
2013-06	RAN#60	R5-131450	0993	-	Addition of band44 in MPR for UL-MIMO	11.0.1	11.1.0
2013-06	RAN#60	R5-131473	0994	-	References to wrong section in TS 36.508	11.0.1	11.1.0
2013-06	RAN#60	R5-131518	0995	-	Corrections to Common Test Parameters User-Specific	11.0.1	11.1.0

2013-06	RAN#60	R5-131519	0996	-	Corrections to Beamforming Model Parameters	11.0.1	11.1.0
2013-06	RAN#60	R5-131521	0997	-	Corrections to Reporting of Channel State Requirements	11.0.1	11.1.0
2013-06	RAN#60	R5-131522	0998	-	Corrections to Reporting of Precoding Matrix Indicator Requirements	11.0.1	11.1.0
2013-06	RAN#60	R5-131527	0999	-	Additions to Annex G for eDL-MIMO	11.0.1	11.1.0
2013-06	RAN#60	R5-131528	1000	-	Additions of eDL-MIMO test cases to Annex F	11.0.1	11.1.0
2013-06	RAN#60	R5-131539	1001	-	LTE RF: Minor changes to test case 7.5A.3	11.0.1	11.1.0
2013-06	RAN#60	R5-131540	1002	-	LTE-RF: Clarification to 7.6.1A.3 test procedure	11.0.1	11.1.0
2013-06	RAN#60	R5-131541	1003	-	Corrections to TC 6.6.2.3A.1 Adjacent Channel Leakage power Ratio for CA (intra-band contiguous DL CA and UL CA)	11.0.1	11.1.0
2013-06	RAN#60	R5-131545	1004	-	Additions to TC 9.2.3.1_D for FDD CQI reporting under AWGN conditions - PUCCH 1-1 for eDL-MIMO	11.0.1	11.1.0
2013-06	RAN#60	R5-131546	1005	-	LTE-RF: Corrections to CA Open Loop Spatial Multiplexing Performance test cases	11.0.1	11.1.0
2013-06	RAN#60	R5-131553	1006	-	Additions to TC 9.2.3.2_D for TDD CQI reporting under AWGN conditions - PUCCH 1-1 for eDL-MIMO	11.0.1	11.1.0
2013-06	RAN#60	R5-131555	1007	-	Additions to TC 9.3.1.2.2_D for TDD CQI reporting under fading conditions - PUSCH 3-1 for eDL-MIMO	11.0.1	11.1.0
2013-06	RAN#60	R5-131559	1008	-	Additions to TC 9.3.2.2.2_D for TDD CQI reporting under fading conditions - PUCCH 1-1 for eDL-MIMO	11.0.1	11.1.0
2013-06	RAN#60	R5-131561	1009	-	Update of 6.2.5A - Delta TIB for CA_11A-18A	11.0.1	11.1.0
2013-06	RAN#60	R5-131562	1010	-	Additions to TC 9.4.1.3.2_D for TDD reporting of PMI-PUSCH 3-1 (Single PMI) for eDL-MIMO	11.0.1	11.1.0
2013-06	RAN#60	R5-131563	1011	-	Update of 7.3A - Delta RIB for CA_11A-18A	11.0.1	11.1.0
2013-06	RAN#60	R5-131567	1012	-	Additions to TC 9.4.2.3.2_D for TDD PMI reporting - PUSCH 1-2 (Multiple PMI) for eDL-MIMO	11.0.1	11.1.0
2013-06	RAN#60	R5-131569	1013	-	Additions to TC 9.5.2.2_D for TDD RI reporting - PUCCH 1-1 for eDL-MIMO	11.0.1	11.1.0
2013-06	RAN#60	R5-131634	1014	-	Removal of Spurious emission UE co-existence test case 6.6.3.2_1 from annex F	11.0.1	11.1.0
2013-06	RAN#60	R5-131649	1015	-	Adding Band28 in some Receiver test cases in section 7	11.0.1	11.1.0
2013-06	RAN#60	R5-131677	1016	-	Correction to the contents of the chapter 5.	11.0.1	11.1.0
2013-06	RAN#60	R5-131711	1017	-	Corrections to test procedure of TC 7.5B Adjacent Channel Selectivity (ACS) for UL-MIMO	11.0.1	11.1.0
2013-06	RAN#60	R5-131900	1018	-	RF: Correction of Imcs for CQI index 10 (15 RBs)	11.0.1	11.1.0
2013-06	RAN#60	R5-131901	1019	-	Corrections to Frequency non-selective scheduling mode	11.0.1	11.1.0
2013-06	RAN#60	R5-131902	1020	-	Correction to the missing title of Rel 9 close loop tests	11.0.1	11.1.0
2013-06	RAN#60	R5-131903	1021	-	Correction to the references of connection diagrams	11.0.1	11.1.0
2013-06	RAN#60	R5-131904	1022	-	Maintenance of Band 23 additional regulatory requirements	11.0.1	11.1.0
2013-06	RAN#60	R5-131905	1023	-	Realignment of A-MPR Configuration Tables for Band 27 in TS 36.521-1	11.0.1	11.1.0
2013-06	RAN#60	R5-131906	1024	-	Update on General section of Tx and Rx for Cell IDs	11.0.1	11.1.0
2013-06	RAN#60	R5-131907	1025	-	LTE RF: Initial conditions update for test 6.2.5A.2	11.0.1	11.1.0

2013-06	RAN#60	R5-131908	1026	-	CA RF: Alignment for inter-band Rx tests with DL tested only as S-Cell	11.0.1	11.1.0
2013-06	RAN#60	R5-131909	1027	-	36.521-1: Inter-band CA operating bands update	11.0.1	11.1.0
2013-06	RAN#60	R5-131911	1028	-	Updates for 7.7A.1 Spurious response for CA	11.0.1	11.1.0
2013-06	RAN#60	R5-131915	1029	-	Additions to TC 9.3.1.2.1_D for FDD CQI reporting under fading conditions - PUSCH 3-1 for eDL-MIMO	11.0.1	11.1.0
2013-06	RAN#60	R5-131916	1030	-	Additions to TC 9.3.2.2.1_D for FDD CQI reporting under fading conditions - PUCCH 1-1 for eDL-MIMO	11.0.1	11.1.0
2013-06	RAN#60	R5-131917	1031	-	Additions to TC 9.4.1.3.1_D for FDD reporting of PMI - PUSCH 3-1 (Single PMI) for eDL-MIMO	11.0.1	11.1.0
2013-06	RAN#60	R5-131918	1032	-	Additions to TC 9.4.2.3.1_D for FDD PMI reporting - PUSCH 1-2 (Multiple PMI) for eDL-MIMO	11.0.1	11.1.0
2013-06	RAN#60	R5-131919	1033	-	Additions to TC 9.5.2.1_D for FDD RI reporting - PUCCH 1-1 for eDL-MIMO	11.0.1	11.1.0
2013-06	RAN#60	R5-131920	1034	-	Adding Band28 in some Transmitter test cases in section 6	11.0.1	11.1.0
2013-06	RAN#60	R5-131921	1035	-	New RF TC for 36.521-1_8.5.1.2.3_C.1_Enhanced ICIC for LTE	11.0.1	11.1.0
2013-06	RAN#60	R5-131929	1036	-	Update TT of 6.2.2B_6.2.3B_6.2.4B and 6.2.5B for UL-MIMO	11.0.1	11.1.0
2013-06	RAN#60	R5-131930	1037	-	Update TT of 6.3.2B_6.3.3B and 6.3.4B for UL-MIMO	11.0.1	11.1.0
2013-06	RAN#60	R5-131931	1038	-	Update TT of 6.3.5B.1_6.3.5B.2 and 6.3.5B.3 for UL- MIMO	11.0.1	11.1.0
2013-06	RAN#60	R5-131932	1039	-	Update TT of 6.5.1B_6.5.2B.1_6.5.2B.2_6.5.2B.3_6.5.2B.4 for UL-MIMO	11.0.1	11.1.0
2013-06	RAN#60	R5-131933	1040	-	Update TT of 6.6.1B Occupied bandwidth for UL-MIMO	11.0.1	11.1.0
2013-06	RAN#60	R5-131934	1041	-	Update TT of 6.6.2.1B_6.6.2.2B and 6.6.2.3B for UL- MIMO	11.0.1	11.1.0
2013-06	RAN#60	R5-131935	1042	-	Update TT of 6.7B Transmit intermodulation for UL-MIMO	11.0.1	11.1.0
2013-06	RAN#60	R5-131936	1043	-	Update TT of 6.8B Time alignment error for UL-MIMO	11.0.1	11.1.0
2013-06	RAN#60	R5-131937	1044	-	Update TT of 7.3B Reference sensitivity level for UL-MIMO	11.0.1	11.1.0
2013-06	RAN#60	R5-131952	1045	-	Corrections to TC 6.2.5A.1 Configured UE transmitted Power for CA (intra-band contiguous DL CA and UL CA)	11.0.1	11.1.0
2013-06	RAN#60	R5-131954	1046	-	Maintenance of Band 23 Spurious Emissions Requirements	11.0.1	11.1.0
2013-06	RAN#60	R5-131955	1047	-	Corrections to Demodulation Requirements	11.0.1	11.1.0
2013-06	RAN#60	R5-131956	1048	-	Updates to sustained data rate test case	11.0.1	11.1.0
2013-06	RAN#60	R5-131957	1049	-	New RF TC for 36.521-1_9.2.1.3_C.1_Enhanced ICIC for LTE	11.0.1	11.1.0
2013-06	RAN#60	R5-131958	1050	-	RF: Structure clean-up for chapter 9 (including eICIC and eDL-MIMO tests)	11.0.1	11.1.0
2013-06	RAN#60	R5-131959	1051	-	Update TT of 7.4B_7.5B_7.6.1B_7.6.2B_7.6.3B_7.7B and 7.8.1B for UL-MIMO	11.0.1	11.1.0
2013-06	RAN#60	R5-131960	1052	-	Update of TC6.6.3B.3 for Additional spurious emissions for UL-MIMO	11.0.1	11.1.0
2013-06	RAN#60	R5-131961	1053	-	Update of TC6.6.3B.2 for Spurious emissions band UE co-existence for UL-MIMO	11.0.1	11.1.0
2013-06	RAN#60	R5-131962	1054	-	Updates of 6.2.2.3 - maximum output power for UE that supports both Band 18 and 26	11.0.1	11.1.0
2013-06	RAN#60	R5-131963	1055	-	Update of 6.2.4 Test points for A-MPR when NS_05 is signalled	11.0.1	11.1.0

2013-06	RAN#60	R5-131964	1056	-	Updates of 7.3.3 - Refsens for UE that supports both Band 18 and Band 26	11.0.1	11.1.0
2013-06	RAN#60	R5-131969	1057	-	CA RF: Alignment for tests with PCC and SCC switching	11.0.1	11.1.0
2013-06	RAN#60	R5-131971	1059	-	Introduction of Maximum Input Level test case for CA (inter-band DL CA without UL CA)	11.0.1	11.1.0
2013-06	RAN#60	R5-131972	1060	-	Addition of Maximum input level for inter-band CA and updates to test configuration for some Rx TCs	11.0.1	11.1.0
2013-06	RAN#60	R5-131973	1061	-	Updates to FDD sustained data rate test case for CA	11.0.1	11.1.0
2013-06	RAN#60	R5-131974	1062	-	Clarification on Time offset between cells	11.0.1	11.1.0
2013-06	RAN#60	R5-131975	1063	-	Update TC 6.2.3A.1 Maximum Power Reduction (MPR) for CA (intra-band contiguous DL CA and UL CA)	11.0.1	11.1.0
2013-06	RAN#60	R5-131976	1064	-	Update of UE co-existence requirement for CA	11.0.1	11.1.0
2013-06	RAN#60	R5-131977	1065	-	Update TC 6.2.5A.1 Configured UE transmitted Output Power for CA_3A-7A, CA_4A-12A and CA_7A-20A (intra-band contiguous DL CA and UL CA)	11.0.1	11.1.0
2013-06	RAN#60	R5-131978	1066	-	Updates for 6.2.4A A-MPR for CA_41C	11.0.1	11.1.0
2013-06	RAN#60	R5-131979	1067	-	Updates for 7.5A.1 Adjacent Channel Selectivity (ACS) for CA_41C	11.0.1	11.1.0
2013-06	RAN#60	R5-131980	1068	-	Updates for 7.6.1A.1 in-band blocking for CA_41C	11.0.1	11.1.0
2013-06	RAN#60	R5-131981	1069	-	Updates for 7.6.2A.1 Out-of-band blocking for CA_41C	11.0.1	11.1.0
2013-06	RAN#60	R5-131982	1070	-	Updates for 7.6.3A.1 Narrow band blocking for CA_41C	11.0.1	11.1.0
2013-06	RAN#60	R5-131983	1071	-	Updates for 7.8.1A.1 Wideband intermodulation for CA_41C	11.0.1	11.1.0
2013-06	RAN#60	R5-131985	1072	-	Update of CA refsens test 7.3A for inter-band CA configurations CA_4A-5A and CA_4A-13A	11.0.1	11.1.0
2013-06	RAN#60	R5-131987	1073	-	Addition of band 44 in MPR	11.0.1	11.1.0
2013-06	RAN#60	R5-131990	1074	-	CA_1A-18A, CA_2A-17A, CA_3A-8A, CA_4A-5A, CA_4A-13A, CA_4A-17A, CA_11A-18A addition and corrections to Reference Sensitivity TC 7.3A	11.0.1	11.1.0
2013-06	RAN#60	R5-132079	1058	-	Corrections to TC 6.6.3.3A.1 Additional spurious emissions for CA (intra-band contiguous DL CA and UL CA)	11.0.1	11.1.0
2013-06	RAN#60	R5-132080	1075	-	CA RF - Corrections to Blocking Characteristics in 7.6	11.0.1	11.1.0
2013-06	RAN#60	R5-132103	1076	-	Change Spurious emission UE co-existence test cases to align with release independence rule	11.0.1	11.1.0
2013-06	RAN#60	R5-132105	1077	-	CA RF: Corrections to message contents with regard to transmission mode	11.0.1	11.1.0
2013-06	RAN#60	R5-132110	1078	-	Updated test points test case 6.2.3 A-MPR for NS_15 band26	11.0.1	11.1.0
2013-06	RAN#60	R5-132113	1079	-	New test cases for LTE B14 public safety high power UE	11.0.1	11.1.0
2013-09	RAN#61	R5-133070	1080	-	Correction to test points in Additional Spurious Emissions Coexistence test case	11.1.0	11.2.0
2013-09	RAN#61	R5-133073	1081	-	LTE Type A performance requirements - Changes to clause 3	11.1.0	11.2.0
2013-09	RAN#61	R5-133074	1082	-	LTE Type A performance requirements - Changes to clause 8.1.1	11.1.0	11.2.0
2013-09	RAN#61	R5-133075	1083	-	LTE Type A performance requirements - Changes to Annex A	11.1.0	11.2.0
2013-09	RAN#61	R5-133076	1084	-	LTE Type A performance requirements - Introduction of Annex B.5	11.1.0	11.2.0

2013-09	RAN#61	R5-133077	1085	-	LTE Type A performance requirements - Introduction of the new test case 9.3.5.1.1.	11.1.0	11.2.0
2013-09	RAN#61	R5-133232	1086	-	Corrections to CA TC 6.5.2A.3	11.1.0	11.2.0
2013-09	RAN#61	R5-133247	1087	-	Addition of Band 31 to 36.521-1 General s05	11.1.0	11.2.0
2013-09	RAN#61	R5-133248	1088	-	Addition of Band 31 to 36.521-1 RX s07	11.1.0	11.2.0
2013-09	RAN#61	R5-133249	1089	-	Addition of Band 31 to 36.521-1 TX s06	11.1.0	11.2.0
2013-09	RAN#61	R5-133252	1090	-	RF: Minor correction to test points for spurious emissions UE co-existence	11.1.0	11.2.0
2013-09	RAN#61	R5-133258	1091	-	Update TC 7.3A.3 Reference sensitivity level for CA_5A-12A (inter-band DL CA without UL CA)	11.1.0	11.2.0
2013-09	RAN#61	R5-133261	1092	-	Update the minimum requirements of TCs 7.6.3A.1, 7.7A.1 and 7.8.1A.1 for CA	11.1.0	11.2.0
2013-09	RAN#61	R5-133262	1093	-	Update TC 6.6.3B.2 of Spurious emission band UE co-existence for UL-MIMO	11.1.0	11.2.0
2013-09	RAN#61	R5-133263	1094	-	Update TCs 6.2.2B and 6.2.5B for UL-MIMO	11.1.0	11.2.0
2013-09	RAN#61	R5-133265	1095	-	RF: Addition of missing UL-RMC-s for Tx testing	11.1.0	11.2.0
2013-09	RAN#61	R5-133266	1096	-	Correction of TCs 7.3 and 7.3B Reference sensitivity level for Band 27	11.1.0	11.2.0
2013-09	RAN#61	R5-133268	1097	-	CA RF: Addition of new CQI tests for CA	11.1.0	11.2.0
2013-09	RAN#61	R5-133298	1098	-	Correction to Spurious emission band UE co-existence	11.1.0	11.2.0
2013-09	RAN#61	R5-133415	1099	-	Correction to the repeat steps in 7.6.1A, 7.6.3A and 7.8.1A	11.1.0	11.2.0
2013-09	RAN#61	R5-133418	1100	-	Correction to CA sustained data rate performance test	11.1.0	11.2.0
2013-09	RAN#61	R5-133423	1101	-	Correction to eICIC Performance test cases	11.1.0	11.2.0
2013-09	RAN#61	R5-133425	1102	-	Correction to UE category in Tx test cases	11.1.0	11.2.0
2013-09	RAN#61	R5-133426	1103	-	Correction to Spurious emission band UE co-existence	11.1.0	11.2.0
2013-09	RAN#61	R5-133431	1104	-	Correction to MBMS Performance test cases	11.1.0	11.2.0
2013-09	RAN#61	R5-133474	1105	-	Update TC of 8.7.2.1_A.1 TDD sustained data rate performance for CA (intra-band contiguous DL CA)	11.1.0	11.2.0
2013-09	RAN#61	R5-133517	1106	-	Adding the minimum channel spacing for intra-band non-contiguous CA	11.1.0	11.2.0
2013-09	RAN#61	R5-133522	1107	-	Corrections to Annex F for Maintenance of Band 23	11.1.0	11.2.0
2013-09	RAN#61	R5-133523	1108	-	Corrections to description for definition of MIMO Correlation Matrices using cross polarized antennas	11.1.0	11.2.0
2013-09	RAN#61	R5-133524	1109	-	Corrections to UE maximum output power for CA	11.1.0	11.2.0
2013-09	RAN#61	R5-133525	1110	-	Corrections to General Maintenance of Operating Bands and Channel Arrangements	11.1.0	11.2.0
2013-09	RAN#61	R5-133532	1111	-	Introduction of eICIC_enh_LTE to Annex C	11.1.0	11.2.0
2013-09	RAN#61	R5-133534	1112	-	Corrections to TC 6.6.2.3A.1 Adjacent Channel Leakage power Ratio for CA (intra-band contiguous DL CA and UL CA)	11.1.0	11.2.0
2013-09	RAN#61	R5-133535	1113	-	Corrections to TC 7.5A.1 Adjacent Channel Selectivity (ACS) for CA (intra-band contiguous DL CA and UL CA)	11.1.0	11.2.0
2013-09	RAN#61	R5-133800	1114	-	Correction to test frequency in Additional Spurious Emissions test cases for NS_15	11.1.0	11.2.0
2013-09	RAN#61	R5-133801	1115	-	Update applicability of test cases 9.4.2.2.1 and 9.4.2.2.2	11.1.0	11.2.0

2013-09	RAN#61	R5-133802	1116	-	Correction to applicability for TDD-TM8 test cases	11.1.0	11.2.0
2013-09	RAN#61	R5-133803	1117	-	Editorial correction to 6.6.3.3 Additional spurious emissions	11.1.0	11.2.0
2013-09	RAN#61	R5-133804	1118	-	Correction the Minimum conformance requirements for test case 6.2.2B	11.1.0	11.2.0
2013-09	RAN#61	R5-133805	1119	-	CA RF: Adding missing DL-RMC-s	11.1.0	11.2.0
2013-09	RAN#61	R5-133806	1120	-	Update TC of 8.2.1.1 FDD PDSCH Single Antenna Port Performance (Cell-Specific Reference Symbols) for CA	11.1.0	11.2.0
2013-09	RAN#61	R5-133807	1121	-	Update TC of 8.2.1.4 FDD PDSCH Closed Loop Spatial Multiplexing Performance (Cell-Specific Reference Symbols) for CA	11.1.0	11.2.0
2013-09	RAN#61	R5-133808	1122	-	Addition of new TC 8.2.1.4.2_A.2 for FDD PDSCH Closed Loop Multi Layer Spatial Multiplexing 4x2 for CA (inter band DL CA)	11.1.0	11.2.0
2013-09	RAN#61	R5-133811	1123	-	Update of CA TC 7.3A.1	11.1.0	11.2.0
2013-09	RAN#61	R5-133812	1124	-	Update of CA TC 7.4A.1	11.1.0	11.2.0
2013-09	RAN#61	R5-133819	1125	-	Correction of applicability for FDD RF TCs 9.3.4.1.1, 9.3.4.2.1 & 9.4.1.2.1 and TDD RF TCs 9.3.4.1.2, 9.3.4.2.2 & 9.4.1.2.2	11.1.0	11.2.0
2013-09	RAN#61	R5-133823	1126	-	Introduction of eICIC_enh_LTE to Annex A to reference measurement channels for PDCCH/PCFICH	11.1.0	11.2.0
2013-09	RAN#61	R5-133824	1127	-	Introduction of eICIC_enh_LTE to Annex A DL reference measurement channels	11.1.0	11.2.0
2013-09	RAN#61	R5-133828	1128	-	Corrections to 6.2.4 A-MPR for Maintenance of Band 23	11.1.0	11.2.0
2013-09	RAN#61	R5-133829	1129	-	Corrections to Transmitter Characteristics Maintenance	11.1.0	11.2.0
2013-09	RAN#61	R5-133830	1130	-	Alignment of test configuration tables (test frequencies) in Additional Spurious Emissions tests cases	11.1.0	11.2.0
2013-09	RAN#61	R5-133831	1131	-	Corrections to Receiver Characteristics Maintenance	11.1.0	11.2.0
2013-09	RAN#61	R5-133832	1132	-	Corrections to 6.6.2.2 Additional Spectrum Emission Mask for Maintenance of Band 23	11.1.0	11.2.0
2013-09	RAN#61	R5-133833	1133	-	Updates to Chapter7 for Inter Band CA combo CA_4A-29A	11.1.0	11.2.0
2013-09	RAN#61	R5-133838	1134	-	Update Minimum Requirements of TCs 6.2.4 and 6.2.5	11.1.0	11.2.0
2013-09	RAN#61	R5-133845	1135	-	Correction to Configured UE transmitted output power for CA	11.1.0	11.2.0
2013-09	RAN#61	R5-133846	1136	-	Corrections to TC 6.2.5A.2 Configured UE transmitted Power for CA (inter-band DL CA without UL CA)	11.1.0	11.2.0
2013-09	RAN#61	R5-133847	1137	-	Updates to Wideband intermodulation for CA test cases	11.1.0	11.2.0
2013-09	RAN#61	R5-133850	1138	-	Correction to measurement target of CA Rx test cases	11.1.0	11.2.0
2013-09	RAN#61	R5-133851	1139	-	Corrections to TC 7.5A.2 Adjacent Channel Selectivity (ACS) for CA (intra-band contiguous DL CA without UL CA)	11.1.0	11.2.0
2013-09	RAN#61	R5-133852	1140	-	Update TC of 8.7.1.1_A.1 FDD Sustained data rate performance for CA (intra band contiguous DL CA)	11.1.0	11.2.0
2013-09	RAN#61	R5-133853	1141	-	Update TC of 8.7.1.1_A.2 FDD Sustained data rate performance for CA (inter band DL CA)	11.1.0	11.2.0
2013-09	RAN#61	R5-133854	1142	-	Updates of Annex for CA test cases	11.1.0	11.2.0
2013-09	RAN#61	R5-133863	1143	-	Clarification on Bandwidth Combination Set for Carrier Aggregation Transmitter tests	11.1.0	11.2.0
2013-09	RAN#61	R5-133865	1144	-	Update TC 6.2.5A.1 Configured UE transmitted Output Power for CA_5A-12A (intra-band contiguous DL CA and UL CA)	11.1.0	11.2.0

2013-09	RAN#61	R5-133866	1145	-	Update the minimum requirements of TCs 7.5A.1, 7.6.1A.1 and 7.6.2A.1 for CA	11.1.0	11.2.0
2013-09	RAN#61	R5-133867	1146	-	Update TC 7.3A.1 Reference sensitivity level for CA (intra-band contiguous DL CA and UL CA)	11.1.0	11.2.0
2013-09	RAN#61	R5-133869	1147	-	Addition of Refsens for intra-band non-contiguous CA	11.1.0	11.2.0
2013-09	RAN#61	R5-133870	1148	-	Update TC 7.3A.3 reference sensitivity level for CA_3-8 (inter-band DL CA without UL CA)	11.1.0	11.2.0
2013-09	RAN#61	R5-133871	1149	-	Test cases and test system uncertainty for LTE B14 public safety highpower UE	11.1.0	11.2.0
2013-09	RAN#61	R5-133873	1150	-	Addition of new TC 8.3.1.1.3 for FDD PDSCH Single-layer Spatial Multiplexing on antenna ports 7 or 8 with TM9 Interference Model	11.1.0	11.2.0
2013-09	RAN#61	R5-133874	1151	-	Addition of new TC 8.3.2.1.4 for TDD PDSCH Single-layer Spatial Multiplexing on antenna ports 7 or 8 with TM9 Interference Model	11.1.0	11.2.0
2013-09	RAN#61	R5-133886	1152	-	eICIC RF: Addition of new RI tests and OCNG patterns for eICIC	11.1.0	11.2.0
2013-09	RAN#61	R5-133887	1153	-	Update of CA TC 6.2.3A and TC 6.2.4A	11.1.0	11.2.0
2013-09	RAN#61	R5-133888	1154	-	CA RF: Corrections to reference sensitivity requirements for CA	11.1.0	11.2.0
2013-09	RAN#61	R5-133889	1155	-	Correction to Test Requirement in 7.3A.3	11.1.0	11.2.0
2013-09	RAN#61	R5-133890	1156	-	Update TC of 8.2.1.3 FDD PDSCH Open Loop Spatial Multiplexing Performance (Cell-Specific Reference Symbols)for CA	11.1.0	11.2.0
2013-09	RAN#61	R5-133898	1157	-	Clarification on Bandwidth Combination Set for Carrier Aggregation Receiver tests	11.1.0	11.2.0
2013-09	RAN#61	R5-133899	1158	-	Addition of CA TC 6.6.2.2A	11.1.0	11.2.0

History

Document history		
V11.0.1	May 2013	Publication
V11.1.0	July 2013	Publication
V11.2.0	October 2013	Publication