

ETSI TS 132 505 V9.2.0 (2010-07)

Technical Specification

**Universal Mobile Telecommunications System (UMTS);
LTE;
Telecommunication management;
Self-configuration of network elements;
Integration Reference Point (IRP):
eXtensible Markup Language (XML) file format definition
(3GPP TS 32.505 version 9.2.0 Release 9)**



Reference

RTS/TSGS-0532505v920

Keywords

LTE, UMTS

ETSI

650 Route des Lucioles
F-06921 Sophia Antipolis Cedex - FRANCE

Tel.: +33 4 92 94 42 00 Fax: +33 4 93 65 47 16

Siret N° 348 623 562 00017 - NAF 742 C
Association à but non lucratif enregistrée à la
Sous-Préfecture de Grasse (06) N° 7803/88

Important notice

Individual copies of the present document can be downloaded from:

<http://www.etsi.org>

The present document may be made available in more than one electronic version or in print. In any case of existing or perceived difference in contents between such versions, the reference version is the Portable Document Format (PDF). In case of dispute, the reference shall be the printing on ETSI printers of the PDF version kept on a specific network drive within ETSI Secretariat.

Users of the present document should be aware that the document may be subject to revision or change of status.

Information on the current status of this and other ETSI documents is available at

<http://portal.etsi.org/tb/status/status.asp>

If you find errors in the present document, please send your comment to one of the following services:

http://portal.etsi.org/chaicor/ETSI_support.asp

Copyright Notification

No part may be reproduced except as authorized by written permission.
The copyright and the foregoing restriction extend to reproduction in all media.

© European Telecommunications Standards Institute 2010.
All rights reserved.

DECT[™], **PLUGTESTS**[™], **UMTS**[™], **TIPHON**[™], the TIPHON logo and the ETSI logo are Trade Marks of ETSI registered for the benefit of its Members.

3GPP[™] is a Trade Mark of ETSI registered for the benefit of its Members and of the 3GPP Organizational Partners.

LTE[™] is a Trade Mark of ETSI currently being registered

for the benefit of its Members and of the 3GPP Organizational Partners.

GSM[®] and the GSM logo are Trade Marks registered and owned by the GSM Association.

Intellectual Property Rights

IPRs essential or potentially essential to the present document may have been declared to ETSI. The information pertaining to these essential IPRs, if any, is publicly available for **ETSI members and non-members**, and can be found in ETSI SR 000 314: *"Intellectual Property Rights (IPRs); Essential, or potentially Essential, IPRs notified to ETSI in respect of ETSI standards"*, which is available from the ETSI Secretariat. Latest updates are available on the ETSI Web server (<http://webapp.etsi.org/IPR/home.asp>).

Pursuant to the ETSI IPR Policy, no investigation, including IPR searches, has been carried out by ETSI. No guarantee can be given as to the existence of other IPRs not referenced in ETSI SR 000 314 (or the updates on the ETSI Web server) which are, or may be, or may become, essential to the present document.

Foreword

This Technical Specification (TS) has been produced by ETSI 3rd Generation Partnership Project (3GPP).

The present document may refer to technical specifications or reports using their 3GPP identities, UMTS identities or GSM identities. These should be interpreted as being references to the corresponding ETSI deliverables.

The cross reference between GSM, UMTS, 3GPP and ETSI identities can be found under <http://webapp.etsi.org/key/queryform.asp>.

Contents

Intellectual Property Rights	2
Foreword.....	2
Foreword.....	4
Introduction	4
1 Scope	5
2 References	5
3 Definitions and abbreviations.....	5
3.1 Definitions	5
3.2 Abbreviations	7
4 Self Configuration IRP XML Definitions	8
4.1 Self Configuration notifications XML definition structure	8
4.2 Self Configuration IRP XML Schema for notifications (file name 'scIRPNotif.xsd')	9
4.3 Self Configuration XML Schema for IOCs (file name 'scIRPIOCs.xsd')	12
4.4 Self Configuration IRP IOC XML definition structure	15
4.5 ARCF NRM XML definition structure	18
4.6 ARCF XML Schemas for IOCs	20
4.6.1 ARCF XML Schema for operation resumeScProcessWithArcfData and usage of FT IRP (file name 'arcfNrm.xsd')	20
4.6.2 ARCF XML Schema for bulkCMIRP usage (file name 'arcfNrm2.xsd')	23
Annex A (informative): Void	24
Annex B (informative): Change history	25
History	26

Foreword

This Technical Specification has been produced by the 3rd Generation Partnership Project (3GPP).

The contents of the present document are subject to continuing work within the TSG and may change following formal TSG approval. Should the TSG modify the contents of the present document, it will be re-released by the TSG with an identifying change of release date and an increase in version number as follows:

Version x.y.z

where:

- x the first digit:
 - 1 presented to TSG for information;
 - 2 presented to TSG for approval;
 - 3 or greater indicates TSG approved document under change control.
- y the second digit is incremented for all changes of substance, i.e. technical enhancements, corrections, updates, etc.
- z the third digit is incremented when editorial only changes have been incorporated in the document.

Introduction

The present document is part of a TS-family covering the 3rd Generation Partnership Project Technical Specification Group Services and System Aspects, Telecommunication management; as identified below:

- 32.501: Self-Configuration of Network Elements; Concepts and Integration Reference Point (IRP) Requirements
- 32.502: Self-Configuration of Network Elements Integration Reference Point (IRP); Information Service (IS)
- 32.503: Self-Configuration of Network Elements Integration Reference Point (IRP); Common Object Request Broker Architecture (CORBA) Solution Set (SS)
- 32.505: Self-Configuration of Network Elements Integration Reference Point (IRP); eXtensible Markup Language (XML) file format definition.**

1 Scope

The present document is the "XML file format definition" of Self-Configuration IRP (SCIRP) for the IRP whose semantics are specified in Self-Configuration IRP Information Service (3GPP TS 32.502 [2]).

This file format definition specification is related to TS 32.502 V9.0.X.

2 References

The following documents contain provisions which, through reference in this text, constitute provisions of the present document.

- References are either specific (identified by date of publication, edition number, version number, etc.) or non-specific.
- For a specific reference, subsequent revisions do not apply.
- For a non-specific reference, the latest version applies. In the case of a reference to a 3GPP document (including a GSM document), a non-specific reference implicitly refers to the latest version of that document *in the same Release as the present document*.

- [1] 3GPP TS 32.150: "Telecommunication management; Integration Reference Point (IRP) Concept and definitions".
- [2] 3GPP TS 32.502: "Telecommunication management; Self-Configuration of Network Elements Integration Reference Point (IRP); Information Service (IS)".
- [3] W3C REC-xml-20001006: "Extensible Markup Language (XML) 1.0 (Second Edition)".
- [4] W3C REC-xmlschema-0-20010502: "XML Schema Part 0: Primer".
- [5] W3C REC-xmlschema-1-20010502: "XML Schema Part 1: Structures".
- [6] W3C REC-xmlschema-2-20010502: "XML Schema Part 2: Datatypes".
- [7] W3C REC-xml-names-19990114: "Namespaces in XML".

3 Definitions and abbreviations

3.1 Definitions

For the purposes of the present document, the following terms and definitions apply:

IRP: See 3GPP TS 32.150 [1].

IRPAgent: See 3GPP TS 32.150 [1].

IRPManager: See 3GPP TS 32.150 [1].

Self Configuration: The process which brings a network element into service requiring minimal human operator intervention or none at all.

XML file: file containing an XML document

XML document: composed of the succession of an optional XML declaration followed by a root XML element

NOTE: See [3]; in the scope of the present document.

XML declaration: it specifies the version of XML being used

NOTE: See [3].

XML element: has a type, is identified by a name, may have a set of XML attribute specifications and is either composed of the succession of an XML start-tag followed by the XML content of the XML element followed by an XML end-tag, or composed simply of an XML empty-element tag; each XML element may contain other XML elements

NOTE: See [3].

empty XML element: having an empty XML content; an empty XML element still possibly has a set of XML attribute specifications; an empty XML element is either composed of the succession of an XML start-tag directly followed by an XML end-tag, or composed simply of an XML empty-element tag

NOTE: See [3].

XML content (of an XML element): empty if the XML element is simply composed of an XML empty-element tag; otherwise the part, possibly empty, of the XML element between its XML start-tag and its XML end-tag

XML start-tag: the beginning of a non-empty XML element is marked by an XML start-tag containing the name and the set of XML attribute specifications of the XML element

NOTE: See [3].

XML end-tag: the end of a non-empty XML element is marked by an XML end-tag containing the name of the XML element

NOTE: See [3].

XML empty-element tag: composed simply of an empty-element tag containing the name and the set of XML attribute specifications of the XML element.

NOTE: See [3].

XML attribute specification: has a name and a value

NOTE: See [3].

DTD: defines structure and content constraints to be respected by an XML document to be valid with regard to this DTD

NOTE: See [3].

XML schema: more powerful than a DTD, an XML schema defines structure and content constraints to be respected by an XML document to conform with this XML schema; through the use of XML namespaces several XML schemas can be used together by a single XML document; an XML schema is itself also an XML document that shall conform with the XML schema for XML schemas

NOTE: See [4], [5] and [6].

XML namespace: enables qualifying element and attribute names used in XML documents by associating them with namespaces identified by different XML schemas

NOTE: See [7], in the scope of the present document.

XML complex type: defined in an XML schema; cannot be directly used in an XML document; can be the concrete type or the derivation base type for an XML element type or for another XML complex type; ultimately defines constraints for an XML element on its XML attribute specifications and/or its XML content

NOTE: See [4], [5] and [6].

XML element type: declared by an XML schema; can be directly used in an XML document; as the concrete type of an XML element, directly or indirectly defines constraints on its XML attribute specifications and/or its XML content; can also be the concrete type or the derivation base type for another XML element type

NOTE: See [4], [5] and [6].

3.2 Abbreviations

For the purposes of the present document, the following abbreviations apply:

SC	Self Configuration
XML	eXtensible Markup Language

4 Self Configuration IRP XML Definitions

4.1 Self Configuration notifications XML definition structure

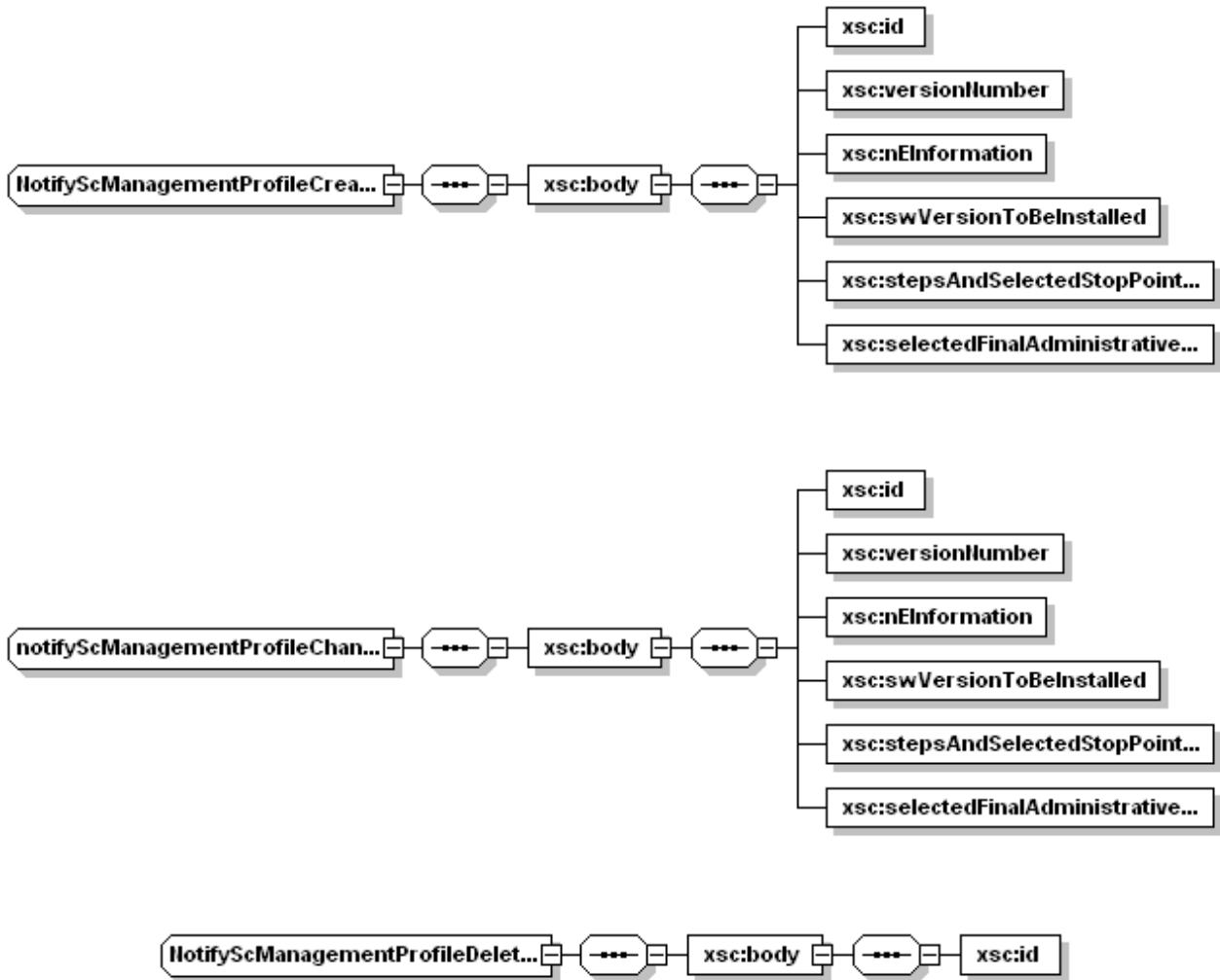

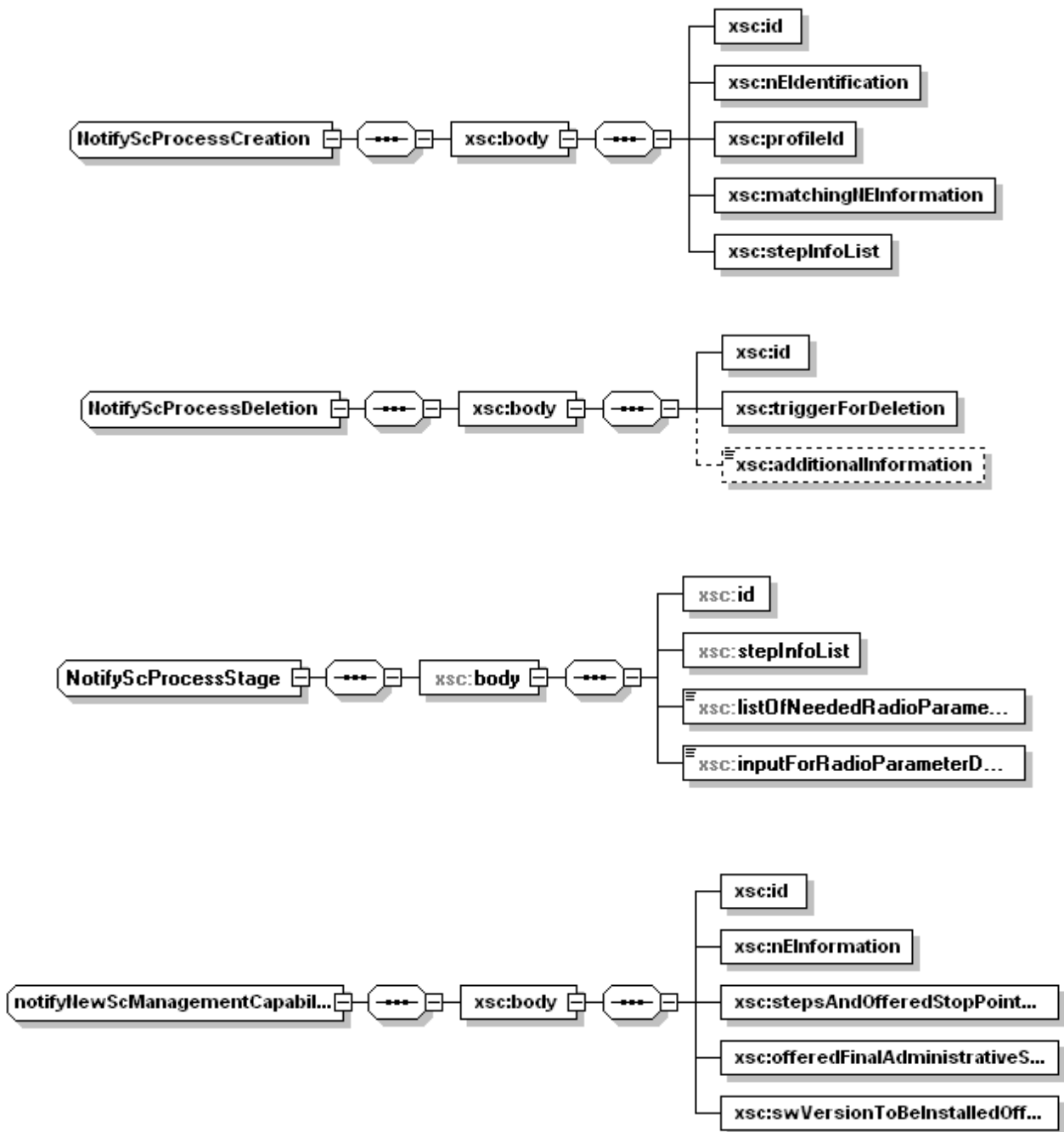

4.2 Self Configuration IRP XML Schema for notifications (file name 'scIRPNotif.xsd')

```
<?xml version="1.0" encoding="UTF-8"?>
<!--
  3GPP TS 32.505 SCIRP Notification XML Schema
  scIRPNotif.xsd
-->
<schema targetNamespace="http://www.3gpp.org/ftp/specs/archive/32_series/32.505#scnIRPNotif"
  xmlns:xsc="http://www.3gpp.org/ftp/specs/archive/32_series/32.505#scnIRPNotif"
  xmlns:swm="http://www.3gpp.org/ftp/specs/archive/32_series/32.535#swManagementIRPNotif"
  xmlns:xe="http://www.3gpp.org/ftp/specs/archive/32_series/32.305#notification"
  xmlns="http://www.w3.org/2001/XMLSchema" elementFormDefault="qualified"
  attributeFormDefault="unqualified">
  <import namespace="xe:Notification" schemaLocation="notification.xsd"/>
  <simpleType name="NeededRadioParameter">
```

```

    <restriction base="string"/>
  </simpleType>
  <simpleType name="SingleInputForRadioParameterDetermination">
    <restriction base="string"/>
  </simpleType>
  <complexType name="NotifyScManagementProfileCreation">
    <complexContent>
      <extension base="xe:Notification">
        <sequence>
          <element name="body">
            <complexType>
              <sequence>
                <element name="id" type="swm:Id"/>
                <element name="versionNumber" type="swm:VersionNumber"/>
                <element name="nEInformation" type="swm:NEInformation"/>
                <element name="swVersionToBeInstalled"
type="swm:SwVersionToBeInstalledConditional"/>
                <element name="stepsAndSelectedStopPointList"
type="swm:StepsAndSelectedStopPointList"/>
                <element name="selectedFinalAdministrativeState"
type="swm:FinalAdministrativeStateValue"/>
              </sequence>
            </complexType>
          </element>
        </sequence>
      </extension>
    </complexContent>
  </complexType>
  <complexType name="NotifyScManagementProfileDeletion">
    <complexContent>
      <extension base="xe:Notification">
        <sequence>
          <element name="body">
            <complexType>
              <sequence>
                <element name="id" type="swm:Id"/>
              </sequence>
            </complexType>
          </element>
        </sequence>
      </extension>
    </complexContent>
  </complexType>
  <complexType name="NotifyScProcessCreation">
    <complexContent>
      <extension base="xe:Notification">
        <sequence>
          <element name="body">
            <complexType>
              <sequence>
                <element name="id" type="swm:Id"/>
                <element name="nEIdentification" type="swm:Id"/>
                <element name="profileId" type="swm:ProfileId"/>
                <element name="matchingNEInformation" type="swm:NEInformation"/>
                <element name="stepInfoList" type="swm:StepInfoList"/>
              </sequence>
            </complexType>
          </element>
        </sequence>
      </extension>
    </complexContent>
  </complexType>
  <complexType name="NotifyScProcessStage">
    <complexContent>
      <extension base="xe:Notification">
        <sequence>
          <element name="body">
            <complexType>
              <sequence>
                <element name="id" type="swm:Id"/>
                <element name="stepInfoList" type="swm:StepInfoList"/>
                <element name="listOfNeededRadioParameters"
type="xsc:NeededRadioParameter"/>
                <element name="inputForRadioParameterDetermination"
type="xsc:SingleInputForRadioParameterDetermination"/>
              </sequence>
            </complexType>
          </element>
        </sequence>
      </extension>
    </complexContent>
  </complexType>

```

```

    </sequence>
  </extension>
</complexContent>
</complexType>
<complexType name="NotifyScProcessDeletion">
  <complexContent>
    <extension base="xe:Notification">
      <sequence>
        <element name="body">
          <complexType>
            <sequence>
              <element name="id" type="swm:Id"/>
              <element name="triggerForDeletion" type="swm:TriggerForDeletion"/>
              <element name="additionalInformation" type="string" minOccurs="0"/>
            </sequence>
          </complexType>
        </element>
      </sequence>
    </extension>
  </complexContent>
</complexType>
<complexType name="notifyNewScManagementCapabilityAvailability">
  <complexContent>
    <extension base="xe:Notification">
      <sequence>
        <element name="body">
          <complexType>
            <sequence>
              <element name="id" type="swm:Id"/>
              <element name="nEInformation" type="swm:NEInformation"/>
              <element name="stepsAndOfferedStopPointList"
type="swm:StepsAndOfferedStopPointList"/>
              <element name="offeredFinalAdministrativeStateInformation"
type="swm:OfferedFinalAdministrativeStateInformation"/>
              <element name="swVersionToBeInstalledOfferList"
type="swm:swVersionToBeInstalledOfferList"/>
            </sequence>
          </complexType>
        </element>
      </sequence>
    </extension>
  </complexContent>
</complexType>
<complexType name="notifyScManagementProfileChange">
  <complexContent>
    <extension base="xe:Notification">
      <sequence>
        <element name="body">
          <complexType>
            <sequence>
              <element name="id" type="swm:Id"/>
              <element name="versionNumber" type="swm:VersionNumber"/>
              <element name="nEInformation" type="swm:NEInformation"/>
              <element name="swVersionToBeInstalled"
type="swm:SwVersionToBeInstalledConditional"/>
              <element name="stepsAndSelectedStopPointList"
type="swm:StepsAndSelectedStopPointList"/>
              <element name="selectedFinalAdministrativeState"
type="swm:FinalAdministrativeStateValue"/>
            </sequence>
          </complexType>
        </element>
      </sequence>
    </extension>
  </complexContent>
</complexType>
<element name="notifyScManagementProfileCreation" type="swm:NotifyScManagementProfileCreation"/>
<element name="notifyScManagementProfileDeletion" type="swm:NotifyScManagementProfileDeletion"/>
<element name="notifyScManagementProcessCreation" type="swm:NotifyScManagementProcessCreation"/>
<element name="notifyScProcessStage" type="swm:NotifyScProcessStage"/>
<element name="notifyScManagementProcessDeletion" type="swm:NotifyScManagementProcessDeletion"/>
<element name="notifyNewScManagementCapabilityAvailability"
type="swm:notifyNewScManagementCapabilityAvailability"/>
<element name="notifyScManagementProfileChange" type="swm:NotifyScManagementProfileChange"/>
</schema>

```

4.3 Self Configuration XML Schema for IOCs (file name 'scIRPIOCs.xsd')

```

<?xml version="1.0" encoding="UTF-8"?>
<!--
3GPP TS 32.505 Self Configuration IRP IOC XML Schema
scIRPIOCs.xsd
-->
<schema xmlns="http://www.w3.org/2001/XMLSchema"
xmlns:xsc="http://www.3gpp.org/ftp/specs/archive/32_series/32.505#scIRPIOCs"
xmlns:xn="http://www.3gpp.org/ftp/specs/archive/32_series/32.535#swManagementIRPIOCs"
xmlns:ns1="http://www.3gpp.org/ftp/specs/archive/32_series/32.535#swManagementIRPIOCs"
targetNamespace="http://www.3gpp.org/ftp/specs/archive/32_series/32.505#scIRPIOCs"
elementFormDefault="qualified" attributeFormDefault="unqualified">
  <import namespace="http://www.3gpp.org/ftp/specs/archive/32_series/32.535#swManagementIRPIOCs"
schemaLocation="swManagementIRPIOCs.xsd"/>
  <simpleType name="id">
    <restriction/>
  </simpleType>
  <simpleType name="neInformation">
    <restriction/>
  </simpleType>
  <simpleType name="radioParameterName">
    <restriction base="string"/>
  </simpleType>
  <simpleType name="radioParameterValue">
    <restriction/>
  </simpleType>
  <simpleType name="FileLocation">
    <restriction base="string"/>
  </simpleType>
  <simpleType name="validationErrorInfo">
    <restriction base="string">
      <enumeration value="ParameterNotSupported"/>
      <enumeration value="InvalidParameter"/>
      <enumeration value="ValueNotSupported"/>
      <enumeration value="MissingParameterValue"/>
      <enumeration value="ConflictingParameterValue"/>
      <enumeration value="SemanticsError"/>
      <enumeration value="OtherError"/>
    </restriction>
  </simpleType>
  <simpleType name="VersionNumber">
    <restriction base="unsignedShort"/>
  </simpleType>
  <complexType name="ProfileId">
    <sequence>
      <element name="id" type="xsc:Id"/>
      <element name="versionNumber" type="xsc:VersionNumber"/>
    </sequence>
  </complexType>
  <simpleType name="FinalAdministrativeStateValue">
    <restriction base="string">
      <enumeration value="LOCKED"/>
      <enumeration value="UNLOCKED"/>
      <enumeration value="DETERMINED_BY_CONFIGURATION_DATA"/>
    </restriction>
  </simpleType>
  <complexType name="listOfNeededRadioParameters">
    <sequence>
      <element name="radioParameterName" type="xsci:radioParameterName"/>
      <element name="radioParameterValue" type="xsci:radioParameterValue"/>
    </sequence>
  </complexType>
  <complexType name="valuesOfNeededRadioParameter">
    <sequence>
      <element name="listOfNeededRadioParameters" type="xsci:listOfNeededRadioParameters"/>
    </sequence>
  </complexType>
  <complexType name="OfferedFinalAdministrativeStateInformation">
    <sequence>
      <element name="OfferedFinalAdministrativeStateValue"
type="xsc:FinalAdministrativeStateValue"/>
    </sequence>
  </complexType>
  <complexType name="StepsAndOfferedStopPointListEntry">

```

```

    <sequence>
      <element name="nameOfStep" type="xsc:NameOfStep"/>
      <element name="sequenceNumberInProgress" type="xsc:SequenceNumberInProgress"/>
      <element name="stopPointCanBeSetBeforeThisStep"
type="xsc:StopPointCanBeSetBeforeThisStep"/>
    </sequence>
  </complexType>
  <complexType name="StepsAndOfferedStopPointList">
    <sequence>
      <element name="stepsAndOfferedStopPointListEntry"
type="xsc:StepsAndOfferedStopPointListEntry" maxOccurs="unbounded"/>
    </sequence>
  </complexType>
  <simpleType name="StopPointCanBeSetBeforeThisStep">
    <restriction base="boolean"/>
  </simpleType>
  <complexType name="StepsAndSelectedStopPointListEntry">
    <sequence>
      <element name="nameOfStep" type="xsc:NameOfStep"/>
      <element name="sequenceNumberInProgress" type="xsc:SequenceNumberInProgress"/>
      <element name="stopPointSetIndication" type="xsc:StopPointSetIndication"/>
    </sequence>
  </complexType>
  <complexType name="StepsAndSelectedStopPointList">
    <sequence>
      <element name="stepsAndSelectedStopPointListEntry"
type="xsc:StepsAndSelectedStopPointListEntry" maxOccurs="unbounded"/>
    </sequence>
  </complexType>
  <simpleType name="StopPointSetIndication">
    <restriction base="string">
      <enumeration value="STOP_POINT_IS_SET_BEFORE_THIS_STEP"/>
      <enumeration value="STOP_POINT_IS_NOT_SET"/>
    </restriction>
  </simpleType>
  <simpleType name="SequenceNumberInProgress">
    <restriction base="unsignedShort"/>
  </simpleType>
  <simpleType name="NameOfStep">
    <restriction base="string">
      <enumeration value="SW_DOWNLOAD"/>
      <enumeration value="SW_INSTALLATION"/>
      <enumeration value="SW_ACTIVATION"/>
      <enumeration value="PREPARE_BASIC_CONFIGURATION_AND_OAMLINK"/>
      <enumeration value="RETRIEVE_CONFIGURATION_DATA"/>
      <enumeration value="SETUP_PRECONFIGURED_SIGNALLING_LINKS"/>
      <enumeration value="SET_FINAL_STATE_OF_NE "/>
    </restriction>
  </simpleType>
  <simpleType name="StepProgress">
    <restriction base="string">
      <enumeration value="NOT_YET_STARTED"/>
      <enumeration value="RUNNING"/>
      <enumeration value="COMPLETED"/>
      <enumeration value="AWAITING_RESUME"/>
      <enumeration value="FAILURE"/>
      <enumeration value="TERMINATED"/>
    </restriction>
  </simpleType>
  <complexType name="StepInfoListEntry">
    <sequence>
      <element name="nameOfStep" type="xsc:NameOfStep"/>
      <element name="sequenceNumberInProgress" type="xsc:SequenceNumberInProgress"/>
      <element name="stopPointSetIndication" type="xsc:StopPointSetIndication"/>
      <element name="stepProgress" type="xsc:StepProgress"/>
    </sequence>
  </complexType>
  <complexType name="StepInfoList">
    <sequence>
      <element name="stepInfoListEntry" type="xsc:StepInfoListEntry" maxOccurs="unbounded"/>
    </sequence>
  </complexType>
  <complexType name="scManagementCapabilityIOC">
    <sequence>
      <element name="id" type="xsc:Id"/>
      <element name="neInformation" type="xsc:NEInformation"/>
      <element name="stepsAndOfferedStopPointList" type="xsc:StepsAndOfferedStopPointList"/>
    </sequence>
  </complexType>

```

```
        <element name="offeredFinalAdministrativeStateInformation"
type="xsc:OfferedFinalAdministrativeStateInformation"/>
      </sequence>
    </complexType>
  <complexType name="scManagementProfileIOC">
    <sequence>
      <element name="id" type="xsc:Id"/>
      <element name="versionNumber" type="xsc:VersionNumber"/>
      <element name="neInformation" type="xsc:NEInformation"/>
      <element name="stepsAndSelectedStopPointList" type="xsc:StepsAndSelectedStopPointList"/>
      <element name="selectedFinalAdministrativeState"
type="xsc:FinalAdministrativeStateValue"/>
    </sequence>
  </complexType>
  <complexType name="scProcessIOC">
    <sequence>
      <element name="id" type="xsc:Id"/>
      <element name="neIdentification" type="xsc:NEInformation"/>
      <element name="profileId" type="xsc:ProfileId"/>
      <element name="stepInfoList" type="xsc:StepInfoList"/>
    </sequence>
  </complexType>
</schema>
```

4.4 Self Configuration IRP IOC XML definition structure

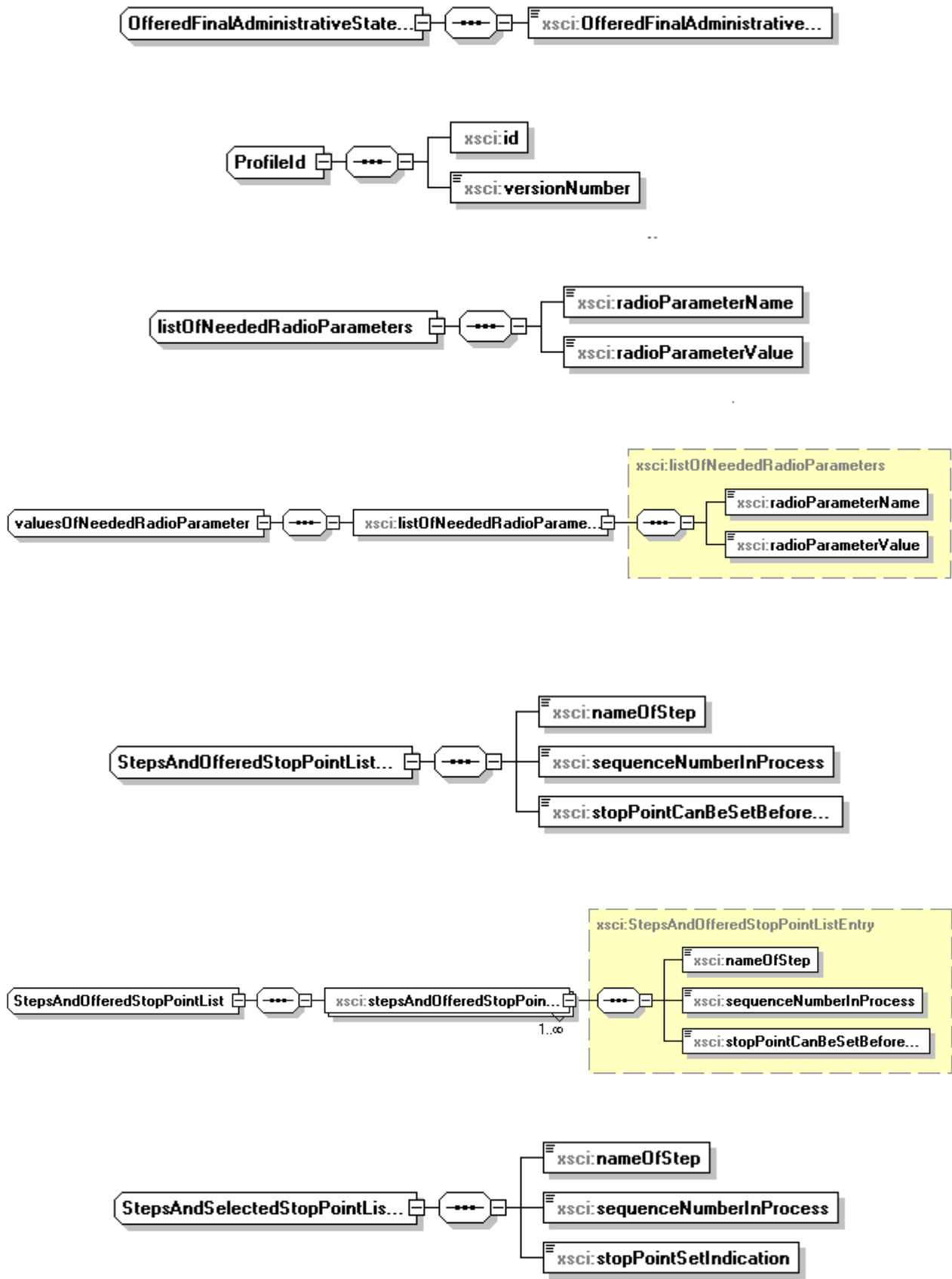

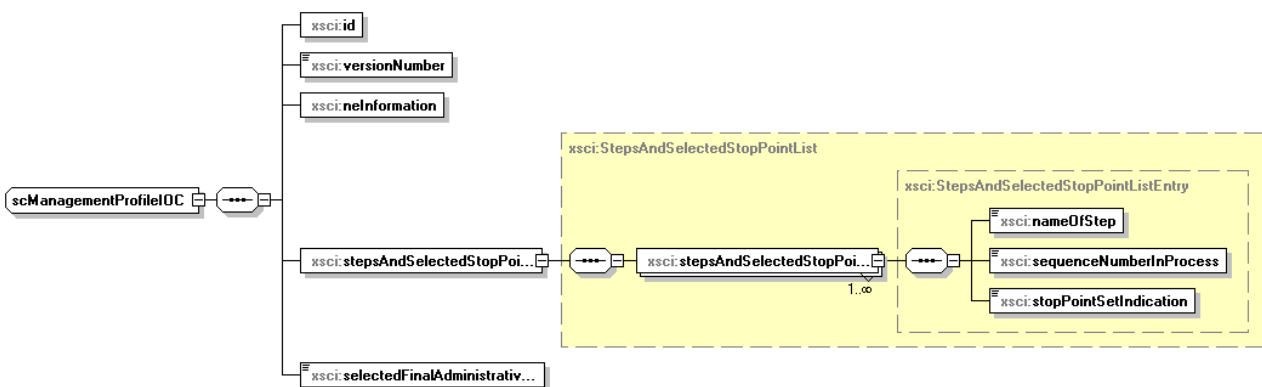
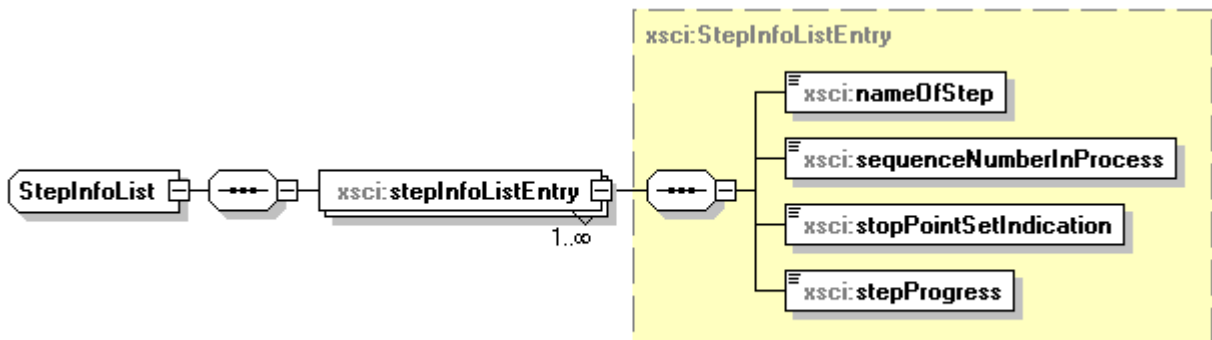
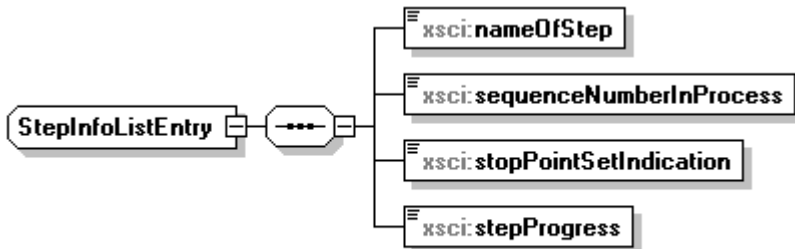
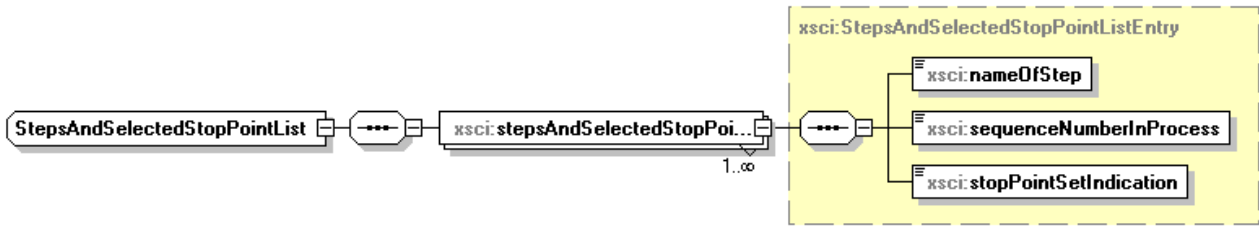

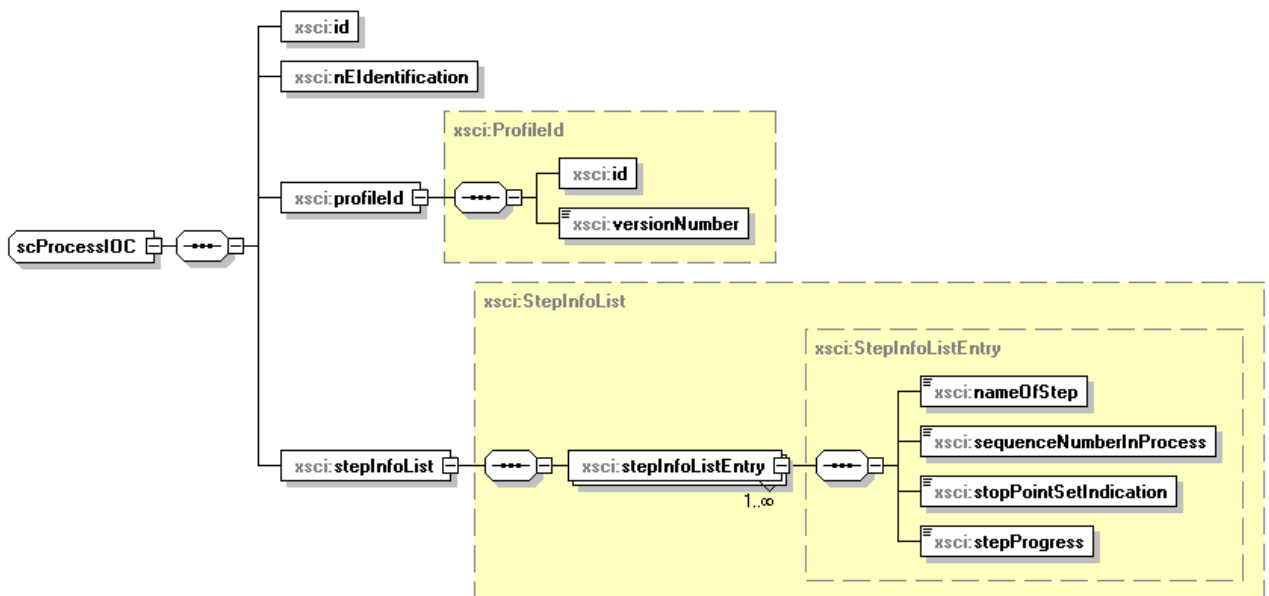
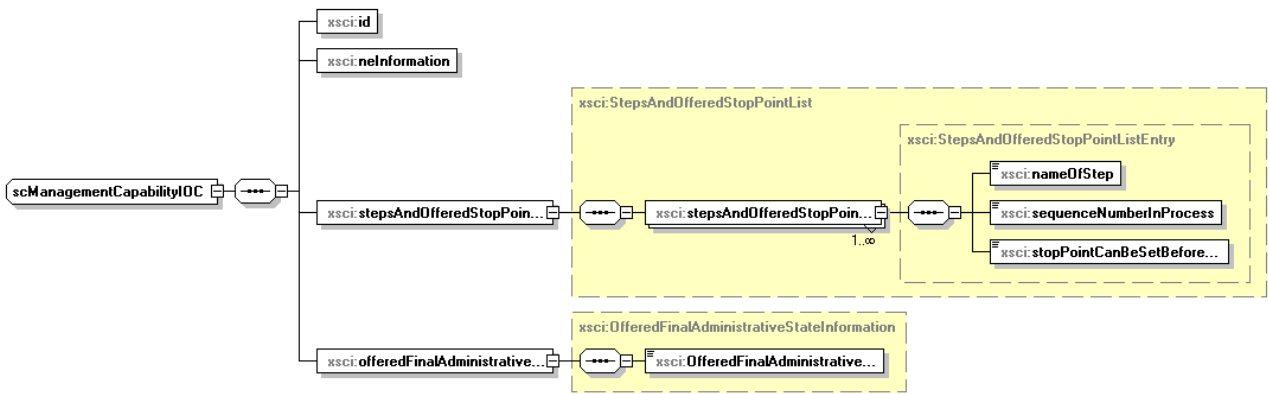

4.5 ARCF NRM XML definition structure

Remark: These definitions are to be used only embedded into SOAP operations defined by Self-Configuration IRP SOAP solution set or by Bulk CM IRP or FT IRP during self-configuration,

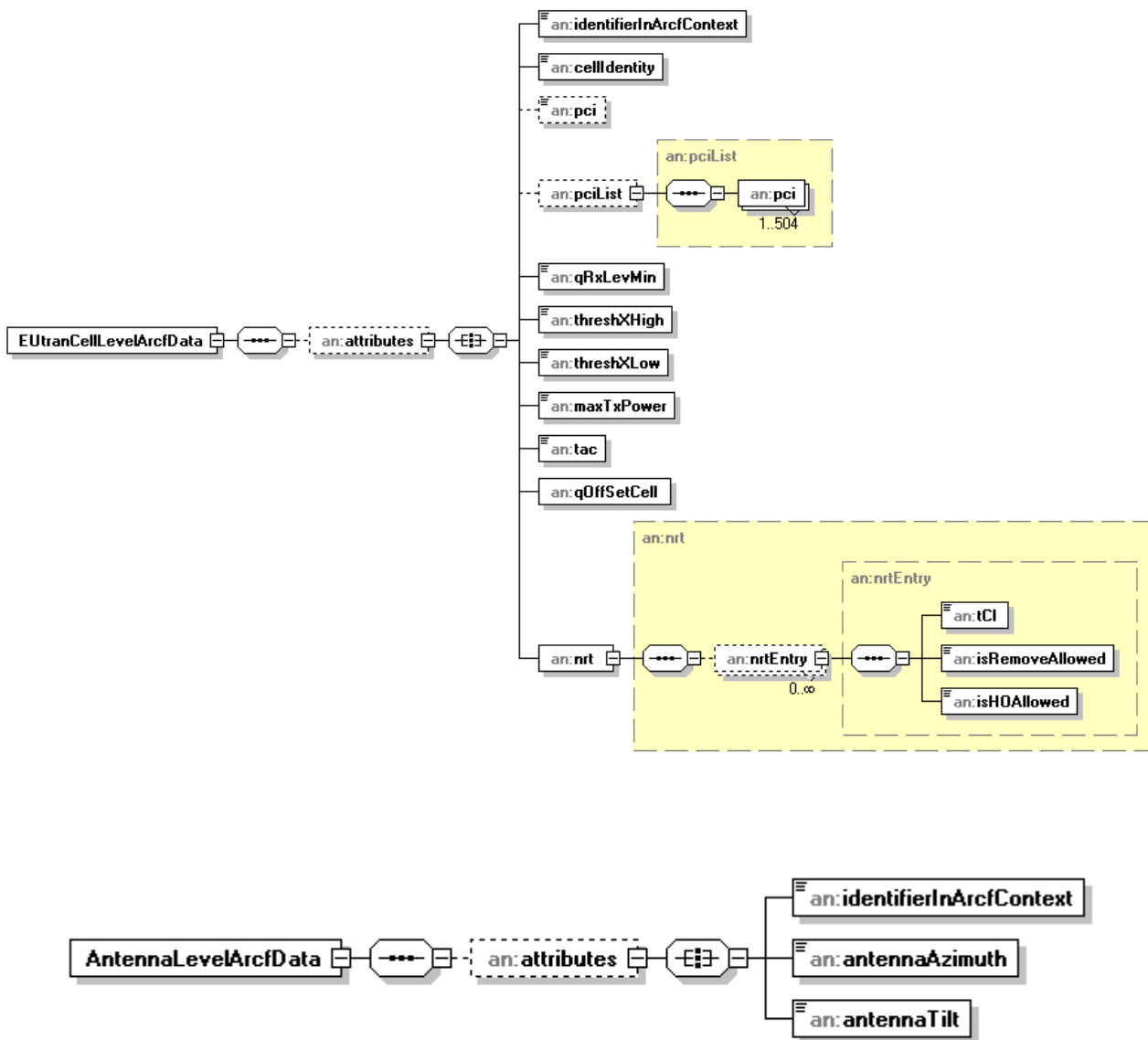

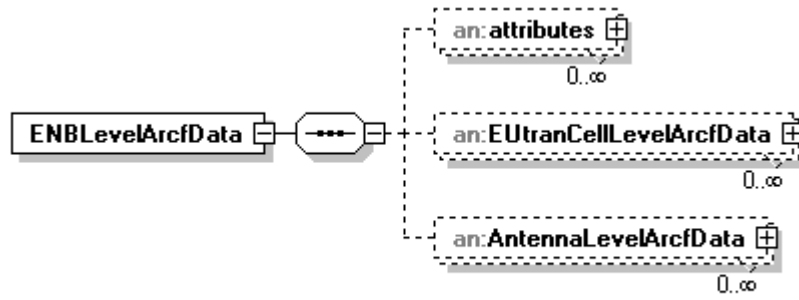

The same definition structure applies for ENBLevelArcfData2, EUTranCellLevelArcfData2 and AntennaLevelArcfData2.

4.6 ARCF XML Schemas for IOCs

4.6.1 ARCF XML Schema for operation resumeScProcessWithArcfData and usage of FT IRP (file name 'arcfNrm.xsd')

```

<?xml version="1.0" encoding="UTF-8"?>
<!--
  3GPP TS 32.505 ARCF Network Resource Model IRP
  XML schema definition
  arcfNrm.xsd
-->
<schema xmlns="http://www.w3.org/2001/XMLSchema"
  xmlns:xn="http://www.3gpp.org/ftp/specs/archive/32_series/32.625#genericNrm"
  xmlns:en="http://www.3gpp.org/ftp/specs/archive/32_series/32.765#eutranNrm"
  xmlns:an="http://www.3gpp.org/ftp/specs/archive/32_series/32.505#arcfNrm"
  targetNamespace="http://www.3gpp.org/ftp/specs/archive/32_series/32.505#arcfNrm"
  elementFormDefault="qualified">
  <import namespace="http://www.3gpp.org/ftp/specs/archive/32_series/32.625#genericNrm"/>
  <import namespace="http://www.3gpp.org/ftp/specs/archive/32_series/32.765#eutranNrm"/>
  <simpleType name="identifierInArcfContext">
    <restriction base="string"/>
  </simpleType>
  <simpleType name="cellIdentity">
    <restriction base="en:cellIdentity"/>
  </simpleType>
  <simpleType name="pci">
    <restriction base="en:pci">
      <maxInclusive value="503"/>
      <!-- Minimum value is 0, maximum value is 3x167+2=503 -->
    </restriction>
  </simpleType>
  <complexType name="pciList">
    <sequence>
      <element name="pci" type="en:Pci" maxOccurs="504"/>
    </sequence>
  </complexType>
  <simpleType name="qRxLevMin">
    <restriction base="short">
      <minInclusive value="-70"/>
      <maxInclusive value="-22"/>
    </restriction>
  </simpleType>
  <simpleType name="threshXHigh">
    <restriction base="short"/>
  </simpleType>
  <simpleType name="threshXLow">
    <restriction base="short"/>
  </simpleType>
  <simpleType name="maxTxPower">
    <restriction base="short"/>
  </simpleType>
  <simpleType name="tac">
    <restriction base="short"/>
  </simpleType>
  <simpleType name="antennaAzimuth">
    <restriction base="short"/>
  </simpleType>
  <simpleType name="antennaTilt">
    <restriction base="short"/>
  </simpleType>
  <simpleType name="qOffsetCell">
    <restriction base="string">
      <enumeration value="dB-24"/>
      <enumeration value="dB-22"/>
      <enumeration value="dB-20"/>
      <enumeration value="dB-18"/>
      <enumeration value="dB-16"/>
      <enumeration value="dB-14"/>
      <enumeration value="dB-12"/>
      <enumeration value="dB-10"/>
      <enumeration value="dB-8"/>
      <enumeration value="dB-6"/>
    </restriction>
  </simpleType>

```

```

    <enumeration value="dB-5"/>
    <enumeration value="dB-4"/>
    <enumeration value="dB-3"/>
    <enumeration value="dB-2"/>
    <enumeration value="dB-1"/>
    <enumeration value="dB-0"/>
    <enumeration value="dB1"/>
    <enumeration value="dB2"/>
    <enumeration value="dB3"/>
    <enumeration value="dB4"/>
    <enumeration value="dB5"/>
    <enumeration value="dB6"/>
    <enumeration value="dB8"/>
    <enumeration value="dB10"/>
    <enumeration value="dB12"/>
    <enumeration value="dB14"/>
    <enumeration value="dB16"/>
    <enumeration value="dB18"/>
    <enumeration value="dB20"/>
    <enumeration value="dB22"/>
    <enumeration value="dB24"/>
  </restriction>
</simpleType>
<complexType name="nrtEntry">
  <sequence>
    <element name="tCI" type="long"/>
    <element name="isRemoveAllowed" type="boolean"/>
    <element name="isHOAllowed" type="boolean"/>
  </sequence>
</complexType>
<complexType name="nrt">
  <sequence>
    <element name="nrtEntry" type="an:nrtEntry" minOccurs="0" maxOccurs="unbounded"/>
  </sequence>
</complexType>
<element name="EUTranCellLevelArcfData">
  <complexType>
    <complexContent>
      <extension base="xn:NrmClass">
        <sequence>
          <element name="attributes" minOccurs="0">
            <complexType>
              <all>
                <element name="identifierInArcfContext"
type="an:identifierInArcfContext"/>
                <element name="cellIdentity" type="an:cellIdentity"/>
                <element name="pci" type="an:pci" minOccurs="0"/>
                <element name="pciList" type="an:pciList" minOccurs="0"/>
                <element name="qRxLevMin" type="an:qRxLevMin"/>
                <element name="threshXHigh" type="an:threshXHigh"/>
                <element name="threshXLow" type="an:threshXLow"/>
                <element name="maxTxPower" type="an:maxTxPower"/>
                <element name="tac" type="an:tac"/>
                <element name="qOffSetCell" type="an:qOffSetCell"/>
                <element name="nrt" type="an:nrt"/>
              </all>
            </complexType>
          </element>
        </sequence>
      </extension>
    </complexContent>
  </complexType>
</element>
<element name="AntennaLevelArcfData">
  <complexType>
    <complexContent>
      <extension base="xn:NrmClass">
        <sequence>
          <element name="attributes" minOccurs="0">
            <complexType>
              <all>
                <element name="identifierInArcfContext"
type="an:identifierInArcfContext"/>
                <element name="antennaAzimuth" type="an:antennaAzimuth"/>
                <element name="antennaTilt" type="an:antennaTilt"/>
              </all>
            </complexType>
          </element>
        </sequence>
      </extension>
    </complexContent>
  </complexType>
</element>

```

```

        </sequence>
      </extension>
    </complexContent>
  </complexType>
</element>
<element name="ENBLevelArcfData">
  <complexType>
    <complexContent>
      <extension base="xn:NrmClass">
        <sequence>
          <element name="attributes" minOccurs="0" maxOccurs="unbounded">
            <complexType>
              <all>
                <element name="identifierInArcfContext"
type="an:identifierInArcfContext"/>
              </all>
            </complexType>
          </element>
          <element name="EUTranCellLevelArcfData" minOccurs="0" maxOccurs="unbounded">
            <complexType>
              <complexContent>
                <extension base="xn:NrmClass">
                  <sequence>
                    <element name="attributes" minOccurs="0">
                      <complexType>
                        <all>
                          <element name="identifierInArcfContext"
type="an:identifierInArcfContext"/>
                          <element name="cellIdentity"
type="an:cellIdentity"/>
                          <element name="pci" type="an:pci"
minOccurs="0"/>
                          <element name="pciList" type="an:pciList"
minOccurs="0"/>
                          <element name="qRxLevMin"
type="an:qRxLevMin"/>
                          <element name="threshXHigh"
type="an:threshXHigh"/>
                          <element name="threshXLow"
type="an:threshXLow"/>
                          <element name="maxTxPower"
type="an:maxTxPower"/>
                          <element name="tac" type="an:tac"/>
                          <element name="qOffSetCell"
type="an:qOffSetCell"/>
                          <element name="nrt" type="an:nrt"/>
                        </all>
                      </complexType>
                    </element>
                  </sequence>
                </extension>
              </complexContent>
            </complexType>
          </element>
        </sequence>
      </extension>
    </complexContent>
  </complexType>
</element>
<element name="AntennaLevelArcfData" minOccurs="0" maxOccurs="unbounded">
  <complexType>
    <complexContent>
      <extension base="xn:NrmClass">
        <sequence>
          <element name="attributes" minOccurs="0">
            <complexType>
              <all>
                <element name="identifierInArcfContext"
type="an:identifierInArcfContext"/>
                <element name="antennaAzimuth"
type="an:antennaAzimuth"/>
                <element name="antennaTilt"
type="an:antennaTilt"/>
              </all>
            </complexType>
          </element>
        </sequence>
      </extension>
    </complexContent>
  </complexType>
</element>
</sequence>
</extension>
</complexContent>
</complexType>
</element>
</sequence>
</extension>
</complexContent>
</complexType>

```

```
        </complexContent>  
      </complexType>  
    </element>  
</schema>
```

4.6.2 ARCF XML Schema for bulkCMIRP usage (file name ' arcfNrm2.xsd ')

Not available in this release.

Annex A (informative):
Void

Annex B (informative): Change history

Change history							
Date	TSG #	TSG Doc.	CR	Rev	Subject/Comment	Old	New
Dec 2009	SA#46	SP-0907355	--	--	Presentation to SA for Information and approval	--	1.0.0
Dec 2009	--	--	--	--	Publication	1.0.0	8.0.0
Dec 2009	-	-	-	-	Update to Rel-9 version	8.0.0	9.0.0
Mar 2010	SA#47	SP-100034	006	--	Correction of XML definitions structure of Self Configuration IOC	9.0.0	9.1.0
Mar 2010	SA#47	SP-100034	009	--	Add XML definitions structure diagram of Self Configuration Notifications	9.0.0	9.1.0
Jun 2010	SA#48	SP-100261	0010	-	Alignment of XML with TS 32.502 for ARCF	9.1.0	9.2.0

History

Document history		
V9.0.0	February 2010	Publication
V9.1.0	April 2010	Publication
V9.2.0	July 2010	Publication