

ETSI TS 132 271 V14.0.0 (2017-04)



**Digital cellular telecommunications system (Phase 2+) (GSM);
Universal Mobile Telecommunications System (UMTS);
LTE;
Telecommunication management;
Charging management;
Location Services (LCS) charging
(3GPP TS 32.271 version 14.0.0 Release 14)**



Reference

RTS/TSGS-0532271ve00

Keywords

GSM,LTE,UMTS

ETSI

650 Route des Lucioles
F-06921 Sophia Antipolis Cedex - FRANCE

Tel.: +33 4 92 94 42 00 Fax: +33 4 93 65 47 16

Siret N° 348 623 562 00017 - NAF 742 C
Association à but non lucratif enregistrée à la
Sous-Préfecture de Grasse (06) N° 7803/88

Important notice

The present document can be downloaded from:

<http://www.etsi.org/standards-search>

The present document may be made available in electronic versions and/or in print. The content of any electronic and/or print versions of the present document shall not be modified without the prior written authorization of ETSI. In case of any existing or perceived difference in contents between such versions and/or in print, the only prevailing document is the print of the Portable Document Format (PDF) version kept on a specific network drive within ETSI Secretariat.

Users of the present document should be aware that the document may be subject to revision or change of status.

Information on the current status of this and other ETSI documents is available at

<https://portal.etsi.org/TB/ETSI/DeliverableStatus.aspx>

If you find errors in the present document, please send your comment to one of the following services:

<https://portal.etsi.org/People/CommiteeSupportStaff.aspx>

Copyright Notification

No part may be reproduced or utilized in any form or by any means, electronic or mechanical, including photocopying and microfilm except as authorized by written permission of ETSI.

The content of the PDF version shall not be modified without the written authorization of ETSI.

The copyright and the foregoing restriction extend to reproduction in all media.

© European Telecommunications Standards Institute 2017.

All rights reserved.

DECT™, PLUGTESTS™, UMTS™ and the ETSI logo are Trade Marks of ETSI registered for the benefit of its Members.

3GPP™ and LTE™ are Trade Marks of ETSI registered for the benefit of its Members and of the 3GPP Organizational Partners.

oneM2M logo is protected for the benefit of its Members

GSM® and the GSM logo are Trade Marks registered and owned by the GSM Association.

Intellectual Property Rights

IPRs essential or potentially essential to the present document may have been declared to ETSI. The information pertaining to these essential IPRs, if any, is publicly available for **ETSI members and non-members**, and can be found in ETSI SR 000 314: "*Intellectual Property Rights (IPRs); Essential, or potentially Essential, IPRs notified to ETSI in respect of ETSI standards*", which is available from the ETSI Secretariat. Latest updates are available on the ETSI Web server (<https://ipr.etsi.org>).

Pursuant to the ETSI IPR Policy, no investigation, including IPR searches, has been carried out by ETSI. No guarantee can be given as to the existence of other IPRs not referenced in ETSI SR 000 314 (or the updates on the ETSI Web server) which are, or may be, or may become, essential to the present document.

Foreword

This Technical Specification (TS) has been produced by ETSI 3rd Generation Partnership Project (3GPP).

The present document may refer to technical specifications or reports using their 3GPP identities, UMTS identities or GSM identities. These should be interpreted as being references to the corresponding ETSI deliverables.

The cross reference between GSM, UMTS, 3GPP and ETSI identities can be found under <http://webapp.etsi.org/key/queryform.asp>.

Modal verbs terminology

In the present document "**shall**", "**shall not**", "**should**", "**should not**", "**may**", "**need not**", "**will**", "**will not**", "**can**" and "**cannot**" are to be interpreted as described in clause 3.2 of the [ETSI Drafting Rules](#) (Verbal forms for the expression of provisions).

"**must**" and "**must not**" are **NOT** allowed in ETSI deliverables except when used in direct citation.

Contents

Intellectual Property Rights	2
Foreword.....	2
Modal verbs terminology.....	2
Foreword.....	5
1 Scope	6
2 References	7
3 Definitions, symbols and abbreviations	8
3.1 Definitions	8
3.2 Symbols.....	10
3.3 Abbreviations	10
4 Architecture considerations	12
4.1 High level LCS architecture	12
4.2 LCS offline charging architecture	13
4.3 LCS online charging architecture	13
5 LCS charging principles and scenarios	14
5.1 LCS charging principles.....	14
5.2 LCS offline charging scenarios	15
5.2.1 Basic principles.....	15
5.2.2 Rf message flows	15
5.2.3 CDR Generation	15
5.2.3.0 Introduction.....	15
5.2.3.1 Mobile Originated Location Request (MO-LR).....	16
5.2.3.2 Mobile Terminated Location Request (MT-LR).....	17
5.2.3.3 Network Induced Location Request (NI-LR).....	19
5.2.4 Ga record transfer flows	19
5.2.5 B _L CDR file transfer	20
5.3 LCS online charging scenarios.....	20
5.3.0 General.....	20
5.3.1 Basic principles.....	20
5.3.2 Ro message flows	20
5.3.2.0 General	20
5.3.2.1 Mobile Originated Location Request (MO-LR).....	21
5.3.2.2 Mobile Terminated Location Request (MT-LR).....	22
6 Definition of charging information	23
6.0 General	23
6.1 Data description for LCS offline charging	23
6.1.0 Introduction.....	23
6.1.1 Rf message contents.....	23
6.1.2 Ga message contents	23
6.1.3 CDR description on the B _L interface	23
6.1.3.0 Introduction.....	23
6.1.3.1 LCS records for Mobile Originated Location Request (LCS-GMO-CDR).....	23
6.1.3.2 LCS records for Mobile Terminated Location Request (MT-LR)	24
6.1.3.2.1 LCS records for Requesting GMLC (LCS-RGMT-CDR)	24
6.1.3.2.2 LCS records for Home GMLC (LCS-HGMT-CDR)	25
6.1.3.2.3 LCS records for Visited GMLC (LCS-VGMT-CDR).....	25
6.1.3.3 LCS Records for Network Initiated Location Request (LCS-GNI-CDR).....	26
6.2 Data description for LCS online charging.....	27
6.2.1 Ro message contents	27
6.2.1.0 General	27
6.2.1.1 <i>Debit / Reserve Units Request</i> message	27
6.2.1.2 <i>Debit / Reserve Units Response</i> message	28

6.3 LCS charging specific parameters.....28

6.3.1 Definition of LCS charging information.....28

6.3.1.0 General.....28

6.3.1.1 LCS charging information assignment for Service Information28

6.3.1.2 Definition of the LCS Information.....28

Annex A (informative): Bibliography.....30

Annex B (informative): Change history31

History32

Foreword

This Technical Specification has been produced by the 3rd Generation Partnership Project (3GPP).

The contents of the present document are subject to continuing work within the TSG and may change following formal TSG approval. Should the TSG modify the contents of the present document, it will be re-released by the TSG with an identifying change of release date and an increase in version number as follows:

Version x.y.z

where:

- x the first digit:
 - 1 presented to TSG for information;
 - 2 presented to TSG for approval;
 - 3 or greater indicates TSG approved document under change control.
- y the second digit is incremented for all changes of substance, i.e. technical enhancements, corrections, updates, etc.
- z the third digit is incremented when editorial only changes have been incorporated in the document.

1 Scope

The present document is part of a series of Technical Specifications (TSs) that specify charging functionality and charging management in GSM/UMTS networks. The GSM/UMTS core network charging architecture and principles are specified in TS 32.240 [1], which provides an umbrella for other charging management documents that specify

- the content of the CDRs per domain and subsystem (offline charging);
- the content of real-time charging events per domain / subsystem (online charging);
- the functionality of online and offline charging for those domains and subsystems;
- the interfaces that are used in the charging framework to transfer the charging information (i.e. CDRs or charging events).

The complete document structure for these TSs is defined in TS 32.240 [1].

The present document specifies the LCS Offline and Online Charging description for the LCS domain, based on the functional stage 2 description of the LCS in TS 23.071 [201]. This charging description includes the offline and online charging architecture and scenarios specific to the LCS, as well as the mapping of the common 3GPP architecture specified in TS 32.240 [1] onto the LCS domain. It further specifies the structure and content of the CDRs for offline charging and the charging events for online charging. The present document is related to other 3GPP charging TSs as follows:

- The common 3GPP charging architecture is specified in TS 32.240 [1];
- The parameters, abstract syntax and encoding rules for these CDR types are specified in TS 32.298 [51].
- A transaction based mechanism for the transfer of CDRs within the network is specified in TS 32.295 [54].
- The file based mechanism used to transfer the CDRs from the network to the operator's billing domain (e.g. the billing system or a mediation device) is specified in TS 32.297 [52].
- The 3GPP Diameter application that is used for LCS domain offline and online charging is specified in TS 32.299 [50].

All terms, definitions and abbreviations, used in the present document, that are common across 3GPP TSs, are defined in TR 21.905 [100]. Those that are common across charging management in GSM/UMTS domains, services, or subsystems are provided in the umbrella document TS 32.240 [1] and are copied into clause 3 of the present document for ease of reading. Finally, those items that are specific to the present document are defined exclusively in the present document.

Furthermore, requirements that govern the charging work are specified in TS 22.115 [101].

2 References

The following documents contain provisions, which through reference in this text, constitute provisions of the present document.

- References are either specific (identified by date of publication, edition number, version number, etc.) or non-specific.
- For a specific reference, subsequent revisions do not apply.
- For a non-specific reference, the latest version applies. In the case of a reference to a 3GPP document (including a GSM document), a non-specific reference implicitly refers to the latest version of that document *in the same Release as the present document*.

- [1] 3GPP TS 32.240: "Telecommunication management; Charging management; Charging architecture and principles".
- [2] - [9] Void.
- [10] 3GPP TS 32.250: "Telecommunication management; Charging management; Circuit Switched (CS) domain charging".
- [11] - [19] Void.
- [20] 3GPP TS 32.260: "Telecommunication management; Charging management; IP Multimedia Subsystem (IMS) charging".
- [21] - [29] Void.
- [30] 3GPP TS 32.270: "Telecommunication management; Charging management; Multimedia Messaging Service (MMS) charging".
- [31] - [49] Void.
- [50] 3GPP TS 32.299: "Telecommunication management; Charging management; Diameter charging application".
- [51] 3GPP TS 32.298: "Telecommunication management; Charging management; Charging Data Record (CDR) encoding rules description".
- [52] 3GPP TS 32.297: "Telecommunication management; Charging management; Charging Data Record (CDR) file format and transfer".
- [53] 3GPP TS 32.296: "Telecommunication management; Charging management; Online Charging System (OCS) applications and interfaces".
- [54] 3GPP TS 32.295: "Telecommunication management; Charging management; Charging Data Record (CDR) transfer".
- [55] - [99] Void.
- [100] 3GPP TR 21.905: "Vocabulary for 3GPP Specifications".
- [101] 3GPP TS 22.115: "Service aspects; Charging and billing".
- [102] - [199] Void.
- [200] Void.
- [201] 3GPP TS 23.271: "Functional stage 2 description of Location Services (LCS)".
- [202] Void.
- [203] 3GPP TS 25.305: "Stage 2 functional specification of User Equipment (UE) positioning in UTRAN".

[204]	3GPP TS 43.059: "Functional stage 2 description of Location Services (LCS) in GERAN".
[205]	3GPP TS 24.002: "GSM - UMTS Public Land Mobile Network (PLMN) Access Reference Configuration".
[206] - [299]	Void.
[301] - [399]	Void.
[400]	Void.
[401]	Void.
[402]	IETF RFC 4006 (2005): "Diameter Credit-Control Application".

3 Definitions, symbols and abbreviations

3.1 Definitions

For the purposes of the present document, the terms and definitions defined in TR 21.905 [100] and TS 32.240 [1], and the following apply:

accounting: process of apportioning charges between the Home Environment, Serving Network and Subscriber.

billing: function whereby CDRs generated by the charging function(s) are transformed into bills requiring payment.

Billing Domain (BD): part of the operator network, which is outside the telecommunications network, that receives and processes CDR files from the network charging functions. It includes functions that can provide billing mediation and billing or other (e.g. statistical) end applications. It is only applicable to offline charging (see "Online Charging System" for equivalent functionality in online charging).

chargeable event: activity utilizing telecommunications network resources and related services for:

- user to user communication (e.g. a single call, a data communication session or a short message); or
- user to network communication (e.g. service profile administration); or
- inter-network communication (e.g. transferring calls, signalling, or short messages); or
- mobility (e.g. roaming or inter-system handover); and
- that the network operator may want to charge for.

As a minimum, a chargeable event characterises the resource / service usage and indicates the identity of the involved end user(s).

charging: a function within the telecommunications network and the associated OCS/BD components whereby information related to a chargeable event is collected, formatted, transferred and evaluated in order to make it possible to determine usage for which the charged party may be billed.

Charging Data Record (CDR): a formatted collection of information about a chargeable event (e.g. time of call set-up, duration of the call, amount of data transferred, etc) for use in billing and accounting. For each party to be charged for parts of or all charges of a chargeable event a separate CDR shall be generated, i.e. more than one CDR may be generated for a single chargeable event, e.g. because of its long duration, or because more than one charged party is to be charged.

charging event: a set of charging information forwarded by the CTF towards the CDF (offline charging) or towards the OCS (online charging). Each charging event matches exactly one chargeable event.

charging function: entity inside the network domain, subsystem or service that is involved in charging for that domain, subsystem or service.

circuit switched domain: domain within GSM / UMTS in which information is transferred in circuit switched mode.

Credit-Control: mechanism which directly interacts in real-time with an account and controls or monitors the charges, related to the service usage. Credit-Control is a process of: checking if credit is available, credit reservation, deduction of credit from the end user account when service is completed and refunding of reserved credit not used.

domain: part of a communication network that provides network resources using a certain bearer technology.

Fully Qualified Partial CDR (FQPC): partial CDR that contains a complete set of the fields specified in the present document. This includes all the mandatory and conditional fields as well as those fields that the PLMN operator has provisioned to be included in the CDR. The first Partial CDR shall be a Fully qualified Partial CDR.

LCS Client: software and/or hardware entity that interacts with a LCS Server for the purpose of obtaining location information for one or more Mobile Stations
LCS Clients subscribe to LCS in order to obtain location information. LCS Clients may or may not interact with human users. The LCS Client is responsible for formatting and presenting data and managing the user interface (dialogue). The LCS Client may reside in the Mobile Station (MS).

LCS Server: software and/or hardware entity offering LCS capabilities. The LCS Server accepts requests, services requests, and sends back responses to the received requests
The LCS server consists of LCS components, which are distributed to one or more PLMN and/or service provider.

Location Based Service (LBS): service provided either by teleoperator or a 3rd party service provider that utilizes the available location information of the terminal
Location Application offers the User Interface for the service. LBS is either a pull or a push type of service (see Location Dependent Services and Location Independent Services). In ETSI/GSM documentation of SoLSA, LBS is called "Location Related Service". ETSI and/or 3GPP -wide terminology harmonization is expected here.

location estimate: geographic location of an UE and/or a valid Mobile Equipment (ME), expressed in latitude and longitude data
The Location Estimate shall be represented in a well-defined universal format. Translation from this universal format to another geographic location system may be supported, although the details are considered outside the scope of the primitive services.

middle tier TS: used for the 3GPP charging TSs that specify the domain / subsystem / service specific, online and offline, charging functionality. These are all the TSs in the numbering range from TS 32.250 to TS 32.279, e.g. TS 32.250 [10] for the CS domain, or TS 32.270 [30] for the MMS service. Currently, there is only one "tier 1" TS in 3GPP, which is TS 32.240 [1] that specifies the charging architecture and principles. Finally, there are a number of top tier TSs in the 32.29x numbering range ([50] ff) that specify common charging aspects such as parameter definitions, encoding rules, the common billing domain interface or common charging applications.

offline charging: charging mechanism where charging information **does not** affect, in real-time, the service rendered.

online charging: charging mechanism where charging information can affect, in real-time, the service rendered and therefore a direct interaction of the charging mechanism with bearer/session/service control is required.

Online Charging System (OCS): the entity that performs real-time credit control.
Its functionality includes transaction handling, rating, online correlation and management of subscriber account balances.

packet switched domain: domain within GSM / UMTS in which data is transferred in packet switched mode.
Corresponds to the term "GPRS".

partial CDR: CDR that provides information on part of a subscriber session. A long session may be covered by several partial CDRs. Two formats are considered for Partial CDRs. One that contains all of the specified fields (FQPC); the second has a reduced format (RPC).

Positioning method (/locating method): method or technical solution, which is used to get an estimate of the target mobile's geographical location

EXAMPLE: Positioning methods based on radio cell coverage, GPS or Assisted GPS methods, which are based on the Time-Of-Arrival (TOA) algorithm, and OTDOA or E-OTD methods, which are based on the Time-Difference-Of-Arrival (TDOA) algorithm.
The positioning methods are further described in UTRAN Stage 2, TS 25.305 [203] and GERAN Stage 2, TS 43.059 [204].

target UE: UE being positioned

user: an entity, not part of the 3GPP System, that uses network resources by means of a subscription. The user may or may not be identical to the subscriber holding that subscription.

User Equipment (UE): a device allowing a user access to network services. For the purpose of 3GPP specifications the interface between the UE and the network is the radio interface. A User Equipment can be subdivided into a number of domains, the domains being separated by reference points. Currently defined domains are the USIM and ME Domains. The ME Domain can further be subdivided into several components showing the connectivity between multiple functional groups. These groups can be implemented in one or more hardware devices. An example of such a connectivity is the TE – MT interface. Further, an occurrence of a User Equipment is an MS for GSM as defined in TS 24.002 [205].

3.2 Symbols

For the purposes of the present document, the following symbols apply:

Bl	Reference point for the CDR file transfer from the GMLC CGF to the BD,
Lr	Interface between Gateway MLCs

3.3 Abbreviations

For the purposes of the present document, the abbreviations defined in TR 21.905 [100], TS 23.271 [20] and TS 32.240 [1], and the following apply:

3G	3 rd Generation
3GPP	3 rd Generation Partnership Project
AVP	Attribute Value Pair
BD	Billing Domain
CCA	Credit-Control-Answer
CCR	Credit-Control-Request
CDF	Charging Data Function
CDR	Charging Data Records
CGF	Charging Gateway Function
CS	Circuit-Switched
CTF	Charging Trigger Function
DCCA	Diameter Credit-Control Application
ECUR	Event Charging with Unit Reservation
FTAM	File Transfer, Access and Management
GERAN	GSM EDGE Radio Access Network
GGSN	Gateway GPRS Support Node
GMLC	Gateway MLC
GPRS	General Packet Radio Service
GSM	Global System for Mobile communication
gsmSCF	GSM Service Control Function
H-GMLC	Home GMLC
HLR	Home Location Register
HPLMN	Home PLMN
HSS	Home Subscriber Server
IE	Information Element
IEC	Immediate Event Charging
IETF	Internet Engineering Task Force
IMS	IP Multimedia Subsystem
IMSI	International Mobile Subscriber Identity
IP	Internet Protocol
ITU-T	International Telecommunication Union - Telecommunications standardization sector
LCS	LoCation Service
MAP	Mobile Application Part
ME	Mobile Equipment
MO	Mobile Originated
MO-LR	Mobile Originated Location Request
MS	Mobile Station

MSISDN	Mobile Station Integrated Services Data Network
MT	Mobile Terminated
MT-LR	Mobile Terminated Location Request
NI-LR	Network Induced Location Request
OCS	Online Charging System
PLMN	Public Land Mobile Network
PMD	Pseudonym Mediation Device functionality
PPR	Privacy Profile Register
PS	Packet Switched
RAN	Radio Access Network
R-GMLC	Requesting GMLC
RPC	Reduced Partial CDR
SGSN	Serving GPRS Support Node
TR	Technical Report
TS	Technical Specification
UE	User Equipment
UMTS	Universal Mobile Telecommunications System
USIM	User Service Identity Module
UTRAN	Universal Terrestrial Radio Access Network
V-GMLC	Visited GMLC
VPLMN	Visited PLMN

4 Architecture considerations

4.1 High level LCS architecture

Figure 4.1.1 depicts the logical LCS architecture, as described in TS 23.271 [201].

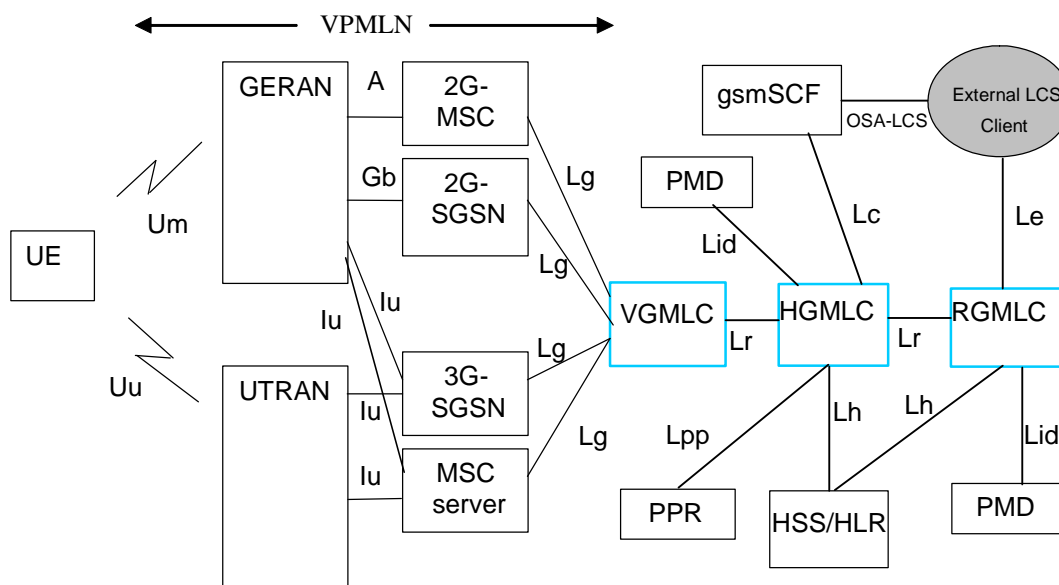

Figure 4.1.1: LCS logical architecture with inter-GMLC [Lr] interface

As can be seen in figure 4.1.1, the following LCS elements are relevant for charging:

- V-GMLC,
- H-GMLC,
- R-GMLC.

Editor's note: Add a statement stating that the SGSN and the MSC have also a role in the LCS Charging and that the associated LCS Charging functionality is described in TS 32.250 and TS 32.251

4.2 LCS offline charging architecture

As described in TS 32.240 [1], the CTF (an integrated component in each charging relevant NE) generates charging events and forwards them to the CDF. The CDF, in turn, generates CDRs which are then transferred to the CGF. Finally, the CGF creates CDR files and forwards them to the Billing Domain.

In LCS, all charging functions (CTF, CDF and CGF) reside within the LCS R/S. I.e. the GMLC is connected directly to the Billing Domain via the B1 interface. B1 is the LCS specific variant of the common Bx interface. This architecture implies that there exists no separate CDF and CGF for LCS, i.e. no corresponding open interfaces between any such functions, within the 3GPP standards.

Figure 4.2.1 depicts the mapping of the 3GPP common charging architecture, as laid down in TS 32.240 [1], onto the LCS.

Editor's note: A clarification for the LCS offline charging reference point is in discussion

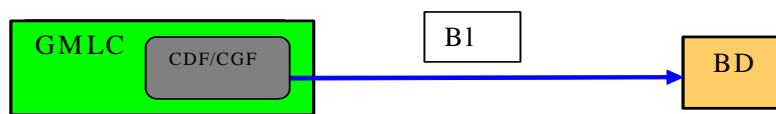

Figure 4.2.1: LCS offline charging architecture

In addition to the standard approach depicted in figure 4.2.1, vendors may choose to implement separate CDF and CGF for LCS. In that case, the interfaces between these functions should comply with the definition of the Rf and Ga interfaces (TS 32.299 [50] and TS 32.295 [54], respectively) as much as possible.

4.3 LCS online charging architecture

LCS online charging is based on GMLC functionality that is further specified in the present document. For online charging, the GMLC utilises the Ro interface and application towards the OCS as specified in TS 32.299 [50]. The Ro reference point covers all online charging functionality required for LCS.

The LCS online charging architecture is depicted in figure 4.3.1.

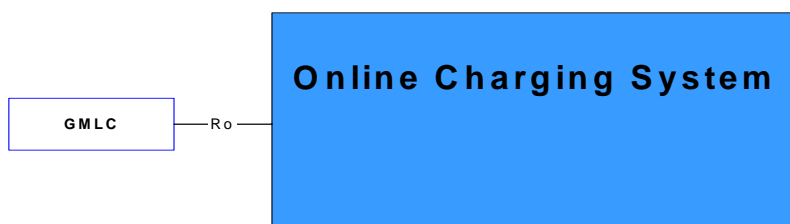

Figure 4.3.1: LCS online charging architecture

Details on the interfaces and functions can be found in TS 32.240 [1] for the general architecture components, TS 32.296 [53] for the OCS, and TS 32.299 [50] for the Ro application.

5 LCS charging principles and scenarios

Editor's note: Include a brief introduction statement saying that this clause contains the CDR and charging event types and their trigger conditions.

5.1 LCS charging principles

Charging information in the Service domain for LCS is collected for inter-operator charging purpose by the GMLC. The basic principle is that a network requesting location information may be charged by the network that provides the location information.

The GMLC shall collect the following charging information:

- Identity of the mobile subscriber to be located and of the entity requesting the location;
- Identity of the GMLC or PLMN serving the LCS Client;
- QoS Requested/Delivered: the charging information shall describe the quality of the location requested and delivered to the LCS client;
- Request Timestamp: the charging information shall record the date and time the location procedure was requested by the LCS client;
- Location services requested: the charging information shall describe the service types for which the LCS client is allowed to locate the particular UE;
- Usage of continuous/periodic tracking;
- Charging for Location Based Services (LBS): the charging information shall describe the service specific information in addition to the above location resource information.

The information listed above is captured for use cases in relation to:

- Mobile Originated Location Request;
- Mobile Terminated Location Request;
- Network Induced Location Request;

Refer to TS 23.271 [201] for further details on the above LCS transactions.

5.2 LCS offline charging scenarios

5.2.1 Basic principles

Editor's note: TBD.

5.2.2 Rf message flows

Not applicable, as the separation of the CTF and CDF is not in the scope of the LCS charging standards. Refer to clause 4.2 for further information.

NOTE: Vendors may nevertheless implement a separate CTF and CDF for LCS charging. In this case, it is recommended that the approach chosen conforms to the principles and protocol applications specified in TS 32.299 [50].

5.2.3 CDR Generation

5.2.3.0 Introduction

Editor's note: This clause shall also include the triggers of the CDR generation, the CDR types

The flows described in the present document specify the charging communications between the GMLC and the billing function for different charging scenarios. The LCS related messages associated with these charging scenarios are shown primarily for general information and to illustrate the charging triggers.

For the purpose of these examples, the following assumptions have been made:

- that the RAN location procedures are not depicted;
- that the CS and PS location procedures are not distinguished;
- that the LCS client has no privacy override capability;
- that the LCS charging procedures in the CS and the PS domains are not depicted

5.2.3.1 Mobile Originated Location Request (MO-LR)

MO-LR allows the UE to obtain its own geographical location or have its location information transferred to another LCS client. In this procedure, the R-GMLC, H-GMLC and V-GMLC are the same as no privacy checking is performed.

Figure 5.2.3.1.1 illustrates a MO-LR that allows a UE to request its own location.

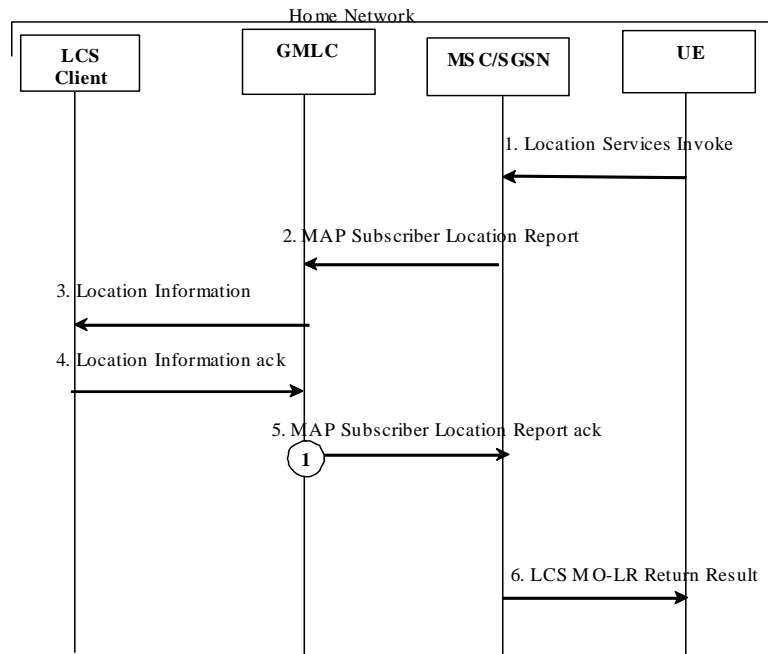

Figure 5.2.3.1.1: Record trigger overview for MO-LR

- 1) The MSC (or SGSN) receives a Location Service Invoke from the UE.
- 2) The MSC (or SGSN) forwards the Location result to the GMLC by sending a MAP Subscriber Location Report.
- 3) The GMLC transfers the location information to the LCS client.
- 4) The LCS Client sends to the GMLC the Location Information ack message signalling the result.
- 5) The GMLC acknowledges the MAP Subscriber Location Report and the associated MO-LR CDR is processed as specified in TS 32.297 [52].
- 6) The MSC (or SGSN) returns a Service Response message to the UE carrying any location estimate requested by the UE.

The record trigger associated to the MO-LR is called 'LCS GMLC Mobile Originated' (LCS-GMO)

5.2.3.2 Mobile Terminated Location Request (MT-LR)

MT-LR allows an external LCS client to ask for the location of a mobile subscriber (target UE). Figure 5.2.3.2.1 illustrates a MT-LR scenario:

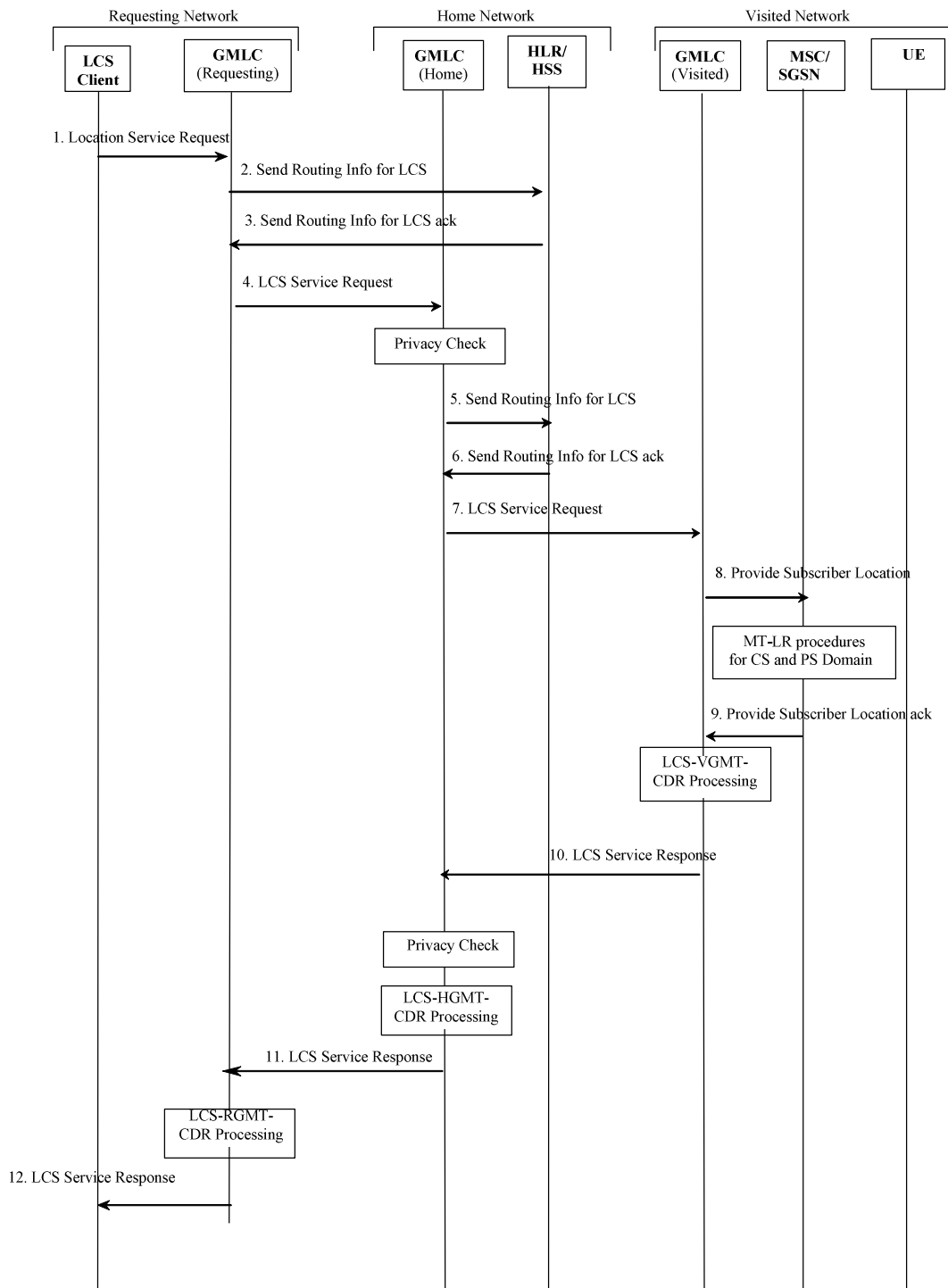

Figure 5.2.3.2.1: Record trigger overview for MT-LR

1. The external LCS client requests the location of a target UE from the R-GMLC.
2. The R-GMLC requests the H-GMLC address by sending a MAP Send Routing Info for LCS message to the home HLR/HSS of the target UE to be located.

3. The HLR/HSS returns a MAP Send Routing Info for LCS ack message that contains the H-GMLC address
4. The R-GMLC forwards the Location Service Request to the H-GMLC.
5. After performing privacy check, the H-GMLC requests the V-GMLC address by sending a MAP Send Routing Info for LCS message to the home HLR/HSS.
6. The HLR/HSS returns a MAP Send Routing Info for LCS ack message that contains the V-GMLC address.
7. The H-GMLC forwards the Location Service Request to the V-GMLC.
8. The V-GMLC forwards the Location request to the MSC or SGSN by sending a MAP Provider Subscriber Location Report.
9. After either a CS-MT-LR or PS-MT-LR was processed, the MSC or SGSN sends the acknowledgement of the MAP Provider Subscriber Location Report.

The associated LCS VGMT CDR is processed as specified in TS 32.297 [52].

10. The V-GMLC sends the location service response to the H-GMLC. After the H-GMLC has performed privacy check, the associated LCS HGMT CDR is processed as specified in TS 32.297 [52].
11. The H-GMLC sends the location service response to the R-GMLC and the associated LCS RGMT CDR is processed as specified in TS 32.297 [52].
12. The R-GMLC returns a Service Response message to the LCS client carrying any location estimate requested by the LCS client.

5.2.3.3 Network Induced Location Request (NI-LR)

NI-LR allows positioning for an emergency service call. Figure 5.2.3.3.1 illustrates a NI-LR scenario:

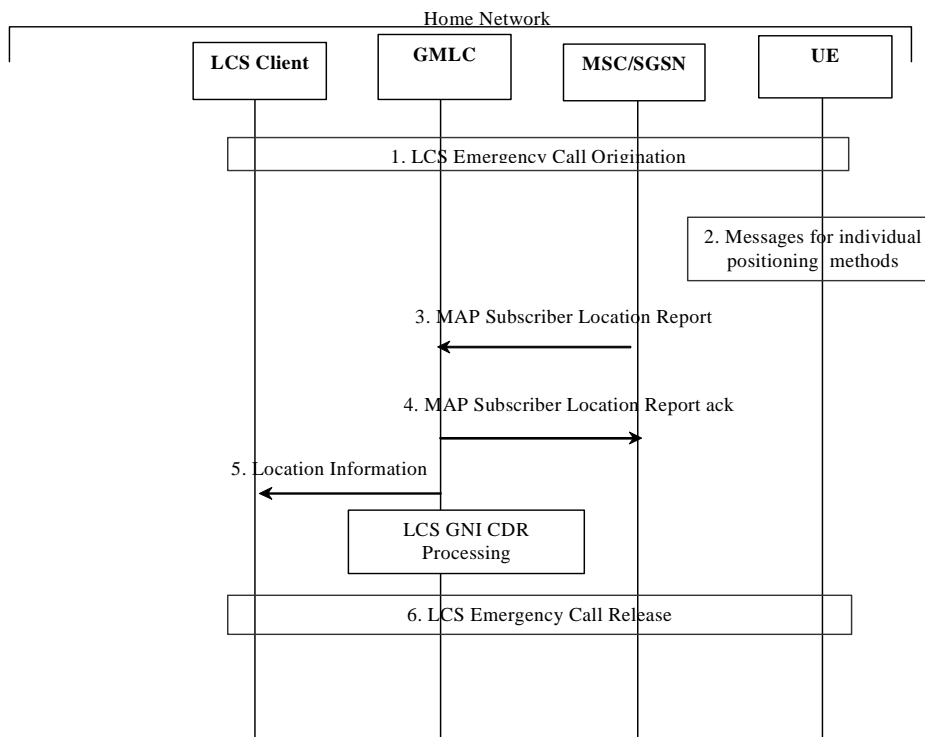

Figure 5.2.3.3.1: Record trigger overview for NI-LR

1. An emergency call procedure is initiated between the UE and the LCS client.
2. Positioning procedures are instigated.
3. The MSC (or SGSN) forwards the Location request to the GMLC by sending a MAP Subscriber Location Report.
4. The GMLC acknowledges the MAP Subscriber Location Report.
5. The GMLC transfers the location information to the LCS client and the associated LCS-GNI-CDR is processed as specified in TS 32.297 [52].
6. At some later time, the emergency services call is released.

5.2.4 Ga record transfer flows

Not applicable, as the separation of the CDF and CGF is not in the scope of the LCS charging standards. Refer to clause 4.2 for further information.

NOTE: Vendors may nevertheless implement a separate CDF and CGF for LCS charging. In this case, it is recommended that the approach chosen conforms to the principles and protocol applications specified in TS 32.295 [54].

5.2.5 BL CDR file transfer

The integrated CGF of the GMLC transfers the CDR files to the BD as described in TS 32.297 [52]. In LCS, both fully qualified partial CDRs (FQPC) and reduced partial CDRs (RPC), as specified in TS 32.240 [1] may be supported on the BI interface. In line with TS 32.240 [1], the support of FQPCs is mandatory, the support of RPCs is optional. For further details on the BI protocol application refer to TS 32.297 [52].

5.3 LCS online charging scenarios

5.3.0 General

LCS online charging uses the Debit / Reserve Units operation as specified in TS 32.299 [50].

5.3.1 Basic principles

Two cases for LCS online charging are distinguished:

- Immediate Event Charging (IEC); and
- Event Charging with Unit Reservation (ECUR).

In the case of IEC, granting units to the GMLC is performed in a single operation that also includes the deduction of the corresponding monetary units from the subscriber's account. The charging process is controlled by the corresponding credit control request which is sent for a given credit control event.

In contrast, ECUR also includes the process of requesting, reserving units and releasing and returning unused units. The deduction of the corresponding monetary units then occurs upon conclusion of the ECUR transaction. In this case, the credit control request is used to control the credit control session.

The GMLC may apply either IEC, where Debit / Reserve Units Request[Event] messages are generated, or ECUR, using Debit / Reserve Units Request[Initial, Update and Terminate]. The decision whether to apply IEC or ECUR is based on the service and/or operator's policy.

5.3.2 Ro message flows

5.3.2.0 General

The message flows described in the present document specify the charging communications between the GMLC and the Online Charging System (OCS) for different charging scenarios. The LCS messages associated with these charging

scenarios are shown primarily for general information and to illustrate the charging triggers that are also used for LCS offline charging.

5.3.2.1 Mobile Originated Location Request (MO-LR)

Figure 5.3.2.1.1 shows the Debit Units operation that are required between GMLC and OCS during the MO-LR. In this scenario the UE is the party to charge for the Location Request.

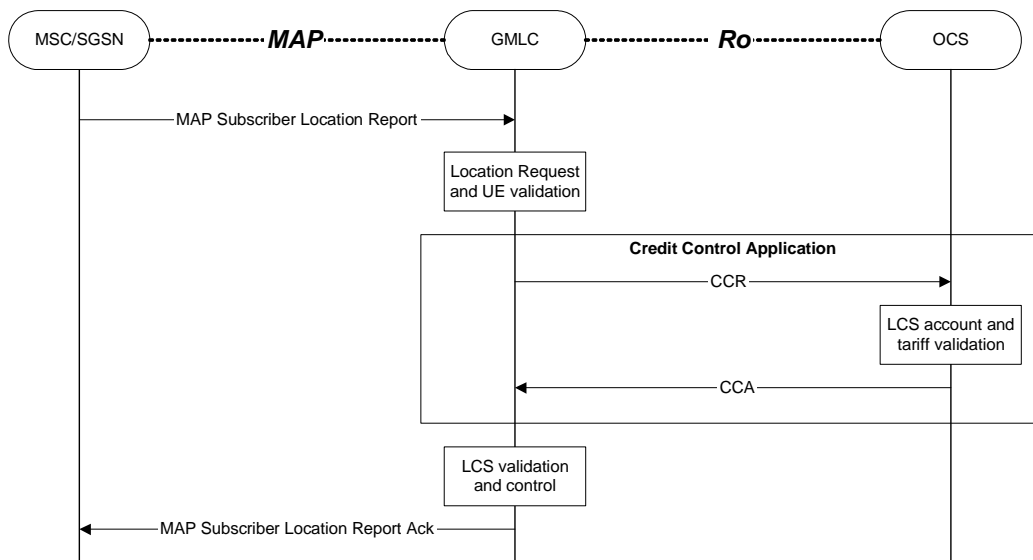

Figure 5.3.2.1.1: LCS online charging scenario for MO-LR

5.3.2.2 Mobile Terminated Location Request (MT-LR)

Figure 5.3.2.2.1 shows the Debit Units operation that are required between GMLC and OCS during the MT-LR .

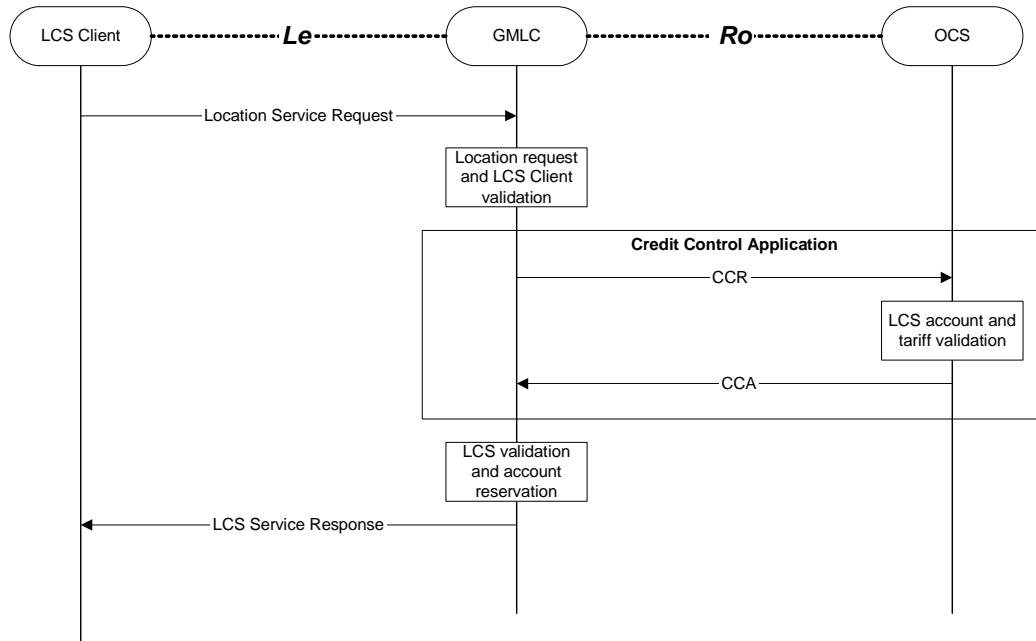

Figure 5.3.2.2.1: LCS online charging scenario for MT-LR

6 Definition of charging information

6.0 General

This clause provides Stage 3 specifications of the CDR type and content in line with the CDR type definitions provided in clause 5.2.3 and Diameter Credit-Control messages for LCS

6.1 Data description for LCS offline charging

6.1.0 Introduction

Dedicated types of CDRs can be generated for LCS by the GMLC. The content of each CDR type is defined in one of the tables that are part of this clause. For each CDR type the parameter definition includes the parameter name, description and category.

The GMLC's CGF shall be able to provide the CDRs at the Billing System interface in the format and encoding described in the present document. In LCS, both fully qualified partial CDRs (FQPC) and reduced partial CDRs (RPC), as specified in TS 32.240 [1] may be supported on the BI interface. In line with TS 32.240 [1], the support of FQPCs is mandatory, the support of RPCs is optional.

6.1.1 Rf message contents

Not applicable. Refer to clause 5.2.2 for further information.

6.1.2 Ga message contents

Not applicable. Refer to clause 5.2.3 for further information.

6.1.3 CDR description on the B_L interface

6.1.3.0 Introduction

This clause provides stage 3 specifications of the CDR type and content for the 3GPP LCS domain. For each of the CDR types, a parameter table, which gives a short description of the parameters, is provided. The category in the tables are used according to the charging data configuration defined in clause 5.4 of TS 32.240 [1]

The detailed specification of the CDR parameters and their encoding is contained in TS 32.298 [51], while TS 32.297 [52] specify the details of the CDR file transfer to the BD.

6.1.3.1 LCS records for Mobile Originated Location Request (LCS-GMO-CDR)

If enabled, a LCS GMLC Mobile Originated Charging Data Record (LCS-GMO-CDR) shall be produced for each MO-LR performed via the GMLC.

The fields in the record are specified in table 6.1.3.1.1, which provides a brief description of each field.

Table 6.1.3.1.1: LCS GMLC Mobile Originated CDR (LCS-GMO-CDR)

Field	Category	Description
Record Type	M	LCS GMLC Mobile Originated Record
Recording Entity	M	The E.164 address of this GMLC
LCS Client Type	C	The type of the LCS client that invoked the LR, if available.
LCS Client Identity	C	Further identification of the LCS client, if available.
Served IMSI	M	The IMSI of the subscriber that requests the location.
Served MSISDN	O _m	The primary MSISDN of the subscriber that requests the location.
Serving Entity	C	The E.164 address of the serving MSC (in case of CS-MO-LR) or SGSN (in case of PS-MO-LR)
Location Estimate	O _c	The location estimate for the subscriber if contained in geographic position and the LR was successful.
Positioning Data	C	The positioning method used or attempted, if available.
User Error	C	The Location Service type of error if any failure happened
Provider Error	O _c	The protocol related type of error if any failure happened
Record Time Stamp	O _m	Time of generation of the CDR
Local Record Sequence Number	O _m	Consecutive record number created by this node. The number is allocated sequentially including all CDR types.
Record extensions	O _c	A set of network/manufacture specific extensions to the record. Conditioned upon the existence of an extension.

6.1.3.2 LCS records for Mobile Terminated Location Request (MT-LR)

6.1.3.2.1 LCS records for Requesting GMLC (LCS-RGMT-CDR)

If enabled, a LCS Requesting GMLC Mobile Terminated Charging Data Record (LCS-RGMT-CDR) shall be produced for each MT-LR is performed via the R-GMLC.

The fields in the record are specified in table 6.1.3.2.1.1, which provides a brief description of each field.

Table 6.1.3.2.1.1: LCS Requesting GMLC Mobile Terminated CDR (LCS-RGMT-CDR)

Field	Category	Description
Record Type	M	LCS Requesting GMLC Mobile Terminated Record
Recording Entity	M	The E.164 address of this GMLC
Home GMLC Identity	C	If available, the IP address of the HGMLC involved in the location request
LCS Client Type	C	The type of the LCS client that invoked the LR, if available.
LCS Client Identity	C	Further identification of the LCS client, if available.
Target IMSI	M	The IMSI of the targeted LCS subscriber
Target MSISDN	O _m	The primary MSISDN of the targeted subscriber.
Location Type	M	The type of location information being requested.
LCS Priority	C	Priority of the LR, if available
Result Code	O _m	The result code that indicate the result of the request or individual positioning
Record Time Stamp	O _m	Time of generation of the CDR
Local Record Sequence Number	O _m	Consecutive record number created by this node. The number is allocated sequentially including all CDR types.
Record extensions	O _c	A set of network/manufacture specific extensions to the record. Conditioned upon the existence of an extension.

6.1.3.2.2 LCS records for Home GMLC (LCS-HGMT-CDR)

If enabled, a LCS Home GMLC Mobile Terminated Charging Data Record (LCS-HGMT-CDR) shall be produced for each MT-LR is performed via the H-GMLC.

The fields in the record are specified in table 6.1.3.2.2.1, which provides a brief description of each field.

Table 6.1.3.2.2.1: LCS Home GMLC Mobile Terminated CDR (LCS-HGMT-CDR)

Field	Category	Description
Record Type	M	LCS Home GMLC Mobile Terminated Record
Recording Entity	M	The E.164 address of this GMLC
Requesting GMLC Identity	C	If available, the IP address of the RGMLC involved in the location request
Visited GMLC Identity	C	If available, the IP address of the VGMLC involved in the location request
Serving Network Identity	O _c	MCC and MNC of the serving network used during this record, if available.
LCS Client Type	C	The type of the LCS client that invoked the LR, if available.
LCS Client Identity	C	Further identification of the LCS client, if available.
Target IMSI	M	The IMSI of the targeted LCS subscriber
Target MSISDN	O _m	The primary MSISDN of the targeted subscriber.
Location Type	M	The type of location information being requested.
LCS Priority	C	Priority of the LR, if available
Result Code	O _m	The result code that indicate the result of the request or individual positioning
Record Time Stamp	O _m	Time of generation of the CDR
Local Record Sequence Number	O _m	Consecutive record number created by this node. The number is allocated sequentially including all CDR types.
Record extensions	O _c	A set of network/manufacturer specific extensions to the record. Conditioned upon the existence of an extension.

6.1.3.2.3 LCS records for Visited GMLC (LCS-VGMT-CDR)

If enabled, a LCS Visited GMLC Mobile Terminated Charging Data Record (LCS-VGMT-CDR) shall be produced for each MT-LR is performed via the V-GMLC.

The fields in the record are specified in table 6.1.3.2.3.1, which provides a brief description of each field.

Table 6.1.3.2.3.1: LCS Visited GMLC Mobile Terminated CDR (LCS-VGMT-CDR)

Field	Category	Description
Record Type	M	LCS Visited GMLC Mobile Terminated Record
Recording Entity	M	The E.164 address of this GMLC
Home GMLC Identity	C	If available, the IP address of the HGMLC involved in the location request
LCS Client Type	C	The type of the LCS client that invoked the LR, if available.
LCS Client Identity	C	Further identification of the LCS client, if available.
Target IMSI	M	The IMSI of the targeted LCS subscriber
Target MSISDN	O _m	The primary MSISDN of the targeted subscriber.
Location Type	M	The type of location information being requested.
LCS Priority	C	Priority of the LR, if available
Result Code	O _m	The result code that indicate the result of the request or individual positioning
Record Time Stamp	O _m	Time of generation of the CDR
Local Record Sequence Number	O _m	Consecutive record number created by this node. The number is allocated sequentially including all CDR types.
Record extensions	O _c	A set of network/manufacturer specific extensions to the record. Conditioned upon the existence of an extension.

6.1.3.3 LCS Records for Network Initiated Location Request (LCS-GNI-CDR)

If enabled, a LCS GMLC Network Induced Charging Data Record (LCS-GNI-CDR) shall be produced for each NI-LR performed via the GMLC.

The fields in the record are specified in table 6.1.3.3.1, which provides a brief description of each field.

Table 6.1.3.3.1: LCS GMLC Network Induced CDR (LCS-GNI-CDR)

Field	Category	Description
Record Type	M	LCS GMLC Network Induced Record
Recording Entity	M	The E.164 address of this GMLC
LCS Client Type	C	The type of the LCS client that invoked the LR, if available.
LCS Client Identity	C	Further identification of the LCS client, if available.
Served IMSI	M	The IMSI of the subscriber that requests the location.
Served MSISDN	O _m	The primary MSISDN of the subscriber that requests the location.
Serving Entity	C	The E.164 address of the serving MSC (in case of CS-NI-LR) or SGSN (in case of PS-NI-LR)
Result Code	O _m	The result code that indicate the result of the request or individual positioning
Record Time Stamp	O _m	Time of generation of the CDR
Local Record Sequence Number	O _m	Consecutive record number created by this node. The number is allocated sequentially including all CDR types.
Record extensions	O _c	A set of network/manufacture specific extensions to the record. Conditioned upon the existence of an extension.

6.2 Data description for LCS online charging

6.2.1 Ro message contents

6.2.1.0 General

The *Debit Units / Reserve Units* operation for the "interim interrogation" and "final interrogation" reports the actual number of "units" that were used, from what was previously reserved. This determines the actual amount debited from the subscriber's account.

Table 6.2.1.0.1 describes the use of these messages for online charging.

Table 6.2.1.0.1: Online charging messages reference table

Message	Source	Destination
<i>Debit / Reserve Units Request</i>	GMLC	OCS
<i>Debit / Reserve Units Response</i>	OCS	GMLC

This clause describes the different Information Elements (IE) used in the *Debit / Reserve Units* messages and the charging data configuration defined in clause 5.4 of TS 32.240 [1].

6.2.1.1 *Debit / Reserve Units Request* message

Table 6.2.1.1.1 illustrates the basic structure of a *Debit / Reserve Units Request* message from GMLC as used for LCS online charging.

Table 6.2.1.1.1: *Debit / Reserve Units Request* message contents for LCS

Information Element	Category	Description
Session Identifier	M	Described in TS 32.299 [50]
Originator Host	M	Described in TS 32.299 [50]
Originator Domain	M	Described in TS 32.299 [50]
Destination Domain	M	Described in TS 32.299 [50]
Operation Identifier	M	Described in TS 32.299 [50]
Operation Token	M	Described in TS 32.299 [50]
Operation Type	M	Described in TS 32.299 [50]
Operation Number	M	Described in TS 32.299 [50]
Destination Host	O _c	Described in TS 32.299 [50]
User Name	O _c	Described in TS 32.299 [50]
Origination State	O _c	Described in TS 32.299 [50]
Origination Timestamp	O _c	Described in TS 32.299 [50]
Subscriber Identifier	O _M	Described in TS 32.299 [50]
Termination Cause	O _c	Described in TS 32.299 [50]
Requested Action	O _c	Described in TS 32.299 [50]
Multiple Operation	O _M	Described in TS 32.299 [50]
Multiple Unit Operation	O _c	Described in TS 32.299 [50]
Subscriber Equipment Number	O _c	Described in TS 32.299 [50]
Service Information	O _c	Holds the LCS service specific parameters. It is further described in the table below

NOTE: A full description and the detailed use of the Information Elements for GMLC and for each CCR request type (initial/update/termination/event) is specified in TS 32.299 [50].

6.2.1.2 Debit / Reserve Units Response message

Table 6.2.1.2.1 illustrates the basic structure of a *Debit / Reserve Units Response* message as used for LCS charging. This message is always used by the OCS as specified below, independent of the receiving GMLC and the *Debit / Reserve Units Request* type that is being replied to.

Table 6.2.1.2.1: Debit / Reserve Units Response message contents for LCS

AVP	Category	Description
Session Identifier	M	Described in TS 32.299 [50]
Operation Result	M	Described in TS 32.299 [50]
Originator Host	M	Described in TS 32.299 [50]
Originator Domain	M	Described in TS 32.299 [50]
Operation Identifier	M	Described in TS 32.299 [50]
Operation Type	M	Described in TS 32.299 [50]
Operation Number	M	Described in TS 32.299 [50]
User-Name	O _c	Described in TS 32.299 [50]
Origin-State-Id	O _c	Described in TS 32.299 [50]
Event-Timestamp	O _c	Described in TS 32.299 [50]
Operation Failover	O _c	Described in TS 32.299 [50]
Multiple Unit Operation	O _c	Described in TS 32.299 [50]
Operation Failure Action	O _c	Described in TS 32.299 [50]
Operation Event Failure Action	O _c	Described in TS 32.299 [50]
Redirection Host	O _c	Described in TS 32.299 [50]
Redirection Host Usage	O _c	Described in TS 32.299 [50]
Redirection Cache Time	O _c	Described in TS 32.299 [50]
Service Information	O _c	This field holds additional 3GPP service specific parameter. It is further described in the table below

6.3 LCS charging specific parameters

6.3.1 Definition of LCS charging information

6.3.1.0 General

The LCS Information parameter used for LCS charging is provided in the Service Information parameter.

6.3.1.1 LCS charging information assignment for Service Information

The components in the Service Information that are use for LCS charging can be found in Table 6.3.1.1.

Table 6.3.1.1.1: Service Information used for LCS Charging

Information Element	Category	Description
Service Information	O _M	A set of fields hold the 3GPP specific parameter as defined in TS 32.299 [50].
Subscriber Identifier	O _M	Used as defined in TS 32.260 [20].
LCS Information	O _M	This field holds a set of MMTel services with theirs specific parameters. The details are defined in clause 6.3.1.2.

6.3.1.2 Definition of the LCS Information

LCS specific charging information is provided within the LCS Information, and the detailed structure of the LCS Information can be found in table 6.3.1.2.1.

Table 6.3.1.2.1: Structure of the LCS Information

Information Element	Category	Description
LCS Client ID	O _c	This field holds the ID of the LCS client that invoked the LR, if available.
Location Type	O _c	This field holds the type of location information being requested in case of MT-LR.
Location Estimate	O _c	This field denotes the location of an MS in universal coordinates and the accuracy of the estimate upon succesful MO-LR.
Positioning Data	O _c	This field indicates the positioning method that was attempted to determine the location estimate for MO-LR, if available.

Annex A (informative): Bibliography

This Annex is a placeholder for documents which are not explicitly cited in this specification.

Annex B (informative): Change history

Change history									
Date	TSG #	TSG Doc.	CR	Rev	Subject/Comment	Cat	Old	New	
Sep 2003	SA_21	SP-030411	--	--	Submitted to TSG SA#21 for Information	--	1.0.0	1.1.0	
Dec 2004	SA_26	SP-040781	--	--	Submitted to TSG SA#26 for Approval	--	2.0.0	6.0.0	
Jun 2005	SA_28	SP-050278	0001	--	Add peer GMLC Identification and network ID to LCS CDRs	C	6.0.0	6.1.0	
Jun 2005	SA_28	SP-050278	0002	--	Correction to scope	F	6.0.0	6.1.0	
Jun 2005	SA_28	SP-050278	0003	--	Correction to references	F	6.0.0	6.1.0	
Sep 2005	SA_29	SP-050622	0004	--	Correct GMLC address used in LCS CDRs	F	6.1.0	6.2.0	
Jun 2007	SA_36	--	--	--	Automatic upgrade to Rel-7 (no CR) at freeze of Rel-7.	--	6.2.0	7.0.0	
Dec 2008	SA_42	SP-080841	0005	--	Correction on Multiple Service indication and parameter	F	7.0.0	7.1.0	
Dec 2008	SA_42	--	--	--	Upgrade to Release 8	--	7.1.0	8.0.0	
Dec 2009	-	-	-	-	Update to Rel-9 version (MCC)	-	8.0.0	9.0.0	
Dec 2010	SA_50	SP-100759	0006	2	Change the Title of Clause 6.1.1 to "Rf message contents"	F	9.0.0	10.0.0	
Jun 2012	SA_56	SP-120361	0012	3	Correction of Location Information field in LCS Charging	F	10.0.0	10.1.0	
2012-09	-	-	-	-	Update to Rel-11 version (MCC)	-	10.1.0	11.0.0	
2013-03	SA_59	SP-130054	0013	1	Correction of invalid reference to LCS offline charging architecture	F	11.0.0	11.1.0	
2013-03					Editorial changes on CDR tables (MCC)		11.1.0	11.1.1	
2014-07	-	-	-	-	Rapporteur/MCC: General editorial changes and clean-up.		11.1.1	11.1.2	
2014-09	SA_65	SP-140564	0014	1	Corrections for alignment between charging specifications	F	11.1.2	12.0.0	
2014-12	SA_66	SP-140804	0015	-	Additional corrections for removal of I-WLAN solution	F	12.0.0	12.1.0	
		SP-140805	0016	-	Corrections on definition for parameter category	F			
2016-01					Upgrade to Rel-13 (MCC)		12.1.0	13.0.0	

Change history								
Date	Meeting	TDoc	CR	Rev	Cat	Subject/Comment	New version	
2017-03	SA#75	SP-170138	0018	1	C	Remove reference to RFC 3588	14.0.0	

History

Document history		
V14.0.0	April 2017	Publication