

# ETSI TS 132 260 V11.19.0 (2017-07)



**Digital cellular telecommunications system (Phase 2+) (GSM);  
Universal Mobile Telecommunications System (UMTS);  
LTE;  
Telecommunication management;  
Charging management;  
IP Multimedia Subsystem (IMS) charging  
(3GPP TS 32.260 version 11.19.0 Release 11)**



---

Reference

RTS/TSGS-0532260vbj0

---

Keywords

GSM,LTE,UMTS

**ETSI**

650 Route des Lucioles  
F-06921 Sophia Antipolis Cedex - FRANCE

Tel.: +33 4 92 94 42 00 Fax: +33 4 93 65 47 16

Siret N° 348 623 562 00017 - NAF 742 C  
Association à but non lucratif enregistrée à la  
Sous-Préfecture de Grasse (06) N° 7803/88

---

**Important notice**

The present document can be downloaded from:

<http://www.etsi.org/standards-search>

The present document may be made available in electronic versions and/or in print. The content of any electronic and/or print versions of the present document shall not be modified without the prior written authorization of ETSI. In case of any existing or perceived difference in contents between such versions and/or in print, the only prevailing document is the print of the Portable Document Format (PDF) version kept on a specific network drive within ETSI Secretariat.

Users of the present document should be aware that the document may be subject to revision or change of status.

Information on the current status of this and other ETSI documents is available at

<https://portal.etsi.org/TB/ETSIDeliverableStatus.aspx>

If you find errors in the present document, please send your comment to one of the following services:

<https://portal.etsi.org/People/CommiteeSupportStaff.aspx>

---

**Copyright Notification**

No part may be reproduced or utilized in any form or by any means, electronic or mechanical, including photocopying and microfilm except as authorized by written permission of ETSI.

The content of the PDF version shall not be modified without the written authorization of ETSI.

The copyright and the foregoing restriction extend to reproduction in all media.

© ETSI 2017.

All rights reserved.

DECT™, PLUGTESTS™, UMTS™ and the ETSI logo are trademarks of ETSI registered for the benefit of its Members.

3GPP™ and LTE™ are trademarks of ETSI registered for the benefit of its Members and of the 3GPP Organizational Partners.

oneM2M logo is protected for the benefit of its Members.

GSM® and the GSM logo are trademarks registered and owned by the GSM Association.

---

## Intellectual Property Rights

IPRs essential or potentially essential to the present document may have been declared to ETSI. The information pertaining to these essential IPRs, if any, is publicly available for **ETSI members and non-members**, and can be found in ETSI SR 000 314: *"Intellectual Property Rights (IPRs); Essential, or potentially Essential, IPRs notified to ETSI in respect of ETSI standards"*, which is available from the ETSI Secretariat. Latest updates are available on the ETSI Web server (<https://ipr.etsi.org>).

Pursuant to the ETSI IPR Policy, no investigation, including IPR searches, has been carried out by ETSI. No guarantee can be given as to the existence of other IPRs not referenced in ETSI SR 000 314 (or the updates on the ETSI Web server) which are, or may be, or may become, essential to the present document.

---

## Foreword

This Technical Specification (TS) has been produced by ETSI 3rd Generation Partnership Project (3GPP).

The present document may refer to technical specifications or reports using their 3GPP identities, UMTS identities or GSM identities. These should be interpreted as being references to the corresponding ETSI deliverables.

The cross reference between GSM, UMTS, 3GPP and ETSI identities can be found under <http://webapp.etsi.org/key/queryform.asp>.

---

## Modal verbs terminology

In the present document "**shall**", "**shall not**", "**should**", "**should not**", "**may**", "**need not**", "**will**", "**will not**", "**can**" and "**cannot**" are to be interpreted as described in clause 3.2 of the [ETSI Drafting Rules](#) (Verbal forms for the expression of provisions).

"**must**" and "**must not**" are **NOT** allowed in ETSI deliverables except when used in direct citation.

# Contents

Intellectual Property Rights .....	2
Foreword.....	2
Modal verbs terminology.....	2
Foreword.....	6
1 Scope .....	7
2 References .....	8
3 Definitions, symbols and abbreviations .....	10
3.1 Definitions .....	10
3.2 Symbols.....	10
3.3 Abbreviations .....	11
4 Architecture Considerations .....	12
4.1 High level IP Multimedia Subsystem (IMS) architecture .....	12
4.2 IMS offline charging architecture.....	13
4.3 IMS online charging architecture .....	14
5 Charging Principles .....	15
5.1 IMS Charging Principles .....	15
5.1.1 IMS Charging applicability .....	15
5.1.2 IMS Charging Correlation .....	15
5.1.2.1 Basic Principles for IMS Domain Correlation .....	15
5.1.2.2 IMS Charging Identifier (ICID) .....	16
5.1.2.2A Related ICID .....	16
5.1.2.3 Access network charging identifier .....	16
5.1.2.4 Inter Operator Identifier (IOI).....	16
5.1.2.5 Void.....	17
5.1.2.6 IMS visited network identifier .....	17
5.1.3 SDP handling.....	17
5.1.4 Trigger conditions.....	17
5.1.5 IMS support of real-time tariff transfer.....	17
5.1.6 Served user identification .....	18
5.1.7 Single Charging session from AS/ATCF acting as B2BUA.....	18
5.1.8 Charging support for Roaming Architecture for Voice over IMS with Local Breakout.....	18
5.1.9 Charging support for Network provided Location information .....	19
5.1.9a Charging support for IMS transit scenarios .....	20
5.1.10 Charging support for TRF.....	20
5.2 IMS Offline Charging Principles.....	20
5.2.1 Basic Principles .....	20
5.2.2 Diameter message flows and types .....	21
5.2.2.1 Message Flows - Successful Cases and Scenarios .....	22
5.2.2.1.1 Session Establishment - Mobile Origination .....	22
5.2.2.1.2 Session Establishment - Mobile Termination.....	25
5.2.2.1.3 Mid-Session Procedures .....	26
5.2.2.1.4 Session Release - Mobile Initiated .....	28
5.2.2.1.5 Session-Unrelated Procedures .....	29
5.2.2.1.6 Session Establishment - PSTN Initiated.....	30
5.2.2.1.7 Session Establishment - IMS Initiated.....	31
5.2.2.1.8 Session Release - PSTN Initiated .....	32
5.2.2.1.9 Session Release - IMS Initiated.....	33
5.2.2.1.10 Multi-Party Call.....	34
5.2.2.1.11 AS Related Procedures - AS Acting as a Redirect Server .....	35
5.2.2.1.12 AS Related Procedures - AS Acting as a Voice Mail Server.....	37
5.2.2.1.13 AS Related Procedures - AS Acting as a SCC AS .....	38
5.2.2.1.13.1 UE originating call (PS only or CS only).....	38
5.2.2.1.13.2 UE originating call (PS and CS combined origination) .....	40

5.2.2.1.13.3	UE terminating call (PS only or CS only).....	43
5.2.2.1.13.4	UE terminating call (PS and CS combined origination) .....	45
5.2.2.1.13.5	Session transfer from PS to CS .....	48
5.2.2.1.13.6	Session transfer from CS to PS .....	50
5.2.2.1.13.7	Session transfer from PS to (CS+PS).....	53
5.2.2.1.13.8	Session transfer from (CS+PS) to PS.....	56
5.2.2.1.13.9	IMS Emergency Session transfer from PS to CS.....	59
5.2.2.1.14	Initiating Alternate Charged Party Call .....	62
5.2.2.1.15	Session Establishment via IBCF to S-CSCF - IMS Initiated.....	63
5.2.2.1.16	AS Related Procedures - AS Acting as a MMTel AS. ....	64
5.2.2.1.17	Session Establishment via IBCF to a third party AS providing tariff information in real time (RTTI) .....	64
5.2.2.1.18	Third party AS providing tariff information in real time (RTTI) during the session.....	65
5.2.2.1.19	Support of Optimal Media Routing (OMR) .....	66
5.2.2.1.19.1	IMS-ALG Related Procedures for OMR – Session establishment and IMS-ALG bypasses its local GW .....	67
5.2.2.1.19.2	IMS-ALG Related Procedures for OMR – Session establishment and alternate IP realm is selected .....	70
5.2.2.1.19.3	IMS-ALG Related Procedures for OMR – Mid-session procedure .....	72
5.2.2.1.19.4	IMS-ALG Related Procedures for OMR – transcoding.....	73
5.2.2.1.19.4.1	IMS-ALG Related Procedures for OMR – transcoder provided by IMS-ALG.....	73
5.2.2.1.19.4.2	IMS-ALG Related Procedures for OMR – transcoder offered by IMS-ALG but not selected.....	75
5.2.2.1.20	AS acting as a B2BUA – Single Charging session.....	77
5.2.2.1.21	Session Establishment for Roaming Architecture for Voice over IMS with Local Breakout .....	79
5.2.2.1.22	Service Continuity using ATCF .....	81
5.2.2.1.22.1	UE originating call (CS only) through ATCF.....	81
5.2.2.1.22.1A	UE originating call (PS only) through ATCF .....	83
5.2.2.1.22.2	UE terminating call (CS only) through ATCF.....	83
5.2.2.1.22.2A	UE terminating call (PS only) through ATCF .....	85
5.2.2.1.22.3	UE session transfer PS to CS using ATCF .....	86
5.2.2.1.22.4	UE session transfer CS to PS using ATCF .....	87
5.2.2.2	Message Flows - Error Cases and Scenarios.....	89
5.2.2.2.1	Session Related SIP Procedures- Reception of SIP error messages .....	89
5.2.2.2.2	Session Related SIP Procedures - SIP session failure .....	89
5.2.2.2.3	Session Unrelated SIP procedures.....	90
5.2.2.2.4	CDF Connection Failure.....	90
5.2.2.2.5	No Reply from CDF .....	90
5.2.2.2.6	Duplicate Detection.....	90
5.2.2.2.7	CDF Detected Failure.....	90
5.2.3	CDR generation .....	90
5.2.4	GTP' record transfer flows .....	90
5.2.5	Bi CDR file transfer.....	91
5.3	IMS Online Charging Scenarios.....	91
5.3.1	Basic Principles .....	91
5.3.2	Diameter Message Flows and Types .....	93
5.3.2.1	Immediate Event Charging (IEC) .....	93
5.3.2.1.1	Message Flows - Successful Cases and Scenarios.....	93
5.3.2.1.1.1	IEC – Debit Units Operation.....	93
5.3.2.1.1.2	Scenarios.....	94
5.3.2.1.2	Message Flows - Error Cases and Scenarios .....	94
5.3.2.1.2.1	Reception of SIP Error Messages .....	95
5.3.2.1.2.2	Debit Units Operation Failure.....	95
5.3.2.1.2.3	Duplicate Detection .....	95
5.3.2.2	Event Charging with Unit Reservation (ECUR) and Session Charging with Unit Reservation (SCUR) .....	95
5.3.2.2.1	Message Flows - Successful Cases and Scenarios.....	95
5.3.2.2.1.1	ECUR and SCUR - Reserve Units and Debit Units Operations .....	95
5.3.2.2.1.2	Expiration of Reservation Validity .....	95
5.3.2.2.1.3	Scenarios.....	96
5.3.2.2.1.3.1	Session Related Procedures (SCUR).....	97
5.3.2.2.1.3.2	Session Unrelated Procedures (ECUR).....	103

5.3.2.2.2	Message Flows - Error Cases and Scenarios .....	104
5.3.2.2.2.1	Reception of SIP Error Messages .....	104
5.3.2.2.2.2	Reserve Units and Debit Units Operation Failure .....	104
5.3.2.2.2.3	Duplicate Detection .....	104
5.3.2.2.2.4	Aborted Session Setup .....	104
5.3.2.3	IMS Service Termination by OCS .....	104
5.3.2.3.1	Triggers on Ro interface which imply the termination of the IMS service .....	104
5.3.2.3.2	Indication to the UE of the reason for IMS service release .....	105
6	Definition of charging information .....	106
6.1	Data description for IMS offline charging .....	106
6.1.1	Rf Message contents .....	106
6.1.1.1	Charging Data-Request Message .....	106
6.1.1.2	Charging Data Response Message .....	107
6.1.2	GTP' message contents .....	107
6.1.3	CDR Description on the Bi Interface .....	107
6.1.3.1	CDR Field Types .....	107
6.1.3.2	CDR Triggers .....	108
6.1.3.2.1	Session Related CDRs .....	108
6.1.3.2.2	Session Unrelated CDRs .....	108
6.1.3.3	S-CSCF CDR Content .....	109
6.1.3.4	P-CSCF CDR Content .....	114
6.1.3.5	I-CSCF CDR Content .....	119
6.1.3.6	MRFC CDR Content .....	121
6.1.3.7	MGCF CDR Content .....	125
6.1.3.8	BGCF CDR Content .....	129
6.1.3.9	SIP AS CDR Content .....	132
6.1.3.10	IBCF CDR Content .....	137
6.1.3.11	E-CSCF CDR Content .....	141
6.1.3.12	TRF CDR Content .....	145
6.1.3.13	ATCF CDR Content .....	149
6.1.3.14	TF CDR Content .....	154
6.2	Data description for IMS online charging .....	158
6.2.1	Ro message contents .....	158
6.2.1.1	Debit and Reserve Units Request Message .....	159
6.2.1.2	Debit and Reserve Units Response Message .....	160
6.3	IMS Charging Specific Parameters .....	161
6.3.1	Definition of IMS charging information .....	161
6.3.1.1	IMS charging information assignment for Service Information .....	161
6.3.1.2	Definition of the IMS Information .....	161
6.3.2	Detailed Message Format for offline charging .....	165
6.3.3	Detailed Message Format for online charging .....	169
6.3.4	Formal IMS charging parameter description .....	172
6.3.4.1	IMS charging information for CDRs .....	172
6.3.4.2	IMS charging information for charging events .....	172
<b>Annex A (informative):</b>	<b>Bibliography .....</b>	<b>173</b>
<b>Annex B (informative):</b>	<b>Message Flows for Service Termination by OCS .....</b>	<b>174</b>
B.1	Scenario 1 - Session Related (SCUR): Service Termination on reception of an initial SIP INVITE Request .....	174
B.2	Scenario 2 - Session Related (SCUR): Service Termination triggered after an early SIP Dialog is established .....	175
B.3	Scenario 3 - Session Related (SCUR): Service Termination triggered after a confirmed SIP Dialog is established .....	178
B.4	Scenario 4 - Session Unrelated (ECUR): Service Termination on reception of an initial SIP non-INVITE Request .....	181
B.5	Scenario 5 - Session Unrelated (IEC): Service Termination on reception of an initial SIP non-INVITE Request .....	182
<b>Annex C (informative):</b>	<b>Change history .....</b>	<b>183</b>
History .....		187

---

# Foreword

This Technical Specification has been produced by the 3<sup>rd</sup> Generation Partnership Project (3GPP).

The contents of the present document are subject to continuing work within the TSG and may change following formal TSG approval. Should the TSG modify the contents of the present document, it will be re-released by the TSG with an identifying change of release date and an increase in version number as follows:

Version x.y.z

where:

- x the first digit:
  - 1 presented to TSG for information;
  - 2 presented to TSG for approval;
  - 3 or greater indicates TSG approved document under change control.
- y the second digit is incremented for all changes of substance, i.e. technical enhancements, corrections, updates, etc.
- z the third digit is incremented when editorial only changes have been incorporated in the document.

---

# 1 Scope

The present document is part of a series of documents that specify charging functionality and charging management in GSM/UMTS networks. The GSM/UMTS core network charging architecture and principles are specified in document TS 32.240 [1], which provides an umbrella for other charging management documents that specify:

- the content of the CDRs per domain and subsystem (offline charging),
- the content of real-time charging events per domain / subsystem (online charging);
- the functionality of online and offline charging for those domains and subsystems;
- the interfaces that are used in the charging framework to transfer the charging information (i.e. CDRs or charging events)

The complete document structure for these TSs is defined in TS 32.240 [1].

The present document specifies the Offline and Online Charging description for the IP Multimedia Subsystem (IMS), based on the functional descriptions of the IMS in 3GPP TS 23.228 [200]. This charging description includes the offline and online charging architecture and scenarios specific to IMS, as well as the mapping of common 3GPP charging architecture specified in TS 32.240 [1] onto IMS. It further specifies the structure and content of the CDRs for offline charging, and the charging events for online charging. The present document is related to other 3GPP charging TSs as follows:

- The common 3GPP charging architecture is specified in TS 32.240 [1];
- The parameters, abstract syntax and encoding rules for these CDR types are specified in TS 32.298 [51].
- A transaction based mechanism for the transfer of CDRs within the network is specified in TS 32.295 [54].
- The file based mechanism used to transfer the CDRs from the network to the operator's billing domain (e.g. the billing system or a mediation device) is specified in TS 32.297 [52].
- The 3GPP Diameter application that is used for IMS offline and online charging is specified in TS 32.299 [50].

All terms, definitions and abbreviations used in the present document, that are common across 3GPP TSs, are defined in the 3GPP Vocabulary, TR 21.905 [100]. Those that are common across charging management in GSM/UMTS domains, services or subsystems are provided in the umbrella document TS 32.240 [1] and are copied into clause 3 of the present document for ease of reading. Finally, those items that are specific to the present document are defined exclusively in the present document.

Furthermore, requirements that govern the charging work are specified in 3GPP TS 22.115 [101].



---

## 2 References

The following documents contain provisions, which, through reference in this text, constitute provisions of the present document.

- References are either specific (identified by date of publication, edition number, version number, etc.) or non-specific.
- For a specific reference, subsequent revisions do not apply.
- For a non-specific reference, the latest version applies. In the case of a reference to a 3GPP document (including a GSM document), a non-specific reference implicitly refers to the latest version of that document *in the same Release as the present document*.

- [1] 3GPP TS 32.240: "Telecommunication management; Charging management; Charging architecture and principles".
- [2] 3GPP TS 32.250: "Telecommunication management; Charging management; Circuit Switched (CS) domain charging".
- [3] - [10] Void.
- [11] 3GPP TS 32.251: "Telecommunication management; Charging management; Packet Switched (PS) domain charging".
- [12] - [34] Void.
- [35] 3GPP TS 32.275: "Telecommunication management; Charging management; MultiMedia Telephony (MMTel) charging".
- [36] 3GPP TS 32.280: "Telecommunication management; Charging management; Advice of Charge (AoC) service".
- [37] - [49] Void.
- [50] 3GPP TS 32.299: "Telecommunication management; Charging management; Diameter charging application".
- [51] 3GPP TS 32.298: "Telecommunication management; Charging management; Charging Data Record (CDR) parameter description".
- [52] 3GPP TS 32.297: "Telecommunication management; Charging management; Charging Data Records (CDR) file format and transfer".
- [53] Void.
- [54] 3GPP TS 32.295: "Telecommunication management; Charging management; Charging Data Record (CDR) transfer".
- [55]- [99] Void.
- [100] 3GPP TR 21.905: "Vocabulary for 3GPP Specifications".
- [101] 3GPP TS 22.115: "Service aspects; Charging and billing".
- [102] Void.
- [103] 3GPP TS 23.002: "Network Architecture".
- [104] 3GPP TS 23.003: "Numbering, addressing and identification".
- [105]- [199] Void.
- [200] 3GPP TS 22.228: "IMS Stage 1".
- [201] 3GPP TS 23.228: "Functional stage 2 description of IMS".

- [202] 3GPP TS 24.228: "Signalling flows for the IP multimedia call control based on SIP and SDP, Stage 3"
- [203] 3GPP TS 23.218: "IP Multimedia (IM) session handling; IM call model; Stage 2".
- [204] 3GPP TS 24.229: "Internet Protocol (IP) multimedia call control protocol based on Session Initiation Protocol (SIP) and Session Description Protocol (SDP); Stage 3".
- [205] 3GPP TS 29.229: "Cx and Dx Interfaces based on the Diameter protocol; Protocol Details".
- [206] 3GPP TS 29.658: "SIP Transfer of IP Multimedia Service Tariff Information".
- [207] 3GPP TS 33.203 "3G security; Access security for IP-based services"
- [208] 3GPP TS 33.210 "3G security; Network Domain Security (NDS); IP network layer security"
- [209] 3GPP TS 33.310" Network Domain Security (NDS); Authentication Framework (AF) "
- [210] 3GPP TS 24.292: "IP Multimedia (IM) Core Network (CN) subsystem Centralized Services (ICS); Stage 3".
- [211] 3GPP TS 29.079: "Optimal Media Routeing within the IP Multimedia Subsystem;Stage 3".
- [212] 3GPP TS 23.167: "IP Multimedia Subsystem (IMS) emergency sessions".
- [213] 3GPP TS 23.203: "Policy and Charging Control architecture".
- [214] 3GPP TS 29.214: "Policy and Charging Control over Rx reference point".
- [215] 3GPP TS 29.328: "IP Multimedia (IM) Subsystem Sh Interface; Signalling flows and message contents".
- [216]- [218] Void.
- [219] 3GPP TS 23.292: "IP Multimedia Subsystem (IMS) centralized services; Stage 2".
- [220] - [299] Void.
- [300] - [399] Void.
- [400] Void.
- [401] IETF RFC 3588 (2003): "Diameter Base Protocol".
- [402] IETF RFC 4006: "Diameter Credit Control Application".
- [403] IETF RFC 2806: "URLs for Telephone Calls".
- [404] IETF RFC 3261: "SIP: Session Initiation Protocol".
- [405] IETF RFC 2486: "The Network Access Identifier".
- [406] RFC 7315 (January 2014): "Private Header (P-Header) Extensions to the Session Initiation Protocol (SIP) for the 3rd-Generation Partnership Project (3GPP)".
- [407] 3GPP TS 23.237: " IP Multimedia Subsystem (IMS) Service Continuity; Stage 2".
- [408] 3GPP TS 24.237: " IP Multimedia Subsystem (IMS) Service Continuity; Stage 3".

## 3 Definitions, symbols and abbreviations

### 3.1 Definitions

For the purposes of the present document, the following terms and definitions given in 3GPP TR 21.905 [50], 3GPP TS 32.240 [1], and the following apply:

**billing:** function whereby CDRs generated by the charging function are transformed into bills requiring payment.

**Billing Domain:** Part of the operator network, which is outside the core network that receives and processes charging information from the core network charging functions. It includes functions that can provide billing mediation and billing end applications.

**CDR field Categories:** the CDR fields are defined in the present document. They are divided into the following categories:

- **Mandatory:** field that shall be present in the CDR.
- **Conditional:** field that shall be present in a CDR if certain conditions are met.
- **Operator Provisionable: Mandatory:** A field that operators have provisioned to be included in the CDR for all conditions.
- **Operator Provisionable: Conditional:** A field that operators have provisioned to be included in the CDR if certain conditions are met.

**charged party:** user involved in a chargeable event that has to pay parts or the whole charges of the chargeable event, or a third party paying the charges caused by one or all users involved in the chargeable event, or a network operator.

**charging:** function whereby information related to a chargeable event is formatted and transferred in order to make it possible to determine usage for which the charged party may be billed.

**Charging Data Record (CDR):** record generated by a network element for the purpose of billing a subscriber for the provided service. It includes fields identifying the user, the session and the network elements as well as information on the network resources and services used to support a subscriber session. In the traditional circuit domain, CDR has been used to denote "Call Detail Record", which is subsumed by "Charging Data Record" hereafter.

**charging function:** entity inside the core network domain, subsystem or service that is involved in charging for that domain, subsystem or service.

**offline charging:** charging mechanism where charging information **does not** affect, in real-time, the service rendered

**online charging:** charging mechanism where charging information can affect, in real-time, the service rendered and therefore a direct interaction of the charging mechanism with session/service control is required

**partial CDR:** CDR that provides information on part of a subscriber session. A long session may be covered by several partial CDRs. Two formats are considered for Partial CDRs. One that contains all of the necessary fields; the second has a reduced format.

### 3.2 Symbols

For the purposes of the present document, the following symbols apply:

Bi	Reference point for the CDR file transfer from the IMS CGF to the BD.
Ga	Reference point for CDR transfer between a CDF and CGF.
Rf	Offline Charging Reference Point between an IMS Network Entity or an AS and CDF
Ro	Online Charging Reference Point between an AS or MRFC and IMS-GWF and the OCS

### 3.3 Abbreviations

For the purposes of the present document, the following abbreviations apply:

ABNF	Augmented Backus-Naur Form
ACA	Accounting Answer
ACR	Accounting Request
AS	Application Server
ATCF	Access Transfer Control Function
ATGW	Access Transfer Gateway
AVP	Attribute Value Pair
B2BUA	Back-to-Back User Agent
BGCF	Breakout Gateway Control Function
BS	Billing System
CCA	Credit Control Answer
CCF	Charging Collection Function
CCR	Credit Control Request
CDF	Charging Data Function
CDIV	Communication Diversion
CDR	Charging Data Record
CGF	Charging Gateway Function
CONF	Conference
CPCF	Content Provider Charging Function
CSCF	Call Session Control Function (I-Interrogating; P-Proxy; and S-Serving)
EATF	Emergency Access Transfer Function
ECF	Event Charging Function
ECUR	Event Charging with Unit Reservation
IBCF	Interconnect Border Control Function
IEC	Immediate Event Charging
IMS	IP Multimedia Subsystem
IMS-AGW	IMS Access Media Gateway
IMS-ALG	IMS - Application Level Gateway
IMS-GWF	IMS Gateway Function
IOI	Inter Operator Identifier
ISC	IMS Service Control
MGCF	Media Gateway Control Function
MMTel	MultiMedia Telephony
MRFC	Media Resource Function Controller
NNI	Network to Network Interface
MRFP	Multimedia Resource Function Processor
NetLoc	Network provided Location information
OCS	Online Charging System
OMR	Optimal Media Routing
RTTI	Real-time Transfer of Tariff Information
SCCF	Subscriber Content Charging Function
SCUR	Session Charging with Unit Reservation
SDP	Session Description Protocol
SIP	Session Initiation Protocol
TIP	Terminating Identity Presentation
TIR	Terminating Identity Restriction
TRF	Transit and Roaming Function
TrGW	Transition GateWay
UA	User Agent
UE	User Equipment
VCC	Voice Call Continuity
VDN	VCC Domain transfer Number

# 4 Architecture Considerations

## 4.1 High level IP Multimedia Subsystem (IMS) architecture

Figure 4.1 depicts the logical IMS architecture, as described in 3GPP TS 23.002 [103]

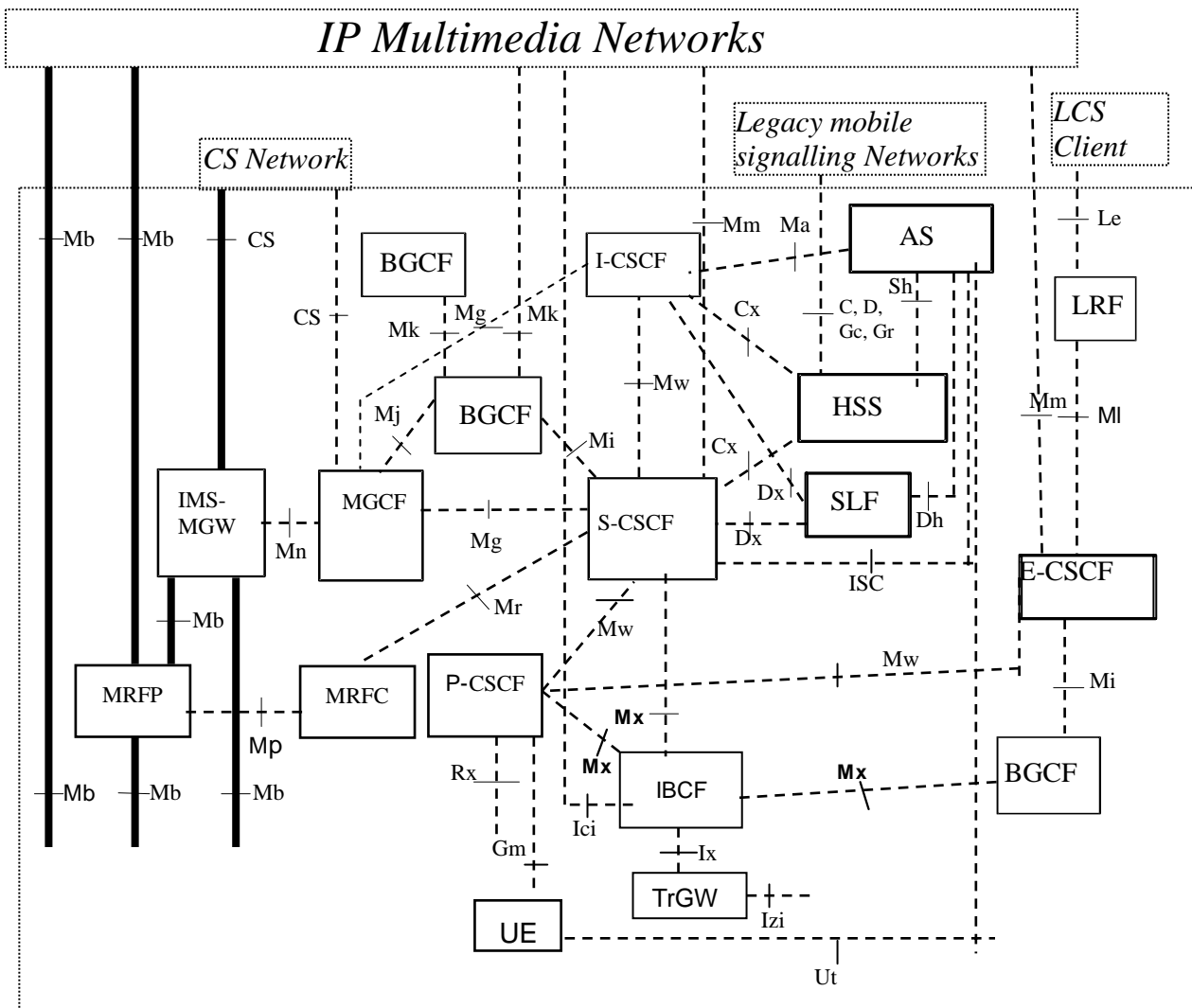

Figure 4.1: IMS logical architecture

## 4.2 IMS offline charging architecture

The architecture for IMS offline charging is described in the following figure. The Rf interface is described in clause 6.1.1 and Bi in clause 6.1.2.

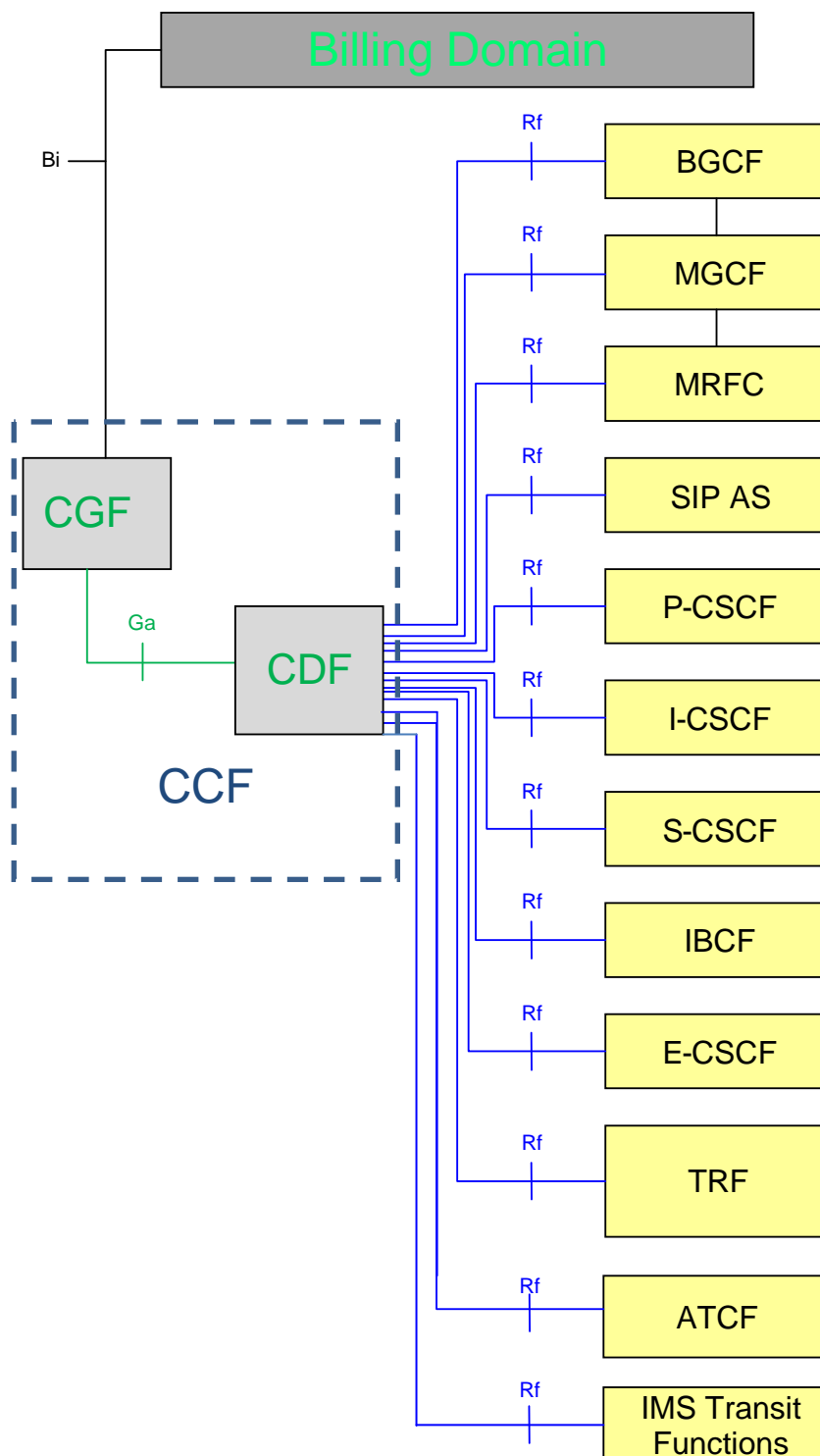

Figure 4.2: IMS offline charging architecture

## 4.3 IMS online charging architecture

The architecture for IMS online charging is described in the following figure. The Ro interface is described in clause 6.2 and ISC in TS 23.228 [201].

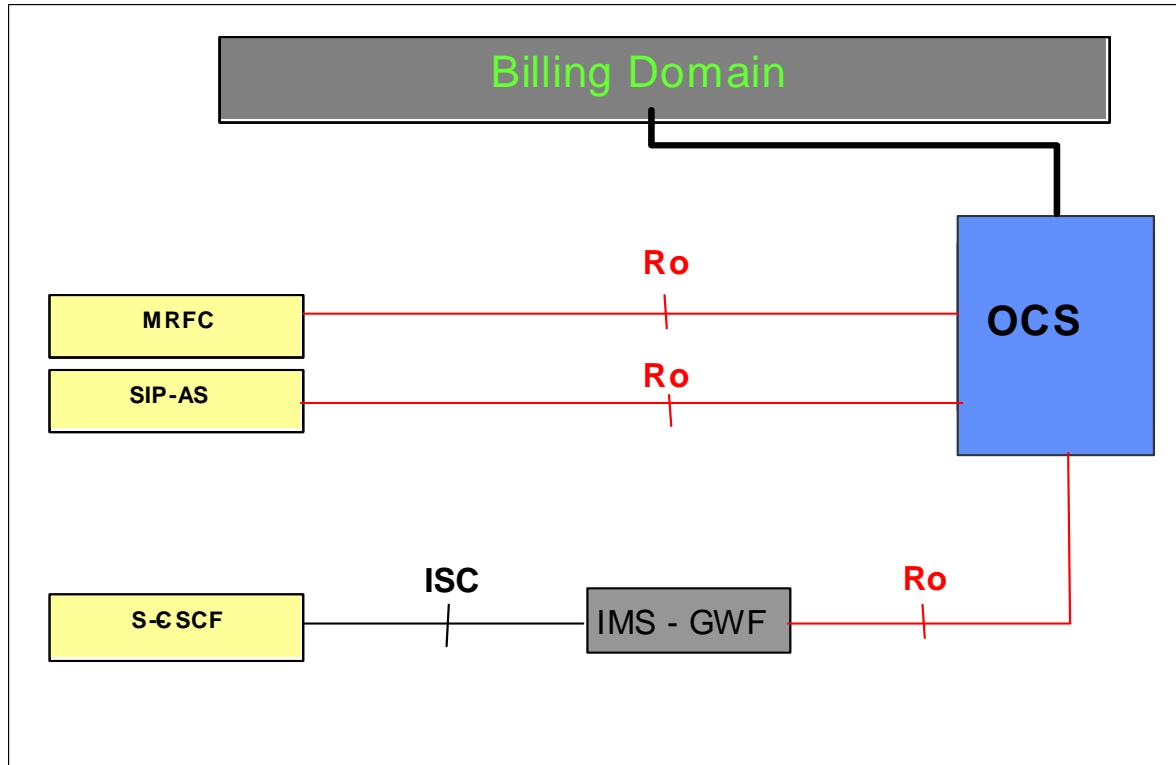

Figure 4.3: IMS online charging Architecture

---

## 5 Charging Principles

### 5.1 IMS Charging Principles

The IMS network elements shall maintain the integrity of all received or created charging-related information when forwarding the information to the offline and online charging systems, whatever the length of the value of any particular parameter is. For example, the IMS Charging Identifier (ICID) may be generated by one IMS network element (e.g. the P-CSCF) and forwarded to another IMS network element (e.g. the S-CSCF). Both may generate charging information and ensure that the data integrity is maintained, in order to make possible correlation based on the ICID.

#### 5.1.1 IMS Charging applicability

The AS and MRFC are able to distinguish whether to apply offline or online charging, i.e. whether to send charging information over the Rf interface to the CDF or over the Ro interface to the OCS, which includes ECF and SCF as described in chapter 4.3 (or to use both). The decision of which interface to use is based on the information (CDF and/or OCS address) the AS/MRFC receives in the SIP signalling and the system configuration as provisioned by the operator. If the AS/MRFC only receive the CDF address and do not receive an OCS address then they use only the Rf interface. If only the OCS address was provided then they use only the Ro interface. In cases where both CDF and OCS addresses are provided it is possible to use both interfaces simultaneously.

However, operators may overrule the addresses received via the SIP signalling and use their own configured rules instead. Operators may configure locally on the AS/MRFC an OCS and/or CDF address. The choice of whether the IMS network elements use locally configured addresses or the addresses received by SIP signalling, and the decision on which interface(s) to use, is left for operator configuration.

All other IMS network elements (S-CSCF, P-CSCF, I-CSCF, BGCF, IBCF, and MGCF) apply offline charging via the Rf interface using the CDF address as received via SIP signalling or the locally configured CDF address in the IMS network element. The S-CSCF supports online charging using:

- the ISC interface, i.e. if the application server addressed over ISC is the IMS Gateway Function, or
- the Ro interface directly instead of the ISC, if the IMS Gateway Function is integrated within the S-CSCF.

The offline and online charging function addresses transferred in SIP signalling are encoded in the P-Charging-Function-Addresses as defined in TS 24.229 [204] and RFC7315 [406]. The P-Charging-Function-Addresses header contains the following parameters: CCF (i.e. CDF) and ECF (i.e. OCS).

#### 5.1.2 IMS Charging Correlation

##### 5.1.2.1 Basic Principles for IMS Domain Correlation

The IMS charging correlation information is encoded in the SIP P-Charging-Vector header as defined in the following sub clauses. The P-Charging-Vector header contains the following parameters: ICID, access network charging identifier and IOI.

General correlation mechanisms are defined in TS 32.240 [1], and further details about the usage of P-Charging-Vector are defined in TS 24.229 [204], TS 24.292 [210], and RFC 7315 [406].

The enhanced MSC server for ICS charging in this specification refers the MSC server which performs IMS registration, as defined in TS 23.292 [219]. The enhanced MSC server for SRVCC charging in this specification refers the MSC server defined in TS 24.237 [408].



### 5.1.2.2 IMS Charging Identifier (ICID)

The IMS domain correlation is based on IMS Charging Identifier (ICID) shared between IMS network elements involved with the same session/transaction. With ICID it is possible to correlate session/transaction related charging data generated in different IMS elements (i.e. x-CSCFs, ASs'). The ICID is included in all SIP methods, if the P-Charging-Vector header is present, and transferred through originating and terminating side nodes, except to UE.

The value of the ICID parameter is identical with the 'icid-value' parameter defined in TS 24.229 [204]. The 'icid-value' is a mandatory part of the P-Charging-Vector and coded as a text-based UTF-8 charset (as are all SIP messages). For further information regarding the composition and usage of the P-Charging-Vector refer to [204] and RFC 7315 [406].

The ICID value is globally unique across all 3GPP IMS networks for a time period of at least one month, implying that neither the node that generated this ICID nor any other IMS network element reuse this value before the uniqueness period expires. The one month minimum uniqueness period counts from the time of release of the ICID, i.e. the ICID value no longer being used. This can be achieved by using node specific information, e.g. high-granularity time information and / or topology / location information. The exact method how to achieve the uniqueness requirement is an implementation issue.

At each SIP session unrelated method, both initial and subsequent (e.g., REGISTER, NOTIFY, MESSAGE etc.), a new, session unrelated ICID is generated at the first IMS network element that processes the method. This ICID value is contained in the SIP request and response of that SIP transaction and must be valid for the duration of the transaction.

At each SIP session establishment a new, session specific ICID is generated at the first IMS network element that processes the session-initiating SIP INVITE message. Enhanced MSC server will generate an ICID for ICS and SRVCC originated calls as described in TS 24.229 [204]. This ICID is then used in all subsequent SIP messages for that session (e.g., 200 OK, (re-)INVITE, BYE etc.) until the session is terminated.

#### 5.1.2.2A Related ICID

During the process of SRVCC access transfer, the Enhanced MSC server or the P-CSCF generates an ICID for the target access leg. For the purpose of charging correlation between the source access leg and the target access leg when the user is roaming the SCC AS and the ATCF includes the ICID used on the source access leg as the Related ICID for the target access leg as described in TS 24.229 [204]. This Related ICID is sent in the 1xx and 2xx responses to the initial INVITE as described in TS 24.237 [408].

### 5.1.2.3 Access network charging identifier

The access network charging identifier is the media flow level data shared among the IMS network elements for one side of the session (either the originating or terminating side). This information is used to correlate the access network charging data with the IMS charging data. The access network is identified by bearer specific correlation identifier, e.g. for Packet Switched Access (GGSN address and PDP context Identifier) or Fixed Broadband Access (Multimedia Charging Identifier). The access network charging identifier is populated in the P-Charging-Vector using the access-network-charging-info parameter. For further information regarding the composition and usage of the access-network-charging-info parameter refer to TS 24.229[204] and RFC 7315 [406].

### 5.1.2.4 Inter Operator Identifier (IOI)

The IOI identifies originating, terminating and transit networks involved in a session/transaction. The IOI may be generated from each side of session/transaction to identify the home networks associated with each side. The orig-ioi and term-ioi parameters of P-Charging-Vector represent the originating and terminating operator identifiers.

For interconnection scenarios in multi operator environments where one or more transit operators are between the originating and terminating operator, a list of Transit IOI values may occur additionally to identify involved transit operators. Due to operator policy, a transit operator may also hide his identity by adding a void value. Addition and deletion of transit IOI values are operator configurable. For further information regarding the composition and usage of the parameters refer to TS 24.229[204], TS 24.292 [210], and IETF RFC 7315 [406].

NOTE: No transit networks are expected between the S-CSCF and a 3<sup>rd</sup> party application server triggered by the initial filter criteria in the S-CSCF.

#### 5.1.2.5 Void

#### 5.1.2.6 IMS visited network identifier

The IMS visited network identifier identifies the visited network involved in a session/transaction. The IMS visited network identifier is available in the SIP P-Visited-Network-ID header of the REGISTER and should be used for all charging events associated with the user.

### 5.1.3 SDP handling

SDP information on SIP can have two different meanings; SDP offer or SDP answer. This is captured in the charging information by a SDP-type parameter that indicates if the SDP Media Component is an SDP offer or SDP answer. SDP offers can be sent by either the calling or called party and the Media Initiator Flag identifies who sent the first SDP offer in a SDP negotiation. SDP can be negotiated more than once in an SIP INVITE or RE-INVITE dialog.

Each occurrence of the List of SDP Media Components in the corresponding CDRs may include either SDP offer or SDP answer. For the first negotiation, the SDP answer defines which media are used in the session, therefore it shall be recorded in case of successful session setup. Additionally the corresponding SDP offer may be recorded. In case of unsuccessful session setup the SDP offer may be recorded, if available.

When session re-negotiations occur, multiple occurrences of List of SDP Media Components may be used to include a series of SDP negotiations in which each occurrence holds an SDP offer or SDP answer as for the first SDP negotiation.

### 5.1.4 Trigger conditions

This chapter contains the details for trigger conditions listed in table 5.2.1.1 for Offline Charging messages (ACR) and 5.3.1.1 for Online Charging messages (CCR) triggered by SIP Methods or ISUP Messages for all IMS nodes except for MRFC and AS.

The I-CSCF and BGCF, which need not be present in the signalling path for subsequent requests after the first SIP INVITE, do not support session based charging using ACR [Start, Interim, and Stop]. In these (and only in these) IMS network elements, successful session set-up completion triggers ACR [Event]. Use of session based charging when the I-CSCF or the BGCF is call stateful is not described in this release.

The initial registration, user-initiated reregistration, and user-initiated de-registration chargeable events relate to SIP REGISTER to trigger ACR [Event]/CCRs, while network-initiated deregistration event relates to SIP NOTIFY to trigger ACR [Event]/CCRs provided that subscription to registration events has been applied (see TS 24.229 [204]).

If at the time when the SIP 200 OK is received only the SDP offer is available, the CTF may trigger ACR [Start] immediately (subsequent SIP ACK containing the SDP answer triggers ACR [Interim]) or may trigger ACR [Start] once the SIP ACK has been received. The precise behaviour shall depend on operator policy.

### 5.1.5 IMS support of real-time tariff transfer

The TS 29.658 [206] describes the Real-time Transfer of Tariff Information (RTTI) in SIP. The RTTI may be supported for the requested service (e.g. tariff information of a value added service residing in the called network or in a specific Application Server).

According to the procedures described in the TS 29.658 [206], tariff information may be included in the content body of the following SIP messages: 1xx provisional response or 200 OK at session setup, mid-dialog requests or responses. The following IMS network elements, IBCF, MGCF, S-CSCF and AS may pass tariff information and record the tariff

information in the corresponding CDRs for IMS offline charging. For online charging, the AS and the IMS-GWF may send charging information related to the content body of RTTI message over Ro interface to the OCS.

The following security mechanisms shall be used for RTTI:

- IBCF shall accept RTTI information only from trusted IMS networks and filter out RTTI information from non trusted IMS networks.
- If RTTI information has to be sent over unsecure domain networks, the security of the domains interconnection shall rely on Network Domain Security specifications: TS 33.210 [208] and TS 33.310 [209].
- The S-CSCF responsible for the handling of RTTI messages shall follow the common IMS security specification TS 33.203 [207] to protect against malicious UE that try to bypass the P-CSCF.

### 5.1.6 Served user identification

Subscriber Identifier is an Information Element used in both online and offline charging information to identify the served user for the specific leg of an IMS session. A list of Subscription Id(s) for IMS CDR shall contain the Public user Id(s) for the served user.

In the case when the served user is obtained from the P-Header P-Served-User (can be available in P-CSCF, S-CSCF and AS) then it shall also be used as Subscription-Id in both online and offline charging.

### 5.1.7 Single Charging session from AS/ATCF acting as B2BUA

When a session-initiating SIP INVITE message is received by an AS/ATCF, this AS/ATCF, per application logic needs, acting as a B2BUA, may decide IMS Charging Identifier (ICID) for the outgoing dialog to be the same as received or different.

In case the same IMS Charging Identifier (ICID) is preserved between incoming and outgoing dialog by the AS/ATCF acting as a B2BUA, a single charging session for both dialogs can be created by this AS/ATCF. This option, referred-to as "OneChargingSession" in the different descriptions, is applicable per Operator configuration.

### 5.1.8 Charging support for Roaming Architecture for Voice over IMS with Local Breakout

The Roaming Architecture for Voice over IMS with Local Breakout is described in the TS 23.228 [201]. The corresponding Charging principles are defined in the TS 32.240 [1]. In the present document, charging support for the Transit and Roaming Function (TRF) requisite for Roaming Architecture for Voice over IMS with Local Breakout is rendered by presuming collocation or standalone.

Figure 5.1.7 shows an example for possible signalling and media flows in a Roaming Architecture for Voice over IMS with Local Breakout.

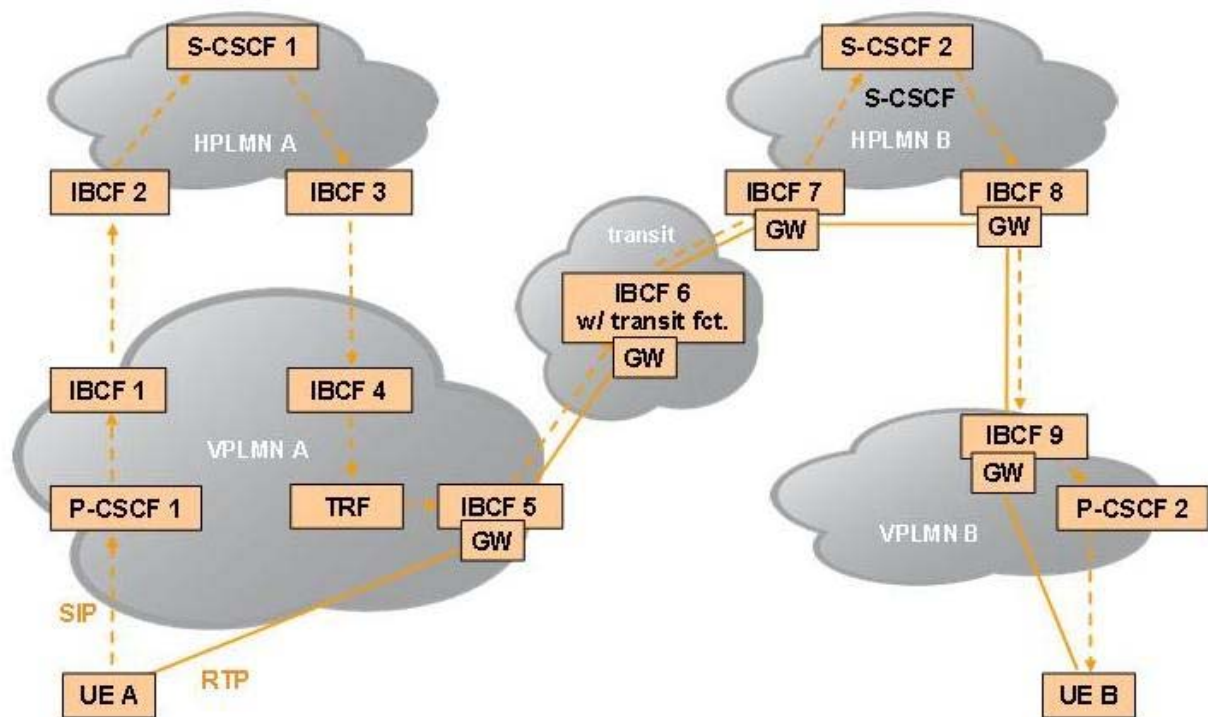

**Figure 5.1.7: Signalling and media flows in a Roaming Architecture for Voice over IMS with Local Breakout (Example)**

### 5.1.9 Charging support for Network provided Location information

The Network provided Location information (NetLoc) is described in the TS 23.228 [201] and for emergency service request using PCC-based solutions for the UE location in mobile networks in TS 23.167 [212]. In some scenarios, an AS can also detect emergency service and obtain the UE location using HSS-based solutions in TS 23.167 [212].

Based on operator policies and the availability of the user location information and/or UE Time Zone from the access network, the solution ensures that relevant SIP messages contain the correct or up to date information about the user location information, and/or UE Time Zone provided by the access network and currently used by the UE.

For the 3GPP access networks, the P-CSCF can retrieve user location information and/or UE Time Zone related to the access network currently used by the UE using PCC mechanisms, as specified in TS 23.203 [213] and TS 29.214 [214]. In some scenarios, an AS can also obtain location information using HSS-based solutions in TS 29.328 [215].

For fixed networks, the P-CSCF is aware of the network provided location information through signalling with the NASS.

As specified in TS 24.229 [204], clause 7.2A.4.3, the network provided location information is transported in the SIP P-Access-Network-Info header with an “np” parameter and indicates details of where the UE is currently located (i.e., SAI, TAI, RAI, CGI, ECGI or access-specific user location information) as defined in TS 23.228 [214].

In the defined CDRs, the network provided location information for 3GPP accesses is directly available in the User Location Info field. For non-3GPP accesses, the network provided location information should be available in the Access Network Information field..

## 5.1.9a Charging support for IMS transit scenarios

The IMS transit network scenarios are described in the TS 23.228 [201] and may require additional functionalities provided by the IMS transit functions. When residing in a stand-alone entity, the IMS Transit Functions may apply offline charging. Applicable fields for the IMS transit functions are in table 6.3.2.1.

## 5.1.10 Charging support for TRF

In order to support traffic for the Roaming Architecture for Voice over IMS with Local Breakout, IMS Transit Functions are enhanced with additional routing functionality, both combined in a Transit and Roaming Function (TRF) and defined in TS 23.228 [201]. Depending on the transit operator configuration, these functions might reside in a stand-alone entity or be collocated with an existing IMS Network Element.

When residing in a stand-alone entity, the TRF may apply offline charging.

When collocated with an existing IMS Network Element, charging information for the TRF is combined with charging information of the corresponding IMS Network Element. Applicable fields are in table 6.3.2.1.

# 5.2 IMS Offline Charging Principles

## 5.2.1 Basic Principles

The offline charging functionality is based on the IMS network nodes reporting accounting information upon reception of various SIP methods or ISUP messages, as most of the accounting relevant information is contained in these messages. This reporting is achieved by sending Diameter *Accounting Requests* (ACR) [Start, Interim, Stop and Event] from the IMS network elements to the CDF.

The Diameter client uses ACR Start, Interim and Stop in procedures related to successful SIP sessions. It uses ACR Events for unsuccessful SIP sessions and for session unrelated procedures. Further details are specified in the tables below and in clause 5.2.2.

It is operator configurable in the nodes for which SIP method or ISUP messages an *Accounting Request* is sent. Table 5.2.1.1 describes all possible ACRs that might be sent from a P-CSCF, I-CSCF, S-CSCF, IBCF, MGCF or BGCF. A list of node specific ACRs, along with the AVPs to be included are detailed in TS 32.299 [50].

The ACRs to be sent from a MRFC are described in table 5.2.1.2.

It is configurable for the operators to enable or disable the generation of an ACR message by the IMS node in response to a particular "Triggering SIP Method /ISUP Message".

**Table 5.2.1.1: Accounting Request Messages Triggered by SIP Methods or ISUP Messages for all IMS nodes except for MRFC and AS**

Diameter Message	Triggering SIP Method /ISUP Message
ACR [Start]	SIP 2xx acknowledging an initial SIP INVITE
	SIP ACK acknowledging an initial SIP INVITE
	ISUP:ANM (applicable for the MGCF)
ACR [Interim]	SIP 2xx acknowledging a SIP RE-INVITE or SIP UPDATE [e.g. change in media components]
	SIP ACK acknowledging an initial SIP INVITE or a SIP RE-INVITE
	Expiration of AVP [Acct-Interim-Interval]
	SIP 1xx provisional response, mid-dialog requests, mid-dialog responses and SIP INFO embedding RTTI XML body (applicable for the S-CSCF and IBCF).
	ISUP charging ASE (applicable for the MGCF).
	SIP Response (4xx, 5xx or 6xx), indicating an unsuccessful SIP RE-INVITE or SIP UPDATE
	SIP BYE message (both normal and abnormal session termination cases)
ACR [Stop]	ISUP:REL (applicable for the MGCF)
	SIP 2xx acknowledging non-session related SIP messages, which are:
ACR [Event]	SIP NOTIFY
	SIP MESSAGE
	SIP REGISTER
	SIP SUBSCRIBE
	SIP PUBLISH
	SIP REFER
	SIP 2xx acknowledging an initial SIP INVITE (BGCF only)
	SIP Final/Redirection Response 3xx
	SIP Final Response (4xx, 5xx or 6xx), indicating an unsuccessful SIP session set-up
	SIP Final Response (4xx, 5xx or 6xx), indicating an unsuccessful session-unrelated procedure
	SIP CANCEL, indicating abortion of a SIP session set-up
	I-CSCF completing a Cx Query that was issued in response to a SIP INVITE

**Table 5.2.1.2: Accounting Request Messages Triggered by SIP Methods for the MRFC**

Diameter Message	Triggering SIP Method
ACR [Start]	SIP 2xx acknowledging an SIP INVITE for initiating a multimedia ad hoc conferencing session
ACR [Interim]	SIP ACK acknowledging a SIP INVITE to connect an UE to the conferencing session
	SIP REINVITE (see Note 1)
	SIP BYE (see Note 2)
	Expiration of AVP [Acct-Interim-Interval]
ACR [Stop]	SIP BYE message (see Note 3)
	SIP CANCEL (see Note 3)
	SIP Final Response with error codes 4xx, 5xx or 6xx indicating termination of an ongoing session (see Note 3)
NOTE 1: This trigger only applies to a user joining an ongoing conferencing session	
NOTE 2: This trigger only applies to a user leaving an ongoing conferencing session	
NOTE 3: This trigger only applies if this causes the ongoing conferencing session to terminate	

## 5.2.2 Diameter message flows and types

The flows described in the present document specify the charging communications between IMS entities and the charging functions for different charging scenarios. The SIP messages and Diameter transactions associated with these charging scenarios are shown primarily for general information and to illustrate the charging triggers. They are not

intended to be exhaustive of all the SIP message flows discussed in TS 24.228 [200] and they depend on the Diameter Accounting Requests triggers configured by the operator.

### 5.2.2.1 Message Flows - Successful Cases and Scenarios

#### 5.2.2.1.1 Session Establishment - Mobile Origination

The following figure shows the Diameter transactions that are required between CSCF and CDF during session establishment originated by a UE.

##### Scenario 1: Successful Session Establishment

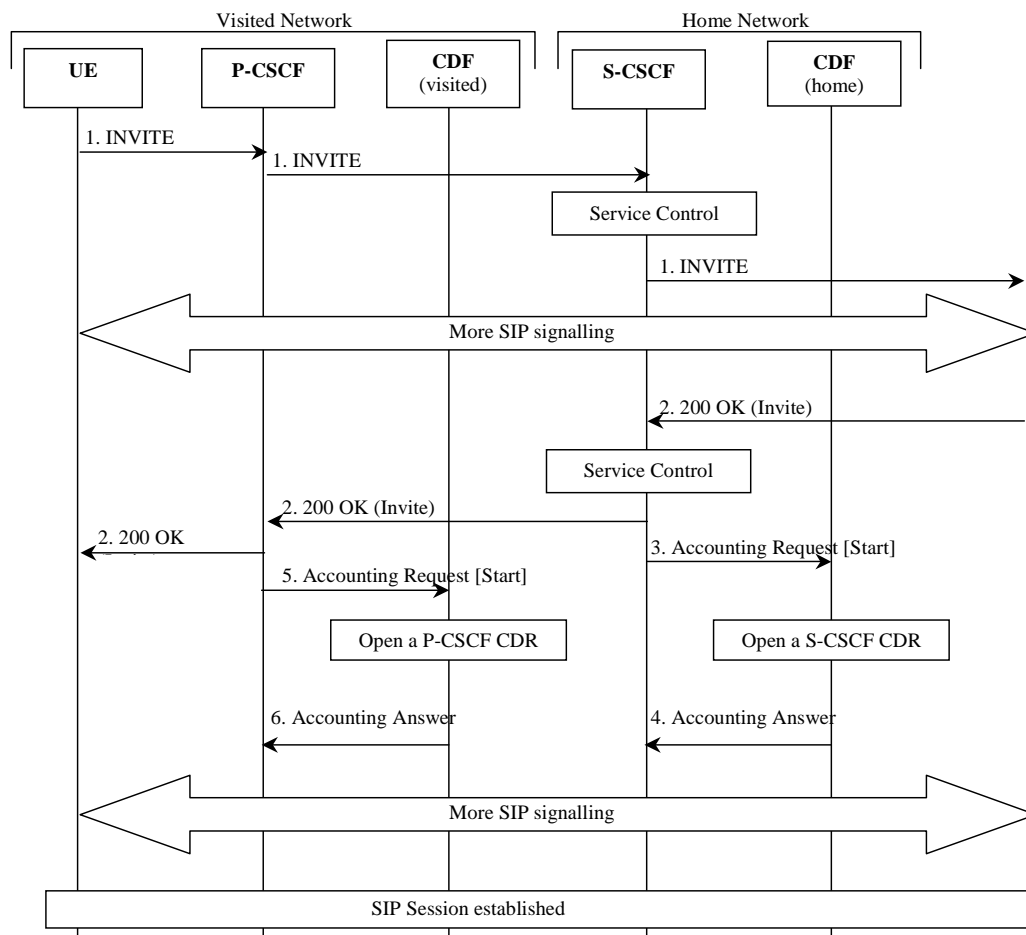
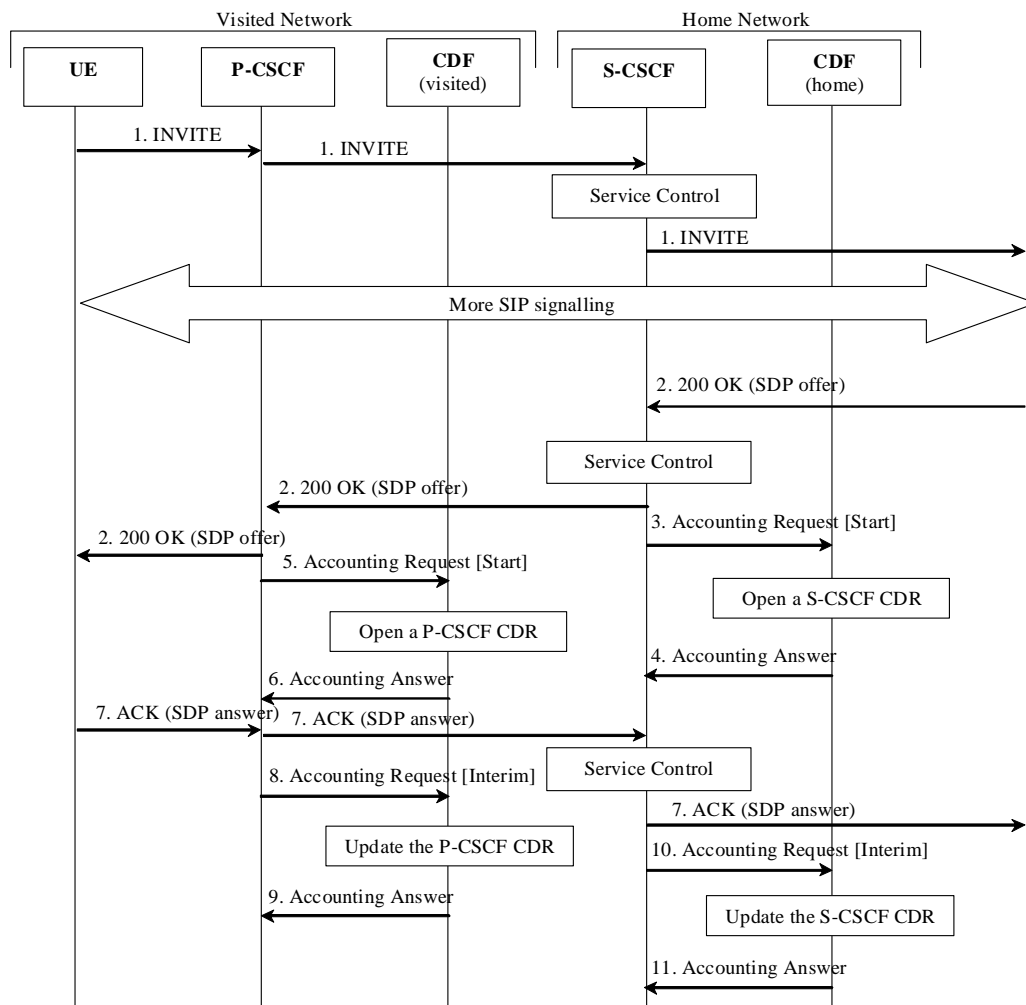

**Figure 5.2.2.1.1-1: Message Sequence Chart for Session Establishment (Mobile Origination)**

1. The session is initiated.
2. The destination party answers and a final response are received.
3. Upon reception of the final response, the S-CSCF sends an *Accounting-Request* with *Accounting-Record-Type* indicating *START\_RECORD* to record start of a user session and start of a media component in the S-CSCF CDR.
4. The CDF acknowledges the reception of the data and opens an S-CSCF CDR.
5. Same as 3, but for P-CSCF.
6. Same as 4, but creating a P-CSCF CDR.

Scenario 2: Successful Session Establishment with late SDP Answer (SIP 200 OK triggering ACR)

The following figure shows the Diameter transactions that are required between CSCF and CDF during session establishment originated by a UE.



**Figure 5.2.2.1.1-2: Message Sequence Chart for Session Establishment (SIP 200 OK triggering ACR) - Mobile Origination**

1. The session is initiated.
2. The destination party answers and a response are received.
3. Upon reception of the SIP 200 OK, the S-CSCF sends an *Accounting-Request* with *Accounting-Record-Type* indicating *START\_RECORD* to record start of a user session and start of a media component in the S-CSCF CDR.
4. The CDF acknowledges the reception of the data and opens an S-CSCF CDR.
5. Same as 3, but for P-CSCF.
6. Same as 4, but creating a P-CSCF CDR.
7. - 11. These steps are identical to steps 3. -7. of scenario 2 described in clause 5.2.2.1.3.



Scenario 3: Successful Session Establishment with late SDP Answer (SIP ACK triggering ACR)

The following figure shows the Diameter transactions that are required between CSCF and CDF during session establishment originated by a UE.

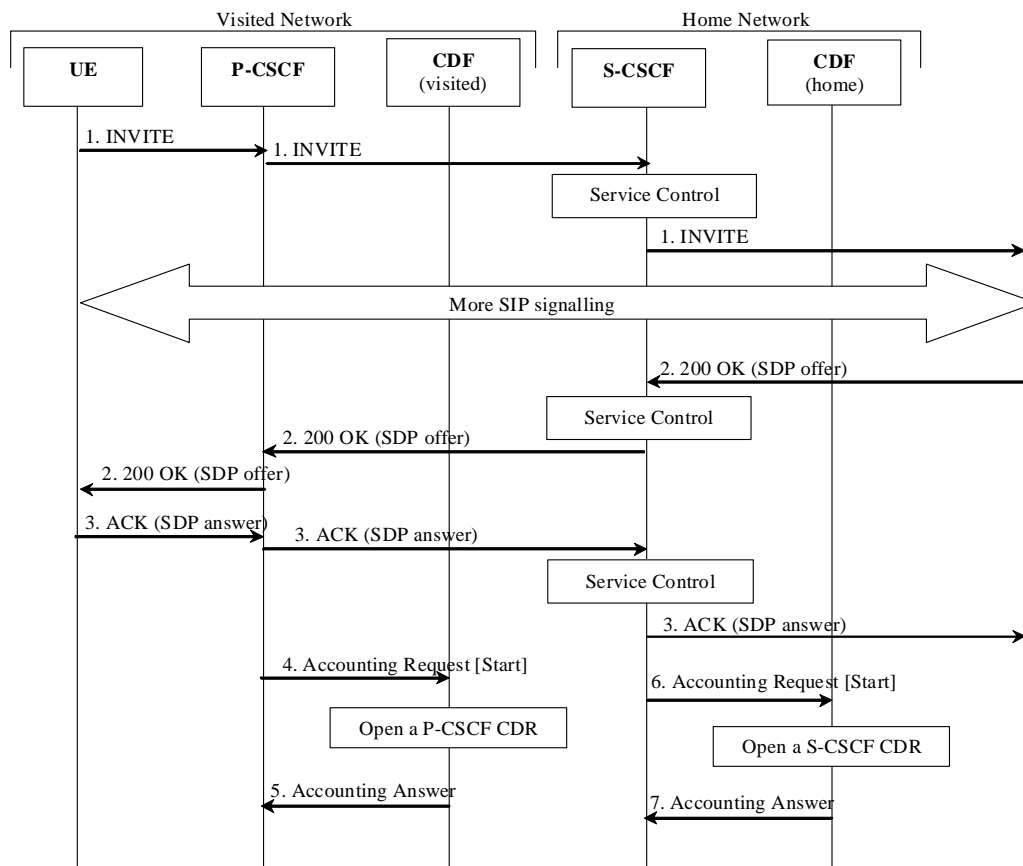

**Figure 5.2.2.1.1-3: Message Sequence Chart for Session Establishment (SIP ACK triggering ACR) - Mobile Origination**

1. The session is initiated.
2. The destination party answers and a final response are received. If the final response includes a SDP offer only, then the CSCF shall wait for the SIP ACK.
3. The SIP ACK including the SDP answer is received.
4. Upon reception of the SIP ACK, the P-CSCF sends an *Accounting-Request* with *Accounting-Record-Type* indicating *START\_RECORD* to record start of a user session and start of a media component in the P-CSCF CDR.
5. The CDF acknowledges the reception of the data and opens an P-CSCF CDR.
6. Same as 4, but for S-CSCF.
7. Same as 5, but creating a S-CSCF CDR.

5.2.2.1.2 Session Establishment - Mobile Termination

The following figure shows the Diameter transactions that are required between CSCF and CDF during a session establishment that is terminated to a mobile. The I-CSCF is only involved in the INVITE transaction.

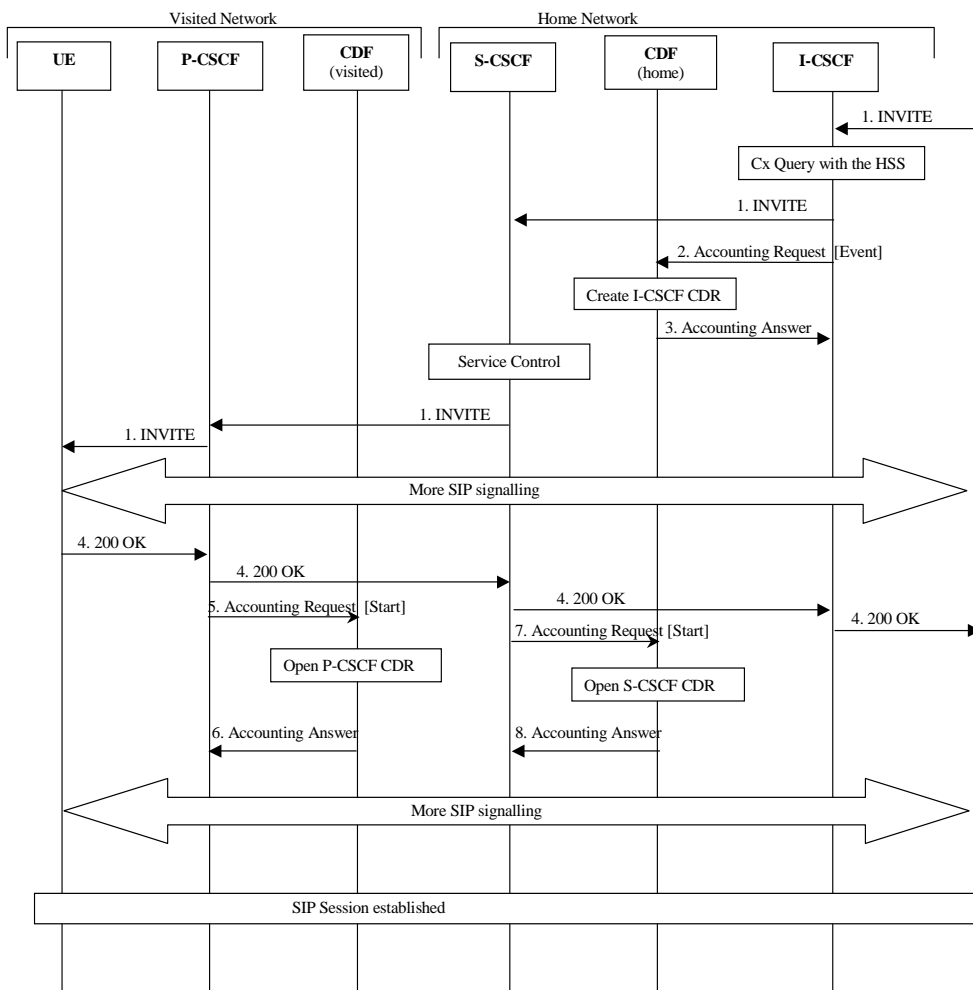

Figure 5.2.2.1.2-1: Message Sequence Chart for Session Establishment (Mobile Termination)

1. The session is initiated.
2. Upon completing a Cx query the I-CSCF sends an *Accounting Request* with the *Accounting-Record-Type* set to EVENT.
3. The CDF acknowledges the data received and creates an I-CSCF CDR.
4. The destination party answers and a final response are sent.
5. - 8. These steps are identical to the corresponding steps described in clause 5.2.2.1.1.

5.2.2.1.3 Mid-Session Procedures

The following figure shows the Diameter transactions that are required between CSCF and CDF when a UE generates a SIP (Re-)INVITE or SIP UPDATE in mid-session, e.g. in order to modify media component(s), or when the hold and resume procedure is executed.

Scenario 1: Mid-Session Procedures

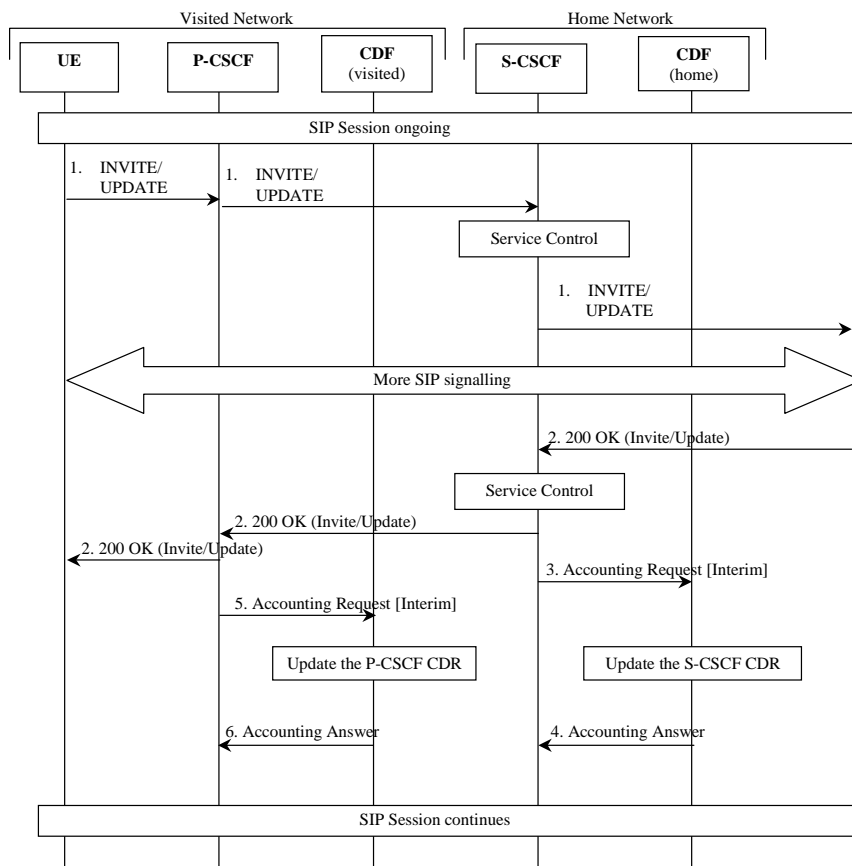

Figure 5.2.2.1.3-1: Message Sequence Chart for Media Modification

1. Modified media information is received from the subscriber.
2. The destination party acknowledges the media modification.
3. At modification of a media, the S-CSCF sends *Accounting-Request* with *Accounting-Record-Type* indicating *INTERIM\_RECORD* to record modification of a media component in the S-CSCF CDR.
4. The CDF acknowledges the reception of the data and updates the S-CSCF CDR.
5. Same as 3, but for P-CSCF.
6. Same as 4, updating the P-CSCF CDR.

Scenario 2 : Mid-Session Procedures with Late SDP Answer (SIP ACK triggering ACR)

The following figure shows the Diameter transactions that are required between CSCF and CDF when a UE generates a SIP (Re-)INVITE or SIP UPDATE in mid-session, e.g. in order to modify media component(s), or when the hold and resume procedure is executed.

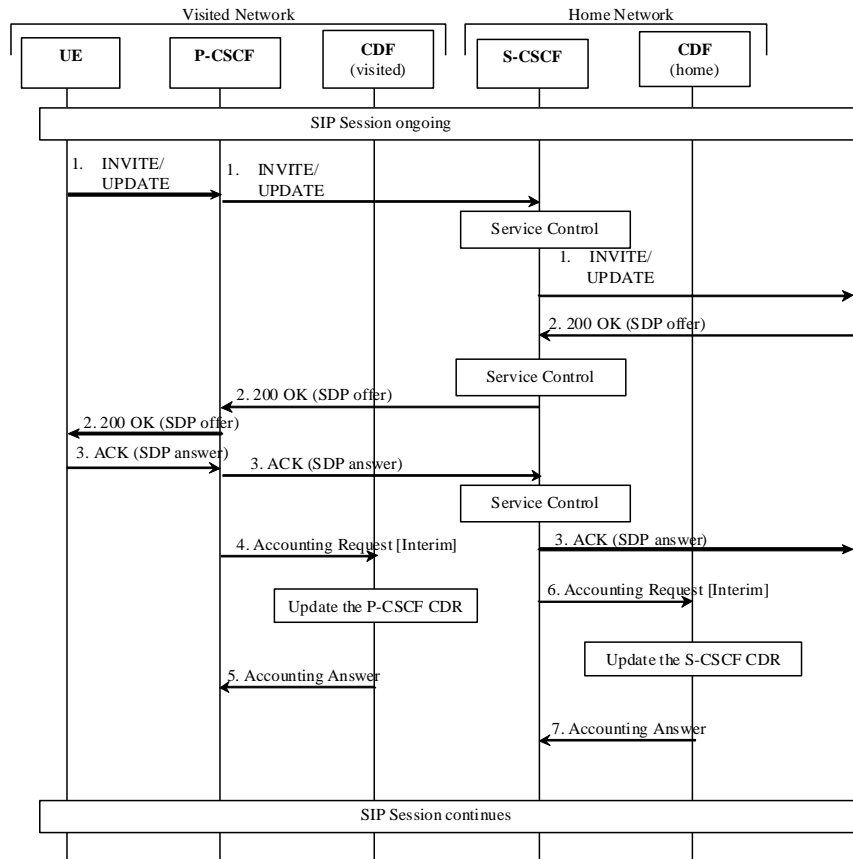
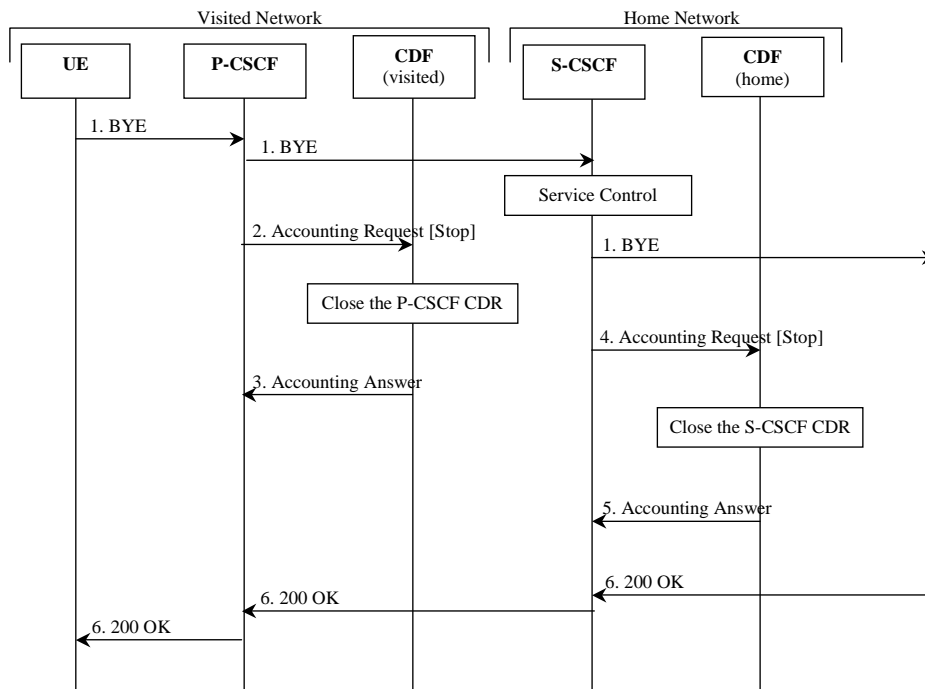

Figure 5.2.2.1.3-2: Message Sequence Chart for Media Modification (SIP ACK triggering ACR)

1. The UE generates a SIP Re-INVITE or SIP UPDATE in mid-session.
2. The destination party replies with a response including a SDP offer. If the final response includes a SDP offer only, then the CSCF shall wait for the SIP ACK.
3. The SIP ACK including the SDP answer is received.
4. At modification of a media, the P-CSCF sends *Accounting-Request* with *Accounting-Record-Type* indicating INTERIM\_RECORD to record modification of a media component in the P-CSCF CDR.
5. The CDF acknowledges the reception of the data and updates the P-CSCF CDR.
6. Same as 4, but for S-CSCF.
7. Same as 5, updating the S-CSCF CDR.

## 5.2.2.1.4 Session Release - Mobile Initiated

The following figure shows the Diameter transactions that are required between CSCF and CDF for a session release that is initiated by the UE.

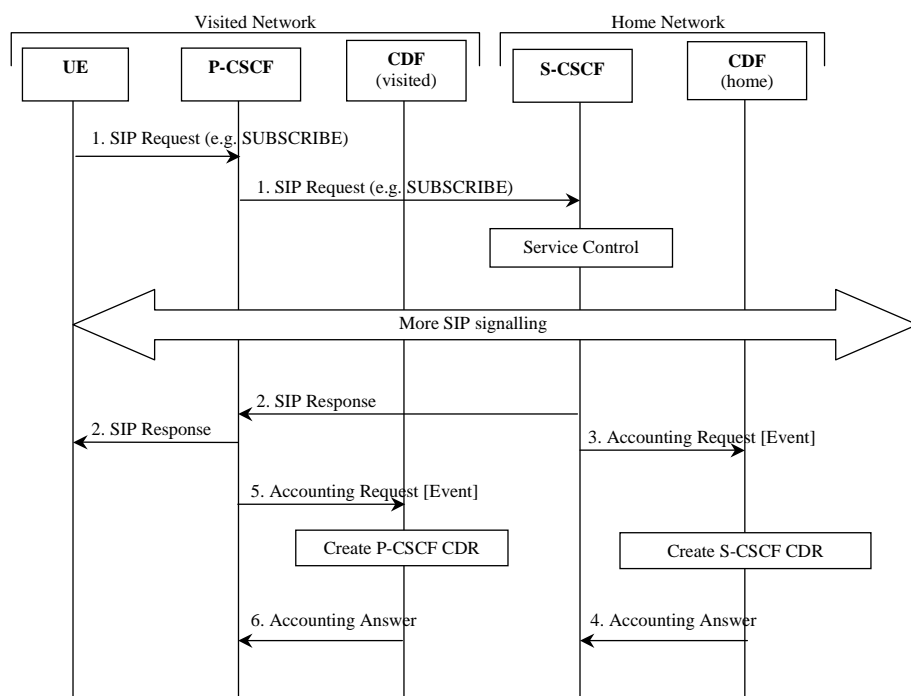

**Figure 5.2.2.1.4-1: Message Sequence Chart for Session Release**

1. The session is released.
2. At session termination the P-CSCF sends *Accounting-Request* with *Accounting-Record-Type* indicating STOP\_RECORD to record stop of a session and stop of a media component in the P-CSCF CDR.
3. The CDF acknowledges the reception of the data and closes the P-CSCF CDR.
4. Same as 2, but for S-CSCF.
5. Same as 3, closing the S-CSCF CDR.
6. The release is acknowledged.

### 5.2.2.1.5 Session-Unrelated Procedures

The following figure shows the Diameter transactions that are required between CSCF and CDF for session-unrelated IMS procedures, i.e. those that relate to the Diameter ACR [Event], as listed in Table 5.2.1.1.



**Figure 5.2.2.1.5-1: Message Sequence Chart for Session-Unrelated Procedure**

1. The P-CSCF receives a "SIP Request" (e.g. SUBSCRIBE) from the subscriber.
2. The "SIP Request" is acknowledged by the "SIP Response" as follows:
  - in the successful case, a 200 OK message is returned;
  - in case of failure an appropriate SIP error message is returned.

Depending on the used SIP method, there might be additional signalling between steps 1 and 2.

3. After the completion of the procedure, the S-CSCF sends *Accounting-Request* with *Accounting-Record-Type* indicating *EVENT\_RECORD* to record transaction specific information in the S-CSCF CDR.
4. The CDF acknowledges the reception of the data and produces an S-CSCF CDR.
5. Same as 3, but for P-CSCF.
6. Same as 4, creating a P-CSCF CDR.

### 5.2.2.1.6 Session Establishment - PSTN Initiated

The following figure shows the Diameter transactions that are required between MGCF and CDF during session establishment initiated from the PSTN side.

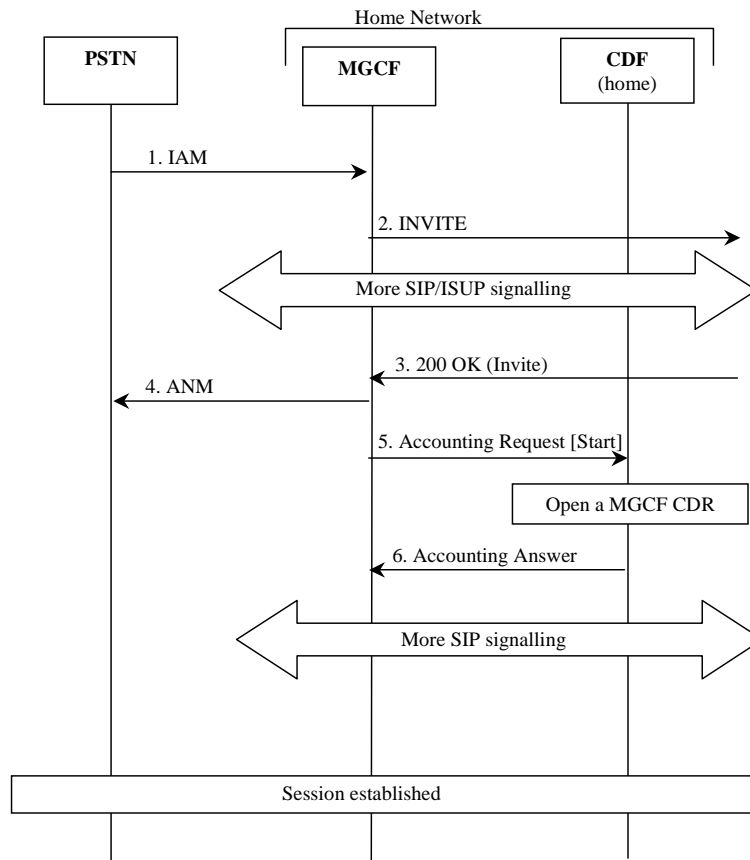

**Figure 5.2.2.1.6-1: Message Sequence Chart for Session Establishment (PSTN Initiated)**

1. The session is originated from the PSTN.
2. The session setup is triggered in the IMS.
3. The destination party answers and a final response are received.
4. MGCF forwards an answer message to the PSTN.
5. Upon reception of the final response, the MGCF sends an *Accounting-Request* with *Accounting-Record-Type* indicating *START\_RECORD* to record start of a user session and start of a media component in the MGCF CDR.
6. The CDF acknowledges the reception of the data and opens a MGCF CDR.

5.2.2.1.7 Session Establishment - IMS Initiated

The following figure shows the Diameter transactions that are required between BGCF, MGCF and CDF during session establishment initiated from the IMS side.

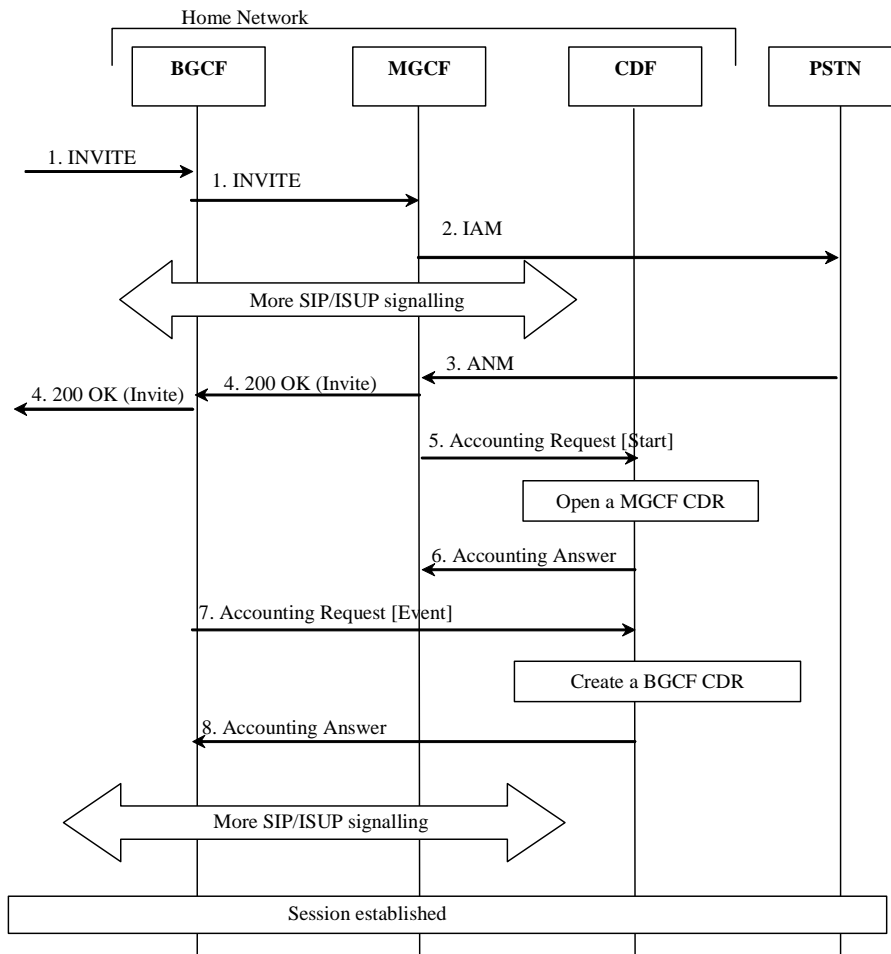

Figure 5.2.2.1.7-1: Message Sequence Chart for Session Establishment (IMS Initiated)

1. The session is originated from the IMS.
2. A session towards PSTN is established.
3. The destination party answers and an answer message are received.
4. A final response message is sent to the session originator.
5. Upon reception of the answer message, the MGCF sends an *Accounting-Request* with *Accounting-Record-Type* indicating START\_RECORD to record start of a user session and start of a media component in the MGCF CDR.
6. The CDF acknowledges the reception of the data and opens a MGCF CDR.
7. Upon reception of the 200 OK message, the BGCF sends an *Accounting-Request* with *Accounting-Record-Type* indicating EVENT\_RECORD to record start of a user session and start of a media component in the BGCF CDR.
8. The CDF acknowledges the reception of the data and creates a BGCF CDR.



## 5.2.2.1.8 Session Release - PSTN Initiated

The following figure shows the Diameter transactions that are required between MGCF and CDF during a PSTN initiated session release.

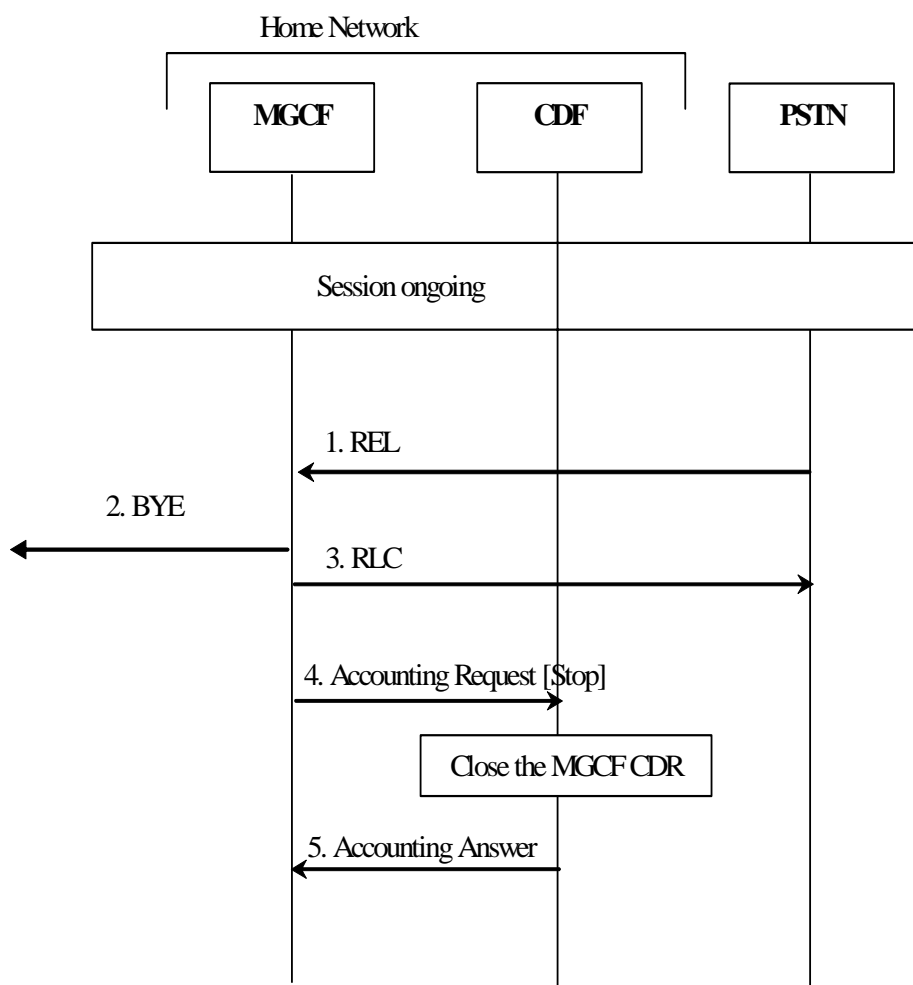
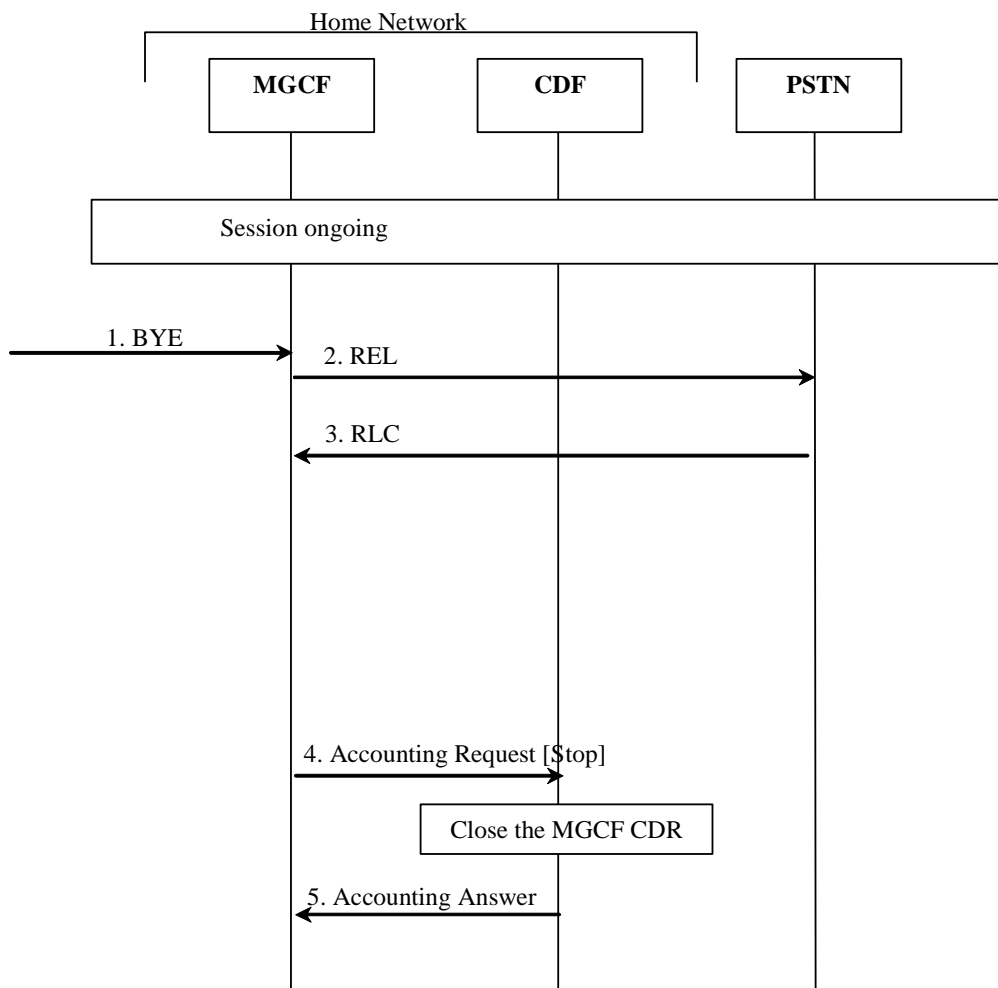

**Figure 5.2.2.1.8-1: Message Sequence Chart for Session Release (PSTN initiated)**

1. The session release is initiated from PSTN.
2. Session release continues within IMS.
3. The reception of the release message is acknowledged.
4. Upon reception of the release message, the MGCF sends an *Accounting-Request* with *Accounting-Record-Type* indicating STOP\_RECORD to record stop of a session in the MGCF CDR.
5. The CDF acknowledges the reception of the data and closes the MGCF CDR.

## 5.2.2.1.9 Session Release - IMS Initiated

The following figure shows the Diameter transactions that are required between MGCF and CDF during a IMS initiated session release.



**Figure 5.2.2.1.9-1: Message Sequence Chart for Session Release (IMS initiated)**

1. The session release is initiated from the IMS side.
2. A release message is sent towards PSTN.
3. The acknowledgement of the release message is received from PSTN.
4. Upon reception of the BYE message the MGCF sends an *Accounting Request* with *Accounting Record Type* indicating STOP\_RECORD to record stop of a session in the MGCF CDR.
5. The CDF acknowledges the reception of the data and closes the MGCF CDR.

5.2.2.1.10 Multi-Party Call

The following figure shows the establishment of an ad hoc conference (multiparty call). An AS (acting as B2BUA) performs third party call control with the MRFC, where the S-CSCF is in the signalling path. The Application Server that is in control of the ad hoc conference is aware of the MRFC capabilities. Note that only accounting information sent from the MRFC is shown in detail in the figure. The SIP messages are for illustrative purpose only.

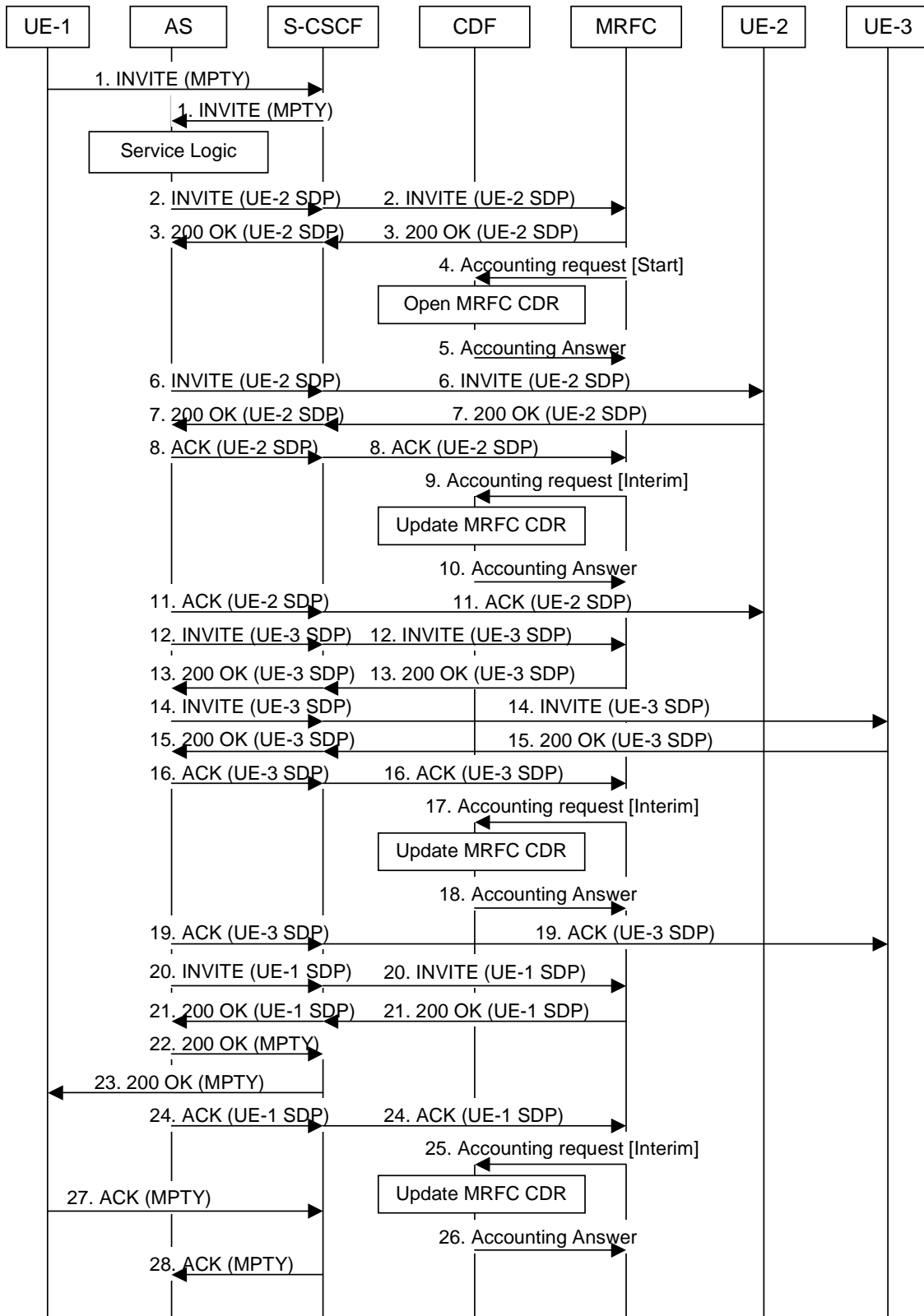

Figure 5.2.2.1.10-1: Message Sequence Chart for Multi-Party Call Establishment in MRFC

1. Sessions exist between UE-1 and UE-2, and between UE-1 and UE-3. A request is received from UE-1 for putting all parties together to a multi-party call.
2. - 3. Request and acknowledgement to initiate multi-party call. MRFC assigns a conference-ID that is used by the AS in subsequent interactions with the MRFC in INVITE messages connecting other endpoints (see TS 23.228 [201]). Path establishment between AS and MRFC for UE-2.
4. At start of session establishment the MRFC sends an *Accounting-Request* with *Accounting-Record-Type* indicating START\_RECORD to record start of multi-party call in the MRFC CDR
5. The CDF acknowledges the reception of the data and creates the MRFC CDR. 'Calling Party Address', 'Service Request Time Stamp', 'Service ID' (holding the conference-ID) etc. are included in the MRFC CDR
- 6 - 7. Path establishment between UE-2 and AS. Same ICID is used as for the path between AS and MRFC for UE-2 (step 2. - 3.).
8. Acknowledgement of path between AS and MRFC for UE-2.
9. The MRFC may send an *Accounting-Request* with *Accounting-Record-Type* indicating INTERIM\_RECORD to report that UE-2 has been connected to the multi-party call.
10. The CDF acknowledges the reception of the data and includes UE-2 in the field 'Application Provided Called Parties' of the MRFC CDR.
11. Acknowledgement of path between AS and UE-2. Now a path between UE-2 and MRFC via AS is established.
- 12 -13.. Request and acknowledgement to establish path between AS and MRFC for UE-3.
14. -15. Path establishment between UE-3 and AS. Same ICID is used as for the path between AS and MRFC for UE-3 (step 12. - 13.).
16. Acknowledgement of path between AS and MRFC for UE-3.
17. The MRFC may send an *Accounting-Request* with *Accounting-Record-Type* indicating INTERIM\_RECORD to report that UE-3 has been connected to the multi-party call.
18. The CDF acknowledges the reception of the data and includes UE-3 in a new field 'Application Provided Called Parties' of the MRFC CDR.
19. Acknowledgement of path between AS and UE-3.
- 20 - 21. Request and acknowledgement to establish path between AS and MRFC for UE-1. Same ICID is used as for the path between UE-1 and AS (step 1.).
- 22 - 23. Request for multi-party conference with UE-2 and UE-3 is acknowledged to UE 1. Implicit acknowledgement of path UE-1 to AS.
24. Acknowledgement of path between AS and MRFC for UE-1.
25. The MRFC may send an *Accounting-Request* with *Accounting-Record-Type* indicating INTERIM\_RECORD to report that UE-1 has been connected to the multi-party call.
26. The CDF acknowledges the reception of the data and includes the field 'Service Delivery Start Time Stamp' into the MRFC CDR.
- 27 -28. UE-1 acknowledges the multi-party call session establishment.

NOTE: It is in the responsibility of the AS to terminate the sessions existing at the beginning of the multi-party call establishment between UE-1 and UE-2 and between UE-1 and UE-3 (see step 1.) in case of successful multi-party call establishment. This is not shown in the diagram above.

#### 5.2.2.1.11 AS Related Procedures - AS Acting as a Redirect Server

Application servers may support a multitude of services which are not specified in 3GPP standards. Therefore it is not possible to standardise charging flows and procedures for those services. However, for all such services, the AS may apply either Event Charging, where ACR [Event] messages are generated, or Session Charging, using ACR [Start, Stop and Interim]. The following clauses depict one example for each of the two scenarios. The first procedure, AS acting as

a Redirect Server, depicts the "event" case, while the second procedure, AS acting as a Voice Mail Server, depicts the "session" case.

The following figure shows the case where an Application Server acts as a Redirect Server. In the figure below, UE-1 sets up a session towards UE-2 but due to Call Forwarding functionality located in the AS, a new number (to UE-3) is returned to UE-1. Finally UE-1 sets up the session towards UE-3.

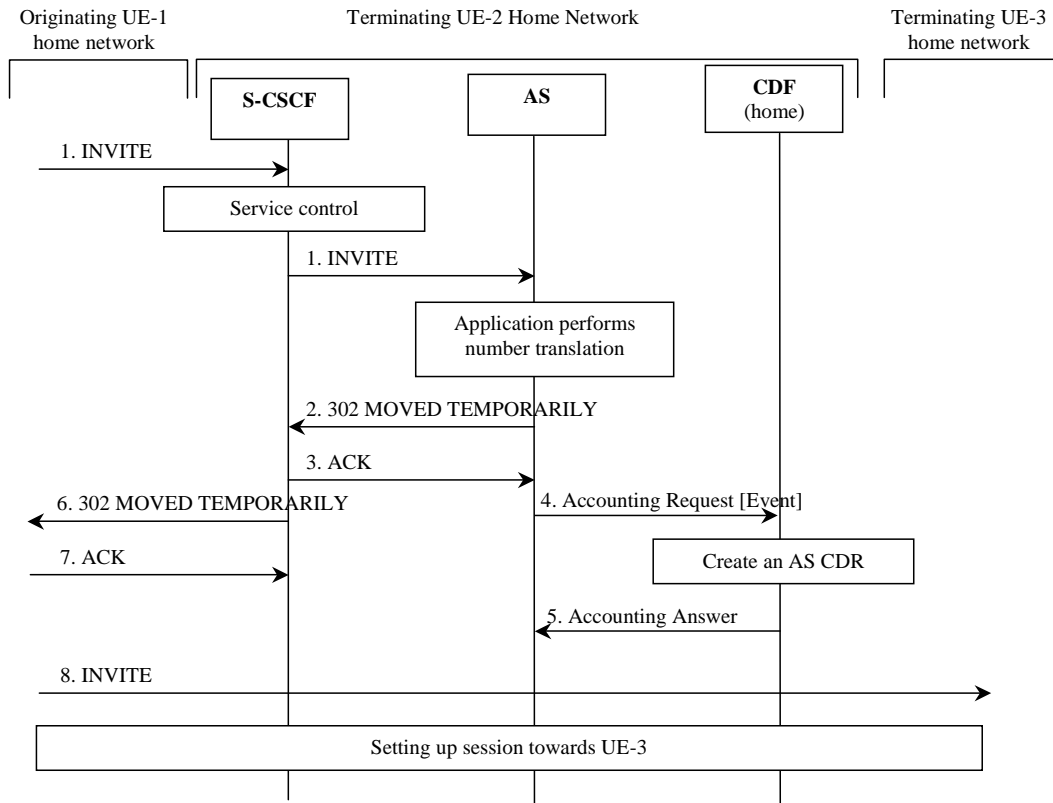
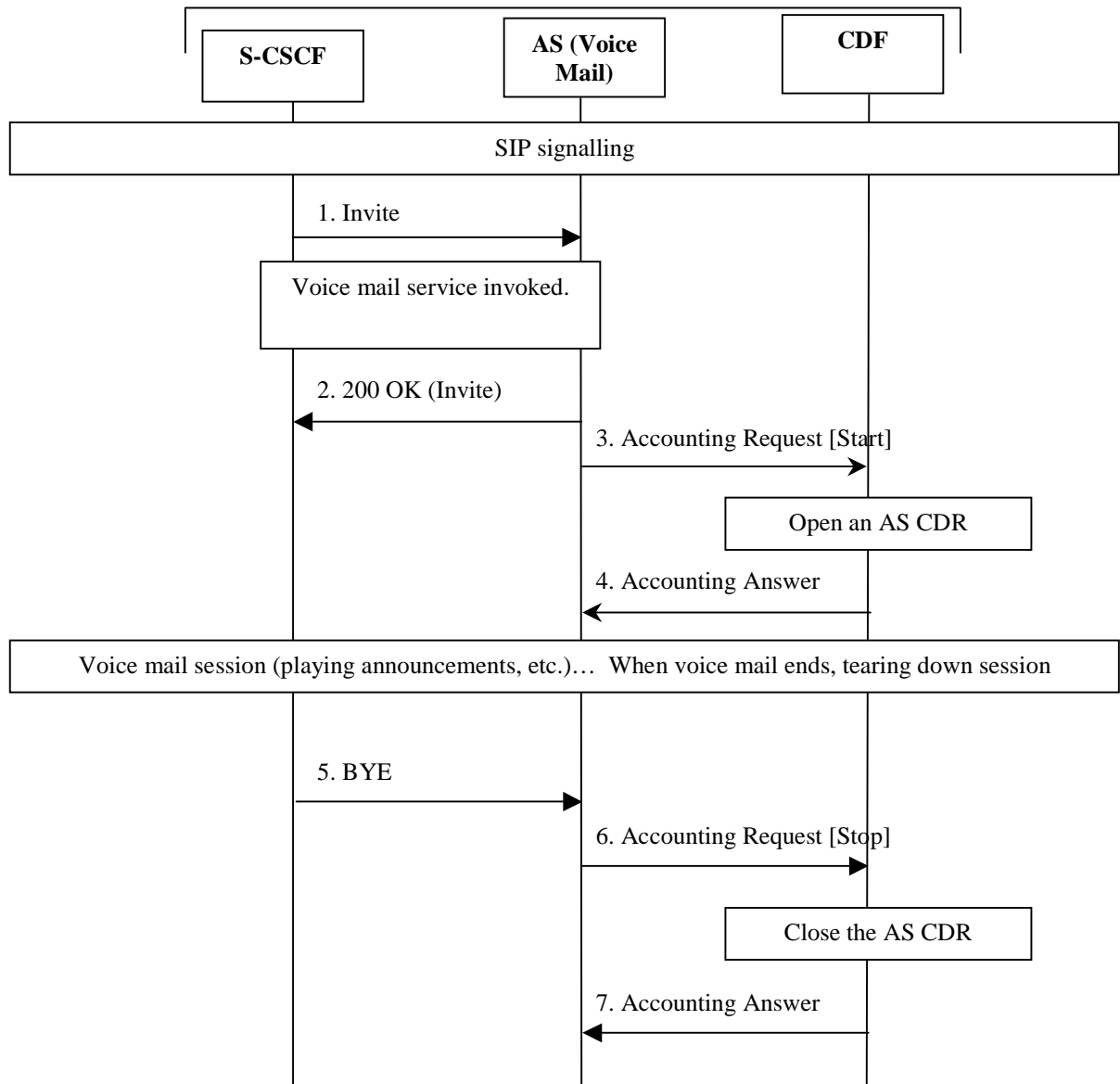

**Figure 5.2.2.1.11-1: Message Sequence Chart for AS Acting as a Redirect Server**

- 1. Sessions initiated by UE-1 towards UE-2.
- 2. - 3. Response indicating that session should be redirected towards another number (UE-3).
- 4. After successful service execution, the AS sends *Accounting-Request* with *Accounting-Record-Type* indicating EVENT\_RECORD to record service specific information in the AS CDR.
- 5. The CDF acknowledges the reception of the data and creates the AS CDR.
- 6-7. Response indicating that session should be redirected towards another number (UE-3).
- 8. Session is initiated by UE-1 towards UE-3.

## 5.2.2.1.12 AS Related Procedures - AS Acting as a Voice Mail Server

The following figure shows the case where an Application Server acts as a Voice Mail Server. S-CSCF invokes the AS acting as Voice Mail Server according to procedure as defined in TS 23.218 [203].



**Figure 5.2.2.1.12-1: Message Sequence Chart for AS Acting as a Mail Server**

1. AS receives the INVITE from the S-CSCF.
2. AS acknowledges the initiated Voice Mail session by issuing a 200 OK in response to the INVITE.
3. AS sends *Accounting-Request* with *Accounting-Record-Type* indicating START\_RECORD to record start of a voice mail session.
4. The CDF acknowledges the reception of the *Accounting-Request* with *Accounting-Record-Type* indicating START\_RECORD and opens a AS CDR.
5. Voice mail session release is initiated.
6. Upon reception of release message AS sends an *Accounting-Request* with *Accounting-Record-Type* indicating STOP\_RECORD to record stop of a session in the AS CDR.
7. The CDF acknowledges the reception of the data and closes the AS CDR.

### 5.2.2.1.13 AS Related Procedures - AS Acting as a SCC AS

The charging requirements for IMS service continuity are specified in TS 23.237 [407].

Alternative “OneChargingSession” option is also reflected in the different flows description, i.e a single charging session from SCC AS.

#### 5.2.2.1.13.1 UE originating call (PS only or CS only)

In this flow, Call-ID #1 is for access leg and Call-ID #2 is for remote leg.

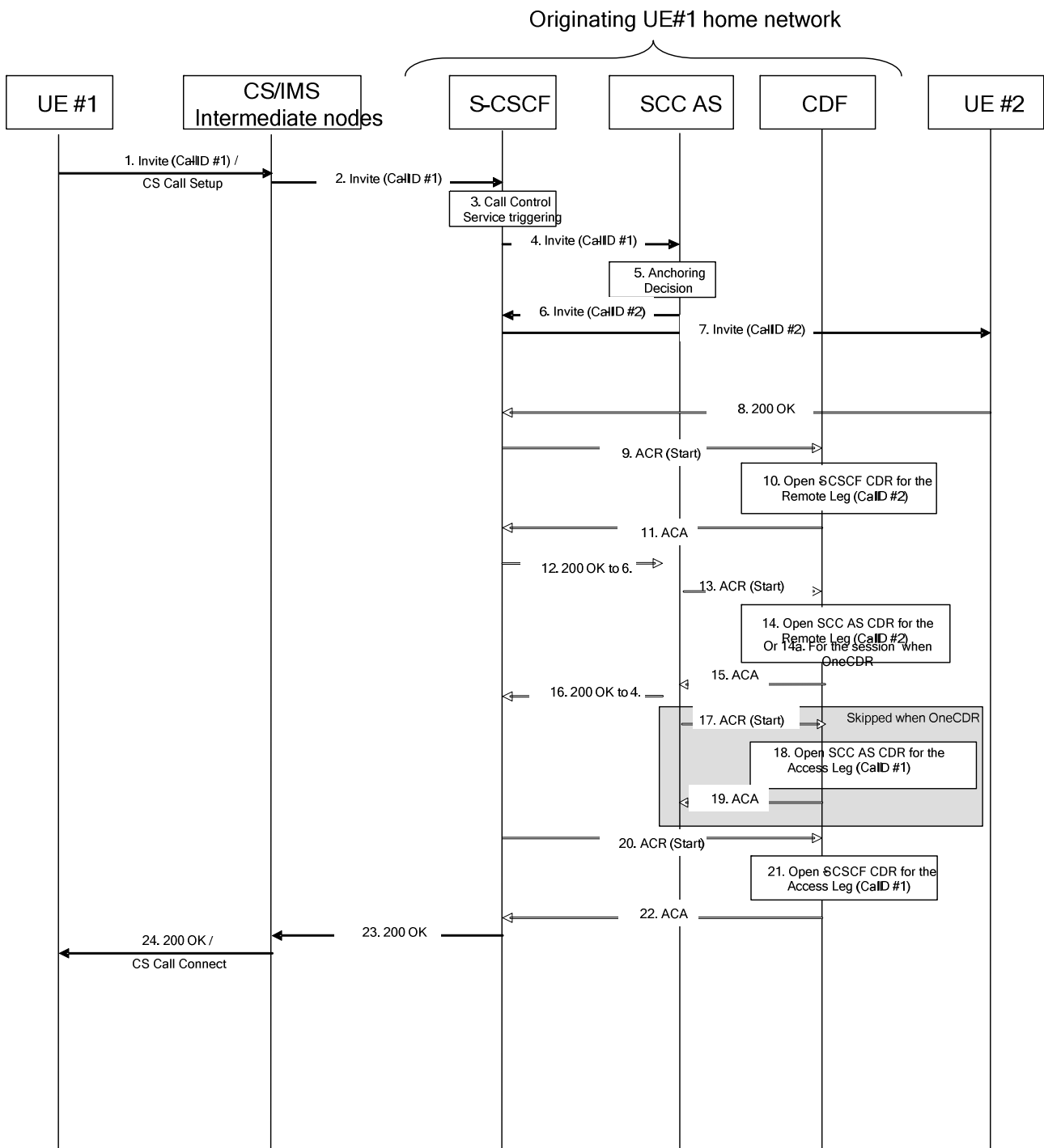

**Figure 5.2.2.1.13.1-1: Message Sequence Chart UE originating call**

1. The SCC session is initiated (an INVITE for IMS, a Call Setup for CS).
2. After processing at CS/PS intermediate nodes, the resulting INVITE is sent to the S-CSCF
3. The S-CSCF validates the service profile, and invokes any appropriate service logic required for this user.
4. The S-CSCF forwards the INVITE request message to the SCC AS, according to the service origination logic defined by initial Filter Criteria (iFC) in the subscriber profile of the HSS.
5. The SCC call is anchored at the SCC AS in the home IMS Domain upon reception of the SIP Invite (Call-ID# 1).



- 6-7. The S-CSCF forwards the INVITE request message to the terminating network (Call-ID #2).
8. The response 200 OK is transmitted to the S-CSCF in the Originating network.
9. Upon reception of the final response, the S-CSCF in the originating network sends an *Accounting-Request* with *Accounting-Record-Type* indicating *START\_RECORD* to record SCC call routing and start of a user session/media component in the S-CSCF CDR.
- 10-11. The CDF from the Originating network opens a S-CSCF CDR related to the Remote leg and acknowledges the reception of the data.
12. Same as 8 but for SCC AS (Remote leg)
13. Same as 9 but for the SCC AS (Remote leg)
- 14-15. Same as 10-11 but opening a SCC AS CDR related to the Remote leg
- 13-14a-15 Alternatively, when “OneChargingSession”, the SCC AS sends an *Accounting-Request* with *Accounting-Record-Type* indicating *START\_RECORD* to record SCC call routing and start of a user session/media components in the SCC AS CDR for the IMS session (ICID) with access leg and remote leg. The CDF opens a SCC AS CDR related to the IMS session, and acknowledges the reception of the data.
16. Same as 8 but for S-CSCF AS (Access leg)
17. Same as 9 but for the SCC AS (Access leg) .
- 18-19. Same as 10-11 but opening a SCC AS CDR (Access leg) .  
.Steps 17 to 19 are not applicable for the “OneChargingSession” option.
20. Same as 9 but for the S-CSCF (Access leg)
- 21-22. Same as 10-11 but opening a S-CSCF CDR (Access leg)
23. The final response to SIP Invite (Call ID #1) is transmitted.
24. The session is set up with CS or PS media.

For IMS Emergency session over PS, the same flow applies in the UE serving Network, between the E-CSCF (instead of S-CSCF) and the EATF (Emergency Access Transfer Function, instead of SCC AS), with E-CSCF and EATF CDRs opened for access and remote legs.

EATF (acting as a B2BUA) performs third party call control and is considered as an AS for the charging description.

#### 5.2.2.1.13.2 UE originating call (PS and CS combined origination)

In this flow, Call-ID #1 is for PS access leg, Call-ID #1' for CS access leg and Call-ID #2 for remote leg.

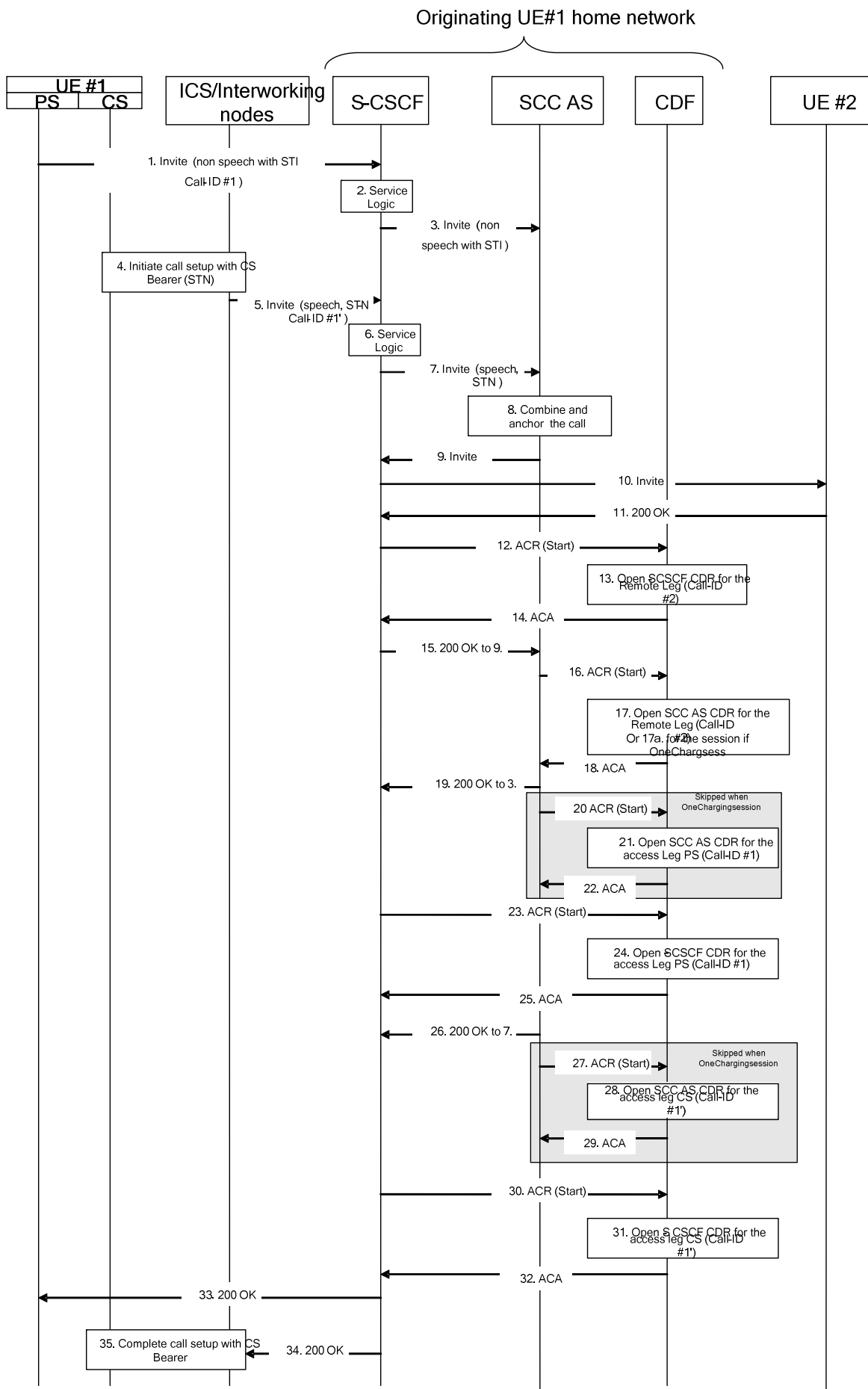

**Figure 5.2.2.1.13.2-1: Message Sequence Chart UE originating call**

1. UE-1 wants to initiate a multimedia session with UE-2 with speech components carried on CS bearers and non-speech components carried on PS bearers. Therefore the multimedia session is split into two parts, each one corresponding to a separate access leg. UE-1 initiates the establishment of the first access leg by sending an INVITE request with non-speech media components. The INVITE contains STI information indicating that a second access leg (with the speech component) will be originated from the CS domain.
2. The S-CSCF executes any service logic as appropriate.
3. The S-CSCF sends the INVITE to the SCC AS. The SCC AS identifies that this access leg has to be correlated to a subsequent access leg based on the STI information in the INVITE.
4. UE-1 request to set up call with CS bearer. The called party number is set to an identifier such as a PSI DN, which is used to indicate to the SCC AS that this access leg is to be combined with a PS leg. The DN is either statically configured on the UE or assigned to the UE by the network upon IMS Registration.
5. After processing at ICS/Interworking nodes, the resulting INVITE is sent to the S-CSCF.
6. The S-CSCF executes any service logic as appropriate.
7. The S-CSCF sends the INVITE to the SCC AS. The SCC AS identifies that this CS leg has to be correlated to a PS leg based on the iFC in the INVITE.
8. After the SCC AS receives both the INVITE requests in step 3 and in step 7, the SCC AS identifies that they are part of the same multimedia session and combines the two access legs of the session by checking the caller's identity and anchor the combined session.
- 9-10. The SCC AS sends INVITE to the remote end point for combined session establishment.
11. The 200 OK response is transmitted to the S-CSCF in the Originating network.
12. Upon reception of the final response, the S-CSCF in the originating network sends an *Accounting-Request* with *Accounting-Record-Type* indicating START\_RECORD to record SCC call routing and start of a user session/media component in the S-CSCF CDR.
- 13-14. The CDF from the Originating network opens an S-CSCF CDR related to the Remote leg and acknowledges the reception of the data.
15. Same as 11 but for SCC AS (Remote leg)
16. Same as 12 but for the SCC AS (Remote leg)
- 17-18. Same as 13-14 but opening a SCC AS CDR related to the Remote leg
- 16-17a-18 Alternatively, when "OneChargingSession", the SCC AS sends an *Accounting-Request* with *Accounting-Record-Type* indicating START\_RECORD to record start of the SCC AS CDR for the IMS session (ICID) with the CS access leg, PS access leg and the Remote leg. The CDF opens a SCC AS CDR related to the IMS session, and acknowledges the reception of the data.
19. Same as 11 but for S-CSCF (Access leg)
20. Same as 12 but for the SCC AS (Access leg)
- 21-22. Same as 13-14 but opening a SCC AS CDR for the PS access leg.  
Steps 20 to 22 are not applicable for the "OneChargingSession" option.
23. Same as 12 but for the S-CSCF (Access leg)
- 24-25. Same as 13-14 but opening a S-CSCF CDR for the PS access leg.
26. Same as 11 but for S-CSCF AS (Access leg).
27. Same as 12 but for the SCC AS (Access leg).

28-29. Same as 13-14 but opening a SCC AS CDR for the CS access leg.

Steps 27 to 29 are not applicable for the “OneChargingSession” option.

29. Same as 12 but for the S-CSCF (Access leg)

30-31. Same as 13-14 but opening a S-CSCF CDR for the CS access leg.

32. The final 200 OK response is sent to the UE #1

33. The 200 OK response is sent to the ICS intermediate nodes.

34. The completion of the CS call bearer is done.

#### 5.2.2.1.13.3 UE terminating call (PS only or CS only)

In this flow, Call-ID #1 is for PS access leg and Call-ID #2 for remote leg.

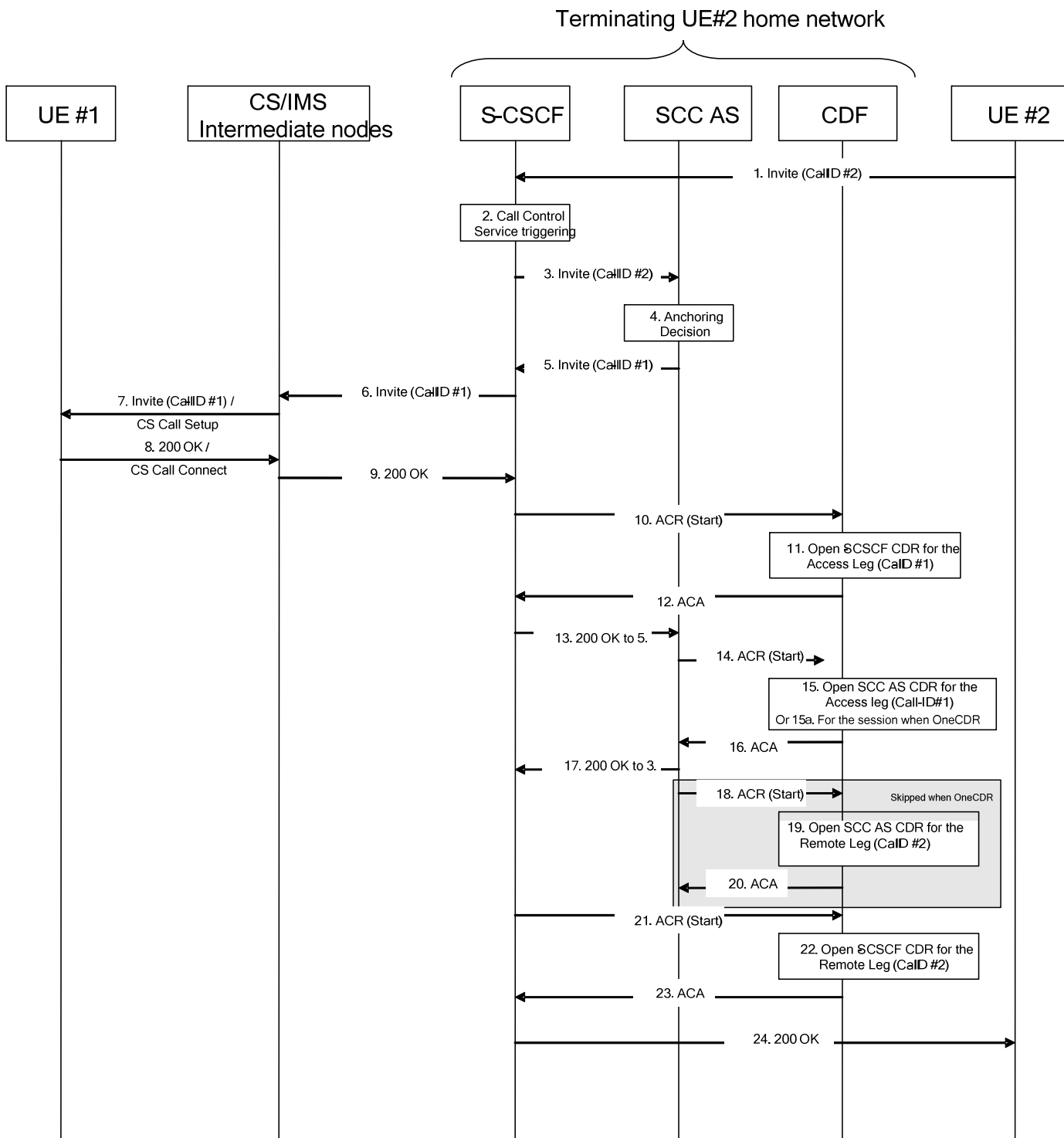

**Figure 5.2.2.1.13.3-1: Message Sequence Chart UE terminating call**

1. The SCC session is initiated by UE #2 sending an INVITE to S-CSCF.
2. The S-CSCF validates the service profile, and invokes any appropriate service logic required for this user.
3. The S-CSCF forwards the INVITE request message to the SCC AS, according to the service origination logic defined by initial Filter Criteria (iFC) in the subscriber profile of the HSS.
4. The SCC call is anchored at the SCC AS in the home IMS Domain upon reception of the SIP Invite (Call ID #2).

- 5-6-7. The S-CSCF forwards the INVITE request message to the terminating network (Call ID #1). After processing at CS/PS intermediate nodes, the resulting message is sent to UE #1.
8. The response 200 OK is transmitted to CS/PS intermediate nodes.
9. After processing at CS/PS intermediate nodes, the 200 OK message is sent to S-CSCF.
10. Upon reception of the final response, the S-CSCF in the originating network sends an *Accounting-Request* with *Accounting-Record-Type* indicating START\_RECORD to record SCC call routing and start of a user session/media component in the S-CSCF CDR.
- 11-12. The CDF from the Originating network opens an S-CSCF CDR related to the Access leg and acknowledges the reception of the data.
13. Same as 9 but for SCC AS (Access leg)
14. Same as 10 but for the SCC AS (Access leg)
- 15-16. Same as 11-12 but opening a SCC AS CDR related to the Access leg
- 14-15a-16 Alternatively, when “OneChargingSession”, the SCC AS sends an *Accounting-Request* with *Accounting-Record-Type* indicating START\_RECORD to record SCC call routing and start of a user session/media components in the SCC AS CDR for the IMS session (ICID) with access leg and remote leg. The CDF opens a SCC AS CDR related to the IMS session and acknowledges the reception of the data.
17. Same as 9 but for SCC AS (Remote leg)
18. Same as 10 but for the SCC AS (Remote leg) .
- 19-20. Same as 11-12 but opening a SCC AS CDR (Remote leg).
- Steps 18 to 20 are not applicable for the “OneChargingSession” option.
21. Same as 10 but for the S-CSCF (Remote leg)
- 22-23. Same as 11-12 but opening a S-CSCF CDR (Remote leg)
24. The final response to SIP Invite (Call ID #2) is transmitted.

#### 5.2.2.1.13.4 UE terminating call (PS and CS combined origination)

In this flow, Call-ID #1 is for PS access leg, Call-ID #1' for CS access leg and Call-ID #2 for remote leg.

Terminating UE#2 home network

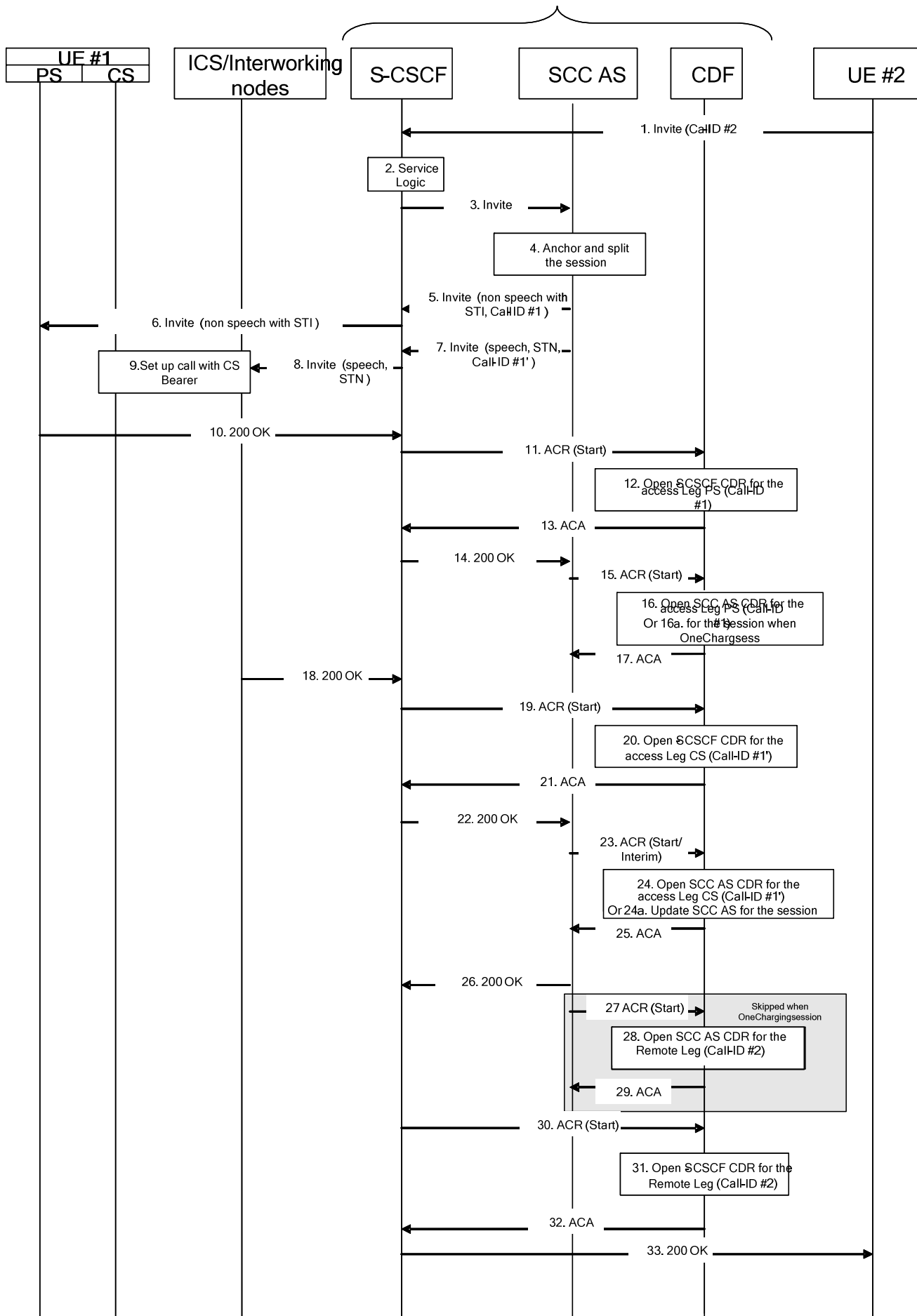

**Figure 5.2.2.1.13.4-1: Message Sequence Chart UE terminating call**

1. UE-2 sends INVITE to UE-1 to establish a session with both speech and non-speech components.
2. The S-CSCF executes any service logic as appropriate.
3. The S-CSCF sends the INVITE to the SCC AS. The SCC AS identifies that this access leg has to be correlated to a subsequent access leg based on the ST information in the INVITE.
4. The session is anchored at the SCC AS. Based on operator policy and on information indicating that UE-1 is accessible over both the PS and CS domains, the SCC AS decides to split the session over PS and CS domains. This behaviour is similar to the behaviour of a CSI AS specified in TS 23.279.
- 5~6. The SCC AS sends INVITE for the non-speech part of the session. The INVITE contains STI information indicating that the speech component will be established from the CS domain.
- 7~8. The SCC AS sends INVITE for the speech part of the session and the S-CSCF forwards the INVITE to the ICS/Interworking nodes.
9. The ICS/Interworking nodes set up call to UE-1 with CS bearer.
- 10~18. A 200 OK response is sent to the S-CSCF. The speech and non-speech part of the session is established.
11. Upon reception of the response, the S-CSCF in the originating network sends an *Accounting-Request* with *Accounting-Record-Type* indicating START\_RECORD to record SCC call routing and start of a user session/media component in the S-CSCF CDR.
- 12-13. The CDF from the Originating network opens an S-CSCF CDR related to the PS Access leg and acknowledges the reception of the data.
14. Same as 10 but for SCC AS (Access leg)
15. Same as 11 but for the SCC AS (Access leg)
- 16-17. Same as 12-13 but opening a SCC AS CDR related to the PS Access leg.
  - 15-16a-17 Alternatively, when "OneChargingSession", the SCC AS sends an *Accounting-Request* with *Accounting-Record-Type* indicating START\_RECORD to record start of the SCC AS CDR for the IMS session (ICID) with the PS access leg and the Remote leg. The CDF opens the SCC AS CDR related to the IMS session and acknowledges the reception of the data.
19. Upon reception of the response, the S-CSCF in the originating network sends an *Accounting-Request* with *Accounting-Record-Type* indicating START\_RECORD to record SCC call routing and start of a user session/media component in the S-CSCF CDR.
- 20-21. The CDF from the Originating network opens an S-CSCF CDR related to the CS Access leg and acknowledges the reception of the data.
22. Same as 10 but for SCC AS (Access leg)
23. Same as 11 but for the SCC AS (Access leg)
- 24-25. Same as 12-13 but opening a SCC AS CDR related to the CS Access leg.
  - 23-24a-25 Alternatively, when "OneChargingSession", the SCC AS sends an *Accounting-Request* with *Accounting-Record-Type* indicating INTERIM\_RECORD to record modification of the SCC AS CDR for the IMS session (ICID) with the CS access leg. The CDF updates the SCC AS CDR related to the IMS session and acknowledges the reception of the data.
26. Same as 10 but for S-CSCF (Remote leg)
27. Same as 11 but for the SCC AS (Remote leg)
- 28-29. Same as 12-13 but opening a SCC AS CDR for the Remote leg.



Steps 27 to 29 are not applicable for the “OneChargingSession” option.

30. Same as 11 but for the S-CSCF (Remote leg)

31-32. Same as 12-13 but opening a S-CSCF CDR for the Remote leg.

33. The 200 OK response is sent to the UE #2.

#### 5.2.2.1.13.5 Session transfer from PS to CS

In this flow, Call-ID #1 is for PS access leg, Call-ID #1' for CS access leg and Call-ID #2 for remote leg.

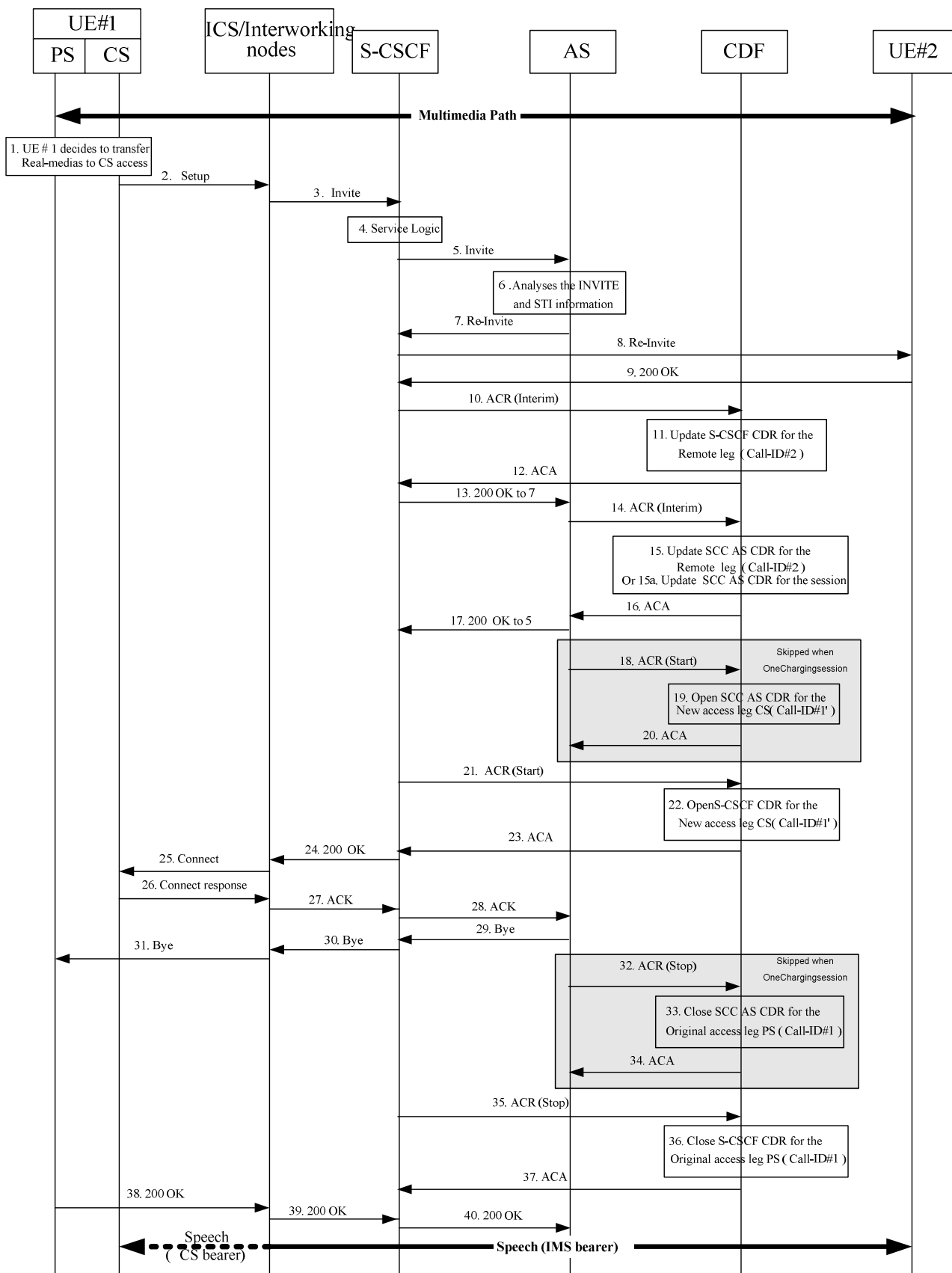

Figure 5.2.2.1.13.5-1: Message Sequence Chart UE Domain Transfer PS access to CS access

The user is engaged in an active multimedia session with UE-2 via PS access.

1-2. UE-1 originates a multimedia call in the CS domain including the STN information to request the real time media transfer to CS access.

3. The ICS intermediate Nodes convert the request into IMS SIP format and then forward the converted request to the S-CSCF.
4. The S-CSCF invokes the SCC Application as the first Application Server of any Application Servers that need to remain in the path of the call after session transfer.
5. The S-CSCF forwards the INVITE to the SCC Application over the ISC interface.
- 6 The SCC AS analyses the INVITE to derive that the INVITE is a request to transfer a multimedia session with video and voice media components to the PS domain..
- 7-9. The SCC AS sends a re-INVITE to the Remote UE to update the media components of the previous dialog. Remote UE answers by a 200 OK message.
- 10-12. At Remote Leg update the S-CSCF in the originating network sends Accounting-Request with Accounting-Record-Type indicating INTERIM\_RECORD to record update of a session in the S-CSCF CDR.
13. The S-CSCF answers to the INVITE message in 7.
- 14-16. At Remote Leg update the SCC AS sends Accounting-Request with Accounting-Record-Type indicating INTERIM\_RECORD to record update of a session in the SCC AS CDR.
- 14-15a-16. Alternatively, when “OneChargingSession”, the SCC AS sends an *Accounting-Request* with *Accounting-Record-Type* indicating INTERIM\_RECORD to record modification of SCC AS CDR for the IMS session (ICID) with the new legs configuration (Remote leg and new CS access leg).The CDF updates the SCC AS CDR related to the IMS session and acknowledges the reception of the data.
17. The SCC AS answers to the INVITE message in 5.18-20. Upon generation of the 200 OK response, the SCC AS in the home IMS of the originating SCC user sends an *Accounting-Request* with Accounting-Record-Type indicating START\_RECORD to record start of a user session in the SCC AS-CDR for Call-ID #1'. The CDF from the originating network opens an AS CDR and acknowledges the reception of the data.  
  
Steps 18 to 20 are not applicable for the “OneChargingSession” option.
- 21-23. Upon generation of the 200 OK response, the S-CSCF in the home IMS of the originating SCC user sends an *Accounting-Request* with Accounting-Record-Type indicating START\_RECORD to record start of a user session in the S-CSCF-CDR for Call-ID #1'. The CDF from the originating network opens an S-CSCF CDR and acknowledges the reception of the data.
24. The 200 OK response is sent by the S-CSCF.
25. The 200 OK response is converted by the ICS/Interworking nodes in CS format.
- 26-28. The UE #1 acknowledges by sending an ACK message to the SCC AS.
- 29-31. The SCC Application sends BYE request to release the old access leg.
- 32-34. At session termination the SCC AS sends *Accounting-Request* with *Accounting-Record-Type* indicating STOP\_RECORD to record stop of a session and stop of a media component in the SCC AS CDR. This CDR may be generated with special handling. One example of special handling is to zero rate the IMS resource usage for the Access leg establishment.  
  
Steps 32 to 34 are not applicable for the “OneChargingSession” option.
- 35-37. The S-CSCF in the originating network sends Accounting-Request with Accounting-Record-Type indicating STOP\_RECORD for closing the S-CSCF CDR related to the initial Access leg. This CDR may be generated with special handling. One example of special handling is to zero rate the IMS resource usage for Access leg establishment. This can be performed using the correlation mechanism with the SCC AS CDR for Access leg.
- 38-40. The UE-1 acknowledges the release of old access leg.

#### 5.2.2.1.13.6 Session transfer from CS to PS

In this flow, Call-ID #1 is for PS access leg, Call-ID #1' for CS access leg and Call-ID #2 for remote leg.

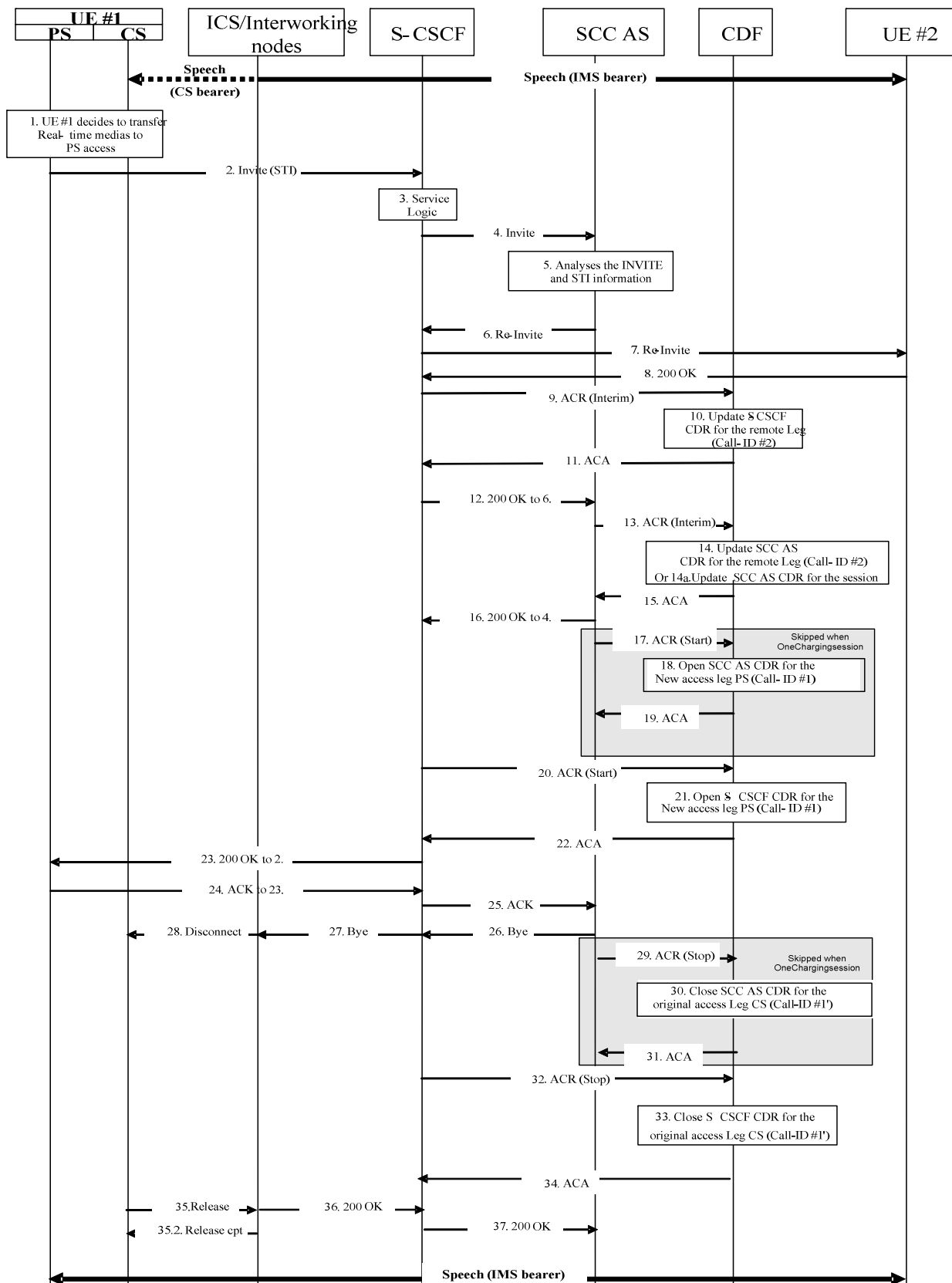

Figure 5.2.2.1.13.6-1: Message Sequence Chart UE Domain Transfer CS access to PS access

The user is engaged in an active multimedia session with UE-2 via CS access.

1. UE-1 originates a call in the PS domain including the STI to request the multimedia session transfer to PS access in conjunction with CS access.
2. The session establishment request is routed to the S-CSCF by the P-CSCF.
3. The S-CSCF invokes the SCC Application as the first Application Server of any Application Servers that need to remain in the path of the call after session transfer.
4. The S-CSCF forwards the INVITE to the SCC Application over the ISC interface.
5. The SCC Application analyses the INVITE to derive that the INVITE is a request to transfer a multimedia session with video and voice media components to the PS domain.
- 6-8. The SCC AS sends a re-INVITE to the Remote UE to update the media components of the previous dialog. Remote UE answers by a 200 OK message.
- 9-11. At Access Leg update the S-CSCF in the originating network sends Accounting-Request with Accounting-Record-Type indicating INTERIM\_RECORD to record update of a session in the S-CSCF CDR.
12. The S-CSCF answers to the INVITE message in 6.
- 13-15. At Access Leg update the SCC AS sends Accounting-Request with Accounting-Record-Type indicating INTERIM\_RECORD to record update of a session in the SCC AS CDR.
- 13-14a-15. Alternatively, when “OneChargingSession”, the SCC AS sends an *Accounting-Request* with *Accounting-Record-Type* indicating INTERIM\_RECORD to record modification of SCC AS CDR for the IMS session (ICID) with the new legs configuration (Remote leg and new PS access leg).The CDF updates the SCC AS CDR related to the IMS session and acknowledges the reception of the data.
16. The SCC AS answers to the INVITE message in 4.
- 17-19. Upon generation of the final response, the SCC AS in the home IMS of the originating SCC user sends an *Accounting-Request* with Accounting-Record-Type indicating START\_RECORD to record start of a user session in the SCC AS-CDR. The CDF from the originating network opens an AS CDR and acknowledges the reception of the data.  
  
Steps 17 to 19 are not applicable for the “OneChargingSession” option.
- 20-22. Upon generation of the final response, the S-CSCF in the home IMS of the originating SCC user sends an *Accounting-Request* with Accounting-Record-Type indicating START\_RECORD to record start of a user session in the S-CSCF-CDR. The CDF from the originating network opens an S-CSCF CDR and acknowledges the reception of the data.
23. The S-CSCF answers to the INVITE message in 2.
- 24-25. The 200 OK is acknowledged.
- 26-28. The SCC Application sends BYE request to release the old access leg. 29-31 The SCC AS sends Accounting-Request with Accounting-Record-Type indicating STOP\_RECORD for closing the SCC AS CDR related to the original Access leg. The CDF updates the SCC AS CDR related to the IMS session and acknowledges the reception of the data  
  
Steps 29 to 31 are not applicable for the “OneChargingSession” option.
- 32-34. The S-CSCF sends Accounting-Request with Accounting-Record-Type indicating STOP\_RECORD for closing the S-CSCF CDR related to the original Access leg. This CDR may be generated with special handling. One example of special handling is to zero rate the IMS resource usage for Access leg establishment. This can be performed using the correlation mechanism with the SCC AS CDR for Access leg.
- 35-37 The UE-1 acknowledges the release of old access leg.

5.2.2.1.13.7 Session transfer from PS to (CS+PS)

In this flow, Call-ID #1 is for PS2 access leg, Call-ID #1' for PS1 access leg, Call-ID #1" for CS access leg and Call-ID #2 for remote leg.

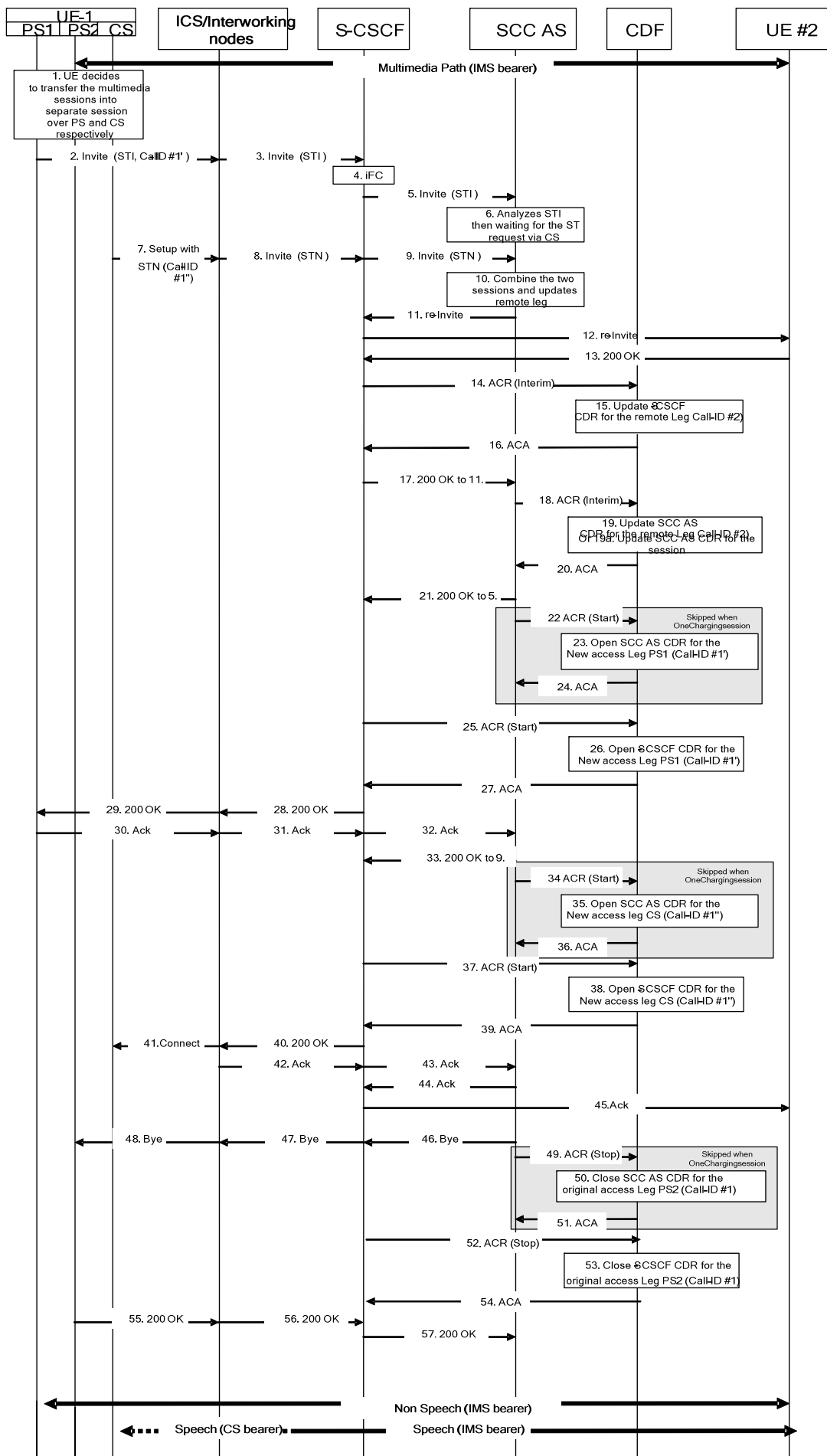

**Figure 5.2.2.1.13.7-1: Message Sequence Chart UE Domain Transfer PS2 access to PS1 and CS access.**

- 1-2. UE-1 originates a call in the PS1 domain including the STI to request the multimedia session transfer to PS1 access in conjunction with CS access.
3. The session establishment request is routed to the S-CSCF by the P-CSCF.
4. The S-CSCF invokes the SCC Application as the first Application Server of any Application Servers that need to remain in the path of the call after session transfer.
5. The S-CSCF forwards the INVITE to the SCC Application over the ISC interface.
6. The SCC Application analyses the STI and decides to wait for the session transfer request in CS access.
7. UE-1 origins a CS call including STN to indicate to the network that this is a session transfer request.
8. The ICS intermediate Nodes convert the request into IMS SIP format and then forward the converted request to the S-CSCF.
9. The S-CSCF forwards the INVITE to the SCC Application over the ISC interface.
10. The SCC Application correlates the two requests and decides to update the Remote leg.
- 11-13. The SCC AS sends a re-INVITE to the Remote UE to modify the media components of the existing dialog identified in the REFER request. The re-INVITE proposes new SDP parameters based on the parameters received from UE-2 in step 6. When the Remote UE receives the new media parameters, it returns an answer and starts the reception/transmission of these media components.
- 14-16. At Access Leg update the S-CSCF in the originating network sends Accounting-Request with Accounting-Record-Type indicating INTERIM\_RECORD to record update of a session in the S-CSCF CDR.
17. The S-CSCF answers to the INVITE message in 11.
- 18-20. At Access Leg update the SCC AS sends Accounting-Request with Accounting-Record-Type indicating INTERIM\_RECORD to record update of a session in the SCC AS CDR.
- 18-19a-20. Alternatively, when “OneChargingSession”, the SCC AS sends an *Accounting-Request* with *Accounting-Record-Type* indicating INTERIM\_RECORD to record modification of SCC AS CDR for the IMS session (ICID) with the new PS access leg, new CS access leg and Remote leg. The CDF updates the SCC AS CDR related to the IMS session and acknowledges the reception of the data..
21. The S-CSCF answers to the INVITE message in 5.
- 22-24. Upon generation of the final response, the SCC AS in the home IMS of the originating SCC user sends an *Accounting-Request* with *Accounting-Record-Type* indicating START\_RECORD to record start of a user session in the SCC AS-CDR for Call-ID #1'. The CDF from the originating network opens an AS CDR and acknowledges the reception of the data.  
  
Steps 22 to 24 are not applicable for the “OneChargingSession” option.
- 25-27. Upon generation of the final response, the S-CSCF in the home IMS of the originating SCC user sends an *Accounting-Request* with *Accounting-Record-Type* indicating START\_RECORD to record start of a user session in the S-CSCF-CDR for Call-ID #1'. The CDF from the originating network opens an S-CSCF CDR and acknowledges the reception of the data.
- 28-29. The S-CSCF accepts session continuity message from the Remote UE by sending a 200 OK response (for the PS1 INVITE message).
- 30-32. UE-1 sends an ACK response to the SCC AS.
33. The S-CSCF answers to the INVITE message in 9.



34-36. Upon generation of the final response, the SCC AS in the home IMS of the originating SCC user sends an *Accounting-Request* with Accounting-Record-Type indicating START\_RECORD to record start of a user session in the SCC AS-CDR for Call-ID #1". The CDF from the originating network opens an AS CDR and acknowledges the reception of the data.

Steps 34 to 36 are not applicable for the "OneChargingSession" option.

37-39. Upon generation of the final response, the S-CSCF in the home IMS of the originating SCC user sends an *Accounting-Request* with Accounting-Record-Type indicating START\_RECORD to record start of a user session in the S-CSCF-CDR for Call-ID #1". The CDF from the originating network opens an S-CSCF CDR and acknowledges the reception of the data.

40-41. The S-CSCF accepts session continuity message from the Remote UE by sending a 200 OK response (for the CS INVITE message).

42-44. UE-1 sends an ACK response to the S-CSCF.

45. Once acknowledgment has been received for the both leg, the ACK message is sent to the remote UE.

46-48. The SCC Application initiates to release the old access leg

49-51. The SCC AS sends Accounting-Request with Accounting-Record-Type indicating STOP\_RECORD for closing the SCC AS CDR related to the original Access leg. The CDF updates the SCC AS CDR related to the IMS session and acknowledges the reception of the data

Steps 49 to 51 are not applicable for the "OneChargingSession" option.

52-54. The S-CSCF sends Accounting-Request with Accounting-Record-Type indicating STOP\_RECORD for closing the S-CSCF CDR related to the original Access leg. This CDR may be generated with special handling. One example of special handling is to zero rate the IMS resource usage for Access leg establishment. This can be performed using the correlation mechanism with the SCC AS CDR for Access leg.

55-56. The UE answers by a 200 OK message to the S-CSCF.

57. The S-CSCF sends a 200 OK message to the SCC AS the releasing of the old access leg.

#### 5.2.2.1.13.8 Session transfer from (CS+PS) to PS

In this flow, Call-ID #1 is for PS2 access leg, Call-ID #1' for CS access leg, Call-ID #1" for PS1 access leg and Call-ID #2 for remote leg.

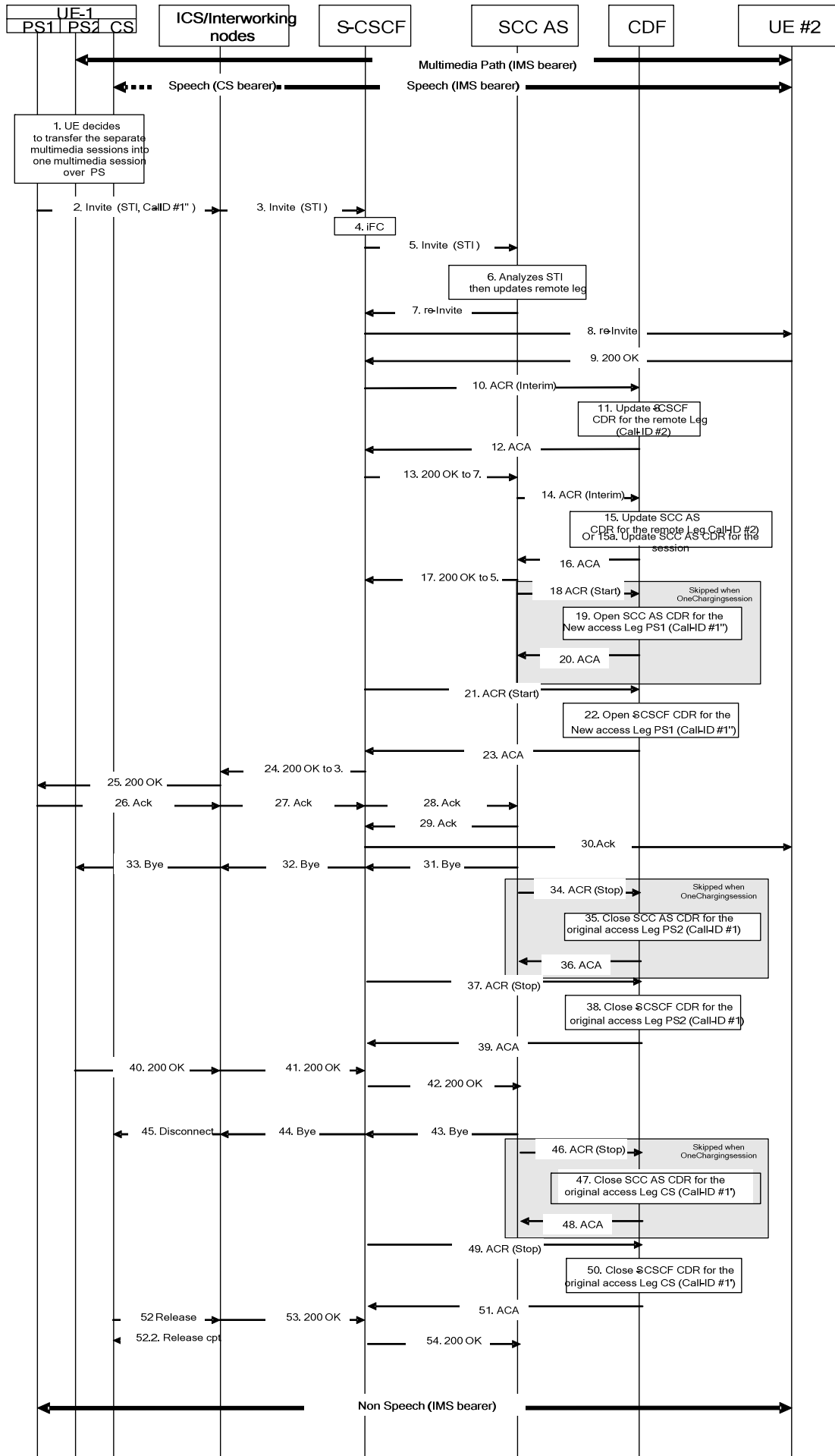

**Figure 5.2.2.1.13.8-1: Message Sequence Chart UE Domain Transfer PS2 access and CS access to PS1 access**

- 1-2. UE-1 originates a call in the PS1 domain including the STI to request the multimedia session transfer to PS1 access.
  3. The session establishment request is routed to the S-CSCF by the P-CSCF.
  4. The S-CSCF invokes the SCC Application as the first Application Server of any Application Servers that need to remain in the path of the call after session transfer.
  5. The S-CSCF forwards the INVITE to the SCC Application over the ISC interface.
  6. The SCC Application analyses the STI and decides to update the Remote leg.
  - 7-9. The SCC AS sends a re-INVITE to the Remote UE to modify the media components of the existing dialog identified in the REFER request. The re-INVITE proposes new SDP parameters based on the parameters received from UE-2 in step 6. When the Remote UE receives the new media parameters, it returns an answer and starts the reception/transmission of these media components.
  - 10-12. At Access Leg update the S-CSCF in the originating network sends Accounting-Request with Accounting-Record-Type indicating INTERIM\_RECORD to record update of a session in the S-CSCF CDR.
  13. The S-CSCF answers to the INVITE message in 7.
  - 14-16. At Access Leg update the SCC AS sends Accounting-Request with Accounting-Record-Type indicating INTERIM\_RECORD to record update of a session in the SCC AS CDR.
  - 14-15a-16. Alternatively, when "OneChargingSession", the SCC AS sends an *Accounting-Request* with *Accounting-Record-Type* indicating INTERIM\_RECORD to record modification of SCC AS CDR for the IMS session (ICID) with remote leg and new PS access leg. The CDF updates the SCC AS CDR related to the IMS session and acknowledges the reception of the data..
  17. The SCC AS answers to the INVITE message in 5.
  - 18-20. Upon generation of the final response, the SCC AS in the home IMS of the originating SCC user sends an *Accounting-Request* with Accounting-Record-Type indicating START\_RECORD to record start of a user session in the SCC AS-CDR. The CDF from the originating network opens an AS CDR and acknowledges the reception of the data.
- Steps 18 to 19 are not applicable for the "OneChargingSession" option.
- 21-23. Upon generation of the final response, the S-CSCF in the home IMS of the originating SCC user sends an *Accounting-Request* with Accounting-Record-Type indicating START\_RECORD to record start of a user session in the S-CSCF-CDR. The CDF from the originating network opens an S-CSCF CDR and acknowledges the reception of the data.
  24. The S-CSCF answers to the INVITE message in 3.
  25. The 200 OK message is sent to UE #1.
  - 26-30. UE-1 sends an ACK response to the S-CSCF. The ACK message is sent to the remote UE.
  - 31-33. The source Access Leg 2 (which is one of the Access Legs previously established over PS2) is released by the SCC Application in this example, however the UE-1 may initiate to release the source Access Leg 2.
  - 34-36. The SCC AS sends Accounting-Request with Accounting-Record-Type indicating STOP\_RECORD for closing the SCC AS CDR related to the original Access leg. The CDF updates the SCC AS CDR related to the IMS session and acknowledges the reception of the data.
- Steps 34 to 36 are not applicable for the "OneChargingSession" option.
- 37-39. The S-CSCF sends Accounting-Request with Accounting-Record-Type indicating STOP\_RECORD for closing the S-CSCF CDR related to the original PS Access leg. This CDR may be generated with special

handling. One example of special handling is to zero rate the IMS resource usage for Access leg establishment. This can be performed using the correlation mechanism with the SCC AS CDR for PS Access leg.

40-42. The UE-1 answers to the BYE message in 33.

43-45. The SCC Application initiates to release the old access leg via CS access in this example, however the UE-1 may initiate to release the source Access Leg.

46-48. The SCC AS sends Accounting-Request with Accounting-Record-Type indicating STOP\_RECORD for closing the SCC AS CDR related to the original CS Access leg. The CDF updates the SCC AS CDR related to the IMS session and acknowledges the reception of the data

Steps 46 to 48 are not applicable for the “OneChargingSession” option.

49-51. The S-CSCF sends Accounting-Request with Accounting-Record-Type indicating STOP\_RECORD for closing the S-CSCF CDR related to the original CS Access leg. This CDR may be generated with special handling. One example of special handling is to zero rate the IMS resource usage for Access leg establishment. This can be performed using the correlation mechanism with the SCC AS CDR for CS Access leg.

52-54. The UE-1 answers to the BYE message in 43.

#### 5.2.2.1.13.9 IMS Emergency Session transfer from PS to CS

In this flow, Call-ID #1 is for PS access leg, Call-ID #1' for CS access leg and Call-ID #2 for remote leg.

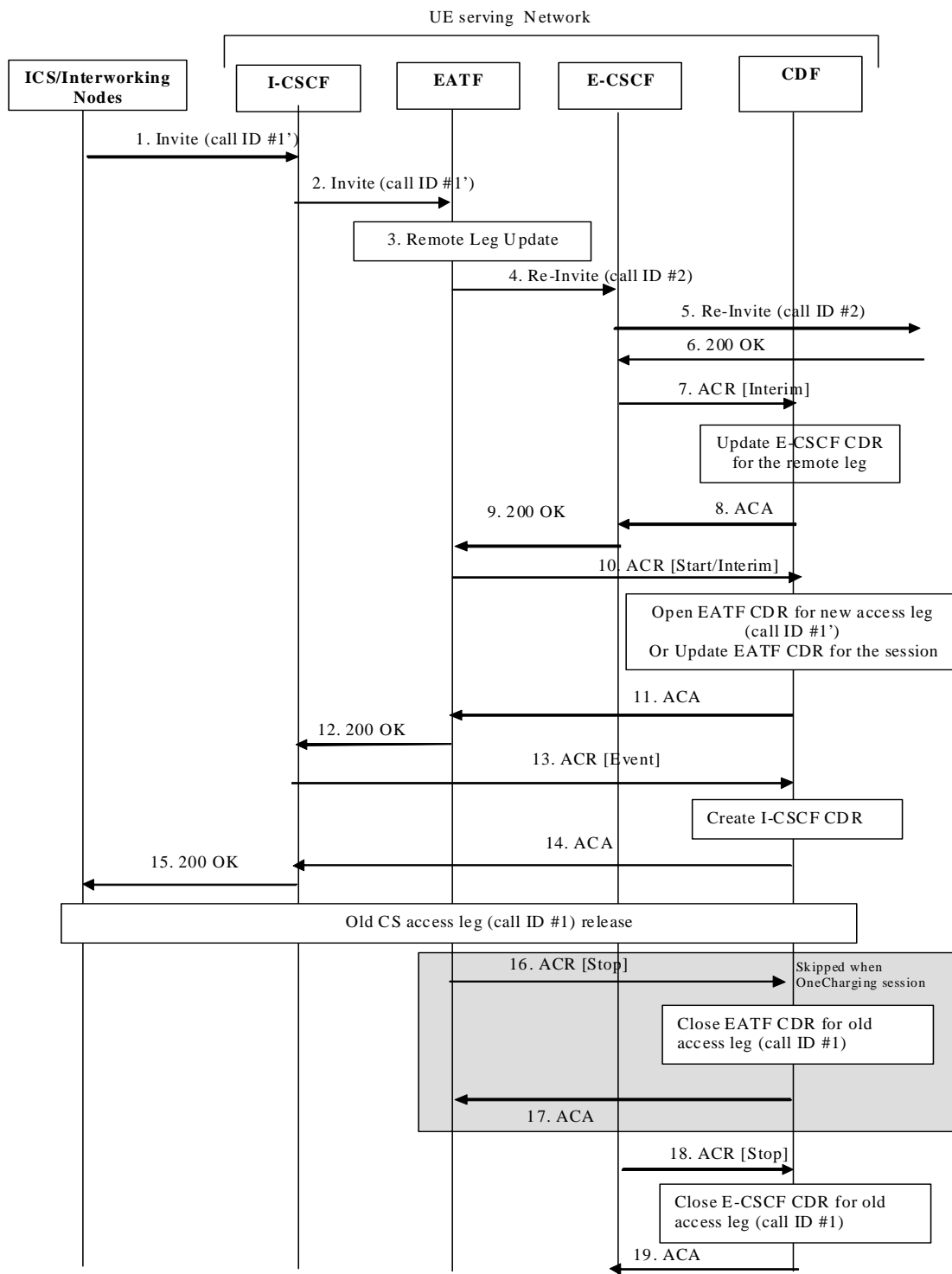

**Figure 5.2.2.1.13.9-1: Message Sequence Chart UE Domain Transfer PS access to CS access for IMS emergency session.**

- 1-2. UE originates an IMS emergency session transfer towards EATF via I-CSCF.
- 3. From the received INVITE analysis, the EATF derives a request for transfer of the existing IMS emergency session to the CS domain, and proceeds with switch of access leg communicating with the Remote Leg from Old PS Access Leg to new CS Access Leg.
- 4-5. The EATF performs the Remote Leg update by sending the SIP re-INVITE request towards the remote end via E-CSCF.

6-8 Upon receipt of the 200 OK response, the E-CSCF sends an *Accounting-Request* with Accounting-Record-Type indicating INTERIM\_RECORD to record update of the E-CSCF CDR for remote leg Call-ID #2.

9-11 Upon receipt of the 200 OK response, the EATF sends an *Accounting-Request* with Accounting-Record-Type indicating START\_RECORD to record start of an EATF CDR for new access leg Call-ID #1'. Alternatively, when "OneChargingSession", the EATF sends an *Accounting-Request* with Accounting-Record-Type indicating INTERIM\_RECORD to record modification of EATF CDR for the IMS session (ICID) with new CS access leg. The CDF updates the EATR CDR related to the IMS session and acknowledges the reception of the data.

12-14 Upon receipt of the 200 OK response, the I-CSCF sends an *Accounting-Request* with Accounting-Record-Type indicating EVENT\_RECORD to create an I-CSCF CDR for new access leg Call-ID #1'.

15. The 200 OK response is sent towards the UE via ICS/Interworking nodes.

16-17 Upon release of old access leg, the EATF sends an *Accounting-Request* with Accounting-Record-Type indicating STOP\_RECORD to record stop of the EATF CDR for old access leg Call-ID #1.

Steps 16 to 17 are not applicable for the "OneChargingSession" option.

18-19 Upon release of old access leg, the E-CSCF sends an *Accounting-Request* with Accounting-Record-Type indicating STOP\_RECORD to record stop of the E-CSCF CDR for old access leg Call-ID #1.

EATF (acting as a B2BUA) performs third party call control and is considered as an AS for the charging description.

## 5.2.2.1.14 Initiating Alternate Charged Party Call

The following figure shows the case where a call with an alternate charged party is successfully initiated.

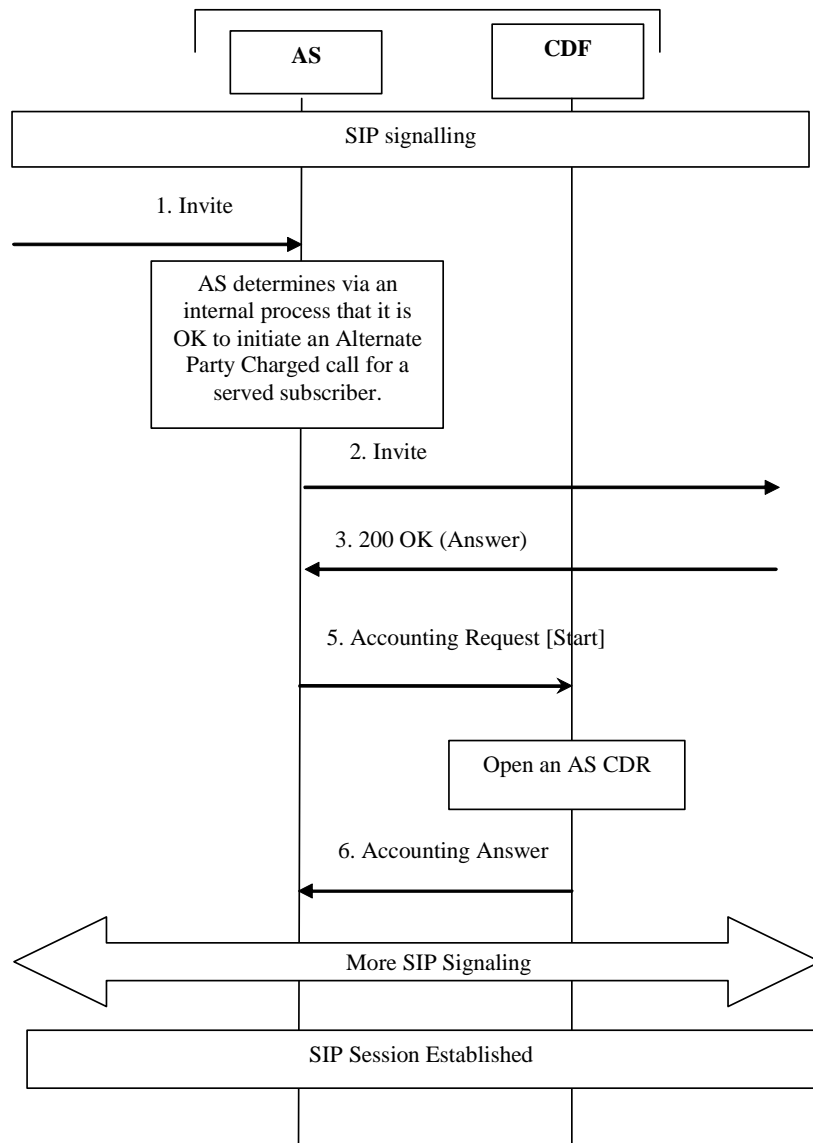

**Figure 5.2.2.1.14-1: Successful Initiation of Alternate Party Charging**

1. The AS receives a SIP Invite.
2. After determining that Alternate Charged Party is supported, the AS initiates an Invite with an "Alternate Party Identity" for charging. The method for determination of the alternate charged party includes accessing subscriber data and doing a security assessment.
3. The terminating side issues a 200 OK (Answer), to AS.
4. The AS sends a 200 OK.
5. The AS sends an accounting request to the CDF.
6. The CDF opens a CDR with the Subscription-ID for the Alternate Charged Party and sends an accounting answer to the AS.
7. The session is established.

5.2.2.1.15 Session Establishment via IBCF to S-CSCF - IMS Initiated

The following figure shows the Diameter transactions that are required between IBCF, S-CSCF and CDF in each IMS network during session establishment.

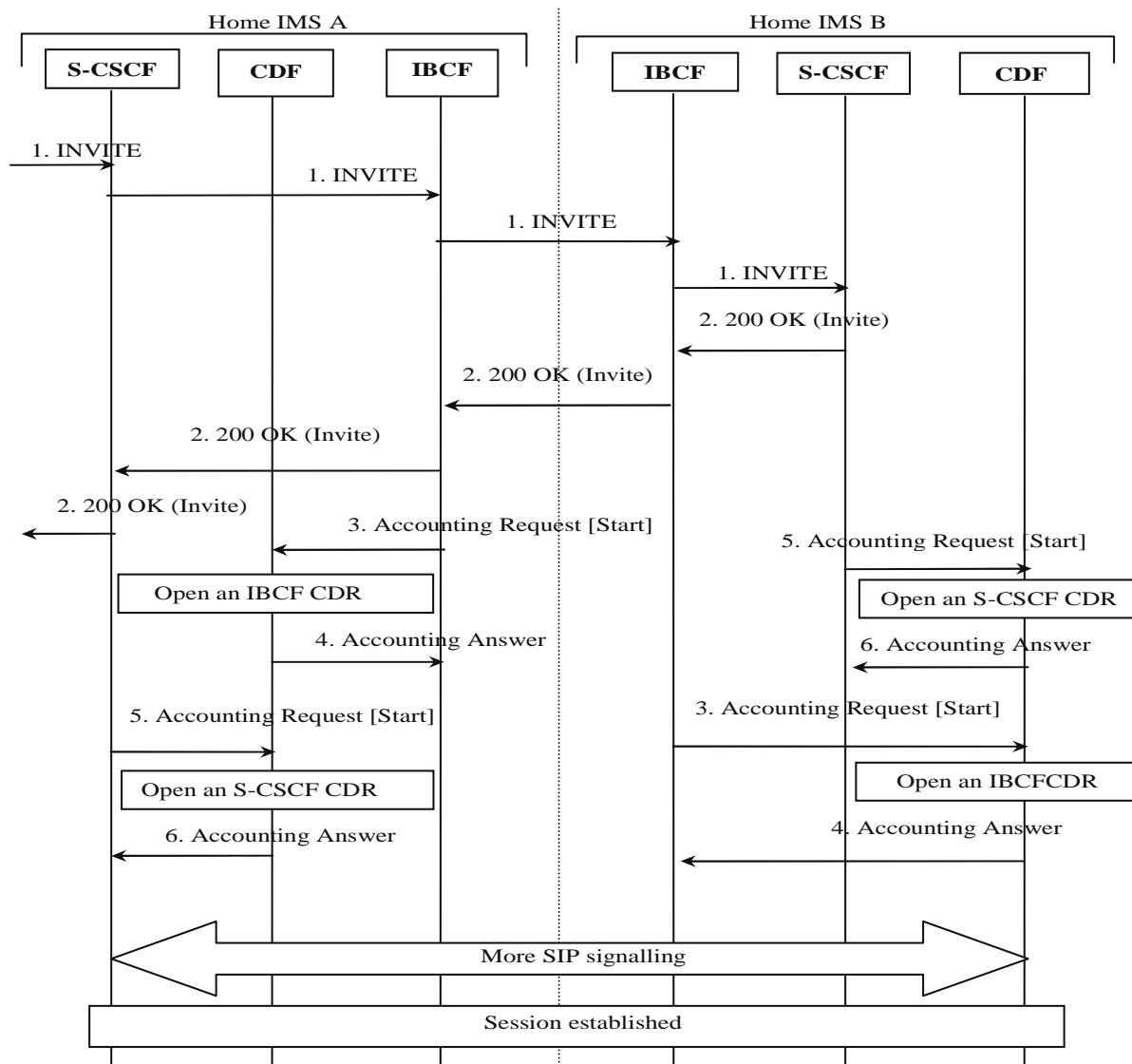

Figure 5.2.2.1.15-1: Message Sequence Chart for IMS Initiated Session Establishment via IBCF

1. The session is originated in Home IMS A, and an INVITE is sent through to Home IMS B via IBCFs.
2. All of the IMS network entities respond with successful 200 OK to the Invite.
3. Upon reception of the answer message, the IBCFs send an *Accounting-Request* with *Accounting-Record-Type* to the CDF in each IMS indicating *START\_RECORD* to record start of a user session and start of a media component in the IBCF and CDRs.
4. The CDF in each IMS acknowledges the reception of the data and opens an IBCF CDR
5. Upon reception of the answer message, the S-CSCFs send an *Accounting-Request* with *Accounting-Record-Type* to the CDF in each IMS indicating *START\_RECORD* to record start of a user session and start of a media component in the and S-CSCF.
6. The CDF in each IMS acknowledges the reception of the data and opens an S-CSCF CDR.
7. The session is established.



5.2.2.1.16 AS Related Procedures - AS Acting as a MMTel AS.

For details on charging at AS acting as an MMTel server, providing service such as CDIV, CONF and TIP/TIR, see the TS 32.275 [35].

5.2.2.1.17 Session Establishment via IBCF to a third party AS providing tariff information in real time (RTTI)

The following figure shows the Diameter transactions that are required between S-CSCF, IBCF and CDF, in each IMS network, during session establishment. It represents a charging interconnect scenario where the third party AS (located in another network) provides e.g. value-added service and real time tariff information according to TS 29.658 [206].

**Editor's Note: The interconnect scenario between IMS network and PSTN (involving MGCF rather than IBCF) is FFS.**

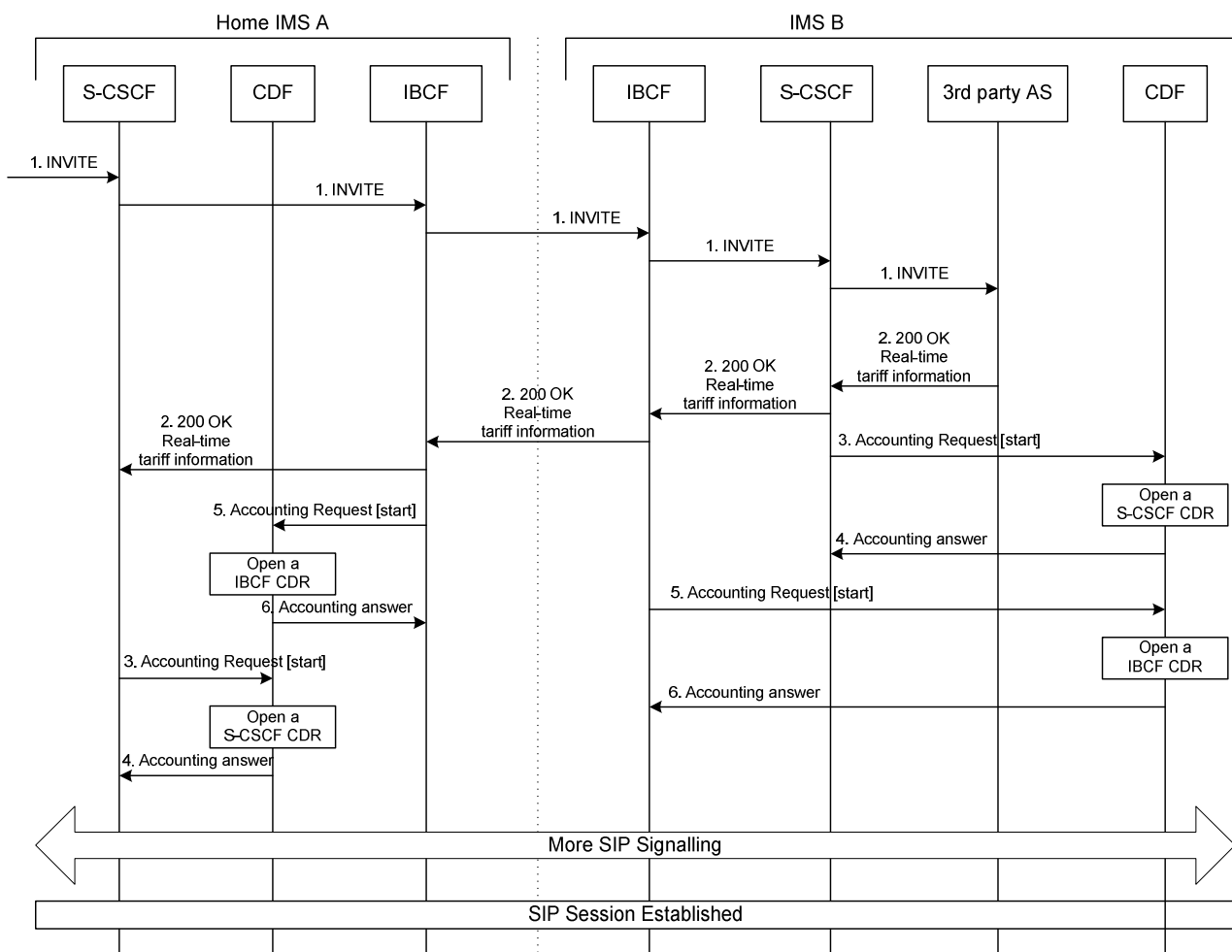

**Figure 5.2.2.1.17-1: Message Sequence Chart for IMS Initiated Session Establishment with a 3<sup>rd</sup> party AS providing real-time tariff information (RTTI)**

1. The session is initiated.
2. The destination (third party AS) answers with successful 200OK to the INVITE. The third party AS includes a real time tariff information within the 200OK response.
3. Upon reception of the final response, the S-CSCF sends an *Accounting-Request* with *Accounting-Record-Type* indicating START\_RECORD to record start of a user session and start of a media component in the S-CSCF.

- 4 The CDF in each IMS network acknowledges the reception of the data and opens an S-CSCF CDR.
- 5 Upon reception of the 200 OK message, the IBCFs send an *Accounting-Request* with *Accounting-Record-Type* to the CDF in each IMS indicating *START\_RECORD* to record start of a user session and start of a media component in the IBCF.
- 6 The CDF in each IMS acknowledges the reception of the data and opens an IBCF CDR.

5.2.2.1.18 Third party AS providing tariff information in real time (RTTI) during the session

The following figure shows the Diameter transactions that are required between S-CSCF, IBCF and CDF, in each IMS network, when a third party AS (located in another network) involved in the session provides e.g. value-added service and real time tariff information according to TS 29.658 [206] during the session.

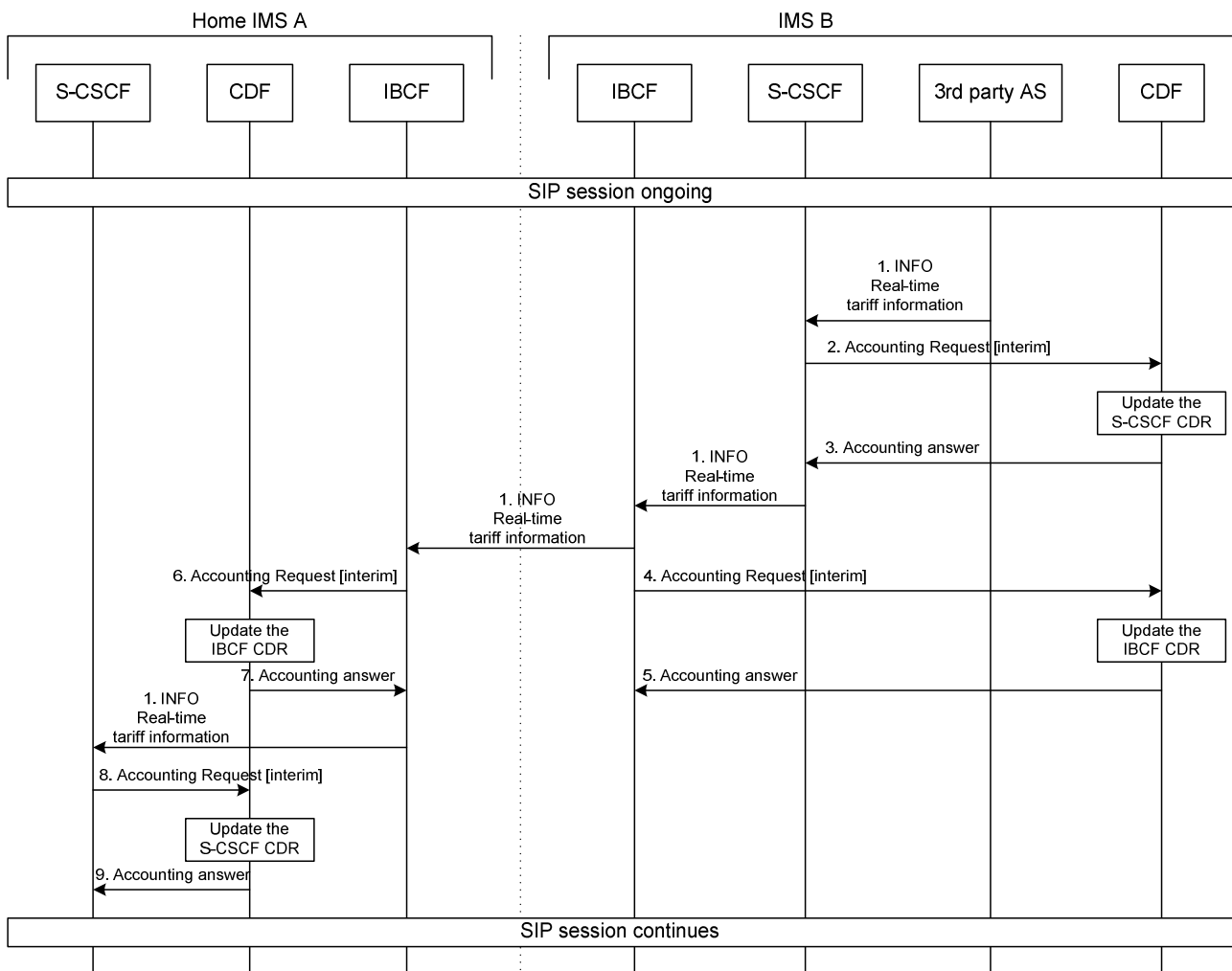

Figure 5.2.2.1.18-1: Message Sequence Chart for third party AS providing tariff information in real time (RTTI) during the session

- 1. The third party AS includes an RTTI within a SIP INFO and sends the message to the originating party.
- 2. Upon reception of the INFO embedding RTTI, the S-CSCF sends an *Accounting-Request* with *Accounting-Record-Type* indicating *INTERIM\_RECORD* to record tariff information in the CDR.
- 3. The CDF acknowledges the reception of the data and updates the S-CSCF CDR.
- 4. Upon reception of the INFO embedding RTTI, the IBCF sends an *Accounting-Request* with *Accounting-Record-Type* indicating *INTERIM\_RECORD* to record tariff information in the CDR.
- 5. The CDF acknowledges the reception of the data and updates the IBCF-CDR.

6. Upon reception of the INFO embedding RTTI, the IBCF sends an *Accounting-Request* with *Accounting-Record-Type* indicating INTERIM\_RECORD to record tariff information in the CDR.
7. The CDF acknowledges the reception of the data and updates the IBCF-CDR.
8. Upon reception of the INFO embedding RTTI, the S-CSCF sends an *Accounting-Request* with *Accounting-Record-Type* indicating INTERIM\_RECORD to record tariff information in the CDR.
9. The CDF acknowledges the reception of the data and updates the S-CSCF CDR.

#### 5.2.2.1.19 Support of Optimal Media Routing (OMR)

Optimal Media Routing (OMR) relies on IMS-ALG function enhancement, used by some IMS Nodes as described in TS 23.228 [201] Annex Q, when performing media functions at transport level such as firewall or NAT, or application level such as transcoding. The purpose of optimal media routing (OMR) is to identify and remove unnecessary media functions from the media path for each media stream associated to a session. The OMR procedures are applicable to the following IMS entities having IMS-ALG function used in a B2BUA mode:

- P-CSCF for support of NAT for signalling and media (with IMS-ALG/IMS-AGW model as described in TS 23.228 [201] Annex G)
- IBCF for border Control Functions towards other IMS/SIP Networks (with IBCF/TrGW model as described in TS 23.228 [201] Annex I)
- Any AS performing as a B2BUA controlling media resources

Although the different TS 23.228 [201] scenarios mainly address the IBCF/TrGW, they are also applicable to P-CSCF/IMS-AGW, except for transcoding function which relates to IBCF only. Consequently, in the different flows, the “GW” stands for TrGW or IMS-AGW, according to the situation.

The following flows focus on one IMS Node behaviour, embedding such IMS-ALG function supporting OMR, when involved in some of OMR scenarios described in TS 23.228 [201] Annex Q.

Each media line of the same session can be applied with separate OMR decision (i.e different optimised paths), however, for simplification, only one media is assumed in the following call flows.

In the Figure, the “Originating side” may be an Originating UA or another IMS-ALG in the same IMS Network, or another IMS Network, and the “Destination side” may be a Terminating UA or another IMS-ALG in the same IMS Network, or another IMS Network.

#### 5.2.2.1.19.1 IMS-ALG Related Procedures for OMR – Session establishment and IMS-ALG bypasses its local GW

The following figure shows the session establishment with SDP offer/answer exchange from Originating side towards a Destination side, traversing an IMS Network Node including IMS-ALG function supporting OMR, and OMR results in IMS-ALG bypasses its local GW.

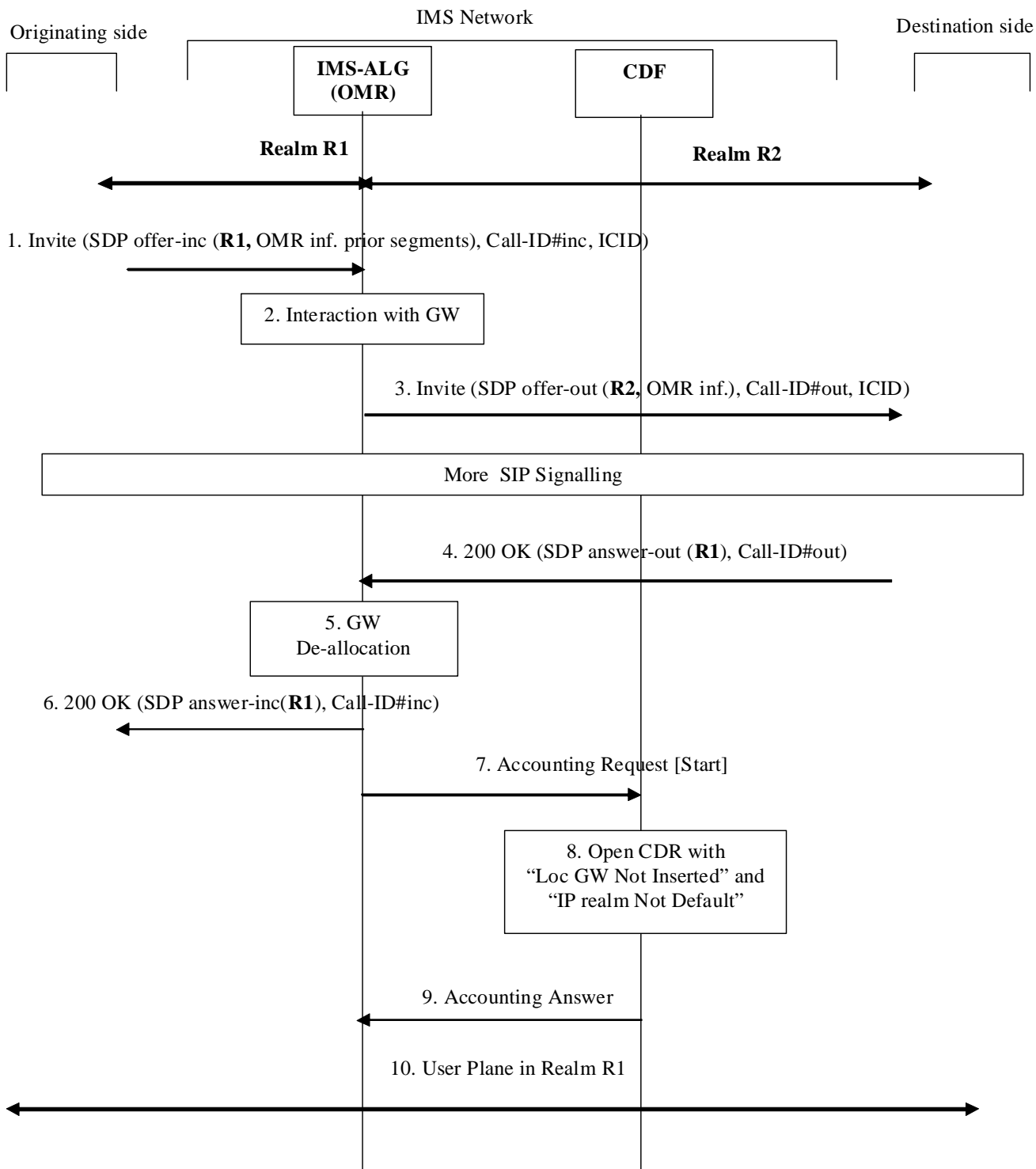

**Figure 5.2.2.1.19.1-1: Message Sequence Chart for Session establishment with IMS-ALG supporting OMR and IMS-ALG bypasses its local GW due to OMR process.**

1. IMS-ALG receives an INVITE with SDP offer-inc (call-ID#-inc) from Originating side, containing the transport address allocated in realm R1 by the Originating side for the media on incoming leg, and potential OMR information from prior user plane segments.
2. IMS-ALG determines the outgoing IP realm (R2) is different from the incoming IP realm (R1) and interacts with a GW in order to allocate a local transport address for the media on outgoing leg, in realm R2.

3. IMS-ALG generates INVITE towards Destination side (call-ID#-out), with a new SDP offer-out including such local transport address, and also OMR extensions (for the segment locally handled, along with those received from prior user plane segments) for further OMR decisions.
4. The destination side answers with 200 OK and SDP answer-out, with the transport address allocated by the destination side for the media on outgoing leg, as result of OMR processing (based on OMR information provided in step 3). This transport address is in realm R1, thus identifying the local GW to be bypassed (i.e same IP realm as in step 1), and also identifying use of a different IP realm from the default one (i.e R2).
5. The Local GW is de-allocated (release of resource allocated in step 2 in realm R2).
6. IMS-ALG forwards the SDP answer-inc for the media on incoming leg, with this transport address received in step 4.
7. IMS-ALG sends *Accounting-Request* with *Accounting-Record-Type* indicating START\_RECORD to record start of session with “Local GW Not Inserted” and “IP realm Not Default” indications for the media.
- 8-9. The CDF opens a session CDR for the IMS Node and acknowledges the reception of the data.
10. A user plane connection is now established in realm R1 without GW insertion for the media.

5.2.2.1.19.2 IMS-ALG Related Procedures for OMR – Session establishment and alternate IP realm is selected

The following figure shows the session establishment with SDP offer/answer exchange from Originating side towards Destination side, traversing an IMS Network Node including IMS-ALG function supporting OMR, and OMR results in alternate IP realm selection (i.e not the default IP realm) for the media.

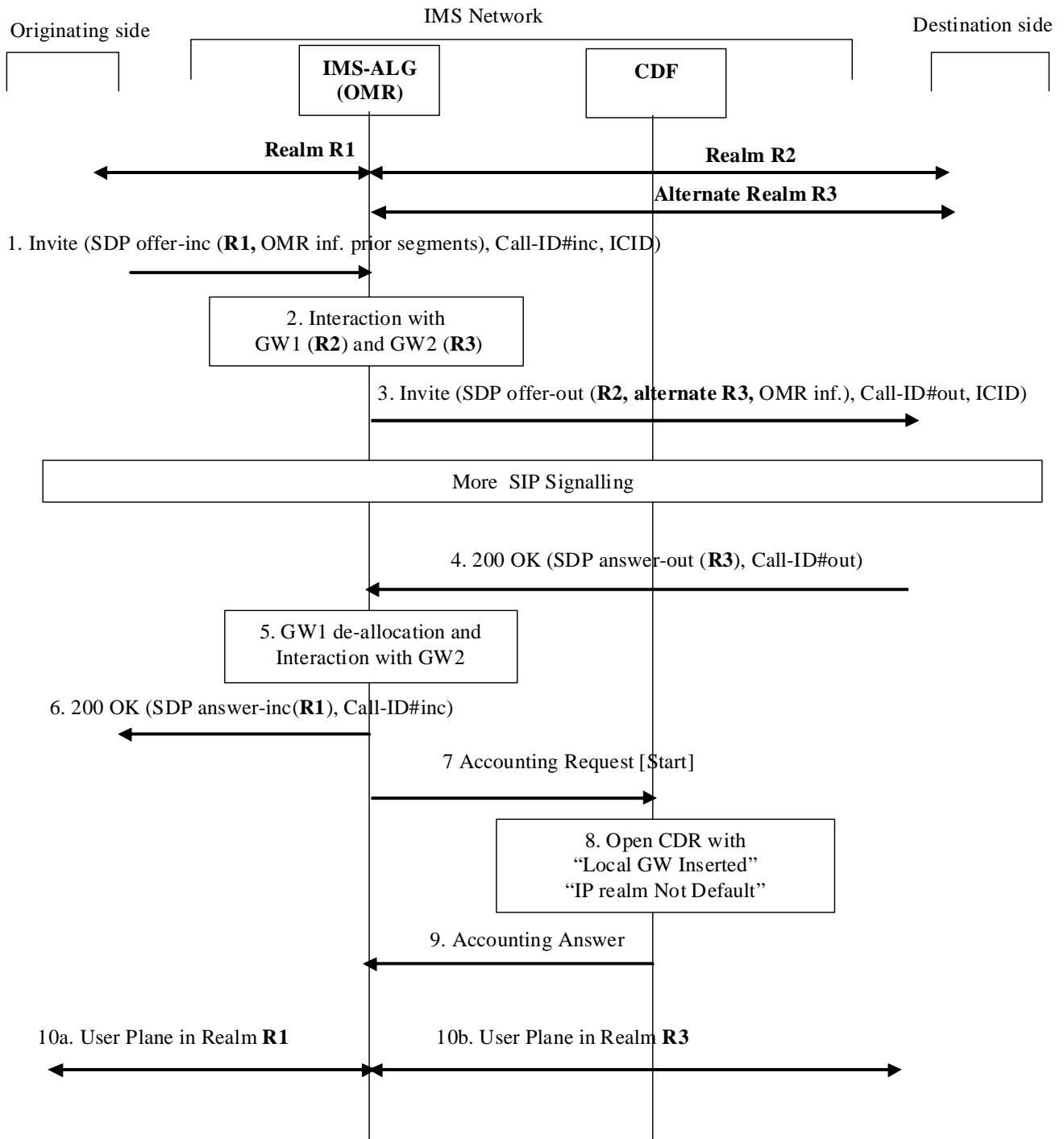

Figure 5.2.2.1.19.2-1: Message Sequence Chart for Session establishment with IMS-ALG supporting OMR, and alternate realm is selected due to OMR process.

1. IMS-ALG receives an INVITE with SDP offer-inc (call-ID#-inc) from Originating side, containing the transport address allocated in realm R1 by the Originating side for the media on incoming leg, and potential OMR information from prior user plane segments.

2. IMS-ALG determines the outgoing IP realm (R2) is different from the incoming IP realm (R1) and interacts with a GW1 in order to allocate a local transport address for the media on outgoing leg, in realm R2. IMS-ALG additionally interacts with GW2 in order to allocate an alternate local transport address for the media in realm R3.
3. IMS-ALG generates INVITE towards Destination side (call-ID#-out), with a new SDP offer-out including such local transport addresses, and also OMR extensions (for the segment locally handled, along with those received from prior user plane segments) for further OMR decisions.
4. The destination side answers with 200 OK and SDP answer-out, with the transport address allocated by the destination side for the media on outgoing leg, as result of OMR processing (based on OMR information provided in step 3). This transport address is in realm R3, thus identifying the local GW2 to be retained, and also identifying use of a different IP realm from the default one (i.e R2).
5. The GW1 is de-allocated (release of resource allocated in step 2 for realm R2), and interaction occurs with GW2 to maintain the user plane connection via R3.
6. IMS-ALG1 forwards the SDP answer-inc, with the transport address allocated by the GW2 in realm R1, for the media on incoming leg.
7. IMS-ALG sends *Accounting-Request* with *Accounting-Record-Type* indicating START\_RECORD to record start of session with "Local GW Inserted" and "IP realm Not Default" indications for the media.
- 8-9. The CDF opens a session CDR for the IMS Node and acknowledges the reception of the data.
- 10a-b. A user plane connection is now established in realm R1 up to the GW2, and in realm R3 from the GW2 for the media.



5.2.2.1.19.3 IMS-ALG Related Procedures for OMR – Mid-session procedure

The following figure shows a scenario when a new SDP offer/answer exchange due to UE generating a SIP (Re-)INVITE or SIP UPDATE in mid-session in order to add a media component , and the OMR procedures is processed for this new media, with same situation as in 5.2.2.1.19.1 (IMS-ALG bypasses its local GW).

This scenario also applies for situations where a (Re-)INVITE or a SIP UPDATE is issued for updating a media and the OMR procedures is processed again, changing the established media path.

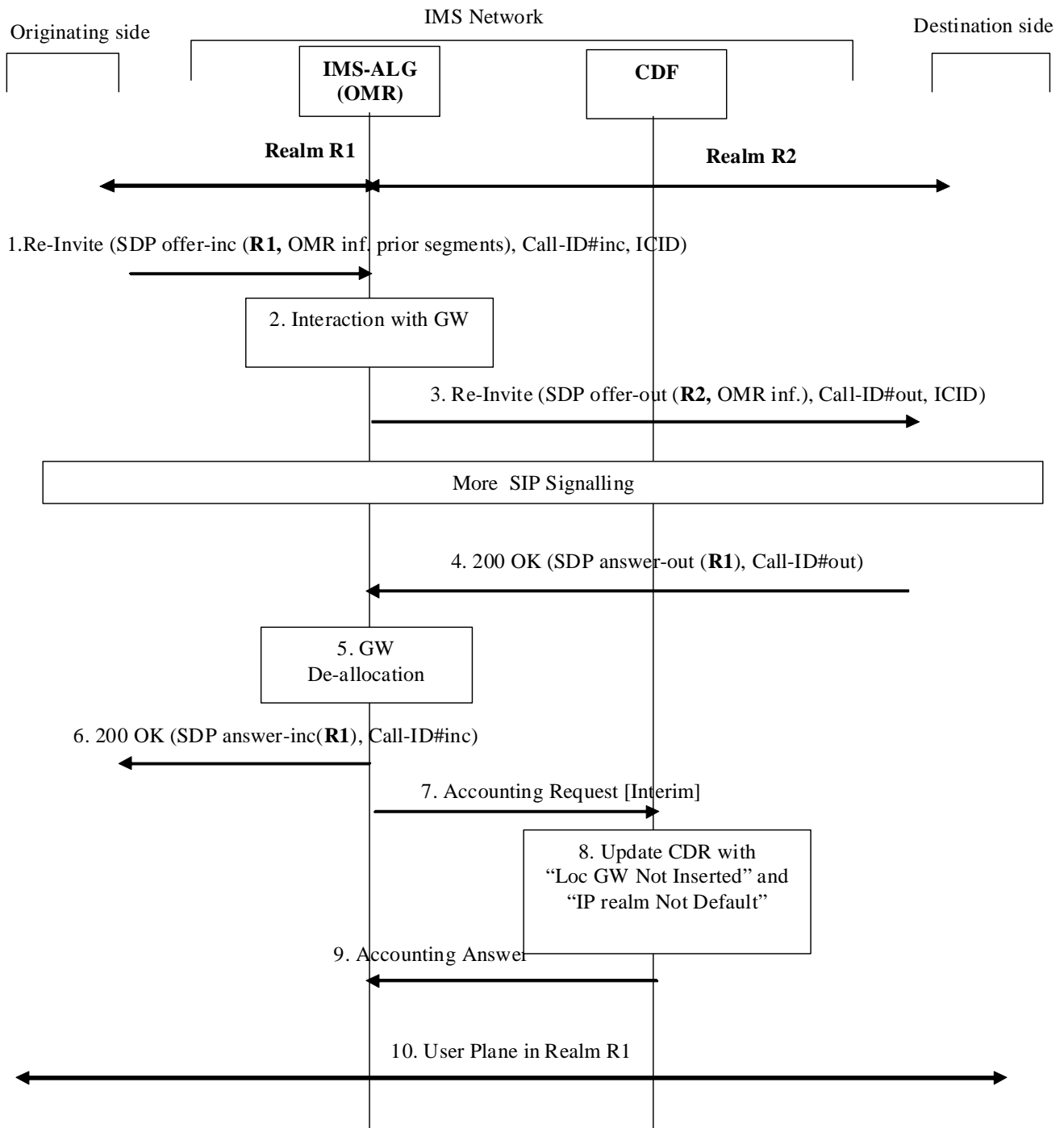

Figure 5.2.2.1.19.3-1: Message Sequence Chart for mid-session procedure with IMS-ALG supporting OMR, IMS-ALG bypasses its GW due to OMR process for the added media.

The same steps described in chapter 5.2.2.1.19.1 apply, with following exceptions:

1 and 3: a Re-INVITE instead of INVITE

7. IMS-ALG sends *Accounting-Request* with *Accounting-Record-Type* indicating INTERIM\_RECORD to record update of session with “Local GW Not Inserted” and “IP realm Not Default” indications for the media.

8-9. The CDF updates the session CDR for the IMS Node and acknowledges the reception of the data.

#### 5.2.2.1.19.4 IMS-ALG Related Procedures for OMR – transcoding

As described in TS 23.228 [201] Annex Q, transcoding is also part of OMR process.

The following flows show session establishment with SDP offer/answer exchange from Originating side towards a Destination side, traversing an IMS Network Node including IMS-ALG function supporting OMR with transcoder inserted by this IMS Node.

Although transcoding aspect is part of the same SDP Offer/Answer different exchanges described in sub-clause 5.2.2.1.19.1 to sub-clause 5.2.2.1.19.3, therefore combined in OMR process, it is reflected here through dedicated flows for simplification.

These procedures apply to IBCF/TrGW only.

#### 5.2.2.1.19.4.1 IMS-ALG Related Procedures for OMR – transcoder provided by IMS-ALG

The following flow describes the situation where IMS-ALG allocates a transcoder for offering an additional transcoding option, and this transcoder is selected.

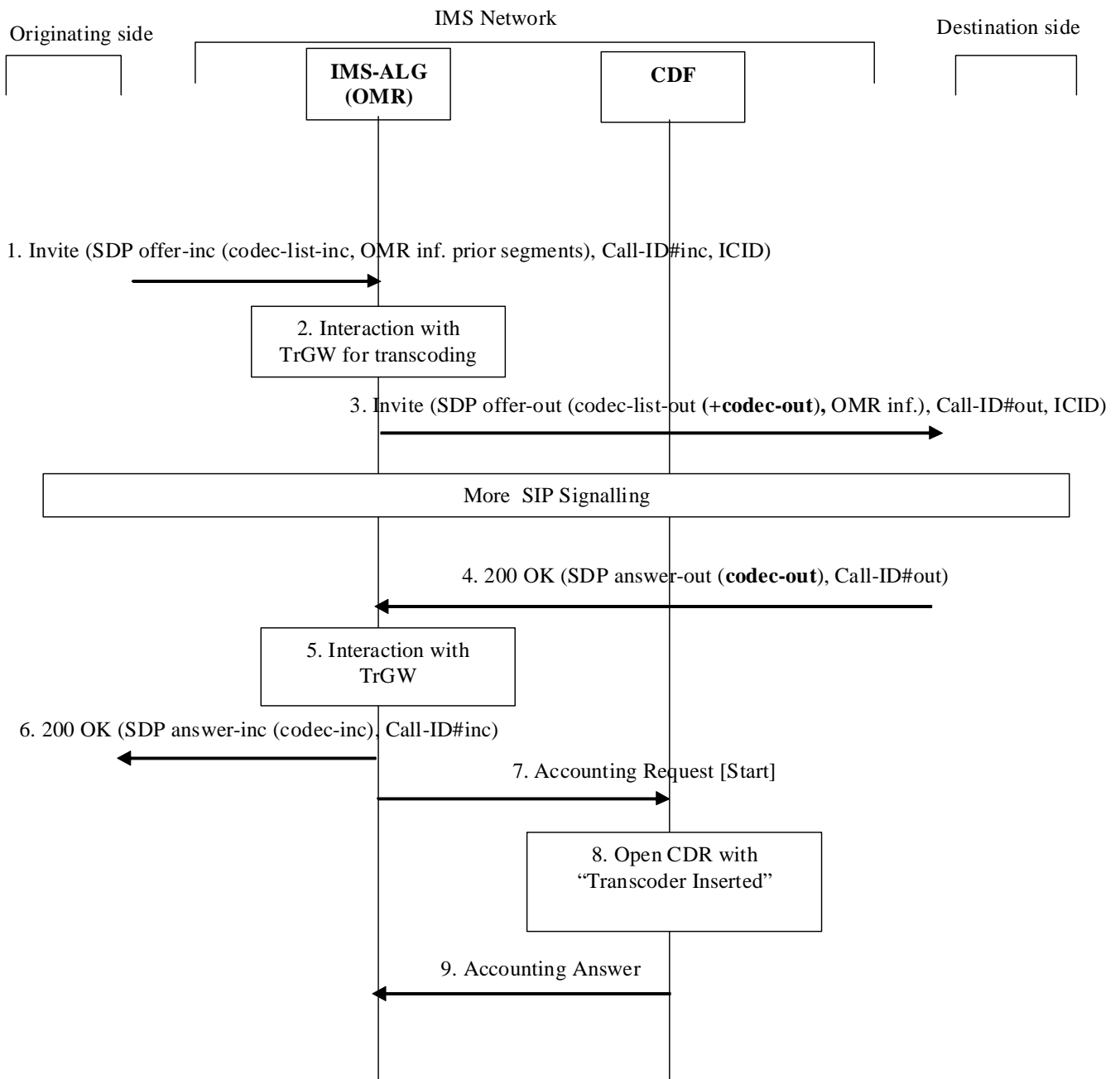

**Figure 5.2.2.1.19.4.1-1: Message Sequence Chart for Session establishment with transcoder offered by IMS-ALG is inserted.**

1. IMS-ALG receives an INVITE with SDP offer-inc (call-ID#-inc) from Originating side, containing a codec-list-inc in the SDP offer, and potential OMR information from prior user plane segments based on an Operator’s configuration.
2. IMS-ALG interacts with TrGW for transcoder allocation for the purpose of offering an additional codec “codec-out”.
3. IMS-ALG generates INVITE towards Destination side (call-ID#-out), the SDP offer-out containing the new codec-list-out (i.e codec-list-inc enriched with “codec-out”), and also OMR extensions (for transcoding options associated to different segments).

4. The destination side answers with 200 OK and SDP answer-out with the selected codec which is the additional one offered by IMS-ALG (i.e codec-out).
5. Interaction occurs with TrGW for media configuration with codec-out for the outgoing leg and with codec-inc for the incoming leg (codec-inc is selected by IBCF from the codec-list-inc received in step 1).
6. IMS-ALG forwards the SDP answer-inc for the incoming leg, with this codec-inc.
7. IMS-ALG sends *Accounting-Request* with *Accounting-Record-Type* indicating START\_RECORD to record start of session with “Transcoder Inserted” indication for the media.
- 8-9. The CDF opens a session CDR for the IMS Node and acknowledges the reception of the data.

#### 5.2.2.1.19.4.2 IMS-ALG Related Procedures for OMR – transcoder offered by IMS-ALG but not selected

The following flow describes the situation where IMS-ALG allocates a transcoder for offering an additional transcoding option, and this transcoder is not selected.

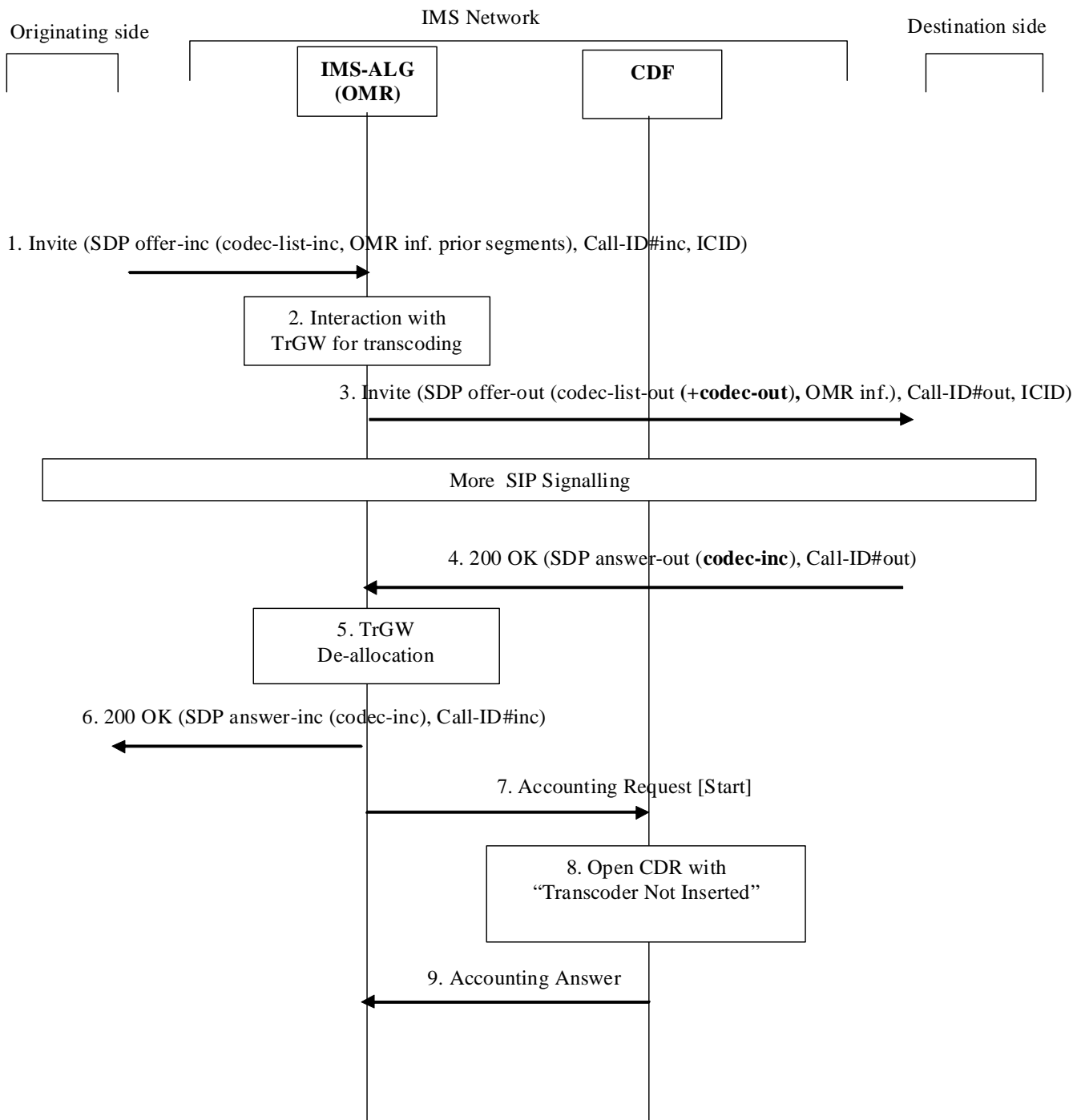

**Figure 5.2.2.1.19.4.2-1: Message Sequence Chart for Session establishment with transcoder offered by IMS-ALG is not selected.**

1. IMS-ALG receives an INVITE with SDP offer-inc (call-ID#-inc) from Originating side, containing a codec-list-inc in the SDP offer, and potential OMR information from prior user plane segments, based on an Operator’s configuration.
2. IMS-ALG interacts with TrGW for transcoder allocation for the purpose of offering additional codec “codec-out”.
3. IMS-ALG generates INVITE towards Destination side (call-ID#-out), the SDP offer-out containing the new codec-list-out (i.e codec-list-inc enriched with “codec-out”), and also OMR extensions (for transcoding options associated to different segments).

4. The destination side answers with 200 OK and SDP answer-out with the selected codec (codec-inc), belonging to the codec-list-inc received in step 1 (original offer).
5. Therefore, transcoding is not needed, and TrGW is de-allocated.
6. IMS-ALG forwards the SDP answer-inc for the incoming leg, with this codec-inc.
7. IMS-ALG sends *Accounting-Request* with *Accounting-Record-Type* indicating START\_RECORD to record start of session with “Transcoder Not Inserted” indication for the media.
- 8-9. The CDF opens a session CDR for the IMS Node and acknowledges the reception of the data.

#### 5.2.2.1.20 AS acting as a B2BUA – Single Charging session

The following figure shows the case where an Application Server acts as a B2BUA, and a single offline charging session is created for the established dialogs (“OneChargingSession” option)

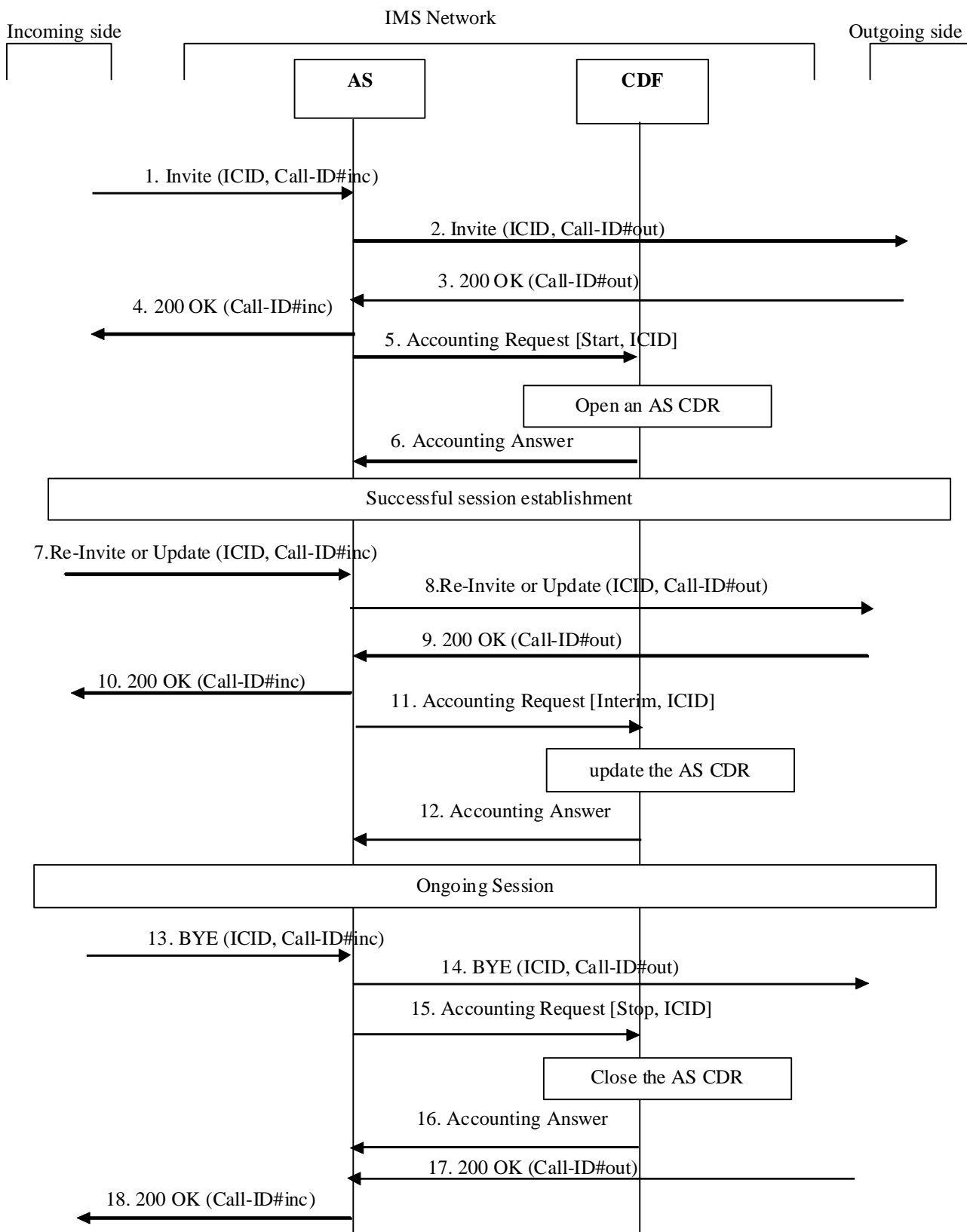

Figure 5.2.2.1.20-1: Message Sequence Chart for AS acting as a B2BUA with single Charging session

1. AS receives the INVITE from Incoming side (Call-ID#inc) containing ICID.

2. AS acting as a B2BUA generates INVITE towards Outgoing side (Call-ID#out) with the same ICID as received in step 1.
3. 200 OK is received in response to the INVITE (Call-ID#out).
4. 200 OK is sent in response to the INVITE (Call-ID#inc).
5. AS sends *Accounting-Request* with *Accounting-Record-Type* indicating START\_RECORD to record start of a session, provided with ICID and information associated to both Call-ID#inc and Call-ID#out.
6. The CDF acknowledges the reception of the *Accounting-Request* with *Accounting-Record-Type* indicating START\_RECORD and opens a AS CDR.
7. AS receives a mid-session (e.g. in order to modify media component(s)) Re-INVITE or UPDATE from Incoming side (Call-ID#inc) for the IMS session (ICID).
8. AS generates Re-INVITE or UPDATE towards Outgoing side (Call-ID#out)
- 9-10. AS sends 200 OK (Call-ID#inc) towards Incoming side, when 200 OK (Call-ID#out) response is received from Outgoing side.
11. AS sends an *Accounting-Request* with *Accounting-Record-Type* indicating INTERIM\_RECORD to record changes associated to Call-ID#inc or/and Call-ID#out (e.g. changed media component(s)) in the AS CDR for the IMS session (ICID).
12. The CDF acknowledges the reception of the data and updates the AS CDR.
13. AS receives BYE from Incoming side (Call-ID#inc)
14. AS sends BYE towards Outgoing side (Call-ID#out)
15. AS sends an *Accounting-Request* with *Accounting-Record-Type* indicating STOP\_RECORD to record stop of a session in the AS CDR for the IMS session (ICID).
16. The CDF acknowledges the reception of the data and closes the AS CDR.
- 17-18. AS sends 200 OK(Call-ID#inc) towards Incoming side, when 200 OK (Call-ID#out) response is received from Outgoing side.

#### 5.2.2.1.21 Session Establishment for Roaming Architecture for Voice over IMS with Local Breakout

The following figure shows the Diameter transactions initiated by the P-CSCF, S-CSCF, IBCF, and Transit and Roaming Function towards the CDF that are required for a Roaming Architecture for Voice over IMS with Local Breakout in each IMS network during session establishment. This example pertains to the flow in Annex M.3.1.3 in TS 23.228 [201] in which loopback and OMR procedures are applied between the Visited Network and the Home Network serving UE A.



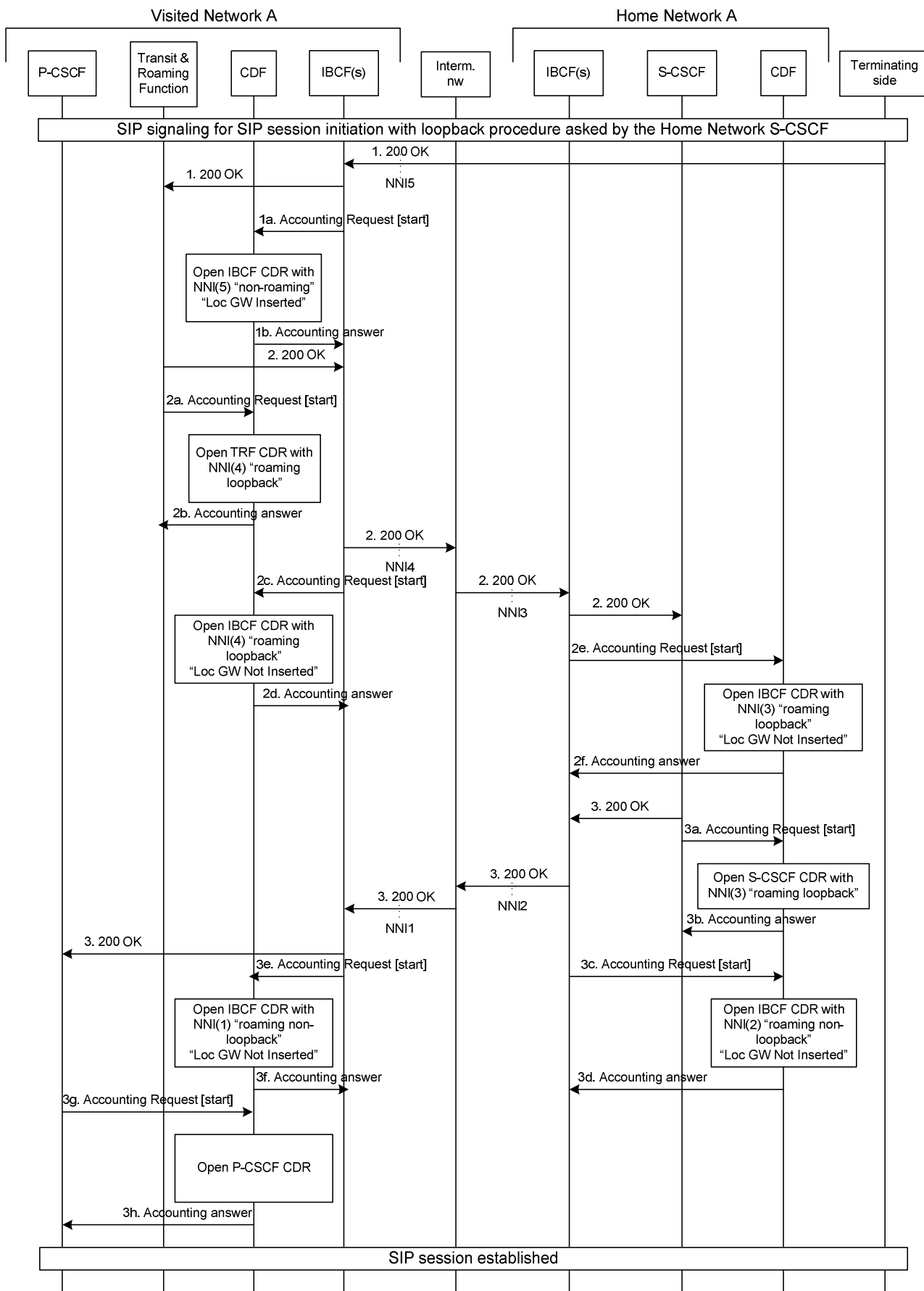

Figure 5.2.2.1.21-1: Message Sequence Chart for Roaming Architecture for Voice over IMS with Local Breakout with "VPLMN routing" and TRF

1. The session initiation is acknowledged by the 200 OK by the termination side and received by the IBCF in the Visited Network A.
- 1a. IBCF sends *Accounting-Request* with *Accounting-Record-Type* indicating START\_RECORD to record start of session with “Local GW Inserted” indication and with information on the non-roaming NNI 5 used for interconnection towards the terminating network.
- 1b. The CDF acknowledges the reception of the data and opens an IBCF CDR.
2. The Visited Network A TRF performs the loopback procedure and the session acknowledgement is routed towards the Home network through an IBCF .
- 2a. Transit and Roaming Function sends *Accounting-Request* with *Accounting-Record-Type* indicating START\_RECORD to record start of session and indicating loopback routing from the roaming NNI.
- 2b. The CDF acknowledges the reception of the data and opens a TRF CDR.
- 2c. IBCF sends *Accounting-Request* with *Accounting-Record-Type* indicating START\_RECORD to record start of session with “Local GW Not Inserted” indication and with information on the roaming NNI 4 interconnecting to the intermediate network for the loopback path.
- 2d. The CDF acknowledges the reception of the data and opens an IBCF CDR.
- 2e. IBCF sends *Accounting-Request* with *Accounting-Record-Type* indicating START\_RECORD to record start of session with “Local GW Not Inserted” indication and with information on the roaming NNI 3 interconnecting to the intermediate network for the loopback path.
- 2f. The CDF acknowledges the reception of the data and opens an IBCF CDR.
3. The S-CSCF in the Home Network A routes the session acknowledgement towards the Visited Network A through an IBCF.
- 3a. S-CSCF sends *Accounting-Request* with *Accounting-Record-Type* indicating START\_RECORD to record start of session and indicating loopback routing to the roaming NNI.
- 3b. The CDF acknowledges the reception of the data and opens an IBCF CDR.
- 3c. IBCF sends *Accounting-Request* with *Accounting-Record-Type* indicating START\_RECORD to record start of session with “Local GW Not Inserted” indication and with information on the roaming NNI 2 interconnecting to the intermediate network for the non-loopback path.
- 3d. The CDF acknowledges the reception of the data and opens an IBCF CDR.
- 3e. IBCF sends *Accounting-Request* with *Accounting-Record-Type* indicating START\_RECORD to record start of session with “Local GW Not Inserted” indication and with information on the roaming NNI 1 interconnecting to the intermediate network for the non-loopback path.
- 3f. The CDF acknowledges the reception of the data and opens an IBCF CDR.
- 3g. P-CSCF sends *Accounting-Request* with *Accounting-Record-Type* indicating START\_RECORD to record start of session.
- 3h. The CDF acknowledges the reception of the data and opens an IBCF CDR.

#### 5.2.2.1.22 Service Continuity using ATCF

Service Continuity using ATCF is specified in TS 23.237 [407].

Alternative “OneChargingSession” option is also reflected in the different flows description, i.e a single charging session from ATCF.

#### 5.2.2.1.22.1 UE originating call (CS only) through ATCF

In this flow, Call-ID #1 is for serving leg and Call-ID #2 is for home leg of CS access leg.

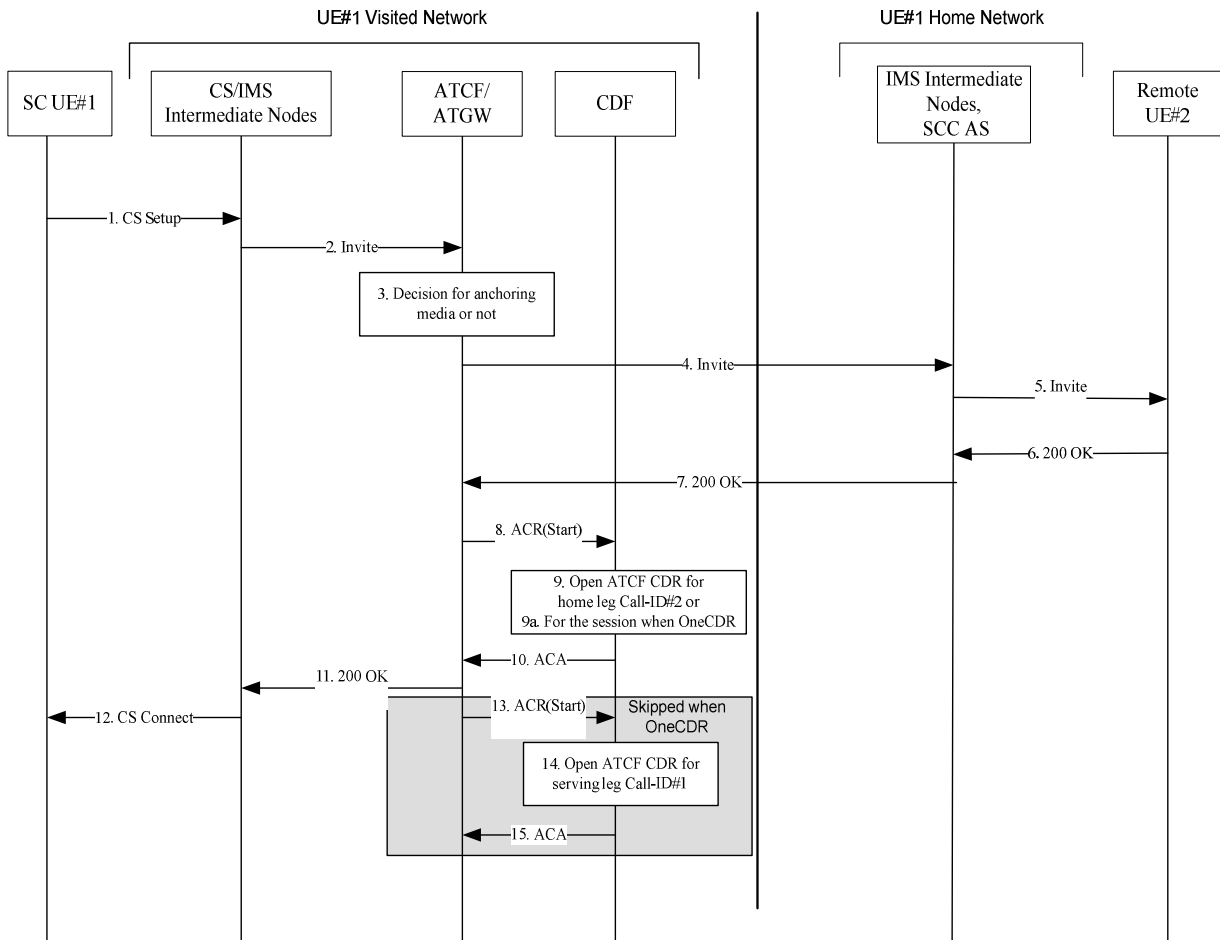
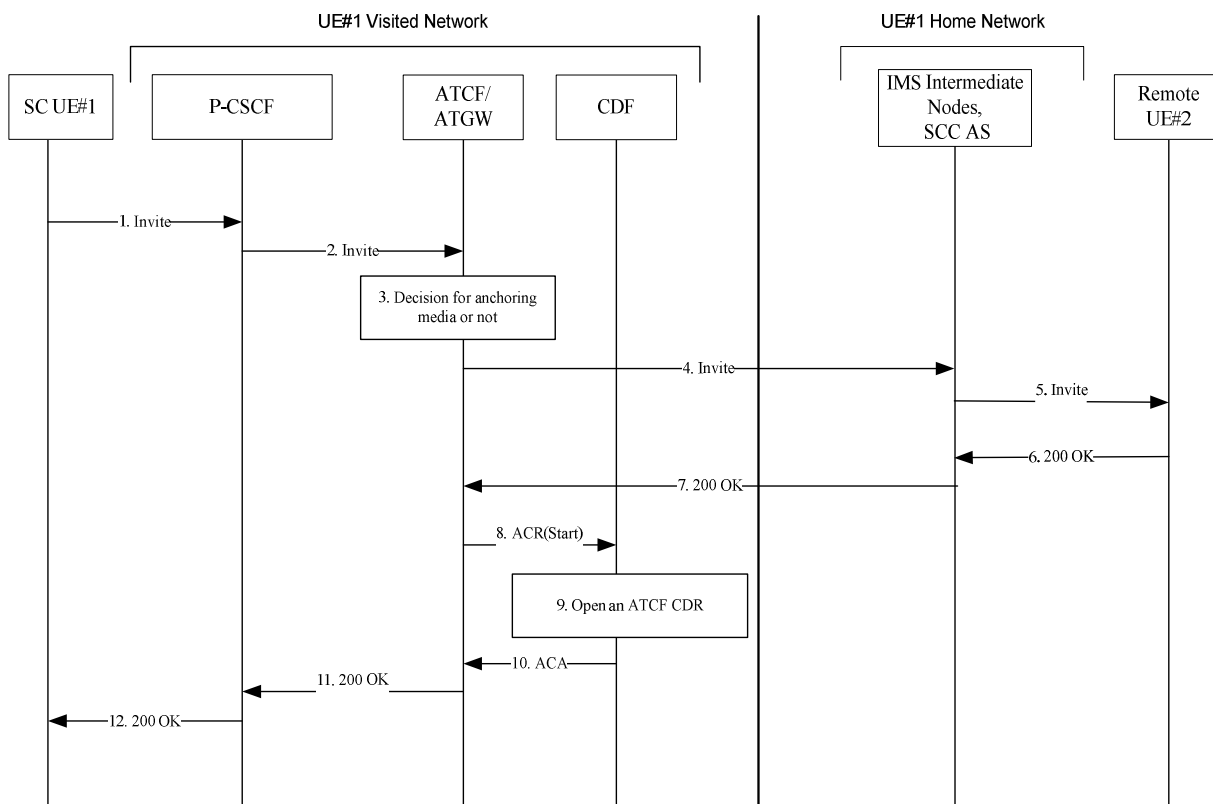

Figure 5.2.2.1.22.1-1: Message Sequence Chart UE originating call (CS only) through ATCF

1. The SCC session is initiated by UE#1 sending a Call Setup.
  2. After processing at CS/PS intermediate nodes, the resulting INVITE goes through the ATCF in the UE#1 serving network.
  3. The ATCF may decide whether to anchor the media session, and allocate if needed, ATGW resources to it.
  4. The ATCF create an INVITE request message and send it to the UE#1 Home Network SCC AS
  5. The call setup proceeds and is routed to the remote UE-2
  - 6-7. On response 200 OK from the remote UE#2, response 200 OK is transmitted to UE#1 serving network
  8. Upon reception of the final response, the ATCF sends an *Accounting-Request* with *Accounting-Record-Type* indicating START\_RECORD to record start of a user session/media component in the ATCF CDR for the IMS session.
  - 9-10. The CDF from the Serving network opens an ATCF CDR for the home leg (Call-ID#2) and acknowledges the reception of the data.
  - 9a-10. Alternatively, when “OneChargingSession”, the CDF opens an ATCF CDR related to the IMS session, with serving leg and home leg, and acknowledges the reception of the data.
  - 11-12. The final response to SIP Invite (Call ID #1) is transmitted.
  - 13-15. Same as 8-9-10 but opening a ATCF CDR for the serving leg (Call-ID#1)
- Steps 13 to 15 are not applicable for the “OneChargingSession” option.

## 5.2.2.1.22.1A UE originating call (PS only) through ATCF

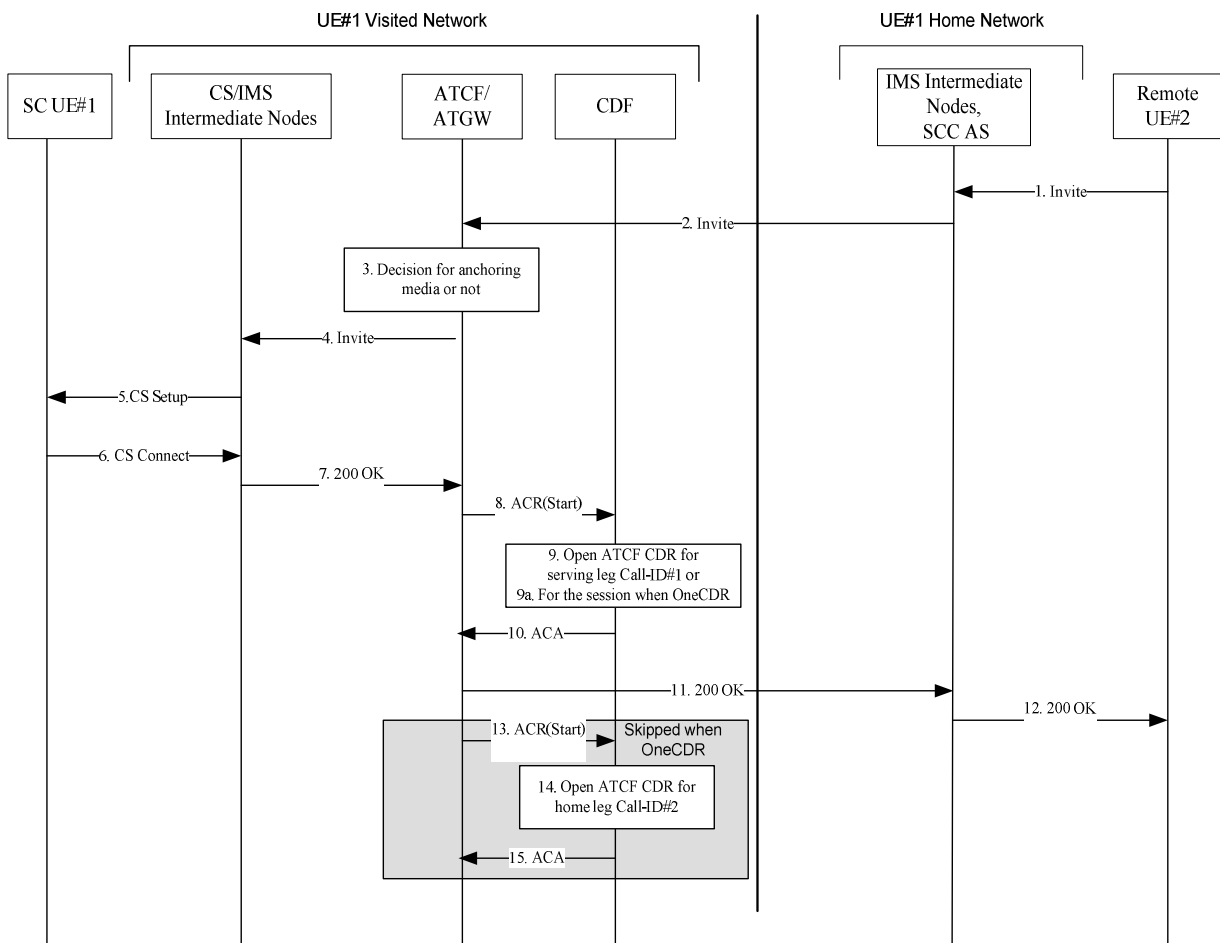

**Figure 5.2.2.1.22.1A -1: Message Sequence Chart UE originating call (PS only) through ATCF**

1. The SCC session is initiated by UE#1 sending an INVITE.
2. After processing at P-CSCF, the resulting INVITE goes through the ATCF in the UE#1 Visited Network.
3. The ATCF may decide whether to anchor the media session, and allocate if needed, ATGW resources to it.
4. The ATCF forwards the INVITE request message to the UE#1 Home Network SCC AS.
5. The call setup proceeds and is routed to the remote UE#2.
- 6-7 On response 200 OK from the remote UE#2, response 200 OK is transmitted to UE#1 Visited Network.
8. Upon reception of the final response, the ATCF sends an *Accounting-Request* with *Accounting-Record-Type* indicating START\_RECORD to record start of a user session/media component in the ATCF CDR for the IMS session.
- 9-10. The CDF from UE#1 Visited Network opens an ATCF CDR and acknowledges the reception of the data.
- 11-12. The final response to SIP Invite is transmitted.

## 5.2.2.1.22.2 UE terminating call (CS only) through ATCF

In this flow, Call-ID #1 is for serving leg and Call-ID #2 is for home leg.

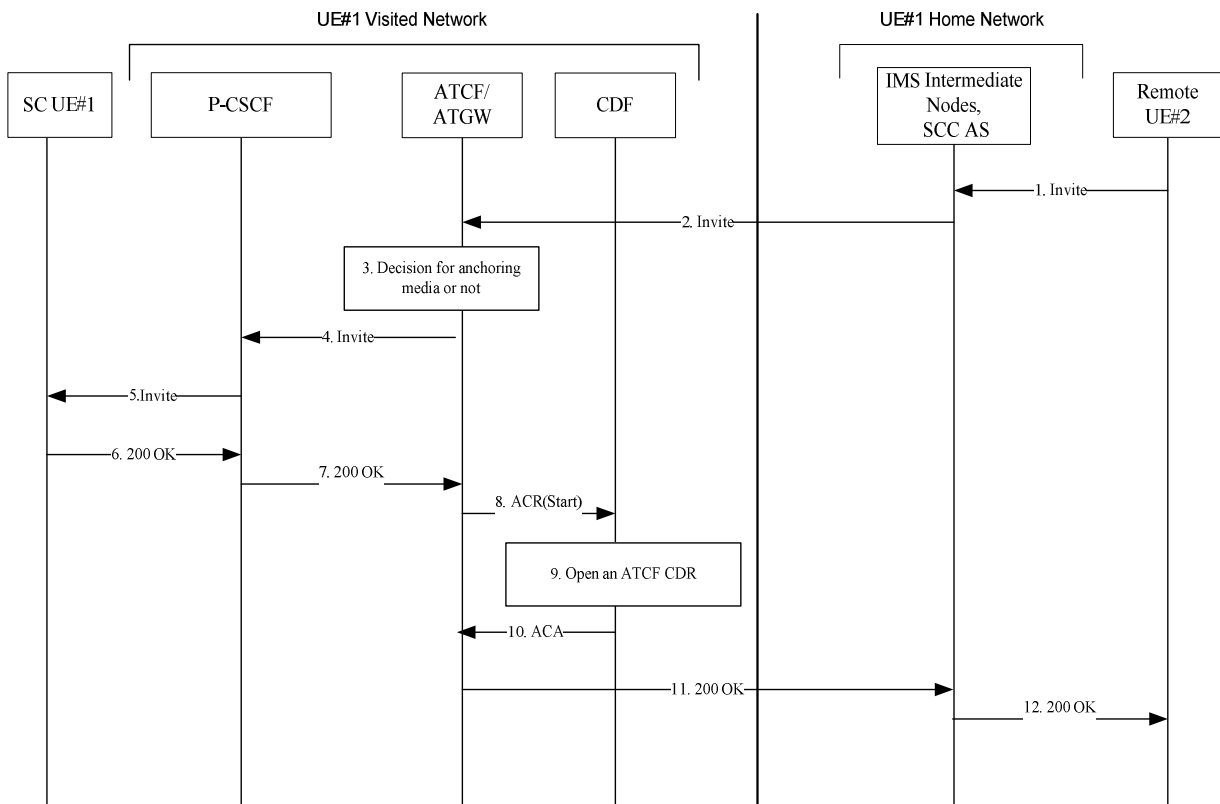

**Figure 5.2.2.1.22.2-1: Message Sequence Chart UE terminating call (CS only) through ATCF**

1. The SCC session is initiated by UE #2 sending an INVITE towards UE-1
2. The call setup proceeds and is routed to the UE-1
3. The ATCF may decide whether to anchor the media session, and allocate if needed, ATGW resources to it.
4. The ATCF create an INVITE request message and send it to the CS/PS intermediate nodes.
5. After processing at CS/PS intermediate nodes, the resulting message is sent to UE #1.
6. The response is transmitted to CS/PS intermediate nodes.
7. After processing at CS/PS intermediate nodes, the 200 OK message is sent to ATCF.
8. Upon reception of the final response, the ATCF in the terminating network sends an *Accounting-Request* with *Accounting-Record-Type* indicating *START\_RECORD* to record start of a user session/media component in the ATCF CDR.
- 9-10. The CDF from the Terminating serving network opens an ATCF CDR for the serving leg (Call ID #1) and acknowledges the reception of the data.
- 9a-10 Alternatively, when “OneChargingSession”, the CDF opens a ATCF CDR related to the IMS session (ICID) with serving leg and home leg, and acknowledges the reception of the data.
- 11-12. The final response to SIP Invite (Call ID #2) is transmitted.
- 13-15. Same as 8-9-10 but for the home leg (Call ID #2).

Steps 13 to 15 are not applicable for the “OneChargingSession” option.

5.2.2.1.22.2A UE terminating call (PS only) through ATCF



**Figure 5.2.2.1.22.2A-1: Message Sequence Chart UE terminating call (PS only) through ATCF**

1. The SCC session is initiated by UE #2 sending an INVITE towards UE#1.
2. The call setup proceeds and is routed to the UE#1.
3. The ATCF may decide whether to anchor the media session, and allocate if needed, ATGW resources to it.
4. The ATCF forwards the INVITE request message to the P-CSCF.
5. After processing at P-CSCF, the resulting message is sent to UE #1.
6. The response is transmitted to P-CSCF.
7. After processing at P-CSCF, the 200 OK is sent to ATCF.
8. Upon reception of the final response, the ATCF sends an *Accounting-Request* with *Accounting-Record-Type* indicating *START\_RECORD* to record start of a user session/media component in the ATCF CDR.
- 9-10. The CDF from UE#1 Visited Network opens an ATCF CDR and acknowledges the reception of the data.
- 11-12. The final response to SIP Invite is transmitted.

5.2.2.1.22.3 UE session transfer PS to CS using ATCF

In this flow, Call-ID #1 is for PS access leg, Call-ID #1' for serving leg of CS access leg and Call-ID #2' for home leg of CS access leg.

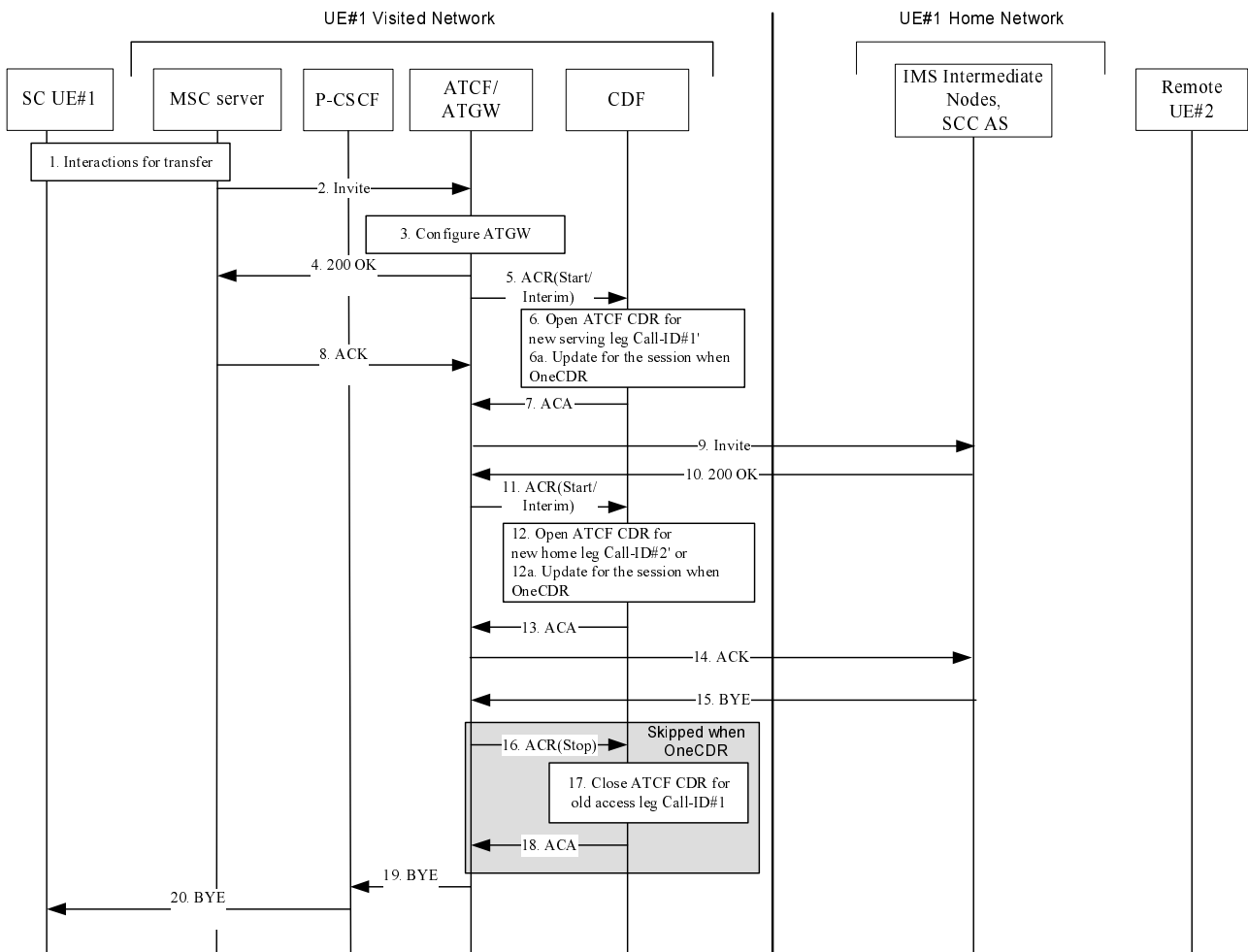

Figure 5.2.2.1.22.3-1: Message Sequence Chart UE session transfer PS to CS using ATCF

1. UE has an ongoing session under PS with media anchored in ATGW, and interactions between UE, RAN, MME/SGSN and MSC take place for session transfer to CS.
2. MSC server sends the resulting INVITE towards the ATCF in the UE#1 serving network.
3. The media session is anchored in ATGW: the ATCF updates the ATGW with new CS access leg resource.
4. The ATCF sends 200 OK answer to MSC server for switching the media path.
- 5-7. the ATCF sends an *Accounting-Request* with *Accounting-Record-Type* indicating START\_RECORD to record start of a user session/media component in the ATCF CDR for the serving leg of new CS access leg.
- 5-6a-7. Alternatively, when “OneChargingSession”, the ATCF sends an *Accounting-Request* with *Accounting-Record-Type* indicating INTERIM\_RECORD to record modification of the ATCF CDR with the serving leg of new CS access leg. The CDF updates ATCF CDR related to the IMS session, with new serving leg, and acknowledges the reception of the data.
8. ACK from MSC server to ATCF
9. The ATCF creates and sends a SIP INVITE request via a new dialog to the SCC AS for indicating the transfer has taken place.

10. The SCC AS sends a 200 OK confirmation response to the ATCF containing SDP answer stored during the original session establishment procedure.
- 11-13. The ATCF sends an *Accounting-Request* with *Accounting-Record-Type* indicating START\_RECORD to record start of a user session/media component in the ATCF CDR for home leg of new CS access leg.
- 11-12a-13 Alternatively, when “OneChargingSession”, the ATCF sends an *Accounting-Request* with *Accounting-Record-Type* indicating INTERIM\_RECORD to record modification of the ATCF CDR with the home leg of new CS access leg. The CDF updates ATCF CDR related to the IMS session, with new home leg, and acknowledges the reception of the data.
14. The ACTF acknowledges the 200 OK.
- 15, 19-20 The SCC AS terminates the old PS access leg, by sending a SIP BYE request.
- 16-18. The ATCF sends an *Accounting-Request* with *Accounting-Record-Type* indicating STOP\_RECORD to close the ATCF CDR for the old PS access leg (conducted for both serving and home leg of the old PS access leg if flow 5.2.2.1.22.4 precedes for the same session).

Steps 16 to 18 are not applicable for the “OneChargingSession” option.

#### 5.2.2.1.22.4 UE session transfer CS to PS using ATCF

In this flow, Call-ID#1 for serving leg of old CS access leg and Call-ID#2 for home leg of old CS access leg, Call-ID#1' is for serving leg of new PS access leg, and Call-ID#2' is for home leg of new PS access leg.



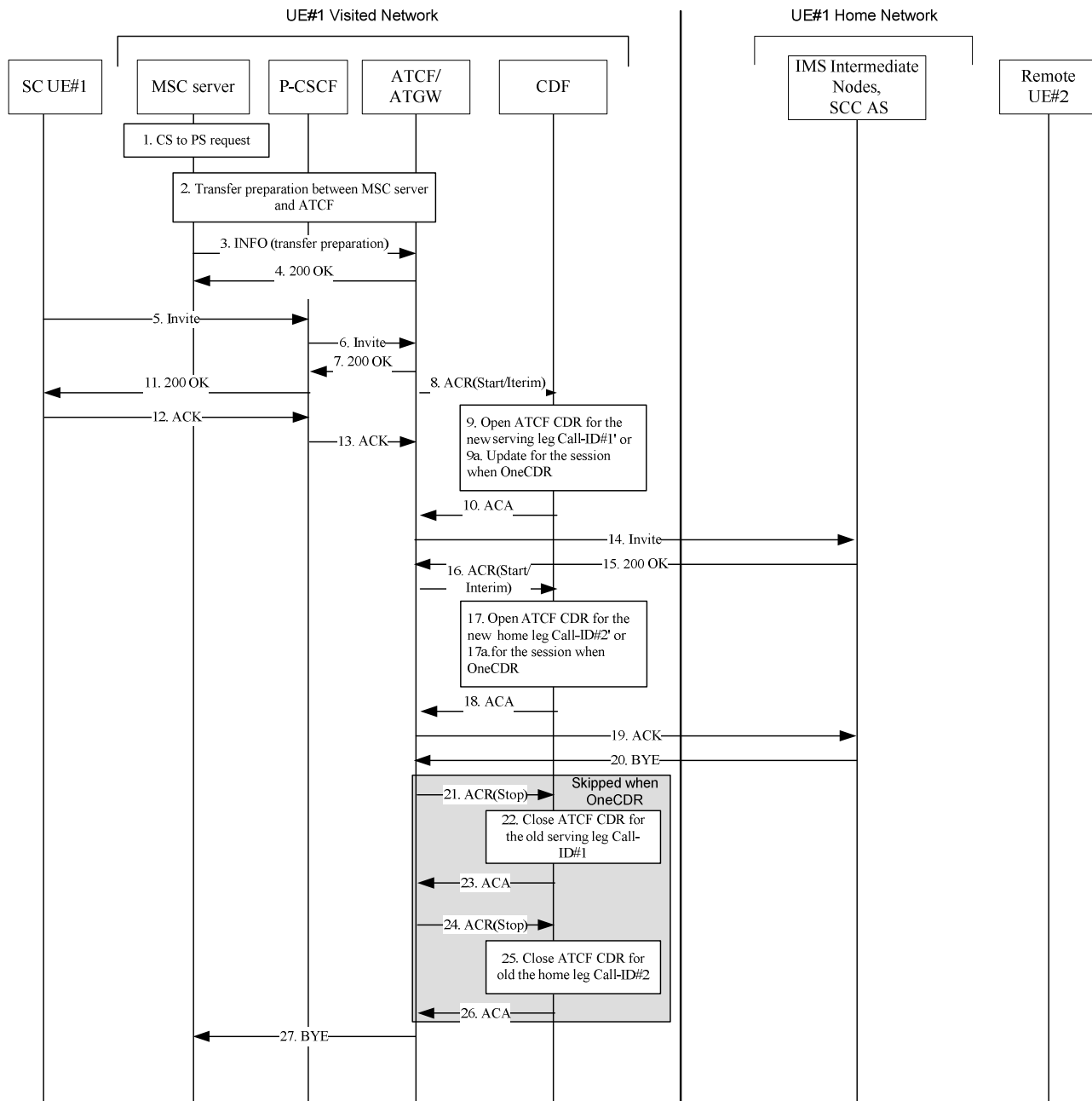

Figure 5.2.2.1.22.4-1: Message Sequence Chart UE session transfer CS to PS using ATCF

1. UE has an ongoing session under CS with media anchored in ATGW, and interactions between UE, RAN, MME/SGSN and MSC take place for session transfer to PS.
2. Transfer preparation procedure between MSC server and ATCF, the MSC interacts with UE for handover.
3. The MSC server sends a SIP INFO request containing a session transfer preparation to the ATCF to instruct the ATCF that media should be switched to the new access leg.
4. The ATCF sends 200 OK answer to MSC server for switching the media path..
- 5-6. UE A sends an SIP INVITE request towards the ATCF to move the session control to the PS access.
- 7,11. The ATCF sends a 200 OK response to the UE.
- 8-10. The ATCF sends an *Accounting-Request* with *Accounting-Record-Type* indicating START\_RECORD to record start of a user session in the ATCF CDR for the serving leg of the new PS access leg.

- 8-9a -10. Alternatively, when “OneChargingSession”, the ATCF sends an *Accounting-Request* with *Accounting-Record-Type* indicating INTERIM\_RECORD to record modification of the ATCF CDR with the serving leg of new PS access leg. The CDF updates ATCF CDR related to the IMS session, with new serving leg, and acknowledges the reception of the data.
- 12-13. UE acknowledges the 200 OK.
14. The ATCF creates and sends a SIP INVITE request via a new dialog to the SCC AS for indicating the transfer has taken place.
15. The SCC AS sends a 200 OK confirmation response to the ATCF containing SDP answer stored during the original session establishment procedure.
- 16-18. The ATCF sends an *Accounting-Request* with *Accounting-Record-Type* indicating START\_RECORD to record start of a user session in the ATCF CDR for the home leg of the new PS access leg.
- 16-17a -18. Alternatively, when “OneChargingSession”, the ATCF sends an *Accounting-Request* with *Accounting-Record-Type* indicating INTERIM\_RECORD to record modification of the ATCF CDR with the home leg of new PS access leg. The CDF updates ATCF CDR related to the IMS session, with new home leg, and acknowledges the reception of the data.
- 20, 27 The SCC AS terminates the old CS access leg, by sending a SIP BYE request.
- 21-23. The ATCF sends an *Accounting-Request* with *Accounting-Record-Type* indicating STOP\_RECORD to close the ATCF CDR for the serving leg of old CS access leg.
- 24-26. The ATCF sends an *Accounting-Request* with *Accounting-Record-Type* indicating STOP\_RECORD to close the ATCF CDR for the home leg of old CS access leg.
- Steps 21 to 26 are not applicable for the “OneChargingSession” option.

### 5.2.2.2 Message Flows - Error Cases and Scenarios

This clause describes various error cases and how these should be handled. The error cases are grouped into the following categories:

- Failure in SIP Related Procedures:
  - Session Related Error Scenarios;
  - Session Unrelated Error Scenarios.
- Errors in Diameter (Accounting) Related Procedures.

#### 5.2.2.2.1 Session Related SIP Procedures- Reception of SIP error messages

A SIP session is closed abnormally by the reception of a BYE message indicating the reason for such termination.

In this case, an ACR [Stop] message that includes an appropriate error indication is sent.

#### 5.2.2.2.2 Session Related SIP Procedures - SIP session failure

All nodes involved in the SIP session are expected to exercise some kind of session supervision. In case a node detects an error in the SIP session, such as a timeout or the occurrence of an invalid SIP message that results in the inability to maintain the session, this IMS node will generate a BYE message towards both ends of the connection.

The node that sent the BYE to trigger session termination identifies the cause of the failure in the ACR [Stop] towards the CDF. All other nodes, i.e. those that receive the BYE, are not aware of an error, and therefore they treat this situation as any normal SIP session termination.

#### 5.2.2.2.3 Session Unrelated SIP procedures

As described in clause 5.1.2.1.2, a session unrelated SIP procedure may either be completed with the reception of a 200OK, or a SIP error message. If the latter occurs, i.e. there is a failure in the procedure, the ACR [Event] sent towards the CDF includes an appropriate error indication.

#### 5.2.2.2.4 CDF Connection Failure

When the connection towards the primary CDF is broken, the process of sending accounting information should continue towards a secondary CDF (if such a CDF is configured). For further CDF connection failure functionality, see clause "*Transport Failure Detection*" in IETF RFC 3588 [401].

If no CDF is reachable the network element may buffer the generated accounting data in non-volatile memory. Once the CDF connection is working again, all accounting messages stored in the buffer is sent to the CDF, in the order they were stored in the buffer.

#### 5.2.2.2.5 No Reply from CDF

In case an IMS node does not receive an ACA in reply to an ACR, it may repeat the ACR message. The waiting time until a repetition is sent, and the maximum number of repetitions are both configurable by the operator. When the maximum number of repetitions is reached and still no ACA reply has been received, the IMS node executes the CDF connection failure procedure as specified above.

If retransmitted ACRs are sent, they are marked with the T-flag as described in IETF RFC 3588 [401] , in order to allow duplicate detection in the CDF, as specified in the next clause.

#### 5.2.2.2.6 Duplicate Detection

A Diameter client marks possible duplicate request messages (e.g. retransmission due to the link failover process) with the T-flag as described in IETF RFC 3588 [401].

If the CDF receives a message that is marked as retransmitted and this message was already received, then it discards the duplicate message. However, if the original of the re-transmitted message was not yet received, it is the information in the marked message that is taken into account when generating the CDR. The CDRs are marked if information from duplicated message(s) is used.

#### 5.2.2.2.7 CDF Detected Failure

The CDF closes a CDR when it detects that expected Diameter ACRs for a particular SIP session have not been received for a period of time. The exact behaviour of the CDF is operator configurable.

### 5.2.3 CDR generation

**Editor's Note:** FFS

### 5.2.4 GTP' record transfer flows

GTP' is not used between CDF and CGF for IMS offline charging because CDF and CGF are combined into CCF (see clause 4.2).

NOTE: Vendors may nevertheless implement a separate CDF and CGF for IMS offline charging. In this case, it is recommended that the approach chosen conforms to the principles and protocol applications specified in TS 32.295 [54].

## 5.2.5 Bi CDR file transfer

The CGF will receive charging events from each AS involved in a SIP dialog. This may result in multiple CDRs, some of these CDRs may be redundant for billing purposes. When preparing these CDRs for the BD, the CGF may elect not to send some CDRs or may perform consolidation before transfer based on the operator's configuration.

# 5.3 IMS Online Charging Scenarios

## 5.3.1 Basic Principles

IMS online charging uses the Credit Control application that is specified in TS 32.299 [50].

Three cases for online charging are distinguished:

- Immediate Event Charging (IEC); and
- Event Charging with Unit Reservation (ECUR), and
- Session Charging with Unit Reservation (SCUR)

Both stage 2 and stage 3 mechanisms for the three cases for online charging are detailed in TS 32.299 [50].

In the case of Immediate Event Charging (IEC), granting units to the IMS network element is performed in a single operation that also includes the deduction of the corresponding monetary units from the subscriber's account. The charging process is controlled by the corresponding credit control request which is sent for a given credit control event.

In contrast, Event Charging with Unit Reservation (ECUR) also includes the process of requesting, reserving, releasing and returning unused units for events. The deduction of the corresponding monetary units then occurs upon conclusion of the ECUR transaction. In this case, the credit control request is used to control the credit control session.

Session Charging with Unit Reservation (SCUR) is used for credit control of sessions. SCUR also includes the process of requesting, reserving, releasing and returning unused units for sessions, and the deduction of the corresponding monetary units. During a SIP session there can be repeated execution of unit reservation and debit operations as specified in TS 32.299 [50].

The IMS network element may apply IEC, where CCR Event messages are generated, or ECUR, using CCR Initial, and Termination or SCUR. The decision whether to apply IEC, ECUR or SCUR is based on the service and/or operator's policy.

The CTF uses CCR Initial, Update, Terminate in procedures related to successful SIP sessions. It uses CCR Events (Event or Initial, Terminate depending on whether IEC or ECUR/SCUR applies) for unsuccessful SIP sessions and for session unrelated procedures. Further details are specified in the tables below.

It is operator configurable in the nodes for which SIP method a *Credit Control Request* is sent. The table below describes all possible CCRs that might be sent from an IMS GWF or an MRFC or an application server.

It is configurable for the operators to enable or disable the generation of a CCR message by the IMS node in response to a particular "Triggering SIP Method".

**Table 5.3.1.1: Credit Control Request Messages Triggered by SIP Methods for IMS-GWF or AS**

Diameter Message	Triggering SIP Method
CCR [Initial]	SIP INVITE (SCUR)
	SIP NOTIFY (ECUR)
	SIP MESSAGE (ECUR)
	SIP REGISTER (ECUR)
	SIP SUBSCRIBE (ECUR)
	SIP REFER (ECUR)
	SIP PUBLISH (ECUR)
CCR [Update]	SIP 2xx acknowledging a SIP INVITE, RE-INVITE or SIP UPDATE [e.g. change in media components] (SCUR)
	RE-INVITE or SIP UPDATE [e.g. change in media components] (SCUR)
	Expiration of quota, Validity time expiry or other authorization triggers (quota threshold reached, ...). (SCUR)
	Any SIP message (except those triggering a CCR INITIAL or those not covered by the above triggers for CCR UPDATE) conveying a SDP offer or its associated SDP answer before SIP session establishment (SCUR)
	SIP 1xx provisional response, mid-dialog requests, mid-dialog responses and SIP INFO embedding RTTI XML body
	SIP Response (4xx, 5xx or 6xx), indicating an unsuccessful SIP RE-INVITE or SIP UPDATE (SCUR)
CCR [Terminate]	SIP BYE message (both normal and abnormal session termination cases) (SCUR)
	SIP 2xx acknowledging non-session related SIP messages (ECUR)
	Aborting a SIP session set-up procedure, using an internal trigger, or a SIP CANCEL.(SCUR/ECUR)
	Deregistration (see NOTE) (SCUR/ECUR)
	SIP Final/Redirection Response 3xx (SCUR/ECUR)
	SIP Final Response (4xx, 5xx or 6xx), indicating an unsuccessful SIP session set-up procedure (SCUR)
	SIP Final Response (4xx, 5xx or 6xx), indicating an unsuccessful session-unrelated procedure (ECUR)
CCR [Event]	SIP NOTIFY (IEC)
	SIP MESSAGE (IEC)
	SIP REGISTER (IEC)
	SIP SUBSCRIBE (IEC)
	SIP REFER (IEC)
	SIP PUBLISH (IEC)
	SIP Final Response (4xx, 5xx or 6xx), indicating an unsuccessful session-unrelated procedure (IEC)

**Table 5.3.1.2: Credit Control Request messages triggered by SIP Methods for MRFC**

Diameter Message	Triggering SIP Method
CCR [Initial]	SIP INVITE(SCUR) for initiating a multimedia ad hoc conferencing session
CCR [Update]	SIP RE-INVITE or SIP UPDATE[e.g. change in media components](SCUR)
	SIP BYE message
	Expiration of quota, Validity time expiry or other authorization triggers (quota threshold reached, ...). (SCUR)
CCR [Terminate]	SIP BYE message(both normal and abnormal session termination cases)(SCUR)
	SIP Final Response with error codes 4xx, 5xx or 6xx indicating termination of an ongoing session(SCUR)
	SIP CANCEL(SCUR)

## 5.3.2 Diameter Message Flows and Types

This clause describes the message flows for the event charging procedures on the Ro interface. The IMS functions providing online charging *via* the Ro interface are the S-CSCF with IMS GWF, the AS and the MRFC.

NOTE: The following subclauses only show the scenarios of the S-CSCF with IMS-GWF case and the AS case. The scenarios of the MRFC are FFS.

### 5.3.2.1 Immediate Event Charging (IEC)

This clause provides the details of the "Debit Units" operation specified in TS 32.299 [50].

#### 5.3.2.1.1 Message Flows - Successful Cases and Scenarios

##### 5.3.2.1.1.1 IEC – Debit Units Operation

The transactions that are required on the Ro interface in order to perform IEC with Debit Units operations are carried out as described in TS 32.299 [50] where "CTF" refers to IMS network element. The Debit Units operation may alternatively be carried out prior to, concurrently with or after service/content delivery. The IMS network element must ensure that the requested service execution is successful, when this scenario is used.

**Editor's Note: Must be aligned with TS 32.299 [50].**

## 5.3.2.1.1.2 Scenarios

The following figure shows the Diameter credit control transactions that are required between the IMS-GWF/AS and the OCS for session-unrelated IMS procedures, i.e. those that relate to the CCR [Event], as listed in Table 5.3.1.

SIP messages and Diameter transactions associated with these charging scenarios are shown primarily for general information and to illustrate the charging triggers. They are not intended to be exhaustive and depend on the Diameter Credit Control Requests triggers configured by the operator.

**Scenario 1: Successful session unrelated case**

NOTE: The Debit Units operation is carried out prior to service/content delivery.

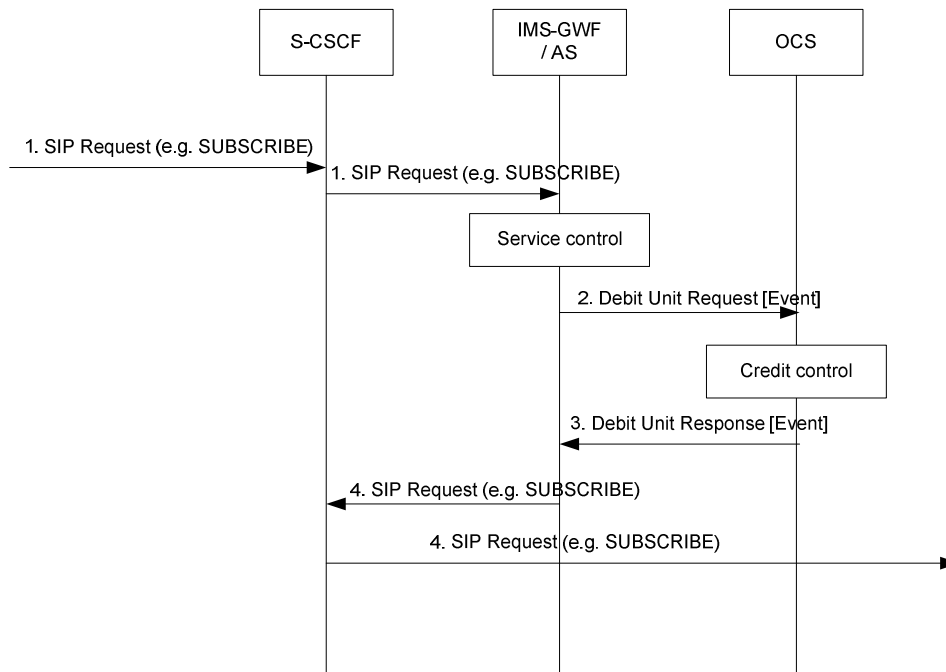

- 1) A session unrelated SIP Request (e.g. SUBSCRIBE) is received in the S-CSCF. The S-CSCF forwards this request to the IMS-GWF/AS.
- 2) The IMS-GWF/AS sends a Debit Unit Request (CC-Request-Type=EVENT\_REQUEST) to the OCS, requesting units in order to provide the service.
- 3) The OCS sends the Debit Unit Response to acknowledge the Debit Unit Request, granting the requested units.
- 4) The IMS-GWF/AS and the S-CSCF forward the SIP Request.

**Figure 5.3.2.1.1.2-1 : Message Sequence Chart for Session-Unrelated Procedure**

## 5.3.2.1.2 Message Flows - Error Cases and Scenarios

This clause describes various error cases and how these should be handled.

The failure handling behaviour is locally configurable in the IMS network element. If the *Direct-Debiting-Failure-Handling* AVP is not used, the locally configured values are used instead.

#### 5.3.2.1.2.1 Reception of SIP Error Messages

If SIP errors in SIP response (4xx, 5xx or 6xx) occur during service delivery, as defined in TS 24.228 [202] and TS 23.218 [203], it is up to the IMS network element to determine to what extent the service was delivered before the error occurred and act appropriately with respect to charging. This may imply that no units at all (or no more units) are debited.

#### 5.3.2.1.2.2 Debit Units Operation Failure

This case comprises situations where either no, or an erroneous response, is received from the OCS. The “no response” case is detected by the IMS network element when the connection supervision timer Tx expires (IETF RFC 4006 [402]) before a response *Credit-Control-Answer* (CCA) is received. The case of receiving an erroneous response implies that the IMS network element receives a *Credit-Control-Answer* (CCA), which it is unable to process, while Tx is running. The failure handling complies with the failure procedures for "Direct Debiting" scenario described in IETF RFC 4006 [402].

#### 5.3.2.1.2.3 Duplicate Detection

The detection of duplicate request is needed and must be enabled. To speed up and simplify as much as possible the duplicate detection, the all-against-all record checking should be avoided and just those records marked as potential duplicates need to be checked against other received requests (within a reasonable time window) by the receiver entity.

The IMS network element marks the request messages that are retransmitted after a link failover as possible duplicates with the T-flag as described in [201]. For optimized performance, uniqueness checking against other received requests is only necessary for those records marked with the T-flag received within a reasonable time window. This focused check is based on the inspection of the *Session-Id* and *CC-Request-Number* AVP pairs.

### 5.3.2.2 Event Charging with Unit Reservation (ECUR) and Session Charging with Unit Reservation (SCUR)

This clause provides the details of the "Reserve Units" and "Debit Units" operation specified in TS 32.299 [50].

#### 5.3.2.2.1 Message Flows - Successful Cases and Scenarios

##### 5.3.2.2.1.1 ECUR and SCUR - Reserve Units and Debit Units Operations

The transactions that are required on the Ro interface in order to perform ECUR/SCUR with Reserve Units and Debit Units operations is carried out as described in TS 32.299 [50] where “CTF” refers to an IMS network element. Multiple replications of both of these operations are possible.

##### 5.3.2.2.1.2 Expiration of Reservation Validity

This clause defines how reserved units are returned, if not used, within a reasonable time. It should be possible that both, reservation and SIP sessions are cancelled or only the reservation is cancelled without removing the SIP session.



### 5.3.2.2.1.3 Scenarios

The following figure shows the Diameter credit control transactions that are required between the IMS-GWF/AS and the OCS for session-related and session-unrelated IMS procedures.

The SIP messages and Diameter transactions associated with these charging scenarios are shown primarily for general information and to illustrate the charging triggers. They are not intended to be exhaustive and they depend on the Diameter Credit Control Requests triggers configured by the operator.

5.3.2.2.1.3.1 Session Related Procedures (SCUR)

Scenario 1: Successful Session Establishment

The following figure shows the Diameter credit control transactions that are required in the IMS-GWF/AS during a SIP session establishment.

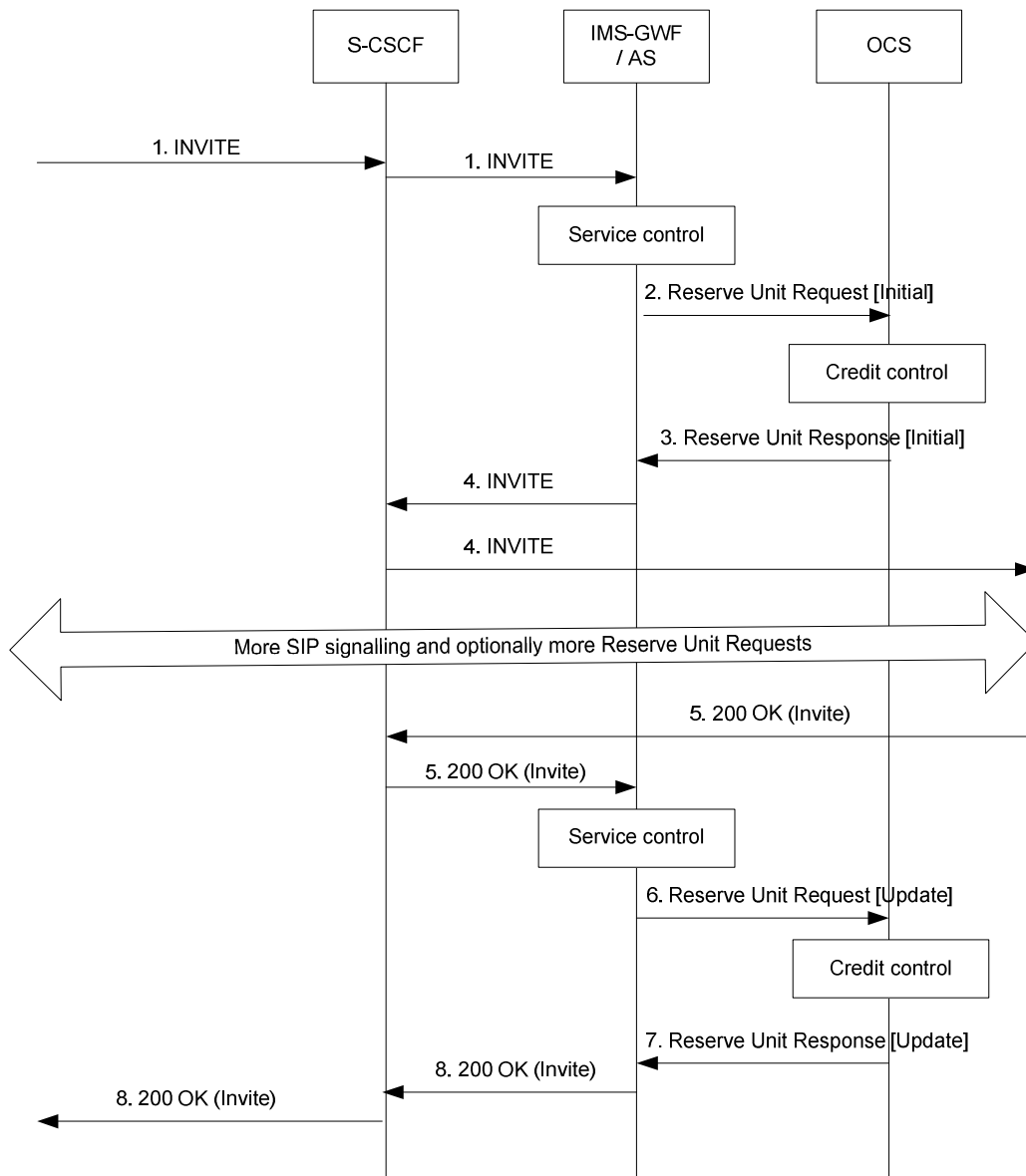

- 1) An initial SIP Invite Request is received in the S-CSCF. This request is forwarded to the IMS-GWF/AS.
- 2) The IMS-GWF/AS sends a Reserve Unit Request (CC-Request-Type =INITIAL\_REQUEST) to the OCS requesting service units. The online credit control session is initiated.
- 3) The OCS grants units in the Reserve Unit Response.
- 4) The IMS-GWF/AS and S-CSCF forward the initial INVITE.
- 5) A final response is received in the IMS-GWF/AS.
- 6) If the trigger is active, the 200 OK answer triggers a Reserve Unit Request (CC-Request-Type =UPDATE\_REQUEST) in the IMS-GWF/AS in order to update the credit control session. New service units are requested. Also the used service units (if any) are reported.
- 7) The OCS sends the Reserve Unit Response to acknowledge the Reserve Unit Request. New service units are granted.
- 8) The final answer is forwarded.

Figure 5.3.2.2.1.3.1-1: Message Sequence Chart for Successful Session Establishment

**Scenario 2 : Successful Session Establishment with Early Media Negotiation**

The following figure shows the Diameter transactions that are required in the IMS-GWF/AS during a SIP session establishment in which SDP negotiation is completed before a final response to the initial INVITE is exchanged.

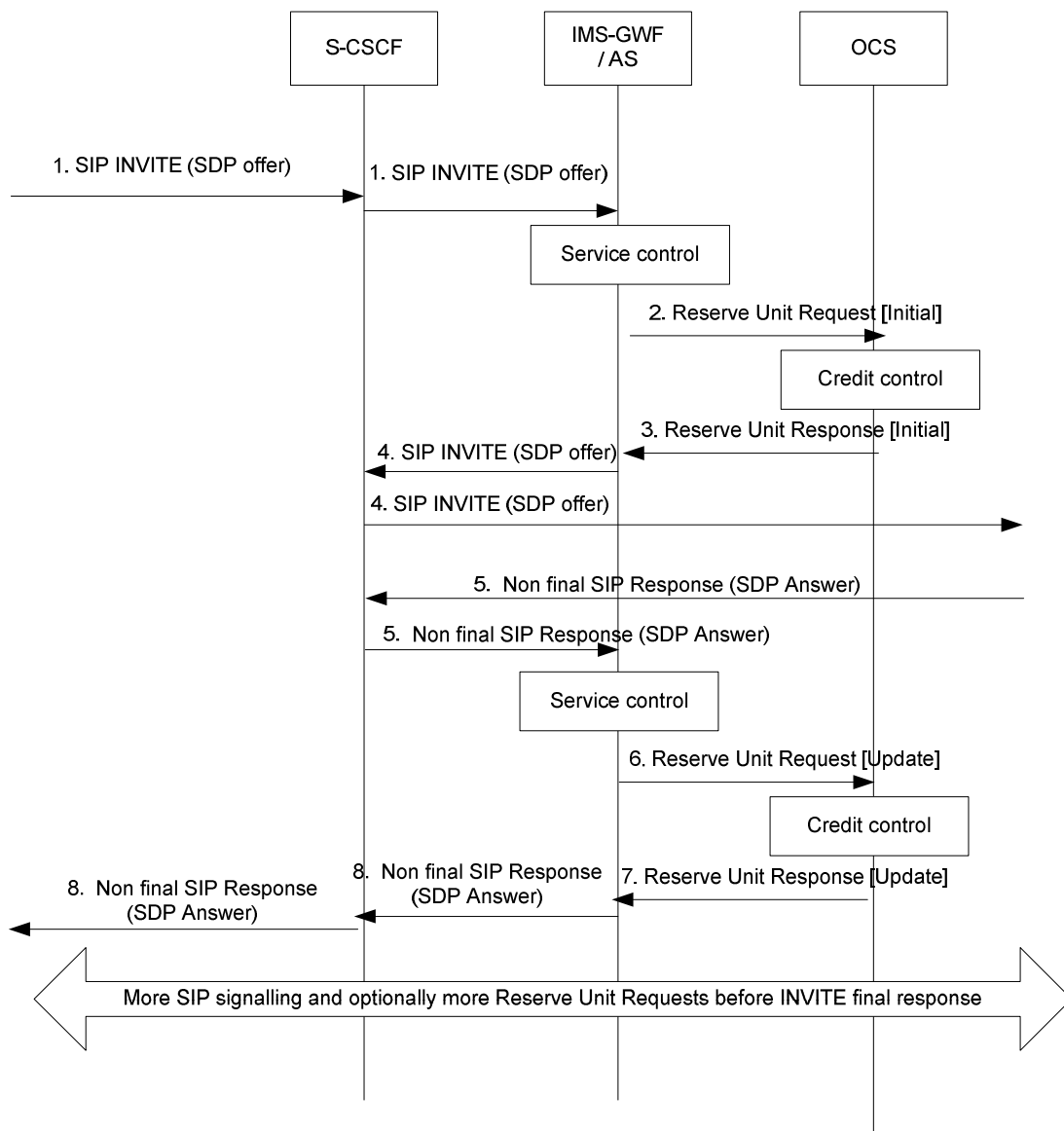

- 1) An initial SDP offer is conveyed in a SIP INVITE message. The SIP INVITE message received in the S-CSCF is forwarded to the IMS-GWF/AS.
- 2) In this example, the SDP offer is conveyed in a SIP request which implies the start of the online session towards the OCS. The IMS-GWF/AS sends a Reserve Unit Request (CC-Request-Type =INITIAL\_REQUEST) to the OCS requesting service units. The online credit control session is initiated.
- 3) The OCS grants units in the Reserve Unit Response.
- 4) The IMS-GWF/AS and S-CSCF forward the SIP Request conveying the SDP offer.
- 5) A non-final SIP message (e.g. a provisional reliable response) conveying an SDP answer is received in the IMS-GWF/AS.
- 6) The received SDP answer triggers a Reserve Unit Request (CC-Request-Type =UPDATE\_REQUEST) in order to update the credit control session. New service units are requested. Also the used service units (if any) are reported.
- 7) The OCS sends the Reserve Unit Response to acknowledge the Reserve Unit Request. New service units are granted.
- 8) The SDP answer is forwarded.

**Figure 5.3.2.2.1.3.1-2 : Message Sequence Chart for Session Establishment with Early Media Negotiation**

**Scenario 3 : Mid-Session Procedures**

The figure shows the Diameter transactions that are required in the IMS-GWF/AS when receiving a SIP Re-INVITE in mid-session, e.g. in order to modify media component(s), or when the hold and resume procedure is executed.

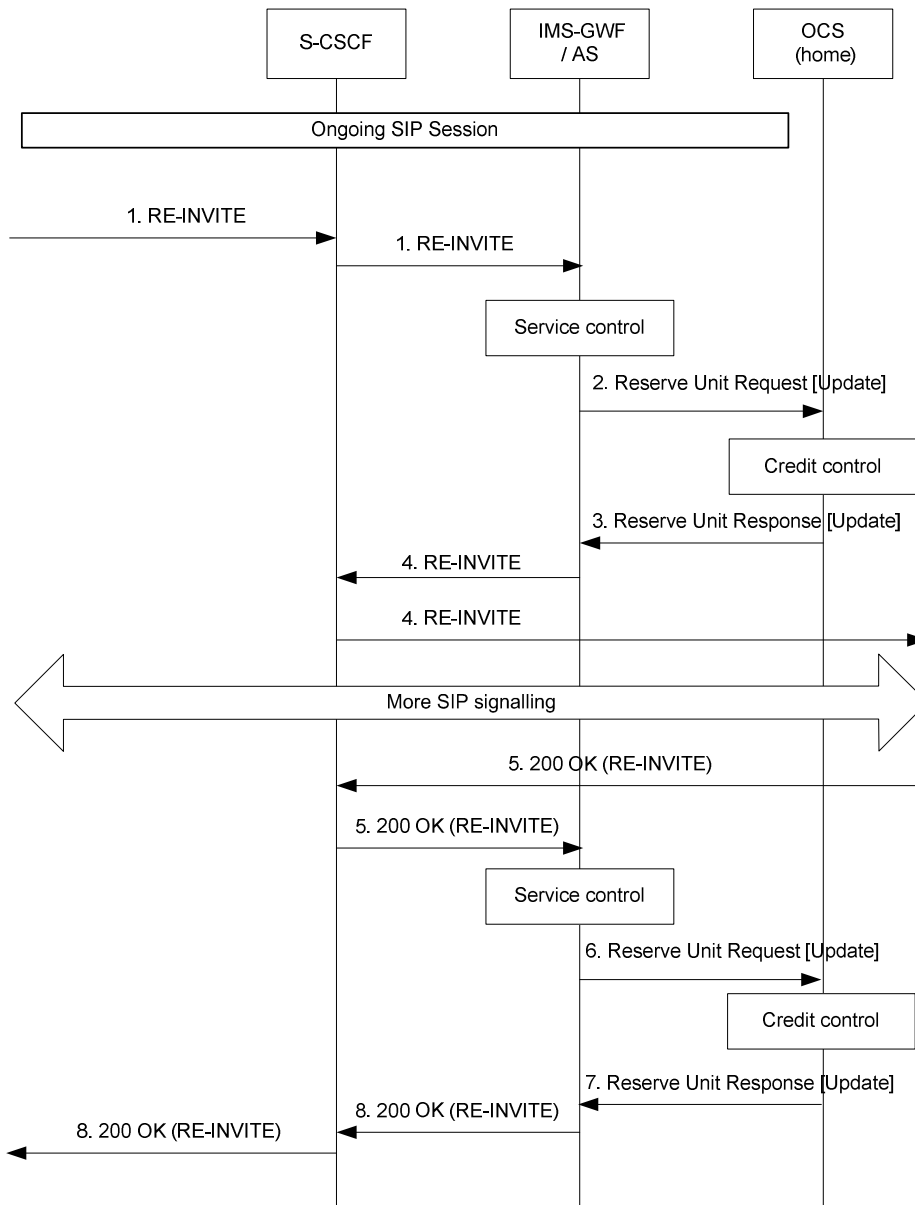

- 1) A SIP RE-INVITE request is received in the S-CSCF. This request is forwarded to the IMS-GWF/AS.
- 2) Upon receiving the SIP RE-INVITE request, the IMS-GWF/AS sends a Reserve Unit Request (CC-Request-Type = UPDATE\_REQUEST) to update the previously initiated credit control session. New service units are requested. The used service units (if any) are also reported.
- 3) The OCS grants new service units in the Reserve Unit Response.
- 4) The RE-INVITE request is forwarded.
- 5) The RE-INVITE request is acknowledged with a 200 OK.
- 6) If the trigger is active, the IMS-GWF/AS sends a Reserve Unit Request (CC-Request-Type =UPDATE\_REQUEST) to the OCS to update the credit control session. New service units are requested. The used service units (if any) are also reported.
- 7) The OCS grants new service units in the Reserve Unit Response.
- 8) The 200 OK message is forwarded.

**Figure 5.3.2.2.1.3.1-3 : Message Sequence Chart for Mid-Session Procedures**

**Scenario 4: Session Release**

The following figure shows the Diameter transactions that are required in the IMS-GWF/AS for a session release scenario.

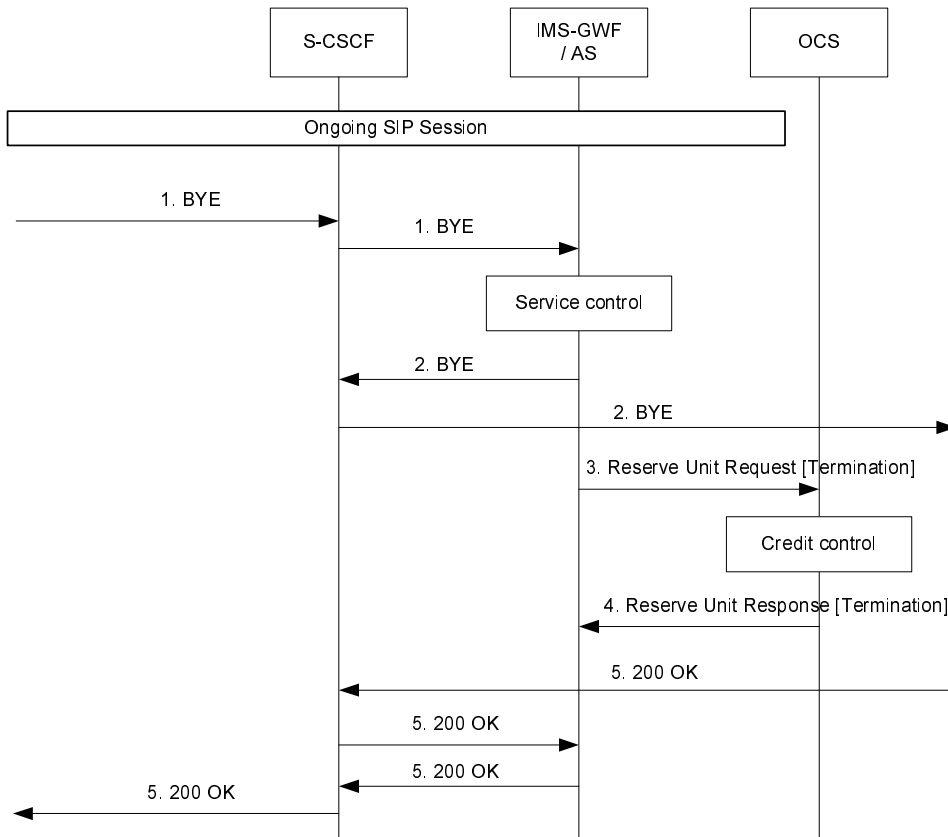

- 1) A SIP session is released by sending a SIP BYE message. The S-CSCF forwards this message to the IMS-GWF/AS.
- 2) Upon receiving the BYE message, the IMS-GWF/AS forwards the SIP BYE request to the UE.
- 3) In case there is an ongoing online control session, the IMS-GWF/AS sends a Reserve Unit Request (CC-Request-Type =TERMINATION\_REQUEST) reporting the used granted units.
- 4) The OCS sends a Reserve Unit Response. The online credit control session is terminated.
- 5) The final answer to the Bye message is forwarded.

**Figure 5.3.2.2.1.3.1-4 : Message Sequence Chart for Session Release.**

**Scenario 5: Successful Session Establishment with reception of RTTI message**

The following figure shows the Diameter credit control transactions that are required in the IMS-GWF/AS during a SIP session establishment when RTTI message is received embedded in the SIP 200 OK.

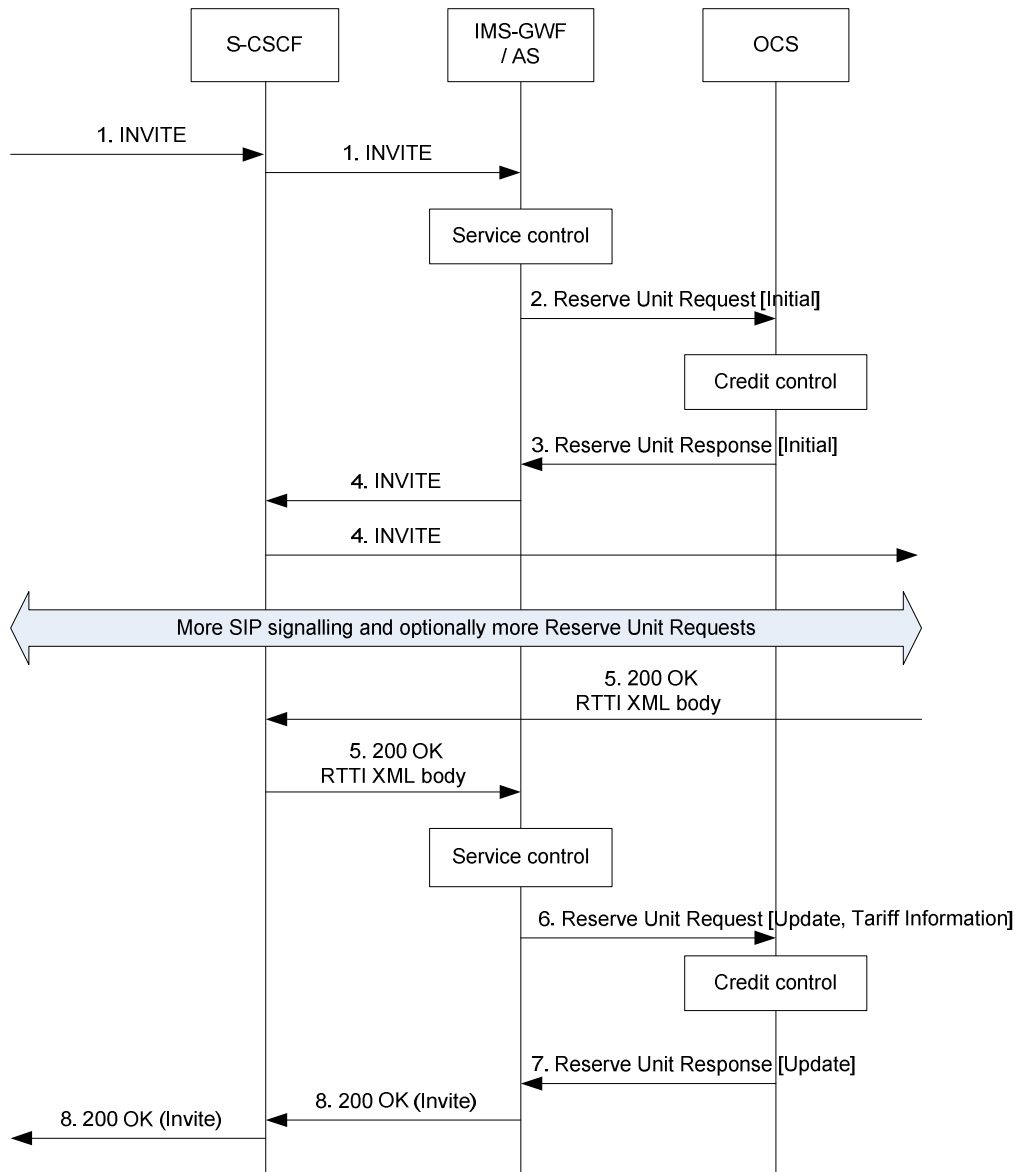

- 1) An initial SIP Invite Request is received in the S-CSCF. This request is forwarded to the IMS-GWF/AS.
- 2) The IMS-GWF/AS sends a Reserve Unit Request (CC-Request-Type =INITIAL\_REQUEST) to the OCS requesting service units. The online credit control session is initiated.
- 3) The OCS grants units in the Reserve Unit Response.
- 4) The IMS-GWF/AS and S-CSCF forward the initial INVITE.
- 5) A final response is received in the IMS-GWF/AS, which embeds a RTTI XML body.
- 6) If the trigger is active, the 200 OK answer triggers a Reserve Unit Request (CC-Request-Type =UPDATE\_REQUEST) in the IMS-GWF/AS in order to update the credit control session and take into account the RTTI XML body within the SIP 200 OK (see NOTE). New service units are requested. Also the used service units (if any) are reported.
- 7) The OCS sends the Reserve Unit Response to acknowledge the Reserve Unit Request. New service units are granted.
- 8) The final answer is forwarded.

NOTE: The mapping of RTTI XML body on Tariff Information structure is described in TS 32.280 [36].

**Figure 5.3.2.1.3.1-5: Message Sequence Chart for Successful Session Establishment with reception of RTTI message**



5.3.2.2.1.3.2 Session Unrelated Procedures (ECUR)

**Scenario 1: Successful session unrelated procedure**

The following figure shows the Diameter transactions that are required in the IMS-GWF/AS for a session unrelated procedure.

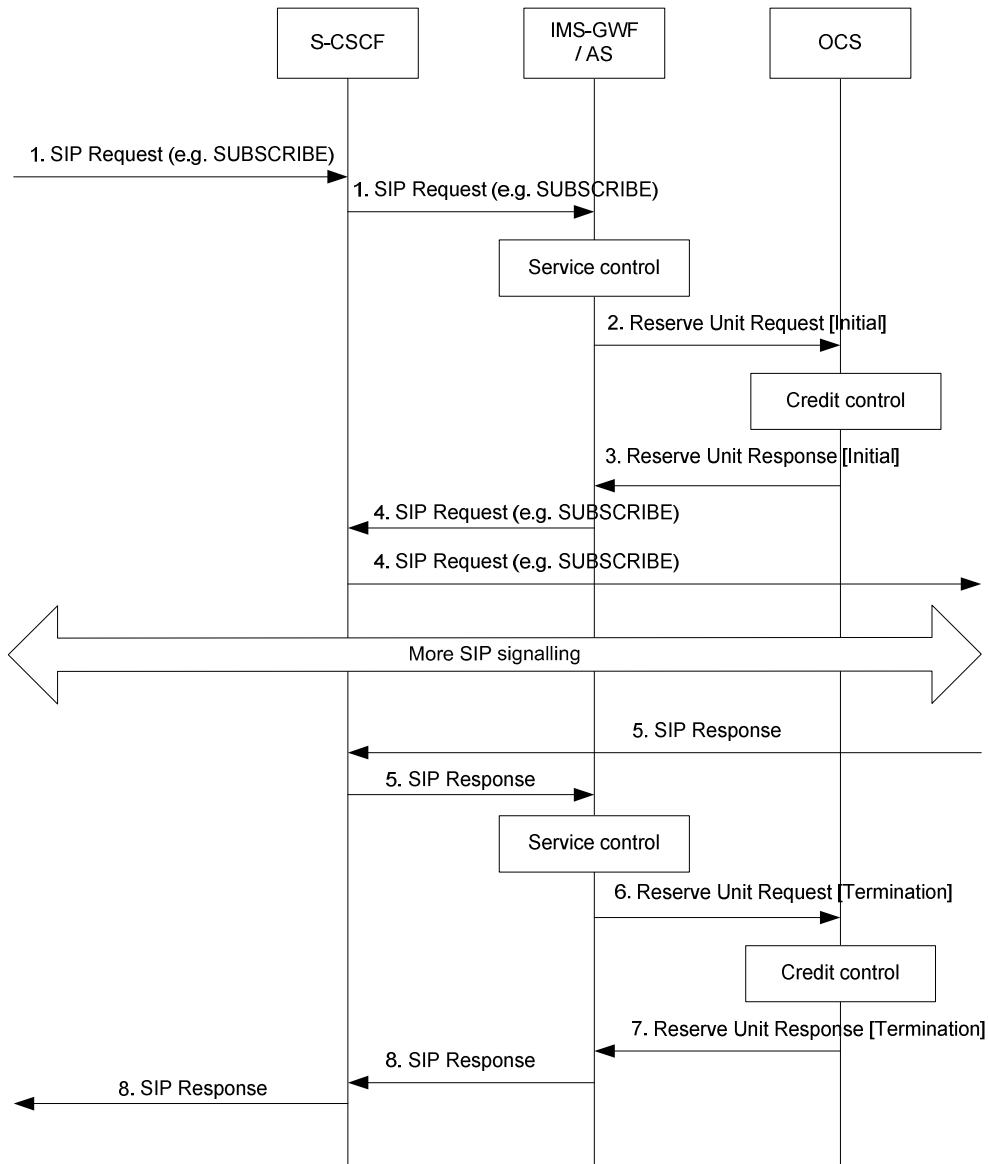

- 1) A session unrelated SIP Request (e.g. SUBSCRIBE) is received in the S-CSCF. The S-CSCF forwards this request to the IMS-GWF/AS.
- 2) The IMS-GWF/AS sends a Reserve Unit Request (CC-Request-Type = INITIAL\_REQUEST) to initiate a credit control session. Service units are requested to the OCS.
- 3) The OCS grants service units in the Reserve Unit Response.
- 4) The IMS-GWF/AS and the S-CSCF forward the SIP Request
- 5) Depending on the used SIP method, there might be additional signalling between steps 4 and 5.
- 6) The SIP Request is acknowledged by a SIP Response.
- 7) The IMS-GWF/AS sends a Reserve Unit Request (CC-Request-Type=TERMINATION\_REQUEST) to the OCS. It also reports the used granted units.
- 8) The OCS sends a Reserve Unit Response to acknowledge the Reserve Unit Request. The online credit control session is terminated.
- 9) The IMS-GWF/AS and S-CSCF forward the SIP Response.

**Figure 5.3.2.2.1.3.2-1: Message Sequence Chart for Session-Unrelated Procedures**



### 5.3.2.2.2 Message Flows - Error Cases and Scenarios

This clause describes various error cases and how these should be handled.

The failure handling behaviour is locally configurable in the IMS network element. If *Credit-Control-Failure-Handling* AVP is not used, the locally configured values are used instead.

#### 5.3.2.2.2.1 Reception of SIP Error Messages

If SIP errors occur during service delivery, as defined in [202] and [203], it is up to the IMS network element to determine to what extent the service was delivered before the error occurred and act appropriately with respect to charging. This may imply that no units at all (or no more units) are reserved or debited.

#### 5.3.2.2.2.2 Reserve Units and Debit Units Operation Failure

This case comprises of OCS connection failure, and/or receiving error responses from the OCS.

The IMS network element detects an OCS connection failure when the timer Tx expires (IETF RFC 4006 [402]) or a transport failure is detected as defined in IETF RFC 3588 [401]. The OCS also has the capability to detect failures when the timer Ts (IETF RFC 3588 [401]) expires. The OCS should indicate the cause of failure by setting the appropriate result code as defined in IETF RFC 3588 [401] and IETF RFC 4006 [402]. In any case, the failure handling of IMS network element and OCS complies with the failure procedures for session based credit control scenario described in IETF RFC 4006 [402].

#### 5.3.2.2.2.3 Duplicate Detection

For credit control duplicate detection is performed only for possible duplicate event requests related to IEC as mentioned in clause 5.3.2.1.2.3, as retransmission of ECUR/SCUR related credit control requests is not allowed.

#### 5.3.2.2.2.4 Aborted Session Setup

If a trigger occurs during session establishment to release a session during the establishment procedure, the IMS Network Element shall initiate procedures to cancel the session establishment as defined in TS 24.229 [204]. On completion of the cancellation procedure, the IMS Network Element shall close the credit-control session (for SCUR and ECUR) indicating an appropriate cause code.

### 5.3.2.3 IMS Service Termination by OCS

Annex B describes several scenarios related to IMS service termination.

NOTE: The annex B only shows the scenario of the S-CSCF with IMS-GWF case.

For IMS session related scenarios charged by means of SCUR in the IMS-GWF, Service Termination shall imply the rejection of a request for IMS session establishment or the release of an established session that is possibly associated to an online Diameter Charging Session.

For IMS session unrelated scenarios charged by means of ECUR in the IMS-GWF, Service Termination shall imply the rejection of the SIP method triggering the Reserve Unit Request as defined in TS 32.299 [50].

For IMS session unrelated scenarios charged by means of IEC prior to service/content delivery in the IMS-GWF, Service Termination shall imply the rejection of the SIP method triggering the Debit Unit Request as defined in TS 32.299 [50].

#### 5.3.2.3.1 Triggers on Ro interface which imply the termination of the IMS service

The procedures in Ro interface which may trigger the IMS Service termination are the following:

- Reception of an unsuccessful Operation Result different from DIAMETER\_CREDIT\_CONTROL\_NOT\_APPLICABLE (TS32.299 [50]) in the Debit and Reserve Unit Response message.

- Reception of an unsuccessful Result Code different from DIAMETER\_CREDIT\_CONTROL\_NOT\_APPLICABLE (TS32.299 [50]) within the Multiple Unit Operation in the Debit and Reserve Unit Response message when only one instance of the Multiple Unit Operation field is used.
- Execution of the Termination Action procedure as defined in TS32.299 [50] when only one instance of the Multiple Unit Operation field is used.
- Execution of the Failure Handling Procedures when the Failure Action is set to 'Terminate' or 'Retry & Terminate'.
- Reception in the IMS-GWF of an Abort-Session-Request Message from OCS.

In case either a Final-Unit-Indication or an erroneous Result-Code at Multiple Unit Operation level trigger the IMS service termination and the charging is based on ECUR or SCUR, the IMS-GWF shall close the Diameter online session by sending a Debit Units and Reserve Units operation of Type 'Termination'.

Refer to TS 32.299 [50] for a detailed description of these procedures.

### 5.3.2.3.2 Indication to the UE of the reason for IMS service release

As a result of Service Termination triggering in IMS-GWF, the IMS service shall be denied to end-users. The network should provide an indication to UEs of the reason the service has been released or rejected. The procedure shall depend on:

- The charged party.

The network should provide UEs with an indication of the reason the service has been released or rejected.

However, this reason shall depend on whether the UE is the charged party or not. The premise is that only the charged party should know that the IMS service is being rejected / released because of OCS interaction.

- IMS specific protocol issues as defined in TS 24.229 [204].

a) The IMS-GWF generates a non-2xx final SIP response as a result of the IMS Service Termination procedure:

In this scenario, the Response Code of the SIP response shall indicate the server understood the request but is refusing to fulfil it and that this request should not be repeated. The SIP response may include additional information about the cause to reject/release the IMS service. The presence of this additional error information in the response shall be operator configurable.

The additional information included in the SIP response may contain a SIP URI. The UE may treat the SIP URI as if it were a Contact in a redirect and generate a new INVITE, resulting, for example, in a recorded announcement session being established.

b) The IMS-GWF generates a SIP request (e.g. SIP BYE or SIP CANCEL) as a result of the IMS Service Termination procedure:

In this scenario, the IMS-GWF may include a 'Reason' field in the request which provides additional information about the cause to reject/release the IMS service. The presence of this additional information in the request shall be operator configurable.

In both scenarios, it shall also be operator configurable both per SIP Method and per Originating/Terminating side, the content of the additional error information sent to the UEs. This error information shall also be configurable based on the procedure in Ro interface which has triggered the release/rejection of the IMS service according to clause 5.3.2.3.1. In particular when the Service Termination is triggered by the reception of an unsuccessful Operation Result (different from DIAMETER\_CREDIT\_CONTROL\_NOT\_APPLICABLE as defined in TS 32.299 [50]) in the Debit and Reserve Unit Response message or the reception of an unsuccessful Result Code (different from DIAMETER\_CREDIT\_CONTROL\_NOT\_APPLICABLE as defined in TS 32.299 [50]) within the Multiple Unit Operation in the Debit and Reserve Unit Response message, the additional error information/reason shall also be configurable based on the Result Code received through Ro interface.

## 6 Definition of charging information

### 6.1 Data description for IMS offline charging

#### 6.1.1 Rf Message contents

The IMS nodes generate accounting information that can be transferred from the CTF to the CDF. For this purpose, IMS offline charging utilises the *Charging Data Transfer* that is specified in the 3GPP accounting application described in TS 32.299 [50].

The *Charging Data Transfer* operation employs the *Charging Data Request* and *Charging Data Response* messages. The following table describes the use of these messages for offline charging.

**Table 6.1.1: Offline Charging Messages Reference Table**

Command-Name	Source	Destination
<i>Charging Data Request</i>	S-CSCF, I-CSCF, P-CSCF, MRFC, MGCF, BGCF, IBCF, AS, E-CSCF, TF, TRF, ATCF	CDF
<i>Charging Data Response</i>	CDF	S-CSCF, I-CSCF, P-CSCF, MRFC, MGCF, BGCF, IBCF, AS, E-CSCF, TF, TRF, ATCF

##### 6.1.1.1 Charging Data-Request Message

The following table illustrates the basic structure of a Diameter *Charging Data-Request* message as used for IMS offline charging.

**Table 6.1.1.1: Charging Data Request Message Contents**

Field	Category	Description
Session Identifier	M	Described in 32.299 [50]
Originator Host	M	Described in 32.299 [50]
Originator Domain	M	Described in 32.299 [50]
Destination Domain	M	Described in 32.299 [50]
Operation Type	M	Described in 32.299 [50]
Operation Number	M	Described in 32.299 [50]
Operation Identifier	O <sub>M</sub>	The field corresponds to the unique operation identification.
User Name	O <sub>C</sub>	This field contains the Private User Identity defined in TS 23.003 [104].
Destination Host	O <sub>C</sub>	Described in 32.299 [50]
Operation Interval	O <sub>C</sub>	TBD
Origination State	O <sub>C</sub>	TBD
Origination Timestamp	O <sub>C</sub>	This field contains the time when the operation is requested.
Proxy Information	O <sub>C</sub>	This field contains the parameter of the proxy.
Route Information	O <sub>C</sub>	This field contains the parameter of the route.
Operation Token	O <sub>M</sub>	This field identifies the domain, subsystem, or service and release.
Service Information	O <sub>M</sub>	This field holds the 3GPP specific IMS parameter, described in 6.3.

### 6.1.1.2 Charging Data Response Message

The following table illustrates the basic structure of a Diameter *Charging Data Response* message as used for IMS offline charging.

**Table 6.1.1.2: Charging Data Response Message Contents**

Field	Category	Description
Session Identifier	M	This field identifies the operation session.
Operation Result	M	This field identifies the result of the operation.
Originator Host	M	This field contains the identification of the source point of the operation and the realm of the operation originator.
Originator Domain	M	This field contains the realm of the operation originator.
Operation Type	M	This field defines the transfer type: event for event based charging and start, interim, stop for session based charging.
Operation Number	M	This field contains the sequence number of the transferred messages.
Operation Identifier	O <sub>M</sub>	The field corresponds to the unique operation identification.
User Name	O <sub>C</sub>	The field contains the Private User Identity defined in TS 23.003 [104].
Operation Interval	O <sub>C</sub>	TBD
Origination State	O <sub>C</sub>	TBD
Origination Timestamp	O <sub>C</sub>	This field contains the time when the operation is requested.
Proxy Information	O <sub>C</sub>	This field contains the parameter of the proxy.

### 6.1.2 GTP' message contents

Not applicable. Refer to subclause 5.2.4 for further information.

### 6.1.3 CDR Description on the Bi Interface

#### 6.1.3.1 CDR Field Types

The following Standard CDR content and format are considered:

S-CSCF-CDR generated based on information from the S-CSCF

I-CSCF-CDR generated based on information from the I-CSCF

P-CSCF-CDR generated based on information from the P-CSCF

BGCF-CDR generated based on information from the BGCF

IBCF-CDR generated based on information from the IBCF

MGCF-CDR generated based on information from the MGCF

MRFC-CDR generated based on information from the MRFC

AS-CDR generated based on information from the AS

E-CSCF-CDR generated based on information from the E-CSCF

TF-CDR generated based on information from the IMS Transit Functions

TRF-CDR generated based on information from the TRF

ATCF-CDR generated based on information from the ATCF

The content of each CDR type is defined in the tables in clauses 6.1.3.3 to 6.1.3.11. For each CDR type the field definition includes the field name, category and description. The detailed field descriptions are provided in TS 32.298 [51].

**Editor's Note:** Equipment vendors shall be able to provide all of the fields listed in the CDR content table in order to claim compliance with the present document. However, since CDR processing and transport consume network resources, operators may opt to eliminate some of the fields that are not essential for their operation.

**Editors note:** Rephrase the above paragraph and ref. to 32.240

The CDF provides the CDRs at the Bi interface in the format and encoding described in TS 32.298 [51]. Additional CDR formats and contents may be available at the interface to the billing system to meet the requirements of the billing system, these are outside of the scope of 3GPP standardisation.

## 6.1.3.2 CDR Triggers

### 6.1.3.2.1 Session Related CDRs

Reflecting the usage of multimedia sessions IMS CDRs are generated by the CDF on a per session level. In the scope of the present document the term "session" refers always to a SIP session. The coherent media components are reflected inside the session CDRs with a media component container comprising of all the information necessary for the description of a media component.

Accounting information for SIP sessions is transferred from the CTF involved in the session to the CDF using Charging Data Request Start, Interim and Stop messages. A session CDR is opened in the CDF upon reception of a Charging Data Request [Start] message. Partial CDRs may be generated upon reception of a Charging Data Request [Interim] message, which is sent by the network entity towards the CDF due to a session modification procedure (i.e. change in media). Session CDRs are updated, or partial CDRs are generated upon reception of a Charging Data Request [Interim] message, which is sent by the network entity due to expiration of the Charging Data Interim Interval. The CDF closes the final session CDR upon reception of a Charging Data Request [Stop] message, which indicates that the SIP session is terminated. Further details on triggers for the generation of IMS CDRs are specified in [1].

Accounting information for unsuccessful session set-up attempts may be sent by the CTF to the CDF employing the Charging Data Request [Event] message. The behaviour of the CDF upon receiving Charging Data Request [Event] messages is specified in clause 6.1.3.2.2.

### 6.1.3.2.2 Session Unrelated CDRs

To reflect chargeable events not directly related to a session the CDF may generate CDRs upon the occurrence of session unrelated SIP procedures, such as registration respectively de-registration events. Accounting information for SIP session-unrelated procedures is transferred from the IMS nodes involved in the procedure to the CDF using Charging Data Request [Event] messages. Session unrelated CDRs are created in the CDF in a "one-off" action based on the information contained in the Charging Data Request [Event] message. One session unrelated CDR is created in the CDF for each Charging Data Request [Event] message received, whereas the creation of partial CDRs is not applicable for session unrelated CDRs. The cases for which the IMS nodes send Charging Data Request [Event] messages are listed per SIP procedure in table 5.2.1.1 and table 5.2.1.2.

Further details on triggers for the generation of IMS CDRs are specified in clause 5.2.2.

### 6.1.3.3 S-CSCF CDR Content

The detailed description of the field is provided in TS 32.298 [51].

**Table 6.1.3.3: Charging Data of S-CSCF CDR**

Field	Category	Description
Record Type	M	Identifies the type of record. The parameter is derived from the Node functionality parameter.
Retransmission	O <sub>C</sub>	This parameter, when present, indicates that information from retransmitted Charging Data Requests has been used in this CDR
SIP Method	O <sub>C</sub>	Specifies the SIP-method for which the CDR is generated. Only available in session unrelated cases.
Event	O <sub>C</sub>	This field identifies the SIP event package to which the SIP request is referred.
Expires Information	O <sub>C</sub>	This field indicates the validity time of either the SIP message or its content, depending on the SIP method.
Role of Node	O <sub>M</sub>	This field indicates whether the S-CSCF is serving the Originating or the Terminating party.
Node Address	O <sub>M</sub>	This item holds the address of the node providing the information for the CDR. This may either be the IP address or the FQDN of the IMS node generating the accounting data.
Session ID	O <sub>M</sub>	The Session identification. For a SIP session the Session-ID contains the SIP Call ID as defined in the Session Initiation Protocol RFC 3261 [404].
Session Priority	O <sub>C</sub>	The field contains the priority of the session.
List Of Calling Party Address	O <sub>M</sub>	The address or addresses (Public User ID or Public Service ID) of the party requesting a service or initiating a session. In the case of no P-Asserted-Identify is known, this list shall include one item with the value "unknown".
List of Associated URI	O <sub>C</sub>	The list of non-barred public user identities (SIP URIs and/or TEL URIs) associated to the public user identity under registration.
Called Party Address	O <sub>M</sub>	For SIP transactions, except for registration, this field holds the address of the party (Public User ID or Public Service ID) to whom the SIP transaction is posted. For registration transactions, this field holds the Public User ID under registration.
Requested Party Address	O <sub>C</sub>	For SIP transactions this field holds the address of the party (Public User ID or Public Service ID) to whom the SIP transaction was originally posted. This field is only present if different from the Called Party Address parameter.
Number Portability routing information	O <sub>C</sub>	This field includes information on number portability after DNS/ENUM request from S-CSCF in the calling user's home network.
Carrier Select routing information	O <sub>C</sub>	This field includes information on carrier select after DNS/ENUM request from S-CSCF in the calling user's home network.
List of Called Asserted Identity	O <sub>C</sub>	The address or addresses of the final asserted identities. Present if the final asserted identities are available in the SIP 2xx response.
Private User ID	O <sub>C</sub>	This field holds the private user identity of the served party defined in TS 23.003 [104], if available.
List of Subscription Id	O <sub>M</sub>	Holds the public user identities of the served user
Service Request Time Stamp	O <sub>M</sub>	This field contains the time stamp, which indicates the time at which the service was requested.
Service Request Time Stamp Fraction	O <sub>M</sub>	This parameter contains the milliseconds fraction in relation to the Service Request Time Stamp.
Service Delivery Start Time Stamp	O <sub>M</sub>	This field holds the time stamp reflecting either: successful session set-up, a delivery unrelated service, an unsuccessful session set-up and an unsuccessful session unrelated request.
Service Delivery Start Time Stamp Fraction	O <sub>M</sub>	This parameter contains the milliseconds fraction in relation to the Service Delivery Start Time Stamp.
Service Delivery End Time Stamp	O <sub>C</sub>	This field records the time at which the service delivery was terminated. It is Present only in SIP session related case.
Service Delivery End Time Stamp Fraction	O <sub>C</sub>	This parameter contains the milliseconds fraction in relation to the Service Delivery End Time Stamp.
Record Opening Time	O <sub>C</sub>	A time stamp reflecting the time the CDF opened this record. Present only in SIP session related case.
Record Closure Time	O <sub>M</sub>	A Time stamp reflecting the time the CDF closed the record.
Application Servers Information	O <sub>C</sub>	This a grouped CDR field containing the fields: "Application Server Involved" and "Application Provided Called Parties".
Application Servers Involved	O <sub>C</sub>	Holds the ASs (if any) identified by the SIP URIs.

Field	Category	Description
Application Provided Called Parties	O <sub>C</sub>	Holds a list of the Called Party Address(es), if the address(es) are determined by an AS (SIP URI, E.164...).
Status	O <sub>C</sub>	Holds the abnormal status information of specific ASs (if any) when AS(s) respond 4xx/5xx or time out to S-CSCF during an IMS session.
List of Inter Operator Identifiers	O <sub>C</sub>	Holds the identification of the home network (originating and terminating) if exchanged via SIP signalling, as recorded in the P-Charging-Vector header. This grouped field may occur several times in one CDR.
Originating IOI	O <sub>C</sub>	This parameter corresponds to Orig-IOI header of the P-Charging-Vector defined in TS 24.229 [204].
Terminating IOI	O <sub>C</sub>	This parameter corresponds to Term-IOI header of the P-Charging-Vector defined in TS 24.229 [204].
Transit IOI List	O <sub>C</sub>	This parameter corresponds to Transit-IOI List of the P-Charging-Vector defined in TS 24.229 [204]. This field may occur several times in one CDR. Each occurrence represents transit IOI values received from the path inbound to or outbound from the S-CSCF.
Local Record Sequence Number	O <sub>M</sub>	This field includes a unique record number created by S-CSCF. The number is allocated sequentially for each partial CDR (or whole CDR) including all CDR types. The number is unique within the CDF.
Record Sequence Number	O <sub>C</sub>	This field contains a running sequence number employed to link the partial records generated by the CDF for a particular session.
Cause For Record Closing	O <sub>M</sub>	This field contains a reason for the close of the CDR.
Incomplete CDR Indication	O <sub>C</sub>	This field provides additional diagnostics when the CDF detects missing Charging Data Requests.
IMS Charging Identifier	O <sub>M</sub>	This parameter holds the IMS charging identifier (ICID) as generated by the IMS node for the SIP session.
List of Early SDP Media Components	O <sub>C</sub>	This is a grouped field which may occur several times in one CDR.  This field shall not be present if no media components are set to active before the final SIP session answer to the initial SIP Invite is received. This field can be present in either session or event CDRs.
SDP Session Description	O <sub>C</sub>	Holds the Session portion of SDP data exchanged in the above mentioned scenario, if available.
SDP Type	O <sub>M</sub>	This parameter indicates if the SDP media component is an SDP offer or SDP answer.
SDP Offer Timestamp	O <sub>M</sub>	This parameter contains the time of the SIP Request which conveys the SDP offer.
SDP Answer Timestamp	O <sub>M</sub>	This parameter contains the time of the response to the SIP Request which conveys the SDP answer.
SDP Media Components	O <sub>M</sub>	This is a grouped field comprising several sub-fields associated with one media component. Since several media components may exist for a session in parallel these sub-fields may occur several times.
SDP Media Name	O <sub>M</sub>	This field holds the name of the media as available in the SDP data.
SDP Media Description	O <sub>M</sub>	This field holds the attributes of the media as available in the SDP data.
Access Correlation ID	O <sub>C</sub>	This parameter holds the charging identifier from the access network, consisting of either GPRS charging ID (GCID) which is generated by the GGSN for a GPRS PDP context, Charging Id which is generated by P-GW for IP-CAN bearer or the Access Network Charging Identifier Value which is generated by another type of access network. It is present only if received from the access network when PCC architecture is implemented.
Media Initiator Flag	O <sub>C</sub>	This field indicates if the called party has requested the session modification and it is present only if the initiator was the called party.
List of SDP Media Components	O <sub>C</sub>	This is a grouped field which may occur several times in one CDR.  The field is present only in a SIP session related case.
SDP Session Description	O <sub>C</sub>	Holds the Session portion of the SDP data exchanged between the User Agents if available in the SIP transaction.



Field	Category	Description
SDP Type	O <sub>M</sub>	This parameter indicates if the SDP media component is an SDP offer or SDP answer.
SIP Request Timestamp	O <sub>C</sub>	This parameter contains the time of the SIP Request (usually a (Re)Invite).
SIP Response Timestamp	O <sub>C</sub>	This parameter contains appropriately the time of 200 OK acknowledging an INVITE or of ACK including an SDP answer.
SIP Request Timestamp Fraction	O <sub>C</sub>	This parameter contains the milliseconds fraction in relation to the SIP Request Timestamp.
SIP Response Timestamp Fraction	O <sub>C</sub>	This parameter contains the milliseconds fraction in relation to the SIP Response Timestamp.
SDP Media Components	O <sub>M</sub>	This is a grouped field comprising several sub-fields associated with one media component. Since several media components may exist for a session in parallel these sub-fields may occur several times.
SDP Media Name	O <sub>M</sub>	This field holds the name of the media as available in the SDP data.
SDP Media Description	O <sub>M</sub>	This field holds the attributes of the media as available in the SDP data.
Access Correlation ID	O <sub>C</sub>	This parameter holds the charging identifier from the access network, consisting of either GPRS charging ID (GCID) which is generated by the GGSN for a GPRS PDP context, Charging Id which is generated by P-GW for IP-CAN bearer or the Access Network Charging Identifier Value which is generated by another type of access network. It is present only if received from the access network when PCC architecture is implemented.
Media Initiator Flag	O <sub>C</sub>	This field indicates if the called party has requested the session modification and it is present only if the initiator was the called party.
GGSN Address	O <sub>C</sub>	This parameter holds the control plane IP address of the GGSN that handles one or more media component(s) of an IMS session.
Service Reason Return Code	O <sub>M</sub>	This parameter provides the returned SIP status code for the service request for the successful and failure case,
List of Message Bodies	O <sub>C</sub>	This grouped field comprising several sub-fields describing the data that may be conveyed end-to-end in the body of a SIP message. Since several message bodies may be exchanged via SIP-signalling, this grouped field may occur several times.
Content-Type	O <sub>M</sub>	This sub-field of Message Bodies holds the MIME type of the message body, Examples are: application/zip, image/gif, audio/mpeg, etc.
Content-Disposition	O <sub>C</sub>	This sub-field of Message Bodies holds the content disposition of the message body inside the SIP signalling, Content-disposition header field equal to "render", indicates that "the body part should be displayed or otherwise rendered to the user". Content disposition values are: session, render, inline, icon, alert, attachment, etc.
Content-Length	O <sub>M</sub>	This sub-field of Message Bodies holds the size of the data of a message body in bytes.
Originator	O <sub>C</sub>	This sub-field of the "List of Message Bodies" indicates the originating party of the message body.
Access Network Information	O <sub>C</sub>	This field contains the content of one SIP P-header "P-Access-Network-Info" if available.
Service Context Id	O <sub>M</sub>	Holds the context information to which the CDR belongs. The information is obtained from the Operation Token of the Charging Data Request message.
IMS Communication Service ID	O <sub>C</sub>	This field contains the IMS communication service identifier if received in the P-Asserted-Service header in the SIP request.
Online Charging Flag	O <sub>C</sub>	This field indicates the Online Charging Request was sent based on the provided ECF address from the SIP P-header "P-Charging-Function-Addresses". NOTE: No proof that online charging action has been taken
Real Time Tariff Information	O <sub>C</sub>	This field holds the tariff/add-on charge received.
User Location Info	O <sub>C</sub>	This field contains the network provided location information for 3GPP accesses, if available.
MS Time Zone	O <sub>C</sub>	This field indicates the offset between universal time and local time in steps of 15 minutes of where the MS currently resides.

Field	Category	Description
NNI Information	O <sub>c</sub>	This grouped field holds information about the NNI used for interconnection and roaming on the loopback routing path. It is present only if "VPLMN routing" is applied in a Roaming Architecture for Voice over IMS with Local breakout.
NNI Type	O <sub>c</sub>	This field indicates usage of the roaming NNI for loopback routing, i.e S-CSCF performed the loopback decision.
From Address	O <sub>M</sub>	Contains the information from the SIP From header.
IMS Emergency Indication	O <sub>c</sub>	This field indicates the registration is an emergency registration or the IMS session is an IMS emergency session, and is present only for emergency cases.
IMS Visited Network Identifier	O <sub>c</sub>	Contains the information from the SIP P-Visited-Network-ID header received in a REGISTER request.
SIP Route header received	O <sub>c</sub>	Contains the information in the topmost route header in a received initial SIP INVITE or non-session related SIP MESSAGE request prior to triggering of any application servers. This field is present only for requests from the served user.
SIP Route header transmitted	O <sub>c</sub>	Contains the information in the route header representing the destination in a transmitted initial SIP INVITE or non-session related SIP MESSAGE request following triggering of all application servers. This field is present for requests toward the served user and for requests from the served user when "VPLMN routing" is applied in a Roaming Architecture for Voice over IMS with Local breakout.
Record Extensions	O <sub>c</sub>	A set of operator/manufacture specific extensions to the record, conditioned upon existence of an extension.

#### 6.1.3.4 P-CSCF CDR Content

The detailed description of the field is provided in TS 32.298 [51].

**Table 6.1.3.4: Charging Data of P-CSCF CDR**

Field	Category	Description
Record Type	M	Identifies the type of record. The parameter is derived from the Node functionality parameter.
Retransmission	O <sub>c</sub>	This parameter, when present, indicates that information from retransmitted Charging Data Requests has been used in this CDR.
SIP Method	O <sub>c</sub>	Specifies the SIP-method for which the CDR is generated. Only available in session unrelated cases.
Event	O <sub>c</sub>	This field identifies the SIP event package to which the SIP request is referred.
Expires Information	O <sub>c</sub>	This field indicates the validity time of either the SIP message or its content, depending on the SIP method.
Role of Node	O <sub>M</sub>	This field indicates whether the P-CSCF is serving the Originating or the Terminating party.
Node Address	O <sub>M</sub>	This item holds the address of the node providing the information for the CDR. This may either be the IP address or the FQDN of the IMS node generating the accounting data.
Session ID	O <sub>M</sub>	The Session identification. For a SIP session the Session-ID contains the SIP Call ID as defined in the Session Initiation Protocol RFC 3261 [404].
Session Priority	O <sub>c</sub>	The field contains the priority of the session.
List Of Calling Party Address	O <sub>M</sub>	The address (Public User ID or Public Service ID) of the party requesting a service or initiating a session. In the case of no P-Asserted-Identify is known, this list shall include one item with the value "unknown" Note: For P-CSCF, only one address is present
List of Associated URI	O <sub>c</sub>	The list of non-barred public user identities (SIP URIs and/or TEL URIs) associated to the public user identity under registration.
Called Party Address	O <sub>M</sub>	In the context of an end-to-end SIP transaction this field holds the address of the party (Public User ID) to whom the SIP transaction is posted. For emergency calls, this parameter could contain an URN.
List of Called Asserted Identity	O <sub>c</sub>	The address or addresses of the final asserted identities. Present if the final asserted identities are available in the SIP 2xx response.
Served Party IP Address	O <sub>M</sub>	This field contains the IP address of either the calling or called party, depending on whether the P-CSCF is in touch with the calling or called network.
Private User ID	O <sub>c</sub>	This field holds the private user identity of the served party defined in TS 23.003 [104], if available.
List of Subscription Id	O <sub>M</sub>	Holds the public user identities of the served user.
Service Request Time Stamp	O <sub>M</sub>	This field contains the time stamp, which indicates the time at which the service was requested.
Service Request Time Stamp Fraction	O <sub>M</sub>	This parameter contains the milliseconds fraction in relation to the Service Request Time Stamp.
Service Delivery Start Time Stamp	O <sub>M</sub>	This field holds the time stamp reflecting either: successful session set-up, a delivery unrelated service, an unsuccessful session set-up and an unsuccessful session unrelated request.
Service Delivery Start Time Stamp Fraction	O <sub>M</sub>	This parameter contains the milliseconds fraction in relation to the Service Delivery Start Time Stamp.
Service Delivery End Time Stamp	O <sub>c</sub>	This field records the time at which the service delivery was terminated. It is Present only in SIP session related case. Present with Charging Data Request [Stop].
Service Delivery End Time Stamp Fraction	O <sub>c</sub>	This parameter contains the milliseconds fraction in relation to the Service Delivery End Time Stamp.
Record Opening Time	O <sub>c</sub>	A time stamp reflecting the time the CDF opened this record. Present only in SIP session related case.
Record Closure Time	O <sub>M</sub>	A Time stamp reflecting the time the CDF closed the record.
Inter Operator Identifiers	O <sub>c</sub>	Holds the identification of the home network (originating and terminating) if exchanged via SIP signalling, as recorded in the <i>P-Charging-Vector header</i> .
Originating IOI	O <sub>c</sub>	This parameter corresponds to Orig-IOI header of the P-Charging-Vector defined in TS 24.229 [204].
Terminating IOI	O <sub>c</sub>	This parameter corresponds to Term-IOI header of the P-Charging-Vector defined in TS 24.229 [204].
Transit IOI List	O <sub>c</sub>	This parameter corresponds to Transit-IOI List of the P-Charging-Vector defined in TS 24.229 [204].

Field	Category	Description
Local Record Sequence Number	O <sub>M</sub>	This field includes a unique record number created by this node. The number is allocated sequentially for each partial CDR (or whole CDR) including all CDR types. The number is unique within the CDF.
Record Sequence Number	O <sub>C</sub>	This field contains a running sequence number employed to link the partial records generated by the CDF for a particular session.
Cause For Record Closing	O <sub>M</sub>	This field contains a reason for the close of the CDR.
Incomplete CDR Indication	O <sub>C</sub>	This field provides additional diagnostics when the CDF detects missing Charging Data Requests.
IMS Charging Identifier	O <sub>M</sub>	This parameter holds the IMS charging identifier (ICID) as generated by the IMS node for the SIP session.
Related IMS Charging Identifier	O <sub>C</sub>	This parameter holds the Related IMS charging identifier when the session is the target access leg in an SRVCC CS to PS handover. The Related IMS charging identifier contains the IMS charging identifier as generated by the Enhanced MSC server.
Related IMS Charging Identifier Generation Node	O <sub>C</sub>	This parameter holds the identifier of the Enhanced MSC server that generated the Related IMS charging identifier.
List of Early SDP Media Components	O <sub>C</sub>	This is a grouped field which may occur several times in one CDR.  This field shall not be present if no media components are set to active before the final SIP session answer to the initial SIP Invite is received. This field can be present in either session or event CDRs.
SDP Session Description	O <sub>C</sub>	Holds the Session portion of SDP data exchanged in the above mentioned scenario, if available.
SDP Type	O <sub>M</sub>	This parameter indicates if the SDP media component is an SDP offer or SDP answer.
SDP Offer Timestamp	O <sub>M</sub>	This parameter contains the time of the SIP Request which conveys the SDP offer.
SDP Answer Timestamp	O <sub>M</sub>	This parameter contains the time of the response to the SIP Request which conveys the SDP answer.
SDP Media Components	O <sub>M</sub>	This is a grouped field comprising several sub-fields associated with one media component. Since several media components may exist for a session in parallel these sub-fields may occur several times.
SDP Media Name	O <sub>M</sub>	This field holds the name of the media as available in the SDP data.
SDP Media Description	O <sub>M</sub>	This field holds the attributes of the media as available in the SDP data.
Access Correlation ID	O <sub>C</sub>	This parameter holds the charging identifier from the access network, consisting of either GPRS charging ID (GCID) which is generated by the GGSN for a GPRS PDP context, Charging Id which is generated by P-GW for IP-CAN bearer or the Access Network Charging Identifier Value which is generated by another type of access network. It is present only if received from the access network when PCC architecture is implemented.
Media Initiator Flag	O <sub>C</sub>	This field indicates if the called party has requested the session modification and it is present only if the initiator was the called party.
List of SDP Media Components	O <sub>C</sub>	This is a grouped field which may occur several times in one CDR.  The field is present only in a SIP session related case.
SDP Session Description	O <sub>C</sub>	Holds the Session portion of the SDP data exchanged between the User Agents if available in the SIP transaction.
SDP Type	O <sub>M</sub>	This parameter indicates if the SDP media component is an SDP offer or SDP answer.
SIP Request Timestamp	O <sub>C</sub>	This parameter contains the time of the SIP Request (usually a (Re)Invite). This parameter corresponds to SIP Request Timestamp in Charging Data Request [Interim].
SIP Response Timestamp	O <sub>C</sub>	This parameter contains appropriately the time of 200 OK acknowledging an INVITE or of ACK including an SDP answer. This parameter corresponds to SIP Response Timestamp in Charging Data Request.
SIP Request Timestamp Fraction	O <sub>C</sub>	This parameter contains the milliseconds fraction in relation to the SIP Request Timestamp.
SIP Response Timestamp Fraction	O <sub>C</sub>	This parameter contains the milliseconds fraction in relation to the SIP Response Timestamp.
SDP Media Components	O <sub>M</sub>	This is a grouped field comprising several sub-fields associated with one media component. Since several media components may exist for a session in parallel these sub-fields may occur several times.

Field	Category	Description
SDP Media Name	O <sub>M</sub>	This field holds the name of the media as available in the SDP data. This parameter corresponds to SDP-Media-Name.
SDP Media Description	O <sub>M</sub>	This field holds the attributes of the media as available in the SDP data. This parameter corresponds to SDP-Media-Description.
Local GW Inserted Indication	O <sub>C</sub>	This field indicates whether the local IMS-AGW is inserted or not, for the media component included in SDP answer, if available.
IP realm Default Indication	O <sub>C</sub>	This field indicates whether the User Plane IP realm associated to the media component included in SDP answer, is the Default IP realm or not, if available.
Access Correlation ID	O <sub>C</sub>	This parameter holds the charging identifier from the access network, consisting of either GPRS charging ID (GCID) which is generated by the GGSN for a GPRS PDP context, Charging Id which is generated by P-GW for IP-CAN bearer or the Access Network Charging Identifier Value which is generated by another type of access network. It is present only if received from the access network when PCC architecture is implemented.
Media Initiator Flag	O <sub>C</sub>	This field indicates if the called party has requested the session modification and it is present only if the initiator was the called party.
GGSN Address	O <sub>C</sub>	This parameter holds the control plane IP address of the GGSN that handles one or more media component(s) of a IMS session.
Service Reason Return Code	O <sub>M</sub>	This parameter provides the returned SIP status code for the service request for the successful and failure case,
List of Message Bodies	O <sub>C</sub>	This grouped field comprising several sub-fields describing the data that may be conveyed end-to-end in the body of a SIP message. Since several message bodies may be exchanged via SIP-signalling, this grouped field may occur several times.
Content-Type	O <sub>M</sub>	This sub-field of Message Bodies holds the MIME type of the message body, Examples are: application/zip, image/gif, audio/mpeg, etc.
Content-Disposition	O <sub>C</sub>	This sub-field of Message Bodies holds the content disposition of the message body inside the SIP signalling, Content-disposition header field equal to "render", indicates that "the body part should be displayed or otherwise rendered to the user". Content disposition values are: session, render, inline, icon, alert, attachment, etc.
Content-Length	O <sub>M</sub>	This sub-field of Message Bodies holds the size of the data of a message body in bytes.
Originator	O <sub>C</sub>	This sub-field of the "List of Message Bodies" indicates the originating party of the message body.
Access Network Information	O <sub>C</sub>	This field contains the content of one SIP P-header "P-Access-Network-Info" if available.
Service Context Id	O <sub>M</sub>	Holds the context information to which the CDR belongs. The information is obtained from the Operation Token of the Charging Data Request message.
IMS Communication Service ID	O <sub>C</sub>	This field contains the IMS communication service identifier if received in the P-Asserted-Service header in the SIP request when the P-CSCF is serving the Terminating party or the topmost occurrence of the "+g.3gpp.icsi-ref" header field parameter of the Feature-Caps header in the SIP response when the P-CSCF is serving the Originating party.
IMS Application Reference ID	O <sub>C</sub>	This field contains the IMS application reference identifier if received in the SIP request.
User Location Info	O <sub>C</sub>	This field contains the network provided location information for 3GPP accesses, if available..
MS Time Zone	O <sub>C</sub>	This field indicates the offset between universal time and local time in steps of 15 minutes of where the MS currently resides.
From Address	O <sub>M</sub>	Contains the information from the SIP From header.
IMS Emergency Indication	O <sub>C</sub>	This field indicates the registration is an emergency registration or the IMS session is an IMS emergency session, and is present only for emergency cases.

Field	Category	Description
IMS Visited Network Identifier	O <sub>c</sub>	Contains the information from the SIP P-Visited-Network-ID header sent in a REGISTER request.
SIP Route header received	O <sub>c</sub>	Contains the information in the topmost route header in a received initial SIP INVITE or non-session related SIP MESSAGE request. This field is used for SIP requests toward the served user.
SIP Route header transmitted	O <sub>c</sub>	Contains the information in the route header representing the destination in a transmitted initial SIP INVITE or non-session related SIP MESSAGE request. This field is used for SIP requests from the served user.
Record Extensions	O <sub>c</sub>	A set of operator/manufacture specific extensions to the record, conditioned upon existence of an extension.

**Editor's Note:** The SIP parameter from which the IMS Application Reference ID (IARI) is to be extracted requires further investigation in CT1. A mechanism to identify the IARI in use is ffs.

### 6.1.3.5 I-CSCF CDR Content

The detailed description of the field is provided in TS 32.298 [51].

**Table 6.1.3.5: Charging Data of I-CSCF CDR**



Field	Category	Description
Record Type	M	Identifies the type of record. The parameter is derived from the Node functionality parameter.
Retransmission	O <sub>C</sub>	This parameter, when present, indicates that information from retransmitted Charging Data Requests has been used in this CDR
SIP Method	O <sub>C</sub>	Specifies the SIP-method for which the CDR is generated. Only available in session unrelated cases.
Event	O <sub>C</sub>	This field identifies the SIP event package to which the SIP request is referred.
Expires Information	O <sub>C</sub>	This field indicates the validity time of either the SIP message or its content, depending on the SIP method.
Role of Node	O <sub>M</sub>	This field indicates whether the I-CSCF is serving the Originating or the Terminating party.
Node Address	O <sub>M</sub>	This item holds the address of the node providing the information for the CDR. This may either be the IP address or the FQDN of the IMS node generating the accounting data.
Session ID	O <sub>M</sub>	The Session identification. For a SIP session the Session-ID contains the SIP Call ID as defined in the Session Initiation Protocol RFC 3261 [404].
Session Priority	O <sub>C</sub>	The field contains the priority of the session.
List Of Calling Party Address	O <sub>M</sub>	The address or addresses (Public User ID or Public Service ID) of the party requesting a service or initiating a session. In the case of no P-Asserted-Identify is known, this list shall include one item with the value "unknown".
List of Associated URI	O <sub>C</sub>	The list of non-barred public user identities (SIP URIs and/or TEL URIs) associated to the public user identity under registration.
Called Party Address	O <sub>M</sub>	In the context of an end-to-end SIP transaction this field holds the address of the party (Public User ID) to whom the SIP transaction is posted.
Number Portability routing information	O <sub>C</sub>	This field includes information on number portability after DNS/ENUM request from S-CSCF in the calling user's home network.
Carrier Select routing information	O <sub>C</sub>	This field includes information on carrier select after DNS/ENUM request from S-CSCF in the calling user's home network.
Service Request Time Stamp	O <sub>M</sub>	This field contains the time stamp, which indicates the time at which the service was requested. This parameter corresponds to SIP Request Timestamp. Present with Charging Data Request [Event].
Service Request Time Stamp Fraction	O <sub>M</sub>	This parameter contains the milliseconds fraction in relation to the Service Request Time Stamp.
Inter Operator Identifiers	O <sub>C</sub>	Holds the identification of the home network (originating and terminating) if exchanged via SIP signalling, as recorded in the <i>P-Charging-Vector header</i> .
Originating IOI	O <sub>C</sub>	This parameter corresponds to Orig-IOI header of the P-Charging-Vector defined in TS 24.229 [204].
Terminating IOI	O <sub>C</sub>	This parameter corresponds to Term-IOI header of the P-Charging-Vector defined in TS 24.229 [204].
Local Record Sequence Number	O <sub>M</sub>	This field includes a unique record number created by this node. The number is allocated sequentially for each partial CDR (or whole CDR) including all CDR types. The number is unique within the CDF.
Cause For Record Closing	O <sub>M</sub>	This field contains a reason for the close of the CDR.
Incomplete CDR Indication	O <sub>C</sub>	This field provides additional diagnostics when the CDF detects missing Charging Data Requests.
S-CSCF Information	O <sub>C</sub>	This field contains Information related to the serving CSCF, e.g. the S-CSCF capabilities upon registration event or the S-CSCF address upon the session establishment event.
IMS Charging Identifier	O <sub>M</sub>	This parameter holds the IMS charging identifier (ICID) as generated by the IMS node for the SIP session.
Service Reason Return Code	O <sub>M</sub>	This parameter provides the returned SIP status code for the service request for the successful and failure case,
Access Network Information	O <sub>C</sub>	This field contains the content of one SIP P-header "P-Access-Network-Info" if available.
Service Context Id	O <sub>M</sub>	Holds the context information to which the CDR belongs. The information is obtained from the Operation Token of the Charging Data Request message.
User Location Info	O <sub>C</sub>	This field contains the network provided location information for 3GPP accesses, if available..

Field	Category	Description
MS Time Zone	O <sub>C</sub>	This field indicates the offset between universal time and local time in steps of 15 minutes of where the MS currently resides.
From Address	O <sub>M</sub>	Contains the information from the SIP From header.
IMS Emergency Indication	O <sub>C</sub>	This field indicates the registration is an emergency registration, and is present only for emergency registrations.
SIP Route header transmitted	O <sub>C</sub>	Contains the information in the route header representing the destination in a transmitted initial SIP INVITE or non-session related SIP MESSAGE request.
Record Extensions	O <sub>C</sub>	A set of operator/manufacture specific extensions to the record, conditioned upon existence of an extension.

### 6.1.3.6 MRFC CDR Content

The detailed description of the field is provided in TS 32.298 [51].

**Table 6.1.3.6: Charging Data of MRFC CDR**

Field	Category	Description
Record Type	M	Identifies the type of record. The parameter is derived from the Node functionality parameter.
Retransmission	O <sub>C</sub>	This parameter, when present, indicates that information from retransmitted Charging Data Requests has been used in this CDR.
SIP Method	O <sub>C</sub>	Specifies the SIP-method for which the CDR is generated. Only available in session unrelated cases.
Event	O <sub>C</sub>	This field identifies the SIP event package to which the SIP request is referred.
Expires Information	O <sub>C</sub>	This field indicates the validity time of either the SIP message or its content, depending on the SIP method.
Node Address	O <sub>M</sub>	This item holds the address of the node providing the information for the CDR. This may either be the IP address or the FQDN of the IMS node generating the accounting data.
Session ID	O <sub>M</sub>	The Session identification. For a SIP session the Session-ID contains the SIP Call ID as defined in the Session Initiation Protocol RFC 3261 [404].
Service ID	O <sub>M</sub>	This field identifies the service the MRFC is hosting. For conferences the conference ID is used here.
Session Priority	O <sub>C</sub>	The field contains the priority of the session.
List Of Calling Party Address	O <sub>M</sub>	The address or addresses (Public User ID or Public Service ID) of the party requesting a service or initiating a session. In the case of no P-Asserted-Identity is known, this list shall include a one item with the value "unknown".
Called Party Address	O <sub>C</sub>	For SIP transactions, except for registration, this field holds the address of the party (Public User ID or Public Service ID) to whom the SIP transaction is posted. For registration transactions, this field holds the Public User ID under registration.
Requested Party Address	O <sub>C</sub>	For SIP transactions this field holds the address of the party (Public User ID or Public Service ID) to whom the SIP transaction was originally posted. This field is only present if different from the Called Party Address parameter.
List of Called Asserted Identity	O <sub>C</sub>	The address or addresses of the final asserted identities. Present if the final asserted identities are available in the SIP 2xx response.
List of Subscription Id	O <sub>M</sub>	Holds the public user identities of the served user
Service Request Time Stamp	O <sub>M</sub>	This field contains the time stamp which indicates the time at which the service was requested. This parameter corresponds to SIP Request Timestamp. Present with Charging Data Request [Start] and Charging Data Request [Event].
Service Request Time Stamp Fraction	O <sub>M</sub>	This parameter contains the milliseconds fraction in relation to the Service Request Time Stamp.
Service Delivery Start Time Stamp	O <sub>M</sub>	This field holds the time stamp reflecting either: successful session set-up, a delivery unrelated service, an unsuccessful session set-up and an unsuccessful session unrelated request. This parameter corresponds to SIP Response Timestamp. Present with Charging Data Request [Start] and Charging Data Request [EVENT].
Service Delivery Start Time Stamp Fraction	O <sub>M</sub>	This parameter contains the milliseconds fraction in relation to the Service Delivery Start Time Stamp.
Service Delivery End Time Stamp	O <sub>C</sub>	This field records the time at which the service delivery was terminated. It is Present only in SIP session related case. This parameter corresponds to SIP Request Timestamp. Present with Charging Data Request [Stop].
Service Delivery End Time Stamp Fraction	O <sub>C</sub>	This parameter contains the milliseconds fraction in relation to the Service Delivery End Time Stamp.
Record Opening Time	O <sub>C</sub>	A time stamp reflecting the time the CDF opened this record. Present only in SIP session related case.
Record Closure Time	O <sub>M</sub>	A Time stamp reflecting the time the CDF closed the record.
Application Servers Information	O <sub>C</sub>	This is a grouped CDR field containing the fields: "Application Server Involved" and "Application Provided Called Parties".
Application Servers Involved	O <sub>C</sub>	Holds the ASs (if any) identified by the SIP URIs.
Application Provided Called Parties	O <sub>C</sub>	Holds a list of the Called Party Address(es), if the address(es) are determined by an AS (SIP URI, E.164...).
Inter Operator Identifiers	O <sub>C</sub>	Holds the identification of the home network (originating and terminating) if exchanged via SIP signalling, as recorded in the P-Charging-Vector header.

Field	Category	Description
Originating IOI	O <sub>C</sub>	This parameter corresponds to Orig-IOI header of the P-Charging-Vector defined in TS 24.229 [204].
Terminating IOI	O <sub>C</sub>	This parameter corresponds to Term-IOI header of the P-Charging-Vector defined in TS 24.229 [204].
Transit IOI List	O <sub>C</sub>	This parameter corresponds to Transit-IOI List of the P-Charging-Vector defined in TS 24.229 [204].
Local Record Sequence Number	O <sub>M</sub>	This field includes a unique record number created by this node. The number is allocated sequentially for each partial CDR (or whole CDR) including all CDR types. The number is unique within the CDF.
Record Sequence Number	O <sub>C</sub>	This field contains a running sequence number employed to link the partial records generated by the CDF for a particular session.
Cause For Record Closing	O <sub>M</sub>	This field contains a reason for the close of the CDR.
Incomplete CDR Indication	O <sub>C</sub>	This field provides additional diagnostics when the CDF detects missing Charging Data Requests.
IMS Charging Identifier	O <sub>M</sub>	This parameter holds the IMS charging identifier (ICID) as generated by the IMS node for the SIP session.
List of Early SDP Media Components	O <sub>C</sub>	This is a grouped field which may occur several times in one CDR.  This field shall not be present if no media components are set to active before the final SIP session answer to the initial SIP Invite is received. This field can be present in either session or event CDRs.
SDP Session Description	O <sub>C</sub>	Holds the Session portion of SDP data exchanged in the above mentioned scenario, if available.
SDP Type	O <sub>M</sub>	This parameter indicates if the SDP media component is an SDP offer or SDP answer.
SDP Offer Timestamp	O <sub>M</sub>	This parameter contains the time of the SIP Request which conveys the SDP offer.
SDP Answer Timestamp	O <sub>M</sub>	This parameter contains the time of the response to the SIP Request which conveys the SDP answer.
SDP Media Components	O <sub>M</sub>	This is a grouped field comprising several sub-fields associated with one media component. Since several media components may exist for a session in parallel these sub-fields may occur several times.
SDP Media Name	O <sub>M</sub>	This field holds the name of the media as available in the SDP data.
SDP Media Description	O <sub>M</sub>	This field holds the attributes of the media as available in the SDP data.
Access Correlation ID	O <sub>C</sub>	This parameter holds the charging identifier from the access network, consisting of either GPRS charging ID (GCID) which is generated by the GGSN for a GPRS PDP context, Charging Id which is generated by P-GW for IP-CAN bearer or the Access Network Charging Identifier Value which is generated by another type of access network. It is present only if received from the access network when PCC architecture is implemented.
Media Initiator Flag	O <sub>C</sub>	This field indicates if the called party has requested the session modification and it is present only if the initiator was the called party.
List of SDP Media Components	O <sub>C</sub>	This is a grouped field which may occur several times in one CDR. The field is present only in a SIP session related case
SDP Session Description	O <sub>C</sub>	Holds the Session portion of the SDP data exchanged between the User Agents if available in the SIP transaction.
SDP Type	O <sub>M</sub>	This parameter indicates if the SDP media component is an SDP offer or SDP answer.
SIP Request Timestamp	O <sub>C</sub>	This parameter contains the time of the SIP Request (usually a (Re)Invite). This parameter corresponds to SIP Request Timestamp in the Charging Data Request [Interim].
SIP Response Timestamp	O <sub>C</sub>	This parameter contains the time of the response to the SIP Request (usually a 200 OK). This parameter corresponds to SIP Response Timestamp In the Charging Data Request [Interim].
SIP Request Timestamp Fraction	O <sub>C</sub>	This parameter contains the milliseconds fraction in relation to the SIP Request Timestamp.
SIP Response Timestamp Fraction	O <sub>C</sub>	This parameter contains the milliseconds fraction in relation to the SIP Response Timestamp.

Field	Category	Description
SDP Media Components	O <sub>M</sub>	This is a grouped field comprising several sub-fields associated with one media component. Since several media components may exist for a session in parallel these sub-fields may occur several times.
SDP Media Name	O <sub>M</sub>	This field holds the name of the media as available in the SDP data. This parameter corresponds to SDP-Media-Name.
SDP Media Description	O <sub>M</sub>	This field holds the attributes of the media as available in the SDP data.
Access Correlation ID	O <sub>C</sub>	This parameter holds the charging identifier from the access network, consisting of either GPRS charging ID (GCID) which is generated by the GGSN for a GPRS PDP context, Charging Id which is generated by P-GW for IP-CAN bearer or the Access Network Charging Identifier Value which is generated by another type of access network. It is present only if received from the access network when PCC architecture is implemented.
Media Initiator Flag	O <sub>C</sub>	This field indicates if the called party has requested the session modification and it is present only if the initiator was the called party.
GGSN Address	O <sub>C</sub>	This parameter holds the control plane IP address of the GGSN that handles one or more media component(s) of a IMS session.
Service Reason Return Code	O <sub>M</sub>	This parameter provides the returned SIP status code for the service request for the successful and failure case,
Access Network Information	O <sub>C</sub>	This field contains the content of one SIP P-header "P-Access-Network-Info" if available.
Service Context Id	O <sub>M</sub>	Holds the context information to which the CDR belongs. The information is obtained from the Operation Token of the Charging Data Request message.
Online Charging Flag	O <sub>C</sub>	This field indicates the Online Charging Request was sent based on the provided ECF address from the SIP P-header "P-Charging-Function-Addresses". NOTE: No proof that online charging action has been taken
User Location Info	O <sub>C</sub>	This field contains the network provided location information for 3GPP accesses, if available..
MS Time Zone	O <sub>C</sub>	This field indicates the offset between universal time and local time in steps of 15 minutes of where the MS currently resides.
From Address	O <sub>M</sub>	Contains the information from the SIP From header.
Record Extensions	O <sub>C</sub>	A set of operator/manufacture specific extensions to the record, conditioned upon existence of an extension.

### 6.1.3.7 MGCF CDR Content

The detailed description of the field is provided in TS 32.298 [51].

**Table 6.1.3.7: Charging Data of MGCF CDR**

Field	Category	Description
Record Type	M	Identifies the type of record. The parameter is derived from the Node functionality parameter.
Retransmission	O <sub>C</sub>	This parameter, when present, indicates that information from retransmitted Charging Data Requests has been used in this CDR.
SIP Method	O <sub>C</sub>	Specifies the SIP-method for which the CDR is generated. Only available in session unrelated cases.
Event	O <sub>C</sub>	This field identifies the SIP event package to which the SIP request is referred.
Expires Information	O <sub>C</sub>	This field indicates the validity time of either the SIP message or its content, depending on the SIP method.
Role of Node	O <sub>M</sub>	This field indicates whether the MGCF is serving the Originating or the Terminating party.
Node Address	O <sub>M</sub>	This item holds the address of the node providing the information for the CDR. This may either be the IP address or the FQDN of the IMS node generating the accounting data.
Session ID	O <sub>M</sub>	The Session identification. For a SIP session the Session-ID contains the SIP Call ID as defined in the Session Initiation Protocol RFC 3261 [404].
Session Priority	O <sub>C</sub>	The field contains the priority of the session.
List Of Calling Party Address	O <sub>M</sub>	The address or addresses (Public User ID or Public Service ID) of the party requesting a service or initiating a session. In the case of no P-Asserted-Identify is known, this list shall include a one item with the value "unknown".
Called Party Address	O <sub>M</sub>	In the context of an end-to-end SIP transaction this field holds the address of the party (Public User ID) to whom the SIP transaction is posted.
Number Portability routing information	O <sub>C</sub>	This field includes information on number portability after DNS/ENUM request from S-CSCF in the calling user's home network.
Carrier Select routing information	O <sub>C</sub>	This field includes information on carrier select after DNS/ENUM request from S-CSCF in the calling user's home network.
Service Request Time Stamp	O <sub>M</sub>	This field contains the time stamp which indicates the time at which the service was requested. This parameter corresponds to SIP Request Timestamp. Present with Charging Data Request [Start] and Charging Data Request [Event].
Service Request Time Stamp Fraction	O <sub>M</sub>	This parameter contains the milliseconds fraction in relation to the Service Request Time Stamp.
Service Delivery Start Time Stamp	O <sub>M</sub>	This field holds the time stamp reflecting either: successful session set-up, a delivery unrelated service, an unsuccessful session set-up and an unsuccessful session unrelated request. This parameter corresponds to SIP Response Timestamp. Present with Charging Data Request [Start] and Charging Data Request [Event].
Service Delivery Start Time Stamp Fraction	O <sub>M</sub>	This parameter contains the milliseconds fraction in relation to the Service Delivery Start Time Stamp.
Service Delivery End Time Stamp	O <sub>C</sub>	This field records the time at which the service delivery was terminated. It is Present only in SIP session related case. This parameter corresponds to SIP Request Timestamp. Present with Charging Data Request [Stop].
Service Delivery End Time Stamp Fraction	O <sub>C</sub>	This parameter contains the milliseconds fraction in relation to the Service Delivery End Time Stamp.
Record Opening Time	O <sub>C</sub>	A time stamp reflecting the time the CDF opened this record. Present only in SIP session related case.
Record Closure Time	O <sub>M</sub>	A Time stamp reflecting the time the CDF closed the record.
Inter Operator Identifiers	O <sub>C</sub>	Holds the identification of the home network (originating and terminating) if exchanged via SIP signalling, as recorded in the <i>P-Charging-Vector header</i> .
Originating IOI	O <sub>C</sub>	This parameter corresponds to Orig-IOI header of the P-Charging-Vector defined in TS 24.229 [204].
Terminating IOI	O <sub>C</sub>	This parameter corresponds to Term-IOI header of the P-Charging-Vector defined in TS 24.229 [204].
Transit IOI List	O <sub>C</sub>	This parameter corresponds to Transit-IOI List of the P-Charging-Vector defined in TS 24.229 [204].
Local Record Sequence Number	O <sub>M</sub>	This field includes a unique record number created by this node. The number is allocated sequentially for each partial CDR (or whole CDR) including all CDR types. The number is unique within the CDF.

Field	Category	Description
Record Sequence Number	O <sub>C</sub>	This field contains a running sequence number employed to link the partial records generated by the CDF for a particular session.
Cause For Record Closing	O <sub>M</sub>	This field contains a reason for the close of the CDR.
Incomplete CDR Indication	O <sub>C</sub>	This field provides additional diagnostics when the CDF detects missing Charging Data Requests.
IMS Charging Identifier	O <sub>M</sub>	This parameter holds the IMS charging identifier (ICID) as generated by the IMS node for the SIP session.
List of Early SDP Media Components	O <sub>C</sub>	This is a grouped field which may occur several times in one CDR.  This field shall not be present if no media components are set to active before the final SIP session answer to the initial SIP Invite is received. This field can be present in either session or event CDRs.
SDP Session Description	O <sub>C</sub>	Holds the Session portion of SDP data exchanged in the above mentioned scenario, if available.
SDP Type	O <sub>M</sub>	This parameter indicates if the SDP media component is an SDP offer or SDP answer.
SDP Offer Timestamp	O <sub>M</sub>	This parameter contains the time of the SIP Request which conveys the SDP offer.
SDP Answer Timestamp	O <sub>M</sub>	This parameter contains the time of the response to the SIP Request which conveys the SDP answer.
SDP Media Components	O <sub>M</sub>	This is a grouped field comprising several sub-fields associated with one media component. Since several media components may exist for a session in parallel these sub-fields may occur several times.
SDP Media Name	O <sub>M</sub>	This field holds the name of the media as available in the SDP data.
SDP Media Description	O <sub>M</sub>	This field holds the attributes of the media as available in the SDP data.
Media Initiator Flag	O <sub>C</sub>	This field indicates if the called party has requested the session modification and it is present only if the initiator was the called party.
List of SDP Media Components	O <sub>C</sub>	This is a grouped field which may occur several times in one CDR. The field is present only in a SIP session related case.
SDP Session Description	O <sub>C</sub>	Holds the Session portion of the SDP data exchanged between the User Agents if available in the SIP transaction.
SDP Type	O <sub>M</sub>	This parameter indicates if the SDP media component is an SDP offer or SDP answer.
SIP Request Timestamp	O <sub>C</sub>	This parameter contains the time of the SIP Request (usually a (Re)Invite). This parameter corresponds to SIP Request Timestamp in Charging Data Request [Interim].
SIP Response Timestamp	O <sub>C</sub>	This parameter contains appropriately the time of 200 OK acknowledging an INVITE or of ACK including an SDP answer. This parameter corresponds to SIP Response Timestamp in Charging Data Request [Interim].
SIP Request Timestamp Fraction	O <sub>C</sub>	This parameter contains the milliseconds fraction in relation to the SIP Request Timestamp.
SIP Response Timestamp Fraction	O <sub>C</sub>	This parameter contains the milliseconds fraction in relation to the SIP Response Timestamp.
SDP Media Components	O <sub>M</sub>	This is a grouped field comprising several sub-fields associated with one media component. Since several media components may exist for a session in parallel these sub-fields may occur several times.
SDP Media Name	O <sub>M</sub>	This field holds the name of the media as available in the SDP data. This parameter corresponds to SDP-Media-Name.
SDP Media Description	O <sub>M</sub>	This field holds the attributes of the media as available in the SDP data.
Media Initiator Flag	O <sub>C</sub>	This field indicates if the called party has requested the session modification and it is present only if the initiator was the called party.
Service Reason Return Code	O <sub>M</sub>	This parameter provides the returned SIP status code for the service request for the successful and failure case.
Trunk Group ID Incoming/Outgoing	O <sub>M</sub>	Contains the outgoing trunk group ID for an outgoing session/call or the incoming trunk group ID for an incoming session/call.
Bearer Service	O <sub>M</sub>	Holds the used bearer service for the PSTN leg.



Field	Category	Description
Access Network Information	O <sub>C</sub>	This field contains the content of the SIP P-header "P-Access-Network-Info" if available.
Service Context Id	O <sub>M</sub>	Holds the context information to which the CDR belongs. The information is obtained from the Operation Token of the Charging Data Request message.
Real Time Tariff Information	O <sub>C</sub>	This field holds the tariff/add-on charge received.
From Address	O <sub>M</sub>	Contains the information from the SIP From header.
Record Extensions	O <sub>C</sub>	A set of operator/manufacture specific extensions to the record, conditioned upon existence of an extension.

### 6.1.3.8 BGCF CDR Content

The detailed description of the field is provided in TS 32.298 [51].

**Table 6.1.3.8: Charging Data of BGCF CDR**

Field	Category	Description
Record Type	M	Identifies the type of record. The parameter is derived from the Node functionality parameter.
Retransmission	O <sub>C</sub>	This parameter, when present, indicates that information from retransmitted Charging Data Requests has been used in this CDR.
SIP Method	O <sub>C</sub>	Specifies the SIP-method for which the CDR is generated. Only available in session unrelated cases.
Event	O <sub>C</sub>	This field identifies the SIP event package to which the SIP request is referred.
Expires Information	O <sub>C</sub>	This field indicates the validity time of either the SIP message or its content, depending on the SIP method.
Role of Node	O <sub>M</sub>	This field indicates whether the BGCF is serving the Originating or the Terminating party.
Node Address	O <sub>M</sub>	This item holds the address of the node providing the information for the CDR. This may either be the IP address or the FQDN of the IMS node generating the accounting data.
Session ID	O <sub>M</sub>	The Session identification. For a SIP session the Session-ID contains the SIP Call ID as defined in the Session Initiation Protocol RFC 3261 [404].
Session Priority	O <sub>C</sub>	The field contains the priority of the session.
List Of Calling Party Address	O <sub>M</sub>	The address or addresses (Public User ID or Public Service ID) of the party requesting a service or initiating a session. In the case of no P-Asserted-Identify is known, this list shall include a one item with the value "unknown".
Called Party Address	O <sub>M</sub>	In the context of an end-to-end SIP transaction this field holds the address of the party (Public User ID) to whom the SIP transaction is posted.
Number Portability routing information	O <sub>C</sub>	This field includes information on number portability after DNS/ENUM request from S-CSCF in the calling user's home network.
Carrier Select routing information	O <sub>C</sub>	This field includes information on carrier select after DNS/ENUM request from S-CSCF in the calling user's home network.
Service Request Time Stamp	O <sub>M</sub>	This field contains the time stamp which indicates the time at which the service was requested. This parameter corresponds to SIP Request Timestamp. Present with Charging Data Request [Start] and Charging Data Request [Event].
Service Request Time Stamp Fraction	O <sub>M</sub>	This parameter contains the milliseconds fraction in relation to the Service Request Time Stamp.
Service Delivery Start Time Stamp	O <sub>M</sub>	This field holds the time stamp reflecting either: successful session set-up, a delivery unrelated service, an unsuccessful session set-up and an unsuccessful session unrelated request. This parameter corresponds to SIP Response Timestamp. Present with Charging Data Request [Start] and Charging Data Request [Event].
Service Delivery Start Time Stamp Fraction	O <sub>M</sub>	This parameter contains the milliseconds fraction in relation to the Service Delivery Start Time Stamp.
Service Delivery End Time Stamp	O <sub>C</sub>	This field records the time at which the service delivery was terminated. It is Present only in SIP session related case. This parameter corresponds to SIP Request Timestamp. Present with Charging Data Request [Stop].
Service Delivery End Time Stamp Fraction	O <sub>C</sub>	This parameter contains the milliseconds fraction in relation to the Service Delivery End Time Stamp.
Record Opening Time	O <sub>C</sub>	A time stamp reflecting the time the CDF opened this record. Present only in SIP session related case.
Record Closure Time	O <sub>M</sub>	A Time stamp reflecting the time the CDF closed the record
Inter Operator Identifiers	O <sub>C</sub>	Holds the identification of the home network (originating and terminating) if exchanged via SIP signalling, as recorded in the <i>P-Charging-Vector header</i> .
Originating IOI	O <sub>C</sub>	This parameter corresponds to Orig-IOI header of the P-Charging-Vector defined in TS 24.229 [204].
Terminating IOI	O <sub>C</sub>	This parameter corresponds to Term-IOI header of the P-Charging-Vector defined in TS 24.229 [204].
Transit IOI List	O <sub>C</sub>	This parameter corresponds to Transit-IOI List of the P-Charging-Vector defined in TS 24.229 [204].
Local Record Sequence Number	O <sub>M</sub>	This field includes a unique record number created by this node. The number is allocated sequentially for each partial CDR (or whole CDR) including all CDR types. The number is unique within the CDF.

Field	Category	Description
Record Sequence Number	O <sub>C</sub>	This field contains a running sequence number employed to link the partial records generated by the CDF for a particular session.
Cause For Record Closing	O <sub>M</sub>	This field contains a reason for the close of the CDR.
Incomplete CDR Indication	O <sub>C</sub>	This field provides additional diagnostics when the CDF detects missing Charging Data Requests.
IMS Charging Identifier	O <sub>M</sub>	This parameter holds the IMS charging identifier (ICID) as generated by the IMS node for the SIP session.
Service Reason Return Code	O <sub>M</sub>	This parameter provides the returned SIP status code for the service request for the successful and failure case,
Access Network Information	O <sub>C</sub>	This field contains the content of the SIP P-header "P-Access-Network-Info" if available.
Service Context Id	O <sub>M</sub>	Holds the context information to which the CDR belongs. The information is obtained from the Operation Token of the Charging Data Request message.
From Address	O <sub>M</sub>	Contains the information from the SIP From header.
Record Extensions	O <sub>C</sub>	A set of operator/manufacture specific extensions to the record, conditioned upon existence of an extension.
NNI Information	O <sub>C</sub>	This grouped field holds information about the NNI used for interconnection and roaming on the loopback routing path. It is present only if RAVEL "VPLMN routing" is applied.
NNI Type	O <sub>C</sub>	This field indicates usage of the roaming NNI for loopback routing, i.e BGCF performed the loopback decision.

### 6.1.3.9 SIP AS CDR Content

The detailed description of the field is provided in TS 32.298 [51].

**Table 6.1.3.9: Charging Data of AS CDR**

Field	Category	Description
Record Type	M	Identifies the type of record. The parameter is derived from the Node functionality parameter.
Retransmission	O <sub>C</sub>	This parameter, when present, indicates that information from retransmitted Charging Data Requests has been used in this CDR
SIP Method	O <sub>C</sub>	Specifies the SIP-method for which the CDR is generated. Only available in session unrelated cases.
Event	O <sub>C</sub>	This field identifies the SIP event package to which the SIP request is referred.
Expires Information	O <sub>C</sub>	This field indicates the validity time of either the SIP message or its content, depending on the SIP method.
Role of Node	O <sub>M</sub>	This field indicates whether the AS is serving the Originating or the Terminating party.
Node Address	O <sub>M</sub>	This item holds the address of the node providing the information for the CDR. This may either be the IP address or the FQDN of the IMS node generating the accounting data.
Session ID	O <sub>M</sub>	The Session identification. For a SIP session the Session-ID contains the SIP Call ID as defined in the Session Initiation Protocol RFC 3261 [404]. When the AS acts as B2BUA, the incoming session is identified , except for the "OneChargingSession" option, where it contains either the incoming or outgoing dialog SIP Call Id involved during IMS session setup.
Outgoing Session ID	O <sub>C</sub>	When the AS acts as B2BUA, the outgoing session is identified by the Outgoing Session ID which contains the SIP Call ID (as defined in the RFC 3261 [404]). This field is not used for the "OneChargingSession" option
Session Priority	O <sub>C</sub>	The field contains the priority of the session.
List Of Calling Party Address	O <sub>M</sub>	The address or addresses (Public User ID or Public Service ID) of the party requesting a service or initiating a session. In the case of no P-Asserted-Identity is known, this list shall include a one item with the value "unknown".
Called Party Address	O <sub>M</sub>	For SIP transactions, except for registration, this field holds the address of the party (Public User ID or Public Service ID) to whom the SIP transaction is posted. For registration transactions, this field holds the Public User ID under registration.
Number Portability routing information	O <sub>C</sub>	This field includes information on number portability after DNS/ENUM request from S-CSCF in the calling user's home network.
Carrier Select routing information	O <sub>C</sub>	This field includes information on carrier select after DNS/ENUM request from S-CSCF in the calling user's home network.
Alternate Charged Party Address	O <sub>C</sub>	The address of an alternate party that is identified by the AS at session initiation, and is charged in place of the calling party.
List of Requested Party Address	O <sub>C</sub>	This field is a list of Requested Party Address. Each occurrence contains: For SIP transactions ,the address of the party (Public User ID or Public Service ID) to whom the SIP transaction was originally posted. For PS to CS transfer, the Session Transfer Number for Single Radio Voice Call Continuity (STN-SR) as described in TS 23.237 [407]. For CS to PS transfer, the Session Transfer Identifier for CS to PS Single Radio Voice Call Continuity (STI-rSR) as described in TS 23.237 [407]. This field is only present if different from the Called Party Address parameter.
Private User ID	O <sub>C</sub>	This field holds the private user identity of the served party defined in TS 23.003 [104], if available.
List of Subscription Id	O <sub>M</sub>	Holds the public user identities of the served user
List of Called Asserted Identity	O <sub>C</sub>	The address or addresses of the final asserted identities. Present if the final asserted identities are available in the SIP 2xx response.

Field	Category	Description
Service Request Time Stamp	O <sub>M</sub>	This field contains the time stamp which indicates the time at which the service was requested. This parameter corresponds to SIP Request Timestamp. Present with Charging Data Request [Start] and Charging Data Request [Event].
Service Request Time Stamp Fraction	O <sub>M</sub>	This parameter contains the milliseconds fraction in relation to the Service Request Time Stamp.
Service Delivery Start Time Stamp	O <sub>M</sub>	This field holds the time stamp reflecting either: successful session set-up, a delivery unrelated service, an unsuccessful session set-up and an unsuccessful session unrelated request. This parameter corresponds to SIP Response Timestamp. Present with Charging Data Request [Start] and Charging Data Request [Event].
Service Delivery Start Time Stamp Fraction	O <sub>M</sub>	This parameter contains the milliseconds fraction in relation to the Service Delivery Start Time Stamp.
Service Delivery End Time Stamp	O <sub>C</sub>	This field records the time at which the service delivery was terminated. It is Present only in SIP session related case. This parameter corresponds to SIP Request Timestamp. Present with Charging Data Request [Stop].
Service Delivery End Time Stamp Fraction	O <sub>C</sub>	This parameter contains the milliseconds fraction in relation to the Service Delivery End Time Stamp.
Record Opening Time	O <sub>C</sub>	A time stamp reflecting the time the CDF opened this record. Present only in SIP session related case.
Record Closure Time	O <sub>M</sub>	A Time stamp reflecting the time the CDF closed the record.
Inter Operator Identifiers	O <sub>C</sub>	Holds the identification of the home network (originating and terminating) if exchanged via SIP signalling, as recorded in the <i>P-Charging-Vector header</i> .
Originating IOI	O <sub>C</sub>	This parameter corresponds to Orig-IOI header of the P-Charging-Vector defined in TS 24.229 [204].
Terminating IOI	O <sub>C</sub>	This parameter corresponds to Term-IOI header of the P-Charging-Vector defined in TS 24.229 [204].
Transit IOI List	O <sub>C</sub>	This parameter corresponds to Transit-IOI List of the P-Charging-Vector defined in TS 24.229 [204]. This field may occur several times in one CDR. Each occurrence represents transit IOI values received from the path inbound to or outbound from the S-CSCF.
Local Record Sequence Number	O <sub>M</sub>	This field includes a unique record number created by this node. The number is allocated sequentially for each partial CDR (or whole CDR) including all CDR types. The number is unique within the CDF.
Record Sequence Number	O <sub>C</sub>	This field contains a running sequence number employed to link the partial records generated by the CDF for a particular session.
Cause For Record Closing	O <sub>M</sub>	This field contains a reason for the close of the CDR.
Incomplete CDR Indication	O <sub>C</sub>	This field provides additional diagnostics when the CDF detects missing Charging Data Requests.
IMS Charging Identifier	O <sub>M</sub>	This parameter holds the IMS charging identifier (ICID) as generated by the IMS node for the SIP session.
List of Early SDP Media Components	O <sub>C</sub>	This is a grouped field which may occur several times in one CDR.  This field shall not be present if no media components are set to active before the final SIP session answer to the initial SIP Invite is received. This field can be present in either session or event CDRs.
SDP Session Description	O <sub>C</sub>	Holds the Session portion of SDP data exchanged in the above mentioned scenario, if available.
SDP Type	O <sub>M</sub>	This parameter indicates if the SDP media component is an SDP offer or SDP answer.
SDP Offer Timestamp	O <sub>M</sub>	This parameter contains the time of the SIP Request which conveys the SDP offer.
SDP Answer Timestamp	O <sub>M</sub>	This parameter contains the time of the response to the SIP Request which conveys the SDP answer.
SDP Media Components	O <sub>M</sub>	This is a grouped field comprising several sub-fields associated with one media component. Since several media components may exist for a session in parallel these sub-fields may occur several times.
SDP Media Name	O <sub>M</sub>	This field holds the name of the media as available in the SDP data.

Field	Category	Description
SDP Media Description	O <sub>M</sub>	This field holds the attributes of the media as available in the SDP data.
Access Correlation ID	O <sub>C</sub>	This parameter holds the charging identifier from the access network, consisting of either GPRS charging ID (GCID) which is generated by the GGSN for a GPRS PDP context, Charging Id which is generated by P-GW for IP-CAN bearer or the Access Network Charging Identifier Value which is generated by another type of access network. It is present only if received from the access network when PCC architecture is implemented.
Media Initiator Flag	O <sub>C</sub>	This field indicates if the called party has requested the session modification and it is present only if the initiator was the called party.
List of SDP Media Components	O <sub>C</sub>	This is a grouped field which may occur several times in one CDR. The field is present only in a SIP session related case. When the AS acts as B2BUA and "OneChargingSession" option applies, only SDP media components received by the AS are included, i.e those generated by the AS are not included.
SDP Session Description	O <sub>C</sub>	Holds the Session portion of the SDP data exchanged between the User Agents if available in the SIP transaction.
SDP Type	O <sub>M</sub>	This parameter indicates if the SDP media component is an SDP offer or SDP answer.
SIP Request Timestamp	O <sub>C</sub>	This parameter contains the time of the SIP Request (usually a (Re)Invite). This parameter corresponds to SIP Request Timestamp in Charging Data Request [Interim].
SIP Response Timestamp	O <sub>C</sub>	This parameter contains appropriately the time of 200 OK acknowledging an INVITE or of ACK including an SDP answer. This parameter corresponds to SIP Response Timestamp in Charging Data Request [Interim].
SIP Request Timestamp Fraction	O <sub>C</sub>	This parameter contains the milliseconds fraction in relation to the SIP Request Timestamp.
SIP Response Timestamp Fraction	O <sub>C</sub>	This parameter contains appropriately the time of 200 OK acknowledging an INVITE or of ACK including an SDP answer. This parameter corresponds to SIP Response Timestamp in Charging Data Request [Interim].
SDP Media Components	O <sub>M</sub>	This is a grouped field comprising several sub-fields associated with one media component. Since several media components may exist for a session in parallel these sub-fields may occur several times.
SDP Media Name	O <sub>M</sub>	This field holds the name of the media as available in the SDP data.
SDP Media Description	O <sub>M</sub>	This field holds the attributes of the media as available in the SDP data.
Access Correlation ID	O <sub>C</sub>	This parameter holds the charging identifier from the access network, consisting of either GPRS charging ID (GCID) which is generated by the GGSN for a GPRS PDP context, Charging Id which is generated by P-GW for IP-CAN bearer or the Access Network Charging Identifier Value which is generated by another type of access network. It is present only if received from the access network when PCC architecture is implemented.
Media Initiator Flag	O <sub>C</sub>	This field indicates if the called party has requested the session modification and it is present only if the initiator was the called party.
GGSN Address	O <sub>C</sub>	This parameter holds the control plane IP address of the GGSN that handles one or more media component(s) of a IMS session.
Service Reason Return Code	O <sub>M</sub>	This parameter provides the returned SIP status code for the service request for the successful and failure case,
Service Specific Info	O <sub>C</sub>	This is a grouped field that contains service specific data if and as provided by an Application Server. It may occur several times in one CDR.
Service Specific Data	O <sub>M</sub>	This sub-field of Service Specific Data holds the value of the Service Specific Data.
Service Specific Type	O <sub>M</sub>	This sub-field of Service Specific Data holds the type of the Service Specific Data.



Field	Category	Description
List of Message Bodies	O <sub>C</sub>	This grouped field comprising several sub-fields describing the data that may be conveyed end-to-end in the body of a SIP message. Since several message bodies may be exchanged via SIP-signalling, this grouped field may occur several times.
Content-Type	O <sub>M</sub>	This sub-field of Message Bodies holds the MIME type of the message body, Examples are: application/zip, image/gif, audio/mpeg, etc.
Content-Disposition	O <sub>C</sub>	This sub-field of Message Bodies holds the content disposition of the message body inside the SIP signalling, Content-disposition header field equal to "render", indicates that "the body part should be displayed or otherwise rendered to the user". Content disposition values are : session, render, inline, icon, alert, attachment, etc.
Content-Length	O <sub>M</sub>	This sub-field of Message Bodies holds the size of the data of a message body in bytes.
Originator	O <sub>C</sub>	This sub-field of the "List of Message Bodies" indicates the originating party of the message body.
Access Network Information	O <sub>C</sub>	This field contains the content of the first available SIP P-header "P-Access-Network-Info" if available.
List of Access Transfer Information	O <sub>C</sub>	This field is a list of grouped field describing the subsequent CS to PS or PS to CS session transfers. Each other occurrence comprises sub-fields describing the session transfer performed.
Access Transfer Type	O <sub>C</sub>	This field contains indication about the access transfer performed: CS to PS, or PS to CS.This field is present only when transfer occurred.
Access Network Information	O <sub>C</sub>	This field holds the content of one SIP P-header "P-Access-Network-Info" from the INVITE requesting the transfer, if available.
Service Context Id	O <sub>M</sub>	Holds the context information to which the CDR belongs. The information is obtained from the Operation Token of the Charging Data Request message.
IMS Communication Service ID	O <sub>C</sub>	This field contains the IMS communication service identifier if received in the P-Asserted-Service header in the SIP request.
Online Charging Flag	O <sub>C</sub>	This field indicates the Online Charging Request was sent based on the provided ECF address from the SIP P-header "P-Charging-Function-Addresses". NOTE: No proof that online charging action has been taken
Real Time Tariff Information	O <sub>C</sub>	This field holds the tariff/add-on charge received.
Initial IMS Charging Identifier	O <sub>C</sub>	This parameter holds the Initial IMS charging identifier (ICID) as generated by the IMS node for the initial SIP session created for IMS service continuity. This field is not used for the "OneChargingSession" option.
User Location Info	O <sub>C</sub>	This field indicates contains the network provided location information for 3GPP accesses, if available..
MS Time Zone	O <sub>C</sub>	This field indicates the offset between universal time and local time in steps of 15 minutes of where the MS currently resides.
From Address	O <sub>M</sub>	Contains the information from the SIP From header.
IMS Visited Network Identifier	O <sub>C</sub>	Contains the information from the SIP P-Visited-Network-ID header received in a REGISTER request.
Record Extensions	O <sub>C</sub>	A set of operator/manufacturer specific extensions to the record, conditioned upon existence of an extension.
TAD Identifier	O <sub>C</sub>	This field indicates the type of access network (CS or PS) through which the session shall be terminated.

### 6.1.3.10 IBCF CDR Content

The detailed description of the field is provided in TS 32.298 [51].

**Table 6.1.3.10: Charging Data of IBCF CDR**

Field	Category	Description
Record Type	M	Identifies the type of record. The parameter is derived from the Node functionality parameter.
Retransmission	O <sub>C</sub>	This parameter, when present, indicates that information from retransmitted Charging Data Requests has been used in this CDR.
SIP Method	O <sub>C</sub>	Specifies the SIP-method for which the CDR is generated. Only available in session unrelated cases.
Event	O <sub>C</sub>	This field identifies the SIP event package to which the SIP request is referred.
Expires Information	O <sub>C</sub>	This field indicates the validity time of either the SIP message or its content, depending on the SIP method.
Role of Node	O <sub>M</sub>	This field indicates whether the IBCF is serving the Originating or the Terminating party.
Node Address	O <sub>M</sub>	This item holds the address of the node providing the information for the CDR. This may either be the IP address or the FQDN of the IMS node generating the accounting data.
Session ID	O <sub>M</sub>	The Session identification. For a SIP session the Session-ID contains the SIP Call ID as defined in the Session Initiation Protocol RFC 3261 [404].
Session Priority	O <sub>C</sub>	The field contains the priority of the session.
List Of Calling Party Address	O <sub>M</sub>	The address or addresses (Public User ID or Public Service ID) of the party requesting a service or initiating a session. In the case of no P-Asserted-Identify is known, this list shall include a one item with the value "unknown".
Called Party Address	O <sub>M</sub>	In the context of an end-to-end SIP transaction this field holds the address of the party (Public User ID) to whom the SIP transaction is posted.
Service Request Time Stamp	O <sub>M</sub>	This field contains the time stamp which indicates the time at which the service was requested. This parameter corresponds to SIP Request Timestamp. Present with Charging Data Request [Start] and Charging Data Request [Event].
Service Request Time Stamp Fraction	O <sub>M</sub>	This parameter contains the milliseconds fraction in relation to the Service Request Time Stamp.
Service Delivery Start Time Stamp	O <sub>M</sub>	This field holds the time stamp reflecting either: successful session set-up, a delivery unrelated service, an unsuccessful session set-up and an unsuccessful session unrelated request. This parameter corresponds to SIP Response Timestamp. Present with Charging Data Request [Start] and Charging Data Request [Event].
Service Delivery Start Time Stamp Fraction	O <sub>M</sub>	This parameter contains the milliseconds fraction in relation to the Service Delivery Start Time Stamp.
Service Delivery End Time Stamp	O <sub>C</sub>	This field records the time at which the service delivery was terminated. It is Present only in SIP session related case. This parameter corresponds to SIP Request Timestamp. Present with Charging Data Request [Stop].
Service Delivery End Time Stamp Fraction	O <sub>C</sub>	This parameter contains the milliseconds fraction in relation to the Service Delivery End Time Stamp.
Record Opening Time	O <sub>C</sub>	A time stamp reflecting the time the CDF opened this record. Present only in SIP session related case.
Record Closure Time	O <sub>M</sub>	A Time stamp reflecting the time the CDF closed the record
Inter Operator Identifiers	O <sub>C</sub>	Holds the identification of the home network (originating and terminating) if exchanged via SIP signalling, as recorded in the <i>P-Charging-Vector header</i> .
Originating IOI	O <sub>C</sub>	This parameter corresponds to Orig-IOI header of the P-Charging-Vector defined in TS 24.229 [204].
Terminating IOI	O <sub>C</sub>	This parameter corresponds to Term-IOI header of the P-Charging-Vector defined in TS 24.229 [204].
Transit IOI List	O <sub>C</sub>	This parameter corresponds to Transit-IOI List of the P-Charging-Vector defined in TS 24.229 [204].
Local Record Sequence Number	O <sub>M</sub>	This field includes a unique record number created by this node. The number is allocated sequentially for each partial CDR (or whole CDR) including all CDR types. The number is unique within the CDF.
Record Sequence Number	O <sub>C</sub>	This field contains a running sequence number employed to link the partial records generated by the CDF for a particular session.
Cause For Record Closing	O <sub>M</sub>	This field contains a reason for the close of the CDR.
Incomplete CDR Indication	O <sub>C</sub>	This field provides additional diagnostics when the CDF detects missing Charging Data Requests.
IMS Charging Identifier	O <sub>M</sub>	This parameter holds the IMS charging identifier (ICID) as generated by the IMS node for the SIP session.

Field	Category	Description
List of Early SDP Media Components	O <sub>C</sub>	This is a grouped field which may occur several times in one CDR.  This field shall not be present if no media components are set to active before the final SIP session answer to the initial SIP Invite is received. This field can be present in either session or event CDRs.
SDP Session Description	O <sub>C</sub>	Holds the Session portion of SDP data exchanged in the above mentioned scenario, if available.
SDP Type	O <sub>M</sub>	This parameter indicates if the SDP media component is an SDP offer or SDP answer.
SDP Offer Timestamp	O <sub>M</sub>	This parameter contains the time of the SIP Request which conveys the SDP offer.
SDP Answer Timestamp	O <sub>M</sub>	This parameter contains the time of the response to the SIP Request which conveys the SDP answer.
SDP Media Components	O <sub>M</sub>	This is a grouped field comprising several sub-fields associated with one media component. Since several media components may exist for a session in parallel these sub-fields may occur several times.
SDP Media Name	O <sub>M</sub>	This field holds the name of the media as available in the SDP data.
SDP Media Description	O <sub>M</sub>	This field holds the attributes of the media as available in the SDP data.
Media Initiator Flag	O <sub>C</sub>	This field indicates if the called party has requested the session modification and it is present only if the initiator was the called party.
List of SDP Media Components	O <sub>C</sub>	This is a grouped field which may occur several times in one CDR. The field is present only in a SIP session related case.
SDP Session Description	O <sub>C</sub>	Holds the Session portion of the SDP data exchanged between the User Agents if available in the SIP transaction.
SDP Type	O <sub>M</sub>	This parameter indicates if the SDP media component is an SDP offer or SDP answer.
SIP Request Timestamp	O <sub>C</sub>	This parameter contains the time of the SIP Request (usually a (Re)Invite). This parameter corresponds to SIP Request Timestamp in Charging Data Request [Interim].
SIP Response Timestamp	O <sub>C</sub>	This parameter contains appropriately the time of 200 OK acknowledging an INVITE or of ACK including an SDP answer. This parameter corresponds to SIP Response Timestamp in Charging Data Request [Interim].
SIP Request Timestamp Fraction	O <sub>C</sub>	This parameter contains the milliseconds fraction in relation to the SIP Request Timestamp.
SIP Response Timestamp Fraction	O <sub>C</sub>	This parameter contains the milliseconds fraction in relation to the SIP Response Timestamp.
SDP Media Components	O <sub>M</sub>	This is a grouped field comprising several sub-fields associated with one media component. Since several media components may exist for a session in parallel these sub-fields may occur several times.
SDP Media Name	O <sub>M</sub>	This field holds the name of the media as available in the SDP data.
SDP Media Description	O <sub>M</sub>	This field holds the attributes of the media as available in the SDP data.
Local GW Inserted Indication	O <sub>C</sub>	This field indicates whether the local TrGW is inserted or not, for the media component included in SDP answer, if available.
IP Realm Default Indication	O <sub>C</sub>	This field indicates whether the User Plane IP realm associated to the media component included in SDP answer, is the Default IP realm or not, if available.
Transcoder Inserted Indication	O <sub>C</sub>	This field indicates whether a transcoder is inserted or not, for the media component included in the SDP answer, if available.
Media Initiator Flag	O <sub>C</sub>	This field indicates if the called party has requested the session modification and it is present only if the initiator was the called party.
Service Reason Return Code	O <sub>M</sub>	This parameter provides the returned SIP status code for the service request for the successful and failure case,
List of Message Bodies	O <sub>C</sub>	This grouped field comprising several sub-fields describing the data that may be conveyed end-to-end in the body of a SIP message. Since several message bodies may be exchanged via SIP-signalling, this grouped field may occur several times.
Content-Type	O <sub>M</sub>	This sub-field of Message Bodies holds the MIME type of the message body, Examples are: application/zip, image/gif, audio/mpeg, etc.
Content-Disposition	O <sub>C</sub>	This sub-field of Message Bodies holds the content disposition of the message body inside the SIP signalling, Content-disposition header field equal to "render", indicates that "the body part should be displayed or otherwise rendered to the user". Content disposition values are : session, render, inline, icon, alert, attachment, etc.
Content-Length	O <sub>M</sub>	This sub-field of Message Bodies holds the size of the data of a message body in bytes.

Field	Category	Description
Originator	O <sub>C</sub>	This sub-field of the "List of Message Bodies" indicates the originating party of the message body.
Access Network Information	O <sub>C</sub>	This field contains the content of one SIP P-header "P-Access-Network-Info" if available.
IMS Communication Service ID	O <sub>C</sub>	This field contains the identifier for the type of communication service the IMS is currently providing for the session if received in the P-Asserted-Service header in the SIP request when the IBCF is downstream from the S-CSCF serving the Originating party or the topmost occurrence of the "+g.3gpp.icsi-ref" header field parameter of the Feature-Caps header in the SIP response when the IBCF is upstream from the S-CSCF serving the Originating party.
Service Context Id	O <sub>M</sub>	Holds the context information to which the CDR belongs. The information is obtained from the Operation Token of the Charging Data Request message.
Real Time Tariff Information	O <sub>C</sub>	This field holds the tariff/add-on charge received.
User Location Info	O <sub>C</sub>	This field indicates contains the network provided location information for 3GPP accesses, if available..
MS Time Zone	O <sub>C</sub>	This field indicates the offset between universal time and local time in steps of 15 minutes of where the MS currently resides.
NNI Information	O <sub>C</sub>	This grouped field comprising several sub-fields holds information about the NNI used for interconnection and roaming. This field may occur more than once in a CDR e.g. when routing capability in support of transit is collocated with the IBCF.
Session Direction	O <sub>C</sub>	This field indicates whether the NNI is used for an inbound or outbound service request on the control plane in case of interconnection and roaming.
NNI Type	O <sub>C</sub>	This field indicates whether the type of used NNI is non-roaming, roaming with loopback routing, or roaming without loopback routing.
Relationship Mode	O <sub>C</sub>	This field indicates whether the other functional entity (contact point of the neighbouring network) is regarded as part of the same trust domain.
Neighbour Node Address	O <sub>C</sub>	This field holds the control plane IP address of the neighbouring network contact point that handles the service request in case of interconnection and roaming.
From Address	O <sub>M</sub>	Contains the information from the SIP From header.
SIP Route header received	O <sub>C</sub>	Contains the information in the topmost route header in a received initial SIP INVITE or non-session related SIP MESSAGE request.
Record Extensions	O <sub>C</sub>	A set of operator/manufacturer specific extensions to the record, conditioned upon existence of an extension.
TAD Identifier	O <sub>C</sub>	This field indicates the type of access network (CS or PS) through which the session shall be terminated.

### 6.1.3.11 E-CSCF CDR Content

The detailed description of the field is provided in TS 32.298 [51].

**Table 6.1.3.11: Charging Data of E-CSCF CDR**

Field	Category	Description
Record Type	M	Identifies the type of record. The parameter is derived from the Node functionality parameter.
Retransmission	O <sub>C</sub>	This parameter, when present, indicates that information from retransmitted Charging Data Requests has been used in this CDR
SIP Method	O <sub>C</sub>	Specifies the SIP-method for which the CDR is generated. Only available in session unrelated cases.
Event	O <sub>C</sub>	This field identifies the SIP event package to which the SIP request is referred.
Expires Information	O <sub>C</sub>	This field indicates the validity time of either the SIP message or its content, depending on the SIP method.
Role of Node	O <sub>M</sub>	This field indicates whether the E-CSCF is serving the Originating or the Terminating party.
Node Address	O <sub>M</sub>	This item holds the address of the node providing the information for the CDR. This may either be the IP address or the FQDN of the IMS node generating the accounting data.
Session ID	O <sub>M</sub>	The Session identification. For a SIP session the Session-ID contains the SIP Call ID as defined in the Session Initiation Protocol RFC 3261 [404].
Session Priority	O <sub>C</sub>	The field contains the priority of the session.
List Of Calling Party Address	O <sub>M</sub>	The address or addresses (Public User ID or Public Service ID) of the party requesting a service or initiating a session. In case no P-Asserted-Identity is known, this list shall include one item with the value "unknown".
Called Party Address	O <sub>M</sub>	For SIP transactions, this field holds the address of the party (Public User ID or Public Service ID) to whom the SIP transaction is posted. It could be in the format of a SIP URI, a TEL URI or a URN
Requested Party Address	O <sub>C</sub>	For SIP transactions this field holds the address of the party (Public User ID or Public Service ID) to whom the SIP transaction was originally posted. It could be in the format of a SIP URI, a TEL URI or a URN. This field is only present if different from the Called Party Address parameter.
List of Called Asserted Identity	O <sub>C</sub>	The address or addresses of the final asserted identities. Present if the final asserted identities are available in the SIP 2xx response.
List of Subscription Id	O <sub>C</sub>	Holds the public user identities of the served user
Service Request Time Stamp	O <sub>M</sub>	This field contains the time stamp, which indicates the time at which the service was requested.
Service Request Time Stamp Fraction	O <sub>M</sub>	This parameter contains the milliseconds fraction in relation to the Service Request Time Stamp.
Service Delivery Start Time Stamp	O <sub>M</sub>	This field holds the time stamp reflecting either: successful session set-up, a delivery unrelated service, an unsuccessful session set-up and an unsuccessful session unrelated request.
Service Delivery Start Time Stamp Fraction	O <sub>M</sub>	This parameter contains the milliseconds fraction in relation to the Service Delivery Start Time Stamp.
Service Delivery End Time Stamp	O <sub>C</sub>	This field records the time at which the service delivery was terminated. It is Present only in SIP session related case.
Service Delivery End Time Stamp Fraction	O <sub>C</sub>	This parameter contains the milliseconds fraction in relation to the Service Delivery End Time Stamp.
Record Opening Time	O <sub>C</sub>	A time stamp reflecting the time the CDF opened this record. Present only in SIP session related case.
Record Closure Time	O <sub>M</sub>	A Time stamp reflecting the time the CDF closed the record.
Application Servers Information	O <sub>C</sub>	This a grouped CDR field containing the fields: "Application Server Involved" and "Application Provided Called Parties".
Application Servers Involved	O <sub>C</sub>	Holds the ASs (if any) identified by the SIP URIs.
Application Provided Called Parties	O <sub>C</sub>	Holds a list of the Called Party Address(es), if the address(es) are determined by an AS (SIP URI, E.164...).
List of Inter Operator Identifiers	O <sub>C</sub>	Holds the identification of the home network (originating and terminating) if exchanged via SIP signalling, as recorded in the P-Charging-Vector header. This grouped field may occur several times in one CDR.
Originating IOI	O <sub>C</sub>	This parameter corresponds to Orig-IOI header of the P-Charging-Vector defined in TS 24.229 [204].

Field	Category	Description
Terminating IOI	O <sub>C</sub>	This parameter corresponds to Term-IOI header of the P-Charging-Vector defined in TS 24.229 [204].
Local Record Sequence Number	O <sub>M</sub>	This field includes a unique record number created by E-CSCF. The number is allocated sequentially for each partial CDR (or whole CDR) including all CDR types. The number is unique within the CDF.
Record Sequence Number	O <sub>C</sub>	This field contains a running sequence number employed to link the partial records generated by the CDF for a particular session.
Cause For Record Closing	O <sub>M</sub>	This field contains a reason for the close of the CDR.
Incomplete CDR Indication	O <sub>C</sub>	This field provides additional diagnostics when the CDF detects missing Charging Data Requests.
IMS Charging Identifier	O <sub>M</sub>	This parameter holds the IMS charging identifier (ICID) as generated by the IMS node for the SIP session.
List of Early SDP Media Components	O <sub>C</sub>	This is a grouped field which may occur several times in one CDR.  This field shall not be present if no media components are set to active before the final SIP session answer to the initial SIP Invite is received. This field can be present in either session or event CDRs.
SDP Session Description	O <sub>C</sub>	Holds the Session portion of SDP data exchanged in the above mentioned scenario, if available.
SDP Type	O <sub>M</sub>	This parameter indicates if the SDP media component is an SDP offer or SDP answer.
SDP Offer Timestamp	O <sub>M</sub>	This parameter contains the time of the SIP Request which conveys the SDP offer.
SDP Answer Timestamp	O <sub>M</sub>	This parameter contains the time of the response to the SIP Request which conveys the SDP answer.
SDP Media Components	O <sub>M</sub>	This is a grouped field comprising several sub-fields associated with one media component. Since several media components may exist for a session in parallel these sub-fields may occur several times.
SDP Media Name	O <sub>M</sub>	This field holds the name of the media as available in the SDP data.
SDP Media Description	O <sub>M</sub>	This field holds the attributes of the media as available in the SDP data.
Access Correlation ID	O <sub>C</sub>	This parameter holds the charging identifier from the access network, consisting of either GPRS charging ID (GCID) which is generated by the GGSN for a GPRS PDP context, Charging Id which is generated by P-GW for IP-CAN bearer or the Access Network Charging Identifier Value which is generated by another type of access network. It is present only if received from the access network when PCC architecture is implemented.
Media Initiator Flag	O <sub>C</sub>	This field indicates if the called party has requested the session modification and it is present only if the initiator was the called party.
List of SDP Media Components	O <sub>C</sub>	This is a grouped field which may occur several times in one CDR.  The field is present only in a SIP session related case.
SDP Session Description	O <sub>C</sub>	Holds the Session portion of the SDP data exchanged between the User Agents if available in the SIP transaction.
SDP Type	O <sub>M</sub>	This parameter indicates if the SDP media component is an SDP offer or SDP answer.
SIP Request Timestamp	O <sub>C</sub>	This parameter contains the time of the SIP Request (usually a (Re)Invite).
SIP Response Timestamp	O <sub>C</sub>	This parameter contains appropriately the time of 200 OK acknowledging an INVITE or of ACK including an SDP answer.
SIP Request Timestamp Fraction	O <sub>C</sub>	This parameter contains the milliseconds fraction in relation to the SIP Request Timestamp.
SIP Response Timestamp Fraction	O <sub>C</sub>	This parameter contains the milliseconds fraction in relation to the SIP Response Timestamp.
SDP Media Components	O <sub>M</sub>	This is a grouped field comprising several sub-fields associated with one media component. Since several media components may exist for a session in parallel these sub-fields may occur several times.



Field	Category	Description
SDP Media Name	O <sub>M</sub>	This field holds the name of the media as available in the SDP data.
SDP Media Description	O <sub>M</sub>	This field holds the attributes of the media as available in the SDP data.
Access Correlation ID	O <sub>C</sub>	This parameter holds the charging identifier from the access network, consisting of either GPRS charging ID (GCID) which is generated by the GGSN for a GPRS PDP context, Charging Id which is generated by P-GW for IP-CAN bearer or the Access Network Charging Identifier Value which is generated by another type of access network. It is present only if received from the access network when PCC architecture is implemented.
Media Initiator Flag	O <sub>C</sub>	This field indicates if the called party has requested the session modification and it is present only if the initiator was the called party.
GGSN Address	O <sub>C</sub>	This parameter holds the control plane IP address of the GGSN that handles one or more media component(s) of an IMS session.
Service Reason Return Code	O <sub>M</sub>	This parameter provides the returned SIP status code for the service request for the successful and failure case,
List of Message Bodies	O <sub>C</sub>	This grouped field comprising several sub-fields describing the data that may be conveyed end-to-end in the body of a SIP message. Since several message bodies may be exchanged via SIP-signalling, this grouped field may occur several times.
Content-Type	O <sub>M</sub>	This sub-field of Message Bodies holds the MIME type of the message body, Examples are: application/zip, image/gif, audio/mpeg, etc.
Content-Disposition	O <sub>C</sub>	This sub-field of Message Bodies holds the content disposition of the message body inside the SIP signalling, Content-disposition header field equal to "render", indicates that "the body part should be displayed or otherwise rendered to the user". Content disposition values are: session, render, inline, icon, alert, attachment, etc.
Content-Length	O <sub>M</sub>	This sub-field of Message Bodies holds the size of the data of a message body in bytes.
Originator	O <sub>C</sub>	This sub-field of the "List of Message Bodies" indicates the originating party of the message body.
Access Network Information	O <sub>C</sub>	This field contains the content of one SIP P-header "P-Access-Network-Info" if available.
Service Context Id	O <sub>M</sub>	Holds the context information to which the CDR belongs. The information is obtained from the Operation Token of the Charging Data Request message.
IMS Communication Service ID	O <sub>C</sub>	This field contains the IMS communication service identifier if received in the P-Asserted-Service header in the SIP request.
User Location Info	O <sub>C</sub>	This field contains the network provided location information for 3GPP accesses, if available..
MS Time Zone	O <sub>C</sub>	This field indicates the offset between universal time and local time in steps of 15 minutes of where the MS currently resides.
From Address	O <sub>M</sub>	Contains the information from the SIP From header.
Record Extensions	O <sub>C</sub>	A set of operator/manufacture specific extensions to the record, conditioned upon existence of an extension.

### 6.1.3.12 TRF CDR Content

The detailed description of the field is provided in TS 32.298 [51].

**Table 6.1.3.12: Charging Data of TRF CDR**

Field	Category	Description
Record Type	M	Identifies the type of record. The parameter is derived from the Node functionality parameter.
Retransmission	O <sub>C</sub>	This parameter, when present, indicates that information from retransmitted Charging Data Requests has been used in this CDR.
SIP Method	O <sub>C</sub>	Specifies the SIP-method for which the CDR is generated. Only available in session unrelated cases.
Event	O <sub>C</sub>	This field identifies the SIP event package to which the SIP request is referred.
Expires Information	O <sub>C</sub>	This field indicates the validity time of either the SIP message or its content, depending on the SIP method.
Role of Node	O <sub>M</sub>	This field indicates whether the TRF is serving the Originating or the Terminating party.
Node Address	O <sub>M</sub>	This item holds the address of the node providing the information for the CDR. This may either be the IP address or the FQDN of the IMS node generating the accounting data.
Session ID	O <sub>M</sub>	The Session identification. For a SIP session the Session-ID contains the SIP Call ID as defined in the Session Initiation Protocol RFC 3261 [404].
Session Priority	O <sub>C</sub>	The field contains the priority of the session.
List Of Calling Party Address	O <sub>M</sub>	The address or addresses (Public User ID or Public Service ID) of the party requesting a service or initiating a session.
Called Party Address	O <sub>M</sub>	In the context of an end-to-end SIP transaction this field holds the address of the party (Public User ID) to whom the SIP transaction is posted.
List of Called Asserted Identity	O <sub>C</sub>	The address or addresses of the final asserted identities. Present if the final asserted identities are available in the SIP 2xx response.
Requested Party Address	O <sub>C</sub>	For SIP transactions this field holds the address of the party (Public User ID or Public Service ID) to whom the SIP transaction was originally posted. This field is only present if different from the Called Party Address parameter.
List of Subscription Id	O <sub>C</sub>	Holds the public user identities of the served user.
Number Portability routing information	O <sub>C</sub>	This field includes information on number portability after DNS/ENUM request from the TRF.
Carrier Select routing information	O <sub>C</sub>	This field includes information on number portability after DNS/ENUM request from the TRF.
Service Request Time Stamp	O <sub>M</sub>	This field contains the time stamp which indicates the time at which the service was requested. This parameter corresponds to SIP Request Timestamp. Present with Charging Data Request [Start] and Charging Data Request [Event].
Service Request Time Stamp Fraction	O <sub>M</sub>	This parameter contains the milliseconds fraction in relation to the Service Request Time Stamp.
Service Delivery Start Time Stamp	O <sub>M</sub>	This field holds the time stamp reflecting either: successful session set-up, a delivery unrelated service, an unsuccessful session set-up and an unsuccessful session unrelated request. This parameter corresponds to SIP Response Timestamp. Present with Charging Data Request [Start] and Charging Data Request [Event].
Service Delivery Start Time Stamp Fraction	O <sub>M</sub>	This parameter contains the milliseconds fraction in relation to the Service Delivery Start Time Stamp.
Service Delivery End Time Stamp	O <sub>C</sub>	This field records the time at which the service delivery was terminated. It is Present only in SIP session related case. This parameter corresponds to SIP Request Timestamp. Present with Charging Data Request [Stop].
Service Delivery End Time Stamp Fraction	O <sub>C</sub>	This parameter contains the milliseconds fraction in relation to the Service Delivery End Time Stamp.
Record Opening Time	O <sub>C</sub>	A time stamp reflecting the time the CDF opened this record. Present only in SIP session related case.
Record Closure Time	O <sub>M</sub>	A Time stamp reflecting the time the CDF closed the record
Application Servers Information	O <sub>C</sub>	This a grouped CDR field containing the fields: "Application Server Involved" and "Application Provided Called Parties".
Application Servers Involved	O <sub>C</sub>	Holds the ASs (if any) identified by the SIP URIs.
Application Provided Called Parties	O <sub>C</sub>	Holds a list of the Called Party Address(es), if the address(es) are determined by an AS (SIP URI, E.164...).

Field	Category	Description
Inter Operator Identifiers	O <sub>C</sub>	Holds the identification of the home network (originating and terminating) if exchanged via SIP signalling, as recorded in the <i>P-Charging-Vector header</i> . This grouped field may occur several times in one CDR.
Originating IOI	O <sub>C</sub>	This parameter corresponds to Orig-IOI header of the P-Charging-Vector defined in TS 24.229 [204].
Terminating IOI	O <sub>C</sub>	This parameter corresponds to Term-IOI header of the P-Charging-Vector defined in TS 24.229 [204].
Transit IOI List	O <sub>C</sub>	This parameter corresponds to Transit-IOI List of the P-Charging-Vector defined in TS 24.229 [204]. This field may occur several times in one CDR. Each occurrence represents transit IOI values received from the path inbound to or outbound from the TRF.
Local Record Sequence Number	O <sub>M</sub>	This field includes a unique record number created by this node. The number is allocated sequentially for each partial CDR (or whole CDR) including all CDR types. The number is unique within the CDF.
Record Sequence Number	O <sub>C</sub>	This field contains a running sequence number employed to link the partial records generated by the CDF for a particular session.
Cause For Record Closing	O <sub>M</sub>	This field contains a reason for the close of the CDR.
Incomplete CDR Indication	O <sub>C</sub>	This field provides additional diagnostics when the CDF detects missing Charging Data Requests.
IMS Charging Identifier	O <sub>M</sub>	This parameter holds the IMS charging identifier (ICID) as generated by the IMS node for the SIP session.
List of Early SDP Media Components	O <sub>C</sub>	This is a grouped field which may occur several times in one CDR.  This field shall not be present if no media components are set to active before the final SIP session answer to the initial SIP Invite is received. This field can be present in either session or event CDRs.
SDP Session Description	O <sub>C</sub>	Holds the Session portion of SDP data exchanged in the above mentioned scenario, if available.
SDP Type	O <sub>M</sub>	This parameter indicates if the SDP media component is an SDP offer or SDP answer.
SDP Offer Timestamp	O <sub>M</sub>	This parameter contains the time of the SIP Request which conveys the SDP offer.
SDP Answer Timestamp	O <sub>M</sub>	This parameter contains the time of the response to the SIP Request which conveys the SDP answer.
SDP Media Components	O <sub>M</sub>	This is a grouped field comprising several sub-fields associated with one media component. Since several media components may exist for a session in parallel these sub-fields may occur several times.
SDP Media Name	O <sub>M</sub>	This field holds the name of the media as available in the SDP data.
SDP Media Description	O <sub>M</sub>	This field holds the attributes of the media as available in the SDP data.
Media Initiator Flag	O <sub>C</sub>	This field indicates if the called party has requested the session modification and it is present only if the initiator was the called party.
List of SDP Media Components	O <sub>C</sub>	This is a grouped field which may occur several times in one CDR. The field is present only in a SIP session related case.
SDP Session Description	O <sub>C</sub>	Holds the Session portion of the SDP data exchanged between the User Agents if available in the SIP transaction.
SDP Type	O <sub>M</sub>	This parameter indicates if the SDP media component is an SDP offer or SDP answer.
SIP Request Timestamp	O <sub>C</sub>	This parameter contains the time of the SIP Request (usually a (Re)Invite). This parameter corresponds to SIP Request Timestamp in Charging Data Request [Interim].
SIP Response Timestamp	O <sub>C</sub>	This parameter contains appropriately the time of 200 OK acknowledging an INVITE or of ACK including an SDP answer. This parameter corresponds to SIP Response Timestamp in Charging Data Request [Interim].
SIP Request Timestamp Fraction	O <sub>C</sub>	This parameter contains the milliseconds fraction in relation to the SIP Request Timestamp.
SIP Response Timestamp Fraction	O <sub>C</sub>	This parameter contains the milliseconds fraction in relation to the SIP Response Timestamp.

Field	Category	Description
SDP Media Components	O <sub>M</sub>	This is a grouped field comprising several sub-fields associated with one media component. Since several media components may exist for a session in parallel these sub-fields may occur several times.
SDP Media Name	O <sub>M</sub>	This field holds the name of the media as available in the SDP data.
SDP Media Description	O <sub>M</sub>	This field holds the attributes of the media as available in the SDP data.
Media Initiator Flag	O <sub>C</sub>	This field indicates if the called party has requested the session modification and it is present only if the initiator was the called party.
Service Reason Return Code	O <sub>M</sub>	This parameter provides the returned SIP status code for the service request for the successful and failure case,
List of Message Bodies	O <sub>C</sub>	This grouped field comprising several sub-fields describing the data that may be conveyed end-to-end in the body of a SIP message. Since several message bodies may be exchanged via SIP-signalling, this grouped field may occur several times.
Content-Type	O <sub>M</sub>	This sub-field of Message Bodies holds the MIME type of the message body, Examples are: application/zip, image/gif, audio/mpeg, etc.
Content-Disposition	O <sub>C</sub>	This sub-field of Message Bodies holds the content disposition of the message body inside the SIP signalling, Content-disposition header field equal to "render", indicates that "the body part should be displayed or otherwise rendered to the user". Content disposition values are : session, render, inline, icon, alert, attachment, etc.
Content-Length	O <sub>M</sub>	This sub-field of Message Bodies holds the size of the data of a message body in bytes.
Originator	O <sub>C</sub>	This sub-field of the "List of Message Bodies" indicates the originating party of the message body.
IMS Communication Service Id	O <sub>C</sub>	Contains the identifier for the type of communication service the IMS is currently providing for the session.
Service Context Id	O <sub>M</sub>	Holds the context information to which the CDR belongs. The information is obtained from the Operation Token of the Charging Data Request message.
User Location Info	O <sub>C</sub>	This field contains the network provided location information for 3GPP accesses, if available..
MS Time Zone	O <sub>C</sub>	This field indicates the offset between universal time and local time in steps of 15 minutes of where the MS currently resides.
NNI Information	O <sub>C</sub>	This grouped field comprising several sub-fields holds information about the NNI used for interconnection and roaming. This field may occur more than once in a CDR e.g. when routing capability in support of transit is collocated with the TRF.
NNI Type	O <sub>C</sub>	This field indicates whether the type of used NNI is non-roaming, roaming with loopback routing, or roaming without loopback routing.
SIP Route header received	O <sub>C</sub>	Contains the information in the topmost route header in a received initial SIP INVITE or non-session related SIP MESSAGE request.
Record Extensions	O <sub>C</sub>	A set of operator/manufacturer specific extensions to the record, conditioned upon existence of an extension.

### 6.1.3.13 ATCF CDR Content

The detailed description of the field is provided in TS 32.298 [51].

**Table 6.1.3.13: Charging Data of ATCF CDR**

Field	Category	Description
Record Type	M	Identifies the type of record. The parameter is derived from the Node functionality parameter.
Retransmission	O <sub>C</sub>	This parameter, when present, indicates that information from retransmitted Charging Data Requests has been used in this CDR
SIP Method	O <sub>C</sub>	Specifies the SIP-method for which the CDR is generated. Only available in session unrelated cases.
Event	O <sub>C</sub>	This field identifies the SIP event package to which the SIP request is referred.
Expires Information	O <sub>C</sub>	This field indicates the validity time of either the SIP message or its content, depending on the SIP method.
Role of Node	O <sub>M</sub>	This field indicates whether the ATCF is serving the Originating or the Terminating party.
Node Address	O <sub>M</sub>	This item holds the address of the node providing the information for the CDR. This may either be the IP address or the FQDN of the IMS node generating the accounting data.
Session ID	O <sub>M</sub>	The Session identification. For a SIP session the Session-ID contains the SIP Call ID as defined in the Session Initiation Protocol RFC 3261 [404]. When the ATCF acts as B2BUA, the incoming session is identified , except for the "OneChargingSession" option, where it contains either the incoming or outgoing dialog SIP Call Id involved during IMS session setup.
Outgoing Session ID	O <sub>C</sub>	When the ATCF acts as B2BUA, the outgoing session is identified by the Outgoing Session ID which contains the SIP Call ID (as defined in the RFC 3261 [404]). This field is not used for the "OneChargingSession " option
Session Priority	O <sub>C</sub>	The field contains the priority of the session.
List Of Calling Party Address	O <sub>M</sub>	The address or addresses (Public User ID or Public Service ID, Correlation MSISDN) of the party requesting a service or initiating a session. In the case of no P-Asserted-Identity is known, this list shall include one item with the value "unknown".
Called Party Address	O <sub>M</sub>	For SIP transactions, except for registration, this field holds the address of the party (Public User ID or Public Service ID) to whom the SIP transaction is posted. For registration transactions, this field holds the Public User ID under registration.
List of Requested Party Address	O <sub>C</sub>	This field is a list of Requested Party Address. Each occurrence contains: For SIP transactions, the address of the party (Public User ID or Public Service ID) to whom the SIP transaction was originally posted. For PS to CS transfer, the Session Transfer Number for Single Radio Voice Call Continuity (STN-SR) as described in TS 23.237 [407]. For CS to PS transfer, the Session Transfer Identifier for CS to PS Single Radio Voice Call Continuity (STI-rSR) as described in TS 23.237 [407].
Private User ID	O <sub>C</sub>	This field holds the private user identity of the served party defined in TS 23.003 [104], if available.
List of Subscription Id	O <sub>M</sub>	Holds the public user identities of the served user
List of Called Asserted Identity	O <sub>C</sub>	The address or addresses of the final asserted identities. Present if the final asserted identities are available in the SIP 2xx response.
Service Request Time Stamp	O <sub>M</sub>	This field contains the time stamp which indicates the time at which the service was requested. This parameter corresponds to SIP Request Timestamp. Present with Charging Data Request [Start] and Charging Data Request [Event].
Service Request Time Stamp Fraction	O <sub>M</sub>	This parameter contains the milliseconds fraction in relation to the Service Request Time Stamp.
Service Delivery Start Time Stamp	O <sub>M</sub>	This field holds the time stamp reflecting either: successful session set-up, a delivery unrelated service, an unsuccessful session set-up and an unsuccessful session unrelated request. This parameter corresponds to SIP Response Timestamp. Present with Charging Data Request [Start] and Charging Data Request [Event].

Field	Category	Description
Service Delivery Start Time Stamp Fraction	O <sub>M</sub>	This parameter contains the milliseconds fraction in relation to the Service Delivery Start Time Stamp.
Service Delivery End Time Stamp	O <sub>C</sub>	This field records the time at which the service delivery was terminated. It is Present only in SIP session related case. This parameter corresponds to SIP Request Timestamp. Present with Charging Data Request [Stop].
Service Delivery End Time Stamp Fraction	O <sub>C</sub>	This parameter contains the milliseconds fraction in relation to the Service Delivery End Time Stamp.
Record Opening Time	O <sub>C</sub>	A time stamp reflecting the time the CDF opened this record. Present only in SIP session related case.
Record Closure Time	O <sub>M</sub>	A Time stamp reflecting the time the CDF closed the record.
Inter Operator Identifiers	O <sub>C</sub>	Holds the identification of the home network (originating and terminating) if exchanged via SIP signalling, as recorded in the <i>P-Charging-Vector header</i> .
Originating IOI	O <sub>C</sub>	This parameter corresponds to Orig-IOI header of the P-Charging-Vector defined in TS 24.229 [204].
Terminating IOI	O <sub>C</sub>	This parameter corresponds to Term-IOI header of the P-Charging-Vector defined in TS 24.229 [204].
Local Record Sequence Number	O <sub>M</sub>	This field includes a unique record number created by this node. The number is allocated sequentially for each partial CDR (or whole CDR) including all CDR types. The number is unique within the CDF.
Record Sequence Number	O <sub>C</sub>	This field contains a running sequence number employed to link the partial records generated by the CDF for a particular session.
Cause For Record Closing	O <sub>M</sub>	This field contains a reason for the close of the CDR.
Incomplete CDR Indication	O <sub>C</sub>	This field provides additional diagnostics when the CDF detects missing Charging Data Requests.
IMS Charging Identifier	O <sub>M</sub>	This parameter holds the IMS charging identifier (ICID) as generated by the IMS node for the SIP session.
List of Early SDP Media Components	O <sub>C</sub>	This is a grouped field which may occur several times in one CDR.  This field shall not be present if no media components are set to active before the final SIP session answer to the initial SIP Invite is received. This field can be present in either session or event CDRs.
SDP Session Description	O <sub>C</sub>	Holds the Session portion of SDP data exchanged in the above mentioned scenario, if available.
SDP Type	O <sub>M</sub>	This parameter indicates if the SDP media component is an SDP offer or SDP answer.
SDP Offer Timestamp	O <sub>M</sub>	This parameter contains the time of the SIP Request which conveys the SDP offer.
SDP Answer Timestamp	O <sub>M</sub>	This parameter contains the time of the response to the SIP Request which conveys the SDP answer.
SDP Media Components	O <sub>M</sub>	This is a grouped field comprising several sub-fields associated with one media component. Since several media components may exist for a session in parallel these sub-fields may occur several times.
SDP Media Name	O <sub>M</sub>	This field holds the name of the media as available in the SDP data.
SDP Media Description	O <sub>M</sub>	This field holds the attributes of the media as available in the SDP data.
Access Correlation ID	O <sub>C</sub>	This parameter holds the charging identifier from the access network, consisting of either GPRS charging ID (GCID) which is generated by the GGSN for a GPRS PDP context, Charging Id which is generated by P-GW for IP-CAN bearer or the Access Network Charging Identifier Value which is generated by another type of access network. It is present only if received from the access network when PCC architecture is implemented.
Media Initiator Flag	O <sub>C</sub>	This field indicates if the called party has requested the session modification and it is present only if the initiator was the called party.



Field	Category	Description
List of SDP Media Components	O <sub>C</sub>	This is a grouped field which may occur several times in one CDR. The field is present only in a SIP session related case. When the ATCF acts as B2BUA and "OneChargingSession" option applies, only SDP media components received by the ATCF are included, i.e those generated by the ATCF are not included.
SDP Session Description	O <sub>C</sub>	Holds the Session portion of the SDP data exchanged between the User Agents if available in the SIP transaction.
SDP Type	O <sub>M</sub>	This parameter indicates if the SDP media component is an SDP offer or SDP answer.
SIP Request Timestamp	O <sub>C</sub>	This parameter contains the time of the SIP Request (usually a (Re)Invite). This parameter corresponds to SIP Request Timestamp in Charging Data Request [Interim].
SIP Response Timestamp	O <sub>C</sub>	This parameter contains appropriately the time of 200 OK acknowledging an INVITE or of ACK including an SDP answer. This parameter corresponds to SIP Response Timestamp in Charging Data Request [Interim].
SIP Request Timestamp Fraction	O <sub>C</sub>	This parameter contains the milliseconds fraction in relation to the SIP Request Timestamp.
SIP Response Timestamp Fraction	O <sub>C</sub>	This parameter contains appropriately the time of 200 OK acknowledging an INVITE or of ACK including an SDP answer. This parameter corresponds to SIP Response Timestamp in Charging Data Request [Interim].
SDP Media Components	O <sub>M</sub>	This is a grouped field comprising several sub-fields associated with one media component. Since several media components may exist for a session in parallel these sub-fields may occur several times.
SDP Media Name	O <sub>M</sub>	This field holds the name of the media as available in the SDP data.
SDP Media Description	O <sub>M</sub>	This field holds the attributes of the media as available in the SDP data.
Access Correlation ID	O <sub>C</sub>	This parameter holds the charging identifier from the access network, consisting of either GPRS charging ID (GCID) which is generated by the GGSN for a GPRS PDP context, Charging Id which is generated by P-GW for IP-CAN bearer or the Access Network Charging Identifier Value which is generated by another type of access network. It is present only if received from the access network when PCC architecture is implemented.
Media Initiator Flag	O <sub>C</sub>	This field indicates if the called party has requested the session modification and it is present only if the initiator was the called party.
GGSN Address	O <sub>C</sub>	This parameter holds the control plane IP address of the GGSN that handles one or more media component(s) of a IMS session.
Service Reason Return Code	O <sub>M</sub>	This parameter provides the returned SIP status code for the service request for the successful and failure case,
List of Message Bodies	O <sub>C</sub>	This grouped field comprising several sub-fields describing the data that may be conveyed end-to-end in the body of a SIP message. Since several message bodies may be exchanged via SIP-signalling, this grouped field may occur several times.
Content-Type	O <sub>M</sub>	This sub-field of Message Bodies holds the MIME type of the message body, Examples are: application/zip, image/gif, audio/mpeg, etc.
Content-Disposition	O <sub>C</sub>	This sub-field of Message Bodies holds the content disposition of the message body inside the SIP signalling, Content-disposition header field equal to "render", indicates that "the body part should be displayed or otherwise rendered to the user". Content disposition values are : session, render, inline, icon, alert, attachment, etc.
Content-Length	O <sub>M</sub>	This sub-field of Message Bodies holds the size of the data of a message body in bytes.
Originator	O <sub>C</sub>	This sub-field of the "List of Message Bodies" indicates the originating party of the message body.
Access Network Information	O <sub>C</sub>	This field contains the content of the first available SIP P-header "P-Access-Network-Info" if available.

Field	Category	Description
List of Access Transfer Information	O <sub>C</sub>	This field is a list of grouped field describing the subsequent CS to PS or PS to CS session transfers. Each other occurrence comprises sub-fields describing the session transfer performed.
Access Transfer Type	O <sub>C</sub>	This field contains indication about the access transfer performed: CS to PS, or PS to CS. This field is present only when transfer occurred.
Access Network Information	O <sub>C</sub>	This field holds the content of one SIP P-header "P-Access-Network-Info" from the INVITE requesting the transfer, if available.
Service Context Id	O <sub>M</sub>	Holds the context information to which the CDR belongs. The information is obtained from the Operation Token of the Charging Data Request message.
IMS Communication Service ID	O <sub>C</sub>	This field contains the IMS communication service identifier if received in the P-Asserted-Service header in the SIP request when the ATCF is downstream from the S-CSCF serving the Originating party or the topmost occurrence of the "+g.3gpp.icsi-ref" header field parameter of the Feature-Caps header in the SIP response when the ATCF is upstream from the S-CSCF serving the Originating party.
Initial IMS Charging Identifier	O <sub>C</sub>	This parameter holds the Initial IMS charging identifier (ICID) as generated by the IMS node for the initial SIP session created for IMS service continuity. This field is not used for the "OneChargingSession" option.
User Location Info	O <sub>C</sub>	This field contains the network provided location information for 3GPP accesses, if available..
MS Time Zone	O <sub>C</sub>	This field indicates the offset between universal time and local time in steps of 15 minutes of where the MS currently resides.
From Address	O <sub>M</sub>	Contains the information from the SIP From header.
SIP Route header received	O <sub>C</sub>	Contains the information in the topmost route header in a received initial SIP INVITE or non-session related SIP MESSAGE request.
SIP Route header transmitted	O <sub>C</sub>	Contains the information in the route header representing the destination in a transmitted SIP INVITE or non-session related SIP MESSAGE request.
Record Extensions	O <sub>C</sub>	A set of operator/manufacturer specific extensions to the record, conditioned upon existence of an extension.

NOTE: ATCF collocated with P-CSCF or IBCF applies combined offline charging with applicable fields described in table 6.3.2.1

### 6.1.3.14 TF CDR Content

The detailed description of the field is provided in TS 32.298 [51].

**Table 6.1.3.14: Charging Data of TF CDR**

Field	Category	Description
Record Type	M	Identifies the type of record. The parameter is derived from the Node functionality parameter.
Retransmission	O <sub>c</sub>	This parameter, when present, indicates that information from retransmitted Charging Data Requests has been used in this CDR
SIP Method	O <sub>c</sub>	Specifies the SIP-method for which the CDR is generated. Only available in session unrelated cases.
Event	O <sub>c</sub>	This field identifies the SIP event package to which the SIP request is referred.
Expires Information	O <sub>c</sub>	This field indicates the validity time of either the SIP message or its content, depending on the SIP method.
Role of Node	O <sub>c</sub>	This field indicates whether the Transit Functions are serving the Originating or the Terminating party.
Node Address	O <sub>M</sub>	This item holds the address of the node providing the information for the CDR. This may either be the IP address or the FQDN of the IMS node generating the accounting data.
Session ID	O <sub>M</sub>	The Session identification. For a SIP session the Session-ID contains the SIP Call ID as defined in the Session Initiation Protocol RFC 3261 [404].
Session Priority	O <sub>c</sub>	The field contains the priority of the session.
List Of Calling Party Address	O <sub>M</sub>	The address or addresses (Public User ID or Public Service ID) of the party requesting a service or initiating a session. In the case of no P-Asserted-Identify is known, this list shall include one item with the value "unknown".
Called Party Address	O <sub>M</sub>	For SIP transactions, except for registration, this field holds the address of the party (Public User ID or Public Service ID) to whom the SIP transaction is posted. For registration transactions, this field holds the Public User ID under registration.
Requested Party Address	O <sub>c</sub>	For SIP transactions this field holds the address of the party (Public User ID or Public Service ID) to whom the SIP transaction was originally posted. This field is only present if different from the Called Party Address parameter.
List of Called Asserted Identity	O <sub>c</sub>	The address or addresses of the final asserted identities. Present if the final asserted identities are available in the SIP 2xx response.
Service Request Time Stamp	O <sub>M</sub>	This field contains the time stamp, which indicates the time at which the service was requested.
Service Request Time Stamp Fraction	O <sub>M</sub>	This parameter contains the milliseconds fraction in relation to the Service Request Time Stamp.
Service Delivery Start Time Stamp	O <sub>M</sub>	This field holds the time stamp reflecting either: successful session set-up, a delivery unrelated service, an unsuccessful session set-up and an unsuccessful session unrelated request.
Service Delivery Start Time Stamp Fraction	O <sub>M</sub>	This parameter contains the milliseconds fraction in relation to the Service Delivery Start Time Stamp.
Service Delivery End Time Stamp	O <sub>c</sub>	This field records the time at which the service delivery was terminated. It is Present only in SIP session related case.
Service Delivery End Time Stamp Fraction	O <sub>c</sub>	This parameter contains the milliseconds fraction in relation to the Service Delivery End Time Stamp.
Record Opening Time	O <sub>c</sub>	A time stamp reflecting the time the CDF opened this record. Present only in SIP session related case.
Record Closure Time	O <sub>M</sub>	A Time stamp reflecting the time the CDF closed the record.
Application Servers Information	O <sub>c</sub>	This a grouped CDR field containing the fields: "Application Server Involved" and "Application Provided Called Parties", to cover the case of transit network providing IMS application services.
Application Servers Involved	O <sub>c</sub>	Holds the ASs (if any) identified by the SIP URIs.
Application Provided Called Parties	O <sub>c</sub>	Holds a list of the Called Party Address(es), if the address(es) are determined by an AS (SIP URI, E.164...).
List of Inter Operator Identifiers	O <sub>c</sub>	Holds the identification of the home network (originating and terminating) if exchanged via SIP signalling, as recorded in the P-Charging-Vector header. This grouped field may occur several times in one CDR.
Originating IOI	O <sub>c</sub>	This parameter corresponds to Orig-IOI header of the P-Charging-Vector defined in TS 24.229 [204].
Terminating IOI	O <sub>c</sub>	This parameter corresponds to Term-IOI header of the P-Charging-Vector defined in TS 24.229 [204].

Field	Category	Description
Transit IOI List	O <sub>C</sub>	This parameter corresponds to Transit-IOI List of the P-Charging-Vector defined in TS 24.229 [204]. This field may occur several times in one CDR. Each occurrence represents transit IOI values received from the path inbound to or outbound from the TF, including the own Transit IOI.
Local Record Sequence Number	O <sub>M</sub>	This field includes a unique record number created by the Transit Functions. The number is allocated sequentially for each partial CDR (or whole CDR) including all CDR types. The number is unique within the CDF.
Record Sequence Number	O <sub>C</sub>	This field contains a running sequence number employed to link the partial records generated by the CDF for a particular session.
Cause For Record Closing	O <sub>M</sub>	This field contains a reason for the close of the CDR.
Incomplete CDR Indication	O <sub>C</sub>	This field provides additional diagnostics when the CDF detects missing Charging Data Requests.
IMS Charging Identifier	O <sub>M</sub>	This parameter holds the IMS charging identifier (ICID) as generated by the IMS node for the SIP session.
List of Early SDP Media Components	O <sub>C</sub>	This is a grouped field which may occur several times in one CDR.  This field shall not be present if no media components are set to active before the final SIP session answer to the initial SIP Invite is received. This field can be present in either session or event CDRs.
SDP Session Description	O <sub>C</sub>	Holds the Session portion of SDP data exchanged in the above mentioned scenario, if available.
SDP Type	O <sub>M</sub>	This parameter indicates if the SDP media component is an SDP offer or SDP answer.
SDP Offer Timestamp	O <sub>M</sub>	This parameter contains the time of the SIP Request which conveys the SDP offer.
SDP Answer Timestamp	O <sub>M</sub>	This parameter contains the time of the response to the SIP Request which conveys the SDP answer.
SDP Media Components	O <sub>M</sub>	This is a grouped field comprising several sub-fields associated with one media component. Since several media components may exist for a session in parallel these sub-fields may occur several times.
SDP Media Name	O <sub>M</sub>	This field holds the name of the media as available in the SDP data.
SDP Media Description	O <sub>M</sub>	This field holds the attributes of the media as available in the SDP data.
Media Initiator Flag	O <sub>C</sub>	This field indicates if the called party has requested the session modification and it is present only if the initiator was the called party.
List of SDP Media Components	O <sub>C</sub>	This is a grouped field which may occur several times in one CDR.  The field is present only in a SIP session related case.
SDP Session Description	O <sub>C</sub>	Holds the Session portion of the SDP data exchanged between the User Agents if available in the SIP transaction.
SDP Type	O <sub>M</sub>	This parameter indicates if the SDP media component is an SDP offer or SDP answer.
SIP Request Timestamp	O <sub>C</sub>	This parameter contains the time of the SIP Request (usually a (Re)Invite).
SIP Response Timestamp	O <sub>C</sub>	This parameter contains appropriately the time of 200 OK acknowledging an INVITE or of ACK including an SDP answer.
SIP Request Timestamp Fraction	O <sub>C</sub>	This parameter contains the milliseconds fraction in relation to the SIP Request Timestamp.
SIP Response Timestamp Fraction	O <sub>C</sub>	This parameter contains the milliseconds fraction in relation to the SIP Response Timestamp.
SDP Media Components	O <sub>M</sub>	This is a grouped field comprising several sub-fields associated with one media component. Since several media components may exist for a session in parallel these sub-fields may occur several times.
SDP Media Name	O <sub>M</sub>	This field holds the name of the media as available in the SDP data.
SDP Media Description	O <sub>M</sub>	This field holds the attributes of the media as available in the SDP data.

Field	Category	Description
Media Initiator Flag	O <sub>C</sub>	This field indicates if the called party has requested the session modification and it is present only if the initiator was the called party.
Service Reason Return Code	O <sub>M</sub>	This parameter provides the returned SIP status code for the service request for the successful and failure case,
List of Message Bodies	O <sub>C</sub>	This grouped field comprising several sub-fields describing the data that may be conveyed end-to-end in the body of a SIP message. Since several message bodies may be exchanged via SIP-signalling, this grouped field may occur several times.
Content-Type	O <sub>M</sub>	This sub-field of Message Bodies holds the MIME type of the message body, Examples are: application/zip, image/gif, audio/mpeg, etc.
Content-Disposition	O <sub>C</sub>	This sub-field of Message Bodies holds the content disposition of the message body inside the SIP signalling, Content-disposition header field equal to "render", indicates that "the body part should be displayed or otherwise rendered to the user". Content disposition values are: session, render, inline, icon, alert, attachment, etc.
Content-Length	O <sub>M</sub>	This sub-field of Message Bodies holds the size of the data of a message body in bytes.
Originator	O <sub>C</sub>	This sub-field of the "List of Message Bodies" indicates the originating party of the message body.
Service Context Id	O <sub>M</sub>	Holds the context information to which the CDR belongs. The information is obtained from the Operation Token of the Charging Data Request message.
IMS Communication Service ID	O <sub>C</sub>	This field contains the IMS communication service identifier if received in the P-Asserted-Service header in the SIP request.
NNI Information	O <sub>C</sub>	This grouped field holds information about the NNI used for interconnection and roaming on the loopback routing path. It is present only if "VPLMN routing" is applied in a Roaming Architecture for Voice over IMS with Local breakout.
NNI Type	O <sub>C</sub>	This field indicates usage of the roaming NNI for loopback routing, i.e S-CSCF performed the loopback decision.
From Address	O <sub>M</sub>	Contains the information from the SIP From header.
SIP Route header received	O <sub>C</sub>	Contains the information in the topmost route header in a received initial SIP INVITE or non-session related SIP MESSAGE request prior to triggering of any application servers.
SIP Route header transmitted	O <sub>C</sub>	Contains the information in the route header representing the destination in a transmitted initial SIP INVITE or non-session related SIP MESSAGE request following triggering of all application servers.
Record Extensions	O <sub>C</sub>	A set of operator/manufacture specific extensions to the record, conditioned upon existence of an extension.

Editor's note: More investigation on parameters occurrence should be worked out.

## 6.2 Data description for IMS online charging

### 6.2.1 Ro message contents

The IMS nodes generate debit and reserve units information that can be transferred from the CTF to the OCF. For this purpose, IMS online charging utilises the *Debit Units and Reserve Units* procedure that is specified in the 3GPP debit unit operation in TS 32.299 [50].

The *Debit and reserve units* procedure employs the *Debit and Reserve Units Request* and *Debit and Reserve Units Response* messages. Table 6.2.1 describes the use of these messages in IMS online charging.

**Table 6.2.1: Online Charging Messages Reference Table**

Command-Name	Source	Destination
Debit and Reserve Units Request	MRFC, AS, IMS-GWF	OCS
Debit and Reserve Units Response	OCS	MRFC, AS, IMS-GWF

### 6.2.1.1 Debit and Reserve Units Request Message

Table 6.2.1.1 illustrates the basic structure of a *Debit and Reserve Units Request* message from the CTF in MRFC and AS and the IMS-GWF as used for IMS online charging.

**Table 6.2.1.1: Debit and reserve units Request Message Contents**

Field	Category	Description
Session Identifier	M	Described in 32.299 [50]
Originator Host	M	Described in 32.299 [50]
Originator Domain	M	Described in 32.299 [50]
Destination Domain	M	Described in 32.299 [50]
Operation Identifier	M	Described in 32.299 [50]
Operation Token	M	Described in 32.299 [50]
Operation Type	M	Described in 32.299 [50]
Operation Number	M	Described in 32.299 [50]
Destination Host	O <sub>C</sub>	Described in 32.299 [50]
User Name	O <sub>C</sub>	The field contains the Private User Identity defined in TS 23.003 [104].
Origination State	O <sub>C</sub>	Described in 32.299 [50]
Origination Timestamp	O <sub>C</sub>	Described in 32.299 [50]
Subscriber Identifier	O <sub>M</sub>	This field contains the identification of the mobile subscriber (i.e. MSISDN or SIP-URI) that uses the requested service.
Termination Cause	O <sub>C</sub>	Described in 32.299 [50]
Requested Action	O <sub>C</sub>	Described in 32.299 [50]
Multiple Operation	O <sub>M</sub>	Described in 32.299 [50]
Multiple Unit Operation	O <sub>C</sub>	Described in 32.299 [50]
Subscriber Equipment Number	O <sub>C</sub>	Described in 32.299 [50]
Proxy Information	O <sub>C</sub>	Described in 32.299 [50]
Route Information	O <sub>C</sub>	Described in 32.299 [50]
Service Information	O <sub>M</sub>	This field holds additional 3GPP service specific parameter: - IMS Information, - PS Information
Extended Information	O <sub>C</sub>	This field holds the network/manufacture specific extensions.



### 6.2.1.2 Debit and Reserve Units Response Message

Table 6.2.1.2 illustrates the basic structure of a Debit and Reserve Units Response message as used for IMS charging. This message is always used by the OCS as specified below, independent of the receiving IMS node and the operation type that is being replied to.

**Table 6.2.1.2: Debit and Reserve Units Response Message Contents for MRFC, AS and IMS-GWF**

Field	Category	Description
Session Identifier	M	Described in 32.299 [50]
Operation Result	M	Described in 32.299 [50]
Originator Host	M	Described in 32.299 [50]
Originator Domain	M	Described in 32.299 [50]
Operation Identifier	M	Described in 32.299 [50]
Operation Type	M	Described in 32.299 [50]
Operation Number	M	Described in 32.299 [50]
Operation Failover	O <sub>C</sub>	Described in 32.299 [50]
Multiple Unit Operation	O <sub>C</sub>	Described in 32.299 [50]
Operation Failure Action	O <sub>C</sub>	Described in 32.299 [50]. This field defines the operation if a failure has occurred at the OCS for SCUR and ECUR.
Operation Event Failure Action	O <sub>C</sub>	Described in 32.299 [50]. This field defines the operation if a failure has occurred at the OCS for IEC.
Redirection Host	O <sub>C</sub>	Described in 32.299 [50]
Redirection Host Usage	O <sub>C</sub>	Described in 32.299 [50]
Redirection Cache Time	O <sub>C</sub>	Described in 32.299 [50]
Proxy Information	O <sub>C</sub>	Described in 32.299 [50]
Route Information	O <sub>C</sub>	Described in 32.299 [50]
Failed parameter	O <sub>C</sub>	Described in 32.299 [50]
Service Information	O <sub>C</sub>	This field holds additional 3GPP service specific parameter: - IMS Information, - PS Information
Extended Information	O <sub>C</sub>	This field holds the network/manufacture specific extensions.

## 6.3 IMS Charging Specific Parameters

### 6.3.1 Definition of IMS charging information

The IMS Information parameter used for IMS charging is provided in the Service Information parameter.

#### 6.3.1.1 IMS charging information assignment for Service Information

The components in the Service Information that are use for IMS charging can be found in Table 6.3.1.1.

**Table 6.3.1.1: Service Information used for IMS Charging**

Field	Category	Description	Provided by IMS NE
Service Information	O <sub>M</sub>	This is a structured field and holds the 3GPP specific parameter as defined in TS 32.299 [50]. For IMS Charging the IMS Information is used.	All
Subscriber Identifier	O <sub>M</sub>	Described in TS 32.299 [50] and contains the Public User Identity/Identities	Not in IBCF, I-CSCF, MGCF, BGCF, TF
IMS Information	O <sub>M</sub>	This is a structured field and holds the IMS specific parameters. The details are defined in clause 6.3.1.2.	All
PS Information	O <sub>C</sub>	This is a structured field and holds PS specific parameters. The complete structure is defined in TS 32.251 [11].	Not in MGCF, BGCF
GGSN Address	O <sub>C</sub>	This field holds the IP-address of the GGSN that generated the GPRS Charging ID, as described in [1].	Not in I-CSCF, MGCF, BGCF, IBCF
User Location Info	O <sub>C</sub>	This field contains the network provided location information for 3GPP accesses, if available.	Not in MGCF, BGCF, TF
MS Time Zone	O <sub>C</sub>	This field indicates the offset between universal time and local time in steps of 15 minutes of where the MS currently resides.	Not in MGCF, BGCF, TF

#### 6.3.1.2 Definition of the IMS Information

IMS specific charging information is provided within the IMS Information. The fields of the IMS Information which are differently covered in several IMS network nodes are indicated by the node specific type.

The detailed structure of the IMS Information can be found in table 6.3.1.2.

**Table 6.3.1.2: Structure of the IMS Information**

Field	Category	Description	Provided by IMS NE
Event Type	O <sub>C</sub>	This field holds the SIP Method, the content of the SIP "Event" header and the content of the SIP "expires" header when present in the SIP request.	All
Node Functionality	M	This field contains the function of the node.	All
Role of Node	O <sub>M</sub>	This field specifies whether the IMS node is serving the Originating or the Terminating party.	Not in MRFC
User Session ID	O <sub>M</sub>	This field holds the session identifier. For a SIP session the <i>Session-ID</i> contains the SIP Call ID. When the AS acts as B2BUA, the incoming session is identified.	All
Outgoing Session ID	O <sub>C</sub>	When the AS acts as B2BUA, the outgoing side session is identified by the Outgoing Session ID which contains the SIP Call ID.	AS only
Session Priority	O <sub>C</sub>	This field contains the priority of the session.	All

Field	Category	Description	Provided by IMS NE
Calling Party Address	O <sub>M</sub>	This field holds the address (SIP URI or TEL URI)URI of the party (Public User Identity or Public Service Identity) initiating a session or requesting a service.	All
Called Party Address	O <sub>M</sub>	For SIP transactions, except for registration, this field holds the address of the party (Public User ID or Public Service ID) to whom the SIP transaction is posted. For registration transactions, this field holds the Public User ID under registration.	All
Number Portability routing information	O <sub>c</sub>	This field includes information on number portability after DNS/ENUM request from IMS node in the calling user's home network.	S-CSCF, I-CSCF, AS, MGCF, BGCF
Carrier Select routing information	O <sub>c</sub>	This field includes information on carrier select after DNS/ENUM request from IMS node in the calling user's home network.	S-CSCF, I-CSCF, AS, MGCF, BGCF
Alternate Charged Party Address	O <sub>c</sub>	The address of an alternate party that is identified by the AS at session initiation, and is charged in place of the calling party.	AS only
Requested Party Address	O <sub>c</sub>	For SIP transactions this field initially holds the address of the party (Public User ID or Public Service ID) to whom the SIP transaction was originally posted. Subsequently, this field holds addresses related to session transfer if available: For PS to CS transfer, the Session Transfer Number for Single Radio Voice Call Continuity (STN-SR) as described in TS 23.237 [407]. For CS to PS transfer, the Session Transfer Identifier for CS to PS Single Radio Voice Call Continuity (STI-rSR) as described in TS 23.237 [407]. This field is only present if different from the Called Party Address parameter.	S-CSCF, P-CSCF, E-CSCF, and AS/MRFC, TF, TRF, ATCF
Called Asserted Identity	O <sub>c</sub>	The address of the final asserted identity. Present if the final asserted identity is available in the SIP 2xx response.	S-CSCF, E-CSCF and AS/MRFC, TF, TRF, ATCF
Associated URI	O <sub>c</sub>	This field holds a non-barred public user identity (SIP URI or TEL URI) associated to the public user identity under registration and is present for registration transactions.	S-CSCF, P-CSCF, I-CSCF, IBCF
Time Stamps	O <sub>c</sub>	This field holds the time of the SIP REQUEST and the time of the response to the SIP REQUEST.	All
Application Server Information	O <sub>c</sub>	This field holds the SIP URI(s) of the AS(s) addressed during the session and the called party number (SIP URI, E.164), if an application server determines it.	S-CSCF, E-CSCF, and MRFC, TF, TRF
Inter Operator Identifier	O <sub>c</sub>	This field holds the identification of the network neighbours (originating and terminating) as exchanged via SIP signalling if available. This field may occur several times.	All
IMS Charging Identifier	O <sub>M</sub>	This field holds the IMS Charging Identifier (ICID) as generated by a IMS node for a SIP session.	All
Related IMS Charging Identifier	O <sub>c</sub>	This field holds the Related IMS charging identifier when the session is the target access leg in an SRVCC CS to PS handover. The Related IMS charging identifier contains the IMS charging identifier as generated by the Enhanced MSC server.	P-CSCF
Related IMS Charging Identifier Generation Node	O <sub>c</sub>	This field holds the identifier of the Enhanced MSC server that generated the Related IMS charging identifier.	P-CSCF
Transit IOI List	O <sub>c</sub>	This field holds the identification of the involved transit networks as exchanged via SIP signalling if available. This field may occur several times. When received from the AS, each occurrence of this field represents transit networks inbound to or outbound from the S-CSCF.	S-CSCF, P-CSCF, MRFC, MGCF, BGCF, SIP AS, IBCF, TF and TRF
Early Media Description	O <sub>c</sub>	This field holds session and media parameters related to media components set to active during the SIP session establishment and before a final successful or unsuccessful SIP answer to the initial SIP INVITE request is received. Once a media component is set to active, subsequent status changes shall be registered. Since several SDP negotiations may occur during the SIP session establishment, this field may occur several times.	Not in I-CSCF, BGCF

Field	Category	Description	Provided by IMS NE
SDP Session Description	Oc	This field holds the content of an "attribute-line" (i=, c=, b=, k=, a=, etc.) related to a session.	Not in I-CSCF, BGCF
SDP Media Component	Oc	This is a grouped field comprising several sub-fields associated with one media component. Since several media components may exist for a session in parallel these sub-fields may occur several times.	Not in I-CSCF, BGCF
Served Party IP Address	Oc	This field holds the IP address of either the calling or called party, depending on whether the P-CSCF is in touch with the calling or the called party.	P-CSCF
Server Capabilities	Oc	This field contains the server capabilities as described in 3GPP TS 29.229 [205].	I-CSCF
Trunk Group ID	Oc	This field identifies the incoming and outgoing PSTN legs.	MGCF
Bearer Service	Oc	This field holds the used bearer service for the PSTN leg.	MGCF
Service Id	Oc	This field identifies the service the MRFC is hosting. For conferences the conference ID is used as the value of this parameter.	MRFC
Service Specific Info	Oc	This field contains service specific data if and as provided by an Application Server.	AS
Message Bodies	Oc	This field holds information about the Message body, Content-Type, Content-Length, Content-Disposition and Originator if available.	P-CSCF, S-CSCF, E-CSCF, MGCF, IBCF, ATCF and AS
Access Network Information	Oc	This field contains the content of one P-header P-Access-Network-Info, if available.	Not in TF nor TRF
Access Transfer Information	Oc	This field contains information related to the CS to PS or PS to CS session transfer.	AS and ATCF
IMS Communication Service ID	Oc	This field contains the IMS communication service identifier if received in the P-Asserted-Service header in the SIP request for all applicable IMS nodes downstream from the S-CSCF serving the Originating party This field contains the IMS communication service identifier if received in the "+g.3gpp.ics i-ref" header field parameter of the Feature-Caps header in the SIP response for all applicable IMS nodes upstream from the S-CSCF serving the Originating party..	S-CSCF, P-CSCF, E-CSCF, IBCF, ATCF, TRF and AS
IMS Application Reference ID	Oc	This field contains the IMS application reference identifier if received in the SIP request.	P-CSCF
Cause Code	Oc	This field contains the cause value.	All
Real Time Tariff Information	Oc	This field holds the tariff/add-on charge received.	S-CSCF, IBCF, MGCF, AS
Online Charging Flag	Oc	This field indicates the Online Charging Request was sent based on the provided ECF address from the SIP P-header "P-Charging-Function-Addresses". NOTE: No proof that online charging action has been taken	S-CSCF and AS/MRFC
Account Expiration	Oc	This field indicates the subscriber account expiration date and time of day.	OCS
Initial IMS Charging Identifier	Oc	This field holds the Initial IMS charging identifier (ICID) as generated by the IMS node for the initial SIP session created for IMS service continuity.	AS and ATCF
NNI Information	Oc	This field holds information about the NNI used for interconnection and roaming.	S-CSCF, BGCF, IBCF, TF, TRF

Field	Category	Description	Provided by IMS NE
From Address	O <sub>M</sub>	Contains the information from the SIP From header.	All
IMS Emergency Indication	O <sub>C</sub>	This field indicates the registration is an emergency registration or the IMS session is an IMS emergency session	P-CSCF, S-CSCF, I-CSCF
IMS Visited Network Information	O <sub>C</sub>	Contains the information from the SIP P-Visited-Network-ID header.	P-CSCF, S-CSCF, and AS
SIP Route header received	O <sub>C</sub>	Contains the information in the topmost route header in a received initial SIP INVITE or non-session related SIP MESSAGE request.	P-CSCF, S-CSCF, IBCF, TRF, ATCF, TF
SIP Route header transmitted	O <sub>C</sub>	Contains the information in the route header representing the destination in a transmitted initial SIP INVITE or non-session related SIP MESSAGE request.	P-CSCF, S-CSCF, I-CSCF, ATCF, TF

## 6.3.2 Detailed Message Format for offline charging

The following chapter specifies per Operation Type the charging data that are sent by each of the IMS network elements for:

- IMS session and IMS event (S/I/S/E)
  - S-CSCF, E-CSCF, P-CSCF, MGFC, AS, IBCF, TRF, ATCF, TF
- IMS session only (S/I/S)
  - MRFC
- IMS event only (E)
  - I-CSCF, BGCF

The Operation Types are listed in the following order: S (start)/I (interim)/S (stop)/E (event). Therefore, when all Operation Types are possible it is marked as SISE. If only some Operation Types are allowed for a node, only the appropriate letters are used (i.e. SIS or E) as indicated in the table heading. The omission of an Operation Type for a particular field is marked with "-" (i.e. SI-E). Also, when an entire field is not allowed in a node the entire cell is marked as "-".

Table 6.3.2.1 illustrates the basic structure of the supported fields in the Charging Data Request message for IMS offline charging.

**Table 6.3.2.1: Supported fields in *Charging Data Request* Message**

Field	Node Type	S-CSCF	E-CSCF	P-CSCF	I-CSCF	MRFC	MGCF	BGCF	AS	IBCF	TF	TRF	ATCF
Supported Operation Types	S/I/S/E	S/I/S/E	S/I/S/E	S/I/S/E	E	S/I/S	S/I/S/E	E	S/I/S/E	S/I/S/E	S/I/S/E	S/I/S/E	S/I/S/E
Session Identifier	SISE	SISE	SISE	SISE	E	SIS	SISE	E	SISE	SISE	SISE	SISE	SISE
Originator Node	SISE	SISE	SISE	SISE	E	SIS	SISE	E	SISE	SISE	SISE	SISE	SISE
Originator Domain	SISE	SISE	SISE	SISE	E	SIS	SISE	E	SISE	SISE	SISE	SISE	SISE
Destination Domain	SISE	SISE	SISE	SISE	E	SIS	SISE	E	SISE	SISE	SISE	SISE	SISE
Operation Type	SISE	SISE	SISE	SISE	E	SIS	SISE	E	SISE	SISE	SISE	SISE	SISE
Operation Number	SISE	SISE	SISE	SISE	E	SIS	SISE	E	SISE	SISE	SISE	SISE	SISE
Operation Identifier	SISE	SISE	SISE	SISE	E	SIS	SISE	E	SISE	SISE	SISE	SISE	SISE
User Name (see note 1)	SISE	-	SISE	-	-	-	-	-	SISE	-	-	-	SISE
Destination Host	SISE	SISE	SISE	SISE	E	SIS	SISE	E	SISE	SISE	SISE	SISE	SISE
Operation Interval	SISE	SISE	SISE	SISE	E	SIS	SISE	E	SISE	SISE	SISE	SISE	SISE
Origination State	SISE	SISE	SISE	SISE	E	SIS	SISE	E	SISE	SISE	SISE	SISE	SISE
Origination Timestamp	SISE	SISE	SISE	SISE	E	SIS	SISE	E	SISE	SISE	SISE	SISE	SISE
Proxy Information	SISE	SISE	SISE	SISE	E	SIS	SISE	E	SISE	SISE	SISE	SISE	SISE
Route Information	SISE	SISE	SISE	SISE	E	SIS	SISE	E	SISE	SISE	SISE	SISE	SISE
Operation Token	SISE	SISE	SISE	SISE	E	SIS	SISE	E	SISE	SISE	SISE	SISE	SISE
Subscriber Identifier	SISE	SISE	SISE	SISE	-	SIS	-	-	SISE	-	-	SISE	SISE
<b>Service Information with PS and IMS Information</b>													
Event Type	SISE	SISE	SISE	SISE	E	SIS	SISE	E	SISE	SISE	SISE	SISE	SISE
Role of Node	SISE	SISE	SISE	SISE	E	---	SISE	E	SISE	SISE	SISE	SISE	SISE
Node Functionality	SISE	SISE	SISE	SISE	E	SIS	SISE	E	SISE	SISE	SISE	SISE	SISE
User Session Id	SISE	SISE	SISE	SISE	E	SIS	SISE	E	SISE	SISE	SISE	SISE	SISE
Outgoing Session ID	-	-	-	-	-	-	-	-	SISE	-	-	-	-
Session Priority	S--E	S--E	S--E	S--E	E	S--	S--E	E	S--E	S--E	S--E	S--E	S--E
Calling Party Address	SISE	SISE	SISE	SISE	E	SIS	SISE	E	SISE	SISE	SISE	SISE	SISE
Called Party Address	SISE	SISE	SISE	SISE	E	SIS	SISE	E	SISE	SISE	SISE	SISE	SISE
Number Portability routing information	S--E	-	-	-	E	-	S--E	E	S--E	-	S--E	S--E	-
Carrier Select routing information	S--E	-	-	-	E	-	S--E	E	S--E	-	S--E	S--E	-
Alternate Charged Party Address	-	-	-	-	-	-	-	-	S---	-	-	-	-
Requested Party Address	S--E	S--E	-	-	-	S--	-	-	SISE	-	S--E	S--E	SISE
Called Asserted Identity	S--E	S--E	S--E	S--E	-	S--	-	-	S--E	-	S--E	S--E	S--E
Associated URI (see note 5)	---E	-	-	---E	E	-	-	-	-	---E	-	-	-
Time stamps (see note 3)	SISE	SISE	SISE	SISE	E	SIS	SISE	E	SISE	SISE	SISE	SISE	SISE



Application server Information (see note 1)	SISE	SISE	-	-	SIS	-	-	-	-	SISE	SISE	-
Inter Operator Identifiers (see note 1)	SISE	SISE	SISE	E	SIS	SISE	E	SISE	SISE	SISE	SISE	SISE
Transit IOI List (see note 1)	SISE	-	SISE	-	SIS	SISE	E	SISE	SISE	SISE	SISE	-
IMS Charging Identifier	SISE	SISE	SISE	E	SIS	SISE	E	SISE	SISE	SISE	SISE	SISE
Related IMS Charging Identifier	-	-	SISE	-	-	-	-	-	-	-	-	-
Related IMS Charging Identifier Generation Node	-	-	SISE	-	-	-	-	-	-	-	-	-
Early Media Description (see note 4)	S--E	S--E	S--E	-	S--	S--E	-	S--E	S--E	S--E	S--E	S--E
SDP Session Description	SI- E	SI- E	SI- E	-	SI- E	SI- E	-	SI- E	SI- E	SI- E	SI- E	SI- E
SDP Media Component (see note 4)	SI- E	SI- E	SI- E	-	SI- E	SI- E	-	SI- E	SI- E	SI- E	SI- E	SI- E
GGSN Address	SI--	SI--	SI--	-	SI--	SI--	-	SI--	-	-	-	SI--
User Location Info	SISE	SISE	SISE	E	SIS	-	-	SISE	SISE	-	SISE	SISE
MS Time Zone	SISE	SISE	SISE	E	SIS	-	-	SISE	SISE	-	SISE	SISE
Served Party (see note 1)	-	-	SISE	-	-	-	-	-	-	-	-	-
Server Capabilities (see note 1)	-	-	-	E	-	-	-	-	-	-	-	-
Trunk Group ID (see note 1)	-	-	-	-	-	SISE	-	-	-	-	-	-
Bearer Service (see note 1)	-	-	-	-	-	SISE	-	-	-	-	-	-
Service Id (see note 1)	-	-	-	-	SIS	-	-	-	-	-	-	-
Service Specific Info (see note 1)	-	-	-	-	-	-	-	SISE	-	-	-	-
Message Bodies (see note 2)	SISE	SISE	SISE	-	-	SISE	-	SISE	SISE	SISE	SISE	SISE
Cause Code	--SE	--SE	--SE	E	--S	--SE	E	--SE	--SE	--SE	--SE	--SE
Access Network Information	SISE	SISE	SISE	E	SIS	SISE	E	SISE	SISE	-	-	SISE
IMS Communication Service ID	S--E	S--E	S--E	-	-	-	-	S--E	S--E	S--E	S--E	S--E
IMS Application Reference ID	-	-	S--E	-	-	-	-	-	-	-	-	-
Real Time Tariff Information	SI-E	-	-	-	-	SI-E	-	SI-E	SI-E	-	-	-
Initial IMS Charging Identifier	-	-	-	-	-	-	-	SISE	-	-	-	SISE
NNI Information	S--E	-	S--E	-	-	-	-	E	S--E	S--E	S--E	-
From Address	SISE	SISE	SISE	E	SIS	SISE	E	SISE	SISE	SISE	-	SISE
Access Transfer Information	-	-	-	-	-	-	-	-ISE	-	-	-	-ISE
IMS Emergency Indication	SISE	-	SISE	E	-	-	-	-	-	-	-	-

IMS Visited Network Identifier (see note 1)	SISE	-	SISE	-	-	-	-	SISE	-	-	-	-
Route Header Received	S--E	-	S--E	E	-	-	-	-	S--E	S--E	S--E	S--E
Route Header Transmitted	S--E	-	S--E	E	-	-	-	-	-	S--E	-	S--E
TAD Identifier	-	-	-	-	-	-	-	S---	-	-	-	-

NOTE 1: Only present if available in the CTF of the IMS node.  
 NOTE 2: Present only if Messages Bodies is included in the SIP message that triggered the Charging Data Request.  
 NOTE 3: Only present if ACR is triggered on a SIP message (e.g. SIP INVITE, SIP UPDATE).  
 NOTE 4: To be determined for presence in IBCF.  
 NOTE 5: Only present if ACR is triggered on SIP REGISTER 200 OK.

Table 6.3.2.2 illustrates the basic structure of the supported fields in the Charging Data Response message for IMS offline charging.

**Table 6.3.2.2: Supported fields in Charging Data Response Message**

Field	Node Type	S-CSCF	E-CSCF	P-CSCF	I-CSCF	MRFC	MGCF	BGCF	AS	IBCF	TRF	ATCF
	Supported Operation Types	S/I/S/E	S/I/S/E	S/I/S/E	E	S/I/S	S/I/S/E	E	S/I/S/E	S/I/S/E	S/I/S/E	S/I/S/E
Session Identifier		SISE	SISE	SISE	E	SIS	SISE	E	SISE	SISE	SISE	SISE
Originator Node		SISE	SISE	SISE	E	SIS	SISE	E	SISE	SISE	SISE	SISE
Originator Domain		SISE	SISE	SISE	E	SIS	SISE	E	SISE	SISE	SISE	SISE
Destination Domain		SISE	SISE	SISE	E	SIS	SISE	E	SISE	SISE	SISE	SISE
Operation Type		SISE	SISE	SISE	E	SIS	SISE	E	SISE	SISE	SISE	SISE
Operation Number		SISE	SISE	SISE	E	SIS	SISE	E	SISE	SISE	SISE	SISE
Operation Identifier		SISE	SISE	SISE	E	SIS	SISE	E	SISE	SISE	SISE	SISE
User Name		SISE	SISE	SISE	E	SIS	SISE	E	SISE	SISE	SISE	SISE
Operation Interval		SISE	SISE	SISE	E	SIS	SISE	E	SISE	SISE	SISE	SISE
Origination State		SISE	SISE	SISE	E	SIS	SISE	E	SISE	SISE	SISE	SISE
Origination Timestamp		SISE	SISE	SISE	E	SIS	SISE	E	SISE	SISE	SISE	SISE
Proxy Information		SISE	SISE	SISE	E	SIS	SISE	E	SISE	SISE	SISE	SISE
Route Information		SISE	SISE	SISE	E	SIS	SISE	E	SISE	SISE	SISE	SISE

### 6.3.3 Detailed Message Format for online charging

The following table specifies per Operation type the charging data that are sent by each of the IMS network elements for:

- IMS session and IMS event (I/U/T/E)
  - IMS-GWF, AS
- IMS session only (I/U/T)
  - MRFC

The Operation types are listed in the following order: I (initial)/U (update)/T (terminate)/E (event). Therefore, when all Operation types are possible it is marked as IUTE. If only some Operation types are allowed for a node, only the appropriate letters are used (i.e. IUT or E) as indicated in the table heading. The omission of an Operation type for a particular field is marked with "-" (i.e. IU-E). Also, when an entire field is not allowed in a node the entire cell is marked as "-".

Note that not for all structured fields the individual field members are listed in the table. Detailed descriptions of the fields are provided in TS 32.299 [50].

Table 6.3.3.1 illustrates the basic structure of the supported fields in the Debit and Reserve Units Request for IMS online charging.

**Table 6.3.3.1: Supported fields in *Debit and Reserve Units Request* Message**

Field	Node Type	IMS-GWF	MRFC	AS
	Supported Operation Types	I/U/T/E	I/U/T	I/U/T/E
Session Identifier		IUTE	IUT	IUTE
Originator Host		IUTE	IUT	IUTE
Originator Domain		IUTE	IUT	IUTE
Destination Domain		IUTE	IUT	IUTE
Operation Identifier		IUTE	IUT	IUTE
Operation Token		IUTE	IUT	IUTE
Operation Type		IUTE	IUT	IUTE
Operation Number		IUTE	IUT	IUTE
Destination Host		IUTE	IUT	IUTE
User Name		IUTE	-	IUTE
Origination State		IUTE	IUT	IUTE
Origination Timestamp		IUTE	IUT	IUTE
Subscriber Identifier		IUTE	IUT	IUTE
Termination Cause		-T-	-T	-T-
Requested Action		---E	-	---E
Multiple Operation		IUTE	IUT	IUTE
Multiple Unit Operation		IUTE	IUT	IUTE
Service Units Requested		IU-E	IU-	IU-E
Service Units Used		-UT-	-UT	-UT-
Subscriber Equipment Number		IUTE	IUT	IUTE
Proxy Information		IUTE	IUT	IUTE
Route Information		IUTE	IUT	IUTE
Extended Information		IUTE	IUT	IUTE
<b>Service Information with PS and IMS Information</b>				
Event Type		IUTE	IUT	IUTE
Role Of Node		IUTE	---	IUTE
Node Functionality		IUTE	IUT	IUTE
User Session Id		IUTE	IUT	IUTE
Outgoing Session ID		-	-	IUTE
Session Priority		I-E	I--	I--E
Calling Party Address		IUTE	IUT	IUTE
Called Party Address		IUTE	IUT	IUTE
Number Portability routing information		I-E	-	I-E
Carrier Select routing information		I-E	-	I-E
Requested Party Address		I-E	I--	I--E
Called Asserted Identity		-U-E	-U-	-U-E
Associated URI		---E	-	-
Application Server Information		IUTE	IUT	-
Inter Operator Identifier		IUTE	IUT	IUTE
Transit IOI List		IUTE	IUT	IUTE
IMS Charging Identifier		IUTE	IUT	IUTE
SDP Session Description		IU--	IU-	IU--
SDP Media Component		IU--	IU-	IU--
GGSN Address		IU--	IU-	IU--
User Location Info		IUTE	IUT	IUTE
MS Time Zone		IUTE	IUT	IUTE
Served Party		-	-	-
Server Capabilities		-	-	-
Trunk Group ID		-	-	-
Bearer Service		-	-	-
Service Id		-	IUT	-
Service Specific Info		-	-	-
Messages Bodies		IUTE	-	IUTE
Cause Code		--TE	--T	--TE
Access Network Information		IUTE	IUT	IUTE
IMS Communication Service ID		I-E	-	I-E
Tariff Information		-U--	-	-U--
Initial IMS Charging Identifier		-	-	IUTE
From Address		IUTE	IUT	IUTE
IMS Emergency Indication		-	-	-
IMS Visited Network Identification		IUTE	-	IUTE
Route Header Received		-	-	-

Route Header Transmitted	-	-	-
--------------------------	---	---	---

Table 6.3.3.2 illustrates the basic structure of the supported fields in the Debit and Reserve Units Response for IMS online charging.

**Table 6.3.3.2: Supported fields in *Debit and Reserve Units Response* Message**

Field	Node Type	IMS-GWF	MRFC	AS
	Supported Operation Types	I/U/T/E	I/U/T	I/U/T/E
Session Identifier		IUTE	IUT	IUTE
Operation Result		IUTE	IUT	IUTE
Originator Host		IUTE	IUT	IUTE
Originator Domain		IUTE	IUT	IUTE
Operation Identifier		IUTE	IUT	IUTE
Operation Type		IUTE	IUT	IUTE
Operation Number		IUTE	IUT	IUTE
Operation Failover		IUTE	IUT	IUTE
Multiple Unit Operation		IUTE	IUT	IUTE
Operation Failure Action		-	-	-
Redirection Host		-	-	-
Redirection Host Usage		-	-	-
Redirection Cache Time		-	-	-
Proxy Information		-	-	-
Route Information		-	-	-
Failed parameter		-	-	-
Extended Information		IUTE	IUT	IUTE
<b>Service Information with IMS Information</b>				
Account Expiration		-	-	IUTE

## 6.3.4 Formal IMS charging parameter description

### 6.3.4.1 IMS charging information for CDRs

The detailed definitions, abstract syntax and encoding of the IMS CDR parameters are specified in TS 32.298 [51].

### 6.3.4.2 IMS charging information for charging events

The detailed charging event parameter definitions are specified in 3GPP TS 32.299 [50].

---

## Annex A (informative): Bibliography

### a) **The 3GPP charging specifications**

- 3GPP TS 32.252: "Telecommunication management; Charging management; Wireless Local Area Network (WLAN) charging".
- 3GPP TS 32.270: "Telecommunication management; Charging management; Multimedia Messaging Service (MMS) charging".
- 3GPP TS 32.271: "Telecommunication management; Charging management; Location Services (LCS) charging".
- 3GPP TS 32.296: "Telecommunication management; Charging management; Online Charging System (OCS) applications and interfaces".

### b) **Common 3GPP specifications**

- 3GPP TS 22.101: "Service aspects; Service Principles".
- 3GPP TS 22.115 "Service aspects; Charging and Billing".
- 3GPP TS 23.003: "Numbering, addressing and identification".
- 3GPP TS 27.001: "General on Terminal Adaptation Functions (TAF) for Mobile Stations (MS)".

### c) **other Domain and Service specific 3GPP / ETSI specifications**

-

### d) **Relevant ITU Recommendations**

- ITU-T Recommendation D.93: "Charging and accounting in the international land mobile telephone service (provided via cellular radio systems)".
- ITU-T Recommendation E.164: "The international public telecommunication numbering plan".
- ITU-T Recommendation Q.767: "Application of the ISDN user part of CCITT signalling System No.7 for international ISDN interconnections".
- ITU-T Recommendation X.25: "Interface between Data Terminal Equipment (DTE) and Data Circuit-terminating Equipment (DCE) for terminals operating in the packet mode and connected to public data networks by dedicated circuit".
- ITU-T Recommendation X.121: "International numbering plan for public data networks".

### e) **Relevant IETF RFCs**

- IETF RFC 959 (1985): "File Transfer Protocol".

# Annex B (informative): Message Flows for Service Termination by OCS

This annex describes several scenarios related to IMS service termination in IMS-GWF.

SIP messages and Diameter transactions associated with these charging scenarios are shown primarily to illustrate the service termination procedures. They are not intended to be exhaustive and depend on the Diameter Credit Control Requests triggers configured by the operator. The triggers for sending Debit and Reserve Unit Requests from the IMS-GWF to the OCS are defined according to table 5.3.1.

## B.1 Scenario 1 - Session Related (SCUR): Service Termination on reception of an initial SIP INVITE Request

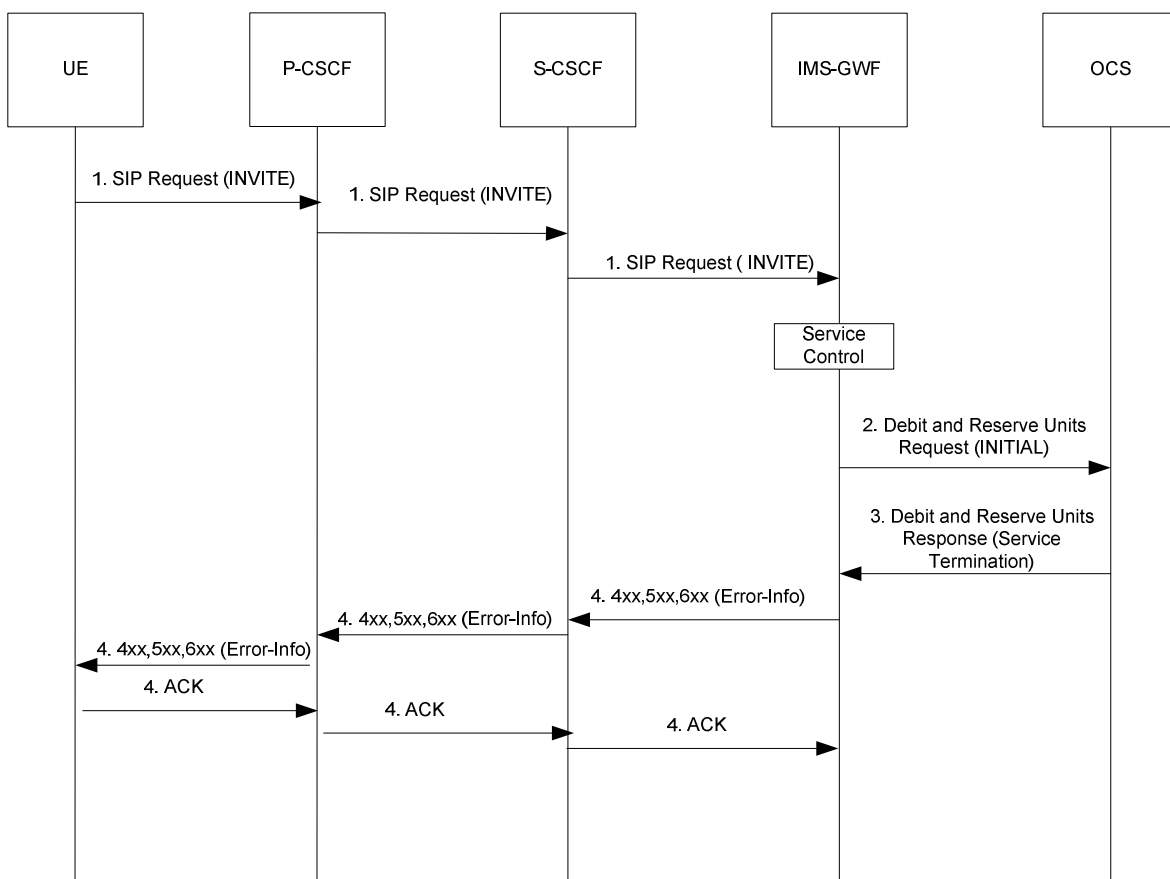

Figure B.1.1 : Service Termination triggered by an initial SIP Request

## B.2 Scenario 2 - Session Related (SCUR): Service Termination triggered after an early SIP Dialog is established

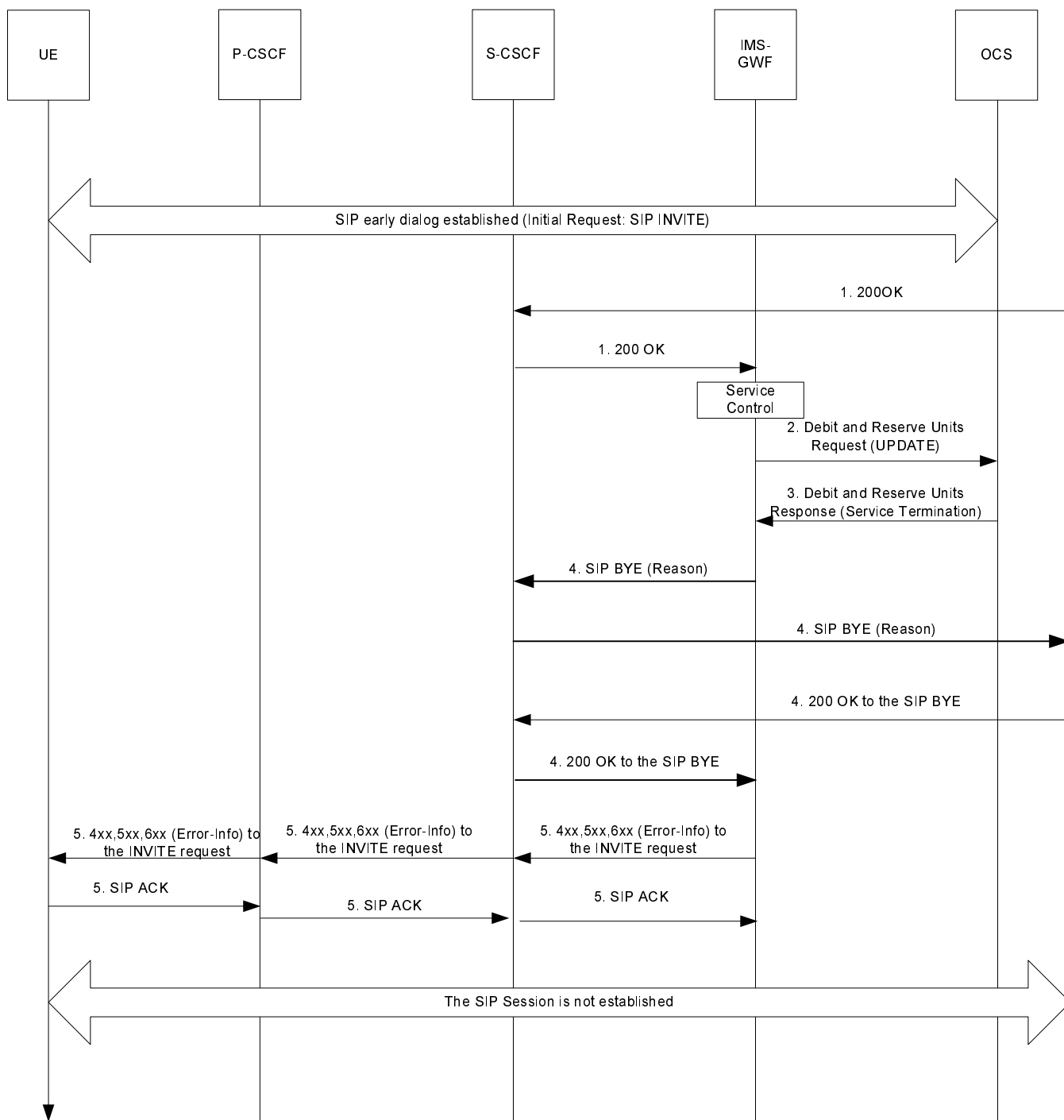

Figure B.2.1: Service Termination triggered by the 200OK response to the initial INVITE



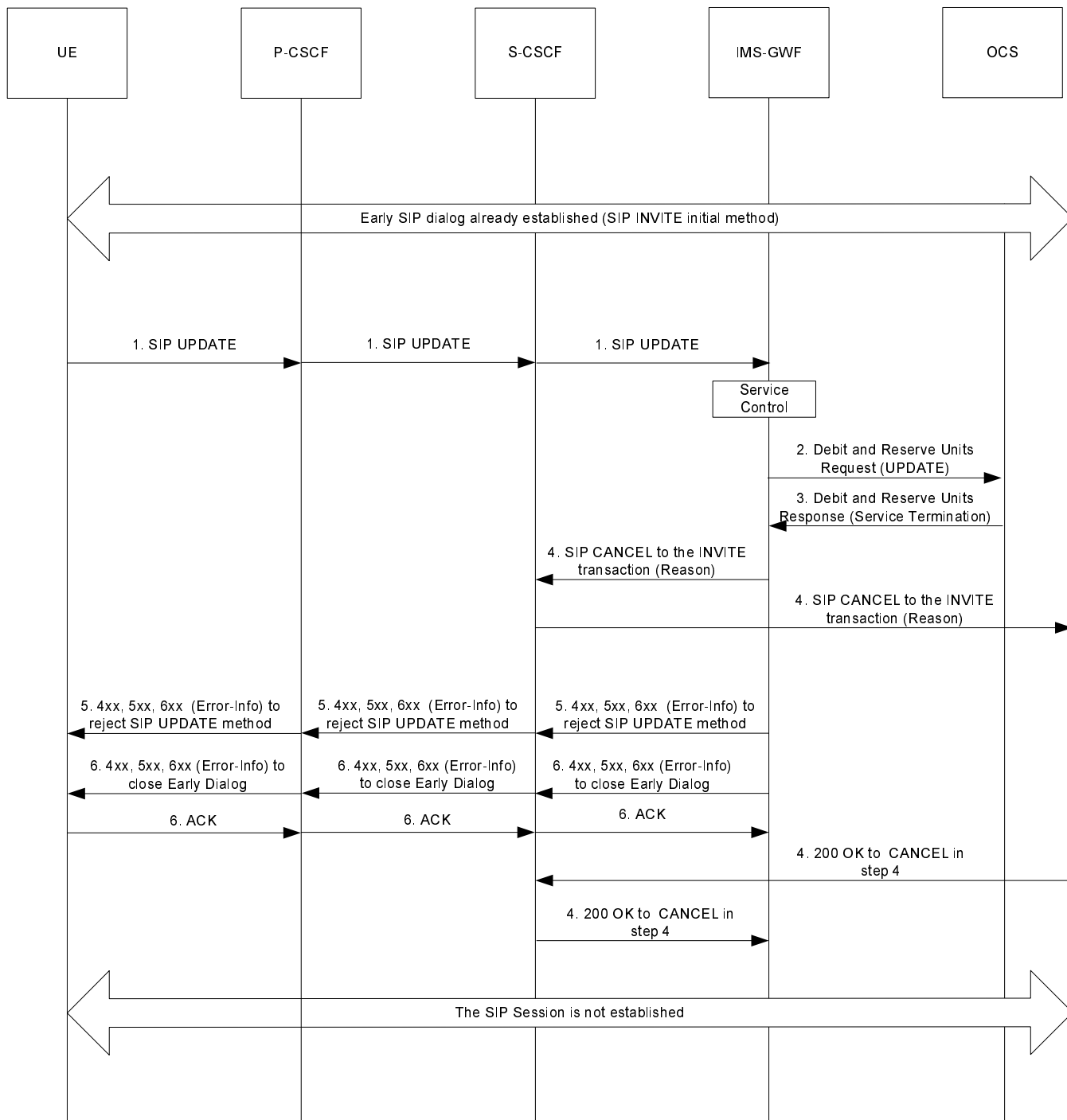

Figure B.2.2 : Service Termination triggered by an UPDATE request within an early SIP dialog

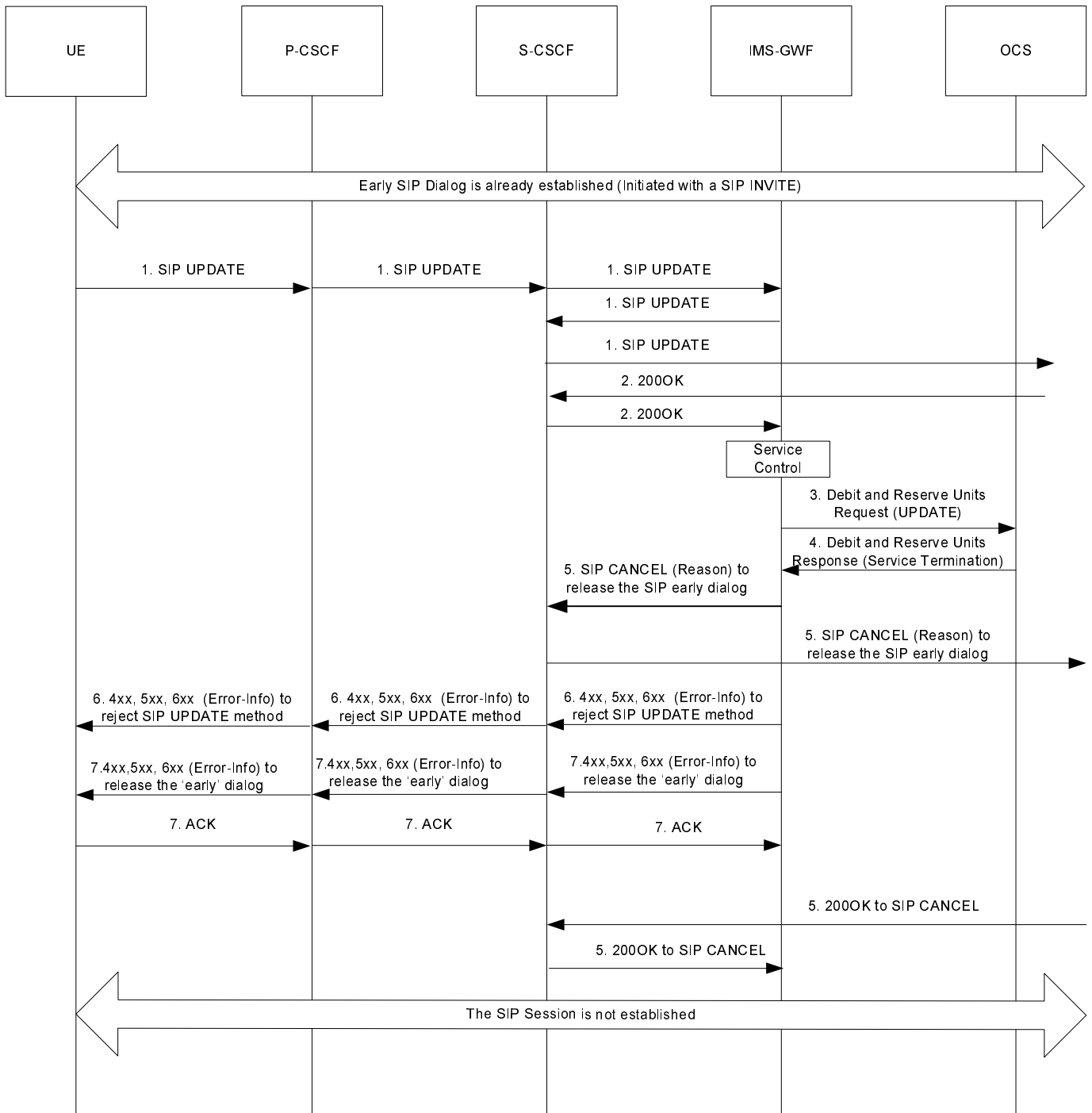

Figure B.2.3 : Service Termination triggered by the 200OK to an UPDATE request within an early SIP dialog

### B.3 Scenario 3 - Session Related (SCUR): Service Termination triggered after a confirmed SIP Dialog is established

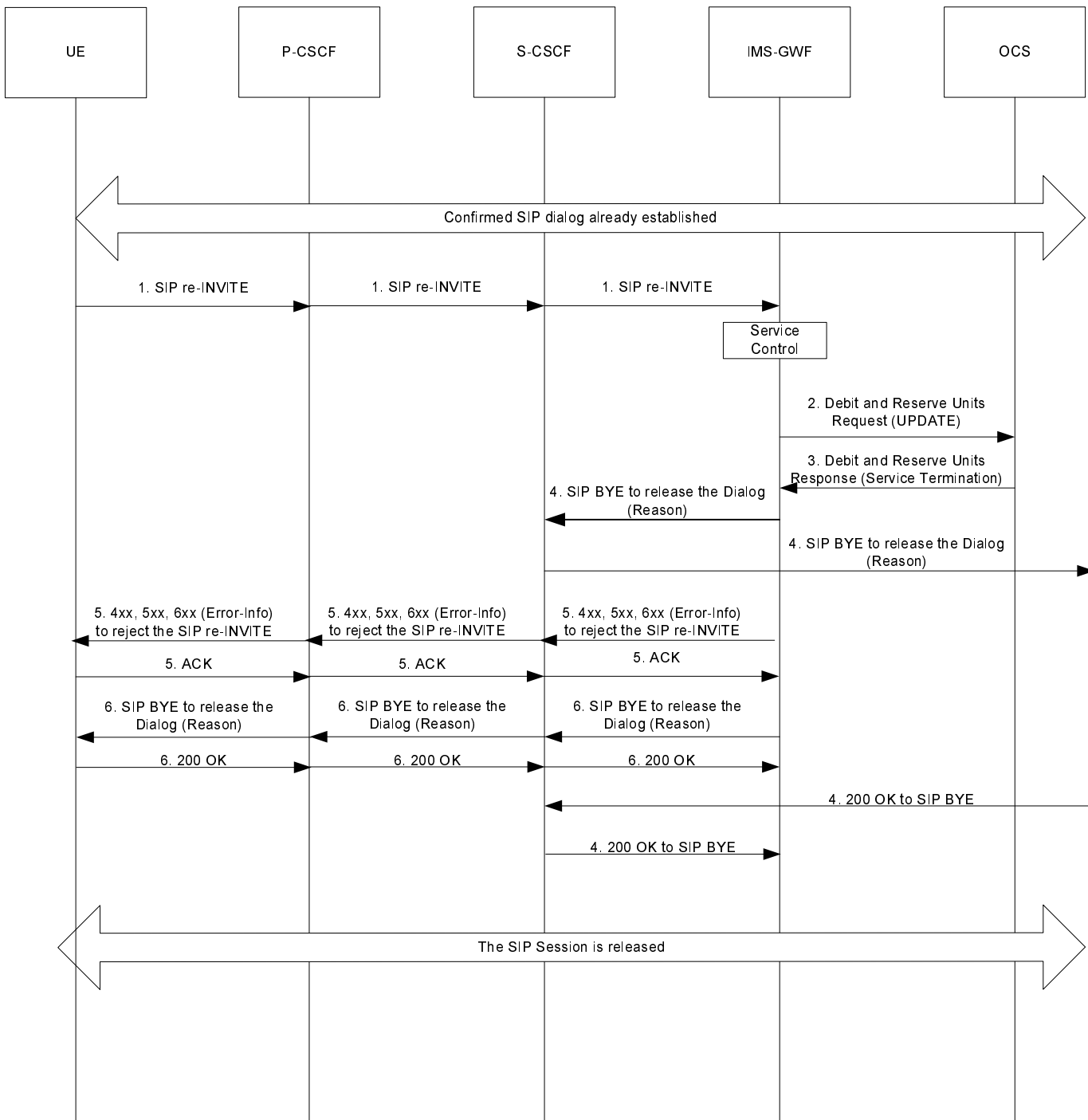

Figure B.3.1 : Service Termination triggered by a re-INVITE request within a confirmed SIP dialog

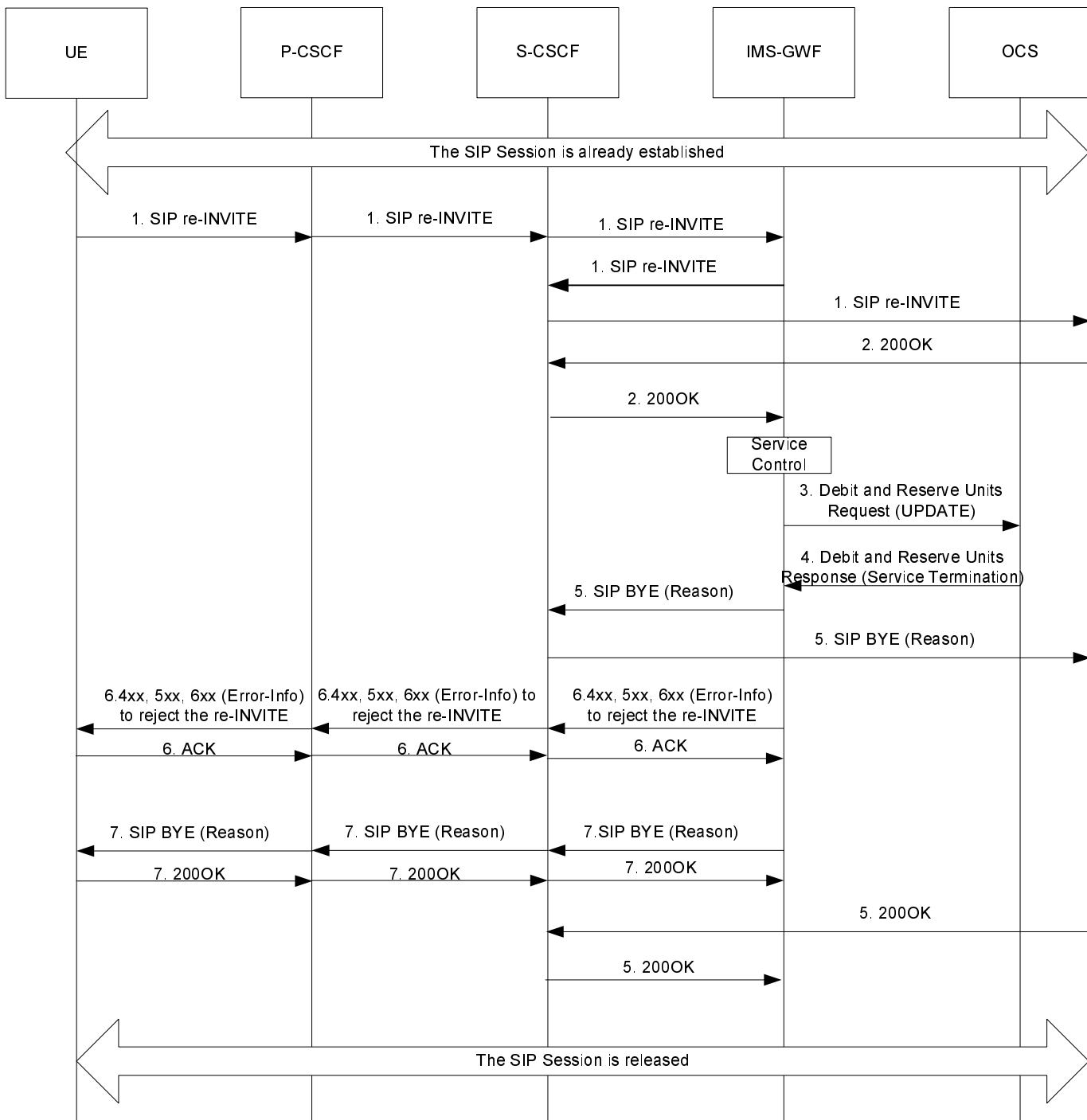
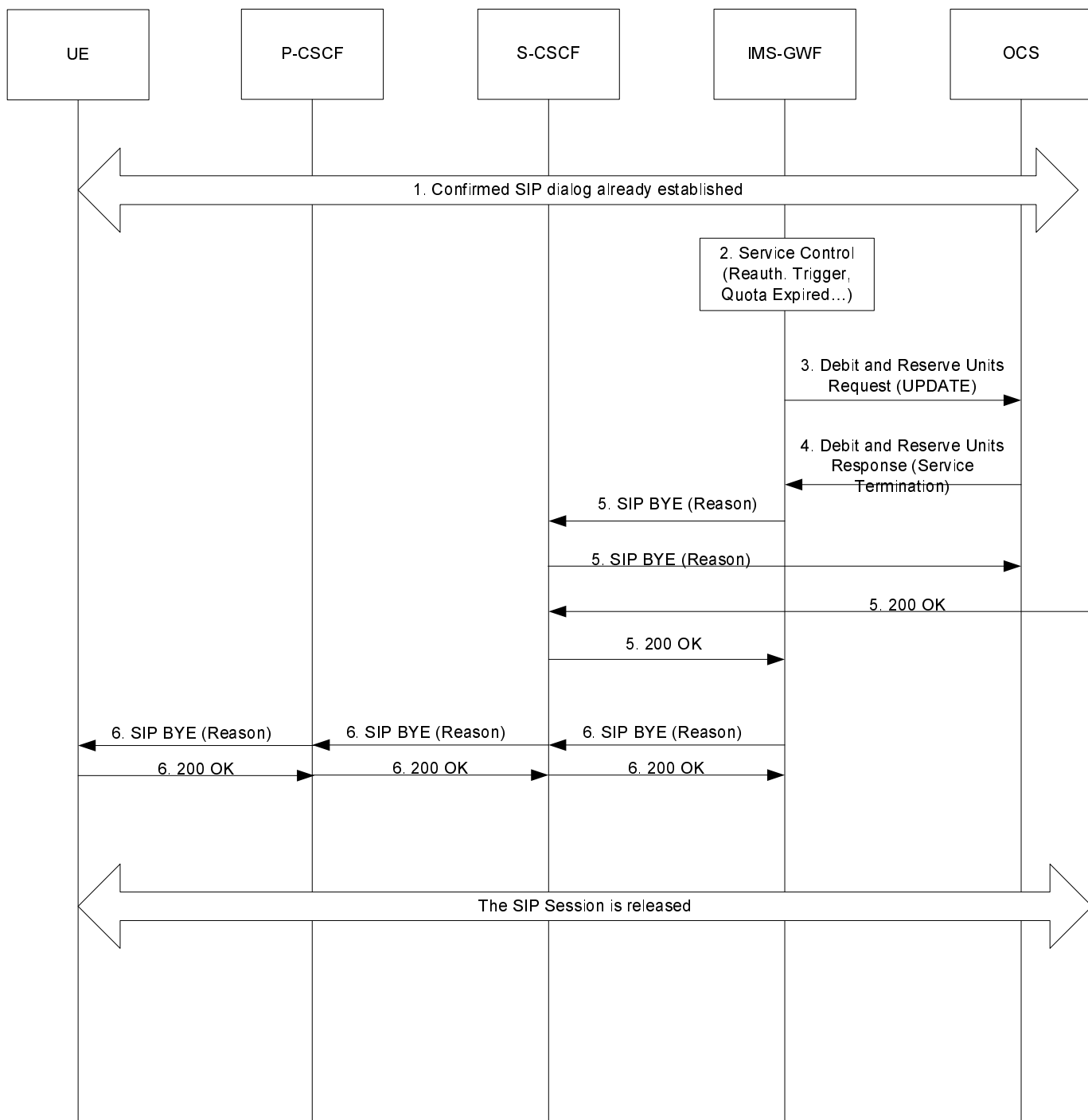

Figure B.3.2: Service Termination triggered by the 200OK response to a re-INVITE request within a confirmed SIP dialog



**Figure B.3.3 : Service Termination triggered by the Charging Application procedures as defined in TS 32.299 [50] within a confirmed SIP dialog**

### B.4 Scenario 4 - Session Unrelated (ECUR): Service Termination on reception of an initial SIP non-INVITE Request

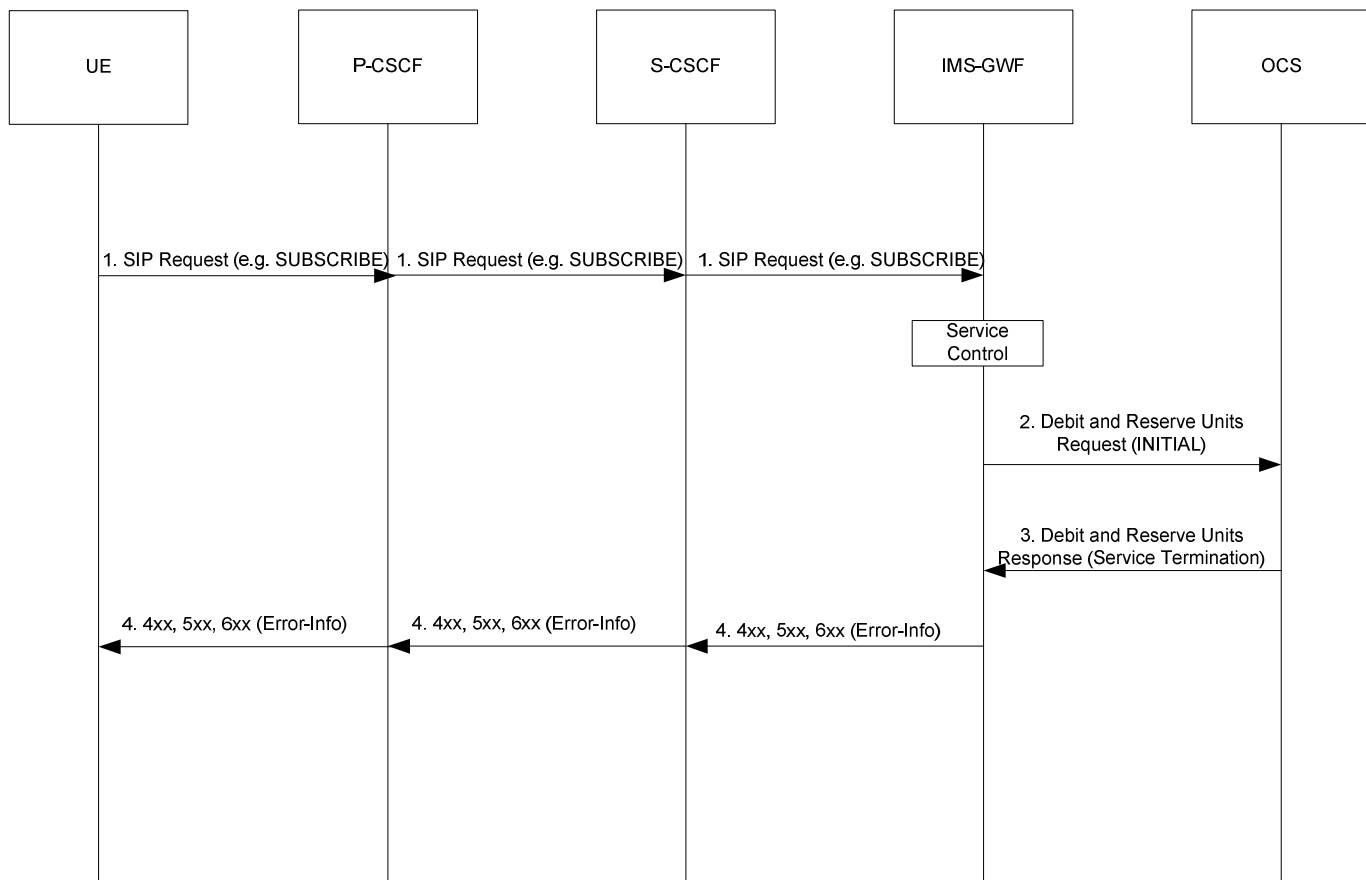

Figure B.4.1 : Service Termination triggered by the reception of a non-INVITE SIP request

### B.5 Scenario 5 - Session Unrelated (IEC): Service Termination on reception of an initial SIP non-INVITE Request

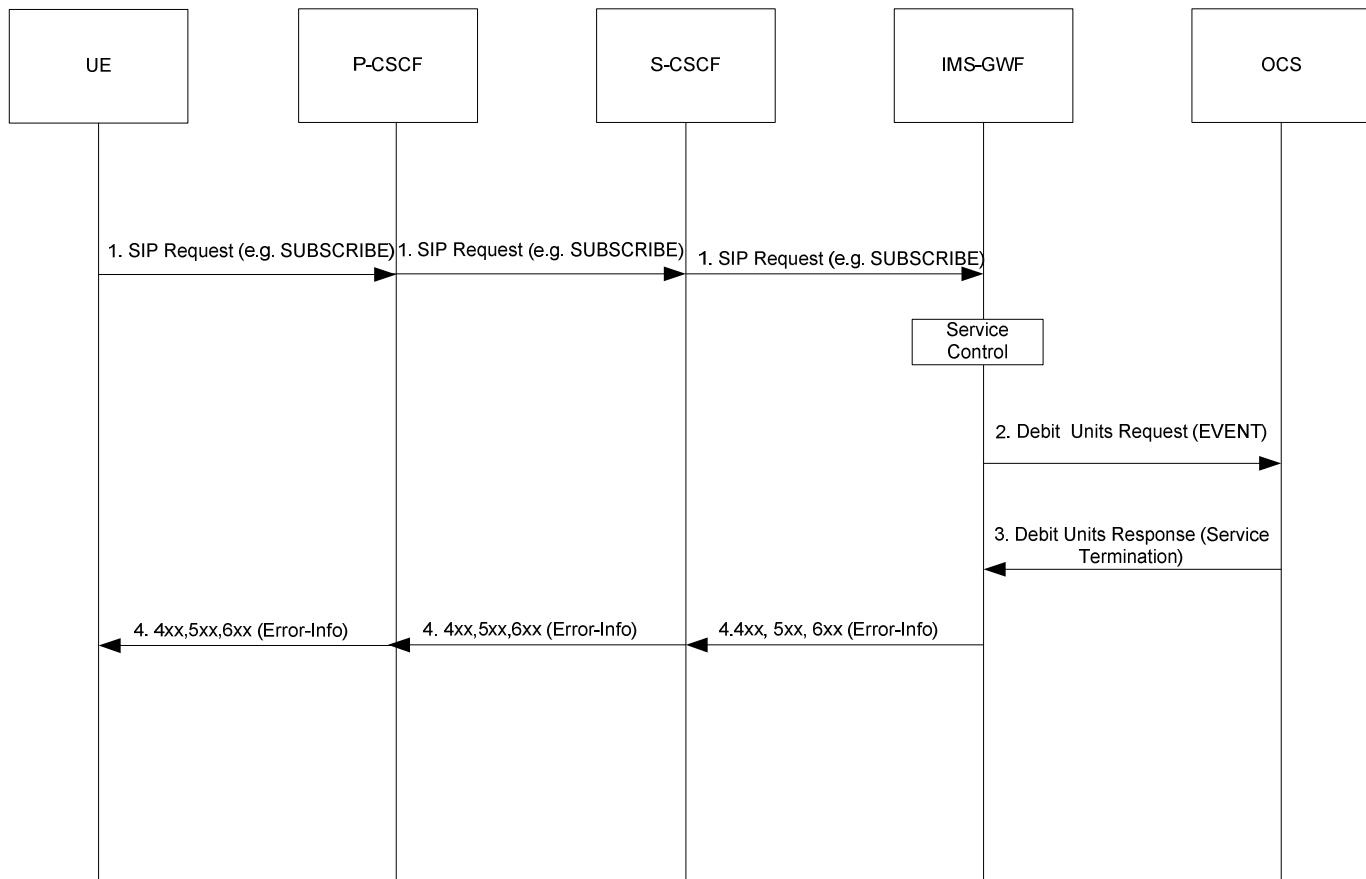

Figure B.5.1 : Service Termination triggered by the reception of a non-INVITE SIP request

## Annex C (informative): Change history



Change history							
Date	TSG #	TSG Doc.	CR	Rev	Subject/Comment	Old	New
Jun 2007	SP-36	SP-070292	0051	--	Clarification of unsuccessful re-INVITE and UPDATE	7.3.0	8.0.0
Sep 2007	SP-37	SP-070674	0053	--	Add IMS Communication Service Identification (ICSI) in Charging information	8.0.0	8.1.0
Dec 2007	SP-38	SP-070745	0054	--	Correct Private User ID - Align with 32.299 Diameter charging applications	8.1.0	8.2.0
Mar 2008	SP-39	SP-080059	0055	1	Add IBCF into stage 2 flows and data descriptions for IMS Charging - Align with 23.002, 23.228	8.2.0	8.3.0
Mar 2008	SP-39	SP-080074	0056	--	Add on Number Portability and Carrier Select routing information	8.2.0	8.3.0
Jun 2008	SP-40	SP-080271	0058	--	Correction on supported fields in the Charging Operations	8.3.0	8.4.0
Sep 2008	SP-41	SP-081214	0059	--	Correction on Number Portability and Carrier Select Routing Information	8.4.0	8.5.0
Sep 2008	SP-41	SP-081287	0060	--	Charging management for IMS service continuity	8.4.0	8.5.0
Dec 2008	SP-42	SP-080706	0063	-	Charging management for IMS service continuity	8.5.0	8.6.0
Dec 2008	SP-42	SP-080841	0062	-	Correction on Multiple Unit Operation category	8.5.0	8.6.0
Dec 2008	SP-42	SP-080706	0064	-	Clarification of the online charging in TS 32.260	8.5.0	8.6.0
Dec 2008	SP-42	SP-080707	0065	-	Reference to MMTel services	8.5.0	8.6.0
Dec 2008	SP-42	SP-080706	0066	-	Addition of the AS in the message flows for online charging scenarios	8.5.0	8.6.0
Dec 2008	SP-42	SP-080706	0067	-	Addition of SDP offer and answer and clarification on media initiator	8.5.0	8.6.0
Jun 2009	SP-44	SP-090432	0068	-	Correction of SIP request/response timestamps category	8.6.0	8.7.0
Sep 2009	SP-45	SP-090536	0073	-	Correction of number portability and carrier select information	9.0.0	9.1.0
Sep 2009	SP-45	SP-090538	0074	-	Add field in CDR contents for RTTI support in IMS offline charging	9.0.0	9.1.0
Sep 2009	SP-45	SP-090538	0075	-	Add ACR triggers for the support of RTTI	9.0.0	9.1.0
Dec 2009	SP-46	SP-090722	0076	-	Support of RTTI in IMS online charging	9.1.0	9.2.0
Dec 2009	SP-46	SP-090720	0078	-	Correction on priority session treatment – alignment with TS 22.153	9.1.0	9.2.0
Dec 2009	SP-46	SP-090721	0079	-	Modification on SDP handling in IMS charging	9.1.0	9.2.0
Dec 2009	SP-46	SP-090721	0080	-	Account expiration information from OCS to IMS Application Servers	9.1.0	9.2.0
Dec 2009	SP-46	SP-090722	0081	-	Addition of ACR triggering SIP method and correction	9.1.0	9.2.0
Mar 2010	SP-47	SP-100039	0083	-	Correction on MRFC Charging Data Record - Alignment with TS 32.298	9.2.0	9.3.0
Mar 2010	SP-47	SP-100040	0086	-	Correction of Role of Node charging parameter description	9.2.0	9.3.0
Mar 2010	SP-47	SP-100040	0088	-	Correction of THIG functionality entity alignment with TS 24.229	9.2.0	9.3.0
Mar 2010	SP-47	SP-100040	0090	-	Data integrity of charging information forwarded to charging domain	9.2.0	9.3.0
Mar 2010	SP-47	SP-100041	0091	-	Correction on Session Id for AS acting as B2BUA	9.2.0	9.3.0
Mar 2010	SP-47	SP-100041	0092	-	Correction on SDP handling in IMS Charging	9.2.0	9.3.0
Mar 2010	SP-47	SP-100044	0093	-	Add message flow for support of RTTI in SIP INFO	9.2.0	9.3.0
Jun 2010	SP-48	SP-100265	0095	-	Correction of trigger conditions	9.3.0	9.4.0
Jun 2010	SP-48	SP-100265	0097	-	Alignment for "Inter Operator Identification" description setting for IMS Centralised service with TS 24.292	9.3.0	9.4.0
Jun 2010	SP-48	SP-100266	0099	-	Charging information for Emergency IMS Sessions	9.3.0	10.0.0
Oct 2010	SP-49	SP-100497	0101	-	Correction on Accounting Request message triggering enablement	10.0.0	10.1.0
Oct 2010	SP-49	SP-100497	0103	-	Clarification on Associated-URI during Registration	10.0.0	10.1.0
Oct 2010	SP-49	SP-100497	0105	-	Alignments on Charging Principles	10.0.0	10.1.0
Oct 2010	SP-49	SP-100498	0106	-	Change of title format	10.0.0	10.1.0
Oct 2010	SP-49	SP-100498	0107	-	Correction on Triggering of unsuccessful SIP session	10.0.0	10.1.0
Dec 2010	SP-50	SP-100757	0114	--	Correction of Operation Interval in the Charging Data Request and Response messages - Align with IETF RFC 3588	10.1.0	10.2.0
Dec 2010	SP-50	SP-100758	0110	2	Add missing timestamp granularity	10.1.0	10.2.0
Dec 2010	SP-50	SP-100759	0108	1	Replace the Authorized-QoS AVP name with Authorised-QoS AVP	10.1.0	10.2.0
Dec 2010	SP-50	SP-100759	0111	2	Replace the non-existing "MRFC" by "MRFC" (Media Resource Function Controller) in Figure 4.3: IMS online charging Architecture	10.1.0	10.2.0
Mar 2011	SP-51	SP-110108	0119	1	Correction on availability of Called Asserted Identity	10.2.0	10.3.0
Mar 2011	SP-51	SP-110109	0115	2	Correction on ICSI availability - Align with SA2 TS 23.228	10.2.0	10.3.0
Mar 2011	SP-51	SP-110109	0116	1	Addition of IARI in IMS Offline charging information, alignment with TS 22.115 and TS 23.228	10.2.0	10.3.0
May 2011	SP-52	SP-110281	0122	1	Correction on Access-Correlation-ID field	10.3.0	10.4.0
May 2011	SP-52	SP-110404	0123	1	Correction on supported fields in IBCF - Alignment with TS 32.298	10.3.0	10.4.0
May 2011	SP-52	SP-110294	0124	1	Introduction of OMR procedures in IMS Charging	10.3.0	10.4.0
May 2011	SP-52	SP-110294	0125	1	Introduction of transcoding related OMR procedures in IMS Charging	10.3.0	10.4.0
May 2011	SP-52	SP-110294	0126	1	CDRs enhancement for OMR Charging introduction	10.3.0	10.4.0
May 2011	SP-52	SP-110280	0128	1	Correction in SCC AS CDR for IMS service continuity	10.3.0	10.4.0
May 2011	SP-52	SP-110281	0131	1	Correction on IMS Application Reference Identifier (IARI) in IMS Charging	10.3.0	10.4.0

May 2011	SP-52	SP-110283	0120	1	Add Transit Inter Operator Identifier for IMS Interconnection Charging	10.4.0	11.0.0
Sep 2011	SP-53	SP-110529	0134	-	Correction for emergency IMS session service continuity	11.0.0	11.1.0
Dec 2011	SP-54	SP-110711	0137	2	Addition of Served User in IMS charging information	11.1.0	11.2.0
Dec 2011	SP-54	SP-110712	0136	2	Add Transit IOI to IMS Offline Charging	11.1.0	11.2.0
Dec 2011	SP-54	SP-110712	0140	2	Correction of Transit IOI description	11.1.0	11.2.0
Dec 2011	--	--	--	--	Editorial correction of figures 5.2.2.1.13.5-1, 5.2.2.1.13.6-1	11.2.0	11.2.1
March 2012	SP-55	SP-120048	0144	2	Correction of Diameter AVP usage on Ro charging interfaces	11.2.1	11.3.0
March 2012	SP-55	SP-120049	0142	--	Add Status in Application Server Information in IMS Charging	11.2.1	11.3.0
March 2012	SP-55	SP-120049	0143	1	Correct description of Charging trigger condition in IMS Charging	11.2.1	11.3.0
June-2012	SP-56	SP-120366	0146	1	Flow description for single charging session from AS acting as B2BUA	11.3.0	11.4.0
June-2012	SP-56	SP-120366	0147	1	Flow description for single charging session from SCC AS – originating and terminating	11.3.0	11.4.0
June-2012	SP-56	SP-120374	0148	2	R11 CR 32260 Enhancing IMS charging for RAVEL	11.3.0	11.4.0
June-2012	SP-56	SP-120397	0149	3	R11 CR 32260 Add charging parameters for NetLoc	11.3.0	11.4.0
June-2012	SP-56	SP-120359	0153	1	Rel-11 CR 32.260 Correction of List of Message Bodies	11.3.0	11.4.0
June-2012	SP-56	SP-120366	0155	-	Flow description for SCC AS session transfert PS to CS and CS to PS– single charging session	11.3.0	11.4.0
June-2012	SP-56	SP-120366	0156	-	Flow description for SCC AS session establishment – CS+PS - single charging session	11.3.0	11.4.0
June-2012	SP-56	SP-120366	0157	1	Flow description for SCC AS session CS+PS transfer --- single charging session	11.3.0	11.4.0
Sep-2012	SP-57	SP-120576	0158	-	Correction on session establishment flow for RAVEL	11.4.0	11.5.0
Sep-2012	SP-57	SP-120576	0159	-	Introduction of Loopback indicator in BGCF CDR for RAVEL	11.4.0	11.5.0
Sep-2012	SP-57	SP-120561	0163	-	Remove Authorised-Qos from P-CSCF CDR	11.4.0	11.5.0
Sep-2012	SP-57	SP-120566	0164	1	Clarify fields under Service information used for IMS Charging	11.4.0	11.5.0
Sep-2012	SP-57	SP-120576	0165	1	Add TRF CDR to Offline Charging	11.4.0	11.5.0
Sep-2012	SP-57	SP-120569	0167	1	Enhancement on flows for “OneChargingSession” option description	11.4.0	11.5.0
Sep-2012	SP-57	SP-120569	0168	1	Introduction EATF flow for “OneChargingSession” option description	11.4.0	11.5.0
Sep-2012	SP-57	SP-120569	0169	1	Update SIP AS CDR description for “OneChargingSession” option	11.4.0	11.5.0
Sep-2012	SP-57	SP-120566	0170	2	Correct flow for SCC AS session transfer PS to CS	11.4.0	11.5.0
Sep-2012	SP-57	SP-120569	0172	1	Flows for SRVCC Originating and Terminating sessions through ATCF	11.4.0	11.5.0
Sep-2012	SP-57	SP-120566	0174	2	Correction of calling party handling	11.4.0	11.5.0
Sep-2012	SP-57	SP-120562	0177	-	Correction of Called-Party-Address AVP	11.4.0	11.5.0
Dic-2012	SP-58	SP-120789	0179	1	Rel-11 CR 32.260 ICID Generation Alignment	11.5.0	11.6.0
Dic-2012	SP-58	SP-120793	0180	1	R11 CR 32260 Flows for SRVCC session transfers through ATCF	11.5.0	11.6.0
Dic-2012	SP-58	SP-120793	0181	3	R11 CR 32260 Offline Charging description for ATCF	11.5.0	11.6.0
Dic-2012	SP-58	SP-120785	0186	2	R11 CR 32260 Emergency Indicator introduction in P-CSCF CDR	11.5.0	11.6.0
Dic-2012	SP-58	SP-120784	0192	1	Rel-11 CR 32.260 Correction on the charging at MRFC	11.5.0	11.6.0
Dic-2012	SP-58	SP-120789	0193	2	Correction on charging for IMS transit functions	11.5.0	11.6.0
Mar 2013	SP-59	SP-130062	0183	3	Multiple sets of inter operator identifiers in IMS CDRs for IMS Roaming	11.6.0	11.7.0
		SP-130054	0199	1	Related ICID Corrections for SRVCC Charging Correlation		
		SP-130051	0202	1	Emergency Indicator introduction in S-CSCF and I-CSCF CDR		
		SP-130054	0203	1	IMS User Charging when Roaming		
		SP-130063	0204	1	Correction for Access Network Information in TRF CDR		
Jun-2013	SP-60	SP-130054	0205	1	Correction of GTP' usage with respect to CCF functionality	11.7.0	11.8.0
		SP-130279	0206	1	Remove RTTI from TRF and TF CDRs		
Jun-2013					Editorial corrections (MCC): Missing chapters in the content added, wrong style used in CDR Category field, colored text in CDR field description removed, empty lines removed, blank lines between the chapters added and tables format adjusted	11.7.0	11.8.0
	SP-61	SP-130443	0213	-	Requested Party Address clarification	11.8.0	11.9.0

Sep-2013		SP-130438	0220	-	Remove RTTI from ACR [Stop] and CCR [Terminate]		
Dec-2013	SP-62	SP-130678	0233	1	Correction for SRVCC Originating and Terminating Flows through ATCF	11.9.0	11.10.0
		SP-130676	0238	-	Correction for use of Destination-Host AVP in ACR		
		SP-130627	0240	1	Correction for Route Header for IMS Interconnection Charging		
Mar-2014	SP-63	SP-140041	0242	-	Correction for SIP Route header transmitted in TF CDR	11.10.0	11.11.0
Jun-2014	SP-64	SP-140346	0245	3	Correction for SRVCC PS to CS transfer Flows through ATCF	11.11.0	11.12.0
			0247	3	Correction for SRVCC CS to PS transfer Flows through ATCF		
			0251	1	correction of ATCF CDR		
			0253	1	Correction for TADS indication in SIP AS CDR		
		SP-140343	0255	1	Clarification on Transit IOI from AS in online and offline charging		
		SP-140346	0264	1	Clarification of OneChargingSession applicable for ATCF		
Sep 2014	SP-65	SP-140561	0275	-	Removal of duplicate Requested Action in IMS online charging	11.12.0	11.13.0
		SP-140568	0277	1	Correction on inconsistent defined parameter for NetLoc		
		SP-140561	0283	1	SDP general handling clarification		
Dec 2014	SP-66	SP-140803	0290	1	Correction for use of Feature-Caps for IMS Communication Service Id	11.13.0	11.14.0
			0294	1	Consistency correction of SDP information occurrence in BGCF CDR		
			0296	-	Correction on general SDP handling		
Mar 2015	SP-67	SP-150060	0301	1	Correction for unavailable fields in E-CSCF CDR	11.14.0	11.15.0
Sep-2015	SP-69	SP-150422	0322	1	Rel11 TS32.260 Update of Reference RFC7315	11.15.0	11.16.0
			0330	1	Correction of enhanced MSC server reference		
Oct 2015					Editorial correction to change history.	11.16.0	11.16.1
Nov 2015	SP-70	SP-150694	0351	-	Correction of 2xx triggers for online and offline charging	11.16.1	11.17.0

#### Change history

Date	Meeting	TDoc	CR	Rev	Cat	Subject/Comment	New version
2016-12	SA#74	SP-160845	0367	-	A	Correction on Requested Party Address for Emergency IMS session	11.18.0
2017-06	SA#76	SP-170507	0382	1	F	Correction on handling of Private and Public user ID for IMS charging	11.19.0

## History

<b>Document history</b>		
V11.5.0	September 2012	Publication
V11.6.0	January 2013	Publication
V11.7.0	April 2013	Publication
V11.8.0	July 2013	Publication
V11.9.0	October 2013	Publication
V11.10.0	January 2014	Publication
V11.11.0	March 2014	Publication
V11.12.0	July 2014	Publication
V11.13.0	October 2014	Publication
V11.14.0	January 2015	Publication
V11.15.0	April 2015	Publication
V11.16.1	November 2015	Publication
V11.17.0	January 2016	Publication
V11.18.0	January 2017	Publication
V11.19.0	July 2017	Publication