

ETSI TS 124 022 V5.5.0 (2003-12)

Technical Specification

**Digital cellular telecommunications system (Phase 2+);
Universal Mobile Telecommunications System (UMTS);
Radio Link Protocol (RLP) for
circuit switched bearer and teleservices
(3GPP TS 24.022 version 5.5.0 Release 5)**



Reference

RTS/TSGN-0324022v550

Keywords

GSM, UMTS

ETSI

650 Route des Lucioles
F-06921 Sophia Antipolis Cedex - FRANCE

Tel.: +33 4 92 94 42 00 Fax: +33 4 93 65 47 16

Siret N° 348 623 562 00017 - NAF 742 C
Association à but non lucratif enregistrée à la
Sous-Préfecture de Grasse (06) N° 7803/88

Important notice

Individual copies of the present document can be downloaded from:

<http://www.etsi.org>

The present document may be made available in more than one electronic version or in print. In any case of existing or perceived difference in contents between such versions, the reference version is the Portable Document Format (PDF). In case of dispute, the reference shall be the printing on ETSI printers of the PDF version kept on a specific network drive within ETSI Secretariat.

Users of the present document should be aware that the document may be subject to revision or change of status. Information on the current status of this and other ETSI documents is available at

<http://portal.etsi.org/tb/status/status.asp>

If you find errors in the present document, send your comment to:

editor@etsi.org

Copyright Notification

No part may be reproduced except as authorized by written permission.
The copyright and the foregoing restriction extend to reproduction in all media.

© European Telecommunications Standards Institute 2003.
All rights reserved.

DECT™, **PLUGTESTS™** and **UMTS™** are Trade Marks of ETSI registered for the benefit of its Members.
TIPHON™ and the **TIPHON logo** are Trade Marks currently being registered by ETSI for the benefit of its Members.
3GPP™ is a Trade Mark of ETSI registered for the benefit of its Members and of the 3GPP Organizational Partners.

Intellectual Property Rights

IPRs essential or potentially essential to the present document may have been declared to ETSI. The information pertaining to these essential IPRs, if any, is publicly available for **ETSI members and non-members**, and can be found in ETSI SR 000 314: *"Intellectual Property Rights (IPRs); Essential, or potentially Essential, IPRs notified to ETSI in respect of ETSI standards"*, which is available from the ETSI Secretariat. Latest updates are available on the ETSI Web server (<http://webapp.etsi.org/IPR/home.asp>).

Pursuant to the ETSI IPR Policy, no investigation, including IPR searches, has been carried out by ETSI. No guarantee can be given as to the existence of other IPRs not referenced in ETSI SR 000 314 (or the updates on the ETSI Web server) which are, or may be, or may become, essential to the present document.

Foreword

This Technical Specification (TS) has been produced by ETSI 3rd Generation Partnership Project (3GPP).

The present document may refer to technical specifications or reports using their 3GPP identities, UMTS identities or GSM identities. These should be interpreted as being references to the corresponding ETSI deliverables.

The cross reference between GSM, UMTS, 3GPP and ETSI identities can be found under <http://webapp.etsi.org/key/queryform.asp>.

Contents

Intellectual Property Rights	2
Foreword.....	2
Foreword.....	5
1 Scope	6
2 References	6
2.1 Definitions and abbreviations.....	8
2.1.1 Abbreviations.....	8
2.1.2 Definitions	8
3 Introduction	9
4 Frame structure.....	10
4.1 Basic frame structure.....	10
4.2 RLP header.....	10
4.3 Order of transmission	10
4.4 Frame check sequence.....	10
5 Elements and procedure	11
5.1 Modes.....	11
5.1.1 Asynchronous Balanced Mode (ABM).....	11
5.1.2 Asynchronous Disconnected Mode (ADM)	11
5.2 Header and parameters	12
5.2.1 Generally used bits.....	12
5.2.1.1 Command/response bit, C/R	12
5.2.1.2 Poll/Final bit, P/F.....	13
5.2.2 Unnumbered frames, U.....	13
5.2.2.1 Set asynchronous balanced mode SABM (11100).....	13
5.2.2.2 Unnumbered Acknowledge. UA (00110)	13
5.2.2.3 Disconnect, DISC (00010).....	13
5.2.2.4 Disconnected Mode, DM (11000).....	13
5.2.2.5 Unnumbered Information, UI (00000)	13
5.2.2.6 Exchange Identification, XID (11101).....	14
5.2.2.7 Test, TEST (00111).....	15
5.2.2.8 Null information, NULL (11110).....	15
5.2.2.9 REMAP (10001)	15
5.2.3 Supervisory frames, S, and numbered information transfer and supervisory frames combined, I+S	16
5.2.3.1 Numbering	16
5.2.3.2 Send Sequence number, N(S).....	16
5.2.3.3 Receive sequence number, N(R)	16
5.2.3.4 L2R Status bit.....	16
5.2.3.5 Receive ready, RR (00)	16
5.2.3.6 Reject, REJ (01)	16
5.2.3.7 Receive not ready, RNR (10)	17
5.2.3.8 Selective reject, SREJ (11).....	17
5.2.3.9 Upgrading Proposal bit, UP bit	17
5.3 Error Recovery	17
5.3.1 Improper frames.....	17
5.3.2 N(S) sequence error	17
5.3.3 N(R) error	18
5.3.4 Time-out and checkpointing	18
5.3.4.1 Treatment of errors during link establishment, link reset and link disconnect.....	18
5.3.4.2 Treatment of errors during numbered information transfer.....	18
5.3.5 Contentious situations.....	18
5.4 Transitions between 240 bit and 576 bit frame lengths	19
5.5 List of system parameters.....	19
5.5.1 RLP Version N°	20

5.5.2	Maximum number of outstanding I frames k (Window size)	20
5.5.3	Timer T1	21
5.5.4	Maximum number of retransmissions N2.....	21
5.5.5	Data Compression Parameters	21
5.5.6	Re-sequencing period (Timer T4).....	21
5.5.7	Optional features.....	21
5.6	Support for discontinuous transmission (DTX).....	22
5.6.1	In case of A/Gb mode	22
5.6.2	In case of Iu mode.....	22
6	Service definitions	22
6.1	Introduction	22
6.2	Conventions.....	23
6.3	Queue model	23
6.4	List of Primitives	24
6.5	Possible RLP time sequence diagrams	26
Annex A (informative): RLP SDL Diagrams		29
A.1	List of RLP entity states	29
A.1.1	(main) states	29
A.1.2	state variables	30
A.2	List of RLP entity events.....	32
Annex B (informative): Change history		64
History		65

Foreword

This Technical Specification (TS) has been produced by the 3rd Generation Partnership Project (3GPP).

The present document specifies the Radio Link Protocol (RLP) for circuit switched data transmission within the 3GPP system.

The contents of the present document are subject to continuing work within the TSG and may change following formal TSG approval. Should the TSG modify the contents of the present document, it will be re-released by the TSG with an identifying change of release date and an increase in version number as follows:

Version x.y.z

where:

- x the first digit:
 - 1 presented to TSG for information;
 - 2 presented to TSG for approval;
 - 3 or greater indicates TSG approved document under change control.
- y the second digit is incremented for all changes of substance, i.e. technical enhancements, corrections, updates, etc.
- z the third digit is incremented when editorial only changes have been incorporated in the document.

1 Scope

The present document specifies the Radio Link Protocol (RLP) for circuit switched data transmission within a PLMN. RLP covers the Layer 2 functionality of the ISO OSI Reference Model (ISO/IEC 7498 [22]). It is based on ideas contained in ISO/IEC 3309 [21], ISO/IEC 4335 [20] and ISO/IEC 7809 [26] (HDLC of ISO) as well as ITU-T Recommendation X.25 [30] and Q.92x (LAP-B and LAP-D of ITU, respectively.) RLP has been tailored to the special needs of digital radio transmission. RLP provides to its users the OSI Data Link Service (ISO/IEC 8886 [24]).

RLP is intended for use with non-transparent data-transfer. Protocol conversion may be provided for a variety of protocol configurations. Those foreseen immediately are:

- character-mode protocols using start-stop transmission (IA5);
- X.25 LAP-B.

For reasons of better presentation, material about protocol conversion has been placed within those Specifications concerned with the relevant Terminal Adapters, i.e. 3GPP TS 27.002 [10] for the asynchronous case and 3GPP TS 27.003 [11] for the synchronous case. Care must be taken that that material also applies to Interworking Functions; see 3GPP TS 29.007 [13].

The present document is valid for a PLMN in A/Gb mode as well as in Iu mode. If text applies only for one of these systems it is explicitly mentioned by using the terms "A/Gb mode" and "Iu mode". Please note, that the Gb interface does not play any role in the scope of the present document although the term "A/Gb mode" is used.

2 References

The following documents contain provisions which, through reference in this text, constitute provisions of the present document.

- References are either specific (identified by date of publication, edition number, version number, etc.) or non-specific.
- For a specific reference, subsequent revisions do not apply.
- For a non-specific reference, the latest version applies. In the case of a reference to a 3GPP document (including a GSM document), a non-specific reference implicitly refers to the latest version of that document *in the same Release as the present document*.

- [1] Void.
- [2] 3GPP TS 44.021: "Rate adaption on the Mobile Station - Base Station System (MS - BSS) interface".
- [3] 3GPP TS 48.004: "Base Station System - Mobile services Switching Centre (BSS - MSC) interface Layer 1 specification".
- [4] 3GPP TS 48.020: "Rate adaption on the Base Station System - Mobile services Switching Centre (BSS - MSC) interface".
- [5] 3GPP TS 25.410: "UTRAN Iu interface: General Aspects and Principles".
- [6] 3GPP TS 25.411: "UTRAN Iu interface Layer 1".
- [7] 3GPP TS 25.414: "UTRAN Iu interface data transport and transport signalling".
- [8] 3GPP TS 25.415: "UTRAN Iu interface user plane protocols".
- [9] 3GPP TS 27.001: "General on Terminal Adaptation Functions (TAF) for Mobile Stations (MS)".
- [10] 3GPP TS 27.002: "Terminal Adaptation Functions (TAF) for services using Asynchronous bearer capabilities".

- [11] 3GPP TS 27.003: "Terminal Adaptation Functions (TAF) for services using Synchronous bearer capabilities".
- [12] Void.
- [13] 3GPP TS 29.007: "General requirements on interworking between the Public Land Mobile Network (PLMN) and the Integrated Services Digital Network (ISDN) or Public Switched Telephone Network (PSTN)".
- [14] ITU-T Recommendation Q.920: "ISDN user-network interface data link layer - General aspects".
- [15] ITU-T Recommendation Q.921: "ISDN user-network interface - Data link layer specification".
- [16] ITU-T Recommendation Q.921bis: "Abstract test suite for LAPD conformance testing".
- [17] ITU-T Recommendation Q.922: "ISDN data link layer specification for frame mode bearer services".
- [18] ITU-T Recommendation V.42bis: "Data compression procedures for Data Circuit-terminating Equipment (DCE) using error correction procedures".
- [19] ITU-T Recommendation X.25: "Interface between Data Terminal Equipment (DTE) and Data Circuit-terminating Equipment (DCE) for terminals operating in packet mode and connected to public data networks by dedicated Circuit".
- [20] ISO/IEC 4335: "Information technology - Telecommunications and information exchange between systems - High-level Data Link Control (HDLC) procedures - Elements of procedures".
- [21] ISO/IEC 3309: "Information technology - Telecommunications and information exchange between systems - High-level Data Link Control (HDLC) procedures - Frame structure".
- [22] ISO/IEC 7498: "Information technology - Open Systems Interconnection - Basic Reference Model".
- [23] ISO/IEC 8885: "Information technology - Telecommunication and information exchange between systems - High-level Data Link Control (HDLC) procedures - General purpose XID frame information field content and format".
- [24] ISO/IEC 8886: "Information technology - Open Systems Interconnection - Data link service definition".
- [25] ISO/TR 8509: "Information processing systems - Open Systems Interconnection - Service conventions".
- [26] ISO/IEC 7809: "Information technology - Telecommunications and information exchange between systems - High-level Data Link Control (HDLC) procedures - Classes of procedures".
- [27] ISO/IEC 7776: "Information technology - Telecommunications and information exchange between systems - High-level data link control procedures - Description of the X.25 LAPB-compatible DTE data link procedures".
- [28] 3GPP TR 21.905: "Vocabulary for 3GPP Specifications".
- [29] 3GPP TS 43.051: "GSM/EDGE Radio Access Network (GERAN) overall description; Stage 2".
- [30] ITU-T Recommendation X.25: "Interface between Data Terminal Equipment (DTE) and Data Circuit-terminating Equipment (DCE) for terminals operating in the packet mode and connected to public data networks by dedicated circuit".

2.1 Definitions and abbreviations

2.1.1 Abbreviations

For the purposes of the present document, the abbreviations given in 3GPP TR 21.905 [28] and the following apply:

ABM	Asynchronous Balanced Mode
ADM	Asynchronous Disconnected Mode
ATM	Asynchronous Transfer Mode.
C/R	Command/Response bit
DISC	Disconnect frame
DM	Disconnected Mode frame
DTX	Discontinuous Transmission
FCS	Frame Check Sequence
L2R	Layer 2 Relay function
N(R)	Receive sequence number
N(S)	Send sequence number
NULL	Null information frame
P/F	Poll/Final bit
REJ	Reject frame
REMAP	Remap frame
RLP	Radio Link Protocol
RNR	Receive Not ready frame
RR	Receive Ready frame
SABM	Set Asynchronous Balanced Mode frame
SREJ	Selected reject frame
STM	Synchronous Transfer Mode
TEST	Test frame
UA	Unnumbered Acknowledge frame
UI	Unnumbered Information frame
XID	Exchange Identification frame

2.1.2 Definitions

For the purposes of the present document, the following terms and definitions apply:

A/Gb mode: system or a subsystem operates in A/Gb mode if an A or Gb interface is used between the radio access network and the core network.

backwards compatibility: RLP defines several backwards-compatible versions. That means that a newer version can interwork with an older one without changing the older one. This is realized by a fall back mechanism during XID exchange.

command: instruction represented in the RLP header, causing the receiving RLP entity to execute a specific function.

frame check sequence: field of redundant information based on a cyclic code, used for error detection.

I + S frame: RLP frame that is used for user information transfer, carrying supervisory information piggyback.

improper frame: RLP frame having an FCS error or having a header the contents of which is inconsistent with the present document.

Iu mode: system or a subsystem operates in Iu mode if an Iu-CS or Iu-PS interface is used between the radio access network and the core network. It operates in UTRAN Iu mode if UTRAN is used as radio access network. It operates in GERAN Iu mode if GERAN is used as radio access network.

non-transparent: in PLMN data transmission, a configuration where at layer 2, protocol information of the fixed network is mapped on RLP elements, and vice versa.

piggybacking: means by which one and the same frame can carry both user information and RLP related supervisory information.

response: reply represented in the RLP-header, by which the sending RLP entity reports back about its status.

RLP frame: sequence of contiguous bits, representing an RLP procedural element.

RLP header: that part of an RLP frame that encodes either a command or a response, located at the beginning of the RLP frame.

S frame: RLP frame that contains supervisory information in the absence of user information.

transparent: in PLMN data transmission, a configuration where at layer 2 (and also at the layers above) no protocol conversion takes place.

U frame: RLP frame that contains unnumbered protocol control information.

3 Introduction

Three versions of RLP are defined:

- RLP version 0: single-link basic version;
- RLP version 1: single-link extended version (e.g. extended by data compression);
- RLP version 2: multi-link version.

RLP uses one substream on one physical link (single-link) or from 1 up to 4 (multi-link) substreams on one or more physical links. However, the RLP multi-link version is designed to be able to support up to 8 substreams.

In A/Gb and GERAN Iu mode:

- If in the call set-up signalling, either end indicates that it cannot support multi-link operation, neither end shall require usage of RLP-versions higher than 1. If the BC negotiation during call set-up results in a possibility for multi-link operation during the call, both ends shall require and accept RLP version 2 only;
- If the BC-IE sent by the UE in the SETUP or CALL CONFIRM message indicates "maximum number of traffic channels" = "1 TCH" and WAIUR \leq 14,4 kbit/s and the BC-IE sent by the UE in the CALL CONFIRM message (MT case) or by the MSC in the CALL PROCEEDING message (MO case) indicates UIMI = "User initiated modification not allowed/required/applicable" or "User initiated modification up to 1 TCH/F allowed/may be requested", this shall be interpreted as if at least one end does not support multi-link operation, and neither end shall require an RLP version higher than 1.

In UTRAN Iu mode, either end is allowed to request the usage of any RLP-version.

RLP makes use of an underlying FEC (Forward Error Correction) mechanism. For RLP to perform adequately it is assumed that the basic radio channel together with FEC provides for a block error rate of less than 10 %, where a block consists of 240 bits or 576 bits (Further study on the BLER for 576-bit blocks is needed). Furthermore, it is assumed that in case of multi-link RLP the difference of the delay between all physical links is less than timer T4.

In A/Gb mode and in GERAN Iu mode, RLP frames are of a fixed size of 240 (TCH/F4,8 and TCH/F9,6 channel codings) or 576 bits (TCH/F14,4, TCH/F28,8 and TCH/F43,2 channel codings). In UTRAN Iu mode, the RLP frame size does not depend on the channel coding, only 576 bit frames are used.

RLP entities running only in an UTRAN Iu mode environment need only to support the 576 bit frame length. The REMAP function is not necessary. RLP entities running in both of the systems have to support the REMAP function. In a handover from UTRAN Iu mode to A/Gb mode or GERAN Iu mode the frame either stays 576 bits long or changes from 576 bits to 240 bits incurring a REMAP. In a handover from A/Gb mode or GERAN Iu mode to UTRAN Iu mode the frame either stays 576 bits long or changes from 240 bits to 576 bits incurring a REMAP.

In A/Gb mode, RLP frames are sent in strict alignment with the radio transmission. (For details, see 3GPP TS 44.021 ([2])). Whenever a frame is to be sent, the RLP entity has to provide the necessary protocol information to be contained in it.

Provision is made for Discontinuous Transmission (DTX).

RLP spans from the User Equipment (UE) to the interworking function (IWF), located at the nearest Mobile Switching Centre (MSC), or beyond. Depending on the exact location of the IWF, handover of the UE may result in link-reset or even total loss of the connection.

The UE shall initiate the RLP link. In addition the MSC/IWF may initiate the RLP link.

In the terminology of HDLC, RLP is used in a balanced configuration, employing asynchronous operation, i.e. either station has the right to set-up, reset, or disconnect a link at any time. Procedural means are provided for to deal with contentious situations, should they ever occur.

RLP is full-duplex in the sense that it allows for information to be transferred in both directions simultaneously.

4 Frame structure

4.1 Basic frame structure

In A/Gb mode and GERAN Iu mode, an RLP-frame has a fixed length of either 240 bits, used when the channel coding is TCH/F4,8 or TCH/F9,6, or 576 bits, used when the channel coding is TCH/F14,4, TCH/F28,8 or TCH/F43,2. In UTRAN Iu mode, the RLP-frame has a fixed length of 576 bits.

A frame consists of a header, an information field, and an FCS (frame check sequence) field. The size of the components depends on the radio channel type, RLP version and on the RLP frame. As a benefit of using strict alignment with underlying radio transmission there is no need for frame delimiters (like flags etc.) in RLP. In consequence, there is no "bit-stuffing" necessary in order to achieve code transparency.

a) 240 bit frame size

	Header	Information	FCS
version 0 and 1, version 2 (U frames only)	16 bit	200 bit	24 bit
version 2 (S and I+S frames only)	24 bit	192 bit	24 bit

b) 576 bit frame size

	Header	Information	FCS
version 0, 1, and version 2 (U frames only)	16 bit	536 bit	24 bit
version 2 (S and I+S frames only)	24 bit	528 bit	24 bit

Figure 1: Frame structure

4.2 RLP header

An RLP-header carries one of three types of control information, the first being unnumbered protocol control information (U frames), the second being supervisory information (S frames), the third being user information carrying supervisory information piggybacked (I + S frames).

4.3 Order of transmission

The header, as defined in subclause 5.2, shall be transmitted from left to right. The FCS shall be transmitted commencing with the highest order term. The order of bit transmission for the information field is from left to right.

4.4 Frame check sequence

The FCS shall be the ones complement of the modulo 2 sum of:

a) the remainder of:

For 240 bit frames:

$$x^{216} (x^{23} + x^{22} + x^{21} + x^{20} + x^{19} + x^{18} + x^{17} + x^{16} + x^{15} + x^{14} + x^{13} + x^{12} + x^{11} + x^{10} + x^9 + x^8 + x^7 + x^6 + x^5 + x^4 + x^3 + x^2 + x + 1)$$

For 576 bit frames:

$$x^{552} (x^{23} + x^{22} + x^{21} + x^{20} + x^{19} + x^{18} + x^{17} + x^{16} + x^{15} + x^{14} + x^{13} + x^{12} + x^{11} + x^{10} + x^9 + x^8 + x^7 + x^6 + x^5 + x^4 + x^3 + x^2 + x + 1)$$

divided modulo 2 by the generator polynomial:

$$x^{24} + x^{23} + x^{21} + x^{20} + x^{19} + x^{17} + x^{16} + x^{15} + x^{13} + x^8 + x^7 + x^5 + x^4 + x^2 + 1$$

and

b) the remainder of the division modulo 2 by the generator polynomial:

$$x^{24} + x^{23} + x^{21} + x^{20} + x^{19} + x^{17} + x^{16} + x^{15} + x^{13} + x^8 + x^7 + x^5 + x^4 + x^2 + 1$$

of the product of x^{24} by the content of the frame, excluding the FCS field. (The first bit transmitted corresponds to the highest order term.)

Implementation note: As a typical implementation, at the transmitter, the initial content of the register of the device computing the remainder of the division is pre-set to all ones and is then modified by division by the generator polynomial (as described above) of the header and information field; the ones complement of the resulting remainder is transmitted as the 24 bit FCS sequence.

At the receiver, the initial content of the register of the device computing the remainder is pre-set to all ones. The final remainder after multiplication by x^{24} and then division (modulo 2) by the generator polynomial:

$$x^{24} + x^{23} + x^{21} + x^{20} + x^{19} + x^{17} + x^{16} + x^{15} + x^{13} + x^8 + x^7 + x^5 + x^4 + x^2 + 1$$

of the serial incoming protected bits and the FCS will be:

$$011011011000100100110000 (x^{23} \text{ to } x^0, \text{ resp.})$$

in the absence of transmission errors.

5 Elements and procedure

5.1 Modes

An RLP entity can be in one of two modes:

- Asynchronous Balanced Mode (ABM);
- Asynchronous Disconnected Mode (ADM).

5.1.1 Asynchronous Balanced Mode (ABM)

In ABM, which is the data link operational mode, either RLP entity may send commands at any time and may initiate response frame transmission without receiving explicit permission to do so from the other RLP-station. In ABM, frames shall be used for information field transfer and/or to indicate status changes in the RLP-station.

5.1.2 Asynchronous Disconnected Mode (ADM)

In ADM, which is the data-link non-operational mode, the RLP entity shall be logically disconnected from the data link and shall, therefore, neither transmit nor accept numbered information frames.

The RLP entity shall, however, be permitted to transmit and accept NULL, DM, UI, TEST and XID frames. Either RLP entity can issue an SABM command at any time, in order to terminate the ADM state. In that case, entrance of the ABM

state will be indicated by a UA response from the opposite station. If the opposite station is not able to enter ABM, it will indicate this by a DM response. All commands other than those mentioned above and any unsolicited response will be ignored in ADM under all circumstances.

5.2 Header and parameters

The formats defined for the header are listed in figure 2.

5.2.1 Generally used bits

NOTE 1: C/R = COMMAND/RESPONSE BIT
 P/F = POLL/FINAL BIT
 X = DON'T CARES

S ₁	S ₂	
0	0	RR
0	1	REJ
1	0	RNR
1	1	SREJ

M ₁ M ₂ M ₃ M ₄ M ₅	
1 1 1 0 0	SABM
0 0 1 1 0	UA
0 0 0 1 0	DISC
1 1 0 0 0	DM
1 1 1 1 0	NULL
0 0 0 0 0	UI
1 1 1 0 1	XID
0 0 1 1 1	TEST
1 0 0 0 1	REMAP

Versions 0 and 1:

NOTE 2: N(S) : Bit 4 low order bit
 N(R) : Bit 11 low order bit

U	C/R	X	X	1	1	1	1	1	1	P/F	M1	M2	M3	M4	M5	X
S	C/R	S1	S2	0	1	1	1	1	1	P/F	N(R)					
I+S	C/R	S1	S2	N(S)						P/F	N(R)					
bit	1	2	3	4	5	6	7	8	9	10	11	12	13	14	15	16

Version 2:

NOTE 3: S = L2R Status Bit
 N(S) : Bit 1 low order bit
 N(R) : Bit 14 low order bit
 UP : UP bit (only if negotiated, 'don't care' otherwise)

U	C/R	X	X	1	1	1	1	1	P/F	M1	M2	M3	M4	M5	X									
S	X	X	X	0	1	1	1	1	P/F	C/R	S1	S2	N(R)			X	UP							
I+S	N(S)								P/F	C/R	S1	S2	N(R)			S	UP							
bit	1	2	3	4	5	6	7	8	9	10	11	12	13	14	15	16	17	18	19	20	21	22	23	24

Figure 2: Header formats

5.2.1.1 Command/response bit, C/R

The C/R-bit is used to indicate whether the frame is a command or response frame and whether the P/F-bit is to be interpreted as a poll or final bit, resp. For commands, the C/R bit shall be set to "1", for responses it shall be set to "0".

5.2.1.2 Poll/Final bit, P/F

The P/F-bit is used to mark a special instance of command/response exchange. With a command, it is called the P-bit, with a response, it is called the F-bit. In any one direction, only one P/F-bit exchange may be outstanding at any time. A response with the F-bit set to "1" shall always reflect the latest receive status of the RLP entity.

A P/F-bit exchange always starts with a command frame with the P-bit set to "1", which shall be answered by a response frame with the F-bit set to "1" at the earliest response opportunity.

No unsolicited F-bit = "1" is allowed. Such a frame shall be considered "improper" (see subclause 5.3.1). In ABM, the use of the P/F-bit with numbered information exchange is only allowed for checkpoint-recovery (see subclause 5.3.3).

5.2.2 Unnumbered frames, U

5.2.2.1 Set asynchronous balanced mode SABM (11100)

The SABM encoding is used as a command only. It is always used with the P-bit set to "1".

The SABM command is used either to initiate a link for numbered information transfer, i.e. to go from ADM to ABM, or to reset a link already established for numbered information transfer. With an SABM command, no information transfer is allowed.

When issuing an SABM, the RLP entity has set to zero its internal variables for sending and receiving numbered information. The other RLP entity, on receiving an SABM command, will either confirm it by setting to zero its internal variables for sending and receiving numbered information and then issuing an UA (unnumbered acknowledgement) response or reject it by sending a DM (disconnected mode) response. In the former case, both entities have entered ABM and numbered information transfer may commence. In the latter case, both entities are in ADM.

When an SABM command is issued, a loss of information may occur. Appropriate action is in the responsibility of the layers above.

5.2.2.2 Unnumbered Acknowledge. UA (00110)

The UA encoding is used as a response only. It is used to positively acknowledge an SABM or DISC command. With the UA response, no information transfer is allowed. In version 2, the UA response is sent no sooner than T4 (see subclause 5.5.6) after the last information frame sent. Information frames received within a period of T4 after reception of the SABM are discarded.

5.2.2.3 Disconnect, DISC (00010)

The DISC encoding is used as a command only. It is used to disestablish a link, previously established for numbered information transfer, i.e. to terminate ABM and go into ADM. With the DISC command, no information transfer is allowed.

The other RLP-entity shall answer with a UA response before actioning the DISC command. When a DISC command is actioned, loss of information may occur. It is the responsibility of the layers above, to provide for a "graceful" disconnect.

5.2.2.4 Disconnected Mode, DM (11000)

The DM encoding is used as a response only. It is used by RLP entity to report that it is in ADM and, as an answer to SABM, that it is (possibly temporary) unable to action a mode setting command. With the DM response, no information transfer is allowed.

5.2.2.5 Unnumbered Information, UI (00000)

The information field is to be interpreted as unnumbered information. Unnumbered Information (UI) frames can be sent in both ADM and ABM. There is no acknowledgement of receipt of UI-frames within RLP.

5.2.2.6 Exchange Identification, XID (11101)

The information field is to be interpreted as exchange identification. This frame is used to negotiate and renegotiate parameters of RLP and layer 2 Relay function. XID frames can be sent in both ADM and ABM.

The negotiation procedure is one step i.e. one side will start the process by sending an XID command, offering a certain set of parameters from the applicable parameter repertoire (see table 1) the sending entity wants to negotiate proposing values within the allowed range. In return, the other side will send an XID response, either confirming these parameter values by returning the requested values, or offering higher or lower ones in their place (see table 1 for sense of negotiation), except when the indicated RLP version is a lower one where a limited set of those parameters presented in the XID command may be answered according to the negotiated version. In RLP versions higher than "0", any unrecognisable parameters will be ignored. Default values will apply to those parameters which are not commented upon by the responding side (see subclause 5.4 for default values). This normally will end the negotiation process. XID frames are always used with the P/F-bit set to "1".

Without any prior XID exchange, default values will apply (see subclause 5.4). A negotiation of data compression parameters (see table 1) is only allowed in ADM. In addition, in RLP version 2, negotiation of RLP version N°(see table 1) is only allowed in ADM.

In the case of a collision of XID commands, all XID commands shall be ignored. The UE shall restart the parameter negotiation on expiry of T1, while the Interworking Function shall do so on expiry of twice the value of T1. An unsuccessful XID exchange shall be repeated on expiry of T1. After N2 times of unsuccessful repetition, the link shall be disconnected.

In table 1 a list of parameters is given which constitute the parameter repertoire. In addition, the format of the XID information field is given.

Table 1: XID parameters

Parameter Name	Type	Length	Format (87654321)	Units	Sense of Negotiation	Valid in Versions
RLP version N°	1	1	bbbbbbbbb (note 1)	./.	down	≥ 0
IWF to UE window size	2	1	00bbbbbbb	./.	down	0..1
IWF to UE window size	2	1	00bbbbbbb	8	down	≥ 2
UE to IWF window size	3	1	00bbbbbbb	./.	down	0..1
UE to IWF window size	3	1	00bbbbbbb	8	down	≥ 2
Acknowledgement Timer(T1)	4	1	bbbbbbbbb	10ms	up	≥ 0
Retransmission attempts (N2)	5	1	bbbbbbbbb	./.	up	≥ 0
Reply delay (T2) (note 2)	6	1	bbbbbbbbb	10ms	up	≥ 0
Compression P _T	7	4	aaaa	./.	none	≥ 1
P ₀			00bb	./.	see ITU-T	
P ₁ low			ccccccc	./.	Q.921 [15]	
P ₁ high			ccccccc	./.	down	
P ₂			ddddddd	./.	down	
Re-sequencing timer (T4) (note 2)	8	1	bbbbbbbbb	10 ms	up	≥ 2
Optional features	9	1	bbbbbbbbb	./.	down	≥ 2
NOTE 1: Characters "a", "b", "c" and "d" indicate a bit which is part of the parameter value in question. Parameters indicated by "a" are not negotiable.						
NOTE 2: In case of negotiation of this parameter it may be necessary to negotiate also the other timer values (e.g. "Acknowledgement timer" (T1)).						

The type and length are encoded within one octet, the type field occupying bits 8 to 5 and the length field occupying bits 4 to 1; 1 resp. 5 being the least significant bit. The least significant bit shall always be transmitted first.

A parameter item consists of the type/length-octet followed by the value of that parameter, where the length-indicator gives the number of octets the value actually occupies. Such parameter items may be arranged in arbitrary order, with the exception of the RLP version number, which shall be sent first in RLP versions higher than "0". The parameter items must begin in the first octet of the XID-information field and follow on contiguously. The parameter list is delimited by parameter type zero.

5.2.2.7 Test, TEST (00111)

The information field of that frame is to be interpreted as test information. Test frames can be sent in both ADM and ABM. A test sequence is always initiated by sending a TEST command in one direction and completed by sending a TEST response in the other direction.

5.2.2.8 Null information, NULL (11110)

In ADM, null-frames shall be sent each time there is a send opportunity but no UI, TEST or XID frame is awaiting transmission.

In ABM, null-frames shall be sent in reset state if there is a send opportunity and no unnumbered frames are to be sent.

The information field is to be interpreted as null information i.e. the information field is not used and its contents may be arbitrary.

5.2.2.9 REMAP (10001)

A REMAP-exchange can only take place in ABM following a change of channel coding. REMAP frames are always used with the P/F-bit set to "0". The exchange is started by the mobile-end which sends a REMAP command U-frame in the information field of which the RLP-entity indicates the N(R) of the frame - according to the 'old' frame format - from which the network-end should resend the information mapped into a frame format corresponding to the new channel coding. The mobile-end sends a REMAP-frame on every sending opportunity until a responding REMAP-frame is received from the network-end. The network-end answers by sending a REMAP U-frame with the C/R-bit set to 'Response'. In the information-field the network-end indicates the N(R)-number of the frame from which the mobile-end should remap the information into the new frame format. The network-end responds to all REMAP-commands it receives as long as it is in the REMAP synchronisation state. The network sends a numbered S frame with poll bit P=1 or an I+S frame after the first REMAP frame to the user equipment to compel it to acknowledge the end of the REMAP condition. This frame is guarded by T1. Upon reception of an I+S frame or an S frame with the final bit F=1 from the UE, the IWF exists the REMAP synchronisation state. Any REMAP-acknowledgement that may arrive at the mobile-end after one of them has been received is discarded by the mobile-end. The RLP shall supervise the synchronisation state by a timer with the value of N2*T1. If the network-end does not receive an appropriate U-frame within N2*T1, it enters ADM. If the mobile-end does not receive a response within N2*T1 measured from the transmission of the first command, it enters ADM.

In addition to the N(R)-information the REMAP-frame information field can include any XID-parameters that should be renegotiated because of the change of channel coding. The procedures concerning these XID-parameters are as defined in subclause 5.2.2.6 except that the mobile-end always starts the negotiation. Also the mapping of the parameters is as defined in subclause 5.2.2.6 except that the first two octets in the REMAP information field are occupied by the N(R)-number (The LSB is transmitted first). The information field shall always include parameter type zero, which delimits the XID-parameter list.

After the change of channel coding, default values according to the new channel coding apply until new values have been negotiated by the REMAP or XID procedure. Default values according to the new channel coding also apply for those XID parameters that are not included in the REMAP information field. Values for XID parameters whose negotiation is only allowed in ADM remain valid after change of channel coding.

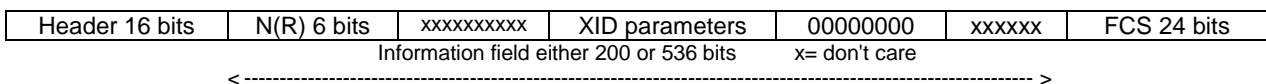

a) version 0 and 1

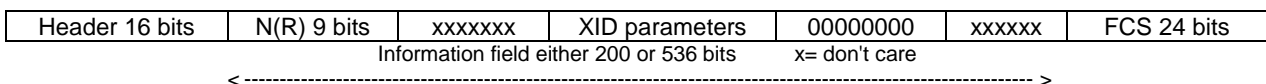

b) version 2

Figure 3: REMAP U-frame format

5.2.3 Supervisory frames, S, and numbered information transfer and supervisory frames combined, I+S

In ABM, there are cases where there is no user information pending transmission. In consequence, supervisory (S) frames alone must be conveyed. In such cases, the information field is to be interpreted as null information, i.e. the information field is not used and may be of arbitrary contents.

For reasons of optimization in the special situation of digital radio transmission, numbered information transfer frames carry also supervisory type information ("piggy-backing"). Numbered information can be exchanged only in ABM.

NOTE: The extent to which piggy-backing is used by the sending RLP entity is optional. An RLP entity receiving any of allowed piggy-backed formats, however, shall take the appropriate actions. Implementers should be aware that not using the full capability of piggy-backing could, in certain circumstances, result in a less than optimal performance.

5.2.3.1 Numbering

Each I frame is sequentially numbered and may have the value 0 through $M-1$, where M is the modulus. The modulus M is 62 (single-link) or 496 (multi-link).

5.2.3.2 Send Sequence number, N(S)

The send sequence number contains the number of the I frame. With the exception of SREJ conditions, information frames are transmitted in numerical order of their N(S). If multiple substreams are used, the frames may arrive at the receiver in another order. Normal information transfer is halted, when the number of outstanding, unacknowledged frames is equal to the currently established window size (see subclause 5.4).

5.2.3.3 Receive sequence number, N(R)

The N(R) field is used in ABM to designate the next information frame to be sent by the other RLP entity and to confirm that all frames up to and including $N(R) - 1$ have been received properly. As an exception to this, in the case of SREJ (selective reject), N(R) designates the information frame that is selectively rejected and thus requested for retransmission. In this case, no previously received frames are confirmed.

5.2.3.4 L2R Status bit

The L2R status bit set to "1" indicates that the L2R PDU transported in the information field of the RLP PDU contains at least a status octet. Otherwise, the L2R PDU contains only user data. The bit is only used for RLP-version 2.

5.2.3.5 Receive ready, RR (00)

The RR encoding can be used either as command or response. In ABM, it is used by an RLP entity to confirm all information frames up to and including $N(R)-1$. In doing so, the RLP-station allows the other station to transmit up to k additional information frames, counting from $N(R)$ onwards. The issue of an RR command/response clears any previous busy condition in that direction.

5.2.3.6 Reject, REJ (01)

The REJ encoding can be used either as command or response. It is used by an RLP entity to indicate that in numbered information transfer one or more out-of sequence frames have been received. Frames up to and including $N(R)-1$ have been received correctly, frames $N(R)$ and following are requested to be retransmitted. Following retransmission of those frames, further frames awaiting initial transmission may be sent. With respect to each direction of transmission, only one REJ condition may exist at any given time.

A REJ condition is cleared:

- on receipt of the frame numbered $N(R)$;
- on time-out;
- or on reset (SABM).

An REJ shall be sent at the earliest opportunity. On time-out, REJ frames shall not be repeated. An RLP-entity receiving an REJ frame with the same N(R), which has already been the starting frame of a retransmission sequence due to P/F-bit checkpointing, shall inhibit the retransmission due to that particular REJ frame.

5.2.3.7 Receive not ready, RNR (10)

The RNR encoding can be used either as command or response. It is used by an RLP entity to indicate that it is temporarily not ready to receive numbered information frames. In that case, the RLP entity is said to be in the busy condition. All frames up to and including N(R)-1 shall be considered acknowledged. Subsequent frames, if any, shall not be considered confirmed. The acceptance status of those is a matter of further status exchange.

5.2.3.8 Selective reject, SREJ (11)

The SREJ encoding can be used either as command or response. The SREJ command/response is used to request retransmission of a single frame, thus, under certain circumstances, providing for more efficient error recovery than by REJ. No acknowledgement of received I frames is indicated by an SREJ frame, thus allowing an RLP entity to transmit one or more SREJ frames with a different N(R) before earlier SREJ conditions have been cleared.

An SREJ condition shall be cleared:

- on receipt of an information frame with N(S) equal N(R) of the SREJ;
- on time out;
- on reset (SABM).

No SREJ shall be issued during a pending REJ condition. For each frame, only one SREJ condition may exist at any time.

SREJ frames shall be sent at the earliest possibility. On time-out, SREJ frames may be repeated.

NOTE: Sending SREJ commands/responses is not mandatory.

5.2.3.9 Upgrading Proposal bit, UP bit

In version 2, the UP bit in the S and I+S frame headers may be used by the IWF to indicate to the UE that a service level upgrading will increase the throughput, and is used in accordance with 3GPP TS 27.001 [9] and 3GPP TS 29.007 [13]. The usage of the UP bit is negotiated by XID exchange.

5.3 Error Recovery

5.3.1 Improper frames

Frames containing an FCS error or having a control field the contents of which is not implemented or inconsistent with those defined in the present document are called improper frames. Improper frames shall be ignored, i.e. the receiving RLP station shall not make any use of their contents.

5.3.2 N(S) sequence error

In numbered information transfer, any information frame with an N(S) out of the normal sequence shall lead to an N(S) sequence error condition, unless that frame is requested for retransmission by an SREJ, sent at an earlier time. In case multiple substreams make up a connection when the multi-link version is used the received frames must be re-sequenced. For that a timer T4 defines a re-sequencing period (see subclause 5.4) during which frames may be out-of-order. An N(S) sequence error condition only occurs if the N(S) arrives after the expiry of T4. There are three mechanisms to deal with N(S) sequence errors:

- REJ recovery;
- SREJ recovery;
- P/F-bit recovery (checkpointing).

The first two being the responsibility of the receiving station, the last being the responsibility of the sending station. There are no strict rules as to whether REJ or SREJ recovery shall be applied, however, if a station decides to initiate REJ or SREJ recovery, it shall do so at the earliest opportunity. The information part of out-of sequence frames shall be discarded, unless the receiving station intends to initiate SREJ recovery.

5.3.3 N(R) error

Any confirming N(R) that is not in the range of the window size shall be ignored.

5.3.4 Time-out and checkpointing

All frames requiring a response or acknowledgement shall be guarded by time-out (timer T1). In detail, those frames are:

- SABM;
- DISC;
- REJ;
- SREJ;
- numbered information frames (see note);
- any frame with the P-bit set to "1" in ABM, i.e. checkpointing.

NOTE: T1 started, or restarted if already running, on the transmission of every numbered information frame.

5.3.4.1 Treatment of errors during link establishment, link reset and link disconnect

An SABM, which is not answered by either UA or DM within the timer period, shall be repeated up to N2 times.

A DISC, which is not answered by UA within the timer period, shall be repeated up to N2 times.

If the SABM or DISC, respectively, is finally unanswered, the RLP station will go into ADM in any case. For this reason, it is the responsibility of the management of any RLP entity to put the RLP entity into ADM, should there be an indication of a permanent outage, i.e. a loss of connectivity longer than N2 times the timer value.

5.3.4.2 Treatment of errors during numbered information transfer

The last frame of a sequence of numbered information frames shall also be guarded by time-out. If neither a positive acknowledgement nor a REJ is received, the RLP entity will start checkpoint recovery, i.e. the station will send a frame with the P-bit set to "1", requesting the latest status information from the other entity, indicated by the F-bit set to "1". In that case, status information is carried either by RR or RNR responses and all frames currently held by the responding RLP entity which are not delivered because of missing frames shall be discarded. A P-bit set to "1" shall only be sent with a Supervisory Frame.

Awaiting the latest status information from the other RLP entity, the sending entity does not react on REJ and SREJ frames received during this time. If such status information is received, retransmission from N(R) onwards will be performed if appropriate. However, no frame sequence starting with a given N(R) shall be retransmitted more than N2 times. If there is a frame sequence that cannot be transmitted successfully after N2 repetitions, the RLP link shall be reset or disconnected.

If no status information is received during the time-out period, this request will be repeated up to N2 times. If still there is no valid status reported back, the RLP link shall be reset or disconnected.

5.3.5 Contentious situations

Due to the asynchronous procedure, various contentious situations may arise. A contention of SABMs shall result into both entities be set into ABM or be reset. A contention of DISC's shall result into both entities be disconnected. A contention of SABM and DISC shall result into both entities be disconnected.

5.4 Transitions between 240 bit and 576 bit frame lengths

The RLP has to change the supported frame length due to transitions between different channel codings. The RLP entities have to be re-synchronised after a change of the channel coding.

Any change of the channel coding is indicated to the RLP- entity by an external event. The RLP-entity at the mobile-end enters the synchronisation state when it receives a relevant Radio Resource Management message, and it starts sending the REMAP-messages at the earliest possible time. The RLP-entity at the network-end enters the synchronisation state when the network-end detects Layer 1 synchronisation after a change of channel coding. The change of channel coding is eventually confirmed by an outband signalling message.

On entering the synchronisation state timers are halted and zeroed, and the TX- and RX-windows are frozen. When the RLP entity enters the synchronisation state it clears all SREJ or REJ conditions, discards all out-of-sequence frames received and clears all previous re-transmission requests received by any SREJ.

After this the mobile-end starts a REMAP-exchange (subclause 5.2.2.9). When an RLP-entity receives a REMAP-frame, it moves the user information contained by the frames to be remapped from the TX-window to a transition buffer between the RLP- and L2R-entities. The L2R uses the information in this buffer before mapping new data into the PDUs. The network-end regards the REMAP-procedure as completed when it has received an I+S-frame, an S-frame or an SABM U-frame from the mobile-end, whereas the mobile-end leaves the synchronisation state after receiving a responding REMAP-frame or an SABM U-frame. The data in the transition buffer at the network-end must not be deleted before an I+S-, or an S-frame is received from the mobile-end.

Supervisory or Information transfer frames or XID U frames are discarded by the receiving entity while in REMAP synchronisation state. If the RLP entity receives another U-frame, it reacts according to the defined procedures. That is, if the frame is an SABM frame it performs a reset procedure and leaves the synchronisation state. If the frame is NULL, UI or TEST frame, RLP performs the defined procedure and remains in the synchronisation state. In the case of a DISC frame RLP terminates ABM and goes into ADM.

After the REMAP-procedure is completed, the RLP-entities leave the synchronisation state and normal operation is resumed. On resuming the normal operation, the TX- and RX- windows are emptied. The N(S)-numbering resumes from the value indicated in the REMAP-message by the N(R)-number.

Abortion of the transition or another transition taking place during the REMAP-procedure restarts the REMAP-procedure in order to resume operation using the channel coding corresponding to the latest transition.

5.5 List of system parameters

The system parameters are as follows.

Table 2: RLP parameter values

Name	Range of values	Default value	Recommended value
Version N°	0 – 2	0	2
k UE ⇒ IWF (for N° = 0/1)	0 – 61	61	61
k UE ⇒ IWF (for N° = 2)	0 - k _{max} (note 3)	480	240 (note 2)
k IWF ⇒ UE (for N° = 0/1)	0 – 61	61	61
k IWF ⇒ UE (for N° = 2)	0 - k _{max} (note 3)	480	240 (note 2)
T1 (note 1)	> 420 ms (version2) > 380 ms > 440 ms > 600 ms	520 ms (fullrate on 14, 5 kbit/s, 29,0 kbit/s or 43,5 kbit/s) 480 ms (fullrate on 12 kbit/s) 540 ms (fullrate on 6 kbit/s) 780 ms (halfrate)	520 ms (fullrate on 14, 5 kbit/s, 29,0 kbit/s or 43,5 kbit/s) 480 ms (fullrate on 12 kbit/s) 540 ms (fullrate on 6 kbit/s) 780 ms (halfrate)
T2 (note 1)		< 80 ms (fullrate on 14,5 kbit/s, 29,0 kbit/s or 43,5 kbit/s) < 80 ms (fullrate on 12 kbit/s) < 80 ms (fullrate on 6 kbit/s) < 80 ms (halfrate)	< 80 ms (fullrate on 14,5 kbit/s, 29,0 kbit/s or 43,5 kbit/s) < 80 ms (fullrate on 12 kbit/s) < 80 ms (fullrate on 6 kbit/s) < 80 ms (halfrate)
N2	> 0	6	6
P _T	0	0	0
P ₀	0 – 3	0	3
P ₁	512 – 65535	512	2048
P ₂	6 – 250	6	20
T4 (note 1)	> 25 ms	30 ms 50 ms (fullrate on 14,5 kbit/s, 29,0 kbit/s or 43,5 kbit/s)	30 ms 50 ms (fullrate on 14,5 kbit/s, 29,0 kbit/s or 43,5 kbit/s)
Optional feature, Up signalling	0 – 1	0	1
<p>NOTE 1: The timer values shall fulfil the formula:</p> <ul style="list-style-type: none"> - T1 > T2 + T4 + (2 * transmission delay) for multi-link operation; - T1 > T2 + (2 * transmission delay) for single link operation. <p>For A/Gb and GERAN lu mode the values apply according to indicated channel types, for UTRAN lu mode the values apply according to "fullrate on 14,5" Timer T4 is ignored in UTRAN lu mode and in single-link operation.</p> <p>NOTE 2: This value is recommended in the case of 4 physical links.</p> <p>NOTE 3: The maximum window size shall fulfil the formula:</p> <ul style="list-style-type: none"> - k_{max} < 496 - n × (1 + T4 / 20 ms), where n denotes the number of channels. <p>Any value k within the given range may be chosen. However, to avoid transmission delay the value k should be:</p> <ul style="list-style-type: none"> - k > n × (2 × transmission delay) / 20 ms. 			

5.5.1 RLP Version N°

The current version of RLP is "2". "0" is the default value for the version N°. RLP-versions are backwards compatible. It is assumed that future versions of RLP will be backwards-compatible with former ones. Backwards-compatible refers to the signalling, i.e. the handling of the parameters in the XID frame. The parameters are defined as specified by the RLP version with the lower number.

5.5.2 Maximum number of outstanding I frames k (Window size)

The window size is the maximum number (k) of sequentially numbered I frames that may be outstanding (i.e. unacknowledged) at any given time. It shall be agreed for a period of time.

In case of a single-link version the value can never exceed 61. In the case of a multi-link version it is necessary to use a window size that is less than the sequence number space to avoid misinterpretations of the confirming N(R). Therefore, a guard section is defined and the value k must not exceed the value k_{max} defined in table 2. On mutual agreement between the communication parties, a smaller window size may be established. For the support of 4 physical links, a value of 240 is recommended.

5.5.3 Timer T1

The period of Timer T1 is regarded to start at the beginning of the transmission of the relevant frame.

The negotiation (or default) value is defined to be the earliest instant to enter recovery.

The period of Timer T1 at the end of which retransmission of a frame may be initiated according to the procedures described in subclause 5.3, is a system parameter agreed for a period of time.

The proper operation of the procedure requires that Timer T1 be greater than the maximum time between transmission of frames (SABM, DM, DISC, I or supervisory commands) and the reception of the corresponding frame returned as a response to this frame (UA, DM or acknowledging frame). Therefore, the RLP entity should not delay the response or acknowledging frame returned to the above frame by more than a value T2. T2 is a system parameter, which is less than T1. T1 is influenced by the value of T4 and shall fulfil the formula in table 2.

5.5.4 Maximum number of retransmissions N2

The value of the maximum number of retransmissions N2 of a frame following the running out of Timer T1 is a system parameter agreed for a period of time.

5.5.5 Data Compression Parameters

If the Layer 2 Relay function supports a data compression function and its use is desired the needed data compression parameters have to be negotiated. The parameter P_T is not negotiable. In case of V.42 bis the parameters P_0 , P_1 and P_2 have to be negotiated. The parameters are defined as follows:

- P_T : Type of data compression:
 - 0 V.42 bis;
 - other values are reserved.
- P_0 : V.42bis data compression request:
 - 0 compress in neither direction;
 - 1 compress in initiator-responder direction only;
 - 2 compress in responder-initiator direction only;
 - 3 compress in both directions.
- P_1 : V.42bis number of possible codewords in the algorithm;
- P_2 : V.42bis maximum encodable data string length.

The initiator is the sender of XID command, the responder is the sender of XID response.

5.5.6 Re-sequencing period (Timer T4)

In the case of a multi-link version frames may be received out of sequence due to different transmission delays. The period of timer T4 guards the re-sequencing period. During this time frames may be out of sequence.

T4 is a system parameter agreed for a period of time. The proper operation of the procedure requires that the timer T4 shall be greater than the re-sequencing period and it shall fulfil the formula in table 2. A change of the timer T4 has impact on the usable maximum window size as defined in table 2.

5.5.7 Optional features

The format of the optional features parameters is an octet where each bit position represents an optional feature that can be negotiated. The optional features are:

Bit position	Optional feature name
1	Up signalling
2	(Not yet assigned)
3	(Not yet assigned)
4	(Not yet assigned)
5	(Not yet assigned)
6	(Not yet assigned)
7	(Not yet assigned)
8	(Not yet assigned)

The 'Optional Features' parameter is negotiated bitwise in the downward sense, meaning that the value of bit i in the XID response shall be less or equal to the value of bit i in the XID command.

Up signalling: If the negotiated value of the 'Up signalling' feature is 1, then the UP bit in the S and I+S frame header is used for indicating an upgrading proposal to the UE, otherwise the UP bit is ignored (don't care). This optional feature is only applicable for A/Gb mode and GERAN Iu mode.

5.6 Support for discontinuous transmission (DTX)

In both ADM and ABM, whenever the RLP entity has no numbered or unnumbered supervisory commands/responses and no information transfer frames pending transmission, the RLP entity shall indicate to the lower layer that the DTX function may be invoked.

5.6.1 In case of A/Gb mode

Protocol of lower layer conforms to 3GPP TS 48.004 [3], 3GPP TS 48.020 [25] and 3GPP TS 44.021 [2]. A/Gb mode specification assumes STM for lower layer protocol. Even if there is no data to be sent, some transmission is needed on STM. RLP acts as follows in case of DTX.

In case DTX is invoked, in ADM a NULL-frame will be sent, and in ABM a RR or RNR S-frame will be sent.

5.6.2 In case of Iu mode

Protocol of lower layer conforms to 3GPP TS 25.410 [5], 3GPP TS 25.411 [6], 3GPP TS 25.414 [7], 3GPP TS 25.415 [8] and 3GPP TS 43.051 [29]. Iu mode specification assumes ATM for lower layer protocol. When there is no data to be sent, no transmission is available on ATM. In consideration of transmission efficiency, no transmission is suitable. RLP acts as follows in case of DTX.

In case DTX is invoked, in ADM and ABM no frame will be sent.

6 Service definitions

6.1 Introduction

This subclause defines the service provided by the RLP-sublayer to the L2R-sublayer at the boundary between the RLP-sublayer and the L2R-sublayer.

The relationships between RLP-sublayer, L2R-sublayer and RLP-protocol are shown in figure 4.

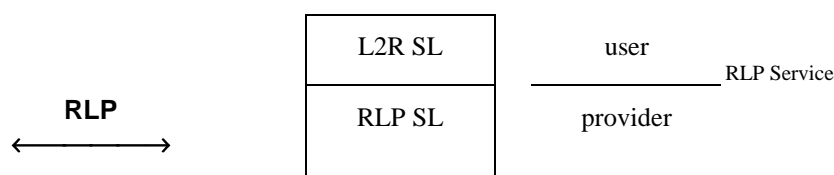

Figure 4: Basic relationship between RLP and L2R

The RLP service is defined in terms of:

- the primitive actions and events of the service;
- the parameters associated with each primitive action and event;
- the inter-relationship between, and the valid sequence of, these actions and events.

6.2 Conventions

For the description of the Data Link Service, the following conventions are used with time-sequence diagrams:

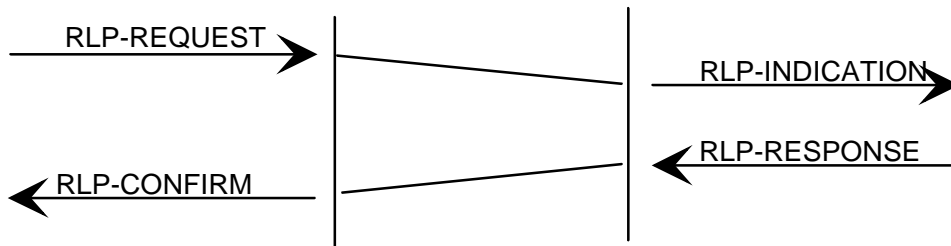

Figure 5: Confirmed service with acknowledgement



Figure 6: Unconfirmed service

In time-sequence diagrams, time moves from top to bottom. Arrows indicate the flow of information. Such flow of information may be subject to implicit flow-control. Skewed lines indicate a logical relationship between arrows. For clarity, the absence of such a relation may be marked by the symbol "~" (tilde).

6.3 Queue model

Between the two endpoints of an RLP-connection, there exists a flow control function. As a means of specifying this flow control feature and its relationship with other capabilities of the RLP, the following queue model is provided.

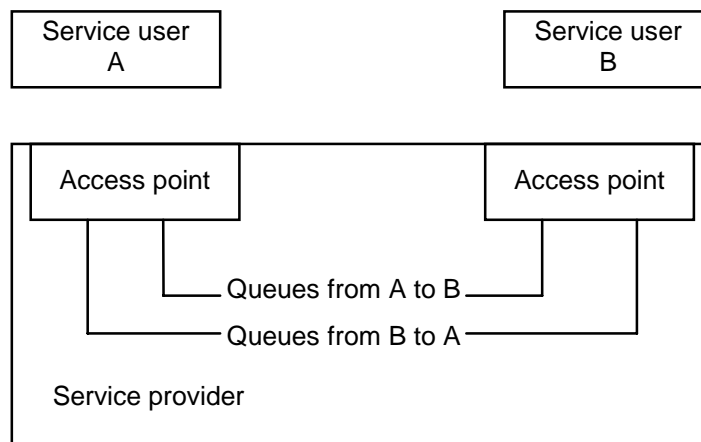

Figure 7: Queue Model

The following objects may be placed in a queue by a service user:

- a) connect;
- b) connection-mode data (numbered information);
- c) reset;
- d) disconnect.

The following objects may be placed in a queue by a service provider:

- a) reset;
- b) synchronization mark;
- c) disconnect.

NOTE: Other possible objects (i.e. unnumbered information, identification, test) are irrelevant (-) to the queue model and for reasons of simplicity are not shown.

Preceding	Following	Connect	Data	Reset	Sync Mark	Disconnect
Connect		NA	----	-----	NA	DES
Data		NA	----	DES	NA	DES
Reset		NA	----	DES	----	DES
Synchronization Mark		NA	----	DES	NA	DES
Disconnect		NA	NA	NA	NA	DES
Legend:						
NA: Not applicable.						
--: not destructive, not able to advance ahead of the preceding object.						
DES: Destructive to the preceding object.						

6.4 List of Primitives

Link establishment:

- RLP-CONNECT-REQUEST
- RLP-CONNECT-INDICATION
- RLP-CONNECT-RESPONSE (-NEG)
- RLP-CONNECT-CONFIRM (-NEG)

Normal Data Transfer:

- RLP-DATA-REQUEST (S, INF)
- RLP-DATA-INDICATION (S, INF)

NOTE: The parameter S (L2R status bit) is only relevant for RLP-version 2.

Reset:

- RLP-RESET-REQUEST
- RLP-RESET-INDICATION
- RLP-RESET-RESPONSE
- RLP-RESET-CONFIRM

Release:

RLP-DISCONNECT-REQUEST

RLP-DISCONNECT-INDICATION

Miscellaneous:

unnumbered information

RLP-UNITDATA-REQUEST (INF)

RLP-UNITDATA-INDICATION (INF)

Exchange Identification:

RLP-XIDDATA-REQUEST (INF)

RLP-XIDDATA-INDICATION (INF)

Test:

RLP-TESTDATA-REQUEST (INF)

RLP-TESTDATA-CONFIRM (-NEG) (INF)

6.5 Possible RLP time sequence diagrams

a) Connection establishment (without collision)

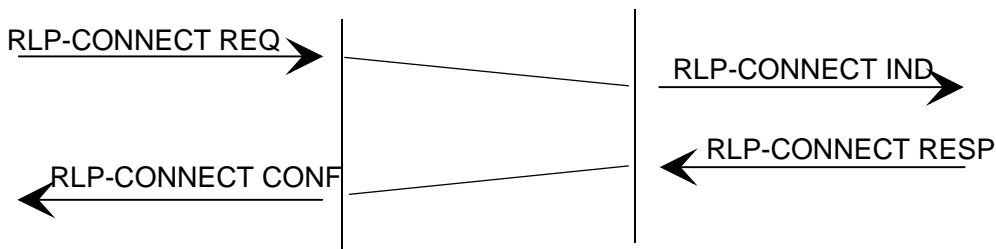

b) Connection establishment (with collision)

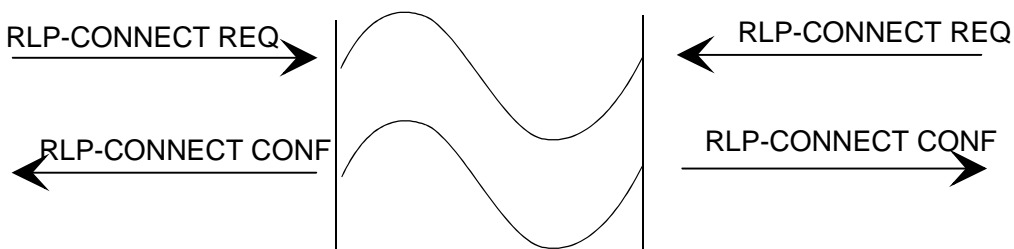

c) User invoked release (without collision)



d) Collision of user invoked releases

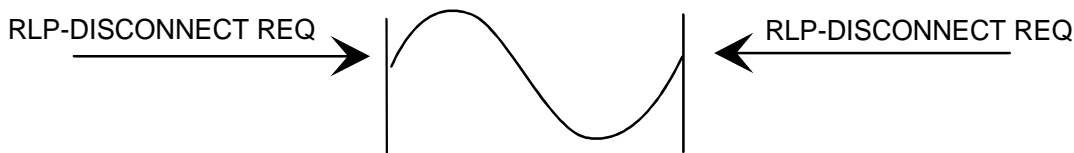

e) Simultaneous user and provider invoked release

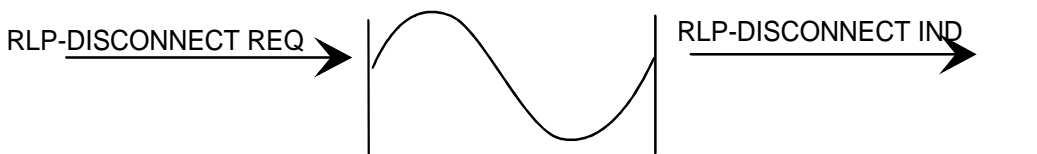

f) Provider invoked release

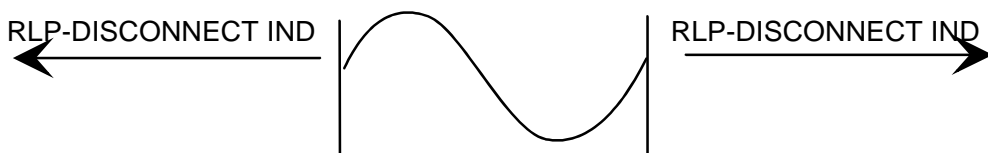

g) Provider rejection of establishment

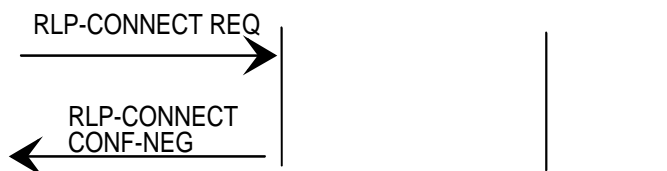

h) Normal data transfer



i) User invoked reset

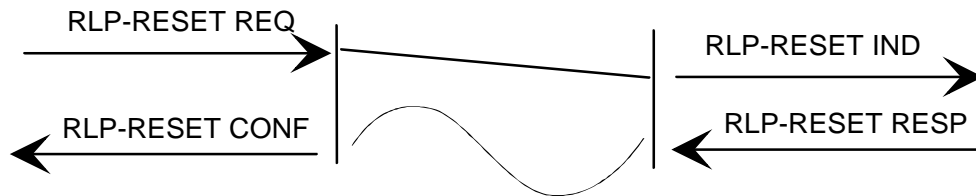

j) Collision of user invoked resets

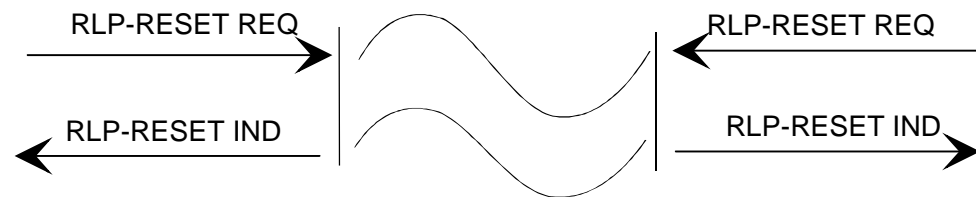

k) provider invoked reset

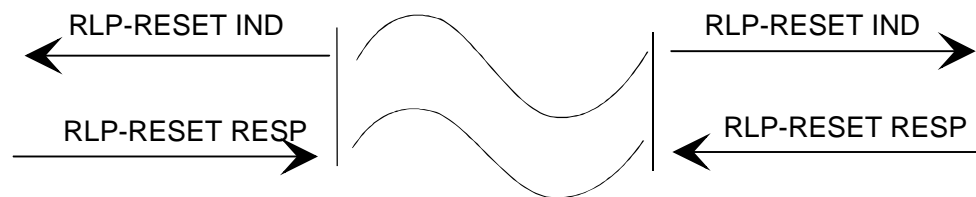

l) simultaneous user and provider invoked reset

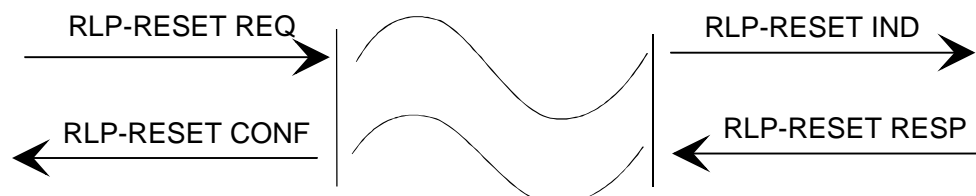

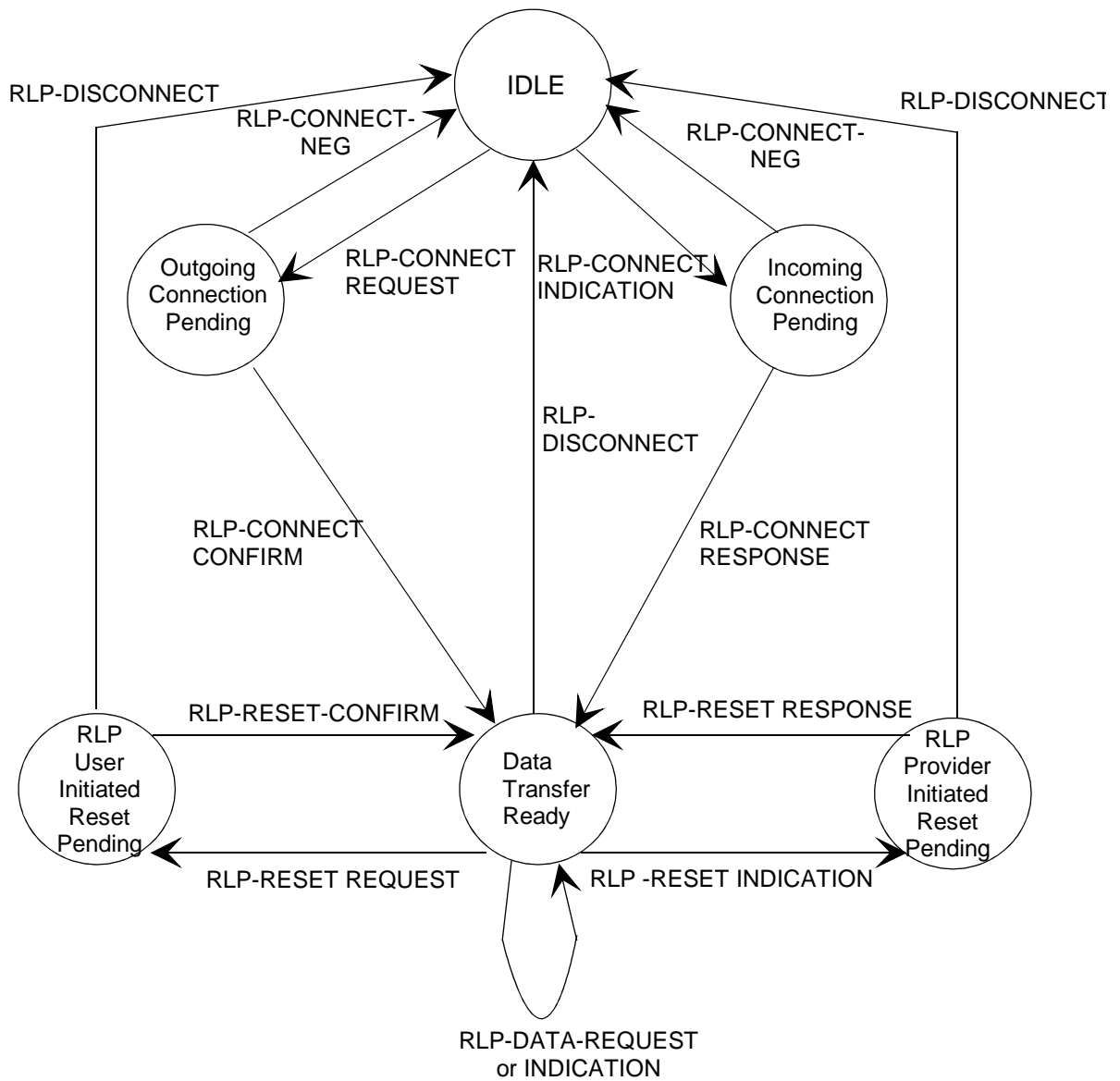

Figure 8: State transition diagram for sequence of RLP connection-mode service primitives

Annex A (informative): RLP SDL Diagrams

This annex describes a model implementation of an RLP entity for RLP version "0".

The description should help to clarify the present document, the RLP service and protocol definition.

However, it is not intended to restrict any implementation of an RLP entity in any way, on condition the implementation shows the correct behaviour at the RLP protocol level.

The model implementation consists of three processes. Process "SEND_PDU" adds the CRC to a given PDU and hands it to the lower layer entity for transmission. Process "RECEIVE_PDU" gets a received PDU block, checks the value of the CRC and the bits of the PDU header. If the CRC has the right value and if the header is syntactically correct, the receipt event is signalled to the "RLP_KERNEL" process, which is the protocol handling automaton.

Each process is described as an extended finite state machine (using SDL-Diagrams).

Each state of the automaton is described by a (main-)state number and a corresponding (main-)state name. The state may further be distinguished by the value of other state variables. This scheme is used because not every state variable needs to be defined in every state. The states are defined in clause A.1.

The RLP machine reacts on events, which may be classified as:

- lower layer interface events;
- upper layer interface events; and
- station management or internal events.

The events of the RLP-Kernel are described in clause A.2.

A.1 List of RLP entity states

A.1.1 (main) states

state number	state symbol	state name
0	S0	ADM and Detached
1	S1	ADM and Attached
2	S2	Pending Connect Request
3	S3	Pending Connect Indication
4	S4	ABM and Connection Established
5	S5	Disconnect Initiated
6	S6	Pending Reset Request
7	S7	Pending Reset Indication

A.1.2 state variables

The main states are further distinguished by the values of the state variables. However, not every state variable is used (evaluated/ defined) in every state.

First some constants need to be defined:

- M = 62 number of different sequence numbers (modulus).
 Nmin = 0 smallest sequence number.
 Nmax = 61 largest sequence number (= M - 1).
 N2 = 6 maximum number of retransmissions.

variable name	variable type and range	semantic
Ackn_FBit	(0, 1)	Value of the F-Bit used in the next acknowledging PDU.
Ackn_State	(idle, send)	Ackn_State = send means, an acknowledging PDU (Supervisory or Data) has to be sent.
C	(0, 1)	to store the C/R-Bit value of a received S- or I-frames
Data	char[25]	to store temporarily the information part (user data) of a received I-frame.
DISC_Count	(0, 1, ..., N2)	to count the transmissions of DISC.
DISC_PBit	(0, 1)	The value of the P-bit in the next DISC command PDU.
DISC_State	(idle, send, wait)	if (DISC_State = send) the DISC command PDU has to be sent at the next possible opportunity. if (DISC_State = wait) the RLP entity waits for the corresponding response.
DM_FBit	(0, 1)	Value of the F-Bit used in the next DM response PDU.
DM_State	(idle, send)	if (DM_State = send) the PDU DM has to be sent.
DTX_SF	(N, RR, RNR)	to store the last Supervisory frame for DTX (only RR or RNR can be suppressed)
DTX_VR	(0, 1, ..., Nmax)	to store the last transmitted value of VR (used to decide the DTX condition)
F	(0, 1)	to store temporarily the F-bit of a received response PDU.
NR	(0, 1, ..., Nmax)	to store temporarily the receive sequence number of a received S- or I-frame
NS	(0, 1, ..., Nmax)	to store temporarily the send sequence number of a received I-frame
P	(0, 1)	to store temporarily the P-bit of a received command PDU
P_F	(0, 1)	to store temporarily the P- or F-bit of received command or response PDUs
Poll_Count	(0, 1, ..., N2)	to count the transmissions of poll requests
Poll_State	(idle, send, wait)	(Poll_State = send) means, a supervisory PDU with P-bit set to one has to be sent (Poll_State = wait) means, the RLP entity waits for the response with F-bit set to one
Poll_xchg	(idle, wait)	(Poll_xchg = idle) means, sending of a frame with P-bit set is allowed (Poll_xchg = wait) means, an acknowledgement of a previous P-bit is outstanding
R[M]	record array	Receiver slots (M slots, numbered 0 to M-1)
R[n].Data	char[25]	to store user information
R[n].State	(idle, rcvd, ackn, srej, wait)	(R[n].State = rcvd) means, data has been received (with sequence number n). (R[n].State = ackn) means, data has been received and acknowledged (R[n].State = srej) means, the retransmission of data has to be requested using srej(n). (R[n].State = wait) means, the entity waits for the requested retransmitted data
REJ_State	(idle, send, wait)	The REJ_State is send if and only if a REJ PDU has to be sent
returncode	Integer	used in procedures to report a result
RRReady	Boolean	Remote Receiver Ready

variable name	variable type and range	semantic
SABM_Count	(0, 1,..., N2)	to count the transmissions of SABM
SABM_State	(idle, send, wait)	if (.._State = send) the SABM PDU has to be sent
		if (.._State = wait) the RLP entity waits for the UA response
S[M]	record array	Sender Slots (M slots, numbered 0 to M-1)
S[n].Data	char[25]	user information to be sent
S[n].State	(idle, send, wait)	(S[n].State = send) means, data has to be sent (with sequence# n).
SF	(RR, RNR, REJ, SREJ)	to store the last superv. PDU type
T	Timer	used by the data sender if waiting for I-frame acknowledgements or F-bits
TEST_Count	(0, 1,...,N2)	to count the transmissions of TEST
TEST_C_Data	char [25]	data to be sent in the next TEST command PDU
TEST_C_PBit	(0, 1)	value of the P-Bit used in the next TEST command PDU
TEST_C_State	(idle, send, wait)	if (.._State = send) the TEST command PDU has to be sent
		if (.._State = wait) the RLP entity waits for the next TEST response
TEST_R_Data	char[25]	data to be sent in the next TEST response PDU
TEST_R_FBit	(0, 1)	value of the P-Bit used in the next TEST response PDU
TEST_R_State	(idle, send)	if (.._State = send) the TEST response PDU has to be sent
T_RCVR	Timer	used by the receiver to timeout a REJ condition
T_RCVS(n)	Timer	used by the receiver to timeout a SREJ condition for Slot n
T_TEST	Timer	used by the sender of a TEST frame if waiting for a TEST response
T_XID	Timer	used by the sender of a XID frame if waiting for the XID response
UA_FBit	(0, 1)	value of the F-Bit used in the next UA response
UA_State	(idle, send)	if (UA_State = send) an UA PDU has to be sent
UI_Data	char[25]	data to be sent in the next UI PDU
UI_PBit	(0, 1)	value of the P-Bit used in the next UI PDU
UI_State	(idle, send)	if (UI_State = send) a UI PDU has to be sent
VA	(0, 1,..., Nmax)	frame sequence number of oldest not yet acknowledged I-frame (if VA = VS then there are no unacknowledged frames)
VD	(0, 1, ..., Nmax)	slot number used in the next Data_Req
VR	(0, 1, ..., Nmax)	receiver sequence number (the next received I-frame is expected to carry this sequence number)
VS	(0, 1, ..., Nmax)	sender sequence number (under normal operating conditions the next I-frame is assigned this number)
XID_Count	(0, 1,...,N2)	to count the transmissions of XID commands
XID_C_Data	char [25]	data to be sent in the next XID command PDU
XID_C_PBit	(0, 1)	value of the P-Bit used in the next XID command PDU
XID_C_State	(idle, send, wait)	if (.._State = send) the XID command PDU has to be sent
		if (.._State = wait) the RLP entity waits for the next XID response
XID_R_FBit	(0, 1)	value of the P-Bit used in the next XID response PDU
XID_R_State	(idle, send)	if (.._State = send) the XID response PDU has to be sent

A.2 List of RLP entity events

The interface is indicated by l:lower, u:upper and m:management. From the formal definition point of view this distinction of course is unnecessary.

event#	name	semantic	interface
1	Attach_Req	Switch to "ADM and Attached"	m
2	Conn_Ind	Connect indication	u
3	Conn_Conf	Connect confirm	u
4	Conn_Conf_Neg	Connect confirm negative	u
5	Conn_Req	Connect request	u
6	Conn_Resp	Connect response	u
7	Conn_Resp_Neg	Connect response negative	u
8	Data_Ind(Data)	Data transfer indication (user data in Data)	u
9	Data_Req(Data)	Data transfer request (user data in Data)	u
10	Detach_Req	Switch to "ADM and Detached"	m
11	Disc_Ind	Disconnection indication	u
12	Disc_Req	Disconnect request	u
13	DISC(P)	PDU DISC received (P-bit in P)	l
14	DM(F)	PDU DM received (F-bit in F)	l
15	Error_Ind	Error Indication	u
16	LL_Data_Req	Data request to lower layer	l
17	LL_Data_Ind	Data indication from lower layer	l
18	NULL	PDU NULL received	l
19	Ready_Ind	Indication that a new PDU may be sent	m
20	Reset_Conf	Reset confirm	u
21	Reset_Ind	Reset indication	u
22	Reset_Req	Reset request	u
23	Reset_Resp	Reset response	u
24	RR_I(C, P_F, NR, NS, Data)	I-frame RR received	l
25	RNR_I(C, P_F, NR, NS, Data)	I-frame RNR received	l
26	REJ_I(C, P_F, NR, NS, Data)	I-frame REJ received	l
27	SREJ_I(C, P_F, NR, NS, Data)	I-frame SREJ received	l
28	RR(C, P_F, NR)	S-frame RR received	l
29	RNR(C, P_F, NR)	S-frame RNR received	l
30	REJ(C, P_F, NR)	S-frame REJ received	l
31	SREJ(C, P_F, NR)	S-frame SREJ received	l
32	SABM(P)	PDU SABM received	l
33	UA(F)	PDU UA received (F-bit in F)	l
34	UI_Req(Data)	Unnumbered Information transfer request	u
35	UI(C, P_F, Data)	UI PDU received	l
36	T	Timeout (Timer of the sender expired)	m
37	Test_Conf(Data)	Test confirm (received data in Data)	u
38	Test_Conf_Neg(Data)	Test confirm negative (received data in Data)	u
39	T_RCVR	Timeout (Timer of the receiver for REJ expired)	m
40	T_RCVS(n)	Timeout (Timer of the receiver for SREJ expired)	m
41	T_TEST	Timeout (Test timer expired)	m
42	T_XID	Timeout (Xid timer expired)	m
43	Test_Req(Data)	Test request (Test data in Data)	m
44	TEST(C, P_F, Data)	TEST command/response PDU received (C/R-bit in C, P/F-bit in P_F, Data in Data)	l
45	XID_Req(Data)	Exchange ID request	m
46	XID_Ind(Data)	Exchange ID indication	m
47	XID(C, P_F, Data)	XID command/response PDU received	l

System RLP - Overview

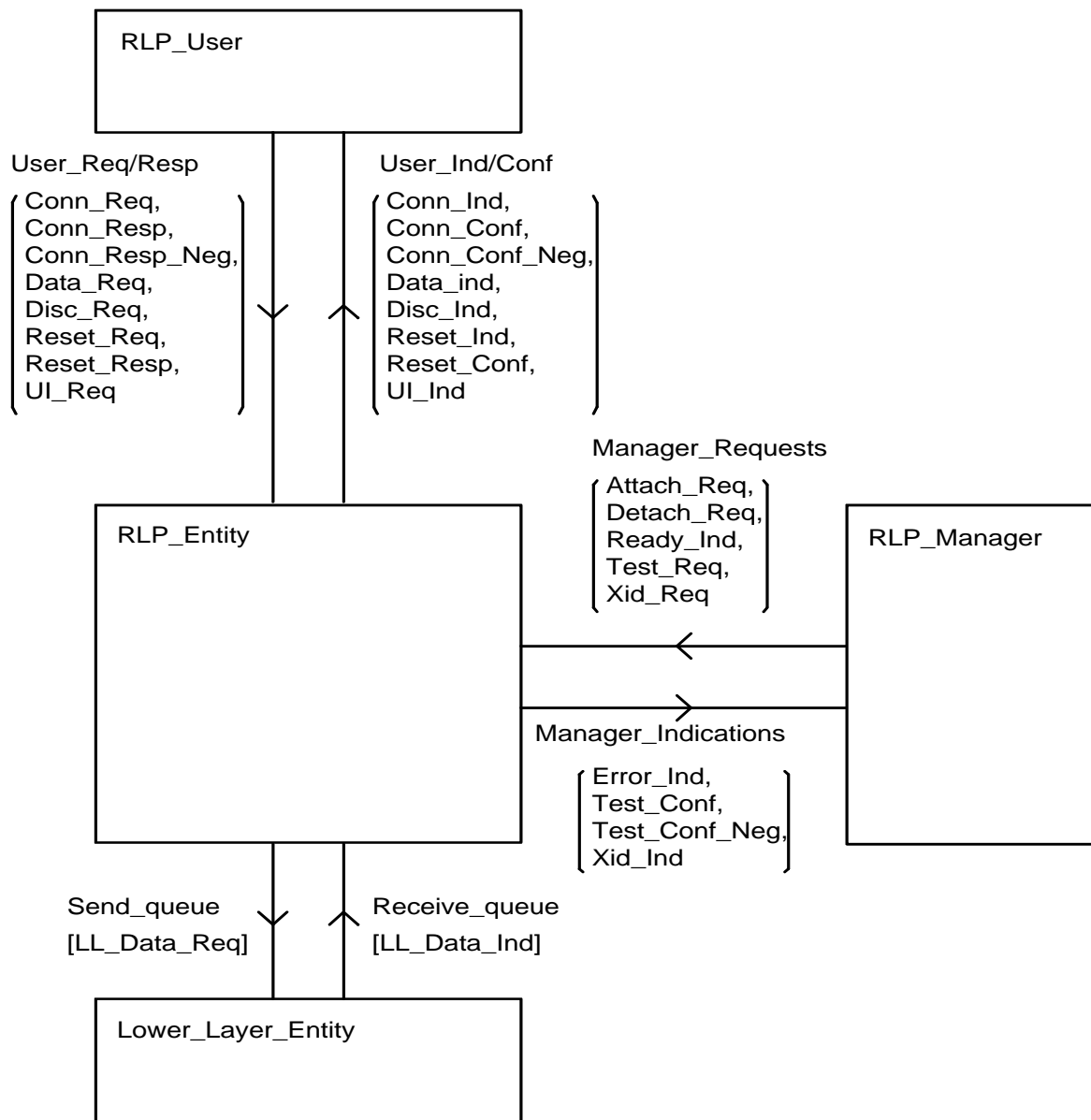

0422AF01.DRW 93-03-01

Figure A.1

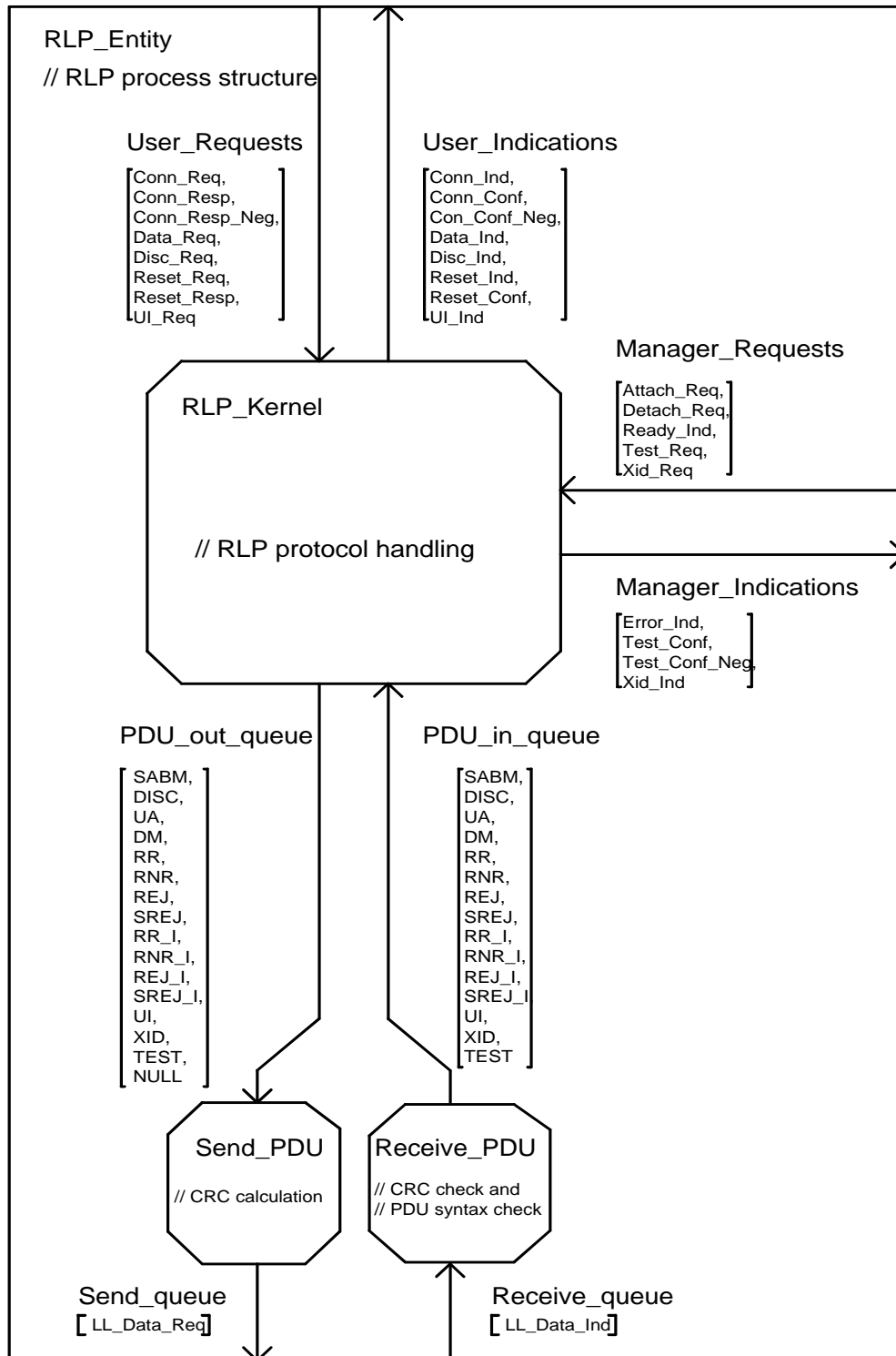

0422AF02.DRW 93-05-25

Figure A.2

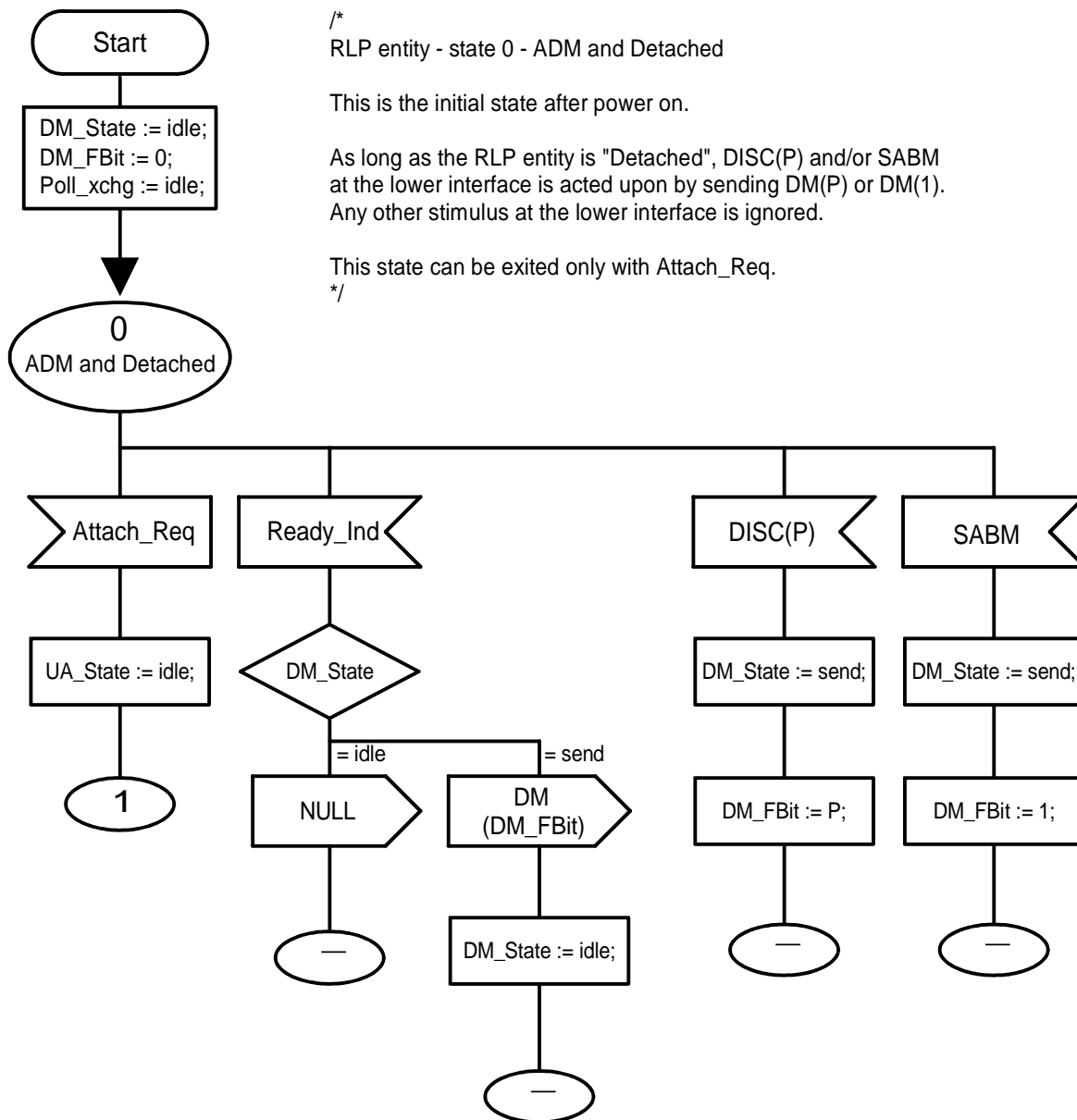

0422AF03.DRW 93-02-26

Figure A.3

/*
 RLP entity - state 1 - ADM and Attached

The RLP entity is ready to establish a connection, either by initiating the connection itself (Conn_Req) or by responding to an incoming connection request (SABM).

Upon receiving a DISC PDU, the sending of the UA response is initiated.
 */

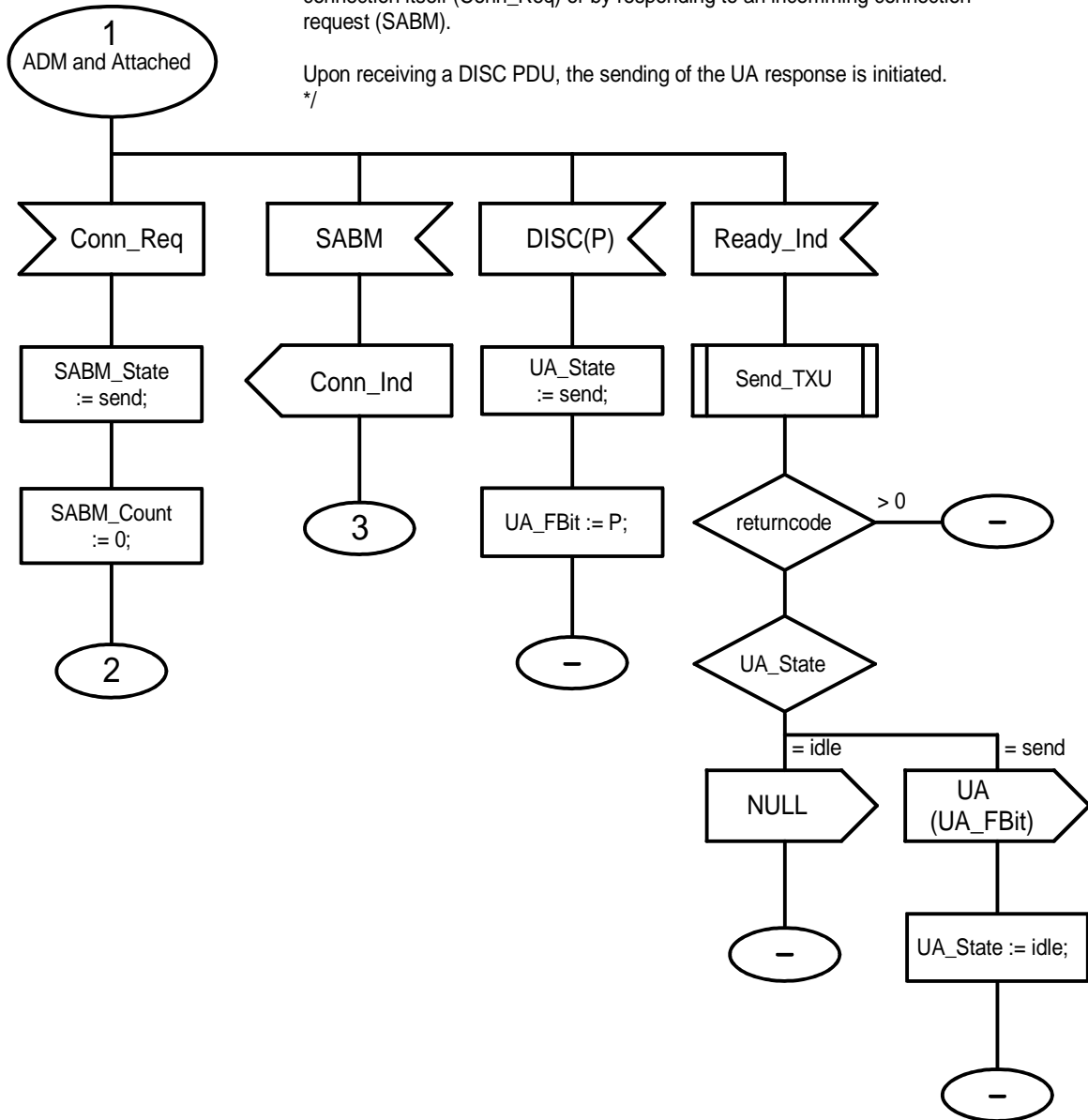

0422AF04.DRW 93-02-25

Figure A.4

/*
 RLP entity - state 2 - Pending connect request

This figure allows up to N2 repetitions of SABM and describes the disconnect and the SABM contention case.
 */

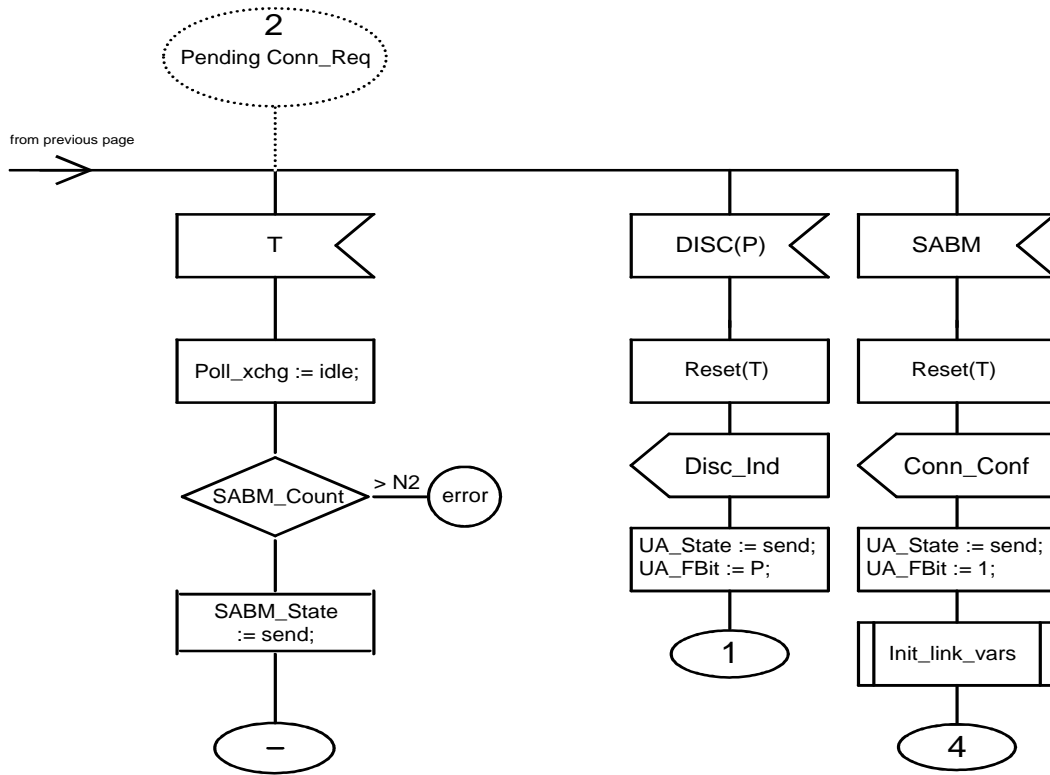

0422AF06.DRW 93-02-25

Figure A.6

/*
 RLP entity - state 3 - pending Connect indication

After having received SABM, the RLP entity is waiting for the Connect response.

The upper layer entity may respond with Conn_Resp or Disc_Req. It is assumed that the upper layer entity does not delay the response more than T2 msec.

The Disconnect request exit is described on a following page (see figure 14).
 */

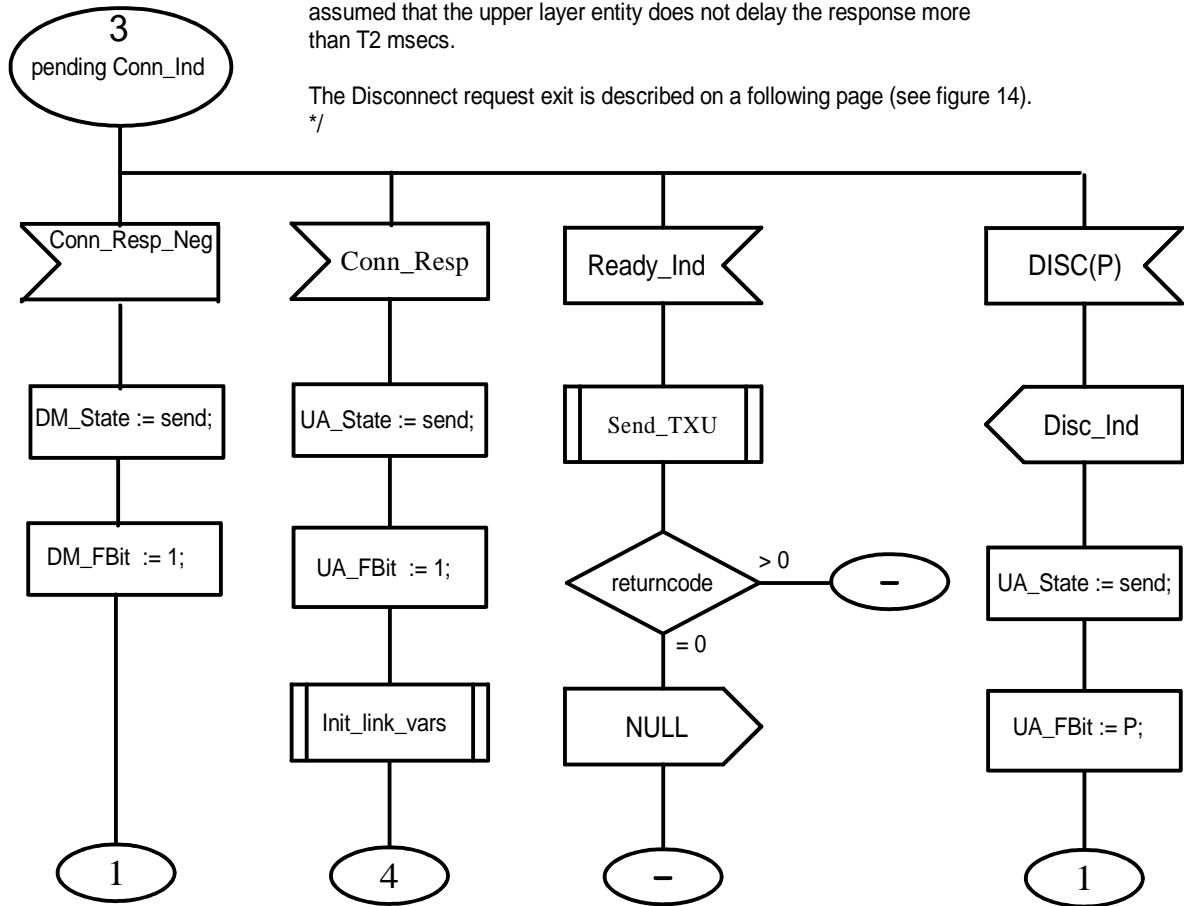

0422AF07.DRW 94-09-15

Figure A.7

/*
 RLP entity - state 4 - Connection established

This is the data transfer state. The user entity may transmit data by firing Data_Requests. However, he is allowed to do so only if there are idle sender slots.

The data stored in the send slots will be transmitted at the next possible opportunity.

This state may be exited by a Disconnect Request (see Figure 14).
 */

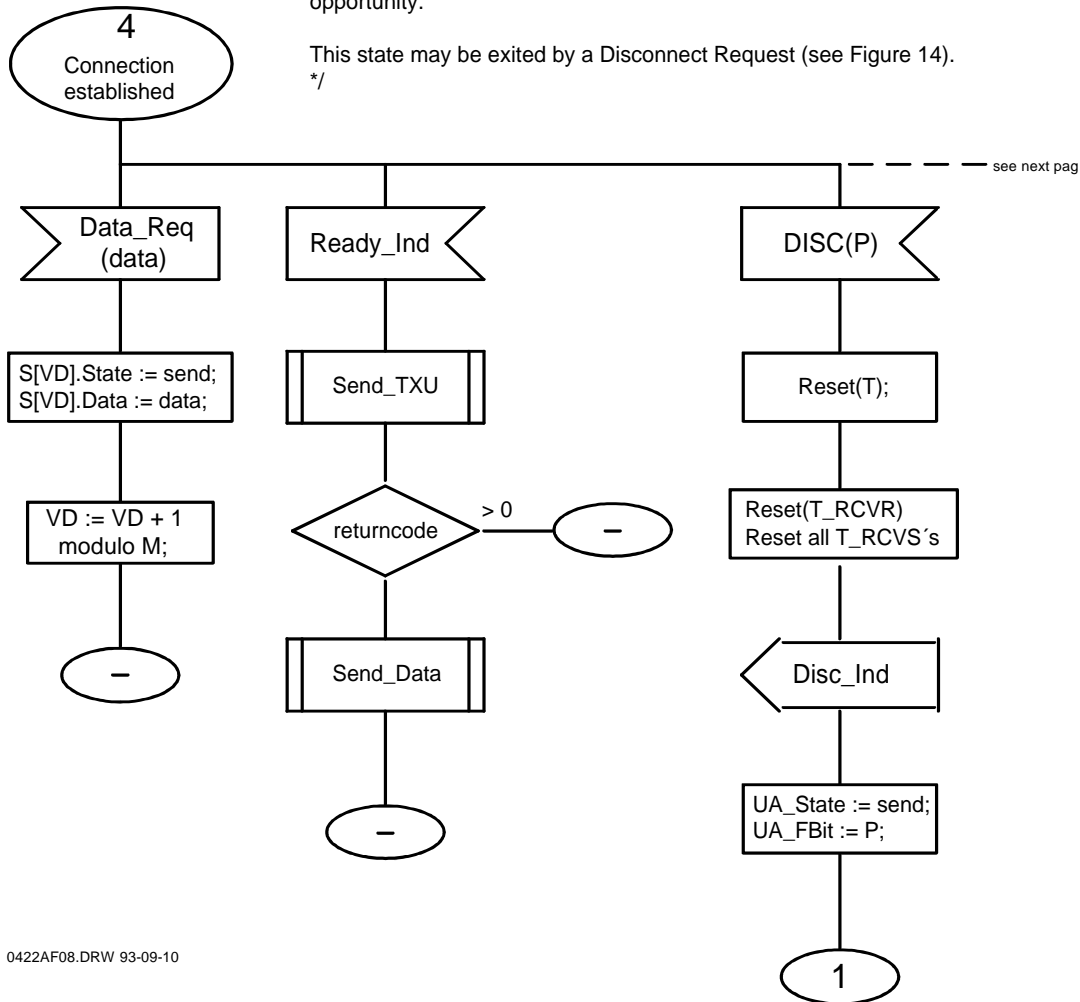

0422AF08.DRW 93-09-10

Figure A.8

/*
 RLP entity - state 4 - Connection established

This diagram describes RESET and the Timeout-handling.

A timeout leads to error recovery by polling. This is controlled by the Poll_State variable. The Poll_State transitions are:

idle -> send <-> wait -> idle

Zero up to N2 transitions wait->send may occur.
 */

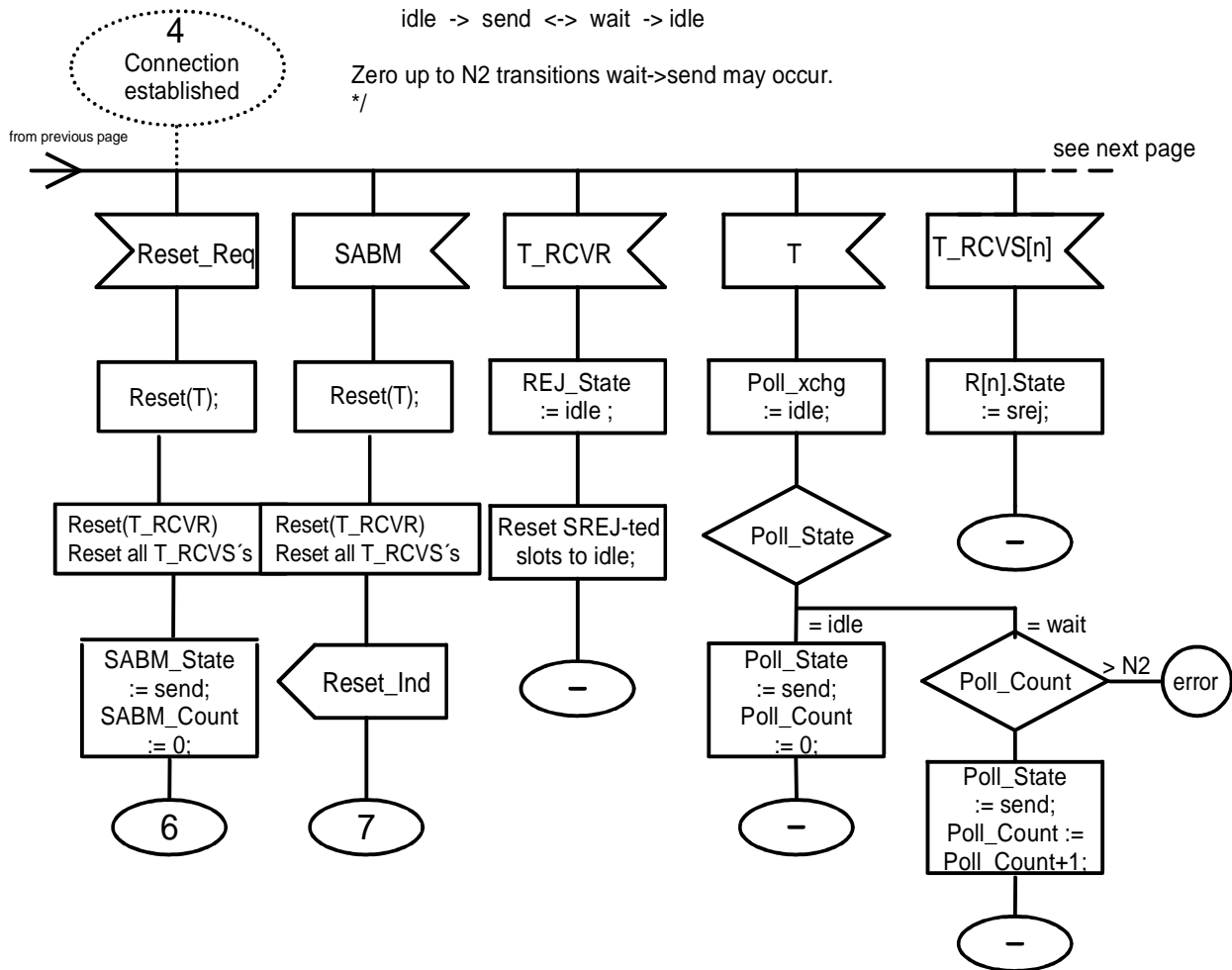

0422AF09.DRW 93-09-10

Figure A.9

/*
 RLP entity - state 4 - Connection established

This diagram describes the handling of I-frames and S-frames
 (PDUs RR, RNR, REJ, SREJ and RR_I, RNR_I, REJ_I, SREJ_I).

If the frame contains user information, this is handled by the I-Handler.
 The supervisory information is handled by the S-handler.

A frame with an unsolicited F-bit is ignored.

*/

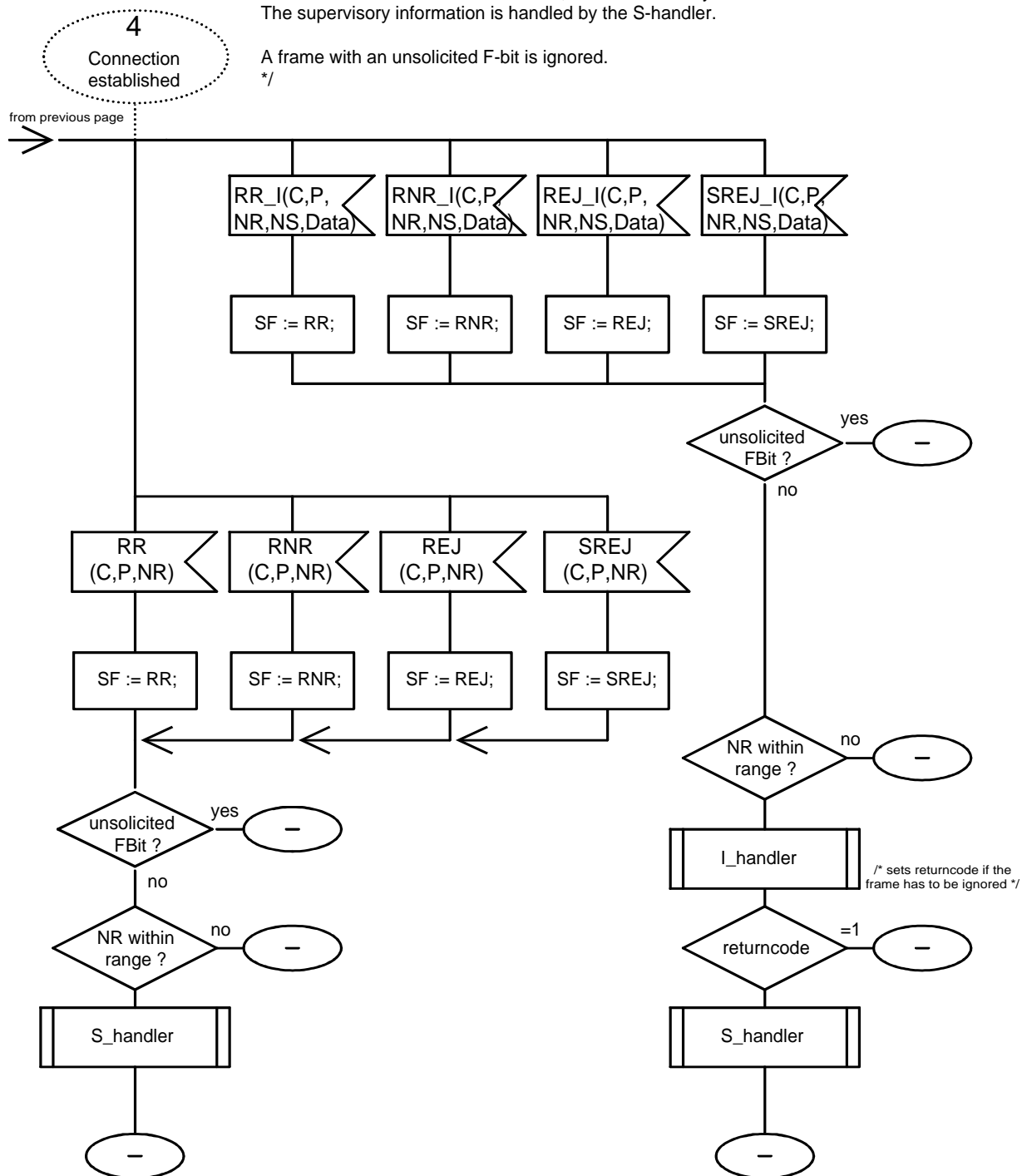

Figure A.10

/*
 RLP entity - state 6 - pending Reset Request

Send (up to N2 repetitions) SABM and wait for the responding UA with FBit=1.

The substate is controlled by the variable SABM_State (values idle, send, wait) and SABM_Count (values 0..N2).

This state may be exited with a Disconnect Request (see Figure 14).

*/

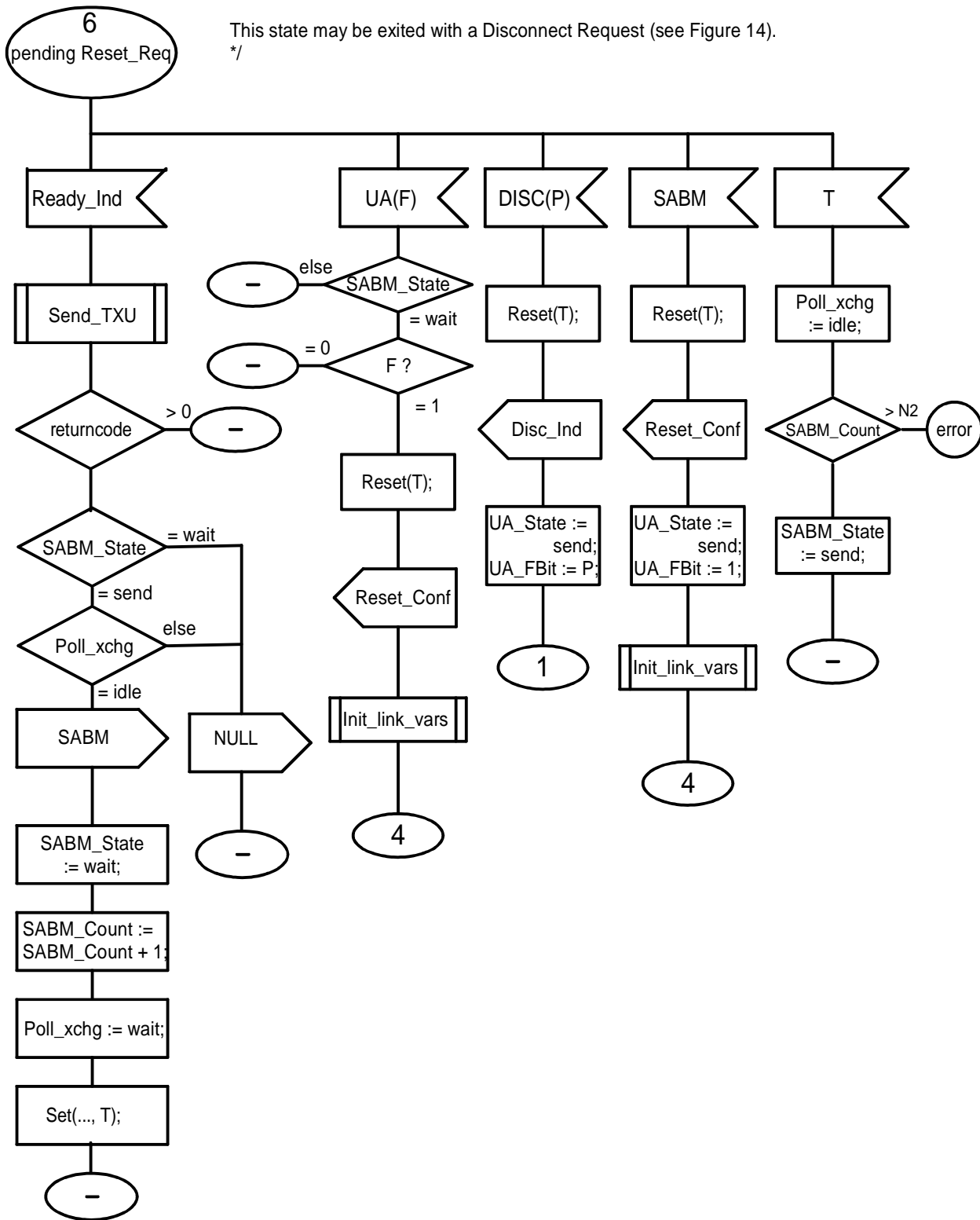

0422AF12.DRW 93-05-27

Figure A.12

/*
 RLP entity - state 7 - pending Reset Indication

After having received SABM and having indicated Reset, the RLP entity is waiting for the Reset_Response.

The upper layer entity may respond with Reset_Resp or Disc_Req. It is assumed, that the upper layer entity does not delay the response more than T2 msec.

The Disconnect Request is described on a following page (see Figure 14).
 */

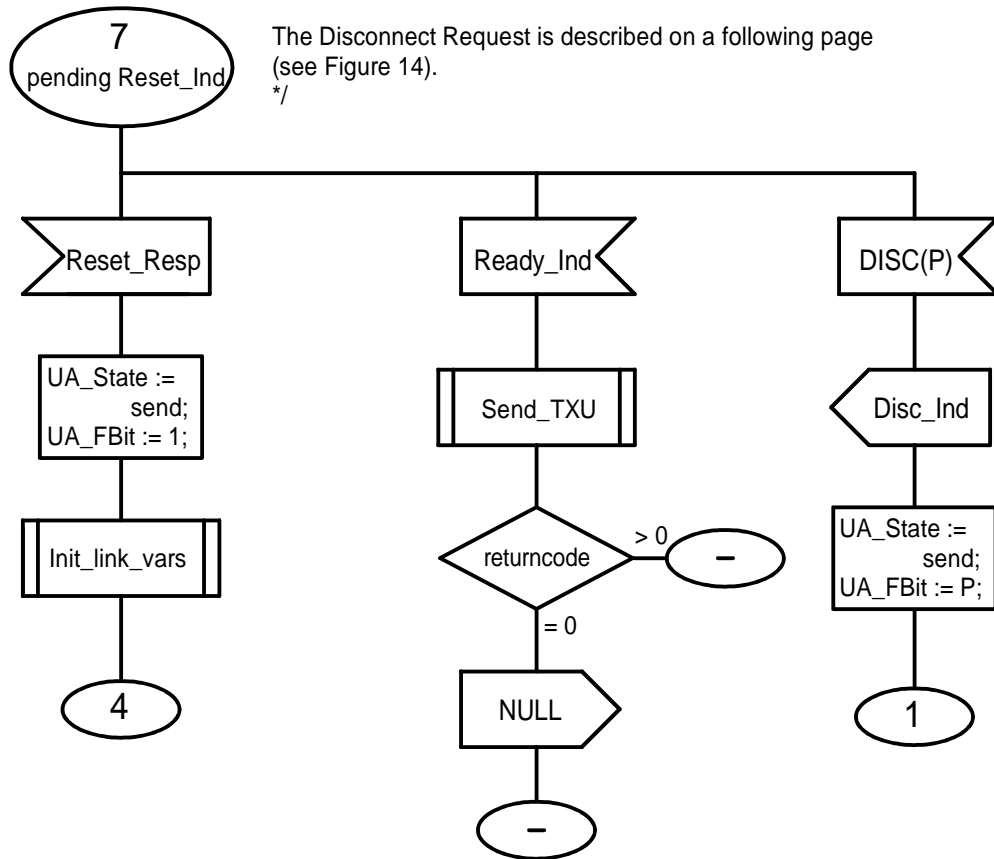

0422AF13.DRW 93-03-01

Figure A.13

/*
 This is the error handling when there is no action from the remote end after N2 repetitions. The error handling and the state transition depends on the situation e.g. ADM in case of DISC
 */

/*
 Detach Request
 Detach is allowed at any time.
 The Detach Request is used to reset the RLP entity to state 0, e.g. if the physical connection is lost.
 */

/*
 Disconnect Request
 Disconnect is used to release a connection.
 The actions to be executed in these cases are: reset the timer, activate sending of the DISC PDU.
 The P-bit in the DISC command is set to one or zero, depending on the Poll_xchg state.
 */

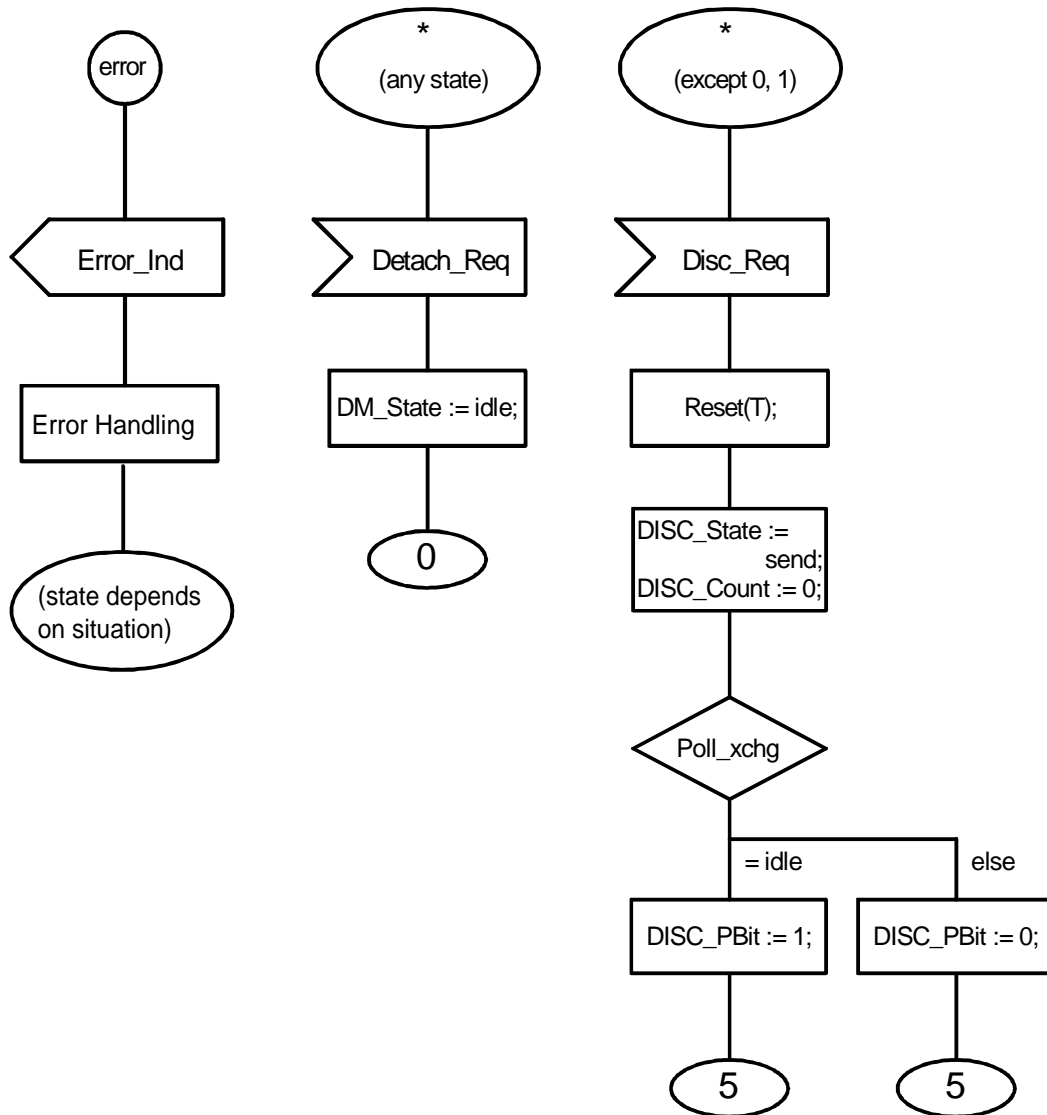

0422AF14.DRW 93-02-25

Figure A.14

/*
 UI handling (UI_Req, UI)

UI_Requests are controlled using the state variable UI_State. The values (state transitions) are: idle -> send -> idle

It is assumed that the upper layer entity issues an UI_Req only if the RLP entity's UI_State is idle. The UI data is stored in the variable UI_Data.

The UI_PDU is generated at the next possible opportunity, i.e. after the higher priviledged PDUs (TEST PDUs, XID PDUs, if any) have been transmitted.

*/

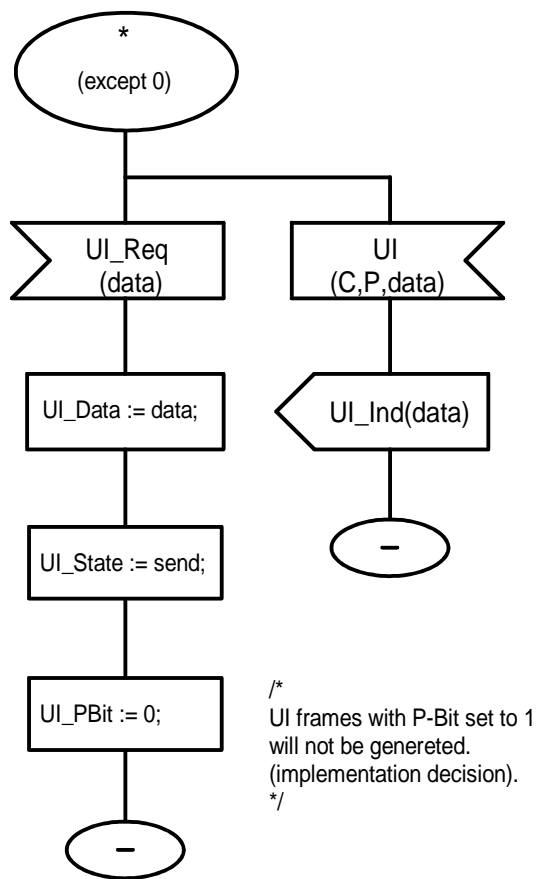

0422AF15.DRW 93-02-26

Figure A.15

/*
XID handling (XID_Req, XID)

XID requests are controlled using the state variable XID_C_State and XID_R_State. The state transitions being used are:

idle -> send -> wait -> idle.

The XID data is stored in the variable XID_C_Data.
*/

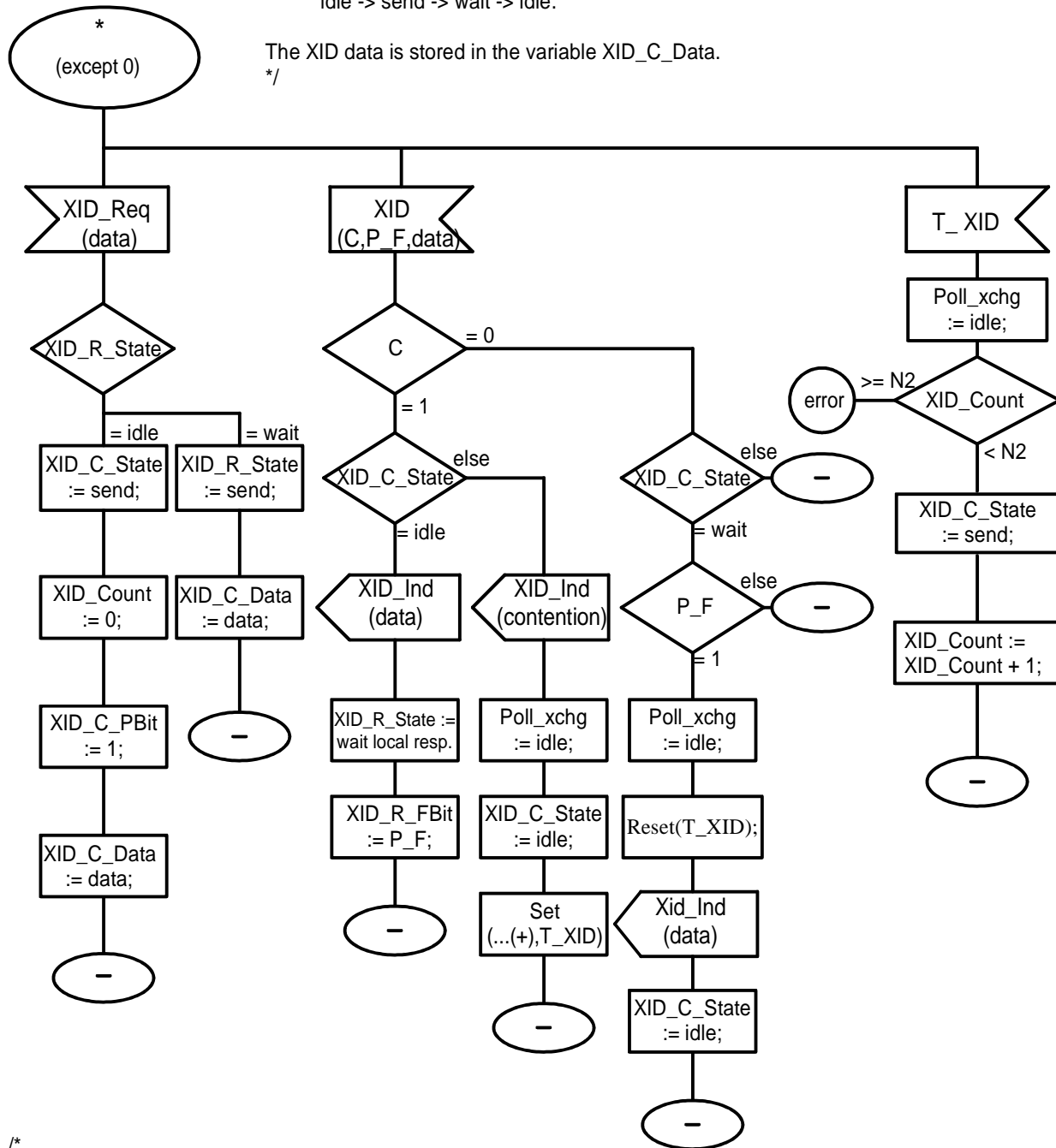

/*
The action on a received XID command PDU depends on the state variable XID_C_State. In the contation case the XID Command is sent again after a certain delay, depending on the 'location' of the RLP entity.

The XID command/response PDU is sent at the earliest possible opportunity, next after a possible pending TEST PDU (see procedure SEND_TXU) The value of the timer should be T1 ms in the Mobile Station, it should be twice this value in the Interworking Unit. This scheme is used to avoid repetinon of contentions.

*/

0422AF16.DRW 93-05-25

Figure A.16

/*
 TEST handling (TEST_Req, TEST_PDU, TEST_timeout)
 */

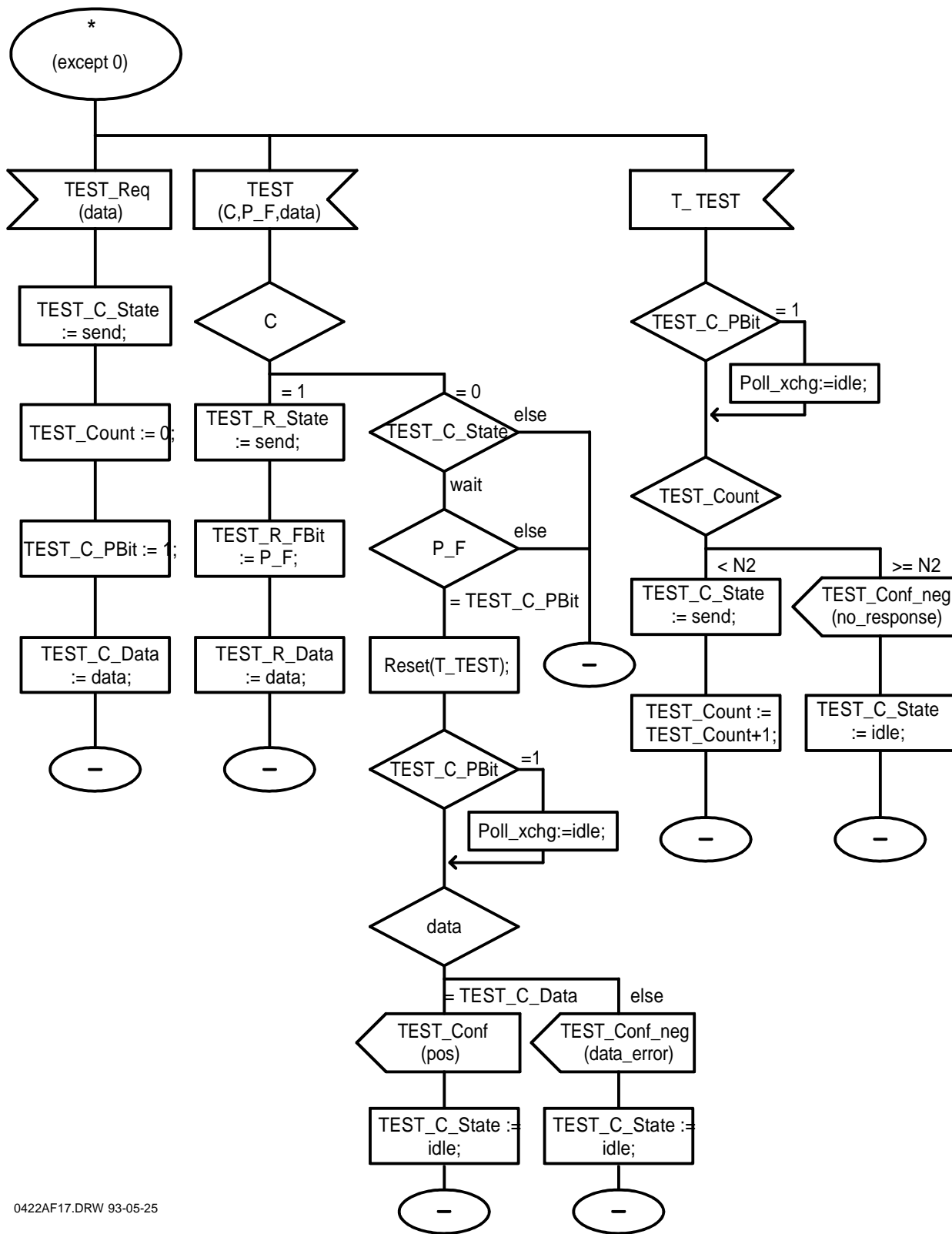

0422AF17.DRW 93-05-25

Figure A.17

Process Receive_PDU

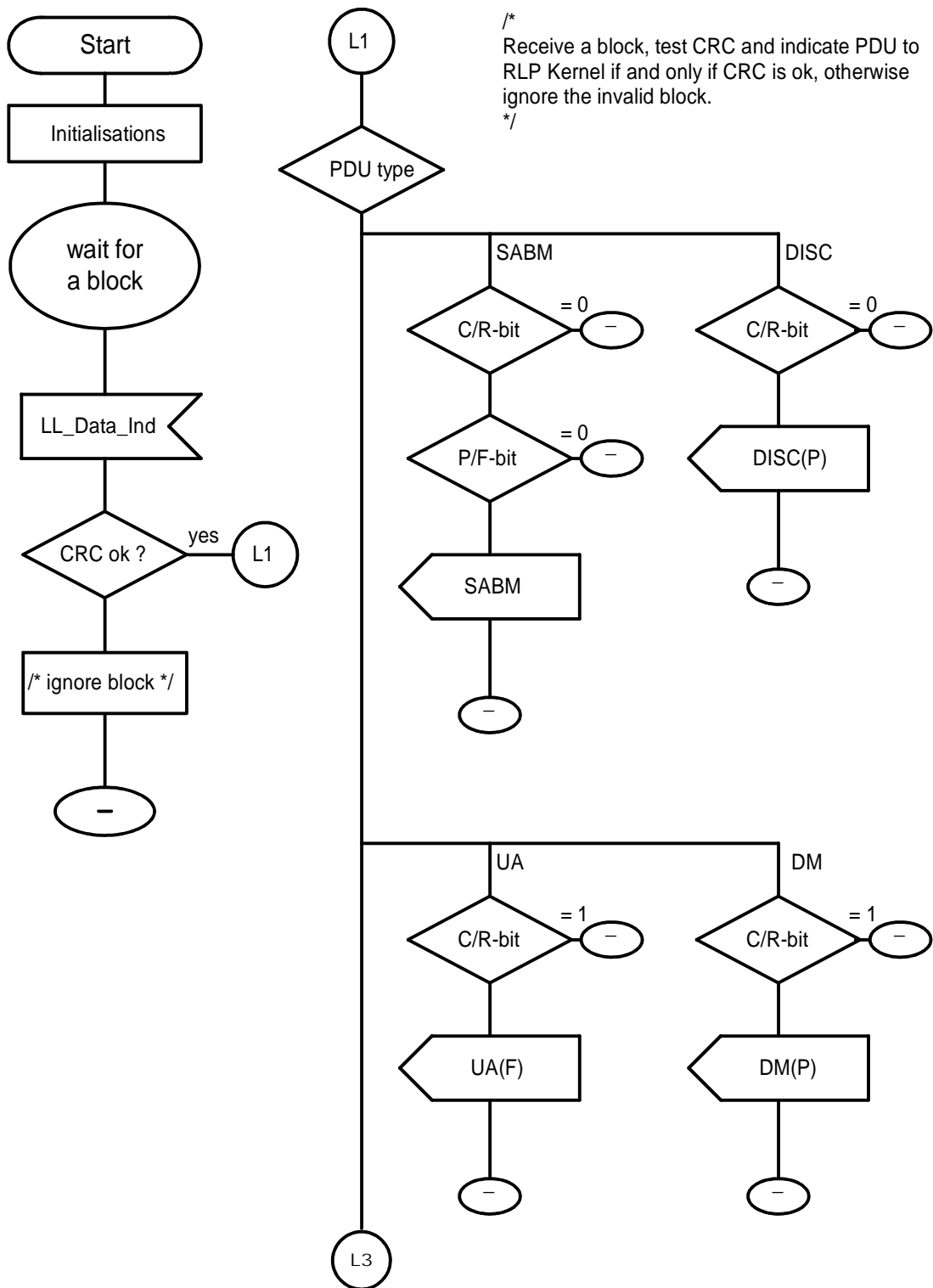

0422AF18.DRW 93-02-25

Figure A.18

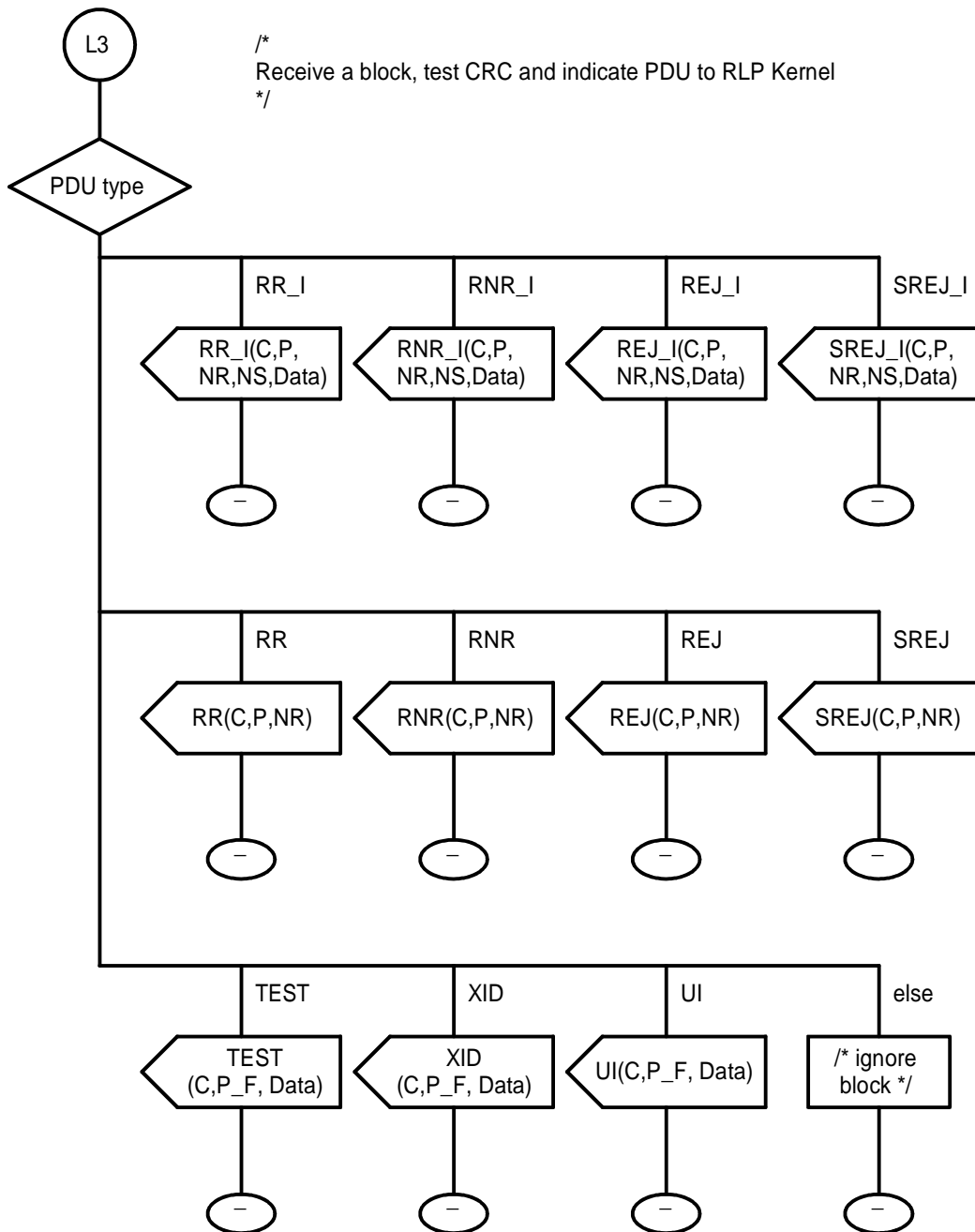

0422AF19.DRW 93-02-25

Figure A.19

Process Send_PDU

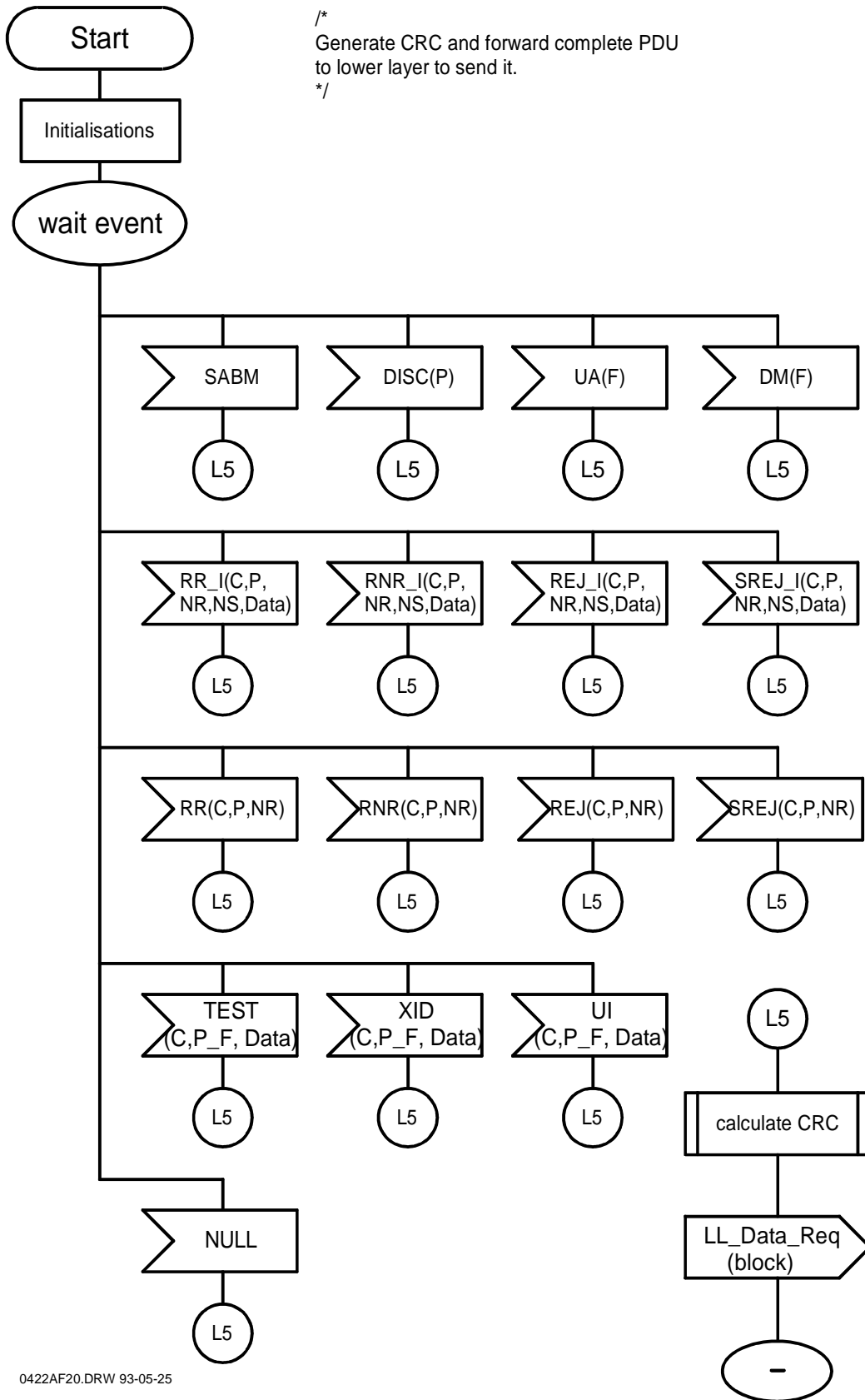

0422AF20.DRW 93-05-25

Figure A.20

/*
 Initialise link variables - This procedure is called if the link is established or the link is reset.
 */

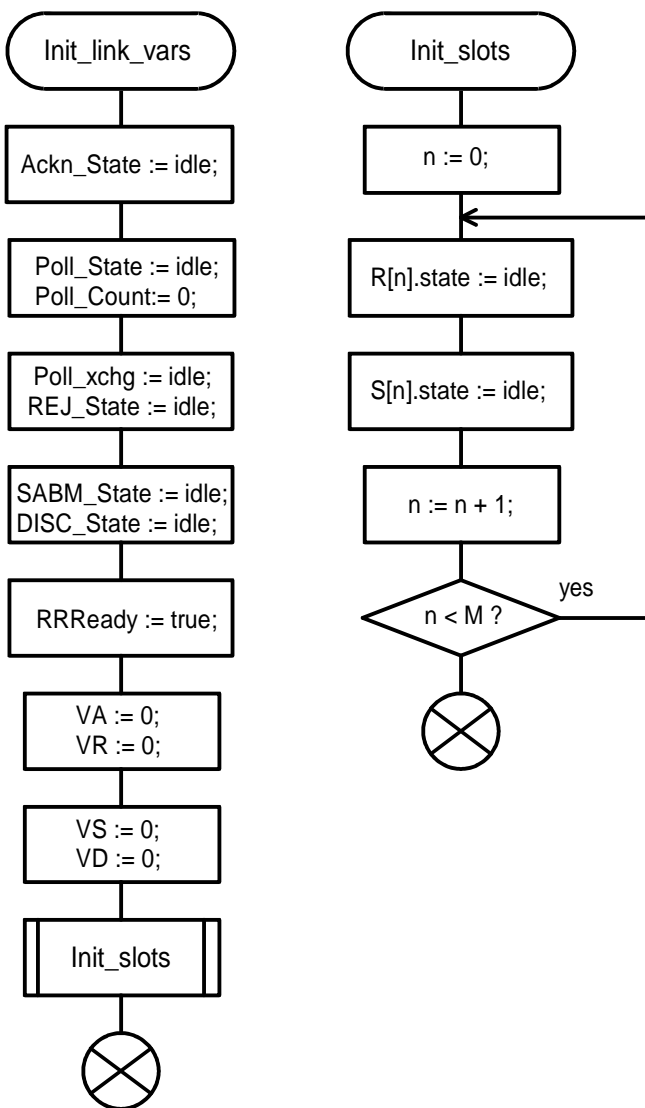

/*
 There are M data receiver slots and M data sender slots (M <= 62).

The receiver states are: idle, rcvd, send, wait.

- State = idle means: nothing received (with this number),
- State = rcvd means: data received, to be delivered and acknowledged only if in sequence.
 If delivered, the state becomes idle again.
- State = send means: pending retransmission request for this block,
- State = wait means : waiting for reception of requested block.

The sender slot states are: idle, send, wait.

- State = idle means: nothing to do, slot may be used (again).
- State = send means: send data at the next possible opportunity.
- State = wait means: wait for the acknowledgement

*/

Figure A.21

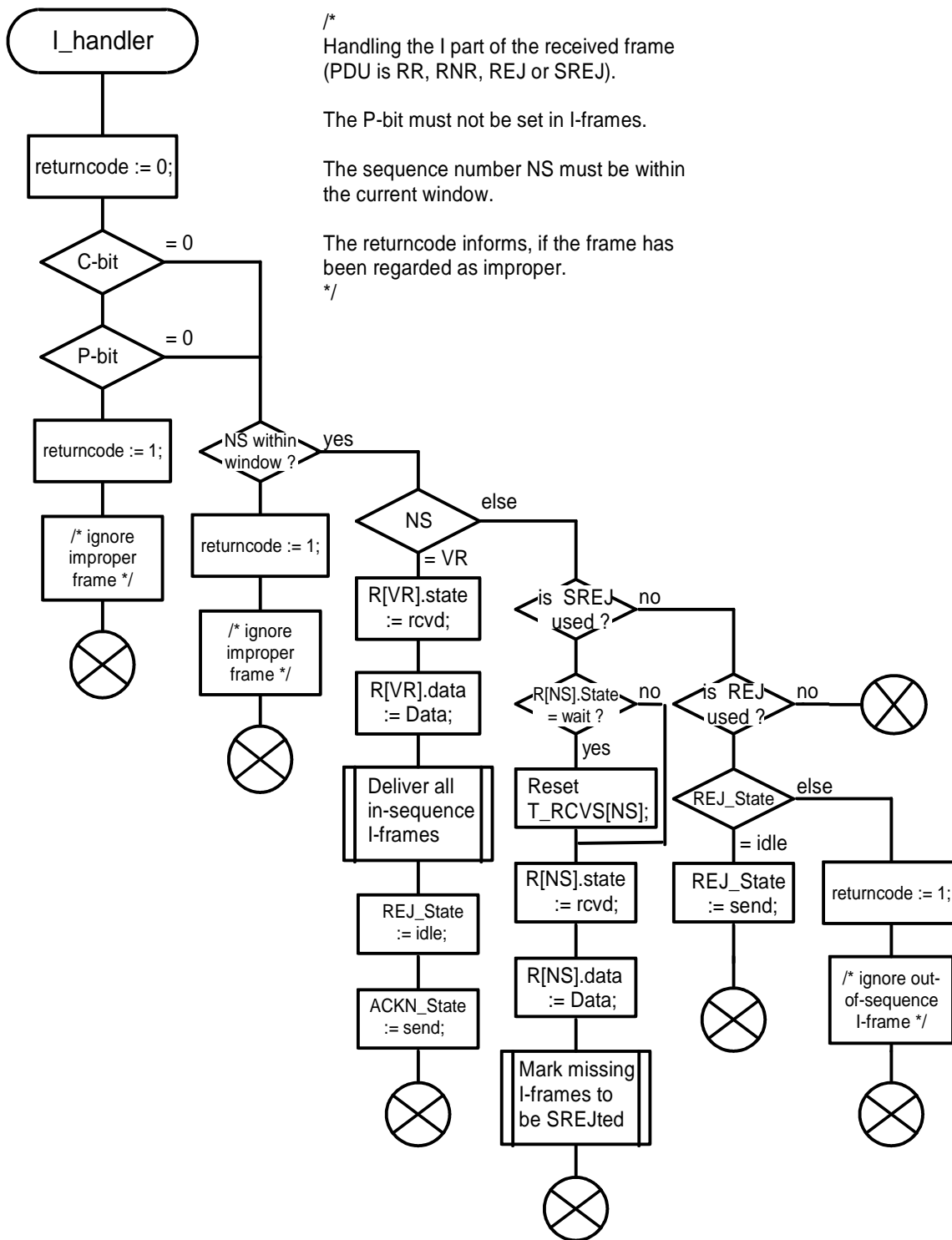

0422AF22.DRW 93-09-10

Figure A.22

/*
 Deliver all in-sequence I-frames

 Indicate all already received in-sequence information blocks. There may be more than one block which has to be indicated due to successful selective recovery.
 */

/*
 mark all missing I-frames

 All missing I-frames "between" VR and NS have to be marked if their state is idle.
 */

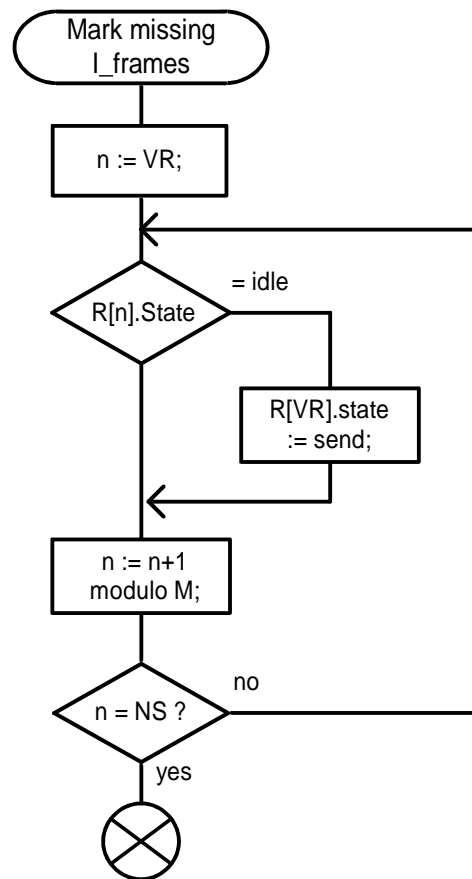
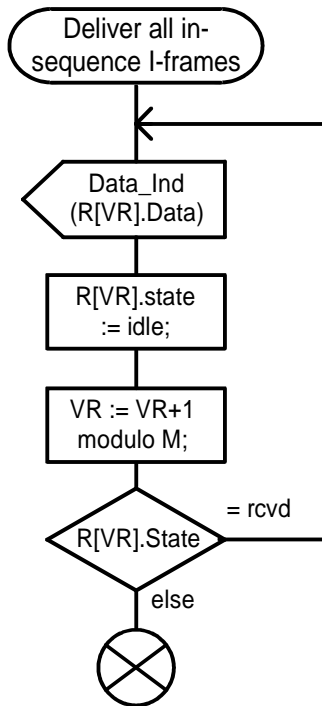

0422AF23.DRW 93-05-25

Figure A.23

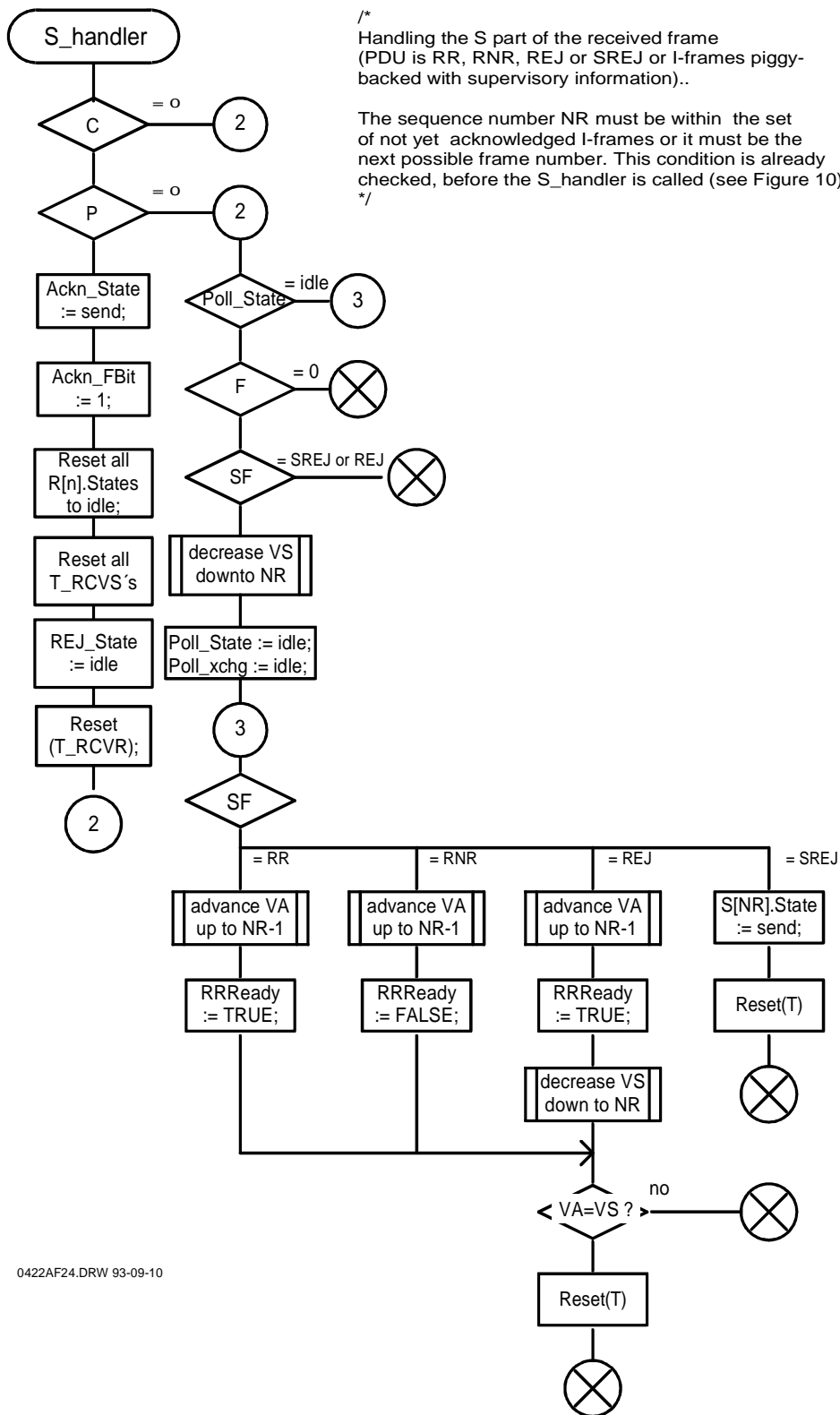
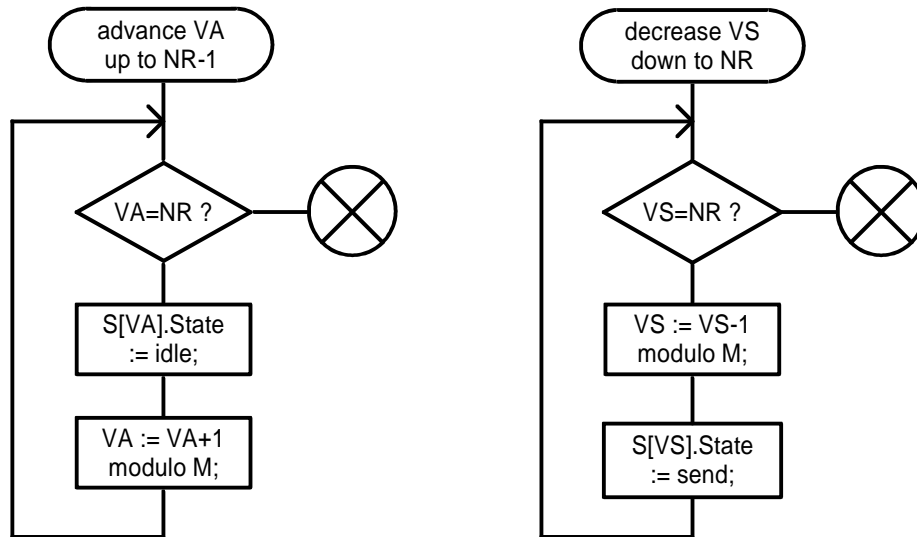

Figure A.24

/*
Advance the lower
window edge
*/

/*
Set the sender slot
states to send again
*/



0422AF25.DRW 93-03-01

Figure A.25

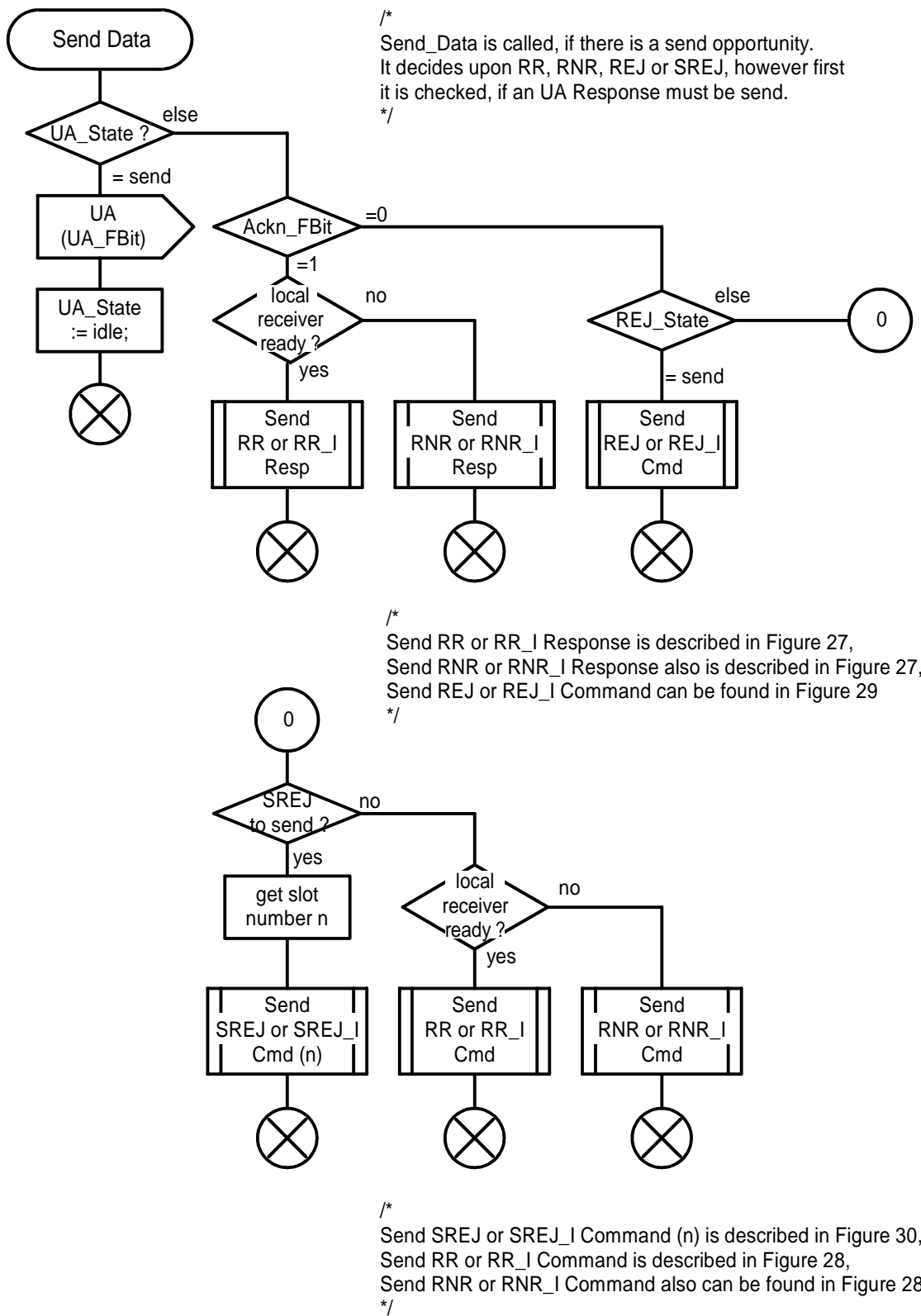

0422AF26.DRW 93-05-25

Figure A.26

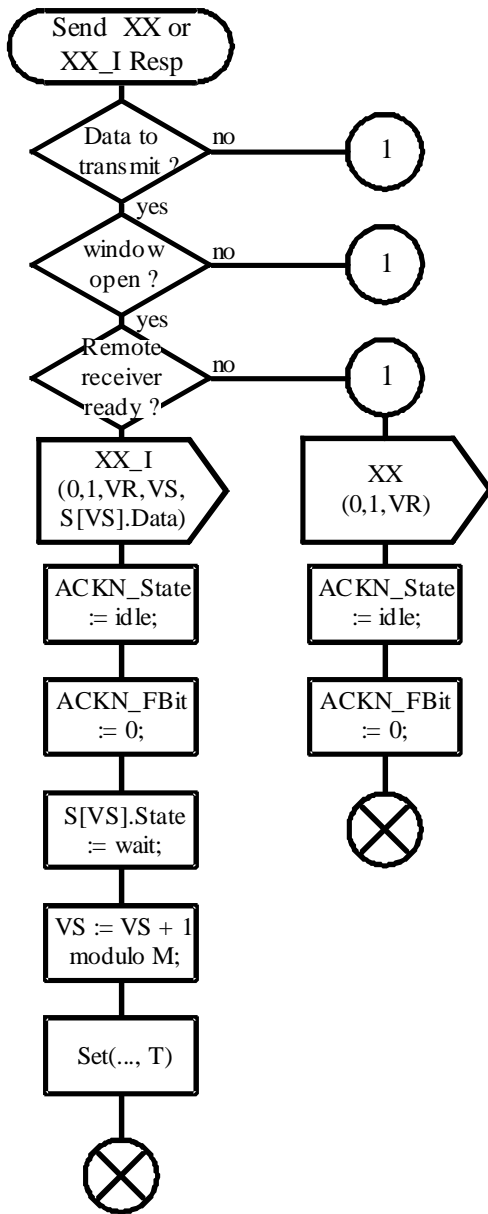

/*
Send XX or XX_I response PDU with F-Bit set to one.

XX may be RR or RNR.
*/

0422AF27.DRW 93-05-25

Figure A.27

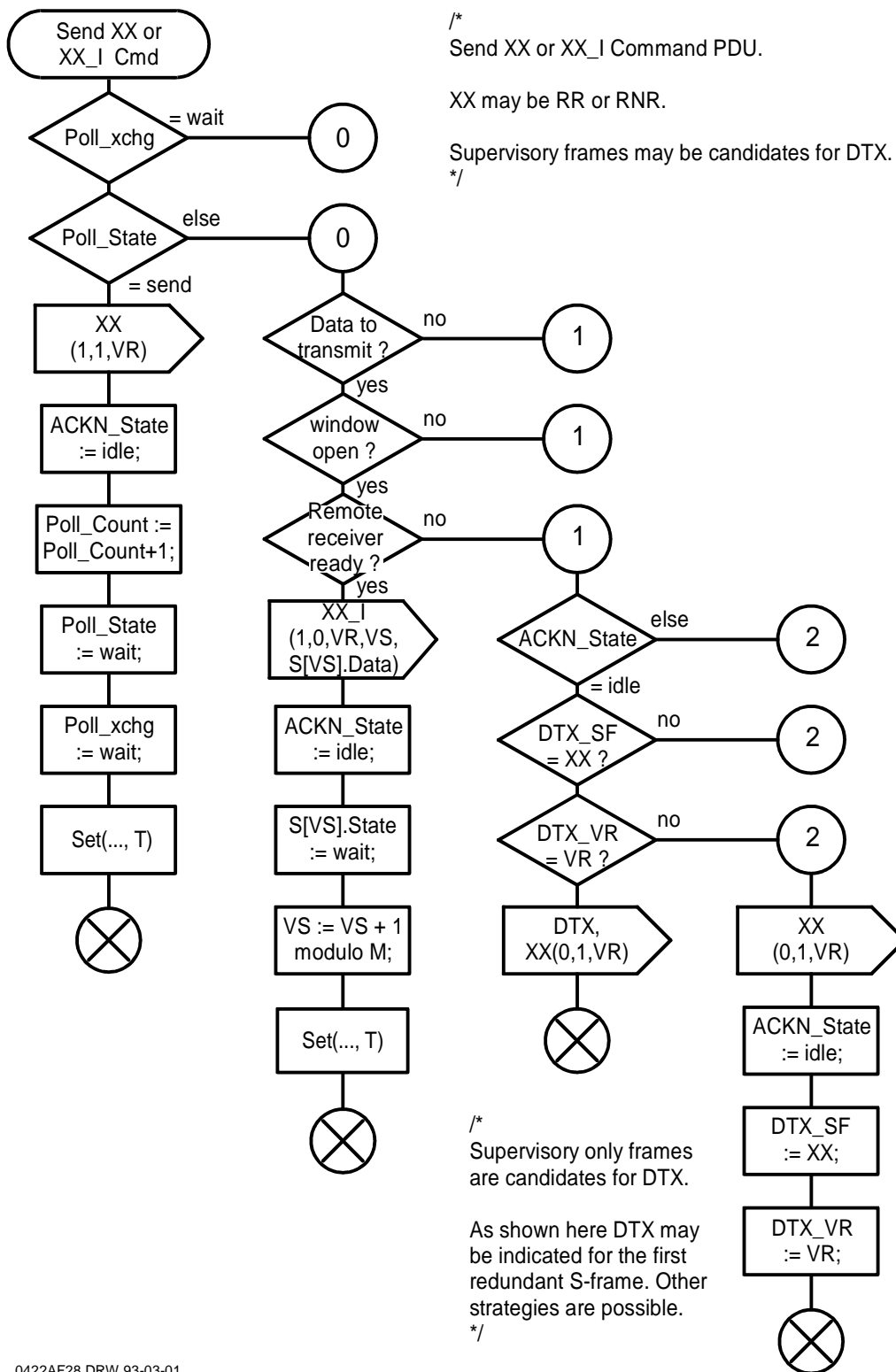

0422AF28.DRW 93-03-01

Figure A.28

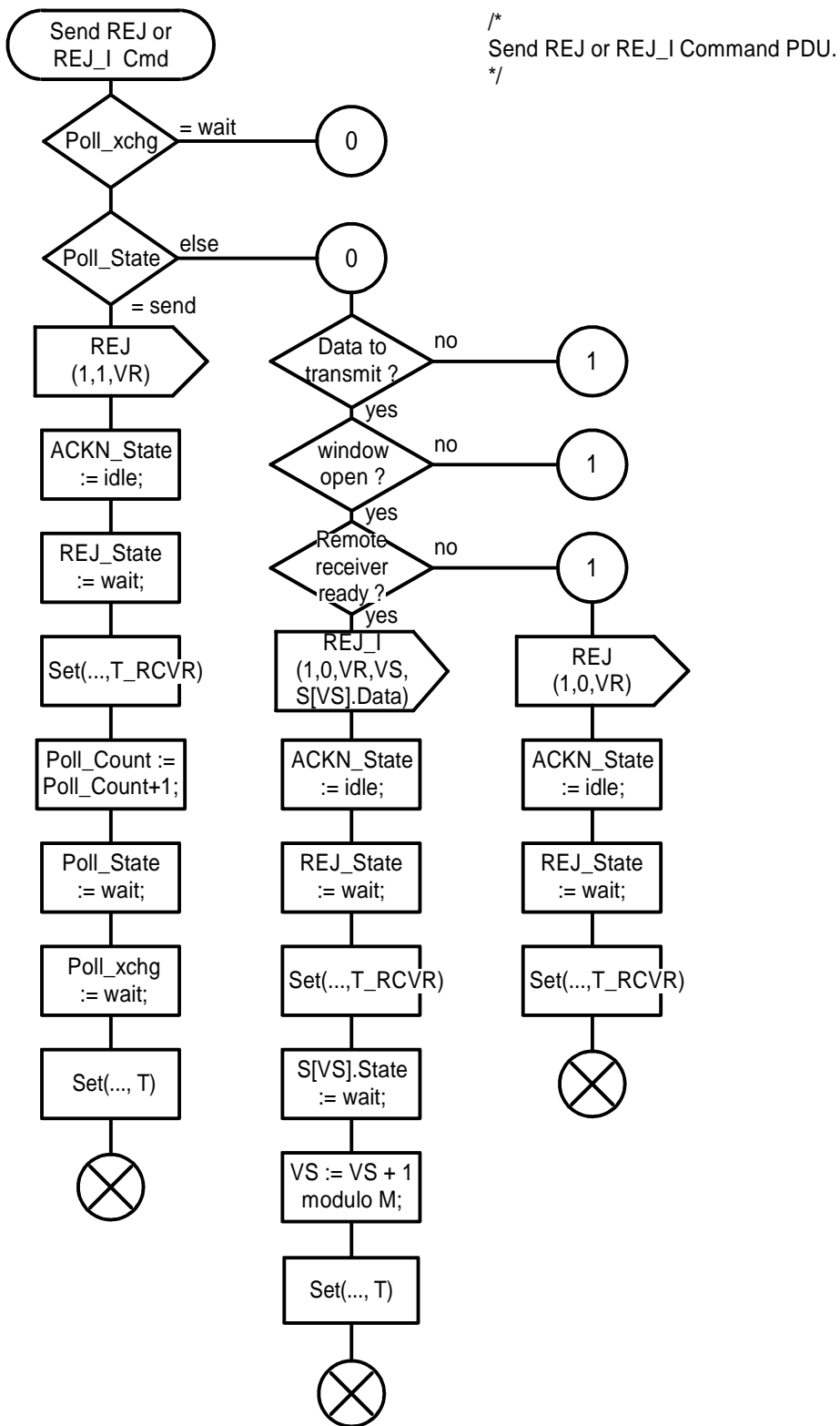

0422AF29.DRW 93-03-01

Figure A.29

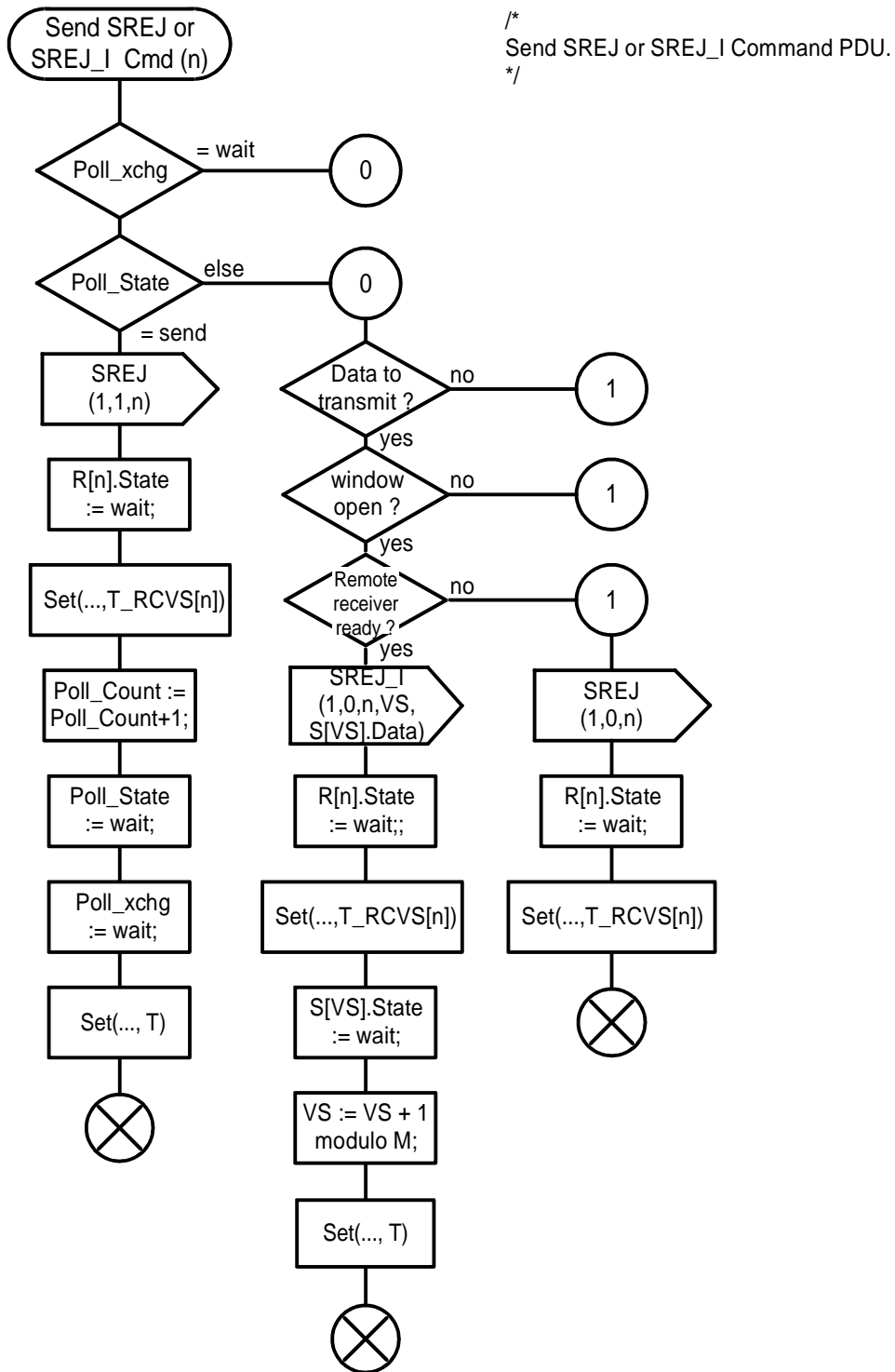

0422AF30.DRW 93-09-10

Figure A.30

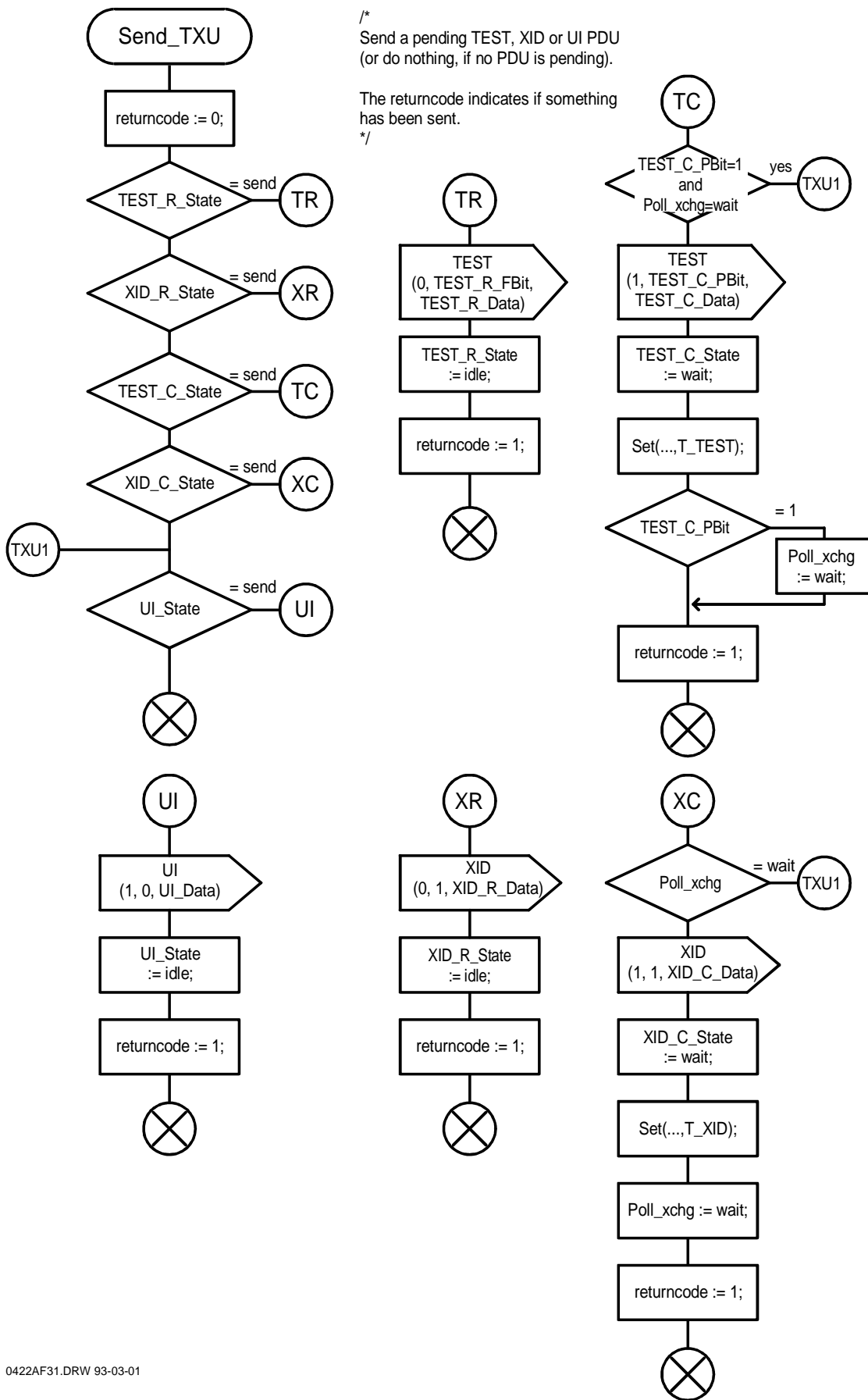

0422AF31.DRW 93-03-01

Figure A.31

Annex B (informative): Change history

Change history							
Date	TSG #	TSG Doc.	CR	Rev	Subject/Comment	Old	New
	05-1999				Transferred to 3GPP CN1	7.0.0	
03-1999	TSG#03				Approved at CN#03		3.0.0
06-1999	TSG#04		001		Introduction of EDGE channel codings into the specifications	3.0.0	3.1.0
12-1999	TSG#06		002	1	Correction to REMAP procedure in RLP	3.1.0	3.2.0
12-1999	TSG#06		003		Updates to RLP and DTX for UMTS	3.1.0	3.2.0
06-2000	TSG#08		004		RLP timer for T4 in UMTS	3.2.0	3.3.0
	-		-		MCC Editorial update to make figures visible	3.3.0	3.3.1
09-2000	TSG#09		005	1	Relevance of GSM specific BC-IE parameters for negotiating RLP version in UMTS	3.3.1	3.4.0
03-2001	TSG#11				Upgraded to Release 4	3.4.0	4.0.0
12-2001	TSG#14	NP-010604	006	3	New terminology required by TSG GERAN	4.0.0	5.0.0
12-2002	TSG#18	NP-020617	007	1	CS Data Services (including HSCSD and EDGE) for GERAN Iu mode	5.0.0	5.1.0
03-2003	TSG#19	NP-030074	008	1	Corrections to References and editorial clean-up	5.1.0	5.2.0
06-2003	TSG#20	NP-030201	011		Determination of the RLP version by the signalled Bearer Capability IE	5.2.0	5.3.0
09-2003	TSG#21	NP-030342	012	2	Usage of RLP versions	5.3.0	5.4.0
12-2003	TSG#22	NP-030566	013	1	Terminology Clarification to correct Wrong and confused terminology	5.4.0	5.5.0

History

Document history		
V5.0.0	December 2001	Publication
V5.1.0	December 2002	Publication
V5.2.0	March 2003	Publication
V5.3.0	June 2003	Publication
V5.4.0	September 2003	Publication
V5.5.0	December 2003	Publication