

ETSI TS 123 088 V13.0.0 (2016-01)



**Digital cellular telecommunications system (Phase 2+);
Universal Mobile Telecommunications System (UMTS);
Call Barring (CB) Supplementary Services;
Stage 2
(3GPP TS 23.088 version 13.0.0 Release 13)**



Reference

RTS/TSGC-0423088vd00

Keywords

GSM,UMTS

ETSI

650 Route des Lucioles
F-06921 Sophia Antipolis Cedex - FRANCE

Tel.: +33 4 92 94 42 00 Fax: +33 4 93 65 47 16

Siret N° 348 623 562 00017 - NAF 742 C
Association à but non lucratif enregistrée à la
Sous-Préfecture de Grasse (06) N° 7803/88

Important notice

The present document can be downloaded from:

<http://www.etsi.org/standards-search>

The present document may be made available in electronic versions and/or in print. The content of any electronic and/or print versions of the present document shall not be modified without the prior written authorization of ETSI. In case of any existing or perceived difference in contents between such versions and/or in print, the only prevailing document is the print of the Portable Document Format (PDF) version kept on a specific network drive within ETSI Secretariat.

Users of the present document should be aware that the document may be subject to revision or change of status. Information on the current status of this and other ETSI documents is available at

<http://portal.etsi.org/tb/status/status.asp>

If you find errors in the present document, please send your comment to one of the following services:

<https://portal.etsi.org/People/CommiteeSupportStaff.aspx>

Copyright Notification

No part may be reproduced or utilized in any form or by any means, electronic or mechanical, including photocopying and microfilm except as authorized by written permission of ETSI.

The content of the PDF version shall not be modified without the written authorization of ETSI.

The copyright and the foregoing restriction extend to reproduction in all media.

© European Telecommunications Standards Institute 2016.

All rights reserved.

DECT™, **PLUGTESTS™**, **UMTS™** and the ETSI logo are Trade Marks of ETSI registered for the benefit of its Members. **3GPP™** and **LTE™** are Trade Marks of ETSI registered for the benefit of its Members and of the 3GPP Organizational Partners.

GSM® and the GSM logo are Trade Marks registered and owned by the GSM Association.

Intellectual Property Rights

IPRs essential or potentially essential to the present document may have been declared to ETSI. The information pertaining to these essential IPRs, if any, is publicly available for **ETSI members and non-members**, and can be found in ETSI SR 000 314: *"Intellectual Property Rights (IPRs); Essential, or potentially Essential, IPRs notified to ETSI in respect of ETSI standards"*, which is available from the ETSI Secretariat. Latest updates are available on the ETSI Web server (<https://ipr.etsi.org/>).

Pursuant to the ETSI IPR Policy, no investigation, including IPR searches, has been carried out by ETSI. No guarantee can be given as to the existence of other IPRs not referenced in ETSI SR 000 314 (or the updates on the ETSI Web server) which are, or may be, or may become, essential to the present document.

Foreword

This Technical Specification (TS) has been produced by ETSI 3rd Generation Partnership Project (3GPP).

The present document may refer to technical specifications or reports using their 3GPP identities, UMTS identities or GSM identities. These should be interpreted as being references to the corresponding ETSI deliverables.

The cross reference between GSM, UMTS, 3GPP and ETSI identities can be found under <http://webapp.etsi.org/key/queryform.asp>.

Modal verbs terminology

In the present document "**shall**", "**shall not**", "**should**", "**should not**", "**may**", "**need not**", "**will**", "**will not**", "**can**" and "**cannot**" are to be interpreted as described in clause 3.2 of the [ETSI Drafting Rules](#) (Verbal forms for the expression of provisions).

"**must**" and "**must not**" are **NOT** allowed in ETSI deliverables except when used in direct citation.

Contents

| | |
|---|----|
| Intellectual Property Rights | 2 |
| Foreword..... | 2 |
| Modal verbs terminology..... | 2 |
| Foreword..... | 5 |
| 1 Scope | 6 |
| 2 References | 6 |
| 3 Abbreviations | 7 |
| 4 Cross-Phase compatibility..... | 7 |
| 5 Data stored in the HLR for all call barring services..... | 7 |
| 6 Barring of outgoing calls..... | 7 |
| 6.1 Handling of barring of outgoing calls..... | 7 |
| 6.1.0 Applicability | 7 |
| 6.1.1 Registration | 7 |
| 6.1.2 Activation | 8 |
| 6.1.2.1 General | 8 |
| 6.1.2.2 Interactions between barring of outgoing call programs | 8 |
| 6.1.2.3 Interactions with call forwarding supplementary services | 8 |
| 6.1.3 Deactivation..... | 12 |
| 6.1.4 Interrogation | 13 |
| 6.2 Functions and information flows..... | 14 |
| 6.3 Information stored in the HSS/HLR..... | 19 |
| 6.4 State transition model..... | 21 |
| 6.5 Transfer of information from HSS/HLR to VLR/SGSN/MME | 22 |
| 6.6 Information stored in the VLR/SGSN/MME | 22 |
| 6.7 Handover | 22 |
| 6.8 Cross Phase compatibility | 22 |
| 6.8.1 MS, MSC, VLR or HLR only support Phase 1 control of SS by the subscriber..... | 22 |
| 6.8.2 HLR only support Phase 1 updating of subscriber information..... | 22 |
| 6.9 Interworking with VLR or SGSN or MME not supporting Call Barring | 22 |
| 7 Barring of incoming calls other than Anonymous Call Rejection..... | 23 |
| 7.1 Handling of barring of incoming calls..... | 23 |
| 7.1.0 Applicability | 23 |
| 7.1.1 Registration..... | 23 |
| 7.1.2 Activation | 23 |
| 7.1.2.1 General | 23 |
| 7.1.2.2 Interactions between barring of incoming call programs | 23 |
| 7.1.2.3 Interactions with call forwarding supplementary services | 23 |
| 7.1.3 Deactivation..... | 27 |
| 7.1.4 Interrogation | 28 |
| 7.2 Functions and information flows..... | 28 |
| 7.3 Information stored in the HSS/HLR..... | 32 |
| 7.4 State transition model..... | 33 |
| 7.5 Transfer of information from HSS/HLR to VLR/SGSN/MME | 34 |
| 7.6 Information stored in the VLR/SGSN/MME | 34 |
| 7.7 Handover | 34 |
| 7.8 Cross Phase compatibility | 34 |
| 7.8.1 MS, MSC, VLR or HLR only support Phase 1 control of SS by the subscriber..... | 34 |
| 7.8.2 HLR only supports Phase 1 updating of subscriber information | 35 |
| 8 Anonymous Call Rejection | 35 |
| 8.1 General | 35 |

| | | |
|--|--|-----------|
| 8.2 | Procedures | 35 |
| 8.2.1 | Provision and withdrawal | 35 |
| 8.2.2 | Registration and erasure..... | 35 |
| 8.2.3 | Activation and deactivation | 35 |
| 8.2.3.1 | General | 35 |
| 8.2.3.2 | Interactions with other incoming call barring programs | 36 |
| 8.2.3.3 | Logical states in the HLR for the ACR supplementary service..... | 36 |
| 8.2.4 | Invocation | 37 |
| 8.2.4.1 | General | 37 |
| 8.2.4.2 | Terminating Network Information flow..... | 37 |
| 8.2.4.2a | Originating Network behaviour | 38 |
| 8.2.4.3 | Mobile Additional Function | 38 |
| 8.2.5 | Interrogation | 39 |
| 8.2.6 | Exceptional procedures..... | 40 |
| 8.3 | Interactions with other supplementary services..... | 40 |
| 8.4 | Interactions with other network features and services..... | 40 |
| 8.4.1 | Operator Determined Barring (ODB) | 40 |
| 8.4.2 | Optimal Routeing..... | 40 |
| Annex A (informative): Change history | | 41 |
| History | | 42 |

Foreword

This Technical Specification (TS) has been produced by the 3rd Generation Partnership Project (3GPP).

The contents of the present document are subject to continuing work within the TSG and may change following formal TSG approval. Should the TSG modify the contents of the present document, it will be re-released by the TSG with an identifying change of release date and an increase in version number as follows:

Version x.y.z

where:

- x the first digit:
 - 1 presented to TSG for information;
 - 2 presented to TSG for approval;
 - 3 or greater indicates TSG approved document under change control.
- y the second digit is incremented for all changes of substance, i.e. technical enhancements, corrections, updates, etc.
- z the third digit is incremented when editorial only changes have been incorporated in the document.

1 Scope

The present document gives the stage 2 description of the call barring services.

The possibility for a mobile subscriber to have certain categories of calls barred originated from or terminated at his access:

| | | |
|--|-------------|----------------------|
| Barring of outgoing calls | (clause 1): | |
| - Barring of all outgoing calls | (BAOC) | (Barring program 1); |
| - Barring of outgoing international calls | (BOIC) | (Barring program 2); |
| - Barring of outgoing international calls EXCEPT those directed to the home PLMN country | (BOIC-exHC) | (Barring program 3). |
| Barring of incoming calls | (clause 2): | |
| - Barring of all incoming calls | (BAIC) | (Barring program 1); |
| - Barring of incoming calls when roaming outside the home PLMN country | (BIC-Roam) | (Barring program 2); |
| - Anonymous Call Rejection | (ACR) | (Barring program 3). |

NOTE: The call barring program "incoming calls when roaming outside the home PLMN country" (clause 2) is only relevant if as a general rule the called mobile subscriber pays the charges for the forwarded part of the call from his home PLMN country to any other country.

2 References

The following documents contain provisions which, through reference in this text, constitute provisions of the present document.

- References are either specific (identified by date of publication, edition number, version number, etc.) or non-specific.
- For a specific reference, subsequent revisions do not apply.
- For a non-specific reference, the latest version applies. In the case of a reference to a 3GPP document (including a GSM document), a non-specific reference implicitly refers to the latest version of that document *in the same Release as the present document*.

- [1] 3GPP TR 21.905: "3G Vocabulary".
- [2] 3GPP TS 22.082: "Call Forwarding (CF) Supplementary Services - Stage 1".
- [3] 3GPP TS 23.011: "Technical realization of supplementary services".
- [4] 3GPP TS 23.078: "Customised Applications for Mobile network Enhanced Logic (CAMEL) Phase 3 - Stage 2".
- [5] 3GPP TS 23.081: "Line identification Supplementary Services; Stage 2".
- [6] 3GPP TS 22.004: "General on supplementary services".
- [7] 3GPP TS 23.090: "Unstructured Supplementary Service Data (USSD) - Stage 2".
- [8] 3GPP TS 22.088: "Call Barring (CB) supplementary services – Stage 1".
- [9] 3GPP TS 24.008: "Mobile radio interface Layer 3 specification; Core network protocols; Stage 3".

[10] 3GPP TS 23.088: "Call Barring (CB) Supplementary Services; Stage 2".

3 Abbreviations

For the purposes of the present document, the abbreviations given in 3GPP TR 21.905 apply.

4 Cross-Phase compatibility

For the following supplementary services, a number of changes exist between the present document and the Phase 1 specification:

- Barring of outgoing calls;
- Barring of incoming calls.

The main body of the present document assumes that all network entities comply with this version of the service. In each case an additional subclause (subclauses 6.6 and 7.6) defines the additional requirements for when one or more network entities or the MS complies with the Phase 1 specifications for the supplementary service procedures.

5 Data stored in the HLR for all call barring services

The following data are stored in the HLR in common for all call barring services other than ACR:

- The "notification to CSE flag". This flag applies for all call barring services. When the data for any Call Barring are changed, the HLR checks this flag. If the flag is set, the change is reported to the gsmSCF(s) defined by the gsmSCF address list. See 3GPP TS 23.078 [4].
- The "gsmSCF address list", which is a list of gsmSCF addresses to which Notification on Change of Subscriber Data is to be sent. This list applies to all call barring services. See TS 23.078.

6 Barring of outgoing calls

6.1 Handling of barring of outgoing calls

6.1.0 Applicability

The user control defined in this section is only applicable in CS domain.

For MME, only MMEs supporting the SMS in MME option described in 3GPP TS 23.272 [10] may handle barring of MO SMS.

6.1.1 Registration

If the served mobile subscriber at provision time has selected the subscription option "control of barring services by subscriber using password", he has to register a password at provision time. Furthermore the served mobile subscriber can change the password by an appropriate control procedure at any time. The control procedure consists of three steps: first, the old password has to be provided. Secondly, the new password has to be given, after which it has to be verified by providing it once more, see 3G TS 23.011.

If the served mobile subscriber at provision time has selected the subscription option "control of barring services by the service provider" an attempt to register a password will be denied and the served mobile subscriber should receive a notification.

The subscriber can register a new password, thus causing the previous registration to be overridden, see 3G TS 23.011.

6.1.2 Activation

6.1.2.1 General

If the served mobile subscriber at provision time has selected the subscription option "control of barring services by subscriber using password" the supplementary service is activated if the subscriber provides the following information to the network:

- 1) password;
- 2) information as to whether the activation applies to all basic services or a specific basic service group;
- 3) selected barring program.

Activation can take place with an appropriate control procedure by the subscriber.

If the served mobile subscriber at provision time has selected the subscription option "control of barring services by the service provider", the supplementary service cannot be activated by the subscriber. The activation has to be performed by the service provider. An attempt to activate the service will be denied and the served mobile subscriber should receive a notification.

If the served mobile subscriber at provision time has selected the subscription option "control of barring services by subscriber using password", and if a wrong password is entered to activate the service the supplementary service will not be activated and the served mobile subscriber is notified.

The information flow for activation of barring of outgoing calls is shown in figure 6.4. For more details see 3G TS 23.011.

6.1.2.2 Interactions between barring of outgoing call programs

In case the served mobile subscriber activates barring of outgoing international calls except those directed to the home PLMN country and this service is not supported by the PLMN in which the served mobile subscriber currently roams, the VPLMN will activate barring of outgoing international calls instead. The SDL diagram in figure 6.1 shows the function to be performed in the VLR in order to deal with this interaction. This function is performed upon receiving the "insert subscriber data" message from the HLR.

In case the mobile subscriber activates one of the call barring programs and another call barring program was already activated, this program will be deactivated and the requested call barring program will be activated. The SDL diagram in figure 6.2 shows the function to be performed in the HLR in order to deal with this interaction between call barring programs.

6.1.2.3 Interactions with call forwarding supplementary services

This section is not applicable for SMS.

For interactions with call forwarding supplementary services see 3G TS 22.082.

The SDL diagram in figure 6.3 shows the function to be performed in the HLR in order to deal with the interactions with call forwarding supplementary services.

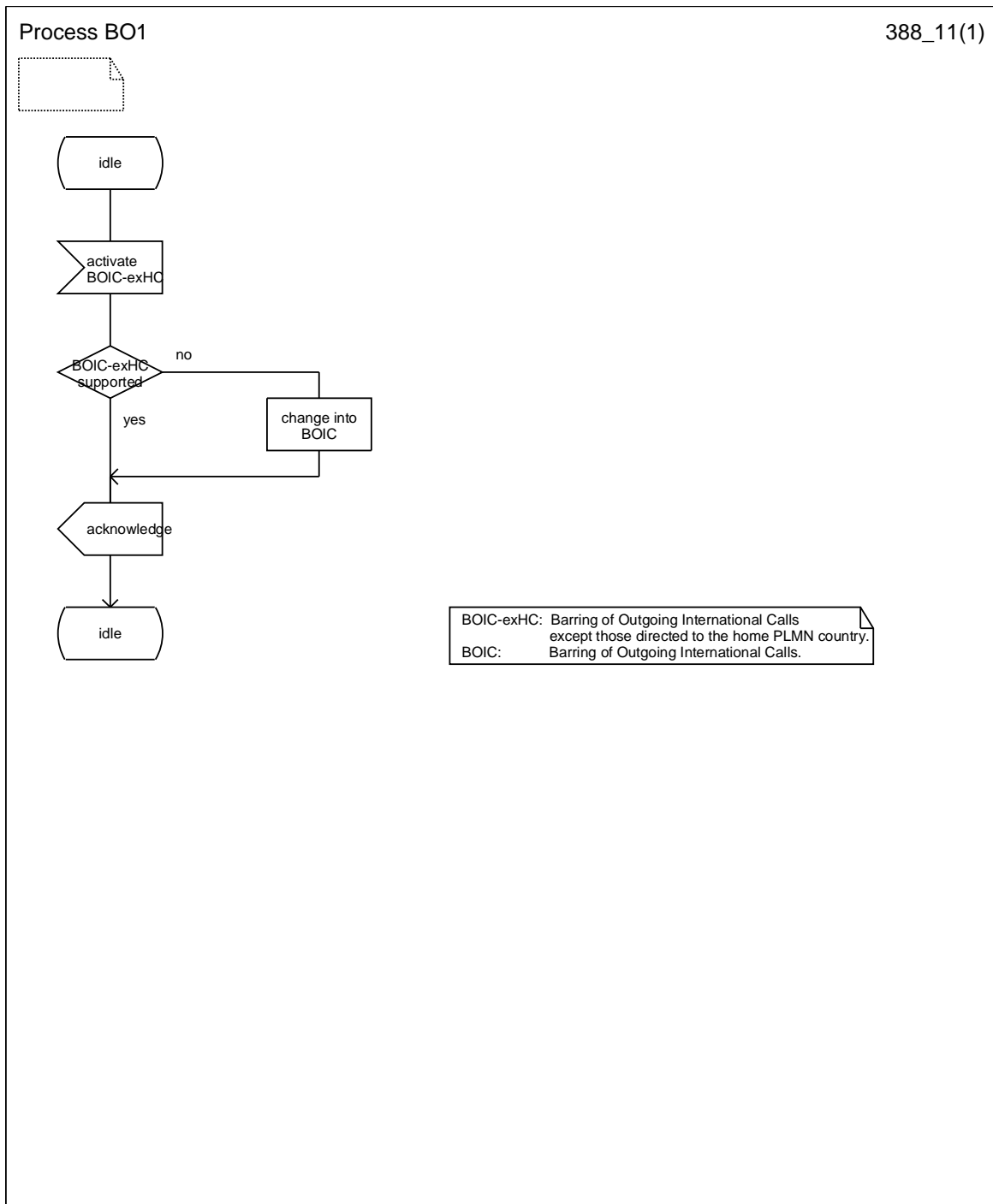

Figure 6.1: BO1 Possible change of barring of outgoing international calls except those directed to the home PLMN country into barring of outgoing international calls

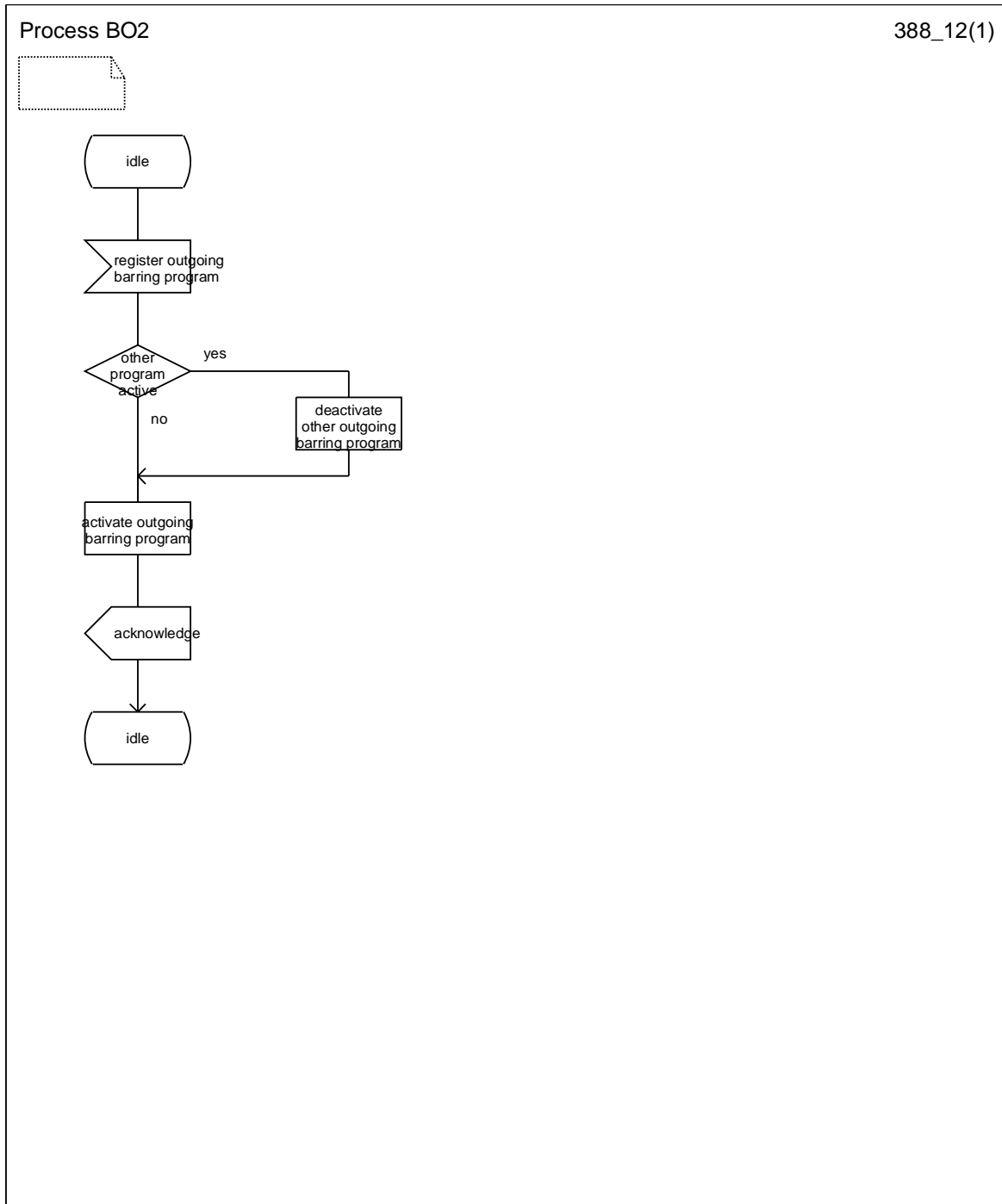

Figure 6.2: BO2 Interaction between call barring programs

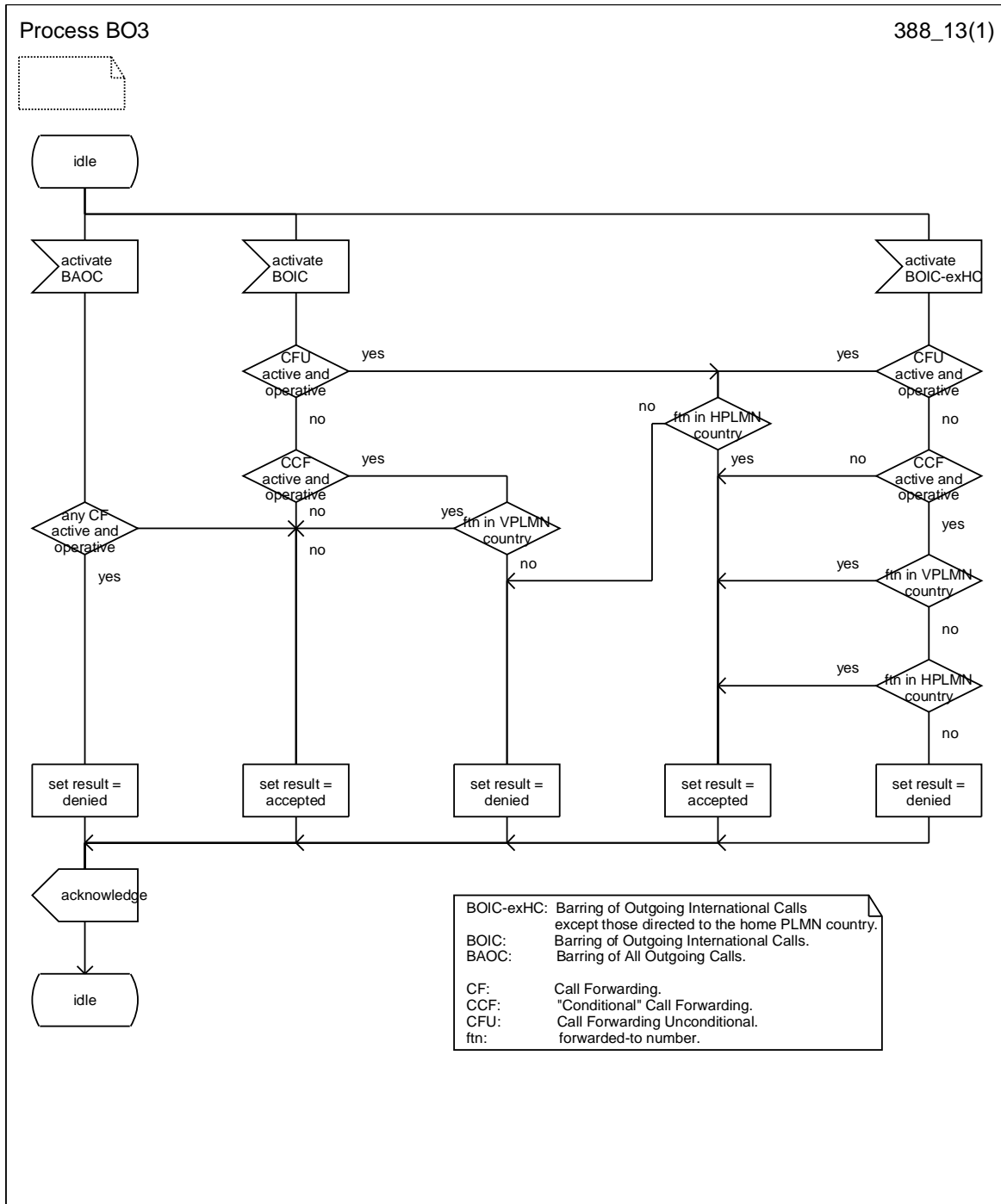

Figure 6.3: BO3 Interaction between call forwarding supplementary services and barring of outgoing calls programs

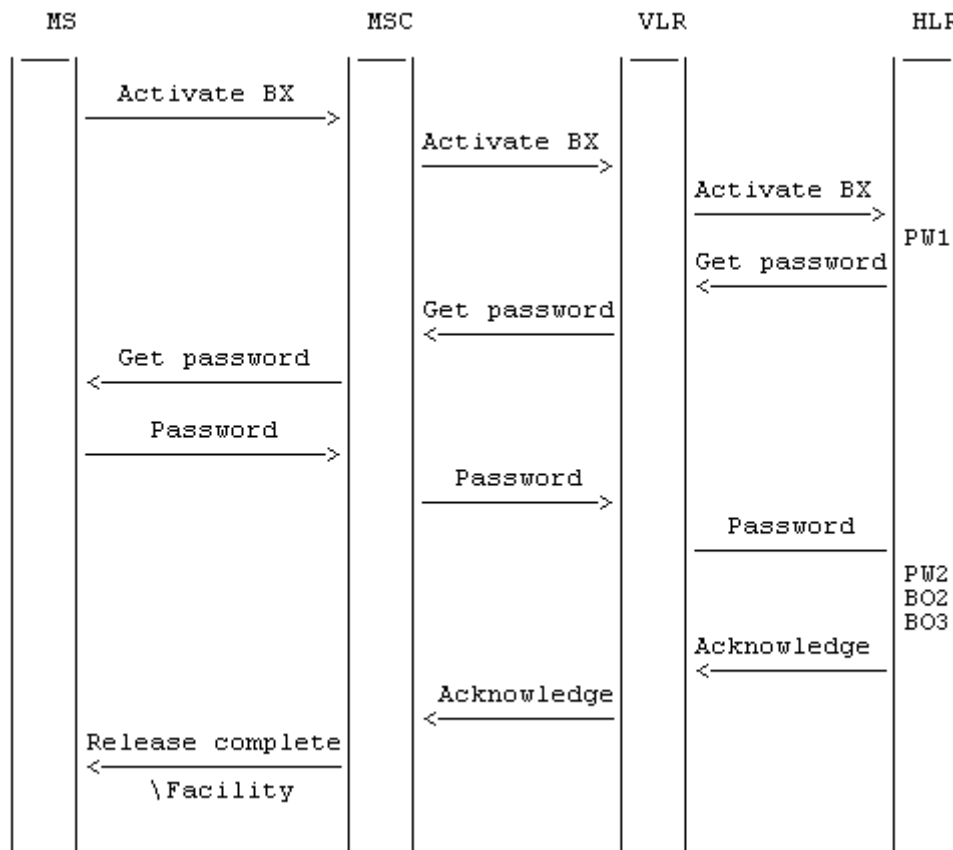

Figure 6.4: Activation of barring of outgoing calls

NOTE: BX indicates any of the barring programs. PW1 and PW2 indicate password handling programs, see 3G TS 23.011.

6.1.3 Deactivation

The procedure for activation, described in subclause 1.1.2.1, is valid also correspondingly for deactivation with the addition that a barring supplementary service, i.e. the Outgoing barring service, or All barring services can be signalled.

The information flow for deactivation of barring of outgoing calls is shown in figure 6.5. For more details see 3G TS 23.011.

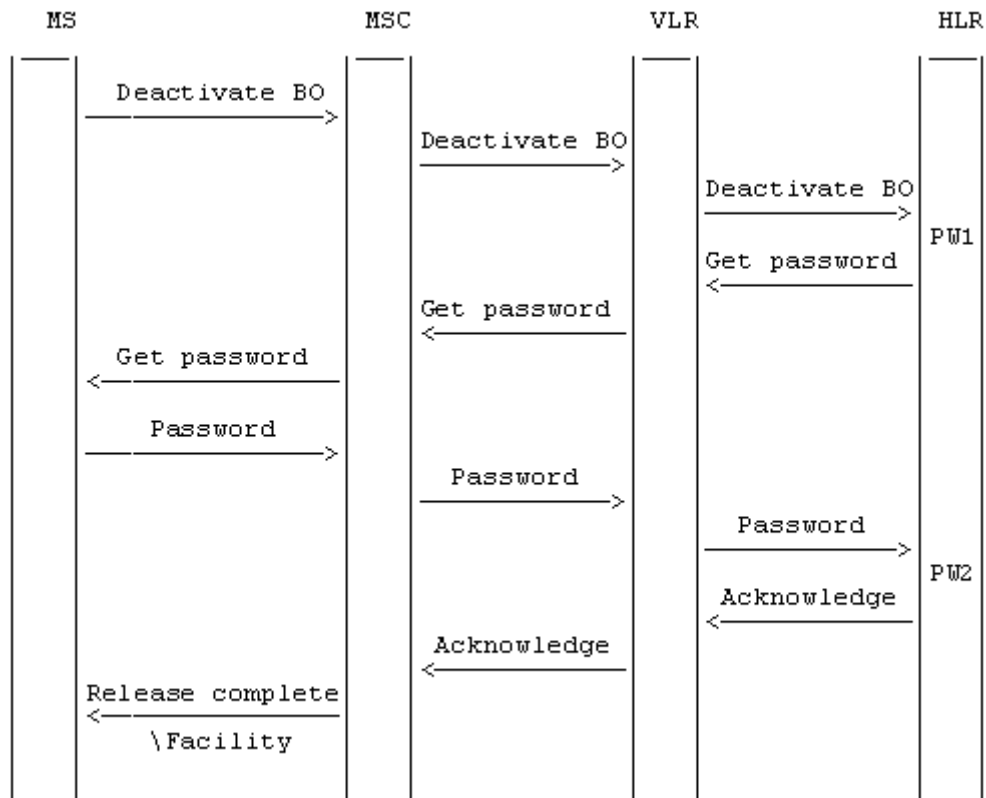

Figure 6.5: Deactivation of barring of outgoing calls

NOTE: BO indicates the general code for barring of outgoing calls. PW1 and PW2 indicate password handling programs, see 3G TS 23.011.

6.1.4 Interrogation

The interrogation procedure enables the mobile subscriber to obtain information about the data stored in the PLMN. After having requested this procedure the network shall return a list of all basic services to which the given barring program is active.

The information flow for interrogation of barring of outgoing calls is shown in figure 6.6.

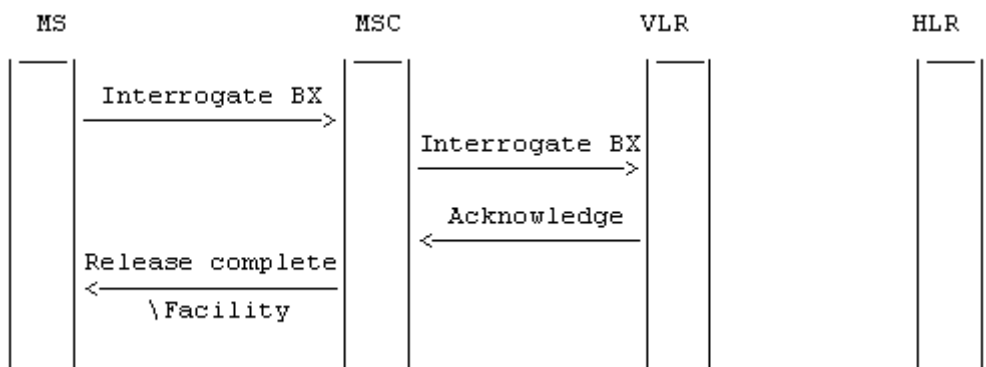

Figure 6.6: Interrogation of barring of outgoing calls

NOTE: BX indicates any of the barring programs.

6.2 Functions and information flows

The following Mobile Additional Functions have been identified:

MAF017

Barring of all outgoing calls related authorizations examination.

The ability of a PLMN component to determine the authorizations relating to barring of all outgoing calls. See figure 6.7.

Location: VLR/SGSN/MME

MAF018

Barring of outgoing international calls related authorizations examination.

The ability of a PLMN component to determine the authorizations relating to barring of outgoing international calls. See figure 6.8. In case of SMS, the Service Centre Address is used to determine whether SMS transfer is international or not.

Location: VLR/SGSN/MME

MAF020

Barring of outgoing international calls except those directed to the home PLMN country related authorizations examination.

The ability of a PLMN component to determine the authorizations relating to barring of outgoing international calls except those directed to the home PLMN country. See figure 6.9. In case of SMS, the Service Centre Address is used to determine whether the destination is in HPLMN country or not.

Location: VLR/SGSN/MME

The information flow for barring of outgoing circuit switched calls in CS domain is shown in figure 6.10A. The information flow for barring of MO SMS is shown in figure 6.10B.

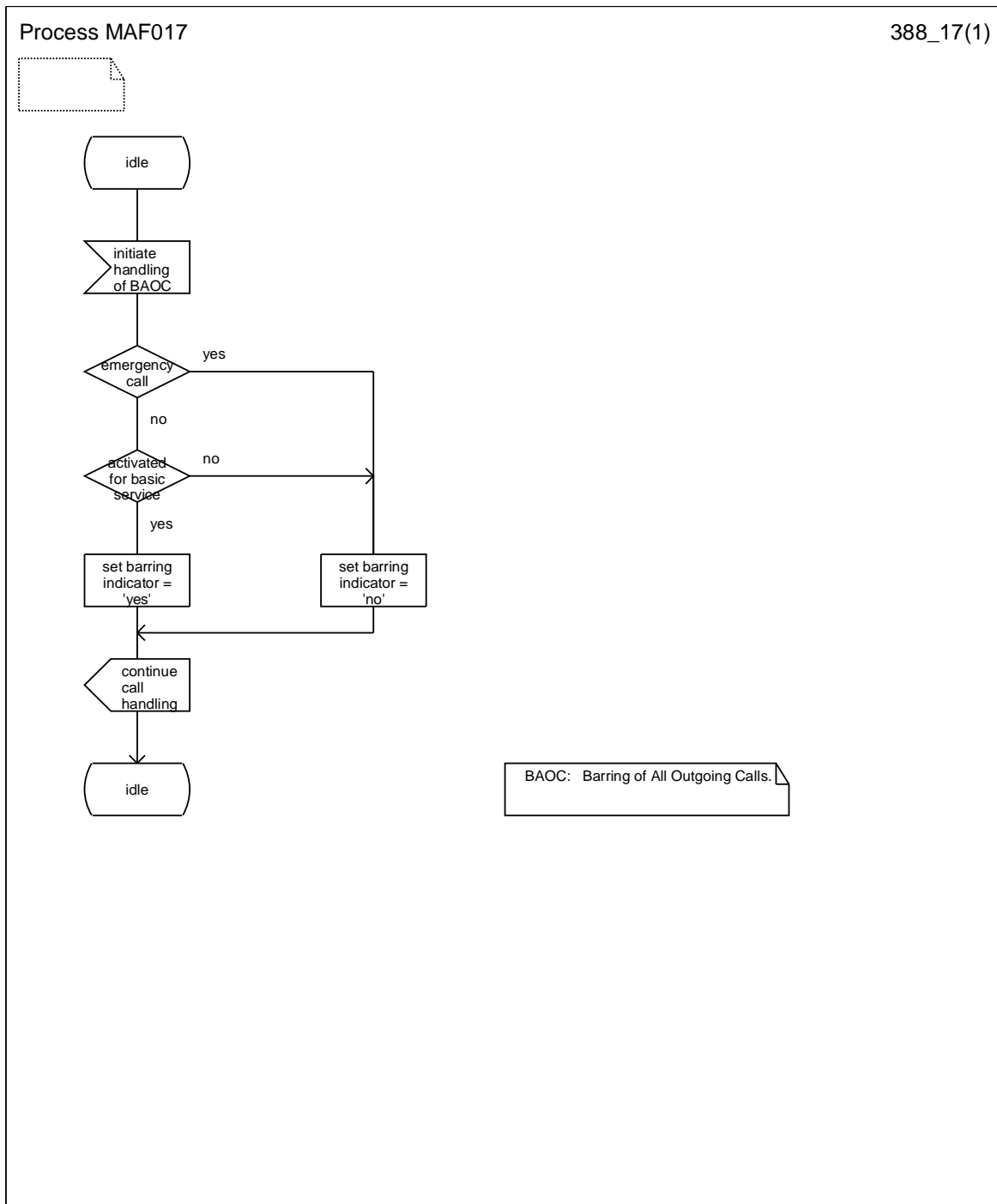

NOTE: Emergency call check is applied only at VLR.

Figure 6.7: MAF017 Barring of all outgoing calls related authorisations examination (VLR/SGSN/MME)

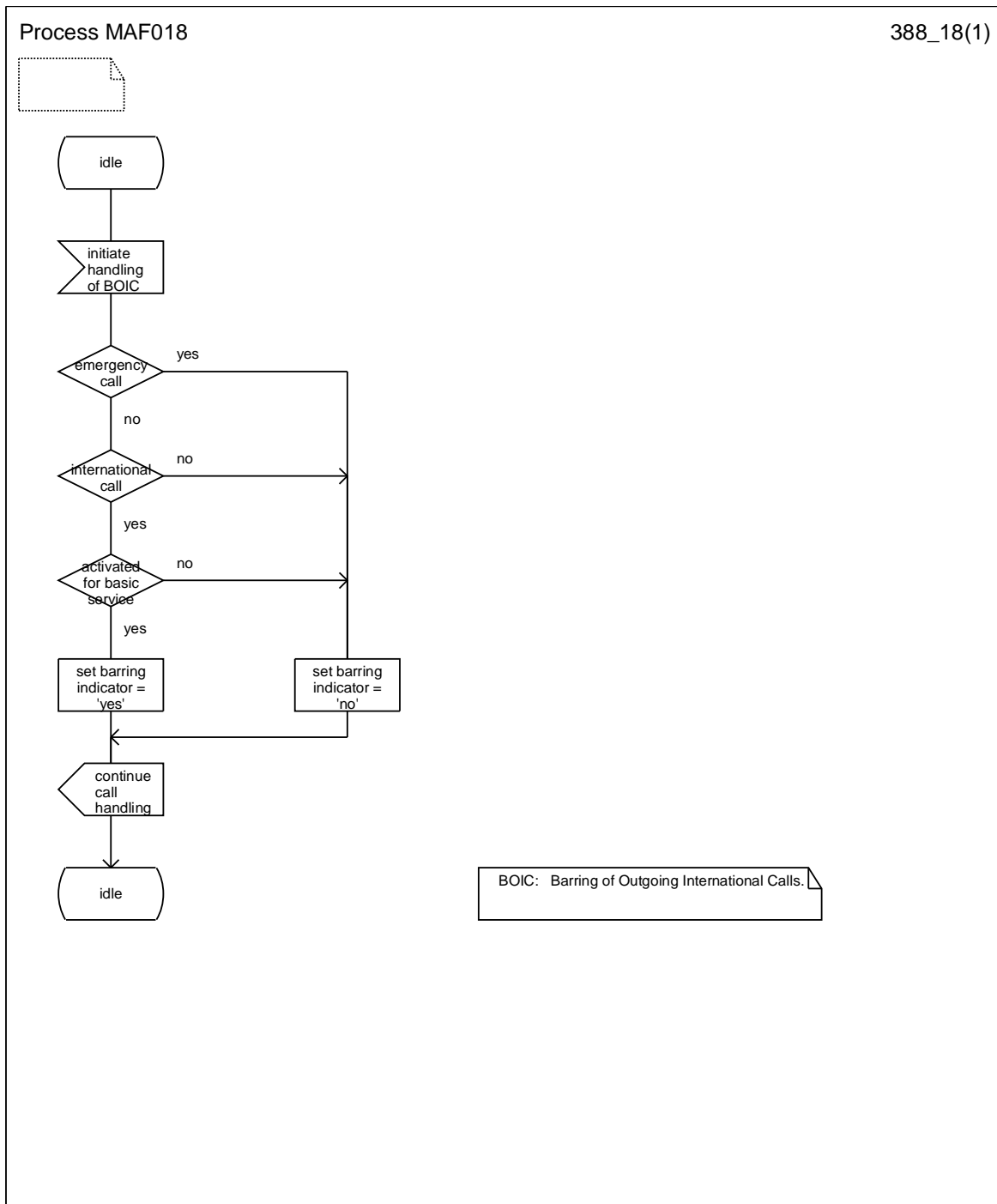

NOTE: Emergency call check is applied only at VLR.

Figure 6.8: MAF018 Barring of all outgoing international calls related authorisations examination (VLR/SGSN/MME)

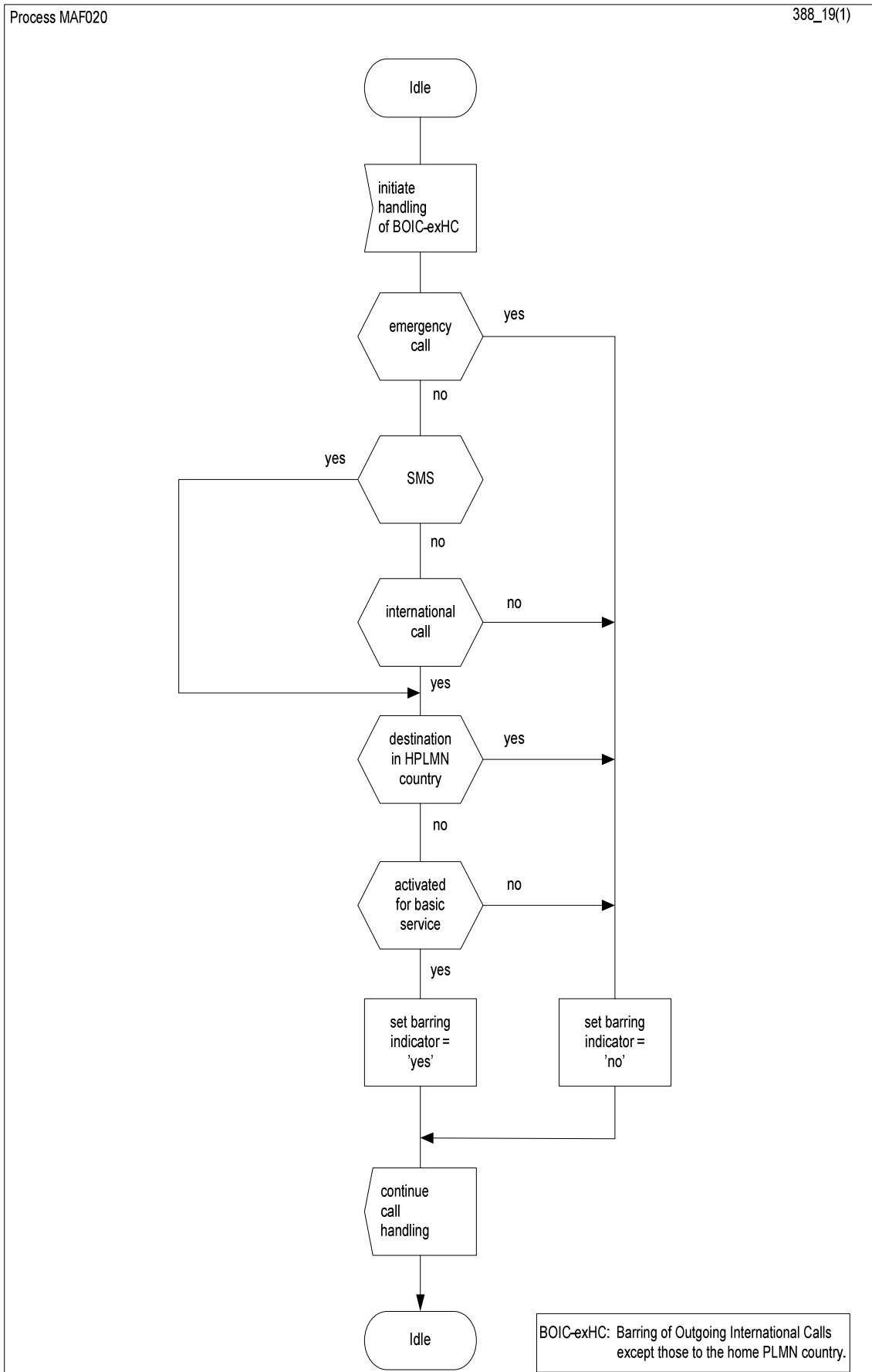

NOTE: Emergency call check is applied only at VLR.

Figure 6.9: MAF020 Barring of outgoing international calls except those directed to the home PLMN country related authorisations examination (VLR/SGSN/MME)

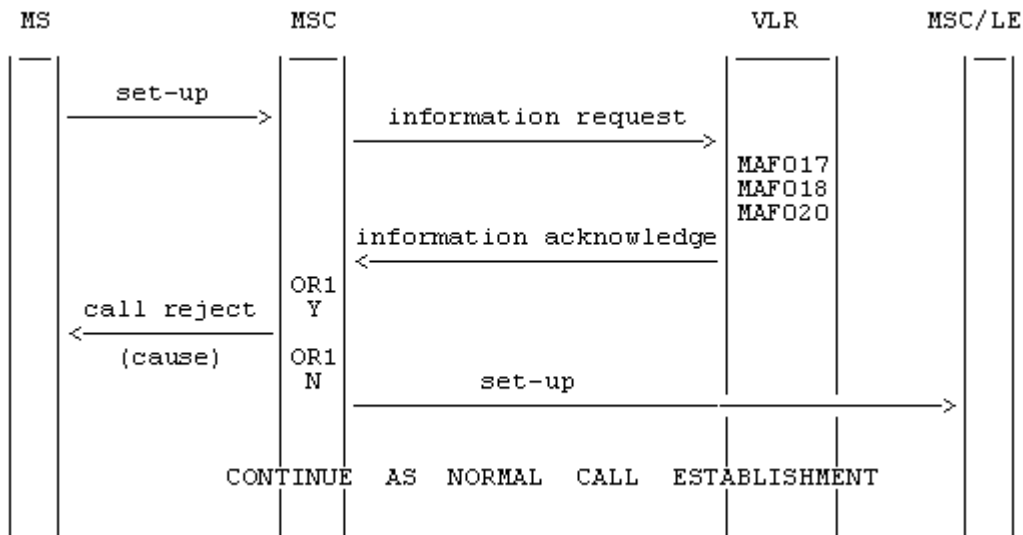

NOTE: OR1: call barred Y: yes
N: no

Figure 6.10A: Information flow for barring of outgoing circuit switched calls

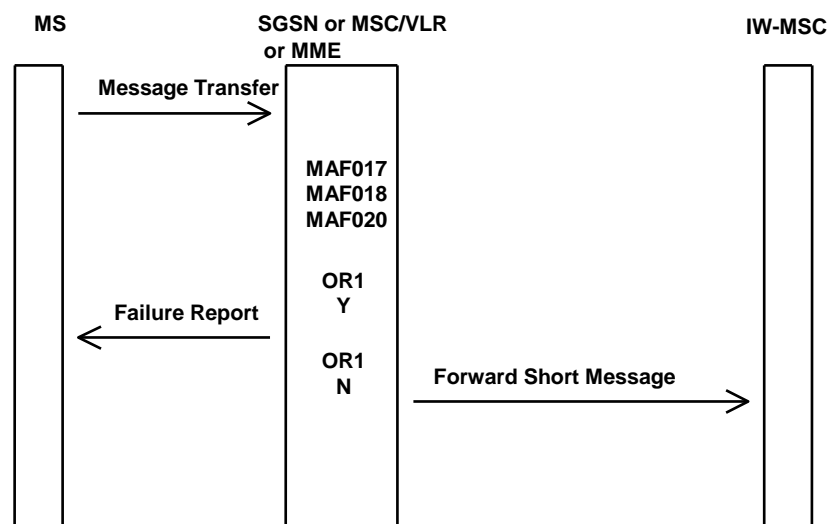

NOTE: OR1: call barred Y: yes
N: no

Figure 6.10B: Information flow for barring of MO SMS

6.3 Information stored in the HSS/HLR

For all call barring supplementary services in the HSS/HLR must be stored:

- the subscription option "control of barring services" on per subscriber basis.

This subscription option takes one of the following values:

- by subscriber using password;
- by the service provider.

If the subscription option "control of barring services" has been set to "by subscriber using password" for barring of outgoing calls in the HLR must be stored on per subscriber basis:

- the registration parameter "call barring password".

The password is valid for all basic services to which barring of outgoing calls applies;

- the status parameter "wrong password attempts counter" associated with the password.

Note that the subscription option and the call barring password are parameters which are associated with all call barring services.

The outgoing calls barring program may have the following logical states (refer to 3G TS 23.011 for an explanation of the notation):

| Provisioning State | Registration State | Activation State | HSS/HLR Induction State |
|---------------------------|---------------------------|-------------------------|--------------------------------|
| (Not Provisioned, | Not Applicable, | Not Active, | Not Induced) |
| (Provisioned, | Not Applicable, | Not Active, | Not Induced) |
| (Provisioned, | Not Applicable, | Active and Operative, | Not Induced) |
| (Not Provisioned, | Not Applicable, | Not Active, | Induced) |
| (Provisioned, | Not Applicable, | Not Active, | Induced) |
| (Provisioned, | Not Applicable, | Active and Operative, | Induced) |

The activation and HSS/HLR induction states may be different for each applicable elementary basic service group.

The provisioning state shall be on a per subscriber basis, and hence the same for all basic service groups.

The HSS/HLR shall also store the logical state of the outgoing calls barring program (which shall be one of the valid states listed above) for each applicable elementary basic service group.

6.4 State transition model

The following figure shows the successful cases of transition between the applicable logical states of the barring of outgoing call program. The state changes are either caused by actions of the service provider, the mobile user or the network.

Note that error cases are not shown in the diagram as they normally do not cause a state change. Additionally, some successful requests may not cause a state change. Hence, they are not shown in diagram.

The diagram only shows operations on an elementary basic service group.

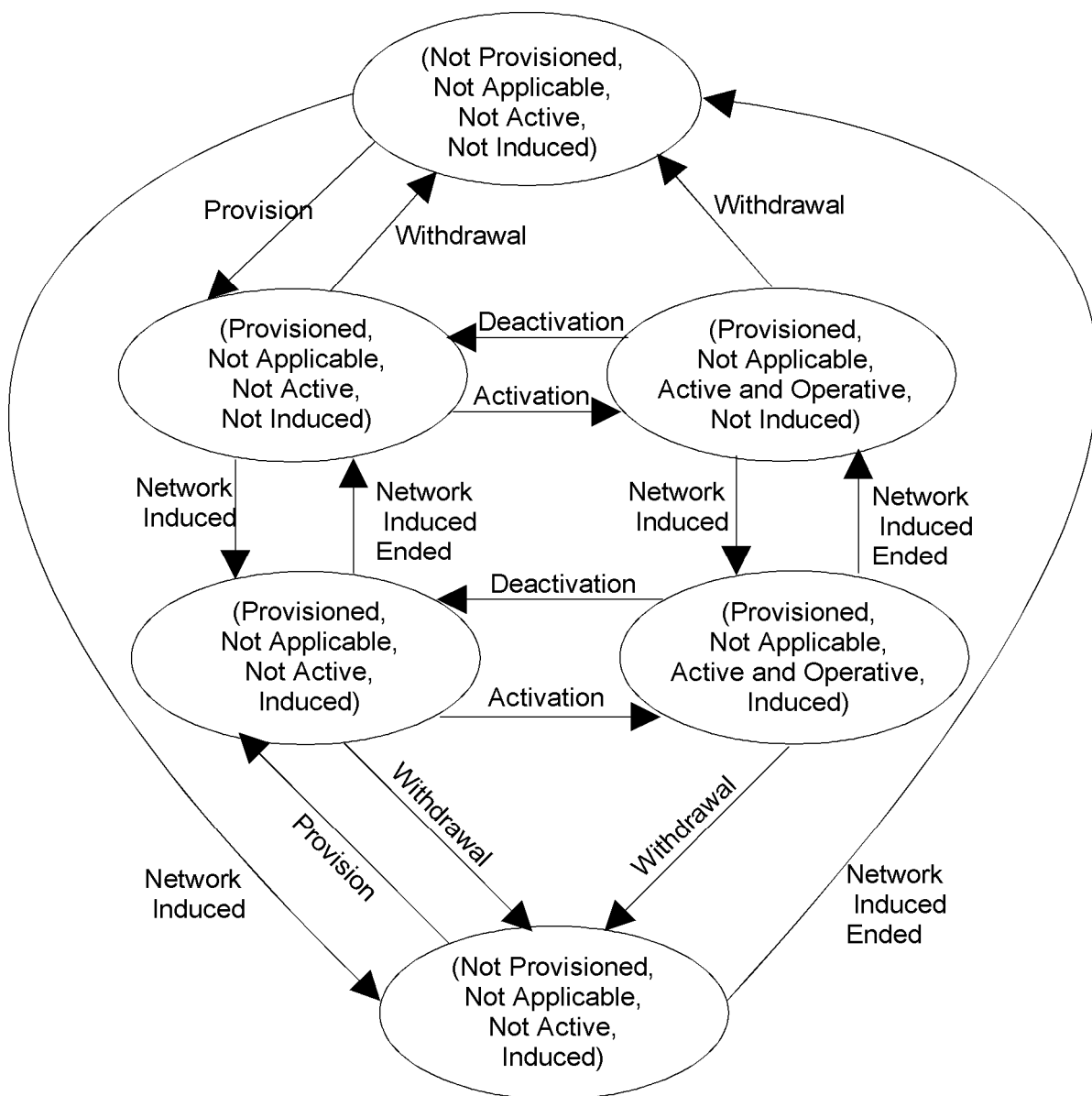

Figure 6.11: State transition model for BAOC, BOIC and BOIC-exHC

6.5 Transfer of information from HSS/HLR to VLR/SGSN/MME

If the provisioning state for the outgoing calls barring program is "Provisioned" then when the subscriber registers on a VLR/SGSN/MME, the HSS/HLR shall send that VLR/SGSN/MME information about the logical state of the program for all relevant elementary basic service groups. Only SMS is relevant for SGSN and MME.

If the HSS/HLR induction state for the outgoing calls barring program is "Induced" then when the subscriber registers on a VLR/SGSN/MME, the HSS/HLR shall send that VLR/SGSN/MME information about the logical state of the program for all relevant elementary basic service groups.

If the logical state of the outgoing calls barring program is changed while a subscriber is registered on a VLR/SGSN/MME then for the affected basic service groups, the HSS/HLR shall inform the VLR/SGSN/MME of the new logical state of the program.

The affected basic service group for SGSN and MME is only SMS.

6.6 Information stored in the VLR/SGSN/MME

For each barring of outgoing calls program the VLR/SGSN/MME shall store the service state information received from the HSS/HLR.

6.7 Handover

Handover will have no impact on the control procedures and the operation of the service.

6.8 Cross Phase compatibility

6.8.1 MS, MSC, VLR or HLR only support Phase 1 control of SS by the subscriber

In response to a Barring of outgoing calls interrogation request, if the MS or any network element involved is of Phase 1, only information concerning basic service groups for which the activation state has the value "Active and Operative" will be returned.

6.8.2 HLR only support Phase 1 updating of subscriber information

If the VLR receives the SS-status parameter from a Phase 1 HLR it shall act as if it has received the SS-Status parameter with the values shown in the following:

- 1) Activated => P bit = 1, R bit = 0 or 1, A bit = 1, Q bit = 0;
- 2) Deactivated => P bit = 1, R bit = 0 or 1, A bit = 0, Q bit = 0 or 1.

6.9 Interworking with VLR or SGSN or MME not supporting Call Barring

When the serving VLR/SGSN/MME does not support call barring, the HLR/HSS may pass to the VLR/SGSN/MME ODB data to bar outgoing circuit switched call or/and MO SMS.

7 Barring of incoming calls other than Anonymous Call Rejection

7.1 Handling of barring of incoming calls

7.1.0 Applicability

The user control defined in this section is only applicable in CS domain.

For MME, only MMEs supporting the SMS in MME option described in 3GPP TS 23.272 [10] may handle barring of MT SMS.

7.1.1 Registration

If the served mobile subscriber at provision time has selected the subscription option "control of barring services by subscriber using password", he has to register a password at provision time. Furthermore the served mobile subscriber can change the password by an appropriate control procedure at any time. The control procedure consists of three steps: first, the old password has to be provided. Secondly, the new password has to be given, after which it has to be verified by providing it once more, see 3G TS 23.011.

If the served mobile subscriber at provision time has selected the subscription option "control of barring services by the service provider" an attempt to register a password will be denied and the served mobile subscriber should receive a notification.

The subscriber can register a new password, thus causing the previous registration to be overridden, see 3G TS 23.011.

7.1.2 Activation

7.1.2.1 General

The procedure for activation of Barring of outgoing calls, described in subclause 1.1.2.1, is valid also for activation of Barring of incoming calls.

The information flow for activation of barring of incoming calls is shown in figure 7.3. For more details see 3G TS 23.011.

7.1.2.2 Interactions between barring of incoming call programs

If the mobile subscriber activates barring of all incoming calls and barring of incoming calls when roaming outside the home PLMN country was already activated, barring of incoming calls when roaming outside the home PLMN country will be deactivated and barring of all incoming calls will be activated.

The SDL diagram in figure 7.1 shows the function to be performed in the HLR in order to deal with this interaction between call barring services.

See subclause 8.2.3.2 for the interactions with the ACR supplementary service.

7.1.2.3 Interactions with call forwarding supplementary services

This section is not applicable for SMS.

For interactions with call forwarding supplementary services see 3G TS 22.082.

The SDL diagram in figure 7.2 shows the function to be performed in the HLR in order to deal with the interactions with call forwarding services.

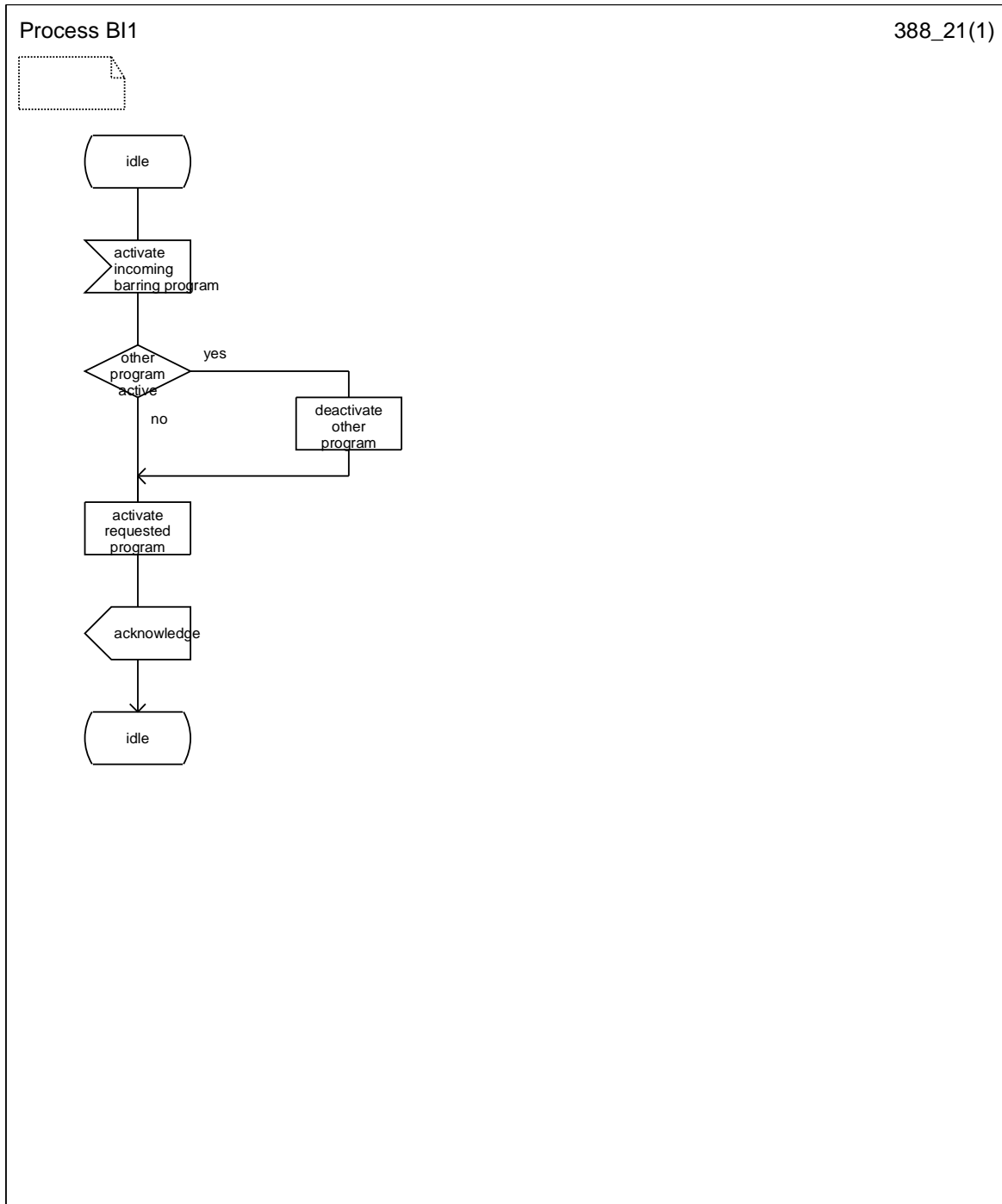

Figure 7.1: BI1 Interaction between call barring programs

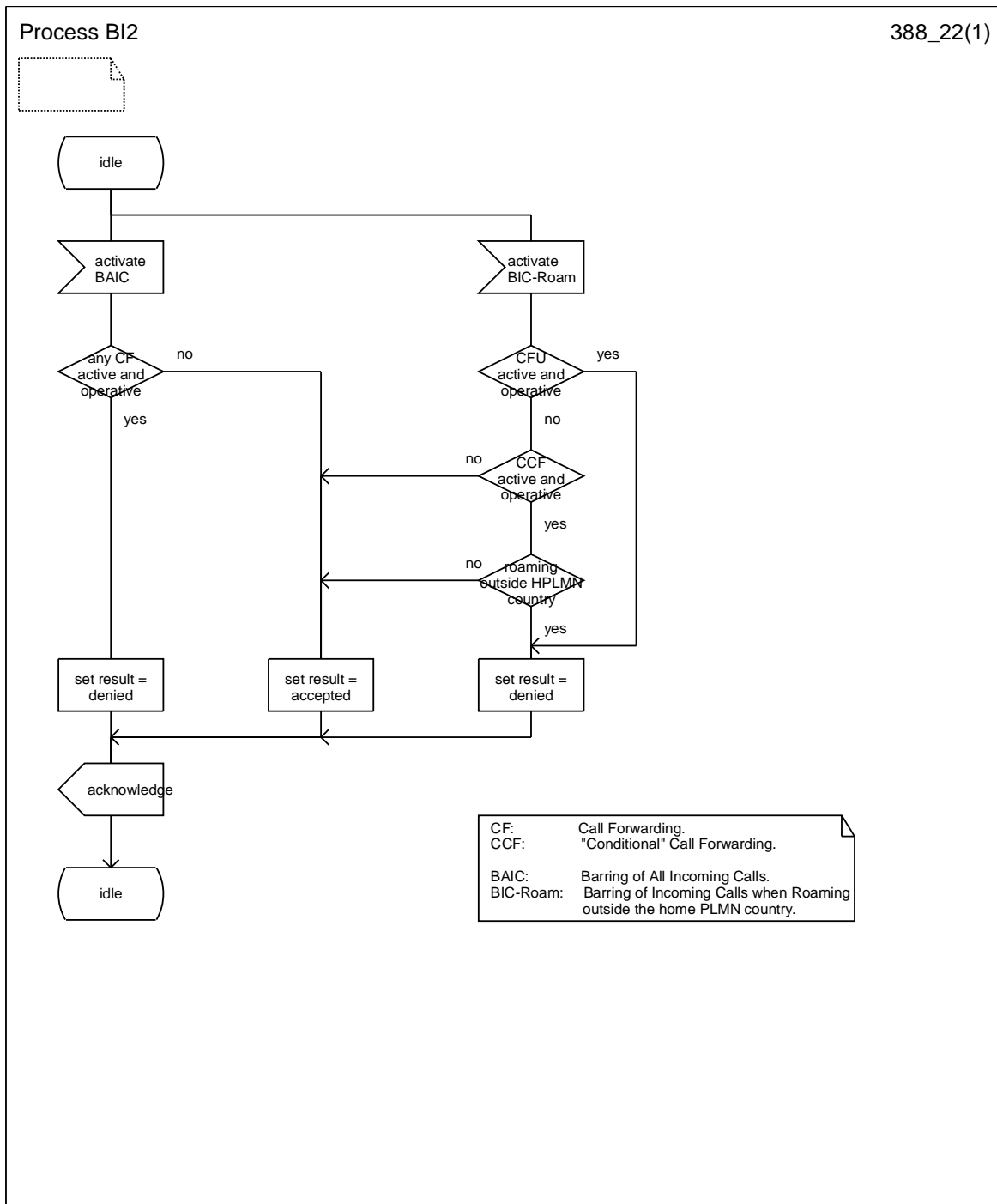

Figure 7.2: BI2 Interaction between call forwarding supplementary services and barring of incoming calls programs

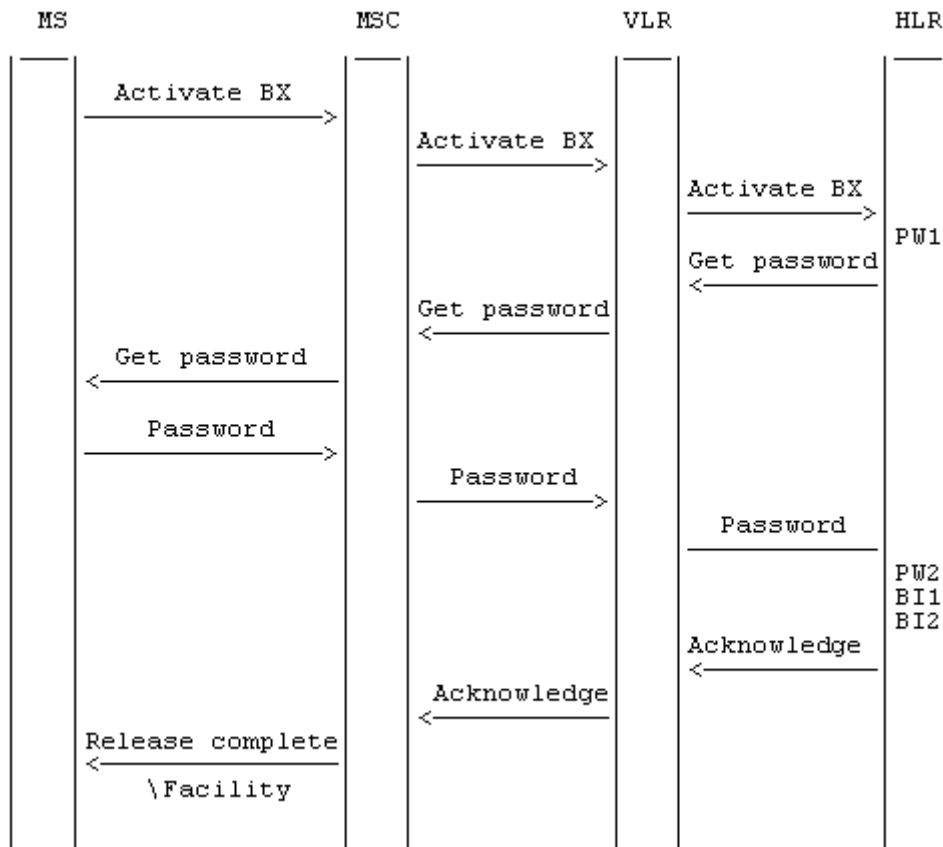

Figure 7.3: Activation of barring of incoming calls

NOTE: BX indicates any of the barring programs.
 PW1 and PW2 indicate password handling programs, see 3G TS 23.011.

7.1.3 Deactivation

The procedure for activation of Barring of outgoing calls, described in subclause 1.1.2.1, is valid also correspondingly for deactivation of Barring of incoming calls with the addition that a barring supplementary service, i.e. the Incoming barring service, or All barring services can be signalled.

The information flow for deactivation of barring of incoming calls is shown in figure 7.4. For more details see 3G TS 23.011.

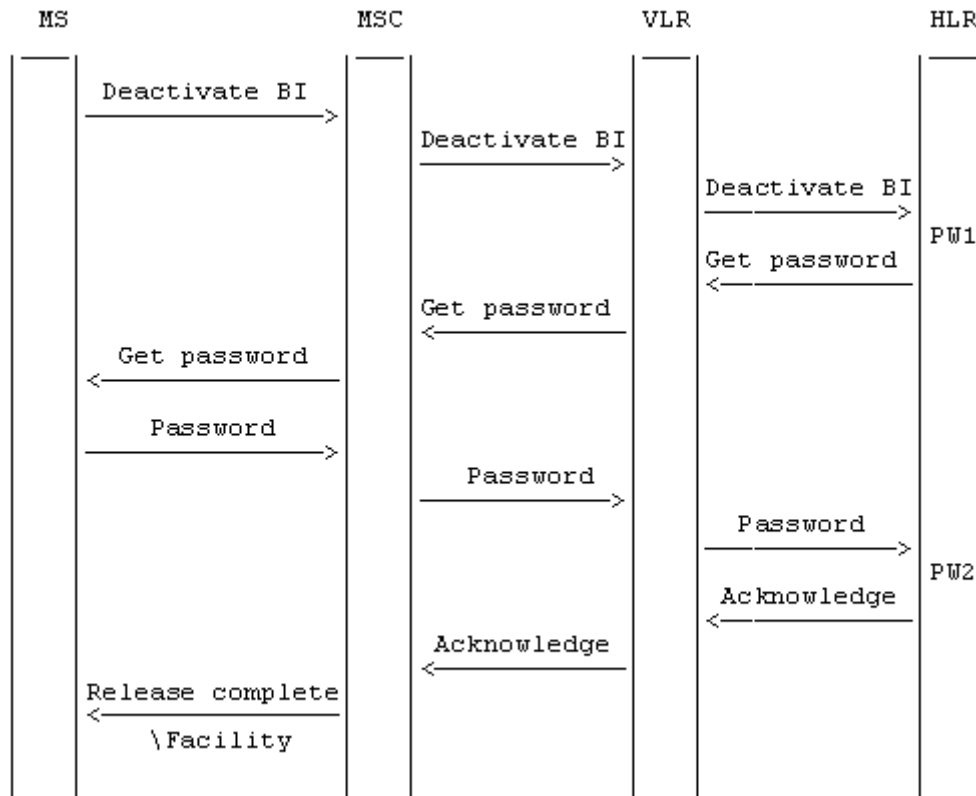

Figure 7.4: Deactivation of barring of incoming calls

NOTE: BI indicates the general code for barring of incoming calls.
 PW1 and PW2 indicate password handling programs, see 3G TS 23.011.

7.1.4 Interrogation

The interrogation procedure enables the mobile subscriber to obtain information about the data stored in the PLMN. After having requested this procedure the network shall return a list of all basic services to which the given program is active.

The information flow for interrogation of barring of incoming calls is shown in figure 7.5.

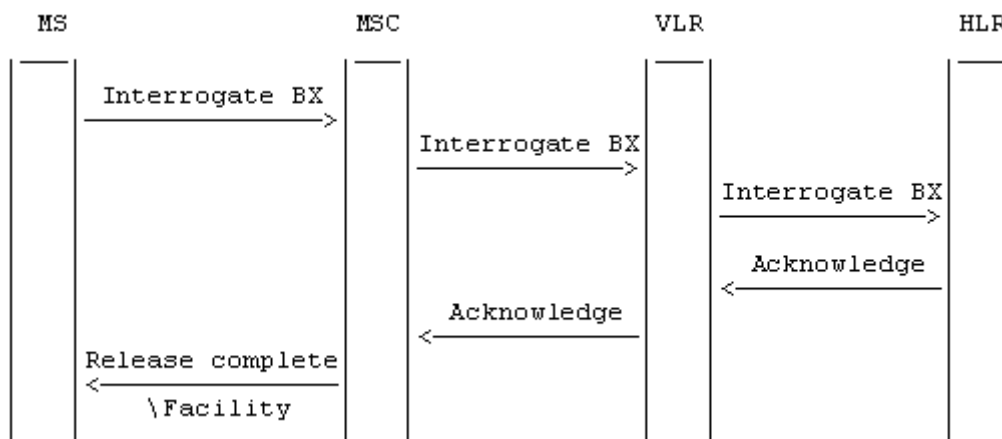

Figure 7.5: Interrogation of barring of incoming calls

NOTE: BX indicates any of the barring programs.

7.2 Functions and information flows

The following Mobile Additional Functions have been identified:

MAF022

Barring of all incoming calls related authorizations examination

The ability of a PLMN component to determine the authorizations relating to barring of incoming calls. See figure 7.6.

Location: HSS/HLR

MAF023

Barring of incoming calls when roaming outside the home PLMN country related authorizations examination

The ability of a PLMN component to determine the authorizations relating to barring of incoming calls when roaming outside the home PLMN country. See figure 7.7.

Location: HSS/HLR

The information flow for barring of incoming circuit switched calls is shown in figure 7.8A. The information flow for barring of MT SMS is shown in figure 7.8B.

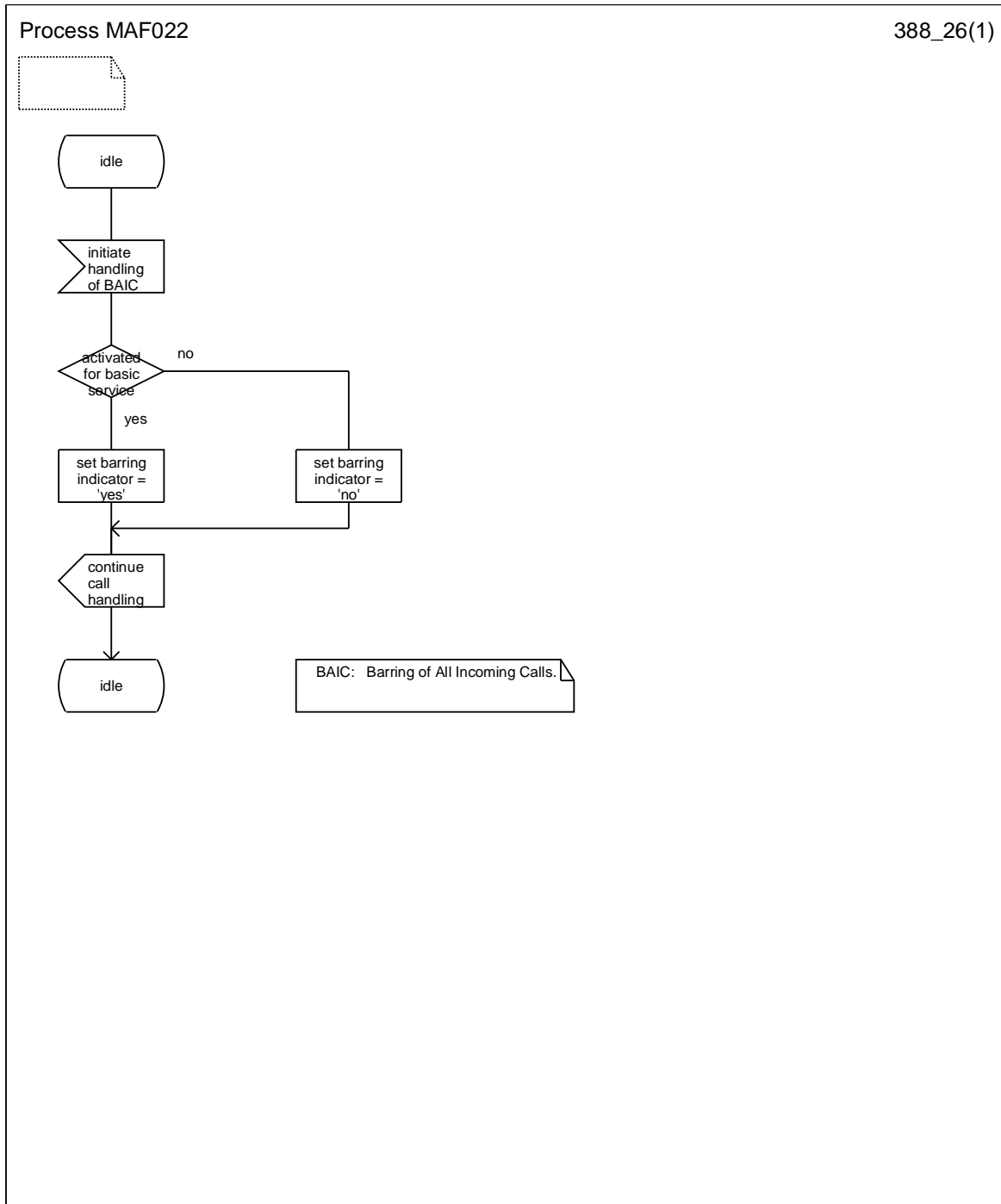

Figure 7.6: MAF022 Barring of all incoming circuit switched calls and MT SMS related authorisations examination (HSS/HLR)

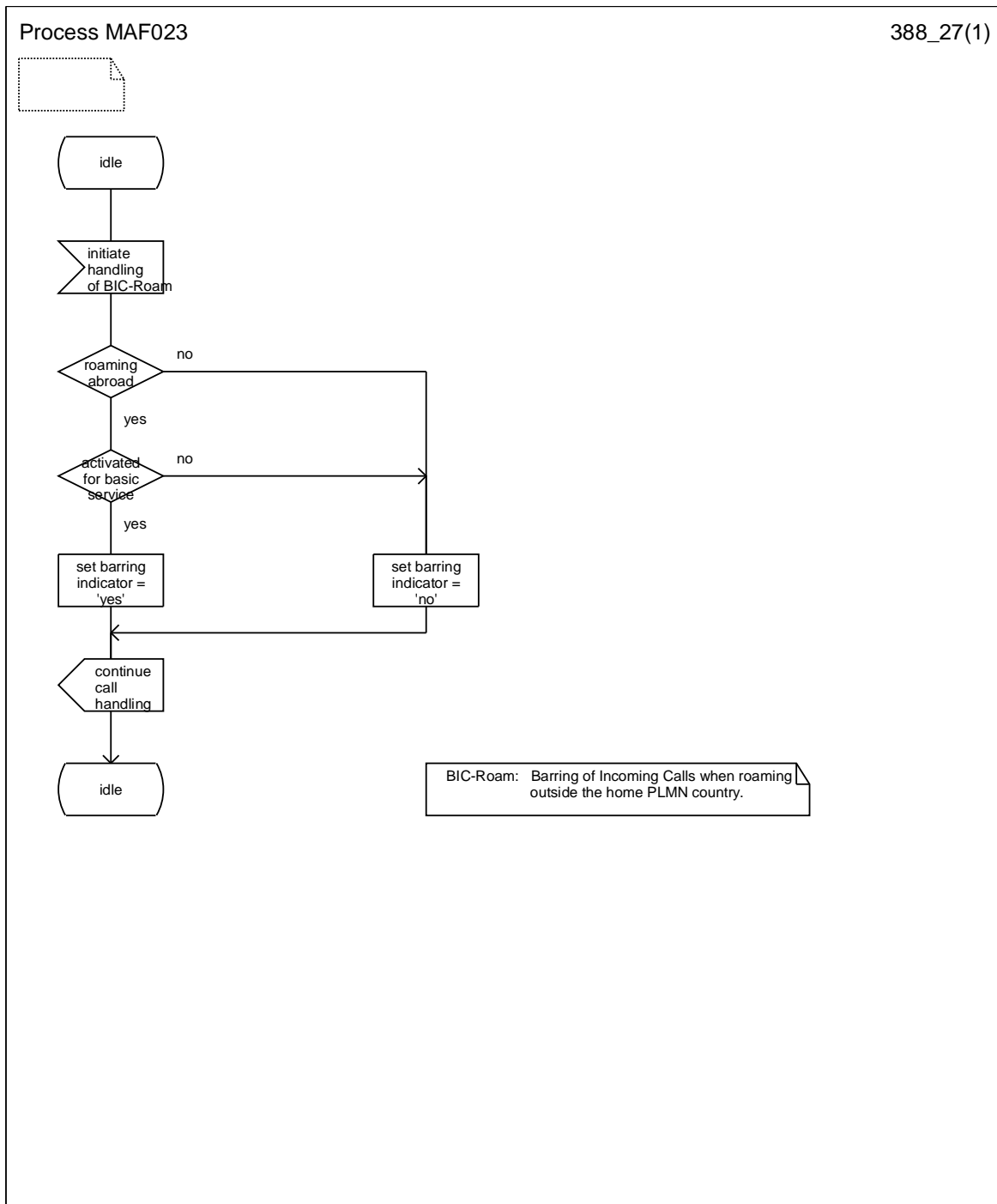
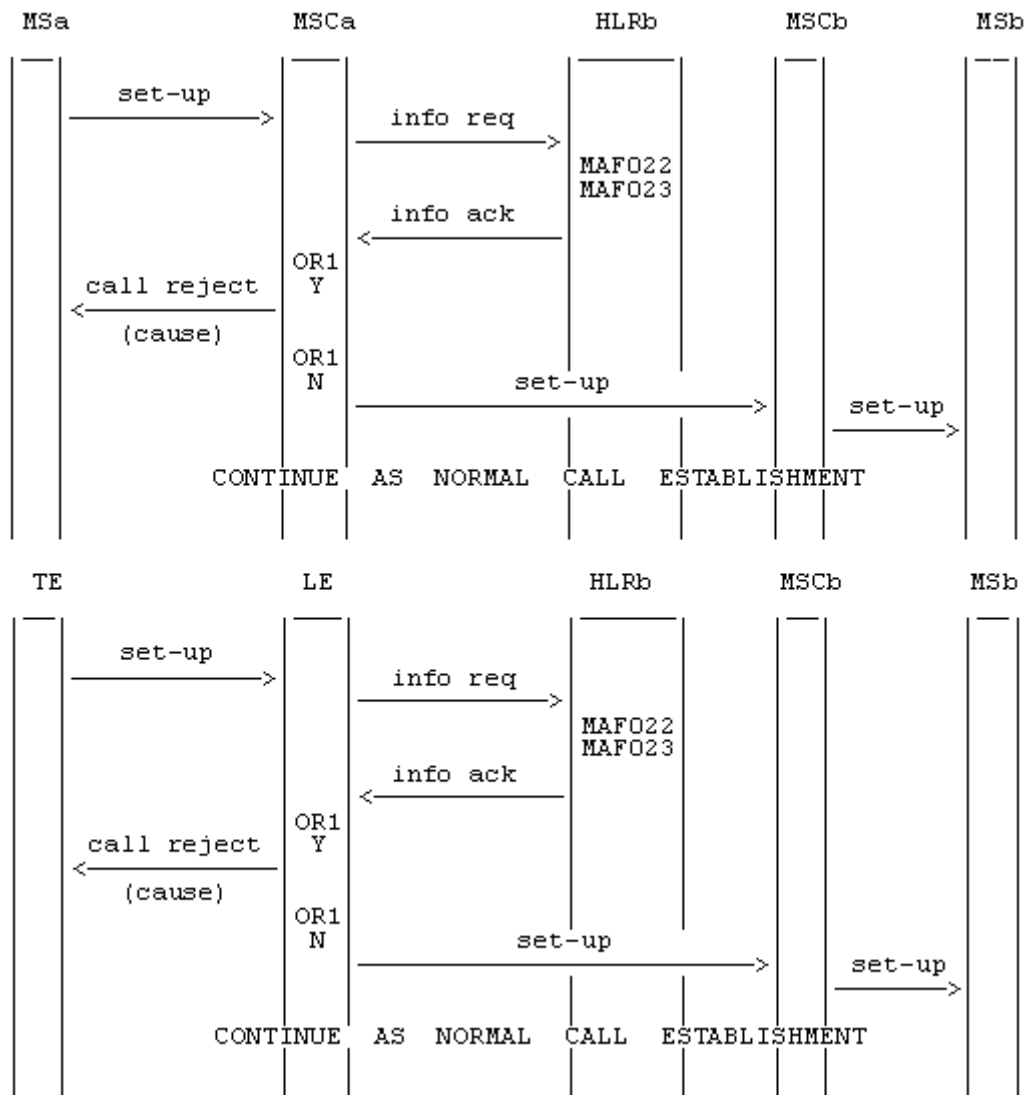
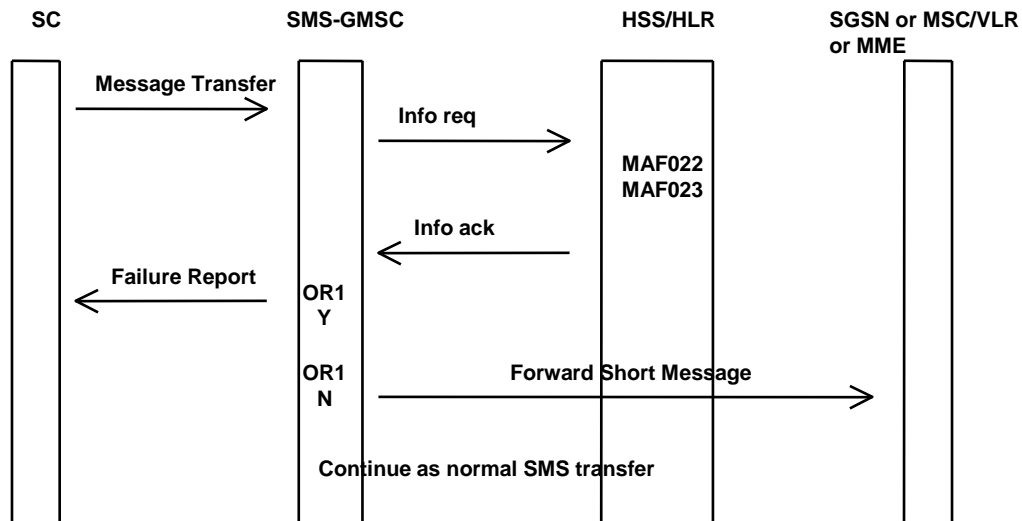

Figure 7.7: MAF023 Barring of incoming circuit switched calls and MT SMS when roaming outside the home PLMN country related authorisations examination (HSS/HLR)



NOTE: info req: information request
 info ack: information acknowledge
 OR1: call barred Y: yes
 N: no.

Figure 7.8A: Information flow for barring of incoming circuit switched calls



NOTE: info req: information request
 info ack: information acknowledge
 OR1: call barred Y: yes
 N: no.

Figure 7.8B: Information flow for barring of MT SMS

7.3 Information stored in the HSS/HLR

For all call barring supplementary services in the HSS/HLR must be stored:

- the subscription option "control of barring services" on per subscriber basis.

This subscription option takes one of the following values:

- by subscriber using password;
- by the service provider.

If the subscription option "control of barring services" has been set to "by subscriber using password" for barring of incoming calls in the HLR must be stored on a per subscriber basis:

- the registration parameter "call barring password".

The password is valid for all basic services to which barring of incoming calls applies;

- the status parameter "wrong password attempts counter" associated with the password.

Note that the subscription option and the call barring password are parameters which are associated with all call barring services.

The incoming calls barring program may have the following logical states (refer to 3G TS 23.011 for an explanation of the notation):

| Provisioning State | Registration State | Activation State | HSS/HLR Induction State |
|--------------------|--------------------|-----------------------|-------------------------|
| (Not Provisioned, | Not Applicable, | Not Active, | Not Induced) |
| (Provisioned, | Not Applicable, | Not Active, | Not Induced) |
| (Provisioned, | Not Applicable, | Active and Operative, | Not Induced) |

The program of barring of incoming call when roaming outside the home PLMN country may also have the following logical state:

| Provisioning State | Registration State | Activation State | HSS/HLR Induction State |
|--------------------|--------------------|-----------------------|-------------------------|
| (Provisioned, | Not Applicable, | Active and Quiescent, | Not Induced) |

The activation and HSS/HLR induction states may be different for each applicable elementary basic service group.

The provisioning state shall be on a per subscriber basis, and hence the same for all basic service groups.

The HSS/HLR shall also store the logical state of the incoming calls barring program (which shall be one of the valid states listed above) for each applicable elementary basic service group.

7.4 State transition model

The following figures show the successful cases of transition between the applicable logical states of the call barring program. The state changes are either caused by actions of the service provider, the mobile user or the network.

Note that error cases are not shown in the diagrams as they normally do not cause a state change. Additionally, some successful requests may not cause a state change. Hence, they are not shown in the diagrams.

The diagrams only show operations on an elementary basic service group.

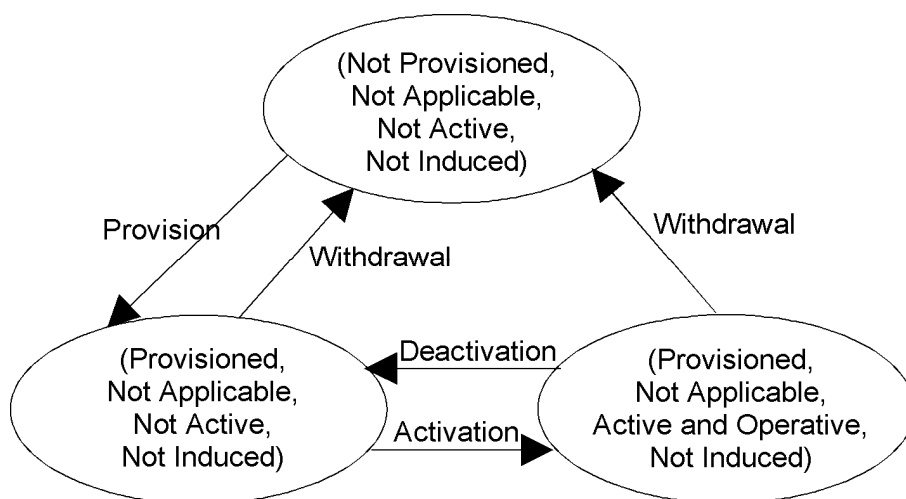

Figure 7.9: State transition model for BAIC

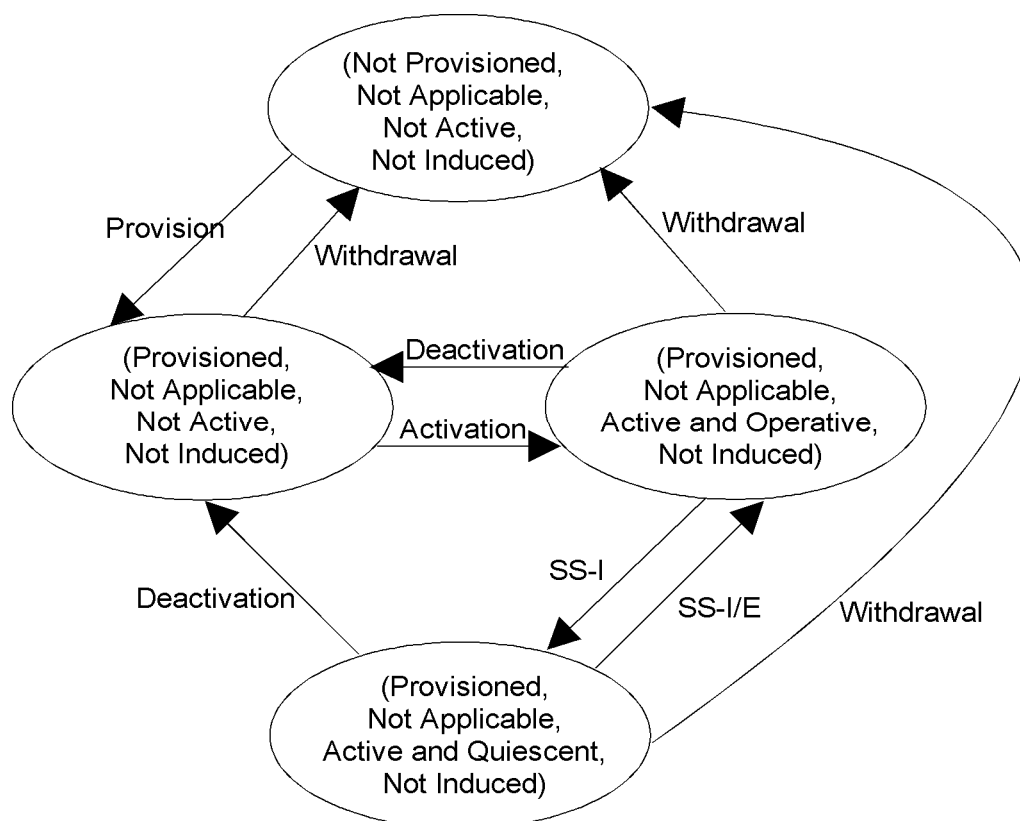

Figure 7.10: State transition model for BIC-Roam

NOTE: SS-I: SS Interaction started or Subscriber in HPLMN country.
 SS-I/E: SS Interaction ended or Subscriber not in HPLMN country.

7.5 Transfer of information from HSS/HLR to VLR/SGSN/MME

No information is transferred from HSS/HLR to VLR/SGSN/MME for the incoming calls barring program.

7.6 Information stored in the VLR/SGSN/MME

No information is stored in the VLR/SGSN/MME.

7.7 Handover

Handover will have no impact on the control procedures and the operation of the service.

7.8 Cross Phase compatibility

7.8.1 MS, MSC, VLR or HLR only support Phase 1 control of SS by the subscriber

In response to a Barring of incoming calls interrogation request, if the MS or any network element involved is of Phase 1, only information concerning basic service groups for which Barring of incoming calls is active will be returned.

In Phase 1 the state active and quiescent is not used in the HLR.

In Phase 2 the HLR will support the quiescent state.

As this quiescent state is only relevant within the HLR a Phase 1 MSC/VLR and a Phase 1 MS can support the Phase 2 interrogation even if the service becomes quiescent, i.e. there is no functional cross Phase compatibility problem.

Note that the interrogation result received by the user will be in Phase 1 and 2 a list of basic services. The only difference is that in Phase 1 it contains the active basic services irrespective of whether it is operative or quiescent.

7.8.2 HLR only supports Phase 1 updating of subscriber information

In Phase 1 the VLR stores the activation status also for barring of incoming calls.

In Phase 2 no information is stored in the VLR in case of barring of incoming calls. The VLR may receive subscription information for barring of incoming calls from a Phase 1 HLR. In this case the VLR shall ignore this information.

8 Anonymous Call Rejection

8.1 General

Anonymous Call Rejection (ACR) is a supplementary service of the CS domain that allows a mobile subscriber to reject incoming calls from users who have restricted the presentation of their calling line identity according to the CLIR supplementary service (see 3GPP TS 23.081 [5]).

The ACR supplementary service shall reject all calls with CLI marked "presentation restricted" according to CLIR. The calls shall be rejected regardless of the current state (e.g. free or busy) of the served subscriber's access. The called mobile subscriber shall not be alerted.

The ACR supplementary service shall not reject calls terminated for the mobile subscriber without a CLI or when the CLI presentation is not available, is allowed, or is restricted by the network.

The ability of the mobile subscriber to set-up outgoing calls shall remain unaffected.

The calling user shall be given an appropriate indication that the call has been rejected due to the application of the ACR supplementary service.

The telecom services to which ACR applies are defined in 3GPP TS 22.004 [6]. The service may be valid for all incoming calls or just associated with a specific basic service group.

8.2 Procedures

8.2.1 Provision and withdrawal

The ACR supplementary service may be provisioned to or withdrawn from a subscription by administrative actions in the HLR. The HLR shall update the subscription information accordingly. This is transparent to the VLR and thus does not require any transfer of updated subscription information to the VLR.

8.2.2 Registration and erasure

Not applicable.

8.2.3 Activation and deactivation

8.2.3.1 General

When provisioned in the subscription, the mobile subscriber should be able to activate or deactivate the ACR supplementary service by USSD procedure (see 3GPP TS 23.090 [7]). The USSD strings to be used to activate or deactivate the service are operator specific and should be operator configurable in the HLR.

The mobile subscriber may be able to activate or deactivate ACR per basic service group, subject to the capabilities of the HLR. An activation or deactivation request without any specific basic service group information shall be interpreted as applying to all basic service groups (applicable to ACR).

Calls that are on-going at the time the ACR supplementary service is activated shall not be affected. Any new incoming call not allowed by the ACR supplementary service shall be barred.

8.2.3.2 Interactions with other incoming call barring programs

ACR may be active simultaneously with Barring of incoming calls when roaming outside of the home PLMN country (BIC-Roam) but can not be active simultaneously with Barring of all incoming calls (BAIC), per basic service group. The HLR shall ensure that exclusive barring programs are not active simultaneously per basic service group. The activation of one specific barring program will override an already active exclusive one (i.e. the old one shall be permanently deactivated).

If ACR and BIC-Roam are active simultaneously for a specific basic service group, BIC-Roam shall apply when the mobile subscriber is roaming outside the HPLMN.

8.2.3.3 Logical states in the HLR for the ACR supplementary service

Table 8.2.3.3.1 shows the logical states that the ACR supplementary service may have in the HLR (see 3GPP TS 23.011 [3] for an explanation of the notation).

Table 8.2.3.3.1: Logical states in the HLR for the ACR supplementary service

| Provisioning State | Registration State | Activation State | HLR Induction State |
|--------------------|--------------------|----------------------|---------------------|
| Not Provisioned | Not Applicable | Not Active | Not Induced |
| Provisioned | Not Applicable, | Not Active | Not Induced |
| Provisioned | Not Applicable | Active and Operative | Not Induced |

The activation state may be different for each applicable elementary basic service group.

The provisioning state shall be on a per subscriber basis, and hence the same for all basic service groups.

Figure 8.2.3.3.1 shows the successful cases of transition between the applicable logical states of the ACR supplementary service. The state changes are either caused by actions of the service provider or the mobile user. Error cases are not shown in the diagram as they normally do not cause a state change. The diagrams only show operations on an elementary basic service group.

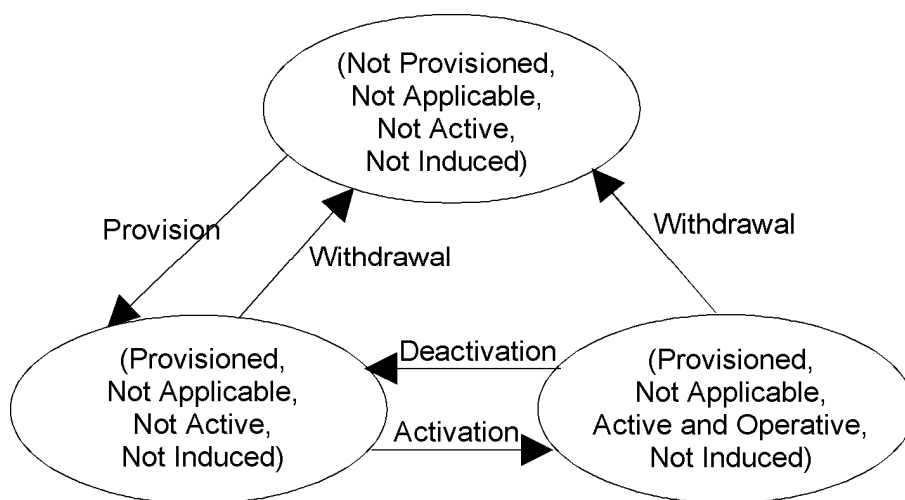

Figure 8.2.3.3.1: State transition model for ACR

8.2.4 Invocation

8.2.4.1 General

When the ACR supplementary service has been activated, then the ACR supplementary service shall automatically be invoked by the HLR. If the HLR receives a request for routing information for a call directed to a mobile subscriber who is subject to ACR for the corresponding basic service group, the HLR shall return a negative response to the request for routing information, with the indication that the call is rejected because of ACR, if the calling line identity is marked as "presentation restricted" according to the CLIR supplementary service. ACR shall not be invoked for incoming calls that do not have their CLI or that have their CLI marked "not available", "presentation allowed" or "presentation restricted by network".

Upon receipt of that indication, the GMSC shall connect the call to a recorded announcement determined by the network operator or/and should relay this error indication to the calling user.

8.2.4.2 Terminating Network Information flow

The information flow for rejection of an anonymous MT call is shown in figure 8.2.4.2.1. It applies to a mobile terminating call with CLI marked "presentation restricted", if the HLR and the GMSC supports the ACR supplementary service and the called mobile subscriber has activated ACR for the corresponding basic service group.

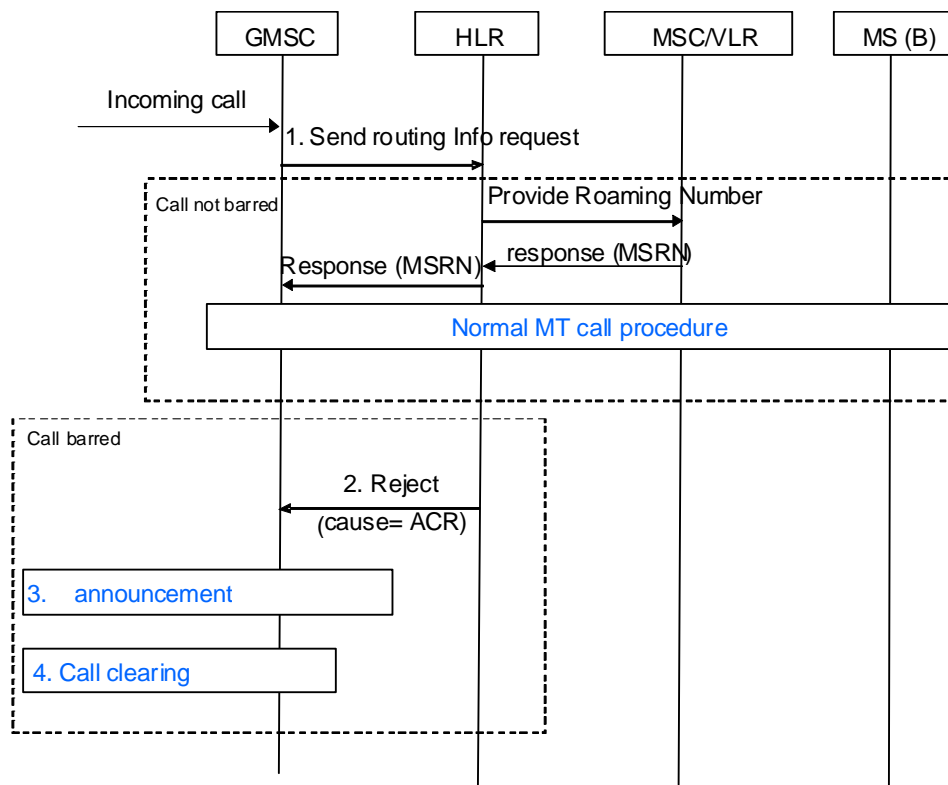

Figure 8.2.4.2.1: Information flow for rejection of an anonymous MT call

1. Upon receipt of an incoming call, the GMSC sends a MAP Send Routing Information request to the HLR. A GMSC that supports the ACR supplementary service shall pass to the HLR the Additional Signal Info IE including the CLI information if available as specified for the CLI supplementary service in 3GPP TS 23.081 [5] subclause 1.2.3.
2. Upon receipt of the MAP Send Routing Information request, an HLR that supports the ACR supplementary service shall return an SRI negative response with a cause indicating Anonymous Call Rejection if the mobile subscriber has activated ACR for the corresponding basic service group and the calling line identity is marked as "presentation restricted" according to the CLIR supplementary service.

The HLR shall determine whether the calling line identity is marked as "presentation restricted" using the 'Address presentation restricted indicator' of the Calling Party Number IE if received in the Additional Signal Info IE.

3. Upon receipt of a SRI negative response with the cause indicating Anonymous Call Rejection, the GMSC shall signal to the originating network that in-band information is available due to anonymous call rejection ("call rejected due to feature at destination") and play a specific in-band announcement towards the calling user to signal that the call has been rejected due to the application of the ACR supplementary service.
4. After the announcement has been completed, the GMSC shall initiate the call release with a cause indicating normal call release.

8.2.4.2a Originating Network behaviour

Upon receipt of the indication from the terminating network that in-band information is available, the originating MSC server shall request the MGW to through-connect the bearer terminations so that the bearer is backward through-connected unless already done. This allows the calling user to hear the announcement played by the terminating network when it rejects an anonymous call.

Upon receipt of a call release request with a cause indicating that the call has been rejected due to anonymous call rejection ("call rejected due to feature at destination"), the originating MSC may play an announcement towards the calling user to signal that the call has been rejected due to anonymous call rejection. If no local announcement is played, the originating MSC shall signal an appropriate cause (e.g. "call rejected due to feature at destination", "call rejected") when releasing the call towards the calling user. This allows the calling user to know why the call is rejected when an external terminating network rejects an anonymous call without providing in-band information towards the originating network.

NOTE: The support of cause 24 "call rejected due to feature at destination" was introduced into 3GPP TS 24.008 [9] from Rel-10 which means that some UEs will not recognise this and will treat as "Normal, unspecified".

8.2.4.3 Mobile Additional Function

The following Mobile Additional Function has been identified:

MAF024

ACR related authorizations examination

The ability of a PLMN component to determine the authorizations relating to ACR. See figure 8.2.4.3.1.

Location: HLR

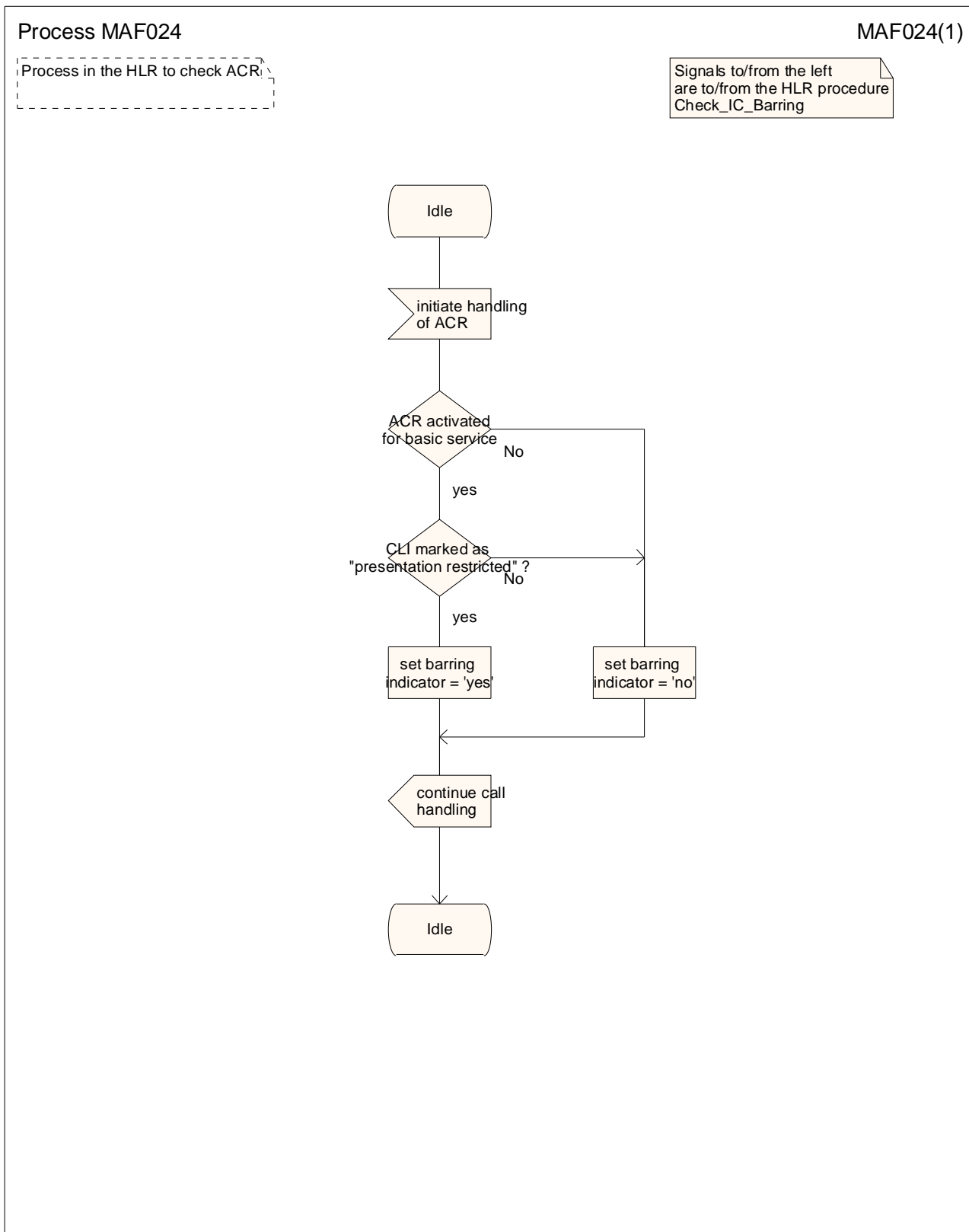

Figure 8.2.4.3.1: MAF024 Anonymous Call Rejection related authorisations examination (HLR)

8.2.5 Interrogation

When provisioned in the subscription, the mobile subscriber should be able to interrogate the network to determine the status of the ACR supplementary service by USSD procedure (see 3GPP TS 23.090 [7]). The USSD string to be used to interrogate the status of the service is operator specific and should be operator configurable in the HLR.

8.2.6 Exceptional procedures

If the mobile subscriber attempts to activate, deactivate or interrogates the ACR supplementary service and the HLR can not comply to the request, the HLR shall reject the request.

Possible reasons for rejection are:

- the ACR supplementary service is not subscribed to.

8.3 Interactions with other supplementary services

See 3GPP TS 22.088 [8] subclause 2.6.

8.4 Interactions with other network features and services

8.4.1 Operator Determined Barring (ODB)

The call shall be barred if the incoming call to the mobile subscriber is determined to be barred by either the Operator Determined Barring service or the ACR supplementary service.

8.4.2 Optimal Routeing

The calling user may not get an indication that the call is rejected due to the application of the ACR supplementary service if the GMSC does not support the ACR supplementary service.

Annex A (informative): Change history

| Change history | | | | | | | | |
|----------------|-----------|---------|------|-----|--------|-----|---------|---|
| TSG CN# | Spec | Old Ver | CR | Rev | Phase | Cat | New Ver | Subject/Comment |
| Apr 1999 | GSM 03.88 | 6.0.0 | | | R97 | | | Transferred to 3GPP CN1 |
| CN#03 | 23.088 | | | | R99 | | 3.0.0 | Approved at CN#03 |
| CN#07 | 23.088 | 3.0.0 | 001 | 1 | R99 | | 3.1.0 | Introduction of "Notification to CSE flag" to the call barring supplementary service. |
| CN#09 | 23.088 | 3.1.0 | 002 | 1 | R99 | F | 3.2.0 | SDL refresh |
| CN#11 | 23.088 | 3.2.0 | | | Rel-4 | | 4.0.0 | Release 4 after CN#11 |
| CN#16 | 23.088 | 4.0.0 | | | Rel-5 | | 5.0.0 | Release 5 after CN#16 |
| CN#19 | 23.088 | 5.0.0 | 003 | 1 | Rel-6 | | 6.0.0 | Introducing SMS Call Barring in PS domain |
| CT#36 | 23.088 | 6.0.0 | | | Rel-7 | | 7.0.0 | Upgraded unchanged from Rel-6 |
| CT#42 | 23.088 | 7.0.0 | | | Rel-8 | | 8.0.0 | Upgraded unchanged from Rel-7 |
| CT#46 | 23.088 | 8.0.0 | - | - | Rel-9 | | 9.0.0 | Update to Rel-9 version (MCC) |
| 2011-03 | 23.088 | 9.0.0 | - | - | Rel-10 | | 10.0.0 | Update to Rel-10 version (MCC) |
| CT#53 | 23.088 | 10.0.0 | 0004 | 2 | Rel-11 | B | 11.0.0 | Addition of Anonymous Call Rejection in the CS domain |
| CT#54 | 23.088 | 11.0.0 | 0005 | 1 | Rel-11 | B | 11.1.0 | Originating & Terminating network Information Flows |
| CT#62 | 23.088 | 11.1.0 | 0006 | 1 | Rel-11 | F | 11.2.0 | SMSC Usage Restriction in Roaming |
| - | 23.088 | 11.2.0 | | | Rel-11 | | 11.2.1 | Change History updated to include CR#0006r1 |
| CT#63 | 23.088 | 11.2.1 | 0007 | 1 | Rel-11 | F | 11.3.0 | Call barring services with the SMS in MME option |
| 2014-09 | 23.088 | 11.3.0 | - | - | Rel-12 | | 12.0.0 | Update to Rel-12 version (MCC) |
| 2015-12 | 23.088 | 12.0.0 | - | - | Rel-13 | | 13.0.0 | Update to Rel-13 version (MCC) |

History

| Document history | | |
|-------------------------|--------------|-------------|
| V13.0.0 | January 2016 | Publication |
| | | |
| | | |
| | | |
| | | |