

ETSI TS 101 727 V7.2.0 (2000-01)

Technical Specification

**Digital cellular telecommunications system (Phase 2+);
Multiple Subscriber Profile (MSP) (Phase 1) - Stage 2
(GSM 03.97 version 7.2.0 Release 1998)**



GSM®
GLOBAL SYSTEM FOR
MOBILE COMMUNICATIONS

ETSI 

Reference

RTS/SMG-030397Q7R2

Keywords

Digital cellular telecommunications system,
Global System for Mobile communications (GSM)

ETSI

Postal address

F-06921 Sophia Antipolis Cedex - FRANCE

Office address

650 Route des Lucioles - Sophia Antipolis
Valbonne - FRANCE
Tel.: +33 4 92 94 42 00 Fax: +33 4 93 65 47 16
Siret N° 348 623 562 00017 - NAF 742 C
Association à but non lucratif enregistrée à la
Sous-Préfecture de Grasse (06) N° 7803/88

Internet

secretariat@etsi.fr
Individual copies of this ETSI deliverable
can be downloaded from
<http://www.etsi.org>
If you find errors in the present document, send your
comment to: editor@etsi.fr

Important notice

This ETSI deliverable may be made available in more than one electronic version or in print. In any case of existing or perceived difference in contents between such versions, the reference version is the Portable Document Format (PDF). In case of dispute, the reference shall be the printing on ETSI printers of the PDF version kept on a specific network drive within ETSI Secretariat.

Copyright Notification

No part may be reproduced except as authorized by written permission.
The copyright and the foregoing restriction extend to reproduction in all media.

© European Telecommunications Standards Institute 2000.
All rights reserved.

Contents

| | |
|--|----|
| Intellectual Property Rights..... | 5 |
| Foreword | 5 |
| 1 Scope..... | 6 |
| 2 References..... | 6 |
| 3 Definitions and abbreviations | 7 |
| 3.1 Definitions | 7 |
| 3.2 Abbreviations | 7 |
| 4 Features needed to support MSP..... | 7 |
| 5 Additional Information stored in network entities | 8 |
| 5.1 Data stored in the HLR..... | 8 |
| 5.2 Data stored in the VLR..... | 8 |
| 6 Additional procedures in network entities | 8 |
| 6.1 OCB_flag | 8 |
| 6.2 ODB flags..... | 8 |
| 7 Description of Multiple Subscriber Profile..... | 9 |
| 7.1 Overview | 9 |
| 7.2 Registration of a Profile..... | 9 |
| 7.3 Interrogation..... | 10 |
| 7.4 Call Handling for an MSP subscriber..... | 13 |
| 7.4.1 Mobile Originating (MO) call handling..... | 13 |
| 7.4.2 Mobile Terminating (MT) call handling..... | 13 |
| 7.5 Functions and Information Flows | 13 |
| 7.5.1 Functions..... | 13 |
| 7.5.2 Information flows..... | 19 |
| 7.6 Interaction with Supplementary Services | 21 |
| 7.6.1 Line Identification services..... | 21 |
| 7.6.1.1 CLIP..... | 21 |
| 7.6.1.2 CLIR | 21 |
| 7.6.1.3 COLP | 21 |
| 7.6.1.4 COLR..... | 21 |
| 7.6.2 Call Hold (HOLD)..... | 21 |
| 7.6.3 Call Waiting (CW)..... | 21 |
| 7.6.4 Call Forwarding | 21 |
| 7.6.5 Multi Party Service (MPTY) | 22 |
| 7.6.6 Closed User Group (CUG) | 22 |
| 7.6.7 Advice of Charge (AoC)..... | 22 |
| 7.6.8 Call Barring | 22 |
| 7.6.9 Explicit Call Transfer (ECT) | 22 |
| 7.6.10 Completion of Calls to Busy Subscriber (CCBS) | 22 |
| 7.6.11 enhanced Multi-Level Precedence and Pre-emption (eMLPP) | 22 |
| 7.6.12 User-to-User Signalling (UUS)..... | 23 |
| 7.6.13 Call Deflection (CD)..... | 23 |
| 7.7 Interaction with other services..... | 23 |
| 7.7.1 The Multi-Numbering Scheme | 23 |
| 7.7.2 The Short Message Service..... | 23 |
| 7.7.3 Interactions with CAMEL..... | 23 |
| 7.7.4 Interactions with OR | 23 |
| 7.7.5 Operator Determined Barring | 23 |
| 7.7.6 Roaming Restrictions..... | 24 |
| 7.8 Data stored in the gsmSCF | 24 |
| 7.9 Equivalent services implemented by the gsmSCF | 24 |

7.9.1 Call Forwarding24

7.9.1.1 Call Forward Unconditional26

7.9.1.2 Call Forward on Busy27

7.9.1.3 Call Forward on No Reply28

7.9.1.4 Call Forward on Not Reachable28

7.9.1.4.1 Early CFNRc28

7.9.1.4.2 Late CFNRc30

7.9.2 Call Barring30

7.9.3 Operator Determined Barring (ODB)31

7.10 Exceptional Procedures31

7.10.1 Roaming into a network not supporting CAMEL Phase 231

7.10.1.1 Actions required on Location Update31

7.10.1.2 MO call handling31

7.10.1.3 MT call handling32

7.10.2 Lack of availability of the Network Indication of Alerting feature32

Annex A (informative): Provision and Withdrawal of MSP33

A.1 Provision of MSP33

A.2 Withdrawal of MSP33

Annex B (Informative): Status of Technical Specification GSM 03.9734

Change History34

History35

Intellectual Property Rights

IPRs essential or potentially essential to the present document may have been declared to ETSI. The information pertaining to these essential IPRs, if any, is publicly available for **ETSI members and non-members**, and can be found in SR 000 314: "*Intellectual Property Rights (IPRs); Essential, or potentially Essential, IPRs notified to ETSI in respect of ETSI standards*", which is available from the ETSI Secretariat. Latest updates are available on the ETSI Web server (<http://www.etsi.org/ipr>).

Pursuant to the ETSI IPR Policy, no investigation, including IPR searches, has been carried out by ETSI. No guarantee can be given as to the existence of other IPRs not referenced in SR 000 314 (or the updates on the ETSI Web server) which are, or may be, or may become, essential to the present document.

Foreword

This Technical Specification (TS) has been produced by the Special Mobile Group (SMG).

The present document gives the stage 2 description of the Multiple Subscriber Profile (MSP) supplementary service within the digital cellular telecommunications system.

The contents of the present document are subject to continuing work within SMG and may change following formal SMG approval. Should SMG modify the contents of the present document it will then be republished by ETSI with an identifying change of release date and an increase in version number as follows:

Version 7.x.y

where:

- 7 GSM Phase 2+ Release 1998;
- x the second digit is incremented for all changes of substance, i.e. technical enhancements, corrections, updates, etc.;
- y the third digit is incremented when editorial only changes have been incorporated in the specification.

1 Scope

The present document specifies the stage 2 description of the Multiple Subscriber Profile (MSP) Supplementary Service Phase 1. MSP Phase 1 is implemented using CAMEL Phase 2. MSP Phase 2 will be implemented using CAMEL Phase 3.

2 References

The following documents contain provisions which, through reference in this text, constitute provisions of the present document.

- References are either specific (identified by date of publication, edition number, version number, etc.) or non-specific.
- For a specific reference, subsequent revisions do not apply.
- For a non-specific reference, the latest version applies.
- A non-specific reference to an ETS shall also be taken to refer to later versions published as an EN with the same number.
- For this Release 1998 document, references to GSM documents are for Release 1998 versions (version 7.x.y).

- [1] GSM 01.04: "Digital cellular telecommunications system (Phase 2+); Abbreviations and acronyms".
- [2] GSM 02.30: "Digital cellular telecommunications system (Phase 2+); Man Machine Interface (MMI) of the Mobile Station (MS)".
- [3] GSM 02.97: "Digital cellular telecommunications system (Phase 2+); Multiple Subscriber Profile (MSP) Service Description – Stage 1".
- [4] GSM 03.08: "Digital cellular telecommunications system (Phase 2+); Organisation of subscriber data".
- [5] GSM 03.16: "Digital cellular telecommunications system (Phase 2+); Subscriber data management – Stage 2".
- [6] GSM 03.18: "Digital cellular telecommunications system (Phase 2+); Basic Call Handling – Technical Realization".
- [7] GSM 03.67: "Digital cellular telecommunications system (Phase 2+); enhanced Multi-Level Precedence and Pre-emption service (eMLPP) – Stage 2".
- [8] GSM 03.72: "Digital cellular telecommunications system (Phase 2+); Call Deflection (CD); Stage 2".
- [9] GSM 03.78: "Digital cellular telecommunication system (Phase 2+); Customised Applications for Mobile network Enhanced Logic (CAMEL) – Phase 2; Stage 2".
- [10] GSM 03.79: "Digital cellular telecommunications system (Phase 2+); Support of Optimal Routeing (SOR); Technical Realisation".
- [11] GSM 03.81: "Digital cellular telecommunications system (Phase 2+); Line identification supplementary services – Stage 2".
- [12] GSM 03.82: "Digital cellular telecommunications system (Phase 2+); Call Forwarding (CF) supplementary services – Stage 2".
- [13] GSM 03.83: "Digital cellular telecommunications system (Phase 2+); Call Waiting (CW) and Call Hold (HOLD) supplementary services – Stage 2".

- [14] GSM 03.84: "Digital cellular telecommunications system (Phase 2+); Multi Party (MPTY) supplementary services – Stage 2".
- [15] GSM 03.85: "Digital cellular telecommunications system (Phase 2+); Closed User Group (CUG) supplementary services – Stage 2".
- [16] GSM 03.86: "Digital cellular telecommunications system (Phase 2+); Advice of Charge (AoC) supplementary services – Stage 2".
- [17] GSM 03.87: "Digital cellular telecommunications system (Phase 2+); User-to-User (UUS) Supplementary Service; Stage 2".
- [18] GSM 03.88: "Digital cellular telecommunications system (Phase 2+); Call Barring (CB) supplementary services – Stage 2".
- [19] GSM 03.90: "Digital cellular telecommunications system (Phase 2+); Unstructured Supplementary Service Data (USSD) – Stage 2".
- [20] GSM 03.91: "Digital cellular telecommunications system (Phase 2+); Explicit Call Transfer (ECT) supplementary service – Stage 2".
- [21] GSM 03.93: "Digital cellular telecommunications system (Phase 2+); Technical Realization of Completion of Calls to Busy Subscriber (CCBS); Stage 2".

3 Definitions and abbreviations

3.1 Definitions

For the purposes of the present document, the following terms and definitions apply.

Default Profile: The profile used when the MSP subscriber roams to a non-supporting network. The MSP subscriber will not be able to change outgoing call barrings for the default profile.

MSP Subscriber: The subscriber provisioned with the MSP service

Profile Identity: The numerical identity (between 1 and 4) of the profile

Profile Status: Specifies if the profile is the registered profile or the default profile

Registered Profile: The profile used for all MO calls if a profile has not been explicitly selected

3.2 Abbreviations

The abbreviations used in the present document are listed in GSM 01.04.

For the purposes of the present document, the following abbreviations apply:

| | |
|-----|---|
| CD | The Call Deflection supplementary service |
| MSP | The Multiple Subscriber Profile supplementary service |
| UUS | The User-to-User Signalling supplementary service |

4 Features needed to support MSP

1. CAMEL Phase 2 is a pre-requisite for MSP.
2. The Network Indication of Alerting feature is also required if the subscriber is to be informed of the called profile.

5 Additional Information stored in network entities

5.1 Data stored in the HLR

The HLR contains all the common data (the data valid for all profiles) and some data specific to the default profile.

The data stored in the HLR are defined in GSM 03.08. The elements specifically used for MSP are:

- List of MSISDNs and associated Bearer Capabilities;
- Default profile (associated with the Basic MSISDN);
- Capabilities of VLR (support of CAMEL Phase 2);
- Supplementary services (per BSG) subscribed per provisioned subscriber (CW, CH, MPTY, ...);
- Call Barring Data (see subclause 7.6.8: Call Barring);
- ODB Data (see subclause 7.7.5: Operator Determined Barring);
- CAMEL data including the MSP service key, O-CSI, T-CSI, UG-CSI and Location information / Subscriber state Interrogation.

5.2 Data stored in the VLR

The data stored in a VLR are defined in GSM 03.08. MSP has no impact on the VLR.

6 Additional procedures in network entities

6.1 OCB_flag

The OCB_flag shall be set in the HLR if Call Barrings are provided in the gsmSCF.

If the OCB_flag is set then

- When the subscriber roams to a VLR which supports CAMEL Phase 2, the HLR shall not send any outgoing call barring supplementary services data to the VLR;
- When the subscriber roams to a VLR which does not support CAMEL Phase 2, the HLR shall send to the VLR outgoing call barring supplementary services data as stored in the HLR.
- The subscriber shall not be allowed to alter the Call Barring data in the HLR

6.2 ODB flags

The ODB flag for the relevant category shall be set in the HLR if ODB is provisioned in the gsmSCF for that category.

If the ODB flag is set for that category, then

- When the subscriber roams to a VLR which supports CAMEL Phase 2, the HLR shall not send any ODB data for that category to the VLR;
- When the subscriber roams to a VLR which does not support CAMEL Phase 2, the HLR shall send to the VLR ODB data for that category to the VLR as stored in the HLR.

7 Description of Multiple Subscriber Profile

7.1 Overview

The MSP service allows the served subscriber to have several profiles, to distinguish between different telecommunication service requirements (e.g. business and home). This is described in GSM 02.97. Subscriber data specific to MSP is stored in the HLR and the gsmSCF.

7.2 Registration of a Profile

Registration of a profile allows the subscriber to register a provisioned profile to be used for mobile originated calls. The request to register a profile shall contain the MSP code and the profile identity and will be sent to the gsmSCF using USSD, see GSM 03.78 and GSM 03.90. The registered profile is stored in the gsmSCF. In response to a successful registration request, the gsmSCF shall return a positive acknowledgement, including the identity of the registered profile, using USSD.

The registration process in the gsmSCF is shown in figure 2. The information flow for registering a profile is shown in figure 1.

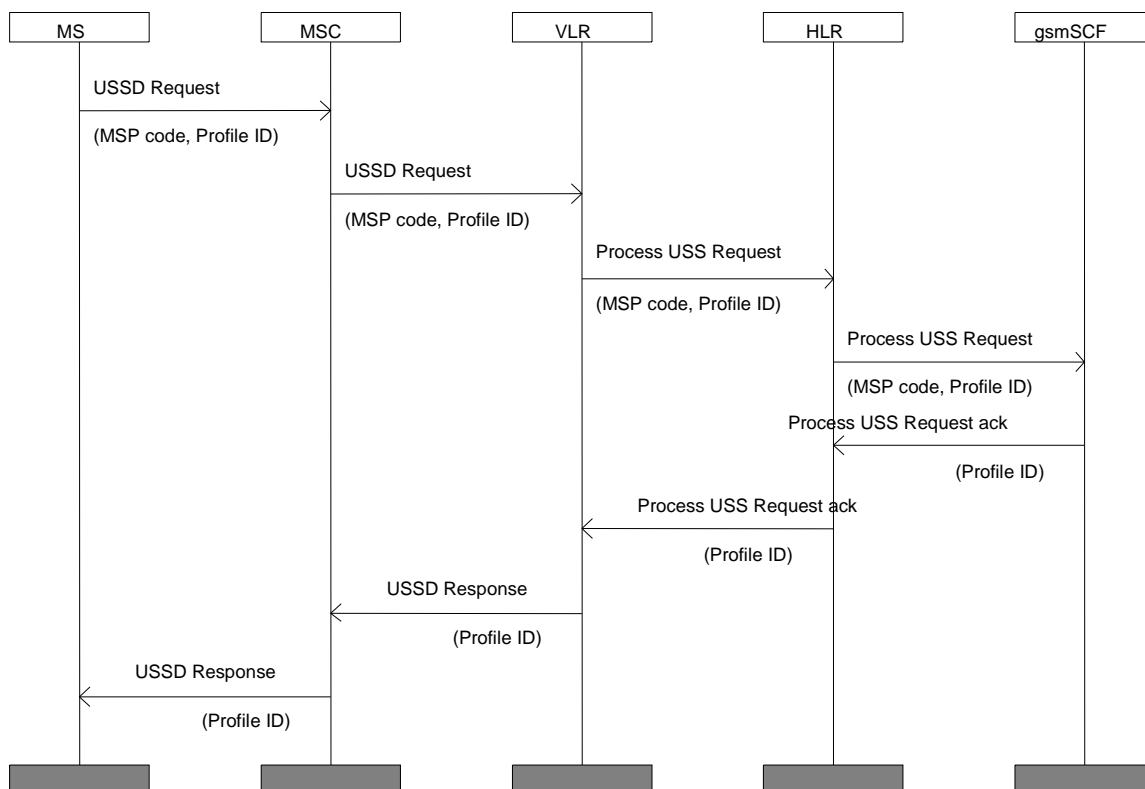

Figure 1: Registration Process

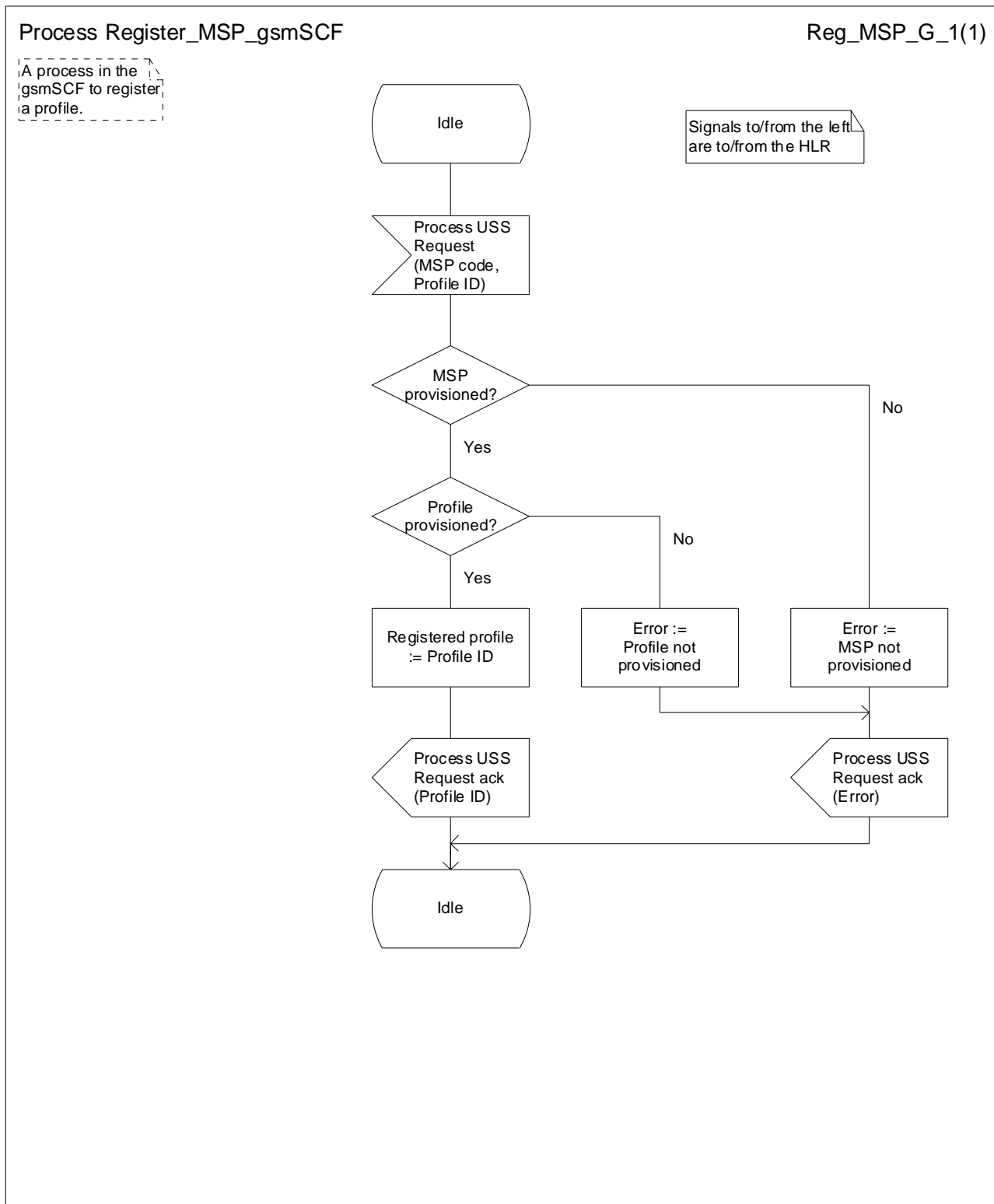

Figure 2: Process Register_MSP_gsmSCF

7.3 Interrogation

The MS can interrogate MSP, using USSD, to identify which profiles are provisioned and which of the provisioned profiles is the currently registered profile.

The interrogation process is shown in figure 4. The information flow for interrogation of MSP is shown in figure 3.

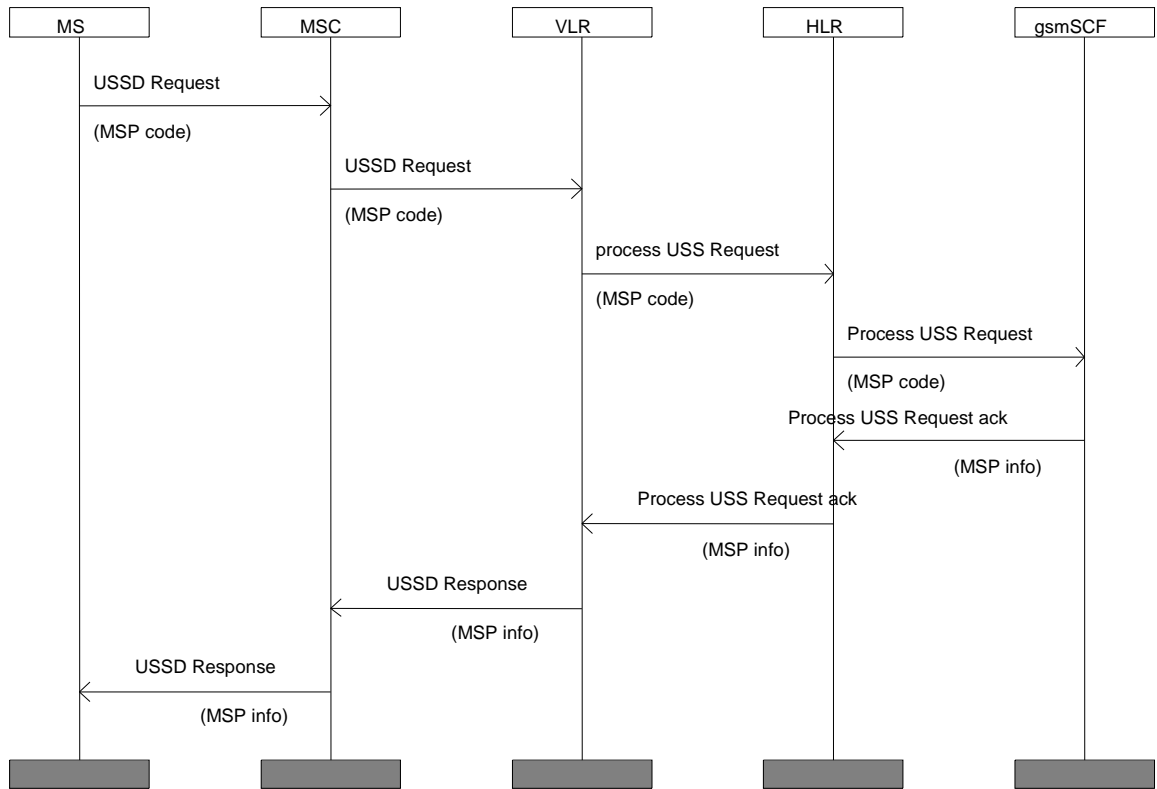

Figure 3: Interrogating MSP

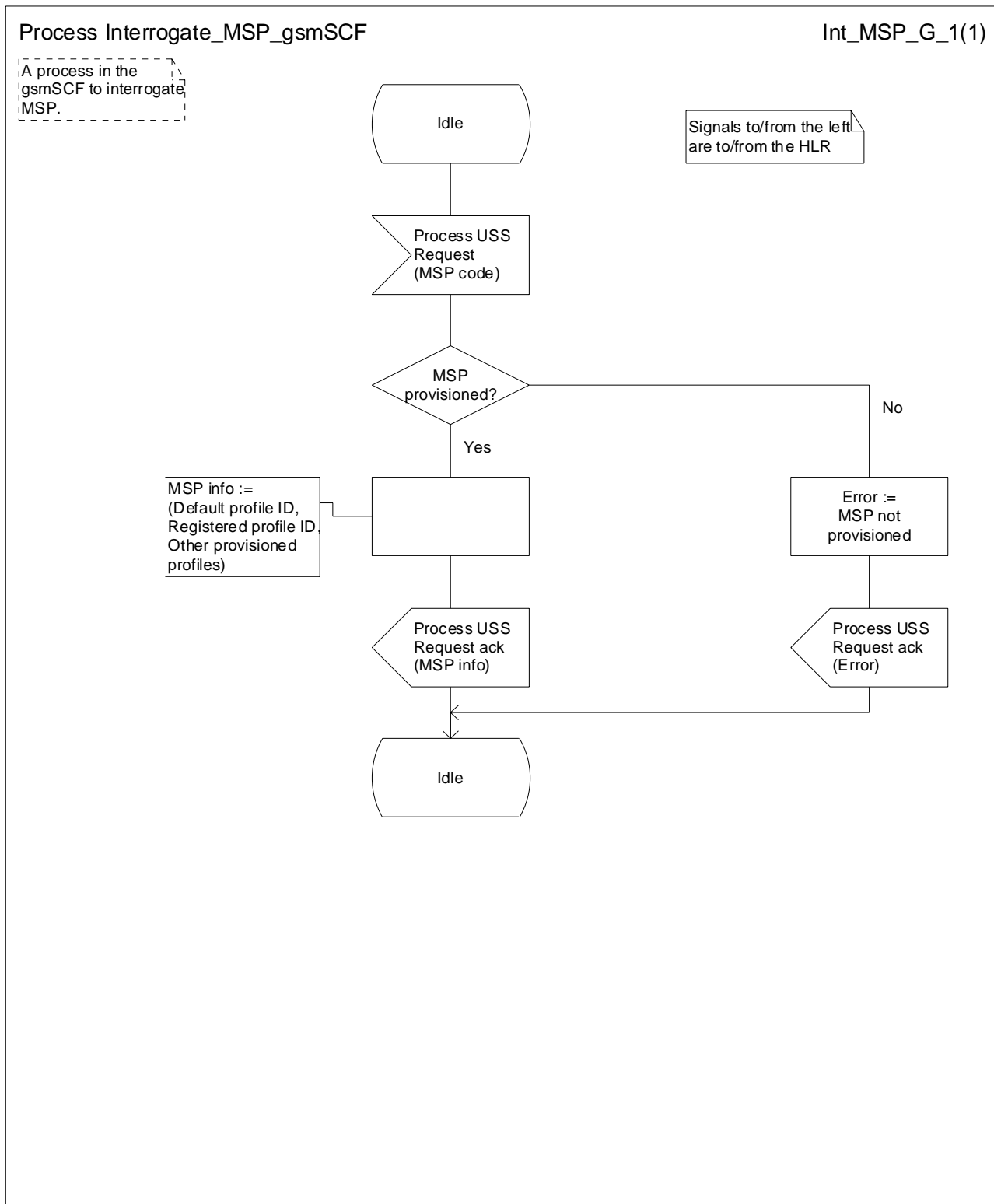

Figure 4: Process Interrogate_MSP_gsmSCF

The interrogate MSP operation shall contain the MSP service code.

In response to a successful interrogation request, the gsmSCF shall return the profile identity and profile status for each provisioned profile.

If the MSP service is not provisioned then the gsmSCF shall return the service status indicating not provisioned.

7.4 Call Handling for an MSP subscriber

The procedure for handling MSP calls can be divided into two areas: mobile originating call handling and mobile terminating call handling.

7.4.1 Mobile Originating (MO) call handling

The served subscriber may use the registered profile or explicitly select a provisioned profile to set up an MO call. If the profile is explicitly selected, the selection information will be included in the called party BCD number and transported to the gsmSCF. If the gsmSCF recognises that a profile has not been explicitly selected (there is no profile selection information in the called party BCD number) then the registered profile is used. The MMI for explicitly selecting a profile is defined in GSM 02.30.

The information flow for an MO call is shown in figure 10.

When the gsmSCF receives an Initial_DP message containing MO call parameters from the gsmSSF, the process MO_MSP_Call_gsmSCF will be invoked, see figures 5-6. All other call handling is described in GSM 03.18 and GSM 03.78.

7.4.2 Mobile Terminating (MT) call handling

The profile used for an MT call to the served subscriber is determined by the called MSISDN.

The information flow for an MT call is shown in figure 11.

When the gsmSCF receives an Initial_DP message containing MT call parameters from the gsmSSF, the process MT_MSP_Call_gsmSCF will be invoked, see figures 7-9. All other call handling is described in GSM 03.18 and GSM 03.78.

7.5 Functions and Information Flows

7.5.1 Functions

The following functions have been added for MSP:

MO_MSP_Call_gsmSCF

Sets the parameters for an MO call

See figures 5-6.

Location: gsmSCF

MT_MSP_Call_gsmSCF

Sets the parameters for an MT call and forwards the call if appropriate

See figures 7-9.

Location: gsmSCF

As far as Call Forwarding is concerned, these functions are based on the assumption that the subscriber is not provided with GSM Call Forwarding supplementary services.

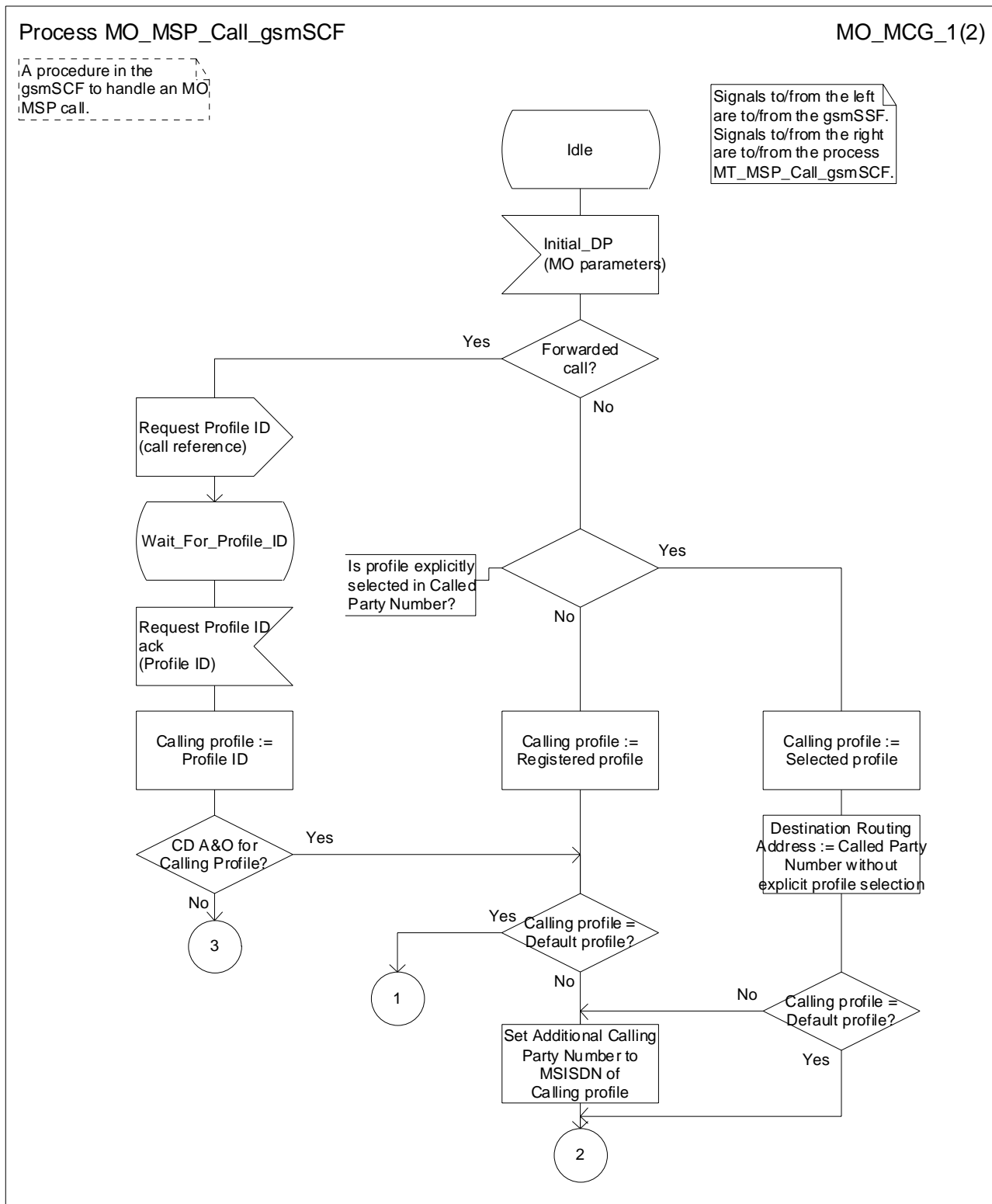

Figure 5: Process MO_MSP_Call_gsmSCF (sheet 1)

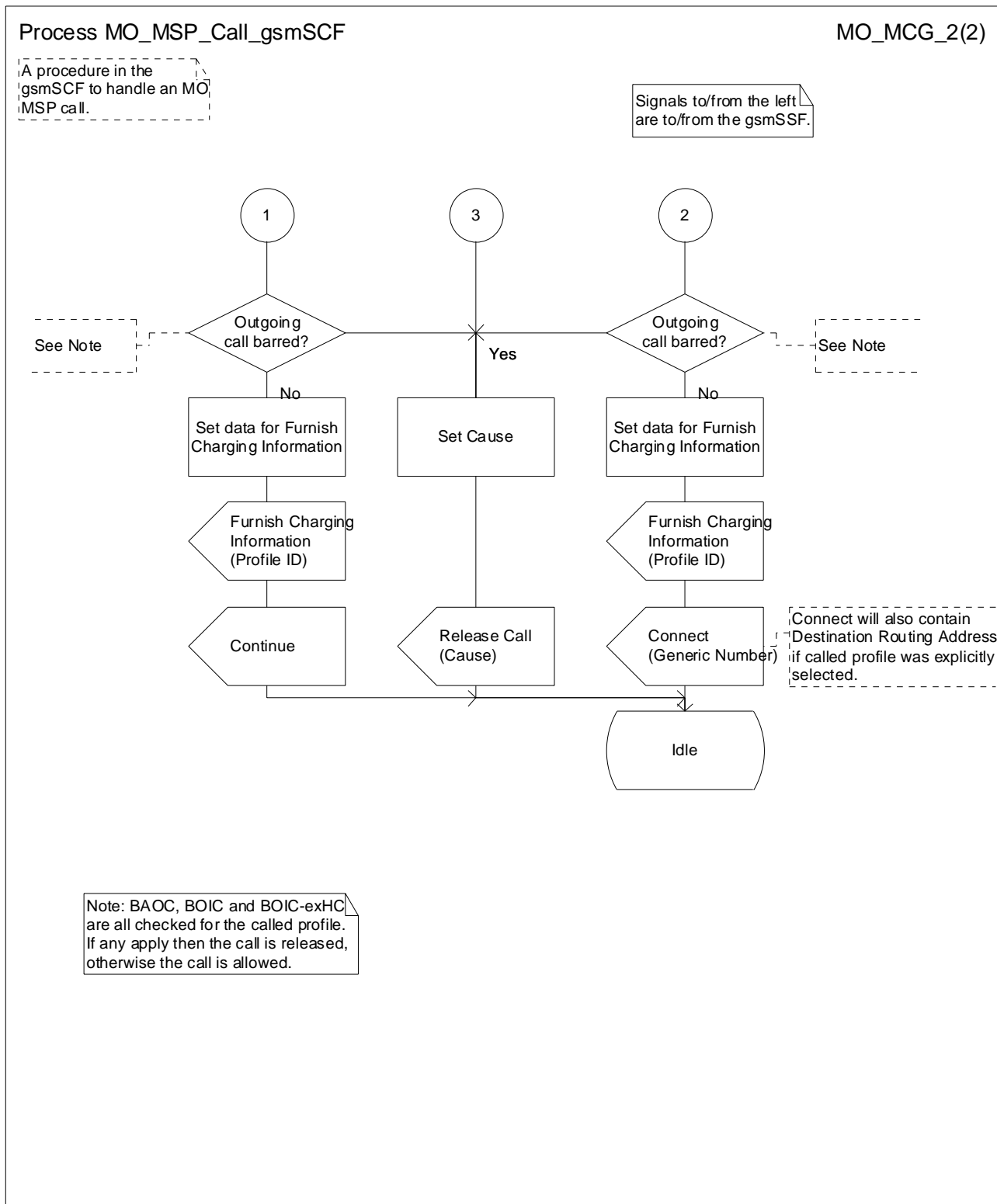

Figure 6: Process MO_MSP_Call_gsmSCF (sheet 2)

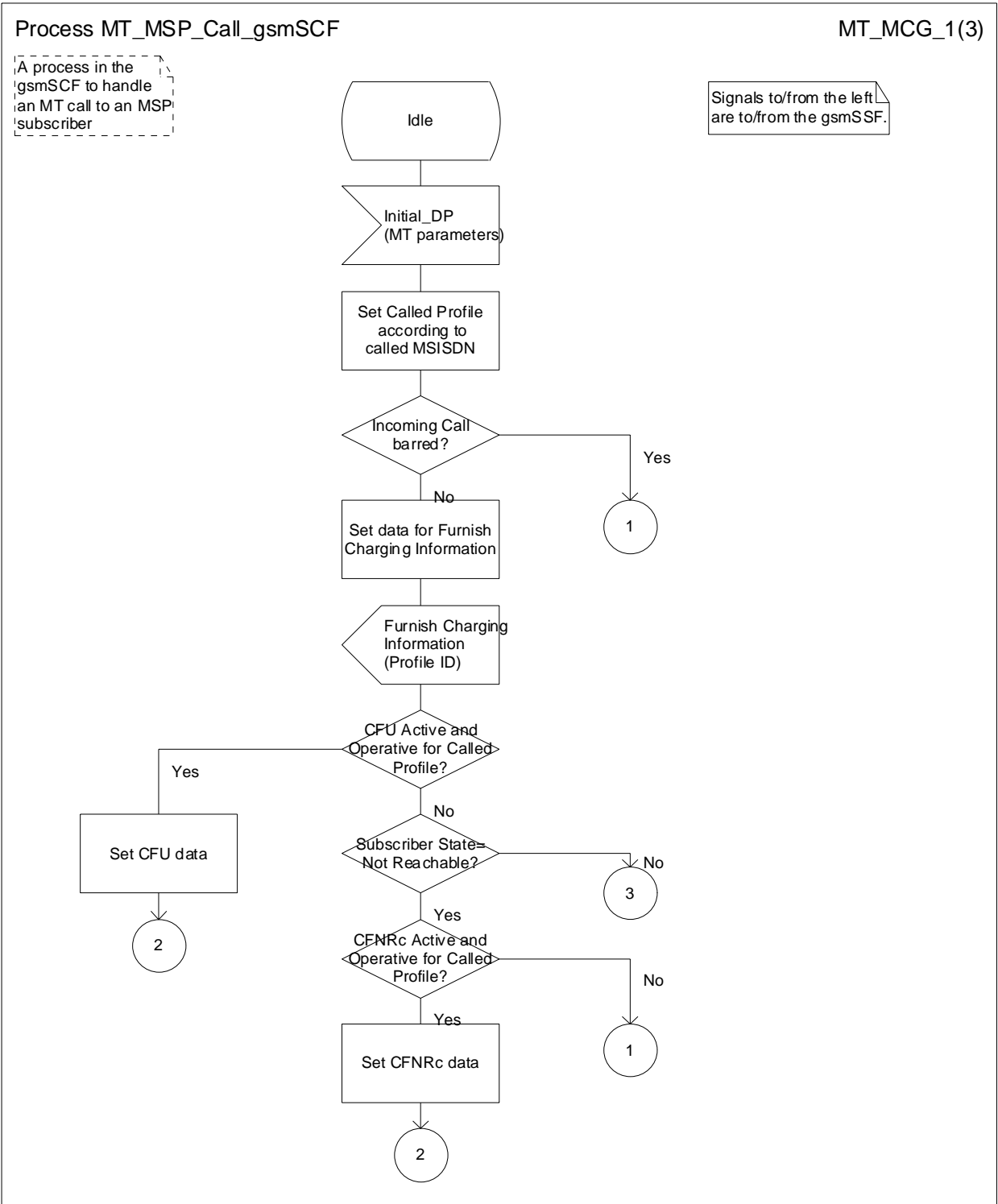

Figure 7: Process MT_MSP_Call_gsmSCF (sheet 1)

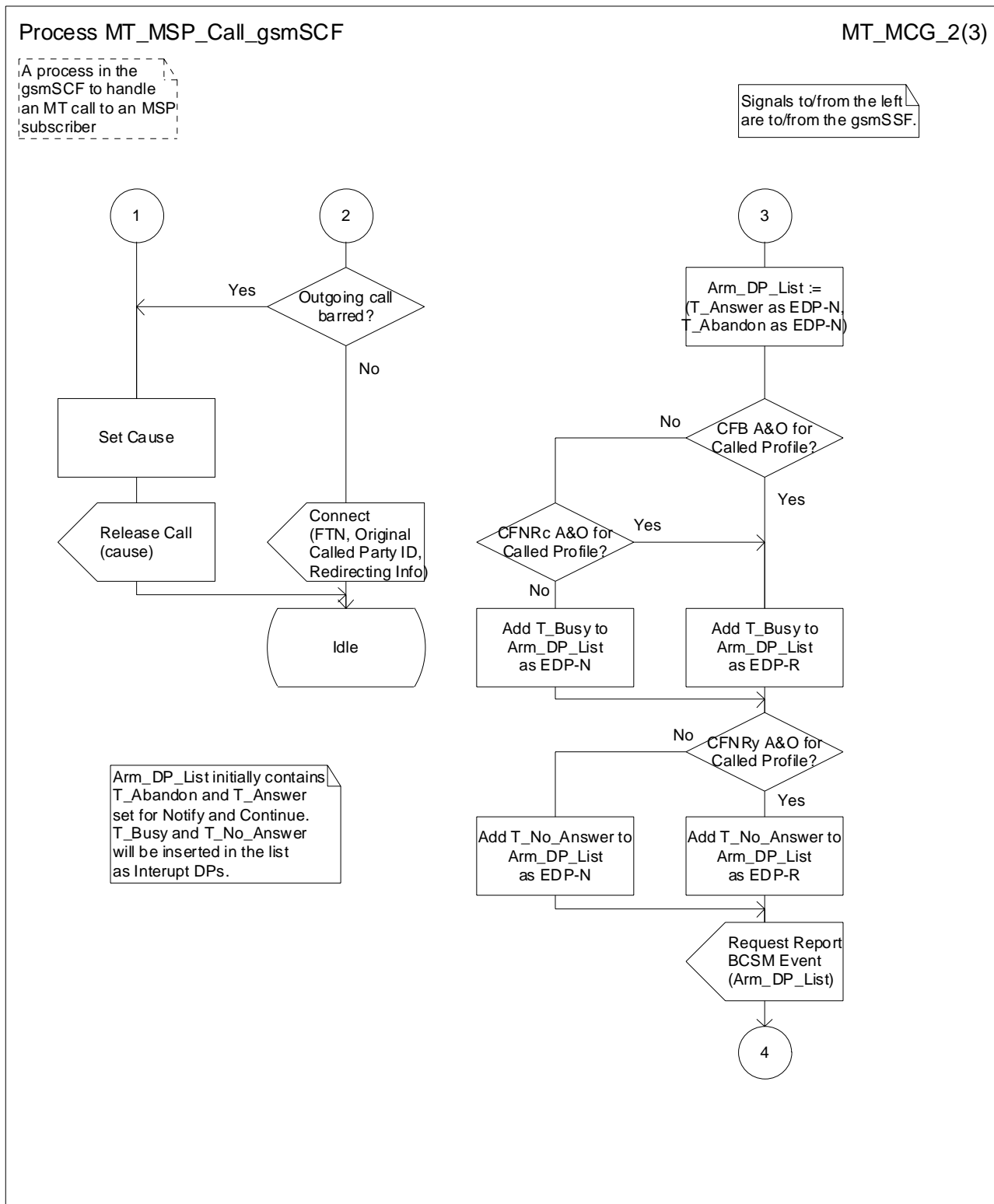

Figure 8: Process MT_MSP_Call_gsmSCF (sheet 2)

Process

MT_MCG_3(3)

A process in the gsmSCF to handle an MT call to an MSP subscriber

Signals to/from the left are to/from the gsmSSF. Signals to/from the right are to/from the process MO_MSP_Call_gsmSCF.

NOTE 1: The possible EDPs in the Report BCSM (Notify and Continue) T_Answer, T_Abandon, T_Busy (if and CFNRc are not A&O for the profile) and T_No_Answer (if CFNRy not A&O for the called)

NOTE 2: The possible EDPs in the Report BCSM (Interrupted) are (if CFB or CFNRc are A&O for the profile) and T_No_Answer (if CFNRy A&O for the called profile).

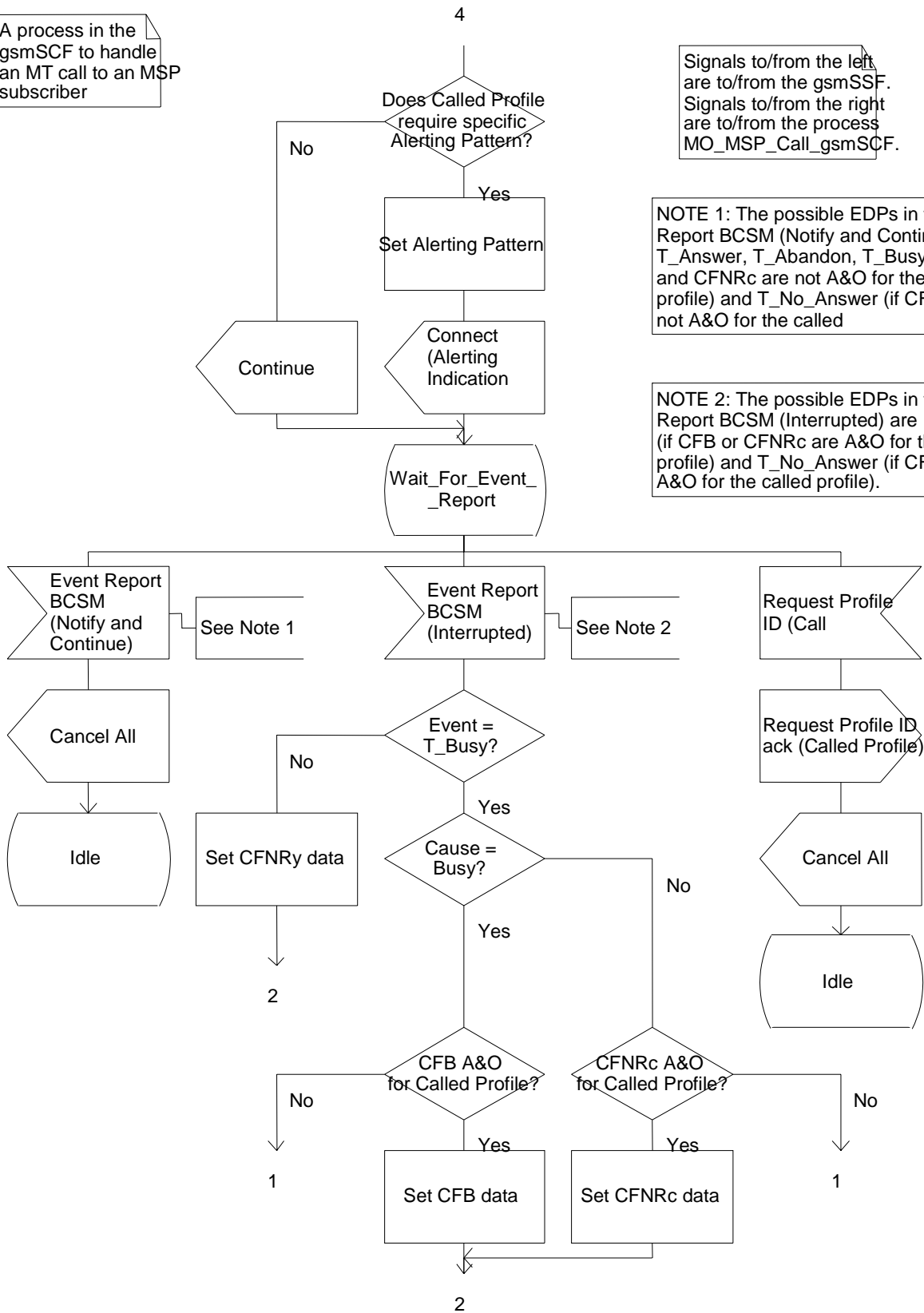

Figure 9: Process MT_MSP_Call_gsmSCF (sheet 3)

7.5.2 Information flows

The information flow for a successful MO call by an MSP subscriber is shown in figure 10.

The information flow for a successful MT call to an MSP subscriber is shown in figure 11.

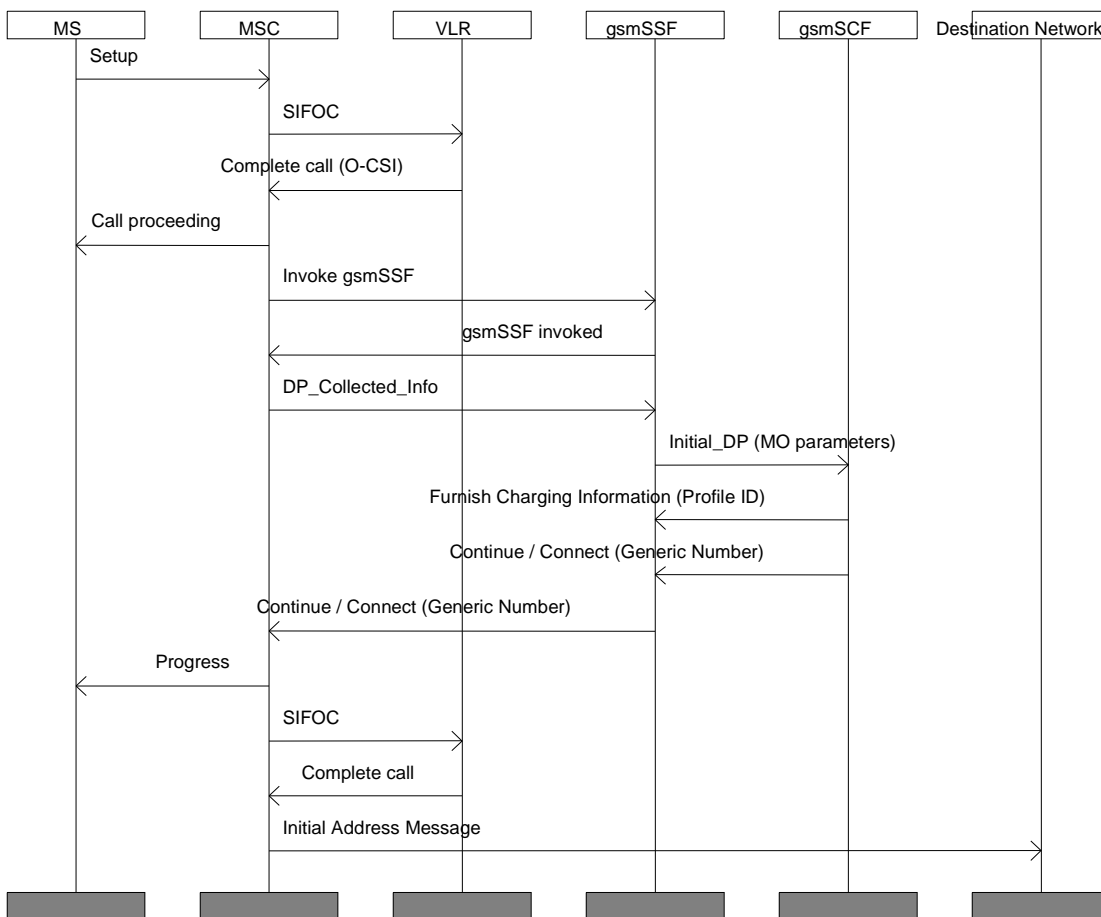

Figure 10: Information flow for a successful MO call

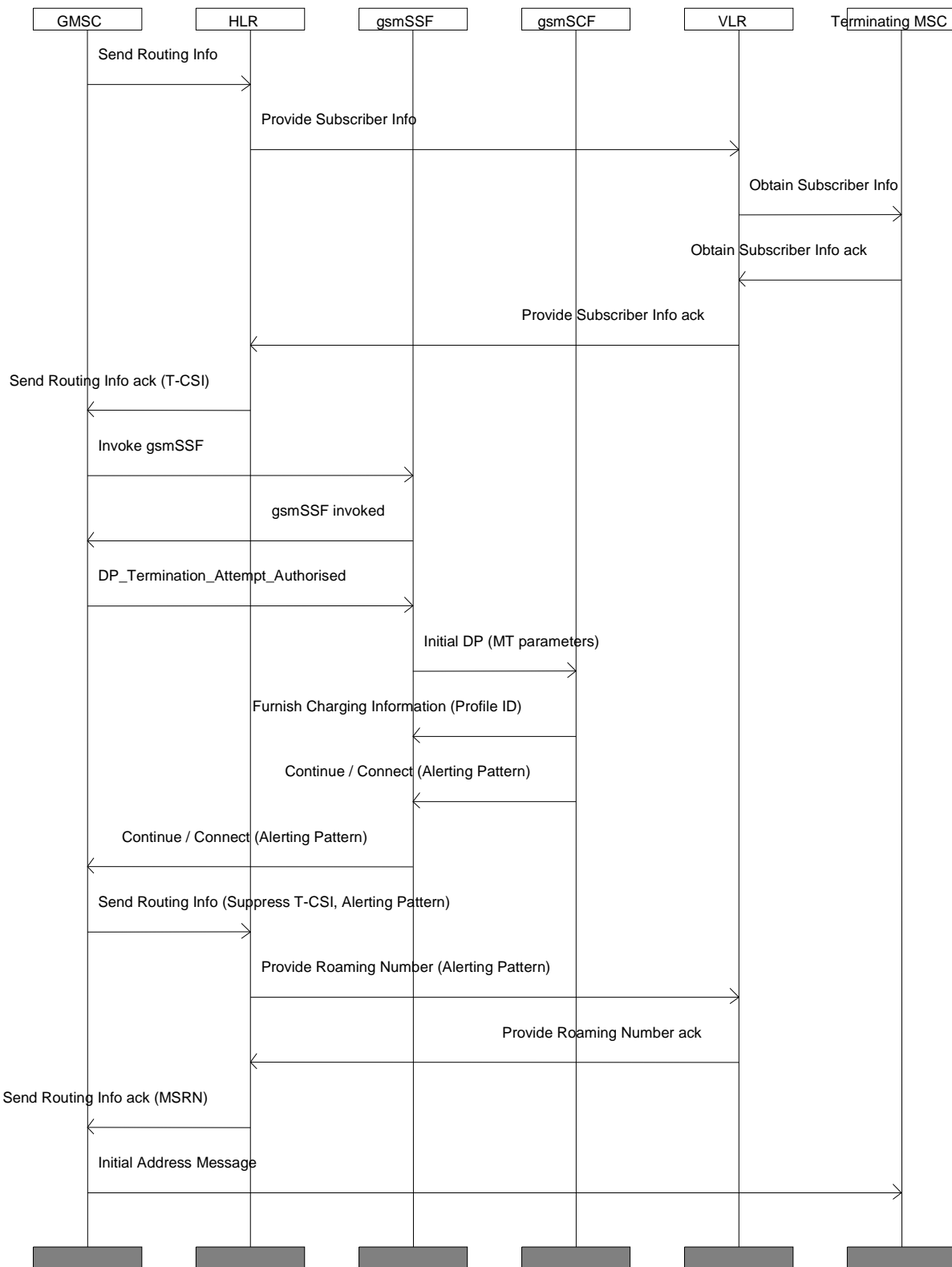

Figure 11: Information flow for a successful MT call to a profile that has no Call Forwardings Active and Operative in the gsmSCF

NOTE: For information flows to a profile that has Call Forwarding services Active and Operative in the gsmSCF, see subclause 7.9.1: Call Forwarding.

7.6 Interaction with Supplementary Services

7.6.1 Line Identification services

7.6.1.1 CLIP

CLIP will be provisioned per subscriber. If CLIP is active, it will be active for all profiles. Data for the CLIP Supplementary Service will be stored in the HLR, and if appropriate in the VLR, in the usual manner. CLIP will function as specified in GSM 03.81 and will not distinguish between MSP and non-MSP subscribers.

7.6.1.2 CLIR

CLIR will be provisioned per subscriber. If CLIR is active, it will be active for all profiles. Data for the CLIR Supplementary Service will be stored in the HLR, and if appropriate in the VLR, in the usual manner. CLIR will function as specified in GSM 03.81 and will not distinguish between MSP and non-MSP subscribers.

7.6.1.3 COLP

COLP will be provisioned per subscriber. If COLP is active, it will be active for all profiles. Data for the COLP Supplementary Service will be stored in the HLR, and if appropriate in the VLR, in the usual manner. COLP will function as specified in GSM 03.81 and will not distinguish between MSP and non-MSP subscribers.

7.6.1.4 COLR

COLR will be provisioned per subscriber. If COLR is active, it will be active for all profiles. Data for the COLR Supplementary Service will be stored in the HLR, and if appropriate in the VLR, in the usual manner. COLR will function as specified in GSM 03.81 and will not distinguish between MSP and non-MSP subscribers.

7.6.2 Call Hold (HOLD)

Call Hold will be provisioned per subscriber. If Call Hold is active, it will be active for all profiles. Data for the Call Hold Supplementary Service will be stored in the HLR, and if appropriate in the VLR, in the usual manner. Call Hold will function as specified in GSM 03.83 and will not distinguish between MSP and non-MSP subscribers.

7.6.3 Call Waiting (CW)

Call Waiting will be provisioned per subscriber. If Call Waiting is active, it will be active for all profiles. Data for the Call Waiting Supplementary Service will be stored in the HLR, and if appropriate in the VLR, in the usual manner. Call Waiting will function as specified in GSM 03.83 and will not distinguish between MSP and non-MSP subscribers.

7.6.4 Call Forwarding

The Call Forwarding Supplementary Services can only be provisioned per subscriber. However, services equivalent to the Call Forwarding Supplementary Services, implemented in the gsmSCF, will be available to the MSP subscriber per profile. This is described in subclause 7.9.1: Call Forwarding.

A subscriber should not be provided with both MSP equivalent Call Forwarding services and with GSM Call Forwarding supplementary services.

If the Call Forwarding Supplementary Services are provisioned per subscriber, then Call Forwarding will function as specified in GSM 03.82 and will not distinguish between MSP and non-MSP subscribers.

7.6.5 Multi Party Service (MPTY)

The Multi Party Supplementary Service will be provisioned per subscriber. If MPTY is active, it will be active for all profiles. Data for the MPTY Supplementary Service will be stored in the HLR, and if appropriate in the VLR, in the usual manner. MPTY will function as specified in GSM 03.84 and will not distinguish between MSP and non-MSP subscribers.

7.6.6 Closed User Group (CUG)

The Closed User Group Supplementary Service will be provisioned per subscriber. If CUG is active, it will be active for all profiles. Data for the CUG Supplementary Service will be stored in the HLR, and if appropriate in the VLR, in the usual manner. CUG will function as specified in GSM 03.85 and will not distinguish between MSP and non-MSP subscribers. The interaction between CAMEL and CUG (in the case of forwarding CUG calls) is defined in GSM 03.78.

7.6.7 Advice of Charge (AoC)

The Advice of Charge Supplementary Service will be provisioned per subscriber. If AoC is active, it will be active for all profiles. Data for the AoC Supplementary Service will be stored in the HLR, and if appropriate in the VLR, in the usual manner. AoC will function as specified in GSM 03.86 and will not distinguish between MSP and non-MSP subscribers.

7.6.8 Call Barring

The Call Barring Supplementary Services can only be provisioned per subscriber. However, services equivalent to the Call Barring Supplementary Services, implemented in the gsmSCF, can be provided to the MSP subscriber per profile. This is described in subclause 7.9.2: Call Barring. This requires the OCB_flag mechanism described in section subclause 6.1: OCB_flag.

If the Call Barring Supplementary Services are provisioned per subscriber, then Call Barring will function as specified in GSM 03.88 and will not distinguish between MSP and non-MSP subscribers.

7.6.9 Explicit Call Transfer (ECT)

Explicit Call Transfer will be provisioned per subscriber. If Explicit Call Transfer is active, it will be active for all profiles. Data for the Explicit Call Transfer Supplementary Service will be stored in the HLR, and if appropriate in the VLR, in the usual manner. ECT will function as specified in GSM 03.91 and will not distinguish between MSP and non-MSP subscribers.

7.6.10 Completion of Calls to Busy Subscriber (CCBS)

CCBS will be provisioned per subscriber.

If a CFU-equivalent service is activated while there are queue entries in MS-B's target queue, HLR-B will not know about this activation and will process these queue entries as normal. As a consequence, the CCBS calls related to these queue entries will be forwarded to the new destination. CCBS activation is not possible if this forwarded call meets NDUB. This results in expiry of recall timer T9 and deletion of the queue entry from MS-B's target queue. For further details on the interaction between CCBS and CAMEL, refer to GSM 03.93.

The same applies to Incoming Call Barring-equivalent services which are activated while there are queue entries in MS-B's target queue.

7.6.11 enhanced Multi-Level Precedence and Pre-emption (eMLPP)

eMLPP will be provisioned per subscriber. If eMLPP is active, it will be active for all profiles. Data for the eMLPP Supplementary Service will be stored in the HLR, and if appropriate in the VLR, in the usual manner. eMLPP will function as specified in GSM 03.67 and will not distinguish between MSP and non-MSP subscribers.

7.6.12 User-to-User Signalling (UUS)

The User-to-User Supplementary Service will be provisioned per subscriber. If UUS is active, it will be active for all profiles. Data for the UUS Supplementary Service will be stored in the HLR, and if appropriate in the VLR, in the usual manner. UUS will function as specified in GSM 03.87 and will not distinguish between MSP and non-MSP subscribers.

7.6.13 Call Deflection (CD)

The Call Deflection Supplementary Service will be provisioned per subscriber. If CD is active, it will be active for all profiles. Data for the CD Supplementary Service will be stored in the HLR, and if appropriate in the VLR, in the usual manner. CD will function as specified in GSM 03.72 and will not distinguish between MSP and non-MSP subscribers.

When the MSP subscriber deflects an MT call, it triggers an interrogation of the gsmSCF for an MO Call. Using the call reference number, the gsmSCF can recognise that there is an ongoing dialogue for the MT call, and can then retrieve the profile to apply for the deflected call, see figure 5 and figure 9.

This gives the gsmSCF the opportunity to reject the call deflection per profile, providing the MSP subscriber is in a supporting network.

A subscriber provided with MSP equivalent Call Deflection service should not be provided with GSM Call Forwarding supplementary services.

7.7 Interaction with other services

7.7.1 The Multi-Numbering Scheme

If the MSP subscriber has different MSISDNs allocated for different Basic Services, all MSISDNs and associated Basic Services will be stored in the HLR. Each MSISDN and associated Basic Services will also be stored in the gsmSCF with associated profile ID.

7.7.2 The Short Message Service

Mobile terminated short messages can be received on any profile although the profile will not be specified.

It is not possible to select a profile for mobile originated short messages since there are no CAMEL interactions. All MO-SMS will be sent by and charged to the default profile.

7.7.3 Interactions with CAMEL

An MSP subscriber will, by definition, have a CAMEL subscription.

If other CAMEL services are designed in such a way that an MSP subscriber can use them, they will be available to the MSP subscriber. It is a network option to design CAMEL services that interact with MSP.

7.7.4 Interactions with OR

The GMSC in the Interrogating PLMN (IPLMN) needs to support CAMEL Phase 2 capability if the called subscriber is an MSP subscriber.

If an interrogation request is received for an MSP subscriber from a GMSC in the IPLMN that does not support the CAMEL Phase 2 capability, the HLR shall return an OR not allowed negative response (see GSM 03.79) to the GMSC. This will force the call to be routed to a GMSC supporting CAMEL Phase 2 capability in the HPLMN.

7.7.5 Operator Determined Barring

ODB will be provisioned per subscriber.

A service, implemented in the gsmSCF equivalent to some elements of the ODB service will be available to an MSP subscriber per profile. This is described in subclause 7.9.7: Operator Determined Barring (ODB); it requires the ODB flags mechanism described in subclause 6.2: ODB flags. The category "Barring of invocation of call transfer" will only be available per subscriber. Outgoing ODB for the default profile will be stored in the HLR for use when the subscriber roams into a non-supporting network, see subclause 7.10.1: Roaming into a network not supporting CAMEL Phase 2 for further details.

If the Operator Determined Barrings are provisioned per subscriber, then barrings for that category will function as specified in GSM 03.15 and will not distinguish between MSP and non-MSP subscribers.

7.7.6 Roaming Restrictions

Roaming Restrictions will apply per subscriber. Data for the Roaming Restrictions will be stored in the HLR in the usual manner.

7.8 Data stored in the gsmSCF

The gsmSCF contains all the data needed to control the MSP service. These data can be divided into the common data (the data valid for all profiles) and the profile specific data.

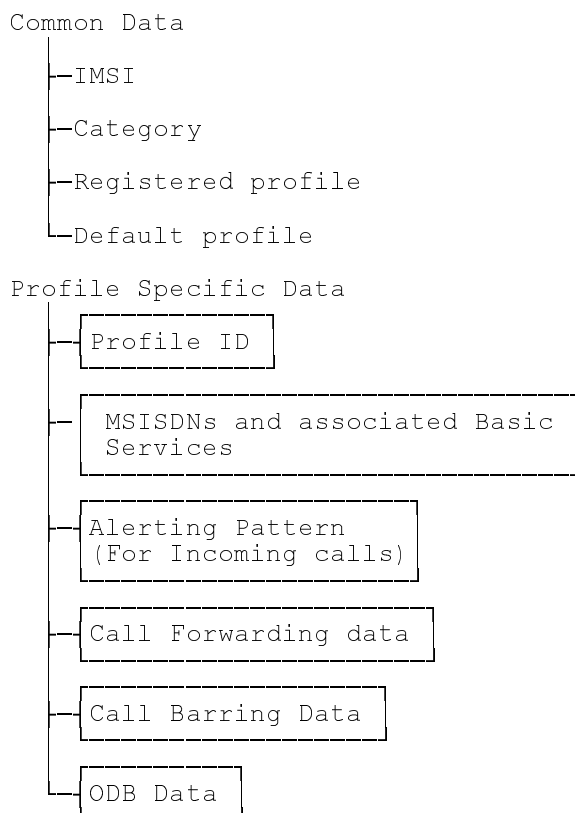

7.9 Equivalent services implemented by the gsmSCF

7.9.1 Call Forwarding

Call Forwarding services will be provided in the gsmSCF per profile. An MT call to an MSP subscriber will be subject to the provided call forwardings for the called profile.

The Call Forwarding services, implemented by the gsmSCF, should operate in the same way as the GSM Call Forwarding Supplementary Services. The MSP subscriber should have control over the call forwarding data (Registration, Erasure, Activation, Deactivation, Interrogation). The method for controlling this data is a network option.

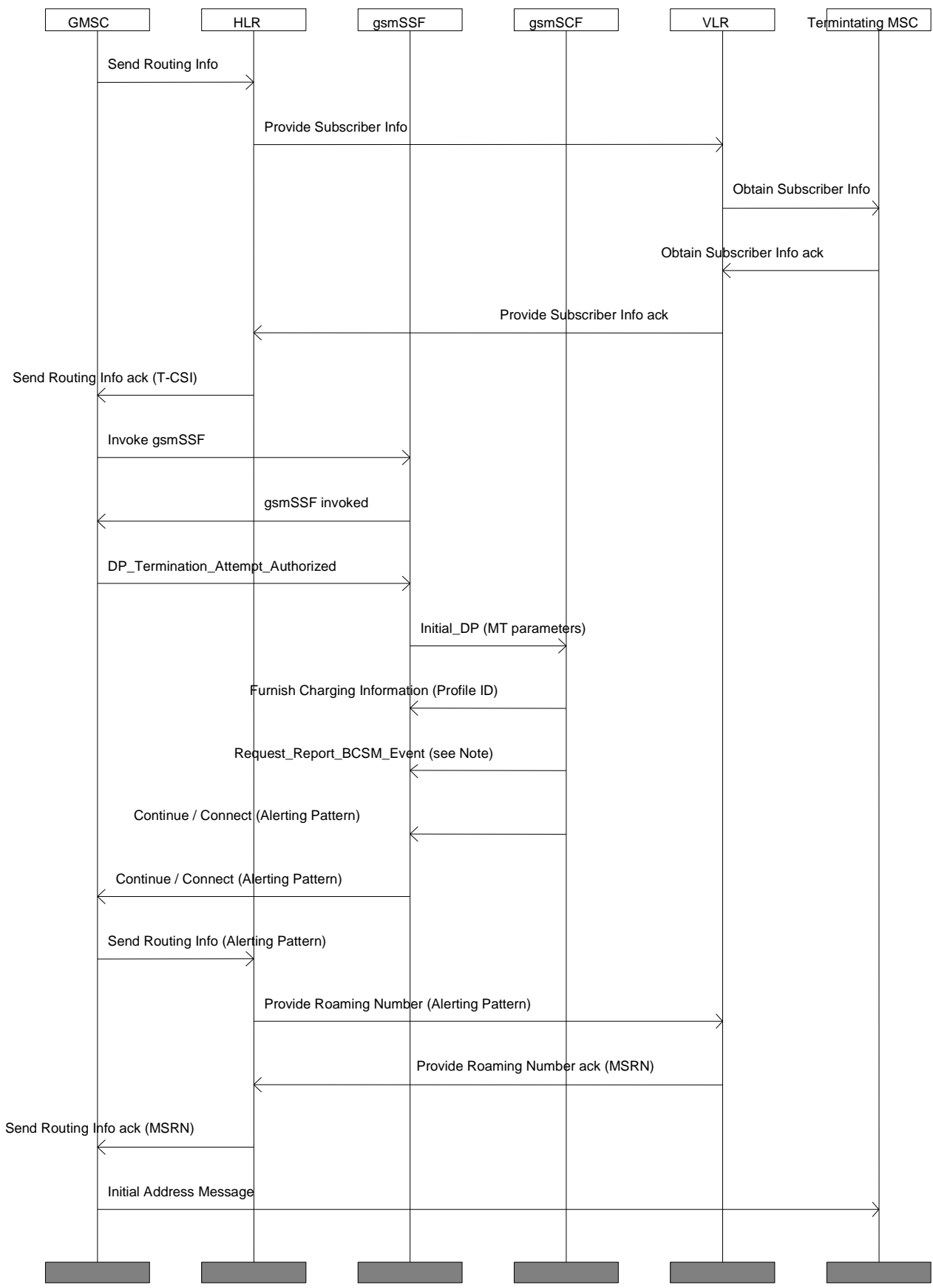

NOTE: Request_Report_BCSM_Event will contain the list Arm_DP_List (see figure 1). This list will contain the following elements:

| | |
|-------------|---|
| T_Answer | EDP-N |
| T_Abandon | EDP-N |
| T_Busy | EDP-N (Unless CFB and/or CFNRc are A&O for the called profile, in which case EDP-R) |
| T_No_Answer | EDP-N (Unless CFNRy is A&O for the called profile, in which case EDP-R) |

Figure 12: Information flow for a successful MT call to a profile with some Call Forwardings Active and Operative

7.9.1.1 Call Forward Unconditional

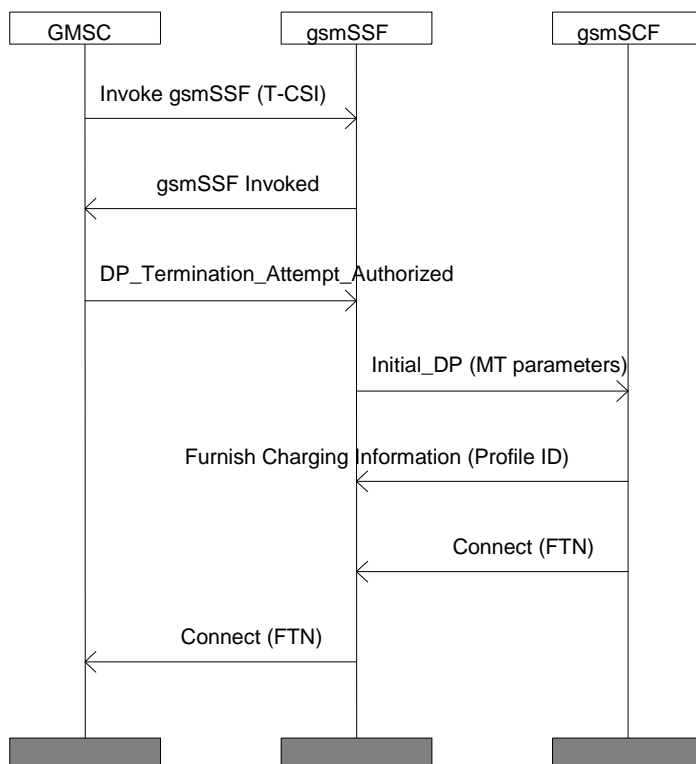

Figure 13: Information flow for an MT call to a profile with CFU active and operative in the gsmSCF

7.9.1.2 Call Forward on Busy

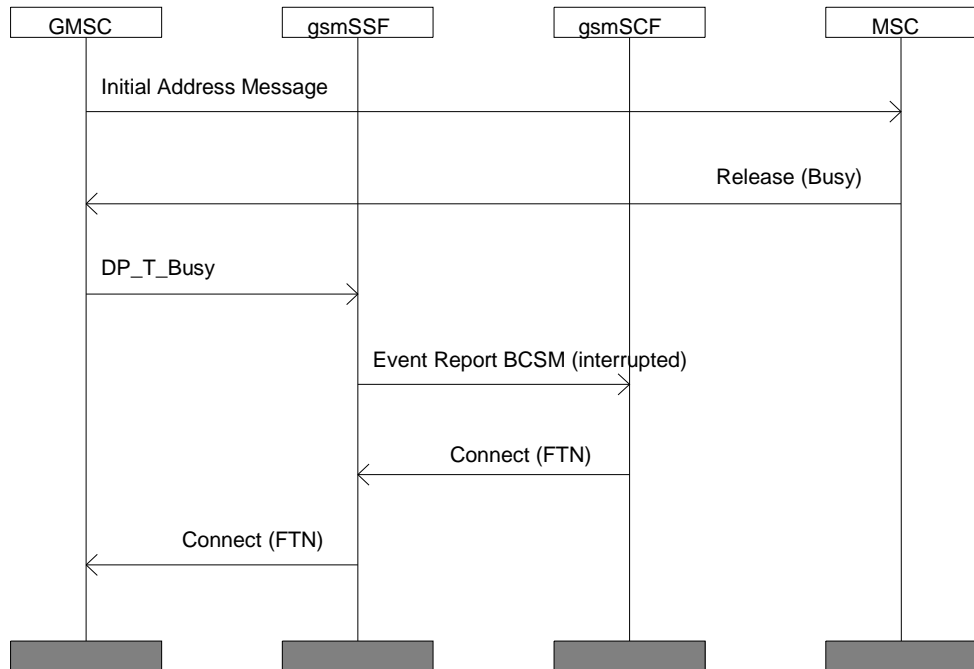
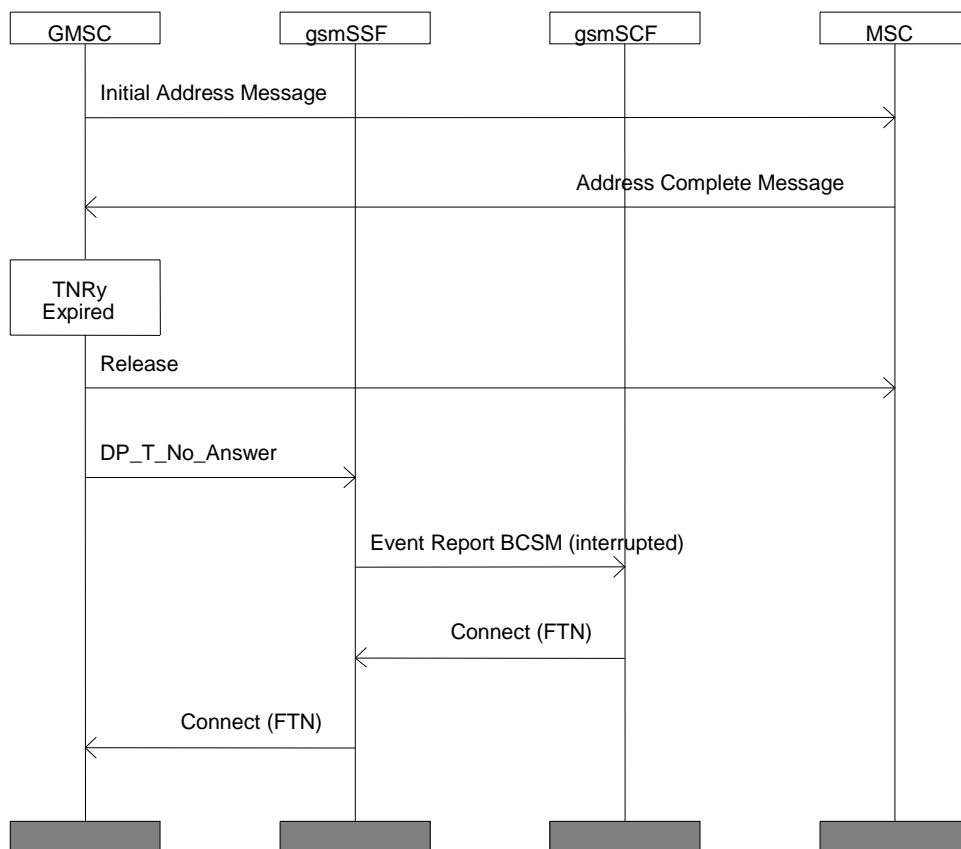

Figure 14: Information flow for an MT call to a profile with CFB active and operative in the gsmSCF, where the called subscriber is NDUB or UDUB

7.9.1.3 Call Forward on No Reply



NOTE: The timer TNRy is started in the GMSC after the Address Complete Message has been received from the destination exchange. If this timer expires before an Answer message is received from the destination exchange, a release message is sent to the destination exchange and the detection point T_No_Answer is reached. This is specified in GSM 03.18 and GSM 03.78.

Figure 15: Information flow for an MT call to a profile with CFNRy active and operative in the gsmSCF, where the called party does not answer

7.9.1.4 Call Forward on Not Reachable

7.9.1.4.1 Early CFNRc

Early Call Forwarding on Not Reachable will apply if the gsmSCF receives the parameter "subscriber state" set as Not Reachable. Due to the presence of the Location information / Subscriber state Interrogation parameter in the CAMEL data, stored in the HLR, the HLR sends a Provide Subscriber Information message to the VLR. This determines if the subscriber state is Not Reachable.

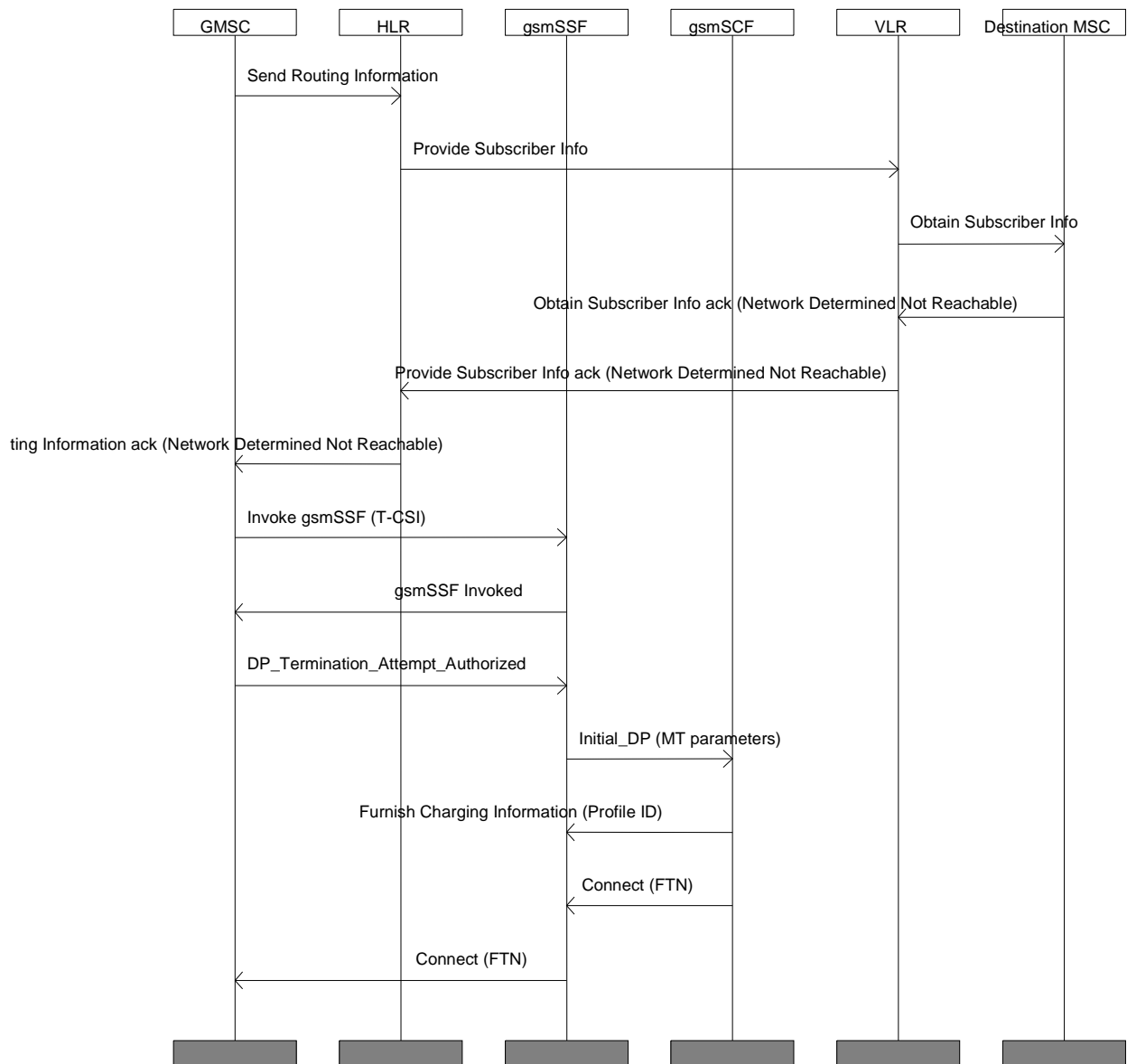

Figure 16: Information flow for an MT call to a profile with CFNRc active and operative in the gsmSCF, where early CFNRc is invoked

7.9.1.4.2 Late CFNRc

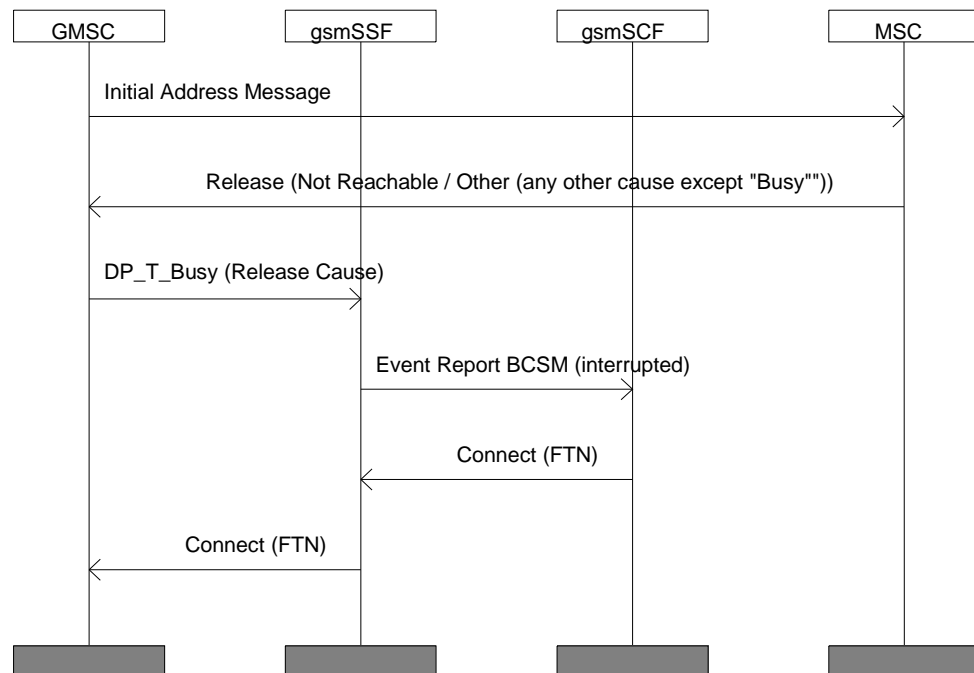

Figure 17: Information flow for an MT call to a profile with CFNRc active and operative in the gsmSCF, where late CFNRc is invoked

7.9.2 Call Barring

Call Barring services will be provided by the gsmSCF per profile. An MO call made by an MSP subscriber will be subject to the outgoing call barrings provided for the calling profile. An MT call to an MSP subscriber will be subject to the incoming call barrings provided for the called profile. If an MT call to an MSP subscriber is forwarded, the forwarded call will be subject to the outgoing call barrings provided for the called profile.

The Call Barring services available per profile are:

- Barring of all outgoing calls (BAOC);
- Barring of outgoing international calls (BOIC);
- Barring of outgoing international calls except those directed to the home PLMN country (BOIC-exHC);
- Barring of all incoming calls (BAIC);
- Barring of incoming calls when roaming outside the home PLMN country (BIC-roam).

The Call Barring services, implemented by the gsmSCF, should operate in the same way as the GSM Call Barring Supplementary Services. The MSP subscriber should have control over the call barring data (Registration, Erasure, Activation, Deactivation, Interrogation). The method for controlling this data is a network option.

The MSP subscriber will not be able to change Outgoing Call Barrings for the default profile.

The GSM Call Barring Supplementary Services may require a password before Call Barring data can be changed. For the Call Barring Services implemented in the gsmSCF, use of a password is a network option.

The operator should ensure that if the equivalent call barring service is provided then:

- The OCB_flag is set in the HLR (See subclause 6.1:OCB_flag).

- If an equivalent outgoing call barring service is in a "Provisioned and Active" state in the gsmSCF for the default profile, that outgoing call barring supplementary service will be in a "Provisioned and Active" state in the HLR.
- If an equivalent outgoing call barring service is in a "Not Active" state in the gsmSCF for the default profile, that outgoing call barring supplementary service will be in a "Not Provisioned" state in the HLR.
- Incoming Call Barrings shall not be provisioned in the HLR.

7.9.3 Operator Determined Barring (ODB)

Operator Determined Barring will be available per profile in the gsmSCF for the following categories:

- Barring of outgoing calls;
- Barring of incoming calls;
- Barring of roaming;
- Barring of outgoing Premium Rate Calls;
- Barring specific to the home PLMN;
- Barring of registration of call forwarding.

However, if zone related barring is implemented in the gsmSCF, the appropriate data will be needed in the gsmSCF as well as the HLR. For barring of incoming calls when roaming outside the zone of the home country, the gsmSCF will need to use Any Time Interrogation to establish the location of the called party.

Management of ODB data is operator specific.

The operator should ensure that if the equivalent ODB service for an ODB category is provided then:

- The ODB flag for the correct category is set in the HLR (See subclause 6.2: ODB flags).
- The ODB data for that category for the default profile is duplicated in the HLR

NOTE 1: Barring of outgoing calls and barring of incoming calls in the gsmSCF will not disallow MO or MT short messages.

7.10 Exceptional Procedures

7.10.1 Roaming into a network not supporting CAMEL Phase 2

This subclause details MSP specific handling for roaming into a network not supporting CAMEL Phase 2. Other handling for this scenario is described in GSM 03.78.

7.10.1.1 Actions required on Location Update

The HLR will send the outgoing call barring data and outgoing ODB data, specific to the default profile, to the VLR.

7.10.1.2 MO call handling

When an MSP subscriber roams into a network not supporting CAMEL Phase 2, the default profile will be used for all outgoing traffic.

7.10.1.3 MT call handling

MT calls to any profile will be received by the subscriber (subject to call forwardings and call barrings provided in the gsmSCF on the called profile), although no indication of the called profile will be received.

The HLR will not allow OR, this means that for MT calls, the GMSC will always support CAMEL Phase 2, allowing the gsmSCF to invoke appropriate Call Forwardings and Call Barrings.

7.10.2 Lack of availability of the Network Indication of Alerting feature

If an MSP subscriber roams into a network not supporting the Network Indication of Alerting feature, or is using an MS that does not support the Network indication of Alerting feature, then the subscriber will still receive all MT calls, but no indication of the called profile will be given.

Annex A (informative): Provision and Withdrawal of MSP

A.1 Provision of MSP

MSP will be provisioned by prior arrangement with the service provider.

For an existing subscriber converting to an MSP subscriber, all profile specific data will be stored in the gsmSCF and removed from the HLR, and MSP will be provisioned in the HLR.

For a new subscriber provisioned with the MSP service, all profile specific data will be stored in the gsmSCF and MSP will be provisioned in the HLR.

Data specific to the Default Profile will be stored in both the HLR and the gsmSCF.

A.2 Withdrawal of MSP

MSP will be withdrawn when there is only one profile remaining. In this event, the subscriber data will be stored in the HLR and removed from the gsmSCF, and the HLR will remove all MSP markings. The subscriber will then be treated as a normal subscriber.

Annex B (Informative): Status of Technical Specification GSM 03.97

Change History

This annex lists all changes made to this document since its initial approval by the ETSI committee, SMG.

| SMG# | SMG tdoc | CN N-SS tdoc | VERS | CR | REV | PHASE | CAT | SUBJECT | Resulting Version |
|------|----------|--------------|-------|------|-----|-------|-----|---|-------------------|
| 29 | P-99-459 | N SS-99006 | 7.0.0 | A002 | | R98 | F | Removal of references to DP_T_Not_Reachable | 7.1.0 |
| 29 | P-99-459 | N SS-99007 | 7.0.0 | A003 | | R98 | F | Correction of handling for Call Deflection | 7.1.0 |
| 29 | P-99-459 | N SS-99035 | 7.0.0 | A004 | 7 | R98 | D | Re-organisation of specification | 7.1.0 |
| CN#5 | NP-99310 | N SS-99055 | 7.1.0 | A005 | | R98 | D | Various editorial corrections | 7.1.1 |
| CN#6 | NP-99462 | N_SS-99152 | 7.1.1 | A006 | | R98 | F | Interaction between MSP Call Forwarding & GSM Call Forwarding | 7.2.0 |
| | | | | | | | | | |

History

| Document history | | |
|-------------------------|---------------|-------------|
| V7.1.0 | August 1999 | Publication |
| V7.1.1 | November 1999 | Publication |
| V7.2.0 | January 2000 | Publication |
| | | |
| | | |