

# ETSI TS 100 936 V7.0.0 (1999-08)

---

*Technical Specification*

**Digital cellular telecommunications system (Phase 2+);  
Layer 1;  
General requirements  
(GSM 04.04 version 7.0.0 Release 1998)**

---



**GSM**®  
GLOBAL SYSTEM FOR  
MOBILE COMMUNICATIONS

**ETSI** 

---

Reference

---

RTS/SMG-030404Q7 (8o003i03.PDF)

Keywords

---

Digital cellular telecommunications system,  
Global System for Mobile communications (GSM)

**ETSI**

Postal address

---

F-06921 Sophia Antipolis Cedex - FRANCE

Office address

---

650 Route des Lucioles - Sophia Antipolis  
Valbonne - FRANCE  
Tel.: +33 4 92 94 42 00 Fax: +33 4 93 65 47 16  
Siret N° 348 623 562 00017 - NAF 742 C  
Association à but non lucratif enregistrée à la  
Sous-Préfecture de Grasse (06) N° 7803/88

Internet

---

[secretariat@etsi.fr](mailto:secretariat@etsi.fr)  
Individual copies of this ETSI deliverable  
can be downloaded from  
<http://www.etsi.org>  
If you find errors in the present document, send your  
comment to: [editor@etsi.fr](mailto:editor@etsi.fr)

---

**Copyright Notification**

---

No part may be reproduced except as authorized by written permission.  
The copyright and the foregoing restriction extend to reproduction in all media.

© European Telecommunications Standards Institute 1999.  
All rights reserved.

# Contents

Intellectual Property Rights .....	4
Foreword .....	4
1 Scope.....	5
1.1 References.....	5
1.2 Definitions and abbreviations .....	7
2 Interfaces to the physical layer .....	7
2.1 Interface to the Data Link Layer .....	7
2.1a Interface to the Radio Link Control and Medium Access Control layer .....	8
2.2 Interface to radio resource management .....	8
2.3 Interface to other functional units .....	8
3 Service of the physical layer.....	8
3.1 Service Access Point.....	8
3.2 Service of the physical layer .....	9
3.2.1 Specific services of the physical layer in the MS .....	10
4 Primitives of the physical layer .....	10
4.1 Generic names of primitives between layers 1 and 2 for the transfer of layer 2 frames and RLC/MAC blocks.....	11
4.2 Generic names of primitives between layer 1 and the RR- management entity of layer 3 .....	11
4.3 Primitive types .....	11
4.4 Parameter definition.....	12
5 Physical layer procedures .....	13
5.1 States of the physical layer.....	13
5.2 Control procedures.....	14
5.3 Physical layer interface procedures.....	14
6 Physical layer protocol header.....	15
6.1 Physical layer protocol fields and procedures.....	15
7 Block transmission.....	15
7.1 SACCH downlink block format.....	15
7.2 SACCH uplink block format.....	15
7.3 FACCH/SDCCH/CCCH/BCCH/CBCH downlink block format .....	16
7.4 FACCH/SDCCH uplink block format .....	16
7.5 PBCCH/PCCCH downlink/PACCH/PDTCH block type 1 (CS-1) format.....	17
7.6 PDTCH block type 2 (CS-2) format .....	17
7.7 PDTCH block type 3 (CS-3) format .....	18
7.8 PDTCH block type 4 (CS-4) format .....	18
7.9 PRACH uplink/PACCH uplink short acknowledgement block formats .....	18
7.10 PTCCCH downlink block format .....	19
7.11 PTCCCH uplink block formats .....	20
7.12 Order of bit transmission .....	20
8 Vocabulary.....	20
<b>Annex A (informative): Document change history .....</b>	<b>22</b>
History.....	23

---

## Intellectual Property Rights

IPRs essential or potentially essential to the present document may have been declared to ETSI. The information pertaining to these essential IPRs, if any, is publicly available for **ETSI members and non-members**, and can be found in SR 000 314: "*Intellectual Property Rights (IPRs); Essential, or potentially Essential, IPRs notified to ETSI in respect of ETSI standards*", which is available **free of charge** from the ETSI Secretariat. Latest updates are available on the ETSI Web server (<http://www.etsi.org/ipr>).

Pursuant to the ETSI IPR Policy, no investigation, including IPR searches, has been carried out by ETSI. No guarantee can be given as to the existence of other IPRs not referenced in SR 000 314 (or the updates on the ETSI Web server) which are, or may be, or may become, essential to the present document.

---

## Foreword

This Technical Specification (TS) has been produced by the Special Mobile Group (SMG).

This specification defines the services offered by the physical layer (layer 1) of the Mobile Station - Base Station System (MS - BSS) interface within the digital cellular telecommunications system.

The contents of the present document is subject to continuing work within SMG and may change following formal SMG approval. Should SMG modify the contents of the present document, it will be re-released by SMG with an identifying change of release date and an increase in version number as follows:

Version 7.x.y

where:

- 7 indicates GSM Phase 2+ Release 1998;
- x the second digit is incremented for all other types of changes, i.e. technical enhancements, corrections, updates, etc.;
- y the third digit is incremented when editorial only changes have been incorporated in the specification.

---

# 1 Scope

The present document defines the service offered by the physical layer (GSM 05-series of Technical Specifications) of the MS-BS interface (GSM 05- and 04-series of Technical Specifications). Its main objective is to be a guidance for the interface between the GSM Technical Specifications in the 05-series and the 04-series. It also specifies the format of signalling channels and the order of bit transmission.

As far as possible, the present document makes use of the layering principles of the Reference Model for Open System Interconnection (OSI) as contained in CCITT Recommendations X.200 and X.210.

## 1.1 References

The following documents contain provisions which, through reference in this text, constitute provisions of the present document.

- References are either specific (identified by date of publication, edition number, version number, etc.) or non-specific.
- For a specific reference, subsequent revisions do not apply.
- For a non-specific reference, the latest version applies.
- A non-specific reference to an ETS shall also be taken to refer to later versions published as an EN with the same number.
- For this Release 1998 document, references to GSM documents are for Release 1998 versions (version 7.x.y).

- [1] GSM 01.04: "Digital cellular telecommunications system (Phase 2+); Abbreviations and acronyms".
- [2] GSM 02.11: "Digital cellular telecommunications system (Phase 2+); Service accessibility".
- [3] GSM 03.13: "Digital cellular telecommunications system (Phase 2+); Discontinuous Reception (DRX) in the GSM system".
- [4] GSM 03.20: "Digital cellular telecommunications system (Phase 2+); Security related network functions".
- [5] GSM 04.01: "Digital cellular telecommunications system (Phase 2+); Mobile Station - Base Station System (MS - BSS) interface; General aspects and principles".
- [6] GSM 04.02: "Digital cellular telecommunications system (Phase 2+); GSM Public Land Mobile Network (PLMN) access reference configuration".
- [7] GSM 04.03: "Digital cellular telecommunications system (Phase 2+); Mobile Station - Base Station System (MS - BSS) interface Channel structures and access capabilities".
- [8] GSM 04.05: "Digital cellular telecommunications system (Phase 2+); Data Link (DL) layer General aspects".
- [9] GSM 04.06: "Digital cellular telecommunications system (Phase 2+); Mobile Station - Base Station System (MS - BSS) interface; Data Link (DL) layer specification".
- [10] GSM 04.07: "Digital cellular telecommunications system (Phase 2+); Mobile radio interface signalling layer 3; General aspects".
- [11] GSM 04.08: "Digital cellular telecommunications system (Phase 2+); Mobile radio interface layer 3 specification".
- [12] GSM 04.10: "Digital cellular telecommunications system (Phase 2+); Mobile radio interface layer 3 Supplementary services specification; General aspects".

- [13] GSM 04.11: "Digital cellular telecommunications system (Phase 2+); Point-to-Point (PP) Short Message Service (SMS) support on mobile radio interface".
- [14] GSM 04.12: "Digital cellular telecommunications system (Phase 2+); Short Message Service Cell Broadcast (SMSCB) support on the mobile radio interface".
- [15] GSM 04.13: "Digital cellular telecommunications system (Phase 2+); Performance requirements on mobile radio interface".
- [16] GSM 04.21: "Digital cellular telecommunications system (Phase 2+); Rate adaption on the Mobile Station - Base Station System (MS - BSS) Interface".
- [17] GSM 04.22: "Digital cellular telecommunications system (Phase 2+); Radio Link Protocol (RLP) for data and telematic services on the Mobile Station - Base Station System (MS - BSS) interface and the Base Station System - Mobile-services Switching Centre (BSS - MSC) interface".
- [17a] GSM 04.60: "Digital cellular telecommunications system (Phase 2+); General Packet Radio Service (GPRS); Mobile Station - Base Station System (MS-BSS) interface; Radio Link Control and Medium Access Control (RLC/MAC) layer specification".
- [18] GSM 04.80: "Digital cellular telecommunications system (Phase 2+); Mobile radio interface layer 3 supplementary services specification; Formats and coding".
- [19] GSM 04.81: "Digital cellular telecommunications system (Phase 2+); Line identification supplementary services - Stage 3".
- [20] GSM 04.82: "Digital cellular telecommunications system (Phase 2+); Call Forwarding (CF) supplementary services - Stage 3".
- [21] GSM 04.83: "Digital cellular telecommunications system; Call Waiting (CW) and Call Hold (HOLD) supplementary services - Stage 3".
- [22] GSM 04.84: "Digital cellular telecommunications system (Phase 2+); MultiParty (MPY) supplementary services - Stage 3".
- [23] GSM 04.85: "Digital cellular telecommunications system (Phase 2+); Closed User Group (CUG) supplementary services - Stage 3".
- [24] GSM 04.86: "Digital cellular telecommunications system (Phase 2+); Advice of Charge (AoC) supplementary services - Stage 3".
- [25] GSM 04.88: "Digital cellular telecommunications system (Phase 2+); Call Barring (CB) supplementary services - Stage 3".
- [26] GSM 04.90: "Digital cellular telecommunications system (Phase 2+); Unstructured Supplementary Services Data (USSD) - Stage 3".
- [27] GSM 05.01: "Digital cellular telecommunications system (Phase 2+); Physical layer on the radio path; General description".
- [28] GSM 05.02: "Digital cellular telecommunications system (Phase 2+); Multiplexing and multiple access on the radio path".
- [29] GSM 05.03: "Digital cellular telecommunications system (Phase 2+); Channel coding".
- [30] GSM 05.04: "Digital cellular telecommunications system (Phase 2+); Modulation".
- [31] GSM 05.05: "Digital cellular telecommunications system (Phase 2+); Radio transmission and reception".
- [32] GSM 05.08: "Digital cellular telecommunications system (Phase 2+); Radio subsystem link control".
- [33] GSM 05.10: "Digital cellular telecommunications system (Phase 2+); Radio subsystem synchronization".

- [34] GSM 05.90: "Digital cellular telecommunications system; GSM Electro Magnetic Compatibility (EMC) considerations".
- [35] CCITT Recommendation X.200: "Reference Model of open systems interconnection for CCITT applications".
- [36] CCITT Recommendation X.210: "Open systems interconnection layer service definition conventions".

## 1.2 Definitions and abbreviations

Abbreviations used in the present document are listed in GSM 01.04.

---

## 2 Interfaces to the physical layer

The physical layer (layer 1) is the lowest layer in the OSI Reference Model and it supports all functions required for the transmission of bit streams on the physical medium. These bit streams are transferred on traffic channels, packet data traffic channels and control channels as defined in GSM 04.03.

NOTE: For GSM application the physical layer may also be referred to as the radio subsystem. However, the radio subsystem supports functions additional to those described in the present document.

The physical layer interfaces the Data Link Layer, the Radio Link Control and Medium Access Control layer and the supported functional units of the application (figure 2.1).

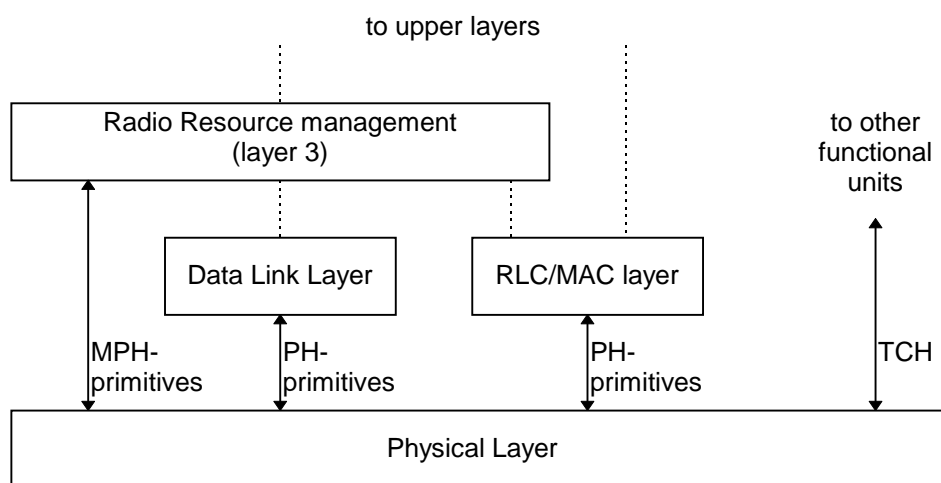

Figure 2.1: Interfaces with the Physical Layer

### 2.1 Interface to the Data Link Layer

The physical layer interfaces the data link layer. On this interface control channels are supported. The data link layer is specified in GSM 04.05 and 04.06. Communication between the Physical Layer and the Data Link Layer is in an abstract way performed by means of PH-primitives. They do not constrain implementations.

NOTE: The terms physical layer and layer 1, and data link layer and layer 2, will be used synonymously in the present document.

The PH-primitives exchanged between the physical layer and the data link layer are used for the transfer of layer 2 frames. They are also used to indicate the establishment of channels to layer 2.

## 2.1a Interface to the Radio Link Control and Medium Access Control layer

The physical layer interfaces the Radio Link Control and Medium Access Control (RLC/MAC) layer. On this interface packet data control channels and packet data traffic channels are supported. The RLC/MAC layer is specified in GSM 04.60. Communication between the Physical Layer and the RLC/MAC layer is in an abstract way performed by means of PH-primitives. They do not constrain implementations.

The PH-primitives exchanged between the physical layer and the RLC/MAC layer are used for the transfer of RLC/MAC blocks. They are also used to indicate the establishment of packet data physical channels to the RLC/MAC layer.

## 2.2 Interface to radio resource management

The physical layer interfaces the radio resource management (RR-management) entity of layer 3 in the MS and in the network.

Communication is performed in an abstract way by means of MPH-primitives. They do not constrain implementations.

The primitives exchanged with the RR-management entity are related to the assignment of channels, physical layer system information (including measurement results), etc.

## 2.3 Interface to other functional units

The physical layer interfaces other functional units in the MS and in the network for supporting traffic channels. These interfaces are described in the 06 and 07 series of Technical Specifications.

---

# 3 Service of the physical layer

The physical layer supports transfer of bit streams on the radio medium according to the Technical Specifications of the 05-series. The scope of the 05-series of Technical Specifications is the definition of a framework for operation on the radio medium. The application of this framework on the radio medium results in a transmission service. General characteristics of the service obtained by applying the framework of the 05-series at the operation on the radio medium are described in this clause.

## 3.1 Service Access Point

In the Reference Model for Open System Interconnection, Service Access Points (SAPs) of a layer are defined as gates through which services are offered to an adjacent higher layer (figure 3.1). Through a SAP the physical layer offers a service to the data link layer. The SAP is used both for the control of the service providing entity (in case this is the physical layer; commands related to the establishment and release of channels) and the transfer of data (in case of the physical layer; the transfer of bits). The physical layer service access points defined in the present document differ from the OSI physical layer Service Access Points; the layer 3 RR-management instead of the data link layer controls the SAPs (establishment and release of channels).



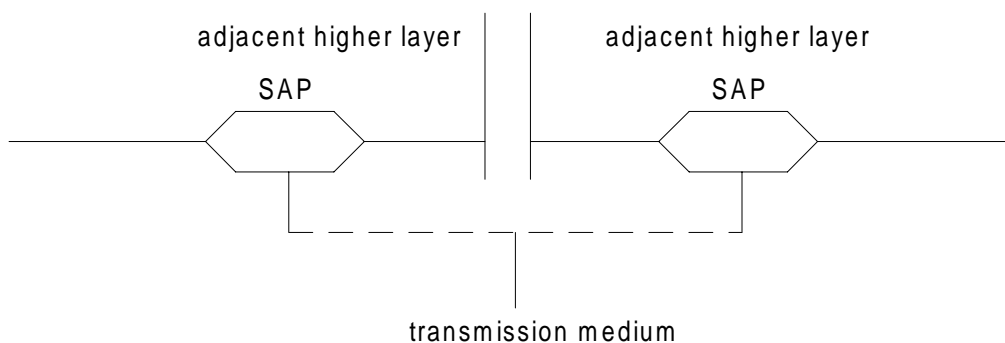

**Figure 3.1: Service Access Point principle**

On the physical layer of the GSM system a SAP is defined between the physical layer and the data link layer for each control channel (figure 3.2). The characteristics of SAPs (channels) are listed in GSM 04.03.

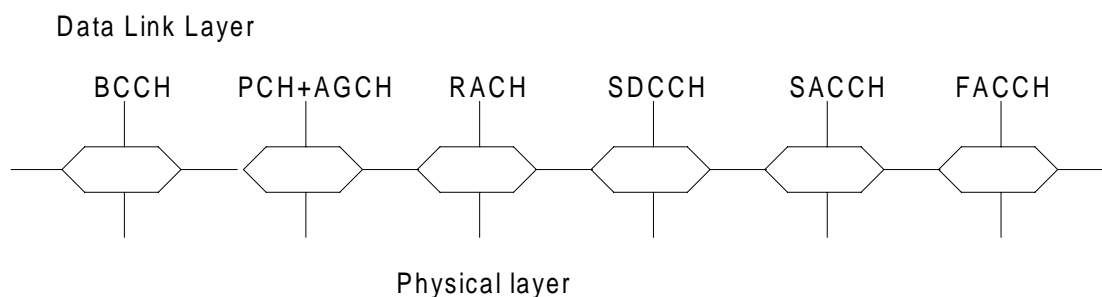

**Figure 3.2: SAPs between the physical layer and the data link layer in the MS**

Moreover, on the physical layer of the GSM system a SAP is defined between the physical layer and the RLC/MAC layer for the packet data control channels and the packet data traffic channel (figure 3.2a). Multiplexing of these channels is controlled by the RLC/MAC layer, see GSM 04.60. The characteristics of channels are listed in GSM 04.03.

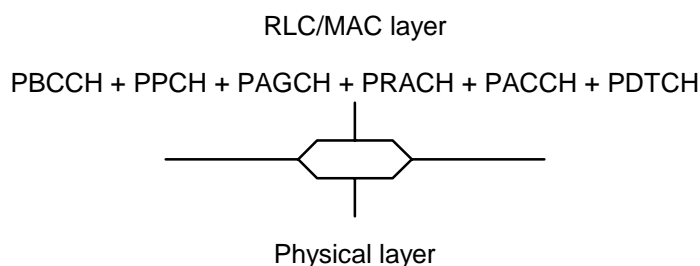

**Figure 3.2a: SAP between the physical layer and the RLC/MAC layer in the MS**

## 3.2 Service of the physical layer

### \* Access capabilities:

The physical layer offers a transmission service on a limited set of logical channels. The BS and MS access capabilities and the characteristics of logical channels (SAPs) are defined in GSM 04.03.

NOTE: Between GSM 04.03 and the GSM 05-series there is a slight difference in terminology. The "channels" mentioned in GSM 04.03 are "logical channels" according to the GSM 05-series (especially GSM 05.02). The "CCCH", a channel name commonly used in the 04-series, covers the logical channels of the type RACH, PCH and AGCH. Similarly, the "PCCCH" covers the logical channels of the type PPCH, PAGCH and PRACH.

Logical channels are multiplexed on physical channels. Physical channels are the units scheduled on the radio medium. Some are reserved by the network for common use (e.g. a combination of CCCH and BCCH), others are assigned to dedicated connections with MSs (dedicated physical channels), or are assigned to a shared usage between MSs for packet switched data traffic (packet data physical channels). In time, the combination of logical channels used on an assigned physical channel may change. Allowed combinations of logical channels on a physical channel are defined in GSM 04.03. Data on SAPs of control channels is exchanged in discrete blocks with a size of 23 or 21 (SACCH) octets. Data on a SAP of packet data traffic channels is exchanged in discrete blocks with a size of 184, 271, 315 or 431 bits.

Synchronization between layer 1 and layer 2 (data link layer) is provided for piggy-backing of RR (receive ready) frames, and the starting of timers (T200). See also GSM 04.06. Synchronization between the physical layer and the RLC/MAC layer is provided for the handling of timers, and the multiplexing of logical channels. See also GSM 04.60 .

\* **Error detection:**

The physical layer offers an error protected transmission service, it includes error detection functions and to a lower level, error correction functions. Erroneous received frames are not offered to the data link layer or the RLC/MAC layer. The probability of one or more errors in a physical block transferred by the physical layer is defined in GSM 05.05. Due to not specified methods of quality detection, the probability of residual errors in transferred blocks may vary between implementations.

\* **Encryption:**

Security related functions implemented at the physical layer are described in GSM 03.20.

An overview of the functions specified in the 05-series which create the service of the physical layer can be found in GSM 05.01.

### 3.2.1 Specific services of the physical layer in the MS

The access capability service of the physical layer in the MS differs depending on the nature of the channel (traffic, packet data traffic or broadcast/common channels).

- **Establishment of dedicated physical channels:**

Establishment of dedicated physical channels on the physical layer is controlled by the radio resources management of layer 3 (GSM 04.08). During operation on a dedicated physical channel, the physical layer measures the signals of neighbouring base stations and the signal quality of the used dedicated physical channel. Measurements are transferred to layer 3, measurement control information is offered by layer 3.

- **Establishment of packet data physical channels :**

Establishment of packet data physical channels on the physical layer is controlled by the radio resource management of layer 3. Packet access and the reservation of radio resource on packet data physical channels is controlled by the RLC/MAC layer in co-operation with layer 3 (GSM 04.60 and GSM 04.08). During operation on packet data physical channels, the physical layer measures the signals of neighbouring base stations and the signal quality of the used packet data physical channel. Measurements are transferred to layer 3, measurement control information is offered by layer 3.

- **cell/PLMN selection in idle mode or in packet mode:**

In idle mode or in packet mode, the physical layer selects the best cell with its BCCH/CCCH in close co-operation with layer 3, meeting requirements for PLMN selection specified in GSM 02.11. The idle mode procedures are not modelled within the present document. Examples of procedures for cell selection are described in GSM 05.08. The physical layer performs automatic crossover.

---

## 4 Primitives of the physical layer

The Physical layer interacts with other entities as illustrated in figure 2.1. The interactions with the data link layer of Dm channels and the interactions with the RLC/MAC layer of packet data physical channels are shown in terms of primitives where the primitives represent the logical exchange of information and control between the physical layer and adjacent layers. They do not specify or constrain implementations. The interactions between the physical layer and layer 1 entities for Bm/Lm channels are for further study. For the physical layer two sets of primitives are defined:

- **Primitives between physical layer and data link layer and RLC/MAC layer respectively:**

PH - Generic name - Type: Parameters.

- **Primitives between layer 1 and the RR-management layer 3 entity:**

MPH - Generic name - Type: Parameters.

## 4.1 Generic names of primitives between layers 1 and 2 for the transfer of layer 2 frames and RLC/MAC blocks

The following primitive generic names are defined on the SAPs between the physical layer and the data link layer:

a) PH-DATA:

The PH-DATA primitives are used on a SAP to pass message units containing frames used for data link layer and RLC/MAC layer respective peer-to-peer communications to and from the physical layer.

b) PH-RANDOM ACCESS:

The PH-RANDOM ACCESS (PH-RA) primitives are used on the SAP of the RACH and the PRACH to request and confirm (in the MS) the sending of a random access frame and to indicate (in the network) the arrival of a random access frame. The random access protocols are specified in GSM 04.08 and GSM 04.60 respectively.

c) PH-CONNECT:

The PH-CONNECT primitive is used on a SAP to indicate that the physical connection on the corresponding control channel or packet data physical channel has been established.

d) PH-READY-TO-SEND:

The PH-READY-TO-SEND primitive is used by the physical layer to trigger, if applicable, piggy backing, the start of timer for the data link layer or the RLC/MAC layer and the forwarding a data unit to the physical layer. It is passed to the upper layer just before a new physical block is transmitted.

e) PH-EMPTY-FRAME:

The PH-EMPTY-FRAME primitive can be used by the data link layer and the RLC/MAC layer to indicate that no frame has to be transmitted after receiving the PH-READY-TO-SEND primitive. It enables polling of several upper layer entities by the physical layer and support DTX.

## 4.2 Generic names of primitives between layer 1 and the RR-management entity of layer 3

The following primitive generic name is defined between layer 1 and the RR-management entity of layer 3:

- MPH-INFORMATION:

MPH-INFORMATION (MPH-INFO) primitives are used for the control of the physical layer by the RR-management of layer 3. This information activates and deactivates, configures and deconfigures, through connects and disconnects physical and logical channels. It is also used for the transfer of measurements and measurement control information from layer 1 to layer 3.

## 4.3 Primitive types

The primitive types defined in the present document are:

a) REQUEST:

The REQUEST primitive type is used when a higher layer is requesting a service from a lower layer.

b) INDICATION:

The INDICATION primitive type is used by a layer providing a service to notify the next higher layer of activities in the layer. This activities are directly related to the occurrence of a REQUEST primitive on the peer-protocol side.

c) RESPONSE:

The RESPONSE primitive type is used by a layer to acknowledge receipt from the INDICATION primitive type.

d) CONFIRM:

The CONFIRM primitive type is used by the layer providing the requested service to confirm that the activity has been completed.

## 4.4 Parameter definition

Primitives contain a variable amount of parameters. The primitives with included parameters are listed in table 4.1.

**Table 4.1: Primitives of the physical layer**

primitive	entity	direction	message unit					
			channel control parameters	system information	absolute frame No.	measurement		
MPH-INFO-REQ	MS/BS	RR(L3)	PH(L1)	x	x			
MPH-INFO-CON	MS/BS	PH(L1)	RR(L3)	x	x			
MPH-INFO-IND	MS/BS	PH(L1)	RR(L3)	x	x		x	
PH-CONNECT-IND	MS/BS	PH(L1)	DL(L2) RLC/MAC	x				
PH-READY-TO-SEND	MS/BS	PH(L1)	DL(L2) RLC/MAC	x			x	
PH-EMPTY-FRAME	MS/BS	DL(L2) RLC/MAC	PH(L1)	x				
PH-DATA-REQ	MS/BS	DL(L2) RLC/MAC	PH(L1)	x	x			
PH-DATA-IND	MS/BS	PH(L1)	DL(L2) RLC/MAC	x	x			x
PH-RA-REQ	MS	DL(L2) RLC/MAC	PH(L1)	x				
PH-RA-IND	BS	PH(L1)	DL(L2) RLC/MAC	x			x	
PH-RA-CON	MS	PH(L1)	DL(L2) RLC/MAC	x			x	

Parameters involved in the primitive exchange with the physical layer are:

a) Message unit:

The message unit contains peer-to-peer information of a layer. It is transferred by the physical layer to the peer layer.

## b) Channel control parameters:

These parameters contain information for channel control, specified in GSM 04.08 and GSM 04.60.

## c) System information:

This information is exchanged in the cell/PLMN selection procedures. It may also contain control information for DRX (sleep mode, see GSM 03.13).

## d) Absolute Frame Number:

The absolute frame number is used (in combination with a random access identifier) to uniquely identify a random access.

## e) Measurements:

This parameter is used to report the quality of a dedicated physical channel (MS and network) and to report the quality of surrounding BCCH carriers (MS only).

## 5 Physical layer procedures

The main body of physical layer procedures is specified in GSM 04.08, GSM 04.60 and 05.08.

### 5.1 States of the physical layer

In the physical layer of the MS the following states are defined:

NULL: the equipment is switched off;

SEARCHING BCH: the physical layer tracks the best BCCH;

BCH: the physical layer listens to a BCCH/CCCH or PBCCH/PCCCH and is able to do random access;

TUNING DCH: the physical layer seizes on a respective dedicated physical channel or packet data physical channel;

DCH: the physical layer has seized a respective dedicated physical channel or packet data physical channel and may establish and through connect logical channels.

NOTE: BCH = Bch/ccch physical CHannel or pbch/pccch physical channel;  
DCH = Dedicated physical CHannel or packet data physical channel.

Figure 5.1 gives a general state diagram of the physical layer. All state transitions of the physical layer are controlled by MPH-INFORMATION primitives.

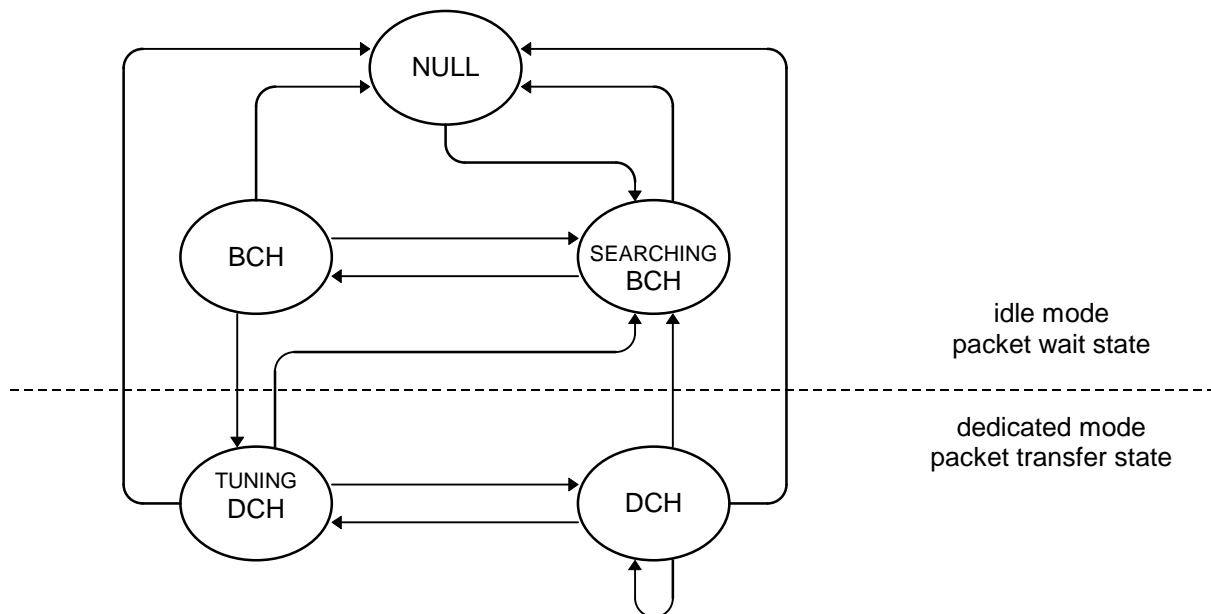

Figure 5.1: States of the physical layer in the MS

The states of the physical layer in the network are not specified. The states in the network will reflect the other characteristics of operation on channels.

## 5.2 Control procedures

Requirements and examples of procedures for idle mode and for packet mode operation of the MS are specified in GSM 02.11 and 05.08. In the idle mode and packet mode procedures the physical layer tracks the best cell and may tune on their BCCH/PBCCH in order to enable layer 3 to read the system information of the BCCH/PBCCH. This system information of the BCCH/PBCCH is used in the selection process.

## 5.3 Physical layer interface procedures

Three types of primitives are defined for the communication between the physical layer and the data link layer both in the MS and the network. When a control channel or a packet data physical channel is being established, a PH-CONNECT-INDICATION is offered to the data link layer or the RLC/MAC layer, the one which is applicable, on the corresponding SAP. On an established full duplex control channel (DCCHs) in both MS and network, on an established packet data physical channel or on the established BCCH/CCCH in the MS, physical blocks received correctly are offered on the corresponding SAP in PH-DATA-INDICATION primitives. On a full duplex control channel (DCCHs) or on the BCCH/CCCH in the network, the data link layer will offer physical blocks to be transmitted in PH-DATA-REQUEST primitives. On a packet data physical channel, the RLC/MAC layer will offer physical blocks to be transmitted in PH-DATA-REQUEST primitives. In the MS in idle mode or in packet wait state, random accesses on RACH or on PRACH can be offered in PH-RANDOM ACCESS-REQUEST primitives. The physical layer of the MS will perform a random access as soon as possible. The physical layer of the MS will confirm the data link layer or the RLC/MAC layer, the one which is applicable, the transmission of the random access attempt in a PH-RANDOM ACCESS-CONFIRM. This confirmation contains the absolute frame number in which the random access is transmitted. The physical layer of the BS offers correctly received random accesses to the data link layer or the RLC/MAC layer, the one which is applicable, in a PH-RANDOM ACCESS-INDICATION. This indication contains the absolute frame number in which the random access is received.

## 6 Physical layer protocol header

The physical layer implements a peer-to-peer protocol for the control of timing advance and power control at the operation on dedicated physical channels, and further, for the control of timing advance at the operation on packet data physical channels. For this purpose a two octet physical header is defined on all blocks transferred via the SACCH, a logical channel always present on a dedicated physical channel. Further more, a 16 octet information field is defined on downlink blocks transferred via the PTCCH, a logical channel present on a packet data physical channel .

### 6.1 Physical layer protocol fields and procedures

Procedures for handling the ordered and actual power level fields are specified in GSM 05.05 and 05.08. The ordered MS power level field and the actual MS power level field are coded as the binary representation of the "power control level", see GSM 05.05.

Procedures for handling the ordered and actual timing advance fields are specified in GSM 05.10. The numbers corresponding to the timing advance steps in GSM 05.10 are included binary coded in the 7 bit ordered and actual timing advance fields of the physical layer header. The bit pattern "111111" indicates that the field does not contain a timing advance value. All other bit combinations (64 to 126 decimal) are reserved.

A MS in packet transfer state which is assigned a TAI shall, when receiving a PTCCH downlink block on the packet data physical channel containing PACCH, read the corresponding ordered timing advance field in that PTCCH block. The ordered timing advance fields corresponding to other TAIs than the assigned one shall be ignored .

## 7 Block transmission

### 7.1 SACCH downlink block format

The originally 23 octets of SACCH blocks are used downlink in the following way:

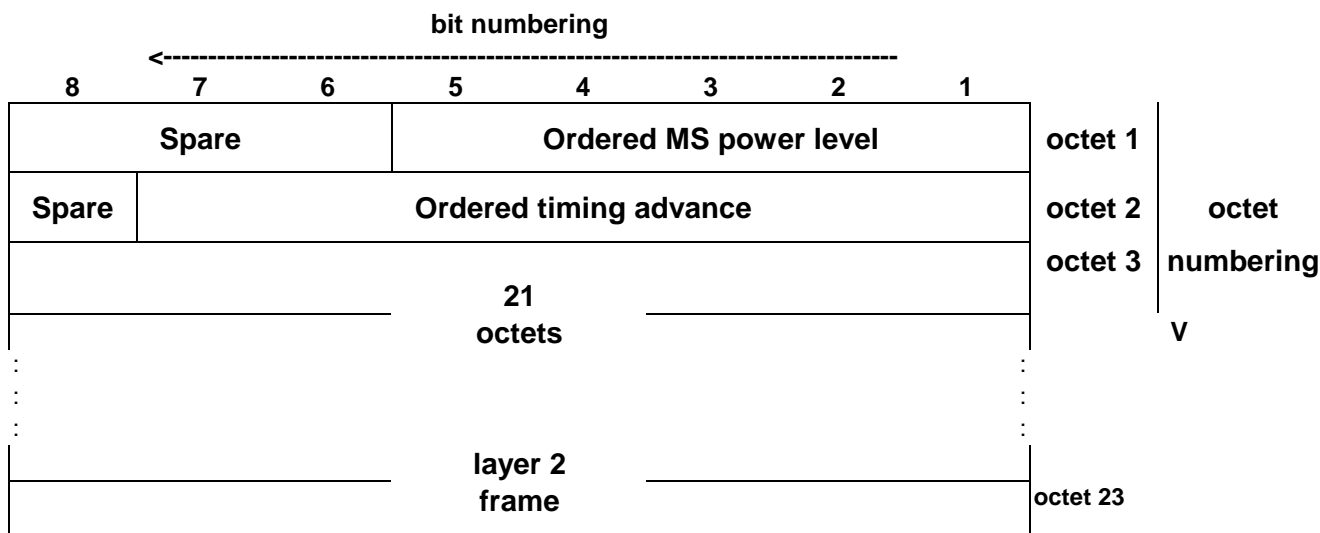

NOTE: The numbering convention specified in GSM 04.06 applies.

Figure 7.1: SACCH downlink block format

### 7.2 SACCH uplink block format

The originally 23 octets of SACCH blocks are used uplink in the following way:

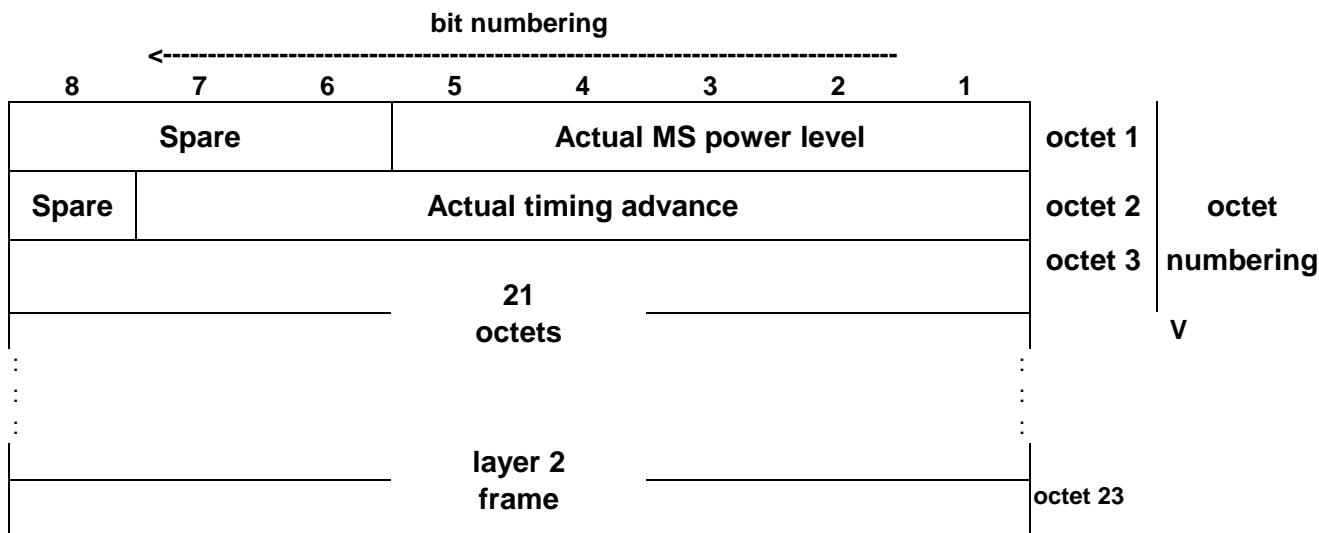

NOTE: The numbering convention specified in GSM 04.06 applies.

Figure 7.2: SACCH uplink block format

### 7.3 FACCH/SDCCH/CCCH/BCCH/CBCH downlink block format

The originally 23 octets blocks are used downlink in the following way:

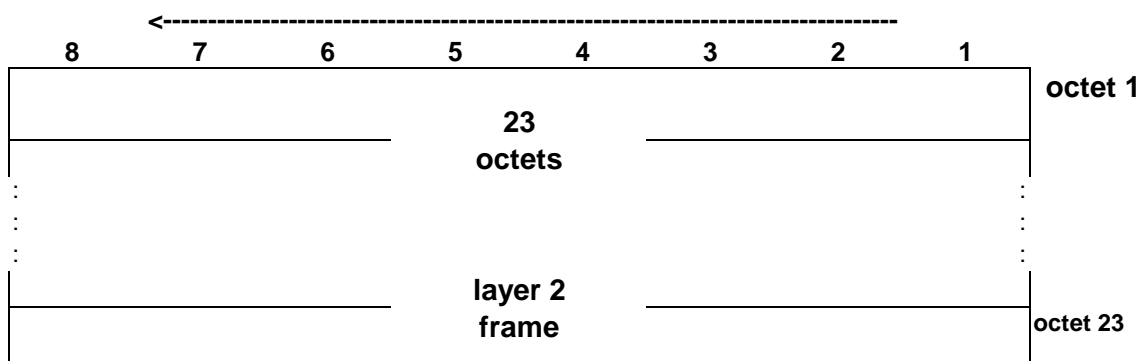

NOTE: The numbering convention specified in GSM 04.06 and 04.12 applies.

Figure 7.3: FACCH/SDCCH/BCCH/CCCH/CBCH downlink block format

### 7.4 FACCH/SDCCH uplink block format

The originally 23 octets blocks are used uplink in the following way:

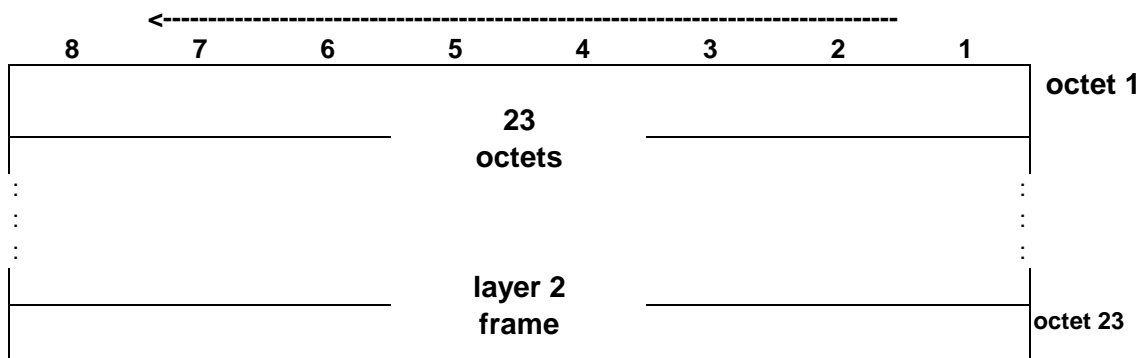

NOTE: The numbering convention specified in GSM 04.06 applies.

Figure 7.4: FACCH/SDCCH uplink block format



### 7.5 PBCCH/PCCCH downlink/PACCH/PDTCH block type 1 (CS-1) format

The originally 184 bit (23 octets) blocks are used in the following way:

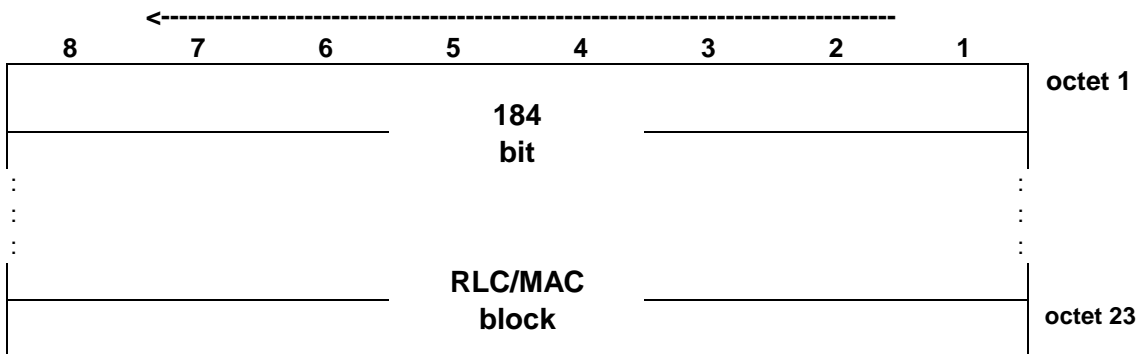

NOTE: The numbering convention specified in GSM 04.60 applies.

Figure 7.5: PBCCH/PCCCH downlink/PACCH/PDTCH block type 1 (CS-1) format

### 7.6 PDTCH block type 2 (CS-2) format

The originally 271 bit blocks are used in the following way:

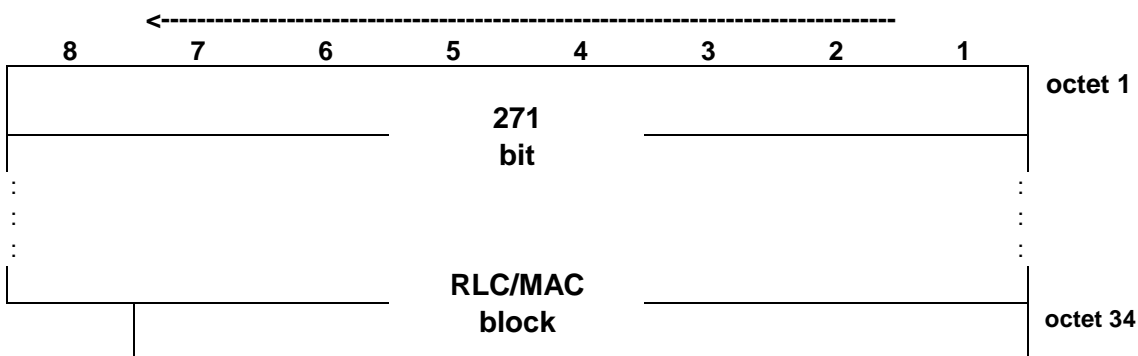

NOTE: The numbering convention specified in GSM 04.60 applies.

Figure 7.6: PDTCH block type 2 (CS-2) format

### 7.7 PDTCH block type 3 (CS-3) format

The originally 315 bit blocks are used in the following way:

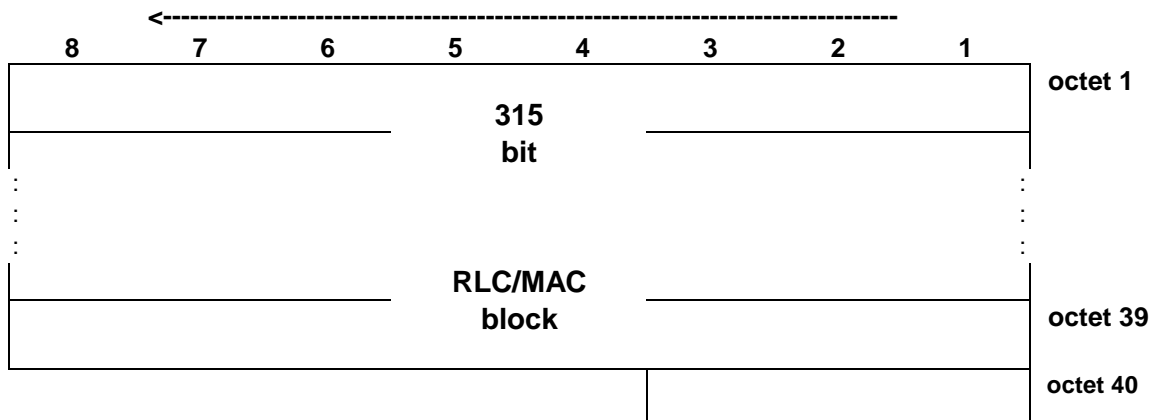

NOTE: The numbering convention specified in GSM 04.60 applies.

Figure 7.7: PDTCH block type 3 (CS-3) format

### 7.8 PDTCH block type 4 (CS-4) format

The originally 431 bit blocks are used in the following way:

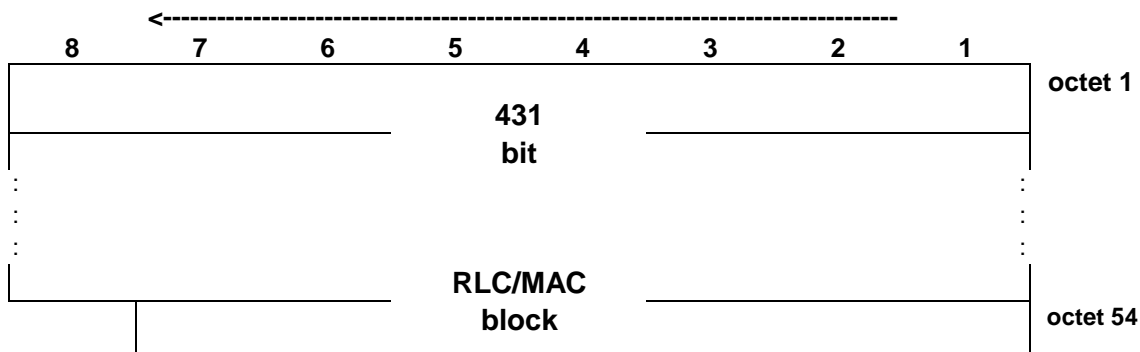

NOTE: The numbering convention specified in GSM 04.60 applies.

Figure 7.8: PDTCH block type 4 (CS-4) format

### 7.9 PRACH uplink/PACCH uplink short acknowledgement block formats

Two alternative PRACH uplink/PACCH uplink short acknowledgement block formats are specified. The originally 8 bit (1 octet) blocks are used uplink in the following way:

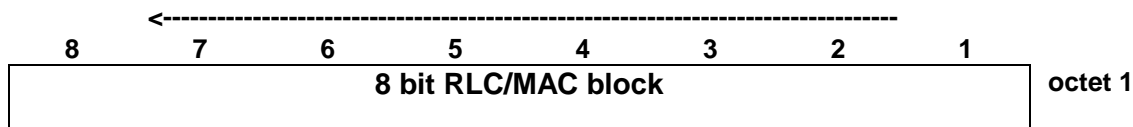

NOTE: The numbering convention specified in GSM 04.60 applies.

Figure 7.9 (sheet 1 of 2): PRACH uplink/PACCH uplink short acknowledgement block format

The originally 11 bit blocks are used uplink in the following way:

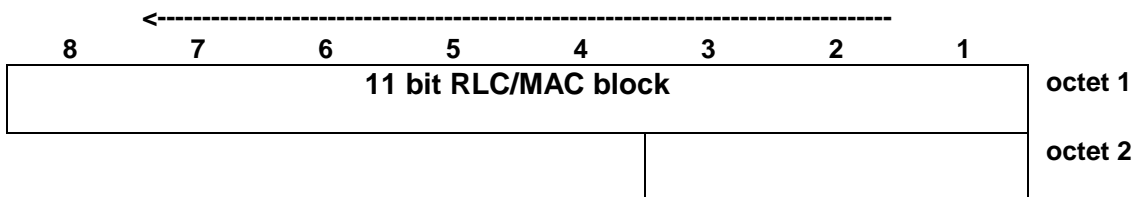

NOTE: The numbering convention specified in GSM 04.60 applies.

**Figure 7.9 (sheet 2 of 2): PRACH uplink/PACCH uplink short acknowledgement block format**

## 7.10 PTCCH downlink block format

The originally 184 bit (23 octets) blocks are used downlink in the following way:

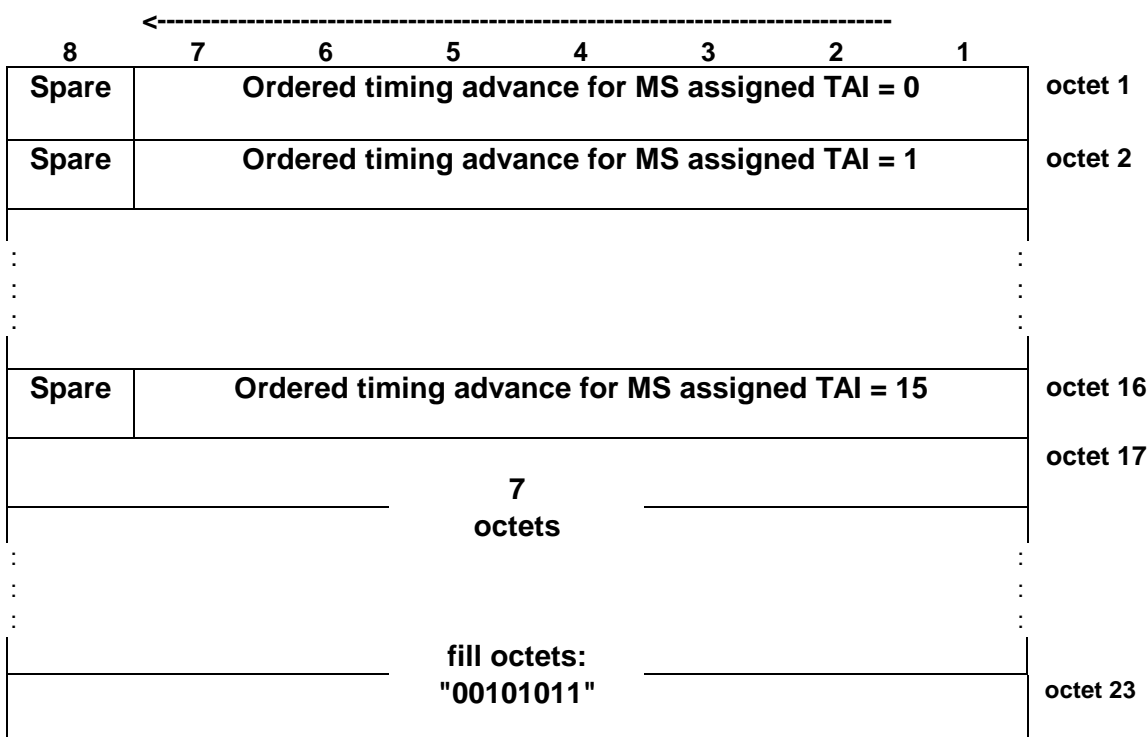

**Figure 7.10: PTCCH downlink block format**

The field mapping convention in this sub-clause is that when a field is contained within a single octet, the highest bit number of the field represents the highest order value and lowest bit number of the field represents the lowest order value.

Spare bits are encoded with the binary value "0". Fill octets are encoded with the binary value "00101011".

### 7.11 PTCCH uplink block formats

Two alternative PTCCH uplink block formats are specified. The originally 8 bit (1 octet) blocks are used uplink in the following way:

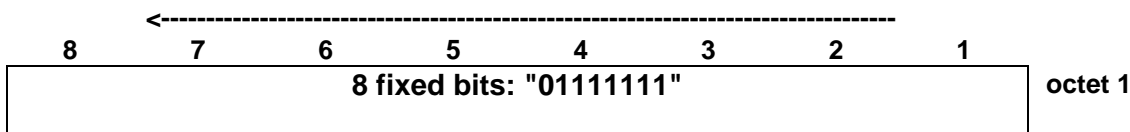

Figure 7.11 (sheet 1 of 2): PTCCH uplink block format

The originally 11 bit blocks are used uplink in the following way:

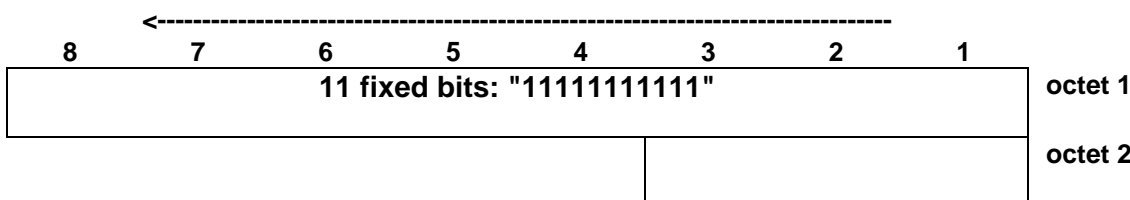

Figure 7.11 (sheet 2 of 2): PTCCH uplink block format

The field mapping convention of sub-clause 7.10 applies. In the addition, when a field spans more than one octet, the order of bit values within each octet progressively decreases as the octet number increases. In that part of a field contained in a given octet the lowest bit number represents the lowest order value.

### 7.12 Order of bit transmission

On channels for normal burst transmission having a block format with an integer N number of octets, the N octets are mapped onto 8N bits, d(0) to d(8N-1), defined in GSM 05.03 clause 4 and 5 as follows:

Bit m of octet n shall be transmitted as bit  $d((n-1)*8+m-1)$  with  $m=(1..8)$  and  $n=(1..N)$ .

On channels for normal burst transmission having a block format with a non-integer number of octets, or for transmission having a defined block format but which does not follow the normal burst transmission, the octets are mapped onto M bits, d(0) to d(M-1), defined in GSM 05.03 clause 5 as follows:

Bit m of octet n shall be transmitted as bit  $d(8(n-1) + m-1)$  with  $n = (1 .. ((M-1) DIV 8) + 1)$  and  $m = (1 .. \min(8, (M - 8(n-1))))$ , and where 'DIV' is the integer division operator.

---

## 8 Vocabulary

The terminology used in the present document is as follows:

- **Idle mode:**

In this mode the MS is not allocated any dedicated physical channel; it listens to the CCCH and the BCCH.

- **Dedicated mode:**

In this mode the MS is allocated a dedicated physical channel, at least containing two logical channels, only one of them being a SACCH.

- **Packet mode :**

In this mode the MS is ready to access and operate on a packet data physical channel. The packet mode includes two sub-states: packet wait state and packet transfer state (see GSM 04.60).

- **Physical block:**

The physical block is the minimal unit which can be transferred by the physical layer.

- **Dedicated physical channel:**

The physical blocks scheduled on the radio medium assigned to a dedicated connection with a MS.

- **Packet data physical channel :**

The physical blocks scheduled on the radio medium assigned to a shared usage between MSs for packet switched data traffic.

---

## Annex A (informative): Document change history

SPEC	SMG#	CR	PHASE	VERS	NEW_VERS	SUBJECT
04.04	s24	A001	R97	5.0.1	6.0.0	Introduction of GPRS
04.04	s29		R98		7.0.0	Specification version upgrade to Release 1998 version 7.0.0

---

# History

<b>Document history</b>		
V7.0.0	August 1999	Publication