

# TS 100 539 V6.0.0 (1999-04)

---

*Technical Specification*

**Digital cellular telecommunications system (Phase 2+);  
Technical realization of facsimile group 3 non-transparent  
(GSM 03.46 version 6.0.0 Release 1997)**

---



Reference

---

DTS/SMG-040346Q6 (4zo03003.PDF)

Keywords

---

Digital cellular telecommunications system,  
Global System for Mobile communications (GSM)

**ETSI**

Postal address

---

F-06921 Sophia Antipolis Cedex - FRANCE

Office address

---

650 Route des Lucioles - Sophia Antipolis  
Valbonne - FRANCE  
Tel.: +33 4 92 94 42 00 Fax: +33 4 93 65 47 16  
Siret N° 348 623 562 00017 - NAF 742 C  
Association à but non lucratif enregistrée à la  
Sous-Préfecture de Grasse (06) N° 7803/88

Internet

---

secretariat@etsi.fr  
Individual copies of this ETSI deliverable  
can be downloaded from  
<http://www.etsi.org>  
If you find errors in the present document, send your  
comment to: editor@etsi.fr

---

**Copyright Notification**

No part may be reproduced except as authorized by written permission.  
The copyright and the foregoing restriction extend to reproduction in all media.

© European Telecommunications Standards Institute 1999.  
All rights reserved.

# Contents

Intellectual Property Rights.....	5
Foreword .....	5
1 Scope.....	6
2 References.....	6
2.1 Abbreviations.....	7
3 Service definition .....	7
4 Network architecture.....	8
5 Reference configuration at the mobile station .....	9
5.1 Fax adaptor functionality .....	10
5.2 GSM facsimile machine functionality.....	10
6 Connection types.....	11
6.1 Protocol model.....	12
6.2 Principles of the Facsimile Protocol Adaptation.....	13
6.2.1 Fax Adaptor Protocol.....	14
6.2.2 Interactions and interventions within the fax adaptors .....	15
6.2.3 Training Check.....	16
6.2.4 Mobile to mobile calls.....	17
6.2.5 Facsimile Message Transfer .....	17
6.2.5.1 Message Transcoding .....	17
6.2.5.2 Generation of the normal data element.....	18
6.2.5.3 Generation of the error correction data element .....	18
6.3 Procedure interrupts.....	18
6.4 Radio channel modification .....	18
6.5 Performance constraints.....	19
7 Use of terminal adaptation functions .....	20
7.1 Standard TAFs for synchronous services.....	20
7.2 Specific TAFs for facsimile service.....	20
7.2.1 BCS phase.....	21
7.2.1.1 BCS command/response procedures.....	21
7.2.1.2 Compatibility checking.....	23
7.2.1.3 Message speed checking.....	23
7.2.1.4 Control of transmission rate.....	23
7.2.1.5 Clocking .....	24
7.2.2 Message phase.....	24
7.2.2.1 Normal facsimile data.....	24
7.2.2.2 Error correction facsimile data .....	24
7.2.2.3 Buffering of facsimile coded data.....	25
7.2.2.3.1 Transmitter adaptation function .....	25
7.2.2.3.2 Receiver adaptation function.....	25
7.2.3 Disconnect procedure.....	25
7.2.4 Timeouts.....	26
8 Signalling aspects.....	26
8.1 Handling of tonal signals .....	26
8.2 Call establishment.....	26
8.2.1 Mobile terminated call .....	26
8.2.1.1 Speech then facsimile .....	26
8.2.1.2 Auto answer.....	27
8.2.2 Mobile originated calls.....	27
8.2.2.1 Speech then facsimile .....	27
8.2.2.2 Auto calling .....	28
8.2.2.3 Manual calling .....	28

9	Interworking to fixed networks.....	29
9.1	Interworking to PSTN.....	29
9.2	Interworking to ISDN.....	30
<b>Annex A (normative): Structure and contents of the fax adaptor protocol elements .....</b>		<b>31</b>
1	Principle structure of an element .....	31
2	Element discriminator coding .....	31
2.1	BCS element .....	31
2.2	BCS abort element.....	31
2.3	BCS transmit request element.....	31
2.4	Preamble element.....	32
2.5	Normal fax data element.....	32
2.6	Error correction fax data element.....	32
2.7	End of data element .....	32
2.8	TCF element .....	32
3	Information field content .....	33
3.1	BCS element .....	33
3.2	BCS abort element.....	33
3.3	BCS transmit request element.....	33
3.4	Preamble element.....	33
3.5	Normal fax data element.....	33
3.6	Error correction fax data element.....	34
3.7	End of data element .....	34
3.8	TCF element .....	34
4	Relationship of FA protocol elements with LAPB, L2RBOP and RLP .....	34
Appendix I (informative): Abbreviations from CCITT Recommendation T.30 and T.4.....		36
Appendix II (informative): Procedure examples.....		37
<b>Annex B (informative): Change Request History .....</b>		<b>50</b>
History .....		51

---

## Intellectual Property Rights

IPRs essential or potentially essential to the present document may have been declared to ETSI. The information pertaining to these essential IPRs, if any, is publicly available for **ETSI members and non-members**, and can be found in SR 000 314: "*Intellectual Property Rights (IPRs); Essential, or potentially Essential, IPRs notified to ETSI in respect of ETSI standards*", which is available **free of charge** from the ETSI Secretariat. Latest updates are available on the ETSI Web server (<http://www.etsi.org/ipr>).

Pursuant to the ETSI IPR Policy, no investigation, including IPR searches, has been carried out by ETSI. No guarantee can be given as to the existence of other IPRs not referenced in SR 000 314 (or the updates on the ETSI Web server) which are, or may be, or may become, essential to the present document.

---

## Foreword

This Technical Specification (TS) has been produced by the Special Mobile Group (SMG).

The present document defines the technical realization of facsimile group 3 using non-transparent network support for the European digital cellular telecommunications system.

The contents of the present document is subject to continuing work within SMG and may change following formal SMG approval. Should SMG modify the contents of the present document, it will be re-released with an identifying change of release date and an increase in version number as follows:

Version 6.x.y

where:

- 6 indicates Release 1997 of GSM Phase 2+
- x the second digit is incremented for all changes of substance, i.e. technical enhancements, corrections, updates, etc.
- y the third digit is incremented when editorial only changes have been incorporated in the specification.

The specification from which the present document has been derived was originally based on CEPT documentation, hence the presentation of the present document may not be entirely in accordance with the ETSI/PNE rules.

---

# 1 Scope

The present document deals with the procedures allowing the technical realization of the real time end-to-end facsimile group 3 service within the GSM PLMN using non-transparent network support according to the definition of the Teleservices 61 and 62 specified in GSM 02.03. Within the present document particular attention is given to Teleservice "Alternate speech/facsimile group 3" (Teleservice 61). However, the definitions apply also to Teleservice "Automatic facsimile group 3" (Teleservice 62) with the exception of all actions concerned with the speech phase. Consequently, in the following descriptions the term "Teleservice" denotes both Teleservice 61 and Teleservice 62 as appropriate.

NOTE: Some facilities associated with alternate speech/ facsimile group 3 may not be available with version 1 of MAP. In particular, the in-call modification procedure following an inter MSC handover is not supported by this version. This imposes the limitation that for all calls it will not be possible to change between speech and facsimile following an inter MSC handover.

---

# 2 References

The following documents contain provisions which, through reference in this text, constitute provisions of the present document.

- References are either specific (identified by date of publication, edition number, version number, etc.) or non-specific.
- For a specific reference, subsequent revisions do not apply.
- For a non-specific reference, the latest version applies.
- A non-specific reference to an ETS shall also be taken to refer to later versions published as an EN with the same number.
- For this Release 1997 document, references to GSM documents are for Release 1997 versions (version 6.x.y).

- [1] GSM 01.04: "Digital cellular telecommunications system (Phase 2+); Abbreviations and acronyms".
- [2] GSM 02.03: "Digital cellular telecommunications system (Phase 2+); Teleservices supported by a GSM Public Land Mobile Network (PLMN)".
- [3] GSM 03.10: "Digital cellular telecommunications system (Phase 2+); GSM Public Land Mobile Network (PLMN) connection types".
- [4] GSM 04.02: "Digital cellular telecommunications system (Phase 2+); GSM Public Land Mobile Network (PLMN) access reference configuration".
- [5] GSM 04.08: "Digital cellular telecommunications system (Phase 2+); Mobile radio interface layer 3 specification".
- [6] GSM 04.21: "Digital cellular telecommunications system (Phase 2+); Rate adaption on the Mobile Station - Base Station System (MS - BSS) interface".
- [7] GSM 07.01: "Digital cellular telecommunications system (Phase 2+); General on Terminal Adaptation Functions (TAF) for Mobile Stations (MS)".
- [8] GSM 07.03: "Digital cellular telecommunications system (Phase 2+); Terminal Adaptation Functions (TAF) for services using synchronous bearer capabilities".
- [9] GSM 09.07: "Digital cellular telecommunications system (Phase 2+); General requirements on interworking between the Public Land Mobile Network (PLMN) and the Integrated Services Digital Network (ISDN) or Public Switched Telephone Network (PSTN)".
- [10] CCITT Recommendation F.160: "General operational provisions for the international public facsimile services".

- [11] CCITT Recommendation T.4: "Standardization of group 3 facsimile apparatus for document transmission".
- [12] CCITT Recommendation T.30: "Procedures for document facsimile transmission in the general switched telephone network".
- [13] CCITT Recommendation T.35: "Procedure for the allocation of CCITT members' codes".
- [14] CCITT Recommendation V.21: "300 bits per second duplex modem standardized for use in the general switched telephone network".
- [15] CCITT Recommendation V.24: "List of definitions for interchange circuits between data terminal equipment (DTE) and data circuit-terminating equipment (DCE)".
- [16] CCITT Recommendation V.25 bis: "Automatic calling and/or answering equipment on the general switched telephone network (GSTN) using the 100-series interchange circuits".
- [17] CCITT Recommendation V.27 ter: "4 800/2 400 bits per second modem standardized for use in the general switched telephone network".
- [18] CCITT Recommendation V.29: "9 600 bits per second modem standardized for use on point-to-point 4-wire leased telephone-type circuits".
- [19] CCITT Recommendation X.300: "General principles and arrangements for interworking between public data networks, and between public data networks and other networks".

## 2.1 Abbreviations

In addition to those below abbreviations used in the present document are listed in GSM 01.04.

BCS	Binary coded signalling
CCT	Circuit(s)
I/F	Interface
RA1,RA1',RA2	Rate adaptation functions
SREJ	Selective reject

The abbreviations for the facsimile specific protocol elements and signals are listed in appendix I.

---

## 3 Service definition

The fixed network facsimile group 3 service, as basically defined in CCITT Recommendation F.160, is an international telematic service for document transmission between two facsimile group 3 terminals.

The service specifications are comprised of two parts:

- the control procedures described in CCITT Recommendation T.30 and
- the document transmission coding described in CCITT Recommendation T.4.

The GSM facsimile group 3 Teleservice is intended to allow connections between facsimile group 3 terminals using:

- a GSM PLMN as stand-alone facility for mobile-to-mobile communication;
- a GSM PLMN to have access to fixed networks PSTN and/or ISDN for mobile to/from fixed network communication.

For this Teleservice, the coding of the facsimile document is as per CCITT Recommendation T.4 and the protocol as per CCITT Recommendation T.30 both modified within the PLMN as detailed in the present document.

The interworking between different networks is based on CCITT Recommendation X.300.

The particular features of this Teleservice are:

- it uses point-to-point communication;
- the information transfer mode is circuit, duplex, synchronous;
- the information transfer capability is alternate speech/ facsimile group 3 or facsimile group 3 only;
- both mobile originated and mobile terminated calls are supported;
- different end-to-end message speeds as per CCITT Recommendation T.30 may be used within the same connection to match the appropriate quality requirements;
- use of the standard synchronous terminal adaptation function for non-transparent network support (as per GSM 07.03) within the MS is envisaged.

---

## 4 Network architecture

The network architecture applicable to this Teleservice is shown in figure 1/03.46 below.

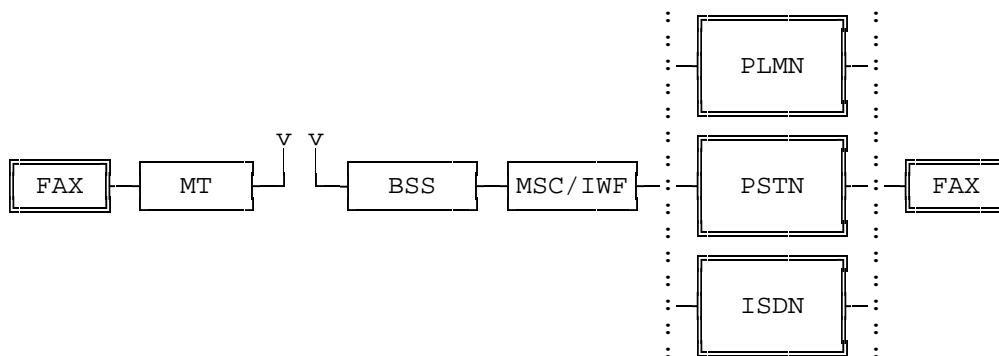

**Figure 1/03.46: Network architecture**

It shows the case of mobile to fixed network interworking. For mobile-to-mobile calls, there would effectively be a loop back within the PLMN using two IWFs.



## 5 Reference configuration at the mobile station

The mobile station reference configurations described in this clause are defined as per GSM 04.02.

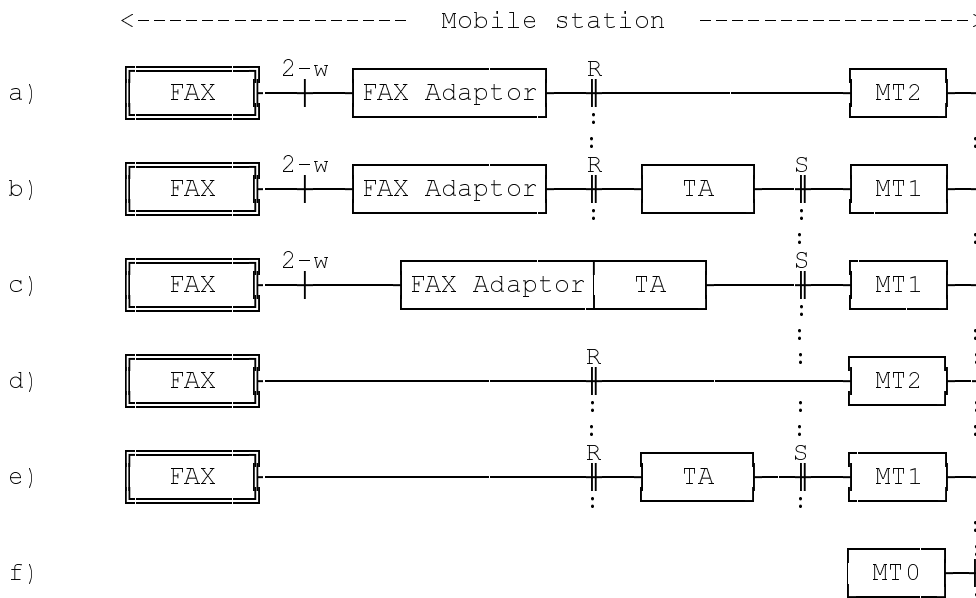

Figure 2/03.46: Reference configurations

The teleservice definitions in GSM 02.03 regard the facsimile group 3 terminal as a 2-wire analogue terminated equipment. In order to connect this to the MT2 a separate "fax adaptor" device is necessary. This configuration, shown in figure 2a/03.46, has to be considered as the standard configuration, so that all the existing facsimile group 3 terminals can be connected to the PLMN.

An alternative realization would be to combine a facsimile group 3 terminal and the fax adaptor into a special "GSM facsimile machine", directly providing a digital output. Although such a terminal must appear to the MT2 as identical as the fax adaptor (i.e. with an identical interface and protocol), it would allow for a significantly smaller and simpler facsimile machine. This configuration is shown in figure 2d/03.46.

In addition of course, it is always possible to realize an MT0, as per figure 2f/03.46, where both the facsimile and mobile termination functions are considered to be part of one integrated unit.

The remaining configurations concern the use of an S interface and are considered as optional configurations. Their use is for further study.

The particular terminal adaptation functions used are those detailed in GSM 07.03 for non-transparent bearer capability. The interface to the MT2 used is according to CCITT Recommendation V.24 with an option for support of CCITT Recommendation V.25bis procedures for auto calling and auto answering.

## 5.1 Fax adaptor functionality

The fax adaptor block, figure 3/03.46, is intended to specifically complement the facsimile group 3 terminal in order to be able to communicate over a GSM PLMN.

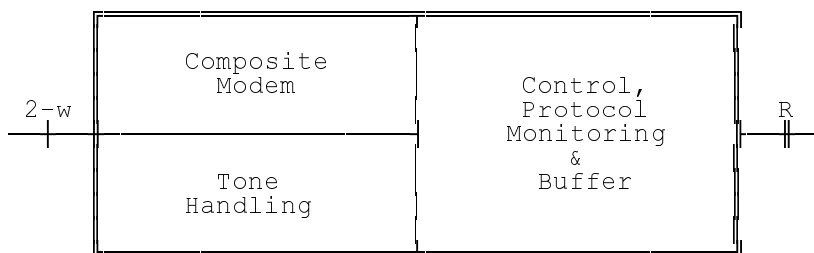

**Figure 3/03.46: Fax adaptor scheme**

Whether it has to be a function internal to the GSM PLMN, or an external accessory associated with the facsimile group 3 terminal, is beyond the scope of the present document, and in any case, does not affect the working of the procedure as described here.

It can be functionally partitioned in two sections:

- an analogue section, dealing with:
  - the modulation and demodulation processes according to CCITT Recommendation V.21, V.27ter, and V.29 as explained in CCITT Recommendation T.4 and T.30;
  - handling of the signalling on the 2-wire path to the associated facsimile terminal, including auto calling and auto answering functions where necessary (see clause 8).
- a digital section, dealing with:
  - overall control of the adaptor;
  - monitoring and, where necessary, manipulating the CCITT Recommendation T.30 protocol as detailed in the present document;
  - connection to the MT using the interface according to CCITT Recommendation V.24 as described in GSM 07.03;
  - buffering of facsimile data;
  - transcoding of the CCITT Recommendation T.4 document content for transmission across the radio interface as detailed in the present document;
  - where necessary, auto calling and auto answering functions according to CCITT Recommendation V.25bis.

## 5.2 GSM facsimile machine functionality

The special GSM facsimile machine shown in the MS configuration of figure 2d/03.46 is similar to the digital part of the fax adaptor, but without any of the analogue portions.

It appears at the CCITT Recommendation V.24 interface as identical as the fax adaptor, i.e. the MT2 needs to have no knowledge of the particular configuration used.

# 6 Connection types

Table 1/03.46 shows the connection elements attributes applicable to these Teleservices, extracted from GSM 03.10.

**Table 1/03.46: Connection elements**

Protocol type of fig. 6 GSM 03.10	Access to TAF of the Mobile Station	Radio interface connection element	Intermediate rate RA1 to RA2	BS-MSC/IWF connection element
Model 6: Speech	----	Speech/GSM	----	CCITT A-law
Model 7: Facsimile Group 3 NT	C/D/S UDI - 9.6 kbit/s (- 4.8 kbit/s) (- 2.4 kbit/s)	C/D/S UDI - 12 kbit/s	C/D/S UDI - 16 kbit/s	C/D/S UDI - 64 kbit/s

C = circuit switched S = synchronous  
D = duplex UDI = unrestricted digital information

Figure 4/03.46 shows the scheme of a typical GSM PLMN connection for these teleservices, considering R and S access, respectively, at network termination.

To support the CCITT Recommendation T.30, requiring different transmission rates, the following strategy shall be implemented:

- the channel on the radio interface shall be a full rate channel used for RLP protocol transmission (non-transparent network support);
- no modification procedure (Channel Mode Modify: CMM) shall be performed during the data phase of the call;
- the user rate of the MT2 is preferably set to 9 600 bit/s;
- the transmission rate between the fax adaptor and the associated facsimile terminal at both ends shall be the same, i.e. there will be only one common end-to-end transmission rate at any given time;
- the negotiation of the message speed shall be end-to-end between the two facsimile terminals; this allows also for a message speed of 7 200 bit/s to be used;
- the connection between the fax terminals is divided into three logical sections (fax terminal -(1)- fax adaptor -(2)- fax adaptor -(3)- fax terminal);
- flag stuffing is applied by the fax adaptor towards the associated facsimile terminal within the constraints of CCITT Recommendation T.30, to keep the data link active whenever a procedure delay occurs;
- the BCS protocol elements and the facsimile coded data are buffered at both ends of the radio interface (in the fax adaptors), if necessary, to guarantee data integrity;
- a specific fax adaptor protocol (FA protocol) is provided between both the fax adaptors to cater for the appropriate link control.

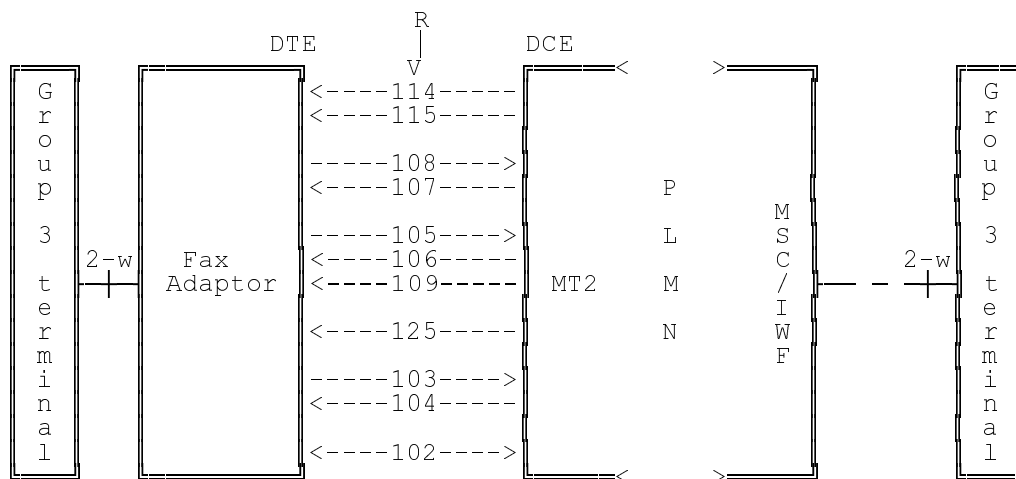

Figure 4a/03.46: Standard Teleservice connection

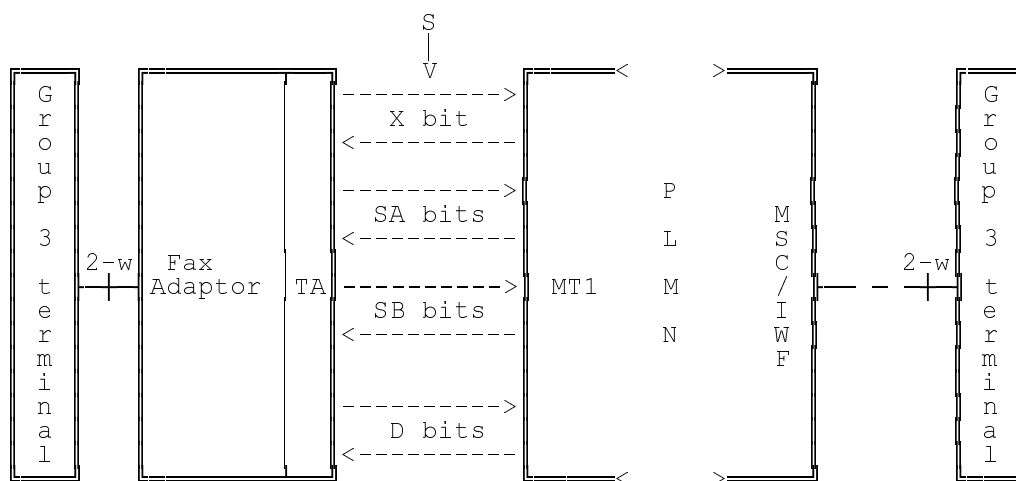

Figure 4b/03.46: Optional Teleservice connection

## 6.1 Protocol model

Figure 5/03.46 depicts the protocol model for this Teleservice, deduced from model 7 of figure 6/GSM 03.10.

It should be noted that depending on the particular implementation the R reference point may not explicitly exist. In this case the LAPB protocol and consequently the LAPB entities operating across this interface may be omitted. The protocol stack at the radio interface, however, is not affected by this consideration, i.e. RLP and L2RBOP always apply.

The main point to be underlined is that all the protocol modules specific for this Teleservice are confined in the fax adaptor functions at both the MT and MSC/IWF ends. This includes the layer 2 entity function for LAPB to be operated towards the standard TAF for synchronous non-transparent bearer capability.

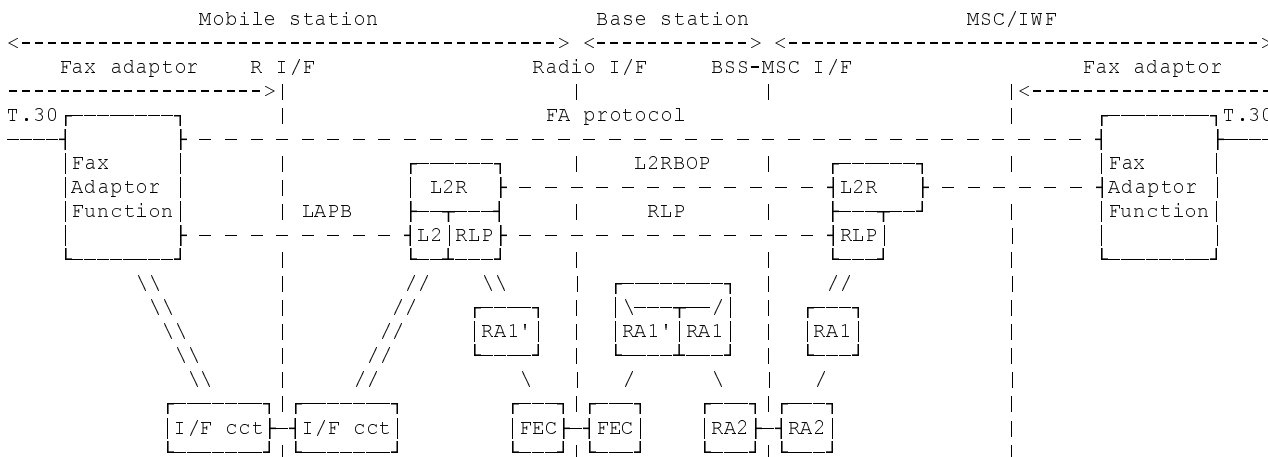

Figure 5/03.46: Protocol model for non-transparent support

## 6.2 Principles of the Facsimile Protocol Adaptation

The basic approach of the present document for facsimile group 3 is:

- to use the standard non-transparent network support (including e.g. standard MT) as basically defined in technical specifications GSM 07.01, GSM 07.03, and GSM 09.07;
- to use the CCITT Recommendation T.30 procedure at both ends of the connection between the fax adaptor and the associated facsimile terminal and to pass the protocol elements according to CCITT Recommendation T.30 functionally unchanged wherever possible;
- to use a specific protocol between both the fax adaptors across the radio interface; and
- to intervene within the fax adaptors in order to concatenate the applicable connection sections.

Basically there are four problem areas:

- support of facsimile group 3 with a digital connection type;
- unpredictable delays on the radio interface due to actual RLP working conditions (ARQ);
- the need to change the transmission rate "locally" in the fax adaptors both in the MS and in the MSC/IWF and to adapt it to the constant user rate of the TAF;
- the inability to support some CCITT Recommendation T.30 features.

To overcome these problems some particular functions within the fax adaptors are necessary, such as:

- buffering of BCS frames and facsimile coded data prior to transfer;
- autonomous interventions such as BCS command inhibiting within the fax adaptors;
- autonomous interactions between any fax adaptor and the associated facsimile terminal such as BCS command/response repetition; and
- provision of a fax adaptor protocol as interchange protocol between the fax adaptors.

Following this strategy, an interchange model is defined concentrating on the facsimile relevant components. According to this model three connection sections can be distinguished:

- a) between fax adaptor and associated facsimile terminal;
- b) between the both fax adaptors and again;
- c) between fax adaptor and associated facsimile terminal.

The fax adaptors fully relying on the standard supporting layers (e.g. TAF) will also have to cater for the correct establishment and control of these layers including traffic channel synchronization and status information exchange in particular with respect to circuit 106 and circuit 109 (according to CCITT Recommendation V.24). Once these circuits have been set to ON (traffic channel synchronization), they must be kept in the ON condition during the entire facsimile phase of a connection (refer subclause 6.3 "Procedure Interrupts").

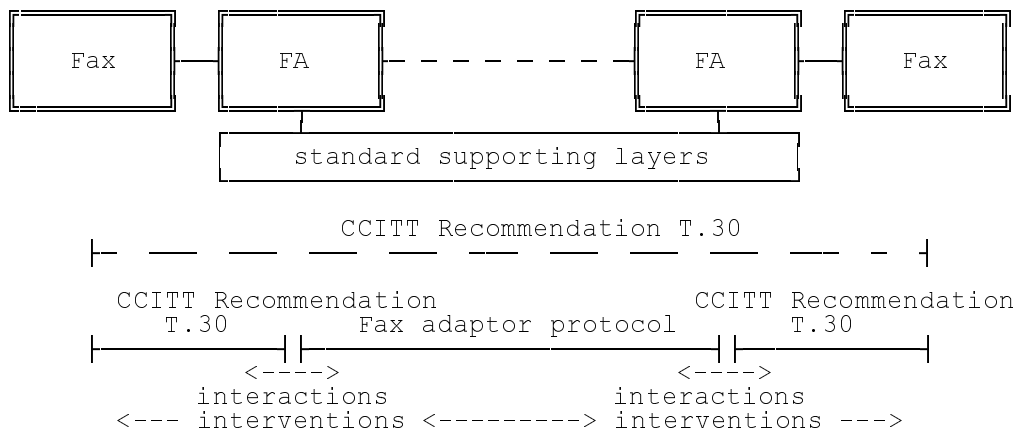

**Figure 6/03.46: Communication model**

### 6.2.1 Fax Adaptor Protocol

To cater for the appropriate facsimile transmission some protocol elements and their use (procedure) are defined. These protocol elements are exchanged between both fax adaptors. They are defined as follows and are structured as outlined in annex A:

- BCS element:

The BCS element is used to relay CCITT Recommendation T.30 BCS frames. It includes the possibility also to transmit parts of an entire BCS frame (segmentation). This will apply when the BCS frame content - excluding the address and control fields of the BCS frame - to be included exceeds a length of 20 octets (e.g. non standardized frames) which otherwise would cause unacceptable delays when relaying the BCS frame as a whole. For that purpose, the BCS frame element carries information on the integrity of a BCS frame element.

To guarantee the overall integrity of the BCS frames each single element includes a sequence number which is set to zero within each first BCS element carrying either a BCS command or BCS response (i.e. triggered by the preamble). It is incremented by one with each successive element belonging to the same BCS command/response transmitted across the radio interface. The counting is carried out independently for each direction of the element transmission. The number of BCS elements which can be transmitted within one sequence (BCS command/response) is limited to 256.

The fax adaptor receiving those elements checks the correct sequence of the numbers and, by this means, is able to detect loss of BCS elements and to act accordingly.

- BCS abort element:

The BCS abort element is used to indicate to the remote fax adaptor that an error occurred during the BCS frame reception and the transmission of the related BCS frame is to be aborted.

- BCS transmit request element:

The BCS transmit request element is used in two ways:

- a) to request initial transmission of a BCS command or response after the preamble element preceding each BCS element sequence carrying such a command/response has been recognized;
- b) to request retransmission of previously transmitted BCS elements in case of an error between both the fax adaptors. This applies e.g. if a sequence error has been recognized. The retransmission starts with the BCS element the number of which is indicated in the transmit request.

- Preamble element:

The preamble element is transmitted once for each received preamble as soon as the preamble has been recognized. It is used to switch on the fax modem and to start transmitting the preamble at the remote side of the radio interface 300 ms after the preamble element reception. The duration of the preamble must be the minimum still permitted by CCITT Recommendation T.30.

- Normal data element:

The normal data element is used to relay buffered facsimile data which have been received and transcoded when not operating in error correction mode.

- Error correction data element:

The error correction data element is used to relay buffered facsimile data frames received when operating in error correcting mode. It contains the entire respective data frame excluding the address and control fields of the frame.

- End of data element:

The end of data element is used to indicate the end of the message transmission. Subsequently, a preamble element is to follow.

- TCF element:

The TCF element TCF\_OK or TCF\_NOK is used to inform the opposite fax adaptor function about the result of the autonomously performed TCF phase.

## 6.2.2 Interactions and interventions within the fax adaptors

Interactions and interventions within the fax adaptors are necessary:

- where protocol elements cannot be passed due to the differences between the PSTN and the GSM system;
- where the content of protocol elements has to be aligned with the capabilities of the supporting GSM PLMN;
- where BCS commands are repeated by the facsimile terminal after a time-out due to transmission delay across the radio interface;
- where BCS commands must be repeated autonomously by the fax adaptor after a time-out when no response has been received from the associated facsimile terminal;
- where the retransmission of BCS commands is requested by the associated facsimile terminal sending a CRP frame due to recognized transmission errors;
- where the retransmission of BCS element(s) is requested by any fax adaptor using the BCS transmit request;
- during the transmission of facsimile coded data where the document content is transcoded to save transmission capacity at the radio interface (however, this does not apply when using the CCITT Recommendation T.30 error correction mode).

To perform the necessary interactions and interventions the fax adaptors both in the MS and in the MSC/IWF have to monitor the BCS frames and the facsimile coded data exchanged between the two facsimile terminals and to act as detailed below:

- reception of CCITT Recommendation T.30 BCS protocol elements from the associated facsimile terminal discarding BCS commands repetitively received due to time-out in the facsimile terminal;
- transmission of CCITT Recommendation T.30 BCS protocol elements to the associated facsimile terminal autonomously repeating BCS commands towards the accepting facsimile terminal if necessary after time-out or on request by CRP;
- control of the half duplex connections between the fax adaptor and the associated facsimile terminal;
- storage of BCS commands/responses completely received from the associated facsimile terminal;

- relay of the CCITT Recommendation T.30 protocol elements between the two facsimile terminals by using the appropriate FA protocol elements and mapping them onto the particular L2R protocol (L2RBOP) elements and vice versa as indicated below;
- changing information elements of the BCS frames indicating capabilities which cannot be supported by the PLMN;
- transmission/reception of the CCITT Recommendation T.30 training check frames (TCF) to/from the associated facsimile terminal;
- phasing/training with the associated facsimile terminal;
- transcoding of the normal facsimile coded data received from the facsimile terminal and writing them into a buffer in the fax adaptor associated with the transmitting facsimile terminal;
- reading of the facsimile coded data from the buffer for transmission across the radio interface using the appropriate FA protocol elements;
- writing of the facsimile coded data received across the radio interface into a buffer at the receiving end of the connection section between MS and MSC/IWF;
- reading and reverse transcoding of the buffered normal facsimile coded data and transmitting them to the associated facsimile terminal;
- control of a response transmission timer, to guarantee the reception of a response right in time (refer to subclause 7.2.1.1).

The algorithm for mapping the CCITT Recommendation T.30 information onto the L2R protocol elements consists of three steps:

- generation of the appropriate FA protocol element including the CCITT Recommendation T.30 protocol element (BCS frames or facsimile coded data);
- generation of a single LAPB I-frame including the FA protocol element in the information field;
- segmentation of a particular LAPB I-frame into L2RBOP PDUs according to GSM 07.03.

To regenerate the original CCITT Recommendation T.30 protocol element the actions must be reversed at the remote fax adaptor.

The support of guard tones by the fax adaptor in the MSC/IWF is an implementation option.

### 6.2.3 Training Check

The training check sequence (TCF) as per CCITT Recommendation T.30 is exchanged only locally between the fax adaptor and the associated facsimile terminal. However, the subsequent exchange of CFR or FTT is, in principle, end-to-end. The training check sequence sent by the fax adaptor must have the minimum duration permitted (ref. to CCITT Recommendation T.30).

As a consequence of this local procedure, the fax adaptors have to check the received TCF whether the quality requirements are satisfied. Depending on the result of that check, the fax adaptor recognizing a bad line will eventually change the CFR to be a FTT, indicating a negative training result and transmits the TCF\_element (TCF\_OK or TCF\_NOK).

With the knowledge of the TCF check result of the opposite fax adaptor function and the received response frame (CFR or FTT) from the fax apparatus, the fax adaptor, which generated the TCF, is able to deduce the following phase.

The message transfer phase in the receiving fax adaptor function is entered upon reception of TCF element TCF\_OK and CFR. The modem training at transmission speed shall start after reception of the first facsimile coded data from the opposite fax adaptor function or autonomously 5.5s after reception of CFR.

In the other cases, the transmitting fax adaptor function shall repeat the last DCS/TCF sequence 3s after reception of the response, if no new DCS frame from the opposite fax adaptor function is available.



Only in case of a mobile to mobile call (refer to subclause 6.2.4/ GSM 03.46) a TCF\_NOK leads to transmission of an invalid TCF.

If no TCF element was received, because of a RLP link reset, until a CFR is received from the fax apparatus, the message phase shall be entered autonomously 5.5s after reception of the CFR or the first facsimile coded data in the receiving adaptation function.

## 6.2.4 Mobile to mobile calls

In this section, an interim solution is described. The final solution depends on the progress in the ITU-T and is expected by the end of 1995.

To get the information about the nature of the call, a GSM specific country code inside the NSF frame is used to identify an inter MSC call.

The GSM country code (refer to CCITT Recommendation T.35) is coded as follows:

bit	8	7	6	5	4	3	2	1
	1	1	0	0	1	1	1	1

In case no NSF has to be transmitted, the IWF shall insert a special NSF frame defined as follows:

```

FCF  FIF
|  |
NSF, GSM country code, stuff byte (0)
    
```

After reception of an NSF frame in the IWF with a GSM country code, the IWF shall enter a specific inter MSC procedure with the following interventions:

- Insertion of NSC respectively NSS with the above mentioned coding before sending of (CIG)DTC or (TSI)DCS.
- Discarding of received NSC and NSS frames which are generated by the opposite IWF.
- The transmission of TCF sequence is triggered by the reception of the TCF Discriminator. In case of TCF\_NOK, an invalid TCF is transmitted to the opposite IWF.
- To save time and to check also the quality of link between the two MSCs, a BCS frame FTT is generated by the IWF and sent to the opposite IWF after reception of an invalid TCF.  
In this case the response CFR or FTT from the mobile side shall not be transferred to the other MSC. If an IWF receives an FTT from the opposite IWF the preceding DCS frame should not be automatically repeated after expiration of the command/response timer (T=3s, refer to CCITT Recommendation T.30).
- The response time supervision (Ts=1.6s, refer to subclause 7.2.1.1) within the IWFs is inactive, that means, a response shall be accepted as a valid frame by the receiving IWF when the BCS carrier is detected within 3s after transmission of the previous command.
- The message transfer phase is only entered after reception of the first facsimile coded data from the radio link.
- The facsimile coded data shall be transferred between the IWFs with minimum scan line transmission time equal to 0 ms (refer to CCITT Recommendation T.4).

## 6.2.5 Facsimile Message Transfer

### 6.2.5.1 Message Transcoding

To save transmission capacity at the radio interface the content of the document shall be transcoded. This applies only, when using the normal facsimile data transfer, i.e. not with the error correction mode.

The facsimile coded data received by the fax adaptor from the facsimile terminal is transcoded and transmitted to the corresponding fax adaptor across the radio interface, where it is transcoded in the reverse direction and transmitted to the receiving facsimile terminal.

The transcoding is based on the minimum line length capability of the T.30 protocol for the normal facsimile data transfer. According to this the transmitting facsimile terminal has to fill up each coded scan line with FILL information to conform to this requirement (ref. CCITT Recommendation T.4).

To take advantage from that, the fax adaptor associated with the transmitting facsimile terminal will force this to use (at least) the standard value of 20 ms by replacing the applicable parameter value of the exchanged DIS/DTC messages. All FILL information of the facsimile coded data received from the facsimile terminal will be deleted prior to forwarding the data across the radio interface. The fax adaptor associated with the receiving facsimile terminal must recognize and store the originally requested minimum line length to be able to regenerate to correct line length.

It should be noted that the CCITT Recommendation T.4 document coding may be 1-dimensional or 2-dimensional and, in addition, uncompressed. The fax adaptors have to take care of this when transcoding the document content.

### 6.2.5.2 Generation of the normal data element

The normal facsimile coded data which have been transcoded and buffered as described in the present document is segmented for transmission across the radio interface into blocks of max. 936 bits (afterwards constituting a sequence of max. 5 L2RBOP PDUs). Each such block is contained in the information field of a normal data element of the FA protocol (see annex A).

The facsimile message transfer is finalized by a trailing end of data element which allows the transmitting fax adaptor to switch off the message speed modem.

It may be necessary to align the content of the normal data element to octet boundary at the end of the facsimile message transmission, i.e. after the RTC. This is done by appending '0's to the RTC. This fill information may be omitted by the remote fax adaptor.

### 6.2.5.3 Generation of the error correction data element

The content of a FCD frame, if received correctly, is stored by the fax adaptor. Each such block is contained in the information field of a error correction data element of the FA protocol (see annex A).

The facsimile message transfer is finalized by a trailing end of data element which allows the transmitting fax adaptor to switch off the message speed modem.

## 6.3 Procedure interrupts

Procedure interrupts are only supported in Teleservices 61; in case of Teleservice 62 any attempt to invoke procedure interrupts by MMI on the MT (see subclause 6.4 below) will have no effect.

## 6.4 Radio channel modification

This applies to Teleservice 61 only, if a change of the radio channel during the call swapping from speech to facsimile or vice versa is required. For this purpose the in-call modification procedure (ICM) as detailed in GSM 04.08 is carried out.

The change from speech to facsimile is initiated by MMI at the MS as in other data services starting the ICM procedure via MODIFY signalling. As a basic requirement for this transition, circuit 108.2 (according to CCITT Recommendation V.24) towards the MT must be in the ON condition.

Additionally the data call direction (DCD) must be known to both the FAs because of a correct tone handling. The DCD identifies the call direction from the calling to the called station according to CCITT Recommendation T.30 phase A tonal signals. The DCD is derived from the evaluation of the behaviour of the mobile fax machine. No later than 3 sec after connecting the fax apparatus to the line the FA/MT is able to determine the DCD. If a CNG tone or nothing is detected by the FA/MT the mobile fax station is the calling station, if a CED tone or a BCS signal is detected by the FA/MT the mobile fax station is the called station. The FA/MT indicates this towards the MT by means of CT105: CT105 in OFF condition indicates "mobile terminated", whereas CT105 ON indicates "mobile originated". The detection of the CT105 condition and subsequent triggering of the MODIFY message has to be done 3 sec after the reception of the ON condition of CT108.2.

A reverse DCD compared with the initial call setup direction is indicated to the FA/IWF by means of the "Reverse Call Setup Direction (RCSD)" IE within the MODIFY message. If the MODIFY message has contained this IE, the same IE shall be included in the MODIFY COMPLETE (ACK) message. On the basis of RCSD and additional information about the initial call setup direction (e.g. transaction identifier flag - ref. 04.07), the FA/IWF shall resolve the actual DCD.

At DCD condition "mobile originated" the FA/IWF has to transmit a CNG tone if neither CED nor a BCS signal has been already received, otherwise nothing. At DCD condition "mobile terminated" the FA/IWF has to transmit a CED. At the moment when CT107 goes to ON condition the FA/MT has to generate CED if CT105 was in ON condition, otherwise nothing (see subclauses 8.2.1.1 and 8.2.2.1).

If during the facsimile call the return to speech is necessary (T.30 procedure interrupt request), this must be initiated by the mobile fax machine as well as by the fixed network fax machine (ref. to the diagrams in figure II.14/15). Upon receipt of the alert operator tone the request will be accepted by manual intervention via MT (phone off-hook) and is reflected to the FA by CT106 and CT109 going to OFF condition. Upon monitoring the transit of the necessary sequence of BCS signals specific for PRI the CT108.2 goes to OFF condition causing ICM from the fax data phase to the speech phase.

In case of procedure interrupt request from the PSTN side a guard timer is necessary to protect against the possible loss of the response to the PRI-Q(PIN/PIP) sent by the MS. After the execution of ICM (MODIFY message), CT107 is set to OFF condition finishing the fax data phase. Subsequent re-selection of the data phase will be done by manual intervention via the MS causing CT108.2 going to ON condition initiating ICM.

During the speech phase of a procedure interrupt, the phone off-hook condition of the MT is reported via the FA R-I/F (CT106/109 in OFF condition) to the fax apparatus which must remain functionally connected to the FA to maintain the connection.

A subsequent reverse change to facsimile phase is also carried out by manual intervention at the MT causing ICM. This will be immediately reflected by circuit 107 going to OFF condition. The successful completion of ICM is indicated towards the fax adaptor by circuit 107 going to ON (provided circuit 108/2 is still in the ON condition).

During the speech phase of a procedure interrupt, the condition of the facsimile terminal of the MS is not reported across the CCITT Recommendation V.24 interface. It may remain functionally connected to the fax adaptor, but in a suspended state.

The precise operation of the fax adaptor for the support of procedure interrupt is implementation dependent.

## 6.5 Performance constraints

In order to perform the procedures described in the present document the MS and the IWF environment should be designed to be able to transmit and receive facsimile data continuously without any need to flow control the procedure by themselves. This applies specifically for the RLP, L2R, and the LAPB entities within the MT or the IWF, respectively, as well as for the fax adaptor itself.

Furthermore, the RLP entity should be able to make error recovery by using the SREJ command/response. The parameters (timers, repetition counters, etc.) should be set to appropriate values using the negotiation capability of the RLP.

The appropriate setting of parameter values applies also for the LAPB procedure.

In addition it is strongly recommended to operate at an user access rate of 9 600 bit/s, even if the facsimile terminal(s) are not able to work with 9 600 bit/s message speed.

---

## 7 Use of terminal adaptation functions

According to the protocol model of the connection types (figure 5/03.46) there are two classes of TAFs to be considered.

### 7.1 Standard TAFs for synchronous services

The TAFs are those described in GSM 07.03 for synchronous bearer capabilities in the non-transparent mode, i.e. presently for LAPB only. The rate adaptation functions shall comply with GSM 04.21. The interchange signalling mapping is in accordance with GSM 07.03.

### 7.2 Specific TAFs for facsimile service

Integral part of an end-to-end connection for this Teleservice is the fax adaptor function, located at both the PLMN ends and in charge of:

- establishment and maintenance of a LAPB link between the fax adaptation function and the standard synchronous terminal adaptation function according to GSM 07.03, where applicable;
- establishment and maintenance of an L2RBOP link between the fax adaptors in the MS and in the MSC/IWF according to GSM 07.03;
- transcoding of the document content to be transmitted across the radio interface as described in clause 6 of the present document;
- adaptation of the CCITT Recommendation T.30 protocol procedures to the GSM PLMN environment and generation of the fax adaptor protocol elements as described in clause 6 of the present document.

The main features relevant to the CCITT Recommendation T.30 adaptation functions are detailed in the following.

For better clarification only, in the following a double configuration will be referenced:

- transmitter adaptation function, established at the PLMN side where the terminal is located actually performing document transmission;
- receiver adaptation function, established at the PLMN side where the terminal is located actually receiving the facsimile document.

The proper configuration is settled on both network sides by detecting DIS/DTC frame just at the beginning of the phase B in the CCITT Recommendation T.30 protocol procedure.

The optional error correction mode, as defined in CCITT Recommendation T.4-Annex A and CCITT Recommendation T.30-Annex A may be fully supported, provided some specific features are included in the fax adaptor procedure.

These features are relevant to:

- additional BCS frames to be detected;
- handling of the message phase.

The overall framework as described in clause 6 of the present document applies, i.e. also the procedures of the error correction mode are, in principle, run end-to-end between the two facsimile terminals.

The error correction mode is entered upon detection of the relevant bits in the DIS/DTC frame.

The working principle of the present document is based on the detection, control, deletion, and generation of key messages in the end-to-end dialogue between the facsimile terminals.

While in BCS phases, the following frames have to be detected:

- DIS/DTC, to monitor all operational parameters of the transmitting terminal;
- DCS, to realize the actual operational parameters, e.g. message transmission speed accepted by the sender terminal and the relevant message transfer direction (see table 2/CCITT Recommendation T.30);
- CFR and MCF, to trigger the message phase;
- CTC/EOR, fixing the retransmission strategy by the facsimile transmitting terminal (error correction mode);
- CTR/ERR, acting as confirmation message and so closing a BCS phase before a new message phase;
- PPR, as above, but after the fourth consecutive PPR request, the BCS phase continues with either CTC or EOR (error correction mode);
- DCN, to initiate the call release procedure.

Furthermore, all BCS command messages have to be monitored to eliminate repeated command messages at the local fax adaptation function and to initiate a repetition of those command messages, if necessary, at the remote fax adaptation function. Additionally, all BCS response messages have to be monitored to be able to clear the former condition.

## 7.2.1 BCS phase

### 7.2.1.1 BCS command/response procedures

The CCITT Recommendation T.30 procedure is segmented in sections of associated BCS commands and responses. Any command sent by a facsimile terminal must be answered by an appropriate BCS response (refer to Appendix III, CCITT Recommendation T.30). To guarantee that transmission and reception of responses take place right in time, a response transmission (including preamble) shall never be started by the fax adaptor function associated with the command sending terminal later than  $T_s$  (response time supervision = 1.6s) after reception of previous command. According to the command/response relationship, the fax adaptor receiving a BCS command from its associated facsimile terminal is further on designated as commanding fax adaptor. Similarly, the fax adaptor receiving a BCS response is called the responding fax adaptor. The procedure is as follows:

Prior to receiving any BCS command/response the preceding preamble is recognized and the "preamble element" is transmitted to the remote fax adaptor. There it is used to start transmission of the preamble towards the associated facsimile terminal with a delay of 300 ms. The preamble preceding a BCS response must be sent with minimum duration permitted (ref. to CCITT Recommendation T.30). If necessary, a preamble must be "aborted" and restarted after an appropriate period as indicated in CCITT Recommendation T.30.

In addition, the recognition of the "preamble element" is immediately confirmed to the other fax adaptor by sending a "BCS transmit request element" (with sequence number set to zero). As this confines a synchronization point, no further protocol transaction can take place except exchanging another "preamble element" until the "BCS transmit request element" has been recognized by the related fax adaptor.

The commanding fax adaptor when receiving the initial "BCS transmit request element" as confirmation to the "preamble element" (condition 1), starts forwarding the received BCS command using "BCS elements" and applying segmentation, if necessary (ref. to subclause 6.2.1). A BCS command which has been received correctly from the associated facsimile terminal (condition 2), is stored within the commanding fax adaptor. If both conditions 1 and 2 apply, any forwarding of BCS commands repetitively received from the facsimile terminal is further on inhibited. Any "BCS transmit request element" received from the responding fax adaptor is answered accordingly, i.e. by the requested BCS element(s), if any. If an error occurs during the reception of the BCS command from the associated facsimile terminal, the commanding fax adaptor transmits a "BCS abort element" towards the responding fax adaptor and regards the whole BCS command as not received. Any "BCS transmit request element" is ignored at this stage. The inhibit status is cleared when either an appropriate BCS response is received and forwarded to the facsimile terminal or the connection is released.

The responding fax adaptor receiving "BCS elements" checks their correct sequence (refer to subclause 6.2.1) and starts reassembling and transmitting the BCS command once either a complete BCS frame or at least the second element of a segmented BCS frame is received from the commanding fax adaptor and no sequence error has been detected. Any "BCS element" received after successful reception of a complete BCS command is ignored. If a BCS command consists of a sequence of BCS frames preceded by a single preamble each BCS frame is forwarded separately across the radio interface. The sequence has to be reconstituted at the responding fax adaptor when sending to the associated facsimile terminal. If necessary, flags are transmitted between the BCS frames.

If during a transmission any required subsequent element is not available, the responding fax adaptor aborts the BCS command transmission to the facsimile terminal, and the rest of the BCS command is not transmitted. The same applies, if due to residual errors on the radio interface (e.g. RLP link reset) "BCS elements" are missing which can be detected by a wrong sequence number. In these cases, any "BCS element" following the error event (e.g. with a number out of sequence) is ignored. The responding fax adaptor may therefore need to use a "BCS transmit request element" in order to ask for (re)transmission of outstanding elements, if any.

If a "BCS abort element" has been received by the responding fax adaptor and the transmission is aborted due to this fact, the complete BCS command including the preceding "preamble element" will be retransmitted autonomously by the commanding fax adaptor.

Contiguously received parts of a BCS command received from the radio interface are stored in the responding fax adaptor. The stored BCS command when completed, is used for autonomous retransmissions towards the associated facsimile terminal which may start at the earliest possible time according to CCITT Recommendation T.30. No repetition counter is provided.

The responding fax adaptor when receiving the initial "BCS transmit request element" as confirmation to the "preamble element" (condition 1), starts forwarding the received BCS response using "BCS elements" and applying segmentation, if necessary (ref. subclause 6.2.1). A BCS response which has been received correctly from the associated facsimile terminal (condition 2), is stored within the responding fax adaptor. Any "BCS transmit request element" received from the commanding fax adaptor is answered accordingly, i.e. by the requested BCS element(s), if any.

If an error occurs during the reception of the BCS response from the associated facsimile terminal, the responding fax adaptor transmits a "BCS abort element" towards the commanding fax adaptor and regards the whole BCS response as not received. Any "BCS transmit request element" is ignored at this stage. The autonomous command repeat status is cleared when both conditions 1 and 2 apply.

The commanding fax adaptor receiving "BCS elements" checks their correct sequence (refer to subclause 6.2.1) and starts reassembling and transmitting the BCS response once either a complete BCS frame or at least the second element of a segmented BCS frame is received from the responding fax adaptor and no sequence error has been detected. Any "BCS element" received after successful reception of a complete BCS response is ignored. If a BCS response consists of a sequence of BCS frames preceded by a single preamble each BCS frame is forwarded separately across the radio interface. The sequence has to be reconstituted at the commanding fax adaptor when sending to the associated facsimile terminal. If necessary, flags are transmitted between the BCS frames.

If during a transmission any required subsequent element is not available, the commanding fax adaptor aborts the BCS frame transmission to the facsimile terminal, and the rest of the BCS frame is not transmitted. The same applies, if due to residual errors on the radio interface (e.g. RLP link reset) "BCS elements" are missing which can be detected by a wrong sequence number. In these cases, any "BCS element" following the error event (e.g. with a number out of sequence) is ignored. The commanding fax adaptor may therefore need to use a "BCS transmit request element" in order to ask for (re)transmission of outstanding elements, if any.

If a "BCS abort element" has been received by the commanding fax adaptor and the transmission is aborted due to this fact, the complete BCS response including the preceding "preamble element" will be retransmitted autonomously by the responding fax adaptor.

Contiguously received parts of a BCS response received from the radio interface are stored in the commanding fax adaptor. The stored BCS response when completed, is used for autonomous answering towards the associated facsimile terminal which may start at the earliest possible time according to CCITT Recommendation T.30.

After transmission of a response towards the fax apparatus by the fax adaptor function, after which the fax adaptor function waits for message data (CFR, CTR, MCF after MPS, PPS\_MPS, PPS\_NULL, ERR after EOR\_MPS, EOR\_NULL) a repeated BCS command shall be locally responded, without transferring a preamble element towards the radio link.

The fax adaptors have to take care of the control of the local modem. The condition is derived from the reception of certain fax adaptor protocol elements. Additionally, there must be a control of the half duplex transmission path towards the associated facsimile terminal. For that purpose, the receiver signal is monitored and the transmitter is only activated, if no receive signal is active.

### 7.2.1.2 Compatibility checking

Some features cannot be supported in the GSM PLMN environment. The fax adaptor function is in charge of dealing with such compatibility checking which is carried out by monitoring certain BCS frames (DIS/DTC).

- Group 1 and group 2 equipments are not supported by the Teleservice as described in the present document.
- Error limiting mode cannot be supported.
- Only standard 300 bit/s Binary Coded Signalling is supported. To this purpose the fax adaptor will ignore the 2400 bit/s capability within the phase B of the CCITT Recommendation T.30 procedure by looking for DIS frames from CCITT Recommendation V.21 modem only.
- Only facsimile message speeds up to and including 9 600 bit/s are supported. For this purpose the fax adaptors are responsible to carry out appropriate actions, e.g. to set the applicable fields in the DIS frame accordingly.
- It is not possible to support non-standard facilities since some of these contain proprietary methods of changing the modem speed, invisible to the IWF and hence impossible to track. If an NSF frame occurs, the country code has to be exchanged in the IWF to the GSM specific country code, which is not supported by a standard fax group 3 apparatus and therefore no private procedure is entered (refer to subclause 6.2.4). However, non-standard BCS frames may carry information which does not affect the correct operation within the PLMN, but is essential for the user (e.g. passwords). Those elements, if any, will be passed end-to-end by the fax adaptors unless an explicit deletion is required by the user (e.g. by specific input at the fax adaptor associated with the mobile station).

### 7.2.1.3 Message speed checking

Although it is strongly recommended to use the maximum user rate of the MT2 (9 600 bit/s), a particular user may signal a lower user rate. In this case the fax adaptors have to carry out the following additional procedures:

- max speed indicated in the call set-up message is 4 800 bit/s:
  - if the fax adaptor receives a DIS or DTC indicating CCITT Recommendation V.29 only, the call shall be released;
  - if CCITT Recommendation V.29 and V.27ter is indicated, this shall be changed to V.27ter;
  - if other values are indicated, no action has to be taken;
- max speed indicated in the call set-up message is 2 400 bit/s:
  - if the fax adaptor receives a DIS or DTC indicating CCITT Recommendation V.29 only, the call shall be released;
  - if CCITT Recommendation V.29 and V.27ter or V.27ter only is indicated, this shall be changed to V.27ter fallback;
  - if CCITT Recommendation V.27ter fallback is indicated, no action shall be taken.

### 7.2.1.4 Control of transmission rate

The controlling entity of the fax adaptor recognizes when a change of the transmission rate - and in conjunction with this a change of the modem function - has to commence. The transmission rate is then changed only locally, i.e. between the facsimile terminal and the fax adaptor at both the MSC/IWF and the MS ends.

The actual message speed and the modem function are derived from the content of the related BCS frames (DIS/DTC, DCS, CTC).

### 7.2.1.5 Clocking

The fax adaptor or the GSM facsimile machine will acquire received data bit timing on circuit 115 (according to CCITT Recommendation V.24). The transmitter element timing circuit 114 shall be synchronized to circuit 115.

The clock rate at the CCITT Recommendation V.24 interface will reflect the user rate of the MT2 as indicated in the set-up message.

## 7.2.2 Message phase

During the message phase (phase C of CCITT Recommendation T.30) a single bit pattern has to be detected, the EOL character (see subclause 4.1.2/CCITT Recommendation T.4), a unique code word that can never be found within a valid line of facsimile coded data, and is used, as per CCITT Recommendation T.4:

- to identify the start of message phase;
- to control the buffer level;
- to mark the end of message phase (6 consecutive instances).

### 7.2.2.1 Normal facsimile data

The message phase (see figure II.6/GSM 03.46 and II.7/GSM 03.46, respectively) at both the PLMN ends is triggered by the transit of a frame (either the CFR or the MCF) sent by the receiving terminal to confirm a previous frame from the transmitting terminal, and marking the end of a BCS phase.

The terminal adaptation function associated with the receiving terminal after receiving facsimile coded data or autonomously 5.5s after detecting the trigger frame (CFR or MCF) will change the modem function to V.27ter or V.29 CCITT Recommendation and initiate the training at the applicable speed.

Following the training segment, 0s bits will be stuffed towards the facsimile terminal (FILL sequence, see subclause 4.1.2 of CCITT Recommendation T.4), disregarding all information received from the radio interface, until a EOL character is detected, that will mark the beginning of the real phase C (see figure 1/CCITT Recommendation T.4).

If due to a preceding error the message phase cannot be entered, this training must be aborted when a new BCS element is received by the transmitting fax adaptor.

### 7.2.2.2 Error correction facsimile data

As these facsimile coded data between the fax adaptor and the facsimile terminal are structured in HDLC frames, the handling of this procedure segment will exploit such formatting. The content of such an HDLC frame is further on called a block.

Each such block is included in the information field of a error correction data element of the FA protocol which is processed for transmission across the radio interface as outlined in clause 6.

The message phase (see figure II.8/GSM 03.46) at both the PLMN ends is triggered by the transit of a confirmation frame (CFR, MCF, PPR, CTR or ERR) sent by the receiving terminal and marking the end of the BCS phase.

If four consecutive PPR are counted within the same "partial page", the BCS phase continues.

The transmitter adaptation function will enter the message phase as per CCITT Recommendation T.30 standard procedure.

The terminal adaptation function associated with the receiving terminal after receiving facsimile coded data or autonomously 5.5s after detecting the trigger frame will change the modem function to V.27ter or V.29 CCITT Recommendation and initiate the training at the applicable speed.

Following the training segment, HDLC flags will be stuffed towards the facsimile terminal until a FCD frame is detected, that will mark the beginning of the real phase C.

If due to a preceding error the message phase cannot be entered, this training must be aborted when a new BCS element is received by the transmitting fax adaptor.



### 7.2.2.3 Buffering of facsimile coded data

The following subclauses only apply, when using the normal facsimile data transfer, i.e. not with the error correction mode.

#### 7.2.2.3.1 Transmitter adaptation function

In the transmitter adaptation function the facsimile coded data being received from the facsimile terminal are transcoded stripping of FILL information and written into the buffer.

If there is enough information available, this data is read out from the buffer, and a FA protocol element is generated which is processed as described in clause 6 to be transferred to the receiver adaptation function using one of the standard TAFs referred to in subclause 7.1. For that purpose the data is segmented in blocks (see subclause 6.2.5.2).

Due to the ARQ techniques of the RLP the throughput across the radio interface may be less than the message speed between the transmitting facsimile terminal and the transmitter adaptation function, i.e. the content of the buffer may increase. When a certain threshold is reached from which the fax adaptor can derive that the actual page cannot be transmitted successfully, the connection may be prematurely released.

If the throughput at the radio interface is greater than the message speed between the transmitting facsimile terminal and the transmitter adaptation function (e.g. when the end-to-end speed is lower than 9 600 bit/s), the buffer may be empty most of the time.

#### 7.2.2.3.2 Receiver adaptation function

In the receiver adaptation function FILL information is transmitted to the facsimile terminal at the beginning of each page, if necessary, to bridge the gap between the training sequence and the real facsimile coded data. In case of normal fax data the FILL 0's can be expanded up to 5s only and therefore after these up to two white scan lines should be inserted, if necessary.

The facsimile coded data received across the radio interface are re-generated from the LAPB, L2R and FA protocol elements, reversely transcoded according to the knowledge of the fax adaptor, and written into the buffer. The reverse transcoding consists of insertion of FILL information before the facsimile coded data is forwarded to the facsimile terminal to comply with the recognized minimum line length as defined in CCITT Recommendation T.4.

At the beginning of each page the facsimile coded data to be sent to the facsimile terminal is not read out from the buffer until at least 2 instances of EOL or an RTC have been received or the following buffer size limit, depending on the end to end data transfer rate, has been exceeded:

2 kByte for 2,400 bit/s;

4 kByte for 4,800 bit/s;

6 kByte for 7,200 bit/s;

8 kByte for 9,600 bit/s.

Once this procedure has been started, i.e. during the page transmission, the facsimile coded data is transmitted, however, the following EOL is delayed by inserting additional FILL information, if necessary, until the pre-set threshold (2 EOLs or the buffer size limit) is reached again. If the actual coding line is going to exceed 5 s, the threshold is temporarily reduced, i.e. the following EOL is sent. However, the buffering algorithm shall try to reach the pre-set threshold again as fast as possible (by inserting FILL also before following EOLs). If no EOL is available to be transmitted to the facsimile terminal for a period greater than 5 s, the connection will be released by an ordinary receiving facsimile terminal (ref. CCITT Recommendation T.4).

### 7.2.3 Disconnect procedure

The transmitter adaptation function, upon detection of the DCN frame (see CCITT Recommendation T.30) sent by the local terminal to indicate the end of the facsimile transmission, initiates the disconnect procedure.

## 7.2.4 Timeouts

The overall fax adaptation function is in principle bound to the timing constraints associated with the end-to-end CCITT Recommendation T.30 procedure. This means that, no matter of the reference configuration used at the mobile station, either the "standard" one (figure 2a/GSM 03.46) or the "GSM facsimile machine" (figure 2d/GSM 03.46), the progress of the call will be mainly subject to the CCITT Recommendation T.30 typical timing protections, settled externally.

However, due to the specific conditions caused by the GSM PLMN system, there is the need for a special support with respect to BCS command repetitions as explained above. For that purpose, the fax adaptors will provide means for local time-out. The timer will be started and stopped as described in the applicable clauses of the CCITT Recommendation T.30.

---

# 8 Signalling aspects

GSM 07.03 identifies the bearer capability requirements to be supported by the terminal adaptation function in the MT (see GSM 07.01 for BC and HLC coding). The specific signalling requirements are those for "speech" and "facsimile group 3" or "facsimile group 3" only, respectively. The MT indicates in the call set up request the requirements, e.g. first speech, second facsimile by sending the bearer capability information element(s) in the appropriate order. For an "auto calling" facsimile request, the facsimile group 3 bearer capability is sent as the first or the only bearer capability for Teleservice 61 or 62, respectively.

For interworking between Teleservice 61 and Teleservice 62 refer to GSM 02.03 and 07.01.

## 8.1 Handling of tonal signals

Because the CCITT defined service uses modems, there are some signals received from the analogue link at the MSC/IWF and (where used) the fax adaptor which do not have a direct binary representation. These signals cannot therefore be passed across the radio interface in the same way as the CCITT Recommendation T.30 and CCITT Recommendation T.4 information.

These signals are the modem called (CED) and calling (CNG) tones sent at the start of each fax data phase of the call; they are generated locally by the FA/MT and/or FA/IWF, exploiting an end-to-end time alignment mechanism, triggered by appropriate messages on the GSM signalling channel. The procedure is detailed in the following.

## 8.2 Call establishment

### 8.2.1 Mobile terminated call

The PSTN facsimile group 3 terminal may be manually or automatically calling.

#### 8.2.1.1 Speech then facsimile

Refer to the diagram in figure II.1a/03.46 and II.1b/03.46. In both of the figures the initial call setup is mobile terminated. In figure I.1a/03.46 the DCD is also mobile terminated (MT), while the DCD in figure I.1b/03.46 is mobile originated (MO).

In order to make the transition from the speech phase to the facsimile phase, the MODIFY command must be initiated by MMI at the MS.

In the case where a GSM facsimile machine is used, it will turn on circuit 108/2 when it is connected to the line by manual intervention.

In the case where a fax adaptor at MT is used, it will turn on circuit 108/2, when the mobile fax apparatus is connected to the line by manual intervention.

After determination of the DCD and ICM (see subclause 6.4) and on completion of the synchronization process over the radio interface or the RLP establishment, CT107 shall be turned on by the MT; in case where a FA is used, on receipt of CT107 from MT, the FA will complete the tonal handshaking according to the rules in subclause 6.4.

The analogue link at the FA/IWF side will be established in accordance with the T.30 rec.; provided the synchronization process is completed (CT108.2 ON condition), the appropriate tone according to the rules in subclause 6.4 shall be transmitted. In case of DCD mobile terminated the CED tone shall be transmitted after a silence of 1.8 to 2.5 sec (see T.30, 4.3.3.2) from the call being answered; during transmission of CED tone (2.6 sec minimum duration, followed by a delay period of 75 +/- 20 ms) the FA/IWF will process data received from the GSM-TCH as usual, but relevant information (e.g. preamble of a BCS frame) shall be discarded without any buffering. Note that circuit 109 and circuit 106 (according CCITT Recommendation V.24) at the R interface of the MT must be turned on by the fax adaptor at the IWF before any further procedure can be carried out between the fax adaptors and consequently end-to-end. Once the connection is established, both circuit 106 and circuit 109 are clamped to the ON condition by the fax adaptor at the IWF, so fixing a full duplex mode throughout the whole facsimile phase of the call.

### 8.2.1.2 Auto answer

Refer to diagram in figure II.2/GSM 03.46. A call received from the PSTN will cause the MT to turn on circuit 125 (according to CCITT Recommendation V.24) at the R interface.

In the case where a GSM facsimile machine is used, CCITT Recommendation V.25bis auto answering process is handled directly by turning on circuit 108/2.

In the case where a fax adaptor is used, circuit 125 will cause ring current to be sent to the mobile facsimile terminal. The fax adaptor will turn on circuit 108/2, when the mobile facsimile terminal answers the call.

On receipt of circuit 108/2, the MT will answer the call and initiate the synchronization process and the establishment of the RLP across the radio interface. On completion of the synchronization process or RLP establishment, the modem at IWF will automatically be selected and send CED to PSTN facsimile terminal. Also circuit 107 shall be turned on by the MT.

In the case where a fax adaptor is used, on receipt of circuit 107 from MT, the fax adaptor will initiate the tonal hand-shake by sending CNG (mandatory).

The analogue links at both the PSTN side and the mobile side (where a fax adaptor is used) will be established in accordance with the appropriate V. series recommendation.

Note that circuit 109 and circuit 106 at the R interface of the MT must be turned on by the fax adaptor at the IWF before any further procedure can be carried out between the fax adaptors and consequently end-to-end. Once the connection is established, both circuit 106 and circuit 109 are clamped to the ON condition by the fax adaptor at the IWF, so fixing a full duplex mode throughout the whole facsimile phase of the call.

## 8.2.2 Mobile originated calls

The PSTN facsimile group 3 terminal may be manually or automatically answered.

### 8.2.2.1 Speech then facsimile

Refer to the diagram in figure II.3a/03.46 and figure II.3b/03.46. In both of the figures the initial call setup is mobile terminated. In figure II.3a/03.46 the DCD is also MO, while in figure II.3b/03.46 the DCD is MT.

In order to make the transition from the speech phase to the facsimile phase, the MODIFY command must be initiated by MMI at the MS, which will result in an establishment of the RLP across the radio interface and connection to line of the FA/IWF.

In the case where a fax adaptor is used, the mobile facsimile terminal must be connected to line by manual intervention at this stage, and will cause the fax adaptor to turn on circuit 108/2 (according to CCITT Recommendation V.24) towards the MT.

In the case where a GSM facsimile machine is used, circuit 108/2 shall be turned on when the GSM facsimile machine is connected to line by manual intervention.

After determination of the DCD and ICM (see subclause 6.4) and on completion of the synchronization process across the radio interface or the establishment of RLP, the modem at the IWF will be automatically selected and send the appropriate modem tone according to the rules in subclause 6.4 to PSTN facsimile terminal. Also circuit 107 shall be turned on by the MT, whereupon the FA/MT will complete the tonal handshaking according to the rules in subclause 6.4.

In the case where a fax adaptor is used, the receipt of circuit 107 shall cause the fax adaptor to connect to line.

The analogue links at both the PSTN side and the mobile side (where a fax adaptor is used) will be established in accordance with the appropriate CCITT V. series recommendation.

Note that circuit 109 and circuit 106 at the R interface of the MT must be turned on by the fax adaptor at the IWF before any further procedure can be carried out between the fax adaptors and consequently end-to-end. Once the connection is established, both circuit 106 and circuit 109 are clamped to the ON condition by the fax adaptor at the IWF, so fixing a full duplex mode throughout the whole facsimile phase of the call.

### 8.2.2.2 Auto calling

Refer to diagram in figure II.4/GSM 03.46. The auto calling procedure of CCITT Recommendation V.25bis is initiated at the CCITT Recommendation V.24 interface. This is done either directly from the GSM facsimile machine or, in the case where a fax adaptor is used, by loop disconnect or DTMF dialling information between the mobile facsimile terminal and the fax adaptor.

When the call is answered, the synchronization process will be started and the RLP will be established across the radio interface.

On completion of the synchronization process across the radio interface or RLP establishment, the modem at the IWF will be automatically selected and send CNG (mandatory) to PSTN facsimile terminal. Also CT107 shall be turned on by the MT.

In the case where a fax adaptor is used, the receipt of circuit 107 shall cause the fax adaptor to connect to line.

The analogue links at both the PSTN side and the mobile side (where a fax adaptor is used) will be established in accordance with the appropriate V. series recommendation.

Note that circuit 109 and circuit 106 (according to CCITT Recommendation V.24) at the R interface of the MT must be turned on by the fax adaptor at the IWF before any further procedure can be carried out between the fax adaptors and consequently end-to-end. Once the connection is established, both circuit 106 and circuit 109 are clamped to the ON condition by the fax adaptor at the IWF, so fixing a full duplex mode throughout the whole facsimile phase of the call.

### 8.2.2.3 Manual calling

Refer to diagram in figure II.5/GSM 03.46. When the call is answered, the RLP will be established across the radio interface providing circuit 108/2 in ON condition.

In the case where a fax adaptor is used, the mobile facsimile terminal must be connected to line by manual intervention at this stage, and will cause the fax adaptor to turn on circuit 108/2 (according to CCITT Recommendation V.24) towards the MT.

In the case where a GSM facsimile machine is used, circuit 108/2 shall be turned on when the GSM facsimile machine is connected to line by manual intervention.

On completion of the synchronization process across the radio interface or RLP establishment, the modem at the IWF will be automatically selected and send CNG (mandatory) to PSTN facsimile terminal. Also circuit 107 shall be turned on by the MT.

In the case where a fax adaptor is used, the receipt of circuit 107 shall cause the fax adaptor to connect to line.

The analogue links at both the PSTN side and the mobile side (where a fax adaptor is used) will be established in accordance with the appropriate CCITT V. series recommendation.

Note that circuit 109 and circuit 106 at the R interface of the MT must be turned on by the fax adaptor at the IWF before any further procedure can be carried out between the fax adaptors and consequently end-to-end. Once the connection is established, both circuit 106 and circuit 109 are clamped to the ON condition by the fax adaptor at the IWF, so fixing a full duplex mode throughout the whole facsimile phase of the call.

## 9 Interworking to fixed networks

PSTN and ISDN only are considered, both used as transit networks to complement the PLMN in the end-to-end connection between facsimile group 3 terminal, figure 7/GSM 03.46.

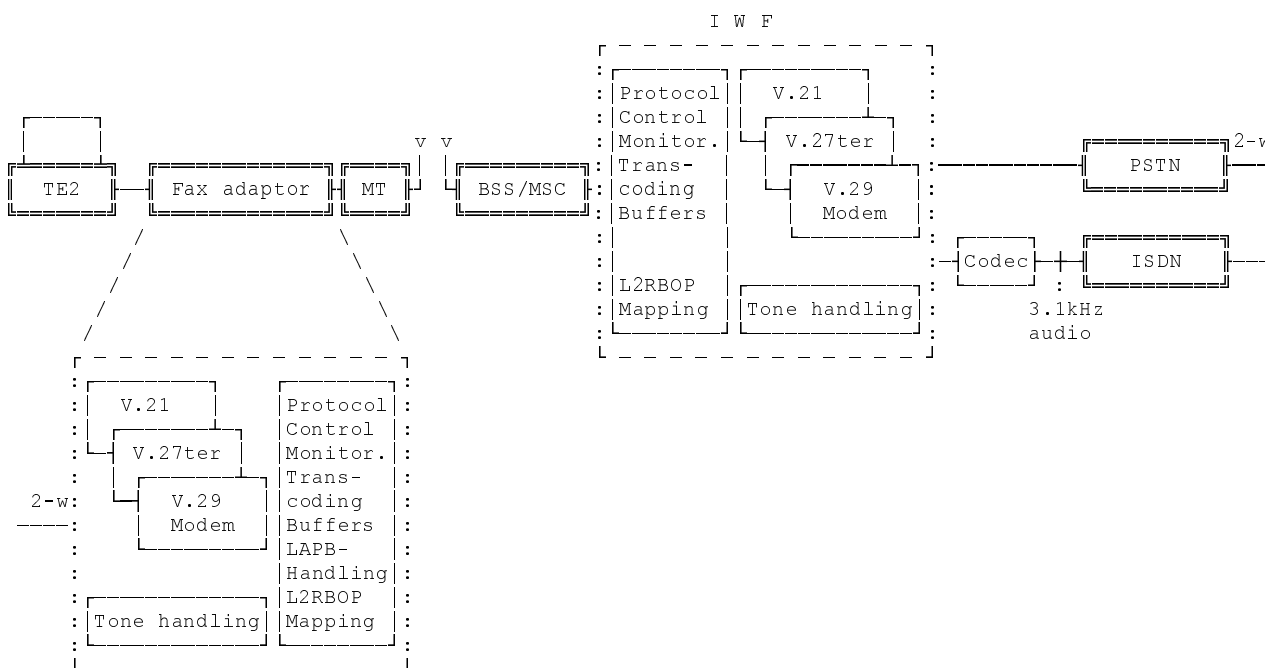

Figure 7/03.46: Network interworking

### 9.1 Interworking to PSTN

As the standard access of facsimile group 3 terminals for this Teleservice is a 2-wire analogue interface, all the technical requirements for network interworking to PSTN are identical in principle to those encountered for the terminal connection to the MT. The key functional block is the fax adaptor described in clause 6 of the present document.

As far as network interworking is concerned, the main function to be performed by such a block is the correct managing of a composite modem, in accordance with the requirements of CCITT Recommendation T.30:

- CCITT Recommendation V.21 synchronous mode, as standard facility for all BCS phases;
- CCITT Recommendation V.27ter for message speeds of 4 800 and 2 400 bit/s;
- CCITT Recommendation V.29 for message speeds of 9 600 and 7 200 bit/s.

The mechanism for selecting the right modem is the following:

- the actual message speed is obtained by detecting the DCS frame (see table 2/CCITT Recommendation T.30) while in BCS phase;
- on entering the message phase, there is an interchange between the V.21 modem and the actual modem agreed upon between the terminals for message transmission;
- on exiting the message phase (RTC) the CCITT Recommendation V.21 modem is selected again.

Times for settling the modem will be in accordance with the requirements of CCITT Recommendation T.30.

## 9.2 Interworking to ISDN

The use of 3.1 kHz audio bearer capability of ISDN allows for an interworking of PLMN very similar in practice to the scheme for PSTN, figure 7/GSM 03.46. The fax adaptor function is in conformance with the description given in clause 4 and subclause 7.1 of the present document.

# Annex A (normative): Structure and contents of the fax adaptor protocol elements

## 1 Principle structure of an element

Each FA protocol element consists of the element discriminator (one single octet) and the optional information field (arbitrary length).

The elements are transmitted with octet 0, bit 1 first. Received information is forwarded with the same bit sequence as received.

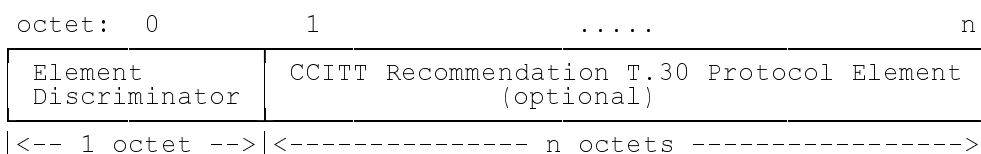

**Figure A.1/03.46: Principle FA protocol element structure**

## 2 Element discriminator coding

### 2.1 BCS element

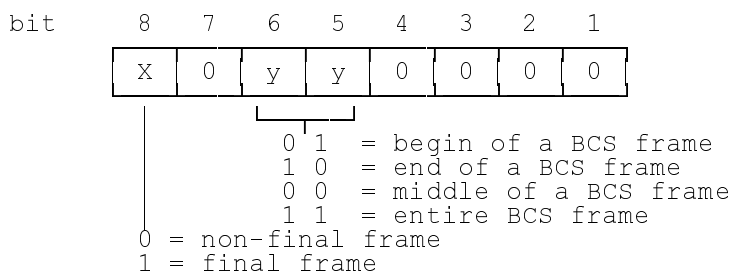

**Figure A.2/03.46: Element discriminator of a BCS element**

### 2.2 BCS abort element

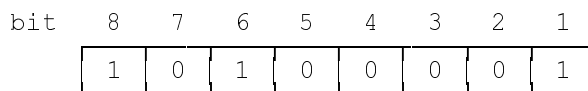

**Figure A.3/03.46: Element discriminator of a BCS abort element**

### 2.3 BCS transmit request element

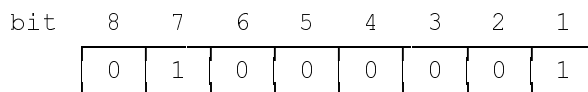

**Figure A.4/03.46: Element discriminator of a BCS transmit request element**

## 2.4 Preamble element

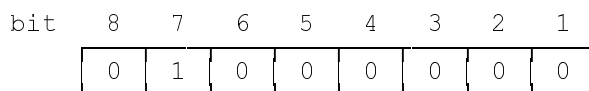

Figure A.5/03.46: Element discriminator of a preamble element

## 2.5 Normal fax data element

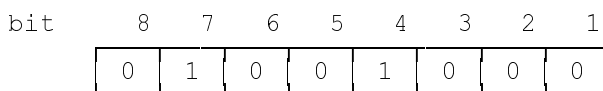

Figure A.6/03.46: Element discriminator of a normal fax data element

## 2.6 Error correction fax data element

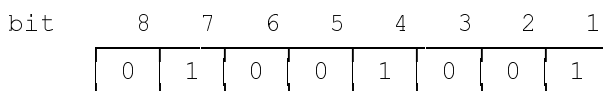

Figure A.7/03.46: Element discriminator of an error correction fax data element

## 2.7 End of data element

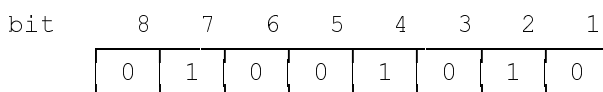

Figure A.8/03.46: Element discriminator of an end of data element

## 2.8 TCF element

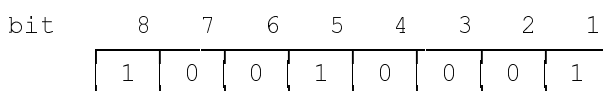
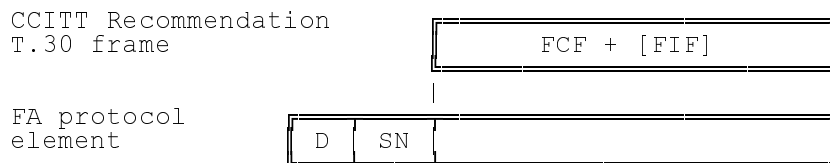

Figure A.9/03.46: Element discriminator of a TCF element



### 3 Information field content

#### 3.1 BCS element



D = discriminator octet  
 SN = sequence number (0 .. 255), bit 1 = LSB

Figure A.10/03.46: Information field content of a BCS element

#### 3.2 BCS abort element

no information field available

#### 3.3 BCS transmit request element



D = discriminator octet  
 SN = sequence number (0 .. 255),  
 bit 1 = LSB = Least significant bit

#### 3.4 Preamble element

no information field available

#### 3.5 Normal fax data element

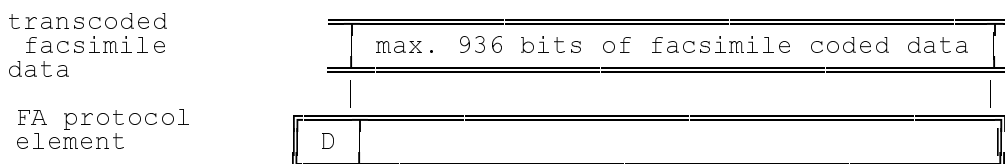

D = discriminator octet

Figure A.11/03.46: Information field content of a normal fax data element

### 3.6 Error correction fax data element

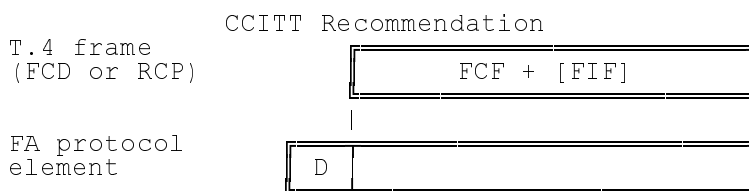

D = discriminator octet

Figure A.12/03.46: Information field content of an error correction fax data element

### 3.7 End of data element

no information field available

### 3.8 TCF element

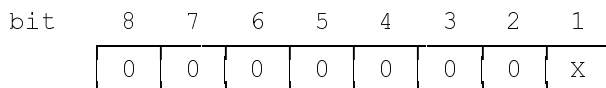

X = 0 : TCF\_OK

X = 1 : TCF\_NOK

Figure A.13/03.46: Information field content of a TCF element

## 4 Relationship of FA protocol elements with LAPB, L2RBOP and RLP

Refer also to GSM 07.03

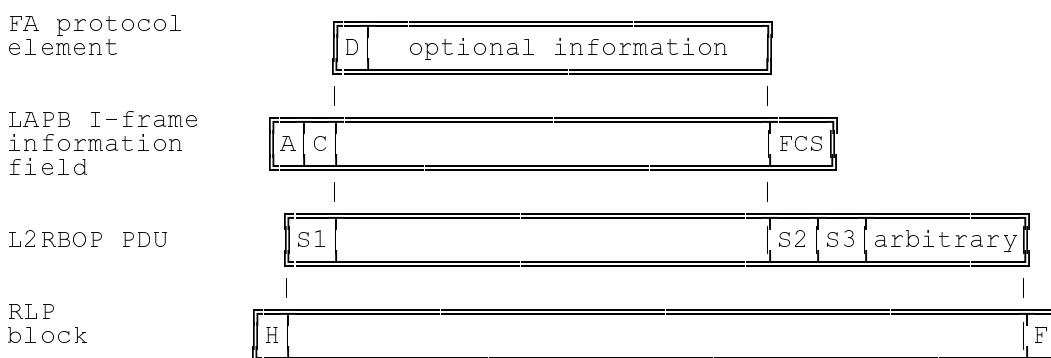

D = Discriminator octet,  
 A = address field, C = control field,  
 S1, S2, S3 = status octets,  
 H = RLP header, F = RLP FCS

Figure A.14/03.46: Mapping for a "short" FA protocol element

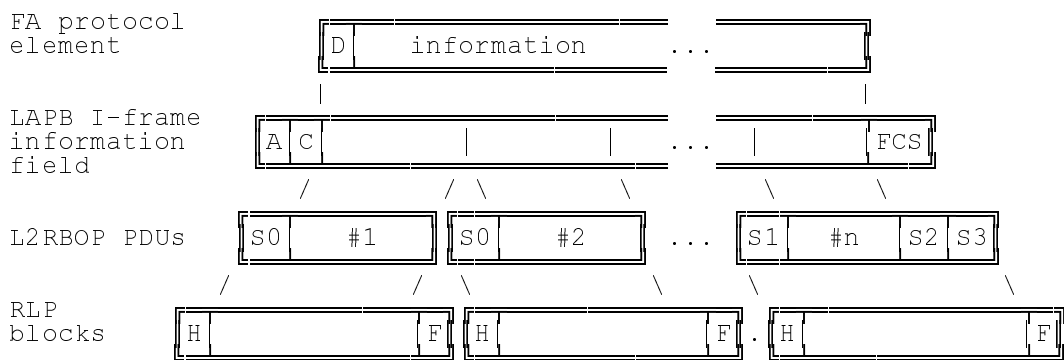

D = Discriminator octet,  
A = address field, C = control field,  
S0, S1, S2, S3 = status octets,  
H = RLP header, F = RLP FCS

Figure A.15/03.46: Mapping for a "long" FA protocol element

## Appendix I (informative): Abbreviations from CCITT Recommendation T.30 and T.4

Table I.1/03.46: Abbreviations from CCITT Recommendation T.30

Abbreviation	Function	Signal format	T.30 standard	T.30 err.corr.
CED	Called station identification	2100 Hz	X	X
CFR	Confirmation to receive	X010 0001	X	X
CRP	Command repeat	X101 1000	X	X
CIG	Calling subscriber identification	1000 1000	X	X
CNG	Calling tone	1100 Hz	X	X
CSI	Called subscriber identification	0000 0010	X	X
CTC	Continue to correct	X100 1000		X
CTR	Response to continue to correct	X010 0011		X
DCN	Disconnect	X101 1111	X	X
DCS	Digital command signal	X100 0001	X	X
DIS	Digital identification signal	0000 0001	X	X
DTC	Digital transmit command	1000 0001	X	X
EOM	End of message	X111 0001	X	
EOP	End of procedure	X111 0100	X	
EOR	End of retransmission	X111 0011		X
ERR	Response to end of retransmission	X011 1000		X
FCD	Facsimile coded data	0110 0000		X
FCF	Facsimile control field	---	X	X
FCS	Frame checking sequence	16 bits	X	X
FIF	Facsimile information field	---	X	X
FTT	Failure to train	X010 0010	X	X
MCF	Message confirmation	X011 0001	X	X
MPS	Multi-page signal	X111 0010	X	
NSC	Non-standard facilities command	1000 0100	X	X
NSF	Non-standard facilities	0000 0100	X	X
NSS	Non-standard set-up	X100 0100	X	X
PIN	Procedural interrupt negative	X011 0100	X	X
PIP	Procedural interrupt positive	X011 0101	X	X
PIS	Procedure interrupt signal	462 Hz	X	X
PPR	Partial page request	X011 1101		X
PPS	Partial page signal	X111 1101		X
PRI	Procedure interrupt	X111 XXXX	X	
RCP	Return to control for partial page	0110 0001		X
RNR	Receive not ready	X011 0111		X
RR	Receive ready	X111 0110		X
RTN	Retrain negative	X011 0010	X	X
RTP	Retrain positive	X011 0011	X	X
TCF	Training check frame	0... 1.5s	X	X
TSI	Transmitting subscriber identification	X100 0010	X	X

Table I.2/03.46: Abbreviations from CCITT Recommendation T.4

Abbreviation	Function	Signal format
EOL	End of line	0000 0000 0001
RTC	Return to control	6 * EOL

# Appendix II (informative): Procedure examples

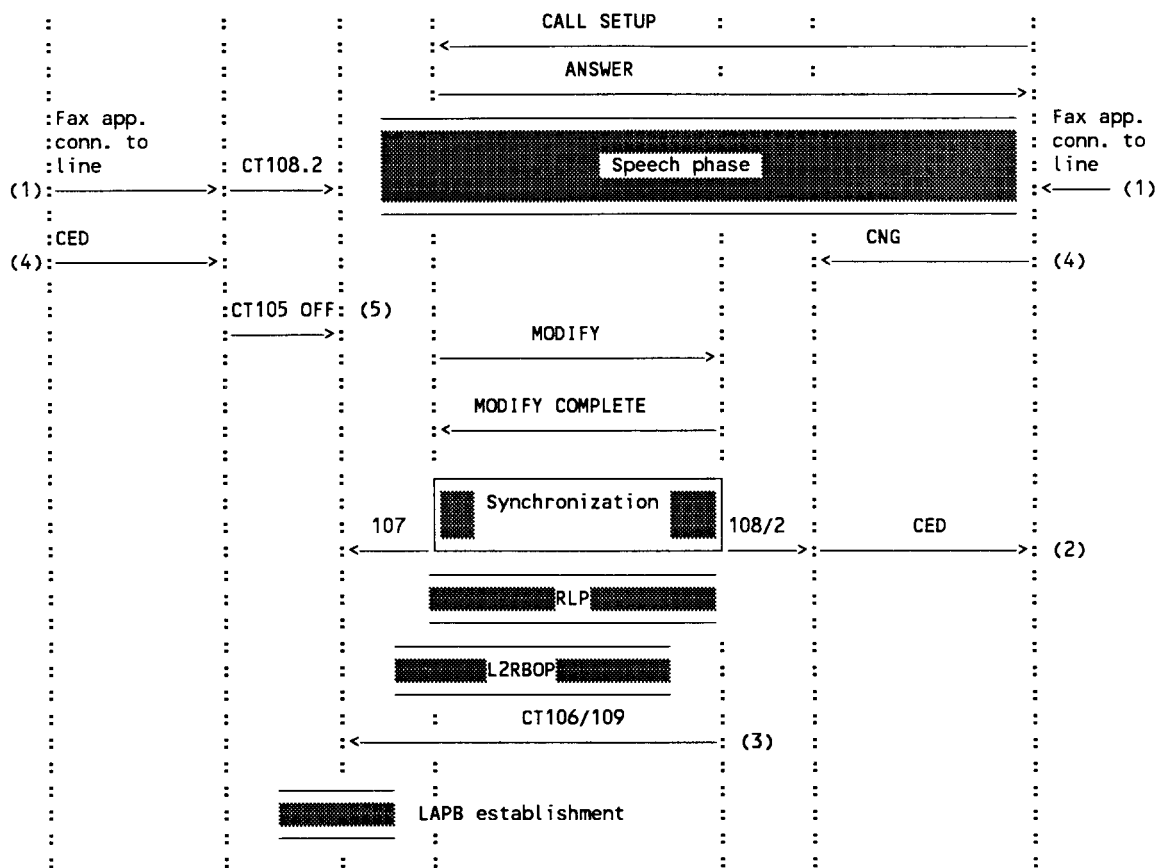
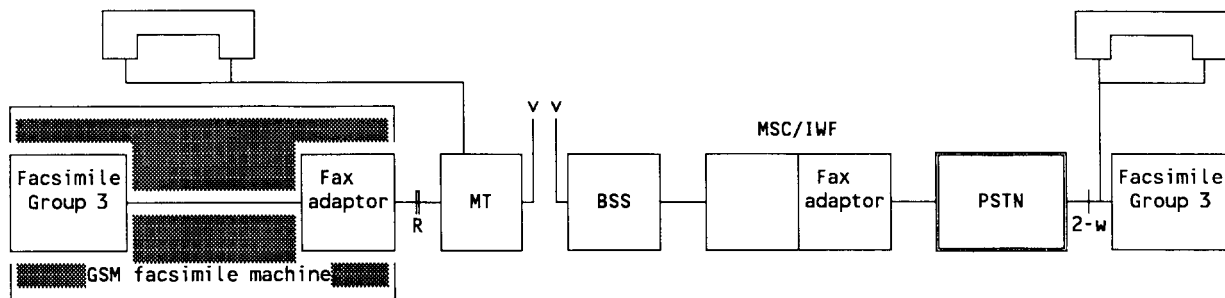

106, 107, 108/2, 109: circuits according to CCITT Recommendation V.24

- (1) manual intervention
- (2) mandatory
- (3) locally generated by the fax adaptor at IWF
- (4) optionally
- (5) triggered by delayed CT108.2 (3 sec)

**Figure II.1a/03.46: Mobile terminated call - speech then facsimile DCD mobile terminated**

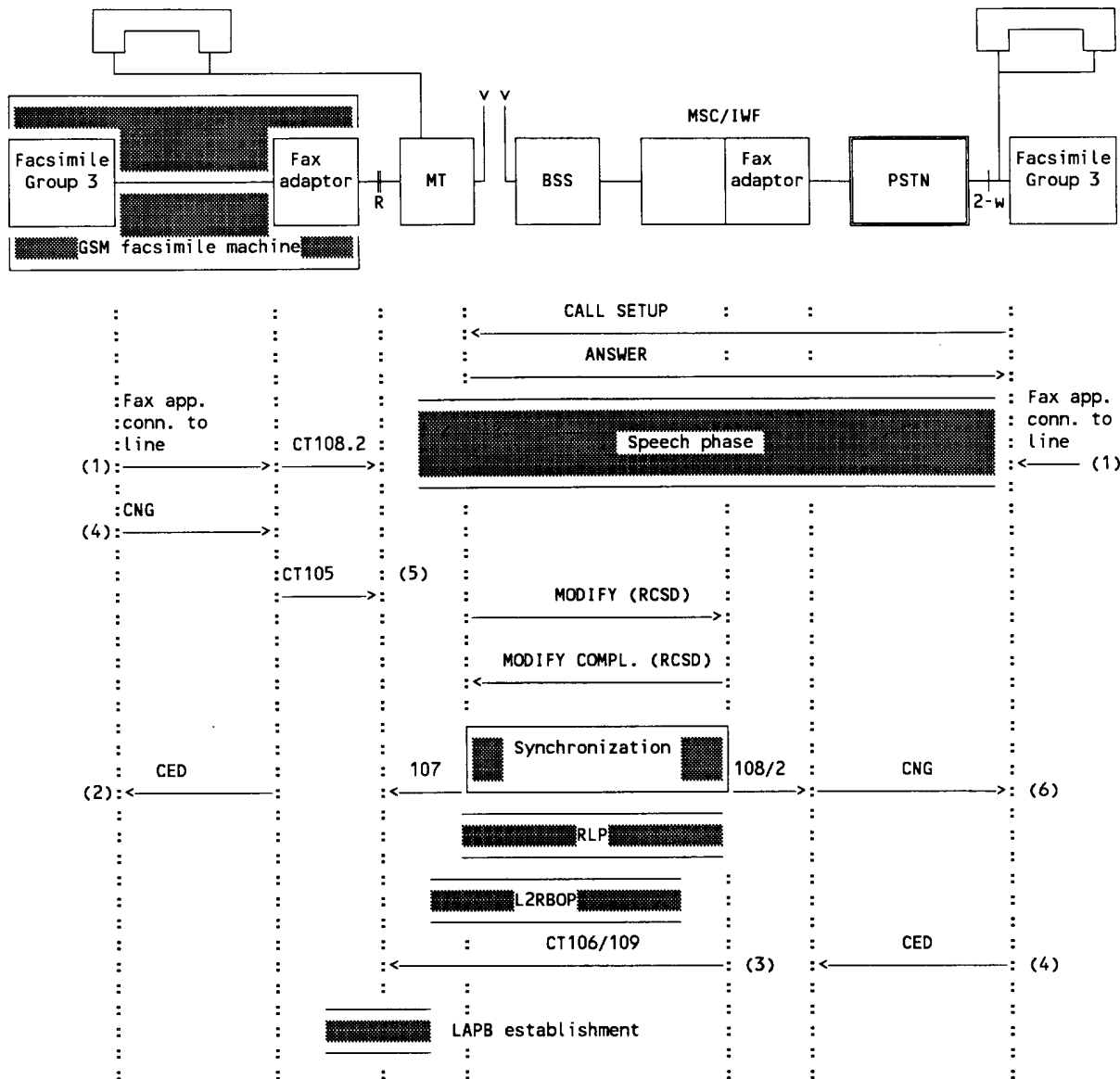

106, 107, 108/2, 109: circuits according to CCITT Recommendation V.24

- (1) manual intervention
- (2) mandatory
- (3) locally generated by fax adaptor at IWF
- (4) optionally
- (5) triggered by delayed CT108.2 (3 sec)
- (6) transmitted only if neither CED nor BCS is already received

Figure II.1b/03.46: Mobile terminated call - speech then facsimile DCD mobile originated

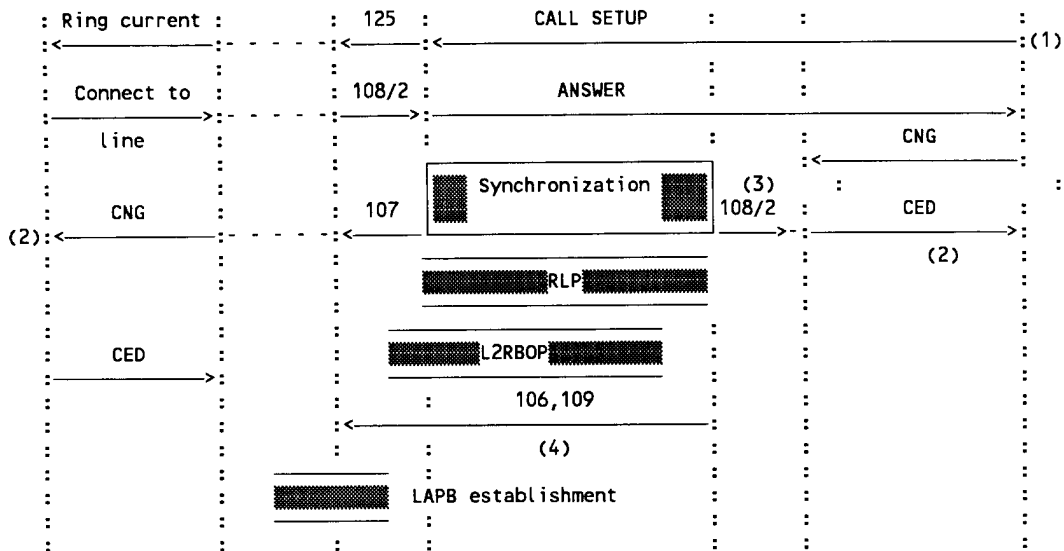
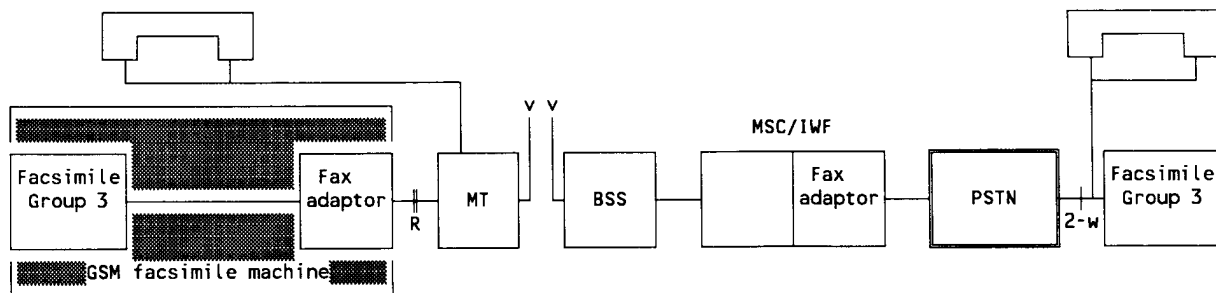

106, 107, 108/2, 109, 125: circuits according to CCITT Recommendation V.24

- (1) manual or automatic operation
- (2) mandatory
- (3) either after synchronization or RLP establishment
- (4) locally generated by fax adaptor at IWF

Figure II.2/03.46: Mobile terminated call - auto answer

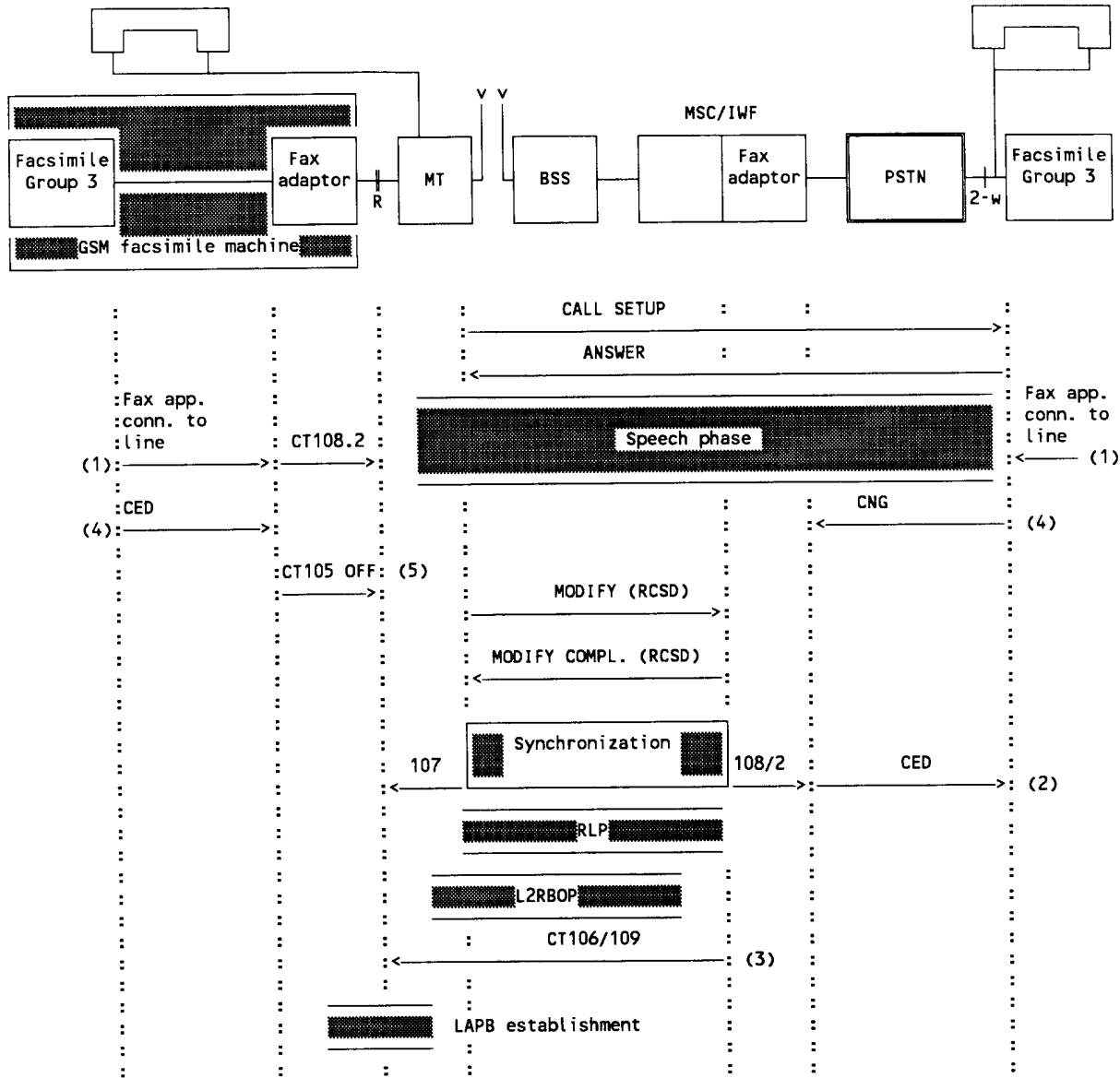

106, 107, 108/2, 109: circuits according to CCITT Recommendation V.24

- (1) manual intervention
- (2) mandatory
- (3) locally generated by fax adaptor at IWF
- (4) optionally
- (5) triggered by delayed CT108.2 (3 sec)

Figure II.3a/03.46: Mobile originated call - speech then facsimile DCD mobile terminated



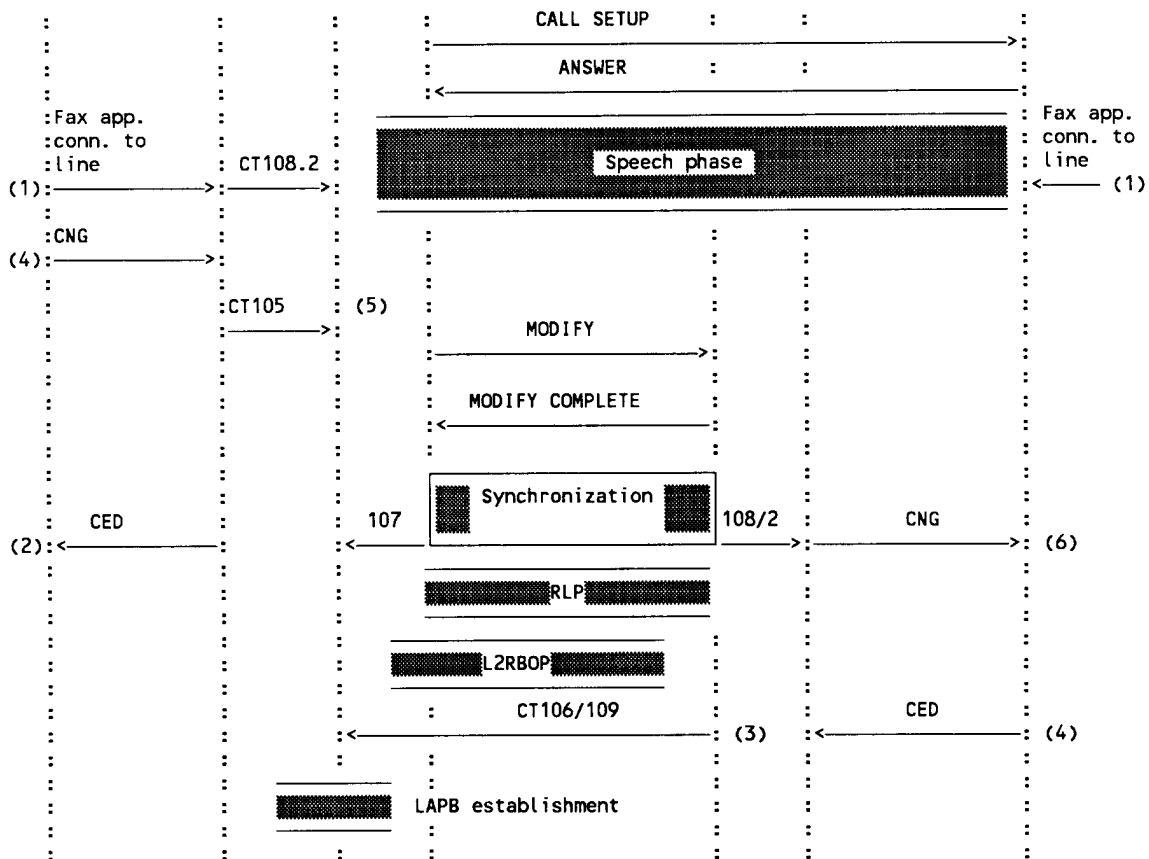
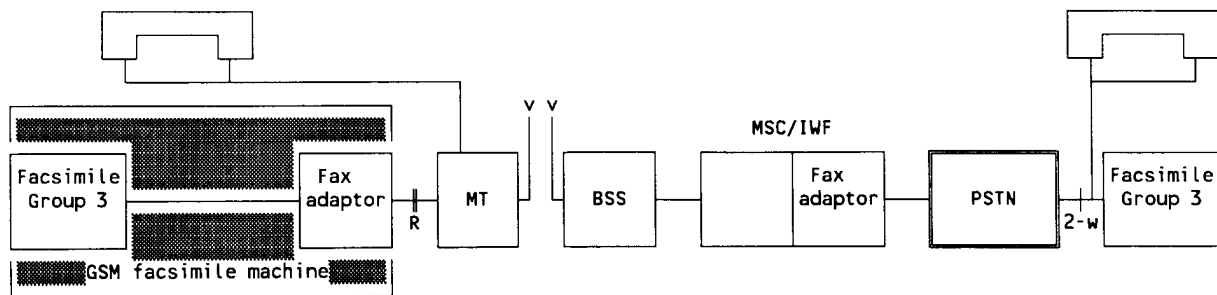

106, 107, 108/2, 109: circuits according to CCITT Recommendation V.24

- (1) manual intervention
- (2) mandatory
- (3) locally generated by fax adaptor at IWF
- (4) optionally
- (5) triggered by delayed CT108.2 (3 sec)
- (6) transmitted only if neither CED nor BCS is already received

**Figure II.3b/03.46: Mobile originated call - speech then facsimile DCD mobile originated**

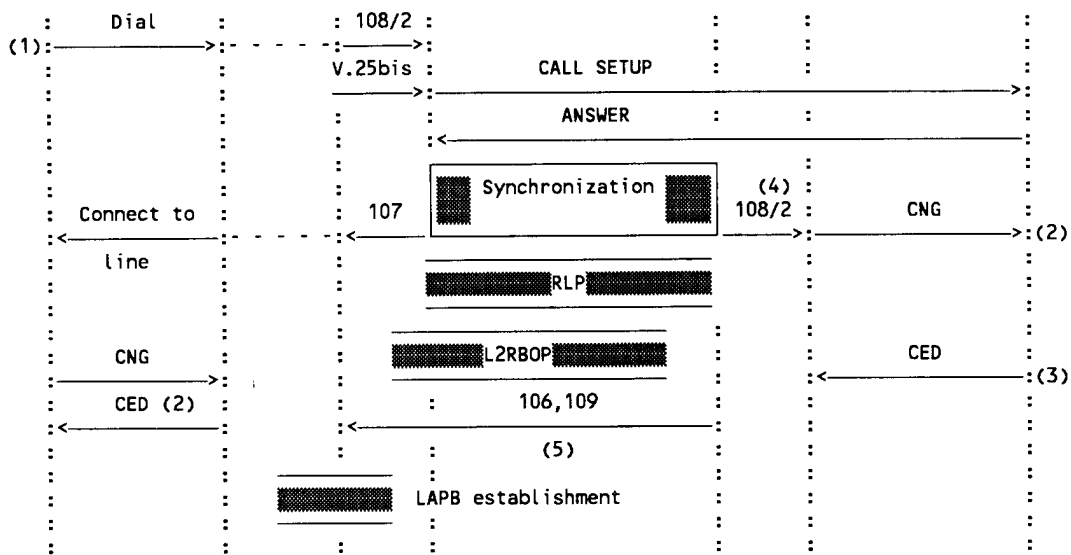
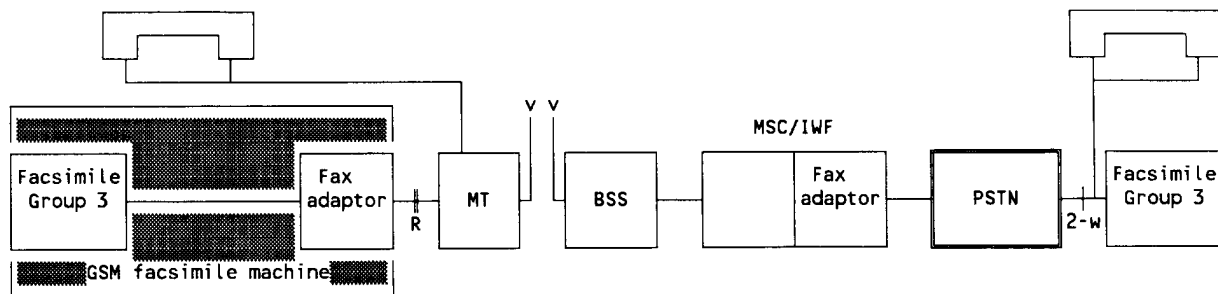

106, 107, 108/2, 109: circuits according to CCITT Recommendation V.24

- (1) manual intervention
- (2) mandatory
- (3) PSTN fax terminal may be manually or automatically answered
- (4) either after synchronization or RLP establishment
- (5) locally generated by fax adaptor at IWF

**Figure II.4/03.46: Mobile originated call - auto calling**

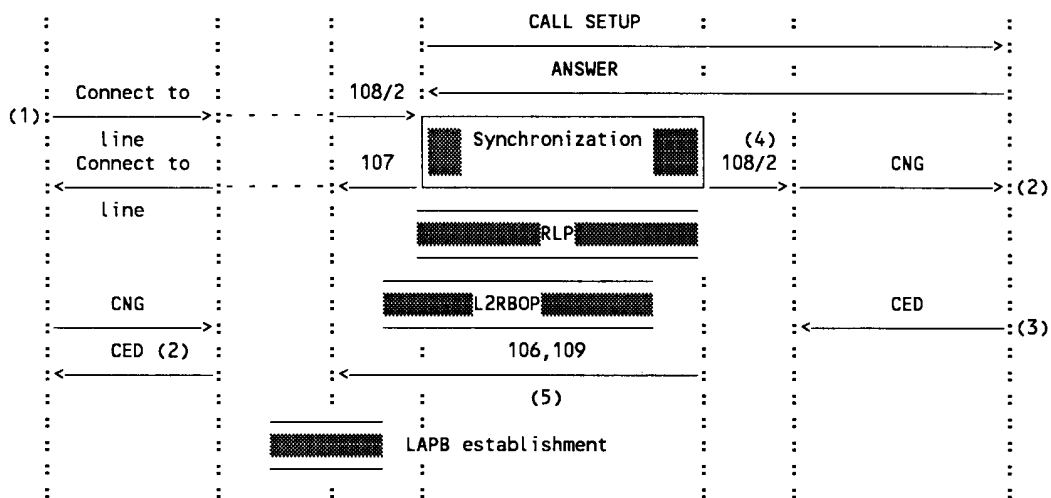
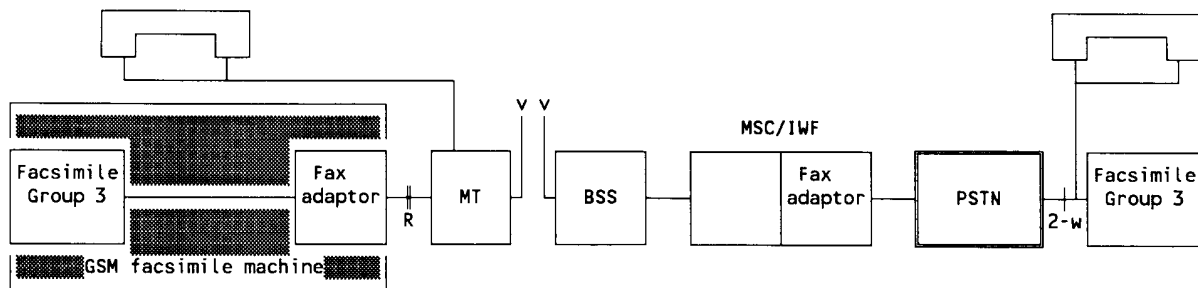

106, 107, 108/2, 109: circuits according to CCITT Recommendation V.24

- (1) manual intervention
- (2) mandatory
- (3) PSTN fax terminal may be manually or automatically answered
- (4) either after synchronization or RLP establishment
- (5) locally generated by fax adaptor at IWF

Figure II.5/03.46: Mobile originated call - manual calling

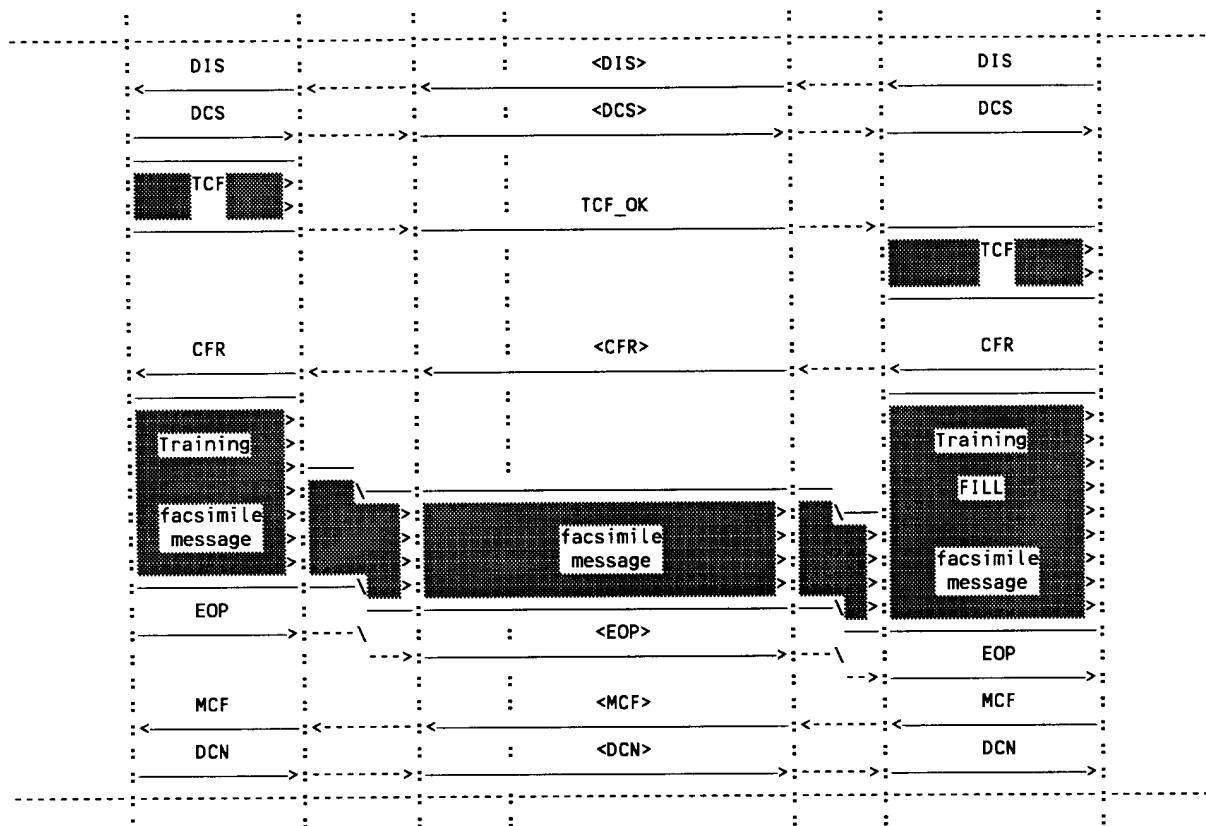
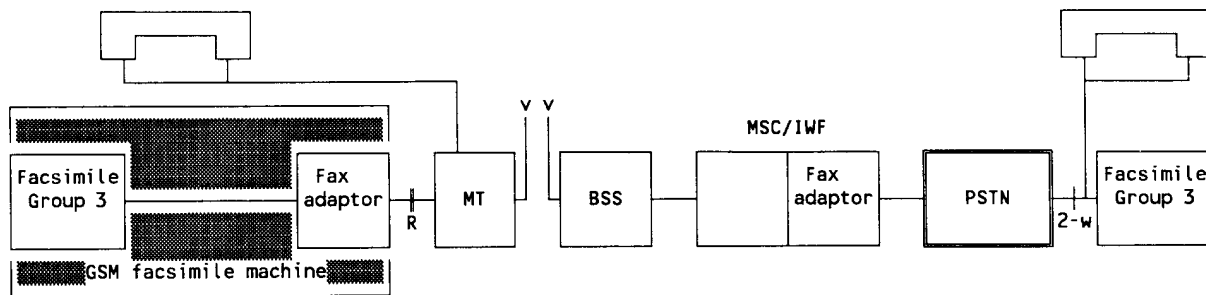

Figure II.6/03.46: Mobile originated facsimile transmission

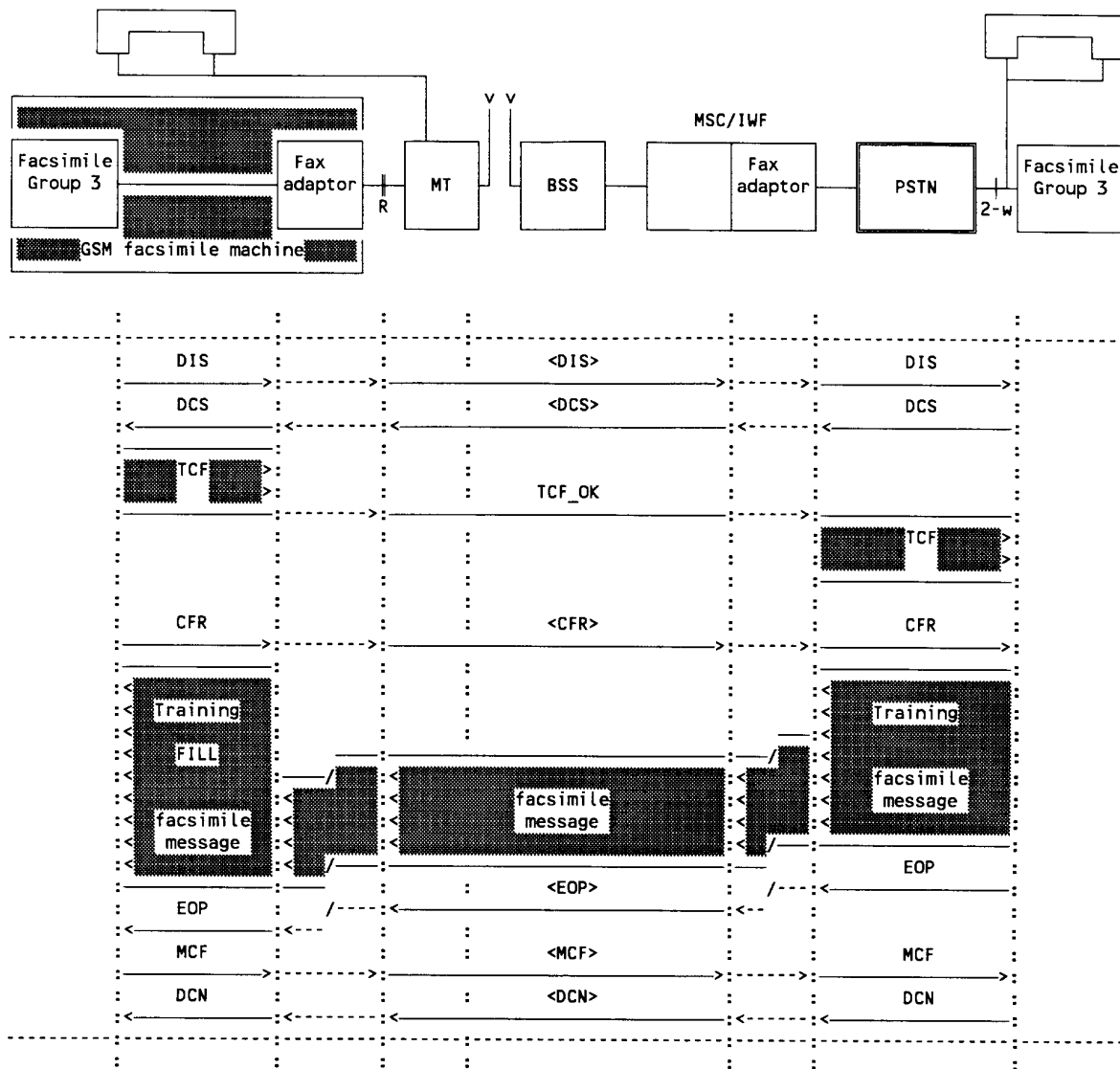

Figure II.7/03.46: Mobile terminated facsimile transmission

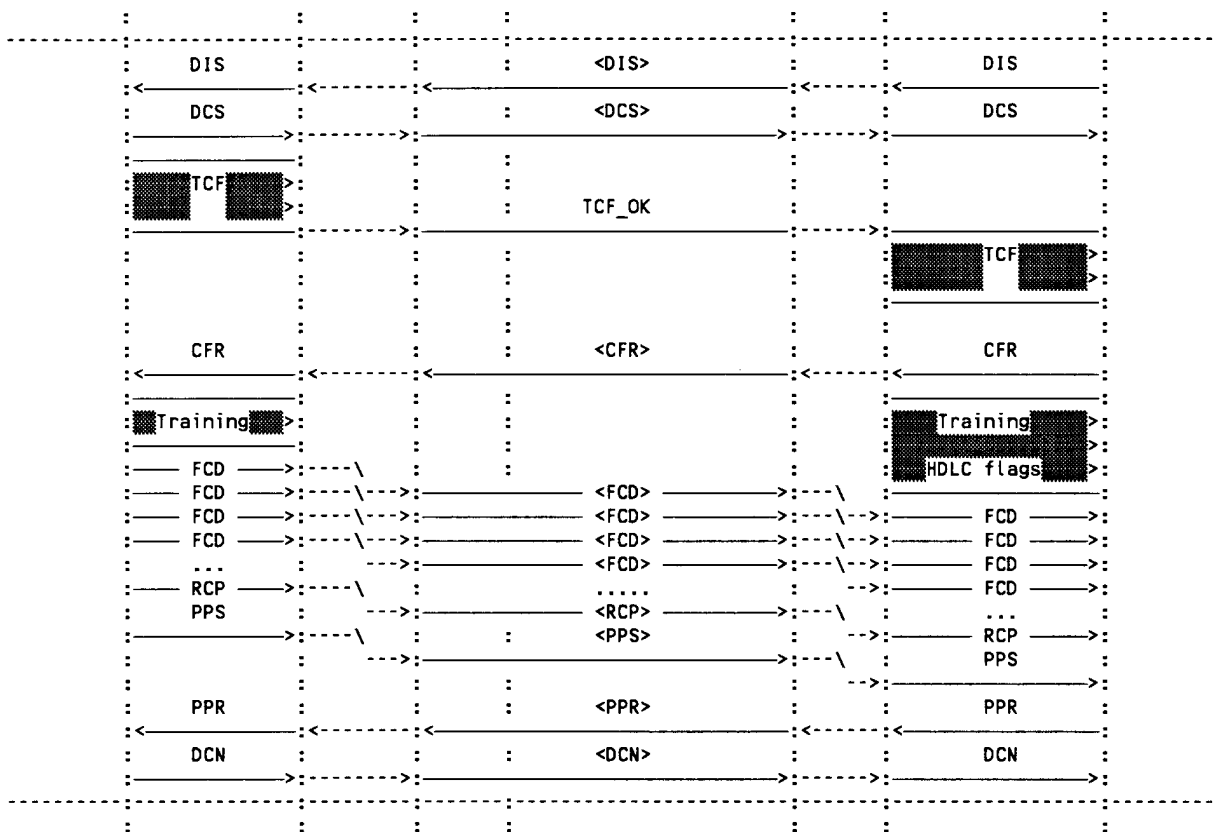
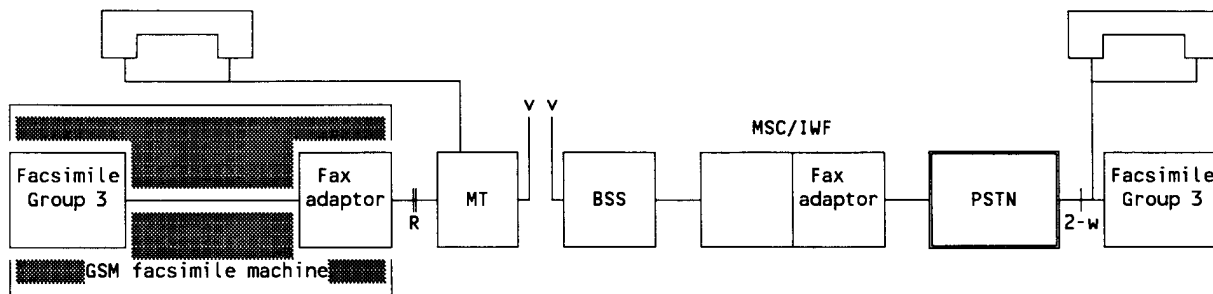

Figure II.8/03.46: Mobile originated facsimile transmission (error correction mode)



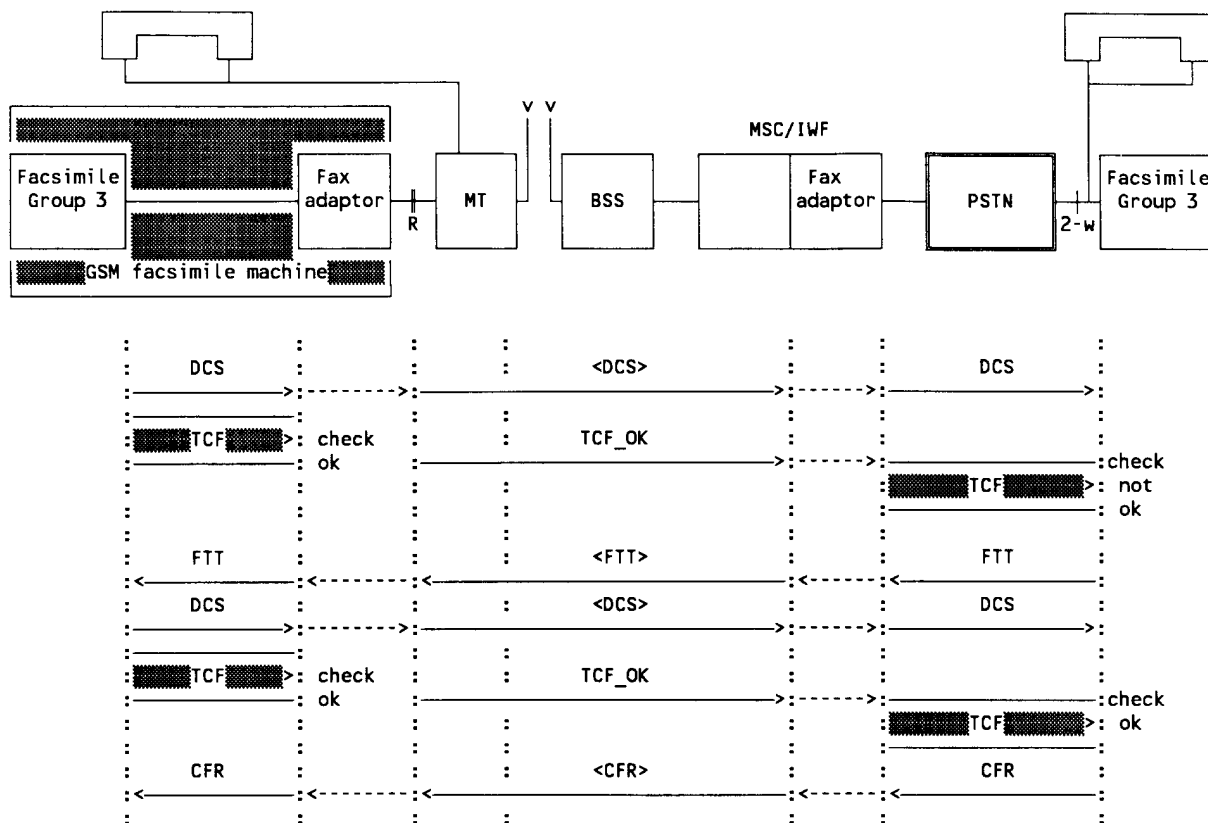

Figure II.11/03.46: Mobile originated facsimile transmission - error recovery (example)

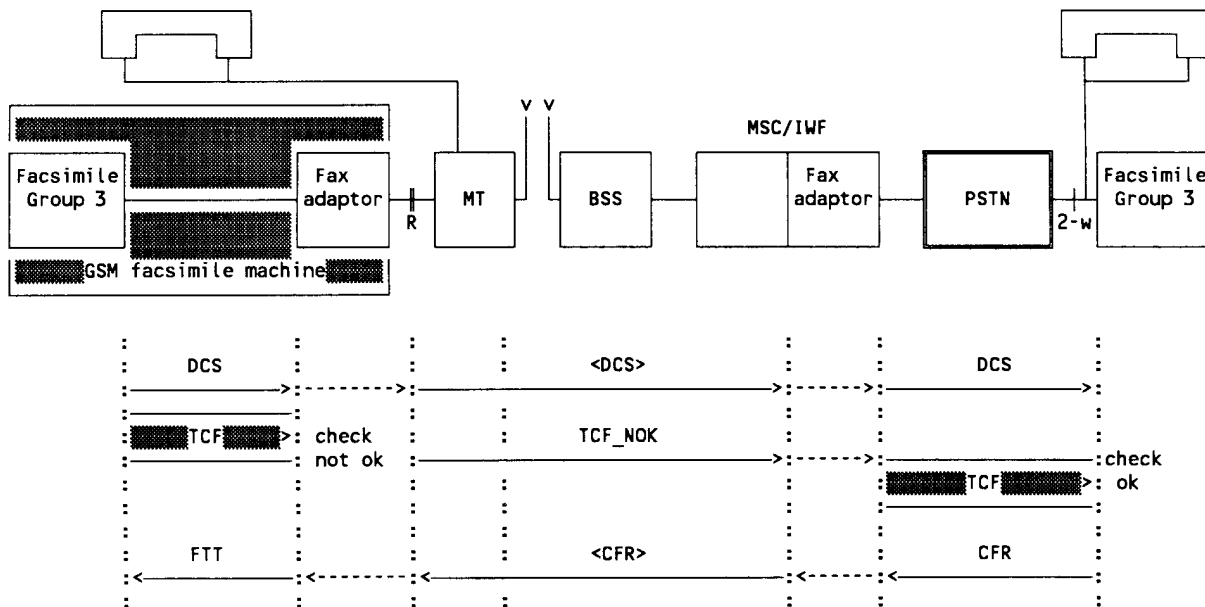

Figure II.12/03.46: Mobile originated facsimile transmission - error recovery (example)



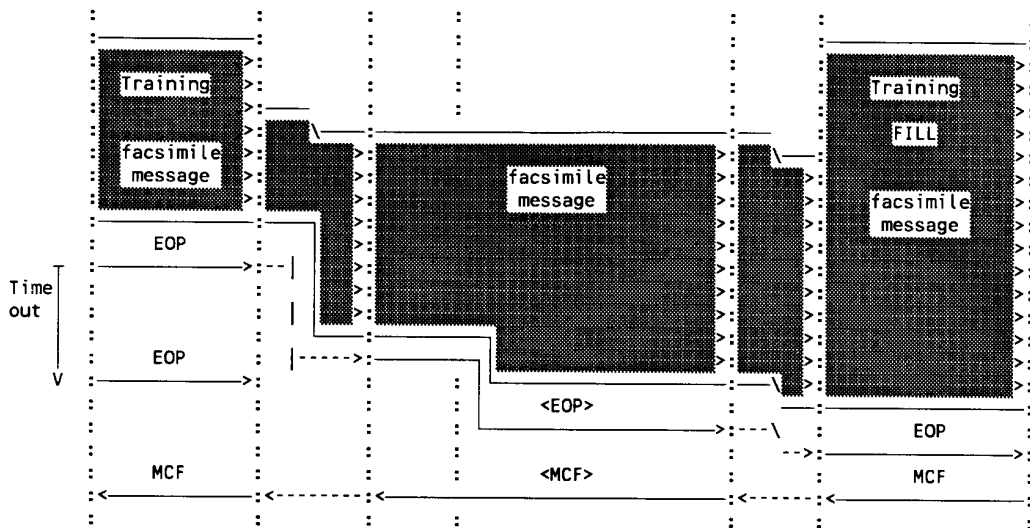
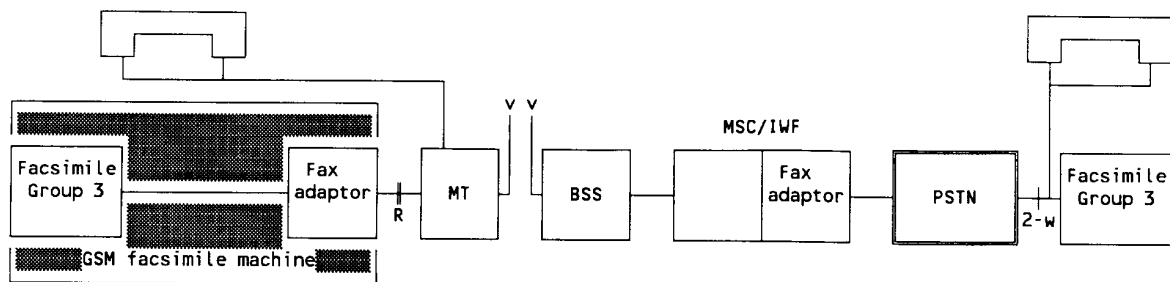

Figure II.13/03.46: Mobile originated facsimile transmission - error recovery (example)

---

## Annex B (informative): Change Request History

<b>Change history</b>					
<b>SMG No.</b>	<b>TDoc. No.</b>	<b>CR. No.</b>	<b>Section affected</b>	<b>New version</b>	<b>Subject/Comments</b>
SMG#11				4.1.2	ETSI Publication
SMG#20				5.0.0	Release 1996 version
SMG#27				6.0.0	Release 1997 version

---

# History

<b>Document history</b>		
V6.0.0	April 1999	Publication