

TS 100 528 V6.0.0 (1999-04)

Technical Specification

Digital cellular telecommunications system (Phase 2+); GSM Public Land Mobile Network (PLMN) connection types (GSM 03.10 version 6.0.0 Release 1997)



GSM®
GLOBAL SYSTEM FOR
MOBILE COMMUNICATIONS

ETSI 

Reference

DTS/SMG-040310Q6 (4w003003.PDF)

Keywords

Digital cellular telecommunications system,
Global System for Mobile communications (GSM)

ETSI

Postal address

F-06921 Sophia Antipolis Cedex - FRANCE

Office address

650 Route des Lucioles - Sophia Antipolis
Valbonne - FRANCE
Tel.: +33 4 92 94 42 00 Fax: +33 4 93 65 47 16
Siret N° 348 623 562 00017 - NAF 742 C
Association à but non lucratif enregistrée à la
Sous-Préfecture de Grasse (06) N° 7803/88

Internet

secretariat@etsi.fr
Individual copies of this ETSI deliverable
can be downloaded from
<http://www.etsi.org>
If you find errors in the present document, send your
comment to: editor@etsi.fr

Copyright Notification

No part may be reproduced except as authorized by written permission.
The copyright and the foregoing restriction extend to reproduction in all media.

© European Telecommunications Standards Institute 1999.
All rights reserved.

Contents

Intellectual Property Rights.....	5
Foreword.....	5
1 Scope.....	6
2 References.....	6
3 Definitions and Abbreviations.....	9
3.1 Definitions.....	9
3.2 Abbreviations.....	10
4 General considerations.....	10
4.1 Relationship between lower layer capabilities and radio traffic channels.....	10
4.2 Transparent and non-transparent lower layer capabilities.....	11
4.3 The GSM environment.....	11
4.3.1 The hand-over procedure.....	11
4.3.2 DTX procedure.....	11
5 Framework for the description of connection types.....	11
5.1 Introduction.....	11
5.2 Purpose of GSM PLMN connection types.....	12
5.3 Functions associated with a GSM PLMN connection.....	12
5.4 Applications of GSM PLMN connection types.....	13
5.5 GSM PLMN connection involving several networks.....	13
6 GSM PLMN connection types.....	14
6.1 Description of GSM PLMN connection types.....	14
6.1.1 Rate adaptation.....	15
6.1.2 Radio Link Protocol.....	16
6.1.3 Layer 2 Relay function.....	17
6.1.4 Resources allocated by the GSM network.....	17
6.2 GSM PLMN connection elements.....	17
6.3 Rules of association for the attribute values of connection elements and connection types.....	18
6.3.1 Information transfer mode.....	18
6.3.2 Information transfer rate (kbit/s).....	18
6.3.3 Information transfer susceptance.....	18
6.3.4 Establishment of connection.....	19
6.3.5 Symmetry.....	19
6.3.6 Connection configuration Topology.....	19
6.3.7 Structure.....	19
6.3.8 Channels.....	20
6.3.8.1 Information channel (rate).....	20
6.3.8.2 Signalling channel (rate).....	20
6.3.9 Connection control protocol.....	20
6.3.10 Information transfer coding/protocol.....	20
6.3.11 Further attributes and attribute values.....	21
6.4 Limited set of GSM PLMN connection types (all channel codings excluding TCH/F14.4).....	21
6.5 Limited set of GSM PLMN connection types (for TCH/F14.4 channel coding).....	22
7 Relationship between Telecommunication services and connection types.....	38
7.1 General.....	38
7.2 Relationship between Bearer services and connection types.....	38
7.3 Relationship between Teleservices and connection types.....	38
7.4 Network capability to support in-call modification.....	38
7.5 Network capability to support channel mode modification.....	39

Annex A (informative): List of definitions of GSM PLMN connection type attributes and values48

A.1 Attribute definition and their values48

A.2 Definition of values.....55

Annex B (informative): Location of the transcoding, multiplexing and RA2 functions57

Annex C (informative): Change Request History62

History63

Intellectual Property Rights

IPRs essential or potentially essential to the present document may have been declared to ETSI. The information pertaining to these essential IPRs, if any, is publicly available for **ETSI members and non-members**, and can be found in SR 000 314: *"Intellectual Property Rights (IPRs); Essential, or potentially Essential, IPRs notified to ETSI in respect of ETSI standards"*, which is available **free of charge** from the ETSI Secretariat. Latest updates are available on the ETSI Web server (<http://www.etsi.org/ipr>).

Pursuant to the ETSI IPR Policy, no investigation, including IPR searches, has been carried out by ETSI. No guarantee can be given as to the existence of other IPRs not referenced in SR 000 314 (or the updates on the ETSI Web server) which are, or may be, or may become, essential to the present document.

Foreword

This Technical Specification (TS) has been produced by the Special Mobile Group (SMG).

A GSM PLMN may be described by a limited set of access interfaces (refer to GSM 04.02 and 02.01) and a limited set of GSM PLMN connection types to support the telecommunication services described in the GSM 02-series of specifications. The present document identifies and defines these connection types in so far as they relate to the particular network capabilities for a GSM PLMN within the digital cellular telecommunications system (Phase 2/Phase 2+).

The contents of the present document is subject to continuing work within SMG and may change following formal SMG approval. Should SMG modify the contents of the present document it will be re-released with an identifying change of release date and an increase in version number as follows:

Version 6.x.y

where:

- 6 indicates Release 1997 of GSM Phase 2+
- x the second digit is incremented for all changes of substance, i.e. technical enhancements, corrections, updates, etc.
- y the third digit is incremented when editorial only changes have been incorporated in the specification.

1 Scope

A GSM PLMN may be described by a limited set of access interfaces (refer to GSM 04.02 and 02.01) and a limited set of GSM PLMN connection types to support the telecommunication services described in the GSM 02-series of specifications. The present document identifies and defines these connection types in so far as they relate to the particular network capabilities for a GSM PLMN.

The basic lower layer capabilities of a GSM PLMN are represented by a set of GSM PLMN connection types. The definition of a set of GSM PLMN connection types provides the necessary input to identify network capabilities of a GSM PLMN. In addition to describing network capabilities of a GSM PLMN, the identification of connection types facilitates the specification of network-to-network interfaces. It may also assist in the allocation of network performance parameters.

The present document should be considered in conjunction with other GSM specifications with particular reference to GSM 01.02, 02.01, 02.02, 02.03, 03.01, 03.02, 04.02 and 04.03.

The present document provides a bridge between the service specification in the GSM 02-series of specifications and the more detailed specifications such as the GSM 03, 04, 07 and 09 series. As such, it establishes a framework for the specification and understanding of the more detailed specifications. It is therefore not a specification against which detailed conformance testing can be performed. However, it shall be considered mandatory for the understanding of the more detailed specifications and used to resolve issues of conflict in these specifications.

2 References

The following documents contain provisions which, through reference in this text, constitute provisions of the present document.

- References are either specific (identified by date of publication, edition number, version number, etc.) or non-specific.
- For a specific reference, subsequent revisions do not apply.
- For a non-specific reference, the latest version applies.
- A non-specific reference to an ETS shall also be taken to refer to later versions published as an EN with the same number.
- For this Release 1997 document, references to GSM documents are for Release 1997 versions (version 6.x.y).

- [1] GSM 01.02: "Digital cellular telecommunications system (Phase 2+); General description of a GSM Public Land Mobile Network (PLMN)".
- [2] GSM 01.04: "Digital cellular telecommunications system (Phase 2+); Abbreviations and acronyms".
- [3] GSM 02.01: "Digital cellular telecommunications system (Phase 2+); Principles of telecommunications services supported by a GSM Public Land Mobile Network (PLMN)".
- [4] GSM 02.02: "Digital cellular telecommunications system (Phase 2+); Bearer Services (BS) supported by a GSM Public Land Mobile Network (PLMN)".
- [5] GSM 02.03: "Digital cellular telecommunications system (Phase 2+); Teleservices supported by a GSM Public Land Mobile Network (PLMN)".
- [6] GSM 03.01: "Digital cellular telecommunications system (Phase 2+); Network functions".
- [7] GSM 03.02: "Digital cellular telecommunications system (Phase 2+); Network architecture".
- [8] GSM 03.09: "Digital cellular telecommunications system (Phase 2+); Handover procedures".
- [9] GSM 03.34: "Digital cellular telecommunications system (Phase 2+); High Speed Circuit Switched Data (HSCSD) - Stage 2 Service Description".

- [10] GSM 03.40: "Digital cellular telecommunications system (Phase 2+); Technical realization of the Short Message Service (SMS) Point-to-Point (PP)".
- [11] GSM 03.41: "Digital cellular telecommunications system (Phase 2+); Technical realization of Short Message Service Cell Broadcast (SMSCB)".
- [12] GSM 03.45: "Digital cellular telecommunications system (Phase 2+); Technical realization of facsimile group 3 transparent".
- [13] GSM 04.01: "Digital cellular telecommunications system (Phase 2+); Mobile Station - Base Station System (MS - BSS) interface General aspects and principles".
- [14] GSM 04.02: "Digital cellular telecommunications system (Phase 2+); GSM Public Land Mobile Network (PLMN) access reference configuration".
- [15] GSM 04.03: "Digital cellular telecommunications system (Phase 2+); Mobile Station - Base Station System (MS - BSS) interface Channel structures and access capabilities".
- [16] GSM 04.05: "Digital cellular telecommunications system (Phase 2+); Data Link (DL) layer; General aspects".
- [17] GSM 04.06: "Digital cellular telecommunications system (Phase 2+); Mobile Station - Base Station System (MS - BSS) interface Data Link (DL) layer specification".
- [18] GSM 04.07: "Digital cellular telecommunications system (Phase 2+); Mobile radio interface signalling layer 3; General aspects".
- [19] GSM 04.08: "Digital cellular telecommunications system (Phase 2+); Mobile radio interface layer 3 specification".
- [20] GSM 04.11: "Digital cellular telecommunications system (Phase 2+); Point-to-Point (PP) Short Message Service (SMS) support on mobile radio interface".
- [21] GSM 04.12: "Digital cellular telecommunications system (Phase 2+); Short Message Service Cell Broadcast (SMSCB) support on the mobile radio interface".
- [22] GSM 04.21: "Digital cellular telecommunications system (Phase 2+); Rate adaption on the Mobile Station - Base Station System (MS - BSS) interface".
- [23] GSM 04.22: "Digital cellular telecommunications system (Phase 2+); Radio Link Protocol (RLP) for data and telematic services on the Mobile Station - Base Station System (MS - BSS) interface and the Base Station System - Mobile-services Switching Centre (BSS - MSC) interface".
- [24] GSM 05.01: "Digital cellular telecommunications system (Phase 2+); Physical layer on the radio path General description".
- [25] GSM 05.03: "Digital cellular telecommunications system (Phase 2+); Channel coding".
- [26] GSM 05.08: "Digital cellular telecommunications system (Phase 2+); Radio subsystem link control".
- [27] GSM 06.31: "Digital cellular telecommunications system (Phase 2+); Full rate speech; Discontinuous Transmission (DTX) for full rate speech traffic channels".
- [28] GSM 07.01: "Digital cellular telecommunications system (Phase 2+); General on Terminal Adaptation Functions (TAF) for Mobile Stations (MS)".
- [29] GSM 07.02: "Digital cellular telecommunications system (Phase 2+); Terminal Adaptation Functions (TAF) for services using asynchronous bearer capabilities".
- [30] GSM 07.03: "Digital cellular telecommunications system (Phase 2+); Terminal Adaptation Functions (TAF) for services using synchronous bearer capabilities".
- [31] GSM 08.04: "Digital cellular telecommunications system (Phase 2+); Base Station System - Mobile-services Switching Centre (BSS - MSC) interface Layer 1 specification".
- [32] GSM 08.06: "Digital cellular telecommunications system (Phase 2+); Signalling transport mechanism specification for the Base Station System - Mobile-services Switching Centre (BSS - MSC) interface".
- [33] GSM 08.08: "Digital cellular telecommunications system (Phase 2+); Mobile Switching Centre - Base Station System (MSC - BSS) interface Layer 3 specification".

- [34] GSM 08.20: "Digital cellular telecommunications system (Phase 2+); Rate adaption on the Base Station System - Mobile-services Switching Centre (BSS - MSC) interface".
- [35] GSM 09.04: "Digital cellular telecommunications system (phase 2+); Interworking between the Public Land Mobile Network (PLMN) and the Circuit Switched Public Data Network (CSPDN)".
- [36] GSM 09.05: "Digital cellular telecommunications system (Phase2 +); Interworking between the Public Land Mobile Network (PLMN) and the Packet Switched Public Data Network (PSPDN) for Packet Assembly/Disassembly facility (PAD) access".
- [37] GSM 09.06: "Digital cellular telecommunications system (Phase 2+); Interworking between a Public Land Mobile Network (PLMN) and a Packet Switched Public Data Network/Integrated Services Digital Network (PSPDN/ISDN) for the support of packet switched data transmission services".
- [38] GSM 09.07: "Digital cellular telecommunications system (Phase 2+); General requirements on interworking between the Public Land Mobile Network (PLMN) and the Integrated Services Digital Network (ISDN) or Public Switched Telephone Network (PSTN)".
- [39] CCITT Recommendation I.460: "Multiplexing, rate adaption and support of existing interfaces".
- [40] CCITT Recommendation V.110: "Support of Data Terminal Equipments (DTEs) with V-Series interfaces by an integrated services digital network".
- [41] CCITT Recommendation V.21: "300 bits per second duplex modem standardised for use in the general switched telephone network".
- [42] CCITT Recommendation V.22: "1 200 bits per second duplex modem standardised for use in the general switched telephone network and on point-to-point 2-wire leased telephone-type circuits".
- [43] CCITT Recommendation V.22bis: "2 400 bits per second duplex modem using the frequency division technique standardised for use on the general switched telephone network and on point-to-point 2-wire leased telephone-type circuits".
- [44] CCITT Recommendation V.23: "600/1 200-band modem standardised for use in the general switched telephone network".
- [45] CCITT Recommendation V.24: "List of definitions for interchange circuits between Data Terminal Equipment (DTE) and Data Circuit-terminating Equipment (DCE)".
- [46] CCITT Recommendation V.25: "Automatic answering equipment and/or parallel automatic calling equipment on the general switched telephone network including procedures for disabling of echo control devices for both manually and automatically established calls".
- [47] CCITT Recommendation V.25bis: "Automatic calling and/or answering equipment on the General Switched Telephone Network (GSTN) using the 100-series interchange circuits".
- [48] CCITT Recommendation V.26bis: "2 400/1 200 bits per second modem standardised for use in the general switched telephone network".
- [49] CCITT Recommendation V.26ter: "2 400 bits per second duplex modem using the echo cancellation technique standardised for use on the general switched telephone network and on point-to-point 2-wire leased telephone-type circuits".
- [50] CCITT Recommendation V.27ter: "4 800/2 400 bits per second modem standardised for use in the general switched telephone network".
- [51] CCITT Recommendation V.28: "Electrical characteristics for unbalanced double-current interchange circuits".
- [52] CCITT Recommendation V.29: "9 600 bits per second modem standardised for use on point-to-point 4-wire leased telephone-type circuits".
- [53] CCITT Recommendation V.32: "A family of 2-wire, duplex modems operating at data signalling rates of up to 9 600 bit/s for use on the general switched telephone network and on leased telephone-type circuits".
- [54] CCITT Recommendation V.32bis: "A duplex modem operating at data signalling rates of up to 14 400 bit/s for use on the general switched telephone network and on leased point-to-point 2-wire telephone-type circuits".

- [55] CCITT Recommendation V.42bis: "Data Compression for Data Circuit terminating Equipment (DCE) using Error Correction Procedures".
- [56] CCITT Recommendation V.120: "Support by an ISDN of data terminal equipment with V-Series type interfaces with provision for statistical multiplexing".
- [57] CCITT Recommendation X.21: "Interface between Data Terminal Equipment (DTE) and Data Circuit-terminating Equipment (DCE) for synchronous operation on public data networks".
- [58] CCITT Recommendation X.21bis: "Use on public data networks of Data Terminal Equipment (DTE) which is designed for interfacing to synchronous V-series modems".
- [59] CCITT Recommendation X.24: "List of definitions for interchange circuits between Data Terminal Equipment (DTE) and Data Circuit-terminating Equipment (DCE) on public data networks".
- [60] CCITT Recommendation X.25: "Interface between Data Terminal Equipment (DTE) and Data Circuit-terminating Equipment (DCE) for terminals operating in the packet mode and connected to public data networks by dedicated circuit".
- [61] CCITT Recommendation X.26: "Electrical characteristics for unbalanced double-current interchange circuits for general use with integrated circuit equipment in the field of data communications".
- [62] CCITT Recommendation X.27: "Electrical characteristics for balanced double-current interchange circuits for general use with integrated circuit equipment in the field of data communications".
- [63] CCITT Recommendation X.28: "DTE/DCE interface for a start-stop mode data terminal equipment accessing the Packet Assembly/Disassembly facility (PAD) in a public data network situated in the same country".
- [64] CCITT Recommendation X.29: "Procedures for the exchange of control information and user data between a Packet Assembly/Disassembly (PAD) facility and a packet mode DTE or another PAD".
- [65] CCITT Recommendation X.30: "Support of X.21, X.21bis and X.20bis based Data Terminal Equipments (DTEs) by an Integrated Services Digital Network (ISDN)".
- [66] CCITT Recommendation X.31: "Support of packet mode terminal equipment by an ISDN".
- [67] CCITT Recommendation X.32: "Interface between Data Terminal Equipment (DTE) and Data Circuit-terminating Equipment (DCE) for terminals operating in the packet mode and accessing a packet switched public data network through a public switched telephone network or an integrated services digital network or a circuit switched public data network".
- [68] CCITT Recommendation X.75: "Packet-switched signalling system between public networks providing data transmission services".
- [69] ITU-T Recommendation V.34 (1994): "A modem operating at data signalling rates of up to 28 800 bits for use on the general switched telephone network and on leased point-to-point 2-wire telephone-type circuits".
- [70] CCITT Recommendation I.440 (1989): "ISDN user-network interface data link layer - General aspects".
- [71] CCITT Recommendation I.450 (1989): "ISDN user-network interface layer 3 General aspects".
- [72] ISO/IEC 6429 (1992): "Information technology - Control functions for coded character sets".

3 Definitions and Abbreviations

3.1 Definitions

For the purposes of the present document, the following definitions apply:

(DIGITAL) connection: A concatenation of (digital) transmission channels or (digital) telecommunication circuits, switching and other functional units set up to provide for the transfer of (digital) signals between two or more points in a telecommunication network to support a single communication.

GSM PLMN connection: A connection that is established through a GSM PLMN between specified GSM PLMN reference points.

GSM PLMN connection type: A description of a set of GSM PLMN connections which have the same characteristics.

3.2 Abbreviations

Abbreviations used in the present document are listed in GSM 01.04.

4 General considerations

Low layer capabilities are defined in GSM 02.01 and characterized in GSM 02.02 for Bearer Services and GSM 02.03 for Teleservices. Apart from the short message service, all Bearer Services and Teleservices are provided using low layer capabilities in the connection mode. Network capabilities to support the short message services are defined in GSM 03.40 and GSM 04.11 for the point-to-point service, and in GSM 03.41 and GSM 04.12 for the cell broadcast service.

4.1 Relationship between lower layer capabilities and radio traffic channels

The realization of low layer capabilities for the provision of telecommunication services will make use of a physical medium consisting of a traffic channel TCH (refer to GSM 04.03) or a combination of several full rate traffic channels (Multislot configuration for data) except for the short message point-to-point which uses a dedicated control channel DCCH (see GSM 04.11) or the cell broadcast service which uses the CBCH (see GSM 04.12). No multiplexing of data connections on one TCH is allowed.

Either a full rate or a half rate channel may be used depending on the requirements of the individual service. User data rates below or equal to 4 800 bit/s may be supported either on a full rate channel or on a half rate channel. User data rate of 9 600 bit/s and 14 400 bit/s are always supported on a full rate channel. Multislot configurations for data use combinations of 4.8 kbit/s or 9.6 kbit/s or 14.4 kbit/s full rate traffic channels only.

Technically every MS, regardless of whether it uses a half or a full rate TCH for speech transmission, should be able to use both half and full rate TCHs for data transmission and telematic services. However, particular designs of MS may only provide access to a limited set of services and therefore only use limited options.

For the alternate speech and data bearer service and the alternate speech and group 3 facsimile teleservice, when a full rate traffic channel is required for the speech or data portion of the service, a full rate traffic channel will be used for the duration of the call, see GSM 02.02.

For the speech followed by data Bearer services, when a full rate traffic channel is required for speech and a half rate traffic channel is required for the data service, a full rate traffic channel will be used for the speech phase of the call. When the data phase is entered, a half rate channel may be used instead. See GSM 02.02.

Within a GSM PLMN, the transport of user data and access interface status information (if present) will use a rate adaptation method based on CCITT Recommendation V.110 except on channels using TCH/F14.4 for which a specific rate adaption is used between the mobile station and the interworking function. For the access interface, the rate adaptation schemes used are referenced in the GSM 07-series.

On the radio path, rate adaptation leads to rates of 14.5, 12.0, 6.0 and 3.6 kbit/s per TCH (see GSM 04.21). However, in multislot configurations for data the 3.6 kbit/s per TCH/F rate is excluded. At the BSS to MSC interface, the rate adaptation scheme used is described in GSM 08.20.

Protection of information from errors on the radio path (i.e. between MS and BSS) will be implemented by use of FEC techniques (see GSM 05.03).

4.2 Transparent and non-transparent lower layer capabilities

Two classes of low layer capabilities have been identified (see GSM 02.02 and GSM 02.03):

- a transparent class which is characterized by constant throughput, constant transit delay and variable error rate;
- a non-transparent class for which an ARQ technique is used (see GSM 04.22) on the radio path and extended to an appropriate interworking function. This class is characterized by improved error rate with variable transit delay and throughput. Data compression can optionally be used in combination of non-transparent lower layer capability, to increase the data rate on the DTE/DCE interface (or the equivalent interface depending on the TE type).

The considerations described above provide the basis for the definition of a limited set of connection types to be implemented by a GSM PLMN.

4.3 The GSM environment

4.3.1 The hand-over procedure

The GSM connection is heterogeneous and merges PCM links and radio path as a unit for the user.

One of the most specific characteristics of the mobile networks is the hand-over procedure (see GSM 03.09, 04.08, 05.08, 08.08) which result in a temporary break of the TCH, and consequently in a loss of information.

The GSM makes it possible to use one TCH slot for signalling (frame stealing for FACCH) in one TDMA frame resulting in a loss of information.

For the transparent data calls, this will result in a period of highly errored stream. For the non-transparent services, the use of the ARQ procedure (GSM 04.22) will overcome this problem.

After a hand-over, in case of loss of synchronization, the process to recover synchronization, as described in GSM 09.07 and 04.21 should apply. If data compression is used, V.42bis procedure should apply.

4.3.2 DTX procedure

For the full rate speech traffic channel, DTX function goes along with other procedures such as voice activity detection, generation of comfort noise, and is described in GSM 06.31.

For the non-transparent traffic channels, DTX apply according to GSM 08.20.

5 Framework for the description of connection types

5.1 Introduction

A GSM PLMN provides a set of network capabilities which enable telecommunication services to be offered to a user.

A GSM PLMN connection is a connection established between GSM PLMN reference points. A GSM PLMN connection type is a way of referring to and describing a GSM PLMN connection. Thus a GSM PLMN connection is a physical or a logical realization of a GSM PLMN connection type. Each GSM PLMN connection can be characterized as belonging to a connection type.

Figure 1 illustrates the concepts (see also figure 1 of GSM 02.01).

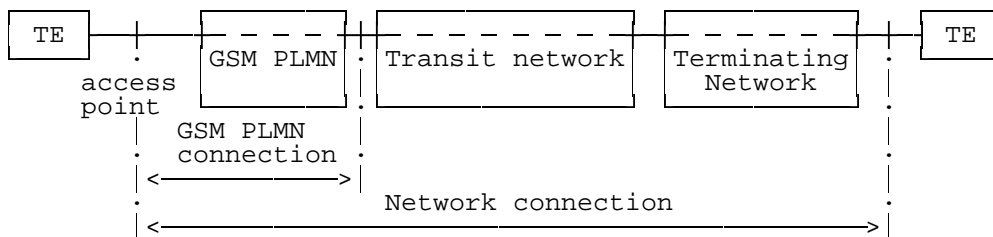

Figure 1: Framework for the description of GSM PLMN connections

5.2 Purpose of GSM PLMN connection types

The definition of a set of GSM PLMN connection types provides the necessary input to identify the network capabilities of a GSM PLMN. Other key requirements of a GSM PLMN are contained in other GSM specifications, in particular GSM 03.01, 04.01 and 04.02. In addition to describing network capabilities of a GSM PLMN, the identification of connection types facilitates the specification of network-to-network interfaces. It may also assist in the allocation of network performance parameters.

NOTE 1: The user specifies only the telecommunication service required while the GSM PLMN allocates the resources to set up a connection of the specific type as necessary to support the requested service. It is further noted that, for certain service offerings, additional network functions, e.g. additional lower layer functions and/or higher layer functions, may be required (see figure 2).

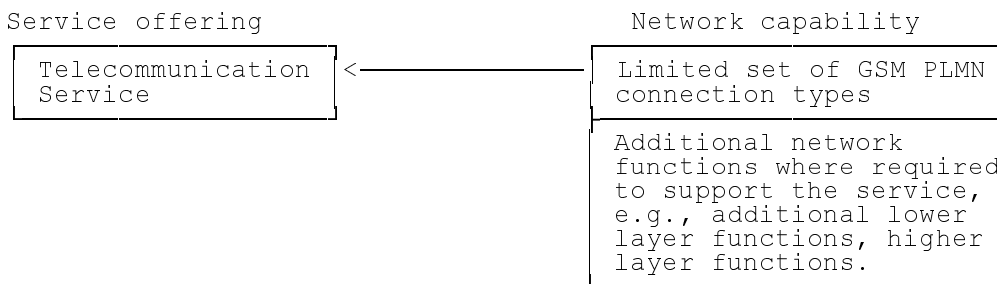

Figure 2: The role of network capabilities in supporting service offerings

5.3 Functions associated with a GSM PLMN connection

Any GSM PLMN connection involves an association of functions to support telecommunication services as shown in figure 3. Three sets of functions are required.

- i) Connection means - including transmission and switching.
- ii) Control functions and protocols - including signalling, flow/congestion control and routing functions.
- iii) Operations and management functions - including network management and maintenance functions.

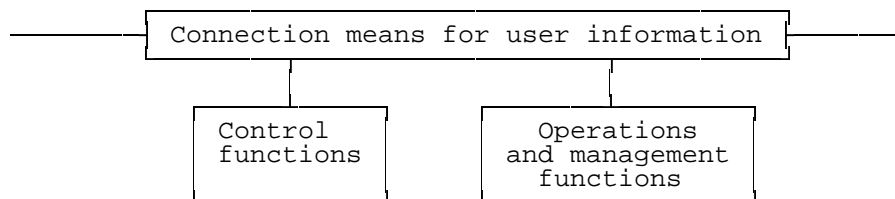

Figure 3: Functional description

5.4 Applications of GSM PLMN connection types

The following situations to which GSM PLMN connection types apply (see figure 4) may arise:

- Between two GSM PLMN user access points (refer to GSM 02.01 and 04.02): see figure 4a.
- Between a GSM PLMN user access point and a network-to-network interface: see figure 4b.
- Between a GSM PLMN user access point and an interface to a specialized resource within the GSM PLMN: see figure 4c.
- Between a GSM PLMN user access point and an interface to a specialized resource outside the GSM PLMN: see figure 4d.

a)

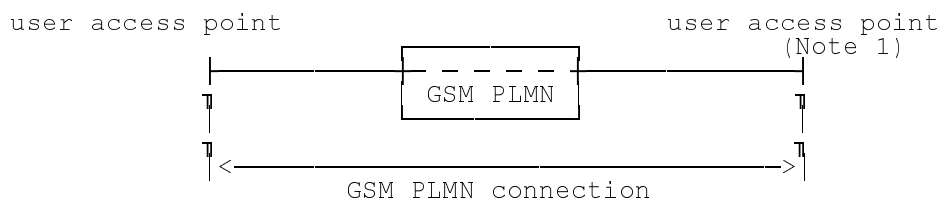

b)

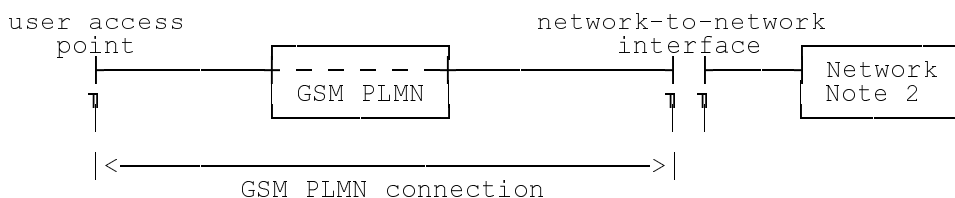

c)

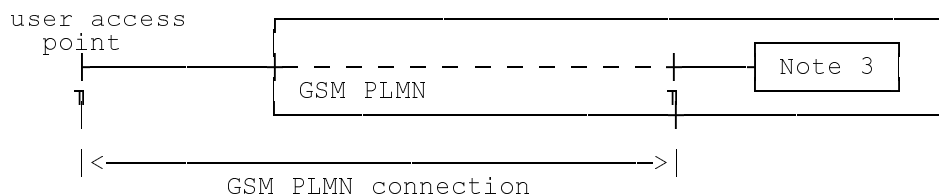

d)

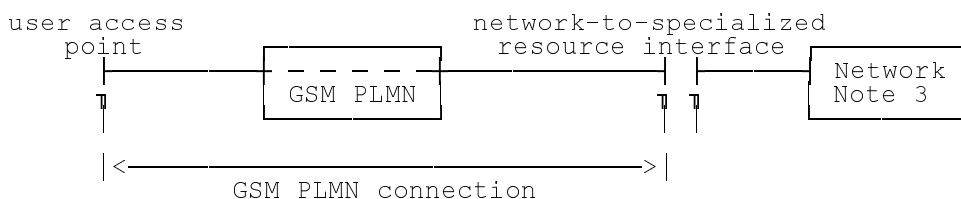

NOTE 1: See GSM 02.01.

NOTE 2: Network means here any fixed network as described in GSM 02.01.

NOTE 3: The box represents a specialized resource. Its use originates from a service request. Further study is required to give some examples.

Figure 4: Applications of GSM PLMN connection types

5.5 GSM PLMN connection involving several networks

A GSM PLMN connection may comprise a number of tandem network connections. Figure 5 shows an example in which each end network is a GSM PLMN. The intermediate network(s) must offer the appropriate network capabilities for the service provided by the (overall) GSM PLMN connection. In (overall) GSM PLMN connections involving several networks, each network provides a part of the connection and may be categorized by different attribute values.

The IWF/MSC can interwork with different type of networks, e.g.:

- analogue (A);
- digital circuit (D) with V.110/X.31 in band protocol;
- packet (P) with X.25 in band protocol.

Examples of such networks are:

- GSM (D);
- PSPDN (P);
- ISDN (A, D, P);
- PSTN (A).

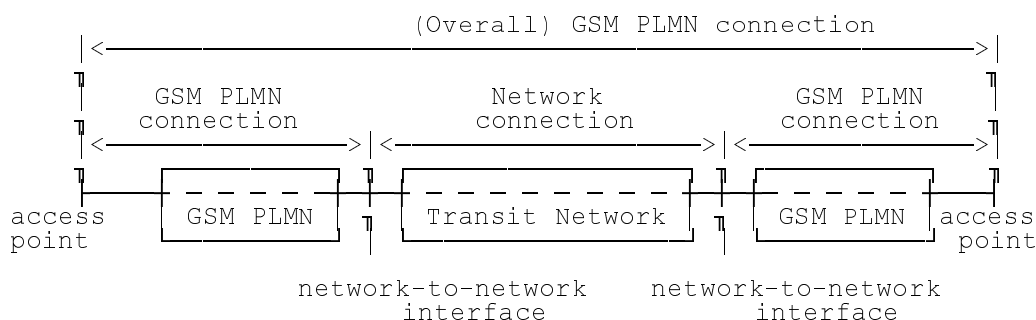

Figure 5: Example of a GSM PLMN connection involving several networks

6 GSM PLMN connection types

6.1 Description of GSM PLMN connection types

The characterization of GSM PLMN connection types is done by using a set of attributes. A GSM PLMN connection type attribute is a specific characteristic of a GSM PLMN connection type whose values distinguish it from another GSM PLMN connection type. Particular values are assigned to each attribute when a given GSM PLMN connection type is described and specified.

A list of definitions of attributes and values is contained in the annex A to the present document.

A GSM PLMN connection type is partitioned into connection elements. This partitioning is based on the two most critical transitions of a connection, firstly, the change of signalling system, secondly, the type of transmission system. In a GSM PLMN, the change in signalling and transmission between the radio interface and the A interface leads to two connection elements, the radio interface connection element and the A interface connection element. Subclause 6.3 describes the relationship between the attributes values of connection elements and connection types.

To complete the description of GSM PLMN connection types, the definition of functions within the different entities of a GSM PLMN which are involved in the realization of a GSM PLMN Connection is needed. These functions will be used in subclauses 6.4 and 6.5 to describe the limited set of GSM PLMN connection types.

The following functions have been identified:

- rate adaptation functions;
- the radio link protocol function;
- the forward error correction function;
- the Layer 2 relay function.

6.1.1 Rate adaptation

The RA0 rate adaptation is only used with asynchronous interfaces. Incoming asynchronous data is padded by the addition of stop elements to fit the nearest higher rate defined by 2 to the power n (where $n \leq 6$) times 600 bit/s or, if applicable, to either 14.4 , or 28.8 kbit/s. Thus both 75 and 300 bit/s user data signalling rate shall be adapted to a synchronous 600 bit/s stream. This function is described in GSM 04.21.

The intermediate rate adaptation function (RA1) is a rate adaptation function which turns either the output of the RA0 function or a synchronous user data stream into a data stream at 8 or 16 kbit/s by bit repetition and frame addition. This function is described in GSM 04.21.

The adaptation of intermediate rates to 64 kbit/s (RA2) performs the final conversion from the intermediate rates generated by the RA1 function to 64 kbit/s.

The radio interface intermediate rate adaptation function (RA1') is in the case of transparent data transmission a variant of the RA1 function and it adapts synchronous user data stream or the output of the RA0 function to one of the following data rates: 3.6 , 6.0 or 12.0 or 14.5 kbit/s over the radio path. For the non-transparent case, the RA1' function provides direct access to the 12.0 or 6.0 kbit/s data rates. This is achieved by allowing the V.110 frame status bits to be used as additional data bits. This function is described in GSM 04.21 and GSM 08.20. RA1' is not applied in TCH/F14.4 non-transparent operation.

For TCH/F14.4 channel coding three GSM-specific adaptation functions are used: namely, RA1'/RAA', RAA', and RAA'' (GSM 08.20). RA1'/RAA' adapts between the 14.5 air-interface rate and the 16 kbit/s rate used across the Abis-interface. RAA' adapts between the 16 kbit/s Abis Interface-rate and 16.0 kbit/s A-interface substream. (Up to four such A-interface substreams may be multiplexed into the 64 kbit/s A-interface stream.) RAA'' converts between the A-interface data substream(s) and the overall synchronous stream. In non-transparent operation the RAA'' converts between the A-interface stream and the 290 -bit blocks containing bits M1, M2, and 288 data bits as described in GSM 04.21.

In multislot data configurations the intermediate rates 16 , 32 , and 64 kbit/s are supported on those sections of the network where the overall data stream is not split into multiple channels (GSM 04.21 and 08.20). RA1-adaptation is not applied to rates higher than 38.4 kbit/s. Instead, a GSM-specific rate adaptation function RA1'' to user rates 48 and 56 kbit/s is applied; this function adapts between these rates and the 64 kbit/s "intermediate" rate. The RA2 function passes rate 64 kbit/s on as such.

In multislot data connections, the rate adaptation functions are performed per TCH/F between the Split/Combine-functions. On the A-interface up to four TCH/Fs are multiplexed into one 64 kbit/s channel according to the procedures defined in GSM 08.20. However, multiplexing is not applied to those user rates which make use of more than four TCH/Fs; for such rates the Split/Combine-function is located at the BSS.

The splitting and recombining of the data flow into/from TCH/Fs takes place at the RA1-function or RAA'' function (transparent service) at the MSC/IWF and at the MS's RA1/RA1'- or RA1''-function, or between the RLP and RA1' (RA1' not applied to TCH/F14.4) (non-transparent service) at the MS and between RA1 or RAA'' and RLP at MSC/IWF (figures 6 and 7). The TCH/Fs are treated as independent channels between the Split/Combine-functions.

For user rates requiring more than four TCH/Fs (transparent only) the Split/Combine-function is located at the RA1/RA1'- or RA1''-function at the MS and at the RA1'/RA1-function at the BSS (figures 6 and 7). The rate adaptation functions for the various user data rates are summarized in tables 1 to 3. It should be noted that in the case of synchronous data transmission, the RA0 is not present.

Table 1: Rate adaptation functions for the support of TE2 in the transparent case

R I/F	RA0	sync	RA1'	Radio I/F
async	<----->			
≤ 2.4	<----->	≤ 2.4	<----->	3.6
4.8	<----->	4.8	<----->	6.0
9.6	<----->	9.6	<----->	12.0 or 2 × 6.0
14.4	<----->	14.4	<----->	14.5 or 2 × 12.0 or 3 × 6.0
19.2	<----->	19.2	<----->	2 × 12.0 or 4 × 6.0
28.8	<----->	28.8	<----->	2 × 14.5 or 3 × 12.0
38.4	<----->	38.4	<----->	3 × 14.5 or 4 × 12.0
		48.0	<----->	4 × 14.5 or 5 × 12.0
		56.0	<----->	4 × 14.5 or 5 × 12.0 note 1
		64.0	<----->	5 × 14.5 or 6 × 12.0 note 1

NOTE 1: AIUR of 11.2 kbit/s per 12.0 kbit/s air interface channel (GSM 04.21).

Table 2: Rate adaptation functions for the support of TE1/TA in the transparent case

async	RA0	sync	RA1	RA2	S I/F	RA2	RA1/RA1'	Radio I/F
≤ 2.4	<----->	≤ 2.4	<----->	8	<----->	64	<----->	8 <-----> 3.6
4.8	<----->	4.8	<----->	8	<----->	64	<----->	8 <-----> 6.0
9.6	<----->	9.6	<----->	16	<----->	64	<----->	16 <-----> 12.0 or 2 × 6.0
14.4	<----->	14.4	<----->	32	<----->	64	<----->	32 <-----> 14.5 or 2 × 12.0 or 3 × 6.0
19.2	<----->	19.2	<----->	32	<----->	64	<----->	32 <-----> 2 × 12.0 or 4 × 6.0
28.8	<----->	28.8	<----->	64	<----->	64	<----->	64 <-----> 2 × 14.5 or 3 × 12.0
38.4	<----->	38.4	<----->	64	<----->	64	<----->	64 <-----> 3 × 14.5 or 4 × 12.0
		48.0	RA1''	RA2	S I/F	RA2	RA1/RA1'	Radio I/F
		48.0	<----->	64	<----->	64	<----->	64 <-----> 4 × 14.5 or 5 × 12.0 note 1
		56.0	<----->	64	<----->	64	<----->	64 <-----> 4 × 14.5 or 5 × 12.0 notes 1, 2
				64	<----->	64	<----->	64 <-----> 5 × 14.5 or 6 × 12.0 notes 1, 2

NOTE 1: RA2 not applicable.

NOTE 2: AIUR of 11.2 kbit/s per 12.0 kbit/s air interface channel (GSM 04.21).

Table 3: RA1' function in the non-transparent case

RA1'
6.0 <-----> 6.0
12.0 <-----> 12.0

NOTE: RA1' not applicable to TCH/F14.4

6.1.2 Radio Link Protocol

The Radio Link Protocol (RLP) is a layer 2 LAPB based protocol which performs grouping of user data for the purpose of implementing error control and retransmission mechanisms in the case of non-transparent low layer capabilities. The RLP layer is in charge of the transmission of the data compression parameters to the peer RLP entity and to the L2R layer, when those parameters have to be negotiated. The function that realizes the implementation of the protocol (described in GSM 04.22) takes place at both ends of the GSM connection in the MT and the IWF/MSC.

6.1.3 Layer 2 Relay function

The Layer 2 Relay function (L2R) performs protocol conversion between the user data structure (e.g. characters or X.25 Layer 2 frames) and a structure more adapted to the radio link protocol. This function is described in the relevant GSM 07-series specifications.

The L2R function includes the data compression function.

6.1.4 Resources allocated by the GSM network

Part of the GSM connection concerns the resources allocated by the GSM network on the basis of the attribute values of the connection elements.

For the speech calls, the GSM codec is allocated.

For data calls, resources are provided at the IWF/MSC such as:

- V.110 based rate adaptation for such channel codings as TCH/F 4,8 and TCH/F9,6 and GSM specific rate adaptation for channel coding TCH/F14.4 (GSM 04.21, 08.20);
- filtering of status bits (GSM 07.01);
- RLP for non-transparent services (GSM 04.22);
- Data compression (GSM 04.22, 07.02).

These are sufficient for data services such as:

- asynchronous circuit (bearer service series 20), used with unrestricted digital information transfer capability;
- synchronous circuit (bearer service series 30), used with unrestricted digital information transfer capability when interworking with circuit switched digital networks.

In addition to the above listed resources, further resources are allocated in the other cases:

- modems for asynchronous circuit (bearer service series 20) or synchronous circuit (bearer service series 30) used with 3.1 kHz information transfer capability;
- fax adaptor for the fax group 3 (teleservice series 60);
- PAD for asynchronous PAD (bearer service series 40), Packet handler and flag stuffing for synchronous packet (bearer service series 50) used with unrestricted digital information transfer capability;
- flag stuffing for synchronous packet using bearer service series 30 with unrestricted digital information transfer capability when interworking with packet switched networks.

6.2 GSM PLMN connection elements

The radio interface connection element is the portion of the connection spanning from the Mobile Termination to an appropriate internal reference point within the Base Station System.

The A interface connection element is the portion of the connection from the above internal reference point within the base station to an appropriate internal reference point within the interworking function (IWF) of the MSC.

By using connection elements and attributes which have a layered nature the construction of a connection type is more easily viewed. The use of different values for the same attribute allows a greater degree of description and flexibility.

6.3 Rules of association for the attribute values of connection elements and connection types

This subclause describes the relationship between the attribute values of connection elements and connection types. For each attribute the various possible values recommended are listed. The definitions of the attributes and attribute values are contained in the annex A. In addition to the (possible) attribute values applicable to the connection elements, an association law is given (where appropriate) for each attribute to show how the value of the attribute for the overall connection type is obtained from the values of the attribute applicable to the connection elements.

6.3.1 Information transfer mode

Attribute values for connection elements:

Circuit.

Attribute values for overall connection type:

Circuit.

Association Law:

Circuit.

6.3.2 Information transfer rate (kbit/s)

Attribute values for connection elements:

3.6 or 6.0 or 12.0 or 13.0 or 14.5 or 64.0

or $n \times 6.0$ ($1 \leq n \leq 4$) or $n \times 12.0$ ($1 \leq n \leq 6$) or $n \times 14.5$ ($1 \leq n \leq 5$)

Attribute values for overall connection type:

3.6 or 6.0 or 12.0 or 13.0 or 14.5 or 64.0;

or $n \times 6.0$ ($1 \leq n \leq 4$) or $n \times 12.0$ ($1 \leq n \leq 6$) or $n \times 14.5$ ($1 \leq n \leq 5$).

Association Law:

The value for the overall connection type will be equal to the lowest value of any of its connection elements.

6.3.3 Information transfer susceptance

Attribute values for connection elements:

Speech processing functions (e.g. GSM Speech Coding/A Law conversion, Discontinuous Transmission) and/or Echo suppression functions and/or Multiple satellite hops or null.

Attribute values for overall connection types:

Unrestricted Digital Information or Speech.

Association Law:

For an overall connection type to have the value Unrestricted digital no connection element may contain speech processing functions or echo suppression functions. Connection elements containing speech processing devices having the flexibility to change operation between speech and unrestricted digital would on the other hand be allowed to be part of a number of different connection types.

For an overall connection type to have the value speech it must contain GSM Speech Coding/A Law conversion equipment and echo suppression functions when appropriate.

6.3.4 Establishment of connection

Attribute values for connection elements:

Demand.

Attribute values for overall connection type:

Demand.

Association Law:

If any of the connection elements are Demand, then the overall connection type is Demand.

6.3.5 Symmetry

Attribute values for connection elements:

Bidirectional Symmetric.

Bidirectional Asymmetric (Multislot connections for data).

Attribute values for overall connection type:

Bidirectional Symmetric.

Bidirectional Asymmetric (Multislot connections for data).

Association Law:

The overall symmetry can only be generated from the connection elements by analysis of the connection element values in the context of the architecture of the connection.

6.3.6 Connection configuration Topology

Attribute values for connection elements:

Point-to-point.

Attribute values for the overall connection type:

Not applicable.

Association Law:

Not applicable.

6.3.7 Structure

Attribute values for connection elements:

Unstructured or Service Data Unit Integrity.

Attribute values for the overall connection type:

As per values for connection elements.

Association Law:

Unspecified.

6.3.8 Channels

6.3.8.1 Information channel (rate)

Attribute values for connection elements:

Radio interface connection element: Full rate TCH or Full rate TCHs or Half rate TCH.

A interface connection element: 64.0 kbit/s.

Attribute values for the overall connection type:

Not applicable.

6.3.8.2 Signalling channel (rate)

Attribute values for connection elements:

Radio interface connection element: Dm.

A interface connection element: Common channel signalling system (64.0 kbit/s).

Attribute values for the overall connection type:

Not applicable.

6.3.9 Connection control protocol

Attribute values for connection elements:

Radio interface connection element:

Layer 1: GSM 04.03 and GSM 05-series.

Layer 2: GSM 04.05 and 04.06.

Layer 3: GSM 04.07 and 04.08, 04.11.

A interface connection element:

Layer 1: GSM 08.04.

Layer 2: GSM 08.06.

Layer 3: GSM 04.07, 04.08 and 08.08.

Attribute values for the overall connection type:

Not applicable.

6.3.10 Information transfer coding/protocol

Attribute values for connection elements:

Radio interface connection elements:

Layer 1: GSM 04.21, GSM 05-series and 06-series.

Layer 2: GSM 04.06, 04.22 and GSM 07.02 or GSM 04.22 and GSM 07.03 or transparent.

Layer 3: Transparent, GSM 04.11.

A interface connection element:

Layer 1: GSM 08.04 and GSM 08.20.

Layer 2: GSM 04.22 and GSM 07.02 or GSM 04.22 and GSM 07.03 or transparent.

Layer 3: Transparent.

Attribute values for the overall connection type:

Not applicable.

6.3.11 Further attributes and attribute values

This subclause has outlined the relationships between those attributes values presently existing, the possibility for new values being added remains.

Table 4 summarizes the attributes values for GSM PLMN connection elements.

Table 4: Values for attributes for GSM PLMN connection elements

Attributes	Values for attributes	
	Radio interface connection element	A interface connection element
1 Information Transfer Mode	Circuit	Circuit
2 Information Transfer Rate Layer 1	3.6 or 6.0 or 12.0 or 13.0 or 14.5 or $n \times 6.0$ ($1 \leq n \leq 4$) or $n \times 12.0$ ($1 \leq n \leq 6$) or $n \times 14.5$ ($1 \leq n \leq 5$) kbit/s	64.0 kbit/s
3 Information Transfer Susceptance	Speech processing equipment, Echo suppression equipment, Null	Speech processing equipment, Echo suppression equipment, Null
4 Establishment of Connection	Demand	Demand
5 Symmetry	Bidirectional symmetric Bidirectional asymmetric	Bidirectional symmetric Bidirectional asymmetric
6 Connection Configuration Topology	Point-to-point	Point-to-point
7 Structure	Unstructured SDU integrity	Unstructured SDU integrity
8 Channel Rate Information Channel Signalling Channel	TCH/F(s) or TCH/H Dm	64.0 kbit/s Common channel signalling system
9 Connection Control Protocol Layer 1 Layer 2 Layer 3	GSM 04.03 and 05 series GSM 04.05 and 04.06 GSM 04.07, 04.08, 04.11	GSM 08.04 GSM 08.06 GSM 04.07, 04.08, 08.08
10 Information Transfer Coding/Protocol Layer 1 Layer 2 Layer 3	GSM 04.21 05 and 06 series GSM 04.22 and 07.02 or 04.22 and 07.03 04.06 or transparent Transparent, 04.11	GSM 08.04 and 08.20 GSM 04.22 and 07.02 or 04.22 and 07.03 or transparent Transparent

6.4 Limited set of GSM PLMN connection types (all channel codings excluding TCH/F14.4)

From the two connection elements defined in subclause 6.2, the list of attributes and their possible values given in subclause 6.3, and from the service requirements defined in GSM 02.02 and 02.03, a limited set of GSM PLMN

connection types have been identified (see also table 5 and table 6 for the relationship between connection elements and telecommunication services).

Figure 6 gives the information transfer protocol models for the identified set of GSM PLMN connection types. The S bits correspond to status bits and the D bits to data bits (GSM 04.21); S* indicates that S bits are used only when 3.1 kHz audio ex PLMN. D' bits corresponds to user bits passed in the place of status bits in the non transparent case. Moreover, it should be noted that the RLP rate of 6 and 12 kbit/s correspond to the 8 and 16 Kbit/s intermediate rate in the transparent case.

Protocol Models 1 a and b are the models for asynchronous data transmission in the transparent mode. Models 1d and 1e are for multislot transparent asynchronous data configurations.

Protocol Models 2 a and b are the models for synchronous data transmission in the transparent mode. Models 2d and 2e are for multislot transparent synchronous data.

Protocol Models 3 a and b are the models for character "asynchronous" mode data transmission in the non-transparent mode. In this case, L2RCOP represents the protocol used between the Layer 2 Relay functions (L2R) to convey characters between the MS and the IWF (see GSM 07.02). The data compression function is located in the L2R COP function. Models 3d and 3e are for multislot character "asynchronous" data transmission in the non-transparent mode.

Protocol Models 4 a, b, and c are the models for synchronous data transmission using the CCITT Recommendation X.25 PSPDN access protocol in the non-transparent mode. In this case, L2RBOP represents the protocol used between the Layer 2 Relay functions (L2R) to convey the LAP-B information between the MS and the IWF (see GSM 07.03).

Models 4d, 4e, and 4f are for multislot synchronous data transmission using the CCITT Recommendation X.25 PSPDN access protocol in the non-transparent mode.

In all the above models, the a, d and b, e variants indicate alternative access arrangements at the MS, i.e. access at the S interface or at the R interface. The c and f variants indicate a further alternative access arrangement where rate adaptation at the S interface is performed by flag stuffing as defined in CCITT Recommendation X.31.

Protocol Model 5a is the model for the transparent support of group 3 facsimile transmission. Model 5b is for transparent support of group 3 facsimile transmission in multislot data configurations.

Protocol Models 6 a and b are the models for speech transmission. As in models 1-4, the a and b variants indicate alternative access arrangements at the MS, i.e. access at the S interface or direct access of the telephony teleservice.

Protocol model 7 a is the model for the non-transparent support of group 3 facsimile transmission. Model 7b is for non-transparent support of group 3 facsimile transmission in multislot data configurations.

In the multislot-data models the data is split into parallel substreams between the Split/Combine-functions (S/C). These substreams are transmitted through parallel TCH/Fs which are treated as independent channels. Between the S/C-functions parallel RA- and FEC-functions are used.

For all the models, only the minimum functionality of the IWF is shown. Additional functions will be required for various interworking situations. These additional functions are described in specifications GSM 09.04, GSM 09.05, GSM 09.06 and GSM 09.07.

It should be noted that, in Figure 6, the representation of the transcoding and rate adaptation from the intermediate rate on the radio interface to the 64 kbit/s rate required by the MSC is not intended to indicate a particular implementation. The annex B to GSM 03.10 identifies alternative arrangements.

6.5 Limited set of GSM PLMN connection types (for TCH/F14.4 channel coding)

Figure 7 provides the information transfer protocol models for the identified set of GSM PLMN connection types for support of TCH/F14.4. The description of models given in subclause 6.4 applies also to figure 7.

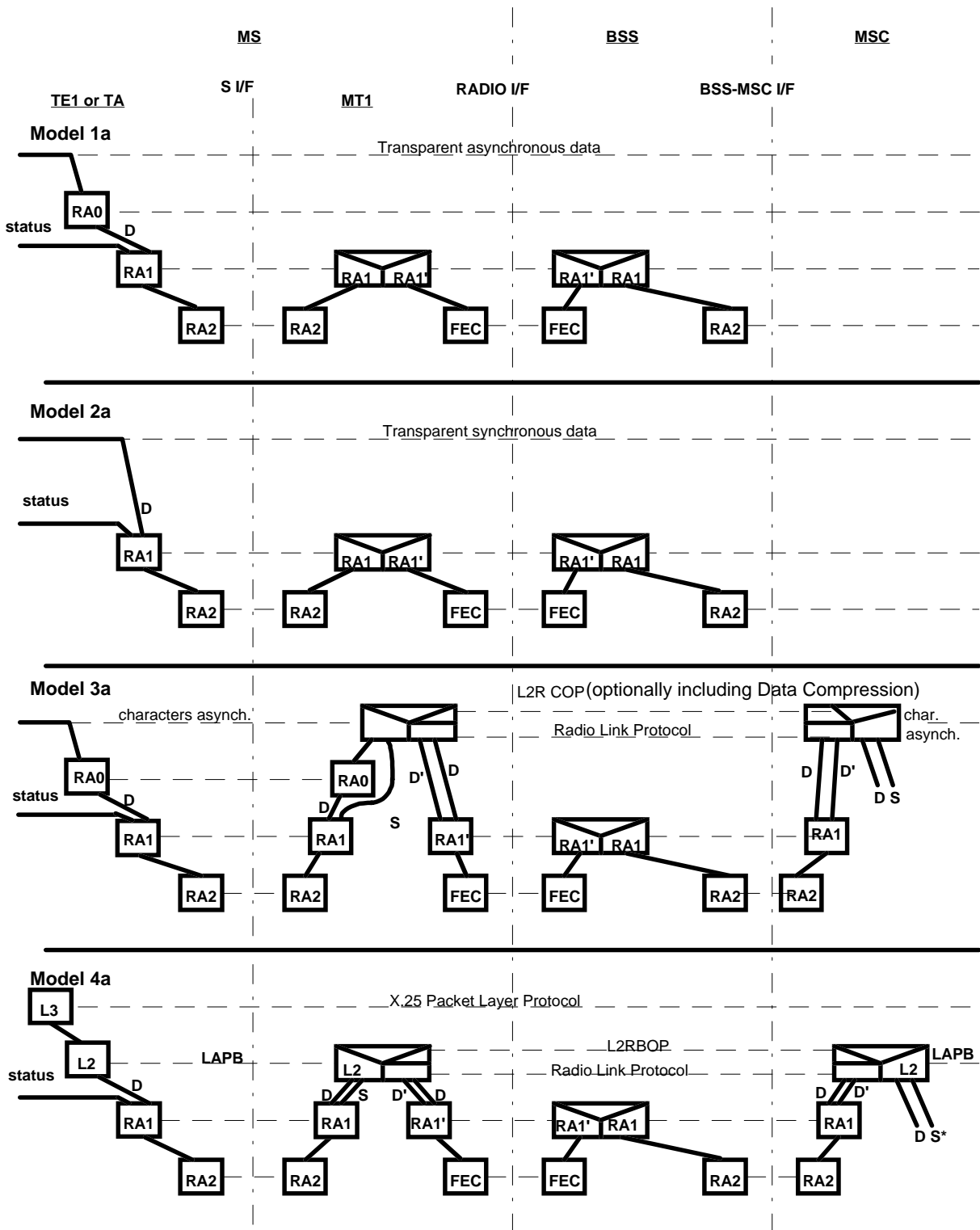

Figure 6: Information transfer protocol models for GSM PLMN connections

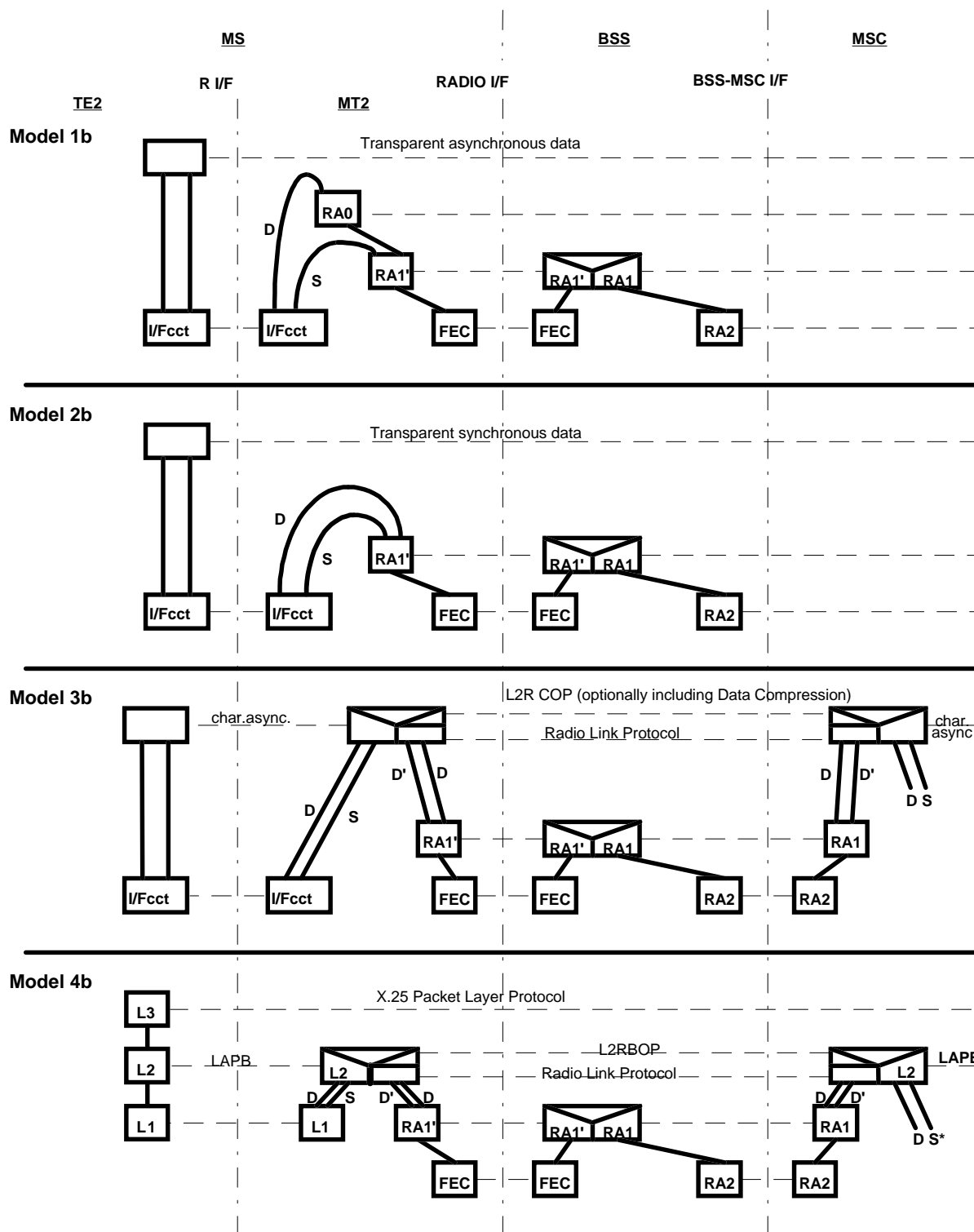

Figure 6 (continued): Information transfer protocol models for GSM PLMN connections

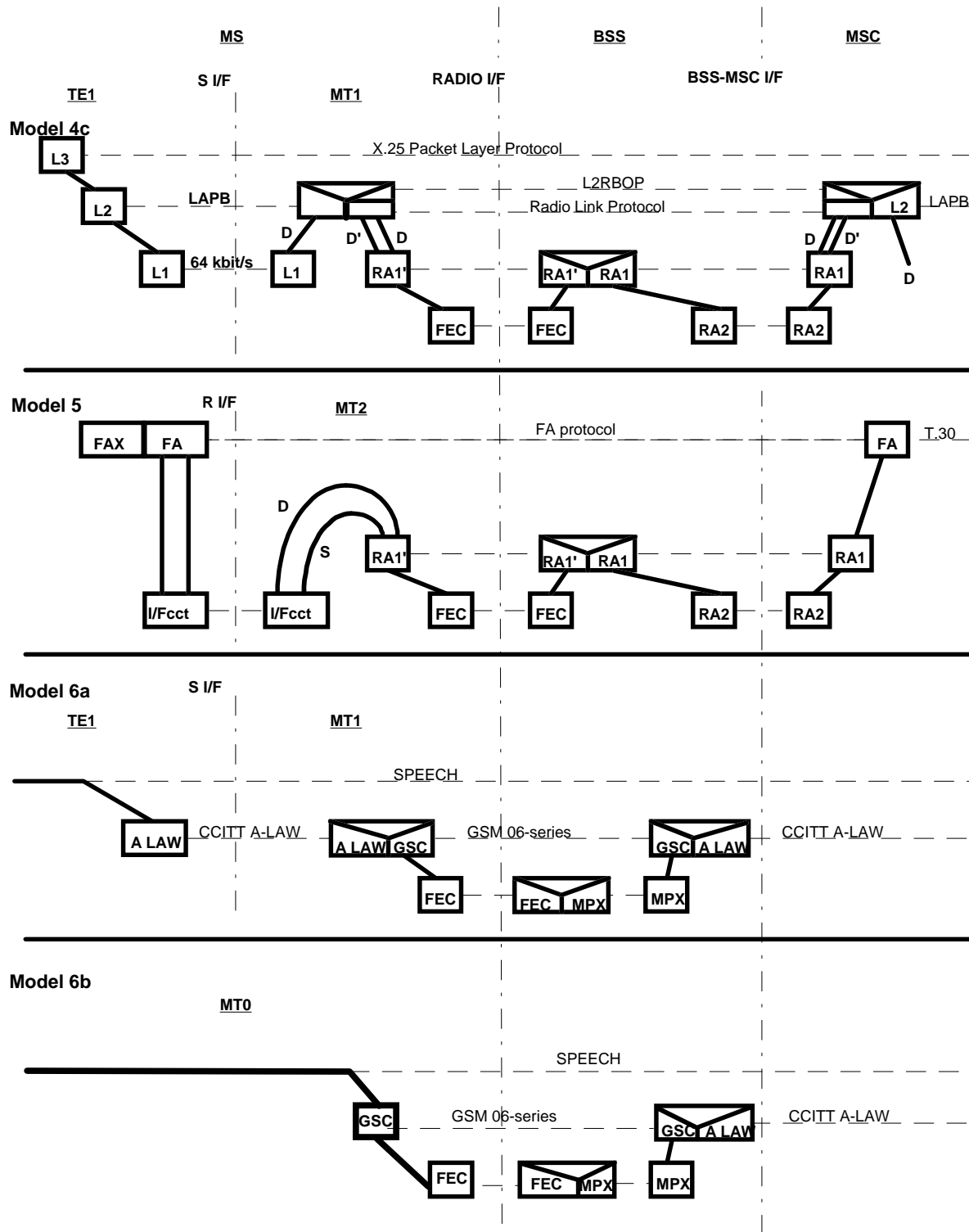

Figure 6 (continued): Information transfer protocol models for GSM PLMN connections

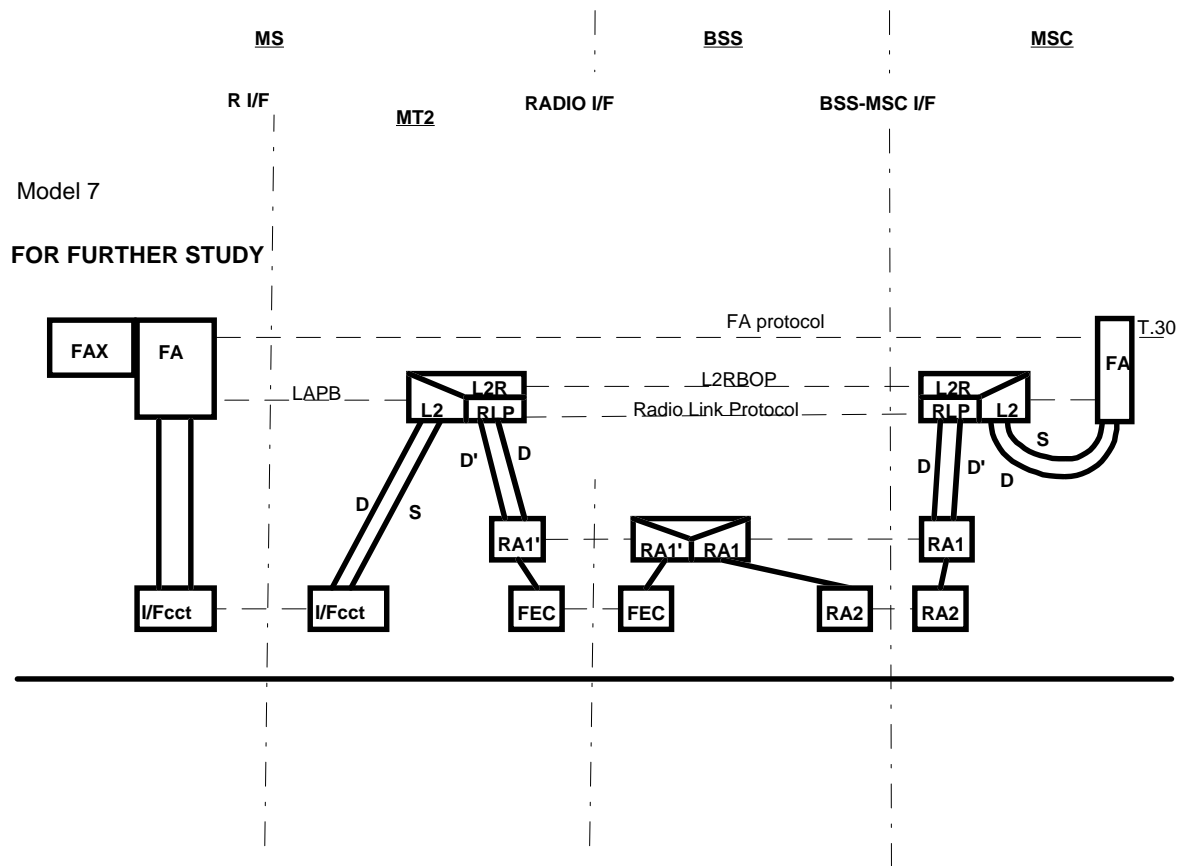

Figure 6 (continued): Information transfer protocol models for GSM PLMN connections

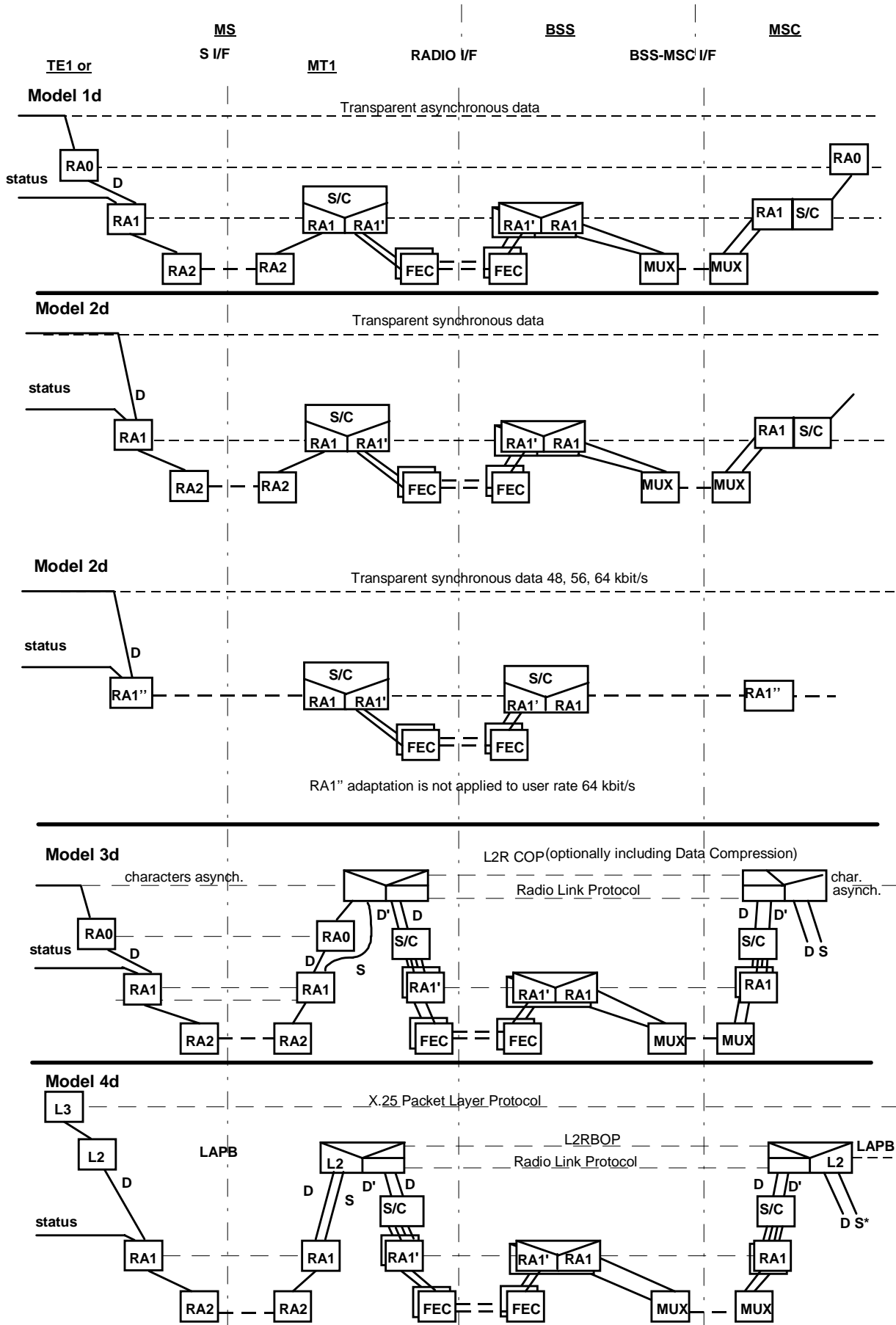

Figure 6 (continued): Information transfer protocol models for GSM PLMN connections

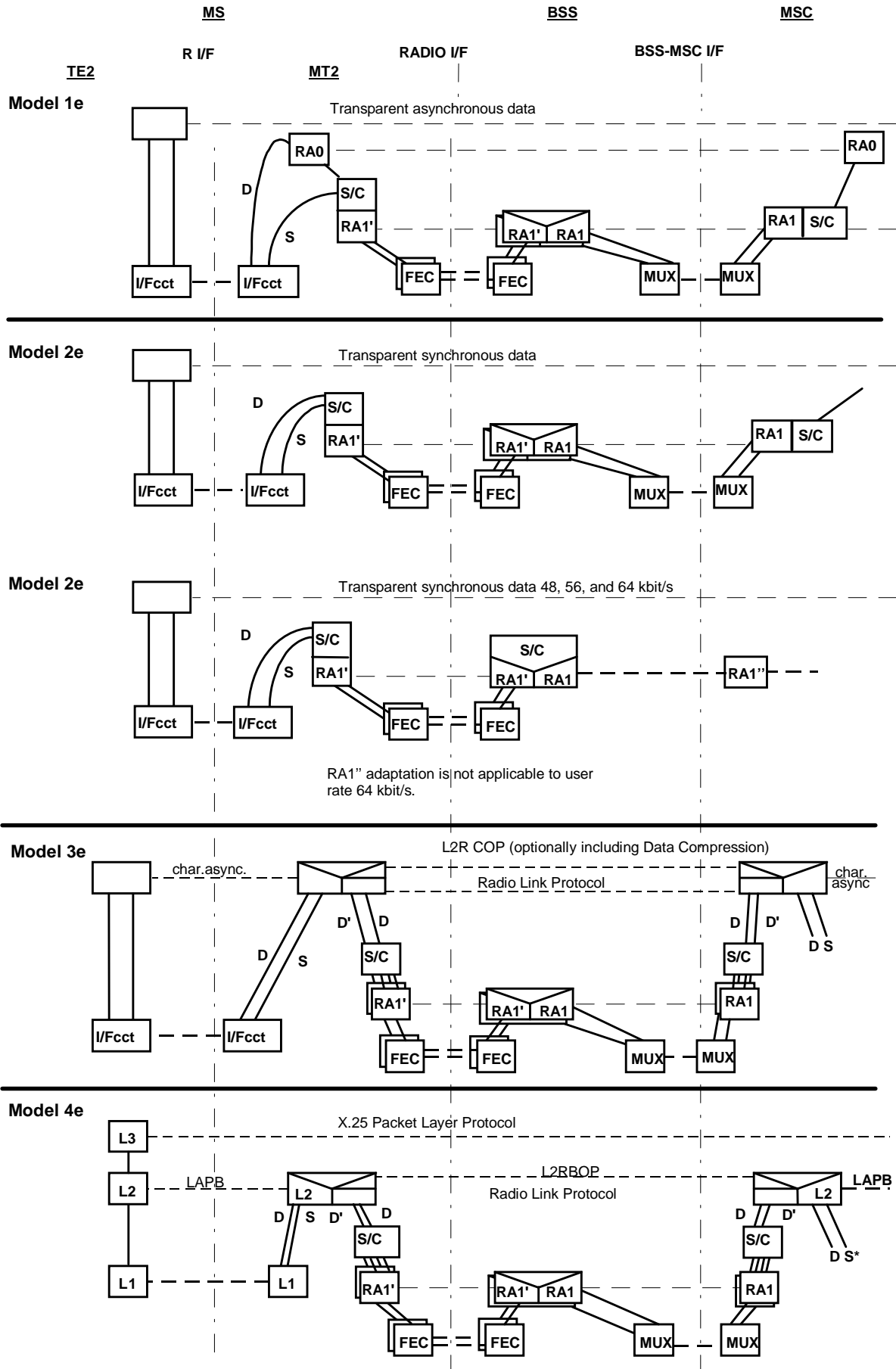

Figure 6 (continued): Information transfer protocol models for GSM PLMN connections

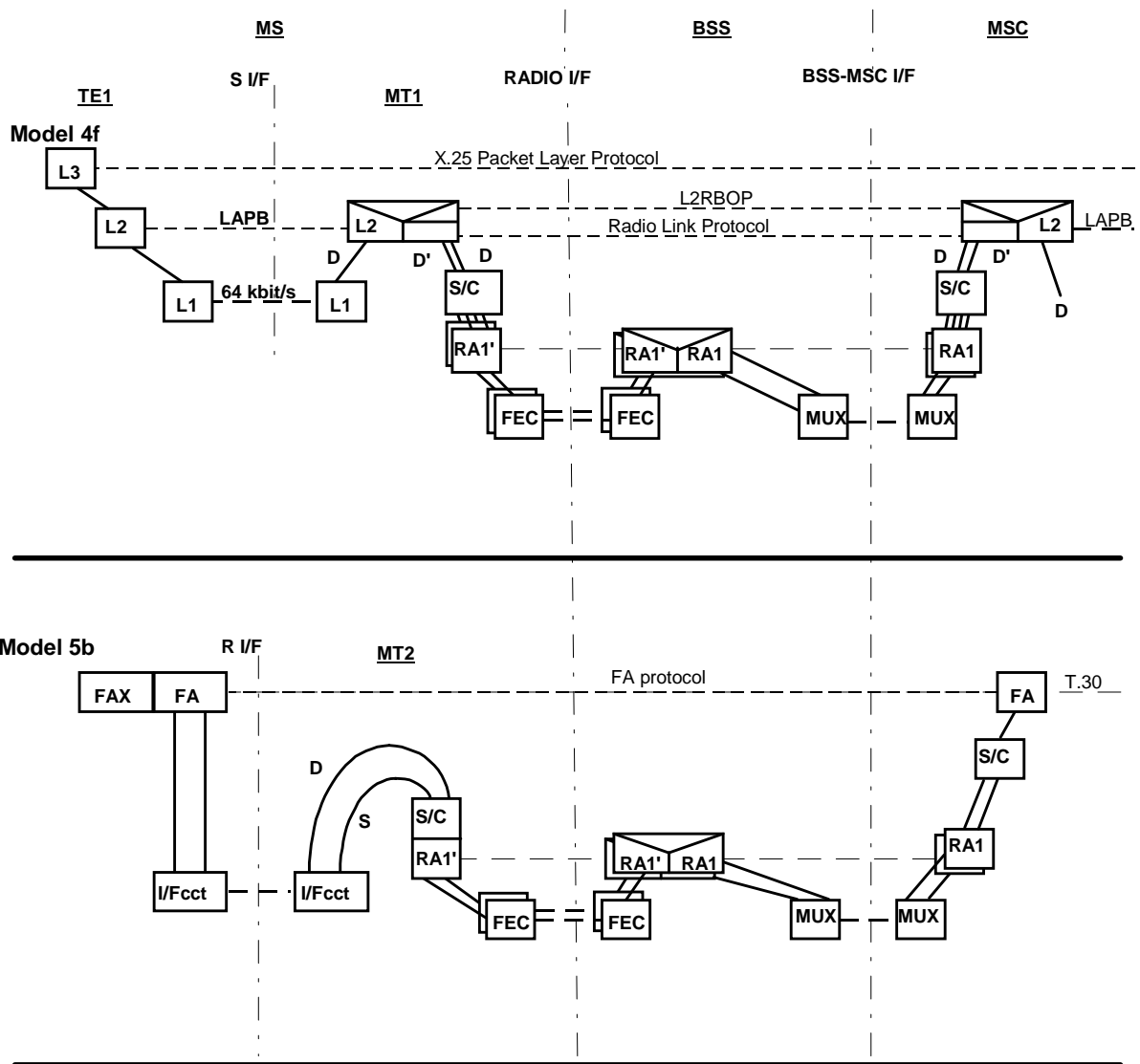

Figure 6 (continued): Information transfer protocol models for GSM PLMN connections

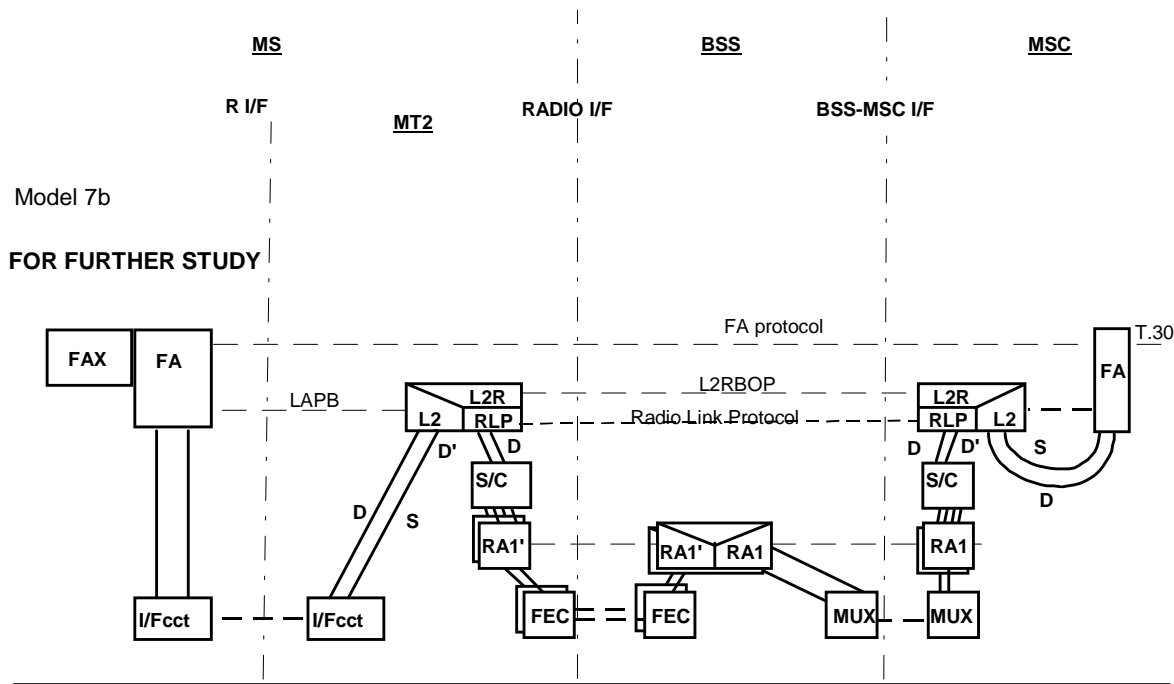

Figure 6 (concluded): Information transfer protocol models for GSM PLMN connections

Legend	to Figure 6:
FA	= Fax Adaptor
GSC	= GSM Speech Codec
FEC	= Forward Error Correction
MPX	= Multiplex/Demultiplex
MUX	= Multiplex/Demultiplex
S/C	= Split/ Combine

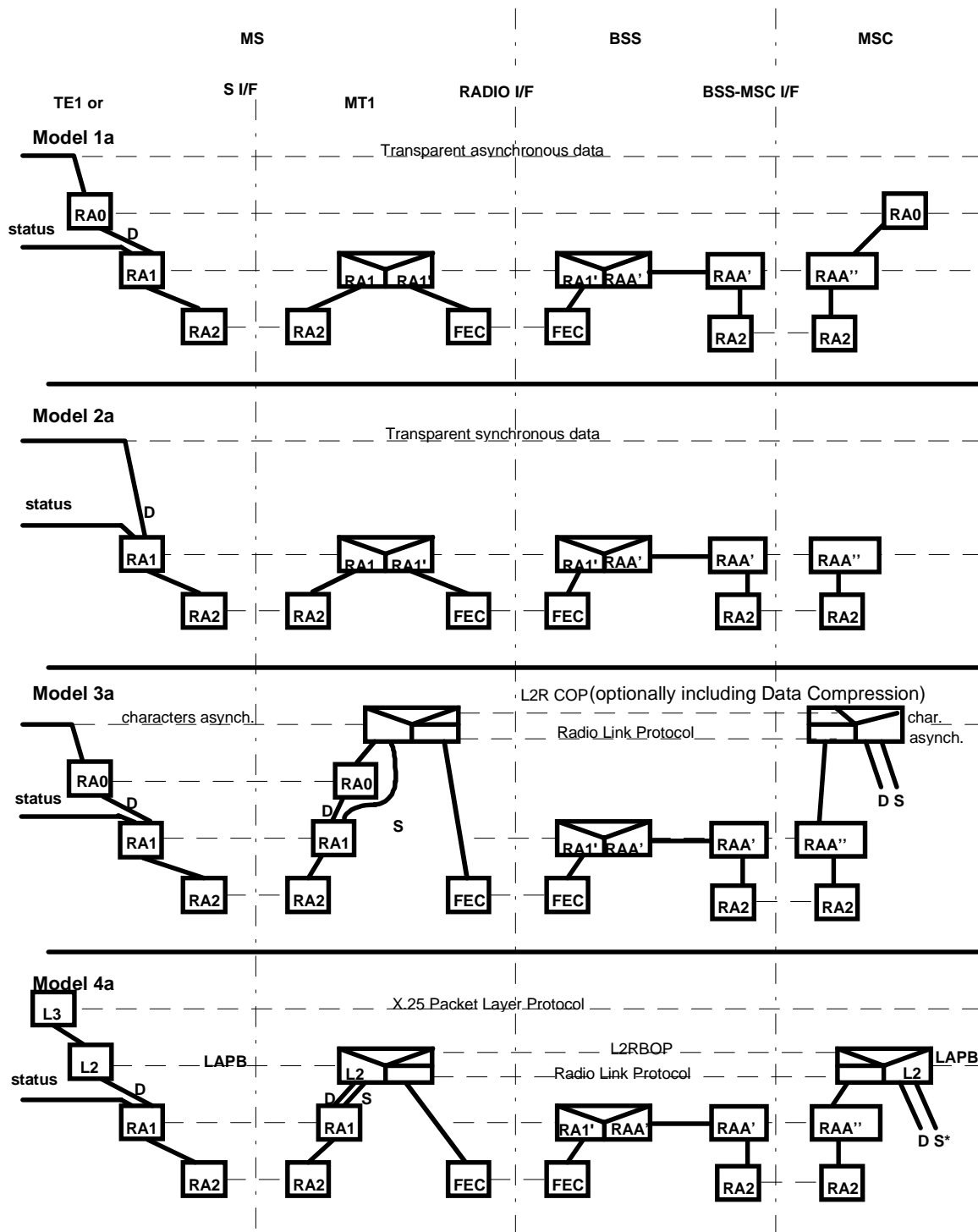

Figure 7: Information transfer protocol models for GSM PLMN connections using 14.4 channels

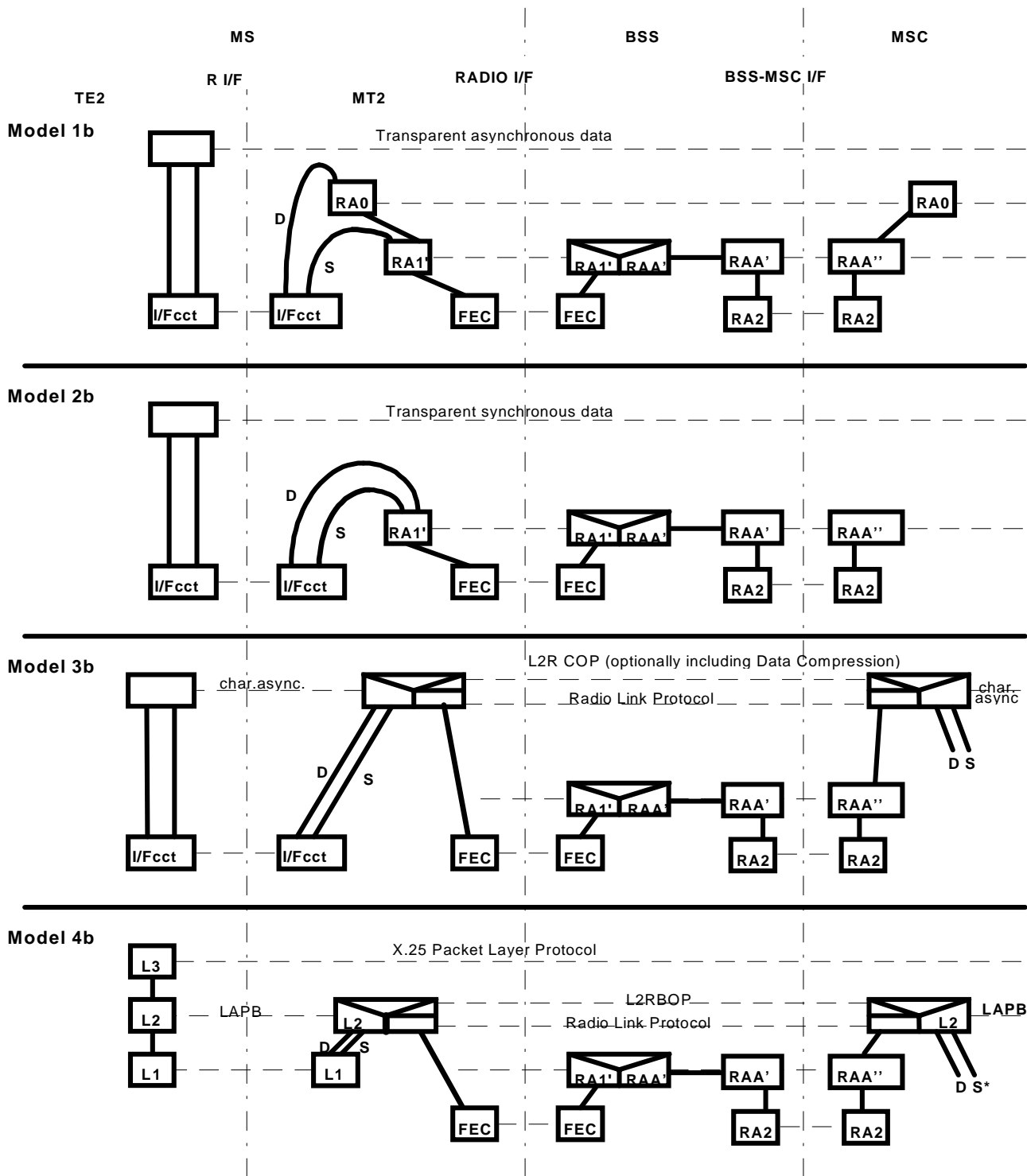

Figure 7 (continued) : Information transfer protocol models for GSM PLMN connections using 14.4 channels

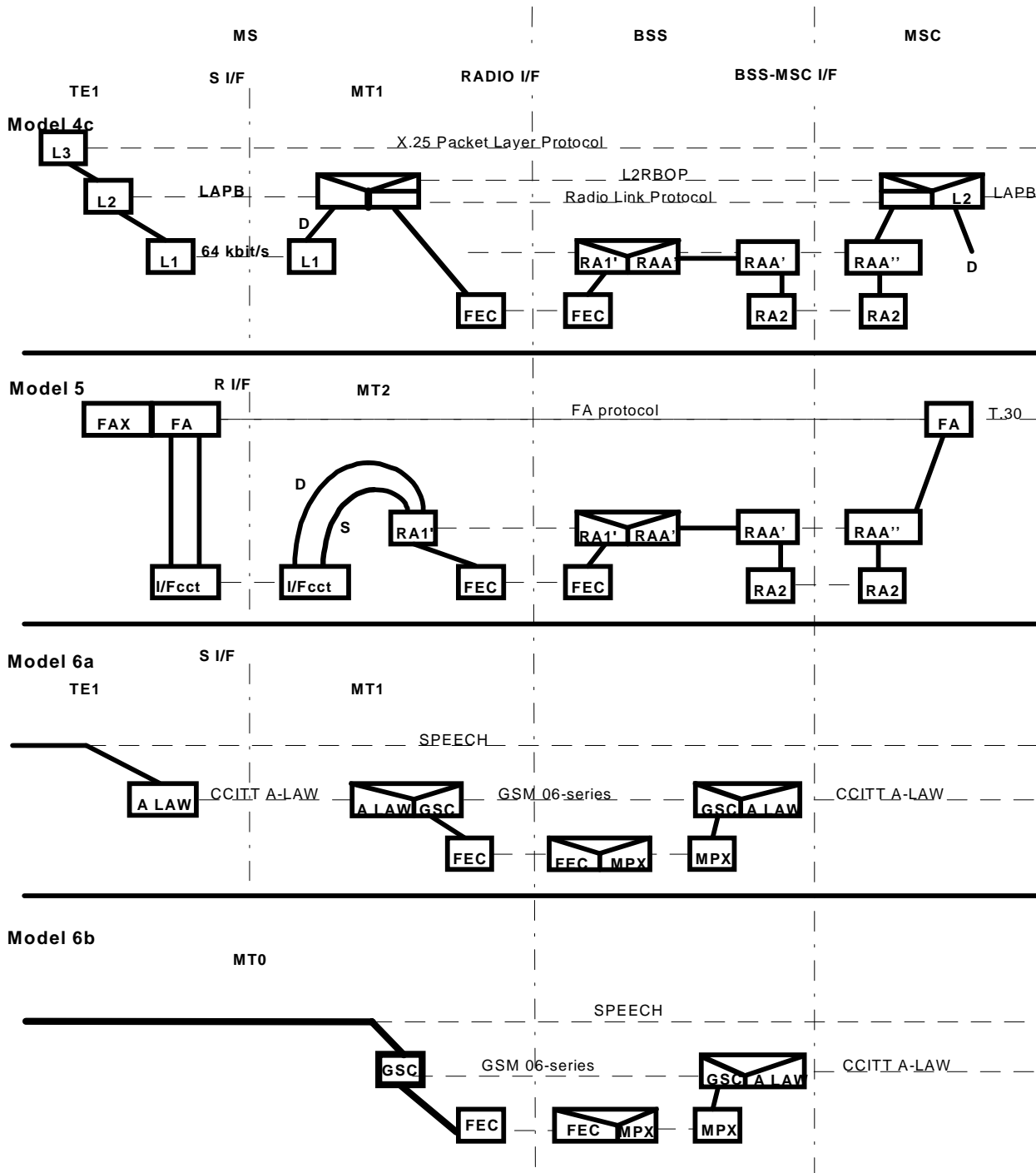

Figure 7 (continued) : Information transfer protocol models for GSM PLMN connections using 14.4 channels

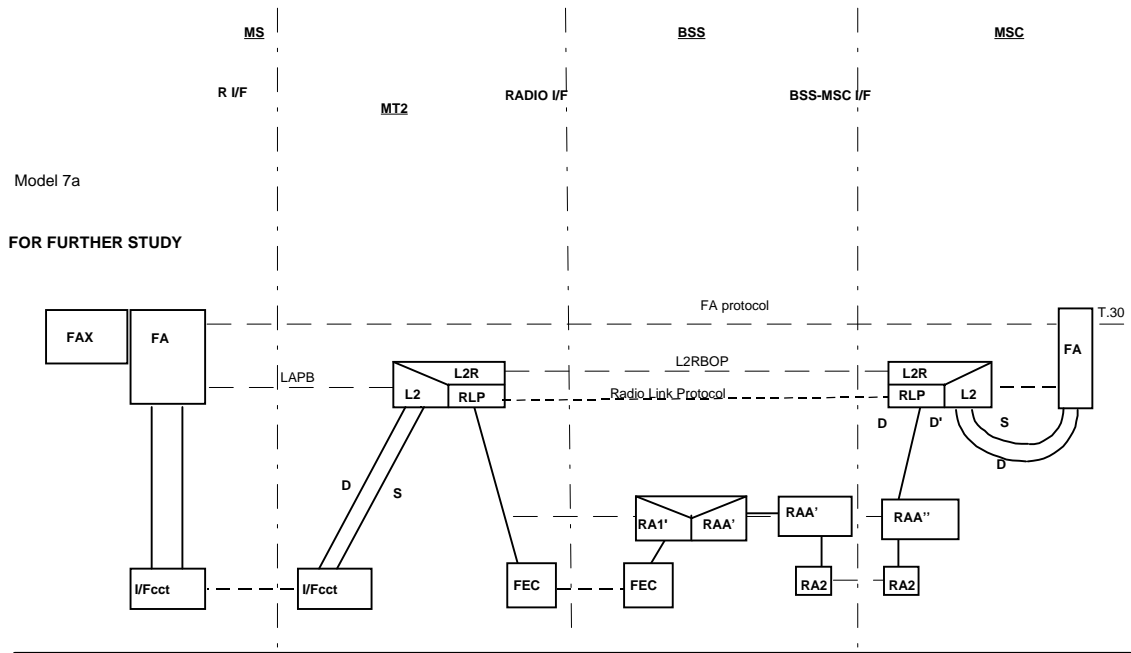

Figure 7 (continued) : Information transfer protocol models for GSM PLMN connections using 14.4 channels

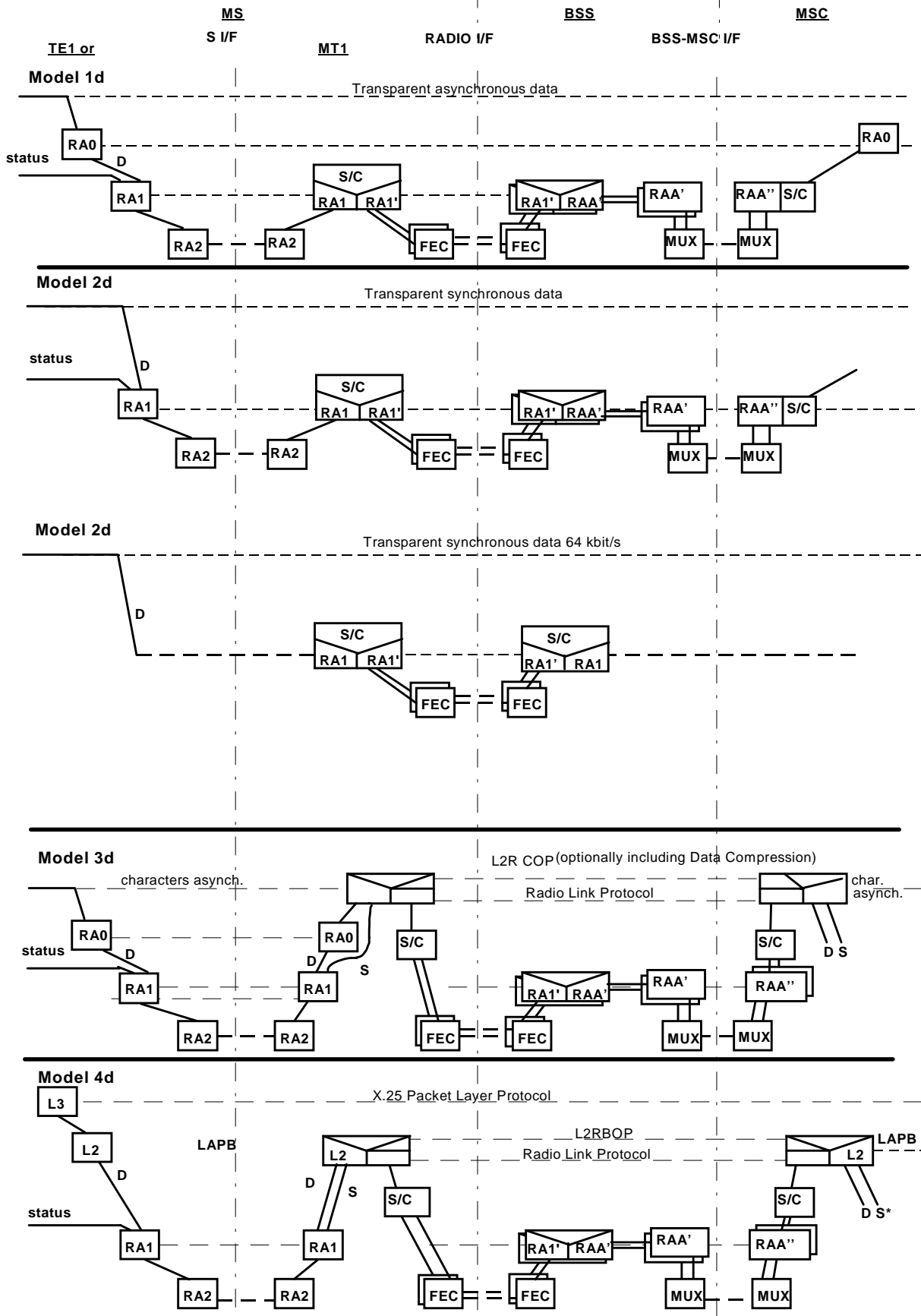

Figure 7 (continued) : Information transfer protocol models for GSM PLMN connections using 14.4 channels

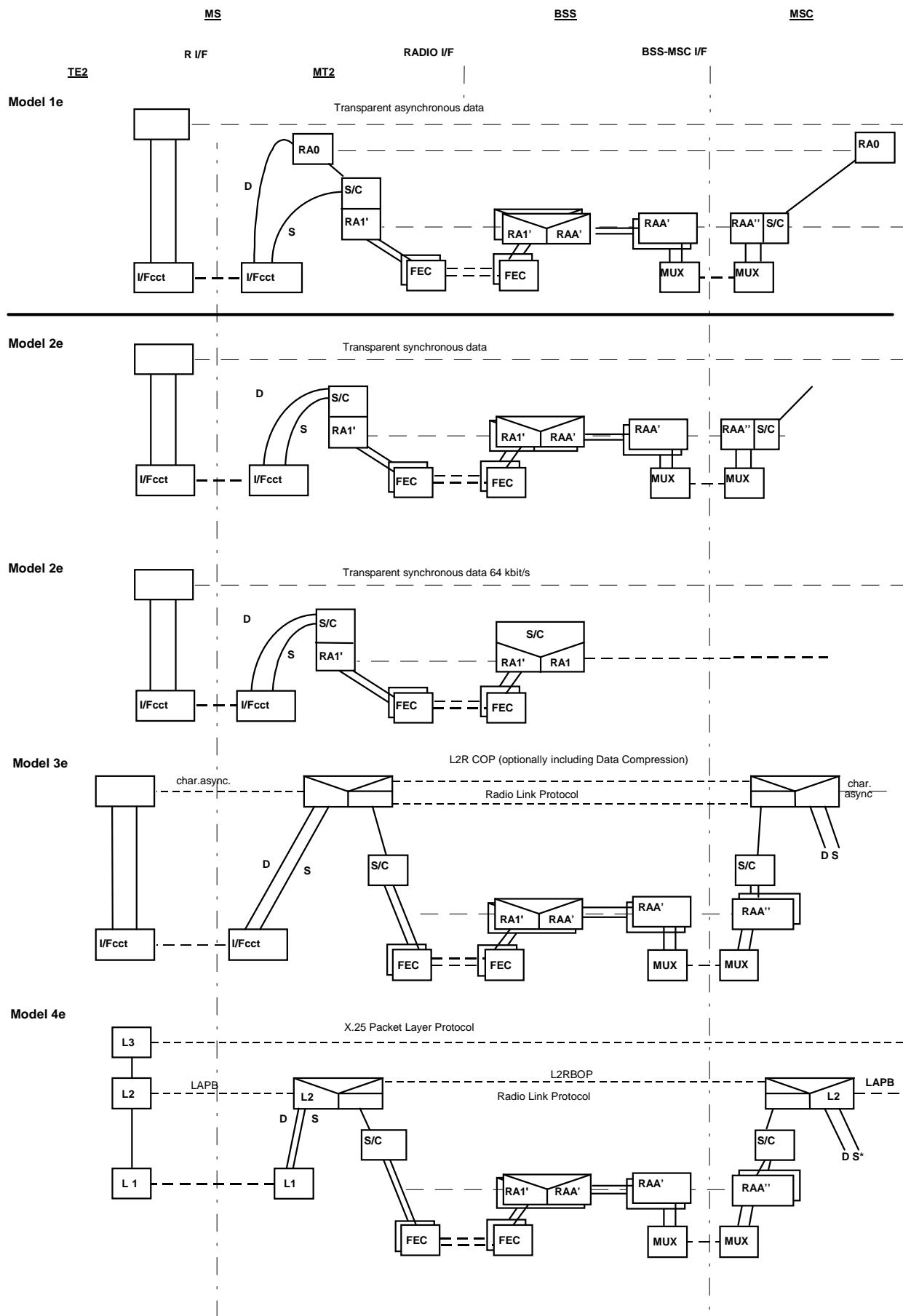

Figure 7 (continued) : Information transfer protocol models for GSM PLMN connections using 14.4 channels

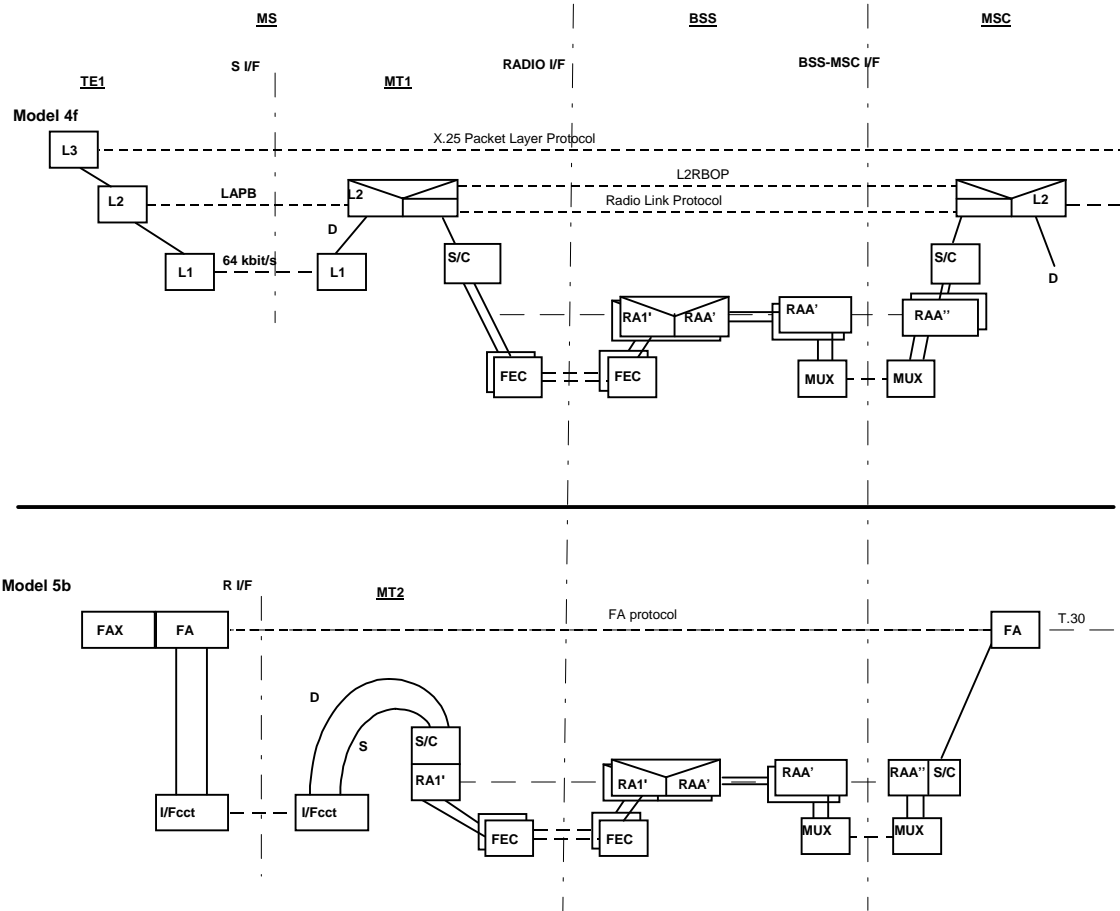

Figure 7 (continued) : Information transfer protocol models for GSM PLMN connections using 14.4 channels

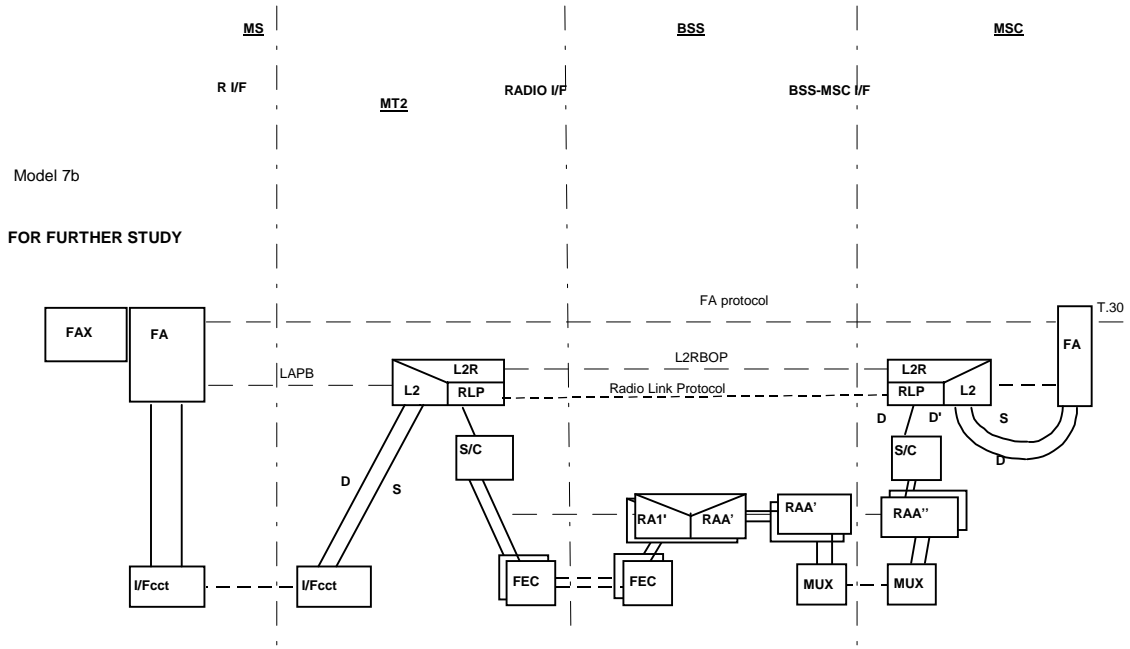

Figure 7 (concluded) : Information transfer protocol models for GSM PLMN connections using 14.4 channels

Legend	to Figure 7:
FA	= Fax Adaptor
GSC	= GSM Speech Codec
FEC	= Forward Error Correction
MPX	= Multiplex/Demultiplex
MUX	= Multiplex/Demultiplex
S/C	= Split/ Combine

7 Relationship between Telecommunication services and connection types

7.1 General

Given a request for a telecommunication service at the initiation of a call, the GSM PLMN must establish a connection of a connection type that supports the attributes of the service requested. This establishment of a connection is effected at the time of call set up.

It should be noted that GSM PLMN connection types represent the technical capabilities of a GSM PLMN and provide a basis for the definition of performance and interworking with other networks. Telecommunication services supported by a GSM PLMN are the packages offered to customers and the definition of their attributes is the means to standardize the service offerings in all GSM PLMNs.

Quality of service and commercial attributes are relevant to telecommunication services whereas connection types are characterized by network performance, network operations and maintenance attributes.

7.2 Relationship between Bearer services and connection types

Table 5 shows the relationship between Bearer services and GSM PLMN connection types. In table 5, the connection elements for each connection type related to a Bearer service are shown.

Dominant attributes of the connection elements, such as information transfer mode, information transfer rate, information transfer capability and structure are indicated. The type of radio traffic channel used is also shown (half rate and full rate). In the multislot cases the minimum number of timeslots per connection (n) is 1.

7.3 Relationship between Teleservices and connection types

Table 6 shows the relationship between teleservices and connection type elements, for those teleservices having a GSM PLMN connection type which does not correspond to the GSM PLMN connection type of a bearer service. As in table 5/GSM 03.10, dominant attributes of the connection elements and the type of radio traffic channel are shown. In the multislot cases the minimum number of timeslots per connection (n) is 1.

7.4 Network capability to support in-call modification

Specifications GSM 02.02 and 02.03 identify a particular need for a GSM PLMN to support the Alternate speech/data (3.1 kHz audio ex PLMN), Alternate speech and group 3 facsimile, and Speech followed by data (3.1 kHz audio).

These services allow the use of in-call modification to change the mode of service. The network capability to support in-call modification is described in GSM 04.08. An in-call modification of the service mode is not possible for other services.

7.5 Network capability to support channel mode modification

Specification GSM 03.45 (Technical Realization of the Group 3 Facsimile Teleservice) identifies a need for a GSM PLMN to support channel mode modification within the facsimile phase of the alternate speech and facsimile group 3 service. The network capability to support channel modification is described in GSM 04.08. Channel mode modification is not possible for other services. A channel mode modification results in a change of connection element over the radio interface with resultant change in access at the mobile station.

Table 5: Relationship between Bearer services and GSM PLMN Connection elements

Connection description	Bearer service user data rate	Radio interface connection element	Intermediate rate at the BSS-MSC interface	BSS-MSC connection element	Protocol model in figure 6 or 7
Circuit mode unstructured with unrestricted digital capability transparent.	Data circuit duplex async $n \times 4\ 800$ ($n \leq 4$) or $n \times 9\ 600$ bit/s ($n \leq 4$). Data circuit duplex sync $n \times 4\ 800$ ($n \leq 4$) or $n \times 9\ 600$ bit/s ($n \leq 5$) or $n \times 1\ 200$ bit/s ($n = 5$ or 6).	cct mode unstructured unrestricted $n \times 6$ kbit/s ($n \leq 4$) or $n \times 12$ kbit/s ($n \leq 6$) on n full rate channels.	8 or 16 kbit/s per TCH/F. For data connections using 5 or 6 TCH/Fs no intermediate rate(s).	cct mode unstructured unrestricted 64 kbit/s.	Fig 6 : 1 d, 1 e, 2 d, 2 e
	Data circuit duplex async $n \times 14\ 400$ bit/s ($n \leq 3$). Data circuit duplex sync $n \times 14\ 400$ bit/s ($n \leq 5$)	cct mode unstructured unrestricted $n \times 14.5$ kbit/s ($n \leq 5$) on n full rate channels	16 kbit/s per TCH/F.		Fig 7 : 1 d, 1 e, 2 d, 2 e
	Data circuit duplex async 14 400 bit/s Data circuit duplex sync 14 400 bit/s	cct mode unstructured unrestricted 14.5 kbit/s on full rate Channel	16 kbit/s	cct mode unstructured unrestricted 64 kbit/s.	Fig 7 : 1 a, 1 b 2 a, 2 b
	Data circuit duplex async 9 600 bit/s. Data circuit duplex sync 9 600 bit/s.	cct mode unstructured unrestricted 12 kbit/s on full rate channel.	16 kbit/s.	cct mode unstructured unrestricted 64 kbit/s.	Fig 6 : 1 a, 1 b Fig 6 2 a, 2 b
	Data circuit duplex async 4 800 bit/s. Data circuit duplex sync 4 800 bit/s.	cct mode unstructured unrestricted 6 kbit/s on full rate channel and half rate channel.	8 kbit/s.	cct mode unstructured unrestricted 64 kbit/s.	Fig 6 1 a, 1 b Fig 6 2 a, 2 b
	Data circuit duplex async 300. Data circuit duplex async 1 200. Data circuit duplex async 1 200/75. Data circuit duplex async 2 400. Data circuit duplex sync 1 200. Data circuit duplex sync 2 400.	cct mode unstructured unrestricted 3.6 kbit/s on full rate channel and half rate channel.	8 kbit/s.	cct mode unstructured unrestricted 64 kbit/s.	Fig 6 : 1 a, 1 b Fig 6 1 a, 1 b Fig 6 1 a, 1 b Fig 6 1 a, 1 b Fig 6 1 a, 1 b Fig 6 2 a, 2 b Fig 6 2 a, 2 b
	Circuit mode unstructured with unrestricted digital capability non transparent.	Data circuit duplex async $n \times 4\ 800$ ($n \leq 4$) or $n \times 9\ 600$ bit/s ($n \leq 4$).	cct mode SDU unrestricted $n \times 6$ kbit/s ($n \leq 4$) or $n \times 12$ kbit/s ($n \leq 4$) on full rate channels.	8 or 16 kbit/s per TCH/F.	cct mode unstructured unrestricted 64 kbit/s.

(continued)

Table 5 (continued): Relationship between Bearer services and GSM PLMN Connection elements

Connection description	Bearer service user data rate	Radio interface connection element	Intermediate rate at the BSS-MSC interface	BSS-MSC connection element	Protocol model in figure 6 or 7
	Data circuit duplex async $n \times 14\,400$ bit/s ($n \leq 4$).	cct mode SDU unrestricted $n \times 14.5$ kbit/s ($n \leq 4$) on full rate channels.	16 kbit/s		Fig 7 : 3 d, 3e
	Data circuit duplex async 14 400 bit/s	cct mode SDUunrestricted 14.5 kbit/s on full rate channel	16 kbit/s		Fig 7 : 3 a, 3 b
	Data circuit duplex async 9 600 bit/s.	cct mode SDU unrestricted 12 kbit/s on full rate channel.	16 kbit/s.	cct mode unstructured unrestricted 64 kbits/s.	Fig 6 : 3 a, 3 b
	Data circuit duplex async 4 800 bit/s.	cct mode SDU unrestricted full rate channel, 12 kbit/s or half rate channel, 6 kbit/s.	16 kbit/s FR 8 kbit/s HR.	cct mode unstructured unrestricted 64 kbits/s.	Fig 6 : 3 a, 3 b
	Data circuit duplex async 300. Data circuit duplex async 1 200. Data circuit duplex async 1 200/75. Data circuit duplex async 2 400.	cct mode SDU unrestricted full rate channel, 12 kbit/s or half rate channel, 6 kbit/s.	16 kbit/s FR 8 kbit/s HR.	cct mode unstructured unrestricted 64 kbits/s.	Fig 6: 3 a, 3 b Fig 6 : 3 a, 3 b Fig 6 3 a, 3 b Fig 6 3 a, 3 b
Circuit mode unstructured with 3.1 kHz audio ex PLMN transparent.	Data circuit duplex async $n \times 4\,800$ bit/s ($n \leq 4$) or $n \times 9\,600$ bit/s ($n \leq 3$). Data circuit duplex sync $n \times 4\,800$ bit/s ($n \leq 4$) or $n \times 9\,600$ bit/s ($n \leq 3$).	cct mode unstructured unrestricted $n \times 6$ kbit/s ($n \leq 4$) or $n \times 12$ kbit/s ($n \leq 3$) on full rate channels.	8 or 16 kbit/s TCH/F.	cct mode unstructured unrestricted 64 kbit/s.	Fig 6 : 1 d, 1 e, 2 d, 2 e
	Data circuit duplex async $n \times 14\,400$ bit/s ($n \leq 2$). Data circuit duplex sync $n \times 14\,400$ bit/s ($n \leq 2$)	cct mode unstructured unrestricted $n \times 14.5$ kbit/s ($n \leq 2$) on full rate channels	16 kbit/s per TCH/F		Fig 7 : 1 d, 1 e, 2 d, 2e
	Data circuit duplex asynch 14 400 bit/s synch 14 400 bit/s	cct mode unstructured unrestricted 14.5 kbit/s on full rate channels	16 kbit/s		Fig 7 : 1 a, 1 b for asynch Fig 7 2 a 2 b for synch
	Data circuit duplex async 9.6 kbit/s sync 9.6 kbit/s.	cct mode unstructured unrestricted 12 kbit/s full rate channel.	16 kbit/s.		
	Data circuit duplex async 4.8 kbit/s sync 4.8 kbit/s.	cct mode unstructured unrestricted 6 kbit/s full and half rate channel.	8 kbit/s.		Fig 6 : 1 a, 1 b for asynch. Fig 6 : 2 a, 2 b for synch.
	Data circuit duplex async $\leq 2\,400$ sync $\leq 2\,400$.	cct mode unstructured unrestricted 3.6 kbit/s full and half rate channel.	16 kbit/s.		
Circuit mode unstructured with 3.1 kHz audio ex PLMN non transparent.	Data circuit duplex async $n \times 4\,800$ ($n \leq 4$) or $n \times 9\,600$ ($n \leq 4$) bit/s. Data circuit duplex sync $n \times 4\,800$ ($n \leq 4$) or $n \times 9\,600$ bit/s ($n \leq 4$).	cct mode SDU unrestricted $n \times 6$ kbit/s ($n \leq 4$) or $n \times 12$ kbit/s ($n \leq 4$) on full rate channels.	8 or 16 kbit/s per TCH/F.	cct mode unstructured unrestricted 64 kbits/s.	Fig 6 : 3 d, 3 e for asynch. Fig 6 : 4 d, 4 e, 4 f for sync.

(continued)

Table 5 (continued): Relationship between Bearer services and GSM PLMN Connection elements

Connection description	Bearer service user data rate	Radio interface connection element	Intermediate rate at the BSS-MSC interface	BSS-MSC connection element	Protocol model in figure 6 or 7	
	Data circuit duplex asynch $n \times 14\,400$ bit/s ($n \leq 4$). Data circuit duplex synch $n \times 14\,400$ bit/s ($n \leq 4$)	cct mode SDU unrestricted $n \times 14.5$ kbit/s ($n \leq 4$) on n full rate channels	16 kbit/s per TCH/F		Fig 7 : 3 d, 3 e for asynch Fig 7 : 4 d, 4 e 4 f for synch	
	Data circuit duplex asynch 14 400 bit/s synch 14 400 bit/s	cct mode SDU unrestricted 14.5 kbit/s full rate channel	16 kbit/s		Fig 7 : 3a, 3b for asynch Fig 7 : 4 a, 4 b, 4 c for synch	
	Data circuit duplex asynch 9.6 kbit/s synch 9.6 kbit/s.	cct mode SDU unrestricted 12 kbit/s full rate channel.	16 kbit/s.			
	Data circuit duplex asynch 4.8 kbit/s synch 4.8 kbit/s.	cct mode SDU unrestricted half rate channel, 6 kbit/s or full rate channel, 12 kbit/s.	16 kbit/s FR 8 kbit/s HR.	cct mode unstructured unrestricted 64 kbit/s.	Fig 6 : 3 a, 3 b for asynch. Fig 6 : 4 a, 4 b, 4 c for synch.	
	Data circuit duplex asynch $\leq 2\,400$ synch $\leq 2\,400$.	cct mode SDU unrestricted half rate channel, 6 kbit/s or full rate channel, 12 kbit/s.				
Pad access transparent.	PAD access circuit asynch 300. PAD access circuit asynch 1 200. PAD access circuit asynch 1 200/75. PAD access circuit asynch 2 400.	cct mode unstructured unrestricted 3.6 kbit/s on full rate channel and half rate channel.	8 kbit/s.	cct mode unstructured unrestricted 64 kbit/s.	Fig 6 : 1 a, 1 b Fig 6 : 1 a, 1 b Fig 6 : 1 a, 1 b Fig 6 : 1 a, 1 b	
	PAD access circuit asynch 4 800.	cct mode unstructured unrestricted 6 kbit/s on half rate channel and full rate channel.			Fig 6 : 1 a, 1 b	
	PAD access circuit asynch 9 600.	cct mode unstructured unrestricted 12 kbit/s on full rate channel.	16 kbit/s.		Fig 6 : 1 a, 1 b	
	PAD access circuit asynch 14 400 bit/s	cct mode unstructured unrestricted 14.5 kbit/s on full rate channel	16 kbit/s		Fig 7 : 1 a, 1 b	
	PAD access circuit asynch $n \times 4\,800$ ($n \leq 4$) or $n \times 9\,600$ bit/s ($n \leq 4$).	cct mode unstructured unrestricted $n \times 6$ kbit/s ($n \leq 4$) or $n \times 12$ kbit/s ($n \leq 4$) on n full rate channels.	8 or 16 kbit/s per TCH/F.		Fig 6 : 1 d, 1 e	
	PAD access circuit asynch $n \times 14\,400$ bit/s ($n \leq 3$).	cct mode unstructured unrestricted $n \times 14.5$ kbit/s ($n \leq 3$) on n full rate channels.	16 kbit/s per TCH		Fig 7 : 1 d, 1 e	

(continued)

Table 5 (continued): Relationship between Bearer services and GSM PLMN Connection elements

Connection description	Bearer service user data rate	Radio interface connection element	Intermediate rate at the BSS-MSC interface	BSS-MSC connection element	Protocol model in figure 6 or 7
Pad access non transparent.	PAD access circuit async 300. PAD access circuit async 1 200. PAD access circuit async 1 200/75. PAD access circuit async 2 400.	cct mode SDU unrestricted half rate channel, 6 kbit/s or full rate channel, 12 kbit/s.	16 kbit/s FR 8 kbit/s HR.	cct mode unstructured unrestricted 64 kbit/s.	Fig 6 : 3 a, 3 b Fig 6 : 3 a, 3 b Fig 6 : 3 a, 3 b Fig 6 : 3 a, 3 b
	PAD access circuit async 4 800.	cct mode SDU unrestricted half rate channel, 6 kbit/s or full rate channel, 12 kbit/s.			Fig 6 : 3 a, 3 b
	PAD access circuit async 14 400 bit/s	cct mode SDU unrestricted 14.5 kbit/s on full rate channel	16 kbit/s		Fig 7 : 3 a, 3 b
	PAD access circuit async 9 600.	cct mode SDU unrestricted 12 kbit/s on full rate channel.	16 kbit/s.		Fig 6 : 3 a, 3 b
	PAD access circuit async $n \times 4 800$ ($n \leq 4$) or $n \times 9 600$ bit/s ($n \leq 4$).	cct mode SDU unrestricted $n \times 6$ kbit/s ($n \leq 4$) or $n \times 12$ kbit/s ($n \leq 4$) on full rate channels.	8 or 16 kbit/s per TCH/F.		Fig 6 : 3 d, 3 e
	PAD access circuit async $n \times 14 400$ bit/s ($n \leq 4$).	cct mode SDU unrestricted $n \times 14.5$ kbit/s ($n \leq 4$) on full rate channels.	16 kbit/s per TCH/F.		Fig 7 : 3 d, 3 e
Packet services, dedicated access, non transparent.	Data packet duplex sync 2 400.	cct mode SDU unrestricted half rate channel, 6 kbit/s or full rate channel, 12 kbit/s.	16 kbit/s FR 8 kbit/s HR.	cct mode unstructured unrestricted 64 kbit/s.	Fig 6 : 4 a, 4 b, 4 c
	Data packet duplex sync 4 800.	cct mode SDU unrestricted half rate channel, 6 kbit/s or full rate channel, 12 kbit/s.			Fig 6 : 4 a, 4 b, 4 c
	Data packet duplex sync 9 600.	cct mode SDU unrestricted 12 kbit/s on full rate channel.	16 kbit/s.		Fig 6 : 4 a, 4 b, 4 c
	Data packet duplex synch 14 400 bit/s	cct mode SDU unrestricted 14.5 kbit/s on full rate channel	16 kbit/s.		Fig 7 : 4 a, 4 b, 4 c
	Data packet duplex sync $n \times 4 800$ ($n \leq 4$) or $n \times 9 600$ bit/s ($n \leq 4$).	cct mode SDU unrestricted $n \times 6$ kbit/s ($n \leq 4$) or $n \times 12$ kbit/s ($n \leq 4$) on full rate channels.	8 or 16 kbit/s per TCH/F.		Fig 6 : 4 d, 4 e, 4 f
	Data packet duplex sync $n \times 14 400$ bit/s ($n \leq 4$).	cct mode SDU unrestricted $n \times 14.5$ kbit/s ($n \leq 4$) on full rate channels.	16 kbit/s per TCH/F		Fig 7 : 4 d, 4 e, 4 f

(continued)

Table 5 (continued): Relationship between Bearer services and GSM PLMN Connection elements

Connection description	Bearer service user data rate	Radio interface connection element	Intermediate rate at the BSS-MSC interface	BSS-MSC connection element	Protocol model in figure 6 or 7
Packet services basic access transparent.	Data circuit duplex sync $n \times 4\,800$ ($n \leq 4$) or $n \times 9\,600$ bit/s ($n \leq 5$) or $n \times 11\,200$ bit/s ($n = 5$ or 6).	cct mode unstructured unrestricted $n \times 6$ kbit/s ($n \leq 4$) or $n \times 12$ kbit/s ($n \leq 6$) on n full rate channels.	8 or 16 kbit/s per TCH/F. For data connections using 5 or 6 TCH/Fs no intermediate rate(s).	cct mode unstructured unrestricted 64 kbit/s.	Fig 6 : 2 d, 2 e
	Data circuit duplex sync $n \times 14\,400$ bit/s ($n \leq 5$)	cct mode unstructured unrestricted $n \times 14.5$ kbit/s ($n \leq 5$) on n full rate channels.	16 kbit/s per TCH/F		Fig 7 : 2 d, 2 e
	Data circuit duplex synch 14 400 bit/s	cct mode unstructured unrestricted 14.5 kbit/s on full rate channel.	16 kbit/s.	cct mode unstructured unrestricted 64 kbit/s.	Fig 7 : 2 a, 2 b
	Data circuit duplex sync 9 600 bit/s.	cct mode unstructured unrestricted 12 kbit/s on full rate channel.	16 kbit/s.	cct mode unstructured unrestricted 64 kbit/s.	Fig 6 : 2 a, 2 b
	Data circuit duplex sync 4 800 bit/s.	cct mode unstructured unrestricted 6 kbit/s on full rate channel and half rate channel.	8 kbit/s.	cct mode unstructured unrestricted 64 kbit/s.	Fig 6 : 2 a, 2 b
	Data circuit duplex sync 2 400 bit/s.	cct mode unstructured unrestricted 3.6 kbit/s on full rate channel and half rate channel.	8 kbit/s.	cct mode unstructured unrestricted 64 kbit/s.	Fig 6 : 2 a, 2 b
Packet services basic access non transparent.	Data circuit duplex sync $n \times 4\,800$ ($n \leq 4$) or $n \times 9\,600$ bit/s ($n \leq 4$).	cct mode SDU unrestricted $n \times 6$ kbit/s ($n \leq 4$) or $n \times 12$ kbit/s ($n \leq 4$) on full rate channels.	8 or 16 kbit/s per TCH/F.	cct mode unstructured unrestricted 64 kbit/s.	Fig 6 : 4 d, 4 e, 4 f
	Data circuit duplex sync $n \times 14\,400$ bit/s ($n \leq 4$).	cct mode SDU unrestricted $n \times 14.5$ kbit/s ($n \leq 4$) on full rate channels	16 kbit/s per TCH/F		Fig 7 : 4 d, 4 e, 4 f
Data circuit duplex synch 14 400 bit/s	cct mode SDU unrestricted 14.5 kbit/s on full rate channel	16 kbit/s			Fig 7 : 4 a, 4 b, 4 c
	Data circuit duplex sync 9 600 bit/s.	cct mode SDU unrestricted 12 kbit/s on full rate channel.	16 kbit/s.	cct mode unstructured unrestricted 64 kbit/s.	Fig 6 : 4 a, 4 b, 4 c
	Data circuit duplex sync 4 800 bit/s.	cct mode SDU unrestricted full rate channel, 12 kbit/s or half rate channel, 6 kbit/s.	16 kbit/s FR 8 kbit/s HR.	cct mode unstructured unrestricted 64 kbit/s.	4 a,b,c
	Data circuit duplex sync 2 400 bit/s.	cct mode SDU unrestricted full rate channel, 12 kbit/s or half rate channel, 6 kbit/s.	16 kbit/s FR 8 kbit/s HR.	cct mode unstructured unrestricted 64 kbit/s.	4 a,b,c

(continued)

Table 5 (continued): Relationship between Bearer services and GSM PLMN Connection elements

Connection description	Bearer service user data rate	Radio interface connection element	Intermediate rate at the BSS-MSC interface	BSS-MSC connection element	Protocol model in figure 6 or 7
Circuit mode unstructured with alternate speech and 3.1 KHz audio ex PLMN transparent.	Alternate speech and data duplex async $n \times 4\ 800$ bit/s ($n \leq 4$) or $n \times 9\ 600$ bit/s ($n \leq 3$). Alternate speech and data duplex sync $n \times 4\ 800$ bit/s ($n \leq 4$) or $n \times 9\ 600$ bit/s ($n \leq 3$).	cct mode speech alternating with cct mode unstructured unrestricted $n \times 6$ kbit/s ($n \leq 4$) or $n \times 12$ kbit/s ($n \leq 3$) on n full rate channels.	Speech NA 8 or 16 kbit/s per TCH/F.	cct mode alternate speech and unstructured unrestricted 64 kbit/s.	Fig 6 : 6 b, 1 d, 1 e, 2 d, 2 e
	Alternate speech and data duplex async $n \times 14\ 400$ bit/s ($n \leq 2$). Alternate speech and data duplex sync $n \times 14\ 400$ bit/s ($n \leq 2$).	cct mode speech alternating with cct mode unstructured unrestricted $n \times 14.5$ kbit/s ($n \leq 2$) on n full rate channels.	Speech NA 16 kbit/s per TCH/F.	cct mode alternate speech and unstructured unrestricted 64 kbit/s	Fig 7 : 6 b and 1d, 1e, 2d, 2e
	Alternate speech and data duplex async 14 400	cct mode speech alternating with cct mode unstructured unrestricted 14.5 kbit/s on full rate channel.	Speech NA 16 kbit/s	cct mode alternate speech and unstructured unrestricted 64 kbit/s	Fig 7 : 6 b and 1 a, 1 b
	Alternate speech and data duplex sync 14 400	cct mode speech alternating with cct mode unstructured unrestricted 14.5 kbit/s on full rate channel.	Speech NA 16 kbit/s.	cct mode alternate speech and unstructured unrestricted 64 kbit/s.	Fig 7 : 6 b and 2 a, 2 b
	Alternate speech and data duplex async 9 600.	cct mode speech alternating with cct mode unstructured unrestricted 12 kbit/s on full rate channel.	Speech NA 16 kbit/s.	cct mode alternate speech and unstructured unrestricted 64 kbit/s.	Fig 6 : 6b and 1 a, 1 b
	Alternate speech and data duplex sync 9 600.				Fig 6 : 6b and 2 a, 2 b
	Alternate speech and data duplex async 4 800.	cct mode speech alternating with cct mode unstructured unrestricted 6 kbit/s on full rate channel or half rate channel.	Speech NA 8 kbit/s.	cct mode alternate speech and unstructured unrestricted 64 kbit/s.	Fig 6 : 6 b and 1 a, 1 b
	Alternate speech and data duplex sync 4 800.				Fig 6 : 6 b and 2 a, 2 b
	Alternate speech and data duplex async $\leq 2\ 400$.	cct mode speech alternating with cct mode unstructured unrestricted 3.6 kbit/s. on full rate channel or half rate channel.	Speech NA 8 kbit/s.	cct mode alternate speech and unstructured unrestricted 64 kbit/s.	Fig 6 : 6b and 3 a, 3 b
Alternate speech and data duplex sync $\leq 2\ 400$.	Fig 6 : 6 b and 4 a, 4 b, 4 c				
Circuit mode unstructured with alternate speech and 3.1 KHz audio ex PLMN non transparent.	Alternate speech and data duplex async $n \times 4\ 800$ ($n \leq 4$) or $n \times 9\ 600$ ($n \leq 4$) bit/s.	cct mode speech alternating with cct mode SDU unrestricted $n \times 6$ kbit/s ($n \leq 4$) or $n \times 12$ kbit/s ($n \leq 4$) on full rate channels.	Speech NA 8 or 16 kbit/s per TCH/F.	cct mode alternate speech and unstructured unrestricted 64 kbit/s.	Fig 6 : 6b and 3d, 3e
	Alternate speech and data duplex async $n \times 14\ 400$ ($n \leq 4$) bit/s.	cct mode speech alternating with cct mode SDU unrestricted $n \times 14.5$ kbit/s ($n \leq 4$) on full rate channels	Speech NA 16 kbit/s per TCH/F	cct mode alternate speech and unstructured unrestricted 64 kbit/s.	Fig 7 : 6 b and 3 d, 3 e

(continued)

Table 5 (continued): Relationship between Bearer services and GSM PLMN Connection elements

Connection description	Bearer service user data rate	Radio interface connection element	Intermediate rate at the BSS-MSC interface	BSS-MSC connection element	Protocol model in figure 6 or 7
	Alternate speech and data duplex async 14 400.	cct mode speech alternating with cct mode SDU unrestricted 14.5 kbit/s on full rate channel	Speech NA 16 kbit/s.	cct mode alternate speech and unstructured unrestricted 64 kbit/s.	Fig 7 : 6 b and 3 a, 3 b
	Alternate speech and data duplex async 9 600.	cct mode speech alternating with cct mode SDU unrestricted 12 kbit/s on full rate channel.	Speech NA 16 kbit/s.	cct mode alternate speech and unstructured unrestricted 64 kbit/s.	Fig 6 6 b and 3 a, 3 b
	Alternate speech and data duplex async 4 800.	cct mode speech alternating with cct mode SDU unrestricted half rate channel, 6 kbit/s or full rate channel, 12 kbit/s.	Speech NA 16 kbit/s FR 8 kbit/s HR.	cct mode alternate speech and unstructured unrestricted 64 kbit/s.	Fig 6 : 6 b and 3 a, 3 b
	Alternate speech and data duplex async ≤ 2 400.	cct mode speech alternating with cct mode SDU unrestricted full rate channel, 12 kbit/s or half rate channel, 6 kbit/s.	Speech NA 16 kbit/s FR 8 kbit/s HR.	cct mode alternate speech and unstructured unrestricted 64 kbit/s.	Fig 6 : 6 b and 3 a, 3 b
Circuit mode unstructured with speech followed by 3.1 KHz audio ex PLMN transparent.	Speech followed by data duplex async $n \times 4\ 800$ bit/s ($n \leq 4$) or $n \times 9\ 600$ bit/s ($n \leq 3$).	cct mode speech followed by cct mode unstructured unrestricted $n \times 6$ kbit/s ($n \leq 4$) or $n \times 12$ kbit/s ($n \leq 3$) on n full rate channels.	Speech NA 8 or 16 kbit/s per TCH/F.	cct mode speech followed by unstructured unrestricted 64 kbit/s.	Fig 6 : 6 a 6 b then 1 e or 2 e
	Speech followed by data duplex sync $n \times 4\ 800$ bit/s ($n \leq 4$) or $n \times 9\ 600$ bit/s ($n \leq 3$).				
	Speech followed by data duplex async $n \times 14\ 400$ bit/s ($n \leq 2$).	cct mode speech followed by cct mode unstructured unrestricted $n \times 14.5$ kbit/s ($n \leq 2$) on n full rate channels.	Speech NA 16 kbit/s per TCH/F.		Fig 7 : 6 a or 6 b then 1 e or 2 e
	Speech followed by data duplex sync $n \times 14\ 400$ bit/s ($n \leq 2$).				
	Speech followed by 14 400 bit/s data duplex async	cct mode speech followed by cct mode unstructured unrestricted 14.5 kbit/s on full rate channel	Speech NA 16 kbit/s.	cct mode speech followed by cct mode unstructured unrestricted 64 kbit/s.	Fig 7 : 6 a or 6 b then 1 b
	Speech followed by 14 400 bit/s data duplex sync	cct mode speech followed by cct mode unstructured unrestricted 14.5 kbit/s on full rate channel	Speech NA 16 kbit/s.	cct mode speech followed by cct mode unstructured unrestricted 64 kbit/s.	Fig 7 : 6 a or 6 b then 2 b
	Speech followed by 9.6 kbit/s data duplex async.	cct mode speech followed by cct mode unstructured unrestricted 12 kbit/s on full rate channel.	Speech NA 16 kbit/s.	cct mode speech followed by cct mode unstructured unrestricted 64 kbit/s.	Fig 6 : 6a or 6b then 1 b
	Speech followed by 9.6 kbit/s data duplex sync.				Fig 6 : 6a or 6b then 2b
	Speech followed by 4.8 kbit/s data duplex async.	cct mode speech followed by cct mode unstructured unrestricted 6 kbit/s on full rate and half rate channel.	Speech NA 8 kbit/s.	cct mode speech followed by cct mode unstructured unrestricted 64 kbit/s.	Fig 6 : 6a or 6b then 1b
Speech followed by 4.8 kbit/s data duplex sync.	Fig 6 : 6a or 6b then 2b				

(continued)

Table 5 (concluded): Relationship between Bearer services and GSM PLMN Connection elements

Connection description	Bearer service user data rate	Radio interface connection element	Intermediate rate at the BSS-MSC interface	BSS-MSC connection element	Protocol model in figure 6 or 7
	Speech followed by ≤ 2.4 kbit/s data duplex async.	cct mode speech followed by cct mode unstructured unrestricted 3.6 kbit/s on full rate and half rate channel.	Speech NA 8 kbit/s.	cct mode speech followed by cct mode unstructured unrestricted 64 kbit/s.	Fig 6 : 6a or 6b then 1b
	Speech followed by ≤ 2.4 kbit/s data duplex sync.				Fig 6 : 6a or 6b then 2b
Circuit mode unstructured with speech followed by 3.1 KHz audio ex PLMN non transparent.	Speech followed by data duplex async $n \times 4\ 800$ ($n \leq 4$) or $n \times 9\ 600$ ($n \leq 4$) bit/s.	cct mode speech followed by cct mode SDU unrestricted $n \times 6$ kbit/s ($n \leq 4$) or $n \times 12$ kbit/s ($n \leq 4$) on full rate channels.	Speech NA 8 or 16 kbit/s per TCH/F.	cct mode speech followed by unstructured unrestricted 64 kbit/s.	Fig 6 : 6a or 6b then 3e
	Speech followed by data duplex async $n \times 14\ 400$ bit/s ($n \leq 4$).	cct mode speech followed by cct mode SDU unrestricted $n \times 14.5$ kbit/s ($n \leq 4$) on n full rate channels.	Speech NA 16 kbit/s per TCH/F.		Fig 7 : 6 a or 6 b then 3 e
	Speech followed by 9.6 kbit/s data duplex async.	cct mode speech followed by cct mode SDU unrestricted 12 kbit/s on full rate and half rate channel.	Speech NA 16 kbit/s.	cct mode speech followed by cct mode unstructured unrestricted 64 kbit/s.	Fig 6 : 6a or 6b then 3b
	Speech followed by 14.4 kbit/s data duplex async.	cct mode speech followed by cct mode SDU unrestricted 14.5 kbit/s on full rate channel.	Speech NA 16 kbit/s.		Fig 7 : 6a or 6b then 3b
	Speech followed by 4.8 kbit/s data duplex async.	cct mode speech followed by cct mode SDU unrestricted half rate channel, 6 kbit/s or full rate channel, 12 kbit/s.	Speech NA 8 kbit/s HR 16 kbit/s FR.	cct mode speech followed by cct mode unstructured unrestricted 64 kbit/s.	Fig 6 : 6a or 6b then 3b
	Speech followed by ≤ 2.4 kbit/s data duplex async.	cct mode speech followed by cct mode SDU unrestricted half rate channel, 6 kbit/s or full rate channel, 12 kbit/s.	Speech NA 8 kbit/s 16 kbit/s FR.		Fig 6 : 6a or 6b then 3b

Table 6: Relationship between Teleservices and GSM PLMN connection types

Teleservice in GSM PLMN	Access at mobile station	Radio interface connection element	Intermediate rate at the BSS-MSC interface	BSS-MSC connection element	Protocol model in figure 6 or 7
Telephony.		cct mode speech.	NA.	cct mode structured 64 kbit/s speech.	Fig 6 : 6 a or 6 b
Emergency calls.		cct mode speech.	NA.	cct mode structured 64 kbit/s speech.	Fig 6 : 6 a or 6 b
Alternate Speech/ Facsimile Group 3.	Data cct duplex synchronous access alternate speech/ group 3 fax.	cct mode speech alternating with unstructured unrestricted 3.6 or 6 or 12 kbit/s or $n \times 6$ kbit/s ($n \leq 3$) or $n \times 12$ kbit/s ($n \leq 2$) on FR transparent.	Speech NA 8 or 16 kbit/s per TCH/F.	cct mode structured 64 kbit/s alternate speech/unrestricted.	Fig 6 : 5, 5b and 6 a or 6 b
		cct mode speech alternating with unstructured unrestricted 14.5 kbit/s or $n \times 14.5$ kbit/s ($n \leq 2$) on FR transparent	Speech NA 16 kbit/s per TCH/F.		Fig 7 : 5 and 5 b and 6 a or 6 b
Automatic Facsimile Group 3.	Data cct duplex synchronous access group 3 fax.	cct mode unstructured unrestricted 3.6 or 6 or 12 kbit/s or $n \times 6$ kbit/s ($n \leq 3$) or $n \times 12$ kbit/s ($n \leq 2$) on FR transparent.	8 or 16 kbit/s per TCH/F.	cct mode structured 64 kbit/s unrestricted.	Fig 6 : 5, 5b
		cct mode unstructured unrestricted 14.5 kbit/s or $n \times 14.5$ kbit/s ($n \leq 2$) on FR transparent	16 kbit/s per TCH/F.		
Alternate speech/ Facsimile Group 3.	Data cct duplex synchronous access alternate speech/ group 3 fax.	cct mode speech alternating with SDU unrestricted 6 or 12 kbit/s or $n \times 6$ kbit/s ($n \leq 3$) or $n \times 12$ kbit/s ($n \leq 2$) on FR non transparent.	Speech NA 8 or 16 kbit/s per TCH/F.	cct mode structured 64 kbit/s alternate speech/unrestricted.	Fig 6 : 6 a or 6 b, 7 a and 7 b
		cct mode speech alternating with SDU unrestricted 14.5 kbit/s or $n \times 14.5$ kbit/s ($n \leq 2$) on FR non transparent.	16 kbit/s per TCH/F.		Fig 7 : 6 a or 6 b and 7 a and 7 b
Automatic Facsimile Group 3.	Data cct duplex synchronous access group 3 fax.	cct mode SDU unrestricted 6 or 12 kbit/s or $n \times 6$ kbit/s ($n \leq 3$) or $n \times 12$ kbit/s ($n \leq 2$) on FR non transparent.	8 or 16 kbit/s per TCH/F.	cct mode structured 64 kbit/s unrestricted.	Fig 6 : 7 a and 7 b
		cct mode SDU unrestricted 14.5 kbit/s or $n \times 14.5$ kbit/s ($n \leq 2$) on FR non transparent.	16 kbit/s per TCH/F.		Fig 7 : 7 a and 7 b

NA: Not Applicable

NOTE: The multislot data connections and the connections using TCH/F14.4 coding belong to the General Bearer Services (Classes 20, 30, 40, and 50 in GSM 02.02).

Annex A (informative): List of definitions of GSM PLMN connection type attributes and values

A.1 Attribute definition and their values

Information transfer mode:

This attribute describes the operational mode for transferring (transportation and switching) user information through a GSM PLMN connection in the network.

Value: - Circuit

Information transfer capability:

This attribute describes the capability associated with the transfer of different types of information through a GSM PLMN connection.

Values: - Unrestricted digital information

- Speech

- Group 3 facsimile

- 3.1 kHz audio ex PLMN

- Restricted digital information (Note: this value is signalled in the "Other ITC" element, due to a lack of further code points in the "ITC" element.)

Information transfer rate:

This attribute describes either the bit rate (circuit mode) or the throughput (packet mode, for further study). It refers to the transfer of digital information on a GSM PLMN connection.

Values: - Appropriate bit rate

- Throughput rate

Establishment of connection:

This attribute describes the mode of establishment used to establish and release GSM PLMN connections.

Value: - Demand

Symmetry:

This attribute describes the relationship of information flow between two (or more) access points or reference points involved in a GSM PLMN connection.

Values: - Bidirectional symmetric

- Bidirectional asymmetric (Multislot configurations for data)

Connection configuration:

This attribute describes the spatial arrangement for transferring information on a given GSM PLMN connection.

Value: - Point-to-point

Structure:

This attribute refers to the capability of a GSM PLMN connection to deliver information to the destination access point or reference point in a structure that was presented in a corresponding signal structured at the origin (access point or reference point).

- Values:
- Service data unit integrity (see note 1)
 - Unstructured (see note 2)

NOTE 1: Applicable for connection element "non transparent".

NOTE 2: Applicable for connection element "transparent".

Channel rate:

This attribute describes the channels and their bit rate used to transfer the user information and/or signalling information.

- Value:
- Name of channel (designation) and/or the corresponding bit rate

NOTE 3: This attribute can be used several times for connection characterization.

Connection control protocol, information transfer coding/protocol (layer 1 to 3):

These attributes characterize the protocols on the connection control and/or user information transfer channel.

- Value:
- Appropriate protocol for each layer

NOTE 4: This attribute can be used several times for connection characterization.

Synchronous/Asynchronous:

This attribute describes the type of transmission between the reference access points.

- Values:
- Synchronous
 - Asynchronous

Negotiation:

This attribute describes the possibility of inband parameter exchange (according to V.110) between reference access points.

- Value:
- In band negotiation not possible

User Rate:

This element is relevant between the IWF and the fixed network.

- Values:
- 0.3 kbit/s
 - 1.2 kbit/s
 - 1 200/75 bit/s
 - 2.4 kbit/s
 - 4.8 kbit/s
 - 9.6 kbit/s

Intermediate rate:

This attribute defines the intermediate rate (according to GSM 08.20 and CCITT V.110) at the A interface connection element part.

- Values: - 8 kbit/s
- 16 kbit/s

Fixed network user rate FNUR (Multislot configurations for data):

This element is relevant between the IWF and the fixed network.

- Values: - 9.6 kbit/s
- 14.4 kbit/s
- 19.2 kbit/s
- 28.8 kbit/s
- 38.4 kbit/s
- 48.0 kbit/s
- 56.0 kbit/s
- 64.0 kbit/s

Acceptable channel coding(s) ACC (Multislot configurations for data):

This attribute indicates the channel codings acceptable to the MS. This parameter is given at call set-up and it is non negotiable.

- Values: 4.8 kbit/s
- and/or 9.6 kbit/s
- and/or 14.4 kbit/s

Maximum number of TCH/Fs (Multislot configurations for data):

This attribute is given at call set-up and it enables the mobile user to limit the number of TCH/Fs used during the call.

- Values: 1
- 2
- 3
- 4
- 5
- 6
- 7 (note 5)
- 8 (note 5)

NOTE 5: Not used by the currently specified services.

Wanted air interface user rate (AIUR) (Multislot configurations for data):

This attribute is applicable to non-transparent services only, and it gives the AIUR that the mobile user wants and which the network tries to achieve but which it is not allowed to exceed.

Values: Not applicable

- 9.6 kbit/s
- 14.4 kbit/s
- 19.2 kbit/s
- 28.8 kbit/s
- 38.4 kbit/s
- 43.2 kbit/s
- 57.6 kbit/s

User initiated modification indication (Multislot configurations for data):

This element is relevant between the MT and the IWF.

- Values:
- User initiated modification not requested
 - User initiated modification up to 1 TCH/F requested
 - User initiated modification up to 2 TCH/F requested
 - User initiated modification up to 3 TCH/F requested
 - User initiated modification up to 4 TCH/F requested

The parameters where it is indicated that they are related to Multislot configurations for data are optional.

For multislot configuration, the following applies to the parameters contained in the BC-IE:

- Half rate channels are not supported. The MS shall code the radio channel requirement as "Full rate support only MS" or "Dual rate support MS, full rate preferred". In the second case, the network shall assign full rate channel(s) only.
- The "fixed network user rate" and "other modem type" take precedence over the "user rate" and "modem type".
- The "intermediate rate" parameter is overridden. The intermediate rate used per each TCH/F is derived from the chosen channel type:

channel type	IR per TCH/F
TCH/F4.8	8 kbit/s
TCH/F9.6	16 kbit/s
TCH/F14.4	16 kbit/s (on the A interface but 32 kbit/s inside the MS)

- The user rate per TCH is derived from the chosen channel type:

channel type	user rate per TCH
TCH/F4.8	4.8 kbit/s
TCH/F9.6	9.6 kbit/s
TCH/F14.4	14.4 kbit/s

For CE: T, the padding procedure described in GSM 03.34 can be applied.

Network independent clocking on Tx:

This attribute defines the usage of NIC at the reference access point in the transmit direction.

- Values: - Not required
- Required

Network independent clocking on Rx:

This attribute defines the usage of NIC at the reference access point in the receive direction.

- Values: - Not accepted
- Accepted

Number of stop bits:

This attribute describes the number of stop bits for the asynchronous type of transmission between reference access points.

- Values: - 1 bit
- 2 bit

Number of data bits excluding parity if present:

This attribute describes the number of data bits for a character oriented mode of transmission between reference access points.

- Values: - 7 bit
- 8 bit

Parity information:

This attribute describes the type of parity information for a character oriented mode of transmission between the reference access points.

- Values: - Odd
- Even
- None
- Forced to 0
- Forced to 1

Duplex mode:

This attribute describes the kind of transmission of the GSM PLMN between reference access points.

- Value: - Full duplex

Modem type:

This attribute describes the modem allocated by the IWF/MSC in the case of a 3.1 kHz audio used outside the GSM PLMN information transfer capability.

- Values: - V.21
- V.22
- V.22bis
- V.23
- V.26ter
- V.32

- Autobauding type 1
- None

Other Modem Type (OMT):

This element is relevant between the MS and IWF.

- Values:
- No other modem type
 - V.32bis
 - V.34

Compression

This attribute describes the possible usage of data compression between the reference access points. In the network to MS direction, it indicates the possibility of using data compression. In the MS to network direction, it indicates the allowance of data compression.

- Values:
- Data compression not possible/not allowed
 - Data compression possible/allowed (see note 6)

NOTE 6: Only applicable for the asynchronous transmission between the reference access points, if connection element is "non transparent".

Radio channel requirement:

This attribute describes the available channels for the transfer of the user information between the reference access points.

- Values:
- Full rate channel (Bm)
 - Half rate channel (Lm)
 - dual rate/full rate preferred
 - Dual rate/half rate preferred

Negotiation of Intermediate Rate Requested (NIRR)

This attribute indicates if 6 kbit/s radio interface rate is requested.

- Values:
- NIRR not requested/not accepted
 - NIRR requested/accepted

Connection element:

This attribute describes the possible usage of GSM layer 2 protocol between the reference access points.

- Values:
- Transparent
 - Non-transparent (RLP)
 - Both, transparent preferred
 - Both, non transparent preferred

User information layer 2 protocol:

This attribute describes the layer 2 relay protocol used between the reference access points in non-transparent transmissions.

- Values:
- ISO 6429, code set 0
 - X.25
 - Character oriented protocol with no flow control

Signalling access protocol:

This attribute characterizes the protocol on the signalling or user information transfer channel at the mobile reference access point.

- Values:
- I.440/450
 - X.21
 - X.28, dedicated PAD, individual NUI
 - X.28, dedicated PAD, universal NUI
 - X.28, non dedicated PAD
 - X.32

Rate adaptation:

This attribute describes the rate adaptation used at the fixed reference access point.

- Values:
- V.110/X.30
 - X.31 flag stuffing
 - No rate adaptation
 - V.120 (Note: This value is signalled in the "Other Rate Adaption" element, due to a lack of further code points in the "Rate Adaptation" element.)

Coding standard:

This attribute refers to the structure of the BC-IE defined in the GSM 04.08.

- Value:
- GSM

User information layer 1 protocol:

This attribute characterizes the layer 1 protocol to be used at the Um interface according to the GSM 05.01.

- Value:
- Default

Rate adaption header/no header:

This attribute is relevant between IWF and the fixed network. It is only applicable for V.120 rate adaptation.

- Values:
- Rate adaption header not included
 - Rate adaption header included

Multiple frame establishment support in data link:

This attribute is relevant between IWF and the fixed network. It is only applicable for V.120 rate adaptation.

- Values:
- Multiple frame establishment not supported. Only UI frames allowed
 - Multiple frame establishment supported

Mode of operation:

This attribute is relevant between IWF and the fixed network. It is only applicable for V.120 rate adaptation.

- Values:
- Bit transparent mode of operation
 - Protocol sensitive mode of operation

Logical link identifier negotiation:

This attribute is relevant between IWF and the fixed network. It is only applicable for V.120 rate adaptation.

- Values:
- Default, LLI=256 only
 - Full protocol negotiation (note 7)

NOTE 7: A connection over which protocol negotiation will be executed is indicated in the "In-band/out-band negotiation" parameter.

Assignor/assignee:

This attribute is relevant between IWF and the fixed network. It is only applicable for V.120 rate adaptation.

- Values:
- Message originator is "default assignee"
 - Message originator is "assignor only"

In-band/out-band negotiation:

This attribute is relevant between IWF and the fixed network. It is only applicable for V.120 rate adaptation.

- Values:
- Negotiation is done with USER INFORMATION messages on a temporary signalling connection
 - Negotiation is done in-band using logical link zero.

A.2 Definition of values

Unrestricted digital data information:

Transfer of information sequence of bits at its specified bit rate without alteration.

This implies:

- bit sequence independence;

- digit sequence integrity;
- bit integrity.

Speech:

Digital representation of speech coded according to a specified encoding rule (e.g. A Law, GSM 06-series).

Demand connection:

A GSM PLMN connection is set up at any time on demand via a digital channel in response to signalling information received from subscriber, other MSCs or other networks, i.e. on a per call basis.

Bidirectional symmetric:

This value applies when the information flow characteristics provided by the GSM PLMN connection are the same between two (or more) access points or reference points in the forward and backward directions.

Bidirectional asymmetric (Multislot configurations for data):

This value applies when the information flow characteristics provided by the GSM PLMN connection differ between two (or more) access points or reference points in the forward and backward directions on one or more TCH/Fs. In Multislot configurations for data the asymmetry is downlink biased, i.e. the MS may receive at a greater rate than it transmits.

Point-to-point connection:

This value applies when only two end points are provided by the connection.

Service data unit integrity:

This value applies when:

- i) at each user-network interface, protocols provide a mechanism for identifying the boundaries of service data units (e.g. X.25 complete packet sequence); and
- ii) all bits submitted within a single service data unit are delivered in a corresponding service data unit.

Unstructured:

This value is applicable when the GSM PLMN connection neither provides structural boundaries nor preserves structural integrity.

Annex B (informative): Location of the transcoding, multiplexing and RA2 functions

The location of the transcoding and data rate adaptation functions used to convert from the data rate used on the radio interface to the 64 kbits/s required by the MSC, is considered in this annex B. There are four alternatives which are equally valid from a connection type point of view. The selection of which alternative to use is not considered in GSM 03.10. The alternatives are shown in figure 8.

Alternative 1 assumes that all the transcoding and data rate adaptation is located at the BSS end of the A interface.

Alternative 2 assumes that all the transcoding and data rate adaptation is located at the MSC end of the A interface and gives no indication how the information is carried on the link.

Alternative 3 assumes that the information is transferred on the A interface in 8 or 16 kbit/s channels using one of the sub-multiplexing schemes described in CCITT Recommendation I.460. The same sub-multiplexing scheme is used for both speech and data.

Alternative 4 illustrates a multislot connection in which the information is transferred on the A-interface in 64 kbit/s channel into which up to four channels of intermediate rate 16 kbit/s have been multiplexed (refer to GSM 08.20). Alternative 4 also shows a situation in which a multislot connection of 5 or 6 TCH/Fs is used; the rate between the RA1'/RA1- and RA1''-functions is 64 kbit/s.

Alternatives 1b, 2b, 3b, and 4b show similar approaches for channel coding TCH/F14.4 (The alternatives explained above correspond to all other channel codings).

It should be noted that in all of the alternatives the transcoding and data rate adaptation are performed on the BSS side of the A-interface and is therefore considered to be a function of the BSS.

In the first three alternatives, the interface at the MSC is always based on 64 kbit/s without sub-multiplexing.

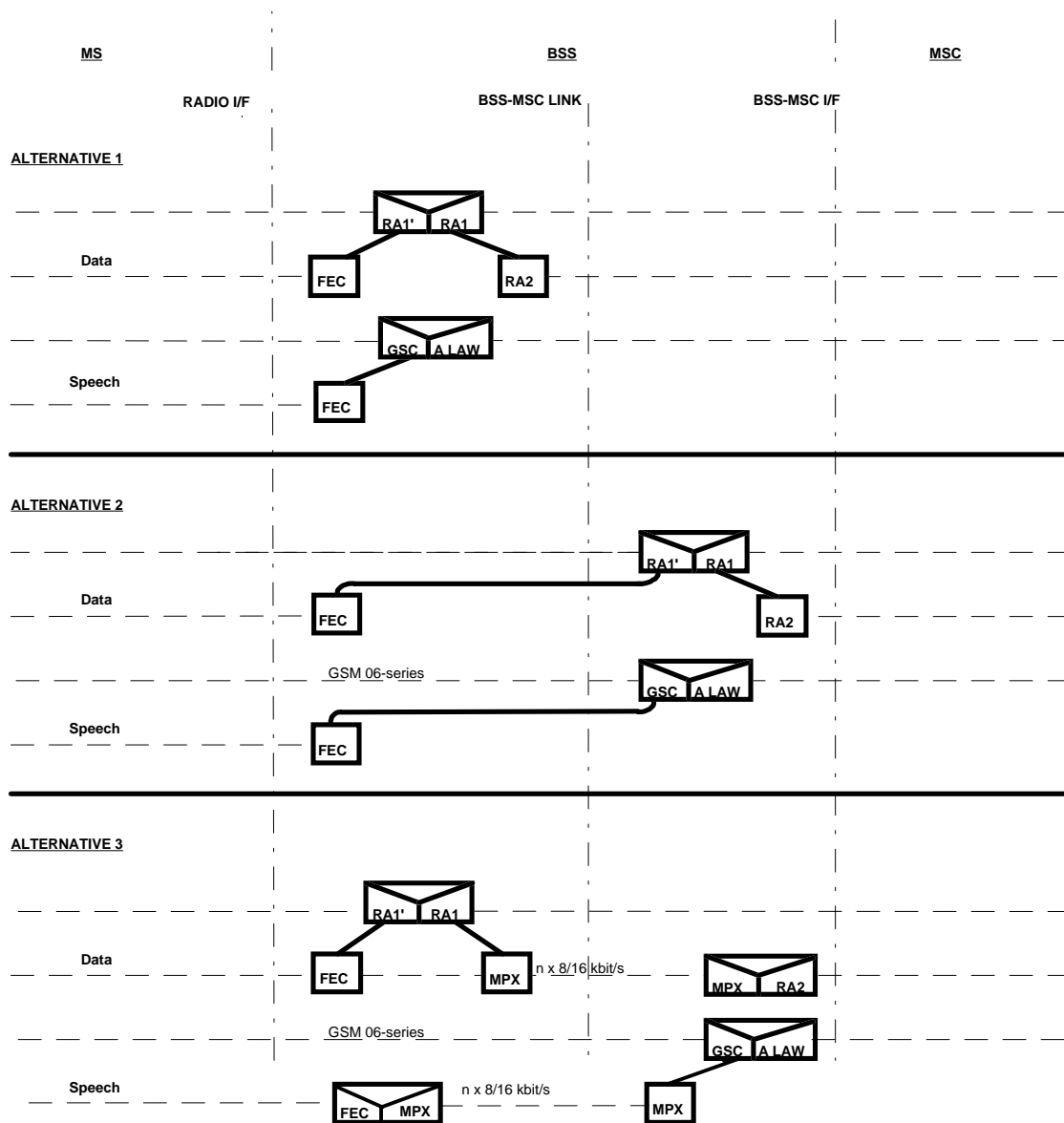

Figure 8: Location of transcoding and rate adaptation

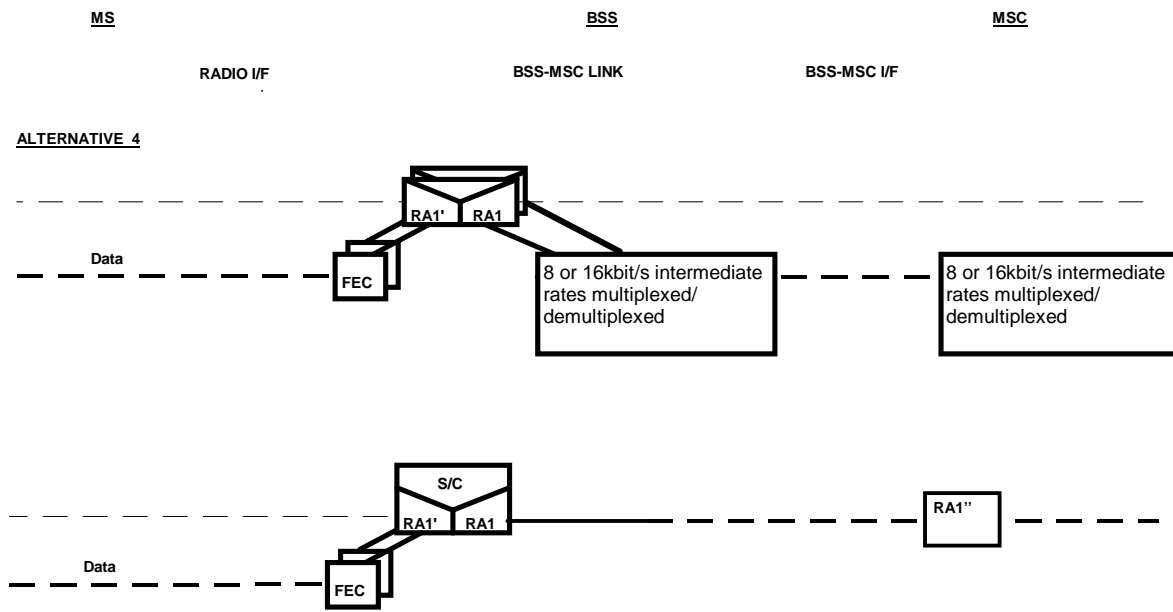

Figure 8 (continued): Location of transcoding and rate adaptation

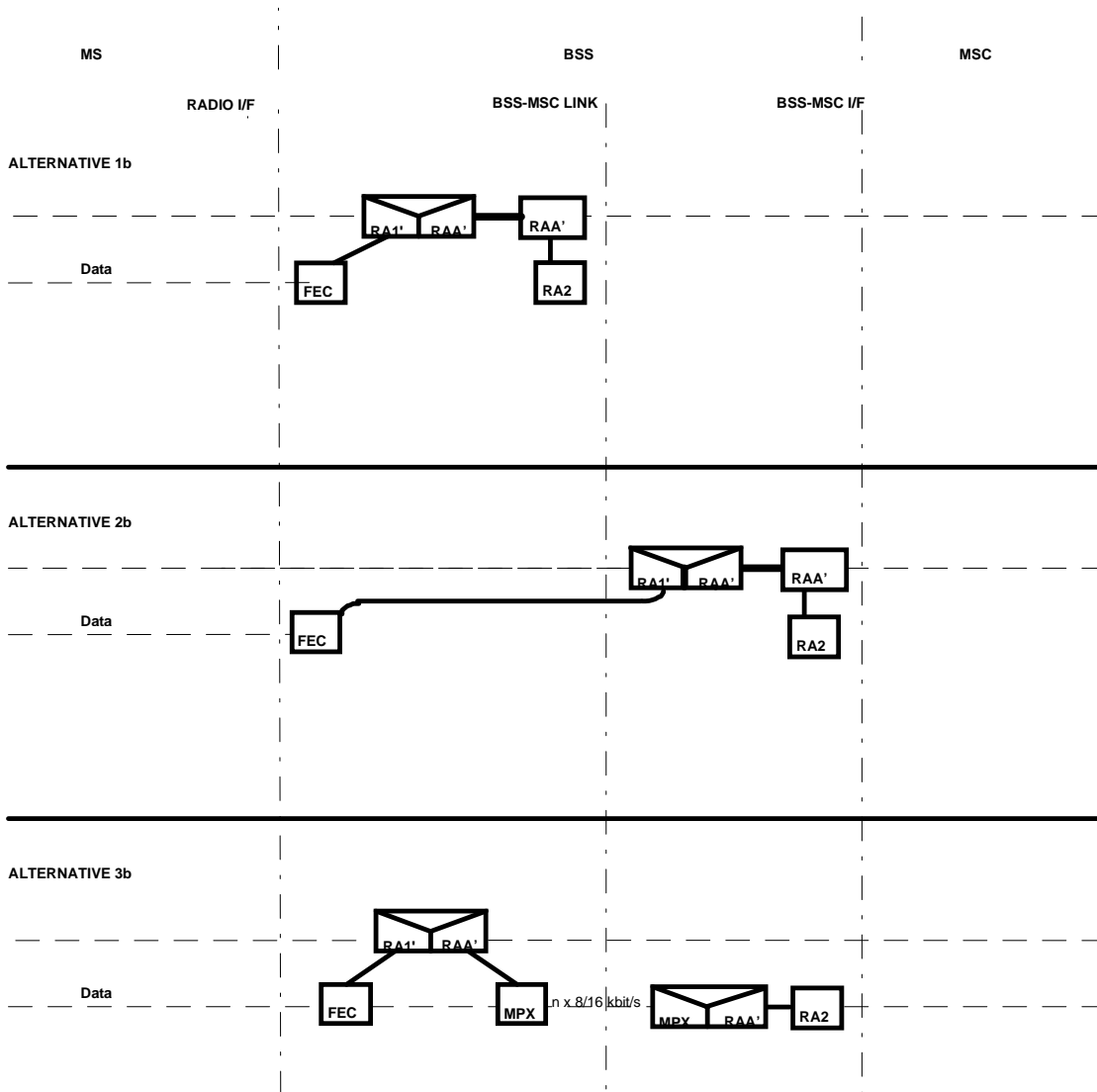

Figure 8 (concluded): Location of transcoding and rate adaptation

Legend to Figure 8

- GSC = GSM Speech Codec
- FEC = Forward Error Correction
- MPX = Multiplex/Demultiplex

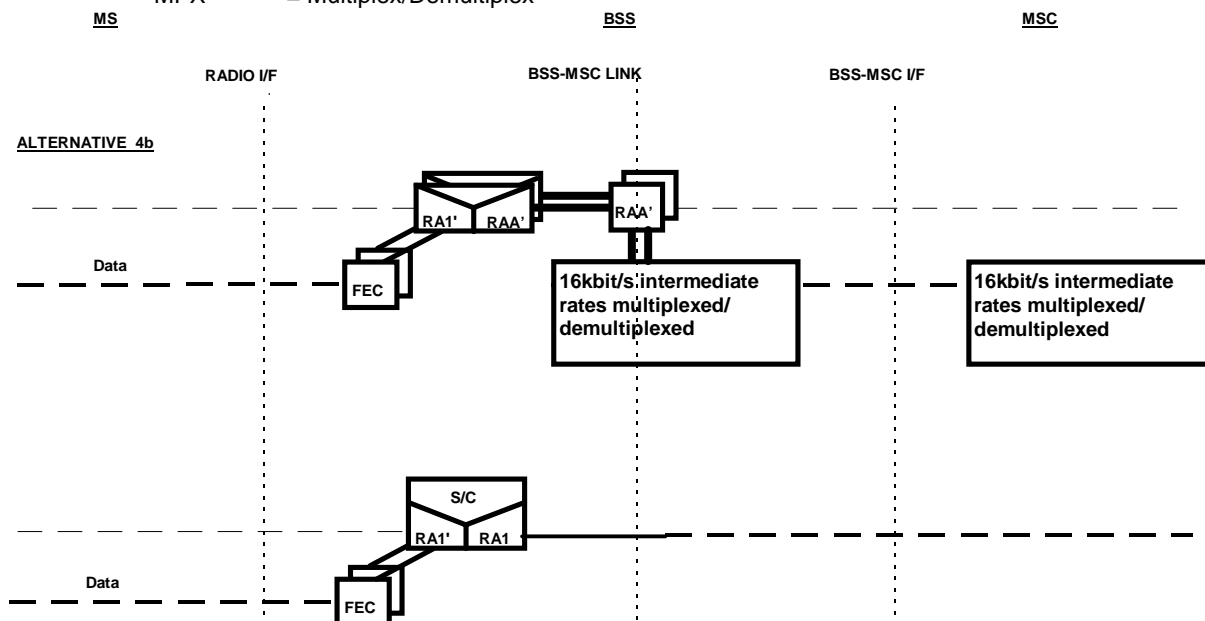

Figure 8 (concluded): Location of transcoding and rate adaptation

Annex C (informative): Change Request History

Change history					
SMG No.	TDoc. No.	CR. No.	Section affected	New version	Subject/Comments
SMG#08				4.3.1	ETSI Publication
SMG#16				5.0.0	Phase 2+ version
SMG#22				5.2.0	Release 1996 version
SMG#27				6.0.0	Release 1997 version

History

Document history		
V6.0.0	April 1999	Publication