

ETSI TS 100 527 V7.0.0 (1999-08)

Technical Specification

Digital cellular telecommunications system (Phase 2+); Handover procedures (GSM 03.09 version 7.0.0 Release 1998)

The GSM logo consists of the letters 'GSM' in a bold, blue, sans-serif font. A small red square is positioned at the top right corner of the 'M'. A registered trademark symbol (®) is located to the right of the 'M'.

GSM®

GLOBAL SYSTEM FOR
MOBILE COMMUNICATIONS



Reference

RTS/SMG-030309Q7 (4vo03i03.PDF)

Keywords

Digital cellular telecommunications system,
Global System for Mobile communications (GSM)

ETSI

Postal address

F-06921 Sophia Antipolis Cedex - FRANCE

Office address

650 Route des Lucioles - Sophia Antipolis
Valbonne - FRANCE
Tel.: +33 4 92 94 42 00 Fax: +33 4 93 65 47 16
Siret N° 348 623 562 00017 - NAF 742 C
Association à but non lucratif enregistrée à la
Sous-Préfecture de Grasse (06) N° 7803/88

Internet

secretariat@etsi.fr
Individual copies of this ETSI deliverable
can be downloaded from
<http://www.etsi.org>
If you find errors in the present document, send your
comment to: editor@etsi.fr

Copyright Notification

No part may be reproduced except as authorized by written permission.
The copyright and the foregoing restriction extend to reproduction in all media.

© European Telecommunications Standards Institute 1999.
All rights reserved.

Contents

Intellectual Property Rights	4
Foreword	4
1 Scope.....	5
2 References.....	6
3 Definitions and abbreviations	9
4 Role, functional composition of MSCs and interfaces for handover	9
4.1 MSC-A.....	9
4.1.1 Role of MSC-A	9
4.1.2 Functional composition of MSC-A and its interfaces for handover	10
4.2 MSC-B.....	12
4.2.1 Role of MSC-B	12
4.2.2 Functional composition of MSC-B and its interfaces for handover	12
5 Handover initiation conditions	13
6 General description of the procedures for intra - MSC handovers.....	14
6.1 Procedure for Intra-MSC Handovers	14
7 General description of the procedures for inter - MSC handovers.....	15
7.1 Basic handover procedure requiring a circuit connection between MSC-A and MSC-B	16
7.2 Basic handover procedure not requiring the establishment of a circuit connection between MSC-A and MSC-B.....	18
7.3 Procedure for subsequent handover requiring a circuit connection between MSC-A and MSC-B.....	19
7.3.1 Description of subsequent handover procedure i): MSC-B to MSC-A	19
7.3.2 Description of the subsequent handover procedure ii): MSC-B to MSC-B'.....	20
7.4 Procedure for subsequent handover not requiring a circuit connection between MSC-A and MSC-B.....	21
7.4.1 Description of the subsequent handover procedure without circuit connection i): MSC-B to MSC-A	22
7.4.2 Description of the subsequent handover procedure without circuit connection ii): MSC-B to MSC-B'	22
8 Detailed procedures in MSC-A	23
8.1 BSS/MSC and MS/MSC procedures in MSC-A (functional unit 1)	23
8.2 Call control procedures MSC-A (functional unit 2).....	23
8.3 Handover control procedures MSC-A (functional unit 3).....	25
8.4 MAP procedures in MSC-A (functional unit 4).....	26
8.5 Interworking between Handover control procedures and MAP procedures in MSC-A	26
8.6 Compatibility with GSM Phase 1.....	26
9 Detailed procedures in MSC-B.....	27
9.1 BSS/MSC (MS/BSS) procedures MSC-B (functional unit 1).....	27
9.2 Call control procedures MSC-B (functional unit 2).....	27
9.3 Handover control procedures MSC-B (functional unit 3).....	28
9.4 MAP procedures MSC-B (functional unit 4).....	28
9.5 Interworking between Handover control procedures and MAP procedures in MSC-B	29
9.6 Compatibility with GSM Phase 1.....	29
10 Subsequent channel assignment using a circuit connection between MSC-A and MSC-B	29
11 Directed retry handover	30
12 SDL diagrams	31
Annex A (informative): Change Request History	77
History.....	78

Intellectual Property Rights

IPRs essential or potentially essential to the present document may have been declared to ETSI. The information pertaining to these essential IPRs, if any, is publicly available for **ETSI members and non-members**, and can be found in SR 000 314: "*Intellectual Property Rights (IPRs); Essential, or potentially Essential, IPRs notified to ETSI in respect of ETSI standards*", which is available **free of charge** from the ETSI Secretariat. Latest updates are available on the ETSI Web server (<http://www.etsi.org/ipr>).

Pursuant to the ETSI IPR Policy, no investigation, including IPR searches, has been carried out by ETSI. No guarantee can be given as to the existence of other IPRs not referenced in SR 000 314 (or the updates on the ETSI Web server) which are, or may be, or may become, essential to the present document.

Foreword

This Technical Specification (TS) has been produced by the Special Mobile Group (SMG).

The present document provides a mechanism giving reliable transfer of signalling messages within the digital cellular telecommunications system (Phase 2/Phase 2+).

The contents of the present document is subject to continuing work within SMG and may change following formal SMG approval. Should SMG modify the contents of the present document it will be re-released with an identifying change of release date and an increase in version number as follows:

Version 7.x.y

where:

- 7 indicates Release 1998 of GSM Phase 2+
- x the second digit is incremented for all changes of substance, i.e. technical enhancements, corrections, updates, etc.
- y the third digit is incremented when editorial only changes have been incorporated in the specification.

1 Scope

The present document contains a detailed description of the handover procedures to be used in GSM PLMNs. The purpose of the handover procedures, as described in the present document, are to ensure that the connection to the Mobile Station (MS) is maintained as it moves from one Base Station System (BSS) area to another.

The present document considers the following two cases:

- i) Handover between Base Stations connected to the same MSC, this is termed an Intra-MSC handover.
- ii) Handover between Base Stations connected to different MSCs, this is termed an Inter-MSC handover. This category can be sub-divided into three further procedures:
 - a) the Basic Inter-MSC Handover procedure, where the MS is handed over from a controlling MSC (MSC-A) to another MSC (MSC-B);
 - b) the Subsequent Inter-MSC Handover procedure, where the MS is handed over from MSC-B to a third MSC (MSC-B');
 - c) the Subsequent Inter-MSC handback, where the MS is handed back from MSC-B to MSC-A.

In both cases i) and ii) the same procedures as defined in the GSM 08.08 and the GSM 04.08 shall be used on the A-interface and on the Radio Interface, respectively. In case ii) the handover procedures shall transport the A-interface messages between MSC-A and MSC-B described in the Mobile Application Part (MAP), GSM 09.02. The split in functionality between the BSS and MSC is described in the GSM 08 series of Technical Specifications.

The interworking between the GSM 09.02 protocol and the GSM 08.08 protocol is described in the GSM 09.10 Technical Specification.

Handovers which take place on the same MSC are termed Intra-MSC handovers; this includes both Inter-BSS and Intra-BSS handovers.

The present document also covers the requirements for handover in ongoing voice group calls, directed retry and the handover without a circuit connection between MSC-A and MSC-B. The present document does not consider the case of handovers between radio channels on the same BSS (Intra-BSS handover) or the handover of packet radio services.

For voice broadcast calls, the speaker uses normal point-to-point handover procedures, whilst the listeners use idle mode cell reselection procedures, as for the voice group call listeners.

Inter-MSC hand-over imposes a few limitations on the system. After inter-MSC hand-over:

- call re-establishment is not supported.

The list of GSM 08.08 features supported during and after Inter-MSC handover is given in GSM 09.08.

In the Inter-MSC handover case, the interworking between a Phase 1 BSSMAP protocol possibly used by one MSC and the Phase 2 BSSMAP protocol used in the Phase 2 MAP protocol on the E-interface is performed by this MSC.

NOTE: The message primitive names used in the SDL diagrams and message flows in the present document do not represent the actual messages specified in the GSM 04 and GSM 08 series or the services specified in the GSM 09 series of technical specifications. The primitive names are only intended to be indicative of their use in the present document.

2 References

The following documents contain provisions which, through reference in this text, constitute provisions of the present document.

- References are either specific (identified by date of publication, edition number, version number, etc.) or non-specific.
- For a specific reference, subsequent revisions do not apply.
- For a non-specific reference, the latest version applies.
- A non-specific reference to an ETS shall also be taken to refer to later versions published as an EN with the same number.
- For this Release 1998 document, references to GSM documents are for Release 1998 versions (version 7.x.y).

- [1] GSM 01.04: "Digital cellular telecommunications system (Phase 2+); Abbreviations and acronyms".
- [2] GSM 04.01: "Digital cellular telecommunications system (Phase 2+); Mobile Station - Base Station System (MS - BSS) interface; General aspects and principles".
- [3] GSM 04.02: "Digital cellular telecommunications system (Phase 2+); GSM Public Land Mobile Network (PLMN) access reference configuration".
- [4] GSM 04.03: "Digital cellular telecommunications system (Phase 2+); Mobile Station - Base Station System (MS - BSS) interface; Channel structures and access capabilities".
- [5] GSM 04.04: "Digital cellular telecommunications system (Phase 2+); layer 1; General requirements".
- [6] GSM 04.05: "Digital cellular telecommunications system (Phase 2+); Data Link (DL) layer; General aspects".
- [7] GSM 04.06: "Digital cellular telecommunications system (Phase 2+); Mobile Station - Base Station System (MS - BSS) interface; Data Link (DL) layer specification".
- [8] GSM 04.07: "Digital cellular telecommunications system (Phase 2+); Mobile radio interface signalling layer 3; General aspects".
- [9] GSM 04.08: "Digital cellular telecommunications system (Phase 2+); Mobile radio interface layer 3 specification".
- [10] GSM 04.10: "Digital cellular telecommunications system (Phase 2+); Mobile radio interface layer 3; Supplementary services specification; General aspects".
- [11] GSM 04.11: "Digital cellular telecommunications system (Phase 2+); Point-to-Point (PP) Short Message Service (SMS) support on mobile radio interface".
- [12] GSM 04.12: "Digital cellular telecommunications system (Phase 2+); Short Message Service Cell Broadcast (SMSCB) support on the mobile radio interface".
- [13] GSM 04.13: "Digital cellular telecommunications system (Phase 2+); Performance requirements on mobile radio interface".
- [14] GSM 04.21: "Digital cellular telecommunications system (Phase 2+); Rate adaption on the Mobile Station - Base Station System (MS - BSS) interface".
- [15] GSM 04.22: "Digital cellular telecommunications system (Phase 2+); Radio Link Protocol (RLP) for data and telematic services on the Mobile Station - Base Station System (MS - BSS) interface and the Base Station System - Mobile-services Switching Centre (BSS - MSC) interface".

- [16] GSM 04.80: "Digital cellular telecommunications system (Phase 2+); Mobile radio interface layer 3 supplementary services specification; Formats and coding".
- [17] GSM 04.81: "Digital cellular telecommunications system (Phase 2+); Line identification supplementary services - Stage 3".
- [18] GSM 04.82: "Digital cellular telecommunications system (Phase 2+); Call Forwarding (CF) supplementary services - Stage 3".
- [19] GSM 04.83: "Digital cellular telecommunications system (Phase 2+); Call Waiting (CW) and Call Hold (HOLD) supplementary services - Stage 3".
- [20] GSM 04.84: "Digital cellular telecommunications system (Phase 2+); MultiParty (MPTY) supplementary services - Stage 3".
- [21] GSM 04.85: "Digital cellular telecommunications system (Phase 2+); Closed User Group (CUG) supplementary services - Stage 3".
- [22] GSM 04.86: "Digital cellular telecommunications system (Phase 2+); Advice of Charge (AoC) supplementary services - Stage 3".
- [23] GSM 04.88: "Digital cellular telecommunications system (Phase 2+); Call Barring (CB) supplementary services - Stage 3".
- [24] GSM 04.90: "Digital cellular telecommunications system (Phase 2+); Unstructured Supplementary Service Data (USSD) - Stage 3".
- [25] GSM 05.01: "Digital cellular telecommunications system (Phase 2+); Physical layer on the radio path; General description".
- [26] GSM 05.02: "Digital cellular telecommunications system (Phase 2+); Multiplexing and multiple access on the radio path".
- [27] GSM 05.03: "Digital cellular telecommunications system (Phase 2+); Channel coding".
- [28] GSM 05.04: "Digital cellular telecommunications system (Phase 2+); Modulation".
- [29] GSM 05.05: "Digital cellular telecommunications system (Phase 2+); Radio transmission and reception".
- [30] GSM 05.08: "Digital cellular telecommunications system (Phase 2+); Radio subsystem link control".
- [31] GSM 05.10: "Digital cellular telecommunications system (Phase 2+); Radio subsystem synchronization".
- [32] GSM 05.90: "Digital cellular telecommunications system (Phase 2+); GSM Electro Magnetic Compatibility (EMC) considerations".
- [33] GSM 08.01: "Digital cellular telecommunications system (Phase 2+); Base Station System - Mobile services Switching Centre (BSS - MSC) interface; General aspects".
- [34] GSM 08.02: "Digital cellular telecommunications system (Phase 2+); Base Station System - Mobile-services Switching Centre (BSS - MSC) interface; Interface principles".
- [35] GSM 08.04: "Digital cellular telecommunications system (Phase 2+); Base Station System - Mobile-services Switching Centre (BSS - MSC) interface; Layer 1 specification".
- [36] GSM 08.06: "Digital cellular telecommunications system (Phase 2+); Signalling transport mechanism specification for the Base Station System - Mobile-services Switching Centre (BSS - MSC) interface".
- [37] GSM 08.08: "Digital cellular telecommunications system (Phase 2+); Mobile Switching Centre - Base Station System (MSC - BSS) interface; Layer 3 specification".

- [38] GSM 08.20: "Digital cellular telecommunications system (Phase 2+); Rate adaption on the Base Station System - Mobile-services Switching Centre (BSS - MSC) interface".
- [39] GSM 08.51: "Digital cellular telecommunications system (Phase 2+); Base Station Controller - Base Transceiver Station (BSC - BTS) interface; General aspects".
- [40] GSM 08.52: "Digital cellular telecommunications system (Phase 2+); Base Station Controller - Base Transceiver Station (BSC - BTS) interface; Interface principles".
- [41] GSM 08.54: "Digital cellular telecommunications system (Phase 2+); Base Station Controller - Base Transceiver Station (BSC - BTS) interface; Layer 1 structure of physical circuits".
- [42] GSM 08.56: "Digital cellular telecommunications system (Phase 2+); Base Station Controller - Base Transceiver Station (BSC - BTS) interface; Layer 2 specification".
- [43] GSM 08.58: "Digital cellular telecommunications system (Phase 2+); Base Station Controller - Base Transceiver Station (BSC - BTS) interface; Layer 3 specification".
- [44] GSM 08.60: "Digital cellular telecommunications system (Phase 2+); Inband control of remote transcoders and rate adaptors for Enhanced Full Rate (EFR) and full rate traffic channels."
- [45] GSM 08.61: "Digital cellular telecommunications system (Phase 2+); In-band control of remote transcoders and rate adaptors for half rate traffic channels"
- [46] GSM 09.01: "Digital cellular telecommunications system (Phase 2+); General network interworking scenarios".
- [47] GSM 09.02: "Digital cellular telecommunications system (Phase 2+); Mobile Application Part (MAP) specification".
- [48] GSM 09.03: "Digital cellular telecommunications system (Phase 2+); Signalling requirements on interworking between the Integrated Services Digital Network (ISDN) or Public Switched Telephone Network (PSTN) and the Public Land Mobile Network (PLMN)".
- [49] GSM 09.04: "Digital cellular telecommunications system (Phase 2+); Interworking between the Public Land Mobile Network (PLMN) and the Circuit Switched Public Data Network (CSPDN)".
- [50] GSM 09.05: "Digital cellular telecommunications system (Phase 2 +); Interworking between the Public Land Mobile Network (PLMN) and the Packet Switched Public Data Network (PSPDN) for Packet Assembly/Disassembly facility access (PAD)".
- [51] GSM 09.06: "Digital cellular telecommunications system (Phase 2+); Interworking between a Public Land Mobile Network (PLMN) and a Packet Switched Public Data Network/Integrated Services Digital Network (PSPDN/ISDN) for the support of packet switched data transmission services".
- [52] GSM 09.07: "Digital cellular telecommunications system (Phase 2+); General requirements on interworking between the Public Land Mobile Network (PLMN) and the Integrated Services Digital Network (ISDN) or Public Switched Telephone Network (PSTN)".
- [53] GSM 09.08: "Digital cellular telecommunications system (Phase 2+); Application of the Base Station System Application Part (BSSAP) on the E-interface".
- [54] GSM 09.10: "Digital cellular telecommunications system (Phase 2+); Information element mapping between Mobile Station - Base Station System and BSS - Mobile-services Switching Centre (MS - BSS - MSC); Signalling procedures and the Mobile Application Part (MAP)"
- [55] GSM 09.11: "Digital cellular telecommunications system (Phase 2+); Signalling interworking for supplementary services".
- [56] GSM 09.90: "Digital cellular telecommunications system (Phase 2+); Interworking between Phase 1 infrastructure and Phase 2+ Mobile Stations (MS)".
- [57] CCITT Recommendation Q.118: "Special release arrangements".

- [58] GSM 03.68: "Digital cellular telecommunications system (Phase 2+); Voice Group Call Service (VGCS) - Stage 2."

3 Definitions and abbreviations

For the purpose of the present document, the following definitions and abbreviations apply:

BSS	Base Station System
BTS	Base Transceiver Station
BSC	Base Station Controller
ISC	International Switching Centre
MS	Mobile Station
MSC	Mobile Services Switching Centre
BSS-A	The BSS from which the MS is being handed over
BSS-B	The BSS to which the MS is being handed over
MSC-A	The controlling MSC on which the call was originally established
MSC-B	The MSC to which the MS is handed over in a Basic Handover
MSC-B'	The MSC to which the MS is handed over in a Subsequent Handover

Other abbreviations used in the GSM specifications are listed in GSM 01.04.

4 Role, functional composition of MSCs and interfaces for handover

4.1 MSC-A

4.1.1 Role of MSC-A

In the Intra-MSC handover case, the MSC-A (simply termed MSC) controls the call, the mobility management and the radio resources before, during and after an Intra-MSC handover. When BSSAP procedures have to be performed, they are initiated and driven by MSC-A.

In the Inter-MSC handover case, MSC-A is the MSC which controls the call and the mobility management of the Mobile during the call, before, during and after a basic or subsequent handover. When BSSAP procedures related to dedicated resources have to be performed towards the MS, they are initiated and driven by MSC-A. The MSC-A - MSC-B interface works as a MSC - BSS interface for a subset of BSSMAP procedures. These BSSMAP procedures, described in GSM 09.08 are only those related to dedicated resources. The DTAP signalling is relayed transparently by MSC-B between MSC-A and the MS.

During a basic handover, MSC-A initiates and controls all the handover procedure, from its initiation (reception of Handover Required from BSS-A on A-interface) until its completion (reception of Handover Complete from MSC-B on E-interface).

During a subsequent handover back to MSC-A, MSC-A acts as a BSS towards MSC-B, which controls the handover procedure until the termination in MSC-A of the handover radio resources allocation (sending of the Handover Request Acknowledge to MSC-B from MSC-A). Then all handover related messages shall terminate at MSC-A (e.g. Handover Detect/Complete from BSS-B, Handover Failure from BSS-A).

During a subsequent handover to a third MSC, MSC-A works towards MSC-B' as described above in the basic handover paragraph and towards MSC-B as described above in subsequent handover paragraph.

4.1.2 Functional composition of MSC-A and its interfaces for handover

In order to simplify the description of the handover procedures the controlling MSC (MSC-A) can be considered to be composed of five functional units, as shown in figure 1.

Signalling functions

- 1) BSC/MSC (MS/BSC) Procedures MSC-A. This unit is used to control the signalling between the MSC, BSC and MS. Interface A' is the connection to the old BSC and interface A'' is the connection to the new BSC, when an Intra-MSC handover takes place. Interface x represents the interworking connection to the Handover Control Procedures MSC-A.
- 2) Call Control Procedures MSC-A. This unit is used to control the call. Interface B' is used for normal call control procedures. When a Basic handover from MSC-A to MSC-B is to be performed then interface B'' is employed to provide a signalling and call control connection to MSC-B. If a Subsequent handover to MSC-B' is to be performed then interface B''' is used.
- 3) Handover Control Procedures MSC-A. This unit provides both the overall control of the handover procedure and interworking between the internal interfaces (x, y and z).
- 4) MAP Procedures MSC-A. This unit is responsible for controlling the exchange of MAP messages between MSCs during an Inter-MSC handover. This unit communicates with the Handover Control Procedures MSC-A via interface z.

Switching functions

- 5) Switch and Handover Device MSC-A. For all calls, except for ongoing voice group calls (see GSM 03.68 for a definition) this unit is responsible for connecting the new path into the network via interface B'. In the case of ongoing voice group calls this unit is responsible for maintaining the connection between the down link group call channels and the active uplink. In specific cases it may be unnecessary to take any explicit action in the MSC concerning the handover device. The handover device interconnections are illustrated in figure 2.

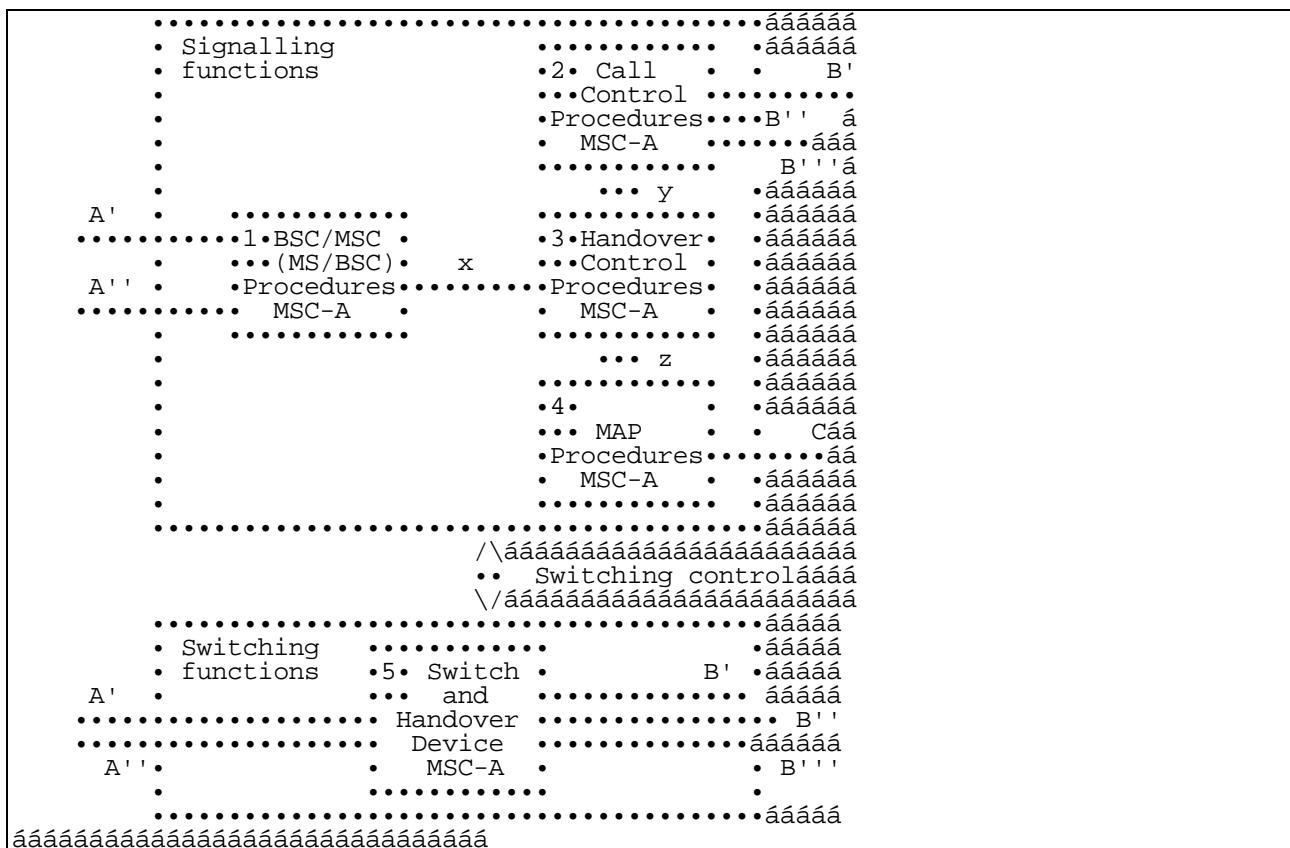

Figure 1: Functional composition of the controlling MSC (MSC-A) for supporting handover

For MS to MS calls in the same MSC the configuration in Figure 2b) applies. In this case interface B'' is internal to MSC-A and does not connect to another MSC.

The handover device can either be a three-party bridge or a switching facility without three-party connection capabilities. For a three-party bridge configuration the states of the handover device are as shown in table 1. The three-party configuration exists in the intermediate state. This type of handover device may reduce the interruption time. However, this may require noise reduction if one of the radio channels is unterminated at some time in the intermediate state.

For a handover device consisting of a simple switch there will be no intermediate state.

Table 1: States of the handover device

Case	Initial Connection	Intermediate Connection	Resulting Connection
Fig 2a)	B' to A'	B' to A' and A''	B' to A' (Successful Procedure), B' to A' (Unsuccessful Procedure)
Fig 2b)	B' to A'	B' to A' and B''	B' to B'' (Successful Procedure), B' to A' (Unsuccessful Procedure)
Fig 2c)	B' to B''	B' to B'' and B'''	B' to B''' (Successful Procedure), B' to B'' (Unsuccessful Procedure)

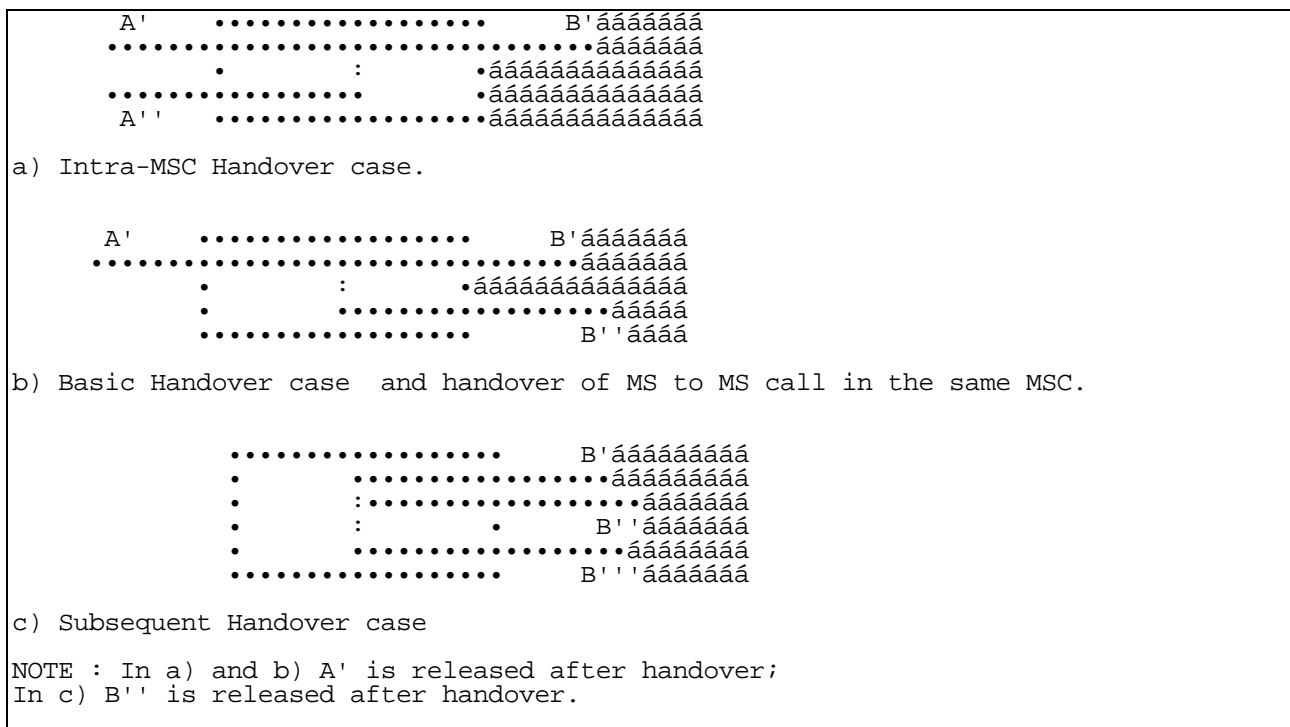

Figure 2: Connections in the handover device (Unit 5)

4.2 MSC-B

4.2.1 Role of MSC-B

In the Intra-MSC handover case, the MSC-B keeps the control of the whole Intra-MSC handover procedure. MSC-A is only notified on the successful completion of the Intra-MSC handover procedure.

In the Inter-MSC handover case, the role of MSC-B (MSC-B') is only to provide radio resources control within its area. This means that MSC-B keeps control of the radio resources connection and release towards BSS-B. MSC-B will do some processing on the BSSMAP information received on the E-interface or A-interface whereas it will relay the DTAP information transparently between A-interface and E-interface. MSC-A initiates and drives a subset of BSSMAP procedures towards MSC-B, while MSC-B controls them towards its BSSs to the extent that MSC-B is responsible for the connections of its BSSs. The release of the dedicated resources between MSC-B and BSS-B is under the responsibility of MSC-B and BSS-B, and is not directly controlled by MSC-A. When clearing is to be performed due to information received from BSS-B, MSC-B shall transfer this clearing indication to MSC-A, to clear its connection with BSS-B, to terminate the dialogue with MSC-A through the E-interface, and to release its circuit connection with MSC-A, if any. In the same way, the release of the connection to its BSS-B, is initiated by MSC-B, when the dialogue with MSC-A ends normally and a release is received from the circuit connection with MSC-A, if any, or when the dialogue with the MSC-A ends abnormally.

When a release is received by MSC-B for the circuit connection with MSC-A then MSC-B shall release the circuit connection.

4.2.2 Functional composition of MSC-B and its interfaces for handover

The functional composition of an MSC acting as MSC-B is essentially the same as that of MSC-A. However, there are some differences. The functional units are as follows (see figure 3):

Signalling functions

- 1) BSC/MSC (MS/BSC) Procedures MSC-B. This unit is used to control the signalling between the MSC, BSC and MS. Interface A" is the connection to the new BSC, when an Intra-MSC handover takes place. Interface x represents the interworking connection to the Handover Control Procedures MSC-B.
- 2) Call Control Procedures MSC-B. This unit is used for normal call control and signalling to MSC-A.
- 3) Handover Control Procedures MSC-B. This unit provides both the overall control of the handover procedure and interworking between the internal interfaces (x, y and z) in MSC-B.
- 4) MAP Procedures MSC-B. This unit is responsible for controlling the exchange of MAP messages between MSC-A and MSC-B and for signalling to the VLR in MSC-B.

Switching functions

- 5) Switch MSC-B. For all calls, except ongoing voice group calls (see GSM 03.68 for a definition) this unit is responsible, with BSS-B, for connecting the circuit from MSC-A to BSS-B. This unit may also need to act as a handover device for Intra-MSC handovers controlled by MSC-B. In the case of ongoing voice group calls this unit is responsible for maintaining the connection between the group member currently assigned the uplink and the distribution device. In specific cases it may be unnecessary to take any explicit action in the MSC concerning the handover device.

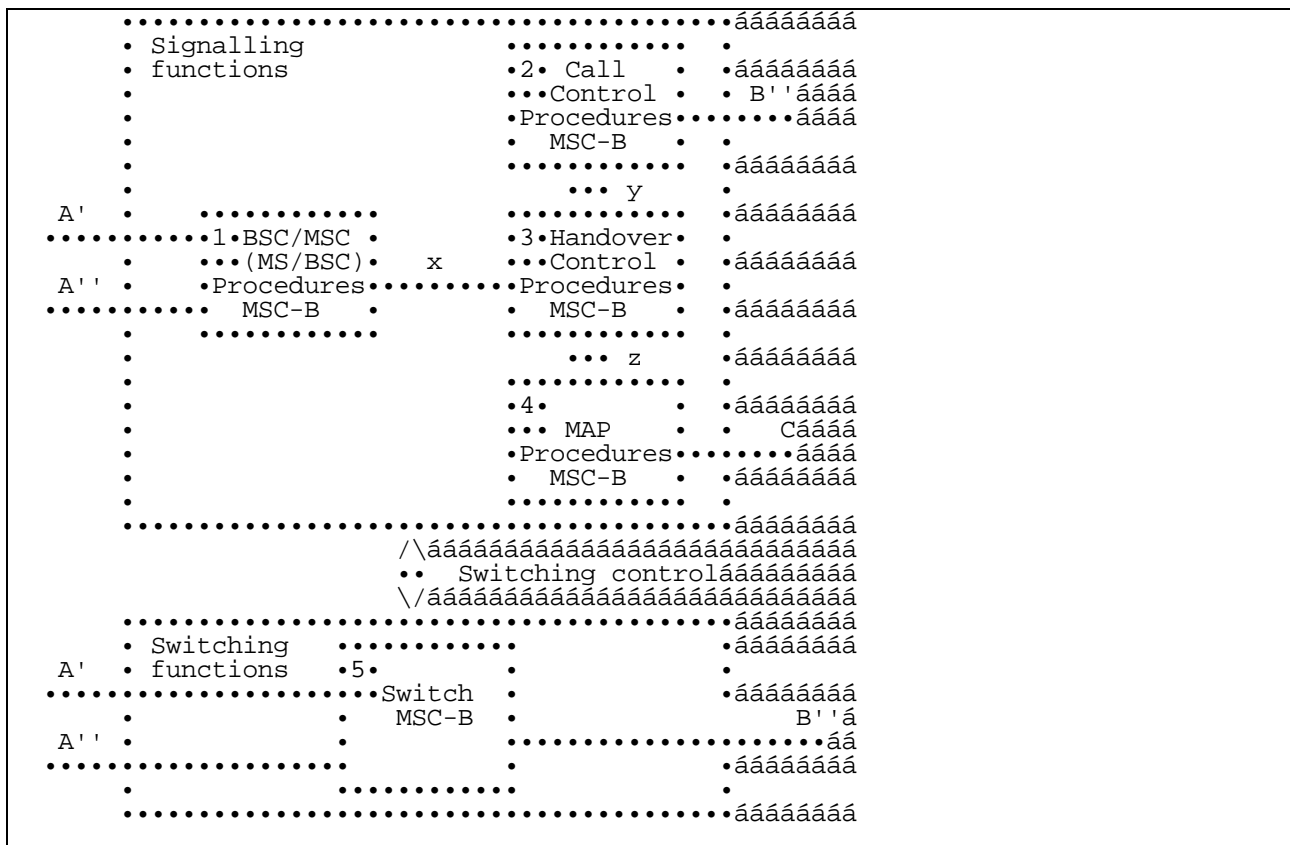

Figure 3: Functional composition of MSC-B for supporting handover

5 Handover initiation conditions

Handover is initiated by the network based on radio subsystem criteria (RF level, quality, distance) as well as network directed criteria (e.g. current traffic loading per cell, maintenance requests, etc.).

In order to determine if a handover is required, due to RF criteria, the MS shall take radio measurements from neighbouring cells. These measurements are reported to the serving cell on a regular basis. When a network determines a need for a handover the procedures given in GSM 08.08 are followed.

Additionally, the handover decision by the network may take into account both the measurement results from the MS and network directed criteria.

The same decision process is used to determine when to perform both the Intra-MSC and Inter-MSC handover in all the procedures described in the present document.

In the case of an ongoing voice group call (see GSM 03.68) the criteria described above shall only apply to the mobile station currently assigned the uplink and other users with a dedicated connection, no actions shall be taken for the listening users.

6 General description of the procedures for intra - MSC handovers

This section gives a brief overview of the procedures that shall be followed when performing Intra-MSC handovers. Detailed explanation of these procedures can be found in GSM 08.08 and GSM 04.08

There are two types of handover that can be considered which involve a BSS and single MSC. These are Internal Handover and External Handover. An Internal Handover is a handover which takes place between channels on a cell or cells controlled by a single BSS, without reference to the MSC, although the MSC maybe informed of its occurrence. This case is not considered in the present document.

Handovers between channels on the same cell or between cells on the same BSS which are controlled by the MSC are termed External Handovers and use identical procedures to those for Intra-MSC handovers. Only the Intra-MSC handover case will be considered in the present document.

6.1 Procedure for Intra-MSC Handovers

The procedure for a successful External Intra-MSC handover is shown in figure 4. It is assumed that selection of a candidate MS has already taken place within the BSS based upon the criteria presented in section 5. The exact algorithm, in the BSS, for determining a candidate MS is not addressed in the present document. The procedures discussed do not make use of the Mobile Application Part (MAP), represented by signalling function 4 in figures 2 and 3. The procedure described in this section covers case i).

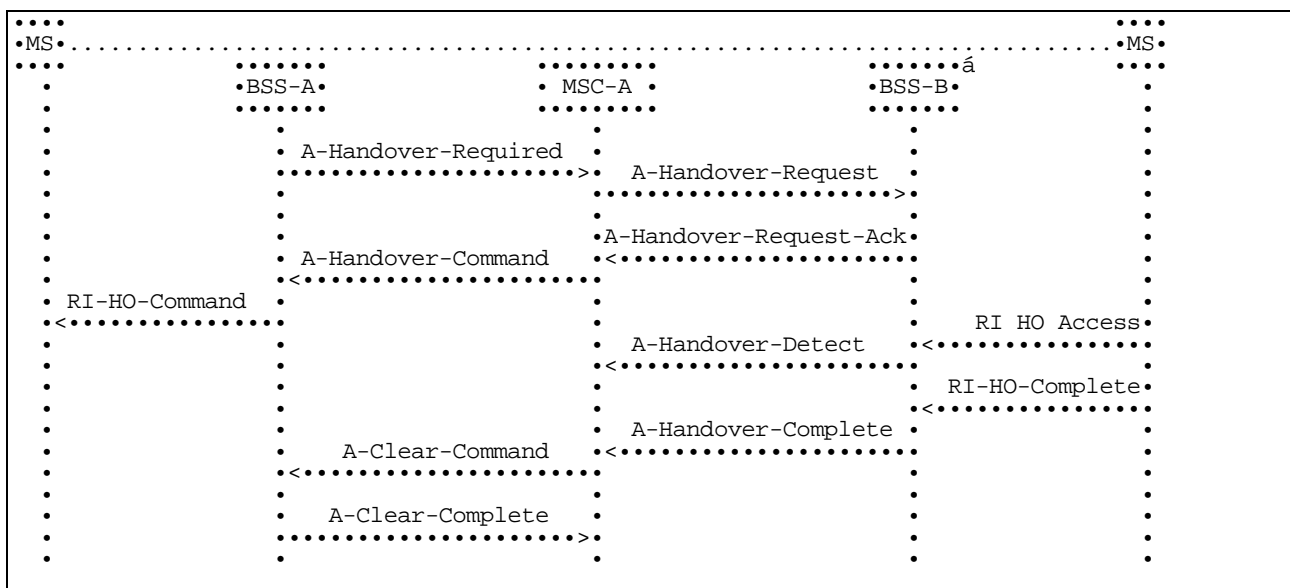

Figure 4: Basic External Intra-MSC Handover Procedure

The successful operation of the procedure is as follows. When the BSS (BSS-A), currently supporting the MS, determines that the MS requires to be handed over it will send an A-HANDOVER-REQUIRED message to the MSC (MSC-A). The A-HANDOVER-REQUIRED message shall contain a list of cells, or a single cell, to which the MS can be handed over. The list of cells shall be given in order of preference based upon operator determined criteria (These criteria are not addressed within the present document and are operator dependent). When the MSC-A receives the A-HANDOVER-REQUIRED message it shall begin the process of handing over the MS to a new BSS (BSS-B). (NOTE: BSS-A and BSS-B maybe the same BSS). The MSC-A shall generate an A-HANDOVER-REQUEST message to the selected BSS (BSS-B). When BSS-B receives the A-HANDOVER-REQUEST message it shall take the necessary action to allow the MS to access the radio resource of BSS-B, this is detailed in GSM 08.58 and the GSM 05 series of Technical Specifications. The switching of the radio resource through the necessary terrestrial resources is detailed in GSM 04.08 and GSM 08.08.

Once resource allocation has been completed by BSS-B it shall return an A-HANDOVER-REQUEST-ACK. to MSC-A. When this message is received by MSC-A it shall begin the process of instructing the MS to tune to a new dedicated radio resource. An A-HANDOVER-COMMAND will be sent by the MSC-A to BSS-A. On receipt of the A-HANDOVER-COMMAND message BSS-A will send the radio interface message RI-HANDOVER-COMMAND, containing a Handover Reference number previously allocated by BSS-B, to the MS. The MS will then access the new radio resource using the Handover Reference number contained in the RI-HANDOVER-ACCESS message. The number will be checked by BSS-B to ensure it is as expected and the correct MS has been captured. If this is the correct MS then the BSS-B shall send an A-HANDOVER-DETECT to MSC-A. When the MS is successfully communicating with the BSS-B a RI-HANDOVER-COMplete message will be sent by the MS to BSS-B. The BSS-B will then send an A-HANDOVER-COMplete message to MSC-A.

NOTE: The A-HANDOVER-REQUEST-ACK from BSS-B contains the complete Radio Interface message that shall be sent by BSS-A to the MS in the RI-HANDOVER-COMMAND, MSC-A transparently passes this radio interface message onto BSS-A.

After MSC-A has received the A-HANDOVER-COMplete message from BSS-B it shall begin to release the resources allocated on BSS-A. In figure 4 the resource is released by using the A-CLEAR-COMMAND sequence.

In the case of ongoing voice group calls the clearing of resources on BSS-A shall not be used if the resources are still be used on the down link.

If a failure occurs during the handover attempt, for example A-HANDOVER-FAILURE returned from BSS-A or BSS-B, then MSC-A will terminate the handover to BSS-B. Under these conditions MSC-A may optionally take one of a number of actions:

- i) retry the handover to the same cell;
- ii) select the next cell from the list contained in the A-HANDOVER-REQUIRED message and attempt a handover to the new cell;
- iii) await the next A-HANDOVER-REQUIRED message;
- iv) send an A-HANDOVER-REQUIRED-REJECT to BSS-A, if an A-HANDOVER-COMMAND has not already been sent.

The exact action taken is dependent on whether the failure occurs before or after the A-HANDOVER-COMMAND has been sent.

In all cases the existing connection to the MS shall not be cleared.

During the period that the MS is not in communication with the network MSC-A shall queue all appropriate messages. All messages shall be delivered to the MS once communication is resumed. In the case of an Intra-MS handover on MSC-B then the messages shall be queued by MSC-B.

In the case of ongoing voice group calls if a failure occurs when handing over a user on a dedicated channel then the procedures described above may optionally be applied.

7 General description of the procedures for inter - MSC handovers

The following sections describe two options for the Basic and Subsequent Handover procedures. The first, as described in section 7.1 and 7.3 respectively, provides for a circuit connection between MSC-A and MSC-B. The second, as described in section 7.2 and 7.4 respectively, provides for a Basic and Subsequent Handover without the provision of a circuit connection between MSC-A and MSC-B.

In all the above mentioned sections, the following principles apply:

During the handover resource allocation, only the handover related messages that are part of the applicable BSSAP subset - as defined in GSM 09.08 - shall be transferred on the E-interface.

The trace related messages that are part of the applicable BSSAP subset - as defined in GSM 09.08- can be sent by the MSC-A on the E-interface after successful handover resource allocation. In the sections 7.1 and 7.2, it is however allowed at basic handover initiation on the E-Interface to transfer one trace related message that is part of the applicable BSSAP subset - as defined in GSM 09.08 - together with the applicable handover related message. The applicable handover related message shall always appear as the first message.

During the handover execution, ie while the MS is not in communication with the network, the MSC-A shall queue all outgoing BSSAP messages until the communication with the MS is resumed.

Finally, during supervision, ie while the MS is not in the area of MSC-A after a successful Inter-MSC handover, the subset of BSSAP procedures and their related messages - as defined in GSM 09.08 - shall apply on the E-Interface.

During the intra-MSC-B handover execution, if any, the MSC-B shall queue all outgoing BSSAP messages until the communication with the MS is resumed.

7.1 Basic handover procedure requiring a circuit connection between MSC-A and MSC-B

The procedure used for successful Inter-MSC Handover is shown in figure 5. Initiation of the handover procedure is described in section 5. The procedure described in this section makes use of messages from the Technical Specification GSM 08.08 and of the transport mechanism from the Mobile Application Part (MAP) (Technical Specification GSM 09.02). After an Inter-MSC handover further Intra-MSC handovers may occur on MSC-B, these handovers will follow the procedures specified in the previous section.



Figure 5: Basic Handover Procedure requiring a circuit connection

The handover is initiated as described in section 6.1. (This is represented by A-HO-REQUIRED in figure 5. Upon receipt of the A-HO-REQUIRED from BSS-A, MSC-A shall send a MAP-PREPARE-HANDOVER request to MSC-B including a complete A-HO-REQUEST message. (NOTE: MSC-A shall not send further MAP-PREPARE-HANDOVER requests while a MAP-PREPARE-HANDOVER response is pending or before any timeouts). The MAP-PREPARE-HANDOVER request shall carry in the A-HO-REQUEST all information needed by MSC-B for allocating a radio channel, see Technical Specification GSM 08.08. For compatibility reasons, the MAP-PREPARE-HANDOVER request will also identify the cell to which the call is to be handed over. MSC-B will return the MAP-PREPARE-HANDOVER response after having retrieved a Handover Number from its associated VLR (exchange of the messages MAP-allocate-handover-number request and MAP-send-handover-report request). The Handover Number shall be used for routing the connection of the call from MSC-A to MSC-B. If a traffic channel is available in MSC-B the MAP-PREPARE-HANDOVER response, sent to MSC-A will contain the complete A-HO-REQUEST-ACKNOWLEDGE message received from BSS-B, containing the radio resources definition to be sent by BSS-A to the MS and possible extra BSSMAP information, amended by MSC-B due to the possible interworking between the BSSMAP protocol carried on the E-interface and the BSSMAP protocol used on the A-interface. If the traffic channel allocation is queued by BSS-B, the A-QUEUING-INDICATION may optionally be sent back to MSC-A. The further traffic channel allocation result (A-HO-REQUEST-ACK or A-HO-FAILURE) will be transferred to MSC-A using the MAP-PROCESS-ACCESS-SIGNALLING request. If the traffic channel allocation is not possible, the MAP-PREPARE-HANDOVER response containing an A-HO-FAILURE will be sent to MSC-A. MSC-B will do the same if a fault is detected on the identity of the cell where the call has to be handed over. MSC-B simply reports the events related to the dialogue. It is up to MSC-A to decide the action to perform if it receives negative responses or the operation fails due to the expiry of the MAP-PREPARE-HANDOVER timer.

If an error related to the TCAP dialogue or to the MAP-PREPARE-HANDOVER request is returned from MSC-B, this will be indicated to MSC-A and MSC-A will terminate the handover attempt. MSC-A may retry the handover attempt using the cell identity list, if provided, or may reject the handover attempt towards BSS-A. The existing connection to the MS shall not be cleared.

When the A-HO-REQUEST-ACKNOWLEDGE has been received, MSC-A shall establish a circuit between MSC-A and MSC-B by signalling procedures supported by the network. In figure 5 this is illustrated by the messages IAM (Initial Address Message) and ACM (Address Complete Message) of Signalling System no 7. MSC-B awaits the capturing of the MS (section 6.1) on the radio path when the ACM is sent and MSC-A initiates the handover execution when ACM is received (illustrated by the A-HO-COMMAND and described in the section 6.1).

MSC-B transfers to MSC-A the acknowledgement received from the correct MS (A-HO-DETECT/A-HO-COMplete). The A-HO-DETECT, if received, is transferred to MSC-A using the MAP-PROCESS-ACCESS-SIGNALLING request. The A-HO-COMplete, when received from the correct MS, is included in the MAP-SEND-END-SIGNAL request and sent back to MSC-A. The circuit is through-connected in MSC-A when the A-HO-DETECT or the A-HO-COMplete is received from MSC-B. The old radio channel is released when the A-HO-COMplete message is received from MSC-B. The sending of the MAP-SEND-END-SIGNAL request starts the MAP supervision timer for the MAP dialogue between MSC-A and MSC-B. When the MAP-SEND-END-SIGNAL request including the A-HO-COMplete message is received in MSC-A the resources in BSS-A shall be cleared.

In order not to conflict with the PSTN/ISDN signalling system(s) used between MSC-A and MSC-B, MSC-B must generate an answer signal when A-HO-DETECT/COMPLETE is received.

MSC-B shall release the Handover Number when the circuit between MSC-A and MSC-B has been established.

If the circuit between MSC-A and MSC-B cannot be established (e.g. an unsuccessful backward message is received instead of ACM). MSC-A terminates the inter-MSC handover attempt by sending an appropriate MAP message, for example an ABORT. MSC-A may retry the handover at this point, see section 6.1.

MSC-A shall retain overall call control until the call is cleared by the fixed subscriber or the MS and there is no further call control functions to be performed (e.g. servicing waiting calls, echo cancellers).

When MSC-A clears the call to the MS it also clears the call control functions in MSC-A and sends the MAP-SEND-END-SIGNAL response to release the MAP resources in MSC-B.

MSC-A may terminate the procedure at any time by sending an appropriate MAP message to MSC-B. If establishment of the circuit between MSC-A and MSC-B has been initiated, the circuit must also be cleared.

The handover will be aborted by MSC-A if it detects clearing or interruption of the radio path before the call has been established on MSC-B.

7.2 Basic handover procedure not requiring the establishment of a circuit connection between MSC-A and MSC-B

The basic handover procedures to be used when no circuit connection is required by MSC-A are similar to those described in section 7.1 for circuit switched calls. The main differences to the procedures described in section 7.1 relate to the establishment of circuits between the network entities and the Handover Number allocation.

In the case of ongoing voice group calls the circuit connections are already established therefore the procedures described in this subclause are also applicable. When applied to ongoing voice group calls the clearing of resources on BSS-A shall not be used if the resources are still be used on the down link. Consequently the A-CLEAR-COMMAND message shall not be sent, but an HANDOVER-SUCCEEDED message shall be sent.

In the case of basic handover, MSC-A shall specify to MSC-B that no Handover Number is required in the MAP-PREPARE-HANDOVER request (see Technical Specification 09.02). As for the basic handover using a circuit connection, the A-HO-REQUEST is transmitted at the same time. Any subsequent Handover Number allocation procedure will not be invoked until the completion of the basic handover procedure (see section: Subsequent Channel Assignment using a circuit connection). MSC-B shall then perform the radio resources allocation as described in section 7.1. The MAP-PREPARE-HANDOVER response shall be returned to MSC-A including either the response of the radio resources allocation request received from BSS-B (A-HO-REQUEST-ACKNOWLEDGE/A-HO-FAILURE with possible extra BSSMAP information. These extra information are amended by MSC-B due to the possible interworking between the BSSMAP protocol carried on the E-interface and the BSSMAP protocol used on the A-interface) or potentially the A-QUEUING-INDICATION . The basic handover procedure will continue as described in section 7.1 except that no circuit connection will be established towards MSC-B.

The relevant case for the basic handover without circuit connection is shown in figure 6. As can be seen the major differences to the equivalent figure 5 is the omission of any circuit establishment messaging and the omission of handover number allocation signalling.

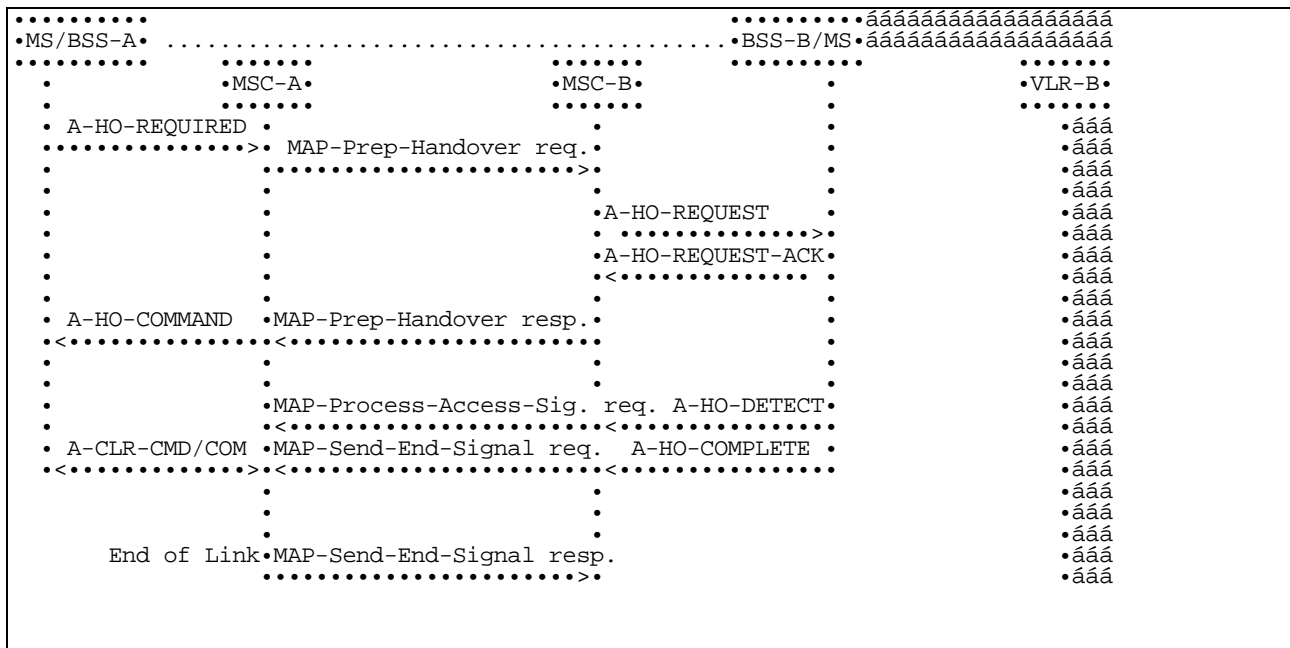

Figure 6: Basic Handover Procedure without circuit connection

7.3 Procedure for subsequent handover requiring a circuit connection between MSC-A and MSC-B

After the call has been handed over from MSC-A to MSC-B, if the MS leaves the area of MSC-B during the same call, subsequent handover is necessary in order to continue the connection.

The following cases apply:

- i) the MS moves back to the area of MSC-A;
- ii) the MS moves into the area of a third MSC (MSC-B').

In both cases the call is switched in MSC-A; the circuit between MSC-A and MSC-B shall be released after a successful subsequent handover has been performed.

7.3.1 Description of subsequent handover procedure i): MSC-B to MSC-A

The procedure for successful handover from MSC-B back to MSC-A is shown in figure 7.

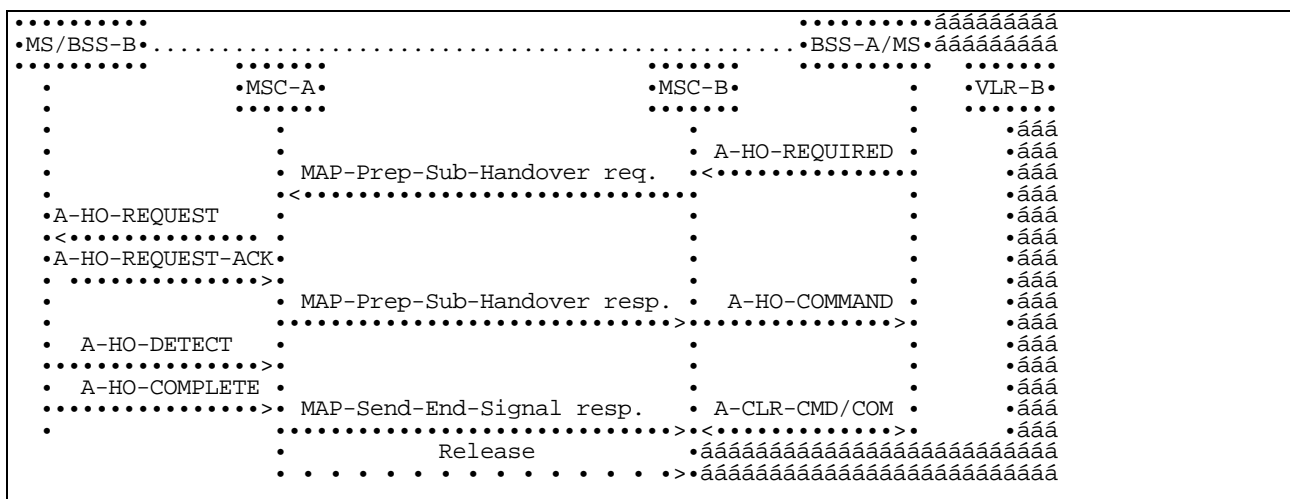

Figure 7: Subsequent handover procedure i):successful handover from MSC-B to MSC-A using a circuit connection

The procedure is as follows:

MSC-B sends the MAP-PREPARE-SUBSEQUENT-HANDOVER request to MSC-A indicating the new MSC number(MSC-A number), indicating also the identity of the cell where the call has to be handed over and including a complete A-HO-REQUEST message. (NOTE: MSC-B shall not send further MAP-PREPARE-SUBSEQUENT-HANDOVER requests while a handover attempt is pending or before any timeouts). Since MSC-A is the call controlling MSC, this MSC needs no Handover Number for routing purposes; MSC-A can immediately initiate the search for a free radio channel.

When a radio channel can be assigned, MSC-A shall return in the MAP-PREPARE-SUBSEQUENT-HANDOVER response the complete A-HO-REQUEST-ACKNOWLEDGE message received from the BSS-B and possible extra BSSMAP information, amended by MSC-A due to the possible interworking between the BSSMAP protocol carried on the E-interface and the BSSMAP protocol used on the A-interface. If the traffic channel allocation is queued by BSS-B, the A-QUEUING-INDICATION may optionally be sent back to MSC-B. The further traffic channel allocation result (A-HO-REQUEST-ACK or A-HO-FAILURE) will be transferred to MSC-B using the MAP-FORWARD-ACCESS-SIGNALLING request.If a radio channel cannot be assigned or if a fault is detected on the target cell identity, or the target cell identity in the A-HO-REQUEST is not consistent with the target MSC number, the MAP-PREPARE-SUBSEQUENT-HANDOVER response containing an A-HO-FAILURE message shall be given to MSC-B, in addition MSC-B shall maintain the connection with the MS.

If the procedure in MSC-A is successful then MSC-B can request the MS to retune to the new BSS-B on MSC-A. This is illustrated in figure 7 by the A-HO-COMMAND message. The operation is successfully completed when MSC-A receives the A-HO-COMplete message.

After handover MSC-A shall release the circuit to MSC-B.

MSC-A must also terminate the MAP procedure for the basic handover between MSC-A and MSC-B by sending an appropriate MAP message. MSC-B will clear the resources in BSS-A when the MAP-SEND-END-SIGNAL response is received.

7.3.2 Description of the subsequent handover procedure ii): MSC-B to MSC-B'

The procedure for successful handover from MSC-B to MSC-B' is shown in figure 8.

The procedure consists of two parts:

- a subsequent handover from MSC-B back to MSC-A as described in section 7.3.1; and
- a basic handover from MSC-A to MSC-B' as described in section 7.1.

MSC-B sends the MAP-PREPARE-SUBSEQUENT-HANDOVER request to MSC-A indicating a new MSC number (which is the identity of MSC-B'), indicating also the target cell identity and including a complete A-HO-REQUEST, MSC-A then starts a basic handover procedure towards MSC-B'.

When MSC-A receives the ACM from MSC-B', MSC-A informs MSC-B that MSC-B' has successfully allocated the radio resources on BSS-B' side by sending the MAP-PREPARE-SUBSEQUENT-HANDOVER response containing the complete A-HO-REQUEST-ACKNOWLEDGE received from BSS-B' and possible extra BSSMAP information, amended by MSC-A due to the possible interworking between the BSSMAP protocol carried on the E-interface between MSC-A and MSC-B' and the BSSMAP protocol carried on the E-interface between MSC-A and MSC-B. Now MSC-B can start the procedure on the radio path.

For MSC-A the handover is completed when it has received the MAP-SEND-END-SIGNAL REQUEST from MSC-B' containing the A-HO-COMplete received from the BSS-B'. The circuit between MSC-A and MSC-B is released. MSC-A also sends the MAP-SEND-END-SIGNAL response to MSC-B in order to terminate the original MAP dialogue between MSC-A and MSC-B. MSC-B releases the radio resources when it receives this message.

If the traffic channel allocation is queued by the BSS-B', the A-QUEUING-INDICATION may optionally be sent back to MSC-B. If no radio channel can be allocated by MSC-B' or no circuit between MSC-A and MSC-B' can be established or a fault is detected on the target cell identity or the target cell identity in the A-HO-REQUEST is not consistent with the target MSC number, MSC-A informs MSC-B by using the A-HO-FAILURE message included in the MAP-PREPARE-SUBSEQUENT-HANDOVER response. MSC-B shall maintain the existing connection with the MS.

When the subsequent handover is completed, MSC-B' is considered as MSC-B. Any further inter-MSC handover is handled as described above for a subsequent handover.

7.4.1 Description of the subsequent handover procedure without circuit connection i): MSC-B to MSC-A

The procedure for successful handover from MSC-B back to MSC-A without circuit connection is shown in figure 9. The only difference with the figure 7, is that no circuit release is needed between MSC-A and MSC-B.

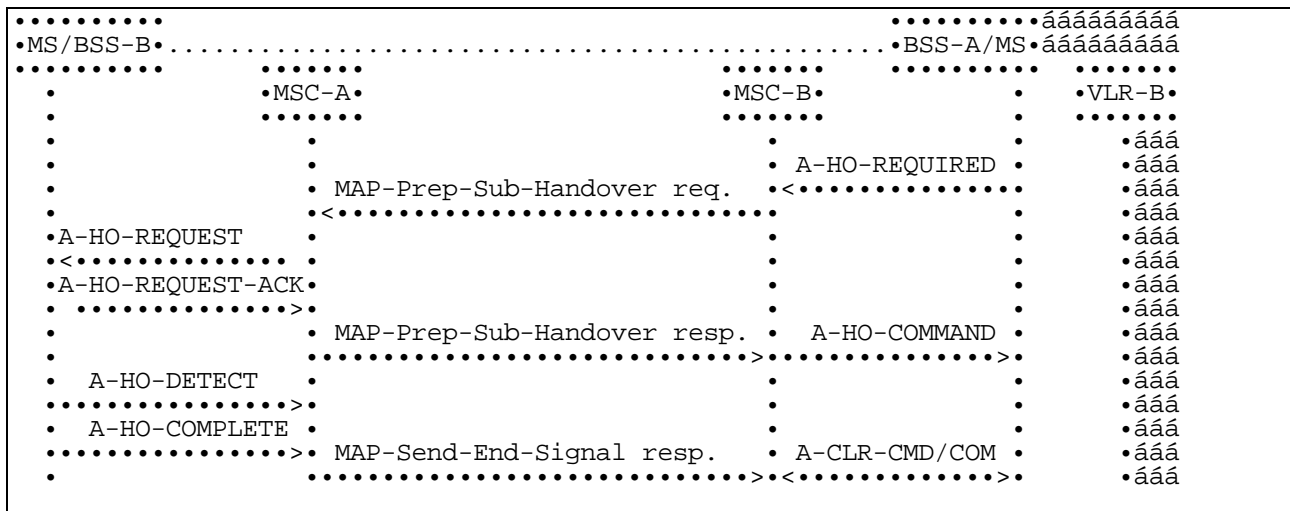

Figure 9: Subsequent handover procedure i): Successful handover from MSC-B to MSC-A not requiring a circuit connection

7.4.2 Description of the subsequent handover procedure without circuit connection ii): MSC-B to MSC-B'

The procedure for successful handover from MSC-B to MSC-B' is shown in figure 10.

The procedure consists of two parts:

- a subsequent handover from MSC-B back to MSC-A as described in section 7.4.1; and
- a basic handover from MSC-A to MSC-B' as described in section 7.2.

The only difference to the equivalent figure 8 is the omission of the circuit and handover number allocation signalling.

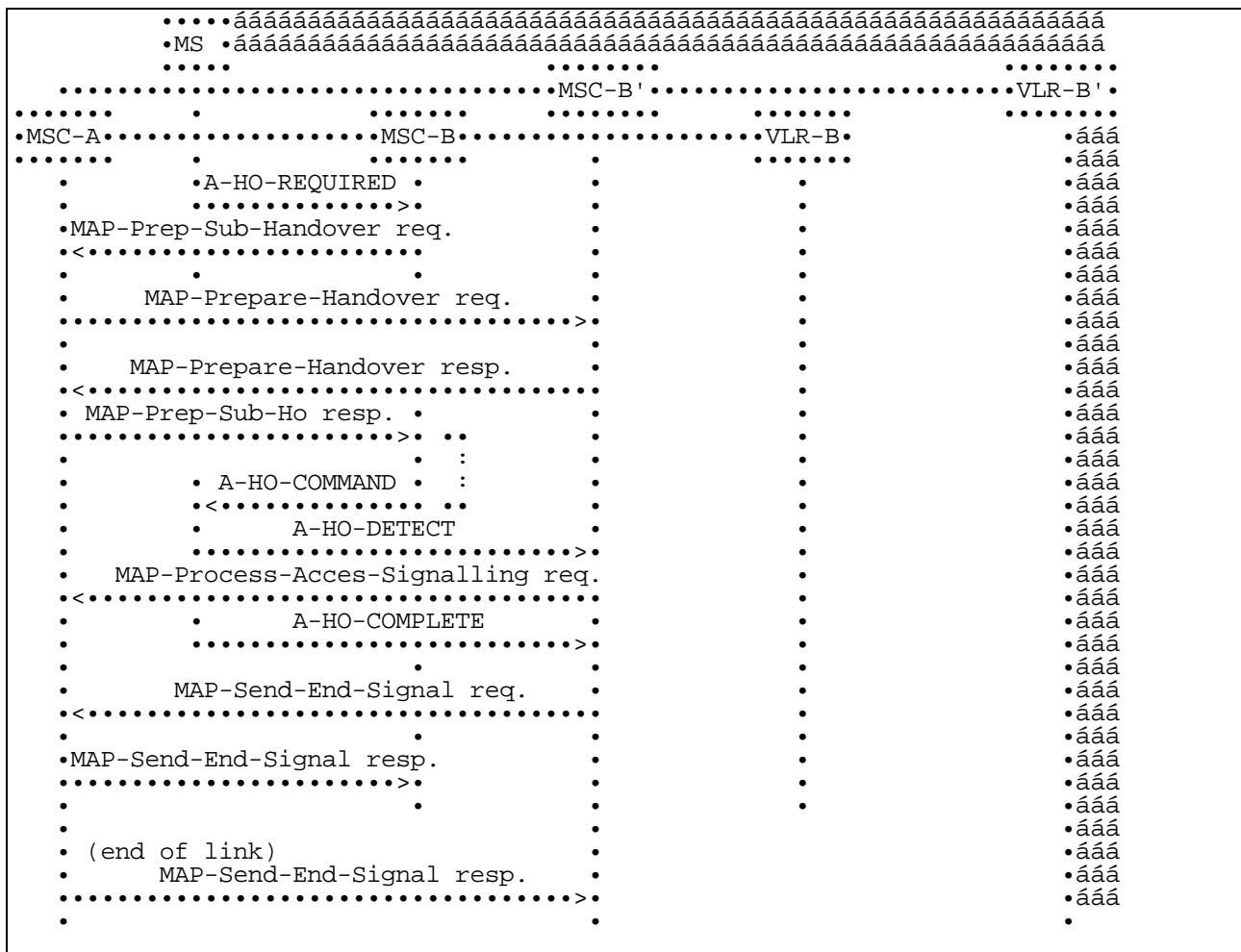

Figure 10: Subsequent handover procedure ii): Successful handover from MSC-B to MSC-B' without circuit connection

8 Detailed procedures in MSC-A

8.1 BSS/MSC and MS/MSC procedures in MSC-A (functional unit 1)

The handover procedures in this functional unit consist of:

- i) signalling between the MS and the MSC;
- ii) signalling between the BSS and the MSC for access management.

8.2 Call control procedures MSC-A (functional unit 2)

The call control procedures related to handover in MSC-A can be divided into two functional entities:

- the first entity is the call control procedure as part of the normal interworking between the PSTN/ISDN and the PLMN; for an MS originating call MSC-A is the originating exchange, for an MS terminating call MSC-A is the destination exchange.
- the second entity is the call control procedure for the connection between MSC-A and MSC-B in case of a handover from MSC-A to MSC-B. For this call control procedure the following applies:

Call set-up

The connection to MSC-B is set up by procedures relevant to the signalling system used in the PSTN/ISDN to which MSC-A is connected. The call is set up by using the MS Handover Number received from MSC-B as part of the MAP procedure.

The call set-up direction will always be from MSC-A to MSC-B, even when the call was originally established by the MS. Functional unit 2 (see figure 2) should therefore keep information on call set-up direction in order to be able to interpret correctly any clearing signals (see below).

The unit should indicate the address complete condition to functional unit 3 and through-connect without awaiting the answer signal from MSC-B. This applies also to signalling systems where address complete signals are not supported. In such cases an artificial address complete is established by functional unit 2.

Call clearing

Call clearing consists of two parts: after inter-MSC handover, clearing of the MS-BSS connection and clearing of the inter-MSC connection. If a request to release the call is generated by the network while the MS is re-tuning from one BSS to another BSS, then MSC-A shall begin clearing the call to the network and queue the call release to the MS until the MS has resumed communication. This includes the case when MSC-B and/or MSC-B' are involved.

The MAP procedures are used to transfer information between MSC-B and MSC-A in order to maintain full call control within MSC-A. MSC-A determines, based on information received from MSC-B, the appropriate signals (according to Technical Specification GSM 04.08) to be sent to the MS, and sends this information to MSC-B.

When MSC-A clears the call to the MS it also clears the call control functions in MSC-B and sends the MAP-SEND-END-SIGNAL response to release the MAP resources in MSC-B. The clearing of the connection is by procedures relevant to the signalling system in the PSTN/ISDN to which MSC-A is connected.

When the Signalling System no 7 ISDN User Part is used, the normal symmetric release procedures apply on both the connection to the fixed network and to MSC-B.

When a signalling system is used without a symmetric release possibility, some notice should be given to the clear-forward and clear-back procedures.

For MS terminating calls the following conditions apply on clear-forward and clear-back:

- when a clear-forward signal is received on interface B' (see figure 1), MSC-A clears the circuit to MSC-B by normal clear-forward procedures.
- when a clear-back signal is received from MSC-B, MSC-A starts normal clear-back procedures towards the fixed network (interface B') and sends the clear-forward signal on interface B'' in order to clear the connection with MSC-B.

NOTE: This case corresponds to a fault situation.

For MS originated calls the following applies:

- when MSC-A receives a clear-back signal from MSC-B, this signal must be interpreted as indicating a clear-forward condition. MSC-A then clears both the connection on interface B' (see figure 1) and to MSC-B by normal clear-forward procedures.

NOTE: This case corresponds to a fault situation.

- when MSC-A receives a clear-back signal on interface B', MSC-A should distinguish between national and international connections:

for international connections where the Q.118 supervision is done in the ISC, MSC-A sends a clear-forward signal on both interface B' to the fixed network and interface B'' to MSC-B;

for national connections or for international connections where the Q.118 supervision is not done in the ISC, a timer is started according to national practice for clear-back supervision and MSC-A proceeds as follows:

- i) if a clear-back signal is received from MSC-B, MSC-A interprets this as indicating a clear-forward condition and proceeds by clearing the connections on interface B' and to MSC-B by normal clear-forward procedures.
- ii) if the timer expires, MSC-A proceeds by normal clear-forward of the connections on interface B' and to MSC-B.

8.3 Handover control procedures MSC-A (functional unit 3)

The procedures of functional unit 3 are given in terms of SDL diagrams in figure 8. To easily distinguish the interface concerned the messages received or sent from this unit are prefixed with either 'MAP' for a MAP message, 'A' for an A-Interface message or 'I' for an ISDN/PSTN message.

The procedures of functional unit 3 include:

- i) Initiation. The initiation condition is shown by the signal A-HANDOVER-REQUIRED.

The diagram also includes queuing when there is no channel available. Calls for which handover has been initiated should be queued with priority higher than normal calls. They should have lower priority than emergency calls.

- ii) handover of calls within the area of MSC-A, i.e. handover case i). In this case MSC-A controls the procedures on both the previous and the new radio channel, using signals A-HANDOVER-REQUEST and A-HANDOVER-COMMAND. The handover procedure is completed when A-HANDOVER-COMplete is received. If this signal is not received, the radio path and the connection on interface B' are either released or the original connection is maintained.

In the case of ongoing voice group calls for subsequent users of the VGCS channel uplink the original connection shall always be maintained.

For handover devices with three-party capabilities the handover device is first set up so that all interfaces A', A'' and B' are connected (illustrated by the signal 'set up handover device'). This is done when the Handover Command is sent to the MS. The device is connected in its final position (i.e. A'' to B' for case ii)) (illustrated by the signal 'connect handover device') when A-HANDOVER-COMplete is received.

- iii) handover to MSC-B. This procedure is the one described in sections 7.1. and 7.2. For handover devices with three-party capabilities the handover device is set-up when MSC-A sends the Handover Command to the MS, i.e. the interfaces A', B' and B'' are then connected. The device is connected in its final position (i.e. B' to B'') when the successful procedure indication is received from functional unit 4.
- iv) subsequent handover to MSC-A. The procedure is described in sections 7.3. and 7.4. When a handover to MSC-A indication is received from functional unit 4, the handover device is set up so that interfaces B', B'' and A' are connected (for handover devices with three-party capabilities). When A-HANDOVER-COMplete is received, the device is connected in its final position (i.e. B' to A').

If A-HANDOVER-COMplete is not received (expiry of timer T104), the handover device releases interface A' and returns to a position where B' and B'' are connected.

- v) subsequent handover to a third MSC (MSC-B'). The procedure is described in sections 7.3. and 7.4. The handover device is set up in its initial position, (i.e. interconnection of interfaces B', B'' and B''') when the connection to MSC-B' has been established. MSC-B is informed via functional unit 4 that the connection has been established and that the procedure on the radio path can be initiated. The device is connected in its final position (i.e. B' to B''') when a successful procedure indication is received from functional unit 4. MSC-B is informed that all procedures in MSC-B can be terminated (illustrated by the MAP-SEND-END-SIGNAL response). The device returns to the state where B' and B'' are connected if the subsequent handover procedure fails.

Timers in MSC-A

The procedures are supervised by timers in order to avoid a deadlock when responses are not received or the procedures fail. The following timers are defined:

- T101: this timer supervises the queuing time for a free channel. If T101 expires, a no channel indication is generated, a retry procedure could be applied as described in section 6.1. T101 is set by O&M.
- T102: this timer supervises the time for handover completion for handover between BSSs in MSC-A. T102 is set by O&M.
- T103: this timer supervises the time between issuing an A-HANDOVER-COMMAND from MSC-A and receiving a successful procedure indication from MSC-B. This timer also supervises the time between sending an A-HO-REQUEST-ACKNOWLEDGE to MSC-B and receiving a successful procedure indication from MSC-B'. If T103 expires, the handover procedure is terminated. T103 is set by O&M.
- T104: this timer supervises the time between sending of an A-HO-REQUEST-ACKNOWLEDGE to MSC-B and receiving the A-HANDOVER-COMplete from BSS-B on MSC-A. If the timer expires, the new radio channel is released and the existing handover device connection to MSC-B is maintained. T104 is set by O&M.

8.4 MAP procedures in MSC-A (functional unit 4)

The MAP procedures for handover are defined in Technical Specification GSM 09.02. They include:

- procedures for basic handover;
- procedures for subsequent handover.

These procedures are as outlined in section 7.

8.5 Interworking between Handover control procedures and MAP procedures in MSC-A

The interworking between the Handover control procedures and the MAP procedures for handover is defined in Technical Specification GSM 09.10. It includes:

- interworking at basic handover initiation;
- interworking at subsequent handover completion.

This interworking is not described in the present document.

8.6 Compatibility with GSM Phase 1

If the MSC-A initiates an Inter-MSC handover procedure according to Phase 2 MAP and BSSMAP protocols while using a Phase 1 BSSMAP protocol towards BSS-A, MSC-A has to perform the protocol interworking.

The same holds if a Phase 2 BSSMAP protocol is used between MSC-A and BSS-A and the E-interface supports only Phase 1 protocol.

9 Detailed procedures in MSC-B

9.1 BSS/MS (MS/BSS) procedures MSC-B (functional unit 1)

The handover procedures in this functional unit consist of:

- i) signalling between the MS and the MSC;
- ii) signalling between the BS and the MSC for access management.

Signals exchanged with functional unit 3 are indicated in section 9.3 below.

9.2 Call control procedures MSC-B (functional unit 2)

These procedures relate to the call control in MSC-B of the "handover" connection with MSC-A. For these procedures the following apply:

Call set-up

The connection is set up by MSC-A. MSC-B should provide, if possible, the following backward signals:

- signals indicating unsuccessful call set-up and, if possible, the cause of call failure;
- address complete signal;
- answer signal (see NOTE).

NOTE: The answer signal is not related to answering by the MS and it has no meaning in the handover procedure between MSC-A and MSC-B. But after successful handover or successful subsequent channel assignment using a circuit connection between MSC-A and MSC-B this signal is needed for bringing the connection in the answered state in the intermediate PSTN/ISDN exchanges.

There will be no indication that the call applies to a handover. This information has to be derived from the MS Handover Number received during call set-up in relation to the earlier MAP-PREPARE-HANDOVER request/MAP-PREPARE-HANDOVER response procedure between MSC-A and MSC-B.

Call clearing

Call clearing consists of two parts after inter-MS handover: clearing of the BSS-MS connection and clearing of the inter-MS connection, this case is only applicable to calls successfully handed over. If a request to release the call is generated by the network while the MS is re-tuning from one BSS to another BSS, then MSC-B shall begin clearing the call to the network and queue the call release to the MS until the MS has resumed communication.

The MAP is used to transfer information between MSC-A and MSC-B in order to make it possible for MSC-B to send the appropriate signals to the MS, specified in Technical Specification GSM 04.08, and still leave the call control to MSC-A. MSC-A normally initiates release of the connection between MSC-A and MSC-B. Exceptionally MSC-B is allowed to release the connection if no MAP-SEND-END-SIGNAL response is received, or if the Handover is to be aborted.

When the Signalling System no 7 ISDN User Part is used, the normal symmetric release procedures apply. When a signalling system is used without a symmetric release possibility or a fault condition occurs, the following may apply:

- when MSC-B receives a clear-forward signal from MSC-A, it shall release the radio resources;
- in fault situation eg. machine malfunction or loss of the connection on interface A, MSC-B may send a clear-back signal to MSC-A.

9.3 Handover control procedures MSC-B (functional unit 3)

The procedures of functional unit 3 are given in form of SDL diagrams in figure 9. To easily distinguish the interface concerned the messages received or sent from this unit are prefixed with either 'MAP' for a MAP message, 'A' for an A-Interface message or 'I' for an ISDN/PSTN message. The procedure in functional unit 3 include:

i) handover from MSC-A.

This case is initiated by MSC-A, and includes allocation and establishment of the new radio channel. The procedure is outlined in sections 7.1. and 7.2.

ii) Intra-MSC handovers within the area controlled by MSC-B.

This procedure is the same as that of i) in section 8.3, except that the A-HANDOVER-REQUERED is received by MSC-B.

iii) subsequent handover to another MSC (MSC-A or MSC-B').

The initiation procedure is essentially the same as that of i) of section 8.3. The Handover Command to the MS is now generated by MSC-B after the A-HO-REQUEST-ACKNOWLEDGE is received from MSC-A (via functional unit 4). The procedure is terminated in MSC-B when MSC-B receives a terminate procedure indication from functional unit 4.

Timers in MSC-B

The following procedures are supervised by timers in order to avoid a deadlock when responses are not received or the procedures fail.

The following timers are defined:

- T201: this timer supervises the queuing time for a free channel. T201 is set by O&M.
- T202: this timer supervises the time for handover completion for handover between BSSs in MSC-B. If T202 expires, the radio path and the connection on interface B' are released. T202 is set by O&M.
- T204: this timer supervises the time between sending of address complete message to MSC-A and receiving the A-HANDOVER-COMPLETE from BSS-B on MSC-B. This timer also supervises the time between issuing the handover command to the MS and receiving the MAP-SEND-END-SIGNAL response from MSC-A, for a subsequent handover. In the case of a handover without circuit connection between MSC-A and MSC-B this timer supervises the time between issuing the A-HO-REQUEST-ACKNOWLEDGE to the MSC-A and receiving the A-HANDOVER-COMPLETE from BSS-B on MSC-B. If the timer expires, then any new radio channel is released. T204 is set by O&M.
- T210: this timer is used to supervise the time for establishing a circuit connection from MSC-A to MSC-B. When T210 expires, the allocated channel in MSC-B is released. T210 is set by O&M. This timer is not started when MSC-A explicitly indicates that no handover number is needed.
- T211: this timer is used to control the time between requesting a subsequent handover (A-HO-REQUEST to the MSC-A) and receiving the response from MSC-A (A-REQUEST-ACKNOWLEDGE/A-HO-FAILURE). If T211 expires, the existing connection with the MS is maintained. T211 is set by O&M.

9.4 MAP procedures MSC-B (functional unit 4)

The MAP procedures for handover are defined in Technical Specification GSM 09.02. They include:

- procedures for basic handover;
- procedures for subsequent handover;
- procedures for obtaining the handover number from the VLR.

These procedures are outlined in section 7.

9.5 Interworking between Handover control procedures and MAP procedures in MSC-B

The interworking between the Handover control procedures and the MAP procedures for handover is defined in Technical Specification GSM 09.10. It includes:

- interworking at basic handover completion;
- interworking at subsequent handover initiation.

This interworking is not described in the present document.

9.6 Compatibility with GSM Phase 1

If the MSC-B accepts an Inter-MSC handover procedure according to Phase 2 MAP and BSSMAP protocols while using a Phase 1 BSSMAP protocol towards BSS-B, MSC-B has to perform the protocol interworking.

The same holds if a Phase 1 MAP protocol is requested on the E-interface and MSC-B uses a Phase 2 BSSMAP protocol towards BSS-B.

10 Subsequent channel assignment using a circuit connection between MSC-A and MSC-B

If a circuit connection has to be set up (for example for a Mobile Originated or Mobile Terminated Call Establishment) after an Inter-MSC handover without circuit connection, MSC-A shall request a Handover Number using a MAP-PREPARE-HANDOVER request, containing the A-ASSIGNMENT-REQUEST, on the established MAP connection. If MSC-B indicates to MSC-B and to MSC-A that at least one of two procedures assignment or Handover Number allocation can not be completed, then MSC-A shall terminate the circuit establishment attempt. The existing connection to the MS shall be maintained, if possible.

Upon receipt of the MAP-PREPARE-HANDOVER request MSC-B shall perform the requested assignment operation towards the BSS. In addition it shall retrieve a Handover Number from VLR-B. If a failure occurs in the assignment or Handover Number allocation then it shall be reflected in the MAP-PREPARE-HANDOVER response that at least one of these two procedures has not been completed (i.e. either by a MAP-PREPARE-HANDOVER result with the assignment procedure outcome and the Handover Number allocation outcome or by a MAP-PREPARE-HANDOVER error).

When MSC-A receives a successful MAP-PREPARE-HANDOVER response it shall establish a circuit connection to MSC-B by using the appropriate network supported procedures. In figure 11 this is indicated by the IAM (Initial Address Message) and ACM (Address Complete Message). MSC-B shall also send the Answer message if appropriate to the signalling system. Upon receipt of the Answer MSC-A shall consider the circuit connection establishment phase complete. If a failure occurs during the circuit establishment phase then the existing connection to the MS shall be maintained, if possible.

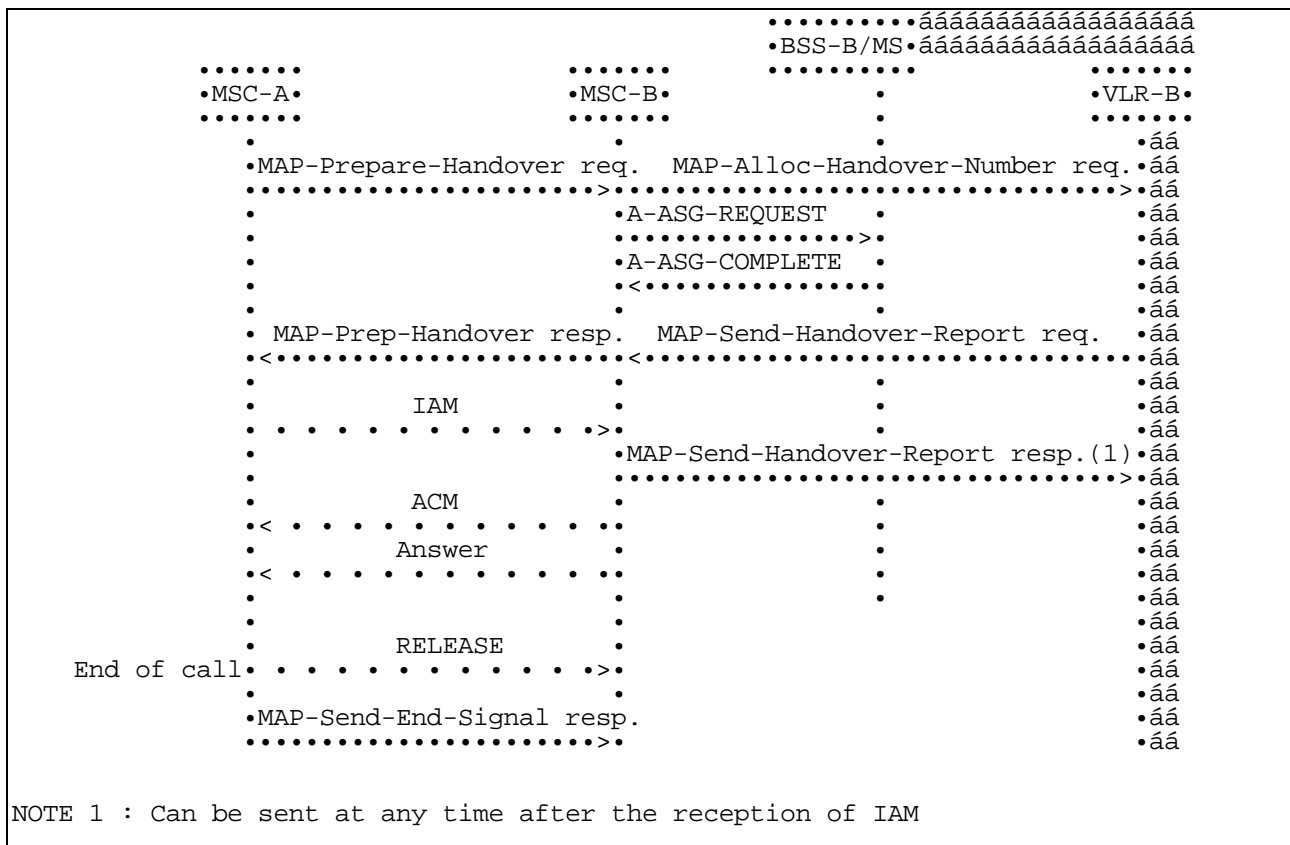

Figure 11: Successful circuit-switched call establishment after a Basic Handover without circuit connection

11 Directed retry handover

The directed retry procedure allows the network to select the optimum cell for the Mobile Station. The process of directed retry involves the assignment of a Mobile Station to a radio channel on a cell other than the serving cell. This process is triggered by the assignment procedures, as described in GSM 08.08, and employs internal or external handover procedures as described in sections 6 and 7. The successful procedure for a directed retry is as shown in figure 12 and as described below.

If during the assignment phase, as represented by the A-ASSIGNMENT-REQUEST message, a handover becomes necessary, due to either radio conditions or congestion, then the Mobile Station may be handed over to a different cell. When the decision has been made to handover the MS the BSS-A may send an A-ASSIGNMENT-FAILURE message, indicating 'directed retry', before sending the A-HANDOVER-REQUIRED message to MSC-A, indicating 'directed retry'. However BSS-A may alternatively send the A-HANDOVER-REQUIRED message, indicating 'directed retry', without sending the A-ASSIGNMENT-FAILURE message. Other cause values may be used instead of "Directed Retry" in the A-HANDOVER-REQUIRED message, this will allow the MSC to take different actions dependent on the received cause. Upon receipt of the A-HANDOVER-REQUIRED message from BSS-A, then MSC-A shall initiate the handover as described in sections 6 and 7. No resources shall be cleared in the MSC-A or BSS-A for this connection.

After receipt of the A-HANDOVER-COMplete message from BSS-B the assignment procedure shall be considered to be complete and the resources on BSS-A shall be cleared.

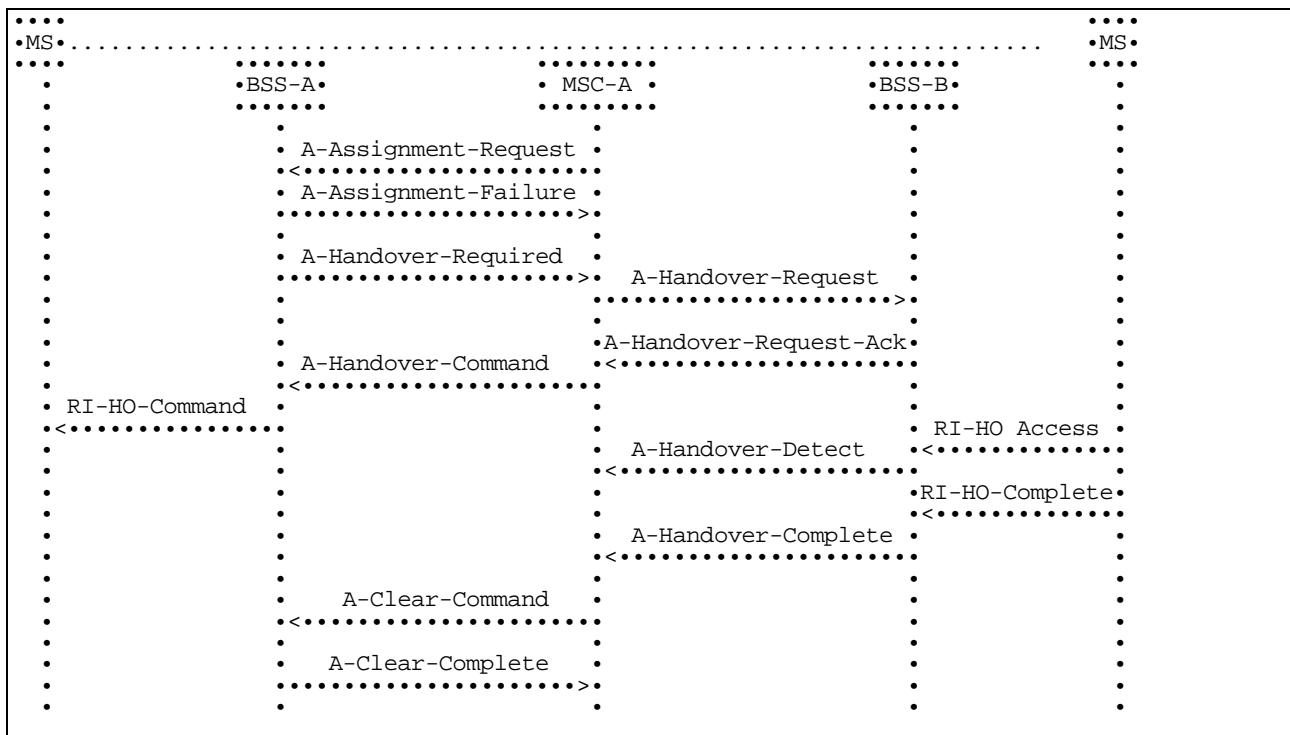

Figure 12: Example of a Directed Retry Intra-MSC Handover Procedure

If a failure occurs during the handover attempt, for example A-HANDOVER-FAILURE returned from BSS-A or BSS-B, then MSC-A will terminate the handover to BSS-B. Under these conditions MSC-A may optionally take one of a number of actions:

- i) retry the handover to the same cell;
- ii) select the next cell from the list contained in the A-HANDOVER-REQUIRED message and attempt a handover to the new cell;
- iii) send an A-HANDOVER-REQUIRED-REJECT to BSS-A, if an A-HANDOVER-COMMAND has not already been sent;
- iv) retry the assignment procedure to BSS-A, if the failure message was returned from BSS-A. This option is additional to those for normal handover;
- v) Clear the complete call.

The procedures for Inter-MSC handover are also applicable to the directed retry process. If an Inter-MSC handover is necessary then the assignment process should be considered to have completed successfully upon receipt of the A-HO-COMplete included in the MAP-SEND-END-SIGNAL request.

12 SDL diagrams

NOTE: The message primitive names used in the SDL diagrams and message flows in the present document do not represent the actual messages specified in the GSM 04 and GSM 08 series or the services specified in the GSM 09 series of technical specifications. The primitive names are only intended to be indicative of their use in the present document.

SDL Annotation:

The following conventions and abbreviations have been used in the SDLs. Text included in '['] is used to indicate either, the BSSMAP message (as defined in GSM 09.08) included in the message, or the transport of a Handover Number.

When traversing the following SDLs it may be possible that resources appear to be released repeatedly, however these operations are only executed once on their first occurrence. Furthermore it maybe that certain messages cannot, in

practice, be received in particular states, after specific events have taken place. In general both of the above cases are obvious. This approach has been adopted (in line with other GSM Technical Specifications) in order to reduce the complexity of the SDLs and improve clarity, without reducing the quality of the functional description.

The following abbreviations have been used in the SDLs:

A-HO-REQUEST	A-HANDOVER-REQUEST
A-HO-REQUEST-ACK	A-HANDOVER-REQUEST-ACK.
A-HO-COMPLETE	A-HANDOVER-COMPLETE
A-HO-DETECT	A-HANDOVER-DETECT
A-HO-PERFORMED	A-HANDOVER-PERFORMED
A-ASG-REQUEST	A-ASSIGNMENT-REQUEST
A-ASG-COMPLETE	A-ASSIGNMENT-COMPLETE
A-ASG-FAILURE	A-ASSIGNMENT-FAILURE
MAP-PAS req	MAP-PROCESS-ACCESS-SIGNALLING req.
MAP-FAS req	MAP-FORWARD-ACCESS-SIGNALLING req.

NOTE : The SDL diagrams have been checked for consistency with the allocation of the A interface circuits by the BSC. The conclusion was that SDLs are expressed in general terms, and offer a sufficient latitude of interpretation to be consistent with the allocation of A interface circuits by the BSC.

Procedure MSC_A_HO

Sheet1 (26)

Procedure for Handover in MSC-A

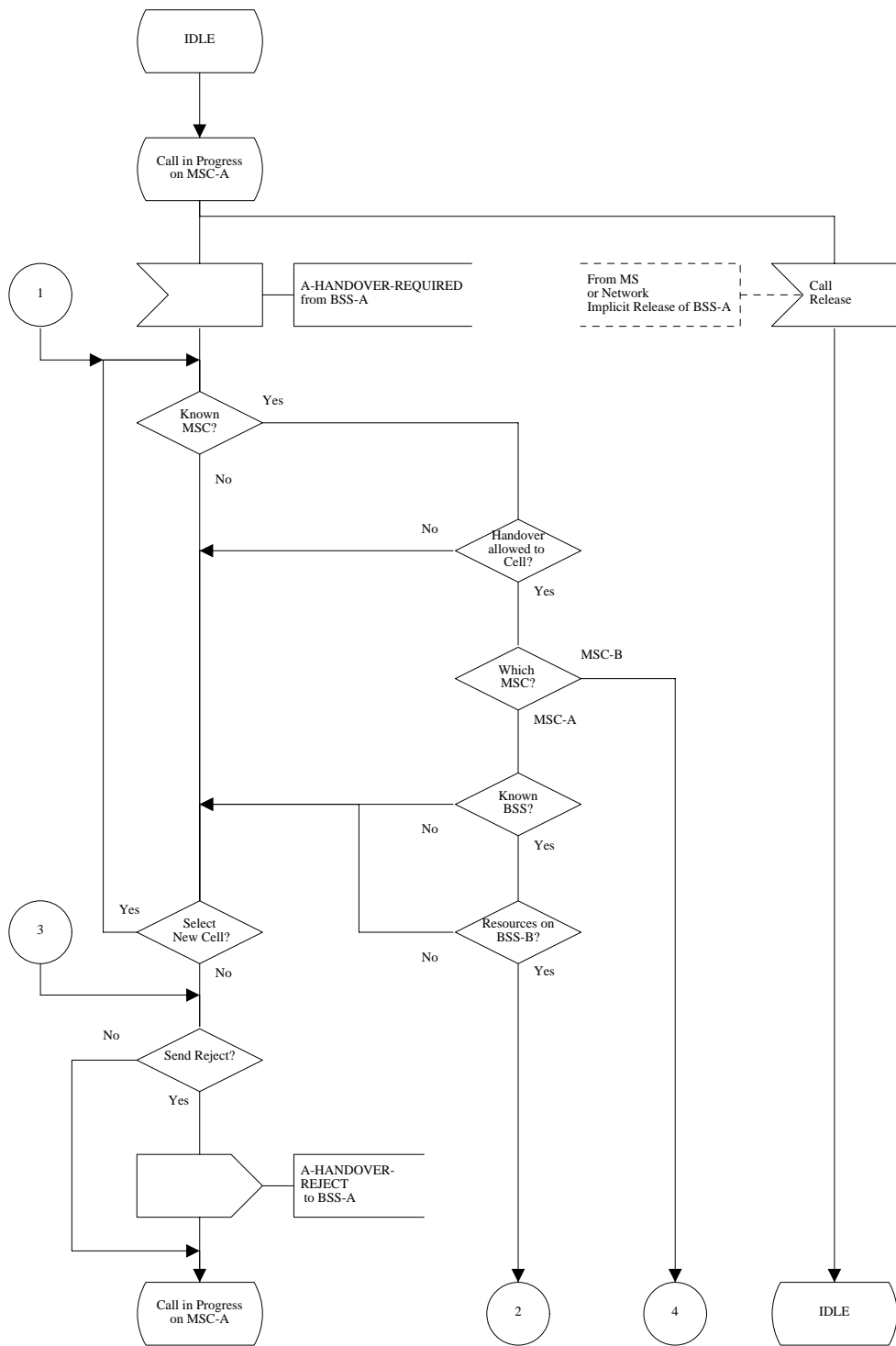

Figure 13 (Sheet 1 of 26): Handover control procedure in MSC-A

Procedure MSC_A_HO

Sheet2 (26)

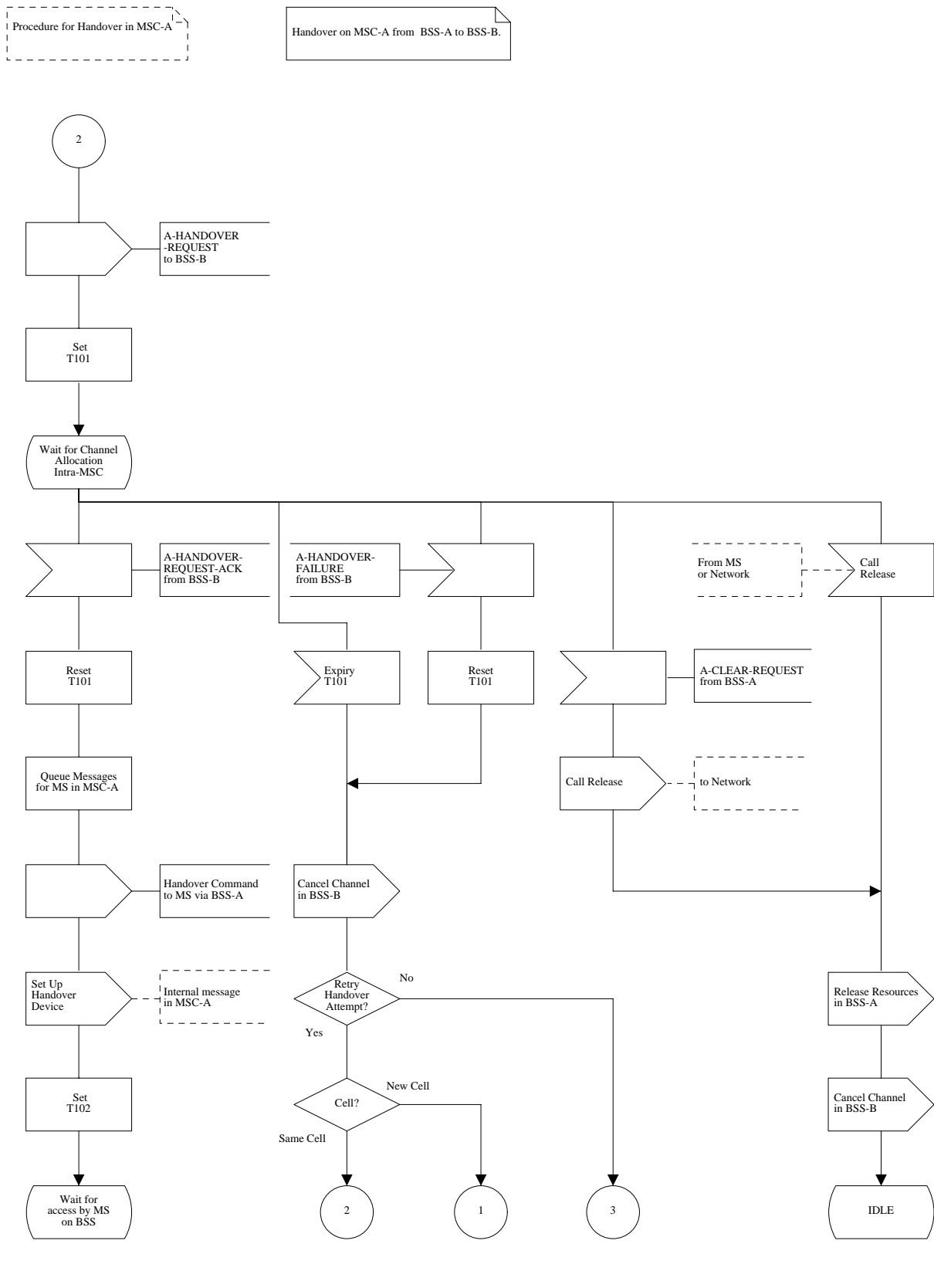

Figure 13 (Sheet 2 of 26): Handover control procedure in MSC-A

Procedure MSC_A_HO

Sheet3 (26)

Procedure for Handover in MSC-A

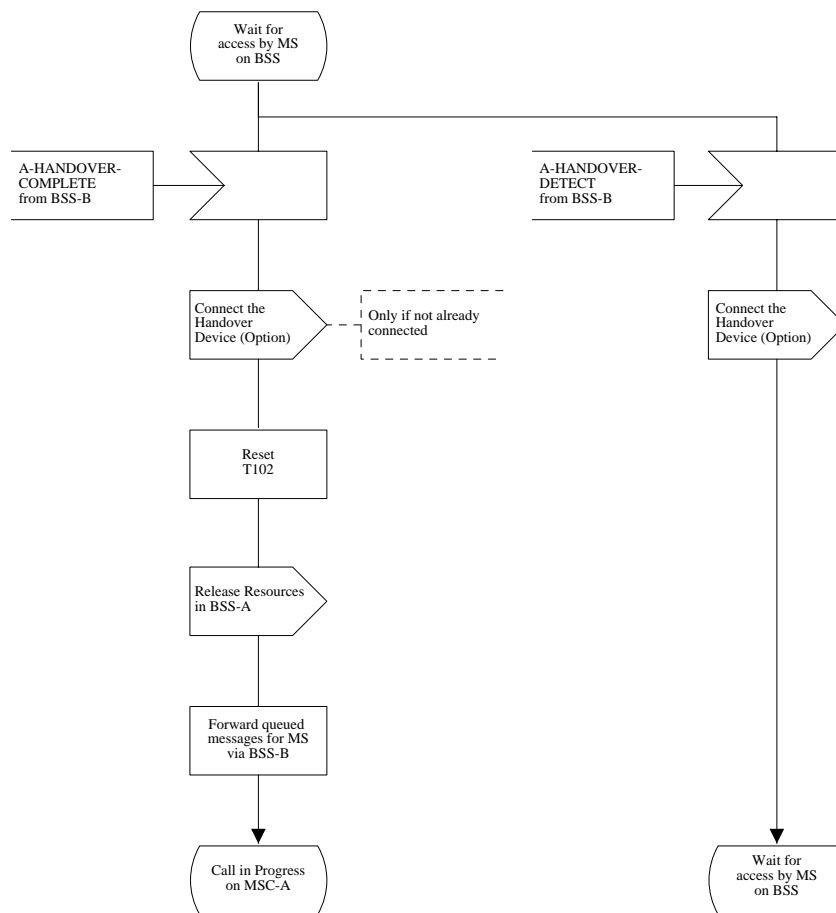

Figure 13 (Sheet 3 of 26): Handover control procedure in MSC-A

Procedure MSC_A_HO

Sheet4(26)

Procedure for Handover in MSC-A

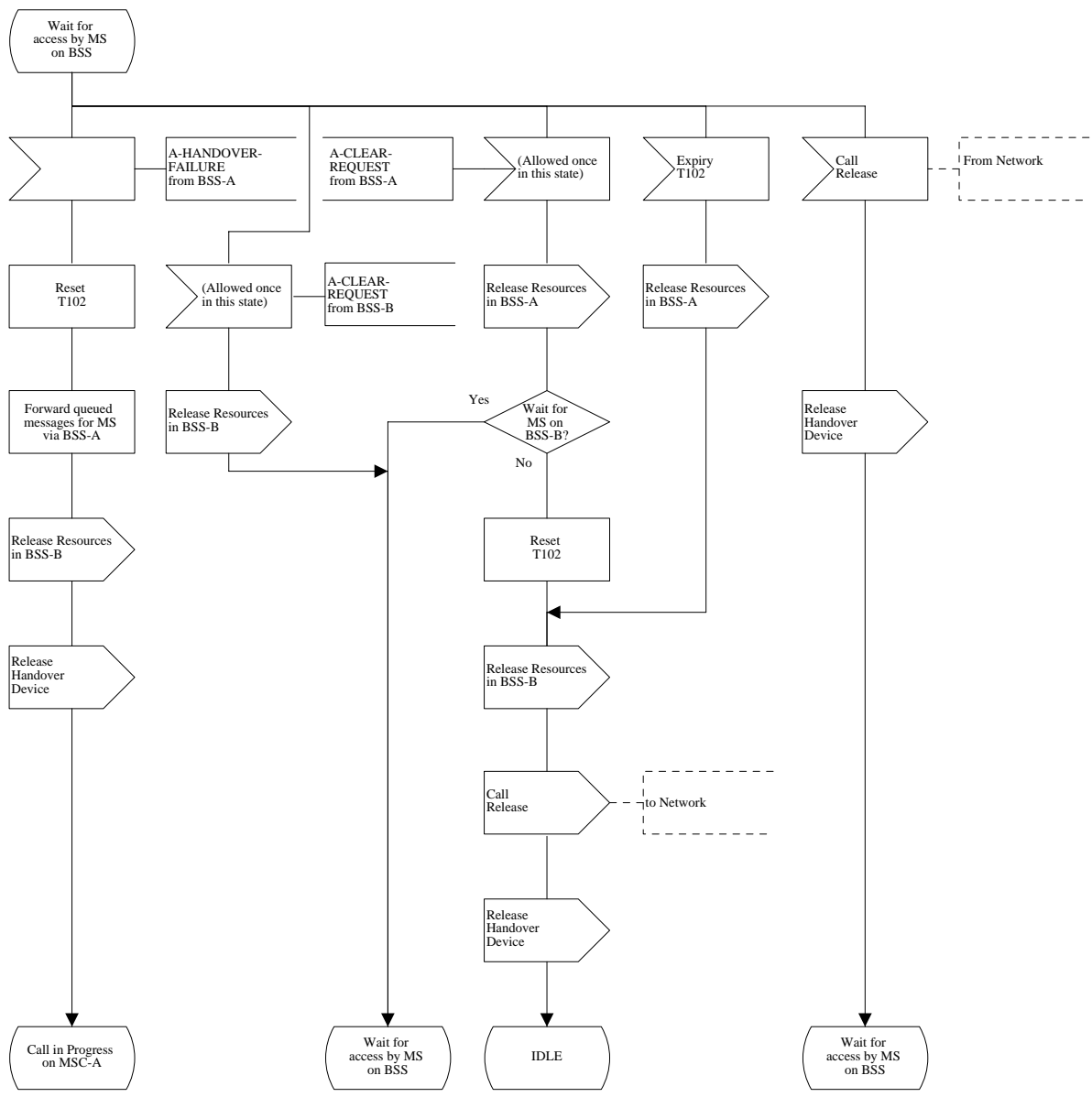

Figure 13 (Sheet 4 of 26): Handover control procedure in MSC-A

Procedure MSC_A_HO

Sheet5 (26)

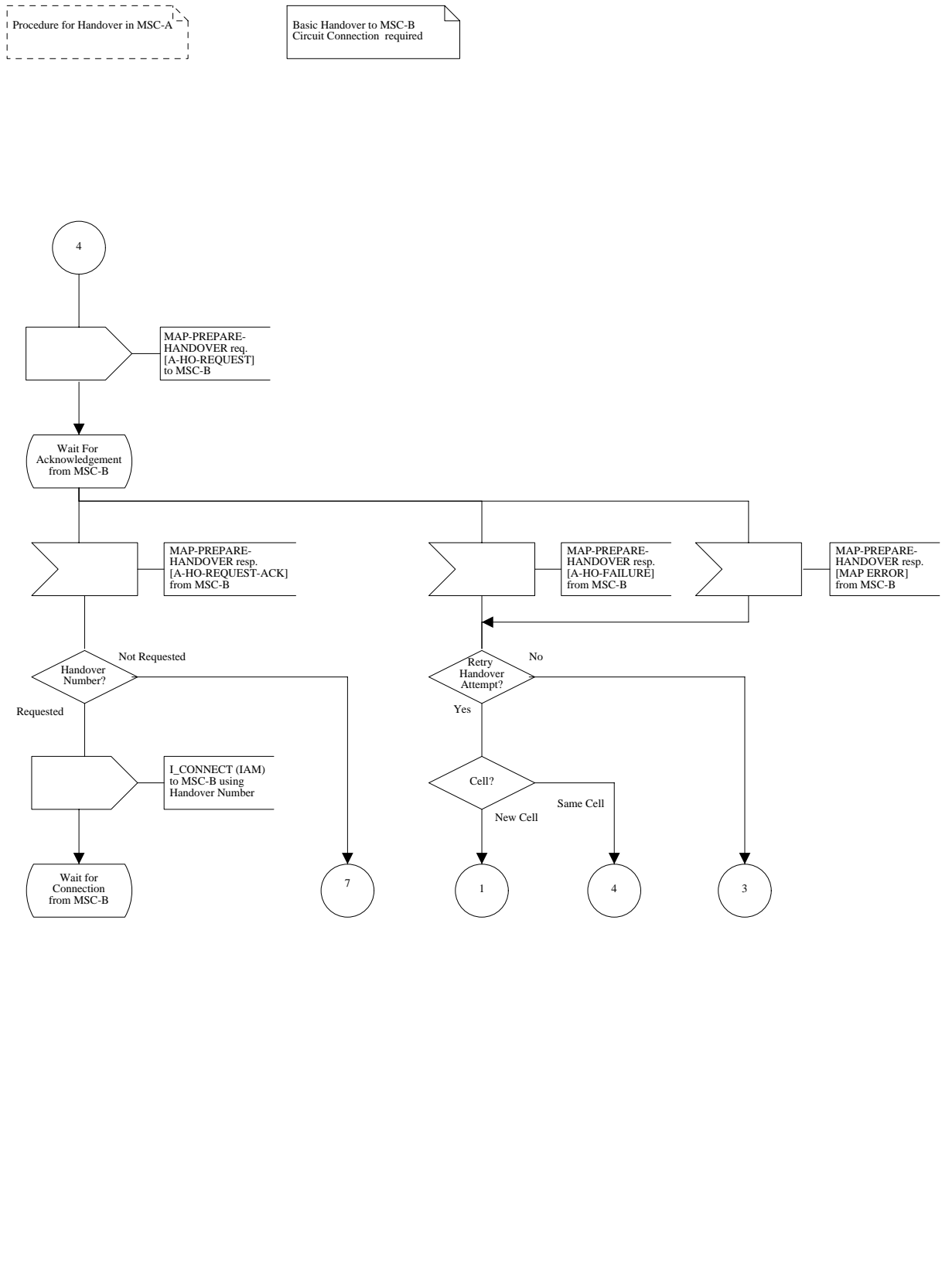

Figure 13 (Sheet 5 of 26): Handover control procedure in MSC-A

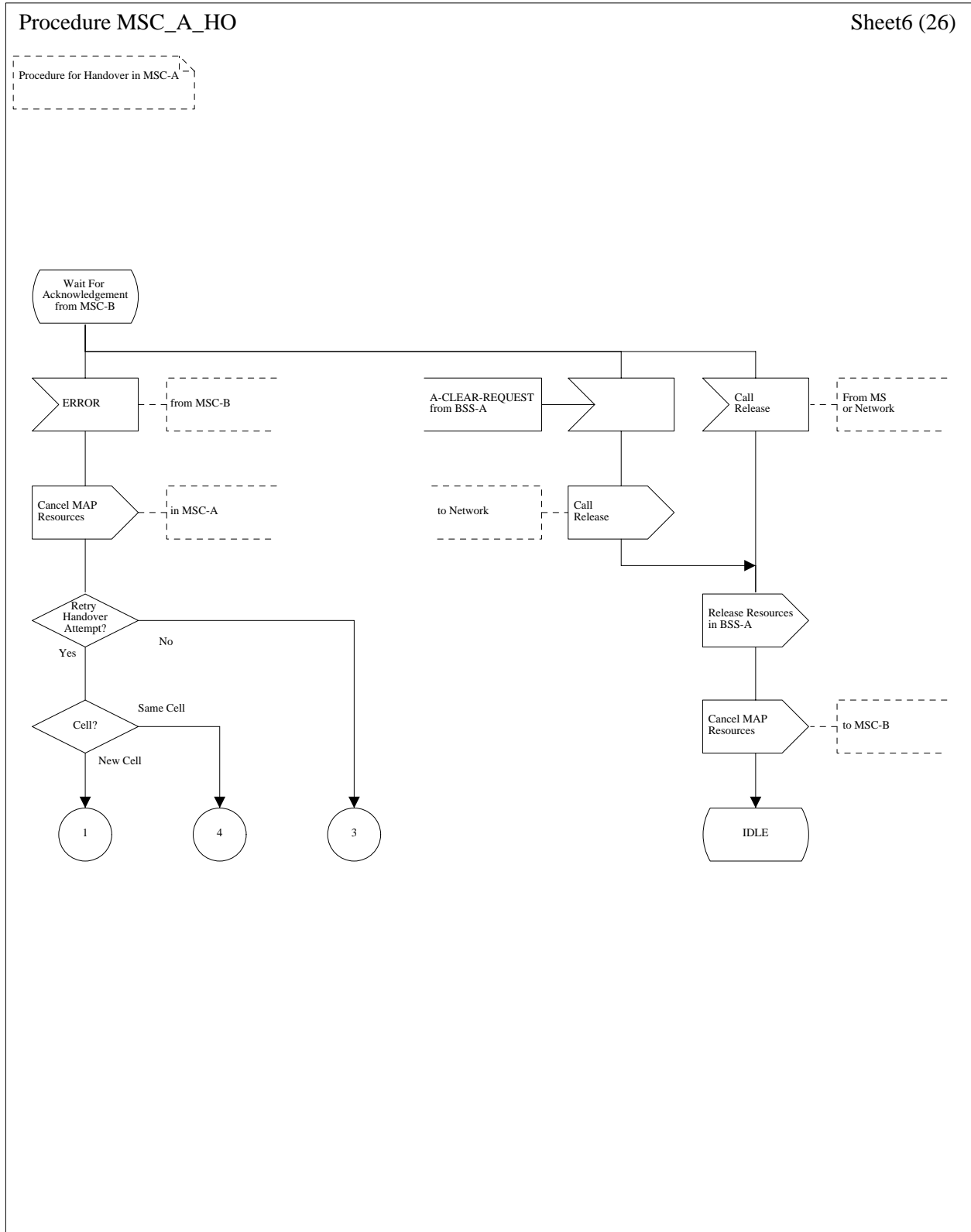

Figure 13 (Sheet 6 of 26): Handover control procedure in MSC-A

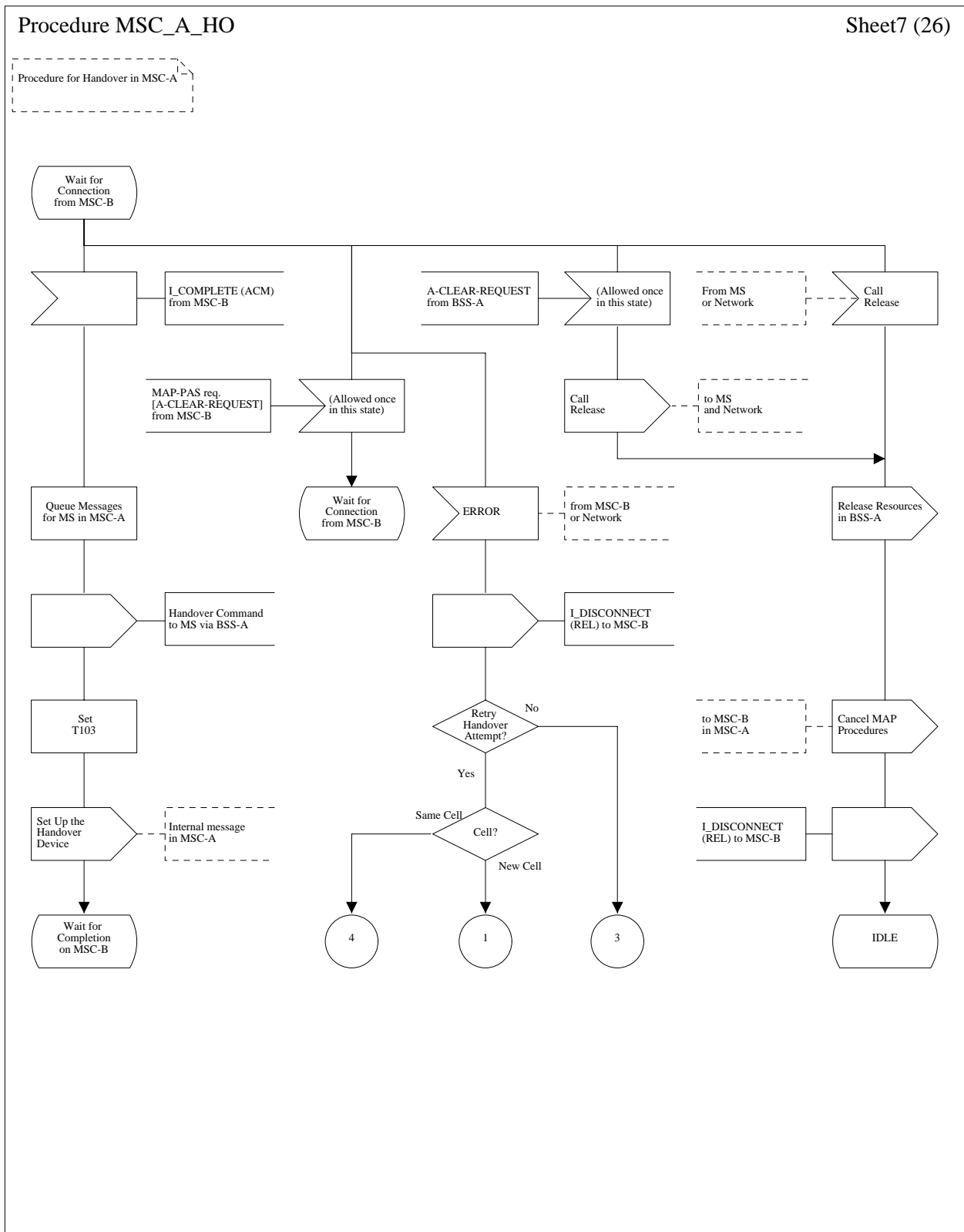

Figure 13 (Sheet 7 of 26): Handover control procedure in MSC-A

Procedure MSC_A_HO

Sheet8 (26)

Procedure for Handover in MSC-A

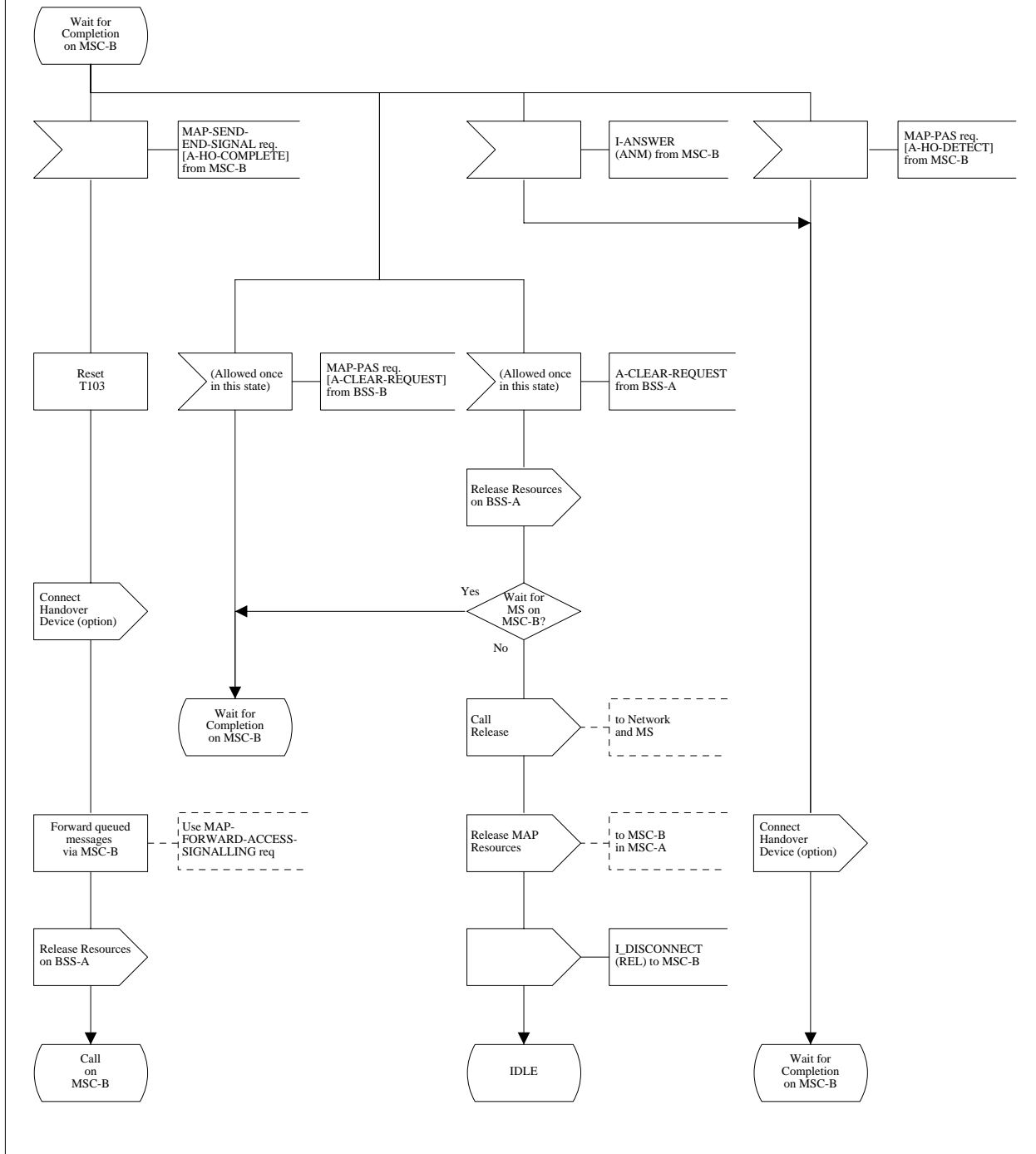

Figure 13 (Sheet 8 of 26): Handover control procedure in MSC-A

Procedure MSC_A_HO

Sheet9 (26)

Procedure for Handover in MSC-A

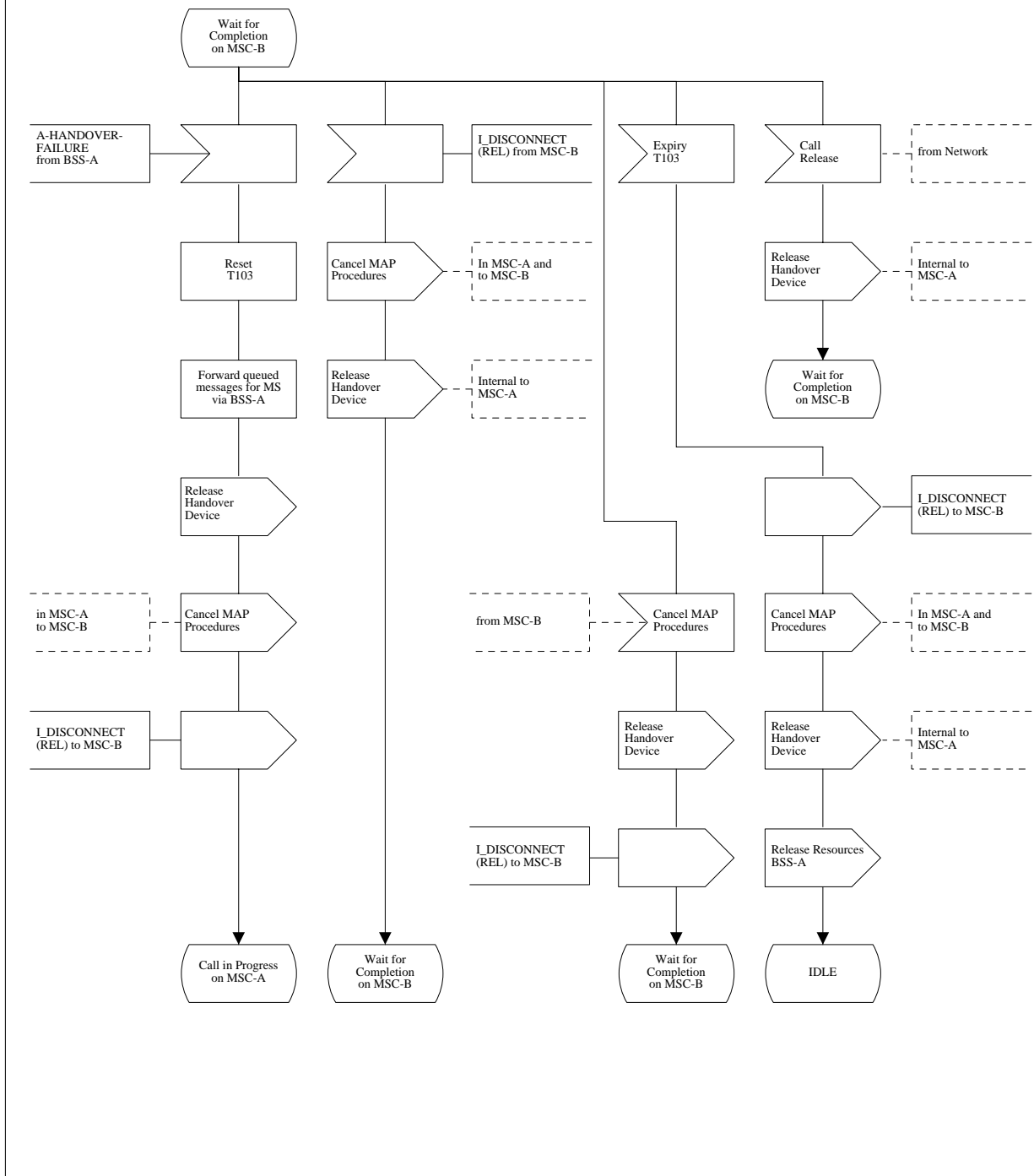

Figure 13 (Sheet 9 of 26): Handover control procedure in MSC-A

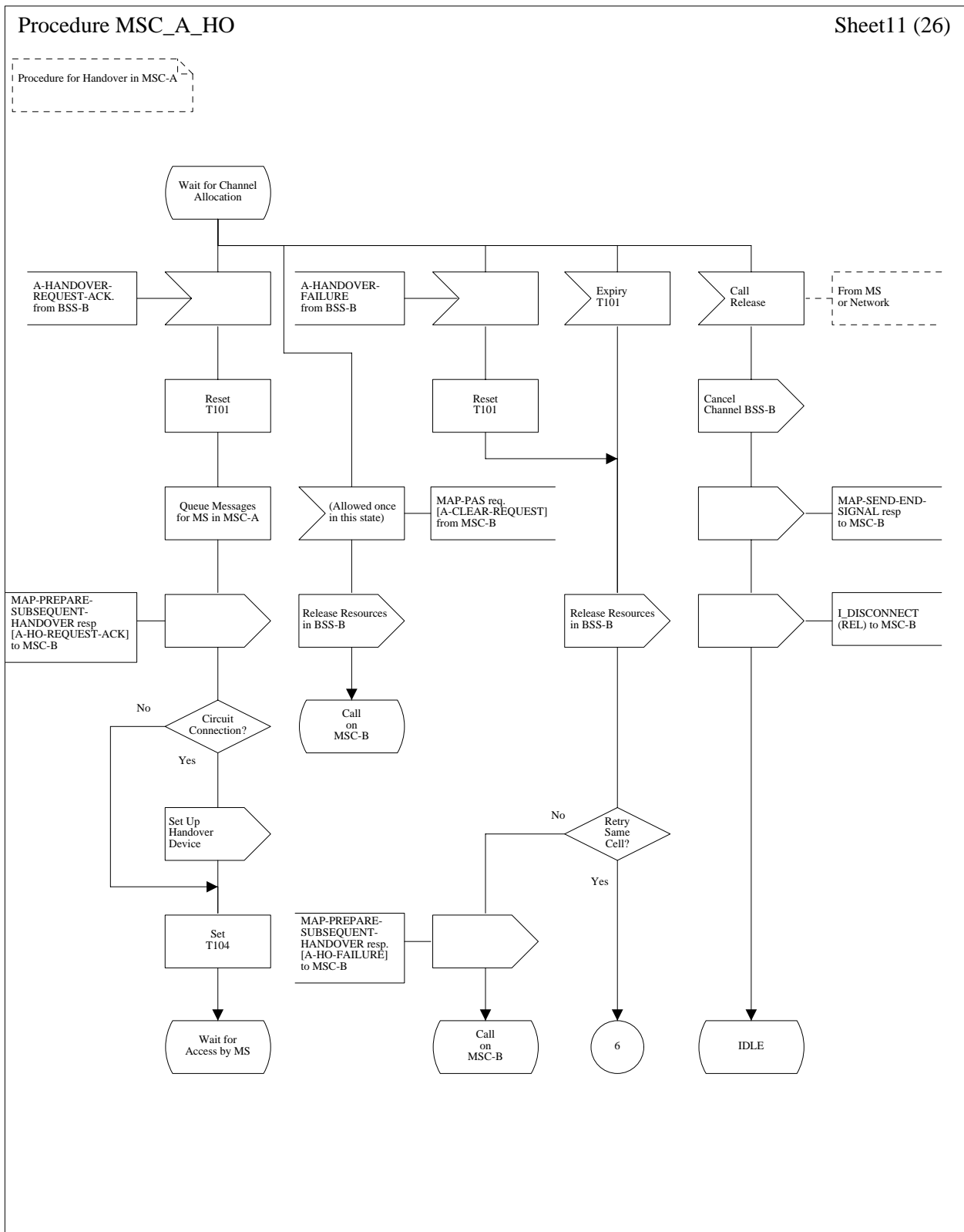

Figure 13 (Sheet 11 of 26): Handover control procedure in MSC-A

Procedure MSC_A_HO

Sheet12 (26)

Procedure for Handover in MSC-A

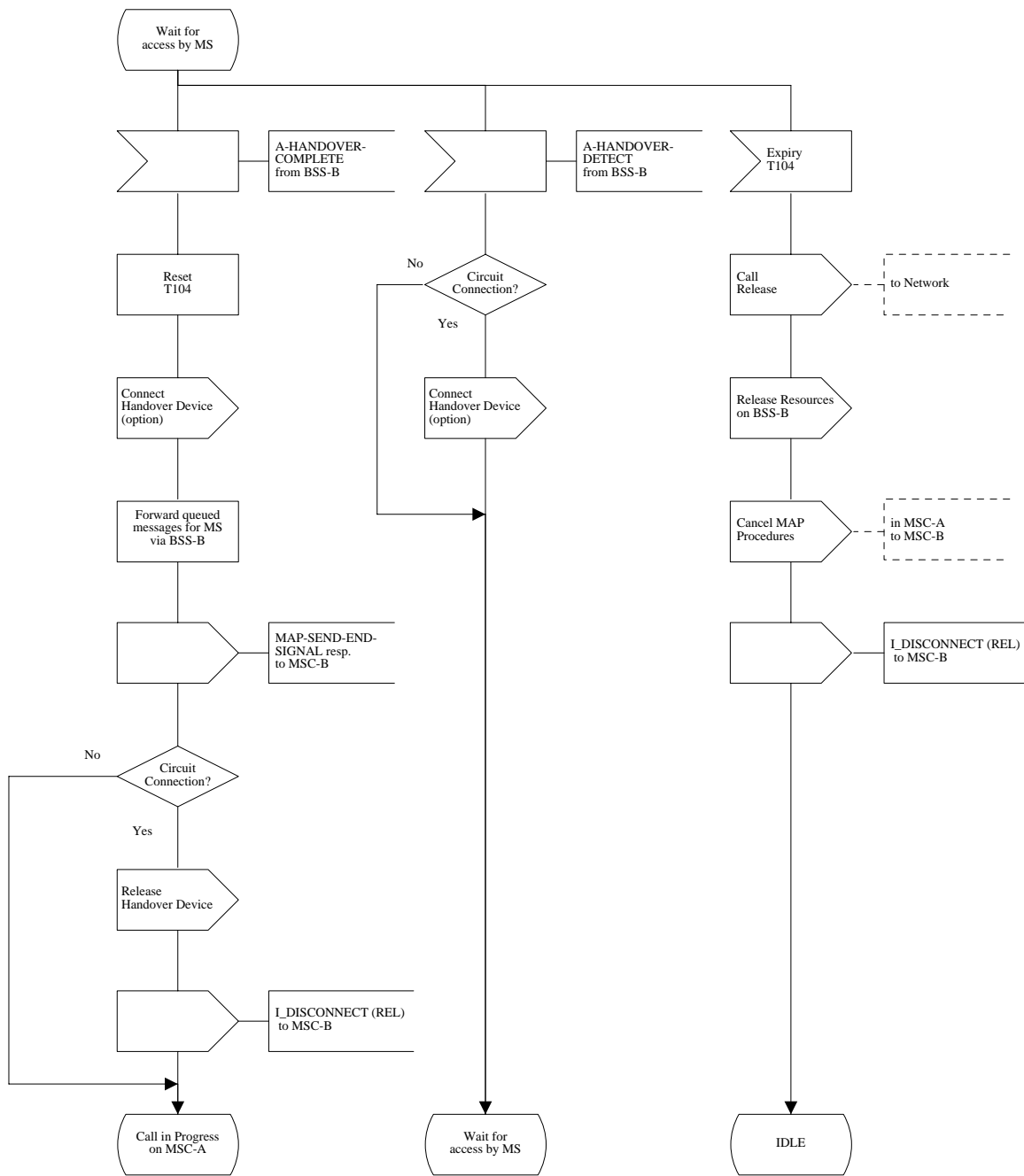

Figure 13 (Sheet 12 of 26): Handover control procedure in MSC-A

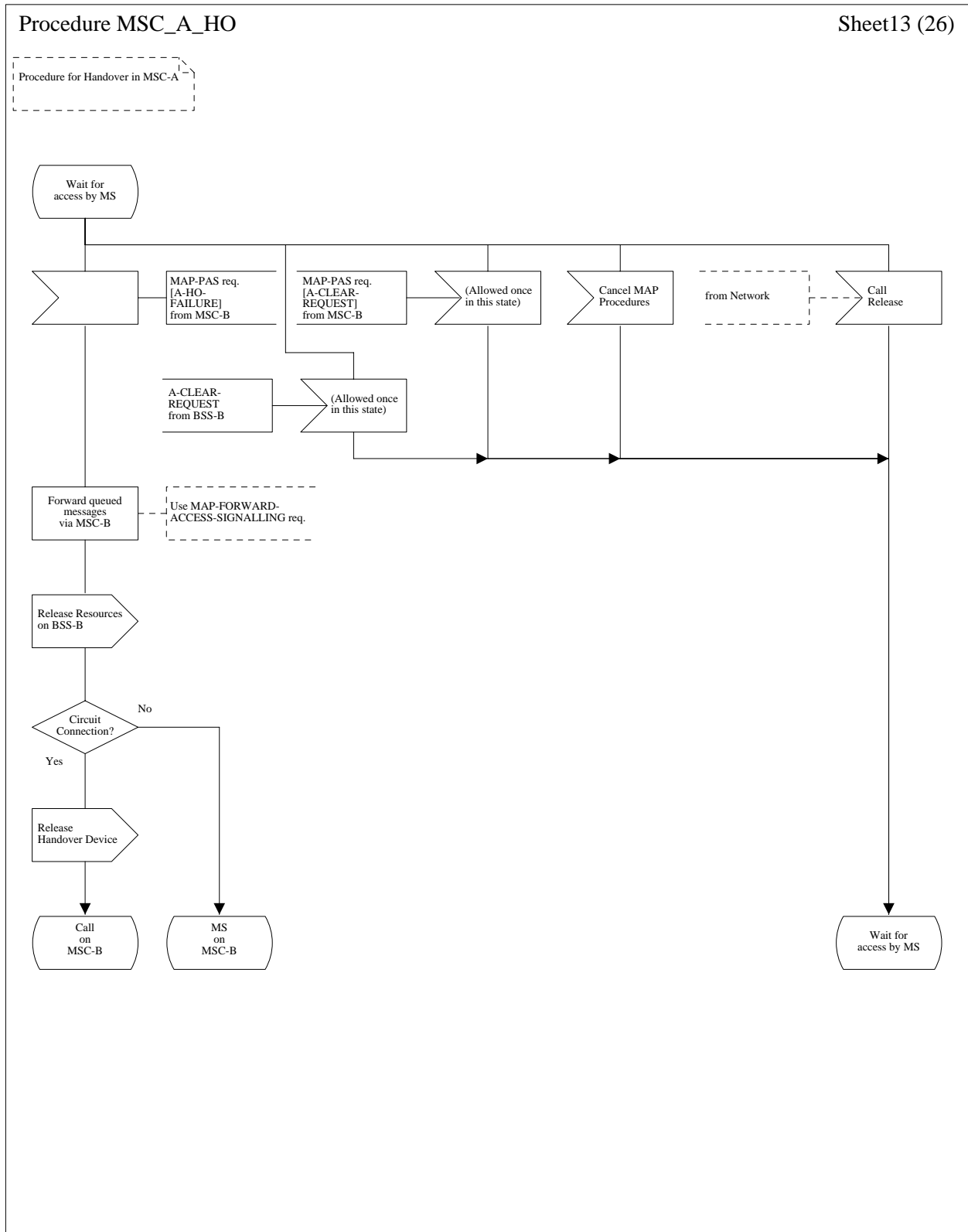

Figure 13 (Sheet 13 of 26): Handover control procedure in MSC-A

Procedure MSC_A_HO

Sheet15 (26)

Procedure for Handover in MSC-A

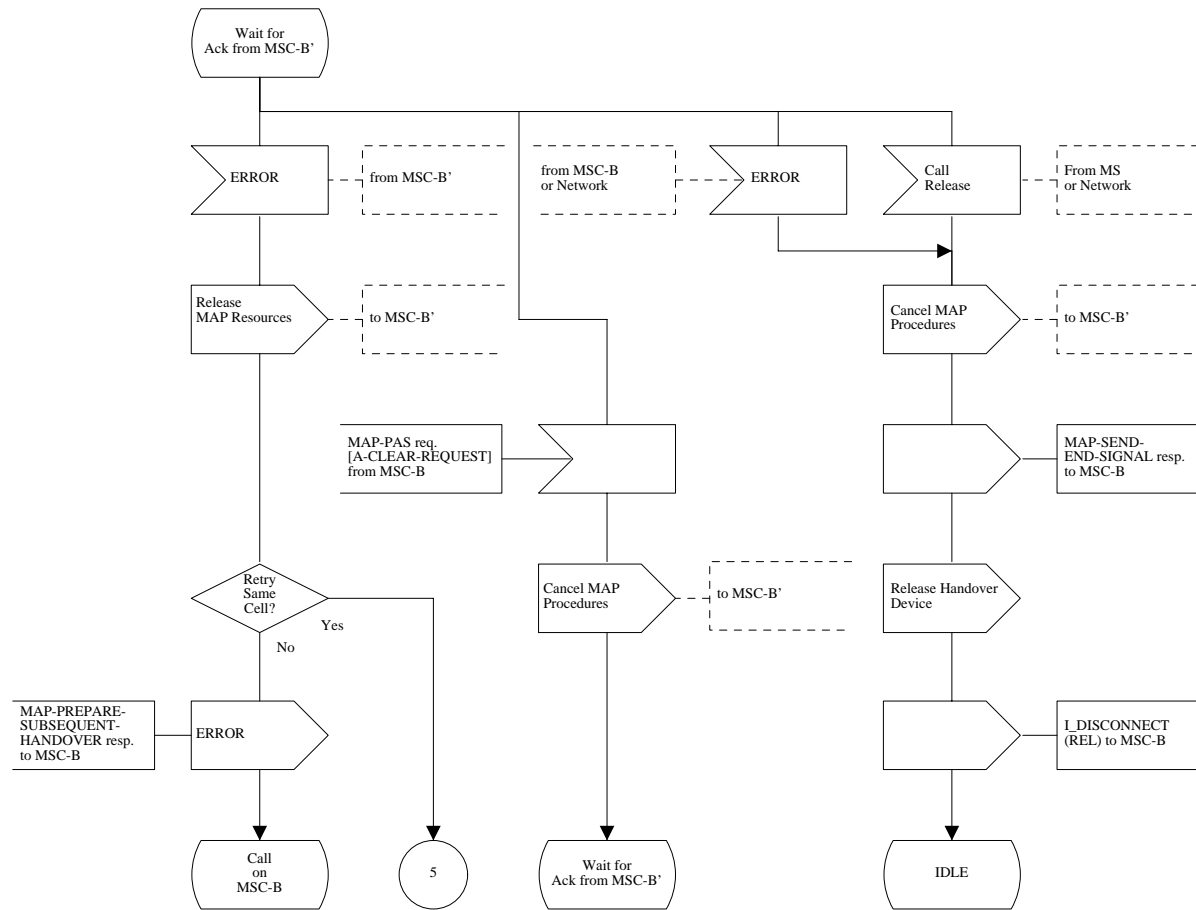

Figure 13 (Sheet 15 of 26): Handover control procedure in MSC-A

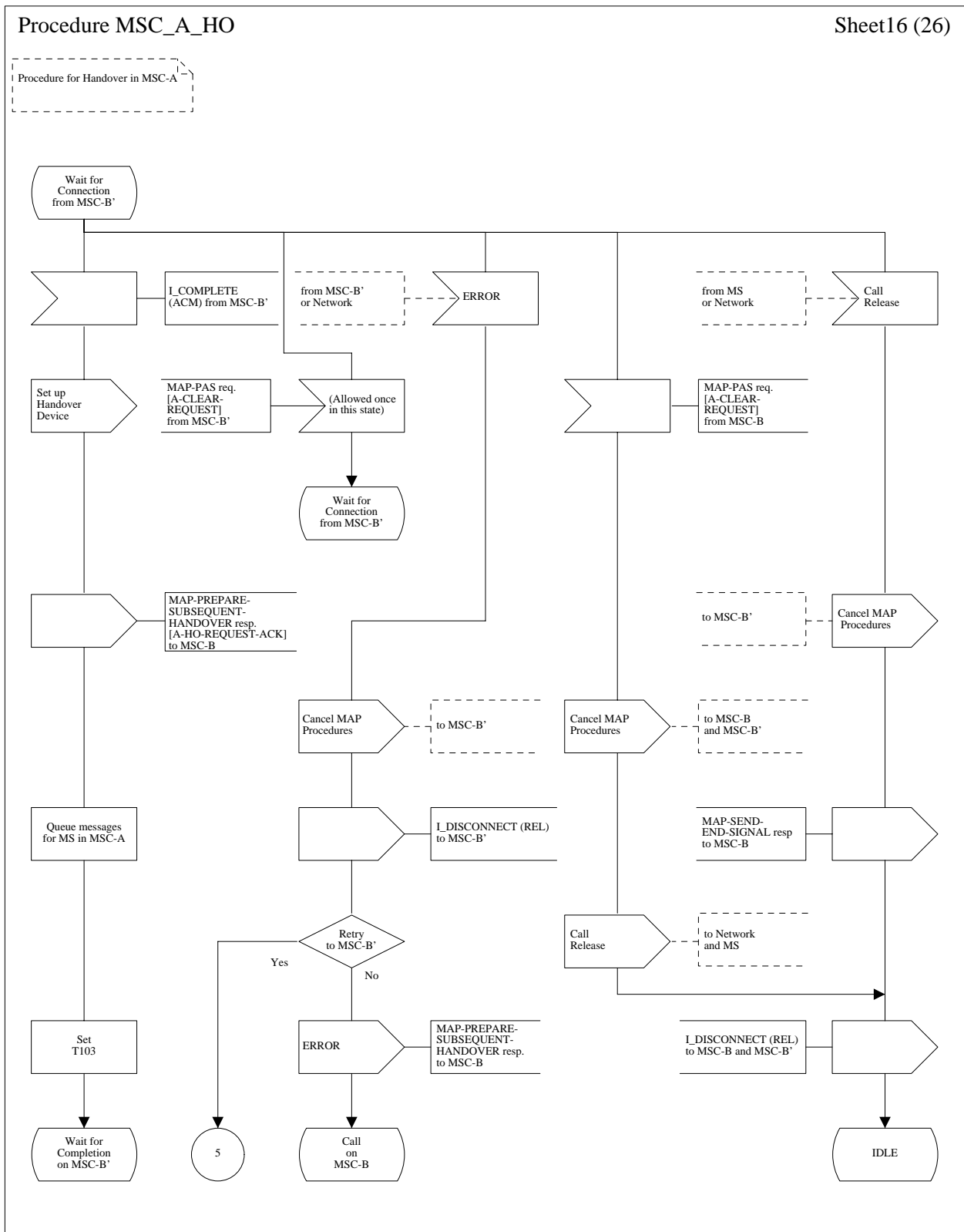

Figure 13 (Sheet 16 of 26): Handover control procedure in MSC-A

Procedure MSC_A_HO

Sheet17 (26)

Procedure for Handover in MSC-A

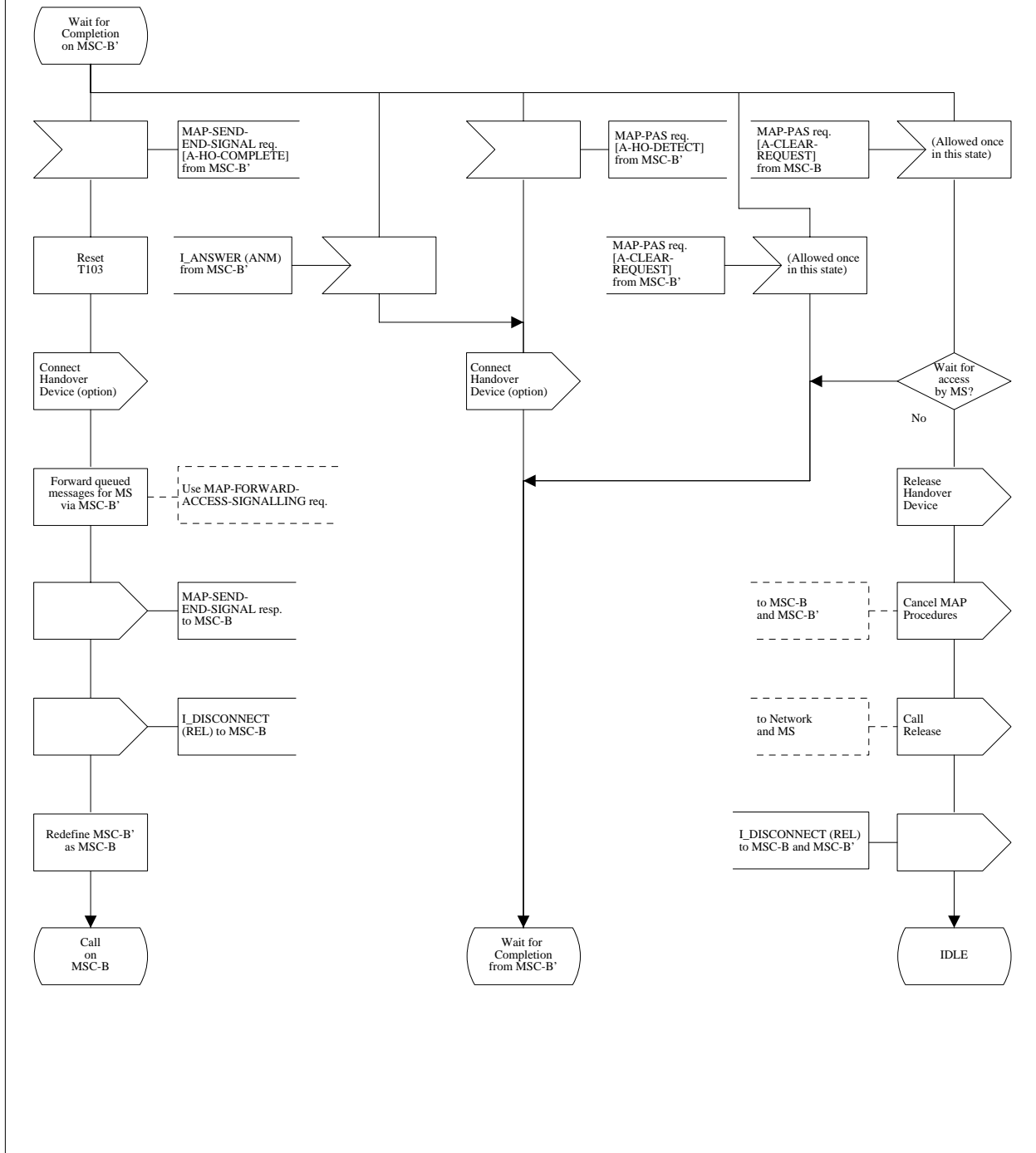

Figure 13 (Sheet 17 of 26): Handover control procedure in MSC-A

Procedure MSC_A_HO

Sheet18 (26)

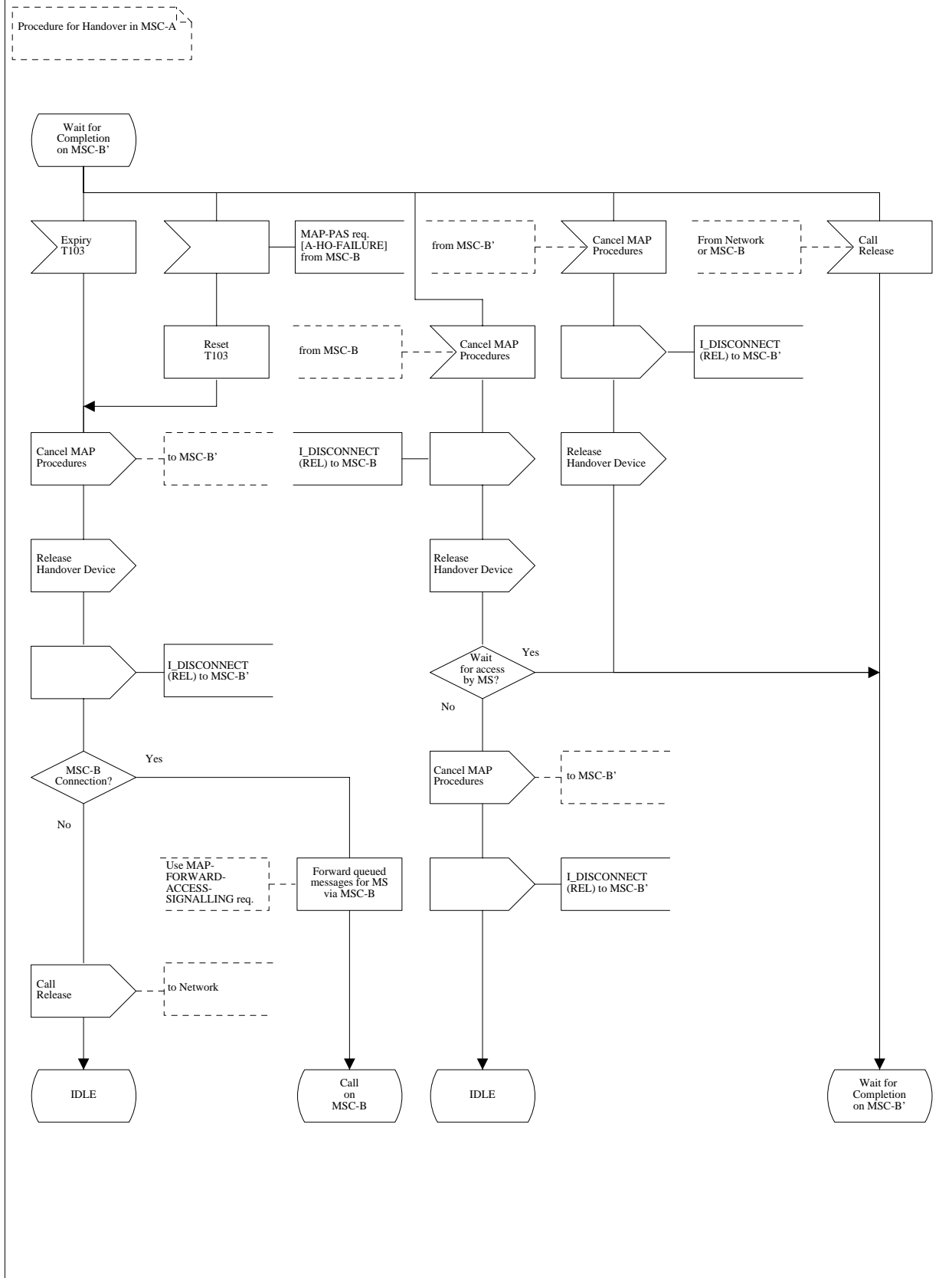

Figure 13 (Sheet 18 of 26): Handover control procedure in MSC-A

Procedure MSC_A_HO

Sheet19 (26)

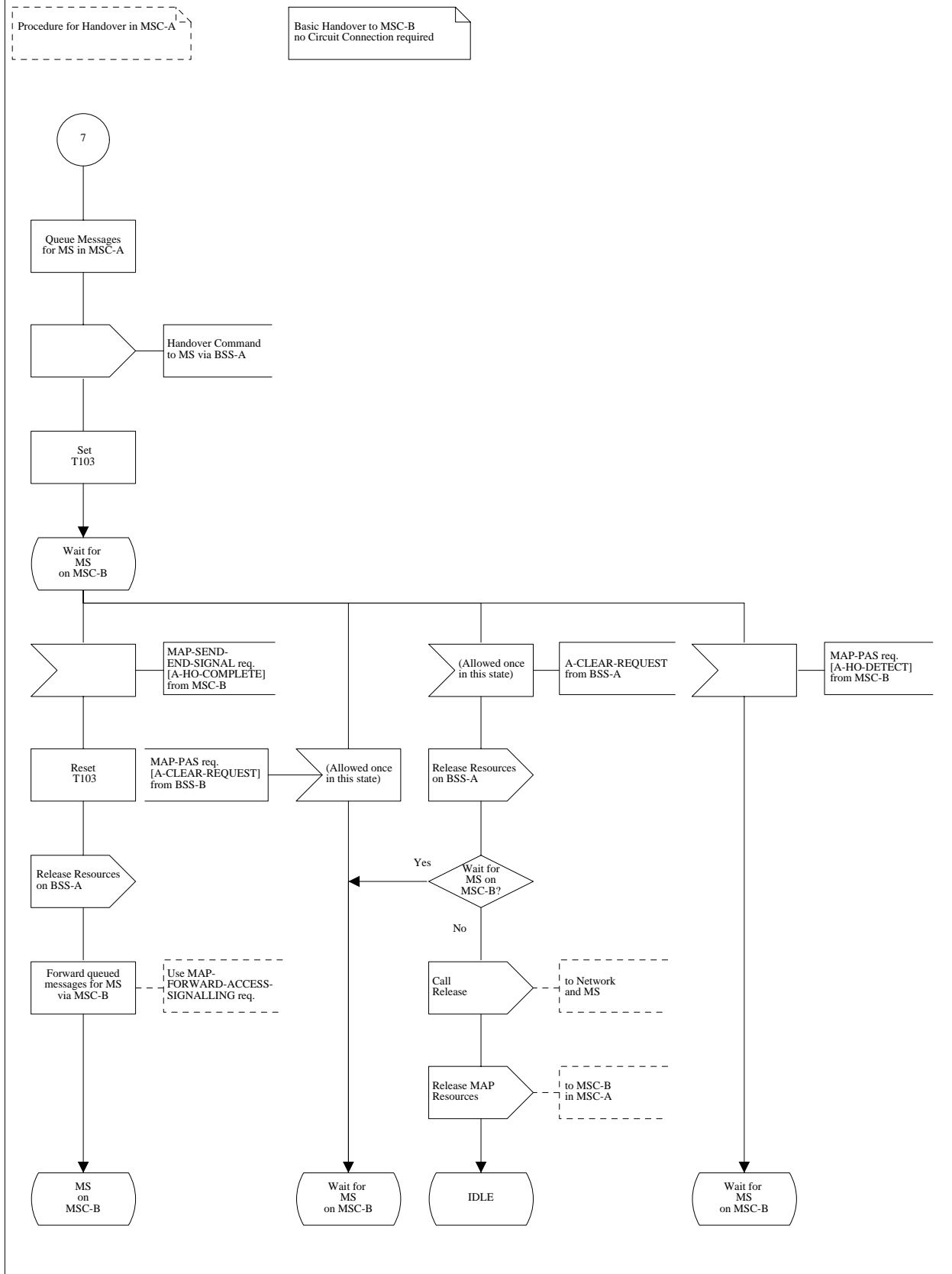

Figure 13 (Sheet 19 of 26): Handover control procedure in MSC-A

Procedure MSC_A_HO

Sheet20 (26)

Procedure for Handover in MSC-A

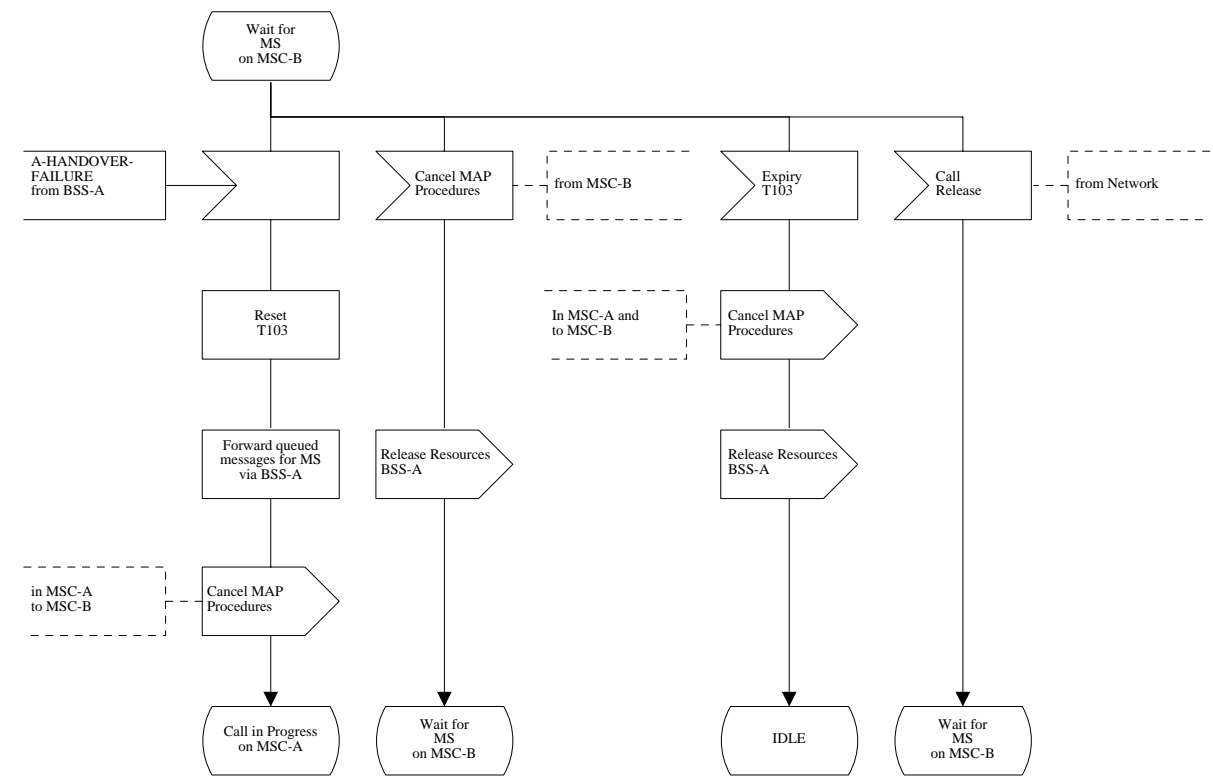

Figure 13 (Sheet 20 of 26): Handover control procedure in MSC-A

Procedure MSC_A_HO

Sheet21 (26)

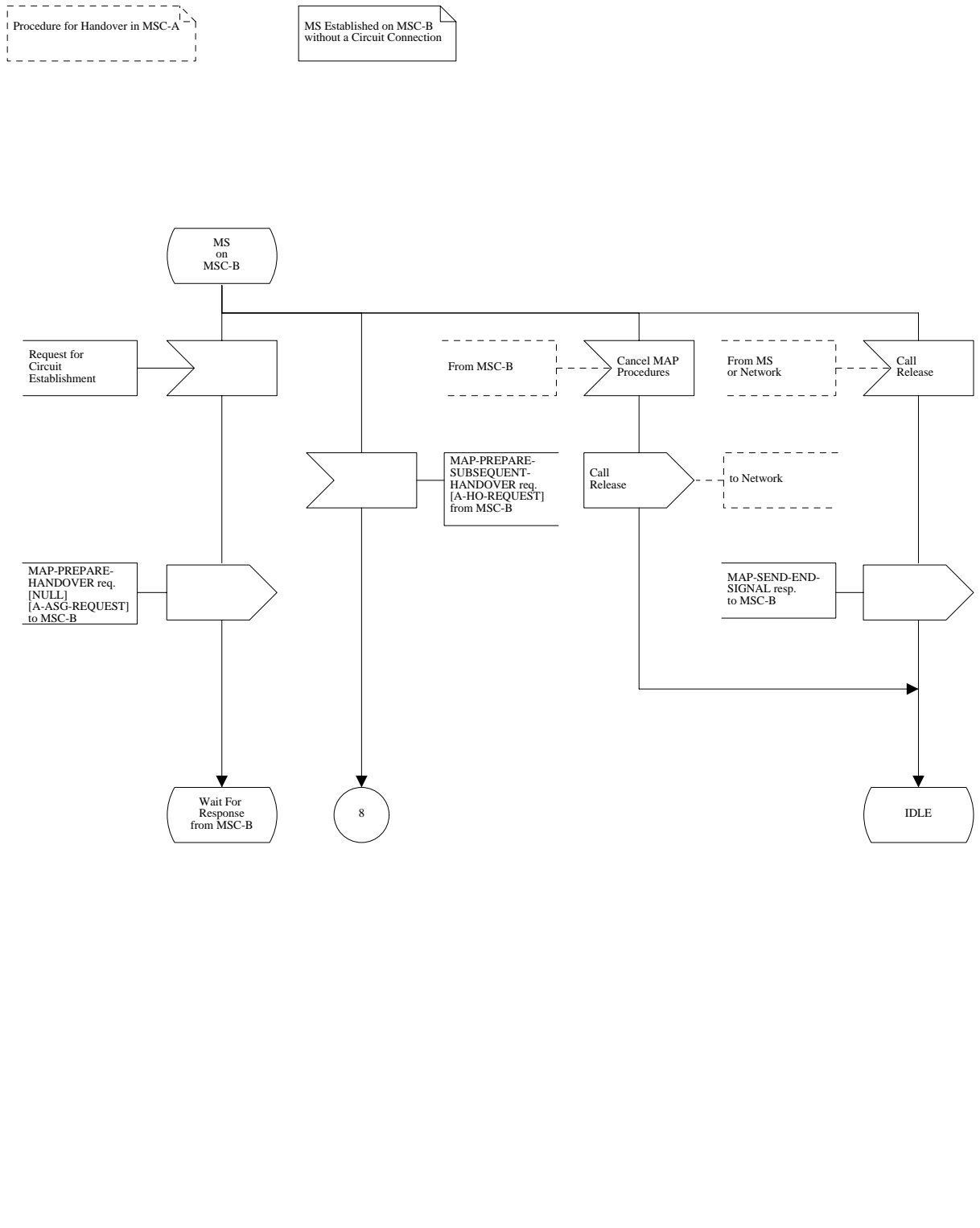

Figure 13 (Sheet 21 of 26): Handover control procedure in MSC-A

Procedure MSC_A_HO

Sheet22 (26)

Procedure for Handover in MSC-A

Circuit Connection Establishment to MSC-B

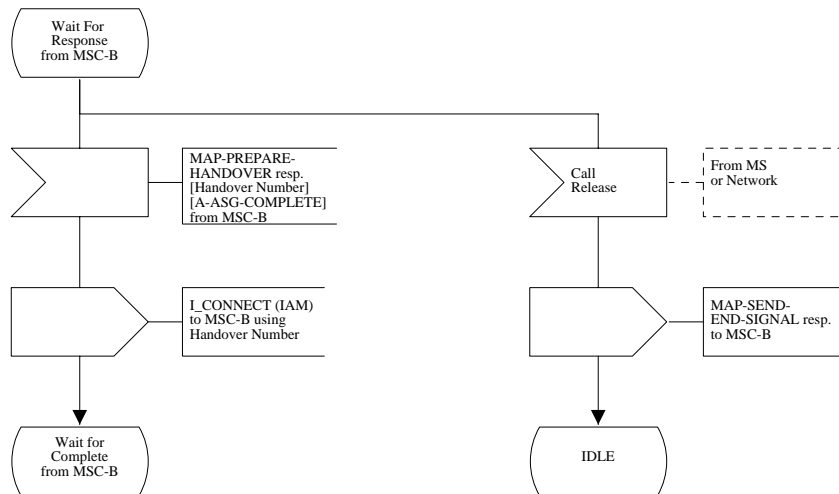

Figure 13 (Sheet 22 of 26): Handover control procedure in MSC-A

Procedure MSC_A_HO

Sheet23 (26)

Procedure for Handover in MSC-A

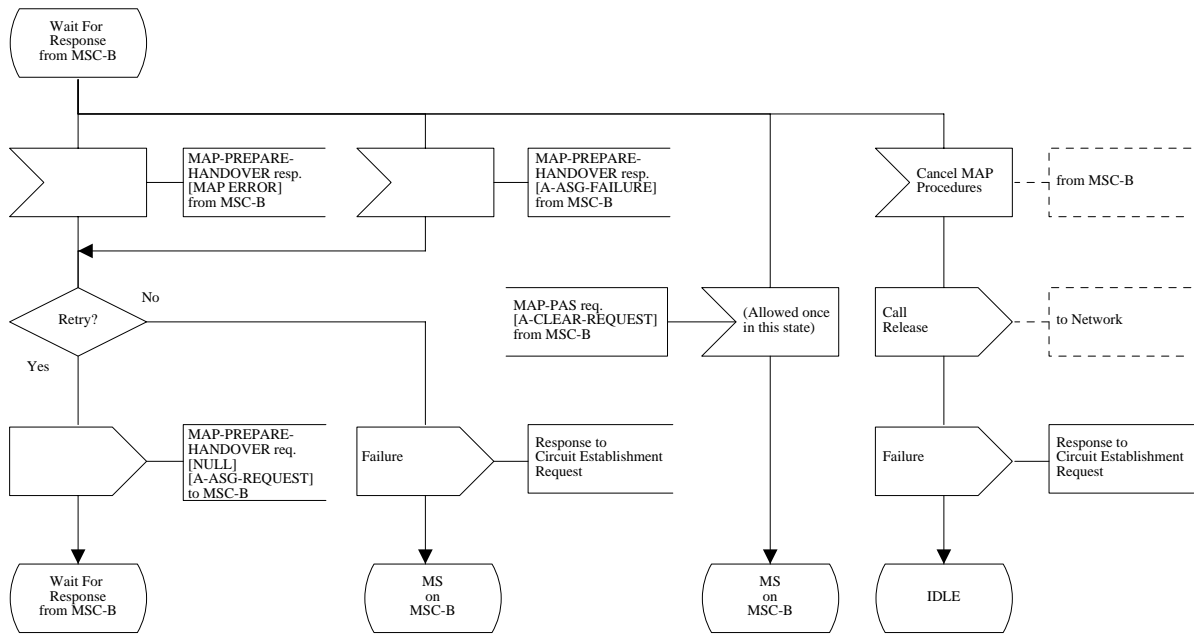

Figure 13 (Sheet 23 of 26): Handover control procedure in MSC-A

Procedure MSC_A_HO

Sheet24 (26)

Procedure for Handover in MSC-A

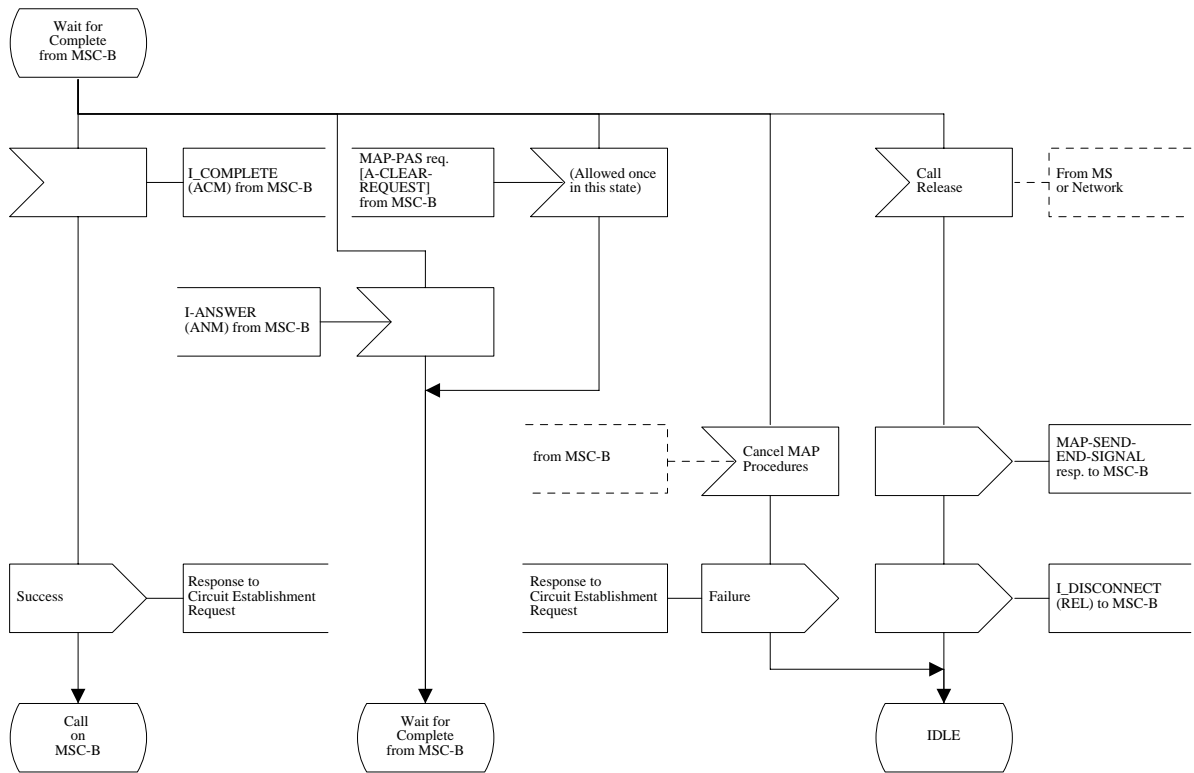

Figure 13 (Sheet 24 of 26): Handover control procedure in MSC-A

Procedure MSC_A_HO

Sheet25 (26)

Procedure for Handover in MSC-A

Subsequent Handover from MSC-B to MSC-B' no Circuit Connection required.

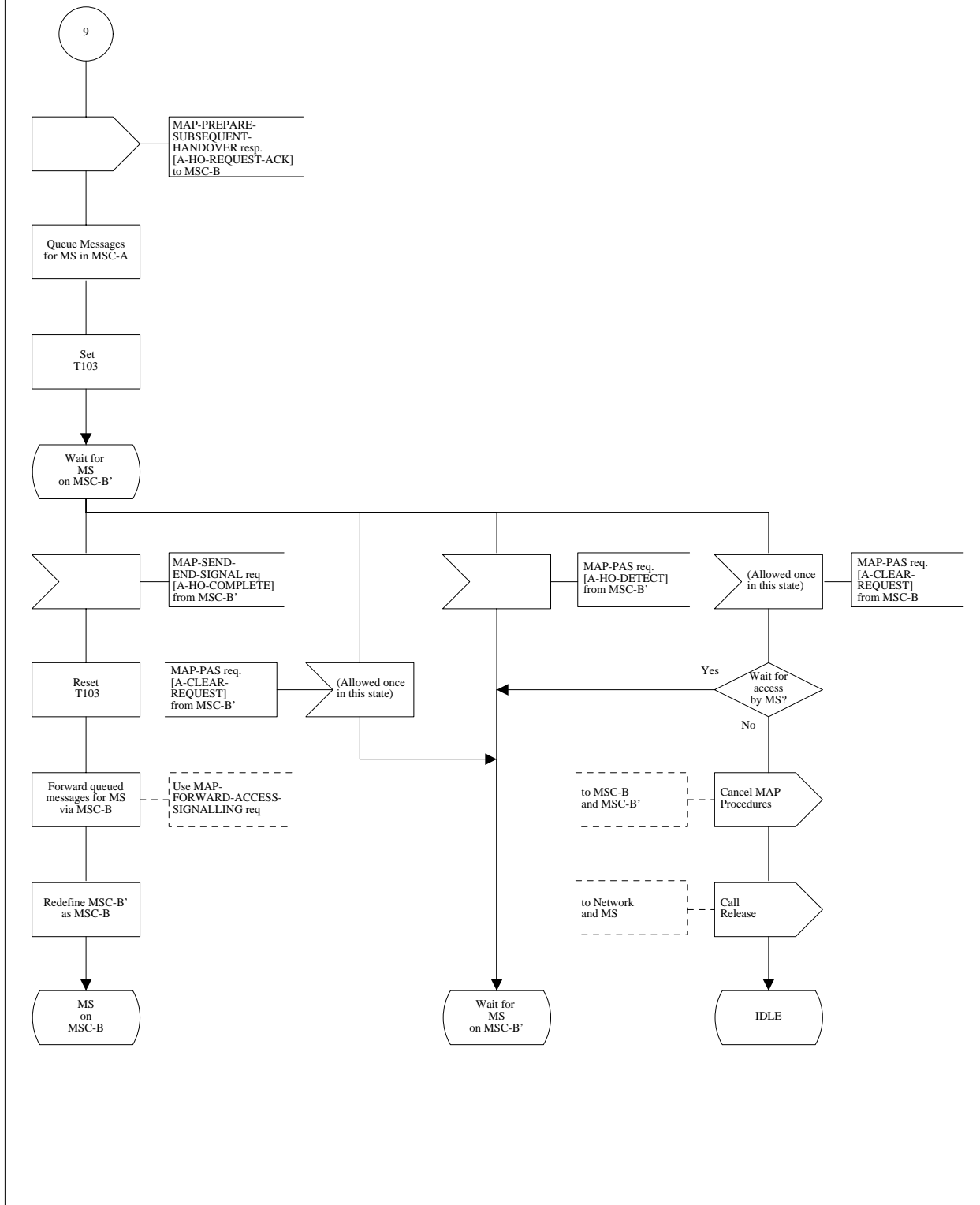

Figure 13 (Sheet 25 of 26): Handover control procedure in MSC-A

Procedure MSC_A_HO

Sheet26 (26)

Procedure for Handover in MSC-A

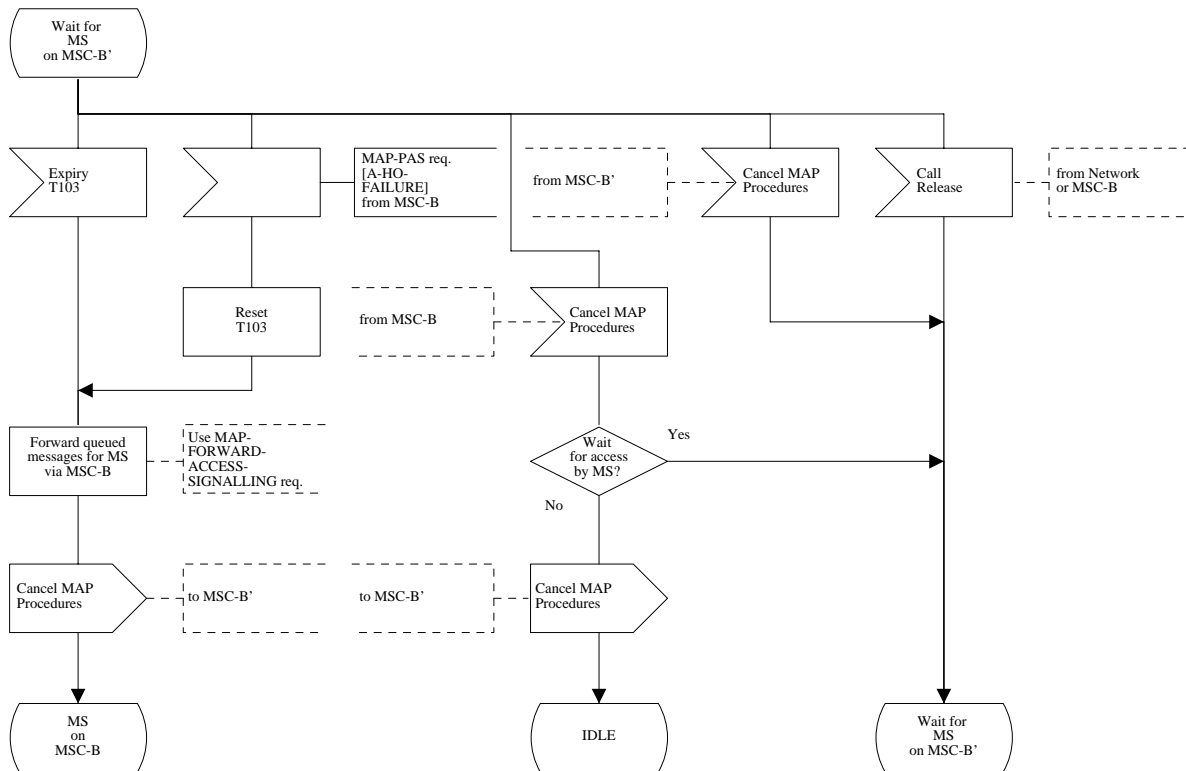

Figure 13 (Sheet 26 of 26): Handover control procedure in MSC-A

Procedure MSC_B_HO

Sheet1 (18)

Procedures for Handover in MSC-B

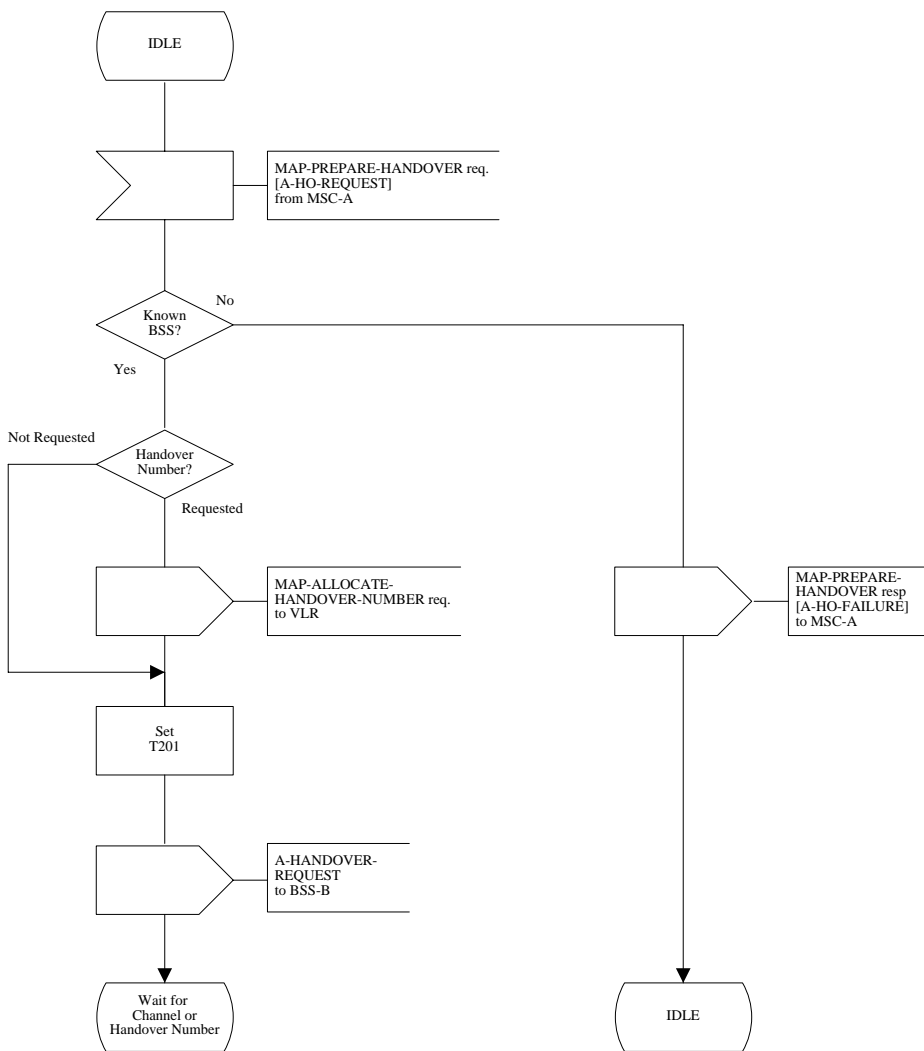

Figure 14 (Sheet 1 of 18): Handover control procedure in MSC-B

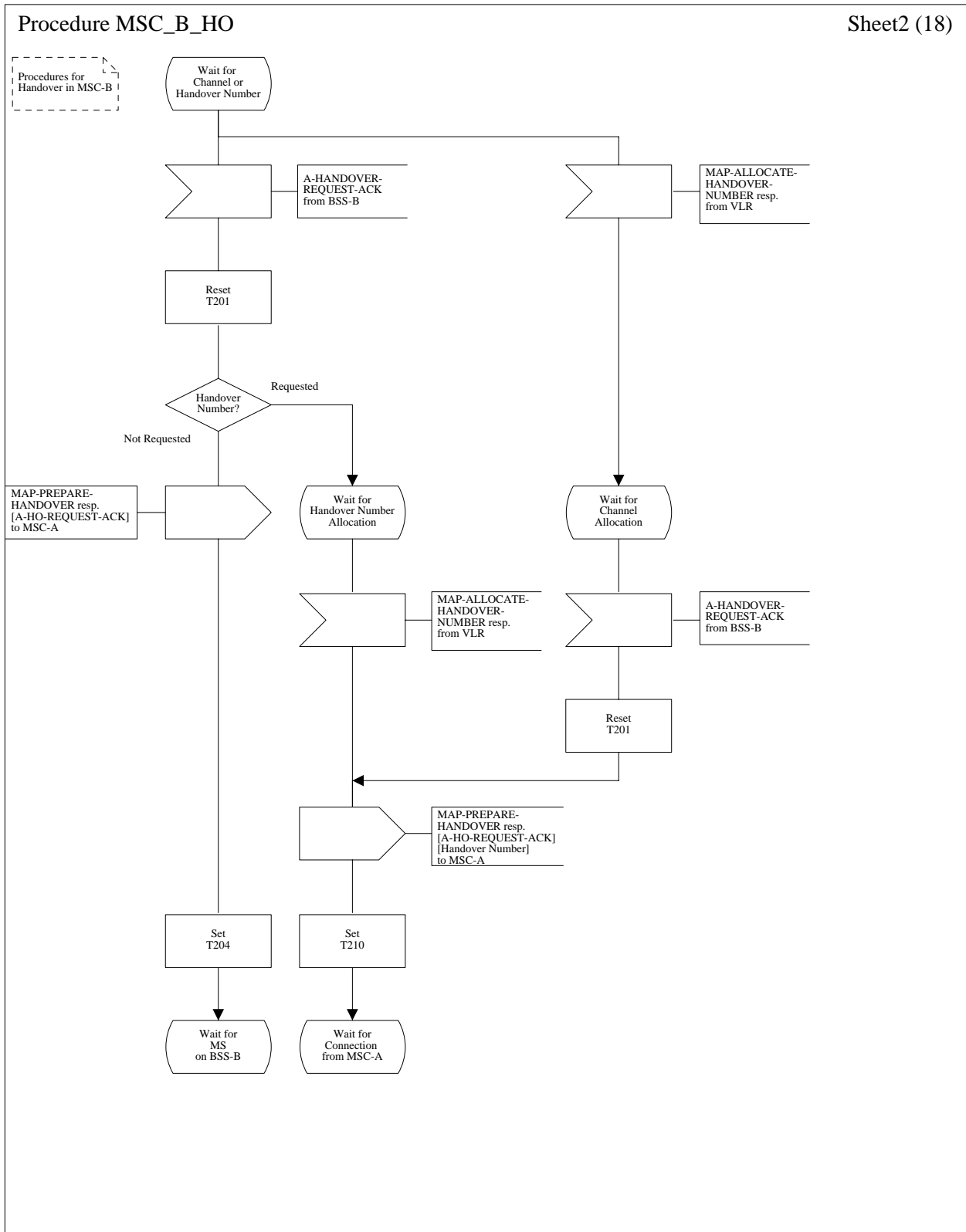

Figure 14 (Sheet 2 of 18): Handover control procedure in MSC-B

Procedure MSC_B_HO

Sheet3 (18)

Procedures for Handover in MSC-B

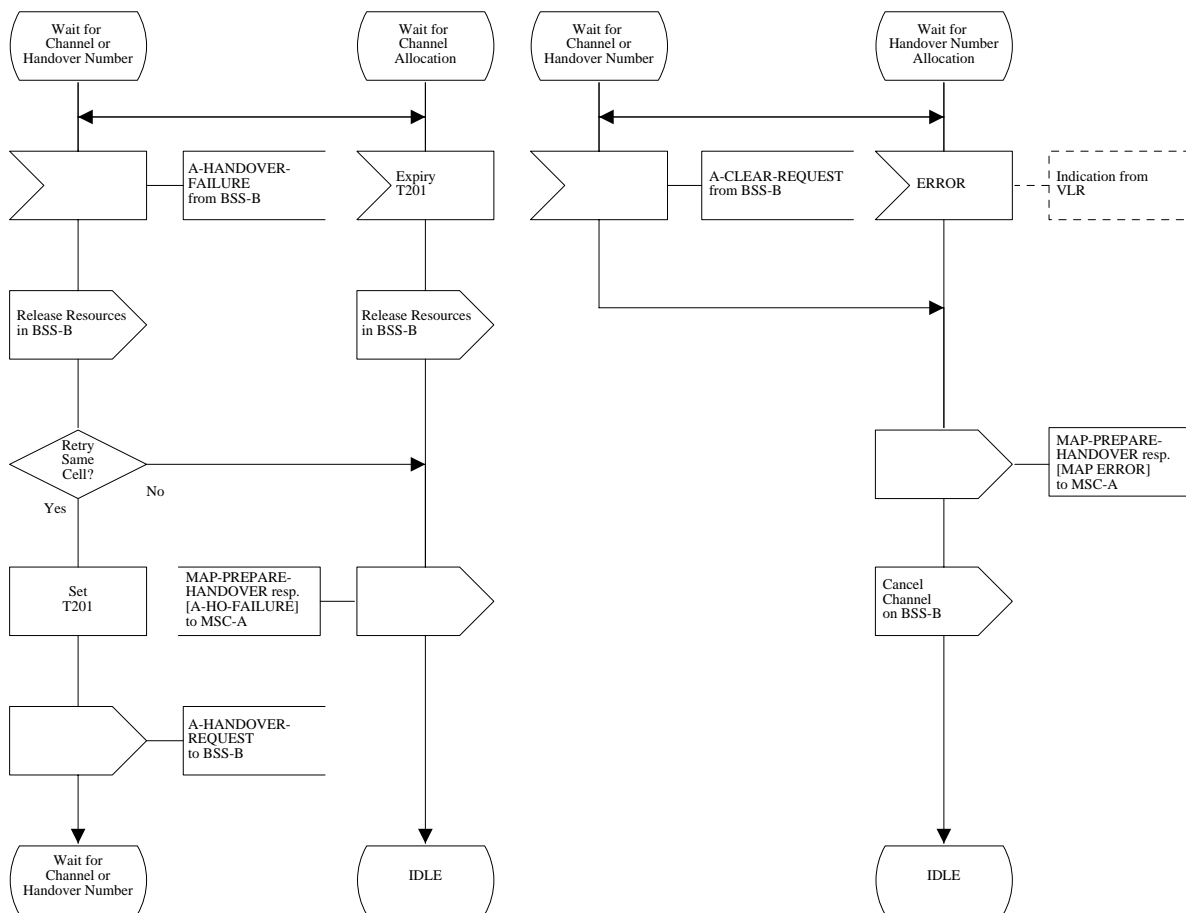

Figure 14 (Sheet 3 of 18): Handover control procedure in MSC-B

Procedure MSC_B_HO

Sheet4 (18)

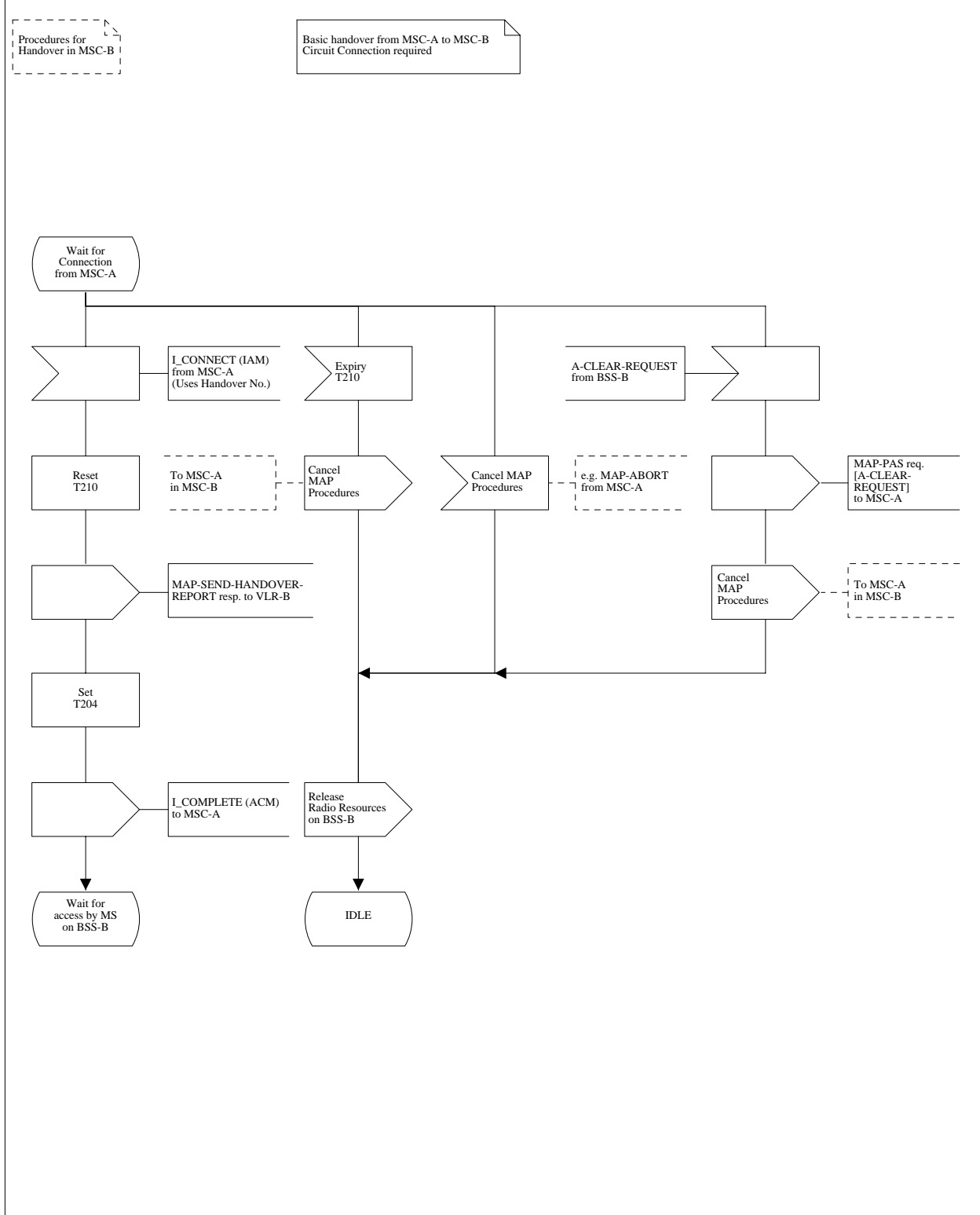

Figure 14 (Sheet 4 of 18): Handover control procedure in MSC-B

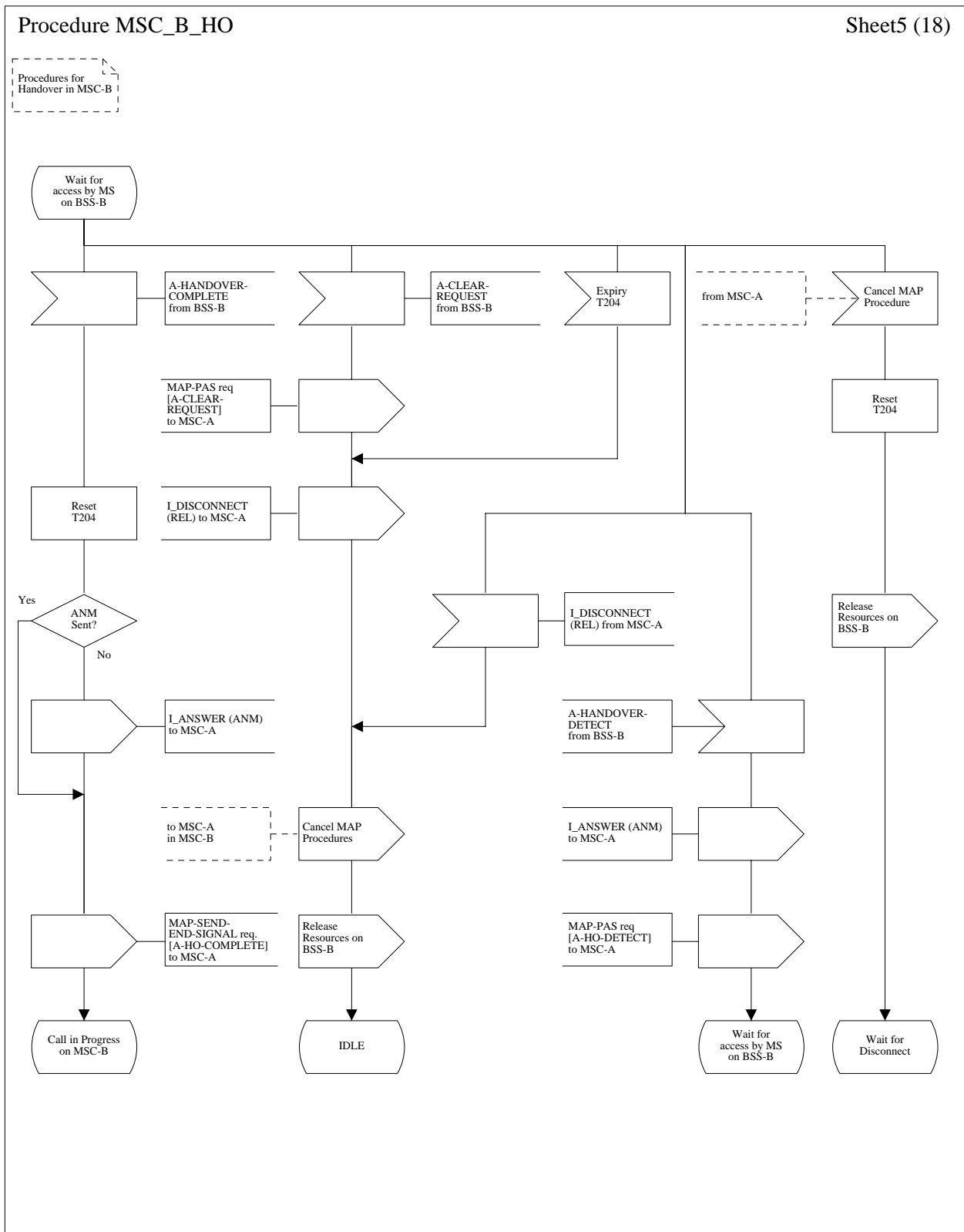

Figure 14 (Sheet 5 of 18): Handover control procedure in MSC-B

Procedure MSC_B_HO

Sheet6 (18)

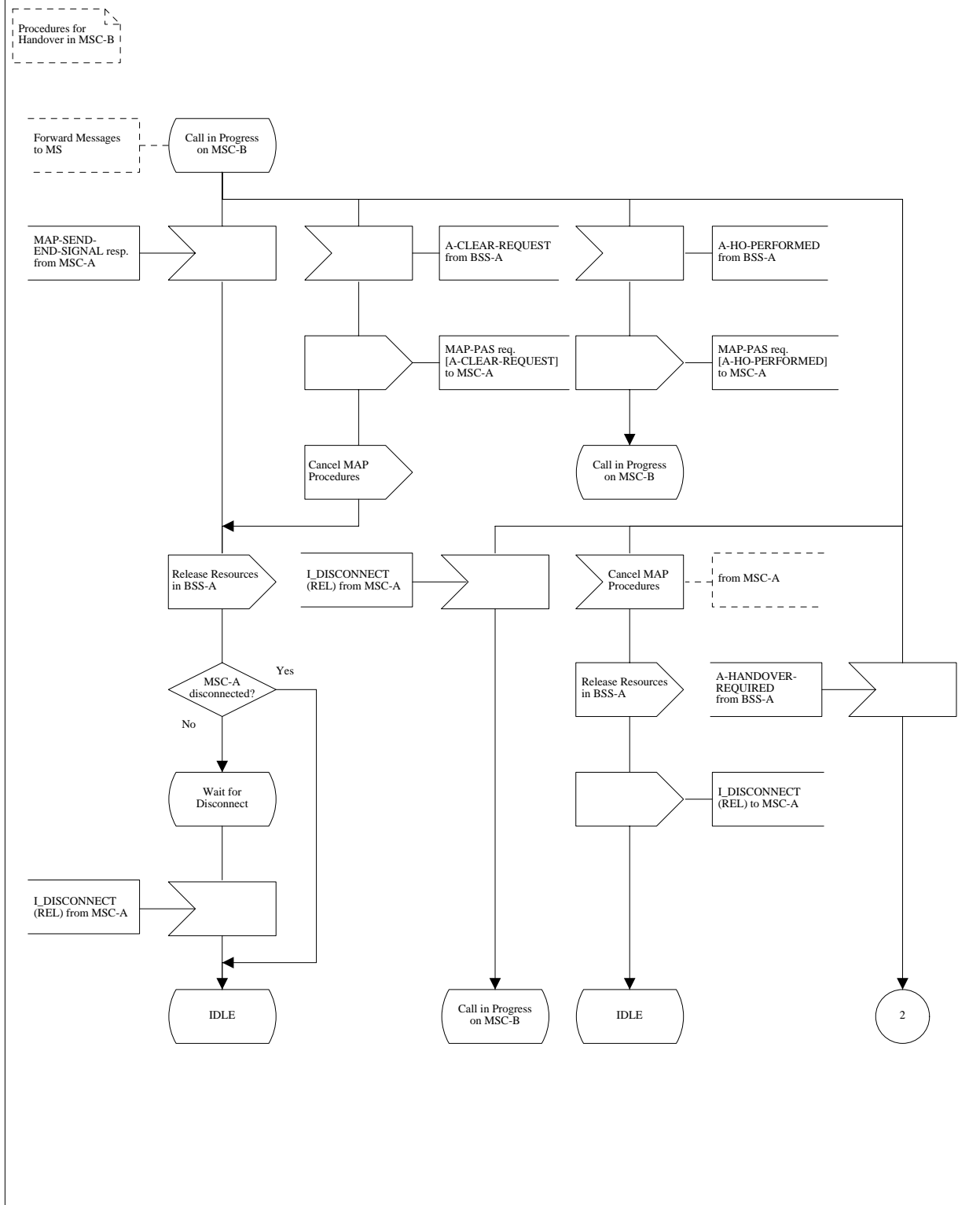

Figure 14 (Sheet 6 of 18): Handover control procedure in MSC-B

Procedure MSC_B_HO

Sheet7 (18)

Procedures for Handover in MSC-B

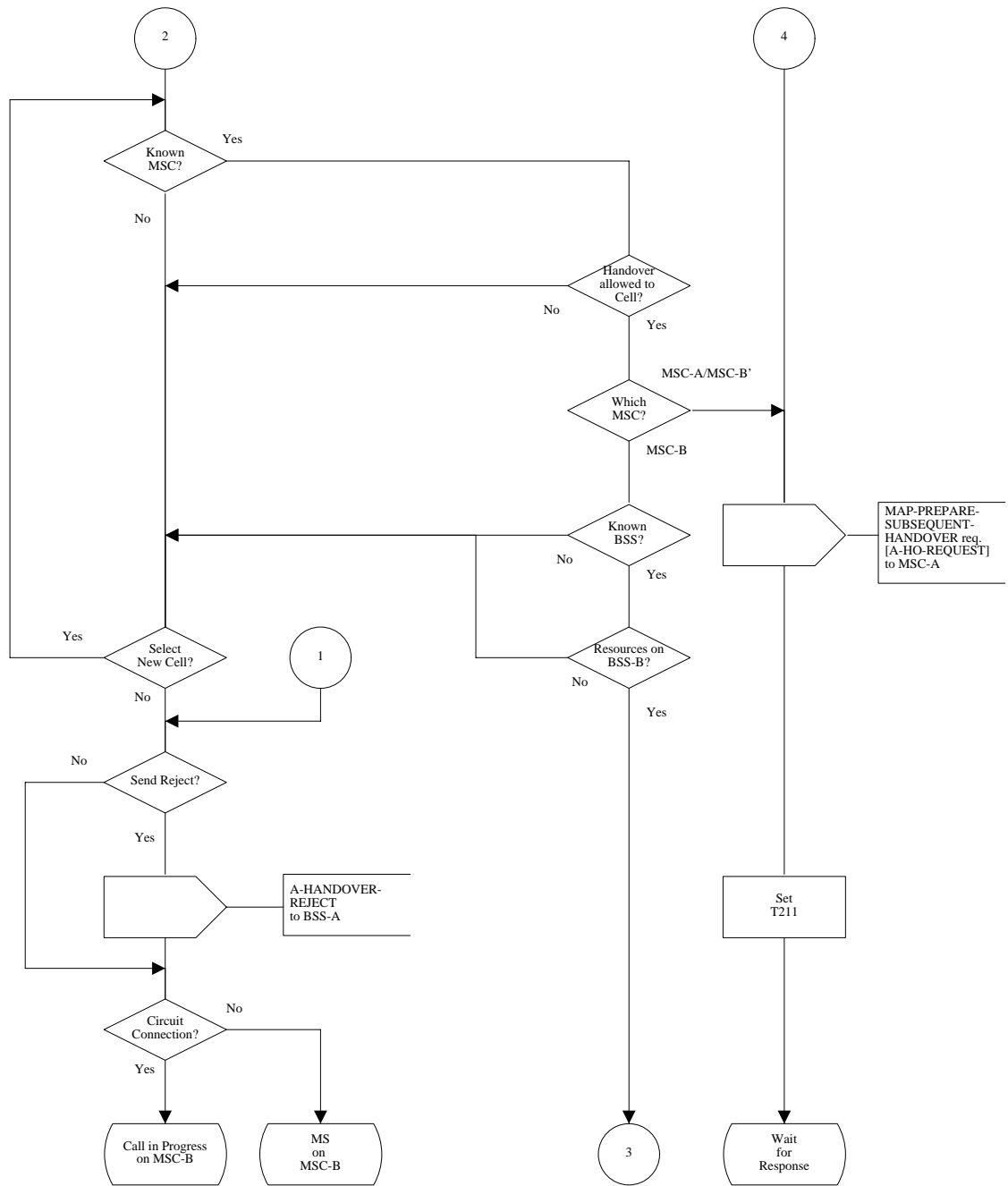

Figure 14 (Sheet 7 of 18): Handover control procedure in MSC-B

Procedure MSC_B_HO

Sheet8 (18)

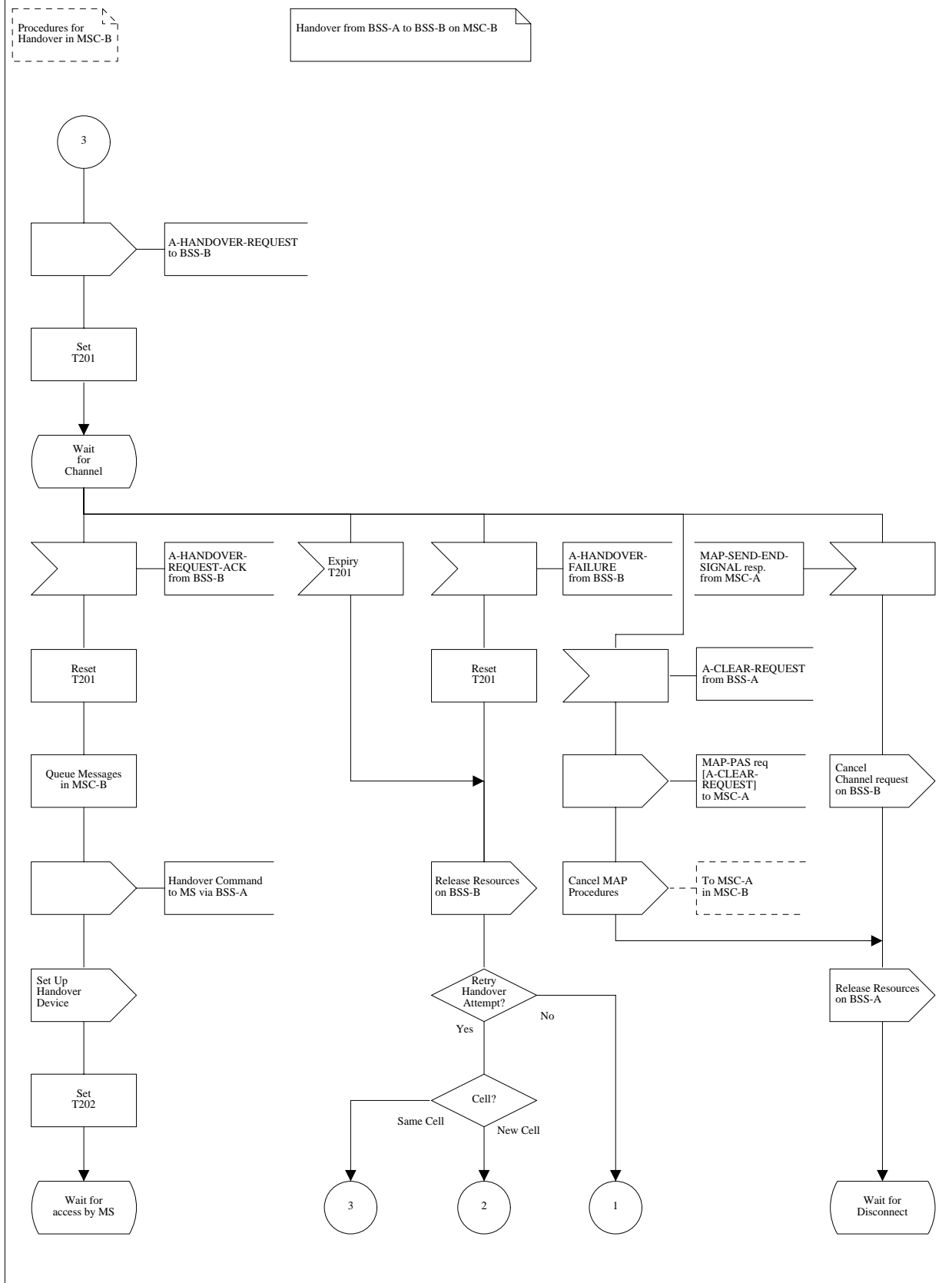

Figure 14 (Sheet 8 of 18): Handover control procedure in MSC-B

Procedure MSC_B_HO

Sheet9 (18)

Procedures for Handover in MSC-B

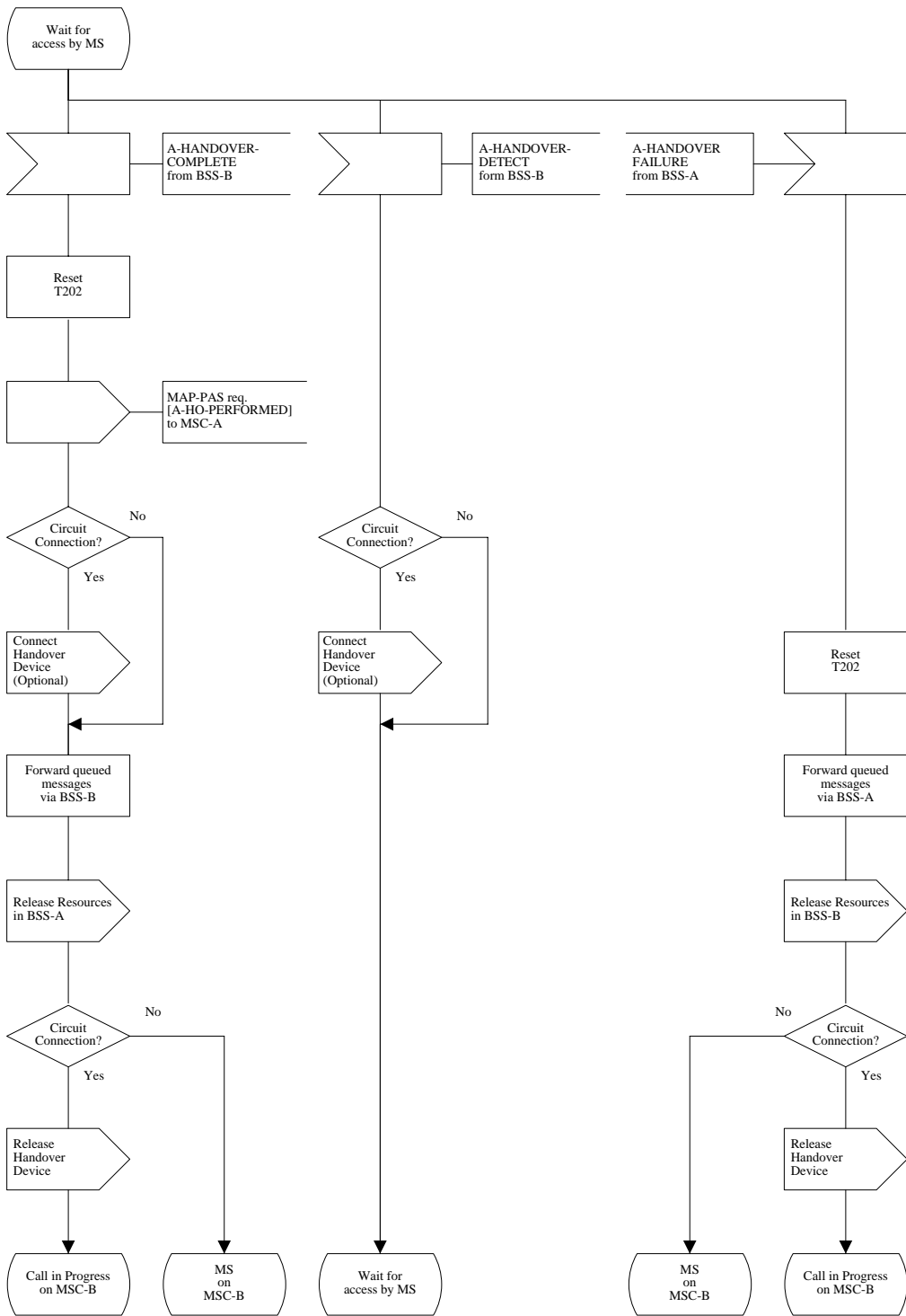

Figure 14 (Sheet 9 of 18): Handover control procedure in MSC-B

Procedure MSC_B_HO

Sheet10 (18)

Procedures for Handover in MSC-B

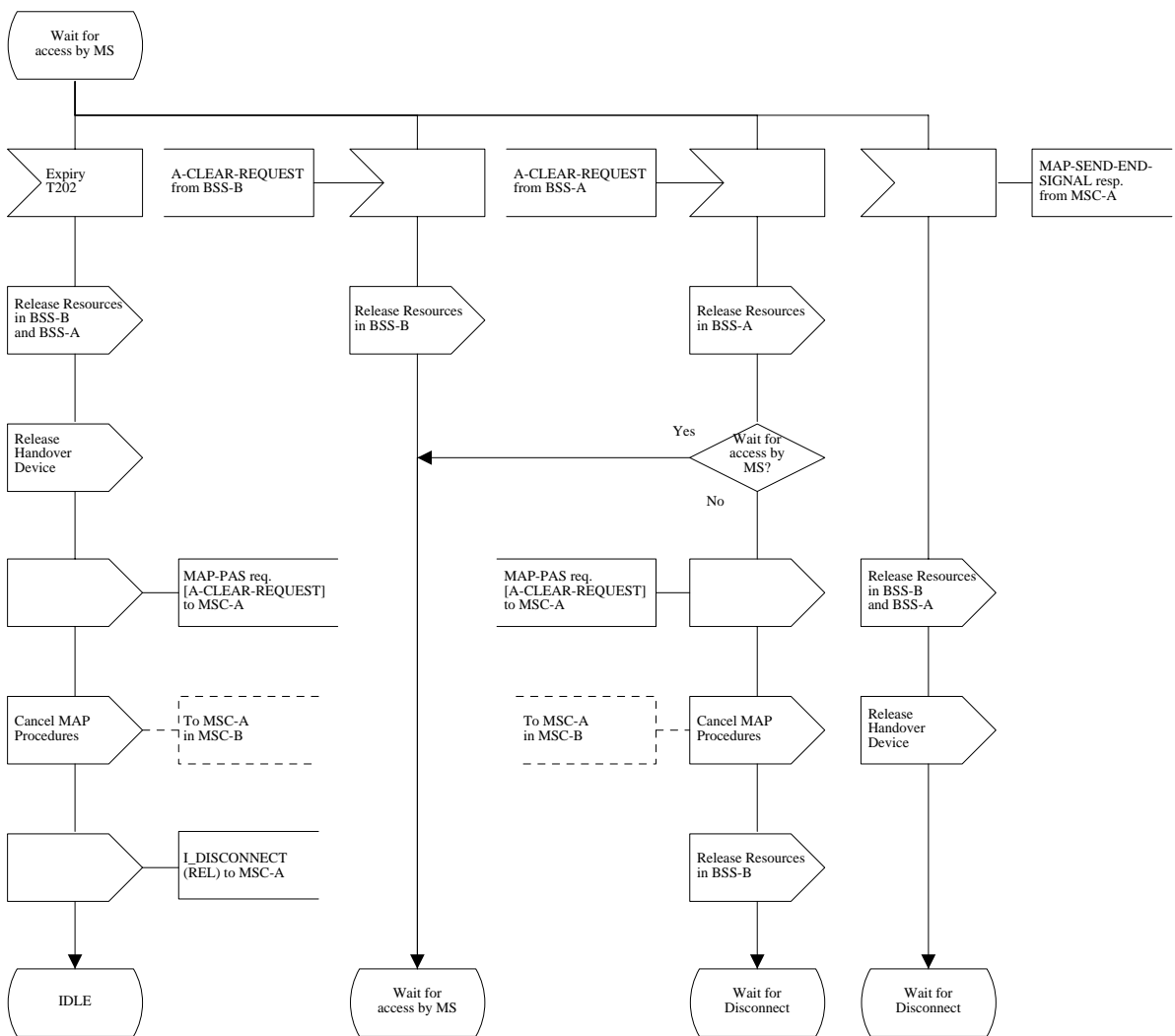

Figure 14 (Sheet 10 of 18): Handover control procedure in MSC-B

Procedure MSC_B_HO

Sheet11 (18)

Procedures for Handover in MSC-B

Subsequent Handover from MSC-B to MSC-A

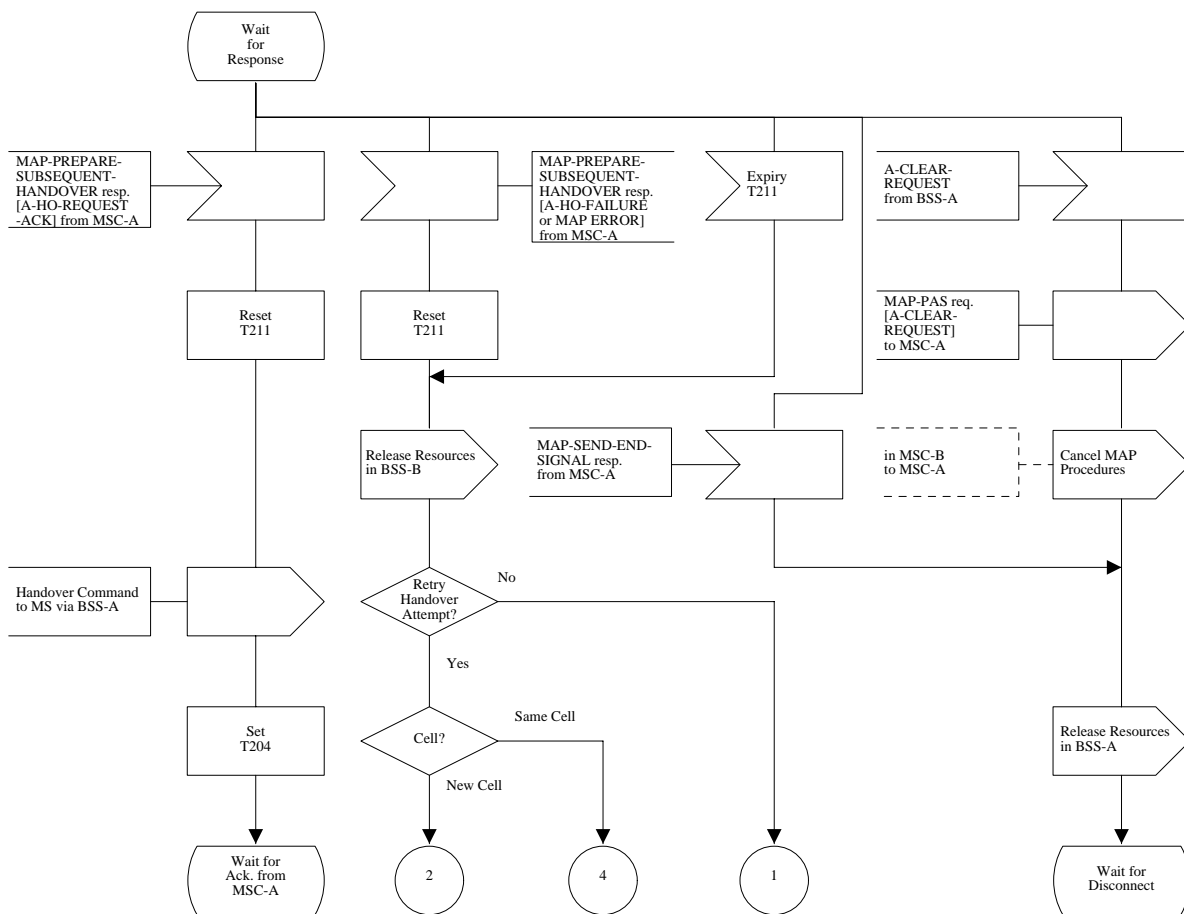

Figure 14 (Sheet 11 of 18): Handover control procedure in MSC-B

Procedure MSC_B_HO

Sheet12 (18)

Procedures for Handover in MSC-B

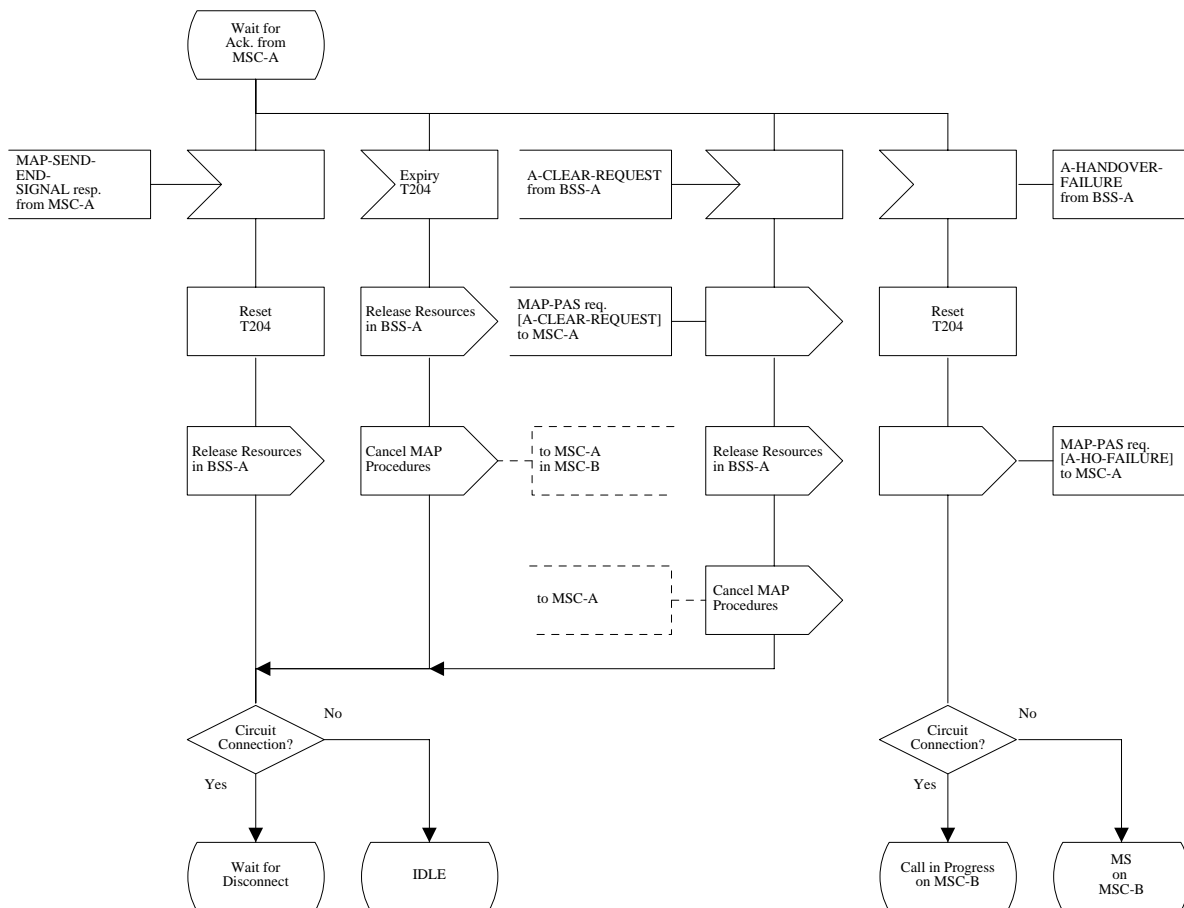

Figure 14 (Sheet 12 of 18): Handover control procedure in MSC-B

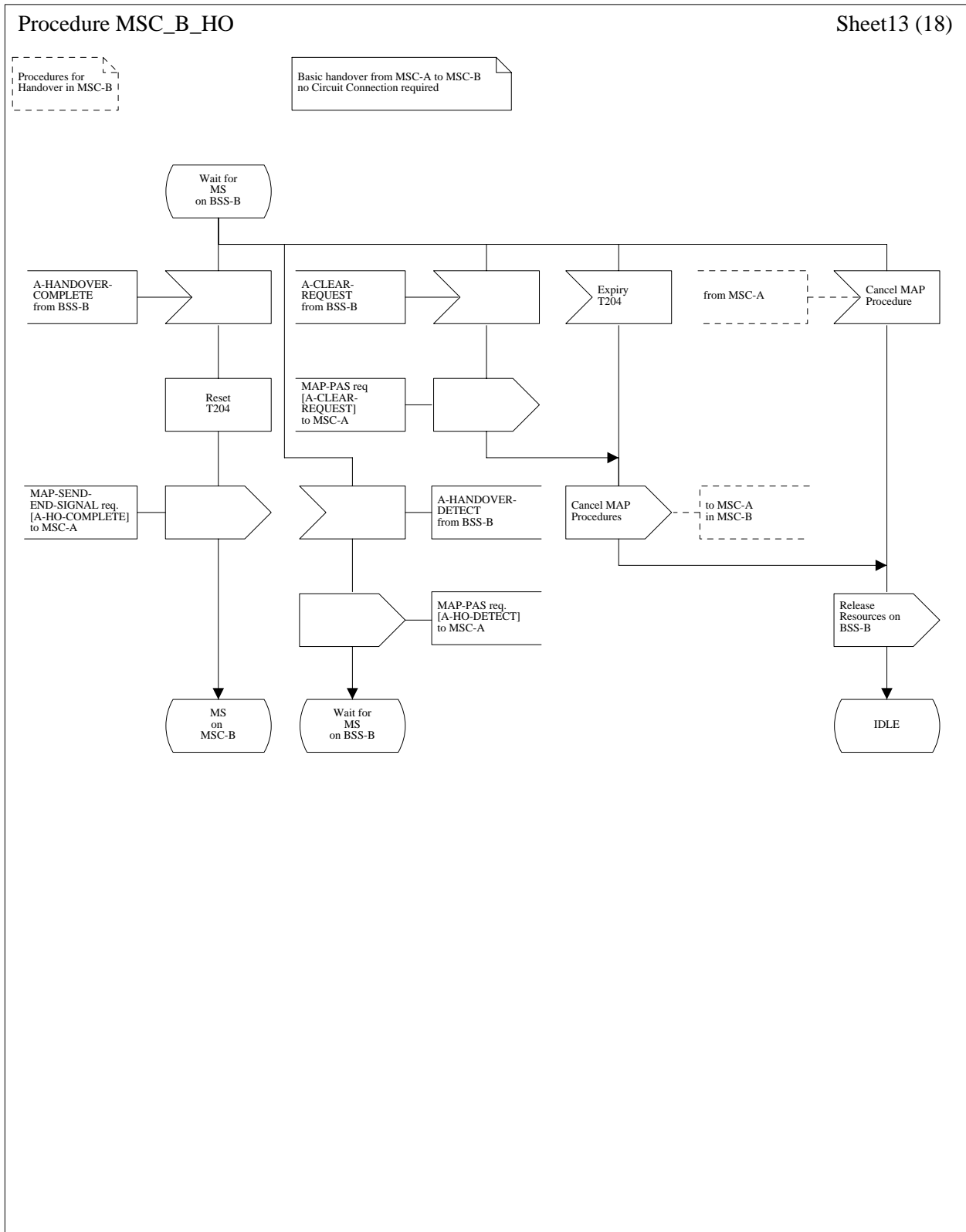

Figure 14 (Sheet 13 of 18): Handover control procedure in MSC-B

Procedure MSC_B_HO

Sheet14 (18)

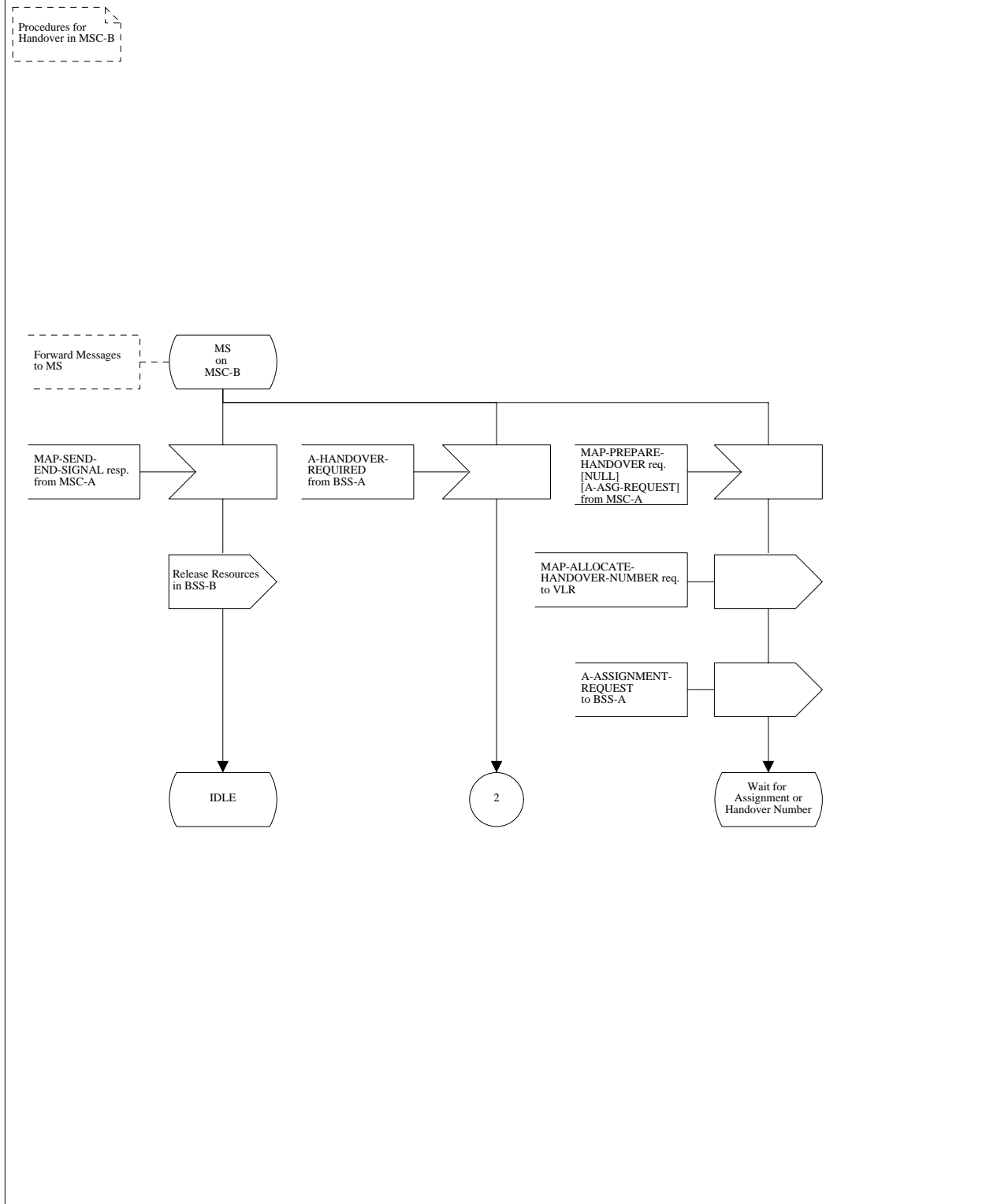

Figure 14 (Sheet 14 of 18): Handover control procedure in MSC-B

Procedure MSC_B_HO

Sheet15 (18)

Procedures for Handover in MSC-B

Circuit Connection Establishment on MSC-B

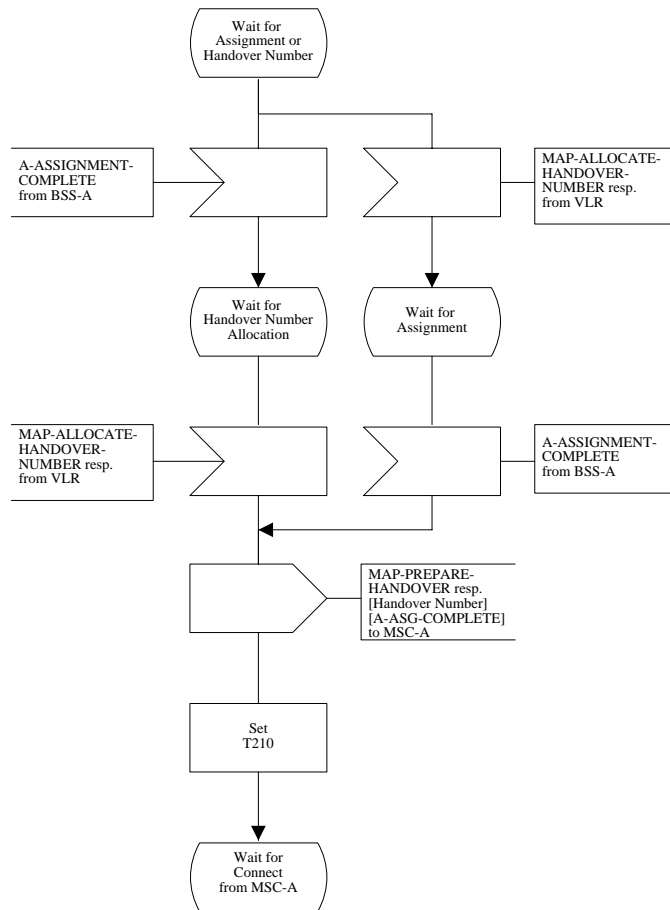

Figure 14 (Sheet 15 of 18): Handover control procedure in MSC-B

Procedure MSC_B_HO

Sheet16 (18)

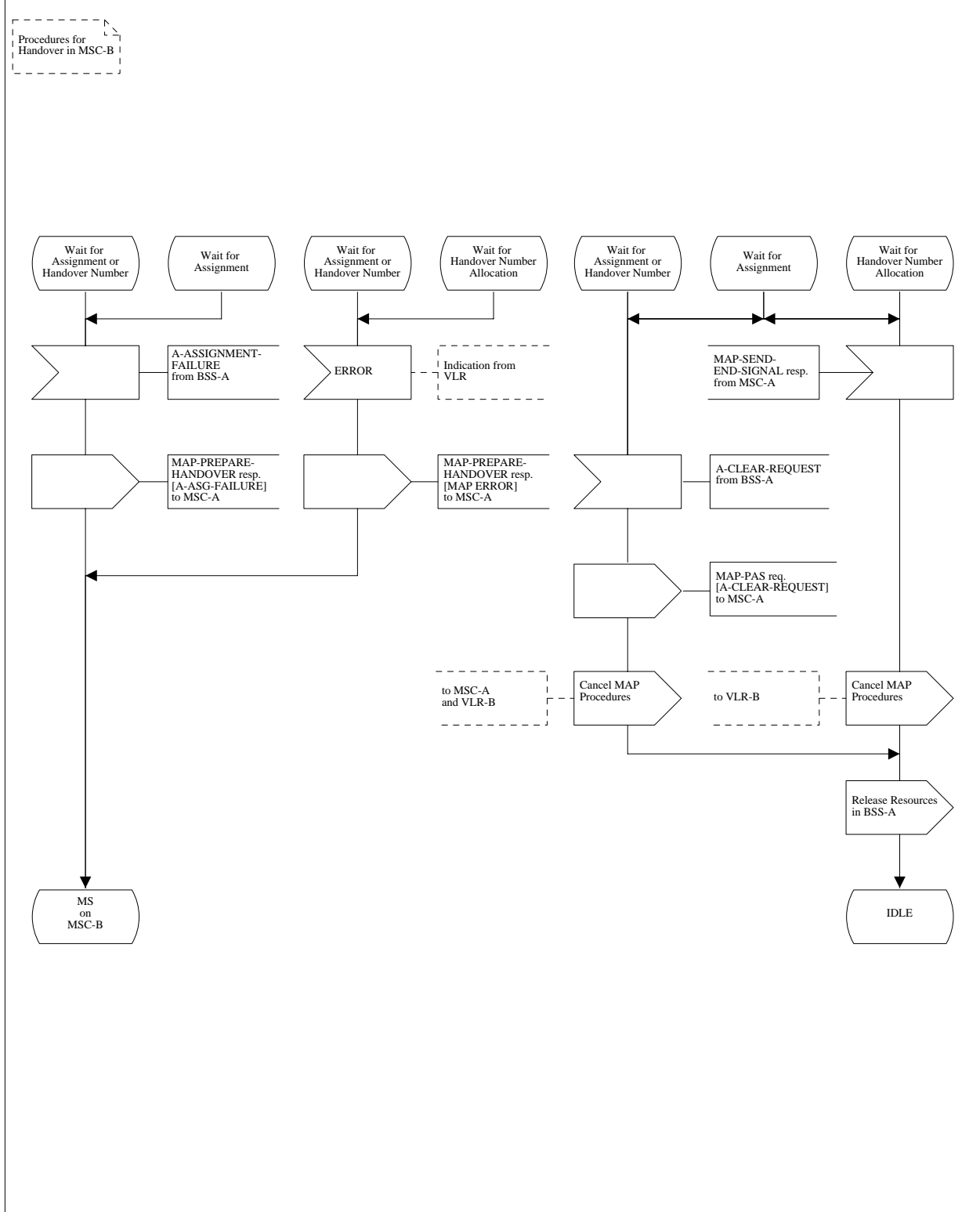

Figure 14 (Sheet 16 of 18): Handover control procedure in MSC-B

Procedure MSC_B_HO

Sheet17 (18)

Procedures for Handover in MSC-B

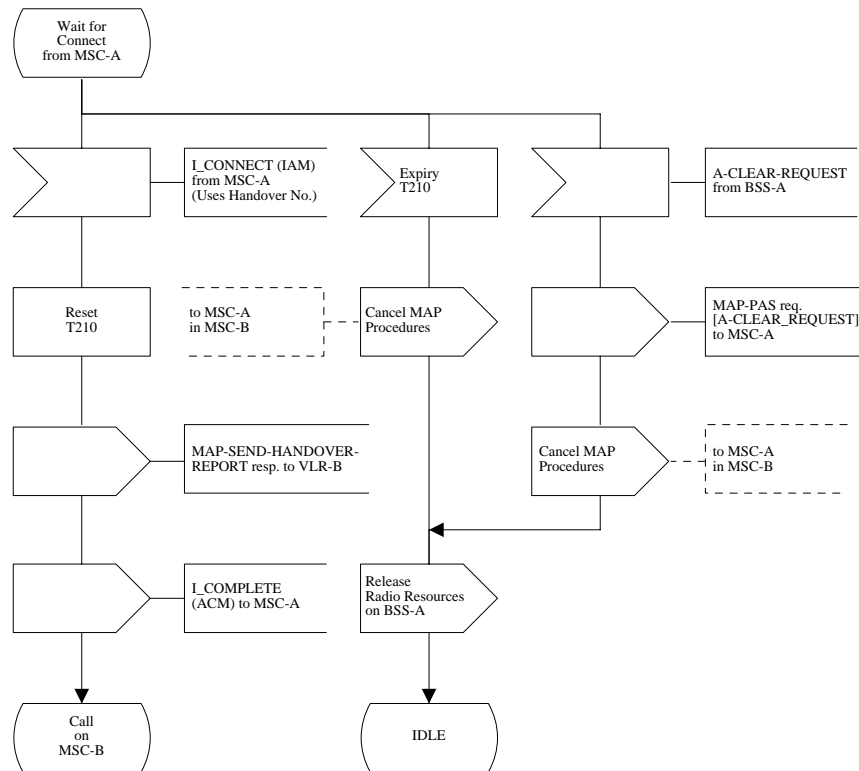

Figure 14 (Sheet 17 of 18): Handover control procedure in MSC-B

Procedure MSC_B_HO

Sheet18 (18)

Procedures for Handover in MSC-B

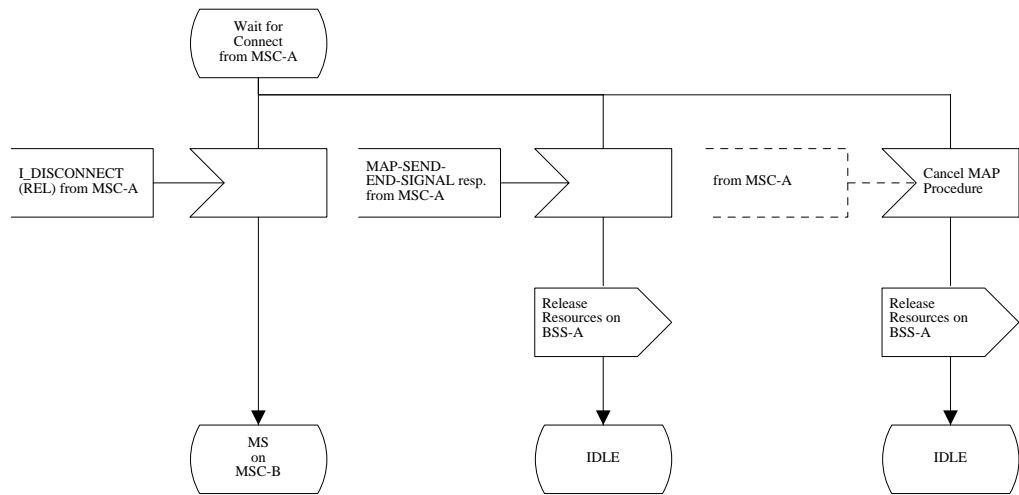

Figure 14 (Sheet 18 of 18): Handover control procedure in MSC-B

Annex A (informative): Change Request History

Date	Status	Information about changes
Oct 91	Version 4.0.0	CR agreed at GSM #32: CR 03.09-003
Apr 92	Working version 2	Based on version 4.0.0 Updated during the WPC ad hoc meeting (Newbury)
May 92	Working version 3	Updated during the SMG3 meeting in Sophia Antipolis
Oct 92	Working version 4	Update of all sections. Addition of section describing External Intra-MSC handover. Complete Updating of sections 5 and 6 New SDLs added using the SDT tool
Nov 92	Working Version 5	Updated after external review. Scope re-written along with section 3. Section 4 clarified. Issued at SMG 3, Turin, Sept 92 as TD817, for review and comment.
Feb 93	Working Version 6	All sections updated following review comments. Addition of sections to cover Directed Retry and the handover of signalling channels.
March 93	Working Version 7	Updated as per CR 4 in TD 168/93 presented in Bonn.
March 93	Version 4.1.0	Approved at SMG #6, based upon Working Version 7
October 93	Version 4.2.0	Change Requests agreed by SMG#8: CR 03.09-005r1 CR 03.09-006r1
January 94	Version 4.2.1	Change Requests agreed by SMG#9: CR 03.09-007r1 CR 03.09-008 CR 03.09-011
April 94	Version 4.3.0	Change Requests agreed by SMG#10: CR 03.09-009r2 CR 03.09-012r1 CR 03.09-013 CR 03.09-014r1
July 94	Version 4.4.0	Change Requests agreed by SMG#11: CR 03.09-015
October 94	Version 4.5.0	Change Requests agreed by SMG#12: CR 03.09-016
1996	Version 5.0.0	Phase 2+ version
July 97	Version 5.1.0	Change Requests agreed by SMG#12: CR 03.09-A006r1
January 1999	Version 6.0.0	Release 1997 version
August 1999	Version 7.0.0	Release 1998 version

History

Document history		
V7.0.0	August 1999	Publication