

**Digital cellular telecommunications system (Phase 2+);
Feasibility study on Single Antenna Interference
Cancellation (SAIC) for GSM networks
(3GPP TR 45.903 version 6.0.1 Release 6)**



Reference

DTR/TSGG-0145903v601

Keywords

GSM

ETSI

650 Route des Lucioles
F-06921 Sophia Antipolis Cedex - FRANCE

Tel.: +33 4 92 94 42 00 Fax: +33 4 93 65 47 16

Siret N° 348 623 562 00017 - NAF 742 C
Association à but non lucratif enregistrée à la
Sous-Préfecture de Grasse (06) N° 7803/88

Important notice

Individual copies of the present document can be downloaded from:

<http://www.etsi.org>

The present document may be made available in more than one electronic version or in print. In any case of existing or perceived difference in contents between such versions, the reference version is the Portable Document Format (PDF). In case of dispute, the reference shall be the printing on ETSI printers of the PDF version kept on a specific network drive within ETSI Secretariat.

Users of the present document should be aware that the document may be subject to revision or change of status. Information on the current status of this and other ETSI documents is available at

<http://portal.etsi.org/tb/status/status.asp>

If you find errors in the present document, please send your comment to one of the following services:

http://portal.etsi.org/chaicor/ETSI_support.asp

Copyright Notification

No part may be reproduced except as authorized by written permission.
The copyright and the foregoing restriction extend to reproduction in all media.

© European Telecommunications Standards Institute 2004.
All rights reserved.

DECTTM, **PLUGTESTS**TM and **UMTS**TM are Trade Marks of ETSI registered for the benefit of its Members.
TIPHONTM and the **TIPHON logo** are Trade Marks currently being registered by ETSI for the benefit of its Members.
3GPPTM is a Trade Mark of ETSI registered for the benefit of its Members and of the 3GPP Organizational Partners.

Intellectual Property Rights

IPRs essential or potentially essential to the present document may have been declared to ETSI. The information pertaining to these essential IPRs, if any, is publicly available for **ETSI members and non-members**, and can be found in ETSI SR 000 314: *"Intellectual Property Rights (IPRs); Essential, or potentially Essential, IPRs notified to ETSI in respect of ETSI standards"*, which is available from the ETSI Secretariat. Latest updates are available on the ETSI Web server (<http://webapp.etsi.org/IPR/home.asp>).

Pursuant to the ETSI IPR Policy, no investigation, including IPR searches, has been carried out by ETSI. No guarantee can be given as to the existence of other IPRs not referenced in ETSI SR 000 314 (or the updates on the ETSI Web server) which are, or may be, or may become, essential to the present document.

Foreword

This Technical Report (TR) has been produced by ETSI 3rd Generation Partnership Project (3GPP).

The present document may refer to technical specifications or reports using their 3GPP identities, UMTS identities or GSM identities. These should be interpreted as being references to the corresponding ETSI deliverables.

The cross reference between GSM, UMTS, 3GPP and ETSI identities can be found under <http://webapp.etsi.org/key/queryform.asp>.

Contents

Intellectual Property Rights	2
Foreword.....	2
Foreword.....	5
Introduction	5
1 Scope / objectives	7
2 References	7
3 Abbreviations	7
4 Network scenarios for SAIC evaluation.....	8
5 Interference modelling	11
5.1 Introduction	11
5.2 Interference statistics	11
5.3 Synchronous link level models.....	14
5.3.1 Interferer levels	14
5.3.2 Delay distributions.....	16
5.3.3 Frequency offset distributions.....	17
5.4 Asynchronous link level models	17
5.4.1 Burst structure.....	17
5.4.2 Time-offset modelling	18
5.4.3 Power control.....	18
5.4.4 Phase transition	19
5.4.5 Guard period and power ramping	19
5.4.6 DTX.....	20
5.5 Summary.....	20
6 SAIC Link Level Characterisation	20
6.1 Introduction	20
6.2 Link level performance	21
6.2.1 Results for exemplary link models	21
6.2.2 Additional results.....	23
6.3 Link-to-system interface.....	23
7 SAIC system level characterization	24
7.1 Introduction	24
7.2 Link-to-system mapping.....	25
7.3 System level simulator	25
7.3.1 Satisfied user definition.....	26
7.4 System level simulation results	27
7.4.1 System capacity for 100% SAIC mobile penetration	27
7.4.1.1 Configuration 1 – unsynchronized network	27
7.4.1.2 Configuration 2 – synchronized network	27
7.4.1.3 Configuration 2 – unsynchronized network	28
7.4.1.4 Configuration 3 – synchronized network	29
7.4.1.5 Configuration 3 – unsynchronized network	30
7.4.1.6 Configuration 4 – unsynchronized network	31
7.4.2 Impact of SAIC Mobile Penetration	32
7.4.3 Additional results.....	36
7.4.3.1 Effect of antenna patterns and Quality of Service (QoS) on system capacity	36
7.4.3.2 System performance for Configuration 1, another perspective	38
7.4.3.3 Impact of 8-PSK interference on GMSK SAIC performance	39
7.5 The effect of SAIC on GPRS performance	39
7.6 Summary and conclusions.....	43
8 SAIC field trials	44

8.1	Asynchronous network field trial	45
8.2	Synchronous network field trial	45
9	Test considerations	46
9.1	Introduction	46
9.2	Discussion	47
9.3	Summary	50
10	Signalling considerations	50
10.1	Logical binding of receiver performance to protocol version	51
10.2	Release-independent indication of receiver performance: Classmark 3 IE	51
10.3	Release-independent indication of receiver performance: MS Radio Access Capability IE	52
10.4	Summary	54
10.5	References	54
11	Conclusions	54
11.1	Specification impacts	55
11.1.1	Core specifications	56
11.1.2	Testing specifications	56
Annex A:	Change History	57
History		58

Foreword

This Technical Report has been produced by the 3rd Generation Partnership Project (3GPP).

The contents of the present document are subject to continuing work within the TSG and may change following formal TSG approval. Should the TSG modify the contents of the present document, it will be re-released by the TSG with an identifying change of release date and an increase in version number as follows:

Version x.y.z

Where:

- x the first digit:
 - 1 presented to TSG for information;
 - 2 presented to TSG for approval;
 - 3 or greater indicates TSG approved document under change control.
- y the second digit is incremented for all changes of substance, i.e. technical enhancements, corrections, updates, etc.
- z the third digit is incremented when editorial only changes have been incorporated in the document.

Introduction

This document studies the feasibility of utilising Single Antenna Interference Cancellation (SAIC) as a means of increasing the downlink spectral efficiency of GSM networks.

SAIC is a generic name for techniques, which attempt to cancel or suppress interference by means of signal processing without the use of multiple antennas. The primary application is the downlink, where terminal space and aesthetics typically preclude the use of multiple antennas.

Clause 1 of this document defines the scope and objectives of this feasibility study. Clause 4 defines the network scenarios that have been defined to evaluate SAIC performance in GSM networks. These scenarios are representative of typical GSM deployments worldwide today. Clause 5 presents the interference statistics associated with the network scenarios defined in Clause 4. These interference statistics are developed via system simulations, and are defined in terms of the distributions of the parameters which are critical to understanding SAIC performance. These critical parameters include;

- The Carrier to Interference plus noise Ratio (CIR)
- The Dominant to rest of Interferer Ratio (DIR)
- The other interferer ratios, which define the relative power of the dominant co-channel interferer to each of the other considered interferers
- The delay between the desired signal and each of the interferers.

It is important to understand the network statistics of these key parameters since most SAIC algorithms can only cancel one interferer, and their effectiveness in doing this is affected by the 'remaining' interference, and delays between the desired signal and the interferers.

In Clause 6, candidate SAIC algorithms are evaluated at the link level based on the interference statistics defined in Clause 5. Both 'long-term average' and per burst results are generated. The long-term average results represent the classical way of looking at link performance via link simulations, defining the Bit Error Rate (BER) and Frame Error Rate (FER) averaged over the entire simulation run as a function of the CIR. This is the type of performance that is typically specified in the GSM standards. However, to develop a system capacity estimate, it is necessary to define the link performance on a per burst basis. To this end, Clause 6 also defines the average BER over the burst as a function of the burst CIR and burst DIR. This burst performance is used to develop a link-to-system level mapping. This

mapping is used in Clause 7 to develop voice capacity and data throughput estimates for both conventional and SAIC receivers. The voice capacity gain and data throughput gain for SAIC is then deduced from these estimates.

Clause 8 describes the field trials that have been conducted using an SAIC prototype Mobile Station (MS). Clause 9 addresses testing considerations for SAIC capable MSs, while Clause 10 defines a couple of signalling options for identifying an MS as being SAIC capable. Finally, Clause 11 provides the relevant conclusions that can be drawn from this feasibility study, the most important of which is the conclusion that SAIC is a viable and feasible technology, which will support significant voice capacity gains for both synchronous and asynchronous networks when applied to GMSK modulation. In addition, modest increases in GPRS data throughput are also supported for the types of data traffic considered. Clause 11 also identifies those clauses of the core and testing specifications that will be impacted by the inclusion of an SAIC capability.

1 Scope / objectives

The objective of this document, as defined in the work item [2], is to determine the potential of SAIC in typical network layouts. This includes study of the following aspects:

- a) Determine the feasibility of SAIC for GMSK and 8PSK scenarios under realistic synchronized and non-synchronized network conditions. Using a single Feasibility Study, both GMSK and 8PSK scenarios will be evaluated individually.
- b) Realistic interference statistics including CIR (Carrier to Interference plus noise Ratio) and DIR (Dominant-to-rest of Interference Ratio) levels and distributions based on network simulations and measurements, where possible.
- c) Robustness against different training sequences.
- d) Determine method to detect/indicate SAIC capability.

2 References

The following documents contain provisions, which, through reference in this text, constitute provisions of the present document.

- References are either specific (identified by date of publication, edition number, version number, etc.) or non-specific.
- For a specific reference, subsequent revisions do not apply.
- For a non-specific reference, the latest version applies. In the case of a reference to a 3GPP document (including a GSM document), a non-specific reference implicitly refers to the latest version of that document *in the same Release as the present document*.

- [1] ETSI TR 101 112 v3.2.0 (1998-04), "Universal Mobile Telecommunications System (UMTS); Selection procedures for the choice of radio transmission technologies of the UMTS".
- [2] 3GPP TSG-GERAN TDOC GP-022891: "Work Item Description, Single Antenna Interference Cancellation", Sophia Antipolis, France, 18-22 November 2002.
- [3] 3GPP TSG-GERAN SAIC Workshop TDOC GAHS-030009: "Network level simulation scenarios and assumptions for SAIC", Atlanta, USA, 8-9 January 2003.
- [4] 3GPP TSG-GERAN SAIC Workshop TDOC GAHS-030005: "Scenarios and Modelling Assumptions for SAIC in GERAN", Atlanta, USA, 8-9 January 2003.
- [5] 3GPP TSG-GERAN SAIC Workshop TDOC GAHS-030002: "Single antenna interference cancellation - evaluation principles and scenarios", Atlanta, USA, 8-9 January 2003.
- [6] 3GPP TSG-GERAN SAIC Workshop TDOC GAHS-030020: "Interference Characterization for SAIC Link Level Evaluation", Seattle, USA, 4-5 March 2003.
- [7] 3GPP TSG-GERAN SAIC Workshop TDOC GAHS-030022: "Link Level model for SAIC", Seattle, USA, 4-5 March 2003.

Additional references are noted in the individual clauses of this document

3 Abbreviations

ACI

AMR	
BEP	
BER	
BLER	
BTS	
CDF	
C/I	
cdfs	
CINR	
DIR	Dominant-to-rest Interference Ratio
DPC	Downlink Power Control
DTX	Discontinuous Transmission
EFL	
FEP	
FER	
FL	Frequency Load
FR	Full Rate
FTP	
GMSK	
GPRS	
HR	Half Rate
IE	
MMS	
MS	
PDF	
PSK	
QoS	
SAIC	Single Antenna Interference Cancellation
TSC	Training Sequence

4 Network scenarios for SAIC evaluation

A multi-step approach was taken to evaluate SAIC performance in realistic network scenarios. This approach consisted of first determining relevant interference statistics based on the network scenarios described in this clause. These interference statistics were then used to determine the link level performance at the GSM burst level. From this link level characterization, link-to-system mapping tables were developed, which were then used in system level simulations to determine the voice and data capacity gains provided by SAIC capable MSs. The network scenarios used in these simulations were discussed and agreed to as part of SAIC Workshop #1.

It was agreed that the network scenarios, also referred to as configurations in this document, should represent typical GERAN networks at the time frame when operators would be deploying SAIC capable MSs. The goal was to try to make the interference statistics as realistic as possible, while trying to keep the overall complexity of the simulations reasonable. As a result of [3], [4], and [5], the following parameters are considered to be the major issues which affect the interference statistics:

- Frequency Hopping scheme
- Reuse (also adjacent channel reuse) and cell radius
- Regularity of the network (different cell sizes, different number of TRXs per cell, hotspots)
- Propagation conditions, including network topology (street corner effects, shadowing from buildings/hills etc.)
- Downlink Power Control (DPC) scheme
- Channel coding, mainly if quality-based DPC is used; schemes with less coding requires higher transmission powers
- Penetration of different MSs/bearers in the network

- SAIC MS penetration: power levels, higher tolerated load/interference for SAIC MSs, but the non-SAIC MS must not be negatively impacted
- Packet-switched connections to support GPRS and EGPRS, which are characterized by short connection times, asymmetry, bursty traffic, multiplexing of several users on the same time slot, and often lack of DPC
- Legacy non-AMR (mainly EFR) mobiles: higher transmit powers, less robustness
- Level of synchronization in the network
- Mobility: speed distribution of the mobiles affects the interference pattern

Going into the study, it was believed that SAIC would support larger gains in tighter reuse networks, as the interference becomes more and more limiting to system performance. Similarly, the higher the load, the more interference to cancel. However, interference scenarios are more complex with a higher load, so the interference cancellation algorithms may be less efficient. Finally, SAIC techniques generally give the largest gains in synchronized networks. These initial observations were found to be true, for the most part as is shown in clause 7, which provides a characterization of the system level performance of SAIC.

Two tables define the network scenario assumptions. Table 4-1 defines operator or configuration specific assumptions, while table 4-2 defines parameters common to all of the configurations. Both tables were derived from [3], [4], [5], and discussed as part of the SAIC Workshop #1. The four configurations defined in Table 4-1, and the common parameters defined in Table 4.2 are described in detail in clause 7.

Table 4-1
Configuration specific network scenario assumptions

Parameter	Value	Unit	Comment
Configuration 1 - Asynchronous			
Frequency	900	MHz	
Bandwidth	7.8	MHz	
Reuse	4/12 (BCCH) 3/9 (TCH)		
Hopping	Baseband		
Voice Codec	AMR 12.2 FR		
Blocking	2	%	
Modulation	<u>Source/Interferer</u> GMSK/GMSK GMSK/8PSK		
Cell Radius	500	m	
Configuration 2 – Sync & Async			
Frequency	1900	MHz	
Bandwidth	1.2	MHz	
Reuse	1/1 (TCH)		
Hopping	Random RF		
Voice Codec	AMR 5.9 FR/HR		
Frequency Load	20, 40 (FR) 10, 20 (HR)	% %	
Modulations	<u>Source/Interferer</u> GMSK/GMSK GMSK/8PSK 8PSK/GMSK 8PSK/8PSK		
Cell Radius	1000	m	
Configuration 3 – Sync & Async (Optional)			
Frequency	900	MHz	
Bandwidth	2.4	MHz	
Reuse	1/1 (TCH)		
Hopping	Random RF		
Voice Codec	AMR 5.9 FR/HR		
Frequency Load	40, 70 (FR) 25, 40 (HR)	% %	
Modulation	<u>Source/Interferer</u> GMSK/GMSK		
Cell Radius	750	m	
Configuration 4 - Asynchronous			
Frequency	900	MHz	
Bandwidth	7.2	MHz	
Reuse	1/3 (TCH)		
Hopping	Random RF		
Voice Codec	AMR 12.2 FR		
Blocking	2	%	
Frequency Load	30	%	
Modulation	<u>Source/Interferer</u> GMSK/GMSK GMSK/8PSK		
Cell Radius	300	m	

Table 4-2
Common network scenario assumptions

Parameter		Value	Unit	Comment
Sectors (cells) per site		3		
Sector antenna pattern		UMTS 30.03		
Propagation model		UMTS 30.03		Pathloss exponent, MCL Per 30.03
Log-normal fading	standard deviation	6 (900) 8 (1900)	dB dB	
	Correlation distance	110	m	
Adjacent channel interference attenuation		18	dB	Carrier +/- 200 KHz
Handover margin		3	dB	
Mobile speed		TU3 and TU50	km/h	
Mean Call length		90	sec.	
Minimum Call Length		5	sec.	
Voice activity		60%		Includes SID signalling.
DTX		Enabled		
Link adaptation		Disabled		
BTS output power		20	W	
Power control		RxQual/RxLev		
Dynamic Range		14	dB	
Step Size		2	dB	
Noise figure		10	dB	Reference temperature 25c
Inter-site Lognormal Correlation Coefficient		0		
Channel Allocation		Random		
Traffic data models for GPRS		See clause 7.5		Web-browsing & FTP/MMS

5 Interference modelling

5.1 Introduction

When assessing the link and system level performance it is important to base the performance investigations on realistic link level models. Especially for SAIC receivers previous studies have demonstrated that the SAIC link level performance for the same interference level will vary significantly for different link level models [GP-030276]. Therefore a lot of work has been done in the SAIC feasibility study to define realistic models and the outcome of this work is recaptured in this clause.

Defining realistic link level models is clearly impossible without investigating the interference statistics seen by mobiles when operating in different network scenarios. Thus an important part of the modelling work has been analysis of network traces generated by network simulators for the four different network configurations defined in clause 4.

Two types of link level models have been derived one for synchronous network configurations and one covering asynchronous networks. The latter is an extension of the model derived for synchronous networks taking into account such effects as delay, power control, DTX, etc..

5.2 Interference statistics

In GSM/EDGE the performance of the mobiles in interference limited scenarios have traditionally been evaluated for a single interfering signal at a high input level where the sensitivity performance of the mobile will have no or very little influence. This can be described by the conventional CIR (Carrier to Interference Ratio):

$$CIR = \frac{C}{I + N_0}$$

where C is the power of the carrier, I the power of an interfering signal (co- or adjacent channel interference) and N_0 the thermal noise¹. Although widely used, for evaluation, this ideal one interferer scenario happens very rarely in practice especially when the network is highly loaded. When using e.g. AMR a high frequency load can be expected and consequently the mobiles will receive interference from a number of base stations at the same time. This can easily be introduced in the above definition of the CIR:

$$CIR = \frac{C}{\sum_k I_k + N_0}$$

I_k can be both co- and adjacent channel interference (for the adjacent channel interference a realistic ACP (Adjacent Channel Protection) shall be used e.g. ACP=18dB).

For a small number of interfering base stations the performance of a conventional receiver will be identical for the two definitions, but for a SAIC mobile the performance (interference cancellation capability) will depend upon the distribution of the interferer powers. An initial, simple measure to capture this is the Dominant to rest of Interference Ratio (DIR), which is the power of the dominant interferer to the sum of the powers of the rest of the interferers plus N_0 . This ratio is defined as:

$$DIR = \frac{I_{\max}}{\sum_k I_k - I_{\max} + N_0}$$

where I_{\max} is the average power of the dominant interfering signal (co- or adjacent channel interference). When only a single interferer is active, as in the standard interference test case in 45.005, then the DIR will be identical to the I/N_0 of the received interfering signal. Although the standard interference test case is widely used it has been demonstrated in a number of contributions that this test case does not reflect a realistic scenario for a SAIC mobile [GAHS-030017][GAHS-030018][GAHS-030022].

In [GAHS-030008] a new measure called DIR_2 was introduced in the link level modelling discussion. The DIR_2 measure is defined as:

$$DIR_2 = \frac{I_{\max 2}}{\sum_k I_k - I_{\max} - I_{\max 2} + N_0}$$

and basically it can be used to investigate the validity of using a simple two cochannel interferer model when evaluating the SAIC link level performance. In TSG GERAN #13 the DIR_2 measure was included in a number of studies and the initial conclusion was that more than two cochannel interferers are needed in the SAIC link level model [GP-030159, GP-030276].

Figures 5-1 through 5-3 are examples of interferer statistics for network configuration 2². The figures clearly demonstrate how the interferer statistics in a network are much more complicated than the single interferer scenario currently tested in 45.005. The DIR and DIR_2 statistics clearly demonstrate the need to define link level models having multiple interferers.

¹ CIR is also referred to in this document as CINR = Carrier to Interference plus Noise Ratio

² The figures have been taken from [GAHS-030017] but similar figures have been presented in [GAHS-030022] and [GAHS-030018].

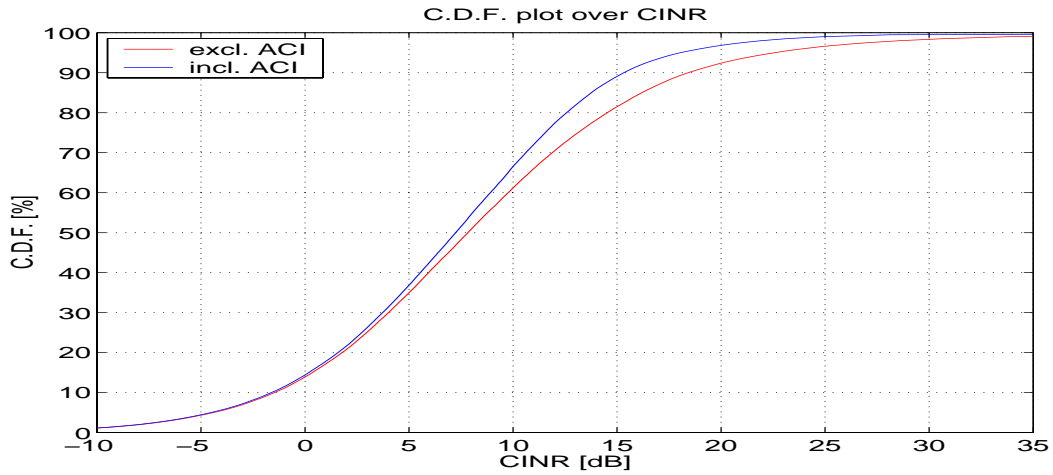

Figure 5.1 The CIR cdfs observed by a MS operating in network configuration 3 [GAHS-030017].

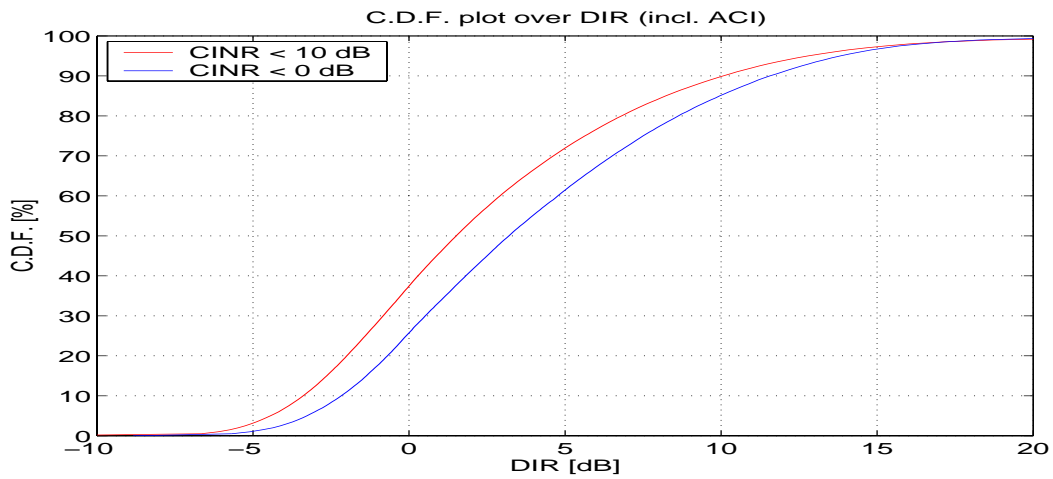

Figure 5-2 The DIR cdfs observed by a MS operating in network configuration 3 [GAHS-030017].

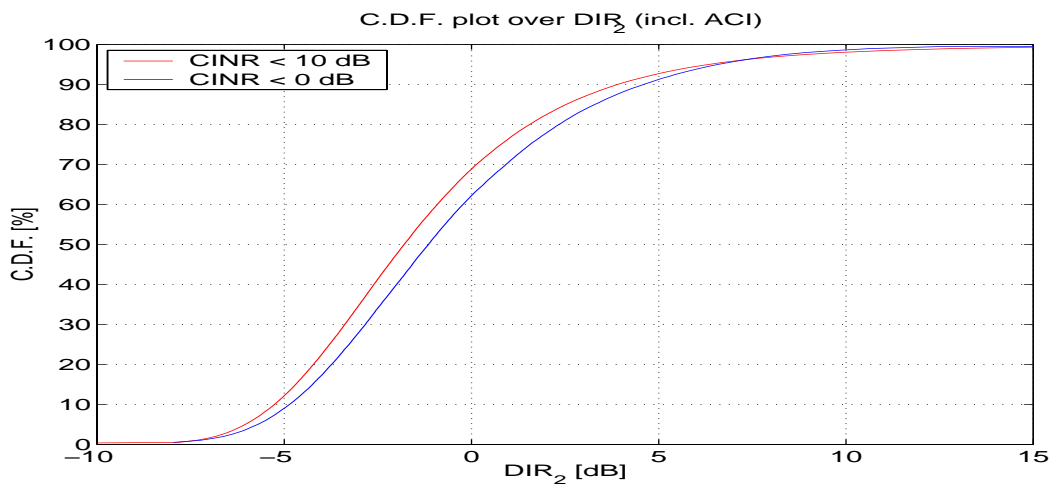

Figure 5-3 The DIR₂ cdfs observed by a MS operating in network configuration 3 [GAHS-

030017].

5.3 Synchronous link level models

Early link level investigations for SAIC demonstrated a higher link level gain when using a synchronous link level configuration compared to an asynchronous one. Consequently it was decided to develop link level models for both types of networks focusing initially on the synchronous mode³, which will be described in this clause.

5.3.1 Interferer levels

Having identified the need to have multiple interferers in the link level model the necessary number of interferers and their levels have to be estimated. During the SAIC Adhoc #2 a procedure for the estimation was agreed based on investigations made in document [GAHS-030018] and [GAHS-030022]. From network traces the cdfs of a number of co- and adjacent channel interferers plus the residual interference were derived. Examples of the cdfs can be seen in Figure 5-4 and Figure 5-5. In the estimation process only bursts having a CIR < 10dB have been taken into account because SAIC algorithms are expected to have the largest link level gain for low CIR. The mean power level of each interferer was chosen as the observed median value, with all ratios defined with respect to the dominant cochannel interferer. For example, in configuration 3 the ratio of the dominant interferer, I_1 to the second dominant interferer I_2 is 4 dB as shown in Figure 5-5. The final agreed-to numbers are listed in Table 5-1, where the following interferers are defined: three discrete co-channel interferers, one discrete adjacent channel interferer, one residual cochannel interferer and one residual adjacent channel interferer⁴. The numbers for the adjacent channel interference are assumed measured after a receive filter having an attenuation of 18dB. Thus, in the channel model the power level should be 18dB higher than shown in the table. For configuration 1 the values have been derived in [GP-031203], for configuration 2 and 3 the values were derived at the SAIC Adhoc #2 and finally for configuration 4 the values have been agreed as the average of the values from [GP-031289] and [GP-031203].

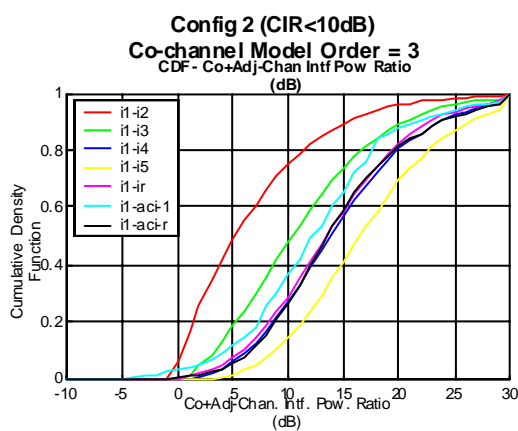

Figure 5-4 cdfs of interferer powers for estimation of link level model for network configuration 2 [GAHS-030024].

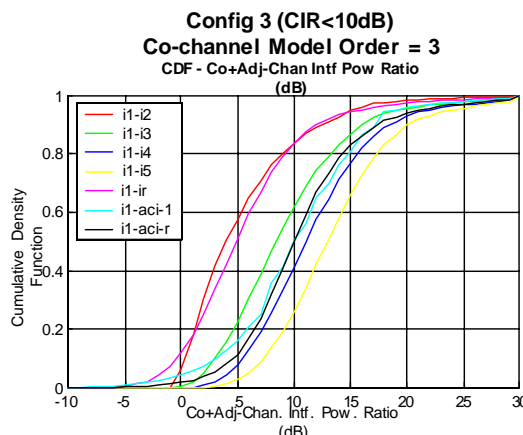

Figure 5-5 cdfs of interferer powers for estimation of link level model for network configuration 3 [GAHS-030024].

For the modelling of residual co- and adjacent channel interference an AWGN source is filtered using the 8PSK modulation filter (linearized GMSK pulse) specified in 45.004 clause 3.5. The filtering is done to ensure the correct spectral properties. The residual adjacent channel interference is applied with half the power on each side of the carrier

³ Only burst wise synchronization is assumed.

⁴ In Table 5-1, the dominant interferer is also referred to as $Ic1$, while the remaining discrete co-channel interferers are referred to as $Ic2$ and $Ic3$. The discrete adjacent channel interferer is referred to as Ia , while the residual interferers are referred to as Icr and Iar , respectively.

i.e. for configuration 2 two residual adjacent channel interferers being offset ± 200 kHz from the carrier and having power level 0 dB^5 should be included.

During the initial investigation of SAIC a number of companies observed that the performance of most SAIC algorithms is degraded when the interferer has a TSC included compared to use of the standard GMSK-modulated random sequence defined in 45.005 [GP-020822]. Therefore an important part of the link level modelling is to include TSCs for all except the residual interferers i.e. the interferers generally have a normal burst structure. Apart from the dominant cochannel interferer, the TSC is taken from a uniform distribution including all eight TSCs defined in 45.002. In an optimized network it is expected that TSC collisions to some extent can be avoided for the dominant interferer and therefore TSC0 is not included for the dominant interferer.

When performing link level analysis the fading is an important part of the modelling and as can be seen in Table 5-1 all except the three residual interferers are subject to fading. Fading is not applied on the residual interferers because these are used to model interference from a number of BTSs each having independent fading. Thus the power variations of the residual interference will be small and are thus, neglected in the link level model.

Table 5-1 Interferer levels for network configuration 1-4.

Link Parameter	Configuration 1	Configuration 2 40% Load	Configuration 3 70% Load	Configuration 4
Desired signal, C				
TSC	TSC0	TSC0	TSC0	TSC0
Fading				
Dominant Coch. Interf.				
TSC	Random TSC excluding TSC0	Random TSC excluding TSC0	Random TSC excluding TSC0	Random TSC excluding TSC0
Fading				
2 nd Strongest Coch. Interf.				
Ic1/Ic2	10 dB	6 dB	4 dB	9 dB
TSC	Random TSC	Random TSC	Random TSC	Random TSC
Fading				
3 rd Strongest Coch Interf.				
Ic1/Ic3	20 dB	10 dB	8 dB	17 dB
TSC	Random TSC	Random TSC	Random TSC	Random TSC
Fading				
Residual Coch. Interf. (filtered AWGN)				
Ic1/Icr				
TSC	-	9 dB	5 dB	20 dB
No Fading	NA	NA	NA	NA
Dominant Adj. Interf.				
Ic1/Ia ⁶	15 dB	14 dB	14 dB	16 dB

⁵ The 18dB adjacent channel protection has been taken into account.

TSC	Random TSC	Random TSC	Random TSC	Random TSC
Fading				
Residual Adj. Interf. (filtered AWGN)				
Ic1/Iar ¹	20 dB	15 dB	14 dB	21 dB
TSC	NA	NA	NA	NA
No Fading				

5.3.2 Delay distributions

Even in a synchronized network the mobile station will receive interference from the different BTSs at various delays due to the distance to the interfering sites. Although most SAIC receivers are expected to be robust to delays less than 10 symbols even small delays can affect the correlation properties between different TSCs and therefore the performance of both conventional and SAIC receivers.

Based on network traces, modelling of delay in the synchronous link level models has been investigated by Motorola for the four network configurations. The outcome of these studies is the delay model summarized in this clause.

Using a delay resolution of 0.2 symbols, and the observation that delays in the four configurations are limited to the range [-2,+5] symbols, the discrete delay distribution can be approximated as:

- for delay less than 0, for k=1 to 10, the probability $P(k)$ of delay equal to $-0.2k$ is:

$$P(k) = A_1 p_1 (1 - p_1)^k$$

- for delay greater than 0, for k=1 to 25, the probability $P(k)$ of delay equal to $0.2k$ is:

$$P(k) = A_2 p_2 (1 - p_2)^k$$

- for zero delay:

$$P(0) = A_0$$

The parameters to be used for the different configurations can be seen in Table 5-2.

Table 5-2 Summary of delay model parameters.

Configuration	p_1	p_2	A_0	A_1	A_2
Configuration 1 @2% blocking	0.9	0.7	0.5602	0.5	2
Configuration 2@40%	0.37	0.09	0.2157	0.1274	0.8555
Configuration 3@70%	0.7	0.26	0.4005	0.1658	0.7433
Configuration 4@30%	0.95	0.25	0.1106	0.1874	1.1742

The model demonstrates that the carrier and the interferers often are synchronized when received by the mobile station.

⁶ After the Rx filter assuming an 18dB ACP.

5.3.3 Frequency offset distributions

Frequency offset is inevitable in practical implementations and consequently also needed in the SAIC link level model [GP-032246]. When a mobile station is connected to a BTS it is synchronized in frequency to this serving BTS. Therefore the mobile station will not detect if the carrier of this BTS is offset compared to a correct carrier frequency. Although synchronized some frequency jitter due to inaccuracy of the frequency estimation procedure will exist in practice. It has been agreed not to include this vendor specific frequency jitter in the model but clearly each vendor has to include their own model when performing simulations.

However, the frequency offset has to be included for each of the three discrete co-channel, and the one discrete adjacent channel interferers having a value that includes the fixed offset of the serving BTS⁷. For each of these interferers the frequency offset will be varying on burst-by-burst basis due to frequency hopping and the fact that the interference in the model comes from a number of BTSs all having different offset. The mean value of these offsets is assumed to be 0Hz (plus the fixed frequency offset of the serving BTS⁸) with a standard deviation of either 17 Hz for 850/900 MHz operation, or 33Hz for 1800. Thus, the frequency offset is modelled as a normal distribution, $N(50,17)$ for 850/900 MHz, and $N(100,33)$ for 1800/1900 MHz.

5.4 Asynchronous link level models

Most of the initial SAIC link level modelling work concentrated on development of link level models for synchronous network configurations. Although the highest SAIC gain is expected in synchronous networks, the majority of networks will, at least in the near future, still be running in asynchronous mode. Consequently, estimation of the expected SAIC capacity in asynchronous networks is seen as an important part of the SAIC feasibility study.

An exact estimation of the network capacity requires a hybrid link and system level simulator taking all system and link level factors into account. In practice such an approach is not possible and instead a more simple solution splitting the system and link level simulations is used. The principle is to make a table of the link level performance as a function of factors like CIR and DIR. The system simulator will then use these values as the link level performance of the mobiles in the network.

Even though the link level models developed for the feasibility study of SAIC in GERAN are very complicated the agreement was reached that the performance can be parameterized by the burst wise CIR and DIR for synchronous networks. For asynchronous networks it would be natural to extend the number of parameters to include information about delay and scaling of the different interferers in order to have an accurate estimate of the capacity. But most system simulators available have been designed for synchronous network operation and updating these for asynchronous operation would be a major task. Therefore the agreement during TSG GERAN #15 was to use the standard system simulators and then restrict the handling of the asynchronous effects to the link level⁹.

By using this simplified approach an estimation of the capacity in asynchronous networks requires the following, where obviously the modelling is a crucial part when estimating the capacity of asynchronous networks:

- Develop statistical link level model including delay offsets, burst power and structure etc.
- Make link to system level mapping tables using simulations of the statistical link level model.
- Simulate network capacity using developed mapping tables and standard system simulators.

5.4.1 Burst structure

When operating in an asynchronous network the mobile will experience a more complex interferer environment than in a synchronous network due to the time offset and propagation delay between the different BTSs. The agreed way to model this is to use the interferer burst structure shown in Figure 5-6. The middle burst of the interferer is referred to as

⁷ Fixed offsets of 50 and 100Hz will be used to reflect worst case offsets at 850/900 MHz and 1800/1900 MHz.

⁸ Each BTS can have a frequency offset of 0.05ppm resulting in a worst case of 0.1ppm between the serving and the interfering BTSs (see 45.010).

⁹ This will result in new link to system level mapping tables, which can be parameterised by the burst wise CIR and DIR. The definitions of burst wise CIR and DIR follows the definition in clause **Error! Reference source not found.** where the energy of an interferer is calculated as the energy during the receive window, i.e., the interferer energy that the desired burst is exposed to.

the main burst. On each side of the main burst, there is an adjacent burst, which is sent in an adjacent timeslot from the same BTS. The interferer is shifted relative to the desired signal and therefore one of the adjacent bursts is shifted into the receive window. Modelling is only necessary for the adjacent burst that is shifted into the receive window.

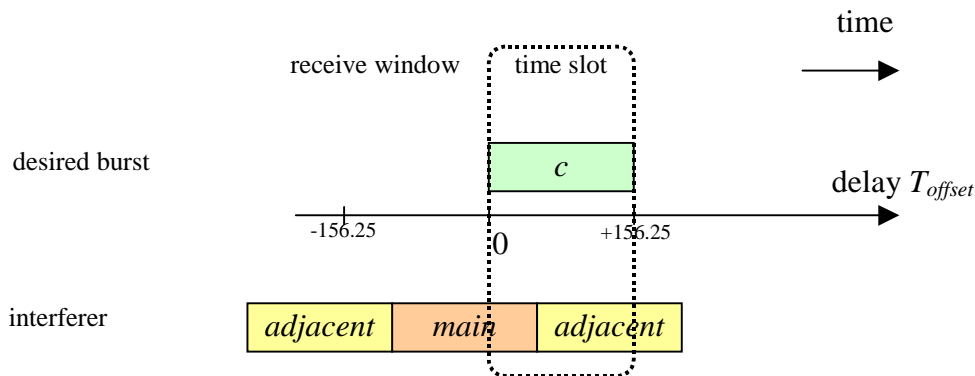

Figure 5-6 Interferer burst structure.

5.4.2 Time-offset modelling

Time-offset modelling is only needed for inter-site interference whereas intra-site interference can be assumed to be time-aligned with the carrier signal. This difference between inter- and intra-site interference can easily be taken into account by using the following equation to describe the time offset¹⁰ [GP-031524]:

$$T_{\text{offset}} = \begin{cases} 0 \text{ symbols} & \text{in } t_{\text{intra-cell}} \% \text{ of the bursts} \\ U[-t_{\text{max}}; t_{\text{max}}] \text{ symbols} & \text{in } (100 - t_{\text{intra-cell}}) \% \text{ of the bursts} \end{cases}$$

where t_{max} represents full slot length (156.25 symbols), and the uniform distribution is using $\frac{1}{4}$ symbol resolution of the timing offset. In this equation $t_{\text{intra-cell}}$ represents the percentage of time the interference is from the same site. One value of $t_{\text{intra-cell}}$ will be used for each configuration. For configurations 1 and 4, $t_{\text{intra-cell}} = 0$ and for configurations 2 and 3, $t_{\text{intra-cell}} = 20\%$ has been identified as realistic values.

5.4.3 Power control

When designing an asynchronous link level model an important issue is the modelling of the power variation between the different interfering bursts (main and adjacent interferer). Assuming the bursts are located within a frame, i.e. not at a frame boundary, then the bursts will be sent from the same BTS and therefore affected by nearly the same channel (pathloss, shadow and multipath fading). Despite this similarity in fading the received power level of the interfering bursts will in general be different due to power control and DTX operation.

Power control is not modelled on the main burst¹¹ but only for the adjacent burst (see Figure 5-6) by multiplying it with a coefficient A. The distribution of A is given in Table 5-3 (A is given in a dB scale). It has an expected value of 1 (in the linear domain) to keep the average power level constant.

¹⁰ The notation $U[-x;x]$ is used to represent a uniform distribution in the range $-x$ to x .

¹¹ It was decided that the effect of power control of the main burst was already taken into account in the development of the network statistics defined in Table 5-1 and, thus, no need to include this effect again.

Table 5-3 – Power control gain probability density function.

Gain $10 \cdot \log_{10}(A)$	Probability Density Function $p(A)$
-18	0.0058
-16	0.0222
-14	0.0338
-12	0.0503
-10	0.0695
-8	0.0937
-6	0.1335
-4	0.1487
-2	0.1362
0	0.1024
2	0.0763
4	0.0541
6	0.0367
8	0.0242
10	0.0106
12	0.0019

5.4.4 Phase transition

When different bursts are transmitted from a BTS on a physical channel the relative phase between these bursts are not specified and it cannot be guaranteed that the phase is continuous. Besides the duration of timeslots will not always be 156.25 symbols but can also be either 156 or 157 symbols, which will be seen as a phase discontinuity by the mobile (see 45.010 clause 5.7). To model these effects it has been decided to have a random generated phase change modelled as a random process uniformly distributed in the range $[0, 2\pi]$. The complex scaling formed jointly by the phase transition and the power control (described in clause 5.4.3) can be considered as a change of channel conditions and can therefore be a challenge for some SAIC receivers.

5.4.5 Guard period and power ramping

The symbols to be sent during the guard time between the different bursts are not covered by the specifications. Due to the power ramping applied between the bursts it is not expected that the guard symbols will have a major impact on the link layer performance. Therefore it has been agreed to use uniformly distributed random symbols.

According to the specifications the BTSs are only required to use power ramping when non-used timeslots are present i.e. the ramping will be used on the non-BCCH frequencies. No specific ramping function has been defined but the ramping should follow the time mask for normal bursts as defined in 45.005. To simplify the asynchronous link level modelling it is agreed to use power ramping on all bursts besides any ramp function can be used as long as it is compliant with the time mask from 45.005.

5.4.6 DTX

When deriving the original synchronous link level model DTX was taken into account in the network simulations and consequently also in the link level model. Because the asynchronous model have been derived from the synchronous model DTX will not be applied to the main burst (see Figure 5-6). For the adjacent burst there are two options:

1. DTX applied
The adjacent burst is present with 60% probability and absent with 40 % probability.
2. DTX not applied
The adjacent burst is always present.

In both cases the complex scaling previously described is applied on the adjacent burst. Option 1 is expected to give slightly more positive performance results because it does not take into account that when in DTX mode in a real network another interferer will pop up and cause interference. Option 2 on the other hand is expected to be very conservative because it does not use DTX at all. In practice it is expected that the performance will be in between the two extremes used in this feasibility study.

With option 1, the average power level of each discrete interferer shall be increased to compensate for the reduced interferer energy by multiplying the signal by a factor $\sqrt{5/4}$ for configurations 1 and 4 and $\sqrt{25/21}$ for configurations 2 and 3. This is done for both the main and the adjacent burst and regardless of the actual number of bursts that were absent at a particular time instant. For configurations 1 and 4, where $t_{\text{intra-cell}} = 0$, on average half of the desired burst is covered by the main burst (that is present with 100% probability) and half by the adjacent burst (that is present with 60% probability), the energy will on average be $(0.5*1+0.5*0.6)=4/5$ of the energy without DTX. Multiplying the amplitude of the interferer with $\sqrt{5/4}$ will make the average energy of the interferer the same with option 1 and option 2. For configurations 2 and 3, where $t_{\text{intra-cell}} = 20\%$, on average 60% of the desired burst is covered by the main burst, and the energy will on average be $(0.6*1+0.4*0.6)=21/25$ of the energy without DTX.

5.5 Summary

In this clause the link level modelling used for assessing the SAIC performance gain has been described. The models developed during the SAIC feasibility study include a high number of parameters, and are much more complex than conventional interference test cases. Consequently there is some risk that the modelling will be done differently by the companies involved, and this discrepancy can make it difficult to compare results between companies. To minimize this risk, an extensive link level simulation verification and alignment effort was carried out [GP-041010] [GP-041011]. The results of this latter effort were quite encouraging with excellent correlation obtained for conventional receiver performance. This effort should ensure that any SAIC performance values that are included in the specification are realistic and consistent among the participating companies.

Link level models have been derived for synchronous and asynchronous mode network configurations. The interference levels for the two setups are identical but the asynchronous model is modified to take into account effects like time offset, power control, DTX ,etc..

Although the goal has been to model the behaviour in real networks as accurate as possible clearly the models are only approximations especially the models for the asynchronous networks. Therefore the link and system level performance estimated in this study can only be used as guidelines for the performance that will be seen in a real network.

6 SAIC Link Level Characterisation

6.1 Introduction

In this clause, the link performance of SAIC receivers is characterized.

In clause 6.2, long-term link level performance is summarized and compared to the performance of conventional receivers. Results are presented for the link interference models described in clause 5.

In clause 6.3, the principles of link-to-system modelling are described.

6.2 Link level performance

In this clause, long-term link level performance is summarized and compared to the performance of conventional receivers. Simulation results are presented for the link interference models described in clause 5, corresponding to the four network configurations described in clause 4. Results from different sources are presented. Detailed simulation results can be found in annex A.

It should be noted that the term "conventional receiver" does not reflect a common reference receiver as no such receiver has been defined. Instead, each source has used a reference receiver of their choice. Consequently, different sources may present different performance for the conventional receiver.

Two performance measures are considered:

- The CIR required to achieve a decoded frame erasure rate of class 1A bits (denoted "FER") of (less than) 1%
- The CIR required to achieve a raw bit error rate (denoted "raw BER") of (less than) 10%

6.2.1 Results for exemplary link models

The results for configurations 1 to 4 with unsynchronized interference are summarized in table 6-1. Two options exist for the link interference model for unsynchronized interference, one modelling DTX while the other does not. Results for both options are presented in the table below.

Table 6-1. Summary of average performance for configurations 1 to 4 with unsynchronized interference.

Configuration	Perf. measure	Receiver	Source						Average
			Ericsson []	Motorola []	Nokia []	Philips [GAHS-030031] NOTE 1	Siemens []	...	
1 DTX on	CIR @ 1%FER AFS 12.2	SAIC				5.2			
		Conv.				8.7			
		Gain				3.5			
	CIR @ 10% raw BER	SAIC			2	2.3			
		Conv.			4.9	5.5			
		Gain			2.9	3.2			
1 DTX off	CIR @ 1%FER AFS 12.2	SAIC				5.2			
		Conv.				8.7			
		Gain				3.5			
	CIR @ 10% raw BER	SAIC			2.3	2.3			
		Conv.			5.1	5.5			
		Gain			2.8	3.2			
2 DTX on	CIR @ 1%FER AFS 5.9	SAIC				2.4			
		Conv.				4.6			
		Gain				2.2			
	CIR @ 10% raw BER	SAIC			4.1	3.8			
		Conv.			5.7	6.0			
		Gain			1.6	2.2			
2 DTX off	CIR @ 1%FER AFS 5.9	SAIC				2.4			
		Conv.				4.6			
		Gain				2.2			
	CIR @ 10% raw BER	SAIC			4.2	3.8			
		Conv.			5.7	6.0			
		Gain			1.5	2.2			
3 DTX on	CIR @ 1%FER AFS 5.9	SAIC				2.6			
		Conv.				4.6			
		Gain				2.0			
	CIR @ 10% raw BER	SAIC			4.7	4.1			
		Conv.			5.8	6.1			
		Gain			1.1	2.0			
3 DTX off	CIR @ 1%FER AFS 5.9	SAIC				2.6			
		Conv.				4.6			
		Gain				2.0			
	CIR @ 10% raw BER	SAIC			4.8	4.1			
		Conv.			5.8	6.1			
		Gain			1.0	2.0			
4 DTX on	CIR @ 1%FER AFS 12.2	SAIC				5.2			
		Conv.				8.7			
		Gain				3.5			
	CIR @ 10% raw BER	SAIC			2.3	2.3			
		Conv.			5.1	5.5			
		Gain			2.8	3.2			
4 DTX off	CIR @ 1%FER AFS 12.2	SAIC				5.2			
		Conv.				8.7			
		Gain				3.5			
	CIR @ 10% raw BER	SAIC			2.6	2.3			
		Conv.			5.2	5.5			
		Gain			2.6	3.2			

NOTE 1: Results with DTX and without DTX are identical (within the precision of this comparison).

Table 6-2. Summary of average performance for configurations 2 to 3 with synchronized interference.

Configur ation	Perf. measure	Receiver	Source				
			Ericsson [GP- 040418]	Motorola []	Nokia []	Philips [GP- 031514] NOTE 1	Siemens []
2	CIR @ 1%FER AFS 5.9	SAIC		3.6		3.1	
		Conv.		4.7		5.2	
		Gain		1.1		2.1	
	CIR @ 10% raw BER	SAIC	5.1	5.0	4.7	4.3	
		Conv.	6.7	6.0	6.5	6.7	
		Gain	1.6	1.0	1.8	2.4	
3	CIR @ 1%FER AFS 5.9	SAIC		3.9		5.2	
		Conv.		4.7		3.2	
		Gain		0.8		2.0	
	CIR @ 10% raw BER	SAIC		5.2	5.2	4.6	
		Conv.		6.0	6.6	6.7	
		Gain		0.8	1.4	2.1	
NOTE 1: Some simulation assumptions, which were not agreed at the time the simulations were run, deviate slightly from the assumptions in this document. No significant impact is foreseen from this (within the precision of this comparison).							

6.2.2 Additional results

One objective of the feasibility study is to determine the performance of SAIC receivers in presence of 8PSK-modulated interference, as well as performance in sensitivity limited operation. While it was never the intention of this feasibility study to investigate SAIC gains with 8-PSK interferers, it is important to ensure that SAIC receivers do not perform worse than conventional receivers in sensitivity limited operation or in the presence of 8-PSK interference. Results have been provided (see e.g. GP-020822 or GP-031965) demonstrating robustness in these cases.

6.3 Link-to-system interface

The purpose of the link-to-system interface is to allow the system simulator to estimate the performance of each link based on the current interference situation for the link. A common approach is described in [Olofsson]. With this approach, the CIR is mapped to a frame erasure rate in two stages. In stage one, the model takes burst level CIR samples as input and maps them onto the (raw) bit error probability (BEP) for a burst. In stage two, the BEP samples of one speech frame are grouped together (hence, for GSM fullrate speech the group consists of eight BEP samples) and used to estimate the frame error probability (FEP). This is done by calculating the mean and (optionally) the standard deviation (or some other variability measure) of the burst BEP samples of the frame, and mapping these parameters onto the FEP. Finally, the FEP value is used to calculate whether the particular frame was in error.

With SAIC, the receiver performance typically depends on the interference environment in a non-trivial manner. Therefore, the burst CIR alone is not sufficient to determine the burst BEP. Earlier investigations [] have shown that a good way to characterize the interference situation in a particular burst is to use the DIR (for definition, see clause 5) in addition to the CIR. A link-to-system interface for a SAIC receiver would then map burst CIR and burst DIR to burst BEP in stage one, and proceed as described above for stage two. The mappings used in the first and second stages are illustrated in figure 6-1 and 6-2, respectively (these figures are for illustration purposes only and do not show actual performance).

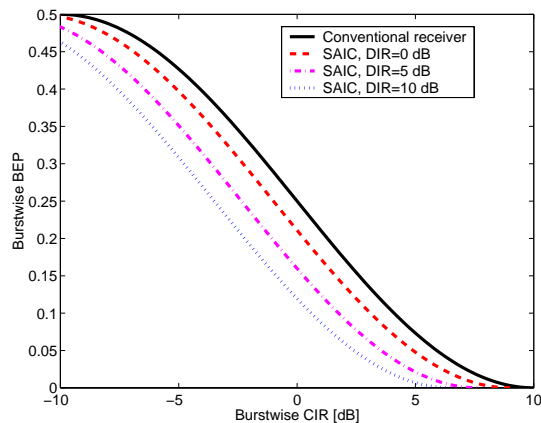

Figure 6-1. Illustration of stage one mapping. The curves show burst-wise BEP versus burst-wise total CIR for SAIC receivers with different DIR. The performance of a conventional receiver has also been included and is assumed to be independent of DIR.

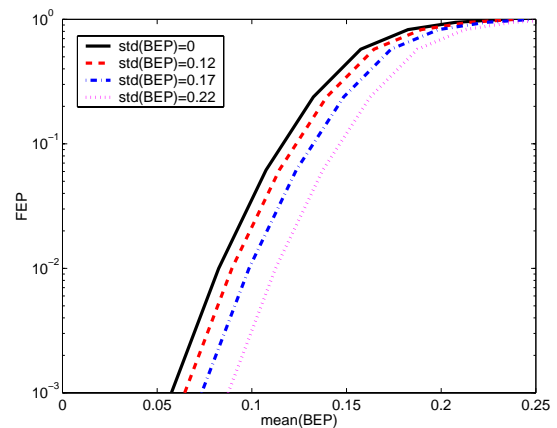

Figure 6-2. Illustration of stage two mapping. The curves show FEP versus mean(BEP) for different std(BEP).

Simulated performance curves from different sources, corresponding to those illustrated in figure 6-1 and figure 6-2, can be found in annex Y. These have been achieved as follows:

- The stage one mapping (burst-wise performance) is achieved by logging the burst-wise DIR, CIR and (raw) BER from each burst in a link level simulation. The bursts are then binned in a two-dimensional "grid", depending on their DIR and CIR. For each bin, the BEP is calculated by averaging the bit error rates of the individual bursts in that bin. The resulting BEP curves are presented as a function of mean of burst CIR and parameterized with DIR.
- The stage two mapping (frame-wise performance) is achieved from the same type of simulations as the stage one mapping, with the addition that frame errors after channel decoding are also logged. The BEP values described above are grouped in groups of eight (corresponding to the speech frames) and the mean and standard deviation for each frame is calculated. The frames are then binned in a two-dimensional "grid", depending on their mean(BEP) and std(BEP). For each bin, the FEP is calculated as the average FER of the frames in that bin. The resulting FEP curves are presented as a function of mean(BEP) and parameterized with std(BEP). Note that a simpler, one dimensional mapping may also be considered. In this case, the std(BEP) is not used.

7 SAIC system level characterization

7.1 Introduction

In this clause, the system level performance of GSM networks with SAIC capable terminals is characterized. System level simulation results for GMSK voice services are presented for the four network configurations described previously in clause 4 of this document. The results presented show the voice system capacity that a network can support when all terminals are SAIC capable. Results are also shown, which describe the system performance as a function of SAIC terminal penetration rate. In addition, results are presented showing the effect of SAIC on GPRS throughput performance. The following clauses describe the methodology employed to develop the system capacity and throughput estimates along with the results. Clause 7.2 describes the link-to-system level mapping required to 'map' the SAIC link level characterization described in clause 6 into a GSM system level simulator. Clause 7.3 describes the framework of the system level simulator including all of the key system assumptions. Clause 7.4 presents the voice system capacity results for both synchronous and asynchronous networks, and as a function of mobile penetration. Clause 7.5 describes the GPRS analysis including a description of the data traffic models and the resulting throughput performance. Finally, clause 7.6 provides a summary along with the relevant conclusions that can be drawn.

7.2 Link-to-system mapping

Two stages of mapping are required to properly map the link level results for conventional and SAIC receivers into the system level simulators. For SAIC receivers, the first stage of mapping attempts to define the average of the burst BER as a function of the burst CIR and burst DIR. This mapping is defined by running link level simulations and collecting BER statistics on a per burst basis. The mean CIR is set to some nominal value, while the mean interference powers are set per the defined interference profiles. The Rayleigh fading imposed on top of the desired signal and some of the interferers will cause variation in the CIR and DIR. In this way the BER 'bins' corresponding to different values of burst CIR and burst DIR will be filled in. Note that multiple simulation runs at different CIR values may be required to adequately fill in all of the bins. For conventional receivers, there is only a mapping between burst CIR and burst BER, since there is little dependence upon the DIR. In the second stage of this process the frame error probability (FEP) of a speech frame is determined based on the average and standard deviation of BER over the speech frame [1].

7.3 System level simulator

In this clause, the framework of the system level simulator used to develop the voice system capacity and GPRS throughput results is described. System simulators have been used extensively in the past to estimate the voice and data capacity of GSM and GPRS/EDGE networks. Most of these simulators actually assume a 'synchronized' GSM network even though the vast majority of GSM deployments to date are non-synchronized (asynchronous). A synchronized network implies that the transmitted bursts (slots) from all of the BTSs modelled in the simulator completely overlap one another. The reason that the synchronization assumption is invoked is that it becomes computationally prohibitive to introduce sub-slot delays into the simulator framework. In addition, up until the SAIC feasibility study, it has been more or less assumed that there is little loss in the accuracy of system capacity estimates under the synchronized assumption, although this has not been verified in detail. However, the performance of SAIC receivers is known to be dependent upon the delay between the desired signal and the interfering signals. Thus, it is important to understand SAIC performance for both synchronous and asynchronous conditions. To circumvent the problem of developing an asynchronous system simulator, which was estimated to be a very complex and time-consuming task, it was agreed to use synchronous system simulators for both synchronous and asynchronous network evaluations. To account for asynchronous operation, a second link level characterization was performed, whereby the interfering signals had the characteristics of an asynchronous network. Thus, 'first-stage, link-to-system level' mappings were developed for both synchronous and asynchronous interferers as described in clause 6.

Four network scenarios or configurations have been evaluated to determine the voice capacity gain that SAIC might provide. These four configurations are defined by a unique set of system parameters, and a common set of system parameters defined in Tables 1 and 2 of clause 4, respectively. The unique set of system parameters include: designation of synchronous or asynchronous operation, frequency of operation, useable bandwidth, reuse pattern, the type of hopping (baseband or RF), the voice codec, whether the system is blocking limited or soft-limited, the modulation combinations of interest for the desired and interfering signals, and the cell radius. The common set of parameters include such parameters as: number of sectors per site (3), BTS antenna pattern, propagation model, standard deviation of log-normal fading, etc. The following will briefly describe each of the configurations along with a discussion of some of the common parameters that may need additional explanation beyond that provided in Table 2 of clause 4. Note all of the configurations are primarily concerned with the performance of SAIC on the hopping layer. This is where SAIC is expected to give its maximum voice capacity gain, and thus, is the primary emphasis of this study. SAIC will also provide benefits for BCCH carriers – e.g. in terms of link frame erasure rate for SAIC users – but because of the typical sparse reuse pattern (4/12) the capacity gains will not be as high as on the hopping layer. The metric used for evaluation of voice performance for the interference-limited configurations is frequency load, which is defined herein to be the number of erlangs carried over the number of hopping time slots. For example, for a sector with 6 hopping carriers, a frequency load of 40% corresponds to 19.2 erlangs of traffic. Note the terms frequency load, effective frequency load, and load are used interchangeably in this clause. For the blocking-limited configuration, the metric employed is the satisfied user percentage for a predefined load since the load is essentially constant under these conditions.

Configuration 1 is representative of a typical 'European' deployment of GSM at 900 MHz. Asynchronous operation is assumed with a total bandwidth of 7.8 MHz. The BCCH is deployed in a 4/12 reuse pattern and thus, requires 2.4 MHz of bandwidth. The remaining 5.4 MHz of bandwidth is deployed in a 3/9 reuse pattern, which implies three frequencies per sector not counting the BCCH frequencies. Baseband hopping is assumed, which implies that the voice traffic channels hop through the BCCH frequencies. The speech codec is the AMR FR at 12.2 kbps, which is assumed to provide performance nearly equivalent to the FR and EFR. The reuse pattern is sparse enough so that a blocking limit of 2% is specified. The modulation combinations of interest are GMSK/GMSK and GMSK/8PSK, where the first entry is the desired signal and the second entry is the interferer. A 500 meter cell radius is assumed.

Configuration 2 is representative of a GSM deployment of limited spectrum as might be encountered in the United States. Both synchronous and asynchronous networks are of interest. Frequency of operation is 1900 MHz with a total bandwidth of 1.2 MHz deployed in a 1/1 reuse pattern for the hopping layer. This implies six hopping carriers per sector over which random RF hopping is deployed. The tight reuse implies that the capacity will be soft-limited by the interference generated as opposed to a hard blocking limit encountered in sparser reuse. Thus, the fractional load at which the network is operated is the primary performance measure. The AMR 5.9 FR and HR speech codecs are assumed. The modulation combinations of interest are GMSK/GMSK, GMSK/8PSK, 8PSK/GMSK, and 8PSK/8PSK. The cell radius is assumed to be 1000 meters.

Configuration 3 is also representative of a GSM deployment of limited spectrum as might be encountered in the United States, but with greater spectrum availability than that of configuration 2. Synchronous operation is the primary interest while study of asynchronous operation is optional. The frequency of operation is 900 MHz¹² with a total of 2.4 MHz deployed in a 1/1 reuse pattern for the hopping layer. This implies twelve hopping carriers per sector over which random RF hopping is deployed. As with configuration 2, fractional load is the performance measure and the speech codecs are assumed to be AMR 5.9 FR and HR. The modulation combinations of interest are GMSK/GMSK and the cell radius is assumed to be 750 meters.

Configuration 4 is another example of a possible 'European' deployment of GSM at 900 MHz. Asynchronous operation is assumed. The frequency of operation is 900 MHz and 7.2 MHz of bandwidth is assumed to be deployed in a 1/3 reuse pattern for the hopping layer. This implies twelve hopping carriers per sector over which random RF hopping is deployed. As with configuration 1, the AMR 12.2 FR speech codec is assumed and a 2% blocking limit is specified. The modulation combinations of interest are GMSK/GMSK and GMSK/8PSK. A cell radius of 300 meters is assumed.

All four network configurations are assumed to have three sectors per cell site, which corresponds to the vehicular environment deployment model given in UMTS 30.03. Each cell is configured with an antenna whose horizontal pattern corresponds to the pattern specified in UMTS 30.03. The propagation model specified in UMTS 30.03 as the path loss model for the vehicular test environment is used for this study. The received signal is assumed to be affected by log-normal fading with a standard deviation of 6 dB for 900 MHz deployments and 8 dB for 1900 MHz deployments. Log-normal fading tends to be correlated over short distances and a log-normal correlation distance of 110 meters is assumed. Inter-site log-normal correlation is assumed to be zero.

Voice calls are generated in the system simulator based on Poisson call arrivals and exponential call durations. The call arrival rate is set according to the frequency load that is to be simulated in the network. The mean call duration is assumed to be 90 seconds, with a minimum call duration of five seconds. A voice activity factor of 60% (including SID signalling) is assumed and discontinuous transmission (DTX) is assumed to be enabled in the network.

Downlink power control (DPC) is enabled in the system simulator for all four network configurations. A common DPC algorithm for the SAIC Feasibility Study was not specified but it was agreed that the DPC algorithm used should be based on RXQUAL and RXLEV. All system level simulations assume a DPC dynamic range of 14 dB and a step size of 2 dB.

7.3.1 Satisfied user definition

To determine voice system capacity it is necessary to define what is meant by a 'satisfied user'. During the study two definitions for a satisfied user were proposed and they are as follows:

- Option 1: The speech quality is measured over the duration of one call. The speech quality is considered satisfactory if the FER is not higher than 2% (the user is said to be satisfied). The network capacity is defined as the network load at which X% of the users are satisfied, where X = 95%, except where noted.
- Option 2: The speech quality is measured over periods of 1.92 seconds (i.e., four SACCH periods). The speech quality (of one particular link) is considered satisfactory during the period if the frame erasure rate (FER) is not higher than 2%. The network capacity is defined as the network load at which the speech quality is satisfactory in X% of the measured 1.92 second periods, where again X = 95%, except where noted.

One must note that each option may have a different capacity for an identical system. [5] suggests the difference is small, but nonetheless caution must be observed when comparing results when different options were used.

¹² Although U.S. deployments would be better characterized at 850 MHz, there is little loss in accuracy using the European 900 MHz frequency.

7.4 System level simulation results

The results for the system simulations are presented in Clauses 0 and 0. Clause 0 presents the results obtained during the feasibility study for 100% SAIC loaded systems versus a benchmark of a system with 100% conventional users¹³.

Clause 0 presents the impact of SAIC mobile penetration rate on the system's performance and on the performance of non-SAIC users.

7.4.1 System capacity for 100% SAIC mobile penetration

In the next six sub-clauses results are presented for asynchronous operation for all four of the configurations, and synchronous operation for configurations 2 and 3. Synchronous system performance results may be expected to match closely with what will be seen in actual deployments. However, for asynchronous networks, the system results may only be approximate due to the complex nature of the link-system mapping in asynchronous networks [6]. The general trends shown for the asynchronous network cases should, however, hold when a real network is deployed, but the absolute capacity of those networks may be different.

7.4.1.1 Configuration 1 – unsynchronized network

In this clause, results are shown for configuration 1 under asynchronous operation. Since this configuration is blocking-limited, the voice performance metric employed to characterize the SAIC gain is the satisfied user percentage for the load associated with 2% blocking, which for the assumed bandwidth and reuse is about 23 erlangs [7]. The satisfied user percentages are shown in Table 7.1 for 100% conventional mobiles and 100% SAIC mobiles. The satisfied user definition corresponding to option 1 was assumed, except that the percentage was allowed to vary. The percentage gain is also shown in the table as the ratio of the respective satisfied user percentages. As expected, the SAIC gain is fairly small for blocking-limited conditions since the 'highest' gains are only achievable in interference-limited conditions. However, SAIC is shown to still provide some gain in the overall user experience. For another perspective on how to quantify gain for this configuration see clause 7.4.3.

Table 7.1. Satisfied user percentage for Configuration 1.

Source	Satisfied user percentage for predefined load (2% blocking)		
	100% Conventional	100% SAIC mobiles	Percentage Gain
Siemens	96.1 %	99.5 %	3.4%

7.4.1.2 Configuration 2 – synchronized network

In this clause, results are shown for configuration 2 under synchronous operation. The loads corresponding to 95% satisfied users are shown in Table 7.2 for 100% conventional mobiles and 100% SAIC mobiles. The number in () defines the option used for the satisfied user definition. The percentage gain is also shown in the table as the ratio of the respective loads. The satisfaction percentage as a function of load is shown in Figure 7.1 for two types of SAIC receivers and for penetration rates of 50 and 100%, respectively. Performance for 100% conventional mobiles is also shown in the figure. Note the effects of mobile penetration rates other than 100% will be discussed in clause 7.4.2.

Table 7.2. Load at which 95% of users are satisfied, Configuration 2 – synchronous.

Source	LOAD for which 95% of Satisfied Users is reached.		
	100% Conventional	100% SAIC	Percentage Gain

¹³ The definition of a conventional terminal and its performance differs between companies. For details on this discussion please refer to Clause 6.

		mobiles	
Motorola¹⁴	34.75 (1)	47.25 (1)	35.9 (1)
Siemens	31.7	50.2	58.4%

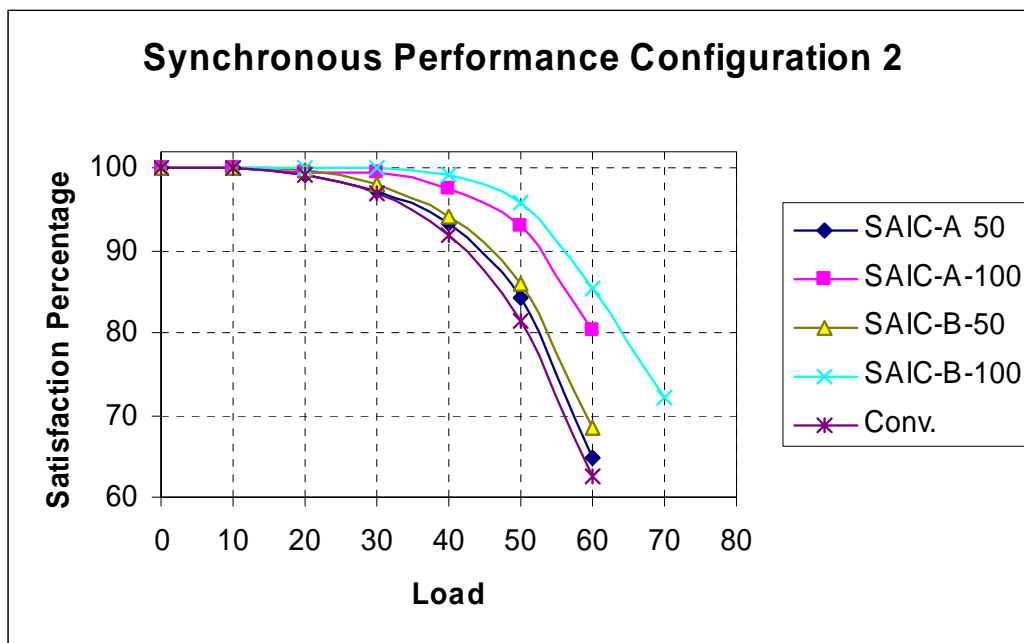

Figure 7.1. System performance for Configuration 2 - Synchronous [8].

7.4.1.3 Configuration 2 – unsynchronized network

In this clause, results are shown for configuration 2 under asynchronous operation. The loads corresponding to 95% satisfied users are shown in Table 7.3 for 100% conventional mobiles and 100% SAIC mobiles. The number in () defines the option used for the satisfied user definition. The percentage gain is also shown in the table as the ratio of the respective loads. The satisfaction percentage as a function of load is shown in Figure 7.2 for two types of SAIC receivers and for a conventional receiver all at 100% penetration.

Table 7.3. Load at which 95% of users are satisfied, Configuration 2 – asynchronous.

	LOAD for which 95% of Satisfied Users is reached.		
Source	100% Conventional	100% SAIC mobiles	Percentage Gain
Motorola	34.00 (1)	43.25 (1)	27.2 (1)
Siemens	31.7	47.1	48.6%

¹⁴ Motorola's performance here is for a receiver architecture denoted SAIC-A in [9]. A different receiver structure SAIC-B provides better SAIC system gains for synchronous networks.

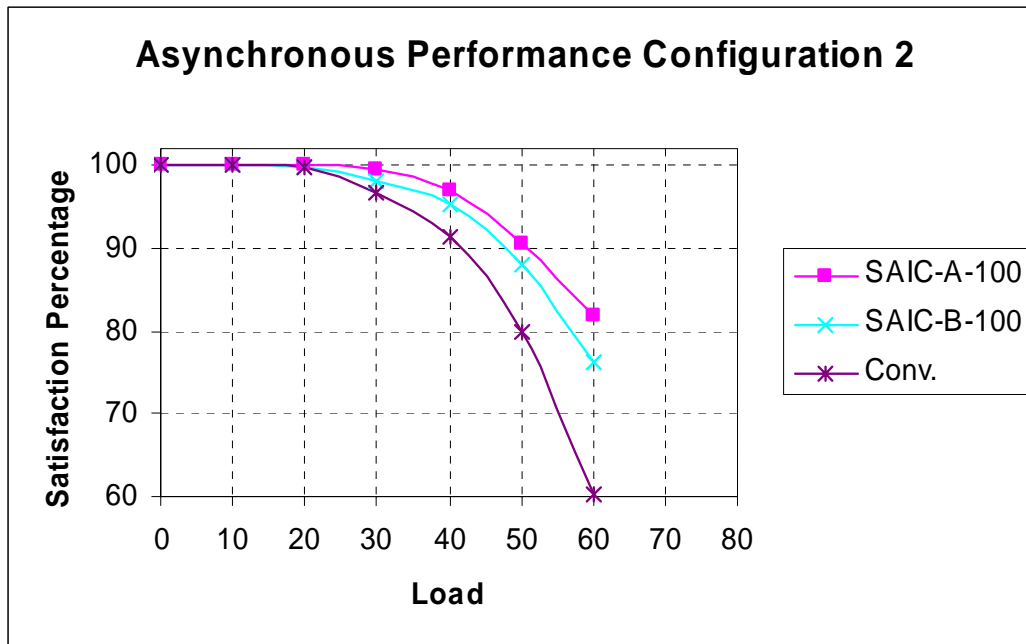

Figure 7.2. System performance for Configuration 2 – Asynchronous [8].

7.4.1.4 Configuration 3 – synchronized network

In this clause, results are shown for configuration 3 under synchronous operation. The loads corresponding to 95% satisfied users are shown in Table 7.4 for 100% conventional mobiles and 100% SAIC mobiles. The number in () defines the option used for the satisfied user definition. Note that Nokia elected to evaluate both satisfied user options and although the loads supported were found to be different, the relative gains were found to be the same. The percentage of bad quality calls, which is equal to 100 minus the satisfaction percentage¹⁵, is shown in Figure 7.3 as a function of load for an SAIC receiver and a conventional receiver both at 100% penetration. Curves are shown for FER averaging over the call (designated as A) and over 1.92 seconds (designated as B).

Table 7.4. Load at which 95% of users are satisfied, Configuration 3, synchronous.

Source	LOAD for which 95% of Satisfied Users is reached.		
	100% Conventional	100% SAIC mobiles	Percentage Gain
Motorola	33.50 (1)	48.75 (1)	45.5 (1)
Nokia ¹⁶	20.9 (1)	32.0 (1)	53.1 (1)
	22.4 (2)	34.3 (2)	53.1 (2)
Siemens	37.0 (1)	51.0 (1)	37.8 (1)
Cingular	35.8 (2)	51.2 (2)	42.8 (2)

¹⁵ The 95% satisfaction percentage is equal to the 5% bad quality call percentage.

¹⁶ Nokia numbers for AMR 7.4 codec. A direct comparison therefore should not be made with different companies' performance, however the trend of showing gains for SAIC are still present.

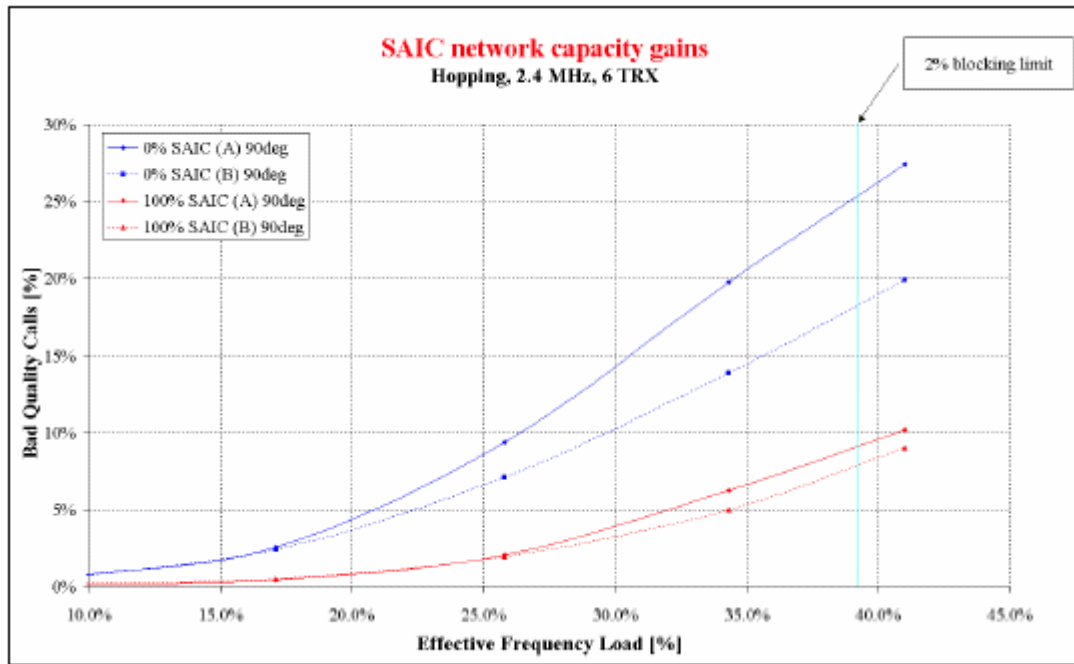

Figure 7.3. System performance for Configuration 3 – Synchronous [10].

7.4.1.5 Configuration 3 – unsynchronized network

In this clause, results are shown for configuration 3 under asynchronous operation. The loads corresponding to 95% satisfied users are shown in Table 7.5 for 100% conventional mobiles and 100% SAIC mobiles, along with the respective gain. The number in () defines the option used for the satisfied user definition. The satisfaction percentage is shown in Figure 7.4 as a function of load for an SAIC receiver and a conventional receiver both at 100% penetration.

Table 7.5. Load at which 95% of users are satisfied, Configuration 3, asynchronous.

Source	LOAD for which 95% of Satisfied Users is reached.		
	100% Conventional	100% SAIC mobiles	Percentage Gain
Motorola	29.75 (1)	40.25 (1)	35.3 (1)
Siemens	34.0 (1)	49.0 (1)	44.1 (1)

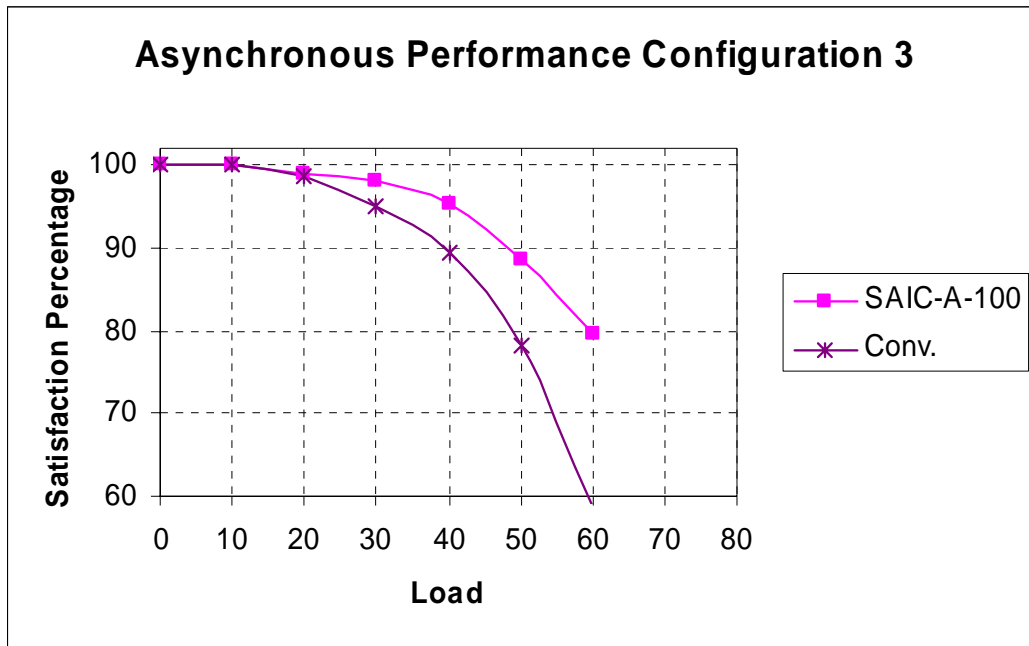

Figure 7.4. System performance for Configuration 3 – Asynchronous [8].

7.4.1.6 Configuration 4 – unsynchronized network

In this clause, results are shown for configuration 4 under asynchronous operation. The loads corresponding to 95% satisfied users are shown in Table 7.6 for 100% conventional mobiles and 100% SAIC mobiles, along with the respective gain. The number in () defines the option used for the satisfied user definition. The satisfaction percentage is shown in Figure 7.5 as a function of load for a SAIC receiver and a conventional receiver both at 100% penetration.

Table 7.6. Load at which 95% of users are satisfied, Configuration 4, asynchronous.

Source	LOAD for which 95% of Satisfied Users is reached.		
	100% Conventional	100% SAIC mobiles	Percentage Gain
Motorola	49.50 (1)	66.50 (1)	34.3 (1)
Siemens	47.2 (1)	76.0 (1)	61.0 (1)

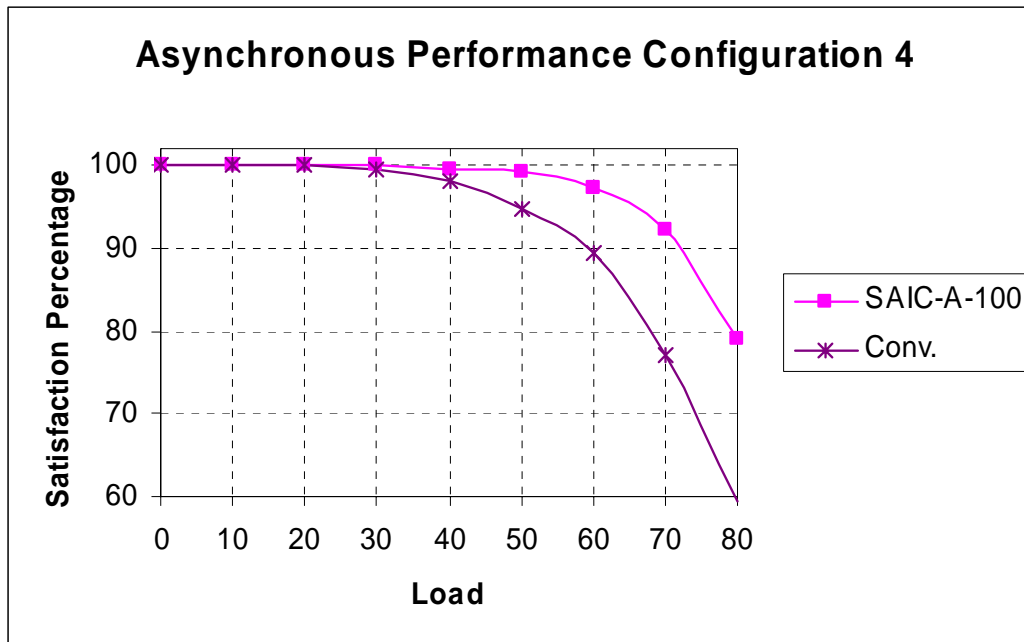

Figure 7.5. System performance for Configuration 4 - Asynchronous. [8]

7.4.2 Impact of SAIC Mobile Penetration

In clause 7.4.1, voice system capacity results were presented assuming 100% penetration of SAIC capable mobiles (except for Figure 7.1, which did show some results for a 50% penetration rate). In this clause we investigate the effects of SAIC mobile penetration on system capacity. Figure 7.6 shows the system capacity as a function of the frequency load for configuration 3 under synchronous operation as the SAIC terminal penetration rate goes from 0% to 100%. The results shown in Figure 7.6 are based on the Philips SAIC and Philips conventional receivers [2]. As the SAIC terminal penetration increases the overall system capacity gradually starts increasing with the peak capacity obtained at 100% penetration. The resulting gains in system capacity as a function of penetration are shown in Figure 7.7. The gains shown are with respect to a network with 0% SAIC terminal penetration (i.e. all terminals are conventional receivers). Capacity gain due to SAIC is not linearly related to SAIC terminal penetration. Hence, for low to moderate terminal penetration rates, SAIC is expected to provide its primary benefit in terms of immediate improvement in call quality (and GPRS throughput) of SAIC-enabled terminals, with the secondary benefit of modest system capacity gain. For high terminal penetration rates, SAIC is expected to provide both, improvement in call quality of SAIC-enabled terminals as well as large gain in overall system capacity.

In Figure 7.8 results are compared from Cingular (SBC Labs), Motorola, and Siemens as presented in GERAN contributions [2] [3] and [4]. This comparison is not totally normalized because the results generated by Motorola and Siemens are based on FER averaged over the entire call duration (option 1), while the Cingular results are based on FER averaged over 1.92 seconds (option 2). Another difference is that the Cingular results are based on Philips' SAIC algorithm while those of Motorola and Siemens are based on their own respective SAIC algorithms. Nevertheless, such a comparison is useful to validate the non-linear nature of the relationship between SAIC terminal penetration and SAIC capacity gain. In spite of the difference in assumptions, all three sets of results show a similar non-linear relationship between system capacity gain and SAIC terminal penetration. More importantly, all three show a significant SAIC gain at 100% penetration.

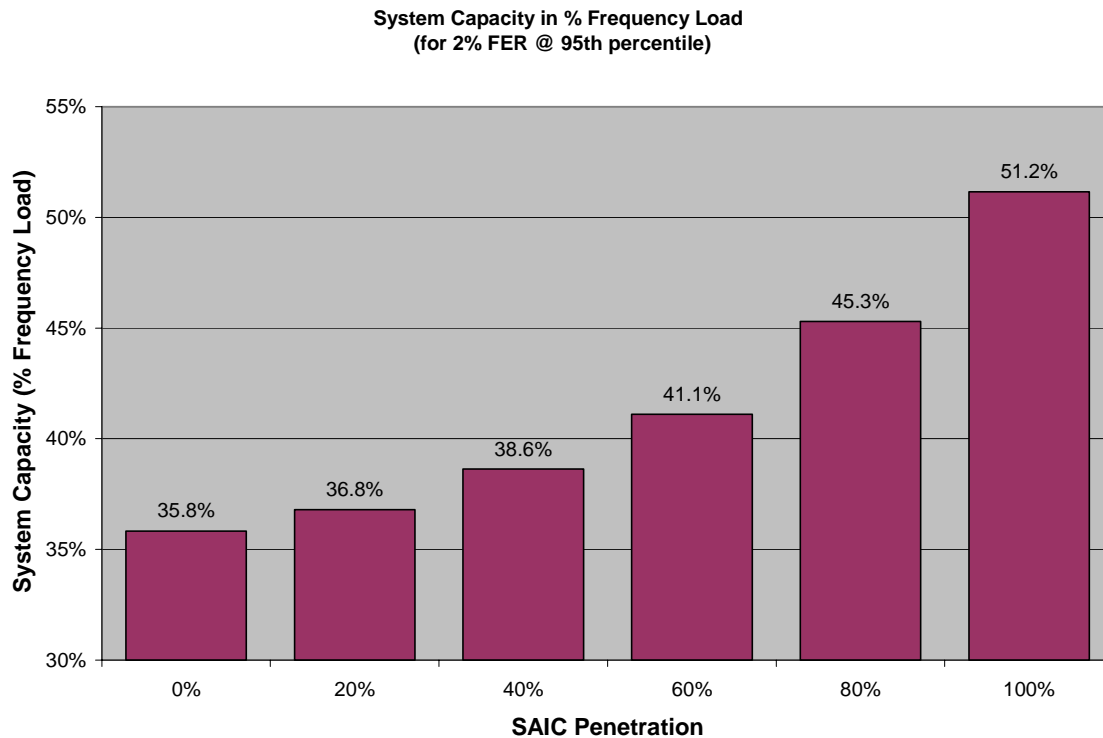

Figure 7.6. System capacity versus SAIC terminal penetration rate for Configuration 3 [2]

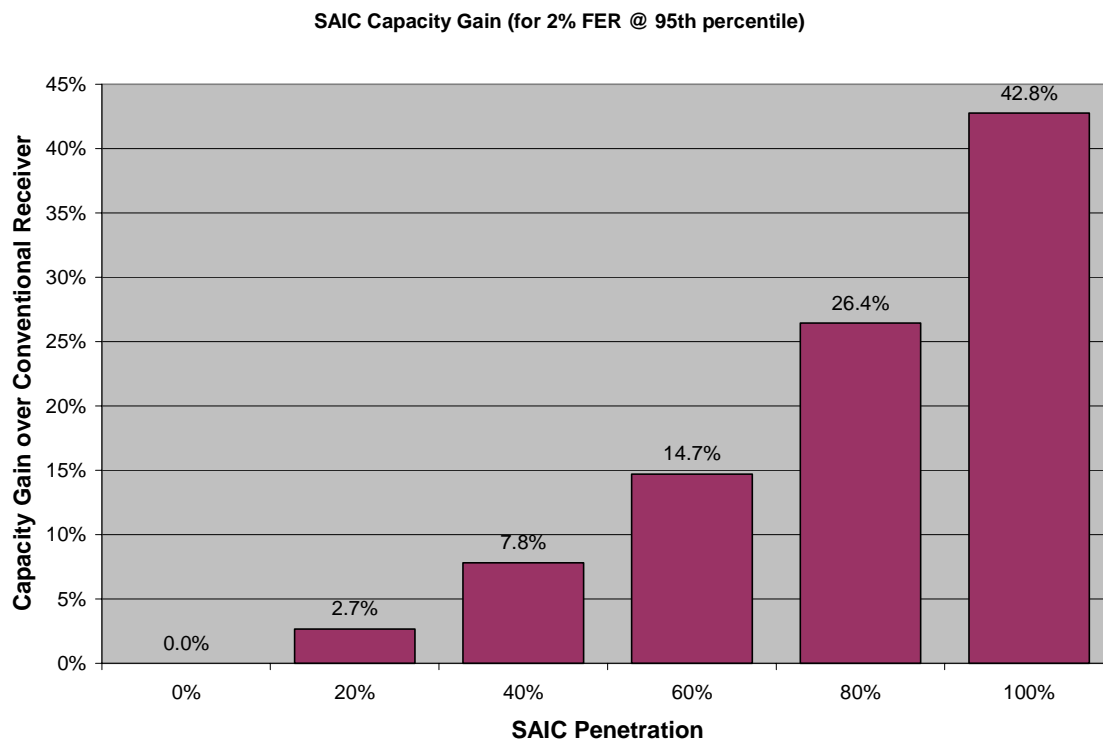

Figure 7.7. Gain in system capacity versus SAIC terminal penetration rate for Configuration 3 [2]

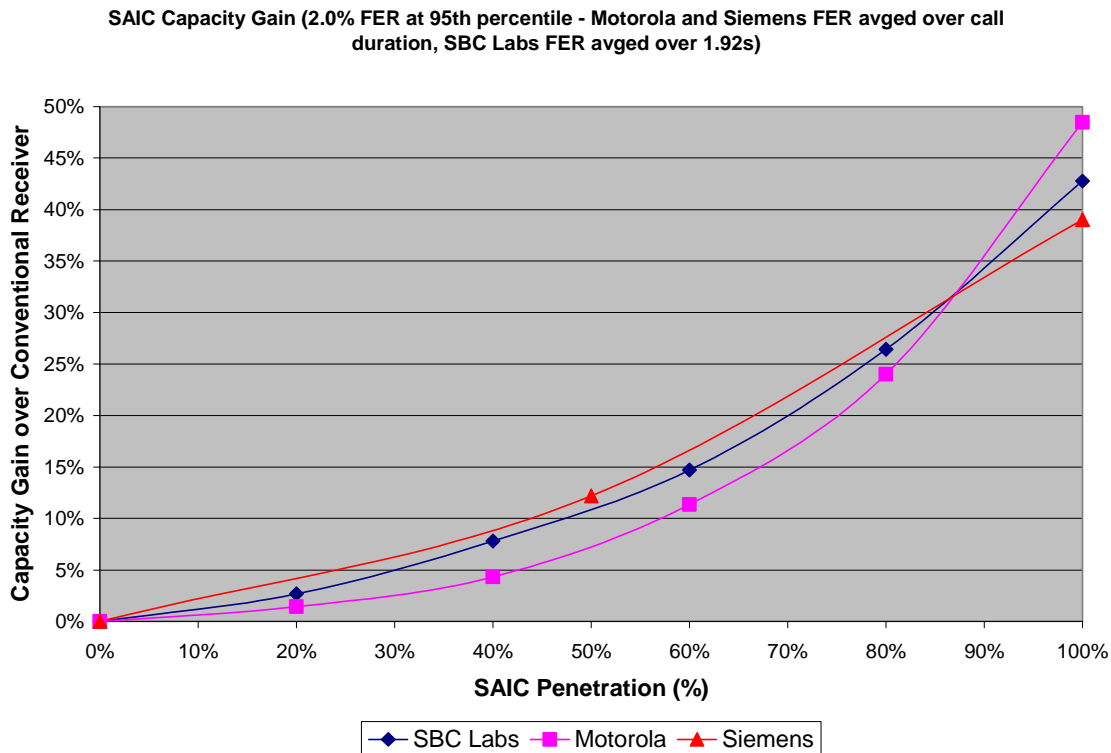

Figure 7.8: Comparison of results presented at TSG-GERAN [2]

In addition to investigating the effect of mobile penetration on system capacity, this study also examined the effect of penetration on the non-SAIC or conventional, legacy mobiles. Figure 7.9 shows results developed by Cingular for configuration 3 [11], which illustrate the outage probabilities experienced by non-SAIC terminals, SAIC terminals, and the total population of terminals for SAIC terminal penetration rates ranging from 0% to 100% for a fixed FL = 50%. Obviously, the 50% FL is too high for the lower SAIC terminal penetration rates, which is why the outage probabilities are large for those cases. For the 100% penetration rate, the outage probability falls below the target of 5%.

The results of Figure 7.9 indicate that the outage probability experienced by non-SAIC terminals decreases as the SAIC terminal penetration rate increases. As the SAIC terminal penetration increases, it is believed that the downlink power control algorithm is able to drive down the power for an increasing number of mobiles. This can be seen in Figure 7.10, which shows the probability distribution functions of carrier power measured at the terminals as the SAIC terminal penetration rate increases from 0% to 100%. This decrease in power is believed to reduce the overall interference in the network as the SAIC terminal penetration increases, thus reducing the outage probability of non-SAIC terminals in the network.

Similar results developed by Nokia are shown in Figures 7.11 and 7.12, also for configuration 3 [12]. From these latter two figures, it is clearly seen that the presence of SAIC mobiles in the network also helps the conventional users. The SAIC mobiles are able to use lower power levels, which mean that they also transmit less interference to other users. This is illustrated in Figure 7.12 where the carrier and interference distributions are plotted. With increased (5% -> 95%) SAIC penetration the interference (and carrier) powers are decreased, leading to improved performance also for the conventional mobiles.

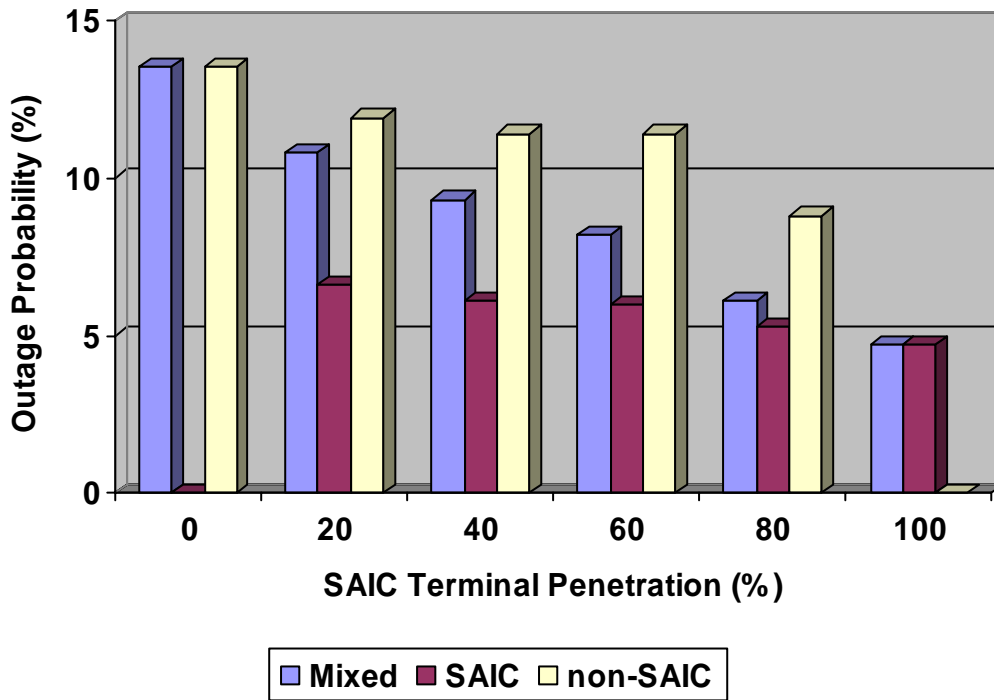

Figure 7.9. Outage probability versus SAIC terminal penetration rate for 50% FL (Results for Configuration 3) [11]

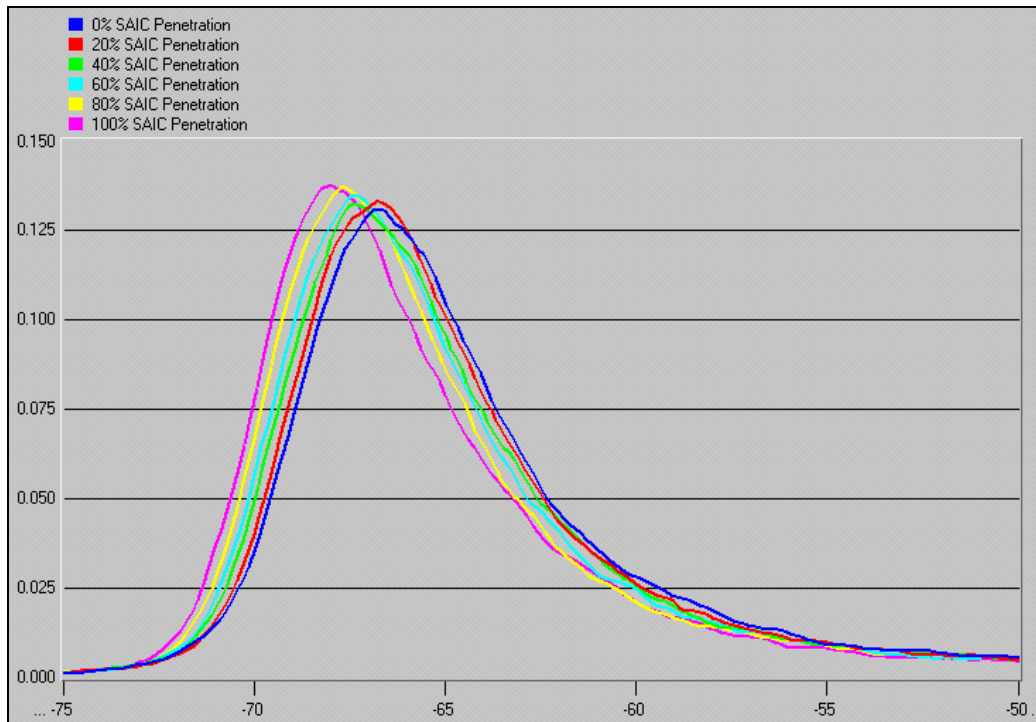

Figure 7.10. PDF of carrier power (dBm) for various SAIC terminal penetration rates (Results for Configuration 3) [11]

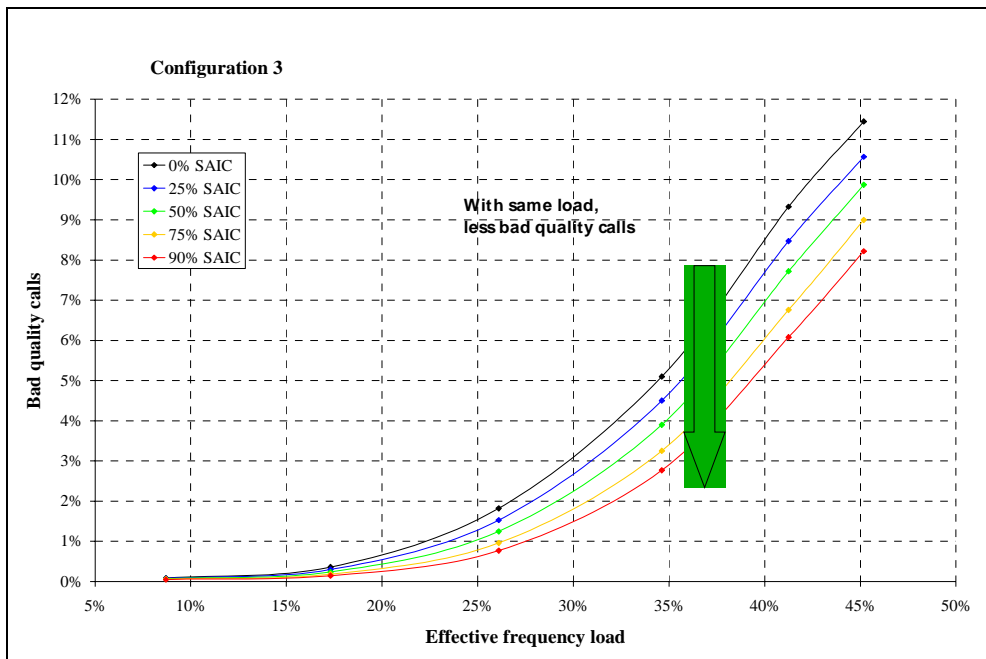

Figure 7.11. Changes in non-SAIC user experience as a factor of SAIC penetration rate for Configuration 3 [12].

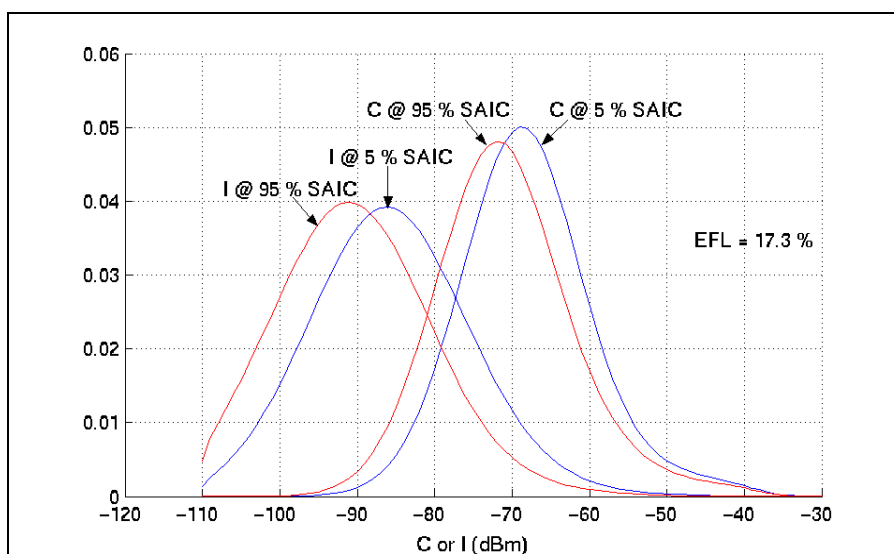

Figure 7.12. Effect of SAIC penetration on carrier (C) and interference (I) power distributions.

7.4.3 Additional results

In this clause results are presented, which do not explicitly conform to the network scenarios defined in clause 4, but are of interest nonetheless.

7.4.3.1 Effect of antenna patterns and Quality of Service (QoS) on system capacity

During the SAIC feasibility study, the effect of antenna beamwidth and QoS (satisfaction percentage) on system capacity results was discussed. The default antenna pattern specified in clause 4 has a 90-degree beamwidth (at 3 dBi point), which may not be the best choice from a capacity point of view. The antenna pattern may also have an effect on the SAIC gains because it changes the DIR distribution experienced by the MS. To give some insight into this issue, simulations were made with both a 90-degree and a more efficient 65-degree beamwidth. The effect of different levels of QoS was also investigated. Figure 7.13 shows the voice capacity gain of a system with 65 degree antennas as a

function of SAIC terminal penetration, two different Quality of Service (QoS) measures (95% and 98% satisfied users), and the two satisfied user definitions specified in 7.3.1 (Option 1 = A, Option 2 = B). As shown in the figure, the higher QoS (98%) actually translates into higher gain approaching 56% at 100% penetration compared to 46% for the lower QoS (95%). The effect of the two satisfied user definitions turns out to be fairly negligible.

Figure 7.14 also includes the effect of the two different beamwidths, and indicates that the antenna pattern does affect the SAIC gain, but that the effect is not that large. With a wider beamwidth the gains are actually 5-10% greater than the narrower beamwidth. The reason for this is that although the narrow beamwidth supports higher absolute performance, there is actually less interference in the system to cancel and thus, the SAIC gain is not as large.

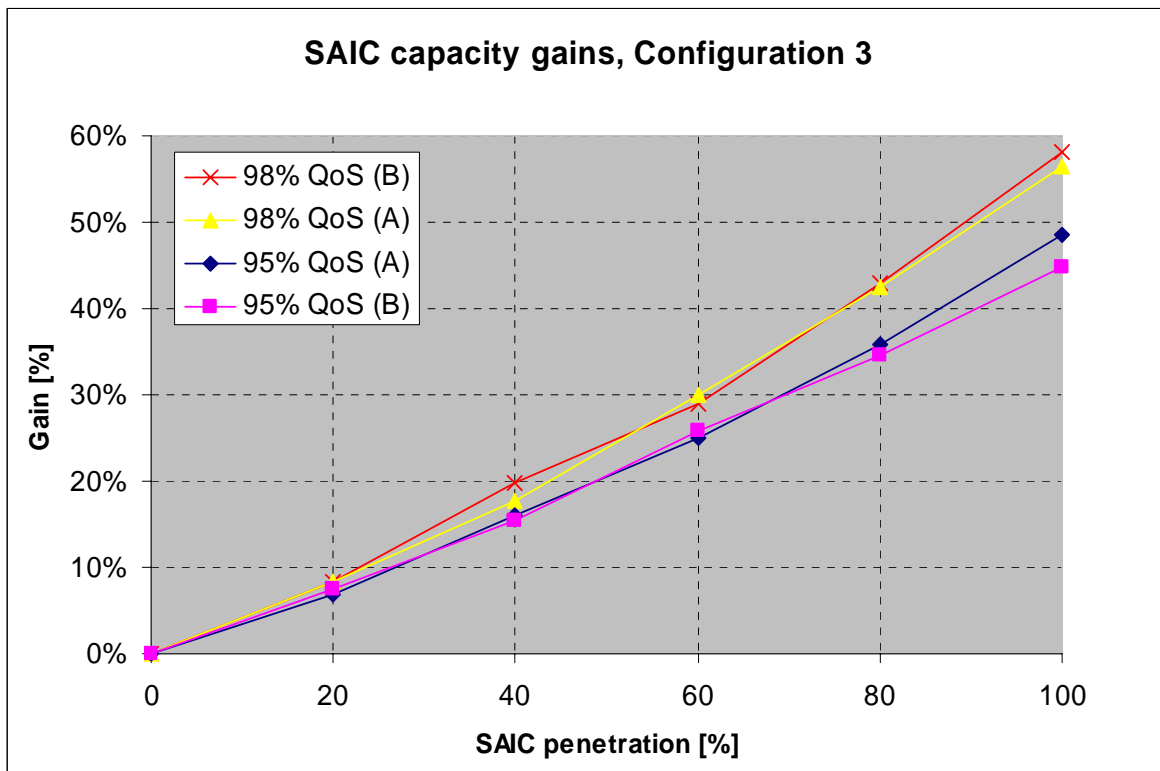

Figure 7.13. SAIC capacity gain as a function of SAIC penetration. A = call level averaging, B = 1.92 sec. averaging. 95% and 98% satisfied user ratios and 2% FER criteria. [5].

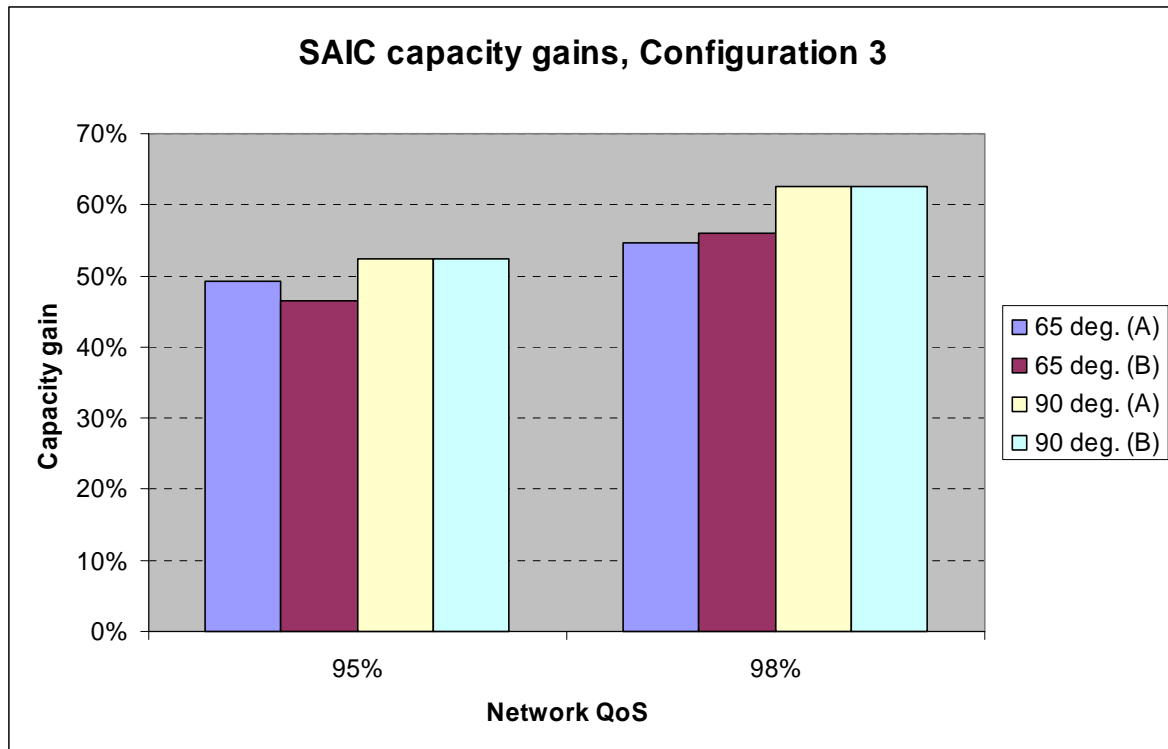

Figure 7.14. SAIC capacity gain with two different antenna patterns. A = call level averaging, B = 1.92 sec. averaging. 95% and 98% satisfied user ratios and 2% FER criteria. [5].

7.4.3.2 System performance for Configuration 1, another perspective

In clause 7.4.1.1, the SAIC gain for configuration 1 was defined in terms of the increase in the percentage of satisfied users as opposed to the increase in load, which is the voice metric used for all of the other configurations. The reason that the gain is defined differently is that configuration 1 happens to be blocking-limited for the target quality threshold considered (FER = 2%), and thus, the load is essentially constant. However, by lowering the FER threshold to 0.6% (thereby increasing the quality and the required C/I), configuration 1 was found to be interference-limited for certain loads, and thus, the increase in load can be used to quantify SAIC gain [13]. Figure 7.15 shows the percentage of bad quality calls as a function of effective frequency load for three levels of SAIC penetration, 0%, 50% and 100%. As shown in the figure, performance eventually becomes blocking-limited as the load increases. However, extrapolating the linear region of each curve to the 2% point (blocking limit), load estimates are obtained for each of the penetration levels as follows: 0% = 6.25 EFL, 50% = 7.3 EFL, 100% = 8.4 EFL. The resulting gains for the 50% and 100% penetrations are 17% and 34%, respectively. These results are based on synchronous operation and the use of the AMR 12.2FR. The percentage decrease in performance in going from synchronous operation to asynchronous for configurations 2 and 3 is estimated to be about 23-24%. If we use the 24% value then the gains adjusted for asynchronous operation of configuration 1 are about 13% and 26%, respectively. Thus, at this different QoS point, SAIC is shown to provide modest gain even for configuration 1.

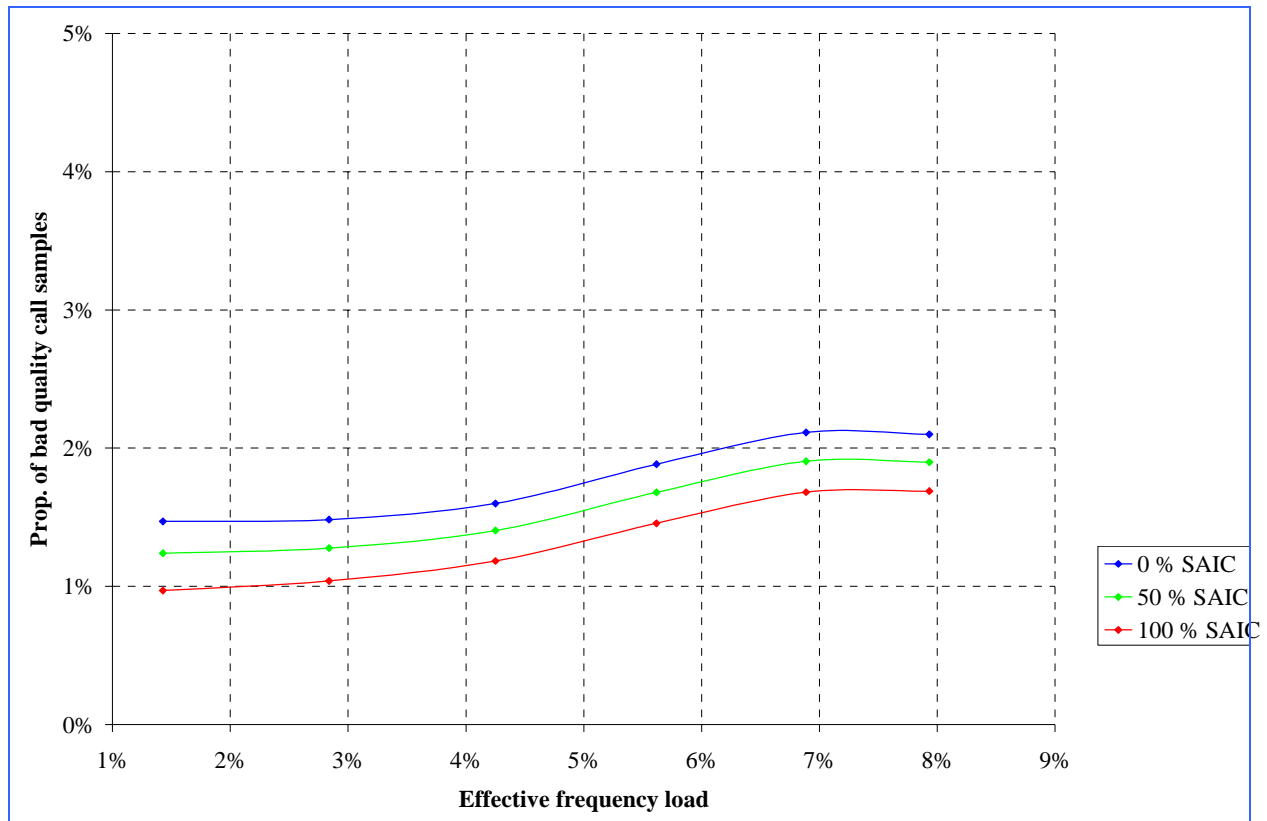

Figure 7.15. System performance for configuration 1, another perspective.

7.4.3.3 Impact of 8-PSK interference on GMSK SAIC performance

Another concern addressed by this study was the effect of 8-PSK interference on the performance of a GMSK transmitted signal processed by an SAIC receiver. In [14], this concern was addressed for both a single co-channel interferer, and the GERAN interference model defined in Table 5-1 for configuration 2. The simulation results presented in [14] indicate that there is gain of 2.5 to 3.0 dB for the single co-channel condition, and 0.8 dB for the GERAN model, when the GMSK interferers are replaced by 8-PSK interferers in each of these conditions. Thus, based on these results we can conclude that the presence of 8-PSK interference will not degrade the performance of a GMSK SAIC link, and in fact will provide some level of gain, albeit not as great as when the interference is GMSK.

7.5 The effect of SAIC on GPRS performance

Although the potential capacity gain of SAIC for GMSK voice services has been the primary focus of this study, it is also important to determine if SAIC will provide benefits for the GPRS packet data service as well. Since GPRS employs GMSK modulation there will be an improvement in both the raw BER and BLER [15], and thus, there should be a corresponding improvement in throughput. To verify this, system level simulations were conducted, which included a mix of speech and GPRS traffic. Two data traffic models were defined - a web-browsing model and an FTP/MMS model. The main parameters of the web-browsing model are summarized in Table 7.6 with a complete definition provided in [16]. This model is a hybrid model based on other existing models with suitable modifications for use on a GPRS bearer. The model includes packet segmentation at the transport layer (TCP/IP), which is based on measurement data and published literature. The model was tested with a system level simulator to verify realistic traffic patterns. The second data traffic model is representative of FTP and MMS applications, and has characteristics very similar to speech traffic.

Table 7.6 Main parameters for web-browsing data traffic model.

General parameters		
Parameter/algorithm	Value	Comment
Downlink power control	OFF	
Link adaptation	OFF	
Coding scheme	CS-2	(For EGPRS: MCS-7)
Number of slots in DL (max)	3	
Session arrival	Poisson arrivals, $\lambda = 5$ calls/hour/terminal	
Traffic model parameters		
Variable	Distribution	Parameters
Number of packet calls in a session	Geometric with cut-off	Mean = 5, cut-off = 15 (=> true mean \approx 4.5)
Packet call size [bytes]	Pareto with cut-off	$\alpha = 1.1$; $k = 2.25$ (kBytes) $m = 225$ (kBytes)
Reading time between packet calls	Geometric	Mean = 5 seconds
Number of packets in packet call	Determined by IP packet size distribution and call size	Mean = 18.3
Packet size	Semi-empirical	Mean = 577.2 bytes
Packet inter-arrival time	Geometric	0.1443 seconds (for input bit rate of 32 kbps)

In order to perform a system level simulation of GPRS it is necessary to define the stage 1 link-to-system level mapping as described for voice services in clauses 6 and 7.2. Extensive system simulations were conducted as described in clause 5 to define the interference models, which were used in the link level characterization to produce the stage 1 mapping for voice services. There was much to be gained if these voice stage 1 mappings could be reused for evaluating data performance, provided of course that the accuracy of the GPRS results were not compromised. That the voice mapping can be reused is definitely the case for the FTP/MMS data traffic model since the characteristics are very similar to a circuit-switched voice connection. However, this conclusion had to be verified for the web traffic model.

In [17] system level simulations were conducted, which showed that the statistics of a combination of voice and web-browsing data users were quite similar to the voice-only statistics for network configuration 3 at 40% FL. Table 7.7 summarizes those findings where the various ratios of the dominant co-channel interferer to the other interferers are shown for the baseline voice-only system, and what the voice and data user experiences for three different data loads. As shown in the table the values of all of the interference ratios decreased by only 0.5 to 1.0 dB. In addition [17] also investigated the effect on the CINR, DIR and DIR₂ distributions, and found that the CINR at the 10% point decreased by about 1 dB, while the median values of DIR and DIR₂ decreased by 0.5 to 0.7 dB, and 0.2 to 0.3 dB, respectively. These small differences in the interference ratios and shifts in the distributions are not expected to have much of an effect, if any, on the link-to-system level mappings. We base this latter statement on the fact that the stage 1 mappings for voice at 40% and 70% FL for network configuration 3 were nearly identical, and the difference in interference ratios between these two loads was of the same order (1-2 dB) as the differences between voice-only and voice plus data described above. Thus, the voice-only stage 1 mapping can be used for the web traffic model defined herein.

Table 7.7. Interference ratios in dBs comparing the baseline voice only and voice plus data for three different data loads (30, 60 and 90 web-browsing data users per sector) [GP-040225].

Interference Ratio	Baseline – Voice	Voice plus Data					
		Voice Users			Data Users		
		30	60	90	30	60	90
Ic1/Ic2	7.3	6.8	6.7	6.7	6.9	6.8	6.8
Ic1/Ic3	12.7	12.0	11.8	11.8	12.0	11.9	11.9
Ic1/Icr	13.0	12.1	11.8	11.8	12.2	11.8	11.9
Ic1/Ia	15.1	14.9	14.6	14.7	13.7	13.2	13.6
Ic1/Iar	18.4	17.7	17.3	17.4	17.1	16.7	16.8

Having defined the data traffic models and stage 1 link-to-system level mappings required, one can now conduct system level simulations to determine the potential benefit of SAIC for GPRS. The results of a system simulation for a mix of voice (70% of the traffic) and web-browsing data users (30%) are shown in Figure 7.16 for network configuration 3 [18]. Figure 7.16 depicts speech call quality and GPRS throughput as a function of the frequency load and penetration of SAIC terminals in the network. The speech quality is defined in terms of the proportion of bad quality calls (100 minus the satisfaction percentage), averaged over SAIC and non-SAIC terminals. The voice codec used was the AFS5.9 with DTX and a voice quality threshold of 2% FER. The GPRS throughput is averaged over the duration of the session, and is also averaged over SAIC and non-SAIC terminals. Figure 7.16 clearly shows that SAIC provides gain in both voice capacity and data throughput. Figure 7.17 depicts the gain in GPRS throughput as a function of the frequency load and SAIC terminal penetration. This latter figure shows that the relative gain is almost linear with frequency load for 100% penetration even though the absolute throughput is decreasing. The range of throughput gain is a modest 2.5 to 13.5% for 100% penetration.

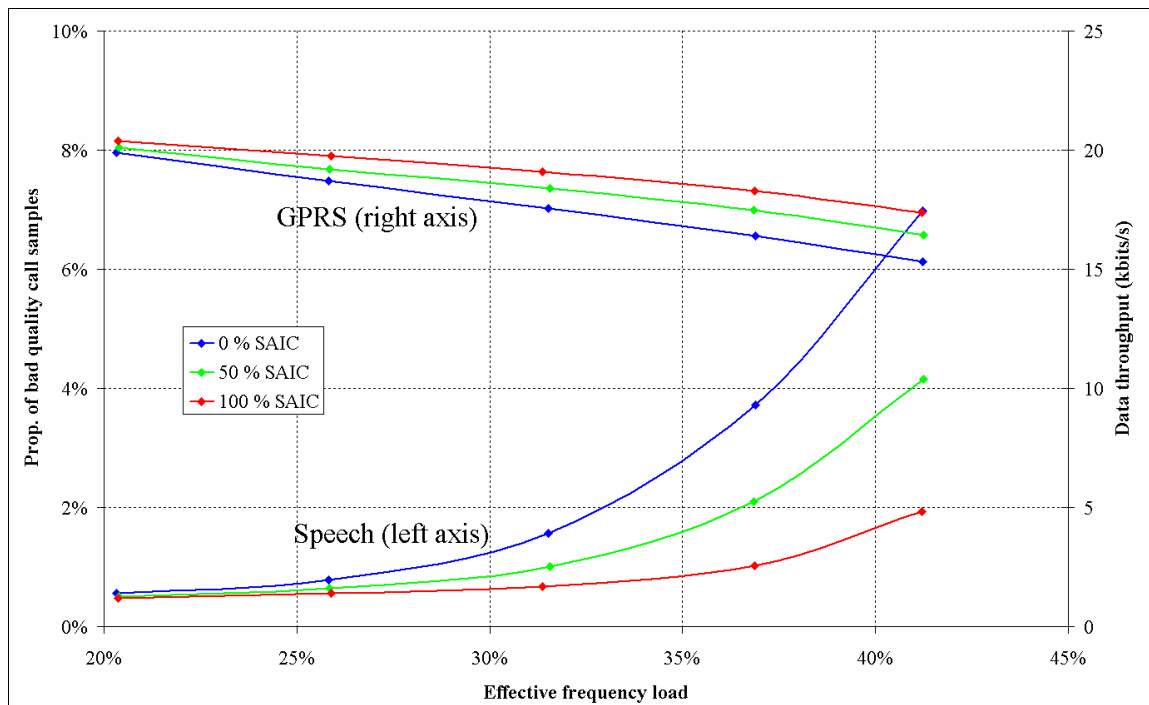

Figure 7.16: Speech and GPRS performance indicators for web data traffic.

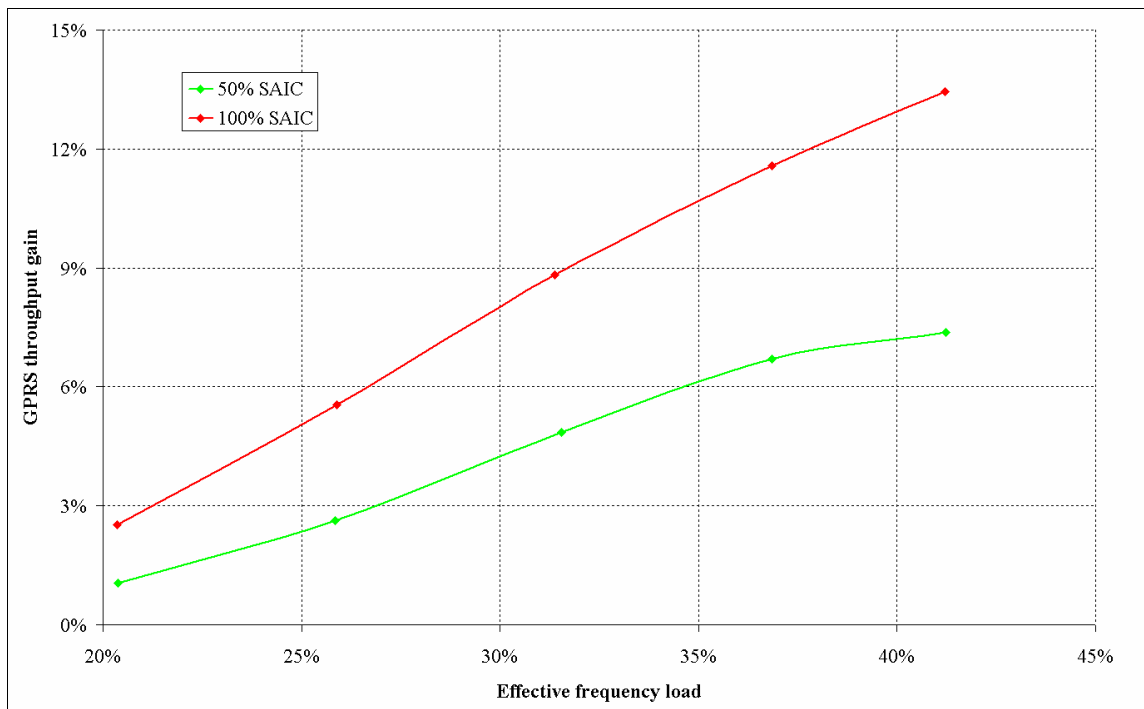

Figure 7.17: GPRS throughput gain for web data traffic.

The results of a similar system simulation for a mix of voice and FTP/MMS data users in shown in Figure 7.18 for network configuration 3 [19]. As with the web traffic model simulation, Figure 7.18 depicts speech call quality and GPRS throughput as function of the frequency load, while Figure 7.19 shows the gain in GPRS throughput also as a function of the frequency load. Figure 7.19 shows that the range of throughput gain for FTP/MMS traffic is 7-37% for 100% SAIC terminal penetration, which is quite a bit better than that achieved for web browsing traffic. The most likely reasons for this latter difference are that the CIR values with web traffic are higher on average, thus less SAIC gain, and the shorter data bursts translate into a higher percentage of overhead, thus decreasing useful data throughput. Nonetheless, SAIC supports throughput gains for both types of data traffic.

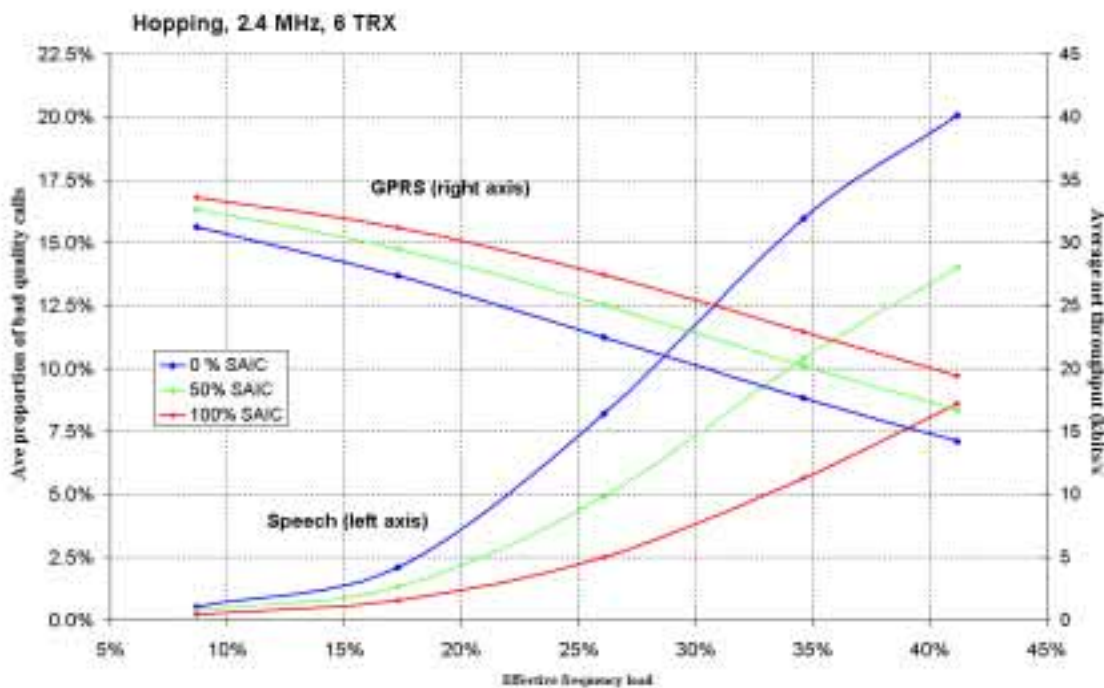

Figure 7.18: Speech and GPRS performance indicators for FTP/MMS data traffic.

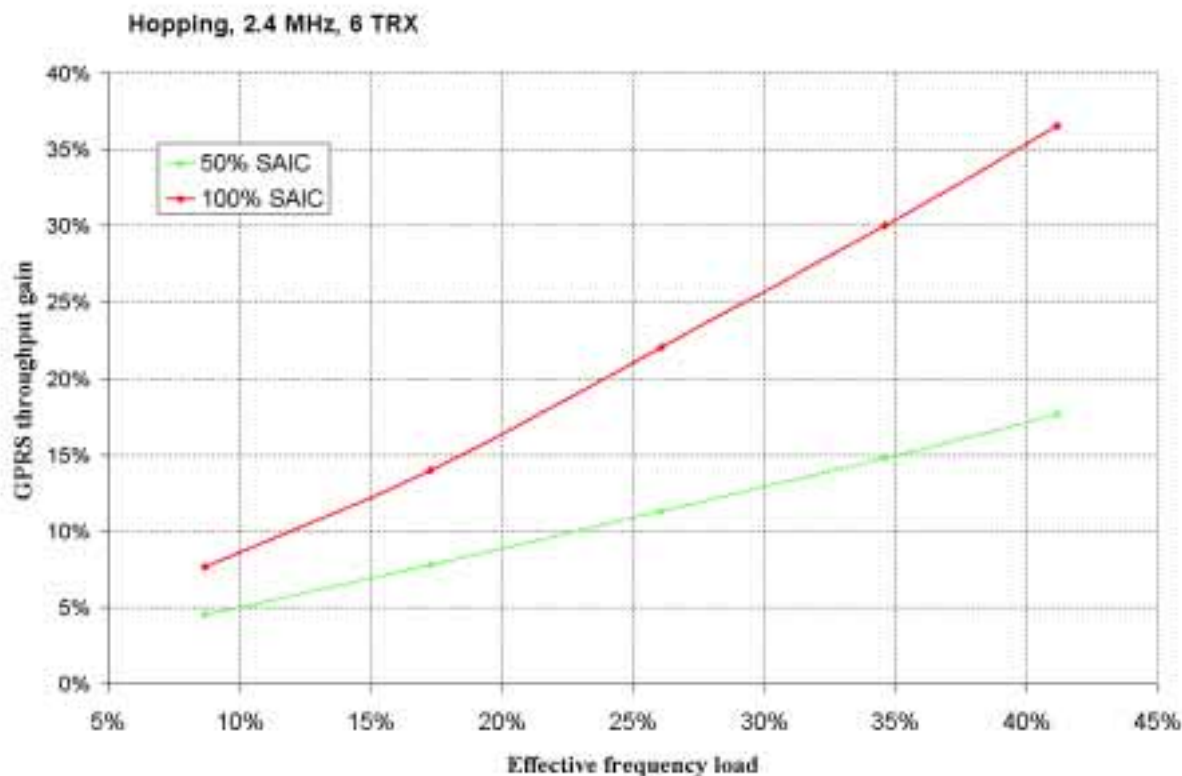

Figure 7.19: GPRS throughput gain versus load for FTP/MMS data traffic.

7.6 Summary and conclusions

In summary, SAIC is expected to provide system voice capacity gains for all four of the configurations studied, and for both synchronous and asynchronous operation as well. What is particularly impressive is that gains were observed for a number of different SAIC receiver implementations and system level simulators. The use of system level simulators has proven to be an effective method for evaluating the performance of new features like SAIC, and even though there were some differences between simulators, considerable effort was expended to make these simulators as representative of the real world as possible. As noted, the synchronous results are expected to be closer to what will be observed in the field, than the asynchronous results. Nonetheless, the gains shown for asynchronous operation do give the operators some confidence that gains will be realized in this environment as well.

The study has shown that the greatest gains are obtained for tighter reuse patterns where there is more interference to cancel, and for synchronous operation where limited, interferer time delays result in better SAIC receiver performance. The greatest gains are also achieved at 100% mobile penetration, although there are immediate benefits with the introduction of SAIC in terms of better voice quality and higher data throughputs. As a side benefit, the performance of non-SAIC mobiles is also expected to improve as SAIC is introduced due to the lower BTS transmit power levels required, which results in less overall downlink interference. SAIC was also shown to provide gains in GPRS throughput for both web-browsing and FTP/MMS type of applications. In conclusion, the results of this clause indicate that SAIC will provide significant gains in voice capacity and data throughput once 100% penetration is achieved, and that the impact to existing MSs is slightly improved performance as well.

References

- [1] H. Olofsson, et al, 'Improved Interface Between Link Level and System Level Simulations Applied to GSM', IEEE Vehicular Technology Conference, 1997.
- [2] GP-032588, 'SAIC System Capacity Results', Source Cingular.
- [3] GP-032107, 'Effect of SAIC Terminal Penetration on System Performance', Source Motorola.
- [4] GP-032023, 'System Performance Results for SAIC' Source Siemens.
- [5] GAHS-032649, 'SAIC network capacity with different antenna patterns and performance criteria' Source Nokia.
- [6] GAHS-030036, Ericsson, 'Working assumptions for capacity estimation for SAIC in unsynchronized networks', Chicago, USA 28-30 October 2003.
- [7] GP-041582, Siemens, 'System Performance for Network Configurations 1 and 3 for Draft Feasibility Study on SAIC', Bilbao, Spain, 21-25 June 2004.
- [8] GAHS-030029, Motorola, 'SAIC System Simulation Results', Chicago, USA, 28-30 October 2003.
- [9] GAHS-030030, Motorola, 'SAIC link level results', Chicago, USA, 28-30 October 2003.
- [10] GAHS-030040, Nokia, 'SAIC network capacity with different antenna patterns and performance criteria', Chicago, USA, 28-30 October 2003.
- [11] GP-032587, Cingular, 'Outage Probability due to SAIC for Legacy Mobiles', Budapest, Hungary, 18-20 November, 2003.
- [12] GP-032648, Nokia, 'The effect of SAIC terminal penetration on non-SAIC terminal performance', Budapest, Hungary, 18-20 November 2003.
- [13] GP-041691, Nokia, 'System performance results for SAIC network configuration 1', Bilbao, Spain, 21-25 June, 2004.
- [14] GP-031965, Philips, 'SAIC Link Performance for 8-PSK Interference (rev.)', New York, USA, 25-29 August 2003.
- [15] GAHS-030010, Cingular, 'Draft Feasibility Study on Single Antenna Interference Cancellation (SAIC) for GSM Networks (Release 6)', Atlanta USA, 8-9 January 2003.
- [16] GP-040408, Nokia, 'A GPRS traffic model for SAIC performance evaluation', Reykjavik, Iceland, 2-6 February 2004.
- [17] GP-040225, Cingular, 'Effect of GPRS Traffic on Interference Characteristics for SAIC Link Level Evaluation', Reykjavik, Iceland, 2-6 February 2004.
- [18] GP-041057, Nokia, 'SAIC gains with mixed speech and GPRS traffic', Cancun, Mexico, 19-23 April 2004.
- [19] GP-040909, Nokia, 'The effect of SAIC on GPRS performance', Reykjavik, Iceland, 2-6 February 2004.

8 SAIC field trials

In order to determine the viability of SAIC technology for GSM networks, Cingular Wireless conducted two separate field trials using a prototype SAIC mobile offered by Philips Semiconductors [1] [2]. The first trial was conducted in an operational, asynchronous (non-synchronized) GSM network. Network parameters were varied to determine performance as function of the Frequency Load (FL). A maximum gain of 2.7 dB in the C/I distribution at the 10% point was obtained at the maximum load. The second trial was conducted in a synchronized network, the status of which was pre-operational at the time of testing. Synchronized networks are expected to provide higher SAIC gains since the amount of overlap between the desired signal and the interference can be controlled. The results of this latter trial support the above conclusion, where a C/I gain of 4.5 dB was observed. The following clauses provide additional information for each of the respective trials.

8.1 Asynchronous network field trial

Cingular's Savannah market was chosen as the test market for the first asynchronous network trial of SAIC technology. The field trial took place in June 2002. Savannah is representative of a relatively mature GSM network, which employs Frequency Hopping (FH) on the voice traffic channels in a very tight 1/1 reuse, with the FL per sector ranging from 10-25%. The results of the trial indicated a gain in the downlink C/I distribution at the 10% points of 2.7 dB for the most heavily loaded test condition, Figure 8.1.1. This gain was measured by alternately toggling SAIC on and off every RXQUAL reporting period (0.48 s). Gain was also observed in terms of a reduction in the BER and FER as recorded by the mobile. For example, for the most heavily loaded condition, the probability of the BER being less than 3% increased from 75% to 82%, while the average FER decreased from 4.4% to 2.5%.

Additional testing was performed where the duty cycle of SAIC on to off was changed to see the effect SAIC might have on Downlink Power Control (DPC). The results of this latter testing at a SAIC on-to-off duty cycle of 15:1 indicated a decrease in the average BTS transmit power of 1.8 dB and a 1.3 dB decrease in the average received signal level at the mobile. In addition, the mobile reported RXQUAL was almost identical for both duty cycles indicating that performance was not compromised for the high SAIC on duty cycle condition.

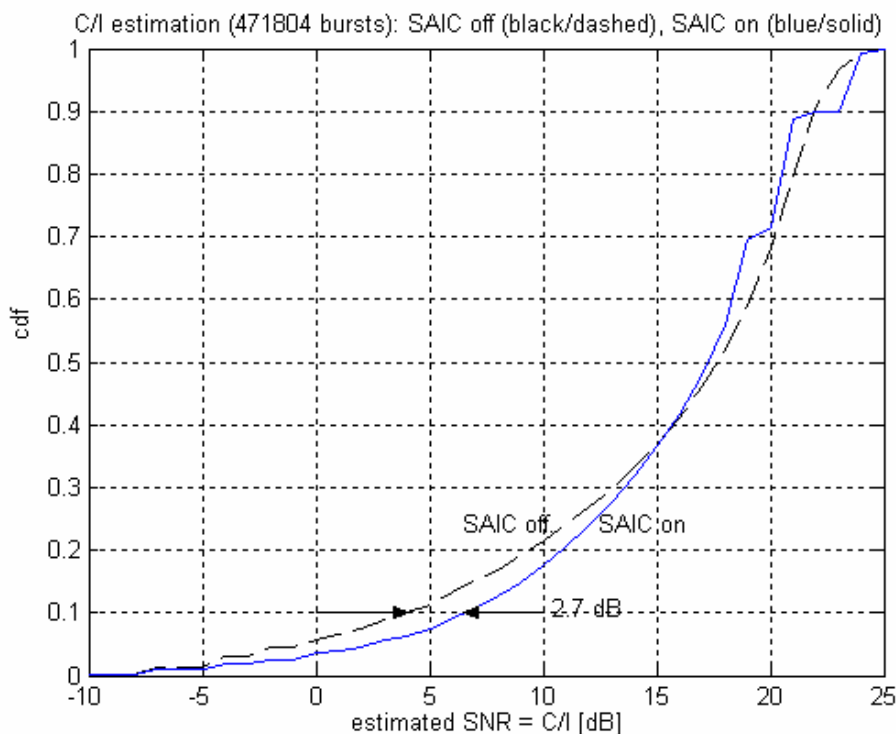

Figure 8.1.1. C/I distributions for asynchronous field trial.

8.2 Synchronous network field trial

To determine performance in a synchronized network the same SAIC Philips' prototype was tested in Cingular's Delaware market in November 2002. This trial was particularly useful as the Delaware network was pre-operational at the time of SAIC testing, and as such offered the unique capability to test SAIC under both synchronized and non-synchronized conditions. Tests were conducted for synchronized random FH with three and five interferers, and for non-synchronized random FH for one and three interferers..

The results of the synchronized random FH tests with five interferers indicate a gain in the C/I distribution of approximately 4.5 and 5.0 dB at the 10 and 20% points, respectively, as shown in Figure 8.2.1. The results of the same test for three interferers indicate a gain in the C/I distribution in the range of 2-3 dB. This decrease is expected since the network load was not as high as the five-interferer condition, and thus, there was not as much interference for SAIC to cancel.

For the non-synchronized tests, the amount of gain observed varied with the delay between the desired signal and the interfering signals. This was expected since as the delay increases a 'second' interferer begins to overlap the slot of

interest and thus, causes degradation in performance. For a single interferer, the gain in C/I distribution at the 10% points ranged from 0 dB when the delay was equal to about 80 symbols (near worst case) to 5.3 dB when the delay was less than 19 symbols. For the three-interferer tests the same trends were observed. The lowest gain of 1.6 dB was observed when all three interferers had delays of greater than 20 symbols, while a gain of 4.0 dB was observed when only one of the three had a delay greater than 20 symbols.

The conclusion from these trials is that SAIC will provide gains in both non-synchronized and synchronized networks, but that maximum gains will be achieved with a synchronized network, where the amount of overlap between desired signal and interference can be controlled.

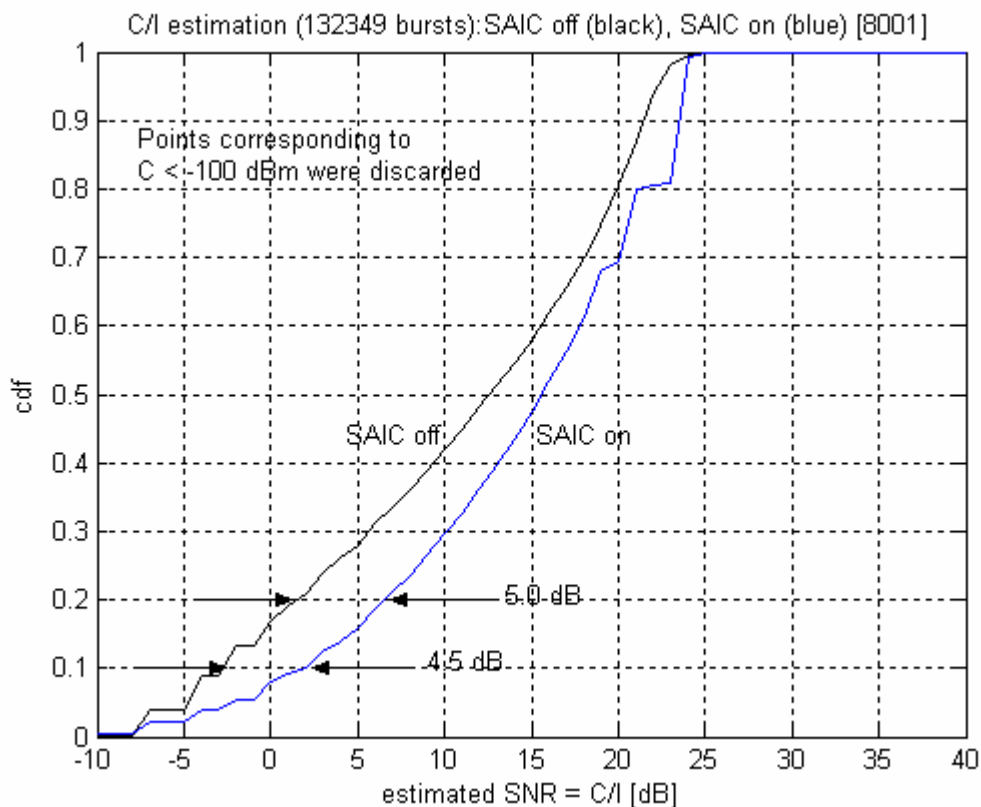

Figure 8.2.1. C/I distributions for synchronous field trial.

References

- [1] GP-022557, "Laboratory & Field Testing of Mono Interference Cancellation (MIC) for GSM Networks", Source: Philips Semiconductors, Cingular Wireless.
- [2] GP-032497, "SAIC Field Trials for Asynchronous and Synchronous GSM Networks", Source: Cingular Wireless.

9 Test considerations

9.1 Introduction

While it is not within the scope of the SAIC Feasibility Study to define detailed performance requirements for inclusion into e.g. 3GPP TS 45.005, nor detailed test scenarios for 3GPP TS 51.010 to verify conformance to those requirements, it is recognized that the Feasibility Study Technical Report should comment on the requirements and practicality of the test apparatus required to assess SAIC receivers.

This clause therefore briefly discusses the testing of SAIC capable MSs, which clearly is far from trivial. In the event SAIC is accepted by GERAN as a feasible technology (which is the recommendation of this report, see clause 12), more comprehensive studies will be needed both in TSG GERAN WG1 and WG3. Note some of these studies are already in

progress with preliminary test scenarios defined for both synchronous and asynchronous operation [GP-041572] [GP-041576]. In performing this work it is respectfully suggested that WG1 and WG3 take particular care to ensure that:

- a) the requirements which are adopted reflect and warrant those receiver performance improvements identified as feasible during the Feasibility Study phase, and in doing so, ensure the realisation of the original goals of the Feasibility Study,
- b) improvements in specific areas of receiver performance are not achieved at the expense of poorer performance in other areas, or by creating the risk of non-robust receiver operation under normal GSM/GPRS/EGPRS system conditions, and
- c) any effort to simplify the assessment criteria used by the Feasibility Study (in order, for example, to simplify test apparatus or procedures) should be done without risking adherence to item a) above.

9.2 Discussion

Conformance to the 3GPP TS 45.005 and 3GPP TS 51.010 specifications requires that a combination of narrowband and modulated signal sources be made available as part of the test apparatus. Fundamentally, however, the most commonly required test configuration can be summarized by the structure shown in Figure 9-1.

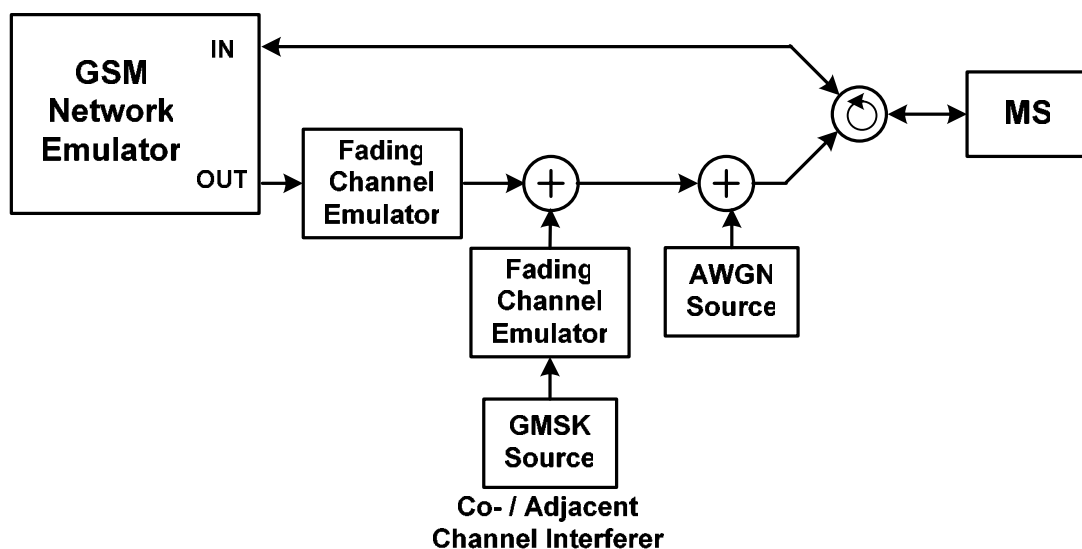

Figure 9.1: Summary – current MS test configuration¹⁷.

At the same time, however, in order to capture real-world network scenarios the synchronous and asynchronous link-level models identified by the SAIC Feasibility Study capture more complex interference scenarios, including:

- a) simultaneous generation of multiple, independently-faded, co- and adjacent channel interferers,
- b) burst-formatted interfering signals with randomly varying training sequences,
- c) randomly-selected interferer delays & frequency offsets, and
- d) interferer inter-burst phase changes, DTX (optional) and power control.

These scenarios were determined to be very important when investigating achievable link and system level performance gains for SAIC mobiles, and it is recommended that they are used as the starting point in determining test procedures and requirements for SAIC-enhanced terminals. If TSG GERAN determines that direct implementation of these scenarios is an essential part of SAIC terminal assessment, one possible approach to synthesising such signals in real-

¹⁷ No AWGN test signal is currently specified in 51.010 although available in most test equipment.

time appears in Figure 9-2¹⁸, where a general-purpose streaming signal source is used to generate multiple interfering signals which are agile in terms of embedded training sequence, delay and frequency offset etc.

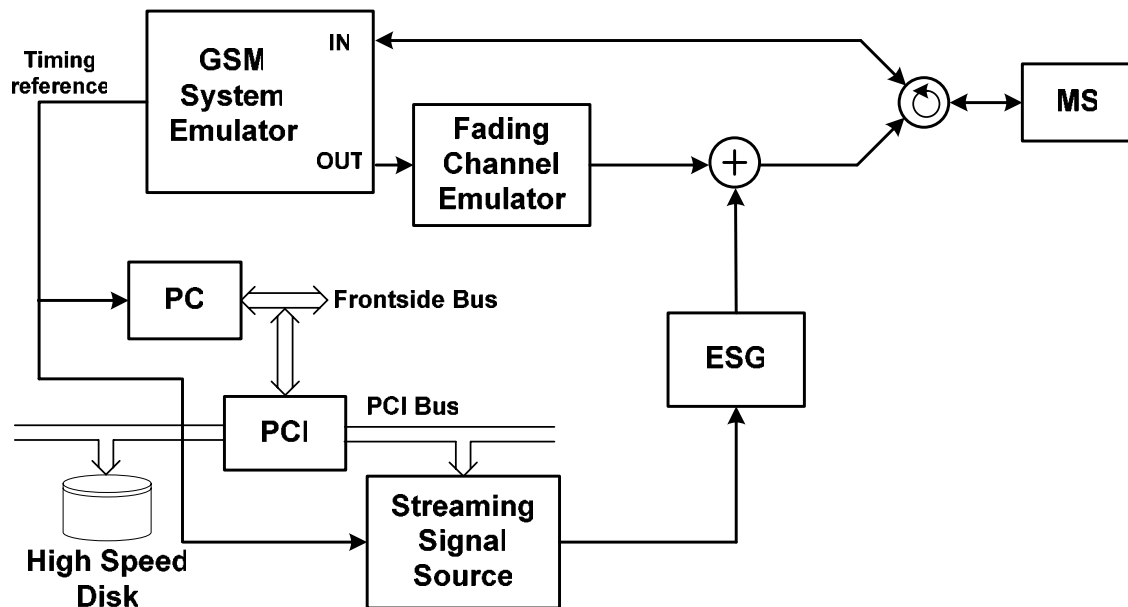

Figure 9.2: Alternative potential configuration for complex test signal scenario generation.

It is also recognized, however, that support for such an approach could represent a considerable technical and economic challenge and may well be too complex to realise in practice. Accordingly, it may be necessary to consider which elements of the GERAN interference models are necessary to verify conformance, and how the models could potentially be simplified.

In considering potential simplifications, the following considerations and options should be considered.

Requirement for Simultaneous Co- and Adjacent Channel Interference – Although the current CIR and DIR definitions do not discriminate between interferer types (i.e. co- or adjacent channel), it may be possible to reduce the required number of simultaneous discrete interferers by restricting performance assessment to be *either* on the basis of co-channel *or* adjacent channel performance. Alternatively if a combined test is seen as necessary, a single co- or adjacent channel interferer could be combined with residual interferers to model more complex scenarios.

Structured Interfering Signals – A departure from the currently-specified continuous, randomly-generated interfering signal definition can be principally divided into a) selection of an interfering burst type, and modification of the interfering signal power burst envelope, and b) modification of the interfering symbol content. It is obviously commonplace to generate interfering signal bursts compliant with the envelope definition of 3GPP TS 45.005, and the normal burst could be a natural choice when synthesising transmitted waveforms for test purposes.

Similarly, generation of an interfering signal with a pseudo-randomly generated training sequence and pseudo-randomly generated data payload is not fundamentally difficult¹⁹. Indeed, training sequences (TSCs) could be selected on a per-burst basis, or – if this was not feasible – selection of constant TSCs per interferer could also be considered. However, either change would most likely require upgrading of test apparatus, depending on the capability of the signal generators currently available to each tester, and could also make calibration of e.g. interferer power marginally more difficult. One possible simplification would be to require only that a specified bit sequence (i.e. tail bits, data payload, and training sequence) be periodically applied to the interfering signal, and that the interfering signal remain a continuously-modulated waveform.²⁰

¹⁸ All of the outline equipment configurations proposed in this clause should be regarded as 'potential' configurations; i.e. the identification of a preferred configuration is for further study.

¹⁹ Such a test signal is currently not available in 3GPP TS 51.010.

²⁰ Note that the nominal 156.25 symbol normal burst duration may create further difficulties with this approach.

Number of Interfering Signals – The GERAN models currently define a total of 3 co-channel interferers, plus a residual co-channel interferer. Synthesis of the residual co-channel interference term could, with the addition of an appropriate filter, be achieved relatively straightforwardly using the apparatus of Figure 9.1. Using the discretely-configured apparatus of Figure 9.1 as a guide, however, a requirement to synthesise 3 co-channel interfering signals could be challenging, since it would imply a requirement for multiple discrete fading channel emulators. An obvious alternative is to reduce the number of co-channel interferers to 2 or even a single interferer. Restricting testing to be performed only with a single interferer would, however, represent a significant departure from the GERAN models, and therefore testing under dual interferer conditions could represent a practical compromise.²¹ For test apparatus where the desired signal fading is handled by the system emulator, this would require the provisioning of only a single dual-channel fading emulator. A possible system configuration appears in Figure 9-3. Importantly, however, the relative power of the interfering signals would need to be established by further work, as would the equivalence (in terms of guaranteeing performance) of this configuration compared to the link scenarios generated in the GERAN Feasibility Study.

Interferer Frequency Offset – The GERAN models currently specify a normally distributed interferer frequency offset, with a new offset generated for each interfering signal burst. Again, provided the network emulator (Figure 9-1) and interfering signal generator have a shared triggering signal, and the interfering signal generator is appropriately programmable, this is not a difficult proposition. However, this requirement again complicates laboratory calibration and traceability, and older apparatus may not possess such a capability. As an alternative, constant interferer frequency offsets could be applied to each interfering signal source (using values specified in the Work Item phase). Indeed, based on future simulation results, such a requirement could be found to have little bearing on receiver performance and might be eliminated as redundant.

Interferer Delay Generation – Again, specification of a pseudo-randomly generated interferer delay (according to the GERAN interferer models) could present practical difficulties to legacy signal generators, or add complexity to the overall timing control of the test apparatus. However, in a similar fashion to the frequency offset problem, a constant delay or set of delays could be specified for each interferer. In more detail, the synchronous case could make use of a constant delay which could include zero relative delay for interferers, or alternatively a simplified delay distribution could be used. Again this would depend on test vendor capability and further simulation work. Potential simplifications for asynchronous operation would also be for further study, since such scenarios are recognized as important in establishing robust receiver operation.

Power Control and DTX – The power control distribution requirement and (optional) DTX aspect of the asynchronous interferer scenario could also be potentially difficult (although not impossible) for contemporary test apparatus to implement. Nevertheless, a subsequent Work Item phase could determine that assessment of robust performance in asynchronous network scenarios is important, and it is therefore worthwhile to consider how the current asynchronous GERAN model could be approximated. One potential approach would be to simply convert the GERAN-specified power control distribution into a simple binary distribution, and to essentially 'gate' each interfering signal (i.e. on or off). This approach has the advantage of a relatively simple calibration procedure.

²¹ Of course, single-interferer tests could be defined in addition to multi-interferer tests.

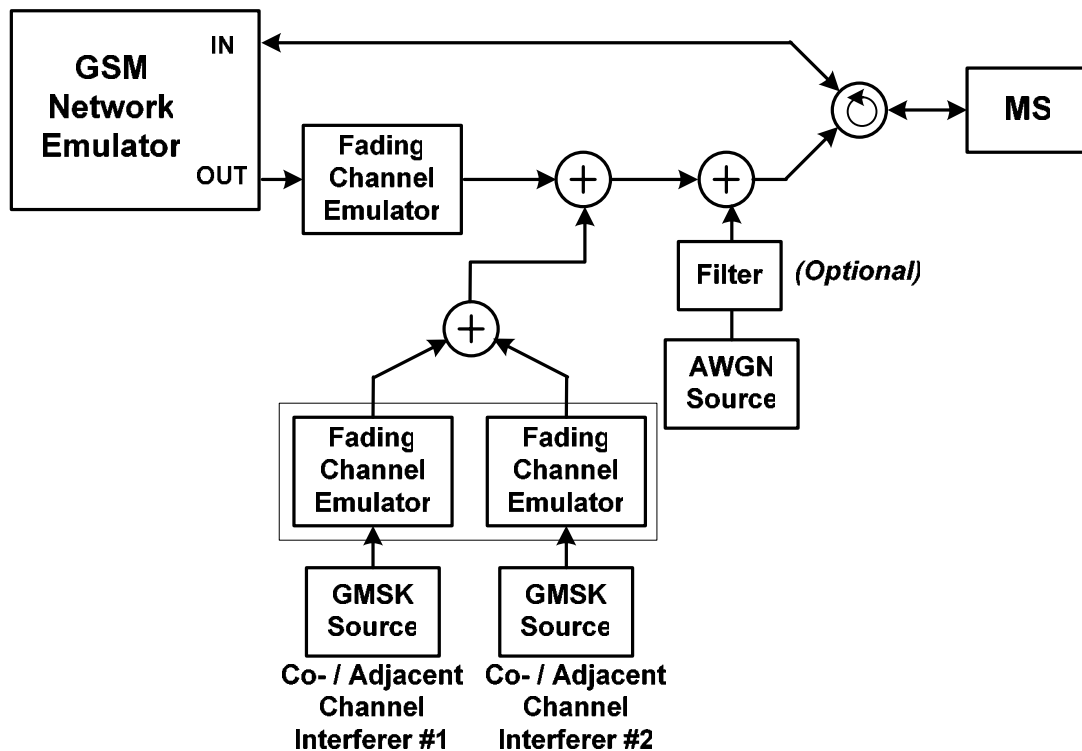

Figure 9-2 – Potential reduced-order co-channel interference configuration.

9.3 Summary

It is beyond the scope of the SAIC Feasibility Study to specify exactly which test scenarios are addressed during a performance specification phase. A variety of options exist for constructing test waveforms that may be either precisely or approximately consistent with the GERAN Feasibility Study. The exact nature of the conformance of these approaches to the original Feasibility Study models is for further study. This clause has identified some potential approaches to achieving this; the views of test equipment vendors will be needed in the performance and test specification phase of SAIC.

10 Signalling considerations

Over the course of the feasibility study, due consideration has been given regarding whether or not the network would benefit from the knowledge of whether a mobile terminal supports a SAIC advanced receiver technique or not [1, 3, 4]. Discussed was the option of eliminating signalling altogether from this work item, but it is noted that without *a priori* knowledge by the network of mobile receiver performance, the network must deduce from multiple uplink measurement reports whether SAIC were supported or not. This may have significant impacts on such radio resource management operations by the network as dynamic channel allocation and/or MAIO allocation strategies.

In order for networks to take full advantage of intelligent radio resource management techniques, the participants involved in the SAIC feasibility study felt that it is generally desirable for the mobile terminal to indicate to the network whether it supports an advanced receiver capabilities. Following are some possibilities for indicating receiver capability to the network:

- 1) Classmark information using the version number, i.e. that advanced receiver support may be inferred for mobiles beyond a certain specification version
- 2) Explicitly specifying level of advanced receiver support in Classmark 3 IE [1,2]
- 3) Explicitly specifying level of advanced receiver support in MS Radio Access Capability IE [3,4,7]

Subsequent discussions among manufacturers have indicated that the most appropriate method, given the constraints of the existing GSM system and specifications, is a means by which the network would be informed by an optional field in

the "Classmark 3" Information Element specified in TS 24.008, clause 10.5.1.7, [5], which was added to accommodate the notification of support for such 2.5G and 3G enhancements as GPRS/EDGE, various Multislot capabilities and Dual Transfer Mode. In case of GPRS, the network would be informed of MS SAIC capability by an optional field in "MS Radio Access Capability" IE.

The Classmark 3 and MS Radio Access Capability Information Elements are easily modifiable to accept an optional element indicating advanced receiver support. The method is inversely-compatible with the legacy mobile population, *viz.* that legacy mobiles would not send the optional information element, thereby allowing the network to infer that they do not support an advanced receiver such as SAIC, but rather use conventional receivers. It is also very simple to implement in both the specifications and equipment. There are nevertheless limitations to this approach which are further addressed in this clause.

10.1 Logical binding of receiver performance to protocol version

One way to specify the signalling requirements for what to send in the Classmark is simply to define a flag in TS 24.008 [1, 6] to indicate advanced receiver availability by the mobile terminal, then to define i) the scope and ii) meaning of the flag as it relates to the current version of the protocol. The following is an example of how the requirement may be worded:

"The optional Boolean flag ADVANCED_RX_SUPPORTED shall be sent in the Classmark 3 message if the mobile station supports advanced receiver requirements. If this flag is present, then it indicates that the mobile station conforms to the optional advanced receiver performance specifications defined by the version of the core specification to which the mobile station was implemented."

For example, if ADVANCED_RX_SUPPORTED is present and the version of the protocol is R6, then the mobile shall exhibit performance requirements consistent with the performance requirements for advanced receiver operation specified by TS 45.005 R6, and accordingly meet certification tests as specified by the tests of TS 51.010 R6 as well.

The consequences of such a technique is that it mandates the continuous upgrade of receiver requirements from one version of the specification to the next, if advanced receiver performance specifications differ from the previous version. This is important, since it may present difficulties for manufacturers and operators who wish to offer their users an additional feature found in a subsequent release, but without incurring the time-to-market impact of having to implement the next level of advanced receiver specifications. In effect, once an advanced receiver is implemented in a mobile terminal product, this signalling approach makes upgrading to the next version of e.g. SAIC mandatory to the next level of GERAN protocol release version. This would mean e.g. to support a new R8 feature, the mobile terminal would also require its receiver to be updated to conform to any updated advanced receiver performance requirements specified in R8. This expectation may or may not be the intention of the industry.

10.2 Release-independent indication of receiver performance: Classmark 3 IE

An alternative to binding advanced receiver support, and therefore receiver performance requirements, to the protocol release is to send an optional field in the Classmark 3 IE indicating an actual level of receiver performance specifications supported by the mobile terminal. For example:

Advanced Receiver Type 00 – Basic conventional receiver support

Advanced Receiver Type 01 – Optional receiver performance enhancement: Level I

Advanced Receiver Type 10 – Optional receiver performance enhancement: Level II

Advanced Receiver Type 11 – Optional receiver performance enhancement: Level III

The core performance specifications would define exactly what is meant by "Level I, II, III" and so on. In this manner, a mobile implemented to any protocol release beyond the initial release²² supporting an SAIC advanced receiver would

²² The current assumption is that the initial release is identical to Release 6. The investigation of signalling support for pre-Release 6 versions is for further study.

be able to implement mobiles compliant to any specified set of receiver performance criteria and then indicate the performance level to the network.

There are some limitations to this approach. For example, we as an industry group must anticipate the ultimate number of advanced receiver versions, and therefore the number of bits required to express this number, over the useful lifetime of GSM.

10.3 Release-independent indication of receiver performance: MS Radio Access Capability IE

There is a significant limitation to the use of the Classmark 3 message in GPRS mode. It is neither used for in one phase access nor in two phase access for TBF establishment. Therefore, if the operator wishes to utilise SAIC with GPRS, then a complementary solution must be devised.

A possibility mentioned in [3,7] may be to include also the advanced receiver capability signalling, i.e. in a similar way as described in [1, 2] within the MS Radio Access Capability IE in 3GPP TS 24.008 [5]. This information is sent by the MS to the network within the first PACKET RESOURCE REQUEST message on the PACCH of the assigned TBF during GPRS two phase access and EGPRS one phase access if requested by the network [4].

For GPRS one phase access the PACKET RESOURCE REQUEST message is not sent by the MS to the network, thus a more sophisticated solution must be found. A possible approach could be to include extra signalling, i.e. one bit, in the IMMEDIATE_ASSIGNMENT message and in the PACKET_UPLINK_ASSIGNMENT message, indicating that the MS shall send the PACKET RESOURCE REQUEST in the beginning of the UL TBF, as proposed in [4]. Another approach would be to use two-phase access for SAIC MS until a more generalized solution is found [7].

The inclusion into both IE, the MS Classmark 3 IE and the MS Radio Access Capability IE, should be considered for an initial release (e.g. Release 6) onwards. Below an example for including the information in the MS Radio Access Capability IE in TS 24.008 is given. The information is sent in a two bit field named Advanced Receiver Type, leading to 3 different levels of advanced receiver support.

Table 10.5.146/3GPP TS 24.008: Mobile Station Radio Access Capability Information Element

```

<MS RA capability value part : < MS RA capability value part struct >>
<spare bits>**; -- may be used for future enhancements

<MS RA capability value part struct >:= --recursive structure allows any number of Access technologies
{ { < Access Technology Type: bit (4) > exclude 1111
  < Access capabilities : <Access capabilities struct> > }

| { < Access Technology Type: bit (4) == 1111 > -- structure adding Access technologies with same capabilities
  < Length : bit (7) >      -- length in bits of list of Additional access technologies and spare bits
  { 1 < Additional access technologies: < Additional access technologies struct > > } ** 0
  <spare bits>** } }

{ 0 | 1 <MS RA capability value part struct> } ;

...

-- Additions in release 5
{ 0 | 1 < High Multislot Capability : bit(2) > }
< GERAN Iu Mode Capability : bit >
{ 0 | 1 < GMSK_MULTISLOT_POWER_PROFILE : bit (2) >
  < 8-PSK_MULTISLOT_POWER_PROFILE : bit (2) > };

-- Additions in release 6
< Advanced Receiver Type : bit(2) >

...

Advanced Receiver Type

This field indicates the level of support of radio receiver improvement.

Bits
2 1
0 0  basic conventional receiver support (no SAIC)
0 1  optional receiver performance enhancement: Level I
1 0  optional receiver performance enhancement: Level II
1 1  optional receiver performance enhancement: Level III

```

We may give further consideration to whether this information field would be mandatory from an initial release (e.g. Release 6) onwards with optional indication of advanced receiver support, or completely optional. Further consideration must also be made on the number of supported advanced receiver levels, and therefore the number of required bits to accommodate future extensibility over the useful lifetime of GSM.

10.4 Summary

The purpose of this clause is not to make recommendations, but to present some possibilities for signalling and an evaluation of extensibility, limitations and issues so that we may have a basis from which to work when GERAN approaches changes to the core specifications for SAIC. At the close of the feasibility study, the generally preferred approach to signalling mobile receiver capabilities is the method proposed here that would send a release-independent indication of receiver support to the network in the Mobile Station Classmark 3 Information Element and the Mobile Station Radio Access Capability Information Element. We welcome the input of operators and especially network manufacturers on this topic so that we may address it in a timely manner in the core specification phase to follow.

In addition to a fundamental method of informing the network of the mobile station's basic receiver capabilities, it may be desirable to introduce an additional, more granular method of signalling for the purpose of managing EGPRS link adaptation when advanced receivers are used.

10.5 References

- [1], Tdoc GP-023100, "SAIC: discussion on signalling requirements", (Motorola; TSG GERAN #12, Sophia Antipolis, France), November 18th – 22nd, 2002.
- [2], Tdoc GP-032105, "SAIC: signalling issues and alternatives", (Motorola; TSG GERAN #16, New York City, U.S.A.), August 25th – 29th, 2003.
- [3], Tdoc GAHS-030046, "Signalling support for SAIC", (Siemens; 3GPP TSG-GERAN SAIC Workshop #3; Schaumburg, IL, USA), 28-30 October 2003.
- [4], Tdoc GP-032569, "Impact of SAIC on radio resource management", (Nokia; 3GPP TSG-GERAN #17 Budapest, Hungary), November 17th – 21st, 2003.
- [5], 3GPP TS 24.008, "3rd Generation Partnership Project; Technical Specification Group GSM EDGE Radio Access Network; Mobile radio interface layer 3 specification, Core network protocols Stage 3 specification", (3rd Generation Partnership Project (3GPP) Technical Specification (TS)).
- [6], 3GPP TS 45.008, "3rd Generation Partnership Project; Technical Specification Group GSM/EDGE Radio Access Network; Radio subsystem link control", (3rd Generation Partnership Project (3GPP) Technical Specification (TS)).
- [7], Tdoc GP-032615, "SAIC signalling aspects", (Nortel; TSG GERAN #17, Budapest, Hungary), November 17th – 21st, 2003.

11 Conclusions

The work item associated with the SAIC feasibility study was approved at GERAN #12 in November of 2002. Since that time a significant amount of work has been accomplished to determine if SAIC is a feasible technology for deployment in GSM networks. Based on this vast body of work, which has only been briefly summarized in this document, it is the conclusion of WG1 that SAIC is indeed a very viable and feasible technology, and that when applied to GMSK modulation and fully deployed, will provide significant gains in voice capacity in interference-limited networks, both synchronous and asynchronous. For example, SAIC was shown to support voice capacity gains ranging from 37.8% to 53.1% for a fractionally loaded, synchronous network with 1/1 reuse and frequency hopping, representative of a highly loaded U.S. deployment. (configuration 3). The gains for an asynchronous network employing 1/3 reuse with frequency hopping, which is representative of a possible European deployment were an equally impressive 34.3% (configuration 4). Even for a blocking-limited deployment (configuration 1), SAIC was shown to support a higher percentage of satisfied users, 99.5% compared to 96.1%. In addition, SAIC was also found to support modest increases in GPRS data throughput for the data traffic models considered.

A very thorough procedure was defined for developing system simulation results, which modelled the SAIC receiver performance as accurately as possible for both synchronous and asynchronous networks. This procedure included the

conduction of initial system level simulations to determine the relevant interference statistics for the four network configurations considered. These statistics, which were defined in terms of each interferer's power relative to the dominant interferer, were then used in a link level characterization to generate not only the traditional 'long-term' average BER and FER as function of long-term, average CIR, but also the 'burst' BER as function of burst CIR and DIR. This latter burst characterization formed the basis of the link-to-system level mapping tables, which were then used in a separate system simulation to determine the estimated voice capacity and data throughput gains.

It is important to note that due to complexity constraints in system simulators, that all of the current simulators developed by the participating companies are synchronous in nature. Thus, the synchronous results are expected to be of a higher fidelity than the asynchronous results. That said, great care was taken to characterize the link level performance for asynchronous conditions so as to develop a second set of mapping tables. These latter mapping tables were then used in the synchronous system simulators to estimate performance in asynchronous networks. One other point to note is that these system simulators are fairly complex and even though a common set of assumptions were agreed to, it is not always possible to duplicate results from one company to the next. In addition, most companies used mapping tables based on their own SAIC receivers, which added even more variability to the comparison. However, for those configurations where multiple results were developed, the results were found to be fairly consistent, thus, showing SAIC to be fairly robust at least in the simulator world.

Other key conclusions that can be drawn from this study include the following:

- Capacity gain due to SAIC is not linearly related to SAIC terminal penetration. Hence, for low to moderate terminal penetration rates, SAIC is expected to provide its primary benefit in terms of immediate improvement in call quality (and GPRS throughput), with the secondary benefit of modest system capacity gain. For high terminal penetration rates (>70-80%), SAIC is expected to provide both, improvement in call quality as well as large gain in overall system capacity.
- There is no degradation to legacy MSs in terms of voice quality statistics as SAIC MSs are introduced. In fact, there is a decrease in the outage probability of legacy MSs due to a higher overall C/I environment resulting from the lower transmit powers of SAIC MSs.
- For the mix of voice and data traffic considered (70% voice, 30% data), the GPRS throughput as a function of voice load is ~2.5-13.5% for web browsing, and ~7-37% for FTP/MMS applications.
- SAIC was shown to experience no degradation in the midst of 8-PSK interference, and in fact, provided some gain, albeit less than what is achieved for GMSK interference.
- In both asynchronous and synchronous field trials, SAIC prototypes were able to demonstrate significant increases in the measured CIR (C/I) distribution. In the asynchronous case, an increase in the CIR of 2.7 dB at the 10% cdf point was observed for the most highly loaded condition. For the synchronous case a gain of 4.5 dB was observed.
- A practical SAIC solution for 8-PSK modulation has not been identified to date. It is expected that a 'joint demodulation' based receiver with a reduced number of states will be required.

Another important aspect of SAIC addressed by this study is how to test SAIC capable MSs in a laboratory environment to establish the performance values that will ultimately go into the next version of the GSM specifications. Clause 9 of this document addressed this issue, and identified some of the key elements required in testing to insure that a tested MS will have the desired SAIC capability. At the time of this writing test scenarios were already being finalized for both synchronous and asynchronous conditions. Finally, in clause 10, two signalling options were identified, which allow the MS to indicate to the network that it is SAIC capable. This capability was judged to be important, since the network could possibly exploit this information in dynamic frequency planning to further increase system capacity. The two basic options considered were to make this feature either release dependent or release independent. At the close of this feasibility study, the recommendation of at least one of the operators, and the generally preferred approach of WG1 is to make this signalling capability a release independent feature, which would be indicated by the MS Classmark 3 Information Element and the MS Radio Access Capability Information Element.

The remainder of this clause addresses the specific impacts to the specification to ensure that future MSs have an SAIC capability.

11.1 Specification impacts

The following two sub-clauses identify the Core and Testing Specifications that will be impacted by the addition of an SAIC capability to MSs.

11.1.1 Core specifications

Clause No	Title	Analysis	TS and clause number
6.3	Reference Interference Level	Test scenarios and performance requirements	TS 45.005 V6.6.0
10.5.1.7	Mobile Station Classmark 3	SAIC capability indication	TS 24.008 V6.5.0
10.5.5.1 2a	Mobile Station Radio Access Capability	SAIC capability indication	TS 24.008 V6.5.0

11.1.2 Testing specifications

Clause No	Title	Analysis	TS and clause number
14.4	Receiver, Co-channel rejection	MS conformance tests	TS 51.010-1 V5.9.0
14.16.2	GPRS Receiver, Co-channel rejection	MS conformance tests	TS 51.010-1 V5.9.0

Annex A: Change History

Change history							
Date	TSG #	TSG Doc.	CR	Rev	Subject/Comment	Old	New
2004-08	21	GP-042261			Approved for Release 6	2.0.0	6.0.0
2004-11	22	GP-042669	001		System Capacity Figures for Network Configuration 4	6.0.0	6.0.1

History

Document history		
V6.0.1	November 2004	Publication