

ETSI TR 143 055 V8.0.0 (2000-11)

Technical Specification

**Digital cellular telecommunications system (Phase 2+);
Dual Transfer Mode;
Stage 2
(3GPP TR 03.55 version 8.0.0 Release 1999)**



Reference

DTR/TSGG-010355Q8

Keywords

GSM

ETSI

650 Route des Lucioles
F-06921 Sophia Antipolis Cedex - FRANCE

Tel.: +33 4 92 94 42 00 Fax: +33 4 93 65 47 16

Siret N° 348 623 562 00017 - NAF 742 C
Association à but non lucratif enregistrée à la
Sous-Préfecture de Grasse (06) N° 7803/88

Important notice

Individual copies of the present document can be downloaded from:

<http://www.etsi.org>

The present document may be made available in more than one electronic version or in print. In any case of existing or perceived difference in contents between such versions, the reference version is the Portable Document Format (PDF). In case of dispute, the reference shall be the printing on ETSI printers of the PDF version kept on a specific network drive within ETSI Secretariat.

Users of the present document should be aware that the document may be subject to revision or change of status. Information on the current status of this and other ETSI documents is available at <http://www.etsi.org/tb/status/>

If you find errors in the present document, send your comment to:
editor@etsi.fr

Copyright Notification

No part may be reproduced except as authorized by written permission.
The copyright and the foregoing restriction extend to reproduction in all media.

© European Telecommunications Standards Institute 2000.

All rights reserved.

Intellectual Property Rights

IPRs essential or potentially essential to the present document may have been declared to ETSI. The information pertaining to these essential IPRs, if any, is publicly available for **ETSI members and non-members**, and can be found in ETSI SR 000 314: "*Intellectual Property Rights (IPRs); Essential, or potentially Essential, IPRs notified to ETSI in respect of ETSI standards*", which is available from the ETSI Secretariat. Latest updates are available on the ETSI Web server (<http://www.etsi.org/ipr>).

Pursuant to the ETSI IPR Policy, no investigation, including IPR searches, has been carried out by ETSI. No guarantee can be given as to the existence of other IPRs not referenced in ETSI SR 000 314 (or the updates on the ETSI Web server) which are, or may be, or may become, essential to the present document.

Foreword

This Technical Report (TR) has been produced by the ETSI 3rd Generation Partnership Project (3GPP).

The present document may refer to technical specifications or reports using their 3GPP identities, UMTS identities or GSM identities. These should be interpreted as being references to the corresponding ETSI deliverables.

The cross reference between GSM, UMTS, 3GPP and ETSI identities can be found under www.etsi.org/key.

Contents

Foreword.....	5
Introduction.....	5
Motivation	5
Concept basis.....	5
Class A mode of operation	6
1 Scope	7
2 References	7
3 Definitions and abbreviations.....	8
3.1 Definitions	8
3.2 Abbreviations	8
4 Class A capabilities	8
4.1 Main DCCH with SAPI=0.....	8
4.1.1 General.....	8
4.1.2 MS-SGSN tunnelling	9
4.2 Single slot operation	9
4.2.1 General.....	9
4.2.2 TCH/H + PDCH/H.....	10
4.3 Multislot operation	10
4.3.1 General.....	10
4.3.2 Shared PDCH.....	10
4.3.3 Exclusive use of uplink PDCH	10
4.4 Bearer capability.....	11
4.5 Indication of the DTM capabilities supported by the MS.....	11
4.5.1 Definition of MS DTM classes	11
4.5.2 Options.....	12
4.6 Indication of the capabilities.....	12
4.7 Compatibility issues	12
5 Layer 1.....	12
5.1 Timing advance	13
5.2 Measurement reporting.....	13
5.3 Power control in multislot operation	13
5.3.1 General.....	13
5.3.2 Uplink multislot power control	13
5.3.3 Downlink multislot power control	13
6 Signalling procedures	14
6.1 Establishment	14
6.1.1 General.....	14
6.1.2 PS establishment while in dedicated mode	14
6.1.2.1 Principles.....	14
6.1.2.2 MO session: packet request procedure	15
6.1.2.3 MT session	16
6.1.2.3.1 Ready state: packet downlink assignment	16
6.1.2.3.2 Standby state: packet notification	17
6.1.3 CS establishment while in packet transfer mode	17
6.1.4 PS establishment while in dual transfer mode	19
6.2 Release.....	19
6.2.1 Release of packet resources	19
6.2.2 Release of CS resources	19
6.3 Handover	19
6.3.1 General.....	19
6.3.2 Internal handover	20
6.3.3 External handover.....	21
6.4 Location management	22

6.4.1	General	22
6.4.2	Cell update	22
6.4.3	Routeing Area update	23
6.4.4	Location update.....	24
6.4.4.1	Change of Location Area in dedicated mode	24
6.4.4.2	Simultaneous Location Area and Routeing Area update procedures	25
6.5	Provision of the IMSI to the BSC.....	26
6.5.1	General.....	26
6.5.2	Call establishment.....	26
6.5.3	Session establishment	27
6.5.3.1	Downlink session establishment	27
6.5.3.2	Uplink session establishment	27
6.5.4	External handover	27
6.6	In-band parameters	27
6.7	MS behaviour in <i>heterogeneous</i> networks.....	28
6.7.1	General.....	28
6.7.1	Suspension procedure	29
6.7.2	Resume procedure.....	29
7	DTM operation	30
8	GPRS attach procedure while in dedicated mode and packet idle mode.....	30
9	Security.....	30
10	Header and Data Compression	30
Annex A:	Possible improvements for future releases	31
Annex B:	Change history.....	32

Foreword

This Technical Report has been produced by the 3rd Generation Partnership Project (3GPP).

The contents of the present document are subject to continuing work within the TSG and may change following formal TSG approval. Should the TSG modify the contents of the present document, it will be re-released by the TSG with an identifying change of release date and an increase in version number as follows:

Version x.y.z

where:

- x the first digit:
 - 1 presented to TSG for information;
 - 2 presented to TSG for approval;
 - 3 or greater indicates TSG approved document under change control.
- y the second digit is incremented for all changes of substance, i.e. technical enhancements, corrections, updates, etc.
- z the third digit is incremented when editorial only changes have been incorporated in the document.

Introduction

Motivation

The definition of GPRS class A mode of operation in Release 97 assumes a total independence between the CS and PS domains. Thus the direct implementation of the existent standards for class A would result in mobile stations that are required to operate in two different frequencies either in the same timeslot, in timeslots n and $n + 3$ or their adjacent ones. This complicates enormously the internal architecture of the ME, resulting in a very high development cost, which both operators and manufacturers would prefer to avoid.

Nevertheless, operators have expressed their need for this type of mobiles, since they want to offer services that demand the simultaneous existence of a CS connection and a PS session. This is particularly important during the coexistence of GSM/GPRS with UMTS, as these capabilities will exist in UMTS. However, UMTS coverage may not be available in some areas where there is GSM/GPRS coverage (e.g. deep inside buildings or when roaming to a 2G network). As coverage is a vital service, in order for an operator to be able to sell "UMTS class A services" it is necessary to be able to imitate class A services in areas of only GSM coverage. On the other hand, the provision of class A services with GERAN technology is also essential for operators without UMTS coverage.

Concept basis

A constant aim throughout this document is to reuse the existing functionality when possible, in order to minimise the impact on current implementations. In general, the changes proposed have little impact on the core network elements (i.e. MSC and SGSN) and 3G TS 24.008 [11].

The solution outlined in this document overcomes the restrictions mentioned above and makes possible to have simultaneous CS and PS active connections. This is achieved by sending PS data (signalling and user data)

- on the timeslot use by the CS connection
- on timeslot(s) not used by the CS connection

The possible timeslot configurations are based on two restrictions in Release 99:

- the number of timeslots allocated to the CS connection is limited to one;
- the timeslots allocated in each direction are contiguous.

More flexible proposals are left for further study. In addition, for the definition of DTM multislot classes, the restrictions in 3G TS 05.02 [6] for multislot capabilities shall apply.

Figure 1 shows an example of a multislot configuration (2 uplink, 3 downlink).

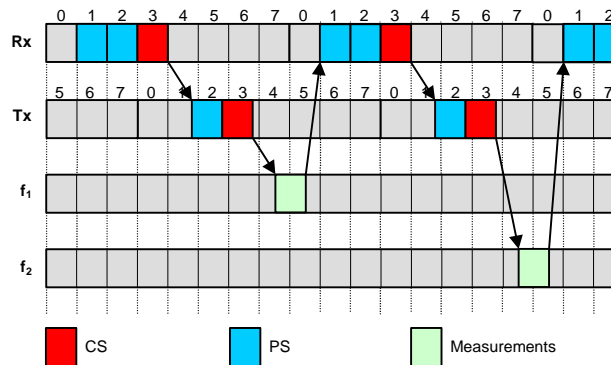

Figure 1: Example of multislot configuration of a GPRS *simple* class A mobile station in dual transfer mode.

In a similar manner to UMTS, the A interface is modified so that the BSC knows the IMSI associated with each SCCP connection to the MSC. This means that the BSC is able to ensure that 'packet paging' messages can be delivered to mobile stations which have a connection to the MSC. The same functionality can be reused to deliver MSC originated pages to mobiles in packet transfer mode while the network is in mode of operation II (i.e. no Gs interface).

Mobility management is basically the same as is specified in 3G TS 23.060 [9] for class A mobiles, but using the same techniques as UMTS for control of "in connection" cell, routing area and location area updates (e.g. System Information 6 message is extended to contain the Routing Area Code).

If GPRS signalling needs to be sent during a standalone voice call, then it is proposed that these LLC frames can be sent on the main DCCH (FACCH or SDCCH) with layer 2 SAPI 0. This uses a new Protocol Discriminator in 3G TS 24.007 for LLC: GTTP (GPRS Transparent Transport Protocol). The use of the main DCCH for GPRS signalling is subject to certain restrictions to reduce the harm to the speech quality.

Inter-BSC handover is planned to be controlled by A interface signalling. The *Old BSS to New BSS* information element is used to indicate to the target BSC that the mobile station is in DTM.

Class A mode of operation

For paging, the behaviour of the mobile station is as in class B mode of operation: the PCH takes priority to PPCH, and both to CBCH.

The implementation described in this document also applies the restriction that the mobile station shall not be required to operate in two different frequencies in the same moment in time. However, GSM CS and GSM GPRS services will be still supported simultaneously. Thus, the feature here described is a subset of the GPRS class A capabilities.

The mentioned subset will be referred as DTM.

The specification of an *unrestricted* class A mode of operation that requires the mobile station to operate in different frequencies simultaneously shall not be forbidden.

1 Scope

The present document is a description of the practical implementation of GSM-GPRS class A mobiles and a basis for discussion on the changes and additions to the current specifications.

This work is part of the Release 99 Work Item "BSS co-ordination of Radio Resource allocation for class A GPRS services - GSM Radio Access (R99)" for which M Mouly of Nortel Networks is rapporteur. This work item was supported by Nortel, Motorola, Vodafone and Lucent.

In the following, GPRS refers to both EGPRS and GPRS unless explicitly stated otherwise.

2 References

The following documents contain provisions which, through reference in this text, constitute provisions of the present document.

- References are either specific (identified by date of publication, edition number, version number, etc.) or non-specific.
- For a specific reference, subsequent revisions do not apply.
- For a non-specific reference, the latest version applies.

- [1] 3G TS 01.04: "Abbreviations and acronyms".
- [2] 3G TS 02.60: "General Packet Radio Service (GPRS); Service description; Stage 1".
- [3] 3G TS 04.13: "Performance requirements on the mobile radio interface".
- [4] 3G TS 04.18: "Mobile radio interface layer 3 specification, Radio Resource Control Protocol".
- [5] 3G TS 04.60: "General Packet Radio Service (GPRS); Mobile Station (MS) - Base Station System (BSS) interface; Radio Link Control/ Medium Access Control (RLC/MAC) protocol".
- [6] 3G TS 05.02: "Multiplexing and multiple access on the radio path".
- [7] 3G TS 05.08: "Radio subsystem link control".
- [8] 3G TS 05.10: "Radio subsystem synchronization".
- [9] 3G TS 23.060: "3rd Generation Partnership Project; Technical Specification Group Services and System Aspects; General Packet Radio Service (GPRS); Service description; Stage 2".
- [10] 3G TS 23.121: "3rd Generation Partnership Project; Technical Specification Group Services and Systems Aspects; Architectural Requirements for Release 1999".
- [11] 3G TS 24.007: "3rd Generation Partnership Project; Technical Specification Group Core Network; Mobile radio interface signalling layer 3; General aspects".
- [12] 3G TS 24.008: "3rd Generation Partnership Project; Universal Mobile Telecommunications System; Mobile radio interface layer 3 specification, Core Network Protocols - Stage 3".

3 Definitions and abbreviations

3.1 Definitions

For the purposes of the present document, the following terms and definitions apply:

Dual transfer mode: It is only applicable for a mobile station that supports GPRS. A mobile station in dual transfer mode has resources for an RR connection and is simultaneously¹ allocated resources for a TBF, provided that the BSS co-ordinates its allocation of radio resources. DTM is optional both for the mobile station and the network. A DTM mobile is a class A mobile. Hence all specifications/requirements for class A apply to this mobile unless specifically altered by the present document. The procedures specified for dedicated and packet transfer modes apply to a mobile station in dual transfer mode unless specifically altered by the present document.

Class A/class B: In the present document "class A" and "class B" is used as a short form of "class A mode of operation" and "class B mode of operation", respectively.

3.2 Abbreviations

For the purposes of the present document, the following abbreviations apply:

CS	Circuit Switched
DTM	Dual Transfer Mode
PS	Packet Switched

4 Class A capabilities

4.1 Main DCCH with SAPI=0

4.1.1 General

The main DCCH (with layer 2 SAPI=0) is used for GSM signalling. GPRS signalling shall be able to use this resource. User data shall not be sent on the main DCCH.

The use of the main DCCH is only allowed when the mobile station is in dedicated mode. In dual transfer mode (i.e. the mobile station has resources allocated for an RR connection and for a TBF), the main DCCH shall not be used and the current procedures described in 3G TS 04.60 [5] apply.

When upper layers request to send a message uplink, the mobile station shall send the message on the main DCCH if:

- the mobile station is in dedicated mode;
- the information contained in the message is signalling; and
- the number of LAPDm frames is smaller than a certain value specified by the network.

Otherwise, the mobile station shall request an uplink TBF as specified in 3G TS 04.18 [4].

On the other hand, the network should not use the main DCCH to send messages that exceed the maximum length specified for the uplink. The mobile station, however, shall not reject messages that exceed the maximum length. Similarly, the network should not use the main DCCH when the mobile station is in dual transfer mode, although the mobile station shall not reject the received messages.

¹ The term "simultaneous" is used in the present document with the same meaning as in 22.060. Different services or connections may happen *simultaneously* and be multiplexed at lower layers so that they e.g. different TDMA time slots in the same carrier.

NOTE: This is needed to prevent erroneous cases caused by race conditions (e.g. if the mobile station leaves the dedicated mode and enters the dual transfer mode at the same time as the network sends a downlink message on the main DCCH, the mobile station would reject the message).

4.1.2 MS-SGSN tunnelling

The GPRS information from upper layers (i.e. GMM or SM) is always sent inside an LLC frame. This LLC frame can now be passed down:

- to RLC and transmitted on a TBF; or
- to RR, if the MS is in dedicated mode, and transmitted on the main DCCH.

The procedures for the transmission of an LLC frame via RLC are defined in 3G TS 04.60 [5]. The procedures for the transmission of an LLC frame on the main DCCH are defined in 3G TS 04.18 [4]. The new tunnelling mechanism for the transmission of the LLC frame is shown graphically in figure 2.

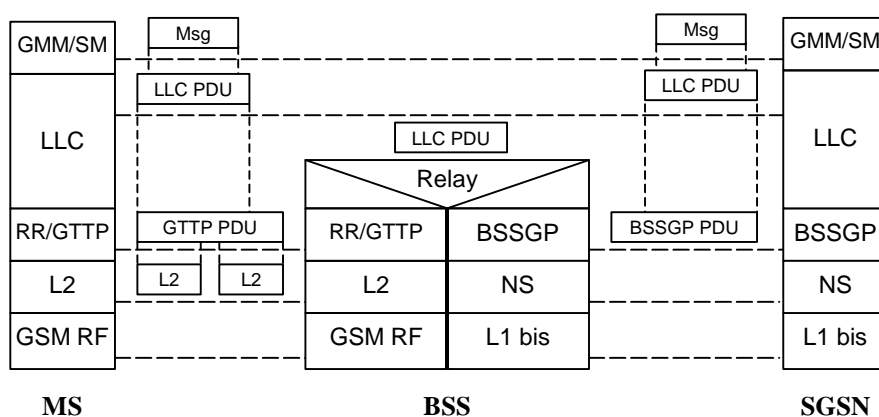

Figure 2: Transmission of an LLC PDU on the main DCCH

In the uplink, the LLC PDU is inserted in a new Layer 3 message². This Layer 3 message is sent to the BSC on the main DCCH, with the existing Layer 2 mechanisms. The BTS re-assembles the Layer 3 message and sends it to the BSC. The BSC extracts the TLLI and the LLC PDU, which are then put into a BSSGP UL-UNITDATA.

In the downlink, when the BSS receives a downlink BSSGP PDU, it can identify:

- if the PDU contains signalling information ("T bit" in the QoS profile IE);
- if the length of the LLC PDU meets the requirements; and
- if it has an RR connection to the addressed MS (with the IMSI);

in which case, it sends the LLC using the same procedure as described above. If any of the conditions above is not met, the BSC sends the information on a downlink TBF.

4.2 Single slot operation

4.2.1 General

A mobile station in dual transfer mode has one timeslot allocated for the CS services. It is possible to reuse the same timeslot for the transmission of GPRS signalling and user data.

² This message is sent with a new Protocol Discriminator (GTPP) so that the BSC identifies the tunnelling mechanism without the need to analyse the Message Type. This helps reduce the processor load in the BSC.

It is desirable to be able to use the same timeslot as the CS connection for GPRS data, due to the impossibility for the network to allocate a TBF in some circumstances (e.g. congested cell, multislot capabilities not supported in the serving cell).

The proposed solution for single timeslot operation is the "TCH/H + PDCH/H" configuration (see 3G TS 05.02 [6]).

4.2.2 TCH/H + PDCH/H

A "TCH/H + PDCH/H" configuration implies the multiplexing of CS information and RLC/MAC blocks in the same timeslot of the TDMA frame. Which domain uses each half shall be flexible and indicated in the assignment command.

On the 'TCH/H' part, the support of AMR as the speech codec is mandatory. Basic half rate is optionally supported.

The PDCH/H is a resource dedicated to the mobile station in both directions. For instance, if an uplink TBF is established, the network may send a control message in any of the downlink blocks. No downlink data, however, shall be sent without a previous downlink assignment.

The existent RLC/MAC block format is used. In the downlink, the mobile station shall only pass to upper layers those blocks with the TFI indicated in the assignment message. In the uplink, the mobile station may transmit in any of the blocks of the PDCH/H, irrespective of the USF in the previous blocks in the dynamic allocation case or the allocation bitmap in the fixed allocation case, if that information was present in the (uplink) assignment message. The mobile station, however, stores this information for possible multislot configurations where fixed or dynamic allocation is supported.

The PDCH/H can be used for both GPRS signalling and user data. A PDCH/H shall not be assigned to a DTM capable mobile station in packet transfer mode.

Apart from the different mapping onto physical resources, the PDCH/H has the same characteristics as a PDCH/F. A PDCH/H is always used in exclusive allocation.

4.3 Multislot operation

4.3.1 General

In multislot operation, the GPRS data is sent on a PDCH. The number of timeslots comprising the PDCH is decided by the network after taking into account the class A multislot capabilities supported by the mobile station.

The PDCH shall always be shared on the downlink direction. In the uplink direction, the PDCH can be either dedicated or shared with other GPRS users.

4.3.2 Shared PDCH

The uplink PDCH may be shared with other GPRS mobile stations. In this case the existent procedures in 3G TS 04.60 [5] apply. In the case of GPRS and EGPRS MSs multiplexed on the same PDCH, the same restrictions as described in 3G TS 04.60 [5] shall apply.

A mobile station that supports the shared operation on the uplink PDCHs does not need to support the exclusive allocation. If the mobile station supports a shared mode (dynamic or fixed allocation) the network shall not assign the PDCH in exclusive allocation.

4.3.3 Exclusive use of uplink PDCH

An uplink PDCH can be assigned in exclusive mode, where the correspondent mobile station has always granted the right to transmit. The existent RLC/MAC block structure shall be kept. The procedures specified in 3G TS 04.60 [5] shall apply.

Despite the dedicated characteristics of the PDCH, the network shall allocate and use a valid USF or allocation bitmap, in order to prevent other mobiles that share the downlink PDCH from transmitting in a dedicated uplink PDCH.

4.4 Bearer capability

The decision of which of the class A capabilities shall be used shall be always made by the network after considering:

- the supported capabilities (by both the network and the mobile station);
- the type of data to be sent;
- the length of the data; and
- the requested QoS parameters;

shows the GPRS data supported by the different class A capabilities.

Table 1: Support of GPRS data by the different class A capabilities

Bearer		Main DCCH with SAPI 0	Single slot operation	Multislot operation
GPRS data				
GPRS signalling	Short frames	Yes	Yes	Yes
	Long frames	No		
User data		No		

NOTE: The use of the main DCCH with SAPI 0 has the following properties:

- it delays RR commands;
- it harms speech quality;
- it places load onto the A-bis LAPD signalling links;
- it has a maximum length of 251 bytes.

4.5 Indication of the DTM capabilities supported by the MS

4.5.1 Definition of MS DTM classes

Different mobile stations may support different DTM capabilities and thus they need to be communicated to the network so that they can be taken into account for the allocation of radio resources. The DTM multislot capabilities are independent from the currently defined 3G TS 05.02 multislot capabilities. When EGPRS is supported, DTM multislot capability for EGPRS operation is indicated independently from DTM multislot capability for GPRS operation.

The following three DTM multislot classes are proposed:

- **DTM multislot class 1:** the mobile station supports single timeslot operation.
- **DTM multislot class 5:** the mobile station supports DTM multislot operation; the restrictions of multislot class 5 apply (cf. 3G TS 05.02 [6]).
- **DTM multislot class 9:** the mobile station supports DTM multislot operation; the restrictions of multislot class 9 apply (cf. 3G TS 05.02 [6]).

Other classes can be defined in the future if strictly required.

In order to reduce the number of possibilities and the length of the coding, incremental support shall be used; that is, a mobile station that supports a certain level of capabilities shall support the capabilities of the less restrictive DTM classes. E.g. a mobile station supporting DTM class 9 capabilities shall support DTM classes 1 and 5.

4.5.2 Options

The support of the following two capabilities has to be indicated independently from the DTM class:

- **Uplink MAC procedure:** shared or exclusive PDCH. This option is only valid for DTM classes 5 and 9. The PDCH/H of DTM multislot class 1 is not shared in Release 99. Other DTM multislot classes defined in the future shall share the PDCHs.
- **E-GPRS:** supported or not.

Incremental support is also applicable for the options:

- in multislot operation, the network shall not allocate PDCH/Fs in exclusive allocation if the mobile station supports shared PDCH/Fs; in single slot operation, exclusive allocation in the PDCH/H shall always be used; a mobile station supporting E-GPRS shall support GPRS. The 8-PSK capability of the MS are the same in DTM and non-DTM mode;
- a mobile station supporting EGPRS as well as the DTM mode of operation shall support EGPRS DTM.

4.6 Indication of the capabilities

The mobile station DTM class is indicated in the Classmark 3 and MS Radio Access Capabilities. The absence of this information shall indicate that the mobile station does not support simple class A (i.e. either it supports *unrestricted* class A or it cannot operate in mode of operation A at all).

4.7 Compatibility issues

The mobile station shall indicate in its classmark whether it is DTM capable or not. The network shall not allocate resources for DTM operation unless the mobile is DTM capable. The resources allocated by the network shall meet the requirements imposed by the classmark.

The network indicates on the BCCH or PBCCH whether or not the cell supports DTM. It shall also indicate it on the SACCH for DTM capable mobile stations in dedicated mode or dual transfer mode. It may also indicate it on the PACCH for DTM capable mobile stations in packet transfer mode. A cell level indication is needed because adjacent BTSs may be in the same RA and LA but may be parented by different BSCs (from different vendors or different releases). The indication in the SACCH is needed to enable/suppress the transmission of packet resource requests when the mobile is in dedicated mode and cannot read the BCCH data. A mobile station shall not attempt to enter the DTM unless DTM is supported in the cell.

The network shall allocate resources taking into account the capabilities commonly supported with the mobile station. In order to avoid situations where both the mobile station and the network are DTM capable but no class A capabilities are shared, a *core set* of capabilities has been defined and shall be supported by the mobile station and the network, consisting of:

- the main DCCH with SAPI 0 for GPRS signalling, with a length restriction controlled by the network;
- the TCH/H + PDCH/H configuration (single slot operation or DTM multislot class 1).

5 Layer 1

Some modifications or extra requirements affect layer 1 areas:

1. Timing advance;
2. Measurement reporting;
3. Power control.

These issues are dealt with in the following clauses.

5.1 Timing advance

A mobile station in DTM shall disable the timing advance features for the GPRS side:

- the mobile station shall inhibit the transmission of timing advance access bursts;
- the mobile station shall ignore the reception of GPRS timing advance messages, if any.

The reporting period and the SACCH message block shall be the same as though the mobile station was in dedicated mode.

5.2 Measurement reporting

The mobile station shall continue to send measurement reports for the circuit switched part, but GPRS measurement reports shall not be sent. The mobile station shall be able to send extended measurement reports when commanded by the network.

NOTE: The impact on interference measurements is left FFS.

5.3 Power control in multislots operation

5.3.1 General

The difference of C/I requirements and the possibility of using different coding schemes in both domains may result in a difference in the power used in adjacent timeslots. This difference in power needs further consideration, which it is done in the following clauses.

5.3.2 Uplink multislots power control

On the network side, there is no restriction for the difference of power received in adjacent timeslots.

On the mobile station side, the power control in different timeslots shall be independent and with no restriction for the difference of power transmitted in adjacent timeslots.

In single timeslot operation, the power control for both domains is performed on the SACCH.

NOTE: The uplink power control when EGPRS is used is left FFS.

5.3.3 Downlink multislots power control

On the network side, there is no restriction for the difference of power transmitted in adjacent timeslots.

As in normal GPRS power control and in addition to the cells present in SI5, the mobile station shall also perform measurements of the serving cell if the FH sequence does not include the BCCH carrier.

To ensure that no additional constraint compared to the current GPRS downlink power control specification be required on the implementation of the MS receiver, special care should be taken regarding the following points:

- the BTS output power variation between all blocks addressed to a particular MS within a TDMA frame shall never exceed 10 dB in DTM multislots configurations. Moreover, the power difference between contiguous CS and PS time slots shall be in the same range of 10 dB.
- the BTS output power on the timeslot immediately preceding each burst of a block addressed to one MS, and belonging to the same multislots allocation, shall not exceed the output power of that block by more than 10 dB in the current GPRS specification. This constraint is valid for both downlink power control modes A and B, and has been specified to avoid the receiver blinding. Such a blinding could last on the following time slot, and this would result on a degradation of the PS link. This constraint is not valid in case of a CS time slot contiguous to a PS time slot. Indeed, even if the PS burst is not addressed to the MS, the power used for that burst shall not exceed by more than 10 dB the power of the CS burst.

6 Signalling procedures

6.1 Establishment

6.1.1 General

The existent establishment procedures for class A mode of operation rely on the capability of the mobile station to be able to operate in different frequencies in the same timeslot, e.g. to listen to the (P)BCCH while in dedicated mode. New procedures need to be added to the specifications to allow mobile stations without such capabilities to be able to enter the dual transfer mode.

The new cases are marked with "✓" in table 1 and explained in detail in this clause.

Table 2: Summary of establishment cases

		Requested				
		CS	PS			
			MO	Ready state	MT	
Active	Nothing	Normal establishment				
		CS	Engaged	✓	✓	✓
	PS	MO	✓	Same TBF	Normal: PACCH	Not applicable
			MT	Normal: PACCH	Same TBF	

6.1.2 PS establishment while in dedicated mode

6.1.2.1 Principles

A new message is defined to enable the mobile station to request to enter the dual transfer mode: the **DTM Request** message. In Release 99, this message only includes information related to the requested packet resources while in dedicated mode. It may be used in future releases to request CS resources while in packet transfer mode.

Two DTM assignment messages are defined:

- the **DTM Assignment Command** message: this message shall describe both the CS and packet resources when a reallocation of the CS resource is needed, e.g. when a multislot configuration cannot be accommodated or when an "TCH/H + PDCH/H" configuration is to be used.
- the **Packet Assignment** message: this message describes the allocated packet resources when no reallocation of the CS resource is necessary, e.g. on an adjacent timeslot.

When there is reallocation of the CS timeslot:

- if the mobile station successfully establishes the new CS connection, it shall send an **Assignment Complete** message on the new main DCCH.
- if the mobile station fails to establish the new CS connection, it shall go back to the old timeslot, send an **Assignment Failure** message on the (old) main DCCH and continue the CS operation. The mobile station shall assume that the old PS resources were released and attempt its re-establishment.

If the network wants to move the mobile station to another cell, it shall send a **Handover Command** message on the main DCCH. After the handover procedure is completed and if the mobile station was in DTM in the old cell, the network may send the **DTM Information** message on the main DCCH to speed up the to resumption of the dual transfer mode of operation by the mobile station.

Editor's note: there may not be a need to send the DTM information in case the network wants to "push" the MS in DTM mode after the handover to establish downlink TBF to transmit downlink PDU to the mobile (in which case the DTM information is provided in the Packet Assignment message).

As described above, the main DCCH can be used in either direction with no prior assignment provided that the required conditions are met. Otherwise, the procedures here described apply.

6.1.2.2 MO session: packet request procedure

If the serving cell of the CS connection indicates that supports DTM, the mobile station may request the establishment of a PS session by sending a DTM Request message on the main DCCH.

The network may answer the request with one of the two defined DTM assignment messages, sent on the main DCCH. If the network cannot allocate the packet resources, it shall answer with a **DTM Reject** message on the main DCCH. The DTM Reject message shall indicate if the mobile is allowed to reattempt the packet establishment in the same cell (possibly after a waiting time).

Figure 3 shows the successful case of the allocation of an uplink TBF when the reallocation of the CS timeslot is needed. The mobile station informs the network about the correct seizure of the new CS resource by sending an Assignment Complete message on the main DCCH of the new resource.

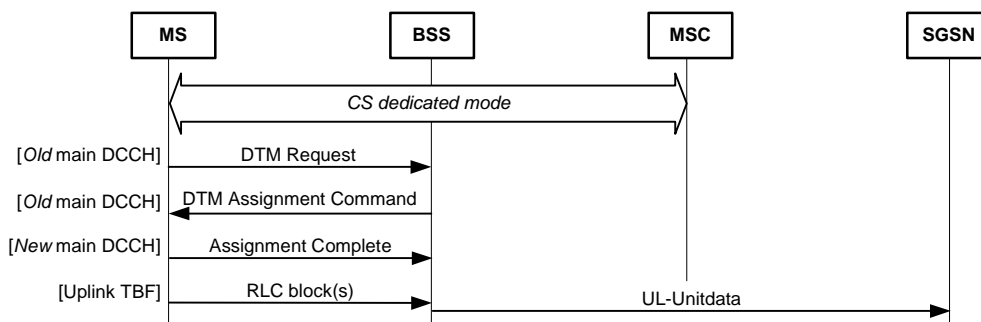

Figure 3: Establishment of a MO PS session while in dedicated mode with reallocation of the CS resource; successful case

Figure 4 shows the failure case. If there is an error when establishing the main signalling link in the new timeslot, the mobile station shall send an Assignment Failure message on the old main DCCH and then it may re-attempt the establishment of the packet session. The timers in the assignment procedure are reused.

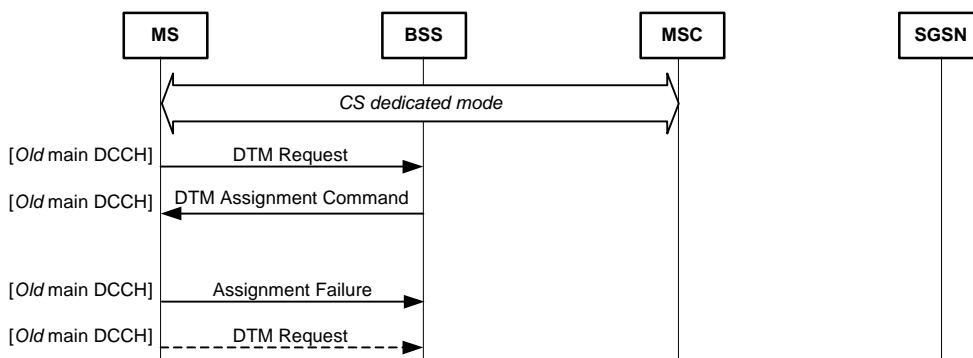

Figure 4: Establishment of a MO PS session while in dedicated mode with reallocation of the CS resource; failure case

In figure 5, the packet resource is mapped onto adjacent timeslot(s) and thus the Packet Assignment message is used. There is no release/re-establishment of the main signalling link, successful and failure messages are not needed. The successful and failure cases for the establishment of the TBF are determined as in normal GPRS (see 3G TS 04.60 [5]).

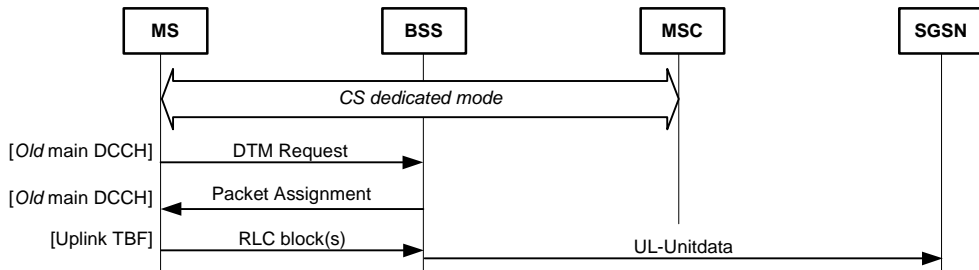

Figure 5: Establishment of a MO PS session in multislot configuration while in dedicated mode; successful case

Figure 6 shows the case of the main DCCH being used as the uplink resource.

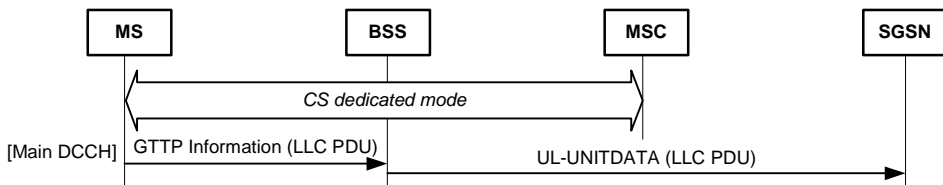

Figure 6: Use of the main DCCH for GPRS information while in dedicated mode

6.1.2.3 MT session

6.1.2.3.1 Ready state: packet downlink assignment

If the mobile station is in the Ready state, the SGSN may send an LLC frame to the BSS parenting the mobile station's serving cell. The downlink LLC PDU shall include the IMSI if it is known. As the IMSI of the mobile station was previously stored, the BSS is able to identify that the mobile station to which the data is sent is in dedicated mode. The BSS shall use the main signalling link to send the downlink assignment command instead of the (P)CCCH. Note that a mobile station in dedicated mode does not listen to the (P)CCCH unless it is "unrestricted class A" capable.

Editor's note : the consequences on the procedures currently defined for the DTM feature shall be analysed if the IMSI can not be provided in the BSSGP DL-UNITDATA PDU.

The assignment is done with one of the DTM assignment messages, sent on the main DCCH.

Figure 7 shows the successful case, when a downlink TBF is assigned without reallocation of the CS resource.

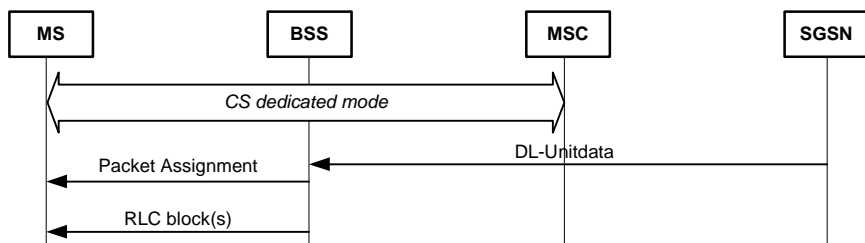

Figure 7: Example of a successful establishment of a PS MT session while in dedicated mode, packet idle mode and Ready state

6.1.2.3.2 Standby state: packet notification

If the mobile station is in the Stand-by state and the SGSN has something to send, it shall send a page to the BSS(s) parenting the RA where the mobile station is, in order to find out the actual serving cell/BVCI. As the mobile station has an established signalling connection with the BSS, the BSS shall not page the mobile station. Instead, the BSS shall inform the mobile station that it is being paged for packet services. This is done by sending the Packet Notification message on the main DCCH. The mobile station shall answer the notification with a Cell Update procedure: sending an LLC frame to act as a "Packet Paging Response".

For that purpose, the GMM layer shall request the establishment of uplink resources. If the LLC frame is *dummy* (i.e. does not convey user data information) and it is short enough, the mobile station shall send it on the main DCCH. Otherwise, an uplink TBF is needed and its establishment shall be done.

Once the LLC frame is sent, the mobile station moves to the GMM Ready state. The SGSN understands the LLC frame as a valid page response and starts sending the downlink information. In order to forward this information to the mobile station, the BSS shall send a (second) assignment message as soon as it receives the data from the SGSN.

The procedure is shown in figure 8.

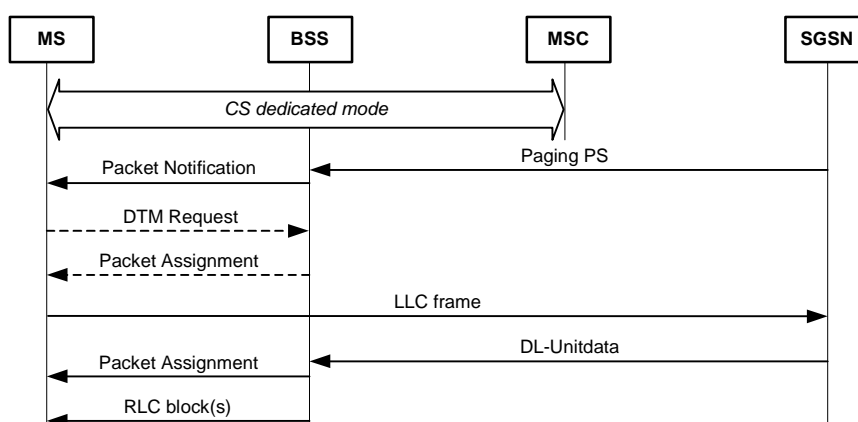

Figure 8: Example of a successful establishment of a PS MT session while in dedicated mode, packet idle mode and Standby state

6.1.3 CS establishment while in packet transfer mode

When in packet transfer mode, either the mobile station or the network may initiate a CS connection establishment. In both cases, the packet session is aborted and the establishment of the CS connection is initiated.

When the establishment of the CS connection is initiated by the network, the CS paging message may come directly from the MSC or via the SGSN if the Gs interface is present. The BSS shall be able to verify in both cases if the paged mobile station is in packet transfer mode and shall send the CS page on the PACCH.

NOTE 1: This paging co-ordination can be reused for GPRS mobile stations in mode of operation B, so that the mobile station does not need to listen to the PCH.

NOTE 2: This feature breaks the link between the presence of the Gs interface and the network capability to perform paging co-ordination. Alignment of 3G TS 23.060 is needed.

Once on the DCCH, the mobile station may request the re-establishment of the packet resources by sending a DTM Request message. The procedure to re-establish an aborted uplink TBF shall be identical to the MO session request. The procedure to re-establish an aborted downlink TBF shall be identical to the MT session request.

Figure 9 shows this procedure graphically.

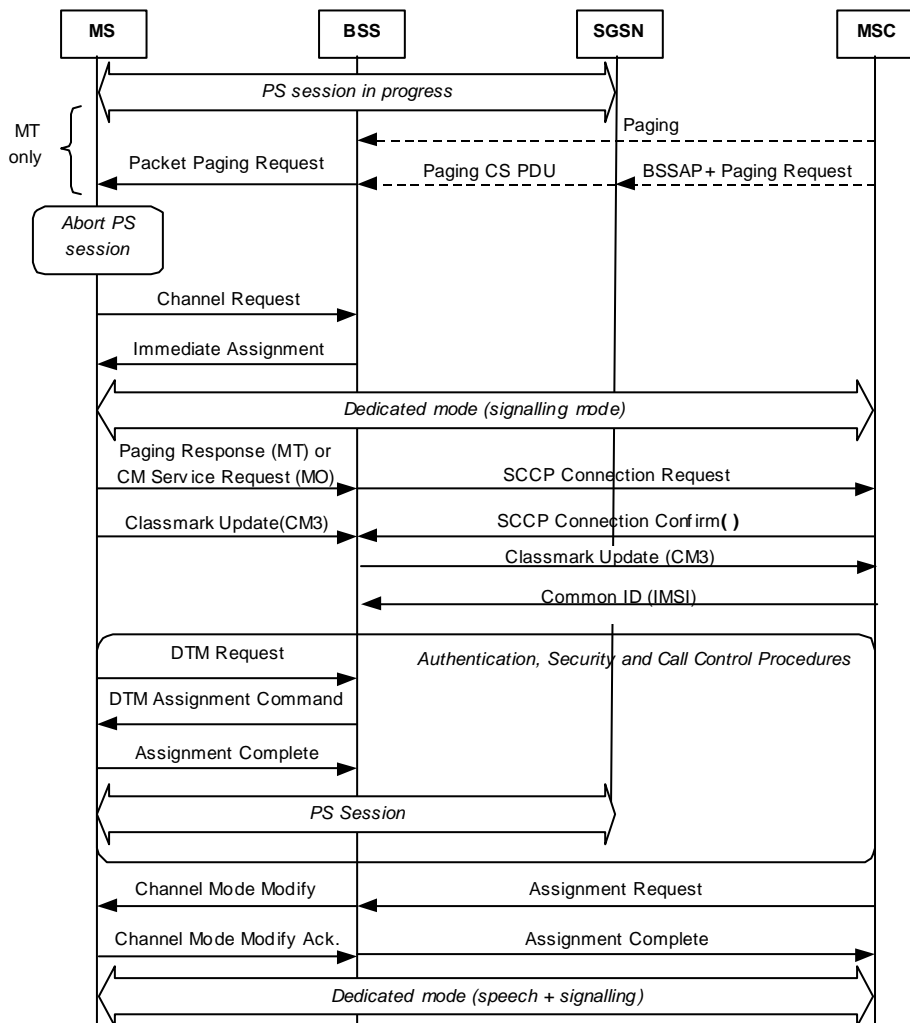

NOTE: The IMSI is sent when available at the MSC and if the BSS supports the DTM feature.

Figure 9: Successful establishment of a CS connection while in packet transfer mode

The definition of a new procedure in 3G TS 04.60 [5] would simplify this process, allowing the establishment of the CS connection without the aborting of the packet session(s). This procedure is shown in figure 10. Once the CS connection is established (in signalling mode) the rest of CC and security procedures take place. This procedure is not defined for Release 99.

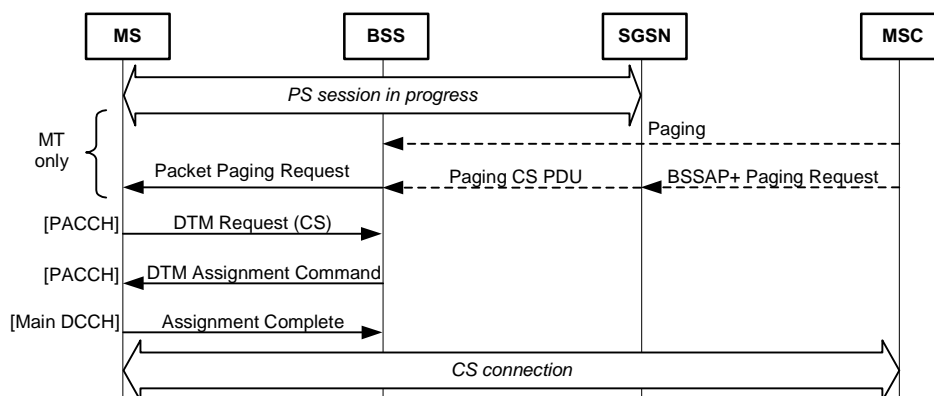

Figure 10: Successful establishment of a CS connection while in packet transfer mode without interruption of the packet session

6.1.4 PS establishment while in dual transfer mode

Once the mobile station is in dual transfer mode with packet resources allocated in one direction only, the establishment of a packet session in the other direction shall be done when possible with the existent mechanisms (see 3G TS 04.60 [5]).

6.2 Release

6.2.1 Release of packet resources

The release of a TBF shall follow the current procedures in 3G TS 04.60 [5]. The use of the main DCCH as a packet resource is stopped when the signalling connection is cleared (during a handover or assignment procedure) or when the mobile station enters the dual transfer mode.

6.2.2 Release of CS resources

In the case of the release of the CS connection while in dual transfer mode, the mobile station shall abandon the packet resources and new ones may be established.

Before the re-establishment of the packet resources, the mobile station may need to read all the relevant information contained in the SI messages that was not sent in the SACCH or the PACCH while in DTM. In order to reduce the interruption of the GPRS session at call release, the network sends a new message (PSI 14) on the PACCH when the mobile station is in dual transfer mode. This message contains

- most of the information in SI 13, if the PBCCH is not allocated; or
- the location of the PBCCH, if this is present.

6.3 Handover

6.3.1 General

Another group of procedures that are affected by the definition a new GPRS class A mode of operation are those related to the change of the serving cell when the mobile station is in dual transfer mode. The term *handover* in this document refers to the network initiated change of serving cell for both domains, unless explicit reference to the CS domain is made.

The handover and the cell change of the CS and PS domains respectively need to be performed at the same time. As 3G TS 05.08 [7] states, the serving cell for a class A mobile station while it is in dedicated mode "is determined by the network according to the handover procedures", irrespective of the Network Control measuring report mode (NC).

The Handover Command message:

- shall describe the CS resources in the target cell;
- if the mobile station is in DTM, it shall indicate whether the target cell belongs to the same routing area or to a different one; (for this purpose, the serving BSS shall include the RAI of the serving cell in the Old BSS to New BSS Information IE;
- if the mobile station is in DTM, it may indicate whether the mobile is allowed to request packet resources in the target cell.

The RAI needs to be included in the SI 6 message sent to a DTM capable mobile station that is not in DTM so that it can detect a change of the RA when it is not indicated in the Handover Command message.

Handover failure cases are determined only from the CS timeslot. In the event of a handover failure, the mobile station shall return to the CS resource in the old cell and send a Handover Failure message on the main DCCH. The mobile station shall assume that the packet resources were released during the handover and it shall try to re-establish them.

Once the main DCCH is established in the cell, if the mobile station in the old cell was in dual transfer mode or, in the case of inter-BSC handover, the target BSC does not have enough knowledge, the network sends the DTM Information message. This message contains:

- the RAI of the new cell: to detect changes of RA without waiting for the SI 6 message;
- the length limitation for the use of the main DCCH.

Then the mobile station or the network may re-establish the packet resource(s).

6.3.2 Internal handover

The network may send a Handover Command message requesting the mobile station to switch to a different cell parented by the same BSC. Prior to that, the BSC shall activate the channels in the target cell. At the receipt of the Handover Command message the mobile station shall abandon the packet session and initiate the access on the target cell, obeying the handover time requirements of 3G TS 05.10 [8] clause 6 and 3G TS 04.13 [3] clause 5.2.6.

The re-establishment of the CS connection shall continue as a CS only handover. When concluded, the BSC shall release the channels in the old cell.

If the mobile station was in dual transfer mode in the old cell, the network sends the DTM Information message, with information needed to resume the GPRS operation immediately. Once the mobile station has the necessary information, it shall perform a cell update or RA update procedure.

If the mobile station also needs to (re-)establish an uplink packet session in the new cell, the GMM signalling procedure shall take precedence and shall be performed first. Once the update procedure is performed, the (re-)establishment of the packet session may continue.

Figure 11 shows the exchange of messages in a successful internal handover.

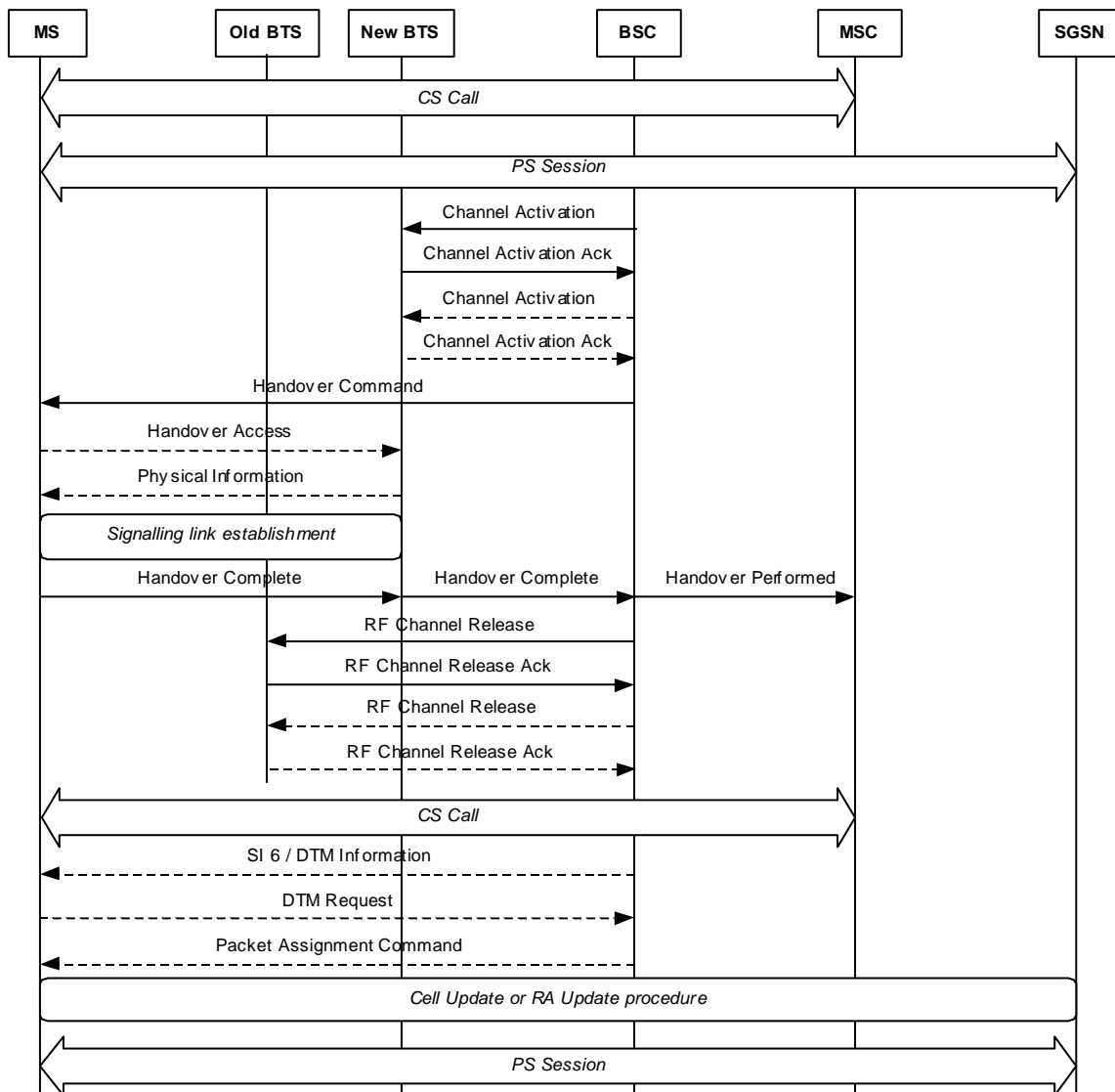

Figure 11: Successful internal, dual handover procedure

6.3.3 External handover

In the case of an external handover, the target BSS:

- shall be provided with the IMSI of the mobile station;
- shall be provided with information about the nature of the packet resources in the serving cell, so that the CS resource is compatible with the packet resources that are going to be requested in the new cell (e.g. transceiver supporting AMR or EDGE, timeslot with a free, adjacent one). This information is conveyed in the Old BSS to New BSS Information IE. Since this IE is optional, if the target BSS does not have any knowledge of the RR mode of the mobile station, it shall send the DTM Information message.

No changes are foreseen for an inter-MSC handover. Current implementations are expected to be able to carry the extended Old BSS to New BSS Information IE without modifications to 3G TS 09.08.

No changes are foreseen for an inter-SGSN handover. The mobile shall perform a Routing Area Update procedure in the new cell. This may be as a result of the SI 6 contents (RAC is now added) or caused by information contained in the DTM Information message.

6.4 Location management

6.4.1 General

The behaviour of a mobile station in idle mode shall be the same as when operating in class B, except that a GPRS simple class A mobile in idle mode can perform the RA update procedure in a DCCH. When the mobile station is in dedicated mode, the change of serving cell may trigger location procedures that require both domains of the mobile station to become active.

Table 3 contains a summary of the procedures to be carried out by a GPRS mobile station operating in Class A when crossing a boundary.

Table 3: Location update procedures for a GPRS mobile station operating in class A

Mode Boundary			CS idle		CS dedicated	
			PS stand-by	PS ready	PS stand-by	PS ready
Cell; same RA			Nothing	Cell Update	Nothing	Cell Update
RA; same LA			RA Update			
LA	Mode ³	I	Combined RA/LA update		RA update. When the CS connection ends in a LA different than the original, a combined RA/LA update is performed	
		II, III	Parallel RA and LA updates		RA update. When the CS connection ends in a LA different than the original an LA update is performed.	

The request from GMM to perform a location management procedure may trigger the request of packet resources, as described above. The contents of the request message (e.g. DTM Request) should help the BSS decide the resources to be allocated.

RA update and LA update procedures shall be supported in parallel in the main DCCH with SAPI 0. This helps reduce the congestion caused by GPRS signalling on GPRS TCHs that naturally exists in cells on the border of a RA or RA/LA without noticeably affecting the QoS of the CS connection.

The following clauses clarify how the mobile station performs the cell update and location/routing area update procedures while in dedicated mode. As previously indicated, the request of the establishment of dual transfer mode may trigger a change of the RR resources in the cell or a change of the serving cell. To simplify the diagrams below, possible assignment or handover procedures are ignored.

The following diagrams consider the *worst* case (no packet resources allocated) as it requires the establishment of uplink and -for RA Update- downlink TBFs. If an uplink TBF already exists, the initial steps leading to the uplink TBF establishment are not necessary. If a downlink TBF already exists, the uplink TBF can also be established as currently by sending the Channel Request Description information element in the Packet Downlink Ack/Nack message on the PACCH; see 3G TS 04.60 [5].

6.4.2 Cell update

Figure 12 and figure 13 show the exchange of messages involved in a Cell Update procedure when the mobile station is in dedicated mode, packet idle mode and Ready state. The mobile station shall request uplink resources, indicating "Cell Update". Typically, the BSS will command the MS to perform the Cell Update procedure in single timeslot operation (figure 12), although it may allocate an uplink TBF on a different time slot (figure 13) if the LLC frame contains user data. In the latter case, a change of the radio resources as was described in the previous clauses may happen before the MS sends the LLC frame on the TBF.

³ Network Operation Modes.

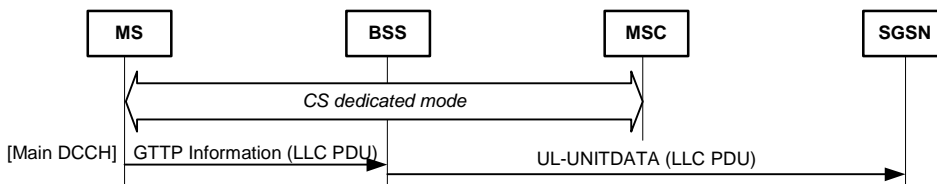

Figure 12: Cell Update procedure in dedicated mode, packet idle mode and Ready state; performed on the main DCCH

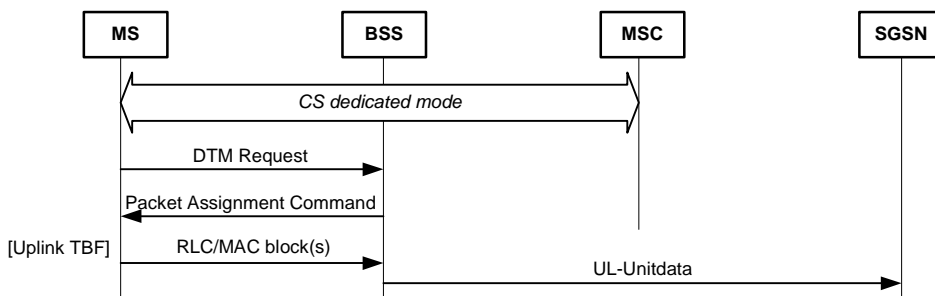

Figure 13: Cell Update procedure in dedicated mode, packet idle mode and Ready state; performed on a TBF

6.4.3 Routing Area update

Figure 14 and figure 15 show the message flow during the Routing Area Update procedure under the same conditions (the MS in CS dedicated mode, packet idle mode and Ready state). Figure 14 shows the procedures when the main DCCH is allowed, whereas two TBFs are used in figure 15. In this case, the uplink TBF is created to send the Routing Area Update Request. The Routing Area Update Accept from the SGSN needs the previous establishment of a downlink TBF.

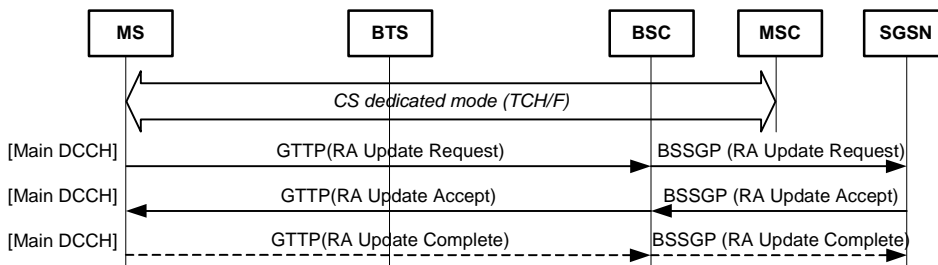

Figure 14: Routing Area Update procedure in dedicated mode, packet idle mode and Ready state; performed on the main DCCH

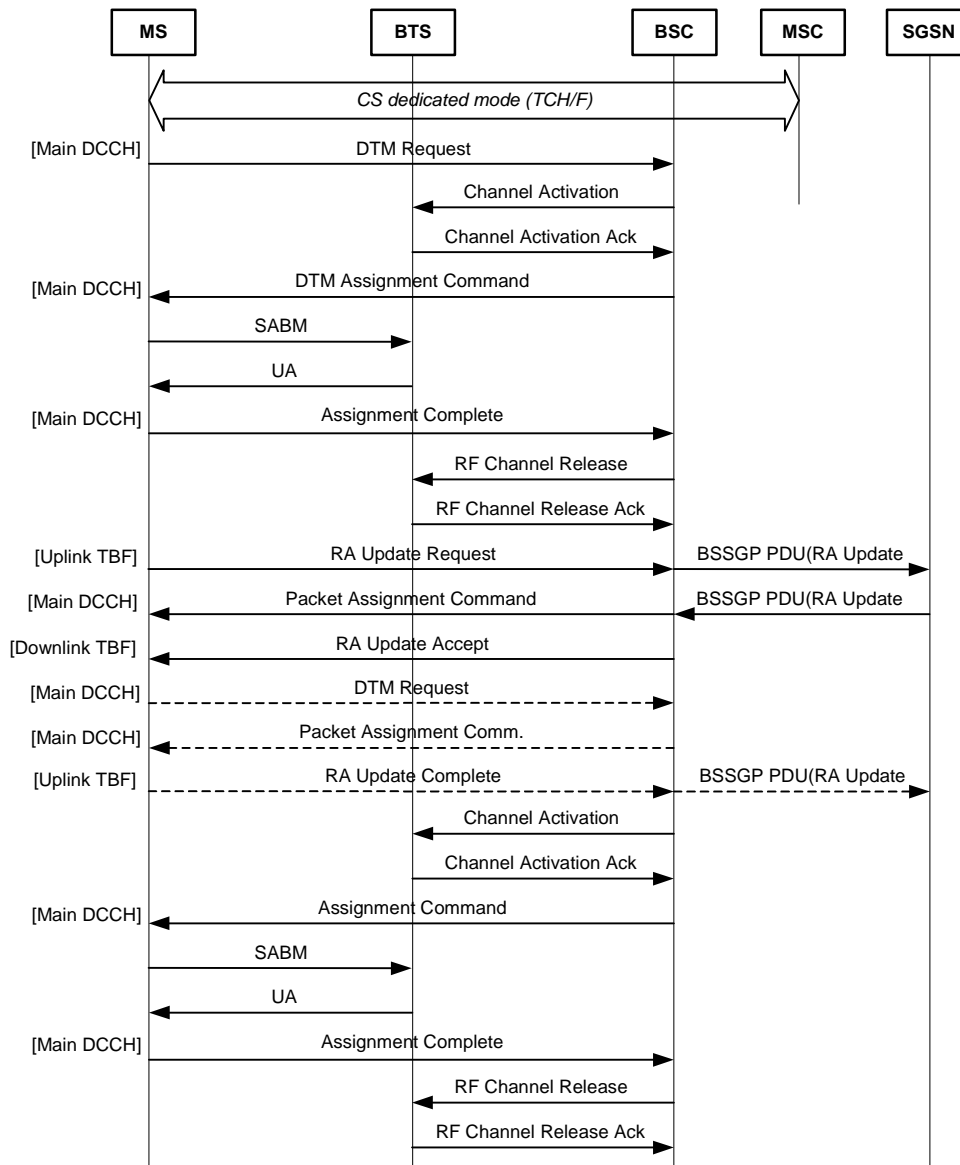
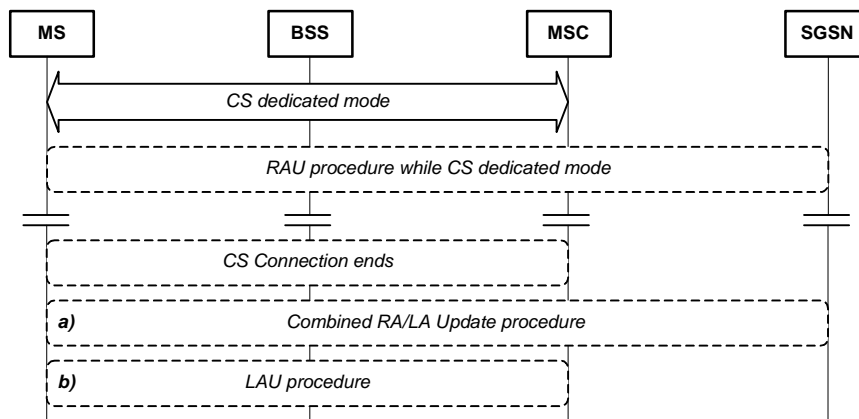

Figure 15: Routing Area Update procedure in dedicated mode, packet idle mode and Ready state; performed on TBFs

6.4.4 Location update

6.4.4.1 Change of Location Area in dedicated mode

Figure 16 shows the exchange of messages when changing **one** Location Area boundary **once** while in dedicated mode. It is identical to the Routing Area Update procedure except for the final group of messages. As the CS domain is not updated in the MSC while the MS is in a CS connection, a Location Area Update procedure is initiated when the CS connection ends to align the MM contexts in the MSC and the SGSN. This procedure is a Combined RA/LA Update procedure when the network is in mode I or a Location Area Update for modes II and III.



- a) for Network Mode of Operation I;
- b) for Network Mode of Operation II and III.

Figure 16: LA Update and RA Update procedures in CS dedicated mode, packet idle mode and Ready state

6.4.4.2 Simultaneous Location Area and Routeing Area update procedures

When the mobile station is in idle mode and crosses a LA boundary, and hence an RA boundary, the mobile station can perform both location procedures (LA and RA update) on the main DCCH. Figure 17 shows the case of the RAU procedure finishing before the LAU. If the LAU procedure finishes before the RAU procedure does, the SDCCH is released and the RAU is completed on standalone TBF(s), as shown in figure 18.

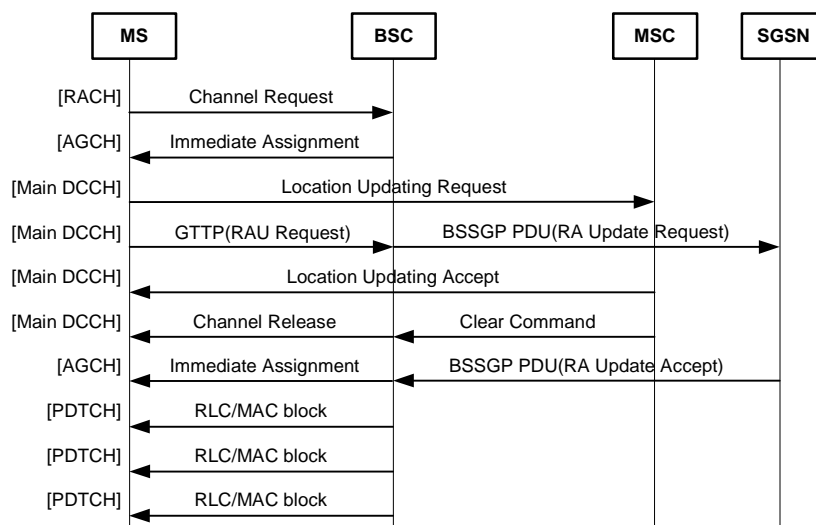

Figure 18 NOTE: Alternatively, the BSC may hold the DCCH for a few seconds until the RAU is finished. This is an improvement of the implementation and has not been standardised.

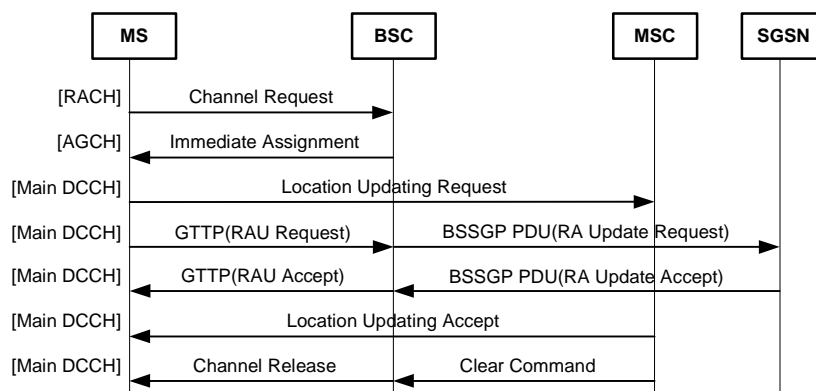

Figure 17: Parallel LA and RA Update procedures: the RAU finishes first

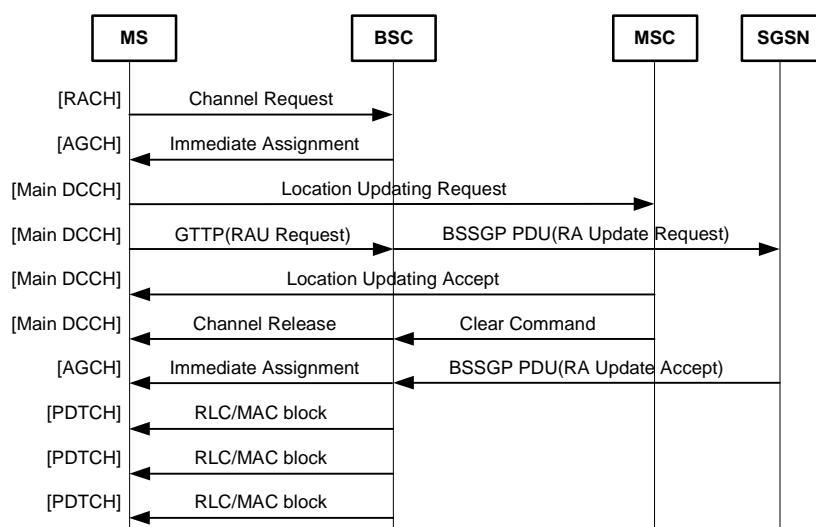

Figure 18: Parallel LA and RA Update procedures: the LAU finishes first

6.5 Provision of the IMSI to the BSC

6.5.1 General

To enable the described implementation of the GPRS class A mode of operation, the BSS and the PCU are required to perform the co-ordination of the allocation of radio resources for both domains. That co-ordination is performed with the IMSI as it is described in the following clauses.

The IMSI shall be provided to the BSC during:

1. call establishment;
2. session establishment; and
3. external handover.

6.5.2 Call establishment

The BSC triggers the establishment of the SCCP connection with the MSC. The MSC shall provide the IMSI to the BSC in a new message: Common ID message. This message can be sent either on the SCCP Connection Confirm message or immediately after, once the connection is already established.

6.5.3 Session establishment

6.5.3.1 Downlink session establishment

Both in the READY and the STANDBY states:

- the IMSI is sent from the SGSN in the PS PAGING BSSGP PDUs;
- the IMSI and the TLLI are sent from the SGSN in the DL-UNITDATA.

6.5.3.2 Uplink session establishment

At the establishment of an uplink TBF, the BSC can identify whether it knows the IMSI of a mobile station for which it has its TLLI. If the IMSI is not known, the BSC can initiate the RA-Capability-Update procedure and request the IMSI (and the RA capabilities) of the mobile to the SGSN.

- If there is a change of cell and the mobile station was in packet transfer mode, it performs a cell update procedure, which can be done with user data and therefore hold for a long time, possibly with no downlink message. During this time the mobile station may not be able to monitor the broadcast channels and miss paging messages. This error situation is prevented by the BSS initiating the RA-Capability-Update procedure.
- The RA-Capability-Update procedure may fail if the SGSN does not have the IMSI (or the RA Capabilities) of the mobile station. This may happen when there is a change of SGSN (hence also of RA). In this case, the mobile station sends the RAU Request message on the uplink TBF and then goes back to (packet) idle mode, where it can receive possible paging messages. When the SGSN answers with the RAU Accept message (after retrieving the PDP and MM contexts from the old SGSN), the DL-UNITDATA message contains the IMSI and the TLLI.

6.5.4 External handover

The IMSI is included in the Handover Request message from the MSC to the target BSC.

6.6 In-band parameters

When the mobile station is in dedicated mode, packet transfer mode or both, some information may need to be passed to the mobile station so that it can enter or maintain the dual transfer mode. Most of that information consists of parameters that are broadcast in the (P)BCCH, but that cannot be read by the mobile station. Some new parameters are added.

Table 4 lists those parameters and indicates whether they have to be sent while in dedicated mode, packet transfer mode or both. When the mobile station is in idle mode, the parameters are sent on the BCCH. When the mobile station is in dedicated mode, the parameters are sent on the SACCH. When the mobile station is in packet transfer mode, they are sent on the PACCH.

Table 4: List of parameters to be passed in-band to the mobile station

(P)BCCH	FACCH	SACCH	PACCH	Parameter	Description
✓	✓	✓		DTM: bit(1)	DTM support in the cell. (P)BCCH: to enable a quick resumption of the GPRS session in the transition from dual transfer mode to packet transfer mode; t enable the LA and RA Update procedures to be performed in parallel on an SDCCH. FACCH: immediately after a handover procedure when the MS was in DTM, in order to enable the packet session to be resume without long interruptions. [DTM Information] SACCH: to enable the packet request procedures while in dedicated mode. [SI 6]
		✓		RAC : bit(8)	Routeing Area Code. It is needed to enable the MS to detect changes of routeing area when in dedicated mode [SI 6]
	✓			RAI : bit(8)	Routeing Area Identity. It is needed to enable the MS to detect changes of routeing area during a handover in dual transfer mode [DTM Information]
	✓	✓		MAX_LAPDm : bit(3)	Maximum size of the message. To limit the use of the main DCCH when the MS in dedicated mode FACCH: immediately after a handover procedure when the MS was in DTM, in order to enable the packet session to be resume without long interruptions. [DTM Information] SACCH: to enable the packet request procedures while in dedicated mode. [SI 6]
	✓			GPRS Cell Options	GPRS Cell Options. Sent on the DTM assignment message (DTM ASSIGNMENT COMMAND or PACKET ASSIGNMENT)
	✓			GPRS Power Control Parameters	GPRS Power Control Parameters. Sent on the DTM assignment message (DTM ASSIGNMENT COMMAND or PACKET ASSIGNMENT)
			✓	(P)SI 13 Information	(P)SI 13 Information: this information is sent so that the mobile station needs not read SI 13 at call release during dual transfer mode

6.7 MS behaviour in *heterogeneous* networks

6.7.1 General

The support of DTM in a network is not likely to be homogeneous. Network operators normally have more than one infrastructure supplier and different manufacturers will support DTM with different time scales. In addition, the rollout of a product release from a certain manufacturer is not performed simultaneously across the network.

It is therefore difficult to avoid the fact that some cells in a network support DTM whereas others do not, making necessary to ensure a consistent behaviour of a DTM mobile station in such scenario. The existing GPRS Suspension and Resume procedures are reused for this purpose.

Table 5 contains the four possible combinations when the mobile station is handed over between two cells, where each of them may or not support DTM.

Table 5: Modification to CS handover to ensure a correct DTM behaviour when DTM is not always supported

		Support of DTM in new cell		
		No	Yes	
Support of DTM in old cell	No	The MS waits for the reception of the SI 6 message indicating whether the cell supports DTM. If DTM is supported, the same message contains the RAC.		
		Normal CS handover.	When the SI6 message is received, the MS performs the Resume procedure: it performs the RR Packet Request procedure for the GMM RA Update procedure.	
	Yes	MS in DM	The MS waits until the reception of the SI 6 message indicating that the cell does not support DTM. Then, if GPRS is supported, the MS performs the GPRS suspension procedure.	
		MS in DTM	The network sends the DTM Information message (implicitly implying the support of DTM) containing the RAC and any other information needed to perform the Packet Request procedure.	

6.7.1 Suspension procedure

The GPRS Suspension procedure is defined in the standards to be used when a mobile station in mode of operation B and in packet transfer mode is paged for circuit switched services.

The GPRS Suspension procedure can be used without modifications when:

- a DTM mobile in dedicated or dual transfer mode is handed over from a cell that supports DTM to one that does not; or
- a DTM mobile in packet transfer mode on a cell that does not support DTM is paged for circuit switched services.

The GPRS Suspension procedure is initiated by the mobile station by sending a GPRS SUSPENSION REQUEST message to the BSS after it has entered dedicated mode.

6.7.2 Resume procedure

The Resume procedure is used for the resumption of GPRS service when the conditions for suspension have disappeared (e.g. a suspended class B mobile station has cleared the resources allocated for the circuit switched service).

The procedure is initiated:

- a) by the **BSS**, when it detects the change of conditions: the BSS indicates the resumption to the SGSN and then the mobile station;
- b) by the **mobile station**, when it detects the change of conditions and the BSS has not resumed GPRS: the mobile station performs a RA Update procedure that resumes GPRS with the SGSN.

For the two new causes for GPRS suspension, there is no message from the BSS to the mobile station and, thus, the Resume procedure is initiated by the mobile station (b).

7 DTM operation

Once the mobile station enters the DTM, the existent RLC/MAC procedures apply, with the exception of the case of an exclusive allocation of an uplink PDCH (including the PDHC/H of a "TCH/H + PDHC/H" configuration). In that case, the mobile station is always granted the transmission of uplink RLC/MAC blocks, which keep the current format. Thus, the mobile station will ignore the USF mechanism or the allocation bitmap for dynamic or fixed allocation, respectively.

Other exceptions to the existent RLC/MAC procedures are:

- The mobile station shall not accept a packet assignment command (addressed to it on the PACCH) that changes the frequency definition of the PDCH. Such change shall be done by means of a DTM Assignment Command message on the main DCCH (changing both TCH and PDCH configurations). A modification of the timeslot allocation may occur by means of a Packet Assignment message. Any violation of the frequency restrictions or the multislot class of the mobile station (taking both TCH and PDCH resources into account) shall be treated as an abnormal case and the TBF(s) shall then be aborted.

NOTE 1: the PCU should know that the mobile station is in dual transfer mode and therefore format the messages correctly.

- When all TBFs have been released (or aborted), the mobile station returns to dedicated mode.
- When the mobile station is in dual transfer mode, it shall ignore a Packet Cell Change Order or a RR-Cell Change Order message and shall remain in dual transfer mode.

NOTE 2: the PCU should know that the mobile station is in dual transfer mode and therefore not send these messages.

- A mobile station in dual transfer mode shall use normal acknowledgements and not access bursts, irrespective of the value of the CONTROL_ACK_TYPE field in the (P)BCCH. Access bursts are not needed since the mobile station is already in dedicated mode.

The mobile station remains in DTM until the CS connection or all the TBFs are released.

8 GPRS attach procedure while in dedicated mode and packet idle mode

In this procedure, the mobile station sends a GPRS Attach Request message to the SGSN. The sequence of messages is very similar to the Routing Area Update procedure, shown in figure 14 and figure 15. The presence of the Gs interface (i.e. network mode of operation I or II/III) needs to be indicated in the SACCH (e.g. SI 6) so that the MS knows what attach type needs to be performed.

9 Security

The current procedures apply.

NOTE: LLC frames containing GPRS signalling messages and sent on the main DCCH are therefore ciphered twice, but that has been confirmed by SMG10 not to be a security problem. In "TCH/H + PDCH/H" and other multislot configurations, current GPRS ciphering is kept.

10 Header and Data Compression

Because this is done at SNDCP layer, there is assumed to be no impact.

Annex A: Possible improvements for future releases

No.	Description
1	New 3G TS 04.60 procedure for the establishment of a CS connection without interruption of the packet services
2	Support of multislot operation comprising single timeslot operation and additional PDCH(s) in the same direction
3	Multislot configurations where the CS connection is using more than one timeslot
4	Multislot configurations where the timeslots allocated to the PS session are not contiguous
5	Support of multislot operation and single timeslot operation in different directions
6	Power control for EGPRS while in DTM

Annex B: Change history

Change history							
Date	TSG #	TSG Doc.	CR	Rev	Subject/Comment	Old	New
10 Nov 00	G02	GP-000705			New specification approved by TSG-GERAN	2.0.0	8.0.0

Rapporteur:

Name: José Luis Carrizo Martínez
Company: Vodafone
Telephone: +44 1635 676093
E-mail: <mailto:jose-luis.carrizo@vodafone.co.uk>

Fax: +44 1635 231847

History

Document history		
V8.0.0	November 2000	Publication