



**5G;
NR;**

**Derivation of test tolerances and measurement uncertainty for
User Equipment (UE) conformance test cases
(3GPP TR 38.903 version 16.10.1 Release 16)**



Reference

RTR/TSGR-0538903vga1

Keywords

5G

ETSI

650 Route des Lucioles
F-06921 Sophia Antipolis Cedex - FRANCE

Tel.: +33 4 92 94 42 00 Fax: +33 4 93 65 47 16

Siret N° 348 623 562 00017 - APE 7112B
Association à but non lucratif enregistrée à la
Sous-Préfecture de Grasse (06) N° w061004871

Important notice

The present document can be downloaded from:

<http://www.etsi.org/standards-search>

The present document may be made available in electronic versions and/or in print. The content of any electronic and/or print versions of the present document shall not be modified without the prior written authorization of ETSI. In case of any existing or perceived difference in contents between such versions and/or in print, the prevailing version of an ETSI deliverable is the one made publicly available in PDF format at www.etsi.org/deliver.

Users of the present document should be aware that the document may be subject to revision or change of status.

Information on the current status of this and other ETSI documents is available at

<https://portal.etsi.org/TB/ETSIDeliverableStatus.aspx>

If you find errors in the present document, please send your comment to one of the following services:

<https://portal.etsi.org/People/CommitteeSupportStaff.aspx>

Notice of disclaimer & limitation of liability

The information provided in the present deliverable is directed solely to professionals who have the appropriate degree of experience to understand and interpret its content in accordance with generally accepted engineering or other professional standard and applicable regulations.

No recommendation as to products and services or vendors is made or should be implied.

No representation or warranty is made that this deliverable is technically accurate or sufficient or conforms to any law and/or governmental rule and/or regulation and further, no representation or warranty is made of merchantability or fitness for any particular purpose or against infringement of intellectual property rights.

In no event shall ETSI be held liable for loss of profits or any other incidental or consequential damages.

Any software contained in this deliverable is provided "AS IS" with no warranties, express or implied, including but not limited to, the warranties of merchantability, fitness for a particular purpose and non-infringement of intellectual property rights and ETSI shall not be held liable in any event for any damages whatsoever (including, without limitation, damages for loss of profits, business interruption, loss of information, or any other pecuniary loss) arising out of or related to the use of or inability to use the software.

Copyright Notification

No part may be reproduced or utilized in any form or by any means, electronic or mechanical, including photocopying and microfilm except as authorized by written permission of ETSI.

The content of the PDF version shall not be modified without the written authorization of ETSI.

The copyright and the foregoing restriction extend to reproduction in all media.

© ETSI 2022.
All rights reserved.

Intellectual Property Rights

Essential patents

IPRs essential or potentially essential to normative deliverables may have been declared to ETSI. The declarations pertaining to these essential IPRs, if any, are publicly available for **ETSI members and non-members**, and can be found in ETSI SR 000 314: "*Intellectual Property Rights (IPRs); Essential, or potentially Essential, IPRs notified to ETSI in respect of ETSI standards*", which is available from the ETSI Secretariat. Latest updates are available on the ETSI Web server (<https://ipr.etsi.org/>).

Pursuant to the ETSI Directives including the ETSI IPR Policy, no investigation regarding the essentiality of IPRs, including IPR searches, has been carried out by ETSI. No guarantee can be given as to the existence of other IPRs not referenced in ETSI SR 000 314 (or the updates on the ETSI Web server) which are, or may be, or may become, essential to the present document.

Trademarks

The present document may include trademarks and/or tradenames which are asserted and/or registered by their owners. ETSI claims no ownership of these except for any which are indicated as being the property of ETSI, and conveys no right to use or reproduce any trademark and/or tradename. Mention of those trademarks in the present document does not constitute an endorsement by ETSI of products, services or organizations associated with those trademarks.

DECT™, **PLUGTESTS™**, **UMTS™** and the ETSI logo are trademarks of ETSI registered for the benefit of its Members. **3GPP™** and **LTE™** are trademarks of ETSI registered for the benefit of its Members and of the 3GPP Organizational Partners. **oneM2M™** logo is a trademark of ETSI registered for the benefit of its Members and of the oneM2M Partners. **GSM®** and the GSM logo are trademarks registered and owned by the GSM Association.

Legal Notice

This Technical Report (TR) has been produced by ETSI 3rd Generation Partnership Project (3GPP).

The present document may refer to technical specifications or reports using their 3GPP identities. These shall be interpreted as being references to the corresponding ETSI deliverables.

The cross reference between 3GPP and ETSI identities can be found under <http://webapp.etsi.org/key/queryform.asp>.

Modal verbs terminology

In the present document "**should**", "**should not**", "**may**", "**need not**", "**will**", "**will not**", "**can**" and "**cannot**" are to be interpreted as described in clause 3.2 of the [ETSI Drafting Rules](#) (Verbal forms for the expression of provisions).

"**must**" and "**must not**" are **NOT** allowed in ETSI deliverables except when used in direct citation.

Contents

Intellectual Property Rights	2
Legal Notice	2
Modal verbs terminology.....	2
Foreword.....	9
Introduction	9
1 Scope	10
2 References	10
3 Definitions, symbols and abbreviations	11
3.1 Definitions	11
3.2 Symbols.....	11
3.3 Abbreviations	11
4 General Principles	12
4.1 Principle of Superposition	12
4.2 Sensitivity analysis	12
4.3 Statistical combination of uncertainties.....	12
4.4 Correlation between uncertainties	13
4.4.1 Uncorrelated uncertainties	13
4.4.2 Positively correlated uncertainties	14
4.4.3 Negatively correlated uncertainties.....	14
4.4.4 Treatment of uncorrelated uncertainties	15
4.4.5 Treatment of positively correlated uncertainties with adverse effect.....	15
4.4.6 Treatment of positively correlated uncertainties with beneficial effect	15
4.4.7 Treatment of negatively correlated uncertainties	15
5 Determination of Test System Uncertainties.....	16
5.1 General	16
5.2 Uncertainty figures	16
6 Determination of Test Tolerances	16
6.1 General	16
7 Grouping of test cases defined in TS 38.521-4	16
8 Grouping of test cases defined in TS 38.533.....	17
Annex A: Derivation documents for test tolerance	26
A.1 Void.....	26
A.2 Handling of common Test Tolerance topics for radiated test cases defined in TS 38.533	26
A.2.1 Angles of Arrival.....	26
A.2.1.1 Relevant core requirements.....	26
A.2.1.2 Modelling of variation within spherical coverage directions.....	27
A.2.1.3 Principles for Test Tolerance analysis	27
A.2.2 UE Fine beams and Rough beams.....	27
A.2.2.1 Relevant core requirements.....	27
A.2.2.2 Modelling of Fine beams and Rough beams.....	28
A.2.2.3 Principles for Test Tolerance analysis	28
A.2.3 UE internal noise.....	29
A.2.3.1 Relevant core requirements.....	29
A.2.3.2 Calculation method	29
A.2.3.3 Principles for Test Tolerance analysis	30
A.2.4 Calculation of Es/Iot at UE baseband.....	30
A.2.4.1 Relevant core requirements.....	30
A.2.4.2 Calculation method	30

A.2.4.3	Principles for Test Tolerance analysis	31
A.2.5	Calculation of Applied Io	31
A.2.5.1	Relevant core requirements.....	31
A.2.5.2	Calculation method	31
A.2.5.3	Principles for Test Tolerance analysis	32
A.2.6	UE Reported RSRP and UE gain	32
A.2.6.1	Relevant core requirements.....	32
A.2.6.2	Absolute RSRP	33
A.2.6.3	Relative RSRP, 2 levels on same cell, same Angle of Arrival.....	34
A.2.6.4	Relative RSRP, 2 intra-frequency cells, same Angle of Arrival.....	35
A.2.6.5	Relative RSRP, 2 inter-frequency cells, same Angle of Arrival.....	35
A.2.6.6	Relative RSRP, 2 cells, different Angles of Arrival	35
A.2.6.7	Principles for Test Tolerance analysis	36
A.2.7	Intra-frequency cells without AWGN, same Angle of Arrival.....	36
A.2.7.1	Test system	36
A.2.7.2	Calculation method for Es/Iot at UE baseband.....	36
A.2.7.3	Calculation method for Applied Io	37
A.2.7.4	Principles for Test Tolerance analysis	38
A.3	Test Tolerance analysis templates for radiated test cases awaiting completion.....	38
A.4	Design of radiated test cases defined in TS 38.533.....	38
A.4.1	Downlink considerations.....	39
A.4.1.1	Side conditions for Rx Beam Peak angle of arrival	39
A.4.1.2	Side conditions for Spherical Coverage angle of arrival.....	39
A.4.1.3	Test case design options to increase downlink dB range.....	40
Annex B:	Acceptable uncertainty of test system for test cases defined in TS	
	38.521-2 for radiative testing	42
B.1	Uncertainty budget calculation principle.....	42
B.1.1	Uncertainty budget calculation principle for DFF.....	42
B.1.2	Uncertainty budget calculation principle for IFF	43
B.1.3	Uncertainty budget calculation principle for NFTF	43
B.2	Measurement error contribution descriptions.....	43
B.2.1	Measurement error contribution descriptions for DFF.....	43
B.2.1.1	Positioning misalignment	43
B.2.1.2	Measure distance uncertainty.....	43
B.2.1.3	Quality of quiet zone.....	43
B.2.1.4	Mismatch	43
B.2.1.5	Standing Wave Between the DUT and measurement antenna.....	45
B.2.1.6	Uncertainty of the RF power measurement equipment.....	45
B.2.1.7	Phase curvature	46
B.2.1.8	Amplifier uncertainties	46
B.2.1.9	Random uncertainty	46
B.2.1.10	Influence of the XPD	47
B.2.1.11	Insertion loss Variation.....	51
B.2.1.12	RF leakage (from measurement antenna to receiver/transmitter)	51
B.2.1.13	Misalignment of positioning System	51
B.2.1.14	Uncertainty of the Network Analyzer.....	51
B.2.1.15	Uncertainty of the absolute gain of the calibration antenna.....	51
B.2.1.16	Positioning and pointing misalignment between the reference antenna and the measurement antenna	51
B.2.1.17	gNB emulator uncertainty.....	51
B.2.1.18	Phase centre offset of calibration	52
B.2.1.19	Quality of quiet zone for calibration process	52
B.2.1.20	Standing wave between reference calibration antenna and measurement antenna	52
B.2.1.21	Influence of the calibration antenna feed cable (Flexing cables, adapters, attenuators, connector repeatability)	53
B.2.1.22	Influence of TRP measurement grid	53
B.2.1.23	Influence of beam peak search grid	53
B.2.1.24	Systematic error due to TRP calculation/quadrature	53
B.2.1.25	Multiple measurement antenna uncertainty	53

B.2.1.26	DUT repositioning	53
B.2.1.27	Influence of noise	53
B.2.1.28	Systematic error related to beam peak search	54
B.2.1.29	Influence of spherical coverage grid	54
B.2.1.30	Systematic error related to EIS spherical coverage	54
B.2.1.31	Misalignment of DUT due to change of DUT orientation	54
B.2.1.32	Additional Impact of Interferer ACLR	54
B.2.1.33	Modulated Interferer uncertainty	54
B.2.1.34	Void	54
B.2.1.35	Influence of offset antenna for blocker signal	54
B.2.1.36	Uncertainty of the RF relative power measurement equipment	55
B.2.2	Measurement error contribution descriptions for IFF	55
B.2.2.1	Positioning misalignment	55
B.2.2.2	Measure distance uncertainty	55
B.2.2.3	Quality of Quiet Zone	55
B.2.2.4	Mismatch	55
B.2.2.5	Standing wave between DUT and measurement antenna	56
B.2.2.6	Uncertainty of the RF power measurement equipment	56
B.2.2.7	Phase Curvature	56
B.2.2.8	Amplifier Uncertainties	56
B.2.2.9	Random uncertainty	56
B.2.2.10	Influence of XPD	56
B.2.2.11	Insertion Loss Variation	56
B.2.2.12	RF leakage (from measurement antenna to receiver/transmitter)	56
B.2.2.13	Misalignment of positioning system	56
B.2.2.14	Uncertainty of the Network Analyzer	56
B.2.2.15	Uncertainty of the absolute gain of the calibration antenna	56
B.2.2.16	Positioning and pointing misalignment between the reference antenna and the measurement antenna	56
B.2.2.17	gNB emulator uncertainty	56
B.2.2.18	Phase centre offset of calibration	57
B.2.2.19	Quality of the Quiet Zone for Calibration Process	57
B.2.2.20	Standing wave between reference calibration antenna and measurement antenna	57
B.2.2.21	Influence of the calibration antenna feed cable (Flexing cables, adapters, attenuators, connector repeatability)	57
B.2.2.22	Influence of TRP measurement grid	57
B.2.2.23	Influence of beam peak search grid	57
B.2.2.24	Systematic error due to TRP calculation/quadrature	57
B.2.2.25	Multiple measurement antenna uncertainty	57
B.2.2.26	DUT repositioning	57
B.2.2.27	Influence of noise	57
B.2.2.28	Systematic error related to beam peak search	57
B.2.2.29	Influence of spherical coverage grid	57
B.2.2.30	Systematic error related to EIS spherical coverage	57
B.2.2.31	Misalignment of DUT due to change of DUT orientation	58
B.2.2.32	Additional Impact of Interferer ACLR	58
B.2.2.33	Modulated Interferer uncertainty	58
B.2.2.34	Influence of ETC on EIRP/EIS	58
B.2.2.35	Influence of offset antenna for blocker signal	58
B.2.2.6	Uncertainty of the RF relative power measurement equipment	58
B.2.3	Measurement error contribution descriptions for NFFT	58
B.2.3.1	Axes Alignment	58
B.2.3.2	Measurement Distance uncertainty	58
B.2.3.3	Quality of the Quiet Zone	58
B.2.3.4	Mismatch	58
B.2.3.5	Multiple Reflections: Coupling Measurement Antenna and DUT	58
B.2.3.6	Uncertainty of the RF power measurement equipment	59
B.2.3.7	Phase curvature	59
B.2.3.8	Amplifier uncertainties	59
B.2.3.9	Random uncertainty	59
B.2.3.10	Influence of the XPD	59
B.2.3.11	NF to FF truncation	59
B.2.3.12	Probe Polarization Amplitude and Phase	59

B.2.3.13	Probe Array Uniformity (for multi-probe systems only)	59
B.2.3.14	Uncertainty of the Network Analyzer	59
B.2.3.15	Uncertainty of the absolute gain of the calibration antenna	59
B.2.3.16	Phase Recovery Non-Linearity over signal bandwidth	60
B.2.3.17	Probe Pattern Effect	60
B.2.3.18	Phase centre offset of calibration	60
B.2.3.19	Quality of the Quiet Zone for Calibration Process	60
B.2.3.20	Phase Drift and Noise	60
B.2.3.21	Mismatch in the connection of the calibration antenna	60
B.2.3.22	Influence of TRP measurement grid	60
B.2.3.23	60
B.2.3.24	60
B.2.3.25	Leakage and Crosstalk	60
B.2.3.26	Systematic error due to TRP calculation/quadrature	60
B.2.3.27	Multiple measurement antenna uncertainty	60
B.2.3.28	DUT repositioning	61
B.2.3.29	Influence of noise	61
B.2.3.30	Uncertainty of the RF relative power measurement equipment	61
B.3	UE maximum output power	61
B.3.1	Uncertainty budget format and assessment for DFF	62
B.3.2	Uncertainty budget format and assessment for IFF	66
B.3.3	Uncertainty budget format and assessment for NFTF	79
B.4	UE maximum output power for modulation / channel bandwidth	80
B.4.1	Uncertainty budget format and assessment for DFF	81
B.4.2	Uncertainty budget format and assessment for IFF	82
B.4.3	Uncertainty budget format and assessment for NFTF	83
B.5 to B6	84
B.7	Minimum Output power	84
B.7.1	Uncertainty budget format and assessment for DFF	84
B.7.2	Uncertainty budget format and assessment for IFF	88
B.8	Transmit OFF power	97
B.8.1	Uncertainty budget format and assessment for DFF	97
B.8.2	Uncertainty budget format and assessment for IFF	100
B.9	109
B.9a	Power control	109
B.9a.1	Absolute power tolerance	109
B.9a.2	Relative power control tolerance	109
B.9a.2.1	Uncertainty budget format and assessment for DFF	109
B.9a.2.2	Uncertainty budget format and assessment for IFF	110
B.9a.2.3	Uncertainty budget format and assessment for NFTF	111
B.9a.3	Aggregate Power control tolerance	112
B.9a.3.1	Uncertainty budget format and assessment for DFF	112
B.9a.3.2	Uncertainty budget format and assessment for IFF	113
B.9a.3.3	Uncertainty budget format and assessment for NFTF	114
B.10	Frequency error	115
B.10.1	Uncertainty budget format and assessment for DFF	115
B.10.2	Uncertainty budget format and assessment for IFF	116
B.11	Carrier leakage	116
B.11.1	Uncertainty budget format and assessment for DFF	116
B.11.2	Uncertainty budget format and assessment for IFF	120
B.12 to B.14	127
B.15	Occupied bandwidth	127
B.15.1	Uncertainty budget format and assessment for DFF	127
B.15.2	Uncertainty budget format and assessment for IFF	127

B.16	Spectrum emission mask	128
B.16.1	Uncertainty budget format and assessment for DFF	128
B.16.2	Uncertainty budget format and assessment for IFF	131
B.17	Adjacent Channel Leakage Ratio	137
B.17.1	Uncertainty budget format and assessment for DFF	138
B.17.2	Uncertainty budget format and assessment for IFF	142
B.18	Spurious emissions	148
B.18.1	Uncertainty budget format and assessment for DFF	151
B.18.2	Uncertainty budget format and assessment for IFF	155
B.18.3	Uncertainty budget format and assessment for NFTF	188
B.18a	Beam correspondence - EIRP	188
B.18a.1	Uncertainty budget format and assessment for DFF	188
B.18a.2	Uncertainty budget format and assessment for IFF	189
B.18a.3	Uncertainty budget format and assessment for NFTF	190
B.19	Reference Sensitivity	191
B.19.1	Uncertainty budget format and assessment for DFF	192
B.19.2	Uncertainty budget format and assessment for IFF	192
B.20	200
B.21	Adjacent Channel Selectivity	200
B.21.1	Uncertainty budget format and assessment for DFF	200
B.21.2	Uncertainty budget format and assessment for IFF	200
B.22	In-Band Blocking	206
B.22.1	Uncertainty budget format and assessment for DFF	206
B.22.2	Uncertainty budget format and assessment for IFF	206
B.23	207
B.24	207
B.25	Receiver spurious emissions	207
B.25.1	Uncertainty budget format and assessment for DFF	208
B.25.2	Uncertainty budget format and assessment for IFF	211
Annex C:	Acceptable uncertainty of test system for test cases defined in TS 38.521-3 for radiative testing	242
Annex D:	Acceptable uncertainty of test system for test cases defined in TS 38.521-4 for radiative testing	243
D.1	Uncertainty budget calculation principle	250
D.1.1	Uncertainty budget calculation principle for DNF	250
D.1.2	Uncertainty budget calculation principle for DFF	250
D.1.3	Uncertainty budget calculation principle for IFF	250
D.2	Measurement error contribution descriptions	250
D.2.1	Measurement error contribution descriptions for DNF	250
D.2.1.1	gNB emulator SNR uncertainty	250
D.2.1.2	gNB emulator Downlink EVM	250
D.2.1.3	gNB emulator fading model impairments	251
D.2.2	Measurement error contribution descriptions for DFF	251
D.2.2.1	gNB emulator SNR uncertainty	251
D.2.2.2	gNB emulator Downlink EVM	251
D.2.2.3	gNB emulator fading model impairments	251
D.2.3	Measurement error contribution descriptions for IFF	251
D.2.3.1	gNB emulator SNR uncertainty	251
D.2.3.2	gNB emulator Downlink EVM	251
D.2.3.3	gNB emulator fading model impairments	251
D.3	Assessment of testable DL SNR range and accuracy	251
D.3.1	Method and Parameters	251

D.3.2.1	SNR range for $SNR_{RP} - SNR_{BB} \leq 1\text{dB}$ for DFF	252
D.3.2.2	SNR range for $SNR_{RP} - SNR_{BB} \leq 1\text{dB}$ for IFF	252

Annex E:	Acceptable uncertainty of test system for test cases defined in TS 38.533 for radiative testing.....	255
E.1	Uncertainty budget calculation principle.....	255
E.1.1	Uncertainty budget calculation principle for DFF.....	255
E.1.2	Uncertainty budget calculation principle for IFF	255
E.2	Measurement error contribution descriptions.....	255
E.2.1	Measurement error contribution descriptions for DFF	255
E.2.1.1	gNB emulator SNR uncertainty	255
E.2.1.2	gNB emulator Downlink EVM.....	255
E.2.1.3	gNB emulator fading model impairments.....	255
E.2.2	Measurement error contribution descriptions for IFF	256
E.2.2.1	gNB emulator SNR uncertainty	256
E.2.2.2	gNB emulator Downlink EVM.....	256
E.2.2.3	gNB emulator fading model impairments.....	256
E.3	Uncertainty assessment for RRM MU quantities.....	256
E.3.1	Uncertainty assessment for DL AWGN absolute power or wanted DL signal absolute power	256
E.3.1.1	Uncertainty budget format and assessment for DFF test setup	257
E.3.1.2	Uncertainty budget format and assessment for Simplified DFF test setup	260
E.3.1.3	Uncertainty budget format and assessment for IFF test setup	260
E.3.1.4	Uncertainty budget format and assessment for Enhanced IFF test setup.....	262
E.3.1.5	Uncertainty budget format and assessment for IFF+DFF Hybrid test setup.....	264
E.3.2	Uncertainty assessment for DL applied SNR	264
E.3.3	Uncertainty assessment for DL Fading profile uncertainty	264
E.3.4	Uncertainty assessment for DL AWGN and signal flatness.....	264
E.3.5	Uncertainty assessment for UL absolute power measurement	264
E.3.5.1	Uncertainty budget format and assessment for DFF.....	264
E.3.5.2	TBD	267
E.3.5.3	Uncertainty budget format and assessment for IFF	267
E.3.5.4	Uncertainty budget format and assessment for Enhanced IFF test setup.....	269
E.3.5.5	Uncertainty budget format and assessment for IFF+DFF Hybrid test setup.....	271
E.3.6	Uncertainty assessment for UL relative power measurement	271
E.3.7	Uncertainty assessment for UL signal transmit timing relative to DL	271
E.3.8	Uncertainty assessment for Relative transmit timing accuracy during UE timing adjustment.....	271
Annex F:	Applicable MTSU for Different QZ/Device Sizes	272
Annex G:	Change history	274
History		279

Foreword

This Technical Report has been produced by the 3rd Generation Partnership Project (3GPP).

The contents of the present document are subject to continuing work within the TSG and may change following formal TSG approval. Should the TSG modify the contents of the present document, it will be re-released by the TSG with an identifying change of release date and an increase in version number as follows:

Version x.y.z

where:

- x the first digit:
 - 1 presented to TSG for information;
 - 2 presented to TSG for approval;
 - 3 or greater indicates TSG approved document under change control.
- y the second digit is incremented for all changes of substance, i.e. technical enhancements, corrections, updates, etc.
- z the third digit is incremented when editorial only changes have been incorporated in the document.

Introduction

FFS

1 Scope

The present document specifies a general method used to derive Measurement Uncertainties and Test Tolerances for UE conformance tests. The acceptable uncertainties for each test case are documented and establish a system for relating the Test Tolerances to the measurement uncertainties of the Test System.

For UE radio transmitting and reception tests, only FR2 is considered in this document. For UE RRM and Demodulation tests, both FR1 and FR2 are considered in this document.

The test cases which have been analysed to determine Test Tolerances are included as .zip files.

The present document is applicable from Release 15 up to the release indicated on the front page of the present Terminal conformance specifications.

2 References

The following documents contain provisions which, through reference in this text, constitute provisions of the present document.

- References are either specific (identified by date of publication, edition number, version number, etc.) or non-specific.
- For a specific reference, subsequent revisions do not apply.
- For a non-specific reference, the latest version applies. In the case of a reference to a 3GPP document (including a GSM document), a non-specific reference implicitly refers to the latest version of that document *in the same Release as the present document*.

- [1] 3GPP TR 21.905: "Vocabulary for 3GPP Specifications".
- [2] 3GPP TR 36.903: " Evolved Universal Terrestrial Radio Access (E-UTRA) and Evolved Universal Terrestrial Radio Access Network (E-UTRAN); Derivation of test tolerances for Radio Resource Management (RRM) conformance tests".
- [3] 3GPP TS 36.904: " Evolved Universal Terrestrial Radio Access (E-UTRA) and Evolved Universal Terrestrial Radio Access Network (E-UTRAN); Derivation of test tolerances for User Equipment (UE) radio reception conformance tests".
- [4] ETSI ETR 273-1-2: "Improvement of radiated methods of measurement (using test sites) and evaluation of the corresponding measurement uncertainties; Part 1: Uncertainties in the measurement of mobile radio equipment characteristics; Sub-part 2: Examples and annexes".
- [5] 3GPP TS 36.521-1: "User Equipment (UE) conformance specification, Radio transmission and reception Part 1: conformance testing".
- [6] 3GPP TS 38.521-1: "NR; User Equipment (UE) conformance specification; Radio transmission and reception; Part 1: Range 1 Standalone".
- [7] 3GPP TS 38.521-2: "NR; User Equipment (UE) conformance specification; Radio transmission and reception; Part 2: Range 2 Standalone".
- [8] 3GPP TS 38.521-3: "NR; User Equipment (UE) conformance specification; Radio transmission and reception; Part 3: NR interworking between NR range1 + NR range2; and between NR and LTE".
- [9] 3GPP TS 38.521-4: "NR; User Equipment (UE) conformance specification; Radio transmission and reception; Part 4: Performance requirements".
- [10] 3GPP TS 38.533: "NR; User Equipment (UE) conformance specification; Radio Resource Management (RRM)".

- [11] ETSI TR 102 273-1-1 V1.2.1 (2001-12): "Electromagnetic compatibility and Radio spectrum Matters (ERM); Improvement on Radiated Methods of Measurement (using test site) and evaluation of the corresponding measurement uncertainties; Part 1: Uncertainties in the measurement of mobile radio equipment characteristics; Sub-part 1: Introduction".
- [12] 3GPP TR 25.914: "Measurement of Radio Performances for UMTS terminals in speech mode".
- [13] 3GPP TR 38.810: "Study on test methods for New Radio".
- [14] CTIA OTA Test Plan version 3.7, <https://www.ctia.org/>.
- [15] 3GPP TS 36.521-3: "User Equipment (UE) conformance specification, Radio transmission and reception Part 3: Radio Resource Management (RRM) conformance testing."
- [16] 3GPP TS 38.101-2: "User Equipment (UE) radio transmission and reception Part 2: Range 2 Standalone"
- [17] 3GPP TS 38.133: "Requirements for support of radio resource management"
- [18] 3GPP TS 38.508-1: "5GS; User Equipment (UE) conformance specification; Part 1: Common test environment"
- [19] 3GPP TS 38.101-4: "NR; User Equipment (UE) radio transmission and reception; Part 4: Performance requirements"

3 Definitions, symbols and abbreviations

3.1 Definitions

For the purposes of the present document, the terms and definitions given in TR 21.905 [1] apply.

3.2 Symbols

For the purposes of the present document, the following symbols apply:

D DUT radiating aperture

3.3 Abbreviations

For the purposes of the present document, the abbreviations given in TR 21.905 [1] and the following apply. An abbreviation defined in the present document takes precedence over the definition of the same abbreviation, if any, in TR 21.905 [1].

BW	Bandwidth
CA	Carrier Aggregation
DFE	Direct Far Field
DUT	Device Under Test
EIS	Effective Isotropic Sensitivity
EIRP	Effective (or equivalent) isotropic radiated power
EVM	Error Vector Magnitude
FF	Far Field
FR1	Frequency Range 1
FR2	Frequency Range 2
FWA	Fixed Wireless Access
IFF	Indirect Far Field
MBW	Maximum Bandwidth
MU	Measurement Uncertainty
NFTF	Near Field To Far-field
NR	New Radio
OTA	Over The Air

SNR	Signal-to-Noise Ratio
TRP	Total Radiated Power
UE	User Equipment

4 General Principles

4.1 Principle of Superposition

For multi-cell tests there are several cells each generating various Physical channels. In general cells are combined along with AWGN, so the signal and noise seen by the UE may be determined by more than one cell.

Since several cells may contribute towards the overall power applied to the UE, a number of test system uncertainties affect the signal and noise seen by the UE. The aim of the superposition method is to vary each controllable parameter of the test system separately, and to establish its effect on the critical parameters as seen by the UE receiver. The superposition principle then allows the effect of each test system uncertainty to be added, to calculate the overall effect.

The contributing test system uncertainties shall form a minimum set for the superposition principle to be applicable.

4.2 Sensitivity analysis

A change in any one channel level or channel ratio generated at source does not necessarily have a 1:1 effect at the UE. The effect of each controllable parameter of the test system on the critical parameters as seen by the UE receiver shall therefore be established. As a consequence of the sensitivity scaling factors not necessarily being unity, the test system uncertainties cannot be directly applied as test tolerances to the critical parameters as seen by the UE.

EXAMPLE: In many of the tests described, the \hat{E}_s / I_{ot} is one of the critical parameters at the UE. Scaling factors are used to model the sensitivity of the \hat{E}_s / I_{ot} to each test system uncertainty. When the scaling factors have been determined, the superposition principle then allows the effect of each test system uncertainty to be added, to give the overall variability in the critical parameters as seen at the UE.

There are often constraints on several parameters at the UE. The aim of the sensitivity analysis, together with the acceptable test system uncertainties, is to ensure that the variability in each of these parameters is controlled within the limits necessary for the specification to apply. The test has then been conducted under valid conditions.

4.3 Statistical combination of uncertainties

The acceptable uncertainties of the test system are specified as the measurement uncertainty tolerance interval for a specific measurement that contains 95 % of the performance of a population of test equipment. In the RRM and UE radio transmission and reception conformance tests covered by the present document, the Test System shall enable the stimulus signals in the test case to be adjusted to within the specified range, with an uncertainty not exceeding the specified values.

The method given in the present document combines the acceptable uncertainties of the test system, to give the overall variability in the critical parameters as seen at the UE. Since the process does not add any new uncertainties, the method of combination should be chosen to maintain the same tolerance interval for the combined uncertainty as is already specified for the contributing test system uncertainties.

The basic principle for combining uncertainties is in accordance with ETR 273-1-2 [4]. In summary, the process requires 3 steps:

- Express the value of each contributing uncertainty as a one standard deviation figure, from knowledge of its numeric value and its distribution.
- Combine all the one standard deviation figures as root-sum-squares, to give the one standard deviation value for the combined uncertainty.
- Expand the combined uncertainty by a coverage factor, according to the tolerance interval required.

Provided that the contributing uncertainties have already been obtained using this method, using a coverage factor of 2, further stages of combination can be achieved by performing step b) alone, since steps a) and c) simply divide by 2 and multiply by 2 respectively.

The root-sum-squares method is therefore used to maintain the same tolerance interval for the combined uncertainty as is already specified for the contributing test system uncertainties. In some cases where correlation between contributing uncertainties has an adverse effect, the method is modified in accordance with clause 4.4.5 of the present document.

In each analysis, the uncertainties are assumed to be uncorrelated, and are added result root-sum-square unless otherwise stated.

The combination of uncertainties is performed using dB values for simplicity. It has been shown that using dB uncertainty values gives a slightly worse combined uncertainty result than using linear values for the uncertainties. The analysis method therefore errs on the safe side.

4.4 Correlation between uncertainties

The statistical (root-sum-square) addition of uncertainties is based on the assumption that the uncertainties are independent of each other. For realisable test systems, the uncertainties may not be fully independent. The validity of the method used to add uncertainties depends on both the type of correlation and on the way in which the uncertainties affect the test requirements.

Clauses 4.4.1 to 4.4.3 give examples to illustrate different types of correlation.

Clauses 4.4.4 to 4.4.7 show how the scenarios applicable to multi-cell RRM tests are treated.

4.4.1 Uncorrelated uncertainties

The graph shows an example of two test system uncertainties, A and B, which affect a test requirement. Each sample from a population of test systems has a specific value of error in parameter A, and a specific value of error in parameter B. Each dot on the graph represents a sample from a population of test systems, and is plotted according to its error values for parameters A and B.

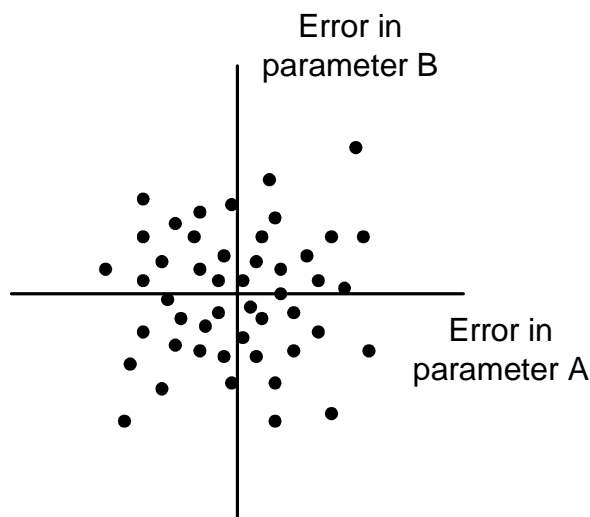

Figure 4.4.1-1: Example of two test system uncertainties affecting a test requirement

It can be seen that a positive value of error in parameter A, for example, is equally likely to occur with either a positive or a negative value of error in parameter B. This is expected when two parameters are uncorrelated, such as two uncertainties which arise from different and unrelated parts of the test system.

4.4.2 Positively correlated uncertainties

The graph shows an example of two test system uncertainties, A and B, which affect a test requirement. Each sample from a population of test systems has a specific value of error in parameter A, and a specific value of error in parameter B. Each dot on the graph represents a sample from a population of test systems, and is plotted according to its error values for parameters A and B.

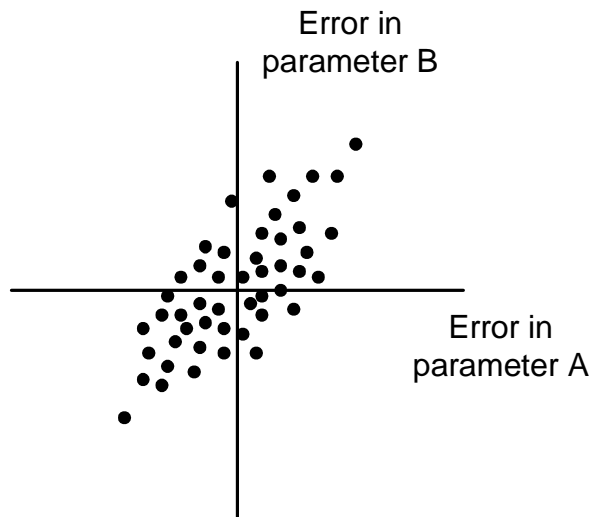

Figure 4.4.2-1: Example of two test system uncertainties affecting a test requirement

It can be seen that a positive value of error in parameter A, for example, is more likely to occur with a positive value of error in parameter B and less likely to occur with a negative value of error in parameter B. This can occur when the two uncertainties arise from similar parts of the test system, or when one component of the uncertainty affects both parameters in a similar way.

In an extreme case, if the error in parameter A and the error in parameter B came from the same sources of uncertainty, and no others, the dots would lie on a straight line of slope +1.

4.4.3 Negatively correlated uncertainties

The graph shows an example of two test system uncertainties, A and B, which affect a test condition. Each sample from a population of test systems has a specific value of error in parameter A, and a specific value of error in parameter B. Each dot on the graph represents a sample from a population of test systems, and is plotted according to its error values for parameters A and B.

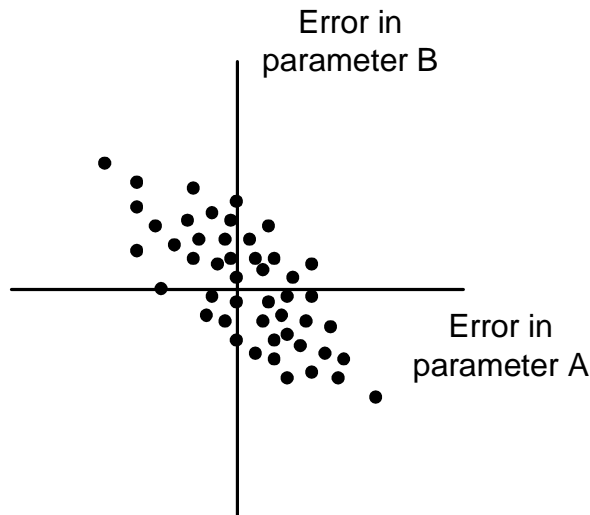

Figure 4.4.3-1: Example of two test system uncertainties affecting a test condition

It can be seen that a positive value of error in parameter A, for example, is more likely to occur with a negative value of error in parameter B and less likely to occur with a positive value of error in parameter B. This effect can theoretically occur, and is included for completeness, but is unlikely in a practical test system.

4.4.4 Treatment of uncorrelated uncertainties

If two uncertainties are uncorrelated, they are added statistically in the analysis. Provided that each uncertainty is already expressed as an expanded uncertainty with coverage factor 2, the contributing uncertainties are added root-sum-squares to give a combined uncertainty which also has coverage factor 2, and the 95% tolerance interval is maintained.

This is the default assumption.

4.4.5 Treatment of positively correlated uncertainties with adverse effect

If two test system uncertainties are positively correlated, and if they affect the value of a critical parameter in the same direction, the combined effect may be greater than predicted by adding the contributing uncertainties root-sum-squares.

In this scenario the two uncertainties are added worst-case in the analysis. Provided that each uncertainty is already expressed as an expanded uncertainty with coverage factor 2, the combined uncertainty will cover a 95% tolerance interval even when the two contributing uncertainties are fully correlated. If the two contributing uncertainties are less than fully correlated, the combined uncertainty will cover a tolerance interval greater than 95%.

4.4.6 Treatment of positively correlated uncertainties with beneficial effect

If two test system uncertainties are positively correlated, and if they affect the value of a critical parameter in opposite directions, the combined effect will be less than predicted by adding the contributing uncertainties root-sum-squares.

In this scenario the two uncertainties are added statistically in the analysis. Provided that each uncertainty is already expressed as an expanded uncertainty with coverage factor 2, the combined uncertainty will cover a 95% tolerance interval when the two contributing uncertainties are uncorrelated. If the two contributing uncertainties are positively correlated, the combined uncertainty will cover a tolerance interval greater than 95%.

4.4.7 Treatment of negatively correlated uncertainties

Negatively correlated uncertainties are excluded by the assumptions. This has been agreed as an acceptable restriction on practical test systems, as the mechanisms which produce correlation generally arise from similarities between two parts of the test system, and therefore produce positive correlation.

5 Determination of Test System Uncertainties

5.1 General

The uncertainty of a test system when making measurements reduces the ability of the test system to distinguish between conformant and non-conformant test subjects. The aim is therefore to minimise uncertainty, subject to a number of practical constraints:

- a) A vendor's test system should be reproducible in the required quantities.
- b) A choice of test systems should be available from different vendors.
- c) The uncertainties should allow reasonable freedom of test system implementation
- d) The test system can be run automatically
- e) The test system may include several radio access technologies
- f) It should be possible to maintain calibration of deployed test systems over reasonable spans of time and environmental conditions

In practice therefore within 3GPP the acceptable uncertainty of the test system is the smallest value that can be agreed between the test system vendors represented, consistent with the above constraints. The uncertainty will not therefore be as low as could be achieved, for example, by a national standards laboratory.

5.2 Uncertainty figures

The actual figures for the acceptable uncertainty of a test system are defined in Annex F of 38.521-1, Annex F of 38.521-2, Annex F of 38.521-3, Annex F of TS 38.521-4 and Annex F of TS 38.533. To avoid maintenance issues with figures in separate specifications, the uncertainties are not formally defined within the present document, but informative guidelines are provided in Annex B to Annex E of the present document.

6 Determination of Test Tolerances

6.1 General

The general principles given in the present document are applied to each test case, according to the applicable uncertainties and requirements to obtain a correct verdict.

The test cases which have been analysed to determine Test Tolerances are included in the present document as .zip files. The name of the zip file indicates the specification and the test cases covered.

Annex A gives the rationale for their inclusion.

7 Grouping of test cases defined in TS 38.521-4

Editor's note: intended to capture grouping of demodulation test cases.

8 Grouping of test cases defined in TS 38.533

Table 8-1: Grouping of FR1 test cases defined in Clauses 4, 6 and 8 of TS 38.533

Group	Test Case Numbers	.zip file name	Comments
SCell_Activation_01	4.5.3.1 4.5.3.2 4.5.3.3 6.5.3.1 6.5.3.2 6.5.3.3	"38.533 4.5.3.1+4.5.3.2+6.5.3.1+6.5.3.2 TT v4.zip"	"2 Inter Frequency NR Cells, 3 time periods, Various number of sub-tests, No fading"
Intra_Freq_Meas_01	4.6.1.1 4.6.1.2 4.6.1.3 4.6.1.4 4.6.1.5 4.6.1.6 4.6.1.7 6.6.1.1 6.6.1.2 6.6.1.3 6.6.1.4 6.6.1.5 6.6.1.6 6.6.1.7	"38.533 4.6.1.1+4.6.1.2+4.6.1.3+4.6.1.4 TT.zip"	"2 Intra Frequency NR Cells, 2 time periods, Various number of sub-tests, No fading"
Inter_Freq_Meas_01	4.6.2.1 4.6.2.2 4.6.2.5 4.6.2.6 6.6.2.1 6.6.2.2 6.6.2.5 6.6.2.6	"4.6.2.1+4.6.2.2+4.6.2.5+4.6.2.6 TT v4.zip"	"2 Inter Frequency NR Cells, 2 time periods, Various number of sub-tests, No fading"
Intra_Reselection_01	6.1.1.1	"38.533 6.1.1.1 TT v2.zip"	"2 Intra Frequency NR Cells, 3 time periods, No fading"
Inter_Reselection_01	6.1.1.2	"38.533 6.1.1.2 TT v2.zip"	"2 Inter Frequency NR Cells, 3 time periods, No fading"
InterRAT_Higher_Reselection_01	6.1.2.1	"38.533 6.1.2.1 TT v2.zip"	"1 E-UTRAN Cell, 1 NR Cells, 3 time periods, No fading"
InterRAT_Lower_Reselection_01	6.1.2.2 6.1.2.3 6.1.2.5	"38.533 6.1.2.2+6.1.2.3+6.1.2.5 TT v3.zip"	"1 E-UTRAN Cell, 1 NR Cells, 2 time periods, No fading"
InterRAT_Lower_Reselection_02	6.1.2.4	"38.533 6.1.2.4 TT.zip"	"1 E-UTRAN Cell, 1 NR Cells, 2 time periods, No fading"
InterRAT_Known_Handover_01	6.3.1.4	"38.533 6.3.1.4 TT v2.zip"	"1 E-UTRAN Cell, 1 NR Cells, 3 time periods, No fading"
InterRAT_Unknown_Handover_01	6.3.1.5	"38.533 6.3.1.5 TT.zip"	"1 E-UTRAN Cell, 1 NR Cells, 2 time periods, No fading"
Intra_RRC_re-establishment_01	6.3.2.1.1	"38.533 6.3.2.1.1 TT.zip"	"2 Intra Frequency NR Cells, 3 time periods, No fading"

Intra_SS-RSRP_Abs_Acc_01	4.7.1.1.1 6.7.1.1.1	"38.533 4.7.1.1.1+6.7.1.1.1 TT v2.zip"	"2 Intra-Frequency NR Cells, 3 Sub-tests, periodic reporting, No fading"
Intra_SS-RSRP_Rel_Acc_01	4.7.1.1.2 6.7.1.1.2	"38.533 4.7.1.1.2+6.7.1.1.2 TT v2.zip"	"2 Intra-Frequency NR Cells, 3 Sub-tests, periodic reporting, No fading"
Inter_RRC_re-establishment_01	6.3.2.1.2	"38.533 6.3.2.1.2 TT.zip"	"2 Inter Frequency NR Cells, 3 time periods, No fading"
Inter_RRC_redirection_01	6.3.2.3.1	"38.533 6.3.2.3.1 TT.zip"	"2 Inter Frequency NR Cells, 2 time periods, No fading"
InterRAT_RRC_redirection_01	6.3.2.3.2	"38.533 6.3.2.3.2 TT.zip"	"1 E-UTRAN Cell, 1 NR Cells, 2 time periods, No fading"
RLM_InSync_01	4.5.1.2 4.5.1.4 6.5.1.2 6.5.1.4 4.5.1.6 4.5.1.8 6.5.1.6 6.5.1.8	"38.533 4.5.1.2+4.5.1.4+6.5.1.2+6.5.1.4 TT.zip"	"1 NR Cell (1 E-UTRA Cell for NSA case), 1 sub-test, Fading, 5 Time Periods"
RLM_Out_of_Sync_01	4.5.1.1 4.5.1.3 6.5.1.1 6.5.1.3 4.5.1.5 4.5.1.7 6.5.1.5 6.5.1.7	"38.533 4.5.1.1+4.5.1.3+6.5.1.1+6.5.1.3 TT.zip"	"1 NR Cell (1 E-UTRA Cell for NSA case), 1 sub-test, Fading, 3 Time Periods"
UE_Timing_Advance_01	4.4.3.1 6.4.3.1	"38.533 4.4.3.1 TT.zip"	"1 NR Cell (1 E-UTRA Cell for NSA case), No Fading"
UE Transmit_Timing_01	4.4.1.1 6.4.1.1	"38.533 4.4.1.1+6.4.1.1 TT.zip"	"1 NR Cell (1 E-UTRA Cell for NSA case), 2 sub-tests, No Fading"
RRC_reconfiguration_delay_01	4.5.4.1 6.5.4.1	"38.533 4.5.4.1+6.5.1.1 TT.zip"	"1 E-UTRA Cell, 2 NR Cells", 3 Time Periods, No Fading"
Intra_Freq_HO_Known_Target	6.3.1.1	"38.533 6.3.1.1 TT v2.zip"	"2 Intra-Freq NR Cells, 3 Time Periods, No Fading"
Intra_Freq_HO_Unknown_Target	6.3.1.2	"38.533 6.3.1.2 TT.zip"	"2 Intra-Freq NR Cells, 2 Time Periods, No Fading"
Inter_Freq_HO	6.3.1.3	"38.533 6.3.1.3 TT.zip"	"2 Inter-Freq NR Cells, 2 Time Periods, No Fading"
InterRAT_Meas_01	6.6.3.1 6.6.3.2	"38.533 6.6.3.1+6.6.3.2 TT.zip"	"1 E-UTRAN Cell, 1 NR Cells, 2 time periods, Fading"
Interruption_Transition_01	4.5.2.1 4.5.2.2	"38.533 4.5.2.1+4.5.2.2 TT.zip"	"1 E-UTRAN Cell, 1 NR Cells, 1 time period, No fading"

Interruption_meas_NR_SCC_01	4.5.2.3 4.5.2.4 6.5.2.1	"38.533 4.5.2.3+4.5.2.4 TT.zip"	"1 E-UTRAN Cell, 2 NR Cells (2 NR Cells for SA case), 1 time period, No fading"
Interruption_meas_NR_SCC_01	4.5.2.5 4.5.2.6	"38.533 4.5.2.5+4.5.2.6 TT.zip"	"2 E-UTRAN Cell, 1 NR Cells, 1 time period, No fading"
Inter_SS-RSRP_Abs_Acc_01	4.7.1.2.1 6.7.1.2.1	"38.533 4.7.1.2.1+6.7.1.2.1 TT v3.zip"	"2 Inter-Frequency NR Cells, periodic reporting, No fading"
Inter_SS-RSRP_Rel_Acc_01	4.7.1.2.2 6.7.1.2.2	"38.533 4.7.1.2.2+6.7.1.2.2 TT v2.zip"	"2 Inter-Frequency NR Cells, periodic reporting, No fading"
Intra_SS-SINR_Acc_01	4.7.3.1 6.7.3.1	"38.533 4.7.3.1+6.7.3.1 TT.zip"	"2 Intra-Frequency NR Cells, periodic reporting, No fading"
SSB_Based_L1-RSRP-Meas	4.6.4.1 4.6.4.2 4.6.4.5 6.6.4.1 6.6.4.2 6.6.4.5	"38.533 4.6.4.1+4.6.4.2+6.6.4.1+6.6.4.2 TT v3.zip"	"1 NR Cell (1 E-UTRA Cell for NSA case), 2 time periods, No fading"
CSI-RS_Based_L1-RSRP-Meas	4.6.4.3 4.6.4.4 6.6.4.3 6.6.4.4	"38.533 4.6.4.3+4.6.4.4 TT v3.zip"	"1 NR Cell (1 E-UTRA Cell for NSA case), one time period, No fading"
Intra_SS-RSRQ_Acc_01	4.7.2.1 6.7.2.1	"38.533 4.7.2.1+6.7.2.1 TT v2.zip"	"2 Intra-Frequency NR Cells, periodic reporting, No fading"
Inter_SS-RSRQ_Abs_Acc_01	4.7.2.2.1 6.7.2.2.1	"38.533 4.7.2.2.1+6.7.2.2.1 TT v2.zip"	"2 Inter-Frequency NR Cells, periodic reporting, No fading"
Inter_SS-RSRQ_Rel_Acc_01	4.7.2.2.2 6.7.2.2.2	"38.533 4.7.2.2.2+6.7.2.2.2 TT v2.zip"	"2 Inter-Frequency NR Cells, periodic reporting, No fading"
Inter_SS-SINR_Abs_Acc_01	4.7.3.2.1 6.7.3.2.1	"38.533 4.7.3.2.1+6.7.3.2.1 TT.zip"	"2 Inter-Frequency NR Cells, periodic reporting, No fading"
Inter_SS-SINR_Rel_Acc_01	4.7.3.2.2 6.7.3.2.2	"38.533 4.7.3.2.2+6.7.3.2.2 TT.zip"	"2 Inter-Frequency NR Cells, periodic reporting, No fading"
Inter_RAT_SS- RSRP_LTE_Serving_01	8.5.2.1.1.1	"38.533 8.5.2.1.1.1 TT.zip"	1 NR Cell, 1 LTE serving cell, periodic SS-RSRP reporting, No fading
Inter_RAT_SS- RSRQ_LTE_Serving_01	8.5.2.2.1	"38.533 8.5.2.2.1 TT.zip"	1 NR Cell, 1 LTE serving cell, periodic SS-RSRQ reporting, No fading
Inter_RAT_SS- SINR_LTE_Serving_01	8.5.2.3.1	"38.533 8.5.2.3.1 TT.zip"	1 NR Cell, 1 LTE serving cell, periodic SS-SINR reporting, No fading
L1-RSRP_Abs_Acc_01	4.7.4.1.1 6.7.4.1.1 4.7.4.2.1 6.7.4.2.1	"38.533 4.7.4.1.1+4.7.4.2.1+6.7.4.1.1+6.7.4.2. 1 TT.zip"	1 NR Cell, periodic L1-RSRP reporting, No fading

L1-RSRP_Rel_Acc_01	4.7.4.1.2 6.7.4.1.2 4.7.4.2.2 6.7.4.2.2	"38.533 4.7.4.1.2+4.7.4.2.2+6.7.4.1.2+6.7.4.2.2 TT.zip"	1 NR Cell with 2 Beams, periodic L1-RSRP reporting, No fading
SSB_Based_BFR	4.5.5.1 4.5.5.2 6.5.5.1 6.5.5.2	"38.533 4.5.5.1+4.5.5.2+6.5.5.1+6.5.5.2 TT v2.zip"	"1 NR Cell (1 E-UTRA Cell for NSA case), 5 time periods, Fading"
CSI-RS_Based_BFR	4.5.5.3 4.5.5.4 6.5.5.3 6.5.5.4	"38.533 4.5.5.3+4.5.5.4+6.5.5.3+6.5.5.4 TT v2.zip"	"1 NR Cell (1 E-UTRA Cell for NSA case), 5 time periods, Fading"
DCI_Based_BWP_Switch	4.5.6.1.1 4.5.6.1.2 6.5.6.1.1 6.5.6.1.2	"38.533 4.5.6.1.1+4.5.6.1.2+6.5.6.1.1+6.5.6.1.2 TT.zip"	"1 NR Cell (2NR Cells for Scell case, 1 E-UTRA Cell for NSA case), 3 time periods, No fading"
RRC_Based_BWP_Switch	4.5.6.2.1 6.5.6.2.1	"38.533 4.5.6.2.1+6.5.6.2.1 TT.zip"	"1 NR Cell (1 E-UTRA Cell for NSA case), 3 time periods, No fading"
Intra_RRC_re-establishment_without_timing	6.3.2.1.3	"38.533 6.3.2.1.3 TT v2.zip"	"2 Intra Frequency NR Cells, 3 time periods, No fading"
InterRAT_re-selection_LTE_Serving	8.2.1.1	"38.533 8.2.1.1 TT.zip"	"1 NR Cell, 1 LTE serving cell, 3 time periods No fading"
InterRAT_HO_LTE_Serving	8.3.1.1	"38.533 8.3.1.1 TT.zip"	"1 NR Cell, 1 LTE serving cell, 3 time periods No fading"
InterRAT_SFTD_Meas_LTE_Serving	8.4.1.1 8.4.1.2	"38.533 8.4.1.1+8.4.1.2 TT.zip"	"1 NR Cell, 1 LTE serving cell, 1 time period No fading"
InterRAT_Meas_LTE_Serving	8.4.2.1 8.4.2.2 8.4.2.3 8.4.2.4	"38.533 8.4.2.1+8.4.2.2+8.4.2.3+8.4.2.4 TT.zip"	"1 NR Cell, 1 LTE serving cell, 2 time periods Fading"
PSCell_Addition	4.5.7.1	"38.533 4.5.7.1 TT.zip"	1 NR Cell, no fading
SFTD_Accuracy	4.7.5.1	"38.533 4.7.5.1 TT.zip"	1 E-UTRA Cell, 1 NR Cell, no fading
iRAT_E-UTRA_RSRP_Accuracy	6.7.5.1	"38.533 6.7.5.1 TT.zip"	1 E-UTRA Cell, 1 NR Cell, no fading
iRAT_E-UTRA_RSRQ_Accuracy	6.7.6.1	"38.533 6.7.6.1 TT.zip"	1 E-UTRA Cell, 1 NR Cell, no fading
iRAT_E-UTRA_RS-SINR_Accuracy	6.7.7.1	"38.533 6.7.7.1 TT.zip"	1 E-UTRA Cell, 1 NR Cell, no fading
InterRAT_SFTD_Meas_Accuracy_LTE_Serving	8.5.1.1	"38.533 8.5.1.1 TT.zip"	1 E-UTRA Cell, 1 NR Cell, no fading
Inter_Freq_HO_DAPS	6.3.1.9 6.3.1.10	"38.533 6.3.1.9+6.3.1.10 TT.zip"	"2 Inter-Freq NR Cells, 5 Time Periods, No Fading"
DL_Interruption_UL_Switching	4.5.8.1	"38.533 4.5.8.1 TT.zip"	1 E-UTRA Cell, 1 NR Cell, no fading
Intra_Reselection_Low_Mobility	6.1.1.3	"38.533 6.1.1.3 TT.zip"	"2 Intra Frequency NR Cells, 2 time periods, No fading"

Intra_Reselection_Not_cell_edge	6.1.1.4	"38.533 6.1.1.4 TT.zip"	"2 Intra Frequency NR Cells, 2 time periods, No fading"
Inter_Reselection_Low_mobility	6.1.1.5	"38.533 6.1.1.5 TT.zip"	"2 Inter Frequency NR Cells, 2 time periods, No fading"
Inter_Reselection_Not_cell_edge	6.1.1.6	"38.533 6.1.1.6 TT.zip"	"2 Inter Frequency NR Cells, 2 time periods, No fading"
InterRAT_HO_UTRA_FDD	6.3.1.6	"38.533 6.3.1.6 TT.zip"	"1 UTRA Cell, 1 NR Cell, 3 time periods, No fading"
InterRAT_Meas_UTRA_FDD	6.6.5.1	"38.533 6.6.5.1 TT.zip"	"1 UTRA Cell, 1 NR Cell, 2 time periods, No fading"
InterRAT_Meas_HST	6.6.3.3	"38.533 6.6.3.3 TT.zip"	1 E-UTRA Cell, 1 NR Cell, no fading
InterRAT_re-selection_LTE_Serving_HST	8.2.1.2	"38.533 8.2.1.2 TT.zip"	1 E-UTRA Cell, 1 NR Cell, no fading
InterRAT_Meas_LTE_Serving_HST	8.4.2.9	"38.533 8.4.2.9 TT.zip"	1 E-UTRA Cell, 1 NR Cell, no fading
Intra_Freq_HO_DAPS	6.3.1.7 6.3.1.8	"38.533 6.3.1.7+6.3.1.8 TT.zip"	"2 Intra-Freq NR Cells, 5 Time Periods, No Fading"
Intra_Freq_CHO	6.3.3.1	"38.533 6.3.3.1 TT.zip"	"2 Intra-Freq NR Cells, 2 Time Periods, No Fading"
Inter_Freq_CHO	6.3.3.2	"38.533 6.3.3.2 TT.zip"	"2 Inter-Freq NR Cells, 2 Time Periods, No Fading"

Table 8-2: Grouping of FR2 test cases defined in Clauses 5, 7 and 8 of TS 38.533

Group	Test Case Numbers	.zip file name	Comments
Timing_Advance_01	5.4.3.1 7.4.3.1	"38.533 5.4.3.1+7.4.3.1 TT.zip"	1 NR FR2 cell, no fading
iRAT_SS-RSRP_01	8.5.2.1.2	"38.533 8.5.2.1.2 TT.zip"	"1 NR FR2 cell, 1 E-UTRA serving cell, 2 sub-tests, No fading"
iRAT_SS-RSRQ_01	8.5.2.2.2	"38.533 8.5.2.2.2 TT.zip"	"1 NR FR2 cell, 1 E-UTRA serving cell, 2 sub-tests, No fading"
iRAT_SS-SINR_01	8.5.2.3.2	"38.533 8.5.2.3.2 TT.zip"	"1 NR FR2 cell, 1 E-UTRA serving cell, 2 sub-tests, No fading"
Interruption_Transition_01	5.5.2.1 5.5.2.2	"38.533 5.5.2.1+5.5.2.2 TT.zip"	"1 E-UTRAN Cell, 1 NR FR2 Cell, 1 time period, No fading"
Inter_Freq_Meas_01	5.6.2.1 5.6.2.3 7.6.2.1 7.6.2.3	"38.533 5.6.2.1+5.6.2.3+7.6.2.1+7.6.2.3 TT v2.zip"	"2 Inter Frequency NR FR2 Cells, 2 time periods, Various number of sub-tests, No fading"
Inter_Freq_Meas_02	5.6.2.5 5.6.2.7 7.6.2.5 7.6.2.7	"38.533 5.6.2.5+5.6.2.7+7.6.2.5+7.6.2.7 TT.zip"	"2 Inter Frequency NR Cells (Cell 1 on FR1 and Cell 2 on FR2), 2 time periods, Various number of sub-tests, No fading"
Inter_Freq_Meas_03	5.6.2.6 5.6.2.8 7.6.2.6 7.6.2.8	"38.533 5.6.2.6+5.6.2.8+7.6.2.6+7.6.2.8 TT.zip"	"2 Inter Frequency NR Cells (Cell 1 on FR1 and Cell 2 on FR2), 2 time periods, Various number of sub-tests, No fading"
Inter_Freq_Meas_04	5.6.2.2 5.6.2.4 7.6.2.2 7.6.2.4	"38.533 5.6.2.2+5.6.2.4+7.6.2.2+7.6.2.4 TT.zip"	"2 Inter Frequency NR Cells (both on FR2), 2 time periods, Various number of sub-tests, No fading"
SSB_Based_L1-RSRP-Meas	5.6.3.1 5.6.3.2 7.6.3.1 7.6.3.2	"38.533 5.6.3.1+5.6.3.2+7.6.3.1+7.6.3.2 TT.zip"	"1 NR FR2 Cell (1 E-UTRA Cell for NSA case), 2 time periods, No fading"
SS-RSRP_01	5.7.1.1 7.7.1.1	"38.533 5.7.1.1+7.7.1.1 TT v2.zip"	"2 Intra-Frequency NR FR2 Cells, 2 sub-tests, No fading"
SS-RSRP_02	5.7.1.2 7.7.1.2	"38.533 5.7.1.2+7.7.1.2 TT v2.zip"	"2 Inter-Frequency NR FR2 Cells, 2 sub-tests, No fading"
SS-RSRQ_01	5.7.2.1 7.7.2.1	"38.533 5.7.2.1+7.7.2.1 TT.zip"	"2 Intra-Frequency NR FR2 Cells, 2 sub-tests, No fading"
SS-RSRQ_02	5.7.2.2 7.7.2.2	"38.533 5.7.2.2+7.7.2.2 TT.zip"	"2 Inter-Frequency NR FR2 Cells, 2 sub-tests, No fading"
SS-SINR_01	5.7.3.1 7.7.3.1	"38.533 5.7.3.1+7.7.3.1 TT.zip"	"2 Intra-Frequency NR FR2 Cells, 2 sub-tests, No fading"

SS-SINR_02	5.7.3.2 7.7.3.2	"38.533 5.7.3.2+7.7.3.2 TT v2.zip"	"2 Inter-Frequency NR FR2 Cells, 3 sub-tests, No fading"
CSI-RS_Based_L1-RSRP-Meas	5.6.3.3 5.6.3.4 7.6.3.3 7.6.3.4	"38.533 5.6.3.3+6.6.3.4+7.6.3.3+7.6.3.4 TT.zip"	"1 NR FR2 Cell (1 E-UTRA Cell for NSA case), 1 time period, No fading"

Annex A: Derivation documents for test tolerance

The documents (and spreadsheets where applicable) used to derive the test tolerances for each test case are included in the present document as zip files.

The aim is to provide a reference to completed test cases, so that test tolerances for similar test cases can be derived on a common basis. The information on test case grouping in clauses 7 and 8 can be used to identify similarities.

A.1 Void

A.2 Handling of common Test Tolerance topics for radiated test cases defined in TS 38.533

The basic principles of Test Tolerance analysis are the same for conducted testing and radiated testing, but for radiated testing additional topics are taken into account. This annex contains methods to handle common additional topics, to allow re-use and to avoid the need for each test case analysis to repeat the same detail.

Individual test case analyses are expected to follow the methods contained here where applicable, and to refer to relevant clauses in this Annex.

A.2.1 Angles of Arrival

A.2.1.1 Relevant core requirements

In FR2, the performance of the UE depends on the downlink signal angle of arrival, and is characterised by two parameters:

- Refsens: lowest signal level for a given demodulation performance in the UE Rx beam peak direction, specified in TS 38.101-2 [16] clause 7.3.2 according to UE Power class, Channel bandwidth and operating band
- EIS spherical coverage: lowest signal level for a given demodulation performance in a specified percentile of other directions, specified in TS 38.101-2 [16] clause 7.3.4 according to UE Power class, Channel bandwidth and operating band

As both of these requirements are defined in the context of a throughput requirement, the UE is assumed to be using fine beams. Note that for directions outside the specified percentile of spherical coverage directions, there are no requirements. Testing must therefore be carried out within the spherical coverage directions. For testing, direction is 3-dimensional, but the principle can be illustrated in a 2-dimensional diagram:

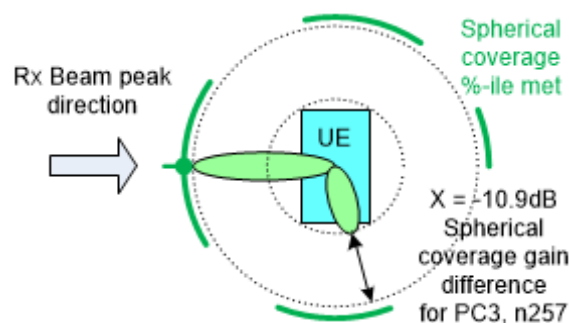

Figure A.2.1.1-1: UE Rx Beam-peak and spherical coverage directions, Fine beams

A.2.1.2 Modelling of variation within spherical coverage directions

Within the spherical coverage directions, a signal may be anywhere from near Rx Beam Peak (high gain direction, close to Refsens) to the worst of the allowed percentile (low gain direction, close to EIS spherical coverage requirement value). This is modelled by taking the midpoint of the Spherical coverage range as the nominal value, and then adding a variation of \pm (half the difference between Refsens and Spherical coverage).

UE Spherical coverage gain midpoint in dB is derived as $(\text{UE Refsens} - \text{UE Spherical coverage})/2$

Figure A.2.1.2-1 shows an example for UE Power class 3, Channel bandwidth 100MHz and operating band n257. In this example the UE Spherical coverage gain midpoint would be -5.45dB, as the gain is lower than in the Rx Beam peak direction. Variation about the midpoint is handled as a UE uncertainty.

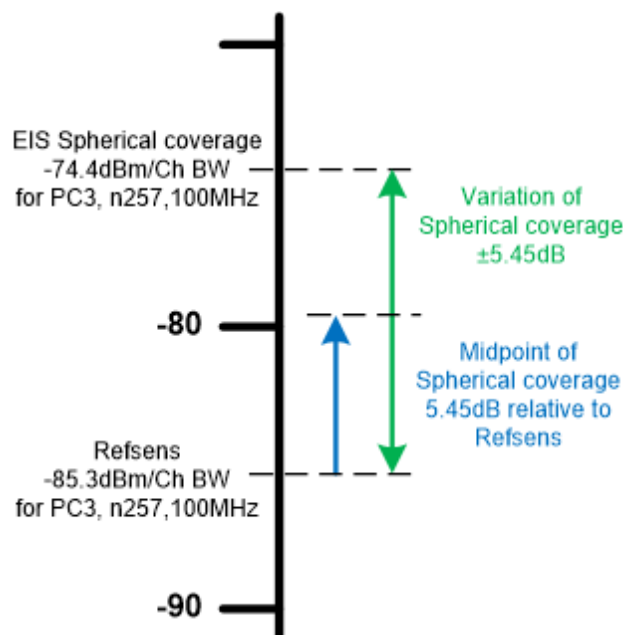

Figure A.2.1.2-1: Example modelling of variation within spherical coverage directions, Fine beams

A.2.1.3 Principles for Test Tolerance analysis

The following principles shall be followed in the test case analysis:

- The Angle of Arrival for each downlink signal shall be defined: either from UE Rx beam peak direction or from a direction within the EIS spherical coverage
- Variations over the EIS spherical coverage directions shall be included, using the method shown in A.2.1.2.

Variations over the EIS spherical coverage directions do not directly affect signals applied to the UE, but they do affect the SS-RSRP level measured by the UE, and the E_s/I_{ot} at UE baseband. Where the test case has requirements on UE baseband $E_s/I_{ot_{BB}}$, UE internal noise calculation is given in clause A.2.3, and calculation of E_s/I_{ot} at UE baseband is given in clauses A.2.4 and A.2.7.

A.2.2 UE Fine beams and Rough beams

A.2.2.1 Relevant core requirements

UE requirements such as Refsens in TS 38.101-2 [16], assume that the UE is using a fine beam which has higher antenna gain to give good demodulation performance. However, in some RRM scenarios where the UE is for example

searching for or measuring other cells, the UE uses rough beams which have lower antenna gain. The difference in gain is specified depending on the Angle of Arrival:

- The Gain difference Y between fine and rough beams in the UE Rx beam peak direction is specified in TS 38.133 [17] Table B.2.1.3.1-1 according to UE Power class
- The Gain difference Z between fine and rough beams in the UE Spherical coverage directions is specified in TS 38.133 [17] Table B.2.1.3.2-1 according to UE Power class

The Gain differences Y and Z are not dependent on Channel bandwidth or operating band. The concept is illustrated in Figures A.2.2.1-1 and A.2.2.1-2.

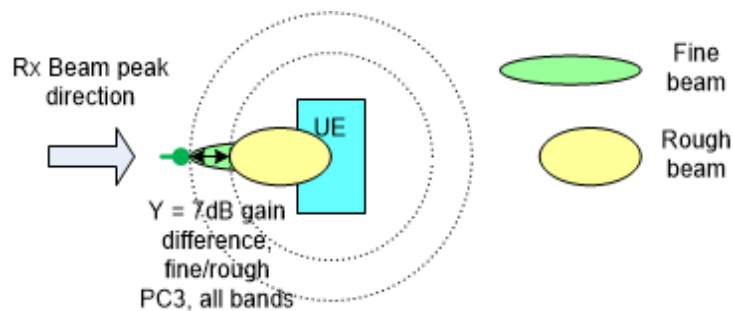

Figure A.2.2.1-1: Fine and rough beams, Rx Beam peak direction

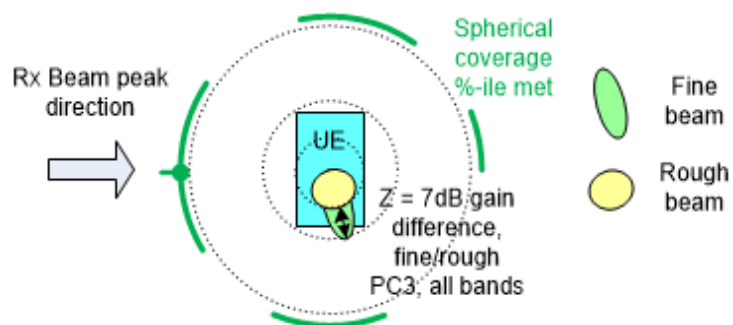

Figure A.2.2.1-2: Fine and rough beams, spherical coverage directions

A.2.2.2 Modelling of Fine beams and Rough beams

Where the UE is assumed to use fine beams, the scenario is already covered in the Refsens and EIS spherical coverage requirements, and no further modifications are needed.

Where the UE is assumed to use rough beams, the effect is modelled as a reduction in gain of Y dB or Z dB, according to the Angle of Arrival of each downlink signal. The reduction in gain translates to a higher UE internal noise seen at the Reference point where the downlink signals are applied. UE noise calculated from Refsens or from EIS spherical coverage requirements is increased by Y dB or Z dB respectively. UE internal noise calculation is given in clause A.2.3.

A.2.2.3 Principles for Test Tolerance analysis

The following principles shall be followed in the test case analysis:

- The Type of beam assumed to be used by the UE for each downlink signal shall be defined: either Fine Beam or Rough Beam
- Where UE internal noise is relevant, and the UE is assumed to be using Rough Beams, it is increased by the value of Y or Z , selected according to UE Power class and Angle of Arrival.

UE internal noise calculation is given in clause A.2.3.

A.2.3 UE internal noise

A.2.3.1 Relevant core requirements

The relevant Core requirements are:

- Refsens or EIS spherical coverage, specified in TS 38.101-2 [16] clauses 7.3.2 and 7.3.4 respectively
- UE baseband SNR at which Refsens or EIS spherical coverage is specified, in TS 38.133 [17] clause B.2.1.3
- N_{RB} in channel BW at which Refsens or EIS spherical coverage is specified, in TS 38.101-2 [16] Table 5.3.2-1
- Gain difference between fine and rough beams, in TS 38.133 [17] clause B.2.1.3
- UE multi-band relaxation factors, in TS 38.101-2 [16] Table 6.2.1.3-4

A.2.3.2 Calculation method

For signals arriving from Rx Beam Peak direction:

$$\text{Noise in dBm/SCS} = \text{Refsens}_{PC, \text{band}, \text{Ch BW}} - \text{SNR}_{\text{Refsens}} - 10\text{Log}_{10}(N_{RB_Ch BW, SCS} \times 12) + Y_{PC} + \Sigma MB_P$$

where:

$\text{Refsens}_{PC, \text{band}, \text{Ch BW}}$ is the reference sensitivity value in dBm specified in TS 38.101-2 [16] clause 7.3.2 according to Power Class, Operating band and Channel bandwidth

$\text{SNR}_{\text{Refsens}}$ is the SNR used for simulation of Refsens and EIS spherical coverage, and is -1 dB

$N_{RB_Ch BW, SCS}$ is the number of PRBs specified in TS 38.101-2 [16] Table 5.3.2-1 according to Channel bandwidth and subcarrier spacing (not necessarily equal to the number of PRBs used in the test case)

12 is the number of subcarriers in a PRB

Y_{PC} is the gain difference in dB specified in TS 38.133 [17] Table B.2.1.3.1-1, according to Power Class, and is only applied when the UE is assumed to be using rough beams. Otherwise, use 0dB

ΣMB_P is the UE multi-band relaxation factor value in dB specified in TS 38.101-2 [16] clause 6.2.1

For signals arriving from Spherical coverage directions:

$$\text{Noise in dBm/SCS} = \text{EIS spherical coverage}_{PC, \text{band}, \text{Ch BW}} - \text{SNR}_{\text{Refsens}} - 10\text{Log}_{10}(N_{RB_Ch BW, SCS} \times 12) + Z_{PC} + \Sigma MB_S$$

where:

$\text{EIS spherical coverage}_{PC, \text{band}, \text{Ch BW}}$ is the EIS spherical coverage value in dBm specified in TS 38.101-2 [16] clause 7.3.4 according to Power Class, Operating band and Channel bandwidth

$\text{SNR}_{\text{Refsens}}$ is the SNR used for simulation of Refsens and EIS spherical coverage, and is -1 dB

$N_{RB_Ch BW, SCS}$ is the number of PRBs specified in TS 38.101-2 [16] Table 5.3.2-1 according to Channel bandwidth and subcarrier spacing (not necessarily equal to the number of PRBs used in the test case)

12 is the number of subcarriers in a PRB

Z_{PC} is the gain difference in dB specified in TS 38.133 [17] Table B.2.1.3.2-1, according to Power Class, and is only applied when the UE is assumed to be using rough beams. Otherwise, use 0dB

ΣMB_S is the UE multi-band relaxation factor value in dB specified in TS 38.101-2 [16] clause 6.2.1

The analysis spreadsheet converts dBm/SCS to linear power in pW/SCS for ease of further calculations.

A.2.3.3 Principles for Test Tolerance analysis

The following principles shall be followed in the test case analysis:

- Where the test case has requirements on UE baseband E_s/I_{otBB} , the Test Tolerance analysis should include UE internal noise in the calculation
- UE internal noise is calculated using the method in A.2.3.2

A.2.4 Calculation of E_s/I_{ot} at UE baseband

A.2.4.1 Relevant core requirements

Core requirements applicable to RRM test cases depend on the test purpose, and should be selected for each test case. For test cases where the UE makes a measurement, the following are relevant:

- Measurement Performance requirements are specified in TS 38.133 [17] clause 10, and side conditions such as E_s/I_{ot} are included in the core requirements for each measurement. For FR2, notes in tables clarify that E_s/I_{ot} is at UE baseband.
- Operating band specific conditions for RRM requirements are specified in TS 38.133 [17] Annex B, and side conditions such as E_s/I_{ot} are included for each measurement. For FR2, notes in tables clarify that E_s/I_{ot} is at UE baseband.

Other UE core requirements may also have conditions on E_s/I_{ot} .

A.2.4.2 Calculation method

An example is provided here for a scenario with applied AWGN and two intra-frequency cells. SSB E_s/I_{ot} at UE baseband is calculated for Cell 1. Interference to Cell 1 comes from the applied AWGN, from the UE internal noise, and from Cell 2. The values are chosen for illustration, and not taken from any specific test case.

Cell 1 SSB $E_s/I_{otBB} = 10\text{Log}_{10}((\text{Cell 1 SSB power}) / (\text{Applied AWGN power} + \text{UE internal noise} + \text{Cell 2 SSB power}))$

Where Applied AWGN power, UE internal noise, Cell 1 power and Cell 2 power are linear powers in W, per subcarrier.

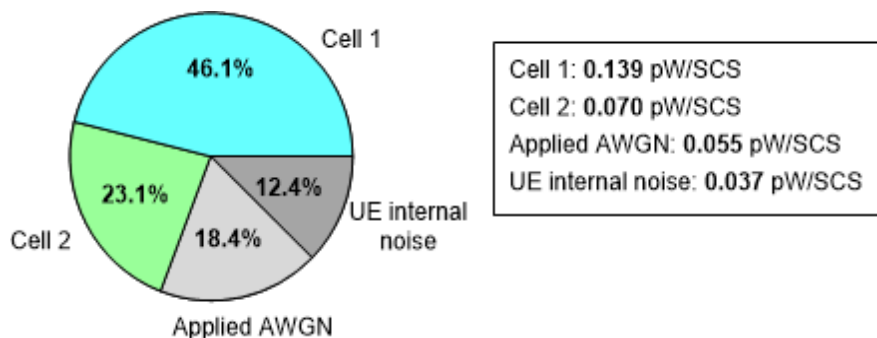

Figure A.2.4.2-1: Example E_s/I_{otBB} scenario, applied AWGN and two intra-frequency cells

In this case, the calculation gives Cell 1 SSB $E_s/I_{otBB} = 10\text{Log}_{10}(0.139 / (0.055 + 0.037 + 0.070)) = -0.67\text{dB}$

The main point is that the E_s/I_{ot} at UE baseband is lower than the applied E_s/I_{ot} , because the UE internal noise adds to the interference, and can be a significant contribution for the parameters used in some test cases.

The presence of UE internal noise also affects the calculation of E_s/I_{ot} sensitivity factors in the Test Tolerance analysis. The UE internal noise is a fixed (worst) value, being based on the UE minimum requirement, and is taken into account in the scaling which uses linear powers:

- Cell 1 SSB E_s/I_{otBB} sensitivity to applied AWGN absolute power = UE internal noise / (Applied AWGN power + UE internal noise + Cell 2 SSB power). In this example, $(0.037 / (0.055 + 0.037 + 0.070)) = +0.230$
- Cell 1 SSB E_s/I_{otBB} sensitivity to Cell 1 E_s/N_{oc} = **+1.000**
- Cell 1 SSB E_s/I_{otBB} sensitivity to Cell 2 E_s/N_{oc} = -Cell 2 SSB power / (Applied AWGN power + UE internal noise + Cell 2 SSB power). In this example, $(0.070 / (0.055 + 0.037 + 0.070)) = -0.429$

A positive sensitivity factor is used where an increase in the quantity produces an increase in Cell 1 SSB E_s/I_{otBB} , for example increasing Cell 1 E_s/N_{oc} . A negative sensitivity factor is used where an increase in the quantity produces a decrease in Cell 1 SSB E_s/I_{otBB} , for example increasing Cell 2 E_s/N_{oc} . The sensitivity factors are used to scale the uncertainties.

Where the uncertainties are uncorrelated, as here, they are added root-sum-square so the sign of the sensitivity factor does not have any effect. In special cases where the uncertainties are correlated, they may be added arithmetically and the sign affects the result, as in clause A.2.7.

A.2.4.3 Principles for Test Tolerance analysis

The following principles shall be followed in the test case analysis:

- UE internal noise is included in the interference when calculating E_s/I_{otBB}
- E_s/I_{otBB} sensitivity factors are calculated using the method in A.2.4.2

A.2.5 Calculation of Applied I_o

A.2.5.1 Relevant core requirements

Core requirements applicable to RRM test cases depend on the test purpose, and should be selected for each test case. For test cases where the UE makes a measurement, the following are relevant:

- Measurement Performance requirements are specified in TS 38.133 [17] clause 10, and side conditions such as I_o are included in the core requirements for each measurement. Normally the maximum I_o condition is specified in the channel bandwidth, whereas the minimum I_o condition is specified as a power density per subcarrier.

A.2.5.2 Calculation method

An example is provided here for a scenario with applied AWGN and two intra-frequency cells. I_o applied to the UE is the arithmetic sum of linear powers in the channel bandwidth. UE internal noise is not counted, as it is not applied to the UE. The values are chosen for illustration, and not taken from any specific test case.

$$\text{Channel } I_o = 10\text{Log}_{10}(\text{Applied AWGN power} + \text{Cell 1 power} + \text{Cell 2 power}) + 10\text{Log}_{10}(N_{RB_TC} \times 12)$$

where:

AWGN, Cell 1 power and Cell 2 power are linear powers in W, per subcarrier

N_{RB_TC} is the number of PRBs allocated in the test case (not necessarily equal to the number of PRBs in the channel bandwidth)

12 is the number of subcarriers in a PRB

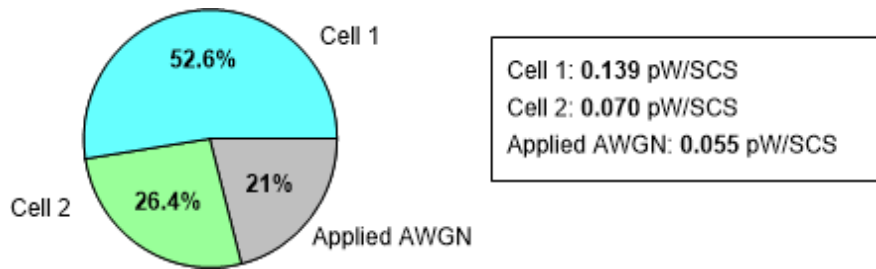

Figure A.2.5.2-1: Example Io scenario, applied AWGN and two intra-frequency cells

With 24 PRBs allocated, the example gives $I_o = 10\text{Log}_{10}((0.055 + 0.139 + 0.070) \times 10^{-9}) + 10\text{Log}_{10}(24 \times 12) = -71.2\text{dBm}$

I_o sensitivity factors in the Test Tolerance analysis are based on linear powers:

- I_o sensitivity to applied AWGN absolute power = **+1.000**
- I_o sensitivity to Cell 1 Es/Noc = Cell 1 power / (Applied AWGN power + Cell 1 power + Cell 2 power). In this example, $(0.139 / (0.055 + 0.139 + 0.070)) = +0.527$
- I_o sensitivity to Cell 2 Es/Noc = Cell 2 power / (Applied AWGN power + Cell 1 power + Cell 2 power). In this example, $(0.070 / (0.055 + 0.139 + 0.070)) = +0.264$

All the sensitivity factors are positive, as an increase in the quantity produces an increase in I_o . The sensitivity factors are used to scale the uncertainties.

A.2.5.3 Principles for Test Tolerance analysis

The following principles shall be followed in the test case analysis:

- I_o is calculated using the method in A.2.5.2
- I_o sensitivity factors are calculated using the method in A.2.5.2

A.2.6 UE Reported RSRP and UE gain

A.2.6.1 Relevant core requirements

SS-RSRP is defined to be measured based on the combined signal from antenna elements corresponding to a given receiver branch. The reference point for requirement parameters from the UE perspective is the input of the UE antenna array. The UE gain “G” relates the combined signal from antenna elements corresponding to a given receiver branch to the reference point for requirement parameters.

For test cases where the UE reports a measured value, or compares a measured value to a signalled threshold, the UE Gain “G” affects the SS-RSRP level measured by the UE

- The UE Gain from the reference point (where test case parameters are specified) to the SS-RSRP measurement point is specified in TS 38.133 [17] clause B.2.1.5. As the UE gain “G” is specified for Rx Beam Peak angle of arrival, it does not include effects related to spherical coverage.
- Measurement Performance requirements are specified in TS 38.133 [17] clause 10, and include accuracy requirements as +/-dB values. For FR2, the accuracy is considered to apply at the combined signal from antenna elements corresponding to a given receiver branch, and does not include the UE gain “G”.

The specified range of UE Gain “G” allows the UE to use either Rough beams or Fine beams, so no further allowance is required for the parameters Y or Z in A.2.2.

A.2.6.2 Absolute RSRP

An example is provided here for a scenario where the UE reports SS-RSRP for a signal arriving from a direction within the UE spherical coverage, to illustrate variation from both UE spherical coverage and variation from UE gain “G”.

$$UE\text{-measured } SS\text{-RSRP}_{nom} = Applied\ SSB_RP + UE\ Spherical\ coverage\ gain\ midpoint + UE\ gain\ G\ midpoint$$

where:

Applied SSB_RP is specified in the test case, either directly as Es or derived from Noc and Es/Noc, and is in dBm per subcarrier

UE Spherical coverage gain midpoint in dB is derived as (UE Refsens - UE Spherical coverage)/2

UE gain G midpoint in dB is derived as (Min value of G + Max value of G)/2

As an example for a UE power class 3 in band n257, measuring SS_RSRP from a spherical coverage direction, UE-measured SS-RSRP_{nom} = Applied SSB_RP -5.45dB +5.0dB.

Figure A.2.1.2-1 shows the derivation of UE Spherical coverage gain midpoint. Variation about the midpoint is handled as a UE uncertainty. For signals arriving from Rx Beam Peak direction, this gain is 0dB and does not vary.

Figure A.2.6.2-1 shows the derivation of UE gain G midpoint. Variation about the midpoint is handled as a UE uncertainty.

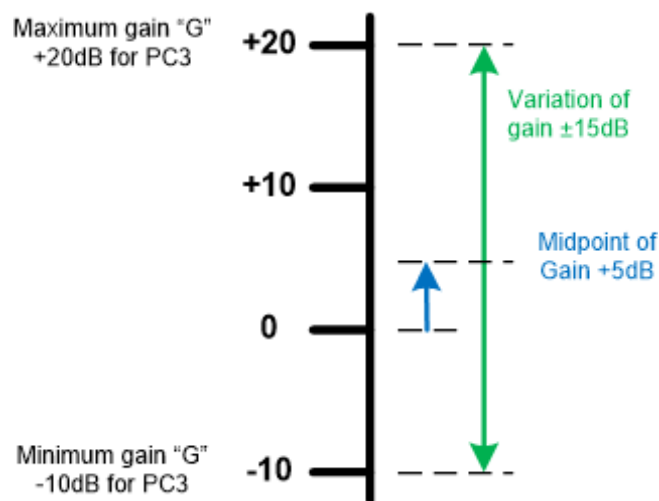

Figure A.2.6.2-1: Example modelling of UE Gain “G” variation

To calculate the range of valid SS-RSRP values that can be reported by the UE, contributions from Spherical coverage gain variation, UE gain variation and UE reporting accuracy are considered:

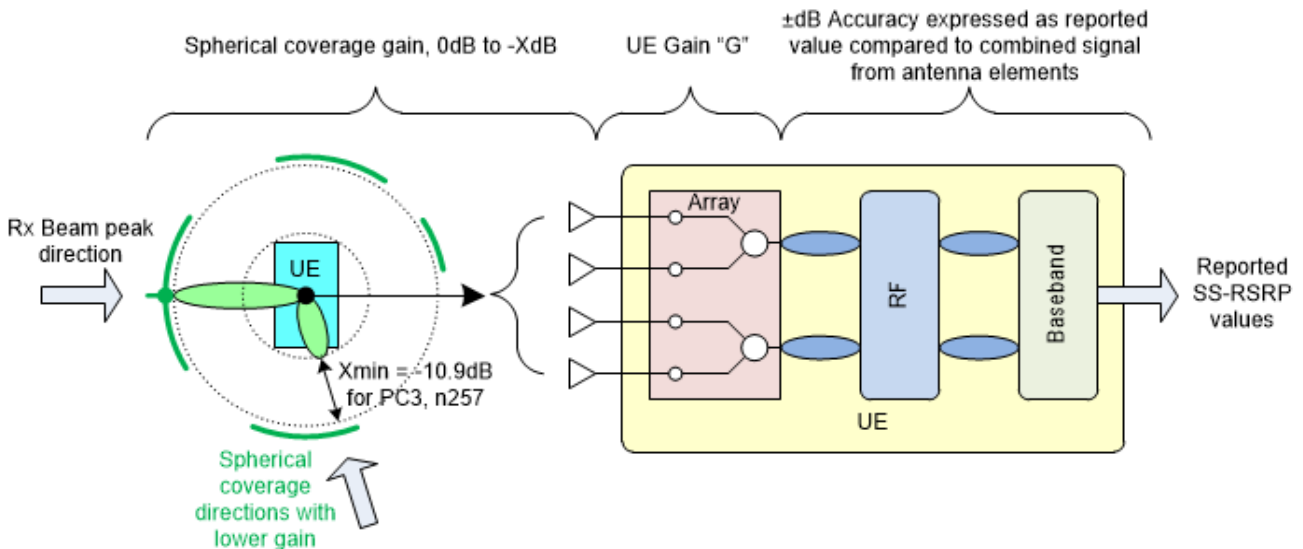

Figure A.2.6.2-2: modelling of contributions affecting SS-RSRP reported values

Reported SS-RSRP = UE measured SS-RSRP_{nom} ± Spherical coverage gain variation ± UE gain variation ± UE accuracy

where:

UE measured SS-RSRP_{nom} is the nominal value derived from Applied SSB_{RP}, UE Spherical coverage gain midpoint and UE gain G midpoint

Spherical coverage gain variation is derived from Refsens and Spherical coverage, as shown in Figure A.2.1.2-1

UE gain variation is derived from Minimum and maximum values of G, as shown in Figure A.2.6.2-1

UE accuracy is the absolute accuracy from the core requirement referred to in A.2.6.1

As an example for a UE power class 3 in band n257, measuring SS_{RSRP} from a spherical coverage direction with applied I_o > -70dBm, the variation would be (±5.45dB ±15dB ±8dB) = **±28.45dB**

These variations are added arithmetically in the test case analysis, as each could be systematic and not random. For signals arriving from Rx Beam Peak direction, spherical coverage gain variation is 0dB.

A.2.6.3 Relative RSRP, 2 levels on same cell, same Angle of Arrival

An example is provided here for a scenario where the test case require the UE to report SS-RSRP for the same cell at two different levels, with the signal arriving from the same direction. The Angle of Arrival may be within the UE spherical coverage, or from Rx Beam peak direction.

UE-measured SS-RSRP_{1nom} = Applied SSB_{RP1} + UE Spherical coverage gain midpoint + UE gain G midpoint

UE-measured SS-RSRP_{2nom} = Applied SSB_{RP2} + UE Spherical coverage gain midpoint + UE gain G midpoint

UE-measured SS-RSRP_{2nom} - UE-measured SS-RSRP_{1nom} = Applied SSB_{RP2} - Applied SSB_{RP1}

where:

Applied SSB_{RP1} and Applied SSB_{RP2} are specified in the test case, either directly as E_s or derived from N_{oc} and E_s/N_{oc}, and are in dBm per subcarrier

It can be seen that UE Spherical coverage gain midpoint and UE gain G midpoint cancel out for this relative measurement, as they remain the same for a signal from the same Angle of Arrival.

Reported SS-RSRP₂ - Reported SS-RSRP₁ = UE-measured SS-RSRP_{2nom} - UE-measured SS-RSRP_{1nom} ± UE accuracy

where:

UE accuracy is the relative accuracy from the core requirement referred to in A.2.6.1

A.2.6.4 Relative RSRP, 2 intra-frequency cells, same Angle of Arrival

An example is provided here for a scenario where the test case require the UE to report SS-RSRP for two different cells, with the signals arriving from the same direction. The Angle of Arrival may be within the UE spherical coverage, or from Rx Beam peak direction.

$$\text{UE-measured SS-RSRP}_{1\text{nom}} = \text{Applied SSB_RP1} + \text{UE Spherical coverage gain midpoint} + \text{UE gain G midpoint}$$

$$\text{UE-measured SS-RSRP}_{2\text{nom}} = \text{Applied SSB_RP2} + \text{UE Spherical coverage gain midpoint} + \text{UE gain G midpoint}$$

$$\text{UE-measured SS-RSRP}_{2\text{nom}} - \text{UE-measured SS-RSRP}_{1\text{nom}} = \text{Applied SSB_RP2} - \text{Applied SSB_RP1}$$

where:

Applied SSB_RP1 and Applied SSB_RP2 are specified in the test case, either directly as Es or derived from Noc and Es/Noc, and are in dBm per subcarrier

It can be seen that UE Spherical coverage gain midpoint and UE gain G midpoint cancel out for this relative measurement, as they are the same for signals from the same Angle of Arrival.

$$\text{Reported SS-RSRP2} - \text{Reported SS-RSRP1} = \text{UE-measured SS-RSRP}_{2\text{nom}} - \text{UE-measured SS-RSRP}_{1\text{nom}} \pm \text{UE accuracy}$$

where:

UE accuracy is the relative accuracy from the core requirement referred to in A.2.6.1

A.2.6.5 Relative RSRP, 2 inter-frequency cells, same Angle of Arrival

[FFS]

A.2.6.6 Relative RSRP, 2 cells, different Angles of Arrival

Examples are provided here for scenarios where the test case requires the UE to report SS-RSRP for two different cells, with the signals arriving from different directions.

For both Angles of Arrival from UE spherical coverage directions:

$$\text{UE-measured SS-RSRP}_{1\text{nom}} = \text{Applied SSB_RP1} + \text{UE Spherical coverage gain midpoint} + \text{UE gain G midpoint}$$

$$\text{UE-measured SS-RSRP}_{2\text{nom}} = \text{Applied SSB_RP2} + \text{UE Spherical coverage gain midpoint} + \text{UE gain G midpoint}$$

$$\text{UE-measured SS-RSRP}_{2\text{nom}} - \text{UE-measured SS-RSRP}_{1\text{nom}} = \text{Applied SSB_RP2} - \text{Applied SSB_RP1}$$

where:

Applied SSB_RP1 and Applied SSB_RP2 are specified in the test case, either directly as Es or derived from Noc and Es/Noc, and are in dBm per subcarrier

For the nominal values, UE Spherical coverage gain midpoint and UE gain G midpoint cancel out for this relative measurement. For the variations, UE gain variation cancels out as the same value affects both cells, but Spherical coverage gain variation applies separately to each Angle of Arrival.

$$\text{Reported SS-RSRP2} - \text{Reported SS-RSRP1} = \text{UE-measured SS-RSRP}_{2\text{nom}} - \text{UE-measured SS-RSRP}_{1\text{nom}} \pm \text{Spherical coverage gain variation}_{A_0A_1} \pm \text{Spherical coverage gain variation}_{A_0A_2} \pm \text{UE accuracy}$$

where:

Spherical coverage gain variation_{A₀A₁} is derived from Refsens and Spherical coverage, as in Figure A.2.1.2-1

Spherical coverage gain variation_{A₀A₂} is derived from Refsens and Spherical coverage, as in Figure A.2.1.2-1

UE accuracy is the relative accuracy from the core requirement referred to in A.2.6.1

For one Angle of Arrival from UE spherical coverage directions, and one from Rx Beam peak direction:

UE-measured SS-RSRP_{1nom} = Applied SSB_RP1 + UE Spherical coverage gain midpoint + UE gain G midpoint

UE-measured SS-RSRP_{2nom} = Applied SSB_RP2 + UE gain G midpoint

UE-measured SS-RSRP_{2nom} - UE-measured SS-RSRP_{1nom} = Applied SSB_RP2 - Applied SSB_RP1 - UE Spherical coverage gain midpoint

where:

Applied SSB_RP1 and Applied SSB_RP2 are specified in the test case, either directly as Es or derived from Noc and Es/Noc, and are in dBm per subcarrier

UE Spherical coverage gain midpoint in dB is derived as (UE Refsens - UE Spherical coverage)/2

For the nominal values, UE gain G midpoint cancels out for this relative measurement, but UE Spherical coverage gain midpoint applies to one Angle of Arrival. For the variations, UE gain variation cancels out as the same value affects both cells, but Spherical coverage gain variation applies to one Angle of Arrival.

Reported SS-RSRP2 - Reported SS-RSRP1 = UE-measured SS-RSRP_{2nom} - UE-measured SS-RSRP_{1nom} ± Spherical coverage gain variation_{AoA1} ± UE accuracy

where:

Spherical coverage gain variation_{AoA1} is derived from Refsens and Spherical coverage, as in Figure A.2.1.2-1

UE accuracy is the relative accuracy from the core requirement referred to in A.2.6.1

A.2.6.7 Principles for Test Tolerance analysis

The following principles shall be followed in the test case analysis:

- UE-measured SS-RSRP_{nom} is calculated using the relevant method in A.2.6.2 to A.2.6.6
- The range of SS-RSRP reported values is calculated using the relevant methods in A.2.6.2 to A.2.6.6

A.2.7 Intra-frequency cells without AWGN, same Angle of Arrival

A.2.7.1 Test system

In a practical test system running a test case where Intra-frequency cells come from the same Angle of Arrival, the level uncertainties for all cells will be highly correlated. If the test case has applied AWGN, it will specify Noc and Es/Noc, and the absolute uncertainty for applied AWGN will be the dominant contribution to the overall Es uncertainty for each cell. As AWGN is common to all cells on that frequency, the correlation is already included.

If the test case does not have applied AWGN, it will specify Es for each cell, with an absolute Es uncertainty for each cell. The method of handling the effect of correlation in the Test Tolerance analysis is given in A.2.7.2 and A.2.7.3.

A.2.7.2 Calculation method for Es/Iot at UE baseband

An example is provided here for a scenario with two intra-frequency cells, without applied AWGN. SSB Es/Iot at UE baseband is calculated for Cell 1. Interference to Cell 1 comes from the UE internal noise and from Cell 2. The values are chosen for illustration, and not taken from any specific test case.

$$\text{Cell 1 SSB Es/Iot}_{\text{BB}} = 10\text{Log}_{10}((\text{Cell 1 SSB power}) / (\text{UE internal noise} + \text{Cell 2 SSB power}))$$

Where UE internal noise, Cell 1 power and Cell 2 power are linear powers in W, per subcarrier.

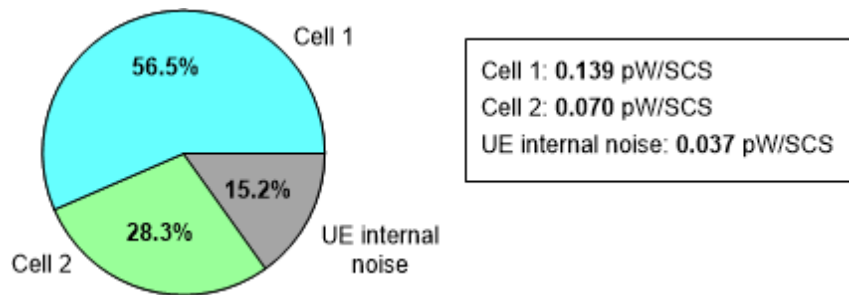

Figure A.2.7.2-1: Example Es/Iot_{BB} scenario, two intra-frequency cells

In this case, the calculation gives Cell 1 SSB Es/Iot_{BB} = 10Log₁₀(0.139 / (0.037 + 0.070)) = **1.14dB**

The presence of UE internal noise also affects the calculation of Es/Iot sensitivity factors in the Test Tolerance analysis. The UE internal noise is a fixed (worst) value, being based on the UE minimum requirement, and is taken into account in the scaling which uses linear powers:

- Cell 1 SSB Es/Iot_{BB} sensitivity to Cell 1 Es = **+1.000**
- Cell 1 SSB Es/Iot_{BB} sensitivity to Cell 2 Es = -Cell 2 SSB power / (UE internal noise + Cell 2 SSB power). In this example, (0.070 / (0.037 + 0.070)) = **-0.651**

A positive sensitivity factor is used where an increase in the quantity produces an increase in Cell 1 SSB Es/Iot_{BB}, for example increasing Cell 1 Es. A negative sensitivity factor is used where an increase in the quantity produces a decrease in Cell 1 SSB Es/Iot_{BB}, for example increasing Cell 2 Es. The sensitivity factors are used to scale the uncertainties.

Where the uncertainties are correlated, as here, they are added arithmetically and the sign affects the result. In this example, increasing Cell 1 Es increases the Cell 1 SSB Es/Iot_{BB}, but the correlated increase in Cell 2 Es decreases the Cell 1 SSB Es/Iot_{BB}. The overall effect is smaller, and depends on the ratios of linear powers.

A.2.7.3 Calculation method for Applied I_o

An example is provided here for a scenario with two intra-frequency cells, without applied AWGN. I_o applied to the UE is the arithmetic sum of linear powers in the channel bandwidth. UE internal noise is not counted, as it is not applied to the UE. The values are chosen for illustration, and not taken from any specific test case.

$$\text{Channel } I_o = 10\text{Log}_{10}(\text{Cell 1 power} + \text{Cell 2 power}) + 10\text{Log}_{10}(N_{RB_TC} \times 12)$$

where:

Cell 1 power and Cell 2 power are linear powers in W, per subcarrier

N_{RB_TC} is the number of PRBs allocated in the test case (not necessarily equal to the number of PRBs in the channel bandwidth)

12 is the number of subcarriers in a PRB

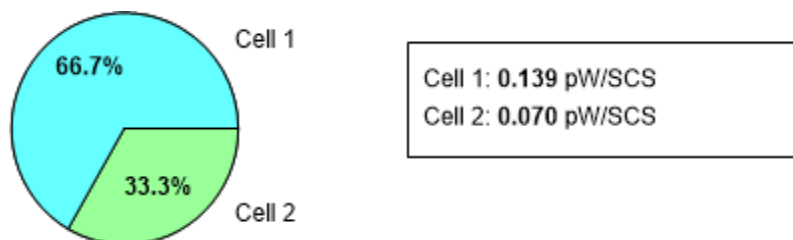

Figure A.2.7.3-1: Example I_o scenario, two intra-frequency cells

With 24 PRBs allocated, the example gives I_o = 10Log₁₀ ((0.139 + 0.070) x 10⁻⁹) + 10Log₁₀(24 x 12) = **-72.2dBm**

Io sensitivity factors in the Test Tolerance analysis are based on linear powers:

- Io sensitivity to Cell 1 Es = Cell 1 power / (Cell 1 power + Cell 2 power). In this example, $(0.139 / (0.139 + 0.070)) = +0.667$
- Io sensitivity to Cell 2 Es = Cell 2 power / (Cell 1 power + Cell 2 power). In this example, $(0.070 / (0.139 + 0.070)) = +0.333$

All the sensitivity factors are positive, as an increase in the quantity produces an increase in Io. The sensitivity factors are used to scale the uncertainties.

Where the uncertainties are correlated, as here, they are added arithmetically, and the sign affects the result. In this example increasing Cell 1 Es increases Io, and the correlated increase in Cell 2 Es also increases Io. The overall effect of scaling adds up to 1, as expected.

A.2.7.4 Principles for Test Tolerance analysis

The following principles shall be followed in the test case analysis:

- For Intra-frequency cells from the same Angle of Arrival without AWGN, Es/Iot_{BB} is calculated using the method in A.2.7.2.
- For Intra-frequency cells from the same Angle of Arrival without AWGN, Es/Iot_{BB} sensitivity factors are calculated using the method in A.2.7.2.
- For Intra-frequency cells from the same Angle of Arrival without AWGN, Io is calculated using the method in A.2.7.3.
- For Intra-frequency cells from the same Angle of Arrival without AWGN, Io sensitivity factors are calculated using the method in A.2.7.3.

A.3 Test Tolerance analysis templates for radiated test cases awaiting completion

Test Tolerance analyses for Radiated testing listed below are not yet complete, but contain the main features for the test cases covered and can be used as templates. For each analysis, the missing aspects are listed.

The analysis documents (and spreadsheets where applicable) are included in the present document as zip files with “draft” at the end of the filename. When the test case analyses are complete, the draft versions and listing in this clause should be removed.

38.533 5.3.2.2.1+5.3.2.2.2+7.3.2.2.1+7.3.2.2.2 TT draft

Editor’s note: This test tolerance analysis is incomplete. The following aspects are missing:

- *Settable window for first preamble uplink power and the uplink calibration process*
- *Derivation of test requirement for absolute uplink power after uplink calibration process*
- *Derivation of test requirement for relative uplink power*
- *The uncertainty value and test requirement for PRACH timing are in [] and not yet finalised*
- *The results of the TT analysis are provisional until the corresponding MU values are agreed*

A.4 Design of radiated test cases defined in TS 38.533

The design of radiated test cases defined in TS 38.533 is more challenging than for conducted test cases, because the over-the-air path loss reduces the downlink power seen by the UE, and reduces the uplink power received by the test system.

The achievable downlink power in a practical test system is restricted, and there is less dB range between the lowest and highest power that can be applied within the UE Core requirement side conditions.

The range of uplink power that can be measured by a practical test system is also restricted, by signal-to-noise ratio considerations at the low end, and by the UE output power at the high end.

For both downlink and uplink, the achievable dB range is most restricted when the signal arrives from the UE Spherical coverage direction. In a test case it is further restricted by downlink power level uncertainty or uplink power measurement uncertainty, which are both larger for radiated signals than for conducted signals. This Annex considers the effect of restricted dB range on radiated RRM test case design.

A.4.1 Downlink considerations

A.4.1.1 Side conditions for Rx Beam Peak angle of arrival

Side conditions for Rx Beam Peak angle of arrival are less stringent than for Spherical Coverage angle of arrival. They are not directly analysed here, but the same principles apply as for Spherical Coverage in clause A.4.1.2.

A.4.1.2 Side conditions for Spherical Coverage angle of arrival

As an example, consider a test case where the UE makes measurements on the downlink signal, for example in Event-triggered reporting. Some side condition values are band-dependent, and also depend on whether the cell being measured is intra-frequency or inter-frequency. An adverse case is chosen for illustration:

- Spherical Coverage angle of arrival
- Inter-frequency
- UE Power Class 3
- Band n259
- Maximum multi-band relaxation
- Full RB allocation
- UE is required to make measurements, so side conditions apply

The scenario is however best case on two points:

- Applied Es only, without Noc (only UE internal noise)
- Only one cell on the frequency (no other intra-frequency cells)

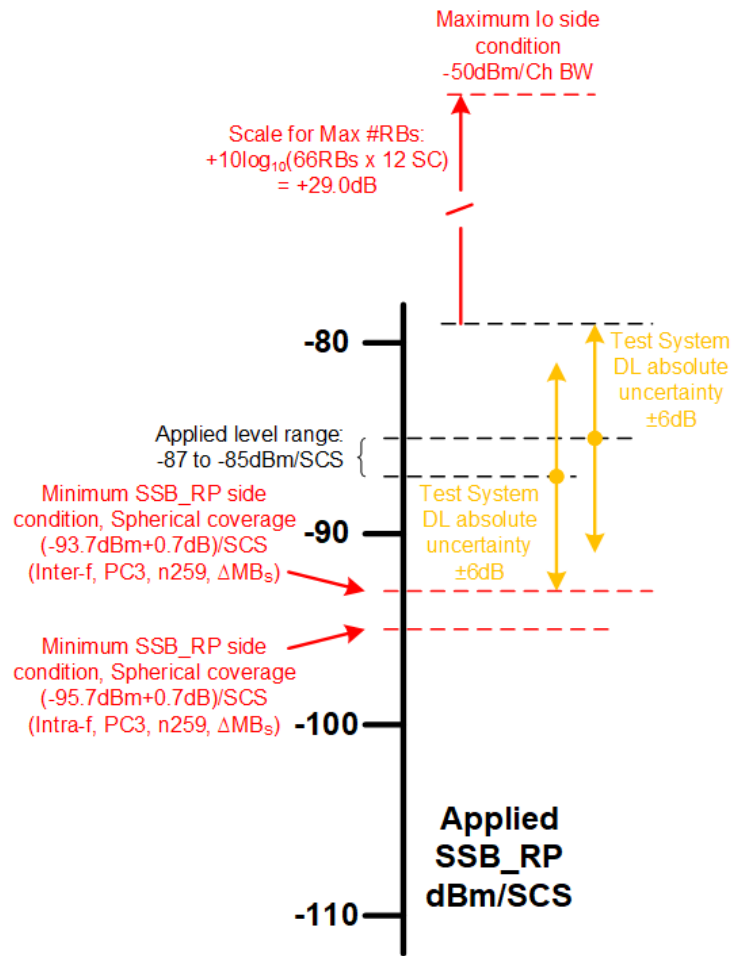

Figure A.4.1.2-1: Example side conditions when UE is making measurements

It can be seen that when uncertainties are taken into account (an indicative value of $\pm 6\text{dB}$ is used), the applied level range can be from -87dBm/SCS to -85dBm/SCS , a range of only 2dB . This is very restrictive for the test case design.

A.4.1.3 Test case design options to increase downlink dB range

A number of options are available to increase the dB range of the applied downlink signal, if necessary. For a specific test case, only some may be available, for example in a test case such as Radio Link Monitoring, it would not be possible to use applied E_s only, because the test case relies on a well-defined SNR at the UE baseband.

Table A.4.1.3-1: Options to increase downlink dB range

Option	Applicability	Comments
Reduce number of allocated RBs	All Test cases	120kHz SSB SCS, use 24RBs 240kHz SSB SCS, use 48RBs Allocated RBs must include CORESET
Use applied Es only, without applied Noc	Test cases where Es/Iot_{BB} requirement is to be \geq defined value	Maximises Es contribution to Io. Not suitable for test cases where Es/Iot_{BB} is intended as well-defined SNR.
If applied Noc is used, reduce margin above UE internal noise	Test cases where Es/Iot_{BB} requirement is to be \geq defined value	Not suitable for test cases where Es/Iot_{BB} is intended as well-defined SNR.
Use time-division multiplexing with SSB#0, SSB#1	Test cases using SSB#0, SSB#1	Avoids intra-frequency interference and degradation of Es/Iot_{BB}
Use Rx Beam Peak AoA instead of Spherical Coverage	Test cases where using Rx Beam Peak for one or both AoA, instead of Spherical Coverage, would provide adequate test coverage	Adequate test coverage may be achievable across several Test cases
Allow $I_o > -50dBm$	Test cases where measurement side conditions are not applicable	Test system may not be able to deliver $>-50dBm$
Restrict to 120kHz SSB SCS	Test cases with a 240kHz SSB SCS Configuration	Adequate test coverage of 120kHz and 240kHz SSB SCS may be achievable across several Test cases

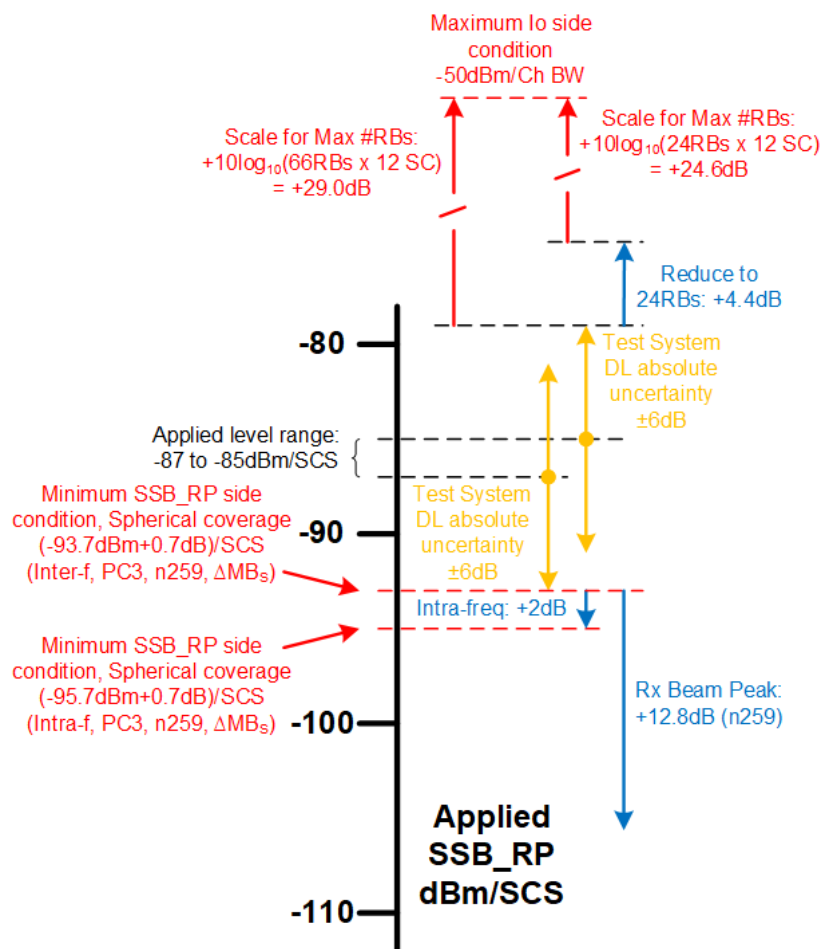

Figure A.4.1.3-1: Example illustration of selected options to increase downlink dB range

Annex B: Acceptable uncertainty of test system for test cases defined in TS 38.521-2 for radiative testing

This annex contains suggested uncertainties for each test case in TS 38.521-2.

B.1 Uncertainty budget calculation principle

Three permitted test methodologies, DFF, IFF and NFTF, have been identified for UE RF FR2 test cases defined in TS 38.521-2.

This Annex is deriving Total expanded Measurement Uncertainties per test case for each test methodology.

Threshold MU is equivalent to Total expanded uncertainty of the reference methodology which has been defined as IFF.

If the Total expanded Measurement Uncertainty per test case of a permitted test method is lower than or equal to the threshold MU, then that test method is applicable to the respective test cases defined in TS 38.521-2.

B.1.1 Uncertainty budget calculation principle for DFF

The uncertainty tables should be presented with two stages:

- Stage 1: the calibration of the absolute level of the DUT measurement results is performed by means of using a calibration antenna whose absolute gain is known at the frequencies of measurement
- Stage 2: the actual measurement with the DUT as either the transmitter or receiver is performed.

The MU budget should comprise the following headings:

- 1) The uncertainty source. Compile a complete list of the individual measurement uncertainty elements that contribute to a measurement
- 2) Determine the maximum value of each uncertainty
- 3) Determine the distribution of each uncertainty (rectangular, U-shaped, etc.),
- 4) Calculate (if necessary) the standard deviation of each uncertainty, u_i , (NOTE 1) for each uncertainty element,
- 5) Convert the units (if necessary) of each uncertainty element into the chosen unit, i.e., dB,
- 6) Combine ALL the standard uncertainties by the root-sum-squares method to derive the 'combined standard uncertainty',
- 7) Multiply the resulting combined standard uncertainty by an expansion factor ' k ' to derive the 'expanded uncertainty' for a given confidence level. All expanded uncertainties are quoted to 95% confidence level, so k is taken as 1.96. This gives 95% confidence that the true value is within 1.96 times the combined standard uncertainty of the measured value to derive the 'expanded uncertainty'.
- 8) Any systematic errors are added to the expanded uncertainty to derive the 'total expanded uncertainty', i.e.,

$$u_{c,\text{total expanded}} = u_{c,\text{expanded}} + u_{c,\text{systematic}} = 1.96 \sqrt{\sum u_i^2} + \sum u_{i,\text{systematic}}$$

NOTE 1: The standard deviation from a data set of N samples is defined as

$$u_i = \sqrt{\frac{1}{N-1} \sum_{k=1}^N |s_k - \bar{s}|^2}$$

where s_k are the respective sample results and \bar{S} the mean of all N samples. For an uncertainty u_i in dB, the dB values (instead of the linear powers) of s_k and \bar{S} are used.

B.1.2 Uncertainty budget calculation principle for IFF

The same as defined in B.1.1.

B.1.3 Uncertainty budget calculation principle for NFFT

The same as defined in B.1.1 with the exception of Stage 2, only the measurement of the DUT transmitter is performed.

B.2 Measurement error contribution descriptions

B.2.1 Measurement error contribution descriptions for DFF

B.2.1.1 Positioning misalignment

This contribution originates from the misalignment of the testing direction and the beam peak direction of the measurement antenna due to imperfect rotation operation. The pointing misalignment may happen in both azimuth and vertical directions and the effect of the misalignment depends highly on the beam width of the beam under test. The same level of misalignment results in a larger measurement error for a narrower beam.

B.2.1.2 Measure distance uncertainty

The cause of this uncertainty contributor is due to the reduction of distance between the measurement antenna and the DUT. If the distance of separation is $2D^2/\lambda$ based on D being the entire device size, then the phase variation is 22.5deg. Whether this is the minimum acceptable criteria of phase taper over the entire DUT is FFS and shall be assessed during final MU definition for the test method. Any reduction in the distance of separation increases the phase variation and creates an error which is DUT dependant. Determination of limit of the error shall be done during final MU definition for the test method.

B.2.1.3 Quality of quiet zone

The quality of the quiet zone procedure characterizes the quiet zone performance of the anechoic chamber, specifically the effect of reflections within the anechoic chamber including any positioners and support structures. The MU term additionally includes the amplitude variations effect of offsetting the directive antenna array inside a DUT from the centre of the quiet zone as well as the directivity MU, i.e., the variation of antenna gains in the different direct line-of-sight links. An additional MU term related to phase variation and phase ripple effects which depends on measurement distance is FFS, and shall be assessed during final MU definition for the test method. This might require an augmentation of the quality of the quiet zone validation procedure.

B.2.1.4 Mismatch

Mismatch uncertainty occurs when;

- Changing the signal path between the measurement and calibration procedure
- Evaluating the insertion loss of a signal path

The mismatch uncertainty for a system consisting of a generator, a load and a component in between is defined as

$$\text{Mismatch contribution (standard deviation)} = \frac{|\Gamma_{generator}| \cdot |\Gamma_{load}| \cdot |S_{21}| \cdot |S_{12}| \cdot 100}{\sqrt{2} \cdot 11.5} \text{ dB,}$$

Where Γ denotes the reflection coefficient and S_{21} is the transmission coefficient, both in linear voltage ratios.

For a cascade of several components, the interactions between all components have to be evaluated. For example, for four devices in a row (shown in Figure B.2.1.4-1) the following contributions have to be accounted for: AB, BC, CD, ABC, BCD, ABCD. The term ABCD represents the interaction between A and D (generator and load) with the components B and C in between.

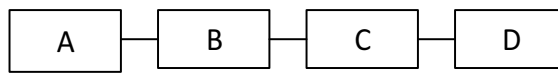

Figure B.2.1.4-1: Cascade of components

The combined mismatch uncertainty is given by the root sum square of the individual contributions:

$$\text{combined mismatch uncertainty} = \sqrt{(AB)^2 + (BC)^2 + (CD)^2 + (ABC)^2 + (BCD)^2 + (ABCD)^2}$$

In an optimized test procedure, the overall mismatch uncertainty is smaller when matching pairs of mismatches exist in the calibration and measurement stage since these pairs cancel each other out. Figure B.2.1.4-2 displays a calibration setup, where device D is replaced by device F. The mismatch contributions for this path are AB, BC, CE, ABC, BCE and ABCE. For a result based on the measurement and calibration stage, the mismatch contributions AB, BC, and ABC are matching pairs as they occur both in the measurement and calibration stage. Thus, they can be eliminated [11], and the system mismatch uncertainty is obtained as $\sqrt{(CD)^2 + (CE)^2 + (BCD)^2 + (BCE)^2 + (ABCD)^2 + (ABCE)^2}$

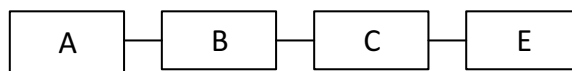

Figure B.2.1.4-2: Sketch of a calibration path

In the following, an example mismatch uncertainty calculation for a TX/RX patch from the measurement equipment to the measurement antenna is performed for a frequency of 43.5GHz. The example path under investigation consists of four SPDT switches, one SP6T switch and one DPDT switch and microwave cable interconnects with PC2.4 mm connectors. The attenuation and reflectance of typical components suitable for frequencies ranging up to 43.5 GHz have been considered in the calculation of the mismatch uncertainty.

Figure B1.1.4.4-3 shows a sample system setup for an EIRP/EIS test case with rather simple complexity of the switch box similar to a current sub 6GHz test setup. It should be noted that the switch unit is significantly less complex than a state-of-the-art switch unit currently used for conformance tests.

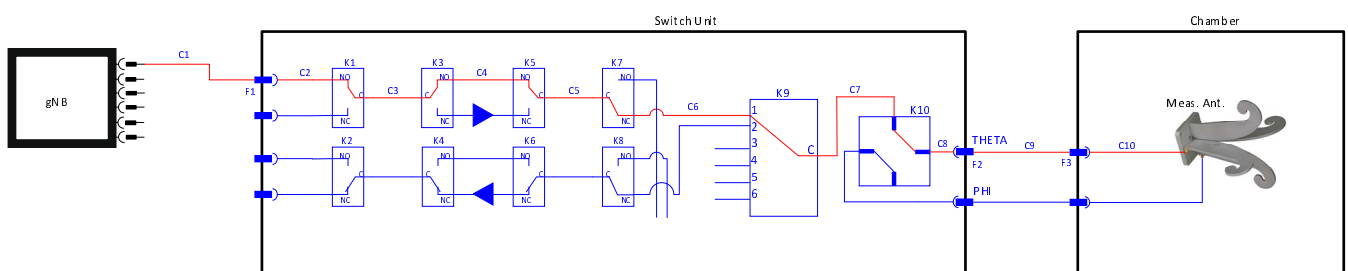

Figure B.2.1.4-3: Block Diagram of an EIRP/EIS test case with components from the gNB to the antenna (only portion of switch unit shown)

Table B.2.1.4-1: comprises the reflection and transmission properties of the components of the example path at a frequency of 43.5 GHz

Device / Component	VSWR	Transmission (dB)	Identifier in Figure B.2.1.4-3	Additional Comment/ Assumption
System Simulator	3.5		gNB	
Cable	1.5	-5.38	C1	Length: 1.5m Loss: 3.59dB/m
Cable	1.5	-0.61	C2, C3, C4, C5, C6, C7, C8	Length: 0.17m Loss: 3.59dB/m
Cable	1.5	-7.18	C9, C10	Length: 2.0m Loss: 3.59dB/m
Feedthrough	1.3	-0.66	F1, F2, F3	
SPDT switch	1.9	-1.10	K1, K3, K5, K7	
SP6T switch	2.2	-1.20	K9	
Transfer switch	2.0	-1.10	K10	
Antenna	2.0		Meas. Ant.	

The calculation of the overall mismatch uncertainty for a frequency of 43.5 GHz results in a value of 2.7 dB for the standard deviation, i.e., the expanded uncertainty is 5.3 dB.

Figure B.2.1.4-4 depicts a possible calibration for a part of the setup.

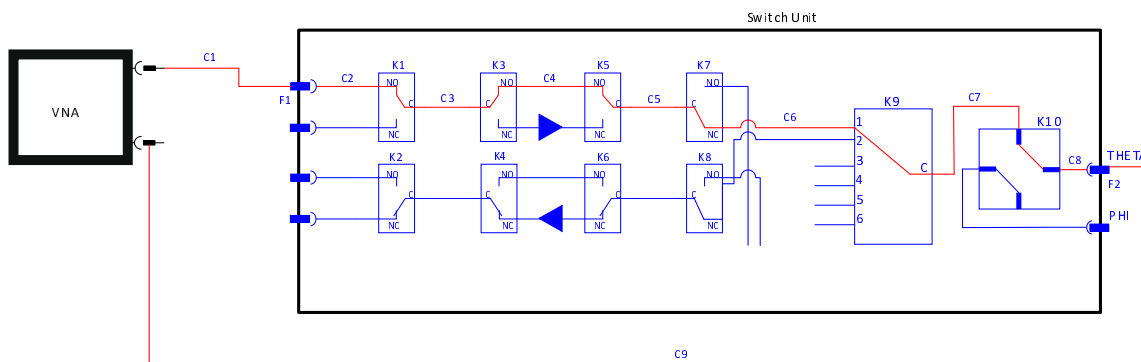

Figure B.2.1.4-4: Block Diagram of the calibration stage

For the VNA a return loss of 30 dB is assumed after a full two-port calibration. The calculation of the system mismatch uncertainty applying the elimination of matching pairs results in a value of 1.0 dB (standard deviation) with an expanded value of 1.9 dB.

Since the overall mismatch uncertainty value is already a standard deviation, which is RSS of values divided by the divisor ($\sqrt{2}$), the overall mismatch uncertainty value should be divided by actual divisor 1 when calculating total mismatch.

B.2.1.5 Standing Wave Between the DUT and measurement antenna

This uncertainty term is related to the amplitude ripple coming from the standing waves between the DUT and measurement antenna. If this term is not considered to be negligible one method to obtain this value is to slide the DUT $\lambda/4$ towards the measurement antenna while measuring the amplitude. The uncertainty term can be derived by performing the standard deviation on the results.

B.2.1.6 Uncertainty of the RF power measurement equipment

The receiving device is used to measure the received signal level in the EIRP tests as an absolute level. These receiving devices are spectrum analysers, communication analysers, or power meters. The uncertainty value will be indicated in the manufacturer's data sheet. It needs to be ensured that appropriate manufacturer's uncertainty contributions are

specified for the settings used such as bandwidth and absolute level. If a power meter is used zero offset, zero drift and measurement noise need to be included.

B.2.1.7 Phase curvature

This contribution originates from the finite far field measurement distance, which causes phase curvature across the antenna of UE/reference antenna. At a measurement distance of $2D^2/\lambda$ the phase curvature is 22.5 degrees. The impact of this factor shall be assessed during final MU definition for the test method.

B.2.1.8 Amplifier uncertainties

Any components in the setup can potentially introduce measurement uncertainty. It is then needed to determine the uncertainty contributors associated with the use of such components. For the case of external amplifiers, the following uncertainties should be considered but the applicability is contingent to the measurement implementation and calibration procedure.

- Stability
 - An uncertainty contribution comes from the output level stability of the amplifier. Even if the amplifier is part of the system for both measurement and calibration, the uncertainty due to the stability shall be considered. This uncertainty can be either measured or determined by the manufacturers' data sheet for the operating conditions in which the system will be required to operate.
- Linearity
 - An uncertainty contribution comes from the linearity of the amplifier since in most cases calibration and measurements are performed at two different input/output power levels. This uncertainty can be either measured or determined by the manufacturers' data sheet.
- Noise Figure
 - When the signal goes into an amplifier, noise is added so that the SNR at the output is reduced with regard to the SNR of the signal at the input. This added noise introduces error on the signal which affects the Error Rate of the receiver thus the EVM (Error Vector Magnitude). An uncertainty can be calculated through the following formula:

$$\varepsilon_{EVM} = 20 \log_{10} \left(1 + 10^{-\frac{SNR}{20}} \right)$$
 - Where SNR is the signal to noise ratio in dB at the signal level used during the sensitivity measurement.
- Mismatch
 - If the external amplifier is used for both stages, measurement and calibration the uncertainty contribution associated with it can be considered systematic and constant -> 0dB. If it is not the case, the mismatch uncertainty at its input and output shall be either measured or determined by the method described in [12].
- Gain
 - If the external amplifier is used for both stages, measurement and calibration the uncertainty contribution associated with it can be considered systematic and constant -> 0dB. If it is not the case, this uncertainty shall be considered.

B.2.1.9 Random uncertainty

This contribution is used to account for all the unknown, unquantifiable, etc. uncertainties associated with the measurements.

Random uncertainty MU contributions are normally distributed.

The random uncertainty term, by definition, cannot be measured, or even isolated completely. However, past system definitions provide an empirical basis for a value. Current LTE SISO OTA measurements have random uncertainty

contributions of ~0.2dB. A value of 0.5dB is suggested due to increased sensitivity to random effects in more complex, higher frequency NR test systems.

B.2.1.10 Influence of the XPD

This factor takes into account the uncertainty caused due to the finite cross polar discrimination (XPD) between the two polarization ports of the measurement probe. The XPD of the probe antenna shall be take into account during final MU definition for the test method.

A typical probe antenna can have XPD of 30dB.

A transmission matrix and calibration setup as shown in Figure B.2.1.10-1 is considered here. Typically, a single-polarized reference antenna with known gain is placed at the centre of the quiet zone and the total attenuation, L , between the reference antenna terminal and the feed antenna terminals is determined as part of the range reference calibration procedure.

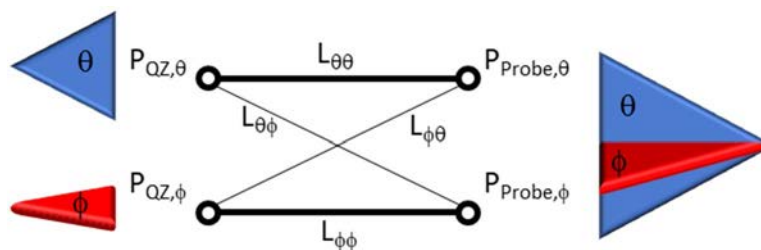

Figure B.2.1.10-1: Calibration Setup

Since the reference antenna is considered a single-polarized antenna, the XPD effect is negligible. Since the measurement probe is assumed to be a dual-linearly polarized antenna, leakage from one terminal/polarization to the other, i.e., XPD, needs to be considered.

The dual-linearly polarized measurement probe has two terminals corresponding to a set of orthogonal polarizations, θ and ϕ which match the orientations of the reference antenna. The most thorough calibration procedure would determine the path losses between the four different combinations of signal paths: $\theta\theta$, $\theta\phi$, $\phi\theta$, and $\phi\phi$, e.g., the power received by the measurement probe at the θ polarization/terminal, $P_{\text{Feed},\theta}$, is attenuated by $L_{\theta\theta}$ with respect to the power delivered to the reference antenna oriented in the ϕ polarization and placed in the centre of quiet zone, $P_{\text{QZ},\phi}$.

The most common calibration approach, however, is based on calibrating the polarization matched paths in Figure B.2.1.10-1 (thick solid lines), i.e., $\theta\theta$ and $\phi\phi$. In this case, as illustrated in Figure B.2.1.10-2, the normalized pathlosses $L_{\theta\theta}$ and $L_{\phi\phi}$ are 1 and the pathlosses of the crossed components become the XPD terms of the measurement probe:

$$\alpha_{\theta\phi} = 10^{\frac{\text{XPD}_{\theta\phi}}{10}} \tag{1.1}$$

and

$$\alpha_{\phi\theta} = 10^{\frac{\text{XPD}_{\phi\theta}}{10}} \tag{1.2}$$

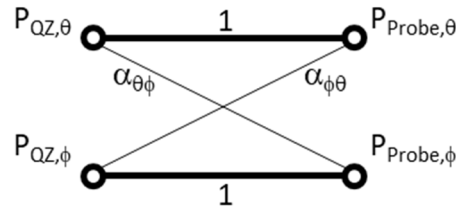

Figure B.2.1.10-2: Common calibration approach based on calibrating the polarization matched signal paths

In the remainder of this analysis, it is assumed that the leakage between the two polarization ports of the measurement probe is assumed to be the same, i.e., $XPD = XPD_{\theta\phi} = XPD_{\phi\theta}$ and $\alpha = \alpha_{\theta\phi} = \alpha_{\phi\theta}$.

The normalized powers at the measurement probe terminals can then be written as

$$P_{\text{Probe},\theta} = P_{\text{QZ},\theta} + \alpha P_{\text{QZ},\phi} \quad (1.3)$$

$$P_{\text{Probe},\phi} = P_{\text{QZ},\phi} + \alpha P_{\text{QZ},\theta} \quad (1.4)$$

The normalized ratio of total powers at measurement probe and the centre of the quiet zone is therefore

$$\frac{P_{\text{Probe}}}{P_{\text{QZ}}} = \frac{P_{\text{Probe},\theta} + P_{\text{Probe},\phi}}{P_{\text{QZ},\theta} + P_{\text{QZ},\phi}} = \frac{(P_{\text{QZ},\theta} + P_{\text{QZ},\phi})(1 + \alpha)}{P_{\text{QZ},\theta} + P_{\text{QZ},\phi}} = 1 + \alpha \quad (1.5)$$

This simple analysis shows that the XPD of the measurement probe introduces a small error of the total power measured by the measurement probe and that the conservation of measured powers is not guaranteed, i.e., the MU based on the XPD can be expressed as

$$\text{MU}_{\text{XPD}} [\text{dB}] = 10 \log_{10} (1 + \alpha) = 10 \log_{10} \left(1 + 10^{\frac{\text{XPD}}{10}} \right) \quad (1.6)$$

This XPD MU is tabulated for different levels of XPD in Table B.2.1.10-1.

Table B.2.1.10-1: XPD MU for different XPD values

XPD [dB]	MU _{XPD} [dB]
-20	0.043
-25	0.014
-30	0.004
-35	0.001
-40	0.000

When the range reference calibration is based on a full matrix-based approach, i.e., all signal paths are calibrated, the conservation of measured powers is guaranteed. As shown in Figure B.2.1.10-3, the polarization-matched signal paths take into account the leakage of power into the cross paths.

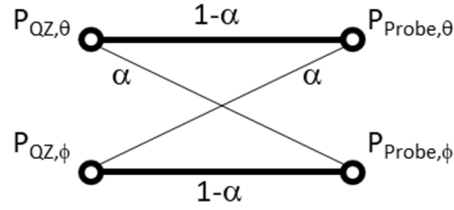

Figure B.2.1.10-3: Calibration approach based on calibrating all signal paths

The powers at the measurement probe can now be written as

$$P_{\text{Probe},\theta} = (1-\alpha)P_{\text{QZ},\theta} + \alpha P_{\text{QZ},\phi} \quad (1.7)$$

$$P_{\text{Probe},\phi} = (1-\alpha)P_{\text{QZ},\phi} + \alpha P_{\text{QZ},\theta} \quad (1.8)$$

The normalized ratio of total powers at measurement probe and the centre of the quiet zone is then

$$\frac{P_{\text{Probe}}}{P_{\text{QZ}}} = \frac{P_{\text{Probe},\theta} + P_{\text{Probe},\phi}}{P_{\text{QZ},\theta} + P_{\text{QZ},\phi}} = \frac{P_{\text{QZ},\theta} + P_{\text{QZ},\phi}}{P_{\text{QZ},\theta} + P_{\text{QZ},\phi}} = 1 \quad (1.9)$$

This simple analysis now shows that for a matrix-based calibration of all signal paths the XPD of the measurement probe no longer introduces any error and that the conservation of measured powers is guaranteed, i.e., the MU based on the XPD is 0dB.

The derivation of the XPD MU based on powers is a more straightforward and less complex approach than with electric fields as attempted in [2]. This annex shows that the same XPU MU result as derived in (1.5) can be derived using electric fields.

The corresponding signal paths are illustrated in Figure B.2.1.10-4.

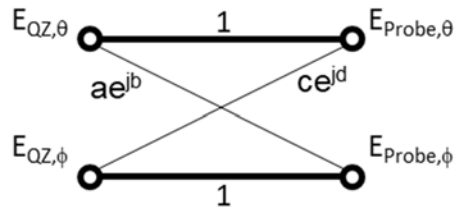

Figure B.2.1.10-4: Signal paths for electric fields (based on calibrating the polarization matched signal paths)

The normalized fields at the measurement probe terminals can then be written as

$$E_{\text{Probe},\theta} = E_{\text{QZ},\theta} + ce^{jd} E_{\text{QZ},\phi} \quad (1.10)$$

$$E_{\text{Probe},\phi} = E_{\text{QZ},\phi} + ae^{jb} E_{\text{QZ},\theta} \quad (1.11)$$

The transmission matrix can be defined as H

$$\begin{bmatrix} E_{\text{Probe},\theta} \\ E_{\text{Probe},\phi} \end{bmatrix} = H \begin{bmatrix} E_{\text{QZ},\theta} \\ E_{\text{QZ},\phi} \end{bmatrix} \quad (1.12)$$

$$H = \begin{bmatrix} 1 & ae^{jb} \\ ce^{jd} & 1 \end{bmatrix} \quad (1.13)$$

The total magnitude component of the electric field including coherence/interference terms at the probe is

$$\begin{aligned} E_{\text{Probe},T} &= \sqrt{|E_{\text{Probe},\theta}|^2 + |E_{\text{Probe},\phi}|^2} = \sqrt{|E_{\text{QZ},\theta} + ce^{jd}E_{\text{QZ},\phi}|^2 + |E_{\text{QZ},\phi} + ae^{jb}E_{\text{QZ},\theta}|^2} \\ &= \sqrt{\left[(E_{\text{QZ},\theta} + cE_{\text{QZ},\phi} \cos(d))^2 + (cE_{\text{QZ},\phi} \sin(d))^2 \right] + \left[(E_{\text{QZ},\phi} + aE_{\text{QZ},\theta} \cos(b))^2 + (aE_{\text{QZ},\theta} \sin(b))^2 \right]} \\ &= \sqrt{\left[E_{\text{QZ},\theta}^2 + 2cE_{\text{QZ},\theta}E_{\text{QZ},\phi} \cos(d) + c^2E_{\text{QZ},\phi}^2 \cos^2(d) + c^2E_{\text{QZ},\phi}^2 \sin^2(d) \right] +} \\ &= \sqrt{\left[E_{\text{QZ},\phi}^2 + 2aE_{\text{QZ},\theta}E_{\text{QZ},\phi} \cos(b) + a^2E_{\text{QZ},\theta}^2 \cos^2(b) + a^2E_{\text{QZ},\theta}^2 \sin^2(b) \right]} \\ &= \sqrt{E_{\text{QZ},\theta}^2 (1+a^2) + E_{\text{QZ},\phi}^2 (1+c^2) + 2E_{\text{QZ},\theta}E_{\text{QZ},\phi} (c \cos(d) + a \cos(b))} \end{aligned} \quad (1.14)$$

When it is assumed that leakage between the two polarization ports of the measurement probe is assumed to be the same, then $a=c=10^{\text{XPD}/20}$ in (1.14). Additionally, it has to be assumed that $d=b+\pi$ which guarantees the orthogonality between the two field vectors, i.e., the dot product between the vectors has to be zero. With these assumptions, Equation (1.14) will become

$$E_{\text{Probe},T} = \sqrt{(E_{\text{QZ},\theta}^2 + E_{\text{QZ},\phi}^2)(1+a^2)} \quad (1.15)$$

The normalized ratio of total powers at measurement probe and the centre of the quiet zone is therefore

$$\frac{P_{\text{Probe}}}{P_{\text{QZ}}} \propto \frac{E_{\text{Probe},T}^2}{E_{\text{QZ},T}^2} = 1 + a^2 = 1 + 10^{\frac{2\text{XPD}}{20}} = 1 + 10^{\frac{\text{XPD}}{10}} \quad (1.16)$$

The derived XPD MU based on electric fields which included the coherence/interference terms in (1.16) is the same as in (1.6).

The XPD of the measurement system shall be determined from the quality of quiet zone measurements, see clause O.2 of [7], at the 7 reference points, P1 through P7, specifically with reference AUT orientations $\gamma=\beta=0^\circ$ for distributed axes systems, Section O.2.6.1 [7], or reference AUT orientations $\beta=\alpha=0^\circ$ for combined-axes systems, Section O.2.6.2 [7]. Alternatively, it can be determined using a reference antenna optimized for XPD measurements and with the corresponding alignment to achieve optimal polarization matching between the reference and the measurement antenna.

The XPD for each reference point shall be calculated as the ratio of cross-polarized to co-polarized measured powers and the largest XPD from the 7 different reference points shall be used to determine the XPD MU, i.e.,

$$\text{MU}_{\text{XPD}} [\text{dB}] = 10 \log_{10} (1 + \alpha_{\text{max}}) = 10 \log_{10} \left(1 + 10^{\frac{\text{XPD}_{\text{max}}}{10}} \right) \quad (1-17)$$

where

$$\text{XPD}_{\text{max}} [\text{dB}] = 10 \log_{10} \left[\max \left(\left. \frac{P_{\text{cross-pol}}}{P_{\text{co-pol}}} \right|_{\text{P1}, \gamma_{\text{rot}}=0^\circ}, \left. \frac{P_{\text{cross-pol}}}{P_{\text{co-pol}}} \right|_{\text{P1}, \gamma_{\text{rot}}=90^\circ}, \dots, \left. \frac{P_{\text{cross-pol}}}{P_{\text{co-pol}}} \right|_{\text{P7}, \gamma_{\text{rot}}=0^\circ}, \left. \frac{P_{\text{cross-pol}}}{P_{\text{co-pol}}} \right|_{\text{P7}, \gamma_{\text{rot}}=90^\circ} \right) \right] \quad (1-18)$$

B.2.1.11 Insertion loss Variation

This uncertainty contribution comes from introducing an additional cable which is not present for both the calibration and DUT measurement. If the cables remain the same for the calibration and DUT measurement, then the contribution should be set to zero.

If an additional cable is added for one part of the test, the insertion loss must be accounted for in the measurement results. If the insertion loss is measured the uncertainty contribution will be the combined uncertainty related to the insertion loss measurement. The insertion loss can also be taken from the datasheet and assumed to have a rectangular distribution.

B.2.1.12 RF leakage (from measurement antenna to receiver/transmitter)

This contribution denotes noise leaking in to connector and cable(s) between measurement antenna and receiving/transmitting equipment. The contribution also includes the noise leakage between the connector and cable(s) between reference antenna and transmitting equipment for the calibration phase. This uncertainty contributor is contained in the contributor quality of quiet zone described in clause B.2.1.3 and its value therefore is set to zero.

B.2.1.13 Misalignment of positioning System

This contribution originates from uncertainty in sliding position and turn table angle/tilt accuracy. If the calibration antenna is aligned to the beam peak this contribution can be considered negligible and therefore set to zero.

B.2.1.14 Uncertainty of the Network Analyzer

This contribution originates from all uncertainties involved transmission magnitude measurement with a network analyser, for example: drift, frequency flatness, temperature variation from kit calibration to path losses measurement as well as interpolation of calibration data if test frequencies were not calibrated during path loss characterization. The uncertainty value will be indicated in the manufacturer's data sheet. It needs to be ensured that appropriate manufacturer's uncertainty contribution is specified for the absolute levels measured.

When an end-to-end system calibration approach is used, the absolute levels are related to the total system losses of the measurement path. When a split calibration approach is used, separate MU contributions need to be determined

- u_{cond} : transmission magnitude uncertainty for the conducted portion of the calibration; the absolute levels are related to the total system losses for the portion of the system calibrated
- u_{rad} : transmission magnitude uncertainty for the radiated portion of the calibration; the absolute levels are related to the total system losses for the portion of the system calibrated

The total MU of the network analyser for the split calibration is the RSS'ed value of u_{cond} and u_{rad} .

B.2.1.15 Uncertainty of the absolute gain of the calibration antenna

The calibration antenna only appears in Stage 2. Therefore, the gain uncertainty has to be taken into account. This uncertainty will come from a calibration report with traceability to a National Metrology Institute with measurement uncertainty budgets generated following the guidelines outlined in internationally accepted standards.

B.2.1.16 Positioning and pointing misalignment between the reference antenna and the measurement antenna

This contribution originates from reference antenna alignment and pointing error. In this measurement if the maximum gain direction of the reference antenna and the transmitting antenna are aligned to each other, this contribution can be considered negligible and therefore set to zero.

B.2.1.17 gNB emulator uncertainty

gNB emulator is used to drive a signal to the horn antenna (via multiple external components such as a switch box, an amplifier and a circulator, etc.) in sensitivity tests either as an absolute level or as a relative level. Receiving device

used is typically a UE/phablet/tablet/FWA. Generally there occurs uncertainty contribution from absolute level accuracy, non-linearity and frequency characteristic of the gNB emulator.

For practical reasons, in a case that a VNA is used as calibration equipment, gNB emulator is connected to the system after the calibration measurement (Stage 2) is performed by the VNA. Hence, the uncertainty on the absolute level of gNB emulator (transmitter device) cannot be assumed as systematic. This uncertainty should be calculated from the manufacturer's data in logs with a rectangular distribution, unless otherwise informed. Furthermore, the uncertainty of the non-linearity is included in the absolute level uncertainty.

B.2.1.18 Phase centre offset of calibration

Gain is defined at the phase centre of the antenna. If the phase centre of the calibration antenna is not aligned at the centre of the set up during the calibration, then there will be uncertainty related to the measurement distance.

The phase centre of a horn antenna moves with frequency along the taper length of the antenna therefore during the calibration the phase centre of all frequencies will not be aligned with the setup centre. The associated uncertainty term can be estimated using the following formula [14]:

$$\pm 20 \log_{10} \left(\frac{d_m - d_p}{d_m} \right)$$

$\pm 20 \log((\text{measurement distance} - d)/\text{measurement distance})$ [14]

Where d_m is the measurement distance and d_p is the maximum positional uncertainty. For a Horn antenna this is equal to 0.5 the length of the taper. This uncertainty is considered to have a rectangular distribution so the standard uncertainty is calculated by dividing the uncertainty by $\sqrt{3}$.

The same equation applies to log periodic antennas with d_m being 0.5 the length of the boom.

For a dipole antenna, given that the phase centre of the antenna is easily aligned with the centre of the set up the measurement uncertainty is zero.

If the calibration antenna (i.e. horn) is adjusted during the calibration to align the phase centre to the setup centre then this uncertainty term can be considered to be zero.

As an example a horn with a taper length of 50 mm, at 43.5 GHz and a measurement distance of 72.55 cm the uncertainty term is 0.62, with a rectangular distribution the standard uncertainty is 0.358 dB.

For DFF systems this uncertainty contribution must be included.

B.2.1.19 Quality of quiet zone for calibration process

During the calibration process the calibration antenna will be placed at the centre of the quiet zone. Therefore, only point P1 from the procedure outlined in B.2.1.3 needs to be considered for the quality of the quiet zone validation measurement.

For gain calibrations, the standard uncertainty of the EIRP results obtained following the method outlined in 2.10 shall be used. For efficiency calibrations, the standard uncertainty of the TRP result obtained following the method outlined in 2.9 shall be used.

B.2.1.20 Standing wave between reference calibration antenna and measurement antenna

This term comes from the amplitude ripple caused by the standing waves between the reference antenna and measurement antenna. This value can be captured by sliding ($\lambda/4$) the reference antenna towards the measurement antenna as the standing waves go in and out of phase causing a ripple in amplitude. The uncertainty term can be derived by performing the standard deviation on the results.

B.2.1.21 Influence of the calibration antenna feed cable (Flexing cables, adapters, attenuators, connector repeatability)

During the calibration measurement a cable (adapters, attenuators) is used to feed the calibration antenna. This uncertainty captures any influence the cable may have on the measurements result. This term can be assessed by repeating measurements while flexing the cables and rotary joints and using the largest difference between the results as the uncertainty. For some calibration test configurations this uncertainty can be considered to be zero.

B.2.1.22 Influence of TRP measurement grid

This contributor describes the uncertainty of the measured TRP value due to the finite number of measurement grid points.

B.2.1.23 Influence of beam peak search grid

This contributor describes the uncertainty of absolute TX power beam peak measurements, e.g., EIRP in beam peak direction, due to the finite number of measurement points in the beam peak search grid.

B.2.1.24 Systematic error due to TRP calculation/quadrature

When calculating TRP using different quadrature of constant step size data, a mean error shall be taken into account. The value of this contributor depends on the number of measurement grid points and the quadrature technique used.

No mean error has to be taken into account for constant density approach (using the charged particle or the golden spiral implementation) for non-sparse antenna arrays.

This measurement uncertainty contributor represents a systematic uncertainty and must not be root sum squared with contributors described by standard deviation.

B.2.1.25 Multiple measurement antenna uncertainty

This contributor describes the uncertainty caused by switching multiple measurement antennas either by mechanically or electrically to measure TRx spurious emission.

A frequency range of spurious tests (e.g. general spurious emission) is defined from 6 GHz to second harmonic of FR2 bands such as 80 GHz. Since that frequency range is quite wide, it is impossible to cover the whole range only by one measurement antenna. Therefore to provide a feature of the spurious emission measurement by FR2 test system, the system has to equip a capability to switch corresponding measurement antennas in an anechoic chamber. One of the mechanical antenna switching methods can be a structure of a slider. Then a repeatability of a bending loss of a feeder cable which is connected to the measurement antennas shall be taken into account. On the other hand for electrical antenna switching, since multiple antennas need to be aligned in a chamber with a different position, the quiet zone characteristics might receive an influence by a displacement from the ideal focal point. In a case of electrical switching system, if the measurement antenna configuration is the same for the quality of the quiet zone measurement and the DUT measurement, then this uncertainty term is encompassed in the quality of the quiet zone results.

B.2.1.26 DUT repositioning

This contributor describes the uncertainty due to a displacement of a DUT. The DUT may need to be re-positioned between measurements, for instance when the battery runs low in charge.

B.2.1.27 Influence of noise

This contributor describes an offset uncertainty factor caused by a noise floor especially in a case of low SNR. This contributor works as a bias to measured results only to a direction to increase values and thus this shall be included in the uncertainty budget table as a systematic uncertainty. The uncertainty value can be derived by the following equation.

$$\text{Influence of noise} = 10 * \log\left(1 + 10^{\left(\frac{SNR}{10}\right)}\right)$$

B.2.1.28 Systematic error related to beam peak search

When calculating beam peak search a systematic error shall be taken into account. The value of this contributor depends on the number of measurement grid points.

This measurement uncertainty contributor represents a systematic uncertainty and must not be root sum squared with contributors described by standard deviation.

B.2.1.29 Influence of spherical coverage grid

This contributor describes the uncertainty of spherical measurements, due to the finite number of measurement points in the spherical coverage grid.

B.2.1.30 Systematic error related to EIS spherical coverage

When calculating EIS spherical coverage, a mean error shall be taken into account. The value of this contributor depends on the DL power step size used for the EIS search and then number of measurement grid points.

This measurement uncertainty contributor represents a systematic uncertainty and must not be root sum squared with contributors described by standard deviation.

B.2.1.31 Misalignment of DUT due to change of DUT orientation

This contributor describes the uncertainty due to a mis-alignment of a DUT after a change of DUT orientations described in Tables J.2-1 through J.2-3 in [3] during spurious emission and spherical coverage measurements. This contribution is negligible with spherical coverage TC as far as the misalignment is within the accuracy of DUT re-positioning.

B.2.1.32 Additional Impact of Interferer ACLR

This contribution describes the effect of the interferer ACLR over the wanted signal channel when testing ACS and in-band blocking. Even if power is set perfectly in the configured transmission bandwidth, interferer power will leak in the wanted signal channel due to its ACLR.

B.2.1.33 Modulated Interferer uncertainty

Modulated Interferer is used to drive a signal to the horn antenna (via multiple external components such as a switch box, an amplifier and a circulator, etc.) in ACS and In-band Blocking tests either as an absolute level or as a relative level. Receiving device used is typically a UE/phablet/tablet/FWA. Generally, there occurs uncertainty contribution from absolute level accuracy, non-linearity and frequency characteristic of the interferer generator.

For practical reasons, in a case that a VNA is used as calibration equipment, Modulated Interferer is connected to the system after the calibration measurement (Stage 2) is performed by the VNA. Hence, the uncertainty on the absolute level of Modulated Interferer (transmitter device) cannot be assumed as systematic. This uncertainty should be calculated from the manufacturer's data in logs with a rectangular distribution, unless otherwise informed. Furthermore, the uncertainty of the non-linearity is included in the absolute level uncertainty.

B.2.1.34 Void

B.2.1.35 Influence of offset antenna for blocker signal

This MU term describes the additional uncertainty caused by using offset antenna for blocker signal for FR2 blocking test cases. The cause of additional MU using offset antenna is the difference of UE antenna's gain between beam peak direction and offset beam peak direction, which will cause the error for the ACS or IBB performance requirement which

is given by the power ratio of the wanted signal power and blocker signal power. Such difference of the UE antenna gain can be compensated by increasing the blocker signal power by the measured EIS difference at beam peak direction and at offset beam peak. Despite this compensation, there still is a residual error corresponding to the antenna gain difference due to different frequency of wanted and blocker signal. Table B.2.1.35-1 summarizes the residual error after compensation for various offset angle assumption.

Table B.2.1.35-1: Residual error when offset antenna is used for FR2 blocking test

offset angle[deg]	Mean error[dB]	Std.dev[dB]	Mean error[dB]	Std.dev[dB]
	2x8 Assumption		1x4 Assumption	
0	0.000	0.000	0.000	0.000
0.5	0.001	0.001	0.000	0.000
1	0.004	0.003	0.001	0.001
1.5	0.010	0.006	0.002	0.002
2	0.018	0.011	0.004	0.003
2.5	0.028	0.018	0.006	0.004
3	0.041	0.026	0.009	0.006
3.5	0.057	0.036	0.013	0.009
4	0.075	0.048	0.016	0.011
4.5	0.096	0.062	0.021	0.015
5	0.120	0.078	0.026	0.018
5.5	0.147	0.096	0.031	0.022
6	0.178	0.117	0.038	0.026
6.5	0.213	0.142	0.044	0.031
7	0.252	0.170	0.051	0.036

NOTE 1: For MU assessment of the test system, the MU values should be taken from the row corresponding to the test system's offset antenna angle.
NOTE 2: Mean error should be counted as systematic offset and Std.dev should be counted as a random uncertainty in the MU budget table.
NOTE 3: For PC3 UE testing, the values for 2x8 Assumption should be used.
NOTE 4: EIS step size used for compensation should be added as mean error.

B.2.1.36 Uncertainty of the RF relative power measurement equipment

The receiving device is used to measure the received signal level in the EIRP tests as a relative level. These receiving devices are spectrum analysers, communication analysers, or power meters. The uncertainty value will be indicated in the manufacturer's data sheet. Basically, the linearity and impact of the averaging time needs to be considered in this MU term.

B.2.2 Measurement error contribution descriptions for IFF

B.2.2.1 Positioning misalignment

See B.2.1.1.

B.2.2.2 Measure distance uncertainty

See B.2.1.2. For IFF1 this can be considered to be zero.

B.2.2.3 Quality of Quiet Zone

See B.2.1.3.

B.2.2.4 Mismatch

See B.2.1.4.

B.2.2.5 Standing wave between DUT and measurement antenna

See B.2.1.5.

B.2.2.6 Uncertainty of the RF power measurement equipment

See B.2.1.6.

B.2.2.7 Phase Curvature

See B.2.1.7. For IFF1 this can be considered to be zero.

B.2.2.8 Amplifier Uncertainties

See B.2.1.8.

B.2.2.9 Random uncertainty

See B.2.1.9.

B.2.2.10 Influence of XPD

See B.2.1.10.

B.2.2.11 Insertion Loss Variation

See B.2.1.11.

B.2.2.12 RF leakage (from measurement antenna to receiver/transmitter)

See B.2.1.12.

B.2.2.13 Misalignment of positioning system

See B.2.1.13.

B.2.2.14 Uncertainty of the Network Analyzer

See B.2.1.14.

B.2.2.15 Uncertainty of the absolute gain of the calibration antenna

See B.2.1.15.

B.2.2.16 Positioning and pointing misalignment between the reference antenna and the measurement antenna

See B.2.1.16.

B.2.2.17 gNB emulator uncertainty

See B.2.1.17.

B.2.2.18 Phase centre offset of calibration

See B.2.1.18. For IFF1 this can be considered to be zero.

B.2.2.19 Quality of the Quiet Zone for Calibration Process

See B.2.1.19.

B.2.2.20 Standing wave between reference calibration antenna and measurement antenna

See B.2.1.20.

B.2.2.21 Influence of the calibration antenna feed cable (Flexing cables, adapters, attenuators, connector repeatability)

See B.2.1.21.

B.2.2.22 Influence of TRP measurement grid

See B.2.1.22.

B.2.2.23 Influence of beam peak search grid

See B.2.1.23.

B.2.2.24 Systematic error due to TRP calculation/quadrature

See B.2.1.24.

B.2.2.25 Multiple measurement antenna uncertainty

See B.2.1.25.

B.2.2.26 DUT repositioning

See B.2.1.26.

B.2.2.27 Influence of noise

See B.2.1.27.

B.2.2.28 Systematic error related to beam peak search

See B.2.1.28.

B.2.2.29 Influence of spherical coverage grid

See B.2.1.29.

B.2.2.30 Systematic error related to EIS spherical coverage

See B.2.1.30.

B.2.2.31 Misalignment of DUT due to change of DUT orientation

See B.2.1.31.

B.2.2.32 Additional Impact of Interferer ACLR

See B.2.1.32.

B.2.2.33 Modulated Interferer uncertainty

See B.2.1.33.

B.2.2.34 Influence of ETC on EIRP/EIS

See B.2.1.34.

B.2.2.35 Influence of offset antenna for blocker signal

See B.2.1.35.

B.2.2.6 Uncertainty of the RF relative power measurement equipment

See B.2.1.36.

B.2.3 Measurement error contribution descriptions for NFTF

B.2.3.1 Axes Alignment

Includes the following mechanical alignment errors:

- The uncertainty related with the lateral displacement between the horizontal and vertical axes of the DUT positioner.
- The differences from 90° of the angle between the horizontal and vertical axes.
- The horizontal mis-pointing of the horizontal axis to the probe reference point for $\Theta=0^\circ$.

These mechanical errors can result in sampling the field on a non-ideal sphere. This uncertainty can be considered to have a normal distribution.

B.2.3.2 Measurement Distance uncertainty

See B.2.1.2.

B.2.3.3 Quality of the Quiet Zone

See B.2.1.3.

B.2.3.4 Mismatch

See B.2.1.4.

B.2.3.5 Multiple Reflections: Coupling Measurement Antenna and DUT

The multiple reflections occur when a portion of the transmitted signal is reflected from the receiving antenna back to the transmitting antenna and re-reflected by the transmitting antenna back to the receiving antenna. This uncertainty can

be determined by multiple measurements of the DUT when at different distance from the probes. This uncertainty is assumed to have a U-shaped distribution.

B.2.3.6 Uncertainty of the RF power measurement equipment

See B.2.1.6.

B.2.3.7 Phase curvature

See B.2.1.7.

B.2.3.8 Amplifier uncertainties

See B.2.1.8.

B.2.3.9 Random uncertainty

See B.2.1.9.

B.2.3.10 Influence of the XPD

Refer to B.2.1.10. If the Probe Polarization Amplitude and Phase is measured and corrected for then this uncertainty term can be considered to be zero.

B.2.3.11 NF to FF truncation

The measured near field is expanded using a finite set of spherical modes. The number of modes is linked to number of samples. The filtering effect generated by the finite number of modes can improve measurement results by removing signals from outside the physical area of the DUT. Care must be taken in order to make sure the removed signals are not from the DUT itself. This term also includes the uncertainty related to the scan area truncation. This uncertainty is usually negligible. This uncertainty is assumed to have a normal distribution.

B.2.3.12 Probe Polarization Amplitude and Phase

The amplitude and phase of the probe polarization coefficients should be measured. This uncertainty is assumed to have a normal distribution.

B.2.3.13 Probe Array Uniformity (for multi-probe systems only)

This is the uncertainty due to the fact that different probes are used for each physical position. Different probes have different radiation patterns. Generally, the probe array is calibrated so that the uniformity of the probes is achieved. This uncertainty term must be considered if the amplitude and phase of each probe is not identical or corrected for. This uncertainty is assumed to have a normal distribution

B.2.3.14 Uncertainty of the Network Analyzer

See B.2.1.14.

B.2.3.15 Uncertainty of the absolute gain of the calibration antenna

See B.2.1.15.

B.2.3.16 Phase Recovery Non-Linearity over signal bandwidth

This uncertainty originates from the non-linearity of the phase recovery for wide band signal. The phase recovery can be due to either phase non-linearity of the receiver and/or the DUT itself. The method to quantify the non-linearities is not defined.

B.2.3.17 Probe Pattern Effect

The probe/s pattern/s is assumed to be known so that the DUT measurement in near field can be corrected when performing the near field to far field transform. If the probe pattern is known, then the uncertainty term is zero. There is no direct dependence between the DUT pattern and the probe pattern in near field measurements. This uncertainty is assumed to have a normal distribution.

B.2.3.18 Phase centre offset of calibration

See B.2.1.18.

B.2.3.19 Quality of the Quiet Zone for Calibration Process

See B.2.1.19.

B.2.3.20 Phase Drift and Noise

This uncertainty is due to the noise level and drift of the test range and should be determined or measured at the DUT location. The noise level is usually measured with a Spectrum Analyzer. This uncertainty is assumed to have a normal distribution.

B.2.3.21 Mismatch in the connection of the calibration antenna

See B.2.1.4.

B.2.3.22 Influence of TRP measurement grid

See B.2.1.22.

B.2.3.23

B.2.3.24

B.2.3.25 Leakage and Crosstalk

This uncertainty can be addressed by measurements on the actual system setup. The leakage and crosstalk cannot be separated from the random amplitude and phase errors so that the relative importance should be determined. This uncertainty is assumed to have a normal distribution.

B.2.3.26 Systematic error due to TRP calculation/quadrature

See B.2.1.24.

B.2.3.27 Multiple measurement antenna uncertainty

See B.2.1.25.

B.2.3.28 DUT repositioning

See B.2.1.26.

B.2.3.29 Influence of noise

See B.2.1.27.

B.2.3.30 Uncertainty of the RF relative power measurement equipment

See B.2.1.36.

B.3 UE maximum output power

Following tables summarize the MU threshold for EIRP and TRP measurements for UE maximum output power. The origin MU values for different test setups with varies parameters can be found in following clauses.

Table B.3-1: MU threshold for EIRP measurement for UE maximum output power

Power Class	Frequency	MBW	Power (NOTE2)	Threshold MU value for NTC [dB] (NOTE1)	Threshold MU value for ETC [dB] (NOTE1)
PC3	23.45GHz ≤ f ≤ 32.125GHz	BW ≤ 400MHz	P = Max Output Power	4.89	5.17
	32.125GHz < f ≤ 40.8GHz			5.09	5.37
PC1	23.45GHz ≤ f ≤ 32.125GHz	BW ≤ 400MHz	P = Max Output Power	FFS	FFS
	32.125GHz < f ≤ 40.8GHz			FFS	FFS
NOTE 1: Total EIRP Expanded MU for IFF for Quiet Zone size ≤30cm in Table B.3.2-2 for PC3 UEs (NTC), in Table B.3.2-8 for PC3 UEs (ETC) and B.3.2-6 for PC1 UEs.					
NOTE 2: Max output power level for device with corresponding power class.					

Table B.3-2: MU threshold for TRP measurement for UE maximum output power

Power Class	Frequency	MBW	Power (NOTE2)	Threshold MU value for NTC [dB] (NOTE 1)	Threshold MU value for ETC [dB] (NOTE 1)
PC3	23.45GHz ≤ f ≤ 32.125GHz	BW ≤ 400MHz	P = Max Output Power	4.42	4.70
	32.125GHz < f ≤ 40.8GHz			4.62	4.90
PC1	23.45GHz ≤ f ≤ 32.125GHz	BW ≤ 400MHz	P = Max Output Power	FFS	FFS

	32.125GHz < f <= 40.8GHz		FFS	FFS
NOTE 1: Total TRP Expanded MU for IFF for Quiet Zone size ≤ 30cm in Table B.3.2-2 for PC3 UEs and B.3.2-6 for PC1 UEs				
NOTE 2: Max output power level for device with corresponding power class.				

Table B.3-3: MU threshold for Spherical coverage measurement for UE maximum output power

Power Class	Frequency	MBW	Power	Threshold MU value (NOTE 1)
PC3	23.45GHz <= f <= 32.125GHz	BW <= 400MHz	P = TBD	4.60
	32.125GHz < f <= 40.8GHz			5.20
PC1	23.45GHz <= f <= 32.125GHz	BW <= 400MHz	P = TBD	FFS
	32.125GHz < f <= 40.8GHz			FFS
NOTE 1: Total Spherical coverage Expanded MU for IFF for Quiet Zone size ≤ 30cm in Tables B.3.2-4 for PC3 UEs and B.3.2-7 for PC1 UEs				

B.3.1 Uncertainty budget format and assessment for DFF

The uncertainty contributions that may impact the overall MU value are listed in Table B.3.1-1.

Table B.3.1-1: Uncertainty contributions for EIRP and TRP measurement

UID	Description of uncertainty contribution	Details in annex
Stage 2: DUT measurement		
1	Positioning misalignment	B.2.1.1
2	Measure distance uncertainty	B.2.1.2
3	Quality of quiet zone	B.2.1.3
4	Mismatch	B.2.1.4
5	Standing Wave Between the DUT and measurement antenna	B.2.1.5
6	Uncertainty of the RF power measurement equipment	B.2.1.6
7	Phase curvature	B.2.1.7
8	Amplifier uncertainties	B.2.1.8
9	Random uncertainty	B.2.1.9
10	Influence of the XPD	B.2.1.10
11	Insertion Loss Variation	B.2.1.11
12	RF leakage (from measurement antenna to the receiver/transmitter)	B.2.1.12
13	Influence of TRP measurement grid	B.2.1.22
14	Influence of beam peak search grid	B.2.1.23
15	Multiple measurement antenna uncertainty	B.2.1.25
16	DUT repositioning	B.2.1.26
17	Influence of spherical coverage grid	B.2.1.29
Stage 1: Calibration measurement		
18	Mismatch	B.2.1.4
19	Amplifier uncertainties	B.2.1.8
20	Misalignment of positioning System	B.2.1.13
21	Uncertainty of the Network Analyzer	B.2.1.14
22	Uncertainty of the absolute gain of the calibration antenna	B.2.1.15
23	Positioning and pointing misalignment between the reference antenna and the measurement antenna	B.2.1.16
24	Phase centre offset of calibration antenna	B.2.1.18
25	Quality of quiet zone for calibration process	B.2.1.19
26	Standing wave between reference calibration antenna and measurement antenna	B.2.1.20
27	Influence of the calibration antenna feed cable	B.2.1.21
28	Insertion Loss Variation	B.2.1.11
Systematic uncertainties		
29	Systematic error due to TRP calculation/quadrature	B.2.1.24
30	Influence of noise	B.2.1.27
31	Systematic error related to beam peak search	B.2.1.28

The uncertainty assessment tables are organized as follows:

- For the purpose of uncertainty assessment, the radiating antenna aperture of the DUT is denoted as D
- The uncertainty assessment has been derived for the case of $D = [5 \text{ cm}]$, $f = \{22.65\text{GHz}, 31.1\text{GHz}, 45.1\text{GHz}\}$, $P = [\text{maximum output power}]$.
- The uncertainty assessment for EIRP and TRP is provided in Table B.3.1-2.

Table B.3.1-2: Uncertainty assessment for EIRP and TRP measurement (f=TBD, D=TBD)

UID	Uncertainty source	Uncertainty value	Distribution of the probability	Divisor	Standard uncertainty (σ) [dB]
Stage 2: DUT measurement					
1	Positioning misalignment				
2	Measure distance uncertainty				
3	Quality of quiet zone (NOTE 2)				
4	Mismatch (NOTE 3)				
5	Standing Wave Between the DUT and measurement antenna				
6	Uncertainty of the RF power measurement equipment (NOTE 4)				
7	Phase curvature				
8	Amplifier uncertainties				
9	Random uncertainty				
10	Influence of the XPD				
11	Insertion Loss Variation				
12	RF leakage (from measurement antenna to the receiver/transmitter)				
13	Influence of TRP measurement grid (NOTE 5)	0.25	Actual	1	0.25
14	Influence of beam peak search grid (NOTE 6)	0.0	Actual	1	0.0
15	Multiple measurement antenna uncertainty				
16	DUT repositioning				
17	Influence of spherical coverage grid (NOTE 8)	0.12	Actual	1	0.12
Stage 1: Calibration measurement					
18	Mismatch				
19	Amplifier uncertainties				
20	Misalignment of positioning System				
21	Uncertainty of the Network Analyzer				
22	Uncertainty of the absolute gain of the calibration antenna				
23	Positioning and pointing misalignment between the reference antenna and the measurement antenna				
24	Phase centre offset of calibration antenna				
25	Quality of quiet zone for calibration process (NOTE 2)				
26	Standing wave between reference calibration antenna and measurement antenna				
27	Influence of the calibration antenna feed cable				
28	Insertion Loss Variation				
Systematic uncertainties (NOTE 7)					Value
29	Systematic error due to TRP calculation/quadrature (NOTE 5)				0.00
30	Influence of noise				
31	Systematic error related to beam peak search (NOTE 6)				0.5
Total measurement uncertainty					Value
EIRP Expanded uncertainty (1.96 σ - confidence interval of 95 %) [dB]					TBD
TRP Expanded uncertainty (1.96 σ - confidence interval of 95 %) [dB]					TBD

NOTE 1:	The impact of phase variation on EIRP shall be taken into account during final MU definition for the test method..
NOTE 2:	The quality of quiet zone is different for EIRP and TRP. For TRP, the standard uncertainty is FFS; for EIRP, the standard uncertainty of quiet zone is FFS.
NOTE 3:	The analysis was done only for the case of operating at max output power, in-band, non-CA.
NOTE 4:	The assessment assumes maximum DUT output power.
NOTE 5:	This contributor shall only be considered for TRP measurements.
NOTE 6:	This contributor shall only be considered for EIRP measurements.
NOTE 7:	In order to obtain the total measurement uncertainty, systematic uncertainties have to be added to the expanded root sum square of the standard deviations of the Stage 1 and Stage 2 contributors.
NOTE 8:	This contributor shall only be considered for spherical EIRP measurements

B.3.2 Uncertainty budget format and assessment for IFF

The uncertainty contributions that may impact the overall MU value are listed in Table B.3.2-1.

Table B.3.2-1: Uncertainty contributions for EIRP and TRP measurement

UID	Description of uncertainty contribution	Details in clause
Stage 2: DUT measurement		
1	Positioning misalignment	B.2.2.1
2	Measure distance uncertainty	B.2.2.2
3	Quality of Quiet Zone	B.2.2.3
4	Mismatch	B.2.2.4
5	Standing wave between the DUT and measurement antenna	B.2.2.5
6	Uncertainty of the RF power measurement equipment	B.2.2.6
7	Phase curvature	B.2.2.7
8	Amplifier uncertainties	B.2.2.8
9	Random uncertainty	B.2.2.9
10	Influence of the XPD	B.2.2.10
11	Insertion Loss Variation	B.2.2.11
12	RF leakage (from measurement antenna to the receiver/transmitter)	B.2.2.12
13	Influence of TRP measurement grid	B.2.2.22
14	Influence of beam peak search grid	B.2.2.23
15	Multiple measurement antenna uncertainty	B.2.2.25
16	DUT repositioning	B.2.2.26
17	Influence of spherical coverage grid	B.2.2.29
Stage 1: Calibration measurement		
18	Mismatch	B.2.2.4
19	Amplifier Uncertainties	B.2.2.8
20	Misalignment of positioning System	B.2.2.13
21	Uncertainty of the Network Analyzer	B.2.2.14
22	Uncertainty of the absolute gain of the calibration antenna	B.2.2.15
23	Positioning and pointing misalignment between the reference antenna and the measurement antenna	B.2.2.16
24	Phase centre offset of calibration antenna	B.2.2.18
25	Quality of quiet zone for calibration process	B.2.2.19
26	Standing wave between reference calibration antenna and measurement antenna	B.2.2.20
27	Influence of the calibration antenna feed cable	B.2.2.21
28	Insertion Loss Variation	B.2.1.11
Systematic uncertainties		
29	Systematic error due to TRP calculation/quadrature	B.2.2.24
30	Influence of noise	B.2.1.27
31	Systematic error related to beam peak search	B.2.2.28

The uncertainty assessment tables are organized as follows:

- For the purpose of uncertainty assessment, the radiating antenna aperture of the DUT is denoted as D

- The uncertainty assessment has been derived for the case of Quiet Zone size \leq [30 cm], $f = \{23.45\text{GHz}, 32.125\text{GHz}, 40.8\text{GHz}\}$, [P = maximum output power].
- The uncertainty assessment for EIRP and TRP is provided in Table B.3.2-2 for PC3 UEs and in Table B.3.2-6 for PC1 UEs.
- The uncertainty assessment for Spherical coverage is provided in Table B.3.2-4 for PC3 UEs in Table B.3.2-7 for PC1 UEs.

Table B.3.2-2: Uncertainty assessment for EIRP and TRP measurement (f=23.45GHz, 32.125GHz, 40.8GHz, Quiet Zone size \leq 30 cm) for PC3 UEs and normal temperature condition

UID	Uncertainty source	Uncertainty value	Distribution of the probability	Divisor	Standard uncertainty (σ) [dB]
Stage 2: DUT measurement					
1	Positioning misalignment	0.00	Normal	2.00	0.00
2	Measure distance uncertainty	0.00	Rectangular	1.73	0.00
3	Quality of Quiet Zone (NOTE 1)	0.6	Actual	1.00	0.6
4	Mismatch	1.30	Actual	1.00	1.30
5	Standing wave between the DUT and measurement antenna	0.00	U-shaped	1.41	0.00
6	Uncertainty of the RF power measurement equipment (NOTE 3)	2.16	Normal	2.00	1.08
7	Phase curvature	0.00	U-shaped	1.41	0.00
8	Amplifier uncertainties	2.10	Normal	2.00	1.05
9	Random uncertainty	0.50	Normal	2.00	0.25
10	Influence of the XPD	0.01	U-shaped	1.41	0.00
11	Insertion Loss Variation	0.00	Rectangular	1.73	0.00
12	RF leakage (from measurement antenna to the receiver/transmitter)	0.00	Actual	1.00	0.00
13	Influence of TRP measurement grid (NOTE 4)	0.25	Actual	1	0.25
14	Influence of beam peak search grid (NOTE 5)	0.00	Actual	1	0.00
15	Multiple measurement antenna uncertainty (NOTE 9)	0.15	Actual	1	0.15
16	DUT repositioning	0.00 (NOTE 4) 0.08 (NOTE 5)	Rectangular	1.73	0.00 (NOTE 4) 0.05 (NOTE 5)
Stage 1: Calibration measurement					
17	Mismatch	0.00	U-shaped	1.41	0.00
18	Amplifier Uncertainties	0.00	Normal	2.00	0.00
19	Misalignment of positioning System	0.00	Normal	2.00	0.00
20	Uncertainty of the Network Analyzer	0.73	Normal	2.00	0.37
21	Uncertainty of the absolute gain of the calibration antenna	0.60	Normal	2.00	0.30
22	Positioning and pointing misalignment between the reference antenna and the measurement antenna	0.01	Rectangular	1.73	0.00
23	Phase centre offset of calibration antenna	0.00	Rectangular	1.73	0.00
24	Quality of quiet zone for calibration process (NOTE 1)	0.4	Actual	1.00	0.4
25	Standing wave between reference calibration antenna and measurement antenna	0.00	U-shaped	1.41	0.00
26	Influence of the calibration antenna feed cable	0.14	Normal	2.00	0.07
27	Insertion Loss Variation	0.00	Rectangular	1.73	0.00
Systematic uncertainties (NOTE 6)					Value
28	Systematic error due to TRP calculation/quadrature (NOTE 4)				0.00
29	Influence of noise (23.45GHz \leq f \leq 32.125GHz)				0.1
29	Influence of noise (32.125GHz < f \leq 40.8GHz)				0.3
30	Systematic error related to beam peak search (NOTE 5)				0.5
Total measurement uncertainty					Value
EIRP Expanded uncertainty (23.45GHz \leq f \leq 32.125GHz) (1.96 σ - confidence interval of 95 %) [dB]					4.89
EIRP Expanded uncertainty (32.125GHz < f \leq 40.8GHz) (1.96 σ - confidence interval of 95 %) [dB]					5.09
TRP Expanded uncertainty (23.45GHz \leq f \leq 32.125GHz) (1.96 σ - confidence interval of 95 %) [dB]					4.42
TRP Expanded uncertainty (32.125GHz < f \leq 40.8GHz) (1.96 σ - confidence interval of 95 %) [dB]					4.62

- NOTE 1: The quality of quiet zone is the same for EIRP and TRP. Value based on procedure defined in clause D.2 of TR 38.810 for Quiet Zone size less or equal to 30 cm.
- NOTE 2: The analysis was done only for the case of operating at max output power, in-band, non-CA.
- NOTE 3: The assessment assumes maximum DUT output power.
- NOTE 4: This contributor shall only be considered for TRP measurements.
- NOTE 5: This contributor shall only be considered for EIRP measurements.
- NOTE 6: In order to obtain the total measurement uncertainty, systematic uncertainties have to be added to the expanded root sum square of the standard deviations of the Stage 1 and Stage 2 contributors.
- NOTE 7: Void.
- NOTE 8: Void
- NOTE 9: Applies to the system which has a structure of mechanical feed antenna positioning.

Table B.3.2-3: Void

Table B.3.2-4: Uncertainty assessment for Spherical coverage measurement (f=23.45GHz, 32.125GHz, 40.8GHz, Quiet Zone size \leq 30 cm) for PC3 UEs and normal temperature condition

UID	Uncertainty source	Uncertainty value	Distribution of the probability	Divisor	Standard uncertainty (σ) [dB]
Stage 2: DUT measurement					
1	Positioning misalignment	0.00	Normal	2.00	0.00
2	Measure distance uncertainty	0.00	Rectangular	1.73	0.00
3	Quality of Quiet Zone (NOTE 1)	0.6	Actual	1.00	0.6
4	Mismatch	1.30	Actual	1.00	1.30
5	Standing wave between the DUT and measurement antenna	0.00	U-shaped	1.41	0.00
6	Uncertainty of the RF power measurement equipment (NOTE 3)	2.16	Normal	2.00	1.08
7	Phase curvature	0.00	U-shaped	1.41	0.00
8	Amplifier uncertainties	2.1	Normal	2.00	1.05
9	Random uncertainty	0.50	Normal	2.00	0.25
10	Influence of the XPD	0.01	U-shaped	1.41	0.00
11	Insertion Loss Variation	0.00	Rectangular	1.73	0.00
12	RF leakage (from measurement antenna to the receiver/transmitter)	0.00	Actual	1.00	0.00
13	Multiple measurement antenna uncertainty (NOTE 5)	0.15	Actual	1	0.15
14	DUT repositioning	0.00	Rectangular	1.73	0.00
15	Influence of spherical coverage grid	0.12	Actual	1	0.12
Stage 1: Calibration measurement					
16	Mismatch	0.00	U-shaped	1.41	0.00
17	Amplifier Uncertainties	0.00	Normal	2.00	0.00
18	Misalignment of positioning System	0.00	Normal	2.00	0.00
19	Uncertainty of the Network Analyzer	0.73	Normal	2.00	0.37
20	Uncertainty of the absolute gain of the calibration antenna	0.60	Normal	2.00	0.30
21	Positioning and pointing misalignment between the reference antenna and the measurement antenna	0.01	Rectangular	1.73	0.00
22	Phase centre offset of calibration antenna	0.00	Rectangular	1.73	0.00
23	Quality of quiet zone for calibration process (NOTE 1)	0.4	Actual	1.00	0.4
24	Standing wave between reference calibration antenna and measurement antenna	0.00	U-shaped	1.41	0.00
25	Influence of the calibration antenna feed cable	0.14	Normal	2.00	0.07
26	Insertion Loss Variation	0.00	Rectangular	1.73	0.00
Systematic uncertainties (NOTE 4)					Value
27	Influence of noise (23.45GHz \leq f \leq 32.125GHz)				0.3
27	Influence of noise (32.125GHz < f \leq 40.8GHz)				0.9
Total measurement uncertainty					Value
Spherical coverage Expanded uncertainty (23.45GHz \leq f \leq 32.125GHz) (1.96 σ - confidence interval of 95 %) [dB]					4.60
Spherical coverage Expanded uncertainty (32.125GHz < f \leq 40.8GHz) (1.96 σ - confidence interval of 95 %) [dB]					5.19
NOTE 1: The quality of quiet zone is the same for EIRP and TRP. Value based on procedure defined in clause D.2 of TR 38.810 for Quiet Zone size less or equal to 30 cm.					
NOTE 2: The analysis was done only for the case of operating at max output power, in-band, non-CA.					
NOTE 3: The assessment assumes maximum DUT output power.					
NOTE 4: In order to obtain the total measurement uncertainty, systematic uncertainties have to be added to the expanded root sum square of the standard deviations of the Stage 1 and Stage 2 contributors.					
NOTE 5: Applies to the system which has a structure of mechanical feed antenna positioning.					

Table B.3.2-5: Void

Table B.3.2-6: Uncertainty assessment for EIRP and TRP measurement (f=23.45GHz, 32.125GHz, 40.8GHz, Quiet Zone size \leq 30 cm) for PC1 UEs and normal temperature condition

UID	Uncertainty source	Uncertainty value	Distribution of the probability	Divisor	Standard uncertainty (σ) [dB]
Stage 2: DUT measurement					
1	Positioning misalignment	0.02	Normal	2.00	0.01
2	Measure distance uncertainty	FFS	Rectangular	1.73	FFS
3	Quality of Quiet Zone (NOTE 1)	FFS	Actual	1.00	FFS
4	Mismatch	FFS	Actual	1.00	FFS
5	Standing wave between the DUT and measurement antenna	FFS	U-shaped	1.41	FFS
6	Uncertainty of the RF power measurement equipment (NOTE 3)	FFS	Normal	2.00	FFS
7	Phase curvature	FFS	U-shaped	1.41	FFS
8	Amplifier uncertainties	FFS	Normal	2.00	FFS
9	Random uncertainty	FFS	Normal	2.00	FFS
10	Influence of the XPD	FFS	U-shaped	1.41	FFS
11	Insertion Loss Variation	FFS	Rectangular	1.73	FFS
12	RF leakage (from measurement antenna to the receiver/transmitter)	FFS	Actual	1.00	FFS
13	Influence of TRP measurement grid (NOTE 4)	0.25	Actual	1	0.25
14	Influence of beam peak search grid (NOTE 5)	0.00	Actual	1	0.00
15	Multiple measurement antenna uncertainty (NOTE 9)	FFS	Actual	1	FFS
16	DUT repositioning	0.00 (NOTE 4) 0.35 (NOTE 5)	Rectangular	1.73	0.00 (NOTE 4) 0.20 (NOTE 5)
Stage 1: Calibration measurement					
17	Mismatch	FFS	U-shaped	1.41	FFS
18	Amplifier Uncertainties	FFS	Normal	2.00	FFS
19	Misalignment of positioning System	FFS	Normal	2.00	FFS
20	Uncertainty of the Network Analyzer	FFS	Normal	2.00	FFS
21	Uncertainty of the absolute gain of the calibration antenna	FFS	Normal	2.00	FFS
22	Positioning and pointing misalignment between the reference antenna and the measurement antenna	FFS	Rectangular	1.73	FFS
23	Phase centre offset of calibration antenna	FFS	Rectangular	1.73	FFS
24	Quality of quiet zone for calibration process (NOTE 1)	FFS	Actual	1.00	FFS
25	Standing wave between reference calibration antenna and measurement antenna	FFS	U-shaped	1.41	FFS
26	Influence of the calibration antenna feed cable	FFS	Normal	2.00	FFS
27	Insertion Loss Variation	FFS	Rectangular	1.73	FFS
Systematic uncertainties (NOTE 6)					Value
28	Systematic error due to TRP calculation/quadrature (NOTE 4)				0.00
29	Influence of noise (23.45GHz \leq f \leq 32.125GHz)				FFS
29	Influence of noise (32.125GHz < f \leq 40.8GHz)				FFS
30	Systematic error related to beam peak search (NOTE 5)				0.7
Total measurement uncertainty					Value
EIRP Expanded uncertainty (23.45GHz \leq f \leq 32.125GHz) (1.96 σ - confidence interval of 95 %) [dB]					FFS
EIRP Expanded uncertainty (32.125GHz < f \leq 40.8GHz) (1.96 σ - confidence interval of 95 %) [dB]					FFS
TRP Expanded uncertainty (23.45GHz \leq f \leq 32.125GHz) (1.96 σ - confidence interval of 95 %) [dB]					FFS
TRP Expanded uncertainty (32.125GHz < f \leq 40.8GHz) (1.96 σ - confidence interval of 95 %) [dB]					FFS

- NOTE 1: The quality of quiet zone is the same for EIRP and TRP. Value based on procedure defined in clause D.2 of TR 38.810 for Quiet Zone size less or equal to 30 cm.
- NOTE 2: The analysis was done only for the case of operating at max output power, in-band, non-CA.
- NOTE 3: The assessment assumes maximum DUT output power.
- NOTE 4: This contributor shall only be considered for TRP measurements.
- NOTE 5: This contributor shall only be considered for EIRP measurements.
- NOTE 6: In order to obtain the total measurement uncertainty, systematic uncertainties have to be added to the expanded root sum square of the standard deviations of the Stage 1 and Stage 2 contributors.
- NOTE 7: Void.
- NOTE 8: Void
- NOTE 9: Applies to the system which has a structure of mechanical feed antenna positioning.

Table B.3.2-7: Uncertainty assessment for Spherical coverage measurement (f=23.45GHz, 32.125GHz, 40.8GHz, Quiet Zone size ≤ 30 cm) for PC1 UEs and normal temperature condition

UID	Uncertainty source	Uncertainty value	Distribution of the probability	Divisor	Standard uncertainty (σ) [dB]
Stage 2: DUT measurement					
1	Positioning misalignment	0.02	Normal	2.00	0.01
2	Measure distance uncertainty	FFS	Rectangular	1.73	FFS
3	Quality of Quiet Zone (NOTE 1)	FFS	Actual	1.00	FFS
4	Mismatch	FFS	Actual	1.00	FFS
5	Standing wave between the DUT and measurement antenna	FFS	U-shaped	1.41	FFS
6	Uncertainty of the RF power measurement equipment (NOTE 3)	FFS	Normal	2.00	FFS
7	Phase curvature	FFS	U-shaped	1.41	FFS
8	Amplifier uncertainties	FFS	Normal	2.00	FFS
9	Random uncertainty	FFS	Normal	2.00	FFS
10	Influence of the XPD	FFS	U-shaped	1.41	FFS
11	Insertion Loss Variation	FFS	Rectangular	1.73	FFS
12	RF leakage (from measurement antenna to the receiver/transmitter)	FFS	Actual	1.00	FFS
13	Multiple measurement antenna uncertainty (NOTE 5)	FFS	Actual	1	FFS
14	DUT repositioning	0.00	Rectangular	1.73	0.00
15	Influence of spherical coverage grid	0.13	Actual	1	0.13
Stage 1: Calibration measurement					
16	Mismatch	FFS	U-shaped	1.41	FFS
17	Amplifier Uncertainties	FFS	Normal	2.00	FFS
18	Misalignment of positioning System	FFS	Normal	2.00	FFS
19	Uncertainty of the Network Analyzer	FFS	Normal	2.00	FFS
20	Uncertainty of the absolute gain of the calibration antenna	FFS	Normal	2.00	FFS
21	Positioning and pointing misalignment between the reference antenna and the measurement antenna	FFS	Rectangular	1.73	FFS
22	Phase centre offset of calibration antenna	FFS	Rectangular	1.73	FFS
23	Quality of quiet zone for calibration process (NOTE 1)	FFS	Actual	1.00	FFS
24	Standing wave between reference calibration antenna and measurement antenna	FFS	U-shaped	1.41	FFS
25	Influence of the calibration antenna feed cable	FFS	Normal	2.00	FFS
26	Insertion Loss Variation	FFS	Rectangular	1.73	FFS
Systematic uncertainties (NOTE 4)					Value
27	Influence of noise (23.45GHz ≤ f ≤ 32.125GHz)				FFS
27	Influence of noise (32.125GHz < f ≤ 40.8GHz)				FFS
Total measurement uncertainty					Value
Spherical coverage Expanded uncertainty (23.45GHz ≤ f ≤ 32.125GHz) (1.96 σ - confidence interval of 95 %) [dB]					FFS
Spherical coverage Expanded uncertainty (32.125GHz < f ≤ 40.8GHz) (1.96 σ - confidence interval of 95 %) [dB]					FFS
NOTE 1: The quality of quiet zone is the same for EIRP and TRP. Value based on procedure defined in clause D.2 of TR 38.810 for Quiet Zone size less or equal to 30 cm.					
NOTE 2: The analysis was done only for the case of operating at max output power, in-band, non-CA.					
NOTE 3: The assessment assumes maximum DUT output power.					
NOTE 4: In order to obtain the total measurement uncertainty, systematic uncertainties have to be added to the expanded root sum square of the standard deviations of the Stage 1 and Stage 2 contributors.					
NOTE 5: Applies to the system which has a structure of mechanical feed antenna positioning.					

Table B.3.2-8: Uncertainty assessment for EIRP and TRP measurement (f=23.45GHz, 32.125GHz, 40.8GHz, Quiet Zone size \leq 30 cm) for PC3 UEs and extreme temperature condition

UID	Uncertainty source	Uncertainty value	Distribution of the probability	Divisor	Standard uncertainty (σ) [dB]
Stage 2: DUT measurement					
1	Positioning misalignment	0.00	Normal	2.00	0.00
2	Measure distance uncertainty	0.00	Rectangular	1.73	0.00
3	Quality of Quiet Zone (NOTE 1)	0.9	Actual	1.00	0.9
4	Mismatch	1.30	Actual	1.00	1.30
5	Standing wave between the DUT and measurement antenna	0.00	U-shaped	1.41	0.00
6	Uncertainty of the RF power measurement equipment (NOTE 3)	2.16	Normal	2.00	1.08
7	Phase curvature	0.00	U-shaped	1.41	0.00
8	Amplifier uncertainties	2.10	Normal	2.00	1.05
9	Random uncertainty	0.50	Normal	2.00	0.25
10	Influence of the XPD	0.01	U-shaped	1.41	0.00
11	Insertion Loss Variation	0.00	Rectangular	1.73	0.00
12	RF leakage (from measurement antenna to the receiver/transmitter)	0.00	Actual	1.00	0.00
13	Influence of TRP measurement grid (NOTE 4)	0.25	Actual	1	0.25
14	Influence of beam peak search grid (NOTE 5)	0.00	Actual	1	0.00
15	Multiple measurement antenna uncertainty (NOTE 7)	0.15	Actual	1	0.15
16	DUT repositioning	0.00 (NOTE 4) 0.08 (NOTE 5)	Rectangular	1.73	0.00 (NOTE 4) 0.05 (NOTE 5)
Stage 1: Calibration measurement					
17	Mismatch	0.00	U-shaped	1.41	0.00
18	Amplifier Uncertainties	0.00	Normal	2.00	0.00
19	Misalignment of positioning System	0.00	Normal	2.00	0.00
20	Uncertainty of the Network Analyzer	0.73	Normal	2.00	0.37
21	Uncertainty of the absolute gain of the calibration antenna	0.60	Normal	2.00	0.30
22	Positioning and pointing misalignment between the reference antenna and the measurement antenna	0.01	Rectangular	1.73	0.00
23	Phase centre offset of calibration antenna	0.00	Rectangular	1.73	0.00
24	Quality of quiet zone for calibration process (NOTE 1)	0.6	Actual	1.00	0.6
25	Standing wave between reference calibration antenna and measurement antenna	0.00	U-shaped	1.41	0.00
26	Influence of the calibration antenna feed cable	0.14	Normal	2.00	0.07
27	Insertion Loss Variation	0.00	Rectangular	1.73	0.00
Systematic uncertainties (NOTE 6)					Value
28	Systematic error due to TRP calculation/quadrature (NOTE 4)				0.00
29	Influence of noise (23.45GHz \leq f \leq 32.125GHz)				0.1
29	Influence of noise (32.125GHz < f \leq 40.8GHz)				0.3
30	Systematic error related to beam peak search (NOTE 5)				0.5
Total measurement uncertainty					Value
EIRP Expanded uncertainty (23.45GHz \leq f \leq 32.125GHz) (1.96 σ - confidence interval of 95 %) [dB]					5.17
EIRP Expanded uncertainty (32.125GHz < f \leq 40.8GHz) (1.96 σ - confidence interval of 95 %) [dB]					5.37
TRP Expanded uncertainty (23.45GHz \leq f \leq 32.125GHz) (1.96 σ - confidence interval of 95 %) [dB]					4.70
TRP Expanded uncertainty (32.125GHz < f \leq 40.8GHz) (1.96 σ - confidence interval of 95 %) [dB]					4.90

NOTE 1:	The quality of quiet zone is the same for EIRP and TRP. Value based on procedure defined in clause D.2 of TR 38.810 for Quiet Zone size less or equal to 30 cm. The ETC QoQZ MU and ETC calibration path losses shall be applied to the NTC test cases if the ETC environment is used for NTC test cases.
NOTE 2:	The analysis was done only for the case of operating at max output power, in-band, non-CA.
NOTE 3:	The assessment assumes maximum DUT output power.
NOTE 4:	This contributor shall only be considered for TRP measurements.
NOTE 5:	This contributor shall only be considered for EIRP measurements.
NOTE 6:	In order to obtain the total measurement uncertainty, systematic uncertainties have to be added to the expanded root sum square of the standard deviations of the Stage 1 and Stage 2 contributors.
NOTE 7:	Applies to the system which has a structure of mechanical feed antenna positioning.

B.3.3 Uncertainty budget format and assessment for NFTF

The uncertainty contributions that may impact the overall MU value are listed in Table B.3.3-1.

Table B.3.3-1: Uncertainty contributions for EIRP and TRP measurement

UID	Description of uncertainty contribution	Details in paragraph
Stage 2: EIRP Near Field Radiation Pattern Measurement and EIRP Near Field DUT power measurement		
1	Axis Alignment	B.2.3.1
2	Measurement Distance Uncertainty	B.2.3.2
3	Quality of the Quiet Zone	B.2.3.3
4	Mismatch	B.2.3.4
5	Multiple Reflections: Coupling between Measurement Antenna and DUT	B.2.3.5
6	Uncertainty of the RF power measurement equipment	B.2.3.6
7	Phase curvature	B.2.3.7
8	Amplifier uncertainties	B.2.3.8
9	Random uncertainty	B.2.3.9
10	Influence of the XPD	B.2.3.10
11	NF to FF truncation	B.2.3.11
12	Probe Polarization Amplitude and Phase	B.2.3.12
13	Probe Array Uniformity (for multi-probe systems only)	B.2.3.13
14	Phase Recovery Non-Linearity over signal bandwidth	B.2.3.16
15	Probe Pattern Effect	B.2.3.17
16	Phase Drift and Noise	B.2.3.20
17	Leakage and Crosstalk	B.2.3.25
Stage 1: Calibration measurement		
18	Mismatch	B.2.3.4
19	Amplifier uncertainties	B.2.3.8
20	Uncertainty of the Network Analyzer	B.2.3.14
21	Uncertainty of the absolute gain of the calibration antenna	B.2.3.15
22	Phase centre offset of calibration	B.2.3.18
23	Quality of the Quiet Zone for Calibration Process	B.2.3.19
24	Mismatch in the connection of the calibration antenna	B.2.3.21

The uncertainty assessment table is organized as follows:

- For the purpose of uncertainty assessment, the radiating antenna aperture of the DUT is denoted as D
- The uncertainty assessment has been derived for the case of $D = [5 \text{ cm}]$, $f = \{22.65\text{GHz}, 31.1\text{GHz}, 45.1\text{GHz}\}$, $P = [\text{maximum output power}]$.
- The uncertainty assessment for EIRP and TRP is provided in Table B.3.1-2.

Table B.3.3-2: Uncertainty assessment for EIRP and TRP measurement (f=TBD, D=TBD)

UID	Description of uncertainty contribution	Uncertainty Value	Distribution of the probability	Divisor	Standard uncertainty (σ) [dB]
Stage 2: EIRP Near Field Radiation Pattern Measurement and EIRP Near Field DUT power measurement					
1	Axis Alignment				
2	Measurement Distance Uncertainty				
3	Quality of the Quiet Zone				
4	Mismatch				
5	Multiple Reflections: Coupling between Measurement Antenna and DUT				
6	Uncertainty of the RF power measurement equipment				
7	Phase curvature				
8	Amplifier uncertainties				
9	Random uncertainty				
10	Influence of the XPD				
11	NF to FF truncation				
12	Probe Polarization Amplitude and Phase				
13	Probe Array Uniformity (for multi-probe systems only)				
14	Phase Recovery Non-Linearity over signal bandwidth				
15	Probe Pattern Effect				
16	Phase Drift and Noise				
17	Leakage and Crosstalk				
Stage 1: Calibration measurement					
18	Mismatch				
19	Amplifier uncertainties				
20	Uncertainty of the Network Analyzer				
21	Uncertainty of the absolute gain of the calibration antenna				
22	Phase centre offset of calibration				
23	Quality of the Quiet Zone for Calibration Process				
24	Mismatch in the connection of the calibration antenna				
EIRP Expanded uncertainty (1.96σ - confidence interval of 95 %) [dB]					
TRP Expanded uncertainty (1.96σ - confidence interval of 95 %) [dB]					
NOTE 1: The impact of phase variation on EIRP shall be taken into account during final MU definition for the test method.					
NOTE 2: The quality of quiet zone is different for EIRP and TRP. For TRP, the standard uncertainty is FFS; for EIRP FFS.					
NOTE 3: The analysis was done only for the case of operating at max output power, in-band, non-CA					
NOTE 4: The assessment assumes maximum DUT output power.					
NOTE 5: The Phase Recovery Non-Linearity over signal bandwidth is shall be taken into account during final MU definition for the test method.					

B.4 UE maximum output power for modulation / channel bandwidth

Following tables summarize the MU threshold for EIRP measurements for UE maximum output power for modulation / channel bandwidth (a.k.a Maximum Power Reduction/MPR). The origin MU values for different test setups with varies parameters can be found in following clauses.

Table B.4-1: MU threshold for EIRP measurement for UE maximum output power for modulation / channel bandwidth

Power Class	Frequency	MBW	Power (NOTE2)	Threshold MU value for NTC [dB] (NOTE1)	Threshold MU value for ETC [dB] (NOTE1)
PC3	23.45GHz <= f <= 32.125GHz	BW <= 400MHz	P = Max Output Power – MBR - MPR – T(MPR)	4.92	5.20
	32.125GHz < f <= 40.8GHz			5.10	5.38
PC1	23.45GHz <= f <= 32.125GHz	BW <= 400MHz	P = Max Output Power – MBR - MPR – T(MPR)	FFS	FFS
	32.125GHz < f <= 40.8GHz			FFS	FFS
NOTE 1: Total EIRP Expanded MU for IFF for Quiet Zone size ≤30cm in Table B.4.2-2 for PC2 UEs and B.4.2-x for PC1 UEs.					
NOTE 2: Max output power level for device with corresponding power class.					

B.4.1 Uncertainty budget format and assessment for DFF

The uncertainty contributions that may impact the overall MU value are listed in Table B.4.1-1.

Table B.4.1-1: Uncertainty contributions for EIRP measurement

UID	Description of uncertainty contribution	Details in annex
	Same as Table 3.1-1 for EIRP	

The uncertainty assessment tables are organized as follows:

- For the purpose of uncertainty assessment, the radiating antenna aperture of the DUT is denoted as D
- The uncertainty assessment has been derived for the case of D = 5 cm, f = {22.65GHz, 31.1GHz, 45.1GHz}, P = maximum output power – MBR - MPR – T(MPR).
- The uncertainty assessment for EIRP is provided in Table B.4.1-2.

Table B.4.1-2: Uncertainty assessment for EIRP measurement (f=TBD, D=TBD)

UID	Uncertainty source	Uncertainty value	Distribution of the probability	Divisor	Standard uncertainty (σ) [dB]
Stage 2: DUT measurement					
1 to 17	Same as Stage 2 of Table 3.1-2 for EIRP				
Stage 1: Calibration measurement					
18 to 28	Same as Stage 1 of Table 3.1-2 for EIRP				
Systematic uncertainties					Value
29	Systematic error due to TRP calculation/quadrature				N/A
30	Influence of noise				
31	Systematic error related to beam peak search				Same as Table 3.1-2
Total measurement uncertainty					Value
EIRP Expanded uncertainty (1.96 σ - confidence interval of 95 %) [dB]					TBD
TRP Expanded uncertainty (1.96 σ - confidence interval of 95 %) [dB]					TBD
NOTE 1: The assessment assumes maximum DUT output power – MBR - MPR – T(MPR)					

B.4.2 Uncertainty budget format and assessment for IFF

The uncertainty contributions that may impact the overall MU value are listed in Table B.4.2-1.

Table B.4.2-1: Uncertainty contributions for EIRP and TRP measurement

UID	Description of uncertainty contribution	Details in annex
	Same as Stage 2 of Table 3.2-1 for EIRP	

The uncertainty assessment tables are organized as follows:

- For the purpose of uncertainty assessment, the radiating antenna aperture of the DUT is denoted as D
- The uncertainty assessment has been derived for the case of Quiet Zone size ≤ 30 cm, $f = \{23.45\text{GHz}, 32.125\text{GHz}, 40.8\text{GHz}\}$, $P =$ maximum output power – MPR – T(MPR).
- The uncertainty assessment for EIRP and TRP is provided in Table B.3.2-2 for PC3 UEs and in Table B.4.2-x for PC1 UEs.

Table B.4.2-2: Uncertainty assessment for EIRP measurement (f=23.45GHz, 32.125GHz, 40.8GHz, Quiet Zone size ≤ 30 cm) for PC3 UEs and normal temperature condition

UID	Uncertainty source	Uncertainty value	Distribution of the probability	Divisor	Standard uncertainty (σ) [dB]
Stage 2: DUT measurement					
1 to 16	Same as Stage 2 of Table 3.2-2 for EIRP				
Stage 1: Calibration measurement					
17 to 27	Same as Stage 1 of Table 3.2-2 for EIRP				
Systematic uncertainties					Value
28	Systematic error due to TRP calculation/quadrature				N/A
29	Influence of noise (23.45GHz ≤ f ≤ 32.125GHz)				0.13
29	Influence of noise (32.125GHz < f ≤ 40.8GHz)				0.31
30	Systematic error related to beam peak search				Same as Table 3.2-2
Total measurement uncertainty					Value
EIRP Expanded uncertainty (23.45GHz ≤ f ≤ 32.125GHz) (1.96σ - confidence interval of 95 %) [dB]					4.92
EIRP Expanded uncertainty (32.125GHz < f ≤ 40.8GHz) (1.96σ - confidence interval of 95 %) [dB]					5.10
NOTE 1: The assessment assumes maximum DUT output power – MBR - MPR – T(MPR)					

Table B.4.2-3: Uncertainty assessment for EIRP measurement (f=23.45GHz, 32.125GHz, 40.8GHz, Quiet Zone size ≤ 30 cm) for PC3 UEs and extreme temperature condition

UID	Uncertainty source	Uncertainty value	Distribution of the probability	Divisor	Standard uncertainty (σ) [dB]
Stage 2: DUT measurement					
1 to 16	Same as Stage 2 of Table 3.2-8 for EIRP				
Stage 1: Calibration measurement					
17 to 27	Same as Stage 1 of Table 3.2-8 for EIRP				
Systematic uncertainties					Value
28	Systematic error due to TRP calculation/quadrature				N/A
29	Influence of noise (23.45GHz ≤ f ≤ 32.125GHz)				0.13
29	Influence of noise (32.125GHz < f ≤ 40.8GHz)				0.31
30	Systematic error related to beam peak search				Same as Table 3.2-8
Total measurement uncertainty					Value
EIRP Expanded uncertainty (23.45GHz ≤ f ≤ 32.125GHz) (1.96σ - confidence interval of 95 %) [dB]					5.20
EIRP Expanded uncertainty (32.125GHz < f ≤ 40.8GHz) (1.96σ - confidence interval of 95 %) [dB]					5.38
NOTE 1: The assessment assumes maximum DUT output power – MBR - MPR – T(MPR)					

B.4.3 Uncertainty budget format and assessment for NFTF

FFS

B.5 to B6

B.7 Minimum Output power

Following tables summarize the MU threshold for EIRP measurements for Minimum Output Power. The origin MU values for different test setups can be found in following clauses.

Table B.7-1: MU threshold for EIRP measurement for Minimum output power

Frequency	MBW	Power	Threshold MU value for NTC [dB] (NOTE1)	Threshold MU value For ETC [dB] (NOTE1)
23.45GHz <= f <= 32.125GHz	BW <= 400MHz	P = Minimum Output Power	<u>PC1:</u> FFS	<u>PC1:</u> FFS
			<u>PC2:</u> FFS	<u>PC2:</u> FFS
			<u>PC3:</u> 6.15	<u>PC3:</u> 6.41
			<u>PC4:</u> FFS	<u>PC4:</u> FFS
32.125GHz < f <= 40.8GHz			<u>PC1:</u> FFS	<u>PC1:</u> FFS
			<u>PC2:</u> FFS	<u>PC2:</u> FFS
			<u>PC3:</u> 6.15	<u>PC3:</u> 6.41
			<u>PC4:</u> FFS	<u>PC4:</u> FFS
NOTE 1: Total Expanded MU for IFF for Quiet Zone size ≤ 30cm in Table B.7.2-2				

B.7.1 Uncertainty budget format and assessment for DFF

The uncertainty contributions that may impact the overall MU value are listed in Table B.7.1-1.

Table B.7.1-1: Uncertainty contributions for EIRP measurement

UID	Description of uncertainty contribution	Details in annex
Stage 2: DUT measurement		
1	Positioning misalignment	B.2.1.1
2	Measure distance uncertainty	B.2.1.2
3	Quality of quiet zone	B.2.1.3
4	Mismatch	B.2.1.4
5	Standing Wave Between the DUT and measurement antenna	B.2.1.5
6	Uncertainty of the RF power measurement equipment	B.2.1.6
7	Phase curvature	B.2.1.7
8	Amplifier uncertainties	B.2.1.8
9	Random uncertainty	B.2.1.9
10	Influence of the XPD	B.2.1.10
11	Insertion Loss Variation	B.2.1.11
12	RF leakage (from measurement antenna to the receiver/transmitter)	B.2.1.12
13	Influence of beam peak search grid	B.2.1.23
14	Multiple measurement antenna uncertainty	B.2.1.25
15	DUT repositioning	B.2.1.26
Stage 1: Calibration measurement		
16	Mismatch	B.2.1.4
17	Amplifier uncertainties	B.2.1.8
18	Misalignment of positioning System	B.2.1.13
19	Uncertainty of the Network Analyzer	B.2.1.14
20	Uncertainty of the absolute gain of the calibration antenna	B.2.1.15
21	Positioning and pointing misalignment between the reference antenna and the measurement antenna	B.2.1.16
22	Phase centre offset of calibration antenna	B.2.1.18
23	Quality of quiet zone for calibration process	B.2.1.19
24	Standing wave between reference calibration antenna and measurement antenna	B.2.1.20
25	Influence of the calibration antenna feed cable	B.2.1.21
26	Insertion Loss Variation	B.2.1.11
Systematic uncertainties		
27	Systematic error related to beam peak search	B.2.1.28
28	Influence of noise	B.2.1.27

The uncertainty assessment tables are organized as follows:

- For the purpose of uncertainty assessment, the radiating antenna aperture of the DUT is denoted as D
- The uncertainty assessment has been derived for the case of $D = [5 \text{ cm}]$, $f = \{23.45 \text{ GHz}, 32.125 \text{ GHz}, 40.8 \text{ GHz}\}$, $P = [\text{Minimum output power}]$.
- The uncertainty assessment for EIRP is provided in Table B.7.1-2.

Table B.7.1-2: Uncertainty assessment for EIRP measurement (f=TBD, D=TBD)

UID	Uncertainty source	Uncertainty value	Distribution of the probability	Divisor	Standard uncertainty (σ) [dB]
Stage 2: DUT measurement					
1	Positioning misalignment				
2	Measure distance uncertainty				
3	Quality of quiet zone (NOTE 2)				
4	Mismatch (NOTE 3)				
5	Standing Wave Between the DUT and measurement antenna				
6	Uncertainty of the RF power measurement equipment (NOTE 4)				
7	Phase curvature				
8	Amplifier uncertainties				
9	Random uncertainty				
10	Influence of the XPD				
11	Insertion Loss Variation				
12	RF leakage (from measurement antenna to the receiver/transmitter)				
13	Influence of beam peak search grid (NOTE 6)				
14	Multiple measurement antenna uncertainty				
15	DUT repositioning		Actual	1	
Stage 1: Calibration measurement					
16	Mismatch				
17	Amplifier uncertainties				
18	Misalignment of positioning System				
19	Uncertainty of the Network Analyzer				
20	Uncertainty of the absolute gain of the calibration antenna				
21	Positioning and pointing misalignment between the reference antenna and the measurement antenna				
22	Phase centre offset of calibration antenna				
23	Quality of quiet zone for calibration process (NOTE 2)				
24	Standing wave between reference calibration antenna and measurement antenna				
25	Influence of the calibration antenna feed cable				
26	Insertion Loss Variation				
EIRP Expanded uncertainty (1.96σ - confidence interval of 95 %) [dB]					
Systematic uncertainties (NOTE 7)					Value
27	Systematic error related to beam peak search				
28	Influence of noise				
Total measurement uncertainty					
EIRP total measurement uncertainty [dB]					
NOTE 1: The analysis was done only for the case of operating at Minimum output power, in-band, non-CA.					
NOTE 2: The assessment assumes DUT Minimum output power.					
NOTE 3: This contributor shall only be considered for EIRP measurements.					
NOTE 4: Void					
NOTE 5: In order to obtain the total measurement uncertainty, systematic uncertainties have to be added to the expanded root sum square of the standard deviations of the Stage 1 and Stage 2 contributors.					
NOTE 6: Void.					
NOTE 7: Void					
NOTE 8: Value based on procedure defined in Annex D.2 of TR 38.810 for Quiet Zone size less or equal to 30 cm.					
NOTE 9: Applies to the system which has a structure of mechanical feed antenna positioning.					

B.7.2 Uncertainty budget format and assessment for IFF

The uncertainty contributions that may impact the overall MU value are listed in Table B.7.2-1.

Table B.7.2-1: Uncertainty contributions for EIRP measurement

UID	Description of uncertainty contribution	Details in annex
Stage 2: DUT measurement		
1	Positioning misalignment	B.2.2.1
2	Measure distance uncertainty	B.2.2.2
3	Quality of Quiet Zone	B.2.2.3
4	Mismatch	B.2.2.4
5	Standing wave between the DUT and measurement antenna	B.2.2.5
6	Uncertainty of the RF power measurement equipment	B.2.2.6
7	Phase curvature	B.2.2.7
8	Amplifier uncertainties	B.2.2.8
9	Random uncertainty	B.2.2.9
10	Influence of the XPD	B.2.2.10
11	Insertion Loss Variation	B.2.2.11
12	RF leakage (from measurement antenna to the receiver/transmitter)	B.2.2.12
13	Influence of beam peak search grid	B.2.2.23
14	Multiple measurement antenna uncertainty	B.2.2.25
15	DUT repositioning	B.2.2.26
Stage 1: Calibration measurement		
16	Mismatch	B.2.2.4
17	Amplifier Uncertainties	B.2.2.8
18	Misalignment of positioning System	B.2.2.13
19	Uncertainty of the Network Analyzer	B.2.2.14
20	Uncertainty of the absolute gain of the calibration antenna	B.2.2.15
21	Positioning and pointing misalignment between the reference antenna and the measurement antenna	B.2.2.16
22	Phase centre offset of calibration antenna	B.2.2.18
23	Quality of quiet zone for calibration process	B.2.2.19
24	Standing wave between reference calibration antenna and measurement antenna	B.2.2.20
25	Influence of the calibration antenna feed cable	B.2.2.21
26	Insertion Loss Variation	B.2.2.11
Systematic uncertainties		
27	Systematic error related to beam peak search	B.2.2.28
28	Influence of noise	B.2.2.27

The uncertainty assessment tables are organized as follows:

- For the purpose of uncertainty assessment, the radiating antenna aperture of the DUT is denoted as D
- The uncertainty assessment has been derived for the case of Quiet Zone size ≤ 30 cm, $f = \{23.45\text{GHz}, 32.125\text{GHz}, 40.8\text{GHz}\}$, $P = \text{Minimum output power}$.
- The uncertainty assessment for EIRP is provided in Table B.7.2-2 for PC3 UEs and in Table B.7.2-3 for PC1 UEs.

Table B.7.2-2: Uncertainty assessment for EIRP measurement (f=23.45GHz, 32.125GHz, 40.8GHz, Quiet Zone size \leq 30 cm) for PC3 UEs and normal temperature condition

UID	Uncertainty source	Uncertainty value	Distribution of the probability	Divisor	Standard uncertainty (σ) [dB]
Stage 2: DUT measurement					
1	Positioning misalignment	0.00	Normal	2.00	0.00
2	Measure distance uncertainty	0.00	Rectangular	1.73	0.00
3	Quality of Quiet Zone (NOTE 8)	0.6	Actual	1.00	0.6
4	Mismatch (NOTE 1)	1.30	Actual	1.00	1.30
5	Standing wave between the DUT and measurement antenna	0.00	U-shaped	1.41	0.00
6	Uncertainty of the RF power measurement equipment (NOTE 2)	2.50	Normal	2.00	1.25
7	Phase curvature	0.00	U-shaped	1.41	0.00
8	Amplifier uncertainties	2.10	Normal	2.00	1.05
9	Random uncertainty	0.50	Normal	2.00	0.25
10	Influence of the XPD	0.01	U-shaped	1.41	0.00
11	Insertion Loss Variation	0.00	Rectangular	1.73	0.00
12	RF leakage (from measurement antenna to the receiver/transmitter)	0.00	Actual	1.00	0.00
13	Influence of beam peak search grid (NOTE 3)	0.00	Actual	1	0.00
14	Multiple measurement antenna uncertainty (NOTE 9)	0.15	Actual	1	0.15
15	DUT repositioning (NOTE 3)	0.08	Rectangular	1.73	0.05
Stage 1: Calibration measurement					
16	Mismatch	0.00	U-shaped	1.41	0.00
17	Amplifier Uncertainties	0.00	Normal	2.00	0.00
18	Misalignment of positioning System	0.00	Normal	2.00	0.00
19	Uncertainty of the Network Analyzer	1.50	Normal	2.00	0.75
20	Uncertainty of the absolute gain of the calibration antenna	0.60	Normal	2.00	0.30
21	Positioning and pointing misalignment between the reference antenna and the measurement antenna	0.01	Rectangular	1.73	0.00
22	Phase centre offset of calibration antenna	0.00	Rectangular	1.73	0.00
23	Quality of quiet zone for calibration process (NOTE 8)	0.4	Actual	1.00	0.4
24	Standing wave between reference calibration antenna and measurement antenna	0.00	U-shaped	1.41	0.00
25	Influence of the calibration antenna feed cable	0.14	Normal	2.00	0.07
26	Insertion Loss Variation	0.00	Rectangular	1.73	0.00
Systematic uncertainties (NOTE 5)					Value
27	Systematic error related to beam peak search				0.5
28	Influence of noise (23.45GHz <= f <= 32.125GHz)				1.0
29	Influence of noise (32.125GHz < f <= 40.8GHz)				1.0
Total measurement uncertainty					Value
EIRP Expanded uncertainty (23.45GHz <= f <= 32.125GHz) (1.96 σ - confidence interval of 95 %) [dB]					6.15
EIRP Expanded uncertainty (32.125GHz < f <= 40.8GHz) (1.96 σ - confidence interval of 95 %) [dB]					6.15

- NOTE 1: The analysis was done only for the case of operating at Minimum output power, in-band, non-CA.
- NOTE 2: The assessment assumes DUT Minimum output power.
- NOTE 3: This contributor shall only be considered for EIRP measurements.
- NOTE 4: Void
- NOTE 5: In order to obtain the total measurement uncertainty, systematic uncertainties have to be added to the expanded root sum square of the standard deviations of the Stage 1 and Stage 2 contributors.
- NOTE 6: Void.
- NOTE 7: Void
- NOTE 8: Value based on procedure defined in Annex D.2 of TR 38.810 for Quiet Zone size less or equal to 30 cm.
- NOTE 9: Applies to the system which has a structure of mechanical feed antenna positioning.

Table B.7.2-3: Uncertainty assessment for EIRP measurement (f=23.45GHz, 32.125GHz, 40.8GHz, Quiet Zone size \leq 30 cm) for PC1 UEs and normal temperature condition

UID	Uncertainty source	Uncertainty value	Distribution of the probability	Divisor	Standard uncertainty (σ) [dB]
Stage 2: DUT measurement					
1	Positioning misalignment	0.02	Normal	2.00	0.01
2	Measure distance uncertainty	FFS	Rectangular	1.73	FFS
3	Quality of Quiet Zone (NOTE 8)	FFS	Actual	1.00	FFS
4	Mismatch (NOTE 1)	FFS	Actual	1.00	FFS
5	Standing wave between the DUT and measurement antenna	FFS	U-shaped	1.41	FFS
6	Uncertainty of the RF power measurement equipment (NOTE 2)	FFS	Normal	2.00	FFS
7	Phase curvature	FFS	U-shaped	1.41	FFS
8	Amplifier uncertainties	FFS	Normal	2.00	FFS
9	Random uncertainty	FFS	Normal	2.00	FFS
10	Influence of the XPD	FFS	U-shaped	1.41	FFS
11	Insertion Loss Variation	FFS	Rectangular	1.73	FFS
12	RF leakage (from measurement antenna to the receiver/transmitter)	FFS	Actual	1.00	FFS
13	Influence of beam peak search grid (NOTE 3)	0.00	Actual	1	0.00
14	Multiple measurement antenna uncertainty (NOTE 9)	FFS	Actual	1	FFS
15	DUT repositioning (NOTE 3)	0.35	Rectangular	1.73	0.20
Stage 1: Calibration measurement					
16	Mismatch	FFS	U-shaped	1.41	FFS
17	Amplifier Uncertainties	FFS	Normal	2.00	FFS
18	Misalignment of positioning System	FFS	Normal	2.00	FFS
19	Uncertainty of the Network Analyzer	FFS	Normal	2.00	FFS
20	Uncertainty of the absolute gain of the calibration antenna	FFS	Normal	2.00	FFS
21	Positioning and pointing misalignment between the reference antenna and the measurement antenna	FFS	Rectangular	1.73	FFS
22	Phase centre offset of calibration antenna	FFS	Rectangular	1.73	FFS
23	Quality of quiet zone for calibration process (NOTE 8)	FFS	Actual	1.00	FFS
24	Standing wave between reference calibration antenna and measurement antenna	FFS	U-shaped	1.41	FFS
25	Influence of the calibration antenna feed cable	FFS	Normal	2.00	FFS
26	Insertion Loss Variation	FFS	Rectangular	1.73	FFS
Systematic uncertainties (NOTE 5)					Value
27	Systematic error related to beam peak search				0.7
28	Influence of noise (23.45GHz <= f <= 32.125GHz)				FFS
29	Influence of noise (32.125GHz < f <= 40.8GHz)				FFS
Total measurement uncertainty					Value
EIRP Expanded uncertainty (23.45GHz <= f <= 32.125GHz) (1.96 σ - confidence interval of 95 %) [dB]					FFS
EIRP Expanded uncertainty (32.125GHz < f <= 40.8GHz) (1.96 σ - confidence interval of 95 %) [dB]					FFS

NOTE 1:	The analysis was done only for the case of operating at Minimum output power, in-band, non-CA.
NOTE 2:	The assessment assumes DUT Minimum output power.
NOTE 3:	This contributor shall only be considered for EIRP measurements.
NOTE 4:	Void
NOTE 5:	In order to obtain the total measurement uncertainty, systematic uncertainties have to be added to the expanded root sum square of the standard deviations of the Stage 1 and Stage 2 contributors.
NOTE 6:	Void.
NOTE 7:	Void
NOTE 8:	Value based on procedure defined in Annex D.2 of TR 38.810 for Quiet Zone size less or equal to 30 cm.
NOTE 9:	Applies to the system which has a structure of mechanical feed antenna positioning.

NOTE: MU assessment in Table B.7.2-2 and Table B7.2-3 is based on the following relaxations for 400MHz BW:

Table B.7.2-4: Minimum output power requirement relaxation considered in MU assessment for 400 MHz EIRP measurement (f=23.45GHz, 32.125GHz, 40.8GHz, Quiet Zone size ≤ 30 cm)

Frequency	Power Class	Relaxation
23.45GHz ≤ f ≤ 32.125GHz	PC1	FFS
	PC2	FFS
	PC3	8.4 dB
	PC4	FFS
32.125GHz ≤ f ≤ 40.8GHz	PC1	FFS
	PC2	FFS
	PC3	13.5 dB
	PC4	FFS

Table B.7.2-5: Uncertainty assessment for EIRP measurement (f=23.45GHz, 32.125GHz, 40.8GHz, Quiet Zone size \leq 30 cm) for PC3 UEs and extreme temperature condition

UID	Uncertainty source	Uncertainty value	Distribution of the probability	Divisor	Standard uncertainty (σ) [dB]
Stage 2: DUT measurement					
1	Positioning misalignment	0.00	Normal	2.00	0.00
2	Measure distance uncertainty	0.00	Rectangular	1.73	0.00
3	Quality of Quiet Zone (NOTE 8)	0.9	Actual	1.00	0.9
4	Mismatch (NOTE 1)	1.30	Actual	1.00	1.30
5	Standing wave between the DUT and measurement antenna	0.00	U-shaped	1.41	0.00
6	Uncertainty of the RF power measurement equipment (NOTE 2)	2.50	Normal	2.00	1.25
7	Phase curvature	0.00	U-shaped	1.41	0.00
8	Amplifier uncertainties	2.10	Normal	2.00	1.05
9	Random uncertainty	0.50	Normal	2.00	0.25
10	Influence of the XPD	0.01	U-shaped	1.41	0.00
11	Insertion Loss Variation	0.00	Rectangular	1.73	0.00
12	RF leakage (from measurement antenna to the receiver/transmitter)	0.00	Actual	1.00	0.00
13	Influence of beam peak search grid (NOTE 3)	0.00	Actual	1	0.00
14	Multiple measurement antenna uncertainty (NOTE 9)	0.15	Actual	1	0.15
15	DUT repositioning (NOTE 3)	0.08	Rectangular	1.73	0.05
Stage 1: Calibration measurement					
16	Mismatch	0.00	U-shaped	1.41	0.00
17	Amplifier Uncertainties	0.00	Normal	2.00	0.00
18	Misalignment of positioning System	0.00	Normal	2.00	0.00
19	Uncertainty of the Network Analyzer	1.50	Normal	2.00	0.75
20	Uncertainty of the absolute gain of the calibration antenna	0.60	Normal	2.00	0.30
21	Positioning and pointing misalignment between the reference antenna and the measurement antenna	0.01	Rectangular	1.73	0.00
22	Phase centre offset of calibration antenna	0.00	Rectangular	1.73	0.00
23	Quality of quiet zone for calibration process (NOTE 8)	0.6	Actual	1.00	0.6
24	Standing wave between reference calibration antenna and measurement antenna	0.00	U-shaped	1.41	0.00
25	Influence of the calibration antenna feed cable	0.14	Normal	2.00	0.07
26	Insertion Loss Variation	0.00	Rectangular	1.73	0.00
Systematic uncertainties (NOTE 5)					Value
27	Systematic error related to beam peak search				0.5
28	Influence of noise (23.45GHz <= f <= 32.125GHz)				1.0
29	Influence of noise (32.125GHz < f <= 40.8GHz)				1.0
Total measurement uncertainty					Value
EIRP Expanded uncertainty (23.45GHz <= f <= 32.125GHz) (1.96 σ - confidence interval of 95 %) [dB]					6.41
EIRP Expanded uncertainty (32.125GHz < f <= 40.8GHz) (1.96 σ - confidence interval of 95 %) [dB]					6.41

NOTE 1:	The analysis was done only for the case of operating at Minimum output power, in-band, non-CA.
NOTE 2:	The assessment assumes DUT Minimum output power.
NOTE 3:	This contributor shall only be considered for EIRP measurements.
NOTE 4:	Void
NOTE 5:	In order to obtain the total measurement uncertainty, systematic uncertainties have to be added to the expanded root sum square of the standard deviations of the Stage 1 and Stage 2 contributors.
NOTE 6:	Void.
NOTE 7:	Void
NOTE 8:	Value based on procedure defined in Annex D.2 of TR 38.810 for Quiet Zone size less or equal to 30 cm.
NOTE 9:	Applies to the system which has a structure of mechanical feed antenna positioning.

NOTE: MU assessment in Table B.7.2-5 is based on the relaxations for 400MHz BW in Table B.7.2-4.

B.8 Transmit OFF power

Following tables summarize the MU threshold for TRP and EIRP measurements for Transmit OFF power. The origin MU values for different test setups can be found in following clauses.

Table B.8-1: MU threshold for TRP measurement for Transmit OFF power

Power Class	Frequency	MBW	Power	Threshold MU value (NOTE1)
PC3	23.45GHz <= f <= 32.125GHz	BW <= 400MHz	P = Off Power	5.49
	32.125GHz < f <= 40.8GHz			N/A
NOTE 1: Total TRP Expanded MU for IFF for Quiet Zone size ≤ 30cm in Table B.8.2-2 for PC3 UEs				

Table B.8-2: MU threshold for EIRP measurement for Transmit OFF power

Frequency	CBW	Power	Threshold MU value for NTC [dB] (NOTE1)	Threshold MU value for ETC [dB] (NOTE1)
23.45GHz <= f <= 32.125GHz	50MHz	P = Off Power	6.15	6.41
	100MHz			
	200MHz			
	400MHz			
32.125GHz < f <= 40.8GHz	50MHz	P = Off Power	6.15	6.41
	100MHz			
	200MHz			
	400MHz			
NOTE 1: Total Expanded MU for IFF for Quiet Zone size ≤ 30cm in Table B.8.2-4 for PC3 UEs				

B.8.1 Uncertainty budget format and assessment for DFF

The uncertainty contributions that may impact the overall MU value are listed in Table B.8.1-1.

Table B.8.1-1: Uncertainty contributions for TRP measurement

UID	Description of uncertainty contribution	Details in annex
Stage 2: DUT measurement		
1	Positioning misalignment	B.2.1.1
2	Measure distance uncertainty	B.2.1.2
3	Quality of quiet zone	B.2.1.3
4	Mismatch	B.2.1.4
5	Standing Wave Between the DUT and measurement antenna	B.2.1.5
6	Uncertainty of the RF power measurement equipment	B.2.1.6
7	Phase curvature	B.2.1.7
8	Amplifier uncertainties	B.2.1.8
9	Random uncertainty	B.2.1.9
10	Influence of the XPD	B.2.1.10
11	Insertion Loss Variation	B.2.1.11
12	RF leakage (from measurement antenna to the receiver/transmitter)	B.2.1.12
13	Influence of TRP measurement grid	B.2.1.22
14	Influence of beam peak search grid	B.2.1.23
15	Multiple measurement antenna uncertainty	B.2.1.25
16	DUT repositioning	B.2.1.26
Stage 1: Calibration measurement		
17	Mismatch	B.2.1.4
18	Amplifier uncertainties	B.2.1.8
19	Misalignment of positioning System	B.2.1.13
20	Uncertainty of the Network Analyzer	B.2.1.14
21	Uncertainty of the absolute gain of the calibration antenna	B.2.1.15
22	Positioning and pointing misalignment between the reference antenna and the measurement antenna	B.2.1.16
23	Phase centre offset of calibration antenna	B.2.1.18
24	Quality of quiet zone for calibration process	B.2.1.19
25	Standing wave between reference calibration antenna and measurement antenna	B.2.1.20
26	Influence of the calibration antenna feed cable	B.2.1.21
27	Insertion Loss Variation	B.2.1.11
Systematic uncertainties		
28	Systematic error due to TRP calculation/quadrature	B.2.1.24
29	Influence of noise	B.2.1.27

The uncertainty assessment tables are organized as follows:

- For the purpose of uncertainty assessment, the radiating antenna aperture of the DUT is denoted as D
- The uncertainty assessment has been derived for the case of $D = [5 \text{ cm}]$, $f = \{23.45 \text{ GHz}, 32.125 \text{ GHz}, 40.8 \text{ GHz}\}$, $P = [\text{Off power}]$.
- The uncertainty assessment for TRP is provided in Table B.8.1-2.

Table B.8.1-2: Uncertainty assessment for TRP measurement (f=TBD, D=TBD)

UID	Uncertainty source	Uncertainty value	Distribution of the probability	Divisor	Standard uncertainty (σ) [dB]
Stage 2: DUT measurement					
1	Positioning misalignment				
2	Measure distance uncertainty				
3	Quality of quiet zone (NOTE 2)				
4	Mismatch (NOTE 3)				
5	Standing Wave Between the DUT and measurement antenna				
6	Uncertainty of the RF power measurement equipment (NOTE 4)				
7	Phase curvature				
8	Amplifier uncertainties				
9	Random uncertainty				
10	Influence of the XPD				
11	Insertion Loss Variation				
12	RF leakage (from measurement antenna to the receiver/transmitter)				
13	Influence of TRP measurement grid (NOTE 5)				
14	Influence of beam peak search grid (NOTE 6)				
15	Multiple measurement antenna uncertainty				
16	DUT repositioning		Actual	1	
Stage 1: Calibration measurement					
17	Mismatch				
18	Amplifier uncertainties				
19	Misalignment of positioning System				
20	Uncertainty of the Network Analyzer				
21	Uncertainty of the absolute gain of the calibration antenna				
22	Positioning and pointing misalignment between the reference antenna and the measurement antenna				
23	Phase centre offset of calibration antenna				
24	Quality of quiet zone for calibration process (NOTE 2)				
25	Standing wave between reference calibration antenna and measurement antenna				
26	Influence of the calibration antenna feed cable				
27	Insertion Loss Variation				
TRP Expanded uncertainty (1.96σ - confidence interval of 95 %) [dB]					
Systematic uncertainties (NOTE 7)					Value
28	Systematic error due to TRP calculation/quadrature (NOTE 5)				
29	Influence of noise				
Total measurement uncertainty					
TRP total measurement uncertainty [dB]					
NOTE 1: The impact of phase variation on EIRP is FFS.					
NOTE 2: The quality of quiet zone is different for EIRP and TRP. For TRP, the standard uncertainty is FFS; for EIRP, the standard uncertainty of quiet zone is FFS.					
NOTE 3: The analysis was done only for the case of operating at max output power, in-band, non-CA.					
NOTE 4: The assessment assumes maximum DUT output power.					
NOTE 5: This contributor shall only be considered for TRP measurements.					
NOTE 6: This contributor shall only be considered for EIRP measurements.					
NOTE 7: In order to obtain the total measurement uncertainty, systematic uncertainties have to be added to the expanded root sum square of the standard deviations of the Stage 1 and Stage 2 contributors.					

B.8.2 Uncertainty budget format and assessment for IFF

The uncertainty contributions that may impact the overall MU value are listed in Table B.8.2-1.

Table B.8.2-1: Uncertainty contributions for TRP and EIRP measurement

UID	Description of uncertainty contribution	Details in annex
Stage 2: DUT measurement		
1	Positioning misalignment	B.2.2.1
2	Measure distance uncertainty	B.2.2.2
3	Quality of Quiet Zone	B.2.2.3
4	Mismatch	B.2.2.4
5	Standing wave between the DUT and measurement antenna	B.2.2.5
6	Uncertainty of the RF power measurement equipment	B.2.2.6
7	Phase curvature	B.2.2.7
8	Amplifier uncertainties	B.2.2.8
9	Random uncertainty	B.2.2.9
10	Influence of the XPD	B.2.2.10
11	Insertion Loss Variation	B.2.2.11
12	RF leakage (from measurement antenna to the receiver/transmitter)	B.2.2.12
13	Influence of TRP measurement grid	B.2.2.22
14	Influence of beam peak search grid	B.2.2.23
15	Multiple measurement antenna uncertainty	B.2.2.25
16	DUT repositioning	B.2.2.26
Stage 1: Calibration measurement		
17	Mismatch	B.2.2.4
18	Amplifier Uncertainties	B.2.2.8
19	Misalignment of positioning System	B.2.2.13
20	Uncertainty of the Network Analyzer	B.2.2.14
21	Uncertainty of the absolute gain of the calibration antenna	B.2.2.15
22	Positioning and pointing misalignment between the reference antenna and the measurement antenna	B.2.2.16
23	Phase centre offset of calibration antenna	B.2.2.18
24	Quality of quiet zone for calibration process	B.2.2.19
25	Standing wave between reference calibration antenna and measurement antenna	B.2.2.20
26	Influence of the calibration antenna feed cable	B.2.2.21
27	Insertion Loss Variation	B.2.2.11
Systematic uncertainties		
28	Systematic error due to TRP calculation/quadrature	B.2.2.24
29	Influence of noise	B.2.2.27

The uncertainty assessment tables are organized as follows:

- For the purpose of uncertainty assessment, the radiating antenna aperture of the DUT is denoted as D
- The uncertainty assessment has been derived for the case of Quiet Zone size ≤ 30 cm, $f = \{23.45\text{GHz}, 32.125\text{GHz}, 40.8\text{GHz}\}$, $P = \text{Off power}$.
- The uncertainty assessment for TRP is provided in Table B.8.2-2.

Table B.8.2-2: Uncertainty assessment for TRP measurement (f=23.45GHz, 32.125GHz, 40.8GHz, Quiet Zone size \leq 30 cm) for PC3 UEs

UID	Uncertainty source	Uncertainty value	Distribution of the probability	Divisor	Standard uncertainty (σ) [dB]
Stage 2: DUT measurement					
1	Positioning misalignment	0.00	Normal	2.00	0.00
2	Measure distance uncertainty	0.00	Rectangular	1.73	0.00
3	Quality of Quiet Zone (NOTE 8)	0.6	Actual	1.00	0.6
4	Mismatch (NOTE 1)	1.30	Actual	1.00	1.30
5	Standing wave between the DUT and measurement antenna	0.00	U-shaped	1.41	0.00
6	Uncertainty of the RF power measurement equipment (NOTE 2)	2.50	Normal	2.00	1.25
7	Phase curvature	0.00	U-shaped	1.41	0.00
8	Amplifier uncertainties	2.10	Normal	2.00	1.05
9	Random uncertainty	0.50	Normal	2.00	0.25
10	Influence of the XPD	0.01	U-shaped	1.41	0.00
11	Insertion Loss Variation	0.00	Rectangular	1.73	0.00
12	RF leakage (from measurement antenna to the receiver/transmitter)	0.00	Actual	1.00	0.00
13	Influence of TRP measurement grid (NOTE 3)	0.25	Actual	1	0.25
14	Influence of beam peak search grid	0.00	Actual	1	0.00
15	Multiple measurement antenna uncertainty (NOTE 9)	0.15	Actual	1	0.15
16	DUT repositioning	0.00	Rectangular	1.73	0.00
Stage 1: Calibration measurement					
17	Mismatch	0.00	U-shaped	1.41	0.00
18	Amplifier Uncertainties	0.00	Normal	2.00	0.00
19	Misalignment of positioning System	0.00	Normal	2.00	0.00
20	Uncertainty of the Network Analyzer	0.73	Normal	2.00	0.37
21	Uncertainty of the absolute gain of the calibration antenna	0.60	Normal	2.00	0.30
22	Positioning and pointing misalignment between the reference antenna and the measurement antenna	0.01	Rectangular	1.73	0.00
23	Phase centre offset of calibration antenna	0.00	Rectangular	1.73	0.00
24	Quality of quiet zone for calibration process (NOTE 8)	0.4	Actual	1.00	0.4
25	Standing wave between reference calibration antenna and measurement antenna	0.00	U-shaped	1.41	0.00
26	Influence of the calibration antenna feed cable	0.14	Normal	2.00	0.07
27	Insertion Loss Variation	0.00	Rectangular	1.73	0.00
Systematic uncertainties (NOTE 5)					Value
28	Systematic error due to TRP calculation/quadrature (NOTE 3)				0.0
29	Influence of noise (23.45GHz \leq f \leq 32.125GHz)				1.0
30	Influence of noise (32.125GHz < f \leq 40.8GHz)				N/A
Total measurement uncertainty					Value
TRP Expanded uncertainty (23.45GHz \leq f \leq 32.125GHz) (1.96 σ - confidence interval of 95 %) [dB]					5.49
TRP Expanded uncertainty (32.125GHz < f \leq 40.8GHz) (1.96 σ - confidence interval of 95 %) [dB]					N/A

NOTE 1: The analysis was done only for the case of operating at TX OFF power, in-band, non-CA.
NOTE 2: The assessment assumes DUT Off power.
NOTE 3: This contributor shall only be considered for TRP measurements.
NOTE 4: Void
NOTE 5: In order to obtain the total measurement uncertainty, systematic uncertainties have to be added to the expanded root sum square of the standard deviations of the Stage 1 and Stage 2 contributors.
NOTE 6: Void.
NOTE 7: Void
NOTE 8: Value based on procedure defined in Annex D.2 of TR 38.810 for Quiet Zone size less or equal to 30 cm.
NOTE 9: Applies to the system which has a structure of mechanical feed antenna positioning.

NOTE: MU assessment in Table B.8.2-2 for FR2a is based on the relaxation of 30.4dB for 400MHz BW.

Table B.8.2-3: Void

Table B.8.2-4: Uncertainty assessment for EIRP measurement (f=23.45GHz, 32.125GHz, 40.8GHz, Quiet Zone size \leq 30 cm) for PC3 UEs and normal temperature condition

UID	Uncertainty source	Uncertainty value	Distribution of the probability	Divisor	Standard uncertainty (σ) [dB]
Stage 2: DUT measurement					
1	Positioning misalignment	0.00	Normal	2.00	0.00
2	Measure distance uncertainty	0.00	Rectangular	1.73	0.00
3	Quality of Quiet Zone (NOTE 8)	0.6	Actual	1.00	0.6
4	Mismatch (NOTE 1)	1.30	Actual	1.00	1.30
5	Standing wave between the DUT and measurement antenna	0.00	U-shaped	1.41	0.00
6	Uncertainty of the RF power measurement equipment (NOTE 2)	2.50	Normal	2.00	1.25
7	Phase curvature	0.00	U-shaped	1.41	0.00
8	Amplifier uncertainties	2.10	Normal	2.00	1.05
9	Random uncertainty	0.50	Normal	2.00	0.25
10	Influence of the XPD	0.01	U-shaped	1.41	0.00
11	Insertion Loss Variation	0.00	Rectangular	1.73	0.00
12	RF leakage (from measurement antenna to the receiver/transmitter)	0.00	Actual	1.00	0.00
13	Influence of beam peak search grid (NOTE 3)	0.00	Actual	1	0.00
14	Multiple measurement antenna uncertainty (NOTE 9)	0.15	Actual	1	0.15
15	DUT repositioning (NOTE 3)	0.08	Rectangular	1.73	0.05
Stage 1: Calibration measurement					
16	Mismatch	0.00	U-shaped	1.41	0.00
17	Amplifier Uncertainties	0.00	Normal	2.00	0.00
18	Misalignment of positioning System	0.00	Normal	2.00	0.00
19	Uncertainty of the Network Analyzer	1.5	Normal	2.00	0.75
20	Uncertainty of the absolute gain of the calibration antenna	0.60	Normal	2.00	0.30
21	Positioning and pointing misalignment between the reference antenna and the measurement antenna	0.01	Rectangular	1.73	0.00
22	Phase centre offset of calibration antenna	0.00	Rectangular	1.73	0.00
23	Quality of quiet zone for calibration process (NOTE 8)	0.4	Actual	1.00	0.4
24	Standing wave between reference calibration antenna and measurement antenna	0.00	U-shaped	1.41	0.00
25	Influence of the calibration antenna feed cable	0.14	Normal	2.00	0.07
26	Insertion Loss Variation	0.00	Rectangular	1.73	0.00
Systematic uncertainties (NOTE 5)					Value
27	Systematic error related to beam peak search				0.5
28	Influence of noise (23.45GHz \leq f \leq 32.125GHz)				1
29	Influence of noise (32.125GHz < f \leq 40.8GHz)				1
Total measurement uncertainty					Value
EIRP Expanded uncertainty (23.45GHz \leq f \leq 32.125GHz) (1.96 σ - confidence interval of 95 %) [dB]					6.15
EIRP Expanded uncertainty (32.125GHz < f \leq 40.8GHz) (1.96 σ - confidence interval of 95 %) [dB]					6.15

NOTE 1: The analysis was done only for the case of operating at TX OFF power, in-band, non-CA.
NOTE 2: The assessment assumes DUT Off power.
NOTE 3: This contributor shall only be considered for EIRP measurements.
NOTE 4: Void
NOTE 5: In order to obtain the total measurement uncertainty, systematic uncertainties have to be added to the expanded root sum square of the standard deviations of the Stage 1 and Stage 2 contributors.
NOTE 6: Void.
NOTE 7: Void
NOTE 8: Value based on procedure defined in Annex D.2 of TR 38.810 for Quiet Zone size less or equal to 30 cm.
NOTE 9: Applies to the system which has a structure of mechanical feed antenna positioning.

NOTE: MU assessment in Table B.8.2-4 is based on the relaxation of 28.4 dB for FR2a and 30.5 dB for FR2b for 400MHz BW.

Table B.8.2-5: Uncertainty assessment for EIRP measurement (f=23.45GHz, 32.125GHz, 40.8GHz, Quiet Zone size \leq 30 cm) for PC3 UEs and extreme temperature condition

UID	Uncertainty source	Uncertainty value	Distribution of the probability	Divisor	Standard uncertainty (σ) [dB]
Stage 2: DUT measurement					
1	Positioning misalignment	0.00	Normal	2.00	0.00
2	Measure distance uncertainty	0.00	Rectangular	1.73	0.00
3	Quality of Quiet Zone (NOTE 8)	0.9	Actual	1.00	0.9
4	Mismatch (NOTE 1)	1.30	Actual	1.00	1.30
5	Standing wave between the DUT and measurement antenna	0.00	U-shaped	1.41	0.00
6	Uncertainty of the RF power measurement equipment (NOTE 2)	2.50	Normal	2.00	1.25
7	Phase curvature	0.00	U-shaped	1.41	0.00
8	Amplifier uncertainties	2.10	Normal	2.00	1.05
9	Random uncertainty	0.50	Normal	2.00	0.25
10	Influence of the XPD	0.01	U-shaped	1.41	0.00
11	Insertion Loss Variation	0.00	Rectangular	1.73	0.00
12	RF leakage (from measurement antenna to the receiver/transmitter)	0.00	Actual	1.00	0.00
13	Influence of beam peak search grid (NOTE 3)	0.00	Actual	1	0.00
14	Multiple measurement antenna uncertainty (NOTE 9)	0.15	Actual	1	0.15
15	DUT repositioning (NOTE 3)	0.08	Rectangular	1.73	0.05
Stage 1: Calibration measurement					
16	Mismatch	0.00	U-shaped	1.41	0.00
17	Amplifier Uncertainties	0.00	Normal	2.00	0.00
18	Misalignment of positioning System	0.00	Normal	2.00	0.00
19	Uncertainty of the Network Analyzer	1.5	Normal	2.00	0.75
20	Uncertainty of the absolute gain of the calibration antenna	0.60	Normal	2.00	0.30
21	Positioning and pointing misalignment between the reference antenna and the measurement antenna	0.01	Rectangular	1.73	0.00
22	Phase centre offset of calibration antenna	0.00	Rectangular	1.73	0.00
23	Quality of quiet zone for calibration process (NOTE 8)	0.6	Actual	1.00	0.6
24	Standing wave between reference calibration antenna and measurement antenna	0.00	U-shaped	1.41	0.00
25	Influence of the calibration antenna feed cable	0.14	Normal	2.00	0.07
26	Insertion Loss Variation	0.00	Rectangular	1.73	0.00
Systematic uncertainties (NOTE 5)					Value
27	Systematic error related to beam peak search				0.5
28	Influence of noise (23.45GHz <= f <= 32.125GHz)				1
29	Influence of noise (32.125GHz < f <= 40.8GHz)				1
Total measurement uncertainty					Value
EIRP Expanded uncertainty (23.45GHz <= f <= 32.125GHz) (1.96 σ - confidence interval of 95 %) [dB]					6.41
EIRP Expanded uncertainty (32.125GHz < f <= 40.8GHz) (1.96 σ - confidence interval of 95 %) [dB]					6.41

NOTE 1:	The analysis was done only for the case of operating at TX OFF power, in-band, non-CA.
NOTE 2:	The assessment assumes DUT Off power.
NOTE 3:	This contributor shall only be considered for EIRP measurements.
NOTE 4:	Void
NOTE 5:	In order to obtain the total measurement uncertainty, systematic uncertainties have to be added to the expanded root sum square of the standard deviations of the Stage 1 and Stage 2 contributors.
NOTE 6:	Void.
NOTE 7:	Void
NOTE 8:	Value based on procedure defined in Annex D.2 of TR 38.810 for Quiet Zone size less or equal to 30 cm.
NOTE 9:	Applies to the system which has a structure of mechanical feed antenna positioning.

NOTE: MU assessment in Table B.8.2-5 is based on the relaxation of 28.4 dB for FR2a and 30.5 dB for FR2b for 400MHz BW.

B.9

B.9a Power control

B.9a.1 Absolute power tolerance

B.9a.2 Relative power control tolerance

B.9a.2.1 Uncertainty budget format and assessment for DFF

The uncertainty contributions that may impact the overall MU value are listed in Table B.9a.2.1-1.

Table B.9a.2.1-1: Uncertainty contributions for EIRP relative power control tolerance measurement

UID	Description of uncertainty contribution	Details in annex
Stage 2: DUT measurement		
1	Uncertainty of the RF relative power measurement equipment	B.2.1.36
2	Amplifier uncertainties	B.2.1.8
3	Impact of frequency response	FFS
Stage 1: Calibration measurement		
	N/A	
Systematic uncertainties		
4	Influence of noise	B.2.1.27

The uncertainty assessment tables are organized as follows:

- For the purpose of uncertainty assessment, the radiating antenna aperture of the DUT is denoted as D
- The uncertainty assessment has been derived for the case of $D = [5 \text{ cm}]$, $f = \{22.65\text{GHz}, 31.1\text{GHz}, 45.1\text{GHz}\}$, $P = [\text{maximum output power}]$.
- The uncertainty assessment for EIRP relative power control tolerance is provided in Table B.9a.2.1-2.

Table B.9a.2.1-2: Uncertainty assessment for EIRP relative power control tolerance measurement (f=TBD, D=TBD)

UID	Uncertainty source	Uncertainty value	Distribution of the probability	Divisor	Standard uncertainty (σ) [dB]
Stage 2: DUT measurement					
1	Uncertainty of the RF relative power measurement equipment	FFS	FFS	FFS	FFS
2	Amplifier uncertainties	FFS	FFS	FFS	FFS
3	Impact of frequency response	FFS	FFS	FFS	FFS
Stage 1: Calibration measurement					
	N/A				
Systematic uncertainties (NOTE 1)					Value
4	Influence of noise				FFS
Total measurement uncertainty					Value
EIRP Expanded uncertainty (1.96 σ - confidence interval of 95 %) [dB]					FFS
NOTE 1: In order to obtain the total measurement uncertainty, systematic uncertainties have to be added to the expanded root sum square of the standard deviations of the Stage 1 and Stage 2 contributors.					

B.9a.2.2 Uncertainty budget format and assessment for IFF

The uncertainty contributions that may impact the overall MU value are listed in Table B.9a.2.2-1.

Table B.9a.2.2-1: Uncertainty contributions for EIRP relative power control tolerance measurement

UID	Description of uncertainty contribution	Details in annex
Stage 2: DUT measurement		
1	Uncertainty of the RF relative power measurement equipment	B.2.2.36
2	Amplifier uncertainties	B.2.2.8
3	Impact of frequency response	FFS
Stage 1: Calibration measurement		
	N/A	
Systematic uncertainties		
4	Influence of noise	B.2.2.27

The uncertainty assessment tables are organized as follows:

- For the purpose of uncertainty assessment, the radiating antenna aperture of the DUT is denoted as D
- The uncertainty assessment has been derived for the case of Quiet Zone size \leq [30 cm], $f = \{23.45\text{GHz}, 32.125\text{GHz}, 40.8\text{GHz}\}$.
- The uncertainty assessment for EIRP relative power control tolerance is provided in Table B.9a.2.2-2 for PC3 UEs and in Table B.9a.2.2-3 for PC1 UEs.

Table B.9a.2.2-2: Uncertainty assessment for EIRP relative power control tolerance measurement (f=23.45GHz, 32.125GHz, 40.8GHz, Quiet Zone size ≤ 30 cm) for PC3 UEs and normal temperature condition

UID	Uncertainty source	Uncertainty value	Distribution of the probability	Divisor	Standard uncertainty (σ) [dB]
Stage 2: DUT measurement					
1	Uncertainty of the RF relative power measurement equipment	[0.4]	Normal	2.00	[0.2]
2	Amplifier uncertainties	0.5	Rectangular	1.73	0.29
3	Impact of frequency response	FFS	FFS	FFS	FFS
Stage 1: Calibration measurement					
	N/A				
Systematic uncertainties (NOTE 1)					Value
4	Influence of noise (23.45GHz ≤ f ≤ 40.8GHz)				1.0
Total measurement uncertainty					Value
EIRP Expanded uncertainty (23.45GHz ≤ f ≤ 32.125GHz) (1.96 σ - confidence interval of 95 %) [dB]					[1.7]
NOTE 1: In order to obtain the total measurement uncertainty, systematic uncertainties have to be added to the expanded root sum square of the standard deviations of the Stage 1 and Stage 2 contributors.					
NOTE 2: Power step size assumed $\Delta P = 1$ dB.					
NOTE 3: Measurement uncertainties in this table assume absolute power measurements involved in the same relative power measurement are performed over the same RF path.					

Table B.9a.2.2-3: Uncertainty assessment for EIRP relative power control tolerance measurement (f=23.45GHz, 32.125GHz, 40.8GHz, Quiet Zone size ≤ 30 cm) for PC1 UEs and normal temperature condition

UID	Uncertainty source	Uncertainty value	Distribution of the probability	Divisor	Standard uncertainty (σ) [dB]
Stage 2: DUT measurement					
1	Uncertainty of the RF power measurement equipment	FFS	Normal	2.0	FFS
2	Amplifier uncertainties	FFS	Rectangular	1.73	FFS
3	Impact of frequency response	FFS	FFS	FFS	FFS
Stage 1: Calibration measurement					
	N/A				
Systematic uncertainties (NOTE 1)					Value
4	Influence of noise (23.45GHz ≤ f ≤ 40.8GHz)				FFS
Total measurement uncertainty					Value
EIRP Expanded uncertainty (23.45GHz ≤ f ≤ 32.125GHz) (1.96 σ - confidence interval of 95 %) [dB]					FFS
NOTE 1: In order to obtain the total measurement uncertainty, systematic uncertainties have to be added to the expanded root sum square of the standard deviations of the Stage 1 and Stage 2 contributors.					

B.9a.2.3 Uncertainty budget format and assessment for NFTF

The uncertainty contributions that may impact the overall MU value are listed in Table B.9a.2.3-1.

Table B.9a.2.3-1: Uncertainty contributions for EIRP relative power control tolerance measurement

UID	Description of uncertainty contribution	Details in annex
Stage 2: DUT measurement		
1	Uncertainty of the RF relative power measurement equipment	B.2.3.30
2	Amplifier uncertainties	B.2.3.8
3	Impact of frequency response	FFS
Stage 1: Calibration measurement		
	N/A	
Systematic uncertainties		
4	Influence of noise	B.2.3.29

The uncertainty assessment table is organized as follows:

- For the purpose of uncertainty assessment, the radiating antenna aperture of the DUT is denoted as D
- The uncertainty assessment has been derived for the case of $D = [5 \text{ cm}]$, $f = \{22.65\text{GHz}, 31.1\text{GHz}, 45.1\text{GHz}\}$, $P = [\text{maximum output power}]$.
- The uncertainty assessment for EIRP relative power control tolerance is provided in Table B.9a.2.3-2

Table B.9a.2.3-2: Uncertainty assessment for EIRP relative power control tolerance measurement (f=TBD, D=TBD)

UID	Uncertainty source	Uncertainty value	Distribution of the probability	Divisor	Standard uncertainty (σ) [dB]
Stage 2: DUT measurement					
1	Uncertainty of the RF relative power measurement equipment	FFS	FFS	FFS	FFS
2	Amplifier uncertainties	FFS	FFS	FFS	FFS
3	Impact of frequency response	FFS	FFS	FFS	FFS
Stage 1: Calibration measurement					
	N/A				
Systematic uncertainties (NOTE 1)					Value
4	Influence of noise				FFS
Total measurement uncertainty					Value
EIRP Expanded uncertainty (1.96 σ - confidence interval of 95 %) [dB]					FFS
NOTE 1: In order to obtain the total measurement uncertainty, systematic uncertainties have to be added to the expanded root sum square of the standard deviations of the Stage 1 and Stage 2 contributors.					

B.9a.3 Aggregate Power control tolerance

B.9a.3.1 Uncertainty budget format and assessment for DFF

The uncertainty contributions that may impact the overall MU value are listed in Table B.9a.3.1-1.

Table B.9a.3.1-1: Uncertainty contributions for EIRP aggregate power control tolerance measurement

UID	Description of uncertainty contribution	Details in annex
Stage 2: DUT measurement		
1	Uncertainty of the RF relative power measurement equipment	B.2.1.36
Stage 1: Calibration measurement		
	N/A	
Systematic uncertainties		
2	Influence of noise	B.2.1.27

The uncertainty assessment tables are organized as follows:

- For the purpose of uncertainty assessment, the radiating antenna aperture of the DUT is denoted as D

- The uncertainty assessment has been derived for the case of $D = [5 \text{ cm}]$, $f = \{22.65\text{GHz}, 31.1\text{GHz}, 45.1\text{GHz}\}$, $P = [\text{maximum output power}]$.
- The uncertainty assessment for EIRP aggregate power control tolerance is provided in Table B.9a.3.1-2.

Table B.9a.3.1-2: Uncertainty assessment for EIRP aggregate power control tolerance measurement (f=TBD, D=TBD)

UID	Uncertainty source	Uncertainty value	Distribution of the probability	Divisor	Standard uncertainty (σ) [dB]
Stage 2: DUT measurement					
1	Uncertainty of the RF relative power measurement equipment	FFS	FFS	FFS	FFS
Stage 1: Calibration measurement					
	N/A				
Systematic uncertainties (NOTE 1)					Value
2	Influence of noise				FFS
Total measurement uncertainty					Value
EIRP Expanded uncertainty (1.96 σ - confidence interval of 95 %) [dB]					FFS
NOTE 1: In order to obtain the total measurement uncertainty, systematic uncertainties have to be added to the expanded root sum square of the standard deviations of the Stage 1 and Stage 2 contributors.					

B.9a.3.2 Uncertainty budget format and assessment for IFF

The uncertainty contributions that may impact the overall MU value are listed in Table B.9a.3.2-1.

Table B.9a.3.2-1: Uncertainty contributions for EIRP aggregate power control tolerance measurement

UID	Description of uncertainty contribution	Details in annex
Stage 2: DUT measurement		
1	Uncertainty of the RF relative power measurement equipment	B.2.2.36
Stage 1: Calibration measurement		
	N/A	
Systematic uncertainties		
2	Influence of noise	B.2.2.27

The uncertainty assessment tables are organized as follows:

- For the purpose of uncertainty assessment, the radiating antenna aperture of the DUT is denoted as D
- The uncertainty assessment has been derived for the case of Quiet Zone size $\leq [30 \text{ cm}]$, $f = \{23.45\text{GHz}, 32.125\text{GHz}, 40.8\text{GHz}\}$.
- The uncertainty assessment for EIRP aggregate power control tolerance is provided in Table B.9a.3.2-2 for PC3 UEs and in Table B.9a.3.2-3 for PC1 UEs.

Table B.9a.3.2-2: Uncertainty assessment for EIRP aggregate power control tolerance measurement (f=23.45GHz, 32.125GHz, 40.8GHz, Quiet Zone size ≤ 30 cm) for PC3 UEs and normal temperature condition

UID	Uncertainty source	Uncertainty value	Distribution of the probability	Divisor	Standard uncertainty (σ) [dB]
Stage 2: DUT measurement					
1	Uncertainty of the RF relative power measurement equipment	0.4	Normal	2.00	0.2
Stage 1: Calibration measurement					
	N/A				
Systematic uncertainties (NOTE 1)					Value
2	Influence of noise (23.45GHz ≤ f ≤ 40.8GHz)				1.0
Total measurement uncertainty					Value
EIRP Expanded uncertainty (23.45GHz ≤ f ≤ 32.125GHz) (1.96σ - confidence interval of 95 %) [dB]					1.4
NOTE 1: In order to obtain the total measurement uncertainty, systematic uncertainties have to be added to the expanded root sum square of the standard deviations of the Stage 1 and Stage 2 contributors.					
NOTE 2: Power step size assumed ΔP = 1 dB.					
NOTE 3: Measurement uncertainties in this table assume absolute power measurements involved in the same relative power measurement are performed over the same RF path.					

Table B.9a.3.2-3: Uncertainty assessment for EIRP aggregate power control tolerance measurement (f=23.45GHz, 32.125GHz, 40.8GHz, Quiet Zone size ≤ 30 cm) for PC1 UEs and normal temperature condition

UID	Uncertainty source	Uncertainty value	Distribution of the probability	Divisor	Standard uncertainty (σ) [dB]
Stage 2: DUT measurement					
1	Uncertainty of the RF power measurement equipment	FFS	Normal	2.0	FFS
Stage 1: Calibration measurement					
	N/A				
Systematic uncertainties (NOTE 1)					Value
2	Influence of noise (23.45GHz ≤ f ≤ 40.8GHz)				FFS
Total measurement uncertainty					Value
EIRP Expanded uncertainty (23.45GHz ≤ f ≤ 32.125GHz) (1.96σ - confidence interval of 95 %) [dB]					FFS
NOTE 1: In order to obtain the total measurement uncertainty, systematic uncertainties have to be added to the expanded root sum square of the standard deviations of the Stage 1 and Stage 2 contributors.					

B.9a.3.3 Uncertainty budget format and assessment for NFTF

The uncertainty contributions that may impact the overall MU value are listed in Table B.9a.3.3-1.

Table B.9a.3.3-1: Uncertainty contributions for EIRP aggregate power control tolerance measurement

UID	Description of uncertainty contribution	Details in annex
Stage 2: DUT measurement		
1	Uncertainty of the RF relative power measurement equipment	B.2.3.30
Stage 1: Calibration measurement		
	N/A	
Systematic uncertainties		
2	Influence of noise	B.2.3.29

The uncertainty assessment table is organized as follows:

- For the purpose of uncertainty assessment, the radiating antenna aperture of the DUT is denoted as D

- The uncertainty assessment has been derived for the case of $D = [5 \text{ cm}]$, $f = \{22.65\text{GHz}, 31.1\text{GHz}, 45.1\text{GHz}\}$, $P = [\text{maximum output power}]$.
- The uncertainty assessment for EIRP aggregate power control tolerance is provided in Table B.9a.3.3-2

Table B.9a.3.3-2: Uncertainty assessment for EIRP aggregate power control tolerance measurement (f=TBD, D=TBD)

UID	Uncertainty source	Uncertainty value	Distribution of the probability	Divisor	Standard uncertainty (σ) [dB]
Stage 2: DUT measurement					
1	Uncertainty of the RF relative power measurement equipment	FFS	FFS	FFS	FFS
Stage 1: Calibration measurement					
	N/A				
Systematic uncertainties (NOTE 1)					Value
2	Influence of noise				FFS
Total measurement uncertainty					Value
EIRP Expanded uncertainty (1.96 σ - confidence interval of 95 %) [dB]					FFS
NOTE 1: In order to obtain the total measurement uncertainty, systematic uncertainties have to be added to the expanded root sum square of the standard deviations of the Stage 1 and Stage 2 contributors.					

B.10 Frequency error

Following tables summarize the MU threshold for EIRP measurements for Frequency error. The origin MU values for different test setups can be found in following subclauses.

Table B.10-1: MU threshold for beam peak measurement for Frequency error

Power Class	Frequency	MBW	Power	Threshold MU value for NTC and ETC (NOTE1)
PC3	23.45GHz <= f <= 32.125GHz	BW <= 400MHz	P = Max Output Power	+/- 0.01 ppm
	32.125GHz < f <= 40.8GHz			+/- 0.01 ppm
PC1	23.45GHz <= f <= 32.125GHz	BW <= 400MHz	P = Max Output Power	FFS
	32.125GHz < f <= 40.8GHz			FFS
NOTE 1: Total Expanded MU for IFF for Quiet Zone size ≤ 30cm in section B.10.2				

B.10.1 Uncertainty budget format and assessment for DFF

+/- 0.01 ppm

- The uncertainty assessment has been derived for the case of $D = [5 \text{ cm}]$, $f = \{23.45 \text{ GHz}, 32.125 \text{ GHz}, 40.8 \text{ GHz}\}$, $P = [\text{Maximum output power}]$. This uncertainty has no dependency with extreme temperature conditions.

B.10.2 Uncertainty budget format and assessment for IFF

+/- 0.01 ppm

- The uncertainty assessment has been derived for the case of Quiet zone size \leq [30 cm], $f = \{23.45\text{GHz}, 32.125\text{GHz}, 40.8\text{GHz}\}$, $P = [\text{Maximum output power}]$.

B.11 Carrier leakage

Editor's Note: MU value analysis for PC1, 2 and 4 are not complete.

Following tables summarize the MU threshold for EIRP measurements for carrier leakage. The origin MU values for different test setups can be found in following subclauses.

Table B.11-1: MU threshold for EIRP measurement for carrier leakage

Power Class	Frequency	MBW	Power (NOTE2)	Threshold MU value for NTC [dB] (NOTE 1)
PC3	23.45GHz \leq f \leq 32.125GHz	BW \leq 400MHz	P = 0 + MU to 0 + (MU + Uplink power control window size) dBm	5.44
	32.125GHz < f \leq 40.8GHz			5.57
PC1	23.45GHz \leq f \leq 32.125GHz	BW \leq 400MHz	FFS	FFS
	32.125GHz < f \leq 40.8GHz			FFS
NOTE 1: Total Expanded MU for IFF for Quiet Zone size \leq 30cm in Table B.11.2-2 for PC3 UEs and FFS for PC1 UEs				

B.11.1 Uncertainty budget format and assessment for DFF

The uncertainty contributions that may impact the overall MU value are listed in Table B.11.1-1.

Table B.11.1-1: Uncertainty contributions for EIRP measurement

UID	Description of uncertainty contribution	Details in annex
Stage 2: DUT measurement		
1	Positioning misalignment	B.2.1.1
2	Measure distance uncertainty	B.2.1.2
3	Quality of quiet zone	B.2.1.3
4	Mismatch	B.2.1.4
5	Standing Wave Between the DUT and measurement antenna	B.2.1.5
6	Uncertainty of the RF power measurement equipment	B.2.1.6
7	Phase curvature	B.2.1.7
8	Amplifier uncertainties	B.2.1.8
9	Random uncertainty	B.2.1.9
10	Influence of the XPD	B.2.1.10
11	Insertion Loss Variation	B.2.1.11
12	RF leakage (from measurement antenna to the receiver/transmitter)	B.2.1.12
13	Influence of TRP measurement grid	B.2.1.22
14	Influence of beam peak search grid	B.2.1.23
15	Multiple measurement antenna uncertainty	B.2.1.25
16	DUT repositioning	B.2.1.26
Stage 1: Calibration measurement		
17	Mismatch	B.2.1.4
18	Amplifier uncertainties	B.2.1.8
19	Misalignment of positioning System	B.2.1.13
20	Uncertainty of the Network Analyzer	B.2.1.14
21	Uncertainty of the absolute gain of the calibration antenna	B.2.1.15
22	Positioning and pointing misalignment between the reference antenna and the measurement antenna	B.2.1.16
23	Phase centre offset of calibration antenna	B.2.1.18
24	Quality of quiet zone for calibration process	B.2.1.19
25	Standing wave between reference calibration antenna and measurement antenna	B.2.1.20
26	Influence of the calibration antenna feed cable	B.2.1.21
27	Insertion Loss Variation	B.2.1.11
Systematic uncertainties		
28	Systematic error due to TRP calculation/quadrature	B.2.1.24
29	Influence of noise	B.2.1.27

The uncertainty assessment tables are organized as follows:

- For the purpose of uncertainty assessment, the radiating antenna aperture of the DUT is denoted as D
- The uncertainty assessment has been derived for the case of $D = [5 \text{ cm}]$, $f = \{23.45 \text{ GHz}, 32.125 \text{ GHz}, 40.8 \text{ GHz}\}$, $P = [\text{Maximum output power}]$.
- The uncertainty assessment is provided in Table B.11.1-2.

Table B.11.1-2: Uncertainty assessment for EIRP measurement (f=TBD, D=TBD)

UID	Uncertainty source	Uncertainty value	Distribution of the probability	Divisor	Standard uncertainty (σ) [dB]
Stage 2: DUT measurement					
1	Positioning misalignment				
2	Measure distance uncertainty				
3	Quality of quiet zone (NOTE 2)				
4	Mismatch (NOTE 3)				
5	Standing Wave Between the DUT and measurement antenna				
6	Uncertainty of the RF power measurement equipment (NOTE 4)				
7	Phase curvature				
8	Amplifier uncertainties				
9	Random uncertainty				
10	Influence of the XPD				
11	Insertion Loss Variation				
12	RF leakage (from measurement antenna to the receiver/transmitter)				
13	Influence of TRP measurement grid (NOTE 5)				
14	Influence of beam peak search grid (NOTE 6)				
15	Multiple measurement antenna uncertainty				
16	DUT repositioning				
Stage 1: Calibration measurement					
17	Mismatch				
18	Amplifier uncertainties				
19	Misalignment of positioning System				
20	Uncertainty of the Network Analyzer				
21	Uncertainty of the absolute gain of the calibration antenna				
22	Positioning and pointing misalignment between the reference antenna and the measurement antenna				
23	Phase centre offset of calibration antenna				
24	Quality of quiet zone for calibration process (NOTE 2)				
25	Standing wave between reference calibration antenna and measurement antenna				
26	Influence of the calibration antenna feed cable				
27	Insertion Loss Variation				
EIRP Expanded uncertainty (1.96 σ - confidence interval of 95 %) [dB]					
Systematic uncertainties (NOTE 7)					Value
28	Systematic error due to TRP calculation/quadrature (NOTE 5)				
29	Influence of noise				
Total measurement uncertainty					
EIRP total measurement uncertainty [dB]					

NOTE 1:	The impact of phase variation on EIRP is FFS.
NOTE 2:	The quality of quiet zone is different for EIRP and TRP. For TRP, the standard uncertainty is FFS; for EIRP, the standard uncertainty of quiet zone is FFS.
NOTE 3:	The analysis was done only for the case of operating at 0dBm output power, in-band, non-CA.
NOTE 4:	The assessment assumes 0 dBm UE output power – carrier leakage requirement.
NOTE 5:	This contributor shall only be considered for TRP measurements.
NOTE 6:	This contributor shall only be considered for EIRP measurements.
NOTE 7:	In order to obtain the total measurement uncertainty, systematic uncertainties have to be added to the expanded root sum square of the standard deviations of the Stage 1 and Stage 2 contributors.
NOTE 8:	Void

B.11.2 Uncertainty budget format and assessment for IFF

The uncertainty contributions that may impact the overall MU value are listed in Table B.12.2-1.

Table B.11.2-1: Uncertainty contributions for EIRP measurement

UID	Description of uncertainty contribution	Details in clause
Stage 2: DUT measurement		
1	Positioning misalignment	B.2.2.1
2	Measure distance uncertainty	B.2.2.2
3	Quality of Quiet Zone	B.2.2.3
4	Mismatch	B.2.2.4
5	Standing wave between the DUT and measurement antenna	B.2.2.5
6	Uncertainty of the RF power measurement equipment	B.2.2.6
7	Phase curvature	B.2.2.7
8	Amplifier uncertainties	B.2.2.8
9	Random uncertainty	B.2.2.9
10	Influence of the XPD	B.2.2.10
11	Insertion Loss Variation	B.2.2.11
12	RF leakage (from measurement antenna to the receiver/transmitter)	B.2.2.12
13	Influence of TRP measurement grid	B.2.2.22
14	Influence of beam peak search grid	B.2.2.23
15	Multiple measurement antenna uncertainty	B.2.2.25
16	DUT repositioning	B.2.2.26
Stage 1: Calibration measurement		
17	Mismatch	B.2.2.4
18	Amplifier Uncertainties	B.2.2.8
19	Misalignment of positioning System	B.2.2.13
20	Uncertainty of the Network Analyzer	B.2.2.14
21	Uncertainty of the absolute gain of the calibration antenna	B.2.2.15
22	Positioning and pointing misalignment between the reference antenna and the measurement antenna	B.2.2.16
23	Phase centre offset of calibration antenna	B.2.2.18
24	Quality of quiet zone for calibration process	B.2.2.19
25	Standing wave between reference calibration antenna and measurement antenna	B.2.2.20
26	Influence of the calibration antenna feed cable	B.2.2.21
27	Insertion Loss Variation	B.2.2.11
Systematic uncertainties		
28	Systematic error due to TRP calculation/quadrature	B.2.2.24
29	Influence of noise	B.2.2.27

The uncertainty assessment tables are organized as follows:

- For the purpose of uncertainty assessment, the radiating antenna aperture of the DUT is denoted as D
- The uncertainty assessment has been derived for the case of Quiet Zone size ≤ 30 cm, $f = \{23.45\text{GHz}, 32.125\text{GHz}, 40.8\text{GHz}\}$, for PC3 with measured UE power in the range 0dBm + MU to 0dBm + MU + uplink power control window size, where

- MU is the test system uplink absolute power measurement uncertainty for minimum output power in Table B.7.2-2.
- Uplink power control window size = 1dB (UE power step size) + 5 dB (UE power step tolerance) + (Test system uplink relative power measurement uncertainty), where, the UE power step tolerance is specified in TS 38.101-1 [2], Table 6.3.4.3-1 and is 5dB for 1dB power step size, and the Test system uplink relative power measurement uncertainty is specified in Table F.1.2-1 in TS 38.521-2 for TC 6.4.2.2 with a value of 1.4 dB.
- The uncertainty assessment for EIRP is provided in Table B.17.2-2 for PC3 UEs and Table B.17.2-3 for PC1 UEs.

Table B.11.2-2: Uncertainty assessment for EIRP measurement (f=23.45GHz, 32.125GHz, 40.8GHz, Quiet Zone size \leq 30 cm) for PC3 UEs and normal temperature condition

UID	Uncertainty source	Uncertainty value	Distribution of the probability	Divisor	Standard uncertainty (σ) [dB]
Stage 2: DUT measurement					
1	Positioning misalignment	0.00	Normal	2.00	0.00
2	Measure distance uncertainty	0.00	Rectangular	1.73	0.00
3	Quality of Quiet Zone (NOTE 10)	0.52	Actual	1.00	0.52
4	Mismatch (NOTE 2)	1.84	Actual	1.00	1.84
5	Standing wave between the DUT and measurement antenna	0.00	U-shaped	1.41	0.00
6	Uncertainty of the RF power measurement equipment (NOTE 3, 7)	2.50	Normal	2.00	1.25
7	Phase curvature	0.00	U-shaped	1.41	0.00
8	Amplifier uncertainties	2.1	Normal	2.00	1.05
9	Random uncertainty	0.50	Normal	2.00	0.25
10	Influence of the XPD	0.00	U-shaped	1.41	0.00
11	Insertion Loss Variation	0.00	Rectangular	1.73	0.00
12	RF leakage (from measurement antenna to the receiver/transmitter)	0.00	Actual	1.00	0.00
13	Influence of TRP measurement grid (NOTE 4)	0.0	Actual	1	0.0
14	Influence of beam peak search grid (NOTE 5)	0.00	Actual	1	0.00
15	Multiple measurement antenna uncertainty (NOTE 9)	0.0	Actual	1	0.0
16	DUT repositioning (NOTE 4)	0.00	Rectangular	1.73	0.00
Stage 1: Calibration measurement					
17	Mismatch	0.00	U-shaped	1.41	0.00
18	Amplifier Uncertainties	0.00	Normal	2.00	0.00
19	Misalignment of positioning System	0.00	Normal	2.00	0.00
20	Uncertainty of the Network Analyzer	1.5	Normal	2.00	0.75
21	Uncertainty of the absolute gain of the calibration antenna	0.60	Normal	2.00	0.30
22	Positioning and pointing misalignment between the reference antenna and the measurement antenna	0.00	Rectangular	1.73	0.00
23	Phase centre offset of calibration antenna	0.00	Rectangular	1.73	0.00
24	Quality of quiet zone for calibration process (NOTE 10)	0.32	Actual	1.00	0.32
25	Standing wave between reference calibration antenna and measurement antenna	0.00	U-shaped	1.41	0.00
26	Influence of the calibration antenna feed cable	0.00	Normal	2.00	0.00
27	Insertion Loss Variation	0.00	Rectangular	1.73	0.00
EIRP Expanded uncertainty (1.96σ - confidence interval of 95 %) [dB]					5.24
Systematic uncertainties (NOTE 6)					Value
28	Systematic error due to TRP calculation/quadrature (NOTE 4)				0.00
29	Influence of noise ($23.45\text{GHz} \leq f \leq 32.125\text{GHz}$)				0.20
30	Influence of noise ($32.125\text{GHz} < f \leq 40.8\text{GHz}$)				0.33
31	Beam peak search				0.00
Total measurement uncertainty					Value
EIRP total measurement uncertainty ($23.45\text{GHz} \leq f \leq 32.125\text{GHz}$) [dB]					5.44
EIRP total measurement uncertainty ($32.125\text{GHz} < f \leq 40.8\text{GHz}$) [dB]					5.57

- NOTE 1: Void
- NOTE 2: The analysis was done only for the case of measured UE power in the range from 0dBm + MU to 0dBm + MU + uplink power control window size, in-band, non-CA.
- NOTE 3: The assessment assumes measured power in the range from 0dBm + MU – carrier leakage requirement to 0dBm + MU + uplink power control window – carrier leakage requirement.
- NOTE 4: This contributor shall only be considered for TRP measurements.
- NOTE 5: Void
- NOTE 6: In order to obtain the total measurement uncertainty, systematic uncertainties have to be added to the expanded root sum square of the standard deviations of the Stage 1 and Stage 2 contributors.
- NOTE 7: Void
- NOTE 8: Void
- NOTE 9: Applies to the system which has a structure of mechanical feed antenna positioning.
- NOTE 10: Defined as fixed value MU contributor.

Table B.11.2-3: Uncertainty assessment for EIRP measurement (f=23.45GHz, 32.125GHz, 40.8GHz, Quiet Zone size \leq 30 cm) for PC1 UEs and normal temperature condition

UID	Uncertainty source	Uncertainty value	Distribution of the probability	Divisor	Standard uncertainty (σ) [dB]
Stage 2: DUT measurement					
1	Positioning misalignment	0.02	Normal	2.00	0.01
2	Measure distance uncertainty	FFS	Rectangular	1.73	FFS
3	Quality of Quiet Zone (NOTE 10)	FFS	Actual	1.00	FFS
4	Mismatch (NOTE 2, NOTE 7)	FFS	Actual	1.00	FFS
5	Standing wave between the DUT and measurement antenna	FFS	U-shaped	1.41	FFS
6	Uncertainty of the RF power measurement equipment (NOTE 3, 7)	FFS	Normal	2.00	FFS
7	Phase curvature	FFS	U-shaped	1.41	FFS
8	Amplifier uncertainties	FFS	Normal	2.00	FFS
9	Random uncertainty	FFS	Normal	2.00	FFS
10	Influence of the XPD	FFS	U-shaped	1.41	FFS
11	Insertion Loss Variation	FFS	Rectangular	1.73	FFS
12	RF leakage (from measurement antenna to the receiver/transmitter)	FFS	Actual	1.00	FFS
13	Influence of TRP measurement grid (NOTE 4)	0.00	Actual	1	0.00
14	Influence of beam peak search grid (NOTE 5)	0.00	Actual	1	0.00
15	Multiple measurement antenna uncertainty (NOTE 9)	FFS	Actual	1	FFS
16	DUT repositioning (NOTE 4)	0.00	Rectangular	1.73	0.00
Stage 1: Calibration measurement					
17	Mismatch	FFS	U-shaped	1.41	FFS
18	Amplifier Uncertainties	FFS	Normal	2.00	FFS
19	Misalignment of positioning System	FFS	Normal	2.00	FFS
20	Uncertainty of the Network Analyzer	FFS	Normal	2.00	FFS
21	Uncertainty of the absolute gain of the calibration antenna	FFS	Normal	2.00	FFS
22	Positioning and pointing misalignment between the reference antenna and the measurement antenna	FFS	Rectangular	1.73	FFS
23	Phase centre offset of calibration antenna	FFS	Rectangular	1.73	FFS
24	Quality of quiet zone for calibration process (NOTE 10)	FFS	Actual	1.00	FFS
25	Standing wave between reference calibration antenna and measurement antenna	FFS	U-shaped	1.41	FFS
26	Influence of the calibration antenna feed cable	FFS	Normal	2.00	FFS
27	Insertion Loss Variation	FFS	Rectangular	1.73	FFS
TRP Expanded uncertainty (1.96σ - confidence interval of 95 %) [dB]					FFS
Systematic uncertainties (NOTE 6)					Value
28	Systematic error due to TRP calculation/quadrature (NOTE 4)				0.00
29	Influence of noise				FFS
30	Beam peak search				FFS
Total measurement uncertainty					Value
EIRP total measurement uncertainty [dB]					FFS

NOTE 1:	Void
NOTE 2:	The analysis was done only for the case of measured UE power in the range from FFS to FFS, in-band, non-CA.
NOTE 3:	The assessment assumes measured power in the range from FFS to FFS.
NOTE 4:	This contributor shall only be considered for TRP measurements.
NOTE 5:	Void
NOTE 6:	In order to obtain the total measurement uncertainty, systematic uncertainties have to be added to the expanded root sum square of the standard deviations of the Stage 1 and Stage 2 contributors.
NOTE 7:	Void.
NOTE 8:	Void.
NOTE 9:	Applies to the system which has a structure of mechanical feed antenna positioning.
NOTE 10:	Defined as fixed value MU contributor.

B.12 to B.14

B.15 Occupied bandwidth

Following tables summarize the MU threshold for EIRP measurements for Occupied bandwidth. The origin MU values for different test setups can be found in following subclauses.

Table B.15-1: MU threshold for beam peak measurement for Occupied bandwidth

Power Class	Frequency	MBW	Power	Threshold MU value (NOTE1)
PC3	23.45GHz <= f <= 32.125GHz	BW <= 400MHz	P = Max Output Power	TBD
	32.125GHz < f <= 40.8GHz			TBD
PC1	23.45GHz <= f <= 32.125GHz	BW <= 400MHz	P = Max Output Power	TBD
	32.125GHz < f <= 40.8GHz			TBD
NOTE 1: Total Expanded MU for IFF for Quiet Zone size ≤ 30cm in Table B.15.2				

B.15.1 Uncertainty budget format and assessment for DFF

FFS

- The uncertainty assessment has been derived for the case of $D = [5 \text{ cm}]$, $f = \{23.45 \text{ GHz}, 32.125 \text{ GHz}, 40.8 \text{ GHz}\}$, $P = [\text{Maximum output power}]$.

B.15.2 Uncertainty budget format and assessment for IFF

FFS

- The uncertainty assessment has been derived for the case of Quiet Zone size ≤ 30 cm, $f = \{23.45\text{GHz}, 32.125\text{GHz}, 40.8\text{GHz}\}$, $P = \text{Maximum output power}$.

B.16 Spectrum emission mask

Following tables summarize the MU threshold for TRP measurements for Spectrum emission mask. The origin MU values for different test setups can be found in following subclauses.

Table B.16-1: MU threshold for TRP measurement for Spectrum emission mask

Power Class	Frequency	MBW	Power	Threshold MU value (NOTE 1)
PC3	23.45GHz <= f <= 32.125GHz	BW <= 400MHz	P = Max Output Power	4.94
	32.125GHz < f <= 40.8GHz			5.32
PC1	23.45GHz <= f <= 32.125GHz	BW <= 400MHz	P = Max Output Power	FFS
	32.125GHz < f <= 40.8GHz			FFS
NOTE 1: Total Expanded MU for IFF for Quiet Zone size ≤ 30cm in Table B.16.2-2 for PC3 UEs and in Table B.16.2-4 for PC1 UEs				

B.16.1 Uncertainty budget format and assessment for DFF

The uncertainty contributions that may impact the overall MU value are listed in Table B.16.1-1.

Table B.16.1-1: Uncertainty contributions for TRP measurement

UID	Description of uncertainty contribution	Details in annex
Stage 2: DUT measurement		
1	Positioning misalignment	B.2.1.1
2	Measure distance uncertainty	B.2.1.2
3	Quality of quiet zone	B.2.1.3
4	Mismatch	B.2.1.4
5	Standing Wave Between the DUT and measurement antenna	B.2.1.5
6	Uncertainty of the RF power measurement equipment	B.2.1.6
7	Phase curvature	B.2.1.7
8	Amplifier uncertainties	B.2.1.8
9	Random uncertainty	B.2.1.9
10	Influence of the XPD	B.2.1.10
11	Insertion Loss Variation	B.2.1.11
12	RF leakage (from measurement antenna to the receiver/transmitter)	B.2.1.12
13	Influence of TRP measurement grid	B.2.1.22
14	Influence of beam peak search grid	B.2.1.23
15	Multiple measurement antenna uncertainty	B.2.1.25
16	DUT repositioning	B.2.1.26
Stage 1: Calibration measurement		
17	Mismatch	B.2.1.4
18	Amplifier uncertainties	B.2.1.8
19	Misalignment of positioning System	B.2.1.13
20	Uncertainty of the Network Analyzer	B.2.1.14
21	Uncertainty of the absolute gain of the calibration antenna	B.2.1.15
22	Positioning and pointing misalignment between the reference antenna and the measurement antenna	B.2.1.16
23	Phase centre offset of calibration antenna	B.2.1.18
24	Quality of quiet zone for calibration process	B.2.1.19
25	Standing wave between reference calibration antenna and measurement antenna	B.2.1.20
26	Influence of the calibration antenna feed cable	B.2.1.21
27	Insertion Loss Variation	B.2.1.11
Systematic uncertainties		
28	Systematic error due to TRP calculation/quadrature	B.2.1.24
29	Influence of noise	B.2.1.27

The uncertainty assessment tables are organized as follows:

- For the purpose of uncertainty assessment, the radiating antenna aperture of the DUT is denoted as D
- The uncertainty assessment has been derived for the case of $D = [5 \text{ cm}]$, $f = \{23.45 \text{ GHz}, 32.125 \text{ GHz}, 40.8 \text{ GHz}\}$, $P = [\text{Maximum output power}]$.
- The uncertainty assessment for TRP is provided in Table B.16.1-2.

Table B.16.1-2: Uncertainty assessment for TRP measurement (f=TBD, D=TBD)

UID	Uncertainty source	Uncertainty value	Distribution of the probability	Divisor	Standard uncertainty (σ) [dB]
Stage 2: DUT measurement					
1	Positioning misalignment				
2	Measure distance uncertainty				
3	Quality of quiet zone (NOTE 2)				
4	Mismatch (NOTE 3)				
5	Standing Wave Between the DUT and measurement antenna				
6	Uncertainty of the RF power measurement equipment (NOTE 4)				
7	Phase curvature				
8	Amplifier uncertainties				
9	Random uncertainty				
10	Influence of the XPD				
11	Insertion Loss Variation				
12	RF leakage (from measurement antenna to the receiver/transmitter)				
13	Influence of TRP measurement grid (NOTE 5)				
14	Influence of beam peak search grid (NOTE 6)				
15	Multiple measurement antenna uncertainty				
16	DUT repositioning				
Stage 1: Calibration measurement					
17	Mismatch				
18	Amplifier uncertainties				
19	Misalignment of positioning System				
20	Uncertainty of the Network Analyzer				
21	Uncertainty of the absolute gain of the calibration antenna				
22	Positioning and pointing misalignment between the reference antenna and the measurement antenna				
23	Phase centre offset of calibration antenna				
24	Quality of quiet zone for calibration process (NOTE 2)				
25	Standing wave between reference calibration antenna and measurement antenna				
26	Influence of the calibration antenna feed cable				
27	Insertion Loss Variation				
TRP Expanded uncertainty (1.96σ - confidence interval of 95 %) [dB]					
Systematic uncertainties (NOTE 7)					Value
28	Systematic error due to TRP calculation/quadrature (NOTE 5)				
29	Influence of noise				
Total measurement uncertainty					
TRP total measurement uncertainty [dB]					
NOTE 1: The impact of phase variation on EIRP is FFS.					
NOTE 2: The quality of quiet zone is different for EIRP and TRP. For TRP, the standard uncertainty is FFS; for EIRP, the standard uncertainty of quiet zone is FFS.					
NOTE 3: The analysis was done only for the case of operating at max output power, in-band, non-CA.					
NOTE 4: The assessment assumes maximum DUT output power.					
NOTE 5: This contributor shall only be considered for TRP measurements.					
NOTE 6: This contributor shall only be considered for EIRP measurements.					
NOTE 7: In order to obtain the total measurement uncertainty, systematic uncertainties have to be added to the expanded root sum square of the standard deviations of the Stage 1 and Stage 2 contributors.					

B.16.2 Uncertainty budget format and assessment for IFF

The uncertainty contributions that may impact the overall MU value are listed in Table B.16.2-1.

Table B.16.2-1: Uncertainty contributions for TRP measurement

UID	Description of uncertainty contribution	Details in clause
Stage 2: DUT measurement		
1	Positioning misalignment	B.2.2.1
2	Measure distance uncertainty	B.2.2.2
3	Quality of Quiet Zone	B.2.2.3
4	Mismatch	B.2.2.4
5	Standing wave between the DUT and measurement antenna	B.2.2.5
6	Uncertainty of the RF power measurement equipment	B.2.2.6
7	Phase curvature	B.2.2.7
8	Amplifier uncertainties	B.2.2.8
9	Random uncertainty	B.2.2.9
10	Influence of the XPD	B.2.2.10
11	Insertion Loss Variation	B.2.2.11
12	RF leakage (from measurement antenna to the receiver/transmitter)	B.2.2.12
13	Influence of TRP measurement grid	B.2.2.22
14	Influence of beam peak search grid	B.2.2.23
15	Multiple measurement antenna uncertainty	B.2.2.25
16	DUT repositioning	B.2.2.26
Stage 1: Calibration measurement		
17	Mismatch	B.2.2.4
18	Amplifier Uncertainties	B.2.2.8
19	Misalignment of positioning System	B.2.2.13
20	Uncertainty of the Network Analyzer	B.2.2.14
21	Uncertainty of the absolute gain of the calibration antenna	B.2.2.15
22	Positioning and pointing misalignment between the reference antenna and the measurement antenna	B.2.2.16
23	Phase centre offset of calibration antenna	B.2.2.18
24	Quality of quiet zone for calibration process	B.2.2.19
25	Standing wave between reference calibration antenna and measurement antenna	B.2.2.20
26	Influence of the calibration antenna feed cable	B.2.2.21
27	Insertion Loss Variation	B.2.2.11
Systematic uncertainties		
28	Systematic error due to TRP calculation/quadrature	B.2.2.24
29	Influence of noise	B.2.2.27

The uncertainty assessment tables are organized as follows:

- For the purpose of uncertainty assessment, the radiating antenna aperture of the DUT is denoted as D
- The uncertainty assessment has been derived for the case of Quiet Zone size $\leq [30 \text{ cm}]$, $f = \{23.45\text{GHz}, 32.125\text{GHz}, 40.8\text{GHz}\}$, $P = [\text{Maximum output power}]$.
- The uncertainty assessment for TRP is provided in Table B.16.2-2 for PC3 UEs and in Table B.16.2-4 for PC1 UEs.

Table B.16.2-2: Uncertainty assessment for TRP measurement (f=23.45GHz, 32.125GHz, 40.8GHz, Quiet Zone size \leq 30 cm) for PC3 UEs

UID	Uncertainty source	Uncertainty value	Distribution of the probability	Divisor	Standard uncertainty (σ) [dB]
Stage 2: DUT measurement					
1	Positioning misalignment	0.00	Normal	2.00	0.00
2	Measure distance uncertainty	0.00	Rectangular	1.73	0.00
3	Quality of Quiet Zone (NOTE 9)	0.6	Actual	1.00	0.6
4	Mismatch (NOTE 1)	1.30	Actual	1.00	1.30
5	Standing wave between the DUT and measurement antenna	0.00	U-shaped	1.41	0.00
6	Uncertainty of the RF power measurement equipment (NOTE 2)	2.16	Normal	2.00	1.08
7	Phase curvature	0.00	U-shaped	1.41	0.00
8	Amplifier uncertainties	2.1	Normal	2.00	1.05
9	Random uncertainty	0.50	Normal	2.00	0.25
10	Influence of the XPD	0.01	U-shaped	1.41	0.00
11	Insertion Loss Variation	0.00	Rectangular	1.73	0.00
12	RF leakage (from measurement antenna to the receiver/transmitter)	0.00	Actual	1.00	0.00
13	Influence of TRP measurement grid (NOTE 3)	0.25	Actual	1	0.25
14	Influence of beam peak search grid (NOTE 4)	0.00	Actual	1	0.00
15	Multiple measurement antenna uncertainty (NOTE 8)	0.15	Actual	1	0.15
16	DUT repositioning (NOTE 3)	0.00	Rectangular	1.73	0.00
Stage 1: Calibration measurement					
17	Mismatch	0.00	U-shaped	1.41	0.00
18	Amplifier Uncertainties	0.00	Normal	2.00	0.00
19	Misalignment of positioning System	0.00	Normal	2.00	0.00
20	Uncertainty of the Network Analyzer	0.73	Normal	2.00	0.37
21	Uncertainty of the absolute gain of the calibration antenna	0.60	Normal	2.00	0.30
22	Positioning and pointing misalignment between the reference antenna and the measurement antenna	0.01	Rectangular	1.73	0.00
23	Phase centre offset of calibration antenna	0.00	Rectangular	1.73	0.00
24	Quality of quiet zone for calibration process (NOTE 9)	0.4	Actual	1.00	0.4
25	Standing wave between reference calibration antenna and measurement antenna	0.00	U-shaped	1.41	0.00
26	Influence of the calibration antenna feed cable	0.14	Normal	2.00	0.07
27	Insertion Loss Variation	0.00	Rectangular	1.73	0.00
Systematic uncertainties (NOTE 5)					Value
28	Systematic error due to TRP calculation/quadrature (NOTE 3)				0.00
29	Influence of noise (23.45GHz \leq f \leq 32.125GHz)				0.62
29	Influence of noise (32.125GHz < f \leq 40.8GHz)				1.00
Total measurement uncertainty					Value
TRP total measurement uncertainty (23.45GHz \leq f \leq 32.125GHz) (1.96 σ - confidence interval of 95 %) [dB]					4.94
TRP total measurement uncertainty (32.125GHz < f \leq 40.8GHz) (1.96 σ - confidence interval of 95 %) [dB]					5.32

- NOTE 1: The analysis was done only for the case of operating at max output power, in-band, non-CA.
- NOTE 2: The assessment assumes maximum DUT output power.
- NOTE 3: This contributor shall only be considered for TRP measurements.
- NOTE 4: This contributor shall only be considered for EIRP measurements.
- NOTE 5: In order to obtain the total measurement uncertainty, systematic uncertainties have to be added to the expanded root sum square of the standard deviations of the Stage 1 and Stage 2 contributors.
- NOTE 6: Values extracted from TR 38.810 v2.6.1 in square brackets pending for further analysis.
- NOTE 7: Void.
- NOTE 8: Applies to the system which has a structure of mechanical feed antenna positioning.
- NOTE 9: Value based on procedure defined in clause D.2 of TR 38.810 for Quiet Zone size less or equal to 30 cm.

Table B.16.2-3: Void

Table B.16.2-4: Uncertainty assessment for TRP measurement (f=23.45GHz, 32.125GHz, 40.8GHz, Quiet Zone size \leq 30 cm) for PC1 UEs

UID	Uncertainty source	Uncertainty value	Distribution of the probability	Divisor	Standard uncertainty (σ) [dB]
Stage 2: DUT measurement					
1	Positioning misalignment	0.02	Normal	2.00	0.02
2	Measure distance uncertainty	FFS	Rectangular	1.73	FFS
3	Quality of Quiet Zone (NOTE 9)	FFS	Actual	1.00	FFS
4	Mismatch (NOTE 1)	FFS	Actual	1.00	FFS
5	Standing wave between the DUT and measurement antenna	FFS	U-shaped	1.41	FFS
6	Uncertainty of the RF power measurement equipment (NOTE 2)	FFS	Normal	2.00	FFS
7	Phase curvature	FFS	U-shaped	1.41	FFS
8	Amplifier uncertainties	FFS	Normal	2.00	FFS
9	Random uncertainty	FFS	Normal	2.00	FFS
10	Influence of the XPD	FFS	U-shaped	1.41	FFS
11	Insertion Loss Variation	FFS	Rectangular	1.73	FFS
12	RF leakage (from measurement antenna to the receiver/transmitter)	FFS	Actual	1.00	FFS
13	Influence of TRP measurement grid (NOTE 3)	FFS	Actual	1	FFS
14	Influence of beam peak search grid (NOTE 4)	FFS	Actual	1	FFS
15	Multiple measurement antenna uncertainty (NOTE 8)	FFS	Actual	1	FFS
16	DUT repositioning (NOTE 3)	0.00	Rectangular	1.73	0.00
Stage 1: Calibration measurement					
17	Mismatch	FFS	U-shaped	1.41	FFS
18	Amplifier Uncertainties	FFS	Normal	2.00	FFS
19	Misalignment of positioning System	FFS	Normal	2.00	FFS
20	Uncertainty of the Network Analyzer	FFS	Normal	2.00	FFS
21	Uncertainty of the absolute gain of the calibration antenna	FFS	Normal	2.00	FFS
22	Positioning and pointing misalignment between the reference antenna and the measurement antenna	FFS	Rectangular	1.73	FFS
23	Phase centre offset of calibration antenna	FFS	Rectangular	1.73	FFS
24	Quality of quiet zone for calibration process (NOTE 9)	FFS	Actual	1.00	FFS
25	Standing wave between reference calibration antenna and measurement antenna	FFS	U-shaped	1.41	FFS
26	Influence of the calibration antenna feed cable	FFS	Normal	2.00	FFS
27	Insertion Loss Variation	FFS	Rectangular	1.73	FFS
Systematic uncertainties (NOTE 5)					Value
28	Systematic error due to TRP calculation/quadrature (NOTE 3)				0.00
29	Influence of noise (23.45GHz <= f <= 32.125GHz)				FFS
29	Influence of noise (32.125GHz < f <= 40.8GHz)				FFS
Total measurement uncertainty					Value
TRP total measurement uncertainty (23.45GHz <= f <= 32.125GHz) (1.96 σ - confidence interval of 95 %) [dB]					FFS
TRP total measurement uncertainty (32.125GHz < f <= 40.8GHz) (1.96 σ - confidence interval of 95 %) [dB]					FFS

NOTE 1:	The analysis was done only for the case of operating at max output power, in-band, non-CA.
NOTE 2:	The assessment assumes maximum DUT output power.
NOTE 3:	This contributor shall only be considered for TRP measurements.
NOTE 4:	This contributor shall only be considered for EIRP measurements.
NOTE 5:	In order to obtain the total measurement uncertainty, systematic uncertainties have to be added to the expanded root sum square of the standard deviations of the Stage 1 and Stage 2 contributors.
NOTE 6:	Values extracted from TR 38.810 v2.6.1 in square brackets pending for further analysis.
NOTE 7:	Void.
NOTE 8:	Applies to the system which has a structure of mechanical feed antenna positioning.
NOTE 9:	Value based on procedure defined in clause D.2 of TR 38.810 for Quiet Zone size less or equal to 30 cm.

B.17 Adjacent Channel Leakage Ratio

Editor's Note: MU value analysis for PC1, 2 and 4 are not complete.

Following tables summarize the MU threshold for EIRP measurements for Adjacent Channel Leakage Ratio. The origin MU values for different test setups can be found in following subclauses.

Table B.17-1: MU threshold for TRP measurement for Spectrum emission mask

Power Class	Frequency	MBW	Power	Threshold MU value (NOTE 1)
PC3	23.45GHz <= f <= 32.125GHz	BW <= 400MHz	P = Max Output Power	TBD
	32.125GHz < f <= 40.8GHz			TBD
PC1	23.45GHz <= f <= 32.125GHz	BW <= 400MHz	P = Max Output Power	TBD
	32.125GHz < f <= 40.8GHz			TBD
NOTE 1: Total Expanded MU for IFF for a Quiet Zone size ≤ 30 cm in Table B.17.2-2 for PC3 UEs and B.17.2-3 for PC1 UEs.				

Table B.17-1B: MU threshold for EIRP measurement for Adjacent Channel Leakage Ratio

Frequency	CBW	Power	Threshold MU value for NTC and ETC (NOTE 1)
23.45GHz ≤ f ≤ 32.125GHz	50MHz	P = Max Output Power	5.63
	100MHz		6.09
	200MHz		6.09 (NOTE5)
	400MHz		6.09 (NOTE2)
32.125GHz < f ≤ 40.8GHz	50MHz	P = Max Output Power	6.09 (NOTE7)
	100MHz		6.09 (NOTE6)
	200MHz		6.09 (NOTE3)
	400MHz		6.09 (NOTE4)
NOTE 1: Total Expanded MU for IFF for a Quiet Zone size ≤ 30 cm in Table B.17.2-2			
NOTE 2: This value is based on the relaxation of (MPR – 3.0) dB for MPR > 3.0dB.			
NOTE 3: Not applicable for MPR > 3.5dB			
NOTE 4: Not applicable for MPR > 2.0dB			
NOTE 5: This value is based on the relaxation of (MPR – 5.0) dB for MPR > 5.0dB.			
NOTE 6: Not applicable for MPR > 5.0dB			
NOTE 7: Not applicable for MPR > 7.5 dB			

B.17.1 Uncertainty budget format and assessment for DFF

The uncertainty contributions that may impact the overall MU value are listed in Table B.17.1-1.

Table B.17.1-1: Uncertainty contributions for EIRP measurement

UID	Description of uncertainty contribution	Details in annex
Stage 2: DUT measurement		
1	Positioning misalignment	B.2.1.1
2	Measure distance uncertainty	B.2.1.2
3	Quality of quiet zone	B.2.1.3
4	Mismatch	B.2.1.4
5	Standing Wave Between the DUT and measurement antenna	B.2.1.5
6	Uncertainty of the RF power measurement equipment	B.2.1.6
7	Phase curvature	B.2.1.7
8	Amplifier uncertainties	B.2.1.8
9	Random uncertainty	B.2.1.9
10	Influence of the XPD	B.2.1.10
11	Insertion Loss Variation	B.2.1.11
12	RF leakage (from measurement antenna to the receiver/transmitter)	B.2.1.12
13	Influence of TRP measurement grid	B.2.1.22
14	Influence of beam peak search grid	B.2.1.23
15	Multiple measurement antenna uncertainty	B.2.1.25
16	DUT repositioning	B.2.1.26
Stage 1: Calibration measurement		
17	Mismatch	B.2.1.4
18	Amplifier uncertainties	B.2.1.8
19	Misalignment of positioning System	B.2.1.13
20	Uncertainty of the Network Analyzer	B.2.1.14
21	Uncertainty of the absolute gain of the calibration antenna	B.2.1.15
22	Positioning and pointing misalignment between the reference antenna and the measurement antenna	B.2.1.16
23	Phase centre offset of calibration antenna	B.2.1.18
24	Quality of quiet zone for calibration process	B.2.1.19
25	Standing wave between reference calibration antenna and measurement antenna	B.2.1.20
26	Influence of the calibration antenna feed cable	B.2.1.21
27	Insertion Loss Variation	B.2.1.11
Systematic uncertainties		
28	Systematic error due to TRP calculation/quadrature	B.2.1.24
29	Influence of noise	B.2.1.27

The uncertainty assessment tables are organized as follows:

- For the purpose of uncertainty assessment, the radiating antenna aperture of the DUT is denoted as D
- The uncertainty assessment has been derived for the case of $D = [5 \text{ cm}]$, $f = \{23.45 \text{ GHz}, 32.125 \text{ GHz}, 40.8 \text{ GHz}\}$, $P = [\text{Maximum output power}]$.
- The uncertainty assessment for TRP is provided in Table B.17.1-2.

Table B.17.1-2: Uncertainty assessment for EIRP measurement (f=TBD, D=TBD)

UID	Uncertainty source	Uncertainty value	Distribution of the probability	Divisor	Standard uncertainty (σ) [dB]
Stage 2: DUT measurement					
1	Positioning misalignment				
2	Measure distance uncertainty				
3	Quality of quiet zone (NOTE 2)				
4	Mismatch (NOTE 3)				
5	Standing Wave Between the DUT and measurement antenna				
6	Uncertainty of the RF power measurement equipment (NOTE 4)				
7	Phase curvature				
8	Amplifier uncertainties				
9	Random uncertainty				
10	Influence of the XPD				
11	Insertion Loss Variation				
12	RF leakage (from measurement antenna to the receiver/transmitter)				
13	Influence of TRP measurement grid (NOTE 5)				
14	Influence of beam peak search grid (NOTE 6)				
15	Multiple measurement antenna uncertainty				
16	DUT repositioning				
Stage 1: Calibration measurement					
17	Mismatch				
18	Amplifier uncertainties				
19	Misalignment of positioning System				
20	Uncertainty of the Network Analyzer				
21	Uncertainty of the absolute gain of the calibration antenna				
22	Positioning and pointing misalignment between the reference antenna and the measurement antenna				
23	Phase centre offset of calibration antenna				
24	Quality of quiet zone for calibration process (NOTE 2)				
25	Standing wave between reference calibration antenna and measurement antenna				
26	Influence of the calibration antenna feed cable				
27	Insertion Loss Variation				
EIRP Expanded uncertainty (1.96σ - confidence interval of 95 %) [dB]					
Systematic uncertainties (NOTE 7)					Value
28	Systematic error due to TRP calculation/quadrature (NOTE 5)				
29	Influence of noise				
Total measurement uncertainty					
TRP total measurement uncertainty [dB]					
NOTE 1: The impact of phase variation on EIRP is FFS.					
NOTE 2: The quality of quiet zone is different for EIRP and TRP. For TRP, the standard uncertainty is FFS; for EIRP, the standard uncertainty of quiet zone is FFS.					
NOTE 3: The analysis was done only for the case of operating at max output power, in-band, non-CA.					
NOTE 4: The assessment assumes maximum DUT output power.					
NOTE 5: This contributor shall only be considered for TRP measurements.					
NOTE 6: This contributor shall only be considered for EIRP measurements.					
NOTE 7: In order to obtain the total measurement uncertainty, systematic uncertainties have to be added to the expanded root sum square of the standard deviations of the Stage 1 and Stage 2 contributors.					
NOTE 8: Void					

B.17.2 Uncertainty budget format and assessment for IFF

The uncertainty contributions that may impact the overall MU value are listed in Table B.17.2-1.

Table B.17.2-1: Uncertainty contributions for EIRP measurement

UID	Description of uncertainty contribution	Details in clause
Stage 2: DUT measurement		
1	Positioning misalignment	B.2.2.1
2	Measure distance uncertainty	B.2.2.2
3	Quality of Quiet Zone	B.2.2.3
4	Mismatch	B.2.2.4
5	Standing wave between the DUT and measurement antenna	B.2.2.5
6	Uncertainty of the RF power measurement equipment	B.2.2.6
7	Phase curvature	B.2.2.7
8	Amplifier uncertainties	B.2.2.8
9	Random uncertainty	B.2.2.9
10	Influence of the XPD	B.2.2.10
11	Insertion Loss Variation	B.2.2.11
12	RF leakage (from measurement antenna to the receiver/transmitter)	B.2.2.12
13	Influence of TRP measurement grid	B.2.2.22
14	Influence of beam peak search grid	B.2.2.23
15	Multiple measurement antenna uncertainty	B.2.2.25
16	DUT repositioning	B.2.2.26
Stage 1: Calibration measurement		
17	Mismatch	B.2.2.4
18	Amplifier Uncertainties	B.2.2.8
19	Misalignment of positioning System	B.2.2.13
20	Uncertainty of the Network Analyzer	B.2.2.14
21	Uncertainty of the absolute gain of the calibration antenna	B.2.2.15
22	Positioning and pointing misalignment between the reference antenna and the measurement antenna	B.2.2.16
23	Phase centre offset of calibration antenna	B.2.2.18
24	Quality of quiet zone for calibration process	B.2.2.19
25	Standing wave between reference calibration antenna and measurement antenna	B.2.2.20
26	Influence of the calibration antenna feed cable	B.2.2.21
27	Insertion Loss Variation	B.2.2.11
Systematic uncertainties		
28	Systematic error due to TRP calculation/quadrature	B.2.2.24
29	Influence of noise	B.2.2.27

The uncertainty assessment tables are organized as follows:

- For the purpose of uncertainty assessment, the radiating antenna aperture of the DUT is denoted as D
- The uncertainty assessment has been derived for the case of Quiet Zone size ≤ 30 cm, $f = \{23.45\text{GHz}, 32.125\text{GHz}, 40.8\text{GHz}\}$, $P = \text{Maximum output power} - \text{MPR} - \text{MBR}(\text{Multi-band relaxation})$.
- The uncertainty assessment for EIRP is provided in Table B.17.2-2 for PC3 UEs and Table B.17.2-3 for PC1 UEs.

Table B.17.2-2: Uncertainty assessment for EIRP measurement (f=23.45GHz, 32.125GHz, 40.8GHz, Quiet Zone size \leq 30 cm) for PC3 UEs and normal and extreme temperature condition

UID	Uncertainty source	Uncertainty value	Distribution of the probability	Divisor	Standard uncertainty (σ) [dB]
Stage 2: DUT measurement					
1	Positioning misalignment	0.00	Normal	2.00	0.00
2	Measure distance uncertainty	0.00	Rectangular	1.73	0.00
3	Quality of Quiet Zone (NOTE 10)	0.52	Actual	1.00	0.52
4	Mismatch (NOTE 2)	1.84	Actual	1.00	1.84
5	Standing wave between the DUT and measurement antenna	0.00	U-shaped	1.41	0.00
6	Uncertainty of the RF power measurement equipment (NOTE 3, 7)	2.16	Normal	2.00	1.08
7	Phase curvature	0.00	U-shaped	1.41	0.00
8	Amplifier uncertainties	2.1	Normal	2.00	1.05
9	Random uncertainty	0.50	Normal	2.00	0.25
10	Influence of the XPD	0.00	U-shaped	1.41	0.00
11	Insertion Loss Variation	0.00	Rectangular	1.73	0.00
12	RF leakage (from measurement antenna to the receiver/transmitter)	0.00	Actual	1.00	0.00
13	Influence of TRP measurement grid (NOTE 4)	0.0	Actual	1	0.0
14	Influence of beam peak search grid (NOTE 5)	0.00	Actual	1	0.00
15	Multiple measurement antenna uncertainty (NOTE 9)	0.0	Actual	1	0.0
16	DUT repositioning (NOTE 4)	0.00	Rectangular	1.73	0.00
Stage 1: Calibration measurement					
17	Mismatch	0.00	U-shaped	1.41	0.00
18	Amplifier Uncertainties	0.00	Normal	2.00	0.00
19	Misalignment of positioning System	0.00	Normal	2.00	0.00
20	Uncertainty of the Network Analyzer	1.5	Normal	2.00	0.75
21	Uncertainty of the absolute gain of the calibration antenna	0.60	Normal	2.00	0.30
22	Positioning and pointing misalignment between the reference antenna and the measurement antenna	0.00	Rectangular	1.73	0.00
23	Phase centre offset of calibration antenna	0.00	Rectangular	1.73	0.00
24	Quality of quiet zone for calibration process (NOTE 10)	0.32	Actual	1.00	0.32
25	Standing wave between reference calibration antenna and measurement antenna	0.00	U-shaped	1.41	0.00
26	Influence of the calibration antenna feed cable	0.00	Normal	2.00	0.00
27	Insertion Loss Variation	0.00	Rectangular	1.73	0.00
EIRP Expanded uncertainty (1.96σ - confidence interval of 95 %) [dB]					5.09
Systematic uncertainties (NOTE 6)					Value
28	Systematic error due to TRP calculation/quadrature (NOTE 4)				0.00
29	Influence of noise				Table B.17.2-4
30	Beam peak search				0.00
Total measurement uncertainty					Value
EIRP total measurement uncertainty [dB]					5.09 + Influence of Noise

- NOTE 1: Void
- NOTE 2: The analysis was done only for the case of operating at max output power – MPR – MBR(Multi-band relaxation), in-band, non-CA.
- NOTE 3: The assessment assumes maximum DUT output power – MPR – MBR(Multi-band relaxation).
- NOTE 4: This contributor shall only be considered for TRP measurements.
- NOTE 5: Void
- NOTE 6: In order to obtain the total measurement uncertainty, systematic uncertainties have to be added to the expanded root sum square of the standard deviations of the Stage 1 and Stage 2 contributors.
- NOTE 7: Void
- NOTE 8: Void
- NOTE 9: Applies to the system which has a structure of mechanical feed antenna positioning.
- NOTE 10: Defined as fixed value MU contributor.

Table B.17.2-3: Uncertainty assessment for EIRP measurement (f=23.45GHz, 32.125GHz, 40.8GHz, Quiet Zone size \leq 30 cm) for PC1 UEs

UID	Uncertainty source	Uncertainty value	Distribution of the probability	Divisor	Standard uncertainty (σ) [dB]
Stage 2: DUT measurement					
1	Positioning misalignment	0.02	Normal	2.00	0.01
2	Measure distance uncertainty	FFS	Rectangular	1.73	FFS
3	Quality of Quiet Zone (NOTE 10)	FFS	Actual	1.00	FFS
4	Mismatch (NOTE 2, NOTE 7)	FFS	Actual	1.00	FFS
5	Standing wave between the DUT and measurement antenna	FFS	U-shaped	1.41	FFS
6	Uncertainty of the RF power measurement equipment (NOTE 3, 7)	FFS	Normal	2.00	FFS
7	Phase curvature	FFS	U-shaped	1.41	FFS
8	Amplifier uncertainties	FFS	Normal	2.00	FFS
9	Random uncertainty	FFS	Normal	2.00	FFS
10	Influence of the XPD	FFS	U-shaped	1.41	FFS
11	Insertion Loss Variation	FFS	Rectangular	1.73	FFS
12	RF leakage (from measurement antenna to the receiver/transmitter)	FFS	Actual	1.00	FFS
13	Influence of TRP measurement grid (NOTE 4)	0.00	Actual	1	0.00
14	Influence of beam peak search grid (NOTE 5)	0.00	Actual	1	0.00
15	Multiple measurement antenna uncertainty (NOTE 9)	FFS	Actual	1	FFS
16	DUT repositioning (NOTE 4)	0.00	Rectangular	1.73	0.00
Stage 1: Calibration measurement					
17	Mismatch	FFS	U-shaped	1.41	FFS
18	Amplifier Uncertainties	FFS	Normal	2.00	FFS
19	Misalignment of positioning System	FFS	Normal	2.00	FFS
20	Uncertainty of the Network Analyzer	FFS	Normal	2.00	FFS
21	Uncertainty of the absolute gain of the calibration antenna	FFS	Normal	2.00	FFS
22	Positioning and pointing misalignment between the reference antenna and the measurement antenna	FFS	Rectangular	1.73	FFS
23	Phase centre offset of calibration antenna	FFS	Rectangular	1.73	FFS
24	Quality of quiet zone for calibration process (NOTE 10)	FFS	Actual	1.00	FFS
25	Standing wave between reference calibration antenna and measurement antenna	FFS	U-shaped	1.41	FFS
26	Influence of the calibration antenna feed cable	FFS	Normal	2.00	FFS
27	Insertion Loss Variation	FFS	Rectangular	1.73	FFS
TRP Expanded uncertainty (1.96σ - confidence interval of 95 %) [dB]					FFS
Systematic uncertainties (NOTE 6)					Value
28	Systematic error due to TRP calculation/quadrature (NOTE 4)				0.00
29	Influence of noise				FFS
30	Beam peak search				FFS
Total measurement uncertainty					Value
TRP total measurement uncertainty [dB]					FFS

NOTE 1: Void
NOTE 2: The analysis was done only for the case of operating at max output power, in-band, non-CA.
NOTE 3: The assessment assumes maximum DUT output power.
NOTE 4: This contributor shall only be considered for TRP measurements.
NOTE 5: Void
NOTE 6: In order to obtain the total measurement uncertainty, systematic uncertainties have to be added to the expanded root sum square of the standard deviations of the Stage 1 and Stage 2 contributors.
NOTE 7: Values extracted from TR 38.810 v2.6.1 in square brackets pending for further analysis.
NOTE 8: Void.
NOTE 9: Applies to the system which has a structure of mechanical feed antenna positioning.
NOTE 10: Defined as fixed value MU contributor.

Table B.17.2-4: Influence of noise measurement (f=23.45GHz, 32.125GHz, 40.8GHz, Quiet Zone size ≤ 30 cm) for PC3 UEs

	FR2a	FR2b
ChBW (50MHz)	0.54	1.0 (NOTE 6)
ChBW (100MHz)	1.0	1.0 (NOTE 5)
ChBW (200MHz)	1.0 (NOTE 4)	1.0 (NOTE 2)
ChBW (400MHz)	1.0 (NOTE 1)	1.0 (NOTE 3)
NOTE 1: This value is based on the relaxation of (MPR – 3.0) dB for MPR > 3.0dB.		
NOTE 2: Not applicable for MPR > 3.5dB		
NOTE 3: Not applicable for MPR > 2.0dB		
NOTE 4: This value is based on the relaxation of (MPR – 5.0) dB for MPR > 5.0dB.		
NOTE 5: Not applicable for MPR > 5.0dB		
NOTE 6: Not applicable for MPR > 7.5 dB		

B.18 Spurious emissions

Editor's Note:

- MU value analysis and offset value analysis for PC1, 2 and 4 are not complete.
- MU value analysis for various test setups in clause B.18.x is not complete for above 80 GHz.
- Offset value analysis is not complete as it is derived from MU value analysis for above 80 GHz.

Test procedure of general spurious emission comprises 2 stages: coarse TRP measurement and fine TRP measurement BW. Coarse TRP measurement is introduced to reduce the measurement time by applying sparser grids and/or wider measurement BW than fine TRP measurement while having offset dB more stringent test requirement in order not to cause additional misjudgement risk. For the frequency ranges for which coarse TRP measurement does not PASS, the measurement is continued with fine TRP measurement procedure.

Tables B.18-1, B.18-1a, B.18-1b summarizes the MU threshold for fine TRP measurements for General spurious emissions, spurious emission band UE co-existence and additional spurious emission, respectively. The origin MU values for fine TRP measurement for different test setups can be found in following subclauses.

Table B.18-1: MU threshold for TRP measurement for general spurious emission

Power Class	Frequency	In-band BW	In-band Power (NOTE2)	Threshold MU value [dB] (NOTE1)
PC3	6 GHz \leq f \leq 12.75 GHz	BW \leq 400MHz	P = Max Output Power	5.14
	12.75 GHz \leq f \leq 23.45 GHz			5.11
	23.45 GHz \leq f \leq 40.8 GHz			5.41
	40.8 GHz \leq f \leq 66 GHz			7.42
	66 GHz \leq f \leq 80 GHz			7.72
PC1	6 GHz \leq f \leq 12.75 GHz	BW \leq 400MHz	P = Max Output Power	FFS
	12.75 GHz \leq f \leq 23.45 GHz			FFS
	23.45 GHz \leq f \leq 40.8 GHz			FFS
	40.8 GHz \leq f \leq 66 GHz			FFS
	66 GHz \leq f \leq 80 GHz			FFS
NOTE 1: Total EIRP Expanded MU for IFF for Quiet Zone size \leq 30cm in Table B.18.2-3 to Table B.18.2-11 for PC3 UEs and in Table B.18.2.12 to Table B.18.2.16 for PC1 UEs.				
NOTE 2: Max output power level for device with corresponding power class.				

Table B.18-1a: MU threshold for TRP measurement for spurious emission band UE co-existence

Power Class	Frequency	In-band BW	In-band Power (NOTE2)	Threshold MU value [dB] (NOTE1)
PC3	n257, n260, n261	BW \leq 400MHz	P = Max Output Power	6.00
	23.6 GHz $<$ f \leq 24.0 GHz			6.00
	36 GHz \leq f \leq 37 GHz			6.00
	57 GHz \leq f \leq 66 GHz			8.01
PC1	n257, n261	BW \leq 400MHz	P = Max Output Power	FFS
	n260			FFS
	23.6 GHz $<$ f \leq 24.0 GHz			FFS
	36 GHz \leq f \leq 37 GHz			FFS
	57 GHz \leq f \leq 66 GHz			FFS
NOTE 1: Total EIRP Expanded MU for IFF for Quiet Zone size \leq 30cm in Table B.18.2-3 to Table B.18.2-11 for PC3 UEs and in Table B.18.2.12 to Table B.18.2.16 for PC1 UEs.				
NOTE 2: Max output power level for device with corresponding power class.				

Table B.18-1b: MU threshold for TRP measurement for additional spurious emission

Power Class	Frequency	In-band BW	In-band Power (NOTE2)	Threshold MU value [dB] (NOTE1)
PC3	6 GHz ≤ f ≤ 12.75 GHz NS_202	BW ≤ 400MHz	P = Max Output Power	5.14
	12.75 GHz ≤ f ≤ 23.45 GHz NS_202			5.70
	23.45 GHz ≤ f ≤ 40.8 GHz NS_202, NS_203			6.00
	40.8 GHz ≤ f ≤ 2nd harmonic of the upper frequency edge of the UL operating band NS_202			8.01
PC1	6 GHz ≤ f ≤ 12.75 GHz NS_202	BW ≤ 400MHz	P = Max Output Power	FFS
	12.75 GHz ≤ f ≤ 23.45 GHz NS_202			FFS
	23.45 GHz ≤ f ≤ 40.8 GHz NS_202, NS_203			FFS
	40.8 GHz ≤ f ≤ 2nd harmonic of the upper frequency edge of the UL operating band NS_202			FFS
NOTE 1: Total EIRP Expanded MU for IFF for Quiet Zone size ≤ 30cm in Table B.18.2-3 to Table B.18.2-11 for PC3 UEs and in Table B.18.2.12 to Table B.18.2.16 for PC1 UEs.				
NOTE 2: Max output power level for device with corresponding power class.				

Table B.18-2 provides valid coarse TRP measurement grids and corresponding offset dB value that may be used for UE general spurious emission test case. The offset value is derived as 95%-tile TRP measurement uncertainty including the effect from uncertainty due to Coarse TRP measurement grid, excluding influence of noise.

Table B.18-2: Coarse TRP measurement grids and offset values for UE Tx spurious emission

Power Class	Coarse TRP measurement grid	Frequency	Min Number of measurement points on the grid	Influence of coarse TRP measurement grid (dB)	Systematic error due to coarse TRP calculation/quadrature (dB)	Offset value (dB)
PC3	Constant density grid (charged particle based)	6 GHz ≤ f ≤ 12.75 GHz	35	0.94	0.09	5.13
		12.75 GHz ≤ f ≤ 23.45 GHz				5.09
		23.45 GHz ≤ f ≤ 40.8 GHz				5.38
		40.8 GHz ≤ f ≤ 66 GHz				7.31
		66 GHz ≤ f ≤ 80 GHz				7.61
	Constant step size grid	6 GHz ≤ f ≤ 12.75 GHz	62	0.97	0.2	5.26
		12.75 GHz ≤ f ≤ 23.45 GHz				5.23
		23.45 GHz ≤ f ≤ 40.8 GHz				5.52
		40.8 GHz ≤ f ≤ 66 GHz				7.43
		66 GHz ≤ f ≤ 80 GHz				7.73
PC1	Constant density grid (charged particle based)	6 GHz ≤ f ≤ 12.75 GHz	FFS	FFS	FFS	FFS
		12.75 GHz ≤ f ≤ 23.45 GHz				FFS
		23.45 GHz ≤ f ≤ 40.8 GHz				FFS
		40.8 GHz ≤ f ≤ 66 GHz				FFS
		66 GHz ≤ f ≤ 80 GHz				FFS
	Constant step size grid	6 GHz ≤ f ≤ 12.75 GHz	FFS	FFS	FFS	FFS
		12.75 GHz ≤ f ≤ 23.45 GHz				FFS
		23.45 GHz ≤ f ≤ 40.8 GHz				FFS
		40.8 GHz ≤ f ≤ 66 GHz				FFS
		66 GHz ≤ f ≤ 80 GHz				FFS
NOTE 1: Based on Total EIRP Expanded MU for IFF for Quiet Zone size ≤ 30cm in Table B.18.2-3 to Table B.18.2-11 for PC3 UEs and in Table B.18.2.12 to Table B.18.2.16 for PC1 UEs, replacing “Influence of TRP measurement grid” and “Systematic error due to TRP calculation/quadrature” by the values for coarse TRP grid, and excluding “Influence of noise”.						
NOTE 2: Max output power level for device with corresponding power class.						

B.18.1 Uncertainty budget format and assessment for DFF

The uncertainty contributions that may impact the overall MU value are listed in Table B.18.1-1.

Table B.18.1-1: Uncertainty contributions for TRP measurement

UID	Description of uncertainty contribution	Details in annex
Stage 2: DUT measurement		
1	Positioning misalignment	B.2.1.1
2	Measure distance uncertainty	B.2.1.2
3	Quality of quiet zone	B.2.1.3
4	Mismatch	B.2.1.4
5	Standing Wave Between the DUT and measurement antenna	B.2.1.5
6	Uncertainty of the RF power measurement equipment	B.2.1.6
7	Phase curvature	B.2.1.7
8	Amplifier uncertainties	B.2.1.8
9	Random uncertainty	B.2.1.9
10	Influence of the XPD	B.2.1.10
11	Insertion Loss Variation	B.2.1.11
12	RF leakage (from measurement antenna to the receiver/transmitter)	B.2.1.12
13	Influence of TRP measurement grid	B.2.1.22
14	Influence of beam peak search grid	B.2.1.23
15	Multiple measurement antenna uncertainty	B.2.1.25
16	DUT repositioning	B.2.1.26
Stage 1: Calibration measurement		
17	Mismatch	B.2.1.4
18	Amplifier uncertainties	B.2.1.8
19	Misalignment of positioning System	B.2.1.13
20	Uncertainty of the Network Analyzer	B.2.1.14
21	Uncertainty of the absolute gain of the calibration antenna	B.2.1.15
22	Positioning and pointing misalignment between the reference antenna and the measurement antenna	B.2.1.16
23	Phase centre offset of calibration antenna	B.2.1.18
24	Quality of quiet zone for calibration process	B.2.1.19
25	Standing wave between reference calibration antenna and measurement antenna	B.2.1.20
26	Influence of the calibration antenna feed cable	B.2.1.21
27	Insertion Loss Variation	B.2.1.11
Systematic uncertainties		
28	Systematic error due to TRP calculation/quadrature	B.2.1.24
29	Influence of noise	B.2.1.27

The uncertainty assessment tables are organized as follows:

- For the purpose of uncertainty assessment, the radiating antenna aperture of the DUT is denoted as D
- The uncertainty assessment has been derived for the case of $D = [5 \text{ cm}]$, $f = \{6 \text{ GHz to } 80 \text{ GHz}\}$, $P = [\text{Maximum output power}]$.
- The uncertainty assessment for TRP is provided in Table B.18.1-2 to B.18.1-xx

Table B.18.1-2: Uncertainty assessment for TRP measurement (f=TBD, D=TBD)

UID	Uncertainty source	Uncertainty value	Distribution of the probability	Divisor	Standard uncertainty (σ) [dB]
Stage 2: DUT measurement					
1	Positioning misalignment				
2	Measure distance uncertainty				
3	Quality of quiet zone (NOTE 2)				
4	Mismatch (NOTE 3)				
5	Standing Wave Between the DUT and measurement antenna				
6	Uncertainty of the RF power measurement equipment (NOTE 4)				
7	Phase curvature				
8	Amplifier uncertainties				
9	Random uncertainty				
10	Influence of the XPD				
11	Insertion Loss Variation				
12	RF leakage (from measurement antenna to the receiver/transmitter)				
13	Influence of TRP measurement grid (NOTE 5)				
14	Influence of beam peak search grid (NOTE 6)				
15	Multiple measurement antenna uncertainty				
16	DUT repositioning				
Stage 1: Calibration measurement					
17	Mismatch				
18	Amplifier uncertainties				
19	Misalignment of positioning System				
20	Uncertainty of the Network Analyzer				
21	Uncertainty of the absolute gain of the calibration antenna				
22	Positioning and pointing misalignment between the reference antenna and the measurement antenna				
23	Phase centre offset of calibration antenna				
24	Quality of quiet zone for calibration process (NOTE 2)				
25	Standing wave between reference calibration antenna and measurement antenna				
26	Influence of the calibration antenna feed cable				
27	Insertion Loss Variation				
TRP Expanded uncertainty (1.96σ - confidence interval of 95 %) [dB]					
Systematic uncertainties (NOTE 7)					Value
28	Systematic error due to TRP calculation/quadrature (NOTE 5)				
29	Influence of noise				
Total measurement uncertainty					
TRP total measurement uncertainty [dB]					
NOTE 1: The impact of phase variation on EIRP is FFS.					
NOTE 2: The quality of quiet zone is different for EIRP and TRP. For TRP, the standard uncertainty is FFS; for EIRP, the standard uncertainty of quiet zone is FFS.					
NOTE 3: The analysis was done only for the case of operating at max output power, in-band, non-CA.					
NOTE 4: The assessment assumes maximum DUT output power.					
NOTE 5: This contributor shall only be considered for TRP measurements.					
NOTE 6: This contributor shall only be considered for EIRP measurements.					
NOTE 7: In order to obtain the total measurement uncertainty, systematic uncertainties have to be added to the expanded root sum square of the standard deviations of the Stage 1 and Stage 2 contributors.					
NOTE 8: Void					

B.18.2 Uncertainty budget format and assessment for IFF

The uncertainty contributions that may impact the overall MU value are listed in Table B.18.2-1.

Table B.18.2-1: Uncertainty contributions for TRP measurement

UID	Description of uncertainty contribution	Details in clause
Stage 2: DUT measurement		
1	Positioning misalignment	B.2.2.1
2	Measure distance uncertainty	B.2.2.2
3	Quality of Quiet Zone	B.2.2.3
4	Mismatch	B.2.2.4
5	Standing wave between the DUT and measurement antenna	B.2.2.5
6	Uncertainty of the RF power measurement equipment	B.2.2.6
7	Phase curvature	B.2.2.7
8	Amplifier uncertainties	B.2.2.8
9	Random uncertainty	B.2.2.9
10	Influence of the XPD	B.2.2.10
11	Insertion Loss Variation	B.2.2.11
12	RF leakage (from measurement antenna to the receiver/transmitter)	B.2.2.12
13	Influence of TRP measurement grid	B.2.2.22
14	Influence of beam peak search grid	B.2.2.23
15	Multiple measurement antenna uncertainty	B.2.2.25
16	DUT repositioning	B.2.2.26
17	Misalignment of DUT due to change of DUT orientation	B.2.2.31
Stage 1: Calibration measurement		
18	Mismatch	B.2.2.4
19	Amplifier Uncertainties	B.2.2.8
20	Misalignment of positioning System	B.2.2.13
21	Uncertainty of the Network Analyzer	B.2.2.14
22	Uncertainty of the absolute gain of the calibration antenna	B.2.2.15
23	Positioning and pointing misalignment between the reference antenna and the measurement antenna	B.2.2.16
24	Phase centre offset of calibration antenna	B.2.2.18
25	Quality of quiet zone for calibration process	B.2.2.19
26	Standing wave between reference calibration antenna and measurement antenna	B.2.2.20
27	Influence of the calibration antenna feed cable	B.2.2.21
28	Insertion Loss Variation	B.2.2.11
Systematic uncertainties		
29	Systematic error due to TRP calculation/quadrature	B.2.2.24
30	Influence of noise	B.2.2.27

The uncertainty assessment tables are organized as follows:

- For the purpose of uncertainty assessment, the radiating antenna aperture of the DUT is denoted as D
- The uncertainty assessment has been derived for the case of Quiet zone size ≤ 30 cm, $f = \{6 \text{ GHz to } 80 \text{ GHz}\}$, P = Maximum output power.
- The uncertainty assessment for TRP is provided from Table B.18.2-2 to Table B.18.2-11 for PC3 UEs and from Table B.18.2.12 to Table B.18.2.16 for PC1 UEs.

Table B.18.2-2: Void

Table B.18.2-3: Uncertainty assessment for TRP measurement (f=6 GHz to 12.75GHz, Quiet Zone size \leq 30 cm) for PC3 UEs

UID	Uncertainty source	Uncertainty value	Distribution of the probability	Divisor	Standard uncertainty (σ) [dB]
Stage 2: DUT measurement					
1	Positioning misalignment	0.00	Normal	2.00	0.00
2	Measure distance uncertainty	0.00	Rectangular	1.73	0.00
3	Quality of Quiet Zone (NOTE 4)	0.70	Actual	1.00	0.70
4	Mismatch	1.50	Actual	1.00	1.50
5	Standing wave between the DUT and measurement antenna	0.00	U-shaped	1.41	0.00
6	Uncertainty of the RF power measurement equipment	2.00	Normal	2.00	1.00
7	Phase curvature	0.00	U-shaped	1.41	0.00
8	Amplifier uncertainties	2.1	Normal	2.00	1.05
9	Random uncertainty	0.5	Normal	2.00	0.25
10	Influence of the XPD	0.09	U-shaped	1.41	0.064
11	Insertion Loss Variation	0.00	Rectangular	1.73	0.00
12	RF leakage (from measurement antenna to the receiver/transmitter)	0.00	Actual	1.00	0.00
13	Influence of TRP measurement grid (NOTE 1)	0.32	Actual	1	0.32
14	Influence of beam peak search grid (NOTE 2)	N/A	Actual	1	N/A
15	Multiple measurement antenna uncertainty (NOTE 5)	0.15	Actual	1	0.15
16	DUT repositioning	0.00	Rectangular	1.73	0.00
17	Misalignment of DUT due to change of DUT orientation	0.10	Actual	1	0.10
Stage 1: Calibration measurement					
18	Mismatch	0.00	U-shaped	1.41	0.00
19	Amplifier Uncertainties	0.00	Normal	2.00	0.00
20	Misalignment of positioning System	0.00	Normal	2.00	0.00
21	Uncertainty of the Network Analyzer	0.90	Normal	2.00	0.45
22	Uncertainty of the absolute gain of the calibration antenna	0.60	Normal	2.00	0.30
23	Positioning and pointing misalignment between the reference antenna and the measurement antenna	0.05	Rectangular	1.73	0.03
24	Phase centre offset of calibration antenna	0.00	Rectangular	1.73	0.00
25	Quality of quiet zone for calibration process (NOTE 4)	0.70	Actual	1.00	0.70
26	Standing wave between reference calibration antenna and measurement antenna	0.00	U-shaped	1.41	0.00
27	Influence of the calibration antenna feed cable	0.14	Normal	2.00	0.07
28	Insertion Loss Variation	0.00	Rectangular	1.73	0.00
Expanded uncertainty (1.96σ - confidence interval of 95 %)					Value
TRP Expanded uncertainty (6 GHz < f <= 12.75 GHz) [dB] (a)					4.73
Systematic uncertainties (NOTE 3)					Value
29	Systematic error due to TRP calculation/quadrature (NOTE 1) (b)				0.0

30	General spurious emissions Influence of noise (c_1) (6 GHz < f <= 12.75 GHz)	0.41
31	Additional spurious emissions Influence of noise (c_2) NS_202 (6 GHz < f <= 12.75 GHz)	0.41
32	Systematic error related to beam peak search (NOTE 2)	N/A
Total measurement uncertainty		Value
General spurious emissions Total measurement uncertainty (a)+(b)+(c ₁) [dB] NS_202 (6 GHz < f <= 12.75 GHz)		5.14
Additional spurious emissions Total measurement uncertainty (a)+(b)+(c ₂) [dB] NS_202 (6 GHz < f <= 12.75 GHz)		5.14
NOTE 1: This contributor shall only be considered for TRP measurements.		
NOTE 2: This contributor shall only be considered for EIRP measurements.		
NOTE 3: In order to obtain the total measurement uncertainty, systematic uncertainties have to be added to the expanded root sum square of the standard deviations of the Stage 1 and Stage 2 contributors.		
NOTE 4: Value based on procedure defined in clause D.2 of TR 38.810 for Quiet Zone size of less or equal to 30 cm.		
NOTE 5: Applies to the system which has a structure of mechanical feed antenna positioning.		

Table B.18.2-4: Void

Table B.18.2-5: Uncertainty assessment for TRP measurement (f=12.75 GHz to 23.45 GHz, Quiet Zone size \leq 30 cm) for PC3 UEs

UID	Uncertainty source	Uncertainty value	Distribution of the probability	Divisor	Standard uncertainty (σ) [dB]
Stage 2: DUT measurement					
1	Positioning misalignment	0.00	Normal	2.00	0.00
2	Measure distance uncertainty	0.00	Rectangular	1.73	0.00
3	Quality of Quiet Zone (NOTE 4)	0.60	Actual	1.00	0.60
4	Mismatch	1.50	Actual	1.00	1.50
5	Standing wave between the DUT and measurement antenna	0.00	U-shaped	1.41	0.00
6	Uncertainty of the RF power measurement equipment	2.16	Normal	2.00	1.08
7	Phase curvature	0.00	U-shaped	1.41	0.00
8	Amplifier uncertainties	2.1	Normal	2.00	1.05
9	Random uncertainty	0.5	Normal	2.00	0.25
10	Influence of the XPD	0.09	U-shaped	1.41	0.064
11	Insertion Loss Variation	0.00	Rectangular	1.73	0.00
12	RF leakage (from measurement antenna to the receiver/transmitter)	0.00	Actual	1.00	0.00
13	Influence of TRP measurement grid (NOTE 1)	0.32	Actual	1	0.32
14	Influence of beam peak search grid (NOTE 2)	N/A	Actual	1	N/A
15	Multiple measurement antenna uncertainty (NOTE 5)	0.15	Actual	1	0.15
16	DUT repositioning	0.00	Rectangular	1.73	0.00
17	Misalignment of DUT due to change of DUT orientation	0.10	Actual	1	0.10
Stage 1: Calibration measurement					
18	Mismatch	0.00	U-shaped	1.41	0.00
19	Amplifier Uncertainties	0.00	Normal	2.00	0.00
20	Misalignment of positioning System	0.00	Normal	2.00	0.00
21	Uncertainty of the Network Analyzer	0.90	Normal	2.00	0.45
22	Uncertainty of the absolute gain of the calibration antenna	0.60	Normal	2.00	0.30
23	Positioning and pointing misalignment between the reference antenna and the measurement antenna	0.05	Rectangular	1.73	0.03
24	Phase centre offset of calibration antenna	0.00	Rectangular	1.73	0.00
25	Quality of quiet zone for calibration process (NOTE 4)	0.60	Actual	1.00	0.60
26	Standing wave between reference calibration antenna and measurement antenna	0.00	U-shaped	1.41	0.00
27	Influence of the calibration antenna feed cable	0.14	Normal	2.00	0.07
28	Insertion Loss Variation	0.00	Rectangular	1.73	0.00
Expanded uncertainty (1.96σ - confidence interval of 95 %)					Value
TRP Expanded uncertainty (12.75 GHz < f <= 23.45 GHz) [dB] (a)					4.70
Systematic uncertainties (NOTE 3)					Value
29	Systematic error due to TRP calculation/quadrature (NOTE 1) (b)				0.0

30	General spurious emissions Influence of noise (c_1) (12.75 GHz < f <= 23.45 GHz)	0.41
31	Additional spurious emissions Influence of noise (c_2) NS_202 (12.75 GHz < f <= 23.45 GHz)	1.0
32	Systematic error related to beam peak search (NOTE 2)	N/A
Total measurement uncertainty		Value
General spurious emissions Total measurement uncertainty (a)+(b)+(c ₁) [dB] (12.75 GHz < f <= 23.45 GHz)		5.11
Additional spurious emissions Total measurement uncertainty (a)+(b)+(c ₂) [dB] NS_202 (12.75 GHz < f <= 23.45 GHz)		5.70
NOTE 1: This contributor shall only be considered for TRP measurements.		
NOTE 2: This contributor shall only be considered for EIRP measurements.		
NOTE 3: In order to obtain the total measurement uncertainty, systematic uncertainties have to be added to the expanded root sum square of the standard deviations of the Stage 1 and Stage 2 contributors.		
NOTE 4: Value based on procedure defined in clause D.2 of TR 38.810 for Quiet Zone size of less or equal to 30 cm.		
NOTE 5: Applies to the system which has a structure of mechanical feed antenna positioning.		

Table B.18.2-6: Void

Table B.18.2-7: Uncertainty assessment for TRP measurement (f=23.45 GHz to 40.8 GHz, Quiet Zone size \leq 30 cm) for PC3 UEs

UID	Uncertainty source	Uncertainty value	Distribution of the probability	Divisor	Standard uncertainty (σ) [dB]
Stage 2: DUT measurement					
1	Positioning misalignment	0.00	Normal	2.00	0.00
2	Measure distance uncertainty	0.00	Rectangular	1.73	0.00
3	Quality of Quiet Zone (NOTE 4)	0.6	Actual	1.00	0.6
4	Mismatch	1.40	Actual	1.00	1.40
5	Standing wave between the DUT and measurement antenna	0.00	U-shaped	1.41	0.00
6	Uncertainty of the RF power measurement equipment	2.73	Normal	2.00	1.37
7	Phase curvature	0.00	U-shaped	1.41	0.00
8	Amplifier uncertainties	2.1	Normal	2.00	1.05
9	Random uncertainty	0.5	Normal	2.00	0.25
10	Influence of the XPD	0.01	U-shaped	1.41	0.00
11	Insertion Loss Variation	0.00	Rectangular	1.73	0.00
12	RF leakage (from measurement antenna to the receiver/transmitter)	0.00	Actual	1.00	0.00
13	Influence of TRP measurement grid (NOTE 1)	0.32	Actual	1	0.32
14	Influence of beam peak search grid (NOTE 2)	N/A	Actual	1	N/A
15	Multiple measurement antenna uncertainty (NOTE 5)	0.15	Actual	1	0.15
16	DUT repositioning	0.00	Rectangular	1.73	0.00
17	Misalignment of DUT due to change of DUT orientation	0.10	Actual	1	0.10
Stage 1: Calibration measurement					
18	Mismatch	0.00	U-shaped	1.41	0.00
19	Amplifier Uncertainties	0.00	Normal	2.00	0.00
20	Misalignment of positioning System	0.00	Normal	2.00	0.00
21	Uncertainty of the Network Analyzer	1.5	Normal	2.00	0.75
22	Uncertainty of the absolute gain of the calibration antenna	0.6	Normal	2.00	0.3
23	Positioning and pointing misalignment between the reference antenna and the measurement antenna	0.05	Rectangular	1.73	0.03
24	Phase centre offset of calibration antenna	0.00	Rectangular	1.73	0.00
25	Quality of quiet zone for calibration process (NOTE 4)	0.6	Actual	1.00	0.6
26	Standing wave between reference calibration antenna and measurement antenna	0.00	U-shaped	1.41	0.00
27	Influence of the calibration antenna feed cable	0.14	Normal	2.00	0.07
28	Insertion Loss Variation	0.00	Rectangular	1.73	0.00
Expanded uncertainty (1.96σ - confidence interval of 95 %)					Value
TRP Expanded uncertainty (23.45 GHz < f <= 40.8 GHz) [dB] (a)					5.00
Systematic uncertainties (NOTE 3)					Value
29	Systematic error due to TRP calculation/quadrature (NOTE 1) (b)				0.0

30	General spurious emissions Influence of noise (c ₁) (23.45 GHz < f <= 40.8 GHz)	0.41
31	Spurious emission band UE co-existence Influence of noise (c ₂) (f within NR Bands n257, n260 or n261)	1.0
32	Spurious emission band UE co-existence Influence of noise (c ₃) (36 GHz <= f <= 37 GHz)	1.0
33	Additional spurious emissions Influence of noise (c ₄) NS_202 (23.6 GHz < f <= 24.0 GHz)	1.0
34	Additional spurious emissions Influence of noise (c ₅) NS_202 (23.45 GHz < f <= 40.8 GHz)	1.0
35	Additional spurious emissions Influence of noise (c ₆) NS_203 (23.6 GHz < f <= 24.0 GHz)	1.0
36	Spurious emission band UE co-existence Influence of noise (c ₇) (23.6 GHz < f <= 24.0 GHz)	1.0
37	Systematic error related to beam peak search (NOTE 2)	N/A
Total measurement uncertainty		Value
General spurious emissions Total measurement uncertainty (a)+(b)+(c ₁) [dB] (23.45 GHz < f <= 40.8 GHz)		5.41
Spurious emission band UE co-existence Total measurement uncertainty (a)+(b)+(c ₂) [dB] (f within NR Bands n257, n260 or n261)		6.00
Spurious emission band UE co-existence Total measurement uncertainty (a)+(b)+(c ₃) [dB] (36 GHz <= f <= 37 GHz)		6.00
Additional spurious emissions Total measurement uncertainty (a)+(b)+(c ₄) [dB] NS_202 (23.6 GHz < f <= 24.0 GHz)		6.00
Additional spurious emissions Total measurement uncertainty (a)+(b)+(c ₅) [dB] NS_202 (23.45 GHz < f <= 40.8 GHz)		6.00
Additional spurious emissions Total measurement uncertainty (a)+(b)+(c ₆) [dB] NS_203 (23.6 GHz < f <= 24.0 GHz)		6.00
Additional spurious emissions Total measurement uncertainty (a)+(b)+(c ₇) [dB] (23.6 GHz < f <= 24.0 GHz)		6.00

<p>NOTE 1: This contributor shall only be considered for TRP measurements.</p> <p>NOTE 2: This contributor shall only be considered for EIRP measurements.</p> <p>NOTE 3: In order to obtain the total measurement uncertainty, systematic uncertainties have to be added to the expanded root sum square of the standard deviations of the Stage 1 and Stage 2 contributors.</p> <p>NOTE 4: Value based on procedure defined in clause D.2 of TR 38.810 for Quiet Zone size of less or equal to 30 cm.</p> <p>NOTE 5: Applies to the system which has a structure of mechanical feed antenna positioning.</p>
--

Table B.18.2-8: Void

Table B.18.2-9: Uncertainty assessment for TRP measurement (f= 40.8 GHz to 66 GHz, Quiet Zone size \leq 30 cm) for PC3 UEs

UID	Uncertainty source	Uncertainty value	Distribution of the probability	Divisor	Standard uncertainty (σ) [dB]
Stage 2: DUT measurement					
1	Positioning misalignment	0.0	Normal	2.00	0.0
2	Measure distance uncertainty	0.00	Rectangular	1.73	0.00
3	Quality of Quiet Zone (NOTE 4)	0.6	Actual	1.00	0.6
4	Mismatch	2.30	Actual	1.00	2.30
5	Standing wave between the DUT and measurement antenna	0.00	U-shaped	1.41	0.00
6	Uncertainty of the RF power measurement equipment	4.0	Normal	2.00	2.00
7	Phase curvature	0.00	U-shaped	1.41	0.00
8	Amplifier uncertainties	2.1	Normal	2.00	1.05
9	Random uncertainty	0.5	Normal	2.00	0.25
10	Influence of the XPD	0.09	U-shaped	1.41	0.064
11	Insertion Loss Variation	0.00	Rectangular	1.73	0.00
12	RF leakage (from measurement antenna to the receiver/transmitter)	0.00	Actual	1.00	0.00
13	Influence of TRP measurement grid (NOTE 1)	0.32	Actual	1	0.32
14	Influence of beam peak search grid (NOTE 2)	N/A	Actual	1	N/A
15	Multiple measurement antenna uncertainty (NOTE 5)	0.15	Actual	1	0.15
16	DUT repositioning	0.00	Rectangular	1.73	0.00
17	Misalignment of DUT due to change of DUT orientation	0.10	Actual	1	0.10
Stage 1: Calibration measurement					
18	Mismatch	0.00	U-shaped	1.41	0.00
19	Amplifier Uncertainties	0.00	Normal	2.00	0.00
20	Misalignment of positioning System	0.00	Normal	2.00	0.00
21	Uncertainty of the Network Analyzer	1.7	Normal	2.00	0.85
22	Uncertainty of the absolute gain of the calibration antenna	1.70	Normal	2.00	0.85
23	Positioning and pointing misalignment between the reference antenna and the measurement antenna	0.05	Rectangular	1.73	0.03
24	Phase centre offset of calibration antenna	0.00	Rectangular	1.73	0.00
25	Quality of quiet zone for calibration process (NOTE 4)	0.6	Actual	1.00	0.6
26	Standing wave between reference calibration antenna and measurement antenna	0.00	U-shaped	1.41	0.00
27	Influence of the calibration antenna feed cable	0.28	Normal	2.00	0.14
28	Insertion Loss Variation	0.00	Rectangular	1.73	0.00
Expanded uncertainty (1.96σ - confidence interval of 95 %)					Value
TRP Expanded uncertainty (40.8 GHz < f <= 66 GHz) [dB] (a)					7.01
Systematic uncertainties (NOTE 3)					Value
29	Systematic error due to TRP calculation/quadrature (NOTE 1) (b)				0.00

30	General spurious emissions Influence of noise (c_1) (40.8 GHz < f <= 66 GHz)	0.41
31	Spurious emission band UE co-existence Influence of noise (c_2) (57 GHz <= f <= 66 GHz)	1.0
32	Additional spurious emissions Influence of noise (c_3) NS_202 (40.8 GHz < f <= 2nd harmonic of the upper frequency edge of the UL operating band)	1.0
33	Systematic error related to beam peak search (NOTE 2)	N/A
Total measurement uncertainty		Value
General spurious emissions Total measurement uncertainty (a)+(b)+(c ₁) [dB] (40.8 GHz < f <= 66 GHz)		7.42
Spurious emission band UE co-existence Total measurement uncertainty (a)+(b)+(c ₂) [dB] (57 GHz <= f <= 66 GHz)		8.01
Additional spurious emissions Total measurement uncertainty (a)+(b)+(c ₃) [dB] NS_202 (40.8 GHz < f <= 2nd harmonic of the upper frequency edge of the UL operating band)		8.01
NOTE 1: This contributor shall only be considered for TRP measurements.		
NOTE 2: This contributor shall only be considered for EIRP measurements.		
NOTE 3: In order to obtain the total measurement uncertainty, systematic uncertainties have to be added to the expanded root sum square of the standard deviations of the Stage 1 and Stage 2 contributors.		
NOTE 4: Value based on procedure defined in clause D.2 of TR 38.810 for Quiet Zone size of less or equal to 30 cm.		
NOTE 5: Applies to the system which has a structure of mechanical feed antenna positioning.		
NOTE 6: Void		

Table B.18.2-10: Void

Table B.18.2-11: Uncertainty assessment for TRP measurement (f= 66 GHz to 80 GHz, Quiet Zone size \leq 30 cm) for PC3 UEs

UID	Uncertainty source	Uncertainty value	Distribution of the probability	Divisor	Standard uncertainty (σ) [dB]
Stage 2: DUT measurement					
1	Positioning misalignment	0.00	Normal	2.00	0.00
2	Measure distance uncertainty	0.00	Rectangular	1.73	0.00
3	Quality of Quiet Zone (NOTE 4)	0.6	Actual	1.00	0.6
4	Mismatch	2.30	Actual	1.00	2.30
5	Standing wave between the DUT and measurement antenna	0.00	U-shaped	1.41	0.00
6	Uncertainty of the RF power measurement equipment	4.00	Normal	2.00	2.00
7	Phase curvature	0.00	U-shaped	1.41	0.00
8	Amplifier uncertainties	3.0	Normal	2.00	1.50
9	Random uncertainty	0.5	Normal	2.00	0.25
10	Influence of the XPD	0.09	U-shaped	1.41	0.064
11	Insertion Loss Variation	0.00	Rectangular	1.73	0.00
12	RF leakage (from measurement antenna to the receiver/transmitter)	0.00	Actual	1.00	0.00
13	Influence of TRP measurement grid (NOTE 1)	0.32	Actual	1	0.32
14	Influence of beam peak search grid (NOTE 2)	N/A	Actual	1	N/A
15	Multiple measurement antenna uncertainty (NOTE 5)	0.15	Actual	1	0.15
16	DUT repositioning	0.00	Rectangular	1.73	0.00
17	Misalignment of DUT due to change of DUT orientation	0.10	Actual	1	0.10
Stage 1: Calibration measurement					
18	Mismatch	0.00	U-shaped	1.41	0.00
19	Amplifier Uncertainties	0.00	Normal	2.00	0.00
20	Misalignment of positioning System	0.00	Normal	2.00	0.00
21	Uncertainty of the Network Analyzer	1.70	Normal	2.00	0.85
22	Uncertainty of the absolute gain of the calibration antenna	1.70	Normal	2.00	0.85
23	Positioning and pointing misalignment between the reference antenna and the measurement antenna	0.05	Rectangular	1.73	0.03
24	Phase centre offset of calibration antenna	0.00	Rectangular	1.73	0.00
25	Quality of quiet zone for calibration process (NOTE 4)	0.60	Actual	1.00	0.60
26	Standing wave between reference calibration antenna and measurement antenna	0.00	U-shaped	1.41	0.00
27	Influence of the calibration antenna feed cable	0.28	Normal	2.00	0.14
28	Insertion Loss Variation	0.00	Rectangular	1.73	0.00
Expanded uncertainty (1.96σ - confidence interval of 95 %)					Value
TRP Expanded uncertainty (66 GHz < f <= 80 GHz) [dB] (a)					7.31
Systematic uncertainties (NOTE 3)					Value
29	Systematic error due to TRP calculation/quadrature (NOTE 1) (b)				0.00

30	General spurious emissions Influence of noise (c_1) (66 GHz < f <= 80 GHz)	0.41
31	Systematic error related to beam peak search (NOTE 2)	N/A
Total measurement uncertainty		Value
General spurious emissions Total measurement uncertainty (a)+(b)+(c ₁) [dB] (66 GHz < f <= 80 GHz)		7.72
<p>NOTE 1: This contributor shall only be considered for TRP measurements.</p> <p>NOTE 2: This contributor shall only be considered for EIRP measurements.</p> <p>NOTE 3: In order to obtain the total measurement uncertainty, systematic uncertainties have to be added to the expanded root sum square of the standard deviations of the Stage 1 and Stage 2 contributors.</p> <p>NOTE 4: Value based on procedure defined in clause D.2 of TR 38.810 for Quiet Zone size of less or equal to 30 cm.</p> <p>NOTE 5: Applies to the system which has a structure of mechanical feed antenna positioning.</p>		

Table B.18.2-12: Uncertainty assessment for TRP measurement (f=6 GHz to 12.75GHz, Quiet Zone size \leq 30 cm) for PC1 UEs

UID	Uncertainty source	Uncertainty value	Distribution of the probability	Divisor	Standard uncertainty (σ) [dB]
Stage 2: DUT measurement					
1	Positioning misalignment	FFS	Normal	2.00	FFS
2	Measure distance uncertainty	FFS	Rectangular	1.73	FFS
3	Quality of Quiet Zone (NOTE 4)	FFS	Actual	1.00	FFS
4	Mismatch	FFS	Actual	1.00	FFS
5	Standing wave between the DUT and measurement antenna	FFS	U-shaped	1.41	FFS
6	Uncertainty of the RF power measurement equipment	FFS	Normal	2.00	FFS
7	Phase curvature	FFS	U-shaped	1.41	FFS
8	Amplifier uncertainties	FFS	Normal	2.00	FFS
9	Random uncertainty	FFS	Normal	2.00	FFS
10	Influence of the XPD	FFS	U-shaped	1.41	FFS
11	Insertion Loss Variation	FFS	Rectangular	1.73	FFS
12	RF leakage (from measurement antenna to the receiver/transmitter)	FFS	Actual	1.00	FFS
13	Influence of TRP measurement grid (NOTE 1)	FFS	Actual	1	FFS
14	Influence of beam peak search grid (NOTE 2)	FFS	Actual	1	FFS
15	Multiple measurement antenna uncertainty (NOTE 5)	FFS	Actual	1	FFS
16	DUT repositioning	FFS	Rectangular	1.73	FFS
17	Misalignment of DUT due to change of DUT orientation	FFS	Actual	1	FFS
Stage 1: Calibration measurement					
18	Mismatch	FFS	U-shaped	1.41	FFS
19	Amplifier Uncertainties	FFS	Normal	2.00	FFS
20	Misalignment of positioning System	FFS	Normal	2.00	FFS
21	Uncertainty of the Network Analyzer	FFS	Normal	2.00	FFS
22	Uncertainty of the absolute gain of the calibration antenna	FFS	Normal	2.00	FFS
23	Positioning and pointing misalignment between the reference antenna and the measurement antenna	FFS	Rectangular	1.73	FFS
24	Phase centre offset of calibration antenna	FFS	Rectangular	1.73	FFS
25	Quality of quiet zone for calibration process (NOTE 4)	FFS	Actual	1.00	FFS
26	Standing wave between reference calibration antenna and measurement antenna	FFS	U-shaped	1.41	FFS
27	Influence of the calibration antenna feed cable	FFS	Normal	2.00	FFS
28	Insertion Loss Variation	FFS	Rectangular	1.73	FFS
Expanded uncertainty (1.96σ - confidence interval of 95 %)					Value
TRP Expanded uncertainty (6 GHz < f <= 12.75 GHz) [dB] (a)					FFS
Systematic uncertainties (NOTE 3)					Value
29	Systematic error due to TRP calculation/quadrature (NOTE 1) (b)				FFS

30	General spurious emissions Influence of noise (c_1) (6 GHz < f <= 12.75 GHz)	FFS
31	Additional spurious emissions Influence of noise (c_2) NS_202 (6 GHz < f <= 12.75 GHz)	FFS
32	Systematic error related to beam peak search (NOTE 2)	N/A
Total measurement uncertainty		Value
General spurious emissions Total measurement uncertainty (a)+(b)+(c ₁) [dB] (6 GHz < f <= 12.75 GHz)		FFS
Additional spurious emissions Total measurement uncertainty (a)+(b)+(c ₂) [dB] NS_202 (6 GHz < f <= 12.75 GHz)		FFS
<p>NOTE 1: This contributor shall only be considered for TRP measurements.</p> <p>NOTE 2: This contributor shall only be considered for EIRP measurements.</p> <p>NOTE 3: In order to obtain the total measurement uncertainty, systematic uncertainties have to be added to the expanded root sum square of the standard deviations of the Stage 1 and Stage 2 contributors.</p> <p>NOTE 4: Value based on procedure defined in clause D.2 of TR 38.810 for Quiet Zone size of less or equal to 30 cm.</p> <p>NOTE 5: Applies to the system which has a structure of mechanical feed antenna positioning.</p>		

Table B.18.2-13: Uncertainty assessment for TRP measurement (f=12.75 GHz to 23.45 GHz, Quiet Zone size \leq 30 cm) for PC1 UEs

UID	Uncertainty source	Uncertainty value	Distribution of the probability	Divisor	Standard uncertainty (σ) [dB]
Stage 2: DUT measurement					
1	Positioning misalignment	FFS	Normal	2.00	FFS
2	Measure distance uncertainty	FFS	Rectangular	1.73	FFS
3	Quality of Quiet Zone (NOTE 4)	FFS	Actual	1.00	FFS
4	Mismatch	FFS	Actual	1.00	FFS
5	Standing wave between the DUT and measurement antenna	FFS	U-shaped	1.41	FFS
6	Uncertainty of the RF power measurement equipment	FFS	Normal	2.00	FFS
7	Phase curvature	FFS	U-shaped	1.41	FFS
8	Amplifier uncertainties	FFS	Normal	2.00	FFS
9	Random uncertainty	FFS	Normal	2.00	FFS
10	Influence of the XPD	FFS	U-shaped	1.41	FFS
11	Insertion Loss Variation	FFS	Rectangular	1.73	FFS
12	RF leakage (from measurement antenna to the receiver/transmitter)	FFS	Actual	1.00	FFS
13	Influence of TRP measurement grid (NOTE 1)	FFS	Actual	1	FFS
14	Influence of beam peak search grid (NOTE 2)	FFS	Actual	1	FFS
15	Multiple measurement antenna uncertainty (NOTE 5)	FFS	Actual	1	FFS
16	DUT repositioning	FFS	Rectangular	1.73	FFS
17	Misalignment of DUT due to change of DUT orientation	FFS	Actual	1	FFS
Stage 1: Calibration measurement					
18	Mismatch	FFS	U-shaped	1.41	FFS
19	Amplifier Uncertainties	FFS	Normal	2.00	FFS
20	Misalignment of positioning System	FFS	Normal	2.00	FFS
21	Uncertainty of the Network Analyzer	FFS	Normal	2.00	FFS
22	Uncertainty of the absolute gain of the calibration antenna	FFS	Normal	2.00	FFS
23	Positioning and pointing misalignment between the reference antenna and the measurement antenna	FFS	Rectangular	1.73	FFS
24	Phase centre offset of calibration antenna	FFS	Rectangular	1.73	FFS
25	Quality of quiet zone for calibration process (NOTE 4)	FFS	Actual	1.00	FFS
26	Standing wave between reference calibration antenna and measurement antenna	FFS	U-shaped	1.41	FFS
27	Influence of the calibration antenna feed cable	FFS	Normal	2.00	FFS
28	Insertion Loss Variation	FFS	Rectangular	1.73	FFS
Expanded uncertainty (1.96σ - confidence interval of 95 %)					Value
TRP Expanded uncertainty (12.75 GHz < f <= 23.45 GHz) [dB] (a)					FFS
Systematic uncertainties (NOTE 3)					Value
29	Systematic error due to TRP calculation/quadrature (NOTE 1) (b)				FFS

30	General spurious emissions Influence of noise (c_1) (12.75 GHz < f <= 23.45 GHz)	FFS
31	Additional spurious emissions Influence of noise (c_2) NS_202 (12.75 GHz < f <= 23.45 GHz)	FFS
32	Systematic error related to beam peak search (NOTE 2)	N/A
Total measurement uncertainty		Value
General spurious emissions Total measurement uncertainty (a)+(b)+(c) [dB] (12.75 GHz < f <= 23.45 GHz)		FFS
Additional spurious emissions Total measurement uncertainty (a)+(b)+(c ₂) [dB] NS_202 (12.75 GHz < f <= 23.45 GHz)		FFS
NOTE 1: This contributor shall only be considered for TRP measurements.		
NOTE 2: This contributor shall only be considered for EIRP measurements.		
NOTE 3: In order to obtain the total measurement uncertainty, systematic uncertainties have to be added to the expanded root sum square of the standard deviations of the Stage 1 and Stage 2 contributors.		
NOTE 4: Value based on procedure defined in clause D.2 of TR 38.810 for Quiet Zone size of less or equal to 30 cm.		
NOTE 5: Applies to the system which has a structure of mechanical feed antenna positioning.		

Table B.18.2-14: Uncertainty assessment for TRP measurement (f=23.45 GHz to 40.8 GHz, Quiet Zone size \leq 30 cm) for PC1 UEs

UID	Uncertainty source	Uncertainty value	Distribution of the probability	Divisor	Standard uncertainty (σ) [dB]
Stage 2: DUT measurement					
1	Positioning misalignment	FFS	Normal	2.00	FFS
2	Measure distance uncertainty	FFS	Rectangular	1.73	FFS
3	Quality of Quiet Zone (NOTE 4)	FFS	Actual	1.00	FFS
4	Mismatch	FFS	Actual	1.00	FFS
5	Standing wave between the DUT and measurement antenna	FFS	U-shaped	1.41	FFS
6	Uncertainty of the RF power measurement equipment	FFS	Normal	2.00	FFS
7	Phase curvature	FFS	U-shaped	1.41	FFS
8	Amplifier uncertainties	FFS	Normal	2.00	FFS
9	Random uncertainty	FFS	Normal	2.00	FFS
10	Influence of the XPD	FFS	U-shaped	1.41	FFS
11	Insertion Loss Variation	FFS	Rectangular	1.73	FFS
12	RF leakage (from measurement antenna to the receiver/transmitter)	FFS	Actual	1.00	FFS
13	Influence of TRP measurement grid (NOTE 1)	FFS	Actual	1	FFS
14	Influence of beam peak search grid (NOTE 2)	FFS	Actual	1	FFS
15	Multiple measurement antenna uncertainty (NOTE 5)	FFS	Actual	1	FFS
16	DUT repositioning	FFS	Rectangular	1.73	FFS
17	Misalignment of DUT due to change of DUT orientation	FFS	Actual	1	FFS
Stage 1: Calibration measurement					
18	Mismatch	FFS	U-shaped	1.41	FFS
19	Amplifier Uncertainties	FFS	Normal	2.00	FFS
20	Misalignment of positioning System	FFS	Normal	2.00	FFS
21	Uncertainty of the Network Analyzer	FFS	Normal	2.00	FFS
22	Uncertainty of the absolute gain of the calibration antenna	FFS	Normal	2.00	FFS
23	Positioning and pointing misalignment between the reference antenna and the measurement antenna	FFS	Rectangular	1.73	FFS
24	Phase centre offset of calibration antenna	FFS	Rectangular	1.73	FFS
25	Quality of quiet zone for calibration process (NOTE 4)	FFS	Actual	1.00	FFS
26	Standing wave between reference calibration antenna and measurement antenna	FFS	U-shaped	1.41	FFS
27	Influence of the calibration antenna feed cable	FFS	Normal	2.00	FFS
28	Insertion Loss Variation	FFS	Rectangular	1.73	FFS
	Expanded uncertainty (1.96σ - confidence interval of 95 %)				Value
	TRP Expanded uncertainty (23.45 GHz < f <= 40.8 GHz) [dB] (a)				FFS
	Systematic uncertainties (NOTE 3)				Value
29	Systematic error due to TRP calculation/quadrature (NOTE 1) (b)				FFS

30	General spurious emissions Influence of noise (c ₁) (23.45 GHz < f <= 40.8 GHz)	FFS
31	Spurious emission band UE co-existence Influence of noise (c ₂) (f within NR Bands n257, n260 or n261)	FFS
32	Spurious emission band UE co-existence Influence of noise (c ₃) (36 GHz <= f <= 37 GHz)	FFS
33	Additional spurious emissions Influence of noise (c ₄) NS_202 (23.6 GHz < f <= 24.0 GHz)	FFS
34	Additional spurious emissions Influence of noise (c ₅) NS_202 (23.45 GHz < f <= 40.8 GHz)	FFS
35	Additional spurious emissions Influence of noise (c ₆) NS_203 (23.6 GHz < f <= 24.0 GHz)	FFS
36	Spurious emission band UE co-existence Influence of noise (c ₇) (23.6 GHz < f <= 24.0 GHz)	FFS
37	Systematic error related to beam peak search (NOTE 2)	N/A
Total measurement uncertainty		Value
General spurious emissions Total measurement uncertainty (a)+(b)+(c ₁) [dB] (23.45 GHz < f <= 40.8 GHz)		FFS
Spurious emission band UE co-existence Total measurement uncertainty (a)+(b)+(c ₂) [dB] (f within NR Bands n257, n260 or n261)		FFS
Spurious emission band UE co-existence Total measurement uncertainty (a)+(b)+(c ₃) [dB] (36 GHz <= f <= 37 GHz)		FFS
Additional spurious emissions Total measurement uncertainty (a)+(b)+(c ₄) [dB] NS_202 (23.6 GHz < f <= 24.0 GHz)		FFS
Additional spurious emissions Total measurement uncertainty (a)+(b)+(c ₅) [dB] NS_202 (23.45 GHz < f <= 40.8 GHz)		FFS
Additional spurious emissions Total measurement uncertainty (a)+(b)+(c ₆) [dB] NS_203 (23.6 GHz < f <= 24.0 GHz)		FFS
Additional spurious emissions Total measurement uncertainty (a)+(b)+(c ₇) [dB] (23.6 GHz < f <= 24.0 GHz)		FFS

- NOTE 1: This contributor shall only be considered for TRP measurements.
- NOTE 2: This contributor shall only be considered for EIRP measurements.
- NOTE 3: In order to obtain the total measurement uncertainty, systematic uncertainties have to be added to the expanded root sum square of the standard deviations of the Stage 1 and Stage 2 contributors.
- NOTE 4: Value based on procedure defined in clause D.2 of TR 38.810 for Quiet Zone size of less or equal to 30 cm.
- NOTE 5: Applies to the system which has a structure of mechanical feed antenna positioning.

Table B.18.2-15: Uncertainty assessment for TRP measurement (f= 40.8 GHz to 66 GHz, Quiet Zone size \leq 30 cm) for PC1 UEs

UID	Uncertainty source	Uncertainty value	Distribution of the probability	Divisor	Standard uncertainty (σ) [dB]
Stage 2: DUT measurement					
1	Positioning misalignment	FFS	Normal	2.00	FFS
2	Measure distance uncertainty	FFS	Rectangular	1.73	FFS
3	Quality of Quiet Zone (NOTE 4)	FFS	Actual	1.00	FFS
4	Mismatch	FFS	Actual	1.00	FFS
5	Standing wave between the DUT and measurement antenna	FFS	U-shaped	1.41	FFS
6	Uncertainty of the RF power measurement equipment	FFS	Normal	2.00	FFS
7	Phase curvature	FFS	U-shaped	1.41	FFS
8	Amplifier uncertainties	FFS	Normal	2.00	FFS
9	Random uncertainty	FFS	Normal	2.00	FFS
10	Influence of the XPD	FFS	U-shaped	1.41	FFS
11	Insertion Loss Variation	FFS	Rectangular	1.73	FFS
12	RF leakage (from measurement antenna to the receiver/transmitter)	FFS	Actual	1.00	FFS
13	Influence of TRP measurement grid (NOTE 1)	FFS	Actual	1	FFS
14	Influence of beam peak search grid (NOTE 2)	FFS	Actual	1	FFS
15	Multiple measurement antenna uncertainty (NOTE 5)	FFS	Actual	1	FFS
16	DUT repositioning	FFS	Rectangular	1.73	FFS
17	Misalignment of DUT due to change of DUT orientation	FFS	Actual	1	FFS
Stage 1: Calibration measurement					
18	Mismatch	FFS	U-shaped	1.41	FFS
19	Amplifier Uncertainties	FFS	Normal	2.00	FFS
20	Misalignment of positioning System	FFS	Normal	2.00	FFS
21	Uncertainty of the Network Analyzer	FFS	Normal	2.00	FFS
22	Uncertainty of the absolute gain of the calibration antenna	FFS	Normal	2.00	FFS
23	Positioning and pointing misalignment between the reference antenna and the measurement antenna	FFS	Rectangular	1.73	FFS
24	Phase centre offset of calibration antenna	FFS	Rectangular	1.73	FFS
25	Quality of quiet zone for calibration process (NOTE 4)	FFS	Actual	1.00	FFS
26	Standing wave between reference calibration antenna and measurement antenna	FFS	U-shaped	1.41	FFS
27	Influence of the calibration antenna feed cable	FFS	Normal	2.00	FFS
28	Insertion Loss Variation	FFS	Rectangular	1.73	FFS
Expanded uncertainty (1.96σ - confidence interval of 95 %)					Value
TRP Expanded uncertainty (40.8 GHz < f <= 66 GHz) [dB] (a)					FFS
Systematic uncertainties (NOTE 3)					Value
29	Systematic error due to TRP calculation/quadrature (NOTE 1) (b)				FFS

30	General spurious emissions Influence of noise (c ₁) (40.8 GHz < f <= 66 GHz)	FFS
31	Spurious emission band UE co-existence Influence of noise (c ₂) (57 GHz <= f <= 66 GHz)	FFS
32	Additional spurious emissions Influence of noise (c ₃) NS_202 (40.8 GHz < f <= 2nd harmonic of the upper frequency edge of the UL operating band)	FFS
33	Systematic error related to beam peak search (NOTE 2)	N/A
Total measurement uncertainty		Value
General spurious emissions Total measurement uncertainty (a)+(b)+(c ₁) [dB] (40.8 GHz < f <= 66 GHz)		FFS
Spurious emission band UE co-existence Total measurement uncertainty (a)+(b)+(c ₂) [dB] (57 GHz <= f <= 66 GHz)		FFS
Additional spurious emissions Total measurement uncertainty (a)+(b)+(c ₃) [dB] NS_202 (40.8 GHz < f <= 2nd harmonic of the upper frequency edge of the UL operating band)		FFS
<p>NOTE 1: This contributor shall only be considered for TRP measurements.</p> <p>NOTE 2: This contributor shall only be considered for EIRP measurements.</p> <p>NOTE 3: In order to obtain the total measurement uncertainty, systematic uncertainties have to be added to the expanded root sum square of the standard deviations of the Stage 1 and Stage 2 contributors.</p> <p>NOTE 4: Value based on procedure defined in clause D.2 of TR 38.810 for Quiet Zone size of less or equal to 30 cm.</p> <p>NOTE 5: Applies to the system which has a structure of mechanical feed antenna positioning.</p> <p>NOTE 6: Void</p>		

Table B.18.2-16: Uncertainty assessment for TRP measurement (f= 66 GHz to 80 GHz, Quiet Zone size \leq 30 cm) for PC1 UEs

UID	Uncertainty source	Uncertainty value	Distribution of the probability	Divisor	Standard uncertainty (σ) [dB]
Stage 2: DUT measurement					
1	Positioning misalignment	FFS	Normal	2.00	FFS
2	Measure distance uncertainty	FFS	Rectangular	1.73	FFS
3	Quality of Quiet Zone (NOTE 4)	FFS	Actual	1.00	FFS
4	Mismatch	FFS	Actual	1.00	FFS
5	Standing wave between the DUT and measurement antenna	FFS	U-shaped	1.41	FFS
6	Uncertainty of the RF power measurement equipment	FFS	Normal	2.00	FFS
7	Phase curvature	FFS	U-shaped	1.41	FFS
8	Amplifier uncertainties	FFS	Normal	2.00	FFS
9	Random uncertainty	FFS	Normal	2.00	FFS
10	Influence of the XPD	FFS	U-shaped	1.41	FFS
11	Insertion Loss Variation	FFS	Rectangular	1.73	FFS
12	RF leakage (from measurement antenna to the receiver/transmitter)	FFS	Actual	1.00	FFS
13	Influence of TRP measurement grid (NOTE 1)	FFS	Actual	1	FFS
14	Influence of beam peak search grid (NOTE 2)	N/A	Actual	1	N/A
15	Multiple measurement antenna uncertainty (NOTE 5)	FFS	Actual	1	FFS
16	DUT repositioning	FFS	Rectangular	1.73	FFS
17	Misalignment of DUT due to change of DUT orientation	FFS	Actual	1	FFS
Stage 1: Calibration measurement					
18	Mismatch	FFS	U-shaped	1.41	FFS
19	Amplifier Uncertainties	FFS	Normal	2.00	FFS
20	Misalignment of positioning System	FFS	Normal	2.00	FFS
21	Uncertainty of the Network Analyzer	FFS	Normal	2.00	FFS
22	Uncertainty of the absolute gain of the calibration antenna	FFS	Normal	2.00	FFS
23	Positioning and pointing misalignment between the reference antenna and the measurement antenna	FFS	Rectangular	1.73	FFS
24	Phase centre offset of calibration antenna	FFS	Rectangular	1.73	FFS
25	Quality of quiet zone for calibration process (NOTE 4)	FFS	Actual	1.00	FFS
26	Standing wave between reference calibration antenna and measurement antenna	FFS	U-shaped	1.41	FFS
27	Influence of the calibration antenna feed cable	FFS	Normal	2.00	FFS
28	Insertion Loss Variation	FFS	Rectangular	1.73	FFS
Expanded uncertainty (1.96σ - confidence interval of 95 %)					Value
TRP Expanded uncertainty (66 GHz < f <= 80 GHz) [dB] (a)					FFS
Systematic uncertainties (NOTE 3)					Value
29	Systematic error due to TRP calculation/quadrature (NOTE 1) (b)				FFS

30	General spurious emissions Influence of noise (c ₁) (66 GHz < f <= 80 GHz)	FFS
31	Systematic error related to beam peak search (NOTE 2)	N/A
Total measurement uncertainty		Value
General spurious emissions Total measurement uncertainty (a)+(b)+(c ₁) [dB] (66 GHz < f <= 80 GHz)		FFS
NOTE 1: This contributor shall only be considered for TRP measurements.		
NOTE 2: This contributor shall only be considered for EIRP measurements.		
NOTE 3: In order to obtain the total measurement uncertainty, systematic uncertainties have to be added to the expanded root sum square of the standard deviations of the Stage 1 and Stage 2 contributors.		
NOTE 4: Value based on procedure defined in clause D.2 of TR 38.810 for Quiet Zone size of less or equal to 30 cm.		
NOTE 5: Applies to the system which has a structure of mechanical feed antenna positioning.		

NOTE: MU assessment for additional spurious in Table B.18.2-3 to Table B.18.2-16 is based on the following relaxations:

Table B.18.2-17: Transmitter Spurious emissions relaxation considered in MU assessment (Quiet Zone size ≤ 30 cm)

Power Class	Frequency	Relaxation
PC1	6 GHz < f <= 12.75 GHz	FFS
	12.75 GHz < f <= 23.45 GHz	FFS
	23.45GHz <= f <= 40.8GHz	FFS
	40.8 GHz < f <= 66 GHz	FFS
	66 GHz < f <= 80 GHz	FFS
PC2	6 GHz < f <= 12.75 GHz	FFS
	12.75 GHz < f <= 23.45 GHz	FFS
	23.45GHz <= f <= 40.8GHz	FFS
	40.8 GHz < f <= 66 GHz	FFS
	66 GHz < f <= 80 GHz	FFS
PC3	6 GHz < f <= 12.75 GHz	0 dB
	12.75 GHz < f <= 23.45 GHz	0 dB
	23.45GHz <= f <= 40.8GHz	0 dB
	40.8 GHz < f <= 66 GHz	0 dB
	66 GHz < f <= 80 GHz	0 dB
PC4	6 GHz < f <= 12.75 GHz	FFS
	12.75 GHz < f <= 23.45 GHz	FFS
	23.45GHz <= f <= 40.8GHz	FFS
	40.8 GHz < f <= 66 GHz	FFS
	66 GHz < f <= 80 GHz	FFS

Table B.18.2-18: Spurious emissions band UE co-existence relaxation considered in MU assessment (Quiet Zone size \leq 30 cm)

Power Class	Frequency	Relaxation
PC1	23.45GHz \leq f \leq 40.8GHz	FFS
	40.8 GHz < f \leq 66 GHz	FFS
PC2	23.45GHz \leq f \leq 40.8GHz	FFS
	40.8 GHz < f \leq 66 GHz	FFS
PC3	23.45GHz \leq f \leq 40.8GHz	3.3 dB (for protected bands n257, n261) 5 dB (for protected band n260) 0.3 dB (for 23.6 GHz \leq f \leq 24.0 GHz)
	40.8 GHz < f \leq 66 GHz	6 dB (for 36.0 GHz \leq f \leq 37.0 GHz) 0 dB (for 57.0 GHz \leq f \leq 66.0 GHz)
PC4	23.45GHz \leq f \leq 40.8GHz	FFS
	40.8 GHz < f \leq 66 GHz	FFS

Table B.18.2-19: Additional Spurious emissions relaxation considered in MU assessment (Quiet Zone size \leq 30 cm)

Power Class	Frequency	Relaxation
PC1	6 GHz < f \leq 12.75 GHz	FFS
	12.75 GHz < f \leq 23.45 GHz	FFS
	23.45GHz \leq f \leq 40.8GHz	FFS
	40.8 GHz < f \leq 66 GHz	FFS
	66 GHz < f \leq 80 GHz	FFS
PC2	6 GHz < f \leq 12.75 GHz	FFS
	12.75 GHz < f \leq 23.45 GHz	FFS
	23.45GHz \leq f \leq 40.8GHz	FFS
	40.8 GHz < f \leq 66 GHz	FFS
	66 GHz < f \leq 80 GHz	FFS
PC3	6 GHz < f \leq 12.75 GHz	0 dB (NS_202)
	12.75 GHz < f \leq 23.45 GHz	13 dB (NS_202)
	23.45GHz \leq f \leq 40.8GHz	13 dB (whole frequency range for NS_202) 0.3 dB (for 23.6 GHz \leq f \leq 24.0 GHz for NS_202 & NS_203)
	40.8 GHz < f \leq 66 GHz	13 dB (NS_202)
	66 GHz < f \leq 80 GHz	13 dB (NS_202)
PC4	6 GHz < f \leq 12.75 GHz	FFS
	12.75 GHz < f \leq 23.45 GHz	FFS
	23.45GHz \leq f \leq 40.8GHz	FFS
	40.8 GHz < f \leq 66 GHz	FFS
	66 GHz < f \leq 80 GHz	FFS

B.18.3 Uncertainty budget format and assessment for NFTF

FFS

B.18a Beam correspondence - EIRP

B.18a.1 Uncertainty budget format and assessment for DFF

The uncertainty contributions that may impact the overall MU value are listed in Table B.18a.1-1.

Table B.18a.1-1: Uncertainty contributions for Beam correspondence - EIRP measurement

UID	Description of uncertainty contribution	Details in annex
Stage 2: DUT measurement		
1	Uncertainty of the RF relative power measurement equipment	B.2.1.36
2	Amplifier uncertainties	B.2.1.8
Stage 1: Calibration measurement		
	N/A	
Systematic uncertainties		
3	Influence of noise	B.2.1.27

The uncertainty assessment tables are organized as follows:

- For the purpose of uncertainty assessment, the radiating antenna aperture of the DUT is denoted as D
- The uncertainty assessment has been derived for the case of $D = [5 \text{ cm}]$, $f = \{22.65\text{GHz}, 31.1\text{GHz}, 45.1\text{GHz}\}$, $P = [\text{maximum output power}]$.
- The uncertainty assessment for Beam correspondence - EIRP is provided in Table B.18a.1-2.

Table B.18a.1-2: Uncertainty assessment for Beam correspondence - EIRP measurement (f=TBD, D=TBD)

UID	Uncertainty source	Uncertainty value	Distribution of the probability	Divisor	Standard uncertainty (σ) [dB]
Stage 2: DUT measurement					
1	Uncertainty of the RF relative power measurement equipment	FFS	FFS	FFS	FFS
2	Amplifier uncertainties	FFS	FFS	FFS	FFS
Stage 1: Calibration measurement					
	N/A				
Systematic uncertainties (NOTE 1)					
3	Influence of noise				Value
Total measurement uncertainty					
Value					
EIRP Expanded uncertainty (1.96σ - confidence interval of 95 %) [dB]					FFS
NOTE 1: In order to obtain the total measurement uncertainty, systematic uncertainties have to be added to the expanded root sum square of the standard deviations of the Stage 1 and Stage 2 contributors.					

B.18a.2 Uncertainty budget format and assessment for IFF

The uncertainty contributions that may impact the overall MU value are listed in Table B.18a.2.-1.

Table B.18a.2-1: Uncertainty contributions for Beam correspondence - EIRP measurement

UID	Description of uncertainty contribution	Details in annex
Stage 2: DUT measurement		
1	Uncertainty of the RF relative power measurement equipment	B.2.2.36
2	Amplifier uncertainties	B.2.2.8
Stage 1: Calibration measurement		
	N/A	
Systematic uncertainties		
3	Influence of noise	B.2.2.27

The uncertainty assessment tables are organized as follows:

- For the purpose of uncertainty assessment, the radiating antenna aperture of the DUT is denoted as D
- The uncertainty assessment has been derived for the case of Quiet Zone size $\leq [30 \text{ cm}]$, $f = \{23.45\text{GHz}, 32.125\text{GHz}, 40.8\text{GHz}\}$.

- The uncertainty assessment for Beam Correspondence - EIRP is provided in Table B.18a.2-2.for PC3.

Table B.18a.2-2: Uncertainty assessment for Beam correspondence - EIRP measurement (f=23.45GHz, 32.125GHz, 40.8GHz, Quiet Zone size ≤ 30 cm) for PC3 UEs and normal temperature condition

UID	Uncertainty source	Uncertainty value	Distribution of the probability	Divisor	Standard uncertainty (σ) [dB]
Stage 2: DUT measurement					
1	Uncertainty of the RF relative power measurement equipment	[0.4]	Normal	2.00	[0.2]
2	Amplifier uncertainties	2.1	Rectangular	1.73	1.05
Stage 1: Calibration measurement					
	N/A				
Systematic uncertainties (NOTE 1)					Value
3	Influence of noise (23.45GHz ≤ f ≤ 32.125GHz)				FFS
4	Influence of noise (32.125GHz < f ≤ 40.8GHz)				FFS
Total measurement uncertainty					Value
EIRP Expanded uncertainty (23.45GHz ≤ f ≤ 32.125GHz) (1.96 σ - confidence interval of 95 %) [dB]					FFS
EIRP Expanded uncertainty (32.125GHz < f ≤ 40.8GHz) (1.96 σ - confidence interval of 95 %) [dB]					FFS
NOTE 1: In order to obtain the total measurement uncertainty, systematic uncertainties have to be added to the expanded root sum square of the standard deviations of the Stage 1 and Stage 2 contributors.					
NOTE 2: Power step size assumed to be no higher than 3.2 dB in 85% of the measurement grid points.					
NOTE 3: Measurement uncertainties in this table assume absolute power measurements involved in the same relative power measurement are performed over the same RF path.					

B.18a.3 Uncertainty budget format and assessment for NFTF

The uncertainty contributions that may impact the overall MU value are listed in Table B.18a.3-1.

Table B.18a.3-1: Uncertainty contributions for Beam correspondence - EIRP measurement

UID	Description of uncertainty contribution	Details in annex
Stage 2: DUT measurement		
1	Uncertainty of the RF relative power measurement equipment	B.2.3.30
2	Amplifier uncertainties	B.2.3.8
Stage 1: Calibration measurement		
	N/A	
Systematic uncertainties		
3	Influence of noise	B.2.3.29

The uncertainty assessment table is organized as follows:

- For the purpose of uncertainty assessment, the radiating antenna aperture of the DUT is denoted as D
- The uncertainty assessment has been derived for the case of D = [5 cm], f = {22.65GHz, 31.1GHz, 45.1GHz}, P = [maximum output power].
- The uncertainty assessment for Beam correspondence - EIRP is provided in Table B.18a.3-2

Table B.18a.3-2: Uncertainty assessment for Beam correspondence - EIRP measurement (f=TBD, D=TBD)

UID	Uncertainty source	Uncertainty value	Distribution of the probability	Divisor	Standard uncertainty (σ) [dB]
Stage 2: DUT measurement					
1	Uncertainty of the RF relative power measurement equipment	FFS	FFS	FFS	FFS
2	Amplifier uncertainties	FFS	FFS	FFS	FFS
Stage 1: Calibration measurement					
	N/A				
Systematic uncertainties (NOTE 1)					Value
3	Influence of noise				FFS
Total measurement uncertainty					Value
EIRP Expanded uncertainty (1.96 σ - confidence interval of 95 %) [dB]					FFS
NOTE 1: In order to obtain the total measurement uncertainty, systematic uncertainties have to be added to the expanded root sum square of the standard deviations of the Stage 1 and Stage 2 contributors.					

B.19 Reference Sensitivity

Following tables summarize the MU threshold for EIS measurements for Reference Sensitivity. The origin MU values for different test setups with varies parameters can be found in following subclauses.

Table B.19-1: MU threshold for EIS for Reference Sensitivity

Power Class	Frequency	MBW	Power	Threshold MU value for NTC (NOTE 1)	Threshold MU value for ETC (NOTE 1)
PC3	23.45GHz ≤ f ≤ 32.125GHz	BW ≤ 400MHz	P = Max Output Power	5.19	5.45
	32.125GHz < f ≤ 40.8GHz			5.19	5.45
PC1	23.45GHz ≤ f ≤ 32.125GHz	BW ≤ 400MHz	P = Max Output Power	FFS	FFS
	32.125GHz < f ≤ 40.8GHz			FFS	FFS
NOTE 1: Total Expanded MU for IFF for Quiet Zone size ≤ 30cm in Table B.19.2-2 for PC3 UEs (NTC), in Table B.19.2-4 for PC3 UEs (ETC), and Table B.19.2-3 for PC1 UEs					

Table B.19-2: MU threshold for Spherical coverage measurement for Reference Sensitivity

Power Class	Frequency	MBW	Power	Threshold MU value (NOTE 1)
PC3	23.45GHz <= f <= 32.125GHz	BW <= 400MHz	P = Max Output Power	4.90
	32.125GHz < f <= 40.8GHz			4.90
PC1	23.45GHz <= f <= 32.125GHz	BW <= 400MHz	P = Max Output Power	FFS
	32.125GHz < f <= 40.8GHz			FFS
NOTE 1: Total Expanded MU for IFF for Quiet Zone size ≤ 30cm in Table B.19.2-2 for PC3 UEs and Table B.19.2-3 for PC1 UEs				

B.19.1 Uncertainty budget format and assessment for DFF

FFS

B.19.2 Uncertainty budget format and assessment for IFF

The uncertainty contributions that may impact the overall MU value are listed in Table B.19.2-1.

Table B.19.2-1: Uncertainty contributions for EIS measurement

UID	Description of uncertainty contribution	Details in clause
Stage 2: DUT measurement		
1	Positioning misalignment	B.2.2.1
2	Measure distance uncertainty	B.2.2.2
3	Quality of Quiet Zone	B.2.2.3
4	Mismatch	B.2.2.4
5	Standing wave between the DUT and measurement antenna	B.2.2.5
6	gNB emulator uncertainty	B.2.2.17
7	Phase curvature	B.2.2.7
8	Amplifier uncertainties	B.2.2.8
9	Random uncertainty	B.2.2.9
10	Influence of the XPD	B.2.2.10
11	Insertion Loss Variation	B.2.2.11
12	RF leakage (from measurement antenna to the receiver/transmitter)	B.2.2.12
13	Multiple measurement antenna uncertainty	B.2.2.25
14	DUT repositioning	B.2.2.26
15	Influence of spherical coverage grid	B.2.2.29
Stage 1: Calibration measurement		
16	Mismatch	B.2.2.4
17	Amplifier Uncertainties	B.2.2.8
18	Misalignment of positioning System	B.2.2.13
19	Uncertainty of the Network Analyzer	B.2.2.14
20	Uncertainty of the absolute gain of the calibration antenna	B.2.2.15
21	Positioning and pointing misalignment between the reference antenna and the measurement antenna	B.2.2.16
22	Phase centre offset of calibration antenna	B.2.2.18
23	Quality of quiet zone for calibration process	B.2.2.19
24	Standing wave between reference calibration antenna and measurement antenna	B.2.2.20
25	Influence of the calibration antenna feed cable	B.2.2.21
26	Insertion Loss Variation	B.2.2.11
Systematic uncertainties		
27	Systematic error related to beam peak search	B.2.2.28
28	Systematic error related to EIS spherical coverage	B.2.2.30

The uncertainty assessment tables are organized as follows:

- For the purpose of uncertainty assessment, the radiating antenna aperture of the DUT is denoted as D
- The uncertainty assessment has been derived for the case of Quiet Zone size $\leq [30 \text{ cm}]$, $f = \{23.45\text{GHz}, 32.125\text{GHz}, 40.8\text{GHz}\}$, [$P = \text{maximum output power}$].
- The uncertainty assessment for EIS is provided in Table B.19.2-2 for PC3 UEs and Table B.19.2-3 for PC1 UEs.

Table B.19.2-2: Uncertainty assessment for EIS measurement (f=23.45GHz, 32.125GHz, 40.8GHz, Quiet Zone size \leq 30 cm) for PC3 UEs and normal temperature condition

UID	Uncertainty source	Uncertainty value	Distribution of the probability	Divisor	Standard uncertainty (σ) [dB]
Stage 2: DUT measurement					
1	Positioning misalignment	0.00	Normal	2.00	0.00
2	Measure distance uncertainty	0.00	Rectangular	1.73	0.00
3	Quality of Quiet Zone (NOTE 7)	0.6	Actual	1.00	0.6
4	Mismatch	1.30	Actual	1.00	1.30
5	Standing wave between the DUT and measurement antenna	0.00	U-shaped	1.41	0.00
6	gNB uncertainty on absolute level	2.9	Normal	2.00	1.45
7	Phase curvature	0.00	U-shaped	1.41	0.00
8	Amplifier uncertainties	2.1	Normal	2.00	1.05
9	Random uncertainty	0.50	Normal	2.00	0.25
10	Influence of the XPD	0.01	U-shaped	1.41	0.00
11	Insertion Loss Variation	0.00	Rectangular	1.73	0.00
12	RF leakage (from measurement antenna to the receiver/transmitter)	0.00	Actual	1.00	0.00
13	Multiple measurement antenna uncertainty (NOTE 6)	0.15	Actual	1.00	0.15
14	DUT repositioning	0.00 (NOTE 4) 0.08	Rectangular	1.73	0.00 (NOTE 4) 0.05
15	Influence of spherical coverage grid (NOTE 4)	0.12	Actual	1	0.12
Stage 1: Calibration measurement					
16	Mismatch	0.00	U-shaped	1.41	0.00
17	Amplifier Uncertainties	0.00	Normal	2.00	0.00
18	Misalignment of positioning System	0.00	Normal	2.00	0.00
19	Uncertainty of the Network Analyzer	0.73	Normal	2.00	0.37
20	Uncertainty of the absolute gain of the calibration antenna	0.60	Normal	2.00	0.30
21	Positioning and pointing misalignment between the reference antenna and the measurement antenna	0.01	Rectangular	1.73	0.00
22	Phase centre offset of calibration antenna	0.00	Rectangular	1.73	0.00
23	Quality of quiet zone for calibration process (NOTE 7)	0.4	Actual	1.00	0.4
24	Standing wave between reference calibration antenna and measurement antenna	0.00	U-shaped	1.41	0.00
25	Influence of the calibration antenna feed cable	0.14	Normal	2.00	0.07
26	Insertion Loss Variation	0.00	Rectangular	1.73	0.00
Systematic uncertainties (NOTE 3)					Value
27	Systematic error related to beam peak search (NOTE 5)				0.5
28	Systematic error related to EIS spherical coverage (NOTE 4)				DL power step size, 0.2
Total measurement uncertainty					Value
EIS Expanded uncertainty (1.96σ - confidence interval of 95 %) [dB]					5.19
EIS Spherical coverage Expanded uncertainty (1.96σ - confidence interval of 95 %) [dB]					4.90
NOTE 1: The analysis was done only for the case of operating at max output power, in-band, non-CA.					
NOTE 2: Void.					
NOTE 3: In order to obtain the total measurement uncertainty, systematic uncertainties have to be added to the expanded root sum square of the standard deviations of the Stage 1 and Stage 2 contributors.					
NOTE 4: This contributor shall only be considered for spherical EIS measurements.					
NOTE 5: This contributor shall only be considered for EIS measurements.					
NOTE 6: Applies to the system which has a structure of mechanical feed antenna positioning.					
NOTE 7: Value based on procedure defined in clause D.2 of TR 38.810 for Quiet Zone size less or equal to 30 cm.					

Table B.19.2-3: Uncertainty assessment for EIS measurement (f=23.45GHz, 32.125GHz, 40.8GHz, Quiet Zone size \leq 30 cm) for PC1 UEs and normal temperature condition

UID	Uncertainty source	Uncertainty value	Distribution of the probability	Divisor	Standard uncertainty (σ) [dB]
Stage 2: DUT measurement					
1	Positioning misalignment	0.02	Normal	2.00	0.01
2	Measure distance uncertainty	FFS	Rectangular	1.73	FFS
3	Quality of Quiet Zone (NOTE 7)	FFS	Actual	1.00	FFS
4	Mismatch	FFS	Actual	1.00	FFS
5	Standing wave between the DUT and measurement antenna	FFS	U-shaped	1.41	FFS
6	gNB uncertainty on absolute level	FFS	Normal	2.00	FFS
7	Phase curvature	FFS	U-shaped	1.41	FFS
8	Amplifier uncertainties	FFS	Normal	2.00	FFS
9	Random uncertainty	FFS	Normal	2.00	FFS
10	Influence of the XPD	FFS	U-shaped	1.41	FFS
11	Insertion Loss Variation	FFS	Rectangular	1.73	FFS
12	RF leakage (from measurement antenna to the receiver/transmitter)	FFS	Actual	1.00	FFS
13	Multiple measurement antenna uncertainty (NOTE 6)	FFS	Actual	1.00	FFS
14	DUT repositioning	0.00 (NOTE 4) 0.35	Rectangular	1.73	0.00 (NOTE 4) 0.20
15	Influence of spherical coverage grid (NOTE 4)	0.13	Actual	1	0.13
Stage 1: Calibration measurement					
16	Mismatch	FFS	U-shaped	1.41	FFS
17	Amplifier Uncertainties	FFS	Normal	2.00	FFS
18	Misalignment of positioning System	FFS	Normal	2.00	FFS
19	Uncertainty of the Network Analyzer	FFS	Normal	2.00	FFS
20	Uncertainty of the absolute gain of the calibration antenna	FFS	Normal	2.00	FFS
21	Positioning and pointing misalignment between the reference antenna and the measurement antenna	FFS	Rectangular	1.73	FFS
22	Phase centre offset of calibration antenna	FFS	Rectangular	1.73	FFS
23	Quality of quiet zone for calibration process (NOTE 7)	FFS	Actual	1.00	FFS
24	Standing wave between reference calibration antenna and measurement antenna	FFS	U-shaped	1.41	FFS
25	Influence of the calibration antenna feed cable	FFS	Normal	2.00	FFS
26	Insertion Loss Variation	FFS	Rectangular	1.73	FFS
Systematic uncertainties (NOTE 3)					Value
27	Systematic error related to beam peak search (NOTE 5)				0.7
28	Systematic error related to EIS spherical coverage (NOTE 4)				DL power step size, 0.2
Total measurement uncertainty					Value
EIS Expanded uncertainty (1.96σ - confidence interval of 95 %) [dB]					FFS
EIS Spherical coverage Expanded uncertainty (1.96σ - confidence interval of 95 %) [dB]					FFS
NOTE 1: The analysis was done only for the case of operating at max output power, in-band, non-CA.					
NOTE 2: Void.					
NOTE 3: In order to obtain the total measurement uncertainty, systematic uncertainties have to be added to the expanded root sum square of the standard deviations of the Stage 1 and Stage 2 contributors.					
NOTE 4: This contributor shall only be considered for spherical EIS measurements.					
NOTE 5: This contributor shall only be considered for EIS measurements.					
NOTE 6: Applies to the system which has a structure of mechanical feed antenna positioning.					
NOTE 7: Value based on procedure defined in clause D.2 of TR 38.810 for Quiet Zone size less or equal to 30 cm.					

Table B.19.2-4: Uncertainty assessment for EIS measurement (f=23.45GHz, 32.125GHz, 40.8GHz, Quiet Zone size \leq 30 cm) for PC3 UEs and extreme temperature condition

UID	Uncertainty source	Uncertainty value	Distribution of the probability	Divisor	Standard uncertainty (σ) [dB]
Stage 2: DUT measurement					
1	Positioning misalignment	0.00	Normal	2.00	0.00
2	Measure distance uncertainty	0.00	Rectangular	1.73	0.00
3	Quality of Quiet Zone (NOTE 7)	0.9	Actual	1.00	0.9
4	Mismatch	1.30	Actual	1.00	1.30
5	Standing wave between the DUT and measurement antenna	0.00	U-shaped	1.41	0.00
6	gNB uncertainty on absolute level	2.9	Normal	2.00	1.45
7	Phase curvature	0.00	U-shaped	1.41	0.00
8	Amplifier uncertainties	2.1	Normal	2.00	1.05
9	Random uncertainty	0.50	Normal	2.00	0.25
10	Influence of the XPD	0.01	U-shaped	1.41	0.00
11	Insertion Loss Variation	0.00	Rectangular	1.73	0.00
12	RF leakage (from measurement antenna to the receiver/transmitter)	0.00	Actual	1.00	0.00
13	Multiple measurement antenna uncertainty (NOTE 6)	0.15	Actual	1.00	0.15
14	DUT repositioning	0.00 (NOTE 4) 0.08	Rectangular	1.73	0.00 (NOTE 4) 0.05
15	Influence of spherical coverage grid (NOTE 4)	0.12	Actual	1	0.12
Stage 1: Calibration measurement					
16	Mismatch	0.00	U-shaped	1.41	0.00
17	Amplifier Uncertainties	0.00	Normal	2.00	0.00
18	Misalignment of positioning System	0.00	Normal	2.00	0.00
19	Uncertainty of the Network Analyzer	0.73	Normal	2.00	0.37
20	Uncertainty of the absolute gain of the calibration antenna	0.60	Normal	2.00	0.30
21	Positioning and pointing misalignment between the reference antenna and the measurement antenna	0.01	Rectangular	1.73	0.00
22	Phase centre offset of calibration antenna	0.00	Rectangular	1.73	0.00
23	Quality of quiet zone for calibration process (NOTE 7)	0.6	Actual	1.00	0.6
24	Standing wave between reference calibration antenna and measurement antenna	0.00	U-shaped	1.41	0.00
25	Influence of the calibration antenna feed cable	0.14	Normal	2.00	0.07
26	Insertion Loss Variation	0.00	Rectangular	1.73	0.00
Systematic uncertainties (NOTE 3)					Value
27	Systematic error related to beam peak search (NOTE 5)				0.5
28	Systematic error related to EIS spherical coverage (NOTE 4)				DL power step size, 0.2
Total measurement uncertainty					Value
EIS Expanded uncertainty (1.96 σ - confidence interval of 95 %) [dB]					5.45
NOTE 1: The analysis was done only for the case of operating at max output power, in-band, non-CA.					
NOTE 2: Void.					
NOTE 3: In order to obtain the total measurement uncertainty, systematic uncertainties have to be added to the expanded root sum square of the standard deviations of the Stage 1 and Stage 2 contributors.					
NOTE 4: This contributor shall only be considered for spherical EIS measurements.					
NOTE 5: This contributor shall only be considered for EIS measurements.					
NOTE 6: Applies to the system which has a structure of mechanical feed antenna positioning.					
NOTE 7: Value based on procedure defined in clause D.2 of TR 38.810 for Quiet Zone size less or equal to 30 cm. The ETC QoQZ MU and ETC calibration path losses shall be applied to the NTC test cases if the ETC environment is used for NTC test cases.					

B.20

B.21 Adjacent Channel Selectivity

Following tables summarize the MU threshold for Adjacent Channel Selectivity measurement. The origin MU values for different test setups with varies parameters can be found in following subclauses.

Table B.21-1: MU threshold for Adjacent Channel Selectivity

Power Class	Frequency	MBW	Power	Threshold MU value (NOTE 1)
PC3	23.45GHz <= f <= 32.125GHz	BW <= 400MHz	P = Max Output Power	7.84
	32.125GHz < f <= 40.8GHz			7.84
PC1	23.45GHz <= f <= 32.125GHz	BW <= 400MHz	P = Max Output Power	FFS
	32.125GHz < f <= 40.8GHz			FFS

NOTE 1: Total Expanded MU for IFF for Quiet Zone size ≤ 30cm in Table B.21.2-2 for PC3 UEs

B.21.1 Uncertainty budget format and assessment for DFF

FFS

B.21.2 Uncertainty budget format and assessment for IFF

The uncertainty contributions that may impact the overall MU value are listed in Table B.21.2-1.

Table B.21.2-1: Total Uncertainty contributions for Adjacent Channel Selectivity measurement

UID	Description of uncertainty contribution	Details in clause
Stage 2: DUT measurement (Wanted Signal contributions)		
1	Positioning misalignment	B.2.2.1
2	Measure distance uncertainty	B.2.2.2
3	Quality of Quiet Zone	B.2.2.3
4	Mismatch	B.2.2.4
5	Standing wave between the DUT and measurement antenna	B.2.2.5
6	gNB emulator uncertainty	B.2.2.17
7	Phase curvature	B.2.2.7
8	Amplifier uncertainties	B.2.2.8
9	Random uncertainty	B.2.2.9
10	Influence of the XPD	B.2.2.10
11	Insertion Loss Variation	B.2.2.11
12	RF leakage (from measurement antenna to the receiver/transmitter)	B.2.2.12
13	Multiple measurement antenna uncertainty	B.2.2.25
14	DUT repositioning	B.2.2.26
Stage 2: DUT measurement (Modulated Interferer Signal specific contributions)		
15	Positioning misalignment	B.2.2.1
16	Measure distance uncertainty	B.2.2.2
17	Quality of Quiet Zone	B.2.2.3
18	Mismatch	B.2.2.4
19	Standing wave between the DUT and measurement antenna	B.2.2.5
20	Modulated Interferer uncertainty	B.2.2.33
21	Phase curvature	B.2.2.7
22	Amplifier uncertainties	B.2.2.8
23	Random uncertainty	B.2.2.9
24	Influence of the XPD	B.2.2.10
25	Insertion Loss Variation	B.2.2.11
26	RF leakage (from measurement antenna to the receiver/transmitter)	B.2.2.12
27	Multiple measurement antenna uncertainty	B.2.2.25
28	DUT repositioning	B.2.2.26
29	Influence of offset antenna (Std.Dev)	B.2.2.35
Stage 1: Calibration measurement (Wanted Signal contributions)		
30	Mismatch	B.2.2.4
31	Amplifier Uncertainties	B.2.2.8
32	Misalignment of positioning System	B.2.2.13
33	Uncertainty of the Network Analyzer	B.2.2.14
34	Uncertainty of the absolute gain of the calibration antenna	B.2.2.15
35	Positioning and pointing misalignment between the reference antenna and the measurement antenna	B.2.2.16
36	Phase centre offset of calibration antenna	B.2.2.18
37	Quality of quiet zone for calibration process	B.2.2.19
38	Standing wave between reference calibration antenna and measurement antenna	B.2.2.20
39	Influence of the calibration antenna feed cable	B.2.2.21
40	Insertion Loss Variation	B.2.2.11
Stage 1: Calibration measurement (Modulated Interferer Signal contributions)		
41	Mismatch	B.2.2.4
42	Amplifier Uncertainties	B.2.2.8
43	Misalignment of positioning System	B.2.2.13
44	Uncertainty of the Network Analyzer	B.2.2.14
45	Uncertainty of the absolute gain of the calibration antenna	B.2.2.15
46	Positioning and pointing misalignment between the reference antenna and the measurement antenna	B.2.2.16
47	Phase centre offset of calibration antenna	B.2.2.18
48	Quality of quiet zone for calibration process	B.2.2.19
48	Standing wave between reference calibration antenna and measurement antenna	B.2.2.20
50	Influence of the calibration antenna feed cable	B.2.2.21
51	Insertion Loss Variation	B.2.2.11
Systematic uncertainties		
52	Systematic error related to beam peak search	B.2.2.28
53	Additional impact of interferer ACLR	B.2.2.32

54	Influence of offset antenna (mean error)	B.2.2.35
----	--	----------

The uncertainty assessment tables are organized as follows:

- For the purpose of uncertainty assessment, the radiating antenna aperture of the DUT is denoted as D
- The uncertainty assessment has been derived for the case of Quiet Zone size $\leq [30 \text{ cm}]$, $f = \{23.45\text{GHz}, 32.125\text{GHz}, 40.8\text{GHz}\}$, [$P = \text{maximum output power}$].
- The uncertainty assessment for ACS is provided in Table B.21.2-2 for PC3 UEs.

Table B.21.2-2: Uncertainty assessment for Adjacent Channel Selectivity measurement (f=23.45GHz, 32.125GHz, 40.8GHz, Quiet Zone size \leq 30 cm) for PC3 UEs

UID	Uncertainty source	Uncertainty value	Distribution of the probability	Divisor	Standard uncertainty (σ) [dB]
Stage 2: DUT measurement (Wanted Signal contributions)					
1	Positioning misalignment	0.00	Normal	2.00	0.00
2	Measure distance uncertainty	0.00	Rectangular	1.73	0.00
3	Quality of Quiet Zone (NOTE 4)	0.6	Actual	1.00	0.6
4	Mismatch	1.30	Actual	1.00	1.30
5	Standing wave between the DUT and measurement antenna	0.00	U-shaped	1.41	0.00
6	gNB uncertainty on absolute level	2.9	Normal	2.00	1.45
7	Phase curvature	0.00	U-shaped	1.41	0.00
8	Amplifier uncertainties	2.1	Normal	2.00	1.05
9	Random uncertainty	0.50	Normal	2.00	0.25
10	Influence of the XPD	0.01	U-shaped	1.41	0.00
11	Insertion Loss Variation	0.00	Rectangular	1.73	0.00
12	RF leakage (from measurement antenna to the receiver/transmitter)	0.00	Actual	1.00	0.00
13	Multiple measurement antenna uncertainty (NOTE 3)	0.15	Actual	1.00	0.15
14	DUT repositioning	0.08	Rectangular	1.73	0.05
Stage 2: DUT measurement (Modulated Interferer Signal specific contributions)					
15	Positioning misalignment	0.00	Normal	2.00	0.00
16	Measure distance uncertainty	0.00	Rectangular	1.73	0.00
17	Quality of Quiet Zone (NOTE 4)	0.6	Actual	1.00	0.6
18	Mismatch	1.30	Actual	1.00	1.30
19	Standing wave between the DUT and measurement antenna	0.00	U-shaped	1.41	0.00
20	Modulated Interferer uncertainty on absolute level	2.9	Normal	2.00	1.45
21	Phase curvature	0.00	U-shaped	1.41	0.00
22	Amplifier uncertainties	2.1	Normal	2.00	1.05
23	Random uncertainty	0.50	Normal	2.00	0.25
24	Influence of the XPD	0.01	U-shaped	1.41	0.00
25	Insertion Loss Variation	0.00	Rectangular	1.73	0.00
26	RF leakage (from measurement antenna to the receiver/transmitter)	0.00	Actual	1.00	0.00
27	Multiple measurement antenna uncertainty (NOTE 3)	0.15	Actual	1.00	0.15
28	DUT repositioning	0.08	Rectangular	1.73	0.05
29	Influence of offset antenna (Std.Dev) (NOTE 5)	0.00	Normal	2.00	0.00
Stage 1: Calibration measurement (Wanted Signal contributions)					
30	Mismatch	0.00	U-shaped	1.41	0.00
31	Amplifier Uncertainties	0.00	Normal	2.00	0.00
32	Misalignment of positioning System	0.00	Normal	2.00	0.00
33	Uncertainty of the Network Analyzer	0.73	Normal	2.00	0.37
34	Uncertainty of the absolute gain of the calibration antenna	0.60	Normal	2.00	0.30
35	Positioning and pointing misalignment between the reference antenna and the measurement antenna	0.01	Rectangular	1.73	0.00
36	Phase centre offset of calibration antenna	0.00	Rectangular	1.73	0.00
37	Quality of quiet zone for calibration process (NOTE 4)	0.4	Actual	1.00	0.4
38	Standing wave between reference calibration antenna and measurement antenna	0.00	U-shaped	1.41	0.00
39	Influence of the calibration antenna feed cable	0.14	Normal	2.00	0.07
40	Insertion Loss Variation	0.00	Rectangular	1.73	0.00

Stage 1: Calibration measurement (Modulated Interferer Signal contributions)					
41	Mismatch	0.00	U-shaped	1.41	0.00
42	Amplifier Uncertainties	0.00	Normal	2.00	0.00
43	Misalignment of positioning System	0.00	Normal	2.00	0.00
44	Uncertainty of the Network Analyzer	0.73	Normal	2.00	0.37
45	Uncertainty of the absolute gain of the calibration antenna	0.60	Normal	2.00	0.30
46	Positioning and pointing misalignment between the reference antenna and the measurement antenna	0.01	Rectangular	1.73	0.00
47	Phase centre offset of calibration antenna	0.00	Rectangular	1.73	0.00
48	Quality of quiet zone for calibration process (NOTE 4)	0.4	Actual	1.00	0.4
48	Standing wave between reference calibration antenna and measurement antenna	0.00	U-shaped	1.41	0.00
50	Influence of the calibration antenna feed cable	0.14	Normal	2.00	0.07
51	Insertion Loss Variation	0.00	Rectangular	1.73	0.00
Systematic uncertainties (NOTE 2)					Value
52	Systematic error related to beam peak search				0.5
53	Additional impact of interferer ACLR				0.7
54	Influence of offset antenna (mean error) (NOTE 5)				0.00
Total measurement uncertainty					Value
ACS Expanded uncertainty (1.96 σ - confidence interval of 95 %) [dB]					7.84
NOTE 1: The analysis was done only for the case of operating at max output power, in-band, non-CA.					
NOTE 2: In order to obtain the total measurement uncertainty, systematic uncertainties have to be added to the expanded root sum square of the standard deviations of the Stage 1 and Stage 2 contributors.					
NOTE 3: Applies to the system which has a structure of mechanical feed antenna positioning.					
NOTE 4: Value based on procedure defined in clause D.2 of TR 38.810 for Quiet Zone size less or equal to 30 cm.					
NOTE 5: For MTSU derivation purpose, this value is set to 0.0 (no offset antenna case).					

B.22 In-Band Blocking

See B.21.

B.22.1 Uncertainty budget format and assessment for DFF

See B.21.1.

B.22.2 Uncertainty budget format and assessment for IFF

See B.21.2.

B.23

B.24

B.25 Receiver spurious emissions

Editor's Note:

- MU value analysis and offset value analysis for PC1, 2 and 4 are not complete.
- MU value analysis for various test setups in subsection B.25.x is not complete for above 80 GHz for PC3
- Offset value analysis is not complete as it is derived from MU value analysis for above 80 GHz for PC3

Test procedure of general spurious emission comprises 2 stages: coarse TRP measurement and fine TRP measurement BW. Coarse TRP measurement is introduced to reduce the measurement time by applying sparser grids and/or wider measurement BW than fine TRP measurement while having offset dB more stringent test requirement in order not to cause additional misjudgement risk. For the frequency ranges for which coarse TRP measurement does not PASS, the measurement is continued with fine TRP measurement procedure.

Table B.25-1 summarizes the MU threshold for fine TRP measurements for General spurious emissions. The origin MU values for fine TRP measurement for different test setups can be found in following subclasses.

Table B.25-1: MU threshold for TRP measurement for Rx spurious emission

Power Class	Frequency	In-band BW	In-band Power (NOTE2)	Threshold MU value [dB] (NOTE1)
PC3	6 GHz \leq f \leq 12.75 GHz	BW \leq 400MHz	P = Max Output Power	5.50
	12.75 GHz \leq f \leq 23.45 GHz			5.46
	23.45 GHz \leq f \leq 40.8 GHz			6.11
	40.8 GHz \leq f \leq 66 GHz			7.65
	66 GHz \leq f \leq 80 GHz			7.95
PC1	6 GHz \leq f \leq 12.75 GHz	BW \leq 400MHz	P = Max Output Power	FFS
	12.75 GHz \leq f \leq 23.45 GHz			FFS
	23.45 GHz \leq f \leq 40.8 GHz			FFS
	40.8 GHz \leq f \leq 66 GHz			FFS
	66 GHz \leq f \leq 80 GHz			FFS
NOTE 1: Total EIRP Expanded MU for IFF for Quiet Zone size \leq 30cm in Table B.25.2-3 to Table B.25.2-11 for PC3 UEs and in Table B.25.2.12 to Table B.25.2.16 for PC1 UEs.				

Table B.25-2 provides valid coarse TRP measurement grids and corresponding offset dB value that may be used for UE general spurious emission test case. The offset value is derived as 95%-tile TRP measurement uncertainty including the effect from uncertainty due to Coarse TRP measurement grid, excluding influence of noise.

Table B.25-2: Coarse TRP measurement grids and offset values for UE Rx spurious emission

Power Class	Coarse TRP measurement grid	Frequency	Min Number of measurement points on the grid	Influence of coarse TRP measurement grid (dB)	Systematic error due to coarse TRP calculation/quadrature (dB)	Offset value (dB)
PC3	Constant density grid (charged particle based)	6 GHz \leq f \leq 12.75 GHz	35	0.94	0.09	5.25
		12.75 GHz \leq f \leq 23.45 GHz				5.21
		23.45 GHz \leq f \leq 40.8 GHz				5.49
		40.8 GHz \leq f \leq 66 GHz				7.31
		66 GHz \leq f \leq 80 GHz				7.61
	Constant step size grid	6 GHz \leq f \leq 12.75 GHz	62	0.97	0.2	5.38
		12.75 GHz \leq f \leq 23.45 GHz				5.34
		23.45 GHz \leq f \leq 40.8 GHz				5.62
		40.8 GHz \leq f \leq 66 GHz				7.43
		66 GHz \leq f \leq 80 GHz				7.73
PC1	Constant density grid (charged particle based)	6 GHz \leq f \leq 12.75 GHz	FFS	FFS	FFS	FFS
		12.75 GHz \leq f \leq 23.45 GHz				FFS
		23.45 GHz \leq f \leq 40.8 GHz				FFS
		40.8 GHz \leq f \leq 66 GHz				FFS
		66 GHz \leq f \leq 80 GHz				FFS
	Constant step size grid	6 GHz \leq f \leq 12.75 GHz	FFS	FFS	FFS	FFS
		12.75 GHz \leq f \leq 23.45 GHz				FFS
		23.45 GHz \leq f \leq 40.8 GHz				FFS
		40.8 GHz \leq f \leq 66 GHz				FFS
		66 GHz \leq f \leq 80 GHz				FFS
NOTE 1: Based on Total TRP Expanded MU for IFF for Quiet Zone size \leq 30cm in Table B.25.2-3 to Table B.25.2-11, replacing "Influence of TRP measurement grid" and "Systematic error due to TRP calculation/quadrature" by the values for coarse TRP grid, and excluding "Influence of noise".						

B.25.1 Uncertainty budget format and assessment for DFF

The uncertainty contributions that may impact the overall MU value are listed in Table B.25.1-1.

Table B.25.1-1: Uncertainty contributions for TRP measurement

UID	Description of uncertainty contribution	Details in annex
Stage 2: DUT measurement		
1	Positioning misalignment	B.2.1.1
2	Measure distance uncertainty	B.2.1.2
3	Quality of quiet zone	B.2.1.3
4	Mismatch	B.2.1.4
5	Standing Wave Between the DUT and measurement antenna	B.2.1.5
6	Uncertainty of the RF power measurement equipment	B.2.1.6
7	Phase curvature	B.2.1.7
8	Amplifier uncertainties	B.2.1.8
9	Random uncertainty	B.2.1.9
10	Influence of the XPD	B.2.1.10
11	Insertion Loss Variation	B.2.1.11
12	RF leakage (from measurement antenna to the receiver/transmitter)	B.2.1.12
13	Influence of TRP measurement grid	B.2.1.22
14	Influence of beam peak search grid	B.2.1.23
15	Multiple measurement antenna uncertainty	B.2.1.25
16	DUT repositioning	B.2.1.26
Stage 1: Calibration measurement		
17	Mismatch	B.2.1.4
18	Amplifier uncertainties	B.2.1.8
19	Misalignment of positioning System	B.2.1.13
20	Uncertainty of the Network Analyzer	B.2.1.14
21	Uncertainty of the absolute gain of the calibration antenna	B.2.1.15
22	Positioning and pointing misalignment between the reference antenna and the measurement antenna	B.2.1.16
23	Phase centre offset of calibration antenna	B.2.1.18
24	Quality of quiet zone for calibration process	B.2.1.19
25	Standing wave between reference calibration antenna and measurement antenna	B.2.1.20
26	Influence of the calibration antenna feed cable	B.2.1.21
27	Insertion Loss Variation	B.2.1.11
Systematic uncertainties		
28	Systematic error due to TRP calculation/quadrature	B.2.1.24
29	Influence of noise	B.2.1.27

The uncertainty assessment tables are organized as follows:

- For the purpose of uncertainty assessment, the radiating antenna aperture of the DUT is denoted as D
- The uncertainty assessment has been derived for the case of $D = [5 \text{ cm}]$, $f = \{6 \text{ GHz to } 80 \text{ GHz}\}$, $P = [\text{Off power}]$.
- The uncertainty assessment for TRP is provided in Table B.25.1-2 to B.25.1-xx

Table B.25.1-2: Uncertainty assessment for TRP measurement (f=TBD, D=TBD)

UID	Uncertainty source	Uncertainty value	Distribution of the probability	Divisor	Standard uncertainty (σ) [dB]
Stage 2: DUT measurement					
1	Positioning misalignment				
2	Measure distance uncertainty				
3	Quality of quiet zone				
4	Mismatch (NOTE 1)				
5	Standing Wave Between the DUT and measurement antenna				
6	Uncertainty of the RF power measurement equipment (NOTE 2)				
7	Phase curvature				
8	Amplifier uncertainties				
9	Random uncertainty				
10	Influence of the XPD				
11	Insertion Loss Variation				
12	RF leakage (from measurement antenna to the receiver/transmitter)				
13	Influence of TRP measurement grid (NOTE 3)				
14	Influence of beam peak search grid (NOTE 4)				
15	Multiple measurement antenna uncertainty				
16	DUT repositioning				
Stage 1: Calibration measurement					
17	Mismatch				
18	Amplifier uncertainties				
19	Misalignment of positioning System				
20	Uncertainty of the Network Analyzer				
21	Uncertainty of the absolute gain of the calibration antenna				
22	Positioning and pointing misalignment between the reference antenna and the measurement antenna				
23	Phase centre offset of calibration antenna				
24	Quality of quiet zone for calibration process				
25	Standing wave between reference calibration antenna and measurement antenna				
26	Influence of the calibration antenna feed cable				
27	Insertion Loss Variation				
TRP Expanded uncertainty (1.96 σ - confidence interval of 95 %) [dB]					
Systematic uncertainties (NOTE 5)					Value
28	Systematic error due to TRP calculation/quadrature (NOTE 3)				
29	Influence of noise				
Total measurement uncertainty					
TRP total measurement uncertainty [dB]					
NOTE 1: The analysis was done only for the case of operating at max output power, in-band, non-CA.					
NOTE 2: The assessment assumes maximum DUT output power.					
NOTE 3: This contributor shall only be considered for TRP measurements.					
NOTE 4: This contributor shall only be considered for EIRP measurements.					
NOTE 5: In order to obtain the total measurement uncertainty, systematic uncertainties have to be added to the expanded root sum square of the standard deviations of the Stage 1 and Stage 2 contributors.					
NOTE 6: Void					

B.25.2 Uncertainty budget format and assessment for IFF

The uncertainty contributions that may impact the overall MU value are listed in Table B.25.2-1.

Table B.25.2-1: Uncertainty contributions for TRP measurement

UID	Description of uncertainty contribution	Details in clause
Stage 2: DUT measurement		
1	Positioning misalignment	B.2.2.1
2	Measure distance uncertainty	B.2.2.2
3	Quality of Quiet Zone	B.2.2.3
4	Mismatch	B.2.2.4
5	Standing wave between the DUT and measurement antenna	B.2.2.5
6	Uncertainty of the RF power measurement equipment	B.2.2.6
7	Phase curvature	B.2.2.7
8	Amplifier uncertainties	B.2.2.8
9	Random uncertainty	B.2.2.9
10	Influence of the XPD	B.2.2.10
11	Insertion Loss Variation	B.2.2.11
12	RF leakage (from measurement antenna to the receiver/transmitter)	B.2.2.12
13	Influence of TRP measurement grid	B.2.2.22
14	Influence of beam peak search grid	B.2.2.23
15	Multiple measurement antenna uncertainty	B.2.2.25
16	DUT repositioning	B.2.2.26
17	Misalignment of DUT due to change of DUT orientation	B.2.2.31
Stage 1: Calibration measurement		
18	Mismatch	B.2.2.4
19	Amplifier Uncertainties	B.2.2.8
20	Misalignment of positioning System	B.2.2.13
21	Uncertainty of the Network Analyzer	B.2.2.14
22	Uncertainty of the absolute gain of the calibration antenna	B.2.2.15
23	Positioning and pointing misalignment between the reference antenna and the measurement antenna	B.2.2.16
24	Phase centre offset of calibration antenna	B.2.2.18
25	Quality of quiet zone for calibration process	B.2.2.19
26	Standing wave between reference calibration antenna and measurement antenna	B.2.2.20
27	Influence of the calibration antenna feed cable	B.2.2.21
28	Insertion Loss Variation	B.2.2.11
Systematic uncertainties		
29	Systematic error due to TRP calculation/quadrature	B.2.2.24
30	Influence of noise	B.2.2.27

The uncertainty assessment tables are organized as follows:

- For the purpose of uncertainty assessment, the radiating antenna aperture of the DUT is denoted as D
- The uncertainty assessment has been derived for the case of Quiet Zone size ≤ 30 cm, $f = \{6 \text{ GHz to } 80 \text{ GHz}\}$, $P = \text{Receiver Spurious Core Requirement Level} + \text{Relaxation}$ (For n_{257} , 10.2dB for $6\text{GHz} \leq f < 20\text{GHz}$, 17.2 dB for $20\text{GHz} \leq f < 40\text{GHz}$, 33.1dB for $40\text{GHz} \leq f \leq 2^{\text{nd}}$ harmonic)
- The uncertainty assessment for TRP is provided from Table B.25.2-2 to Table B.25.2-11 for PC3 UEs and from Table B.25.2.12 to Table B.25.2.16 for PC1 UEs.

Table B.25.2-2: Void

Table B.25.2-3: Uncertainty assessment for TRP measurement (f=6 GHz to 12.75 GHz, Quiet Zone size \leq 30 cm) for PC3 UEs

UID	Uncertainty source	Uncertainty value	Distribution of the probability	Divisor	Standard uncertainty (σ) [dB]
Stage 2: DUT measurement					
1	Positioning misalignment	0.00	Normal	2.00	0.00
2	Measure distance uncertainty	0.00	Rectangular	1.73	0.00
3	Quality of Quiet Zone (NOTE 4)	0.70	Actual	1.00	0.70
4	Mismatch	1.60	Actual	1.00	1.60
5	Standing wave between the DUT and measurement antenna	0.00	U-shaped	1.41	0.00
6	Uncertainty of the RF power measurement equipment	2.00	Normal	2.00	1.00
7	Phase curvature	0.00	U-shaped	1.41	0.00
8	Amplifier uncertainties	2.1	Normal	2.00	1.05
9	Random uncertainty	0.5	Normal	2.00	0.25
10	Influence of the XPD	0.09	U-shaped	1.41	0.064
11	Insertion Loss Variation	0.00	Rectangular	1.73	0.00
12	RF leakage (from measurement antenna to the receiver/transmitter)	0.00	Actual	1.00	0.00
13	Influence of TRP measurement grid (NOTE 1)	0.32	Actual	1	0.32
14	Influence of beam peak search grid (NOTE 2)	N/A	Actual	1	N/A
15	Multiple measurement antenna uncertainty (NOTE 5)	0.15	Actual	1	0.15
16	DUT repositioning	0.00	Rectangular	1.73	0.00
17	Misalignment of DUT due to change of DUT orientation	0.10	Actual	1	0.10
Stage 1: Calibration measurement					
18	Mismatch	0.00	U-shaped	1.41	0.00
19	Amplifier Uncertainties	0.00	Normal	2.00	0.00
20	Misalignment of positioning System	0.00	Normal	2.00	0.00
21	Uncertainty of the Network Analyzer	0.90	Normal	2.00	0.45
22	Uncertainty of the absolute gain of the calibration antenna	0.60	Normal	2.00	0.30
23	Positioning and pointing misalignment between the reference antenna and the measurement antenna	0.05	Rectangular	1.73	0.03
24	Phase centre offset of calibration antenna	0.00	Rectangular	1.73	0.00
25	Quality of quiet zone for calibration process (NOTE 4)	0.70	Actual	1.00	0.70
26	Standing wave between reference calibration antenna and measurement antenna	0.00	U-shaped	1.41	0.00
27	Influence of the calibration antenna feed cable	0.14	Normal	2.00	0.07
28	Insertion Loss Variation	0.00	Rectangular	1.73	0.00
Expanded uncertainty (1.96σ - confidence interval of 95 %)					Value
TRP Expanded uncertainty (6 GHz < f <= 12.75 GHz) [dB] (a)					4.86
Systematic uncertainties (NOTE 3)					Value
29	Systematic error due to TRP calculation/quadrature (NOTE 1) (b)				0.0
30	Influence of noise (6 GHz < f <= 12.75 GHz) (c)				0.64

31	Systematic error related to beam peak search (NOTE 2)	N/A
Total measurement uncertainty		Value
Total measurement uncertainty (a)+(b)+(c) [dB]		5.50
<p>NOTE 1: This contributor shall only be considered for TRP measurements.</p> <p>NOTE 2: This contributor shall only be considered for EIRP measurements.</p> <p>NOTE 3: In order to obtain the total measurement uncertainty, systematic uncertainties have to be added to the expanded root sum square of the standard deviations of the Stage 1 and Stage 2 contributors.</p> <p>NOTE 4: Value based on procedure defined in clause D.2 of TR 38.810 for Quiet Zone size of less or equal to 30 cm.</p> <p>NOTE 5: Applies to the system which has a structure of mechanical feed antenna positioning.</p>		

Table B.25.2-4: void

Table B.25.2-5: Uncertainty assessment for TRP measurement (f=12.75 GHz to 23.45 GHz, Quiet Zone size \leq 30 cm) for PC3 UEs

UID	Uncertainty source	Uncertainty value	Distribution of the probability	Divisor	Standard uncertainty (σ) [dB]
Stage 2: DUT measurement					
1	Positioning misalignment	0.00	Normal	2.00	0.00
2	Measure distance uncertainty	0.00	Rectangular	1.73	0.00
3	Quality of Quiet Zone (NOTE 4)	0.60	Actual	1.00	0.60
4	Mismatch	1.60	Actual	1.00	1.60
5	Standing wave between the DUT and measurement antenna	0.00	U-shaped	1.41	0.00
6	Uncertainty of the RF power measurement equipment	2.16	Normal	2.00	1.08
7	Phase curvature	0.00	U-shaped	1.41	0.00
8	Amplifier uncertainties	2.1	Normal	2.00	1.05
9	Random uncertainty	0.5	Normal	2.00	0.25
10	Influence of the XPD	0.09	U-shaped	1.41	0.064
11	Insertion Loss Variation	0.00	Rectangular	1.73	0.00
12	RF leakage (from measurement antenna to the receiver/transmitter)	0.00	Actual	1.00	0.00
13	Influence of TRP measurement grid (NOTE 1)	0.32	Actual	1	0.32
14	Influence of beam peak search grid (NOTE 2)	N/A	Actual	1	N/A
15	Multiple measurement antenna uncertainty (NOTE 5)	0.15	Actual	1	0.15
16	DUT repositioning	0.00	Rectangular	1.73	0.00
17	Misalignment of DUT due to change of DUT orientation	0.10	Actual	1	0.10
Stage 1: Calibration measurement					
18	Mismatch	0.00	U-shaped	1.41	0.00
19	Amplifier Uncertainties	0.00	Normal	2.00	0.00
20	Misalignment of positioning System	0.00	Normal	2.00	0.00
21	Uncertainty of the Network Analyzer	0.90	Normal	2.00	0.45
22	Uncertainty of the absolute gain of the calibration antenna	0.60	Normal	2.00	0.30
23	Positioning and pointing misalignment between the reference antenna and the measurement antenna	0.05	Rectangular	1.73	0.03
24	Phase centre offset of calibration antenna	0.00	Rectangular	1.73	0.00
25	Quality of quiet zone for calibration process (NOTE 4)	0.60	Actual	1.00	0.60
26	Standing wave between reference calibration antenna and measurement antenna	0.00	U-shaped	1.41	0.00
27	Influence of the calibration antenna feed cable	0.14	Normal	2.00	0.07
28	Insertion Loss Variation	0.00	Rectangular	1.73	0.00
Expanded uncertainty (1.96σ - confidence interval of 95 %)					Value
TRP Expanded uncertainty ([12.75] GHz < f <= 23.45 GHz) [dB] (a)					4.82
Systematic uncertainties (NOTE 3)					Value
29	Systematic error due to TRP calculation/quadrature (NOTE 1) (b)				0.0
30	Influence of noise (12.75 GHz < f <= 23.45 GHz) (c)				0.64

31	Systematic error related to beam peak search (NOTE 2)	N/A
Total measurement uncertainty		Value
Total measurement uncertainty (a)+(b)+(c) [dB]		5.46
<p>NOTE 1: This contributor shall only be considered for TRP measurements.</p> <p>NOTE 2: This contributor shall only be considered for EIRP measurements.</p> <p>NOTE 3: In order to obtain the total measurement uncertainty, systematic uncertainties have to be added to the expanded root sum square of the standard deviations of the Stage 1 and Stage 2 contributors.</p> <p>NOTE 4: Value based on procedure defined in clause D.2 of TR 38.810 for Quiet Zone size of less or equal to 30 cm.</p> <p>NOTE 5: Applies to the system which has a structure of mechanical feed antenna positioning.</p>		

Table B.25.2-6: Void

Table B.25.2-7: Uncertainty assessment for TRP measurement (f=23.45 GHz to 40.8 GHz, Quiet Zone size \leq 30 cm) for PC3 UEs

UID	Uncertainty source	Uncertainty value	Distribution of the probability	Divisor	Standard uncertainty (σ) [dB]
Stage 2: DUT measurement					
1	Positioning misalignment	0.00	Normal	2.00	0.00
2	Measure distance uncertainty	0.00	Rectangular	1.73	0.00
3	Quality of Quiet Zone (NOTE 4)	0.6	Actual	1.00	0.6
4	Mismatch	1.50	Actual	1.00	1.50
5	Standing wave between the DUT and measurement antenna	0.00	U-shaped	1.41	0.00
6	Uncertainty of the RF power measurement equipment	2.73	Normal	2.00	1.37
7	Phase curvature	0.00	U-shaped	1.41	0.00
8	Amplifier uncertainties	2.1	Normal	2.00	1.05
9	Random uncertainty	0.5	Normal	2.00	0.25
10	Influence of the XPD	0.01	U-shaped	1.41	0.0071
11	Insertion Loss Variation	0.00	Rectangular	1.73	0.00
12	RF leakage (from measurement antenna to the receiver/transmitter)	0.00	Actual	1.00	0.00
13	Influence of TRP measurement grid (NOTE 1)	0.32	Actual	1	0.32
14	Influence of beam peak search grid (NOTE 2)	N/A	Actual	1	N/A
15	Multiple measurement antenna uncertainty (NOTE 5)	0.15	Actual	1	0.15
16	DUT repositioning	0.00	Rectangular	1.73	0.00
17	Misalignment of DUT due to change of DUT orientation	0.10	Actual	1	0.10
Stage 1: Calibration measurement					
18	Mismatch	0.00	U-shaped	1.41	0.00
19	Amplifier Uncertainties	0.00	Normal	2.00	0.00
20	Misalignment of positioning System	0.00	Normal	2.00	0.00
21	Uncertainty of the Network Analyzer	1.5	Normal	2.00	0.75
22	Uncertainty of the absolute gain of the calibration antenna	0.6	Normal	2.00	0.3
23	Positioning and pointing misalignment between the reference antenna and the measurement antenna	0.05	Rectangular	1.73	0.03
24	Phase centre offset of calibration antenna	0.00	Rectangular	1.73	0.00
25	Quality of quiet zone for calibration process (NOTE 4)	0.6	Actual	1.00	0.6
26	Standing wave between reference calibration antenna and measurement antenna	0.00	U-shaped	1.41	0.00
27	Influence of the calibration antenna feed cable	0.14	Normal	2.00	0.07
28	Insertion Loss Variation	0.00	Rectangular	1.73	0.00
Expanded uncertainty (1.96σ - confidence interval of 95 %)					Value
TRP Expanded uncertainty (23.45 GHz < f <= 40.8 GHz) [dB] (a)					5.11
Systematic uncertainties (NOTE 3)					Value
29	Systematic error due to TRP calculation/quadrature (NOTE 1) (b)				0.0
30	Influence of noise (23.45 GHz < f <= 40.8 GHz) (c)				1.0

31	Systematic error related to beam peak search (NOTE 2)	N/A
Total measurement uncertainty		Value
Total measurement uncertainty (a)+(b)+(c) [dB]		6.11
<p>NOTE 1: This contributor shall only be considered for TRP measurements.</p> <p>NOTE 2: This contributor shall only be considered for EIRP measurements.</p> <p>NOTE 3: In order to obtain the total measurement uncertainty, systematic uncertainties have to be added to the expanded root sum square of the standard deviations of the Stage 1 and Stage 2 contributors.</p> <p>NOTE 4: Value based on procedure defined in clause D.2 of TR 38.810 for Quiet Zone size of less or equal to 30 cm.</p> <p>NOTE 5: Applies to the system which has a structure of mechanical feed antenna positioning.</p>		

Table B.25.2-8: Void

Table B.25.2-9: Uncertainty assessment for TRP measurement ($f = 40.8$ GHz to 66 GHz, Quiet Zone size ≤ 30 cm) for PC3 UEs

UID	Uncertainty source	Uncertainty value	Distribution of the probability	Divisor	Standard uncertainty (σ) [dB]
Stage 2: DUT measurement					
1	Positioning misalignment	0.00	Normal	2.00	0.0
2	Measure distance uncertainty	0.00	Rectangular	1.73	0.00
3	Quality of Quiet Zone (NOTE 4)	0.6	Actual	1.00	0.6
4	Mismatch	2.30	Actual	1.00	2.30
5	Standing wave between the DUT and measurement antenna	0.00	U-shaped	1.41	0.00
6	Uncertainty of the RF power measurement equipment	4.0	Normal	2.00	2.00
7	Phase curvature	0.00	U-shaped	1.41	0.00
8	Amplifier uncertainties	2.1	Normal	2.00	1.05
9	Random uncertainty	0.5	Normal	2.00	0.25
10	Influence of the XPD	0.09	U-shaped	1.41	0.064
11	Insertion Loss Variation	0.00	Rectangular	1.73	0.00
12	RF leakage (from measurement antenna to the receiver/transmitter)	0.00	Actual	1.00	0.00
13	Influence of TRP measurement grid (NOTE 1)	0.32	Actual	1	0.32
14	Influence of beam peak search grid (NOTE 2)	N/A	Actual	1	N/A
15	Multiple measurement antenna uncertainty (NOTE 5)	0.15	Actual	1	0.15
16	DUT repositioning	0.00	Rectangular	1.73	0.00
17	Misalignment of DUT due to change of DUT orientation	0.10	Actual	1	0.10
Stage 1: Calibration measurement					
18	Mismatch	0.00	U-shaped	1.41	0.00
19	Amplifier Uncertainties	0.00	Normal	2.00	0.00
20	Misalignment of positioning System	0.00	Normal	2.00	0.00
21	Uncertainty of the Network Analyzer	1.7	Normal	2.00	0.85
22	Uncertainty of the absolute gain of the calibration antenna	1.70	Normal	2.00	0.85
23	Positioning and pointing misalignment between the reference antenna and the measurement antenna	0.05	Rectangular	1.73	0.03
24	Phase centre offset of calibration antenna	0.00	Rectangular	1.73	0.00
25	Quality of quiet zone for calibration process (NOTE 4)	0.6	Actual	1.00	0.6
26	Standing wave between reference calibration antenna and measurement antenna	0.00	U-shaped	1.41	0.00
27	Influence of the calibration antenna feed cable	0.28	Normal	2.00	0.14
28	Insertion Loss Variation	0.00	Rectangular	1.73	0.00
Expanded uncertainty (1.96σ - confidence interval of 95 %)					Value
TRP Expanded uncertainty (40.8 GHz < f <= 66 GHz) [dB] (a)					7.01
Systematic uncertainties (NOTE 3)					Value
29	Systematic error due to TRP calculation/quadrature (NOTE 1) (b)				0.0
30	Influence of noise (40.8 GHz < f <= 66 GHz) (c)				0.64

31	Systematic error related to beam peak search (NOTE 2)	N/A
Total measurement uncertainty		Value
Total measurement uncertainty (a)+(b)+(c) [dB]		7.65
NOTE 1: This contributor shall only be considered for TRP measurements.		
NOTE 2: This contributor shall only be considered for EIRP measurements.		
NOTE 3: In order to obtain the total measurement uncertainty, systematic uncertainties have to be added to the expanded root sum square of the standard deviations of the Stage 1 and Stage 2 contributors.		
NOTE 4: Value based on procedure defined in clause D.2 of TR 38.810 for Quiet Zone size of less or equal to 30 cm.		
NOTE 5: Applies to the system which has a structure of mechanical feed antenna positioning.		

Table B.25.2-10: Void

Table B.25.2-11: Uncertainty assessment for TRP measurement (f= 66 GHz to 80 GHz, Quiet Zone size \leq 30 cm) for PC3 UEs

UID	Uncertainty source	Uncertainty value	Distribution of the probability	Divisor	Standard uncertainty (σ) [dB]
Stage 2: DUT measurement					
1	Positioning misalignment	0.00	Normal	2.00	0.00
2	Measure distance uncertainty	0.00	Rectangular	1.73	0.00
3	Quality of Quiet Zone (NOTE 4)	0.6	Actual	1.00	0.6
4	Mismatch	2.30	Actual	1.00	2.30
5	Standing wave between the DUT and measurement antenna	0.00	U-shaped	1.41	0.00
6	Uncertainty of the RF power measurement equipment	4.0	Normal	2.00	2.0
7	Phase curvature	0.00	U-shaped	1.41	0.00
8	Amplifier uncertainties	3.0	Normal	2.00	1.50
9	Random uncertainty	0.5	Normal	2.00	0.25
10	Influence of the XPD	0.09	U-shaped	1.41	0.064
11	Insertion Loss Variation	0.00	Rectangular	1.73	0.00
12	RF leakage (from measurement antenna to the receiver/transmitter)	0.00	Actual	1.00	0.00
13	Influence of TRP measurement grid (NOTE 1)	0.32	Actual	1	0.32
14	Influence of beam peak search grid (NOTE 2)	N/A	Actual	1	N/A
15	Multiple measurement antenna uncertainty (NOTE 5)	0.15	Actual	1	0.15
16	DUT repositioning	0.00	Rectangular	1.73	0.00
17	Misalignment of DUT due to change of DUT orientation	0.10	Actual	1	0.10
Stage 1: Calibration measurement					
18	Mismatch	0.00	U-shaped	1.41	0.00
19	Amplifier Uncertainties	0.00	Normal	2.00	0.00
20	Misalignment of positioning System	0.00	Normal	2.00	0.00
21	Uncertainty of the Network Analyzer	1.7	Normal	2.00	0.85
22	Uncertainty of the absolute gain of the calibration antenna	1.70	Normal	2.00	0.85
23	Positioning and pointing misalignment between the reference antenna and the measurement antenna	0.05	Rectangular	1.73	0.03
24	Phase centre offset of calibration antenna	0.00	Rectangular	1.73	0.00
25	Quality of quiet zone for calibration process (NOTE 4)	0.60	Actual	1.00	0.60
26	Standing wave between reference calibration antenna and measurement antenna	0.00	U-shaped	1.41	0.00
27	Influence of the calibration antenna feed cable	0.28	Normal	2.00	0.14
28	Insertion Loss Variation	0.00	Rectangular	1.73	0.00
Expanded uncertainty (1.96σ - confidence interval of 95 %)					Value
TRP Expanded uncertainty (66 GHz < f <= 80 GHz) [dB] (a)					7.31
Systematic uncertainties (NOTE 3)					Value
29	Systematic error due to TRP calculation/quadrature (NOTE 1) (b)				0.0
30	Influence of noise (66 GHz < f <= 80 GHz) (c)				0.64

31	Systematic error related to beam peak search (NOTE 2)	N/A
Total measurement uncertainty		Value
Total measurement uncertainty (a)+(b)+(c) [dB]		7.95
<p>NOTE 1: This contributor shall only be considered for TRP measurements.</p> <p>NOTE 2: This contributor shall only be considered for EIRP measurements.</p> <p>NOTE 3: In order to obtain the total measurement uncertainty, systematic uncertainties have to be added to the expanded root sum square of the standard deviations of the Stage 1 and Stage 2 contributors.</p> <p>NOTE 4: Value based on procedure defined in clause D.2 of TR 38.810 for Quiet Zone size of less or equal to 30 cm.</p> <p>NOTE 5: Applies to the system which has a structure of mechanical feed antenna positioning.</p>		

Table B.25.2-12: Uncertainty assessment for TRP measurement (f=[6] GHz to [12.75] GHz, Quiet Zone size \leq 30 cm) for PC1 UEs

UID	Uncertainty source	Uncertainty value	Distribution of the probability	Divisor	Standard uncertainty (σ) [dB]
Stage 2: DUT measurement					
1	Positioning misalignment	FFS	Normal	2.00	FFS
2	Measure distance uncertainty	FFS	Rectangular	1.73	FFS
3	Quality of Quiet Zone (NOTE 4)	FFS	Actual	1.00	FFS
4	Mismatch	FFS	Actual	1.00	FFS
5	Standing wave between the DUT and measurement antenna	FFS	U-shaped	1.41	FFS
6	Uncertainty of the RF power measurement equipment	FFS	Normal	2.00	FFS
7	Phase curvature	FFS	U-shaped	1.41	FFS
8	Amplifier uncertainties	FFS	Normal	2.00	FFS
9	Random uncertainty	FFS	Normal	2.00	FFS
10	Influence of the XPD	FFS	U-shaped	1.41	FFS
11	Insertion Loss Variation	FFS	Rectangular	1.73	FFS
12	RF leakage (from measurement antenna to the receiver/transmitter)	FFS	Actual	1.00	FFS
13	Influence of TRP measurement grid (NOTE 1)	FFS	Actual	1	FFS
14	Influence of beam peak search grid (NOTE 2)	FFS	Actual	1	FFS
15	Multiple measurement antenna uncertainty (NOTE 5)	FFS	Actual	1	FFS
16	DUT repositioning	FFS	Rectangular	1.73	FFS
17	Misalignment of DUT due to change of DUT orientation	FFS	Actual	1	FFS
Stage 1: Calibration measurement					
18	Mismatch	FFS	U-shaped	1.41	FFS
19	Amplifier Uncertainties	FFS	Normal	2.00	FFS
20	Misalignment of positioning System	FFS	Normal	2.00	FFS
21	Uncertainty of the Network Analyzer	FFS	Normal	2.00	FFS
22	Uncertainty of the absolute gain of the calibration antenna	FFS	Normal	2.00	FFS
23	Positioning and pointing misalignment between the reference antenna and the measurement antenna	FFS	Rectangular	1.73	FFS
24	Phase centre offset of calibration antenna	FFS	Rectangular	1.73	FFS
25	Quality of quiet zone for calibration process (NOTE 4)	FFS	Actual	1.00	FFS
26	Standing wave between reference calibration antenna and measurement antenna	FFS	U-shaped	1.41	FFS
27	Influence of the calibration antenna feed cable	FFS	Normal	2.00	FFS
28	Insertion Loss Variation	FFS	Rectangular	1.73	FFS
Expanded uncertainty (1.96σ - confidence interval of 95 %)					Value
TRP Expanded uncertainty ([6] GHz < f <= [12.75] GHz) [dB] (a)					FFS
Systematic uncertainties (NOTE 3)					Value
29	Systematic error due to TRP calculation/quadrature (NOTE 1) (b)				FFS
30	Influence of noise ([6] GHz < f <= [12.75] GHz) (c)				FFS

31	Systematic error related to beam peak search (NOTE 2)	N/A
Total measurement uncertainty		Value
Total measurement uncertainty (a)+(b)+(c) [dB]		FFS
<p>NOTE 1: This contributor shall only be considered for TRP measurements.</p> <p>NOTE 2: This contributor shall only be considered for EIRP measurements.</p> <p>NOTE 3: In order to obtain the total measurement uncertainty, systematic uncertainties have to be added to the expanded root sum square of the standard deviations of the Stage 1 and Stage 2 contributors.</p> <p>NOTE 4: Value based on procedure defined in clause D.2 of TR 38.810 for Quiet Zone size of less or equal to 30 cm.</p> <p>NOTE 5: Applies to the system which has a structure of mechanical feed antenna positioning.</p>		

Table B.25.2-13: Uncertainty assessment for TRP measurement (f=[12.75] GHz to 23.45 GHz, Quiet Zone size \leq 30 cm) for PC1 UEs

UID	Uncertainty source	Uncertainty value	Distribution of the probability	Divisor	Standard uncertainty (σ) [dB]
Stage 2: DUT measurement					
1	Positioning misalignment	FFS	Normal	2.00	FFS
2	Measure distance uncertainty	FFS	Rectangular	1.73	FFS
3	Quality of Quiet Zone (NOTE 4)	FFS	Actual	1.00	FFS
4	Mismatch	FFS	Actual	1.00	FFS
5	Standing wave between the DUT and measurement antenna	FFS	U-shaped	1.41	FFS
6	Uncertainty of the RF power measurement equipment	FFS	Normal	2.00	FFS
7	Phase curvature	FFS	U-shaped	1.41	FFS
8	Amplifier uncertainties	FFS	Normal	2.00	FFS
9	Random uncertainty	FFS	Normal	2.00	FFS
10	Influence of the XPD	FFS	U-shaped	1.41	FFS
11	Insertion Loss Variation	FFS	Rectangular	1.73	FFS
12	RF leakage (from measurement antenna to the receiver/transmitter)	FFS	Actual	1.00	FFS
13	Influence of TRP measurement grid (NOTE 1)	FFS	Actual	1	FFS
14	Influence of beam peak search grid (NOTE 2)	N/A	Actual	1	N/A
15	Multiple measurement antenna uncertainty (NOTE 5)	FFS	Actual	1	FFS
16	DUT repositioning	FFS	Rectangular	1.73	FFS
17	Misalignment of DUT due to change of DUT orientation	FFS	Actual	1	FFS
Stage 1: Calibration measurement					
18	Mismatch	FFS	U-shaped	1.41	FFS
19	Amplifier Uncertainties	FFS	Normal	2.00	FFS
20	Misalignment of positioning System	FFS	Normal	2.00	FFS
21	Uncertainty of the Network Analyzer	FFS	Normal	2.00	FFS
22	Uncertainty of the absolute gain of the calibration antenna	FFS	Normal	2.00	FFS
23	Positioning and pointing misalignment between the reference antenna and the measurement antenna	FFS	Rectangular	1.73	FFS
24	Phase centre offset of calibration antenna	FFS	Rectangular	1.73	FFS
25	Quality of quiet zone for calibration process (NOTE 4)	FFS	Actual	1.00	FFS
26	Standing wave between reference calibration antenna and measurement antenna	FFS	U-shaped	1.41	FFS
27	Influence of the calibration antenna feed cable	FFS	Normal	2.00	FFS
28	Insertion Loss Variation	FFS	Rectangular	1.73	FFS
Expanded uncertainty (1.96σ - confidence interval of 95 %)					Value
TRP Expanded uncertainty ([12.75] GHz < f <= 23.45 GHz) [dB] (a)					FFS
Systematic uncertainties (NOTE 3)					Value
29	Systematic error due to TRP calculation/quadrature (NOTE 1) (b)				FFS
30	Influence of noise ([12.75] GHz < f <= 23.45 GHz) (c)				FFS

31	Systematic error related to beam peak search (NOTE 2)	N/A
Total measurement uncertainty		Value
Total measurement uncertainty (a)+(b)+(c) [dB]		FFS
<p>NOTE 1: This contributor shall only be considered for TRP measurements.</p> <p>NOTE 2: This contributor shall only be considered for EIRP measurements.</p> <p>NOTE 3: In order to obtain the total measurement uncertainty, systematic uncertainties have to be added to the expanded root sum square of the standard deviations of the Stage 1 and Stage 2 contributors.</p> <p>NOTE 4: Value based on procedure defined in clause D.2 of TR 38.810 for Quiet Zone size of less or equal to 30 cm.</p> <p>NOTE 5: Applies to the system which has a structure of mechanical feed antenna positioning.</p>		

Table B.25.2-14: Uncertainty assessment for TRP measurement (f=23.45 GHz to 40.8 GHz, Quiet Zone size \leq 30 cm) for PC1 UEs

UID	Uncertainty source	Uncertainty value	Distribution of the probability	Divisor	Standard uncertainty (σ) [dB]
Stage 2: DUT measurement					
1	Positioning misalignment	FFS	Normal	2.00	FFS
2	Measure distance uncertainty	FFS	Rectangular	1.73	FFS
3	Quality of Quiet Zone (NOTE 4)	FFS	Actual	1.00	FFS
4	Mismatch	FFS	Actual	1.00	FFS
5	Standing wave between the DUT and measurement antenna	FFS	U-shaped	1.41	FFS
6	Uncertainty of the RF power measurement equipment	FFS	Normal	2.00	FFS
7	Phase curvature	FFS	U-shaped	1.41	FFS
8	Amplifier uncertainties	FFS	Normal	2.00	FFS
9	Random uncertainty	FFS	Normal	2.00	FFS
10	Influence of the XPD	FFS	U-shaped	1.41	FFS
11	Insertion Loss Variation	FFS	Rectangular	1.73	FFS
12	RF leakage (from measurement antenna to the receiver/transmitter)	FFS	Actual	1.00	FFS
13	Influence of TRP measurement grid (NOTE 1)	FFS	Actual	1	FFS
14	Influence of beam peak search grid (NOTE 2)	N/A	Actual	1	N/A
15	Multiple measurement antenna uncertainty (NOTE 5)	FFS	Actual	1	FFS
16	DUT repositioning	FFS	Rectangular	1.73	FFS
17	Misalignment of DUT due to change of DUT orientation	FFS	Actual	1	FFS
Stage 1: Calibration measurement					
18	Mismatch	FFS	U-shaped	1.41	FFS
19	Amplifier Uncertainties	FFS	Normal	2.00	FFS
20	Misalignment of positioning System	FFS	Normal	2.00	FFS
21	Uncertainty of the Network Analyzer	FFS	Normal	2.00	FFS
22	Uncertainty of the absolute gain of the calibration antenna	FFS	Normal	2.00	FFS
23	Positioning and pointing misalignment between the reference antenna and the measurement antenna	FFS	Rectangular	1.73	FFS
24	Phase centre offset of calibration antenna	FFS	Rectangular	1.73	FFS
25	Quality of quiet zone for calibration process (NOTE 4)	FFS	Actual	1.00	FFS
26	Standing wave between reference calibration antenna and measurement antenna	FFS	U-shaped	1.41	FFS
27	Influence of the calibration antenna feed cable	FFS	Normal	2.00	FFS
28	Insertion Loss Variation	FFS	Rectangular	1.73	FFS
Expanded uncertainty (1.96σ - confidence interval of 95 %)					Value
TRP Expanded uncertainty (23.45 GHz < f <= 40.8 GHz) [dB] (a)					FFS
Systematic uncertainties (NOTE 3)					Value
29	Systematic error due to TRP calculation/quadrature (NOTE 1) (b)				FFS
30	Influence of noise (23.45 GHz < f <= 40.8 GHz) (c)				FFS

31	Systematic error related to beam peak search (NOTE 2)	N/A
Total measurement uncertainty		Value
Total measurement uncertainty (a)+(b)+(c) [dB]		FFS
<p>NOTE 1: This contributor shall only be considered for TRP measurements.</p> <p>NOTE 2: This contributor shall only be considered for EIRP measurements.</p> <p>NOTE 3: In order to obtain the total measurement uncertainty, systematic uncertainties have to be added to the expanded root sum square of the standard deviations of the Stage 1 and Stage 2 contributors.</p> <p>NOTE 4: Value based on procedure defined in clause D.2 of TR 38.810 for Quiet Zone size of less or equal to 30 cm.</p> <p>NOTE 5: Applies to the system which has a structure of mechanical feed antenna positioning.</p>		

Table B.25.2-15: Uncertainty assessment for TRP measurement (f= 40.8 GHz to 66 GHz, Quiet Zone size \leq 30 cm) for PC1 UEs

UID	Uncertainty source	Uncertainty value	Distribution of the probability	Divisor	Standard uncertainty (σ) [dB]
Stage 2: DUT measurement					
1	Positioning misalignment	FFS	Normal	2.00	FFS
2	Measure distance uncertainty	FFS	Rectangular	1.73	FFS
3	Quality of Quiet Zone (NOTE 4)	FFS	Actual	1.00	FFS
4	Mismatch	FFS	Actual	1.00	FFS
5	Standing wave between the DUT and measurement antenna	FFS	U-shaped	1.41	FFS
6	Uncertainty of the RF power measurement equipment	FFS	Normal	2.00	FFS
7	Phase curvature	FFS	U-shaped	1.41	FFS
8	Amplifier uncertainties	FFS	Normal	2.00	FFS
9	Random uncertainty	FFS	Normal	2.00	FFS
10	Influence of the XPD	FFS	U-shaped	1.41	FFS
11	Insertion Loss Variation	FFS	Rectangular	1.73	FFS
12	RF leakage (from measurement antenna to the receiver/transmitter)	FFS	Actual	1.00	FFS
13	Influence of TRP measurement grid (NOTE 1)	FFS	Actual	1	FFS
14	Influence of beam peak search grid (NOTE 2)	N/A	Actual	1	N/A
15	Multiple measurement antenna uncertainty (NOTE 5)	FFS	Actual	1	FFS
16	DUT repositioning	FFS	Rectangular	1.73	FFS
17	Misalignment of DUT due to change of DUT orientation	FFS	Actual	1	FFS
Stage 1: Calibration measurement					
18	Mismatch	FFS	U-shaped	1.41	FFS
19	Amplifier Uncertainties	FFS	Normal	2.00	FFS
20	Misalignment of positioning System	FFS	Normal	2.00	FFS
21	Uncertainty of the Network Analyzer	FFS	Normal	2.00	FFS
22	Uncertainty of the absolute gain of the calibration antenna	FFS	Normal	2.00	FFS
23	Positioning and pointing misalignment between the reference antenna and the measurement antenna	FFS	Rectangular	1.73	FFS
24	Phase centre offset of calibration antenna	FFS	Rectangular	1.73	FFS
25	Quality of quiet zone for calibration process (NOTE 4)	FFS	Actual	1.00	FFS
26	Standing wave between reference calibration antenna and measurement antenna	FFS	U-shaped	1.41	FFS
27	Influence of the calibration antenna feed cable	FFS	Normal	2.00	FFS
28	Insertion Loss Variation	FFS	Rectangular	1.73	FFS
Expanded uncertainty (1.96σ - confidence interval of 95 %)					Value
TRP Expanded uncertainty (40.8 GHz < f <= 66 GHz) [dB] (a)					FFS
Systematic uncertainties (NOTE 3)					Value
29	Systematic error due to TRP calculation/quadrature (NOTE 1) (b)				FFS
30	Influence of noise (40.8 GHz < f <= 66 GHz) (c)				FFS

31	Systematic error related to beam peak search (NOTE 2)	N/A
Total measurement uncertainty		Value
Total measurement uncertainty (a)+(b)+(c) [dB]		FFS
<p>NOTE 1: This contributor shall only be considered for TRP measurements.</p> <p>NOTE 2: This contributor shall only be considered for EIRP measurements.</p> <p>NOTE 3: In order to obtain the total measurement uncertainty, systematic uncertainties have to be added to the expanded root sum square of the standard deviations of the Stage 1 and Stage 2 contributors.</p> <p>NOTE 4: Value based on procedure defined in clause D.2 of TR 38.810 for Quiet Zone size of less or equal to 30 cm.</p> <p>NOTE 5: Applies to the system which has a structure of mechanical feed antenna positioning.</p>		

Table B.25.2-16: Uncertainty assessment for TRP measurement (f= 66 GHz to 80 GHz, Quiet Zone size \leq 30 cm) for PC1 UEs

UID	Uncertainty source	Uncertainty value	Distribution of the probability	Divisor	Standard uncertainty (σ) [dB]
Stage 2: DUT measurement					
1	Positioning misalignment	FFS	Normal	2.00	FFS
2	Measure distance uncertainty	FFS	Rectangular	1.73	FFS
3	Quality of Quiet Zone (NOTE 4)	FFS	Actual	1.00	FFS
4	Mismatch	FFS	Actual	1.00	FFS
5	Standing wave between the DUT and measurement antenna	FFS	U-shaped	1.41	FFS
6	Uncertainty of the RF power measurement equipment	FFS	Normal	2.00	FFS
7	Phase curvature	FFS	U-shaped	1.41	FFS
8	Amplifier uncertainties	FFS	Normal	2.00	FFS
9	Random uncertainty	FFS	Normal	2.00	FFS
10	Influence of the XPD	FFS	U-shaped	1.41	FFS
11	Insertion Loss Variation	FFS	Rectangular	1.73	FFS
12	RF leakage (from measurement antenna to the receiver/transmitter)	FFS	Actual	1.00	FFS
13	Influence of TRP measurement grid (NOTE 1)	FFS	Actual	1	FFS
14	Influence of beam peak search grid (NOTE 2)	N/A	Actual	1	N/A
15	Multiple measurement antenna uncertainty (NOTE 5)	FFS	Actual	1	FFS
16	DUT repositioning	FFS	Rectangular	1.73	FFS
17	Misalignment of DUT due to change of DUT orientation	FFS	Actual	1	FFS
Stage 1: Calibration measurement					
18	Mismatch	FFS	U-shaped	1.41	FFS
19	Amplifier Uncertainties	FFS	Normal	2.00	FFS
20	Misalignment of positioning System	FFS	Normal	2.00	FFS
21	Uncertainty of the Network Analyzer	FFS	Normal	2.00	FFS
22	Uncertainty of the absolute gain of the calibration antenna	FFS	Normal	2.00	FFS
23	Positioning and pointing misalignment between the reference antenna and the measurement antenna	FFS	Rectangular	1.73	FFS
24	Phase centre offset of calibration antenna	FFS	Rectangular	1.73	FFS
25	Quality of quiet zone for calibration process (NOTE 4)	FFS	Actual	1.00	FFS
26	Standing wave between reference calibration antenna and measurement antenna	FFS	U-shaped	1.41	FFS
27	Influence of the calibration antenna feed cable	FFS	Normal	2.00	FFS
28	Insertion Loss Variation	FFS	Rectangular	1.73	FFS
Expanded uncertainty (1.96σ - confidence interval of 95 %)					Value
TRP Expanded uncertainty (66 GHz < f <= 80 GHz) [dB] (a)					FFS
Systematic uncertainties (NOTE 3)					Value
29	Systematic error due to TRP calculation/quadrature (NOTE 1) (b)				FFS
30	Influence of noise (66 GHz < f <= 80 GHz) (c)				FFS

31	Systematic error related to beam peak search (NOTE 2)	N/A
Total measurement uncertainty		Value
Total measurement uncertainty (a)+(b)+(c) [dB]		FFS
<p>NOTE 1: This contributor shall only be considered for TRP measurements.</p> <p>NOTE 2: This contributor shall only be considered for EIRP measurements.</p> <p>NOTE 3: In order to obtain the total measurement uncertainty, systematic uncertainties have to be added to the expanded root sum square of the standard deviations of the Stage 1 and Stage 2 contributors.</p> <p>NOTE 4: Value based on procedure defined in clause D.2 of TR 38.810 for Quiet Zone size of less or equal to 30 cm.</p> <p>NOTE 5: Applies to the system which has a structure of mechanical feed antenna positioning.</p>		

Annex C: Acceptable uncertainty of test system for test cases defined in TS 38.521-3 for radiative testing

FFS

Annex D: Acceptable uncertainty of test system for test cases defined in TS 38.521-4 for radiative testing

Editor's note: The MU tables in D-1, D-2, and D-3 serve as sample, consolidated baseline tables for demodulation test cases and can be removed once the MU tables customized for each TS 38.521-4 test case have been finalized.

This annex contains suggested uncertainties for each test case in TS 38.521-4.

The baseline MU table for Mode 1 (conditions with external noise) is shown in Table D-1 for baseband-combining implementation and in Table D-2 for external-combining implementation.

Table D-1: Uncertainty Contributions for Mode 1 Demodulation Test Cases (Baseband-Combining Implementation)

UID	Uncertainty source	Uncertainty value	Distribution of the probability	Divisor	Standard uncertainty (σ) [dB]
Signal-to-noise ratio uncertainty					
Stage 2: DUT measurement					
1	Positioning misalignment		N/A	N/A	
2	Measure distance uncertainty		N/A	N/A	
3	Quality of Quiet Zone		N/A	N/A	
4	Mismatch		N/A	N/A	
5	Standing wave between the DUT and measurement antenna		N/A	N/A	
6	gNB emulator SNR uncertainty	0.3	Note 3	1.96	0.153
7	Phase curvature		N/A	N/A	
8	Amplifier uncertainties		N/A	N/A	
9	Random uncertainty		N/A	N/A	
10	Influence of the XPD		N/A	N/A	
11	Insertion Loss Variation		N/A	N/A	
12	RF leakage (from measurement antenna to the receiver/transmitter)		N/A	N/A	
13	Multiple measurement antenna uncertainty		N/A	N/A	
14	DUT repositioning		N/A	N/A	
Stage 1: Calibration measurement					
15	Mismatch		N/A	N/A	
16	Amplifier Uncertainties		N/A	N/A	
17	Misalignment of positioning System		N/A	N/A	
18	Uncertainty of the Network Analyzer		N/A	N/A	
19	Uncertainty of the absolute gain of the calibration antenna		N/A	N/A	
20	Positioning and pointing misalignment between the reference antenna and the measurement antenna		N/A	N/A	
21	Phase centre offset of calibration antenna		N/A	N/A	
22	Quality of quiet zone for calibration process		N/A	N/A	
23	Standing wave between reference calibration antenna and measurement antenna		N/A	N/A	
24	Influence of the calibration antenna feed cable		N/A	N/A	
25	Insertion Loss Variation		N/A	N/A	
Total Signal-to-Noise ratio uncertainty					0.153
Other contributors affecting test result					
27	gNB emulator fading model impairments	0.5 for 1Tx 0.7 for 2Tx	Note 3	1.96	0.255 for 1Tx 0.357 for 2Tx
28	AWGN flatness and signal flatness, max deviation for any Resource Block, relative to average over BW_{Config} (Note 4)	3.6	Note 3	1.96	1.837
29	SNR uncertainty due to finite test time	0.3 for PDSCH and Doppler < 100 Hz 0.0 for PDSCH and Doppler \geq 100 Hz 0.4 for PDCCH	Note 3	1.96	0.153 for PDSCH and Doppler < 100 Hz 0.0 for PDSCH and Doppler \geq 100 Hz 0.204 for PDCCH
Systematic uncertainties					Value

26	Impact on non-ideal isolation between branches for the wireless cable mode	0.45 (Note 1) 0.60 (Note 2)
Overall system uncertainty		Value
		Note 5
<p>Note 1: applies to Rank 2 test cases for FR2a, FR2b, and FR2c Note 2: applies to Rank 1 test cases for FR2a, FR2b, and FR2c Note 3: Divisor of 1.96 is applied as the uncertainty value is based on 95% confidence level $k=1.96$. Note 4: AWGN flatness and signal flatness has $\times 0.25$ effect on the required SNR. This sensitivity factor shall be considered in the calculation of the test case specific uncertainty. Note 5: Example calculation for fading conditions: Overall system uncertainty for fading conditions comprises five quantities: 1. Total Signal-to-noise ratio uncertainty 2. gNB emulator fading model impairments 3. Effect of AWGN flatness and signal flatness 4. SNR uncertainty due to finite test time 5. Impact on non-ideal isolation between branches for the wireless cable mode Items 1, 2, 3 and 4 are assumed to be uncorrelated so can be root sum squared. Item 5 is systematic and is added: AWGN flatness and signal flatness has $\times 0.25$ effect on the required SNR, so use sensitivity factor of $\times 0.25$ for the uncertainty contribution. Overall system uncertainty = $1.96 \times \text{SQRT}(\text{Total Signal-to-noise ratio uncertainty}^2 + \text{gNB emulator fading model impairments}^2 + (0.25 \times \text{AWGN flatness and signal flatness})^2 + \text{SNR uncertainty due to finite test time}^2) + \text{Impact on non-ideal isolation between branches for the wireless cable model}$</p>		

Table D-1a: Overall system uncertainty for Mode 1 Demodulation Test Cases (Baseband-Combining Implementation)

Overall system uncertainty	Value
PDSCH 1Tx with Doppler < 100 Hz	1.71
PDSCH 2Tx with Doppler < 100 Hz, rank 1	1.82
PDSCH 2Tx with Doppler < 100 Hz, rank 2	1.67
PDSCH 1Tx with Doppler \geq 100 Hz	1.67
PDSCH 2Tx with Doppler \geq 100 Hz, rank 1	1.78
PDSCH 2Tx with Doppler \geq 100 Hz, rank 2	1.63
PDCCH 1Tx, rank 1	1.74
PDCCH 2Tx, rank 1	1.84

Table D-2: Uncertainty Contributions for Mode 1 Demodulation Test Cases (External-Combining Implementation)

UID	Uncertainty source	Uncertainty value	Distribution of the probability	Divisor	Standard uncertainty (σ) [dB]
Signal-to-noise ratio uncertainty					
Stage 2: DUT measurement					
1	Positioning misalignment		[Normal]	[2.00]	
2	Measure distance uncertainty		[Rectangular]	[1.73]	
3	Quality of Quiet Zone		[Actual]	[1.00]	
4	Mismatch		[Actual]	[1.00]	
5	Standing wave between the DUT and measurement antenna		[U-shaped]	[1.41]	
6	gNB emulator SNR uncertainty		[Normal]	[2.00]	
7	Phase curvature		[U-shaped]	[1.41]	
8	Amplifier uncertainties		[Normal]	[2.00]	
9	Random uncertainty		[Normal]	[2.00]	
10	Influence of the XPD		[U-shaped]	[1.41]	
11	Insertion Loss Variation		[Rectangular]	[1.73]	
12	RF leakage (from measurement antenna to the receiver/transmitter)		[Actual]	[1.00]	
13	Multiple measurement antenna uncertainty		[Actual]	[1.00]	
14	DUT repositioning		[Rectangular]	[1.73]	
Stage 1: Calibration measurement					
15	Mismatch		[U-shaped]	[1.41]	
16	Amplifier Uncertainties		[Normal]	[2.00]	
17	Misalignment of positioning System		[Normal]	[2.00]	
18	Uncertainty of the Network Analyzer		[Normal]	[2.00]	
19	Uncertainty of the absolute gain of the calibration antenna		[Normal]	[2.00]	
20	Positioning and pointing misalignment between the reference antenna and the measurement antenna		[Rectangular]	[1.73]	
21	Phase centre offset of calibration antenna		[Rectangular]	[1.73]	
22	Quality of quiet zone for calibration process		[Actual]	[1.00]	
23	Standing wave between reference calibration antenna and measurement antenna		[U-shaped]	[1.41]	
24	Influence of the calibration antenna feed cable		[Normal]	[2.00]	
25	Insertion Loss Variation		[Rectangular]	[1.73]	
Systematic uncertainties					Value
26	Impact on non-ideal isolation between branches for the wireless cable mode				0.45 (Note 1) 0.60 (Note 2)
Total Signal-to-Noise ratio uncertainty					
Other contributors affecting test result					
27	gNB emulator fading model impairments		[Normal]	[2.00]	
28	AWGN flatness and signal flatness, max deviation for any Resource Block, relative to average over BW_{Config} (Note 3)		[Actual]	1.00	
29	Result variation due to finite test time		[Actual]	[1.00]	
<p>Note 1: applies to Rank 2 test cases for FR2a, FR2b, and FR2c</p> <p>Note 2: applies to Rank 1 test cases for FR2a, FR2b, and FR2c</p> <p>Note 3: AWGN flatness and signal flatness has x 0.25 effect on the required SNR. This sensitivity factor shall be considered in the calculation of the test case specific uncertainty.</p>					

The baseline MU table for Mode 2 (noise free conditions) is shown in Table D-3.

Table D-3: Uncertainty Contributions for Mode 2 Demodulation Test Cases

UID	Uncertainty source	Uncertainty value	Distribution of the probability	Divisor	Standard uncertainty (σ) [dB]
Stage 2: DUT measurement					
1	Positioning misalignment		[Normal]	[2.00]	
2	Measure distance uncertainty		[Rectangular]	[1.73]	
3	Quality of Quiet Zone		[Actual]	[1.00]	
4	Mismatch		[Actual]	[1.00]	
5	Standing wave between the DUT and measurement antenna		[U-shaped]	[1.41]	
6	gNB uncertainty on absolute level		[Normal]	[2.00]	
7	Phase curvature		[U-shaped]	[1.41]	
8	Amplifier uncertainties		[Normal]	[2.00]	
9	Random uncertainty		[Normal]	[2.00]	
10	Influence of the XPD		[U-shaped]	[1.41]	
11	Insertion Loss Variation		[Rectangular]	[1.73]	
12	RF leakage (from measurement antenna to the receiver/transmitter)		[Actual]	[1.00]	
13	Multiple measurement antenna uncertainty		[Actual]	[1.00]	
14	DUT repositioning		[Rectangular]	[1.73]	
Stage 1: Calibration measurement					
15	Mismatch		[U-shaped]	[1.41]	
16	Amplifier Uncertainties		[Normal]	[2.00]	
17	Misalignment of positioning System		[Normal]	[2.00]	
18	Uncertainty of the Network Analyzer		[Normal]	[2.00]	
19	Uncertainty of the absolute gain of the calibration antenna		[Normal]	[2.00]	
20	Positioning and pointing misalignment between the reference antenna and the measurement antenna		[Rectangular]	[1.73]	
21	Phase centre offset of calibration antenna		[Rectangular]	[1.73]	
22	Quality of quiet zone for calibration process		[Actual]	[1.00]	
23	Standing wave between reference calibration antenna and measurement antenna		[U-shaped]	[1.41]	
24	Influence of the calibration antenna feed cable		[Normal]	[2.00]	
25	Insertion Loss Variation		[Rectangular]	[1.73]	
Systematic uncertainties					Value
26	Systematic error related to beam peak search				
27	Impact on non-ideal isolation between branches for the wireless cable mode				0.45 (Note 1) 0.60 (Note 2)
Other contributors affecting test result					
28	Result variation due to finite test time		[Actual]	[1.00]	
Note 1: applies to Rank 2 test cases for FR2a, FR2b, and FR2c					
Note 2: applies to Rank 1 test cases for FR2a, FR2b, and FR2c					

D.1 Uncertainty budget calculation principle

D.1.1 Uncertainty budget calculation principle for DNF

The uncertainty tables cover the actual measurement using the DUT receiver. If applicable, any uncertainty arising from a calibration or alignment process before the measurements should also be included.

The MU budget should comprise of a minimum 5 headings:

- 1) The uncertainty source,
- 2) Uncertainty value,
- 3) Distribution of the probability,
- 4) Divisor based on distribution shape,
- 5) Calculated standard uncertainty (based on uncertainty value and divisor).

D.1.2 Uncertainty budget calculation principle for DFF

The same as defined in D.1.1.

D.1.3 Uncertainty budget calculation principle for IFF

The same as defined in D.1.1.

D.2 Measurement error contribution descriptions

D.2.1 Measurement error contribution descriptions for DNF

D.2.1.1 gNB emulator SNR uncertainty

This contribution originates from setting the ratio of signal and noise in the conducted part of the test system. It is estimated to be the same as for LTE conducted testing in TS 36.521-1 Annex F, which is ± 0.3 dB. The default for values in 36.521-1 Annex F is 95% confidence interval, normal distribution.

D.2.1.2 gNB emulator Downlink EVM

When simulations of demodulation performance are run, the downlink signal is modelled with a defined EVM, representing imperfections in the signal transmitted by the gNB. This EVM value is agreed across companies to align simulations, and is normally lower than the gNB EVM requirement, to represent “typical” conditions. The EVM used for simulations is therefore built in to the requirement points, normally specified as the SNR required to meet a specified throughput, with a defined modulation and Reference channel, under defined propagation conditions.

For a conformance test, the EVM defined for the simulations is taken as a maximum allowed value for the test system, as a worse gNB emulator EVM would make the signal harder to demodulate, and disadvantage the UE. In a test system the EVM cannot normally be set to a specific value, but is specified to be no higher than a defined value.

Following this approach, the uncertainty from gNB emulator Downlink EVM is a one-sided distribution, with beneficial effect. Without treating the positive and negative uncertainties separately, and as it would not make the SNR worse, the effective uncertainty is 0dB.

D.2.1.3 gNB emulator fading model impairments

This contribution originates from imperfections in the gNB emulator fading model, compared to the applied fading model. It is estimated to be the same as for LTE conducted testing in TS 36.521-1 Annex F, which is ± 0.5 dB. The default for values in 36.521-1 Annex F is 95% confidence interval, normal distribution.

D.2.2 Measurement error contribution descriptions for DFF

D.2.2.1 gNB emulator SNR uncertainty

See D.2.1.1.

D.2.2.2 gNB emulator Downlink EVM

See D.2.1.2.

D.2.2.3 gNB emulator fading model impairments

See D.2.1.3.

D.2.3 Measurement error contribution descriptions for IFF

The Measurement uncertainty contributions and uncertainty assessment are expected to be the same as for the Direct near field (DNF) setup in D.2.1.

D.2.3.1 gNB emulator SNR uncertainty

See D.2.1.1.

D.2.3.2 gNB emulator Downlink EVM

See D.2.1.2.

D.2.3.3 gNB emulator fading model impairments

See D.2.1.3.

D.3 Assessment of testable DL SNR range and accuracy

The signal and the noise provided by the test system are both attenuated by the over-the-air link loss. The UE noise then adds to the noise provided by the test system, hence degrading the SNR seen by the UE and potentially limiting the testable SNR range. The calculations and graphs in this clause allow this SNR degradation to be assessed over a range of scenarios.

For conducted tests, the noise provided by the test system can be set much higher than the UE noise and the SNR degradation is negligible. However for over-the-air test systems, the power that can realistically be delivered into the test system probe antenna is limited, so the test point is likely to be closer to the UE noise and a small SNR degradation is allowable.

D.3.1 Method and Parameters

The method is the same as in clause B.2.1.5.1 of TR 38.810 [13], but some values related to the test system are different. The calculation of noise level is described in clause 7.2.1.3 of TR 38.810 [13]. Under fading conditions the backoff is [17.71] dB instead of 13 dB when no fading applies.

D.3.2.1 SNR range for $SNR_{RP} - SNR_{BB} \leq 1\text{dB}$ for DFF

FFS

D.3.2.2 SNR range for $SNR_{RP} - SNR_{BB} \leq 1\text{dB}$ for IFF

Based on the method of setting the noise from the Test system to give a maximum of 1dB degradation in overall SNR between reference point and baseband, we can then work back through the signal chain to determine how high the SNR can be set. As the noise is set to a fixed level, the maximum SNR is set by the test system power amplifier and the channel bandwidth to be tested.

The SNR upper bound depends on the type of test system. For the Indirect Far field (IFF) setup the diagram below illustrates the principle, and is based on the “IFF 100MHz (n257, n258, n261)” tab of the accompanying spreadsheet.

The process works back through the signal chain, from left to right in the diagram.

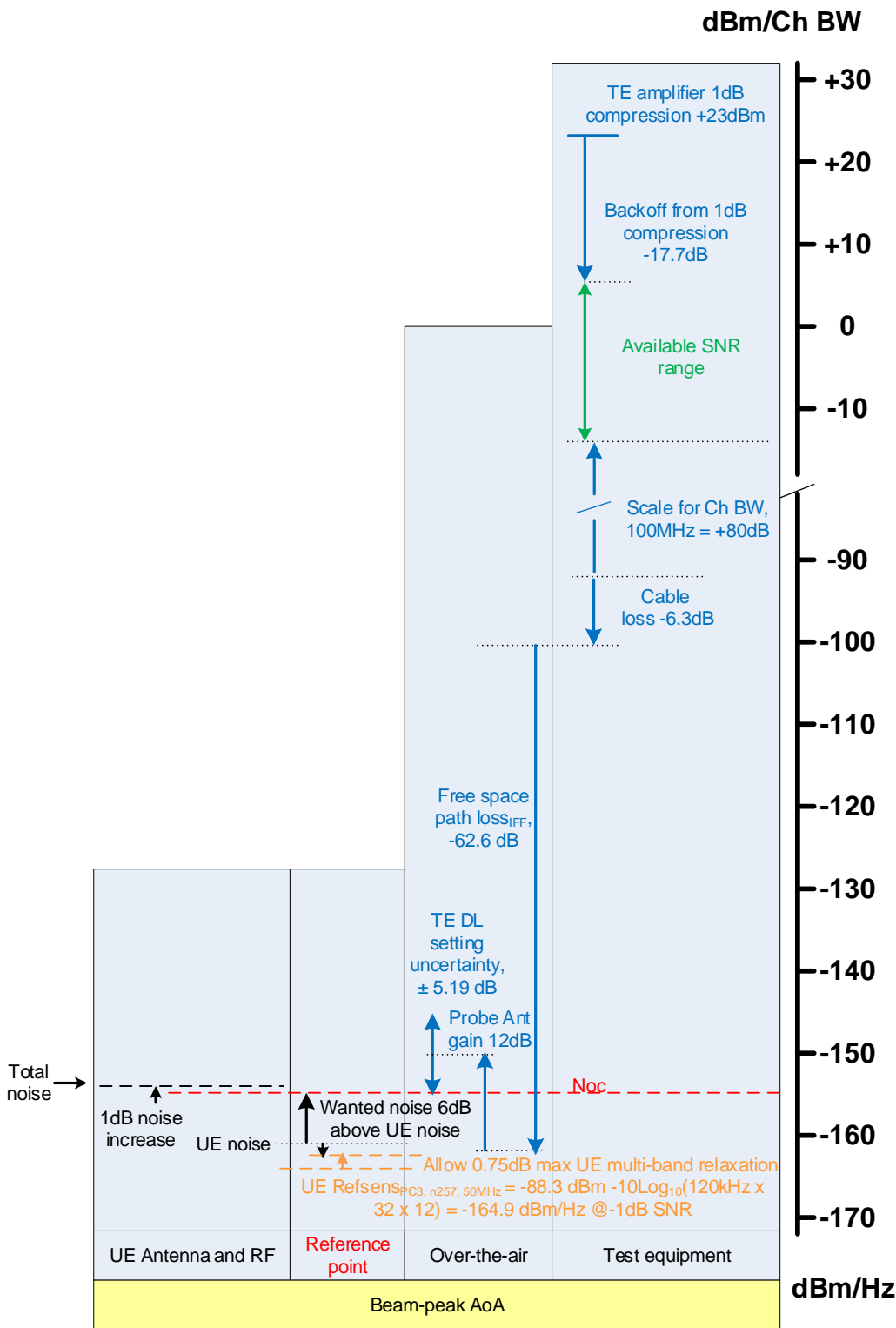

Figure D.3.2.2-1: Estimation of single band UE SNR range for Indirect far field (IFF) when no fading applies

The test equipment must supply at least the wanted noise level at the reference point. If the noise was lower, the degradation in SNR would be greater than 1dB, and may cause a conformant UE to fail.

The accuracy of setting the signal and noise levels has been taken as ±5.19 dB.

Inclusion of this contribution directly reduces the maximum SNR that can be measured by a test system for a given channel bandwidth. To find the maximum SNR that can be measured by a test system with a specific Channel BW, the baseband SNR in the spreadsheet is increased until the value “Wanted signal + headroom, dBm/Ch BW” is just below

the “Available DL power at CW 1dB compression at QZ, dBm” value. For fading conditions, the working assumption for the “Backoff from P1dB” with a value of [-17.71] dB valid for modulations up to 64 QAM has been applied. In the case without fading, the “Backoff from P1dB” is [-13] dB valid for modulations up to 64 QAM. The resulting values for SNR_{BB} are given in Table D.3.2.2-1 for tests cases making use of fading and D.3.2.2-2 for test cases without fading. Single band UE values are obtained by setting the UE multi-band relaxation factor to 0 dB.

Table D.3.2.2-1: Predicted SNR_{BB} upper bound values for Indirect far field (IFF) with 30cm QZ, PC3, 100MHz CHBW, modulation up to 64 QAM under fading conditions

	Operating Band	Maximum SNR _{BB} (dB)		
		CHBW 50 MHz	CHBW 100 MHz	CHBW 200 MHz
Multi-band UE ^(Note)	n257	[24.0]	[20.8]	[17.8]
	n258	[24.0]	[20.8]	[17.8]
	n259	[13.6]	[10.3]	[7.0]
	n260	[17.7]	[14.5]	[11.4]
	n261	[24.0]	[20.8]	[17.8]
Note: For \sum MBp from TS 38.101-2 [16] Table 6.2.1.3-4 allow up to 0.75 dB in Rel-15.				

Table D.3.2.2-2: Predicted SNR_{BB} upper bound values for Indirect far field (IFF) with 30cm QZ, PC3, 100MHz CHBW, modulation up to 64 QAM when no fading conditions apply

	Operating Band	Maximum SNR _{BB} (dB)		
		CHBW 50 MHz	CHBW 100 MHz	CHBW 200 MHz
Multi-band UE ^(Note)	n257	[28.7]	[25.5]	[22.5]
	n258	[28.7]	[25.5]	[22.5]
	n259	[18.4]	[15.2]	[12.1]
	n260	[22.5]	[19.3]	[16.3]
	n261	[28.7]	[25.5]	[22.5]
Note: For \sum MBp from TS 38.101-2 [16] Table 6.2.1.3-4 allow up to 0.75 dB in Rel-15.				

Note that these are UE baseband SNR values (SNR_{BB}), so the Reference point figures used in TS 38.101-4 [19] will be 1 dB higher.

An example of SNR calculation for IFF method is provided in “38.521-4 Spreadsheet - Demod SNR range calculator.zip” file attached to the TR.

Annex E: Acceptable uncertainty of test system for test cases defined in TS 38.533 for radiative testing

This annex contains suggested uncertainties for each test case or MU quantity in TS 38.533 [10].

E.1 Uncertainty budget calculation principle

E.1.1 Uncertainty budget calculation principle for DFF

The uncertainty tables cover the actual measurement using the DUT. In some cases, uncertainty may also arise from a calibration or alignment process before the measurements.

When a calibration process is used before the measurements, the uncertainty tables should be presented with two stages:

- Stage 1: the calibration of the absolute level of the DUT measurement results is performed by means of using a calibration antenna whose absolute gain is known at the frequencies of measurement
- Stage 2: the actual measurement with the DUT as either the transmitter or receiver is performed.

The MU budget should comprise of a minimum 5 headings:

- 1) The uncertainty source,
- 2) Uncertainty value,
- 3) Distribution of the probability,
- 4) Divisor based on distribution shape,
- 5) Calculated standard uncertainty (based on uncertainty value and divisor).

E.1.2 Uncertainty budget calculation principle for IFF

The same as defined in E.1.1.

E.2 Measurement error contribution descriptions

E.2.1 Measurement error contribution descriptions for DFF

All the measurement error contributions defined in Section B.2.1, with the following additions.

E.2.1.1 gNB emulator SNR uncertainty

See D.2.1.1.

E.2.1.2 gNB emulator Downlink EVM

See D.2.1.2.

E.2.1.3 gNB emulator fading model impairments

See D.2.1.3.

E.2.2 Measurement error contribution descriptions for IFF

All the measurement error contributions defined in Section B.2.2, with the following additions.

E.2.2.1 gNB emulator SNR uncertainty

See D.2.1.1.

E.2.2.2 gNB emulator Downlink EVM

See D.2.1.2.

E.2.2.3 gNB emulator fading model impairments

See D.2.1.3.

E.3 Uncertainty assessment for RRM MU quantities.

RRM measurement uncertainty analysis shall define the values for the following MU quantities:

- DL AWGN absolute power or wanted DL signal absolute power
- DL applied SNR
- DL Fading profile uncertainty
- DL AWGN and signal flatness
- UL absolute power measurement
- UL relative power measurement
- UL signal transmit timing relative to DL
- Relative transmit timing accuracy during UE timing adjustment

E.3.1 Uncertainty assessment for DL AWGN absolute power or wanted DL signal absolute power

Table E.3.1-1 summarizes the MU threshold for DL AWGN absolute power for RRM FR2 test cases. The origin MU values for different test setups with varies parameters can be found in following subclauses.

Table E.3.1-1: MU threshold for DL AWGN absolute power for RRM FR2

Power Class	Frequency	MBW	Power	Threshold MU value (NOTE 1)
PC3	23.45GHz <= f <= 32.125GHz	BW <= 400MHz	As configured in the test case	5.65 dB ²
	32.125GHz < f <= 40.8GHz			5.65 dB ²
PC1	23.45GHz <= f <= 32.125GHz	BW <= 400MHz	As configured in the test case	FFS
	32.125GHz < f <= 40.8GHz			FFS
NOTE 1: Total Expanded MU for IFF for Quiet Zone size ≤ 30cm in Table E.3.1.3-2 for PC3 UEs and Table FFS for PC1 UEs				
NOTE 2: If the TT analysis for a specific test case based on this MU value results in an unsolvable conflict, making the test case untestable, even after the alternative solutions listed in clause A.4 have been considered for the test case in TS 38.133 [6] Annex A, the TT analysis shall be repeated using a lower MU value, taking into account the lower values defined in this clause. The test case will be applicable for the subset of the test systems meeting this reduced MU Threshold.				

The types of test setup are defined in clause 7.1.3.2 of TS 38.508-1 [18]

E.3.1.1 Uncertainty budget format and assessment for DFF test setup

The uncertainty contributions that may impact the overall MU value are listed in Table E.3.1.1-1.

Table E.3.1.1-1: Uncertainty contributions for DL AWGN absolute power or wanted DL signal absolute power

UID	Description of uncertainty contribution	Details in annex
Stage 2: DUT measurement		
1	Positioning misalignment	B.2.1.1
2	Measure distance uncertainty	B.2.1.2
3	Quality of Quiet Zone	B.2.1.3
4	Mismatch	B.2.1.4
5	Standing wave between the DUT and measurement antenna	B.2.1.5
6	gNB emulator uncertainty	B.2.1.17
7	Phase curvature	B.2.1.7
8	Amplifier uncertainties	B.2.1.8
9	Random uncertainty	B.2.1.9
10	Influence of the XPD	B.2.1.10
11	Insertion Loss Variation	B.2.1.11
12	RF leakage (from measurement antenna to the receiver/transmitter)	B.2.1.12
13	Multiple measurement antenna uncertainty	B.2.1.25
14	DUT repositioning	B.2.1.26
Stage 1: Calibration measurement		
15	Mismatch	B.2.1.4
16	Amplifier Uncertainties	B.2.1.8
17	Misalignment of positioning System	B.2.1.13
18	Uncertainty of the Network Analyzer	B.2.1.14
19	Uncertainty of the absolute gain of the calibration antenna	B.2.1.15
20	Positioning and pointing misalignment between the reference antenna and the measurement antenna	B.2.1.16
21	Phase centre offset of calibration antenna	B.2.1.18
22	Quality of quiet zone for calibration process	B.2.1.19
23	Standing wave between reference calibration antenna and measurement antenna	B.2.1.20
24	Influence of the calibration antenna feed cable	B.2.1.21
25	Insertion Loss Variation	B.2.1.11
Systematic uncertainties		
26	Systematic error related to beam peak search	B.2.1.28

The uncertainty assessment tables are organized as follows:

- For the purpose of uncertainty assessment, the radiating antenna aperture of the DUT is denoted as D
- The uncertainty assessment has been derived for the case of Quiet Zone size $\leq [30 \text{ cm}]$, $f = \{23.45\text{GHz}, 32.125\text{GHz}, 40.8\text{GHz}\}$.
- The uncertainty assessment is applicable for 1AoA and 2AoA test cases
- The uncertainty assessment is provided in Table E.3.1.1-2.

Table E.3.1.1-2: Uncertainty assessment for DL AWGN absolute power or wanted DL signal absolute power (f=23.45GHz, 32.125GHz, 40.8GHz, Quiet Zone size ≤ 30 cm)

UID	Uncertainty source	Uncertainty value	Distribution of the probability	Divisor	Standard uncertainty (σ) [dB]
Stage 2: DUT measurement					
1	Positioning misalignment	0.00	Normal	2.00	0.00
2	Measure distance uncertainty	0.15	Rectangular	1.73	0.08
3	Quality of Quiet Zone (NOTE 4)	1.2	Actual	1.00	1.2
4	Mismatch	1.30	Actual	1.00	1.30
5	Standing wave between the DUT and measurement antenna	0.00	U-shaped	1.41	0.00
6	gNB uncertainty on absolute level	2.9	Normal	2.00	1.45
7	Phase curvature	0.00	U-shaped	1.41	0.00
8	Amplifier uncertainties	2.1	Normal	2.00	1.05
9	Random uncertainty	0.50	Normal	2.00	0.25
10	Influence of the XPD	0.06	U-shaped	1.41	0.043
11	Insertion Loss Variation	0.00	Rectangular	1.73	0.00
12	RF leakage (from measurement antenna to the receiver/transmitter)	0.00	Actual	1.00	0.00
13	Multiple measurement antenna uncertainty (NOTE 3)	0.15	Actual	1.00	0.15
14	DUT repositioning	0.08	Rectangular	1.73	0.05
Stage 1: Calibration measurement					
15	Mismatch	0.00	U-shaped	1.41	0.00
16	Amplifier Uncertainties	0.00	Normal	2.00	0.00
17	Misalignment of positioning System	0.00	Normal	2.00	0.00
18	Uncertainty of the Network Analyzer	0.73	Normal	2.00	0.37
19	Uncertainty of the absolute gain of the calibration antenna	0.60	Normal	2.00	0.30
20	Positioning and pointing misalignment between the reference antenna and the measurement antenna	0.01	Rectangular	1.73	0.00
21	Phase centre offset of calibration antenna	0.47	Rectangular	1.73	0.27
22	Quality of quiet zone for calibration process (NOTE 4)	0.4	Actual	1.00	0.4
23	Standing wave between reference calibration antenna and measurement antenna	0.00	U-shaped	1.41	0.00
24	Influence of the calibration antenna feed cable	0.14	Normal	2.00	0.07
25	Insertion Loss Variation	0.00	Rectangular	1.73	0.00
Systematic uncertainties (NOTE 2)					Value
26	Systematic error related to beam peak search				0.5
Total measurement uncertainty					Value
DL AWGN absolute power or wanted DL signal absolute power expanded uncertainty (1.96 σ - confidence interval of 95 %) [dB]					5.65
NOTE 1: The analysis was done only for the case of operating in-band, non-CA.					
NOTE 2: In order to obtain the total measurement uncertainty, systematic uncertainties have to be added to the expanded root sum square of the standard deviations of the Stage 1 and Stage 2 contributors.					
NOTE 3: Applies to the system which has a structure of mechanical feed antenna positioning.					
NOTE 4: Value based on procedure defined in Annex D.2 of TR 38.810 [13] for Quiet Zone size less or equal to 30 cm.					
NOTE 5: The values in this table have been derived for DL powers above and equal to REFSENS. The values might need to be revisited for power levels below REFSENS					

E.3.1.2 Uncertainty budget format and assessment for Simplified DFF test setup

[FFS]

E.3.1.3 Uncertainty budget format and assessment for IFF test setup

The uncertainty contributions that may impact the overall MU value are listed in Table E.3.1.3-1.

Table E.3.1.3-1: Uncertainty contributions for DL AWGN absolute power or wanted DL signal absolute power

UID	Description of uncertainty contribution	Details in annex
Stage 2: DUT measurement		
1	Positioning misalignment	B.2.2.1
2	Measure distance uncertainty	B.2.2.2
3	Quality of Quiet Zone	B.2.2.3
4	Mismatch	B.2.2.4
5	Standing wave between the DUT and measurement antenna	B.2.2.5
6	gNB emulator uncertainty	B.2.2.17
7	Phase curvature	B.2.2.7
8	Amplifier uncertainties	B.2.2.8
9	Random uncertainty	B.2.2.9
10	Influence of the XPD	B.2.2.10
11	Insertion Loss Variation	B.2.2.11
12	RF leakage (from measurement antenna to the receiver/transmitter)	B.2.2.12
13	Multiple measurement antenna uncertainty	B.2.2.25
14	DUT repositioning	B.2.2.26
Stage 1: Calibration measurement		
15	Mismatch	B.2.2.4
16	Amplifier Uncertainties	B.2.2.8
17	Misalignment of positioning System	B.2.2.13
18	Uncertainty of the Network Analyzer	B.2.2.14
19	Uncertainty of the absolute gain of the calibration antenna	B.2.2.15
20	Positioning and pointing misalignment between the reference antenna and the measurement antenna	B.2.2.16
21	Phase centre offset of calibration antenna	B.2.2.18
22	Quality of quiet zone for calibration process	B.2.2.19
23	Standing wave between reference calibration antenna and measurement antenna	B.2.2.20
24	Influence of the calibration antenna feed cable	B.2.2.21
25	Insertion Loss Variation	B.2.2.11
Systematic uncertainties		
26	Systematic error related to beam peak search	B.2.2.28

The uncertainty assessment tables are organized as follows:

- For the purpose of uncertainty assessment, the radiating antenna aperture of the DUT is denoted as D
- The uncertainty assessment has been derived for the case of Quiet Zone size $\leq [30 \text{ cm}]$, $f = \{23.45\text{GHz}, 32.125\text{GHz}, 40.8\text{GHz}\}$.
- The uncertainty assessment is applicable for 1AoA test cases- The uncertainty assessment is provided in Table E.3.1.3-2.

Table E.3.1.3-2: Uncertainty assessment for DL AWGN absolute power or wanted DL signal absolute power (f=23.45GHz, 32.125GHz, 40.8GHz, Quiet Zone size ≤ 30 cm)

UID	Uncertainty source	Uncertainty value	Distribution of the probability	Divisor	Standard uncertainty (σ) [dB]
Stage 2: DUT measurement					
1	Positioning misalignment	0.00	Normal	2.00	0.00
2	Measure distance uncertainty	0.00	Rectangular	1.73	0.00
3	Quality of Quiet Zone (NOTE 4)	0.6	Actual	1.00	0.6
4	Mismatch	1.30	Actual	1.00	1.30
5	Standing wave between the DUT and measurement antenna	0.00	U-shaped	1.41	0.00
6	gNB uncertainty on absolute level	2.9	Normal	2.00	1.45
7	Phase curvature	0.00	U-shaped	1.41	0.00
8	Amplifier uncertainties	2.1	Normal	2.00	1.05
9	Random uncertainty	0.50	Normal	2.00	0.25
10	Influence of the XPD	0.01	U-shaped	1.41	0.00
11	Insertion Loss Variation	0.00	Rectangular	1.73	0.00
12	RF leakage (from measurement antenna to the receiver/transmitter)	0.00	Actual	1.00	0.00
13	Multiple measurement antenna uncertainty (NOTE 3)	0.15	Actual	1.00	0.15
14	DUT repositioning	0.08	Rectangular	1.73	0.05
Stage 1: Calibration measurement					
15	Mismatch	0.00	U-shaped	1.41	0.00
16	Amplifier Uncertainties	0.00	Normal	2.00	0.00
17	Misalignment of positioning System	0.00	Normal	2.00	0.00
18	Uncertainty of the Network Analyzer	0.73	Normal	2.00	0.37
19	Uncertainty of the absolute gain of the calibration antenna	0.60	Normal	2.00	0.30
20	Positioning and pointing misalignment between the reference antenna and the measurement antenna	0.01	Rectangular	1.73	0.00
21	Phase centre offset of calibration antenna	0.00	Rectangular	1.73	0.00
22	Quality of quiet zone for calibration process (NOTE 4)	0.4	Actual	1.00	0.4
23	Standing wave between reference calibration antenna and measurement antenna	0.00	U-shaped	1.41	0.00
24	Influence of the calibration antenna feed cable	0.14	Normal	2.00	0.07
25	Insertion Loss Variation	0.00	Rectangular	1.73	0.00
Systematic uncertainties (NOTE 2)					Value
26	Systematic error related to beam peak search				0.5
Total measurement uncertainty					Value
DL AWGN absolute power expanded uncertainty (1.96 σ - confidence interval of 95 %) [dB]					5.19
NOTE 1: The analysis was done only for the case of operating in-band, non-CA.					
NOTE 2: In order to obtain the total measurement uncertainty, systematic uncertainties have to be added to the expanded root sum square of the standard deviations of the Stage 1 and Stage 2 contributors.					
NOTE 3: Applies to the system which has a structure of mechanical feed antenna positioning.					
NOTE 4: Value based on procedure defined in Annex D.2 of TR 38.810 [13] for Quiet Zone size less or equal to 30 cm.					
NOTE 5: The values in this table have been derived for DL powers above and equal to REFSENS. The values might need to be revisited for power levels below REFSENS					

E.3.1.4 Uncertainty budget format and assessment for Enhanced IFF test setup

The uncertainty contributions that may impact the overall MU value are listed in Table E.3.1.4-1.

Table E.3.1.4-1: Uncertainty contributions for DL AWGN absolute power or wanted DL signal absolute power

UID	Description of uncertainty contribution	Details in annex
Stage 2: DUT measurement		
1 to 14	See 1-14 of Table E.3.1.3-1	N/A
Stage 1: Calibration measurement		
15 to 25	See 15-25 of Table E.3.1.3-1	N/A
Systematic uncertainties		
26	See 26 of Table E.3.1.3-1	N/A

The uncertainty assessment tables are organized as follows:

- For the purpose of uncertainty assessment, the radiating antenna aperture of the DUT is denoted as D
- The uncertainty assessment has been derived for the case of Quiet Zone size $\leq [30 \text{ cm}]$, $f = \{23.45\text{GHz}, 32.125\text{GHz}, 40.8\text{GHz}\}$.
- The uncertainty assessment is applicable for 1AoA and 2AoA test cases
- The uncertainty assessment is provided in Table E.3.1.4-2.

Table E.3.1.4-2: Uncertainty assessment for fDL AWGN absolute power or wanted DL signal absolute power (f=23.45GHz, 32.125GHz, 40.8GHz, Quiet Zone size ≤ 30 cm)

UID	Uncertainty source	Uncertainty value	Distribution of the probability	Divisor	Standard uncertainty (σ) [dB]
Stage 2: DUT measurement					
1	Positioning misalignment	0.00	Normal	2.00	0.00
2	Measure distance uncertainty	0.00	Rectangular	1.73	0.00
3	Quality of Quiet Zone (NOTE 4)	0.7	Actual	1.00	0.7
4	Mismatch	1.30	Actual	1.00	1.30
5	Standing wave between the DUT and measurement antenna	0.00	U-shaped	1.41	0.00
6	gNB uncertainty on absolute level	2.9	Normal	2.00	1.45
7	Phase curvature	0.00	U-shaped	1.41	0.00
8	Amplifier uncertainties	2.1	Normal	2.00	1.05
9	Random uncertainty	0.50	Normal	2.00	0.25
10	Influence of the XPD	0.01	U-shaped	1.41	0.00
11	Insertion Loss Variation	0.00	Rectangular	1.73	0.00
12	RF leakage (from measurement antenna to the receiver/transmitter)	0.00	Actual	1.00	0.00
13	Multiple measurement antenna uncertainty (NOTE 3)	0.15	Actual	1.00	0.15
14	DUT repositioning	0.08	Rectangular	1.73	0.05
Stage 1: Calibration measurement					
17	Mismatch	0.00	U-shaped	1.41	0.00
18	Amplifier Uncertainties	0.00	Normal	2.00	0.00
19	Misalignment of positioning System	0.00	Normal	2.00	0.00
20	Uncertainty of the Network Analyzer	0.73	Normal	2.00	0.37
21	Uncertainty of the absolute gain of the calibration antenna	0.60	Normal	2.00	0.30
22	Positioning and pointing misalignment between the reference antenna and the measurement antenna	0.01	Rectangular	1.73	0.00
23	Phase centre offset of calibration antenna	0.00	Rectangular	1.73	0.00
24	Quality of quiet zone for calibration process (NOTE 4)	0.4	Actual	1.00	0.4
25	Standing wave between reference calibration antenna and measurement antenna	0.00	U-shaped	1.41	0.00
26	Influence of the calibration antenna feed cable	0.14	Normal	2.00	0.07
27	Insertion Loss Variation	0.00	Rectangular	1.73	0.00
Systematic uncertainties (NOTE 2)					Value
28	Systematic error related to beam peak search				0.5
Total measurement uncertainty					Value
DL AWGN absolute power expanded uncertainty (1.96 σ - confidence interval of 95 %) [dB]					5.25
NOTE 1: The analysis was done only for the case of operating in-band, non-CA.					
NOTE 2: In order to obtain the total measurement uncertainty, systematic uncertainties have to be added to the expanded root sum square of the standard deviations of the Stage 1 and Stage 2 contributors.					
NOTE 3: Applies to the system which has a structure of mechanical feed antenna positioning.					
NOTE 4: Value based on procedure defined in Annex M of TR 38.521-2 [7] for Quiet Zone size less or equal to 30 cm.					
NOTE 5: The values in this table have been derived for DL powers above and equal to REFSENS. The values might need to be revisited for power levels below REFSENS					

E.3.1.5 Uncertainty budget format and assessment for IFF+DFF Hybrid test setup

For DFF probe, Uncertainty shall be evaluated using the Uncertainty budget format as specified in E.3.1.1.

For IFF probe, Uncertainty shall be evaluated using the Uncertainty budget format as specified in E.3.1.3.

The overall uncertainty of the IFF+DFF Hybrid test set up shall be calculated with the max(Total DFF probe MU, Total IFF probe MU).

E.3.2 Uncertainty assessment for DL applied SNR

E.3.3 Uncertainty assessment for DL Fading profile uncertainty

E.3.4 Uncertainty assessment for DL AWGN and signal flatness

E.3.5 Uncertainty assessment for UL absolute power measurement

Editor's Note : Applicability of MU in this section for 2AoA Test Cases needs to be reassessed once 2AoA Test Cases requiring UL power measurement is defined.

Following tables summarize the MU threshold for EIRP UL absolute power measurement in FR2 RRM test cases. The origin MU values for different test setups with varies parameters can be found in following clauses.

Table B.3.5-1: MU threshold for EIRP UL absolute power measurement

TBD

E.3.5.1 Uncertainty budget format and assessment for DFF

Editor's Note : Applicability of MU in this section for 2AoA Test Cases needs to be reassessed once 2AoA Test Cases requiring UL power measurement is defined.

The uncertainty contributions that may impact the overall MU value are listed in Table B.3.5.1-1.

Table B.3.5.1-1: Uncertainty contributions for EIRP UL absolute power measurement

UID	Description of uncertainty contribution	Details in annex
Stage 2: DUT measurement		
1	Positioning misalignment	B.2.1.1
2	Measure distance uncertainty	B.2.1.2
3	Quality of quiet zone	B.2.1.3
4	Mismatch	B.2.1.4
5	Standing Wave Between the DUT and measurement antenna	B.2.1.5
6	Uncertainty of the RF power measurement equipment	B.2.1.6
7	Phase curvature	B.2.1.7
8	Amplifier uncertainties	B.2.1.8
9	Random uncertainty	B.2.1.9
10	Influence of the XPD	B.2.1.10
11	Insertion Loss Variation	B.2.1.11
12	RF leakage (from measurement antenna to the receiver/transmitter)	B.2.1.12
13	Influence of beam peak search grid	B.2.1.23
14	Multiple measurement antenna uncertainty	B.2.1.25
15	DUT repositioning	B.2.1.26
Stage 1: Calibration measurement		
16	Mismatch	B.2.1.4
17	Amplifier uncertainties	B.2.1.8
18	Misalignment of positioning System	B.2.1.13
19	Uncertainty of the Network Analyzer	B.2.1.14
20	Uncertainty of the absolute gain of the calibration antenna	B.2.1.15
21	Positioning and pointing misalignment between the reference antenna and the measurement antenna	B.2.1.16
22	Phase centre offset of calibration antenna	B.2.1.18
23	Quality of quiet zone for calibration process	B.2.1.19
24	Standing wave between reference calibration antenna and measurement antenna	B.2.1.20
25	Influence of the calibration antenna feed cable	B.2.1.21
26	Insertion Loss Variation	B.2.1.11
Systematic uncertainties		
27	Influence of noise	B.2.1.27
28	Systematic error related to beam peak search	B.2.1.28

The uncertainty assessment tables are organized as follows:

- For the purpose of uncertainty assessment, the radiating antenna aperture of the DUT is denoted as D
- The uncertainty assessment has been derived for the case of Quiet Zone size ≤ 30 cm, $f = \{23.45\text{GHz}, 32.125\text{GHz}, 40.8\text{GHz}\}$.
- The uncertainty assessment is applicable for 1AoA and 2AoA test cases
- The uncertainty assessment is provided in Table B.3.5.1-2.

Table B.3.5.3-2: Uncertainty assessment for EIRP measurement (f=23.45GHz, 32.125GHz, 40.8GHz, Quiet Zone size ≤ 30 cm) for PC3 UEs and normal temperature condition

UID	Uncertainty source	Uncertainty value	Distribution of the probability	Divisor	Standard uncertainty (σ) [dB]
Stage 2: DUT measurement					
1	Positioning misalignment	0.00	Normal	2.00	0.00
2	Measure distance uncertainty	0.15	Rectangular	1.73	0.08
3	Quality of quiet zone (NOTE 1)	1.2	Actual	1.00	1.2
4	Mismatch	1.30	Actual	1.00	1.30
5	Standing Wave Between the DUT and measurement antenna	0.00	U-shaped	1.41	0.00
6	Uncertainty of the RF power measurement equipment (NOTE 2)	2.50	Normal	2.00	1.25
7	Phase curvature	0.00	U-shaped	1.41	0.00
8	Amplifier uncertainties	2.10	Normal	2.00	1.05
9	Random uncertainty	0.50	Normal	2.00	0.25
10	Influence of the XPD	0.06	U-shaped	1.41	0.043
11	Insertion Loss Variation	0.00	Rectangular	1.73	0.00
12	RF leakage (from measurement antenna to the receiver/transmitter)	0.00	Actual	1.00	0.00
13	Influence of beam peak search grid	0.00	Actual	1	0.00
14	Multiple measurement antenna uncertainty(NOTE 4)	0.15	Actual	1	0.15
15	DUT repositioning	0.08	Rectangular	1.73	0.05
Stage 1: Calibration measurement					
16	Mismatch	0.00	U-shaped	1.41	0.00
17	Amplifier uncertainties	0.00	Normal	2.00	0.00
18	Misalignment of positioning System	0.00	Normal	2.00	0.00
19	Uncertainty of the Network Analyzer	0.73	Normal	2.00	0.37
20	Uncertainty of the absolute gain of the calibration antenna	0.60	Normal	2.00	0.30
21	Positioning and pointing misalignment between the reference antenna and the measurement antenna	0.01	Rectangular	1.73	0.00
22	Phase centre offset of calibration antenna	0.47	Rectangular	1.73	0.27
23	Quality of quiet zone for calibration process (NOTE 1)	0.4	Actual	1.00	0.4
24	Standing wave between reference calibration antenna and measurement antenna	0.00	U-shaped	1.41	0.00
25	Influence of the calibration antenna feed cable	0.14	Normal	2.00	0.07
26	Insertion Loss Variation	0.00	Rectangular	1.73	0.00
Systematic uncertainties (NOTE 3)					Value
27	Influence of noise				TBD
28	Systematic error related to beam peak search				0.5
Total measurement uncertainty					Value
EIRP Expanded uncertainty (1.96 σ - confidence interval of 95 %) [dB]					TBD
NOTE 1: Value based on procedure defined in clause D.2 of TR 38.810 for Quiet Zone size less or equal to 30 cm.					
NOTE 2: The assessment assumes minimum output power level.					
NOTE 3: In order to obtain the total measurement uncertainty, systematic uncertainties have to be added to the expanded root sum square of the standard deviations of the Stage 1 and Stage 2 contributors.					
NOTE 4: Applies to the system which has a structure of mechanical feed antenna positioning.					

E.3.5.2 TBD

E.3.5.3 Uncertainty budget format and assessment for IFF

Editor's Note : Applicability of MU in this section for 2AoA Test Cases needs to be reassessed once 2AoA Test Cases requiring UL power measurement is defined.

The uncertainty contributions that may impact the overall MU value are listed in Table B.3.5.3-1.

Table E.3.5.3-1: Uncertainty contributions for EIRP UL absolute power measurement

UID	Description of uncertainty contribution	Details in clause
Stage 2: DUT measurement		
1	Positioning misalignment	B.2.2.1
2	Measure distance uncertainty	B.2.2.2
3	Quality of Quiet Zone	B.2.2.3
4	Mismatch	B.2.2.4
5	Standing wave between the DUT and measurement antenna	B.2.2.5
6	Uncertainty of the RF power measurement equipment	B.2.2.6
7	Phase curvature	B.2.2.7
8	Amplifier uncertainties	B.2.2.8
9	Random uncertainty	B.2.2.9
10	Influence of the XPD	B.2.2.10
11	Insertion Loss Variation	B.2.2.11
12	RF leakage (from measurement antenna to the receiver/transmitter)	B.2.2.12
13	Influence of beam peak search grid	B.2.2.23
14	Multiple measurement antenna uncertainty	B.2.2.25
15	DUT repositioning	B.2.2.26
Stage 1: Calibration measurement		
16	Mismatch	B.2.2.4
17	Amplifier Uncertainties	B.2.2.8
18	Misalignment of positioning System	B.2.2.13
19	Uncertainty of the Network Analyzer	B.2.2.14
20	Uncertainty of the absolute gain of the calibration antenna	B.2.2.15
21	Positioning and pointing misalignment between the reference antenna and the measurement antenna	B.2.2.16
22	Phase centre offset of calibration antenna	B.2.2.18
23	Quality of quiet zone for calibration process	B.2.2.19
24	Standing wave between reference calibration antenna and measurement antenna	B.2.2.20
25	Influence of the calibration antenna feed cable	B.2.2.21
26	Insertion Loss Variation	B.2.2.11
Systematic uncertainties		
27	Influence of noise	B.2.2.27
28	Systematic error related to beam peak search	B.2.2.28

The uncertainty assessment tables are organized as follows:

- For the purpose of uncertainty assessment, the radiating antenna aperture of the DUT is denoted as D
- The uncertainty assessment has been derived for the case of Quiet Zone size ≤ 30 cm, $f = \{23.45\text{GHz}, 32.125\text{GHz}, 40.8\text{GHz}\}$.
- The uncertainty assessment is applicable for 1AoA test cases
- The uncertainty assessment for EIRP is provided in Table B.3.5.3-2 for PC3 UEs

Table B.3.5.3-2: Uncertainty assessment for EIRP UL absolute power measurement (f=23.45GHz, 32.125GHz, 40.8GHz, Quiet Zone size ≤ 30 cm) for PC3 UEs and normal temperature condition

UID	Uncertainty source	Uncertainty value	Distribution of the probability	Divisor	Standard uncertainty (σ) [dB]
Stage 2: DUT measurement					
1	Positioning misalignment	0.00	Normal	2.00	0.00
2	Measure distance uncertainty	0.00	Rectangular	1.73	0.00
3	Quality of Quiet Zone (NOTE 1)	0.6	Actual	1.00	0.6
4	Mismatch	1.30	Actual	1.00	1.30
5	Standing wave between the DUT and measurement antenna	0.00	U-shaped	1.41	0.00
6	Uncertainty of the RF power measurement equipment (NOTE 2)	2.50	Normal	2.00	1.25
7	Phase curvature	0.00	U-shaped	1.41	0.00
8	Amplifier uncertainties	2.10	Normal	2.00	1.05
9	Random uncertainty	0.50	Normal	2.00	0.25
10	Influence of the XPD	0.01	U-shaped	1.41	0.00
11	Insertion Loss Variation	0.00	Rectangular	1.73	0.00
12	RF leakage (from measurement antenna to the receiver/transmitter)	0.00	Actual	1.00	0.00
13	Influence of beam peak search grid	0.00	Actual	1	0.00
14	Multiple measurement antenna uncertainty (NOTE 4)	0.15	Actual	1	0.15
15	DUT repositioning	0.08	Rectangular	1.73	0.05
Stage 1: Calibration measurement					
16	Mismatch	0.00	U-shaped	1.41	0.00
17	Amplifier Uncertainties	0.00	Normal	2.00	0.00
18	Misalignment of positioning System	0.00	Normal	2.00	0.00
19	Uncertainty of the Network Analyzer	0.73	Normal	2.00	0.37
20	Uncertainty of the absolute gain of the calibration antenna	0.60	Normal	2.00	0.30
21	Positioning and pointing misalignment between the reference antenna and the measurement antenna	0.01	Rectangular	1.73	0.00
22	Phase centre offset of calibration antenna	0.00	Rectangular	1.73	0.00
23	Quality of quiet zone for calibration process (NOTE 1)	0.4	Actual	1.00	0.4
24	Standing wave between reference calibration antenna and measurement antenna	0.00	U-shaped	1.41	0.00
25	Influence of the calibration antenna feed cable	0.14	Normal	2.00	0.07
26	Insertion Loss Variation	0.00	Rectangular	1.73	0.00
Systematic uncertainties (NOTE 3)					Value
27	Influence of noise (23.45GHz ≤ f ≤ 32.125GHz)				TBD
28	Systematic error related to beam peak search				0.5
Total measurement uncertainty					Value
EIRP Expanded uncertainty (1.96 σ - confidence interval of 95 %) [dB]					TBD
NOTE 1: Value based on procedure defined in clause D.2 of TR 38.810 for Quiet Zone size less or equal to 30 cm.					
NOTE 2: The assessment assumes minimum output power level.					
NOTE 3: In order to obtain the total measurement uncertainty, systematic uncertainties have to be added to the expanded root sum square of the standard deviations of the Stage 1 and Stage 2 contributors.					
NOTE 4: Applies to the system which has a structure of mechanical feed antenna positioning.					

E.3.5.4 Uncertainty budget format and assessment for Enhanced IFF test setup

Editor's Note : Applicability of MU in this section for 2AoA Test Cases needs to be reassessed once 2AoA Test Cases requiring UL power measurement is defined.

The uncertainty contributions that may impact the overall MU value are listed in Table E.3.5.4-1.

Table E.3.5.4-1: Uncertainty contributions for EIRP UL absolute power measurement

UID	Description of uncertainty contribution	Details in annex
Stage 2: DUT measurement		
1 to 15	See 1-15 of Table E.3.5.3-1	N/A
Stage 1: Calibration measurement		
16 to 26	See 16-26 of Table E.3.5.3-1	N/A
Systematic uncertainties		
27 to 28	See 27-28 of Table E.3.5.3-1	N/A

The uncertainty assessment tables are organized as follows:

- For the purpose of uncertainty assessment, the radiating antenna aperture of the DUT is denoted as D
- The uncertainty assessment has been derived for the case of Quiet Zone size ≤ 30 cm, $f = \{23.45\text{GHz}, 32.125\text{GHz}, 40.8\text{GHz}\}$.
- The uncertainty assessment is applicable for 1AoA and 2AoA test cases
- The uncertainty assessment is provided in Table E.3.5.4-2.

Table B.3.5.4-2: Uncertainty assessment for EIRP UL absolute power measurement (f=23.45GHz, 32.125GHz, 40.8GHz, Quiet Zone size ≤ 30 cm) for PC3 UEs and normal temperature condition

UID	Uncertainty source	Uncertainty value	Distribution of the probability	Divisor	Standard uncertainty (σ) [dB]
Stage 2: DUT measurement					
1	Positioning misalignment	0.00	Normal	2.00	0.00
2	Measure distance uncertainty	0.00	Rectangular	1.73	0.00
3	Quality of Quiet Zone (NOTE 1)	0.7	Actual	1.00	0.7
4	Mismatch	1.30	Actual	1.00	1.30
5	Standing wave between the DUT and measurement antenna	0.00	U-shaped	1.41	0.00
6	Uncertainty of the RF power measurement equipment (NOTE 2)	2.50	Normal	2.00	1.25
7	Phase curvature	0.00	U-shaped	1.41	0.00
8	Amplifier uncertainties	2.10	Normal	2.00	1.05
9	Random uncertainty	0.50	Normal	2.00	0.25
10	Influence of the XPD	0.01	U-shaped	1.41	0.00
11	Insertion Loss Variation	0.00	Rectangular	1.73	0.00
12	RF leakage (from measurement antenna to the receiver/transmitter)	0.00	Actual	1.00	0.00
13	Influence of beam peak search grid	0.00	Actual	1	0.00
14	Multiple measurement antenna uncertainty (NOTE 4)	0.15	Actual	1	0.15
15	DUT repositioning	0.08	Rectangular	1.73	0.05
Stage 1: Calibration measurement					
16	Mismatch	0.00	U-shaped	1.41	0.00
17	Amplifier Uncertainties	0.00	Normal	2.00	0.00
18	Misalignment of positioning System	0.00	Normal	2.00	0.00
19	Uncertainty of the Network Analyzer	0.73	Normal	2.00	0.37
20	Uncertainty of the absolute gain of the calibration antenna	0.60	Normal	2.00	0.30
21	Positioning and pointing misalignment between the reference antenna and the measurement antenna	0.01	Rectangular	1.73	0.00
22	Phase centre offset of calibration antenna	0.00	Rectangular	1.73	0.00
23	Quality of quiet zone for calibration process (NOTE 1)	0.4	Actual	1.00	0.4
24	Standing wave between reference calibration antenna and measurement antenna	0.00	U-shaped	1.41	0.00
25	Influence of the calibration antenna feed cable	0.14	Normal	2.00	0.07
26	Insertion Loss Variation	0.00	Rectangular	1.73	0.00
Systematic uncertainties (NOTE 3)					Value
27	Influence of noise (23.45GHz ≤ f ≤ 32.125GHz)				TBD
28	Systematic error related to beam peak search				0.5
Total measurement uncertainty					Value
EIRP Expanded uncertainty (1.96 σ - confidence interval of 95 %) [dB]					TBD
NOTE 1: Value based on procedure defined in clause D.2 of TR 38.810 for Quiet Zone size less or equal to 30 cm.					
NOTE 2: The assessment assumes minimum output power level.					
NOTE 3: In order to obtain the total measurement uncertainty, systematic uncertainties have to be added to the expanded root sum square of the standard deviations of the Stage 1 and Stage 2 contributors.					
NOTE 4: Applies to the system which has a structure of mechanical feed antenna positioning.					

E.3.5.5 Uncertainty budget format and assessment for IFF+DFF Hybrid test setup

For DFF probe, Uncertainty shall be evaluated using the Uncertainty budget format as specified in E.3.5.1.

For IFF probe, Uncertainty shall be evaluated using the Uncertainty budget format as specified in E.3.5.3.

The overall uncertainty of the IFF+DFF Hybrid test set up shall be calculated with the $\max(\text{Total DFF probe MU}, \text{Total IFF probe MU})$.

E.3.6 Uncertainty assessment for UL relative power measurement

E.3.7 Uncertainty assessment for UL signal transmit timing relative to DL

E.3.8 Uncertainty assessment for Relative transmit timing accuracy during UE timing adjustment

Annex F: Applicable MTSU for Different QZ/Device Sizes

The applicability mapping between minimum QZ size, maximum device size and MTSU is outlined in Table F-1. The underlying assumptions for the mapping are as follows:

- The maximum device size ranges/limits follow the currently defined quiet zone sizes, i.e., 20cm, 30cm, 40cm, and 55cm [7], [18]
- The applicable MTSU follows the max device size, e.g., a max device size of 30cm to 40cm yields an MTSU of $MTSU_{40cm}$
- The applicable MTSU is the same regardless of whether a grey-box or black-box approach [7], [18] is selected to simplify the mapping and to prevent different test requirements for the same device depending on whether black or grey box is applied
- A maximum device size exceeding 55cm but with antenna separations of $\leq 55cm$ does not have an applicable MTSU given the lack of a larger QZ
- Devices with $>55cm$ maximum device size do not have an applicable MTSU given the lack of a larger QZ

Table F-1: Mapping between minimum QZ size, maximum device size, and applicable MTSU

Minimum QZ required to contain all active antennas within the quiet zone (optional vendor declaration)	Max Device Size	Applicable MTSU	Note
20cm	<20cm	MTSU _{30cm}	A system supporting a {20cm, 30cm, 40cm, 55cm} QZ can be used as long as the assessed MU with a {20cm, 30cm, 40cm, 55cm} QoQZ validation is \leq MTSU _{30cm}
20cm	20cm to 30cm	MTSU _{30cm}	A system supporting a {20cm, 30cm, 40cm, 55cm} QZ can be used as long as the assessed MU with a {20cm, 30cm, 40cm, 55cm} QoQZ validation is \leq MTSU _{30cm}
20cm	30cm to 40cm	MTSU _{40cm}	A system supporting a {20cm, 30cm, 40cm, 55cm} QZ can be used as long as the assessed MU with a {20cm, 30cm, 40cm, 55cm} QoQZ validation is \leq MTSU _{40cm}
20cm	40cm to 55cm	MTSU _{55cm}	A system supporting a {20cm, 30cm, 40cm, 55cm} QZ can be used as long as the assessed MU with a {20cm, 30cm, 40cm, 55cm} QoQZ validation is \leq MTSU _{55cm}
20cm	>55cm	Not applicable until larger QZ is defined	Pending larger QZ (exceeding 55cm) definition
30cm	\leq 30cm	MTSU _{30cm}	A system supporting a {30cm, 40cm, 55cm} QZ can be used as long as the assessed MU with a {30cm, 40cm, 55cm} QoQZ validation is \leq MTSU _{30cm}
30cm	30cm to 40cm	MTSU _{40cm}	A system supporting a {30cm, 40cm, 55cm} QZ can be used as long as the assessed MU with a {30cm, 40cm, 55cm} QoQZ validation is \leq MTSU _{40cm}
30cm	40cm to 55cm	MTSU _{55cm}	A system supporting a {30cm, 40cm, 55cm} QZ can be used as long as the assessed MU with a {30cm, 40cm, 55cm} QoQZ validation is \leq MTSU _{55cm}
30cm	>55cm	Not applicable until larger QZ is defined	Pending larger QZ (exceeding 55cm) definition
40cm	\leq 40cm	MTSU _{40cm}	A system supporting a {40cm, 55cm} QZ can be used as long as the assessed MU with a {40cm, 55cm} QoQZ validation is \leq MTSU _{40cm}
40cm	40cm to 55cm	MTSU _{55cm}	A system supporting a {40cm, 55cm} QZ can be used as long as the assessed MU with a {40cm, 55cm} QoQZ validation is \leq MTSU _{55cm}
40cm	>55cm	Not applicable until larger QZ is defined	Pending larger QZ (exceeding 55cm) definition
55cm	40cm to 55cm	MTSU _{55cm}	
55cm	>55cm	Not applicable until larger QZ is defined	Pending larger QZ (exceeding 55cm) definition
>55cm	>55cm	Not applicable until larger QZ is defined	Note: QZs exceeding 55cm cannot be declared due to lack of larger QZ definition

Annex G: Change history

Change history							
Date	Meeting	TDoc	CR	Rev	Cat	Subject/Comment	New version
2017-09	RAN5 #76	R5-174706				Initial skeleton	0.0.1
2018-04	RAN5 #2-5G-NR-Adhoc	R5-182093				Implementation of pCRs to TS 38.903 V0.0.1	0.1.0
2018-05	RAN5#79	R5-182670				Editorial update of TR 38.903.	0.2.0
2018-09	RAN5#80	R5-185213				Making Measurement Uncertainty Terms Common between methods in TR 38.90	1.0.0
2018-09	RAN5#80	R5-185214				TP on Measurement Uncertainty Contributions in FR2	1.0.0
2018-09	RAN5#80	R5-185212				Adding MU values for EIRPTRP measurements with Near Field test range (NFTF) at mmWave	1.0.0
2018-09	RAN#81	-	-	-	-	raised to v15.0.0 with editorial changes only	15.0.0
2018-12	RAN#82	R5-187023	0010	-	F	Editorial update of Annex B	15.1.0
2018-12	RAN#82	R5-187024	0011	-	F	Addition of MU contribution for demodulation test cases	15.1.0
2018-12	RAN#82	R5-187025	0012	-	F	Addition of MU contribution for RRM test cases	15.1.0
2018-12	RAN#82	R5-187148	0013	-	F	General clauses updated for TR38.903	15.1.0
2018-12	RAN#82	R5-187848	0008	1	F	FR2 Spurious Emission measurement grids and offset values	15.1.0
2018-12	RAN#82	R5-188060	0019	1	F	Update of MU budget and contributor description to TR 38.903	15.1.0
2018-12	RAN#82	R5-188224	0009	1	F	Update MU budget in TR 38.903	15.1.0
2018-12	RAN#82	R5-188225	0016	1	F	Update of MU budget tables in TR 38.903	15.1.0
2018-12	RAN#82	R5-188226	0017	2	F	Addition of descriptions on new MU contributions	15.1.0
2019-03	RAN#83	R5-192476	0030	1	F	Addition of Test Tolerance analysis for FR1 PRACH Test cases	15.2.0
2019-03	RAN#83	R5-192504	0038	1	F	Addition of TT analysis for Transmit timing accuracy Tests	15.2.0
2019-03	RAN#83	R5-192505	0031	1	F	Addition common text for RRM	15.2.0
2019-03	RAN#83	R5-192534	0039	-	F	Addition of TT Analysis for Timing Advance Adjustment Accuracy 4.4.3.1	15.2.0
2019-03	RAN#83	R5-192671	0033	1	F	Addition of TT analysis for event triggered test cases	15.2.0
2019-03	RAN#83	R5-192679	0036	1	F	Addition of TT analysis for handover with known cell	15.2.0
2019-03	RAN#83	R5-192845	0029	1	F	CR to update TR 38.903	15.2.0
2019-06	RAN#84	R5-193799	0048	-	F	FR1 Test tolerance analysis for intra re-selection 6.1.1.1	15.3.0
2019-06	RAN#84	R5-193800	0049	-	F	FR1 Test tolerance analysis for inter re-selection 6.1.1.2	15.3.0
2019-06	RAN#84	R5-193801	0050	-	F	FR1 Test tolerance analysis for interRAT higher priority re-selection 6.1.2.1	15.3.0
2019-06	RAN#84	R5-193802	0051	-	F	FR1 Test tolerance analysis for interRAT lower priority re-selection 6.1.2.2	15.3.0
2019-06	RAN#84	R5-193803	0052	-	F	FR1 Test tolerance analysis for interRAT known handover 6.3.1.4	15.3.0
2019-06	RAN#84	R5-194027	0057	-	F	CR on spurious emission MU in FR2	15.3.0
2019-06	RAN#84	R5-194123	0058	-	F	Definition of MU terminologies in TR 38.903	15.3.0
2019-06	RAN#84	R5-195014	0054	1	F	FR1 Test tolerance analysis for EN-DC SCell activation 4.5.3.1-4.5.3.3	15.3.0
2019-06	RAN#84	R5-195015	0060	1	F	Test Tolerance analysis for Inter-Freq measurement Test Cases	15.3.0
2019-06	RAN#84	R5-195159	0059	1	F	CR to update TR 38.903 after RAN5#5-5G NR Adhoc	15.3.0
2019-06	RAN#84	R5-195181	0055	1	F	FR1 Test tolerance analysis for EN-DC measurement reporting 4.6.1.1-4.6.1.4	15.3.0
2019-06	RAN#84	-	-	-	-	Administrative release upgrade to match the release of 3GPP TS 38.521-1 which was upgraded at RAN#84 to Rel-16 due to Rel-16 relevant CR(s)	16.0.0
2019-09	RAN#85	R5-195583	0061	-	F	Update FR1 Test tolerance of 4.5.3.1-4.5.3.3 SCell activation	16.1.0
2019-09	RAN#85	R5-195584	0062	-	F	Update FR1 Test tolerance of 6.1.1.1 FR1 cell re-selection	16.1.0
2019-09	RAN#85	R5-195585	0063	-	F	Update FR1 Test tolerance of 6.1.1.2 FR1-FR1 cell re-selection	16.1.0
2019-09	RAN#85	R5-195586	0064	-	F	Update FR1 Test tolerance of 6.1.2.1 inter-RAT cell re-selection to higher priority	16.1.0
2019-09	RAN#85	R5-195587	0065	-	F	Update FR1 Test tolerance of 6.1.2.2 inter-RAT cell re-selection to lower priority	16.1.0
2019-09	RAN#85	R5-195588	0066	-	F	Update FR1 Test tolerance of 6.3.1.4 inter-RAT handover to known cell	16.1.0
2019-09	RAN#85	R5-195589	0067	-	F	Addition FR1 Test tolerance of 6.3.1.5 inter-RAT handover to unknown cell	16.1.0
2019-09	RAN#85	R5-195590	0068	-	F	Addition FR1 Test tolerance of 6.3.2.1.1 intra-freq RRC re-establishment	16.1.0
2019-09	RAN#85	R5-195591	0069	-	F	Addition FR1 Test tolerance of 6.3.2.1.2 inter-freq RRC re-establishment	16.1.0
2019-09	RAN#85	R5-195592	0070	-	F	Addition FR1 Test tolerance of 6.3.2.3.1 NR RRC redirection	16.1.0
2019-09	RAN#85	R5-195593	0071	-	F	Addition FR1 Test tolerance of 6.3.2.3.2 inter-RAT RRC redirection	16.1.0
2019-09	RAN#85	R5-197362	0072	1	F	FR1 Test Tolerance Analysis for SSB-based RLM IS Tests	16.1.0
2019-09	RAN#85	R5-197363	0073	1	F	FR1 Test Tolerance Analysis for SA Tx Timing Accuracy 6.4.1.1	16.1.0
2019-09	RAN#85	R5-197365	0083	1	F	TT_Analysis_ENDC_FR1_RLM_OOS	16.1.0
2019-09	RAN#85	R5-197369	0087	1	F	TT_Analysis_SA_FR1_TAAA	16.1.0
2019-09	RAN#85	R5-197494	0077	1	F	CR on DUT turnover and relations with QoQZ MU	16.1.0
2019-09	RAN#85	R5-197505	0081	1	F	Update of FR2 MUs in TR 38.903	16.1.0

2019-09	RAN#85	R5-197571	0078	1	F	TT Analysis for SS-RSRP FR1 tests	16.1.0
2019-09	RAN#85	R5-197625	0080	1	F	CR on FR2 OFF Power MU	16.1.0
2019-09	RAN#85	R5-197659	0076	2	F	CR on spurious emission MU in FR2	16.1.0
2019-12	RAN#86	R5-198260	0099	-	F	CR to 38.903 to define Reference Methodology for SE	16.2.0
2019-12	RAN#86	R5-198285	0100	-	F	FR1 Test tolerance analysis for interRAT measurement	16.2.0
2019-12	RAN#86	R5-198427	0101	-	F	Correction to uncertainty budget calculation principles	16.2.0
2019-12	RAN#86	R5-199070	0098	1	F	Editorial corrections to FR1 Test Tolerance files	16.2.0
2019-12	RAN#86	R5-199082	0104	2	F	FR1 Test Tolerance : Addition of TT Analysis for 6.3.1.1 NR SA FR1 Intra-Freq Handover	16.2.0
2019-12	RAN#86	R5-199083	0105	2	F	FR1 Test Tolerance : Addition of TT Analysis for 6.3.1.2 NR SA FR1 Intra-Freq Handover	16.2.0
2019-12	RAN#86	R5-199084	0106	2	F	FR1 Test Tolerance : Addition of TT Analysis for 6.3.1.3 NR SA FR1 Inter-Freq Handover	16.2.0
2019-12	RAN#86	R5-199091	0102	1	F	Update on FR2 MUs in 38.903	16.2.0
2019-12	RAN#86	R5-199092	0103	1	F	Update on FR2 Spurious MUs in 38.903	16.2.0
2019-12	RAN#86	R5-199362	0091	1	F	FR1 Test tolerance analysis for interruptions active and non-active	16.2.0
2019-12	RAN#86	R5-199363	0094	1	F	FR1 Test tolerance analysis for CSI-RS based RLM	16.2.0
2020-03	RAN#87	R5-200163	0107	-	F	Add Annex A.2 handling of common Test Tolerance Topics for FR2	16.3.0
2020-03	RAN#87	R5-200329	0112	-	F	CR to 38.903 on XPD Verification	16.3.0
2020-03	RAN#87	R5-200470	0114	-	F	FR1 Test tolerance analysis for interruptions deactivated NR SCC	16.3.0
2020-03	RAN#87	R5-200918	0116	1	F	Update to FR2 TRx Measurement Uncertainties	16.3.0
2020-03	RAN#87	R5-201037	0108	1	F	Test tolerance analysis inter-frequency SS-RSRP and intra-frequency SS-SINR	16.3.0
2020-03	RAN#87	R5-201038	0109	1	F	Test tolerance analysis SS-RSRQ and inter-frequency SS-SINR	16.3.0
2020-03	RAN#87	R5-201042	0110	1	F	Test Tolerance analysis for CSI-RS-Based L1-RSRP measurement test cases	16.3.0
2020-03	RAN#87	R5-201043	0111	1	F	Test Tolerance analysis for SSB-Based L1-RSRP measurement test cases	16.3.0
2020-06	RAN#88	R5-201662	0118	-	F	FR1 Test tolerance analysis for interruptions deactivated E-UTRAN SCC	16.4.0
2020-06	RAN#88	R5-203094	0119	1	F	FR1 Test tolerance analysis for SCell activation	16.4.0
2020-06	RAN#88	R5-202104	0124	-	F	Test tolerance correction for event triggered measurement test cases	16.4.0
2020-06	RAN#88	R5-202105	0125	-	F	Test tolerance correction for CSI-RS-based L1-RSRP measurement test cases	16.4.0
2020-06	RAN#88	R5-202702	0130	1	F	Test Tolerance analysis TC 4.5.4 and 6.5.4 RRC reconfiguration delay	16.4.0
2020-06	RAN#88	R5-202769	0127	1	F	CR to 38.903 to introduce baseline Demod MU tables	16.4.0
2020-06	RAN#88	R5-202915	0117	1	F	MU contributors for RRM FR2 TC 7.7.1.1	16.4.0
2020-06	RAN#88	R5-202916	0126	1	F	CR to 38.903 to introduce PC1 MU Tables	16.4.0
2020-06	RAN#88	R5-202917	0128	1	F	Update to FR2 Measurement Uncertainties	16.4.0
2020-06	RAN#88	R5-202938	0129	1	F	Addition of EIRP to Transmit OFF power MU analysis	16.4.0
2020-09	RAN#89	R5-203231	0131	-	F	TT analysis for RRM TC 8.5.2.1.1.1	16.5.0
2020-09	RAN#89	R5-203232	0132	-	F	TT analysis for RRM TC 8.5.2.2.1	16.5.0
2020-09	RAN#89	R5-203233	0133	-	F	TT analysis for RRM TC 8.5.2.3.1	16.5.0
2020-09	RAN#89	R5-203237	0134	-	F	TT analysis for RRM TC 4.7.4.1.1	16.5.0
2020-09	RAN#89	R5-203238	0135	-	F	TT analysis for RRM TC 4.7.4.1.2	16.5.0
2020-09	RAN#89	R5-203323	0140	-	F	Add Draft Test Tolerance analysis for FR2 Tx Timing Test cases	16.5.0
2020-09	RAN#89	R5-203324	0141	-	F	Add Draft Test Tolerance analysis for FR2 Inter-freq Event-trig Test cases	16.5.0
2020-09	RAN#89	R5-203325	0142	-	F	Add Draft Test Tolerance analysis for FR2 Intra-freq SS-RSRP Test case	16.5.0
2020-09	RAN#89	R5-203825	0149	-	F	Addition of FR1 Test tolerance analysis for 6.3.2.1.3 RRC Re-establishment	16.5.0
2020-09	RAN#89	R5-203826	0150	-	F	Update of grouping of test cases in clause 8	16.5.0
2020-09	RAN#89	R5-204190	0154	-	F	On Standard Deviation Definition in 38.903	16.5.0
2020-09	RAN#89	R5-204788	0138	1	F	Correction to the extreme conditions in TT analysis of 4.7.1.2.1	16.5.0
2020-09	RAN#89	R5-204887	0139	1	F	CR to update the DL AWGN absolute power for RRM test cases	16.5.0
2020-09	RAN#89	R5-204888	0143	1	F	Adjacent Channel Selectivity FR2 MU definition in 38.903	16.5.0
2020-09	RAN#89	R5-204889	0144	1	F	In-band Blocking FR2 MU definition in 38.903	16.5.0
2020-09	RAN#89	R5-204890	0153	1	F	CR to update MU in 38.903	16.5.0
2020-09	RAN#89	R5-204891	0155	1	F	FR2 Minimum output power measurement uncertainty	16.5.0
2020-09	RAN#89	R5-204945	0152	1	F	CR to 38.903 on some of the Transmit OFF power MU parameters	16.5.0
2020-09	RAN#89	R5-204946	0156	1	F	Update of AWGN flatness in TR 38.903	16.5.0
2020-09	RAN#89	R5-204947	0157	1	F	FR2 EIRP OFF power measurement uncertainty	16.5.0
2020-09	RAN#89	R5-205001	0145	1	F	Addition of FR1 Test tolerance analysis for DCI based BWP switch	16.5.0
2020-09	RAN#89	R5-205002	0146	1	F	Addition of FR1 Test tolerance analysis for RRC based BWP switch	16.5.0
2020-09	RAN#89	R5-205003	0147	1	F	Addition of FR1 Test tolerance analysis for SSB based BFR	16.5.0
2020-09	RAN#89	R5-205004	0148	1	F	Addition of FR1 Test tolerance analysis for CSI-RS based BFR	16.5.0
2020-12	RAN#90	R5-205628	0174	-	F	RRM FR2 DL AWGN absolute power MU	16.6.0
2020-12	RAN#90	R5-205704	0176	-	F	Update of demod MU	16.6.0
2020-12	RAN#90	R5-205831	0177	-	F	Editorial correction of clause 5.2	16.6.0

2020-12	RAN#90	R5-205949	0183	-	F	Update of grouping of test cases in clause 8	16.6.0
2020-12	RAN#90	R5-206809	0158	1	F	TT analysis for RRM 6.7.5.1	16.6.0
2020-12	RAN#90	R5-206810	0159	1	F	TT analysis for RRM 6.7.6.1	16.6.0
2020-12	RAN#90	R5-206811	0160	1	F	TT analysis for RRM 6.7.7.1	16.6.0
2020-12	RAN#90	R5-206812	0161	1	F	TT analysis for RRM 4.7.5.1	16.6.0
2020-12	RAN#90	R5-206813	0163	1	F	TT analysis for RRM 8.5.2.1.2	16.6.0
2020-12	RAN#90	R5-206814	0166	1	F	Add Draft Test Tolerance analysis for FR2 PRACH Test cases	16.6.0
2020-12	RAN#90	R5-206815	0178	1	F	Addition of FR1 TT analysis for inter-RAT cell reselection	16.6.0
2020-12	RAN#90	R5-206816	0179	1	F	Addition of FR1 TT analysis for inter-RAT handover	16.6.0
2020-12	RAN#90	R5-206817	0180	1	F	Addition of FR1 TT analysis for inter-RAT SFTD measurement	16.6.0
2020-12	RAN#90	R5-206818	0181	1	F	Addition of FR1 TT analysis for inter-RAT event-triggered reporting	16.6.0
2020-12	RAN#90	R5-206835	0184	1	F	CR to 38.903 on ETC Testing	16.6.0
2020-12	RAN#90	R5-206836	0185	1	F	CR to add DFF MU Tables in 38.903	16.6.0
2020-12	RAN#90	R5-206837	0187	1	F	Update FR2 TRx MU in 38.903	16.6.0
2020-12	RAN#90	R5-206838	0189	1	F	FR2 Time masks updates	16.6.0
2020-12	RAN#90	R5-206845	0164	1	F	TT analysis for RRM 8.5.2.2.2	16.6.0
2020-12	RAN#90	R5-206846	0167	1	F	Update Draft Test Tolerance analysis for FR2 Tx Timing Test cases	16.6.0
2020-12	RAN#90	R5-206847	0169	1	F	Add Draft Test Tolerance analysis FR2 RLM Peak Test cases	16.6.0
2020-12	RAN#90	R5-206848	0170	1	F	Add Draft Test Tolerance analysis for FR2 Intra-freq Event-trig Test cases	16.6.0
2020-12	RAN#90	R5-206849	0171	1	F	Update Draft Test Tolerance analysis for FR2 Inter-freq Event-trig Test cases	16.6.0
2020-12	RAN#90	R5-206850	0172	1	F	Update Draft Test Tolerance analysis for FR2 Intra-freq SS-RSRP Test case	16.6.0
2020-12	RAN#90	R5-206851	0173	1	F	Add Draft Test Tolerance analysis for FR2 Inter-freq SS-RSRP Test case	16.6.0
2020-12	RAN#90	R5-206852	0182	1	F	Update of FR1 TT analysis for 6.1.1.1 intra-freq cell re-selection	16.6.0
2020-12	RAN#90	R5-206911	0165	1	F	TT analysis for RRM 8.5.2.3.2	16.6.0
2021-03	RAN#91	R5-210431	0193	-	F	Test tolerance analysis for 7.4.3.1 and 5.4.3.1	16.7.0
2021-03	RAN#91	R5-210438	0195	-	F	Update TT analyses for FR2 iRAT measurement accuracy test cases	16.7.0
2021-03	RAN#91	R5-210445	0197	-	F	Update SS-RSRQ measurement accuracy TT analyses for SNR uncertainty change	16.7.0
2021-03	RAN#91	R5-210815	0203	-	F	Update Test Tolerance analyses for FR2 Tx Timing Test cases	16.7.0
2021-03	RAN#91	R5-210817	0204	-	F	Update Test Tolerance analyses for FR2 RLM Test cases	16.7.0
2021-03	RAN#91	R5-210818	0205	-	F	Update Test Tolerance analyses for FR2 Event-Trig Test cases	16.7.0
2021-03	RAN#91	R5-210819	0206	-	F	Update Test Tolerance analyses for FR2 SS-RSRP Test cases	16.7.0
2021-03	RAN#91	R5-210820	0207	-	F	Update Test Tolerance analyses for FR1 RLM Test cases	16.7.0
2021-03	RAN#91	R5-210846	0210	-	F	Update of grouping of test cases in clause 8	16.7.0
2021-03	RAN#91	R5-211175	0216	-	F	FR2 Minimum output power measurement uncertainty update	16.7.0
2021-03	RAN#91	R5-211191	0218	-	F	CR to 38.903 on PC1 Measurement Grid MUs	16.7.0
2021-03	RAN#91	R5-211642	0194	1	F	Test tolerance analysis for 4.5.7.1	16.7.0
2021-03	RAN#91	R5-211643	0196	1	F	Update SS-RSRP measurement accuracy TT analyses for SNR uncertainty change	16.7.0
2021-03	RAN#91	R5-211644	0199	1	F	Update RRM MU values for FR2	16.7.0
2021-03	RAN#91	R5-211645	0211	1	F	Update of FR1 TT for SCell activation	16.7.0
2021-03	RAN#91	R5-211646	0212	1	F	Update of FR1 TT for SSB based link recovery	16.7.0
2021-03	RAN#91	R5-211647	0213	1	F	Update of FR1 TT for CSI-RS based link recovery	16.7.0
2021-03	RAN#91	R5-211648	0214	1	F	Update of FR1 TT for RRC re-establishment	16.7.0
2021-03	RAN#91	R5-211649	0219	1	F	Update of Test Tolerance analysis for FR1 event triggered reporting test cases	16.7.0
2021-03	RAN#91	R5-211650	0220	1	F	Update of Test Tolerance analysis for FR1 SSB-based L1-RSRP test cases	16.7.0
2021-03	RAN#91	R5-211651	0221	1	F	Update of Test Tolerance analysis for FR1 CSI-RS based L1-RSRP test cases	16.7.0
2021-03	RAN#91	R5-211652	0224	1	F	Test Tolerance analysis for FR2 event triggered reporting test cases	16.7.0
2021-03	RAN#91	R5-211732	0202	1	F	Editorial correction to several MU factors	16.7.0
2021-03	RAN#91	R5-211892	0198	1	F	Correct 6.3.1.1 TT analysis	16.7.0
2021-03	RAN#91	R5-211930	0191	1	F	Adjacent Channel Selectivity FR2 MU definition in 38.903	16.7.0
2021-03	RAN#91	R5-211931	0192	1	F	In-band Blocking FR2 MU definition in 38.903	16.7.0
2021-03	RAN#91	R5-211932	0208	1	F	Update on FR2 Blocking Test MU	16.7.0
2021-03	RAN#91	R5-211933	0209	1	F	Update MU for FR2 RRM	16.7.0
2021-03	RAN#91	R5-211934	0215	1	F	Update FR2 MU and TT in 38.903	16.7.0
2021-03	RAN#91	R5-211935	0217	1	F	CR to 38.903 on ETC Testing	16.7.0
2021-03	RAN#91	R5-211936	0222	1	F	Update of demod SNR testability	16.7.0
2021-06	RAN#92	R5-212352	0230	-	F	ACS and IBB - FR2 MU definition in 38.903	16.8.0
2021-06	RAN#92	R5-213851	0228	1	F	Update of demod SNR testability	16.8.0
2021-06	RAN#92	R5-213852	0237	1	F	Measurement uncertainties for FR2 Relative and aggregate power tolerance	16.8.0
2021-06	RAN#92	R5-213940	0225	1	F	Update TT analysis for 5.7.1.1	16.8.0
2021-06	RAN#92	R5-213941	0226	1	F	New TT analysis for 5.7.2.1	16.8.0
2021-06	RAN#92	R5-213942	0227	1	F	New TT analysis for 5.7.3.1	16.8.0
2021-06	RAN#92	R5-213943	0235	1	F	Test Tolerance analysis for FR2 event triggered reporting test cases	16.8.0

2021-06	RAN#92	R5-213944	0236	1	F	Test Tolerance analysis for FR2 event triggered reporting test cases	16.8.0
2021-06	RAN#92	R5-213945	0239	1	F	Update of ACLR testability	16.8.0
2021-06	RAN#92	R5-214069	0234	1	F	Measurement Uncertainties updates for FR2 Extreme Testing Conditions	16.8.0
2021-06	RAN#92	R5-214114	0231	1	F	Add Test Tolerance analyses for FR2 RLM Test cases	16.8.0
2021-06	RAN#92	R5-214115	0232	1	F	Update and add Test Tolerance analysis for FR2 Intra-freq Event-trig Test cases	16.8.0
2021-06	RAN#92	R5-214116	0233	1	F	Update Test Tolerance analysis for FR2 Inter-freq SS-RSRP Test case	16.8.0
2021-09	RAN#93	R5-214189	0240	-	F	TT analysis for RRM test cases 5.7.2.2 and 7.7.2.2	16.9.0
2021-09	RAN#93	R5-214190	0241	-	F	TT analysis for RRM test cases 5.7.3.2 and 7.7.3.2	16.9.0
2021-09	RAN#93	R5-214919	0247	-	F	Update TT analysis for RRM test cases 5.7.1.2 and 7.7.1.2	16.9.0
2021-09	RAN#93	R5-215002	0248	-	F	TT analysis for LTE SA TC 8.5.1.1-SFTD accuracy	16.9.0
2021-09	RAN#93	R5-215330	0250	-	F	Correction to MU for spurious emission band UE co-existence	16.9.0
2021-09	RAN#93	R5-215433	0252	-	F	Correction of Test Tolerance analysis for FR2 event triggered reporting in DRX test cases	16.9.0
2021-09	RAN#93	R5-215834	0255	1	F	Introduction of MTSU mapping related to Max Device Size	16.9.0
2021-09	RAN#93	R5-216102	0242	1	F	Update of demod SNR testability	16.9.0
2021-09	RAN#93	R5-216103	0243	1	F	Add Test Tolerance analyses for EN-DC FR2 interruptions at transitions between active and non-active during DRX Test cases	16.9.0
2021-09	RAN#93	R5-216104	0244	1	F	Introducing EIRP UL Absolute Power MU for FR2 RRM	16.9.0
2021-09	RAN#93	R5-216105	0249	1	F	Correction of power control in 38.903	16.9.0
2021-09	RAN#93	R5-216117	0256	1	F	38.903 CR FR2 ETC MU updates for new ETC test cases	16.9.0
2021-09	RAN#93	R5-216362	0251	1	F	Correction of Test Tolerance analysis for FR2 event triggered reporting in non-DRX test cases	16.9.0
2021-09	RAN#93	R5-216363	0253	1	F	Test Tolerance analysis for FR2 SSB-based L1-RSRP measurement for beam reporting test cases	16.9.0
2021-12	RAN#94	R5-218208	0280	-	F	Correct TT analysis for TC 5.7.3.2 and 7.7.3.2	16.10.0
2021-12	RAN#94	R5-218242	0270	1	F	TT analysis for Mob_enh RRM TC 6.3.1.9+6.3.1.10	16.10.0
2021-12	RAN#94	R5-218262	0275	1	F	Test Tolerance analysis for FR2 CSI-RS based L1-RSRP measurement for beam reporting test cases	16.10.0
2021-12	RAN#94	R5-218295	0272	1	F	Addition of test tolerance analysis for test cases of EN-DC FR1 DL Interruptions at switching between two uplink carriers	16.10.0
2021-12	RAN#94	R5-218330	0261	1	F	TT analysis for PS RRM TC 6.1.1.3	16.10.0
2021-12	RAN#94	R5-218331	0262	1	F	TT analysis for PS RRM TC 6.1.1.4	16.10.0
2021-12	RAN#94	R5-218332	0263	1	F	TT analysis for PS RRM TC 6.1.1.5	16.10.0
2021-12	RAN#94	R5-218333	0264	1	F	TT analysis for PS RRM TC 6.1.1.6	16.10.0
2021-12	RAN#94	R5-218334	0273	1	F	Addition of test tolerance analysis for test cases of inter-RAT cell re-selection with relaxed measurement criterion	16.10.0
2021-12	RAN#94	R5-218337	0265	1	F	TT analysis for SRVCC RRM TC 6.3.1.6	16.10.0
2021-12	RAN#94	R5-218338	0266	1	F	TT analysis for SRVCC RRM TC 6.6.5.1	16.10.0
2021-12	RAN#94	R5-218353	0269	1	F	TT analysis for HST RRM TC 6.1.2.5	16.10.0
2021-12	RAN#94	R5-218354	0276	1	F	Test Tolerance analysis for SA FR1 - E-UTRAN event-triggered reporting in DRX for HST	16.10.0
2021-12	RAN#94	R5-218355	0277	1	F	Test Tolerance analysis for E-UTRA - NR FR1 Cell reselection tests for HST	16.10.0
2021-12	RAN#94	R5-218356	0278	1	F	Test Tolerance analysis for SA FR1 - E-UTRAN event-triggered reporting in DRX for HST	16.10.0
2021-12	RAN#94	R5-218394	0257	1	F	TT analysis for Mob_enh RRM TC 6.3.1.7+6.3.1.8	16.10.0
2021-12	RAN#94	R5-218395	0258	1	F	TT analysis for Mob_enh RRM TC 6.3.3.1	16.10.0
2021-12	RAN#94	R5-218396	0259	1	F	TT analysis for Mob_enh RRM TC 6.3.3.2	16.10.0
2021-12	RAN#94	R5-218397	0267	1	F	TT analysis for HST RRM TC 4.6.1.7+6.6.1.7	16.10.0
2021-12	RAN#94	R5-218398	0268	1	F	TT analysis for HST RRM TC 4.6.4.5+6.6.4.5	16.10.0
2021-12	RAN#94	R5-218402	0274	1	F	MU for Tx modulation quality test cases	16.10.0
2021-12	RAN#94	R5-218408	0279	1	F	38.903 Beam correspondence Measurement Uncertainties	16.10.0
2021-12	RAN#94	-	-	-	-	missing attachment file added	16.10.1

History

Document history		
V16.4.0	July 2020	Publication
V16.5.0	November 2020	Publication
V16.6.0	January 2021	Publication
V16.7.0	April 2021	Publication
V16.8.0	August 2021	Publication
V16.9.0	October 2021	Publication
V16.10.1	January 2022	Publication